

**Report No. CDOT-DTD-R-2001-4
Final Report**

BICYCLE-FRIENDLY RUMBLE STRIPS

William (Skip) Outcalt



May 2001

**COLORADO DEPARTMENT OF TRANSPORTATION
RESEARCH BRANCH**

The contents of this report reflect the views of the author, who is responsible for the facts and accuracy of the data presented herein. The contents do not necessarily reflect the official views of the Colorado Department of Transportation or the Federal Highway Administration. This report does not constitute a standard, specification, or regulation.

REPORT DOCUMENTATION PAGE			FORM APPROVED OMB NO. 0704-0188
Public reporting burden for this collection of information is estimated to average 1 hour per response, including the time for reviewing instructions, searching existing data sources, gathering and maintaining the data needed, and completing and reviewing the collection of information. Send comments regarding this burden estimate or any other aspect of this collection of information, including suggestions for reducing this burden, to Washington Headquarters Services, Directorate for Information Operations and Reports, 1215 Jefferson Davis Highway, Suite 1204, Arlington, VA 22202-4302, and to the Office of Management and Budget, Paperwork Reduction Project (0704-0188), Washington, DC 20503.			
1. AGENCY USE ONLY (Leave Blank)	2. REPORT DATE May 2001	3. REPORT TYPE AND DATES COVERED Final Report May 2001	
4. TITLE AND SUBTITLE Bicycle-Friendly Rumble Strips			5. FUNDING NUMBERS
6. AUTHOR(S) William (Skip) Outcalt			
7. PERFORMING ORGANIZATION NAME(S) AND ADDRESS(S) Colorado Department of Transportation 4201 E. Arkansas Ave. Denver, Colorado 80222			8. PERFORMING ORGANIZATION REPORT NUMBER CDOT-DTD-R-2001-4
9. SPONSORING/MONITORING AGENCY NAME(S) AND ADDRESS(S) Colorado Department of Transportation 4201 E. Arkansas Ave. Denver, Colorado 80222			10. SPONSORING/MONITORING AGENCY REPORT NUMBER CDOT-DTD-R-2001-4
11. SUPPLEMENTARY NOTES Prepared in Cooperation with the U.S. Department of Transportation, Federal Highway Administration			
12a. DISTRIBUTION/AVAILABILITY STATEMENT No Restrictions: This report is available to the public through the National Technical Information Service. Springfield, VA 22161			12b. DISTRIBUTION CODE
13. ABSTRACT (Maximum 200 words) While rumble strips save lives and reduce property damage for motorists, they can be a problem for bicyclists. For obvious reasons most cyclists ride on the shoulder. However, when debris or a parked vehicle blocks the shoulder, it becomes necessary for the cyclist to cross the rumble strip to move into the lane and go around the obstacle. An aggressive rumble strip, with wide deep grooves, can cause a very unpleasant level of vibration in the bicycle and possible loss of control. This study, funded by CDOT and the FHWA, compared three styles of rumble strips in an attempt to find a rumble strip that will provide a warning for motorists who have drifted off the highway without making the shoulders unusable for bicyclists. The rumble strips evaluated were: 1. Colorado's standard ground-in asphalt rumble strip, 2. Colorado's standard concrete rolled-in rumble strip, 3. A new two-inch-groove rumble strip ground into asphalt. Recommendation: The standard type of ground in rumble strips 12 inches wide with groove depth of 3/8 inch ± 1/8 inch ground in an interrupted pattern is the recommended configuration for asphalt rumble strips based on the data collected for this report. No recommendation is made concerning rolled-in concrete rumble strips. Implementation: The recommendations of this study will be presented to the Discussion Group Panel for Standard Plans, which will determine if a revision to the Colorado Standard Plans will be made. If the standards are changed, those changes would apply to all new rumble strips construction on Colorado highways. These recommendations will also be evaluated and possibly incorporated into the standards used by other state and national agencies.			
14. SUBJECT TERMS shoulders, ground-in, asphalt, sound, vibration			15. NUMBER OF PAGES 126
			16. PRICE CODE
17. SECURITY CLASSIFICATION OF REPORT Unclassified	18. SECURITY CLASSIFICATION OF THIS PAGE Unclassified	19. SECURITY CLASSIFICATION OF ABSTRACT Unclassified	20. LIMITATION OF ABSTRACT

BICYCLE-FRIENDLY RUMBLE STRIPS

By

William (Skip) Outcalt, E/PS Tech II, CDOT Research Branch

Report No., CDOT-DTD-R-2001-4

Sponsored by the
Colorado Department of Transportation
In Cooperation with the
U. S. Department of Transportation
Federal Highway Administration

May, 2001

Colorado Department of Transportation
Research Branch
4201 East Arkansas Avenue
Denver CO 80222
(303) 757-9506

ACKNOWLEDGMENTS

Special thanks to the all of the people who participated in the tests and data collection.

The Research Study Panel: Ahmad Ardani, Bryan Allery, Gay Page, Joe Tempel, Larry Brinck, Martha Roskowski, Peter Eun (FHWA), Rich Griffin, and Sasan Delshad.

The bicycle riders: Alan Severn, Bob Brigham, Buzz Feldman, Chris Tough, Dan Smith, Dave Anderson, Dave Simonson, Gail Longenecker, Greg Mihalik, Hank Seeberg, Jay Meyer, Jerry and Diane Seguin, Jim Flint, Jim Levy, John Guintire, John McKay, John McLain, John Waitman, Karen Phillips, Martha Roskowski, Paul Balaguer, Phil Demosthenes, Rob Nutt, Rob Price, Stephanie Schroeder, Tom Preble.

Wheat Ridge Cyclery: Eugene Keifel, Ron Feeback

The CDOT engineers who were in charge of the construction of the test sites: Keith Powers and Greg Fowles.

CDOT Maintenance patrols 17 at Gypsum and 25 at Greeley.

CDOT Research Branch personnel David Weld and Joan Pinamont.

EXECUTIVE SUMMARY

The Colorado Department of Transportation is making extensive use of shoulder rumble strips in an effort to reduce the number of single vehicle run-off-the-road accidents on rural highways. Because of the increasing use of these highways by bicyclists, there is considerable concern for the safety of bicyclists when they encounter a shoulder rumble strip. This study evaluates several different rumble strips ground into asphalt shoulders. A third style of rumble strip - rolled-into concrete - was included in the study for comparison. The first is a new (to Colorado) style of rumble strip that has square-bottomed grooves only two inches wide. Seven test sections were constructed using this new-style groove with different spacing: twelve inches on center, seven inches on center, and five inches on center. They were also constructed in continuous and interrupted patterns. The interrupted pattern has twelve feet of rumble strip followed by a six-foot gap. The second style of rumble strip is the old standard round-bottom style used in Colorado. It has grooves seven inches across with a five-inch flat in between. Five sections were constructed using grooves of varying depths from 3/4 inch to 1/8 inch. Since all depths were ground using the same diameter grinder, the shallower grooves are narrower with a corresponding wider flat in between.

Twenty nine bicyclists, who donated their time and provided their own bicycles, evaluated and compared the sections according to comfort and controllability. During the bicyclists' evaluations a consultant measured the vibrations of a bicycle that had an accelerometer mounted to the frame. On later dates, the same consultant measured sound levels in a minivan, a pickup truck, a station wagon, and a dump truck, and vibrations on the floor and steering wheel of the minivan.

Recommendation

The study recommends using the standard design rumble strip with gaps, grinding the grooves to a depth of 3/8 inch (\pm 1/8 inch). This depth provides a relatively high level of sound and vibration in motor vehicles and can be crossed by a bicycle without causing loss of control.

Using the standard design rumble strip ground to a shallower depth will not require any new equipment or procedures on the part of contractors or CDOT so costs for installation should remain the same. It will be necessary to closely monitor the depth of the grooves during the grinding of the rumble strips.

Implementation

The recommendations of this study will be presented to the Discussion Group Panel for Standard Plans, which determines if a revision to the standard plans will be made. If the recommendations are accepted, the new standards will be incorporated into rumble strips constructed in conjunction with asphalt overlays and/or new asphalt pavement construction. These recommendations will also be evaluated and possibly incorporated into the standards used by other state and national agencies.

This change will result in a standard rumble strip for use on all rural highways. It will help to insure that a bicyclist will know what to expect when encountering a rumble strip anywhere in the state of Colorado

TABLE OF CONTENTS

1.0	INTRODUCTION.....	1
2.0	BACKGROUND.....	3
3.0	OBJECTIVE OF THE STUDY.....	3
4.0	RUMBLE STRIP DESCRIPTIONS.....	5
4.1	Standard Rumble Strips.....	6
4.2	Two-inch-groove Rumble Strips.....	11
4.3	Rolled-in Rumble Strips in Concrete.....	16
5.0	BICYCLE TESTING.....	19
5.1	Bicycle Riders.....	19
5.2	Bicycle Vibration Levels.....	23
6.0	MOTOR VEHICLE TESTING.....	27
6.1	Motor Vehicle Sound Levels.....	27
6.2	Motor Vehicle Vibration Levels.....	31
7.0	CONCLUSIONS AND RECOMMENDATIONS.....	35
7.1	Conclusions.....	35
7.2	Recommendations.....	36

REFERENCES

APPENDIX A RUMBLE STRIPS

APPENDIX B BICYCLE RIDERS

APPENDIX C SOUND DATA

APPENDIX D VIBRATION DATA

LIST OF FIGURES

Figure 1. Profile of standard ground-in rumble strip.....	7
Figure 2. The machine that grinds the standard rumble strips.....	7
Figure 3. The equipment used to grind the standard rumble strips.....	8
Figure 4. The standard rumble strip.	8
Figure 5. One of the shallower sections of standard rumble strip.....	9
Figure 6. The underside of the grinder trailer.....	9
Figure 7. A spare drum for the grinder.....	10
Figure 8. The grinding drum determines the length of the grooves.....	10
Figure 9. The new-style two -inch-groove rumble strip.....	12
Figure 10. The machine used to make the two -inch-groove rumble strips.....	12
Figure 11. The grinding drum on the new two -inch-groove machine.....	13
Figure 12. Sets of grinder teeth on the shaft.....	13
Figure 13. Test section 1 on I 70 at Eagle – 2” groove 10” flat.	14
Figure 14. Test section 4A on I 70 at Eagle – 2” groove 3” flat.....	14
Figure 15. The roller that forms rumble strips in new concrete pavement.	17
Figure 16. The roller that forms rumble strips in new concrete pavement.....	17
Figure 17. The concrete rumble strip on US 34 east of Greeley.....	18
Figure 18. A road bike tire and wheel on a rolled-in concrete rumble strip.....	18
Figure 19. A cyclist on one of the new 2-inch rumble strips.....	21
Figure 20. Riders on one of the standard rumble strip sections.	21
Figure 21. Mechanics from Wheatridge Cyclery volunteered their time.....	22
Figure 22. This graph shows the rider ratings for all of the sections.....	22
Figure 23. Bicycle vibration levels and frequency.....	25
Figure 24. The increase in the sound level inside the vehicles at 55 MPH.....	30
Figure 25. The increase in the sound level inside the vehicles at 65 MPH.....	30
Figure 26. An accelerometer was mounted to the floor of the van.....	31
Figure 27. The accelerometer mounted to the top of the steering wheel.....	31
Figure 28. Comparison of sound level increase and vibration in a motor vehicle.	33

LIST OF TABLES

Table 1. The rumble strip dimensions.....	5
Table 2. Rider comfort and control ratings.....	23
Table 3. Measured vibration levels on a test bike.....	24
Table 4. Estimated sound intensity and decibel levels of common sounds.....	28
Table 5. Approximate human perception of changes in sound level.....	29
Table 6. Vibration levels and frequencies.....	32
Table 7. Bicyclist preference versus vehicle sound and vibration levels.....	35

1.0 INTRODUCTION

Nationally, more than 15,000 fatalities result every year from single vehicles running off the road due to overtired, drowsy or inattentive drivers⁽¹⁾. Studies have shown that these accidents, which most often involve a single vehicle whose driver has either dozed or is inattentive, can be reduced by 20 to 80 percent by the use of shoulder rumble strips. A shoulder rumble strip is a series of small bumps or depressions in the pavement on the shoulder just outside the traveled lanes. Rumble strips can be used on either the right or left shoulder, or both, of the highway. When a vehicle leaves the lane and passes onto the shoulder a noticeable sound and/or vibration alerts the driver to the fact that he has left the driving lanes. While the effect can be achieved by raised bumps, rumble strips on Colorado highways are depressions or grooves because anything protruding above the surface of the pavement interferes with snowplows, and is soon removed.

Colorado DOT has been installing rumble strips on the shoulders of rural highways for several years. During that time the configuration of rumble strips has changed considerably. The current standards (November 2000) call for intermittent rumble strips in asphalt pavements and for continuous rumble strips in new concrete pavements. Other considerations such as the width of the shoulder, use of guardrails, and a history of problems with run-off-the-road accidents contribute to the decision to use rumble strips on a particular section of highway.

While rumble strips save lives and reduce property damage for motorists, they can be a problem for bicyclists. For obvious reasons most cyclists ride on the shoulder. However, when debris or a parked vehicle blocks the shoulder, it becomes necessary for the cyclist to cross the rumble strip to move into the lane and go around the obstacle. An aggressive rumble strip, with wide deep grooves, can cause a very unpleasant level of vibration in the bicycle and possible loss of control.

In addition to the bicyclists' problems with rumble strips, there have been complaints about rumble strips from motorists. Fowler (a small farming town in southeast Colorado) City Council Meeting Minutes from October 3, 2000 have the following entries: "REMOVE rumble strips. Cars, trucks and agricultural equipment cannot or won't get over to allow faster traffic or even an ambulance to pass." "I have watched onions drop off of agricultural trucks from going over the rumble strips."

This study, funded by CDOT and the FHWA, compared three styles of rumble strips:

1. Colorado's standard asphalt rumble strip,
2. Colorado's standard concrete rolled-in rumble strip,
3. A new two-inch-groove rumble strip ground into asphalt.

The purpose of the study is to find a rumble strip that will provide a warning for motorists who have drifted off the highway without making the shoulders unusable for bicyclists.

2.0 BACKGROUND

The number of bicyclists using the highways is increasing every year. More and more riders are using bicycles for transportation and many ride for pleasure. Large group rides attract several thousand riders every summer. The increase in riders, along with the increased usage of rumble strips, has caused an increase in the exposure of bicyclists to shoulder rumble strips. Part of the problem can be addressed through education of riders about where to expect rumble strips and how to deal with them when they are encountered. A change in the rumble strips to a less severe configuration may be helpful to both bicyclists and motorists.

3.0 OBJECTIVE OF THE STUDY

This study compares four variations of a new configuration of rumble strip, the state standard design ground to five different depths, and standard concrete rumble strips. The comparisons are drawn from evaluations by bicyclists and an acoustic consulting company. The objective of the study is to find a configuration that is less disruptive to bicyclists than the standard rumble strip but still provides a safety factor to help prevent accidents caused by motorists running off the road.

4.0 RUMBLE STRIP DESCRIPTIONS

During September of 2000, rumble strip test sections were ground for this study. They were installed on the right shoulder of an asphalt overlay project on I 70 just east of Eagle, Colorado. Four new configurations, different from any used previously in Colorado were installed. In addition, five sections similar to the Colorado standard configuration asphalt rumble strips were installed in the same project. The standard type rumble strips had the depth of the grooves varying from 3/4" to 1/8". Although they were not originally planned as part of the research project, the project engineers decided to add the modified standard sections since they only required a depth adjustment to the grinding machine.

Table 1. The rumble strip dimensions. This table lists the rumble strip dimensions and average depth, target depth, maximum measured and minimum measured groove depth for each of the asphalt test sections.

Section	1	1A	2	2A	3	4	4A	5	6	7	8	9
Groove Width (in.)	2	2	2	2	2	2	2	7-7/2	6-1/2	6	5-1/2	5
Flat Width (in.)	10	10	5	5	5	3	3	4-1/2	5-1/2	6	6-1/2	7
Rumble Strip/Gap (ft)	Cont	12/6	Cont.	12/6	12/6	Cont.	12-6	48/12	Cont.	Cont.	Cont.	Cont.
Average Depth (in.)	0.44	0.44	0.44	0.44	0.29	0.39	0.39	0.58	0.49	0.46	0.41	0.28
Target Depth	0.5	0.5	0.5	0.5	0.375	0.5	0.5	0.75	0.5	0.375	0.25	0.125
Max. Measured (in)	0.58	0.58	0.46	0.46	0.38	0.48	0.48	0.71	0.59	0.53	0.47	0.40
Min. Measured (in)	0.36	0.36	0.43	0.43	0.20	0.33	0.33	0.50	0.35	0.42	0.37	0.22

A Georgia Fault Meter (GFM) was used to measure the depth of a random selection of four grooves near the center of each section. The GFM uses a linear variable differential transformer to measure the distance its probe moves above or below a pre-set zero location to an accuracy of 0.1 mm (about 0.004 inches). Each groove was measured at four locations along the length of the groove near the centerline. All of the readings were then averaged for the test section. Because of the coarse teeth used in the grinding operations, the depth of each groove varied considerably. The maximum and minimum measured depths for each section are shown in Table 1 to illustrate this. No effort was made to locate or avoid high or low points during the measurements. Section 5 was actually ground about 3/16 inch shallower than intended and sections 7, 8, and 9 were deeper than planned as shown in the table. See Appendix A for a detailed explanation of the different rumble strips and the standards.

As part of this study, a section of concrete with a rolled-in rumble strip was also examined. The section is on US 34 east of Greeley on a reconstruction project that opened during the summer of 2000.

4.1 Standard Rumble Strips

In December, 2000, as this report was being written, the Colorado standard specifications for asphalt pavement call for rumble strips in the following configuration (drawing Figure 1):

- Rumble strip is to be 12 inches wide perpendicular to the direction of travel, with grooves $\frac{3}{8}$ inch deep and 5 inches across, and a 7-inch flat between grooves ground on 12-inch centers.
- They are to be constructed on the shoulder beginning at the right edge of the shoulder stripe.
- Rumble strips are not to be constructed on shoulders less than 6 feet wide when there is a guardrail next to the shoulder.
- A 12-foot gap is to be left un-ground every 60 feet.
- Rumble strips will be omitted at auxiliary lanes, road approaches, and other interruptions as directed by the engineer. They shall be stopped at least 250 feet before road approaches.

The standards are in Appendix A along with photographs of each section.

A grinder (Figures 2 & 3) mounted on a trailer pulled by a large truck made the standard rumble strips. The grinder drum, turning on an axis perpendicular to the travel lanes of the highway, made round-bottomed grooves (Figures 4 & 5). The length of the grinder drum (Figures 6, 7, & 8) determines the width of the rumble strip. Without stopping its forward motion (about the speed of a slow walk), this machine cuts one groove at a time in a continuous operation. A non-adjustable spacing mechanism lowers the spinning drum into the pavement at a pre-set interval to cut the groove. Occasionally the operator stops to check the depth of the grooves and make minor adjustments as the grinder teeth wear down. This system can grind about 13 miles of rumble strip in a day, with periodic stops for adjustment and a complete replacement of the teeth once or twice a day.

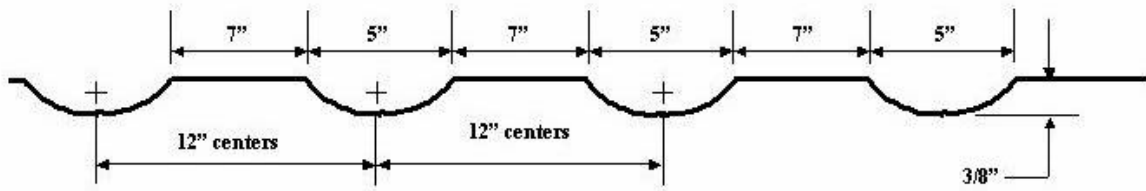

Figure 1. Profile of standard ground-in rumble strip. A typical section of standard ground in rumble strip installed on existing asphalt or concrete pavement.



Figure 2. The machine that grinds the standard rumble strips. Inside the large wheel at the front of the machine is the cam that determines the spacing of the rumble strip grooves.



Figure 3. The equipment used to grind the standard rumble strips. The operation is stopped and the trailer raised so the operator can replace worn teeth on the grinding drum.



Figure 4. The standard rumble strip. This is one of the shallower sections. The operator stopped to check the grooves here. A power broom follows along to sweep the grindings off the roadway.



Figure 5. One of the shallower sections of standard rumble strip. The grooves are on 12-inch centers. The wear on the grinder teeth is shown by the uneven shape and variation in depth along the grooves.

Figure 6. The underside of the grinder trailer. This shows the grinding drum with its teeth. Notice the empty sockets at the right of the drum. By adding more teeth or taking some out the length of the grooves - the width of the rumble strip can be adjusted. The lateral offset in the teeth causes the rough texture of the grooves.





Figure 7. A spare drum for the grinder. The diameter is about 17 inches. By using a drum of smaller diameter grooves could be ground deeper with more flat in between them and still be on 12 inch centers.



Figure 8. The grinding drum determines the length of the grooves. By leaving some of the end sockets empty, the length of the grooves (the width of the rumble strip) can be varied.

For this study five different depths of the Colorado standard rumble strip were ground, one section each with grooves 3/4", 1/2", 3/8", 1/4", and 1/8" deep. Changing the depth of the groove varied the width and, since the spacing was kept constant, the width of the flat changed also. Grooves cut 3/8 inch deep on 12-inch centers are five inches across with 7-inch flats in between. Deeper grooves are wider with narrower flats and shallower grooves are narrower with wider flats.

4.2 Two-inch-groove Rumble Strips

The new two-inch-groove rumble strips for this study have grooves with a roughly rectangular cross section (drawing Figure 9). The rumble strip is 12 inches wide with grooves perpendicular to the direction of travel just like the standard rumble strip grooves. However, the grooves for this type of rumble strip are only two inches wide and half an inch deep. Because the diameter of a bicycle is about 27 inches, the tire does not drop down into the groove when the bike crosses it. There is less vertical movement to be felt by the rider. Two-inch wide grooves cause vibration on a bicycle that is "not much worse than some bad roads" according to one test rider.

Thomas Grinding, of Moore Haven, Florida, specially configured a machine to grind this new style of rumble strip. A self-contained, self-propelled machine that looks like a small motor grader (Figure 10) ground the two-inch grooves.

The new machine's grinding drum spins on an axis parallel to the travel lanes. The drum (Figure 11) has rows of teeth that cut grooves with a roughly rectangular cross section. The cutting action is similar to the action of a gang of saw blades spaced along a shaft (Figure 12). The width of the row of teeth determines the width of the groove. Space between rows of teeth equals the flats between grooves (Figures 13 & 14). And the distance the cutter is moved across the pavement determines the length of the grooves, which equals the width of the rumble strip. Raising or lowering the grinding drum sets the depth of the grooves. Since the grinding drum assembly is six feet long, sections of rumble strip have to be ground in six foot multiples.

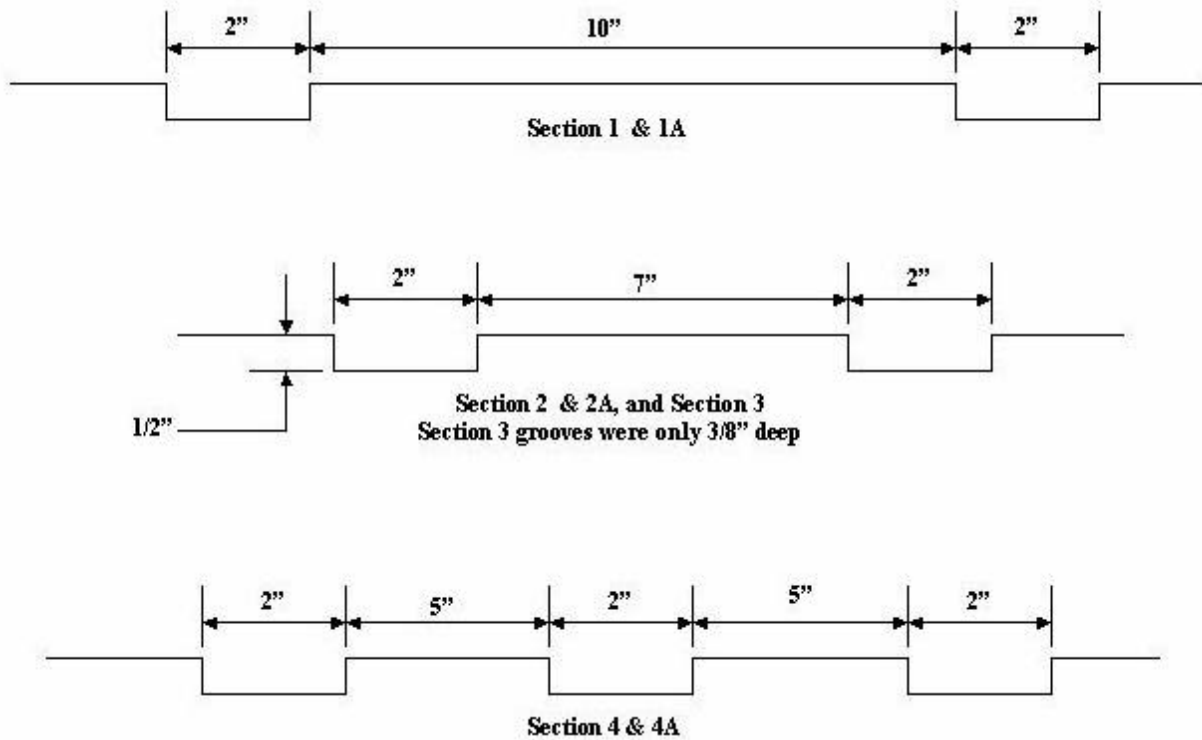

Figure 9. The new style-two-inch-groove rumble strip. Sections 1, 2, and 4 were 1000' continuous and sections 1A, 2A, 3, and 4A were 1000' interrupted with rumble strip for 12' and a 4' space.



Figure 10. The machine used to make the two-inch-groove rumble strips. The grinding drum is located near the center of the machine and moves from the operators left to his right to grind the grooves. The drum is six feet long so the machine grinds six feet of rumble strip at each stop.



Figure 11. The grinding drum on the new two-inch-groove machine. The spaces between the sets of teeth that adjusts the spacing of the grooves can be seen. The spinning drum is lowered into the pavement and moved to the left to cut the rumble strip grooves - six feet at a time.

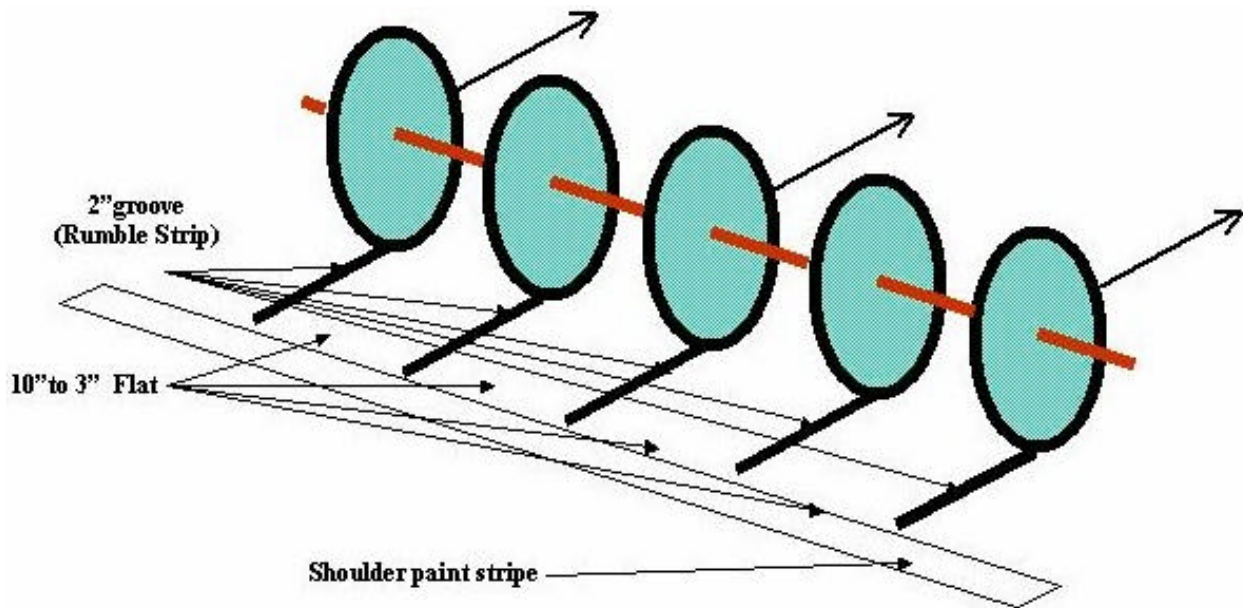

Figure 12. Sets of grinder teeth on the shaft. The green circles represent sets of teeth on the shaft. The shaft is moved to the side to grind a set of grooves - one groove for each tooth set on the shaft. Spacing the tooth sets at different intervals on the shaft changes the spacing of the grooves and the width of the flat between them; the width of the groove is set by the width of the tooth set. The six-foot-long shaft grinds six feet of rumble strip with each pass.

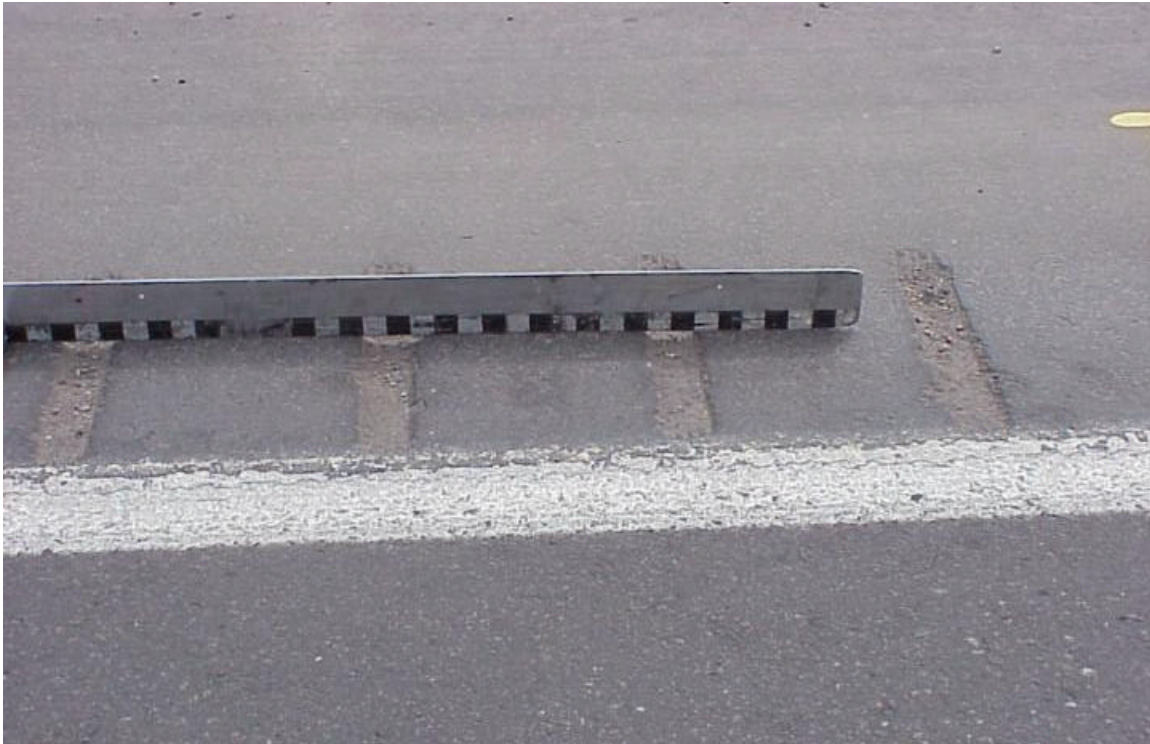

Figure 13. Test section 1 on I 70 at Eagle - 2" groove 10" flat. This is one of the new two-inch-groove style rumble strips. Bicyclists liked it but it didn't generate loud enough sound in a motor vehicle.



Figure 14. Test section 4A on I 70 at Eagle - 2" groove 3" flat. This picture shows how the rumble strip may capture water and debris. The slight variations in the groove spacing are caused by the spacers used on the grinding drum.

The new machine is considerably slower than the standard rumble strip grinder because it must be stopped in the desired position, the grinding drum lowered into the pavement and moved to the side to cut the grooves, the drum raised, the machine moved forward six feet to the next position, and the process repeated. The length of the drum sets the distance between stops – it grinds six feet of rumble strip at a time no matter what combination of grooves and spaces is used. Simply moving the machine before resuming grinding can leave any gap length desired.

According to Chad Thomas of Thomas Grinding, this machine grinds about three miles of rumble strip per day; the standard configuration machine (also manufactured by Thomas Grinding) grinds 10 to 13 miles per day. This factor needs to be taken into consideration. Two-inch-groove rumble strips, on a fifteen mile interstate job with rumble strip on both shoulders, would take about 20 days compared to 6 days for the standard rumble strips. Since the rumble strip is the last thing done on a job that would extend construction time by 14 working days – nearly 3 weeks.

The new machine ground seven test sections in the following configurations (see Table 1 on page 3, above):

- 1: grooves 2” wide by 1/2” deep, with 10” flats, continuous
- 1A: grooves 2” wide by 1/2” deep, with 10” flats, 1000’ interrupted
- 2: grooves 2” wide by 1/2” deep, with 5” flats, continuous
- 2A: grooves 2” wide by 1/2” deep, with 5” flats, interrupted
- 3: grooves 2” wide by 3/8” deep, with 5” flats, 1000’ interrupted
- 4: grooves 2” wide by 1/2” deep, with 3” flats, continuous
- 4A: grooves 2” wide by 1/2” deep, with 10” flats, 1000’ interrupted

Since sections 1 and 1A are the same groove/flat pattern they are treated as one section for the study. The same is done with sections 2 and 2A, and sections 4 and 4A. Section 3 is the same spacing as section 2A, but the grooves are 3/8” deep instead of 1/2”. For the riders’ evaluations, sections 1 & 1A were called section 1; 2 & 2A were called section 2; section 3 was called 3; and sections 4 & 4A were called 4.

4.3 Rolled-in Rumble Strips in Concrete

In new concrete pavement, rumble strips are pressed into the plastic concrete during the paving operations. Specifications for rolled-in rumble strips are:

- The rumble strip is to be 18 inches wide perpendicular to the direction of travel, with grooves 1/2 to 1 inch deep and 2-3/8 inches across, and with a 1-5/8 inch flat between grooves.
- Rumble strips are to be constructed on the shoulder beginning at the right edge of the shoulder stripe, or as close to the shoulder stripe as possible on lanes with 14-foot slabs.
- Rumble strips are not to be constructed on shoulders less than 6 feet wide when there is a guardrail next to the shoulder.
- The rumble strip is to be continuous.
- Rumble strips will be omitted at auxiliary lanes, road approaches, and other interruptions as directed by the engineer. They shall be stopped at least 250 feet before road approaches.
- Rumble strip is constructed on shoulder slabs not the outside edge of the lane slabs. This means that on highways with 14-foot-wide slabs, the rumble strip will be about 2 feet to the right of the shoulder stripe - to the right of the shoulder joint.) A roller mounted on the paving machine behind the screed (Figures 15 & 16) forms the rumble strip into the plastic concrete. The depth the roller is pressed into the concrete sets the groove depth.

The standards are in Appendix A.

The concrete rumble strip site used for this report is on a newly constructed section of US 34 east of Greeley. The grooves at this site are 1/2" deep (Figure 17 & 18), which is at the shallow extreme of the standards.



Figure 15. The roller that forms rumble strips in new concrete pavement. The roller has been raised because the paving operation is approaching an intersection. This roller forms rumble strips on the left shoulder.



Figure 16. The roller that forms rumble strips in new concrete pavement. The roller that forms the right shoulder rumble strip can be seen at the far side of the paving machine. It has been raised off the surface because the paving operation is approaching an intersection.



Figure 17. The concrete rumble strip on US 34 east of Greeley. This strip is 18 inches wide with grooves on about 3-1/2" centers. The light below the floppy disk shows the depth of the groove - about 1/2" which is at the low end of the allowed range of 1/2" to 1".



Figure 18. A road bike tire and wheel on a rolled-in concrete rumble strip. The tire has approximately 95 psi air pressure and the riders weight is on the bike. The tire does not sink completely to the bottom of the groove. The rider said this rumble strip would not be a problem for bicyclists.

5.0 BICYCLE TESTING

What better way to find “Bicycle-Friendly Rumble Strips” than to ask friendly bicyclists? A group of volunteers, only three of whom were CDOT employees, rode the various configurations of rumble strip and rated them according to comfort and controllability. A consultant was hired to gather data about the vibration of a bicycle, the sound levels of motor vehicles, and vibration in motor vehicles.

At both the asphalt site on I 70 and the concrete site on US 34, the right lane was closed to provide a buffer between the cyclists and traffic during the testing. Both sites are four-lane rural highways where the testing did not cause any disruption in traffic flow.

5.1 Bicycle Riders

Original plans called for 24 riders. When the ride date arrived, a few welcome “extras” did too, so there were a total of 29 riders. Nearly all of the 29 volunteer riders who took part in the study were members of Bicycle Colorado – “an organization dedicated to improving safety and riding conditions for all bicyclists in the state of Colorado”. Martha Roskowski of Bicycle Colorado and Gay Page, CDOT’s Bicycle/Pedestrian Program Manager, contacted all of the riders to tell them about the time and place for the testing. They also contacted a bicycle mechanic who volunteered to be at the test site, and arranged for lodging and meals for the riders during the testing. The riders came from all over Colorado and at least one came from Wyoming.

Before the ride each cyclist was given a booklet containing a brief explanation of the study, a Waiver and Release of Liability Form, an Accident Insurance information sheet, a list of general information questions, a set of rumble strip evaluation sheets, and a drawing of how the test sections were set up. A copy of the booklet is in Appendix B.

Each rider filled out the general information questionnaire asking their level of experience, the type of bicycle, and where and how much they ride. Fifteen of them rated themselves as very experienced, twelve as intermediate, and two as inexperienced. Some of them ride hundreds of miles per week (15 of them ride between 100 and 400 miles per week in the summer); 22 ride in all weather conditions; and three of them race. One rider spent the summer riding across the nation. One of the riders is the director of and a participant in Ride The Rockies, an annual 6-7

day, 400 to 500 mile ride on Colorado highways that attracts two thousand participants. The executive director and the manager of Bicycle Colorado both participated in the tests in addition to arranging for most of the volunteer riders. Of 29 riders who took part in the test, 27 used road bikes with narrow, high-pressure (around 100 psi.) tires and 2 rode mountain bikes with fat, low-pressure tires.

To reduce confusion and keep riders from interfering with each other during the test rides, they were formed into three groups. Only one group was in a section at a time. Each group tested a section until all the riders were satisfied with their ratings, then the whole group moved to the next section. Each rider rated each section for both controllability and comfort on a scale from 1 - No Effect to 5 - Severely Uncomfortable/Uncontrollable. The cyclists rode each section at 5 MPH, 10 MPH, 15 MPH, and 20 MPH for a total of eight ratings for each section. Some of the cyclists were unable or unwilling to ride some of the sections at higher speeds because their bicycles became uncontrollable. Those sections were recorded as a 5 (Severely Uncomfortable/Uncontrollable) for that speed.

At the start of each test section the riders were asked to ride directly on the rumble strips (Figure 19) for whatever distance they felt was necessary to evaluate the rumble strip in that section. Cones were set on the shoulder to represent obstacles and the riders were asked to cross the strips (Figure 20) the way they would to avoid an obstacle on the shoulder of the highway. The riders made as many trips through the sections as they needed to be satisfied with their evaluations.

Maintaining exact speed for the tests was not essential since the information was based on riders' opinions, but speedometers on the bicycles were used to determine the test speeds. Those who did not already have one were given a speedometer donated by the Cateye Service and Research Center in Boulder, Colorado. The speedometers were installed and calibrated at the site by mechanics from Wheat Ridge Cyclery (Figure 21).



Figure 19. A cyclist on one of the new 2 inch rumble strips. This is a section of interrupted rumble strip



Figure 20. Riders on one of the standard rumble strip sections. The dark stripe over the rumble strip is where CDOT Maintenance crews have applied a sealer to protect the asphalt in the rumble strip grooves. Some of the riders were concerned that this area might become slippery in wet weather.



Figure 21. Mechanics from Wheatridge Cyclery volunteered their time. They installed and adjusted speedometers donated by the Cateye Service and Research Center in Boulder and were available if adjustments or repairs to any of the riders' bikes were needed.

The ratings from all riders for all speeds for each section were totaled together and averaged to generate the graph in Figure 22 and Table 2. As Table 2 and the graph in Figure 22 show, the ¾-

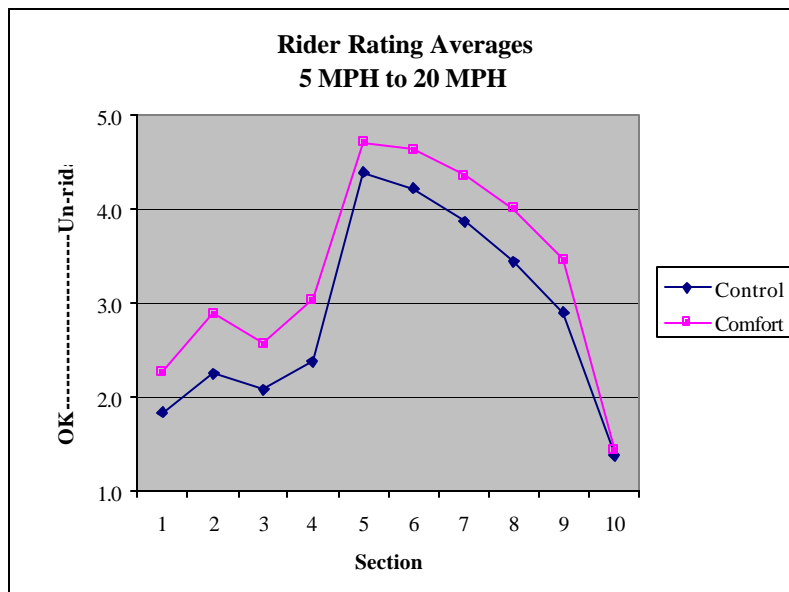

Figure 22. This graph shows the rider ratings for all of the sections.

inch-deep standard-style rumble strip (section 5) is the most objectionable to cyclists and the concrete strip (section 10) is their favorite. The graph of the rider ratings in Figure 22 is very similar to the graph of the sound level increase in a car, a van, and a pickup truck in Figures 24 and 25 (page 27). Rougher rumble strips to a bicyclist are louder rumble strips with more vibration felt in a motor vehicle.

Table 2. Rider comfort and control ratings. This table lists the average of the rider comfort and control ratings by test section. (A rating of 1 meant no problems, 5 meant severely uncomfortable or uncontrollable.)

Section	Average Control Rating	Average Comfort Rating
1	1.8	2.3
2	2.3	2.9
3	2.1	2.6
4	2.4	3.0
5	4.4	4.7
6	4.2	4.6
7	3.9	4.3
8	3.4	4.0
9	2.9	3.5
10	1.4	1.4

5.2 Bicycle Vibration Levels

Vibration is the reason bicyclists object to rumble strips. During the evaluations several complaints about the magnitude of the vibrations were recorded. Some comments from section 5 (the 3/4" deep version of the standard rumble strip):

- “A bit dangerous to ride these at high speeds. Body and bike took a beating.”
- “At 15 MPH water bottle vibrated out – feet were disengaging from foot pedals. Horrible!”
- “Horrible control and unbearably uncomfortable at 5 MPH. 10 MPH worse yet. 15 & 20 MPH have no control. Can’t see straight.”
- “Unsafe at any speed. At 20 MPH the gaps are difficult to negotiate for an experienced rider. Riding on the rumble strip is uncontrollable and unsafe.”
 - “Feet bounce off pedals at higher speeds. Lack of control, adrenaline rush at 20 MPH. Vision blurred at 15 & 20 MPH. Mirror bounced out of adjustment.”

Experienced riders who knew what lay ahead of them before they rode onto the rumble strips made the above comments. From them it is easy to understand how an inexperienced rider encountering the same rumble strips unexpectedly at high speeds or in a large group could have problems. The problem can be very serious in a large group: If one rider in the middle of the group falls, it is probable that others will go down too. If the accident happens at high speed, serious injury could result.

The ratings given by the bicyclists were subjective values - they depended on the individual rider and to a certain extent on his or her experience. A consultant was hired to get an objective measurement of the vibration felt by the cyclists. An accelerometer was mounted on a bicycle and connected by a lightweight cable to a computer in the bed of a small pickup truck. This arrangement allowed the accelerometer to measure the vibrations of the bicycle and rider without the extra mass of the computer. The pickup drove on the shoulder, off the rumble strip, pacing the bicycle through the test sections at the required speeds.

Table 3. Measured vibration levels on a test bike.

	Bicycle Speed							
	5 MPH		10 MPH		15 MPH		20 MPH	
	Max (dB)	Freq. (Hz)	Max (dB)	Freq. (Hz)	Max (dB)	Freq. (Hz)	Max (dB)	Freq. (Hz)
Section 1, 1A	8	31.5	21	25	21	20	23	25
Section 2, 2A	11	12.5	18	20	27	31.5	26	40
Section 3, 4, 4A	10	12.5	25	31.5	34	40	21	63
Section 5	12	20	28	12.5	35	20	NA	NA
Section 6	13	25	25	12.5, 25	33	20	35	25
Section 7	11	31.5	26	25	32	20	33	25
Section 8	10	25	24	25	31	16	33	25
Section 9	6	31.5	21	25	26	20	31	25
Section 10	8	31.5	18	40	15	63	12	20

Table 3 and the graphs in Figure 23 show the frequency and amplitude of the vibrations measured on the test bike. Vibrations were not measured at 20 MPH in section 5; the consultant felt it was unsafe to ride at that speed. The vibration maximum level is expressed in decibels (dB) (re: 1 m/s²). Table 3 shows the frequency at which the highest level of vibration occurred. In many cases there were peak levels at more than one frequency. For those cases the highest peak is listed. All of the data and graphs showing vibration levels for all frequencies for each test section for all speeds are in Appendix D. It is interesting to note that the frequency of the maximum vibration level did not necessarily increase with an increase in speed.

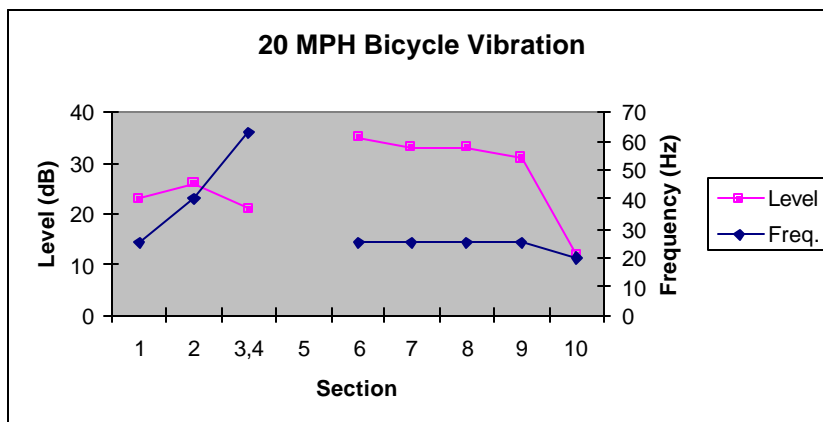
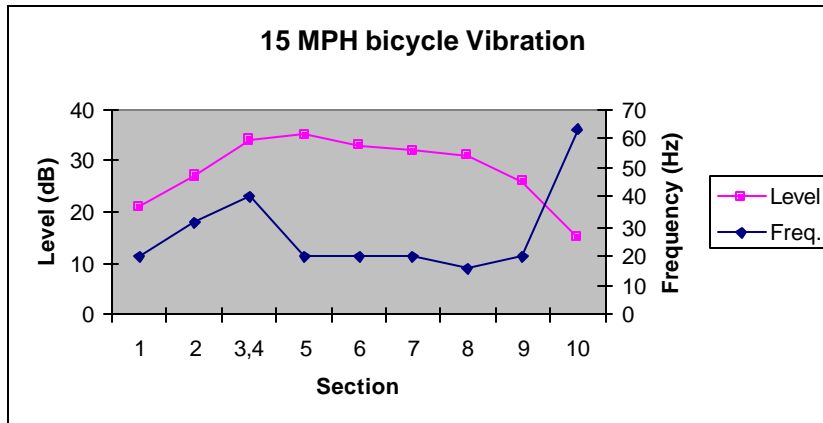
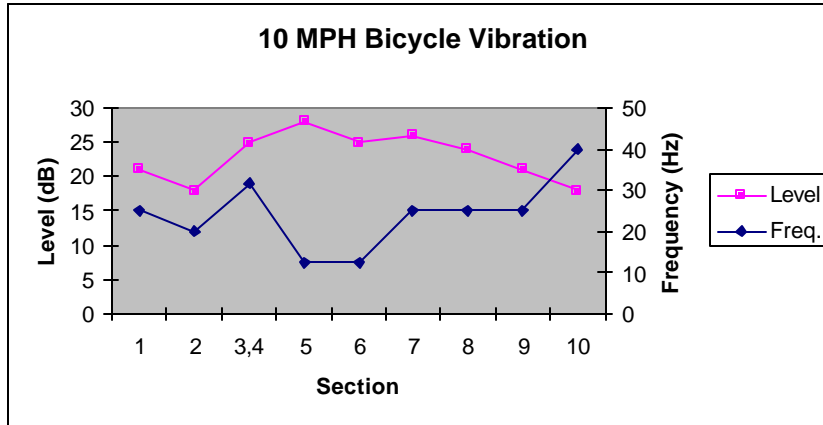
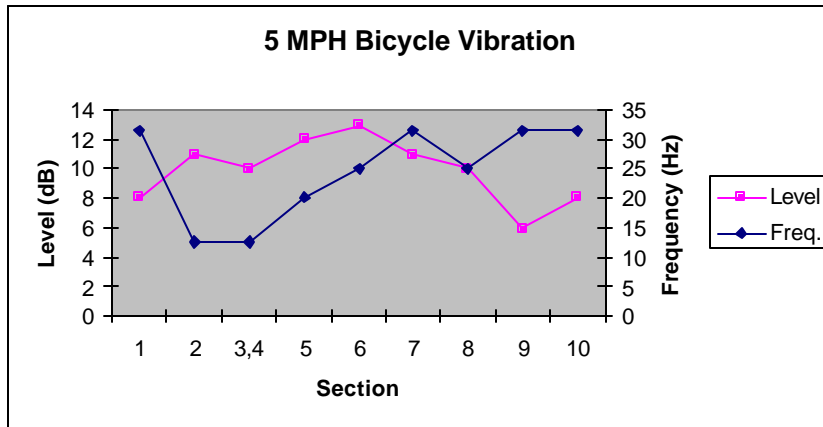

Figure 23. Bicycle vibration levels and frequency.

6.0 MOTOR VEHICLE TESTING

The purpose of a rumble strip is to warn a motorist who has drifted out of the driving lanes for some reason. The warning comes from the sound and vibration of the vehicle when its tires contact the rumble strip. Obviously, a louder sound works better than a softer one, and an intermittent sound is believed by some to work better than a continuous one. The frequency of the sound may also play a part in the effectiveness of the rumble strip. David L. Adams Associates, an acoustic consultant, performed the testing to determine the sound levels generated by the different rumble strips.

6.1 Motor Vehicle Sound Levels

One of the main problems with choosing the best rumble strip is the fact that there is no standard for the sound level required from an effective rumble strip. Sound levels generated by the rumble strips were compared to the sound levels generated inside the vehicles on smooth pavement and to a 6 dB change generally accepted as a “clearly noticeable change”.

Since different vehicles have different levels of ambient noise during normal operation, tests were done using four different types of vehicles:

1. A 1994 Oldsmobile Cutlass station wagon,
2. A 1999 Dodge full sized pickup truck
3. A 2000 GMC minivan with only front seats and no interior soundproofing in the rear.
4. An unloaded tandem axle dump truck. (One dump truck was used at the asphalt site on I 70 and another was used at the concrete site on US 34. Logistics prevented using the same truck at both sites.)

The sound generated by rumble strips does not necessarily add to the sound inside a vehicle. For example, the cab of a dump truck at 65 MPH is so noisy in normal operation that most of the rumble strips tested did not raise the sound level a noticeable amount. This could also be the case in a car with the sound system turned up in an effort to keep the operator awake.

Sound loudness is subjective - it depends on the person hearing the sound and the conditions at the time. While loudness is subjective, sound intensity is objective and can be measured using

sensitive instruments. Sound intensity is generally measured in Watts per square meter (W/m^2). The human ear can perceive sound across a wide range of intensity from the threshold of hearing at about $1 \cdot 10^{-12} W/m^2$ to a level that will cause instant perforation of the eardrum at $1 \cdot 10^4 W/m^2$. Because this is a very large range, sound intensity is usually given on a logarithmic decibel (dB) scale. The threshold of hearing is set at a value of 0 dB then using the logarithmic scale perforation of the eardrum would occur at about 160 dB₍₂₎. It is important to realize that 160 dB is not 160 times as loud as 1 dB – it is 10^{16} times as loud. Table 4 shows some common sounds with their estimated intensity and decibel levels.

Table 4. Estimated sound intensity and decibel levels of common sounds₍₂₎

Sound	Intensity	Decibel Level	Number of times greater than the threshold of hearing
Threshold of Hearing	$1 \cdot 10^{-12} W/m^2$	0 dB	10^0
Rustling Leaves	$1 \cdot 10^{-11} W/m^2$	10 dB	10^1
Whisper	$1 \cdot 10^{-10} W/m^2$	20 dB	10^2
Normal Conversation	$1 \cdot 10^{-6} W/m^2$	60 dB	10^6
Busy Street	$1 \cdot 10^{-5} W/m^2$	70 dB	10^7
Vacuum Cleaner	$1 \cdot 10^{-4} W/m^2$	80 dB	10^8
Large Orchestra	$6.3 \cdot 10^{-3} W/m^2$	98 dB	$10^{9.8}$
Walkman at Maximum	$1 \cdot 10^{-2} W/m^2$	100 dB	10^{10}
Rock Concert – Front Rows	$1 \cdot 10^{-1} W/m^2$	110 dB	10^{11}
Threshold of Pain	$1 \cdot 10^1 W/m^2$	130 dB	10^{13}
Military Jet Take-off	$1 \cdot 10^2 W/m^2$	140 dB	10^{14}
Instant Perforation of Eardrum	$1 \cdot 10^4 W/m^2$	160 dB	10^{16}

David L. Adams Associates, the sound and vibration measurement consultant, used a Larsen-Davis Model 2900 sound level meter to measure the sounds inside the vehicles when they drove with their right wheels continuously in the rumble strips for several seconds. The sound level meter samples sound at frequencies from 25 Hz to 10,000 Hz and applies a correction factor which results in an A-weighted sound level.

An A-weighted sound level is a measure of sound pressure level designed to reflect the acuity of the human ear, which does not respond equally to all frequencies. The ear is less efficient at low and high frequencies than at medium or speech-range frequencies. Therefore, to describe a sound containing a wide range of frequencies in a manner representative of the ear's response, it is necessary to reduce the effects of the high and low frequencies with respect to the medium

frequencies. The resultant sound level is said to be A-weighted, and the units are dBA. The A-weighted sound level is also called the noise level.

The graphs in Figures 24 & 25 show the sound level increase at 55 MPH and at 65 MPH inside the vehicles. Zero represents normal road sound levels. The graphs show sound level increases when the vehicle tires are on the rumble strips. Lines on the graphs at 6 dB and 10 dB show changes that would be clearly noticeable and twice as loud, respectively. The graphs clearly show that drivers in different vehicles will hear much different changes in sound levels when they are driving on the rumble strips. Table 5 shows how a typical person perceives different amounts of change in sound levels.

Table 5. Approximate human perception of changes in sound level.

Change in sound level (dB)	Change in apparent loudness
1 dB	Imperceptible
3 dB	Barely noticeable
6 dB	Clearly noticeable
10 dB	About twice – or half as loud
20 dB	About four times – or one-fourth as loud

Intuitively, a more severe rumble strip would make a louder noise at a given speed. However, Figures 26 & 27 show considerable variation in which rumble strip is loudest in each vehicle. Also, the loudest at 55 MPH is not necessarily the loudest in the same vehicle at 65 MPH. Note that Figure 25 shows that only the standard style rumble strip at ½-inch depth (not the deepest) made enough noise to be clearly noticeable in the dump truck. All of the motor vehicle sound data is in Appendix C.

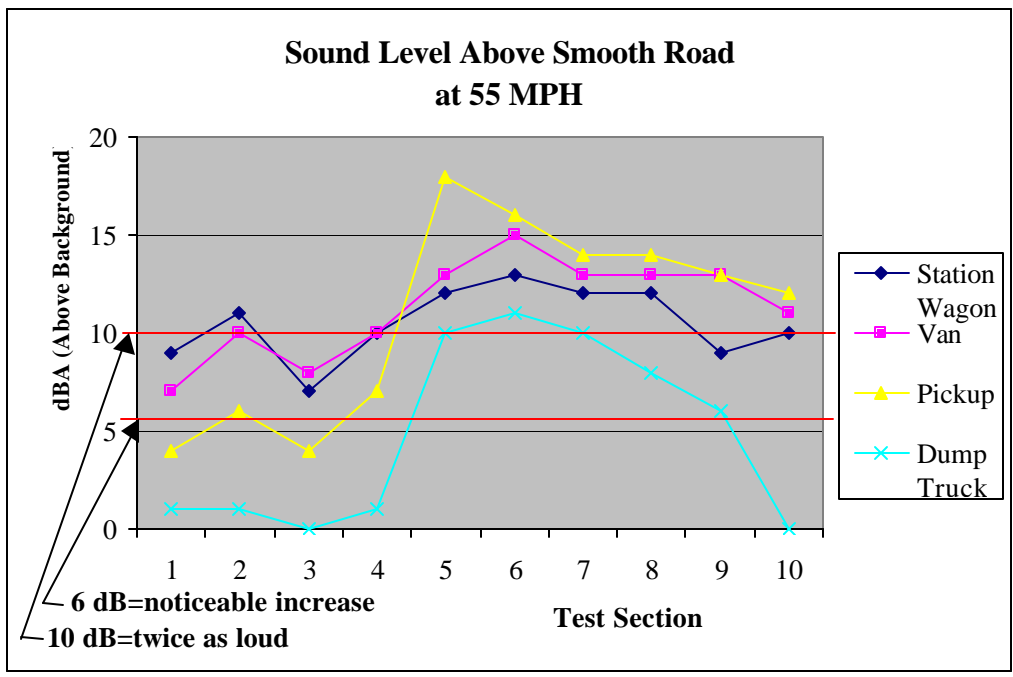

Figure 24. The increase in the sound level inside the vehicles at 55 MPH.

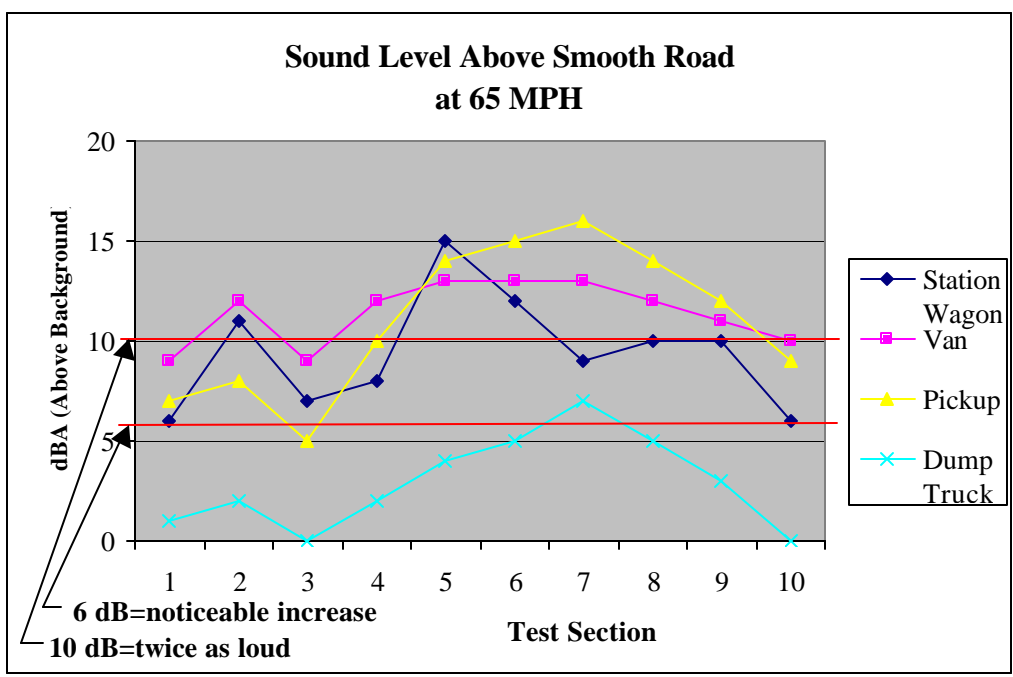

Figure 25. The increase in the sound level inside the vehicles at 65 MPH.

6.2 Motor Vehicle Vibration Levels

CDOT provided a 2000 GMC Safari all wheel drive mini-van, for the vibration measurements. It was one of the vehicles used for the sound measurements also. Technicians from the acoustic consultant firm, David L. Adams Associates, took all measurements with a Larson-Davis Model 2900 sound level meter, together with a Brüel & Kjær Type 4370 accelerometer. They calibrated the instruments before and after measurements with a Brüel & Kjær Type 4294 Calibration Exciter.



Figure 26. An accelerometer was mounted to the floor of the van.

(Figure 27). Vibration was measured perpendicular to the plane of the steering wheel and perpendicular to the floor of the van.

Vibration measurements were taken at 55 and 65 mph in each rumble strip section. “Background” measurements were taken in the travel lane at each speed to provide a comparison to the vibration measurements in the rumble strips.

Table 6 represents the vibration levels in decibels (re: 1 m/s^2) and the frequency at which it occurred in each section of rumble strip. Each vibration level shown in Table 6 is the average of the two highest vibration levels sampled during the time the vehicle was traveling in that rumble strip test section. Each section was sampled until two maximum levels were within 3 decibels of each other and at the same frequency. This required driving through each rumble strip section several times. See graphs of the vibrations in Appendix D, pages D-20 through D-32. Please note that negative decibel levels occur since the reference acceleration is 1 m/s^2 .

Also note that the numbers in *italics* represent vibration levels that were within 10 dB of the background condition and were corrected to

To determine whether vibrations were felt more thorough the steering wheel or through the body of the vehicle, measurements were taken with the accelerometer in two different locations: One location was on the floor of the van just behind the driver’s seat at spot where the floor was welded to the vehicle frame (Figure 26). The second location was with the accelerometer mounted to the steering wheel with a U-bolt



Figure 27. The accelerometer mounted to the top of the steering wheel. It measured vibration levels perpendicular to the plane of the wheel.

omit the influence of the background levels. The vibration levels for rumble strips 4 and 4A at 65 mph were too close to the background levels to measure. Graphs of the vibration data are in Appendix D.

Table 6. Vibration levels and frequencies. Vibration levels were measured in a GMC minivan using a Brüel & Kjær Type 4370 accelerometer. Maximum levels and frequencies for each section are listed.

	Accelerometer Mounted to Floor				Accelerometer Mounted to Steering Wheel			
	55 MPH		65 MPH		55 MPH		65 MPH	
	Max (dB)*	Freq. (Hz)	Max (dB)	Freq. (Hz)	Max (dB)	Freq. (Hz)	Max (dB)	Freq. (Hz)
Rumble Strip 1	-6	80	-9	100	5	80	-5	40
Rumble Strip 1A	-9	80	-11	200	5	80	-5	100
Rumble Strip 2	-8	125	-6	160	0	80	-6	40 & 160
Rumble Strip 2A	-9	125	-8	160	-3	125	-4	160
Rumble Strip 3	-10	125	-9	160	-5	125	-6	160
Rumble Strip 4	-9	200	-1	250	-6	80	-**	-**
Rumble Strip 4A	-17	25	-4	250	-4	80	-**	-**
Rumble Strip 5	6	80	3	100	11	80	7	100
Rumble Strip 6	8	80	3	100	8	80	2	100
Rumble Strip 7	8	80	3	100	9	80	3	100
Rumble Strip 8	5	80	2	100	5	80 & 160	5	100
Rumble Strip 9	-2	160	-1	100	2	80 & 160	7	100
Rumble Strip 10	3	630	8	630	1	63	1	63

* dB, re: 1 m/s²

** Data at or below background acceleration (as measured on smooth pavement alongside rumble strips).

Figure 28 is a graph showing the sound levels and vibration levels measured in the various test sections. Sections 5 through 10 had the highest vibration levels and 5 through 9 had the highest sound levels.

Comparison of Sound Level Increase and Vibration in a Motor Vehicle

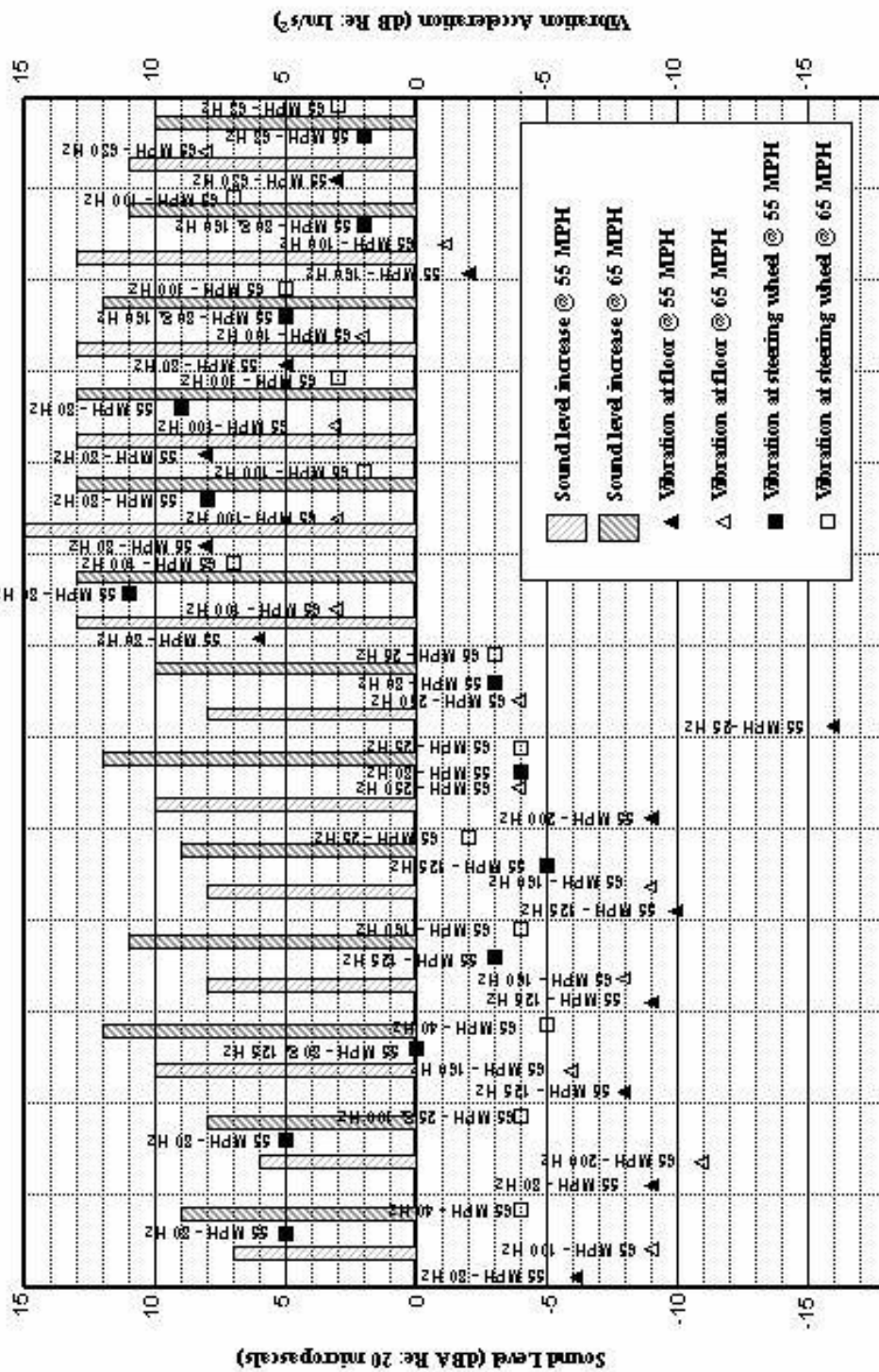

Rumble Strip Section
Figure 28

7.0 CONCLUSIONS AND RECOMMENDATIONS

7.1 Conclusions

Table 7 shows the rider ratings with the sections rated as best at the top; the vehicle sound levels with the loudest section at the top; and the average vibration measured with the most vibration at the top. There is no ideal solution. The motor vehicle tables are very nearly opposite the bicycle table for all configurations of rumble strips. The best rumble strips from the sound/vibration viewpoint are the worst from the bicycle riders' viewpoint.

Table 7. Bicyclist preference versus vehicle sound and vibration levels.

Bicyclist Preference Best at the top Worst at the bottom	Motor Vehicle Sound Level Loudest at the top Quietest at the bottom	Average Motor Vehicle Vibration Strongest at the top Weakest at the bottom
Section 10	Section 6	Section 5
Section 1	Section 5	Section 7
Section 3	Section 7	Section 6
Section 2	Section 8	Section 8
Section 4	Section 9	Section 10
Section 9	Section 2	Section 9
Section 8	Section 4	Section 1
Section 7	Section 10	Section 2
Section 6	Section 1	Section 4
Section 5	Section 3	Section 3

Here is where a decision must be made. Sections 5, 6, and 7 gave the best sound and vibration levels in the vehicles. However, they were the worst for the cyclists. Sections 10, 1, and 3 were the best from the bicycle point of view but were at the bottom of the motor vehicle columns. Sections 2, 4, 8 and 9 rated near the middle for all three tests.

During the testing for this study, it was found that the new-style 2-inch-groove rumble strip and the rolled-in concrete rumble strip did not produce a “noticeable increase” (6dB) in sound over the sound levels in the cab of the dump truck during normal highway operation. Only the “standard design” configurations produced enough sound increase to be noticeable in the cab of a tandem axel dump truck. (Vibration testing was not done in the dump truck.)

Rumble strips 2, 8, and 9 offer the best compromise of the 10 tested. Rider ratings for these four sections are nearly the same and, for three of the four vehicles tested, they have more than a 6 dB sound increase over the driving lane. However, in the dump truck only section 8 has a sound level close to the 6 dB needed to be “clearly noticeable” (8 dB at 55 MPH - Figure 24 and 5 dB at 65 MPH - Figure 25).

If we use sound level as the determining factor for an acceptable rumble strip, sections 2, 8, and 9 are all acceptable for small vehicles. However, only sections 8 and 9 raise the sound level 6dBA in the dump truck at 55 MPH, and only section 8 is close (5dB) at 65 MPH. The grooves in section 8 measured an average depth of 0.41 inches, which is slightly over 3/8 inch.

Standards in Colorado call for the rumble strips to be constructed with gaps at regular intervals. With the gaps and the less aggressive grooves in the section 8 rumble strips, bicyclists should be able to use the shoulders without problems. Cyclists need to be aware that the rumble strips are there and to respect them. But they should be able to avoid the strips most of the time and, by using caution when they do have to ride across a rumble strip, be able to enjoy riding without worry of injury or damage to their bicycles.

7.2 Recommendations

1. Use a standard style rumble strip with grooves ground to a depth of 3/8 inch ($\pm 1/8$ inch) on 12-inch centers in a gap pattern of 48 feet of rumble strip followed by 12 feet of gap. It is important that the depth of the grooves is closely monitored. The survey shows that while a cyclist can navigate 3/8-inch deep grooves fairly easily, when the grooves are 1/2-inch deep or more severe control problems occur.
2. Provide some form of warning for bicyclists at the beginning of a shoulder rumble strip. A major factor in the danger of a rumble strip to a cyclist is the element of surprise. A sign or a wide paint stripe across the shoulder in advance of the actual start of the strip could help to reduce the probability of a cyclist going into a rumble strip unaware. A warning would be especially valuable to cyclists riding at high speed or in a group.
3. Establish a standard level of sound and vibration needed from a vehicle for a rumble strip to be effective.

4. Educate cyclists about where to expect rumble strips and what to expect when they encounter them.

The recommendations of this study will be presented to the Discussion Group Panel for Standard Plans, which determines if a revision to the standard plans will be made. If the recommendations are accepted, the new standards will be incorporated into rumble strips constructed in conjunction with asphalt overlays and/or new asphalt pavement construction. It is hoped that these recommendations will also be evaluated for incorporation into the standards used by other state and national agencies.

The recommended rumble strip design was ground using the present equipment. Since it is the same as the rumble strip that has been the standard in the past, there will be no learning curve. The cost of the recommended design is the same as the cost of the design that has been used in the past; it is the same rumble strip with the grooves ground to a shallower depth.

REFERENCES

1. Federal Highway Administration “Connecting America 1999 Report to the Nation,” October 2000. <<http://www.fhwa.dot.gov/reports/1999annual/safety.htm>> (12 Dec. 2000)
2. Henderson, Thomas J. “The Physics Classroom” <<http://www.glenbrook.k12.il.us/gbssci/phys/Class/sound/u1112b.html>> (2 Jan. 2001)

Appendix A



Figure A-1. At Eagle on I 70 eastbound , CDOT constructed nine rumble strip configurations. This figure shows the spacing of the grooves in section 1 – the first section at the west end of the test sections. The black and white squares on the straight edge are one inch on a side. The straight edge shows that the grooves are 2” wide with 10” flats in between. This spacing was ground for 1000 feet in a continuous configuration and then for another 1000 feet in an interrupted configuration – 12 feet of grooves and 6 feet without grooves.

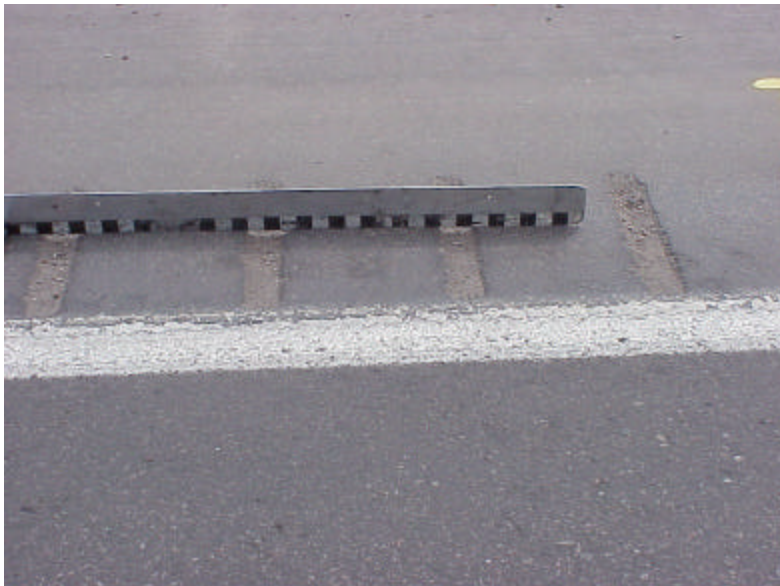

Figure A-2. The 2-inch-wide grooves in section one were ground 1/2 inch deep.



Figure A-3. This two -inch wide groove in section one had trapped a considerable amount of sand and dirt. This photo was taken on March 6, 2001. There had not been any snow on the roadway for several days.



Figure A-4. The uneven bottom of the groove in this picture shows where the teeth on the grinder drum cut the asphalt. A quarter is leaning against the side of the groove for a rough size comparison. This groove was full of dirt and sand like the one above but the debris was swept out before the picture was taken.



Figure A-5. Spacing for sections 1 and 1A were the same. The only difference was that the rumble strip was ground with gaps for section 1A. For every 12 feet of rumble strip, a six- foot gap with no grooves was left.



Figure A-6. Section 2 uses 2-inch grooves with 5-inch flats between. This section is continuous rumble strip.

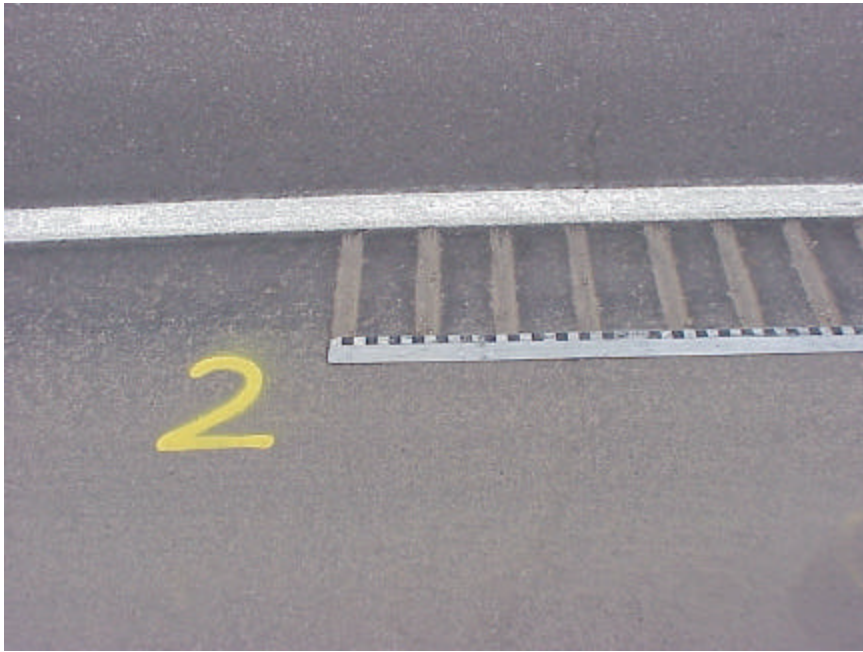

Figure A-7. This view of section 2 shows the 5-inch spacing between the grooves. The grooves in this section had a lot of dirt and sand like the ones in the earlier sections.



Figure A-8. Section 2A, like sections 1A and 4A, is interrupted every 12 feet. The grooves are 2 inches wide with 5-inch flats, and were ground $\frac{1}{2}$ inch deep.

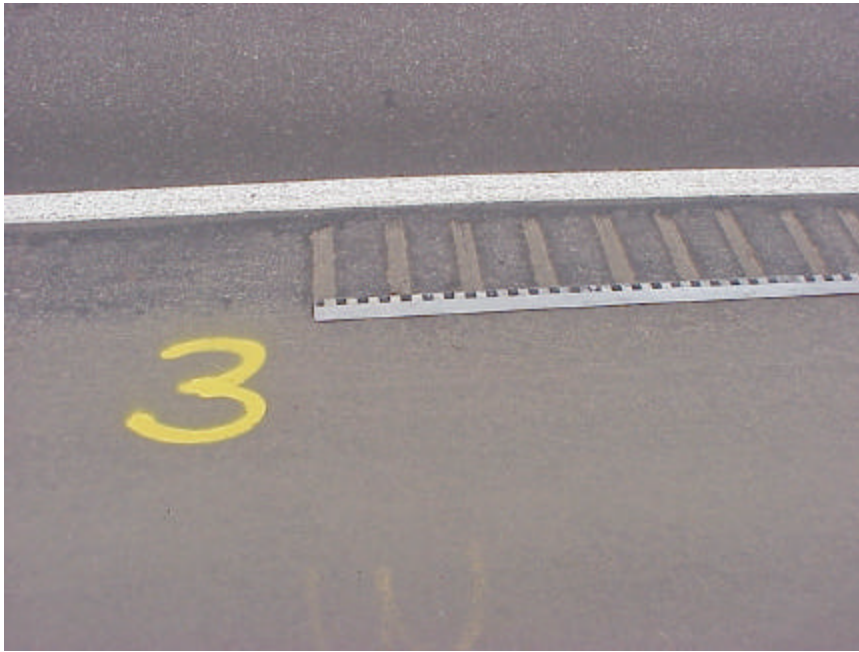

Figure A-9. Section 3 was ground the same as section 2A except for the depth of the grooves. They were cut 3/8 inch deep for section 3.



Figure A-10. Section 3 was ground in an interrupted pattern.



Figure A-11. Section 4 starts at the far end of the straight edge. Grooves are 2 inches wide but with only 3-inch flats between. Section 4 is continuous rumble strip.



Figure A-12. Section 4A is ground in an interrupted pattern using the same spacing as section 4 – 2-inch grooves, ½ inch deep, with 3-inch flats.

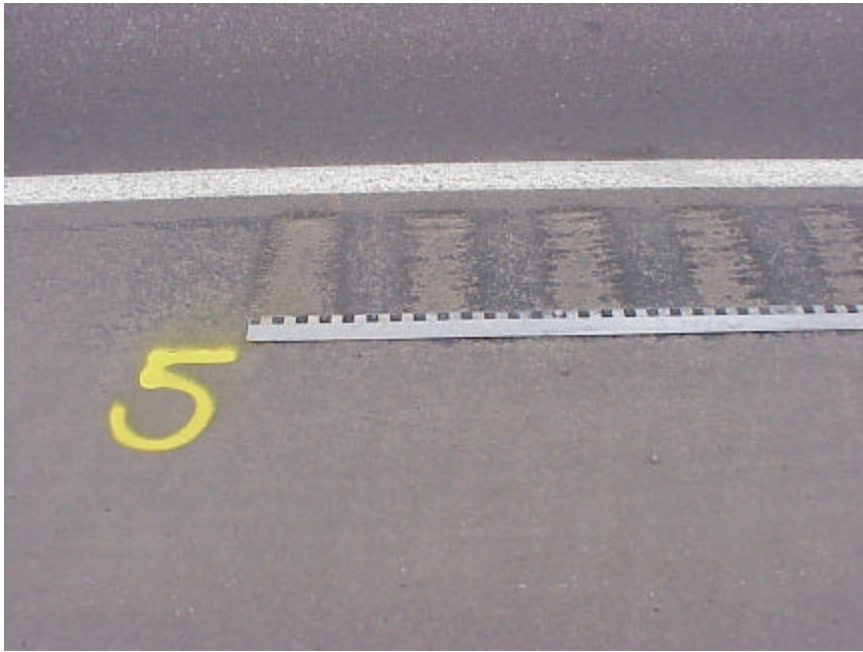

Figure A-13. Section 5 is the old state standard with grooves 7-8 inches wide and flats 4-5 inches wide. This test section was planned to have grooves $\frac{3}{4}$ inch deep. However, the measured depth averages less than $\frac{5}{8}$ ". Section 5 has the deepest grooves of any of the test sections. There is some dirt in the bottom of the grooves but traffic has blown most of the sand and gravel out.



Figure A-14. Section 5 was ground in an interrupted pattern. The old standard style rumble strip has 12 foot gaps after 48 feet of rumble strip. The white arrow points to a gap in the rumble strip.

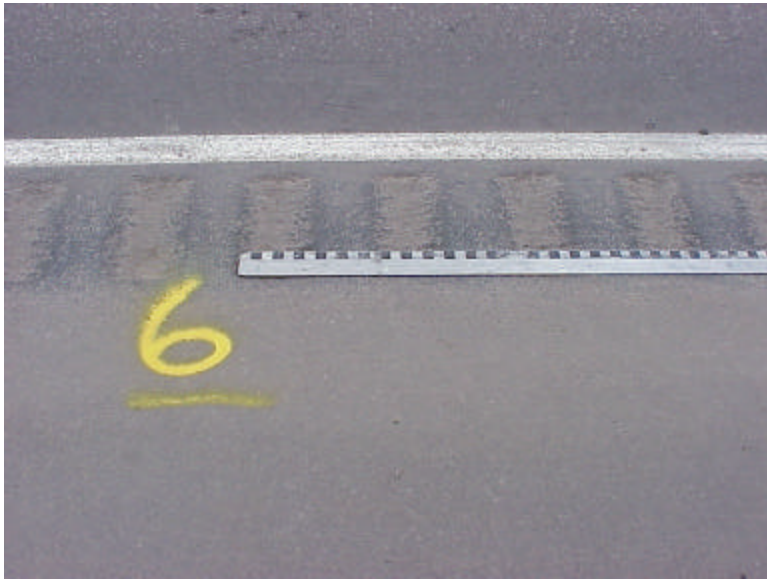

Figure A-15. Section 6 has 6-1/2-inch grooves and 5-1/2-inch flats. The average depth of the grooves is 0.49 inches – very close to the planned depth of 1/2”.

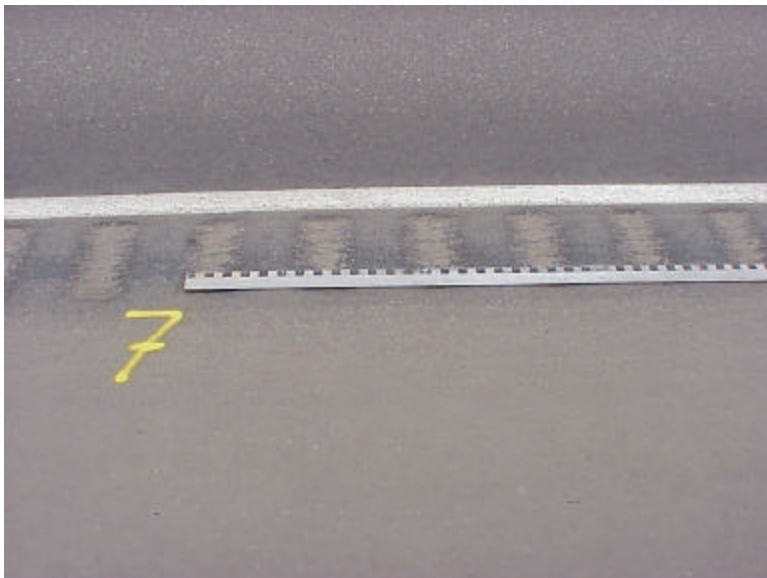

Figure A-16. Section 7 has 6-inch grooves and 6-inch flats with an average groove depth of 0.46 inches. The plans called for a depth of 3/8 inch – 0.375 inches.

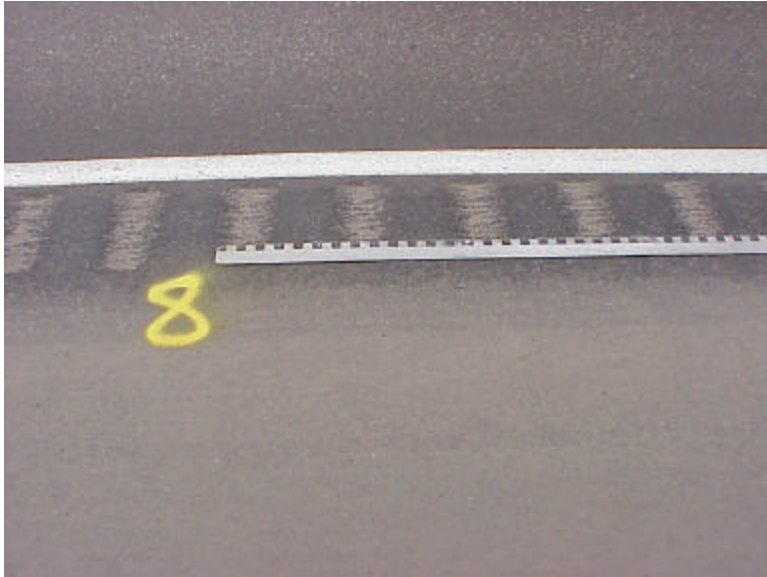

Figure A-17. Section 8 has 5-1/2-inch wide grooves with 7-1/2-inch wide flats. The average depth is .41 inches – slightly more than 3/8 inches. The plans called for 1/4 inch depth.

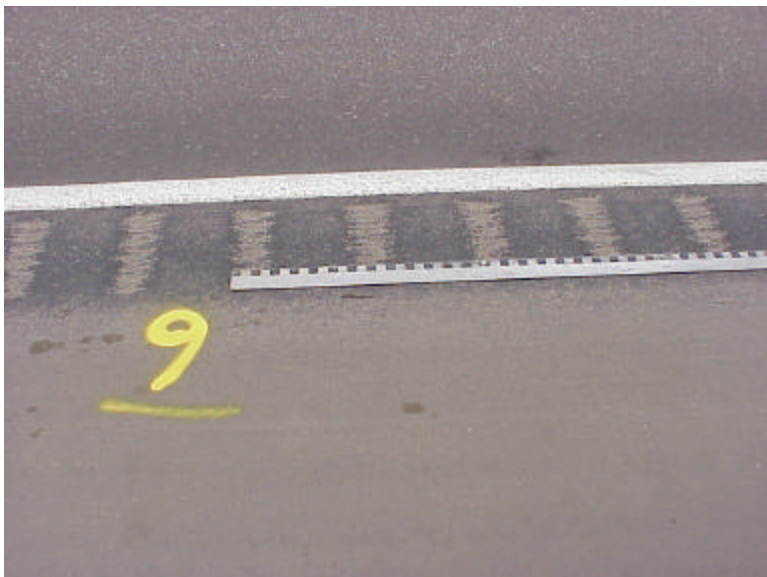

Figure A-18. Section 9 has 4-1/2 to 5-inch grooves with 6-1/2 to 7-inch flats. The plans called for a depth of 1/8 inch but they average .28 inches – slightly over 1/4- inch.



Figure A-19. The concrete rolled-in rumble strip used for the study was placed away from the shoulder stripe at the request of CDOT maintenance.



Figure A-20. The cyclists preferred section 10 - rolled-in concrete. This photo shows the difference in size between high-pressure road bike tires and low-pressure mountain bike tires.

The following text is from a CDOT Design Manual Bulletin on Rumble Strips:

This Design Manual Bulletin will:

- 1. Provides guidance for the use and installation of Rumble Strips.**
- 2. Discusses installation of Rumble Strips on High-Priority Bicycle Corridors.**

Studies have shown that rumble strips can reduce the frequency of run-off-the-road crashes. Rumble strips are designed to alert drivers when their vehicle strays onto the shoulder of the roadway. Rumble strips may also provide protection to pedestrians and bicyclists on the shoulder by discouraging motorists from straying onto the shoulder. However, no comprehensive studies have analyzed the impact of rumble strips on motorcyclists and bicyclists. Poorly designed or improperly installed rumble strips could endanger these modes of transportation. Improperly installed rumble strips can force the bicyclist out into the travel lane causing conflict with the motorists.

According to TEA-21, bicyclists and pedestrians should be considered when scoping all projects. Therefore, bicycle and pedestrian usage, shoulder width, and shoulder rumble strip issues need to be addressed during the scoping stage of any project, including resurfacing type projects.

The AASHTO publication, *Guide for the Development of Bicycle Facilities* recommends that a 4 ft. (1.2 m) minimum width from the rumble strip to the outside of the shoulder be provided to adequately accommodate bicycle travel. On High-Priority Bicycle Corridors, the Colorado Transportation Commission recommends paved shoulders be at least 6 ft. (1.8 m) wide to accommodate bicycle travel and rumble strips.

The decision to use or not to use rumble strips on rural roadways should be documented in the project files.

For further information on rumble strips, refer to the FHWA Rumble Strip web site and to NCHRP Synthesis 191, "Use of Rumble Strips to Enhance Safety."⁴

General criteria for use of rumble strips:

Construct rumble strips according to Standard Plan M-614-1.

To achieve the goal of maximizing a smooth shoulder surface suitable for bicycle use, rumble strips should be installed as close to the white lane stripe/edge of the travel lane as possible. AASHTO considers a 4 foot (1.2 m) width on the shoulder beyond the rumble strip to be the minimum for safe bicycling (*see page 17, Guide for the Development of Bicycle Facilities*).

Use rumble strips on rural highways where run-off-the-road type crashes occur. These locations include long tangents, approach ends of isolated horizontal curves, along steep fill slopes, at approaches to narrow bridges, and other documented high crash locations.

Rumble strips should not be used where guardrail is installed on shoulders of less than 6 ft. (1.8 m) width. When rumble strips are discontinued for guardrail or narrow shoulders, the rumble strip should

end at least 20 ft. (6 m) prior to the end section of the guardrail or narrowing of the shoulder to allow the bicyclist room to transition their riding position.

Centerline rumble strips have been used in mountainous areas to mitigate head-on and side-swipe accidents.

Rumble strips are not normally used in urban areas because of noise and frequent use of the roadway shoulder for turning or parking.

In mountainous areas, or on roadways with a high frequency of horizontal curves, rumble strips may be omitted to provide bicyclists with more maneuvering room.

If bicycle usage is high, the designer may consider eliminating rumble strips to accommodate higher speed bicycle usage on steep downslopes, particularly when run-off-the-road accident history is low.

Rumble strips should be installed on Interstate highways as follows:

- ❖ Use rumble strips on the inside shoulders of all rural Interstate highways. Use on the outside shoulders 6 ft. (1.8 m) or greater.

Rumble strips should be installed on highways not designated High-Priority Bicycle Corridors as follows:

- ❖ Rumble strips should be installed for the *entire length* of a project only where shoulders are 5 feet (1.5 m) or greater.
- ❖ For shoulder widths ranging from 4 to 5 feet (1.2-1.5 m), install rumble strips when the engineer can document a significant occurrence of run-off-the-road accidents. *Note: Installation of rumble strips, on shoulders narrower than 5 ft. (1.5 m) will not allow the AASHTO recommended 4 foot (1.2 m) bicycle width.*

Rumble Strips on Narrow Shoulders:

Before installing rumble strips on narrow shoulders, the designer should weigh the benefits to motorists, versus the reduction in usable bicycle riding space. Installation of rumble strips on shoulders which are 4 feet (1.2 m) or narrower will result in providing bicycles with less than the AASHTO recommended 4 foot bike clear path and have a negative impact on bicycle travel. Based on a significant history of run-off-the-road crashes consistent with the system-wide evaluation, rumble strips may be considered when the engineer documents that bicycle traffic can still be accommodated. In corridors with bicycle traffic and narrow shoulders, the designer may be able to address crash history by applying rumble strips only in high crash locations rather than the entire length of the corridor.

High-Priority Bicycle Corridors

Rumble strips should be installed on High-Priority Bicycle Corridors as follows:

- ❖ Rumble strips should be installed for the *entire length* of a project only where shoulders are six feet (1.8 m) or greater.
- ❖ For shoulder widths ranging from 4 feet (1.2 m) to less than 6 feet (1.8 m), install rumble strips when the engineer can document a significant occurrence of run-off-the-road accidents. *Note: Installation of rumble strips on shoulders narrower than 5 ft. (1.5 m) will not allow the AASHTO recommended four-foot (1.2 m) bicycle width.*
- ❖ Do not install rumble strips on shoulders less than 4 feet (1.2 m), as this will impede bicycle travel.

References:

Guide for the Development of Bicycle Facilities, American Association of State Highway and Transportation Officials (AASHTO), Washington, D.C., 1999.

Colorado Bicycling Manual, Colorado Department of Transportation Bicycle/ Pedestrian Program, 7th Edition, 1998

Transportation Commission of Colorado Resolution TC-747, June 17, 1999

CDOT Policy Directive 902.0, Shoulder Policy, June 17, 1999

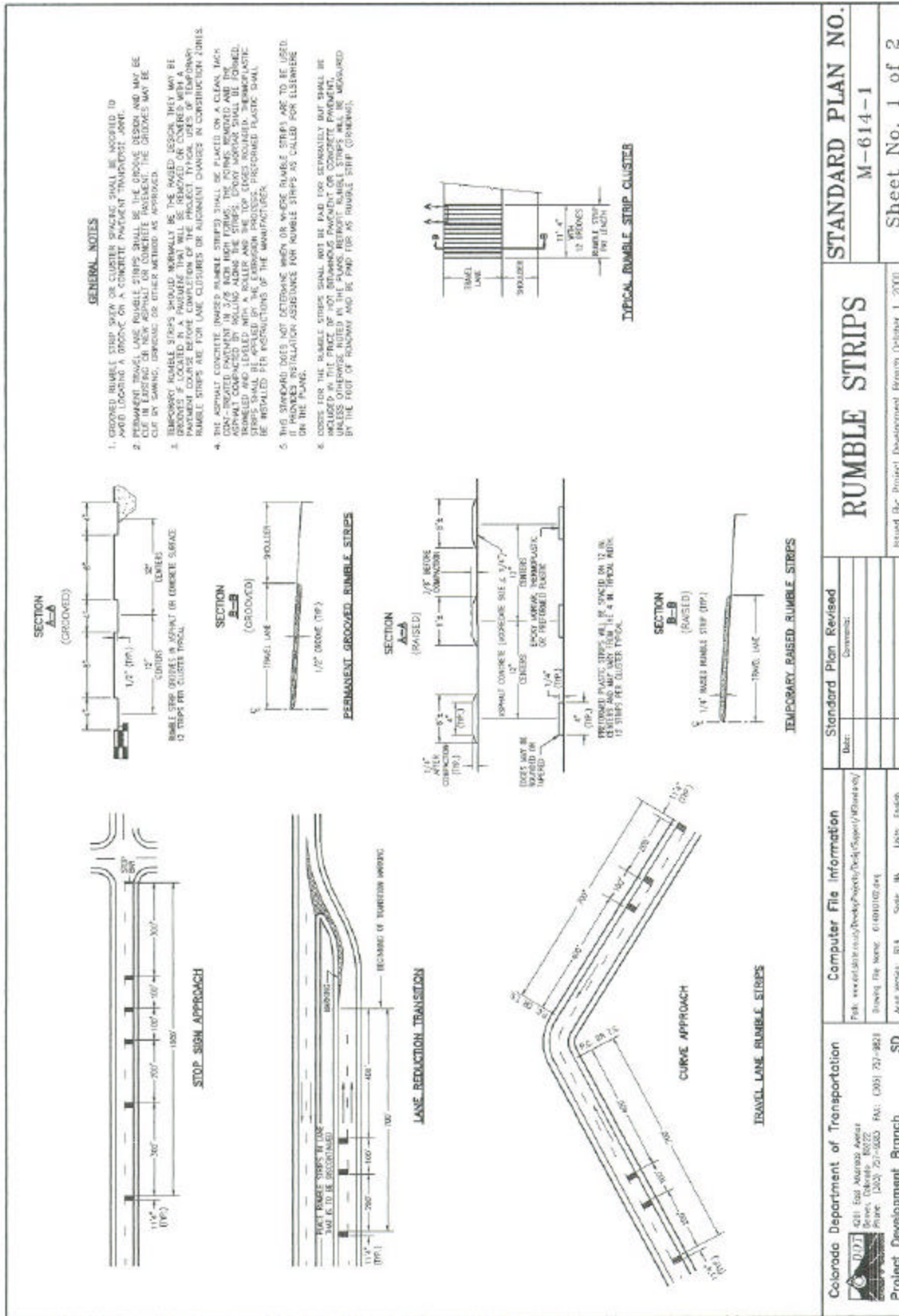

Figure A-21. Rumble strip sheet 1 from standard plans.

Colorado Department of Transportation 4201 East Alameda Avenue Denver, CO 80246 Phone: (303) 761-5855 FAX: (303) 737-9828	Computer File Information Path: \\ced\cd\projects\2006\20060102\20060102.dwg Drawing File Name: 0100102.dwg	Standard Plan Revised Date: _____ Comments: _____	STANDARD PLAN NO. M-614-1
	Project Development Branch SD	Issue Date: 01/10/06 Scale: 1/4" = 1'-0" Units: English	RUMBLE STRIPS

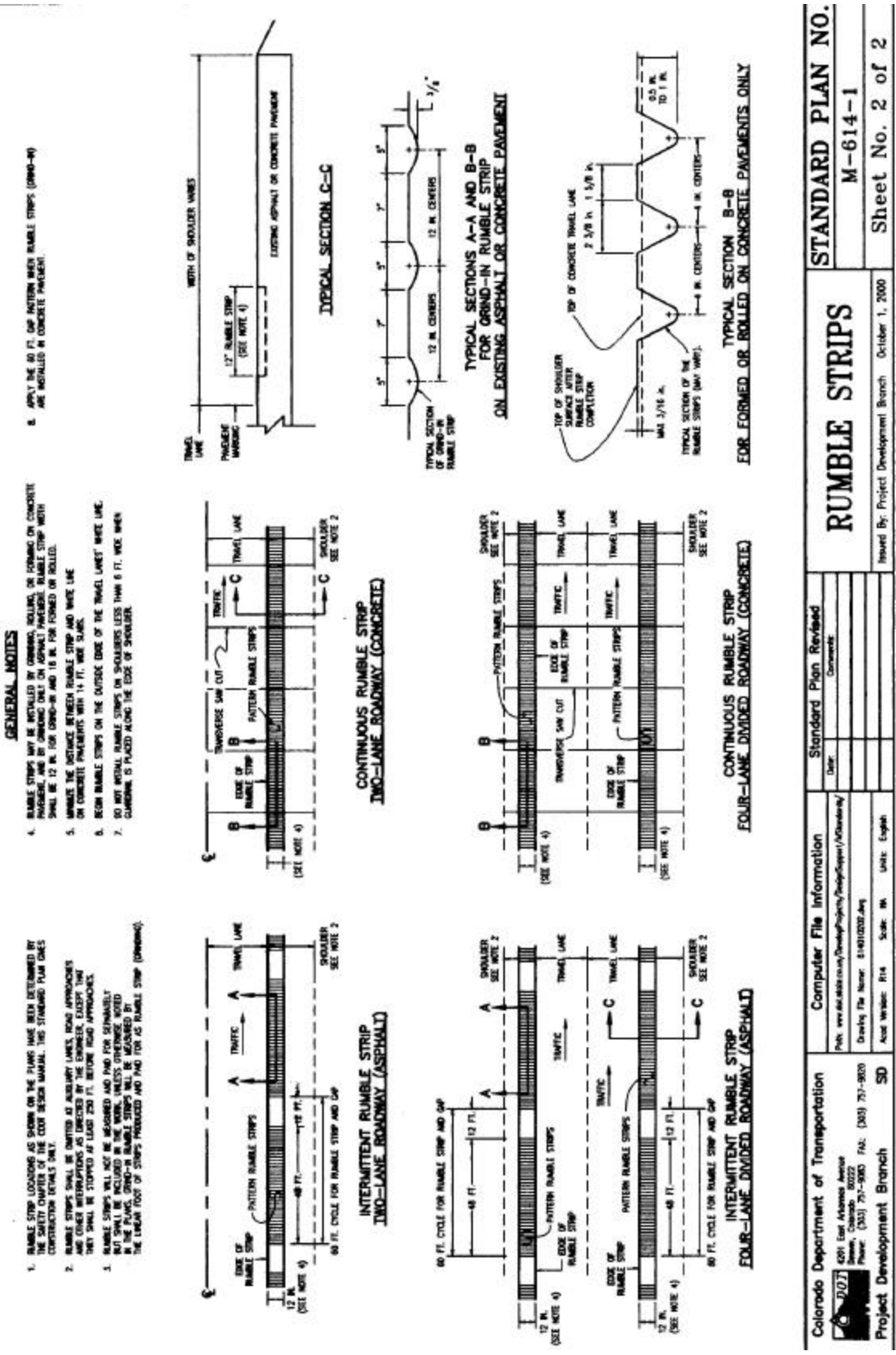
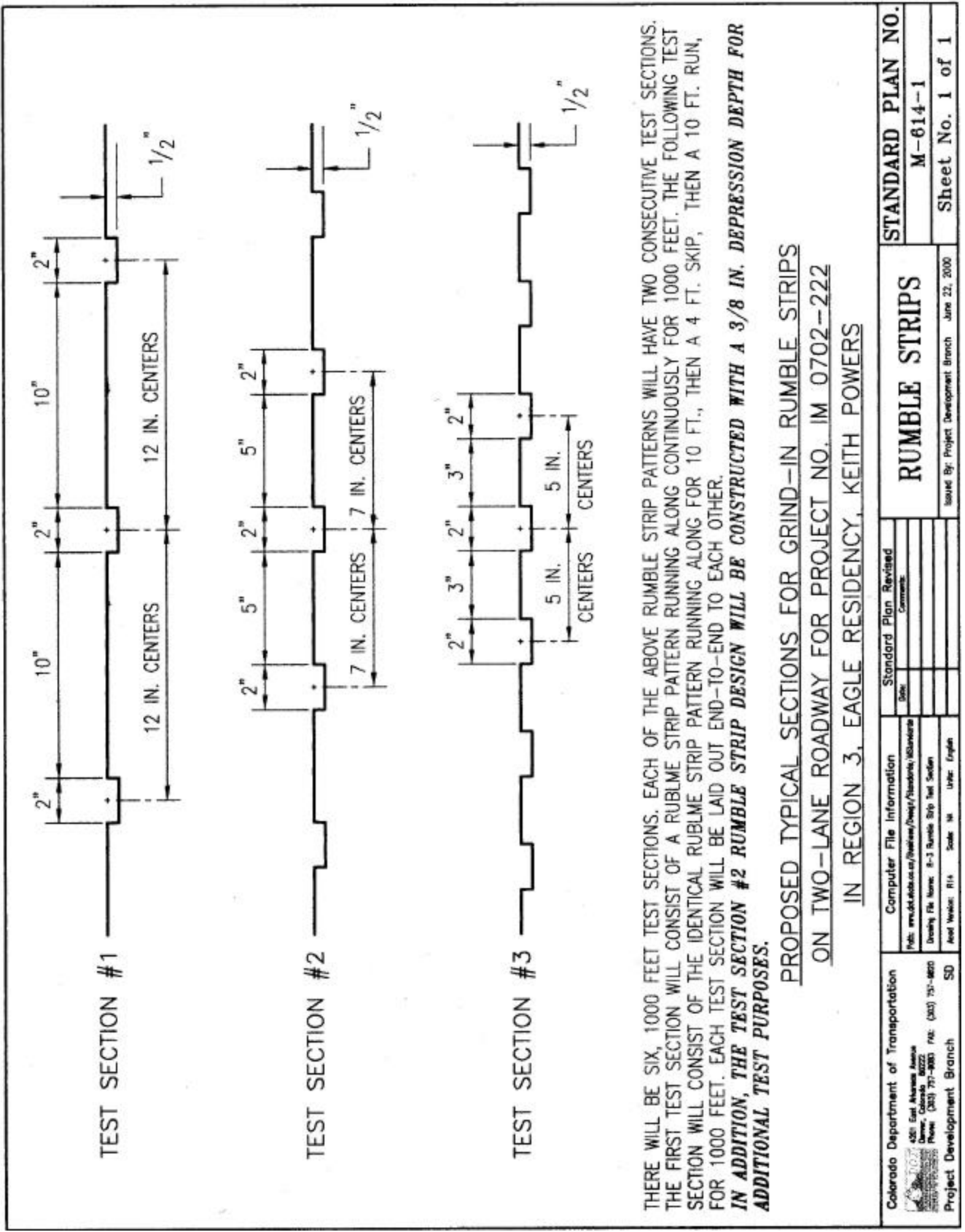

Figure A-22. Rumble strip sheet 2 from standard plans.

 Colorado Department of Transportation 4201 East Arkansas Avenue Denver, CO 80231-0001 Phone: (303) 761-9900 FAX: (303) 751-9820	Computer File Information Date: _____ Drawing File Name: 61012002.dwg Acad Worker: R14 Scale: IN Unit: English	Standard Plan Revised Date: _____ Description: _____	STANDARD PLAN NO. M-614-1
	Project Development Branch SD	Issued By: Project Development Branch October 1, 2000	RUMBLE STRIPS Sheet No. 2 of 2



THERE WILL BE SIX, 1000 FEET TEST SECTIONS. EACH OF THE ABOVE RUMBLE STRIP PATTERNS WILL HAVE TWO CONSECUTIVE TEST SECTIONS. THE FIRST TEST SECTION WILL CONSIST OF A RUMBLE STRIP PATTERN RUNNING CONTINUOUSLY FOR 1000 FEET. THE FOLLOWING TEST SECTION WILL CONSIST OF THE IDENTICAL RUMBLE STRIP PATTERN RUNNING ALONG FOR 10 FT., THEN A 4 FT. SKIP, THEN A 10 FT. RUN, FOR 1000 FEET. EACH TEST SECTION WILL BE LAID OUT END-TO-END TO EACH OTHER.

IN ADDITION, THE TEST SECTION #2 RUMBLE STRIP DESIGN WILL BE CONSTRUCTED WITH A 3/8 IN. DEPRESSION DEPTH FOR ADDITIONAL TEST PURPOSES.

PROPOSED TYPICAL SECTIONS FOR GRIND-IN RUMBLE STRIPS
ON TWO-LANE ROADWAY FOR PROJECT NO. IM 0702-222
IN REGION 3, EAGLE RESIDENCY, KEITH POWERS

Colorado Department of Transportation 4201 East Alameda Avenue Denver, Colorado 80222 Phone: (303) 737-9883 FAX: (303) 737-9820	Computer File Information	Standard Plan Revised	STANDARD PLAN NO. M-614-1 Sheet No. 1 of 1
	Path: www.dot.state.co.us/Planning/Design/Standards/MSPlans Drawing File Name: R-3 Rumble Strip Test Section Auto Version: R14 Scale: 1/4" = 1'-0" Units: English	Date:	
Project Development Branch			RUMBLE STRIPS Issued By: Project Development Branch June 22, 2000

Figure A-23. Rumble strip sections for test sections for this study.

Appendix B

Rider Survey Responses						
		Rating				
		No Effect←				→Severely Uncomfortable/ Uncontrollable
Test Section	Speed Category	1	2	3	4	5
Section 1	5 mph Control	13	11	4	1	
2" groove	5 mph Comfort	7	12	8	2	
- 10"flat -	10 mph Control	10	13	6		
1/2" deep	10 mph Comfort	4	15	9	1	
	15 mph Control	11	12	6		
	15 mph Comfort	4	15	9	1	
	20 mph Control	11	14	3		1
	20 mph Comfort	2	17	7	2	1
Section 2	5 mph Control	10	9	8	1	1
2" groove	5 mph Comfort	1	9	12	5	2
- 5"flat -	10 mph Control	9	7	10	3	
1/2" deep	10 mph Comfort	2	9	8	10	
	15 mph Control	8	8	7	6	
	15 mph Comfort	3	9	6	11	
	20 mph Control	7	11	8	2	1
	20 mph Comfort	2	9	13	2	3
Section 3	5 mph Control	10	11	5	3	
2" groove	5 mph Comfort	3	11	7	7	1
5" flat	10 mph Control	9	13	5	2	
3/8" deep	10 mph Comfort	3	11	12	3	
	15 mph Control	10	9	8	2	
	15 mph Comfort	3	13	6	7	
	20 mph Control	10	9	7	1	2
	20 mph Comfort	5	12	8	3	1
Section 4	5 mph Control	5	10	7	7	
2" groove	5 mph Comfort	1	3	11	10	4
3"flat	10 mph Control	6	8	7	8	
1/2" deep	10 mph Comfort	2	3	10	10	4
	15 mph Control	10	7	9	3	
	15 mph Comfort	5	8	6	8	2
	20 mph Control	10	7	11		1
	20 mph Comfort	4	13	6	5	1
Section 5	5 mph Control	1	3	6	8	11
5" groove	5 mph Comfort			4	8	17
7"flat	10 mph Control	1		6	4	18
3/4" deep	10 mph Comfort		1	1	6	21
	15 mph Control		1	2	8	18
	15 mph Comfort				5	24
	20 mph Control			1	2	26
	20 mph Comfort				3	26

Rider Survey Responses

		Rating				
		No Effect←				→Uncomfortable/ Uncontrollable
Test Section	Speed category	1	2	3	4	5
Section 6	5 mph Control	2	4	5	10	8
5" groove	5 mph Comfort		1	6	7	15
7" flat	10 mph Control	1	2	5	7	14
1/2" deep	10 mph Comfort		1	3	4	21
	15 mph Control		1	4	8	16
	15 mph Comfort				4	25
	20 mph Control			1	3	25
	20 mph Comfort				3	26
Section 7	5 mph Control	2	6	8	10	3
5" groove	5 mph Comfort		2	8	10	9
7" flat	10 mph Control	2	3	6	9	9
3/8" deep	10 mph Comfort			6	7	16
	15 mph Control		3	3	11	12
	15 mph Comfort			3	9	17
	20 mph Control		1	5	4	19
	20 mph Comfort			2	6	21
Section 8	5 mph Control	4	9	9	5	2
5" groove	5 mph Comfort		5	10	8	6
7" flat	10 mph Control	2	7	6	9	5
1/4" deep	10 mph Comfort		1	9	8	11
	15 mph Control		6	4	10	9
	15 mph Comfort		1	8	5	15
	20 mph Control		2	8	7	12
	20 mph Comfort			5	10	14
Section 9	5 mph Control	3	14	9	2	1
5" groove	5 mph Comfort		11	10	5	3
7" flat	10 mph Control	3	9	10	6	1
1/8" deep	10 mph Comfort		3	14	8	4
	15 mph Control	1	9	12	3	3
	15 mph Comfort		4	10	9	6
	20 mph Control	1	7	8	6	7
	20 mph Comfort		2	11	7	9
Section 10						
concrete	5 mph Control	22	5	1		1
2-3/8"	5 mph Comfort	19	7	2		1
groove	10 mph Control	23	5			1
1-5/8" flat	10 mph Comfort	22	6			1
1" deep	15 mph Control	23	5			1
	15 mph Comfort	22	6			1
	20 mph Control	22	5			2
	20 mph Comfort	21	6			2

Rumble Strip Rider Information

Introduction Studies have shown that rumble strips reduce the frequency of run-off-the-road (RoR) accidents by 20% to 80% depending on where the study was done (20% - 50% Maine, 70% - 80% New York, 80% FHWA). The FHWA says that about one-third of the country's traffic fatalities are caused by RoR crashes. These facts mean that rumble strips are going to be a fact of life for the foreseeable future – they save lives.

The reason for this CDOT study is to find a rumble strip configuration that bicyclists can ride over without problems but will still provide added safety for motor vehicle operators.

You are going to ride over several different types of rumble strip during the two day session. Please complete the questionnaire section for each type of strip as fairly and impartially as possible. You will be asked to ride at different speeds and to perform various maneuvers. Do not attempt anything that you are not completely confident you can do safely and comfortably.

There is an Emergency Medical Service Team at the site and there are CDOT personnel wearing orange ball caps at each of the test sections. If you are injured or experience any problems please contact one of them immediately. There is also a bicycle mechanic at the site if you have mechanical problems.

Video tape will be taken of riders. The video tape will be used to analyze the effects of the rumble strips on bicycles and riders. The video may also be used to make a documentary presentation describing this study and its results.

In the following sections you will find:

1. Waiver and Release of Liability Form – Please read it carefully and sign at the designated places.
2. Accident Insurance information sheet.
3. General information Questions – Please answer as completely as possible.
4. Rumble strip evaluation questions – Please complete each section after riding the corresponding type of rumble strip.
5. Comment Section – Please feel free to provide comments about the study.

General Information Questions:

1. Have you ever encountered rumble strips while driving? Please describe the encounter.

2. Have you ever encountered rumble strips while bicycling? Please describe the encounter.

3. What type of bicycle do you ride most often? Road? Mountain?

4. What type of bicycle are you riding for the test? Road? Mountain?

5. Does your bicycle have any type of suspension? Do you carry panniers?

6. Do you ride for recreation? Transportation? Touring?

7. Approximately how many miles do you ride per week?

8. Do you ride mainly alone or in a group? How many in a group?

9. What percent of your mileage is in town? On highway with wide (8' +) shoulder?

Highway with narrow/no shoulder?

10. If you ride highways often, what highways and where? Are there rumble strips there?

11. Do you ride at night? In cold/wet weather?

12. Please characterize your riding skill level:

- Very Experienced– I ride often and in all weather conditions and at night and am very confident in my abilities.
- Experienced – I ride frequently and occasionally at night or in bad weather, and am comfortable in most situations.
- Inexperienced – I ride infrequently, very seldom at night or in bad weather, and am not comfortable in situations where there is heavy motor vehicle traffic.

13. Have you ever been involved in an accident while riding a bicycle?

- | | |
|---------------------------------------|--|
| • What was the cause of the accident? | Was a motor vehicle involved? |
| • Where did the accident occur? | Was law enforcement notified? |
| • Did you require medical attention? | What were the extents of the injuries? |
| • Was your bicycle damaged? | To what extent? |

Please rate the rumble strips from least difficult to most difficult to ride.

Test Section	Effect	Rating –circle one				
		No Severely Effect Uncomfortable/ Uncontrollable				
Section 1 2”groove – 10”flat – 1/2” deep	5 mph Control	1	2	3	4	5
	5 mph Comfort	1	2	3	4	5
	10 mph Control	1	2	3	4	5
	10 mph Comfort	1	2	3	4	5
	15 mph Control	1	2	3	4	5
	15 mph Comfort	1	2	3	4	5
	20 mph Control	1	2	3	4	5
	20 mph Comfort	1	2	3	4	5
	Comment					
Section 2 2”groove – 5”flat - 1/2” deep	5 mph Control	1	2	3	4	5
	5 mph Comfort	1	2	3	4	5
	10 mph Control	1	2	3	4	5
	10 mph Comfort	1	2	3	4	5
	15 mph Control	1	2	3	4	5
	15 mph Comfort	1	2	3	4	5
	20 mph Control	1	2	3	4	5
	20 mph Comfort	1	2	3	4	5
	Comment					
Section 3 2”groove – 5”flat – 3/8” deep	5 mph Control	1	2	3	4	5
	5 mph Comfort	1	2	3	4	5
	10 mph Control	1	2	3	4	5
	10 mph Comfort	1	2	3	4	5
	15 mph Control	1	2	3	4	5
	15 mph Comfort	1	2	3	4	5
	20 mph Control	1	2	3	4	5
	20 mph Comfort	1	2	3	4	5
	Comment					

Section 4 2”groove – 3”flat - 1/2” deep	5 mph Control	1	2	3	4	5
	5 mph Comfort	1	2	3	4	5
	10 mph Control	1	2	3	4	5
	10 mph Comfort	1	2	3	4	5
	15 mph Control	1	2	3	4	5
	15 mph Comfort	1	2	3	4	5
	20 mph Control	1	2	3	4	5
	20 mph Comfort	1	2	3	4	5
	Comment					
Section 5 5”groove – 7”flat – 3/4” deep	5 mph Control	1	2	3	4	5
	5 mph Comfort	1	2	3	4	5
	10 mph Control	1	2	3	4	5
	10 mph Comfort	1	2	3	4	5
	15 mph Control	1	2	3	4	5
	15 mph Comfort	1	2	3	4	5
	20 mph Control	1	2	3	4	5
	20 mph Comfort	1	2	3	4	5
	Comment					
Section 6 5”groove – 7”flat – 1/2” deep	5 mph Control	1	2	3	4	5
	5 mph Comfort	1	2	3	4	5
	10 mph Control	1	2	3	4	5
	10 mph Comfort	1	2	3	4	5
	15 mph Control	1	2	3	4	5
	15 mph Comfort	1	2	3	4	5
	20 mph Control	1	2	3	4	5
	20 mph Comfort	1	2	3	4	5
	Comment					

Section 7 5"groove – 7"flat – 3/8" deep	5 mph Control	1	2	3	4	5
	5 mph Comfort	1	2	3	4	5
	10 mph Control	1	2	3	4	5
	10 mph Comfort	1	2	3	4	5
	15 mph Control	1	2	3	4	5
	15 mph Comfort	1	2	3	4	5
	20 mph Control	1	2	3	4	5
	20 mph Comfort	1	2	3	4	5
	Comment					
Section 8 5"groove – 7"flat – 1/4" deep	5 mph Control	1	2	3	4	5
	5 mph Comfort	1	2	3	4	5
	10 mph Control	1	2	3	4	5
	10 mph Comfort	1	2	3	4	5
	15 mph Control	1	2	3	4	5
	15 mph Comfort	1	2	3	4	5
	20 mph Control	1	2	3	4	5
	20 mph Comfort	1	2	3	4	5
	Comment					
Section 9 5"groove – 7"flat – 1/8" deep	5 mph Control	1	2	3	4	5
	5 mph Comfort	1	2	3	4	5
	10 mph Control	1	2	3	4	5
	10 mph Comfort	1	2	3	4	5
	15 mph Control	1	2	3	4	5
	15 mph Comfort	1	2	3	4	5
	20 mph Control	1	2	3	4	5
	20 mph Comfort	1	2	3	4	5
	Comment					
Kersey - concrete 2-3/8"groove – 1-5/8"flat 1" deep	5 mph Control	1	2	3	4	5
	5 mph Comfort	1	2	3	4	5
	10 mph Control	1	2	3	4	5
	10 mph Comfort	1	2	3	4	5
	15 mph Control	1	2	3	4	5
	15 mph Comfort	1	2	3	4	5
	20 mph Control	1	2	3	4	5
	20 mph Comfort	1	2	3	4	5
	Comment					

WAIVER, RELEASE OF LIABILITY AND AGREEMENT TO
INDEMNIFY AND HOLD HARMLESS

I, _____, whose address is _____,
in consideration for participation in the rumble-strip testing program with the Department of
Transportation, do hereby state and agree:

1. I acknowledge that my participation in the rumble strip testing program involves certain dangers, including, but not necessarily limited to, those associated with bicycle riding over uneven terrain and other bicycling activities, the risks of which I assume, and which include, but are not necessarily limited to, injury or death.

2. I expressly represent to the Department of Transportation that I have no medical condition or physical limitation which would adversely effect my ability to participate in the rumble strip testing program; and that I have adequately prepared myself for such activity.

3. I do hereby, RELEASE the State of Colorado, the Department of Transportation and all other departments, agencies, commissions, boards, institutions, officials, employees, and agents of the State, from any and all liability for any and all causes of action which I may hereafter have on account of any and all injuries to my person or property, including death, arising out of or related in any way to my participation in the rumble strip testing program, whether such injury results from the negligence of the State of Colorado, the Department of Transportation or any other departments, agencies, commissions, boards, institutions, officials, employees, or agents of the State, or from any other cause.

4. I do hereby COVENANT NOT TO SUE the State of Colorado, the Department of Transportation and all other departments, agencies, commissions, boards, institutions, officials, employees, and agents of the State and agree to INDEMNIFY, SAVE AND FOREVER HOLD THEM AND EACH OF THEM HARMLESS from any liability, and do hereby WAIVE any and all claims, demands, actions or causes of actions against them or each of them arising out of or related in any way to my participation in the rumble strip testing program, whether said claim, demand, or cause of action arises from the negligence of the State of Colorado, the Department of Transportation or any other departments, agencies, commissions, boards, institutions, officials, employees or agents of the State, or from any other cause.

5. I do hereby ASSUME ALL RISK of loss, damage or injury to my person or my property, including death, arising out of or related in any way to my participation in the rumble strip testing program.

6. This RELEASE OF LIABILITY AND AGREEMENT TO INDEMNIFY AND HOLD HARMLESS shall be binding upon me and my heirs, executors, administrators, personal representatives, successors and assigns, and shall benefit the State of Colorado, the Department of Transportation and all other departments, agencies, commissions, boards, institutions, officials, employees, or agents of the State, and their heirs, executors, administrators, personal representatives, assigns and successors in office.

DATE: _____ SIGNATURE:

Volunteer Accident Insurance

Policy Number: *TBD*
Policy Period: *October 10, 2000 & October 11, 2000*
Insurer: *Life Insurance Company of North America*
Best Rating: *A+ X*

LIMITS OF LIABILITY:

\$ 25,000 Accident Medical Expense
\$ 50,000 Dismemberment & Paralysis Benefit
\$ 15,000 Accidental Death Benefit

POLICYHOLDER:

State of Colorado Department of Transportation

Deductible:

\$ 50 Per Claim

ELIGIBLE CLASSES:

All volunteers for Rumble Strip Study

COVERAGE PROVISIONS:

Medical expenses include the Usual and Customary charge for services or supplies which are incurred by the Covered Person for medically necessary treatment of any injury sustained during the course of volunteer activity.

MAJOR EXCLUSIONS, INCLUDING BUT NOT LIMITED TO:

- Suicide, attempted suicide or whenever a covered person injures himself on purpose
- War or acts of war
- Injury while on full time active duty in armed forces
- Taking part in a felony
- Travel of flight in any spacecraft
- Any bacterial infection that was not caused by an accidental cut, wound, or food poisoning

IMPORTANT REPORTING REQUIREMENTS:

- Covered person must send written notice within 30 days or as soon after that as reasonably possible

Appendix C

The following are the results of sound measurements taken on Interstate Highway 70 in Eagle and Bennett, Colorado, as well as on Colorado State Highway 34 near Kersey, Colorado. The purpose of the measurements is to acoustically assess the impact of various rumble strips inside a vehicle. A total of 14 rumble strips were measured. Rumble Strips 1 through 9 were asphalt pavement on I 70 east of Eagle, Colorado. Rumble Strip 10 was concrete pavement on US 34 near Kersey, Colorado. A description (as provided by CDOT) of the various types are as follows:

Type	Description
1:	Asphalt, 2" wide by 1/2" deep groove, 10" flat, Continuous
1A:	Asphalt, 2" wide by 1/2" deep groove, 10" flat, Interrupted Pattern
2:	Asphalt, 2" wide by 1/2" deep groove, 5" flat, Continuous
2A:	Asphalt, 2" wide by 1/2" deep groove, 5" flat, Interrupted Pattern
3:	Asphalt, 2" wide by 3/8" deep groove, 5" flat, Interrupted Pattern
4:	Asphalt, 2" wide by 1/2" deep groove, 3" flat, Continuous
4A:	Asphalt, 2" wide by 1/2" deep groove, 3" flat, Interrupted Pattern
5:	Asphalt, 3/4" deep standard groove, Continuous
6:	Asphalt, 1/2" deep standard groove, Continuous
7:	Asphalt, 3/8" deep standard groove, Continuous
8:	Asphalt, 1/4" deep standard groove, Continuous
9:	Asphalt, 1/8" deep standard groove, Continuous
10:	Concrete, 1-3/8" wide groove, 1-5/8" flat, Continuous

The vehicles used were a station wagon, van, pick-up truck, and large dump truck all provided by CDOT. All measurements were taken with a Larson-Davis Model 2900 sound level meter on "fast" response, together with a Brüel & Kjær Type 4165 microphone. Calibration was checked before, during, and after measurements with a Larson-Davis CA250 Precision Acoustic Calibrator. A-weighted sound level measurements were recorded as well as 1/3-octave frequency bands between 25 and 10,000 Hz.

Measurements were taken with the vehicles traveling at 55 and 65 mph. Since noise generated by the engine of the vehicle is also a consideration, we conducted sound measurements on smooth pavement to determine whether the sound levels are raised as a result of traveling over the rumble strips. We

have noted these sound measurements as "background sound." In some cases, the noise generated from the rumble strips did not raise the background sound significantly, in which case, the levels are indeterminate. We have tagged these levels in the table with a "-" symbol.

Sound measurements were taken with the microphone inside the vehicle at center, front seat position. The microphone was positioned at ear height. The sound measurements reported reflect the average sound pressure levels sampled throughout the period in which the vehicle was traveling over sections of each pavement surface, typically about two to five seconds.

Table C-1 represents the average sound levels corrected to omit the contribution of the background noise.

Table C-1: Sound Level (dBA) from Rumble Strips (Corrected for Background)

Vehicle Type	Speed (mph)	Rumble Strips													
		1	1A	2	2A	3	4	4A	5	6	7	8	9	10	11
Station Wagon	55	72	68	74	70	96	73	71	75	75	74	75	72	75	-
Van	55	75	74	79	76	76	79	77	82	84	82	82	82	82	85
Pick-Up	55	69	67	72	70	68	74	71	85	83	81	81	80	80	82
Dump Truck	55	74	-	74	73	-	75	78	88	89	88	86	83	-	-
Station Wagon	65	70	68	76	74	72	74	72	81	78	75	75	71	72	-
Van	65	78	77	82	80	79	82	80	83	82	82	82	80	83	73
Pick-Up	65	74	74	76	75	73	79	77	82	84	84	83	81	81	82
Dump Truck	65	77	70	79	75	70	80	77	84	85	88	84	81	-	-

The data in Table C-1 is also plotted in Graphs in Figures C-1 and C-2.

Since the design criteria may require that the rumble strips generate a certain level of sound over the background sound level of smooth pavement, we have provided the difference in noise level when traveling over the rumble strips in Table C-2.

Table C-2: Increase in Sound Level (dBA) Above Background (smooth road)

Vehicle Type	Speed (mph)	Rumble Strips													
		1	1A	2	2A	3	4	4A	5	6	7	8	9	10	11
Station Wagon	55	9	6	11	8	7	10	9	12	13	12	12	9	10	-
Van	55	7	6	10	8	8	10	8	13	15	13	13	13	11	17
Pick-Up	55	4	3	6	5	4	7	6	18	16	14	14	13	12	14
Dump Truck	55	1	0	1	1	0	1	3	10	11	10	8	6	0	-
Station Wagon	65	6	4	11	8	7	8	7	15	12	9	10	10	6	-
Van	65	9	8	12	11	9	12	10	13	13	13	12	11	10	12
Pick-Up	65	7	6	8	7	5	10	9	14	15	16	14	12	9	11
Dump Truck	65	1	0	2	1	0	2	1	4	5	7	5	3	0	-

The data in Table C-2 is also plotted in Graphs in Figures C-3 and C-4. To relate the A-weighted sound level increase to a subjective rating, Table C-3 below provides an approximation of human perception to changes in sound level.

Table C-3. Human perception of changes in sound levels.

Change in Sound Level (dB)	Change in Apparent Loudness
1	Imperceptible (except for tones)
3	Just barely perceptible
6	Clearly Noticeable
10	About twice (or half) as loud
20	About 4 times (or one-fourth) as loud

A summary of octave-band data organized by rumble strip type is provided in Table C-4. A summary of octave data organized by vehicle is available from CDOT Research.

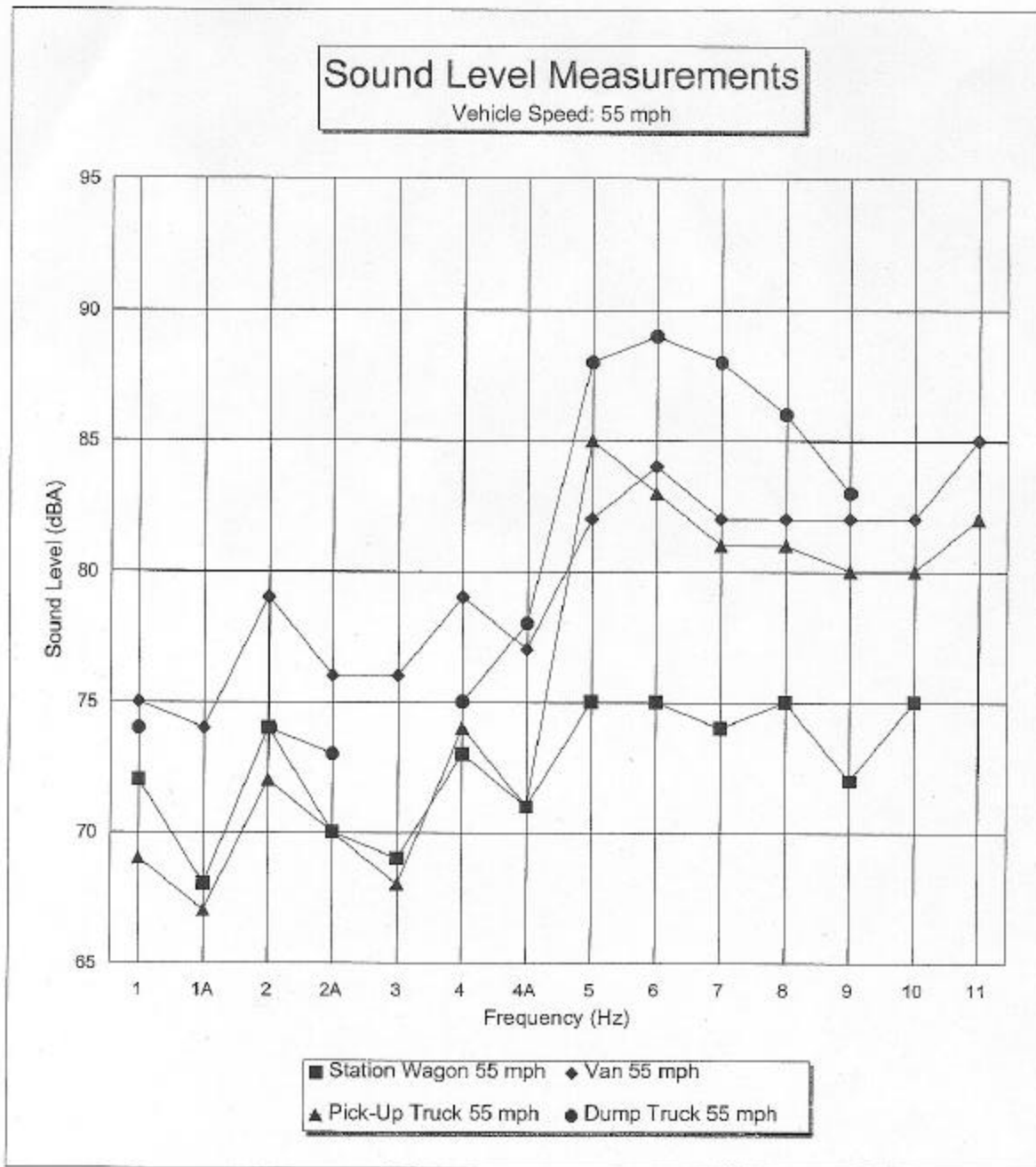

Figure C-1. This graph shows the sound levels measured inside the vehicles as they drove along the rumble strip at 55 mph.

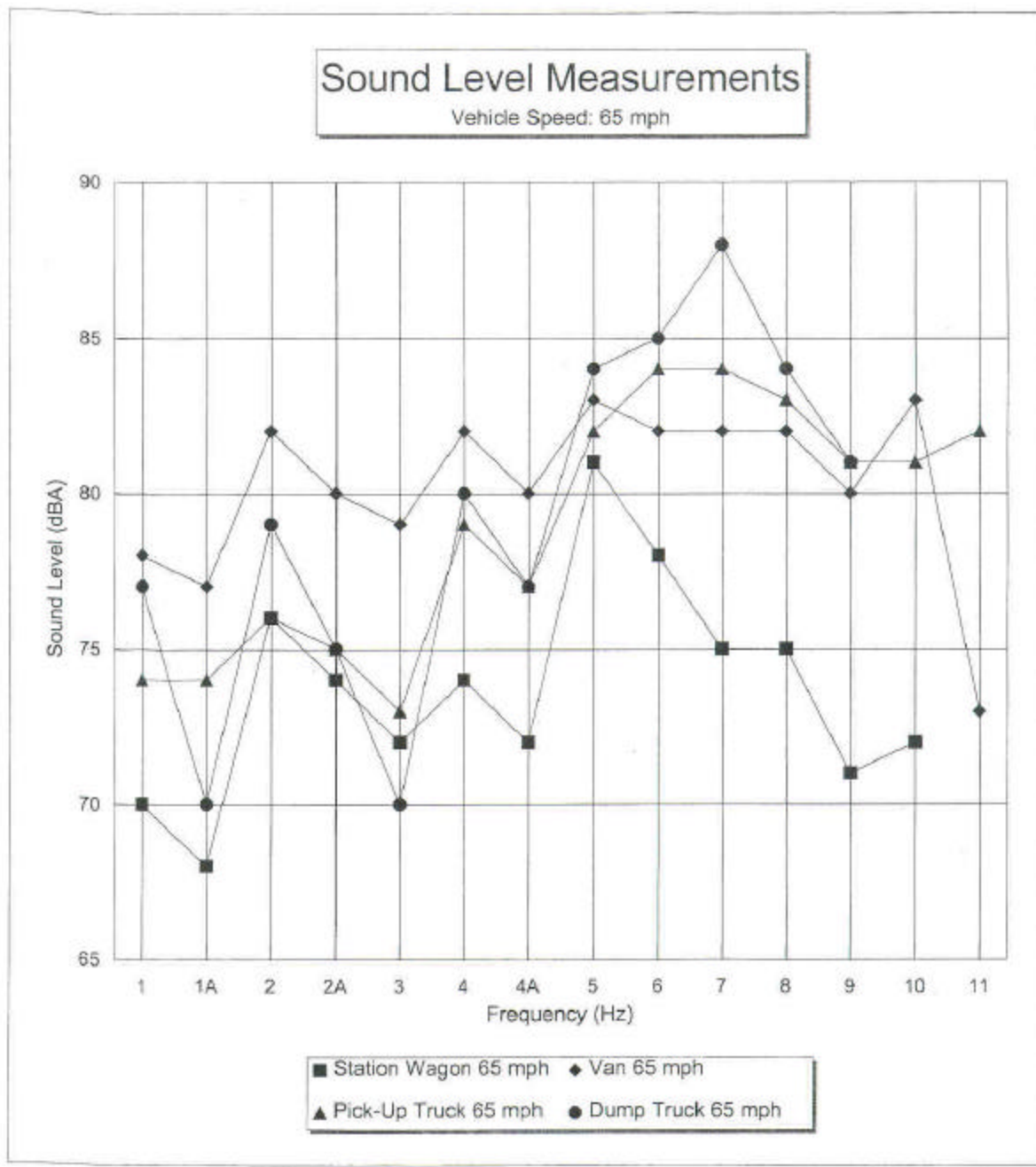

Figure C-2. This graph shows the sound levels measured inside the vehicles as they drove along the rumble strip at 65 mph.

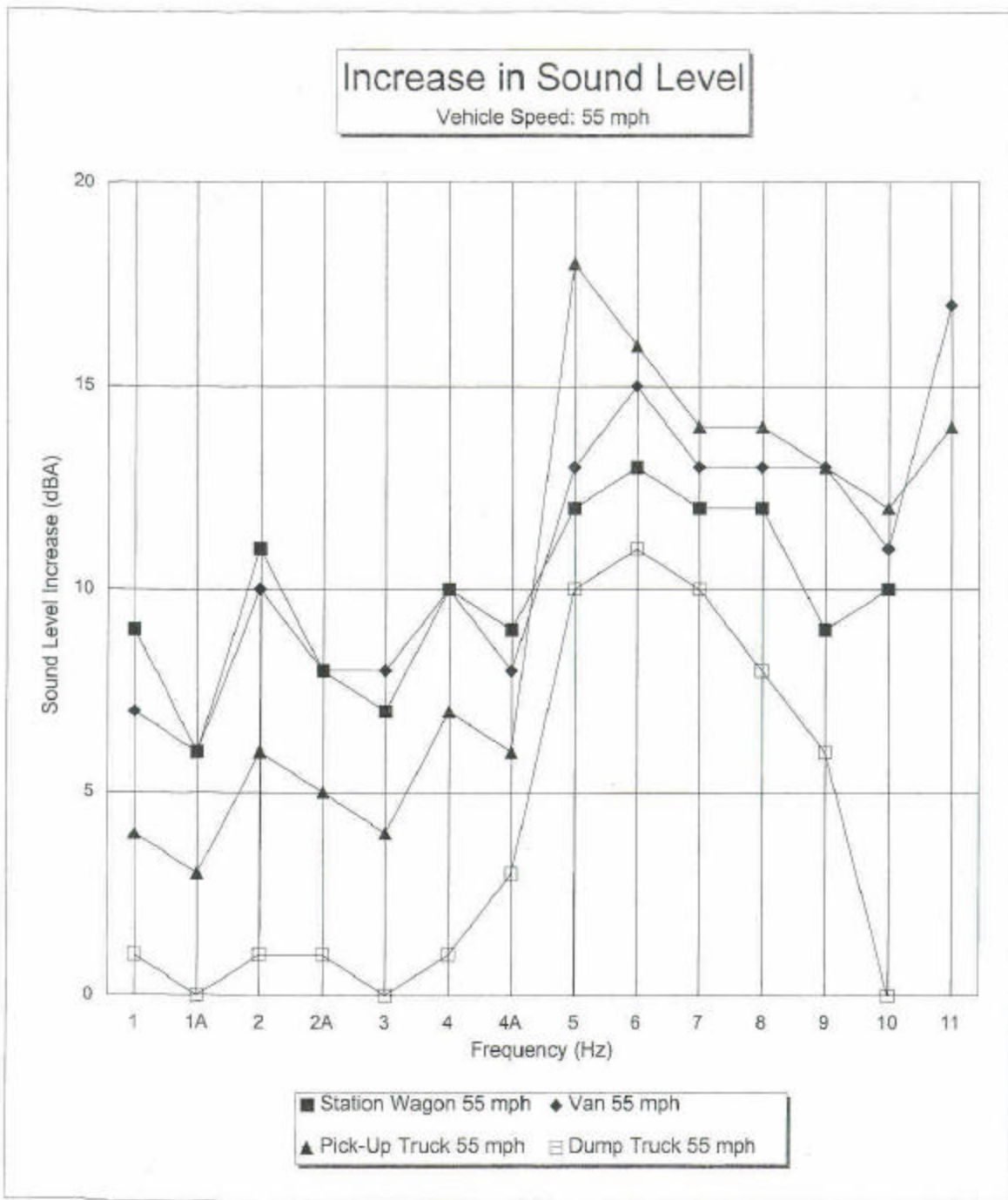

Figure C-3. This graph shows the difference between sound levels measured on smooth pavement at 55 mph and sound levels measured in the rumble strip at 55 mph.

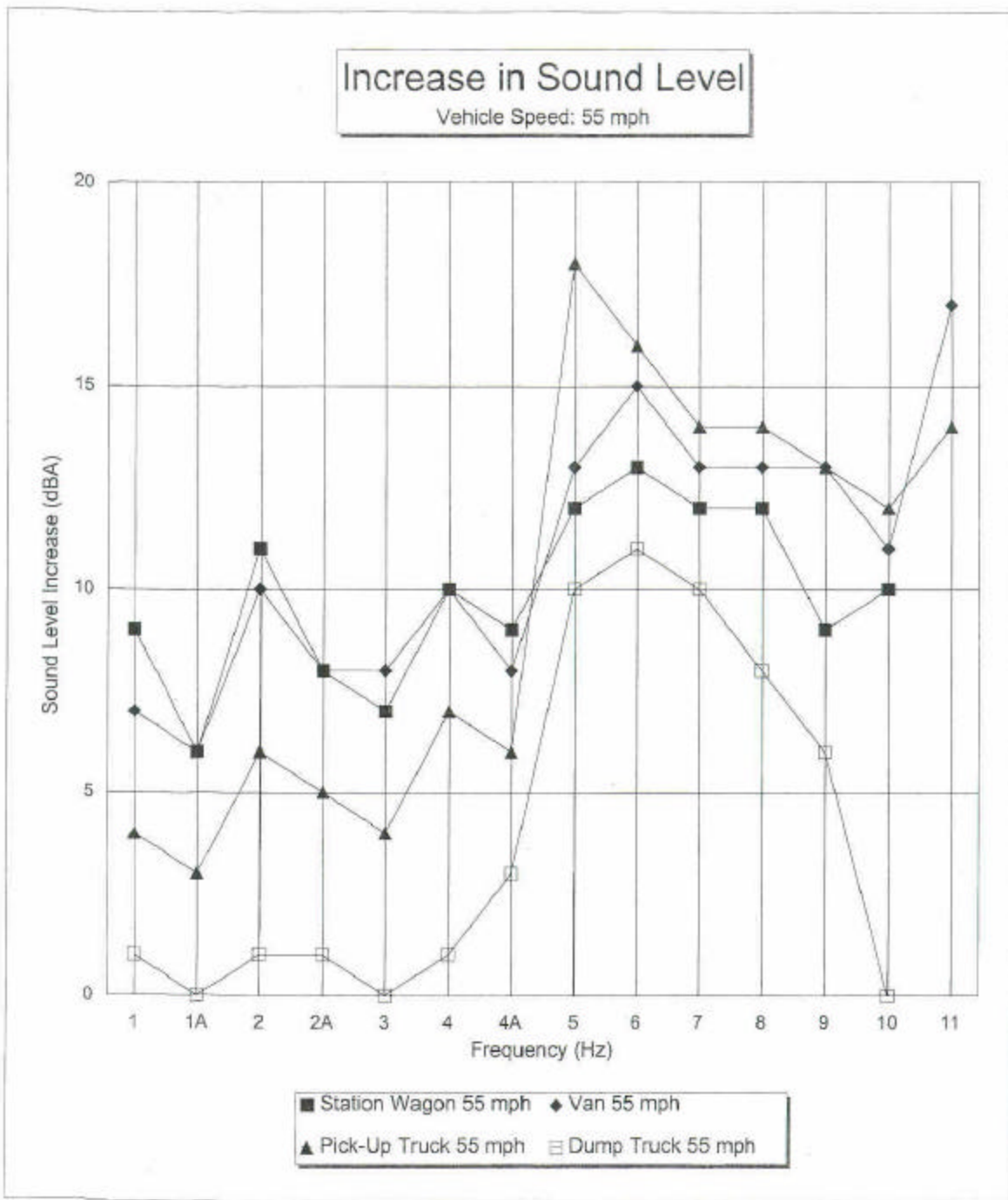

Figure C-4. This graph shows the difference between sound levels measured on smooth pavement at 55 mph and sound levels measured in the rumble strip at 65 mph.

Table C-4: Octave-Band Data Organized by Rumble Strip

Rumble Strip 3	25	31.5	40	50	63	80	100	125	160	200	250	315	400	500	630	800	1000	1250	1600	2000	2500	3150	4000	5000	6300	8000	10000	dBA	
Station Wagon 55 mph	-	81	-	-	-	71	68	74	67	56	70	68	67	65	60	52	35	-	-	-	23	-	-	-	-	-	-	69	
Station Wagon 65 mph	-	-	-	-	-	-	64	65	69	57	61	76	61	68	61	55	-	-	-	-	-	-	-	-	-	-	-	72	
Van 55 mph	-	76	83	-	72	69	60	82	77	61	72	73	75	70	69	67	55	48	49	42	37	32	29	24	-	-	-	76	
Van 65 mph	-	-	-	81	73	66	70	72	83	66	67	77	70	78	71	66	60	57	54	47	42	39	42	32	28	23	22	79	
Pick-Up 55 mph	-	-	-	-	-	-	-	69	71	-	-	59	66	60	64	64	54	-	-	-	-	-	-	-	-	-	-	68	
Pick-Up 65 mph	-	-	-	-	-	-	-	-	74	65	-	68	61	67	70	69	59	45	-	27	-	-	-	-	-	-	-	73	
Dump Truck 55 mph	-	-	-	-	-	78	-	64	66	-	66	60	51	72	66	-	-	-	-	-	-	-	-	-	-	48	50	-	
Dump Truck 65 mph	83	93	-	-	-	-	-	-	70	-	-	-	-	70	69	68	-	74	-	-	-	-	-	-	-	-	-	48	70
Rumble Strip 4	25	31.5	40	50	63	80	100	125	160	200	250	315	400	500	630	800	1000	1250	1600	2000	2500	3150	4000	5000	6300	8000	10000	dBA	
Station Wagon 55 mph	-	-	-	-	57	-	70	58	65	73	68	70	73	70	64	57	51	35	-	-	32	18	-	-	-	-	-	73	
Station Wagon 65 mph	85	-	-	-	-	67	73	63	68	80	70	71	73	68	64	59	47	-	-	-	30	-	-	-	-	-	-	74	
Van 55 mph	83	76	-	-	75	70	69	70	67	76	72	72	80	75	69	64	64	58	54	56	55	51	52	53	53	51	50	79	
Van 65 mph	-	74	-	89	73	70	69	71	70	76	82	74	78	83	71	65	67	60	53	52	48	42	43	35	32	29	27	82	
Pick-Up 55 mph	-	-	-	-	-	-	70	-	-	78	-	47	71	66	70	67	59	44	-	35	-	-	31	33	36	32	30	74	
Pick-Up 65 mph	-	-	-	-	-	-	68	-	65	64	80	63	67	75	74	75	65	54	30	38	32	-	-	-	-	-	-	79	
Dump Truck 55 mph	-	-	-	-	-	77	-	64	-	69	-	-	65	74	74	71	62	-	-	-	-	-	-	-	-	-	45	50	75
Dump Truck 65 mph	84	93	-	-	-	-	-	-	-	73	71	-	70	77	79	75	68	72	-	-	-	-	-	-	-	-	-	51	80
Rumble Strip 4A	25	31.5	40	50	63	80	100	125	160	200	250	315	400	500	630	800	1000	1250	1600	2000	2500	3150	4000	5000	6300	8000	10000	dBA	
Station Wagon 55 mph	-	73	-	-	61	-	71	62	63	68	66	70	71	69	60	55	47	-	-	-	23	-	-	-	-	-	-	71	
Station Wagon 65 mph	80	-	-	-	-	-	71	62	57	77	68	68	71	67	62	56	43	-	-	-	-	-	-	-	-	-	-	72	
Van 55 mph	95	77	79	-	76	70	65	70	68	77	70	70	78	73	68	62	60	51	50	54	50	40	37	32	27	24	21	77	
Van 65 mph	-	-	-	90	71	72	70	71	69	75	81	72	77	80	70	62	64	55	49	50	47	39	42	33	29	26	25	80	
Pick-Up 55 mph	-	-	-	-	-	-	68	-	-	76	-	-	69	64	68	64	54	-	-	-	-	-	-	-	-	-	-	71	
Pick-Up 65 mph	-	-	-	-	-	-	67	-	63	64	77	60	65	73	73	74	64	53	-	-	-	-	-	-	-	-	-	77	
Dump Truck 55 mph	77	-	-	-	68	79	73	72	68	74	68	63	69	74	77	72	65	-	-	-	-	51	-	-	50	54	54	78	
Dump Truck 65 mph	-	93	-	-	-	-	-	-	-	-	-	-	71	75	77	73	64	69	-	-	-	-	-	-	-	-	-	46	77
Rumble Strip 5	25	31.5	40	50	63	80	100	125	160	200	250	315	400	500	630	800	1000	1250	1600	2000	2500	3150	4000	5000	6300	8000	10000	dBA	
Station Wagon 55 mph	-	75	-	-	83	92	75	80	82	74	71	72	68	66	63	62	56	52	51	50	46	43	40	36	33	32	31	75	
Station Wagon 65 mph	89	86	80	-	74	97	88	78	80	71	85	72	71	70	65	65	60	58	56	53	51	48	46	41	37	35	34	81	
Van 55 mph	-	78	79	81	86	94	73	76	87	74	83	76	78	77	70	70	69	67	62	60	56	53	51	49	47	46	47	82	
Van 65 mph	-	-	84	-	87	86	86	79	77	82	84	76	79	78	72	75	73	72	66	63	59	55	53	50	48	45	44	83	
Pick-Up 55 mph	-	-	81	64	76	106	81	71	88	79	83	78	74	73	71	72	69	64	61	55	53	52	50	49	46	43	41	85	
Pick-Up 65 mph	-	-	-	-	63	83	93	65	73	88	76	79	71	72	72	76	69	64	60	53	51	49	46	39	35	-	-	82	
Dump Truck 55 mph	-	-	-	-	74	82	-	78	86	67	74	76	79	88	85	73	70	60	60	-	49	52	45	-	48	50	53	88	
Dump Truck 65 mph	86	93	-	-	68	89	83	75	75	54	77	-	74	84	81	75	-	68	-	-	-	-	-	-	-	-	-	52	84

Table C-4: Octave-Band Data Organized by Rumble Strip (continued)

Rumble Strip 6	25	31.5	40	50	63	80	100	125	160	200	250	315	400	500	630	800	1000	1250	1600	2000	2500	3150	4000	5000	6300	8000	10000	dBA
Station Wagon 55 mph	-	-	-	-	68	92	74	72	83	70	74	73	67	66	62	63	56	54	52	48	45	42	38	34	30	26	21	75
Station Wagon 65 mph	-	-	-	-	57	93	89	74	76	72	84	70	68	65	61	62	57	55	54	50	48	45	42	38	32	28	26	78
Van 55 mph	91	65	81	-	80	91	73	75	88	71	82	81	78	79	75	76	73	71	67	63	59	55	52	48	45	43	48	84
Van 65 mph	-	-	-	78	80	78	82	77	74	80	83	76	78	78	71	74	73	71	67	61	57	53	51	47	43	41	37	82
Pick-Up 55 mph	-	-	-	-	62	104	78	57	88	73	81	73	73	70	68	70	66	60	56	51	49	47	45	42	39	34	31	83
Pick-Up 65 mph	-	-	-	-	-	72	94	63	71	91	76	85	70	71	73	75	68	64	61	53	50	47	44	37	33	-	-	84
Dump Truck 55 mph	74	-	-	-	67	82	79	78	84	71	81	74	78	89	85	79	70	66	63	59	60	56	54	50	50	52	51	89
Dump Truck 65 mph	75	93	-	-	-	86	81	68	73	75	74	-	73	85	82	78	-	73	-	-	53	-	-	-	-	-	47	85
Rumble Strip 7	25	31.5	40	50	63	80	100	125	160	200	250	315	400	500	630	800	1000	1250	1600	2000	2500	3150	4000	5000	6300	8000	10000	dBA
Station Wagon 55 mph	-	71	-	-	67	85	70	72	85	67	73	72	66	66	61	61	57	54	53	48	45	41	38	34	29	26	23	74
Station Wagon 65 mph	-	-	-	-	-	86	87	73	72	75	78	67	66	64	58	61	56	54	52	48	47	43	40	36	34	33	34	75
Van 55 mph	94	76	79	-	81	87	75	75	89	71	82	77	77	75	71	73	71	69	64	61	57	54	50	45	42	39	36	82
Van 65 mph	-	76	84	89	80	79	83	77	74	80	83	77	79	76	71	74	73	71	68	61	57	53	51	47	43	40	37	82
Pick-Up 55 mph	-	-	-	-	-	101	73	-	87	69	76	70	66	66	66	68	59	55	51	46	44	41	39	37	34	30	28	81
Pick-Up 65 mph	-	-	-	-	-	74	93	-	69	92	78	84	70	71	72	75	68	63	60	53	50	48	45	39	34	-	-	84
Dump Truck 55 mph	-	-	61	-	69	82	78	79	83	73	79	75	76	87	84	79	69	65	63	57	58	53	52	46	44	-	39	88
Dump Truck 65 mph	87	97	-	-	68	84	84	69	76	80	77	65	76	87	83	80	65	77	-	-	61	60	43	-	-	-	-	88
Rumble Strip 8	25	31.5	40	50	63	80	100	125	160	200	250	315	400	500	630	800	1000	1250	1600	2000	2500	3150	4000	5000	6300	8000	10000	dBA
Station Wagon 55 mph	84	73	-	-	81	90	73	79	83	74	71	70	68	67	65	63	55	53	52	47	44	40	35	32	24	21	16	75
Station Wagon 65 mph	78	90	-	-	67	88	82	72	76	70	81	71	65	66	61	59	54	52	51	45	44	39	36	32	-	17	22	75
Van 55 mph	86	72	-	-	82	84	71	75	90	70	81	78	79	75	71	72	69	67	65	59	54	51	47	43	40	38	35	82
Van 65 mph	-	-	83	84	80	79	83	77	73	79	80	75	79	77	71	74	70	70	68	61	56	52	49	45	41	39	38	82
Pick-Up 55 mph	-	-	-	-	-	101	74	-	85	70	80	70	68	70	66	67	63	56	53	48	45	43	41	38	35	32	31	81
Pick-Up 65 mph	-	-	-	-	-	74	93	-	69	89	78	83	71	71	72	75	69	62	59	51	47	45	41	35	27	-	-	83
Dump Truck 55 mph	76	-	-	-	72	82	76	78	83	72	77	76	73	85	82	78	69	64	62	57	56	50	49	45	37	-	44	86
Dump Truck 65 mph	-	96	-	-	-	77	76	-	56	77	74	-	73	84	78	78	-	75	-	-	-	-	-	-	-	-	-	84
Rumble Strip 9	25	31.5	40	50	63	80	100	125	160	200	250	315	400	500	630	800	1000	1250	1600	2000	2500	3150	4000	5000	6300	8000	10000	dBA
Station Wagon 55 mph	-	-	-	-	80	81	66	82	80	74	66	67	62	60	58	55	48	41	43	35	32	-	-	-	-	-	-	72
Station Wagon 65 mph	81	-	-	-	-	85	78	67	75	67	77	68	60	60	59	56	-	-	41	-	36	-	-	-	-	-	-	71
Van 55 mph	91	78	-	-	81	79	70	72	90	69	81	77	78	72	72	72	67	67	64	57	52	48	45	41	38	35	31	82
Van 65 mph	87	78	72	-	77	77	84	76	71	77	82	74	76	77	70	73	68	67	65	57	51	47	45	40	35	32	28	80
Pick-Up 55 mph	-	-	-	-	67	100	75	64	82	72	78	67	69	69	68	69	62	53	50	45	43	40	37	35	31	30	27	80
Pick-Up 65 mph	78	-	77	69	69	75	92	64	72	85	75	80	70	70	74	74	68	59	55	49	46	42	37	31	-	-	-	81
Dump Truck 55 mph	81	82	-	-	71	82	70	76	82	70	74	75	72	83	79	74	67	61	61	54	56	47	49	43	37	-	43	83
Dump Truck 65 mph	82	96	-	-	-	79	-	-	62	76	-	-	66	83	74	73	-	75	-	-	-	-	-	-	-	-	-	81

Table C-4: Octave-Band Data Organized by Rumble Strip (continued)

Rumble Strip 10	25	31.5	40	50	63	80	100	125	160	200	250	315	400	500	630	800	1000	1250	1600	2000	2500	3150	4000	5000	6300	8000	10000	dB(A)
Station Wagon 55 mph	91	-	-	-	70	63	73	64	64	62	79	75	57	70	63	65	57	52	50	47	45	42	34	21	-	-	20	75
Station Wagon 65 mph	-	-	69	-	-	57	-	-	-	58	65	77	57	60	64	58	63	55	52	49	47	45	36	-	-	-	-	72
Van 55 mph	-	80	79	-	78	70	56	73	67	63	80	74	68	77	78	78	70	68	60	55	51	46	42	39	35	30	29	82
Van 65 mph	-	82	86	93	80	73	63	73	68	66	72	83	70	71	80	76	75	71	64	55	54	50	46	43	38	33	29	83
Pick-Up 55 mph	82	88	83	73	69	-	-	-	-	-	-	-	-	-	-	-	-	-	-	-	-	-	-	-	-	-	-	80
Pick-Up 65 mph	70	69	-	-	-	73	-	-	-	47	57	74	65	64	78	76	76	62	55	47	48	43	34	29	22	15	15	81
Dump Truck 55 mph	-	-	-	-	-	-	-	-	-	-	-	66	65	-	65	63	-	-	-	-	-	-	-	-	-	-	-	-
Dump Truck 65 mph	-	-	73	-	-	-	-	-	-	-	-	68	60	-	70	62	-	-	-	-	-	-	61	-	-	57	-	-

Appendix D

Bicycle Vibration

The following are the results of the bicycle vibration measurements taken by the acoustic consultant, David L. Adams Associates. The purpose of the measurements is to assess the vibration of various rumble strips on a bicycle at speeds of 5, 10, 15, and 20 mph. A total of 13 sections were measured.

The bicycle used was a Schwinn Varsity bicycle. The size of the tires were 27" x 1 1/4". The distance between the center of the front and rear tire was 40-1/2". The tires were inflated to approximately 50 psi. All measurements were taken with a Larson-Davis Model 2900 sound level meter, together with a Brüel & Kjær Type 4370 accelerometer. Calibration was checked before and after measurements with a Brüel & Kjær Type 4294 Calibration Exciter. The accelerometer was mounted to the frame of the bicycle just below the seat with a U-bolt and metal plate as shown in Figure D-1. The accelerometer was connected by a cable to a computer in a small pickup truck. The truck drove next to the bicycle as the measurements were taken.

Measurements were taken on each rumble strip at each speed and on the adjacent smooth road to establish a comparison. The vibration of the bicycle on rumble strip 5 (the standard style ground to a depth of 5/8") at 20 mph was too dangerous so no data was collected at that speed for that section.

The vibration levels reported are the maximum levels sampled during the time the bicycle was in the section of rumble strip. Table D-1 represents the vibration in decibels (re: 1 m/s²). Since the maximum vibration level is of significance, we provide these levels, as well as the frequency in which they occur. Only the highest level peak (tone) is shown in Table D-1. In many cases there were multiple peaks. This is shown better by the graphs in Figures D-2 through D-5. All measurements are vertical acceleration.

Table D-1: Maximum Bicycle Vertical Acceleration

	Bicycle Speed							
	5 MPH		10 MPH		15 MPH		20 MPH	
	Max (dB)	Freq (Hz)	Max (dB)	Freq (Hz)	Max (dB)	Freq (Hz)	Max (dB)	Freq (Hz)
Rumble Strip 1, 1 A	8	31.5	21	25	21	20	2.3	25
Rumble Strip 2, 2A	11	12.5	18	20	27	31.5	26	40
Rumble Strip 3, 4, 4A	10	12.5	25	31.5	34	40	21	63
Rumble Strip 5	12	20	28	12.5	35	20	-	-
Rumble Strip 6	13	25	25	12.5, 25	33	20	35	25
Rumble Strip 7	11	31.5	26	25	32	20	33	25
Rumble Strip 8	10	25	24	25	31	16	33	25
Rumble Strip 9	6	31.5	21	25	26	20	31	25
Rumble Strip 10	8	31.5	18	40	15	63	12	20

Note: A vibration level of 10 dB is approximately equal to 1 G.

The data in Table 1 is plotted in graphs in Figures D-2 through D-5 which compare each rumble strip at a constant bicycle speed. Graphs in figures D-6 through D-14 show the same data plotted at various bicycle speeds for each rumble strip.

In an attempt to compare rumble strips based on bicycle vibration impact and sound level increase in a vehicle, all the bicycle vibration and vehicle sound data is plotted in graphs in figures D-15 and D-16. Figures D-15 and D-16 show the vehicle speed at 55 and 65 mph, respectively. Graphs of the entire vibration spectrum measured in each rumble strip can be seen in Figures D-17 through D-92. Note that the increase in sound level in the vehicle typically decreases as the vehicle speed increases from 55 to 65 mph.

Motor Vehicle Vibration

The following are the results of the vibration measurements taken by the acoustic consultant, David L. Adams Associates. The measurements assess the vibration of various rumble strips in a vehicle at speeds of 55 and 65 mph. Thirteen rumble strips were measured.

The van used for the measurements, a GMC Safari minivan, was owned by CDOT. All measurements were taken with a Larson-Davis Model 2900 sound level meter, together with a Brüel & Kjær Type 4370 accelerometer. Calibration was checked before and after measurements with a Brüel & Kjær Type 4294 Calibration Exciter. The accelerometer (Figure 26) was mounted to the floor of the minivan just behind the middle of the driver's seat at a location where the floor was welded to the vehicle frame. Measurements were also taken with the accelerometer mounted to the steering wheel (Figure 27) with a U-bolt. Vibration was measured perpendicular to the floor of the minivan and perpendicular to the plane of the steering wheel.

Measurements were taken at 55 and 65 mph in each rumble strip section. Measurements were also taken in the travel lanes to get "background" measurements, at each speed to insure that the rumble strip vibration measurements were well above the smooth road condition.

The vibration levels reported are the average of at least two maximum vibration levels sampled during the time the vehicle was in each section. It was difficult to keep the tires of the van in the rumble strip continuously at high speeds. This is especially true for the more aggressive rumble strips. For that reason, repeat runs were made in each test section until at least two maximum measurements were within 3 decibels of each other. Table D-2 represents the vibration in decibels (re: 1 m/s^2). Since the maximum vibration level is of significance, we provide these levels, as well as the one-third octave-band frequency band in which they occur. Only the highest level peak (tone) is shown in Table 1. In many cases there were multiple peaks. Please note that negative decibel levels occur since the reference acceleration is 1 m/s^2 .

Also note that the numbers in italics represent vibration levels that were within 10 dB of the background condition and were corrected to omit the influence of the background levels. The vibration levels for rumble strips 4 and 4A at 65 mph were too close to the background levels to measure.

Table D-2. Vibration levels were measured in a GMC mini-van using a Brüel & Kjær Type 4370 accelerometer. Maximum levels and frequencies for each section are listed.

	Accelerometer Mounted to Floor				Accelerometer Mounted to Steering Wheel			
	55 MPH		65 MPH		55 MPH		65 MPH	
	Max (dB)*	Freq. (Hz)	Max (dB)	Freq. (Hz)	Max (dB)	Freq. (Hz)	Max (dB)	Freq. (Hz)
Rumble Strip 1	-6	80	-9	100	5	80	-5	40
Rumble Strip 1A	-9	80	-11	200	5	80	-5	100
Rumble Strip 2	-8	125	-6	160	0	80	-6	40 & 160
Rumble Strip 2A	-9	125	-8	160	-3	125	-4	160
Rumble Strip 3	-10	125	-9	160	-5	125	-6	160
Rumble Strip 4	-9	200	-1	250	-6	80	-.**	-.**
Rumble Strip 4A	-17	25	-4	250	-4	80	-.**	-.**
Rumble Strip 5	6	80	3	100	11	80	7	100
Rumble Strip 6	8	80	3	100	8	80	2	100
Rumble Strip 7	8	80	3	100	9	80	3	100
Rumble Strip 8	5	80	2	100	5	80 & 160	5	100
Rumble Strip 9	-2	160	-1	100	2	80 & 160	7	100
Rumble Strip 10	3	630	8	630	1	63	1	63

* dB, re: 1 m/s²

** Data at or below background acceleration (as measured on smooth pavement alongside rumble strips).

A vibration level of 10 dB is approximately equal to 1 G.

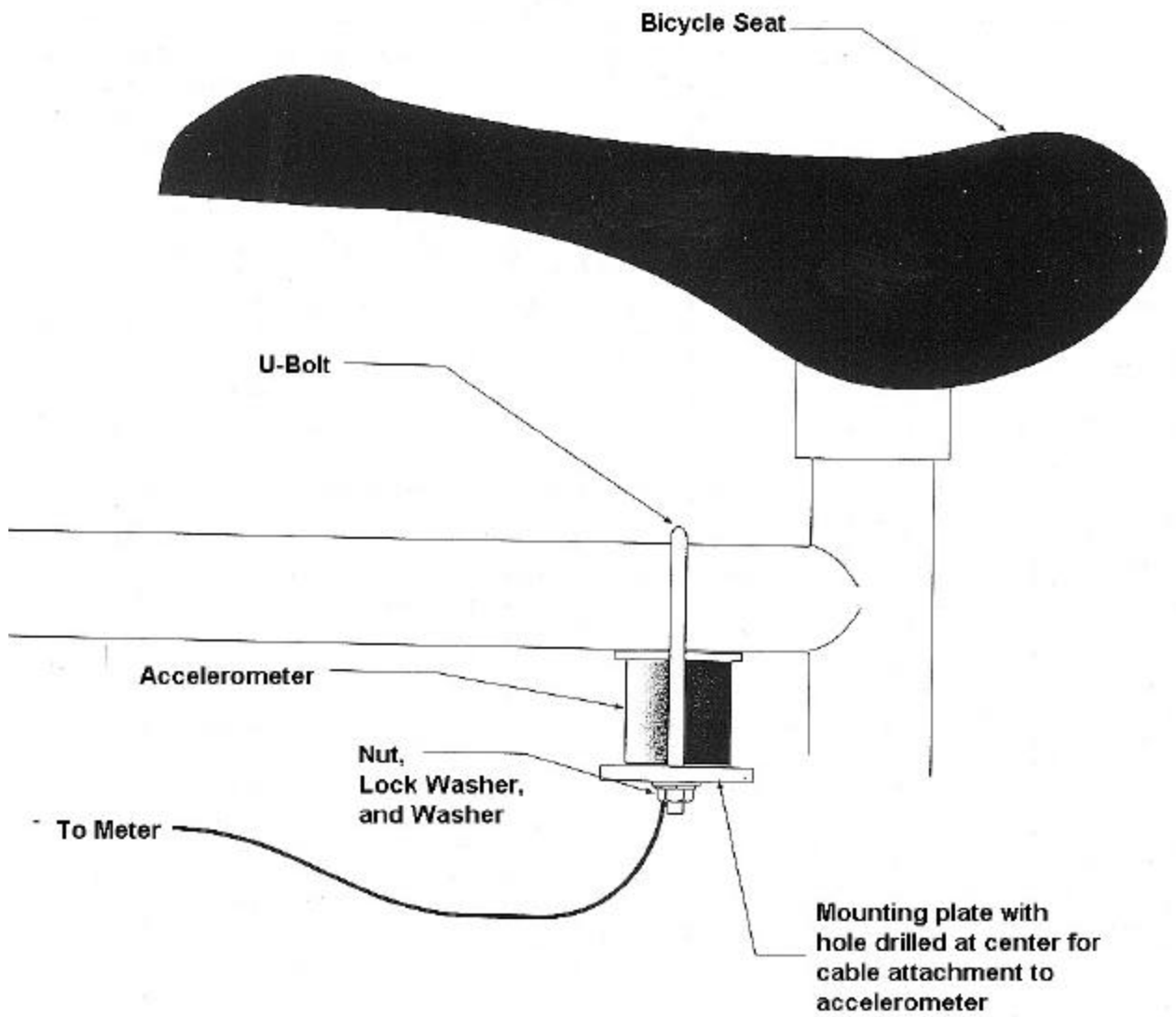

Figure D-1. Accelerometer mounting for bicycle vibration testing.

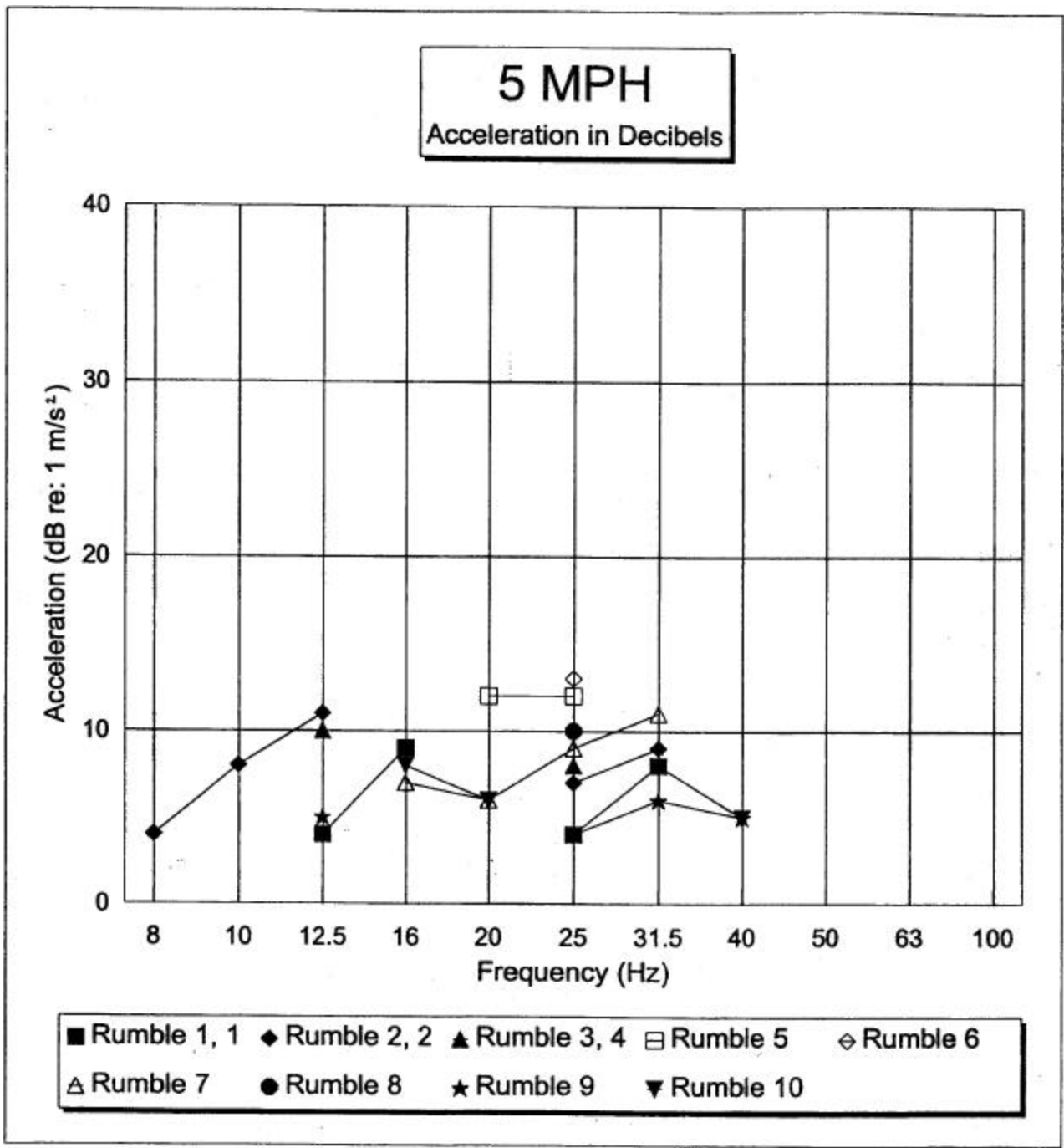
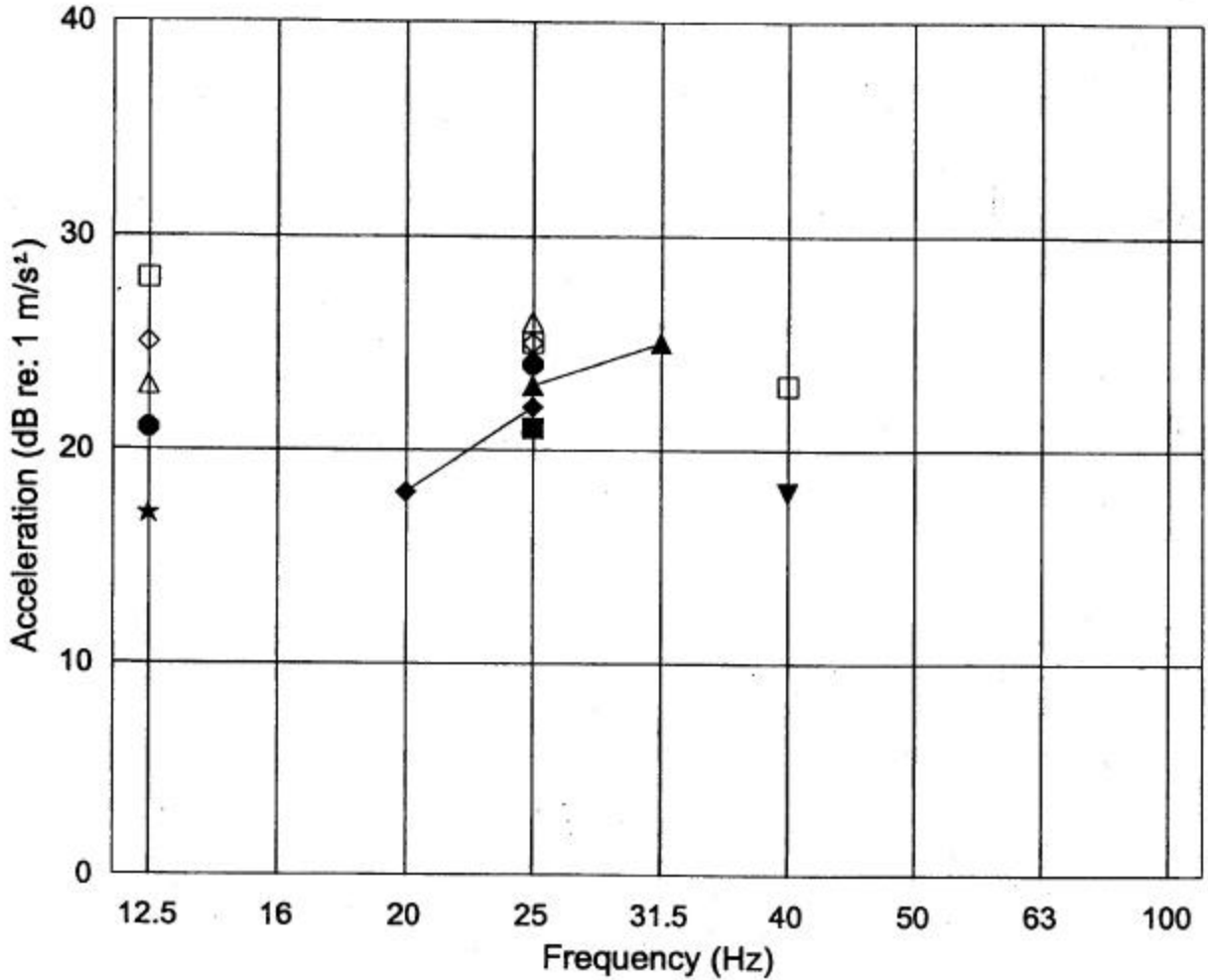

Figure D-2.

10 MPH
Acceleration in Decibels



- Rumble 1, 1 ◆ Rumble 2, 2 ▲ Rumble 3, 4 □ Rumble 5 ◇ Rumble 6
- △ Rumble 7 ● Rumble 8 ★ Rumble 9 ▼ Rumble 10

Figure D-3.

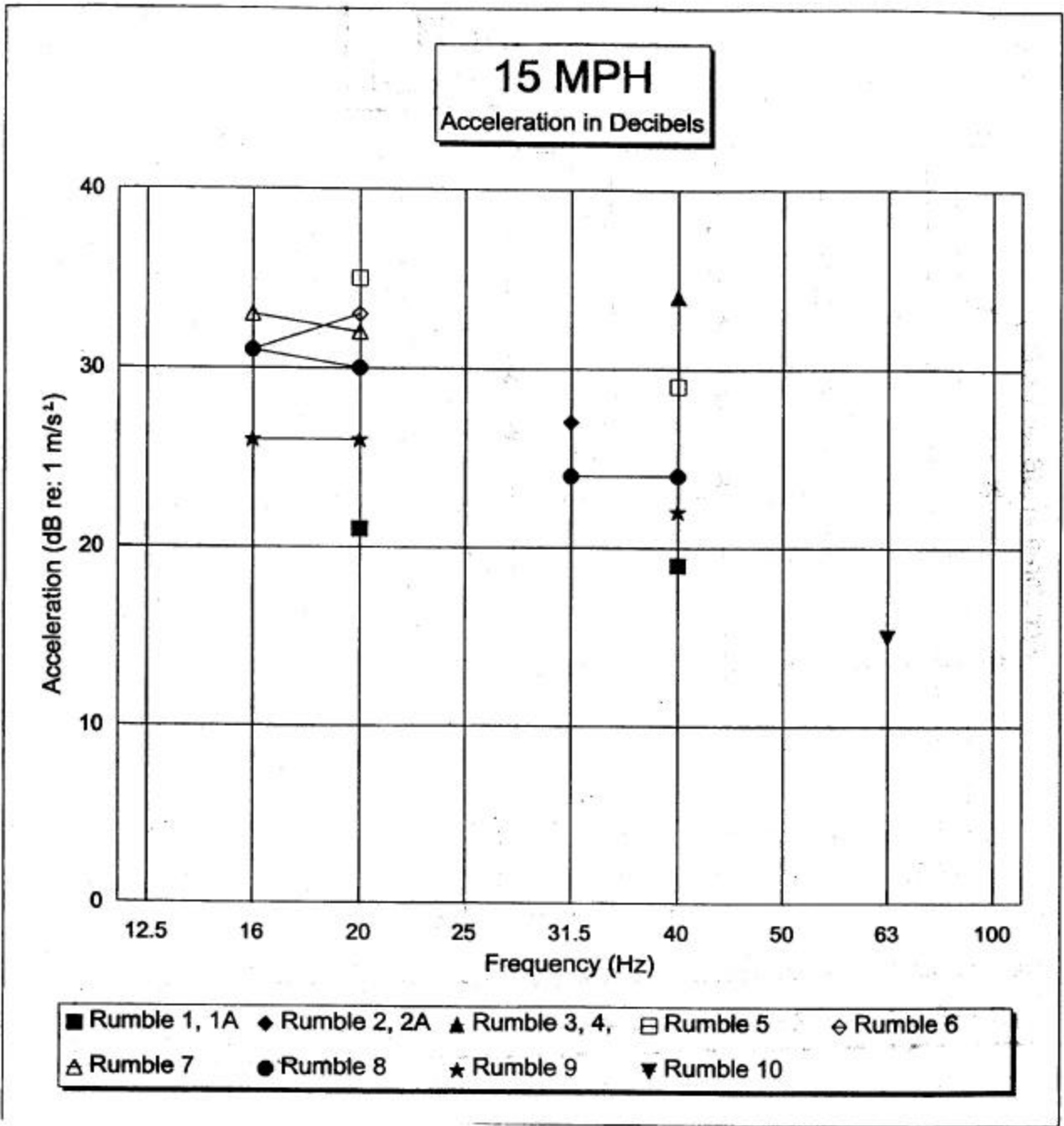

Figure D-4.

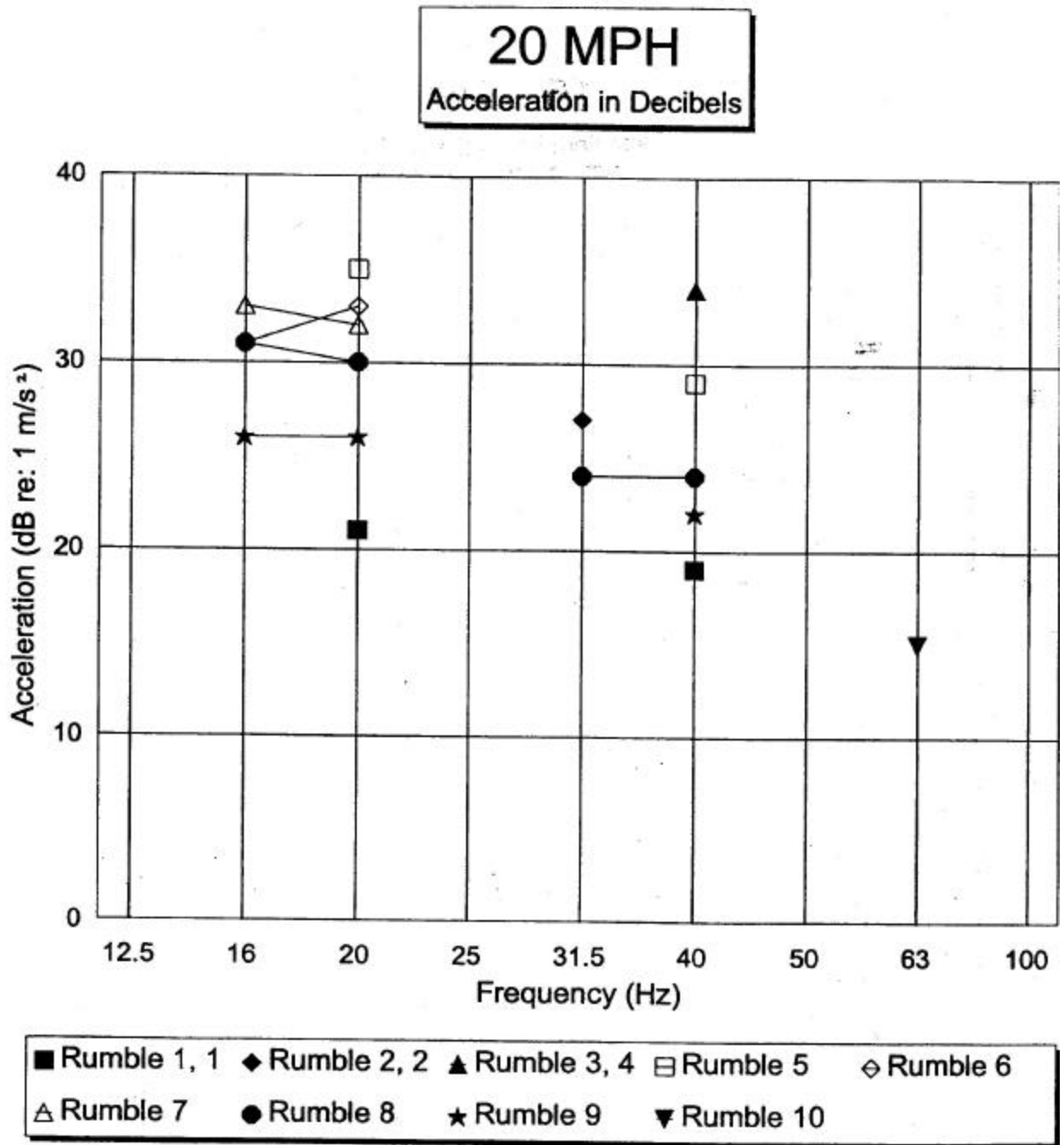

Figure D-5.

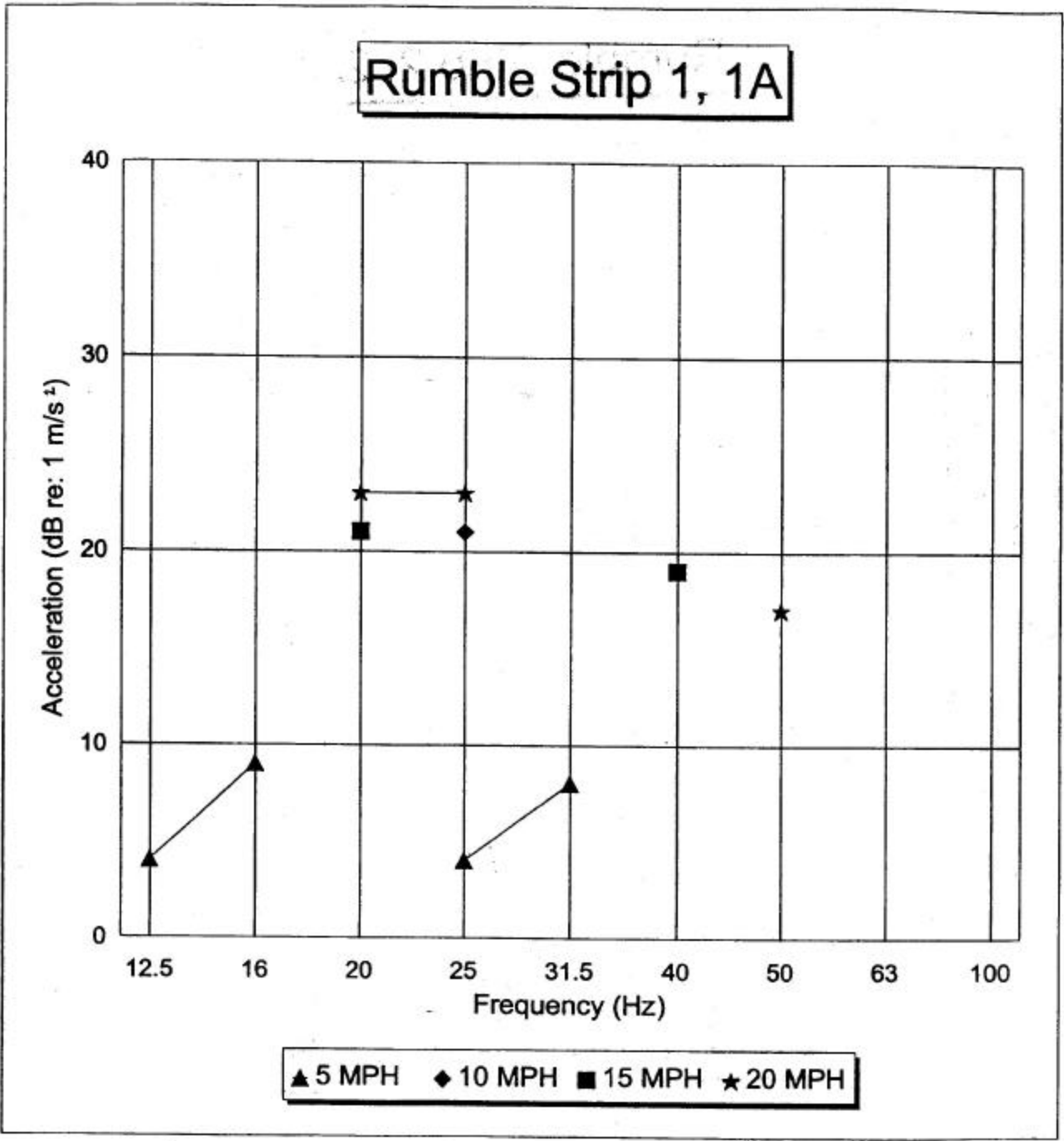

Figure D-6.

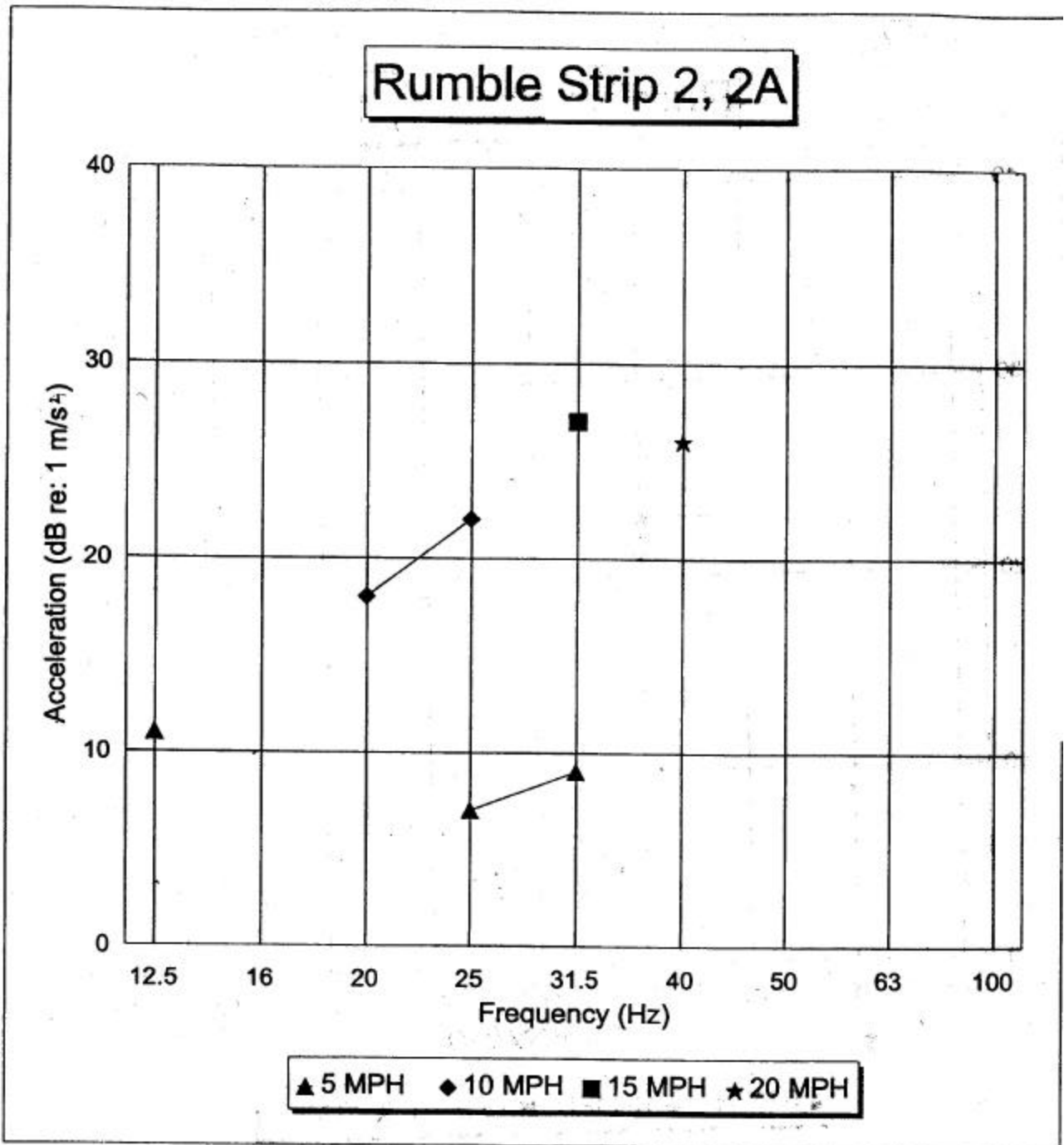

Figure D-7.

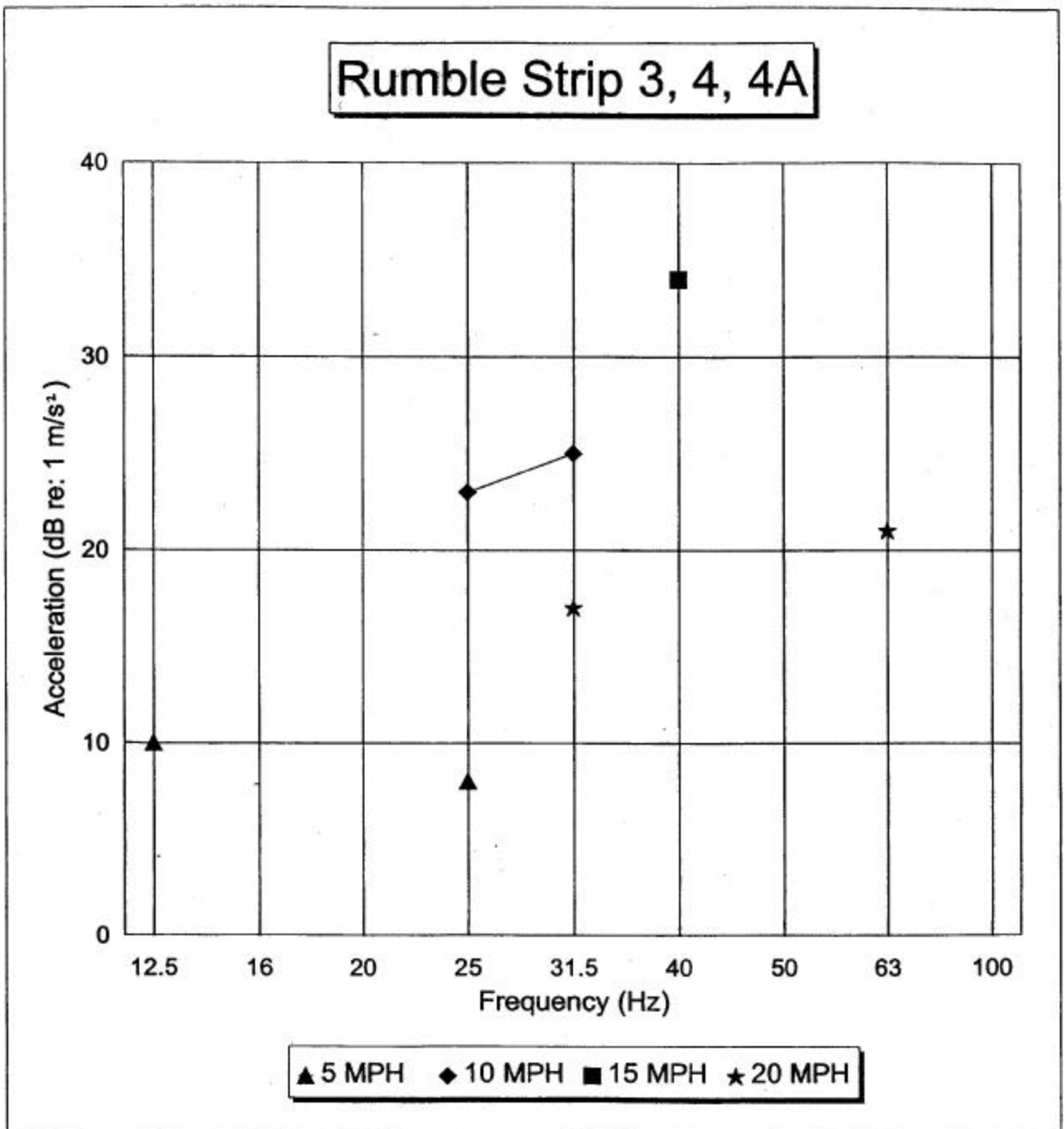

Figure D-8.

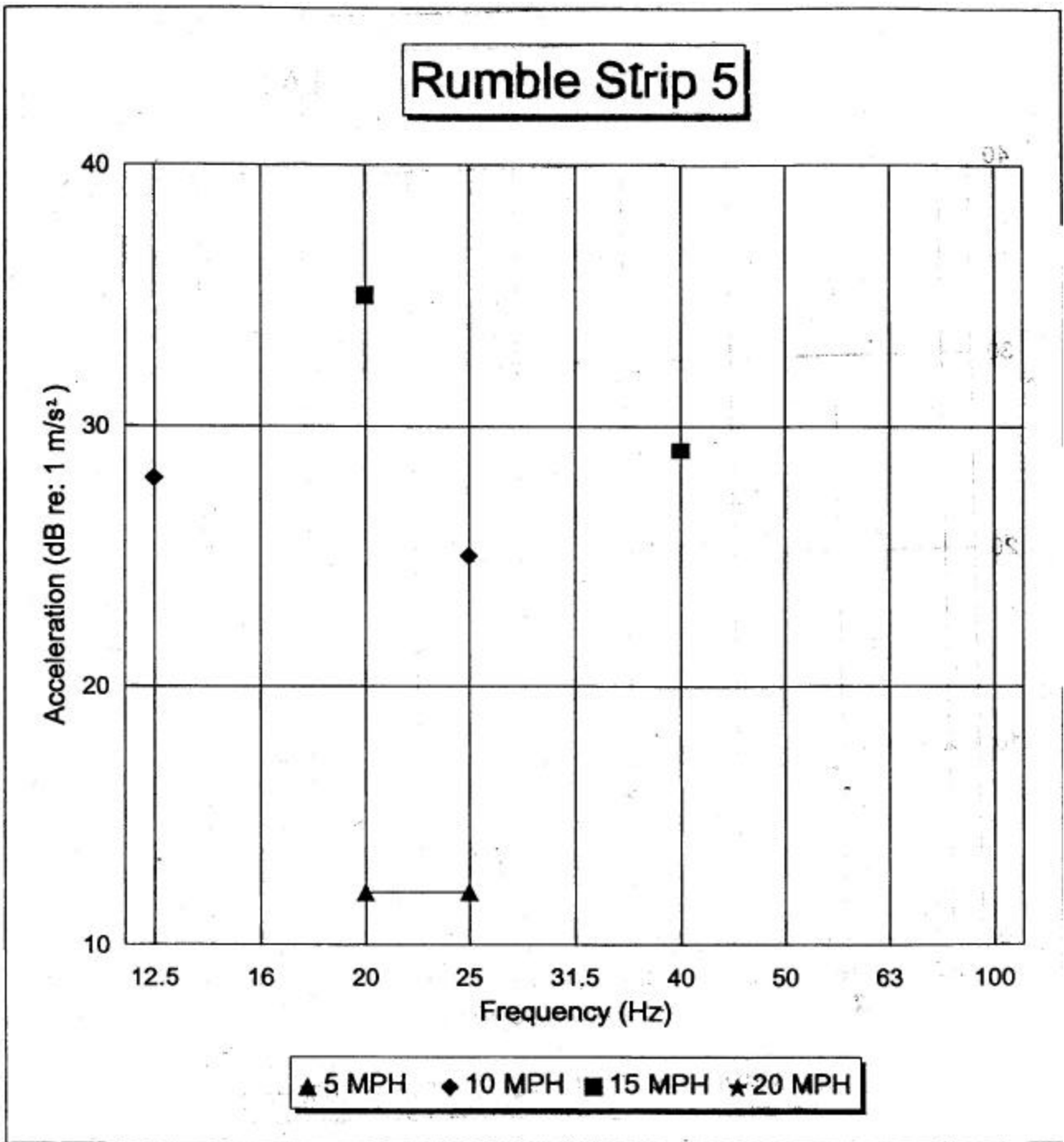

Figure D-9.

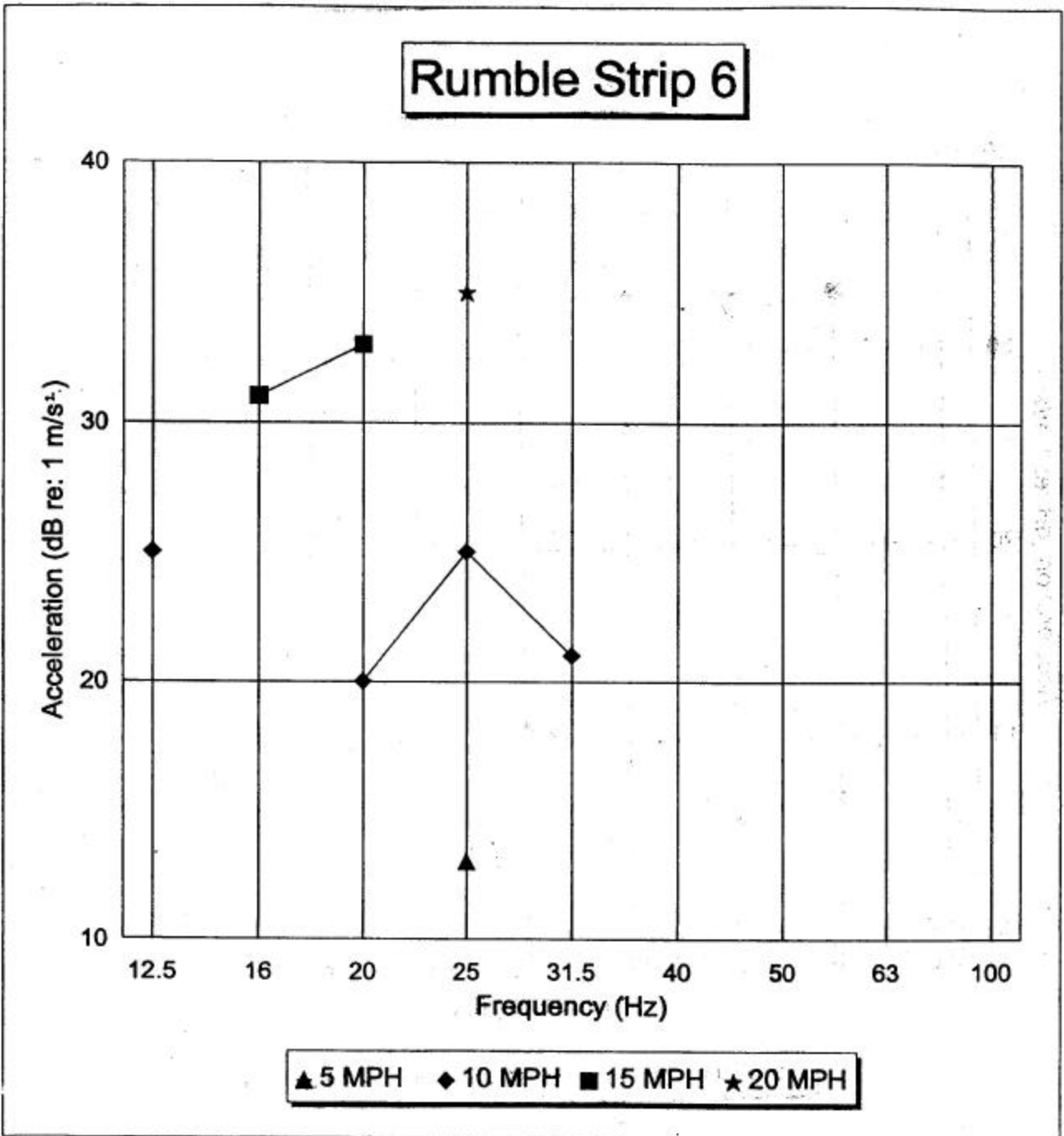

Figure D-10.

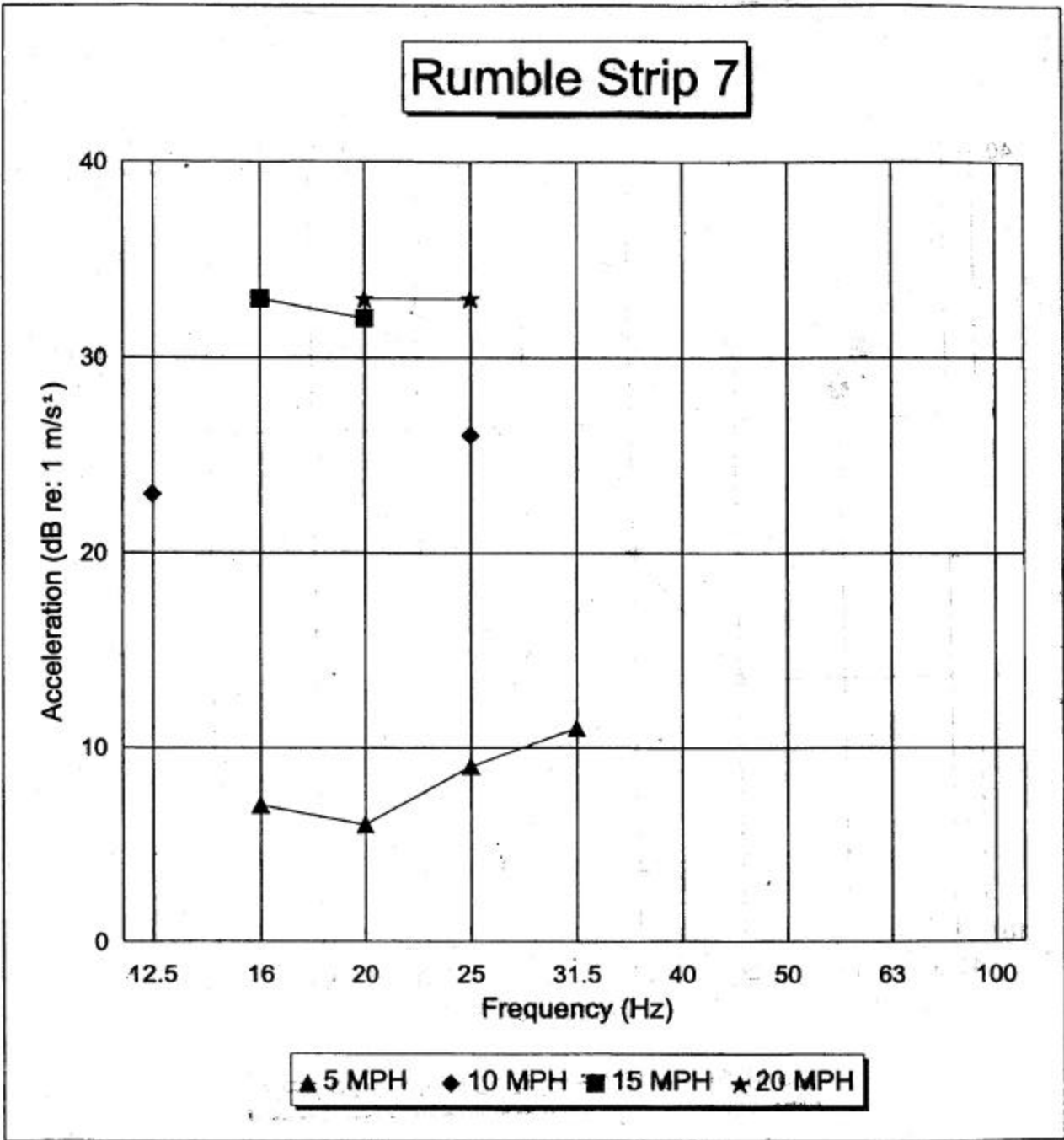

Figure D-11.

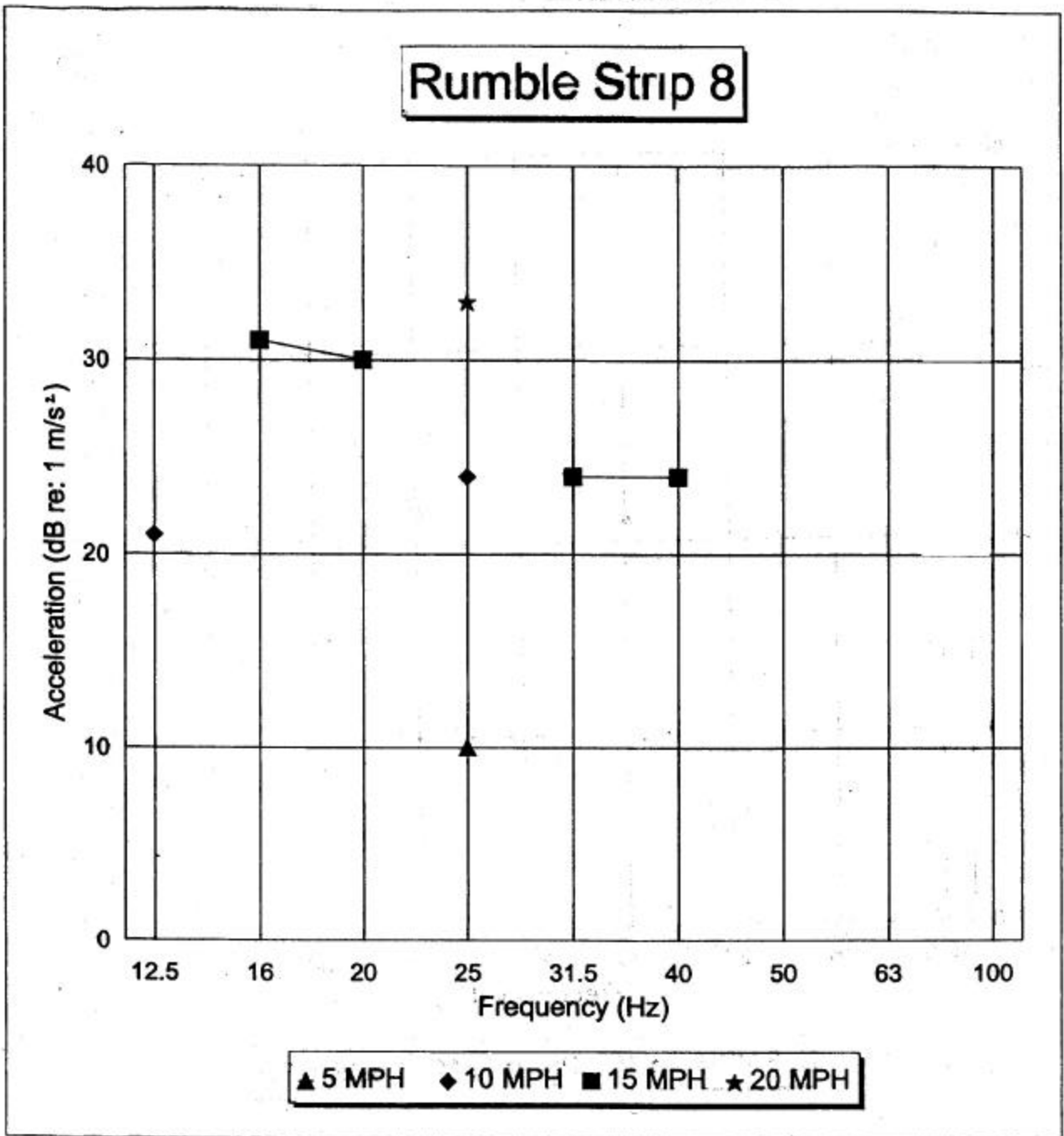

Figure D-12.

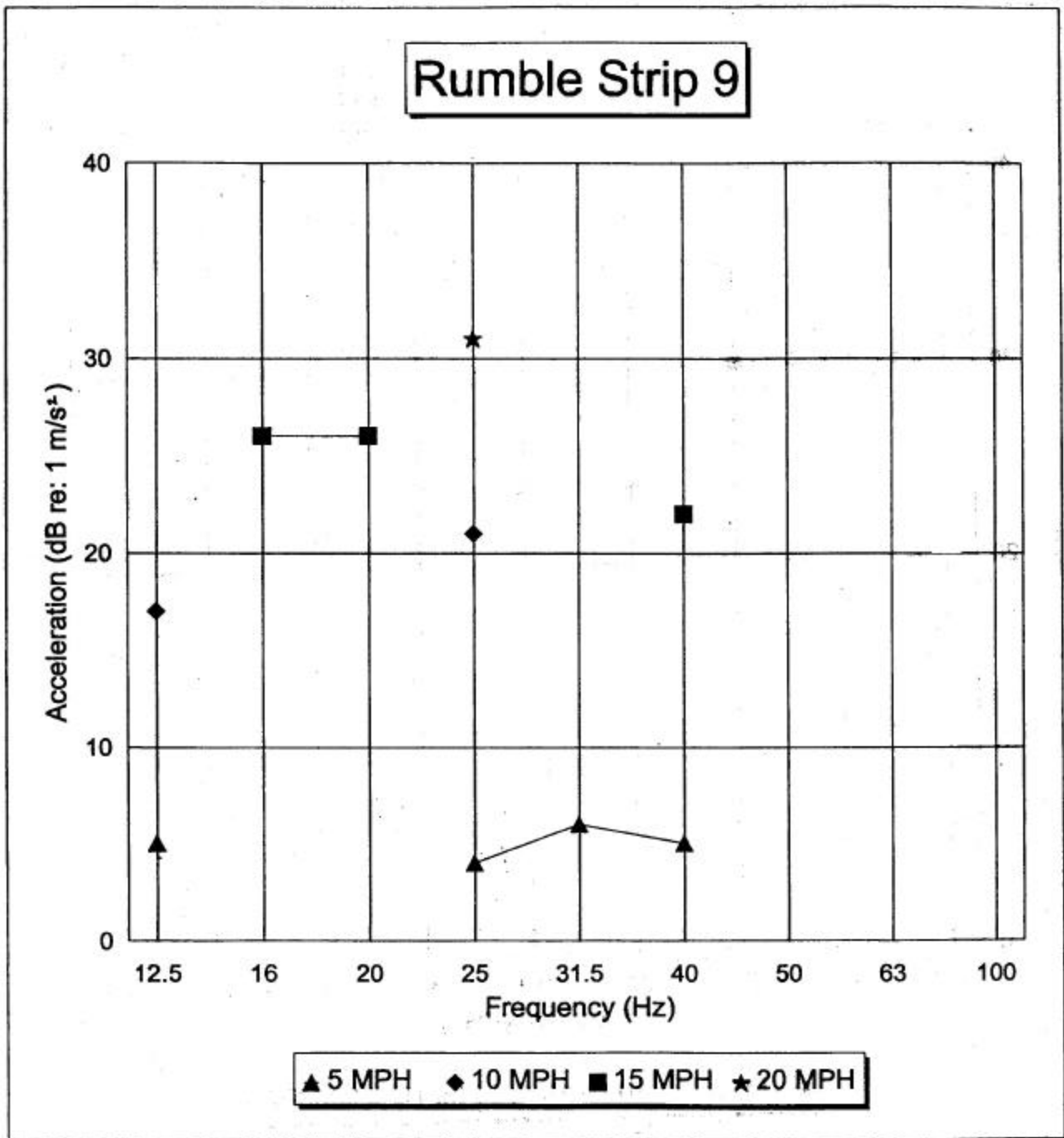

Figure D-13.

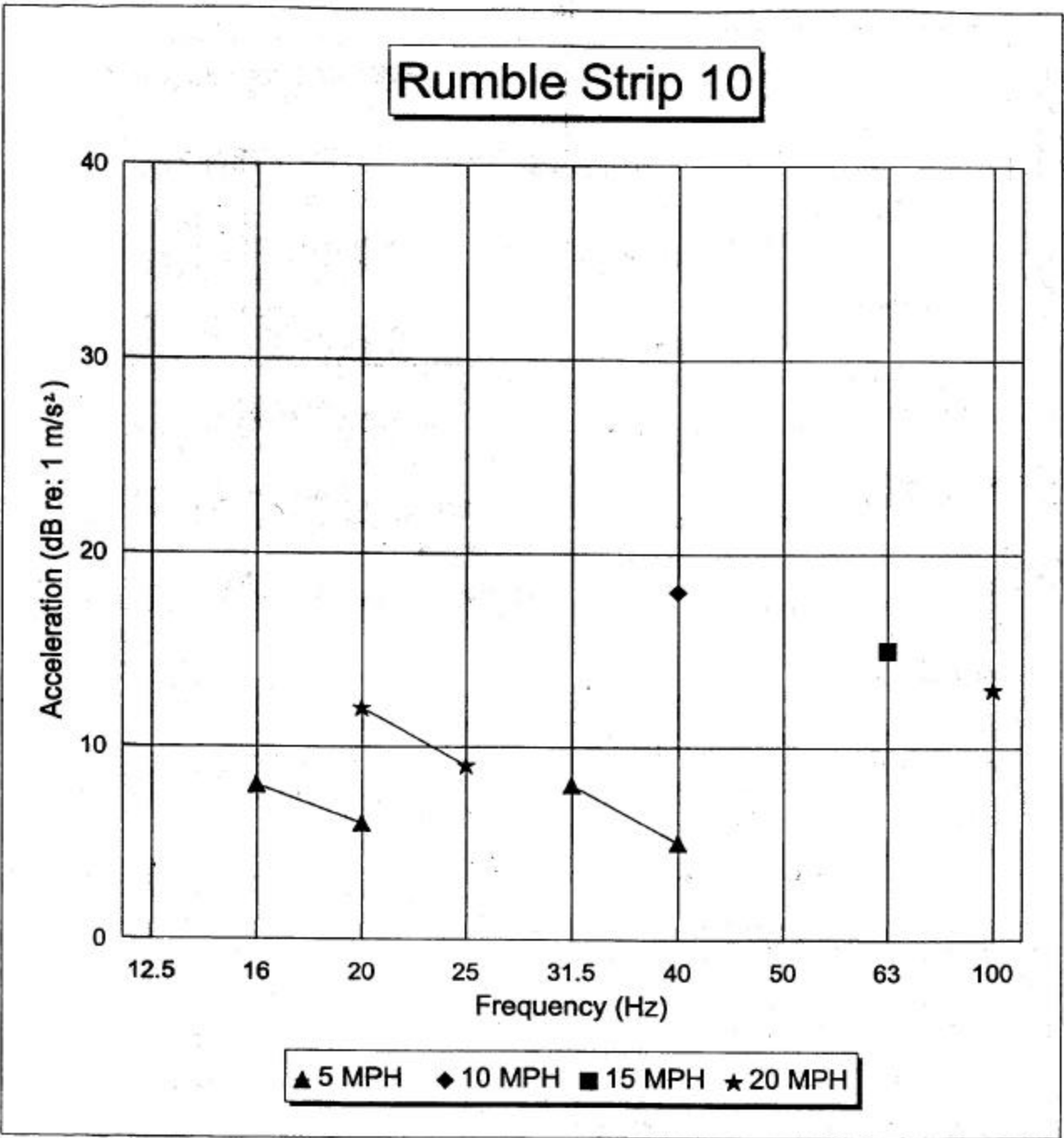

Figure D-14.

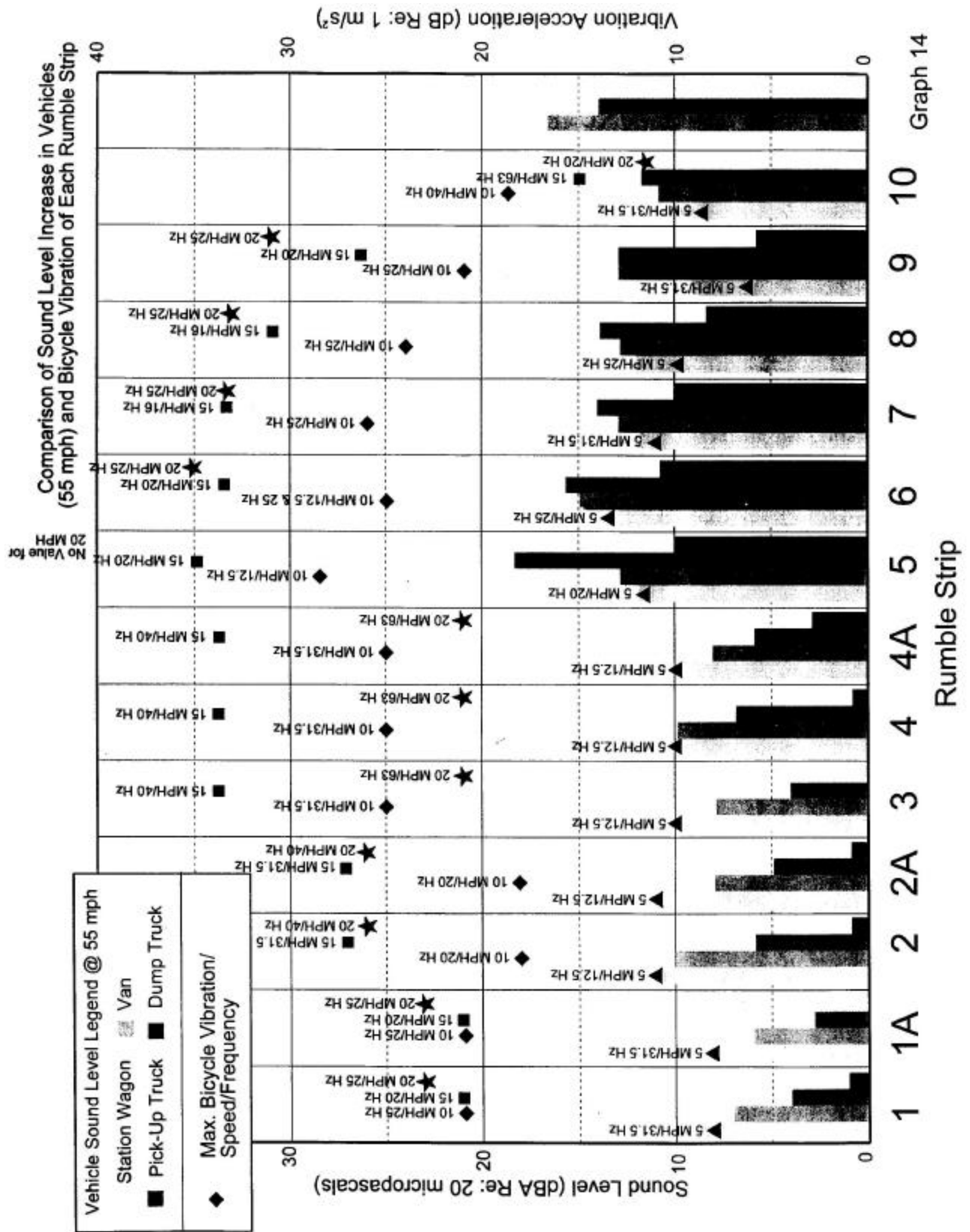

Figure D-15.

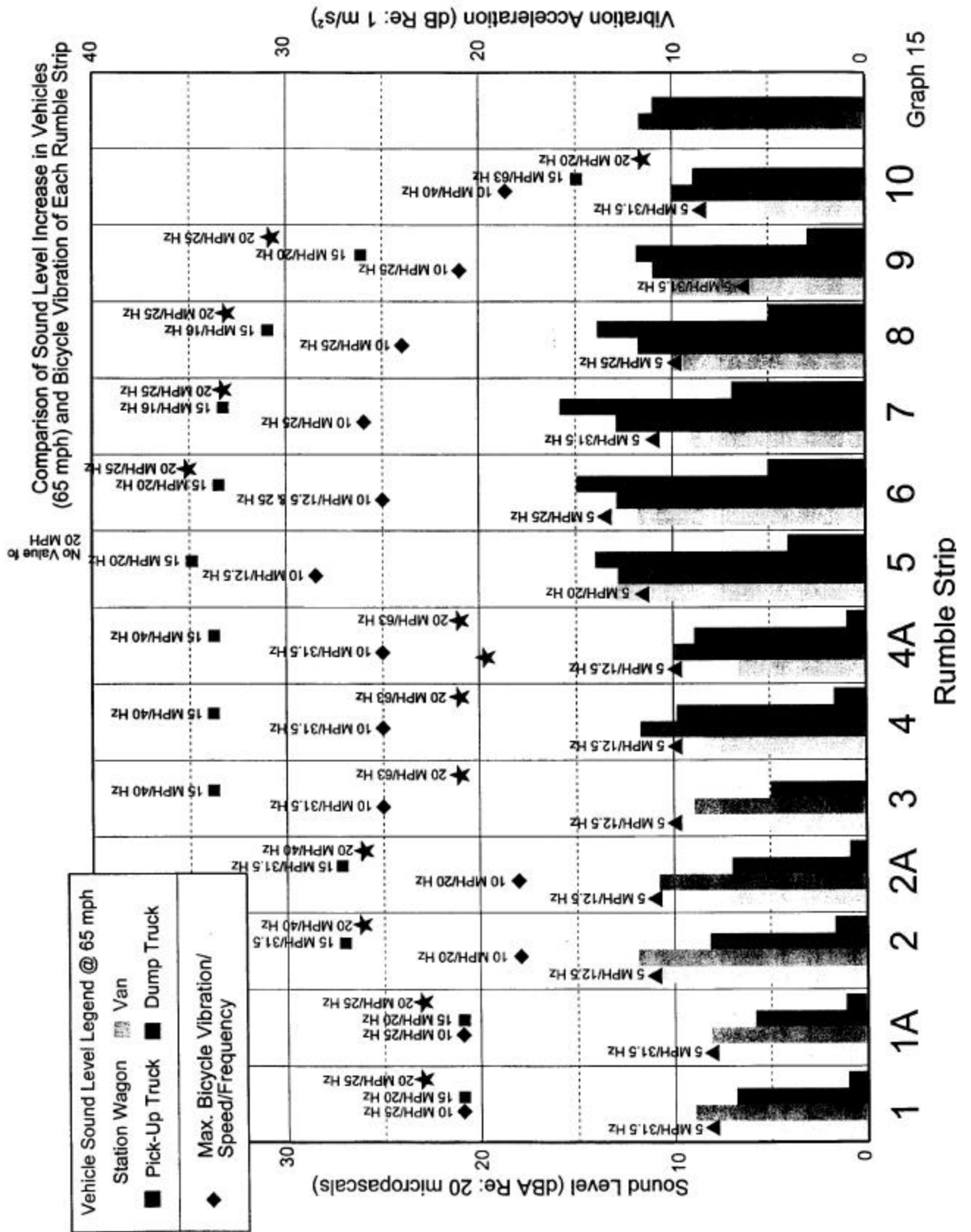

Figure D-16.

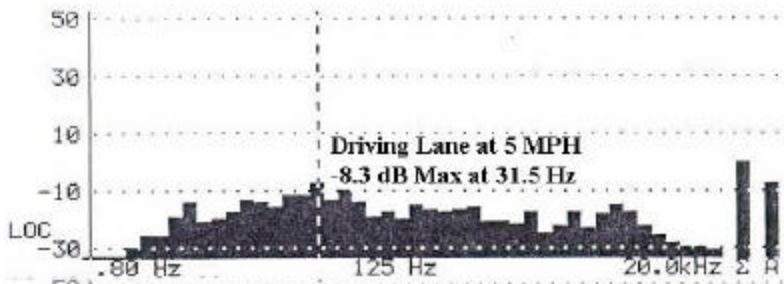

Figure D-17.

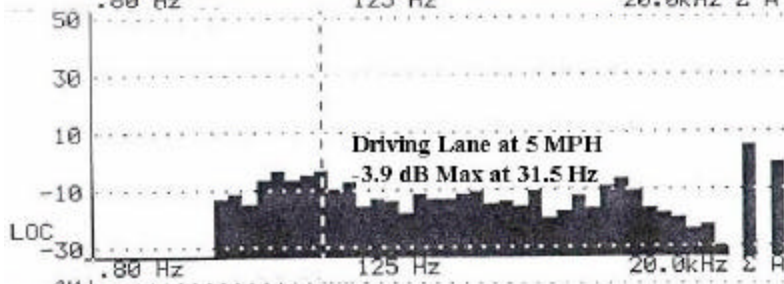

Figure D-18.

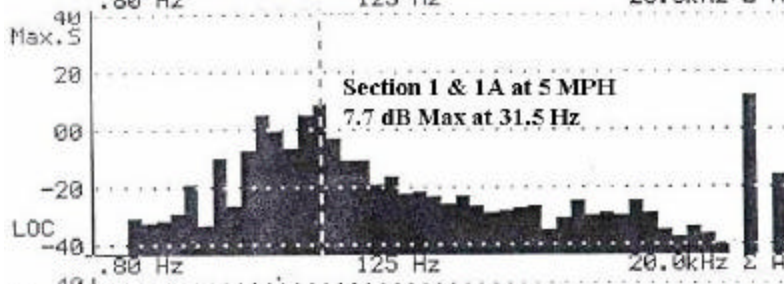

Figure D-19.

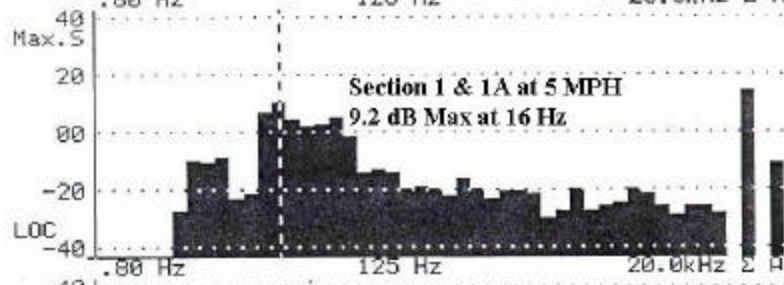

Figure D-20.

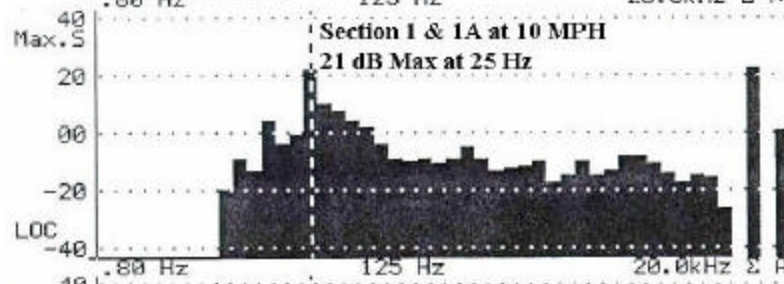

Figure D-21.

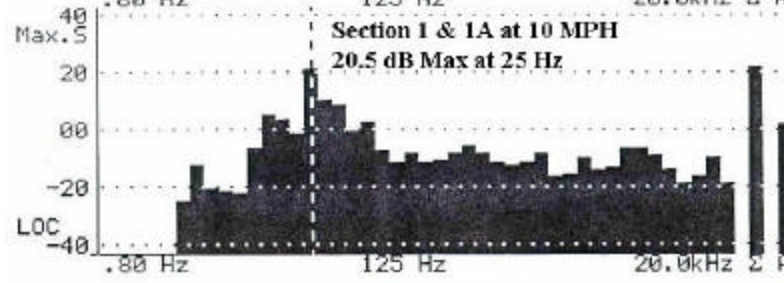

Figure D-22.

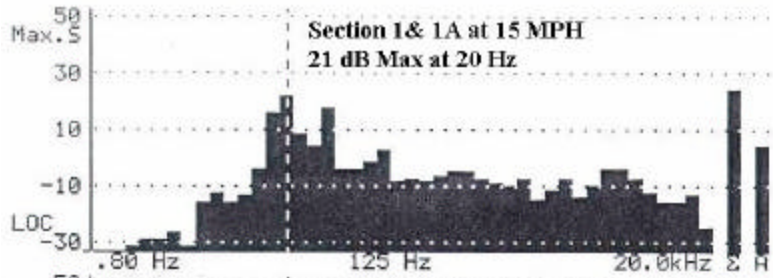

Figure D-23.

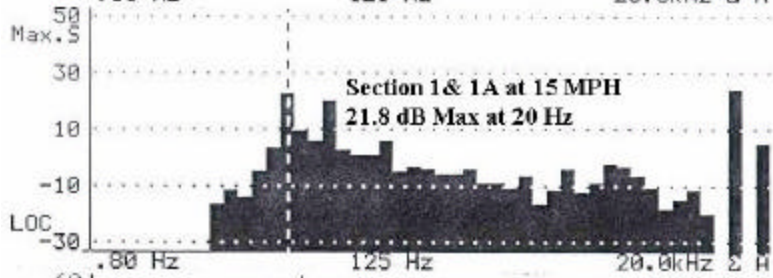

Figure D-24.

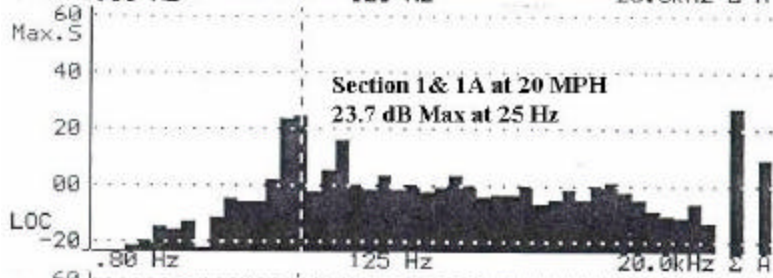

Figure D-25.

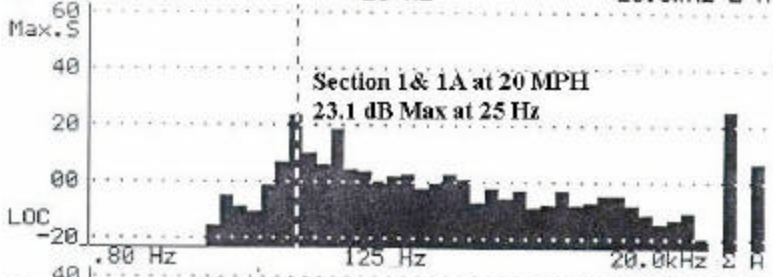

Figure D-26.

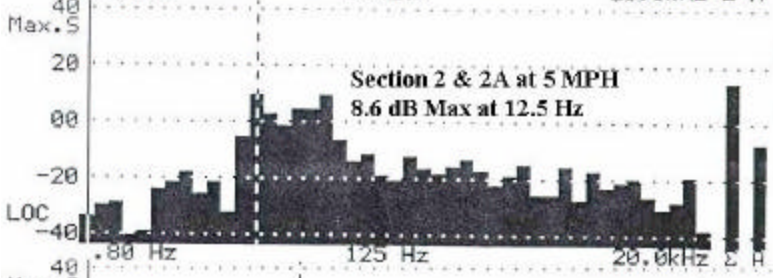

Figure D-27.



Figure D-28.

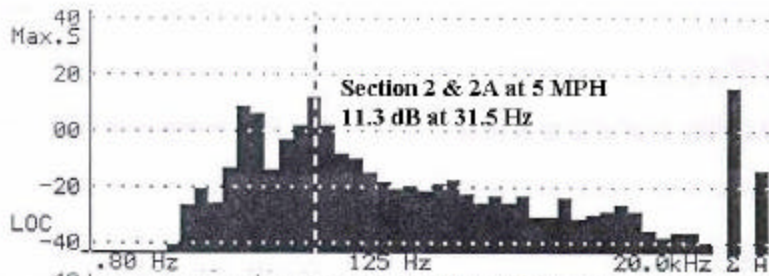

Figure D-29.

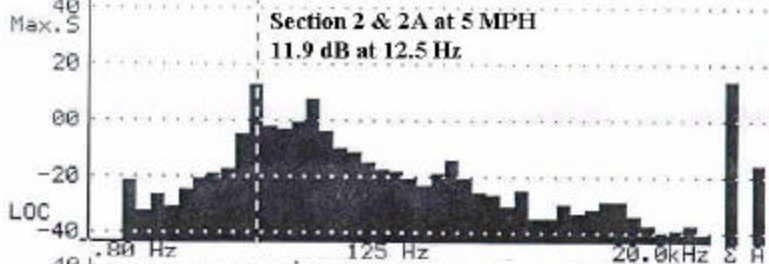

Figure D-30.

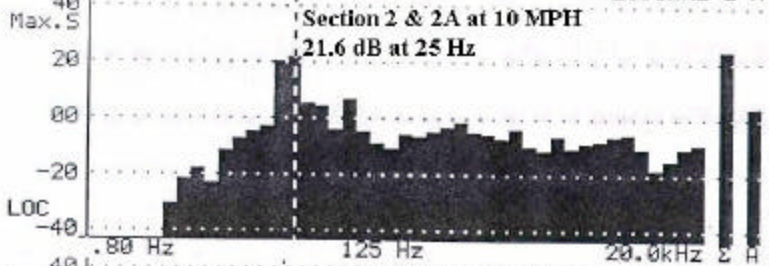

Figure D-31.

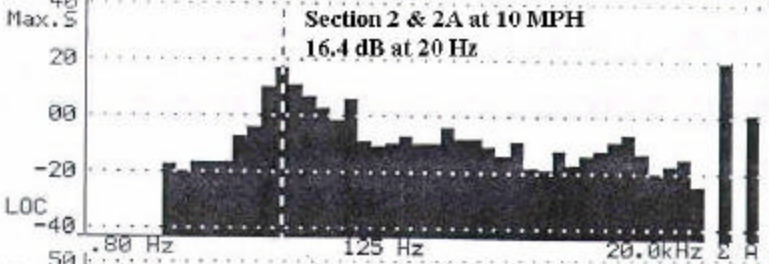

Figure D-32.

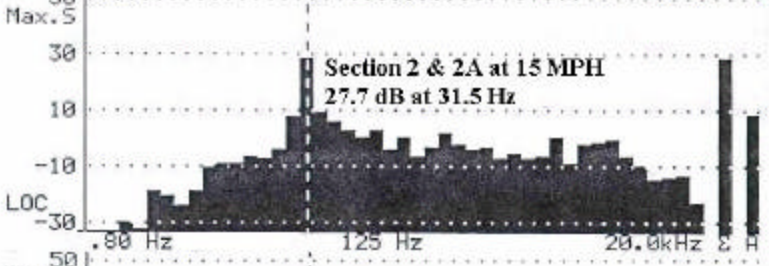

Figure D-33.

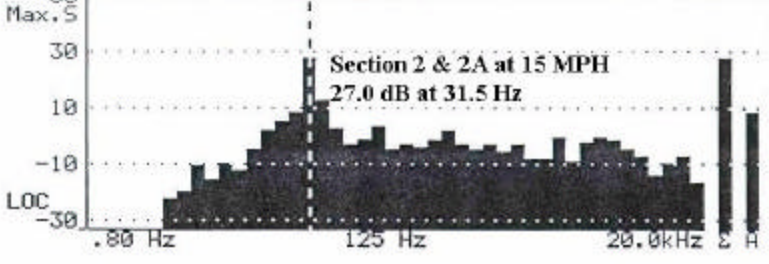

Figure D-34.

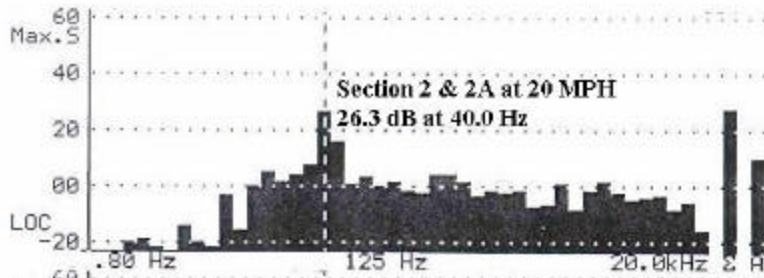

Figure D-35.

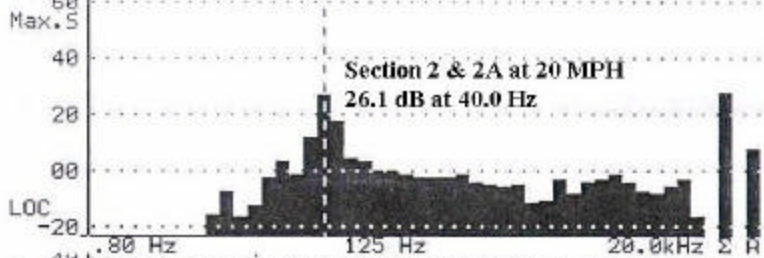

Figure D-36.

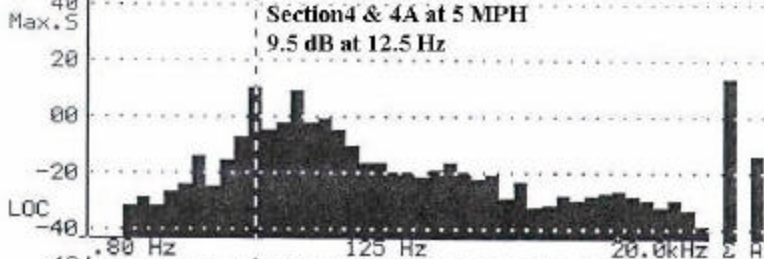

Figure D-37.

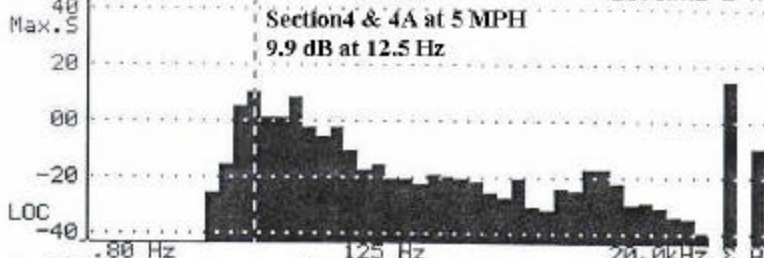

Figure D-358.

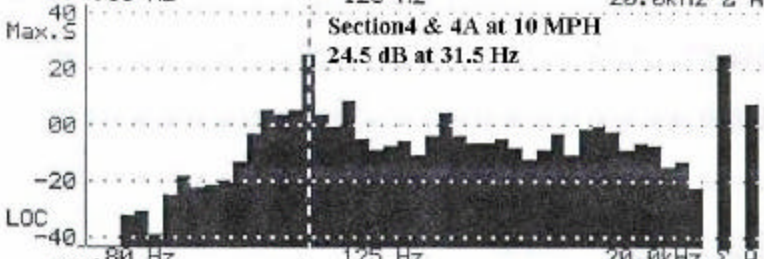

Figure D-39.

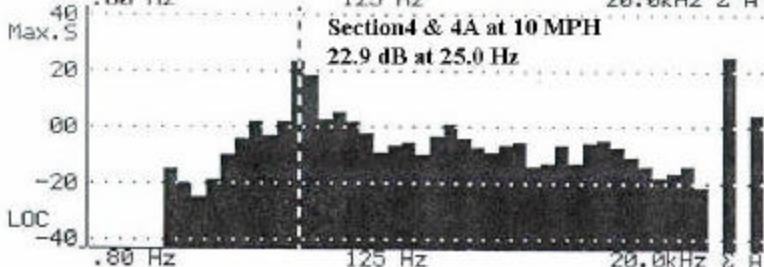

Figure D-40.

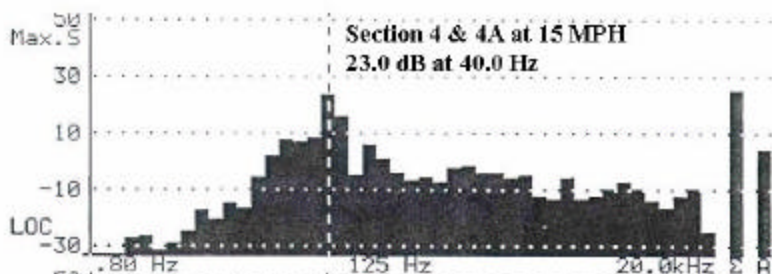

Figure D-41.

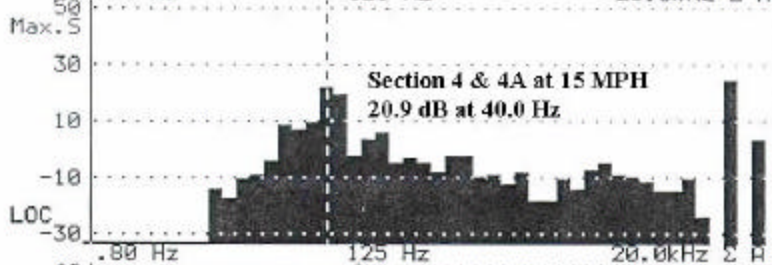

Figure D-42.

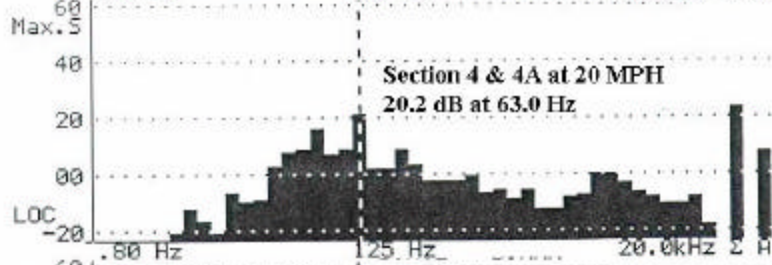

Figure D-43.

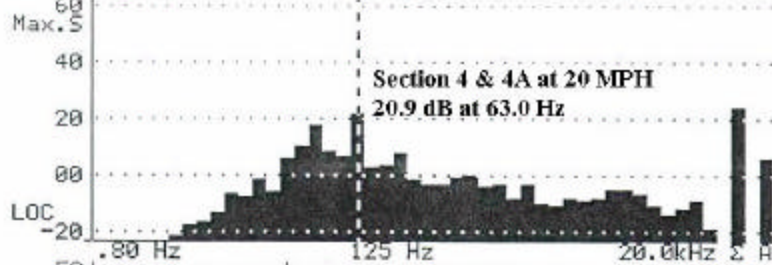

Figure D-44.

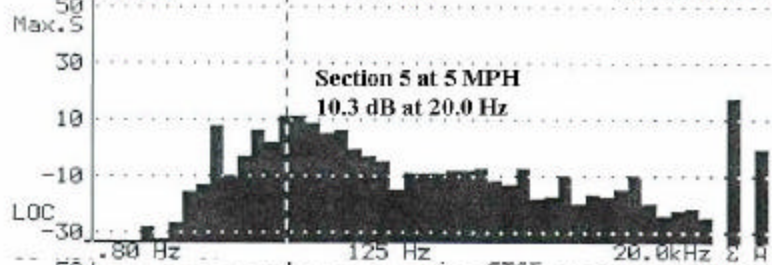

Figure D-45.

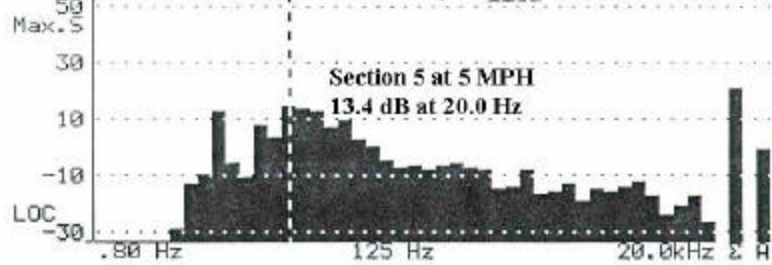

Figure D-46.

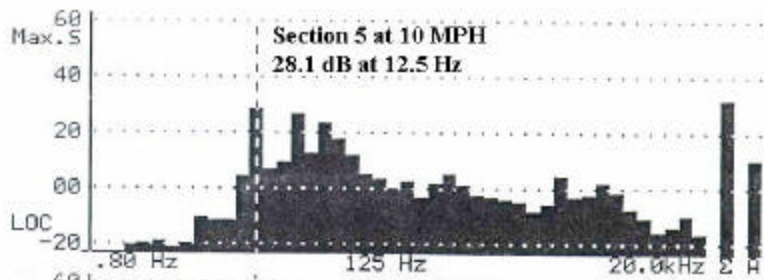

Figure D-47.

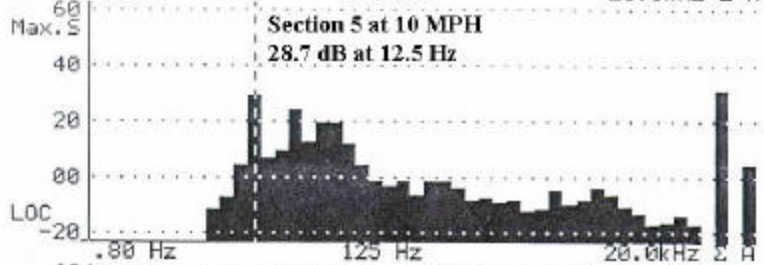

Figure D-48.

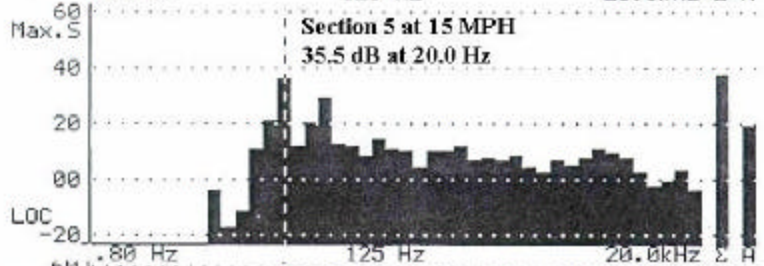

Figure D-49.

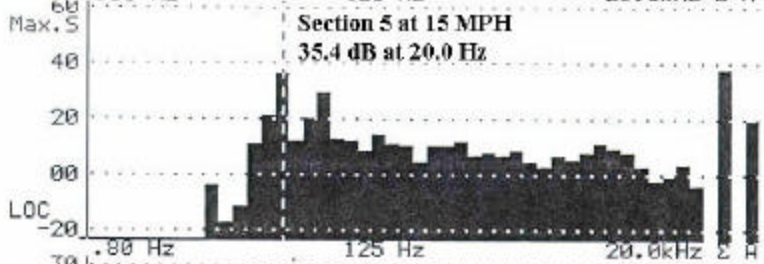

Figure D-50.

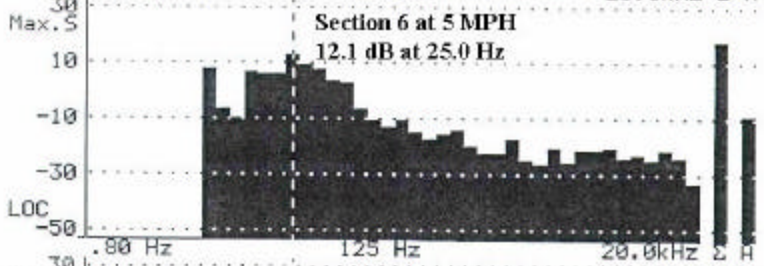

Figure D-51.

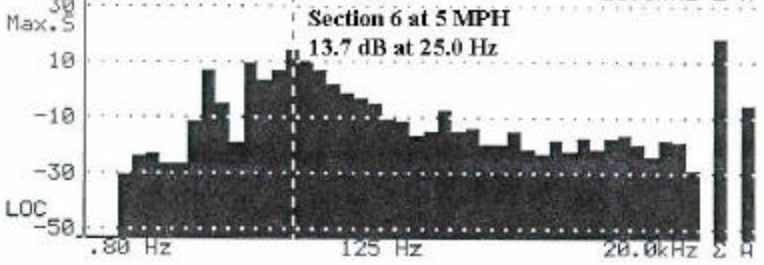

Figure D-52.

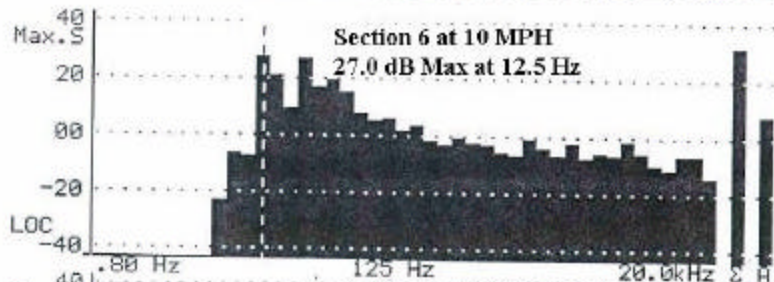

Figure D-53.

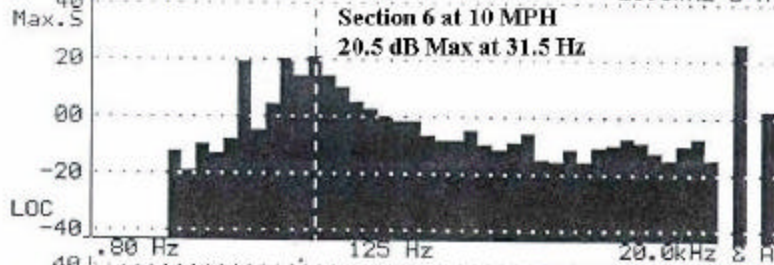

Figure D-54.

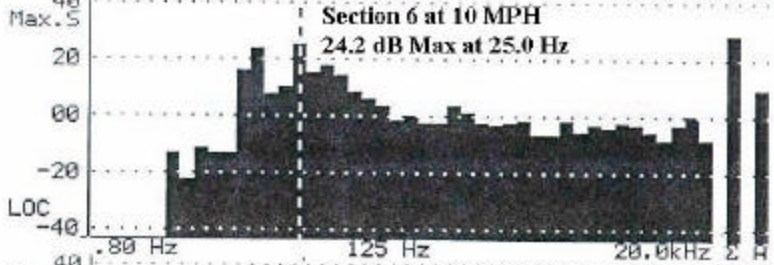

Figure D-55.

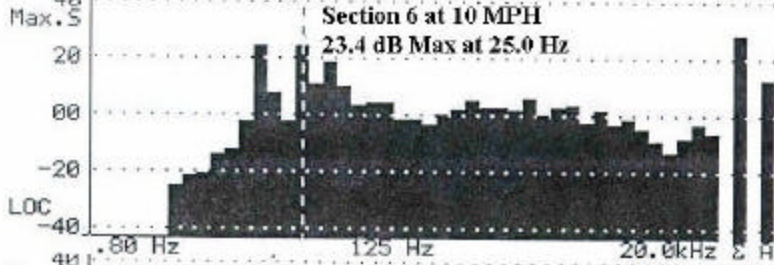

Figure D-53.

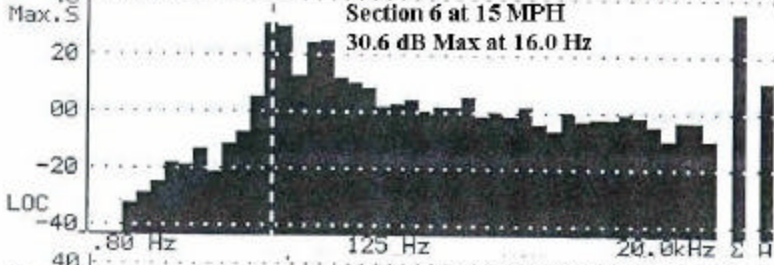

Figure D-57.

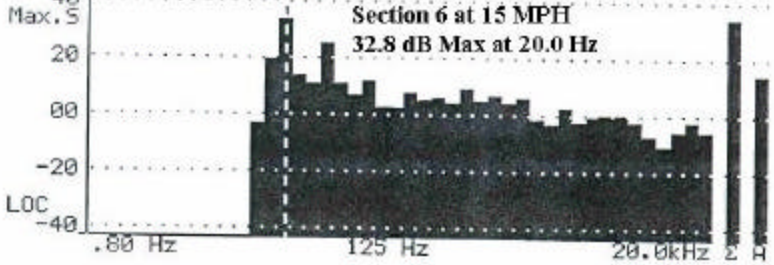

Figure D-58.

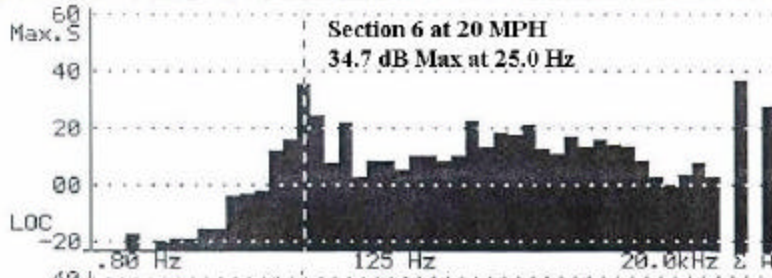

Figure D-59.

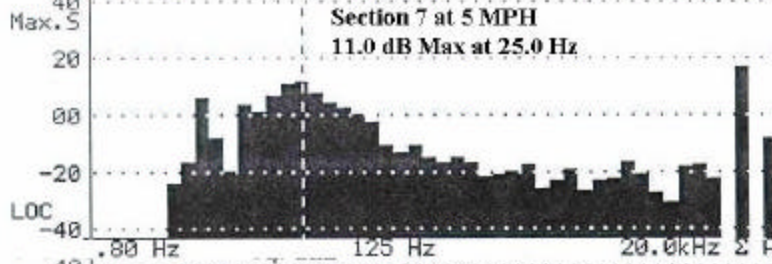

Figure D-60.

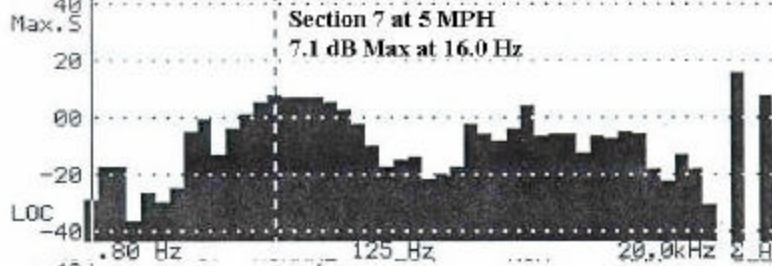

Figure D-61.

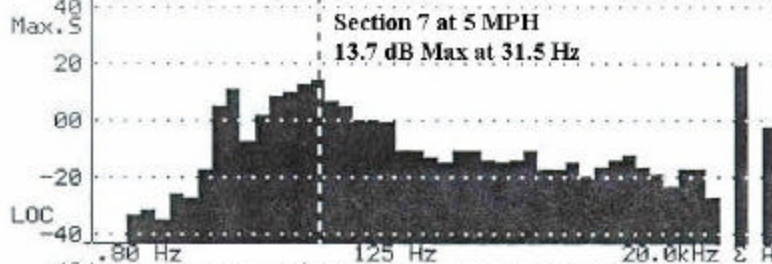

Figure D-62.

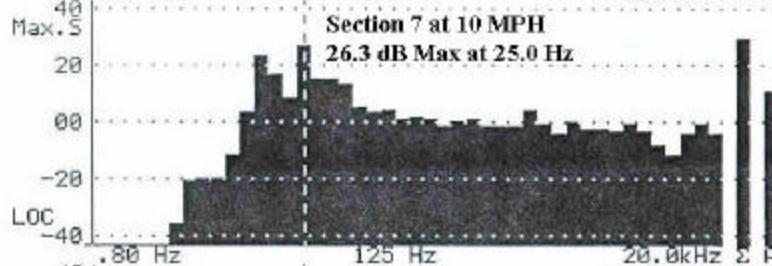

Figure D-63.

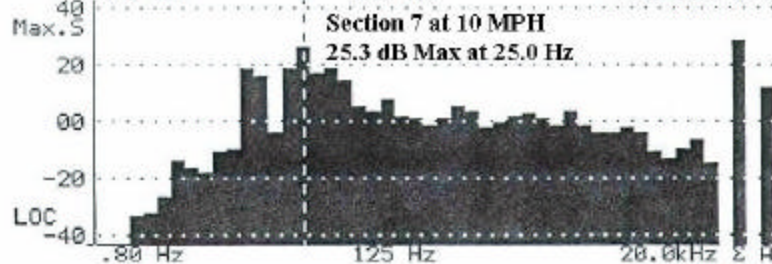

Figure D-64.

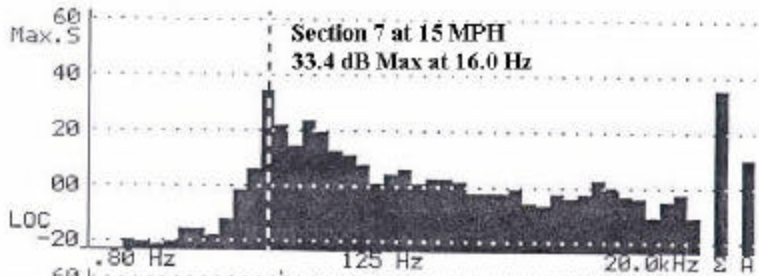

Figure D-65.

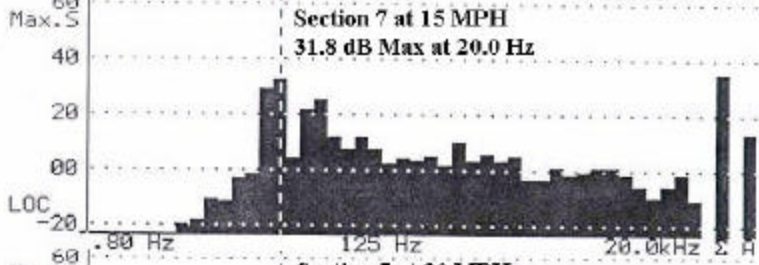

Figure D-66.

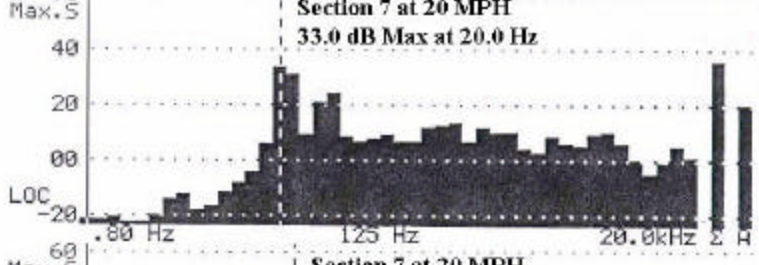

Figure D-67.

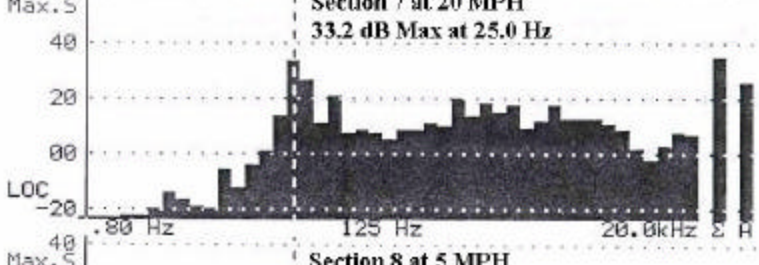

Figure D-68.

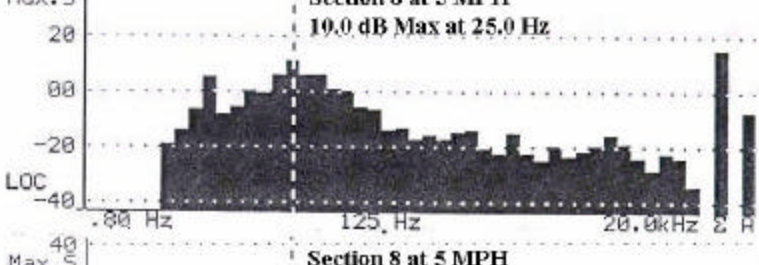

Figure D-69.

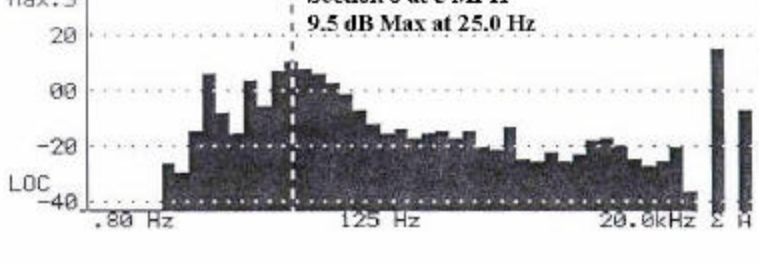

Figure D-70.

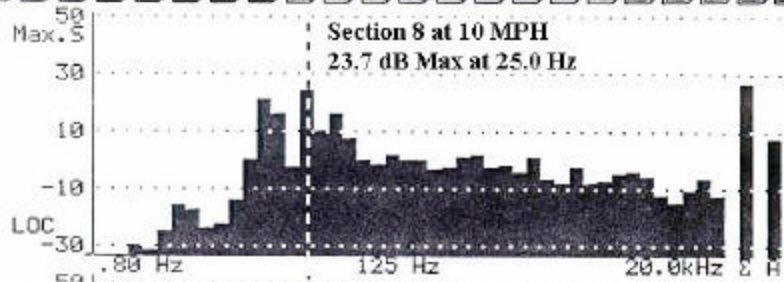

Figure D-71.

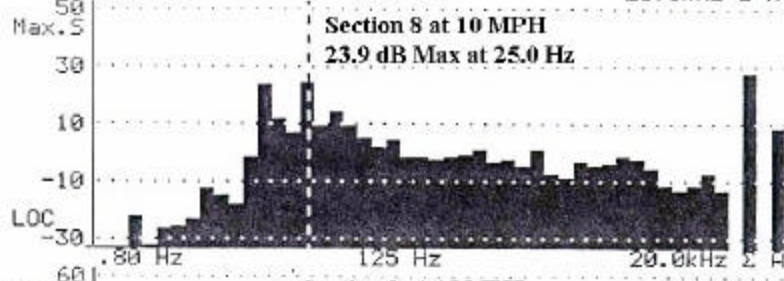

Figure D-72.

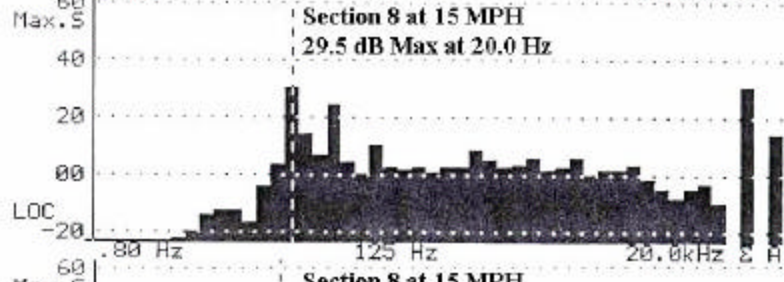

Figure D-73.

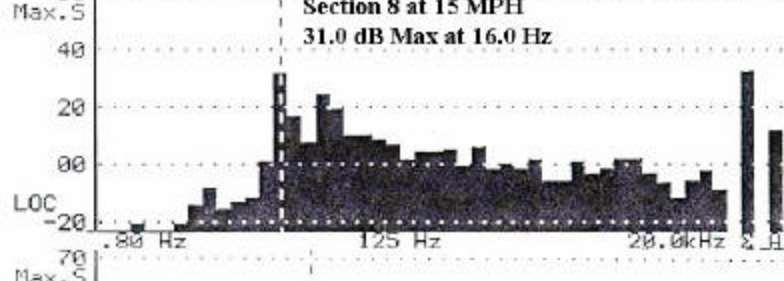

Figure D-74.

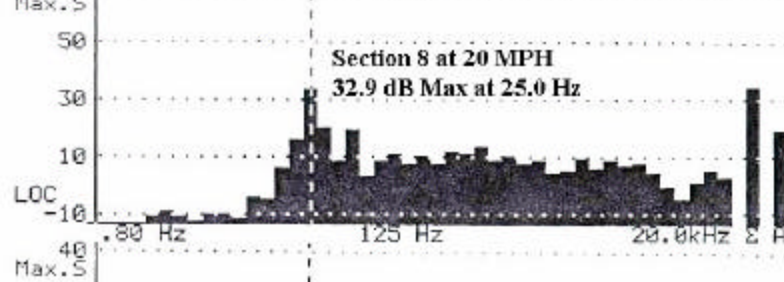

Figure D-75.

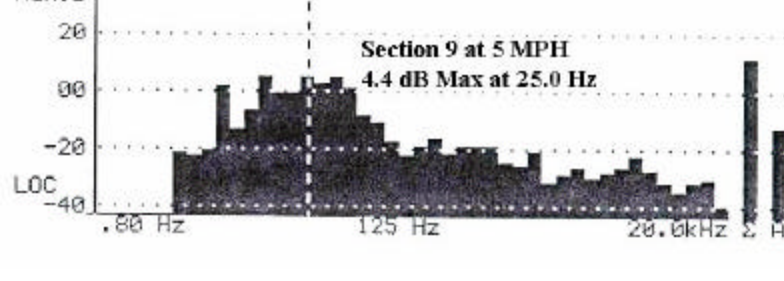

Figure D-76.

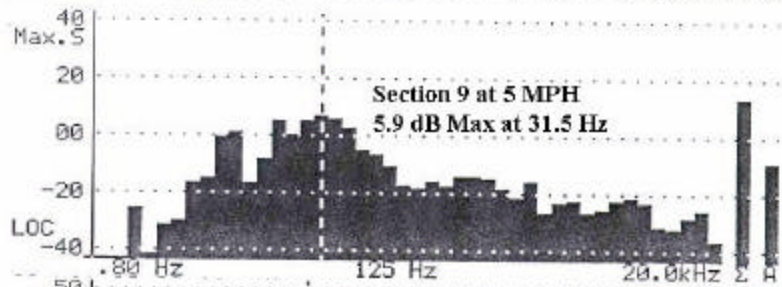

Figure D-77.

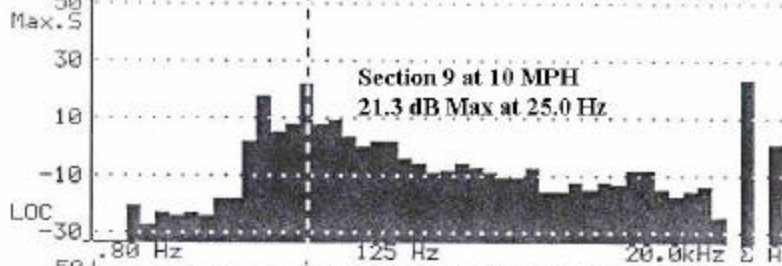

Figure D-78.

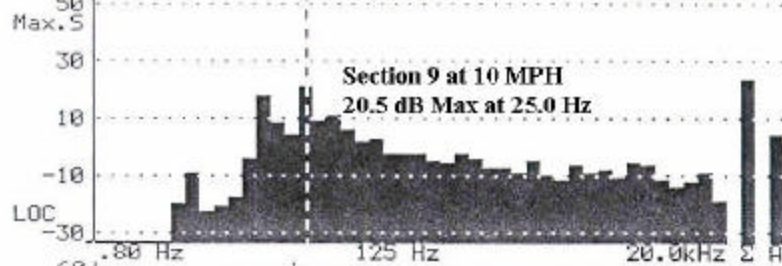

Figure D-79.

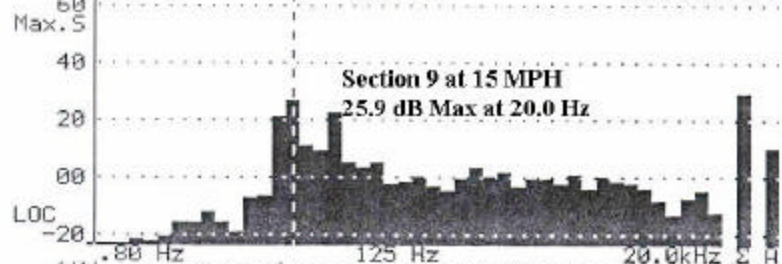

Figure D-80.

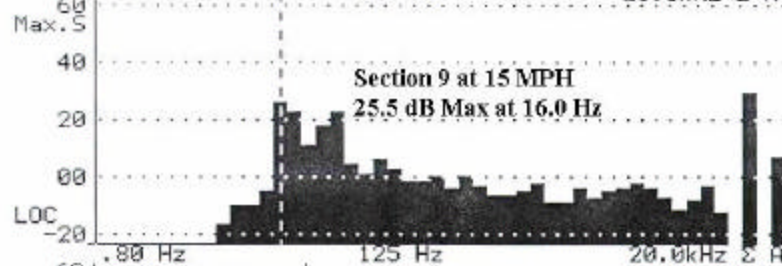

Figure D-81.

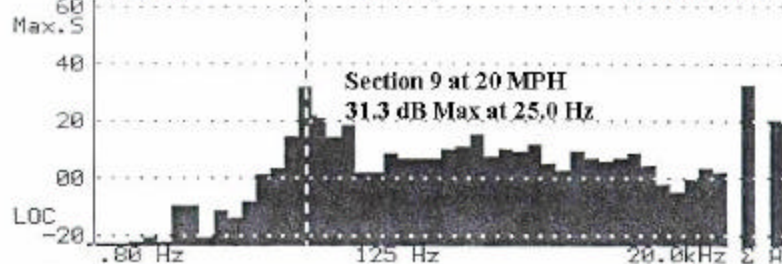

Figure D-82.

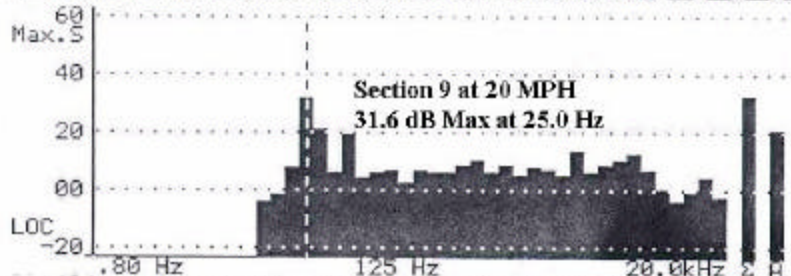

Figure D-83.

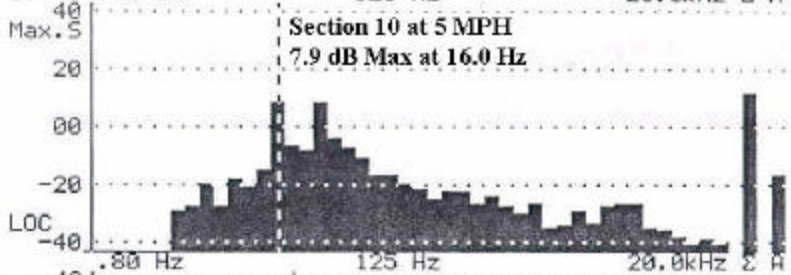

Figure D-84.

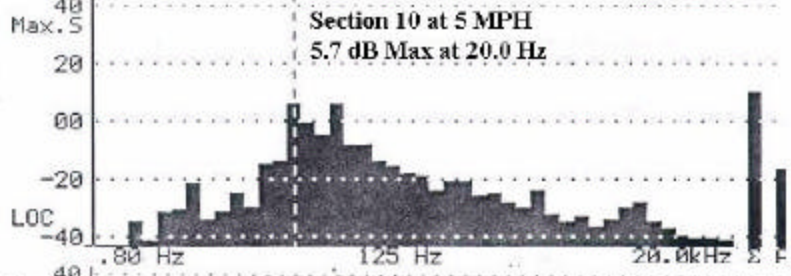

Figure D-85.

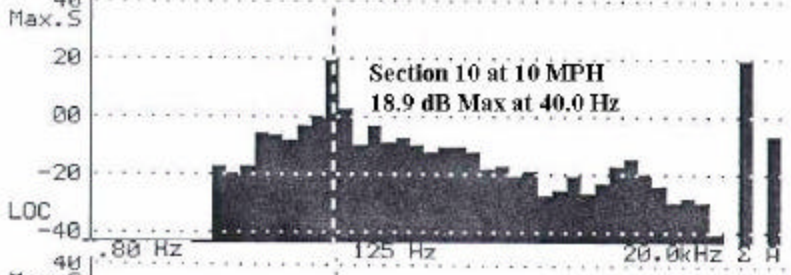

Figure D-86.

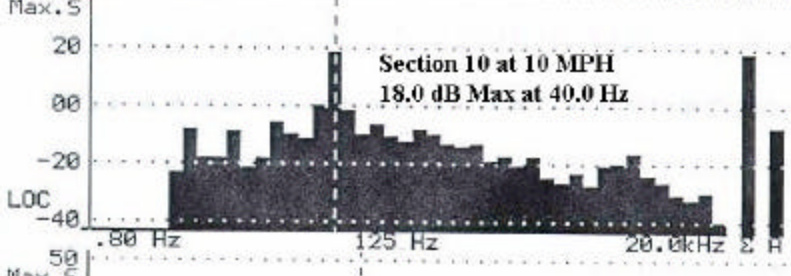

Figure D-87.

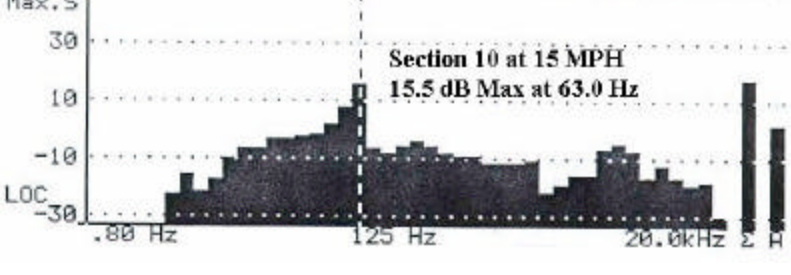

Figure D-88.

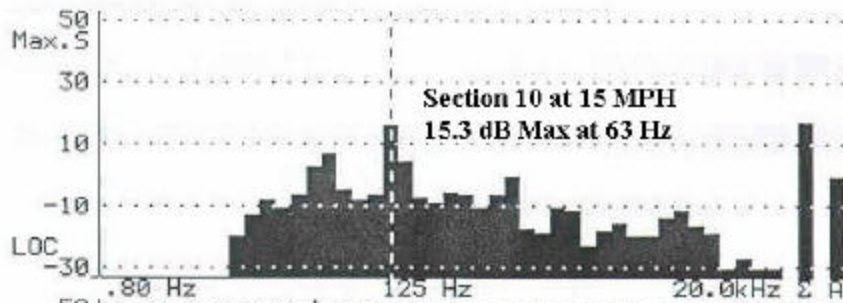

Figure D-89.

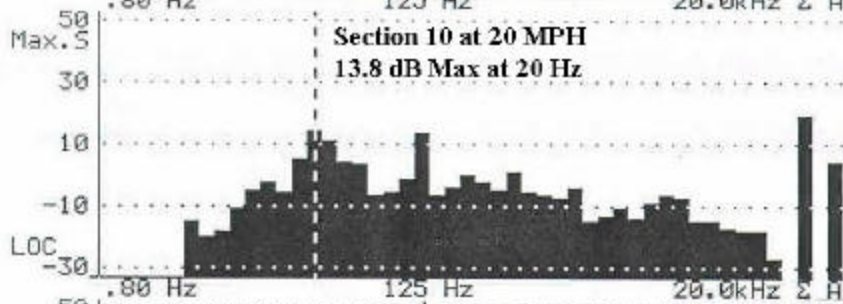

Figure D-90.

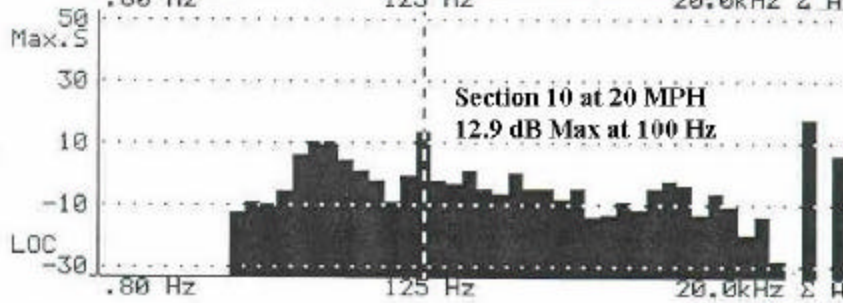

Figure D-92.

Comparison of Sound Level Increase and Vibration in a Motor Vehicle

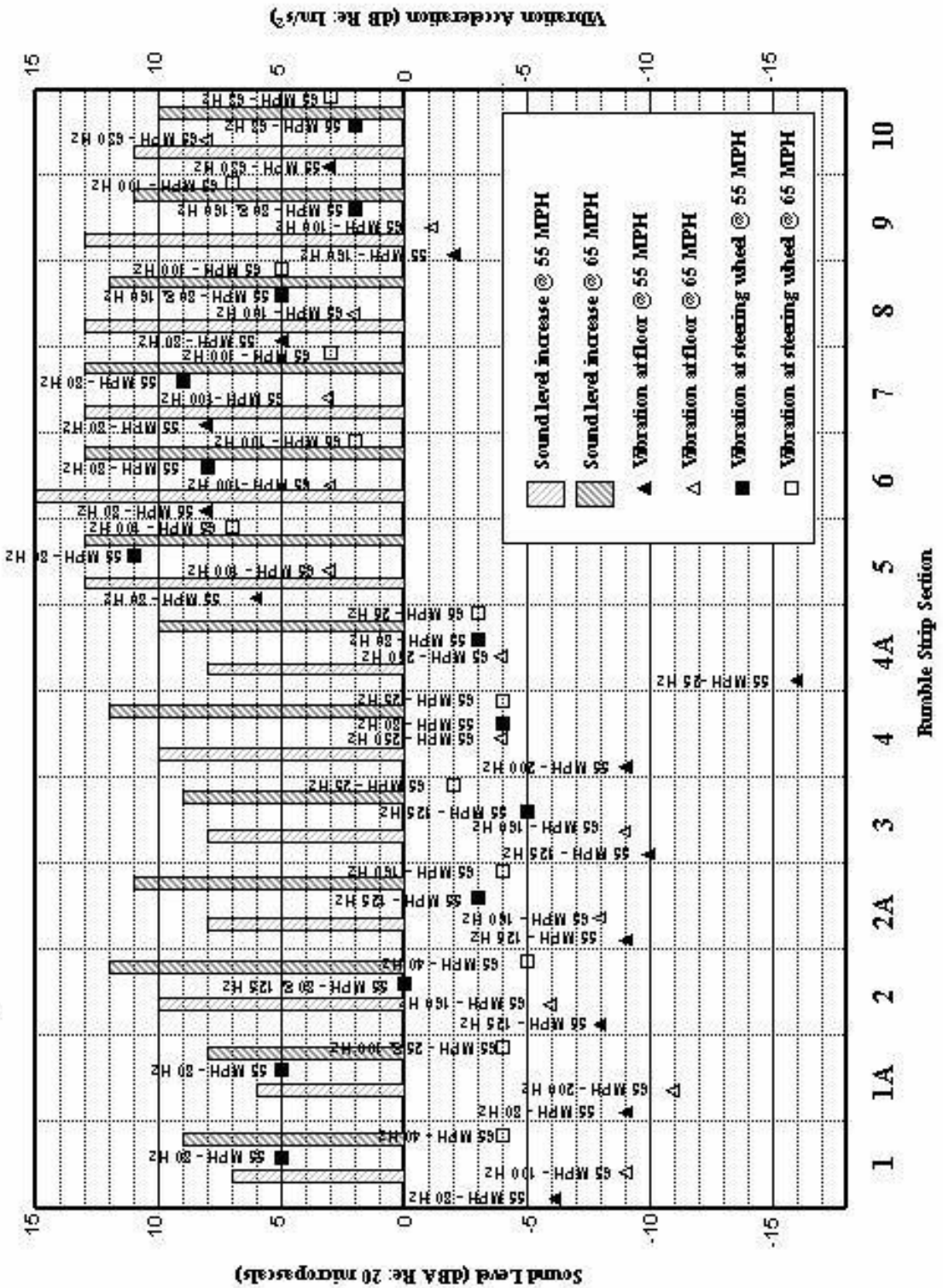

Figure 93.