

Notice of Determination

Appendix D

To:

[X] Office of Planning and Research
U.S. Mail: P.O. Box 3044 Sacramento, CA 95812-3044
Street Address: 1400 Tenth St., Rm 113 Sacramento, CA 95814

[X] County Clerk
County of: San Bernardino
Address: 222 W. Hospitality Lane, 1st Floor San Bernardino, CA 92415-0022

From:

Public Agency: San Bernardino County Transportation Authority
Address: 1170 W. 3rd Street, 2nd Floor San Bernardino, CA 92410
Contact: Andres Ramirez
Phone: (909) 884-8276

Lead Agency (if different from above):
Address:
Contact:
Phone:

SUBJECT: Filing of Notice of Determination in compliance with Section 21108 or 21152 of the Public Resources Code.

State Clearinghouse Number (if submitted to State Clearinghouse): 2012041012

Project Title: Redlands Passenger Rail Project (RPRP)

Project Applicant: San Bernardino County Transportation Authority (SBCTA)

Project Location (include county): City (and County) of San Bernardino, Santa Ana River, Mission Zanja Channel

Project Description:

RPRP is an approximately nine mile corridor extending east from the City of San Bernardino to the City of Redlands and includes local and express train service. SBCTA certified a Final EIR for the project in March of 2015. Following additional engineering during final design, SBCTA is proposing several refinements to the project at Bridge 3.4 and along portions of Mission Zanja Channel (MZC). These refinements include, but are not limited to, the incorporation of a bike trail at Bridge 3.4 and expanded channel improvements along the western bank, a reduction in the number of drainage connections and related bank improvements along the MZC, and capacity improvements to the MZC.

This is to advise that the San Bernardino County Transportation Authority has approved the above (X) Lead Agency or () Responsible Agency

described project on (date) and has made the following determinations regarding the above described project.

- 1. The project (X) will () will not have a significant effect on the environment.
2. (X) An Environmental Impact Report was prepared for this project pursuant to the provisions of CEQA. () A Negative Declaration was prepared for this project pursuant to the provisions of CEQA.
3. Mitigation measures (X) were () were not made a condition of the approval of the project.
4. A mitigation reporting or monitoring plan (X) was () was not adopted for this project.
5. A statement of Overriding Considerations (X) was () was not adopted for this project.
6. Findings (X) were () were not made pursuant to the provisions of CEQA.

This is to certify that the final EIR with comments and responses and record of project approval, or the negative Declaration, is available to the General Public at: 1170 W. 3rd Street, 2nd Floor, San Bernardino, CA 92410

Signature (Public Agency): [Signature] Title: Director of Transit & Rail

Date: 10/12/17 Date Received for filing at OPR:

Authority cited: Sections 21083, Public Resources Code. Reference Section 21000-21174, Public Resources Code.

DATE FILED & POSTED Posted On: 10-12-17 Revised 2017

Removed On: 11-29-17

Receipt No: 316-101217-013

Governor's Office of Planning & Research

STATE CLEARINGHOUSE



State of California - Department of Fish and Wildlife
2017 ENVIRONMENTAL FILING FEE CASH RECEIPT
 DFW 753.5a (Rev. 01/01/17) Previously DFG 753.5a

Print **StartOver** **Finalize&Email**

RECEIPT NUMBER:
 36 — 101217 — 613
 STATE CLEARINGHOUSE NUMBER (if applicable)

SEE INSTRUCTIONS ON REVERSE. TYPE OR PRINT CLEARLY.

LEAD AGENCY San Bernardino County Transportation Authority	LEAD AGENCY EMAIL	DATE 101217
COUNTY/STATE AGENCY OF FILING San Bernardino	DOCUMENT NUMBER	

PROJECT TITLE Redlands Passenger Rail Project (RPRP)			
PROJECT APPLICANT NAME San Bernardino County Transportation Authority	PROJECT APPLICANT EMAIL	PHONE NUMBER (909) 884-8276	
PROJECT APPLICANT ADDRESS 1170 West 3rd Street, 2nd Floor	CITY San Bernardino	STATE CA	ZIP CODE 92410

PROJECT APPLICANT (Check appropriate box)

Local Public Agency
 School District
 Other Special District
 State Agency
 Private Entity

CHECK APPLICABLE FEES:

<input checked="" type="checkbox"/> Environmental Impact Report (EIR)	\$3,078.25	\$	3,078.25
<input type="checkbox"/> Mitigated/Negative Declaration (MND)(ND)	\$2,216.25	\$	0.00
<input type="checkbox"/> Certified Regulatory Program document (CRP)	\$1,046.50	\$	0.00

- Exempt from fee
 Notice of Exemption (attach)
 CDFW No Effect Determination (attach)
 Fee previously paid (attach previously issued cash receipt copy)

<input type="checkbox"/> Water Right Application or Petition Fee (State Water Resources Control Board only)	\$850.00	\$	0.00
<input checked="" type="checkbox"/> County documentary handling fee		\$	50.00
<input type="checkbox"/> Other		\$	

PAYMENT METHOD:

- Cash
 Credit
 Check
 Other

TOTAL RECEIVED \$ 3,128.25

SIGNATURE 	AGENCY OF FILING PRINTED NAME AND TITLE Mariela Barrera, Deputy Clerk
---------------	--

Governor's Office of Planning & Research

OCT 16 2017

STATE CLEARINGHOUSE

SAN BERNARDINO COUNTY TRANSPORTATION AUTHORITY

OCT 16 2017

STATE CLEARINGHOUSE

INVOICE NUMBER	DATE	P. O. NUMBER	DESCRIPTION	DISCOUNT	AMOUNT
EIR 10/10/17	10/10/2017		ENVIRONMENTAL IMPACT REPORT NOTICE OF DETERMINATION	0.00	3,078.25
Notice Fee 10/10/17	10/10/2017			0.00	50.00
					3,128.25

CLERK OF THE
BOARD OF SUPERVISORS

2017 OCT 12 PM 3:04

COUNTY OF SAN BERNARDINO
CALIFORNIA

PLEASE DETACH BEFORE DEPOSITING



Addendum No. 4 to the EIR

San Bernardino County Transportation Authority |
Redlands Passenger Rail Project

SCH No. 2012041012

August 2017



This page is intentionally blank.



Contents

1	Purpose and Background.....	1
1.1	Applicability and Use of an Addendum	1
1.2	Format of This Addendum.....	1
1.3	Summary of Findings	2
1.4	Lead Agency and Discretionary Approvals	2
2	Description of Refined Project.....	3
2.1	Introduction.....	3
2.2	Project Location.....	3
2.3	Refined Project.....	3
2.4	Status of Approved Project.....	8
3	Environmental Analysis Checklist	9
4	Mitigation Measures	37

Tables

Table 1.	Comparison of Approved Project (2015 EIR) and Proposed Design Refinements (August 2017)	7
Table 2.	Environmental Analysis Checklist Summary	9
Table 3.	Aesthetics.....	11
Table 4.	Agricultural Resources	12
Table 5.	Air Quality.....	13
Table 6.	Biological Resources.....	14
Table 7.	Cultural Resources.....	16
Table 8.	Geology and Soils	17
Table 9.	Greenhouse Gas Emissions	19
Table 10.	Hazards and Hazardous Materials.....	20
Table 11.	Hydrology and Water Quality	22
Table 12.	Land Use and Planning.....	25
Table 13.	Mineral Resources	26
Table 14.	Noise	27
Table 15.	Population and Housing	28
Table 16.	Public Services.....	29
Table 17.	Recreation.....	30
Table 18.	Transportation/Traffic.....	31
Table 19.	Utilities and Service Systems.....	33
Table 20.	Mandatory Findings	35

Attachments

Attachment A. Figures

Attachment B. Biology Letter Report

Attachment C: H&H Analysis (Bridge 3.4)

Attachment D. Mitigation Monitoring and Reporting Program



1 Purpose and Background

On March 4, 2015, the San Bernardino Associated Governments (now referred to as the San Bernardino County Transportation Authority [SBCTA]) certified the Final Environmental Impact Report (EIR) for the Redlands Passenger Rail Project (RPRP or Project) (State Clearinghouse No. 2012041012). The approved Project will provide passenger rail service along an approximately 9-mile corridor extending east from the City of San Bernardino to the City of Redlands. As approved, the Project would include local and express train service via five station stops; two in the City of San Bernardino and three in the City of Redlands.

Following additional coordination with local stakeholders, including the San Bernardino County Flood Control District (Flood Control District) and completion of the Project's 90 percent design, SBCTA is proposing several design refinements to the approved Project. In general, these design refinements are in response to additional hydraulic modeling of the Mission Zanja Channel (MZC) and Santa Ana River (SAR) as part of the approved Project's final design.

SBCTA has prepared this addendum to the EIR for RPRP (State Clearinghouse No. 2012041012) to address the potential environmental impacts associated with the proposed design refinements (refined Project). This addendum is prepared in accordance with the California Environmental Quality Act (CEQA) (Public Resources Code § 21000, et. seq.) and the CEQA Guidelines (California Administrative Code, Title 14, § 15000, et. seq.).

1.1 Applicability and Use of an Addendum

SBCTA's intent through preparation of this addendum is to demonstrate whether the previously adopted CEQA document (i.e., Final EIR), including mitigation measures, are still both adequate and valid for the refined Project. Pursuant to Public Resources Code Section 21166 and the CEQA Guidelines, Sections 15162 through 15164, SBCTA as the lead agency is required to conduct a fact-based evaluation of proposed changes to a Project to determine whether supplemental environmental documentation is required. CEQA Guidelines, Section 15162(a), states that when an EIR is certified for a Project, no Subsequent or Supplemental EIR shall be prepared for that Project unless the lead agency determines that one of the conditions described in Section 15162(a) has occurred.

Based on the analysis set forth in this addendum, SBCTA has concluded that the refined Project does not trigger any of these circumstances, and that an addendum is the appropriate form of documentation to comply with CEQA.

1.2 Format of This Addendum

The previously certified EIR serves as the initial environmental compliance document for the approved Project, and this addendum provides additional clarification and information about the refined Project. This addendum should be read together with the full text of the previously certified EIR (2015). All mitigation measures applicable from the EIR would be

applicable to the refined Project and, therefore, are incorporated by reference into this addendum.

This addendum relies on the use of an Environmental Checklist Form (Checklist), as suggested in Section 15063(d)(3) of the CEQA Guidelines.

1.3 Summary of Findings

Based upon the Checklist prepared for the refined Project and supporting responses (Section 3), implementation of the refined Project would not result in substantial changes requiring major revisions to the EIR. Further, the refined Project would not result in any environmental impacts that have not already been addressed in the EIR, and no new mitigation measures are required for the refined Project. Since only minor additions and clarifications are required to the EIR, and none of the conditions described in Public Resources Code Section 21166 or CEQA Guideline Section 15162 has occurred, SBCTA finds that the preparation of an addendum to the EIR is appropriate and consistent with Public Resources Code Section 21166 and CEQA Guideline Section 15162.

1.4 Lead Agency and Discretionary Approvals

This addendum and the previously certified EIR are intended to serve as the environmental documentation for the design changes being proposed under the refined Project. The SBCTA is the lead agency under CEQA and maintains authority to approve the addendum.

2 Description of Refined Project

2.1 Introduction

The approved Project proposes passenger rail operations along an approximately 9-mile corridor extending east from the City of San Bernardino to the City of Redlands. The approved Project would overlay local and express train service using a diesel multiple unit (DMU) and standard Metrolink trainset, respectively. Local service would occur via five station stops: E Street and Tippecanoe Avenue¹ located in the City of San Bernardino; and New York Street, Orange Street (Downtown Redlands) and University Street (University of Redlands) located in the City of Redlands. Metrolink express service would be limited to downtown Redlands and E Street. Components approved as part of the Project include replacement of the existing railroad tracks and ties, reconstruction or rehabilitation of existing bridge structures, and construction of station platforms and a train layover facility. The EIR also considered auxiliary improvements such as parking, at-grade roadway crossings, pedestrian access, and new and relocated utilities, including water, sewer, storm drain, power, gas, fiber optic, and telephone lines.

SBCTA staff is currently negotiating operations and maintenance agreements with Omnitrans and Metrolink to operate and maintain the Project. Omnitrans, as the San Bernardino Valley transit provider, will operate and maintain the DMUs and Metrolink, as the Southern California region commuter rail operator will provide maintenance-of-way and dispatching services of the Redlands Corridor. Revenue service is anticipated to begin in 2020.

2.2 Project Location

The refined Project encompasses the same general Study Area as described for the approved Project in Section 2.3 of the Final EIR, which extends along existing railroad ROW owned by SBCTA between the cities of San Bernardino and Redlands, San Bernardino County, California (see Attachment A, Figure 1). Section 2.3 of the EIR provides a detailed description of the Project's location and Study Area. The refinements considered in this addendum are generally contained between mileposts (MP) 3.4 and 6.75.

2.3 Refined Project

Subsequent to Project approval in 2015, SBCTA has advanced the Project's design to 90 percent. As part of the Project's final design, SBCTA is proposing several minor design refinements to the approved Project, as previously defined and analyzed in the Final EIR. The design refinements comprise a series of physical improvements proposed for installation (or removal) along the MZC and SAR and are derived from a combination

¹ SBCTA has considered the environmental effects of relocating the station stop at Waterman Avenue, as proposed in the Final EIR, to Tippecanoe Avenue. Addendum #1 to the EIR provides an assessment of the station relocation to Tippecanoe Avenue, as considered as part of the Preferred Alternative in the EIR.

of value engineering, the completion of risk workshops conducted in 2016 and 2017, and design coordination with the County Flood Control District.

Proposed Refinements: SBCTA is proposing three design refinements to the approved Project. Table 1 provides a summary of these refinements in relation to the improvements originally contemplated in the approved Project (and certified EIR). These refinements include the following as described further below.

Refinement No. 1: Bridge 3.4 - Santa Ana River (SAR) Crossing: SBCTA is proposing the construction of a single-track bridge² structure at MP 3.4 as previously considered in the approved Project and Final EIR. SBCTA has identified multiple refinements to the design for Bridge 3.4 to optimize constructability and address the results and recommendations from more recent hydraulic modeling and geotechnical investigation as required by MM GEO-1 in the adopted MMRP. Refinement 1 would include the following refinements to the design for Bridge 3.4:

- A. Revised Abutment and Pier Scour Protection: Following additional hydrologic/hydraulic (H&H) modeling and geotechnical investigation as part of the approved Project's final design, SBCTA has identified scour conditions and liquefiable soils at Bridge 3.4 that require the incorporation of revised ground improvement measures for the bridge piers and abutments. The 90 percent design reflects the incorporation of a soil slurry/cement within deeper excavations; capped with articulate concrete block (ACB) (see Figure 2 of Attachment A). These ground improvements would be required at both the west and east bridge abutments and would result in a widening of the channel to 380 feet (previously 365 feet).
- B. Bank Protection Improvements: Based on additional H&H modeling, additional channel improvements along the western bank are required to address the potential for meandering of the channel to the north of Bridge 3.4. SBCTA is proposing the use of a combination of ACB and vegetated riprap and/or revetment to stabilize the western bank; north and south of the bridge (see Figure 3 of Attachment). The proposed protection would support plant growth and propagation, including the placement of willows (*Salix* spp.) and other native understory plantings. These improvements would extend beyond the previously evaluated physical footprint at Bridge 3.4 (see Figure 3 of Attachment A).
- C. Incorporation of SAR Bike Trail: As required by Mitigation Measure (MM) PCS-1, SBCTA has coordinated with the County Department of Public Works regarding the placement of the SAR Trail across SBCTA's right-of-way (ROW). As proposed in the 90 percent design, the SAR trail would run along the eastern bank and underneath Bridge 3.4 near the seventh abutment (see Figure 4). ACB would be used on the bank above the trail and the trail surface with a protection wall composed of concrete placed below the trail. The County's Department of Public Works will be responsible for constructing the SAR Trail connections to the north and south of SBCTA's ROW.

² Addendum #2 to the EIR provides an assessment of the design refinement from a double to single track bridge structure.

Refinement No 2. – Mission Zanja Channel Improvements (MZC): Improvements to the MZC between mile posts (MP) 3.4 and 6.0 in conjunction with the Project were contemplated in the approved Project and analyzed in the Final EIR, including complete reconstruction of the channel between the Gage Canal (MP 3.8) and Tippecanoe Avenue (MP 3.8 and 4). Following additional coordination with the County Flood Control District, several refinements to the approved Project’s design have occurred along the MZC between the 30 and 90 percent design. These proposed refinements are in part the result of additional HEC-RAS 2D modeling of the MZC completed by SBCTA and reviewed by the County Flood Control District (HDR 2017³). Each of these refinements are identified and described in greater detail below:

- A. *Removal of Previously Proposed Drainage Connections to the MZC:* The approved Project and Final EIR considered the protection in place, replacement, and construction of new drainage connections to the MZC. The approved Project’s preliminary design reflected the placement of 12 new drainage connections to the MZC. An additional three existing drainage connections would be reconstructed to address the loading requirements of the track infrastructure and locomotive train sets (e.g. Metrolink). Nine of these drainage connections would not be constructed as part of the refined Project. Figure 5 in Attachment A illustrates the locations of these drainage connections and provides an indication of those removed and retained as part of the refined Project.
- B. *Replace Three Existing Drainage Connections:* The refined Project would include the replacement of three existing drainage connections along the MZC east of Mountain View Avenue. At Lugonia Avenue, an existing wooden box culvert (deteriorated) would be replaced with a 48-inch RCP with associated outlet protection (see Figure 6 in Attachment A). At I-10, an existing 42-inch RCP would be replaced with a 4-foot by 8-foot reinforced concrete box (RCB) culvert with associated outlet protection (see Figure 7 of Attachment A). East of Bryn Mawr Avenue, an existing 12-inch RCP would be replaced with a 24-inch CMP (see Figure 8 of Attachment A).
- C. *Construct Three New Drainage Connections West of the Gage Canal:* The approved Project contemplated one new drainage connection west of the Gage Canal (MP 3.8). As part of the refined Project, a total of three new connections would be constructed; one at the confluence with the SAR. The easternmost connection would be constructed just west of the Gage Canal and would consist of a 36-inch diameter reinforced concrete pipe (RCP) with associated outlet protection. Approximately 500 feet west, a second 24-inch corrugated metal pipe (CMP) would be installed. Figure 9 illustrates the current design for these two drainage connections. A third 24-inch CMP would be constructed at Bridge 3.4 (see Figure 10 in Attachment A). These improvements would be constructed within SBCTA’s ROW.

³ HDR 2017. Draft Final Mission Zanja Channel HEC-RAS 2D Hydraulic Analysis, Redlands Passenger Rail Project, Prepared for: SBCTA, Prepared by HDR, July 2017

- D. *Construct Retaining Walls at MP 3.6 and 5:* As part of the refined Project, SBCTA is proposing the installation of two new retaining structures along the southern portion of the ROW in the vicinity of MP 3.6 and 5. These retaining walls would be installed in order to maintain a minimum 15-foot zone of influence between the top of slope (or bank) and the nearest track centerline consistent with Metrolink standards. At MP 3.6, the retaining wall structure would extend up to 500 feet and stand 2 to 5 feet in height. At MP 5, a retaining structure would extend up to 500 feet and stand up to 3 feet in height.
- E. *Reduced Bank Stabilization along the MZC (North Bank):* As originally approved, SBCTA contemplated the potential need for extensive bank stabilization improvements along the north bank of the MZC from MP 3.5 to 6. Under the refined Project, bank improvements would be limited to less than 500 linear feet total at three locations along the MZC. Figure 11 illustrates the segments of the MZC that would no longer require armoring as part of the refined Project.
- F. *MZC Capacity Enhancements:* As part of the refined Project, SBCTA completed additional hydraulic modeling of the MZC to identify improvements. These improvements would increase the capacity of the MZC between MP 5.78 and 3.8 and are described further below.
1. *Construct Flood Walls at Gage Canal.* The approved Project included the potential construction of an up to 160-foot, 2 to 3 foot floodwall along the north side of the MZC and within SBCTA's ROW. The refined Project includes this feature along with the construction of an up to 3-foot floodwall along the top of the southern bank of the MZC. The southern floodwall would extend up to 100 feet in length. Figure 12 in Attachment A illustrates the approximate locations of the floodwalls.
 2. *Construct a New Reinforced Concrete Box (RCB) Culvert at Tippecanoe Avenue:* This Project refinement would install a new 11-foot by 7-foot RCB culvert at Tippecanoe Avenue. Figure 14 illustrates the proposed design for the proposed RCB culvert. This improvement would be constructed in within the City of San Bernardino's roadway ROW.
 3. *Remove Bryn Mawr Bridge (M 5.78) and Realign MZC:* This refinement involves the removal of the concrete bridge structure at the Bryn Mawr Avenue Crossing (MP 5.78). In addition to removing the concrete bridge structure, an up to 600-foot section of the MZC would be realigned and graded to increase the existing channel's capacity (see Figure 12).

Refinement No. 3 – Caltrans ROW (I-10): In addition to the proposed improvements identified in Refinement No.2, SBCTA is proposing drainage improvements that intersect with the I-10 ROW. SBCTA is proposing a new 30-inch RCP that would extend north from the railroad ROW along Nevada Street to I-10. At I-10, the RCP would outfall into an existing concrete ditch that runs along the southern edge of the I-10 ROW (see Figure 15). These flows would then be conveyed west within Caltrans I-10 ROW via an existing concrete-lined ditch and would enter the MZC via the proposed 4-foot by 8-foot RCB culvert described under Refinement 2B. Figure 13 in Attachment A illustrates the proposed improvement.



Table 1. Comparison of Approved Project (2015 EIR) and Proposed Design Refinements (August 2017)

Design Basin for Refinement	Refinement Tracking No.	Approved Project (2015 EIR)	Proposed Refinements (90% Design Refinements–June 2017)	Milepost(s)	Figure No. ⁽¹⁾
Bridge 3.4 (SAR) Crossing	1	<ul style="list-style-type: none"> • Double Track Bridge Structure; up to 365 feet in length and 20 feet in width • Scour Protection: ACB within approved footprint • Bank Protection (within approved footprint) • Accommodation of SAR Trail (per MM PCS-1) • Pile installation and work zone isolation proposed via steel sleeve (or cast-in-steel shell [CISS]) pile method or traditional cofferdam 	<ul style="list-style-type: none"> • Single-track bridge; up to 380 feet in length⁽²⁾ • Scour Protection: Use of soil slurry/cement • Expanded Bank Protection (west and east banks) • SAR Trail Undercrossing • Pile installation and work zone isolation proposed via CIDH (cast-in-drilled hole pile method) 	3.4	2, 3, and 4
Mission Zanja Channel (MZC)	2	<ul style="list-style-type: none"> • Reconfiguration of the existing channel from MP 3.9 to 4.2, including, modifications to the existing hydraulic grade structure or construction of a short • Approved Project contemplated drainage improvements such as new drainage connections (12 new connections originally considered) • New floodwall along the north bank of the MZC at MP 3.8 	<ul style="list-style-type: none"> • Reduce the number of new drainage connections to MZC (previously 12) • Three new drainage connections between MP 3.4 and 3.8 • Replace three drainage connections (east of Mtn. View) • Remove bank stabilization and armoring along northern bank of MZC • Add Tippecanoe Box Culvert • Add retaining walls at MP 3.5 and 5 • Add floodwall to southern bank of MZC at MP 3.8 • Remove Bryn Mawr Bridge (MP 5.78) Crossing. • Realign Channel-600 ft 	3.4 to 6.0	5, 6, 7, 8, 9, 10, 11, and 12

Table 1. Comparison of Approved Project (2015 EIR) and Proposed Design Refinements (August 2017)

Design Basin for Refinement	Refinement Tracking No.	Approved Project (2015 EIR)	Proposed Refinements (90% Design Refinements–June 2017)	Milepost(s)	Figure No. ⁽¹⁾
Caltrans ROW (I-10)	3	<ul style="list-style-type: none"> Approved Project contemplated drainage improvements, including the construction of new drainage connections outside of SBCTA's ROW 	<ul style="list-style-type: none"> New drainage connection to Caltrans I-10 ROW via Nevada Street Flows would be discharged to the MZC via new RCB culvert (replacing existing) 	6.8	13

⁽¹⁾ Figures provided in Attachment A.

⁽²⁾ Bridge 3.4 will be constructed as a single track bridge structure per Addendum #2.

2.4 Status of Approved Project

SBCTA has completed the 90 percent plans and specifications for the approved Project. Construction of the approved Project will be phased into three major construction contracts: (1) E Street Demo; (2) Early Utilities; (3) and Mainline Construction. The E Street Demo work will occur in the second half of 2017. Construction of the Early Utilities is scheduled to start in the second half of 2017 and extend into early 2018. Construction of the mainline track improvements, including station platforms and bridge replacements, is scheduled to start in 2018 and extend into 2020.



3 Environmental Analysis Checklist

The following Environmental Analysis Checklist (Checklist) (Table 2) was developed for projects with previously certified/approved environmental documents. This Checklist takes into consideration the preparation of an environmental document prepared at an earlier stage of a project (e.g., RPRP), evaluates the adequacy of the earlier document in assessing potential environmental impacts resulting from refinements proposed to the Project, and is consistent with Section 21166 of the Public Resources Code and Section 15162 of the CEQA Guidelines. The results of this evaluation are summarized below with the detailed analysis provided in subsequent sections.

Table 2. Environmental Analysis Checklist Summary

Environmental Issue Area:	Was Impact Analyzed in Prior Environmental Document(s)?	Do Project Refinements Involve New Significant Impacts or Substantially More Severe Impacts?	Any New Circumstances Involving New Significant Impacts or Substantially More Severe Impacts?	Any New Information Requiring New Analysis or Verification?
1. Aesthetics (Table 3)	Yes	No	No	No
2. Agriculture and Forestry Resources (Table 4)	Yes	No	No	No
3. Air Quality (Table 5)	Yes	No	No	No
4. Biological Resources (Table 6)	Yes	No	No	No
5. Cultural Resources (Table 7)	Yes	No	No	No
6. Geology/Soils (Table 8)	Yes	No	No	No
7. Greenhouse Gas Emissions (Table 9)	Yes	No	No	No
8. Hazards and Hazardous Materials (Table 10)	Yes	No	No	No
9. Hydrology and Water Quality (Table 11)	Yes	No	No	No
10. Land Use and Planning (Table 12)	Yes	No	No	No
11. Mineral Resources (Table 13)	Yes	No	No	No
12. Noise (Table 14)	Yes	No	No	No
13. Population and Housing (Table 15)	Yes	No	No	No
14. Public Services (Table 16)	Yes	No	No	No
15. Recreation (Table 17)	Yes	No	No	No
16. Transportation/Traffic (Table 18)	Yes	No	No	No
17. Utilities and Service Systems (Table 19)	Yes	No	No	No

Table 2. Environmental Analysis Checklist Summary

Environmental Issue Area:	Was Impact Analyzed in Prior Environmental Document(s)?	Do Project Refinements Involve New Significant Impacts or Substantially More Severe Impacts?	Any New Circumstances Involving New Significant Impacts or Substantially More Severe Impacts?	Any New Information Requiring New Analysis or Verification?
18. Mandatory Findings(Table 20)	Yes	No	No	No

Note: See preceding checklist sections for detailed discussion of each environmental issue area.



Table 3. Aesthetics

Environmental Issue Area:	Was Impact Analyzed in Prior Environmental Document(s)?	Do Project Refinements Involve New Significant Impacts or Substantially More Severe Impacts?	Any New Circumstances Involving New Significant Impacts or Substantially More Severe Impacts?	Any New Information Requiring New Analysis or Verification?
---------------------------	---	--	---	---

Would the project:

a) Have a substantial adverse effect on a scenic vista?	Yes	No	No	No
b) Substantially damage scenic resources, including, but not limited to, trees, rock outcroppings, and historic building within a state scenic highway?	Yes	No	No	No
c) Substantially degrade the existing visual character or quality of the site and its surroundings?	Yes	No	No	No
d) Create a new source of substantial light or glare which would adversely affect day or nighttime views in the area?	Yes	No	No	No

Discussion: Since the certification of the Final EIR, there have been no substantial changes to the existing aesthetic environment as described for Landscape Units 2, 3, and 4 in Section 3.4, Visual Quality and Aesthetics, of the Final EIR. The refined Project features would generally be located at-or below grade and within SBCTA, County Flood Control, or Caltrans ROW, once constructed. The refined Project features are generally located within the previously described Study Area, which is urbanized, and does not contain any designated scenic vistas or scenic resources. Further, the refined Project features are not located within the viewshed of a State designated scenic highway. As a result, no substantial changes or major revisions to the previous EIR analysis are required.

The EIR concluded that with implementation of Mitigation Measures VQA-1, VQA-2, VQA-3, and VQA-5, the Project would not substantially degrade the existing visual character or quality of the site and its surroundings or create significant sources of light or glare. These mitigation measures would continue to apply to the refined Project features, where applicable. In this context, the refined Project would not result in new or substantially more severe impacts to aesthetics and no new mitigation measures would be required.

Table 4. Agricultural Resources

Environmental Issue Area:	Was Impact Analyzed in Prior Environmental Document(s)?	Do Project Refinements Involve New Significant Impacts or Substantially More Severe Impacts?	Any New Circumstances Involving New Significant Impacts or Substantially More Severe Impacts?	Any New Information Requiring New Analysis or Verification?
---------------------------	---	--	---	---

In determining whether impacts to agricultural resources are significant environmental effects, lead agencies may refer to the California Agricultural Land Evaluation and Site Assessment Model (1997) prepared by the California Department of Conservation as an optional model to use in assessing impacts on agriculture and farmland.

Would the project:

a) Convert Prime Farmland, Unique Farmland, or Farmland of Statewide Importance (Farmland), as shown on the maps prepared pursuant to the Farmland Mapping and Monitoring Program of the California Resources Agency, to non-agricultural use?	Yes	No	No	No
b) Conflict with existing zoning for agricultural use, or a Williamson Act contract?	Yes	No	No	No
c) Conflict with existing zoning for, or cause rezoning of, forest land (as defined in Public Resources Code section 12220(g)), timberland (as defined by Public Resources Code section 4526), or timberland zoned Timberland Production (as defined by Government Code section 51104(g))?	Yes	No	No	No
d) Result in the loss of forest land or conversion of forest land to non-forest use?	Yes	No	No	No
e) Involve other changes in the existing environment which, due to their location or nature, could result in conversion of Farmland, to non-agricultural use or conversion of forest land to non-forest use?	Yes	No	No	No

Discussion: Since the adoption of the Final EIR, there have been no substantial changes to the agricultural environment as described in Section 5.4, Less Than Significant Impacts of the Build Alternatives and Design Options, of the Final EIR. The refined Project features would be constructed within SBCTA's ROW and land identified as "Urban and Built-up" as previously identified in the Final EIR. Therefore, the refined Project features would not result in new or substantially more severe impacts to agricultural and no mitigation would be required.



Table 5. Air Quality

Environmental Issue Area:	Was Impact Analyzed in Prior Environmental Document(s)?	Do Project Refinements Involve New Significant Impacts or Substantially More Severe Impacts?	Any New Circumstances Involving New Significant Impacts or Substantially More Severe Impacts?	Any New Information Requiring New Analysis or Verification?
---------------------------	---	--	---	---

Where available, the significance criteria established by the applicable air quality management or air pollution control district may be relied upon to make the following determinations.

Would the project:

a) Conflict with or obstruct implementation of the applicable air quality plan?	Yes	No	No	No
b) Violate any air quality standard or contribute substantially to an existing or projected air quality violation?	Yes	No	No	No
c) Result in a cumulatively considerable net increase of any criteria pollutant for which the project region is non-attainment under an applicable federal or state ambient air quality standard (including releasing emissions, which exceed quantitative thresholds for ozone precursors)?	Yes	No	No	No
d) Expose sensitive receptors to substantial pollutant concentrations?	Yes	No	No	No
e) Create objectionable odors affecting a substantial number of people?	Yes	No	No	No

Discussion: Since the adoption of the Final EIR, there have been no substantial changes to the existing air quality environment as described in Section 3.5, Air Quality and Climate Change, of the Final EIR. The EIR identified that the approved Project would generate short-term construction emissions due to construction activities that include demolition/reconstruction of the railroad corridor and construction employee and haul-related vehicle trips. These impacts were determined to be less than significant based on detailed air quality modeling completed in support of the EIR and included in Appendix G. The refined Project features would require similar construction activities of comparable duration and intensity as described for the approved Project and analyzed in the EIR. In this context, the construction of the refined Project features would not result in a substantial increase in construction activities and related emissions as analyzed in the EIR. As a result, the refined Project would not result in new or substantially more severe construction-related air quality impacts and no mitigation would be required.

Similar to the approved Project, the refined Project operations would remain similar to that as described in the EIR; therefore, comparable operational emissions would result over the long-term. As a result, the refined Project would not result in new or substantially more severe operational air quality impacts and no mitigation would be required.

Table 6. Biological Resources

Environmental Issue Area:	Was Impact Analyzed in Prior Environmental Document(s)?	Do Project Refinements Involve New Significant Impacts or Substantially More Severe Impacts?	Any New Circumstances Involving New Significant Impacts or Substantially More Severe Impacts?	Any New Information Requiring New Analysis or Verification?
---------------------------	---	--	---	---

Would the project:

a) Have a substantial adverse effect, either directly or through habitat modifications, on any species identified as a candidate, sensitive, or special status species in local or regional plans, policies, or regulations, or by the California Department of Fish and Game or U.S. Fish and Wildlife Service?	Yes	No	No	No
b) Have a substantial adverse effect on any riparian habitat or other sensitive natural community identified in local or regional plans, policies, and regulations or by the California Department of Fish and Game or U.S. Fish and Wildlife Service?	Yes	No	No	No
c) Have a substantial adverse effect on federally protected wetlands as defined by Section 404 of the Clean Water Act (including, but not limited to, marsh, vernal pool, coastal, etc.) through direct removal, filling, hydrological interruption, or other means?	Yes	No	No	No
d) Interfere substantially with the movement of any native resident or migratory fish or wildlife species or with established native resident or migratory wildlife corridors, or impede the use of wildlife nursery sites?	Yes	No	No	No
e) Conflict with any local policies or ordinances protecting biological resources, such as a tree preservation policy or ordinance?	Yes	No	No	No
f) Conflict with the provisions of an adopted Habitat Conservation Plan, Natural Community Conservation Plan, or other approved local, regional, or state habitat conservation plan?	Yes	No	No	No



Table 6. Biological Resources

Environmental Issue Area:	Was Impact Analyzed in Prior Environmental Document(s)?	Do Project Refinements Involve New Significant Impacts or Substantially More Severe Impacts?	Any New Circumstances Involving New Significant Impacts or Substantially More Severe Impacts?	Any New Information Requiring New Analysis or Verification?
---------------------------	---	--	---	---

Discussion: Since the adoption of the Final EIR, there have been no substantial changes to the existing environmental conditions as described in Section 3.7, Biological and Wetland Resources and Appendix I, of the Final EIR. The refined Project features are located within the previously described Study Area and analyzed Project footprint. Minor extensions of the approved Project’s physical footprint would occur in the vicinity of Bridge 3.4 and the MZC, including the Gage Canal at MP 3.8.

Section 3.7.2 of the Final EIR identifies and describes the sensitive vegetation communities potentially affected by the construction and operation of the approved Project. Similar to the approved Project, the physical footprint at Bridge 3.4 under the refined Project would result in direct impacts to southern willow scrub (SWS), southern cottonwood willow riparian forest (SCWRF), non-vegetated channel (NVC), and Riversidean alluvial fan sage scrub (RAFSS). Based on the revised footprint for the refined Project, project construction would result in direct impacts to RAFSS (0.047 acre), SWS (0.163 acre), SCWRF (0.317 acre), and NVC (0.992 acre) (see Attachment B). At the MZC, the refined Project’s footprint would result in direct impacts to NVC (1.115 acres) and SCWRF (0.219 acres) (see Attachment B). Similar to the conclusions provided in the Final EIR, these direct impacts could be significant and would require the implementation of Mitigation Measures BIO-1, BIO-2, BIO-3, BIO-4, BIO-5, and BIO-6.

As provided in Section 3.7 of the Final EIR, these sensitive communities provide suitable habitat for multiple special status species, including ten special-status terrestrial wildlife species that were identified as having a moderate to high potential to occur. These species include the federally endangered least Bell’s vireo (LBV), the federally and state endangered southwestern willow flycatcher, the federally endangered San Bernardino kangaroo rat, the federally threatened Santa Ana sucker, and the yellow-billed cuckoo. In addition, state designated species of concern including the western burrowing owl, loggerhead shrike, yellow-breasted chat, yellow warbler, and western spadefoot toad have a moderate to high potential to occur. Similar to the approved Project, construction of the refined Project could result in direct or indirect impacts to the wildlife species listed in Table 3.7-4 of the Final EIR. Similar impacts to special status botanical species, including the Santa Ana woolly star, could also result. Mitigation Measures BIO-1, BIO-2, BIO-3, BIO-4, and BIO-7 are proposed to mitigate these potential direct effects.

Similar to the approved Project, the refined Project would result in direct impacts to waters of the U.S. as result of the placement of fill materials or excavation within jurisdictional waters of the U.S. and state, including wetlands, within the railroad corridor. A majority of these effects occur at the SAR and along the MZC (see Attachment B). Additionally, construction of the refined Project would result in direct effects to waters of the State within CDFW’s jurisdiction. Direct effects to USACE and CDFW jurisdictional areas were considered significant in the Final EIR. Based on these combined construction-related impacts, the refined Project has the potential to result in significant impacts to federal and state-protected wetlands through direct fill or excavation, and hydrological interruption. Direct effects to USACE and CDFW jurisdictional areas are considered a significant impact under CEQA. Similar to the approved Project, Mitigation Measure BIO-6 is proposed to mitigate these impact to a less than significant level by securing the required permit authorizations and implementing all permit conditions to ensure no net loss of functions of wetlands, Other Waters of the U.S., and Waters of the State.

Based on the conclusions of the biological letter report contained in Attachment B, no new or more severe biological resources impacts would occur as a result of the refined Project features. All mitigation measures adopted as part of SBCTA’s MMRP, including Mitigation Measures BIO-1, BIO-2, BIO-3, BIO-4, BIO-5, BIO-6, and BIO-7, would continue to apply to the refined Project features, as applicable, and potential impacts to biological resources would be mitigated to a less than significant level. No new mitigation would be required.

Table 7. Cultural Resources

Environmental Issue Area:	Was Impact Analyzed in Prior Environmental Document(s)?	Do Project Refinements Involve New Significant Impacts or Substantially More Severe Impacts?	Any New Circumstances Involving New Significant Impacts or Substantially More Severe Impacts?	Any New Information Requiring New Analysis or Verification?
---------------------------	---	--	---	---

Would the project:

a) Cause a substantial adverse change in the significance of a historical resource as defined in §15064.5?	Yes	No	No	No
b) Cause a substantial adverse change in the significance of an archaeological resource pursuant to §15064.5?	Yes	No	No	No
c) Directly or indirectly destroy a unique paleontological resource or site or unique geologic feature?	Yes	No	No	No
d) Disturb any human remains, including those interred outside of formal cemeteries?	Yes	No	No	No

Discussion: Since the adoption of the Final EIR, there have been no substantial changes to the existing environmental conditions for historic architectural and archaeological resources as described in Section 3.12, Cultural and Historic Resources, and Appendix M of the Final EIR. The refined Project features are located within the previously analyzed area of potential effect (APE). Although Refinements 1, 2, and 3 would result in minor extensions of the approved Project's physical footprint as previously evaluated in the Final EIR, these refinements would occur in the previously evaluated APE and in areas previously determined to not contain significant cultural resources (e.g. bed of the Santa Ana River [SAR], Gage Canal, etc.).

There have been no archaeological resources identified within or adjacent to the areas proposed for minor design refinements. However, there is ground disturbing work associated with the proposed design refinement and the possibility exists for the discovery of unanticipated archaeological resources. The recommendation of Mitigation Measures CUL-4 to implement specific measures immediately following an unanticipated discovery remains unchanged and consistent with the Final EIR.

Overall, the proposed refinements would not be considered to have a significant impact to historical resources under CEQA. The updated cultural resources analysis confirms that the proposed engineering refinements to the approved Project do not change the previous conclusions regarding cultural resources. No new or more severe cultural resources impacts would occur and Mitigation Measure CUL-4 as contained in SBCTA's MMRP for the approved Project would continue to apply to the refined Project features. There would be no changes required to the prior *Cultural Resources Technical Memorandum* (Appendix M of the Final EIR). No new mitigation is required.



Table 8. Geology and Soils

Environmental Issue Area:	Was Impact Analyzed in Prior Environmental Document(s)?	Do Project Refinements Involve New Significant Impacts or Substantially More Severe Impacts?	Any New Circumstances Involving New Significant Impacts or Substantially More Severe Impacts?	Any New Information Requiring New Analysis or Verification?
---------------------------	---	--	---	---

Would the project:

a) Expose people or structures to potential substantial adverse effects, including the risk of loss, injury or death involving:				
i) Rupture of a known earthquake fault, as delineated on the most recent Alquist-Priolo Earthquake Fault Zoning Map issued by the State Geologist for the area or based on other substantial evidence of a known fault? Refer to Division of Mines and Geology Special Publication 42.	Yes	No	No	No
j) Strong seismic ground shaking?	Yes	No	No	No
k) Seismic-related ground failure, including liquefaction?	Yes	No	No	No
l) Landslides?	Yes	No	No	No
b) Result in substantial soil erosion or the loss of topsoil?	Yes	No	No	No
c) Be located on a geologic unit or soil that is unstable, or that would become unstable as a result of the project and potentially result in on- or off-site landslide, lateral spreading, subsidence, liquefaction or collapse?	Yes	No	No	No
d) Be located on expansive soil, as defined in Table 18-1-B of the Uniform Building Code (1994), creating substantial risks to life or property?	Yes	No	No	No
e) Have soils incapable of adequately supporting the use of septic tanks or alternative wastewater disposal systems where sewers are not available for the disposal of wastewater?	Yes	No	No	No

Table 8. Geology and Soils

Environmental Issue Area:	Was Impact Analyzed in Prior Environmental Document(s)?	Do Project Refinements Involve New Significant Impacts or Substantially More Severe Impacts?	Any New Circumstances Involving New Significant Impacts or Substantially More Severe Impacts?	Any New Information Requiring New Analysis or Verification?
---------------------------	---	--	---	---

Discussion: Since the certification of the Final EIR, there have been no substantial changes to the existing geological environment as described in Section 3.9, Geology, Soils and Seismicity, and Appendix K of the Final EIR. The refined Project features would be constructed in the same general vicinity as the approved Project and would not be located within 500 feet of a major active fault or fault zone. Similar to the approved Project, the refined Project features would be required to be in conformance with applicable seismic standards in the Uniform Building Code and Mitigation Measure GEO-1 as contained in SBCTA's MMRP. Some of the proposed refinements, including those proposed at Bridge 3.4 under Refinement 1, are a direct result of the additional geotechnical work completed as part of the approved Project's final design; consistent with Mitigation Measures GEO-1. No new or more severe geological impacts would occur and the proposed mitigation would continue to apply to the refined Project. No new mitigation would be required.



Table 9. Greenhouse Gas Emissions

Environmental Issue Area:	Was Impact Analyzed in Prior Environmental Document(s)?	Do Project Refinements Involve New Significant Impacts or Substantially More Severe Impacts?	Any New Circumstances Involving New Significant Impacts or Substantially More Severe Impacts?	Any New Information Requiring New Analysis or Verification?
---------------------------	---	--	---	---

Would the project:

a) Generate greenhouse gas emissions, either directly or indirectly, that may have an adverse effect on the environment?	Yes	No	No	No
b) Conflict with an applicable plan, policy, or regulation adopted for the purpose of reducing the emissions of greenhouse gases?	Yes	No	No	No

Discussion: Since the adoption of the Final EIR, there have been no substantial changes to the existing environmental conditions as described in Section 3.5, Air Quality and Climate Change, and Appendix G of the Final EIR. The refined Project features would be constructed and operated consistent with the assumptions applied in the Final EIR. No increase in the emission of GHGs would result from the proposed refinements. As a result, no new or more severe impacts related to GHGs would occur with the refined Project and no mitigation is required.

Table 10. Hazards and Hazardous Materials

Environmental Issue Area:	Was Impact Analyzed in Prior Environmental Document(s)?	Do Project Refinements Involve New Significant Impacts or Substantially More Severe Impacts?	Any New Circumstances Involving New Significant Impacts or Substantially More Severe Impacts?	Any New Information Requiring New Analysis or Verification?
Would the project:				
a) Create a significant hazard to the public or the environment through the routine transport, use, or disposal of hazardous materials?	Yes	No	No	No
b) Create a significant hazard to the public or the environment through reasonably foreseeable upset and accident conditions involving the likely release of hazardous materials into the environment?	Yes	No	No	No
c) Emit hazardous emissions or handle hazardous or acutely hazardous materials, substances, or waste within 0.25 mile of an existing or proposed school?	Yes	No	No	No
d) Be located on a site which is included on a list of hazardous materials sites compiled pursuant to Government Code Section 65962.5 and, as a result, would it create a significant hazard to the public or the environment?	Yes	No	No	No
e) For a project located within an airport land use plan or, where such a plan has not been adopted, within 2 miles of a public airport or public use airport, would the project result in a safety hazard for people residing or working in the project area?	Yes	No	No	No
f) For a project within the vicinity of a private airstrip, would the project result in a safety hazard for people residing or working in the project area?	Yes	No	No	No
g) Impair implementation of or physically interfere with an adopted emergency response plan or emergency evacuation plan?	Yes	No	No	No



Table 10. Hazards and Hazardous Materials

Environmental Issue Area:	Was Impact Analyzed in Prior Environmental Document(s)?	Do Project Refinements Involve New Significant Impacts or Substantially More Severe Impacts?	Any New Circumstances Involving New Significant Impacts or Substantially More Severe Impacts?	Any New Information Requiring New Analysis or Verification?
---------------------------	---	--	---	---

Would the project:

h) Expose people or structures to a significant risk of loss, injury or death involving wildland fires, including where wildlands are adjacent to urbanized areas or where residences are intermixed with wildlands?	Yes	No	No	No
--	-----	----	----	----

Discussion: Since the certification of the Final EIR, there have been no substantial changes to the existing environment conditions as described in Section 3.10, Hazardous Waste and Materials, and Appendix L of the Final EIR. Similar to the approved Project, the refined Project features would be located within the previously considered Study Area as part of the Final EIR. In instances where the refined Project features extend beyond the previously approved footprint, SBCTA would comply with Mitigation Measure HAZ-3, which requires an updated Phase 1 Environmental Site Assessment (ESA) and Phase 2 Investigation, if necessary. No additional demolition of existing structures would be required than would otherwise require the implementation of Mitigation Measure HAZ-2.

Similar to the approved Project, the transport, use, and storage of hazardous materials during construction would be conducted in accordance with all applicable State and Federal laws. For this reason, the refined Project features, as applicable, would be subject to the hazardous materials management requirements contained in Mitigation Measure HAZ-1.

Based on a review of the Department of Toxic Substance's Control EnviroStor Database, the refined Project features are not identified as being located on a hazardous materials site compiled pursuant to Government Code Section 65962.5. Mitigation Measure HAZ-4 would continue to apply to the refined Project in order to reduce the potential impacts associated with the discovery of hazardous materials and/or contaminants. Mitigation Measures HAZ-5 and HAZ-6 would also continue to be applicable to the refined Project features, where construction within very high wildlife hazard areas.

Based on the above analysis, no new or more severe hazards and hazardous materials impacts would occur as a result of the refined Project features. All mitigation measures adopted as part of SBCTA's MMRP for the Project would continue to apply to the refined Project, as applicable. No new mitigation measures would be required.

Table 11. Hydrology and Water Quality

Environmental Issue Area:	Was Impact Analyzed in Prior Environmental Document(s)?	Do Project Refinements Involve New Significant Impacts or Substantially More Severe Impacts?	Any New Circumstances Involving New Significant Impacts or Substantially More Severe Impacts?	Any New Information Requiring New Analysis or Verification?
Would the project:				
a) Violate any water quality standards or waste discharge requirements?	Yes	No	No	No
b) Substantially deplete groundwater supplies or interfere substantially with groundwater recharge such that there would be a net deficit in aquifer volume or a lowering of the local groundwater table level (e.g., the production rate of pre-existing nearby wells would drop to a level which would not support existing land uses or planned uses for which permits have been granted)?	Yes	No	No	No
c) Substantially alter the existing drainage pattern of area, including through the alteration of the course of a stream or river, in a manner which would result in substantial erosion or siltation on- or off-site?	Yes	No	No	No
d) Substantially alter the existing drainage pattern of the site or area, including through the alteration of the course of a stream or river, or substantially increase the rate or amount of surface runoff in a manner, which would result in flooding on- or off-site?	Yes	No	No	No
e) Create or contribute runoff water which would exceed the capacity of existing or planned stormwater drainage systems or provide substantial additional sources of polluted runoff?	Yes	No	No	No
f) Otherwise substantially degrade water quality?	Yes	No	No	No
g) Place housing within a 100-year flood hazard area as mapped on a federal Flood Hazard Boundary or Flood Insurance Rate Map or other flood hazard delineation map?	Yes	No	No	No
h) Place within a 100-year flood hazard area structures, which would impede or redirect flood flows?	Yes	No	No	No



Table 11. Hydrology and Water Quality

Environmental Issue Area:	Was Impact Analyzed in Prior Environmental Document(s)?	Do Project Refinements Involve New Significant Impacts or Substantially More Severe Impacts?	Any New Circumstances Involving New Significant Impacts or Substantially More Severe Impacts?	Any New Information Requiring New Analysis or Verification?
---------------------------	---	--	---	---

Would the project:

i) Expose people or structures to a significant risk of loss, injury or death involving flooding, including flooding as a result of the failure of a levee or dam?	Yes	No	No	No
j) Inundation by seiche, tsunami, or mudflow?	Yes	No	No	No

Discussion: Since the certification of the Final EIR, there have been no substantial changes to the existing hydrological environment as described in Section 3.8, Floodplain and Hydrology, and Appendix J of the Final EIR. Similar to the approved Project, the refined Project features would be located within the vicinity of the approved footprint as previously evaluated in the Final EIR. Where the refinements extend beyond the previously approved footprint, the improvements would be located in the same general vicinity as the approved Project features. Similar to the approved Project, the refined Project features, as applicable, would be subject to Mitigation Measure HWQ-1, which requires the preparation of a site-specific drainage plan for all structural components associated with the Project. The treatment of project-related stormwater would be addressed through compliance with Mitigation Measure HWQ-6, such that long-term water quality impacts would be less than significant.

Similar to the approved Project, the refined Project features would include grading and land disturbance activities that would require compliance. Most of the refinements proposed as part of the refined Project are located within or adjacent to waterways, including the SAR (Refinement #1) and MZC. The analysis contained in Section 3.8 of the Final EIR contemplated extensive in-channel construction activities for both of these waterways. Construction of the refined Project would entail the same types of construction activities as analyzed in the Final EIR and Mitigation Measures HWQ-2 and HWQ-3 were adopted to address these impacts. As a result, no greater or more severe water quality impacts are expected from the construction of the refined Project features.

Similar to the approved Project, some of the proposed refinements would be constructed within areas subject to flooding during a 100-year storm event. Based on additional modeling completed as part of the approved Project's final design, these improvements proposed under Refinements 1 and 2 would not exacerbate existing flooding conditions within the affected reaches of the SAR and MZC. Similar to the conclusions provided in the Final EIR, the proposed design for Bridge 3.4 would result in a slight decrease in the water surface elevation (WSE) from 1017.19 feet mean sea level (msl) under existing conditions to 1017.17 feet msl (see Attachment C). In addition to modeling changes in water surface elevations, SBCTA also completed a scour analysis for the proposed design. The results of the scour analysis indicate a total scour depth of 18.5 feet for the 100-year flood event and 27.9 feet for the 200-year flood event. The refinements proposed at Bridge 3.4 are in direct response to these modeled scour depths and additional geotechnical analysis conducted in support of Mitigation Measure GEO-1. In this context, the refined Project's design at Bridge 3.4 would result in a less than significant impact.

At the MZC, SBCTA completed a HEC-RAS 2D model that includes reaches of the MZC between the SAR (MP 3.4) and the existing Bryn Mawr Bridge crossing (MP 5.78) along with upstream tributary areas, including the Mission Storm Drain. The model evaluates multiple storm events capable of generating flows up to 8,945 cubic feet per second (csf) at the MZC's confluence with the SAR (HDR 2017). Under existing conditions as documented in the Final EIR, the Bryn Mawr Avenue bridge severely restricts flow within MZC and results in flooding to the north and south of the channel for the 10- to 100-year flood events. Further downstream, the existing double box culvert beneath Tippecanoe Avenue is similarly overwhelmed during the 10- to 100-year events with flooding occurring north of the channel and within SBCTA's ROW. The proposed refinements identified under Refinement 2F would improve these existing conditions along the MZC; however, as described in the Final EIR, portions of the Study Area would continue to be subject flooding during a 100-year event. For this reason, impacts related to flooding could be significant as described in the Final EIR. Mitigation Measure HWQ-4 would continue to apply to the refined Project.

Table 11. Hydrology and Water Quality

Environmental Issue Area:	Was Impact Analyzed in Prior Environmental Document(s)?	Do Project Refinements Involve New Significant Impacts or Substantially More Severe Impacts?	Any New Circumstances Involving New Significant Impacts or Substantially More Severe Impacts?	Any New Information Requiring New Analysis or Verification?
---------------------------	---	--	---	---

Based on the above analysis, no new or more severe hydrology or water quality impacts would occur as a result of the proposed refinements. All mitigation measures adopted as part of SBCTA's MMRP for the Project would continue to apply to the refined Project. No new mitigation is required.



Table 12. Land Use and Planning

Environmental Issue Area:	Was Impact Analyzed in Prior Environmental Document(s)?	Do Project Refinements Involve New Significant Impacts or Substantially More Severe Impacts?	Any New Circumstances Involving New Significant Impacts or Substantially More Severe Impacts?	Any New Information Requiring New Analysis or Verification?
---------------------------	---	--	---	---

Would the project:

a) Physically divide an established community?	Yes	No	No	No
b) Conflict with any applicable land use plan, policy, or regulation of an agency with jurisdiction over the project (including, but not limited to the general plan, specific plan, local coastal program, or zoning ordinance) adopted for the purpose of avoiding or mitigating an environmental effect?	Yes	No	No	No
c) Conflict with any applicable habitat conservation plan or natural communities' conservation plan?	Yes	No	No	No

Discussion: Since the adoption of the Final EIR, there have been no substantial changes to the existing environmental conditions as described in Section 3.2, Land Use, Planning and Communities, and Appendix D of the Final EIR. The refined Project features would be located within or in close proximity to the approved Project footprint as previously evaluated in the Final EIR. As proposed, the refined Project features would not introduce new land uses that were not otherwise previously considered as part of the Final EIR. For this reason, the no substantive changes to the previous analysis of plan consistency would result and the previous less than significant determination would continue to apply.

Similar to the approved Project, the refined Project features would not physically divide the community or conflict with any applicable habitat conservation plan or natural communities' conservation plan. Temporary and permanent encroachments into adjacent properties, as applicable to the refined Project features, would be required to comply with Mitigation Measure LU-1.

Based on the above evaluation, no new or more severe land use, planning and communities impacts would occur as a result of the refined Project features. Mitigation adopted as part of SBCTA's MMRP for the Project would continue to apply to the refined Project, as applicable. No new mitigation measures would be required.

Table 13. Mineral Resources

Environmental Issue Area:	Was Impact Analyzed in Prior Environmental Document(s)?	Do Project Refinements Involve New Significant Impacts or Substantially More Severe Impacts?	Any New Circumstances Involving New Significant Impacts or Substantially More Severe Impacts?	Any New Information Requiring New Analysis or Verification?
---------------------------	---	--	---	---

Would the project:

a) Result in the loss of availability of a known mineral resource that would be of value to the region and the residents of the state?	Yes	No	No	No
b) Result in the loss of availability of a locally-important mineral resource recovery site delineated on a local general plan, specific plan or other land use plan?	Yes	No	No	No

Discussion: Since the certification of the Final EIR, there have been no changes to the existing environmental conditions as described in Section 5.4, Less Than Significant Impacts of the Build Alternatives and Design Options, of the Final EIR. The refined Project feature would be located within the same general vicinity of the approved Project as previously evaluated in the Final EIR. As a result, implementation of the refined Project would not result in the loss of a known mineral resource and no new or more severe impacts would result from the refined Project.



Table 14. Noise

Environmental Issue Area:	Was Impact Analyzed in Prior Environmental Document(s)?	Do Project Refinements Involve New Significant Impacts or Substantially More Severe Impacts?	Any New Circumstances Involving New Significant Impacts or Substantially More Severe Impacts?	Any New Information Requiring New Analysis or Verification?
---------------------------	---	--	---	---

Would the project result in:

a) Exposure of persons to or generation of noise levels in excess of standards established in the local general plan or noise ordinance, or applicable standards of other agencies?	Yes	No	No	No
b) Exposure of persons to or generation of excessive groundborne vibration or groundborne noise levels?	Yes	No	No	No
c) A substantial permanent increase in ambient noise levels in the project vicinity above levels existing without the project?	Yes	No	No	No
d) A substantial temporary or periodic increase in ambient noise levels in the project vicinity above levels existing without the project?	Yes	No	No	No
e) For a project located within an airport land use plan or, where such a plan has not been adopted, within 2 miles of a public airport or public use airport, would the project expose people residing or working in the project area to excessive noise levels?	Yes	No	No	No
f) For a project within the vicinity of a private airstrip, would the project expose people residing or working in the project area to excessive noise levels?	Yes	No	No	No

Discussion: Since the certification of the Final EIR, there have been no substantial changes to the noise environment as described in Section 3.6, Noise and Vibration, and Appendix H of the Final EIR. The refined Project would be located within the same general vicinity of the approved Project as previously evaluated in the Final EIR. The refined Project features would result in construction noise levels similar to that evaluated in the Final EIR. Construction of the refined Project features would be subject to the requirements of Mitigation Measure NV-1 and NV-2.

Operational noise levels and related impacts to noise sensitive land uses associated within the refined Project would be similar to the approved Project. Under the refined Project, DMU and Metrolink operations would generally function as described and analyzed in the Final EIR.

Based on the evaluation above, no new or more severe noise impacts would occur as a result of the Refined Project. Mitigation Measures NV-1, NV-2, NV-3, NV-5, NV-6, and NV-7 as contained in SBCTA's MMRP for the approved Project would continue to apply to the refined Project. No new mitigation measures would be required.

Table 15. Population and Housing

Environmental Issue Area:	Was Impact Analyzed in Prior Environmental Document(s)?	Do Project Refinements Involve New Significant Impacts or Substantially More Severe Impacts?	Any New Circumstances Involving New Significant Impacts or Substantially More Severe Impacts?	Any New Information Requiring New Analysis or Verification?
---------------------------	---	--	---	---

Would the project:

a) Induce substantial population growth in an area, either directly (e.g., by proposing new homes and businesses) or indirectly (e.g., through extension of roads or other infrastructure)?	Yes	No	No	No
b) Displace substantial numbers of existing housing, necessitating the construction of replacement housing elsewhere?	Yes	No	No	No
c) Displace substantial numbers of people necessitating the construction of replacement housing elsewhere?	Yes	No	No	No

Discussion: No substantial changes to existing environmental conditions as it relates to population and housing have changed since the certification of the Final EIR. Similar to the approved Project, the refined Project features would be limited to existing roadway and rail improvements in the vicinity of the approved Project. These improvements would not increase the relocation or displacement impacts of the approved Project. No new land uses are proposed as part of the refinements that would otherwise increase the population estimates contained in the Final EIR. Based on these considerations, no new or more severe population and housing impacts would occur. No new mitigation would be required.



Table 16. Public Services

Environmental Issue Area:	Was Impact Analyzed in Prior Environmental Document(s)?	Do Project Refinements Involve New Significant Impacts or Substantially More Severe Impacts?	Any New Circumstances Involving New Significant Impacts or Substantially More Severe Impacts?	Any New Information Requiring New Analysis or Verification?
---------------------------	---	--	---	---

Would the project result in substantial adverse physical impacts associated with the provision of new or physically altered governmental facilities, need for new or physically altered governmental facilities, the construction of which could cause significant environmental impacts, in order to maintain acceptable service ratios, response times or other performance objectives for any of the public services:

a) Fire Protection?	Yes	No	No	No
b) Police Protection?	Yes	No	No	No
c) Schools?	Yes	No	No	No
d) Parks?	Yes	No	No	No
e) Other public facilities?	Yes	No	No	No

Discussion: Since the certification of the Final EIR, there have been no substantial changes to existing environmental conditions as described in Section 3.13, Parklands, Community Services, and Other Public Facilities, of the Final EIR. Similar to the approved Project, the refined Project features are limited to bridge and drainage improvements and would not generate population growth that would otherwise place new demands on local public service providers. Additionally, the refined Project does not include a residential component, which would otherwise result in an incremental increase in demand on public services. Based on these considerations, no new or more severe public or community services and other facilities impacts would occur as a result of the refined Project. No new mitigation would be required.

Table 17. Recreation

Environmental Issue Area:	Was Impact Analyzed in Prior Environmental Document(s)?	Do Project Refinements Involve New Significant Impacts or Substantially More Severe Impacts?	Any New Circumstances Involving New Significant Impacts or Substantially More Severe Impacts?	Any New Information Requiring New Analysis or Verification?
---------------------------	---	--	---	---

Would the project:

a) Would the project increase the use of existing neighborhood and regional parks or other recreational facilities such that substantial physical deterioration of the facility would occur or be accelerated?	Yes	No	No	No
b) Does the project include recreational facilities or require the construction or expansion of recreational facilities, which might have an adverse physical effect on the environment?	Yes	No	No	No

Discussion: Since the certification of the Final EIR, there have been no substantial changes to the existing environmental conditions as described in Section 3.13, Parklands, Community Services, and Other Public Facilities, of the Final EIR. Similar to the approved Project, the refined Project would not contribute to population growth that could result in an increased use of existing neighborhood and regional parks nor does it include or require construction or expansion of recreational facilities.

The refined Project features would include the integration of the SAR Trail at Bridge 3.4 per the requirements of Mitigation Measure PCS-1. No new mitigation is required. The refined Project does not propose substantial changes that require major revisions to the EIR's discussion of potential impacts to recreation. No new or more severe impacts to parks and recreation would occur under the refined Project.



Table 18. Transportation/Traffic

Environmental Issue Area:	Was Impact Analyzed in Prior Environmental Document(s)?	Do Project Refinements Involve New Significant Impacts or Substantially More Severe Impacts?	Any New Circumstances Involving New Significant Impacts or Substantially More Severe Impacts?	Any New Information Requiring New Analysis or Verification?
---------------------------	---	--	---	---

Would the project:

a) Conflict with an applicable plan, ordinance or policy establishing measures of effectiveness for the performance of the circulation system, taking into account all modes of transportation including mass transit and non-motorized travel and relevant components of the circulation system, including but not limited to intersections, streets, highways and freeways, pedestrian and bicycle paths, and mass transit?	Yes	No	No	No
b) Conflict with an applicable congestion management program, including, but not limited to level of service standards and travel demand measures, or other standards established by the county congestion management agency for designated roads or highways?	Yes	No	No	No
c) Result in a change in air traffic patterns, including either an increase in traffic levels or change in location that result in substantial safety risks?	Yes	No	No	No
d) Substantially increase hazards due to a design feature (e.g., sharp curves or dangerous intersections) or incompatible uses (e.g., farm equipment)?	Yes	No	No	No
e) Result in inadequate emergency access?	Yes	No	No	No
f) Conflict with adopted policies, plans, or programs regarding public transit, bicycle, or pedestrian facilities, or otherwise decrease the performance or safety of such facilities?	Yes	No	No	No

Table 18. Transportation/Traffic

Environmental Issue Area:	Was Impact Analyzed in Prior Environmental Document(s)?	Do Project Refinements Involve New Significant Impacts or Substantially More Severe Impacts?	Any New Circumstances Involving New Significant Impacts or Substantially More Severe Impacts?	Any New Information Requiring New Analysis or Verification?
---------------------------	---	--	---	---

Discussion: The existing traffic and circulations conditions described in Section 3.3, Transportation and Circulation, and Appendix E of the Final EIR have not substantially changed since the EIR's certification. Similar to the approved Project, implementation of the refined Project would include various improvements at roadways and at-grade crossings to maintain existing traffic levels of service (LOS) and accommodate future traffic levels as forecasted under each City's General Plan. Construction of these improvements would require compliance with Mitigation Measures TR-1 to minimize impacts to existing roadway and intersection LOS, including emergency access, during construction of the refined Project.

Based on this evaluation, no new or more severe traffic impacts would occur as a result of the refined Project features. Mitigation Measures TR-1, TR-2, TR-3, TR-4, and TR-5 as contained in SBCTA's MMRP would continue to apply to the refined Project. No new mitigation measures would be required.



Table 19. Utilities and Service Systems

Environmental Issue Area:	Was Impact Analyzed in Prior Environmental Document(s)?	Do Project Refinements Involve New Significant Impacts or Substantially More Severe Impacts?	Any New Circumstances Involving New Significant Impacts or Substantially More Severe Impacts?	Any New Information Requiring New Analysis or Verification?
---------------------------	---	--	---	---

Would the project:

a) Exceed wastewater treatment requirements of the applicable Regional Water Quality Control Board?	Yes	No	No	No
b) Require or result in the construction of new water or wastewater treatment facilities or expansion of existing facilities, the construction of which could cause significant environmental effects?	Yes	No	No	No
c) Require or result in the construction of new storm water drainage facilities or expansion of existing facilities, the construction of which could cause significant environmental effects?	Yes	No	No	No
d) Have sufficient water supplies available to serve the project from existing entitlements and resources, or are new or expanded entitlements needed?	Yes	No	No	No
e) Result in a determination by the wastewater treatment provider, which serves or may serve the project that it has adequate capacity to serve the project's projected demand in addition to the provider's existing commitments?	Yes	No	No	No
f) Be served by a landfill with sufficient permitted capacity to accommodate the project's solid waste disposal needs?	Yes	No	No	No
g) Comply with federal, state, and local statutes and regulations related to solid waste?	Yes	No	No	No

Table 19. Utilities and Service Systems

Environmental Issue Area:	Was Impact Analyzed in Prior Environmental Document(s)?	Do Project Refinements Involve New Significant Impacts or Substantially More Severe Impacts?	Any New Circumstances Involving New Significant Impacts or Substantially More Severe Impacts?	Any New Information Requiring New Analysis or Verification?
---------------------------	---	--	---	---

Discussion: The Final EIR concluded that the approved Project would not result in significant environmental impacts as it relates to utilities and service systems (see Section 5.5 of the Final EIR). As provided in Chapter 2 of the EIR, the approved Project contemplated the placement of new or relocated utility infrastructure. The refined Project does not entail any substantial changes (or new improvements) that require major revisions to the EIR’s discussion regarding utilities and service systems.

Similar to the approved Project, the refined Project would not introduce new land uses that would increase demand for potable water supply or wastewater treatment. Similar to the approved Project, new drainage infrastructure proposed in conjunction with the refined Project would be constructed in compliance with Mitigation Measure HWQ-1, which requires the attenuation of post-project runoff to pre-project levels. Similar to the approved Project, the refined Project would adhere to all applicable local, State, and Federal standards for the disposal of solid waste.

The refined Project does not entail any substantial changes that require major revisions to the EIR’s discussion regarding utilities and service systems. No new or more severe utilities and service systems impacts would occur as a result of the refined Project. No new mitigation measures would be required.



Table 20. Mandatory Findings

Environmental Issue Area:	Was Impact Analyzed in Prior Environmental Document(s)?	Do Project Refinements Involve New Significant Impacts or Substantially More Severe Impacts?	Any New Circumstances Involving New Significant Impacts or Substantially More Severe Impacts?	Any New Information Requiring New Analysis or Verification?
a) Does the project have the potential to degrade the quality of the environment, substantially reduce the habitat of a fish or wildlife species, cause a fish or wildlife population to drop below self-sustaining levels, threaten to eliminate a plant or animal community, reduce the number or restrict the range of a rare or endangered plant or animal, or eliminate important examples of the major periods of California history or prehistory?	Yes	No	No	No
b) Does the project have impacts that are individually limited, but cumulatively considerable? (“Cumulatively considerable” means that the incremental effects of a project are considerable when viewed in connection with the effects of past projects, the effects of other current projects, and the effects of probable future projects.)	Yes	No	No	No
c) Does the project have environmental effects, which will cause substantial adverse effects on human beings, either directly or indirectly?	Yes	No	No	No

Discussion: As discussed in the Biological and Cultural Resources Sections, the refined Project features would not create new or more severe impacts when compared to the approved Project. With the implementation of Mitigation Measures BIO-1, BIO-2, BIO-3, BIO-4, BIO-5, BIO-6, and BIO-7, the refined Project would not substantially reduce the habitat of a fish or wildlife species, cause a fish or wildlife population to drop below self-sustaining levels, threaten to eliminate a plant or animal community, or reduce the number or restrict the range of a rare or endangered plant or animal. Similar to the approved Project, the refined Project would not eliminate important examples of the major periods of California history or prehistory through compliance with Mitigation Measures CUL-1, CUL-3, and CUL-4.

Cumulative impacts were evaluated for each of the environmental issue areas in Chapter 3 of the Final EIR. Similar to the approved Project, the refined Project would be required to comply with mitigation requirements relating to traffic, noise, hydrology and water quality, and vibration. With mitigation, these impacts would be minimized to a less than significant level for the refined Project features and not cumulatively considerable.

Based on this evaluation, the proposed refinements to the approved Project would not result in any significant cumulative impacts or any new or substantially more severe cumulative impacts. Mitigation measures adopted by SBCTA for the approved Project would be effective in minimizing adverse environmental effects on human beings. Other projects proposed in the vicinity of the refined Project features would be subject to similar mitigation requirements. Therefore, the refined Project would not result in substantially more severe cumulative impacts and no new mitigation measures would be required.

Environmental Determination

Based upon the evidence in light of the whole record documented in the attached environmental checklist explanation, cited incorporations and attachments, I find that the Project:

- Has previously been analyzed** as part of an earlier CEQA document (which either mitigated the project or adopted impacts pursuant to findings) adopted/certified pursuant to State and County CEQA Guidelines. The proposed project is a component of the whole action analyzed in the previously adopted/certified CEQA document.
- Has previously been analyzed** as part of an earlier CEQA document (which either mitigated the project or adopted impacts pursuant to findings) adopted/certified pursuant to State and County CEQA Guidelines. **Minor additions and/or clarifications** are needed to make the previous documentation adequate to cover the project which are documented in this addendum to the earlier CEQA document (CEQA §15164).
- Has previously been analyzed** as part of an earlier CEQA document (which either mitigated the project or adopted impacts pursuant to findings) adopted/certified pursuant to State and County CEQA Guidelines. However, there is important new information and/or **substantial changes have occurred** requiring the preparation of an additional CEQA document (ND or EIR) pursuant to CEQA Guidelines Sections 15162 through 15163.

Signed: _____



4 Mitigation Measures

A listing of applicable mitigation measures from the Redlands Passenger Rail Project's EIR is provided as Attachment D of this EIR Addendum. All mitigation measures adopted as part of SBCTA's MMRP for the Project would continue to apply following the approval of the refined Project. SBCTA, as the CEQA lead agency, is responsible for adopting and implementing the approved mitigation.

This page is intentionally blank.



Attachment A. Figures

Figure 1: Regional Location

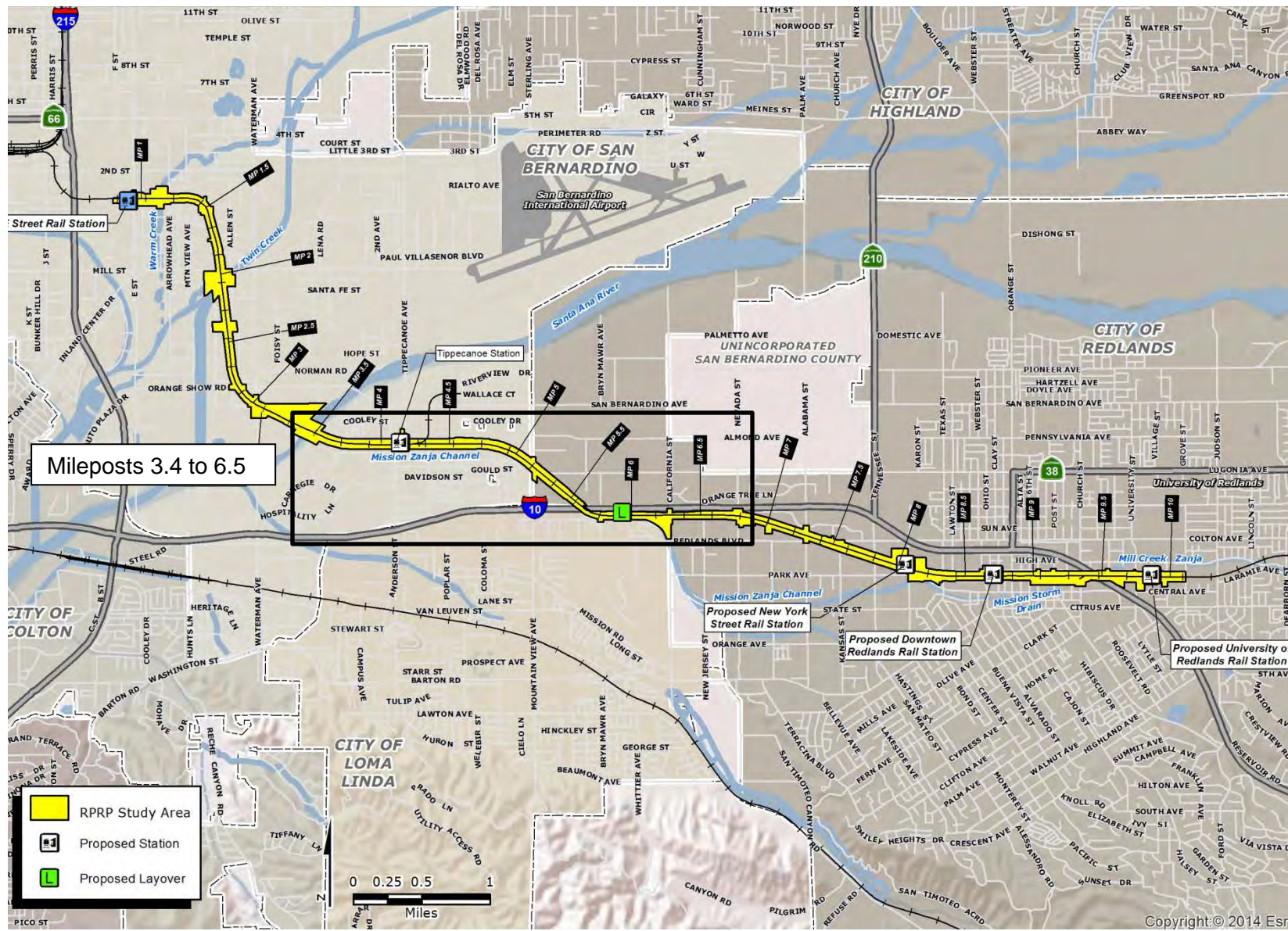

Figure 2: Foundation Design at Bridge 3.4 (Vertical)

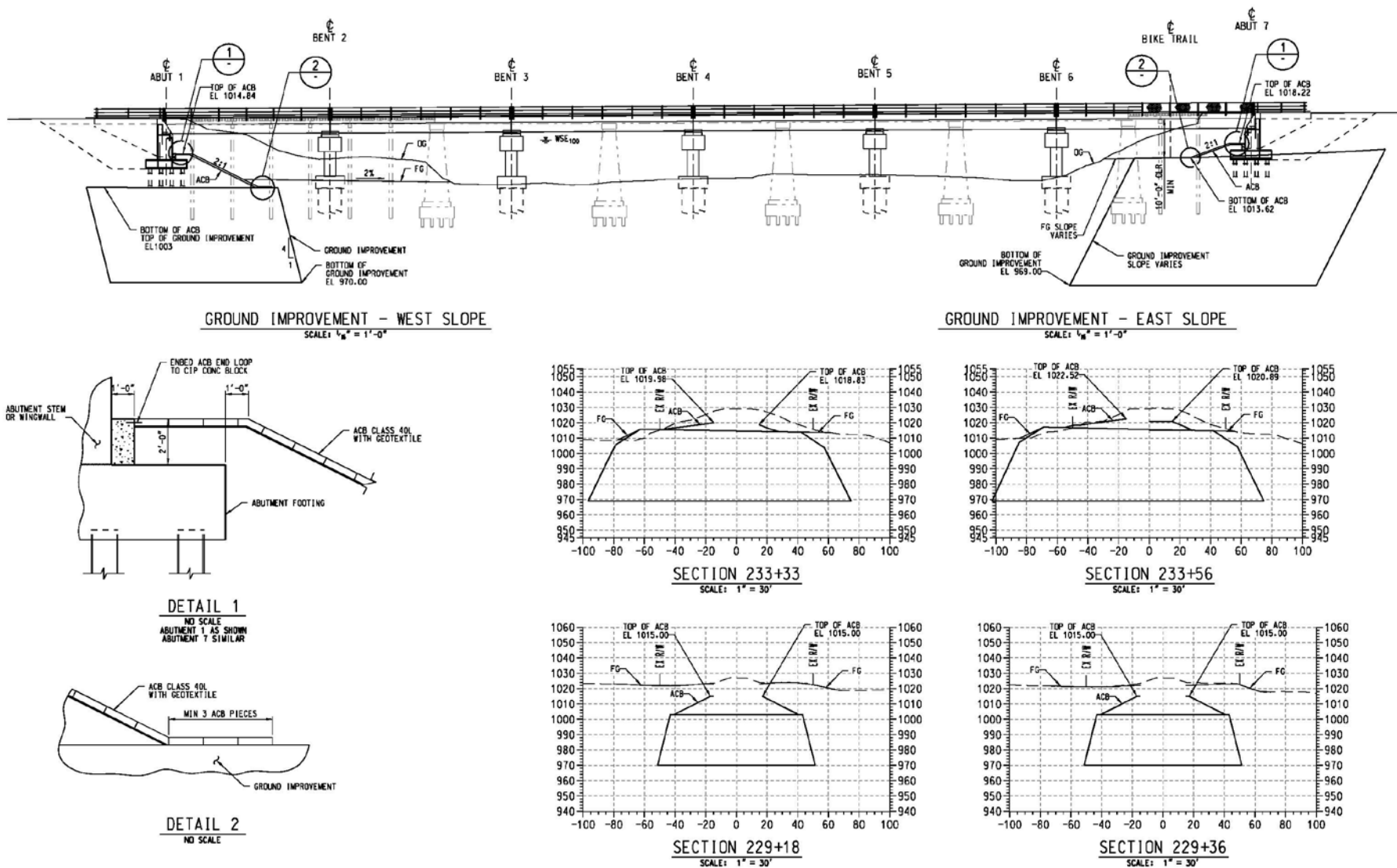

Figure 3: Construction Limits at Bridge 3.4 (2015 and 2017 Comparison)



G:\GIS_Production\Projects\SANBAG_351426\RPRP_Final_Design_268339\7.2_Work_In_Progress\map_docs\mxd\Addendum_4\Construction_Lists_Bridge_3_4.mxd-aburvall-8/21/2017

LEGEND

-  Footprint (2015)
-  Footprint (2017)
-  Right-of-Way



Figure 4: SAR Bike Trail (Proposed Alignment)

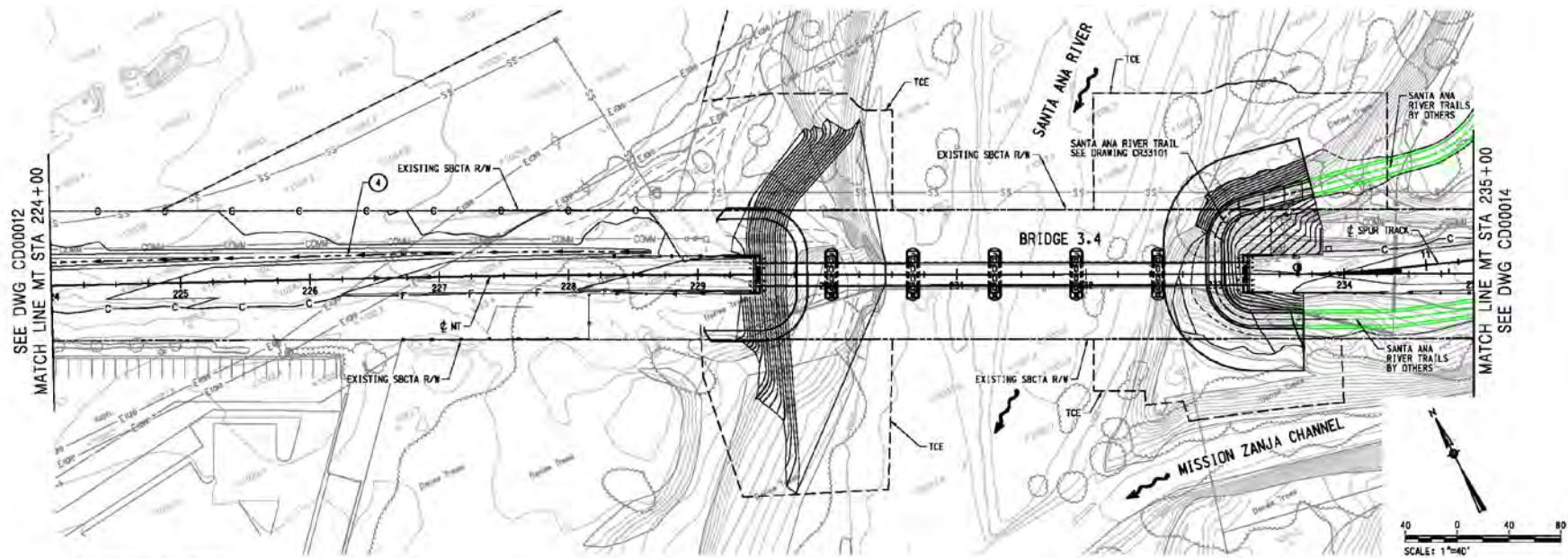

CONSTRUCTION NOTES:

- ① CONST. TYPE A-4 DITCH PER DETAIL IN DRAWING CRO0050

LEGEND:

- DITCH
- CHANNEL FLOW DIRECTION

Figure 5: Mission Zanja Channel – Revised Drainage Connections

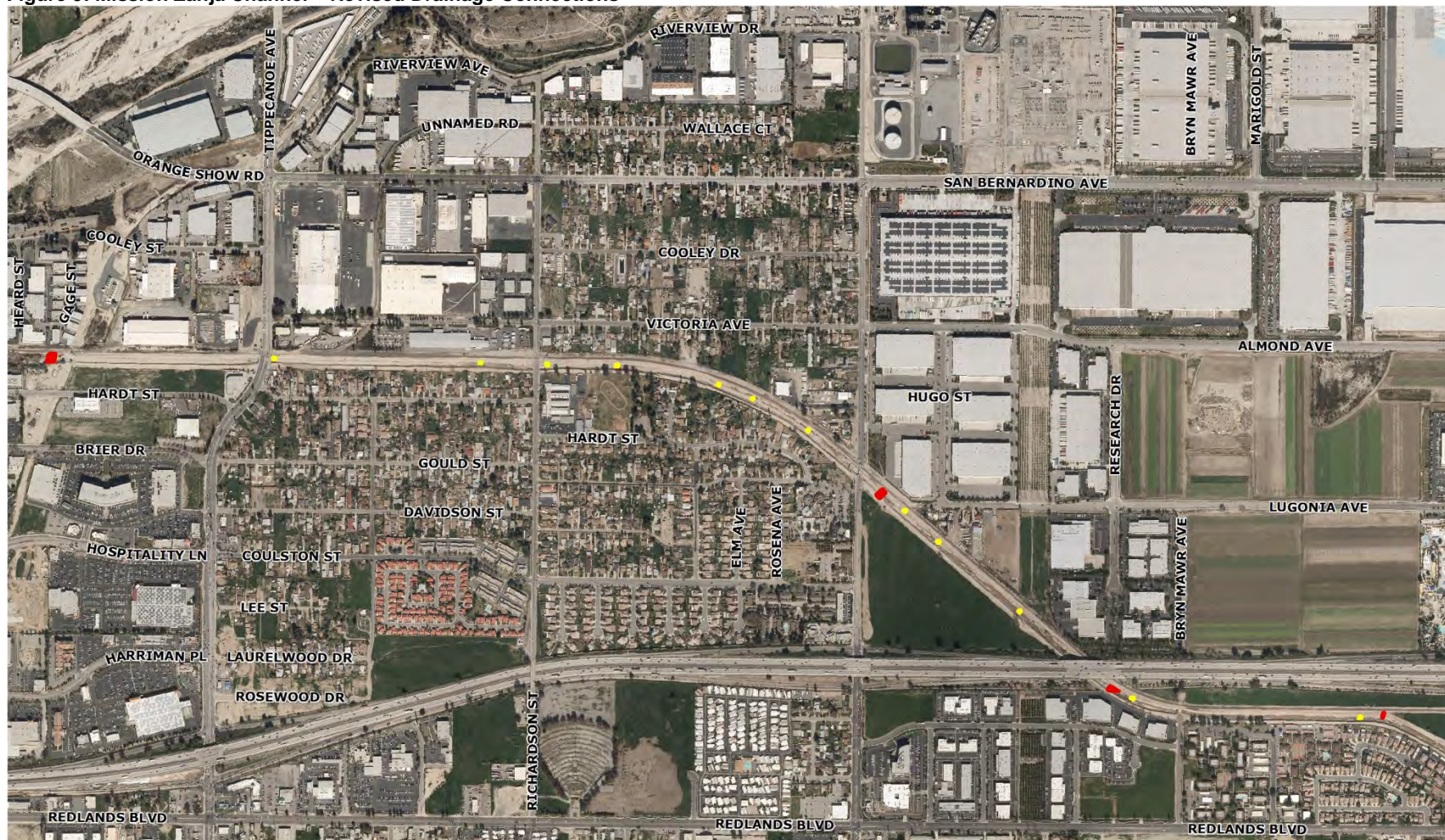

G:\GIS_Production\Projects\SANBAG_351426\RPRP_Final_Design_268339\7.2_Work_In_Progress\map_docs\mxd\Addendum_4\MZC_Outfalls.mxd-aburvall-8/21/2017

LEGEND

- Outfall Improvements (2015)
- Outfall Improvements (2017)

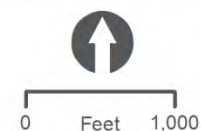
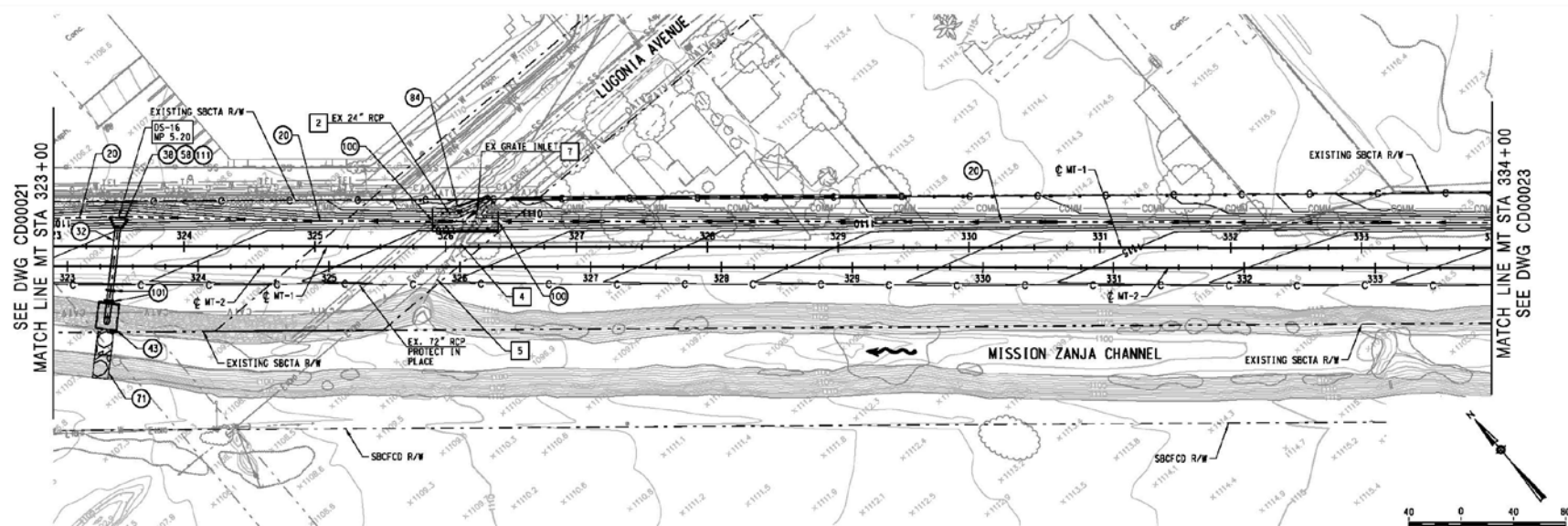

Figure 6: Replacement of Existing Drainage Connection at Lugonia Avenue



CONSTRUCTION NOTES:

- 20 CONST. TYPE B-5 DITCH PER DETAIL ON DRAWING C00050
- 32 CONST. 48" RCP (3000-D)
- 38 CONST. HEADWALL PER METROLINK STD. 6304
- 43 CONST. JUNCTION STRUCTURE NO.8 PER RIVERSIDE COUNTY FLOOD CONTROL STD. PLAN JS233
- 58 CONST. ROUNDED PIPE ENDS PER SAN DIEGO REGIONAL STANDARD DRAWING D-61
- 71 CONST. CLASS Y CONCRETED RSP PER RIVERSIDE COUNTY FLOOD CONTROL STD. PLAN JS233
- 84 CONST. DITCH JUNCTION #1 PER DETAIL ON DRAWING C00053
- 100 CONST. CUTOFF WALL PER DETAIL ON DRAWING C00053
- 101 CONST. CONCRETE PIPE ANCHOR PER DETAIL ON DRAWING C00054
- 111 CONST. HANDRAIL PER METROLINK STD. 6330

DISPOSITION NOTES:

- 2 ABANDON STORM DRAIN
- 4 REMOVE HEADWALL
- 5 REMOVE WOODEN BOX CULVERT
- 7 REMOVE INLET

LEGEND:

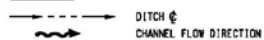

PLAN

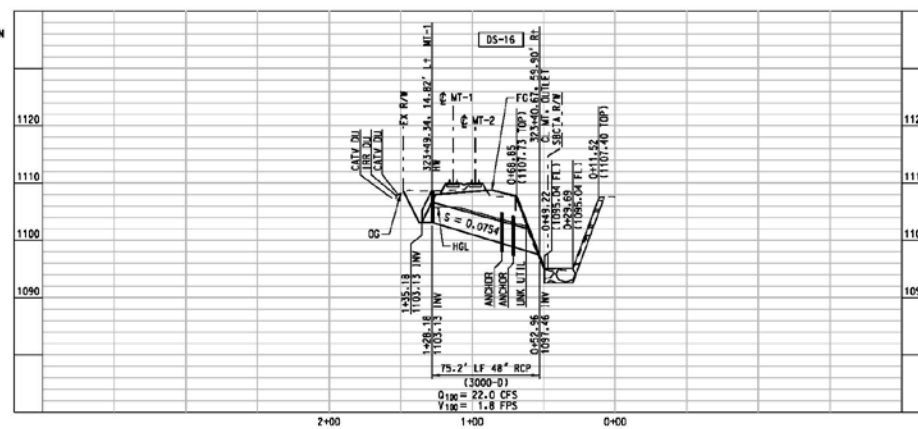

PROFILE

NOTE:

1. SEE TRACK PLANS FOR DITCH PROFILES AND SECTIONS.

Figure 7: Replacement of Existing Drainage Connection at I-10

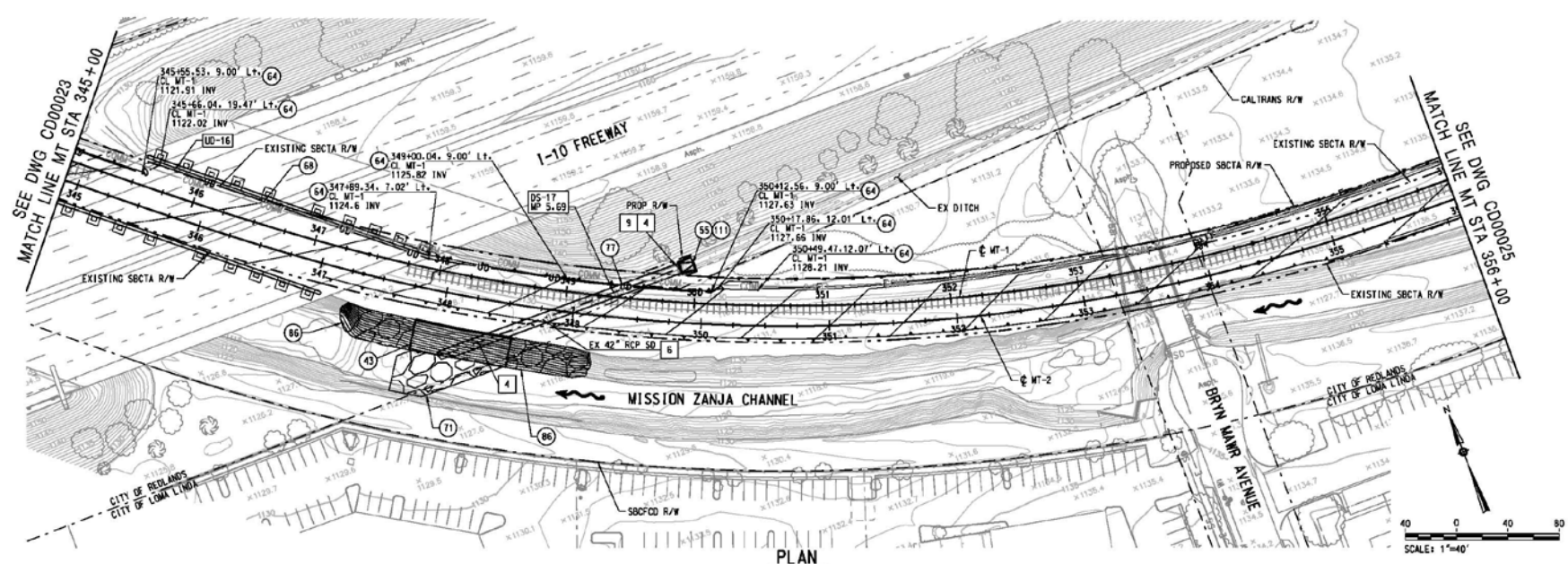

CONSTRUCTION NOTES:

- 43 CONST. JUNCTION STRUCTURE NO. 8 PER RIVERSIDE COUNTY FLOOD CONTROL STD. PLAN JS233
- 55 CONST. HEADWALL W/ WARPED WING WALLS PER DETAIL ON DRAWING C00064
- 64 CONST. UNDERDRAIN CLEANDOUT PER DETAIL ON DRAWING C00049
- 68 CONST. 12" PERFORATED HDPE UNDERDRAIN PIPE PER DETAIL ON DRAWING C00049
- 71 CONST. CLASS V CONCRETE RSP PER RIVERSIDE COUNTY FLOOD CONTROL STD. PLAN JS233
- 77 CONST. 4' H X 8' W REINFORCED CONCRETE BOX PER METROLINK STD. 6003
- 86 CONST. CLASS V RSP PER DETAIL ON DRAWING C00052
- 111 CONST. HANDRAIL PER METROLINK STD. 6330

DISPOSITION NOTES:

- 4 REMOVE HEADWALL
- 6 REMOVE CULVERT
- 9 REMOVE EXIST CONCRETE DITCH

LEGEND:

CHANNEL FLOW DIRECTION

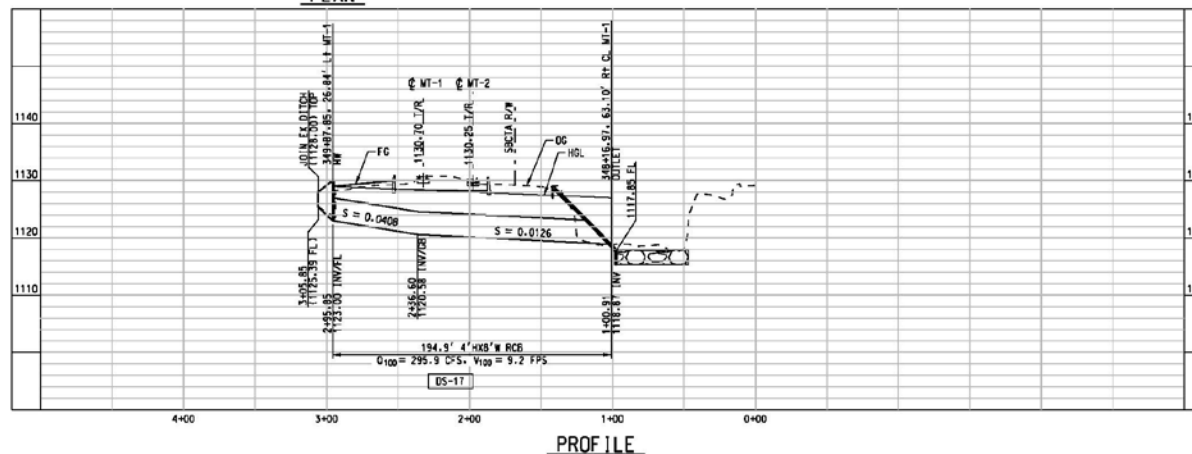

NOTE:

1. SEE TRACK PLANS FOR DITCH PROFILES AND SECTIONS.

Figure 8: Replacement of Existing Drainage Connection East of Bryn Mawr Avenue

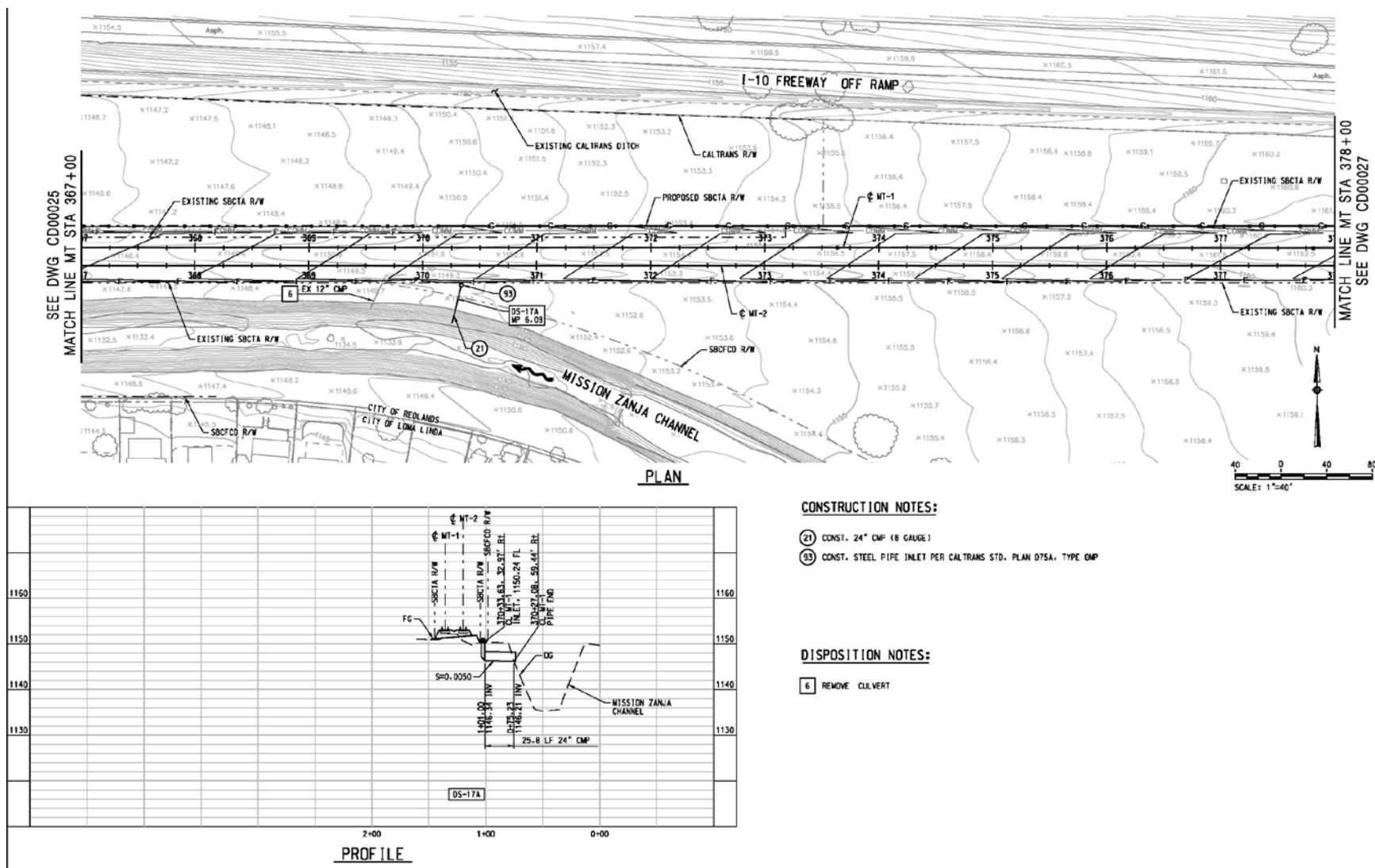

Figure 9: New Drainage Connections West of Gage Canal

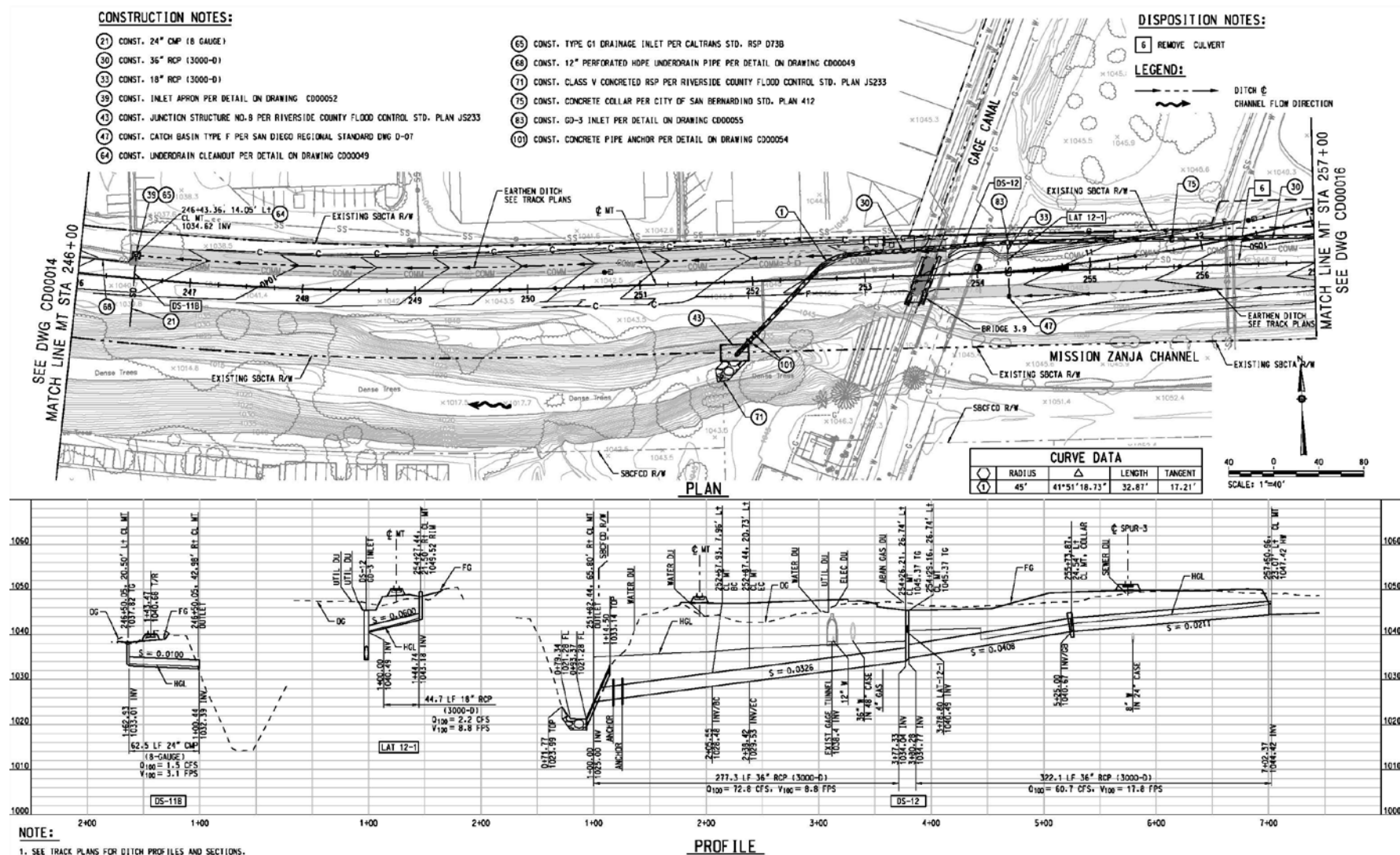
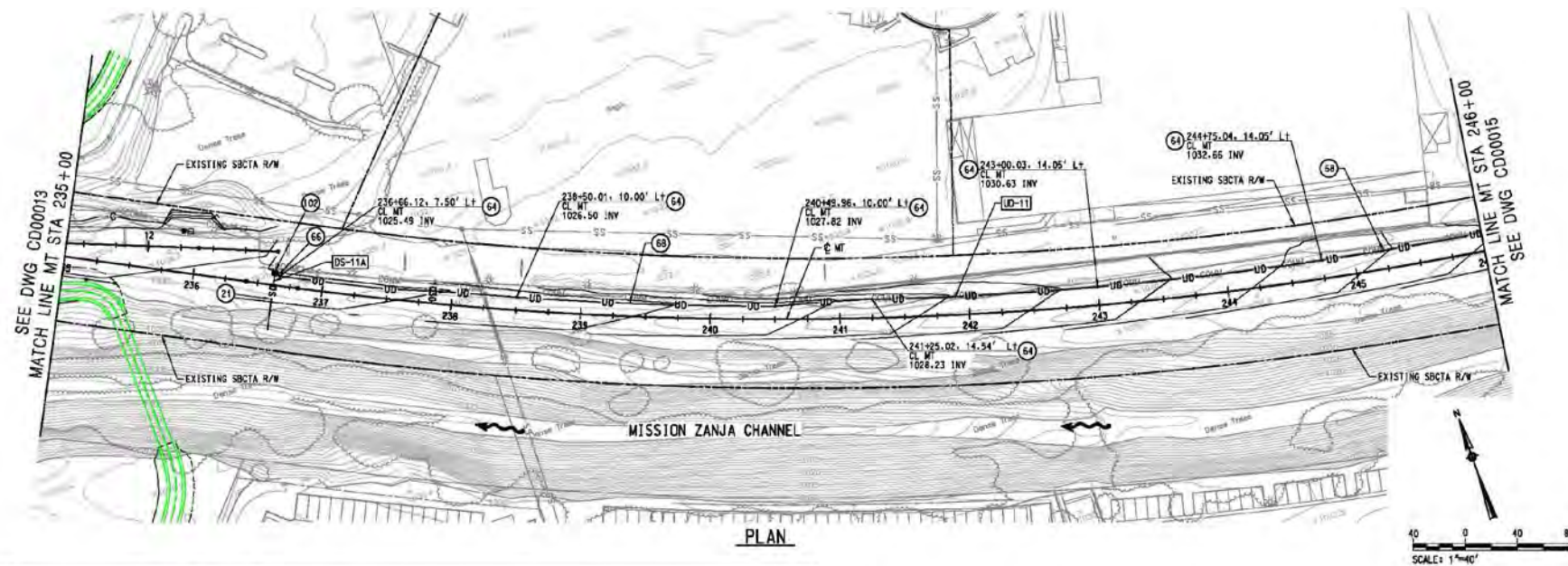
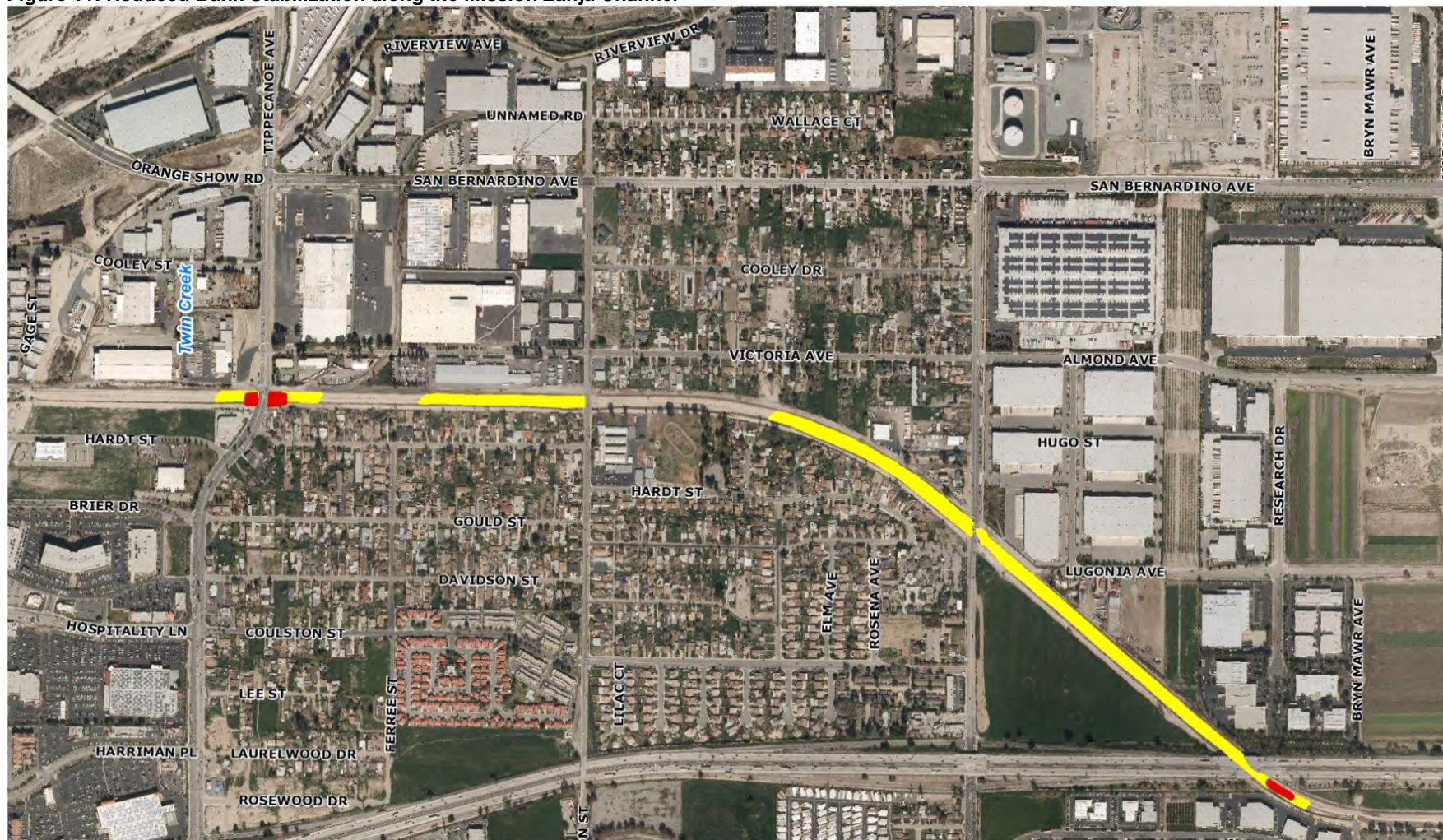

Figure 10: New Drainage Connection at Bridge 3.4



- (21) CONST. 24" CMP (18 GAUGE)
- (64) CONST. UNDERDRAIN CLEANOUT PER DETAIL ON DRAWING C000049
- (66) CONST. 12" NON-PERFORATED HDPE PIPE
- (68) CONST. 12" PERFORATED HDPE UNDERDRAIN PIPE PER DETAIL ON DRAWING C000049
- (102) CONST. MANHOLE PER DETAIL ON DRAWING C000063

Figure 11: Reduced Bank Stabilization along the Mission Zanja Channel



G:\GIS_Production\Projects\SANBAG_351426\RPRP_Final_Design_268339\7.2_Work_In_Progress\map_docs\mxd\Addendum_4\MZC_ReducedBankStabilization.mxd-YLI-8/18/2017

LEGEND

- Bank Improvements (2015)
- Bank Improvements (2017)



Figure 12: MZC Capacity Improvements

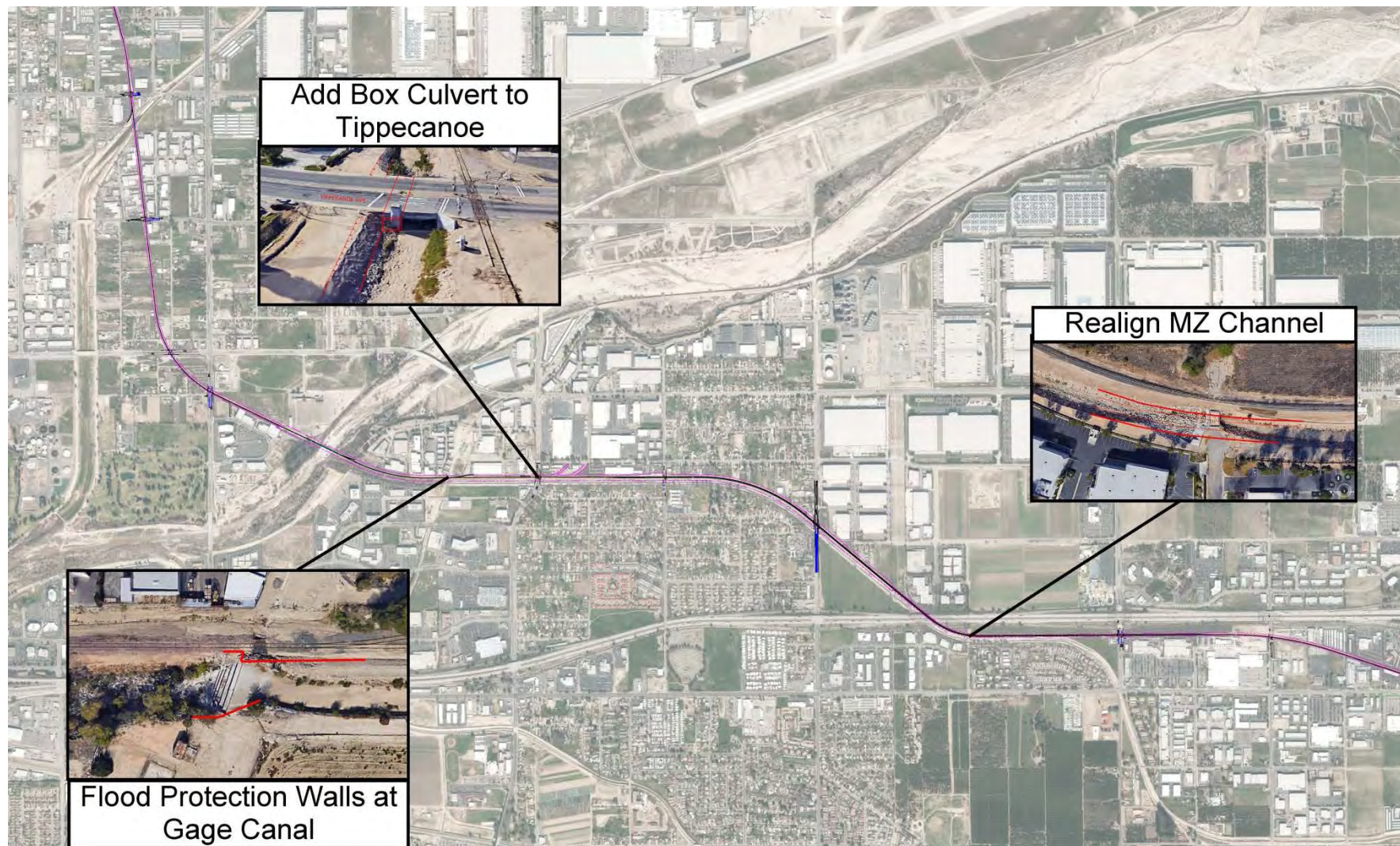
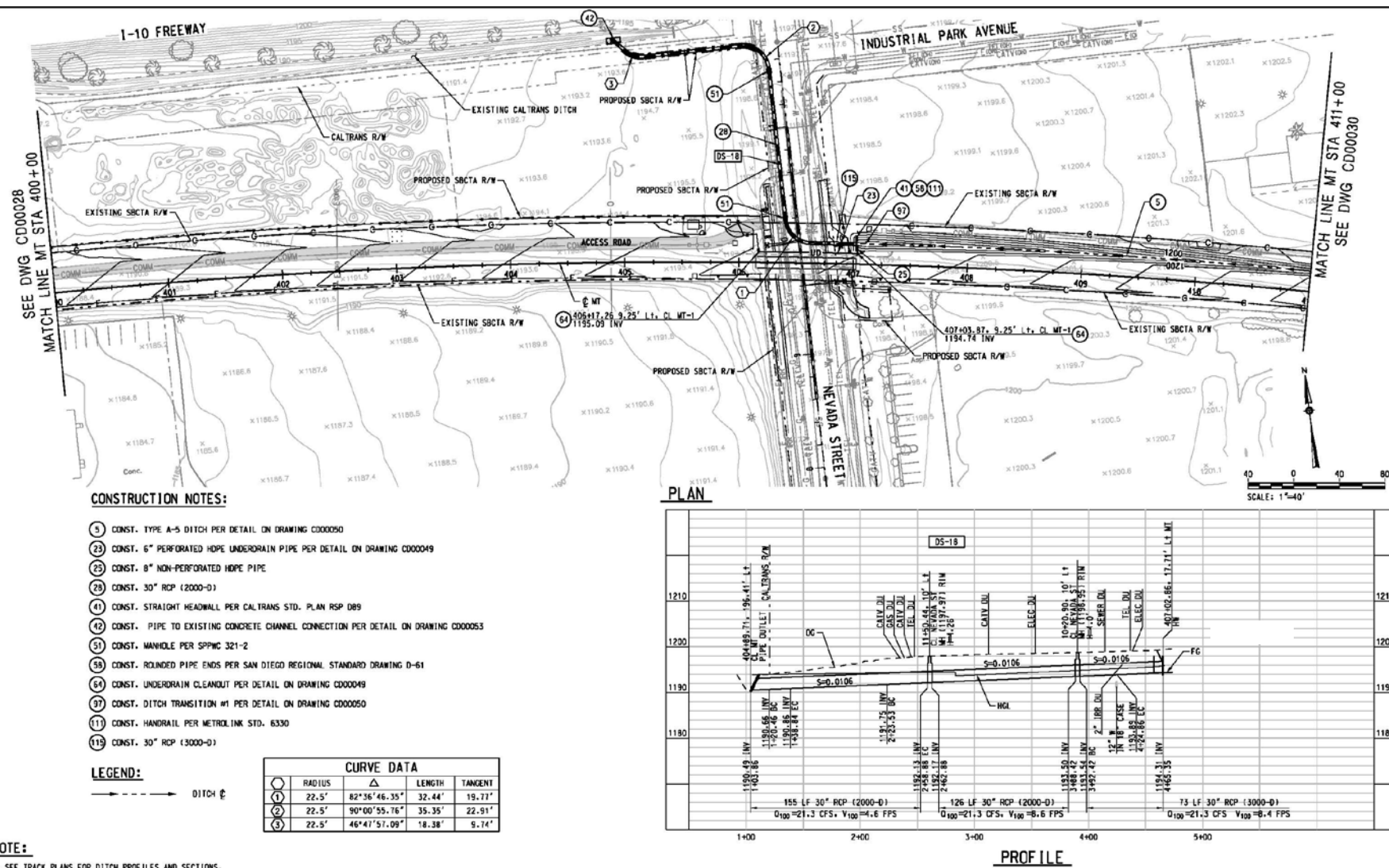

Figure 13: Drainage Connection to I-10 ROW at Nevada Street



Memo

Date: Wednesday, August 23, 2017

Project: Redlands Passenger Rail Project

To: Justin Fornelli, P. E. SBCTA

From: Ingrid Eich, HDR

Subject: **Biological Letter Supporting Addendum No. 4 to the EIR for the Redlands Passenger Rail Project**

1.0 Introduction

This biological memo addresses a refinement to the Redlands Passenger Rail Project (RPRP or approved Project) that has occurred since the certification of the Final Environmental Impact Report (EIR) on March 4, 2015. Specifically, this memo addresses design refinements associated with Bridge 3.4 at the Santa Ana River and the Mission Zanja Channel (MZC) at mileposts 3.4 to 6. As previously analyzed in the EIR, improvements to existing facilities would be necessary along the railroad corridor as part of the approved Project; including the replacement of Bridge 3.4, new drainage connections along the MZC, and improvements to the north bank of the MZC.

The proposed refinements occur within the original survey area covered in the Biological Technical Report (BTR) that was prepared in conjunction with the approved Project and included in Appendix I of the Final EIR. The BTR included a review of the California Department of Fish and Wildlife's (CDFW) California Natural Diversity Database (CNDDDB) Rarefind program and California Native Plant Society's (CNPS) Inventory of Rare and Endangered Plants of California for special-status species with potential to occur in the vicinity of the approved Project. The CNDDDB and CNPS record search results are found in the RPRP BTR (HDR 2015) and is incorporated by reference for the purposes of the memo.

1.1 Project Location

The refined Project encompasses the same general Study Area as described for the approved Project in Section 2.3 of the Final EIR, which extends along existing railroad right-of-way (ROW) owned by SBCTA between the cities of San Bernardino and Redlands, San Bernardino County, California (Attachment A, Figure 1). Section 2.3 of the EIR provides a detailed description of the Project's location and Study Area. The refinements considered in this addendum are generally contained between mileposts (MP) 3.4 and 6.75.

1.1.1 Refined Project

SBCTA is proposing three design refinements to the approved Project. Table 1 provides a summary of these refinements in relation to the improvements originally contemplated in the



approved Project (and certified EIR). Attachment A, Figures 2A through 2F, illustrates the proposed improvements overlaid on biological resource mapping.

Design Basin for Refinement	Refinement Tracking No.	Approved Project (2015 EIR)	Proposed Refinements (90% Design Refinements– June 2017)	Milepost(s)
Bridge 3.4 (SAR) Crossing	1	<ul style="list-style-type: none"> • Double Track Bridge Structure; up to 365 feet in length and 20 feet in width • Scour Protection: ACB within approved footprint • Bank Protection (within approved footprint) • Accommodation of SAR Trail (per MM PCS-1) • Pile installation and work zone isolation proposed via steel sleeve (or cast-in-steel shell [CISS]) pile method or traditional cofferdam 	<ul style="list-style-type: none"> • Single-track bridge; up to 380 feet in length⁽¹⁾ • Scour Protection: Use of soil slurry/cement • Expanded Bank Protection (west and east banks) • SAR Trail Undercrossing • Pile installation and work zone isolation proposed via CIDH (cast-in-drilled hole pile method) 	3.4
Mission Zanja Channel (MZC)	2	<ul style="list-style-type: none"> • Reconfiguration of the existing channel from MP 3.9 to 4.2, including, modifications to the existing hydraulic grade structure or construction of a short • Approved Project contemplated drainage improvements such as new drainage connections (12 new connections originally considered) • New floodwall along the north bank of the MZC at MP 3.8 	<ul style="list-style-type: none"> • Reduce the number of new drainage connections to MZC (previously 12) • Three new drainage connections between MP 3.4 and 3.8 • Replace three drainage connections (east of Mtn. View) • Remove bank stabilization and armoring along northern bank of MZC • Add Tippecanoe Box Culvert • Add retaining walls at MP 3.5 and 5 • Add floodwall to southern bank of MZC at MP 3.8 • Remove Bryn Mawr Bridge (MP 5.78) Crossing. • Realign Channel-600 ft 	3.4 to 6.0
Caltrans ROW (I-10)	3	<ul style="list-style-type: none"> • Approved Project contemplated drainage improvements, including the construction of new drainage connections outside of SBCTA's ROW 	<ul style="list-style-type: none"> • New drainage connection to Caltrans I-10 ROW via Nevada Street • Flows would be discharged to the MZC via new RCB culvert (replacing existing) 	6.8

2.0 Evaluation – Area of Potential Effect

Vegetation was classified using the R.F. Holland system of natural communities, as described in *Preliminary Descriptions of the Terrestrial Natural Communities of California* (Holland R.F. 1986). Detailed descriptions of vegetation communities found within the refined Project

area can be found in the 2015 BTR (HDR 2015), which is provided as Appendix I of the Final EIR. The refined Project area supports 12 cover types: disturbed habitat (DH; Holland Code 11300), disturbed wetland (Holland Code 11200), eucalyptus woodland (Holland Code 11100), flat-top buckwheat Scrub (Holland Code 37K00), non-native grassland (NNG; Holland Code 42200), non-vegetated channel (Holland Code 64200), oak woodland (Holland Code 71100), orchard and vineyards (Holland Code 18100), Riversidean alluvial fan sage scrub (Holland Code 32720), southern cottonwood willow riparian forest (Holland Code 61330), southern willow scrub (Holland Code 63320), and urban developed (UD; Holland Code 12000) (see Attachment A, Figures 2A through 2F). In reviewing the CDFW Natural Communities List (CDFW 2010), southern willow scrub, southern cottonwood willow riparian forest, and Riversidean alluvial fan sage scrub are considered sensitive communities.

Several sensitive botanical and zoological species are also known to occur within the vicinity of the RPRP (HDR 2015). As identified in the 2015 BTR, the Santa Ana River and Mission Zanja Channel are suitable habitats for the following sensitive species:

- Santa Ana River woolly star (*Eriastrum densifolium* ssp. *Sanctorum*; Federally and State listed as Endangered) – present
- Slender-horned spineflower (*Dodecahema leptoceras*; Federally and State listed as Endangered) – moderately suitable habitat present
- Smooth tarplant (*Centromadia pungens* ssp. *laevis*; CNPS list 1B.1¹) – present
- Salt spring checkerbloom (*Sidalcea neomexicana*; CNPS list 2.2 – moderately suitable habitat present
- Santa Ana sucker (*Catostomus santaanae*; Federal threatened and SSC2) - moderately suitable habitat present
- Least Bell's vireo (*Vireo bellii pusillus*; Federally and State listed as Endangered) – species present
- Southwestern willow flycatcher (*Empidonax traillii extimus*; Federally and State listed as Endangered) – moderately suitable habitat present
- San Bernardino kangaroo rat (*Dipodomys merriami parvus*; Federally listed Endangered and SSC) – moderately suitable habitat present
- Santa Ana sucker (*Catostomus santaanae*; Federally listed as Threatened and SSC) - moderately suitable habitat present
- Western spadefoot toad (*Spea hammondi*; SSC) - moderately suitable habitat present
- Western Yellow-billed Cuckoo (*Coccyzus americanus occidentalis*; federal threatened and State endangered) - moderately suitable habitat present
- Yellow-breasted chat (*Icteria virens*; SSC breeding) - highly suitable habitat present
- Yellow warbler (*Dendroica petechial*; SSC) - highly suitable habitat present
- Western burrowing owl (*Athene cunicularis hypugaea*; SSC) - moderately suitable habitat present
- Loggerhead shrike (*Lanius ludovicianus*; SSC) - species present
- Migratory Bird Treaty Act (MBTA) protected avian species

¹ SSC- State Species of Concern, CNPS – California Native Plant Society

² SSC- State Species of Concern, CNPS – California Native Plant Society



Additional information on these species can be found in the RPRP BTR (HDR 2015).

USACE and CDFW Jurisdictional Areas

The Addendum 4 project refinements occur within and adjacent to the Santa Ana River and Mission Zanja Channel (see Attachment A, Figure 3A through 3F). Both the Santa Ana River and the Mission Zanja Channel support federal waters of the U.S. and CDFW riparian and unvegetated streambed.

Additional information on these drainage features can be found in the RPRP BTR (HDR 2015).

2.1 Direct Impacts

Sensitive Vegetation Communities, Botanical Species, and Zoological Species

CONSTRUCTION

The Bridge 3.4 refinements would increase permanent impacts to sensitive communities (southern cottonwood willow riparian forest and southern willow scrub), which also provides suitable LBVI habitat by 0.06 acre and increase temporary impacts to these habitats by 0.22 acre.

Mission Zanja Channel refinements, including those in the Caltrans ROW, would increase permanent impacts to sensitive communities (southern cottonwood willow riparian forest), which also provides suitable LBVI habitat by 0.01 acre but reduces temporary impacts to this habitats by 0.69 acre.

All the proposed refinements combined increase permanent impacts to special status vegetation that can support special-status species by 0.07 acre but reduce temporary impacts to these communities by 0.47 acre. Additionally, the project refinements result in avoidance of direct impacts to Santa Ana River Woolly Star.

Potential impacts to special status vegetation communities and species are consistent with impacts identified in the EIR for the approved Project and would be less than significant after application of Mitigation Measures **BIO-1 through BIO-5**, as identified in SBCTA's adopted Mitigation Monitoring and Reporting Program (MMRP) and included as Attachment B.

OPERATION

No previously unidentified direct impacts would result following construction of the project refinements. Similar to existing conditions, future operation and maintenance activities would be conducted by the County Flood Control District, including mowing. Long-term impacts would be less than significant.

USACE and CDFW Jurisdictional Areas

The Bridge 3.4 refinements would increase permanent impacts to CDFW streambed by 0.12 acre, of which 0.06 acre consists of riparian habitat. The Bridge 3.4 refinements would increase temporary impacts to CDFW streambed by 0.46 acre, of which 0.22 acre consists of riparian habitat.

The Bridge 3.4 refinements would reduce the net loss of USACE-regulated Waters of the U.S. by 0.01 acre, none of which consists of wetland. The Bridge 3.4 refinements would increase temporary loss of USACE-regulated Waters of the U.S. by 0.12 acre, none of which consists of wetland.

Mission Zanja Channel refinements, including those in the Caltrans ROW, would reduce the net loss of USACE-regulated Waters of the U.S. by 0.02 acre, none of which consists of wetland and reduces temporary loss of USACE-regulated Waters of the U.S. by 3.42 acres.

All the proposed refinements combined reduce net loss of USACE-regulated Waters of the U.S. by 0.03, none of which consist of wetland and reduce temporary loss of USACE-regulated Waters of the U.S. by 3.30 acres.

These impacts are consistent with impacts identified in the EIR for the approved Project and would be less than significant after application of **Mitigation Measure BIO-6**, as identified in SBCTA's adopted MMRP as provided in Attachment B.

2.2 Indirect Impacts

Sensitive Vegetation Communities, Botanical Species, and Zoological Species

CONSTRUCTION

Potential indirect impacts to sensitive vegetation communities, botanical species, and wildlife species from construction remain unchanged from those analyzed in the EIR for the approved Project and would be continue to be less than significant after application of Mitigation Measures **BIO-1 through BIO-5, HWQ-2 and HWQ-3** (see Attachment B).

OPERATION

No previously unidentified indirect impacts would result following construction of the project refinements.

USACE and CDFW Jurisdictional Areas

CONSTRUCTION

Potential indirect impacts to USACE and CDF jurisdictional areas from construction remain unchanged from those analyzed in the EIR for the approved Project and would be continue to be less than significant after application of Mitigation Measures **BIO-6, HWQ-2 and HWQ-3** (see Attachment B).

OPERATION

No previously unidentified indirect impacts would result following construction of the project refinements.



3.0 References

CDFW 2012. California Department of Fish and Wildlife (CDFW) 2012 Staff Report on Burrowing Owl Mitigation. State of California Natural Resources Agency, Sacramento. March 7, 2012.

CDFW 2010. List of Vegetation Alliances and Associations. Vegetation Classification and Mapping Program, California Department of Fish and Game. Sacramento, CA. September 2010.

HDR 2015. HDR Engineering. Revised Biological Technical Report for the Redlands Passenger Rail Project. Prepared January 2015.

Holland, R.F. 1986. Preliminary descriptions of the terrestrial natural communities of California. State of California, Nongame-Heritage Program. 156p (amended).

USFWS 2010. U. S. Fish and Wildlife Service. Publication date 2010. National Wetlands Inventory website. U.S. Department of the Interior, Fish and Wildlife Service, Washington, D.C. <http://www.fws.gov/wetlands/>



Attachment A. Figures



This page is intentionally blank.

Figure 1: Regional and Vicinity Map

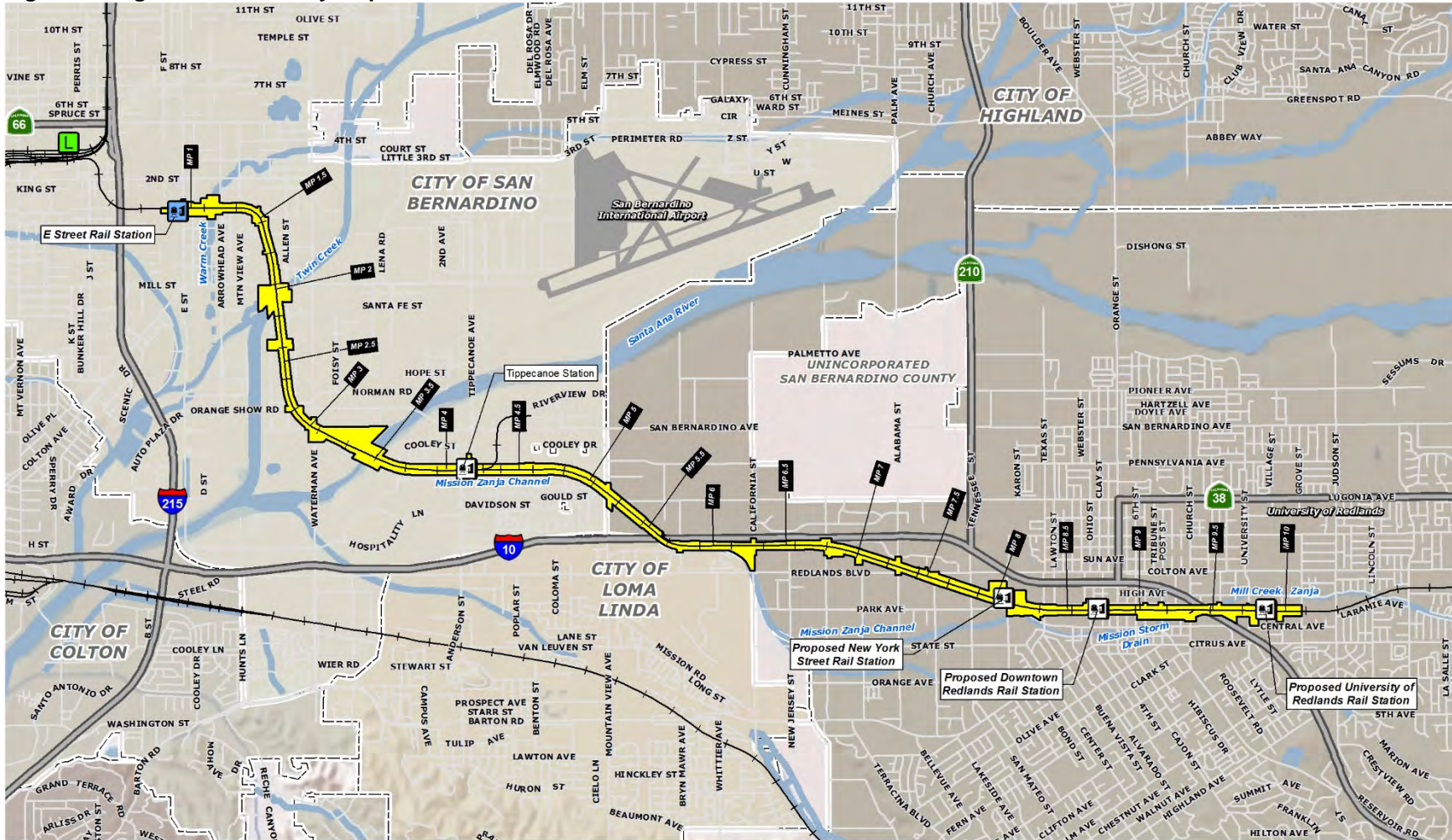

G:\GIS_Production\Projects\SANBAG_351426\RPRP_Final_Design_268339\7.2_Work_In_Progress\map_docs\mxd\Addendum_4\StudyAreaOverview.mxd-aburvall-8/21/2017

LEGEND

- RPRP Study Area
- Proposed Station
- Proposed Layover





Figure 2A: Biological Resource Overlay Sheet 1



LEGEND

- Permanent Impact
- Permanent Impact - No Loss of Water
- Temporary Impact

- Disturbed Habitat
- Eucalyptus Woodland
- Mulefat Scrub
- Non Jurisdictional Ditch
- Non-native Grassland
- Non-Vegetated Channel
- Riversidean Alluvial Fan Sage Scrub
- Southern Willow Scrub

- Southern Cottonwood Willow Riparian Forest
- Urban/Developed

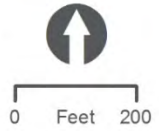
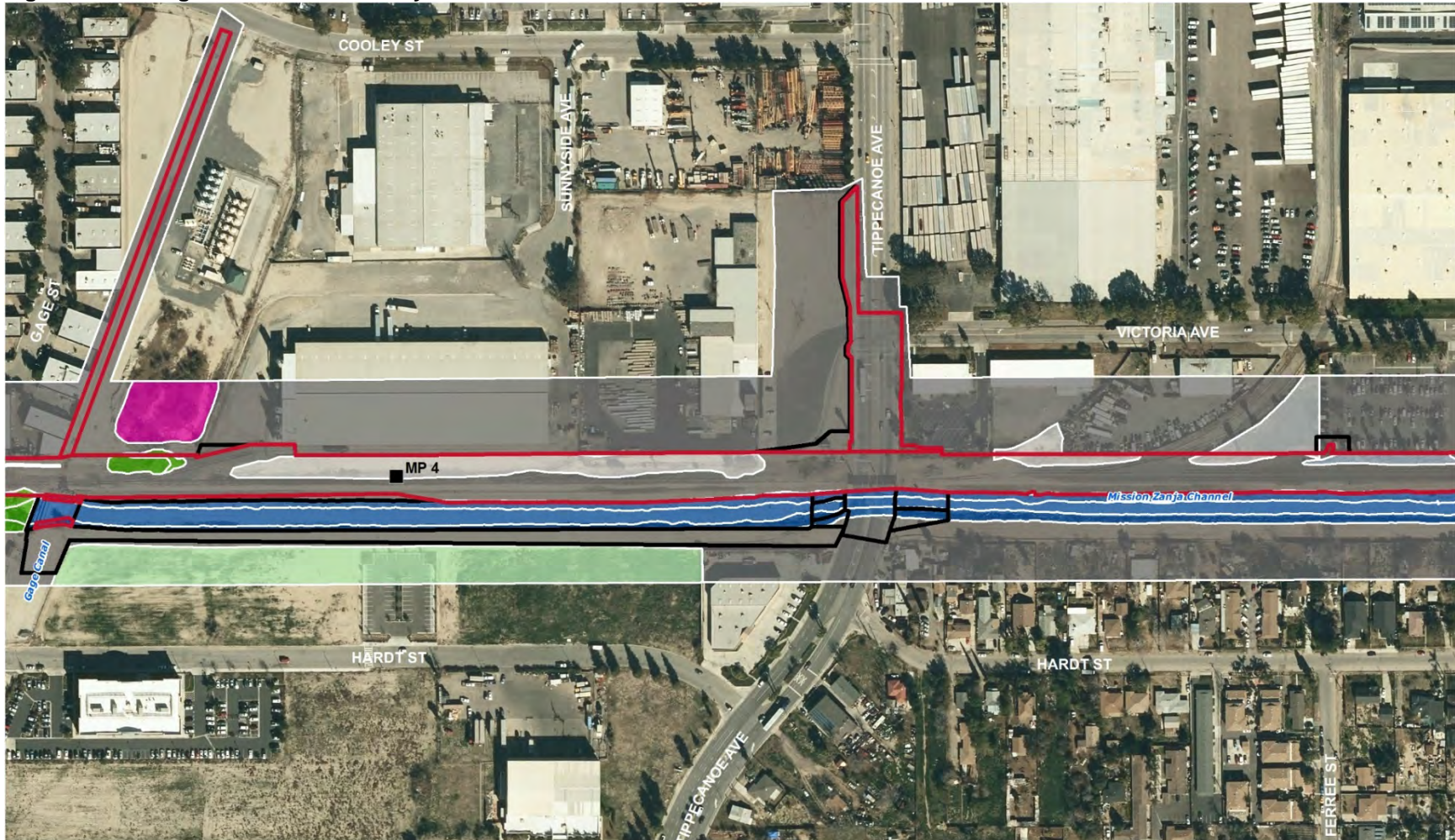

Figure 2B: Biological Resource Overlay Sheet 2



LEGEND

- | | | | |
|------------------|--------------------------|--|-----------------|
| Permanent Impact | Disturbed Habitat | Non-Vegetated Channel | Tamarisk Scrub |
| Temporary Impact | Non-Jurisdictional Ditch | Southern Cottonwood Willow Riparian Forest | Urban/Developed |
| | Non-native Grassland | | |

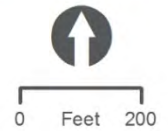
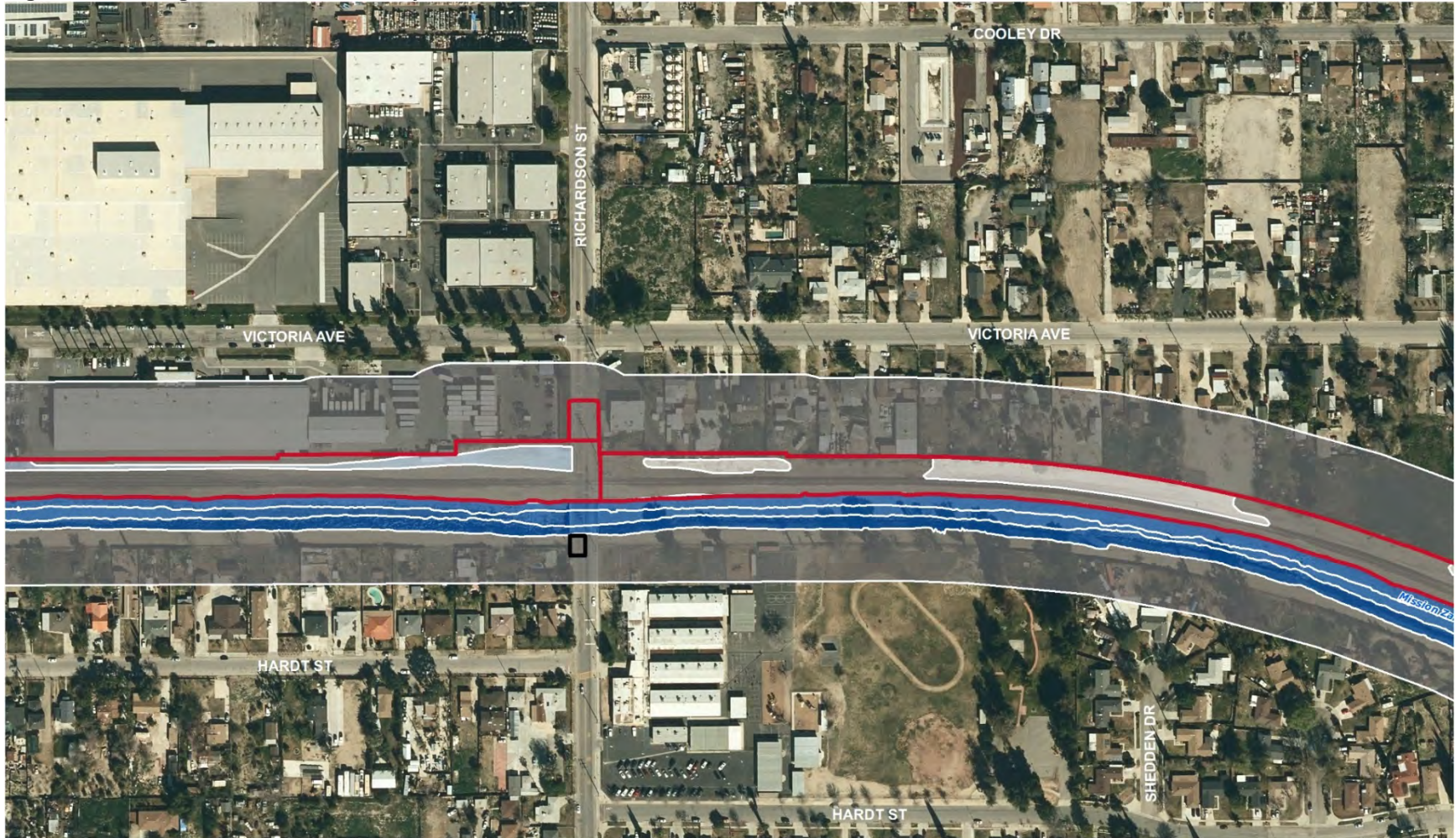



Figure 2C: Biological Resource Overlay Sheet 3



LEGEND

- Permanent Impact
- Disturbed Habitat
- Non Jurisdictional Ditch
- NonVegetated Channel
- Urban/Developed
- Temporary Impact

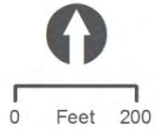

Figure 2D: Biological Resource Overlay Sheet 4



LEGEND

- | | | | |
|------------------|--------------------------|-----------------------|-----------------|
| Permanent Impact | Disturbed Habitat | Non-native Grassland | Urban/Developed |
| Temporary Impact | Non Jurisdictional Ditch | Non-Vegetated Channel | |

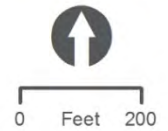
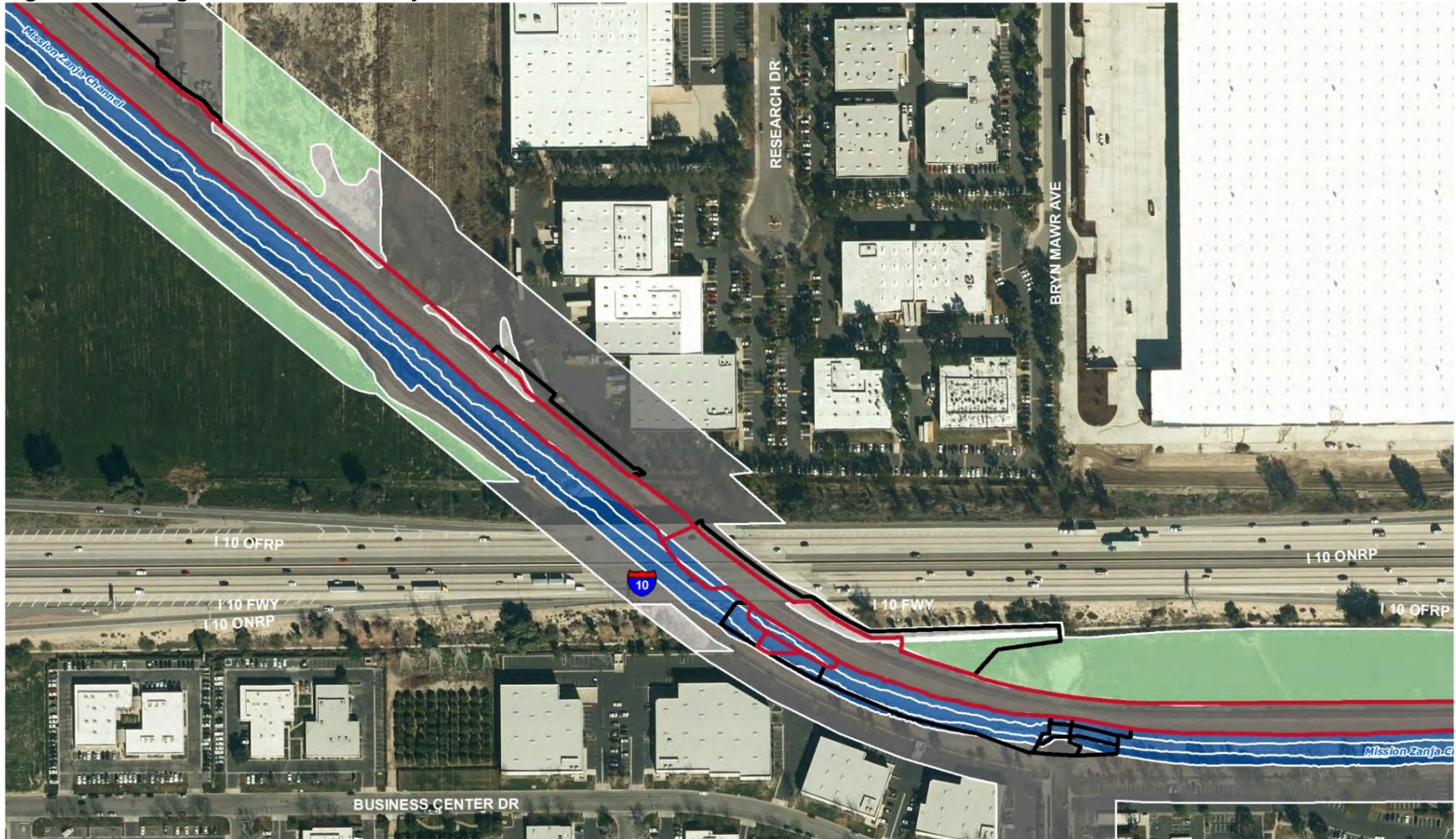



Figure 2E: Biological Resource Overlay Sheet 5



LEGEND

- | | | | |
|------------------|--------------------------|----------------------|-----------------|
| Permanent Impact | Disturbed Habitat | Non-native Grassland | Urban/Developed |
| Temporary Impact | Non Jurisdictional Ditch | NonVegetated Channel | |

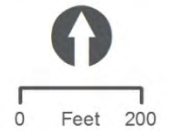
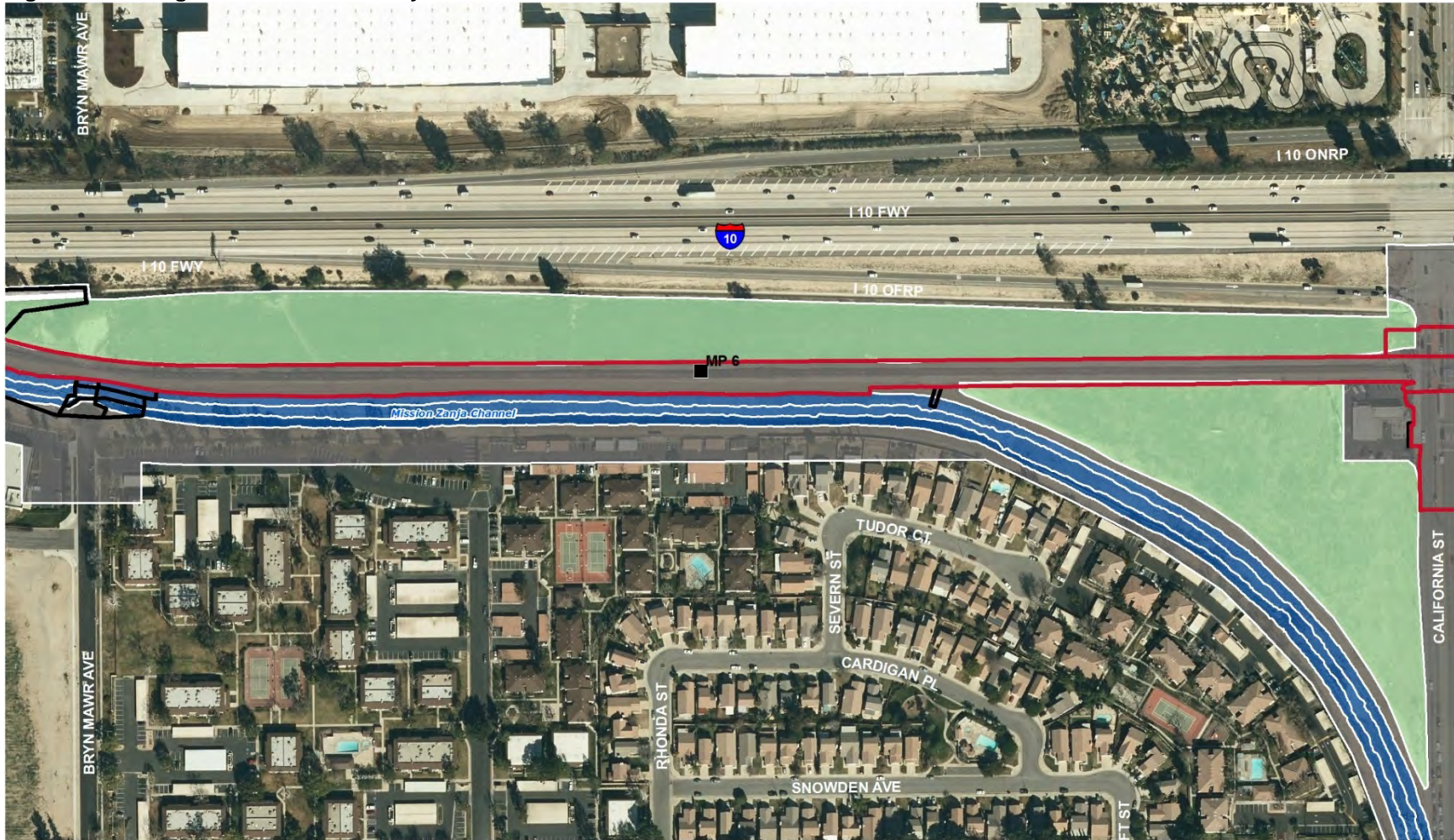

Figure 2F: Biological Resource Overlay Sheet 6



LEGEND

- Permanent Impact
- Temporary Impact
- Disturbed Habitat
- Non-native Grassland
- Urban/Developed
- Non Jurisdictional Ditch
- NonVegetated Channel

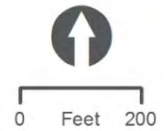

Figure 3A: Jurisdictional Delineation Overlay Sheet 1



LEGEND

- Permanent Impact
- Permanent Impact - No Loss of Water
- Temporary Impact
- USACE Jurisdiction
- CDFW Jurisdiction

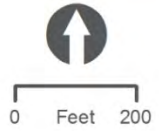
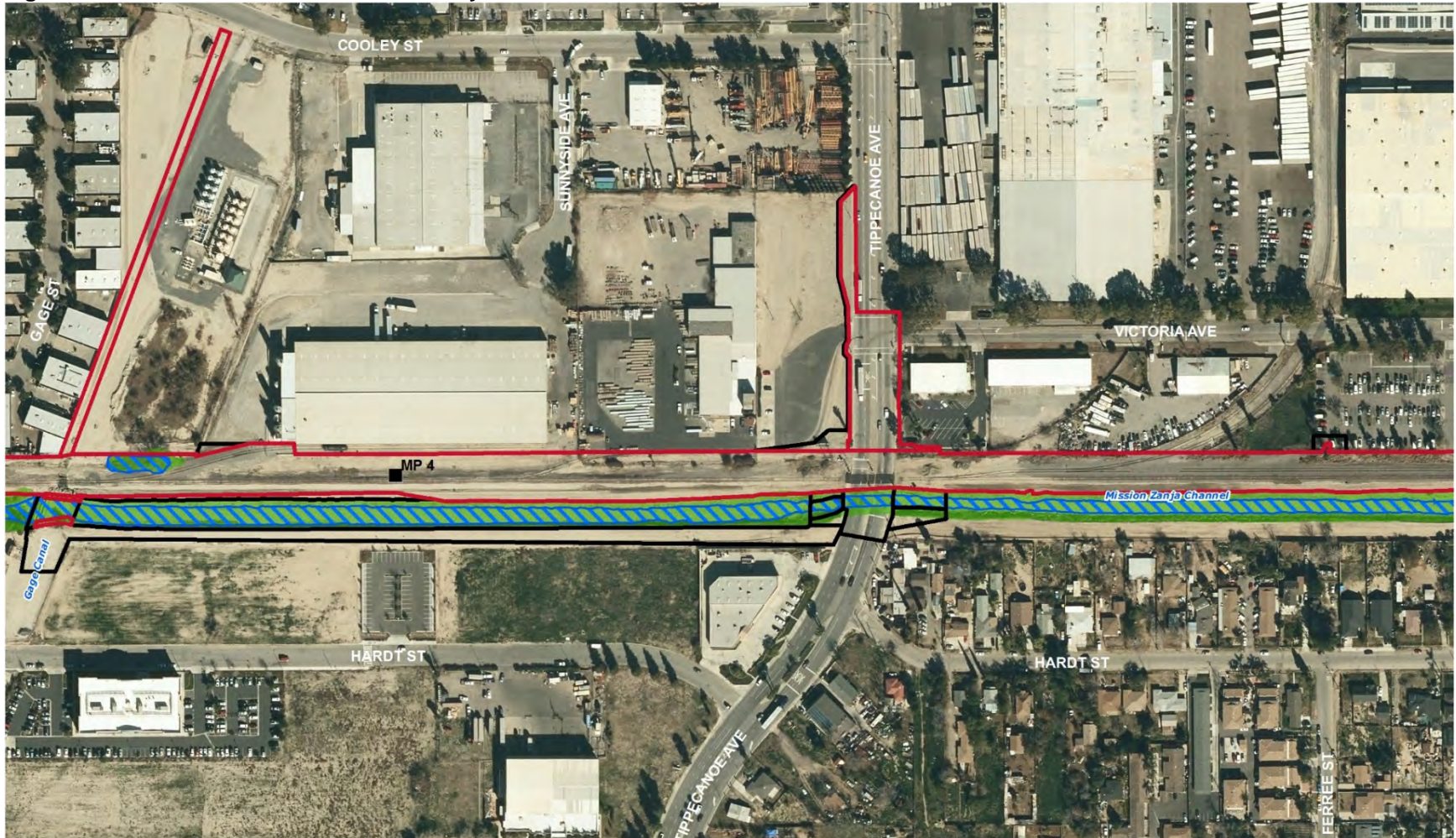

Figure 3B: Jurisdictional Delineation Overlay Sheet 2



LEGEND

- Permanent Impact
- Temporary Impact
- USACE Jurisdiction
- CDFW Jurisdiction

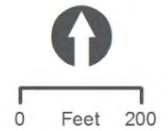
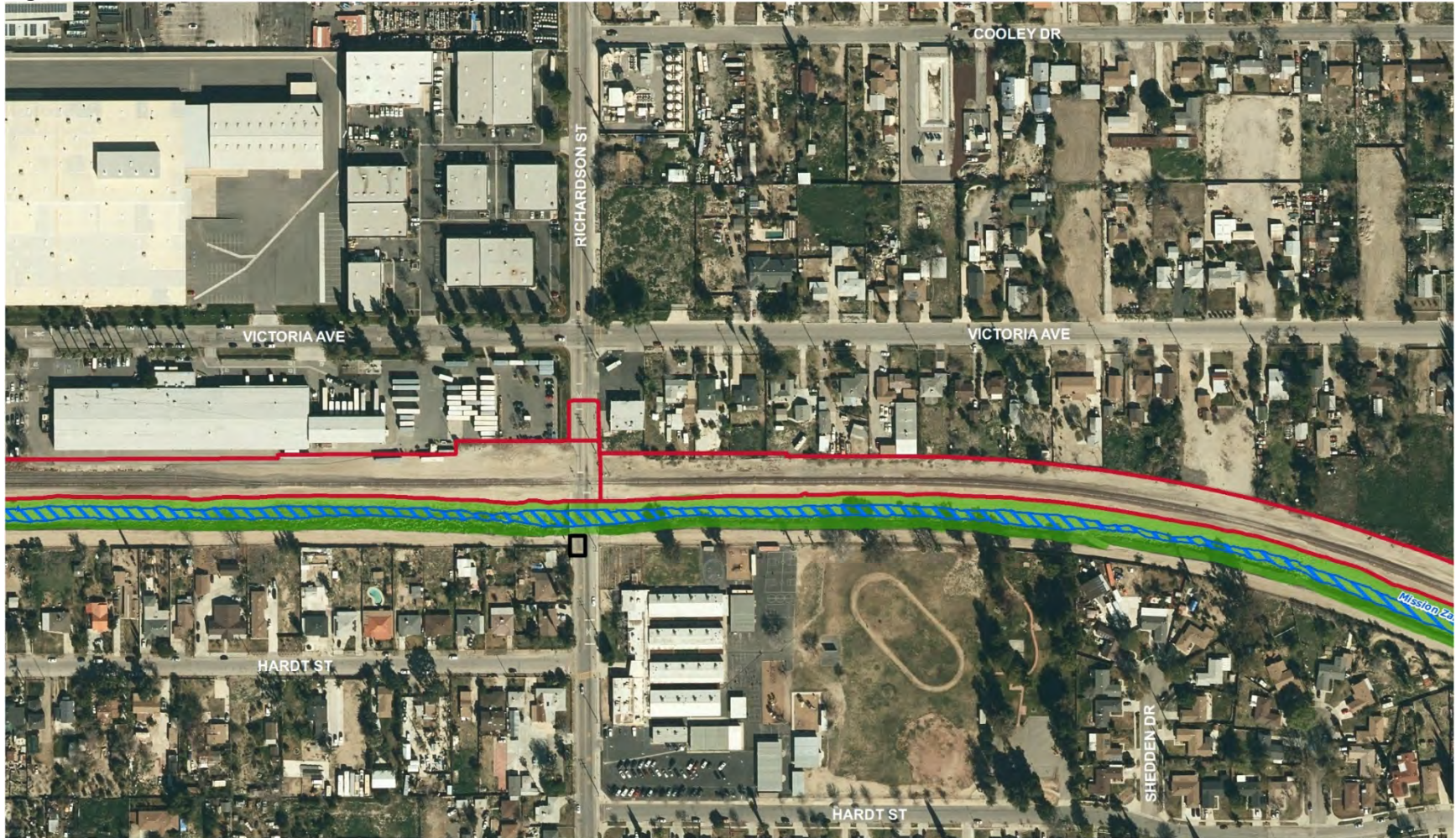

Figure 3C: Jurisdictional Delineation Overlay Sheet 3



LEGEND

- Permanent Impact
- Temporary Impact
- USACE Jurisdiction
- CDFW Jurisdiction

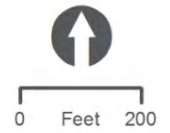

Figure 3D: Jurisdictional Delineation Overlay Sheet 4



LEGEND

- Permanent Impact
- Temporary Impact
- USACE Jurisdiction
- CDFW Jurisdiction

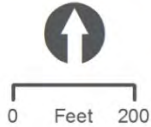



Figure 3E: Jurisdictional Delineation Overlay Sheet 5



LEGEND

- Permanent Impact
- Temporary Impact
- USACE Jurisdiction
- CDFW Jurisdiction

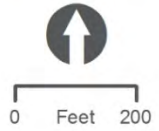
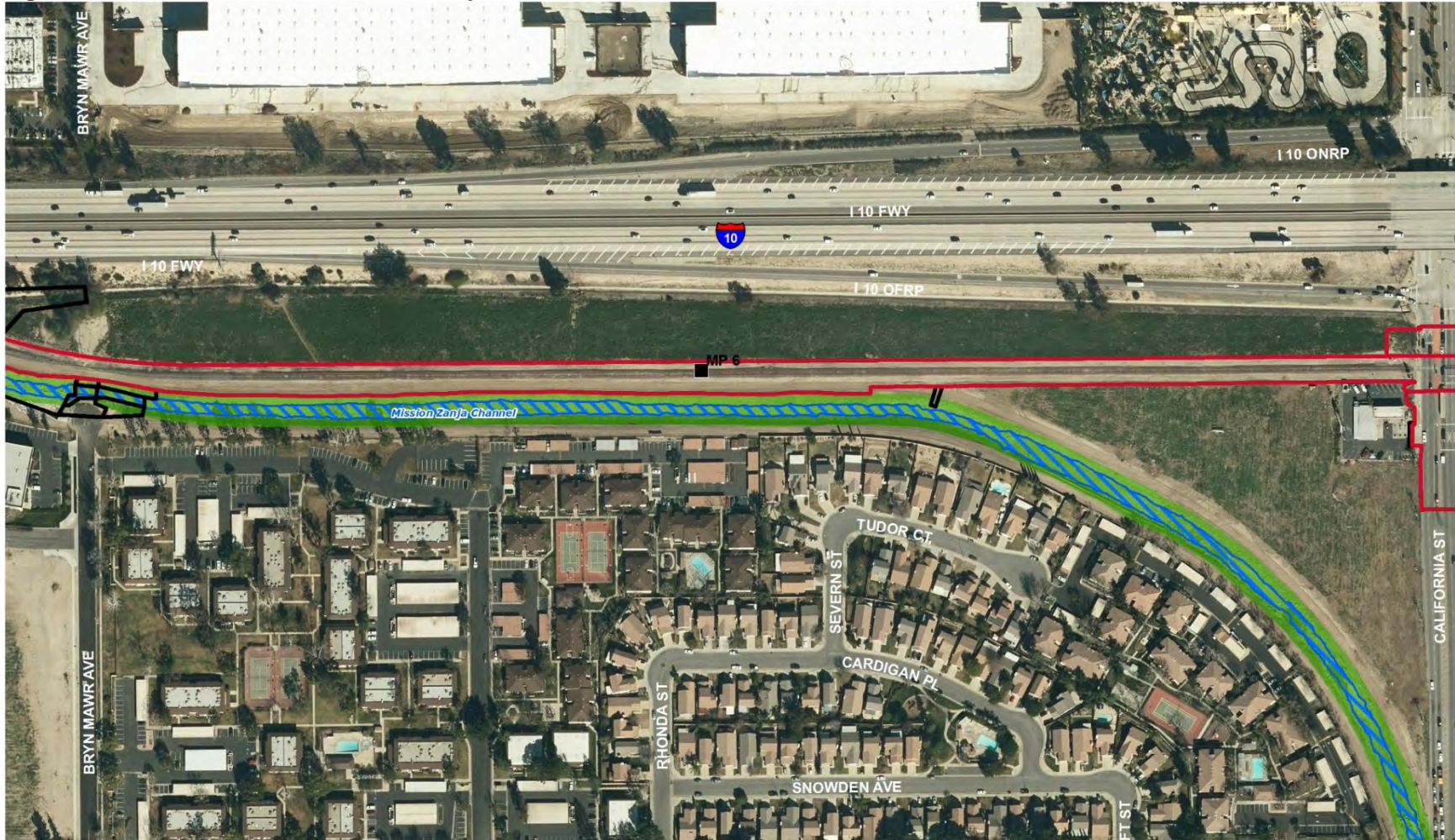
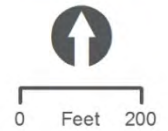

Figure 3F: Jurisdictional Delineation Overlay Sheet 6



LEGEND

- Permanent Impact
- USACE Jurisdiction
- Temporary Impact
- CDFW Jurisdiction





This page is intentionally blank.



Attachment B. Mitigation Monitoring and Reporting Program



This page is intentionally blank.



Table 1. MMRP Mitigation Measures

Mitigation Measure	Timing	Applicable Project Location/ Feature	Primary Responsible Party	Secondary Responsible Party	Verification
Biological and Wetland Resources					
BIO-1: Pre-Construction Survey - Conduct Preconstruction Survey for Special Status Plants and Wildlife and, if Found, Implement Avoidance and Compensation Measures. Prior to construction, a qualified biologist retained by SANBAG shall conduct pre-construction surveys for special status plant species including woolly star, slender-horned spineflower, smooth tarplant, and salt spring checkerbloom. Pre-construction surveys will also be required for special status wildlife species including least Bell's vireo, southwestern willow flycatcher, San Bernardino kangaroo rat, yellow-billed cuckoo, burrowing owl, and western spadefoot toad to verify presence or absence in the Project area. If one or more species are detected, then SANBAG shall consult with the USFWS (or CDFW if appropriate) to develop additional minimization measures prior to project construction (if necessary). These additional measures may include construction timing restrictions and/or construction monitoring.	Prior to and during construction	Entire Project	SANBAG	U. S. Fish and Wildlife Service (USFWS) and California Department of Fish and Wildlife (CDFW)	
BIO-2: Least Bells Vireo (LBV). The following measures will be implemented to minimize direct and indirect impacts to LBV during construction: <ul style="list-style-type: none"> a. Impacts associated with clearing and grubbing of Southern Cottonwood Willow Riparian Forest (SCWRF) and Southern Willow Scrub (SWS) will be timed to avoid the breeding season of the least Bell's vireo (March 15 to September 15), unless SANBAG provides survey documentation to USFWS that confirms the riparian habitat is not occupied by LBV. b. Temporary impact areas will be restored to pre-grade contours following bridge construction. 	Prior to and during construction	Mile Posts 3.3 to 4 (only)	SANBAG	USFWS	



Table 1. MMRP Mitigation Measures

Mitigation Measure	Timing	Applicable Project Location/ Feature	Primary Responsible Party	Secondary Responsible Party	Verification
<p>Natural recruitment is anticipated to occur rapidly due to the large amount of intact native riparian habitat that will remain as a seed source. Additionally, the riparian habitat being impacted is adapted to frequent disturbance. The individual species making up the community tend to have large quantities of seeds and very rapid growth that promote rapid re-establishment. Container planting and seeding has not been proposed due to potential conflicts with County Flood Control Maintenance requirements, high risk of plant material being washed out during subsequent storm events and potential conflicts with future Santa Ana River Trail construction. For erosion control purposes, temporarily impacted areas outside of the active floodplain will be hydroseeded with native grasses and shrubs.</p> <p>i. The temporarily impacted SCWRF and SWS habitat will be monitored annually for five years, until LBV is documented using the re-established habitat or until habitat attains 80 percent cover including both shrub and overstory stratum. If recruitment of SCWRF and SWS species is not evident within two years of project construction or habitat has not attained 60 percent cover within three years, impacts will be treated as permanent and additional mitigation for areas not meeting success criteria shall be provided through in-lieu fee payment to an appropriate mitigation bank for enhancement, restoration or establishment of LBV habitat at a ratio of 1:1.</p>					



Table 1. MMRP Mitigation Measures

Mitigation Measure	Timing	Applicable Project Location/ Feature	Primary Responsible Party	Secondary Responsible Party	Verification
<p>ii. Temporary direct impacts to potentially suitable LBV habitat will be mitigated as follows: The temporal loss of occupied LBV habitat resulting from temporary removal of SCWRF associated with the Mission Zanja Channel shall be mitigated through in-lieu fee payment to an appropriate mitigation bank for enhancement, restoration or establishment of LBV habitat at a ratio of 3:1. The temporal loss of suitable unoccupied LBV habitat resulting from temporary removal of SCWRF and SWS shall be mitigated through in-lieu fee payment to an appropriate mitigation bank for enhancement, restoration or establishment of LBV habitat at a ratio of 2:1.</p> <p>c. Permanent direct impacts to occupied LBV habitat (SCWRF) shall be mitigated at a ratio of 3:1 through in-lieu fee payment to an appropriate mitigation bank for enhancement, restoration and/or creation of LBV habitat within the Santa Ana River watershed.</p> <p>d. If active LBV nests are identified during pre-construction surveys and noise levels at the nest exceed 60 dBA Leq, noise attenuation structures will be placed or other noise attenuation measures (e.g., reducing the number of construction vehicles or using different types of construction vehicles) will be implemented to reduce noise levels at the nest to 60 dBA Leq (or ambient noise level if greater than 60 dBA Leq). During construction adjacent to these areas, noise monitoring shall occur during the LBV</p>					

Table 1. MMRP Mitigation Measures

Mitigation Measure	Timing	Applicable Project Location/ Feature	Primary Responsible Party	Secondary Responsible Party	Verification
breeding season and be reported daily to USFWS. Construction activities that create noise in excess of the aforementioned levels will cease operation until effective noise attenuation measures are in place to the extent practicable.					
BIO-3: MBTA Covered Species. Prior to habitat removal during the avian breeding season (February 15-August 31), a qualified biologist shall conduct a pre-construction nest survey (in suitable areas) no more than 3 days prior to ground disturbing activities for migratory birds. Pre-construction surveys will be preformed year-round between MP 3.3 and 4.0 with the timing and implementation done in coordination with the CDFW and USFWS. Should an active nest of any MBTA covered species occur within or adjacent to the project impact area, a 100-foot buffer (300 feet for raptors) shall be established around the nest and no construction shall occur within this area until a qualified biologist determines the nest is no longer active or the young have fledged.	Prior to and during construction	Mile Posts 3.3 to 4 (only)	SANBAG	USFWS	
BIO-4: Protection of Sensitive Plants and Habitats. SANBAG shall require the construction contractor to implement the following measures to protect sensitive plants and habitats during project-related construction. <ul style="list-style-type: none"> SANBAG shall designate an approved biologist (project biologist) who will be responsible for overseeing compliance with protective measures for the biological resources during clearing and work activities within and adjacent to areas of native habitat. The project biologist will be familiar with the local habitats, plants, and wildlife and maintain communications with the contractor to ensure that issues relating to biological resources are 	Prior to and during construction	Mile Post 3.3 to 4	SANBAG	USFWS and CDFW	

Table 1. MMRP Mitigation Measures

Mitigation Measure	Timing	Applicable Project Location/ Feature	Primary Responsible Party	Secondary Responsible Party	Verification
<p>appropriately and lawfully managed. The project biologist will review final plans, designate areas that need temporary fencing, and monitor construction. The biologist will monitor activities within designated areas during critical times such as vegetation removal, the installation of Best Management Practices (BMPs) and fencing to protect native species, and ensure that all avoidance and minimization measures are properly constructed and followed.</p> <ul style="list-style-type: none"> Project employees and contractors that will be on-site shall complete environmental worker-awareness training conducted by the project biologist. The training will advise workers of potential impacts to the sensitive habitat and listed species and the potential penalties for impacts to such habitat and species. At a minimum, the program will include the following topics: occurrences of the listed species and sensitive vegetation communities in the area, a physical description and their general ecology, sensitivity of the species to human activities, legal protection afforded these species, penalties for violations of Federal and State laws, reporting requirements, and work features designed to reduce the impacts to these species; and to the extent practicable, promote continued successful occupation of areas adjacent to the work footprint. Included in this program will be color photos of the listed species, which will be shown to the employees. Following the education program, the photos will be posted in the contractor and resident engineer's office, where they will remain through the duration of 					



Table 1. MMRP Mitigation Measures

Mitigation Measure	Timing	Applicable Project Location/ Feature	Primary Responsible Party	Secondary Responsible Party	Verification
<p>the work. Photos of the habitat in which sensitive species are found will also be posted on-site. The contractor will be required to provide SANBAG with evidence of the employee training (e.g., sign in sheet or stickers) upon request. Employees and contractors will be instructed to immediately notify the project biologist of any incidents, such as construction vehicles that move outside of the work area boundary. The project biologist will be responsible for notifying the USFWS within 72 hours of any similar incident.</p> <ul style="list-style-type: none"> • Prior to construction, SANBAG shall delineate the construction area (including staging and laydown areas) between Mile Posts 3.3 and 4.0 and erect exclusionary construction fencing along the perimeter of the identified construction area to protect adjacent sensitive habitats (SWS, SCWRF, RAFSS, and Santa Ana woolly star). Limits of the exclusionary fencing shall be confirmed by the project biologist prior to habitat clearing. Exclusionary fencing shall be maintained throughout the duration of construction work from Mile Posts 3.3 to 4.0. Exclusionary fencing can be removed at the conclusion of construction work as approved by the project biologist. <p>All construction-related vehicles and equipment storage shall occur in the construction area and/or previously disturbed areas as approved by the project biologist. Project-related vehicle traffic shall be restricted to established access roads, construction areas, storage areas, and staging and parking areas.</p>					

Table 1. MMRP Mitigation Measures

Mitigation Measure	Timing	Applicable Project Location/ Feature	Primary Responsible Party	Secondary Responsible Party	Verification
<p>If construction activity extends beyond the exclusionary fencing into sensitive vegetation communities, areas of disturbance shall be quantified and an appropriate restoration approach shall be developed in consultation with USFWS and CDFW. For example, if construction extends beyond the limits of the exclusionary fencing, temporarily disturbed areas shall be restored to the natural (preconstruction) conditions, which may include the following: salvage and stockpiling of topsoil, re-grading of disturbed sites with salvaged topsoil, and re-vegetation with native locally available species.</p>					
<p>BIO-5: Burrowing Owl. SANBAG will conduct take avoidance (pre-construction) surveys for burrowing owl within 30 days prior to initiating ground disturbance activities. These surveys will be completed in no less than 14 days prior to construction. If burrowing owl is identified, the following shall apply:</p> <ul style="list-style-type: none"> • If burrowing owl is identified during the breeding season (February 1 through August 31) then an appropriate buffer will be established by the biological monitor in accordance with the 2012 Staff Report on Burrowing Owl Mitigation (CDFW 2012). Construction within the buffer will be avoided until a qualified biologist determines that burrowing owl is no longer present or until young have fledged and a CDFW-approved exclusion plan has been implemented. In addition to avoidance of the occupied habitat, off-site mitigation will be provided as described below: <ul style="list-style-type: none"> - Replacement of occupied habitat with occupied habitat: 1.5 times 6.5 (9.75) acres per pair or single bird. 	<p>Prior to construction</p>	<p>Entire Project</p>	<p>SANBAG</p>	<p>CDFW</p>	

Table 1. MMRP Mitigation Measures

Mitigation Measure	Timing	Applicable Project Location/ Feature	Primary Responsible Party	Secondary Responsible Party	Verification
<ul style="list-style-type: none"> - Replacement of occupied habitat with habitat contiguous to currently occupied habitat: 2 times 6.5 (13.0) acres per pair or single bird. - Replacement of occupied habitat with suitable unoccupied habitat: 3 times 6.5 (19.5) acres per pair or single bird. • If burrowing owl is identified during the non-breeding season (September 1 through January 31), then a 50 meter buffer will be established by the biological monitor. Construction within the buffer will be avoided until a qualified biologist determines that burrowing owl is no longer present or until a CDFW-approved exclusion plan has been implemented. 					
<p>BIO-6: Secure Clean Water Act (CWA) Section 404 Permit and Implement All Permit Conditions to Ensure No Net Loss of Functions of Wetlands, Other Waters of the U.S., and Waters of the State). Before the approval of grading or other ground disturbing activities within 50 feet of jurisdictional areas, SANBAG shall obtain a CWA Section 404 permit, Section 401 water quality certification, and CDFW 1602 Streambed Alteration Agreement.</p> <p>As part of the Section 404 permitting process, if the USACE (and/or CDFW) requires compensatory mitigation, a draft wetland mitigation and monitoring plan (MMP) shall be developed for the selected Build Alternative. The MMP shall be consistent with USACE's and EPA's April 10, 2008 Final Rule for Comp Compensatory Mitigation for Losses of Aquatic Resources (33 CFR Parts 325 and 332 and 40 CFR Part 230).</p> <p>Potential mitigation for impacts to federal and state jurisdictional areas may occur at the following ratios:</p>	Prior to construction	Warm Creek (Historic), Twin Creek, Santa Ana River, Mission Zanja Channel, and Mill Creek Zanja	SANBAG	U. S. Army Corps of Engineers (USACE), Los Angeles District, CDFW, and Regional Water Quality Control Board (RWQCB), Santa Ana Region	



Table 1. MMRP Mitigation Measures

Mitigation Measure	Timing	Applicable Project Location/ Feature	Primary Responsible Party	Secondary Responsible Party	Verification
<ul style="list-style-type: none"> • USACE Wetland <ul style="list-style-type: none"> - Permanent: 3:1 - Temporary: restoration (in-kind) • USACE Waters <ul style="list-style-type: none"> - Permanent: 1:1 - Temporary: restoration (in-kind) • CDFW Riparian <ul style="list-style-type: none"> - Permanent: 3:1 (SWS, RAFSS, and SCWRF) - Permanent: 1:1 (unvegetated stream bank) - Temporary: restoration (in-kind) 					
<p>BIO-7. Reseeding for Woolly Star. Seeds from the closest known occurrences of woolly-star plants found both upstream and downstream of Bridge 3.4 shall be collected in the fall prior to construction of the SAR crossing. If construction activities require the loss of the single woolly-star at the SAR crossing, the collected seeds will be broadcast in the temporary impact areas, near the impacted woolly-star plant, after construction activities are complete and soils have been restored to pre-Project contours.</p> <ol style="list-style-type: none"> 1. Seed collection and broadcast methodologies will be proposed by a qualified seed collector approved by the Service prior to seed collection in a Santa Ana Woolly-Star Management Plan. 2. Seed harvest shall be from a minimum of three plants per collection location, limited to no more than 50 percent of the available seeds from any one woolly-star plant. 3. Seeds shall be held at the appropriate temperature and humidity for the shortest length of time necessary prior to planting. 	Prior to, during, and following construction	Mile Posts 3.4 to 4	SANBAG	CDFW	



Table 1. MMRP Mitigation Measures

Mitigation Measure	Timing	Applicable Project Location/ Feature	Primary Responsible Party	Secondary Responsible Party	Verification
<p>4. Planting of seeds shall be coordinated to occur prior to the first rains of the season, typically during early fall.</p> <p>5. If the woolly-star plant known in the Project area is avoided, collected seeds will be hand broadcast near the parental plants where they were collected.</p> <p>If SANBAG confirms that removal of the one individual is required during final design, SANBAG will purchase ILF or mitigation credits from a qualified mitigation program to address the Project's temporal affect on woolly-star during the up to three-year construction period. Credits will be purchased to cover affects to the on-site individual and off-site parental plants.</p>					
<i>Floodplains, Hydrology, and Water Quality</i>					
<p>HWQ-1: Prepare Drainage Plan(s) for Structural Facilities. SANBAG shall prepare a site specific Drainage Plan for all major structural facilities constructed in conjunction with the Project, including stations and parking areas, track improvements, and the proposed layover facility. The Final Drainage Plan shall incorporate measures to maintain on-site runoff during peak conditions to pre-construction discharge levels. Design specifications for the detention and/or infiltration facilities shall provide sufficient temporary storage capacity to attenuate runoff to pre-Project conditions. These improvements will be coordinated with the applicable jurisdictions, including the Cities of Redlands and San Bernardino and the SBCFCD, as appropriate.</p>	Final design	Entire Project	SANBAG	Cities of San Bernardino and Redlands, and the SBCFCD	
<p>HWQ-2: Prepare and Implement a SWPPP. The construction contractor will develop a SWPPP that complies with the requirements of the NPDES General Construction Permit (Order 2009-0009-DWQ as amended by Order No. 2010-0014-DWQ and 2012-0006-DWQ) for Risk Level 2</p>	Final design, during construction, and post-construction	Entire Project	SANBAG	RWQCB	



Table 1. MMRP Mitigation Measures

Mitigation Measure	Timing	Applicable Project Location/ Feature	Primary Responsible Party	Secondary Responsible Party	Verification
<p>projects and implement the BMPs described in the SWPPP. The SWPPP shall identify specific actions and BMPs relating to the prevention of stormwater pollution from project-related construction sources by identifying a practical sequence for site restoration, BMP implementation, contingency measures, responsible parties, and agency contacts. The SWPPP shall reflect localized surface hydrological conditions and shall be reviewed and approved by SANBAG prior to commencement of work and shall be made conditions of the contract with the contractor.</p> <p>The SWPPP shall be prepared by a qualified SWPPP developer with BMPs selected to achieve maximum pollutant removal and that represent the best available technology that is economically achievable. Emphasis for BMPs shall be placed on controlling discharges of oxygen-depleting substances, floating material, oil and grease, acidic or caustic substances or compounds, and turbidity. BMPs for soil stabilization and erosion control practices and sediment control practices will also be required. Performance and effectiveness of these BMPs shall be determined either by visual means where applicable (i.e., observation of above-normal sediment release), or by actual water sampling in cases where verification of contaminant reduction or elimination, (inadvertent petroleum release) is required to determine adequacy of the measure.</p> <p>Following construction, SANBAG will ensure the provision of sufficient drainage inlet and outlet protection through the use of energy dissipaters, vegetated riprap, and/or other appropriate BMPs to slow runoff velocities and prevent erosion at discharge locations from the rail station and parking areas.</p>					

Table 1. MMRP Mitigation Measures

Mitigation Measure	Timing	Applicable Project Location/ Feature	Primary Responsible Party	Secondary Responsible Party	Verification
HWQ-3: Prepare and Implement a Flow Diversion Plan for Construction. SANBAG or SANBAG’s construction contractor shall develop a Flow Diversion Plan(s) for in-channel construction activities proposed within Warm Creek (Historic)(Bridge 1.1); Twin Creek (Bridge 2.2), SAR (Bridge 3.4), Zanja Channel (Bridges 3.9, and 5.8, and bank improvements), and Mill Creek Zanja (Bridge 9.4). SANBAG’s contractor shall incorporate measures to minimize changes to flood flow elevation(s) during construction, address accumulation of floating debris, provide measures that minimize sedimentation to surface waters, and include contingency measures in the event of substantial rainfall.	During construction	Warm Creek (Historic)(Bridge 1.1); Twin Creek (Bridge 2.2), SAR (Bridge 3.4), Zanja Channel (Bridges 3.9, and 5.8, and bank improvements), and Mill Creek Zanja (Bridge 9.4).	SANBAG		
HWQ-4: Prepare a Natural Hazard Management Plan. SANBAG shall develop a Natural Hazard Management Plan for the Project. The Natural Hazard Management Plan will include a flood monitoring and evacuation plan for all Project infrastructure located within a delineated 100-year flood zone based on the most recent FEMA mapping. The Plan shall include protocols and procedures for emergency response in the event of a flood, the investigation and repair of track, station, and bridge facilities following inundation, and the provision of interim transit until Project operations resume.	Prior to operation	Entire Project	SANBAG	None	
HWQ-5: Flood-Proofing of Critical Infrastructure. Where feasible, stations and building pads for the proposed train layover facility shall be designed such that the finished floor elevation will be one-foot above the base 100-year flood elevation, where established.	Final design	Stations at Downtown Redlands and University Street	SANBAG	None	
HWQ-6: Incorporate Post-Construction Runoff BMPs into Project Drainage Plan, Final WQMP, and Industrial SWPPP. The Project Drainage Plan, Final WQMP, and the	Final design and post-construction	Entire Project	SANBAG	None	



Table 1. MMRP Mitigation Measures

Mitigation Measure	Timing	Applicable Project Location/ Feature	Primary Responsible Party	Secondary Responsible Party	Verification
<p>NPDES Industrial SWPPP shall demonstrate treatment, control, and management of the on- and off-site discharge of stormwater to existing drainage systems or drainage features. The final Drainage Plan shall provide both short- and long-term drainage solutions to ensure the proper sequencing of drainage facilities and the final WQMP will ensure sufficient treatment of runoff generated from Project impervious surfaces prior to off-site discharge.</p> <p>SANBAG shall ensure the provision of sufficient outlet protection through the use of energy dissipaters, vegetated rip-rap, soil protection, and/or other appropriate BMPs to slow runoff velocities and prevent erosion at discharge locations for the station platforms, parking areas, and layover facility. A long-term maintenance plan shall be developed and implemented to support the functionality of drainage control devices. The layover facility layout(s) shall also include sufficient container storage and on-site containment and pollution-control devices for drainage facilities to avoid the off-site release of water quality pollutants, including, but not limited to oil and grease, fertilizers, treatment chemicals, and sediment. These measures shall be reflected in the final Industrial SWPPP and WQMP for applicable facilities. The NPDES Industrial SWPPP shall incorporate required maintenance practices and housekeeping to maximize the long-term effectiveness of post-construction BMPs.</p>					
Geology, Soils, and Seismicity					
<p>GEO-1: Prepare Final Geotechnical Report for the Project and Implement Recommended Measures. Facility design for all Project components shall comply with the site-specific design recommendations as provided by a licensed geotechnical or civil engineer to be retained by SANBAG.</p>	Design, prior to and post-construction	Entire Project	SANBAG	None	



Draft Santa Ana River Bridge
3.4 - Hydrologic and
Hydraulic Analysis (60%
Design)

Redlands Passenger Rail Project

Prepared for:
SBCTA

February 2017

Prepared by:

HDR
8690 Balboa Avenue, Suite 200
San Diego, CA 92123



Table of Contents

1. Purpose	1
2. Background	1
3. Hydrology	4
4. Hydraulic Modeling	5
4.1 Modeling Overview.....	5
4.2 Model Inputs.....	6
4.2.1 FEMA Effective Model.....	6
4.2.2 Duplicate Effective Model (HEC-2).....	6
4.2.3 Corrected Effective Model (HEC-RAS)	6
4.2.4 Existing Conditions Model (HEC-RAS)	7
4.2.5 Proposed Condition Bridge Model (HEC-RAS)	7
4.3 Model Results	8
5. Scour Analysis	12
6. Conclusions	14
7. References	14

Figures

Figure 1: Santa Ana River, AT&SF Bridge 3.4 Downstream Face	3
Figure 2: Existing AT&SF Bridge 3.4	4
Figure 3: Profile of Existing Condition	9
Figure 4: Profile of Proposed Condition	10
Figure 5: Cross-Section of Existing Conditions Upstream of Bridge 3.4.....	10
Figure 6: Cross-Section of Proposed Conditions Upstream Face of Bridge 3.4	11

Tables

Table 1: Structures in Santa Ana River Reach	2
Table 2: Hydrology - Flowrates	5
Table 3: Existing Conditions Model Results for Cross-Section 28.62 (Upstream of Bridge 3.4)...	8
Table 4: AT&SF Bridge 3.4 (28.615) Hydraulic Results.....	9
Table 5: Hydraulic Freeboard Criteria.....	11
Table 6: Hydraulic Analysis Results (ft, NGVD29).....	12



Table 7: Scour Depths (ft) 13
 Exhibit 1: RPRP Project Overview 1
 Exhibit 2: Santa Ana River Reach Limits 2
 Exhibit 3: Modeling Overview – Cross Sections 3
 Exhibit 4: FEMA FIRM 06071C Panel 8684H 4
 Exhibit 5: Proposed Bridge Alternative Plans 5

List of Exhibits

- Exhibit 1: RPRP Project Overview
- Exhibit 2: Santa Ana River Reach Limits
- Exhibit 3: Modeling Overview–Cross-Sections
- Exhibit 4: FEMA FIRM 06071C Panel 8684H
- Exhibit 5: Proposed Bridge Alternative Plans

Attachments

- Attachment 1 – HEC-RAS Modeling Exhibits
- Attachment 2 – Hydraulic Analysis Results
- Attachment 3 – Engineering “No-Rise” Certificate
- Attachment 4 – Scour Analysis
- Attachment 5 – Digital Information (CD)
 - HEC-2
 - HEC-RAS Model
 - WRC
 - Feature Design Memorandum No.2 – Seven Oaks Dam Floodway Delineation

1. Purpose

The rail from historic Warm Creek (that portion of Warm Creek that was not combined with East Twin Creek and Warm Creek Improvements) to Mill Creek Zanja is proposed to be improved as part of the Redlands Passenger Rail Project (RPRP) (see Exhibit 1). This report covers the hydraulic impacts for AT&SF Bridge 3.4 (Bridge 3.4), which is a railroad crossing over Santa Ana River. The improvements are proposed to reconstruct the bridge from its existing freight-only operation to current standards required for regular passenger rail operations. As part of this project, recommendations, including hydraulic analysis, are being provided to assist in this process.

The purpose of the hydraulic modeling is to: (1) to analyze the existing hydraulic condition of the Santa Ana River to establish current conditions considering Federal Emergency Management Agency (FEMA) models and updated site conditions; (2) evaluate the hydraulic impact on the rail from proposed Bridge 3.4; and (3) evaluate the potential hydraulic impacts of proposed Bridge 3.4 on the proposed passenger rail.

2. Background

The RPRP will design a track alignment for passenger and freight service from the proposed San Bernardino Transit Center east to the University of Redlands. The Redlands Corridor Strategic Plan (RCSP) was developed by San Bernardino County Transit Authority (SBCTA) to address the transportation needs of the Redlands Corridor, assess the capability of transit service and multimodal improvements to meet mobility needs, and describe a course of action to implement transit service in the Redlands Corridor in a cost-effective manner. The first phase of the RCSP calls for the development of a passenger rail service operating between the San Bernardino Transit Center and the University of Redlands, a distance of approximately nine miles. Exhibit 1 shows the overall project.

The general hydraulic modeling approach was to initially review hydraulic models from FEMA to examine flooding conditions in the Santa Ana River reach with Bridge 3.4. Exhibit 2 shows the limits of the analysis. A revised hydraulic model was developed of the project area based on the additional information obtained to model existing and proposed conditions through the bridge and to evaluate the relative changes in water surface for a 100-year flood. The proposed bridge will be designed per structure, constructability, and geotechnical and hydraulic issues.

The Santa Ana River model reach in this study is located between River Mile (RM) 28.3 to RM 29.64, from approximately 1,660 feet downstream of AT&SF Bridge 3.4 to 700 feet upstream of Tippecanoe Avenue (see Exhibit 2). Total reach length is approximately 7,000 feet. The reach is a soft-bottom channel with riprap side slopes. Figure 1 shows Bridge 3.4 downstream face in the Santa Ana River. Figure 2 shows the rail on existing Bridge 3.4. Hydraulic analyses are required to evaluate the existing and proposed bridges to determine if they meet current design requirements. There are three structures in the reach, as shown below in Table 1.



Table 1: Structures in Santa Ana River Reach

Structure	Approximate Location (RM)
AT&SF Railroad Bridge 3.4	28.62
Orange Show Road	29.06
Tippecanoe Avenue	29.51

The existing effective FEMA model for the Santa Ana River was obtained and used as the base model. The model was revised based upon information contained in the WRC (2003) report prepared to model proposed river trail improvements. Modeling of the Santa Ana River and Bridge 3.4 was conducted using the U.S. Army Corps of Engineers (USACE) Hydrologic Engineering Center River Analysis System (HEC-RAS v4.1) program. All reference topography is based on the NGVD 1929 datum.

The standard hydraulic design criteria selected for the bridge (in the following priority) are shown below. For this project, because the 50-year flow rate is not available, only the 100-year flow rate was evaluated.

1. 100-year flood water surface elevation below low chord;
2. 100-year flood energy grade line (EGL) elevation below top of subgrade and 50-year water surface [hydraulic grade line (HGL)] elevation below low chord;
3. 50-year flood water surface (HGL) elevation below low chord; and
4. No increase of water surface elevations within project area.



Figure 1: Santa Ana River, AT&SF Bridge 3.4 Downstream Face

A draft FEMA “no rise” certificate is included within this report. Bridge 3.4 is within a FEMA floodway and therefore this certification is required to document that no change to 100-year base flood elevation will occur due to bridge replacement.

This report presents hydraulic analysis results; however, it does contain some assumptions. Prior to 100% design, the assumptions made within this report should be verified. Major assumptions include: 1) the 60% design bridge geometry and 2) a study reach geometry mostly derived from the 2003 WRC study.



Figure 2: Existing AT&SF Bridge 3.4

3. Hydrology

The 100-year flowrate for the Santa Ana River tabulated in the San Bernardino County Flood Insurance Study (FIS) is 113,000 cfs upstream of Warm Creek. 10-, 50- and 500-year flowrates are not available in the FIS. The 100-year Santa Ana River flow rate contained in the effective FEMA model and in the WRC report and model are less. The flowrate of 113,000 cfs is believed to be the flowrate before the construction of Seven Oaks dam upstream of the reach. The 100-year flowrate in Santa Ana River FEMA and WRC model are the same and are verified with “Santa Ana River Trail Hydraulic Design and Analysis” and “Santa Ana River Mainstream Project, Feature Design Memorandum No. 2” (Memo #2) reports. The 100-year flowrates in the FEMA Effective Model are shown in Table 2 and indicate a flow change location just downstream of Bridge 3.4. The 100-year discharge at Bridge 3.4 is 33,000 cfs and was used for this evaluation. The 500-year flow rate was obtained from the Memo #2. The 200-year flow rate was determined using the Discharge versus Exceedance probability chart with interpolating between 100-year and 500-year flow rates. The 200-year and 500-year flow rates are also shown in Table 2.

Table 2: Hydrology - Flowrates

Channel Reach (River Mile)	100-Year Flood Discharge (cfs)	200-Year Flood Discharge (cfs)	500-Year Flood Discharge (cfs)
RM 27.91 to RM 28.57	36,500	56,000	92,000
RM 28.58 to RM 33.27	33,000	51,500	86,000
Note: Flowrates are in cubic feet per second (cfs)			

4. Hydraulic Modeling

4.1 Modeling Overview

Hydraulic modeling was conducted using the USACE HEC-RAS (v.4.1) program. The existing FEMA Effective Model was available in HEC-2 format for the Santa Ana River reach. The FEMA effective models were broken into several reaches. Bridge 3.4 is located in the reach from River Mile (RM) 28.30 to 29.64, which covers from downstream of Bridge 3.4 to upstream of Tippecanoe Bridge. The HEC-2 model was originally prepared in July 1987, and then revised in January 1990. There are two structures in the model – Bridge 3.4 and Tippecanoe Bridge. Bridge 3.4 is located at RM 28.615.

The original HEC-2 model does not include the Orange Show Bridge. Also, bridge piers were modeled as one pier with the total pier width in the HEC-2 model. WRC Consulting Services prepared “Santa Ana River Trail, Alabama Street to Waterman Avenue, Hydraulic Design and Analysis” in 2003 and updated the original effective model. The WRC model reach ranges from RM 26.98 to 33.37. There are three models in the WRC report:

- **Model 1** – Original FEMA effective HEC-2 model prepared by the USACE.
- **Model 2** – Converted Model 1 to the HEC-RAS format, added an additional bridge at Orange Show Road, revised bridge pier data to match existing, and added channel geometry from RM 28.10 to 29.51 based on as-built plan data.
- **Model 3** – Prepared from Model 2 for the proposed trail ramps and removed them from flow conveyance.

Only a hard copy of the WRC report was available. Digital copies of the HEC-RAS models described in the report were not available. Since the report has tabulation of the HEC-RAS input and output data, HDR first converted the effective FEMA HEC-2 model to HEC-RAS format, then revised the HEC-RAS model per the WRC report Model 2 input data printout to duplicate Model 2. The bridge pier widths were revised again based on the as-built/survey data in the WRC report. This HEC-RAS model

was then used to address the impact of the proposed improvements to Bridge 3.4. The 100-year flowrate was used to compare between the existing bridge and the proposed condition to see if the proposed condition has any hydraulic impacts.

4.2 Model Inputs

4.2.1 FEMA Effective Model

The effective HEC-2 model was obtained from FEMA. The original model was run with the HEC-2 (v.1991) program. The digital model files were provided by FEMA. Model results are shown in Table 7. The floodplain boundaries are shown on FEMA Flood Insurance Rate Map (FIRM) panel 06071C8684H. See Exhibit 4: FEMA FIRM 06071C8684H.

4.2.2 Duplicate Effective Model (HEC-2)

The HEC-2 model provided by FEMA was run by HDR using the HEC-2 (1991) program. The results run by HDR match the FEMA Effective model results and the WRC Model 1 results. As explained, Model 1 in the WRC report is the same model as the FEMA Effective Model prepared by the U.S. Army Corps of Engineers.

4.2.3 Corrected Effective Model (HEC-RAS)

The Duplicate Effective HEC-2 model was imported to HEC-RAS (v4.1). Water surface results match exactly just downstream of Bridge 3.4 but are over 4 feet lower in the HEC-RAS model just upstream of the bridge as shown in Table 7. The discrepancy is attributed to differences in the way that HEC-2 and HEC-RAS are computing bridge hydraulic losses. The Corrected Effective Model was then developed based on the information available in WRC report. Model 2 in WRC report added an additional bridge at Orange Show Road, added channel geometry from River Mile (RM) 28.10 to 29.51, and revised pier data at all bridges.

As explained, the WRC HEC-RAS digital model was not available, but the input and output of the HEC-RAS model were contained in the WRC report. The Corrected Effective HEC-RAS model HDR created was intended to duplicate the WRC Model 2. The results between the duplicate HEC-RAS model and the output from the WRC report were compared. The results agreed and the differences are within 0.01 feet. Some modeling detail notes include:

- Manning's n values were kept the same as in the effective FEMA model (overbank=0.075, channel=0.04).
- Ineffective flow areas were added to cross-sections as needed.
- The bridges were modeled using the Highest Energy Answer for low flow and the pressure/weir option for high flow.
- The downstream boundary condition used known water surface, it was kept from the HEC-2 model. The 100-year known water surface elevation was also

used as downstream boundary condition for 200-year and 500-year, which were not available in HEC-2 model. A sensitivity analysis was performed to use normal depth ($s = 0.005$) as the downstream boundary condition, the results show no significant impact at the Bridge 3.4.

- The model was run under subcritical flow conditions.
- Note that several cross sections downstream of Bridge 3.4 and one cross section upstream do not have enough ground geometry to contain the water in the cross section. Geometry revisions were not made to these cross sections.

4.2.4 Existing Conditions Model (HEC-RAS)

WRC completed survey and as-built plans review for Bridge 3.4. The actual pier width is 6.5 feet compared to 7.6 feet used in WRC Model 2 and in the Corrected Effective HEC-RAS model. The pier width was adjusted to 6.5 feet and this revised model was named the Existing Conditions Model. The pier width for Orange Show Rd and Tippecanoe Ave Bridge were not changed. The actual pier width for Orange Show Rd Bridge and Tippecanoe Ave Bridge is 1.6 feet. Considering 2 feet debris on each side of the pier, the resulting pier width is approximately the same as in WRC Model 2. The Existing Conditions Model was used to evaluate the hydraulics for the existing and proposed conditions. In summary:

- Existing bridge geometry was kept the same for all bridges, except the pier width for Bridge 3.4 was corrected to 6.5 feet per WRC survey/as-built review.
- Per the discussion in the FIS, the Santa Ana River has medium debris potential. Since Bridge 3.4 pier size is over six feet, pier debris accumulation was not applied following typical procedures used by the Los Angeles District USACE.

4.2.5 Proposed Condition Bridge Model (HEC-RAS)

Proposed condition channel geometry and modeling approach for Bridge 3.4 are identical to the existing conditions bridge model for all cross sections outside of the bridge area. The proposed bridge geometry was based on the 60% design plans. Proposed bridge design plans can be found at Exhibit 5. The model was modified as following:

- One single track design was proposed for Bridge 3.4 replacement. Proposed condition for Bridge 3.4 was taken from the design plans.
- The proposed design includes W40X431 and W40X277 steel beams with five piers. The total span is 380 feet. The abutments were assumed to be sloped at a 2:1 inclination to meet grade at the channel bottom. A bike path was proposed at the east side abutment. Bridge profile was assumed to be steel beam with concrete tie, subgrade and rails.

- Comparing the existing and current topography, scour has occurred at the bridge. The proposed bridge is designed with 3 feet pile cap above the ground. The current ground surface elevation was used as baseline for the pile cap.
- No skew was assumed for the deck and piers.
- The highest energy answer for the Energy, Momentum and Yarnell was used for the Low Flow calculations. The shape coefficient was used the average of the pier, bent and pile cap. The pressure and/or weir method was used for High Flow calculations.
- The proposed condition survey was based on NAVD 88 vertical datum. The Corpscon program was used to convert elevations in NAVD 88 to NGVD 29. The conversion relationship of NAVD 88 – NGVD 29 = 2.5 feet was used based on the proposed bridge location (N34.07515, W117.2721).

4.3 Model Results

Table 3 shows the Existing Conditions Model hydraulic results for Cross Section 28.622 upstream of Bridge 3.4. Figure 3 and Figure 4 shows the profile of the existing AT&SF Bridge, respectively. Figure 5 shows the cross section view of the existing Bridge 3.4 and Figure 6 shows the cross-section view of the proposed bridge. The model exhibits for the existing and proposed condition profile and cross sections can be found in Attachment 1.

Table 3: Existing Conditions Model Results for Cross-Section 28.622 (Upstream of Bridge 3.4)

	100-Year
WSE	1017.93 ft
EGL	1019.03 ft
VCH	8.42 ft/s
WSE = water surface elevation, EGL = energy grade line elevation, VCH = main channel average velocity. All elevations are NGVD 1929.	

The results obtained from 100-year flow rate analysis of Bridge 3.4 are shown in Table 4. Full hydraulic model results are shown in Attachment 2 (Hydraulic Analysis Results).

Table 4: AT&SF Bridge 3.4 (28.615) Hydraulic Results

		Existing Bridge	60% Design
100-Yr event	WSE	1017.19 ft	1017.17 ft
	EGL	1018.79 ft	1018.43 ft
	Velocity	15.55 ft/s	11.87 ft/s
	Froude #	0.82	0.65

WSE = water surface elevation; EGL = energy grade line elevation;
 VCH = main channel average velocity; All elevations are NGVD 1929.

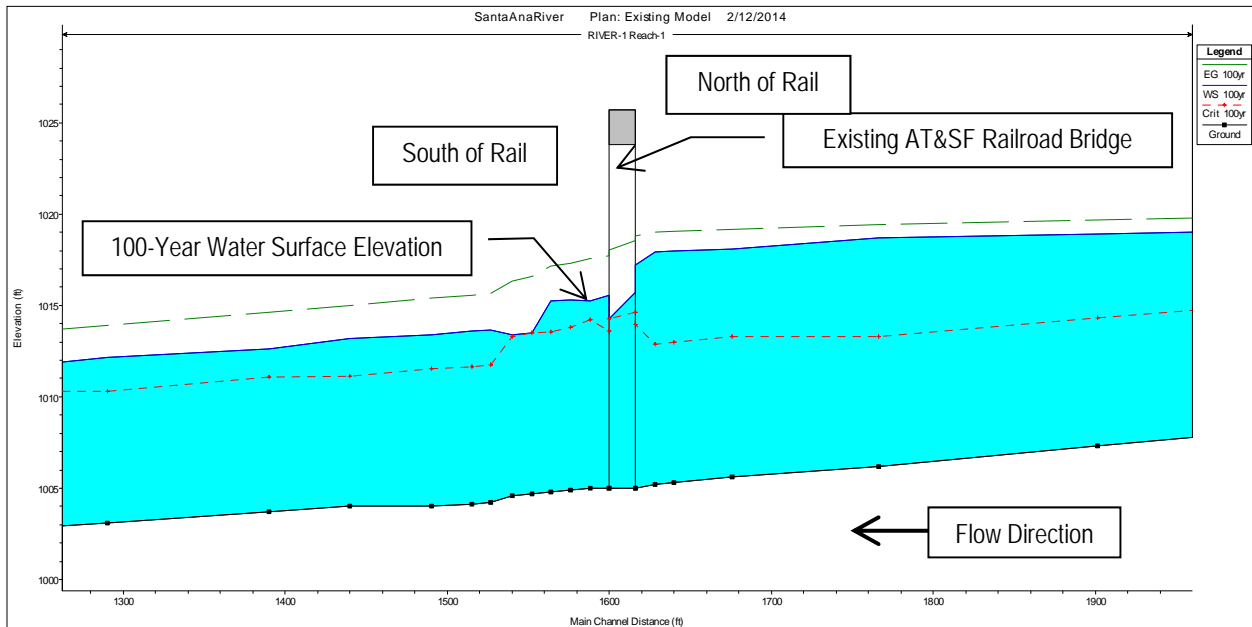
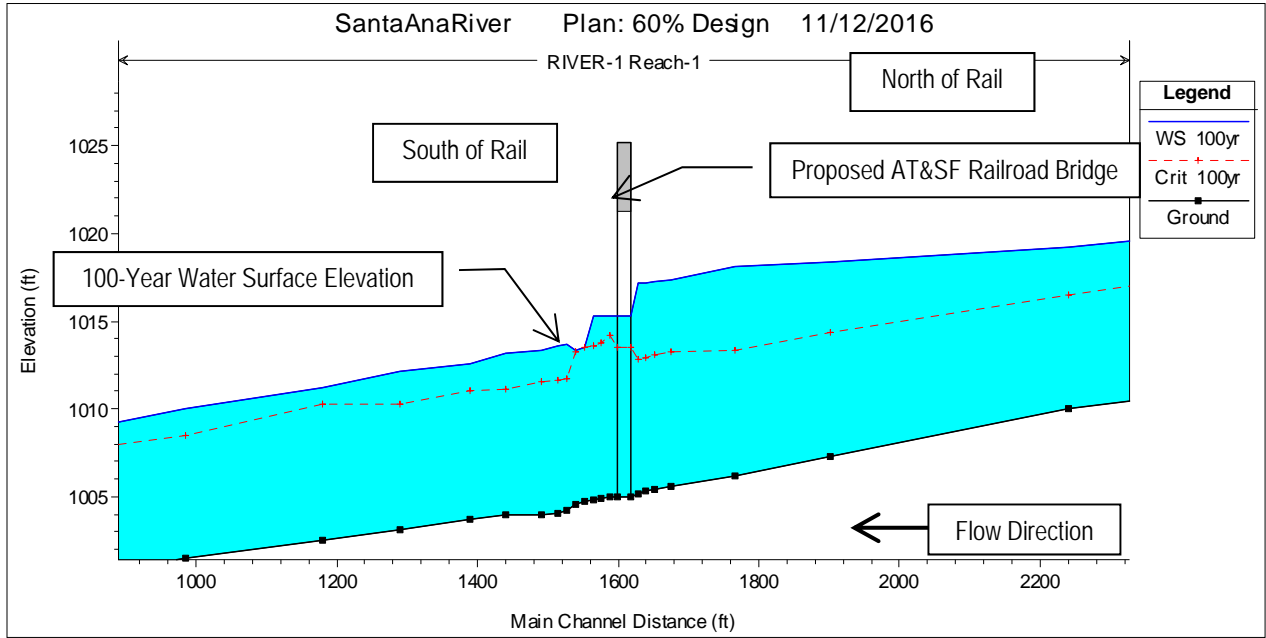
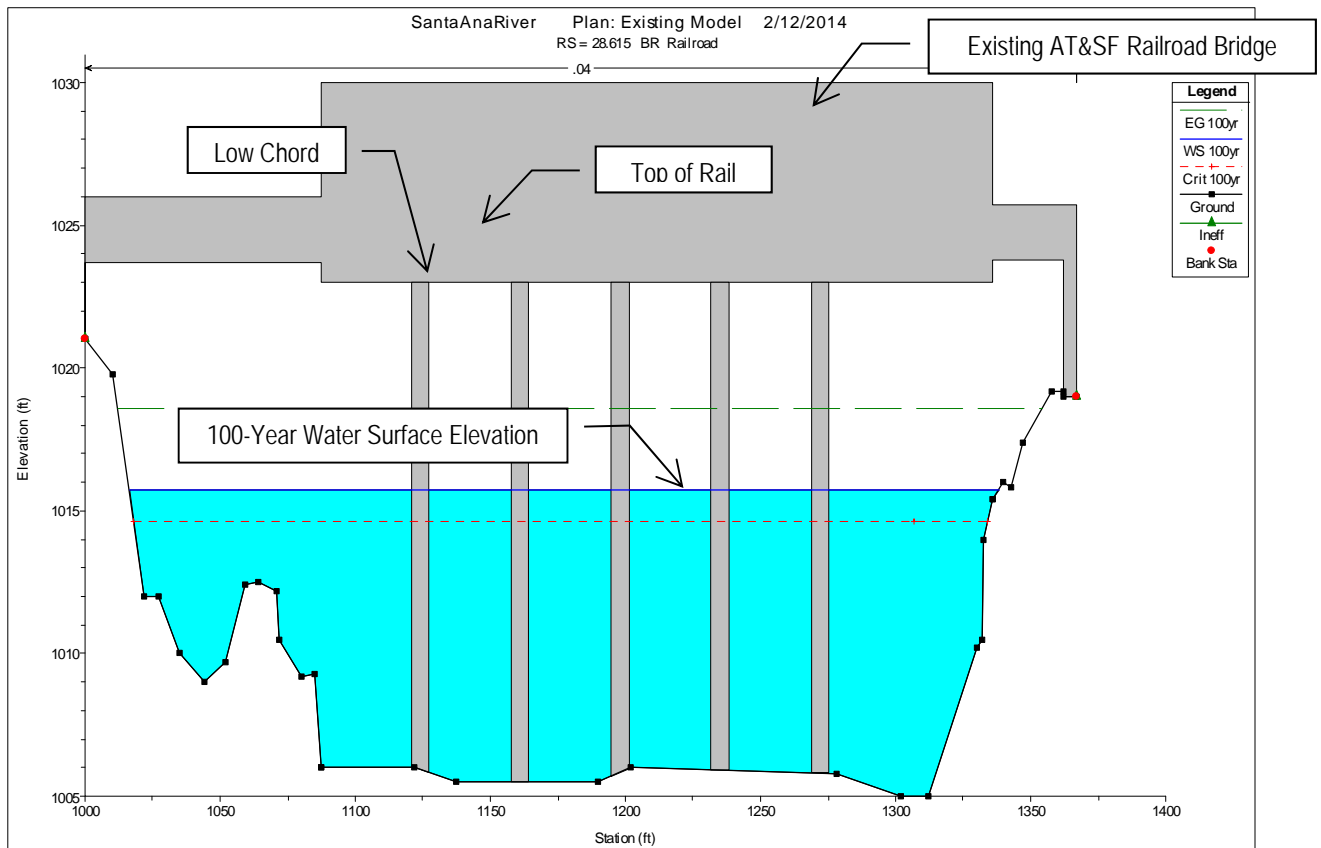

Figure 3: Profile of Existing Condition



EG = energy grade line (ft), WS = water surface (ft), yr = year

Figure 4: Profile of Proposed Condition



EG = energy grade line (ft), WS = water surface (ft), yr = year

Figure 5: Cross-Section of Existing Conditions Upstream of Bridge 3.4

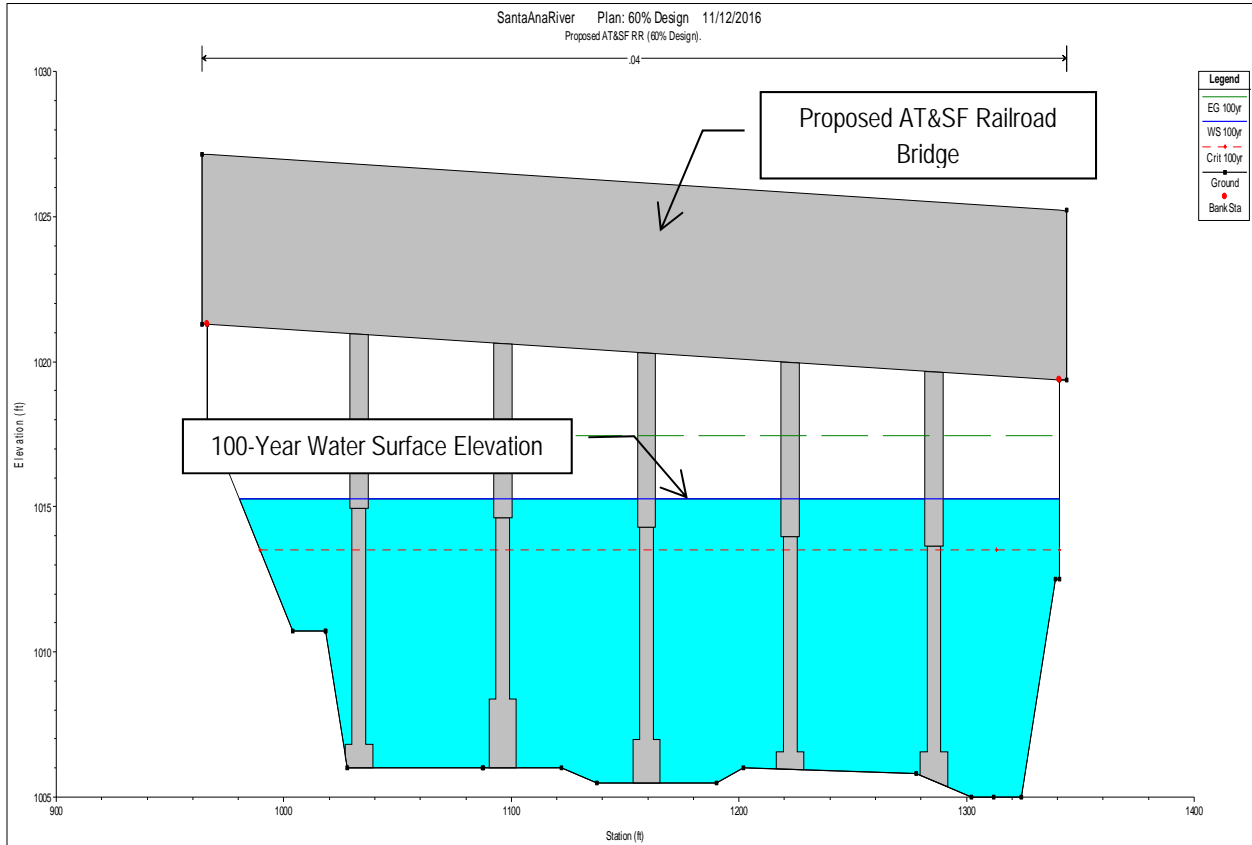

Figure 6: Cross-Section of Proposed Conditions Upstream Face of Bridge 3.4

The freeboard criteria selected for the bridge (in the following priority) are presented in Table 5 for the 60% Design. The 100-year EGL is below the top of the subgrade, meeting 100 year flood design requirement, and also is below the low chord, therefore meeting 50-year requirement by default.

Table 5: Hydraulic Freeboard Criteria

Criterion	Standard	Proposed Model Results	Criterion Met?
1. 100-yr WSE < Low Chord	Low Chord = 1021.85	100-yr WSE = 1017.17	Yes
2. 100-yr EGL < Top of SBGD	Top of SBGD = 1024.71	100-yr EGL = 1018.43	Yes
3. Proposed WSE ≤ Existing WSE	Existing 100-yr WSE = 1017.19	Proposed 100-yr WSE = 1017.17	Yes

WSE = water surface elevation (ft); EGL = energy grade line elevation (ft); SBGD = subgrade. All elevations are NGVD 1929. 136 RE Rail = 7 5/16", concrete tie = 2.25'. Subgrade = TOR-Rail-Tie

The results of the hydraulic analysis upstream and downstream of the Bridge 3.4 are shown in Table 6. For both Alternatives, the results show no rise in the study reach.

Table 6: Hydraulic Analysis Results (ft, NGVD29)

<i>River Station</i>	<i>FEMA Effective HEC-2</i>	<i>Duplicate Effective HEC-RAS</i>	<i>Corrected Effective</i>	<i>Existing</i>	<i>60% Design</i>	<i>60% Design-Existing</i>
29.01	1025.27	1025.14	1025.01	1025.01	1025.01	0
28.95	1024.34	1023.97	1023.97	1023.97	1023.97	0
28.84	1023.16	1021.56	1021.55	1021.51	1021.41	-0.1
28.737	1022.57	1019.79	1019.75	1019.65	1019.25	-0.4
28.673	1022.27	1019.09	1019.04	1018.9	1018.34	-0.56
28.647	1022.18	1018.9	1018.85	1018.7	1018.1	-0.6
28.63	1021.92	1018.34	1018.28	1018.1	1017.36	-0.74
28.626	-	-	-	1017.98	1017.23	-0.75
28.624	1021.84	1018.23	1018.17	1017.97	1017.22	-0.75
28.622	1021.81	1018.19	1018.13	1017.93	1017.17	-0.76
28.62	1021.63	1017.53	1017.46	1017.19	-	-
28.615	Railroad Bridge					
28.61	1015.58	1015.58	1015.58	1015.58	-	-
28.608	1015.30	1015.29	1015.28	1015.28	1015.28	0
28.606	1015.32	1015.3	1015.29	1015.29	1015.29	0
28.604	1015.30	1015.28	1015.27	1015.27	1015.27	0
28.602	1013.49	1013.52	1013.52	1013.52	1013.52	0
28.6	1013.41	1013.38	1013.38	1013.38	1013.38	0
28.597	1013.67	1013.65	1013.65	1013.65	1013.65	0
28.595	1013.61	1013.59	1013.59	1013.59	1013.59	0
28.59	1013.38	1013.37	1013.37	1013.37	1013.37	0
28.58	1013.22	1013.21	1013.21	1013.21	1013.21	0

5. Scour Analysis

Bridge scour analysis was conducted according to the Federal Highway Administration (FHWA) Hydraulic Engineering Circular 18, Evaluating Scour at Bridges (HEC-18) methodology (FHWA 2012). Total scour consists of the components of long-term bed degradation, contraction scour, abutment scour, and pier scour. Comparing the average stream bed elevations at the bridge between the 1987 effective model and current survey data shows a degradation of 1.5 ft. Therefore, assuming an average annual change of 0.052 ft and 50-year project life, the long-term degradation would be 2.6 ft. According to the HEC-18, the foundations for proposed bridges shall be designed to withstand the effects of total scour caused by hydraulic conditions from floods larger than the design flood. Since the hydraulic design flood frequency is 100-year, the 200-year flood scour results shall be used for design and 500-year scour results evaluated

for the Check Flood analysis. For the 100-year flood event, horizontal contraction scour was calculated since the water surface is below the low chord of the proposed structure. Pressure flows occur through the proposed bridge during the 200-year and 500-year flood events, therefore pressure scour was estimated in the scour analysis due to a vertical flow contraction. The abutment scour was also calculated for reference according to the HEC-18 guidelines. Table 7 summarizes the estimated scour depths for the 60% Design.

Table 7: Scour Depths (ft)

Flow	Contraction Scour (ft)	Pier Scour (ft)	Pressure Scour ¹ (ft)	Long Term Scour (ft)	Total Scour (ft)	Abutment Scour (ft)	Pier Toe-down Depth (ft)	Revetment Toe-down Depth (ft)
100 Year	1.3	14.6	0.0	2.6	18.5	6.9	18.5	-
200 Year	5.2	15.2	10.2	2.6	27.9	16.3	27.9	12.8
500 Year	14.5	17.2	27.8	2.6	47.7	20.8	47.6	-

1: Horizontal contraction scour included in pressure scour

In support of structural analysis and design, bridge bents should consider a scour depth equal to the sum of the 200-year pressure scour, pier scour, and long term degradation (27.9 ft). This design scour depth should be assumed at the deepest portion of the channel (thalweg) for each bent. The thalweg elevation assumed for revetment design is 1005.85 feet NAVD 88.

The bridge revetments are designed to mitigate abutment induced local scour. The revetments themselves are designed to accommodate general scour, long term degradation and thalweg migration and still remain functional against the hydraulic affects of the abutment during the scour design event. The revetments at Bridge 3.4 are designed to a total depth equal to the 200-year pressure scour plus long term degradation. This scour depth (12.8 ft) starts at the lowest point in the channel, again assuming thalweg migration. The revetments do extend further immediately beneath the bridge structure to accommodate deeper scour caused by the bridge piers. The bridge pier scour holes could potentially undermine the bridge revetments if the revetments did not account for this additional depth. This extension of the revetment does not mitigate pier scour, but ensures the stability of the revetment itself during the design scour event.

Revetment design is on going. A range of materials and design concepts are being considered based upon cost, effectiveness, environmental impact, constructability, etc. A decision will be made prior to final design. Currently the following options are being assessed:

- Articulated Concrete Block (ACB) revetment and toe down to pier scour depth. The ACB system is made up of a blanket of interlocked open celled concrete blocks, which stabilizes the soil while allowing for growth of vegetation. The ACB system will consist of a continuous 1.5:1 slope terminating at a depth to avoid undermining from the adjacent pier scour. Terminating elevation of the revetment lessens as the revetment wraps around the abutment embankment.

- ACB revetment and pier scour countermeasure for the nearest bent. This option extends the ACB system below the long term degradation elevation and extends the ACB mattress horizontally through the nearest pier. This eliminates the localized pier scour, which allows the ACB revetment to terminate at the shallower contraction scour depth. This saves excavation volume and depth, but adds complexity to the ACB design.
- ACB and slurry wall combination. This option uses an ACB slope to protect the embankment down to a depth beneath long term degradation, but utilizes injection grouting or slurry column technology to provide scour protection and slope stability at depth without excavation.
- ACB and steel sheet pile combination. This option uses an ACB slope to protect the embankment down to a depth beneath long term degradation, but utilizes sheet piling to provide scour protection and slope stability at depth without excavation.
- Soil cement revetment. This is an alternate technique to rock or ACBs and can potentially be applied at a steeper slope. However, the riverbed would still need to be excavated significantly to allow the revetment to be laid in lifts.

6. Conclusions

Using the data and resources available, the hydraulic conditions for both existing and proposed conditions were modeled for Bridge 3.4 at the 60% design level. The results of the modeling indicate that the proposed bridge improvements would result in a slightly lower water surface and velocity and the proposed bridge would meet the freeboard criteria. A scour analysis was conducted based upon the procedures recommended by FHWA's HEC-18. The bridge scour depth shall be considered in the structural design. A draft FEMA "No-Rise" Certificate was completed for the proposed bridge.

7. References

- Federal Emergency Management Agency (FEMA). 1987. FEMA Effective Model for Santa Ana River. HEC-2 format.
- Federal Emergency Management Agency. 2008. Flood Insurance Study, San Bernardino County, California.
- HDR, Inc. 2012. SANBAG Redlands Passenger Rail Project Plans.
- National Geodetic Survey. 1991. North American Vertical Datum (NAVD) 88.
- National Geodetic Survey. 1929. National Geodetic Vertical Datum (NGVD) 29.
- U.S. Army Corps of Engineers (USACE). 1991. Santa Ana River Mainstream Project, CA. Feature Design Memorandum No. 2, Seven Oaks Dam Floodway Delineation (including 500-Year and Seven Oaks Dam Failure Floodplains) Report and Plates.
- U.S. Army Corps of Engineers. 2010. HEC-RAS v.4.1 User's Manual and Technical Reference Manual



WRC Consulting Services, Inc. 2003. Santa Ana River Trail, Alabama Street to Waterman Avenue, Hydraulic Design and Analysis.



Exhibit 1: RPRP Project Overview

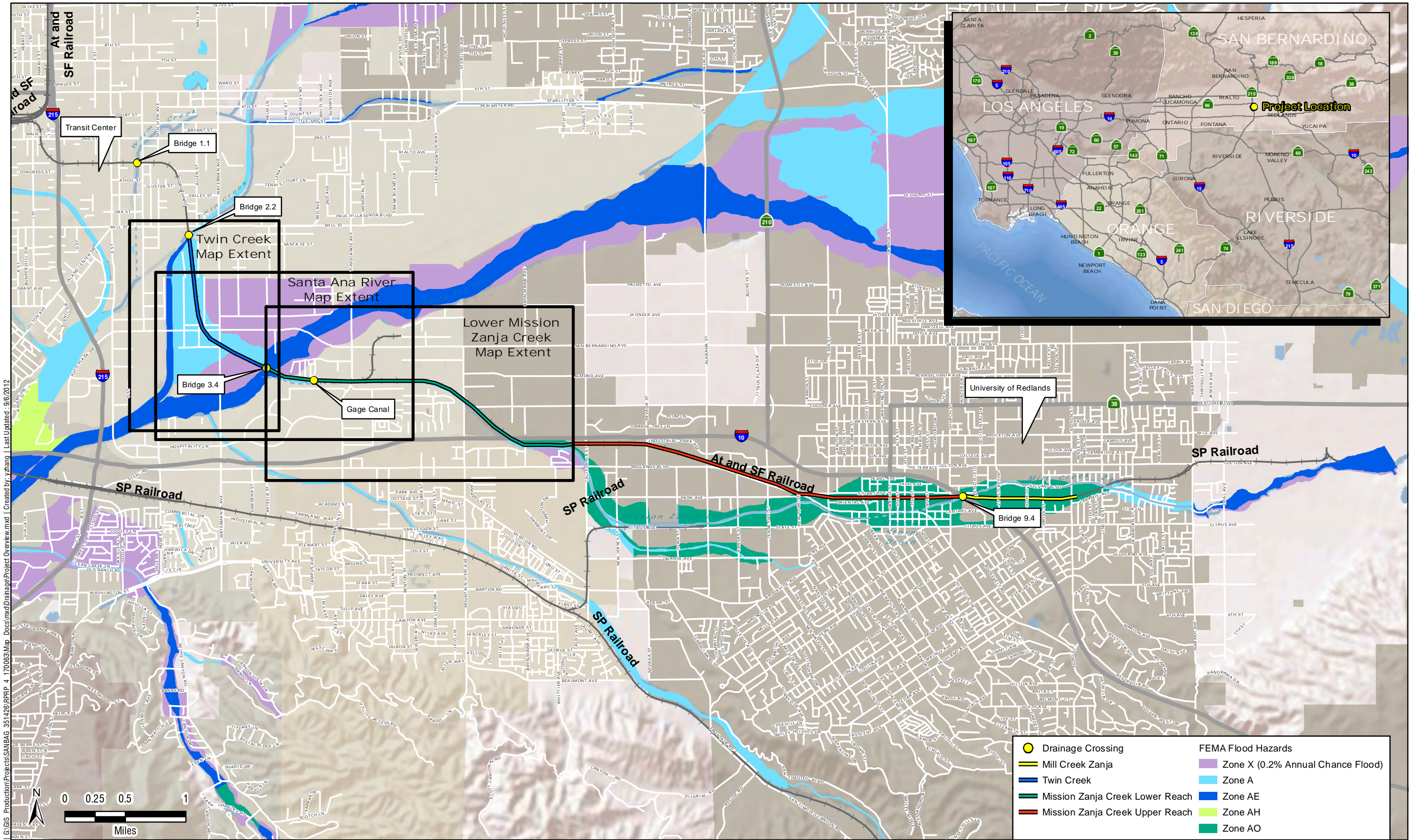

G:\GIS Production\Projects\SANBAG_351426\RRPP_4_170063\Map Docs\mxd\DrainageProject Overview.mxd | Created by: yzhang | Last Updated: 9/6/2012

- | | |
|---|---|
| <ul style="list-style-type: none"> ● Drainage Crossing Mill Creek Zanja Twin Creek Mission Zanja Creek Lower Reach Mission Zanja Creek Upper Reach | <p>FEMA Flood Hazards</p> <ul style="list-style-type: none"> Zone X (0.2% Annual Chance Flood) Zone A Zone AE Zone AH Zone AO |
|---|---|



Exhibit 2: Santa Ana River Reach Limits



Exhibit 3: Modeling Overview – Cross Sections

Exhibit 3 – Modeling Overview – Cross Sections

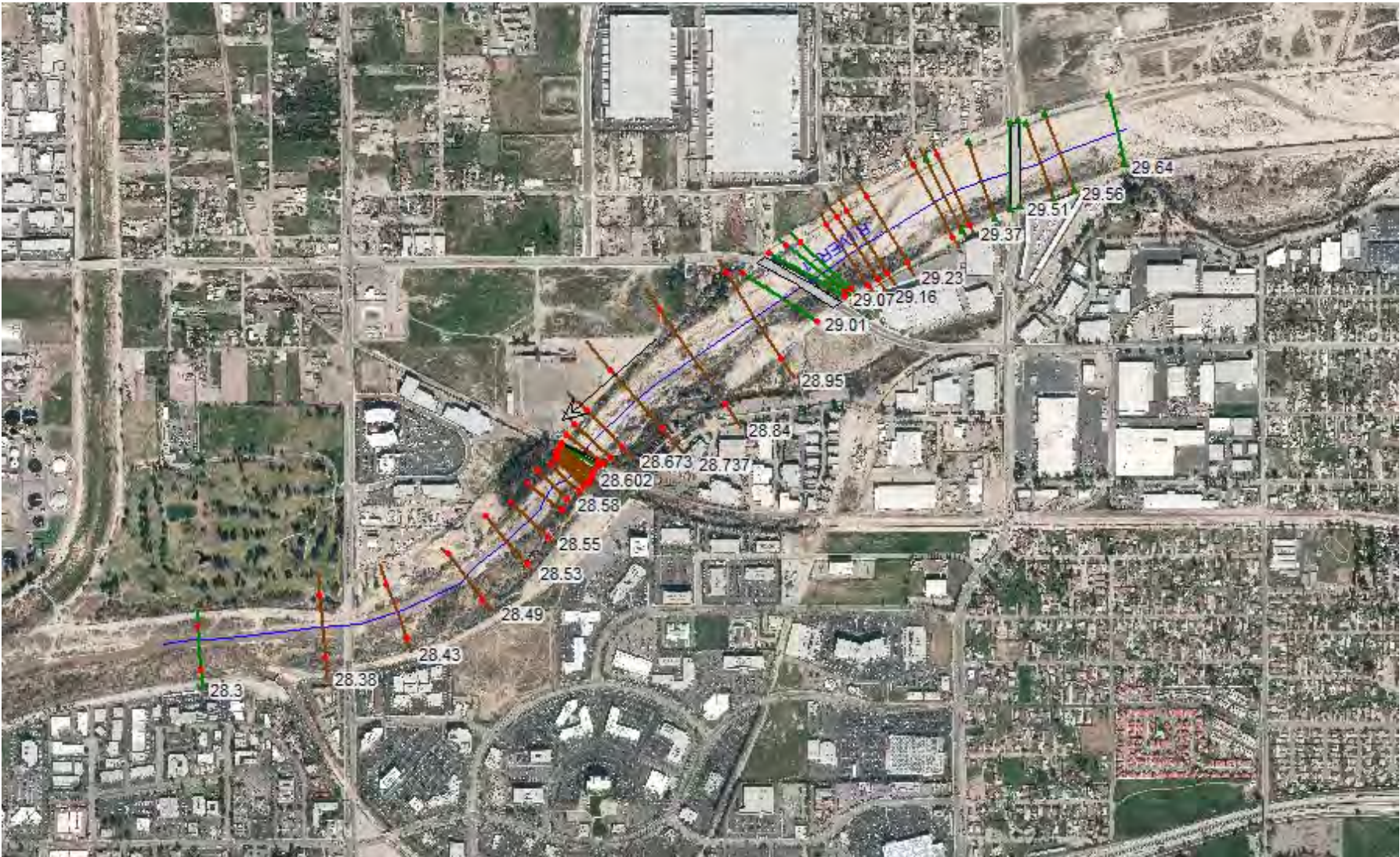

Exhibit 4: FEMA FIRM 06071C Panel 8684H

NOTES TO USERS

This map is for use in administering the National Flood Insurance Program. It does not necessarily identify all areas subject to flooding, particularly from local drainage sources of small size. The community map repository should be consulted for possible updated or additional flood hazard information.

To obtain more detailed information in areas where **Base Flood Elevations (BFEs)** and/or **floodways** have been determined, users are encouraged to consult the Flood Profiles and Floodway Data and/or Summary of Stillwater Elevations Tables contained within the Flood Insurance Study (FIS) report that accompanies this FIRM. Users should be aware that BFEs shown on the FIRM represent rounded whole-foot elevations. These BFEs are intended for flood insurance rating purposes only and should not be used as the sole source of flood elevation information. Accordingly, flood elevation data presented in the FIS report should be utilized in conjunction with the FIRM for purposes of construction and/or floodplain management.

Coastal Base Flood Elevations shown on this map apply only landward of 0.0' North American Vertical Datum of 1988 (NAVD 88). Users of this FIRM should be aware that coastal flood elevations are also provided in the Summary of Stillwater Elevations Tables in the Flood Insurance Study report for this jurisdiction. Elevations shown in the Summary of Stillwater Elevations Tables should be used for construction and/or floodplain management purposes when they are higher than the elevations shown on this FIRM.

Boundaries of the **floodways** were computed at cross sections and interpolated between cross sections. The floodways were based on hydraulic considerations with regard to requirements of the National Flood Insurance Program. Floodway widths and other pertinent floodway data are provided in the Flood Insurance Study report for this jurisdiction.

Certain areas not in Special Flood Hazard Areas may be protected by **flood control structures**. Refer to Section 2.4 "Flood Protection Measures" of the Flood Insurance Study report for information on flood control structures for this jurisdiction.

The **projection** used in the preparation of this map was Universal Transverse Mercator (UTM) zone 11 North. The **horizontal datum** was NAD 83, GRS80 spheroid. Differences in datum, spheroid, projection or UTM zones used in the production of FIRMs for adjacent jurisdictions may result in slight positional differences in map features across jurisdiction boundaries. These differences do not affect the accuracy of this FIRM.

Flood elevations on this map are referenced to the North American Vertical Datum of 1988. These flood elevations must be compared to structure and ground elevations referenced to the same **vertical datum**. For information regarding conversion between the National Geodetic Vertical Datum of 1929 and the North American Vertical Datum of 1988, visit the National Geodetic Survey website at <http://www.ngs.noaa.gov> or contact the National Geodetic Survey at the following address:

NGS Information Services
NOAA, NNGS12
National Geodetic Survey
SSMC-3, #9202
1315 East-West Highway
Silver Spring, Maryland 20910-3282
(301) 713-3242

To obtain current elevation, description, and/or location information for **bench marks** shown on this map, please contact the Information Services Branch of the National Geodetic Survey at (301) 713-3242, or visit its website at <http://www.ngs.noaa.gov>.

Base map information shown on this FIRM was derived from digital orthophotography collected by the U.S. Department of Agriculture Farm Service Agency. This imagery was flown in 2005 and was produced with a 1-meter ground sample distance.

This map may reflect more detailed and up-to-date stream channel configurations than those shown on the previous FIRM for this jurisdiction. The floodplains and floodways that were transferred from the previous FIRM may have been adjusted to conform to these new stream channel configurations. As a result, the Flood Profiles and Floodway Data tables in the Flood Insurance Study Report (which contains authoritative hydraulic data) may reflect stream channel distances that differ from what is shown on this map.

Corporate limits shown on this map are based on the best data available at the time of publication. Because changes due to annexations or de-annexations may have occurred after this map was published, map users should contact appropriate community officials to verify current corporate limit locations.

Please refer to the separately printed **Map Index** for an overview map of the county showing the layout of map panels; community map repository addresses; and a Listing of Communities table containing National Flood Insurance Program dates for each community as well as a listing of the panels on which each community is located.

Contact the **FEMA Map Service Center** at 1-800-358-9616 for information on available products associated with this FIRM. Available products may include previously issued Letters of Map Change, a Flood Insurance Study report, and/or digital versions of this map. The FEMA Map Service Center may also be reached by Fax at 1-800-358-9620 and its website at <http://mcs.fema.gov>.

If you have **questions about this map** or questions concerning the National Flood Insurance Program in general, please call 1-877-FEMA MAP (1-877-336-2627) or visit the FEMA website at <http://www.fema.gov>.

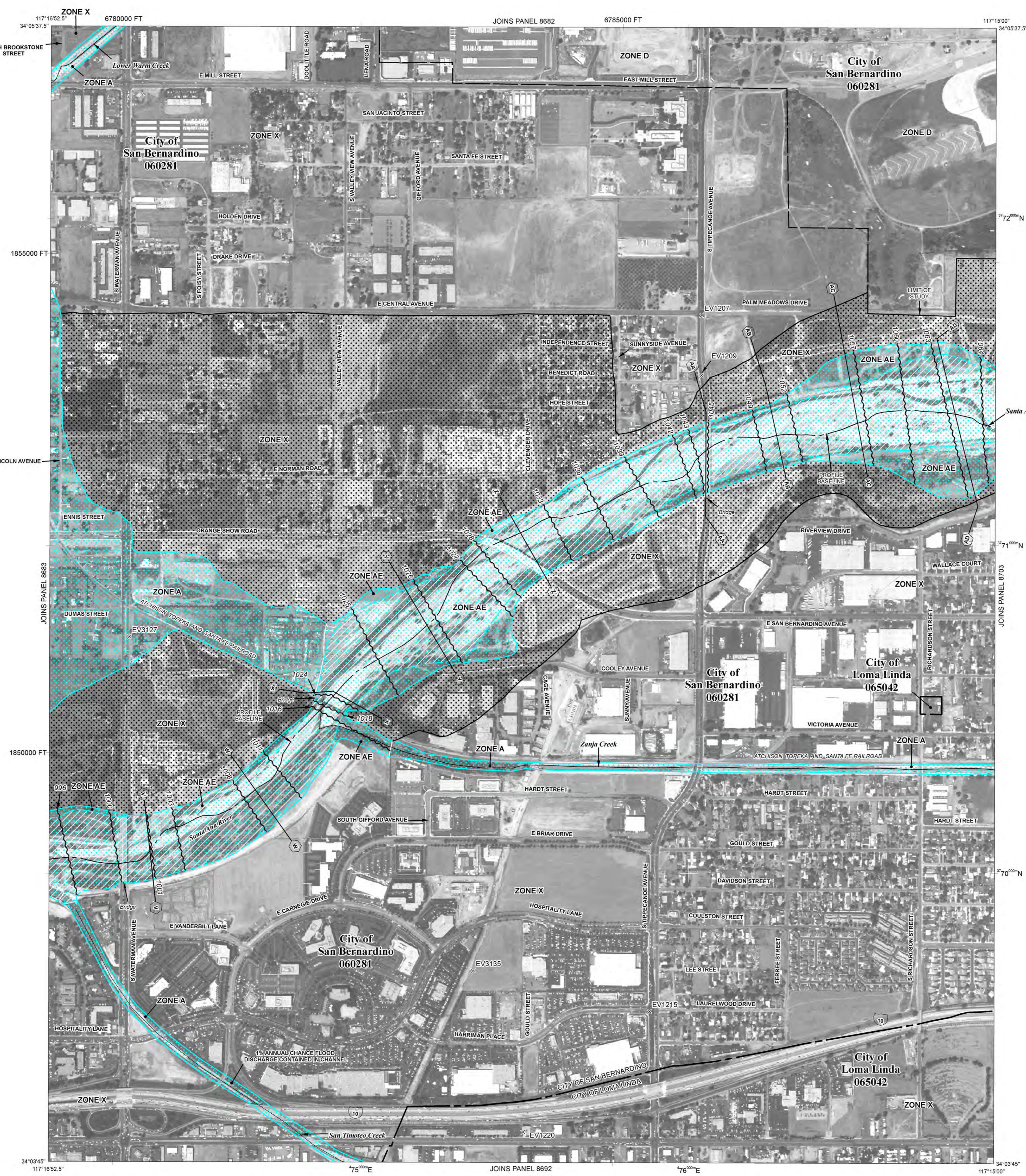

LEGEND

SPECIAL FLOOD HAZARD AREAS SUBJECT TO INUNDATION BY THE 1% ANNUAL CHANCE FLOOD

The 1% annual flood (100-year flood), also known as the base flood, is the flood that has a 1% chance of being equaled or exceeded in any given year. The Special Flood Hazard Area is the area subject to flooding by the 1% annual chance flood. Areas of Special Flood Hazard include Zones A, AE, AH, AO, AR, A99, V, and VE. The Base Flood Elevation is the water-surface elevation of the 1% annual chance flood.

- ZONE A** No Base Flood Elevations determined.
- ZONE AE** Base Flood Elevations determined.
- ZONE AH** Flood depths of 1 to 3 feet (usually areas of ponding); Base Flood Elevations determined.
- ZONE AO** Flood depths of 1 to 3 feet (usually sheet flow on sloping terrain); average depths determined. For areas of alluvial fan flooding, velocities also determined.
- ZONE AR** Special Flood Hazard Area formerly protected from the 1% annual chance flood by a flood control system that was subsequently identified. Zone AR indicates that the former flood control system is being restored to provide protection from the 1% annual chance or greater flood.
- ZONE A99** Area to be protected from 1% annual chance flood by a Federal flood protection system under construction; no Base Flood Elevations determined.
- ZONE V** Coastal flood zone with velocity hazard (wave action); no Base Flood Elevations determined.
- ZONE VE** Coastal flood zone with velocity hazard (wave action); Base Flood Elevations determined.

FLOODWAY AREAS IN ZONE AE

The floodway is the channel of a stream plus any adjacent floodplain areas that must be kept free of encroachment so that the 1% annual chance flood can be carried without substantial increases in flood heights.

OTHER FLOOD AREAS

- ZONE X** Areas of 0.2% annual chance flood; areas of 1% annual chance flood with average depths of less than 1 foot or with drainage areas less than 1 square mile; and areas protected by levees from 1% annual chance flood.

OTHER AREAS

- ZONE X** Areas determined to be outside the 0.2% annual chance floodplain.
- ZONE D** Areas in which flood hazards are undetermined, but possible.

COASTAL BARRIER RESOURCES SYSTEM (CBRS) AREAS

OTHERWISE PROTECTED AREAS (OPAs)

CBRS areas and OPAs are normally located within or adjacent to Special Flood Hazard Areas.

- 1% annual chance floodplain boundary
- 0.2% annual chance floodplain boundary
- Floodway boundary
- Zone D boundary
- CBRS and OPA boundary
- Boundary dividing Special Flood Hazard Area Zones and boundary dividing Special Flood Hazard Areas of different Base Flood Elevations, flood depths or flood velocities.
- Base Flood Elevation line and value; elevation in feet*
- Base Flood Elevation value where uniform within zone; elevation in feet* (EL 987)

* Referenced to the North American Vertical Datum of 1988

- Cross section line
- Transect line

87°07'45", 32°22'30"

776°00"N

600000 FT

5000-foot grid ticks: California State Plane coordinate system, zone V (FIPSZONE 0405), Lambert Conformal Conic projection

Bench mark (see explanation in Notes to Users section of this FIRM panel)

● M1.5 River Mile

MAP REPOSITORY
Refer to listing of Map Repositories on Map Index

EFFECTIVE DATE OF COUNTYWIDE FLOOD INSURANCE RATE MAP
March 18, 1996

EFFECTIVE DATE(S) OF REVISION(S) TO THIS PANEL
August 28, 2008 - to update corporate limits, to change Base Flood Elevations and Special Flood Hazard Areas, to update map format, to add roads and road names, and to incorporate previously issued Letters of Map Revision.

For community map revision history prior to countywide mapping, refer to the Community Map History table located in the Flood Insurance Study report for this jurisdiction.

To determine if flood insurance is available in this community, contact your Insurance agent or call the National Flood Insurance Program at 1-800-638-6620.

NATIONAL FLOOD INSURANCE PROGRAM

PANEL 8684H

FIRM
FLOOD INSURANCE RATE MAP

SAN BERNARDINO COUNTY, CALIFORNIA AND INCORPORATED AREAS
PANEL 8684 OF 9400
(SEE MAP INDEX FOR FIRM PANEL LAYOUT)

CONTAINS:

COMMUNITY	NUMBER	PANEL	SUFFIX
LOMA LINDA, CITY OF	065042	8684	H
SAN BERNARDINO, CITY OF	060281	8684	H

Notice to User: The Map Number shown below should be used when placing map orders; the Community Number shown above should be used on insurance applications for the subject community.

MAP NUMBER
06071C8684H

MAP REVISED
AUGUST 28, 2008

Federal Emergency Management Agency

Exhibit 5: Proposed Bridge Plan

10:58:12 AM
 p:\P\WAPPS\AC01\California_Sacramento\Documents\351426\CON0102831\0000000268339\6.0_CAD_BIM\6.2_Work_in_Progress\6.2.2_Contract_Files\FinalDesign\08_STRUCTURES - BRIDGES\26495-06-ST00303.dgn
 mdequzma
 c:\pwworking\src\d0761459\SANBAG-11x17bw.pdf.plt:ctg

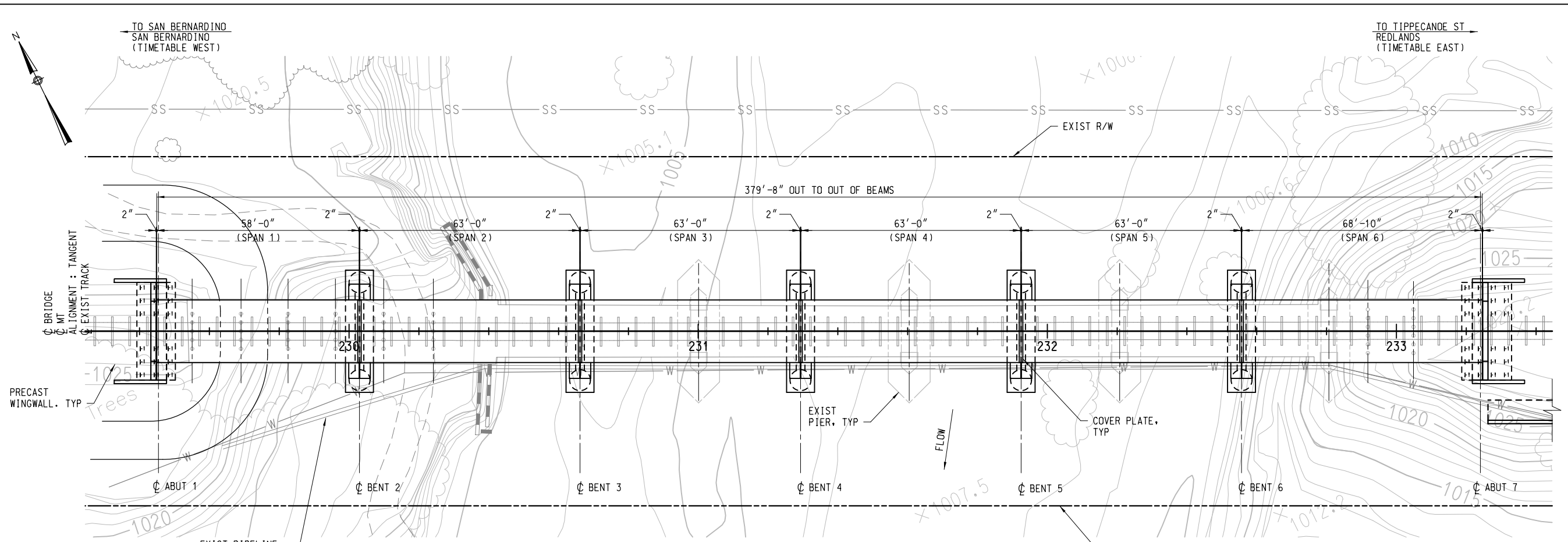

PLAN
 SCALE: 1/16" = 1'-0"

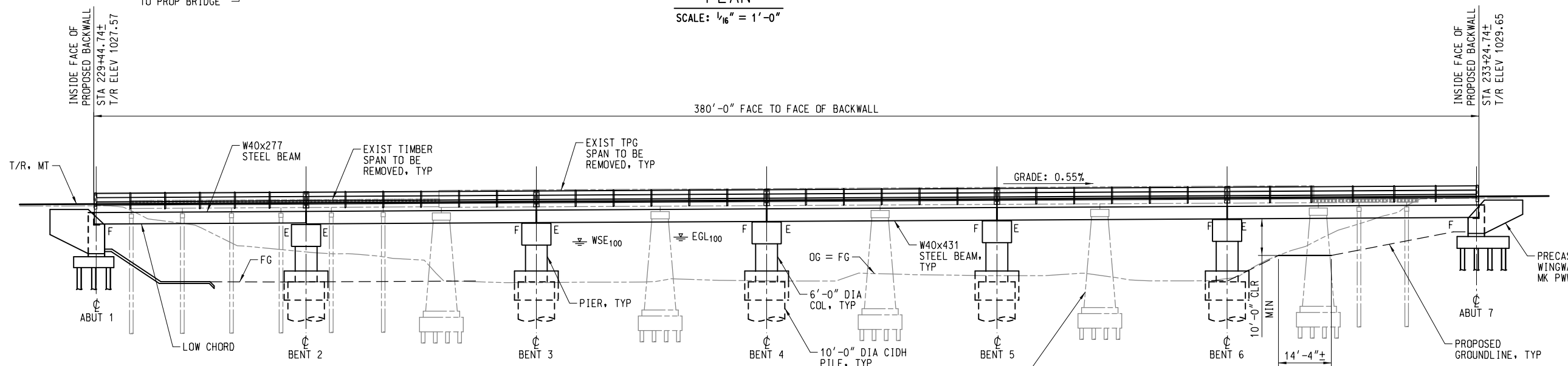

ELEVATION
 SCALE: 1/16" = 1'-0"

EGL ₁₀₀	= 1018.47
WSE ₁₀₀	= 1017.18
VCH ₁₀₀	= 15.3fc/s

NOTES:

1. THE EXISTENCE AND LOCATION OF ANY UNDERGROUND UTILITY PIPES, CONDUITS, DUCTS OR STRUCTURES SHOWN ON THIS PLAN ARE OBTAINED BY A SEARCH OF THE AVAILABLE RECORDS. TO THE BEST OF OUR KNOWLEDGE, THERE ARE NO EXISTING UTILITIES EXCEPT AS SHOWN ON THIS PLAN. THE CONTRACTOR IS REQUIRED TO TAKE DUE PRECAUTIONARY MEASURES TO PROTECT THE UTILITY LINES SHOWN ON THIS DRAWING. IT SHALL BE THE CONTRACTOR'S RESPONSIBILITY TO NOTIFY THE OWNERS OF THE UTILITIES OR STRUCTURES CONCERNED BEFORE STARTING WORK. CONTRACTOR FURTHER ASSUMES ALL LIABILITY AND RESPONSIBILITY FOR UNDERGROUND UTILITY PIPES, CONDUITS, DUCTS OR STRUCTURES SHOWN OR NOT SHOWN ON THIS DRAWING.
2. FOR PROPOSED TRACK ALIGNMENT AND PROFILE INFORMATION, SEE "TRACK PLAN AND PROFILES".
3. FOR HANDRAIL DETAILS, SEE SHEET XXXXXXS.
4. STRUCTURE BACKFILL SHALL BE COMPACTED TO A RELATIVE COMPACTION OF NOT LESS THAN 95 PERCENT.
5. LEAN CONCRETE BACKFILLING BEHIND OF ABUTMENT - CONTRACTOR OPTION.

NOTES:

- F = FIXED END
- E = EXPANSION END

LEGEND

- EXIST STRUCTURE
- NEW STRUCTURE

DESIGNED BY M. SARWAR		SAN BERNARDINO ASSOCIATED GOVERNMENTS Working Together	60% SUBMITTAL NOT FOR CONSTRUCTION	REDLANDS PASSENGER RAIL PROJECT		CONTRACT NO.
DRAWN BY M. DeGUZMAN						DRAWING NO. ST00303
CHECKED BY		HDR Engineering, Inc. 2280 Market Street, Suite 100 Riverside, CA 92501-2110 (951) 320-7300	BRIDGE 3.4 GENERAL PLAN		REVISION	SHEET NO.
APPROVED BY R. KLOVSKY					SUBMITTED: _____	SCALE
REV.	DATE	BY	SUBJ.	APP.	DATE	
					12-16-2016	



Attachment 1

HEC-RAS Modeling Exhibits

SantaAnaRiver Plan: Duplicated Effective Model 2/18/2014

RIVER-1 Reach-1

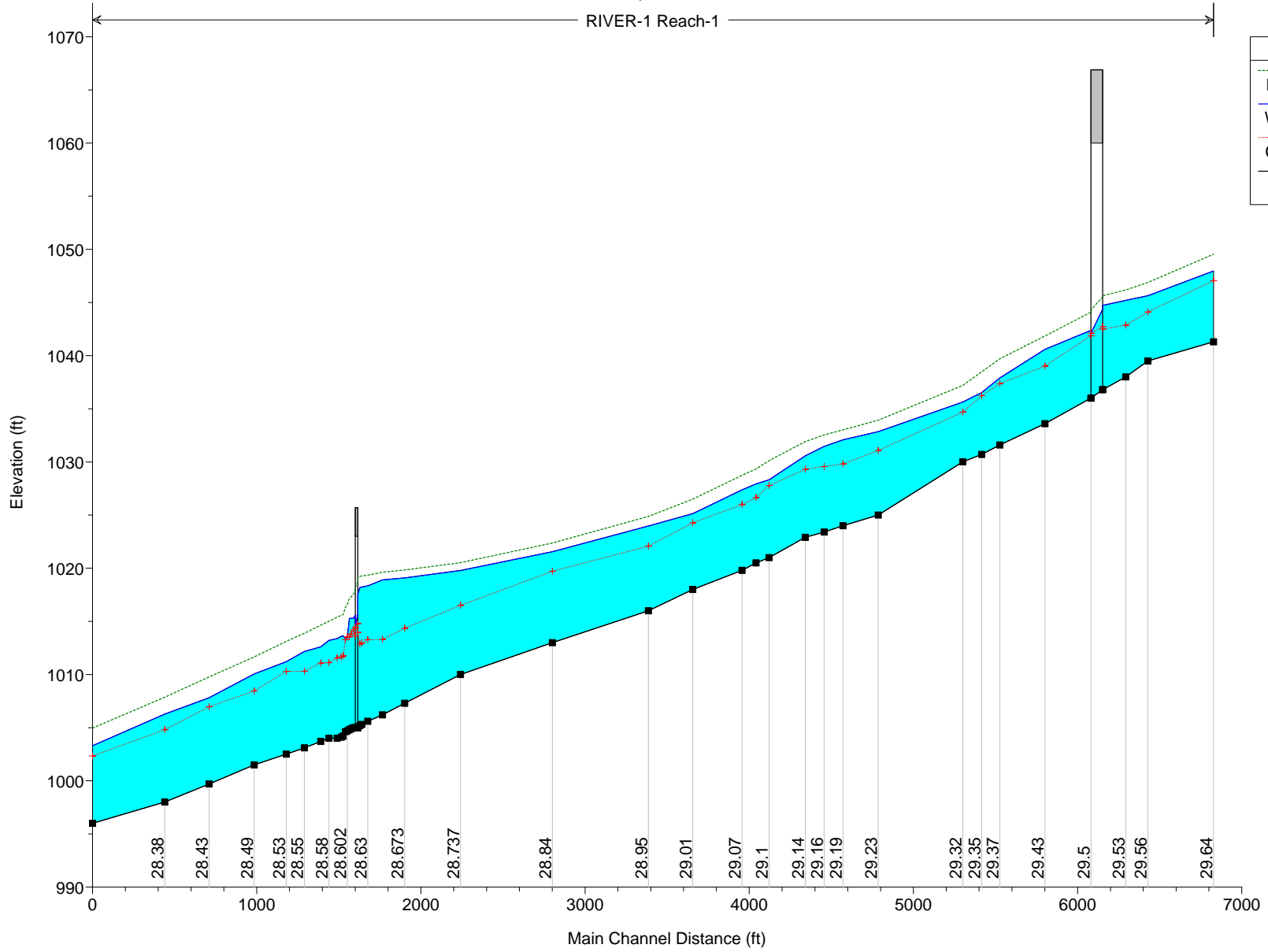

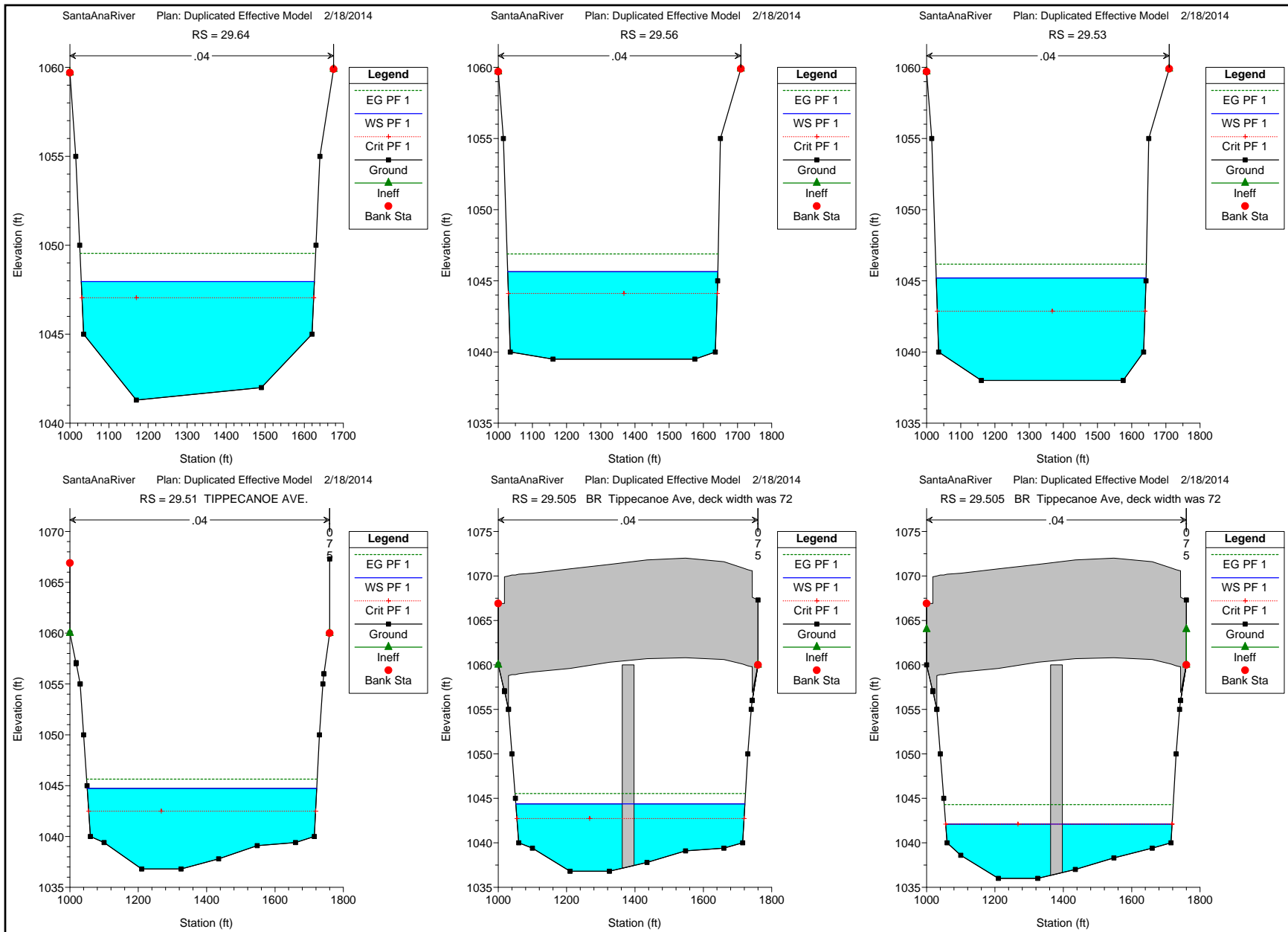

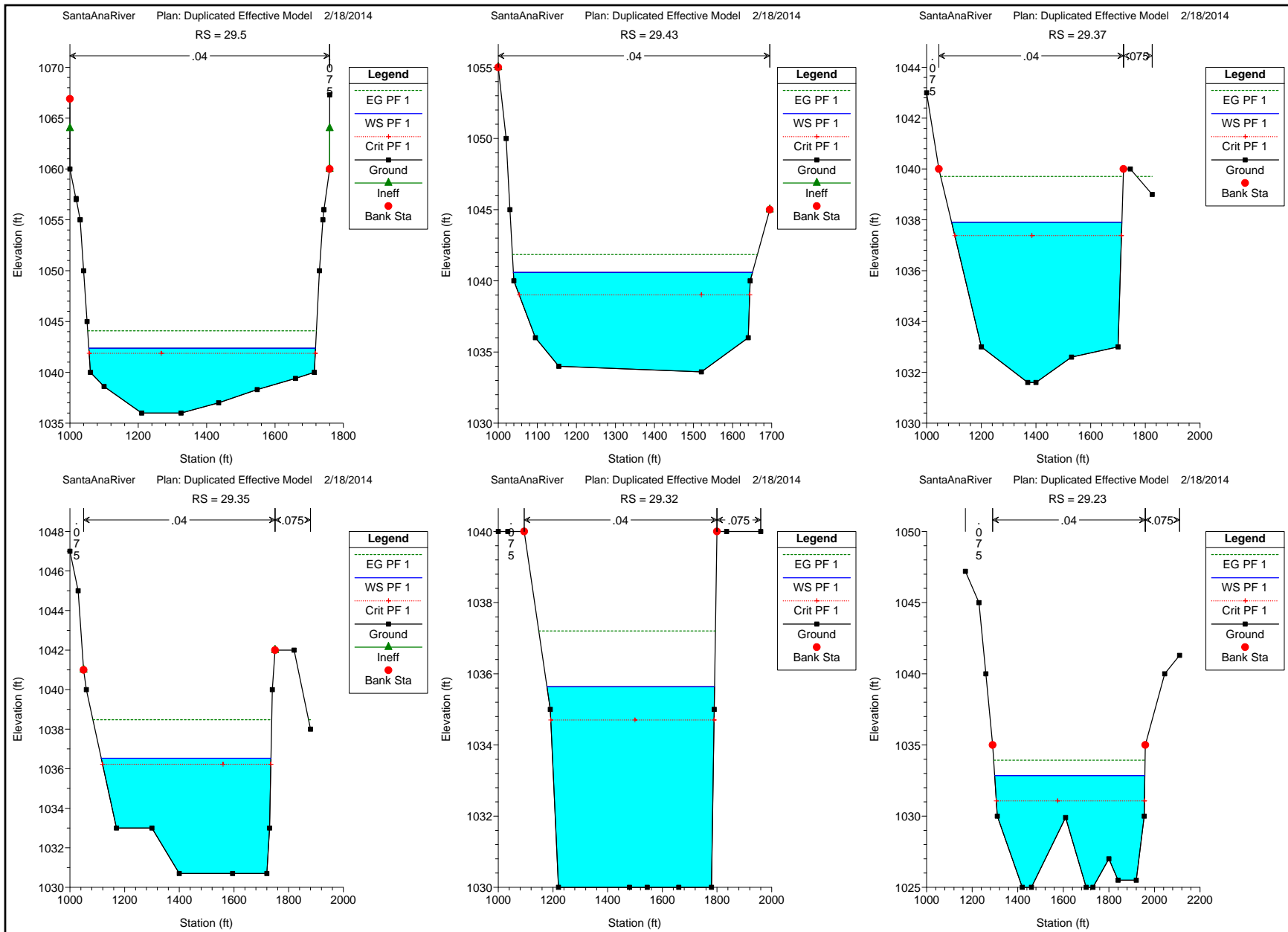

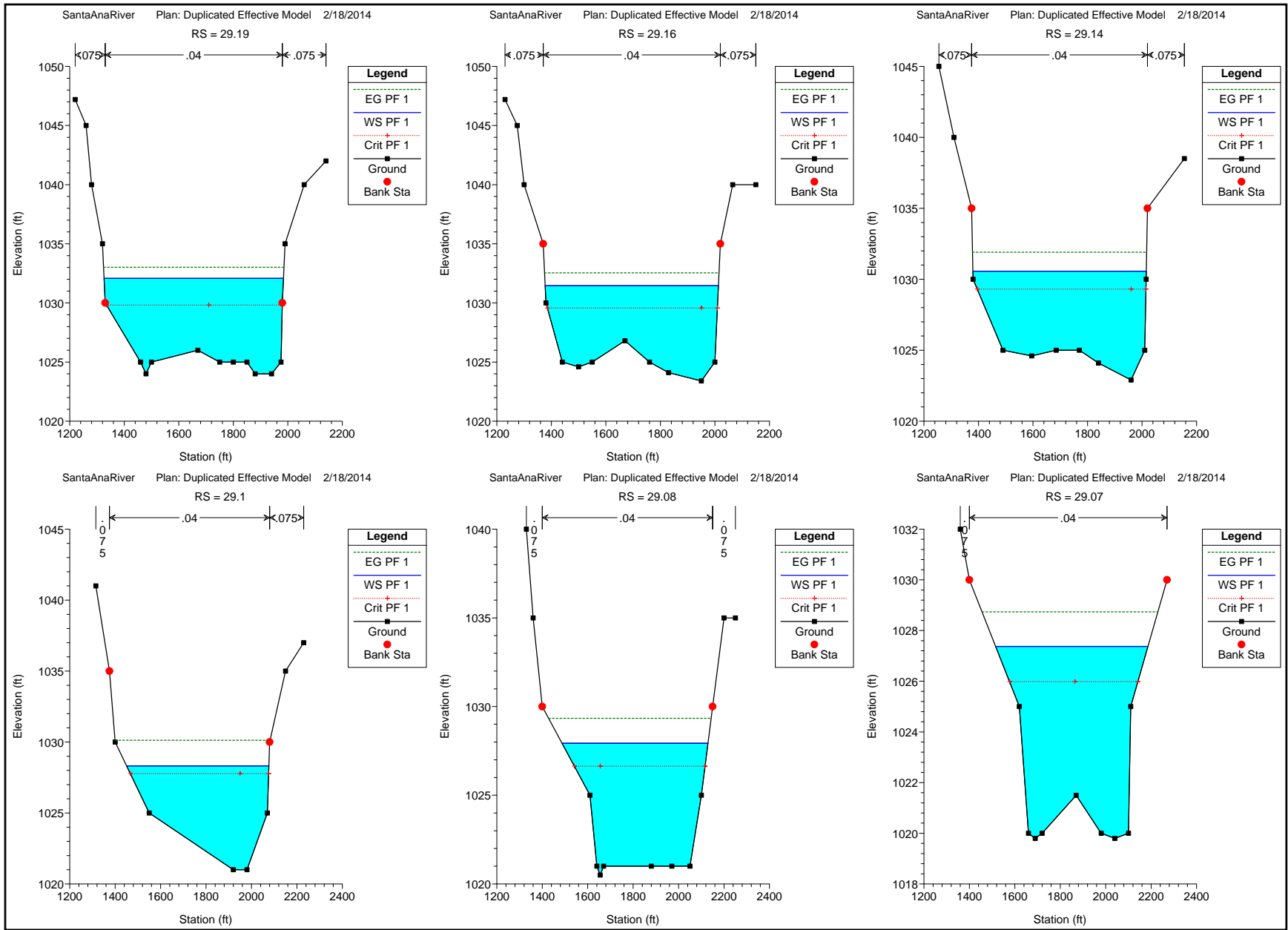

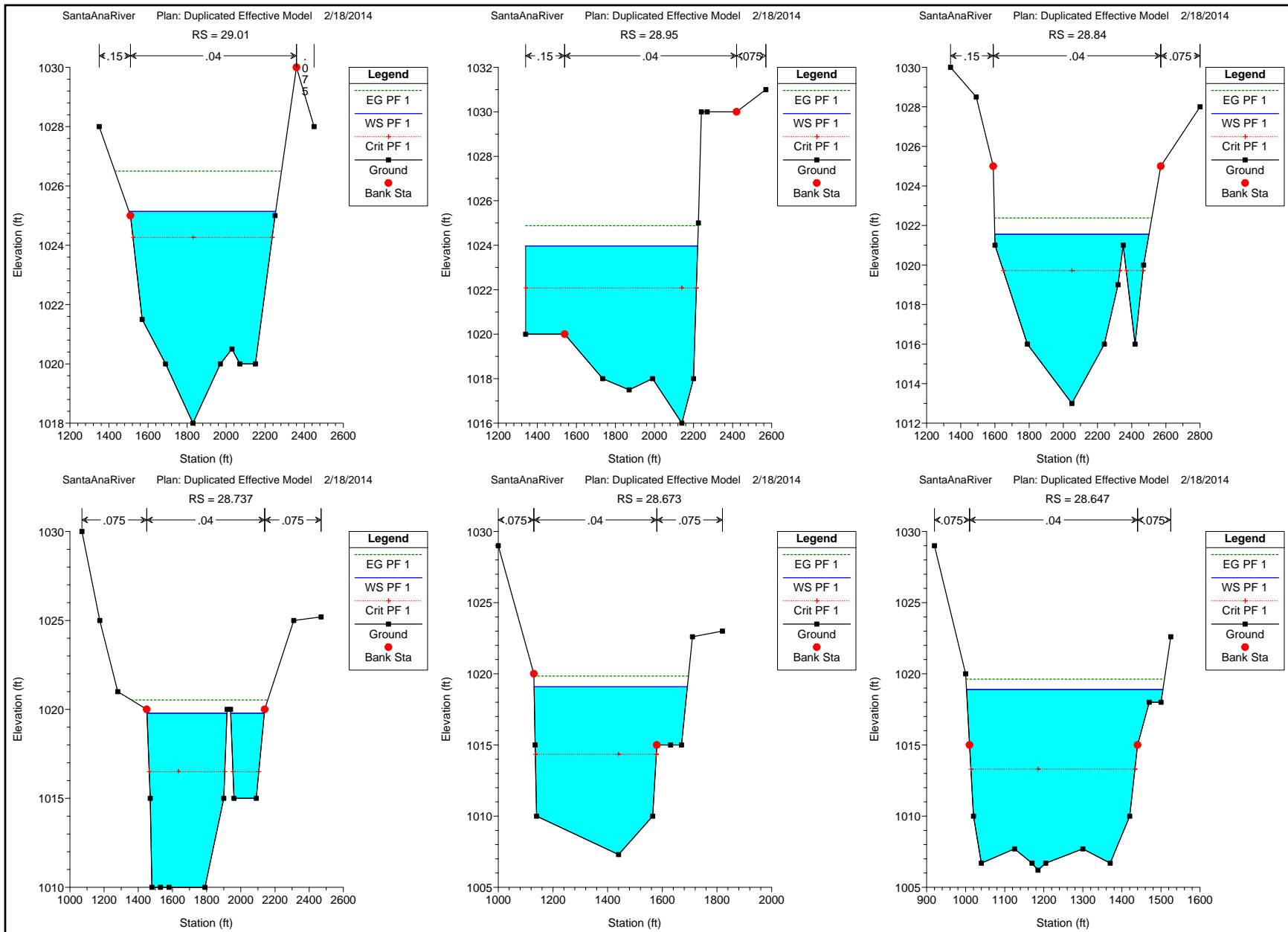

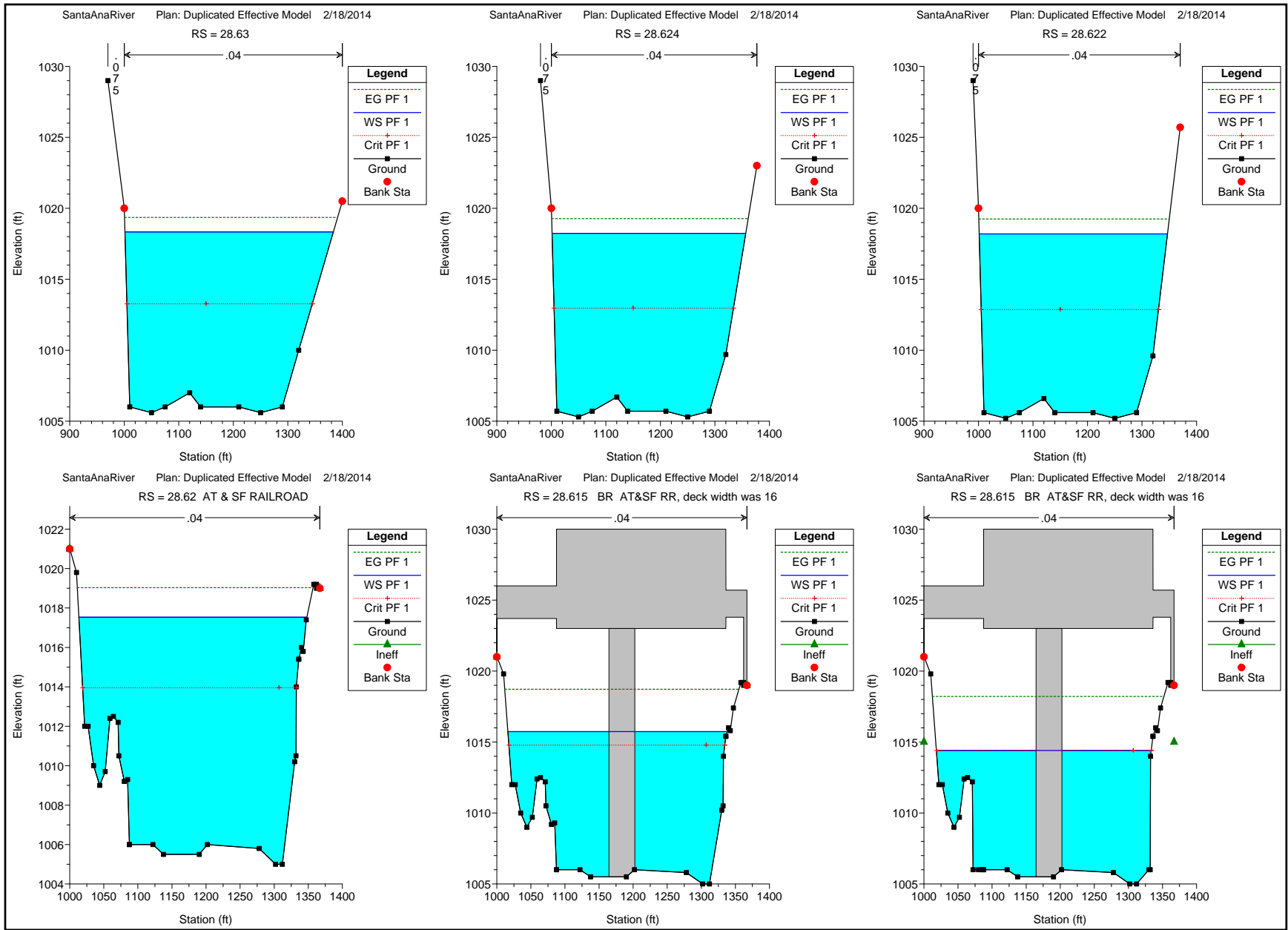

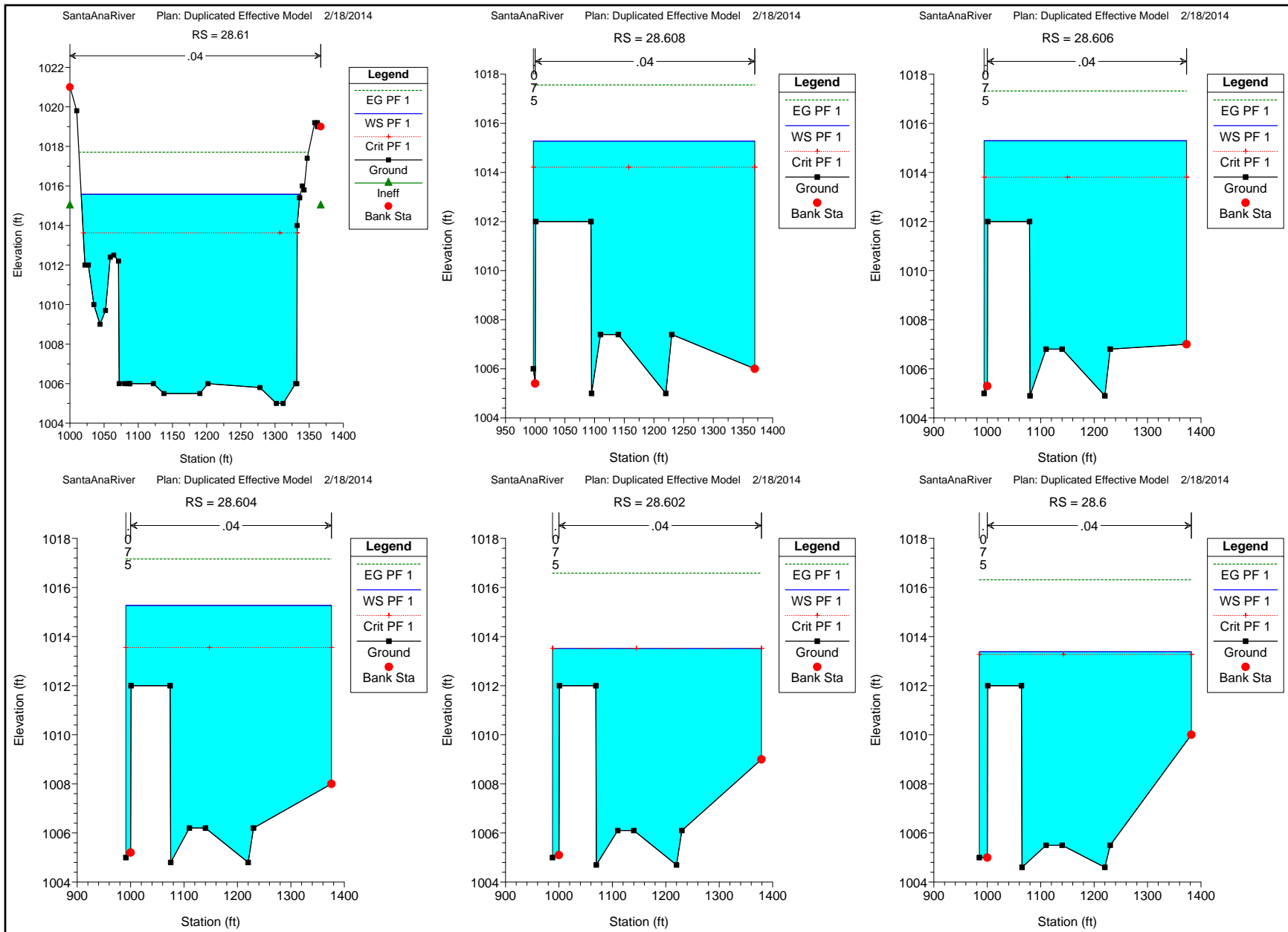

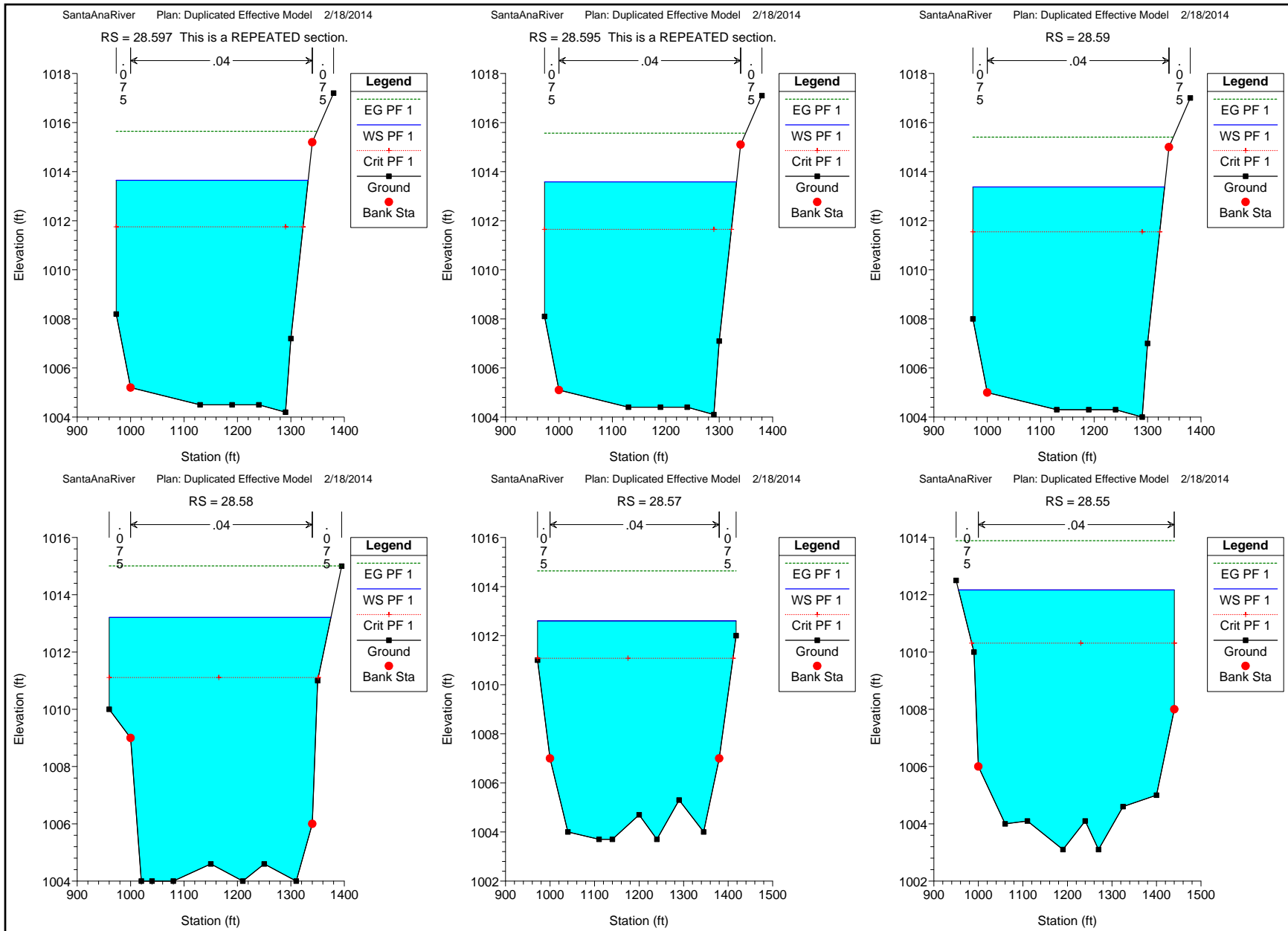

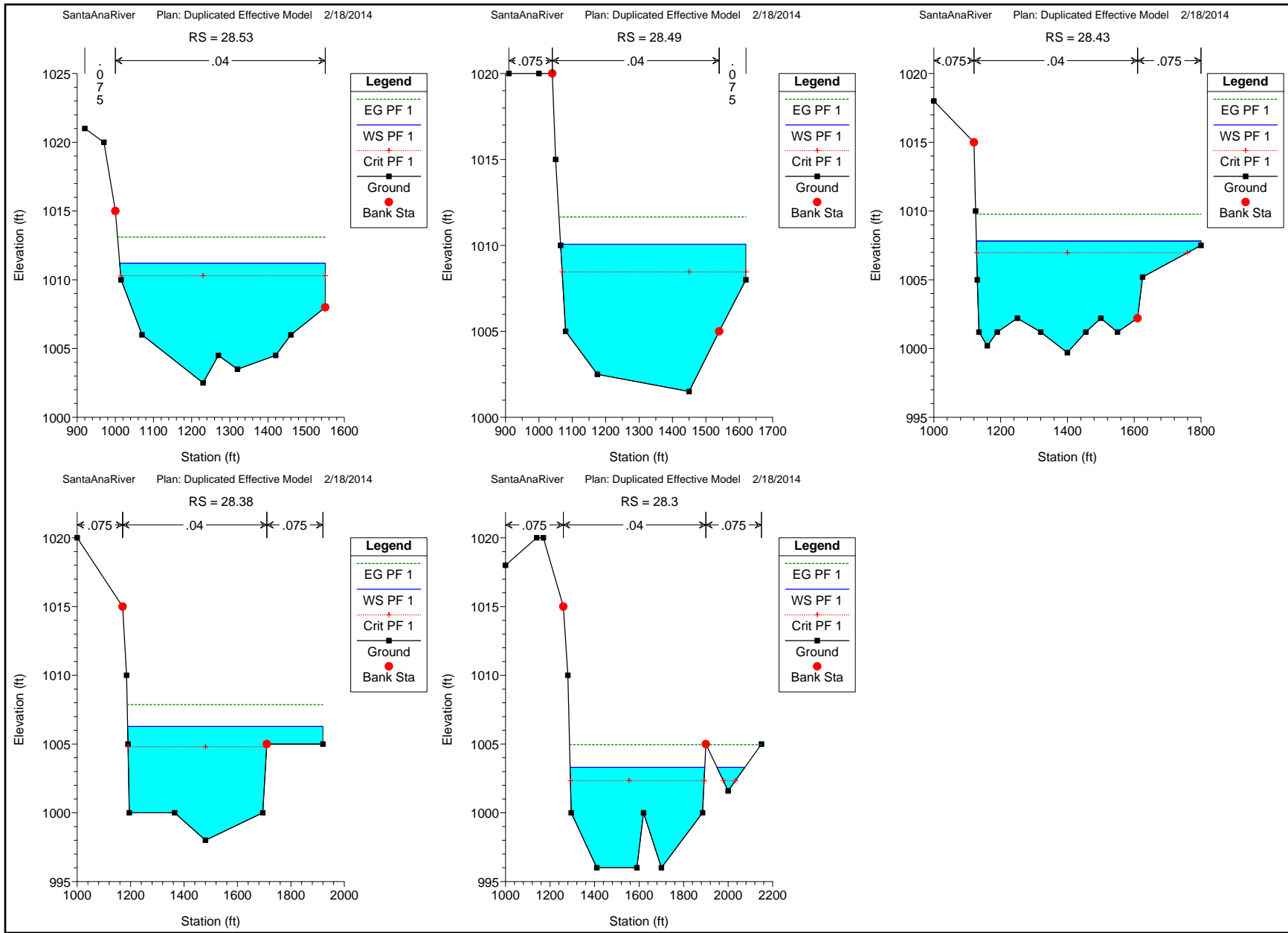

SantaAnaRiver Plan: Corrected Effective Model 2/18/2014

RIVER-1 Reach-1

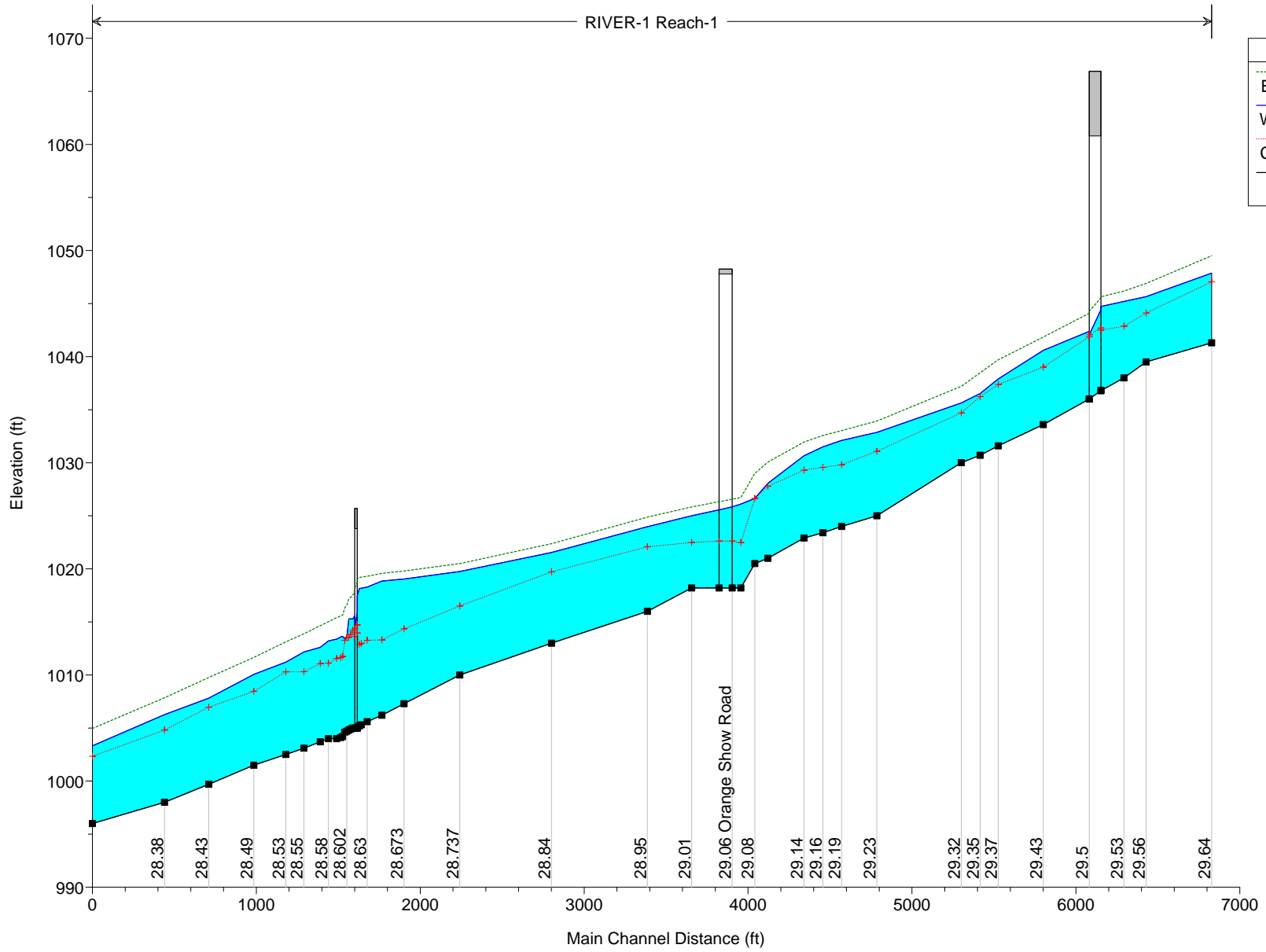

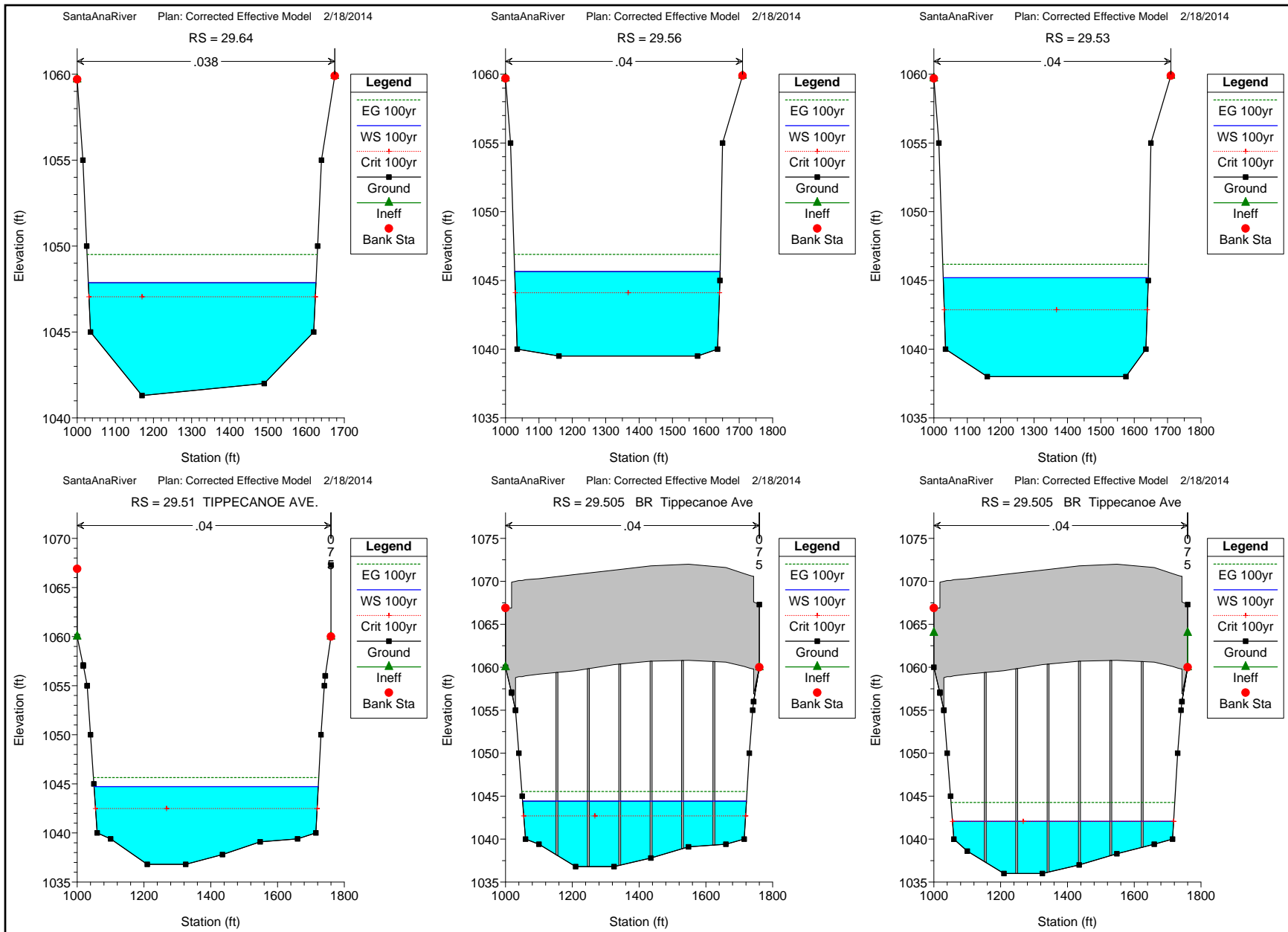

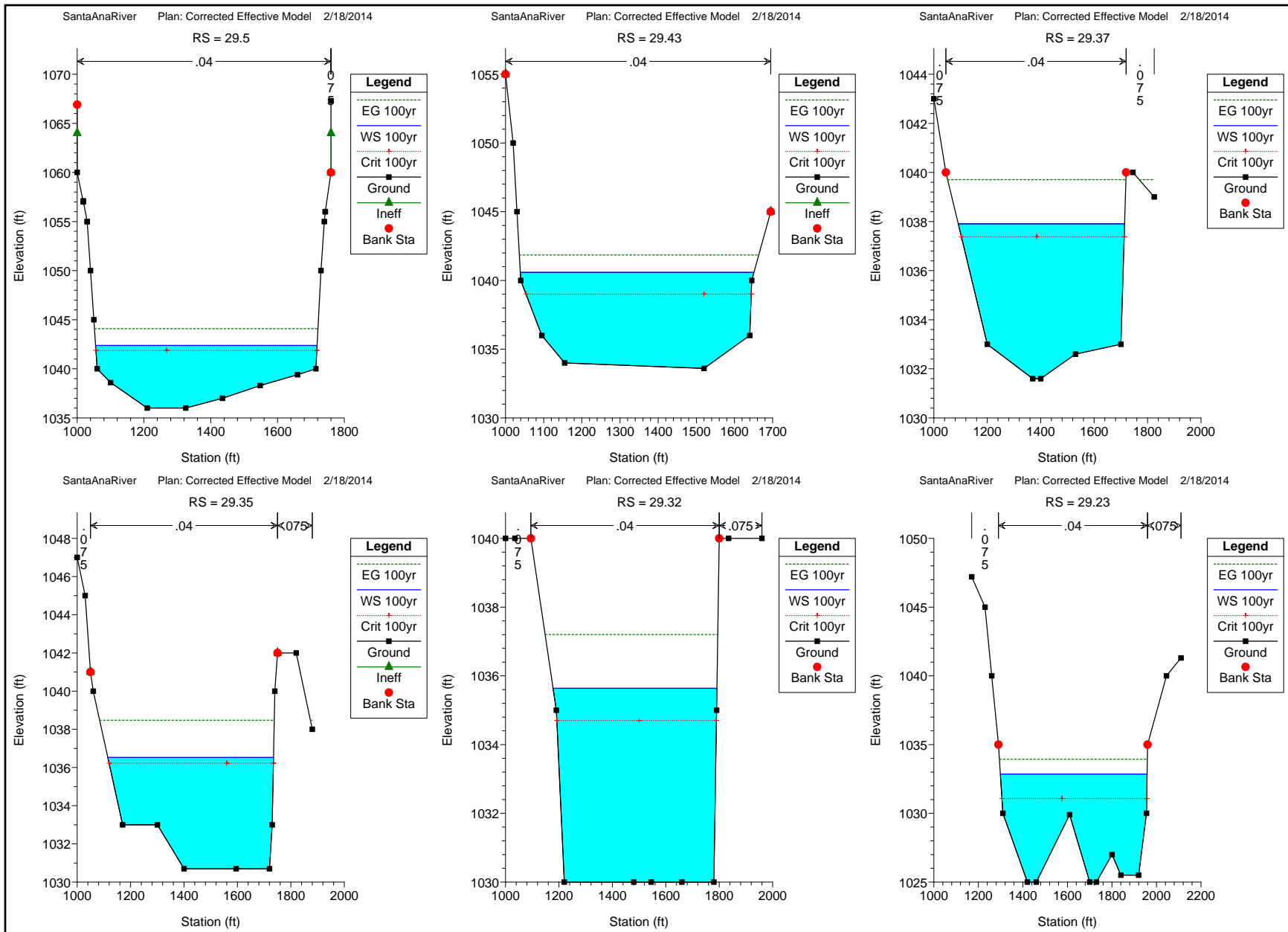

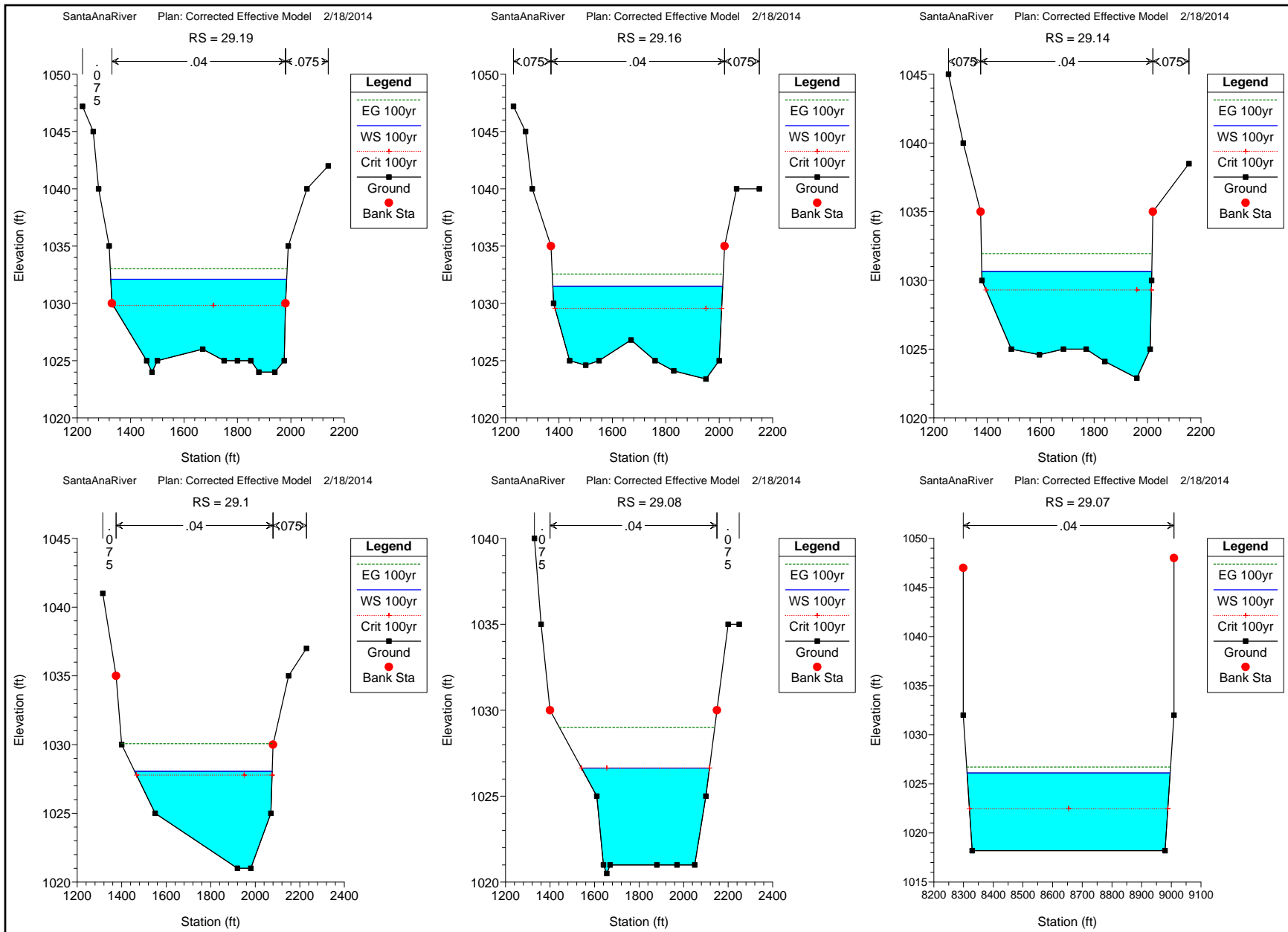

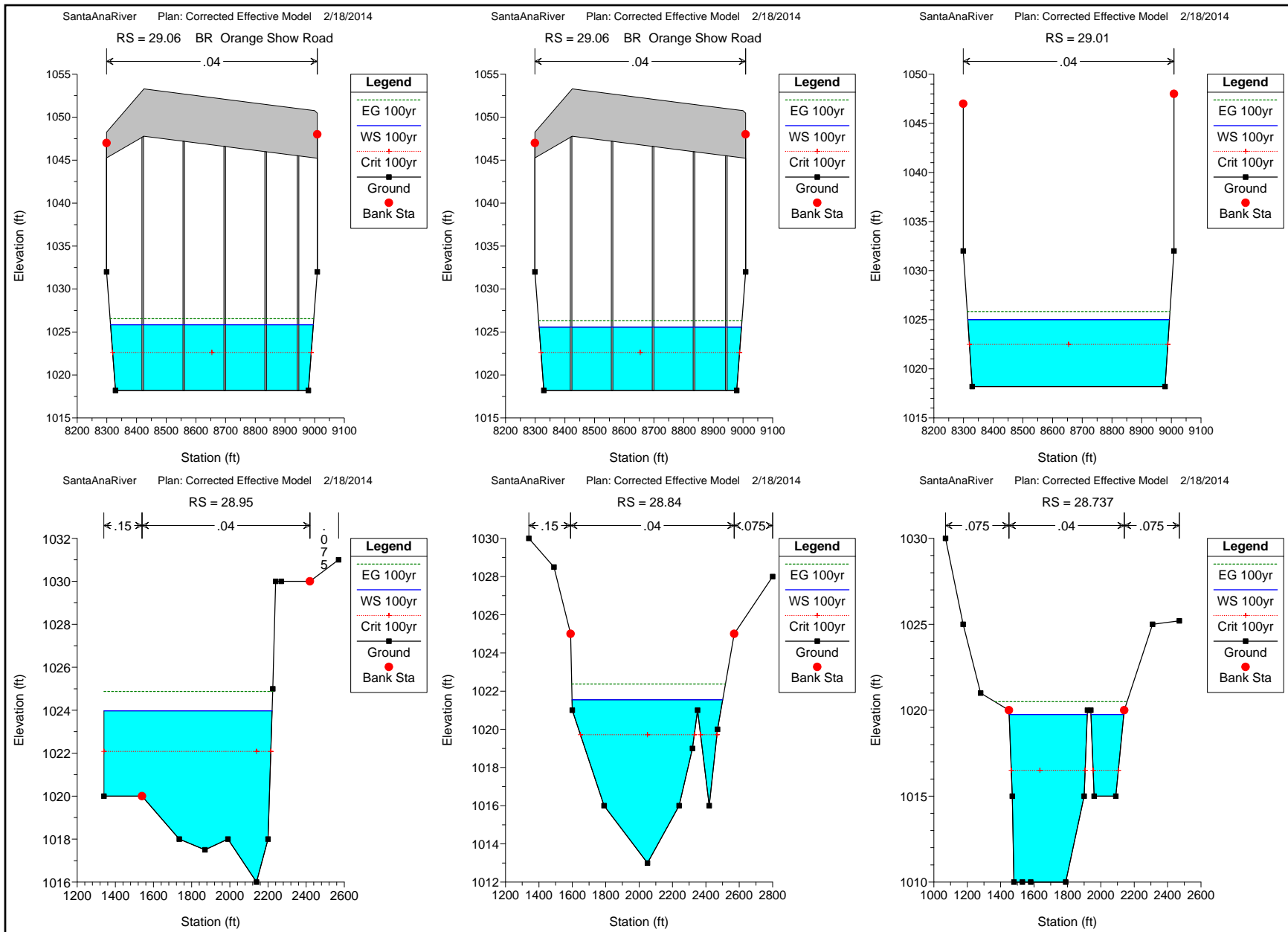

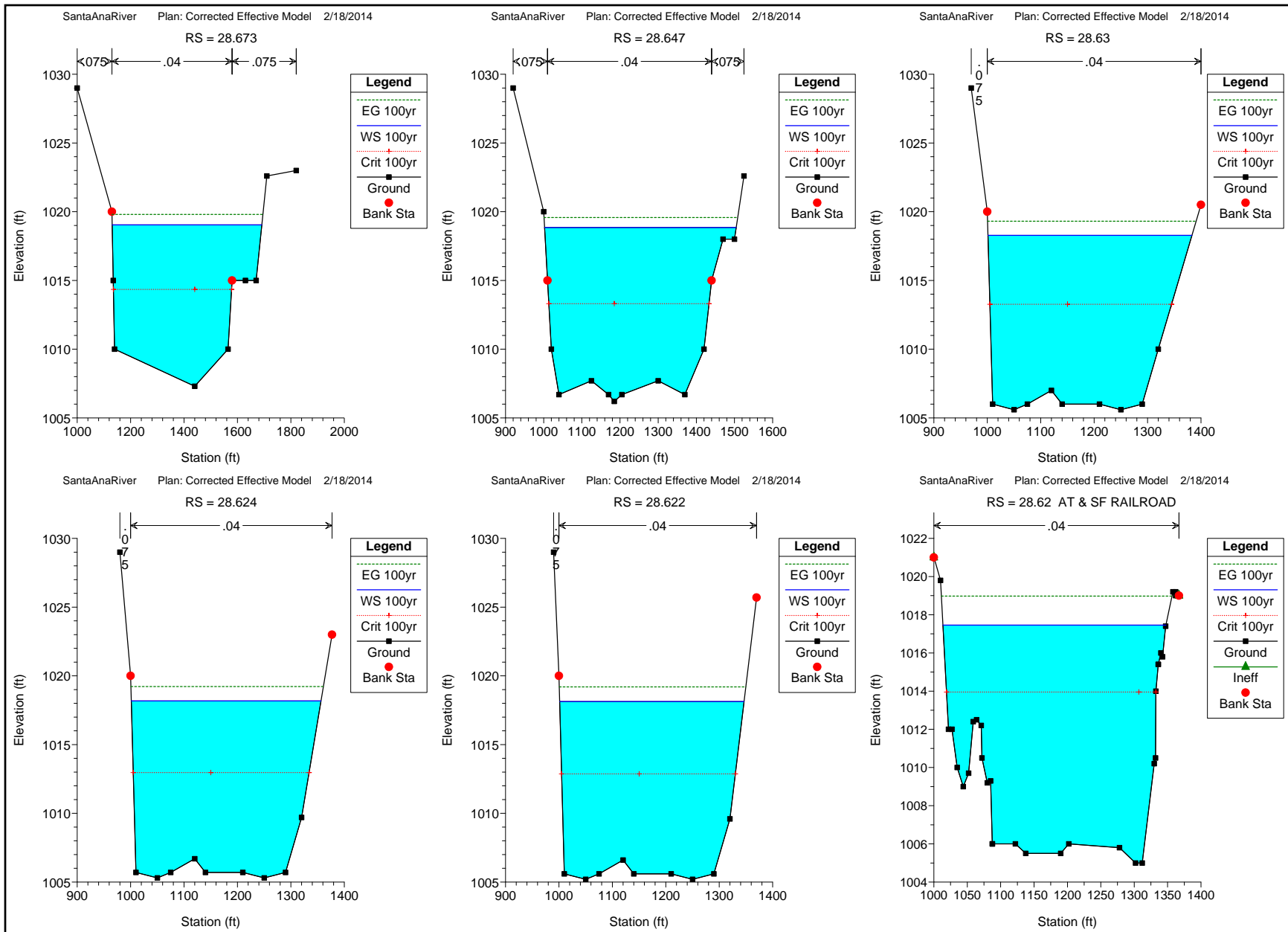

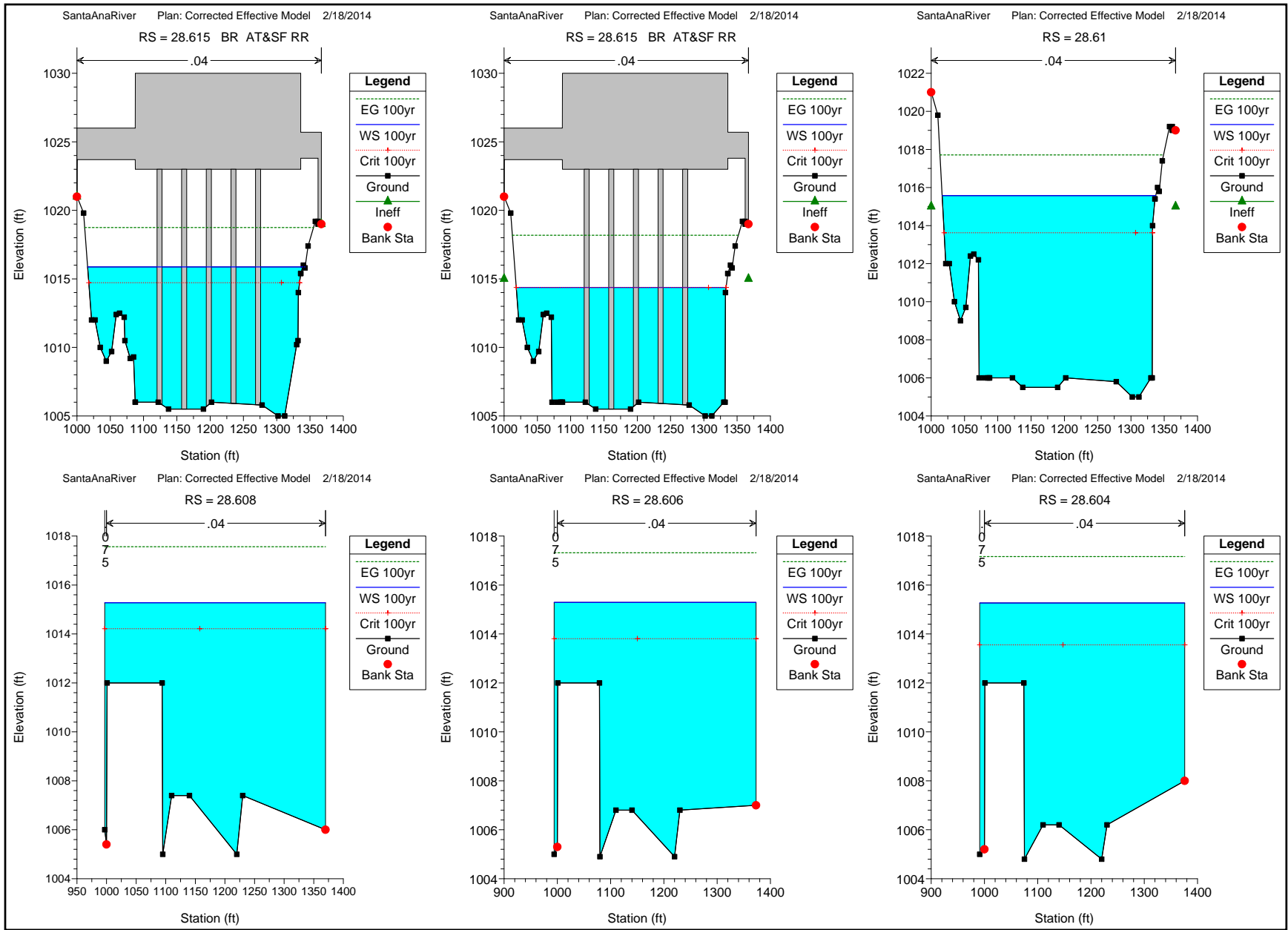

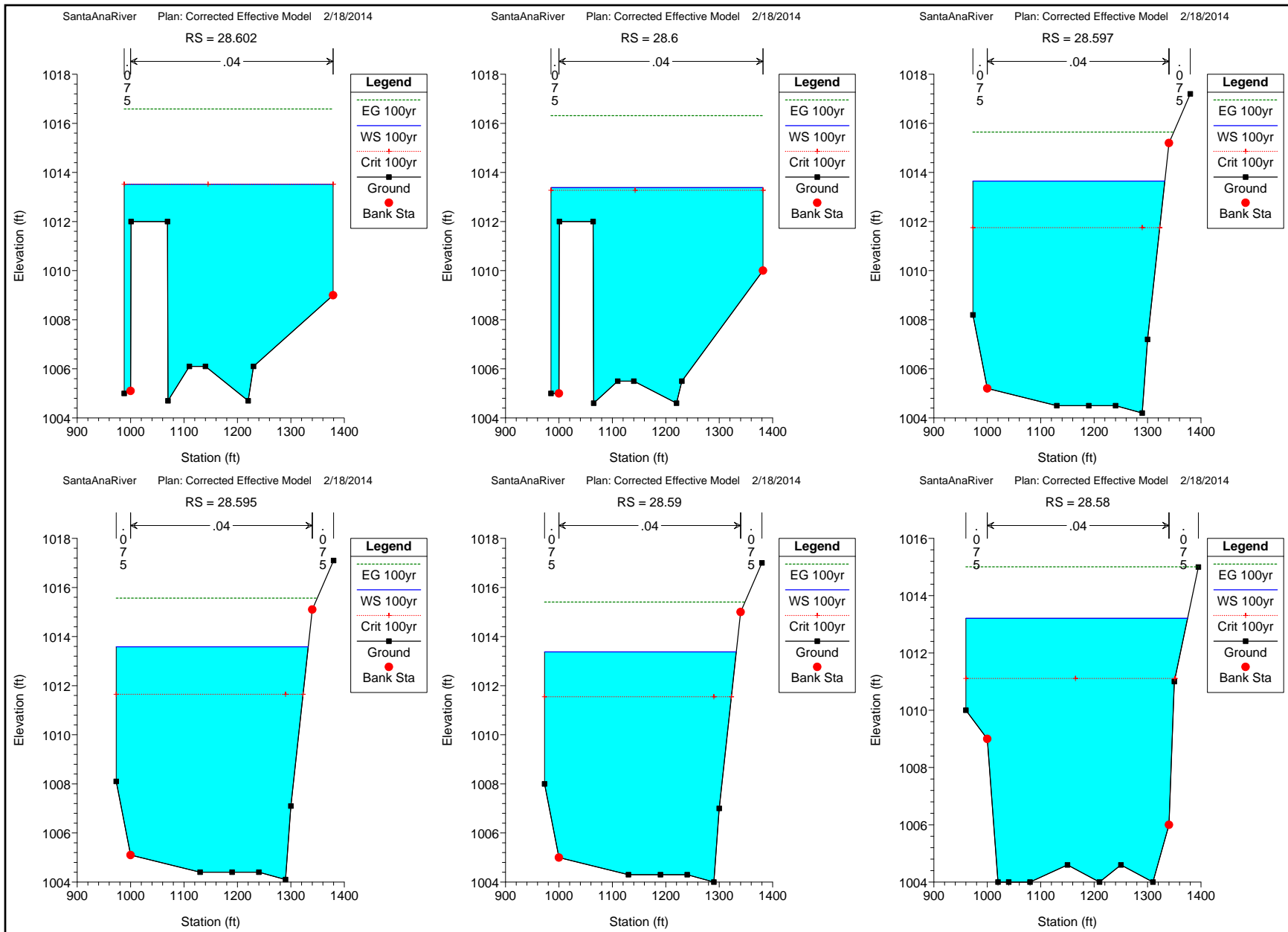

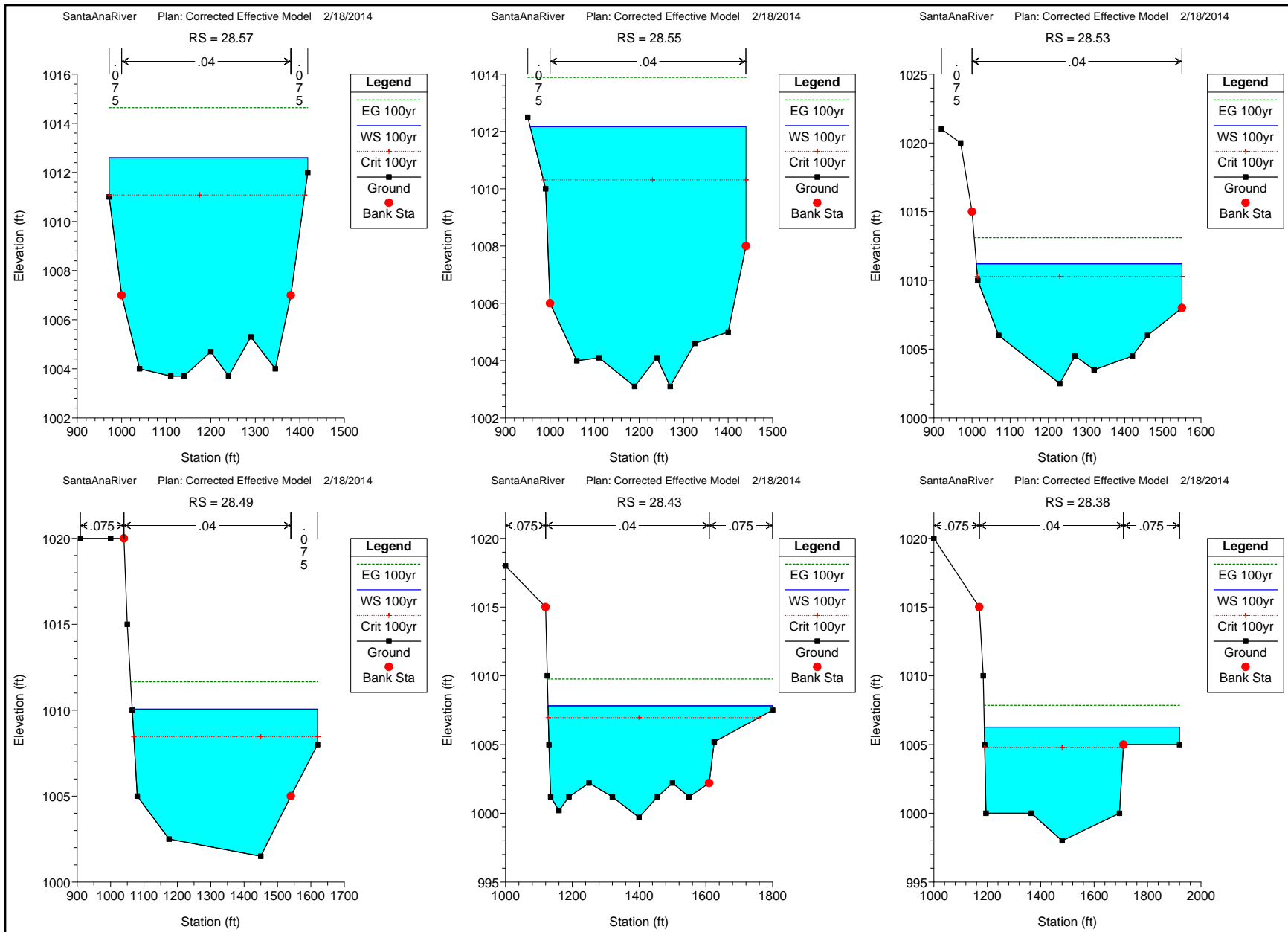

RS = 28.3

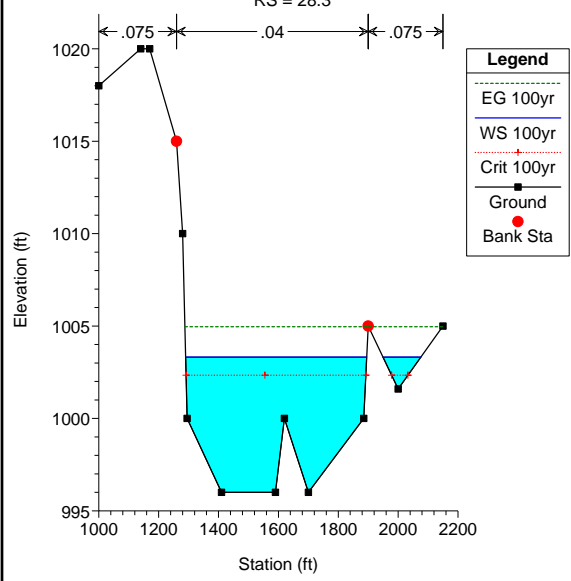

SantaAnaRiver Plan: Existing Model 2/18/2014

RIVER-1 Reach-1

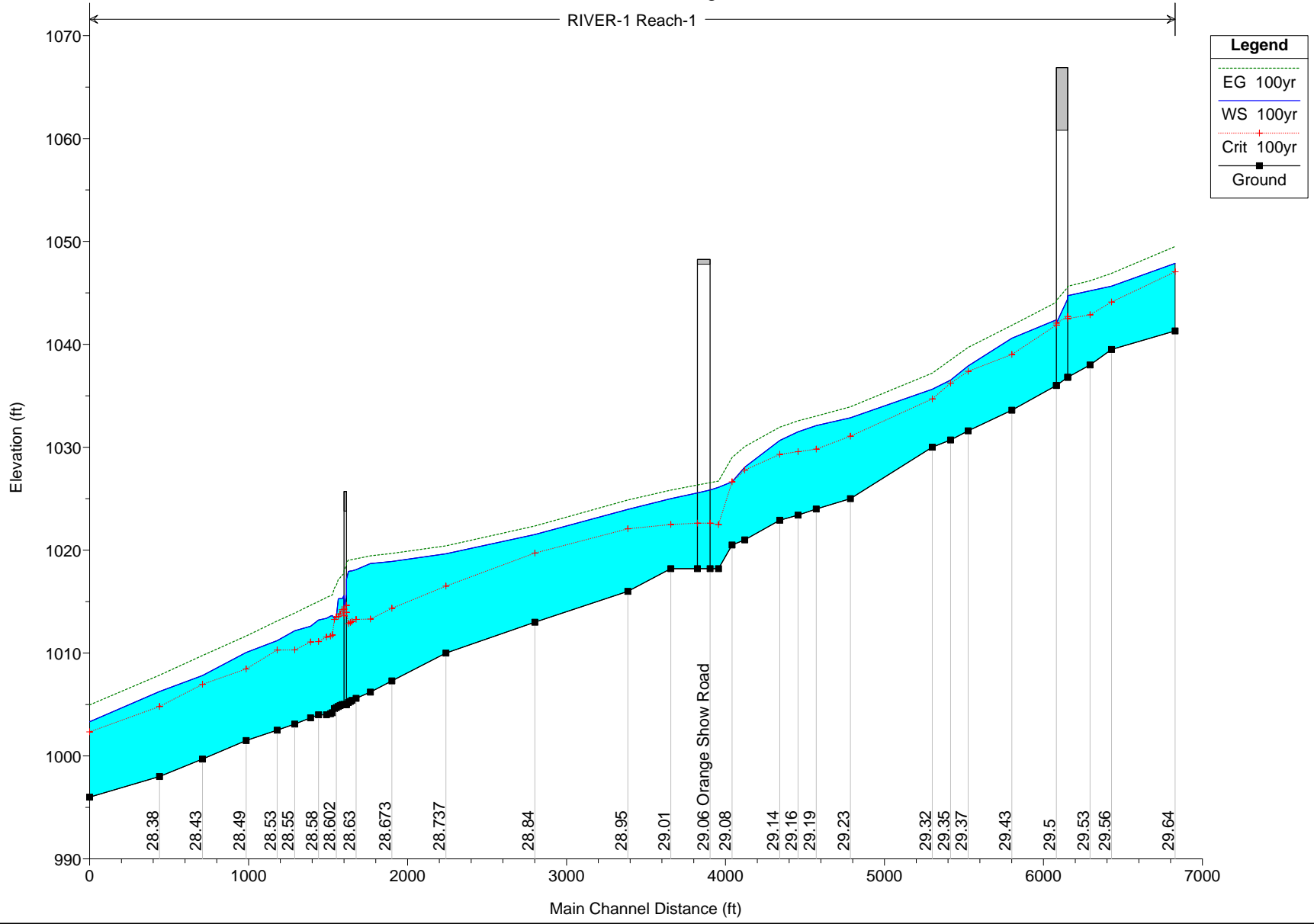

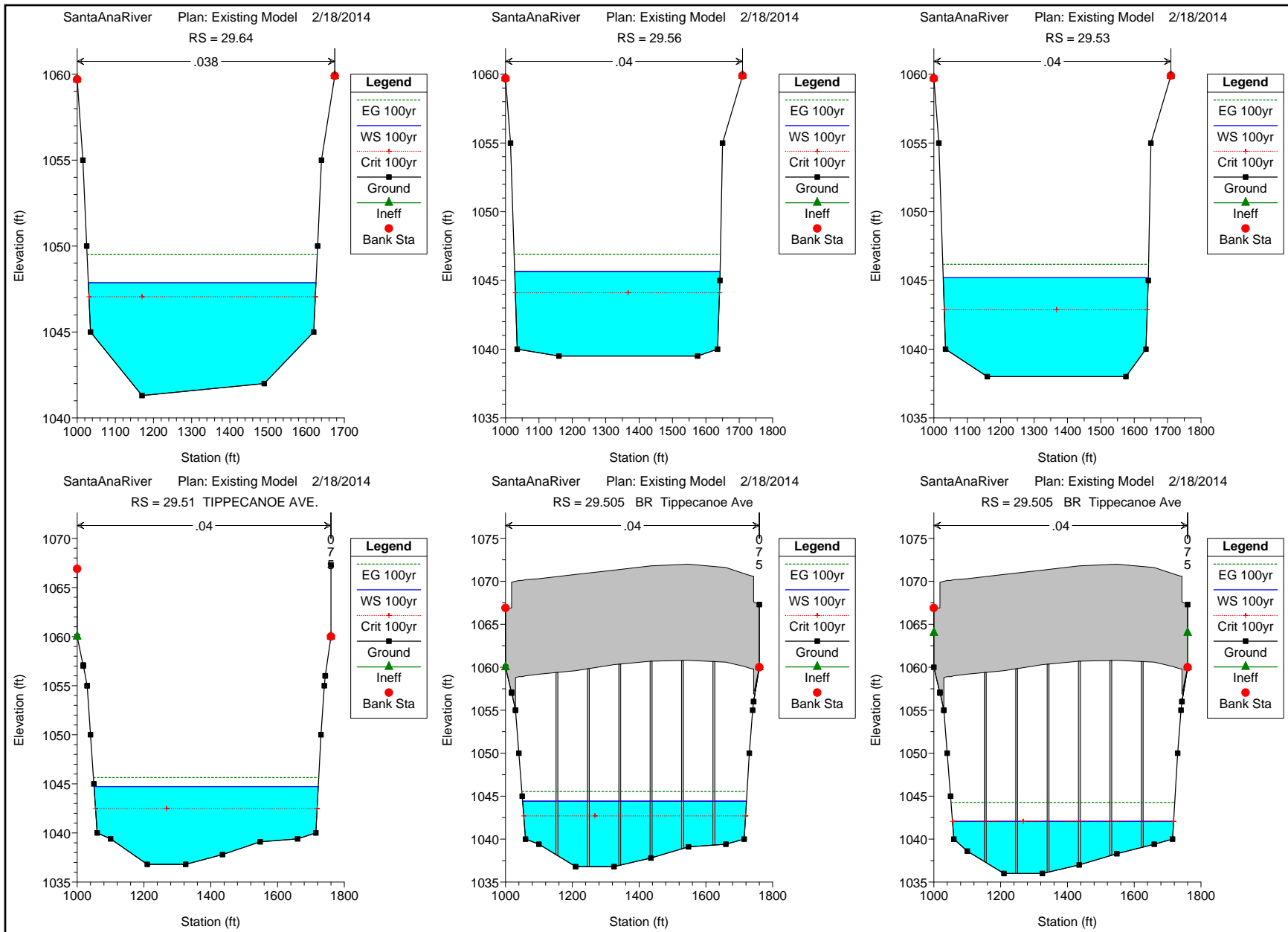

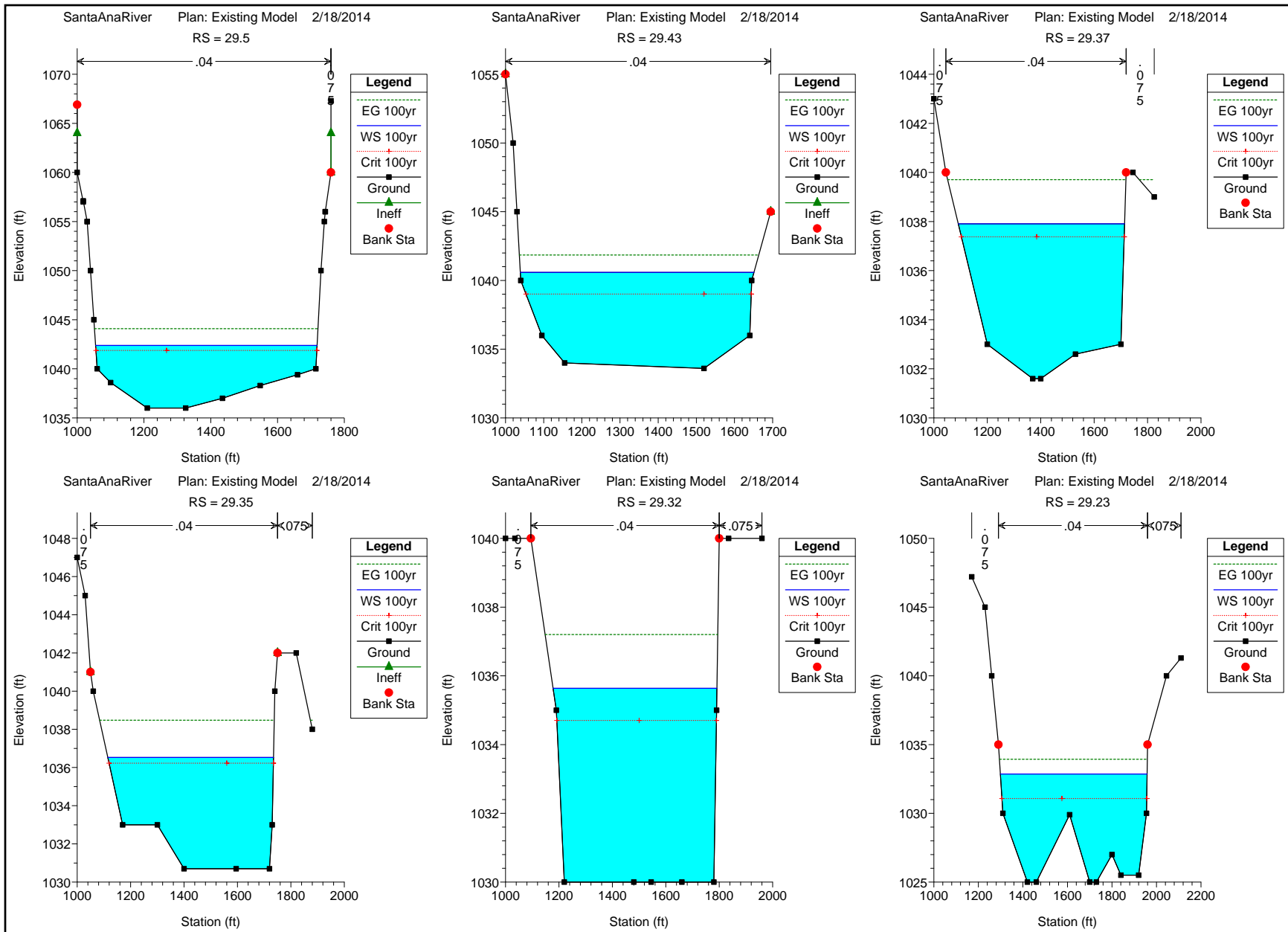

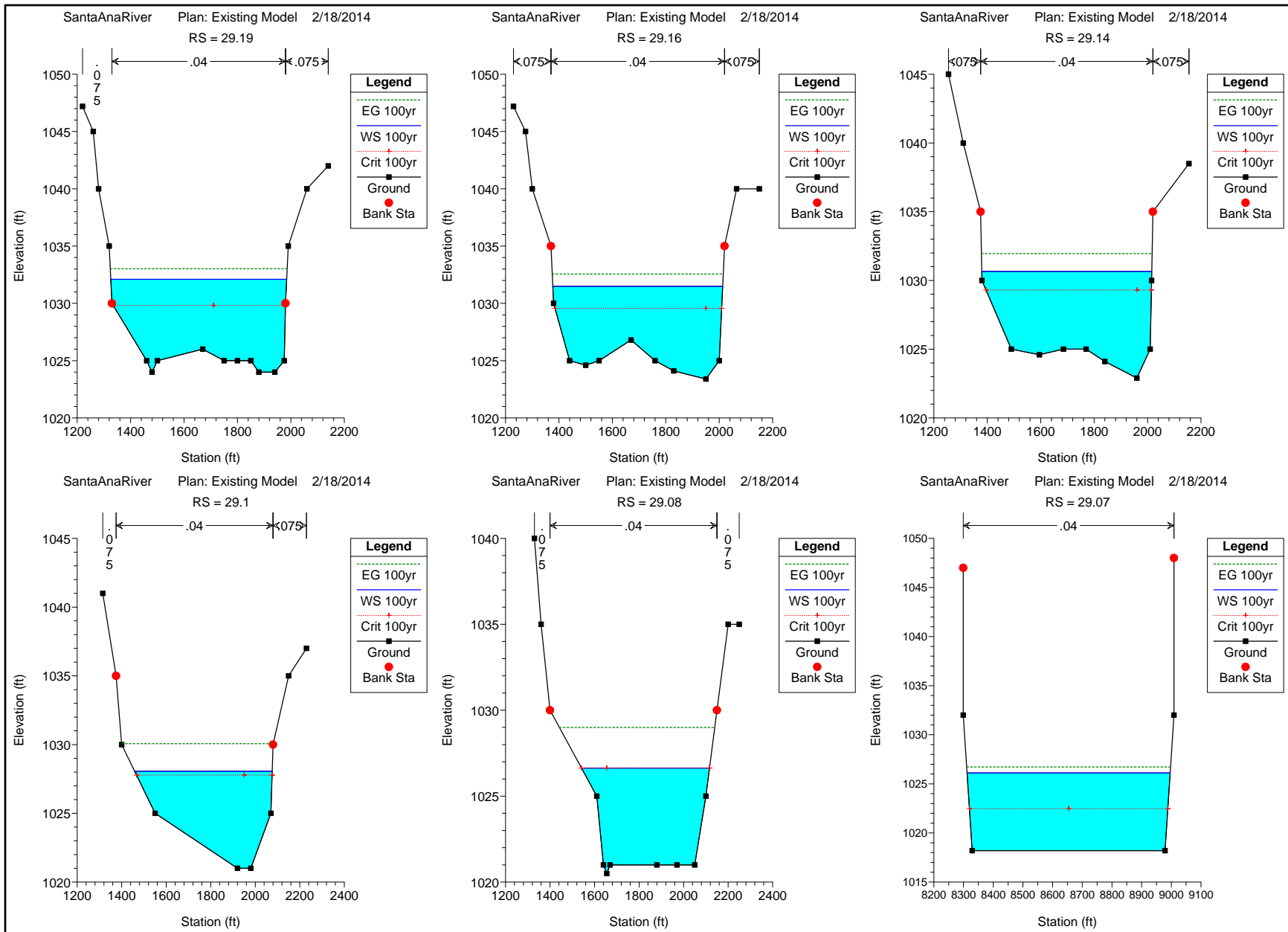

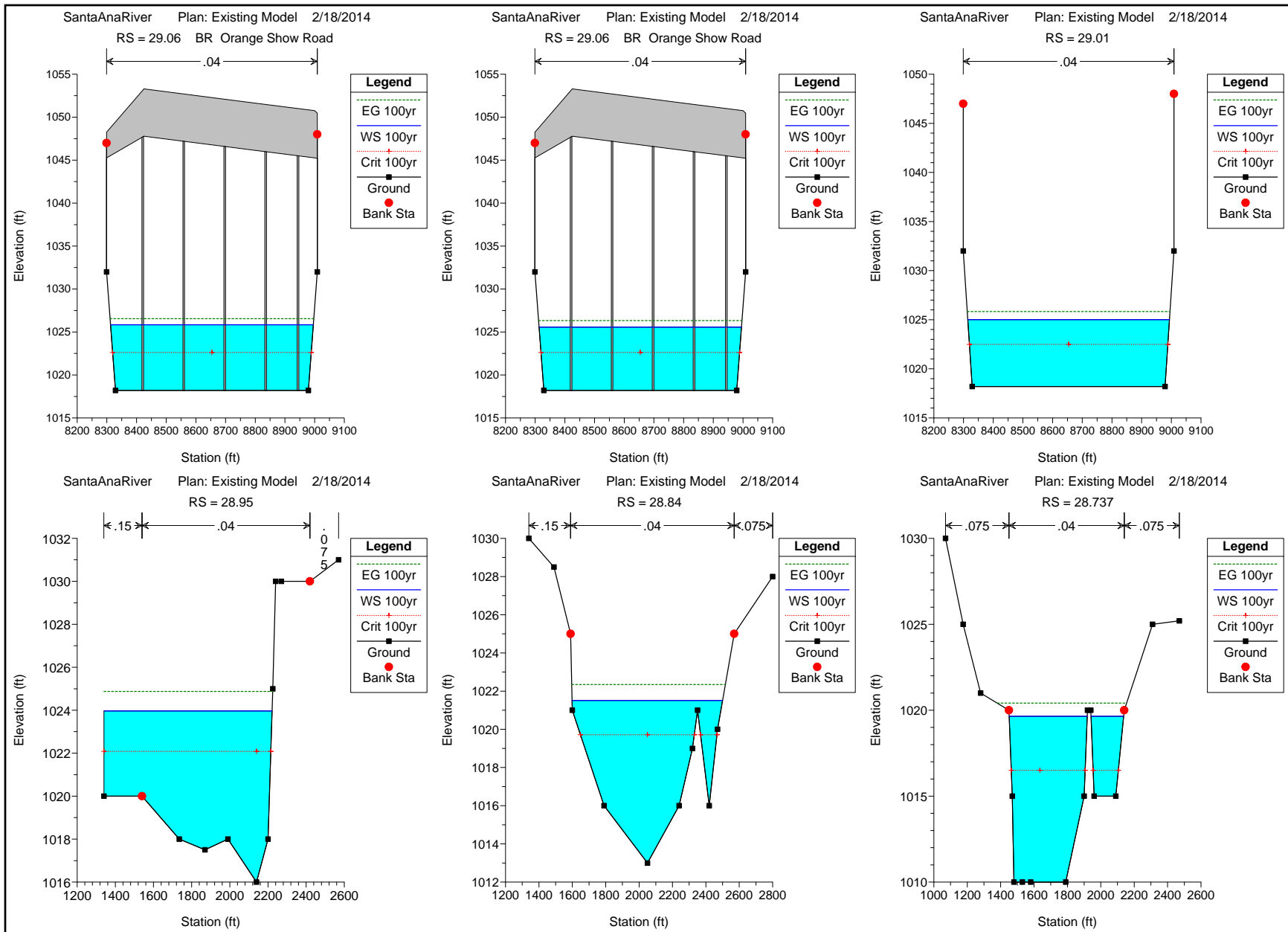

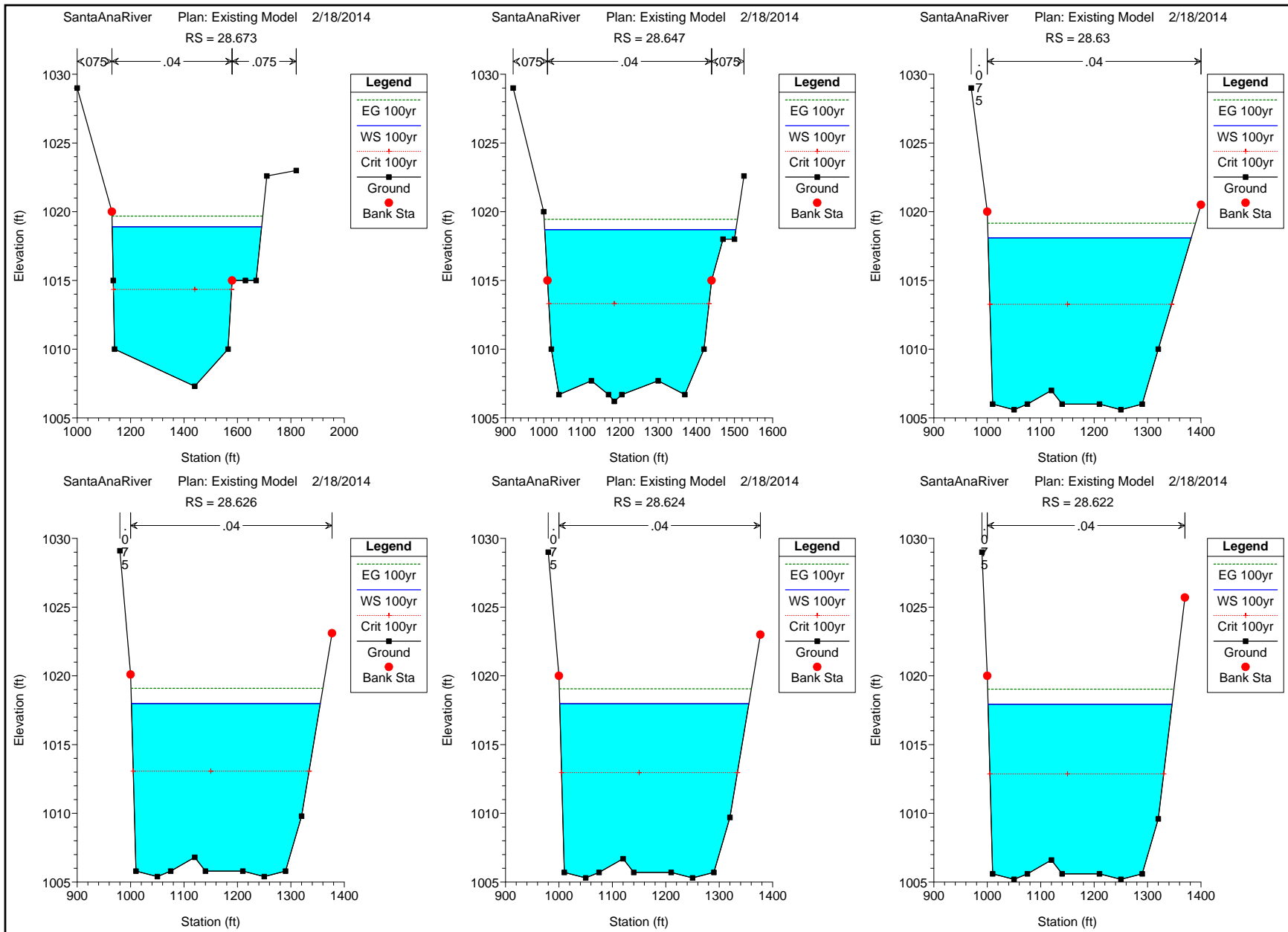

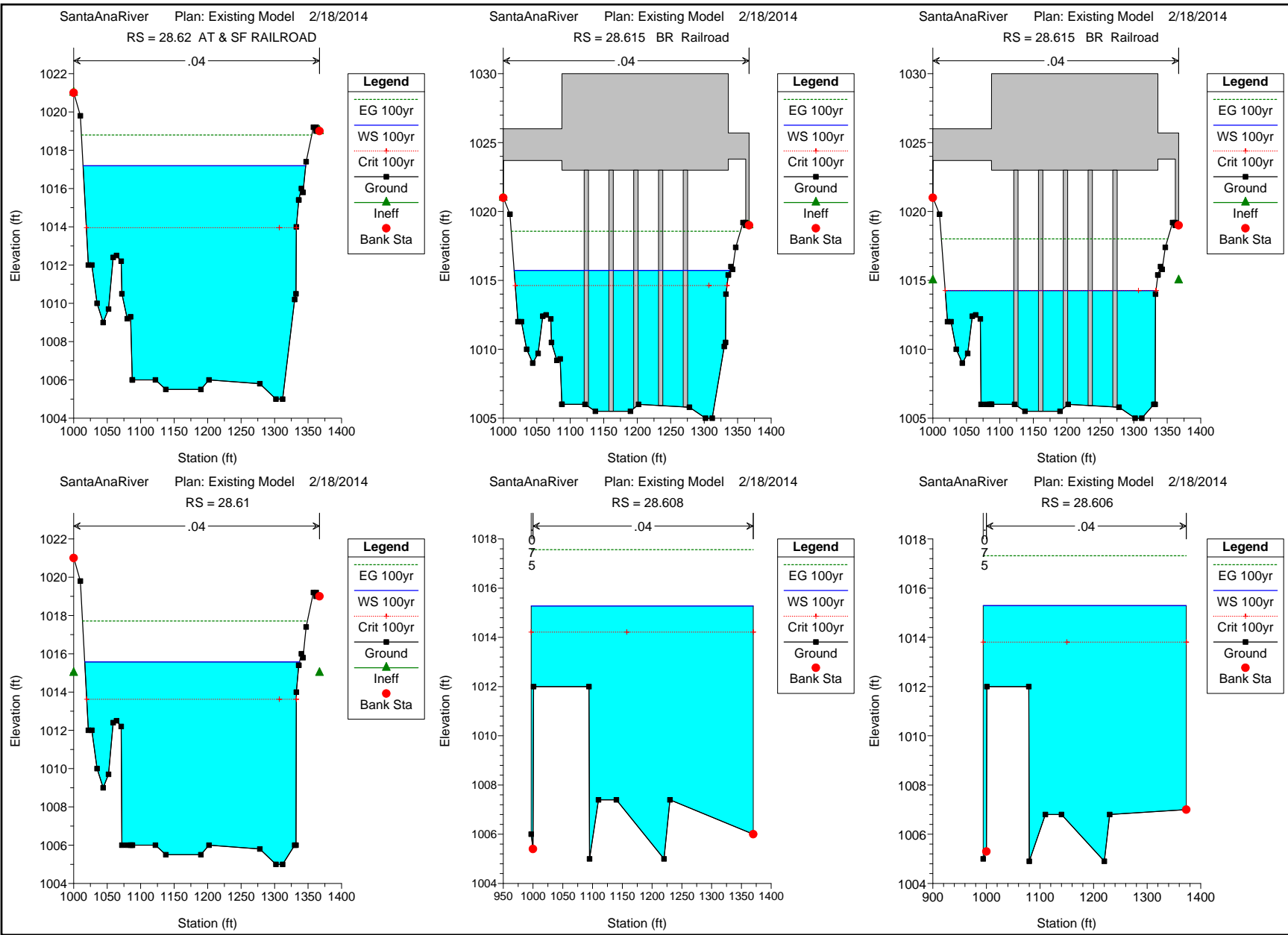

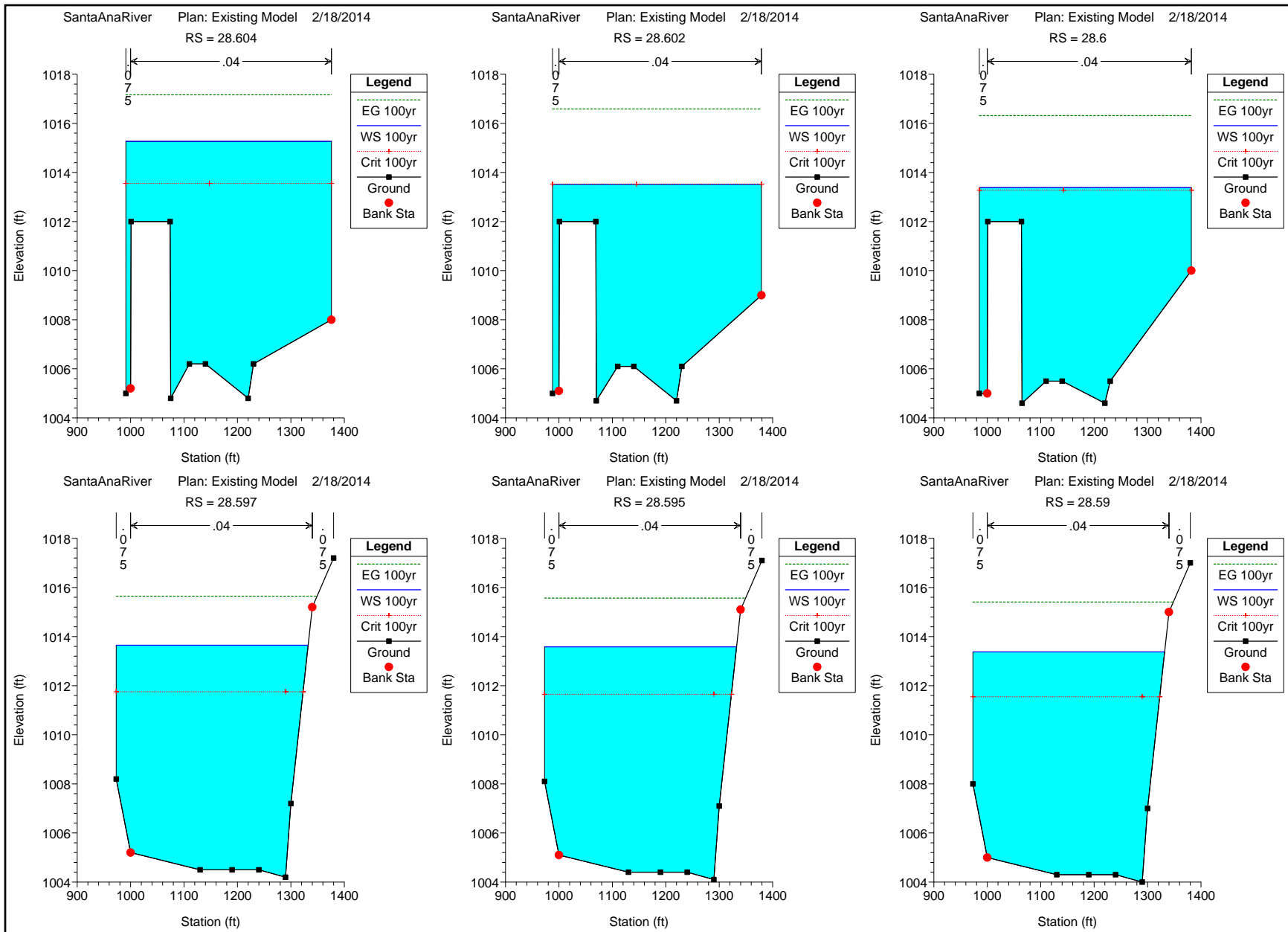

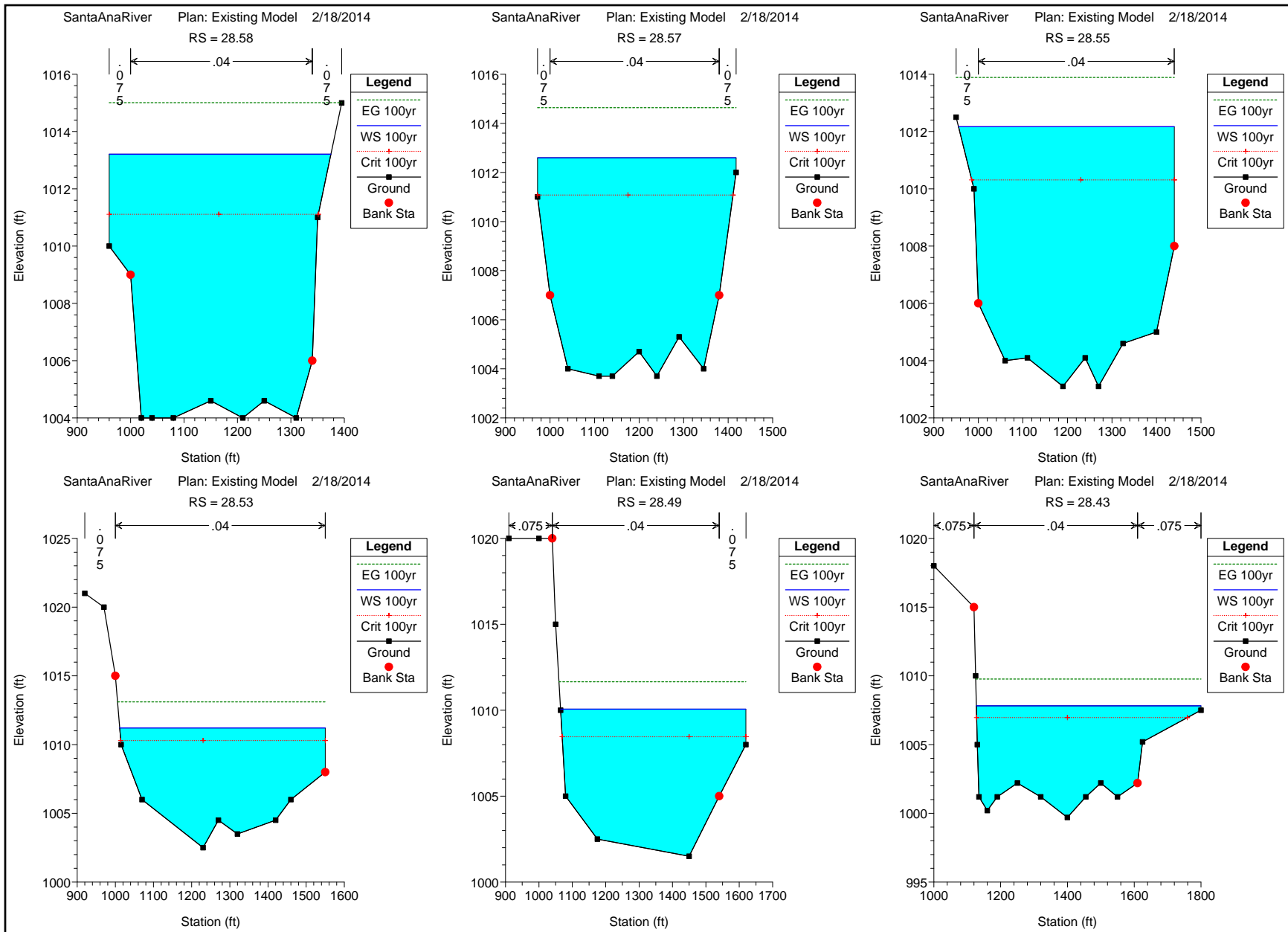

SantaAnaRiver Plan: Existing Model 2/18/2014

RS = 28.38

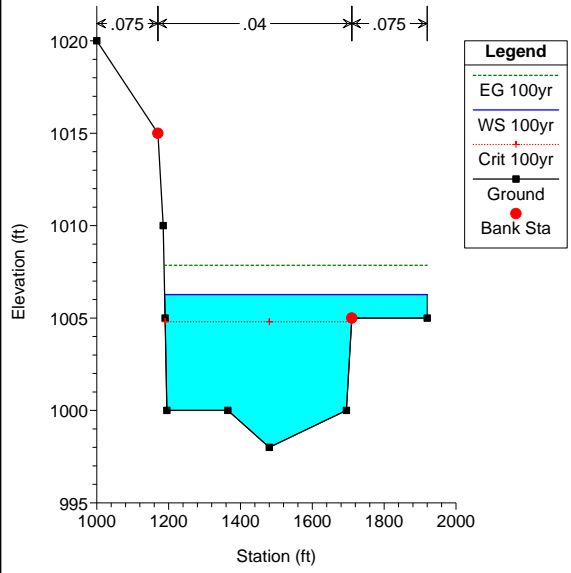

SantaAnaRiver Plan: Existing Model 2/18/2014

RS = 28.3

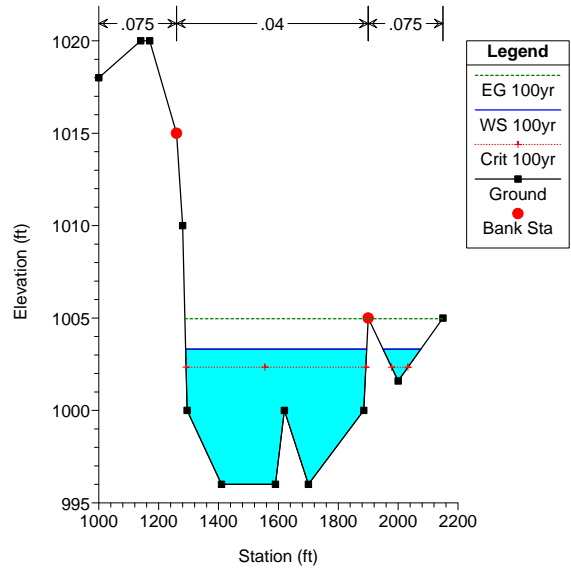

SantaAnaRiver Plan: 60% Design 11/12/2016

RIVER-1 Reach-1

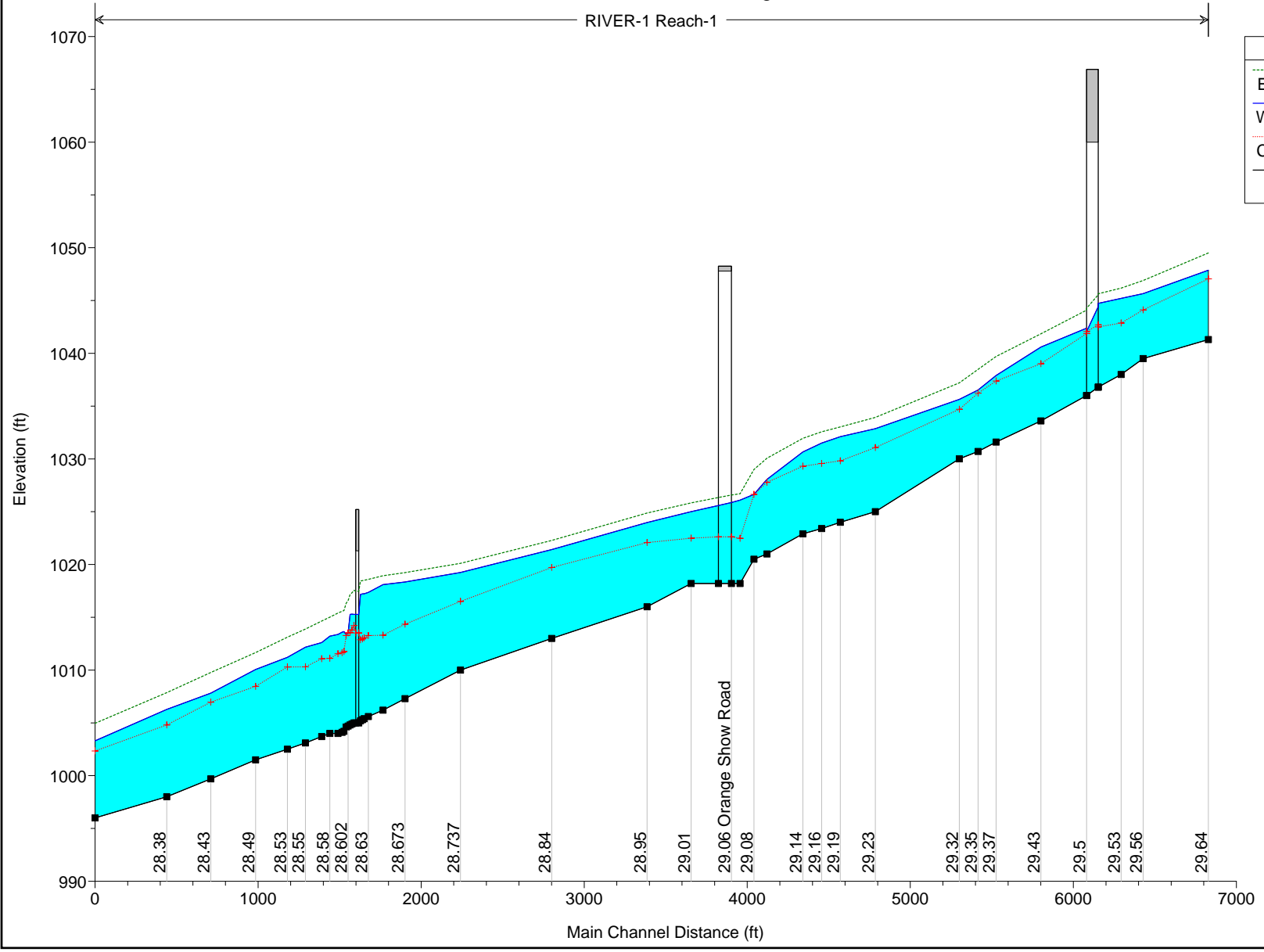

Legend	
EG 100yr	(dotted green line)
WS 100yr	(solid blue line)
Crit 100yr	(dotted red line with '+' markers)
Ground	(solid black line with square markers)

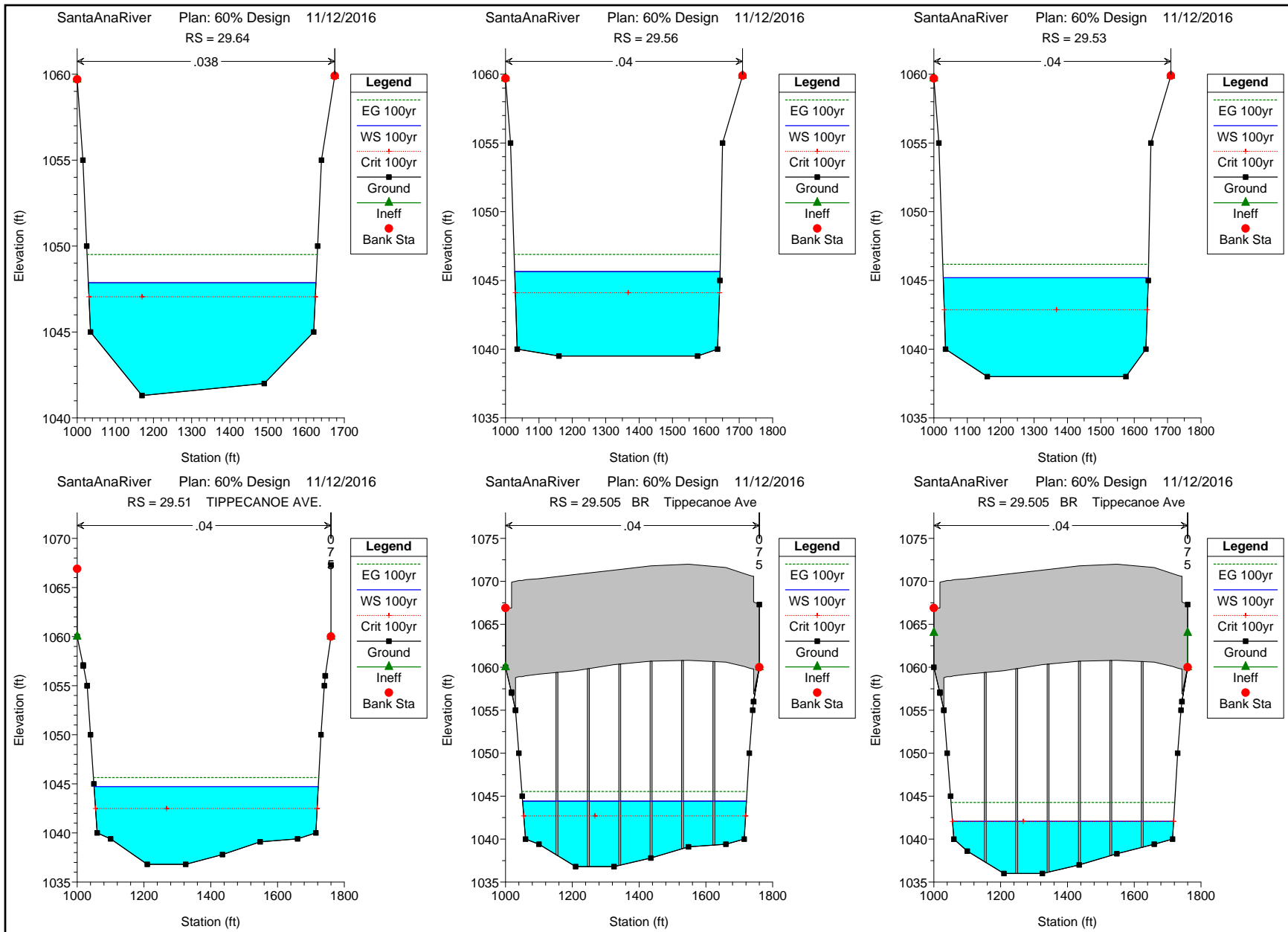

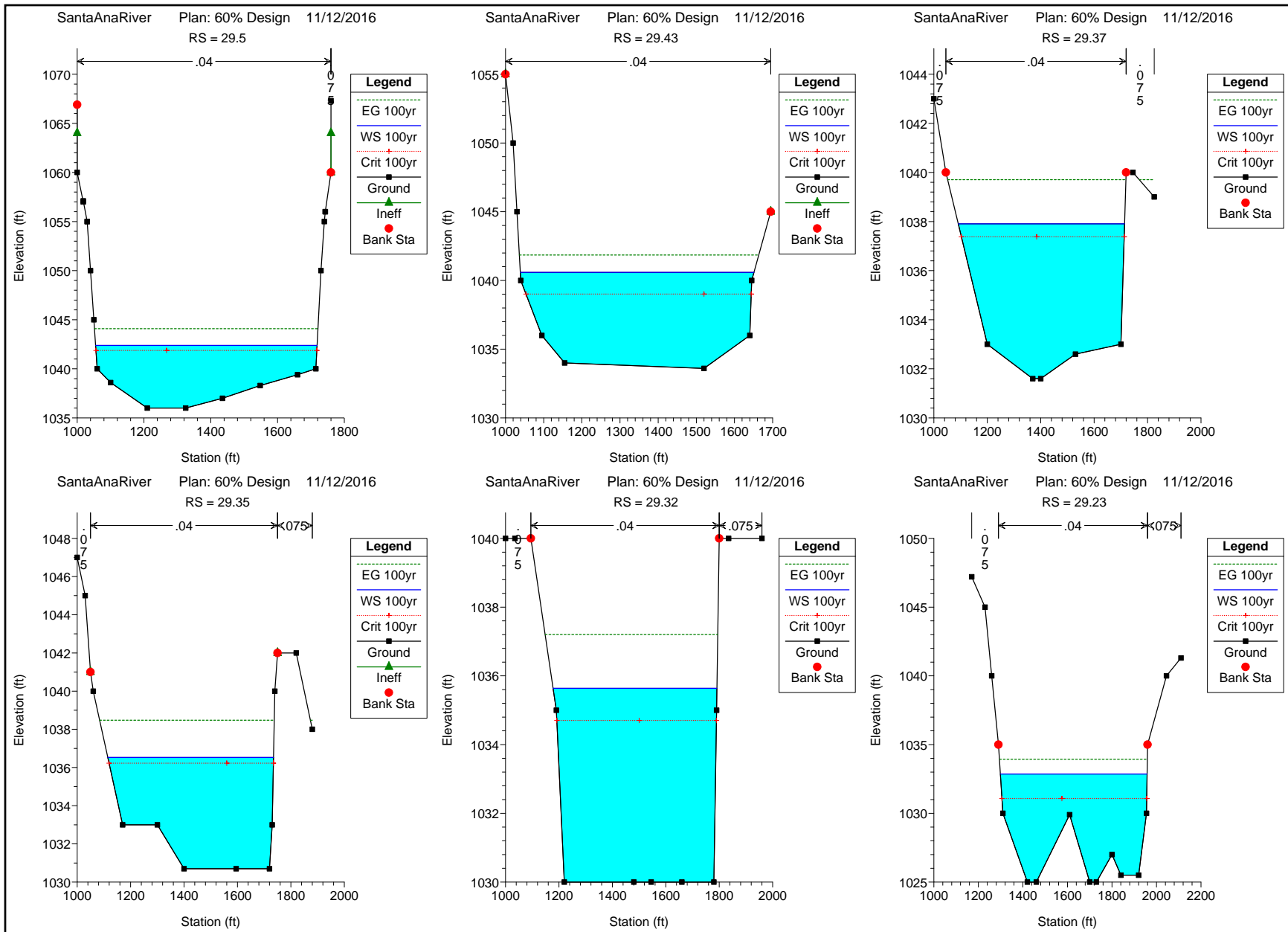

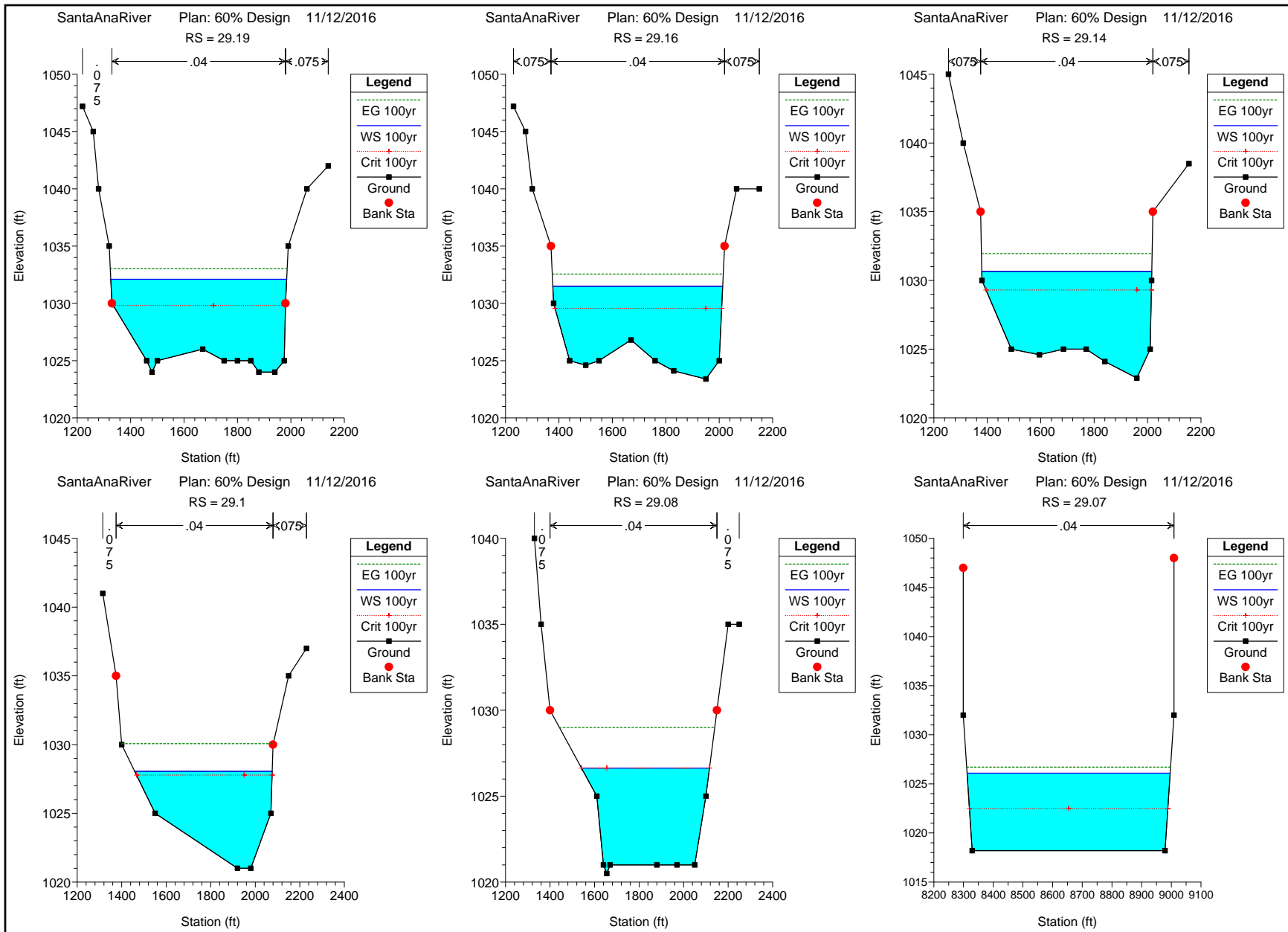

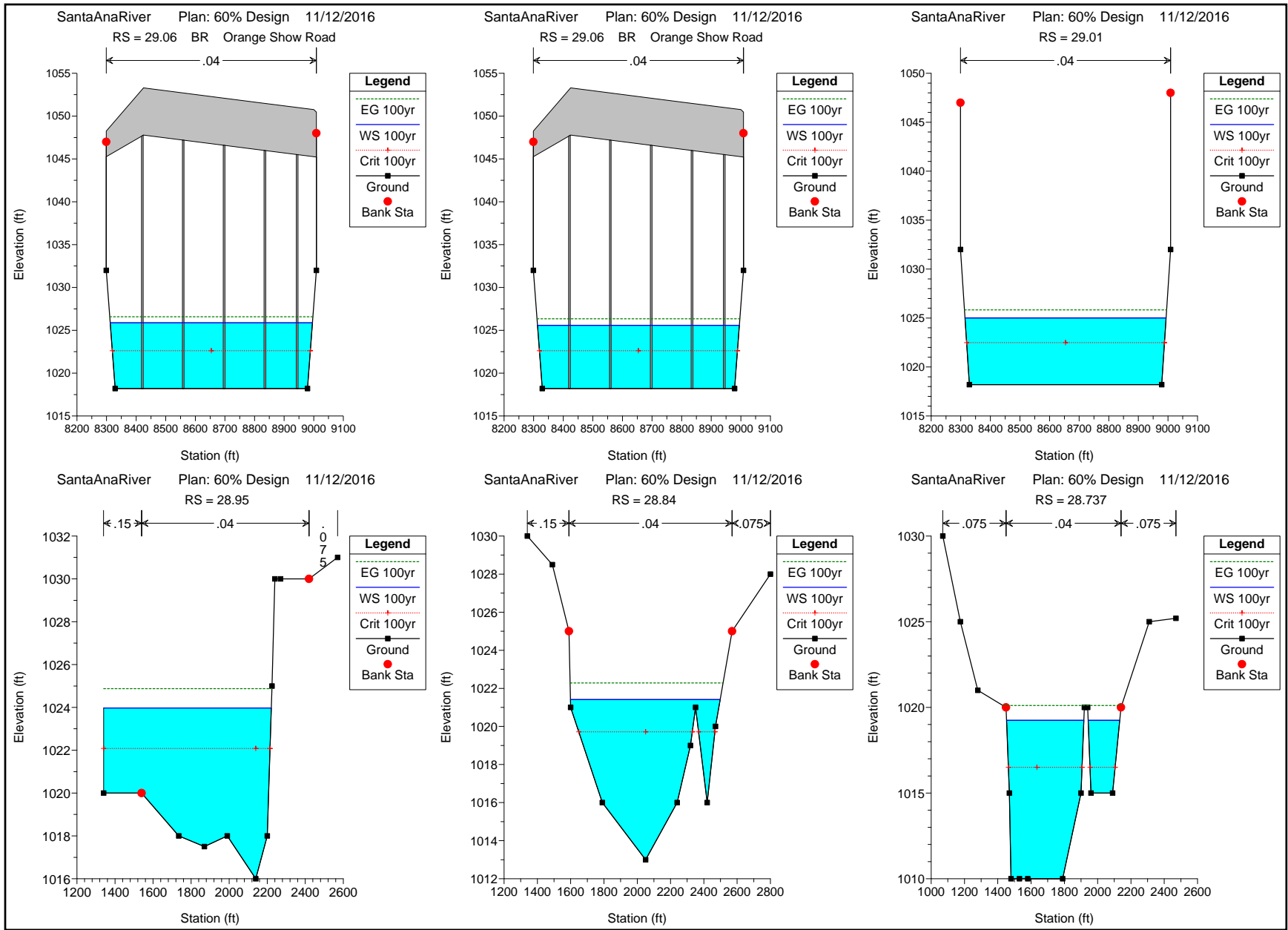

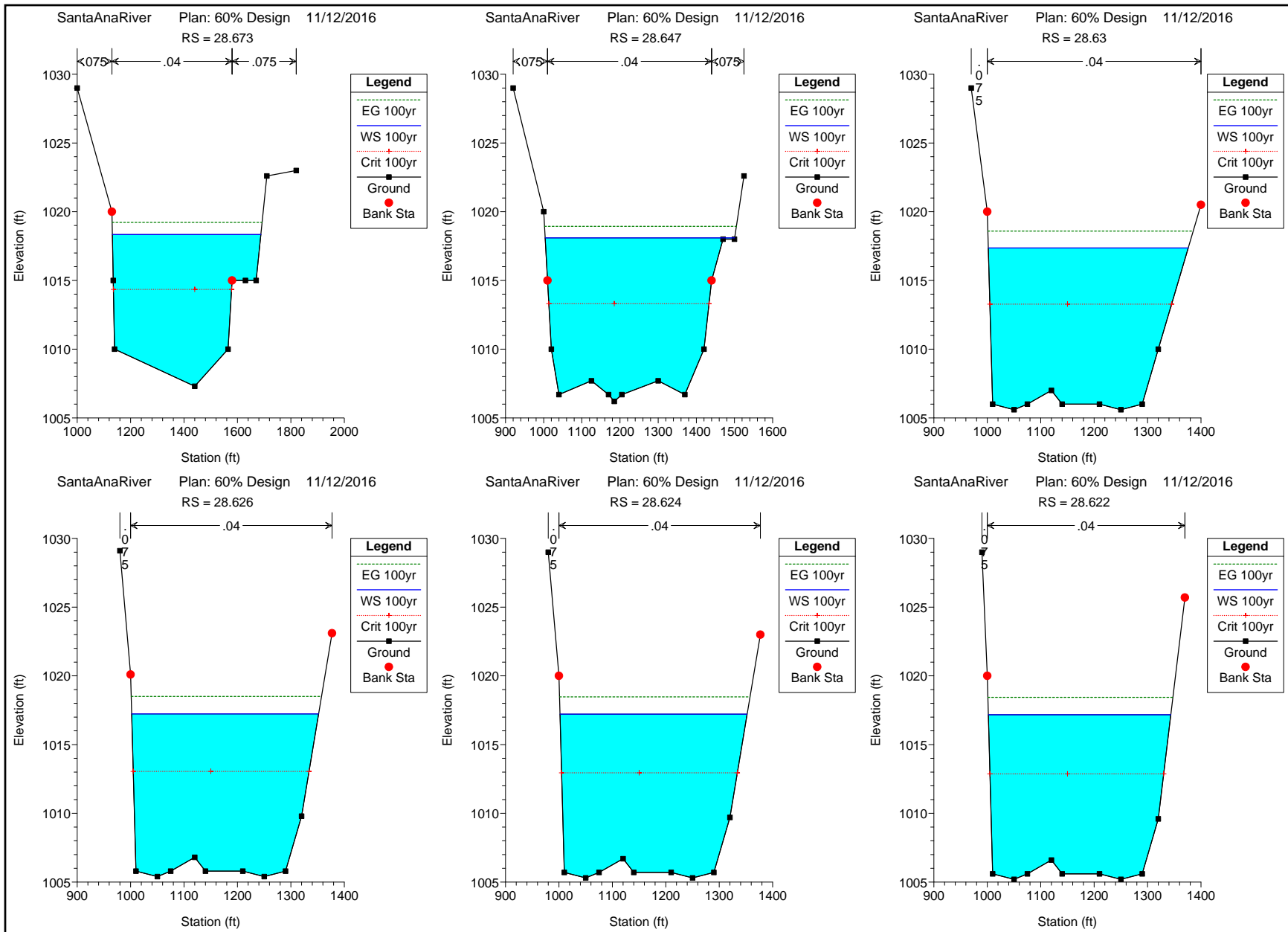

SantaAnaRiver Plan: 60% Design 11/12/2016
RS = 28.615 BR Proposed AT&SF RR (60% Design).

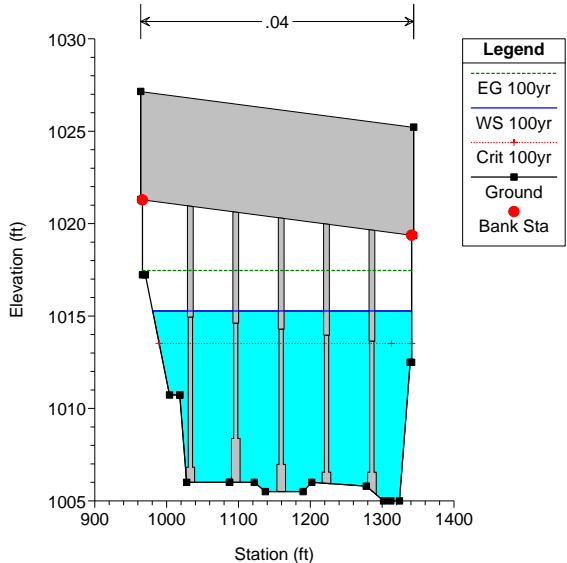

SantaAnaRiver Plan: 60% Design 11/12/2016
RS = 28.615 BR Proposed AT&SF RR (60% Design).

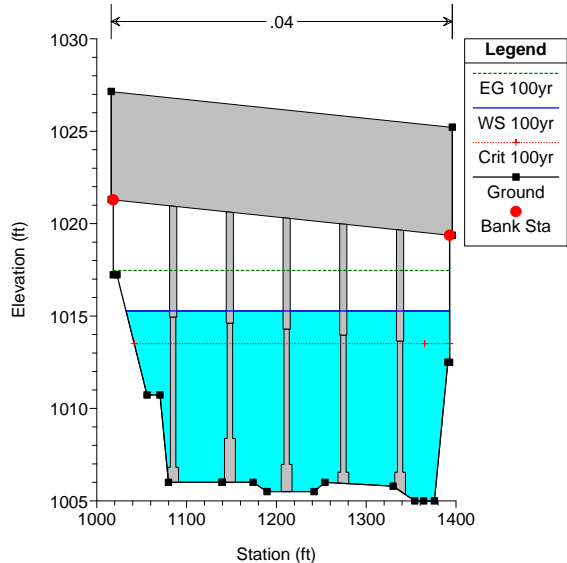

SantaAnaRiver Plan: 60% Design 11/12/2016
RS = 28.608

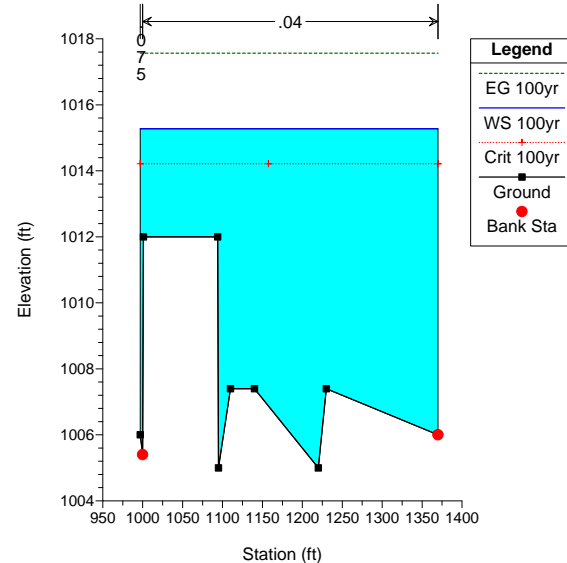

SantaAnaRiver Plan: 60% Design 11/12/2016
RS = 28.606

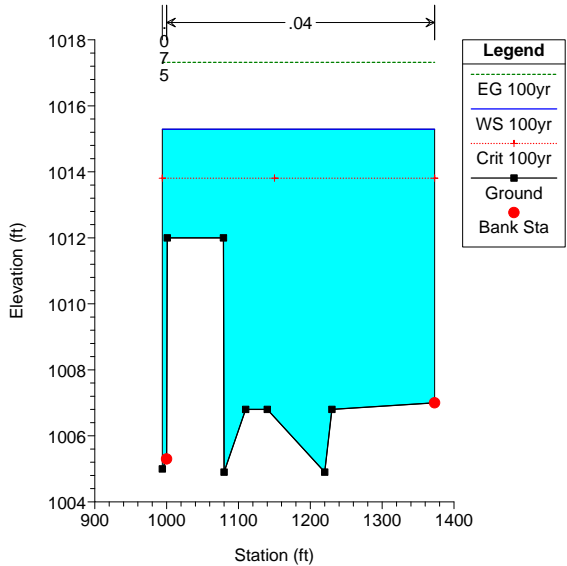

SantaAnaRiver Plan: 60% Design 11/12/2016
RS = 28.604

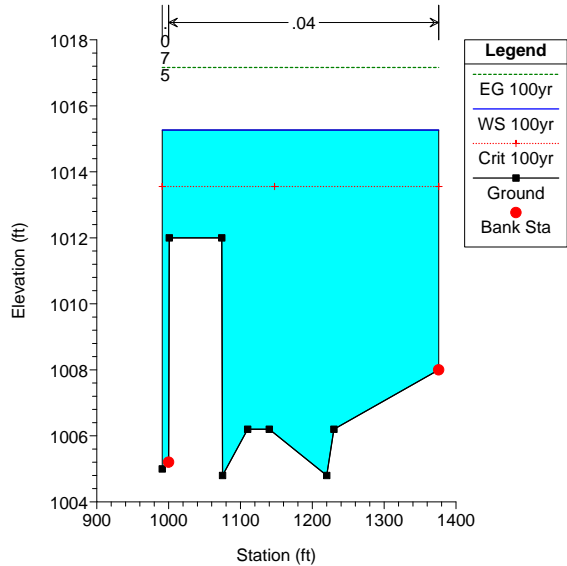

SantaAnaRiver Plan: 60% Design 11/12/2016
RS = 28.602

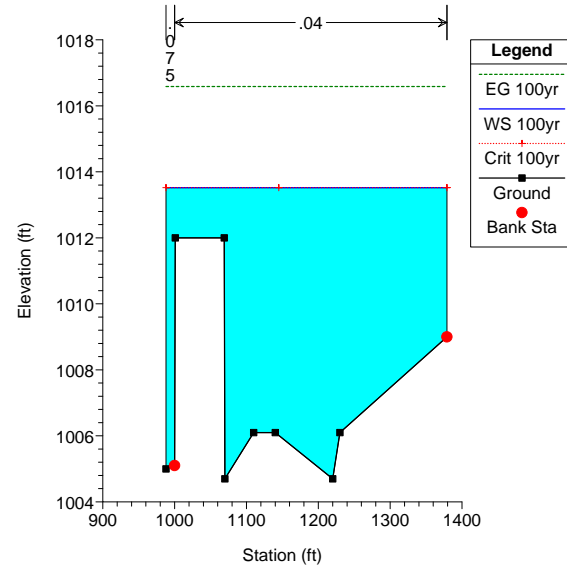

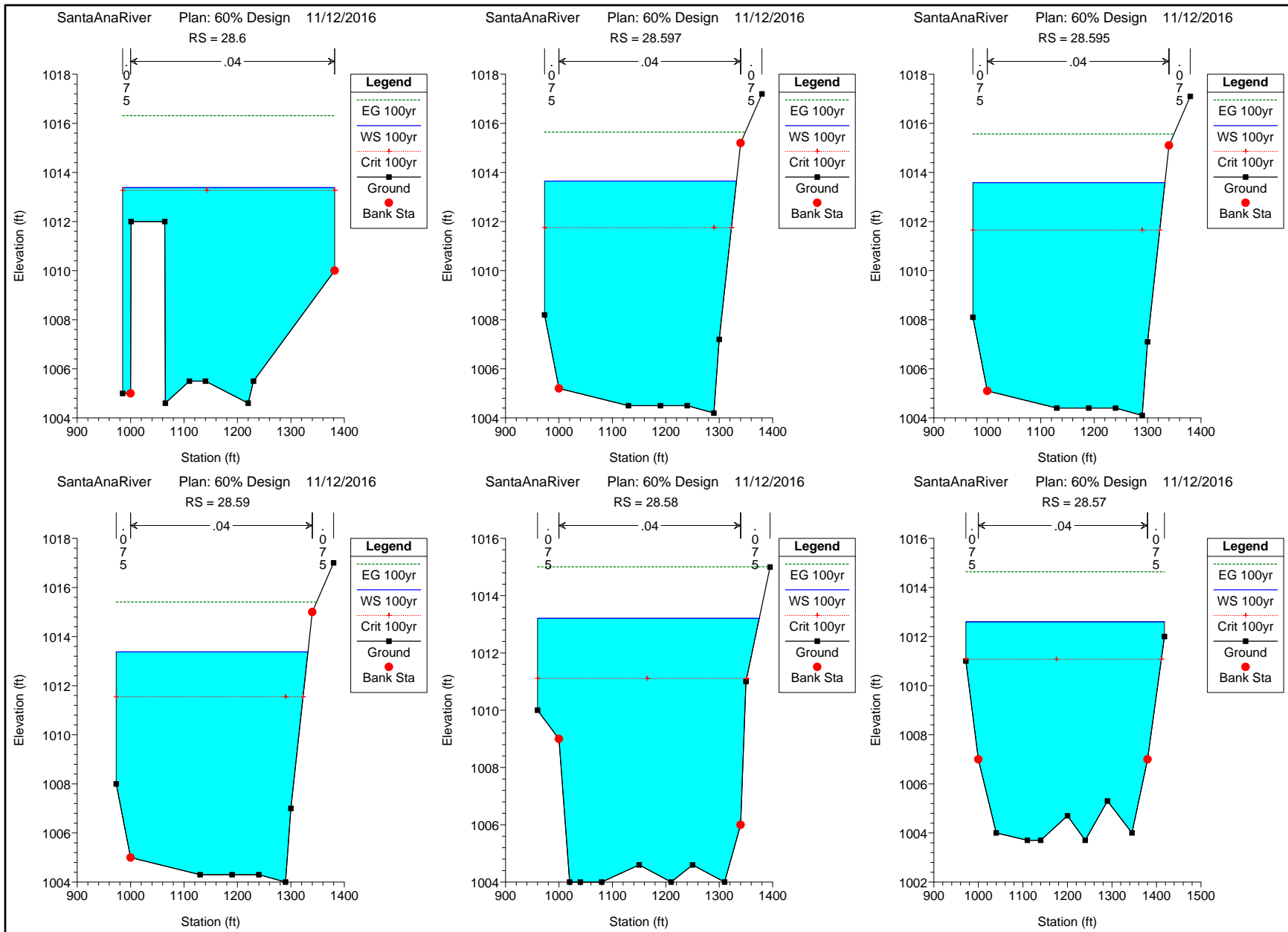

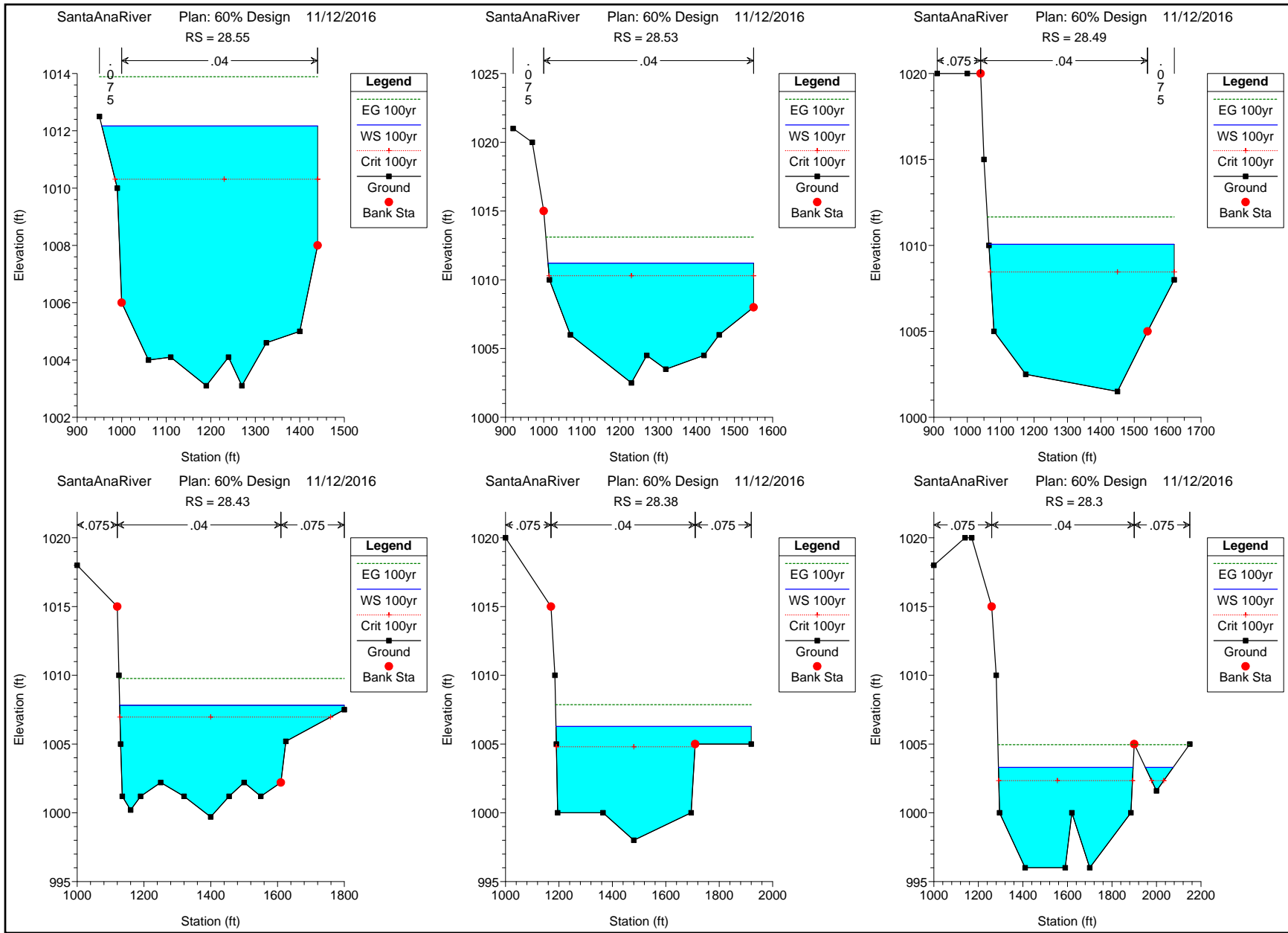



Attachment 2

Hydraulic Analysis Results

HEC-RAS Plan: Dup Eff River: RIVER-1 Reach: Reach-1 Profile: PF 1

Reach	River Sta	Profile	Q Total (cfs)	Min Ch El (ft)	W.S. Elev (ft)	Crit W.S. (ft)	E.G. Elev (ft)	E.G. Slope (ft/ft)	Vel Chnl (ft/s)	Flow Area (sq ft)	Top Width (ft)	Froude # Chl
Reach-1	29.64	PF 1	33000.00	1041.30	1047.96	1047.05	1049.55	0.007688	10.10	3267.22	596.85	0.76
Reach-1	29.56	PF 1	33000.00	1039.50	1045.65	1044.11	1046.89	0.005387	8.96	3684.41	615.04	0.64
Reach-1	29.53	PF 1	33000.00	1038.00	1045.20	1042.87	1046.17	0.003554	7.91	4170.56	614.09	0.54
Reach-1	29.51	PF 1	33000.00	1036.80	1044.72	1042.49	1045.64	0.003625	7.69	4294.00	671.53	0.54
Reach-1	29.505		Bridge									
Reach-1	29.5	PF 1	33000.00	1036.00	1042.38	1041.88	1044.09	0.009995	10.48	3149.66	663.33	0.85
Reach-1	29.43	PF 1	33000.00	1033.60	1040.59	1039.01	1041.85	0.005416	9.00	3666.62	612.09	0.65
Reach-1	29.37	PF 1	33000.00	1031.60	1037.90	1037.38	1039.71	0.010053	10.77	3064.88	622.61	0.86
Reach-1	29.35	PF 1	33000.00	1030.70	1036.52	1036.23	1038.48	0.011476	11.22	2942.43	620.41	0.91
Reach-1	29.32	PF 1	33000.00	1030.00	1035.64	1034.70	1037.20	0.007810	10.04	3288.16	613.44	0.76
Reach-1	29.23	PF 1	33000.00	1025.00	1032.85	1031.07	1033.93	0.004612	8.32	3964.53	659.25	0.60
Reach-1	29.19	PF 1	33000.00	1024.00	1032.08	1029.82	1033.01	0.003585	7.76	4259.50	658.31	0.53
Reach-1	29.16	PF 1	33000.00	1023.40	1031.46	1029.57	1032.54	0.004434	8.35	3954.00	635.84	0.59
Reach-1	29.14	PF 1	33000.00	1022.90	1030.57	1029.30	1031.91	0.006344	9.29	3552.98	636.14	0.69
Reach-1	29.1	PF 1	33000.00	1021.00	1028.32	1027.78	1030.12	0.010139	10.77	3064.25	626.32	0.86
Reach-1	29.08	PF 1	33000.00	1020.50	1027.93	1026.64	1029.34	0.006933	9.51	3469.11	642.58	0.72
Reach-1	29.07	PF 1	33000.00	1019.80	1027.38	1025.98	1028.74	0.006960	9.36	3526.50	670.55	0.72
Reach-1	29.01	PF 1	33000.00	1018.00	1025.14	1024.26	1026.50	0.007981	9.36	3524.35	750.55	0.76
Reach-1	28.95	PF 1	33000.00	1016.00	1023.97	1022.08	1024.88	0.004036	7.78	4877.05	881.32	0.56
Reach-1	28.84	PF 1	33000.00	1013.00	1021.56	1019.72	1022.38	0.004427	7.26	4546.32	902.58	0.57
Reach-1	28.737	PF 1	33000.00	1010.00	1019.79	1016.50	1020.53	0.002501	6.90	4784.20	665.36	0.45
Reach-1	28.673	PF 1	33000.00	1007.30	1019.09	1014.35	1019.84	0.001647	7.04	4988.58	560.61	0.39
Reach-1	28.647	PF 1	33000.00	1006.20	1018.90	1013.31	1019.62	0.001356	6.83	4934.14	502.69	0.36
Reach-1	28.63	PF 1	33000.00	1005.60	1018.34	1013.27	1019.35	0.002067	8.09	4080.76	382.35	0.44
Reach-1	28.624	PF 1	33000.00	1005.30	1018.23	1012.97	1019.27	0.001959	8.18	4032.21	355.33	0.43
Reach-1	28.622	PF 1	33000.00	1005.20	1018.19	1012.87	1019.24	0.001927	8.23	4009.70	345.43	0.43
Reach-1	28.62	PF 1	33000.00	1005.00	1017.53	1013.96	1019.03	0.003353	9.83	3358.28	334.34	0.55
Reach-1	28.615		Bridge									
Reach-1	28.61	PF 1	33000.00	1005.00	1015.58	1013.62	1017.71	0.005847	11.72	2815.08	320.75	0.70
Reach-1	28.608	PF 1	33000.00	1005.00	1015.28	1014.21	1017.56	0.008124	12.15	2736.49	373.00	0.79
Reach-1	28.606	PF 1	33000.00	1004.90	1015.29	1013.81	1017.32	0.006773	11.46	2918.43	379.00	0.73
Reach-1	28.604	PF 1	33000.00	1004.80	1015.27	1013.55	1017.16	0.006161	11.10	3028.83	385.00	0.70
Reach-1	28.602	PF 1	33000.00	1004.70	1013.52	1013.52	1016.58	0.014065	14.16	2383.33	391.00	1.02
Reach-1	28.6	PF 1	33000.00	1004.60	1013.38	1013.27	1016.31	0.013356	13.88	2439.63	397.00	0.99
Reach-1	28.597	PF 1	33000.00	1004.20	1013.65	1011.75	1015.65	0.005596	11.48	2985.06	359.23	0.70
Reach-1	28.595	PF 1	33000.00	1004.10	1013.59	1011.65	1015.57	0.005512	11.42	2999.61	359.43	0.69
Reach-1	28.59	PF 1	33000.00	1004.00	1013.37	1011.55	1015.41	0.005751	11.58	2959.14	358.87	0.71
Reach-1	28.58	PF 1	33000.00	1004.00	1013.21	1011.11	1015.01	0.004741	10.86	3203.69	414.82	0.65
Reach-1	28.57	PF 1	36500.00	1003.70	1012.60	1011.08	1014.64	0.005922	11.56	3312.65	446.00	0.71
Reach-1	28.55	PF 1	36500.00	1003.10	1012.17	1010.31	1013.89	0.005260	10.55	3523.15	484.69	0.66
Reach-1	28.53	PF 1	36500.00	1002.50	1011.21	1010.29	1013.11	0.007997	11.07	3297.88	538.62	0.79
Reach-1	28.49	PF 1	36500.00	1001.50	1010.06	1008.46	1011.65	0.005397	10.25	3752.02	555.18	0.67
Reach-1	28.43	PF 1	36500.00	999.70	1007.82	1006.96	1009.77	0.007629	11.31	3477.74	672.82	0.78
Reach-1	28.38	PF 1	36500.00	998.00	1006.28	1004.80	1007.86	0.005863	10.16	3812.25	731.28	0.69
Reach-1	28.3	PF 1	36500.00	996.00	1003.30	1002.34	1004.96	0.007470	10.35	3617.75	729.85	0.76

HEC-RAS Plan: Corr Eff River: RIVER-1 Reach: Reach-1 Profile: 100yr

Reach	River Sta	Profile	Q Total (cfs)	Min Ch El (ft)	W.S. Elev (ft)	Crit W.S. (ft)	E.G. Elev (ft)	E.G. Slope (ft/ft)	Vel Chnl (ft/s)	Flow Area (sq ft)	Top Width (ft)	Froude # Chl
Reach-1	29.64	100yr	33000.00	1041.30	1047.87	1047.05	1049.51	0.007337	10.27	3212.01	596.48	0.78
Reach-1	29.56	100yr	33000.00	1039.50	1045.65	1044.11	1046.89	0.005383	8.95	3685.31	615.05	0.64
Reach-1	29.53	100yr	33000.00	1038.00	1045.20	1042.87	1046.17	0.003551	7.91	4171.84	614.09	0.53
Reach-1	29.51	100yr	33000.00	1036.80	1044.73	1042.49	1045.64	0.003619	7.68	4295.97	671.54	0.54
Reach-1	29.505		Bridge									
Reach-1	29.5	100yr	33000.00	1036.00	1042.38	1041.88	1044.09	0.009995	10.48	3149.66	663.33	0.85
Reach-1	29.43	100yr	33000.00	1033.60	1040.59	1039.01	1041.85	0.005416	9.00	3666.62	612.09	0.65
Reach-1	29.37	100yr	33000.00	1031.60	1037.91	1037.38	1039.71	0.010051	10.77	3065.04	622.62	0.86
Reach-1	29.35	100yr	33000.00	1030.70	1036.52	1036.23	1038.48	0.011479	11.22	2942.21	620.41	0.91
Reach-1	29.32	100yr	33000.00	1030.00	1035.64	1034.70	1037.20	0.007815	10.04	3287.56	613.41	0.76
Reach-1	29.23	100yr	33000.00	1025.00	1032.86	1031.07	1033.93	0.004581	8.31	3972.50	659.31	0.60
Reach-1	29.19	100yr	33000.00	1024.00	1032.10	1029.82	1033.03	0.003548	7.74	4273.08	658.40	0.53
Reach-1	29.16	100yr	33000.00	1023.40	1031.49	1029.57	1032.56	0.004358	8.30	3974.96	635.97	0.59
Reach-1	29.14	100yr	33000.00	1022.90	1030.66	1029.30	1031.96	0.006036	9.15	3606.95	636.31	0.68
Reach-1	29.1	100yr	33000.00	1021.00	1028.06	1027.78	1030.07	0.011944	11.37	2901.58	617.95	0.92
Reach-1	29.08	100yr	33000.00	1020.50	1026.64	1026.64	1028.99	0.014144	12.32	2679.49	575.14	1.01
Reach-1	29.07	100yr	33000.00	1018.20	1026.11	1022.48	1026.72	0.001873	6.25	5277.17	684.39	0.40
Reach-1	29.06		Bridge									
Reach-1	29.01	100yr	33000.00	1018.20	1025.01	1022.49	1025.83	0.003092	7.29	4526.32	679.60	0.50
Reach-1	28.95	100yr	33000.00	1016.00	1023.97	1022.08	1024.88	0.004038	7.78	4876.41	881.32	0.56
Reach-1	28.84	100yr	33000.00	1013.00	1021.55	1019.72	1022.37	0.004459	7.28	4535.80	902.32	0.57
Reach-1	28.737	100yr	33000.00	1010.00	1019.75	1016.50	1020.50	0.002538	6.93	4760.54	664.58	0.46
Reach-1	28.673	100yr	33000.00	1007.30	1019.04	1014.35	1019.80	0.001673	7.07	4962.66	560.32	0.39
Reach-1	28.647	100yr	33000.00	1006.20	1018.85	1013.31	1019.58	0.001376	6.86	4909.51	502.33	0.36
Reach-1	28.63	100yr	33000.00	1005.60	1018.28	1013.27	1019.31	0.002101	8.13	4058.79	381.87	0.44
Reach-1	28.624	100yr	33000.00	1005.30	1018.17	1012.97	1019.22	0.001991	8.23	4011.46	355.04	0.43
Reach-1	28.622	100yr	33000.00	1005.20	1018.13	1012.87	1019.20	0.001958	8.27	3989.42	345.20	0.43
Reach-1	28.62	100yr	33000.00	1005.00	1017.46	1013.96	1018.98	0.003432	9.90	3332.63	333.75	0.55
Reach-1	28.615		Bridge									
Reach-1	28.61	100yr	33000.00	1005.00	1015.58	1013.62	1017.71	0.005847	11.72	2815.08	320.75	0.70
Reach-1	28.608	100yr	33000.00	1005.00	1015.28	1014.21	1017.56	0.008124	12.15	2736.49	373.00	0.79
Reach-1	28.606	100yr	33000.00	1004.90	1015.29	1013.81	1017.32	0.006773	11.46	2918.43	379.00	0.73
Reach-1	28.604	100yr	33000.00	1004.80	1015.27	1013.55	1017.16	0.006161	11.10	3028.83	385.00	0.70
Reach-1	28.602	100yr	33000.00	1004.70	1013.52	1013.52	1016.58	0.014065	14.16	2383.33	391.00	1.02
Reach-1	28.6	100yr	33000.00	1004.60	1013.38	1013.27	1016.31	0.013357	13.88	2439.56	397.00	0.99
Reach-1	28.597	100yr	33000.00	1004.20	1013.65	1011.75	1015.65	0.005597	11.48	2985.02	359.23	0.70
Reach-1	28.595	100yr	33000.00	1004.10	1013.59	1011.65	1015.57	0.005512	11.42	2999.57	359.43	0.69
Reach-1	28.59	100yr	33000.00	1004.00	1013.37	1011.55	1015.41	0.005752	11.58	2959.12	358.87	0.71
Reach-1	28.58	100yr	33000.00	1004.00	1013.21	1011.11	1015.01	0.004741	10.86	3203.66	414.82	0.65
Reach-1	28.57	100yr	36500.00	1003.70	1012.60	1011.08	1014.64	0.005922	11.56	3312.57	446.00	0.71
Reach-1	28.55	100yr	36500.00	1003.10	1012.17	1010.31	1013.89	0.005260	10.55	3523.03	484.69	0.66
Reach-1	28.53	100yr	36500.00	1002.50	1011.21	1010.29	1013.11	0.007996	11.07	3298.01	538.62	0.79
Reach-1	28.49	100yr	36500.00	1001.50	1010.06	1008.46	1011.66	0.005396	10.25	3752.26	555.18	0.67
Reach-1	28.43	100yr	36500.00	999.70	1007.82	1006.96	1009.77	0.007633	11.31	3477.09	672.82	0.78
Reach-1	28.38	100yr	36500.00	998.00	1006.27	1004.80	1007.86	0.005885	10.18	3806.98	731.27	0.69
Reach-1	28.3	100yr	36500.00	996.00	1003.32	1002.34	1004.96	0.007384	10.31	3632.37	731.41	0.75

HEC-RAS Plan: Existing Model River: RIVER-1 Reach: Reach-1 Profile: 100yr

Reach	River Sta	Profile	Q Total (cfs)	Min Ch El (ft)	W.S. Elev (ft)	Crit W.S. (ft)	E.G. Elev (ft)	E.G. Slope (ft/ft)	Vel Chnl (ft/s)	Flow Area (sq ft)	Top Width (ft)	Froude # Chl
Reach-1	29.64	100yr	33000.00	1041.30	1047.87	1047.05	1049.51	0.007337	10.27	3212.01	596.48	0.78
Reach-1	29.56	100yr	33000.00	1039.50	1045.65	1044.11	1046.89	0.005383	8.95	3685.31	615.05	0.64
Reach-1	29.53	100yr	33000.00	1038.00	1045.20	1042.87	1046.17	0.003551	7.91	4171.84	614.09	0.53
Reach-1	29.51	100yr	33000.00	1036.80	1044.73	1042.49	1045.64	0.003619	7.68	4295.97	671.54	0.54
Reach-1	29.505		Bridge									
Reach-1	29.5	100yr	33000.00	1036.00	1042.38	1041.88	1044.09	0.009995	10.48	3149.66	663.33	0.85
Reach-1	29.43	100yr	33000.00	1033.60	1040.59	1039.01	1041.85	0.005416	9.00	3666.62	612.09	0.65
Reach-1	29.37	100yr	33000.00	1031.60	1037.91	1037.38	1039.71	0.010051	10.77	3065.04	622.62	0.86
Reach-1	29.35	100yr	33000.00	1030.70	1036.52	1036.23	1038.48	0.011479	11.22	2942.21	620.41	0.91
Reach-1	29.32	100yr	33000.00	1030.00	1035.64	1034.70	1037.20	0.007815	10.04	3287.56	613.41	0.76
Reach-1	29.23	100yr	33000.00	1025.00	1032.86	1031.07	1033.93	0.004581	8.31	3972.50	659.31	0.60
Reach-1	29.19	100yr	33000.00	1024.00	1032.10	1029.82	1033.03	0.003548	7.74	4273.08	658.40	0.53
Reach-1	29.16	100yr	33000.00	1023.40	1031.49	1029.57	1032.56	0.004358	8.30	3974.96	635.97	0.59
Reach-1	29.14	100yr	33000.00	1022.90	1030.66	1029.30	1031.96	0.006036	9.15	3606.95	636.31	0.68
Reach-1	29.1	100yr	33000.00	1021.00	1028.06	1027.78	1030.07	0.011944	11.37	2901.58	617.95	0.92
Reach-1	29.08	100yr	33000.00	1020.50	1026.64	1026.64	1028.99	0.014144	12.32	2679.49	575.14	1.01
Reach-1	29.07	100yr	33000.00	1018.20	1026.11	1022.48	1026.72	0.001873	6.25	5276.67	684.39	0.40
Reach-1	29.06		Bridge									
Reach-1	29.01	100yr	33000.00	1018.20	1025.01	1022.49	1025.83	0.003094	7.29	4525.33	679.60	0.50
Reach-1	28.95	100yr	33000.00	1016.00	1023.97	1022.08	1024.87	0.004045	7.79	4873.40	881.31	0.56
Reach-1	28.84	100yr	33000.00	1013.00	1021.51	1019.72	1022.35	0.004556	7.32	4505.19	901.56	0.58
Reach-1	28.737	100yr	33000.00	1010.00	1019.65	1016.50	1020.41	0.002658	7.04	4688.23	662.18	0.47
Reach-1	28.673	100yr	33000.00	1007.30	1018.90	1014.35	1019.68	0.001756	7.18	4882.28	559.42	0.40
Reach-1	28.647	100yr	33000.00	1006.20	1018.70	1013.31	1019.45	0.001442	6.95	4833.01	501.19	0.37
Reach-1	28.63	100yr	33000.00	1005.60	1018.10	1013.27	1019.16	0.002212	8.27	3989.93	380.36	0.45
Reach-1	28.626	100yr	33000.00	1005.40	1017.98	1013.07	1019.09	0.002158	8.44	3908.80	353.59	0.45
Reach-1	28.624	100yr	33000.00	1005.30	1017.97	1012.97	1019.06	0.002105	8.38	3940.23	354.04	0.44
Reach-1	28.622	100yr	33000.00	1005.20	1017.93	1012.87	1019.03	0.002069	8.42	3919.80	344.44	0.44
Reach-1	28.62	100yr	33000.00	1005.00	1017.19	1013.96	1018.79	0.003740	10.18	3241.99	332.37	0.57
Reach-1	28.615		Bridge									
Reach-1	28.61	100yr	33000.00	1005.00	1015.58	1013.62	1017.71	0.005847	11.72	2815.08	320.75	0.70
Reach-1	28.608	100yr	33000.00	1005.00	1015.28	1014.21	1017.56	0.008124	12.15	2736.49	373.00	0.79
Reach-1	28.606	100yr	33000.00	1004.90	1015.29	1013.81	1017.32	0.006773	11.46	2918.43	379.00	0.73
Reach-1	28.604	100yr	33000.00	1004.80	1015.27	1013.55	1017.16	0.006161	11.10	3028.83	385.00	0.70
Reach-1	28.602	100yr	33000.00	1004.70	1013.52	1013.52	1016.58	0.014065	14.16	2383.33	391.00	1.02
Reach-1	28.6	100yr	33000.00	1004.60	1013.38	1013.27	1016.31	0.013357	13.88	2439.56	397.00	0.99
Reach-1	28.597	100yr	33000.00	1004.20	1013.65	1011.75	1015.65	0.005597	11.48	2985.02	359.23	0.70
Reach-1	28.595	100yr	33000.00	1004.10	1013.59	1011.65	1015.57	0.005512	11.42	2999.57	359.43	0.69
Reach-1	28.59	100yr	33000.00	1004.00	1013.37	1011.55	1015.41	0.005752	11.58	2959.12	358.87	0.71
Reach-1	28.58	100yr	33000.00	1004.00	1013.21	1011.11	1015.01	0.004741	10.86	3203.66	414.82	0.85
Reach-1	28.57	100yr	36500.00	1003.70	1012.60	1011.08	1014.64	0.005922	11.56	3312.57	446.00	0.71
Reach-1	28.55	100yr	36500.00	1003.10	1012.17	1010.31	1013.89	0.005260	10.55	3523.03	484.69	0.66
Reach-1	28.53	100yr	36500.00	1002.50	1011.21	1010.29	1013.11	0.007996	11.07	3298.01	538.62	0.79
Reach-1	28.49	100yr	36500.00	1001.50	1010.06	1008.46	1011.66	0.005396	10.25	3752.26	555.18	0.67
Reach-1	28.43	100yr	36500.00	999.70	1007.82	1006.96	1009.77	0.007633	11.31	3477.09	672.82	0.78
Reach-1	28.38	100yr	36500.00	998.00	1006.27	1004.80	1007.86	0.005885	10.18	3806.98	731.27	0.69
Reach-1	28.3	100yr	36500.00	996.00	1003.32	1002.34	1004.96	0.007384	10.31	3632.37	731.41	0.75

HEC-RAS Plan: 60% Design River: RIVER-1 Reach: Reach-1 Profile: 100yr

Reach	River Sta	Profile	Q Total (cfs)	Min Ch El (ft)	W.S. Elev (ft)	Crit W.S. (ft)	E.G. Elev (ft)	E.G. Slope (ft/ft)	Vel Chnl (ft/s)	Flow Area (sq ft)	Top Width (ft)	Froude # Chl
Reach-1	29.64	100yr	33000.00	1041.30	1047.87	1047.05	1049.51	0.007337	10.27	3212.01	596.48	0.78
Reach-1	29.56	100yr	33000.00	1039.50	1045.65	1044.11	1046.89	0.005383	8.95	3685.31	615.05	0.64
Reach-1	29.53	100yr	33000.00	1038.00	1045.20	1042.87	1046.17	0.003551	7.91	4171.84	614.09	0.53
Reach-1	29.51	100yr	33000.00	1036.80	1044.73	1042.49	1045.64	0.003619	7.68	4295.97	671.54	0.54
Reach-1	29.505		Bridge									
Reach-1	29.5	100yr	33000.00	1036.00	1042.38	1041.88	1044.09	0.009995	10.48	3149.66	663.33	0.85
Reach-1	29.43	100yr	33000.00	1033.60	1040.59	1039.01	1041.85	0.005416	9.00	3666.62	612.09	0.65
Reach-1	29.37	100yr	33000.00	1031.60	1037.91	1037.38	1039.71	0.010051	10.77	3065.04	622.62	0.86
Reach-1	29.35	100yr	33000.00	1030.70	1036.52	1036.23	1038.48	0.011479	11.22	2942.21	620.41	0.91
Reach-1	29.32	100yr	33000.00	1030.00	1035.64	1034.70	1037.20	0.007815	10.04	3287.56	613.41	0.76
Reach-1	29.23	100yr	33000.00	1025.00	1032.86	1031.07	1033.93	0.004581	8.31	3972.50	659.31	0.60
Reach-1	29.19	100yr	33000.00	1024.00	1032.10	1029.82	1033.03	0.003548	7.74	4273.08	658.40	0.53
Reach-1	29.16	100yr	33000.00	1023.40	1031.49	1029.57	1032.56	0.004358	8.30	3974.96	635.97	0.59
Reach-1	29.14	100yr	33000.00	1022.90	1030.66	1029.30	1031.96	0.006036	9.15	3606.95	636.31	0.68
Reach-1	29.1	100yr	33000.00	1021.00	1028.06	1027.78	1030.07	0.011944	11.37	2901.58	617.95	0.92
Reach-1	29.08	100yr	33000.00	1020.50	1026.64	1026.64	1028.99	0.014144	12.32	2679.49	575.14	1.01
Reach-1	29.07	100yr	33000.00	1018.20	1026.09	1022.48	1026.70	0.001888	6.27	5264.47	684.31	0.40
Reach-1	29.06		Bridge									
Reach-1	29.01	100yr	33000.00	1018.20	1025.01	1022.49	1025.83	0.003091	7.29	4526.57	679.60	0.50
Reach-1	28.95	100yr	33000.00	1016.00	1023.97	1022.08	1024.88	0.004035	7.78	4877.27	881.32	0.56
Reach-1	28.84	100yr	33000.00	1013.00	1021.41	1019.72	1022.28	0.004858	7.48	4414.62	899.30	0.59
Reach-1	28.737	100yr	33000.00	1010.00	1019.25	1016.50	1020.11	0.003164	7.46	4425.34	653.39	0.50
Reach-1	28.673	100yr	33000.00	1007.30	1018.34	1014.35	1019.23	0.002139	7.63	4569.48	555.91	0.44
Reach-1	28.647	100yr	33000.00	1006.20	1018.10	1013.31	1018.94	0.001745	7.37	4532.67	496.72	0.40
Reach-1	28.63	100yr	33000.00	1005.60	1017.36	1013.27	1018.59	0.002753	8.89	3711.21	374.21	0.50
Reach-1	28.626	100yr	33000.00	1005.40	1017.23	1013.05	1018.50	0.002685	9.06	3643.56	349.83	0.49
Reach-1	28.624	100yr	33000.00	1005.30	1017.22	1012.95	1018.47	0.002617	8.98	3673.39	350.26	0.49
Reach-1	28.622	100yr	33000.00	1005.20	1017.17	1012.87	1018.43	0.002571	9.02	3658.29	341.54	0.49
Reach-1	28.615		Bridge									
Reach-1	28.608	100yr	33000.00	1005.00	1015.28	1014.21	1017.56	0.008124	12.15	2736.49	373.00	0.79
Reach-1	28.606	100yr	33000.00	1004.90	1015.29	1013.81	1017.32	0.006773	11.46	2918.43	379.00	0.73
Reach-1	28.604	100yr	33000.00	1004.80	1015.27	1013.55	1017.16	0.006161	11.10	3028.83	385.00	0.70
Reach-1	28.602	100yr	33000.00	1004.70	1013.52	1013.52	1016.58	0.014065	14.16	2383.33	391.00	1.02
Reach-1	28.6	100yr	33000.00	1004.60	1013.38	1013.27	1016.31	0.013356	13.88	2439.63	397.00	0.99
Reach-1	28.597	100yr	33000.00	1004.20	1013.65	1011.75	1015.65	0.005596	11.48	2985.06	359.23	0.70
Reach-1	28.595	100yr	33000.00	1004.10	1013.59	1011.65	1015.57	0.005512	11.42	2999.61	359.43	0.69
Reach-1	28.59	100yr	33000.00	1004.00	1013.37	1011.55	1015.41	0.005751	11.58	2959.14	358.87	0.71
Reach-1	28.58	100yr	33000.00	1004.00	1013.21	1011.11	1015.01	0.004741	10.86	3203.69	414.82	0.65
Reach-1	28.57	100yr	36500.00	1003.70	1012.60	1011.08	1014.64	0.005922	11.56	3312.65	446.00	0.71
Reach-1	28.55	100yr	36500.00	1003.10	1012.17	1010.31	1013.89	0.005260	10.55	3523.15	484.69	0.66
Reach-1	28.53	100yr	36500.00	1002.50	1011.21	1010.29	1013.11	0.007997	11.07	3297.88	538.62	0.79
Reach-1	28.49	100yr	36500.00	1001.50	1010.06	1008.46	1011.65	0.005397	10.25	3752.02	555.18	0.67
Reach-1	28.43	100yr	36500.00	999.70	1007.82	1006.96	1009.77	0.007629	11.31	3477.74	672.82	0.78
Reach-1	28.38	100yr	36500.00	998.00	1006.28	1004.80	1007.86	0.005863	10.16	3812.25	731.28	0.69
Reach-1	28.3	100yr	36500.00	996.00	1003.30	1002.34	1004.96	0.007470	10.35	3617.75	729.85	0.76



Attachment 3

Engineering "No Rise" Certificate

NATIONAL FLOOD INSURANCE PROGRAM
ENGINEERING "NO-RISE" CERTIFICATE

SITE INFORMATION

Community	San Bernardino Associated Governments (SANBAG)	County	San Bernardino County
Applicant	SANBAG	Date	11/09/2016
Address	1170 W. 3 rd St, San Bernardino, CA 92410	Engineer	Mark Seits, P.E., HDR Engineering, Inc.
Telephone	909-884-8276	Address	8690 Balboa Ave, Suite 200, San Diego, CA 92123
	Santa Ana River Bridge 3.4	Telephone	858-712-8312
Site Address/ Location	N34.07515 and W117.2721, California Coordinate System 1983 (ft), Zone 5	Township	
		Section	

PROJECT INFORMATION



Description of Development:	New bridge development with ties, subgrade and rails.
Type of Development:	Filling <input type="checkbox"/> Grading <input checked="" type="checkbox"/> Excavation <input checked="" type="checkbox"/> Minor Improv <input type="checkbox"/> Substantial Improv <input checked="" type="checkbox"/> New Construction <input type="checkbox"/> Other <input type="checkbox"/>

FLOOD INSURANCE RATE MAP (FIRM) INFORMATION

NFIP map(s) and panel(s) affected:	FIRM Map Number- 06071C8684H
Effective date of map:	August 28, 2008
Base Flood Elevation (feet):	Existing <u>1017.19</u> ; Proposed <u>1017.17</u>
Name of flooding source:	Santa Ana River

CERTIFICATION

This is to certify that I am a duly qualified Professional Engineer licensed to practice in the State of California. I further certify that the attached engineering data supports the fact the proposed development in the floodway described above will not create any increase in the base flood elevations (100-year flood), floodway elevations and the floodway widths on Santa Ana River at published cross sections listed in the Flood Insurance Study for the above community dated August 28, 2008 and will not create any increase to the base flood elevations (100-year flood), floodway elevations and the floodway widths at unpublished cross-section in the vicinity of the proposed development.

Mark Seits, P.E. CERTIFIER'S NAME HDR Engineering, Inc. COMPANY NAME  SIGNATURE	CA 41103 LICENSE NUMBER November 09, 2016 DATE	
---	---	---

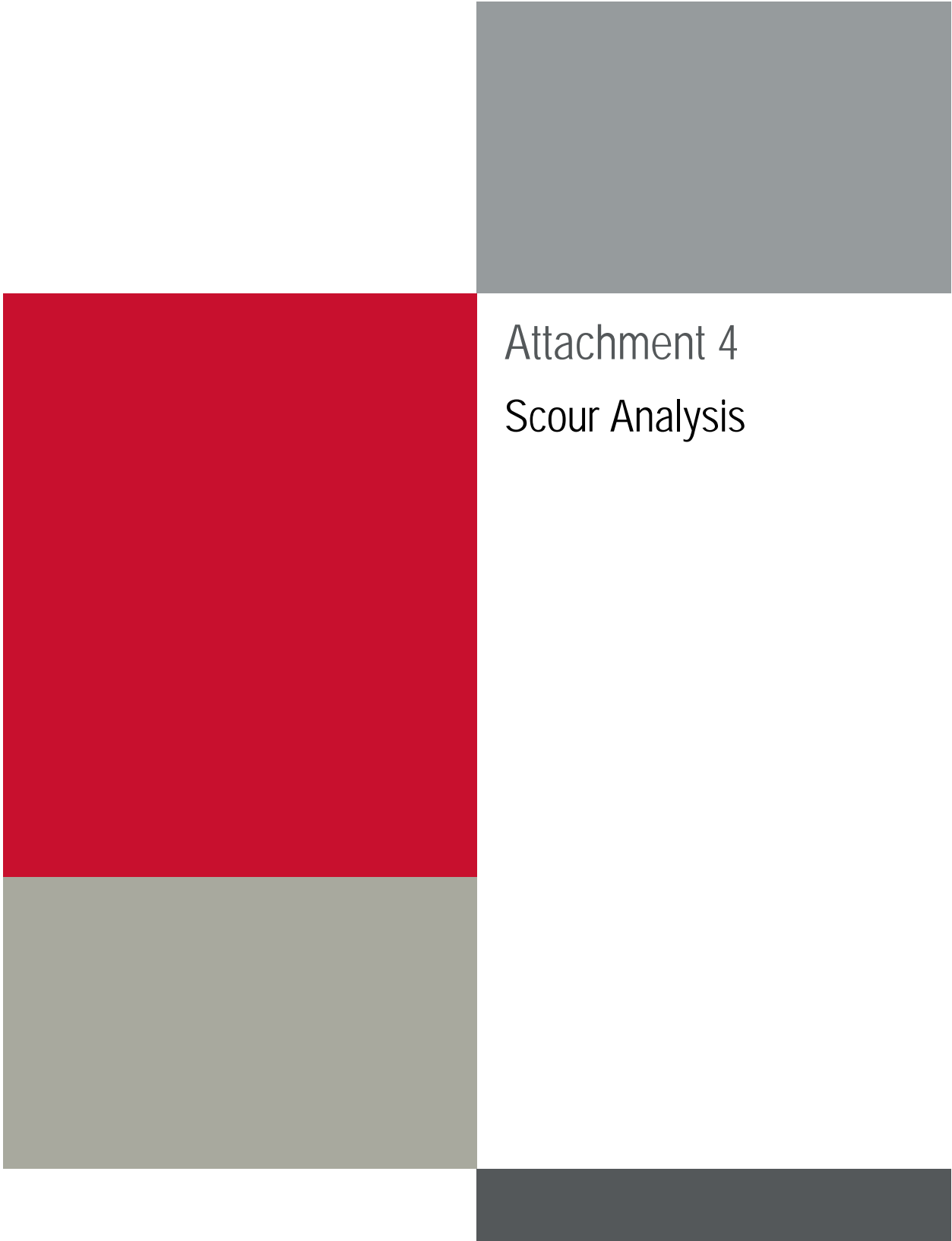
A decorative graphic on the left side of the page, composed of several overlapping rectangular blocks in various shades of gray, red, and olive green.

Attachment 4
Scour Analysis



Project: **Redlands Passenger Rail Project**
Subject: **Proposed Br 3.4 Scour_60% Design**
Task: **Summary 100-Year Scour**
Job#: **10026495-268339**

Prepared: **VZ** Date: **11/12/2016**
Checked: **JH** Date: **11/16/2016**
No:

Flow	Contraction Scour (ft)	Pier Scour (ft)	Pressure Scour ¹ (ft)	Long Term Scour ² (ft)	Total Scour (ft)	Abutment Scour (ft)
100 Year	1.3	14.6	0.0	2.6	18.6	4.4
1: Horizontal contraction scour included in pressure scour						
2: Long term scour is based on the Effective Model and current survey data						



Project: **Redlands Passenger Rail Project**
 Subject: **Proposed Br 3.4 Scour_60% Design**
 Task: **Contraction Scour 100-Year**
 Job#: **10026495-268339**

Prepared: **VZ** Date: **11/12/2016**
 Checked: **JH** Date: **11/16/2016**
 No:

Reference: FHWA - HEC-18 Evaluating Scour at Bridges 2012, Chapter 6

US XS: **28.84** Cross Section upstream of Bridge 3.4

Contraction Scour, Chapter 6.2

EQ 6.1

Proposed

K_u 11.17
 y 4.91
 D_{50} 0.25
 D_{50} 0.0008202
 V_c 1.36

$$V_c = K_u y^{1/6} D^{1/3}$$

English Units

Average depth of flow upstream of the contraction, ft (hydraulic depth at approach cross section)

Particle size for V_c , mm

Particle size for V_c , ft

Critical velocity above which bed material of size D and smaller will be transported, ft/s

Velocity in Channel **7.48**

ft/s Average velocity at approach cross section

Live-Bed
 Contraction
 Scour

Contraction Scour **1.3**

ft

Live-bed Contraction Scour, Chapter 6.3

EQ 6-2

$$\frac{y_2}{y_1} = \left(\frac{Q_2}{Q_1} \right)^{6/7} \left(\frac{W_1}{W_2} \right)^{k_1}$$

Y_2 **10.0**
 Y_1 4.91
 Y_0 8.68
 Q_2 33000
 Q_1 33000
 W_1 899.3
 W_2 321.35
 k_1 0.69
 V_s 0.88
 ω 0.10
 g 32.2
 S_1 0.004858
 V_s/ω 8.35
 Y_s 1.3

Average depth in the contracted section, ft

Average depth in the upstream main channel section, ft

Existing depth in the contracted section before scour, ft

Flow in the contracted channel ft³/s

Flow in the upstream channel transporting sediment, ft³/s

Top width of the upstream main channel that is transporting bed material, ft

Top width of the main channel in the contracted section less pier widths, ft

Exponent

Shear velocity in the upstream section, ft/s

Fall velocity of bed material based on the D50

Acceleration of gravity, 32.3 ft/s²

Slope of energy grade line of main channel, ft/ft

Average contraction scour depth, ft

Clear-water Contraction Scour, Chapter 6.4

EQ 6.4

$$y_2 = \left[\frac{K_u Q^2}{D_m^{2/3} W^2} \right]^{3/7}$$

Y_2 47.03632697
 K_u 0.0077
 Q 33000
 D_m 0.00102525
 D_{50} 0.0008202
 W 321.3490909
 Y_0 8.68
 Y_s 38.36

Average equilibrium depth in the contracted section after contraction scour, ft

English Units

Discharge through the contracted section or on the set-back overbank area at the section associated with the width W, ft³/s

Diameter of the smallest nontransportable particle in the bed material (1.25*D50) in the contracted section, ft

Median diameter of the bed material, ft

Top width of the contracted section less pier widths

Average existing depth in the contracted section, ft

Average contraction scour depth, ft



Project: **Redlands Passenger Rail Project**
 Subject: **Proposed Br 3.4 Scour_60% Design**
 Task: **Pier Scour 100-Year**
 Job#: **10026495-268339**

Prepared: **VZ**

Date: **11/12/2016**

Checked: **JH**

Date: **11/16/2016**

No:

Equations taken from US Department of Transportation Federal Highway Administration HEC-18 (2012)

With No Debris Accumulation

Proposed			
1	K1	Shape factor (= 1.0 for approach angle > 5 degrees or with debris)	Table 7.1
1	K2	Skew factor (= 1.0 when using aproj or with debris)	Table 7.2
1.1	K3	Bed forms factor	Table 7.3
11.97	y	Depth of approach flow (ft) (used max channel depth)	
7.82	a	Projected pier width (ft)	
9.55	V	Approach velocity (ft/s) (from flow distribution just upstream of pier)	
0.49	Fr	Froude number = $V/(gy)^{1/2}$	
14.6	y_s	Pier scour (ft) = $2.0 a K_1 K_2 K_3 (y/a)^{0.35} Fr^{0.43}$	EQ 7.3

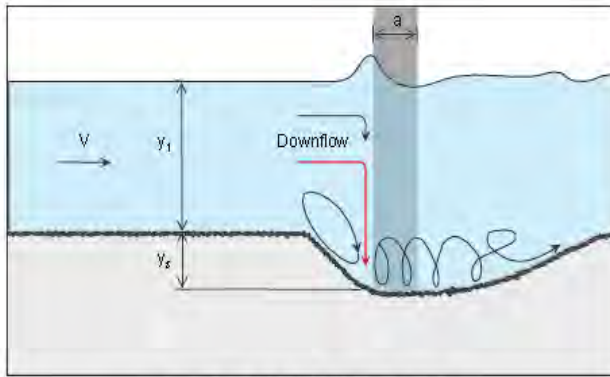

Figure 7.2. Definition sketch for pier scour.

$$\frac{y_s}{a} = 2.0 K_1 K_2 K_3 \left(\frac{y_1}{a} \right)^{0.35} Fr^{0.43}$$

- y_s = Scour depth, ft (m)
- y_1 = Flow depth directly upstream of the pier, ft (m)
- K_1 = Correction factor for pier nose shape from Figure 7.3 and Table 7.1
- K_2 = Correction factor for angle of attack of flow from Table 7.2 or Equation 7.4
- K_3 = Correction factor for bed condition from Table 7.3
- a = Pier width, ft (m)
- L = Length of pier, ft (m)
- Fr_1 = Froude Number directly upstream of the pier = $V\sqrt{(gy_1)^{-1/2}}$
- V_1 = Mean velocity of flow directly upstream of the pier, ft/s (m/s)
- g = Acceleration of gravity (32.2 ft/s²) (9.81 m/s²)



Project: **Redlands Passenger Rail Project**
 Subject: **Proposed Br 3.4 Scour_60% Design**
 Task: **Abutment Scour 100-Year**
 Job#: **10026495-268339**

Prepared: **VZ** Date: **11/12/2016**
 Checked: **JH** Date: **11/16/2016**
 No:

Reference: FHWA - HEC-18 Evaluating Scour at Bridges 2012, Chapter 8

Set-Back Ratio and Unit Discharge

Proposed
 0.0 Set-back Length, ft
 8.7 Average channel depth, ft No overbank flow under bridge.
 SBR 0.0 Set-Back Ratio

SBR<5 both abutments Figure 8.14

0.2
 A 2780.0 Flow Area, ft²
 Q 33000.0 Total Bridge Flow, cfs
 V 11.87 Velocity Bridge Opening, ft/s
 321.35 Top Width, ft (net top width BR)
 d 8.65 Hydraulic Depth Bridge, ft
 q_{2c} 102.69 Unit Bridge Discharge, cfs/ft

Projected Length

L 1.0 Project Length of Abutment, L
 B_f 1.0 Width of Floodplain, ft
 L/B_f 100.00%

>75%
0.08528

$$y_c = y_1 \left(\frac{q_{2c}}{q_1} \right)^{6/7}$$

y₁ 4.91 Upstream flow depth, ft
 q₁ 36.70 Upstream unit discharge ft²/s
 q_{2c} 102.69 Unit discharge in the constricted opening accounting for non-uniform flow distribution, ft²/s
 y_c 11.9 Flow depth including live-bed contraction scour, ft

$$V*d$$

Live-Bed Abutment Scour Equation

$$y_{max} = \alpha_A y_c$$

q_{2c}/q₁ 2.80
 α_A 1.10 Amplification Factor from Fig 8.9
 y_c 11.9 Flow depth including live-bed contraction scour, ft
 y_{max} 13.0 Maximum flow depth resulting from abutment scour, ft
 y_o 8.65 Flow depth prior to scour, ft
 y_s 4.4 Abutment Scour depth, ft



Project: **Redlands Passenger Rail Project**
Subject: **Proposed Br 3.4 Scour_60% Design**
Task: **Summary 200-Year Scour**
Job#: **10026495-268339**

Prepared: **VZ** Date: **11/12/2016**
Checked: **JH** Date: **11/16/2016**
No:

Flow	Contraction Scour (ft)	Pier Scour (ft)	Pressure Scour ¹ (ft)	Long Term Scour ² (ft)	Total Scour (ft)	Abutment Scour (ft)
200 Year	5.2	15.2	10.2	2.6	27.9	13.8
1: Horizontal contraction scour included in pressure scour						
2: Long term scour is based on the Effective Model and current survey data						



Project: **Redlands Passenger Rail Project**
 Subject: **Proposed Br 3.4 Scour_60% Design**
 Task: **Contraction Scour 200-Year**
 Job#: **10026495-268339**

Prepared: **VZ** Date: **11/12/2016**
 Checked: **JH** Date: **11/16/2016**
 No:

Reference: FHWA - HEC-18 Evaluating Scour at Bridges 2012, Chapter 6

US XS: **28.84**

Contraction Scour, Chapter 6.2

EQ 6.1

Proposed

K_u 11.17
 y 8.84
 D_{50} 0.25
 D_{50} 0.0008202
 V_c 1.50

$$V_c = K_u y^{1/6} D^{1/3}$$

English Units

Average depth of flow upstream of the contraction, ft (hydraulic depth at approach cross section)

Particle size for V_c , mm

Particle size for V_c , ft

Critical velocity above which bed material of size D and smaller will be transported, ft/s

Velocity in Channel **5.94**

ft/s Average velocity at approach cross section

Live-Bed
 Contraction
 Scour

Contraction Scour **5.2**

ft

Live-bed Contraction Scour, Chapter 6.3

EQ 6-2

y_2 **18.5**
 y_1 8.84
 y_0 13.28
 Q_2 51500
 Q_1 51500
 W_1 980
 W_2 335.42
 k_1 0.69
 V_s 0.63
 ω 0.10
 g 32.2
 S_1 0.001404
 V_s/ω 6.02
 y_s 5.2

$$\frac{y_2}{y_1} = \left(\frac{Q_2}{Q_1} \right)^{6/7} \left(\frac{W_1}{W_2} \right)^{k_1}$$

Average depth in the contracted section, ft

Average depth in the upstream main channel section, ft

Existing depth in the contracted section before scour, ft

Flow in the contracted channel ft³/s

Flow in the upstream channel transporting sediment, ft³/s

Top width of the upstream main channel that is transporting bed material, ft

Top width of the main channel in the contracted section less pier widths, ft

Exponent

Shear velocity in the upstream section, ft/s

Fall velocity of bed material based on the D_{50}

Acceleration of gravity, 32.3 ft/s²

Slope of energy grade line of main channel, ft/ft

Average contraction scour depth, ft

Clear-water Contraction Scour, Chapter 6.4

EQ 6.4

y_2 66.39881424
 K_u 0.0077
 Q 51500
 D_m 0.00102525
 D_{50} 0.0008202
 W 335.42
 y_0 13.27592272
 y_s 53.12

$$y_2 = \left[\frac{K_u Q^2}{D_m^{2/3} W^2} \right]^{3/7}$$

Average equilibrium depth in the contracted section after contraction scour, ft

English Units

Discharge through the contracted section or on the set-back overbank area at the section associated with the width W , ft³/s

Diameter of the smallest nontransportable particle in the bed material ($1.25 \cdot D_{50}$) in the contracted section, ft

Median diameter of the bed material, ft

Top width of the contracted section less pier widths

Average existing depth in the contracted section, ft

Average contraction scour depth, ft



Project: **Redlands Passenger Rail Project**
 Subject: **Proposed Br 3.4 Scour_60% Design**
 Task: **Pier Scour 200-Year**
 Job#: **10026495-268339**

Prepared: **VZ**
 Checked: **JH**
 No:

Date: **11/12/2016**
 Date: **11/16/2016**

Equations taken from US Department of Transportation Federal Highway Administration HEC-18 (2012)

With No Debris Accumulation

Proposed				
1	K1	Shape factor (= 1.0 for approach angle > 5 degrees or with debris)	Table 7.1	
1	K2	Skew factor (= 1.0 when using aproj or with debris)	Table 7.2	
1.1	K3	Bed forms factor	Table 7.3	
18.76	y	Depth of approach flow (ft) (used max channel depth)		
7.82	a	Projected pier width (ft)		
9.02	V	Approach velocity (ft/s) (from flow distribution just upstream of pier)		
0.37	Fr	Froude number = $V/(gy)^{1/2}$		
15.2	y_s	Pier scour (ft) = $2.0 a^* K_1 K_2 K_3 (y/a)^{0.35} Fr^{0.43}$	EQ. 7.3	

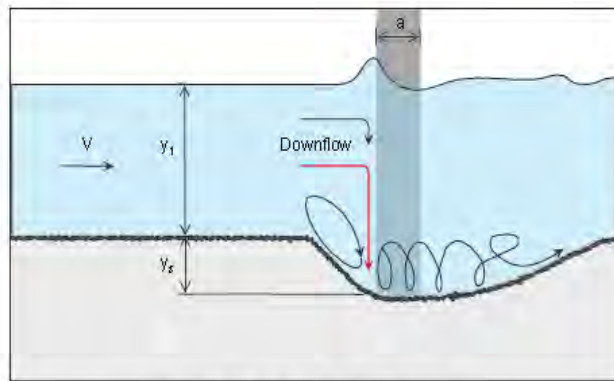

$$\frac{y_s}{a^*} = 2.0 K_1 K_2 K_3 \left(\frac{y_1}{a^*} \right)^{0.35} Fr_1^{0.43}$$

- y_s = Scour depth, ft (m)
- y_1 = Flow depth directly upstream of the pier, ft (m)
- K_1 = Correction factor for pier nose shape from Figure 7.3 and Table 7.1
- K_2 = Correction factor for angle of attack of flow from Table 7.2 or Equation 7.4
- K_3 = Correction factor for bed condition from Table 7.3
- a = Pier width, ft (m)
- L = Length of pier, ft (m)
- Fr_1 = Froude Number directly upstream of the pier = $V_1/(gy_1)^{1/2}$
- V_1 = Mean velocity of flow directly upstream of the pier, ft/s (m/s)
- g = Acceleration of gravity (32.2 ft/s²) (9.81 m/s²)

$$a^*_d = \frac{K_1(HW) + (y - K_1H)a}{y} \tag{7.32}$$

where:

- a^*_d = Effective width of pier when debris is present, ft (m)
- a = Width of pier perpendicular to flow, ft (m)
- K_1 = 0.79 for rectangular debris, 0.21 for triangular debris
- H = Height (thickness) of the debris, ft (m)
- W = Width of debris perpendicular to the flow direction, ft (m)
- y = Depth of approach flow, ft (m)



Project: **Redlands Passenger Rail Project**
 Subject: **Proposed Br 3.4 Scour 60% Design**
 Task: **Pressure Scour (non-overflow) 200-Year**
 Job#: **10026495-268339**

Prepared: **VZ** Date: **11/12/2016**
 Checked: **JH** Date: **11/16/2016**

No:

Equations taken from US Department of Transportation Federal Highway Administration HEC-18 (2012)
 Example 6.10.2, Problems 1 and 2, pdf page 162

Pressure Flow Scour - Non-Overtopping Flow

Proposed

Q1	51500	Upstream channel discharge as defined for horizontal contraction scour (ft ³ /s)
Q2	51500	Discharge through bridge (ft ³ /s)
h _u	16.62	Upstream channel flow depth as defined for horizontal contraction scour (ft)
h _b	13.28	Vertical size of the bridge opening prior to scour (ft)
h _t	4.59	Distance from the water surface to the lower face of the bridge girders equals h _u -h _b (ft)
h _w	0.00	Weir flow height equals h _t -T for h _t >T, h _w =0 for h _t <T
t	4.91	flow separation thickness (ft)

Live-Bed Contraction Scour

Y _s	10.2	Average contraction scour depth, ft	$y_s = y_2 + t - h_b$
----------------	------	-------------------------------------	-----------------------

Contraction Scour, Chapter 6.2

EQ 6.1

$$V_c = K_u y^{1/6} D^{1/3}$$

K _u	11.17	English Units
y	8.84	Average depth of flow upstream of the contraction, ft
D ₅₀	0.25	Particle size for V _c , mm
D ₅₀	0.0008202	Particle size for V _c , ft
V _c	1.50	Critical velocity above which bed material of size D and smaller will be transported, ft/s
	5.94	Velocity in Channel (ft/s)

Live-Bed Contraction Scour

Live-bed Contraction Scour, Chapter 6.3

EQ 6-2

$$\frac{y_2}{y_1} = \left(\frac{Q_2}{Q_1} \right)^{6/7} \left(\frac{W_1}{W_2} \right)^{k_1}$$

Y ₂	18.5	Average depth in the contracted section, ft
Y ₁	8.8	Average depth in the upstream main channel section, ft
Y ₀	13.3	Existing depth in the contracted section before scour, ft
Q ₂	51500.0	Flow in the contracted channel ft ³ /s
Q ₁	51500.0	Flow in the upstream channel transporting sediment, ft ³ /s
W ₁	980.0	Top width of the upstream main channel that is transporting bed material, ft
W ₂	335.4	Top width of the main channel in the contracted section less pier widths, ft
k ₁	0.7	Exponent
V _*	0.6	Shear velocity in the upstream section, ft/s
ω	0.1	Fall velocity of bed material based on the D50
g	32.2	Acceleration of gravity, 32.3 ft/s ²
S ₁	0.0	Slope of energy grade line of main channel, ft/ft

Clear Water Contraction Scour, Chapter 6.4

EQ 6-2

$$y_2 = \left(\frac{K_u Q^2}{D_m^{2/3} W^2} \right)^{3/7}$$

Y ₂	66.40	Average depth in the contracted section, ft
Q	51500.0	Total Discharge through Bridge
D ₅₀	0.25	Particle size for V _c , mm
D ₅₀	0.0008202	Particle size for V _c , ft
D _m	0.00103	Effective channel discharge for live-bed conditions and bridge overtopping flow (ft ³ /s)
W	335.42	Bottom width of the contracted section less pier widths
K _u	0.0077	English Units

	Project: Redlands Passenger Rail Project	Prepared: VZ	Date: 11/12/2016
	Subject: Proposed Br 3.4 Scour_60% Design	Checked: JH	Date: 11/16/2016
	Task: Abutment Scour 200-Year		
	Job#: 10026495-268339	No:	

Reference: FHWA - HEC-18 Evaluating Scour at Bridges 2012, Chapter 8

Set-Back Ratio and Unit Discharge

Proposed
0.0 Set-back Length, ft
13.3 Average channel depth, ft
SBR **0.0** Set-Back Ratio

No overbank flow under bridge.

SBR<5 both abutments Figure 8.14

A **3546.6** Flow Area, ft²
Q **51500.0** Total Bridge Flow, cfs
V **14.52** Velocity Bridge Opening, ft/s
335.4 Top Width, ft (net top width BR)
d **10.57** Hydraulic Depth Bridge, ft
q_{2c} **153.54** Unit Bridge Discharge, cfs/ft

SBR>5 one of the abutments Figure 8.15 Not Applicable

A **0.0** Flow Area, ft²
Q **0.0** Overbank Flow, cfs
V #DIV/0! Velocity Bridge Opening, ft/s
d **13.28** Overbank Hydraulic Depth Bridge, ft
q_{2f} #DIV/0! Unit discharge in the constricted opening accounting for non-uniform flow distribution, ft²/s

Projected Length

L **1.0** Project Length of Abutment, L
B_r **1.0** Width of Floodplain, ft
L/B_r 100.00%

>75%

Live-Bed Contraction Scour

y₁ **8.84** Upstream flow depth, ft
q₁ **52.55** Upstream unit discharge ft²/s
q_{2c} **153.54** Unit discharge in the constricted opening accounting for non-uniform flow distribution, ft²/s
y_c **22.2** Flow depth including live-bed contraction scour, ft

$$y_c = y_1 \left(\frac{q_{2c}}{q_1} \right)^{6/7}$$

V*d

Live-Bed Abutment Scour Equation

$$y_{max} = \alpha_A y_c$$

q_{2c}/q₁ 2.92
α_A **1.10** Amplification Factor from Fig 8.9
y_c **22.2** Flow depth including live-bed contraction scour, ft
y_{max} **24.4** Maximum flow depth resulting from abutment scour, ft
y_o **10.57** Flow depth prior to scour, ft
y_s **13.8** Abutment Scour depth, ft



Project: **Redlands Passenger Rail Project**
Subject: **Proposed Br 3.4 Scour_60% Design**
Task: **Summary 500-Year Scour**
Job#: **10026495-268339**

Prepared: **VZ** Date: **11/12/2016**
Checked: **JH** Date: **11/16/2016**
No:

Flow	Contraction Scour (ft)	Pier Scour (ft)	Pressure Scour ¹ (ft)	Long Term Scour ² (ft)	Total Scour (ft)	Abutment Scour (ft)
500 Year	14.5	17.2	27.8	2.6	47.7	18.3
1: Horizontal contraction scour included in pressure scour						
2: Long term scour is based on the Effective Model and current survey data						



Project: **Redlands Passenger Rail Project**
 Subject: **Proposed Br 3.4 Scour_60% Design**
 Task: **Contraction Scour 500-Year**
 Job#: **10026495-268339**

Prepared: **VZ** Date: **11/12/2016**
 Checked: **JH** Date: **11/16/2016**
 No:

Reference: FHWA - HEC-18 Evaluating Scour at Bridges 2012, Chapter 6

US XS: **28.84**

Contraction Scour, Chapter 6.2

EQ 6.1

Proposed

K_u 11.17
 y **15.11**
 D_{50} **0.25**
 D_{50} 0.0008202
 V_c 1.64

$$V_c = K_u y^{1/6} D^{1/3}$$

English Units

Average depth of flow upstream of the contraction, ft (hydraulic depth at approach cross section)

Particle size for V_c , mm

Particle size for V_c , ft

Critical velocity above which bed material of size D and smaller will be transported, ft/s

Velocity in Channel **5.63**

Live-Bed
 Contraction
 Scour

ft/s Average velocity at approach cross section

Contraction Scour **14.5**

ft

Live-bed Contraction Scour, Chapter 6.3

EQ 6-2

y_2 **27.8**
 y_1 **15.11**
 y_0 **13.28**
 Q_2 **73834.84**
 Q_1 **86000**
 W_1 **980**
 W_2 **335.42**
 k_1 0.69
 V^* 0.55
 ω **0.10**
 g 32.2
 S_1 **0.000617**
 V^*/ω 5.22
 y_s **14.5**

$$\frac{y_2}{y_1} = \left(\frac{Q_2}{Q_1} \right)^{6/7} \left(\frac{W_1}{W_2} \right)^{k_1}$$

Average depth in the contracted section, ft

Average depth in the upstream main channel section, ft

Existing depth in the contracted section before scour, ft

Flow in the contracted channel ft³/s

Flow in the upstream channel transporting sediment, ft³/s

Top width of the upstream main channel that is transporting bed material, ft

Top width of the main channel in the contracted section less pier widths, ft

Exponent

Shear velocity in the upstream section, ft/s

Fall velocity of bed material based on the D_{50}

Acceleration of gravity, 32.3 ft/s²

Slope of energy grade line of main channel, ft/ft

Average contraction scour depth, ft

Clear-water Contraction Scour, Chapter 6.4

EQ 6.4

y_2 90.41986323
 K_u **0.0077**
 Q 73834.84
 D_m 0.00102525
 D_{50} 0.0008202
 W 335.42
 y_0 13.27592272
 y_s **77.14**

$$y_2 = \left[\frac{K_u Q^2}{D_m^{2/3} W^2} \right]^{3/7}$$

Average equilibrium depth in the contracted section after contraction scour, ft

English Units

Discharge through the contracted section or on the set-back overbank area at the section associated with the width W , ft³/s

Diameter of the smallest nontransportable particle in the bed material ($1.25 \cdot D_{50}$) in the contracted section, ft

Median diameter of the bed material, ft

Top width of the contracted section less pier widths

Average existing depth in the contracted section, ft

Average contraction scour depth, ft



Project: **Redlands Passenger Rail Project**
 Subject: **Proposed Br 3.4 Scour_60% Design**
 Task: **Pier Scour 500-Year**
 Job#: **10026495-268339**

Prepared: **VZ**
 Checked: **JH**
 No:

Date: **11/12/2016**
 Date: **11/16/2016**

Equations taken from US Department of Transportation Federal Highway Administration HEC-18 (2012)

With No Debris Accumulation

Proposed			
1	K1	Shape factor (= 1.0 for approach angle > 5 degrees or with debris)	Table 7.1
1	K2	Skew factor (= 1.0 when using aproj or with debris)	Table 7.2
1.1	K3	Bed forms factor	Table 7.3
24.60	y	Depth of approach flow (ft) (used max channel depth)	
7.82	a	Projected pier width (ft)	
11.1	V	Approach velocity (ft/s) (from flow distribution just upstream of pier)	
0.39	Fr	Froude number = $V/(gy)^{1/2}$	
17.2	y_s	Pier scour (ft) = $2.0 a^* K_1 K_2 K_3 (y/a)^{0.35} Fr^{0.43}$	EQ. 7.3

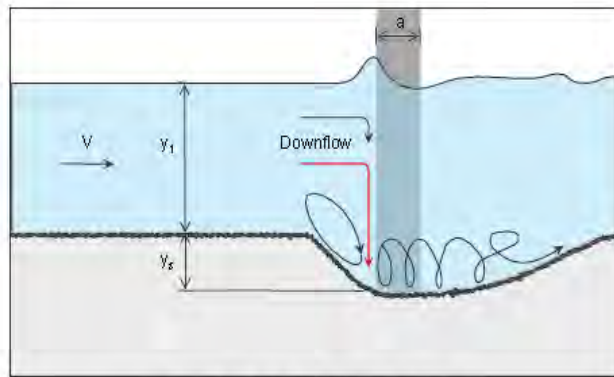

$$\frac{y_s}{a^*} = 2.0 K_1 K_2 K_3 \left(\frac{y_1}{a^*} \right)^{0.35} Fr_1^{0.43}$$

dur.

- y_s = Scour depth, ft (m)
- y_1 = Flow depth directly upstream of the pier, ft (m)
- K_1 = Correction factor for pier nose shape from Figure 7.3 and Table 7.1
- K_2 = Correction factor for angle of attack of flow from Table 7.2 or Equation 7.4
- K_3 = Correction factor for bed condition from Table 7.3
- a = Pier width, ft (m)
- L = Length of pier, ft (m)
- Fr_1 = Froude Number directly upstream of the pier = $V\sqrt{(gy_1)^{-1/2}}$
- V_1 = Mean velocity of flow directly upstream of the pier, ft/s (m/s)
- g = Acceleration of gravity (32.2 ft/s²) (9.81 m/s²)

$$a^* = \frac{K_1(HW) + (y - K_1H)a}{y} \quad (7.32)$$

where:

- a^* = Effective width of pier when debris is present, ft (m)
- a = Width of pier perpendicular to flow, ft (m)
- K_1 = 0.79 for rectangular debris, 0.21 for triangular debris
- H = Height (thickness) of the debris, ft (m)
- W = Width of debris perpendicular to the flow direction, ft (m)
- y = Depth of approach flow, ft (m)



Project: **Redlands Passenger Rail Project**
 Subject: **Proposed Br 3.4 Scour_60% Design**
 Task: **Pressure Scour 500-Year**
 Job#: **10026495-268339**

Prepared: **VZ**
 Checked: **JH**
 No:

Date: **11/12/2016**
 Date: **11/16/2016**

Equations taken from US Department of Transportation Federal Highway Administration HEC-18 (2012)

Pressure Flow Scour - Overtopping Flow

Proposed

Q1	86000	Upstream channel discharge as defined for horizontal contraction scour (ft ³ /s)
Q2	73835	Discharge through bridge (ft ³ /s)
h _{ue}	19.13	Effective upstream channel flow depth for live-bed conditions and bridge overtopping (ft)
h _u	24.74	Upstream channel flow depth as defined for horizontal contraction scour (ft)
Q _{ue}	64119	Effective channel discharge for live-bed conditions and bridge overtopping flow (ft ³ /s)
h _b	13.28	Vertical size of the bridge opening prior to scour (ft)
h _t	11.46	Distance from the water surface to the lower face of the bridge girders equals h _u -h _b (ft)
h _w	5.61	Weir flow height equals h _t -T for h _t >T, h _w =0 for h _t <T
t	5.37	flow separation thickness (ft)
T	5.85	height of the obstruction (ft)

Live-Bed Contraction Scour

y_s **27.8** Average contraction scour depth, ft

$$y_s = y_2 + t - h_b$$

Live-bed Contraction Scour, Chapter 6.3

EQ 6-2

$$\frac{y_2}{y_1} = \left(\frac{Q_2}{Q_1} \right)^{0.77} \left(\frac{W_1}{W_2} \right)^{k_1}$$

y ₂	35.7	Average depth in the contracted section, ft
y ₁	15.11	Average depth in the upstream main channel section, ft
y ₀	13.28	Existing depth in the contracted section before scour, ft
Q _{ue}	64119.3	Effective channel discharge for live-bed conditions and bridge overtopping flow (ft ³ /s)
Q ₂	73835	Flow in the contracted channel ft ³ /s
W ₁	980	Bottom width of the upstream main channel that is transporting bed material, ft
W ₂	335.42	Bottom width of the main channel in the contracted section less pier widths, ft
k ₁	0.69	Exponent (see adjacent table)
V*	0.55	Shear velocity in the upstream section, ft/s
ω	0.10496	Fall velocity of bed material based on the D50
g	32.2	Acceleration of gravity, 32.3 ft/s ²
S ₁	0.000617	Slope of energy grade line of main channel, ft/ft
V*/ω	5.22	



Project: **Redlands Passenger Rail Project**
 Subject: **Proposed Br 3.4 Scour_60% Design**
 Task: **Abutment Scour 500-Year**
 Job#: **10026495-268339**

Prepared: **VZ**
 Checked: **JH**
 No:

Date: **11/12/2016**
 Date: **11/16/2016**

Reference: FHWA - HEC-18 Evaluating Scour at Bridges 2012, Chapter 8

Set-Back Ratio and Unit Discharge

Proposed
 0.0 Set-back Length, ft
 5.0 Average channel depth, ft
 SBR 0.0 Set-Back Ratio
 No overbank flow under bridge.

SBR<5 both abutments Figure 8.14

A 6475.8 Flow Area, ft²
 Q 73834.8 Total Bridge Flow, cfs
 V 11.40 Velocity Bridge Opening, ft/s
 335.4 Top Width, ft (net top width BR)
 d 19.31 Hydraulic Depth Bridge, ft
 q_{2c} 220.13 Unit Bridge Discharge, cfs/ft

Projected Length

L 1.0 Project Length of Abutment, L
 B_r 1.0 Width of Floodplain, ft
 L/B_r 100.00%

>75%

Live-Bed Contraction Scour

$$y_c = y_1 \left(\frac{q_{2c}}{q_1} \right)^{6/7}$$

y₁ 15.11 Upstream flow depth, ft
 q₁ 87.76 Upstream unit discharge ft²/s
 q_{2c} 220.13 Unit discharge in the constricted opening accounting for non-uniform flow distribution, ft²/s
 y_c 33.2 Flow depth including live-bed contraction scour, ft

v*d

Live-Bed Abutment Scour Equation

$$y_{\max} = \alpha_A y_c$$

q_{2c}/q₁ 2.51
 α_A 1.13 Amplification Factor from Fig 8.9
 y_c 33.2 Flow depth including live-bed contraction scour, ft
 y_{max} 37.6 Maximum flow depth resulting from abutment scour, ft
 y_o 19.31 Flow depth prior to scour, ft
 y_s 18.3 Abutment Scour depth, ft



Attachment 5

Digital Information (CD)



MITIGATION MONITORING AND REPORTING PROGRAM

1.0 INTRODUCTION

The California Environmental Quality Act (CEQA) requires a lead or responsible agency to adopt a monitoring and reporting program (MMRP) when approving or carrying out a project (Section 21081.6 of the California Public Resources Code). The purpose of this program is to ensure that when an environmental document, either an Environmental Impact Report (EIR) or a mitigated negative declaration, identifies measures to reduce potential adverse environmental impacts to less than significant levels that those measures are implemented as detailed in the environmental document. As lead agency for the Project, the San Bernardino Associated Governments (SANBAG), acting in its roles as the San Bernardino County Transportation Commission, is responsible for implementation of this MMRP per the requirements of the (CEQA). In its role as the federal lead agency under the National Environmental Policy Act (NEPA), the Federal Transit Administration (FTA), Region IX, will use this MMRP for verifying the implementation of the mitigation measures proposed in conjunction with its issuance of the Record of Decision.

In this context, this MMRP was prepared to provide a monitoring strategy to ensure the implementation of the adopted mitigation measures. Once SANBAG adopts the MMRP, the mitigation monitoring/reporting requirements will be incorporated into the appropriate permits and construction documents (i.e., engineering specifications, engineering and construction plans, real estate entitlements, etc.). Therefore, in accordance with the aforementioned requirements, this MMRP lists each mitigation measure, describes the methods for implementation and verification, and identifies the responsible party or parties as detailed below in Section 3.

2.0 MONITORING AND REPORTING PROCEDURES

This MMRP was developed for the Locally Preferred Alternative (LPA) for SANBAG's Redlands Passenger Rail Project (RPRP or Project) (State Clearinghouse Number 2012041012). The MMRP will be in place through all phases of the Project, including design, construction, and operation, and will facilitate the implementation of mitigation measures proposed to avoid, minimize, or reduce significant environmental effects. SANBAG will be responsible for administering the MMRP and ensuring that all parties, including its contractors, comply with its provisions. SANBAG may delegate implementation and monitoring activities to staff, consultants, or contractors. SANBAG will require that its construction contractors submit an environmental compliance plan for approval by SANBAG and construction manager prior to the beginning construction activities. This plan shall document how the contractor intends to comply with all measures applicable to the contract, including the application of best management practices (BMPs) in accordance with instruction listed in the construction specifications. SANBAG also will ensure that monitoring is documented through systematic compliance verification and reporting and that deficiencies are promptly corrected. The designated environmental compliance manager will track and document compliance with mitigation measures, notify SANBAG of any problems or deficiencies, as appropriate, and take appropriate action to rectify problems.



3.0 MITIGATION MONITORING AND REPORTING PROGRAM IMPLEMENTATION

This MMRP was prepared to verify compliance with individual mitigation measures proposed in the Final Environmental Impact Statement (EIS)/EIR for the Project. Table 1 of this MMRP identifies each mitigation measure by discipline, the entity responsible for its implementation, and the performance standard required to demonstrate compliance with each measure. Certain inspections and reports may require preparation by qualified individuals and these are specified as needed. The timing and method of verification for each measure are also specified.



Table 1. MMRP Mitigation Measures

Mitigation Measure	Timing	Applicable Project Location/ Feature	Primary Responsible Party	Secondary Responsible Party	Verification
Land Use, Planning, and Communities					
LU-1: Minimize Project Land Requirements and Comply with Federal and State Relocation Laws. As part of final design, SANBAG shall maximize opportunities to minimize the Project's land requirements and associated property acquisition. In instances where avoidance is not feasible, SANBAG shall provide just compensation consistent with the requirements of the Uniform Relocation Assistance and Real Property Acquisition Policies Act and California Relocation Act. If the acquisition of one or more properties requires relocation of existing residences or businesses, SANBAG shall provide relocation assistance to residential and business tenants prior to the start of construction.	Final design	Entire Project	SANBAG	None	
Transportation					
TR-1: Prepare a Traffic Management Plan. SANBAG shall prepare a Traffic Management Plan prior to the start of construction, and the provisions of the Traffic Management Plan shall be implemented prior to, and during construction, as appropriate, to address traffic considerations of pedestrian and bicycle access and safety, and vehicular flow. The objective of the Traffic Management Plan will be to reduce construction related effects to traffic, non-motorized forms of transportation (e.g., bicycle and pedestrians), and existing public transit (e.g., buses) and will include the following: <ul style="list-style-type: none"> • Construction detour plans and designated construction truck access routes for each phase of construction; • Maintain maximum travel lane capacity to the greatest extent possible during construction periods and provide advanced notice to drivers or roadway changes or closures; 	Prior to and during construction	Entire Project	SANBAG	Cities of San Bernardino and Redlands	



Table 1. MMRP Mitigation Measures

Mitigation Measure	Timing	Applicable Project Location/ Feature	Primary Responsible Party	Secondary Responsible Party	Verification
<ul style="list-style-type: none"> • Signage indicating the construction limits, access routes, and entrances to individual business sites and community facilities that may be affected by construction activities. In addition, the construction contractor would supply “open for business” signs to encourage normal business activity during construction; • Pre-planning, outreach, and signage indicating pedestrian and bicycle routes detours; • Coordination with public transit service providers, as necessary; • Heavy trucks and other construction transport vehicles shall avoid the busiest commute hours to the greatest extent possible (weekdays 7 a.m. to 8 a.m. and 5 p.m. to 6 p.m. – High traffic intersections (Greater than 10,000 ADT) – 6:30 a.m. to 8:30 a.m. and 4:30 p.m. to 6:30 p.m.); • Early notification to emergency service providers and area drivers of any road closures or detours and the timeframes of the closures or detours. This information will be posted in a local newspaper, via SANBAG’s web site and will be updated on a monthly basis; • Coordination with the Cities of San Bernardino, Loma Linda, and Redlands for community events in the area to accommodate crowds and road closures; • Pavement damage resulting from project construction will be repaired prior to the completion of construction; and • SANBAG shall maximize opportunities for coordinated construction and installation of 					

Table 1. MMRP Mitigation Measures

Mitigation Measure	Timing	Applicable Project Location/ Feature	Primary Responsible Party	Secondary Responsible Party	Verification
improvements that occurs outside the SANBAG ROW with the Cities of San Bernardino, Loma Linda, and Redlands to the greatest extent practical.					
<p>TR-2: Existing LOS and V/C Year 2018 and 2038 Impact Roadway Improvements. As part of the Project construction, SANBAG shall coordinate with the appropriate agency in which the intersection improvement is located (Cities of San Bernardino, Loma Linda, Redlands, or Caltrans) to pay SANBAG’s “fair share” of the identified roadway improvements prior to the start of operations of the Project in 2018:</p> <ul style="list-style-type: none"> California Street and I-10 Eastbound Off-Ramp – SANBAG shall coordinate with Caltrans to fund its fair share of construction for a ramp improvement to include a right-turn pocket. The existing right-turn lane will become a shared right-turn lane to accommodate the high number of right turns. <u>The improvements will include replacing existing pedestrian and bicycle facilities, where present.</u> <p>SANBAG shall provide its fair share for the funding of the following improvements prior to the year 2038:</p> <ul style="list-style-type: none"> California Street and I-10 West On-Ramp – SANBAG shall coordinate with Caltrans to fund its fair share to the construction of a dual southbound right and a dual northbound left turn pocket. <u>The improvements will include replacing existing pedestrian and bicycle facilities, where present.</u> Alabama Street and Industrial Avenue – SANBAG shall coordinate with the City of Redlands to stripe an exclusive westbound right turn lane with 50-feet of storage to accommodate a high number of right turns. <u>The improvements will include</u> 	<p>Prior to the start of operations (2038 improvements will be evaluated at 5-year increments following 2018)</p>	<p>Roadway improvements</p>	<p>SANBAG</p>	<p>Cities of San Bernardino and Redlands; Caltrans</p>	



Table 1. MMRP Mitigation Measures

Mitigation Measure	Timing	Applicable Project Location/ Feature	Primary Responsible Party	Secondary Responsible Party	Verification
<u>replacing existing pedestrian and bicycle facilities, where present.</u>					
TR-3: Approval from CPUC for Grade Crossings and Safety Measures. SANBAG shall coordinate with the CPUC prior to the start of construction for re-design and/or closure of all grade crossings to ensure that all grade crossings and safety improvements comply with CPUC standards. SANBAG shall provide verification to the CPUC that all rail safety measures identified in the hazard analysis as part of the "formal application" or "GO 88-B" authorization" from CPUC have been installed.	Final design and post-construction	Grade Crossings	SANBAG	CPUC	
TR-4: Recommended Pre-Signals for Queuing. Prior to the start of operations, pre-signals shall be implemented at the following grade crossing locations and shall be operational prior to the start of 2018: <ul style="list-style-type: none"> • Eastbound I-10 Ramps and California Street crossing; • Industrial Park Avenue and Alabama Street crossing; and • Redlands Boulevard and Tennessee Street crossing. Prior to 2038 and if warranted based on future intersection operations (as determined through reevaluation in 5-year increments by SANBAG following procedures in the Los Angeles Metropolitan Transportation Authority (MTA) Grade Crossing Policy for Light Rail Transit), pre-signals will be implemented at the following grade crossing locations: <ul style="list-style-type: none"> • Waterman Avenue and Orange Show Road Crossing (Northbound Approach); • Orange Show Road and Waterman Avenue Crossing (Eastbound Approach); 	Prior to the start of operations (2038 improvements will be evaluated at 5-year increments following 2018)	Grade Crossings	SANBAG	CPUC, Cities of San Bernardino and Redlands	



Table 1. MMRP Mitigation Measures

Mitigation Measure	Timing	Applicable Project Location/ Feature	Primary Responsible Party	Secondary Responsible Party	Verification
<ul style="list-style-type: none"> Redlands Boulevard and California Street Crossing; and Redlands Boulevard and Alabama Street Crossing. 					
<p>TR-5: Transit Operations Realignment. SANBAG will work with affected transit service providers as part of their service realignment process (or major service change) to maximize transit efficiencies offered by interfacing existing transit service with Project operations. SANBAG shall develop a transit integration plan in coordination with local transit service providers to establish a framework for service integration. The plan shall, at a minimum, include an approach or strategy for coordinating existing transit scheduling with proposed train operations, maximizing route interfaces with the proposed station locations, and optimizing existing transit routes to minimize duplication in service.</p>	Prior to the start of operations	Project station stops	SANBAG	Omnitrans	
Visual Quality and Aesthetics					
<p>VQA-1: Screening of Construction Staging Areas. For construction staging areas within 500 feet of a residence, park, or educational facility, the contractor will be required to shield the staging area to the extent feasible and coordinate with the local jurisdiction regarding the type and method of screening, which may include but is not limited to, the use of fence slats, netting, or mesh or tarps. SANBAG shall limit construction to daylight hours to the extent possible. If nighttime lighting or construction is necessary, the SANBAG shall ensure that unshielded lights, reflectors, or spotlights are not located and directed to shine toward or be directly visible from adjacent properties or streets. To the extent possible, SANBAG shall minimize the use of nighttime construction lighting within 500 feet of existing residences. This measure shall be identified on grading plans and in construction contracts.</p>	Prior to and during construction	Entire Project	SANBAG	Cities of San Bernardino and Redlands	



Table 1. MMRP Mitigation Measures

Mitigation Measure	Timing	Applicable Project Location/ Feature	Primary Responsible Party	Secondary Responsible Party	Verification
<p>VQA-2: Enhance Exterior Appearance of Structural Facilities. The external appearance of the stations and layover facility, including the choice of color and materials, shall seek to reduce the visual impact of these facilities on adjacent land uses. Bright reflective materials and colors shall be avoided. As appropriate, the exterior design of these facilities should follow design guidelines provided in applicable land use plans. Minimum exterior design requirements shall include, but are not limited to, the following:</p> <ul style="list-style-type: none"> • Painting (with earth-colored tones) of structural façades to blend with surrounding land uses; • Maximize the use of textured or other non-reflective exterior surfaces and non-reflective glass to prevent glare; • Use of fencing or structural materials, shall be similar to those used by nearby land uses and compatible with surrounding architecture; • Development of a landscaping plan for each station and layover facility site that uses a combination of locally derived native vegetation, earthen features (e.g., boulders), and, if appropriate, topographical separations (e.g., berms) to maximize site appearance and shield the new facilities from nearby sensitive receptors to the extent feasible; and • Clustering of structural facilities to maximize open space buffering. <p>SANBAG shall coordinate final design plans with the Cities of San Bernardino and Redlands prior to final approval.</p>	Final design	Stations	SANBAG	Cities of San Bernardino and Redlands	



Table 1. MMRP Mitigation Measures

Mitigation Measure	Timing	Applicable Project Location/ Feature	Primary Responsible Party	Secondary Responsible Party	Verification
VQA-3: Tree Replacement. Prior to construction, SANBAG shall have a registered arborist conduct a tree survey to identify native and ornamental trees requiring removal outside SANBAG's ROW. The arborist will identify measures to avoid and minimize indirect impacts on trees, where feasible, and develop a plan for the replacement of trees that cannot be avoided. The plan will include planting and irrigation design details and a weaning schedule for the establishment period. Trees with a diameter at breast height of 6 inches or greater will be replaced at a minimum ratios of 1:1 and consistent with City of Redlands and San Bernardino standards.	Prior to construction	Entire Project	SANBAG	Cities of San Bernardino and Redlands	
VQA-4: Sound Barrier Screening and Surface Treatments. To reduce effects associated with the sound walls, where SANBAG ROW widths allow, drought tolerant landscaping (i.e., trees, vines, and/or shrubs) shall be provided. If the SANBAG ROW width is insufficient to permit landscaping or if landscaping cannot adequately reduce visual impacts, surface treatments that are compatible with surrounding architecture shall be applied to the outside of the sound walls (residential or school facing side). Architectural detailing such as pilasters, wall caps, interesting block patterns, and offset wall layouts shall be used to add visual interest and reduce apparent height of the walls. SANBAG shall coordinate the final design plans with the Cities of San Bernardino and Redlands, as applicable, prior to final approval.	Final design (if constructed)	Sound wall locations	SANBAG	Cities of San Bernardino and Redlands	
VQA-5: Minimize Exterior Lighting in Adjacent Uses. To prevent unintended spillover of lighting, lighting fixtures constructed or relocated as part of the Project shall be oriented and focused onto the specific on-site location intended for illumination (e.g., parking lots) and shielded	Final design	Stations and Layover Facility	SANBAG	Cities of San Bernardino and Redlands	

Table 1. MMRP Mitigation Measures

Mitigation Measure	Timing	Applicable Project Location/ Feature	Primary Responsible Party	Secondary Responsible Party	Verification
<p>away from adjacent sensitive uses (e.g., schools, residential properties) and public rights of way to minimize light spillover onto off-site areas. New driveways shall be located and oriented into parking lots, to the extent feasible, in a manner that will not result in headlights from vehicles entering or exiting the parking areas oriented directly at off-site sensitive uses. SANBAG shall coordinate the final design plans with the Cities of San Bernardino and Redlands, as applicable, prior to final approval.</p>					
Noise and Vibration					
<p>NV-1: Employ Noise-Reducing Measures during Construction. SANBAG shall require its construction contractors to employ measures to minimize and reduce construction noise. Noise reduction measures that shall be implemented to reduce construction noise to acceptable levels may include but are not limited to the following:</p> <ul style="list-style-type: none"> • Use available noise suppression devices and techniques, including: <ul style="list-style-type: none"> - Equipping all internal combustion engine-driven equipment with mufflers, air-inlet silencers, and any other shrouds, shields, or other noise-reducing features that are in good operating condition and appropriate for the equipment (5 to 10 dB reduction possible). - Using “quiet” models of air compressors and other stationary noise sources where such technology exists. - Using electrically powered equipment instead of pneumatic or internal combustion-powered equipment, where feasible. 	During Construction	Entire Project	SANBAG	Cities of San Bernardino and Redlands	



Table 1. MMRP Mitigation Measures

Mitigation Measure	Timing	Applicable Project Location/ Feature	Primary Responsible Party	Secondary Responsible Party	Verification
<ul style="list-style-type: none"> - Using noise-producing signals, including horns, whistles, alarms, and bells, for safety-warning purposes only. - Locating stationary noise-generating equipment, construction parking, and maintenance areas as far as reasonable from sensitive receivers when sensitive receivers adjoin or are near the construction Project APE. - Prohibiting unnecessary idling of internal combustion engines (i.e., in excess of 5 minutes). - Placing temporary soundwalls or enclosures around stationary noise-generating equipment when located near noise-sensitive areas (5 to 15 decibel reduction possible). - Ensuring that project-related public address or music systems are not audible at any adjacent receiver. - Notifying adjacent residents in advance of construction work. 					
<p>NV-2: Prepare a Community Notification Plan for Project Construction. The construction contractor shall prepare and maintain a community notification plan to address project construction issues the community may have during construction. Components of the plan may include construction phasing to minimize the duration of noise or vibration at any one location. Initial information packets shall be prepared and mailed to all residences within a 500-foot radius of project construction, with updates prepared as necessary to indicate new scheduling or processes. A project liaison shall be identified who will be available to</p>	<p>Prior to and during construction</p>	<p>Entire Project</p>	<p>SANBAG</p>	<p>Cities of San Bernardino and Redlands</p>	



Table 1. MMRP Mitigation Measures

Mitigation Measure	Timing	Applicable Project Location/ Feature	Primary Responsible Party	Secondary Responsible Party	Verification
respond to questions from the community or other interested groups.					
<p>NV-3: Establish Quiet Zones. At-grade crossings shall be designed and constructed to be compatible with the formation of Quiet Zones. Prior to the operation, SANBAG shall coordinate with the City of San Bernardino, City of Loma Linda, and the City of Redlands, to construct and establish quiet zones at the following grade crossings:</p> <ul style="list-style-type: none"> • South Arrowhead Avenue; • South Sierra Way; • West Central Avenue; • East Orange Show Road; • South Waterman Avenue; • South Tippecanoe Avenue; • South Richardson Street; • Mountain View Avenue; • West Colton Avenue; • Alabama Street • Tennessee Street; • Church Street; and • North University Street 	Prior to operation	Grade Crossing Locations	SANBAG	Cities of San Bernardino and Redlands; CPUC; FRA	
<p>NV-4: Construct Sound Barriers. SANBAG shall install up to 12-foot in height sound barriers at priority locations along portions of the rail corridor to reduce noise levels at receivers identified with severe noise impacts following the application of quiet zones.</p>	During construction (if required in the absence of quiet zones)	See Figures 8-2A through G (without quiet zones) and 8-3A-F) of the Noise and Vibration TM (October 2014)– See Appendix H of the Final EIS/EIR)	SANBAG	None	



Table 1. MMRP Mitigation Measures

Mitigation Measure	Timing	Applicable Project Location/ Feature	Primary Responsible Party	Secondary Responsible Party	Verification
NV-5: Wayside Rail Lubrication. SANBAG shall install wayside applicators for all tight-radius curves on the project alignment prior to the start of Project operations. If the wayside applicators are not sufficient to reduce squeal to an acceptable level, additional reduction may be required through customized profiling of the rail to reduce the forces required for trains to negotiate the curve.	Final design and post-construction	All tight-radius curve locations on the project alignment	SANBAG	None	
NV-6: Use Ballast Mats, Resiliently Supported Ties, or Measures of Comparable Effectiveness on Portions of the Rail near Sensitive Receivers. SANBAG shall install track design specifications as part of project design to include the use of ballast mats or resiliently supported ties on portions of the track near sensitive receivers to minimize project-related ground-borne vibration and wheel rail noise generated when the trains pass sensitive receivers. The actual measures and their corresponding placement will be determined following more detailed vibration testing and analysis during final engineering design.	Final design and post-construction	Entire Project	SANBAG	None	
NV-7: Provide Building Noise Insulation to Severe- and Moderate-Impact Residences. For the ten residential structures represented by Receivers 3, 22, and 41, SANBAG will offer to install sound insulation. Treatments may include sealing and relocating vents, caulking and sealing gaps in the building façade and installing new doors and windows that are specially designed to meet acoustical transmission-loss requirements. Acoustical performance ratings are published in terms of Sound Transmission Class (STC) for these special windows. A minimum STC rating of 39 will be used on any window exposed to the noise source.	Final design and during construction	Applicable Receivers	SANBAG	None	



Table 1. MMRP Mitigation Measures

Mitigation Measure	Timing	Applicable Project Location/ Feature	Primary Responsible Party	Secondary Responsible Party	Verification
Biological and Wetland Resources					
BIO-1: Pre-Construction Survey - Conduct Preconstruction Survey for Special Status Plants and Wildlife and, if Found, Implement Avoidance and Compensation Measures. Prior to construction, a qualified biologist retained by SANBAG shall conduct pre-construction surveys for special status plant species including woolly star, slender-horned spinyflower, smooth tarplant, and salt spring checkerbloom. Pre-construction surveys will also be required for special status wildlife species including least Bell's vireo, southwestern willow flycatcher, San Bernardino kangaroo rat, yellow-billed cuckoo, burrowing owl, and western spadefoot toad to verify presence or absence in the Project area. If one or more species are detected, then SANBAG shall consult with the USFWS (or CDFW if appropriate) to develop additional minimization measures prior to project construction (if necessary). These additional measures may include construction timing restrictions and/or construction monitoring.	Prior to and during construction	Entire Project	SANBAG	U. S. Fish and Wildlife Service (USFWS) and California Department of Fish and Wildlife (CDFW)	
BIO-2: Least Bells Vireo (LBV). The following measures will be implemented to minimize direct and indirect impacts to LBV during construction: <ul style="list-style-type: none"> a. Impacts associated with clearing and grubbing of Southern Cottonwood Willow Riparian Forest (SCWRF) and Southern Willow Scrub (SWS) will be timed to avoid the breeding season of the least Bell's vireo (March 15 to September 15), unless SANBAG provides survey documentation to USFWS that confirms the riparian habitat is not occupied by LBV. b. Temporary impact areas will be restored to pre-grade contours following bridge construction. 	Prior to and during construction	Mile Posts 3.3 to 4 (only)	SANBAG	USFWS	



Table 1. MMRP Mitigation Measures

Mitigation Measure	Timing	Applicable Project Location/ Feature	Primary Responsible Party	Secondary Responsible Party	Verification
<p>Natural recruitment is anticipated to occur rapidly due to the large amount of intact native riparian habitat that will remain as a seed source. Additionally, the riparian habitat being impacted is adapted to frequent disturbance. The individual species making up the community tend to have large quantities of seeds and very rapid growth that promote rapid re-establishment. Container planting and seeding has not been proposed due to potential conflicts with County Flood Control Maintenance requirements, high risk of plant material being washed out during subsequent storm events and potential conflicts with future Santa Ana River Trail construction. For erosion control purposes, temporarily impacted areas outside of the active floodplain will be hydroseeded with native grasses and shrubs.</p> <p>i. The temporarily impacted SCWRF and SWS habitat will be monitored annually for five years, until LBV is documented using the re-established habitat or until habitat attains 80 percent cover including both shrub and overstory stratum. If recruitment of SCWRF and SWS species is not evident within two years of project construction or habitat has not attained 60 percent cover within three years, impacts will be treated as permanent and additional mitigation for areas not meeting success criteria shall be provided through in-lieu fee payment to an appropriate mitigation bank for enhancement, restoration or establishment of LBV habitat at a ratio of 1:1.</p>					



Table 1. MMRP Mitigation Measures

Mitigation Measure	Timing	Applicable Project Location/ Feature	Primary Responsible Party	Secondary Responsible Party	Verification
<p>ii. Temporary direct impacts to potentially suitable LBV habitat will be mitigated as follows: The temporal loss of occupied LBV habitat resulting from temporary removal of SCWRF associated with the Mission Zanja Channel shall be mitigated through in-lieu fee payment to an appropriate mitigation bank for enhancement, restoration or establishment of LBV habitat at a ratio of 3:1. The temporal loss of suitable unoccupied LBV habitat resulting from temporary removal of SCWRF and SWS shall be mitigated through in-lieu fee payment to an appropriate mitigation bank for enhancement, restoration or establishment of LBV habitat at a ratio of 2:1.</p> <p>c. Permanent direct impacts to occupied LBV habitat (SCWRF) shall be mitigated at a ratio of 3:1 through in-lieu fee payment to an appropriate mitigation bank for enhancement, restoration and/or creation of LBV habitat within the Santa Ana River watershed.</p> <p>d. If active LBV nests are identified during pre-construction surveys and noise levels at the nest exceed 60 dBA Leq, noise attenuation structures will be placed or other noise attenuation measures (e.g., reducing the number of construction vehicles or using different types of construction vehicles) will be implemented to reduce noise levels at the nest to 60 dBA Leq (or ambient noise level if greater than 60 dBA Leq). During construction adjacent to these areas, noise monitoring shall occur during the LBV</p>					

Table 1. MMRP Mitigation Measures

Mitigation Measure	Timing	Applicable Project Location/ Feature	Primary Responsible Party	Secondary Responsible Party	Verification
breeding season and be reported daily to USFWS. Construction activities that create noise in excess of the aforementioned levels will cease operation until effective noise attenuation measures are in place to the extent practicable.					
BIO-3: MBTA Covered Species. Prior to habitat removal during the avian breeding season (February 15-August 31), a qualified biologist shall conduct a pre-construction nest survey (in suitable areas) no more than 3 days prior to ground disturbing activities for migratory birds. Pre-construction surveys will be preformed year-round between MP 3.3 and 4.0 with the timing and implementation done in coordination with the CDFW and USFWS. Should an active nest of any MBTA covered species occur within or adjacent to the project impact area, a 100-foot buffer (300 feet for raptors) shall be established around the nest and no construction shall occur within this area until a qualified biologist determines the nest is no longer active or the young have fledged.	Prior to and during construction	Mile Posts 3.3 to 4 (only)	SANBAG	USFWS	
BIO-4: Protection of Sensitive Plants and Habitats. SANBAG shall require the construction contractor to implement the following measures to protect sensitive plants and habitats during project-related construction. <ul style="list-style-type: none"> SANBAG shall designate an approved biologist (project biologist) who will be responsible for overseeing compliance with protective measures for the biological resources during clearing and work activities within and adjacent to areas of native habitat. The project biologist will be familiar with the local habitats, plants, and wildlife and maintain communications with the contractor to ensure that issues relating to biological resources are 	Prior to and during construction	Mile Post 3.3 to 4	SANBAG	USFWS and CDFW	



Table 1. MMRP Mitigation Measures

Mitigation Measure	Timing	Applicable Project Location/ Feature	Primary Responsible Party	Secondary Responsible Party	Verification
<p>appropriately and lawfully managed. The project biologist will review final plans, designate areas that need temporary fencing, and monitor construction. The biologist will monitor activities within designated areas during critical times such as vegetation removal, the installation of Best Management Practices (BMPs) and fencing to protect native species, and ensure that all avoidance and minimization measures are properly constructed and followed.</p> <ul style="list-style-type: none"> Project employees and contractors that will be on-site shall complete environmental worker-awareness training conducted by the project biologist. The training will advise workers of potential impacts to the sensitive habitat and listed species and the potential penalties for impacts to such habitat and species. At a minimum, the program will include the following topics: occurrences of the listed species and sensitive vegetation communities in the area, a physical description and their general ecology, sensitivity of the species to human activities, legal protection afforded these species, penalties for violations of Federal and State laws, reporting requirements, and work features designed to reduce the impacts to these species; and to the extent practicable, promote continued successful occupation of areas adjacent to the work footprint. Included in this program will be color photos of the listed species, which will be shown to the employees. Following the education program, the photos will be posted in the contractor and resident engineer's office, where they will remain through the duration of 					



Table 1. MMRP Mitigation Measures

Mitigation Measure	Timing	Applicable Project Location/ Feature	Primary Responsible Party	Secondary Responsible Party	Verification
<p>the work. Photos of the habitat in which sensitive species are found will also be posted on-site. The contractor will be required to provide SANBAG with evidence of the employee training (e.g., sign in sheet or stickers) upon request. Employees and contractors will be instructed to immediately notify the project biologist of any incidents, such as construction vehicles that move outside of the work area boundary. The project biologist will be responsible for notifying the USFWS within 72 hours of any similar incident.</p> <ul style="list-style-type: none"> • Prior to construction, SANBAG shall delineate the construction area (including staging and laydown areas) between Mile Posts 3.3 and 4.0 and erect exclusionary construction fencing along the perimeter of the identified construction area to protect adjacent sensitive habitats (SWS, SCWRF, RAFSS, and Santa Ana woolly star). Limits of the exclusionary fencing shall be confirmed by the project biologist prior to habitat clearing. Exclusionary fencing shall be maintained throughout the duration of construction work from Mile Posts 3.3 to 4.0. Exclusionary fencing can be removed at the conclusion of construction work as approved by the project biologist. <p>All construction-related vehicles and equipment storage shall occur in the construction area and/or previously disturbed areas as approved by the project biologist. Project-related vehicle traffic shall be restricted to established access roads, construction areas, storage areas, and staging and parking areas.</p>					



Table 1. MMRP Mitigation Measures

Mitigation Measure	Timing	Applicable Project Location/ Feature	Primary Responsible Party	Secondary Responsible Party	Verification
<p>If construction activity extends beyond the exclusionary fencing into sensitive vegetation communities, areas of disturbance shall be quantified and an appropriate restoration approach shall be developed in consultation with USFWS and CDFW. For example, if construction extends beyond the limits of the exclusionary fencing, temporarily disturbed areas shall be restored to the natural (preconstruction) conditions, which may include the following: salvage and stockpiling of topsoil, re-grading of disturbed sites with salvaged topsoil, and re-vegetation with native locally available species.</p>					
<p>BIO-5: Burrowing Owl. SANBAG will conduct take avoidance (pre-construction) surveys for burrowing owl within 30 days prior to initiating ground disturbance activities. These surveys will be completed in no less than 14 days prior to construction. If burrowing owl is identified, the following shall apply:</p> <ul style="list-style-type: none"> • If burrowing owl is identified during the breeding season (February 1 through August 31) then an appropriate buffer will be established by the biological monitor in accordance with the 2012 Staff Report on Burrowing Owl Mitigation (CDFW 2012). Construction within the buffer will be avoided until a qualified biologist determines that burrowing owl is no longer present or until young have fledged and a CDFW-approved exclusion plan has been implemented. In addition to avoidance of the occupied habitat, off-site mitigation will be provided as described below: <ul style="list-style-type: none"> - Replacement of occupied habitat with occupied habitat: 1.5 times 6.5 (9.75) acres per pair or single bird. 	<p>Prior to construction</p>	<p>Entire Project</p>	<p>SANBAG</p>	<p>CDFW</p>	

Table 1. MMRP Mitigation Measures

Mitigation Measure	Timing	Applicable Project Location/ Feature	Primary Responsible Party	Secondary Responsible Party	Verification
<ul style="list-style-type: none"> - Replacement of occupied habitat with habitat contiguous to currently occupied habitat: 2 times 6.5 (13.0) acres per pair or single bird. - Replacement of occupied habitat with suitable unoccupied habitat: 3 times 6.5 (19.5) acres per pair or single bird. • If burrowing owl is identified during the non-breeding season (September 1 through January 31), then a 50 meter buffer will be established by the biological monitor. Construction within the buffer will be avoided until a qualified biologist determines that burrowing owl is no longer present or until a CDFW-approved exclusion plan has been implemented. 					
<p>BIO-6: Secure Clean Water Act (CWA) Section 404 Permit and Implement All Permit Conditions to Ensure No Net Loss of Functions of Wetlands, Other Waters of the U.S., and Waters of the State). Before the approval of grading or other ground disturbing activities within 50 feet of jurisdictional areas, SANBAG shall obtain a CWA Section 404 permit, Section 401 water quality certification, and CDFW 1602 Streambed Alteration Agreement.</p> <p>As part of the Section 404 permitting process, if the USACE (and/or CDFW) requires compensatory mitigation, a draft wetland mitigation and monitoring plan (MMP) shall be developed for the selected Build Alternative. The MMP shall be consistent with USACE's and EPA's April 10, 2008 Final Rule for Comp Compensatory Mitigation for Losses of Aquatic Resources (33 CFR Parts 325 and 332 and 40 CFR Part 230).</p> <p>Potential mitigation for impacts to federal and state jurisdictional areas may occur at the following ratios:</p>	Prior to construction	Warm Creek (Historic), Twin Creek, Santa Ana River, Mission Zanja Channel, and Mill Creek Zanja	SANBAG	U. S. Army Corps of Engineers (USACE), Los Angeles District, CDFW, and Regional Water Quality Control Board (RWQCB), Santa Ana Region	



Table 1. MMRP Mitigation Measures

Mitigation Measure	Timing	Applicable Project Location/ Feature	Primary Responsible Party	Secondary Responsible Party	Verification
<ul style="list-style-type: none"> • USACE Wetland <ul style="list-style-type: none"> - Permanent: 3:1 - Temporary: restoration (in-kind) • USACE Waters <ul style="list-style-type: none"> - Permanent: 1:1 - Temporary: restoration (in-kind) • CDFW Riparian <ul style="list-style-type: none"> - Permanent: 3:1 (SWS, RAFSS, and SCWRF) - Permanent: 1:1 (unvegetated stream bank) - Temporary: restoration (in-kind) 					
<p>BIO-7. Reseeding for Woolly Star. Seeds from the closest known occurrences of woolly-star plants found both upstream and downstream of Bridge 3.4 shall be collected in the fall prior to construction of the SAR crossing. If construction activities require the loss of the single woolly-star at the SAR crossing, the collected seeds will be broadcast in the temporary impact areas, near the impacted woolly-star plant, after construction activities are complete and soils have been restored to pre-Project contours.</p> <ol style="list-style-type: none"> 1. Seed collection and broadcast methodologies will be proposed by a qualified seed collector approved by the Service prior to seed collection in a Santa Ana Woolly-Star Management Plan. 2. Seed harvest shall be from a minimum of three plants per collection location, limited to no more than 50 percent of the available seeds from any one woolly-star plant. 3. Seeds shall be held at the appropriate temperature and humidity for the shortest length of time necessary prior to planting. 	Prior to, during, and following construction	Mile Posts 3.4 to 4	SANBAG	CDFW	



Table 1. MMRP Mitigation Measures

Mitigation Measure	Timing	Applicable Project Location/ Feature	Primary Responsible Party	Secondary Responsible Party	Verification
<p>4. Planting of seeds shall be coordinated to occur prior to the first rains of the season, typically during early fall.</p> <p>5. If the woolly-star plant known in the Project area is avoided, collected seeds will be hand broadcast near the parental plants where they were collected.</p> <p>If SANBAG confirms that removal of the one individual is required during final design, SANBAG will purchase ILF or mitigation credits from a qualified mitigation program to address the Project's temporal affect on woolly-star during the up to three-year construction period. Credits will be purchased to cover affects to the on-site individual and off-site parental plants.</p>					
<i>Floodplains, Hydrology, and Water Quality</i>					
<p>HWQ-1: Prepare Drainage Plan(s) for Structural Facilities. SANBAG shall prepare a site specific Drainage Plan for all major structural facilities constructed in conjunction with the Project, including stations and parking areas, track improvements, and the proposed layover facility. The Final Drainage Plan shall incorporate measures to maintain on-site runoff during peak conditions to pre-construction discharge levels. Design specifications for the detention and/or infiltration facilities shall provide sufficient temporary storage capacity to attenuate runoff to pre-Project conditions. These improvements will be coordinated with the applicable jurisdictions, including the Cities of Redlands and San Bernardino and the SBCFCD, as appropriate.</p>	Final design	Entire Project	SANBAG	Cities of San Bernardino and Redlands, and the SBCFCD	
<p>HWQ-2: Prepare and Implement a SWPPP. The construction contractor will develop a SWPPP that complies with the requirements of the NPDES General Construction Permit (Order 2009-0009-DWQ as amended by Order No. 2010-0014-DWQ and 2012-0006-DWQ) for Risk Level 2</p>	Final design, during construction, and post-construction	Entire Project	SANBAG	RWQCB	



Table 1. MMRP Mitigation Measures

Mitigation Measure	Timing	Applicable Project Location/ Feature	Primary Responsible Party	Secondary Responsible Party	Verification
<p>projects and implement the BMPs described in the SWPPP. The SWPPP shall identify specific actions and BMPs relating to the prevention of stormwater pollution from project-related construction sources by identifying a practical sequence for site restoration, BMP implementation, contingency measures, responsible parties, and agency contacts. The SWPPP shall reflect localized surface hydrological conditions and shall be reviewed and approved by SANBAG prior to commencement of work and shall be made conditions of the contract with the contractor.</p> <p>The SWPPP shall be prepared by a qualified SWPPP developer with BMPs selected to achieve maximum pollutant removal and that represent the best available technology that is economically achievable. Emphasis for BMPs shall be placed on controlling discharges of oxygen-depleting substances, floating material, oil and grease, acidic or caustic substances or compounds, and turbidity. BMPs for soil stabilization and erosion control practices and sediment control practices will also be required. Performance and effectiveness of these BMPs shall be determined either by visual means where applicable (i.e., observation of above-normal sediment release), or by actual water sampling in cases where verification of contaminant reduction or elimination, (inadvertent petroleum release) is required to determine adequacy of the measure.</p> <p>Following construction, SANBAG will ensure the provision of sufficient drainage inlet and outlet protection through the use of energy dissipaters, vegetated riprap, and/or other appropriate BMPs to slow runoff velocities and prevent erosion at discharge locations from the rail station and parking areas.</p>					



Table 1. MMRP Mitigation Measures

Mitigation Measure	Timing	Applicable Project Location/ Feature	Primary Responsible Party	Secondary Responsible Party	Verification
HWQ-3: Prepare and Implement a Flow Diversion Plan for Construction. SANBAG or SANBAG's construction contractor shall develop a Flow Diversion Plan(s) for in-channel construction activities proposed within Warm Creek (Historic)(Bridge 1.1); Twin Creek (Bridge 2.2), SAR (Bridge 3.4), Zanja Channel (Bridges 3.9, and 5.8, and bank improvements), and Mill Creek Zanja (Bridge 9.4). SANBAG's contractor shall incorporate measures to minimize changes to flood flow elevation(s) during construction, address accumulation of floating debris, provide measures that minimize sedimentation to surface waters, and include contingency measures in the event of substantial rainfall.	During construction	Warm Creek (Historic)(Bridge 1.1); Twin Creek (Bridge 2.2), SAR (Bridge 3.4), Zanja Channel (Bridges 3.9, and 5.8, and bank improvements), and Mill Creek Zanja (Bridge 9.4).	SANBAG		
HWQ-4: Prepare a Natural Hazard Management Plan. SANBAG shall develop a Natural Hazard Management Plan for the Project. The Natural Hazard Management Plan will include a flood monitoring and evacuation plan for all Project infrastructure located within a delineated 100-year flood zone based on the most recent FEMA mapping. The Plan shall include protocols and procedures for emergency response in the event of a flood, the investigation and repair of track, station, and bridge facilities following inundation, and the provision of interim transit until Project operations resume.	Prior to operation	Entire Project	SANBAG	None	
HWQ-5: Flood-Proofing of Critical Infrastructure. Where feasible, stations and building pads for the proposed train layover facility shall be designed such that the finished floor elevation will be one-foot above the base 100-year flood elevation, where established.	Final design	Stations at Downtown Redlands and University Street	SANBAG	None	
HWQ-6: Incorporate Post-Construction Runoff BMPs into Project Drainage Plan, Final WQMP, and Industrial SWPPP. The Project Drainage Plan, Final WQMP, and the	Final design and post-construction	Entire Project	SANBAG	None	



Table 1. MMRP Mitigation Measures

Mitigation Measure	Timing	Applicable Project Location/ Feature	Primary Responsible Party	Secondary Responsible Party	Verification
<p>NPDES Industrial SWPPP shall demonstrate treatment, control, and management of the on- and off-site discharge of stormwater to existing drainage systems or drainage features. The final Drainage Plan shall provide both short- and long-term drainage solutions to ensure the proper sequencing of drainage facilities and the final WQMP will ensure sufficient treatment of runoff generated from Project impervious surfaces prior to off-site discharge.</p> <p>SANBAG shall ensure the provision of sufficient outlet protection through the use of energy dissipaters, vegetated rip-rap, soil protection, and/or other appropriate BMPs to slow runoff velocities and prevent erosion at discharge locations for the station platforms, parking areas, and layover facility. A long-term maintenance plan shall be developed and implemented to support the functionality of drainage control devices. The layover facility layout(s) shall also include sufficient container storage and on-site containment and pollution-control devices for drainage facilities to avoid the off-site release of water quality pollutants, including, but not limited to oil and grease, fertilizers, treatment chemicals, and sediment. These measures shall be reflected in the final Industrial SWPPP and WQMP for applicable facilities. The NPDES Industrial SWPPP shall incorporate required maintenance practices and housekeeping to maximize the long-term effectiveness of post-construction BMPs.</p>					
Geology, Soils, and Seismicity					
<p>GEO-1: Prepare Final Geotechnical Report for the Project and Implement Recommended Measures. Facility design for all Project components shall comply with the site-specific design recommendations as provided by a licensed geotechnical or civil engineer to be retained by SANBAG.</p>	Design, prior to and post-construction	Entire Project	SANBAG	None	



Table 1. MMRP Mitigation Measures

Mitigation Measure	Timing	Applicable Project Location/ Feature	Primary Responsible Party	Secondary Responsible Party	Verification
<p>The final geotechnical and/or civil engineering report shall address and make recommendations on the following:</p> <ul style="list-style-type: none"> • Site preparation; • Soil bearing capacity; • Appropriate sources and types of fill; • Liquefaction; • Lateral spreading; • Settlement; • Landslides (with emphasis on improvements that border the Mission Zanja Flood Control Channel); • Hydroconsolidation; • Compressible/Collapsible soils; • Corrosive soils; • Structural foundations; and • Grading practices. <p>In addition to the recommendations for the conditions listed above, the geotechnical report shall include subsurface testing of soil and groundwater conditions, and shall determine appropriate foundation designs that are consistent with the latest version of the CBC, as applicable at the time building and grading permits are pursued. All recommendations contained in the final geotechnical engineering report shall be implemented by SANBAG.</p>					
Hazardous Waste and Materials					
<p>HAZ-1: Prepare and Implement a Construction Hazardous Materials Management Plan and Operational Hazardous Materials Business Plan. Prior to operation, SANBAG shall prepare and implement a Hazardous Materials Management Plan (HMMP) and Hazardous</p>	<p>Prior to construction (HMMP) and operation (HMBP)</p>	<p>Entire Project</p>	<p>SANBAG</p>	<p>None</p>	



Table 1. MMRP Mitigation Measures

Mitigation Measure	Timing	Applicable Project Location/ Feature	Primary Responsible Party	Secondary Responsible Party	Verification
<p>Materials Business Plan (HMBP) for the Project. The HMMP shall provide for safe storage, containment, and disposal of chemicals and hazardous materials related to Project construction, including the proper disposal of waste materials. The HMBP will provide for safe storage, containment, and disposal of chemicals and hazardous materials related to Project operations. The HMMP and HMBP shall include, but shall not be limited to, the following:</p> <ul style="list-style-type: none"> • A description of hazardous materials and hazardous wastes used; • A description of handling, transport, treatment, and disposal procedures, as relevant for each hazardous material or hazardous waste; • Preparedness, prevention, contingency, and emergency procedures, including emergency contact information; • A description of personnel training including, but not limited to: (1) recognition of existing or potential hazards resulting from accidental spills or other releases; (2) implementation of evacuation, notification, and other emergency response procedures; (3) management, awareness, and handling of hazardous materials and hazardous wastes, as required by their level of responsibility; • Instructions on keeping Materials Safety and Data Sheets (MSDS) on-site for each on-site hazardous chemical; and • Identification of the locations of hazardous material storage areas, including temporary storage areas, which shall be equipped with secondary containment sufficient in size to contain the volume of the largest container or tank. 					



Table 1. MMRP Mitigation Measures

Mitigation Measure	Timing	Applicable Project Location/ Feature	Primary Responsible Party	Secondary Responsible Party	Verification
<p>HAZ-2: Pre-Demolition Investigation. Prior to the demolition of any structures within the Project footprint, a survey shall be conducted for the presence of hazardous building materials such as asbestos-containing materials, lead based paints, and other materials falling under Universal Waste requirements. The results of this survey shall be submitted to SANBAG and the City of San Bernardino’s Department of Environmental Health or City of Redlands Department of Environmental Health, as applicable. If any hazardous building materials are discovered, a plan for their proper removal shall be prepared in accordance with applicable requirements of the California Division of Occupational Safety and Health and the County of San Bernardino Environmental Health Services. The contractor performing the work will be required to have a license in the State of California, and possess a C-21, A or B classification. Further and if required, the contractor or their subcontractor will be required to possess a California Contractor License (ASB) to perform any asbestos related work. Prior to any demolition activities, the contractor will be required to secure the site and ensure the disconnection of utilities.</p>	Prior to demolition of any structures	Entire Project	SANBAG	City of San Bernardino Department of Environmental Health or City of Redlands Department of Health, as applicable	
<p>HAZ-3: Prepare Phase I and/or Phase II ESA for Indeterminate or High-Risk Sites. Prior to grading, further investigation at any of the identified sites of concern with an indeterminate or high risk-ranking shall be conducted, if it is known that ground disturbance at those sites would exceed 18 inches within 50 feet of the site of concern. The additional investigation shall be in the form of a site-specific ASTM-compliant Phase I ESA investigation. The Phase I ESA recommendation would determine if a Phase II Preliminary Site Investigation (drilling and sampling) would be required, as appropriate. Both the Phase I and Phase II</p>	Prior to construction	Entire Project	SANBAG	None	



Table 1. MMRP Mitigation Measures

Mitigation Measure	Timing	Applicable Project Location/ Feature	Primary Responsible Party	Secondary Responsible Party	Verification
ESA investigations would be completed prior to parcel acquisition (therefore, prior to any construction activity). The Project shall comply with recommendations provided in the Phase I ESA and/or Phase II ESA(s).					
HAZ-4: Halt Construction Work if Potentially Hazardous Materials are Encountered. All construction contractors shall immediately stop all subsurface activities in the event that potentially hazardous materials are encountered, an odor is identified, or considerably stained soil is visible. Contractors shall follow all applicable local, state, and federal regulations regarding discovery, response, disposal, and remediation for hazardous materials encountered during the construction process.	During construction	Entire Project	SANBAG	None	
HAZ-5: Keep Construction Area Clear of Combustible Materials. SANBAG shall ensure, through the enforcement of contractual obligations that during construction, staging areas, welding areas, or areas slated for development using spark-producing equipment shall be cleared of dried vegetation or other materials that could serve as fire fuel. The contractor shall keep these areas clear of combustible materials in order to maintain a firebreak. Any construction equipment that normally includes a spark arrester shall be equipped with an arrester in good working order. This includes, but is not limited to, vehicles, heavy equipment, and chainsaws.	During construction	Entire Project (Emphasis Mile Posts 3 to 6)	SANBAG		
HAZ-6: Provide Accessible Fire Suppression Equipment. Work crews shall be required to have sufficient fire suppression equipment readily available to ensure that any fire resulting from construction activities is immediately extinguished. All off-road equipment using internal combustion engines shall be equipped with spark arrestors.	During construction	Entire Project	SANBAG	None	



Table 1. MMRP Mitigation Measures

Mitigation Measure	Timing	Applicable Project Location/ Feature	Primary Responsible Party	Secondary Responsible Party	Verification
Cultural and Historic Resources					
CUL-1: Structural Evaluations. In order to determine the structural stability of the Redlands Depot, Cope Commercial Company Warehouse, Haight Packing House, Redlands City Transfer, and the brick warehouse at 440 Oriental Avenue, structural evaluations shall be prepared by a qualified engineer for these five buildings prior to the commencement of construction. The structural evaluations will also address maximum allowable levels of vibration during construction and, if appropriate, will recommend reduced levels of stabilization in conjunction with vibration monitoring. Qualified recommendations within the structural evaluation shall be adhered to, as appropriate. Permanent stabilization will follow the Secretary of the Interior's guidelines for the treatment of historic properties; if the buildings are temporarily stabilized for the duration of construction activities, when removed, the buildings will be restored to their pre-construction condition when the stabilization measures are removed.	Final design and prior to construction	Redlands Depot, Cope Commercial Company Warehouse, Haight Packing House, Redlands City Transfer, and the brick warehouse at 440 Oriental Avenue	SANBAG	State Historic Preservation Officer (SHPO), if required	
CUL-2a: Minimize Indirect Visual Effects of Potential Sound Barriers. Visual surface treatments and drought-tolerant landscaping will be implemented as necessary to minimize indirect effects on the setting and feeling of the Redlands Lawn Bowling Club portion of Sylvan Park and the Second Baptist Church from introduction of sound barriers (if constructed). The surface treatments and landscaping for the sound barrier at the Redlands Lawn Bowling Club will be designed and implemented to harmonize the barrier with the surrounding pastoral park landscape. If a sound barrier is necessary at the Second Baptist Church, surface treatments will be designed and implemented to harmonize the barrier with the Spanish Colonial Revival architecture of the church building. Drought tolerant landscaping will be incorporated into the design of the barrier at the church as needed.	Final design and post-construction (if required)	Redlands Lawn Bowling Club portion of Sylvan Park and the Second Baptist Church	SANBAG	Cities of Redlands and San Bernardino	



Table 1. MMRP Mitigation Measures

Mitigation Measure	Timing	Applicable Project Location/ Feature	Primary Responsible Party	Secondary Responsible Party	Verification
<p>CUL-2b: Conduct Potential Noise Insulation Work at Second Baptist Church in Accordance with Secretary of Interior Standards and Guidelines and Applicable Preservation Briefs. Sound-attenuating insulation may be necessary for the Second Baptist Church building. If sound-attenuating insulation measures are implemented at the church building, the work will be conducted in accordance with the Secretary of the Interior's Standards for Rehabilitation with Guidelines for Applying the Standards (Hume et al. 1990) and applicable National Park Service preservation briefs, including #3 (Improving Energy Efficiency in Historic Buildings); #22 (The Preservation and Repair of Historic Stucco); #24 (Heating, Ventilating, and Cooling Historic Buildings: Problems and Recommended Approaches); and # 30 (The Preservation and Repair of Historic Clay Tile Roofs). SANBAG will select and implement the recommended insulation measures in coordination with the property owner and SHPO.</p>	Prior to operations (if required)	Second Baptist Church	SANBAG	SHPO, if required	
<p>CUL-3: Off-Site Replacement of Citrus Trees Removed from California/I-10-Grove. SANBAG shall coordinate with the City of Redlands, including the Citrus Preservation Commission, to provide for the planting of citrus trees at properties within the Redlands Historical Preserve of Citrus to compensate for the trees removed from the California/I-10 Grove in association with the Preferred Project Alternative. The number of citrus trees planted will be equal to the number of trees removed from the California/I-10 Grove. The types of trees to be planted will be determined through consultation between SANBAG and the City of Redlands, including the Citrus Preservation Commission.</p>	Prior to construction	California/I-10 Grove	SANBAG	City of Redlands, Citrus Preservation Commission	



Table 1. MMRP Mitigation Measures

Mitigation Measure	Timing	Applicable Project Location/ Feature	Primary Responsible Party	Secondary Responsible Party	Verification
<p>CUL-4: Construction Monitoring. Full-time monitoring for archaeological deposits will be conducted in the Project APE in the vicinity of the Redlands Chinatown site (and a 50-foot buffer on each side of the site boundary) during ground disturbing construction activities. Monitoring will be conducted in accordance with a Construction Monitoring and Discovery Plan to be prepared for the project. Monitoring will occur under the supervision of an archaeologist who meets the Secretary of the Interior's Professional Qualifications Standards.</p> <p><i>Unanticipated Discoveries.</i> In the event an unanticipated discovery of archaeological resources occurs during construction, the following measures will be implemented immediately following the discovery:</p> <ul style="list-style-type: none"> • All construction within a 50-foot radius of the resource will be halted until a qualified archaeologist can evaluate the resource. • FTA and SHPO will be notified in the event of an unanticipated discovery. • If the discovery is determined to be significant or potentially significant by the qualified archaeologist, the adverse effects under Section 106 to portions of archeological resources determined to be eligible for the NRHP would be resolved in consultation with SHPO through the following tasks: <ul style="list-style-type: none"> - Discussion with project engineers to determine if impacts can be avoided/minimized, including consideration of preservation in place - Recovery and analysis of archaeological material and associated data 	<p>During construction</p>	<p>Project APE in the vicinity of the Redlands Chinatown site</p>	<p>SANBAG</p>	<p>SHPO, if required</p>	



Table 1. MMRP Mitigation Measures

Mitigation Measure	Timing	Applicable Project Location/ Feature	Primary Responsible Party	Secondary Responsible Party	Verification
<ul style="list-style-type: none"> - Preparation of a data recovery report or other reports - Recovered archaeological material shall be provided to an accredited archaeological repository. <p>Archaeological monitor qualification requirements, detailed approaches to archaeological monitoring of various project elements, and the procedures to follow in the event that unanticipated archaeological resources or human remains are discovered will be defined in the Construction Monitoring and Discovery Plan.</p> <p><i>Stop Work if Unanticipated Human Remains Are Encountered.</i> If human remains are exposed during construction, State Health and Safety Code Section 7050.5 states that no further disturbance shall occur until the county coroner has made the necessary findings as to origin and disposition pursuant to PRC 5097.98. If the coroner determines the remains to be Native American, the coroner must contact the Native American Heritage Commission and the Project must comply with state laws relating to the disposition of Native American burials that are under the jurisdiction of the Native American Heritage Commission (PRC Section 5097). Construction must halt in the area of the discovery of human remains, the area must be protected, and consultation and treatment would occur as prescribed by law.</p>					
Parklands, Community Services, and Other Public Facilities					
<p>PCS-1: Coordinate Trail Planning with Local Jurisdictions. SANBAG will implement the following activities to minimize Project-related conflicts with proposed trails:</p>	Final design	Bridge 3.4 and Orange Blossom Trail	SANBAG	San Bernardino County Parks and Recreation Department and Public Works	

Table 1. MMRP Mitigation Measures

Mitigation Measure	Timing	Applicable Project Location/ Feature	Primary Responsible Party	Secondary Responsible Party	Verification
<ul style="list-style-type: none"> Santa Ana River Trail - SANBAG shall coordinate final design and construction of Bridge 3.4 with the San Bernardino County Department of Public Works, Transportation Design Division, and Parks and Recreation Department to integrate the trail as contemplated in the SANBAG's Non-Motorized Transportation Plan (2011) (NMTP), so as to maintain it's planned future continuity along the Santa Ana River. If the trail is constructed and operational in advance of the bridge structure, SANBAG will maintain trail access during the course of construction, to the extent feasible. In instances, where trail closures are required the construction contractor will be required to minimize the duration of the closure and support the County with any noticing, outreach, or implementation of temporary detours. Orange Blossom Trail - SANBAG shall update the NMTP (2011) as part of it's next cycle update, to include the realignment of the trail segment of the Orange Blossom Trail that is currently shown as being located within the railroad right-of-way, so as to not conflict with the proposed project. SANBAG will coordinate with the City of Redlands and the County Flood Control District to determine available rights-of-way for the placement of the trail and, if necessary, realign the trail to take advantage of connections via existing roadway and other public right-of-ways. 				Department, City of Redlands, and the San Bernardino County Flood Control District	



Table 1. MMRP Mitigation Measures

Mitigation Measure	Timing	Applicable Project Location/ Feature	Primary Responsible Party	Secondary Responsible Party	Verification
Safety and Security					
SS-1: Develop Safety and Security Management Plan. Prior to construction, SANBAG shall coordinate and consult with local safety and crime prevention authorities to develop a Safety and Security Management Plan (SSMP) for the track alignment, bridges, parking facilities, and station areas. The SSMP shall include a station surveillance element to be developed in coordination with the local jurisdiction and private properties owners, as applicable. If a non-FRA compliant DMU vehicle type is selected for the Project, the SSMP shall include a plan element that includes appropriate levels of safety as may be necessary to facilitate a shared-use operation.	Final design and post construction	Entire Project	SANBAG	Cities of San Bernardino and Redlands	
SS-2: Fencing. SANBAG's contractor shall erect temporary fencing and visual screening for staging areas and provide security personnel during construction to minimize trespassing and vandalism throughout the duration of construction.	Prior to and during construction	Entire Project	SANBAG	None	