

Complete Intersections:

A Guide to Reconstructing Intersections
and Interchanges for Bicyclists and Pedestrians

California Department of Transportation

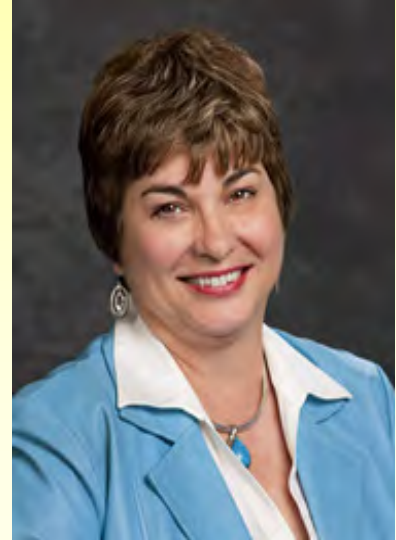
2010



Complete Intersections

A GUIDE TO RECONSTRUCTING INTERSECTIONS AND INTERCHANGES FOR BICYCLISTS AND PEDESTRIANS

The California Department of Transportation (Caltrans) is pleased to present *Complete Intersections: A Guide to Reconstructing Intersections and Interchanges for Bicyclists and Pedestrians* (Complete Intersections Guide). This one-of-a-kind guide provides direction on implementing an important aspect of Caltrans' Complete Streets policy. For the first time, a comprehensive and easy-to-follow guide identifies actions that will improve safety and mobility for bicyclists and pedestrians at intersections and interchanges. The Complete Intersections Guide can help California, and perhaps the nation, continue to make progress in developing a sustainable transportation system for all users.



The Complete Intersections Guide provides tools and techniques to improve bicycle and pedestrian transportation using basic guiding principles for common intersection types. The focus is on intersections and interchanges where transportation safety and mobility issues can be most challenging. By creating Complete Streets with complete intersections, Caltrans can increase the number of bicycle, pedestrian, and transit trips, helping California meet its goals for reducing greenhouse gas emissions. The Complete Intersections Guide also will serve as a model for other states.

I commend Caltrans staff, project partners, and consultants that participated in developing the Complete Intersections Guide.

A handwritten signature in black ink that reads "Cindy McKim".

CINDY McKIM
Director



Disclaimer

This reference guide (Guide) does not constitute a standard, specification, or regulation. It is not intended to replace the existing California Department of Transportation (Caltrans) mandatory or advisory standards, nor the exercise of engineering judgment by licensed professionals. The Guide is compiled of information and concepts from various agencies and organizations faced with similar transportation issues. Caltrans acknowledges the existence of other practices and provides this Guide for those responsible for making professional engineering or other design decisions.



Acknowledgements

Special thanks to Ryan Greene-Roesel of Cambridge Systematics, and to Lauren Ledbetter of Alta Planning + Design, the consultant project team. Thanks to Asif Haq in the Division of Traffic Operations and Alex Kennedy, a former employee with the Division of Traffic Operations. The individuals named below participated in the Technical Advisory Committee (TAC), and/or provided extensive feedback.

Richard Haggstrom, TAC Chair	Caltrans Division of Traffic Operations, Headquarters
David Cordova	Caltrans Division of Design, Headquarters
Brian Hadley	Caltrans Division of Traffic Operations, District Eleven
Wayne Henley	Caltrans Division of Traffic Operations, Headquarters
Kevin Herritt	Caltrans Division of Design, Headquarters
Alex Kennedy	Caltrans Division of Traffic Operations, Headquarters
Ken McGuire	Caltrans Division of Local Assistance, Headquarters
Maggie O'Mara	Caltrans Division of Design, Headquarters
Scott Sauer	Caltrans Division of Mass Transit, Headquarters
Heidi Sykes	Caltrans Division of Design, Headquarters
Robert Shanteau	Independent Advisor

We would like to thank the following internal and external stakeholders who contributed their time and expertise to this project: the Active Transportation and Livable Communities advisory group, the Strategic Highway Safety Plan (SHSP) pedestrian and bicycle safety teams (Challenge Areas 8 and 13), the California Bicycle Advisory Committee, the California Pedestrian Advisory Committee, and the Traffic Safety Steering Committee. Thank you.



Table of Contents

1. Introduction	1
1.1. Policy Context	1
1.2. Who Is This Guide For?	2
1.3. Terminology	3
1.4. Organization.....	3
1.5. How Should This Guide Be Used?	4
1.6. When Should This Guide Be Used?	5
2. All Intersections Overview	7
2.1. Guiding Principles.....	7
2.2. Safety Effectiveness of General Design Treatments.....	15
2.3. Other General Considerations	16
3. Four-Leg Intersections.....	19
3.1. Signalized Four-Leg Intersections.....	19
3.2. Four-Leg Intersections: Two-Way STOP Controlled.....	29
4. Three-Leg and Offset Intersections	35
4.1. Ninety-Degree T	35
4.2. Offset	38
5. Skewed and Multi-leg Intersections	43
5.1. Skewed Intersections.....	44
5.2. Multi-leg Intersections	47
5.3. Y-Intersections.....	50
6. Special Cases.....	53
6.1. Midblock Crossing.....	53
6.2. Shared Use Path Intersections with Roads.....	57
7. Intersections with Transit.....	63
7.1. Bus Stops at Intersections	63
7.2. Railroad Crossings.....	67
8. Roundabouts.....	71
8.1. Common Issues.....	71
8.2. Treatments	74
9. Interchanges	79
9.1. Free-Flow Ramps.....	80
9.2. Single Point Interchange.....	90
9.3. Trumpet Interchanges.....	93
9.4. Diverging Diamond Interchanges.....	97



10. Treatments on the Horizon	99
10.1. 2009 MUTCD	99
10.2. Interim Approved Device: Rectangular Rapid Flashing Beacons	103
10.3. California Experiments	103
11. Background	105
11.1. Pedestrian and bicycle Injuries and Fatalities in California	105
11.2. Characteristics of Bicyclist- and Pedestrian-Friendly Environments.....	107
11.3. Pedestrian and Bicyclist Collision Types at Intersections.....	109
11.4. Effectiveness of Pedestrian and Bicyclist Safety Countermeasures	113
11.5. Using a “4-E” Approach.....	114

Appendix A: Treatments by Collision Type

Appendix B: Related Resources



List of Figures

Figure 3.1	Issues Associated with Signalized Intersections	22
Figure 3.2	Common Intersection Treatments for Pedestrians	25
Figure 3.3	Common Intersection Treatments for Bicyclists	26
Figure 3.4	Issues Associated with Two-Way STOP Controlled, Four-Leg Intersections	30
Figure 3.5	Less Expensive Treatments: Reducing Turn Radii and Signage and Striping.....	32
Figure 3.6	More Expensive Treatments: Constructing Raised Islands.....	32
Figure 3.7	Flashing Beacons and Medians	33
Figure 4.1	Common Issues at Signalized T-Intersections.....	36
Figure 4.2	Signage and Operations Treatments for Signalized T-Intersections.....	37
Figure 4.3	Signage Treatments for T-Intersections Where Major Road is Uncontrolled	38
Figure 4.4	Legal Crossings at Offset Intersections	39
Figure 4.5	Pedestrian and Bicycle Issues at a Left-Right Offset Intersection.....	39
Figure 4.6	Pedestrian and Bicycle Issues at Right-Left Offset Intersections.....	40
Figure 4.7	Selective Crosswalk Enhancement at Offset Intersections	41
Figure 4.8	Experimental Bicycle Treatments at Offset Intersections	42
Figure 5.1	Issues Associated with Skewed Intersections	44
Figure 5.2	Signage, Striping and Minor Construction Treatments for Skewed Intersections	46
Figure 5.3	Reconstruction of Skewed Intersections to a 90-Degree Angle	46
Figure 5.4	Issues Associated with Multi-leg Intersections.....	48
Figure 5.5	Reconstruction of a Five-Leg Intersection.....	49
Figure 5.6	Reconstruction of a Six-Leg Intersection.....	50
Figure 5.7	Common Issues Associated with Y-Intersections.....	51
Figure 5.8	Signage, Striping, and Infrastructure Treatments for Y-Intersections	52
Figure 6.1	Common Issues at Midblock Crossings	54
Figure 6.2	Treatments for Unsignalized Midblock Pedestrian Crossings	57
Figure 6.3	Common Issues at Intersections of Side-paths and Roads	58
Figure 6.4	Option 1 for Shared-Use Path Road Crossing: <i>Reroute</i>	59
Figure 6.5	Option 2 for Shared-Use Path Road Crossing: <i>New Signal</i>	60
Figure 6.6	Option 3 for Shared-Use Path: <i>Uncontrolled Midblock Crossing</i>	61
Figure 7.1	Issues at Intersections with Bus Stops	64
Figure 7.2	Treatments for Intersections with Bus Stops	66
Figure 7.3	Treatment for Median Bus/BRT/Light Rail Stops.....	66
Figure 7.4	Railroad Crossing Issues	68
Figure 7.5	Railroad Crossing Treatments	70
Figure 8.1	Common Issues at Roundabouts.....	73



Figure 8.2	Treatments for Urban Multilane Roundabouts.....	77
Figure 8.3	Treatments for Rural Multilane Roundabouts	78
Figure 9.1	Interchange Types That Accommodate Pedestrians and Bicyclists	79
Figure 9.2	Interchange Types That Do Not Easily Accommodate Pedestrians and Bicyclists	80
Figure 9.3	Issues Associated with Free-Flow On- and Off-Ramps	82
Figure 9.4	Preferred Treatment for Free-Flow Ramp Intersections	86
Figure 9.5	Signage and Striping Treatments for Free-Flow Ramp Intersections	87
Figure 9.6	Double-Lane Free-Flow On-Ramp Treatment: Channelize Turn Movements	88
Figure 9.7	Treatments for Dual-Lane On-Ramps	89
Figure 9.8	Common Pedestrian and bicycle Issues at Single Point Interchanges.....	91
Figure 9.9	Treatments for Pedestrians and bicyclists at Single Point Interchanges	93
Figure 9.10	Common Issues with Trumpet Interchanges	94
Figure 9.11	Trumpet Interchange Treatment	96
Figure 10.1	New Signs and Signals in the 2009 National MUTCD.....	101
Figure 10.2	Experimental “Bikes in Lane” Sign	104
Figure 11.1	Pedestrian and Bicycle Fatalities in California.....	106
Figure 11.2	Fatal Injury Rates by Vehicle Speed by Pedestrian Age	109
Figure 11.3	Pedestrian Crash Types at Intersections	111
Figure 11.4	Bicycle Crash Types at Intersections.....	113



List of Tables

Table 1.1	General Design Treatments for Intersections	12
Table 3.1	Treatments for Signalized Intersections	23
Table 3.2	Treatments for Two-Way STOP Controlled Intersections.....	31
Table 4.1	Treatments for T-Intersections.....	37
Table 4.2	Treatments for Offset Intersections.....	41
Table 5.1	Crosswalk Placement at Skewed Intersections	43
Table 5.2	Treatments for Skewed Intersections	45
Table 5.3	Treatments for 5-Leg Intersections	49
Table 5.4	Treatments for Y-Intersections	52
Table 6.1	Treatments for Midblock Crosswalks.....	55
Table 6.2	Treatments for Intersections of Paths and Roads	62
Table 7.1	Treatments for Intersections with Bus Transit	65
Table 7.2	Treatments for Railroad Crossings	68
Table 8.1	Treatments for Roundabouts	75
Table 9.1	Basic Treatments to Accommodate Pedestrians and Bicyclists at Interchanges	84
Table 9.2	Treatments for Single Point Interchanges.....	92
Table 9.3	Treatments for Trumpet Interchanges.....	95



1. INTRODUCTION

Intersections and interchanges are major points of conflict for road users and are the frequent site of injuries and fatalities. In California, nearly 20 percent of pedestrian fatalities, and nearly a quarter of bicyclist fatalities occur at intersections.

Intersections also have a significant impact on the mobility of pedestrians and bicyclists. The speed and ease with which they can move through an intersection is affected by the signal timing scheme, the number and configuration of lanes, width of the traveled way, presence of a median or refuge islands, traffic calming configurations, roadsides, landscaping features, traffic volumes, and other factors.



Image: www.pedbikeimages.org/Dan Burden.

Improving both safety and mobility at intersections for pedestrians and bicyclists presents a significant technical challenge for planners, engineers and other highway designers due to the complexity of the road environment and the number of tradeoffs to consider. This Guide is intended to help meet that challenge by presenting common issues faced by pedestrians and bicyclists at intersections and interchanges and best practices for addressing them through design and operational changes.

1.1. Policy Context

The material in this Guide supports several Caltrans and State of California (California) plans and policies requiring improvement in conditions for pedestrians and bicyclists. Recent examples include:

- **The California Strategic Highway Safety Plan** identifies 16 top priority areas (“Challenge Areas”) for improving road safety in California. This Guide will help address three priority areas: intersections (Challenge Area 7), pedestrians (Challenge Area 8), and bicyclists (Challenge Area 13).
- **Assembly Bill 1358 “The Complete Streets Act”**, passed in California in 2008, codified a statewide policy that streets be designed to accommodate all road users. It requires a circulation element with city and county general plans to provide safe travel for motorists, pedestrians, bicyclists, children, seniors, transit patrons, and individuals with disabilities.
- **Effective October 2008**, Caltrans Deputy Directive 64-R1, codified Caltrans’ intention to integrate motorized, transit, pedestrian and bicycle travel by creating complete



streets that provide safe travel for all road users, beginning early in system planning and continuing through project delivery and maintenance and operations.

- **The California Blueprint for Bicycling and Walking** was prepared by Caltrans for the 2002 California State Legislature. The blueprint laid out ambitious goals for improving bicycling and walking, including a 50 percent increase in bicycling and walking trips by 2010; a 50 percent decrease in pedestrian and bicycle fatality rates by 2010; and increased funding for **pedestrian and bicycle programs**.
- **Climate Change Legislation.** Assembly Bill 32, the Global Warming Solutions Act of 2006, and Senate Bill 375, the Sustainable Communities and Climate Protection Act of 2008, set up a process for California to meet its aggressive greenhouse gas reduction goals. The legislation includes goals to reduce greenhouse gases from transportation and land use strategies that support greater levels of walking, bicycling, and transit use.
- **Caltrans Highway Design Manual Update.** Caltrans is in the process of updating the Highway Design Manual (HDM) to include more detail on complete streets concepts, bicycle and pedestrian crossings, pedestrian issues, and related topics.
- **United States Department of Transportation (U.S. DOT) Policy Statement on Bicycle and Pedestrian Accommodation.** Signed on March 11, 2010, this statement announces the U.S. DOT's support for the integration of pedestrian and bicyclist needs in federally funded road projects. The policy states that bicyclists and pedestrians should be considered throughout the planning process and should not be adversely affected by other transportation projects.

In addition to these specific policy changes, Caltrans and other agencies throughout California are embracing a multimodal approach to transportation planning, engineering, and design, which this Guide supports.

1.2. Who Is This Guide For?

This Guide is intended primarily for Caltrans planners, engineers, and other highway designers working as generalists or specialists in advising, engineering or designing for safe travel for all highway users at intersections and interchanges. It may also be useful to local government planners, engineers, and other highway designers; transit planners involved in the siting of transit stops and stations; site planners involved in designing or modifying intersections around new developments; local government pedestrian and bicycle planners; and those whose work may influence or be directly involved in designing or modifying intersections. Finally, the background information on educational and enforcement strategies for addressing pedestrian and bicyclist safety could be useful to practitioners in other areas, such as law enforcement, public health, or advocacy.



1.3. Terminology

This guide uses the following terminology based on the California Vehicle Code (CVC) definitions for bicyclist, pedestrian, driver, and vehicle:

- **Vehicle:** A “vehicle” is a device by which any person or property may be propelled, moved, or drawn upon a highway, excepting a device moved exclusively by human power or used exclusively upon stationary rails or tracks (CVC Division 1 § 670).
- **Motor vehicle:** A “motor vehicle” is a vehicle that is self-propelled. (b) “Motor vehicle” does not include a self-propelled wheelchair, motorized tricycle, or motorized quadricycle, if operated by a person who, by reason of physical disability, is otherwise unable to move about as a pedestrian (CVC Division 1 § 415).
- **Bicycle:** A bicycle is a device upon which any person may ride, propelled exclusively by human power through a belt, chain, or gears, and having one or more wheels (CVC Division 1 § 231).
- **Driver:** A “driver” is a person who drives or is in actual physical control of a vehicle (CVC Division 1 § 305).

Note that this includes bicyclists; however, for clarity, this Guide uses the term “motorist” to refer to someone operating a motor vehicle and the term “bicyclist” to refer to someone operating a bicycle (CVC Division 1 § 415)

- **Pedestrian:** (a) A “pedestrian” is a person who is afoot or who is using any of the following: (1) A means of conveyance propelled by human power other than a bicycle; (2) An electric personal assistive mobility device; (b) “Pedestrian” includes a person who is operating a self-propelled wheelchair, motorized tricycle, or motorized quadricycle and, by reason of physical disability, is otherwise unable to move about as a pedestrian, as specified in subdivision (a) (CVC Division 1 § 467).

1.4. Organization

This Guide is organized by intersection type. Eight major intersection types are included, along with a background sections:

- Section 2: All Intersections - General Guidance
- Section 3: Four-Leg Intersections
- Section 4: Three-Leg Intersections
- Section 5: Multi-leg, Offset and Skewed Intersections
- Section 6: Special Cases
- Section 7: Intersections with Transit
- Section 8: Roundabouts
- Section 9: Interchanges



- Section 10: Treatments on the Horizon
- Section 11: Background Information covering pedestrian and bicyclists' collision data, crash types, and other topics.

Each chapter includes:

- An introduction to the intersection type
- Discussion and illustration of typical issues facing pedestrians and bicyclists
- Discussion and illustration of treatments to be used in providing safe and convenient travel for pedestrians and bicyclists at each intersection subtype. In many cases, multiple types of treatments are provided, ranging from signing and striping to complete intersection redesign.

Treatments are cross-referenced with a list of guiding principles presented in Section 2.0: All Intersections Overview.

Individual treatments in this Guide are not described in detail. There are a large number of resources available that cover the details of specific treatments. Selections of these are listed in Appendix B.

1.5. How Should This Guide Be Used?

Users can approach this Guide as follows:

- First review the general guiding principles contained in Section 2.0: *All Intersections Overview*.
- Then select the intersection type or types that best relates to the planning, design or engineering challenge you are facing. Review the issues and best practices contained within the section and consider how they could be applied in your situation.
- For additional context and information, review the background information in Section 11. Also, be sure to consult local bicycle and pedestrian experts, whether they are transportation professionals or advocates.

Not all treatments included in this Guide will be suitable for all intersections, and not all possible treatments are listed for each intersection type. Users should apply the principles in this Guide along with obtaining or ensuring the use of engineering judgment when making design decisions.

Additionally, users should keep in mind that although this Guide focuses on pedestrians and bicyclists, intersection design should be holistic and consider the needs of all users including bicyclists, pedestrians, transit vehicles, commercial vehicles, passenger vehicles, and should take into consideration the special needs of the disabled, elderly, and young children.



1.6. When Should This Guide Be Used?

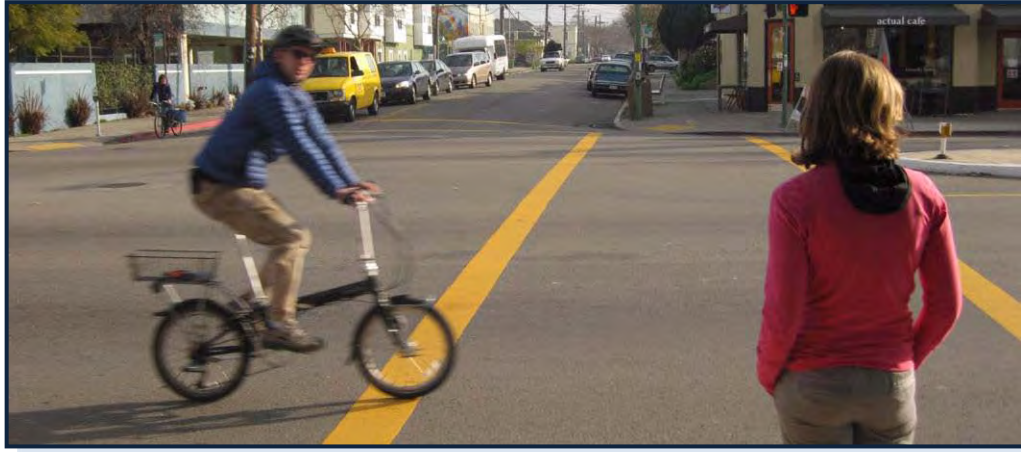
This Guide can be used to inform minor signage and striping changes to intersections and interchanges and major geometric changes and designs for new intersections. For major projects, the needs of pedestrians and bicyclists should be addressed as early as possible in the planning and project development process, starting in the **planning stage**, when the project goals and objectives are determined and a rough concept for the project is developed. This Guide can be used to develop project concepts that address the safety and mobility needs of pedestrians and bicyclists.

The planning stage is followed by development of the project **purpose and need statement** that describes why the project is being undertaken. The purpose and need statement should be succinct, project-specific, and describe the primary reason for undertaking the project. An example of a project's purpose statement for an intersection improvement might be: to improve the operation and safety of the intersection for all users.

Whether or not pedestrian and bicyclist safety and mobility are the primary reasons the project is undertaken, the transportation needs of these users should be considered. Potential transportation deficiencies must be identified and addressed to properly scope the project, justify design decisions, and ensure the final project meets expectations. These deficiencies and project-driven requirements would not always be included in the purpose and need statement, but should be identified early and documented as additional criteria to evaluate and select the preferred alternative. Appropriate performance requirements should be included in the project initiation document and project report. Addressing pedestrian and bicyclist needs early in the planning process helps avoid expensive and time-consuming design changes later on.



Complete Intersections:
*A Guide to Reconstructing Intersections
and Interchanges for Bicyclists and Pedestrians*





2. ALL INTERSECTIONS OVERVIEW

Many of the issues affecting pedestrians and bicyclists can occur at any type of intersection. For example, at all intersections it is important for motorists, pedestrians and bicyclists to be able to see one another approaching, and to not have their stopping or corner sight distance blocked by parked vehicles, trees, transit vehicles, or other obstructions. The guiding principles listed below are meant to summarize some of these common considerations. These principles should be used to guide the development of pedestrian and bicycle accommodations in the project scoping, planning and design phases.

2.1. Guiding Principles

“Observe”

Watch how the intersection is being used. How are bicyclists, pedestrians, transit users, and motorists currently navigating the intersection? Where are they crossing? People will not detour very far to cross a highway. Will people actually use the proposed design change? Rather than restrict desired movements, intersection designs should encourage legal movements, per the California Vehicle Code.



Does the crosswalk placement meet the needs of this pedestrian?

“Pedestrians and Bicyclists Will Be There”

Expect pedestrians and bicyclists to travel anywhere it is legal. Whether or not you meet the transportation needs of pedestrians and bicyclists, they will use a facility, regardless of perceived safety concerns. It is better to meet basic pedestrian and bicyclist mobility and safety needs rather than assuming they will not use the facility.



Was this road designed with pedestrians in mind?

“Maintain and Improve”

When improving an intersection, do not remove existing non-motorized facilities, or reduce safety or mobility for pedestrians or bicyclists. Instead, improve existing facilities for pedestrian and bicyclists. Consult the local pedestrian and bicycle coordinator and local and regional pedestrian, bicycle or transit plans to identify additional improvements the community would like incorporated into the intersection project.



Keeping facilities well maintained and improving them during maintenance or road construction provides a benefit to pedestrians and bicyclists. This image shows construction of a bulb-out.

Image: Dan Burden, www.pedbikeimages.org

“Tee It Up”

Bring intersections to a 90-degree angle; this forces motorists to make slower turns at intersections.



The high-speed ramp has been replaced with a 90-degree intersection.

“One Decision at a Time”

Design intersections so motorists, pedestrians, and bicyclists only need to make one decision at a time.



Median refuges allow pedestrians to consider one direction of traffic at a time.

“Slow it Down”

Where appropriate, use treatments that reduce the speed of motorized vehicles at intersections while maintaining operational efficiency, since there is a documented relationship between vehicle speeds and pedestrian and bicyclist crash severity.¹

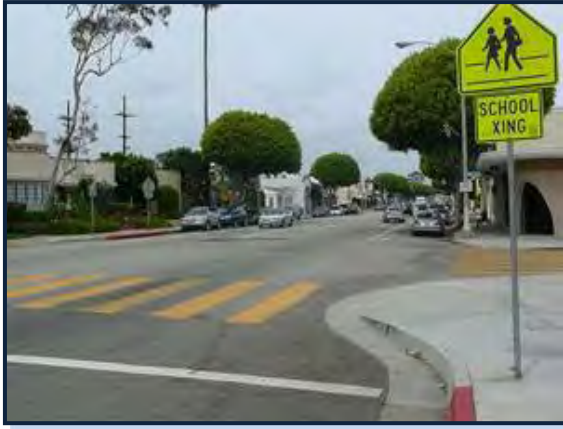


Road diets can improve pedestrian and bicycle access while reducing motor vehicle crashes.

“Shorten Crossings”

Reducing crossing distance reduces the time it takes for pedestrians and bicyclists to cross and results in less exposure to crashes. However, avoid increasing safety for one mode while decreasing it for another. For example, while curb extensions help pedestrians, if they extend past parked vehicles they can reduce the useable width of the shoulder, bike lane or shared lane, increasing the risk that bicyclists may strike the curb extension.

¹ About 5 percent of pedestrians are likely to be killed when struck at 20 miles per hours (MPH), about 40 percent when struck at 30 mph; about 80 percent when struck at 40 mph, and nearly all are likely to be killed when struck at 50 mph or above. Source: Preusser Research Group, 1999. *Literature Review on Vehicle Travel Speeds and Pedestrian Injuries*. National Highway Traffic Safety Administration.



Curb extensions shorten crossings and make pedestrians more visible to motorists.

“Improve Visibility”

Always ensure maximum visibility of pedestrians and bicyclists through providing ample sight distance at crosswalks, lighting weaving, merging and crossing areas, and installing appropriate pedestrian and bicyclist markings, signage, and signals.



Good design makes motorists more aware that bicyclists or pedestrians are expected, thus increasing visibility.

“Clarify the Right-of-Way”

Use design treatments to clarify to pedestrians, bicyclists, and motorists who has the right-of-way.



Bike lanes striped to the left of a right-turn only lane reduce the risk of a weaving-related collision.



“Keep it Direct”

Design pedestrian and bicycle paths to be as direct as possible. Avoid restricting crossings or forcing bicyclists or pedestrians to use a detour instead of providing a direct route through an intersection. When comparing the directness of alternative routes, planners, engineers, and other highway designers should consider not only distance, but also time and the physical effort that must be expended by pedestrians and bicyclists.



Restricting crossing movements increases the distance a pedestrian must travel to cross a road.

“Light at Night”

Install lighting at pedestrian and bicycle crossings, weaving and merging areas, and along shared use paths.



Lighting increases safety and security for pedestrians and bicyclists.

Image: Dan Burden, www.pedbikeimages.org.

“Access for All”

Design facilities so that pedestrians and bicyclists of all abilities, ages, and skills can navigate with ease.



Pedestrian facilities must be reconstructed to meet or exceed ADA requirements.

Image: Jan Moser, www.pedbikeimages.org.



Table 1.1 identifies potential design treatments for intersections that support the guiding design principles introduced above. Dollar signs indicate the relative cost of the treatment, from the least expensive (\$) to the most expensive (\$\$\$). Actual costs will vary on case-by-case basis.

Table 1.1 General Design Treatments for Intersections

Design Principle	Treatments	Cost	User
Observe	Place sidewalks, marked crosswalks, and shared use path crossings where people are already walking and crossing.	\$	Both
	Redesign the intersection to make the desired bicycling or walking movement safer, more comfortable, and more convenient.	\$\$-\$\$\$	Both
Pedestrians and Bicyclists Will Be There	Construct or reconstruct intersections with sidewalks on both sides.	\$\$-\$\$\$	Pedestrians
	Allow or create adequate width for on-street bicycle lanes or wide curb lanes where appropriate.	\$\$-\$\$\$	Bicyclists
	Establish a limit line detection zone at traffic-actuated signals that will detect bicyclists and enable them to actuate the signal (per Caltrans Traffic Operations Policy Directive 09-06).	\$\$	Bicyclists
	Redesign the intersection to make the desired bicycling or walking movement safer, more comfortable, and more convenient.	\$\$-\$\$\$	Both
	Time signals to allow adequate time for pedestrians to cross in one signal phase and bicyclists to travel through the intersection before the opposing traffic receives a green light ² .	\$	Both
	Avoid prohibiting pedestrian crossing on any leg of an intersection.	\$	Pedestrians
	Coordinate with transit providers to provide adequate widths for transit stops.	\$	Both
	Provide accessible pedestrian countdown signals at signalized intersections.	\$	Pedestrians

² Proposed Amendment to the National Manual for Uniform Traffic Control Devices (MUTCD) recommends 3.5 feet (ft) per second maximum, and the California MUTCD (CA MUTCD) recommends 2.8 seconds where pedestrians with disabilities or elderly will be regularly using the crosswalk. Caltrans Traffic Operations Policy Directive 09-06 provides minimum bicycle timing requirements for signals.



Design Principle	Treatments	Cost	User
Maintain and Improve	When widening an intersection, extend bike lanes to the intersection and stripe bike lanes to the left of right-turn only lanes.	\$\$	Bicyclists
	When reconstructing an intersection, widen sidewalks and provide sidewalks on both sides of the road.	\$\$	Pedestrians
	Regularly maintain on-street and off-street bicycle facilities, including sweeping the bike lane, shoulder or right-most traffic lane, trimming vegetation, and clearing snow from bicycle facilities during the winter.	\$\$	Bicyclists
	Regularly maintain pedestrian facilities, including trimming vegetation at pedestrian crossings, and inspecting and maintaining curb ramps.	\$\$	Pedestrians
	When reconstructing an intersection, install Americans with Disabilities Act-compliant (ADA) curb ramps at all corners with sidewalks.	\$\$	Pedestrians
	When repaving, pave out to existing edge of pavement to maintain the shoulder surface and prevent longitudinal lips in shoulder or between traffic lanes.	\$\$	Bicyclist
	Crosswalk markings should not be allowed to fade. Use high-visibility styles such as the “ladder” when installing or replacing crosswalk markings.	\$	Pedestrians
Tee It Up	Design or reconstruct intersections and interchanges so that roads and ramps meet at a 90-degree angle.	\$\$\$	Both
	Use stripe crosswalks so they cross traffic lanes at a 90-degree angle, unless this placement does not follow the pedestrian’s natural path.	\$	Pedestrians
One Decision at a Time	Provide appropriate weaving distance for bicyclists and motorists in advance of a right-turn only lane.	\$\$-\$\$\$	Bicyclists
	Separate the decision to yield to a pedestrian or bicyclist from the decision to merge into traffic by restricting right turns on red or controlling free right-turn only lanes with STOP control or signalization, if warranted.	\$\$-\$\$\$	Both
	Design weaving movements so the path of travel for the through bicyclist is maintained in a straight line and motorists preparing for a turn must weave across the bicyclist line of travel and yield to the bicyclist.	\$	Bicyclists



Design Principle	Treatments	Cost	User
Slow it Down	Design or reconstruct intersections to allow <u>maximum</u> motor vehicle turning movement speeds of 20 mph through reducing turning radii and bringing intersections close to a 90-degree angle.	\$\$-\$\$\$	Both
	Use proven speed management techniques, such as construction of roundabouts, median islands, or in-road way warning lights to slow motorized traffic.	\$\$-\$\$\$	Both
	Use enforcement measures such as speed-feedback signs in advance of intersections, to slow motorized traffic.	\$\$-\$\$	Both
Shorten Crossings	Reduce turning radii for motorists	\$\$	Both
	Construct curb extensions, raised pedestrian refuge islands, raised medians, or raised channelizing islands	\$\$-\$\$\$	Pedestrians
	Reconstruct skewed intersections to meet at a 90-degree angle.	\$\$\$	Both
	Reconstruct road to provide narrower motor vehicle lanes and wider pedestrian and bicycle facilities.	\$\$\$	Both
Improve visibility	Provide ample sight distance in advance of crossings.	\$\$-\$\$\$	Both
	Reconstruct intersections to meet at a 90-degree angle.	\$\$\$	Both
	Paint stop lines or advance yield lines in advance of crosswalks or intersections.	\$	Pedestrians
	Restrict parking at least 20 feet in advance of crossings, will reduce bicycle conflicts with car doors opening unexpectedly.	\$	Both
	Regularly trim vegetation at crossings.	\$\$	Pedestrians
Clarify the Right-of-Way	Use signing and striping to remind motorists to expect and yield to pedestrians and bicyclists.	\$	Both
	For all approaches with bike lanes, stripe bike lanes to the left of right-turn only lanes, and if significant left turn bicycle movements are expected, stripe bike lanes to the right of left-turn only traffic lanes.	\$	Bicyclists
Keep it Direct	Do not restrict crossings on any leg of an intersection unless there is strong justification.	\$	Pedestrians
	Reconstruct skewed intersections to meet at a 90-degree angle.	\$\$\$	Both
	Design crossings so pedestrians can cross in one signal phase.	\$\$-\$\$\$	Pedestrians
	Provide well-designed grade separation, if a feasibility study suggests that pedestrians and bicyclists will use the grade-separated facility.	\$\$\$	Both



Design Principle	Treatments	Cost	User
Light at Night	Provide ample lighting at crosswalks.	\$\$-\$\$\$	Both
	Install flashing beacons or in-pavement flashers at marked crosswalks and shared use path crossings.	\$\$	Both
Access for All	Construct ADA-compliant curb ramps at all corners with sidewalks unless a particular crossing is prohibited. If a crossing is prohibited, all pedestrians, regardless of disability, must erect a barrier to prevent crossings.	\$	Pedestrians
	Reconstruct existing non-compliant median refuges to be ADA-compliant.	\$\$-\$\$	Pedestrians
	Construct ADA-compliant median refuges if pedestrians cannot cross in one cycle.	\$\$	Pedestrians
	Construct ADA-compliant sidewalks on both sides of the road.	\$\$-\$\$\$	Pedestrians
	Construct accessible pedestrian countdown signals at signalized intersections.	\$\$-\$\$	Pedestrians
	Provide transit stops that meet ADA standards.	\$\$	Pedestrians
	Reconstruct skewed intersections to meet at a 90-degree angle so pedestrians with visual impairments can more easily navigate the intersection.	\$\$\$	Pedestrians

2.2. Safety Effectiveness of General Design Treatments

Treatments listed in Table 1.1 vary in their effectiveness in reducing injuries and fatalities among pedestrians and bicyclists. In general, the most effective treatments are those that reduce vehicle speeds or those that reduce the pedestrian or bicyclist’s exposure to vehicle traffic. Any reduction in vehicle speed benefits pedestrian and bicyclist safety, since there is a direct link between impact speeds and the likelihood of fatality.³ Methods to reduce pedestrian and bicyclist exposure to vehicles improve safety by lessening the time that the user is in the likely path of a motor vehicle. These methods include the construction of physically separated facilities such as sidewalks, raised medians, refuge islands, and off-road paths and trails, or reductions in crossing distances through roadway narrowing. The safety effectiveness of all these measures has been established in the research literature, although there are still some safety issues associated with paths at intersections. Improved lighting has also been proven very effective in reducing nighttime collisions. Section 11.4 lists relevant references and provides additional detail.

³ Preusser Research Group, 1999. *Literature Review on Vehicle Travel Speeds and Pedestrian Injuries*. National Highway Traffic Safety Administration.



2.3. Other General Considerations

Experts contributing to the intersection design process must take into account the characteristics of all road users, including the following considerations:

- **Pedestrian volumes and abilities.** Pedestrian volumes, age ranges (age affects depth perception, vision, judgment, hearing, walking speed and start-up time), and physical abilities affect crossing treatments and intersection operations.
- **Bicyclist volumes and abilities.** Bicyclist volumes and skill levels affect the type of bicycle facility or general roadway design provided.
- **Bicycle characteristics.** The acceleration and stopping speed of a bicycle, turning radius, length of bicycle (and trailer), and width of a bicycle affect the design of a bicycle facility.
- **Vehicle and motorist characteristics.** Size and maneuverability of motor vehicles affect corner radii and roadway widths. Motorist's perceptive ability and reaction time varies by age and skill level. Commercial vehicles and transit vehicles generally require larger corner radii and lane widths than smaller motor vehicles, which can cause longer pedestrian crossing distances and promote higher vehicular turning speeds.
- **Land use context.** Includes street parking, presence of transit, intersection siting, as well as factors that impact bicyclist and pedestrian volumes, such as development density.

2.3.1. A Note about Reaction Time

Intersection design should consider that motorist reaction time increases when unexpected information or events are encountered and when many decisions must be made simultaneously. Reaction time is measurably higher when motorists must process unexpected information. The AASHTO Green Book cites a study that showed motorist reaction times to be 35 percent higher when processing unexpected events and states that, "...for a simple, unexpected decision and action, some drivers may take as long as 2.7 seconds to respond. A complex decision with several alternatives may take several seconds longer than a simple decision."⁴

Intersections should be designed so that motorists learn to expect pedestrians and bicyclists. As stated by AASHTO, these "reinforced expectancies help drivers respond rapidly and correctly."⁵ Pedestrian and bicyclist warning signage, flashing beacons,

⁴ Page 50, *Geometric Design of Highways and Streets*, American Association of State Highway and Transportation Officials, 2004. Also see Exhibit 2-26 Median Driver Reaction Time to Expected and Unexpected Information on page 51.

⁵ *Ibid*, Page 53.



crosswalks, and other signage and striping should be used to indicate to motorists that they should expect to see and yield to pedestrians and bicyclists.

Formal information from traffic control devices should be reinforced by informal sources of information such as lane widths, landscaping, street furniture, and other road design features. Intersections should be designed to allow motorists, bicyclists, and pedestrians to perceive and react to one piece of information at a time. Intersections should separate the different driving, bicycling, and walking tasks, promoting the orderly behavior of each travel mode.



This page left intentionally blank



3. FOUR-LEG INTERSECTIONS

Four-leg intersections are the most common intersection type and are very familiar to motorists, pedestrians, and bicyclists. Many issues that pedestrians and bicyclists face at four-leg intersections also apply to the other intersection types discussed in this guide. Similarly, many treatments for four-leg intersections can also be applied to the other intersection types.

This guide describes issues and treatments at two types of four-leg intersections:

- Signalized intersections, including fixed or pre-timed signals, and traffic-actuated signals
- Two-way STOP controlled intersections

Four-way STOP controlled intersections are not discussed, but many of the treatments described in Table 3.2 can improve these intersections for pedestrians and bicyclists.

3.1. Signalized Four-Leg Intersections

Issues for pedestrian and bicyclists at intersections of two major roads are primarily related to long crossing distances, turning conflicts, high speeds, bicycle detection, sufficient crossing signal time, roadway width, and number of travel lanes. These can all be exacerbated when the pavement is widened to provide turn lanes. A right-turn only lane may allow high turning speeds and, particularly if the turning traffic is YIELD controlled rather than STOP controlled or signalized, may reduce the likelihood that motorists will yield to pedestrians crossing the turn lane. On the other hand, right-turn only lanes, in conjunction with bicycle lanes striped to the left, can be beneficial to bicyclists by reducing the potential for a right hook type collision, in which a motorist turns right across the path of a bicyclist moving straight through the intersection.⁶

When the intersection of a minor road and a major road is controlled by fully actuated or semi-actuated signals, special consideration should be given to pedestrians and bicyclists who will be crossing the major road. If pedestrians have to wait an unreasonably long time for a WALK signal, they will likely cross against a red light. If bicyclists cannot actuate the signal, it is likely that they will cross or turn against a red light rather than wait for a motor vehicle to actuate the signal.

Signal operations can also negatively affect pedestrians and bicyclists. If a green phase of a signal is too short, bicyclists may not be able to finish traveling through the intersection before the opposing traffic is released. Six percent of urban bicycle-motor vehicle

⁶“Section 11.3. Pedestrian and Bicyclist Collision Types at Intersections” illustrates the different types of common pedestrian and bicyclist collisions, including the right hook.



collisions are related to these users not being able to finish crossing an intersection before the opposing traffic is released.⁷ Similarly, if the pedestrian phase is too short, pedestrians, particularly pedestrians with disabilities, children and the elderly, may not be able to finish crossing an intersection before the opposing traffic is released. Currently, signal timing for pedestrian crossings in California is based on a crossing time of 4 feet per second. The 2009 National MUTCD is proposing a reduction to 2.8 feet under certain conditions. If extending the green phase or allowing a longer walk phase significantly increases motorist delay, the signal can be configured to use pedestrian and bicycle detection or actuation devices to provide longer bicycle or pedestrian phases only when these users are present.

3.1.1. Common Issues

Common issues associated with signalized intersections include:

- A. **Long crossing distances**, due to multiple through lanes, turn-only lanes, and large corner radii.
- B. **Obstructions in the crosswalk** from medians or median noses
- C. Wide turning radii encourage **fast turns** and increase crossing distances.
- D. **Inadequate refuge area** if the crossing cannot be made in one walk cycle.
- E. **Restricted pedestrian crossing movements** such as closed crosswalks.
- F. The intersection may be designed to force **through-moving bicyclists to weave across multiple right-turn only lanes** to continue straight.⁸ This problem is worsened when one of the lanes is for optional through or right-turning movements.
- G. Motor vehicles may encroach on crosswalk, **limiting visibility**.
- H. **Bicyclists may not be able to actuate** traffic-actuated signal.

⁷ From NCHRP Report 500 series, Volume 18: A Guide for Reducing Collisions Involving Bicycles; Pg. V-11: It has been estimated that bicycle clearance-time crashes, where a motor vehicle hits a bicyclist who has entered a signalized intersection lawfully but has been unable to clear the intersection before the signal changes, constitute approximately 6 percent of urban bicycle/motor vehicle crashes (Wachtel et al., 1995). Wachtel, A., Forester, J., and Pelz, D. "Signal Clearance Timing for Bicyclists." ITE Journal. 65(3): 38-45, March 1995.

⁸ CA MUTCD Section 9C.04 provides guidance for striping bicycle lanes at intersections. If right turns are permitted, and there is no right-turn only lane, bicycle lanes may be dropped or dashed for the last 100 to 200 feet. If right turns are not permitted, "the solid bike lane stripe should extend to the edge of the intersection." For some special cases ("extremely long" right-turn only lanes, double right turn lanes) "all striping should be dropped to permit judgment by the bicyclists to prevail." At ramp interchanges, "the bike lane stripe should be dropped 100 feet prior to the ramp intersection to allow for adequate weaving distance." Additionally, "an optional through-right turn lane next to a right-turn only lane should not be used where there is a through bicycle lane. If a capacity analysis indicates the need for an optional through-right turn lane, the bicycle lane should be discontinued at the intersection approach."



- I. **Pedestrian clearance time may not be long enough** to permit slower pedestrians to clear the intersection.
- J. Intersection clearance interval may not be long enough for bicyclists to clear the intersection.⁹ This may become problematic in the case of large intersections. One potentially helpful technology now under development is bicycle-specific passive actuation.
- K. If pedestrian and motor vehicle volumes are high, there may be significant **conflicts between pedestrians and turning motor vehicles**. A significant number of pedestrian injuries and fatalities are associated with permissive left turns.
- L. **Loop detectors are placed at location where crosswalk would ideally be striped**, requiring the crosswalk to be striped at a less-than-optimal location (not shown);
- M. Signal poles, pull boxes, cabinet boxes, light standards, and other related electrical equipment obstructs the pedestrian path and blocks the view of pedestrians.¹⁰



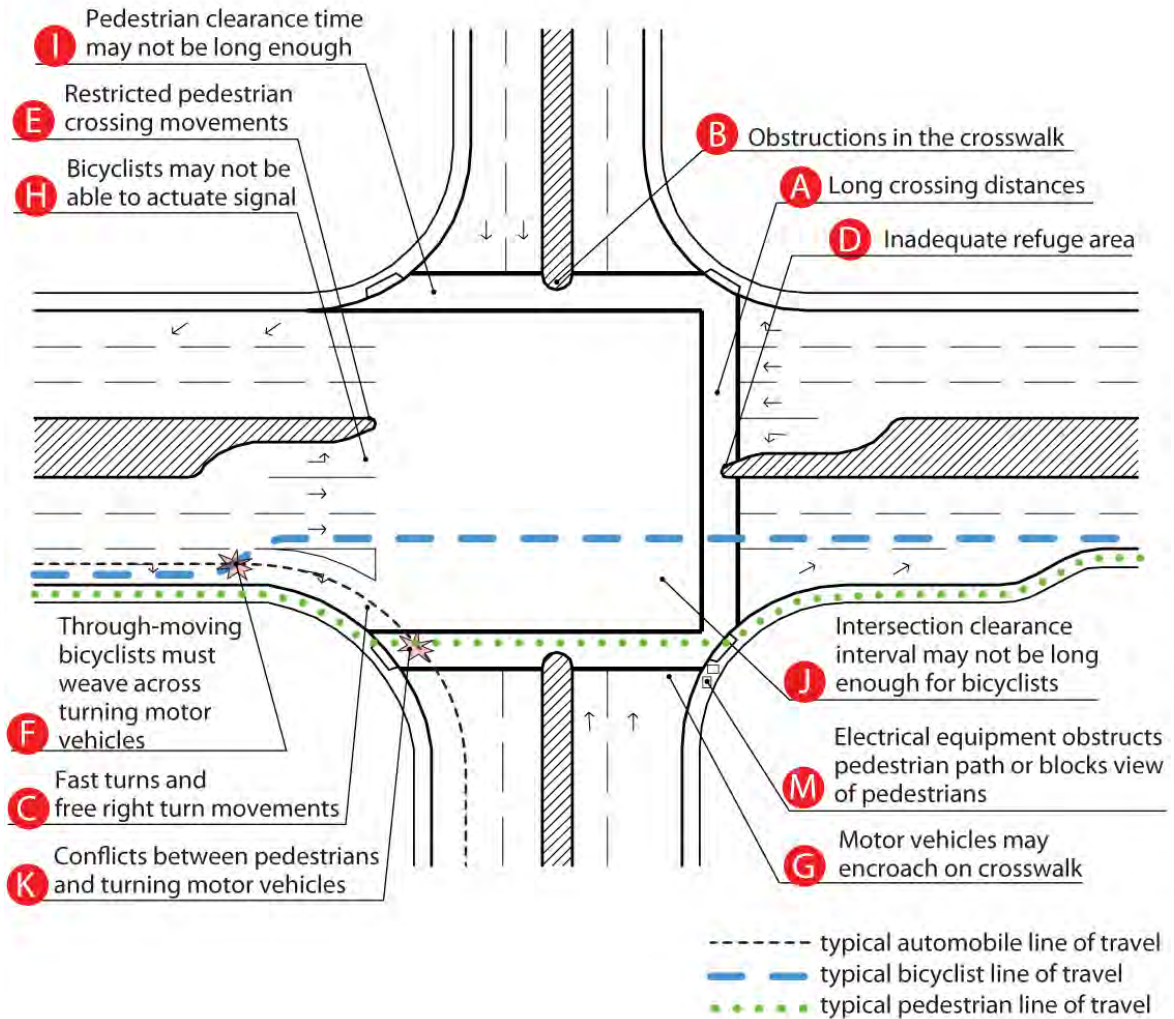
Long crossing distance can be especially challenging for bicyclists and pedestrians.

⁹ See Traffic Operations Policy Directive 09-06 for detail.

¹⁰ Electrical equipment makes up more than half of the obstructions at intersections. Locations of pedestrian push buttons and crosswalk markings depend heavily on the placement of signal poles and loop detectors. Electrical plans should be developed precisely, and at scale, to allow reviewers to identify potential ADA and visibility issues and to proactively solve these issues.



Figure 3.1 Issues Associated with Signalized Intersections



3.1.2. Treatments

Treatments for signalized intersections focus on slowing motor vehicle speeds, reducing crossing distances, improving driver yielding, and ensuring that the signal actuation and timing can meet the needs of pedestrians and bicyclists. Specific treatments are described in Table 3.1.



Table 3.1 Treatments for Signalized Intersections

Treatment	Design Principles	Figure No.
<i>Signage and Striping</i>		
Stripes limit lines in advance of the crosswalk.	Clarify the Right-of-Way, Improve Visibility	3.2, 3.3
Stripe bicycle lane to the left of right-turn only lane, install “Right Turn Must Yield to Bicycles” sign and bicycle warning signs.	One Decision at a Time, Clarify the Right-of-Way	3.3
Stripe bicycle lane to the right of left-turn only lane.	Clarify the Right of Way, Pedestrians and Bicyclists There	3.3
Consider striping high-visibility crosswalks across all legs.	Improve Visibility, Clarify the Right-of-Way	Not shown
At signalized intersections, prohibit parking for two parking stall lengths (48 feet) on the near side of the intersection and one parking stall length (24 feet) at the far side of the intersection (CA MUTCD 3B.18).	Improve Visibility	Not shown
<i>Infrastructure</i>		
Reduce corner radii. If large vehicle turning movements is a concern, a solution may be to extend a mountable small-radius apron beyond the existing large-radius corner curbing (excluding crosswalks and curb ramps). The pedestrian waiting area would be behind the existing curbing.	Slow it Down, Shorten Crossings	3.2
Construct raised channelizing islands for right turns.	Slow it Down, Shorten Crossings, Improve Visibility, Clarify the Right-of-Way	3.2
Reconstruct median noses so they do not obstruct the crosswalk and provide a pedestrian refuge area.	Access for All	3.2
Install countdown signals.	Access for All	Not shown
Install Accessible Pedestrian Signals.	Access for All	Not shown
Construct right-turn lane as compound curve that meets intersecting street at close to 90-degree angle.	Slow it Down, Clarify the Right-of-Way	3.2
Design right-turn only lanes so that turning motorists must weave across through-moving bicyclists rather than vice-versa.	Clarify the Right of Way	3.3
Place loop detectors back from intersection to allow crosswalk to be marked at optimal location.	Improve Visibility	Not shown



Treatment	Design Principles	Figure No.
Place electrical equipment to avoid impeding pedestrian travel, visibility, or installation of ADA accessible push button.	Access for All, Improve Visibility	3.2
Operations		
Control channelized right-turns with STOP or YIELD signs.	Slow it Down, Clarify the Right-of-Way	3.2
Where there are significant conflicts between pedestrians and right turning motor vehicles provide a leading pedestrian interval.	Clarify the Right of Way, Improve Visibility	Not Shown
Where there are significant conflicts between left turning vehicles and pedestrians, provide protected left turn.	Clarify the Right of Way	Not Shown
Install bicycle detection as indicated in Traffic Operations Directive 09-06.	Pedestrians and Bicyclists Will Be There	3.3
Time signal phase to 3.5 feet/second maximum (National MUTCD 2009) or 2.8 feet/second where older or disabled pedestrians routinely use the crosswalk (CA MUTCD 4E.10) Alternatively, push buttons to provide additional crossing time only on request may be installed.	Pedestrians and Bicyclists Will Be There, Access for All	3.2
Remove restrictions on pedestrian crossing.	Keep it Direct, Shorten Crossings	3.2

Two illustrations of treatments are shown:

- Figure 3.2 illustrates treatments for pedestrians
- Figure 3.3 illustrates treatments for bicyclists



Figure 3.2 Common Intersection Treatments for Pedestrians

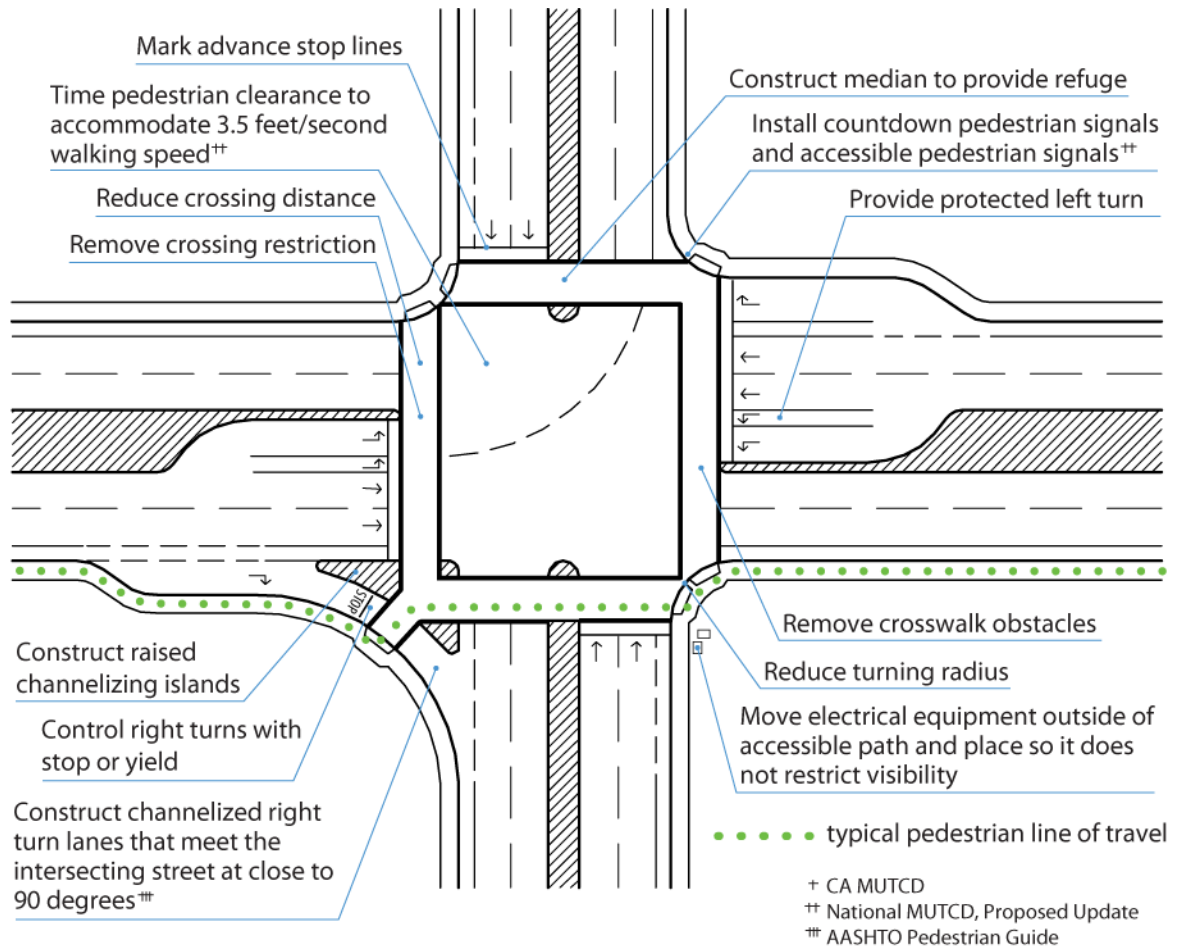
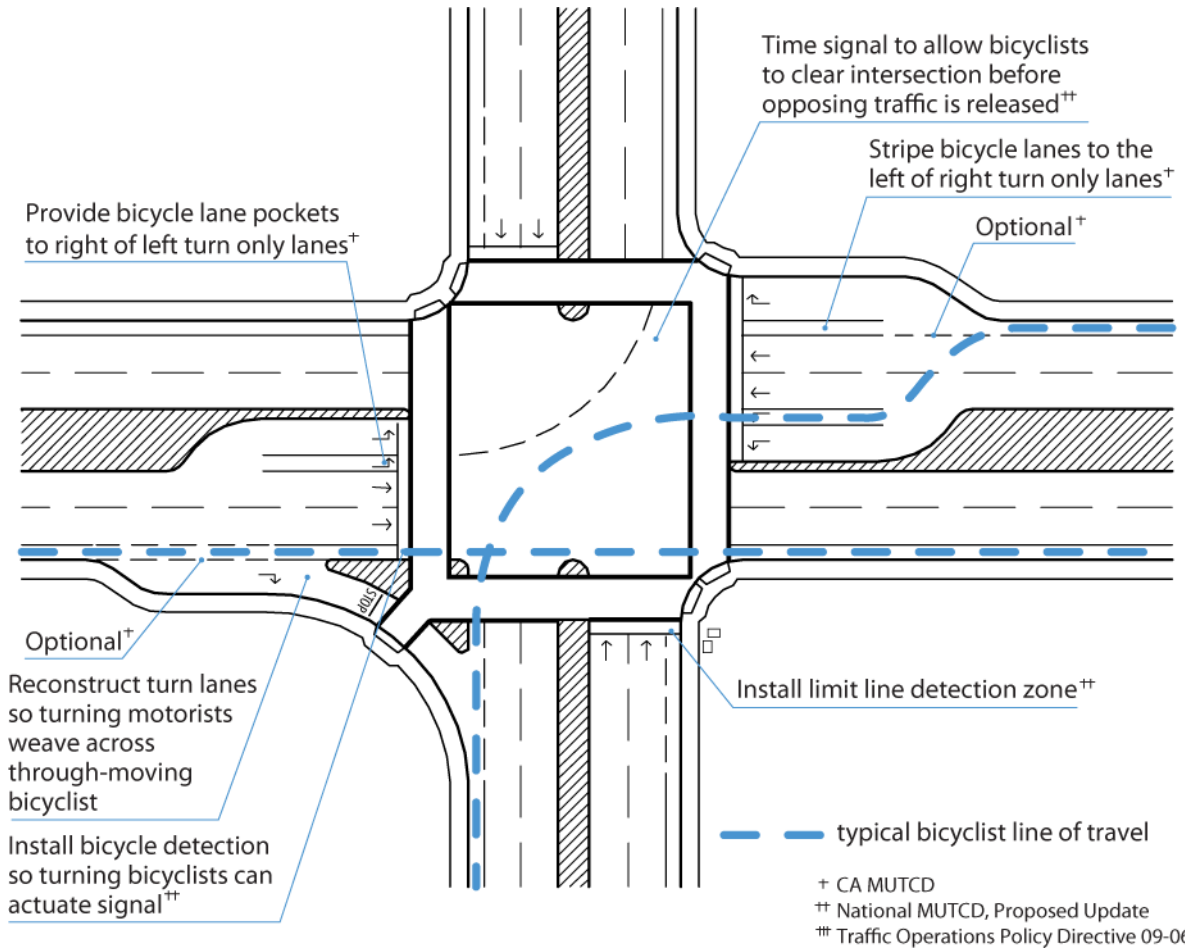




Figure 3.3 Common Intersection Treatments for Bicyclists





Determining the Appropriate Design Vehicle

The Caltrans HDM indicates that design of California highways should consider the needs of large vehicles to ensure they have space to maneuver. The HDM recommends using the Surface Transportation Assistance Act (STAA) design vehicle (figure 404.5A or B, 50- or 60-foot radius) in the design of all projects on the National Network or Terminal Access truck routes and the California Legal Design Vehicle (404.5D or E, 50- or 60-foot radius) in the design of all interchanges and intersections of California Legal routes and California kingpin to rear axle advisory routes (Section 404.2). Depending on the mix of motor vehicles on a roadway, this may lead to overbuilding streets for large, but infrequent vehicles to the detriment of the safety of more frequent roadway users. Large turning radii and wide travel lanes can negatively impact pedestrians and bicyclists by increasing crossing distances, increasing motor vehicle speeds, and reducing the visibility of nonmotorized users to motorists.

However, the HDM provides some flexibility, and indicates that “[i]n some cases, factors such as cost, right of way, environmental issues, local agency desires, and the type of community being served may limit the use of the STAA design vehicle template” (Section 404.3 (b)).

Rather than design every intersection with a California Legal route to 50- or 60-foot turning radii, planners, engineers, and other highway designers may consider the type of roadway that is intersecting with the California Legal route. Since STAA design vehicles are not expected to use local roads that are not California Legal routes, intersections with these roads do not always need to use the 50-foot or 60-foot radius.

This guidebook recommends that project planners, engineers, and other highway designers consider the following when determining turning radii:

- Consider the relative mix of vehicles on a roadway and the volumes of non-motorized users when selecting a design vehicle, and use the minimum appropriate turning radius.
- For intersections of California Legal routes and local roads, communicate with the local jurisdiction to determine the preferred turning radii. Where STAA design vehicles are used, a smaller design vehicle than the California Legal Design Vehicle should be considered.

The following are examples of guidance from other states on selecting a design vehicle:

- The Florida Department of Transportation (DOT) "Greenbook" requires that the design vehicle be at least 5 percent of the traffic volume.
- The Oregon DOT HDM allows lane widths of less than 12 ft where the 4-axle truck Average Daily Traffic is less than 250.
- Vermont DOT State Design Standards document provides a table showing acceptable lane and shoulder widths relative to design speed and traffic volume.



Speed Management Treatments

Reducing motor vehicle speeds can improve safety for pedestrians and bicyclists. Reducing legal speed limits is not usually an appropriate means of accomplishing this goal, since speed limits are set by engineering surveys that reflect most drivers desired speeds given conditions. If speed limits are set artificially low, drivers may not comply.

There are several engineering techniques available to accomplish the goal of reduced speeds. The table below provides a list of proven speed management treatments applicable to the Caltrans roadway system, along with speed reductions observed in relevant studies.

Engineering Countermeasures for Speed Management	
Countermeasure	Reduction in 85th
Roundabout <i>In urban and suburban environments where posted speed is 45 mph or less</i>	25% to 42%
Lateral Shift <i>Travel Lane shift</i>	8% to 25%
Center Island <i>Narrows travel lanes</i>	12%
Converging Chevron Marking Pattern ^a <i>Transverse pavement marking</i>	11% to 24%
In-Roadway Warning Lights <i>At pedestrian crossings</i>	5% to 7%
Speed Activated Feedback Signs <i>Dynamic display speed warnings</i>	7% to 19%
Gateway Treatment <i>Combined use of signs, landscaping, etc.</i>	5% to 7%

^a Experimental treatment.

Source: FHWA, *Engineering Countermeasures for Reducing Speeds: A Desktop Reference of Potential Effectiveness*, May 2009. A full list along with studies cited can be found at http://safety.fhwa.dot.gov/speedmgt/ref_mats/eng_count/.



Bicycle Detection at Traffic-Actuated Signals

Traffic Operations Policy Directive 09-06, issued August 27, 2009, modified CA MUTCD 4D.105 to require bicyclists to be detected at all traffic-actuated signals on public and private roads and driveways. The Policy Directive includes the following:

- Defines a 6 foot by 6 foot Limit Line Detection Zone in which a Reference Bicycle-Rider must be detected.
- Provides guidelines for when non-compliant limit line detectors must be replaced.
- Defines bicycle start-up and travel times that should be used to time signal phases to accommodate bicyclists.

The Policy Directive is still being revised, so readers should refer to the most recent version of the directive for specifics.

3.2. Four-Leg Intersections: Two-Way STOP Controlled

The intersection of a minor road with a major road can be challenging for bicyclists and pedestrians. Most issues are related to difficulties with crossing the major road and potential conflicts between bicyclists, pedestrians, and turning vehicles.



If the major road is not controlled, pedestrians and bicyclists may experience a long delay before there is a large enough gap in traffic to allow them to cross the major road. The major road may not be adequately and appropriately designed to cue motorists to look for or expect pedestrians and bicyclists crossing at the minor road.

Medians in the major road can provide a refuge for crossing pedestrians and bicyclists, but only if they are designed to do so. If the median holds a left-turn only lane, it does not provide a refuge area, and may exacerbate a multiple threat situation since vehicles stopped waiting to turn left will block approaching motorists' view of the crosswalk.

3.2.1. Common Issues

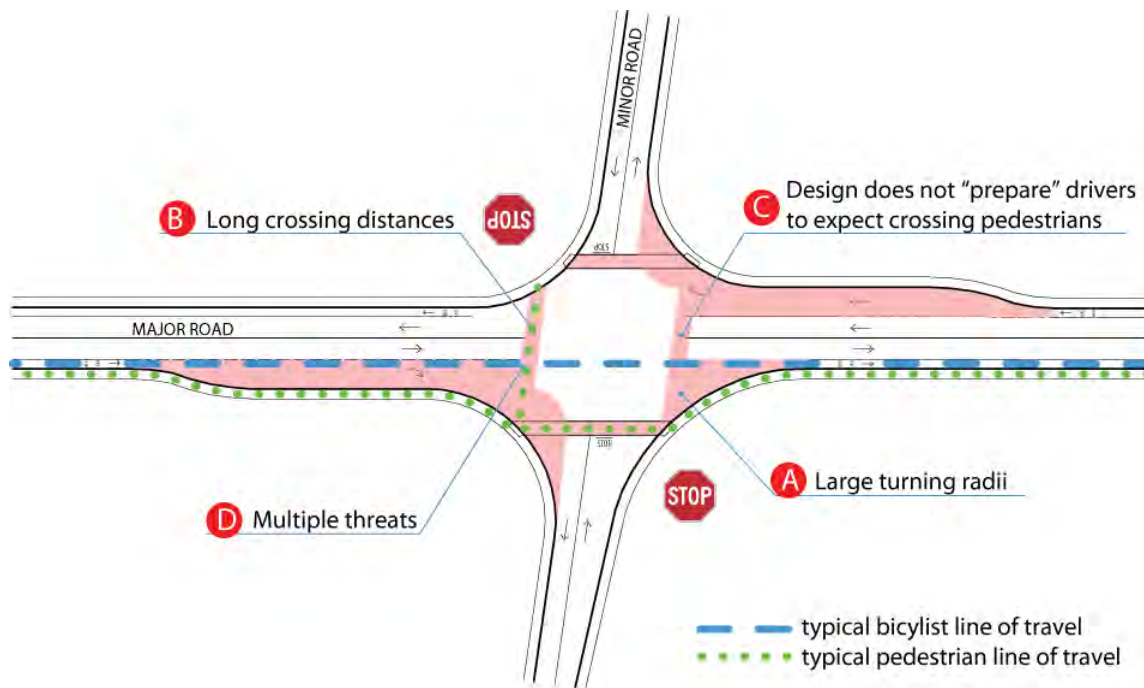
Common issues seen at two-way STOP-controlled, four-leg intersections are illustrated in Figure 3.4. They include:

- A. **Large turning radii** and right-turn only lanes allow motorists to take the corner at high speeds and increase pedestrian crossing distance. This design also decreases opportunities to cross when traffic is heavy.



- B. **Long crossing distances**, particularly in conjunction with high motor vehicle volumes and speeds make it difficult to cross the major road at an uncontrolled crossing.
- C. **Intersection is not adequately and appropriately designed so that drivers expect pedestrians to cross major road.**
- D. **Multiple threat** issues when crossing multilane roads (see Section 11.3 for discussion of multiple threat collisions).

Figure 3.4 Issues Associated with Two-Way STOP Controlled, Four-Leg Intersections



3.2.2. Treatments

Table 3.2 lists treatments to improve the comfort and safety of pedestrians and bicyclists at two-way STOP controlled intersections.

Three figures illustrating treatments are shown:

- Figure 3.5 shows less-expensive treatments to an intersection reducing curb radii and signage and striping improvements.
- Figure 3.6 shows more expensive treatments to an intersection: constructing raised islands to provide a refuge area for pedestrians and to shorten crossing distances.
- Figure 3.7 shows a treatment for a crossing of a multilane road that includes pedestrian actuated flashing beacons and refuge medians.



Table 3.2 Treatments for Two-Way STOP Controlled Intersections

Treatment	Design Principles	Figure No.
<i>Signage and Striping</i>		
Stripe high-visibility crosswalks	Pedestrians and Bicyclists Will Be There, Improve Visibility	3.5, 3.6, 3.7
Stripe yield lines and “Yield here to pedestrians” signs (per National MUTCD Proposed Update).	Pedestrians and Bicyclists Will Be There, Clarify the Right-of-Way	3.5, 3.6, 3.7
Stripe advanced stop lines.	One Decision at a Time, Improve Visibility, Clarify the Right-of-Way	3.5, 3.7
Restrict parking for at least one car length from each side (CA MUTCD 3B.18).	Improve Visibility	Not shown
If the uncontrolled crosswalk is a school crosswalk, install pedestrian actuated flashing beacon, as warranted (CA MUTCD 4K.103).	Clarify the Right-of-Way Light at Night	Not shown
Install in-road lights on the uncontrolled, marked crosswalks, as warranted (CA MUTCD 4L.02).	Clarify the Right-of-Way Light at Night	3.7
<i>Infrastructure</i>		
Construct raised pedestrian refuge if pedestrians cannot cross in one cycle, or if otherwise appropriate.	One Decision at a Time, Improve Visibility, Shorten Crossings	3.7



Image: www.pedbikeimages.org / Dan Burden

Crosswalks at uncontrolled locations on high volume arterials should be paired with enhancements such as a raised median or pedestrian-actuated beacon.



Figure 3.5 Less Expensive Treatments: Reducing Turn Radii and Signage and Striping

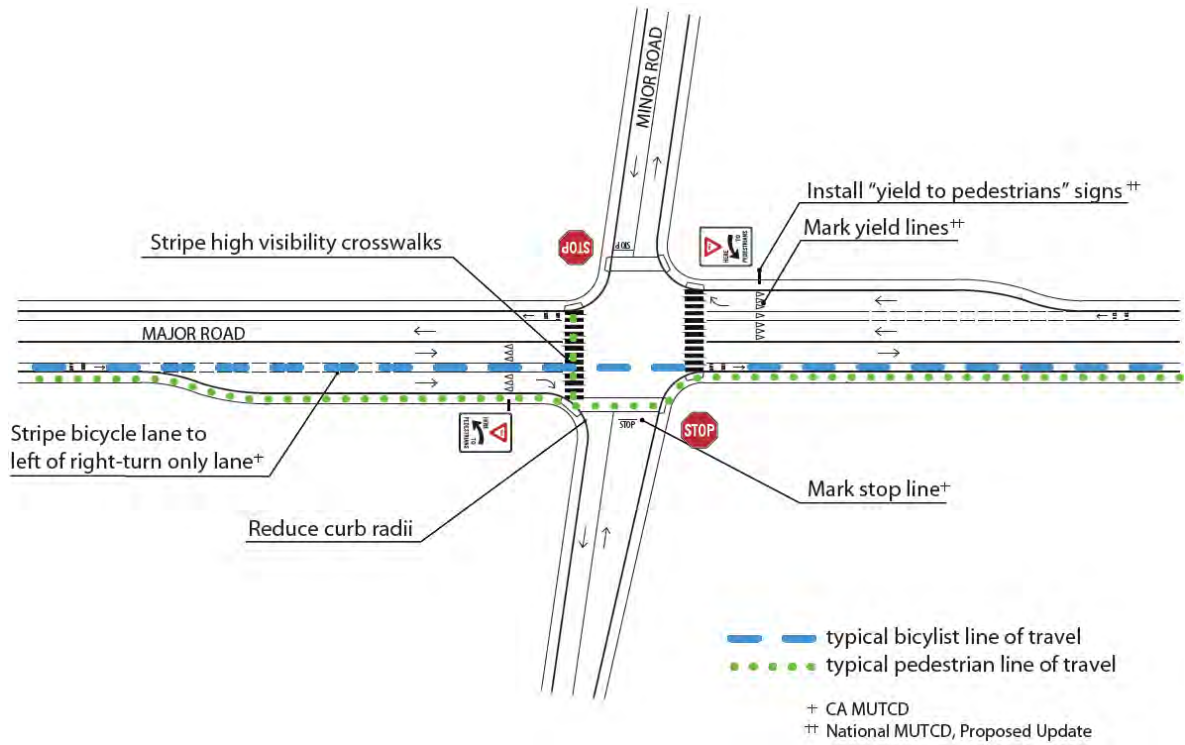


Figure 3.6 More Expensive Treatments: Constructing Raised Islands

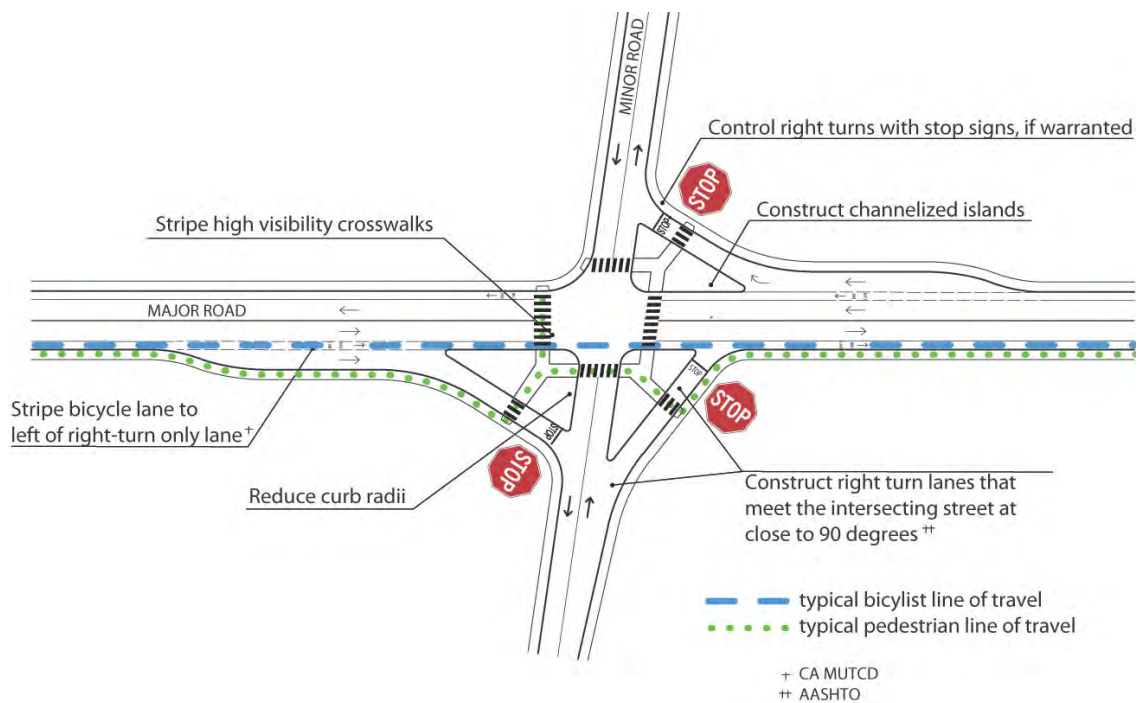
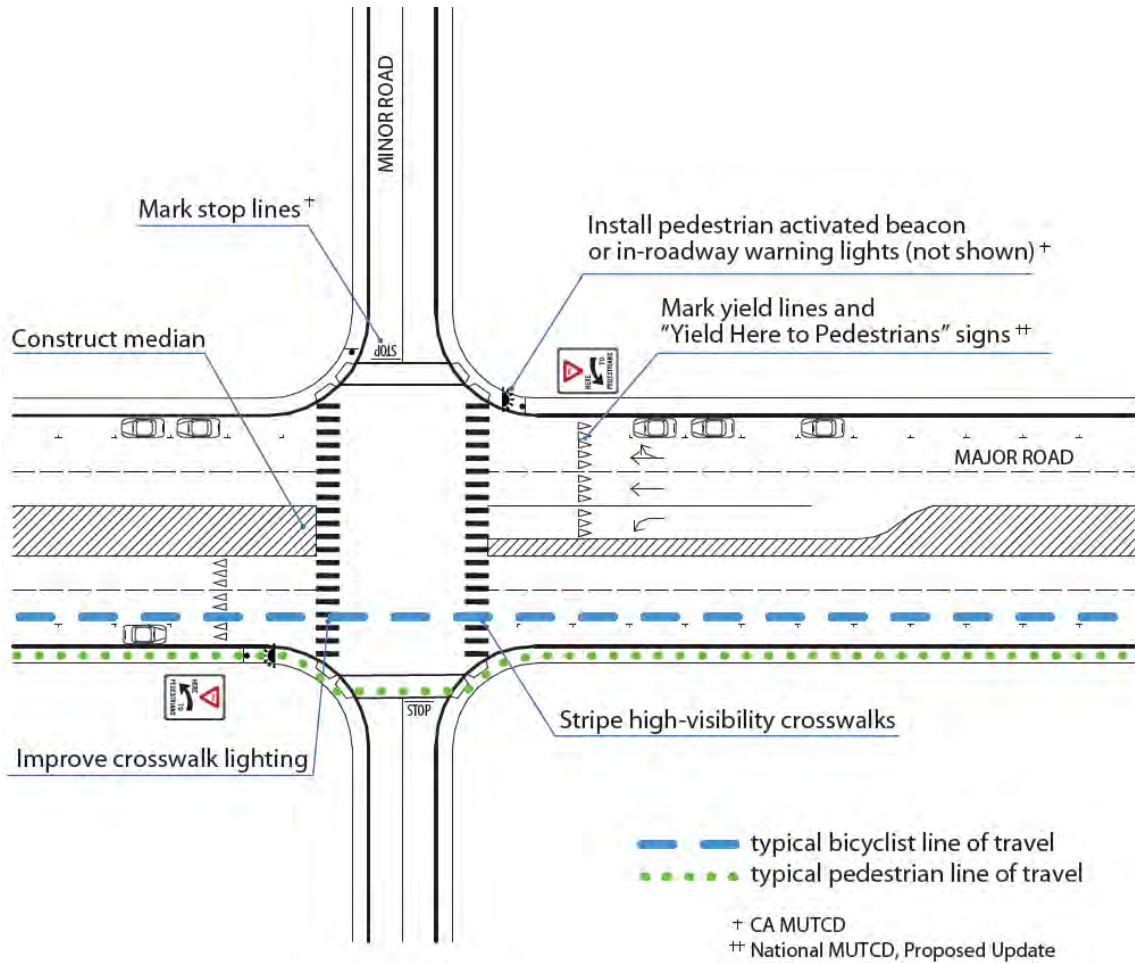




Figure 3.7 Flashing Beacons and Medians





Marked Versus Unmarked Crosswalks at Uncontrolled Locations

Crosswalk lines should not be used indiscriminately. An engineering study should be performed before they are installed at uncontrolled locations. A comprehensive study on the safety effects of marked crosswalks at uncontrolled locations was published by FHWA in 2001. The study compares the number of vehicle pedestrian crashes at matched pairs of marked and unmarked crosswalks at the same intersection.

Several key points from the study are important to the design of crosswalks:

1. Volumes of pedestrian crossings were three to four times higher at marked crosswalks than at equivalent unmarked crosswalks.
2. When adjusted for pedestrian volumes, there were no statistically significant differences in number of pedestrian-vehicle crashes at marked and unmarked crosswalks on the following types of roadways:
 - Two-lane roadways
 - Multilane roadways with Average Daily Traffic (ADT) less than 12,000
 - Multilane roadways with a raised median (pedestrian refuge) and ADT less than 15,000
3. Conversely, providing a marked crosswalk with no additional treatment (e.g. medians, flashing beacons, curb extensions, signage) at the following types of roadways was shown to increase the rate of pedestrian-vehicle crashes:
 - Roadways with speed limits of 40 mph or greater
 - Roadways with four or more lanes, no raised median, and an ADT of greater than 12,000
 - Roadways with four or more lanes, with a raised median, and an ADT greater than 15,000

Source: Zegeer et al. *Safety Effects of Marked vs. Unmarked Crosswalks at Uncontrolled Locations*. Highway Safety Research Center, University of North Carolina, Chapel Hill, North Carolina, 2001. (FHWA-RD-01-075). The complete study and a table of recommended treatments by location type can be accessed from <http://www.walkinginfo.org/library/details.cfm?id=54>.



4. THREE-LEG AND OFFSET INTERSECTIONS

Three-leg and offset intersections present similar issues as four-leg intersections but have unique issues related to sightlines at one end of the crosswalk and conflicts between turning motor vehicles and pedestrians and bicyclists.

4.1. Ninety-Degree T

4.1.1. Common Issues

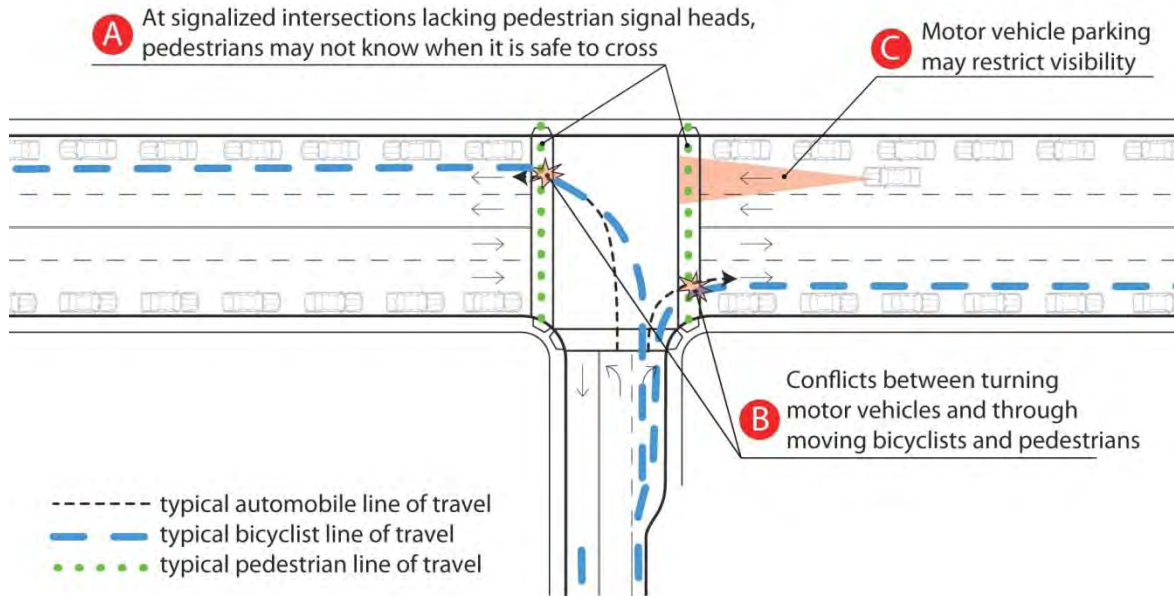
Pedestrian and bicycle issues related to T-intersections stem from the fact that a T-intersection is a three-way intersection for motorists, but a four-way intersection for pedestrians or bicyclists. Conflicts occur between turning vehicles and crossing pedestrians and bicyclists. This is problematic at STOP or YIELD controlled T's, but especially problematic at signal-controlled intersections.

Issues unique to T-Intersection are illustrated in Figure 4.1 and include:

- A. Signalized intersections, if vehicular signal indications are not visible to pedestrians, **pedestrians waiting to cross the major road against traffic may not know when it is legal** to do so
- B. **Turning vehicles conflict** with through-moving pedestrians and bicyclists
- C. Motor vehicle **parking may restrict visibility or obstruct the end of the crosswalk** that lands on a straight section of sidewalk



Figure 4.1 Common Issues at Signalized T-Intersections



4.1.2. Treatments

T-intersection treatments should focus on reducing conflicts between through-moving pedestrians and turning motor vehicles, indicating to pedestrians when they may legally cross the street, and improving visibility at the non-corner end of the crosswalk. All the standard treatments identified in four-leg intersections apply to T-intersections.

Figure 4.2 illustrates treatments for signalized T-intersections.

Figure 4.3 illustrates treatments for T-intersections where the major road is uncontrolled.



Table 4.1 Treatments for T-Intersections

Treatment	Design Principles	Figure No.
<i>Signage and Striping</i>		
Stripe high-visibility crosswalks across the main road.	Improve Visibility	4.2,4.3
Install pedestrian warning and yield signage at the uncontrolled crosswalk.	Improve Visibility	4.2
Stripe yield lines and “Yield Here to Pedestrian (R1-5a)” signs in advance of the crosswalk.	Clarify the Right-of-Way	4.2
Restrict parking between yield line and crosswalk (20 feet minimum).	Improve Visibility	4.2
<i>Infrastructure</i>		
Construct curb extension at non-corner crosswalk end.	Shorten Crossings, Improve Visibility	4.3
<i>Operations</i>		
Configure signal to provide a leading pedestrian interval to reduce conflicts between crossing pedestrians and turning motorists.	Pedestrians and Bicyclists Will Be There	4.3
Install pedestrian signal head for pedestrians and bicyclists waiting to cross main road opposite minor road. Bicyclists crossing as pedestrians should dismount and walk their bike.	Pedestrians and Bicyclists Will Be There	4.3

Figure 4.2 Signage and Operations Treatments for Signalized T-Intersections

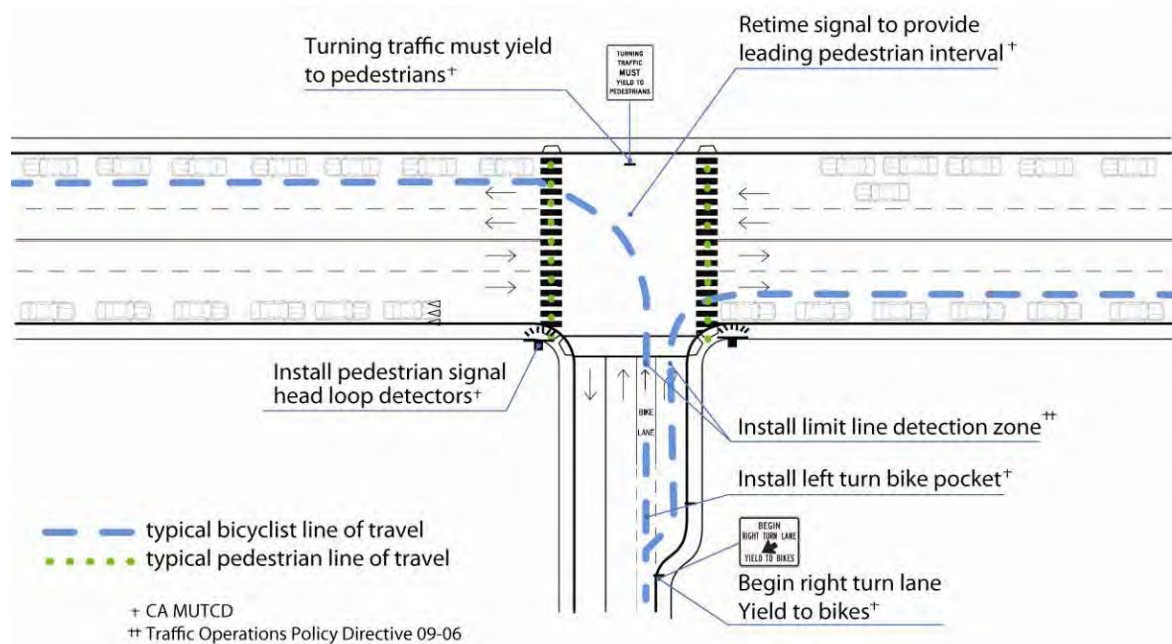
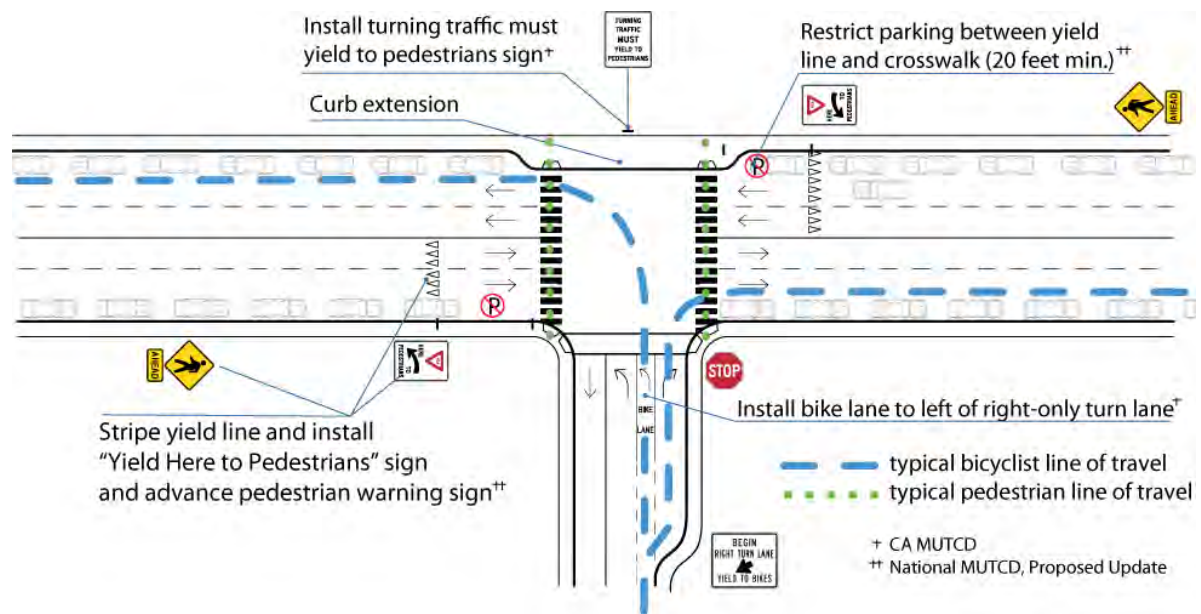




Figure 4.3 Signage Treatments for T-Intersections Where Major Road is Uncontrolled



4.2. Offset

4.2.1. Common Issues

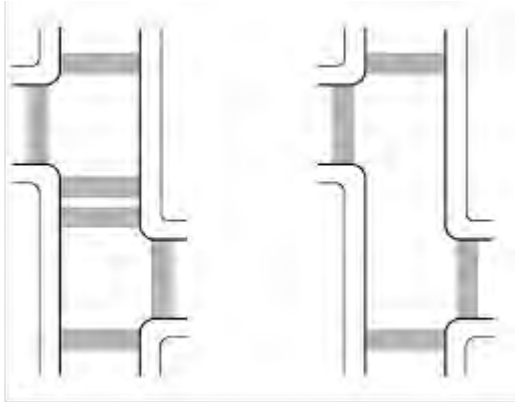
Offset intersections can be thought of as two closely spaced T-intersections, and have the same issues as T-intersections. A few issues, however, are unique to offset intersections:

- Conflicts between **turning motorists and through-moving bicyclists**.
- If crosswalks are not marked, **pedestrians may be uncertain which of the many legal crosswalks they should use**.
- For left-right offset intersections, **bicyclists crossing the main road are exposed to motor vehicles while waiting to turn left**.
- Bicyclists and drivers responding to gaps in traffic **may fail to notice crossing pedestrians**.
- Bicyclists continuing on the minor (offset) road must **cross opposing traffic streams all at once**; at right-left offset intersections, in particular there may be no logical refuge area.
- At signalized offset intersections, **bicycle clearance time may be insufficient** [not shown].

Figures 4.5 and 4.6 illustrate these issues at left-right and right-left offset intersections.



Figure 4.4 Legal Crossings at Offset Intersections



Source: Portland Pedestrian Master Plan.

The left hand diagram shown above illustrates all the legal crosswalks in a typical offset intersection. A more practical and effective striping application is shown at right.

Figure 4.5 Pedestrian and Bicycle Issues at a Left-Right Offset Intersection

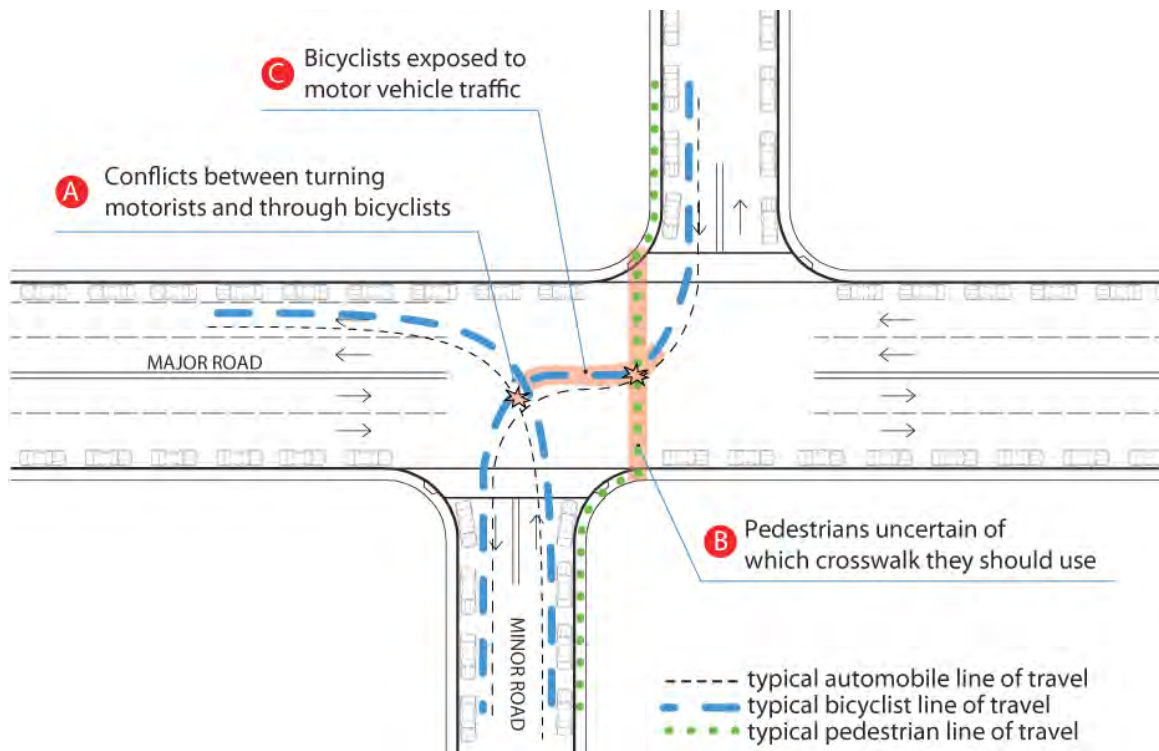
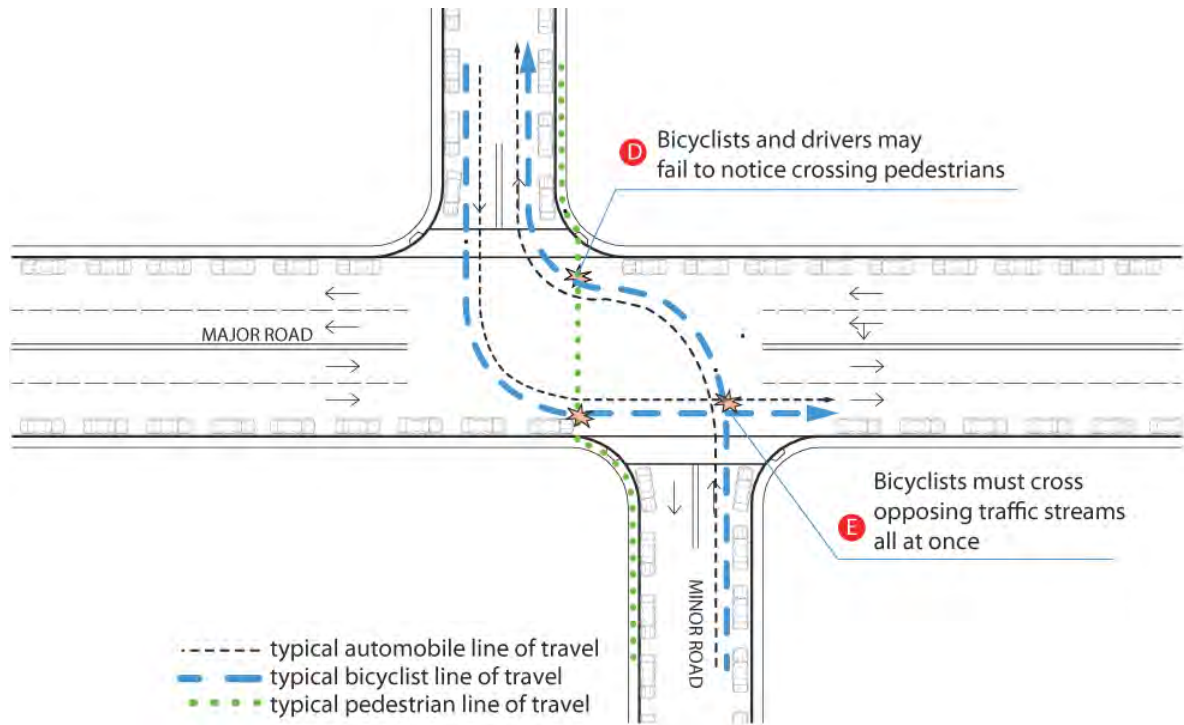




Figure 4.6 Pedestrian and Bicycle Issues at Right-Left Offset Intersections



4.2.2. Treatments

All the standard treatments for four-leg and T-intersections apply to offset intersections. At offset intersections, pedestrian safety and convenience can be improved by selectively removing some legal crosswalks and enhancing others.

Treatments to improve bicyclist travel through offset intersections should focus on making it easier for through-moving bicyclists to cross both directions of traffic on the major road, clarifying who has the right-of-way at the intersection, and improving the yielding behavior of turning motorists. These improvements may include signage indicating who must yield the right-of-way, striping, such as left-turn only lanes with bicycle pockets, and physical treatments such as median refuges. Several examples of innovative treatments for bicyclists at offset intersections exist, but these are not yet incorporated into the California HDM or the CA MUTCD. These include striping bicycle-only center turn lane or restricting motorist through movements at the intersection but allowing bicyclist movements (See Figure 4.8.).



Example of bike only left-turn lane.

Treatments specific to offset intersections are listed in Table 4.2.



Figure 4.7 illustrates ways in which pedestrians can be better accommodated at offset intersections.

Figure 4.8 illustrates striping treatments that can be used to accommodate bicyclists at offset intersections.

Table 4.2 Treatments for Offset Intersections

Treatment	Design Principles	Figure No.
<i>Signage and Striping</i>		
Enhance outer crosswalks while removing inner crosswalks. (Install “Pedestrians Use Marked Crosswalk” sign).	Clarify Right-of-Way	4.7,4.8
<i>Infrastructure</i>		
Provide refuge for turning bicyclists, through striping or construction of a refuge island.	Shorten Crossings, Clarify Right-of-Way	4.8
Construct curb extensions for pedestrians.	Shorten Crossings	4.7, 4.8
<i>Operations</i>		
Provide leading pedestrian interval or pedestrian-only phase at signalized offset intersections.		Not shown

Figure 4.7 Selective Crosswalk Enhancement at Offset Intersections

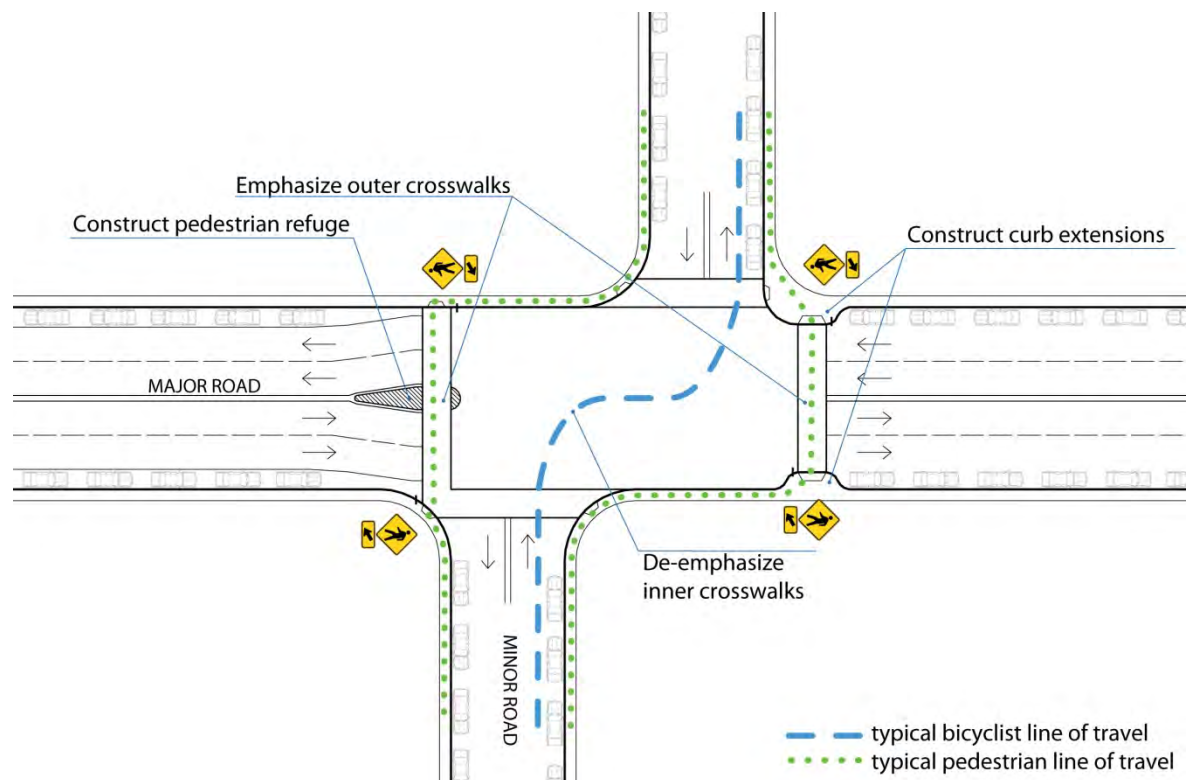
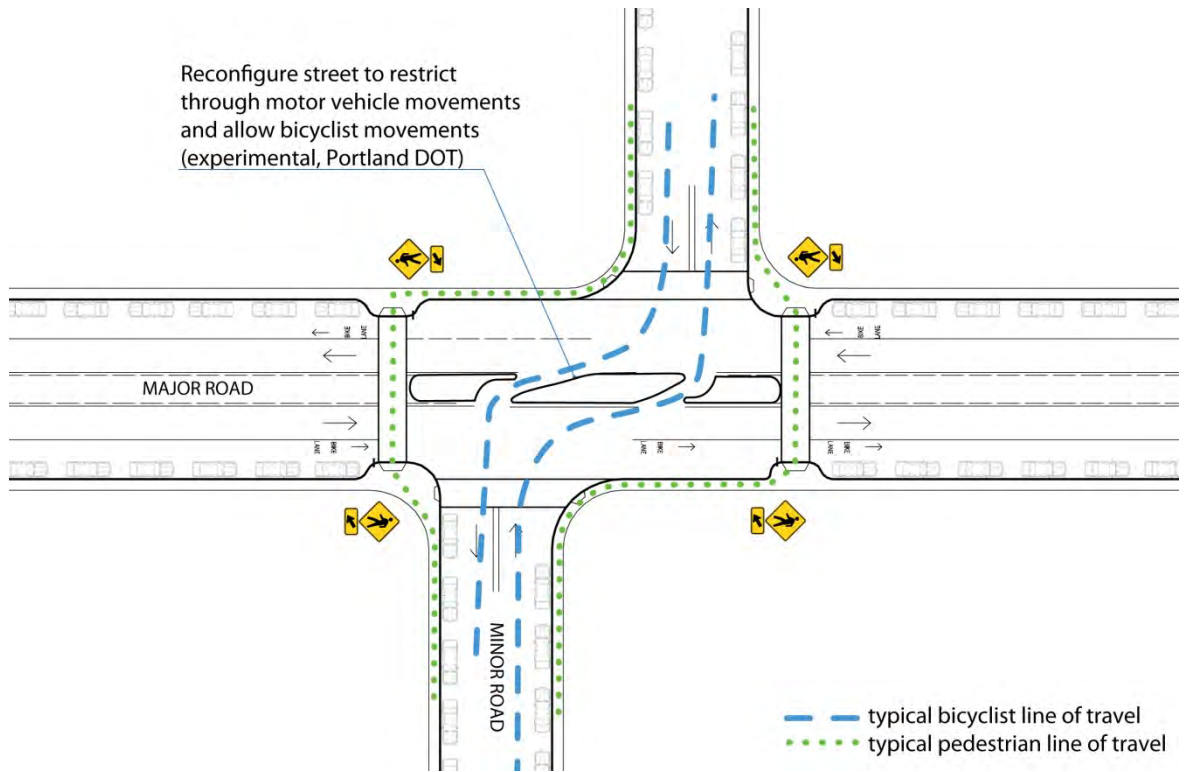




Figure 4.8 Experimental Bicycle Treatments at Offset Intersections





5. SKEWED AND MULTI-LEG INTERSECTIONS

Issues experienced by pedestrians and bicyclists at standard intersections are made more complicated at skewed and multi-leg intersections. These intersections increase crossing distances, may pose navigation difficulties for pedestrians with visual impairments, and can reduce the visibility of pedestrians and bicyclists to motorists.

For pedestrians, the key concerns at these types of intersections are related to crosswalk placement. When determining where to place crosswalks at skewed or multi-leg intersections, designers should observe the natural pedestrian path and place crosswalks at a location as close to the pedestrians' natural path as possible while maximizing visibility, driver and pedestrian expectation and minimizing crossing distances.

The AASHTO Guide for *"The Planning, Design, and Operation of Pedestrian Facilities"* notes that placement of crosswalks at skewed intersections generally falls between placing the crosswalk as a continuation of the sidewalk and at a right angle to the road.

Table 5.1 Crosswalk Placement at Skewed Intersections

Crosswalk Location	Advantages	Disadvantages
As a continuation of the sidewalk.	In line with the approach sidewalk; continues walking path; shortest overall distance.	Reduces visibility for pedestrians crossing some intersection legs where they travel on a path facing partly away from traffic approaching from the right; exposes pedestrians to traffic for a longer period.
At a right angle to road.	Shortest crossing distance; pedestrians have good visibility of approaching motorists.	Longer overall walking distance; may be counterintuitive; places crosswalk away from intersection where motorists may not expect pedestrians.

Note: Adapted from AASHTO Guide for The Planning, Design, and Operation of Pedestrian Facilities.

Skewed and multi-leg intersections present similar issues for bicyclists as they do for motorists. At these intersections, some bicyclist turning movements and crossing distances are increased. Where legs intersect at a non-perpendicular (skewed) angle, motorists, and bicyclists must turn their heads significantly to see across an entire sight triangle.¹¹

¹¹ AASHTO Geometric Design of Highways and Streets, 2004.



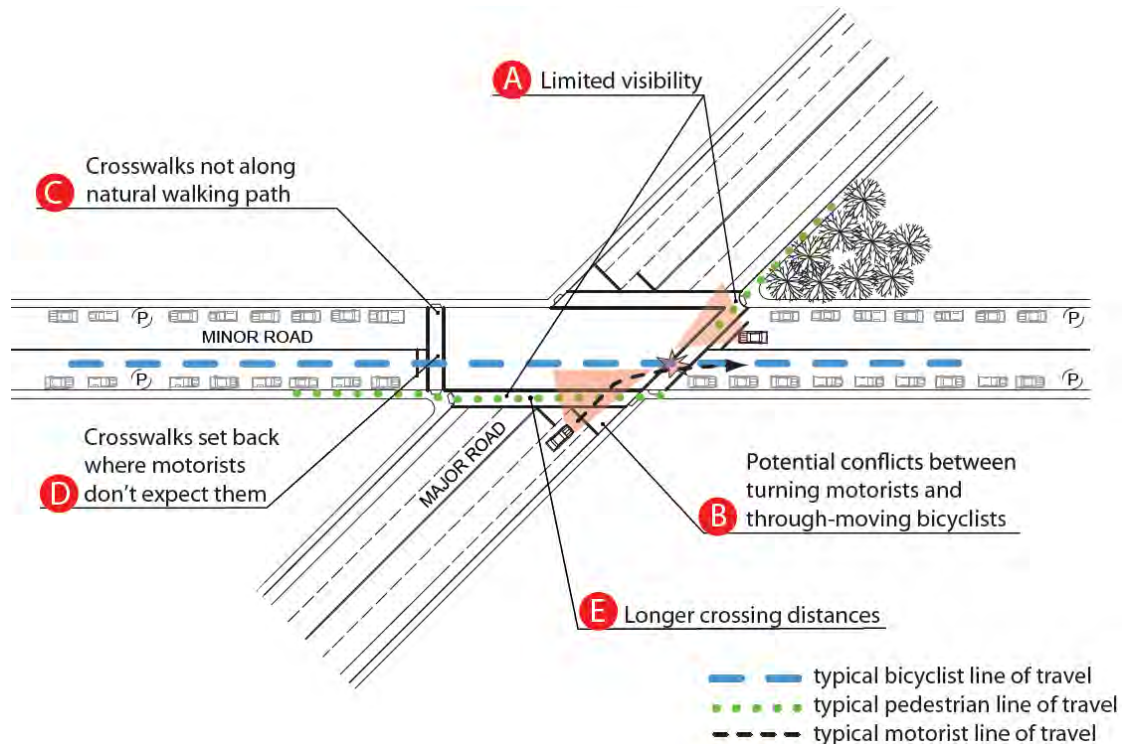
5.1. Skewed Intersections

5.1.1. Common Issues

Skewed intersections occur when two roads meet at a non-perpendicular angle. Common issues seen at skewed intersections are illustrated in Figure 5.1. They include:

- A. **Pedestrians and bicyclists approaching from a skew angle may be less visible to motorists.**
- B. **Turning motorists do not need to slow down for some movements, thus exacerbating conflicts between turning motorists and through moving bicyclists.**
- C. **Crosswalks may not be situated along the natural walking path.**
- D. **Crosswalks may be set back from the intersection, where motorists and bicyclists do not expect them.**
- E. **Longer crossing distances.**
- F. In skewed intersections, **poor pavement quality** may be an issue. Due to the skew, bicycle wheels can catch in grooves or along uneven pavement joints, increasing the possibility of a crash (not shown).

Figure 5.1 Issues Associated with Skewed Intersections





5.1.2. Treatments

Planners, engineers, and other highway designers can accommodate pedestrians and bicyclists at skewed intersections by reducing crossing distances, clarifying appropriate bicyclist movements, and improving visibility of pedestrians and bicyclists. Specific treatments are described in Table 5.2 and may be applied in addition to the basic treatments for all four-leg intersections listed in and Table 3.2.

Two illustrations are shown:

- Figure 5.2 illustrates less expensive treatments: modified crosswalk placement, improvements to visibility, construction of refuge islands, curb extensions and signage and striping; and
- Figure 5.3 illustrates a more expensive treatment: reconstructing the intersection to 90-degree angle.

Table 5.2 Treatments for Skewed Intersections

Treatment	Design Principles	Figure No.
Signage and Striping		
Place crosswalks as close to the pedestrians' natural path as possible.	Improve Visibility, Tee It Up, Shorten Crossings	5.2
Set stop lines back from intersection to allow through moving bicyclists to wait in advance of right-turning motorists.	One Decision/Lane At a Time, Improve Visibility	5.2
Stripe right-turn only lane and bicycle lane to left of turn lane.	Clarify Right-of-Way, Improve Visibility	Not shown
Infrastructure		
Reconstruct intersection so that legs intersect at close to a 90- degree angle, or reconstruct intersection as a single-lane roundabout. See Section 8.0 in this document for issues and treatments associated with roundabouts.	Tee it Up	Not shown
Remove vegetation or physical structures to increase sight lines at acute corners.	Improve Visibility	5.2
Provide refuge islands or curb extensions to reduce crossing distance ^a .	Shorten Crossings	Not shown
Maintain pavement quality through intersection to minimize pavement lips that run less than 45 degrees to the bicyclist line of travel.	Maintain and Improve	Not shown
Operations		
If signalized, time pedestrian phase and green phase to take into account longer crossing distances for pedestrians and bicyclists, respectively.	Pedestrians and Bicyclists Will Be There	Not shown
Consider bicycle signal to give bicyclists a lead so that they may have enough time to clear the weaving area before the motorists are given the green.	Clarify the Right of Way	Not shown

^a See AASHTO *Geometric Design of Highways and Streets*, page 677 for an illustration of increased sight triangles at skewed intersections.



Figure 5.2 Signage, Striping and Minor Construction Treatments for Skewed Intersections

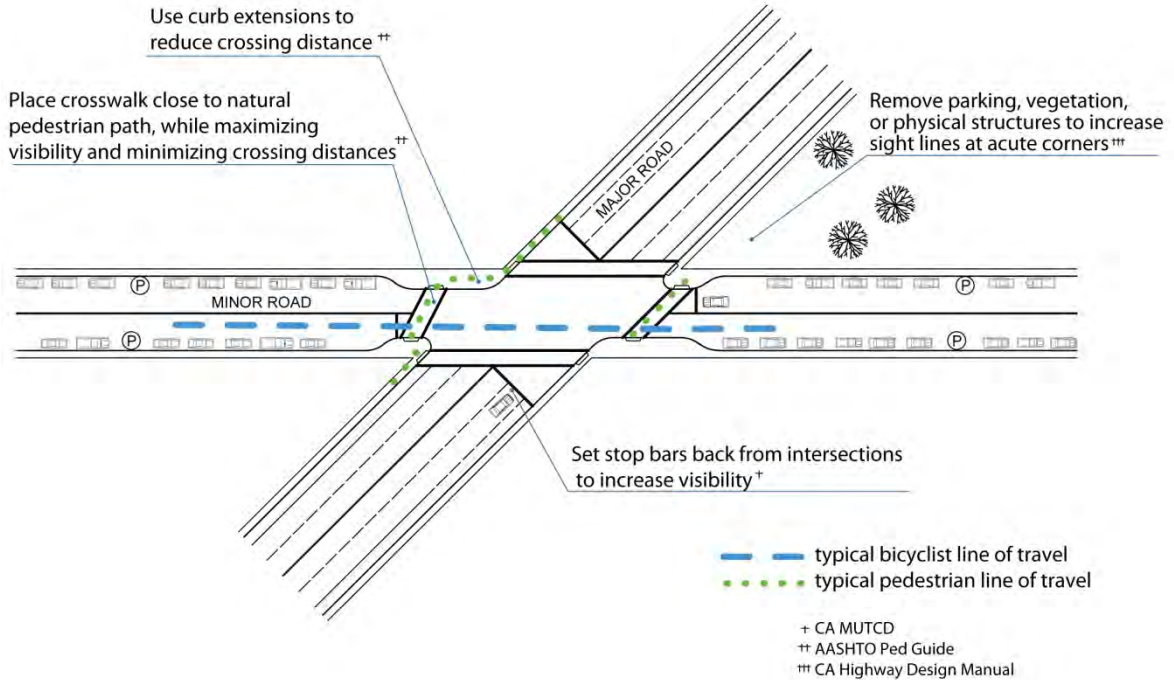
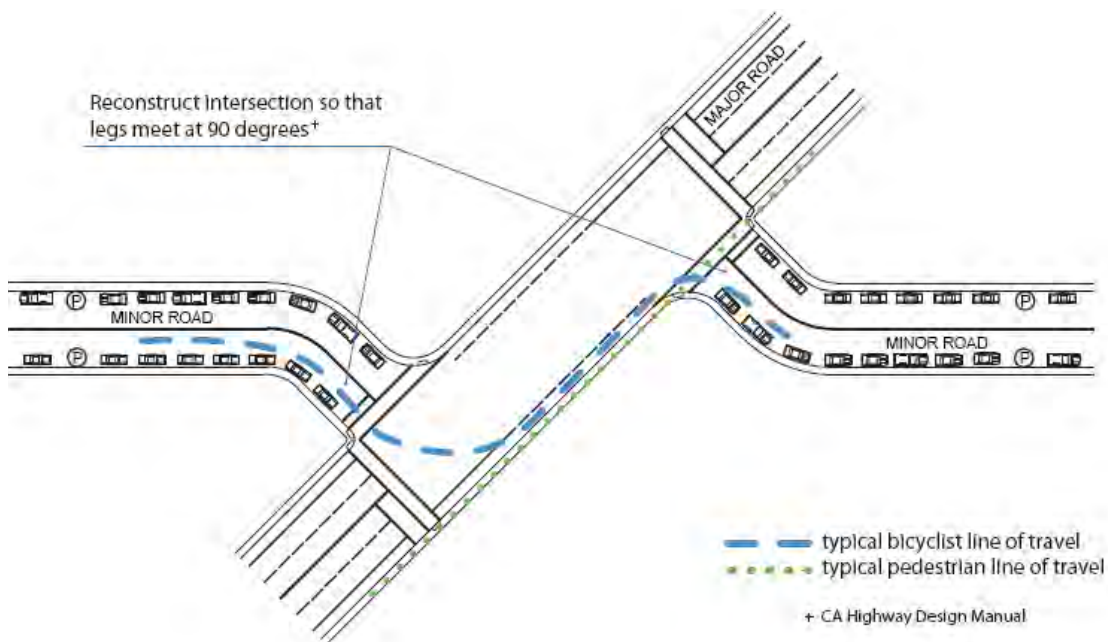


Figure 5.3 Reconstruction of Skewed Intersections to a 90-Degree Angle





5.2. Multi-leg Intersections

5.2.1. Common Issues

Multi-leg intersections are those with five or more intersection legs. *AASHTO Geometric Design of Highways and Streets* states, “multi-leg intersections should be avoided wherever practical” (page 571).

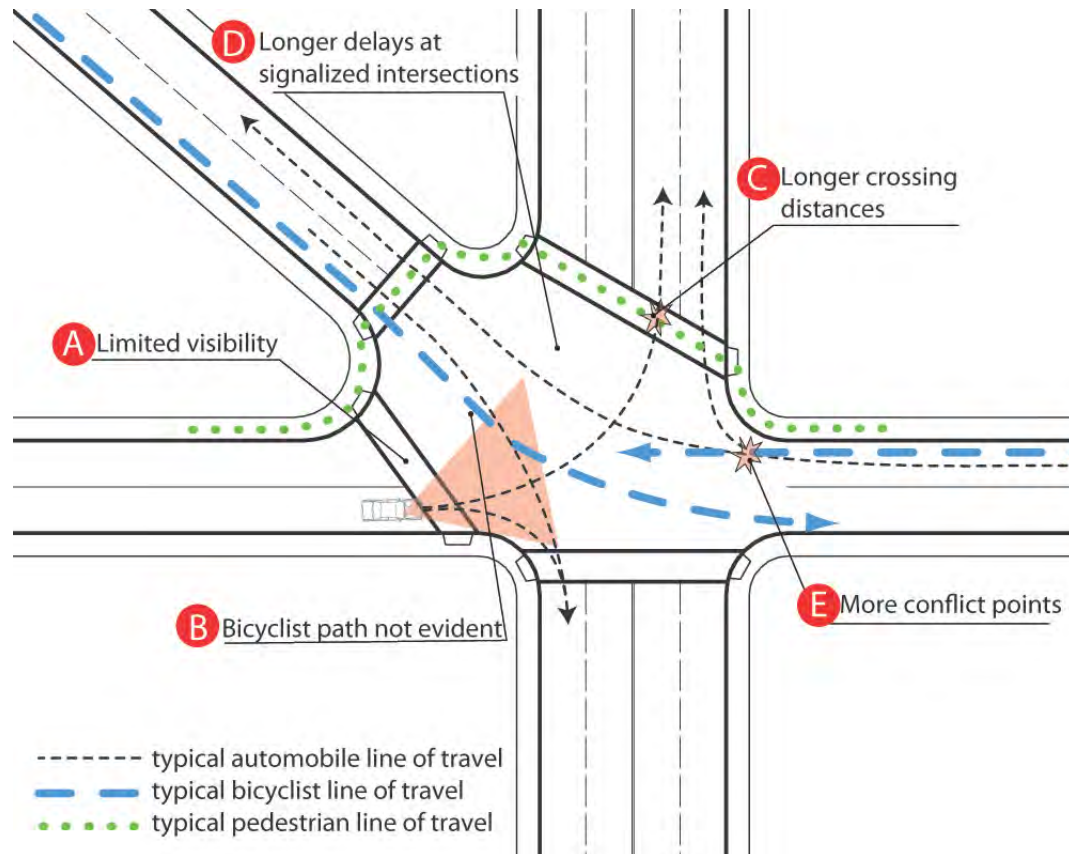
More than other types of intersections, issues for pedestrians and bicyclists at multi-leg intersections are difficult to generalize and tied to unique characteristics of the intersection. In general, issues associated with multi-leg intersections are similar to those at skewed intersections.

Common issues seen at multi-leg intersections are illustrated in Figure 5.4. They include:

- A. **Pedestrians and bicyclists approaching from an acute angle may not be visible to motorists.**
- B. **The bicyclists' path is not evident.**
- C. **Longer crossing distances.**
- D. **Longer delays for pedestrians and bicyclists at signalized multi-leg intersections.**
- E. **More conflict points between pedestrians, bicyclists, and turning motorists.**



Figure 5.4 Issues Associated with Multi-leg Intersections



5.2.2. Treatments

Aside from applying the treatments listed for skewed intersections in this document, the most effective way a designer can improve a multi-leg intersection for pedestrians and bicyclists is to reconstruct the intersection to provide two or more four-leg intersections, or to reconstruct the intersection as a roundabout with circulating speeds of 12 to 22 mph. Roundabouts are covered in Section 8. If reconstructing an intersection is not possible, designers should refer to treatments provided in this document for skewed intersections (Section 4) and four-leg intersections (Section 2).

Two illustrations of treatments are shown:

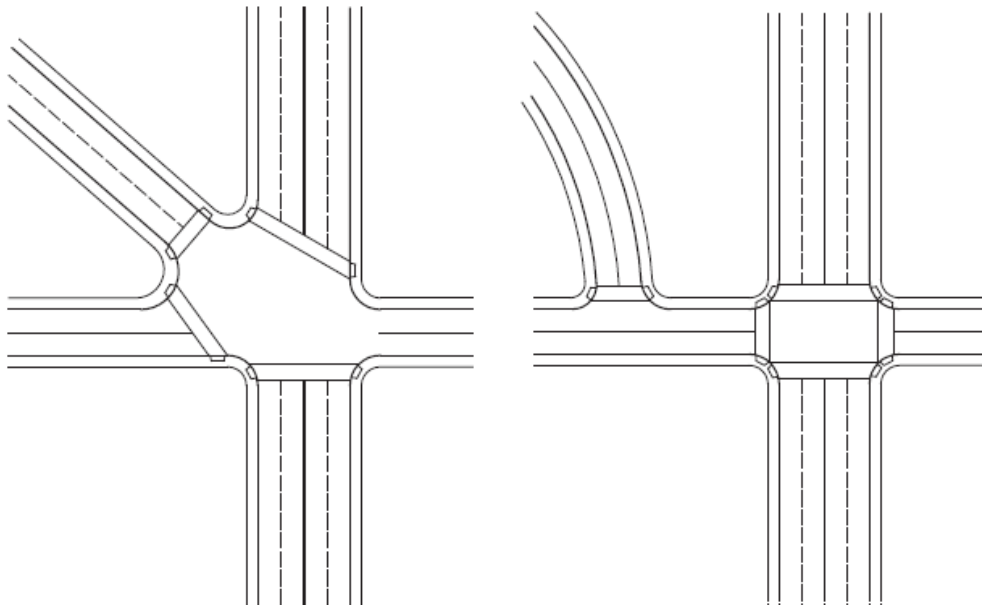
- Figure 5.5 illustrates a reconstruction of a five-leg intersection; and
- Figure 5.6 illustrates a reconstruction of a six-leg intersection.



Table 5.3 Treatments for 5-Leg Intersections

Treatment	Design Principles	Figure No.
<i>Infrastructure</i>		
Reconstruct intersection into two or more separate intersection. The design concept will depend largely on available right-of-way and the major traffic movements.	Tee it Up	5.5,5.6
Reconstruct intersection as roundabout with circulating speeds of 12 to 22 mph.	Clarify the Right-of-Way	Not shown

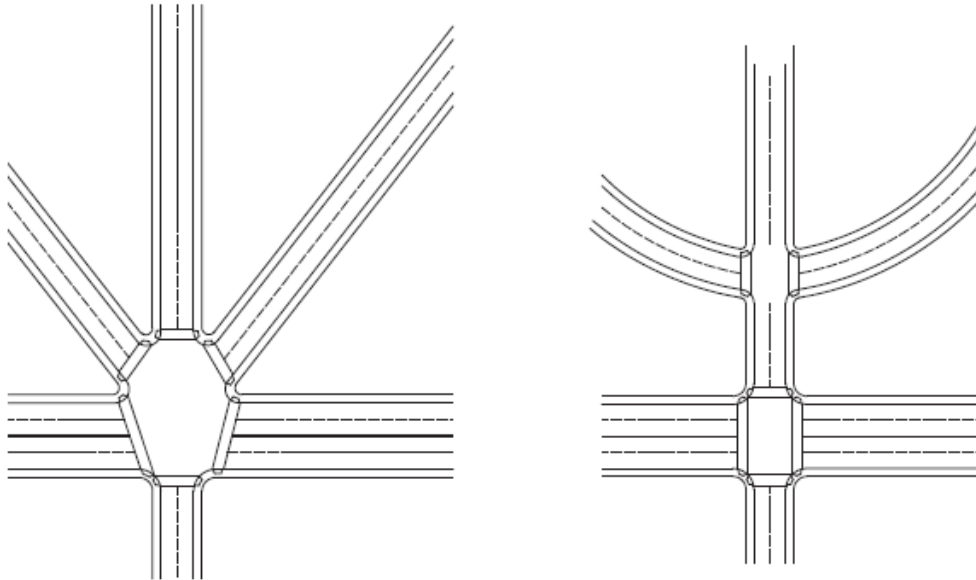
Figure 5.5 Reconstruction of a Five-Leg Intersection



Note: Adapted from Caltrans HDM.



Figure 5.6 Reconstruction of a Six-Leg Intersection



Note: Adapted from Caltrans HDM.

5.3. Y-Intersections

5.3.1. Common Issues

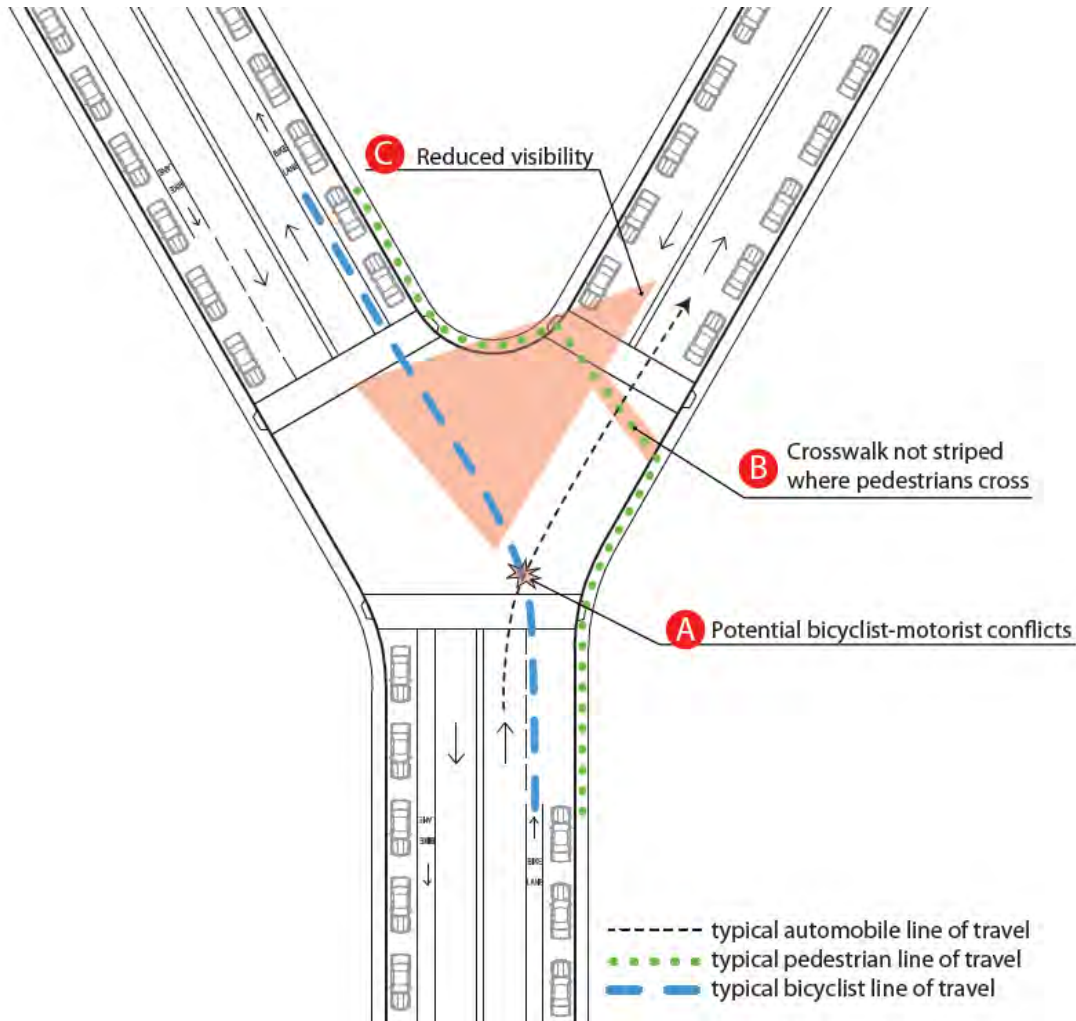
Y-intersections are skewed T-intersections. In addition to the challenges associated with T-intersections and skewed intersections, Y-intersections present special challenges to bicyclists who are approaching the Y.

Common issues seen at Y-intersections are illustrated in Figure 5.7. They include:

- A. Bicyclist and motor vehicle movements are not clear, **increasing the potential for conflicts** between through moving bicyclists and turning motorists.
- B. **Crosswalk may not be striped where pedestrians naturally want to cross.**
- C. **Visibility may be reduced** at the acute approach.



Figure 5.7 Common Issues Associated with Y-Intersections



5.3.2. Treatments

To improve a Y-intersection for pedestrians and bicyclists, designers may reconstruct the intersection so that the legs meet as close as possible to a 90-degree angle. If reconstruction is not possible, designers should use treatments that improve visibility of pedestrians and bicyclists, clarify the appropriate bicyclist path, reduce crossing distances, or increase the time available for crossing.

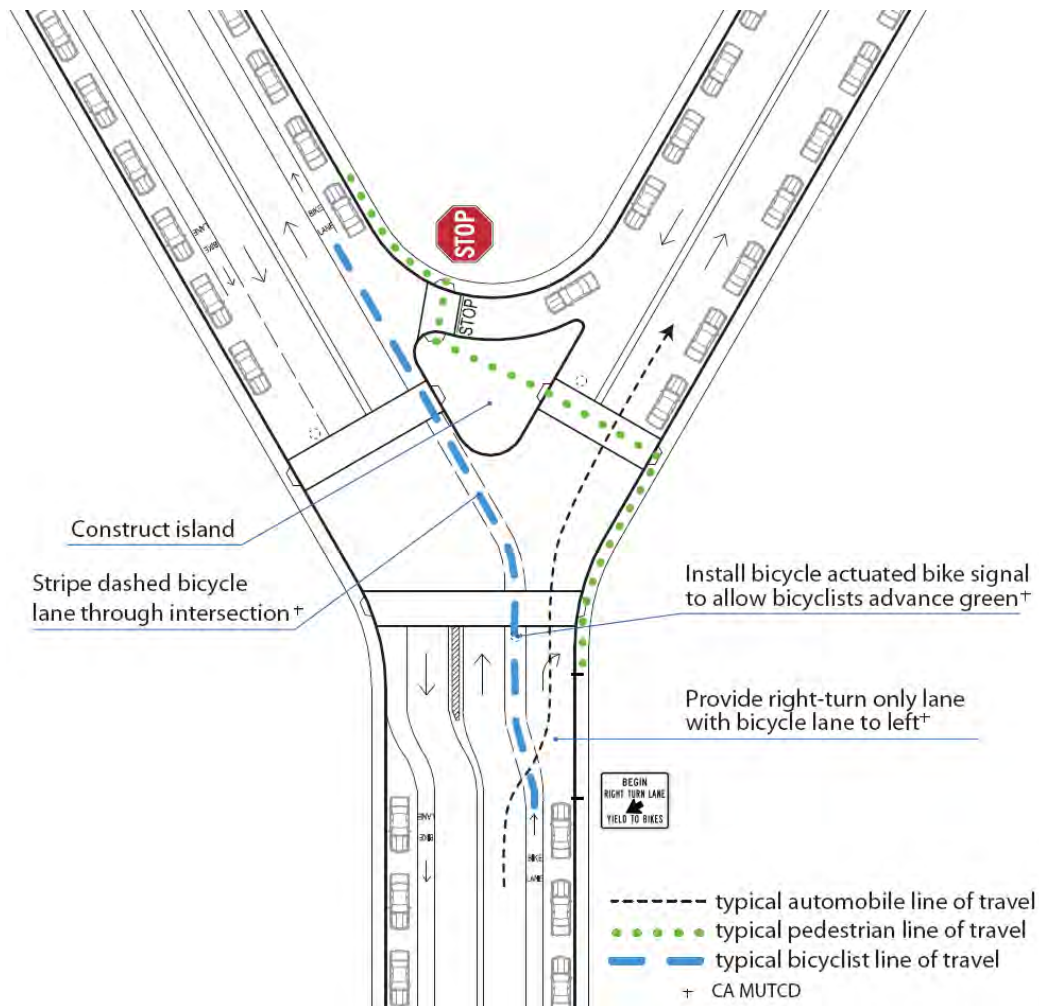
Figure 5.8 illustrates a treatment of a Y-intersection that relies on signage, striping, and infrastructure improvements. Table 5.4 lists treatments for Y-intersections.



Table 5.4 Treatments for Y-Intersections

Treatment	Design Principles	Figure No.
<i>Signage, Striping, and Operations</i>		
Stripe dashed bicycle lane through intersection to clarify bicyclist path.	Clarify Right-of-Way	5.8
Provide bicycle lane to the left of a right-turn only lane to separate through bicyclists and turning motorists.	Clarify Right-of-Way, One at a Time	5.8
Install bicycle-actuated signal to allow bicyclists advance green.	One decision at a time	5.8
<i>Infrastructure</i>		
Construct island to shorten crossing distance for pedestrians.	Shorten Crossings	5.8

Figure 5.8 Signage, Striping, and Infrastructure Treatments for Y-Intersections





6. SPECIAL CASES

6.1. Midblock Crossing

6.1.1. Common Issues

Midblock crossings are important tools for improving pedestrian mobility, and if designed properly, can improve pedestrian ease and safety. The *CA MUTCD* states that midblock marked crosswalks “should be provided at appropriate points of pedestrian concentration, such as at loading islands, midblock pedestrian crossings, or where pedestrians could not otherwise recognize the proper place to cross.”¹² At the same time, the *MUTCD* acknowledges that midblock crossings are “generally unexpected by the motorist”, indicating the importance of alerting the motorist when a midblock crossing is present.

Common issues related to midblock are illustrated in Figure 6.1 and listed below:

- A. **Motorists and bicyclists do not expect crossings at midblock locations** and may not yield;
- B. **Multiple-threat situations**, in which a motorist yielding to a pedestrian may block the view of the pedestrian from another motorist or a bicyclist; and
- C. **Parked motor vehicles may block crosswalk or obstruct motorist or bicyclist sightlines.**

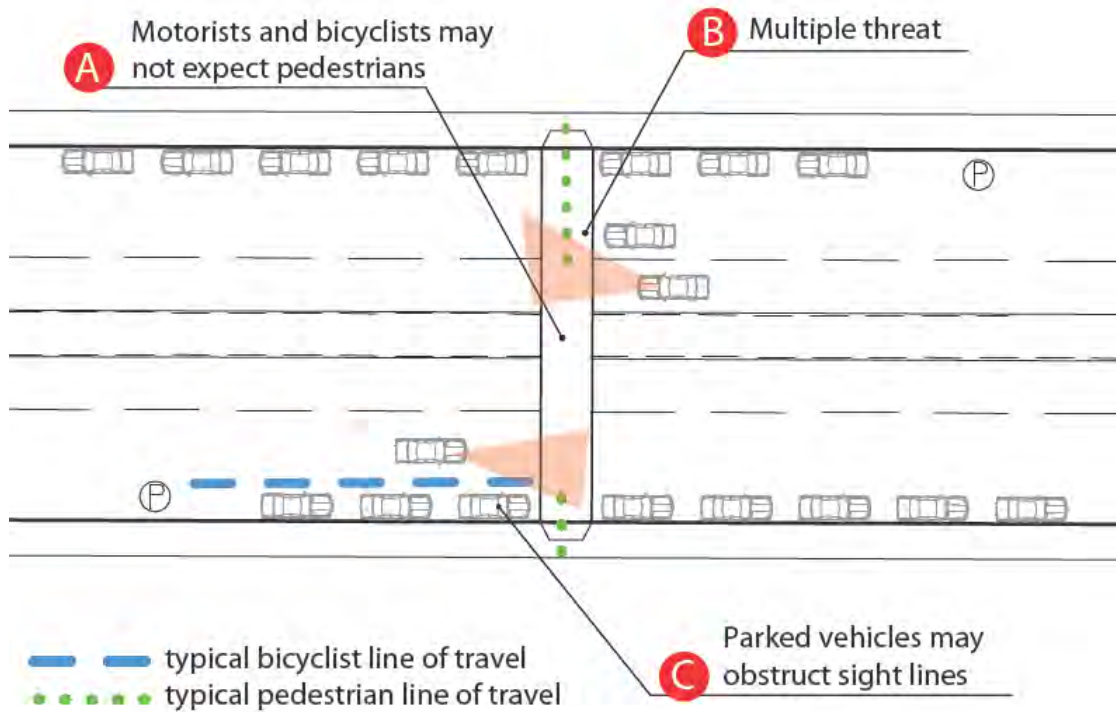
On high-speed or high-volume roads with four or more lanes, installing crosswalks alone, without other improvements, can increase the rate of pedestrian-vehicle crashes.¹³

¹²CA MUTCD Section 3B.17.

¹³Zeeger, Charles, et al. University of North Carolina Highway Safety Research Center. *Safety Effects of Marked versus Unmarked Crosswalks at Uncontrolled Locations: Final Report and Recommended Guidelines*. Sponsored by Office of Safety Research and Development, Federal Highway Administration, August 2005.



Figure 6.1 Common Issues at Midblock Crossings



On high speed (40 mph) or high volume (12,000 ADT) roadways, installing crosswalks alone without other improvements can increase the rate of pedestrian-vehicle crashes. (Zeeger, 2005)

6.1.2. Treatments

Table 6.1 lists treatments for improving crossings at uncontrolled midblock locations. Figure 6.2 illustrates the treatments.



Table 6.1 Treatments for Midblock Crosswalks

Treatment	Design Principles	Figure No.
<i>Signage and Striping</i>		
Install pedestrian warning signage.	Improve Visibility	6.2
Install yield lines and “Yield Here to Pedestrians” Signage.	Clarify Right-of-Way, Slow it Down	6.2
Prohibit parking adjacent to crosswalk.	Improve Visibility	6.2
<i>Infrastructure</i>		
Construct raised pedestrian refuge or raised medians if appropriate.	Shorten Crossings, One Decision at a Time	6.2
Construct curb extensions while ensuring they do not extend into the bicyclists’ path; use reflective materials on curbs to ensure visibility to bicyclists and motorists.	Shorten Crossings, Improve Visibility	6.2
Install lighting at crossing for pedestrian visibility, and to allow bicyclists to see curb extensions at night.	Improve Visibility	6.2
Construct speed table.	Slow It Down	Not shown
<i>Operations</i>		
Install pedestrian actuated beacon or in-pavement flashing lights as warranted.	Slow It Down, Clarify Right-of-Way	Not shown

As explained in the sidebar on page 26, crosswalks without additional treatments are not recommended on:

- Roads with speeds limits of 40 mph or greater.
- Roads with four or more lanes, no raised median, and an ADT of greater than 12,000.
- Roads with four or more lanes, with a raised median, and an ADT greater than 15,000.



Pedestrian-Actuated Beacons

The CA MUTCD recognizes overhead flashing pedestrian beacons and in-pavement flashing lights. Section 4K.03 of the CA MUTCD governs warning beacons and Section 4K.103 permits flashing beacons at school crosswalks. Beacons are typically used to supplement advance warning signals or at midblock crosswalks. Section 4L governs in-roadway lights, including in-roadway warning lights at crosswalks (4L.02). Section 4C.05 describes pedestrian volume warrant requirements for a pedestrian-actuated signal. Section 4C.06 describes warrants for a signal on a route to school.

There are other experimental pedestrian beacons that have higher yielding rates than the standard flashing beacon. These include:

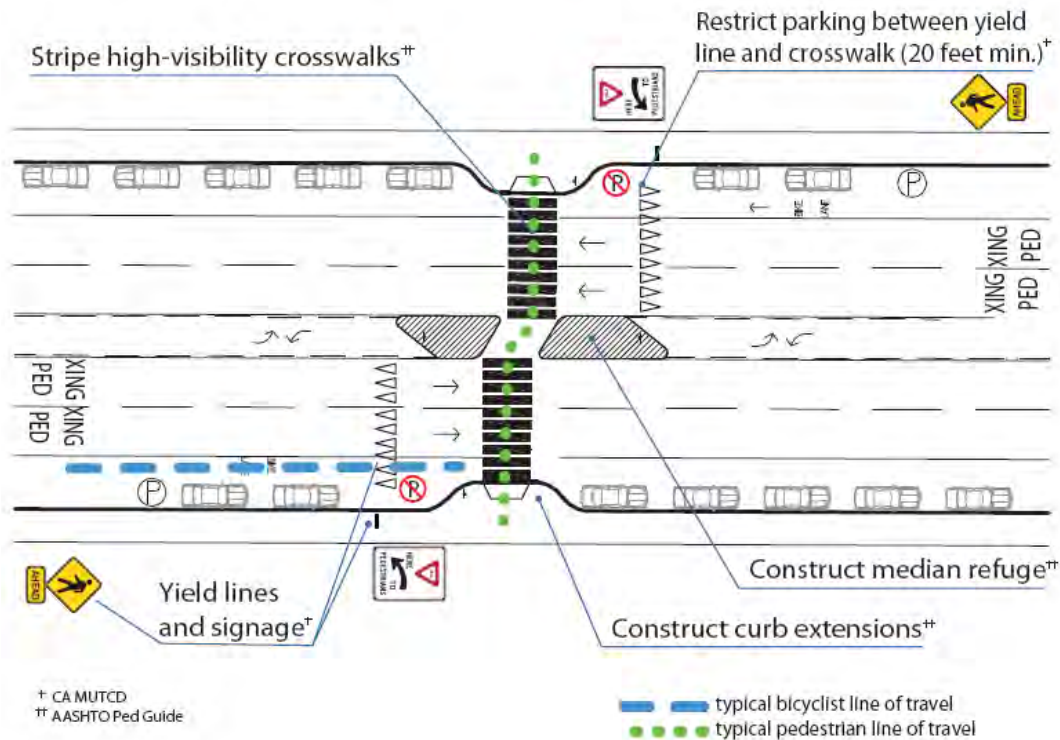
- Rectangular-Shaped Rapid Flash light emitting diode (LED) Beacons, which have an 80 to 90 percent compliance rate in the field^a; and
- High-Intensity Actuated Crosswalk (HAWK) beacons, which have a driver yielding rate of 97 percent and in one case were shown to reduce pedestrian-motor vehicle crashes by 58 percent.^b The HAWK was approved by the Signal Technical Committee in January 2006 and is included in the 2009 National MUTCD.
- The TOUCAN, an experimental wider crossing, incorporates a bicycle signal that allows pedestrians and bicyclists to cross together. One portion of the crosswalk is marked for pedestrians and another is marked for bicyclists so that they can cross at the same time.

^a Van Houton, Ron and J.E. Louis Malenfant, "An Analysis of the Efficacy of Rectangular-shaped Rapid-Flash LED Beacons to Increase Yielding to Pedestrians Using Crosswalks on Multilane Roadways in the City of St. Petersburg, FL.", Center for Education in Research and Safety, Documentation provided as part of MUTCD's Interim Approval for Optional Use of Rectangular Rapid Flashing Beacons (IA-11), July 16, 2008. mutcd.fhwa.dot.gov/resources/interim_approval/ia11/stpetersburgpt/index.htm.

^b Fitzpatrick, Kay, et. Al. "Improving Pedestrian Safety at Unsignalized Crossings," TCRP Report 112, NCHRP Report 562. Published by: Transportation Research Board, 2006.



Figure 6.2 Treatments for Unsignalized Midblock Pedestrian Crossings



6.2. Shared Use Path Intersections with Roads

6.2.1. Common Issues

Shared use paths can intersect with roads at midblock locations or road intersections.¹⁴ This section addresses both types of crossings.

Common issues at intersections of shared use paths and roads are illustrated in Figure 6.3. They include:

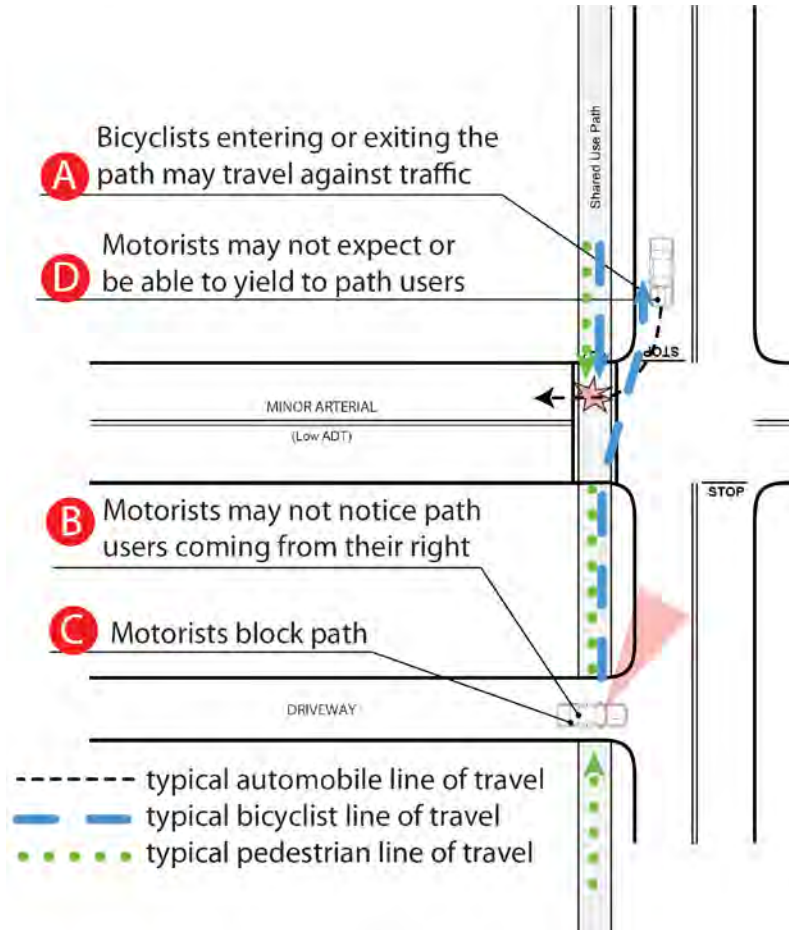
- A. Bicyclists entering or exiting the path may travel against motor vehicle traffic;
- B. Motorists crossing the shared use path at driveways and intersections may not notice path users coming from their right;
- C. Stopped motor vehicle traffic or vehicles exiting side streets or driveways may block the path; and

¹⁴Both the HDM and the AASHTO Guide for the Development of Bicycle Facilities generally recommend against the development of multi-use paths directly adjacent to roadways, or sidepaths.



D. Motorists may not be able to yield to fast-moving bicyclists at the intersection.

Figure 6.3 Common Issues at Intersections of Side-paths and Roads



6.2.2. Treatments

Pedestrian and bicycle pathway designers and traffic engineers generally have four options for designing multi-use pathway crossings. These include:

- **Option 1** - Reroute to the nearest at-grade controlled intersection crossing, shown in Figure 6.4;
- **Option 2** - Create a new at-grade midblock crossing with traffic controls where the pathway intersects with the road as shown in Figure 6.5;
- **Option 3** - Create a new unprotected midblock crossing where the pathway intersects the road, as shown in Figure 6.6; and
- **Option 4** - Create a grade-separated undercrossing or overcrossing of the road where the pathway intersects the road (not shown).

Table 6.2 summarizes the treatments applicable at side-path intersections.



Figure 6.4 Option 1 for Shared-Use Path Road Crossing: Reroute

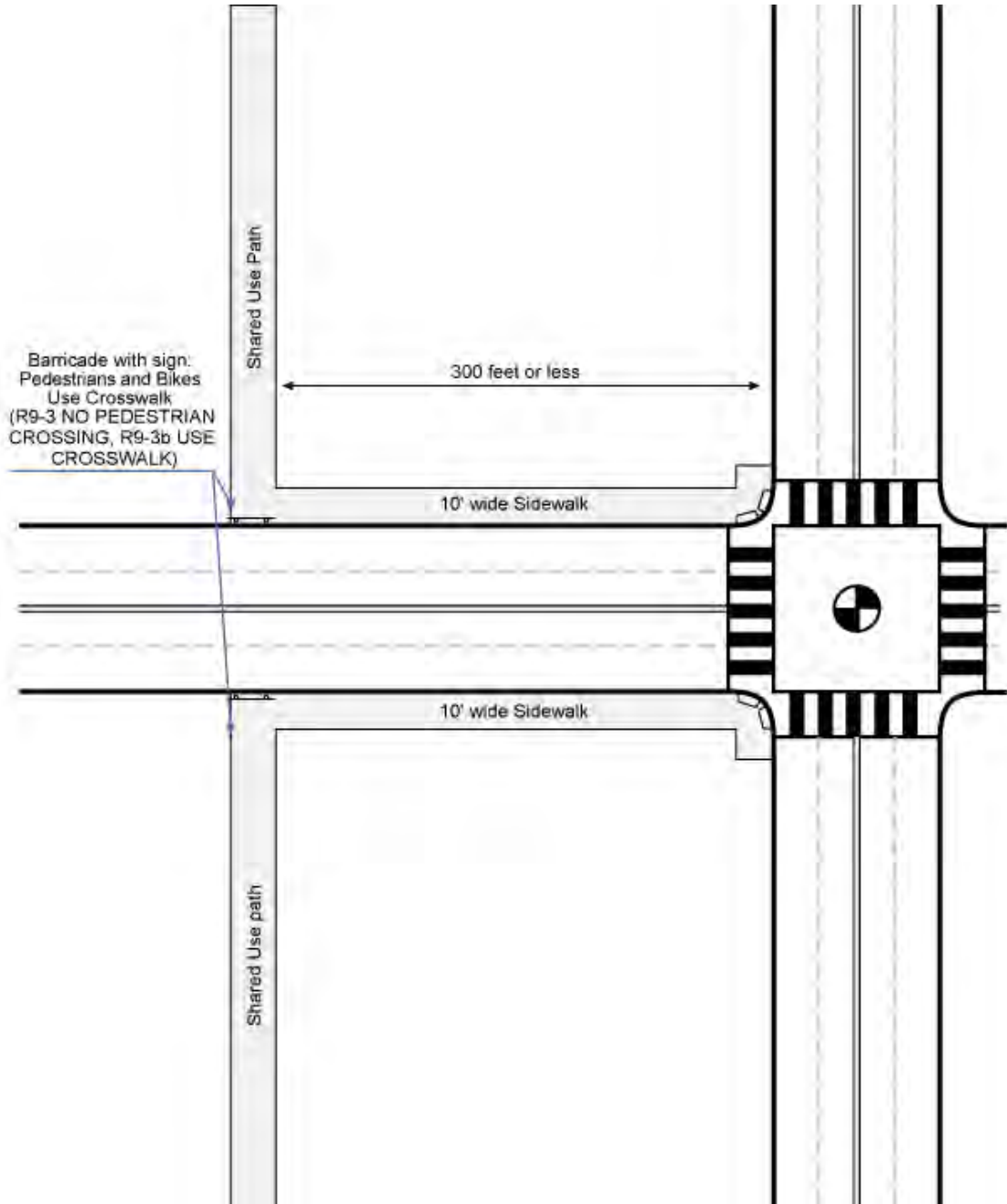




Figure 6.5 Option 2 for Shared-Use Path Road Crossing: New Signal

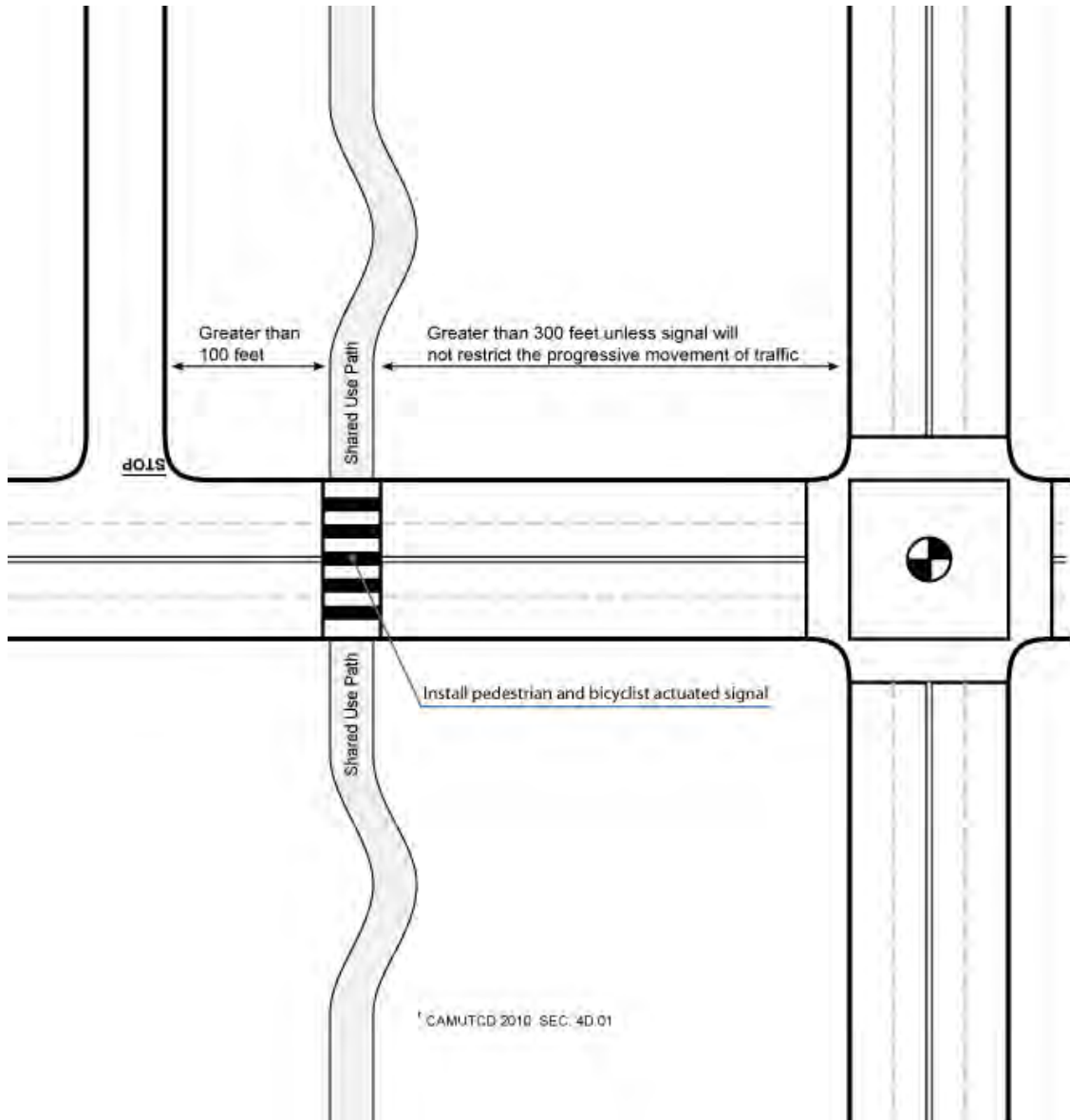




Figure 6.6 Option 3 for Shared-Use Path: *Uncontrolled Midblock Crossing*

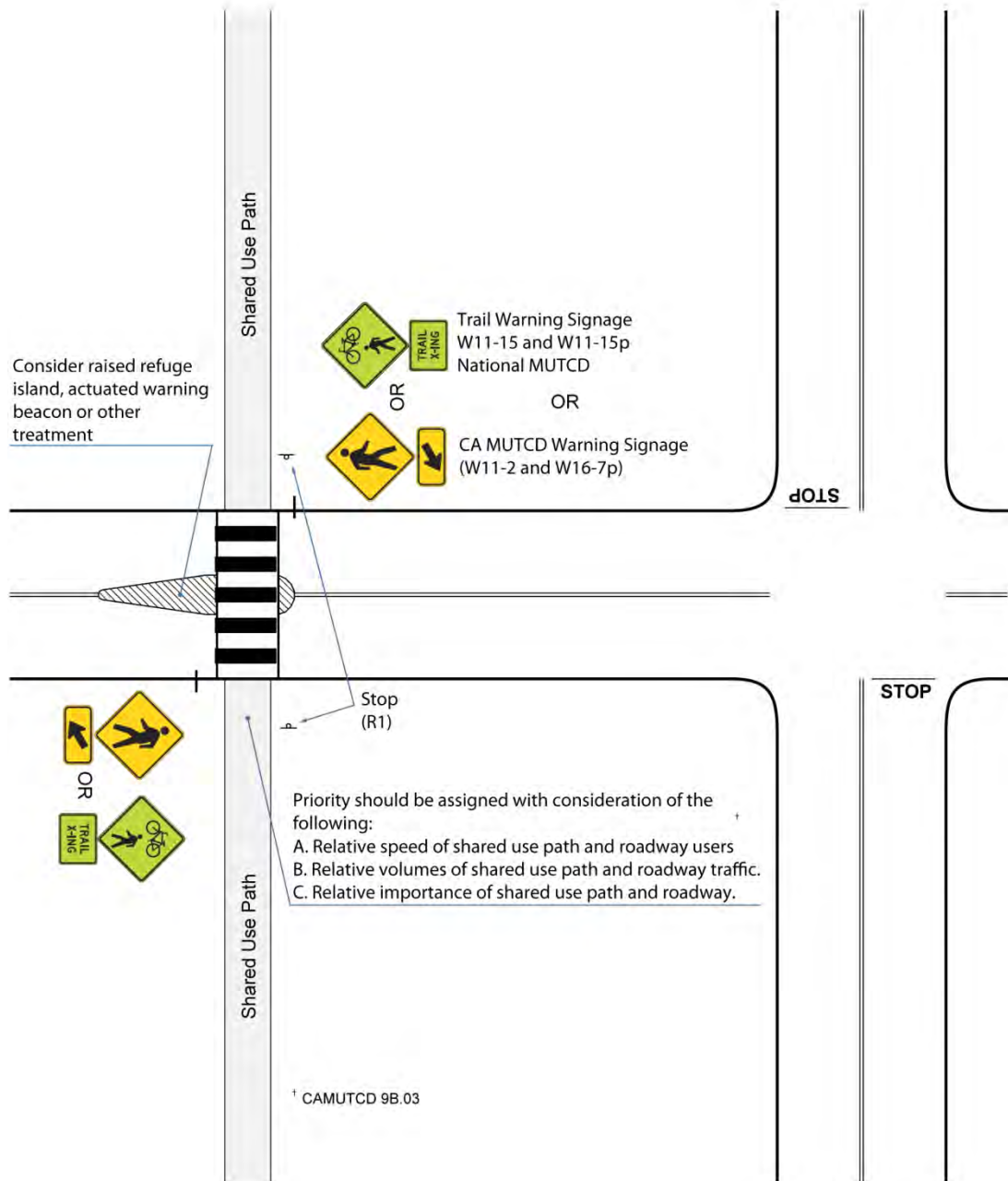




Table 6.2 Treatments for Intersections of Paths and Roads

Treatment	Design Principles	Figure No.
<i>Signage and Striping</i>		
Install STOP sign on intersecting road in advance of path intersection.	Clarify Right-of-Way	Not shown
Install STOP signs on path.	Clarify Right-of-Way	Not shown
Stripe high-visibility crosswalks.	Improve Visibility	6.4,6.5,6.6
Install warning signage on intersecting road.	Improve Visibility	6.6
<i>Infrastructure</i>		
Construct pedestrian refuge if warranted.	One Decision at a Time, Shorten Crossings	6.6
Slow trail users in advance of crossing using horizontal curves on the path.	Slow It Down	6.5
<i>Operations</i>		
Install pedestrian actuated beacon, including experimental HAWK and TOUCAN beacons.	Clarify Right-of-Way	6.6
Install signal, possibly including bicycle signal.	Pedestrians and Bicyclists Will Be There	6.5



7. INTERSECTIONS WITH TRANSIT

This section provides guidance on how to design intersections with transit to ensure they accommodate pedestrians and bicyclists. Transit vehicles should be considered at all intersections and interchange types, even if they lack a transit stop. Transit vehicles may still pass through the intersection, or do so in the future.

7.1. Bus Stops at Intersections

Several aspects of bus stop design affect pedestrians and bicyclists, including the decision to use nearside or far side bus stops; whether buses use a pullout or stop in the travel lane; location of the bus lane; and location of bus stops in the median or on the side of the road.

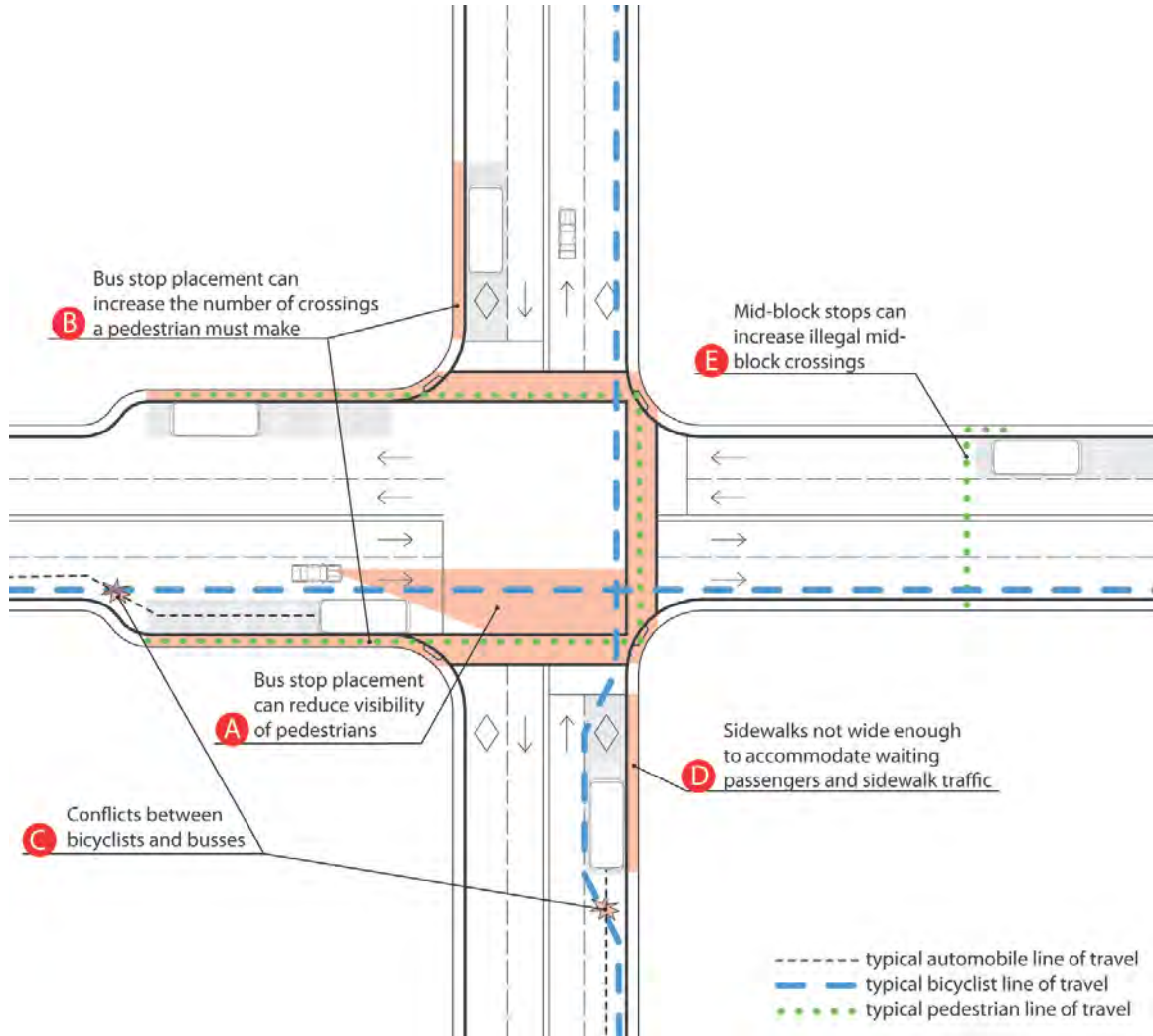
7.1.1. Common Issues

Common issues for pedestrians and bicyclists at intersections with bus stops are listed below, and illustrated in Figure 7.1:

- A. **Bus stop placement can reduce visibility** for crossing pedestrians.
- B. Bus stop placement at transfer points can **increase the number of crossings** a pedestrian must make to transfer, particularly if some crossings are prohibited.
- C. **Conflicts likely between bicyclists and buses** at right-side bus stops.
- D. **Sidewalks are not wide enough** to accommodate waiting passengers and sidewalk traffic.
- E. **Increased potential for illegal midblock crossings** when bus stops are located midblock.
- F. **Asphalt pavement at bus stops tends to ripple and crack over time.** (Not shown).



Figure 7.1 Issues at Intersections with Bus Stops





7.1.2. Treatments

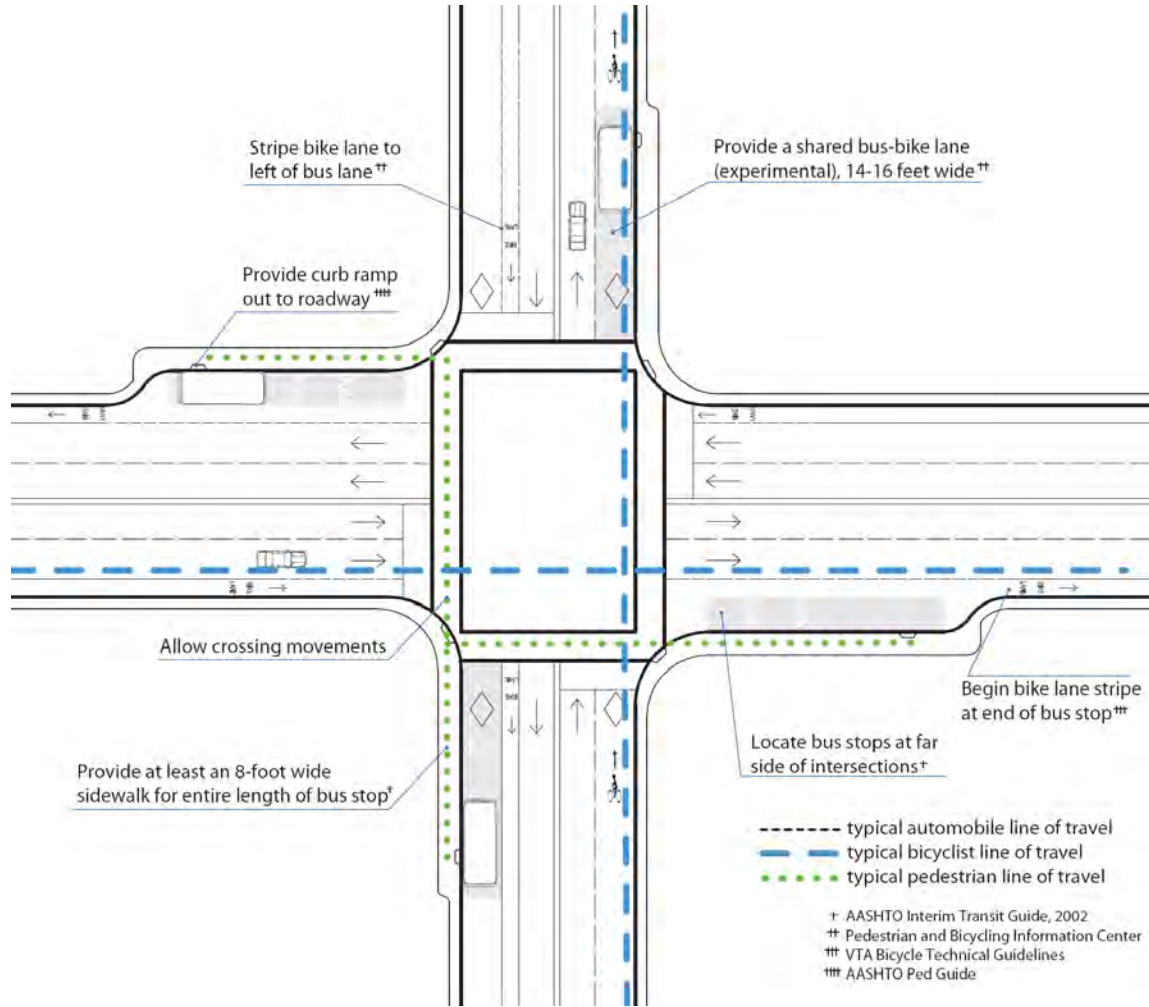
Table 7.1 Treatments for Intersections with Bus Transit

Treatment	Design Principles	Figure No.
<i>Infrastructure</i>		
Locate bus stops near intersections to discourage midblock crossings.	Keep It Direct	7.2
Provide an 8-foot-by-5-foot pedestrian landing pad (ADAAG 10.2.1).	Access for All	Not shown
Provide a continuous 8-foot-wide sidewalk for length of bus stop (minimum width).	Access for All	7.2
Provide a curb ramp out to road to allow waiting passengers to board a bus if it cannot pull up to sidewalk due to illegally parked vehicles or other obstructions.	Access for all	7.2
Provide bus shelters.	Pedestrians and Bicyclists Will Be There	Not shown
Provide an area to allow bicyclists to load and unload bicycles from front-mounted bike racks.	Pedestrians and Bicyclists Will Be There	Not shown
Locate bus stops farside to improve bus operations and visibility at intersections.	Improve Visibility	7.2
Provide a shared bus-bike lane (experimental) ¹⁵ .	Clarify Right-of-Way	7.2
Stripe bike lane to left of bus lane.	Clarify Right-of-Way	7.2
Provided dedicated bus lane in center median.	Clarify Right-of-Way	7.3
Provide Portland cement concrete (PCC) pavement at all bus stops to reduce rippling and cracking.	Maintain and Improve	Not shown

¹⁵From the Pedestrian and Bicycling Information Center, bicyclinginfo.org: “A growing number of communities are using shared bus and bike lanes to give preferential treatment to both bikes and public transport. Examples currently include Tucson, AZ; Madison, WI; Toronto, Ontario; Vancouver, BC; and Philadelphia, PA. Often the lanes are also able to be used by taxis and right-turning vehicles. Because buses and bikes will pass each other in these lanes, lane width is an important issue. The city of Madison likes to use 16 foot lanes to allow a clear three feet of separation between the bicyclist and a passing bus, but if either bus or bike traffic is light and space is limited, the width of a shared lane might be 14 ft or even less.”



Figure 7.2 Treatments for Intersections with Bus Stops



Intersections with bus rapid transit and light rail may require special consideration as they frequently require placement of the transit stop in the median. Figure 7.3 illustrates alternative intersection configurations developed by AASHTO.

Figure 7.3 Treatment for Median Bus/BRT/Light Rail Stops





Source: AASHTO Interim Geometric Design Guide for Transit Facilities on Highways and Streets, 2001.



Image: www.pedbikeimages.org / Dan Burden.

A wide landing pad and bus shelter can provide additional comfort to pedestrians and transit users.

7.2. Railroad Crossings

7.2.1. Common Issues

Where bicycle or pedestrian facilities cross railroads at grade, the primary issues relate to trespassing and safety concerns. There is greater difficulty of crossing the tracks if the crossing is not perpendicular. People using wheelchairs can have difficulty crossing railroad tracks if the gap between railroad tracks and flange way¹⁶ is wide, or if there is a significant vertical change between the sidewalk and the tracks.

Common issues at these intersections include:

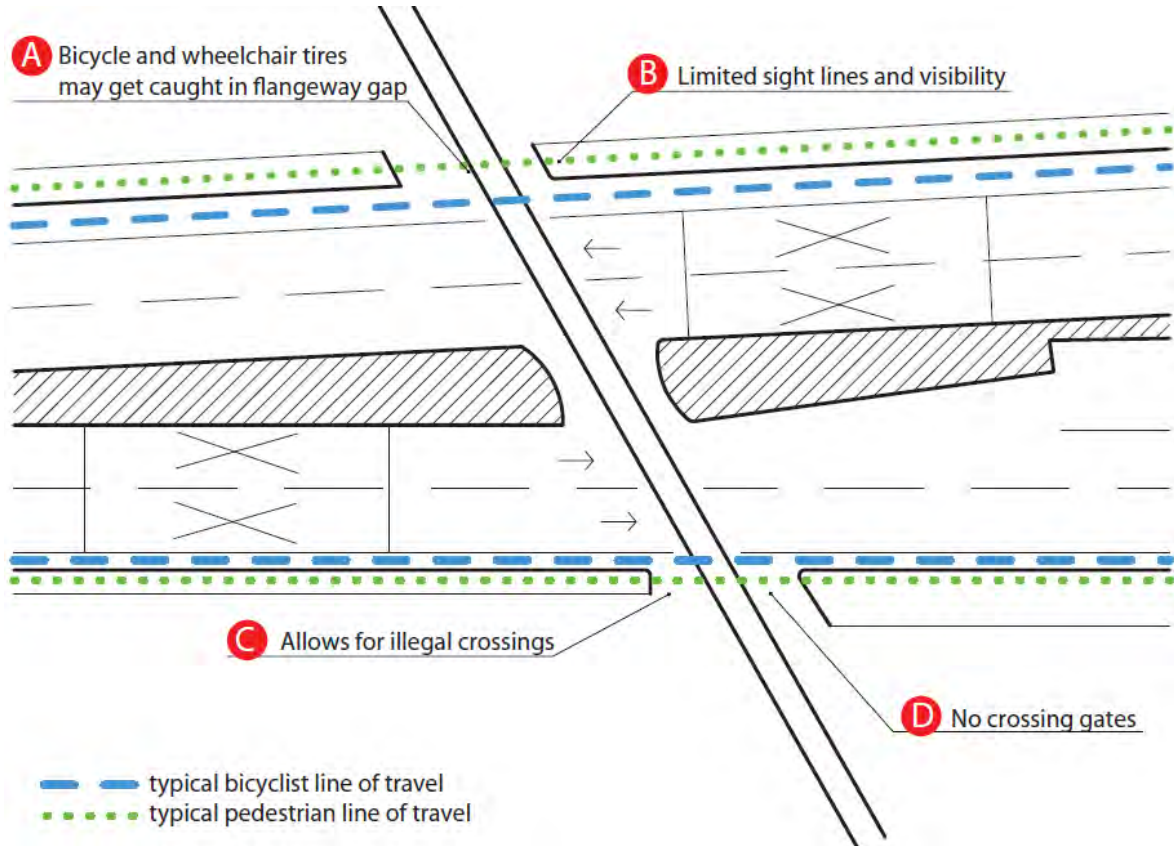
- Pedestrians and bicyclists in wheelchairs may catch wheel in flange way gap if crossing is less than 45 degrees.
- Limited sight lines and visibility may not allow pedestrians and bicyclists to see approaching trains.

¹⁶A flangeway is an opening, parallel to a rail; made through platforms, pavements, track structures, etc., to permit passage of wheel flanges.



- Pedestrians may cross tracks illegally or trespass.
- Crossing gates for pedestrians or bicyclists may not be provided.

Figure 7.4 Railroad Crossing Issues



7.2.2. Treatments

Pedestrians and bicyclists can be accommodated at at-grade railroad crossings by modifying the intersection to provide for a close to 90-degree crossing, and providing structures such as fences and mast arms to discourage trespassing.

Treatments for railroad intersections are listed in Table 7.2 and illustrated in Figure 7.5 Railroad Crossing Treatments. Additional information and suggestions can be found in the Public Utilities Commission’s 2008 Guide "Pedestrian Rail Crossings in California."¹⁷

Table 7.2 Treatments for Railroad Crossings

Treatment	Design Principles	Figure No.
-----------	-------------------	------------

¹⁷ The guide can be found here: <http://docs.cpuc.ca.gov/PUBLISHED/GRAPHICS/83568.PDF>.

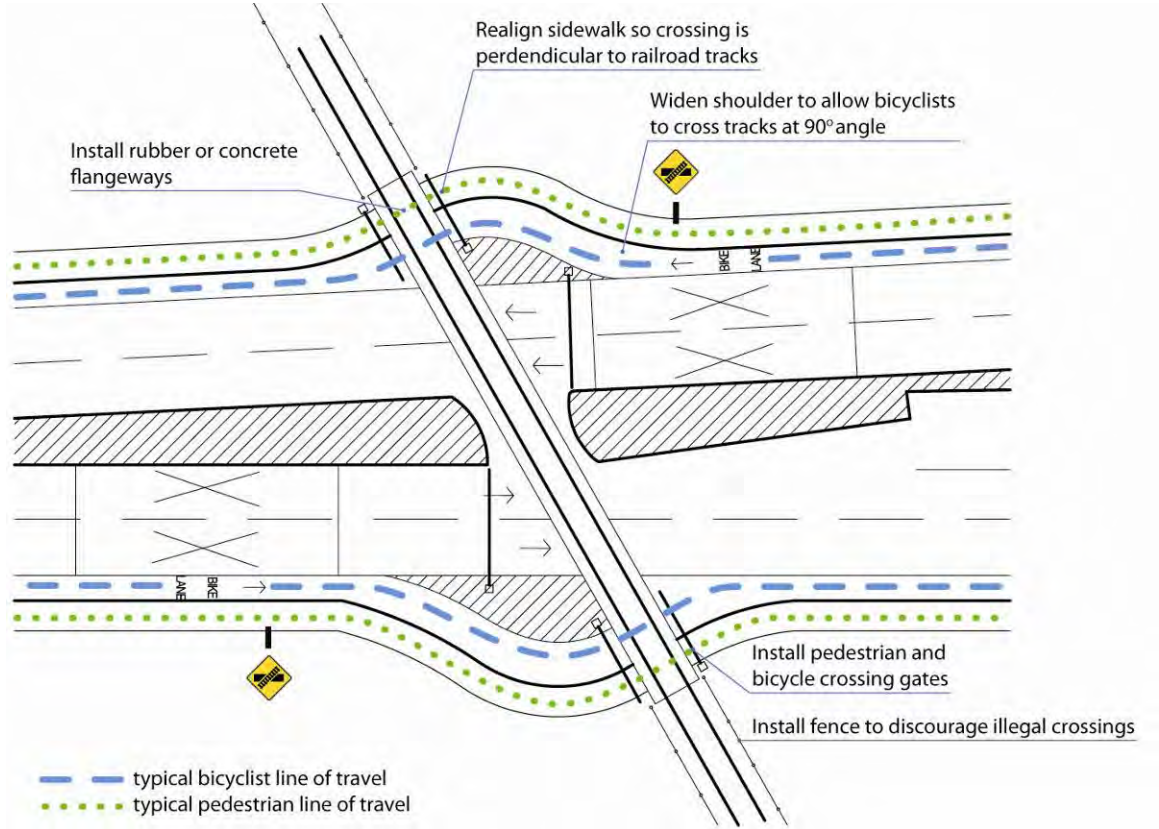


<i>Signage and Striping</i>		
Install signage in advance of crossing to warn bicyclists.	Improve Visibility	Not shown
<i>Infrastructure</i>		
Construct widened paved shoulder or separate path to allow bicyclists to turn to cross railroad tracks at close to a 90-degree angle.	Tee it Up	7.5
Construct sidewalks so they cross railroad tracks at close to a 90-degree angle.	Tee It Up	7.5
Provide flange way so that crossing is level and flush with the top of the rail at the outer edge. Between the rails, flange way gaps should not exceed 2.5 inches (passenger only) to 3 inches (freight). ¹⁸		Not shown
Install detectible warnings in advance of crossing.		Not shown
Construct pedestrian-only crossing gates.		7.5
Install fencing along tracks to discourage trespassing or illegal crossing.		7.5
Remove abandoned railroad tracks.		Not shown

¹⁸ Revised Draft Guidelines for Public Rights of Way, Access Board, November 23, 2005.
<http://www.access-board.gov/PROWAC/draft.htm>.



Figure 7.5 Railroad Crossing Treatments





8. ROUNDABOUTS

The modern roundabout is a circular intersection with three primary characteristics: (1) motorists and bicyclists must yield on entry (2) the intersection has a central island that deflects traffic and forces it to slow down, (3) approaches have splitter islands that separate entering and exiting traffic. Although roundabouts should not be installed unless a need has been established, they should be considered at locations where signalization is warranted; where they could effectively address safety issues; or where new roads create new intersections.

Numerous studies have shown that single-lane roundabouts have the potential to increase both motor vehicle capacity and motor vehicle and pedestrian safety.¹⁹ The conversion of a unsignalized intersection to a single-lane roundabout is frequently indicated as a pedestrian safety countermeasure.

Research suggests multilane roundabouts may not have the same safety benefits, and may actually increase bicyclist collisions.²⁰ Chapter 5 of the U.S. DOT FHWA publication, “Roundabouts: An Informational Guide,” states that adding an additional lane to a one-lane roundabout is likely to increase overall injury crashes by 25 percent.²¹

8.1. Common Issues

Pedestrians and bicyclists experience the following issues when navigating roundabout intersections:

- A. **All pedestrian crosswalks are uncontrolled.**
- B. At multilane roundabouts, pedestrians and bicyclists using the crosswalk are at risk for **multiple-threat** scenarios.
- C. **Bicyclists must control the lane** to avoid conflicts with circulating motorists.

¹⁹For example, the Federal Highway Administration’s *Toolbox of Countermeasures and Their Potential Effectiveness for Pedestrian Crashes (2008)* indicates that converting an unsignalized intersection to a roundabout can reduce fatal crashes by as much as 27 percent and injury crashes by 12 percent.

²⁰Multilane roundabouts have been observed to have more bicyclist collisions when compared to comparable single-lane roundabouts, as a result of a greater difference in speeds between modes (Furtado, 2004). Several studies (including Furtado, Brude & Larsson (2000), Harkey & Carter (2006), Shen (2000), and U.S. DOT FHWA (2000)) have found that multilane roundabouts are perceived as more dangerous, and often result in more collisions for all users when compared to single-lane roundabouts. This leads to a consensus that multilane roundabouts can significantly increase bicyclist safety risk. Brude and Larsson (2000) found that in Sweden, bicycle collisions were six times more frequent on multilane roundabouts compared to single-lane roundabouts.

²¹Federal Highway Administration, 2000. *Roundabouts: An Informational Guide*. <http://www.tfhrc.gov/safety/00068.htm>.

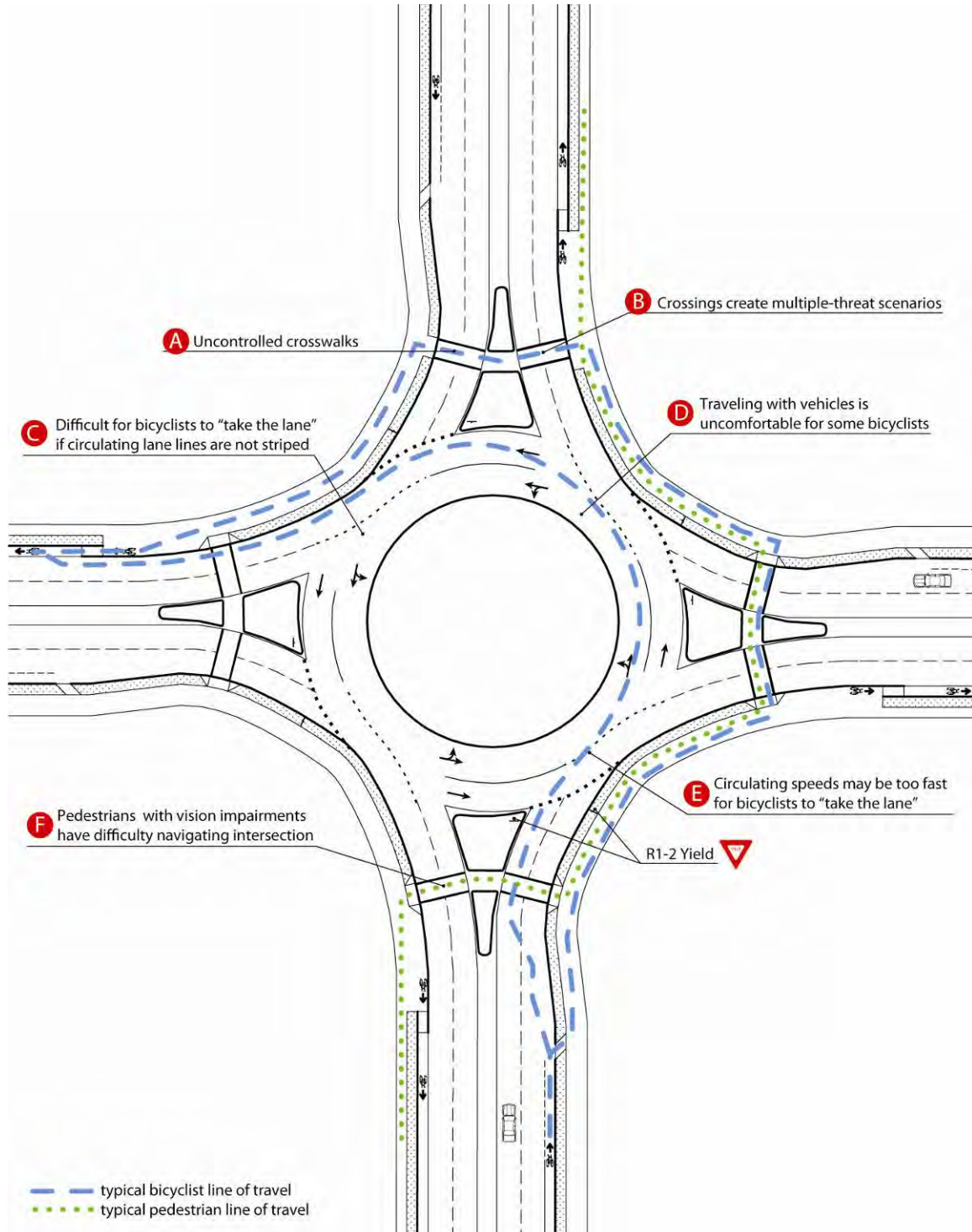


- D. **Bicyclists may not be comfortable traveling through the roundabout** on the road with motor vehicles.²²
- E. At larger roundabouts, **circulating speeds may be too high for bicyclists to control the lane comfortably.**
- F. **Pedestrians with visual impairments may have difficulty navigating roundabouts,** particularly multilane roundabouts.
- G. Care must be taken to design turns so that large vehicles do not off-track onto sidewalks [not shown].

²²U.C. Berkeley Traffic Safety Center, Identifying Factors that Determine Bicyclist and Pedestrian-Involved Collision Rates and Bicyclist and Pedestrian Demand at Multilane Roundabouts Draft Summary of Research and Recommendations, Task Order 6222. Prepared for Caltrans. Prepared by Lindsay Arnold et al. September 30, 2009.



Figure 8.1 Common Issues at Roundabouts





8.2. Treatments

Design of roundabouts is addressed in Caltrans Design Information Bulletin 80-01 and in the Federal Highway Administration's *Roundabouts: An Informational Guide FHWA-RD-00-067*. A forthcoming study sponsored by Caltrans Department of Innovation and Research and prepared by U.C. Berkeley's Traffic Safety Center and Alta Planning + Design discusses treatments for pedestrians and bicyclists at multilane roundabouts. Design recommendations from that document are reproduced below:

- Design roundabouts to accommodate on-street bicyclists by **reducing the speed differential between circulating motorists and bicyclists**. The recommended maximum circulating design speed is 25 mph.²³
- **Design approaches and exits to the lowest speeds possible**, in order to reduce the severity of potential collisions with pedestrians.
- Design roundabout approaches, circulating lanes and exits to **encourage bicyclists navigating the roundabout in the circulating roadway to control the lane**. This approach reduces the chances of a bicyclist being cut off by a "right hook".
- Utilize the most effective tools possible to maximize yielding rate of motorists to pedestrians and bicyclists at crosswalks.
- **Provide separated facilities for bicyclists** who prefer not to navigate the roundabout on the roadway.
- Clearly **indicate to motorists and bicyclists the correct way to circulate** through the roundabout through appropriately designed signage, pavement markings, and geometric design elements.
- **Clearly indicate to motorists, bicyclists, and pedestrians the right-of-way rules** at multilane roundabouts through appropriately designed signage, pavement markings, and geometric design elements.

Specific treatments for roundabouts are listed in and illustrated in Figure 8.2 and Figure 8.3.

²³A 2004 FHWA study that collected field data in 21 locations around the United States measured the 85th percentile speed of bicyclists at 14 mph. <http://www.tfhr.gov/safety/pubs/04103/index.htm>.



Table 8.1 Treatments for Roundabouts

Treatment	Design Principles	Figure No.
<i>Signage and Striping</i>		
Stripe ladder style crosswalks at all crosswalks.	Improve Visibility	8.2, 8.3
Install “Yield Here to Pedestrian” signs in advance of crosswalks.	Clarify Right-of-Way	8.2, 8.3
Install Pedestrian Warning signs at crosswalks (on both sides of crosswalk at multilane approaches).	Improve Visibility	8.2, 8.3
Install experimental “Bikes May Use Full Lane” signs after ramp up to path (see below) (Proposed Amendment to National MUTCD).	Clarify Right-of-Way	Not shown
On multi-lane roundabouts, delineate circulating lanes with spiral striping so that weaving does not occur in the roundabout (Proposed Amendment to National MUTCD).	Clarify Right-of-Way	8.2, 8.3
Stripe “fishhook” guidance arrows on pavement on approach to intersection to assist motorists with lane placement.	One Decision at a Time	Not shown
<i>Infrastructure</i>		
Construct the smallest diameter roundabout necessary, with the minimum number of lanes (single lane preferred).	Slow It Down	Not shown
Construct roundabouts with maximum circulating speed of 25 mph.	Slow It Down	8.2
Construct speed tables at crosswalks.	Slow It Down	8.2
Slow motorists in advance of roundabout using reverse curves, rumble strips, speed feedback signs, or other physical or enforcement strategies.	Slow It Down	Not shown
Construct splitter islands at all approaches	Shorten Crossings	8.2, 8.3
Construct separate bike path, with ramps connecting bike path and approaches.	Clarify Right-of-Way, Pedestrians and Bicyclists Will Be There	8.2, 8.3
<i>Operations</i>		
Consider pedestrian signals at the roundabout if the elderly or people with disabilities and particularly people with visual impairments regularly walk through the intersection.	Access for All	Not shown



Signalizing Roundabouts

Roundabouts typically include multiple uncontrolled crossings which can be challenging for pedestrians, especially those with visual impairments or other disabilities. In an effort to develop safer roundabout crossing facilities, the Transportation Research Board is investigating various technologies which will be published in NCHRP report 3-78A "Crossing Solutions at Roundabouts and Channelized Turn Lanes for Pedestrians with Vision Disabilities." This research involves field studies with visually impaired participants and is expected to be completed in March 2010. Additional information on this study can be found at the Transportation Research Board website.

Pedestrian hybrid beacons show promise for improving roundabout operations for pedestrians and bicyclists in general and specifically for pedestrians with disabilities. These beacons allow pedestrians to actuate overhead signals, which will first flash yellow, then steady yellow, then steady red. The signal is dark when it is not activated. Pedestrian hybrid beacons and rapid rectangular flashing beacons are not part of the current California MUTCD and thus must be treated as experimental traffic control devices. Pedestrian hybrid beacons are currently being tested at a high-volume three-lane roundabout in Oakland County, Michigan.



Figure 8.2 Treatments for Urban Multilane Roundabouts

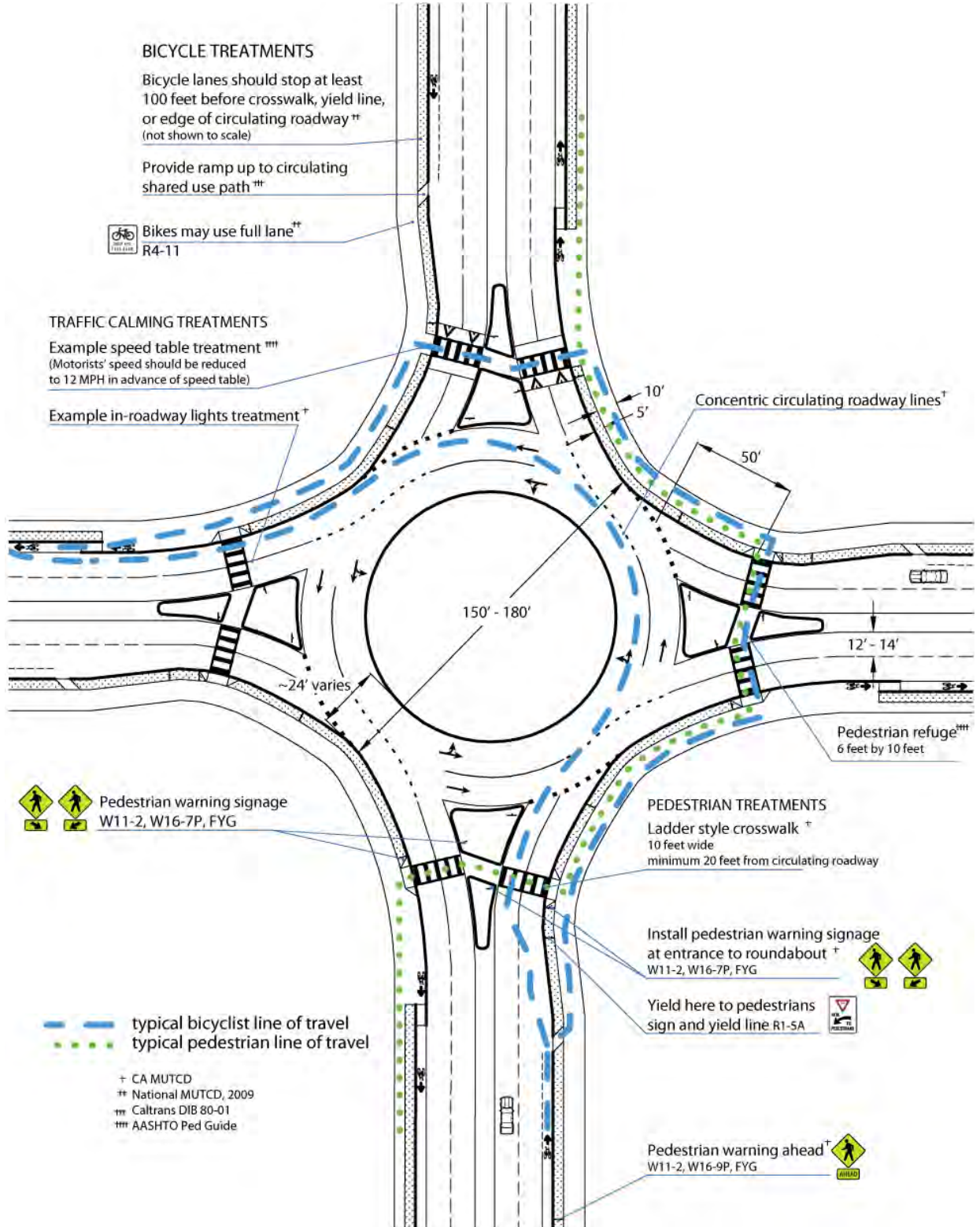
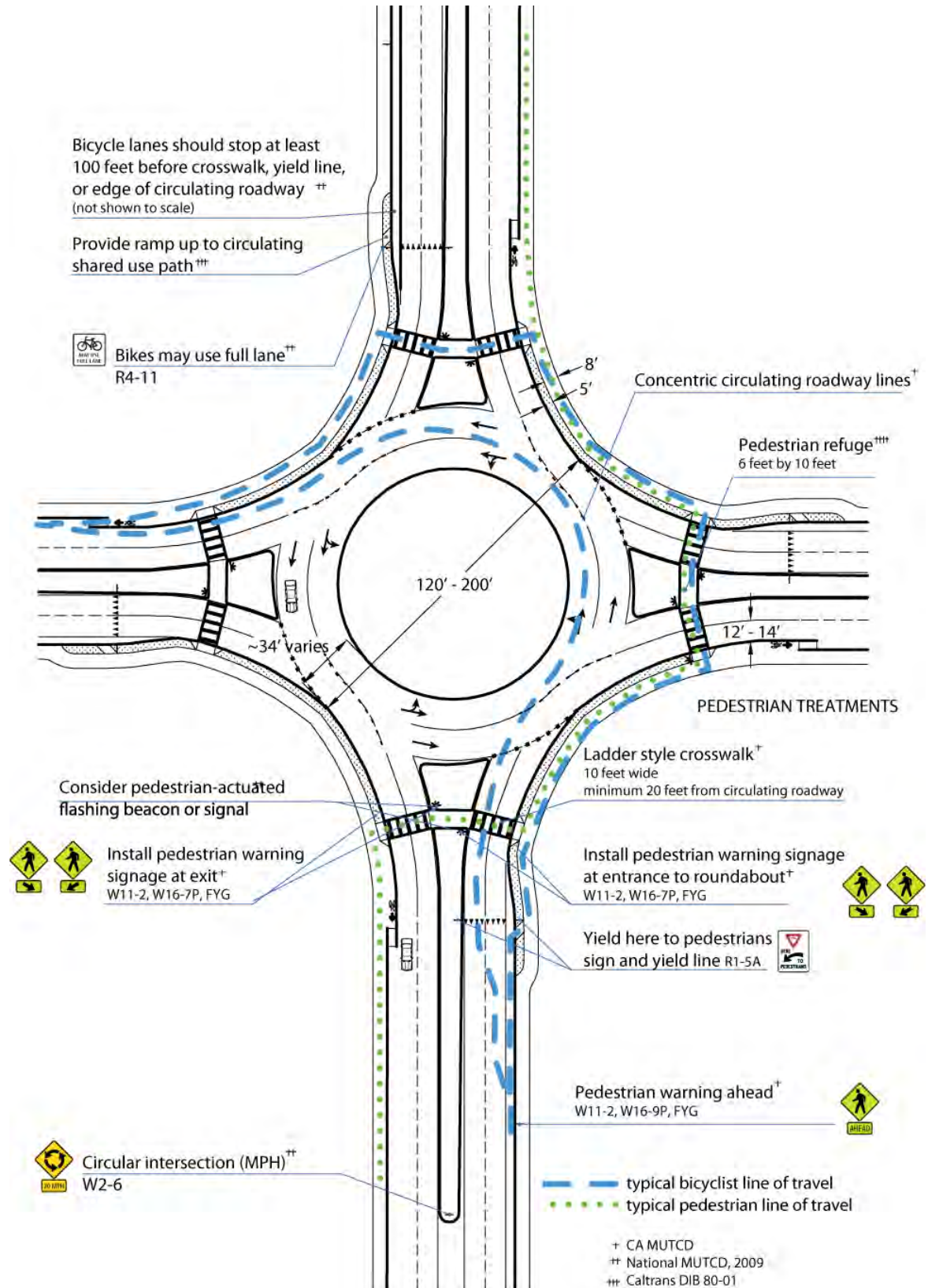




Figure 8.3 Treatments for Rural Multilane Roundabouts



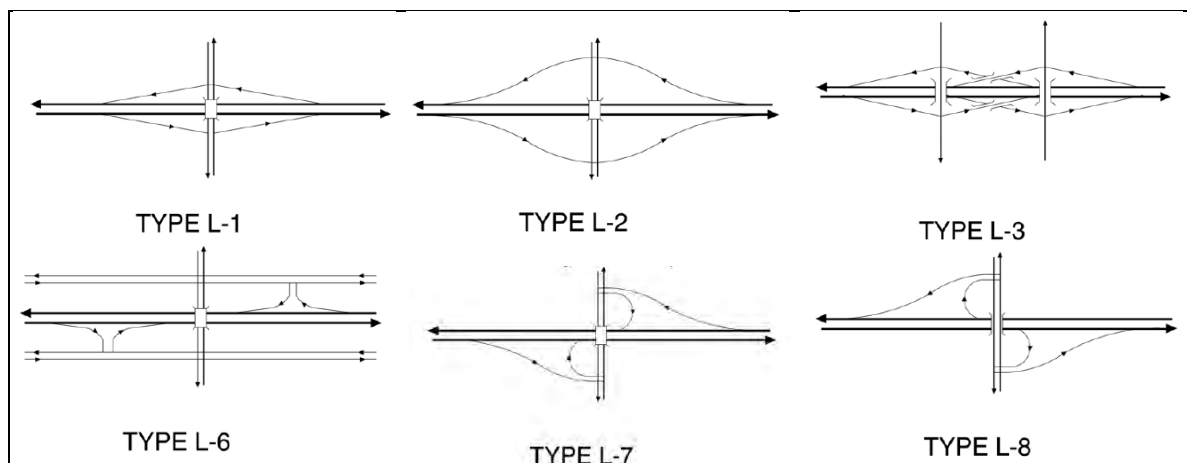


9. INTERCHANGES

Interchanges often provide the only pedestrian and bicycle access across a freeway, but are not always designed to provide comfortable or safe pedestrian and bicycle access. The best interchange configurations for pedestrians and bicyclists are those where the ramp intersects the crossroad at a 90-degree angle and where the intersection is controlled by a stop or signal. These characteristics cause motorists to slow down before turning, increasing the likelihood that they will see and yield to non-motorists. If an impact occurs, severity is lessened because of slower vehicular speeds.

The Caltrans HDM classifies interchanges into 13 different types. As illustrated in Figure 9.1, six of these types have ramp intersection designs that generally meet the crossroad at 90-degrees and are STOP-controlled or signalized. These interchanges generally incorporate diamond-type ramps or J-loop ramps.

Figure 9.1 Interchange Types That Accommodate Pedestrians and Bicyclists



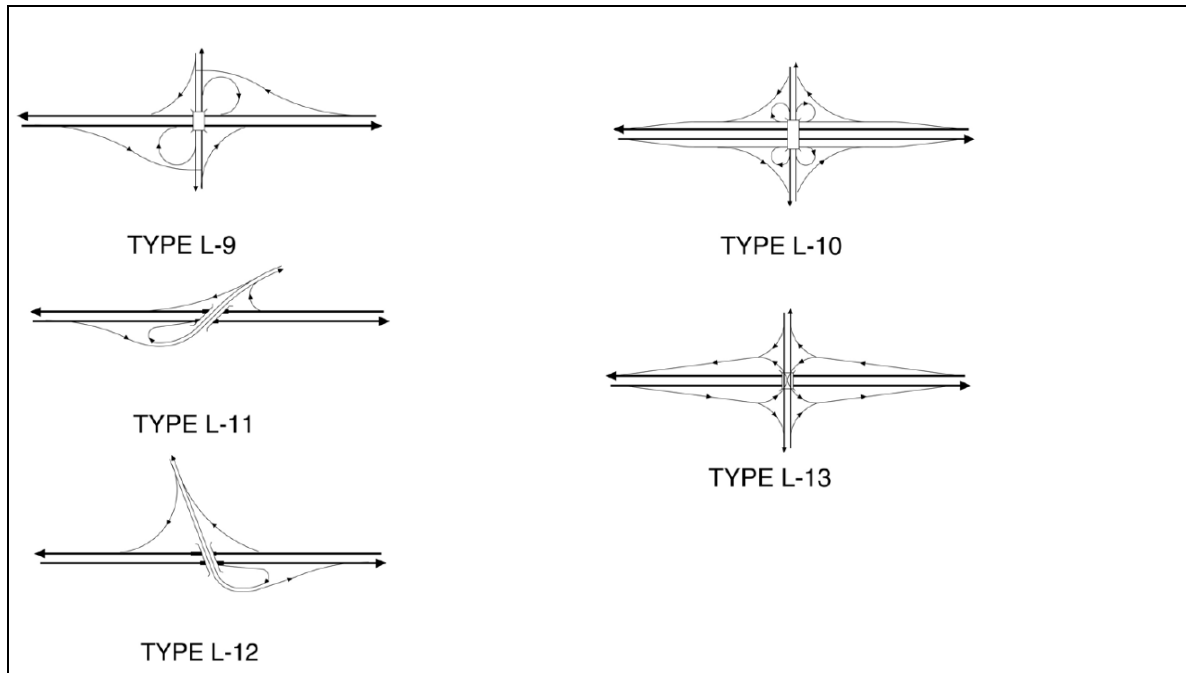
Source: Figure 502.2 Caltrans HDM.

The remaining interchange types do not easily accommodate pedestrians and bicyclists (Figure 9.2). These interchanges include high-speed free-flow ramps or complicated and large intersections. High-speed on- and off-ramps designed to encourage high-speed, free-flow turning movements are the major barrier to providing adequate pedestrian and bicycle access through interchanges. Even skilled and fit bicyclists find crossing such ramps difficult. Less skilled bicyclists, elderly or very young pedestrians and pedestrians with disabilities may face particular difficulty when navigating these types of interchanges.

Pedestrians and bicyclists may face greater crossing difficulty when a crossroad is widened, and design speeds are increased through the interchange. Often, designs allow and encourage motorists to accelerate to highway speeds while still on the crossroad, reducing the driver's ability to recognize and respond to pedestrians and bicyclists.



Figure 9.2 Interchange Types That Do Not Easily Accommodate Pedestrians and Bicyclists



Source: Figure 502.2 Caltrans HDM.

Techniques for addressing issues at high-speed free-flow ramps are discussed below. Additional issues specific to single point interchanges and trumpet interchanges are also discussed.

Ramps that intersect the crossroad at a five-leg intersection, as in Type L-5, have all the issues associated with multi-leg and skewed intersections, and are addressed in Section 5– Skewed and Multi-leg Intersections.

9.1. Free-Flow Ramps

When crossing free-flow ramps, pedestrians and bicyclists face challenges related to unyielding motorists, high motor vehicle speeds, limited visibility, and the absence of bicycle or pedestrian facilities. Bicyclists additionally face challenges related to unclear path of travel.

If motor vehicle traffic volumes are high, multi-lane on-ramps are used to accommodate motorists. Though multi-lane ramps can prevent upstream motor vehicle queuing (unless a ramp meter is present), they pose significant challenges for pedestrians and bicyclists, and further exacerbate the problems these users face at free-flow ramps.

9.1.1. Common Issues

Common issues associated with free-flow on- and off-ramps are:



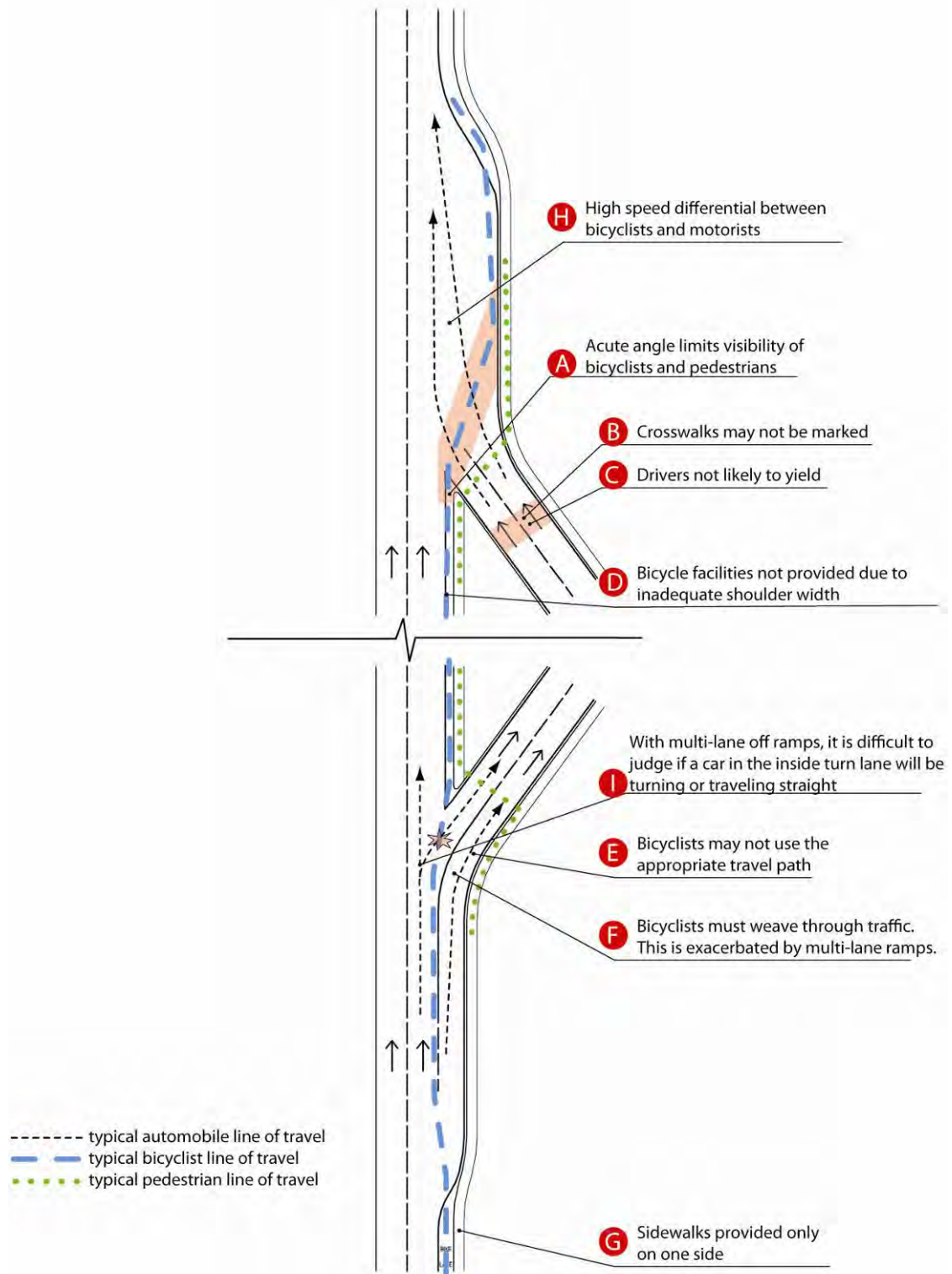
- A. Acute intersecting **angle limits visibility** of pedestrians and bicyclists;
- B. **Crosswalks are not marked** across ramps.
- C. Ramp traffic is not controlled, and **motorists traveling at high speed are not likely to yield** to bicyclists or pedestrians;
- D. If the outside lane or shoulder is not wide enough, **bicycle facilities are often not provided** through an interchange;
- E. **Bicyclists may not use the best travel path** when navigating through the intersection;
- F. **Bicyclists must weave** through free-flow turning traffic traveling at a much higher speed. This is exacerbated with multi-lane ramps; and
- G. **Sidewalks are sometimes not provided or only provided on one side** of a crossroad.

Common issues associated with multilane free-flow on- and off-ramps:

- H. **Motor vehicles travel at high speeds, resulting in a large speed differential with pedestrians and bicyclists;** and
- I. With multi-lane ramps and lanes with dual destinations, it is **difficult for pedestrians and bicyclists to judge when a vehicle in the inside lane will be turning or traveling straight.**



Figure 9.3 Issues Associated with Free-Flow On- and Off-Ramps





9.1.2. Treatments

Treatments for pedestrian and bicyclist concerns at on- and off-ramps range from striping and signage to make motorists more aware of and more likely to yield to pedestrians and bicyclists; reconstructing the intersection to eliminate all free-flow turning movements; and reconfiguring intersections so that on and off ramps meet the crossroad at or near 90-degrees. Even with signage and striping improvements, free-flow ramps present significant challenges for pedestrians and bicyclists; reconfiguring the intersection is the preferred treatment. This is easiest to achieve when the intersection is still in the planning phase; once constructed, interchanges are very costly to reconfigure.

The ITE Pedestrian and Bike Council recommends the following when designing interchanges:

- Encourage slower vehicle speeds until past on-ramp;
- Locate the crosswalk to maximize pedestrian visibility and before the location where vehicles begin to accelerate;
- Use short crosswalks;
- Where bicyclists travel between moving vehicles for more than 200 feet, install a painted or raised buffer; and
- Where bicyclists weave across a vehicle lane allow flexibility to transition when/where safe.²⁴

Table 9.1 lists a range of treatments to help alleviate some of the challenges listed above.

Figure 9.4 illustrates a preferred intersection design for ramps: 90-degree signalized or stop-controlled intersections.

Figure 9.5 illustrates signage and striping treatments that help address some issues at single-lane free-flow ramps.

Figure 9.6 illustrates geometric changes that can make multiple-lane ramps easier for bicyclists to navigate.

Figure 9.7 illustrates the use of signage, striping, and medians to make it easier for bicyclists and pedestrians to navigate across multiple-lane on-ramps.

²⁴ Adapted from: ITE Pedestrian and Bike Council, 2010, “Accommodating Bicyclists and Pedestrians at Interchanges Summary of Draft Recommendations,” *Transportation Research Board Annual Conference*, Washington D.C.



Table 9.1 Basic Treatments to Accommodate Pedestrians and Bicyclists at Interchanges

Treatment	Design Principles	Figure No.
<i>Signage and Striping</i>		
Stripe high-visibility crosswalks at all intersections.	Improve Visibility	9.4, 9.5, 9.6, 9.7
Provide bicycle facilities on all crossroads leading up to the interchange, and appropriate facilities through the interchange. Consider experimental treatments such as colored bike lanes. Drop bicycle lanes as appropriate to indicate where weaving movements may occur.	Pedestrians and Bicyclists Will Be There, Improve Visibility, Clarify the Right-of-Way	9.4, 9.5, 9.6
Stripe on- and off-ramps so that through-moving bicyclists do not need to weave across turning motorists, but instead can travel straight.	Clarify the Right of Way	9.4, 9.5, 9.6
Where bicyclists travel between moving vehicles for more than 200 feet, install a painted or raised buffer.	Clarify the Right of Way	9.7
Provide bicycle lanes to the left of dedicated right-turn lanes.	Clarify the Right-of-Way	9.4, 9.5, 9.6
Install pedestrian warning signage, yield lines, and pedestrian-actuated beacons at all uncontrolled crossings.	Pedestrians and Bicyclists Will Be There, Clarify the Right-of-Way, Improve Visibility	9.5
<i>Infrastructure</i>		
Provide sidewalks on both sides of crossroad.	Pedestrians and Bicyclists Will Be There	Not Shown
Reconstruct ramps to intersect crossroad at 90-degree angle with as low a radius as possible. Bring under stop or signal control if warranted.	Tee It Up, Slow it Down, Shorten Crossings, Improve Visibility, Clarify the Right-of-Way	9.4, 9.6
Construct single, rather than dual, right-turn only lanes.	One Decision at a Time	9.4, 9.5
If a dual right-turn only lane is required, channelize it and split into two separate movements. If a triple right-turn only lane is required, add the third turning lane to the left of the channelization, maintaining a single channelized right turn lane.	One Decision at a Time	9.6



<i>Operations</i>		
Design speed of local road to the minimum required by Caltrans (35 mph). ²⁵ If speeds on the approaches are more than 35 mph, consider seeking a design exception.	Slow it Down	Not shown
For ramp crossings, consider adding pedestrian signals coordinated with adjacent traffic signals.	Clarify the Right of Way, Slow it Down	Not shown

²⁵ Caltrans HDM, Section 101.1 “Design Speed.”



Figure 9.4 Preferred Treatment for Free-Flow Ramp Intersections

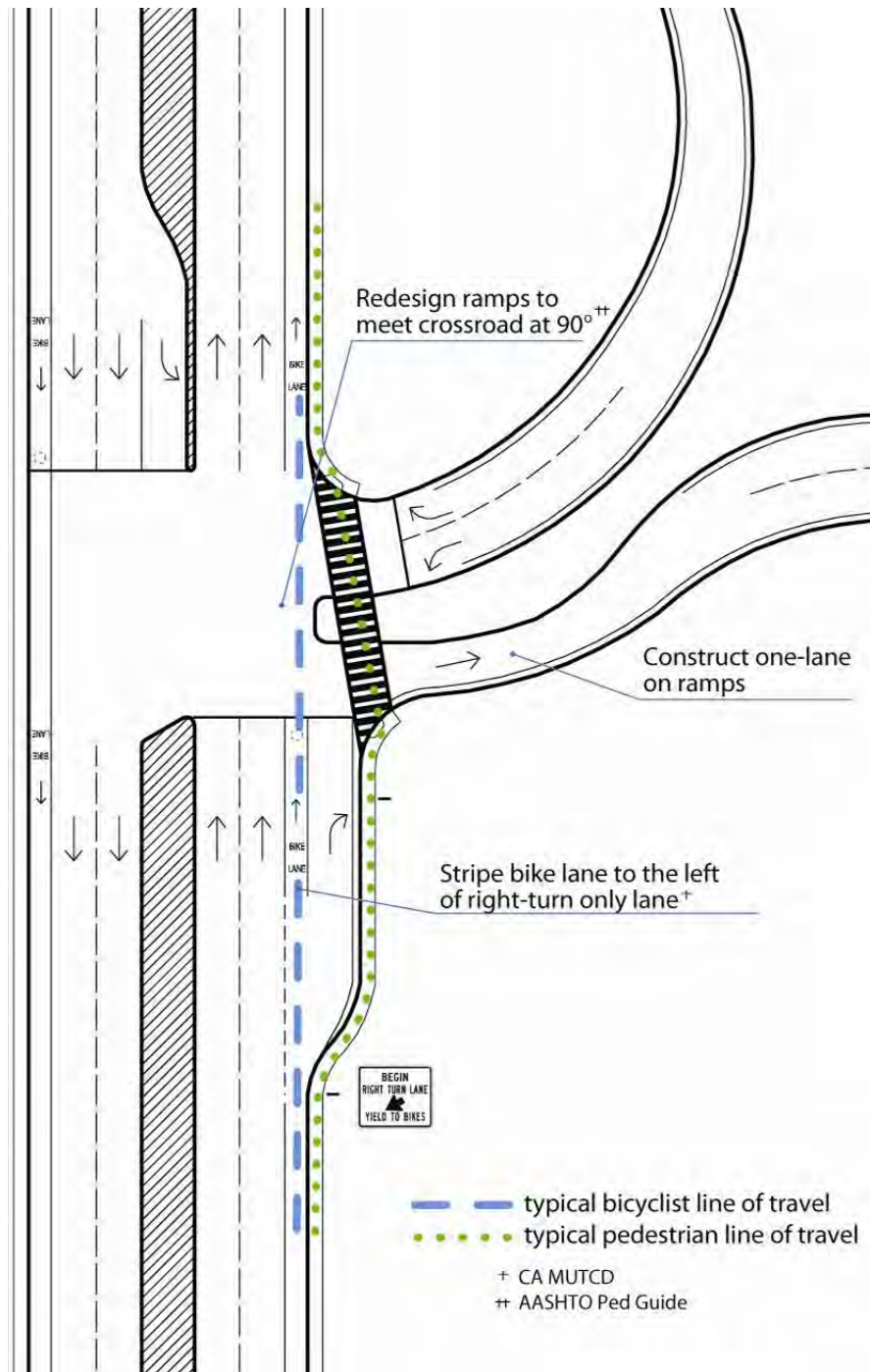
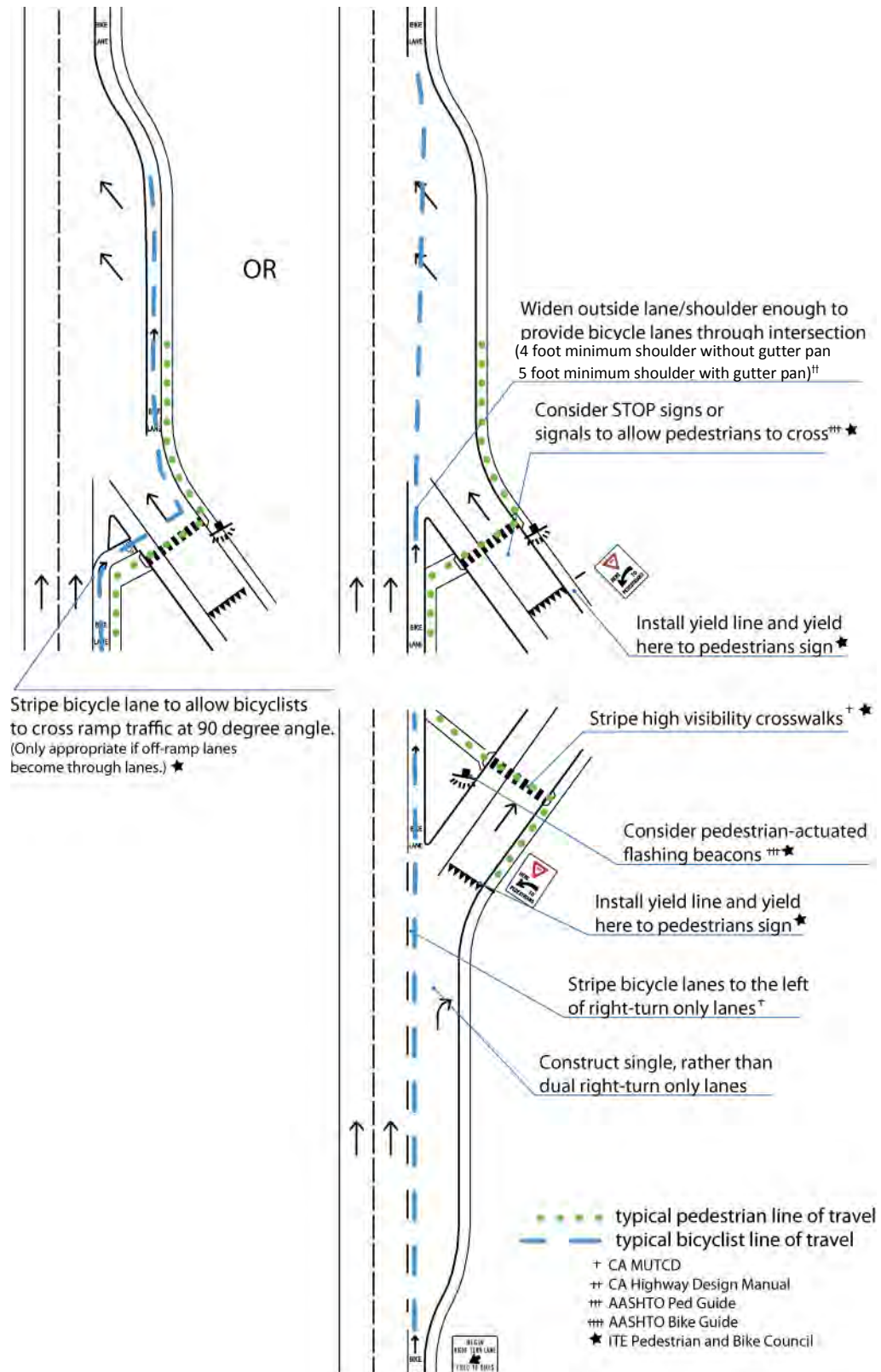




Figure 9.5 Signage and Striping Treatments for Free-Flow Ramp Intersections





**Figure 9.6 Double-Lane Free-Flow On-Ramp Treatment:
Channelize Turn Movements**

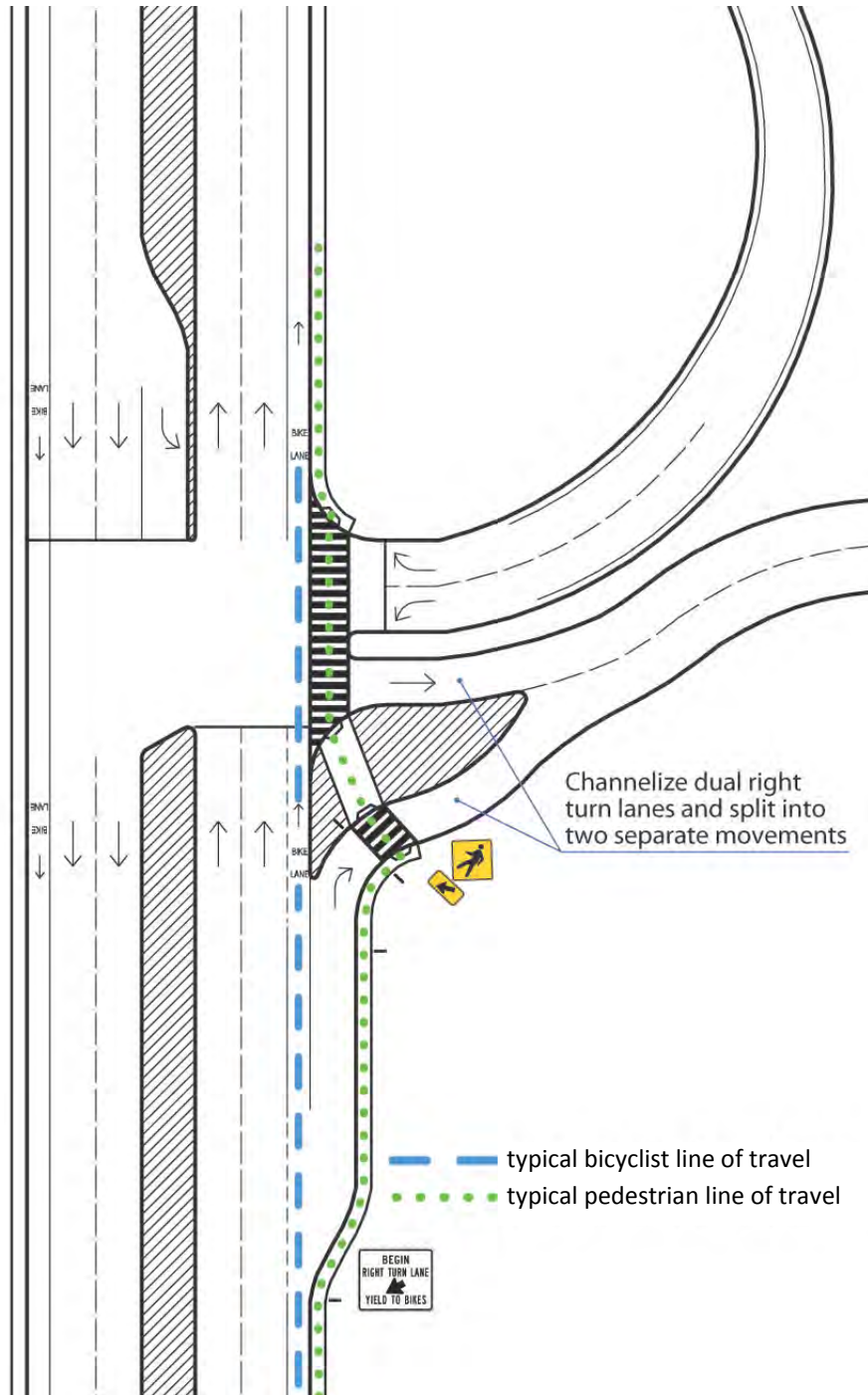
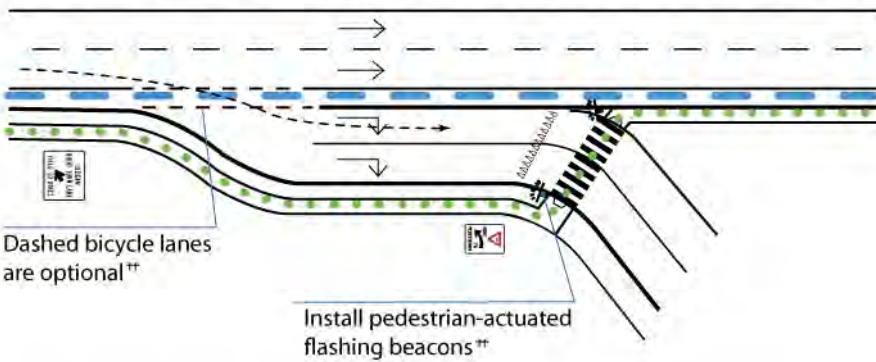


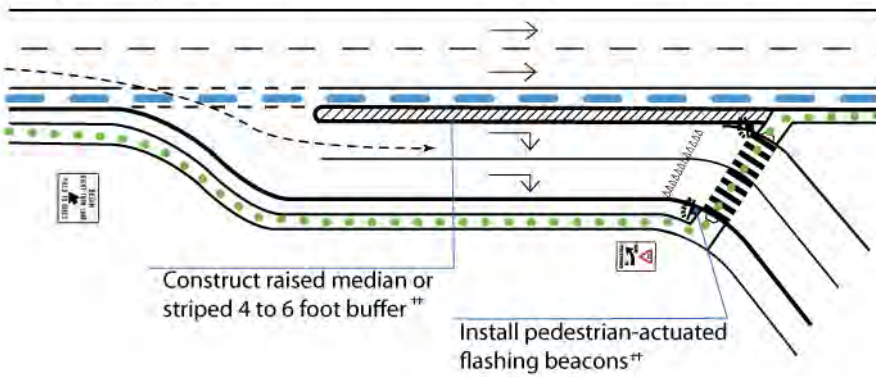


Figure 9.7 Treatments for Dual-Lane On-Ramps

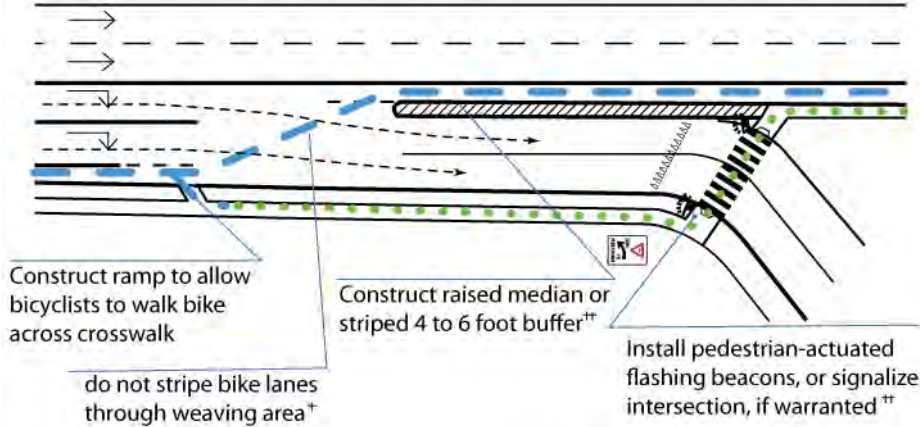
Short Dual Right Turn On-Ramp (right turn lanes less than or equal to 200 feet)**



Long Dual Right Turn On-Ramp (right turn lanes greater than 200 feet)**



Long Dual Trap Right Turn Lane (right turn lanes greater than 200 feet)**



- typical automobile line of travel
- typical bicyclist line of travel
- typical pedestrian line of travel

Figures adapted from ITE Pedestrian and Bike Council.

† CA MUTCD
** ITE Pedestrian and Bike Council



9.2. Single Point Interchange

A Single Point Interchange (SPI) combines two diamond ramp intersections into a single at-grade intersection. Most SPI's operate with a three-phase signal, and due to the size of the intersection, long clearance intervals are required for all movements. These intersections can be efficient at moving high volumes of traffic, particularly left turns. However, the signal timing and intersection configuration required to provide the efficient movement of motor vehicles adversely affect pedestrians and bicyclists. Compact SPI's can be configured to mitigate some of the bicyclist issues. In its June 2001 Design Memorandum, "Single Point Interchange Design, Planning, and Operations Guidelines", Caltrans requires that "If an SPI alternative other than a Compact SPI is chosen, a separate bicycle facility shall be constructed in conjunction with the SPI." Note that even if a separate facility is provided, the SPI should still meet bicyclist signal timing guidance provided in Traffic Operations Policy Directive 09-06.

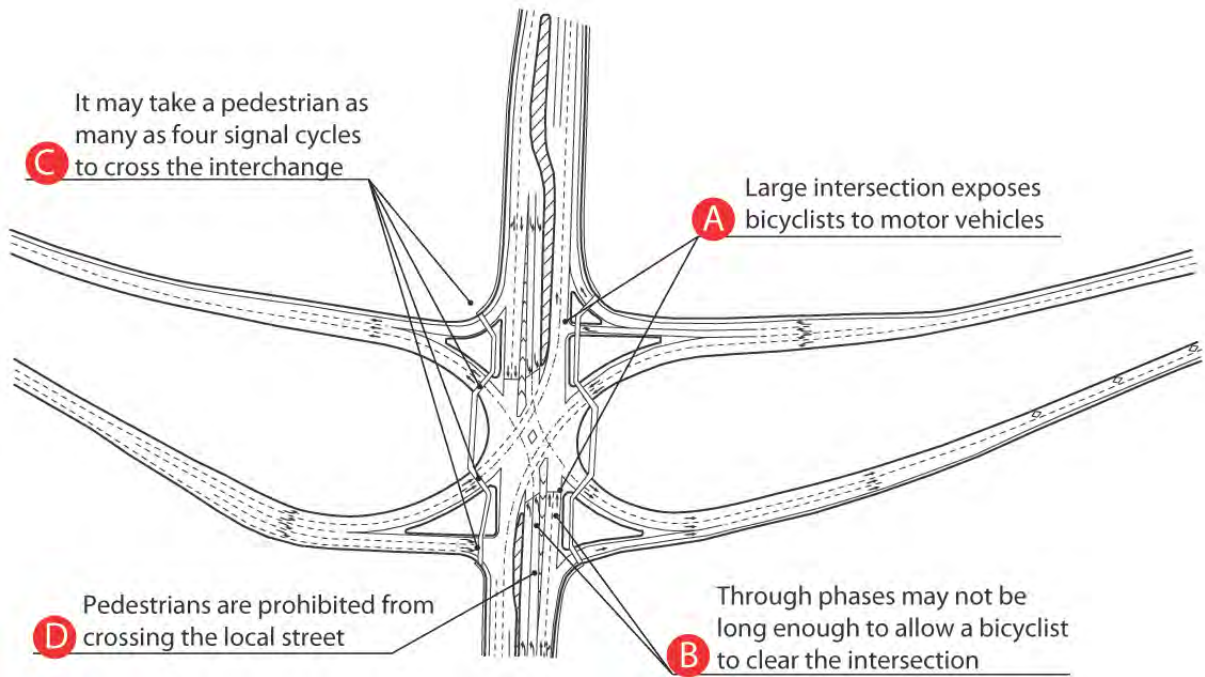
9.2.1. Common Issues

Many of the issues faced by pedestrians and bicyclists at free-flow ramp intersections apply at single point intersections. The following issues specific to SPIs also apply:

- A. The **large size of SPI intersections** exposes bicyclists to motor vehicles for a longer time than other interchange types.
- B. Typical through **green phases are not long enough to allow a bicyclist to clear the intersection.**
- C. Pedestrians can only cross a portion of the interchange in a single signal cycle. **It may take a pedestrian as many as four signal cycles to cross the interchange.**
- D. **Pedestrians are prohibited from crossing the local street** at an SPI.



Figure 9.8 Common Pedestrian and bicycle Issues at Single Point Interchanges





9.2.2. Treatments

Table 9.2 Treatments for Single Point Interchanges

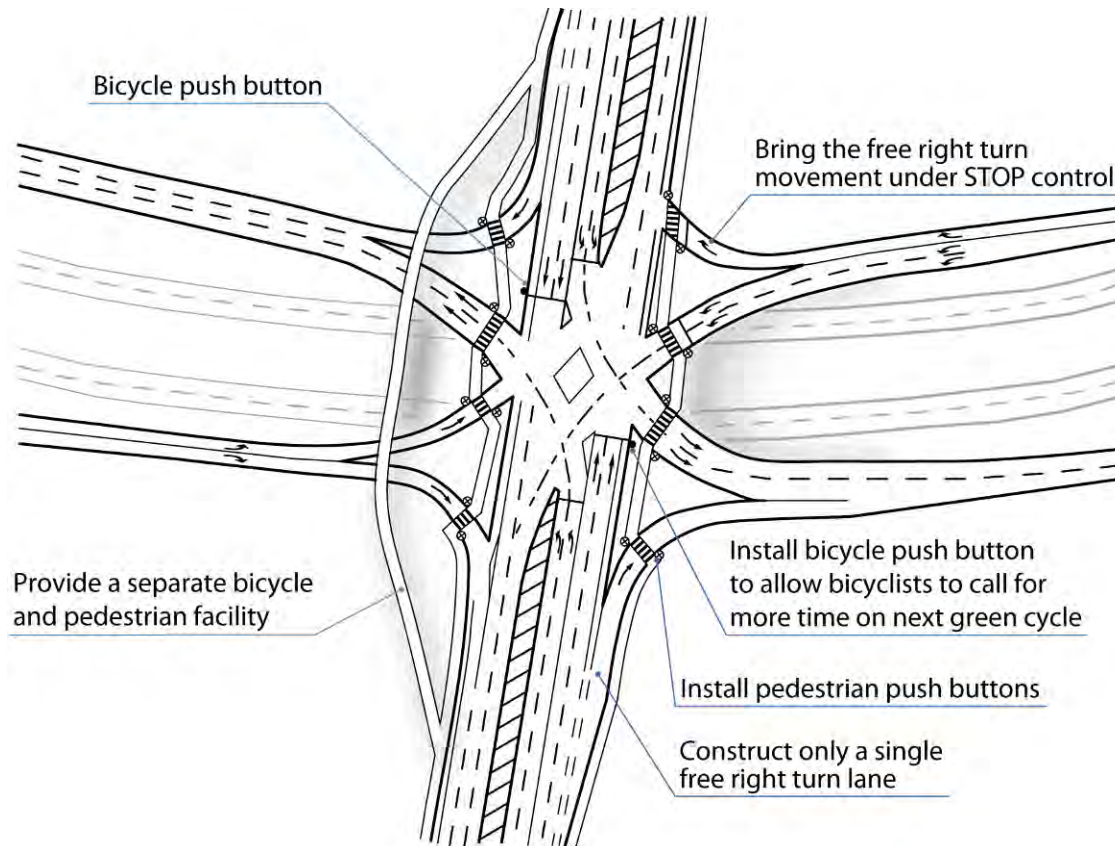
Treatment	Design Principles	Figure No.
<i>Signage and Striping</i>		
Stripe high-visibility crosswalks at all intersections.	Improve Visibility	9.9
<i>Infrastructure</i>		
Select a different interchange type if “moderate to heavy bicycle use is expected” ^a or if bicycle signal timing guidance in TOPD 09-06 cannot be met.	Maintain and Improve	Not Shown
Construct a compact SPI if separate bicycle facilities will not be provided. ^a	Maintain and Improve	9.9
Construct only a single free right turn lane, rather than a dual free right turn lane, to reduce weaving conflicts between bicyclists and turning motorists and reduce pedestrian crossing distance and multiple threat. ^a	Clarify the Right of Way, One Decision at a Time	9.9
Provide a separate undercrossing or overcrossing in the immediate vicinity of the interchange. “If it is anticipated that in the future the right turn move at a Compact SPI will be signalized, a separate bicycle facility should be incorporated into the current project.” ^a	Pedestrians and Bicyclists Will Be There, Maintain and Improve	9.9
<i>Operations</i>		
Install bicycle push button to allow bicyclists to call for more time on next green cycle and/or a detection system that detects bicyclists and automatically adjusts signal timing to allow the bicyclist enough time to clear the intersection per TOPD 09-06.	Pedestrians and Bicyclists Will Be There	9.9
Install pedestrian push buttons.	Pedestrians and Bicyclists Will Be There	9.9
Bring the free right turn movement under STOP, YIELD, or signal control.	Clarify the Right of Way, Slow It Down	9.9

^a Caltrans Design Memo, “Single Point Interchange Design, Planning, and Operations Guidelines.” June 2001.

Note: Some items adapted from VTA Bicycle Technical Guide, December 2007.



Figure 9.9 Treatments for Pedestrians and bicyclists at Single Point Interchanges



9.3. Trumpet Interchanges

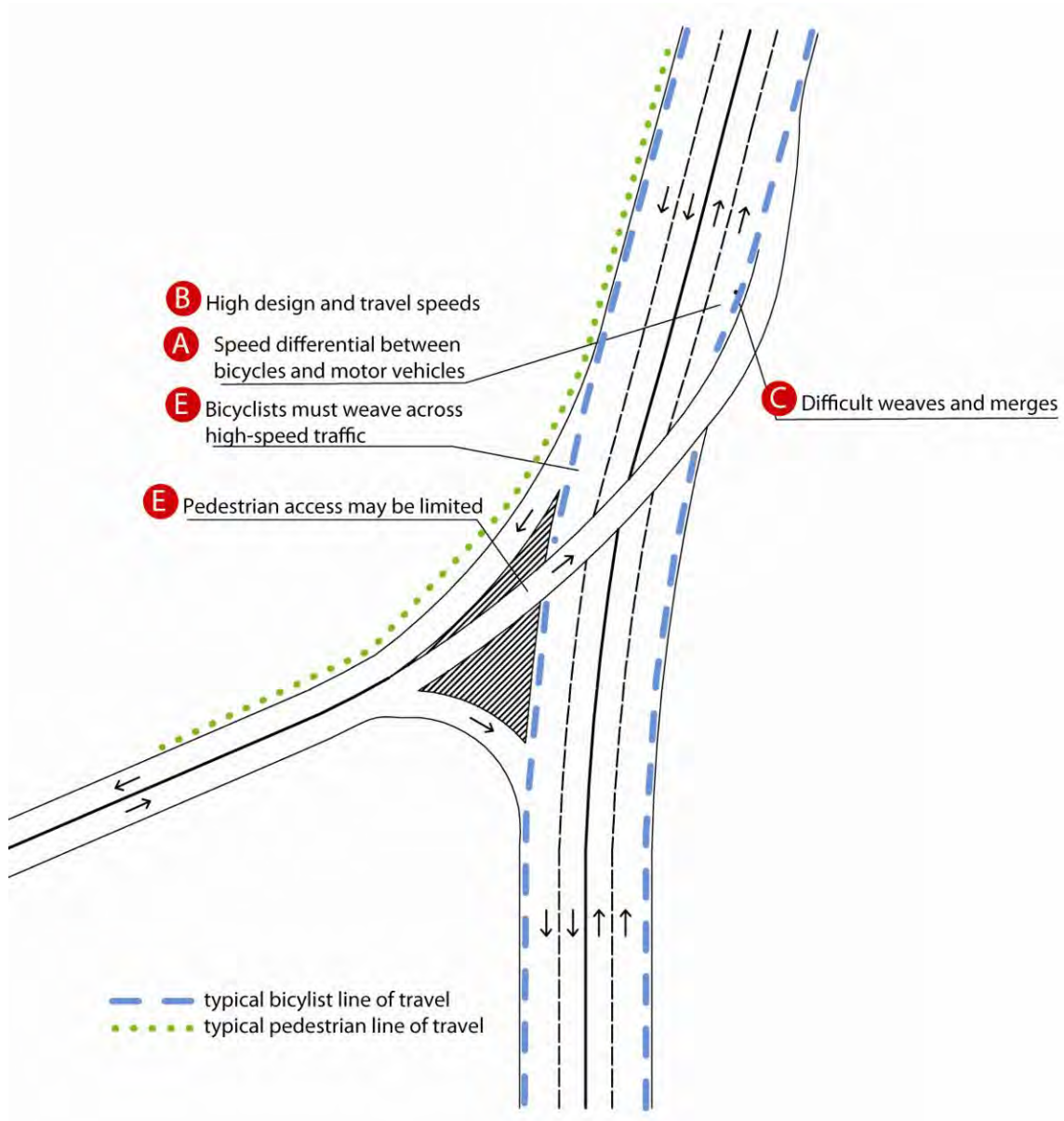
9.3.1. Common Issues

Trumpet interchanges are grade-separated three-leg intersections. Many of the issues faced by pedestrians and bicyclists at free-flow ramp intersections apply at trumpet interchanges. Trumpet interchanges pose the following additional safety issues for pedestrians and bicyclists:

- A. Grade of overpass exacerbates **speed differential between bicyclists and motor vehicles.**
- B. Trumpet interchanges generally have a **high design speed and travel speed.**
- C. Bicyclists are required to make difficult **weaves and merges** to traverse the intersection.
- D. Bicyclists are placed in lanes that are difficult to navigate or **forced to merge across high-speed traffic.**
- E. **Pedestrian access may be limited.**



Figure 9.10 Common Issues with Trumpet Interchanges





9.3.2. Treatments

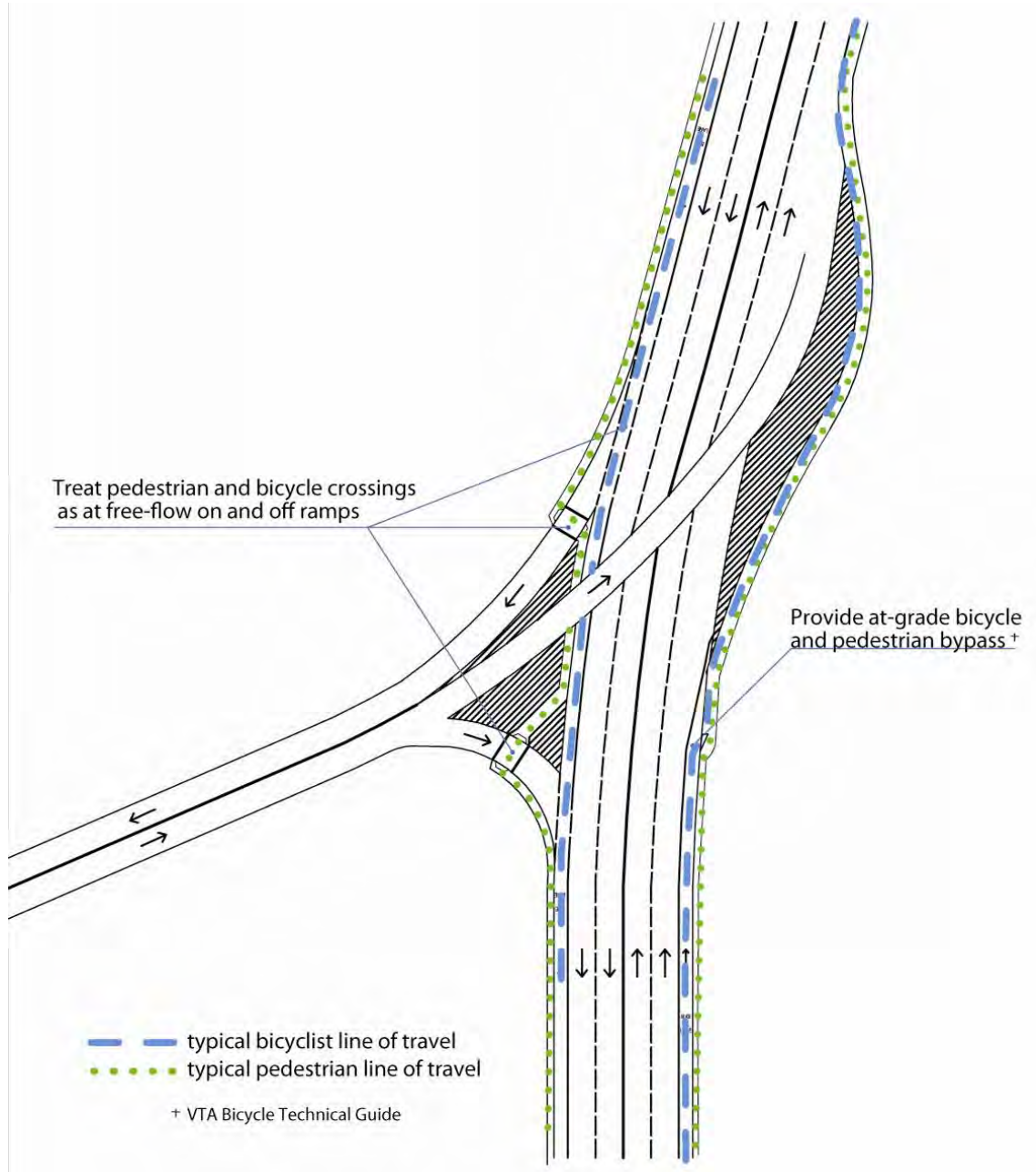
Table 9.3 Treatments for Trumpet Interchanges

Treatment	Design Principles	Figure No.
<i>Signage and Striping</i>		
8 foot wide shoulders or bike lanes throughout	Pedestrians and Bicyclists Will Be There	Not Shown
<i>Infrastructure</i>		
Maximum grades of 5 percent	Access for All	Not Shown
Provide at-grade bicycle bypass	Maintain and Improve, Pedestrians and Bicyclists Will Be There	9.11
<i>Operations</i>		
Design for a maximum speed of 35 mph	Slow It Down	Not Shown

Note: Adapted from VTA Bicycle Technical Guide, December 2007.



Figure 9.11 Trumpet Interchange Treatment



Note: Recommendations from *VTA Bicycle Technical Guide*, December 2007.



9.4. Diverging Diamond Interchanges

The diverging diamond interchange is an unusual design and, as such, presents possible unknown challenges to the safe accommodation of pedestrians and bicyclists. In design, it will be important to first obtain the latest data and research on non-motorized safety through and across this type of interchange, and then to thoroughly incorporate the design principles of this Guide.



10. TREATMENTS ON THE HORIZON

Treatments suggested in this Guide reflect current California standards for striping and signage from the 2006 CA MUTCD. The CA MUTCD is based on the 2003 MUTCD with certain amendments, along with policies on traffic control devices issued by the California Department of Transportation. The National MUTCD was updated in 2009 and incorporates several modifications to pedestrian and bicycle related signage and new traffic control devices, some of which are being experimented with in California. The 2009 MUTCD is not effective in California until Caltrans and CTCDC review it and incorporate the changes into CA MUTCD through formal efforts. Although devices included in the 2009 MUTCD are not yet standard in California, they may be included in a revised version of the CA MUTCD and are discussed here as potential future treatments. California has two years to review the National MUTCD and adopt a new CA MUTCD.

10.1.2009 MUTCD

Several changes in the 2009 MUTCD update are significant for pedestrians and bicyclists at intersections, all shown in Table 10.1:

- **Bicyclist push button signs.** This sign supplements bicyclist push buttons at intersections.
- **Bicycle “May Use Full Lane” sign.** This sign is intended for roads where bicyclists may need to use the full travel lane due to lack of bicycle lanes, shoulders, or where travel lanes are too narrow for bicyclists and motor vehicles to operate side by side.
- **Bicycle Route Guide Signage.** These signs direct bicyclists to destinations and may include the distance to destinations.
- **Pedestrian Hybrid Beacon.** Also known as, the High-Intensity Activated Crosswalk (HAWK) signal, the Pedestrian Hybrid Beacon assists pedestrians crossing streets at unsignalized marked crosswalks. Pedestrians actuate the signal when crossing, causing it to begin flashing yellow and then solid yellow, advising motorists to prepare to stop. A steady red phase occurs during the pedestrian walk interval. After the red call, an alternating flashing red signal indicates that motorists may proceed when safe after coming to a full stop. When not activated, the signal is blank. The 2009 MUTCD has specific guidelines for installing Pedestrian Hybrid Beacons including the volume of pedestrian crossings and road speeds and volumes.
- **Countdown Signals.** Countdown Signals: The 2009 MUTCD states that countdown signals are now required on all pedestrian signal heads where the pedestrian change interval is more than 7 seconds (previously not required). Also, the signals now shall



not be used during the red clearance interval of a concurrent vehicular phase (previously yellow).

- **Slower Walking Speed.** The 2009 MUTCD states that pedestrian clearance time should be based on a walking speed of 3.5 feet per second (reduced from 4.0 feet per second in previous versions). At intersections where extended pedestrian time is provided, a walking speed of 4.0 feet per second may be used to evaluate crossing time.
- **Additional Crossing Time Sign.** In both the 2010 CA MUTCD and the 2009 MUTCD, pedestrians may be provided with extended crossing time by pressing an extended pushbutton. The 2009 MUTCD requires that these pushbuttons shall be identified by a PUSH BUTTON FOR 2 SECONDS FOR EXTRA CROSSING TIME (R10-32P) plaque.
- **Pedestrian Lead Interval.** At intersections with high pedestrian volumes and high conflicting turning vehicle volumes, a brief leading pedestrian interval, during which an advance WALKING PERSON (symbolizing WALK) indication is displayed for the crosswalk while red indications continue to be displayed to parallel through and/or turning traffic, may be used to reduce conflicts between pedestrians and turning vehicles. If a leading pedestrian interval is used it should be at least 3 seconds in duration and should allow pedestrians to cross at least one lane of traffic before turning traffic is released.

Unsignalized Pedestrian Crossing Sign. Overhead pedestrian crossing signs (R1-9 or R1-9a) for unsignalized intersections were added to the 2009 MUTCD. They are intended to remind motorists of laws regarding right-of-way at an unsignalized pedestrian crosswalk. The legend STATE LAW must be displayed at the top of the sign. The sign must be placed at the crosswalk, not in advance of it.

- **Trail Crossing Sign.** This new trail crossing sign (W11-15) displays both a pedestrian and bicycle symbol. An optional TRAIL XING plaque may accompany this sign.
- **Shared Lane Marking.** The 2009 MUTCD includes the Shared Lane Marking originally adopted in California. This marking is intended to assist bicyclists with lateral positioning in lanes with parallel parking or in lanes too narrow to share side-by-side. One key difference from the CA MUTCD is that the 2009 MUTCD does not require the Shared Lane Marking to be used on roads with on-street parallel parking.



Figure 10.1 New Signs and Signals in the 2009 National MUTCD

Bicyclist push button signs



R10-4

Existing Sign



R10-24

New Sign



R10-25

Existing Sign



R10-26

New Sign

Bicyclist May Use Full Lane Sign



R4-11

Bicycle Route Guide Signs



D1-1b



D1-1c



D1-2b



D1-2c



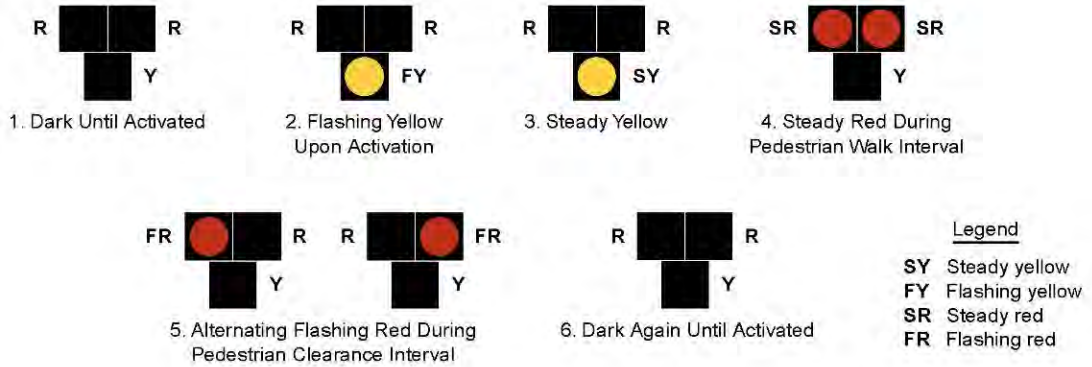
D1-3b



D1-3c



Pedestrian Hybrid Beacon



Unsignalized Pedestrian Crossing Signs



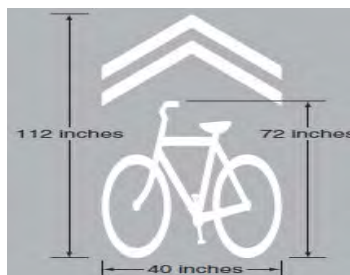
R1-9

Trail Crossing Sign



* Fluorescent yellow green may be used

Shared Lane Marking





10.2. Interim Approved Device: Rectangular Rapid Flashing Beacons

FHWA has issued an Interim Approval for the optional use of Rectangular Rapid Flashing Beacons (RRFB) as warning beacons. Interim Approval allows interim use of a new traffic control device not specifically described in the MUTCD by written request to FHWA. RRFB do not meet current MUTCD standards because of their rectangular shape and flashing rate. RRFB devices supplement pedestrian and school crossing signs, using rectangular-shaped high-intensity LED-based indications that flash rapidly in a wigwag “flickering” flash pattern. They are mounted immediately between the crossing sign and the sign’s supplemental arrow plaque.



*Rectangular Rapid Flashing Beacons are installed between the crossing sign and the supplemental arrow.
Source: FHWA.*

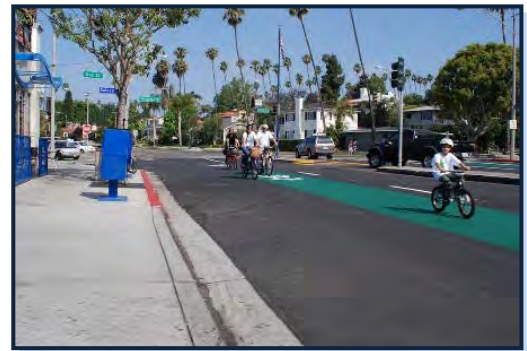
Based on data from experimental studies, FHWA considers the RRFB to be highly successful for uncontrolled crosswalk locations. FHWA believes that the RRFB offers significant potential safety and cost benefits; because it achieves very high rates of compliance at a very low relative cost in comparison to other more restrictive devices that provide comparable results, such as full midblock signalization. The components of RRFB are not proprietary and can be assembled by any jurisdiction with off-the-shelf hardware.

10.3. California Experiments

There are several bicycle traffic control device experiments underway in California.

The City of San Francisco has received FHWA approval for experimentation of colored bicycle lanes. This experiment will involve evaluation of green solid and dashed asphalt pavement for bike lanes at several locations.

Caltrans District 5 is experimenting with a “Bikes in Lane” sign as shown in Figure 10.2. This sign is for bikeways where there is limited space for both bicycles and vehicles and as a result, the two users must share a travel lane.



*The City of Long Beach is experimenting with shared lane marking augmented with a green colored strip.
Source: Long Beach Department of Health.*

The City of Long Beach is conducting an FHWA-approved experiment evaluating shared lane markings augmented with a strip of green paint to further delineate the appropriate positioning of bicyclists in the travel lane. Long Beach is also requesting approval to experiment with separated/protected bikeways along two one-way streets.



Figure 10.2 Experimental “Bikes in Lane” Sign





11. BACKGROUND

This section provides background information on issues to be considered when designing and retrofitting intersections and interchanges for pedestrians and bicyclists, including:

- **Pedestrian and bicyclist injury and fatality data** - provides an overview of the numbers of pedestrian and bicyclist injuries and fatalities occurring at intersections in California;
- **Characteristics of bicycle- and pedestrian-friendly environments** - describes the land use and environmental characteristics that encourage travel by foot and bicycle;
- **Typical collision types at intersections** - describes the most common types of collisions involving pedestrians and bicyclists at intersections;
- **Safety benefits of treatments** - summarizes research on the relative safety benefits of design treatments for pedestrians and bicyclists;
- **Using a 4E approach to safety** - describes educational and enforcement strategies to address non-motorized user safety at intersections.

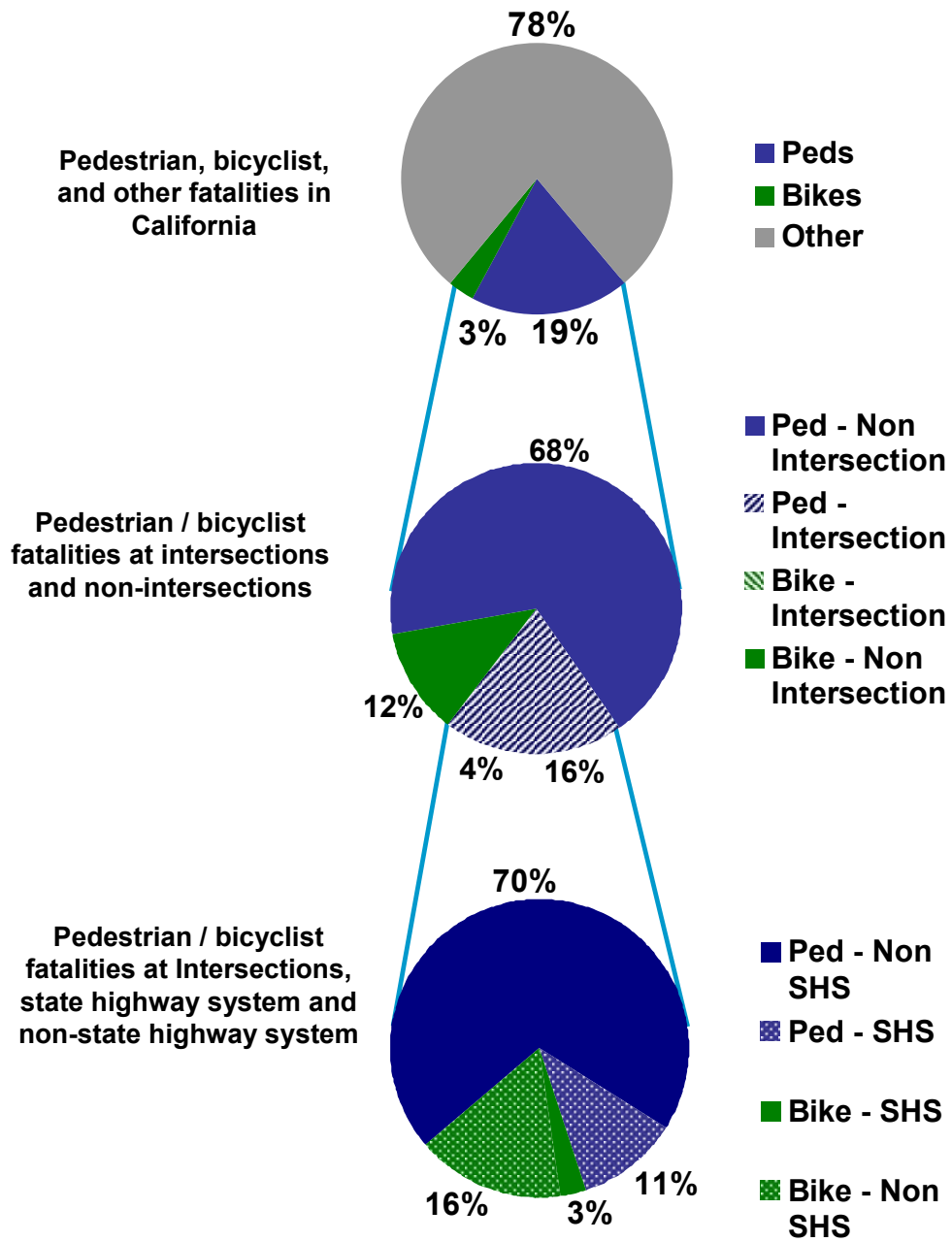
11.1. Pedestrian and bicycle Injuries and Fatalities in California

The following is a brief overview of the characteristics of police-reported pedestrian and bicyclist injuries and fatalities in California:

- Pedestrians and bicyclists accounted for 22 percent of all traffic fatalities between 2003 and 2007 in California.
- Twenty percent of pedestrian and bicyclist fatalities occurred at or near intersections.



Figure 11.1 Pedestrian and Bicycle Fatalities in California



Source: SWITRS, 2003-2007.

Injury data for pedestrians and bicyclists is less reliable due to underreporting. Comparisons of emergency room and hospital discharge records and reported police collisions in California show that pedestrian and bicyclist injuries are significantly



under-reported to the police, (43 percent of bicyclist-motor vehicle injuries are not reported, and 45 percent of pedestrian-motor vehicle injuries are not reported).²⁶ Consequently, SWITRS data significantly underestimates the total number of pedestrians and bicyclists involved in crashes.

Available data shows that 39 and 33 percent of pedestrian and bicyclist injuries, respectively, occurred at intersections between 2003 and 2007. Of all pedestrian and bicyclist injuries occurring at intersections, 9 and 7 percent, respectively, occurred on the State Highway System.²⁷

Additional analysis of SWITRS fatality data, 2003-2007, indicates that:

- Twenty-eight percent of pedestrian and 21 percent of bicyclist fatalities at intersections involved alcohol usage by one or more individuals involved in the collision;
- Ninety-two percent of pedestrian and 82 percent of bicyclist fatalities at intersections occurred in incorporated areas; the remainder occurred in unincorporated areas; and
- Sixty-six percent of pedestrian and 76 percent of bicyclist fatalities occurring at intersections involved a properly functioning control device. Most of the remaining fatalities occurred at intersections indicated as having no control device.²⁸
- Information on pedestrian injury and fatality rates is difficult to obtain given the lack of reliable, consistent information on pedestrian and bicycle volumes in California. When it becomes available, the 2008 California National Household Travel Survey Add-On data will provide the most up-to-date and comprehensive information on statewide rates of bicycling and walking.

11.2. Characteristics of Bicyclist- and Pedestrian-Friendly Environments

While users of this Guide may not be able to directly influence land use decisions, they should be aware of the impact the land use context may have on the mobility and safety of pedestrians and bicyclists at intersections, and the characteristics that make certain environments more attractive to pedestrians and bicyclists than others.

²⁶ Jane C. Stutts and William W. Hunter. *Injuries to Pedestrians and Bicyclists: An Analysis Based on Hospital Emergency Department Data*. Table 59. Percentage of cases reported by participating hospital emergency departments identified in California crash files. Sponsored by: Office of Safety Research, Development, and Technology, FHWA, Washington D.C. FHWA-RD 99-078. June 1997.

²⁷ All data are cumulative, 2003-2007, from SWITRS.

²⁸ Police officers may mark “no control” on the crash form when the intersection is stop controlled.



Major characteristics of bicyclist- and pedestrian-friendly environments include:

- **Closely spaced destinations.** Pedestrian and bicycle travel is not convenient unless destinations are close together. The distances between destinations can be shortened by building at higher densities, mixing land uses, and by creating direct routes to destinations.
- **Direct routes.** Direct routes facilitate pedestrian and bicycle travel and help shorten the distances between destinations. Routes can be made more direct by providing adequate roadway crossing opportunities; reducing crossing distances; providing an interconnected street network (as opposed to suburban-style disconnected street network), and by limiting the need for pedestrians and bicyclists to cross major obstacles, such as large parking lots, to get to their destination. Additionally, off-road paths and bicycle-pedestrian bridges can overcome barriers to pedestrian and bicycle mobility.
- **Slow-moving vehicles.** Fast-moving vehicle traffic reduces the comfort of pedestrians and bicyclists, and increases the risk of surveying if a collision occurs. Many of the treatments in this Guide can help reduce vehicle traveling and turning speeds, therefore increasing the safety and comfort of pedestrians and bicyclists. Figure 11.2–Fatal Injury Rates by Vehicle Speed by Pedestrian Age illustrates the rapid increase in the likelihood of pedestrian death that occurs as vehicle speeds increase, and shows how older pedestrians are particularly vulnerable.
- **Other pedestrians and bicyclists.** Pedestrian and bicycle-friendly environments can be identified simply by looking for areas where many pedestrians and bicyclists are present. There is evidence that more pedestrians and bicyclists may actually make the environment safer, a phenomenon known as “safety in numbers”. The reason for this has not been fully defined, but may be due to changes in driver behavior.²⁹

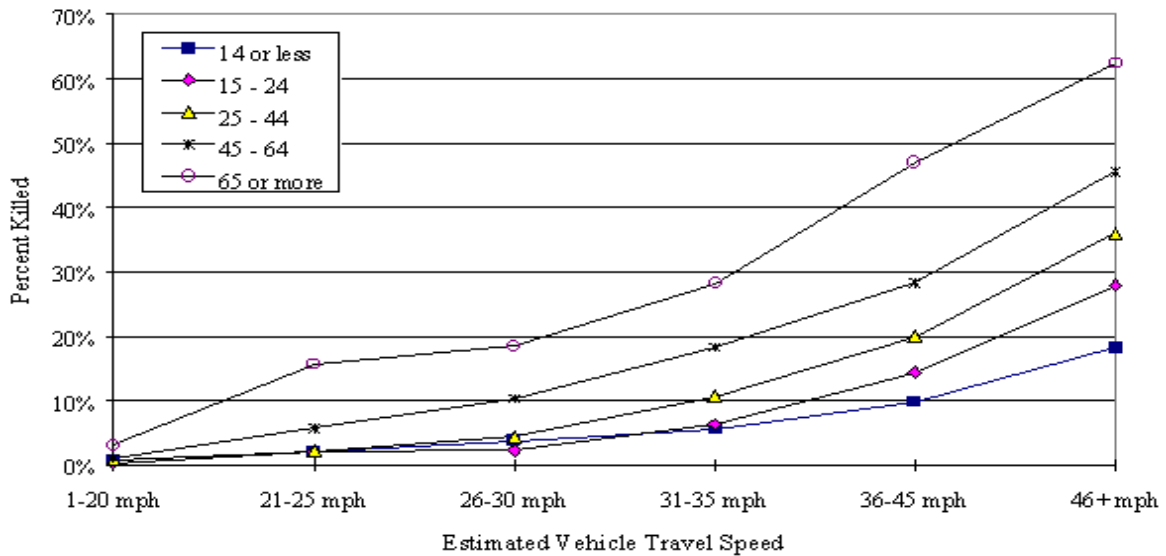
Context-Sensitive Solutions

When designing intersections it is critical to consider the needs of the transportation system from the viewpoint of all users. Caltrans has adopted policy on “Context-Sensitive Solutions” to ensure the protection and enhancement of the environment and quality of life while meeting multimodal transportation needs. Context-sensitive solutions use innovative and inclusive approaches to integrate and balance community, aesthetic, historic, and environmental values with transportation safety, maintenance, and performance goals through a multidisciplinary approach. Utilizing context-sensitive solutions during the design process will promote the creation of intersections where it is safe, convenient, and comfortable to walk and bicycle.

²⁹See Jacobsen, P, 2003. More Walkers and Bicyclists, Safer Walking and Bicycling. Injury Prevention 9:205-209.



Figure 11.2 Fatal Injury Rates by Vehicle Speed by Pedestrian Age



Source: Preusser Research Group, 1999. *Literature Review on Vehicle Travel Speeds and Pedestrian Injuries*. National Highway Traffic Safety Administration. Data are from Florida, 1993-1996; pedestrians in single vehicle crashes.

11.3. Pedestrian and Bicyclist Collision Types at Intersections

To understand how to address pedestrian and bicyclist safety at intersections, it is helpful to be familiar with common collision types. The crash type describes the pre-crash actions of the pedestrian or bicyclist and motor vehicle involved in the collision. Each crash type may be linked to various problems and causes. It is critical to understand the predominant crash types to identify appropriate safety treatments.

Common pedestrian-vehicle crash types at intersections include:³⁰

- A. **Intersection dash.** The pedestrian is struck while running through an intersection and/or the pedestrian was obstructed from view until right before impact;
- B. **Trapped.** The pedestrian began crossing a signalized intersection on a green phase or WALK interval and becomes trapped in the roadway when the signal changes;
- C. **Through vehicle.** The pedestrian is struck at an unsignalized intersection, when either the pedestrian or motorist fails to yield, or the pedestrian is struck at a signalized intersection by a vehicle traveling straight ahead (not shown);

³⁰Pedestrian Safety Guide and Countermeasure Selection System (PEDSAFE). http://www.walkinginfo.org/pedsafe/pedsafe_ca_crashtypes.cfm.

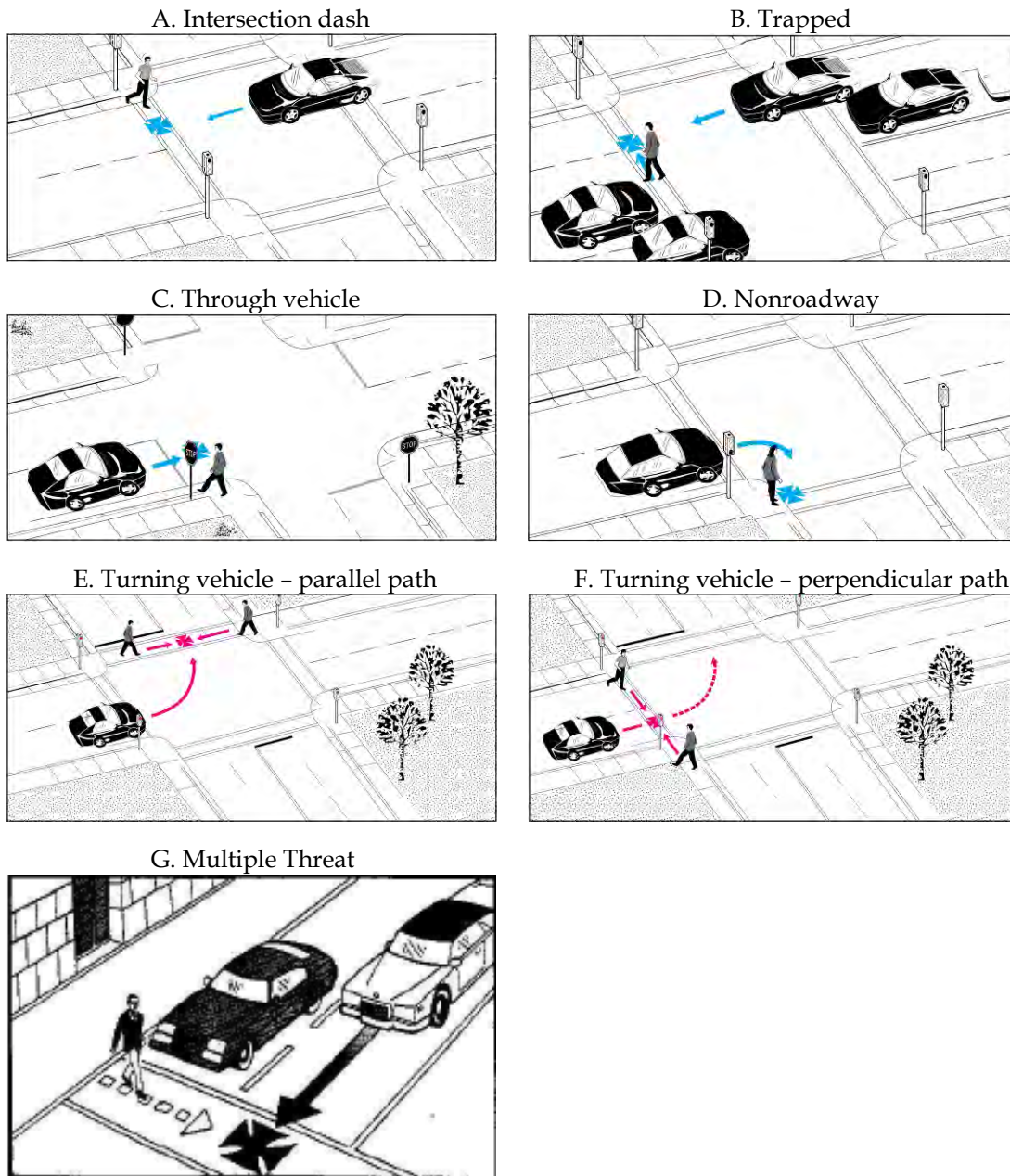


- D. Nonroadway.** The pedestrian is waiting to cross the intersection near the roadway edge or on a sidewalk and struck by a vehicle;
- E. Turning vehicle - parallel path.** The pedestrian is crossing the intersection and is struck by a vehicle turning left or right and traveling in the same direction as the pedestrian;
- F. Turning vehicle - perpendicular path.** The pedestrian is crossing the intersection and is struck by a vehicle turning left or right and traveling in a direction perpendicular to the pedestrian; and
- G. Multiple Threats.** The pedestrian crosses in front of a stopped vehicle in a one lane of a multi-lane road, and is subsequently struck by a vehicle in an adjacent lane.

These types are illustrated in Figure 11.3 - Pedestrian Crash Types at Intersections. Suggested treatments to address these crash types are listed in Appendix A. There are other collision types not listed here. A complete typology of crash types can be found on www.walkinginfo.org.



Figure 11.3 Pedestrian Crash Types at Intersections



Source: Adapted from http://www.walkinginfo.org/facts/pbcat/ped_images.cfm. The image of multiple threat crashes is from Safety Effects of Marked Versus Unmarked Crosswalks at Uncontrolled Locations Final Report and Recommended Guidelines, FHWA-RD-04-100, 2005.



Common bicyclist-vehicle crash types at intersections include:³¹

- A. Motorist fails to yield.** The bicyclist was struck by a motorist traveling in a perpendicular path that failed to properly stop or yield at a stop sign, yield sign, or traffic signal. In many of these crashes, the bicyclist is riding the wrong way against traffic.
- B. Bicyclist fails to yield.** The bicyclist entered an intersection without stopping or yielding, or was caught during the intersection by a signal change and is struck by a motorist traveling through the intersection.
- C. Motorist turns left into path of bicyclist – opposite direction.** The bicyclist is struck by an oncoming motorist turning left or by a motorist traveling in opposite direction making a left turn.
- D. Motorist turns left into path of bicyclist – same direction.** The bicyclist is struck by a motorist traveling in the same direction making a left turn.
- E. Motorist turns right into path of bicyclist – same direction.** The motorist turned right into the path of a bicyclist traveling in the same direction.
- F. Motorist turns right into path of bicyclist – opposite direction.** The motorist turned right into the path of a bicyclist traveling in the opposite direction or a motorist turned right and struck an oncoming bicyclist riding against traffic.
- G. Bicyclist turns left into path of motorist.** The bicyclist attempted to make a left turn into the path of an oncoming motorist or a bicyclist merged into the path of a motorist traveling in the same direction to make a left turn.
- H. Bicyclist turns right into path of motorist.** A bicyclist was riding in the wrong direction of traffic and turned right into an oncoming motorist or a motorist traveling in the same direction.

These collision types are illustrated in Figure 11.4. There are other collision types not listed here, such as those involving bicyclists riding out into traffic from driveways or bike path intersections. A complete typology of crash types can be found on www.bicyclinginfo.org.

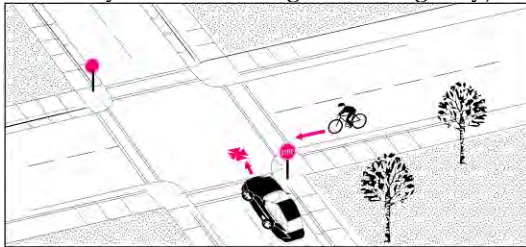
The appropriate treatment will depend on the prevalent crash type and the prevailing conditions at the intersection. Appendix A provides a summary table of potential safety treatments for each crash type discussed. Many common crashes involve improper pedestrian, bicyclist, or motorist behavior, and infrastructure and operations treatments should be selected to encourage legal and safe behavior. In addition, safety education and enforcement measures, which are not discussed in this Guide, can be used to provide benefits.

³¹Bicycle Countermeasure Selection System (BIKESAFE). <http://www.bicyclinginfo.org/bikesafe/crash_analysis-types.cfm>

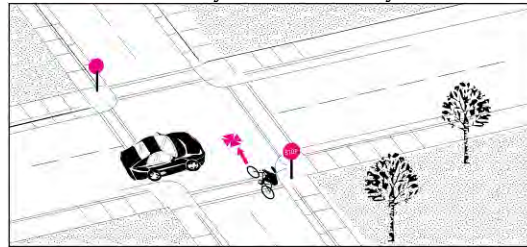


Figure 11.4 Bicycle Crash Types at Intersections

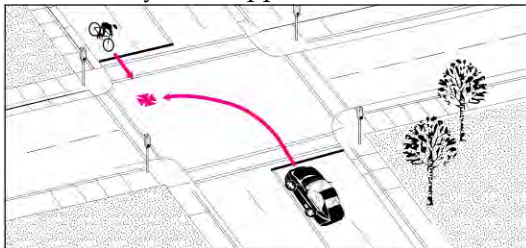
A. Motorist failed to yield (in many crashes, the bicyclist was riding the wrong way)



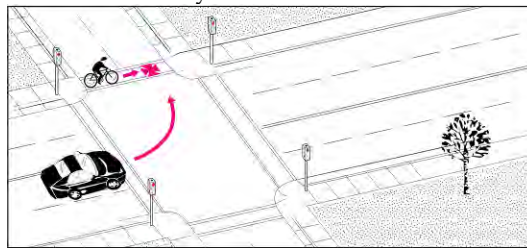
B. Bicyclist failed to yield



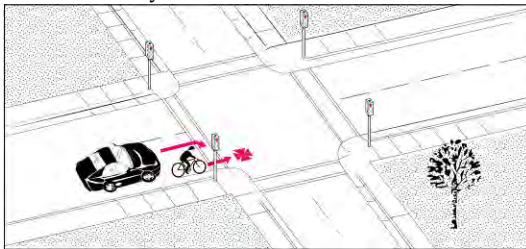
C. Motorist turned left into path of bicyclist – opposite direction



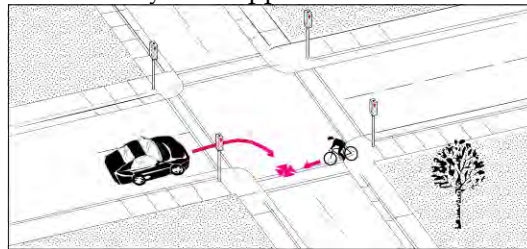
D. Motorist turned left into path of bicyclist – same direction



E. Motorist turned right into path of bicyclist – same direction



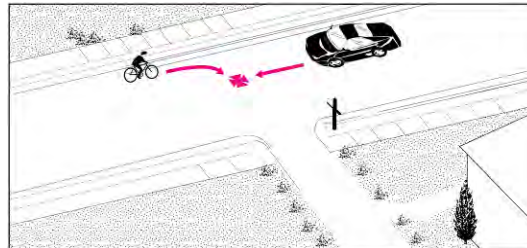
F. Motorist turned right into path of bicyclist - opposite direction



G. Bicyclist turned left into path of motorist



H. Bicyclist turned right into path of motorist



Source: Adapted from http://www.walkinginfo.org/facts/pbcat/bike_images.cfm.

11.4. Effectiveness of Pedestrian and Bicyclist Safety Countermeasures

In many cases, there may be more than one treatment option identified to address a particular crash type. Treatments will vary in cost, and may have varying degrees of effectiveness in reducing pedestrian or bicyclist collisions. For some countermeasures,



Crash Reduction Factors (CRFs) are available. CRFs indicate the percentage crash reduction expected after implementing a safety treatment, and are developed from before and after studies. The most up-to-date source of pedestrian and bicyclist crash reduction factors is the FHWA's Clearinghouse of Crash Modification Factors. The site provides CRFs for a wide range of countermeasures including a quality rating (one to five stars) and a reference. CRFs based on simplistic before-and-after studies that do not account for changes in pedestrian, bicyclist, and vehicle exposure should be avoided or used with caution. Additionally, while CRFs and previous case studies can provide an indication of the expected effectiveness of a countermeasure, the actual effectiveness may vary from site to site. It remains necessary to apply engineering judgment and to assess specific site conditions, which may impact the effectiveness of a countermeasure.

The NCHRP Report 500 Volume 10: A Guide for Reducing Collisions Involving Pedestrians³² and Volume 18: A Guide for Reducing Collisions Involving Bicycles³³ provide several strategies for reducing collisions involving pedestrians and are classified as proven, tried, or experimental based on the quality of research demonstrating their effectiveness.

PEDSAFE³⁴ and BIKESAFE³⁵ are additional tools to assist in identifying and assessing the effectiveness of various treatments. Both of these tools include several countermeasures for improving the safety of pedestrians and bicyclists at intersections and include case studies documenting the effectiveness of the countermeasures.

11.5. Using a “4-E” Approach

A “4-E” approach to safety looks beyond the road and incorporates a multidisciplinary approach by considering human behavior, vehicle engineering, road engineering, and the availability of medical care. The 4-E's of safety include engineering, education, enforcement, and emergency response.

While this Guide focuses on engineering countermeasures, there are some educational and enforcement countermeasures that are appropriate for implementation at or near intersections, such as:

³²Zegeer, C.V. et al. 2004. *NCHRP Report 500 Volume 10: A Guide for Reducing Collisions Involving Pedestrians*. Washington, D.C.: Transportation Research Board. http://onlinepubs.trb.org/onlinepubs/nchrp/nchrp_rpt_500v10.pdf.

³³Raborn, C. et al. 2008. *NCHRP Report 500 Volume 18: A Guide for Reducing Collisions Involving Bicycles*. Washington, D.C.: Transportation Research Board. http://onlinepubs.trb.org/onlinepubs/nchrp/nchrp_rpt_500v18.pdf.

³⁴Harkey, D.L. and C.V. Zegeer. 2004. *PEDSAFE: Pedestrian Safety Guide and Countermeasure Selection System*. Report No. FHWA-SA-04-003. Federal Highway Administration. Washington, D.C. <http://www.walkinginfo.org/pedsafe>.

³⁵Hunter, W.W. et al. 2006. *BIKESAFE: Bicycle Countermeasure Selection System*. Report No. FHWA-SA-05-006. Federal Highway Administration. Washington, D.C. <http://www.bicyclinginfo.org/bikesafe/index.cfm>.



- **School pedestrian and bicyclist training.** Children in schools near problematic or high-volume intersections can be trained in safe intersection crossing techniques. One study showed that training children at elementary schools in safe walking techniques has an estimated effect of a 12 percent reduction in child pedestrian injuries.³⁶ Such a program should be implemented on an ongoing basis otherwise, its effects will be limited.
- **Automated enforcement.** Automated enforcement utilizes technology to capture violations made by motorists, such as red light-running and speeding. Studies in Canada, Australia and Europe have shown that the implementation of speed cameras, on average, have resulted in a 20 to 40 percent reduction in crashes.³⁷ Another study showed that red light cameras can result in a 16 percent reduction in all injury crashes, a 24 percent reduction in right-angle crashes, and no significant increase in rear-end crashes.³⁸
- **Pedestrian or bicyclist safety zones.** Pedestrian or bicyclist safety zones combine targeted enforcement, education, and engineering efforts in geographic areas with a high incidence of pedestrian or bicyclist collisions. One program in Phoenix, Arizona, identified zones with high incidence of collisions involving older pedestrians. Countermeasures appropriate for older pedestrians were implemented in the zones, including signal retiming, communications and outreach for both drivers and pedestrians living near the crash zones, and enhanced enforcement. The program resulted in a significant reduction in crashes and injuries to older pedestrians in the target areas.³⁹

³⁶Blomberg, R.D., Preusser, D.F., Hale, A., Leaf, W.A. (1983). Experimental Field Test of Proposed Pedestrian Safety Messages, Vol. 2: Child Messages. Washington, D.C.: Federal Highway Administration.

³⁷Pilkington, P. and Kinra, S. (2005). Effectiveness of Speed Cameras in Preventing Road Traffic Collisions and Related Casualties: Systematic Review. *British Medical Journal* 330(7487), 331-334.

³⁸Aeron-Thomas, A.S. and Hess, S. (2005). *Red Light Cameras for the Prevention of Road Traffic Crashes (Review)*. *The Cochrane Database of Systematic Reviews*, 2, Art. No. CD003862.pub2. Hoboken, N.J.: John Wiley & Sons Ltd.

³⁹ Source: Blomberg, R. D., & Cleven, A. M. (1998). Development, Implementation, and Evaluation of a Pedestrian Safety Zone for Elderly Pedestrians. Publication No. DOT HS 808 692. Washington, DC: National Highway Traffic Safety Administration.



Appendix A. Treatments by Collision Type

Table A.1 Pedestrian Countermeasures by Crash Type

Countermeasure	Crash Type					
	Intersection Dart	Trapped	Through Vehicle at Unsignalized Intersection	Through Vehicle at Signalized Intersection	Non Roadway	Turning Vehicle
Sidewalks/ Walkways & Curb Ramps			◆	◆	◆	◆
Install or Upgrade Signals	◆	◆	◆	◆		◆
Refuge Islands & Raised Medians	◆	◆	◆	◆		◆
Crosswalk Enhancements	◆	◆	◆	◆		◆
Lighting/ Crosswalk Illumination	◆	◆	◆	◆	◆	◆
Improve sight distance	◆		◆	◆		◆
Revise Curb Radii			◆		◆	◆
Turning Restrictions						◆
Install or Improve Signing	◆		◆			◆
Traffic Calming	◆		◆	◆	◆	◆

Source: NCHRP Report 500 Volume 10: A Guide for Reducing Collisions Involving Pedestrians and Pedestrian Safety Guide and Countermeasure Selection System: PEDSAFE. http://www.walkinginfo.org/pedsafe/pedsafe_ca_crashtypes.cfm.



Table A.2 Bicyclist Countermeasure by Crash Type

Countermeasure	Crash Type							
	Motorist failed to yield signalized intersection	Motorist failed to yield unsignalized intersection	Bicyclist failed to yield signalized intersection	Bicyclist failed to yield unsignalized intersection	Motorist turned left into path of bicyclist	Motorist turned right into path of bicyclist	Bicyclist turned left into path of motorist	Bicyclist turned right into path of motorist
Revise Curb Radii	◆	◆			◆	◆		
Add or Widen Bike Lanes					◆	◆		◆
Refuge Islands					◆		◆	
Install or Upgrade Signal		◆	◆	◆	◆		◆	
Lighting Improvements	◆	◆	◆	◆	◆	◆		
Install or Improve Signing	◆	◆	◆	◆	◆	◆		
Intersection Markings	◆	◆	◆	◆	◆	◆	◆	◆
Improve Sight Distance	◆	◆	◆	◆	◆		◆	
Use minimum lane width	◆	◆	◆	◆		◆	◆	◆
Turning Restrictions	◆				◆	◆		
Traffic Calming	◆	◆	◆	◆	◆	◆	◆	◆

Source: Bicycle Countermeasure Selection System: BIKESAFE. http://www.bicyclinginfo.org/bikesafe/crash_analysis-types.cfm.



Appendix B. Related Resources

This section presents brief descriptions of key resources in the area of pedestrian and bicycle accommodation at intersections and related topics.



Zegeer, Charles V., et al., 2002, *Pedestrian Facilities User Guide - Providing Safety and Mobility*, for the Federal Highway Administration, U.S. Department of Transportation, Publication No. FHWA-RD-01-102, March 2002.

The Guide provides useful information regarding walkable environments, pedestrian crashes and their countermeasures, and engineering improvements for pedestrians. Includes cost estimates for several improvement options. Available on-line:

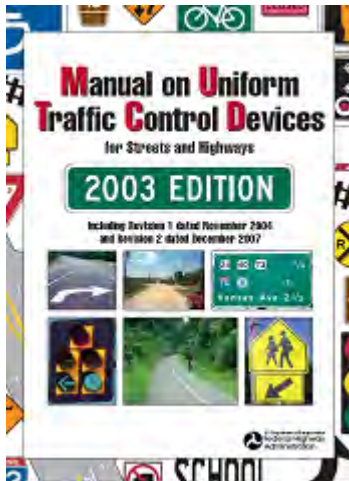
http://drusilla.hsrc.unc.edu/cms/downloads/PedFacility_UserGuide2002.pdf



Zegeer, Charles V., et al., 1998, *Design and Safety of Pedestrian Facilities*, Institute of Transportation Engineers, March 1998.

This report describes recommended practices and discusses guidelines for the design and safety of pedestrian facilities. Available on-line:

http://safety.fhwa.dot.gov/ped_bike/docs/designsafety.pdf



MUTCD, 2003, *Manual on Uniform Traffic Control Devices for Streets and Highways 2003 Edition*, Federal Highway Administration, U.S. Department of Transportation.

This is comprehensive guide on signalization, signage, and other traffic control tools. Contains FHWA approved guidelines and warrants for different traffic control elements. Available on-line:

<http://mutcd.fhwa.dot.gov/pdfs/2003/pdf-index.htm>



FHWA, 2006, *Federal Highway Administration University Course on Bicycle and Pedestrian Transportation*, Report No. FHWA-HRT-05-085, Federal Highway Administration, U.S. Department of Transportation.

This report is a detailed 24-lesson course in planning and designing for non-motorized transportation. Key lessons include 3: “Pedestrian and Bicyclist Safety”, 11: “Pedestrian Design at Intersections”, and 21: “Bicycle and Pedestrian Accommodation in Work Zones”. Available on-line:

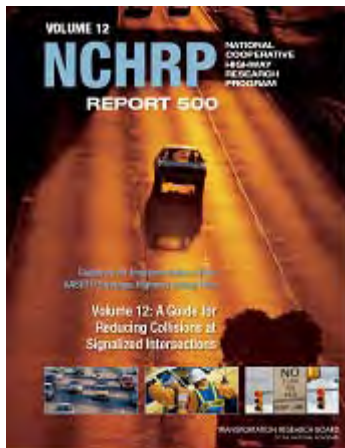
<http://www.tfhr.gov/safety/pedbike/pubs/05085/>



Fitzpatrick, K., et al., 2006, *Improving Pedestrian Safety at Unsignalized Crossings*, Transit Cooperative Research Program (TCRP) Report 112/National Cooperative Highway Research Program (NCHRP) Report 562, Transportation Research Board, U.S. Department of Transportation.

This report is a detailed guide on methods for improving pedestrian safety, including pavement markings, signage, beacons, warning lights, and signal warrant reviews and revisions. Based on surveys and field studies. Available on-line:

http://onlinepubs.trb.org/onlinepubs/nchrp/nchrp_rpt_562.pdf



Antonucci, N. D., et al., 2004, *Volume 12: A Guide for Reducing Collisions at Signalized Intersections*, Guidance for Implementation of the American Association of State Highway and Transportation Officials (AASHTO) Strategic Highway Safety Plan, NCHRP Report 500, Transportation Research Board, U.S. Department of Transportation.

This report describes types of strategies for reducing intersection collisions, including vehicle-pedestrian collisions. Includes relative implementation timeframes and cost estimates. Available on-line:

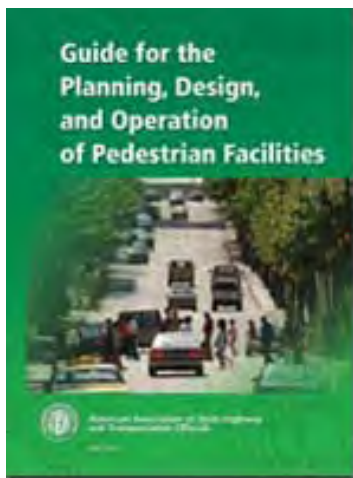
http://onlinepubs.trb.org/Onlinepubs/nchrp/nchrp_rpt_500v12.pdf



AASHTO, 1999, *Guide for the Development of Bicycle Facilities*, American Association of State Highway and Transportation Officials.

This guide contains suggested guidelines for bicycle facilities, including lane widths, turning lanes, intersections, shared use paths, pavement, lighting, and maintenance. Available on-line:

http://www.sccrtc.org/bikes/AASHTO_1999_BikeBook.pdf. The document is under revision with a new version expected in 2010.



AASHTO, 2004. *Guide for the Planning, Design, and Operation of Pedestrian Facilities*, American Association of State Highway and Transportation Officials.

This guide contains suggested guidelines and procedures for planning, designing, and operating pedestrian facilities, including pedestrian characteristics, planning strategies, sidewalk design, intersection design, midblock crossings, pedestrian signals, pedestrian signage, and maintenance of facilities.

<https://bookstore.transportation.org/home.aspx>



OTAK, 1997, *Pedestrian Facilities Guide*, prepared for Washington State Department of Transportation, September 1997.

This is a comprehensive guidebook to pedestrian facility design, including sidewalks, grades, curb ramps, traffic calming and control, and grade-separated crossings. Features helpful illustrations. Available on-line:

<http://www.wsdot.wa.gov/publications/manuals/fulltext/M0000/PedFacGB.pdf>



McMillan, B., et al., 1999, *Designing Sidewalks and Trails for Access Part I of II: Review of Existing Guidelines and Practices*, Federal Highway Administration, U.S. Department of Transportation.

This report presents a compilation of existing guidelines and recommendations for developing sidewalks and trails. Quantitative measurements of sidewalk and trail characteristics that affect accessibility are included as well. Available on-line:

<http://www.fhwa.dot.gov/environment/sidewalks/>



McMillan, B., et al., 2001, *Designing Sidewalks and Trails for Access Part II of II: Best Practices Design Guide*, Federal Highway Administration, U.S. Department of Transportation.

This guide outlines a comprehensive approach to creating accessible sidewalk networks, including planning, design, and maintenance. Includes chapters on pedestrian crossings, traffic calming, and construction site safety. Available on-line:

<http://www.fhwa.dot.gov/environment/sidewalk2/pdf.htm>

[No Image Available]

Revised Draft Guidelines for Accessible Public Rights of Way, 2005, United States Access Board.

The Draft PROWAG provides guidelines for providing pedestrian access to sidewalks and streets, crosswalks, curb ramps, street furnishings, pedestrian signals, parking, and other components of public rights-of-way.

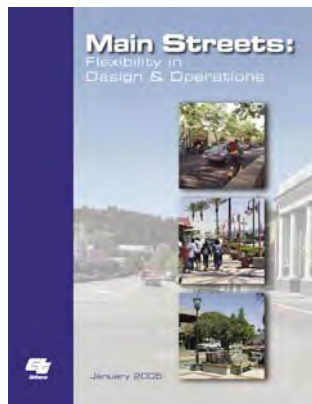
<http://www.access-board.gov/prowac/draft.htm>



California Department of Transportation, 2005, Pedestrian and Bicycle Facilities in California: A Technical Reference and Technology Transfer Synthesis for Caltrans Planners and Engineers.

This synthesis includes an exhaustive inventory of standard and innovative engineering and design treatments to benefit non-motorized users as well as background information on pedestrian and bicycle policy and funding sources.

http://www.dot.ca.gov/hq/traffops/survey/pedestrian/TR_MAY0405.pdf



California Department of Transportation, 2005 Main Streets: Flexibility in Design and Operations.

This report identifies Context Sensitive Solutions and Livable Community concepts that can assist communities and Caltrans in balancing community values with transportation concerns for safe and efficient operations for travelers, pedestrians, bicyclists, transit users, and highway workers.

<http://www.dot.ca.gov/hq/oppd/context/main-streets-flexibility-in-design.pdf>