

# California Manual on Uniform Traffic Control Devices

FHWA's MUTCD 2009 Edition, including Revisions 1 & 2 as amended for use in California.

## 2014 Edition

Revision 4 (March 29, 2019)

State of California  
California State Transportation Agency  
Department of Transportation





The Manual on Uniform Traffic Control Devices (MUTCD) is approved by the Federal Highway Administrator as the National Standard in accordance with Title 23 U.S. Code, Sections 109(d), 114(a), 217, 315, and 402(a), 23 CFR 655, and 49 CFR 1.48(b)(8), 1.48(b)(33), and 1.48(c)(2).

The California Manual on Uniform Traffic Control Devices (California MUTCD) is published by the State of California, Department of Transportation (Caltrans) and is issued to adopt uniform standards and specifications for all official traffic control devices, in accordance with Section 21400 of the California Vehicle Code.

This manual is current as of the date of publication on the footer page. However, it may be necessary from time to time to modify, change or adopt new standards and specifications for traffic control devices and/or issue errata or editorial changes to the manual. To ensure that the traffic control device practitioner is accessing the most current information regarding traffic control device topics for California, the practitioner is advised to always reference the California MUTCD web site.

The California MUTCD, California Sign Specifications and other publications and related current information is available on the Internet at the following web link:

<http://www.dot.ca.gov/traffops/engineering/>

Addresses for Publications Referenced in the California MUTCD

American Automobile Association (AAA)  
1000 AAA Drive  
Heathrow, FL 32746  
calstate.aaa.com  
800-222-4357

American Association of State Highway and Transportation Officials (AASHTO)  
444 North Capitol Street, NW, Suite 249  
Washington, DC 20001  
www.transportation.org  
202-624-5800

American National Standards Institute (ANSI)  
1819 L Street, NW, 6th floor  
Washington, DC 20036  
www.ansi.org  
202-293-8020

American Railway Engineering and Maintenance-of-Way Association (AREMA)  
10003 Derekwood Lane, Suite 210  
Lanham, MD 20706  
www.arena.org  
301-459-3200

California Building Standards Code  
International Conference of Building Officials  
5360 South Workman Mill Road  
Whittier, CA 90601  
www.icbo.org  
916-263-0916

California Code Publications &  
California Law  
<http://leginfo.legislature.ca.gov/faces/codes.xhtml>

California Department of Transportation Publications  
Publications Distribution Unit  
1900 Royal Oaks Drive  
Sacramento, CA 95815-3800  
<http://caltrans-opac.ca.gov/publicat.htm>  
916-263-0822

California Vehicle Code  
Department of Motor Vehicles  
Sacramento, California  
<http://www.dmv.ca.gov/pubs/pubs.htm>  
800-777-0133

Federal Highway Administration Report Center  
Facsimile number: 814-239-2156  
[report.center@fhwa.dot.gov](mailto:report.center@fhwa.dot.gov)

Illuminating Engineering Society (IES)  
120 Wall Street, Floor 17  
New York, NY 10005  
[www.iesna.org](http://www.iesna.org)  
212-248-5000

Institute of Makers of Explosives  
1120 19th Street, NW, Suite 310  
Washington, DC 20036-3605  
[www.ime.org](http://www.ime.org)  
202-429-9280

Institute of Transportation Engineers (ITE)  
1099 14th Street, NW, Suite 300 West  
Washington, DC 20005-3438  
[www.ite.org](http://www.ite.org)  
202-785-0060

International Organization for Standardization  
1, ch. de la Voie-Creuse  
Case Postale 56  
CH-1211  
Geneva 20, Switzerland  
[www.iso.ch](http://www.iso.ch)  
011-41-22-749-0111

International Safety Equipment Association (ISEA)  
1901 North Moore Street, Suite 808  
Arlington, VA 22209  
[www.safetyequipment.org](http://www.safetyequipment.org)  
703-525-1695

National Association of City Transportation Officials (NACTO)  
120 Park Avenue, 23rd Floor  
New York, NY 10017  
Email: [nacto@nacto.org](mailto:nacto@nacto.org)  
Telephone: 929-276-2286

National Committee on Uniform Traffic Laws and Ordinances (NCUTLO)  
107 South West Street, Suite 110  
Alexandria, VA 22314  
[www.ncutlo.org](http://www.ncutlo.org)

National Electrical Manufacturers Association (NEMA)  
1300 North 17th Street, Suite 1752  
Rosslyn, VA 22209  
[www.nema.org](http://www.nema.org)  
703-841-3200

Occupational Safety and Health Administration (OSHA)  
U.S. Department of Labor  
200 Constitution Avenue, NW  
Washington, DC 20210  
[www.osha.gov](http://www.osha.gov)  
800-321-6742

Transportation Research Board (TRB)  
The National Academies  
500 Fifth Street, NW  
Washington, DC 20001  
[www.nas.edu/trb](http://www.nas.edu/trb)  
202-334-2934

U.S. Architectural and Transportation Barriers Compliance Board (The U.S. Access Board)  
1331 F Street, NW, Suite 1000  
Washington, DC 20004-1111  
[www.access-board.gov](http://www.access-board.gov)  
202-272-0080



## Acknowledgments

The Federal Highway Administration gratefully acknowledges the valuable assistance that it received from the National Committee on Uniform Traffic Control Devices and its over 200 voluntary members in the development of this Manual.

Caltrans gratefully acknowledges the participation from the following contributors for providing invaluable time, support, guidance and direction in the development of this Manual:

- Federal Highway Administration's California Division
- California Traffic Control Devices Committee (CTCDC) members;
- Staff from various cities and counties in California who participated in CTCDC meetings
- Caltrans headquarters' and districts' staff

Information regarding the California portion (blue text and/or blue border line) of this Manual can be obtained by writing to:

State of California  
Department of Transportation,  
Chief, Division of Traffic Operations, MS-36  
1120 N Street, Sacramento, CA 95814

**NOTE: The contents of this publication are not copyrighted. They may be reprinted freely.**

**The California MUTCD is available on the Caltrans Web Page at:  
<http://www.dot.ca.gov/camutcd>**





**DEPARTMENT OF TRANSPORTATION**

DIVISION OF TRAFFIC OPERATIONS

P.O. BOX 942873, MS-36

SACRAMENTO, CA 94273-0001

PHONE (916) 654-2366

FAX (916) 653-6080

TTY 711

[www.dot.ca.gov/trafficops](http://www.dot.ca.gov/trafficops)*Making Conservation  
a California Way of Life.*

March 27, 2019

Mr. Robert W. Bronkall, Chair  
California Traffic Control Devices Committee  
P.O. Box 942874, MS-36  
Sacramento, CA 94274-0001

Dear Mr. Bronkall:

Effective March 29th, 2019, the California Department of Transportation (Caltrans) will be adopting the California Manual on Uniform Traffic Control Devices (CA MUTCD) 2014 Revision 4 to provide uniform standards and specifications for all official traffic control devices in California. This action was taken pursuant to the provisions of California Vehicle Code Section 21400 and the recommendations of the California Traffic Control Devices Committee (CTCDC).

Caltrans received a letter from the Federal Highway Administration (FHWA) confirming substantial conformance of the CA MUTCD 2014, Revision 4 edition. The revised CA MUTCD includes the FHWA's Manual on Uniform Traffic Control Devices, policies on traffic control devices issued by Caltrans since March 9<sup>th</sup>, 2018, and other corrections and format changes. The CA MUTCD revision is available on the Internet at <[www.dot.ca.gov/trafficops/camutcd/](http://www.dot.ca.gov/trafficops/camutcd/)>.

The Division of Traffic Operations appreciates the CTCDC for providing valuable time, support, and guidance in the development of this version of CA MUTCD.

If you have any questions or concerns, please contact Mr. Vijay Talada, CA MUTCD Editor and CTCDC Executive Secretary, at (916) 653-1816, or by email at <[vijay.talada@dot.ca.gov](mailto:vijay.talada@dot.ca.gov)>.

Sincerely,

A handwritten signature in blue ink, reading "Jasvinderjit S. Bhullar".

JASVINDERJIT S. BHULLAR, P.E., T.E., Chief  
Division of Traffic Operations

c: Vijay Talada, CA MUTCD Editor, Division of Traffic Operations, Caltrans





U.S. Department  
of Transportation  
**Federal Highway  
Administration**

**California Division**

March 19, 2019

650 Capitol Mall, Suite 4-100  
Sacramento, CA 95814  
(916) 498-5001  
(916) 498-5008 (FAX)

In Reply Refer To:  
HDA-CA

Ms. Laurie Berman  
Director, California Department of Transportation  
1120 N Street  
Sacramento, CA 95814

Attention: Jasvinderjit Bhullar, Chief, Division of Traffic Operations

SUBJECT: 2014 CA MUTCD Revision 4 Substantial Conformance with 2009 National  
MUTCD.

Dear Ms. Berman:

This letter is in response to the March 14, 2019 letter from Mr. Jasvinderjit Bhullar requesting the Federal Highway Administration (FHWA) to find the 2014 California Manual on Uniform Traffic Control Devices (CA MUTCD) Revision 4 in substantial conformance with the current 2009 Edition of the National Manual on Uniform Traffic Control Devices (MUTCD) for Streets and Highways, Revisions 1 and 2.

Per Title 23, Code of Federal Regulations [23 CFR 655.603(b)(1)], FHWA has reviewed the 2014 CA MUTCD Revision 4 and found the proposed revisions to be in substantial conformance with the 2009 National MUTCD.

We look forward to continue working with Caltrans, local public agencies, and the California Traffic Control Devices Committee on needed revisions to the CA MUTCD. This effort results in traffic control devices that enhance the safety of California's roadways for all road users. We commend the effort that Caltrans' Office of Traffic Engineering devotes to achieve this objective.

If you have any questions, please contact Steve Pyburn, Senior Traffic Safety and ITS Engineer, at (916) 498-5057 or [Steve.Pyburn@dot.gov](mailto:Steve.Pyburn@dot.gov).

Sincerely,

A handwritten signature in black ink, appearing to read "Vincent Mammiano".

For: Vincent Mammiano  
Division Administrator

Enclosures: Signed CT Letter to FHWA  
List of Changes for 2014 CA MUTCD Revision

---



**DEPARTMENT OF TRANSPORTATION**

## DIVISION OF TRAFFIC OPERATIONS

P.O. BOX 942873, MS-36

SACRAMENTO, CA 94273-0001

PHONE (916) 654-2366

FAX (916) 653-6080

TTY 711

www.dot.ca.gov/trafficops

*Making Conservation  
a California Way of Life.*

March 14, 2019

Mr. Vincent Mammano  
Division Administrator  
Federal Highway Administration  
650 Capitol Mall, Suite 4-100  
Sacramento, CA 95814

Dear Mr. Mammano:

The California Department of Transportation (Caltrans) requests that the Federal Highway Administration (FHWA) provide a letter to Caltrans confirming substantial conformance with FHWA's 2009 Manual on Uniform Traffic Control Devices (MUTCD) for the revised 2014 California Manual on Uniform Traffic Control Devices (CA MUTCD), as required by Title 23 Code of Federal Regulations, section 655.603(b)(1).

The revised CA MUTCD includes FHWA's MUTCD, policies on traffic control devices issued by Caltrans since March 9, 2018, and other corrections and format changes. The approved revision will be available on the Internet at <<http://www.dot.ca.gov/trafficops/camutcd/>> after substantial conformance has been granted by FHWA.

Caltrans would like to acknowledge the efforts of Steve Pyburn for working in partnership with Vijay Talada of Caltrans' Division of Traffic Operations in reviewing the draft revision of the CA MUTCD. An electronic version of the changes has been provided to Steve Pyburn.

Please send the requested letter by March 25, 2019, to Vijay Talada via e-mail at <[Vijay.Talada@dot.ca.gov](mailto:Vijay.Talada@dot.ca.gov)>. If you have any questions, you may contact Vijay Talada at (916) 653-1816.

Sincerely,

A handwritten signature in blue ink, appearing to read "Jasvinderjit S. Bhullar".

JASVINDERJIT S. BHULLAR, P.E., T.E., Chief  
Division of Traffic Operations

c: Vijay Talada, CA MUTCD Editor, Division of Traffic Operations



## CALIFORNIA MANUAL ON UNIFORM TRAFFIC CONTROL DEVICES

### TABLE OF CONTENTS

|   | <u>Page</u> |
|---|-------------|
| <b>REFERENCES</b>   | <b>i</b>    |
| <b>ACKNOWLEDGMENTS</b>  | <b>v</b>    |
| <b>CTCDC NOTIFICATION LETTER</b>  | <b>vii</b>  |
| <b>FHWA LETTER OF SUBSTANTIAL CONFORMANCE</b>                                   | <b>ix</b>   |
| <b>LIST OF FIGURES</b>  | <b>25</b>   |
| <b>LIST OF TABLES</b>   | <b>38</b>   |
| <b>FOREWORD</b>   | <b>41</b>   |
| <b>INTRODUCTION</b>   | <b>43</b>   |
| <b>PART 1. GENERAL</b>  | <b>53</b>   |
| <b>CHAPTER 1A. GENERAL</b>  | <b>53</b>   |
| Section 1A.01 Purpose of Traffic Control Devices                                | 53          |
| Section 1A.02 Principles of Traffic Control Devices                             | 53          |
| Section 1A.03 Design of Traffic Control Devices                                 | 54          |
| Section 1A.04 Placement and Operation of Traffic Control Devices                | 54          |
| Section 1A.05 Maintenance of Traffic Control Devices                            | 54          |
| Section 1A.06 Uniformity of Traffic Control Devices                             | 54          |
| Section 1A.07 Responsibility for Traffic Control Devices                        | 55          |
| Section 1A.08 Authority for Placement of Traffic Control Devices                | 56          |
| Section 1A.09 Engineering Study and Engineering Judgment                        | 58          |
| Section 1A.10 Interpretations, Experimentations, Changes, and Interim Approvals | 58          |
| Section 1A.11 Relation to Other Publications                                    | 65          |
| Section 1A.12 Color Code  | 67          |
| Section 1A.13 Definitions of Headings, Words, and Phrases in this Manual        | 67          |
| Section 1A.14 Meanings of Acronyms and Abbreviations in this Manual             | 85          |
| Section 1A.15 Abbreviations Used on Traffic Control Devices                     | 91          |
| <b>PART 2. SIGNS</b>  | <b>99</b>   |
| <b>CHAPTER 2A. GENERAL</b>  | <b>99</b>   |
| Section 2A.01 Function and Purpose of Signs                                     | 99          |
| Section 2A.02 Definitions   | 99          |
| Section 2A.03 Standardization of Application                                    | 99          |

|                                    |   |                     |
|------------------------------------|---|---------------------|
| Section 2A.04                      | Excessive Use of Signs  | 100                 |
| Section 2A.05                      | Classification of Signs   | 100                 |
| Section 2A.06                      | Design of Signs   | 100                 |
| Section 2A.07                      | Retroreflectivity and Illumination  | 102                 |
| Section 2A.08                      | Maintaining Minimum Retroreflectivity   | 103                 |
| Section 2A.09                      | Shapes  | 104                 |
| Section 2A.10                      | Sign Colors   | 104                 |
| Section 2A.11                      | Dimensions  | 104                 |
| Section 2A.12                      | Symbols   | 105                 |
| Section 2A.13                      | Word Messages   | 106                 |
| Section 2A.14                      | Sign Borders  | 107                 |
| Section 2A.15                      | Enhanced Conspicuity for Standard Signs   | 107                 |
| Section 2A.16                      | Standardization of Location   | 108                 |
| Section 2A.17                      | Overhead Sign Installations   | 109                 |
| Section 2A.18                      | Mounting Height   | 110                 |
| Section 2A.19                      | Lateral Offset  | 112                 |
| Section 2A.20                      | Orientation   | 113                 |
| Section 2A.21                      | Posts and Mountings   | 113                 |
| Section 2A.22                      | Maintenance   | 114                 |
| Section 2A.23                      | Median Opening Treatments for Divided Highways with Wide Medians                  | 114                 |
| <a href="#">Section 2A.101(CA)</a> | <a href="#">Signs Off the State Right-of-Way</a>                                  | <a href="#">114</a> |
| <br>                               |   |                     |
| <b>CHAPTER 2B.</b>                 | <b>REGULATORY SIGNS, BARRICADES, AND GATES</b>                                    | <b>125</b>          |
| <br>                               |   |                     |
| Section 2B.01                      | Application of Regulatory Signs   | 125                 |
| Section 2B.02                      | Design of Regulatory Signs  | 125                 |
| Section 2B.03                      | Size of Regulatory Signs  | 125                 |
| Section 2B.04                      | Right-of-Way at Intersections   | 126                 |
| Section 2B.05                      | STOP Sign (R1-1) and ALL WAY Plaque (R1-3P)                                       | 128                 |
| Section 2B.06                      | STOP Sign Applications  | 129                 |
| Section 2B.07                      | Multi-Way Stop Applications   | 129                 |
| Section 2B.08                      | YIELD Sign (R1-2)   | 130                 |
| Section 2B.09                      | YIELD Sign Applications   | 130                 |
| Section 2B.10                      | STOP Sign or YIELD Sign Placement   | 130                 |
| Section 2B.11                      | Yield Here To Pedestrians Signs and Stop Here For Pedestrians Signs (R1-5 Series) | 132                 |
| Section 2B.12                      | In-Street and Overhead Pedestrian Crossing Signs (R1-6, R1-6a, R1-9, and R1-9a)   | 132                 |
| Section 2B.13                      | Speed Limit Sign (R2-1)   | 133                 |
| Section 2B.14                      | Truck Speed Limit Plaque (R2-2P)  | 143                 |
| Section 2B.15                      | Night Speed Limit Plaque (R2-3P)  | 143                 |
| Section 2B.16                      | Minimum Speed Limit Plaque (R2-4P)  | 143                 |
| Section 2B.17                      | Higher Fines Signs and Plaque (R2-6P, R2-10, and R2-11)                           | 144                 |
| Section 2B.18                      | Movement Prohibition Signs (R3-1 through R3-4, R3-18, and R3-27)                  | 145                 |
| Section 2B.19                      | Intersection Lane Control Signs (R3-5 through R3-8)                               | 147                 |
| Section 2B.20                      | Mandatory Movement Lane Control Signs (R3-5, R3-5a, R3-7, and R3-20)              | 148                 |
| Section 2B.21                      | Optional Movement Lane Control Sign (R3-6)  | 150                 |
| Section 2B.22                      | Advance Intersection Lane Control Signs (R3-8 Series)                             | 150                 |
| Section 2B.23                      | RIGHT (LEFT) LANE MUST EXIT Sign (R3-33)  | 151                 |
| Section 2B.24                      | Two-Way Left Turn Only Signs (R3-9a, R3-9b)                                       | 151                 |
| Section 2B.25                      | BEGIN and END Plaques (R3-9cP, R3-9dP)  | 151                 |
| Section 2B.26                      | Reversible Lane Control Signs (R3-9e through R3-9i)                               | 152                 |
| Section 2B.27                      | Jughandle Signs (R3-23, R3-24, R3-25, and R3-26 Series)                           | 153                 |
| Section 2B.28                      | DO NOT PASS Sign (R4-1)   | 154                 |
| Section 2B.29                      | PASS WITH CARE Sign (R4-2)  | 154                 |



|                    |  |     |
|--------------------|--|-----|
| Section 2B.30      | KEEP RIGHT EXCEPT TO PASS Sign (R4-16) and SLOWER TRAFFIC KEEP RIGHT Sign (R4-3)                       | 154 |
| Section 2B.31      | TRUCKS USE RIGHT LANE Sign (R4-5)  | 155 |
| Section 2B.32      | Keep Right and Keep Left Signs (R4-7, R4-8)  | 156 |
| Section 2B.33      | STAY IN LANE Sign (R4-9)   | 156 |
| Section 2B.34      | RUNAWAY VEHICLES ONLY Sign (R4-10)   | 156 |
| Section 2B.35      | Slow Vehicle Turn-Out Signs (R4-12, R4-13, and R4-14)  | 156 |
| Section 2B.36      | DO NOT DRIVE ON SHOULDER Sign (R4-17) and DO NOT PASS ON SHOULDER Sign (R4-18)                         | 157 |
| Section 2B.37      | DO NOT ENTER Sign (R5-1)   | 157 |
| Section 2B.38      | WRONG WAY Sign (R5-1a)   | 158 |
| Section 2B.39      | Selective Exclusion Signs  | 158 |
| Section 2B.40      | ONE WAY Signs (R6-1, R6-2)   | 161 |
| Section 2B.41      | Wrong-Way Traffic Control at Interchange Ramps   | 162 |
| Section 2B.42      | Divided Highway Crossing Signs (R6-3, R6-3a)   | 165 |
| Section 2B.43      | Roundabout Directional Arrow Signs (R6-4, R6-4a, and R6-4b)  | 166 |
| Section 2B.44      | Roundabout Circulation Plaque (R6-5P)  | 166 |
| Section 2B.45      | Examples of Roundabout Signing   | 166 |
| Section 2B.46      | Parking, Standing, and Stopping Signs (R7 and R8 Series)   | 167 |
| Section 2B.47      | Design of Parking, Standing, and Stopping Signs  | 173 |
| Section 2B.48      | Placement of Parking, Stopping, and Standing Signs   | 175 |
| Section 2B.49      | Emergency Restriction Signs (R8-4, R8-7, R8-8)   | 175 |
| Section 2B.50      | WALK ON LEFT FACING TRAFFIC and No Hitchhiking Signs (R9-1, R9-4, R9-4a)                               | 176 |
| Section 2B.51      | Pedestrian Crossing Signs (R9-2, R9-3)   | 176 |
| Section 2B.52      | Traffic Signal Pedestrian and Bicycle Actuation Signs (R10-1 through R10-4, and R10-24 through R10-26) | 176 |
| Section 2B.53      | Traffic Signal Signs (R10-5 through R10-30)  | 177 |
| Section 2B.54      | No Turn on Red Signs (R10-11 Series, R10-17a, and R10-30)  | 178 |
| Section 2B.55      | Photo Enforced Signs and Plaques (R10-18, R10-19P, R10-19aP)   | 180 |
| Section 2B.56      | Ramp Metering Signs (R10-28 and R10-29)  | 180 |
| Section 2B.57      | KEEP OFF MEDIAN Sign (R11-1)   | 181 |
| Section 2B.58      | ROAD CLOSED Sign (R11-2) and LOCAL TRAFFIC ONLY Signs (R11-3 Series, R11-4)                            | 181 |
| Section 2B.59      | Weight Limit Signs (R12-1 through R12-5)   | 181 |
| Section 2B.60      | Weigh Station Signs (R13 Series)   | 182 |
| Section 2B.61      | TRUCK ROUTE Sign (R14-1)   | 183 |
| Section 2B.62      | Hazardous Material Signs (R14-2, R14-3)  | 184 |
| Section 2B.63      | National Network Signs (R14-4, R14-5)  | 185 |
| Section 2B.64      | Headlight Use Signs (R16-5 through R16-11)   | 185 |
| Section 2B.65      | FENDER BENDER Sign (R16-4)   | 186 |
| Section 2B.66      | Seat Belt Symbol   | 187 |
| Section 2B.67      | Barricades   | 187 |
| Section 2B.68      | Gates  | 187 |
| Section 2B.101(CA) | NO FISHING (JUMPING) FROM BRIDGE Sign (R23(CA))  | 188 |
| Section 2B.102(CA) | TWO WAY TRAFFIC AHEAD Sign (R40(CA))   | 189 |
| Section 2B.103(CA) | \$1000 Fine Signs (R47(CA) and R47A(CA))   | 189 |
| Section 2B.104(CA) | PRIVATE ROAD (PRIVATE PROPERTY) VEHICLE CODE ENFORCED Sign (R101(CA))                                  | 189 |
| Section 2B.105(CA) | Rest Area Disclaimer Sign (SR2(CA))  | 189 |
| Section 2B.106(CA) | Garbage Prohibition Signs (SR22-1(CA) and SR23-1(CA))  | 189 |
| Section 2B.107(CA) | GOLF CARTS OK DAYLIGHT HOURS Sign (SR43(CA))   | 189 |
| Section 2B.108(CA) | Bus and Truck Registration Sign (SR44(CA))   | 190 |
| Section 2B.109(CA) | EMERGENCY ACCESS KEEP CLEAR Sign (SR46(CA))  | 190 |
| Section 2B.110(CA) | Off Highway Vehicle Signs (SR47(CA) and SR48(CA))  | 190 |

|                    |   |            |
|--------------------|---|------------|
| Section 2B.111(CA) | State Property Signs (S8(CA) and S20(CA))   | 190        |
| Section 2B.112(CA) | MOVE OVER OR SLOW FOR STOPPED EMERGENCY AND MAINTENANCE VEHICLES Sign (R110(CA))      | 190        |
| <b>CHAPTER 2C.</b> | <b>WARNING SIGNS AND OBJECT MARKERS</b>   | <b>257</b> |
| Section 2C.01      | Function of Warning Signs   | 257        |
| Section 2C.02      | Application of Warning Signs  | 257        |
| Section 2C.03      | Design of Warning Signs   | 257        |
| Section 2C.04      | Size of Warning Signs   | 258        |
| Section 2C.05      | Placement of Warning Signs  | 258        |
| Section 2C.06      | Horizontal Alignment Warning Signs  | 259        |
| Section 2C.07      | Horizontal Alignment Signs (W1-1 through W1-5, W1-11, W1-15)                          | 259        |
| Section 2C.08      | Advisory Speed Plaque (W13-1P)  | 260        |
| Section 2C.09      | Chevron Alignment Sign (W1-8)   | 261        |
| Section 2C.10      | Combination Horizontal Alignment/Advisory Speed Signs (W1-1a, W1-2a)                  | 262        |
| Section 2C.11      | Combination Horizontal Alignment/Intersection Signs (W1-10 Series)                    | 263        |
| Section 2C.12      | One-Direction Large Arrow Sign (W1-6)   | 263        |
| Section 2C.13      | Truck Rollover Warning Sign (W1-13)   | 264        |
| Section 2C.14      | Advisory Exit and Ramp Speed Signs (W13-2 and W13-3)                                  | 264        |
| Section 2C.15      | Combination Horizontal Alignment/Advisory Exit and Ramp Speed Signs (W13-6 and W13-7) | 265        |
| Section 2C.16      | Hill Signs (W7-1, W7-1a)  | 265        |
| Section 2C.17      | Truck Escape Ramp Signs (W7-4 Series)   | 266        |
| Section 2C.18      | HILL BLOCKS VIEW Sign (W7-6)  | 266        |
| Section 2C.19      | ROAD NARROWS Sign (W5-1)  | 266        |
| Section 2C.20      | NARROW BRIDGE Sign (W5-2)   | 267        |
| Section 2C.21      | ONE LANE BRIDGE Sign (W5-3)   | 267        |
| Section 2C.22      | Divided Highway Sign (W6-1)   | 267        |
| Section 2C.23      | Divided Highway Ends Sign (W6-2)  | 267        |
| Section 2C.24      | Freeway or Expressway Ends Signs (W19 Series)   | 267        |
| Section 2C.25      | Double Arrow Sign (W12-1)   | 268        |
| Section 2C.26      | DEAD END/NO OUTLET Signs (W14-1, W14-1a, W14-2, W14-2a)                               | 268        |
| Section 2C.27      | Low Clearance Signs (W12-2 and W12-2a)  | 268        |
| Section 2C.28      | BUMP and DIP Signs (W8-1, W8-2)   | 269        |
| Section 2C.29      | SPEED HUMP Sign (W17-1)   | 270        |
| Section 2C.30      | PAVEMENT ENDS Sign (W8-3)   | 270        |
| Section 2C.31      | Shoulder Signs (W8-4, W8-9, W8-17, W8-23, and W8-25)                                  | 270        |
| Section 2C.32      | Surface Condition Signs (W8-5, W8-7, W8-8, W8-11, W8-13, and W8-14)                   | 271        |
| Section 2C.33      | Warning Signs and Plaques for Motorcyclists (W8-15, W8-15P, and W8-16)                | 272        |
| Section 2C.34      | NO CENTER LINE Sign (W8-12)   | 272        |
| Section 2C.35      | Weather Condition Signs (W8-18, W8-19, W8-21, and W8-22)                              | 272        |
| Section 2C.36      | Advance Traffic Control Signs (W3-1, W3-2, W3-3, W3-4)                                | 273        |
| Section 2C.37      | Advance Ramp Control Signal Signs (W3-7 and W3-8)                                     | 274        |
| Section 2C.38      | Reduced Speed Limit Ahead Signs (W3-5, W3-5a)   | 274        |
| Section 2C.39      | DRAW BRIDGE Sign (W3-6)   | 275        |
| Section 2C.40      | Merge Signs (W4-1, W4-5)  | 275        |
| Section 2C.41      | Added Lane Signs (W4-3, W4-6)   | 276        |
| Section 2C.42      | Lane Ends Signs (W4-2, W9-1, W9-2)  | 276        |
| Section 2C.43      | RIGHT (LEFT) LANE EXIT ONLY AHEAD Sign (W9-7)   | 277        |
| Section 2C.44      | Two-Way Traffic Sign (W6-3)   | 278        |
| Section 2C.45      | NO PASSING ZONE Sign (W14-3)  | 278        |
| Section 2C.46      | Intersection Warning Signs (W2-1 through W2-8)  | 278        |

|               |   |     |
|---------------|---|-----|
| Section 2C.47 | Two-Direction Large Arrow Sign (W1-7)   | 279 |
| Section 2C.48 | Traffic Signal Signs (W25-1, W25-2)   | 280 |
| Section 2C.49 | Vehicular Traffic Warning Signs (W8-6, W11-1, W11-5, W11-5a, W11-8, W11-10, W11-11, W11-12P, W11-14, W11-15, and W11-15a) | 280 |
| Section 2C.50 | Non-Vehicular Warning Signs (W11-2, W11-3, W11-4, W11-6, W11-7, W11-9, and W11-16 through W11-22)                         | 281 |
| Section 2C.51 | Playground Sign (W15-1)   | 283 |
| Section 2C.52 | NEW TRAFFIC PATTERN AHEAD Sign (W23-2)  | 283 |
| Section 2C.53 | Use of Supplemental Warning Plaques   | 283 |
| Section 2C.54 | Design of Supplemental Warning Plaques  | 284 |
| Section 2C.55 | Distance Plaques (W16-2 Series, W16-3 Series, W16-4P, W7-3aP)   | 284 |
| Section 2C.56 | Supplemental Arrow Plaques (W16-5P, W16-6P)   | 284 |
| Section 2C.57 | Hill-Related Plaques (W7-2 Series, W7-3 Series)   | 284 |
| Section 2C.58 | Advance Street Name Plaque (W16-8P, W16-8aP)  | 284 |
| Section 2C.59 | CROSS TRAFFIC DOES NOT STOP Plaque (W4-4P)  | 285 |
| Section 2C.60 | SHARE THE ROAD Plaque (W16-1P)  | 285 |
| Section 2C.61 | Photo Enforced Plaque (W16-10P)   | 285 |
| Section 2C.62 | NEW Plaque (W16-15P)  | 286 |
| Section 2C.63 | Object Marker Design and Placement Height   | 286 |
| Section 2C.64 | Object Markers for Obstructions Within the Roadway  | 287 |
| Section 2C.65 | Object Markers for Obstructions Adjacent to the Roadway   | 287 |
| Section 2C.66 | Object Markers for Ends of Roadways   | 288 |

**CHAPTER 2D. GUIDE SIGNS—CONVENTIONAL ROADS 315**

|               |   |     |
|---------------|---|-----|
| Section 2D.01 | Scope of Conventional Road Guide Sign Standards           | 315 |
| Section 2D.02 | Application   | 315 |
| Section 2D.03 | Color, Retroreflection, and Illumination                  | 315 |
| Section 2D.04 | Size of Signs   | 317 |
| Section 2D.05 | Lettering Style   | 317 |
| Section 2D.06 | Size of Lettering   | 317 |
| Section 2D.07 | Amount of Legend  | 318 |
| Section 2D.08 | Arrows  | 318 |
| Section 2D.09 | Numbered Highway Systems                                  | 320 |
| Section 2D.10 | Route Signs and Auxiliary Signs                           | 321 |
| Section 2D.11 | Design of Route Signs                                     | 322 |
| Section 2D.12 | Design of Route Sign Auxiliaries                          | 323 |
| Section 2D.13 | Junction Auxiliary Sign (M2-1)                            | 324 |
| Section 2D.14 | Combination Junction Sign (M2-2)                          | 324 |
| Section 2D.15 | Cardinal Direction Auxiliary Signs (M3-1 through M3-4)    | 324 |
| Section 2D.16 | Auxiliary Signs for Alternative Routes (M4 Series)        | 325 |
| Section 2D.17 | ALTERNATE Auxiliary Signs (M4-1, M4-1a)                   | 325 |
| Section 2D.18 | BY-PASS Auxiliary Sign (M4-2)                             | 325 |
| Section 2D.19 | BUSINESS Auxiliary Sign (M4-3)                            | 325 |
| Section 2D.20 | TRUCK Auxiliary Sign (M4-4)                               | 325 |
| Section 2D.21 | TO Auxiliary Sign (M4-5)                                  | 326 |
| Section 2D.22 | END Auxiliary Sign (M4-6)                                 | 326 |
| Section 2D.23 | BEGIN Auxiliary Sign (M4-14)                              | 326 |
| Section 2D.24 | TEMPORARY Auxiliary Signs (M4-7, M4-7a)                   | 326 |
| Section 2D.25 | Temporary Detour and Auxiliary Signs                      | 326 |
| Section 2D.26 | Advance Turn Arrow Auxiliary Signs (M5-1, M5-2, and M5-3) | 327 |
| Section 2D.27 | Lane Designation Auxiliary Signs (M5-4, M5-5, and M5-6)   | 327 |
| Section 2D.28 | Directional Arrow Auxiliary Signs (M6 Series)             | 327 |

|                                    |  |                     |
|------------------------------------|--|---------------------|
| Section 2D.29                      | Route Sign Assemblies  | 328                 |
| Section 2D.30                      | Junction Assembly  | 328                 |
| Section 2D.31                      | Advance Route Turn Assembly  | 329                 |
| Section 2D.32                      | Directional Assembly   | 330                 |
| Section 2D.33                      | Combination Lane-Use/Destination Overhead Guide Sign (D15-1)           | 331                 |
| Section 2D.34                      | Confirming or Reassurance Assemblies                                   | 331                 |
| Section 2D.35                      | Trailblazer Assembly   | 331                 |
| Section 2D.36                      | Destination and Distance Signs   | 332                 |
| Section 2D.37                      | Destination Signs (D1 Series)  | 332                 |
| Section 2D.38                      | Destination Signs at Circular Intersections                            | 335                 |
| Section 2D.39                      | Destination Signs at Jughandles  | 336                 |
| Section 2D.40                      | Location of Destination Signs  | 336                 |
| Section 2D.41                      | Distance Signs (D2 Series)   | 336                 |
| Section 2D.42                      | Location of Distance Signs   | 337                 |
| Section 2D.43                      | Street Name Signs (D3-1 or D3-1a)                                      | 337                 |
| Section 2D.44                      | Advance Street Name Signs (D3-2)                                       | 339                 |
| Section 2D.45                      | Signing on Conventional Roads on Approaches to Interchanges            | 340                 |
| Section 2D.46                      | Freeway Entrance Signs (D13-3 and D13-3a)                              | 341                 |
| Section 2D. 47                     | Parking Area Guide Sign (D4-1)   | 342                 |
| Section 2D.48                      | PARK - RIDE Sign (D4-2)  | 342                 |
| Section 2D.49                      | Weigh Station Signing (D8 Series)                                      | 343                 |
| Section 2D.50                      | Community Wayfinding Signs   | 343                 |
| Section 2D.51                      | Truck, Passing, or Climbing Lane Signs (D17-1 and D17-2)               | 347                 |
| Section 2D.52                      | Slow Vehicle Turn-Out Sign (D17-7)                                     | 347                 |
| Section 2D.53                      | Signing of Named Highways  | 347                 |
| Section 2D.54                      | Crossover Signs (D13-1 and D13-2)                                      | 348                 |
| Section 2D.55                      | National Scenic Byways Signs (D6-4, D6-4a)                             | 348                 |
| <a href="#">Section 2D.101(CA)</a> | <a href="#">Inventory Markers</a>                                      | <a href="#">349</a> |
| <a href="#">Section 2D.102(CA)</a> | <a href="#">Intersection Number (G98(CA)) Sign</a>                     | <a href="#">351</a> |
| <a href="#">Section 2D.103(CA)</a> | <a href="#">State Property Signs (SG26(CA), S1-1(CA), and S27(CA))</a> | <a href="#">352</a> |

**CHAPTER 2E. GUIDE SIGNS—FREEWAYS AND EXPRESSWAYS 387**

|               |  |     |
|---------------|--|-----|
| Section 2E.01 | Scope of Freeway and Expressway Guide Sign Standards           | 387 |
| Section 2E.02 | Freeway and Expressway Signing Principles                      | 387 |
| Section 2E.03 | Guide Sign Classification                                      | 387 |
| Section 2E.04 | General  | 388 |
| Section 2E.05 | Color of Guide Signs   | 388 |
| Section 2E.06 | Retroreflection or Illumination                                | 388 |
| Section 2E.07 | Characteristics of Urban Signing                               | 388 |
| Section 2E.08 | Characteristics of Rural Signing                               | 389 |
| Section 2E.09 | Signing of Named Highways                                      | 389 |
| Section 2E.10 | Amount of Legend on Guide Signs                                | 389 |
| Section 2E.11 | Number of Signs at an Overhead Installation and Sign Spreading | 389 |
| Section 2E.12 | Pull-Through Signs (E6-2, E6-2a)                               | 390 |
| Section 2E.13 | Designation of Destinations                                    | 390 |
| Section 2E.14 | Size and Style of Letters and Signs                            | 391 |
| Section 2E.15 | Interline and Edge Spacing                                     | 392 |
| Section 2E.16 | Sign Borders   | 392 |
| Section 2E.17 | Abbreviations  | 392 |
| Section 2E.18 | Symbols  | 393 |
| Section 2E.19 | Arrows for Interchange Guide Signs                             | 393 |
| Section 2E.20 | Signing for Option Lanes at Splits and Multi-Lane Exits        | 393 |

|                    |   |            |
|--------------------|---|------------|
| Section 2E.21      | Design of Overhead Arrow-per-Lane Guide Signs for Option Lanes                      | 394        |
| Section 2E.22      | Design of Freeway and Expressway Diagrammatic Guide Signs for Option Lanes          | 396        |
| Section 2E.23      | Signing for Intermediate and Minor Interchange Multi-Lane Exits with an Option Lane | 397        |
| Section 2E.24      | Signing for Interchange Lane Drops  | 397        |
| Section 2E.25      | Overhead Sign Installations   | 398        |
| Section 2E.26      | Lateral Offset  | 399        |
| Section 2E.27      | Route Signs and Trailblazer Assemblies  | 399        |
| Section 2E.28      | Eisenhower Interstate System Signs (M1-10, M1-10a)                                  | 400        |
| Section 2E.29      | Signs for Intersections at Grade  | 400        |
| Section 2E.30      | Interchange Guide Signs   | 400        |
| Section 2E.31      | Interchange Exit Numbering  | 401        |
| Section 2E.32      | Interchange Classification  | 404        |
| Section 2E.33      | Advance Guide Signs   | 404        |
| Section 2E.34      | Next Exit Plaques   | 405        |
| Section 2E.35      | Other Supplemental Guide Signs  | 406        |
| Section 2E.36      | Exit Direction Signs  | 407        |
| Section 2E.37      | Exit Gore Signs (E5-1 Series)   | 408        |
| Section 2E.38      | Post-Interchange Signs  | 409        |
| Section 2E.39      | Post-Interchange Distance Signs   | 409        |
| Section 2E.40      | Interchange Sequence Signs  | 409        |
| Section 2E.41      | Community Interchanges Identification Signs   | 410        |
| Section 2E.42      | NEXT XX EXITS Sign  | 411        |
| Section 2E.43      | Signing by Type of Interchange  | 411        |
| Section 2E.44      | Freeway-to-Freeway Interchange  | 411        |
| Section 2E.45      | Cloverleaf Interchange  | 412        |
| Section 2E.46      | Cloverleaf Interchange with Collector-Distributor Roadways                          | 412        |
| Section 2E.47      | Partial Cloverleaf Interchange  | 412        |
| Section 2E.48      | Diamond Interchange   | 413        |
| Section 2E.49      | Diamond Interchange in Urban Area   | 413        |
| Section 2E.50      | Closely-Spaced Interchanges   | 413        |
| Section 2E.51      | Minor Interchange   | 414        |
| Section 2E.52      | Signing on Conventional Road Approaches and Connecting Roadways                     | 414        |
| Section 2E.53      | Wrong-Way Traffic Control at Interchange Ramps                                      | 414        |
| Section 2E.54      | Weigh Station Signing   | 414        |
| <br>               |   |            |
| <b>CHAPTER 2F.</b> | <b>TOLL ROAD SIGNS</b>  | <b>465</b> |
| Section 2F.01      | Scope   | 465        |
| Section 2F.02      | Sizes of Toll Road Signs  | 465        |
| Section 2F.03      | Use of Purple Backgrounds and Underlay Panels with ETC Account Pictographs          | 465        |
| Section 2F.04      | Size of ETC Pictographs   | 466        |
| Section 2F.05      | Regulatory Signs for Toll Plazas  | 466        |
| Section 2F.06      | Pay Toll Advance Warning Sign (W9-6)  | 467        |
| Section 2F.07      | Pay Toll Advance Warning Plaque (W9-6P)   | 468        |
| Section 2F.08      | Stop Ahead Pay Toll Warning Sign (W9-6a)  | 468        |
| Section 2F.09      | Stop Ahead Pay Toll Warning Plaque (W9-6aP)   | 469        |
| Section 2F.10      | LAST EXIT BEFORE TOLL Warning Plaque (W16-16P)                                      | 469        |
| Section 2F.11      | TOLL Auxiliary Sign (M4-15)   | 469        |
| Section 2F.12      | Electronic Toll Collection (ETC) Account-Only Auxiliary Signs (M4-16 and M4-20)     | 469        |
| Section 2F.13      | Toll Facility and Toll Plaza Guide Signs – General                                  | 469        |
| Section 2F.14      | Advance Signs for Conventional Toll Plazas  | 471        |

|                                    |  |                     |
|------------------------------------|--|---------------------|
| Section 2F.15                      | Advance Signs for Toll Plazas on Diverging Alignments from Open-Road ETC Account-Only Lanes                          | 472                 |
| Section 2F.16                      | Toll Plaza Canopy Signs  | 472                 |
| Section 2F.17                      | Guide Signs for Entrances to ETC Account-Only Facilities   | 473                 |
| Section 2F.18                      | ETC Program Information Signs  | 473                 |
| <b>CHAPTER 2G.</b>                 | <b>PREFERENTIAL AND MANAGED LANE SIGNS</b>   | <b>483</b>          |
| Section 2G.01                      | Scope  | 483                 |
| Section 2G.02                      | Sizes of Preferential and Managed Lane Signs   | 483                 |
| Section 2G.03                      | Regulatory Signs for Preferential Lanes – General  | 483                 |
| Section 2G.04                      | Preferential Lane Vehicle Occupancy Definition Regulatory Signs (R3-10 Series and R3-13 Series)                      | 486                 |
| Section 2G.05                      | Preferential Lane Periods of Operation Regulatory Signs (R3-11 Series and R3-14 Series)                              | 487                 |
| Section 2G.06                      | Preferential Lane Advance Regulatory Signs (R3-12, R3-12e, R3-12f, R3-15, R3-15a, and R3-15d)                        | 489                 |
| Section 2G.07                      | Preferential Lane Ends Regulatory Signs (R3-12a, R3-12b, R3-12c, R3-12d, R3-12g, R3-12h, R3-15b, R3-15c, and R3-15e) | 490                 |
| Section 2G.08                      | Warning Signs on Median Barriers for Preferential Lanes  | 490                 |
| Section 2G.09                      | High-Occupancy Vehicle (HOV) Plaque (W16-11P)  | 491                 |
| Section 2G.10                      | Preferential Lane Guide Signs – General  | 491                 |
| Section 2G.11                      | Guide Signs for Initial Entry Points to Preferential Lanes   | 494                 |
| Section 2G.12                      | Guide Signs for Intermediate Entry Points to Preferential Lanes  | 494                 |
| Section 2G.13                      | Guide Signs for Egress from Preferential Lanes to General-Purpose Lanes  | 495                 |
| Section 2G.14                      | Guide Signs for Direct Entrances to Preferential Lanes from Another Highway  | 496                 |
| Section 2G.15                      | Guide Signs for Direct Exits from Preferential Lanes to Another Highway  | 496                 |
| Section 2G.16                      | Signs for Priced Managed Lanes – General   | 497                 |
| Section 2G.17                      | Regulatory Signs for Priced Managed Lanes  | 498                 |
| Section 2G.18                      | Guide Signs for Priced Managed Lanes   | 499                 |
| <a href="#">Section 2G.101(CA)</a> | <a href="#">Preferential Lane Enforcement Signing (SR50(CA)) Series</a>  | <a href="#">500</a> |
| <a href="#">Section 2G.102(CA)</a> | <a href="#">Regulatory Signs for Preferential Lanes at Metered On-Ramps</a>  | <a href="#">500</a> |
| <b>CHAPTER 2H.</b>                 | <b>GENERAL INFORMATION SIGNS</b>   | <b>535</b>          |
| Section 2H.01                      | Sizes of General Information Signs   | 535                 |
| Section 2H.02                      | General Information Signs (I Series)   | 535                 |
| Section 2H.03                      | Traffic Signal Speed Sign (I1-1)   | 538                 |
| Section 2H.04                      | Miscellaneous Information Signs  | 538                 |
| Section 2H.05                      | Reference Location Signs (D10-1 through D10-3) and Intermediate Reference Location Signs (D10-1a through D10-3a)     | 539                 |
| Section 2H.06                      | Enhanced Reference Location Signs (D10-4, D10-5)   | 540                 |
| Section 2H.07                      | Auto Tour Route Signs  | 541                 |
| Section 2H.08                      | Acknowledgment Signs   | 541                 |
| <b>CHAPTER 2I.</b>                 | <b>GENERAL SERVICE SIGNS</b>   | <b>551</b>          |
| Section 2I.01                      | Sizes of General Service Signs   | 551                 |
| Section 2I.02                      | General Service Signs for Conventional Roads   | 551                 |
| Section 2I.03                      | General Service Signs for Freeways and Expressways   | 552                 |
| Section 2I.04                      | Interstate Oasis Signing   | 562                 |

|               |   |     |
|---------------|---|-----|
| Section 2I.05 | Rest Area and Other Roadside Area Signs       | 563 |
| Section 2I.06 | Brake Check Area Signs (D5-13 and D5-14)      | 565 |
| Section 2I.07 | Chain-Up Area Signs (D5-15 and D5-16)         | 565 |
| Section 2I.08 | Tourist Information and Welcome Center Signs  | 565 |
| Section 2I.09 | Radio Information Signing                     | 568 |
| Section 2I.10 | TRAVEL INFO CALL 511 Signs (D12-5 and D12-5a) | 570 |
| Section 2I.11 | Carpool and Ridesharing Signing               | 571 |

**CHAPTER 2J. SPECIFIC SERVICE SIGNS 583**

|                    |   |     |
|--------------------|---|-----|
| Section 2J.01      | Eligibility                                   | 583 |
| Section 2J.02      | Application                                   | 587 |
| Section 2J.03      | Logos and Logo Sign Panels                    | 588 |
| Section 2J.04      | Number and Size of Signs and Logo Sign Panels | 589 |
| Section 2J.05      | Size of Lettering                             | 590 |
| Section 2J.06      | Signs at Interchanges                         | 590 |
| Section 2J.07      | Single-Exit Interchanges                      | 590 |
| Section 2J.08      | Double-Exit Interchanges                      | 591 |
| Section 2J.09      | Specific Service Trailblazer Signs            | 592 |
| Section 2J.10      | Signs at Intersections                        | 593 |
| Section 2J.11      | Signing Policy                                | 593 |
| Section 2J.101(CA) | Signs at Ramps                                | 594 |

**CHAPTER 2K. TOURIST-ORIENTED DIRECTIONAL SIGNS 601**

|               |                               |     |
|---------------|-------------------------------|-----|
| Section 2K.01 | Purpose and Application       | 601 |
| Section 2K.02 | Design                        | 601 |
| Section 2K.03 | Style and Size of Lettering   | 602 |
| Section 2K.04 | Arrangement and Size of Signs | 602 |
| Section 2K.05 | Advance Signs                 | 603 |
| Section 2K.06 | Sign Locations                | 603 |
| Section 2K.07 | State Policy                  | 603 |

**CHAPTER 2L. CHANGEABLE MESSAGE SIGNS 609**

|                    |   |     |
|--------------------|---|-----|
| Section 2L.01      | Description of Changeable Message Signs               | 609 |
| Section 2L.02      | Applications of Changeable Message Signs              | 609 |
| Section 2L.03      | Legibility and Visibility of Changeable Message Signs | 611 |
| Section 2L.04      | Design Characteristics of Changeable Message Signs    | 611 |
| Section 2L.05      | Message Length and Units of Information               | 613 |
| Section 2L.06      | Installation of Permanent Changeable Message Signs    | 614 |
| Section 2L.101(CA) | Extinguishable Message Signs                          | 614 |

**CHAPTER 2M. RECREATIONAL AND CULTURAL INTEREST AREA SIGNS 615**

|               |   |     |
|---------------|---|-----|
| Section 2M.01 | Scope   | 615 |
| Section 2M.02 | Application of Recreational and Cultural Interest Area Signs                                  | 615 |
| Section 2M.03 | Regulatory and Warning Signs  | 621 |
| Section 2M.04 | General Design Requirements for Recreational and Cultural Interest Area Symbol<br>Guide Signs | 621 |
| Section 2M.05 | Symbol Sign Sizes   | 621 |
| Section 2M.06 | Use of Educational Plaques  | 621 |

|                    |  |            |
|--------------------|--|------------|
| Section 2M.07      | Use of Prohibitive Circle and Diagonal Slash for Non-Road Applications                 | 621        |
| Section 2M.08      | Placement of Recreational and Cultural Interest Area Symbol Signs                      | 622        |
| Section 2M.09      | Destination Guide Signs  | 622        |
| Section 2M.10      | Memorial or Dedication Signing   | 623        |
| Section 2M.101(CA) | Historical Landmark Signs (G13-1(CA), G13-2(CA) and G14(CA))                           | 626        |
| Section 2M.102(CA) | POINT OF HISTORICAL INTEREST Sign (G15(CA))  | 627        |
| Section 2M.103(CA) | Historic Route Signs (SG2(CA), SG2A(CA), S18(CA) and S25(CA))                          | 627        |
| Section 2M.104(CA) | Historic Bridge Signs (S29(CA), S29-1(CA) and S29-2(CA))                               | 628        |
| <b>CHAPTER 2N.</b> | <b>EMERGENCY MANAGEMENT SIGNING</b>  | <b>644</b> |
| Section 2N.01      | Emergency Management   | 644        |
| Section 2N.02      | Design of Emergency Management Signs   | 644        |
| Section 2N.03      | Evacuation Route Signs (EM-1 and EM-1a)  | 644        |
| Section 2N.04      | AREA CLOSED Sign (EM-2)  | 645        |
| Section 2N.05      | TRAFFIC CONTROL POINT Sign (EM-3)  | 645        |
| Section 2N.06      | MAINTAIN TOP SAFE SPEED Sign (EM-4)  | 646        |
| Section 2N.07      | ROAD (AREA) USE PERMIT REQUIRED FOR THRU TRAFFIC Sign (EM-5)                           | 646        |
| Section 2N.08      | Emergency Aid Center Signs (EM-6 Series)   | 646        |
| Section 2N.09      | Shelter Directional Signs (EM-7 Series)  | 647        |
| <b>PART 3.</b>     | <b>MARKINGS</b>  | <b>649</b> |
| <b>CHAPTER 3A.</b> | <b>GENERAL</b>   | <b>649</b> |
| Section 3A.01      | Functions and Limitations  | 649        |
| Section 3A.02      | Standardization of Application   | 649        |
| Section 3A.03      | Maintaining Minimum Pavement Marking Retroreflectivity                                 | 649        |
| Section 3A.04      | Materials  | 650        |
| Section 3A.05      | Colors   | 650        |
| Section 3A.06      | Functions, Widths, and Patterns of Longitudinal Pavement Markings                      | 651        |
| <b>CHAPTER 3B.</b> | <b>PAVEMENT AND CURB MARKINGS</b>  | <b>667</b> |
| Section 3B.01      | Yellow Center Line Pavement Markings and Warrants                                      | 667        |
| Section 3B.02      | No-Passing Zone Pavement Markings and Warrants   | 668        |
| Section 3B.03      | Other Yellow Longitudinal Pavement Markings  | 670        |
| Section 3B.04      | White Lane Line Pavement Markings and Warrants   | 671        |
| Section 3B.05      | Other White Longitudinal Pavement Markings   | 673        |
| Section 3B.06      | Edge Line Pavement Markings  | 674        |
| Section 3B.07      | Warrants for Use of Edge Lines   | 674        |
| Section 3B.08      | Extensions Through Intersections or Interchanges                                       | 675        |
| Section 3B.09      | Lane-Reduction Transition Markings   | 675        |
| Section 3B.10      | Approach Markings for Obstructions   | 676        |
| Section 3B.11      | Raised Pavement Markers – General  | 677        |
| Section 3B.12      | Raised Pavement Markers as Vehicle Positioning Guides with Other Longitudinal Markings | 678        |
| Section 3B.13      | Raised Pavement Markers Supplementing Other Markings                                   | 679        |
| Section 3B.14      | Raised Pavement Markers Substituting for Pavement Markings                             | 679        |
| Section 3B.15      | Transverse Markings  | 680        |
| Section 3B.16      | Stop and Yield Lines   | 680        |
| Section 3B.17      | Do Not Block Intersection Markings   | 682        |



|                                    |  |                     |
|------------------------------------|--|---------------------|
| Section 3B.18                      | Crosswalk Markings   | 682                 |
| Section 3B.19                      | Parking Space Markings   | 685                 |
| Section 3B.20                      | Pavement Word, Symbol, and Arrow Markings                                  | 686                 |
| Section 3B.21                      | Speed Measurement Markings   | 690                 |
| Section 3B.22                      | Speed Reduction Markings   | 691                 |
| Section 3B.23                      | Curb Markings  | 691                 |
| Section 3B.24                      | Chevron and Diagonal Crosshatch Markings                                   | 693                 |
| Section 3B.25                      | Speed Hump Markings  | 694                 |
| Section 3B.26                      | Advance Speed Hump Markings  | 694                 |
| <a href="#">Section 3B.101(CA)</a> | <a href="#">Turnouts</a>   | <a href="#">694</a> |
| <b>CHAPTER 3C.</b>                 | <b>ROUNDABOUT MARKINGS</b>   | <b>769</b>          |
| Section 3C.01                      | General  | 769                 |
| Section 3C.02                      | White Lane Line Pavement Markings for Roundabouts                          | 769                 |
| Section 3C.03                      | Edge Line Pavement Markings for Roundabout Circulatory Roadways            | 769                 |
| Section 3C.04                      | Yield Lines for Roundabouts  | 770                 |
| Section 3C.05                      | Crosswalk Markings at Roundabouts  | 770                 |
| Section 3C.06                      | Word, Symbol, and Arrow Pavement Markings for Roundabouts                  | 770                 |
| Section 3C.07                      | Markings for Other Circular Intersections                                  | 770                 |
| <b>CHAPTER 3D</b>                  | <b>MARKINGS FOR PREFERENTIAL LANES</b>                                     | <b>785</b>          |
| Section 3D.01                      | Preferential Lane Word and Symbol Markings                                 | 785                 |
| Section 3D.02                      | Preferential Lane Longitudinal Markings for Motor Vehicles                 | 786                 |
| <b>CHAPTER 3E.</b>                 | <b>MARKINGS FOR TOLL PLAZAS</b>  | <b>795</b>          |
| Section 3E.01                      | Markings for Toll Plazas   | 795                 |
| <b>CHAPTER 3F</b>                  | <b>DELINEATORS</b>   | <b>797</b>          |
| Section 3F.01                      | Delineators  | 797                 |
| Section 3F.02                      | Delineator Design  | 797                 |
| Section 3F.03                      | Delineator Application   | 797                 |
| Section 3F.04                      | Delineator Placement and Spacing   | 798                 |
| <a href="#">Section 3F.101(CA)</a> | <a href="#">Culvert Markers</a>  | <a href="#">800</a> |
| <a href="#">Section 3F.102(CA)</a> | <a href="#">Emergency Passageway Marker</a>                                | <a href="#">800</a> |
| <a href="#">Section 3F.103(CA)</a> | <a href="#">Narrow Bridge Signing and Marking</a>                          | <a href="#">800</a> |
| <a href="#">Section 3F.104(CA)</a> | <a href="#">Median Barrier Delineation</a>                                 | <a href="#">801</a> |
| <b>CHAPTER 3G</b>                  | <b>COLORED PAVEMENTS</b>   | <b>809</b>          |
| Section 3G.01                      | General  | 809                 |
| <b>CHAPTER 3H</b>                  | <b>CHANNELIZING DEVICES USED FOR EMPHASIS OF PAVEMENT MARKING PATTERNS</b> | <b>811</b>          |
| Section 3H.01                      | Channelizing Devices   | 811                 |

|                    |   |            |
|--------------------|---|------------|
| <b>CHAPTER 3I</b>  | <b>ISLANDS</b>  | <b>813</b> |
| Section 3I.01      | General   | 813        |
| Section 3I.02      | Approach-End Treatment                                      | 813        |
| Section 3I.03      | Island Marking Application                                  | 813        |
| Section 3I.04      | Island Marking Colors                                       | 814        |
| Section 3I.05      | Island Delineation  | 814        |
| Section 3I.06      | Pedestrian Islands and Medians                              | 814        |
| <b>CHAPTER 3J</b>  | <b>RUMBLE STRIP MARKINGS</b>                                | <b>815</b> |
| Section 3J.01      | Longitudinal Rumble Strip Markings                          | 815        |
| Section 3J.02      | Transverse Rumble Strip Markings                            | 815        |
| <b>PART 4</b>      | <b>HIGHWAY TRAFFIC SIGNALS</b>                              | <b>817</b> |
| <b>CHAPTER 4A</b>  | <b>GENERAL</b>  | <b>817</b> |
| Section 4A.01      | Types   | 817        |
| Section 4A.02      | Definitions Relating to Highway Traffic Signals             | 817        |
| <b>CHAPTER 4B</b>  | <b>TRAFFIC CONTROL SIGNALS—GENERAL</b>                      | <b>819</b> |
| Section 4B.01      | General   | 819        |
| Section 4B.02      | Basis of Installation or Removal of Traffic Control Signals | 819        |
| Section 4B.03      | Advantages and Disadvantages of Traffic Control Signals     | 819        |
| Section 4B.04      | Alternatives to Traffic Control Signals                     | 820        |
| Section 4B.05      | Adequate Roadway Capacity                                   | 820        |
| Section 4B.101(CA) | Traffic Signal Development Procedures – Introduction        | 821        |
| Section 4B.102(CA) | Project Report  | 821        |
| Section 4B.103(CA) | Submittals  | 822        |
| Section 4B.104(CA) | Financing   | 822        |
| Section 4B.105(CA) | Design Cost   | 822        |
| Section 4B.106(CA) | Construction Costs - Conventional Highways                  | 823        |
| Section 4B.107(CA) | Construction Costs – Freeways                               | 824        |
| Section 4B.108(CA) | Roadway Improvements by Local Agencies                      | 825        |
| Section 4B.109(CA) | Cooperative Agreements                                      | 825        |
| Section 4B.110(CA) | Engineering Services for Local Agencies                     | 825        |
| Section 4B.111(CA) | Salvaged Electrical Equipment                               | 825        |
| Section 4B.112(CA) | Encroachment Permits  | 826        |
| Section 4B.113(CA) | Modifications of Existing Signals                           | 826        |
| Section 4B.114(CA) | Signals on Poles Owned by Others                            | 826        |
| <b>CHAPTER 4C</b>  | <b>TRAFFIC CONTROL SIGNAL NEEDS STUDIES</b>                 | <b>827</b> |
| Section 4C.01      | Studies and Factors for Justifying Traffic Control Signals  | 827        |
| Section 4C.02      | Warrant 1, Eight-Hour Vehicular Volume                      | 829        |
| Section 4C.03      | Warrant 2, Four-Hour Vehicular Volume                       | 830        |
| Section 4C.04      | Warrant 3, Peak Hour  | 830        |
| Section 4C.05      | Warrant 4, Pedestrian Volume                                | 831        |
| Section 4C.06      | Warrant 5, School Crossing                                  | 832        |

|                    |   |     |
|--------------------|---|-----|
| Section 4C.07      | Warrant 6, Coordinated Signal System          | 832 |
| Section 4C.08      | Warrant 7, Crash Experience                   | 833 |
| Section 4C.09      | Warrant 8, Roadway Network                    | 833 |
| Section 4C.10      | Warrant 9, Intersection Near a Grade Crossing | 833 |
| Section 4C.101(CA) | Criterion for School Crossing Traffic Signals | 835 |

**CHAPTER 4D TRAFFIC CONTROL SIGNAL FEATURES 851**

|                    |  |     |
|--------------------|--|-----|
| Section 4D.01      | General  | 851 |
| Section 4D.02      | Responsibility for Operation and Maintenance   | 851 |
| Section 4D.03      | Provisions for Pedestrians   | 852 |
| Section 4D.04      | Meaning of Vehicular Signal Indications  | 853 |
| Section 4D.05      | Application of Steady Signal Indications   | 855 |
| Section 4D.06      | Signal Indications – Design, Illumination, Color, and Shape                                      | 859 |
| Section 4D.07      | Size of Vehicular Signal Indications   | 859 |
| Section 4D.08      | Positions of Signal Indications Within a Signal Face – General                                   | 860 |
| Section 4D.09      | Positions of Signal Indications Within a Vertical Signal Face                                    | 861 |
| Section 4D.10      | Positions of Signal Indications Within a Horizontal Signal Face                                  | 862 |
| Section 4D.11      | Number of Signal Faces on an Approach  | 863 |
| Section 4D.12      | Visibility, Aiming, and Shielding of Signal Faces  | 864 |
| Section 4D.13      | Lateral Positioning of Signal Faces  | 865 |
| Section 4D.14      | Longitudinal Positioning of Signal Faces   | 866 |
| Section 4D.15      | Mounting Height of Signal Faces  | 866 |
| Section 4D.16      | Lateral Offset (Clearance) of Signal Faces   | 867 |
| Section 4D.17      | Signal Indications for Left-Turn Movements – General   | 867 |
| Section 4D.18      | Signal Indications for Permissive Only Mode Left-Turn Movements                                  | 868 |
| Section 4D.19      | Signal Indications for Protected Only Mode Left-Turn Movements                                   | 870 |
| Section 4D.20      | Signal Indications for Protected/Permissive Mode Left-Turn Movements                             | 871 |
| Section 4D.21      | Signal Indications for Right-Turn Movements – General  | 873 |
| Section 4D.22      | Signal Indications for Permissive Only Mode Right-Turn Movements                                 | 875 |
| Section 4D.23      | Signal Indications for Protected Only Mode Right-Turn Movements                                  | 876 |
| Section 4D.24      | Signal Indications for Protected/Permissive Mode Right-Turn Movements                            | 877 |
| Section 4D.25      | Signal Indications for Approaches With Shared Left-Turn/Right-Turn Lanes and No Through Movement | 880 |
| Section 4D.26      | Yellow Change and Red Clearance Intervals  | 881 |
| Section 4D.27      | Preemption and Priority Control of Traffic Control Signals                                       | 883 |
| Section 4D.28      | Flashing Operation of Traffic Control Signals – General  | 887 |
| Section 4D.29      | Flashing Operation – Transition Into Flashing Mode   | 888 |
| Section 4D.30      | Flashing Operation – Signal Indications During Flashing Mode                                     | 888 |
| Section 4D.31      | Flashing Operation – Transition Out of Flashing Mode   | 889 |
| Section 4D.32      | Temporary and Portable Traffic Control Signals   | 889 |
| Section 4D.33      | Lateral Offset of Signal Supports and Cabinets   | 890 |
| Section 4D.34      | Use of Signs at Signalized Locations   | 891 |
| Section 4D.35      | Use of Pavement Markings at Signalized Locations   | 891 |
| Section 4D.101(CA) | Traffic Signal Design and Operations   | 892 |
| Section 4D.102(CA) | Signal Plan Schedules  | 892 |
| Section 4D.103(CA) | Vehicle Detectors  | 892 |
| Section 4D.104(CA) | Optional Use of Bicycle Signal Faces   | 893 |
| Section 4D.105(CA) | Bicycle/Motorcycle Detection   | 893 |
| Section 4D.106(CA) | Selection of Traffic Signal Operation  | 894 |
| Section 4D.107(CA) | Selection of Left-Turn Phasing   | 895 |
| Section 4D.108(CA) | Dual Left-Turn Phasing   | 895 |

|                    |  |            |
|--------------------|--|------------|
| Section 4D.109(CA) | Lead-Lag Left-Turn Phasing   | 895        |
| Section 4D.110(CA) | Opposite or Opposing (Six Phase Opposing Operation)                              | 895        |
| Section 4D.111(CA) | Permissive Left-Turn Phasing   | 895        |
| Section 4D.112(CA) | Signals at Interchanges  | 896        |
| Section 4D.113(CA) | Timing of Green Intervals  | 896        |
| Section 4D.114(CA) | Review of Traffic Signal Operations  | 896        |
| <b>CHAPTER 4E</b>  | <b>PEDESTRIAN CONTROL FEATURES</b>   | <b>941</b> |
| Section 4E.01      | Pedestrian Signal Heads  | 941        |
| Section 4E.02      | Meaning of Pedestrian Signal Head Indications                                    | 941        |
| Section 4E.03      | Application of Pedestrian Signal Heads   | 941        |
| Section 4E.04      | Size, Design, and Illumination of Pedestrian Signal Head Indications             | 942        |
| Section 4E.05      | Location and Height of Pedestrian Signal Heads                                   | 943        |
| Section 4E.06      | Pedestrian Intervals and Signal Phases   | 943        |
| Section 4E.07      | Countdown Pedestrian Signals   | 945        |
| Section 4E.08      | Pedestrian Detectors   | 946        |
| Section 4E.09      | Accessible Pedestrian Signals and Detectors – General                            | 947        |
| Section 4E.10      | Accessible Pedestrian Signals and Detectors – Location                           | 949        |
| Section 4E.11      | Accessible Pedestrian Signals and Detectors – Walk Indications                   | 949        |
| Section 4E.12      | Accessible Pedestrian Signals and Detectors – Tactile Arrows and Locator Tones   | 951        |
| Section 4E.13      | Accessible Pedestrian Signals and Detectors – Extended Pushbutton Press Features | 951        |
| <b>CHAPTER 4F</b>  | <b>PEDESTRIAN HYBRID BEACONS</b>   | <b>959</b> |
| Section 4F.01      | Application of Pedestrian Hybrid Beacons   | 959        |
| Section 4F.02      | Design of Pedestrian Hybrid Beacons  | 959        |
| Section 4F.03      | Operation of Pedestrian Hybrid Beacons   | 960        |
| <b>CHAPTER 4G</b>  | <b>TRAFFIC CONTROL SIGNALS AND HYBRID BEACONS FOR EMERGENCY-VEHICLE ACCESS</b>   | <b>965</b> |
| Section 4G.01      | Application of Emergency-Vehicle Traffic Control Signals and Hybrid Beacons      | 965        |
| Section 4G.02      | Design of Emergency-Vehicle Traffic Control Signals                              | 965        |
| Section 4G.03      | Operation of Emergency-Vehicle Traffic Control Signals                           | 966        |
| Section 4G.04      | Emergency-Vehicle Hybrid Beacons   | 966        |
| <b>CHAPTER 4H</b>  | <b>TRAFFIC CONTROL SIGNALS FOR ONE-LANE, TWO-WAY FACILITIES</b>                  | <b>969</b> |
| Section 4H.01      | Application of Traffic Control Signals for One-Lane, Two-Way Facilities          | 969        |
| Section 4H.02      | Design of Traffic Control Signals for One-Lane, Two-Way Facilities               | 969        |
| Section 4H.03      | Operation of Traffic Control Signals for One-Lane, Two-Way Facilities            | 969        |
| <b>CHAPTER 4I</b>  | <b>TRAFFIC CONTROL SIGNALS FOR FREEWAY ENTRANCE RAMPS</b>                        | <b>971</b> |
| Section 4I.01      | Application of Freeway Entrance Ramp Control Signals                             | 971        |
| Section 4I.02      | Design of Freeway Entrance Ramp Control Signals                                  | 971        |
| Section 4I.03      | Operation of Freeway Entrance Ramp Control Signals                               | 972        |

|                                    |  |                     |
|------------------------------------|--|---------------------|
| <b>CHAPTER 4J</b>                  | <b>TRAFFIC CONTROL FOR MOVABLE BRIDGES</b>   | <b>973</b>          |
| Section 4J.01                      | Application of Traffic Control for Movable Bridges   | 973                 |
| Section 4J.02                      | Design and Location of Movable Bridge Signals and Gates  | 973                 |
| Section 4J.03                      | Operation of Movable Bridge Signals and Gates  | 975                 |
| <b>CHAPTER 4K</b>                  | <b>HIGHWAY TRAFFIC SIGNALS AT TOLL PLAZAS</b>  | <b>977</b>          |
| Section 4K.01                      | Traffic Signals at Toll Plazas   | 977                 |
| Section 4K.02                      | Lane-Use Control Signals at or Near Toll Plazas  | 977                 |
| Section 4K.03                      | Warning Beacons at Toll Plazas   | 977                 |
| <b>CHAPTER 4L</b>                  | <b>FLASHING BEACONS</b>  | <b>979</b>          |
| Section 4L.01                      | General Design and Operation of Flashing Beacons   | 979                 |
| Section 4L.02                      | Intersection Control Beacon  | 979                 |
| Section 4L.03                      | Warning Beacon   | 981                 |
| Section 4L.04                      | Speed Limit Sign Beacon  | 981                 |
| Section 4L.05                      | Stop Beacon  | 982                 |
| <a href="#">Section 4L.101(CA)</a> | <a href="#">Flashing Beacons at School Crosswalks</a>  | <a href="#">982</a> |
| <a href="#">Section 4L.102(CA)</a> | <a href="#">Flashing Beacons for Fire Stations</a>   | <a href="#">982</a> |
| <a href="#">Section 4L.103(CA)</a> | <a href="#">Flashing Beacons at Bus Stops on Freeway Interchanges</a>                            | <a href="#">983</a> |
| <b>CHAPTER 4M</b>                  | <b>LANE-USE CONTROL SIGNALS</b>  | <b>985</b>          |
| Section 4M.01                      | Application of Lane-Use Control Signals  | 985                 |
| Section 4M.02                      | Meaning of Lane-Use Control Signal Indications   | 985                 |
| Section 4M.03                      | Design of Lane-Use Control Signals   | 986                 |
| Section 4M.04                      | Operation of Lane-Use Control Signals  | 987                 |
| <b>CHAPTER 4N</b>                  | <b>IN-ROADWAY LIGHTS</b>   | <b>989</b>          |
| Section 4N.01                      | Application of In-Roadway Lights   | 989                 |
| Section 4N.02                      | In-Roadway Warning Lights at Crosswalks  | 989                 |
| <a href="#">Section 4N.101(CA)</a> | <a href="#">In-Roadway Warning Lights at Crosswalks Financing and Maintenance-State Highways</a> | <a href="#">991</a> |
| <b>PART 5</b>                      | <b>TRAFFIC CONTROL DEVICES FOR LOW-VOLUME ROADS</b>  | <b>993</b>          |
| <b>CHAPTER 5A</b>                  | <b>GENERAL</b>   | <b>993</b>          |
| Section 5A.01                      | Function   | 993                 |
| Section 5A.02                      | Application  | 993                 |
| Section 5A.03                      | Design   | 994                 |
| Section 5A.04                      | Placement  | 994                 |
| <b>CHAPTER 5B</b>                  | <b>REGULATORY SIGNS</b>  | <b>997</b>          |
| Section 5B.01                      | Introduction   | 997                 |
| Section 5B.02                      | STOP and YIELD Signs (R1-1 and R1-2)   | 997                 |
| Section 5B.03                      | Speed Limit Signs (R2 Series)  | 997                 |

|                   |   |             |
|-------------------|---|-------------|
| Section 5B.04     | Traffic Movement and Prohibition Signs (R3, R4, R5, R6, R9, R10, R11, R12, R13, and R14 Series) | 997         |
| Section 5B.05     | Parking Signs (R8 Series)   | 997         |
| Section 5B.06     | Other Regulatory Signs  | 998         |
| <b>CHAPTER 5C</b> | <b>WARNING SIGNS</b>  | <b>999</b>  |
| Section 5C.01     | Introduction  | 999         |
| Section 5C.02     | Horizontal Alignment Signs (W1-1 through W1-8)  | 999         |
| Section 5C.03     | Intersection Warning Signs (W2-1 through W2-6)  | 999         |
| Section 5C.04     | Stop Ahead and Yield Ahead Signs (W3-1, W3-2)   | 999         |
| Section 5C.05     | NARROW BRIDGE Sign (W5-2)   | 999         |
| Section 5C.06     | ONE LANE BRIDGE Sign (W5-3)   | 999         |
| Section 5C.07     | Hill Sign (W7-1)  | 1000        |
| Section 5C.08     | PAVEMENT ENDS Sign (W8-3)   | 1000        |
| Section 5C.09     | Vehicular Traffic Warning and Non-Vehicular Warning Signs (W11 Series and W8-6)                 | 1000        |
| Section 5C.10     | Advisory Speed Plaque (W13-1P)  | 1000        |
| Section 5C.11     | DEAD END or NO OUTLET Signs (W14-1, W14-1a, W14-2, W14-2a)                                      | 1000        |
| Section 5C.12     | NO TRAFFIC SIGNS Sign (W18-1)   | 1001        |
| Section 5C.13     | Other Warning Signs   | 1001        |
| Section 5C.14     | Object Markers and Barricades   | 1001        |
| <b>CHAPTER 5D</b> | <b>GUIDE SIGNS</b>  | <b>1005</b> |
| Section 5D.01     | Introduction  | 1005        |
| <b>CHAPTER 5E</b> | <b>MARKINGS</b>   | <b>1007</b> |
| Section 5E.01     | Introduction  | 1007        |
| Section 5E.02     | Center Line Markings  | 1007        |
| Section 5E.03     | Edge Line Markings  | 1007        |
| Section 5E.04     | Delineators   | 1007        |
| Section 5E.05     | Other Markings  | 1007        |
| <b>CHAPTER 5F</b> | <b>TRAFFIC CONTROL FOR HIGHWAY-RAIL GRADE CROSSINGS</b>   | <b>1009</b> |
| Section 5F.01     | Introduction  | 1009        |
| Section 5F.02     | Grade Crossing (Crossbuck) Sign and Number of Tracks Plaque (R15-1, R15-2P)                     | 1009        |
| Section 5F.03     | Grade Crossing Advance Warning Signs (W10 Series)   | 1009        |
| Section 5F.04     | STOP and YIELD Signs (R1-1, R1-2)   | 1009        |
| Section 5F.05     | Pavement Markings   | 1010        |
| Section 5F.06     | Other Traffic Control Devices   | 1010        |
| <b>CHAPTER 5G</b> | <b>TEMPORARY TRAFFIC CONTROL ZONES</b>  | <b>1011</b> |
| Section 5G.01     | Introduction  | 1011        |
| Section 5G.02     | Applications  | 1011        |
| Section 5G.03     | Channelization Devices  | 1011        |
| Section 5G.04     | Markings  | 1012        |
| Section 5G.05     | Other Traffic Control Devices   | 1012        |

|                                    |  |                      |
|------------------------------------|--|----------------------|
| <b>CHAPTER 5H</b>                  | <b>TRAFFIC CONTROL FOR SCHOOL AREAS</b>                                      | <b>1013</b>          |
| Section 5H.01                      | Introduction   | 1013                 |
| <b>PART 6</b>                      | <b>TEMPORARY TRAFFIC CONTROL</b>   | <b>1015</b>          |
| <b>CHAPTER 6A</b>                  | <b>GENERAL</b>   | <b>1015</b>          |
| Section 6A.01                      | General  | 1015                 |
| <b>CHAPTER 6B</b>                  | <b>FUNDAMENTAL PRINCIPLES</b>  | <b>1017</b>          |
| Section 6B.01                      | Fundamental Principles of Temporary Traffic Control                          | 1017                 |
| <b>CHAPTER 6C</b>                  | <b>TEMPORARY TRAFFIC CONTROL ELEMENTS</b>                                    | <b>1021</b>          |
| Section 6C.01                      | Temporary Traffic Control Plans  | 1021                 |
| Section 6C.02                      | Temporary Traffic Control Zones  | 1023                 |
| Section 6C.03                      | Components of Temporary Traffic Control Zones                                | 1023                 |
| Section 6C.04                      | Advance Warning Area   | 1024                 |
| Section 6C.05                      | Transition Area  | 1024                 |
| Section 6C.06                      | Activity Area  | 1024                 |
| Section 6C.07                      | Termination Area   | 1025                 |
| Section 6C.08                      | Tapers   | 1026                 |
| Section 6C.09                      | Detours and Diversions   | 1027                 |
| Section 6C.10                      | One-Lane, Two-Way Traffic Control  | 1027                 |
| Section 6C.11                      | Flagger Method of One-Lane, Two-Way Traffic Control                          | 1027                 |
| Section 6C.12                      | Flag Transfer Method of One-Lane, Two-Way Traffic Control                    | 1028                 |
| Section 6C.13                      | Pilot Car Method of One-Lane, Two-Way Traffic Control                        | 1028                 |
| Section 6C.14                      | Temporary Traffic Control Signal Method of One-Lane, Two-Way Traffic Control | 1028                 |
| Section 6C.15                      | Stop or Yield Control Method of One-Lane, Two-Way Traffic Control            | 1028                 |
| <b>CHAPTER 6D</b>                  | <b>PEDESTRIAN AND WORKER SAFETY</b>  | <b>1035</b>          |
| Section 6D.01                      | Pedestrian Considerations  | 1035                 |
| Section 6D.02                      | Accessibility Considerations   | 1037                 |
| Section 6D.03                      | Worker Safety Considerations   | 1038                 |
| <a href="#">Section 6D.101(CA)</a> | <a href="#">Bicycle Considerations</a>                                       | <a href="#">1040</a> |
| <b>CHAPTER 6E</b>                  | <b>FLAGGER CONTROL</b>   | <b>1041</b>          |
| Section 6E.01                      | Qualifications for Flaggers  | 1041                 |
| Section 6E.02                      | High-Visibility Safety Apparel   | 1041                 |
| Section 6E.03                      | Hand-Signaling Devices   | 1042                 |
| Section 6E.04                      | Automated Flagger Assistance Devices   | 1043                 |
| Section 6E.05                      | STOP/SLOW Automated Flagger Assistance Devices                               | 1044                 |
| Section 6E.06                      | Red/Yellow Lens Automated Flagger Assistance Devices                         | 1046                 |
| Section 6E.07                      | Flagger Procedures   | 1047                 |
| Section 6E.08                      | Flagger Stations   | 1048                 |

**CHAPTER 6F      TEMPORARY TRAFFIC CONTROL ZONE DEVICES      1053**

|               |   |      |
|---------------|---|------|
| Section 6F.01 | Types of Devices  | 1053 |
| Section 6F.02 | General Characteristics of Signs                          | 1054 |
| Section 6F.03 | Sign Placement  | 1055 |
| Section 6F.04 | Sign Maintenance  | 1056 |
| Section 6F.05 | Regulatory Sign Authority                                 | 1056 |
| Section 6F.06 | Regulatory Sign Design                                    | 1056 |
| Section 6F.07 | Regulatory Sign Applications                              | 1056 |
| Section 6F.08 | ROAD (STREET) CLOSED Sign (R11-2)                         | 1056 |
| Section 6F.09 | Local Traffic Only Signs (R11-3a, R11-4)                  | 1057 |
| Section 6F.10 | Weight Limit Signs (R12-1, R12-2, R12-5)                  | 1057 |
| Section 6F.11 | STAY IN LANE Sign (R4-9)                                  | 1057 |
| Section 6F.12 | Work Zone and Higher Fines Signs and Plaques              | 1057 |
| Section 6F.13 | PEDESTRIAN CROSSWALK Sign (R9-8)                          | 1059 |
| Section 6F.14 | SIDEWALK CLOSED Signs (R9-9, R9-10, R9-11, R9-11a)        | 1059 |
| Section 6F.15 | Special Regulatory Signs                                  | 1059 |
| Section 6F.16 | Warning Sign Function, Design, and Application            | 1059 |
| Section 6F.17 | Position of Advance Warning Signs                         | 1060 |
| Section 6F.18 | ROAD (STREET) WORK Sign (W20-1)                           | 1060 |
| Section 6F.19 | DETOUR Sign (W20-2)                                       | 1061 |
| Section 6F.20 | ROAD (STREET) CLOSED Sign (W20-3)                         | 1061 |
| Section 6F.21 | ONE LANE ROAD Sign (W20-4)                                | 1061 |
| Section 6F.22 | Lane(s) Closed Signs (W20-5, W20-5a)                      | 1062 |
| Section 6F.23 | CENTER LANE CLOSED AHEAD Sign (W9-3)                      | 1062 |
| Section 6F.24 | Lane Ends Sign (W4-2)                                     | 1062 |
| Section 6F.25 | ON RAMP Plaque (W13-4P)                                   | 1062 |
| Section 6F.26 | RAMP NARROWS Sign (W5-4)                                  | 1062 |
| Section 6F.27 | SLOW TRAFFIC AHEAD Sign (W23-1)                           | 1063 |
| Section 6F.28 | EXIT OPEN and EXIT CLOSED Signs (E5-2, E5-2a)             | 1063 |
| Section 6F.29 | EXIT ONLY Sign (E5-3)                                     | 1064 |
| Section 6F.30 | NEW TRAFFIC PATTERN AHEAD Sign (W23-2)                    | 1064 |
| Section 6F.31 | Flagger Signs (W20-7, W20-7a)                             | 1064 |
| Section 6F.32 | Two-Way Traffic Sign (W6-3)                               | 1064 |
| Section 6F.33 | Workers Signs (W21-1, W21-1a)                             | 1065 |
| Section 6F.34 | FRESH OIL (TAR) Sign (W21-2)                              | 1065 |
| Section 6F.35 | ROAD MACHINERY AHEAD Sign (W21-3)                         | 1065 |
| Section 6F.36 | Motorized Traffic Signs (W8-6, W11-10)                    | 1065 |
| Section 6F.37 | Shoulder Work Signs (W21-5, W21-5a, W21-5b)               | 1065 |
| Section 6F.38 | SURVEY CREW Sign (W21-6)                                  | 1066 |
| Section 6F.39 | UTILITY WORK Sign (W21-7)                                 | 1066 |
| Section 6F.40 | Signs for Blasting Areas                                  | 1066 |
| Section 6F.41 | BLASTING ZONE AHEAD Sign (W22-1)                          | 1066 |
| Section 6F.42 | TURN OFF 2-WAY RADIO AND CELL PHONE Sign (W22-2)          | 1066 |
| Section 6F.43 | END BLASTING ZONE Sign (W22-3)                            | 1066 |
| Section 6F.44 | Shoulder Signs and Plaque (W8-4, W8-9, W8-17, and W8-17P) | 1066 |
| Section 6F.45 | UNEVEN LANES Sign (W8-11)                                 | 1067 |
| Section 6F.46 | STEEL PLATE AHEAD Sign (W8-24)                            | 1067 |
| Section 6F.47 | NO CENTER LINE Sign (W8-12)                               | 1067 |
| Section 6F.48 | Reverse Curve Signs (W1-4 Series)                         | 1068 |
| Section 6F.49 | Double Reverse Curve Signs (W24-1 Series)                 | 1068 |
| Section 6F.50 | Other Warning Signs                                       | 1068 |
| Section 6F.51 | Special Warning Signs                                     | 1068 |



|                    |  |      |
|--------------------|--|------|
| Section 6F.52      | Advisory Speed Plaque (W13-1P)   | 1069 |
| Section 6F.53      | Supplementary Distance Plaque (W7-3aP)                                       | 1069 |
| Section 6F.54      | Motorcycle Plaque (W8-15P)   | 1069 |
| Section 6F.55      | Guide Signs  | 1069 |
| Section 6F.56      | ROAD WORK NEXT XX MILES Sign (G20-1)   | 1070 |
| Section 6F.57      | END ROAD WORK Sign (G20-2)   | 1070 |
| Section 6F.58      | PILOT CAR FOLLOW ME Sign (G20-4)   | 1070 |
| Section 6F.59      | Detour Signs (M4-8, M4-8a, M4-8b, M4-9, M4-9a, M4-9b, M4-9c, and M4-10)      | 1071 |
| Section 6F.60      | Portable Changeable Message Signs  | 1071 |
| Section 6F.61      | Arrow Boards   | 1074 |
| Section 6F.62      | High-Level Warning Devices (Flag Trees)                                      | 1076 |
| Section 6F.63      | Channelizing Devices   | 1077 |
| Section 6F.64      | Cones  | 1078 |
| Section 6F.65      | Tubular Markers  | 1079 |
| Section 6F.66      | Vertical Panels  | 1080 |
| Section 6F.67      | Drums  | 1081 |
| Section 6F.68      | Type 1, 2, or 3 Barricades   | 1081 |
| Section 6F.69      | Direction Indicator Barricades   | 1083 |
| Section 6F.70      | Temporary Traffic Barriers as Channelizing Devices                           | 1083 |
| Section 6F.71      | Longitudinal Channelizing Devices  | 1083 |
| Section 6F.72      | Temporary Lane Separators  | 1084 |
| Section 6F.73      | Other Channelizing Devices   | 1084 |
| Section 6F.74      | Detectable Edging for Pedestrians  | 1085 |
| Section 6F.75      | Temporary Raised Islands   | 1085 |
| Section 6F.76      | Opposing Traffic Lane Divider and Sign (W6-4)                                | 1086 |
| Section 6F.77      | Pavement Markings  | 1086 |
| Section 6F.78      | Temporary Markings   | 1087 |
| Section 6F.79      | Temporary Raised Pavement Markers  | 1088 |
| Section 6F.80      | Delineators  | 1088 |
| Section 6F.81      | Lighting Devices   | 1089 |
| Section 6F.82      | Floodlights  | 1089 |
| Section 6F.83      | Warning Lights   | 1089 |
| Section 6F.84      | Temporary Traffic Control Signals  | 1091 |
| Section 6F.85      | Temporary Traffic Barriers   | 1092 |
| Section 6F.86      | Crash Cushions   | 1093 |
| Section 6F.87      | Rumble Strips  | 1094 |
| Section 6F.88      | Screens  | 1095 |
| Section 6F.101(CA) | LOOSE GRAVEL Sign (W8-7)   | 1095 |
| Section 6F.102(CA) | NARROW LANE(S) Sign (C12(CA))  | 1095 |
| Section 6F.103(CA) | OPEN TRENCH Sign (C27(CA))   | 1095 |
| Section 6F.104(CA) | Moving Lane Closure Signs (W23-1 and SC10(CA), SC11(CA), SC13(CA), SC15(CA)) | 1096 |
| Section 6F.105(CA) | Object Markers   | 1096 |
| Section 6F.106(CA) | Slow For The Cone Zone (SC19(CA) and SC20(CA)) Signs                         | 1097 |
| Section 6F.107(CA) | FRESH CONCRETE (C43(CA)) Sign  | 1097 |
| Section 6F.108(CA) | CAUTION FREQUENT STOPPING AND BACKING STAY BACK 100 FEET (SC21(CA)) Sign     | 1097 |
| Section 6F.109(CA) | Construction Project Funding Identification Signs                            | 1097 |

**CHAPTER 6G TYPE OF TEMPORARY TRAFFIC CONTROL ZONE ACTIVITIES 1119**

|               |  |      |
|---------------|--|------|
| Section 6G.01 | Typical Applications                             | 1119 |
| Section 6G.02 | Work Duration                                    | 1119 |
| Section 6G.03 | Location of Work                                 | 1121 |
| Section 6G.04 | Modifications To Fulfill Special Needs           | 1121 |
| Section 6G.05 | Work Affecting Pedestrian and Bicycle Facilities | 1122 |

|                    |  |             |
|--------------------|--|-------------|
| Section 6G.06      | Work Outside of the Shoulder   | 1123        |
| Section 6G.07      | Work on the Shoulder with No Encroachment  | 1123        |
| Section 6G.08      | Work on the Shoulder with Minor Encroachment                                     | 1124        |
| Section 6G.09      | Work Within the Median   | 1124        |
| Section 6G.10      | Work Within the Traveled Way of a Two-Lane Highway                               | 1124        |
| Section 6G.11      | Work Within the Traveled Way of an Urban Street                                  | 1125        |
| Section 6G.12      | Work Within the Traveled Way of a Multi-Lane, Non-Access Controlled Highway      | 1126        |
| Section 6G.13      | Work Within the Traveled Way at an Intersection                                  | 1127        |
| Section 6G.14      | Work Within the Traveled Way of a Freeway or Expressway                          | 1128        |
| Section 6G.15      | Two-Lane, Two-Way Traffic on One Roadway of a Normally Divided Highway           | 1129        |
| Section 6G.16      | Crossovers   | 1129        |
| Section 6G.17      | Interchanges   | 1129        |
| Section 6G.18      | Work in the Vicinity of a Grade Crossing   | 1130        |
| Section 6G.19      | Temporary Traffic Control During Nighttime Hours                                 | 1130        |
| <b>CHAPTER 6H</b>  | <b>TYPICAL APPLICATIONS</b>  | <b>1133</b> |
| Section 6H.01      | Typical Applications   | 1133        |
| <b>CHAPTER 6I</b>  | <b>CONTROL OF TRAFFIC THROUGH TRAFFIC INCIDENT MANAGEMENT AREAS</b>              | <b>1251</b> |
| Section 6I.01      | General  | 1251        |
| Section 6I.02      | Major Traffic Incidents  | 1252        |
| Section 6I.03      | Intermediate Traffic Incidents   | 1253        |
| Section 6I.04      | Minor Traffic Incidents  | 1253        |
| Section 6I.05      | Use of Emergency-Vehicle Lighting  | 1254        |
| Section 6I.101(CA) | FLOODING AHEAD TURN AROUND DON'T DROWN Sign (W86(CA))                            | 1254        |
| Section 6I.102(CA) | EMERGENCY SCENE AHEAD W90(CA) Sign   | 1254        |
| <b>PART 7</b>      | <b>TRAFFIC CONTROL FOR SCHOOL AREAS</b>  | <b>1257</b> |
| <b>CHAPTER 7A</b>  | <b>GENERAL</b>   | <b>1257</b> |
| Section 7A.01      | Need for Standards   | 1257        |
| Section 7A.02      | School Routes and Established School Crossings                                   | 1257        |
| Section 7A.03      | School Crossing Control Criteria   | 1259        |
| Section 7A.04      | Scope  | 1259        |
| <b>CHAPTER 7B</b>  | <b>SIGNS</b>   | <b>1261</b> |
| Section 7B.01      | Size of School Signs   | 1261        |
| Section 7B.02      | Illumination and Reflectorization  | 1261        |
| Section 7B.03      | Position of Signs  | 1261        |
| Section 7B.04      | Height of Signs  | 1261        |
| Section 7B.05      | Installation of Signs  | 1261        |
| Section 7B.06      | Lettering  | 1262        |
| Section 7B.07      | Sign Color for School Warning Signs  | 1262        |
| Section 7B.08      | School Sign (S1-1) and Plaques   | 1262        |
| Section 7B.09      | School Zone Sign (S1-1) and Plaques (S4-3P, S4-7P) & END SCHOOL ZONE Sign (S5-2) | 1262        |
| Section 7B.10      | Higher Fines Zone Signs (R2-10, R2-11) and Plaques                               | 1263        |

|                                    |   |                      |
|------------------------------------|---|----------------------|
| Section 7B.11                      | School Advance Crossing Assembly  | 1263                 |
| Section 7B.12                      | School Crossing Assembly  | 1264                 |
| Section 7B.13                      | School Bus Stop Ahead Sign (S3-1)   | 1265                 |
| Section 7B.14                      | SCHOOL BUS TURN AHEAD Sign (S3-2)   | 1265                 |
| Section 7B.15                      | School Speed Limit Assembly (S4-1P, S4-2P, S4-3P, S4-4P, S4-6P, S5-1) and<br>END SCHOOL SPEED LIMIT Sign (S5-3)       | 1265                 |
| Section 7B.16                      | Reduced School Speed Limit Ahead Sign (S4-5, S4-5a)   | 1268                 |
| Section 7B.17                      | Parking and Stopping Signs (R7 and R8 Series)   | 1268                 |
| <b>CHAPTER 7C</b>                  | <b>MARKINGS</b>   | <b>1283</b>          |
| Section 7C.01                      | Functions and Limitations   | 1283                 |
| Section 7C.02                      | Crosswalk Markings  | 1283                 |
| Section 7C.03                      | Pavement Word, Symbol, and Arrow Markings   | 1284                 |
| <b>CHAPTER 7D</b>                  | <b>CROSSING SUPERVISION</b>   | <b>1287</b>          |
| Section 7D.01                      | Types of Crossing Supervision   | 1287                 |
| Section 7D.02                      | Adult Crossing Guards   | 1287                 |
| Section 7D.03                      | Qualifications of Adult Crossing Guards   | 1288                 |
| Section 7D.04                      | Uniform of Adult Crossing Guards  | 1288                 |
| Section 7D.05                      | Operating Procedures for Adult Crossing Guards  | 1289                 |
| <a href="#">Section 7D.101(CA)</a> | <a href="#">School Safety Patrols</a>   | <a href="#">1289</a> |
| <b>PART 8</b>                      | <b>TRAFFIC CONTROL FOR RAILROAD AND LIGHT RAIL TRANSIT<br/>GRADE CROSSINGS</b>  | <b>1291</b>          |
| <b>CHAPTER 8A</b>                  | <b>GENERAL</b>  | <b>1291</b>          |
| Section 8A.01                      | Introduction  | 1291                 |
| Section 8A.02                      | Use of Standard Devices, Systems, and Practices at Highway-Rail Grade Crossings                                       | 1292                 |
| Section 8A.03                      | Use of Standard Devices, Systems, and Practices at Highway-LRT Grade Crossings  | 1293                 |
| Section 8A.04                      | Uniform Provisions  | 1294                 |
| Section 8A.05                      | Grade Crossing Elimination  | 1294                 |
| Section 8A.06                      | Illumination at Grade Crossings   | 1294                 |
| Section 8A.07                      | Quiet Zone Treatments at Highway-Rail Grade Crossings   | 1295                 |
| Section 8A.08                      | Temporary Traffic Control Zones   | 1295                 |
| <a href="#">Section 8A.101(CA)</a> | <a href="#">Relation to Other Documents</a>   | <a href="#">1295</a> |
| <b>CHAPTER 8B</b>                  | <b>SIGNS AND MARKINGS</b>   | <b>1297</b>          |
| Section 8B.01                      | Purpose   | 1297                 |
| Section 8B.02                      | Sizes of Grade Crossing Signs   | 1297                 |
| Section 8B.03                      | Grade Crossing (Crossbuck) Sign (R15-1) and Number of Tracks Plaque (R15-2P)<br>at Active and Passive Grade Crossings | 1297                 |
| Section 8B.04                      | Crossbuck Assemblies with YIELD or STOP Signs at Passive Grade Crossings  | 1298                 |
| Section 8B.05                      | Use of STOP (R1-1) or YIELD (R1-2) Signs without Crossbuck Signs at<br>Highway-LRT Grade Crossings                    | 1300                 |
| Section 8B.06                      | Grade Crossing Advance Warning Signs (W10 Series)   | 1300                 |
| Section 8B.07                      | EXEMPT Grade Crossing Plaques (R15-3P, W10-1aP)   | 1301                 |
| Section 8B.08                      | Turn Restrictions During Preemption   | 1302                 |

|                                    |  |                      |
|------------------------------------|--|----------------------|
| Section 8B.09                      | DO NOT STOP ON TRACKS Sign (R8-8)  | 1303                 |
| Section 8B.10                      | TRACKS OUT OF SERVICE Sign (R8-9)  | 1303                 |
| Section 8B.11                      | STOP HERE WHEN FLASHING Signs (R8-10, R8-10a)                              | 1303                 |
| Section 8B.12                      | STOP HERE ON RED Signs (R10-6, R10-6a)                                     | 1303                 |
| Section 8B.13                      | Light Rail Transit Only Lane Signs (R15-4 Series)                          | 1304                 |
| Section 8B.14                      | Do Not Pass Light Rail Transit Signs (R15-5, R15-5a)                       | 1304                 |
| Section 8B.15                      | No Motor Vehicles On Tracks Signs (R15-6, R15-6a)                          | 1304                 |
| Section 8B.16                      | Divided Highway with Light Rail Transit Crossing Signs (R15-7 Series)      | 1304                 |
| Section 8B.17                      | LOOK Sign (R15-8)  | 1305                 |
| Section 8B.18                      | Emergency Notification Sign (I-13)   | 1305                 |
| Section 8B.19                      | Light Rail Transit Approaching-Activated Blank-Out Warning Sign (W10-7)    | 1306                 |
| Section 8B.20                      | TRAINS MAY EXCEED 80 MPH Sign (W10-8)                                      | 1306                 |
| Section 8B.21                      | NO TRAIN HORN Sign or Plaque (W10-9, W10-9P)                               | 1306                 |
| Section 8B.22                      | NO GATES OR LIGHTS Plaque (W10-13P)  | 1306                 |
| Section 8B.23                      | Low Ground Clearance Grade Crossing Sign (W10-5)                           | 1306                 |
| Section 8B.24                      | Storage Space Signs (W10-11, W10-11a, W10-11b)                             | 1307                 |
| Section 8B.25                      | Skewed Crossing Sign (W10-12)  | 1307                 |
| Section 8B.26                      | Light Rail Transit Station Sign (I-12)                                     | 1307                 |
| Section 8B.27                      | Pavement Markings  | 1307                 |
| Section 8B.28                      | Stop and Yield Lines   | 1308                 |
| Section 8B.29                      | Dynamic Envelope Markings  | 1308                 |
| <a href="#">Section 8B.101(CA)</a> | <a href="#">Train Station Signs (I-7, G95F(CA), G95G(CA) and G97A(CA))</a> | <a href="#">1309</a> |
| <a href="#">Section 8B.102(CA)</a> | <a href="#">Trolley Crossing Signs (W82(CA) and W82-1(CA))</a>             | <a href="#">1309</a> |

**CHAPTER 8C FLASHING-LIGHT SIGNALS, GATES, AND TRAFFIC CONTROL SIGNALS 1327**

|               |   |      |
|---------------|---|------|
| Section 8C.01 | Introduction  | 1327 |
| Section 8C.02 | Flashing-Light Signals  | 1328 |
| Section 8C.03 | Flashing-Light Signals at Highway-LRT Grade Crossings                         | 1329 |
| Section 8C.04 | Automatic Gates   | 1329 |
| Section 8C.05 | Use of Automatic Gates at LRT Grade Crossings                                 | 1330 |
| Section 8C.06 | Four-Quadrant Gate Systems  | 1330 |
| Section 8C.07 | Wayside Horn Systems  | 1332 |
| Section 8C.08 | Rail Traffic Detection  | 1332 |
| Section 8C.09 | Traffic Control Signals at or Near Highway-Rail Grade Crossings               | 1332 |
| Section 8C.10 | Traffic Control Signals at or Near Highway-LRT Grade Crossings                | 1334 |
| Section 8C.11 | Use of Traffic Control Signals for Control of LRT Vehicles at Grade Crossings | 1335 |
| Section 8C.12 | Grade Crossings Within or In Close Proximity to Circular Intersections        | 1335 |
| Section 8C.13 | Pedestrian and Bicycle Signals and Crossings at LRT Grade Crossings           | 1336 |

**CHAPTER 8D PATHWAY GRADE CROSSINGS 1347**

|               |  |      |
|---------------|--|------|
| Section 8D.01 | Purpose  | 1347 |
| Section 8D.02 | Use of Standard Devices, Systems, and Practices            | 1347 |
| Section 8D.03 | Pathway Grade Crossing Signs and Markings                  | 1347 |
| Section 8D.04 | Stop Lines, Edge Lines, and Detectable Warnings            | 1347 |
| Section 8D.05 | Passive Devices for Pathway Grade Crossings                | 1348 |
| Section 8D.06 | Active Traffic Control Systems for Pathway Grade Crossings | 1348 |

|                    |  |             |
|--------------------|--|-------------|
| <b>PART 9</b>      | <b>TRAFFIC CONTROL FOR BICYCLE FACILITIES</b>  | <b>1351</b> |
| <b>CHAPTER 9A</b>  | <b>GENERAL</b>   | <b>1351</b> |
| Section 9A.01      | Requirements for Bicyclist Traffic Control Devices   | 1351        |
| Section 9A.02      | Scope  | 1351        |
| Section 9A.03      | Definitions Relating to Bicycles   | 1351        |
| Section 9A.04      | Maintenance  | 1351        |
| Section 9A.05      | Relation to Other Documents  | 1351        |
| Section 9A.06      | Placement Authority  | 1352        |
| Section 9A.07      | Meaning of Standard, Guidance, Option, and Support   | 1353        |
| Section 9A.08      | Colors   | 1353        |
| Section 9A.101(CA) | Traffic Controls for Bicycle Facilities at Rail Crossings  | 1353        |
| <b>CHAPTER 9B</b>  | <b>SIGNS</b>   | <b>1355</b> |
| Section 9B.01      | Application and Placement of Signs   | 1355        |
| Section 9B.02      | Design of Bicycle Signs  | 1355        |
| Section 9B.03      | STOP and YIELD Signs (R1-1, R1-2)  | 1355        |
| Section 9B.04      | Bike Lane Signs and Plaques (R3-17, R3-17aP, R3-17bP)  | 1356        |
| Section 9B.05      | BEGIN RIGHT TURN LANE YIELD TO BIKES Sign (R4-4)   | 1356        |
| Section 9B.06      | Bicycles May Use Full Lane Sign (R4-11)  | 1356        |
| Section 9B.07      | Bicycle WRONG WAY Sign and RIDE WITH TRAFFIC Plaque (R5-1b, R9-3cP)  | 1357        |
| Section 9B.08      | NO MOTOR VEHICLES Sign (R5-3)  | 1357        |
| Section 9B.09      | Selective Exclusion Signs  | 1357        |
| Section 9B.10      | No Parking Bike Lane Signs (R7-9, R7-9a)   | 1357        |
| Section 9B.11      | Bicycle Regulatory Signs (R9-5, R9-6, R10-4, R10-24, R10-25, and R10-26)   | 1357        |
| Section 9B.12      | Shared-Use Path Restriction Sign (R9-7)  | 1358        |
| Section 9B.13      | Bicycle Signal Actuation Sign (R10-22)   | 1358        |
| Section 9B.14      | Other Regulatory Signs   | 1358        |
| Section 9B.15      | Turn or Curve Warning Signs (W1 Series)  | 1358        |
| Section 9B.16      | Intersection Warning Signs (W2 Series)   | 1358        |
| Section 9B.17      | Bicycle Surface Condition Warning Sign (W8-10)   | 1358        |
| Section 9B.18      | Bicycle Warning and Combined Bicycle/Pedestrian Signs (W11-1 and W11-15)   | 1359        |
| Section 9B.19      | Other Bicycle Warning Signs  | 1359        |
| Section 9B.20      | Bicycle Guide Signs (D1-1b, D1-1c, D1-2b, D1-2c, D1-3b, D1-3c, D11-1, D11-1c)                                    | 1359        |
| Section 9B.21      | Bicycle Route Signs (M1-8, M1-8a, M1-9)  | 1360        |
| Section 9B.22      | Bicycle Route Sign Auxiliary Plaques   | 1361        |
| Section 9B.23      | Bicycle Parking Area Sign (D4-3)   | 1361        |
| Section 9B.24      | Reference Location Signs (D10-1 through D10-3) and Intermediate Reference Location Signs (D10-1a through D10-3a) | 1362        |
| Section 9B.25      | Mode-Specific Guide Signs for Shared-Use Paths (D11-1a, D11-2, D11-3, D11-4)                                     | 1362        |
| Section 9B.26      | Object Markers   | 1363        |
| Section 9B.101(CA) | Freeway Bicycle Signs (R5-10a, R5-10b, R5-10c, R44B(CA), R44C(CA))   | 1363        |
| Section 9B.102(CA) | PASS Bicycle 3 FT MIN Sign (R117(CA))  | 1363        |
| Section 9B.103(CA) | EXCEPT Bicycle Plaque (R118(CA))   | 1363        |
| Section 9B.104(CA) | Signs on Overcrossing Structures   | 1363        |
| <b>CHAPTER 9C</b>  | <b>MARKINGS</b>  | <b>1379</b> |
| Section 9C.01      | Functions of Markings  | 1379        |
| Section 9C.02      | General Principles   | 1379        |

|                     |   |             |
|---------------------|---|-------------|
| Section 9C.03       | Marking Patterns and Colors on Shared-Use Paths | 1379        |
| Section 9C.04       | Markings For Bicycle Lanes                      | 1380        |
| Section 9C.05       | Bicycle Detector Symbol                         | 1384        |
| Section 9C.06       | Pavement Markings for Obstructions              | 1384        |
| Section 9C.07       | Shared Lane Marking                             | 1384        |
| Section 9C.101(CA)  | Barrier Posts on Class I Bikeways               | 1385        |
| Section 9C.102(CA)  | Class IV Bikeways                               | 1386        |
| <b>CHAPTER 9D</b>   | <b>SIGNALS</b>                                  | <b>1411</b> |
| Section 9D.01       | Application                                     | 1411        |
| Section 9D.02       | Signal Operations for Bicycles                  | 1411        |
| <b>APPENDIX A1.</b> | <b>CONGRESSIONAL LEGISLATION</b>                | <b>1415</b> |
| <b>APPENDIX A2.</b> | <b>METRIC CONVERSIONS</b>                       | <b>1417</b> |

## LIST OF FIGURES

## Page

|                   |  |     |
|-------------------|--|-----|
| Figure 1A-1       | Process for Requesting and Conducting Experimentations for New Traffic Control Devices   | 92  |
| Figure 1A-1(CA)   | Process for Requesting and Conducting Experimentations for New Traffic Control Devices in California   | 93  |
| Figure 1A-2       | Process for Incorporating New Traffic Control Devices into the MUTCD   | 94  |
| Figure 1A-101(CA) | Process for the Use of Traffic Control Devices in California Approved as Interim Approval (IA) by FHWA   | 95  |
| Figure 2A-1       | Examples of Enhanced Conspicuity for Signs   | 115 |
| Figure 2A-2       | Examples of Heights and Lateral Locations of Sign Installations  | 116 |
| Figure 2A-2(CA)   | Examples of Heights and Lateral Locations of Sign Installations  | 117 |
| Figure 2A-3       | Examples of Locations for Some Typical Signs at Intersections  | 118 |
| Figure 2A-4       | Relative Locations of Regulatory, Warning, and Guide Signs on an Intersection Approach   | 119 |
| Figure 2B-1       | STOP and YIELD Signs and Plaques   | 191 |
| Figure 2B-2       | Unsignalized Pedestrian Crosswalk Signs  | 191 |
| Figure 2B-3       | Speed Limit and Photo Enforcement Signs and Plaques  | 192 |
| Figure 2B-3(CA)   | Speed Limit and Photo Enforcement Signs and Plaques  | 193 |
| Figure 2B-4       | Movement Prohibition and Lane Control Signs and Plaques  | 194 |
| Figure 2B-4(CA)   | Movement Prohibition and Lane Control Signs and Plaques  | 195 |
| Figure 2B-5       | Intersection Lane Control Sign Arrow Options for Roundabouts   | 196 |
| Figure 2B-6       | Center and Reversible Lane Control Signs and Plaques   | 196 |
| Figure 2B-7       | Location of Reversible Two-Way Left-Turn Signs   | 197 |
| Figure 2B-8       | Jughandle Regulatory Signs   | 198 |
| Figure 2B-9       | Examples of Applications of Jughandle Regulatory and Guide Signing   | 199 |
| Figure 2B-10      | Passing, Keep Right, and Slow Traffic Signs  | 202 |
| Figure 2B-10(CA)  | Passing, Keep Right, and Slow Traffic Signs  | 203 |
| Figure 2B-11      | Selective Exclusion Signs  | 204 |
| Figure 2B-11(CA)  | Selective Exclusion Signs  | 205 |
| Figure 2B-12      | Locations of Wrong-Way Signing for Divided Highways with Median Widths of 30 Feet or Wider   | 206 |
| Figure 2B-12(CA)  | Locations of Wrong-Way Signing for Divided Highways<br>A – with Median Widths of 30 feet or Wider  | 207 |
|                   | B – with Median Widths Narrower than 30 feet   | 208 |
| Figure 2B-13      | ONE WAY and Divided Highway Crossing Signs   | 209 |
| Figure 2B-14      | Locations of ONE WAY Signs   | 210 |
| Figure 2B-15      | ONE WAY Signing for Divided Highways with Median Widths of 30 Feet or Wider  | 211 |
| Figure 2B-16      | ONE WAY Signing for Divided Highways with Median Widths Narrower Than 30 Feet  | 212 |
| Figure 2B-17      | ONE WAY Signing for Divided Highways with Median Widths Narrower Than 30 Feet and Separated Left-Turn Lanes  | 213 |
| Figure 2B-18      | Example of Application of Regulatory Signing and Pavement Markings at an Exit Ramp Termination to Deter Wrong-Way Entry  | 214 |
| Figure 2B-18(CA)  | Examples of Application of Regulatory Signing and Pavement Markings at an Exit Ramp Termination to Deter Wrong-Way Entry   | 215 |
| Figure 2B-19      | Example of Application of Regulatory Signing and Pavement Markings at an Entrance Ramp Terminal Where the Design Does Not Clearly Indicate the Direction of Flow | 220 |
| Figure 2B-20      | Roundabout Signs and Plaques   | 220 |
| Figure 2B-21      | Example of Regulatory and Warning Signs for a Mini-Roundabout  | 221 |

|                         |   |     |
|-------------------------|---|-----|
| Figure 2B-22            | Example of Regulatory and Warning Signs for a One-Lane Roundabout   | 222 |
| Figure 2B-23            | Example of Regulatory and Warning Signs for a Two-Lane Roundabout with<br>Consecutive Double Lefts            | 223 |
| Figure 2B-24            | Parking and Standing Signs and Plaques (R7 Series)  | 224 |
| Figure 2B-24(CA)        | Parking and Standing Signs and Plaques (R7 Series)  | 226 |
| Figure 2B-25            | Parking and Stopping Signs and Plaques (R8 Series)  | 229 |
| Figure 2B-25(CA)        | Parking and Stopping Signs and Plaques (R8 Series)  | 229 |
| Figure 2B-26            | Pedestrian Signs and Plaques  | 230 |
| Figure 2B-26(CA)        | Pedestrian Signs and Plaques  | 231 |
| Figure 2B-27            | Traffic Signal Signs and Plaques  | 232 |
| Figure 2B-27(CA)        | Traffic Signal Signs and Plaques  | 233 |
| <del>Figure 2B-28</del> | <del>Ramp Metering Signs</del>  | 233 |
| Figure 2B-28(CA)        | Ramp Metering Signs   | 233 |
| Figure 2B-29            | Road Closed and Weight Limit Signs  | 234 |
| Figure 2B-29(CA)        | Road Closed and Weight Limit Signs  | 234 |
| Figure 2B-30            | Truck Signs   | 235 |
| Figure 2B-30(CA)        | Truck Signs   | 236 |
| Figure 2B-31            | Headlight Use Signs   | 237 |
| Figure 2B-32            | Other Regulatory Signs and Symbols  | 237 |
| Figure 2B-32(CA)        | Other Regulatory Signs and Symbols  | 237 |
| Figure 2B-101(CA)       | Example of Speed Zone Survey Sheet  | 238 |
| Figure 2B-102(CA)       | Example of Cumulative Speed Curve Sheet   | 239 |
| Figure 2B-103(CA)       | Example of Vehicle Speed Survey Sheet for City and County Through Highways, Arterials,<br>and Collector Roads | 240 |
| Figure 2B-104(CA)       | Example of Vehicle Speed Survey Sheet for (For 40 MPH and Under)  | 241 |
| Figure 2B-105(CA)       | U-Turn Signs for Signalized Intersections with Separate Turn Phase  | 242 |
| Figure 2B-106(CA)       | California Miscellaneous Regulatory Signs   | 243 |
| Figure 2C-1             | Horizontal Alignment Signs and Plaques  | 289 |
| Figure 2C-1(CA)         | Horizontal Alignment Signs and Plaques  | 290 |
| Figure 2C-2             | Example of Warning Signs for a Turn   | 291 |
| Figure 2C-3             | Example of Advisory Speed Signing for an Exit Ramp  | 292 |
| Figure 2C-4             | Vertical Grade Signs and Plaques  | 293 |
| Figure 2C-4(CA)         | Vertical Grade Signs and Plaques  | 293 |
| Figure 2C-5             | Miscellaneous Warning Signs   | 294 |
| Figure 2C-5(CA)         | Miscellaneous Warning Signs   | 294 |
| Figure 2C-6             | Roadway and Weather Condition and Advance Traffic Control Signs and Plaques                                   | 295 |
| Figure 2C-6(CA)         | Roadway and Weather Condition and Advance Traffic Control Signs and Plaques                                   | 296 |
| Figure 2C-7             | Reduced Speed Limit Ahead Signs   | 296 |
| Figure 2C-8             | Merging and Passing Signs and Plaques   | 297 |
| Figure 2C-8(CA)         | Merging and Passing Signs and Plaques   | 297 |
| Figure 2C-9             | Intersection Warning Signs and Plaques  | 298 |
| Figure 2C-9(CA)         | Intersection Warning Signs and Plaques  | 298 |
| Figure 2C-10            | Vehicular Traffic Warning Signs and Plaques   | 299 |
| Figure 2C-10(CA)        | Vehicular Traffic Warning Signs and Plaques   | 299 |
| Figure 2C-11            | Non-Vehicular Warning Signs   | 300 |
| Figure 2C-11(CA)        | Non-Vehicular Warning Signs   | 300 |
| Figure 2C-12            | Supplemental Warning Plaques  | 301 |
| Figure 2C-12(CA)        | Supplemental Warning Plaques  | 301 |
| Figure 2C-13            | Object Markers  | 302 |
| Figure 2C-13(CA)        | California Object Markers   | 303 |
| Figure 2C-101(CA)       | Determination of Comfortable Speed from Ball Bank Indicator Readings  | 305 |
| Figure 2D-1             | Examples of Color-Coded Destination Guide Signs   | 353 |
| Figure 2D-2             | Arrows for Use on Guide Signs   | 353 |



|                         |  |                |
|-------------------------|--|----------------|
| Figure 2D-2(CA)         | Arrows for Use on Guide Signs  | 354            |
| Figure 2D-3             | Route Signs  | 356            |
| Figure 2D-3(CA)         | California Route Signs   | 356            |
| Figure 2D-4             | Route Sign Auxiliaries   | 357            |
| Figure 2D-4(CA)         | Route Sign Auxiliaries   | 357            |
| Figure 2D-5             | Advance Turn and Directional Arrow Auxiliary Signs   | 358            |
| Figure 2D-5(CA)         | Advance Turn and Directional Arrow Auxiliary Signs   | 358            |
| Figure 2D-6             | Illustration of Directional Assemblies and Other Route Signs (for One Direction of Travel Only)                            | 359            |
| Figure 2D-7             | Destination and Distance Signs   | 363            |
| Figure 2D-7(CA)         | California Destination and Distance Signs  | 364            |
| Figure 2D-8             | Destination Signs for Roundabouts  | 365            |
| Figure 2D-9             | Examples of Guide Signs for Roundabouts  | 366            |
| Figure 2D-10            | Street Name and Parking Signs  | 368            |
| Figure 2D-10(CA)        | Street Name and Parking Signs  | 368            |
| <del>Figure 2D-11</del> | <del>Example of Interchange Crossroad Signing for a One-Lane Approach</del>  | <del>369</del> |
| <del>Figure 2D-12</del> | <del>Example of Minor Interchange Crossroad Signing</del>  | <del>370</del> |
| <del>Figure 2D-13</del> | <del>Examples of Multi-Lane Crossroad Signing for a Diamond Interchange</del>  | <del>371</del> |
| <del>Figure 2D-14</del> | <del>Examples of Multi-Lane Crossroad Signing for a Partial Cloverleaf Interchange</del>                                   | <del>372</del> |
| <del>Figure 2D-15</del> | <del>Examples of Multi-Lane Crossroad Signing for a Cloverleaf Interchange</del>   | <del>373</del> |
| Figure 2D-16            | Example of Crossroad Signing for an Entrance Ramp with a Nearby Frontage Road  | 374            |
| Figure 2D-17            | Example of Weigh Station Signing   | 375            |
| Figure 2D-17(CA)        | Example of Weigh Station Signing   | 376            |
| Figure 2D-18            | Examples of Community Wayfinding Guide Signs   | 376            |
| Figure 2D-19            | Example of a Community Wayfinding Guide Sign System Showing Direction from a Freeway or Expressway                         | 377            |
| Figure 2D-20            | Example of a Color-Coded Community Wayfinding Guide Sign System  | 378            |
| Figure 2D-21            | Crossover, Truck Lane, and Slow Vehicle Signs  | 379            |
| Figure 2D-21(CA)        | Crossover, Truck Lane, and Slow Vehicle Signs  | 379            |
| Figure 2D-22            | Examples of Use of the National Scenic Byways Sign   | 379            |
| Figure 2D-101(CA)       | California Miscellaneous Guide Signs   | 380            |
| Figure 2E-1             | Example of Guide Sign Spreading  | 415            |
| Figure 2E-2             | Pull-Through Signs   | 415            |
| Figure 2E-2(CA)         | California Pull-Through Signs  | 416            |
| Figure 2E-3             | Overhead Arrow-per-Lane Guide Sign for a Multi-Lane Exit with an Option Lane   | 416            |
| Figure 2E-4             | Overhead Arrow-per-Lane Guide Signs for a Two-Lane Exit to the Right with an Option Lane                                   | 417            |
| Figure 2E-5             | Overhead Arrow-per-Lane Guide Signs for a Two-Lane Exit to the Right with an Option Lane (Through Lanes Curve to the Left) | 418            |
| Figure 2E-6             | Overhead Arrow-per-Lane Guide Signs for a Split with an Option Lane  | 419            |
| <del>Figure 2E-7</del>  | <del>Diagrammatic Guide Sign for a Multi-Lane Exit with an Option Lane</del>   | <del>420</del> |
| <del>Figure 2E-8</del>  | <del>Diagrammatic Guide Signs for a Two-Lane Exit to the Right with an Option Lane</del>                                   | <del>421</del> |
| <del>Figure 2E-9</del>  | <del>Diagrammatic Guide Signs for a Two-Lane Exit to the Right with an Option Lane (Through Lanes Curve to the Left)</del> | <del>422</del> |
| <del>Figure 2E-10</del> | <del>Diagrammatic Guide Signs for a Split with an Option Lane</del>  | <del>423</del> |
| Figure 2E-11            | Example of Signing for a Two-Lane Intermediate or Minor Interchange Exit with an Option Lane and a Dropped Lane            | 424            |
| Figure 2E-12            | Example of Signing for a Two-Lane Intermediate or Minor Interchange Exit with Option and Auxiliary Lanes                   | 425            |
| Figure 2E-13            | EXIT ONLY and LEFT Sign Panels   | 426            |
| Figure 2E-13(CA)        | EXIT ONLY and LEFT Sign Panels   | 426            |
| Figure 2E-14            | Guide Signs for a Split with Dedicated Lanes   | 427            |
| Figure 2E-15            | Guide Signs for a Single-Lane Exit to the Left with a Dropped Lane   | 428            |

|                                  |   |                     |
|----------------------------------|---|---------------------|
| Figure 2E-16                     | Guide Signs for a Single-Lane Exit to the Right with a Dropped Lane   | 429                 |
| Figure 2E-17                     | Interstate, Off-Interstate, and U.S. Route Signs  | 430                 |
| Figure 2E-18                     | Eisenhower Interstate System Signs  | 430                 |
| Figure 2E-19                     | Example of Interchange Numbering for Mainline and Circumferential Routes                                    | 431                 |
| Figure 2E-20                     | Example of Interchange Numbering for Mainline, Loop, and Spur Routes  | 432                 |
| Figure 2E-21                     | Example of Interchange Numbering for Overlapping Routes   | 433                 |
| Figure 2E-22                     | Examples of Interchange Advance Guide Signs, Exit Number Plaques, and LEFT Plaque                           | 434                 |
| <a href="#">Figure 2E-22(CA)</a> | <a href="#">Examples of Interchange Advance Guide Signs, Exit Number Plaques, and LEFT Plaque</a>           | <a href="#">435</a> |
| Figure 2E-23                     | Next Exit Plaques   | 435                 |
| Figure 2E-24                     | Supplemental Guide Sign for a Multi-Exit Interchange  | 436                 |
| Figure 2E-25                     | Supplemental Guide Sign for a Park – Ride Facility  | 436                 |
| Figure 2E-26                     | Examples of Interchange Exit Direction Signs  | 437                 |
| <a href="#">Figure 2E-26(CA)</a> | <a href="#">Examples of Interchange Exit Direction Signs</a>  | <a href="#">438</a> |
| Figure 2E-27                     | Interchange Exit Direction Sign with an Advisory Speed Panel  | 438                 |
| Figure 2E-28                     | Exit Gore Signs   | 439                 |
| <a href="#">Figure 2E-28(CA)</a> | <a href="#">Exit Gore Signs</a>   | <a href="#">439</a> |
| Figure 2E-29                     | Post-Interchange Distance Sign  | 440                 |
| Figure 2E-30                     | Example of Using an Interchange Sequence Sign for Closely-Spaced Interchanges                               | 441                 |
| Figure 2E-31                     | Interchange Sequence Sign   | 442                 |
| <a href="#">Figure 2E-31(CA)</a> | <a href="#">Interchange Sequence Sign</a>   | <a href="#">442</a> |
| <del>Figure 2E-32</del>          | <del>Community Interchanges Identification Sign</del>   | 443                 |
| Figure 2E-33                     | NEXT EXITS Sign   | 443                 |
| <a href="#">Figure 2E-33(CA)</a> | <a href="#">NEXT EXITS Sign</a>   | <a href="#">443</a> |
| <del>Figure 2E-34</del>          | <del>Examples of Guide Signs for a Freeway-to-Freeway Interchange</del>                                     | 444                 |
| <a href="#">Figure 2E-34(CA)</a> | <a href="#">Examples of Guide Signs for a Freeway-to-Freeway Interchange</a>                                | <a href="#">446</a> |
| <del>Figure 2E-35</del>          | <del>Examples of Guide Signs for a Full Cloverleaf Interchange</del>  | 447                 |
| <a href="#">Figure 2E-35(CA)</a> | <a href="#">Examples of Guide Signs for a Full Cloverleaf Interchange</a>                                   | <a href="#">448</a> |
| <del>Figure 2E-36</del>          | <del>Examples of Guide Signs for a Full Cloverleaf Interchange with Collector-Distributor Roadways</del>    | 449                 |
| <del>Figure 2E-37</del>          | <del>Examples of Guide Signs for a Partial Cloverleaf Interchange</del>                                     | 450                 |
| <a href="#">Figure 2E-37(CA)</a> | <a href="#">Examples of Guide Signs for a Partial Cloverleaf Interchange</a>                                | <a href="#">451</a> |
| <del>Figure 2E-38</del>          | <del>Examples of Guide Signs for a Diamond Interchange</del>  | 452                 |
| <a href="#">Figure 2E-38(CA)</a> | <a href="#">Examples of Guide Signs for a Diamond Interchange</a>   | <a href="#">453</a> |
| <del>Figure 2E-39</del>          | <del>Examples of Guide Signs for a Diamond Interchange in an Urban Area</del>                               | 454                 |
| <a href="#">Figure 2E-39(CA)</a> | <a href="#">Examples of Guide Signs for a Diamond Interchange in an Urban Area</a>                          | <a href="#">455</a> |
| <del>Figure 2E-40</del>          | <del>Examples of Guide Signs for a Minor Interchange</del>  | 456                 |
| <a href="#">Figure 2E-40(CA)</a> | <a href="#">Examples of Guide Signs for a Minor Interchange</a>   | <a href="#">457</a> |
| Figure 2F-1                      | Examples of ETC Account Pictographs and Use of Purple Backgrounds and Underlay Panels                       | 474                 |
| Figure 2F-2                      | Toll Plaza Regulatory Signs and Plaques   | 474                 |
| Figure 2F-3                      | Toll Plaza Warning Signs and Plaques  | 475                 |
| Figure 2F-4                      | ETC Account-Only Auxiliary Signs for Use in Route Sign Assemblies   | 475                 |
| Figure 2F-5                      | Examples of Guide Signs for Entrances to Toll Highways or Ramps   | 476                 |
| Figure 2F-6                      | Examples of Guide Signs for the Entrance to a Toll Highway on which Tolls are Collected Electronically Only | 477                 |
| Figure 2F-7                      | Examples of Guide Signs for Alternative Toll and Non-Toll Ramp Connections to a Non-Toll Highway            | 478                 |
| Figure 2F-8                      | Examples of Conventional Toll Plaza Advance Signs   | 479                 |
| Figure 2F-9                      | Examples of Toll Plaza Canopy Signs   | 479                 |
| Figure 2F-10                     | Examples of Mainline Toll Plaza Approach and Canopy Signing   | 480                 |

|                                  |  |                     |
|----------------------------------|--|---------------------|
| Figure 2F-11                     | Examples of Guide Signs for a Mainline Toll Plaza on a Diverging Alignment from Open-Road ETC Lanes  | 481                 |
| Figure 2G-1                      | Preferential Lane Regulatory Signs and Plaques   | 502                 |
| <a href="#">Figure 2G-1(CA)</a>  | <a href="#">Preferential Lane Regulatory Signs and Plaques</a>   | <a href="#">504</a> |
| Figure 2G-2                      | Example of Signing for an Added Continuous-Access Contiguous or Buffer-Separated HOV Lane  | 505                 |
| Figure 2G-3                      | Example of Signing for a General-Purpose Lane that Becomes a Continuous-Access Contiguous or Buffer-Separated HOV Lane                         | 506                 |
| Figure 2G-4                      | Examples of Warning Signs and Plaques Applicable Only to Preferential Lanes  | 507                 |
| <a href="#">Figure 2G-4(CA)</a>  | <a href="#">Examples of Warning Signs and Plaques Applicable Only to Preferential Lanes</a>  | <a href="#">507</a> |
| Figure 2G-5                      | Example of an Overhead Advance Guide Sign for a Preferential Lane Entrance   | 508                 |
| Figure 2G-6                      | Examples of Overhead or Post-Mounted Preferential Lane Entrance Direction Signs  | 508                 |
| <a href="#">Figure 2G-6(CA)</a>  | <a href="#">Examples of Overhead or Post-Mounted Preferential Lane Entrance Direction Signs</a>  | <a href="#">509</a> |
| Figure 2G-7                      | Entrance Gore Signs for Barrier-Separated Preferential Lanes   | 509                 |
| Figure 2G-8                      | Example of Signing for an Entrance to Access-Restricted HOV Lanes  | 510                 |
| Figure 2G-9                      | Example of Signing for an Intermediate Entry to a Barrier- or Buffer-Separated HOV Lane  | 511                 |
| Figure 2G-10                     | Example of Signing for the Intermediate Entry to, Egress from, and End of Access-Restricted HOV Lanes  | 512                 |
| Figure 2G-11                     | Examples of Barrier-Mounted Guide Signs for an Intermediate Egress from Preferential Lanes   | 513                 |
| Figure 2G-12                     | Examples of Guide Signs for an Intermediate Egress from a Barrier- or Buffer-Separated HOV Lane  | 514                 |
| <del>Figure 2G-13</del>          | <del>Example of Signing for a Direct Entrance Ramp to an HOV Lane from a Park and Ride Facility and a Local Street</del>                       | <del>515</del>      |
| Figure 2G-14                     | Exit Gore Sign for a Direct Exit from a Preferential Lane  | 516                 |
| <a href="#">Figure 2G-14(CA)</a> | <a href="#">Advance Exit and Exit Gore Sign for a Direct Exit from a Preferential Lane</a>   | <a href="#">516</a> |
| <del>Figure 2G-15</del>          | <del>Examples of Guide Signs for Direct HOV Lane Entrance and Exit Ramps</del>   | <del>517</del>      |
| <a href="#">Figure 2G-15(CA)</a> | <a href="#">Examples of Guide Signs for Direct HOV Lane Entrance and Exit Ramps</a>  | <a href="#">518</a> |
| Figure 2G-16                     | Examples of Guide Signs for a Direct Access Ramp between HOV Lanes on Separate Freeways  | 519                 |
| Figure 2G-17                     | Regulatory Signs for Managed Lanes   | 520                 |
| Figure 2G-18                     | Examples of Guide Signs for Entrances to Priced Managed Lanes  | 521                 |
| Figure 2G-19                     | Example of an Exit Destinations Sign for a Managed Lane  | 521                 |
| Figure 2G-20                     | Example of a Comparative Travel Time Information Sign for Preferential or Managed Lanes  | 521                 |
| Figure 2G-21                     | Example of Signing for the Entrance to an Access-Restricted Priced Managed Lane  | 522                 |
| Figure 2G-22                     | Example of Signing for the Entrance to an Access-Restricted Priced Managed Lane Where a General-Purpose Lane Becomes the Managed Lane          | 523                 |
| Figure 2G-23                     | Example of Signing for an Intermediate Entry to a Barrier- or Buffer-Separated Priced Managed Lane   | 524                 |
| Figure 2G-24                     | Example of Signing for the Intermediate Entry to, Egress from, and End of Access-Restricted Priced Managed Lanes                               | 525                 |
| Figure 2G-25                     | Examples of Guide Signs for an Intermediate Egress from a Barrier- or Buffer-Separated HOV Lane  | 526                 |
| Figure 2G-26                     | Examples of Guide Signs for Direct Managed Lane Entrance and Exit Ramps  | 527                 |
| Figure 2G-27                     | Examples of Guide Signs for a Direct Access Ramp between Managed Lanes on Separate Freeways  | 528                 |
| Figure 2G-28                     | Examples of Guide Signs for a Direct Entrance Ramp to a Priced Managed Lane and Trailblazing to a Nearby Entrance to the General-Purpose Lanes | 529                 |
| Figure 2G-29                     | Examples of Guide Signs for Separate Entrance Ramps to General-Purpose and Priced Managed Lanes from the Same Crossroad                        | 530                 |
| Figure 2H-1                      | General Information and Miscellaneous Information Signs  | 544                 |

|                   |  |     |
|-------------------|--|-----|
| Figure 2H-1(CA)   | General Information and Miscellaneous Information Signs  | 544 |
| Figure 2H-2       | Reference Location Signs   | 545 |
| Figure 2H-3       | Intermediate Reference Location Signs  | 545 |
| Figure 2H-4       | Enhanced Reference Location Signs  | 546 |
| Figure 2H-5       | Examples of Acknowledgment Sign Designs  | 547 |
| Figure 2H-5(CA)   | Examples of Adopt-A-Highway Sign Designs   | 547 |
| Figure 2I-1       | General Service Signs and Plaques  | 572 |
| Figure 2I-1(CA)   | General Service Signs and Plaques  | 573 |
| Figure 2I-2       | Example of Next Services Plaque  | 574 |
| Figure 2I-3       | Examples of General Service Signs with and without Exit Numbering  | 574 |
| Figure 2I-4       | Examples of Interstate Oasis Signs and Plaques   | 575 |
| Figure 2I-5       | Rest Area and Other Roadside Area Signs  | 575 |
| Figure 2I-5(CA)   | Rest Area and Other Roadside Area Signs  | 575 |
| Figure 2I-6       | Brake Check Area and Chain-Up Area Signs   | 576 |
| Figure 2I-6(CA)   | Brake Check Area and Chain-Up Area Signs   | 576 |
| Figure 2I-7       | Examples of Tourist Information and Welcome Center Signs   | 576 |
| Figure 2I-7(CA)   | Examples of Tourist Information and Welcome Center Signs   | 577 |
| Figure 2I-8       | Radio, Telephone, and Carpool Information Signs  | 578 |
| Figure 2I-8(CA)   | Radio, Telephone, and Carpool Information Signs  | 579 |
| Figure 2J-1       | Examples of Specific Service Signs   | 595 |
| Figure 2J-1(CA)   | Examples of Specific Service Signs   | 596 |
| Figure 2J-2       | Examples of Specific Service Sign Locations  | 597 |
| Figure 2J-3       | Examples of Supplemental Messages on Logo Sign Panels  | 598 |
| Figure 2J-3 (CA)  | Examples of Supplemental Messages on Logo Sign Panels  | 598 |
| Figure 2J-4       | Examples of RV Access Supplemental Messages on Logo Sign Panels  | 598 |
| Figure 2J-5       | Examples of Specific Service Trailblazer Signs   | 598 |
| Figure 2K-1       | Examples of Tourist-Oriented Directional Signs   | 605 |
| Figure 2K-1(CA)   | Examples of Tourist-Oriented Directional Signs   | 606 |
| Figure 2K-2       | Examples of Intersection Approach Signs and Advance Signs for Tourist-Oriented Directional Signs           | 607 |
| Figure 2M-1       | Examples of Use of Arrows, Educational Plaques, and Prohibitory Slashes                                    | 629 |
| Figure 2M-1(CA)   | Examples of Use of Arrows, Educational Plaques, and Prohibitory Slashes                                    | 629 |
| Figure 2M-2       | Examples of Recreational and Cultural Interest Area Guide Signs  | 630 |
| Figure 2M-2(CA)   | Examples of Recreational and Cultural Interest Area Guide Signs  | 631 |
| Figure 2M-3       | Arrangement, Height, and Lateral Position of Signs Located Within Recreational and Cultural Interest Areas | 632 |
| Figure 2M-4       | Examples of Symbol and Destination Guide Signing Layout  | 633 |
| Figure 2M-5       | Recreational and Cultural Interest Area Symbol Signs for General Applications                              | 634 |
| Figure 2M-6       | Recreational and Cultural Interest Area Symbol Signs for Accommodations                                    | 635 |
| Figure 2M-7       | Recreational and Cultural Interest Area Symbol Signs for Services  | 635 |
| Figure 2M-8       | Recreational and Cultural Interest Area Symbol Signs for Land Recreation                                   | 636 |
| Figure 2M-8(CA)   | Recreational and Cultural Interest Area Symbol Signs for Land Recreation                                   | 636 |
| Figure 2M-9       | Recreational and Cultural Interest Area Symbol Signs for Water Recreation                                  | 637 |
| Figure 2M-10      | Recreational and Cultural Interest Area Symbol Signs for Winter Recreation                                 | 638 |
| Figure 2M-10(CA)  | Recreational and Cultural Interest Area Symbol Signs for Winter Recreation                                 | 638 |
| Figure 2M-101(CA) | Memorial or Dedication Signing   | 639 |
| Figure 2M-102(CA) | Prohibited Recreational and Cultural Interest Area Symbol Signs and Educational Plaque                     | 640 |
| Figure 2N-1       | Emergency Management Signs   | 648 |
| Figure 3A-101(CA) | Centerlines – 2 Lane Highways  | 652 |
| Figure 3A-102(CA) | Lane Lines – Multilane Highways  | 653 |
| Figure 3A-103(CA) | No Passing Zones – One Direction   | 654 |
| Figure 3A-104(CA) | No Passing Zones – Two Direction   | 655 |
| Figure 3A-105(CA) | Left Edge Lines for Divided Highways   | 656 |

|                         |  |                |
|-------------------------|--|----------------|
| Figure 3A-106(CA)       | Right Edge Line and Right Edge Line Extension Through Intersections                              | 657            |
| Figure 3A-107(CA)       | Median Islands   | 658            |
| Figure 3A-108(CA)       | Two-Way Left-Turn lanes  | 659            |
| Figure 3A-109(CA)       | Intersection Markings  | 660            |
| Figure 3A-110(CA)       | Freeway Exit and Entrance Ramp Channelizing Lines  | 661            |
| Figure 3A-111(CA)       | Lane Drop Markings   | 663            |
| Figure 3A-112(CA)       | Channelizing Line and Lane Line/Centerline Extensions  | 664            |
| Figure 3A-113(CA)       | Examples of Preferential Lane Lines  | 665            |
| Figure 3B-1             | Examples of Two-Lane, Two-Way Marking Applications   | 695            |
| Figure 3B-2             | Examples of Four-or-More Lane, Two-Way Marking Applications                                      | 696            |
| Figure 3B-3             | Examples of Three-Lane, Two-Way Marking Applications   | 697            |
| Figure 3B-4             | Method of Locating and Determining the Limits of No-Passing Zones at Curves                      | 698            |
| Figure 3B-5             | Example of Application of Three-Lane, Two-Way Marking for Changing Direction of the Center Lane  | 699            |
| Figure 3B-6             | Example of Reversible Lane Marking Application   | 700            |
| <del>Figure 3B-7</del>  | <del>Example of Two-Way Left-Turn Lane Marking Applications</del>                                | <del>701</del> |
| Figure 3B-7(CA)         | Example of Two-Way Left-Turn Lane Marking Applications   | 702            |
| <del>Figure 3B-8</del>  | <del>Examples of Dotted Line and Channelizing Line Applications for Exit Ramp Markings</del>     | <del>703</del> |
| Figure 3B-8(CA)         | Examples of Dotted Line and Channelizing Line Applications for Exit Ramp Markings                | 705            |
| <del>Figure 3B-9</del>  | <del>Examples of Dotted Line and Channelizing Line Applications for Entrance Ramp Markings</del> | <del>708</del> |
| Figure 3B-9(CA)         | Examples of Dotted Line and Channelizing Line Applications for Entrance Ramp Markings            | 710            |
| <del>Figure 3B-10</del> | <del>Examples of Applications of Freeway and Expressway Lane Drop Markings</del>                 | <del>712</del> |
| Figure 3B-10(CA)        | Examples of Applications of Freeway and Expressway Lane-Drop Markings                            | 717            |
| Figure 3B-11            | Examples of Applications of Conventional Road Lane-Drop Markings                                 | 718            |
| Figure 3B-12            | Example of Solid Double White Lines Used to Prohibit Lane Changing                               | 720            |
| Figure 3B-13            | Examples of Line Extensions through Intersections  | 721            |
| <del>Figure 3B-14</del> | <del>Examples of Applications of Lane-Reduction Transition Markings</del>                        | <del>723</del> |
| Figure 3B-14(CA)        | Examples of Applications of Lane-Reduction Transition Markings                                   | 724            |
| Figure 3B-15            | Examples of Applications of Markings for Obstructions in the Roadway                             | 727            |
| Figure 3B-16            | Recommended Yield Line Layouts   | 729            |
| Figure 3B-17            | Examples of Yield Lines at Unsignalized Midblock Crosswalks                                      | 730            |
| Figure 3B-17(CA)        | Examples of Crosswalk Enhancements at Uncontrolled Multilane Approaches                          | 731            |
| <del>Figure 3B-18</del> | <del>Do Not Block Intersection Markings</del>  | <del>732</del> |
| Figure 3B-18(CA)        | Do Not Block Intersection Markings   | 733            |
| Figure 3B-19            | Examples of Crosswalk Markings   | 734            |
| Figure 3B-19(CA)        | Examples of Crosswalk Markings   | 734            |
| Figure 3B-20            | Example of Crosswalk Markings for an Exclusive Pedestrian Phase that Permits Diagonal Crossing   | 735            |
| <del>Figure 3B-21</del> | <del>Examples of Parking Space Markings</del>  | <del>736</del> |
| Figure 3B-21(CA)        | Examples of Parking Space Markings   | 737            |
| <del>Figure 3B-22</del> | <del>International Symbol of Accessibility Parking Space Marking</del>                           | <del>738</del> |
| Figure 3B-22(CA)        | Examples of Disabled Persons Parking Symbol, Legend and Related Markings                         | 739            |
| <del>Figure 3B-23</del> | <del>Example of Elongated Letters for Word Pavement Markings</del>                               | <del>741</del> |
| Figure 3B-23(CA)        | Example of Elongated Letters for Word Pavement Markings  | 742            |
| <del>Figure 3B-24</del> | <del>Examples of Standard Arrows for Pavement Markings</del>                                     | <del>743</del> |
| Figure 3B-24(CA)        | Examples of Standard Arrows for Pavement Markings  | 745            |
| Figure 3B-25            | Examples of Elongated Route Shields for Pavement Markings  | 753            |
| Figure 3B-26            | Yield Ahead Triangle Symbols   | 753            |
| Figure 3B-27            | Examples of Lane-Use Control Word and Arrow Pavement Markings                                    | 754            |
| Figure 3B-28            | Example of the Application of Speed Reduction Markings   | 755            |
| Figure 3B-29            | Pavement Markings for Speed Humps without Crosswalks   | 756            |

|                   |  |     |
|-------------------|--|-----|
| Figure 3B-30      | Pavement Markings for Speed Tables or Speed Humps with Crosswalks                                | 757 |
| Figure 3B-31      | Advance Warning Markings for Speed Humps   | 758 |
| Figure 3B-101(CA) | Examples of Left-Turn Channelization Markings  | 759 |
| Figure 3B-102(CA) | Examples of Fire Hydrant Location Pavement Markings  | 760 |
| Figure 3B-103(CA) | Examples of Intersection Markings  | 761 |
| Figure 3B-104(CA) | Treatment of Divided Highway Illusion  | 762 |
| Figure 3B-105(CA) | Examples of Signs and Markings for Highways Where Speed is Enforced by Aircraft                  | 763 |
| Figure 3B-106(CA) | Passing Lanes  | 764 |
| Figure 3B-107(CA) | Examples of Signing and Marking Turnouts   | 765 |
| Figure 3B-108(CA) | Electric Vehicle Charging Station Pavement Marking Details                                       | 766 |
| Figure 3C-1       | Example of Markings for Approach and Circulatory Roadways at a Roundabout                        | 771 |
| Figure 3C-2       | Lane-Use Arrow Pavement Marking Options for Roundabout Approaches                                | 771 |
| Figure 3C-3       | Example of Markings for a One-Lane Roundabout  | 772 |
| Figure 3C-4       | Example of Markings for a Two-Lane Roundabout with One- and Two-Lane Approaches                  | 773 |
| Figure 3C-5       | Example of Markings for a Two-Lane Roundabout with One-Lane Exits                                | 775 |
| Figure 3C-6       | Example of Markings for a Two-Lane Roundabout with Two-Lane Exits                                | 776 |
| Figure 3C-7       | Example of Markings for a Two-Lane Roundabout with a Double Left Turn                            | 777 |
| Figure 3C-8       | Example of Markings for a Two-Lane Roundabout with a Double Right Turn                           | 778 |
| Figure 3C-9       | Example of Markings for a Two-Lane Roundabout with Consecutive Double Lefts                      | 779 |
| Figure 3C-10      | Example of Markings for a Three-Lane Roundabout with Two- and Three-Lane Approaches              | 780 |
| Figure 3C-11      | Example of Markings for a Three-Lane Roundabout with Three-Lane Approaches                       | 781 |
| Figure 3C-12      | Example of Markings for a Three-Lane Roundabout with Two-Lane Exits                              | 782 |
| Figure 3C-13      | Example of Markings for Two Linked Roundabouts   | 783 |
| Figure 3C-14      | Example of Markings for a Diamond Interchange with Two Circular-Shaped Roundabout Ramp Terminals | 784 |
| Figure 3D-1       | Markings for Barrier-Separated Preferential Lanes  | 789 |
| Figure 3D-2       | Markings for Buffer-Separated Preferential Lanes   | 789 |
| Figure 3D-3       | Markings for Contiguous Preferential Lanes   | 791 |
| Figure 3D-4       | Markings for Counter-Flow Preferential Lanes on Divided Highways                                 | 792 |
| Figure 3D-101(CA) | Diamond Symbol (HOV Lane)  | 793 |
| Figure 3F-1       | Examples of Delineator Placement   | 802 |
| Figure 3F-101(CA) | Examples of Delineators  | 803 |
| Figure 3F-102(CA) | Examples of Delineator Placement When Used at Intersections, Islands, Ramps and Connectors       | 804 |
| Figure 3F-103(CA) | Examples of Runaway Truck Ramp Signs and Markings  | 806 |
| Figure 3F-104(CA) | Narrow Bridge Signs and Markings (One-Way and Two-Way Roadways)                                  | 807 |
| Figure 3F-105(CA) | Examples of Median Barrier Delineation   | 808 |
| Figure 3H-101(CA) | Example of Channelizers  | 812 |
| Figure 3J-1       | Examples of Longitudinal Rumble Strip Markings   | 816 |
| Figure 4C-1       | Warrant 2, Four-Hour Vehicular Volume  | 836 |
| Figure 4C-2       | Warrant 2, Four-Hour Vehicular Volume (70% Factor)   | 836 |
| Figure 4C-3       | Warrant 3, Peak Hour   | 837 |
| Figure 4C-4       | Warrant 3, Peak Hour (70% Factor)  | 837 |
| Figure 4C-5       | Warrant 4, Pedestrian Four-Hour Volume   | 838 |
| Figure 4C-6       | Warrant 4, Pedestrian Four-Hour Volume (70% Factor)  | 838 |
| Figure 4C-7       | Warrant 4, Pedestrian Peak Hour  | 839 |
| Figure 4C-8       | Warrant 4, Pedestrian Peak Hour (70% Factor)   | 839 |
| Figure 4C-9       | Warrant 9, Intersection Near a Grade Crossing (One Approach Lane at the Track Crossing)          | 840 |
| Figure 4C-10      | Warrant 9, Intersection Near a Grade Crossing (Two or More Approach Lanes at the Track Crossing) | 840 |

|                   |   |     |
|-------------------|---|-----|
| Figure 4C-101(CA) | Traffic Signal Warrants Worksheet   | 841 |
| Figure 4C-102(CA) | Traffic Count Worksheet   | 846 |
| Figure 4C-103(CA) | Traffic Signal Warrants Worksheet (Average Traffic Estimate Form)   | 847 |
| Figure 4D-1       | Example of U-Turn Signal Face   | 897 |
| Figure 4D-2       | Typical Arrangements of Signal Sections in Signal Faces That Do Not Control Turning Movements   | 897 |
| Figure 4D-3       | Recommended Vehicular Signal Faces for Approaches with Posted, Statutory, or 85th-Percentile Speed of 45 mph or Higher                                  | 898 |
| Figure 4D-4       | Lateral and Longitudinal Location of Primary Signal Faces   | 899 |
| Figure 4D-5       | Maximum Mounting Height of Signal Faces Located Between 40 Feet and 53 Feet from Stop Line  | 900 |
| Figure 4D-6       | Typical Position and Arrangements of Shared Signal Faces for Permissive Only Mode Left Turns  | 900 |
| Figure 4D-7       | Typical Position and Arrangements of Separate Signal Faces with Flashing Yellow Arrow for Permissive Only Mode Left Turns                               | 901 |
| Figure 4D-8       | Typical Position and Arrangements of Separate Signal Faces with Flashing Red Arrow for Permissive Only Mode and Protected/Permissive Mode Left Turns    | 901 |
| Figure 4D-9       | Typical Positions and Arrangements of Shared Signal Faces for Protected Only Mode Left Turns  | 902 |
| Figure 4D-10      | Typical Position and Arrangements of Separate Signal Faces for Protected Only Mode Left Turns   | 903 |
| Figure 4D-11      | Typical Position and Arrangements of Shared Signal Faces for Protected/Permissive Mode Left Turns   | 903 |
| Figure 4D-12      | Typical Position and Arrangements of Separate Signal Faces with Flashing Yellow Arrow for Protected/Permissive Mode and Protected Only Mode Left Turns  | 904 |
| Figure 4D-13      | Typical Positions and Arrangements of Shared Signal Faces for Permissive Only Mode Right Turns  | 904 |
| Figure 4D-14      | Typical Position and Arrangements of Separate Signal Faces with Flashing Yellow Arrow for Permissive Only Mode Right Turns                              | 905 |
| Figure 4D-15      | Typical Position and Arrangements of Separate Signal Faces with Flashing Red Arrow for Permissive Only Mode and Protected/Permissive Mode Right Turns   | 905 |
| Figure 4D-16      | Typical Positions and Arrangements of Shared Signal Faces for Protected Only Mode Right Turns   | 906 |
| Figure 4D-17      | Typical Position and Arrangements of Separate Signal Faces for Protected Only Mode Right Turns  | 907 |
| Figure 4D-18      | Typical Positions and Arrangements of Shared Signal Faces for Protected/Permissive Mode Right Turns   | 908 |
| Figure 4D-19      | Typical Position and Arrangements of Separate Signal Faces with Flashing Yellow Arrow for Protected/Permissive Mode and Protected Only Mode Right Turns | 909 |
| Figure 4D-20      | Signal Indications for Approaches with a Shared Left-Turn/Right-Turn Lane and No Through Movement   | 910 |
| Figure 4D-101(CA) | Left-Turn Phasing Methods (Phase Diagrams)  | 913 |
| Figure 4D-102(CA) | Typical Signal Layout at Offset Intersections, Signalized and Marked as a Single Intersection   | 914 |
| Figure 4D-103(CA) | Typical Signal Layout (Two Phase Operation)   | 918 |
| Figure 4D-104(CA) | Typical Signal Layout (Three Phase Operation)   | 919 |
| Figure 4D-105(CA) | Typical Signal Layout (Five Phase "Dual Left" Operation)  | 920 |
| Figure 4D-106(CA) | Typical Signal Layout (Six Phase "Opposing" Operation)  | 921 |
| Figure 4D-107(CA) | Typical Signal Layout (Eight Phase "Quad Left" Operation)   | 922 |
| Figure 4D-108(CA) | Typical Traffic Signal Installation   | 923 |
| Figure 4D-109(CA) | Diamond Interchange Timing Chart (Heavy Left-Turn – 200 vphpl or More – Using Two Controllers)  | 924 |
| Figure 4D-110(CA) | Diamond Interchange Timing Chart (Light Left-Turn – 200 vphpl or Less– Using Two Controllers)   | 925 |

|                         |  |                 |
|-------------------------|--|-----------------|
| Figure 4D-111(CA)       | Bicycle Detection Systems  | 926             |
| Figure 4D-112(CA)       | Example of Bicycle Signal Face   | 929             |
| Figure 4E-1             | Typical Pedestrian Signal Indications  | 953             |
| Figure 4E-2             | Pedestrian Intervals   | 954             |
| Figure 4E-3             | Pushbutton Location Area   | 955             |
| Figure 4E-4             | Typical Pushbutton Locations   | 956             |
| Figure 4F-1             | Guidelines for the Installation of Pedestrian Hybrid Beacons on Low-Speed Roadways                     | 962             |
| Figure 4F-2             | Guidelines for the Installation of Pedestrian Hybrid Beacons on High-Speed Roadways                    | 962             |
| Figure 4F-3             | Sequence for a Pedestrian Hybrid Beacon  | 963             |
| Figure 4G-1             | Sequence for an Emergency-Vehicle Hybrid Beacon  | 968             |
| Figure 4L-101(CA)       | Flashing Beacon at School Crossings Worksheet  | 984             |
| Figure 4M-1             | Left-Turn Lane-Use Control Signals   | 988             |
| Figure 4M-101(CA)       | Example of Lane Control Signal Face  | 988             |
| Figure 4N-101(CA)       | Typical Layout For In Roadway Warning Lights (IRWL's)  | 992             |
| Figure 5B-1             | Regulatory Signs on Low-Volume Roads   | 998             |
| <del>Figure 5B-2</del>  | <del>Parking Signs and Plaques on Low-Volume Roads</del>   | <del>998</del>  |
| Figure 5C-1             | Horizontal Alignment and Intersection Warning Signs and Plaques and Object Markers on Low-Volume Roads | 1002            |
| Figure 5C-2             | Other Warning Signs and Plaques on Low-Volume Roads  | 1003            |
| Figure 5C-2(CA)         | Other Warning Signs and Plaques on Low-Volume Roads  | 1004            |
| Figure 5F-1             | Highway-Rail Grade Crossing Signs and Plaques for Low-Volume Roads                                     | 1010            |
| Figure 5G-1             | Temporary Traffic Control Signs and Plaques on Low-Volume Roads  | 1012            |
| Figure 6C-1             | Component Parts of a Temporary Traffic Control Zone  | 1029            |
| Figure 6C-2             | Types of Tapers and Buffer Spaces  | 1030            |
| Figure 6C-3             | Example of a One-Lane, Two-Way Traffic Taper   | 1031            |
| Figure 6E-1             | Example of the Use of a STOP/SLOW Automated Flagger Assistance Device (AFAD)                           | 1049            |
| Figure 6E-2             | Example of the Use of a Red/Yellow Lens Automated Flagger Assistance Device (AFAD)                     | 1050            |
| Figure 6E-3             | Use of Hand-Signaling Devices by Flaggers  | 1051            |
| Figure 6F-1             | Height and Lateral Location of Signs—Typical Installations   | 1098            |
| Figure 6F-2             | Methods of Mounting Signs Other Than on Posts  | 1099            |
| Figure 6F-3             | Regulatory Signs and Plaques in Temporary Traffic Control Zones  | 1100            |
| Figure 6F-4             | Warning Signs and Plaques in Temporary Traffic Control Zones   | 1102            |
| Figure 6F-5             | Exit Open and Closed and Detour Signs  | 1105            |
| Figure 6F-6             | Advance Warning Arrow Board Display Specifications   | 1106            |
| Figure 6F-7             | Channelizing Devices   | 1107            |
| Figure 6F-101(CA)       | California Temporary Traffic Control Signs   | 1108            |
| Figure 6F-102(CA)       | Channelizer (CA) and Portable Delineator   | 1110            |
| Figure 6F-103(CA)       | Examples of Object Markers in Temporary Traffic Control Zones  | 1111            |
| Figure 6F-104(CA)       | Typical Layout Using Channelizing Devices to Delineate a Portable Changeable Message Sign on Shoulder  | 1112            |
| Figure 6H-1             | Work Beyond the Shoulder (TA-1)  | 1139            |
| Figure 6H-2             | Blasting Zone (TA-2)   | 1141            |
| Figure 6H-3             | Work on the Shoulders (TA-3)   | 1143            |
| Figure 6H-4             | Short-Duration or Mobile Operation on a Shoulder (TA-4)  | 1145            |
| <del>Figure 6H-5</del>  | <del>Shoulder Closure on a Freeway (TA-5)</del>  | <del>1147</del> |
| Figure 6H-5(CA)         | Shoulder Closure on a Freeway (TA-5)   | 1148            |
| Figure 6H-6             | Shoulder Work with Minor Encroachment (TA-6)   | 1150            |
| Figure 6H-7             | Road Closure with a Diversion (TA-7)   | 1152            |
| Figure 6H-8             | Road Closure with an Off-Site Detour (TA-8)  | 1154            |
| Figure 6H-9             | Overlapping Routes with a Detour (TA-9)  | 1156            |
| <del>Figure 6H-10</del> | <del>Lane Closure on a Two-Lane Road Using Flaggers (TA-10)</del>                                      | <del>1158</del> |



|                         |   |                 |
|-------------------------|---|-----------------|
| Figure 6H-10(CA)        | Lane Closure on a Two-Lane Road Using Flaggers (TA-10)  | 1159            |
| Figure 6H-10A(CA)       | Lane Closure on a Two-Lane Road Using Flaggers (TA-10A) Using Portable Transverse Rumble Strips       | 1160            |
| Figure 6H-11            | Lane Closure on a Two-Lane Road with Low Traffic Volumes (TA-11)                                      | 1162            |
| Figure 6H-12            | Lane Closure on a Two-Lane Road Using Traffic Control Signals (TA-12)                                 | 1164            |
| Figure 6H-13            | Temporary Road Closure (TA-13)  | 1166            |
| <del>Figure 6H-14</del> | <del>Haul Road Crossing (TA-14)</del>   | <del>1168</del> |
| Figure 6H-14(CA)        | Haul Road Crossing (TA-14)  | 1169            |
| Figure 6H-15            | Work in the Center of a Road with Low Traffic Volumes (TA-15)   | 1171            |
| Figure 6H-16            | Surveying Along the Center Line of a Road with Low Traffic Volumes (TA-16)                            | 1173            |
| Figure 6H-17            | Mobile Operations on a Two-Lane Road (TA-17)  | 1175            |
| Figure 6H-18            | Lane Closure on a Minor Street (TA-18)  | 1177            |
| Figure 6H-19            | Detour for One Travel Direction (TA-19)   | 1179            |
| Figure 6H-20            | Detour for a Closed Street (TA-20)  | 1181            |
| Figure 6H-21            | Lane Closure on the Near Side of an Intersection (TA-21)  | 1183            |
| Figure 6H-22            | Right-Hand Lane Closure on the Far Side of an Intersection (TA-22)                                    | 1185            |
| Figure 6H-22A(CA)       | Right-Hand Lane Closure on the Far Side of an Intersection (TA-22A(CA))                               | 1186            |
| Figure 6H-22B(CA)       | Right-Hand Lane Closure on the Far Side of an Intersection (TA-22B(CA))                               | 1187            |
| Figure 6H-23            | Left-Hand Lane Closure on the Far Side of an Intersection (TA-23)                                     | 1189            |
| Figure 6H-24            | Half Road Closure on the Far Side of an Intersection (TA-24)  | 1191            |
| Figure 6H-24A(CA)       | Half Road Closure on the Far Side of an Intersection (TA-24A(CA))                                     | 1192            |
| Figure 6H-25            | Multiple Lane Closures at an Intersection (TA-25)   | 1194            |
| Figure 6H-25A(CA)       | Multiple Lane Closures at an Intersection (TA-25A(CA))  | 1195            |
| Figure 6H-26            | Closure in the Center of an Intersection (TA-26)  | 1197            |
| Figure 6H-27            | Closure at the Side of an Intersection (TA-27)  | 1199            |
| Figure 6H-28            | Sidewalk Detour or Diversion (TA-28)  | 1201            |
| Figure 6H-29            | Crosswalk Closures and Pedestrian Detours (TA-29)   | 1203            |
| Figure 6H-30            | Interior Lane Closure on a Multi-Lane Street (TA-30)  | 1205            |
| Figure 6H-31            | Lane Closures on a Street with Uneven Directional Volumes (TA-31)                                     | 1207            |
| <del>Figure 6H-32</del> | <del>Half Road Closure on a Multi-Lane, High-Speed Highway (TA-32)</del>                              | <del>1209</del> |
| Figure 6H-32(CA)        | Half Road Closure on a Multi-Lane, High-Speed Highway (TA-32)   | 1210            |
| Figure 6H-33            | Stationary Lane Closure on a Divided Highway (TA-33)  | 1212            |
| Figure 6H-34            | Lane Closure with a Temporary Traffic Barrier (TA-34)   | 1214            |
| Figure 6H-35            | Mobile Operation on a Multi-Lane Road (TA-35)   | 1216            |
| <del>Figure 6H-36</del> | <del>Lane Shift on a Freeway (TA-36)</del>  | <del>1219</del> |
| Figure 6H-36(CA)        | Lane Shift on a Freeway (TA-36)   | 1220            |
| Figure 6H-37            | Double Lane Closure on a Freeway (TA-37)  | 1222            |
| <del>Figure 6H-38</del> | <del>Interior Lane Closure on a Freeway (TA-38)</del>   | <del>1224</del> |
| Figure 6H-39            | Median Crossover on a Freeway (TA-39)   | 1225            |
| Figure 6H-40            | Median Crossover for an Entrance Ramp (TA-40)   | 1227            |
| Figure 6H-41            | Median Crossover for an Exit Ramp (TA-41)   | 1229            |
| Figure 6H-42            | Work in the Vicinity of an Exit Ramp (TA-42)  | 1232            |
| Figure 6H-43            | Partial Exit Ramp Closure (TA-43)   | 1234            |
| Figure 6H-44            | Work in the Vicinity of an Entrance Ramp (TA-44)  | 1236            |
| Figure 6H-45            | Temporary Reversible Lane Using Movable Barriers (TA-45)  | 1238            |
| Figure 6H-46            | Work in the Vicinity of a Grade Crossing (TA-46)  | 1240            |
| Figure 6H-101(CA)       | Shoulder Closure on Urban (Low Speed) Locations to Accommodate Bicyclists                             | 1242            |
| Figure 6H-102(CA)       | Lane Closure on Freeway, Expressway, Rural and Urban (High Speed) Locations to Accommodate Bicyclists | 1244            |
| Figure 6H-103(CA)       | Detour for Bike Lane on Roads with Closure of One Travel Direction                                    | 1246            |
| Figure 6H-104(CA)       | Right Lane and Bike Lane Closure on Far Side of Intersection  | 1248            |
| Figure 6H-105(CA)       | Lane Shift on Road with Low Traffic Volumes   | 1250            |
| Figure 6I-1             | Examples of Traffic Incident Management Area Signs  | 1255            |
| Figure 6I-1(CA)         | Examples of Traffic Incident Management Area Signs  | 1255            |

|                                   |  |                      |
|-----------------------------------|--|----------------------|
| Figure 7A-1                       | Example of School Route Plan Map   | 1260                 |
| Figure 7B-1                       | School Area Signs  | 1269                 |
| <a href="#">Figure 7B-1(CA)</a>   | <a href="#">School Area Signs</a>  | <a href="#">1270</a> |
| <del>Figure 7B-2</del>            | <del>Example of Signing for a Higher Fines School Zone without a School Crossing</del>                                   | <del>1272</del>      |
| <del>Figure 7B-3</del>            | <del>Example of Signing for a Higher Fines School Zone with a School Speed Limit</del>                                   | <del>1273</del>      |
| Figure 7B-4                       | Example of Signing for a School Crossing Outside of a School Zone  | 1274                 |
| Figure 7B-5                       | Example of Signing for a School Zone with a School Speed Limit and a School Crossing                                     | 1275                 |
| <a href="#">Figure 7B-5(CA)</a>   | <a href="#">Example of Signing for a School Zone with a School Speed Limit and a School Crossing</a>                     | <a href="#">1276</a> |
| Figure 7B-6                       | In-Street Signs in School Areas  | 1277                 |
| <a href="#">Figure 7B-101(CA)</a> | <a href="#">Example of School Area Signs with Flashing Yellow Beacons</a>  | <a href="#">1278</a> |
| <a href="#">Figure 7B-102(CA)</a> | <a href="#">Example of Signing for Traffic Control in School Areas with Flashing Yellow Beacons</a>                      | <a href="#">1279</a> |
| <a href="#">Figure 7B-103(CA)</a> | <a href="#">Example of Signing for School Area Traffic Control with Extended and/or Reduced School Zone Speed Limits</a> | <a href="#">1280</a> |
| <a href="#">Figure 7B-104(CA)</a> | <a href="#">Example of Signing for School Crosswalk Warning Assembly</a>   | <a href="#">1281</a> |
| <del>Figure 7C-1</del>            | <del>Two-Lane Pavement Marking of "SCHOOL"</del>   | <del>1285</del>      |
| <a href="#">Figure 7C-101(CA)</a> | <a href="#">Pavement Word Markings for School Areas</a>  | <a href="#">1286</a> |
| Figure 8B-1                       | Regulatory Signs and Plaques for Grade Crossings   | 1310                 |
| <a href="#">Figure 8B-1(CA)</a>   | <a href="#">Regulatory Signs and Plaques for Grade Crossings</a>   | <a href="#">1311</a> |
| Figure 8B-2                       | Crossbuck Assembly with a YIELD or STOP Sign on the Crossbuck Sign Support   | 1311                 |
| Figure 8B-3                       | Crossbuck Assembly with a YIELD or STOP Sign on a Separate Sign Support  | 1312                 |
| Figure 8B-4                       | Warning Signs and Plaques for Grade Crossings  | 1314                 |
| <a href="#">Figure 8B-4(CA)</a>   | <a href="#">Warning Signs and Plaques for Grade Crossings</a>  | <a href="#">1314</a> |
| Figure 8B-5                       | Example of an Emergency Notification Sign  | 1314                 |
| <del>Figure 8B-6</del>            | <del>Example of Placement of Warning Signs and Pavement Markings at Grade Crossings</del>                                | <del>1315</del>      |
| <a href="#">Figure 8B-6(CA)</a>   | <a href="#">Example of Placement of Warning Signs and Pavement Markings at Grade Crossings</a>                           | <a href="#">1316</a> |
| <del>Figure 8B-7</del>            | <del>Grade Crossing Pavement Markings</del>  | <del>1319</del>      |
| <a href="#">Figure 8B-7(CA)</a>   | <a href="#">Grade Crossing Pavement Markings</a>   | <a href="#">1320</a> |
| <del>Figure 8B-8</del>            | <del>Example of Dynamic Envelope Pavement Markings at Grade Crossings</del>  | <del>1321</del>      |
| Figure 8B-9                       | Examples of Light Rail Transit Vehicle Dynamic Envelope Markings for Mixed-Use Alignments                                | 1322                 |
| <a href="#">Figure 8B-101(CA)</a> | <a href="#">Train Station Signs</a>  | <a href="#">1323</a> |
| Figure 8C-1                       | Composite Drawing of Active Traffic Control Devices for Grade Crossings Showing Clearances                               | 1337                 |
| Figure 8C-2                       | Example of Location Plan for Flashing-Light Signals and Four-Quadrant Gates  | 1338                 |
| <del>Figure 8C-3</del>            | <del>Light Rail Transit Signals</del>  | <del>1339</del>      |
| <a href="#">Figure 8C-3(CA)</a>   | <a href="#">Light Rail Transit Signals</a>   | <a href="#">1340</a> |
| Figure 8C-4                       | Example of Flashing-Light Signal Assembly for Pedestrian Crossings   | 1341                 |
| Figure 8C-5                       | Example of a Shared Pedestrian/Roadway Gate  | 1342                 |
| Figure 8C-6                       | Example of a Separate Pedestrian Gate  | 1342                 |
| Figure 8C-7                       | Examples of Placement of Pedestrian Gates  | 1343                 |
| Figure 8C-8                       | Example of Swing Gates   | 1344                 |
| Figure 8C-9                       | Example of Pedestrian Barriers at an Offset Grade Crossing   | 1344                 |
| Figure 8C-10                      | Examples of Pedestrian Barrier Installation at an Offset Non-Intersection Grade Crossing                                 | 1345                 |
| Figure 8D-1                       | Example of Signing and Markings for a Pathway Grade Crossing   | 1350                 |
| Figure 9B-1                       | Sign Placement on Shared-Use Paths   | 1364                 |
| Figure 9B-2                       | Regulatory Signs and Plaques for Bicycle Facilities  | 1365                 |
| <a href="#">Figure 9B-2(CA)</a>   | <a href="#">California Regulatory Signs for Bicycle Facilities</a>   | <a href="#">1366</a> |
| Figure 9B-3                       | Warning Signs and Plaques and Object Markers for Bicycle Facilities  | 1367                 |
| Figure 9B-4                       | Guide Signs and Plaques for Bicycle Facilities   | 1368                 |
| <a href="#">Figure 9B-4(CA)</a>   | <a href="#">California Guide Signs for Bicycle Facilities</a>  | <a href="#">1370</a> |

|                   |   |      |
|-------------------|---|------|
| Figure 9B-5       | Example of Signing for the Beginning and End of a Designated Bicycle Route on a Shared-Use Path   | 1371 |
| Figure 9B-6       | Example of Bicycle Guide Signing  | 1372 |
| Figure 9B-7       | Examples of Signing and Markings for a Shared-Use Path Crossing   | 1373 |
| Figure 9B-8       | Example of Mode-Specific Guide Signing on a Shared-Use Path   | 1374 |
| Figure 9C-1       | Example of Intersection Pavement Markings—Designated Bicycle Lane with Left-Turn Area, Heavy Turn Volumes, Parking, One-Way Traffic, or Divided Highway | 1387 |
| Figure 9C-2       | Examples of Center Line Markings for Shared-Use Paths   | 1388 |
| Figure 9C-3       | Word, Symbol, and Arrow Pavement Markings for Bicycle Lanes   | 1389 |
| Figure 9C-4       | Example of Bicycle Lane Treatment at a Right Turn Only Lane   | 1390 |
| Figure 9C-4(CA)   | Example of Bicycle Lane Treatment at a Right Turn Only Lane   | 1391 |
| Figure 9C-5       | Example of Bicycle Lane Treatment at Parking Lane into a Right Turn Only Lane   | 1394 |
| Figure 9C-6       | Example of Pavement Markings for Bicycle Lanes on a Two-Way Street  | 1395 |
| Figure 9C-7       | Bicycle Detector Pavement Marking   | 1396 |
| Figure 9C-8       | Examples of Obstruction Pavement Markings   | 1397 |
| Figure 9C-9       | Shared Lane Marking   | 1397 |
| Figure 9C-101(CA) | Marking Details for Bicycle Lanes   | 1398 |
| Figure 9C-102(CA) | Examples of Bicycle Lane Treatment Where Vehicle Parking is Prohibited/Permitted  | 1399 |
| Figure 9C-103(CA) | Example of Bicycle Lane Treatment Through an Interchange  | 1400 |
| Figure 9C-104(CA) | Examples of Markings for Buffered Bicycle Lanes Where Vehicle Parking is Prohibited/Permitted   | 1401 |
| Figure 9C-105(CA) | Example of Contraflow Bicycle Lanes   | 1403 |
| Figure 9C-106(CA) | Example of Bicycle Lane Extensions Through an Intersection  | 1404 |
| Figure 9C-107(CA) | Example of Marking for a One-Lane Roundabout with Shared Lane Markings and Bicycle Lanes  | 1405 |
| Figure 9C-108(CA) | Example of Placement of Shared Lane Markings  | 1406 |
| Figure 9C-109(CA) | Example of Shared Lane Markings While Approaching an Intersection   | 1407 |
| Figure 9C-110(CA) | Example of Markings for Separated Bikeways  | 1401 |

## LIST OF TABLES

|                                  |   | <u>Page</u>    |
|----------------------------------|---|----------------|
| Table I-1                        | Evolution of the MUTCD  | 49             |
| <a href="#">Table I-1(CA)</a>    | <a href="#">Evolution of the California MUTCD</a>   | 49             |
| Table I-2                        | Target Compliance Dates Established by the FHWA   | 50             |
| <a href="#">Table I-2(CA)</a>    | <a href="#">Target Compliance Dates Established by CTCDC/Caltrans</a>                               | 51             |
| <a href="#">Table 1A-101(CA)</a> | <a href="#">Status of Interim Approvals Issued By FHWA in California</a>                            | 64             |
| Table 1A-1                       | Acceptable Abbreviations  | 96             |
| Table 1A-2                       | Abbreviations that Shall be Used Only on Portable Changeable Message Signs                          | 97             |
| Table 1A-3                       | Unacceptable Abbreviations  | 98             |
| Table 2A-1                       | Illumination of Sign Elements   | 120            |
| Table 2A-2                       | Retroreflection of Sign Elements  | 120            |
| Table 2A-3                       | Minimum Maintained Retroreflectivity Levels   | 121            |
| Table 2A-4                       | Use of Sign Shapes  | 122            |
| <del>Table 2A-5</del>            | <del>Common Uses of Sign Colors</del>   | <del>123</del> |
| <a href="#">Table 2A-5(CA)</a>   | <a href="#">Common Uses of Sign Colors</a>  | 124            |
| <a href="#">Table 2B-1</a>       | <a href="#">Regulatory Sign and Plaque Sizes</a>  | 244            |
| <a href="#">Table 2B-1(CA)</a>   | <a href="#">California Regulatory Sign and Plaque Sizes</a>   | 248            |
| Table 2B-2                       | Meanings of Symbols and Legends on Reversible Lane Control Signs                                    | 254            |
| <a href="#">Table 2B-101(CA)</a> | <a href="#">Standard Application of Speed Limits per California Vehicle Code</a>                    | 254            |
| <a href="#">Table 2B-102(CA)</a> | <a href="#">Optional Application of Speed Limits per California Vehicle Code</a>                    | 255            |
| Table 2C-1                       | Categories of Warning Signs and Plaques   | 306            |
| Table 2C-2                       | Warning Sign and Plaque Sizes   | 307            |
| <a href="#">Table 2C-2(CA)</a>   | <a href="#">California Warning Sign and Plaque Sizes</a>  | 310            |
| Table 2C-3                       | Minimum Size of Supplemental Warning Plaques  | 311            |
| Table 2C-4                       | Guidelines for Advance Placement of Warning Signs   | 312            |
| Table 2C-5                       | Horizontal Alignment Sign Selection   | 312            |
| Table 2C-6                       | Approximate Spacing of Chevron Alignment Signs on Horizontal Curves                                 | 313            |
| <a href="#">Table 2C-101(CA)</a> | <a href="#">California Object Markers</a>   | 313            |
| Table 2D-1                       | Conventional Road Guide Sign Sizes  | 381            |
| <a href="#">Table 2D-1(CA)</a>   | <a href="#">California Conventional Road Guide Sign Sizes</a>                                       | 382            |
| Table 2D-2                       | Recommended Minimum Letter Heights on Street Name Signs   | 383            |
| <a href="#">Table 2D-101(CA)</a> | <a href="#">Route Shield Sizes for Guide Signs</a>  | 384            |
| <a href="#">Table 2D-102(CA)</a> | <a href="#">Criteria for Supplemental Destination Signs</a>   | 385            |
| Table 2E-1                       | Freeway or Expressway Guide Sign and Plaque Sizes   | 458            |
| <a href="#">Table 2E-1(CA)</a>   | <a href="#">California Freeway or Expressway Guide Sign and Plaque Sizes</a>                        | 460            |
| Table 2E-2                       | Minimum Letter and Numeral Sizes for Expressway Guide Signs According to Interchange Classification | 461            |
| Table 2E-3                       | Minimum Letter and Numeral Sizes for Expressway Guide Signs According to Sign Type                  | 462            |
| Table 2E-4                       | Minimum Letter and Numeral Sizes for Freeway Guide Signs According to Interchange Classification    | 463            |
| Table 2E-5                       | Minimum Letter and Numeral Sizes for Freeway Guide Signs According to Sign Type                     | 464            |
| Table 2F-1                       | Toll Facility Sign and Plaque Minimum Sizes   | 482            |
| Table 2G-1                       | Managed and Preferential Lanes Sign and Plaque Minimum Sizes  | 531            |
| <a href="#">Table 2G-1(CA)</a>   | <a href="#">California Managed and Preferential Lanes Sign and Plaque Minimum Sizes</a>             | 532            |
| Table 2H-1                       | General Information Sign Sizes  | 548            |
| <a href="#">Table 2H-1(CA)</a>   | <a href="#">California General Information Sign Sizes</a>   | 549            |
| Table 2I-1                       | General Service Sign and Plaque Sizes   | 580            |
| <a href="#">Table 2I-1(CA)</a>   | <a href="#">California General Service Sign and Plaque Sizes</a>                                    | 581            |
| Table 2J-1                       | Minimum Letter and Numeral Sizes for Specific Service Signs According to Sign                       |                |

|                  |   |      |
|------------------|---|------|
|                  | Type  | 599  |
| Table 2J-101(CA) | California Specific Service Sign and Plaque Sizes   | 599  |
| Table 2K-101(CA) | California Tourist-Oriented Directional Sign Sizes  | 607  |
| Table 2L-1       | Example of Units of Information   | 614  |
| Table 2M-1       | Category Chart for Recreational and Cultural Interest Area Symbols  | 641  |
| Table 2M-1(CA)   | California Category Chart for Recreational and Cultural Interest Area Symbols   | 642  |
| Table 2M-101(CA) | California Recreational and Cultural Interest Area Sign and Plaque Sizes  | 643  |
| Table 2N-1       | Emergency Management Sign Sizes   | 648  |
| Table 3B-1       | Minimum Passing Sight Distances for No-Passing Zone Markings  | 767  |
| Table 3D-1       | Standard Edge Line and Lane Line Markings for Preferential Lanes  | 794  |
| Table 3F-1       | Approximate Spacing for Delineators on Horizontal Curves  | 808  |
| Table 4C-1       | Warrant 1, Eight-Hour Vehicular Volume  | 848  |
| Table 4C-2       | Warrant 9, Adjustment Factor for Daily Frequency of Rail Traffic  | 849  |
| Table 4C-3       | Warrant 9, Adjustment Factor for Percentage of High-Occupancy Buses   | 849  |
| Table 4C-4       | Warrant 9, Adjustment Factor for Percentage of Tractor-Trailer Trucks   | 849  |
| Table 4D-1       | Recommended Minimum Number of Primary Signal Faces for Through Traffic on Approaches with Posted, Statutory, or 85th-Percentile Speed of 45 mph or Higher | 930  |
| Table 4D-2       | Minimum Sight Distance for Signal Visibility  | 930  |
| Table 4D-101(CA) | Suggested Detector Setbacks from Limit Line   | 931  |
| Table 4D-102(CA) | Minimum Yellow Change Interval  | 932  |
| Table 4D-103(CA) | Traffic Signal Timing Analysis Chart  | 933  |
| Table 4D-104(CA) | Signal Operations – Vehicular Speed   | 934  |
| Table 4D-105(CA) | Pole and Equipment Schedule   | 935  |
| Table 4D-106(CA) | Conductor and Conduit Schedule  | 936  |
| Table 4D-107(CA) | Available Conduit Area  | 937  |
| Table 4D-108(CA) | Conductor Size  | 938  |
| Table 4D-109(CA) | Signal Operations – Minimum Bicycle Timing  | 939  |
| Table 5A-1       | Sign and Plaque Sizes on Low-Volume Roads   | 995  |
| Table 6C-1       | Recommended Advance Warning Sign Minimum Spacing  | 1032 |
| Table 6C-2       | Stopping Sight Distance as a Function of Speed  | 1032 |
| Table 6C-3       | Taper Length Criteria for Temporary Traffic Control Zones   | 1032 |
| Table 6C-3(CA)   | Taper Length Criteria for Temporary Traffic Control Zones (for 12 feet Offset Width)  | 1033 |
| Table 6C-4       | Formulas for Determining Taper Length   | 1033 |
| Table 6C-101(CA) | Stopping Sight Distance as a Function of Speed on Downgrades  | 1034 |
| Table 6E-1       | Stopping Sight Distance as a Function of Speed  | 1052 |
| Table 6E-101(CA) | Longitudinal Buffer Space or Flagger Station Spacing on Downgrades  | 1052 |
| Table 6F-1       | Temporary Traffic Control Zone Sign and Plaque Sizes  | 1113 |
| Table 6F-1(CA)   | California Temporary Traffic Control Zone Sign and Plaque Sizes   | 1116 |
| Table 6F-101(CA) | Maximum Spacing of Channelizing Devices   | 1117 |
| Table 6F-102(CA) | Pavement Surface Tolerances   | 1118 |
| Table 6H-1       | Index to Typical Applications   | 1134 |
| Table 6H-1(CA)   | Index to Typical Applications   | 1135 |
| Table 6H-2       | Meaning of Symbols on Typical Application Diagrams  | 1135 |
| Table 6H-3       | Meaning of Letter Codes on Typical Application Diagrams   | 1136 |
| Table 6H-4       | Formulas for Determining Taper Length   | 1136 |
| Table 6H-4(CA)   | Taper Length Criteria for Temporary Traffic Control Zones (for 12 feet Offset Width)  | 1137 |
| Table 7B-1       | School Area Sign and Plaque Sizes   | 1282 |
| Table 7B-1(CA)   | California School Area Sign Assembly Sizes  | 1282 |
| Table 8B-1       | Grade Crossing Sign and Plaque Minimum Sizes  | 1324 |
| Table 8B-1(CA)   | California Grade Crossing Sign and Plaque Minimum Sizes   | 1325 |
| Table 9B-1       | Bicycle Facility Sign and Plaque Minimum Sizes  | 1375 |
| Table 9B-1(CA)   | California Bicycle Facility Sign and Plaque Minimum Sizes   | 1377 |
| Table A2-1       | Conversion of Inches to Millimeters   | 1417 |

|            |   |      |
|------------|---|------|
| Table A2-2 | Conversion of Feet to Meters                    | 1417 |
| Table A2-3 | Conversion of Miles to Kilometers               | 1417 |
| Table A2-4 | Conversion of Miles per Hour to Kilometers/Hour | 1417 |

## ***CALIFORNIA MANUAL ON UNIFORM TRAFFIC CONTROL DEVICES 2014***

### **FOREWORD**

The California Department of Transportation (Caltrans) is pleased to announce the 2014 update of the *California Manual on Uniform Traffic Control Devices* (CA MUTCD). This update coincides with implementation of Caltrans' 2014 mission to provide a safe, sustainable, integrated, and efficient transportation system to enhance California's economy and livability. This update to the CA MUTCD aims to improve safety and mobility for all travelers in California by providing guidance to transportation practitioners that strives to balance safety and convenience for everyone in traffic—drivers, pedestrians, and bicyclists.

Significantly, the CA MUTCD integrates multimodal policies for safer crossings, work zones, and intersections, with improvements including:

- Crosswalks Enhancements Policy (TOPD 12–03, CA MUTCD 2014 Section 3B.18)
- Temporary Traffic Control Plans (CA MUTCD 2014 Section 6C.01)
- Work Zone and Higher Fines Signs and Plaques (CA MUTCD 2014 Section 6F.12)
- Traffic Control for School Areas (CA MUTCD 2014 Part 7)

As part of this update, Section 1A.10 of the CA MUTCD now includes Table 1A-101(CA), “Status of Interim Approvals Issued By FHWA in California,” which lists adopted statewide policies or approvals authorized by the Federal Highway Administration (FHWA) for use on all California streets and highways (without the Section 1A.10 experimentation approval requirement). Caltrans regularly updates the CA MUTCD with guidance from the California Traffic Control Devices Committee (CTCDC). We encourage all practitioners to not only use this manual but also to visit the CTCDC Web site at <http://www.dot.ca.gov/traffops/engineering/ctcdc/> for the most recent updates and actions by the CTCDC.

In addition, on April 11, 2014, Caltrans endorsed the National Association of City Transportation Officials (NACTO) *Urban Street Design Guide* as a valuable resource when making planning and design decisions about the State Highway System and local streets and roads. The NACTO *Urban Street Design Guide* includes many concepts contained in *Main Street, California: A Guide for Improving Community Transportation Vitality*. Similarly, much of the NACTO *Urban Bikeway Design Guide* is consistent with the guidance provided in the CA MUTCD for related topics. We continue to analyze NACTO guidance and will work with all stakeholders to ensure flexibility and innovation in the design and operation of California streets and highways.

As Caltrans continues to implement its new mission, transportation practitioners should rely on the CA MUTCD for mandatory standards, guidance, and options for twenty-first-century operation of California's multimodal transportation system.



MALCOLM DOUGHERTY  
Director  
California Department of Transportation





## CALIFORNIA MANUAL ON UNIFORM TRAFFIC CONTROL DEVICES

### INTRODUCTION

#### Support:

<sup>00a</sup> This California Manual on Uniform Traffic Control Devices (California MUTCD) is published by the State of California, Caltrans and is issued to adopt uniform standards and specifications for all official traffic control devices in California, in accordance with Section 21400 of the California Vehicle Code (CVC).

<sup>00b</sup> This California MUTCD incorporates Federal Highway Administration's Manual on Uniform Traffic Control Devices (2009 Edition) dated December 16, 2009 and the previous California MUTCD dated January 13, 2012. It also incorporates all policies on traffic control devices issued by Caltrans that have been issued since January 13, 2012 and other editorial, errata and format changes that were necessary to update the previous documents.

#### Standard:

<sup>00c</sup> **The California MUTCD is hereby adopted as, and shall be the standard for all official traffic control devices, under Section 11340.9(h) of California Government Code and Section 21400 of California Vehicle Code.**

#### Support:

<sup>00d</sup> The California MUTCD supersedes and replaces the previously adopted (on January 13, 2012) California MUTCD. It does not supersede Caltrans' Standard Plans, Standard Specifications or the Standard Special Provisions publications.

<sup>00e</sup> Caltrans publishes Standard Specifications, Standard Special Provisions, Standard Plans and other manuals, which contain specifications and requirements for traffic control devices, including their use and placement, when performing work on State highways. In some cases those specifications and requirements can vary from, and be more stringent than those shown in the California MUTCD.

#### Standard:

<sup>00f</sup> **On State highways, the California MUTCD shall mean to include Caltrans' Standard Plans, Standard Specifications and Standard Special Provisions publications.**

<sup>00g</sup> **On State highways, the California MUTCD shall not supersede Caltrans' Standard Plans, Standard Specifications or the Special Provisions publications but all Standard statements of the California MUTCD shall be met. On State highways, whenever there is a discrepancy between the specifications and requirements contained in the California MUTCD, and those contained in the Caltrans' Standard Plans, Standard Specifications or the Special Provisions publications, the Caltrans' Standard Plans, Standard Specifications or the Special Provisions publications shall govern.**

<sup>00h</sup> **Nothing contained in the California MUTCD shall prevent Caltrans from modifying, changing or adopting new specifications as necessary. Any revisions to the Caltrans' Standard Plans, Standard Specifications or the Special Provisions shall conform to the Standard statements of the California MUTCD.**

<sup>00i</sup> **Whenever there is a discrepancy between the specifications and requirements incorporated from FHWA's MUTCD and the California MUTCD amendments, the California MUTCD amendments shall govern.**

<sup>01</sup> **Traffic control devices shall be defined as all signs, signals, markings, and other devices used to regulate, warn, or guide traffic, placed on, over, or adjacent to a street, highway, pedestrian facility, bikeway, or private road open to public travel (see definition in Section 1A.13)-by authority of a public agency or official having jurisdiction, or, in the case of a private road, by authority of the private owner or private official having jurisdiction.**

<sup>02</sup> **The Manual on Uniform Traffic Control Devices (MUTCD) is incorporated by reference in 23 Code of Federal Regulations (CFR), Part 655, Subpart F and shall be recognized as the national standard for all traffic control devices installed on any street, highway, bikeway, or private road open to public travel (see definition in Section 1A.13)-in accordance with 23 U.S.C. 109(d) and 402(a). The MUTCD national standard and Caltrans standards and specifications for traffic control devices shall not be applicable to privately owned and maintained roads or commercial establishments, unless the particular city or county enacts an ordinance or resolution to this effect. Refer to CVC Sections 21100, 21100.1, 21107, 21107.5,**

**21107.6, and 21107.7. The policies and procedures of the Federal Highway Administration (FHWA) to obtain basic uniformity of traffic control devices shall be as described in 23 CFR 655, Subpart F.**

**<sup>03</sup> In accordance with 23 CFR 655.603(a), for the purposes of applicability of the MUTCD:**

- A. Toll roads under the jurisdiction of public agencies or authorities or public-private partnerships shall be considered to be public highways;**
- B. Private roads open to public travel shall be as defined in Section 1A.13; Privately owned and maintained roads or commercial establishments, if the particular city or county enacts an ordinance or resolution to this effect. Refer to CVC Sections 21100, 21100.1, 21107, 21107.5, 21107.6, and 21107.7.**
- C. ~~Parking areas, including the driving aisles within those parking areas, that are either publicly or privately owned shall not be considered to be “open to public travel” for purposes of MUTCD applicability.~~ All publicly owned parking areas and only those privately owned parking areas where the particular city or county has enacted a resolution to this effect, including the driving aisles within those parking areas shall be subject to MUTCD applicability.**

**<sup>04</sup> Any traffic control device design or application provision contained in this Manual shall be considered to be in the public domain. Traffic control devices contained in this Manual shall not be protected by a patent, trademark, or copyright, except for the Interstate Shield and any items owned by FHWA. The Caltrans logos consisting of the “CT” symbol and the “Caltrans” logotype are registered service marks and when used on any traffic control device they shall be presented in a uniform and consistent manner as outlined in Caltrans’ Deputy Directive DD-33-R1.**

Support:

<sup>05</sup> Pictographs, as defined in Section 1A.13, are embedded in traffic control devices but the pictographs themselves are not considered traffic control devices for the purposes of Paragraph 4.

<sup>05a</sup> This Manual is not applicable to privately owned and maintained roads or commercial establishments in California, unless the particular city or county enacts an ordinance or resolution to this effect. Refer to CVC Sections 21100, 21100.1, 21107, 21107.5, 21107.6, and 21107.7. However, the use of this Manual is encouraged on all privately owned and maintained roads or commercial establishments, in general, as a good practice. See Section 1A.07 for more information.

<sup>06</sup> The need for uniform standards was recognized long ago. The American Association of State Highway Officials (AASHO), now known as the American Association of State Highway and Transportation Officials (AASHTO), published a manual for rural highways in 1927, and the National Conference on Street and Highway Safety (NCSHS) published a manual for urban streets in 1930. In the early years, the necessity for unification of the standards applicable to the different classes of road and street systems was obvious. To meet this need, a joint committee of AASHO and NCSHS developed and published the original edition of this Manual on Uniform Traffic Control Devices (MUTCD) in 1935. That committee, now called the National Committee on Uniform Traffic Control Devices (NCUTCD), though changed from time to time in name, organization, and personnel, has been in continuous existence and has contributed to periodic revisions of this Manual. The FHWA has administered the MUTCD since the 1971 edition. The FHWA and its predecessor organizations have participated in the development and publishing of the previous editions. There were nine previous editions of the MUTCD, and several of those editions were revised one or more times. Table I-1 traces the evolution of the MUTCD, including the two manuals developed by AASHO and NCSHS.

<sup>06a</sup> The Division of Highways in California Department of Public Works, now known as Department of Transportation (Caltrans), published a Planning Manual of Instructions in 1952. Part 8, called Traffic was subsequently added to the Planning Manual in 1955. In 1972, the first separate publication called the Traffic Manual was published. Efforts were undertaken in 2000 by Caltrans along with California Traffic Control Devices Committee (CTCDC) to reconcile the Traffic Manual with the National Manual on Uniform Traffic Control Devices (MUTCD). These efforts culminated in the adoption of the National MUTCD with a California Supplement in 2004. In 2006, the California Supplement and the National MUTCD were combined into a single document, called the California MUTCD. Table I-1(CA) traces the evolution of the California MUTCD.

**Standard:**

**<sup>07</sup> The U.S. Secretary of Transportation, under authority granted by the Highway Safety Act of 1966, decreed that traffic control devices on all public streets and highways ~~open to public travel~~ (and privately owned and maintained roads or commercial establishments, if the particular city or county enacts an ordinance or resolution to this effect), in accordance with 23 U.S.C. 109(d) and 402(a) in each State shall be in substantial conformance with the Standards issued or endorsed by the FHWA.**

**Support:**

<sup>08</sup> The "Uniform Vehicle Code (UVC)" is one of the publications referenced in the MUTCD. The UVC contains a model set of motor vehicle codes and traffic laws for use throughout the United States.

**Guidance:**

<sup>09</sup> *The States should adopt Section 15-116 of the UVC, which states that, "No person shall install or maintain in any area of private property used by the public any sign, signal, marking, or other device intended to regulate, warn, or guide traffic unless it conforms with the State manual and specifications adopted under Section 15-104."*

**Support:**

<sup>10</sup> The Standard, Guidance, Option, and Support material described in this edition of the MUTCD provide the transportation professional with the information needed to make appropriate decisions regarding the use of traffic control devices on streets, highways, bikeways, and private roads open to public travel (see definition in Section 1A.13).

<sup>11</sup> Throughout this Manual the headings Standard, Guidance, Option, and Support are used to classify the nature of the text that follows. Figures and tables, including the notes contained therein, supplement the text and might constitute a Standard, Guidance, Option, or Support. The user needs to refer to the appropriate text to classify the nature of the figure, table, or note contained therein.

<sup>11a</sup> *The figures shown in the California MUTCD are typical or example applications of the traffic control devices to illustrate their use and manner. Criteria for position, location, and use of traffic control devices in the figures are furnished solely for the purpose of guidance, understanding and information, and are not a legal standard. Engineering judgment must be used to apply these guidelines to the typical or example applications, or adjust them to fit individual field site conditions. The California MUTCD is not intended to be a substitute for engineering knowledge, experience or judgment.*

**Standard:**

**<sup>12</sup> When used in this Manual, the text headings of Standard, Guidance, Option, and Support shall be as defined in Paragraph 1 of Section 1A.13. For all purposes, regardless of the text heading, any sentence containing the verb shall or MUTCD text edited to the verb shall, shall be considered a Standard. Similarly, any sentence containing the verb should or MUTCD text edited to the verb should, shall be considered Guidance and any sentence containing the verb may or MUTCD text edited to the verb may, shall be considered an Option.**

**Support:**

<sup>13</sup> Throughout this Manual all dimensions and distances are provided in English units. Appendix A2 contains tables for converting each of the English unit numerical values that are used in this Manual to the equivalent Metric (International System of Units) values.

**Guidance:**

<sup>14</sup> *If Metric units are to be used in laying out distances or determining sizes of devices, such units should be specified on plan drawings and made known to those responsible for designing, installing, or maintaining traffic control devices.*

<sup>14a</sup> *In 1993, Caltrans had adopted the International System of Units as the preferred system of weights and measures to comply with federal law. The law was subsequently changed making the use of the Metric System optional. Caltrans made the decision in 2004 to readopt the U.S. Customary (English) system of units and measures as the preferred system. Guidance on the use of the Metric and U.S. Customary Systems of Measurement is available from Caltrans' Division of Design.*

<sup>15</sup> *Except when a specific numeral is required or recommended by the text of a Section of this Manual, numerals displayed on the images of devices in the figures that specify quantities such as times, distances, speed limits, and weights should be regarded as examples only. When installing any of these devices, the numerals should be appropriately altered to fit the specific situation.*

Support:

<sup>16</sup> The following information will be useful when reference is being made to a specific portion of text in this Manual.

<sup>17</sup> There are nine Parts in this Manual and each Part is comprised of one or more Chapters. Each Chapter is comprised of one or more Sections. Parts are given a numerical identification, such as Part 2 – Signs. Chapters are identified by the Part number and a letter, such as Chapter 2B – Regulatory Signs, Barricades, and Gates. Sections are identified by the Chapter number and letter followed by a decimal point and a number, such as Section 2B.03 – Size of Regulatory Signs.

<sup>18</sup> Each Section is comprised of one or more paragraphs. The paragraphs are indented and are identified by a number. Paragraphs are counted from the beginning of each Section without regard to the intervening text headings (Standard, Guidance, Option, or Support). Some paragraphs have lettered or numbered items. As an example of how to cite this Manual, the phrase “Not less than 40 feet beyond the stop line” that appears in Section 4D.14 of this Manual would be referenced in writing as “Section 4D.14, P1, A.1,” and would be verbally referenced as “Item A.1 of Paragraph 1 of Section 4D.14.”

<sup>18a</sup> The California MUTCD uses a format similar to the National MUTCD. It incorporates National MUTCD in its entirety and explicitly shows which portions thereof are applicable or not applicable in California. The unedited National MUTCD text is shown in “Times New Roman” font with black color. Text portions of the National MUTCD content that are not applicable in California are shown with a strikethrough and a blue margin line on the right. The California text additions, including new paragraphs, and enhancements are incorporated into the combined document at appropriate locations and shown in an “Arial Narrow” font with blue color and a blue margin line on the right to keep them distinct from the National MUTCD content. Changes or additions to text, figures and tables in Revision 1 of the California MUTCD, effective December 9, 2015, are shown with an orange-color margin line on the left. Changes or additions to text, figures and tables in Revision 2 of the California MUTCD, effective April 7, 2017, are shown with a green-color margin line on the left. Changes or additions to text, figures and tables in Revision 3 of the California MUTCD, effective March 9, 2018, are shown with a purple-color margin line on the left. Changes or additions to text, figures and tables in Revision 4 of the California MUTCD, effective March 29, 2019, are shown with a gray-color margin line on the left.

<sup>18b</sup> All MUTCD figures and tables, or portions thereof, which are not applicable in California, are shown with appropriate size blue X cross-outs. The MUTCD figures and tables that have been modified or added to, in the California MUTCD retain the same MUTCD Figure or Table number but include “(CA)” to indicate that it is the California version of the MUTCD Figure or Table. For example:

- A. Figure 3B-18(CA) Do Not Block Intersection Markings
- B. Table 2H-1(CA) California General Information Sign Sizes

<sup>18c</sup> For California topics where there is no corresponding section, figure or table in the MUTCD, the California MUTCD gives a number that begins with the number 101 for that section, figure or table and increases in sequence, followed with a “(CA)” to indicate that this is a California created section, figure or table number. For example:

- A. Section 4D.105(CA) – Bicycle/Motorcycle Detection
- B. Figure 6H-103(CA) – Detour for Bike Lane on Roads with Closure of One Travel Direction
- C. Table 4D-102(CA) – Minimum Yellow Change Interval Timing

<sup>18d</sup> The California MUTCD contents within each chapter (Chapter 2B shown as example below) appear in a consistent order for ease of reference. This sequence is as follows:

- A. MUTCD Sections per sequential numbering. For example, Sections 2B.01 through 2B.68.
- B. California Sections per sequential numbering. For example, Sections 2B.101(CA) through 2B.111(CA).
- C. MUTCD Figures (including edited and deleted) per sequential numbering. For example, Figures 2B-1 through 2B-32.
- D. California Figures based upon or modifying MUTCD Figures are placed immediately after the respective MUTCD figure. For example, Figure 2B-12(CA) follows immediately after the deleted MUTCD Figure 2B-12 it replaces. Another example is Figure 2B-10(CA) which immediately follows MUTCD (undeleted) Figure 2B-10 as the California figure supplements the MUTCD Figure, it does not replace it.
- E. California Figures that are stand alone and not based upon MUTCD Figures follow in sequence per their numbering. For example, Figures 2B-101(CA) through 2B-106(CA) follow after the end of MUTCD numbered figures.
- F. MUTCD and California Tables follow the Figures under similar rules described above for the figures.

**Standard:**

**<sup>19</sup> In accordance with 23 CFR 655.603(b)(3), States or other Federal agencies that have their own MUTCDs or Supplements shall revise these MUTCDs or Supplements to be in substantial conformance with changes to the National MUTCD within 2 years of the effective date of the Final Rule for the changes. Substantial conformance of such State or other Federal agency MUTCDs or Supplements shall be as defined in 23 CFR 655.603(b)(1).**

**<sup>20</sup> After the effective date of a new edition of the MUTCD or a revision thereto, or after the adoption thereof by the State, whichever occurs later, new or reconstructed devices installed shall be in compliance with the new edition or revision.**

**<sup>21</sup> In cases involving Federal-aid projects for new highway or bikeway construction or reconstruction, the traffic control devices installed (temporary or permanent) shall be in conformance with the most recent edition of the National MUTCD before that highway is opened or re-opened to the public for unrestricted travel [23 CFR 655.603(d)(2) and (d)(3)].**

**<sup>22</sup> Unless a particular device is no longer serviceable, non-compliant devices on existing highways and bikeways shall be brought into compliance with the current edition of the National MUTCD as part of the systematic upgrading of substandard traffic control devices (and installation of new required traffic control devices) required pursuant to the Highway Safety Program, 23 U.S.C. §402(a). The FHWA has the authority to establish other target compliance dates for implementation of particular changes to the MUTCD [23 CFR 655.603(d)(1)]. These target compliance dates established by the FHWA shall be as shown in Table I-2.**

**<sup>23</sup> Except as provided in Paragraph 24, when a non-compliant traffic control device is being replaced or refurbished because it is damaged, missing, or no longer serviceable for any reason, it shall be replaced with a compliant device.**

Option:

**<sup>24</sup> A damaged, missing, or otherwise non-serviceable device that is non-compliant may be replaced in kind if engineering judgment indicates that:**

A. One compliant device in the midst of a series of adjacent non-compliant devices would be confusing to road users; and/or

B. The schedule for replacement of the whole series of non-compliant devices will result in achieving timely compliance with the MUTCD.

**Standard:**

**<sup>25</sup> Unless allowed per the Option below, in cases involving new highway or bikeway construction or reconstruction, the traffic control devices installed (temporary or permanent) shall be in conformance with the current edition of the California MUTCD before that highway is opened or re-opened to the public for unrestricted travel pursuant to the California Vehicle Code 21401.**

Option:

**<sup>26</sup> In cases involving new highway or bikeway construction or reconstruction, the traffic control devices installed (temporary or permanent) may be in accordance with previous traffic control device standards of January 13, 2012, January 21, 2010 or September 26, 2006 California MUTCD or prior to that of MUTCD 2003 and MUTCD 2003 California Supplement or Caltrans Traffic Manual, if in the judgment of the engineer, incorporating the California MUTCD standards would impose a significant delay or a significant increase in costs for the project.**

Support:

**<sup>27</sup> Reconstruction, as used in the previous Standard and Option topics, for the purpose of a traffic control device would mean if a particular device is modified in any form or shape or is relocated. If a reconstruction project does not modify or relocate a traffic control device, although encouraged, there would be no obligation to upgrade the traffic control device per current edition of the California MUTCD standards.**

**Standard:**

**<sup>28</sup> Unless allowed per the option below, non-compliant traffic control devices on existing highways and bikeways shall be brought into compliance with the California MUTCD as part of the systematic upgrading of substandard traffic control devices (and installation of new required traffic control devices) required pursuant to the California Vehicle Code 21401.**

Option:

<sup>29</sup> All traffic control devices on existing highways and bikeways that have become non-compliant per California MUTCD adopted standards may remain in service through the end of their useful service life.

<sup>30</sup> To limit financial impact on agencies and for fiscal responsibility reasons, existing inventory of non-compliant traffic control devices may continue to be used until these inventories are depleted.

**Table I-1. Evolution of the MUTCD**

| Year | Name   | Month / Year Revised                              |
|------|--|---|
| 1927 | Manual and Specifications for the Manufacture, Display, and Erection of U.S. Standard Road Markers and Signs (for rural roads) | 4/29, 12/31                                       |
| 1930 | Manual on Street Traffic Signs, Signals, and Markings (for urban streets)  | No revisions                                      |
| 1935 | Manual on Uniform Traffic Control Devices for Streets and Highways (MUTCD)   | 2/39  |
| 1942 | Manual on Uniform Traffic Control Devices for Streets and Highways — War Emergency Edition                                     | No revisions                                      |
| 1948 | Manual on Uniform Traffic Control Devices for Streets and Highways   | 9/54  |
| 1961 | Manual on Uniform Traffic Control Devices for Streets and Highways   | No revisions                                      |
| 1971 | Manual on Uniform Traffic Control Devices for Streets and Highways   | 11/71, 4/72, 3/73, 10/73, 6/74, 6/75, 9/76, 12/77 |
| 1978 | Manual on Uniform Traffic Control Devices for Streets and Highways   | 12/79, 12/83, 9/84, 3/86                          |
| 1988 | Manual on Uniform Traffic Control Devices for Streets and Highways   | 1/90, 3/92, 9/93, 11/94, 12/96, 6/98, 1/00        |
| 2000 | Manual on Uniform Traffic Control Devices for Streets and Highways — Millennium Edition  | 7/02  |
| 2003 | Manual on Uniform Traffic Control Devices for Streets and Highways   | 11/04, 12/07                                      |
| 2009 | Manual on Uniform Traffic Control Devices for Streets and Highways   | 5/12  |

**Table I-1(CA) Evolution of the California MUTCD**

| Year | Name   |
|------|--|
| 1955 | Planning Manual of Instructions, Part 8 – Traffic<br>Department of Public Works, Division of Highways  |
| 1972 | Traffic Manual<br>Department of Public Works, Division of Highways   |
| 1996 | Traffic Manual (Metric Version)<br>Department of Transportation, Division of Traffic Operations  |
| 2004 | FHWA's MUTCD 2003 & MUTCD 2003 California Supplement<br>Department of Transportation, Division of Traffic Operations   |
| 2006 | California MUTCD<br>Department of Transportation, Division of Traffic Operations   |
| 2010 | California MUTCD (including Revisions. 1 and 2 of FHWA's MUTCD 2003)<br>Department of Transportation, Division of Traffic Operations                             |
| 2012 | California MUTCD (including FHWA's MUTCD 2009)<br>Department of Transportation, Division of Traffic Operations   |
| 2014 | California MUTCD (including FHWA's MUTCD 2009 Revisions 1 & 2, as amended for use in California)<br>Department of Transportation, Division of Traffic Operations |
| 2015 | California MUTCD, Revision 1<br>Department of Transportation, Division of Traffic Operations   |
| 2017 | California MUTCD, Revision 2<br>Department of Transportation, Division of Traffic Operations   |
| 2018 | California MUTCD, Revision 3<br>Department of Transportation, Division of Traffic Operations   |
| 2019 | California MUTCD, Revision 4<br>Department of Transportation, Division of Traffic Operations   |

**Table I-2. Target Compliance Dates Established by the FHWA**

| 2009 MUTCD Section Number(s) | 2009 MUTCD Section Title   | Specific Provision   | Compliance Date  |
|------------------------------|--|--|--|
| 2A.08                        | Maintaining Minimum Retroreflectivity                                    | Implementation and continued use of an assessment or management method that is designed to maintain regulatory and warning sign retroreflectivity at or above the established minimum levels (see Paragraph 2) | June 13, 2014<br><del>2 years from the effective date of this revision of the 2009 MUTCD*</del>  |
| <del>2A.19</del>             | <del>Lateral Offset</del>  | <del>Crashworthiness of sign supports on roads with posted speed limit of 50 mph or higher (see Paragraph 2)</del>   | <del>January 17, 2014<br/>(date established in the 2009 MUTCD)</del>   |
| 2B.40                        | ONE WAY Signs (R6-1, R6-2)   | New requirements in the 2009 MUTCD for the number and locations of ONE WAY signs (see Paragraphs 4, 9, and 10)   | December 31, 2019  |
| 2C.06 through 2C.14          | Horizontal Alignment Warning Signs                                       | Revised requirements in the 2009 MUTCD regarding the use of various horizontal alignment signs (see Table 2C-5)  | December 31, 2019  |
| 2E.31, 2E.33, and 2E.36      | Plaques for Left-Hand Exits  | New requirement in the 2009 MUTCD to use E1-5aP and E1-5bP plaques for left-hand exits   | December 31, 2014  |
| 4D.26                        | Yellow Change and Red Clearance Intervals                                | New requirement in the 2009 MUTCD that durations of yellow change and red clearance intervals shall be determined using engineering practices (see Paragraphs 3 and 6)   | June 13, 2017<br><del>5 years from the effective date of this revision of the 2009 MUTCD, or when timing adjustments are made to the individual intersection and/or corridor, whichever occurs first</del> |
| 4E.06                        | Pedestrian Intervals and Signal Phases                                   | New requirement in the 2009 MUTCD that the pedestrian change interval shall not extend into the red clearance interval and shall be followed by a buffer interval of at least 3 seconds (see Paragraph 4)      | June 13, 2017<br><del>5 years from the effective date of this revision of the 2009 MUTCD, or when timing adjustments are made to the individual intersection and/or corridor, whichever occurs first</del> |
| 6D.03**                      | Worker Safety Considerations   | New requirement in the 2009 MUTCD that all workers within the right-of-way shall wear high-visibility apparel (see Paragraphs 4, 6, and 7)   | December 31, 2011  |
| 6E.02**                      | High-Visibility Safety Apparel   | New requirement in the 2009 MUTCD that all flaggers within the right-of-way shall wear high-visibility apparel   | December 31, 2011  |
| 7D.04**                      | Uniform of Adult Crossing Guards   | New requirement in the 2009 MUTCD for high-visibility apparel for adult crossing guards  | December 31, 2011  |
| 8B.03, 8B.04                 | Grade Crossing (Crossbuck) Signs and Supports                            | Retroreflective strip on Crossbuck sign and support (see Paragraph 7 in Section 8B.03 and Paragraphs 15 and 18 in Section 8B.04)   | December 31, 2019  |
| 8B.04                        | Crossbuck Assemblies with YIELD or STOP Signs at Passive Grade Crossings | New requirement in the 2009 MUTCD for the use of STOP or YIELD signs with Crossbuck signs at passive grade crossings   | December 31, 2019  |

\* Types of signs other than regulatory or warning are to be added to an agency's management or assessment method as resources allow.

\*\* MUTCD requirement is a result of a legislative mandate.

Note: All compliance dates that were previously published in Table I-2 of the 2009 MUTCD and that do not appear in this revised table have been eliminated.



**Table I-2(CA). Target Compliance Dates Established by the CTCDC/Caltrans**

| 2014 CA MUTCD Section Number(s) | 2014 CA MUTCD Section Title             | Specific Provision  | Compliance Date |
|---------------------------------|---|---|-----------------|
| 4D.26                           | Yellow Change & Red Clearance Intervals | Signalized intersections equipped with Red Light Cameras shall comply with 2014 CA MUTCD, Section 4D.26 | August 1, 2015  |
| 4D.26                           | Yellow Change & Red Clearance Intervals | All signalized intersections shall comply with 2014 CA MUTCD, Section 4D.26                             | August 1, 2017  |



# PART 1 GENERAL

## CHAPTER 1A. GENERAL

### **Section 1A.01 Purpose of Traffic Control Devices**

**Support:**

01 The purpose of traffic control devices, as well as the principles for their use, is to promote highway safety and efficiency by providing for the orderly movement of all road users on streets, highways, bikeways, and private roads open to public travel (see definition in Section 1A.13) throughout the Nation.

02 Traffic control devices notify road users of regulations and provide warning and guidance needed for the uniform and efficient operation of all elements of the traffic stream in a manner intended to minimize the occurrences of crashes.

**Standard:**

03 **Traffic control devices or their supports shall not bear any advertising message or any other message that is not related to traffic control.**

**Support:**

04 Tourist-oriented directional signs and Specific Service signs are not considered advertising; rather, they are classified as motorist service signs.

### **Section 1A.02 Principles of Traffic Control Devices**

**Support:**

01 This Manual contains the basic principles that govern the design and use of traffic control devices for all streets, highways, bikeways, and private roads open to public travel (see definition in Section 1A.13) regardless of type or class or the public agency, official, or owner having jurisdiction. This Manual's text specifies the restriction on the use of a device if it is intended for limited application or for a specific system. It is important that these principles be given primary consideration in the selection and application of each device.

**Guidance:**

02 *To be effective, a traffic control device should meet five basic requirements:*

*A. Fulfill a need;*

*B. Command attention;*

*C. Convey a clear, simple meaning;*

*D. Command respect from road users; and*

*E. Give adequate time for proper response.*

03 *Design, placement, operation, maintenance, and uniformity are aspects that should be carefully considered by the engineer in order to maximize the ability of a traffic control device to meet the five requirements listed in the previous paragraph. Vehicle speed, geometrics and other relevant factors should be carefully considered as ~~an~~ elements that governs the design, operation, placement, and location of various traffic control devices.*

**Support:**

04 The definition of the word "speed" varies depending on its use. The definitions of specific speed terms are contained in Section 1A.13.

**Guidance:**

05 *The actions required of road users to obey regulatory devices should be specified by State statute, or in cases not covered by State statute, by local ordinance or resolution. Such statutes, ordinances, and resolutions should be consistent with the "Uniform Vehicle Code" and California Vehicle Code (CVC) (see Section 1A.11).*

06 *The proper use of traffic control devices should provide the reasonable and prudent road user with the information necessary to efficiently and lawfully use the streets, highways, pedestrian facilities, and bikeways.*

Support:

07 Uniformity of the meaning of traffic control devices is vital to their effectiveness. The meanings ascribed to devices in this Manual are in general accord with the publications mentioned in Section 1A.11.

### **Section 1A.03 Design of Traffic Control Devices**

*Guidance:*

01 *Devices should be designed so that features such as size, shape, color, composition, lighting or retroreflection, and contrast are combined to draw attention to the devices; that size, shape, color, and simplicity of message combine to produce a clear meaning; that legibility and size combine with placement to permit adequate time for response; and that uniformity, size, legibility, and reasonableness of the message combine to command respect.*

02 *Aspects of a device's standard design should be modified only if there is a demonstrated need.*

Support:

03 An example of modifying a device's design would be to modify the Combination Horizontal Alignment/Intersection (W1-10) sign to show intersecting side roads on both sides rather than on just one side of the major road within the curve.

Option:

04 With the exception of symbols and colors, minor modifications in the specific design elements of a device may be made provided the essential appearance characteristics are preserved.

### **Section 1A.04 Placement and Operation of Traffic Control Devices**

*Guidance:*

01 *Placement of a traffic control device should be within the road user's view so that adequate visibility is provided. To aid in conveying the proper meaning, the traffic control device should be appropriately positioned with respect to the location, object, or situation to which it applies. The location and legibility of the traffic control device should be such that a road user has adequate time to make the proper response in both day and night conditions.*

02 *Traffic control devices should be placed and operated in a uniform and consistent manner.*

03 *Unnecessary traffic control devices should be removed. The fact that a device is in good physical condition should not be a basis for deferring needed removal or change.*

04 *Traffic control devices, which are used on a part-time basis, should be in operation only during the time periods that they are required.*

### **Section 1A.05 Maintenance of Traffic Control Devices**

*Guidance:*

01 *Functional maintenance of traffic control devices should be used to determine if certain devices need to be changed to meet current traffic conditions.*

02 *Physical maintenance of traffic control devices should be performed to retain the legibility and visibility of the device, and to retain the proper functioning of the device.*

Support:

03 Clean, legible, properly mounted devices in good working condition command the respect of road users.

### **Section 1A.06 Uniformity of Traffic Control Devices**

Support:

01 Uniformity of devices simplifies the task of the road user because it aids in recognition and understanding, thereby reducing perception/reaction time. Uniformity assists road users, law enforcement officers, and traffic courts by giving everyone the same interpretation. Uniformity assists public highway officials through efficiency in manufacture, installation, maintenance, and administration. Uniformity means treating similar situations in a similar way. The use of uniform traffic control devices does not, in itself, constitute uniformity. A standard device used where it is not appropriate is as objectionable as a non-standard device; in fact, this might be worse, because such misuse might result in disrespect at those locations where the device is needed and appropriate.

**Standard:**

**02 Any given device for the control of traffic shall have the same meaning and require the same action on the part of motorists regardless of where it is encountered.**

**Section 1A.07 Responsibility for Traffic Control Devices**

**Standard:**

**01 The responsibility for the design, placement, operation, maintenance, and uniformity of traffic control devices shall rest with the public agency or the official having jurisdiction, or, in the case of private roads open to public travel (see definition in Section 1A.13), with the private owner or private official having jurisdiction. 23 CFR 655.603 adopts the MUTCD as the national standard for all traffic control devices installed on any street, highway, bikeway, or private road open to public travel (see definition in Section 1A.13). When a State or other Federal agency manual or supplement is required, that manual or supplement shall be in substantial conformance with the National MUTCD.**

**01a On State highways, the California MUTCD shall not supersede Caltrans' Standard Plans, Standard Specifications or the Special Provisions publications but all Standard statements of the California MUTCD shall be met. On State highways, whenever there is a discrepancy between the specifications and requirements contained in the California MUTCD, and those contained in Caltrans' Standard Plans, Standard Specifications or the Special Provisions publications, Caltrans' Standard Plans, Standard Specifications or the Special Provisions publications shall govern.**

**01b Nothing contained in the California MUTCD shall prevent Caltrans from modifying, changing or adopting new specifications as necessary. Any revisions to Caltrans' Standard Plans, Standard Specifications or the Special Provisions shall conform to the Standard statements of the California MUTCD.**

**02 23 CFR 655.603 also states that traffic control devices on all streets, highways, bikeways, and private roads open to public travel (see definition in Section 1A.13) in each State shall be in substantial conformance with standards issued or endorsed by the Federal Highway Administrator.**

**Support:**

**03 The Introduction of this Manual contains information regarding the meaning of substantial conformance and the applicability of the MUTCD to private roads open to public travel (see definition in Section 1A.13).**

**04 The "Uniform Vehicle Code" (see Section 1A.11) has the following provision in Section 15-104 for the adoption of a uniform manual:**

**"(a) The [State Highway Agency] shall adopt a manual and specification for a uniform system of traffic control devices consistent with the provisions of this code for use upon highways within this State. Such uniform system shall correlate with and so far as possible conform to the system set forth in the most recent edition of the Manual on Uniform Traffic Control Devices for Streets and Highways, and other standards issued or endorsed by the Federal Highway Administrator."**

**"(b) The Manual adopted pursuant to subsection (a) shall have the force and effect of law."**

**05 All States have officially adopted the National MUTCD either in its entirety, with supplemental provisions, or as a separate published document.**

**Guidance:**

**06 These individual State manuals or supplements should be reviewed for specific provisions relating to that State.**

**Support:**

**07 The National MUTCD has also been adopted by the National Park Service, the U.S. Forest Service, the U.S. Military Command, the Bureau of Indian Affairs, the Bureau of Land Management, and the U.S. Fish and Wildlife Service.**

**Guidance:**

**08 States should adopt Section 15-116 of the "Uniform Vehicle Code," which states that, "No person shall install or maintain in any area of private property used by the public any sign, signal, marking, or other device intended to regulate, warn, or guide traffic unless it conforms with the State manual and specifications adopted under Section 15-104."**

Support:

<sup>09</sup> Pursuant to the provisions in CVC Section 21400, Caltrans adopts uniform standards and specifications for all traffic control devices after consultation with local agencies and public hearings. Caltrans consults with local agencies and the public through the California Traffic Control Devices Committee (CTCDC). Caltrans publicizes these uniform standards and specifications for traffic control devices through the California MUTCD.

**Standard:**

<sup>10</sup> **In accordance with CVC Section 21401, only traffic control devices conforming to Caltrans standards and specifications shall be placed on streets and highways.**

<sup>11</sup> **Subject to the requirements in CVC Sections 21100, 21100.1, 21107, 21107.5, 21107.6, and 21107.7, no person shall install or maintain in any area of private property used by the public any sign, signal, or marking or other device intended to regulate, warn, or guide traffic unless it conforms to Caltrans standards and specifications.**

Support:

<sup>12</sup> The delegation of maintenance activities to local authorities is usually exercised under the authority of Streets and Highways Code Section 130.

<sup>13</sup> Caltrans standards and specifications for traffic control devices are not applicable to privately owned and maintained roads or commercial establishments, unless the particular city or county enacts an ordinance or resolution to this effect. Refer to CVC Sections 21100, 21100.1, 21107, 21107.5, 21107.6, and 21107.7. However, the use of Caltrans standards and specifications for traffic control devices are encouraged on all privately owned and maintained roads or commercial establishments, in general, as a good practice.

## **Section 1A.08 Authority for Placement of Traffic Control Devices**

**Standard:**

<sup>01</sup> **Traffic control devices, advertisements, announcements, and other signs or messages within the highway right-of-way shall be placed only as authorized by a public authority or the official having jurisdiction, or, in the case of private roads open to public travel (see definition in Section 1A.13), by the private owner or private official having jurisdiction, for the purpose of regulating, warning, or guiding traffic.**

<sup>02</sup> **When the public agency or the official having jurisdiction over a street or highway or, in the case of private roads open to public travel (see definition in Section 1A.13), the private owner or private official having jurisdiction, has granted proper authority, others such as contractors and public utility companies shall be permitted to install temporary traffic control devices in temporary traffic control zones. Such traffic control devices shall conform with the Standards of this Manual.**

<sup>02a</sup> **On State highways, the California MUTCD shall not supersede Caltrans' Standard Plans, Standard Specifications or the Special Provisions publications but all Standard statements of the California MUTCD shall be met. On State highways, whenever there is a discrepancy between the specifications and requirements contained in the California MUTCD, and those contained in Caltrans' Standard Plans, Standard Specifications or the Special Provisions publications, Caltrans' Standard Plans, Standard Specifications or the Special Provisions publications shall govern.**

<sup>02b</sup> **Nothing contained in the California MUTCD shall prevent Caltrans from modifying, changing or adopting new specifications as necessary. Any revisions to Caltrans' Standard Plans, Standard Specifications or the Special Provisions shall conform to the Standard statements of the California MUTCD.**

<sup>03</sup> **All regulatory traffic control devices shall be supported by laws, ordinances, or regulations.**

Support:

<sup>04</sup> Provisions of this Manual are based upon the concept that effective traffic control depends upon both appropriate application of the devices and reasonable enforcement of the regulations.

<sup>05</sup> Although some highway design features, such as curbs, median barriers, guardrails, speed humps or tables, and textured pavement, have a significant impact on traffic operations and safety, they are not considered to be traffic control devices and provisions regarding their design and use are generally not included in this Manual.

<sup>06</sup> Certain types of signs and other devices that do not have any traffic control purpose are sometimes placed within the highway right-of-way by or with the permission of the public agency or the official having jurisdiction over the street or highway. Most of these signs and other devices are not intended for use by road users in general, and their message is only important to individuals who have been instructed in their meanings. These

signs and other devices are not considered to be traffic control devices and provisions regarding their design and use are not included in this Manual. Among these signs and other devices are the following:

- A. Devices whose purpose is to assist highway maintenance personnel. Examples include markers to guide snowplow operators, devices that identify culvert and drop inlet locations, and devices that precisely identify highway locations for maintenance or mowing purposes.
- B. Devices whose purpose is to assist fire or law enforcement personnel. Examples include markers that identify fire hydrant locations, signs that identify fire or water district boundaries, speed measurement pavement markings, small indicator lights to assist in enforcement of red light violations, and photo enforcement systems.
- C. Devices whose purpose is to assist utility company personnel and highway contractors, such as markers that identify underground utility locations.
- D. Signs posting local non-traffic ordinances.
- E. Signs giving civic organization meeting information.

**Standard:**

**07 Signs and other devices that do not have any traffic control purpose that are placed within the highway right-of-way shall not be located where they will interfere with, or detract from, traffic control devices.**

*Guidance:*

*08 Any unauthorized traffic control device or other sign or message placed on the highway right-of-way by a private organization or individual constitutes a public nuisance and should be removed. All unofficial or non-essential traffic control devices, signs, or messages should be removed.*

*Support:*

*09 CVC references are used throughout this California MUTCD when the subject matter relates to State law.*

**Standard:**

**10 CVC 21400 provides that Caltrans shall, after consultation with local agencies and public hearings, adopt rules and regulations prescribing uniform standards and specifications for all official traffic control devices placed pursuant to the provisions of the Code.**

**11 CVC 21401 provides that only those official traffic control devices that conform to the uniform standards and specifications promulgated by Caltrans shall be placed upon a street or highway.**

**12 CVC 21350 and 21351 give basic authority to Caltrans and local authorities, in their respective jurisdictions, to place and maintain such official traffic control devices.**

*Option:*

*13 Local authorities may adopt rules and regulations by ordinance or resolution for regulating traffic by means of official traffic control devices meeting the requirements of CVC Section 21400. Refer to CVC Section 21100 (d).*

**Standard:**

**14 Local agencies responsible for the development or operation of bikeways or roadways where bicycle travel is permitted shall utilize all minimum safety design criteria and uniform specifications and symbols for signs, markers, and traffic control devices established by Caltrans. Refer to Streets and Highways Code 891.**

**15 The use of unauthorized traffic control devices is prohibited by CVC 21465. Prohibited traffic control devices constitute a public nuisance and shall be removed per CVC 21467. This does not modify or limit the authority of the Public Utilities Commission to erect or maintain traffic control devices as authorized by law. Refer to CVC 21468.**

**16 Private advertising is prohibited on any highway right-of-way by Section 5403 (a) of the Business and Professions Code. "Highway" in this context includes roads, streets, boulevards, lanes, courts, places, commons, trails, ways or other rights-of-way or easements used for or laid out and intended for the public passage of vehicles or of vehicles and persons per Section 5213 of the Business and Professions Code. Also refer to CVC 360 for definition of "highway".**

*Support:*

*17 The California Public Utilities Commission is the state regulatory agency with statutory authority over highway-rail grade crossings and highway-light rail transit grade crossings. Refer to Public Utilities Code Section 1202(a).*

## **Section 1A.09 Engineering Study and Engineering Judgment**

### **Support:**

01 Definitions of an engineering study and engineering judgment are contained in Section 1A.13.

01a Refer to CVC 627 for definition and requirements of "Engineering and Traffic Survey". It is also abbreviated in this manual as E&TS.

### **Standard:**

02 **This Manual describes the application of traffic control devices, but shall not be a legal requirement for their installation.**

### **Guidance:**

03 *The decision to use a particular device at a particular location should be made on the basis of either an engineering study or the application of engineering judgment. Thus, while this Manual provides Standards, Guidance, and Options for design and applications of traffic control devices, this Manual should not be considered a substitute for engineering judgment. Engineering judgment should be exercised in the selection and application of traffic control devices, as well as in the location and design of roads and streets that the devices complement.*

04 *Early in the processes of location and design of roads and streets, engineers should coordinate such location and design with the design and placement of the traffic control devices to be used with such roads and streets.*

05 *Jurisdictions, or owners of private roads open to public travel (see definition in Section 1A.13), with responsibility for traffic control that do not have engineers on their staffs who are trained and/or experienced in traffic control devices should seek engineering assistance from others, such as the State transportation agency, their county, a nearby large city, or a traffic engineering consultant.*

### **Support:**

06 As part of the Federal-aid Program, each State is required to have a Local ~~Technology~~ Technical Assistance Program (LTAP) and to provide technical assistance to local highway agencies. Requisite technical training in the application of the principles of the MUTCD is available from the State's Local ~~Technology~~ Technical Assistance Program for needed engineering guidance and assistance.

## **Section 1A.10 Interpretations, Experimentations, Changes, and Interim Approvals**

### **Standard:**

01 **Design, application, and placement of traffic control devices other than those adopted in this Manual shall be prohibited unless the provisions of this Section are followed.**

### **Support:**

02 Continuing advances in technology will produce changes in the highway, vehicle, and road user proficiency; therefore, portions of the system of traffic control devices in this Manual will require updating. In addition, unique situations often arise for device applications that might require interpretation or clarification of this Manual. It is important to have a procedure for recognizing these developments and for introducing new ideas and modifications into the system.

### **Standard:**

03 **Except as provided in Paragraph 4, requests for any interpretation, permission to experiment, interim approval, or change shall be submitted electronically to the Federal Highway Administration (FHWA), Office of Transportation Operations, MUTCD team, at the following e-mail address:**

**MUTCDofficialrequest@dot.gov.**

### **Option:**

04 If electronic submittal is not possible, requests for interpretations, permission to experiment, interim approvals, or changes may instead be mailed to the

Office of Transportation Operations, HOTO-1,  
Federal Highway Administration,  
1200 New Jersey Avenue, SE,  
Washington, DC 20590.



Support:

<sup>05</sup> Communications regarding other MUTCD matters that are not related to official requests will receive quicker attention if they are submitted electronically to the MUTCD Team Leader or to the appropriate individual MUTCD team member. Their e-mail addresses are available through the links contained on the “Who’s Who” page on the MUTCD website at

<http://mutcd.fhwa.dot.gov/team.htm>.

<sup>05a</sup> Requests for experimentation, interpretation, or changes relating to the California edited portion of the California MUTCD are covered later in this section.

<sup>06</sup> An interpretation includes a consideration of the application and operation of standard traffic control devices, official meanings of standard traffic control devices, or the variations from standard device designs.

Guidance:

<sup>07</sup> Requests for an interpretation of this Manual should contain the following information:

- A. A concise statement of the interpretation being sought;
- B. A description of the condition that provoked the need for an interpretation;
- C. Any illustration that would be helpful to understand the request; and
- D. Any supporting research data that is pertinent to the item to be interpreted.

Support:

<sup>08</sup> Requests to experiment include consideration of field deployment for the purpose of testing or evaluating a new traffic control device, its application or manner of use, or a provision not specifically described in this Manual.

<sup>09</sup> A request for permission to experiment will be considered only when submitted by the public agency or toll facility operator responsible for the operation of the road or street on which the experiment is to take place. For a private road open to public travel (see definition in Section 1A.13), the request will be considered only if it is submitted by the private owner or private official having jurisdiction.

<sup>10</sup> A diagram indicating the process for experimenting with traffic control devices is shown in Figure 1A-1 and 1A-1(CA).

Guidance:

<sup>11</sup> The request for permission to experiment should contain the following:

- A. A statement indicating the nature of the problem.
- B. A description of the proposed change to the traffic control device or application of the traffic control device, how it was developed, the manner in which it deviates from the standard, and how it is expected to be an improvement over existing standards.
- C. Any illustration that would be helpful to understand the traffic control device or use of the traffic control device.
- D. Any supporting data explaining how the traffic control device was developed, if it has been tried, in what ways it was found to be adequate or inadequate, and how this choice of device or application was derived.
- E. A legally binding statement certifying that the concept of the traffic control device is not protected by a patent or copyright. (An example of a traffic control device concept would be countdown pedestrian signals in general. Ordinarily an entire general concept would not be patented or copyrighted, but if it were it would not be acceptable for experimentation unless the patent or copyright owner signs a waiver of rights acceptable to the FHWA. An example of a patented or copyrighted specific device within the general concept of countdown pedestrian signals would be a manufacturer's design for its specific brand of countdown signal, including the design details of the housing or electronics that are unique to that manufacturer's product. As long as the general concept is not patented or copyrighted, it is acceptable for experimentation to incorporate the use of one or more patented devices of one or several manufacturers.)
- F. The time period and location(s) of the experiment.
- G. A detailed research or evaluation plan that must provide for close monitoring of the experimentation, especially in the early stages of its field implementation. The evaluation plan should include before and after studies as well as quantitative data describing the performance of the experimental device.
- H. An agreement to restore the site of the experiment to a condition that complies with the provisions of this Manual within 3 months following the end of the time period of the experiment. This agreement must also provide that the agency sponsoring the experimentation will terminate the experimentation at any time that it

*determines significant safety concerns are directly or indirectly attributable to the experimentation. The FHWA's Office of Transportation Operations has the right to terminate approval of the experimentation at any time if there is an indication of safety concerns. If, as a result of the experimentation, a request is made that this Manual be changed to include the device or application being experimented with, the device or application will be permitted to remain in place until an official rulemaking action has occurred.*

- I. *An agreement to provide semi-annual progress reports for the duration of the experimentation, and an agreement to provide a copy of the final results of the experimentation to the FHWA's Office of Transportation Operations within 3 months following completion of the experimentation. The FHWA's Office of Transportation Operations has the right to terminate approval of the experimentation if reports are not provided in accordance with this schedule.*

**Support:**

12 A change includes consideration of a new device to replace a present standard device, an additional device to be added to the list of standard devices, or a revision to a traffic control device application or placement criteria.

**Guidance:**

13 *Requests for a change to this Manual should contain the following information:*

- A. *A statement indicating what change is proposed;*
- B. *Any illustration that would be helpful to understand the request; and*
- C. *Any supporting research data that is pertinent to the item to be reviewed.*

**Support:**

14 Interim approval allows interim use, pending official rulemaking, of a new traffic control device, a revision to the application or manner of use of an existing traffic control device, or a provision not specifically described in this Manual. The FHWA issues an Interim Approval by official memorandum signed by the Associate Administrator for Operations and posts this memorandum on the MUTCD website. The issuance by FHWA of an interim approval will typically result in the traffic control device or application being placed into the next scheduled rulemaking process for revisions to this Manual.

15 Interim approval is considered based on the results of successful experimentation, results of analytical or laboratory studies, and/or review of non-U.S. experience with a traffic control device or application. Interim approval considerations include an assessment of relative risks, benefits, costs, impacts, and other factors.

16 Interim approval allows for optional use of a traffic control device or application and does not create a new mandate or recommendation for use. Interim approval includes conditions that jurisdictions agree to comply with in order to use the traffic control device or application until an official rulemaking action has occurred.

[16a Refer to Table 1A-101\(CA\) for the status of Interim Approvals issued by FHWA in California.](#)

**Standard:**

17 **A jurisdiction, toll facility operator, or owner of a private road open to public travel (see definition in Section 1A.13) that desires to use a traffic control device for which FHWA has issued an interim approval shall request permission from FHWA.**

**Guidance:**

18 *The request for permission to place a traffic control device under an interim approval should contain the following:*

- A. *A description of where the device will be used, such as a list of specific locations or highway segments or types of situations, or a statement of the intent to use the device jurisdiction-wide;*
- B. *An agreement to abide by the specific conditions for use of the device as contained in the FHWA's interim approval document;*
- C. *An agreement to maintain and continually update a list of locations where the device has been installed; and*
- D. *An agreement to:*
  1. *Restore the site(s) of the interim approval to a condition that complies with the provisions in this Manual within 3 months following the issuance of a final rule on this traffic control device; and*
  2. *Terminate use of the device or application installed under the interim approval at any time that it determines significant safety concerns are directly or indirectly attributable to the device or application. The FHWA's Office of Transportation Operations has the right to terminate the interim approval at any time if there is an indication of safety concerns.*

**Option:**

19 A State may submit a request for the use of a device under interim approval for all jurisdictions in that State, as long as the request contains the information listed in Paragraph 18.

**Support:**

19a Figure 1A-101(CA) shows the process for the use of traffic control devices in California approved as interim approval by FHWA.

**Guidance:**

20 A local jurisdiction, toll facility operator, or owner of a private road open to public travel (see definition in Section 1A.13) using a traffic control device or application under an interim approval that was granted by FHWA either directly or on a statewide basis based on the State's request should inform the State of the locations of such use.

21 A local jurisdiction, toll facility operator, or owner of a private road open to public travel (see definition in Section 1A.13) that is requesting permission to experiment or permission to use a device or application under an interim approval should first check for any State laws and/or directives covering the application of the MUTCD provisions that might exist in their State.

**Option:**

22 A device or application installed under an interim approval may remain in place, under the conditions established in the interim approval, until an official rulemaking action has occurred.

**Support:**

23 A diagram indicating the process for incorporating new traffic control devices into this Manual is shown in Figure 1A-2.

24 For additional information concerning interpretations, experimentation, changes, or interim approvals, visit the MUTCD website at <http://mutcd.fhwa.dot.gov>.

**Standard:**

25 **Requests shall be made to the FHWA for experimenting with any new traffic control device, its application or manner of use, or a provision not specifically described in the Manual on Uniform Traffic Control Devices.**

**Support:**

26 In addition to the requirements of the FHWA, experimental traffic control devices are subject to the laws, regulations and policies of the State of California.

**Standard:**

27 **The agency shall request and receive approval from the California Traffic Control Devices Committee and Federal Highway Administration, when needed, prior to installation of experimentation devices on public roadways in California.**

**Support:**

28 For information contact:

Executive Secretary,  
California Traffic Control Devices Committee  
<http://www.dot.ca.gov/traffops/engineering/ctcdc/index.htm>.

29 The California MUTCD contains the official standards and policies of the State of California for the design, application, and placement of traffic control devices.

30 Experimentation is defined as research involving the acts of testing, evaluating, analyzing or discovering the effect of a specific device, principle, supposition, etc., usually carried out in an operational context. Experimentation could also be performed in a laboratory. The request for experimentation is a submission specifically requesting approval to use a non-standard device on public roadways for purposes of gathering verification data.

31 As used herein, the term "device" includes not only signs, signals, and markings, but also their application and manner of use.

**Guidance:**

32 *Requests for experimentation, interpretation, or changes relating to the California edited portion of the California MUTCD should be sent to:*

*Executive Secretary,  
California Traffic Control Devices Committee – MS36  
P.O. Box 942874, Sacramento, CA-94274-0001*

Support:

<sup>33</sup> The following procedures apply to requests for experimentation:

### **Submission of Projects**

<sup>34</sup> A request for permission to experiment will be considered only when submitted by the public agency or private toll facility responsible for the operation of the road or street on which the experiment is to take place.

Guidance:

<sup>35</sup> *Experimentation requests should contain the following information:*

- A. *A statement indicating the nature of the problem.*
- B. *A description of the proposed change, how it was developed, the manner in which it deviates from the standard, and how it is expected to be an improvement over existing standards.*
- C. *Any illustration, photograph, or videos, which would help, explain the experimental device or use of this device.*
- D. *Any supporting data as to how the experimental device was developed, if it has been tried, in what ways it was found to be adequate or inadequate, and how was this choice of device or application arrived at.*

Support:

<sup>36</sup> Requests for experimentation that are submitted without an explanation of the objective, scope, and duration will be returned to the originator for amplification.

### **Procedure for Processing Requests**

- A. All requests for experimentation will be reviewed by the Secretary of the California Traffic Control Devices Committee to determine whether other related experimentation has been scheduled, in process, or already completed.
- B. The Secretary of the California Traffic Control Devices Committee will list the experimentation proposal on the next Committee agenda for review and approval. The Committee's approval would also include the specific guidelines to be followed for the experimentation.
- C. Action by the California Traffic Control Devices Committee on any request for experimental use of a non-conforming device could take several forms:
  1. Approval of the device for limited use on an experimental project.
  2. Approval of the device for limited use in a formal research project.
  3. Disapproval until such time as satisfactory research or other justification is submitted.
  4. Disapproval.
- D. After action by the California Traffic Control Devices Committee, the Secretary of the California Traffic Control Devices Committee will notify the originating party of its decision. If approved, the originating parties will be requested to submit a status report on the experimental testing at appropriate intervals. When the results of experimentation are completed, a final report will be prepared and forwarded to the Secretary for Committee review.
- E. The agency receiving approval for experimentation must agree to faithfully follow the specific guidelines for the experimentation, must forward reports as indicated, and must agree to terminate the experimentation upon notification.

### **Specific Guidelines for Experimental Proposal**

Guidance:

<sup>37</sup> *A specific proposal should be submitted for each request.*

Support:

<sup>38</sup> This proposal can be submitted with the initial request or could be a follow-up to specific comments by the California Traffic Control Devices Committee. The proposal, after approval by the Committee, will become an integral part of the approved experimentation.

Guidance:

<sup>39</sup> *Each proposal should include:*

- A. Scope: *A detailed description of the experimentation, locations of installation, and number of experimental projects.*
- B. Work Plan: *A description of the proposed plan of study; the variables that are to be measured; the criteria against which the devices is to be evaluated; observations, measures and data which will be collected; whether the experimentation will be carried out in the field or under laboratory conditions; how installations of the experimental device or application will be made; the indication if any adverse effects on safety or traffic operations can be anticipated, together with the means that may be taken to minimize them; and the factors which will be held constant or measured and controlled in order to ensure that the true effects of the device are measured.*
- C. Time Periods: *Time periods for experimentation will normally not be less than six months nor more than two years.*

- D. Evaluation Procedures: *The California Traffic Control Devices Committee will approve criteria, which will be used to evaluate experimental devices or applications. To permit meaningful comparisons with standard installations, advice from specialists such as human factor experts, statisticians, etc., could be included.*
- E. Reporting: *A written status report must be forwarded to the sponsor 45 days prior to each public meeting. A final report must be completed within 90 days of the terminal date of the experimentation and forwarded to the Secretary of the California Traffic Control Devices Committee. Status reports will describe the progress of the work, any particular deviation from the work plan and anticipated time of conclusion. The final report will contain, as a minimum, the basic information on the problem, the preliminary investigations, the proposed solutions, the study procedures, the detailed analysis of the data, the results of the work, a discussion of the results, and whatever conclusions are drawn. If a change in the California MUTCD is proposed, the recommended text (wording) for the California MUTCD should be included.*
- F. Administration: *All experimentation proposals will include the agency sponsoring the study, the agency conducting the study, and the name and titles of principal researchers. There must be proof of professional traffic engineering capabilities and other related professional expertise to perform the experimentation and related evaluation processes.*

### Termination of Experimentation

#### **Standard:**

**<sup>40</sup> The project shall terminate at the end of the approved period unless an extension is granted, and all experimental devices and applications shall be removed unless specific permission is given for continued operation.**

#### Support:

<sup>41</sup> The California Traffic Control Devices Committee could, at any time, terminate approval of experimentation if significant safety hazards are indicated to be directly or indirectly attributable to the experimentation. Approval of any experimentation could also be terminated if no status report is received 45 days prior to each public meeting or no final report is received within 90 days of the terminal date of the experimentation.

### Removal of Experimentation Installations

#### **Standard:**

**<sup>42</sup> All experimentation installations shall be removed upon termination of the experiment-when a decision is made by the California Traffic Control Devices Committee that the device is not warranted.**

#### Support:

<sup>43</sup> Authority and reference cited for removal of experimentation installation is CVC Section 21400.

**Table 1A-101(CA). Status of Interim Approvals Issued By FHWA in California**

| No.   | Description   | Date Issued by FHWA | Date Adopted in CA                 |
|-------|---|---------------------|------------------------------------|
| IA-1  | Optional use of retroreflective borders on traffic signal backplates  | 2/6/04              | 12/7/06                            |
| IA-2  | Optional use of wayside horn system (WHS) at highway-rail grade crossings   | 8/2/04              | 12/7/06                            |
| IA-4R | REVISED Interim Approval for Use of Automated Flagger Assistance Devices  | 1/28/05             | 5/9/06                             |
| IA-5  | <del>Interim Approval for Use of Clearview Font for Positive Contrast Legends on Guide Signs</del>                                | 9/2/04              | <del>12/7/06</del>                 |
| IA-8  | Interim Approval for Optional Use of RV Friendly Symbol Sign  | 9/6/05              | 12/7/06                            |
| IA-9  | Interim Approval to Display More than Six Specific Service Logo Panels for a Type of Service                                      | 9/21/06             | Incorporated in the CA MUTCD 2012  |
| IA-10 | Interim Approval for Optional Use of Flashing Yellow Arrow for Permissive Left  | 3/20/06             | 11/3/08                            |
| IA-11 | <del>Optional Use of Rectangular Rapid Flashing Beacons</del>   | 7/16/08             | 8/10/11                            |
| IA-12 | Interim Approval for Optional Use of Traffic Signal Photo Enforced Signs  | 11/12/10            | Continue to use SR56(CA) sign spec |
| IA-13 | Interim Approval for Optional Use of an Alternative Electric Vehicle Charging General Service Symbol Sign                         | 4/1/11              | 8/10/11                            |
| IA-14 | Interim Approval for the Optional Use of Green Colored Pavement for Bike Lanes  | 4/15/11             | 8/12/11                            |
| IA-15 | Interim Approval for the Optional Use of an Alternative Design for the U.S. Bicycle Route (M1-9) Sign                             | 6/1/12              | 10/27/12                           |
| IA-16 | Interim Approval for the Optional Use of Bicycle Signal Faces   | 12/24/13            | 11/27/15                           |
| IA-17 | Interim Approval for Optional Use of Three-Section Flashing Yellow Arrow Signal Faces   | 8/12/14             | 4/7/17                             |
| IA-18 | Interim Approval for Optional Use of an Intersection Bicycle box  | 10/12/16            | 4/6/17                             |
| IA-19 | Interim Approval for the Optional Use of an Alternative Signal Warrant 7 - Crash Experience                                       | 2/24/17             | ---                                |
| IA-20 | Interim Approval for the Optional Use of Two-Stage Bicycle Turn Boxes   | 7/13/17             | 8/15/17                            |
| IA-21 | Interim Approval for the Optional Use of Pedestrian-Actuated Rectangular Rapid-Flashing Beacons at Uncontrolled Marked Crosswalks | 3/21/18             | 4/9/18                             |

Notes:

- Interim Approvals IA-1, 2, 4R, 8, 9, and 10 were issued by FHWA during the time that the 2003 National MUTCD was in effect, for devices that have been incorporated into the 2009 National MUTCD. These Interim Approvals have been terminated by FHWA and are no longer in effect. Refer [https://mutcd.fhwa.dot.gov/res-interim\\_approvals.htm](https://mutcd.fhwa.dot.gov/res-interim_approvals.htm)
- Visit [http://mutcd.fhwa.dot.gov/res-interim\\_approvals.htm](http://mutcd.fhwa.dot.gov/res-interim_approvals.htm) for Interim Approval IA-5 Termination Memorandum dated January 28, 2016 and IA 11 Termination Memorandum dated December 21, 2017.
- Visit <http://www.dot.ca.gov/trafficops/camutcd/interim.html> for full table including web links and pdf file links. Refer to TOPD 13-01 for use on Electric Vehicle Charging Station sign G66-21B(CA) <http://www.dot.ca.gov/trafficops/policy/13-01.pdf>

## **Section 1A.11 Relation to Other Publications**

### **Standard:**

**01 To the extent that they are incorporated by specific reference, the latest editions of the following publications, or those editions specifically noted, shall be a part of this Manual: “Standard Highway Signs and Markings” book (FHWA); and “Color Specifications for Retroreflective Sign and Pavement Marking Materials” (appendix to subpart F of Part 655 of Title 23 of the Code of Federal Regulations).**

### **Support:**

02 The “Standard Highway Signs and Markings” book includes standard alphabets and symbols and arrows for signs and pavement markings.

03 For information about the publications mentioned in Paragraph 1, visit the Federal Highway Administration’s MUTCD website at

<http://mutcd.fhwa.dot.gov>,

or write to the

FHWA,  
1200 New Jersey Avenue, SE, HOTO,  
Washington, DC 20590.

04 Other publications that are useful sources of information with respect to the use of this Manual are listed in this paragraph. See Page i of this Manual for ordering information for the following publications (later editions might also be available as useful sources of information):

1. “AAA School Safety Patrol Operations Manual,” 2006 Edition (American Automobile Association—AAA)
2. “A Policy on Geometric Design of Highways and Streets,” 2004 Edition (American Association of State Highway and Transportation Officials—AASHTO)
3. “Guide for the Development of Bicycle Facilities,” 1999 Edition (AASHTO)
4. “Guide for the Planning, Design, and Operation of Pedestrian Facilities,” 2004 Edition (AASHTO)
5. “Guide to Metric Conversion,” 1993 Edition (AASHTO)
6. “Guidelines for the Selection of Supplemental Guide Signs for Traffic Generators Adjacent to Freeways,” 4th Edition/Guide Signs, Part II: Guidelines for Airport Guide Signing/Guide Signs, Part III: List of Control Cities for Use in Guide Signs on Interstate Highways,” Item Code: GSGLC-4, 2001 Edition (AASHTO)
7. “Roadside Design Guide,” 2006 Edition (AASHTO)
8. “Standard Specifications for Movable Highway Bridges,” 1988 Edition (AASHTO)
9. “Traffic Engineering Metric Conversion Folders—Addendum to the Guide to Metric Conversion,” 1993 Edition (AASHTO)
10. “2009 AREMA Communications & Signals Manual,” (American Railway Engineering & Maintenance-of-Way Association—AREMA)
11. “Changeable Message Sign Operation and Messaging Handbook (FHWA-OP-03-070),” 2004 Edition (Federal Highway Administration—FHWA)
12. “Designing Sidewalks and Trails for Access—Part 2—Best Practices Design Guide (FHWA-EP-01-027),” 2001 Edition (FHWA)
13. “Federal-Aid Highway Program Guidance on High Occupancy Vehicle (HOV) Lanes,” 2001 (FHWA)
14. “Maintaining Traffic Sign Retroreflectivity,” 2007 Edition (FHWA)
15. “Railroad-Highway Grade Crossing Handbook—Revised Second Edition (FHWA-SA-07-010),” 2007 Edition (FHWA)
16. “Ramp Management and Control Handbook (FHWA-HOP-06-001),” 2006 Edition (FHWA)
17. “Roundabouts-An Informational Guide (FHWA-RD-00-067),” 2000 Edition (FHWA)
18. “Signal Timing Manual (FHWA-HOP-08-024),” 2008 Edition (FHWA)
19. “Signalized Intersections: an Informational Guide (FHWA-HRT-04-091),” 2004 Edition (FHWA)
20. “Travel Better, Travel Longer: A Pocket Guide to Improving Traffic Control and Mobility for Our Older Population (FHWA-OP-03-098),” 2003 Edition (FHWA)
21. “Practice for Roadway Lighting,” RP-8, 2001 (Illuminating Engineering Society—IES)

22. "Safety Guide for the Prevention of Radio Frequency Radiation Hazards in the Use of Commercial Electric Detonators (Blasting Caps)," Safety Library Publication No. 20, July 2001 Edition (Institute of Makers of Explosives)
23. "American National Standard for High-Visibility Public Safety Vests," (ANSI/ISEA 207-2006), 2006 Edition (International Safety Equipment Association—ISEA)
24. "American National Standard for High-Visibility Safety Apparel and Headwear," (ANSI/ISEA 107-2004), 2004 Edition (ISEA)
25. "Manual of Traffic Signal Design," 1998 Edition (Institute of Transportation Engineers—ITE)
26. "Manual of Transportation Engineering Studies," 1994 Edition (ITE)
27. "Pedestrian Traffic Control Signal Indications," Part 1—1985 Edition; Part 2 (LED Pedestrian Traffic Signal Modules)—2004 Edition (ITE)
28. "Preemption of Traffic Signals Near Railroad Crossings," 2006 Edition (ITE)
29. "Purchase Specification for Flashing and Steady Burn Warning Lights," 1981 Edition (ITE)
30. "Traffic Control Devices Handbook," 2001 Edition (ITE)
31. "Traffic Detector Handbook," 1991 Edition (ITE)
32. "Traffic Engineering Handbook," 2009 Edition (ITE)
33. "Traffic Signal Lamps," 1980 Edition (ITE)
34. "Vehicle Traffic Control Signal Heads," Part 1—1985 Edition; Part 2 (LED Circular Signal Supplement)—2005 Edition; Part 3 (LED Vehicular Arrow Traffic Signal Supplement)—2004 Edition (ITE)
35. "Uniform Vehicle Code (UVC) and Model Traffic Ordinance," 2000 Edition (National Committee on Uniform Traffic Laws and Ordinances—NCUTLO)
36. "NEMA Standards Publication TS 4-2005 Hardware Standards for Dynamic Message Signs (DMS) With NTCIP Requirements," 2005 Edition (National Electrical Manufacturers Association—NEMA)
37. "Occupational Safety and Health Administration Regulations (Standards - 29 CFR), General Safety and Health Provisions - 1926.20," amended June 30, 1993 (Occupational Safety and Health Administration—OSHA)
38. "Accessible Pedestrian Signals—A Guide to Best Practices (NCHRP Web-Only Document 117A)," 2008 Edition (Transportation Research Board—TRB)
39. "Guidelines for Accessible Pedestrian Signals (NCHRP Web-Only Document 117B)," 2008 Edition (TRB)
40. "Highway Capacity Manual," 2000 Edition (TRB)
41. "Recommended Procedures for the Safety Performance Evaluation of Highway Features," (NCHRP Report 350), 1993 Edition (TRB)
42. "The Americans with Disabilities Act Accessibility Guidelines for Buildings and Facilities (ADAAG)," July 1998 Edition (The U.S. Access Board)

**Standard:**

**<sup>05</sup> The latest edition of Caltrans' California Sign Specifications shall be a part of this manual.**

**Support:**

<sup>06</sup> Refer to the following web link for more information: <http://www.dot.ca.gov/trafficops/tcd/specs.html>

<sup>07</sup> The latest version of other documents that are useful sources of information with respect to the use of this Manual are listed below. See the Introduction Part of this California MUTCD for ordering information for the following publications:

1. "California Building Standards Code" (California Building Standards Commission)
2. "California Business and Professions Code" (State of California)
3. "California Code of Regulations" (State of California)
4. "California Education Code" (State of California)
5. "California Government Code" (State of California)
6. "California Health and Safety Code" (State of California)
7. "California Streets and Highways Code" (State of California)
8. "California Vehicle Code" (CVC) (Department of Motor Vehicles)
9. "Changeable Message Sign Guidelines" (Caltrans)
10. "Construction Manual" (Caltrans)
11. "Highway Design Handbook For Older Drivers And Pedestrians" (Federal Highway Administration)
12. "Highway Design Manual" (Caltrans)
13. "High Occupancy Vehicle Guidelines for Planning, Design, and Operations" (Caltrans)



14. "Historic Highway Bridges of California" (Caltrans)
15. "Maintenance Manual" (Caltrans)
16. "Manual for Encroachment Permits on California State Highways" (Caltrans)
17. "Plans, Specifications and Estimates Guide" (PS&E) (Caltrans)
18. "Project Development Procedures Manual" (Caltrans)
19. "Ramp Meter Design Manual" (Caltrans)
20. "Ready to List and Construction Contract Award Guide" (Caltrans)
21. "Signal, Lighting and Electrical System Design Guide" (Caltrans)
22. "Standard Plans" (Caltrans)
23. "Standard Specifications" (Caltrans)
24. "Standard Special Provisions" (Caltrans)
25. "Transportation Management Plan Guidelines" (Caltrans)
26. "Traffic Engineering Metric Conversion Factors" (American Association of State Highway and transportation Officials - AASHTO).
27. "Traffic Manual" (Caltrans)
28. "Transportation Management Plan Guidelines", (Caltrans)

### **Section 1A.12 Color Code**

#### **Support:**

<sup>01</sup> The following color code establishes general meanings for 11 colors of a total of 13 colors that have been identified as being appropriate for use in conveying traffic control information. tolerance limits for each color are contained in 23 CFR Part 655, Appendix to Subpart F and are available at the Federal Highway Administration's MUTCD website at <http://mutcd.fhwa.dot.gov> or by writing to the FHWA, Office of Safety Research and Development (HRD-T-301), 6300 Georgetown Pike, McLean, VA 22101.

<sup>02</sup> The two colors for which general meanings have not yet been assigned are being reserved for future applications that will be determined only by FHWA after consultation with the States, the engineering community, and the general public. The meanings described in this Section are of a general nature. More specific assignments of colors are given in the individual Parts of this Manual relating to each class of devices.

#### **Standard:**

<sup>03</sup> **The general meaning of the 13 colors shall be as follows:**

**A. Black—regulation**

**B. Blue—road user services guidance, tourist information, and evacuation route**

**C. Brown—recreational and cultural interest area guidance**

**D. Coral—unassigned**

**E. Fluorescent Pink—incident management**

**F. Fluorescent Yellow-Green—pedestrian warning, bicycle warning, playground warning, school bus and school warning**

**G. Green—indicated movements permitted, direction guidance**

**H. Light Blue—unassigned**

**I. Orange—temporary traffic control**

**J. Purple—lanes restricted to use only by vehicles with registered electronic toll collection (ETC) accounts**

**K. Red—stop or prohibition**

**L. White—regulation**

**M. Yellow—warning**

### **Section 1A.13 Definitions of Headings, Words, and Phrases in this Manual**

#### **Standard:**

<sup>01</sup> **When used in this Manual, the text headings of Standard, Guidance, Option, and Support shall be defined as follows:**

**A. Standard—a statement of required, mandatory, or specifically prohibitive practice regarding a traffic control device. All Standard statements are labeled, and the text appears in bold type. The**

verb “shall” is typically used. The verbs “should” and “may” are not used in Standard statements. Standard statements are sometimes modified by Options.

**B. Guidance**—a statement of recommended, but not mandatory, practice in typical situations, with deviations allowed if engineering judgment or engineering study indicates the deviation to be appropriate. All Guidance statements are labeled, and the text appears in unbold type. The verb “should” is typically used. The verbs “shall” and “may” are not used in Guidance statements. Guidance statements are sometimes modified by Options.

**C. Option**—a statement of practice that is a permissive condition and carries no requirement or recommendation. Option statements sometime contain allowable modifications to a Standard or Guidance statement. All Option statements are labeled, and the text appears in unbold type. The verb “may” is typically used. The verbs “shall” and “should” are not used in Option statements.

**D. Support**—an informational statement that does not convey any degree of mandate, recommendation, authorization, prohibition, or enforceable condition. Support statements are labeled, and the text appears in unbold type. The verbs “shall,” “should,” and “may” are not used in Support statements.

<sup>02</sup> Unless otherwise defined in this Section, or in other Parts of this Manual, words or phrases shall have the meaning(s) as defined in the most recent editions of the “Uniform Vehicle Code,” “AASHTO Transportation Glossary (Highway Definitions),” “California Vehicle Code” and other publications mentioned in Section 1A.11.

<sup>03</sup> The following words and phrases, when used in this Manual, shall have the following meanings:

1. **Accessible Pedestrian Signal**—a device that communicates information about pedestrian signal timing in non-visual format such as audible tones, speech messages, and/or vibrating surfaces.
2. **Accessible Pedestrian Signal Detector**—a device designated to assist the pedestrian who has visual or physical disabilities in activating the pedestrian phase.
3. **Active Grade Crossing Warning System**—the flashing-light signals, with or without warning gates, together with the necessary control equipment used to inform road users of the approach or presence of rail traffic at grade crossings.
4. **Actuated Operation**—a type of traffic control signal operation in which some or all signal phases are operated on the basis of actuation.
5. **Actuation**—initiation of a change in or extension of a traffic signal phase through the operation of any type of detector.
6. **Advance Preemption**—the notification of approaching rail traffic that is forwarded to the highway traffic signal controller unit or assembly by the railroad or light rail transit equipment in advance of the activation of the railroad or light rail transit warning devices.
7. **Advance Preemption Time**—the period of time that is the difference between the required maximum highway traffic signal preemption time and the activation of the railroad or light rail transit warning devices.
8. **Advisory Speed**—a recommended speed for all vehicles operating on a section of highway and based on the highway design, operating characteristics, and conditions.
9. **Alley**—a street or highway intended to provide access to the rear or side of lots or buildings in urban areas and not intended for the purpose of through vehicular traffic. Refer to CVC 110, for definition of “Highway”.
10. **Altered Speed Zone**—a speed limit, other than a statutory speed limit, that is based upon an engineering study. Refer to CVC 22357 and 22358.
11. **Approach**—all lanes of traffic moving toward an intersection or a midblock location from one direction, including any adjacent parking lane(s).
12. **Arterial Highway (Street)**—a general term denoting a highway primarily used by through traffic, usually on a continuous route or a highway designated as part of an arterial system.
13. **Attended Lane (Manual Lane)**—a toll lane adjacent to a toll booth occupied by a human toll collector who makes change, issues receipts, and perform other toll-related functions. Attended lanes at toll plazas typically require vehicles to stop to pay the toll.
14. **Automatic Lane**—see Exact Change Lane.
15. **Average Annual Daily Traffic (AADT)**—the total volume of traffic passing a point or segment of a highway facility in both directions for one year divided by the number of days in the year. Normally,

- periodic daily traffic volumes are adjusted for hours of the day counted, days of the week, and seasons of the year to arrive at average annual daily traffic.
16. **Average Daily Traffic (ADT)**—the average 24 hour volume, being the total volume during a stated period divided by the number of days in that period. Normally, this would be periodic daily traffic volumes over several days, not adjusted for days of the week or seasons of the year.
  17. **Average Day**—a day representing traffic volumes normally and repeatedly found at a location, typically a weekday when volumes are influenced by employment or a weekend day when volumes are influenced by entertainment or recreation.
  18. **Backplate**—see Signal Backplate.
  19. **Barrier-Separated Lane**—a preferential lane or other special purpose lane that is separated from the adjacent general-purpose lane(s) by a physical barrier.
  20. **Beacon**—a highway traffic signal with one or more signal sections that operates in a flashing mode.
  21. **Bicycle**—a pedal-powered vehicle upon which the human operator sits. **As per CVC 231, a bicycle is a device upon which any person may ride, propelled exclusively by human power through a belt, chain, or gears, and having one or more wheels. Persons riding bicycles are subject to the provisions of this code specified in Sections 21200 and 21200.5. Also refer to CVC 39000 and S&H Code Section 890.2.**
  22. **Bicycle Facilities**—a general term denoting improvements and provisions that accommodate or encourage bicycling, including parking and storage facilities, and shared roadways not specifically defined for bicycle use.
  23. **Bicycle Lane**—a portion of a roadway that has been designated for preferential or exclusive use by bicyclists by pavement markings and, if used, signs. **See Class II Bikeway.**
  - 23a. **Bicycle Path** – A "bicycle path" or "bike path" is a Class I bikeway, as defined in subdivision (a) of Section 890.4 of the Streets and Highways Code. Refer to CVC 231.5. **See Class I Bikeway.**
  - 23b. **Bicycle Path Crossing** - That portion of a roadway included within the prolongation or connection of the boundary lines of a bike path at intersections where the intersecting roadways meet at approximately right angles or any portion of a roadway distinctly indicated for bicycle crossing by lines or other markings on the surface. Refer to CVC 231.6.
  24. **Bikeway**—a generic term for any road, street, path, or way that in some manner is specifically designated for bicycle travel, regardless of whether such facilities are designated for the exclusive use of bicycles or are to be shared with other transportation modes. **Bikeway – All facilities that provide primarily for bicycle travel. Refer California Streets and Highways Code Section 890.4.**
  - 24a. **Bike Route** – See Class III Bikeway.
  - 24b. **Buffered Bicycle Lane** – A buffered bicycle lane is a bicycle lane that is separated from the adjacent general-purpose lane or parking lane by a pattern of standard longitudinal markings. The buffer area might include chevron or diagonal markings.
  25. **Buffer-Separated Lane**—a preferential lane or other special purpose lane that is separated from the adjacent general-purpose lane(s) by a pattern of standard longitudinal pavement markings that is wider than a normal or wide lane line marking. The buffer area might include rumble strips, textured pavement, or channelizing devices such as tubular markers or traversable curbs, but does not include a physical barrier.
  - 25a. **Business District** - A "business district" is that portion of a highway and the property contiguous thereto (a) upon one side of which highway, for a distance of 600 feet, 50 percent or more of the contiguous property fronting thereon is occupied by buildings in use for business, or (b) upon both sides of which highway, collectively, for a distance of 300 feet, 50 percent or more of the contiguous property fronting thereon is so occupied. A business district may be longer than the distances specified in this section if the above ratio of buildings in use for business to the length of the highway exists. Refer to CVC 235.
  - 25b. **CVC** – California Vehicle Code.
  - 25c. **California Sign Specifications** – Detailed drawings of signs approved by Caltrans for use in California.
  26. **Cantilevered Signal Structure**—a structure, also referred to as a mast arm, that is rigidly attached to a vertical pole and is used to provide overhead support of highway traffic signal faces or grade crossing signal units.

27. **Center Line Markings**—the yellow pavement marking line(s) that delineates the separation of traffic lanes that have opposite directions of travel on a roadway. These markings need not be at the geometrical center of the pavement.
28. **Changeable Message Sign**—a sign that is capable of displaying more than one message (one of which might be a “blank” display), changeable manually, by remote control, or by automatic control. Electronic-display changeable message signs are referred to as Dynamic Message Signs in the National Intelligent Transportation Systems (ITS) Architecture and are referred to as Variable Message Signs in the National Electrical Manufacturers Association (NEMA) standards publication.
29. **Channelizing Line Markings**—a wide or double solid white line used to form islands where traffic in the same direction of travel is permitted on both sides of the island.
30. **Circular Intersection**—an intersection that has an island, generally circular in design, located in the center of the intersection where traffic passes to the right of the island. Circular intersections include roundabouts, rotaries, and traffic circles.
31. **Circulatory Roadway**—the roadway within a circular intersection on which traffic travels in a counterclockwise direction around an island in the center of the circular intersection.
- 31a. **Civil Engineer** - a professional engineer in the branch of civil engineering and refers to one who practices or offers to practice civil engineering in any of its phases. Refer to California Business and Professions Code Section 6702.
- 31b. **Class I Bikeway (such as a Bike Path or a Shared-Use Path)** – Provides a completely separated right-of-way designated for the exclusive use of bicycles and pedestrians with crossflows by motorists minimized. Refer California Streets and Highways Code Section 890.4. Refer to Caltrans' Highway Design Manual Index 1003.1 for design criteria.
- 31c. **Class II Bikeway (such as a Bike Lane)** – Provides a restricted right-of-way designated for the exclusive or semi-exclusive use of bicycles with through travel by motor vehicles or pedestrians prohibited, but with vehicle parking and crossflows by pedestrians and motorists permitted. Refer to California Streets and Highways Code Section 890.4. Refer to Caltrans' Highway Design Manual Index 1003.2 for design criteria.
- 31d. **Class III Bikeway (such as a Bike Route)** – provide a right-of-way designated by signs or permanent markings and shared with pedestrians or motorists. Refer to California Streets and Highways Code Section 890.4. Refer to Caltrans' Highway Design Manual Index 1003.3 for design criteria.
- 31e. **Class IV Bikeway (such as a cycle track or separated bikeway)** – Provides a right-of-way designated exclusively for bicycle travel adjacent to a roadway and which is separated from vehicular traffic. Types of separation include, but are not limited to, grade separation, flexible posts, inflexible physical barriers, or on-street parking. Refer to California Streets and Highways Code Section 890.4. Refer to Caltrans' Design Information Bulletin Number 89 for design criteria.
- 31f. **Contraflow Bicycle Lane** – A contraflow bicycle lane is an area of the roadway designated to allow for the lawful use by bicyclists to travel in the opposite direction from vehicular traffic on a roadway that allows vehicular traffic to travel in only one direction.
32. **Clear Storage Distance**—when used in Part 8, the distance available for vehicle storage measured between 6 feet from the rail nearest the intersection to the intersection stop line or the normal stopping point on the highway. At skewed grade crossings and intersections, the 6-foot distance shall be measured perpendicular to the nearest rail either along the center line or edge line of the highway, as appropriate, to obtain the shorter distance. Where exit gates are used, the distance available for vehicle storage is measured from the point where the rear of the vehicle would be clear of the exit gate arm. In cases where the exit gate arm is parallel to the track(s) and is not perpendicular to the highway, the distance is measured either along the center line or edge line of the highway, as appropriate, to obtain the shorter distance.
33. **Clear Zone**—the total roadside border area, starting at the edge of the traveled way, that is available for an errant driver to stop or regain control of a vehicle. This area might consist of a shoulder, a recoverable slope, and/or a non-recoverable, traversable slope with a clear run-out area at its toe.
34. **Collector Highway**—a term denoting a highway that in rural areas connects small towns and local highways to arterial highways, and in urban areas provides land access and traffic circulation within residential, commercial, and business areas and connects local highways to the arterial highways.

35. **Concurrent Flow Preferential Lane**—a preferential lane that is operated in the same direction as the adjacent mixed flow lanes, separated from the adjacent general-purpose freeway lanes by a standard lane stripe, painted buffer, or barrier.
36. **Conflict Monitor**—a device used to detect and respond to improper or conflicting signal indications and improper operating voltages in a traffic controller assembly.
37. **Constant Warning Time Detection**—a means of detecting rail traffic that provides relatively uniform warning time for the approach of trains or light rail transit traffic that are not accelerating or decelerating after being detected.
- 37a. **Consulting Engineer** – See **Professional Engineer**. Refer to **California Business and Professions Code Section 6704**.
38. **Contiguous Lane**—a lane, preferential or otherwise, that is separated from the adjacent lane(s) only by a normal or wide lane line marking.
39. **Controller Assembly**—a complete electrical device mounted in a cabinet for controlling the operation of a highway traffic signal.
40. **Controller Unit**—that part of a controller assembly that is devoted to the selection and timing of the display of signal indications.
41. **Conventional Road**—a street or highway other than a low-volume road (as defined in Section 5A.01), expressway, or freeway.
42. **Counter-Flow Lane**—a lane operating in a direction opposite to the normal flow of traffic designated for peak direction of travel during at least a portion of the day. Counter-flow lanes are usually separated from the off-peak direction lanes by tubular markers or other flexible channelizing devices, temporary lane separators, or movable or permanent barrier.
43. **Crashworthy**—a characteristic of a roadside appurtenance that has been successfully crash tested in accordance with a national standard such as the National Cooperative Highway Research Program Report 350, “Recommended Procedures for the Safety Performance Evaluation of Highway Features” or the **Manual for Assessing Safety Hardware (MASH) crash guidelines**.
44. **Crosswalk**—(a) that part of a roadway at an intersection included within the connections of the lateral lines of the sidewalks on opposite sides of the highway measured from the curbs or in the absence of curbs, from the edges of the traversable roadway, and in the absence of a sidewalk on one side of the roadway, the part of a roadway included within the extension of the lateral lines of the sidewalk at right angles to the center line; (b) any portion of a roadway at an intersection or elsewhere distinctly indicated as a pedestrian crossing by pavement marking lines on the surface, which might be supplemented by contrasting pavement texture, style, or color. **As per CVC 275, "Crosswalk" is either: (a) That portion of a roadway included within the prolongation or connection of the boundary lines of sidewalks at intersections where the intersecting roadways meet at approximately right angles, except the prolongation of such lines from an alley across a street. (b) Any portion of a roadway distinctly indicated for pedestrian crossing by lines or other markings on the surface. Notwithstanding the foregoing provisions of this section, there shall not be a crosswalk where local authorities have placed signs indicating no crossing.**
45. **Crosswalk Lines**—white or yellow (in school areas per CVC 21368) pavement marking lines that identify a crosswalk.
46. **Cycle Length**—the time required for one complete sequence of signal indications.
47. **Dark Mode**—the lack of all signal indications at a signalized location. (The dark mode is most commonly associated with power failures, ramp meters, hybrid beacons, beacons, and some movable bridge signals.)
48. **Delineator**—a retroreflective device mounted on the roadway surface or at the side of the roadway in a series to indicate the alignment of the roadway, especially at night or in adverse weather.
- 48a. **Department of Transportation** – **California Department of Transportation or Caltrans**.
49. **Design Vehicle**—the longest vehicle permitted by statute of the road authority (State or other) on that roadway.
50. **Designated Bicycle Route**—a system of bikeways designated by the jurisdiction having authority with appropriate directional and informational route signs, with or without specific bicycle route numbers.

51. **Detectable**—having a continuous edge within 6 inches of the surface so that pedestrians who have visual disabilities can sense its presence and receive usable guidance information.
52. **Detector**—a device used for determining the presence or passage of vehicles (including motorcycles), bicycles or pedestrians.
- 52a. **Divided Highway** – A highway with separated roadbeds for traffic in opposing directions.
53. **Downstream**—a term that refers to a location that is encountered by traffic subsequent to an upstream location as it flows in an “upstream to downstream” direction. For example, “the downstream end of a lane line separating the turn lane from a through lane on the approach to an intersection” is the end of the lane line that is closest to the intersection.
54. **Dropped Lane**—a through lane that becomes a mandatory turn lane on a conventional roadway, or a through lane that becomes a mandatory exit lane on a freeway or expressway. The end of an acceleration lane and reductions in the number of through lanes that do not involve a mandatory turn or exit are not considered dropped lanes.
55. **Dual-Arrow Signal Section**—a type of signal section designed to include both a yellow arrow and a green arrow.
56. **Dynamic Envelope**—the clearance required for light rail transit traffic or a train and its cargo overhang due to any combination of loading, lateral motion, or suspension failure (see Figure 8B-8 8B-6(CA) Sheet 1 of 3).
57. **Dynamic Exit Gate Operating Mode**—a mode of operation where the exit gate operation is based on the presence of vehicles within the minimum track clearance distance.
58. **Edge Line Markings**—white or yellow pavement marking lines that delineate the right or left edge(s) of a traveled way.
- 58a. **Electrical Engineer** – a professional engineer in the branch of electrical engineering and refers to one who practices or offers to practice electrical engineering in any of its phases. Refer to California Business and Professions Code Section 6702.1.
59. **Electronic Toll Collection (ETC)**—a system for automated collection of tolls from moving or stopped vehicles through wireless technologies such as radio-frequency communication or optical scanning. ETC systems are classified as one of the following: (1) systems that require users to have registered toll accounts, with the use of equipment inside or on the exterior of vehicles, such as a transponder or barcode decal, that communicates with or is detected by roadside or overhead receiving equipment, or with the use of license plate optical scanning, to automatically deduct the toll from the registered user account, or (2) systems that do not require users to have registered toll accounts because vehicle license plates are optically scanned and invoices for the toll amount are sent through postal mail to the address of the vehicle owner.
60. **Electronic Toll Collection (ETC) Account-Only Lane**—a non-attended toll lane that is restricted to use only by vehicles with a registered toll payment account.
61. ~~Emergency Vehicle Hybrid Beacon—a special type of hybrid beacon used to warn and control traffic at an unsignalized location to assist authorized emergency vehicles in entering or crossing a street or highway. Refer to CVC 21355.~~
62. **Emergency-Vehicle Traffic Control Signal**—a special traffic control signal that assigns the right-of-way to an authorized emergency vehicle.
63. **End-of-Roadway Marker**—a device used to warn and alert road users of the end of a roadway in other than temporary traffic control zones.
- 63a. **Engineer** – a person registered under California Professional Engineers Act as a professional engineer, including any of the branches thereof. Refer to California Business and Professions Code Section 6706.
- 63b. **Engineering and Traffic Survey** – Refer to CVC 627.
64. **Engineering Judgment**—the evaluation of available pertinent information, and the application of appropriate principles, experience, education, discretion, provisions, and practices as contained in this Manual and other sources, for the purpose of deciding upon the applicability, design, operation, or installation of a traffic control device. Engineering judgment shall be exercised by an engineer, or by an individual working under the supervision of an engineer, through the application of procedures and criteria established by the engineer. Documentation of engineering judgment is not required.

65. **Engineering Study**—the comprehensive analysis and evaluation of available pertinent information, and the application of appropriate principles, **engineering judgment, experience, education, discretion, provisions, and practices** as contained in this Manual and other sources, for the purpose of deciding upon the applicability, design, operation, or installation of a traffic control device. An engineering study shall be performed by an engineer, or by an individual working under the supervision of an engineer, through the application of procedures and criteria established by the engineer. An engineering study shall be documented.
66. **Entrance Gate**—an automatic gate that can be lowered across the lanes approaching a grade crossing to block road users from entering the grade crossing.
67. **Exact Change Lane (Automatic Lane)**—a non-attended toll lane that has a receptacle into which road users deposit coins totaling the exact amount of the toll. Exact Change lanes at toll plazas typically require vehicles to stop to pay the toll.
68. **Exit Gate**—an automatic gate that can be lowered across the lanes departing a grade crossing to block road users from entering the grade crossing by driving in the opposing traffic lanes.
69. **Exit Gate Clearance Time**—for Four-Quadrant Gate systems at grade crossings, the amount of time provided to delay the descent of the exit gate arm(s) after entrance gate arm(s) begin to descend.
70. **Exit Gate Operating Mode**—for Four-Quadrant Gate systems at grade crossings, the mode of control used to govern the operation of the exit gate arms.
71. **Expressway**—a divided highway with partial control of access. **As per CVC 314, an "expressway" is a portion of highway that is part of either of the following: (a) An expressway system established by a county under Section 941.4 of the Streets and Highways Code. (b) An expressway system established by a county before January 1, 1989, as described in subdivision (g) of Section 941.4 of the Streets and Highways Code.**
72. **Flagger**—a person who actively controls the flow of vehicular traffic into and/or through a temporary traffic control zone using hand-signaling devices or an Automated Flagger Assistance Device (AFAD).
73. **Flasher**—a device used to turn highway traffic signal indications on and off at a repetitive rate of approximately once per second.
74. **Flashing**—an operation in which a light source, such as a traffic signal indication, is turned on and off repetitively.
75. **Flashing-Light Signals**—a warning device consisting of two red signal indications arranged horizontally that are activated to flash alternately when rail traffic is approaching or present at a grade crossing.
76. **Flashing Mode**—a mode of operation in which at least one traffic signal indication in each vehicular signal face of a highway traffic signal is turned on and off repetitively.
77. **Freeway**—a divided highway with full control of access. **As per CVC 332, "Freeway" is a highway in respect to which the owners of abutting lands have no right or easement of access to or from their abutting lands or in respect to which such owners have only limited or restricted right or easement of access.**
78. **Full-Actuated Operation**—a type of traffic control signal operation in which all signal phases function on the basis of actuation.
79. **Gate**—an automatically-operated or manually-operated traffic control device that is used to physically obstruct road users such that they are discouraged from proceeding past a particular point on a roadway or pathway, or such that they are discouraged from entering a particular grade crossing, ramp, lane, roadway, or facility.
80. **Grade Crossing**—the general area where a highway and a railroad and/or light rail transit route cross at the same level, within which are included the tracks, highway, and traffic control devices for traffic traversing that area.
81. **Guide Sign**—a sign that shows route designations, destinations, directions, distances, services, points of interest, or other geographical, recreational, or cultural information.
82. **High-Occupancy Vehicle (HOV)**—a motor vehicle carrying at least two or more persons, including carpools, vanpools, and buses.
83. **Highway**—a general term for denoting a public way for purposes of vehicular travel, including the entire area within the right-of-way. **As per CVC 360, "Highway" is a way or place of whatever nature,**

publicly maintained and open to the use of the public for purposes of vehicular travel. Highway includes street. Also, refer to CVC 590 definition of "Street".

84. **Highway-Light Rail Transit Grade Crossing**—the general area where a highway and a light rail transit route cross at the same level, within which are included the light rail transit tracks, highway, and traffic control devices for traffic traversing that area.
85. **Highway-Rail Grade Crossing**—the general area where a highway and a railroad cross at the same level, within which are included the railroad tracks, highway, and traffic control devices for highway traffic traversing that area.
86. **Highway Traffic Signal**—a power-operated traffic control device by which traffic is warned or directed to take some specific action. These devices do not include power-operated signs, steadily-illuminated pavement markers, warning lights (see Section 6F.83), or steady burning electric lamps.
87. **HOV Lane**—any preferential lane designated for exclusive use by high-occupancy vehicles for all or part of a day—including a designated lane on a freeway, other highway, street, or independent roadway on a separate right-of-way.
88. **Hybrid Beacon**—a special type of beacon that is intentionally placed in a dark mode (no indications displayed) between periods of operation and, when operated, displays both steady and flashing traffic control signal indications.
89. **Inherently Low Emission Vehicle (ILEV)**—any kind of vehicle that, because of inherent properties of the fuel system design, will not have significant evaporative emissions, even if its evaporative emission control system has failed.
90. **In-Roadway Lights**—a special type of highway traffic signal installed in the roadway surface to warn road users that they are approaching a condition on or adjacent to the roadway that might not be readily apparent and might require the road users to slow down and/or come to a stop.
91. **Interchange**—a system of interconnecting roadways providing for traffic movement between two or more highways that do not intersect at grade.
92. **Interconnection**—when used in Part 8, the electrical connection between the railroad or light rail transit active warning system and the highway traffic signal controller assembly for the purpose of preemption.
93. **Intermediate Interchange**—an interchange with an urban or rural route that is not a major or minor interchange as defined in this Section.
94. **Intersection**—intersection is defined as follows:

As per CVC 365, an "intersection" is the area embraced within the prolongation of the lateral curb lines, or, if none, then the lateral boundary lines of the roadways, of two highways which join one another at approximately right angles or the area within which vehicles traveling upon different highways joining at any other angle may come in conflict.

  - (a) The area embraced within the prolongation or connection of the lateral curb lines, or if none, the lateral boundary lines of the roadways of two highways that join one another at, or approximately at, right angles, or the area within which vehicles traveling on different highways that join at any other angle might come into conflict.
  - (b) The junction of an alley or driveway with a roadway or highway shall not constitute an intersection, unless the roadway or highway at said junction is controlled by a traffic control device.
  - (c) If a highway includes two roadways that are 30 feet or more apart (see definition of Median), then every crossing of each roadway of such divided highway by an intersecting highway shall be a separate intersection.
  - (d) If both intersecting highways include two roadways that are 30 feet or more apart, then every crossing of any two roadways of such highways shall be a separate intersection.
  - (e) At a location controlled by a traffic control signal, regardless of the distance between the separate intersections as defined in (c) and (d) above:
    - (1) If a stop line, yield line, or crosswalk has not been designated on the roadway (within the median) between the separate intersections, the two intersections and the roadway (median) between them shall be considered as one intersection;



- (2) Where a stop line, yield line, or crosswalk is designated on the roadway on the intersection approach, the area within the crosswalk and/or beyond the designated stop line or yield line shall be part of the intersection; and
  - (3) Where a crosswalk is designated on a roadway on the departure from the intersection, the intersection shall include the area extending to the far side of such crosswalk.
- 95. **Intersection Control Beacon**—a beacon used only at an intersection to control two or more directions of travel.
  - 96. **Interval**—the part of a signal cycle during which signal indications do not change.
  - 97. **Interval Sequence**—the order of appearance of signal indications during successive intervals of a signal cycle.
  - 98. **Island**—a defined area between traffic lanes for control of vehicular movements, for toll collection, or for pedestrian refuge. It includes all end protection and approach treatments. Within an intersection area, a median or an outer separation is considered to be an island.
  - 99. **Lane Drop**—see **Dropped Lane**.
  - 100. **Lane Line Markings**—white pavement marking lines that delineate the separation of traffic lanes that have the same direction of travel on a roadway.
  - 101. **Lane-Use Control Signal**—a signal face displaying indications to permit or prohibit the use of specific lanes of a roadway or to indicate the impending prohibition of such use.
  - 102. **Legend**—see **Sign Legend**.
  - 103. **Lens**—see **Signal Lens**.
  - 104. **Light Rail Transit Traffic (Light Rail Transit Equipment)**—every device in, upon, or by which any person or property can be transported on light rail transit tracks, including single-unit light rail transit cars (such as streetcars and trolleys) and assemblies of multiple light rail transit cars coupled together.
  - 104a. **Limit Line - A "limit line" is a solid white line not less than 12 nor more than 24 inches wide, extending across a roadway or any portion thereof to indicate the point at which traffic is required to stop in compliance with legal requirements. Refer to CVC 377.**
  - 104b. **Limit Line Detection Zone – a Referenced Bicycle-Rider must be detected in a 6 x 6 feet area immediately behind the limit line, centered either in a normal width lane or if the lane is more than 12 feet wide, centered 6 feet from the left lane line. For a lane of 20 feet or greater, two minimum 6 x 6 feet areas shall constitute the Limit Line Detection Zone.**
  - 105. **Locomotive Horn**—an air horn, steam whistle, or similar audible warning device (see 49 CFR Part 229.129) mounted on a locomotive or control cab car. The terms “locomotive horn,” “train whistle,” “locomotive whistle,” and “train horn” are used interchangeably in the railroad industry.
  - 106. **Logo**—a distinctive emblem or trademark that identifies a commercial business and/or the product or service offered by the business.
  - 107. **Longitudinal Markings**—pavement markings that are generally placed parallel and adjacent to the flow of traffic such as lane lines, center lines, edge lines, channelizing lines, and others.
  - 108. **Louver**—see **Signal Louver**.
  - 109. **Major Interchange**—an interchange with another freeway or expressway, or an interchange with a high-volume multi-lane highway, principal urban arterial, or major rural route where the interchanging traffic is heavy or includes many road users unfamiliar with the area.
  - 110. **Major Street**—the street normally carrying the higher volume of vehicular traffic.
  - 111. **Malfunction Management Unit**—same as **Conflict Monitor**.
  - 112. **Managed Lane**—a highway lane or set of lanes, or a highway facility, for which variable operational strategies such as direction of travel, tolling, pricing, and/or vehicle type or occupancy requirements are implemented and managed in real-time in response to changing conditions. Managed lanes are typically buffer- or barrier-separated lanes parallel to the general-purpose lanes of a highway in which access is restricted to designated locations. There are also some highways on which all lanes are managed.
  - 113. **Manual Lane**—see **Attended Lane**.
  - 113a. **Markings – All lines, words, or symbols, except signs, officially placed within the roadway to regulate, warn or guide traffic.**

114. **Maximum Highway Traffic Signal Preemption Time**—the maximum amount of time needed following initiation of the preemption sequence for the highway traffic signals to complete the timing of the right-of-way transfer time, queue clearance time, and separation time.
115. **Median**—the area between two roadways of a divided highway measured from edge of traveled way to edge of traveled way. The median excludes turn lanes. The median width might be different between intersections, interchanges, and at opposite approaches of the same intersection.
116. **Minimum Track Clearance Distance**—for standard two-quadrant warning devices, the minimum track clearance distance is the length along a highway at one or more railroad or light rail transit tracks, measured from the highway stop line, warning device, or 12 feet perpendicular to the track center line, to 6 feet beyond the track(s) measured perpendicular to the far rail, along the center line or edge line of the highway, as appropriate, to obtain the longer distance. For Four-Quadrant Gate systems, the minimum track clearance distance is the length along a highway at one or more railroad or light rail transit tracks, measured either from the highway stop line or entrance warning device, to the point where the rear of the vehicle would be clear of the exit gate arm. In cases where the exit gate arm is parallel to the track(s) and is not perpendicular to the highway, the distance is measured either along the center line or edge line of the highway, as appropriate, to obtain the longer distance.
117. **Minimum Warning Time**—when used in Part 8, the least amount of time active warning devices shall operate prior to the arrival of rail traffic at a grade crossing.
118. **Minor Interchange**—an interchange where traffic is local and very light, such as interchanges with land service access roads. Where the sum of the exit volumes is estimated to be lower than 100 vehicles per day in the design year, the interchange is classified as local.
119. **Minor Street**—the street normally carrying the lower volume of vehicular traffic.
120. **Movable Bridge Resistance Gate**—a type of traffic gate, which is located downstream of the movable bridge warning gate, that provides a physical deterrent to vehicle and/or pedestrian traffic when placed in the appropriate position.
121. **Movable Bridge Signal**—a highway traffic signal installed at a movable bridge to notify traffic to stop during periods when the roadway is closed to allow the bridge to open.
122. **Movable Bridge Warning Gate**—a type of traffic gate designed to warn, but not primarily to block, vehicle and/or pedestrian traffic when placed in the appropriate position.
123. **Multi-Lane**—more than one lane moving in the same direction. A multi-lane street, highway, or roadway has a basic cross-section comprised of two or more through lanes in one or both directions. A multi-lane approach has two or more lanes moving toward the intersection, including turning lanes.
124. **Neutral Area**—the paved area between the channelizing lines separating an entrance or exit ramp or a channelized turn lane or channelized entering lane from the adjacent through lane(s).
- 124a. **Night or Nighttime** – is equivalent of “darkness” defined by CVC Section 280: “Darkness” is any time from one-half hour after sunset to one-half hour before sunrise and any other time when visibility is not sufficient to render clearly discernible any person or vehicle on the highway at a distance of 1000 feet.
- 124b. **Non-motorized Traffic** – Bicycle and pedestrian component of traffic.
125. **Object Marker**—a device used to mark obstructions within or adjacent to the roadway.
126. **Occupancy Requirement**—any restriction that regulates the use of a facility or one or more lanes of a facility for any period of the day based on a specified number of persons in a vehicle.
127. **Occupant**—a person driving or riding in a car, truck, bus, or other vehicle.
128. **Open-Road ETC Lane**—a non-attended lane that is designed to allow toll payments to be electronically collected from vehicles traveling at normal highway speeds. Open-Road ETC lanes are typically physically separated from the toll plaza, often following the alignment of the mainline lanes, with toll plaza lanes for cash toll payments being on a different alignment after diverging from the mainline lanes or a subset thereof.
129. **Open-Road Tolling**—a system designed to allow electronic toll collection (ETC) from vehicles traveling at normal highway speeds. Open-Road Tolling might be used on toll roads or toll facilities in conjunction with toll plazas. Open-Road Tolling is also typically used on managed lanes and on toll facilities that only accept payment by ETC.

130. **Open-Road Tolling Point**—the location along an Open-Road ETC lane at which roadside or overhead detection and receiving equipment are placed and vehicles are electronically assessed a toll.
131. **Opposing Traffic**—vehicles that are traveling in the opposite direction. At an intersection, vehicles entering from an approach that is approximately straight ahead would be considered to be opposing traffic, but vehicles entering from approaches on the left or right would not be considered to be opposing traffic.
132. **Overhead Sign**—a sign that is placed such that a portion or the entirety of the sign or its support is directly above the roadway or shoulder such that vehicles travel below it. Typical installations include signs placed on cantilever arms that extend over the roadway or shoulder, on sign support structures that span the entire width of the pavement, on mast arms or span wires that also support traffic control signals, and on highway bridges that cross over the roadway.
133. **Parking Area**—a parking lot or parking garage that is separated from a roadway. Parallel or angle parking spaces along a roadway are not considered a parking area.
134. **Passive Grade Crossing**—a grade crossing where none of the automatic traffic control devices associated with an Active Grade Crossing Warning System are present and at which the traffic control devices consist entirely of signs and/or markings.
135. **Pathway**—a general term denoting a public way for purposes of travel by authorized users outside the traveled way and physically separated from the roadway by an open space or barrier and either within the highway right-of-way or within an independent alignment. Pathways include shared-use paths, but do not include sidewalks.
136. **Pathway Grade Crossing**—the general area where a pathway and railroad or light rail transit tracks cross at the same level, within which are included the tracks, pathway, and traffic control devices for pathway traffic traversing that area.
137. **Paved**—a bituminous surface treatment, mixed bituminous concrete, or Portland cement concrete roadway surface that has both a structural (weight bearing) and a sealing purpose for the roadway.
138. **Pedestrian**—a person on foot, in a wheelchair, on skates, or on a skateboard. **As per CVC 467, (a) A "pedestrian" is a person who is afoot or who is using any of the following: (1) A means of conveyance propelled by human power other than a bicycle. (2) An electric personal assistive mobility device. (b) "Pedestrian" includes a person who is operating a self-propelled wheelchair, motorized tricycle, or motorized quadricycle and, by reason of physical disability, is otherwise unable to move about as a pedestrian, as specified in subdivision(a).**
139. **Pedestrian Change Interval**—an interval during which the flashing UPRAISED HAND (symbolizing DONT WALK) signal indication is displayed.
140. **Pedestrian Clearance Time**—the time provided for a pedestrian crossing in a crosswalk, after leaving the curb or shoulder, to travel to the far side of the traveled way or to a median.
141. **Pedestrian Facilities**—a general term denoting improvements and provisions made to accommodate or encourage walking.
142. **Pedestrian Hybrid Beacon**— a special type of hybrid beacon used to warn and control traffic at an unsignalized location to assist pedestrians in crossing a street or highway at a marked crosswalk.
143. **Pedestrian Signal Head**—a signal head, which contains the symbols WALKING PERSON (symbolizing WALK) and UPRAISED HAND (symbolizing DONT WALK), that is installed to direct pedestrian traffic at a traffic control signal.
144. **Permissive Mode**—a mode of traffic control signal operation in which left or right turns are permitted to be made after yielding to pedestrians, if any, and/or opposing traffic, if any. When a CIRCULAR GREEN signal indication is displayed, both left and right turns are permitted unless otherwise prohibited by another traffic control device. When a flashing YELLOW ARROW or flashing RED ARROW signal indication is displayed, the turn indicated by the arrow is permitted.
145. **Physical Gore**—a longitudinal point where a physical barrier or the lack of a paved surface inhibits road users from crossing from a ramp or channelized turn lane or channelized entering lane to the adjacent through lane(s) or vice versa.
146. **Pictograph**—a pictorial representation used to identify a governmental jurisdiction, an area of jurisdiction, a governmental agency, a military base or branch of service, a governmental-approved university or college, a toll payment system, or a government-approved institution.

147. **Plaque**—a traffic control device intended to communicate specific information to road users through a word, symbol, or arrow legend that is placed immediately adjacent to a sign to supplement the message on the sign. The difference between a plaque and a sign is that a plaque cannot be used alone. The designation for a plaque includes a “P” suffix.
148. **Platoon**—a group of vehicles or pedestrians traveling together as a group, either voluntarily or involuntarily, because of traffic signal controls, geometrics, or other factors.
149. **Portable Traffic Control Signal**—a temporary traffic control signal that is designed so that it can be easily transported and reused at different locations.
150. **Post-Mounted Sign**—a sign that is placed to the side of the roadway such that no portion of the sign or its support is directly above the roadway or shoulder.
151. **Posted Speed Limit**—a speed limit determined by law or regulation and displayed on Speed Limit signs.
152. **Preemption**—the transfer of normal operation of a traffic control signal to a special control mode of operation.
153. **Preferential Lane**—a highway lane reserved for the exclusive use of one or more specific types of vehicles or vehicles with at least a specific number of occupants.
154. **Pre-Signal**—traffic control signal faces that control traffic approaching a grade crossing in conjunction with the traffic control signal faces that control traffic approaching a highway-highway intersection beyond the tracks. Supplemental near-side traffic control signal faces for the highway-highway intersection are not considered pre-signals. Pre-signals are typically used where the clear storage distance is insufficient to store one or more design vehicles.
155. **Pre-timed Operation**—a type of traffic control signal operation in which none of the signal phases function on the basis of actuation.
156. **Primary Signal Face**—one of the required or recommended minimum number of signal faces for a given approach or separate turning movement, but not including near-side signal faces required as a result of the far-side signal faces exceeding the maximum distance from the stop line.
157. **Principal Legend**—place names, street names, and route numbers placed on guide signs.
158. **Priority Control**—a means by which the assignment of right-of-way is obtained or modified.
159. **Private Road Open to Public Travel**—private toll roads and roads (including any adjacent sidewalks that generally run parallel to the road) within shopping centers, airports, sports arenas, and other similar business and/or recreation facilities that are privately owned, but where the public is allowed to travel without access restrictions. Roads within private gated properties (except for gated toll roads) where access is restricted at all times, parking areas, driving aisles within parking areas, and private grade crossings shall not be included in this definition. [The MUTCD national standard and Caltrans standards and specifications for traffic control devices shall not be applicable to privately owned and maintained roads or commercial establishments, unless the particular city or county enacts an ordinance or resolution to this effect. Refer to CVC Sections 21100, 21100.1, 21107, 21107.5, 21107.6, and 21107.7.](#)
- 159a. **Private Road or Driveway** - "Private road or driveway" is a way or place in private ownership and used for vehicular travel by the owner and those having express or implied permission from the owner but not by other members of the public. Refer to CVC 490.
- 159b. **Professional Engineer** - a person engaged in the professional practice of rendering service or creative work requiring education, training and experience in engineering sciences and the application of special knowledge of the mathematical, physical and engineering sciences in such professional or creative work as consultation, investigation, evaluation, planning or design of public or private utilities, structures, machines, processes, circuits, buildings, equipment or projects, and supervision of construction for the purpose of securing compliance with specifications and design for any such work. Refer to California Business and Professions Code Section 6701.
160. **Protected Mode**—a mode of traffic control signal operation in which left or right turns are permitted to be made when a left or right GREEN ARROW signal indication is displayed.
161. **Public Road**—any road, street, or similar facility under the jurisdiction of and maintained by a public agency and open to public travel ([see definition of private road open to public travel](#)).
162. **Pushbutton**—a button to activate a device or signal timing for pedestrians, bicyclists, or other road users.

163. **Pushbutton Information Message**—a recorded message that can be actuated by pressing a pushbutton when the walk interval is not timing and that provides the name of the street that the crosswalk associated with that particular pushbutton crosses and can also provide other information about the intersection signalization or geometry.
164. **Pushbutton Locator Tone**—a repeating sound that informs approaching pedestrians that a pushbutton exists to actuate pedestrian timing or receive additional information and that enables pedestrians who have visual disabilities to locate the pushbutton.
165. **Queue Clearance Time**—when used in Part 8, the time required for the design vehicle of maximum length stopped just inside the minimum track clearance distance to start up and move through and clear the entire minimum track clearance distance. If pre-signals are present, this time shall be long enough to allow the vehicle to move through the intersection, or to clear the tracks if there is sufficient clear storage distance. If a Four-Quadrant Gate system is present, this time shall be long enough to permit the exit gate arm to lower after the design vehicle is clear of the minimum track clearance distance.
166. **Quiet Zone**—a segment of a rail line, with one or a number of consecutive public highway-rail grade crossings at which locomotive horns are not routinely sounded per 49 CFR Part 222.
167. **Rail Traffic**—every device in, upon, or by which any person or property can be transported on rails or tracks and to which all other traffic must yield the right-of-way by law at grade crossings, including trains, one or more locomotives coupled (with or without cars), other railroad equipment, and light rail transit operating in exclusive or semi-exclusive alignments. Light rail transit operating in a mixed-use alignment, to which other traffic is not required to yield the right-of-way by law, is a vehicle and is not considered to be rail traffic.
168. **Raised Pavement Marker**—a device mounted on or in a road surface that has a height generally not exceeding approximately 1 inch above the road surface for a permanent marker, or not exceeding approximately 2 inches above the road surface for a temporary flexible marker, and that is intended to be used as a positioning guide and/or to supplement or substitute for pavement markings.
169. **Ramp Control Signal**—a highway traffic signal installed to control the flow of traffic onto a freeway at an entrance ramp or at a freeway-to-freeway ramp connection.
170. **Ramp Meter**—see Ramp Control Signal.
171. **Red Clearance Interval**—an interval that follows a yellow change interval and precedes the next conflicting green interval.
- 171a. **Reference Bicycle-Rider** – a minimum 4 feet tall person, weighing minimum 90 lb, riding on an unmodified minimum 16 inch wheel bicycle with non-ferromagnetic frame, non-ferromagnetic fork and cranks, aluminum rims, stainless steel spokes, and headlight.
- 171b. **Registered Engineer** – See Professional Engineer. Refer to California Business and Professions Code Section 6704.
172. **Regulatory Sign**—a sign that gives notice to road users of traffic laws or regulations.
173. **Retroreflectivity**—a property of a surface that allows a large portion of the light coming from a point source to be returned directly back to a point near its origin.
174. **Right-of-Way [Assignment]**—the permitting of vehicles and/or pedestrians to proceed in a lawful manner in preference to other vehicles or pedestrians by the display of a sign or signal indications.
175. **Right-of-Way Transfer Time**—when used in Part 8, the maximum amount of time needed for the worst case condition, prior to display of the track clearance green interval. This includes any railroad or light rail transit or highway traffic signal control equipment time to react to a preemption call, and any traffic control signal green, pedestrian walk and clearance, yellow change, and red clearance intervals for conflicting traffic.
176. **Road**—see Roadway.
177. **Road User**—a vehicle operator, bicyclist, or pedestrian, including persons with disabilities, within the highway or on a private road open to public travel (see definition of private road open to public travel).
178. **Roadway**—that portion of a highway improved, designed, or ordinarily used for vehicular travel and parking lanes, but exclusive of the sidewalk, berm, or shoulder even though such sidewalk, berm, or shoulder is used by persons riding bicycles or other human-powered vehicles. In the event a

- highway includes two or more separate roadways, the term roadway as used in this Manual shall refer to any such roadway separately, but not to all such roadways collectively. Refer to CVC 527.
179. Roadway Network—a geographical arrangement of intersecting roadways.
180. Roundabout—a circular intersection with yield control at entry, which permits a vehicle on the circulatory roadway to proceed, and with deflection of the approaching vehicle counter-clockwise around a central island.
181. Rumble Strip—a series of intermittent, narrow, transverse areas of rough-textured, slightly raised, or depressed road surface that extend across the travel lane to alert road users to unusual traffic conditions or are located along the shoulder, along the roadway center line, or within islands formed by pavement markings to alert road users that they are leaving the travel lanes.
182. Rural Highway—a type of roadway normally characterized by lower volumes, higher speeds, fewer turning conflicts, and less conflict with pedestrians.
183. Safe-Positioned—the positioning of emergency vehicles at an incident in a manner that attempts to protect both the responders performing their duties and road users traveling through the incident scene, while minimizing, to the extent practical, disruption of the adjacent traffic flow.
- 183a. Scenic Highway – An officially designated portion of the State Highway System traversing areas of outstanding scenic beauty which together with the adjacent scenic corridors requires special scenic conservation treatment.
184. School—a public or private educational institution recognized by the state education authority for one or more grades K through 12 or as otherwise defined by the State.
185. School Zone—a designated roadway segment approaching, adjacent to, and beyond school buildings or grounds, or along which school related activities occur. As per CVC 22352(a)(2)(B) When approaching or passing a school building or the grounds thereof, contiguous to a highway and posted with a standard "SCHOOL" warning sign, while children are going to or leaving the school either during school hours or during the noon recess period. The prima facie limit shall also apply when approaching or passing any school grounds which are not separated from the highway by a fence, gate, or other physical barrier while the grounds are in use by children and the highway is posted with a standard "SCHOOL" warning sign.
186. Semi-Actuated Operation—a type of traffic control signal operation in which at least one, but not all, signal phases function on the basis of actuation.
187. Separate Turn Signal Face—a signal face that exclusively controls a turn movement and that displays signal indications that are applicable only to the turn movement.
188. Separation Time—the component of maximum highway traffic signal preemption time during which the minimum track clearance distance is clear of vehicular traffic prior to the arrival of rail traffic.
189. Shared Roadway—a roadway that is officially designated and marked as a bicycle route, but which is open to motor vehicle travel and upon which no bicycle lane is designated. Shared Roadway (No Bikeway Designation) – A roadway that permits bicycle use but is not officially designated as a bikeway.
190. Shared Turn Signal Face—a signal face, for controlling both a turn movement and the adjacent through movement, that always displays the same color of circular signal indication that the adjacent through signal face or faces display.
191. Shared-Use Path (Class I Bikeway) —a bikeway outside the traveled way and physically separated from motorized vehicular traffic by an open space or barrier and either within the highway right-of-way or within an independent alignment. Shared-use paths are also used by pedestrians (including skaters, users of manual and motorized wheelchairs, and joggers) and other authorized motorized and non-motorized users. Refer to the Caltrans' Highway Design Manual Index 1003.1 for design criteria.
- 191a. Shoulder – The portion of the highway contiguous with the roadway for accommodations of pedestrians, bicyclists, stopped vehicles, for emergency use, and for lateral support of base and surface courses.
192. Sidewalk—that portion of a street between the curb line, or the lateral line of a roadway, and the adjacent property line or on easements of private property that is paved or improved and intended for use by pedestrians. As per CVC 555, "Sidewalk" is that portion of a highway, other than the roadway, set apart by curbs, barriers, markings or other delineation for pedestrian travel.

193. **Sign**—any traffic control device that is intended to communicate specific information to road users through a word, symbol, and/or arrow legend. Signs do not include highway traffic signals, pavement markings, delineators, or channelization devices.
194. **Sign Assembly**—a group of signs, located on the same support(s), that supplement one another in conveying information to road users.
195. **Sign Illumination**—either internal or external lighting that shows similar color by day or night. Street or highway lighting shall not be considered as meeting this definition.
196. **Sign Legend**—all word messages, logos, pictographs, and symbol and arrow designs that are intended to convey specific meanings. The border, if any, on a sign is not considered to be a part of the legend.
197. **Sign Panel**—a separate panel or piece of material containing a word, symbol, and/or arrow legend that is affixed to the face of a sign.
198. **Signal Backplate**—a thin strip of material that extends outward from and parallel to a signal face on all sides of a signal housing to provide a background for improved visibility of the signal indications.
199. **Signal Coordination**—the establishment of timed relationships between adjacent traffic control signals.
200. **Signal Face**—an assembly of one or more signal sections that is provided for controlling one or more traffic movements on a single approach.
201. **Signal Head**—an assembly of one or more signal faces that is provided for controlling traffic movements on one or more approaches.
202. **Signal Housing**—that part of a signal section that protects the light source and other required components.
203. **Signal Indication**—the illumination of a signal lens or equivalent device.
204. **Signal Lens**—that part of the signal section that redirects the light coming directly from the light source and its reflector, if any.
205. **Signal Louver**—a device that can be mounted inside a signal visor to restrict visibility of a signal indication from the side or to limit the visibility of the signal indication to a certain lane or lanes, or to a certain distance from the stop line.
206. **Signal Phase**—the right-of-way, yellow change, and red clearance intervals in a cycle that are assigned to an independent traffic movement or combination of movements.
207. **Signal Section**—the assembly of a signal housing, signal lens, if any, and light source with necessary components to be used for displaying one signal indication.
208. **Signal System**—two or more traffic control signals operating in signal coordination.
209. **Signal Timing**—the amount of time allocated for the display of a signal indication.
210. **Signal Visor**—that part of a signal section that directs the signal indication specifically to approaching traffic and reduces the effect of direct external light entering the signal lens.
211. **Signing**—individual signs or a group of signs, not necessarily on the same support(s), that supplement one another in conveying information to road users.
212. **Simultaneous Preemption**—notification of approaching rail traffic is forwarded to the highway traffic signal controller unit or assembly and railroad or light rail transit active warning devices at the same time.
213. **Special Purpose Road**—a low-volume, low-speed road that serves recreational areas or resource development activities.
214. **Speed**—speed is defined based on the following classifications:
  - (a) **Average Speed**—the summation of the instantaneous or spot-measured speeds at a specific location of vehicles divided by the number of vehicles observed.
  - (b) **Design Speed**—a selected speed used to determine the various geometric design features of a roadway.
  - (c) **85th-Percentile Speed**—the speed at or below which 85 percent of the motor vehicles travel.
  - (d) **Operating Speed**—a speed at which a typical vehicle or the overall traffic operates. Operating speed might be defined with speed values such as the average, pace, or 85th-percentile speeds.
  - (e) **Pace**—the 10 mph speed range representing the speeds of the largest percentage of vehicles in the traffic stream.

- 215. **Speed Limit**—the maximum (or minimum) speed applicable to a section of highway as established by law or regulation.
- 216. **Speed Limit Sign Beacon**—a beacon used to supplement a SPEED LIMIT sign.
- 217. **Speed Measurement Markings**—a white transverse pavement marking placed on the roadway to assist the enforcement of speed regulations.
- 218. **Speed Zone**—a section of highway with a speed limit that is established by law or regulation, but which might be different from a legislatively specified statutory speed limit.
- 219. **Splitter Island**—a median island used to separate opposing directions of traffic entering and exiting a roundabout.
- 219a. **State highway – Any highway owned and operated by Caltrans.**
- 220. **Station Crossing**—a pathway grade crossing that is associated with a station platform.
- 221. **Statutory Speed Limit**—a speed limit established by legislative action that typically is applicable for a particular class of highways with specified design, functional, jurisdictional and/or location characteristics and that is not necessarily displayed on Speed Limit signs.
- 222. **Steady (Steady Mode)**—the continuous display of a signal indication for the duration of an interval, signal phase, or consecutive signal phases.
- 223. **Stop Beacon**—a beacon used to supplement a STOP sign, a DO NOT ENTER sign, or a WRONG WAY sign.
- 224. **Stop Line**—a solid white pavement marking line extending across approach lanes to indicate the point at which a stop is intended or required to be made. **For all purposes, limit line(s) as defined per CVC 377 shall mean stop line(s).**
- 225. **Street**—see Highway. **As per CVC 590, "Street" is a way or place of whatever nature, publicly maintained and open to the use of the public for purposes of vehicular travel.**
- 226. **Supplemental Signal Face**—a signal face that is not a primary signal face but which is provided for a given approach or separate turning movement to enhance visibility or conspicuity.
- 227. **Symbol**—the approved design of a pictorial representation of a specific traffic control message for signs, pavement markings, traffic control signals, or other traffic control devices, as shown in the MUTCD.
- 228. **Temporary Traffic Control Signal**—a traffic control signal that is installed for a limited time period.
- 229. **Temporary Traffic Control Zone**—an area of a highway where road user conditions are changed because of a work zone or incident by the use of temporary traffic control devices, flaggers, uniformed law enforcement officers, or other authorized personnel.
- 230. **Theoretical Gore**—a longitudinal point at the upstream end of a neutral area at an exit ramp or channelized turn lane where the channelizing lines that separate the ramp or channelized turn lane from the adjacent through lane(s) begin to diverge, or a longitudinal point at the downstream end of a neutral area at an entrance ramp or channelized entering lane where the channelizing lines that separate the ramp or channelized entering lane from the adjacent through lane(s) intersect each other.
- 231. **Timed Exit Gate Operating Mode**—a mode of operation where the exit gate descent at a grade crossing is based on a predetermined time interval.
- 232. **Toll Booth**—a shelter where a toll attendant is stationed to collect tolls or issue toll tickets. A toll booth is located adjacent to a toll lane and is typically set on a toll island.
- 233. **Toll Island**—a raised island on which a toll booth or other toll collection and related equipment are located.
- 234. **Toll Lane**—an individual lane located within a toll plaza in which a toll payment is collected or, for toll-ticket systems, a toll ticket is issued.
- 235. **Toll Plaza**—the location at which tolls are collected consisting of a grouping of toll booths, toll islands, toll lanes, and, typically, a canopy. Toll plazas might be located on highway mainlines or on interchange ramps. A mainline toll plaza is sometimes referred to as a barrier toll plaza because it interrupts the traffic flow.
- 236. **Toll-Ticket System**—a system in which the user of a toll road receives a ticket from a machine or toll booth attendant upon entering a toll system. The ticket denotes the user's point of entry and, upon



- exiting the toll system, the user surrenders the ticket and is charged a toll based on the distance traveled between the points of entry and exit.
237. **Traffic**—pedestrians, bicyclists, ridden or herded animals, vehicles, streetcars, and other conveyances either singularly or together while using for purposes of travel any highway or private road open to public travel (see definition of private road open to public travel). As per CVC 620, the term "traffic" includes pedestrians, ridden animals, vehicles, street cars, and other conveyances, either singly or together, while using any highway for purposes of travel.
238. **Traffic Control Device**—a sign, signal, marking, or other device used to regulate, warn, or guide traffic, placed on, over, or adjacent to a street, highway, private road open to public travel (see definition of private road open to public travel), pedestrian facility, or shared-use path by authority of a public agency or official having jurisdiction, or, in the case of a private road open to public travel (see definition of private road open to public travel), by authority of the private owner or private official having jurisdiction.
239. **Traffic Control Signal (Traffic Signal)**—any highway traffic signal by which traffic is alternately directed to stop and permitted to proceed.
240. **Train**—one or more locomotives coupled, with or without cars, that operates on rails or tracks and to which all other traffic must yield the right-of-way by law at highway-rail grade crossings.
241. **Transverse Markings**—pavement markings that are generally placed perpendicular and across the flow of traffic such as shoulder markings; word, symbol, and arrow markings; stop lines; crosswalk lines; speed measurement markings; parking space markings; and others.
242. **Traveled Way**—the portion of the roadway for the movement of vehicles, exclusive of the shoulders, berms, sidewalks, and parking lanes.
243. **Turn Bay**—a lane for the exclusive use of turning vehicles that is formed on the approach to the location where the turn is to be made. In most cases where turn bays are provided, drivers who desire to turn must move out of a through lane into the newly formed turn bay in order to turn. A through lane that becomes a turn lane is considered to be a dropped lane rather than a turn bay.
244. **Upstream**—a term that refers to a location that is encountered by traffic prior to a downstream location as it flows in an "upstream to downstream" direction. For example, "the upstream end of a lane line separating the turn lane from a through lane on the approach to an intersection" is the end of the line that is furthest from the intersection.
245. **Urban Street**—a type of street normally characterized by relatively low speeds, wide ranges of traffic volumes, narrower lanes, frequent intersections and driveways, significant pedestrian traffic, and more businesses and houses.
246. **Vehicle**—every device in, upon, or by which any person or property can be transported or drawn upon a highway, except trains and light rail transit operating in exclusive or semi-exclusive alignments. Light rail transit equipment operating in a mixed-use alignment, to which other traffic is not required to yield the right-of-way by law, is a vehicle. As per CVC 670, a "vehicle" is a device by which any person or property may be propelled, moved, or drawn upon a highway, excepting a device moved exclusively by human power or used exclusively upon stationary rails or tracks.
247. **Vibrotactile Pedestrian Device**—an accessible pedestrian signal feature that communicates, by touch, information about pedestrian timing using a vibrating surface.
248. **Visibility-Limited Signal Face or Visibility-Limited Signal Section**—a type of signal face or signal section designed (or shielded, hooded, or louvered) to restrict the visibility of a signal indication from the side, to a certain lane or lanes, or to a certain distance from the stop line.
249. **Walk Interval**—an interval during which the WALKING PERSON (symbolizing WALK) signal indication is displayed.
250. **Warning Beacon**—a beacon used only to supplement an appropriate warning or regulatory sign or marker.
251. **Warning Light**—a portable, powered, yellow, lens-directed, enclosed light that is used in a temporary traffic control zone in either a steady burn or a flashing mode.
252. **Warning Sign**—a sign that gives notice to road users of a situation that might not be readily apparent.

- 253. Warrant**—a warrant describes a threshold condition based upon average or normal conditions that, if found to be satisfied as part of an engineering study, shall result in analysis of other traffic conditions or factors to determine whether a traffic control device or other improvement is justified. Warrants are not a substitute for engineering judgment. The fact that a warrant for a particular traffic control device is met is not conclusive justification for the installation of the device.
- 254. Wayside Equipment**—the signals, switches, and/or control devices for railroad or light rail transit operations housed within one or more enclosures located along the railroad or light rail transit right-of-way and/or on railroad or light rail transit property.
- 255. Wayside Horn System**—a stationary horn (or series of horns) located at a grade crossing that is used in conjunction with train-activated or light rail transit-activated warning systems to provide audible warning of approaching rail traffic to road users on the highway or pathway approaches to a grade crossing, either as a supplement or alternative to the sounding of a locomotive horn.
- 256. Worker**—a person on foot whose duties place him or her within the right-of-way of a street, highway, or pathway, such as street, highway, or pathway construction and maintenance forces, survey crews, utility crews, responders to incidents within the street, highway, or pathway right-of-way, and law enforcement personnel when directing traffic, investigating crashes, and handling lane closures, obstructed roadways, and disasters within the right-of-way of a street, highway, or pathway.
- 257. Wrong-Way Arrow**—a slender, elongated, white pavement marking arrow placed upstream from the ramp terminus to indicate the correct direction of traffic flow. Wrong-way arrows are intended primarily to warn wrong-way road users that they are going in the wrong direction.
- 258. Yellow Change Interval**—the first interval following the green or flashing arrow interval during which the steady yellow signal indication is displayed.
- 259. Yield Line**—a row of solid white isosceles triangles pointing toward approaching vehicles extending across approach lanes to indicate the point at which the yield is intended or required to be made.

Support:

<sup>04</sup> The following terms are defined in the California Vehicle Code:

- 1. Alley - Section 110.
- 2. Amber - Section 112.
- 3. Authorized Emergency Vehicle - Section 165.
- 4. Automated Enforcement System - Section 210.
- 5. Axle - Section 230.
- 6. Bicycle - Section 231.
- 7. Bicycle Path - Section 231.5
- 8. Bicycle Path Crossing – Section 231.6
- 9. Bus - Section 233.
- 10. Business District - Section 235.
- 11. Business and Residence Districts: Determination – Section 240
- 12. Clean Fuel Vehicle - Section 257.
- 13. Commercial Vehicle - Section 260.
- 14. Crosswalk - Section 275.
- 15. Darkness – Section 280
- 16. Department of Transportation - Section 291.
- 17. Disabled Person - Section 295.5.
- 18. Engineering and Traffic Survey - Section 627.
- 19. Expressway – Section 314.
- 20. Freeway - Section 332.
- 21. Golf Cart - Section 345.
- 22. Hazardous Material - Section 353.
- 23. Highway - Section 360.
- 24. Intersection - Section 365.
- 25. Limit Line - Section 377.
- 26. Liquefied Petroleum Gas – Section 380.

27. Local Authorities - Section 385.
28. Low Speed Vehicle – Section 385.5.
29. Motorcycle - Section 400.
30. Motor-Driven Cycle – Section 405.
31. Motorized Bicycle – Section 406.
32. Motorized Quadricycle and Motorized Tricycle – Section 407.
33. Motorized Scooter – Section 407.5.
34. Motor Vehicle - Section 415.
35. Official Traffic Control Device - Section 440.
36. Official Traffic Control Signal - Section 445.
37. Park or Parking - Section 463.
38. Pedestrian - Section 467.
39. Pickup Truck - Section 471.
40. Pilot Car – Section 472.
41. Pocket Bike – Section 473.
42. Private Road or Driveway - Section 490.
43. Private School - Section 492.
44. Residence District – Section 515.
45. Ridesharing – Section 522.
46. Right-of-way – Section 525.
47. Road - Section 527.
48. Roadway - Section 530.
49. Safety Zone – Section 540.
50. Schoolbus - Section 545.
51. Sidewalk - Section 555.
52. Snowmobile - Section 557.
53. Stop or Stopping - Section 587.
54. Street - Section 590.
55. Street or Highway - Section 591.
56. Street or Highway – Highway Exclusion - Section 592.
57. Through Highway - Section 600.
58. Toll Highway or Toll Road – Section 611.
59. Traffic - Section 620.
60. Trailer - Section 630.
61. U-Turn - Section 665.5.
62. Vehicle - Section 670.

### **Section 1A.14 Meanings of Acronyms and Abbreviations in this Manual**

#### **Standard:**

**01 The following acronyms and abbreviations, when used in this Manual, shall have the following meanings:**

- 1. AADT—annual average daily traffic**
- 2. AASHTO—American Association of State Highway and Transportation Officials**
- 3. ADA—Americans with Disabilities Act**
- 4. ADAAG—Americans with Disabilities Accessibility Guidelines**
- 5. ADT—average daily traffic**
- 6. AFAD—Automated Flagger Assistance Device**
- 7. ANSI—American National Standards Institute**
- 8. CFR—Code of Federal Regulations**
- 9. CMS—changeable message sign**
- 10. dBA—A-weighted decibels**
- 11. EPA—Environmental Protection Agency**

12. ETC—electronic toll collection
13. EV—electric vehicle
14. FHWA—Federal Highway Administration
15. FRA—Federal Railroad Administration
16. FTA—Federal Transit Administration
17. HOT—high occupancy tolls
18. HOTM—FHWA's Office of Transportation Management
19. HOTO—FHWA's Office of Transportation Operations
20. HOV—high-occupancy vehicle
21. ILEV—inherently low emission vehicle
22. ISEA—International Safety Equipment Association
23. ITE—Institute of Transportation Engineers
24. ITS—intelligent transportation systems
25. LED—light emitting diode
26. LP—liquid petroleum
27. MPH or mph—miles per hour
28. MUTCD—Manual on Uniform Traffic Control Devices
29. NCHRP—National Cooperative Highway Research Program
30. ORT—open-road tolling
31. PCMS—portable changeable message sign
32. PRT—perception-response time
33. RPM—raised pavement marker
34. RRPM—raised retroreflective pavement marker
35. RV—recreational vehicle
36. TDD—telecommunication devices for the deaf
37. TRB—Transportation Research Board
38. TTC—temporary traffic control
39. U.S.—United States
40. U.S.C.—United States Code
41. USDOT—United States Department of Transportation
42. UVC—Uniform Vehicle Code
43. VPH or vph—vehicles per hour

Support:

<sup>02</sup> The following list of acronyms are related to traffic control devices and provided for ease of use and as a handy reference:

1. AADT Average Annual Daily Traffic
2. AASHTO American Association of State Highway and Transportation Officials
3. ADA Americans with Disabilities Act
4. ADT Average Daily Traffic
5. AHS Automated Highway System
6. Alt Alternate
7. AMBER Use of CMS signs for child abduction alert messages
8. AMIS Automated Management Information System
9. ANSI American National Standards Institute
10. APWA American Public Works Association
11. ASCE American Society of Civil Engineers
12. ASTM American Society for Testing and Materials
13. ATIS Advanced Traveler Information Systems
14. ATMS Advanced Traffic Management System
15. ATSSA American Traffic Safety Services Association
16. AVCS Automated Vehicle Control System
17. BART Bay Area Rapid Transit
18. BT&H Business, Transportation & Housing Agency

|                |   |
|----------------|---|
| 19. CA         | California  |
| 20. CAC        | California Administrative Code  |
| 21. Cal/OSHA   | California Occupational Safety and Health Administration                      |
| 22. CA MUTCD   | California Manual on Uniform Traffic Control Devices for Streets and Highways |
| 23. Caltrans   | California Department of Transportation                                       |
| 24. CBD        | Central Business District   |
| 25. CCMP       | County Congestion Management Plan   |
| 26. CCO        | Contract Change Order   |
| 27. CCR        | California Code of Regulations  |
| 28. CDC        | California Department of Conservation   |
| 29. CDF        | California Department of Forestry   |
| 30. CDFW       | California Department of Fish and Wildlife                                    |
| 31. CEAC       | County Engineers Association of California                                    |
| 32. CELSOC     | Consulting Engineering and Land Surveyors of California                       |
| 33. CFR        | Code of Federal Regulations   |
| 34. CHIN       | California Highway Information Network  |
| 35. CHP        | California Highway Patrol   |
| 36. CMA        | Congestion Management Agency  |
| 37. CMP        | Congestion Management Program   |
| 38. CMS        | Changeable Message Sign or Congestion Management System                       |
| 39. COB        | Close of Business   |
| 40. COZEEP     | Construction Zone Enhanced Enforcement Program                                |
| 41. CPC        | California Penal Code   |
| 42. CPH        | California Permit Handbook  |
| 43. CPM        | Critical Path Method  |
| 44. CPUC       | California Public Utilities Commission  |
| 45. CRHR       | California Register of Historical Resources                                   |
| 46. CT         | Caltrans or California Department of Transportation                           |
| 47. CTA        | California Trucking Association   |
| 48. CTC        | California Transportation Commission  |
| 49. CTCDC      | California Traffic Control Devices Committee                                  |
| 50. CTP        | California Transportation Plan  |
| 51. CURE       | Clean-up Roadside Environment   |
| 52. CVC        | California Vehicle Code   |
| 53. Del        | Delineator  |
| 54. DHV        | Design Hourly Volume  |
| 55. DI         | Delay Index, Drop Inlet or Drainage Inlet                                     |
| 56. DIB        | Design Information Bulletin   |
| 57. DMV        | Department of Motor Vehicles  |
| 58. DOT        | Department of Transportation  |
| 59. DTO        | Division of Traffic Operations  |
| 60. DYS        | Double Yellow Stripe  |
| 61. ENGR       | Engineer or Engineering   |
| 62. EP         | Edge of Pavement or Environmental Planning                                    |
| 63. ES         | Edge of Shoulder or End Section   |
| 64. ESA        | Environmentally Sensitive Area or Endangered Species Act                      |
| 65. ESAL       | Equivalent Single-Axle Loads  |
| 66. ETW        | Edge of Traveled Way  |
| 67. Exp or EXP | Expressway  |
| 68. F&E System | Freeway and Expressway System   |
| 69. FAI        | Federal-aid Interstate  |
| 70. FAP        | Federal-aid Primary   |
| 71. FCC        | Federal Communication Commission  |

|                   |   |
|-------------------|---|
| 72. FEBT          | Facing Eastbound Traffic  |
| 73. FHWA          | Federal Highway Administration  |
| 74. FNBT          | Facing Northbound Traffic   |
| 75. FR            | Federal Register  |
| 76. Fr Rd         | Frontage Road   |
| 77. FS            | Far Side  |
| 78. FSBT          | Facing Southbound Traffic   |
| 79. FSP           | Freeway Service Patrol  |
| 80. FWBT          | Facing Westbound Traffic  |
| 81. Fwy or FWY    | Freeway   |
| 82. GR            | Guard Railing   |
| 83. HAR           | Highway Advisory Radio  |
| 84. HAZMAT        | Hazardous Material  |
| 85. HCM           | Highway Capacity Manual   |
| 86. HDM           | Highway Design Manual   |
| 87. HOT           | High Occupancy Toll   |
| 88. HOV           | High-Occupancy Vehicle  |
| 89. HOVL          | High-Occupancy Vehicle Lane   |
| 90. HM            | Hazardous Material  |
| 91. HQ            | Caltrans Headquarters   |
| 92. HW            | Hazardous Waste   |
| 93. Hwy or HWY    | Highway   |
| 94. IGR           | Intergovernmental Review  |
| 95. ILEV          | Inherently Low Emission Vehicle   |
| 96. IRLs          | In-Roadway Lights   |
| 97. IRWLs         | In-Roadway Warning Lights   |
| 98. ISO           | International Standards Organization                                      |
| 99. ISTEAD        | Intermodal Surface Transportation Efficiency Act of 1991 (Federal)        |
| 100. ITE          | Institute of Transportation Engineers                                     |
| 101. ITS          | Intelligent Transportation Systems or Institute of Transportation Studies |
| 102. ITTE         | Institute of Transportation & Traffic Engineering                         |
| 103. IVHS         | Intelligent Vehicle Highway System  |
| 104. KP           | Kilometer Post  |
| 105. LED          | Light Emitting Diode  |
| 106. LF           | Linear Foot   |
| 107. Ln or LN     | Lane  |
| 108. Loc or LOC   | Location  |
| 109. LOS          | Level of service (Traffic Congestion Measure)                             |
| 110. LPA          | Local Public Agency   |
| 111. LRT          | Light Rail Transit  |
| 112. MADT         | Monthly Average Daily Traffic   |
| 113. Maint        | Maintenance   |
| 114. Max or MAX   | Maximum   |
| 115. MAZEEP       | Maintenance Zone Enhanced Enforcement Program                             |
| 116. MBGR         | Metal Beam Guard Rail   |
| 117. Med or MED   | Median  |
| 118. MF           | Mixed Flow  |
| 119. mi or MI     | Mile or Miles   |
| 120. Min or MIN   | Minimum   |
| 121. Misc or MISC | Miscellaneous   |
| 122. mm           | Millimeter  |
| 123. mph or MPH   | Miles per Hour  |
| 124. MPO          | Metropolitan Planning Organization  |

|                  |   |
|------------------|---|
| 125.MT           | Mass Transit  |
| 126.MTC          | Metropolitan Transportation Commission (for the San Francisco Bay Area) |
| 127.MUTCD        | Manual on Uniform Traffic Control Devices                               |
| 128.MVM          | Per Million Vehicle Miles   |
| 129.NCEES        | National Council of Examiners for Engineering and Surveying             |
| 130.NCHRP        | National Cooperative Highway Research Program                           |
| 131.NCRP         | National Cooperative Research Program                                   |
| 132.NCUT         | National Committee on Urban Transportation                              |
| 133.NCUTCD       | National Committee on Uniform Traffic Control Devices                   |
| 134.NCUTLO       | National Committee on Uniform Traffic Laws and Ordinances               |
| 135.NHI          | National Highway Institute  |
| 136.NHL          | National Historic Landmark  |
| 137.NHS          | National Highway System   |
| 138.NHSB         | National Highway Safety Bureau  |
| 139.NHTSA        | National Highway Traffic Safety Administration                          |
| 140.NNIH         | National Network of Interstate Highways                                 |
| 141.NPRM         | Notice of Proposed Rule Making  |
| 142.NPS          | National Park Service (U.S.)  |
| 143.NR           | National Register (of Historic Places, abbreviation)                    |
| 144.NRHP         | National Register of Historic Places                                    |
| 145.NS           | Near Side   |
| 146.NTS          | National Transportation System or Not To Scale                          |
| 147.NTSB         | National Transportation Safety Board                                    |
| 148.O & D        | Origin and Destination  |
| 149.OCTA         | Orange County Transportation Authority                                  |
| 150.ODA          | Outdoor Advertising (Act)   |
| 151.OES          | Office of Emergency Services  |
| 152.OG           | Original Ground   |
| 153.OH           | Overhead (Structure)  |
| 154.OHP          | Office of Historic Preservation   |
| 155.OSA          | Office of the State Architect   |
| 156.OSHA         | Occupational Safety and Health Administration                           |
| 157.P2P          | Peer-to-Peer Program  |
| 158.P&P          | Policy & Procedure  |
| 159.PCH          | Pacific Coast Highway   |
| 160.PCMS         | Portable Changeable Message Sign  |
| 161.PDO          | Property Damage Only  |
| 162.PE           | Professional Engineer or Project Engineer                               |
| 163.Ped or PED   | Pedestrian  |
| 164.PHF          | Peak Hour Factor  |
| 165.PHI          | Point of Historic Interest  |
| 166.PM           | Post Mile   |
| 167.PMS          | Pavement Management System  |
| 168.PMT          | Passenger Miles Traveled  |
| 169.PS&E         | Plans, Specifications, and Estimate                                     |
| 170.Pvmt or PVMT | Pavement  |
| 171.PUC          | California Public Utilities Commission                                  |
| 172.R&D          | Research and Development  |
| 173.RCE          | Registered Civil Engineer   |
| 174.RE           | Resident Engineer or Right of Entry                                     |
| 175.ROW          | Right of Way  |
| 176.RR           | Railroad  |
| 177.Rte or RTE   | Route or Registered Traffic Engineer                                    |

|                  |  |
|------------------|--|
| 178.RV           | Recreational Vehicle                                   |
| 179.R/W          | Right of Way   |
| 180.Rwy          | Railway  |
| 181.RXR          | Railroad Crossing                                      |
| 182.S&H Code     | Streets & Highways Code                                |
| 183.SACOG        | Sacramento Area Council of Governments                 |
| 184.SAFE         | Service Authority for Freeways & Expressways           |
| 185.SB           | Southbound or Senate Bill                              |
| 186.SCAG         | Southern California Association of Governments         |
| 187.SCRRA        | Southern California Regional Rail Authority            |
| 188.SCRTD        | Southern California Rapid Transit District             |
| 189.SHELL        | State Highway Extra Legal Loads                        |
| 190.SHL          | State Historical Landmark                              |
| 191.SHOPP        | State Highway Operation and Protection Program         |
| 192.SHS          | Standard Highway Signs and Markings book (FHWA)        |
| 193.SI           | Safety Index or International System of Units (Metric) |
| 194.SR           | State Route or Senate Resolution                       |
| 195.SRRA         | Safety Roadside Rest Area                              |
| 196.SSD          | Stopping Sight Distance                                |
| 197.SSP's        | Standard Special Provisions                            |
| 198.STA          | State Transit Assistance                               |
| 199.STIP         | State Transportation Improvement Program               |
| 200.Str or STR   | Structure  |
| 201.SW           | Sidewalk or Soundwall                                  |
| 202.SWITRS       | Statewide Integrated Traffic Records Systems           |
| 203.TASAS        | Traffic Accident Surveillance and Analysis System      |
| 204.TC           | Traffic Control  |
| 205.TCM          | Transportation Control Measure                         |
| 206.TCP          | Traffic/Transportation Control Plan                    |
| 207.TEA21        | Transportation Efficiency Act for the 21st Century     |
| 208.Temp or TEMP | Temporary  |
| 209.TI           | Traffic Index  |
| 210.TM           | Caltrans Traffic Manual                                |
| 211.TMC          | Traffic Management Center                              |
| 212.TMP          | Transportation Management Plan                         |
| 213.TMT          | Traffic Management Team                                |
| 214.TODS         | Tourist-Oriented Directional Signs                     |
| 215.TOPD         | Traffic Operations Policy Directives                   |
| 216.TOS          | Traffic Operations System                              |
| 217.TRB          | Transportation Research Board                          |
| 218.TS           | Traffic Signal   |
| 219.TSS          | Caltrans Traffic Sign Specifications                   |
| 220.TTC          | Temporary Traffic Control                              |
| 221.UC           | Under Crossing   |
| 222.UP           | Underpass  |
| 223.UPRR         | Union Pacific Railroad                                 |
| 224.URR          | Urban Rail Transit Program (State)                     |
| 225.USA          | Underground Service Alert                              |
| 226.USC          | United States Code (Federal)                           |
| 227.USCE         | United States (Army) Corps of Engineers (Federal)      |
| 228.USDOT        | United States Department of Transportation             |
| 229.VMS          | Variable Message Sign                                  |
| 230.VMT          | Vehicle Miles Traveled                                 |



|                    |                                    |
|--------------------|------------------------------------|
| 231.vph or VPH     | Vehicles Per Hour                  |
| 232.vphpl or VPHPL | Vehicles Per Hour Per Lane         |
| 233.WATCH          | Work Area Traffic Control Handbook |
| 234.WIM            | Weigh-in Motion                    |
| 235.WS             | White Stripe                       |
| 236.Xing or XING   | Crossing                           |
| 237.YS             | Yellow Stripe                      |

### **Section 1A.15 Abbreviations Used on Traffic Control Devices**

**Standard:**

**01 When the word messages shown in Table 1A-1 need to be abbreviated in connection with traffic control devices, the abbreviations shown in Table 1A-1 shall be used.**

**02 When the word messages shown in Table 1A-2 need to be abbreviated on a portable changeable message sign, the abbreviations shown in Table 1A-2 shall be used. Unless indicated by an asterisk, these abbreviations shall only be used on portable changeable message signs.**

*Guidance:*

*03 The abbreviations for the words listed in Table 1A-2 that also show a prompt word should not be used on a portable changeable message sign unless the prompt word shown in Table 1A-2 either precedes or follows the abbreviation, as applicable.*

**Standard:**

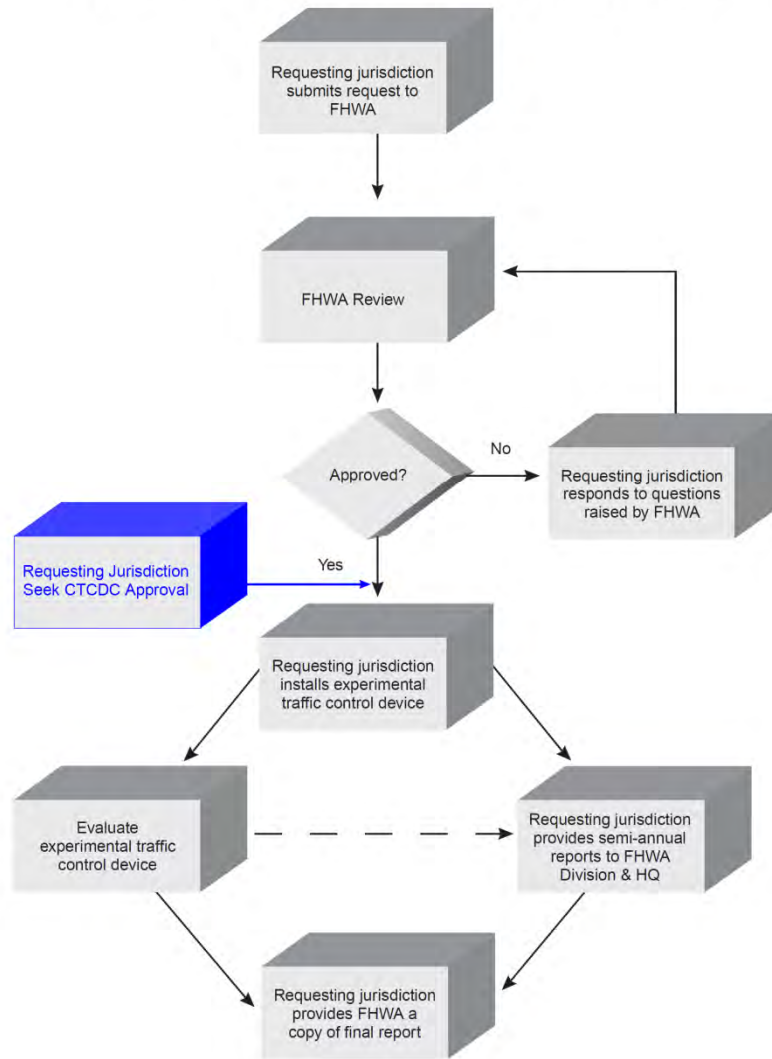
**04 The abbreviations shown in Table 1A-3 shall not be used in connection with traffic control devices because of their potential to be misinterpreted by road users.**

*Guidance:*

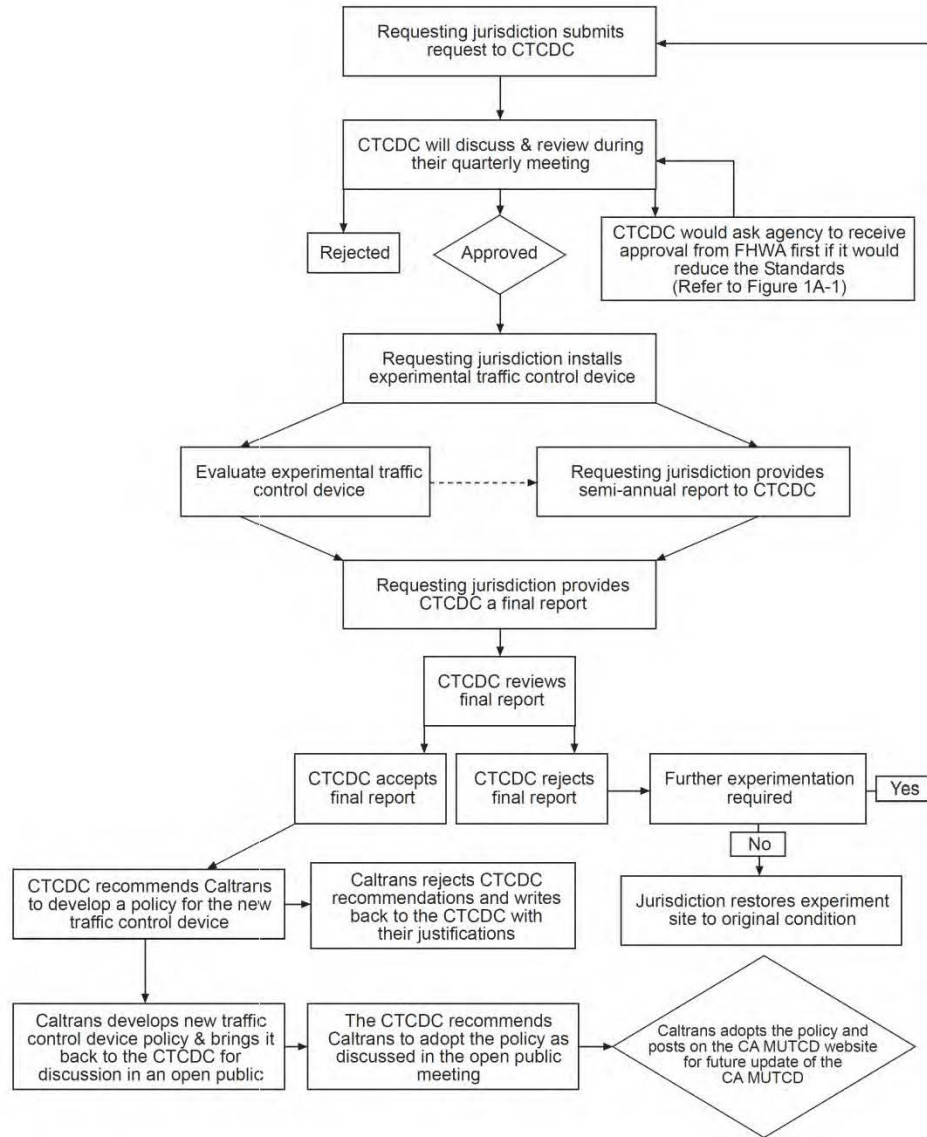
*05 If multiple abbreviations are permitted in Table 1A-1 or 1A-2, the same abbreviation should be used throughout a single jurisdiction.*

*06 Except as otherwise provided in Table 1A-1 or 1A-2 or unless necessary to avoid confusion, periods, commas, apostrophes, question marks, ampersands, and other punctuation marks or characters that are not letters or numerals should not be used in any abbreviation.*

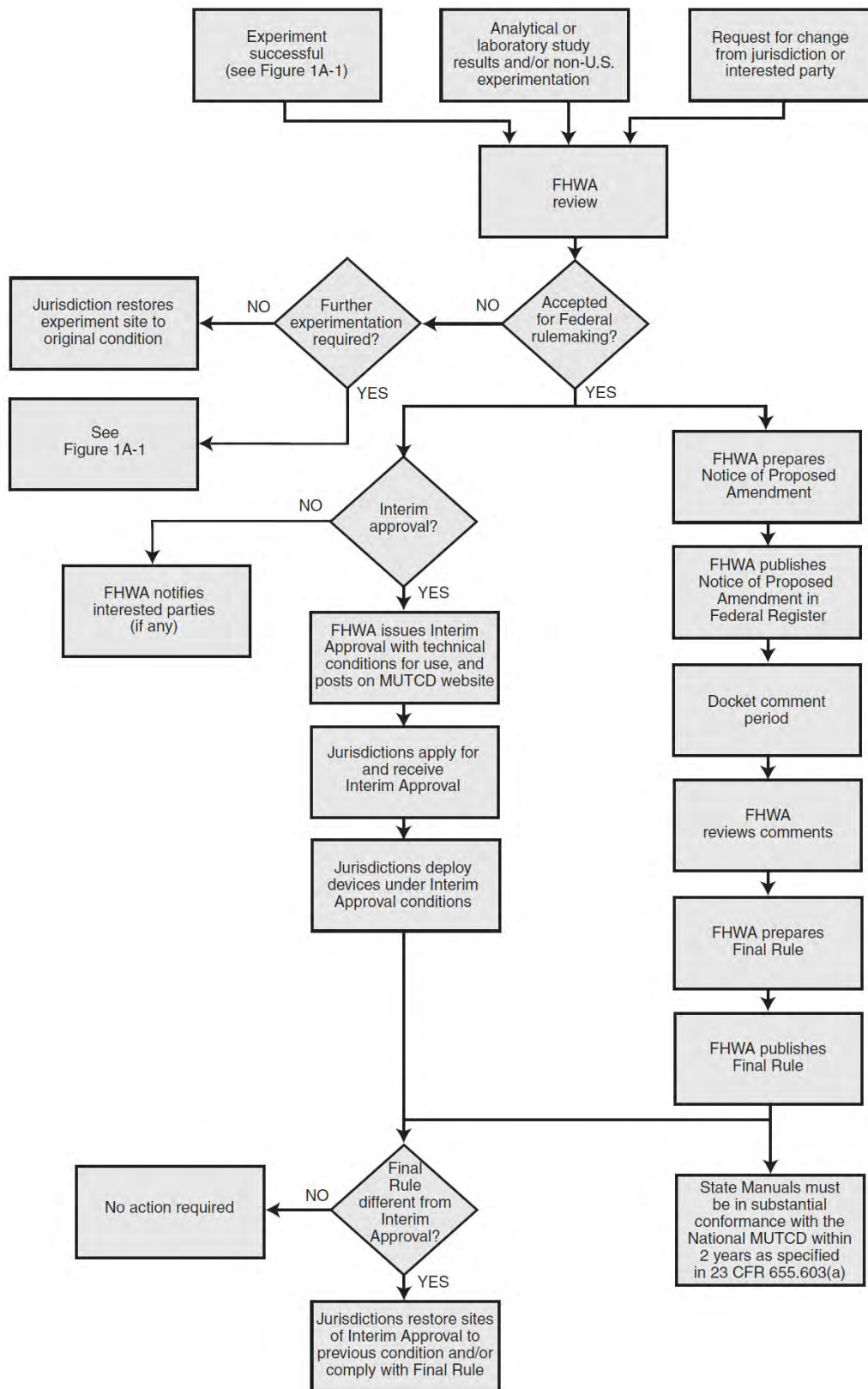
**Figure 1A-1. Process for Requesting and Conducting Experimentations for New Traffic Control Devices**



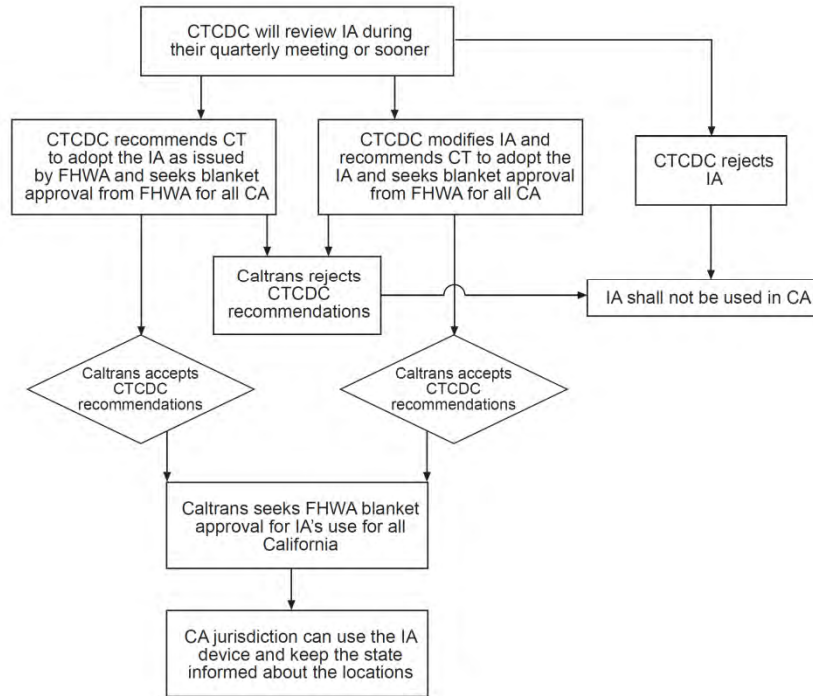
**Figure 1A-1 (CA). Process for Requesting and Conducting Experimentations for New Traffic Control Devices in California**



**Figure 1A-2. Process for Incorporating New Traffic Control Devices into the MUTCD**



**Figure 1A-101 (CA). Process for the Use of Traffic Control Devices in California Approved as Interim Approval (IA) by FHWA**



**Table 1A-1. Acceptable Abbreviations**

| Word Message                       | Standard Abbreviation |
|------------------------------------|-----------------------|
| Afternoon / Evening                | PM                    |
| Alternate                          | ALT                   |
| AM Radio                           | AM                    |
| Avenue                             | AVE, AV               |
| Bicycle                            | BIKE                  |
| Boulevard                          | BLVD*                 |
| Bridge                             | (See Table 1A-2)      |
| CB Radio                           | CB                    |
| Center (as part of a place name)   | CTR                   |
| Circle                             | CIR*                  |
| Civil Defense                      | CD                    |
| Compressed Natural Gas             | CNG                   |
| Court                              | CT*                   |
| Crossing (other than highway-rail) | X-ING                 |
| Drive                              | DR*                   |
| East                               | E                     |
| Electric Vehicle                   | EV                    |
| Expressway                         | EXPWY*                |
| Feet                               | FT                    |
| FM Radio                           | FM                    |
| Freeway                            | FRWY, FWY*            |
| Friday                             | FRI                   |
| Hazardous Material                 | HAZMAT                |
| High Occupancy Vehicle             | HOV                   |

| Word Message                    | Standard Abbreviation |
|---------------------------------|-----------------------|
| Highway                         | HWY*                  |
| Hospital                        | HOSP                  |
| Hour(s)                         | HR, HRS               |
| Information                     | INFO                  |
| Inherently Low Emission Vehicle | ILEV                  |
| International                   | INTL                  |
| Interstate                      | (See Table 1A-2)      |
| Junction / Intersection         | JCT                   |
| Lane                            | (See Table 1A-2)      |
| Liquid Propane Gas              | LP-GAS                |
| Maximum                         | MAX                   |
| Mile(s)                         | MI                    |
| Miles Per Hour                  | MPH                   |
| Minimum                         | MIN                   |
| Minute(s)                       | MIN                   |
| Monday                          | MON                   |
| Morning / Late Night            | AM                    |
| Mount                           | MT                    |
| Mountain                        | MTN                   |
| National                        | NATL                  |
| North                           | N                     |
| Parkway                         | PKWY*                 |
| Pedestrian                      | PED                   |
| Place                           | PL*                   |

| Word Message  | Standard Abbreviation |
|---|-----------------------|
| Pounds  | LBS                   |
| Road  | RD*                   |
| Saint   | ST                    |
| Saturday  | SAT                   |
| South   | S                     |
| State, county, or other non-US or non-Interstate numbered route | (See Table 1A-2)      |
| Street  | ST*                   |
| Sunday  | SUN                   |
| Telephone   | PHONE                 |
| Temporary   | TEMP                  |
| Terrace   | TER*                  |
| Thursday  | THURS                 |
| Thruway   | THWY*                 |
| Tons of Weight  | T                     |
| Trail   | TR*                   |
| Tuesday   | TUES                  |
| Turnpike  | TPK*                  |
| Two-Way Intersection  | 2-WAY                 |
| US Numbered Route   | US                    |
| Wednesday   | WED                   |
| West  | W                     |

\*This abbreviation shall not be used for any application other than the name of a roadway.

**Table 1A-2. Abbreviations That Shall be Used Only on Portable Changeable Message Signs**

| Word Message  | Standard Abbreviation                               | Prompt Word That Should Precede the Abbreviation | Prompt Word That Should Follow the Abbreviation |
|---|---|--|---|
| Access  | ACCS  | —  | Road  |
| Ahead   | AHD   | Fog  | —   |
| Blocked   | BLKD  | Lane   | —   |
| Bridge  | BR*   | [Name]   | —   |
| Cannot  | CANT  | —  | —   |
| Center  | CNTR  | —  | Lane  |
| Chemical  | CHEM  | —  | Spill   |
| Condition   | COND  | Traffic  | —   |
| Congested   | CONG  | Traffic  | —   |
| Construction  | CONST   | —  | Ahead   |
| Crossing  | XING  | —  | —   |
| Do Not  | DONT  | —  | —   |
| Downtown  | DWNTN   | —  | Traffic   |
| Eastbound   | E-BND   | —  | —   |
| Emergency   | EMER  | —  | —   |
| Entrance, Enter   | ENT   | —  | —   |
| Exit  | EX  | Next   | —   |
| Express   | EXP   | —  | Lane  |
| Frontage  | FRNTG   | —  | Road  |
| Hazardous   | HAZ   | —  | Driving   |
| Highway-Rail Grade Crossing                                     | RR XING   | —  | —   |
| Interstate  | I-*   | —  | [Number]  |
| It Is   | ITS   | —  | —   |
| Lane  | LN  | [Roadway Name]*, Right, Left, Center             | —   |
| Left  | LFT   | —  | —   |
| Local   | LOC   | —  | Traffic   |
| Lower   | LWR   | —  | Level   |
| Maintenance   | MAINT   | —  | —   |
| Major   | MAJ   | —  | Accident  |
| Minor   | MNR   | —  | Accident  |
| Normal  | NORM  | —  | —   |
| Northbound  | N-BND   | —  | —   |
| Oversized   | OVRSZ   | —  | Load  |
| Parking   | PKING   | —  | —   |
| Pavement  | PVMT  | Wet  | —   |
| Prepare   | PREP  | —  | To Stop   |
| Quality   | QLTY  | Air  | —   |
| Right   | RT  | Keep, Next                                       | —   |
| Right   | RT  | —  | Lane  |
| Roadwork  | RDWK  | —  | Ahead, [Distance]                               |
| Route   | RT, RTE   | Best   | —   |
| Service   | SERV  | —  | —   |
| Shoulder  | SHLDR   | —  | —   |
| Slippery  | SLIP  | —  | —   |
| Southbound  | S-BND   | —  | —   |
| Speed   | SPD   | —  | —   |
| State, county, or other non-US or non-Interstate numbered route | [Route Abbreviation determined by highway agency]** | —  | [Number]  |
| Tires With Lugs   | LUGS  | —  | —   |
| Traffic   | TRAF  | —  | —   |
| Travelers   | TRVLR   | —  | —   |
| Two-Wheeled Vehicles  | CYCLES  | —  | —   |
| Upper   | UPR   | —  | Level   |
| Vehicle(s)  | VEH, VEHS   | —  | —   |
| Warning   | WARN  | —  | —   |
| Westbound   | W-BND   | —  | —   |
| Will Not  | WONT  | —  | —   |

\* This abbreviation, when accompanied by the prompt word, may be used on traffic control devices other than portable changeable message signs.

\*\* A space and no dash shall be placed between the abbreviation and the number of the route.

**Table 1A-3. Unacceptable Abbreviations**

| <b>Abbreviation</b> | <b>Intended Word</b> | <b>Common Misinterpretation</b> |
|---------------------|----------------------|---------------------------------|
| ACC                 | Accident             | Access (Road)                   |
| CLRS                | Clears               | Colors                          |
| DLY                 | Delay                | Daily                           |
| FDR                 | Feeder               | Federal                         |
| L                   | Left                 | Lane (Merge)                    |
| LT                  | Light (Traffic)      | Left                            |
| PARK                | Parking              | Park                            |
| POLL                | Pollution (Index)    | Poll                            |
| RED                 | Reduce               | Red                             |
| STAD                | Stadium              | Standard                        |
| WRNG                | Warning              | Wrong                           |



# PART 2

## SIGNS

### CHAPTER 2A. GENERAL

#### **Section 2A.01 Function and Purpose of Signs**

Support:

01 This Manual contains Standards, Guidance, and Options for the signing of all types of highways, and private roads open to public travel (see definition in Section 1A.13). The functions of signs are to provide regulations, warnings, and guidance information for road users. Words, symbols, and arrows are used to convey the messages. Signs are not typically used to confirm rules of the road.

Detailed sign requirements are located in the following Chapters of Part 2:

- Chapter 2B — Regulatory Signs, Barricades, and Gates
- Chapter 2C — Warning Signs and Object Markers
- Chapter 2D — Guide Signs for Conventional Roads
- Chapter 2E — Guide Signs for Freeways and Expressways
- Chapter 2F — Toll Road Signs
- Chapter 2G — Preferential and Managed Lane Signs
- Chapter 2H — General Information Signs
- Chapter 2I — General Service Signs
- Chapter 2J — Specific Service (Logo) Signs
- Chapter 2K — Tourist-Oriented Directional Signs
- Chapter 2L — Changeable Message Signs
- Chapter 2M — Recreational and Cultural Interest Area Signs
- Chapter 2N — Emergency Management Signs

**Standard:**

02 **Because the requirements and standards for signs depend on the particular type of highway upon which they are to be used, the definitions for freeway, expressway, conventional road, and special purpose road given in Section 1A.13 shall apply in Part 2.**

#### **Section 2A.02 Definitions**

Support:

01 Definitions and acronyms that are applicable to signs are given in Sections 1A.13 and 1A.14.

#### **Section 2A.03 Standardization of Application**

Support:

01 It is recognized that urban traffic conditions differ from those in rural environments, and in many instances signs are applied and located differently. Where pertinent and practical, this Manual sets forth separate recommendations for urban and rural conditions.

*Guidance:*

02 *Signs should be used only where justified by engineering judgment or studies, as provided in Section 1A.09.*

03 *Results from traffic engineering studies of physical and traffic factors should indicate the locations where signs are deemed necessary or desirable.*

04 *Roadway geometric design and sign application should be coordinated so that signing can be effectively placed to give the road user any necessary regulatory, warning, guidance, and other information.*

04a *After a sign has been erected, observations should be made to determine if the desired effect on traffic has been achieved.*

**Standard:**

**05 Each standard sign shall be displayed only for the specific purpose as prescribed in this Manual. Determination of the particular signs to be applied to a specific condition shall be made in accordance with the provisions set forth in Part 2. Before any new highway, private road open to public travel (see definition in Section 1A.13), detour, or temporary route is opened to public travel, all necessary signs shall be in place. Signs required by road conditions or restrictions shall be removed when those conditions cease to exist or the restrictions are withdrawn.**

**Section 2A.04 Excessive Use of Signs**

*Guidance:*

*01 Regulatory and warning signs should be used conservatively because these signs, if used to excess, tend to lose their effectiveness. If used, route signs and directional guide signs should be used frequently because their use promotes efficient operations by keeping road users informed of their location.*

*Support:*

*02 Sign information overload occurs when the frequency of signing, complexity of messages or diversity of messages is so great that they cannot be readily assimilated by motorists in time to respond properly and safely to roadway situations. Sign information overload can be avoided by:*

- A. Increasing the spacing between signs so that they can be understood before encountering new messages.*
- B. Minimizing content and using accepted symbols so as to simplify messages.*
- C. Spreading the information so that each element of stand-alone information is presented in a separate sign.*
- D. Using standard sign formats applied in a consistent fashion to enhance motorist recognition.*
- E. Using redundant signing or a combination of signing and pavement messages to offer multiple opportunities for motorists to recognize and respond to the situation.*
- F. Reducing or eliminating less-essential signs.*

*03 See ITE's Traffic Control Devices Handbook, Chapter 2 for more information on this topic. See Section 1A.11 for information regarding this publication.*

**Section 2A.05 Classification of Signs**

**Standard:**

**01 Signs shall be defined by their function as follows:**

- A. Regulatory signs give notice of traffic laws or regulations.**
- B. Warning signs give notice of a situation that might not be readily apparent.**
- C. Guide signs show route designations, destinations, directions, distances, services, points of interest, and other geographical, recreational, or cultural information.**

**Support:**

*01a In California, prior to the adoption of Federal Highway Administration's Manual on Uniform Traffic Control Devices (MUTCD) on May 20, 2004, signs were classified into four categories, the fourth category being Construction signs. In general, Construction signs are Warning, Regulatory or Guide signs. Hence, this categorical classification is deleted for Construction signs in California and as per the MUTCD only the three basic categories are recognized. Construction signs are now included in Part 6.*

*02 Object markers are defined in Section 2C.63.*

**Section 2A.06 Design of Signs**

**Support:**

*01 This Manual shows many typical standard signs and object markers approved for use on streets, highways, bikeways, and pedestrian crossings.*

*02 In the specifications for individual signs and object markers, the general appearance of the legend, color, and size are shown in the accompanying tables and illustrations, and are not always detailed in the text.*

*03 Detailed drawings of standard signs, object markers, alphabets, symbols, and arrows (see Figure 2D-2) are shown in the "Standard Highway Signs and Markings" book. Section 1A.11 contains information regarding how to obtain this publication.*

04 The basic requirements of a sign are that it be legible to those for whom it is intended and that it be understandable in time to permit a proper response. Desirable attributes include:

- A. High visibility by day and night; and
- B. High legibility (adequately sized letters, symbols, or arrows, and a short legend for quick comprehension by a road user approaching a sign).

05 Standardized colors and shapes are specified so that the several classes of traffic signs can be promptly recognized. Simplicity and uniformity in design, position, and application are important.

**Standard:**

06 **The term legend shall include all word messages and symbol and arrow designs that are intended to convey specific meanings.**

07 **Uniformity in design shall include shape, color, dimensions, legends, borders, and illumination or retroreflectivity.**

08 **Standardization of these designs does not preclude further improvement by minor changes in the proportion or orientation of symbols, width of borders, or layout of word messages, but all shapes and colors shall be as indicated.**

09 **All symbols shall be unmistakably similar to, or mirror images of, the adopted symbol signs, all of which are shown in the "Standard Highway Signs and Markings" book (see Section 1A.11). Symbols and colors shall not be modified unless otherwise provided in this Manual. All symbols and colors for signs not shown in the "Standard Highway Signs and Markings" book shall follow the procedures for experimentation and change described in Section 1A.10.**

**Option:**

10 Although the standard design of symbol signs cannot be modified, the orientation of the symbol may be changed to better reflect the direction of travel, if appropriate.

**Standard:**

11 **Where a standard word message is applicable, the wording shall be as provided in this Manual.**

12 **In situations where word messages are required other than those provided in this Manual, the signs shall be of the same shape and color as standard signs of the same functional type.**

**Option:**

13 ~~State and local highway agencies~~ **Caltrans** may develop special word message signs in situations where roadway conditions make it necessary to provide road users with additional regulatory, warning, or guidance information, such as when road users need to be notified of special regulations or warned about a situation that might not be readily apparent. Unlike colors that have not been assigned or symbols that have not been approved for signs, new word message signs may be used without the need for experimentation.

**Standard:**

13a **Except as noted in the Option below, highway agencies shall not develop word message signs. In accordance with CVC Section 21401, only word message signs conforming to Caltrans standards and specifications shall be placed on streets and highways.**

**Option:**

13b Local agencies may develop place/facility name or day, date, time portion of the word message on signs to notify road users of special events/circumstances or to warn road users of a situation that might not be readily apparent. Unlike symbol signs and colors, these place/facility name or day, date, time modified word message signs may be used without the need for experimentation.

**Support:**

13c Sign design details are contained in FHWA's "Standard Highway Signs and Markings" book and Caltrans' California Sign Specifications. Signs other than those shown in these publications, the MUTCD or this California MUTCD may be required under special conditions. See Section 1A.11 for information regarding these publications.

**Standard:**

14 **Except as provided in Paragraph 16 and except for the Carpool Information (D12-2) sign (see Section 2I.11), Internet addresses and e-mail addresses, including domain names and uniform resource locators (URL), shall not be displayed on any sign, supplemental plaque, sign panel (including logo sign panels on Specific Service signs), or changeable message sign.**

*Guidance:*

<sup>15</sup> Unless otherwise provided in this Manual for a specific sign, and except as provided in Paragraph 16, telephone numbers of more than four characters should not be displayed on any sign, supplemental plaque, sign panel (including logo sign panels on specific service signs), or changeable message sign.

*Option:*

<sup>16</sup> Internet addresses, e-mail addresses, or telephone numbers with more than four characters may be displayed on signs, supplemental plaques, sign panels, and changeable message signs that are intended for viewing only by pedestrians, bicyclists, occupants of parked vehicles, or drivers of vehicles on low-speed roadways where engineering judgment indicates that an area is available for drivers to stop out of the traffic flow to read the message.

**Standard:**

<sup>17</sup> **Pictographs (see definition in Section 1A.13) shall not be displayed on signs except as specifically provided in this Manual. Pictographs shall be simple, dignified, and devoid of any advertising. When used to represent a political jurisdiction (such as a State, county, or municipal corporation) the pictograph shall be the official designation adopted by the jurisdiction. When used to represent a college or university, the pictograph shall be the official seal adopted by the institution. Pictorial representations of university or college programs shall not be permitted to be displayed on a sign.**

## **Section 2A.07 Retroreflectivity and Illumination**

*Support:*

<sup>01</sup> There are many materials currently available for retroreflection and various methods currently available for the illumination of signs and object markers. New materials and methods continue to emerge. New materials and methods can be used as long as the signs and object markers meet the standard requirements for color, both by day and by night.

**Standard:**

<sup>02</sup> **Regulatory, warning, and guide signs and object markers shall be retroreflective (see Section 2A.08) or illuminated to show the same shape and similar color by both day and night, unless otherwise provided in the text discussion in this Manual for a particular sign or group of signs.**

<sup>03</sup> **The requirements for sign illumination shall not be considered to be satisfied by street or highway lighting.**

*Option:*

<sup>04</sup> Sign elements may be illuminated by the means shown in Table 2A-1.

<sup>05</sup> Retroreflection of sign elements may be accomplished by the means shown in Table 2A-2.

<sup>06</sup> ~~Light Emitting Diode (LED) units may be used individually within the legend or symbol of a sign and in the border of a sign, except for changeable message signs, to improve the conspicuity, increase the legibility of sign legends and borders, or provide a changeable message.~~

<sup>06a</sup> ~~Light Emitting Diode (LED) units may be used in the border of regulatory or warning signs, except for Changeable Message Signs, to improve the conspicuity of signs.~~

**Standard:**

<sup>07</sup> **Except as provided in Paragraphs 11 and 12, neither individual LEDs nor groups of LEDs shall be placed within the background area of a sign.**

<sup>08</sup> **If used, the LEDs shall have a maximum diameter of 1/4 inch and shall be the following colors based on the type of sign:**

- A. ~~White or~~ Red, if used with STOP, DO NOT ENTER, or WRONG WAY signs. ~~or YIELD signs.~~
- B. White, if used with regulatory signs including other than STOP or YIELD signs.
- C. ~~White or~~ Yellow, if used with warning signs.
- D. ~~White, if used with guide signs.~~
- E. ~~White, yellow, or~~ Amber, if used with temporary traffic control signs of warning type.
- F. ~~White or yellow, if used with school area signs.~~

<sup>09</sup> **If flashed, all LED units shall flash simultaneously at a rate of more than 50 and less than 60 times per minute.**

**10 The uniformity of the sign design shall be maintained without any decrease in visibility, legibility, or driver comprehension during either daytime or nighttime conditions.**

Option:

11 For STOP and YIELD signs, LEDs may be placed within the border or within one border width within the background of the sign.

12 For STOP/SLOW paddles (see Section 6E.03) used by flaggers and the STOP paddles (see Section 7D.05) used by adult crossing guards, individual LEDs or groups of LEDs may be used.

Support:

13 Other methods of enhancing the conspicuity of standard signs are described in Section 2A.15.

14 Information regarding the use of retroreflective material on the sign support is contained in Section 2A.21.

### **Section 2A.08 Maintaining Minimum Retroreflectivity**

Support:

01 Retroreflectivity is one of several factors associated with maintaining nighttime sign visibility (see Section 2A.22).

**Standard:**

**02 Public agencies or officials having jurisdiction shall use an assessment or management method that is designed to maintain sign retroreflectivity at or above the minimum levels in Table 2A-3.**

Support:

03 Compliance with the Standard in Paragraph 2 is achieved by having a method in place and using the method to maintain the minimum levels established in Table 2A-3. Provided that an assessment or management method is being used, an agency or official having jurisdiction would be in compliance with the Standard in Paragraph 2 even if there are some individual signs that do not meet the minimum retroreflectivity levels at a particular point in time.

*Guidance:*

04 *Except for those signs specifically identified in Paragraph 6, one or more of the following assessment or management methods should be used to maintain sign retroreflectivity:*

- A. *Visual Nighttime Inspection—The retroreflectivity of an existing sign is assessed by a trained sign inspector conducting a visual inspection from a moving vehicle during nighttime conditions. Signs that are visually identified by the inspector to have retroreflectivity below the minimum levels should be replaced.*
- B. *Measured Sign Retroreflectivity—Sign retroreflectivity is measured using a retroreflectometer. Signs with retroreflectivity below the minimum levels should be replaced.*
- C. *Expected Sign Life—When signs are installed, the installation date is labeled or recorded so that the age of a sign is known. The age of the sign is compared to the expected sign life. The expected sign life is based on the experience of sign retroreflectivity degradation in a geographic area compared to the minimum levels. Signs older than the expected life should be replaced.*
- D. *Blanket Replacement—All signs in an area/corridor, or of a given type, should be replaced at specified intervals. This eliminates the need to assess retroreflectivity or track the life of individual signs. The replacement interval is based on the expected sign life, compared to the minimum levels, for the shortest-life material used on the affected signs.*
- E. *Control Signs—Replacement of signs in the field is based on the performance of a sample of control signs. The control signs might be a small sample located in a maintenance yard or a sample of signs in the field. The control signs are monitored to determine the end of retroreflective life for the associated signs. All field signs represented by the control sample should be replaced before the retroreflectivity levels of the control sample reach the minimum levels.*
- F. *Other Methods—Other methods developed based on engineering studies can be used.*

Support:

05 Additional information about these methods is contained in the 2007 Edition of FHWA's "Maintaining Traffic Sign Retroreflectivity" (see Section 1A.11).

Option:

<sup>06</sup> Highway agencies may exclude the following signs from the retroreflectivity maintenance guidelines described in this Section:

- A. Parking, Standing, and Stopping signs (R7 and R8 series)
- B. Walking/Hitchhiking/Crossing signs (R9 series, R10-1 through R10-4b)
- C. Acknowledgment signs
- D. All signs with blue or brown backgrounds
- E. Bikeway signs that are intended for exclusive use by bicyclists or pedestrians

## Section 2A.09 Shapes

**Standard:**

<sup>01</sup> Particular shapes, as shown in Table 2A-4, shall be used exclusively for specific signs or series of signs, unless otherwise provided in the text discussion in this Manual for a particular sign or class of signs.

## Section 2A.10 Sign Colors

**Standard:**

<sup>01</sup> The colors to be used on standard signs and their specific use on these signs shall be as provided in the applicable Sections of this Manual. The color coordinates and values shall be as described in 23 CFR, Part 655, Subpart F, Appendix.

Support:

<sup>02</sup> As a quick reference, common uses of sign colors are shown in Table ~~2A-5~~ 2A-5(CA). Color schemes on specific signs are shown in the illustrations located in each appropriate Chapter.

<sup>03</sup> Whenever white is specified in this Manual or in the “Standard Highway Signs and Markings” book (see Section 1A.11) as a color, it is understood to include silver-colored retroreflective coatings or elements that reflect white light.

<sup>04</sup> The colors coral and light blue are being reserved for uses that will be determined in the future by the Federal Highway Administration.

<sup>05</sup> Information regarding color coding of destinations on guide signs, including community wayfinding signs, is contained in Chapter 2D.

<sup>05a</sup> The fluorescent version of red, yellow, green or orange colors provide higher conspicuity than the standard colors, especially during twilight.

Option:

<sup>06</sup> The approved fluorescent version of the standard red, yellow, green, or orange color may be used as an alternative to the corresponding standard color.

## Section 2A.11 Dimensions

Support:

<sup>01</sup> The “Standard Highway Signs and Markings” book (see Section 1A.11) prescribes design details for up to five different sizes depending on the type of traffic facility, including bikeways. Smaller sizes are designed to be used on bikeways and some other off-road applications. Larger sizes are designed for use on freeways and expressways, and can also be used to enhance road user safety and convenience on other facilities, especially on multi-lane divided highways and on undivided highways having five or more lanes of traffic and/or high speeds. The intermediate sizes are designed to be used on other highway types.

**Standard:**

<sup>02</sup> The sign dimensions prescribed in the sign size tables in the various Parts and Chapters in this Manual and in the “Standard Highway Signs and Markings” book (see Section 1A.11) shall be used unless engineering judgment determines that other sizes are appropriate. Except as provided in Paragraph 3, where engineering judgment determines that sizes smaller than the prescribed dimensions are appropriate for use, the sign dimensions shall not be less than the minimum dimensions specified in this Manual. The sizes shown in the Minimum columns that are smaller than the sizes shown in the Conventional Road columns in the various sign size tables in this Manual shall only be used on low-speed roadways, and alleys,

**and private roads open to public travel (see definition in Section 1A.13) where the reduced legend size would be adequate for the regulation or warning or where physical conditions preclude the use of larger sizes.**

**02a The standard sign dimensions prescribed in this California MUTCD, FHWA's "Standard Highway Signs and Markings" book and Caltrans' California Sign Specifications shall be used unless engineering judgment determines that other sizes are appropriate. Where engineering judgment determines that sizes smaller than the standard dimensions are appropriate for use, the sign dimensions shall not be less than the minimum dimensions specified in this California MUTCD, "Standard Highway Signs and Markings" book or the California Sign Specifications. See Section 1A.11 for information regarding these publications.**

**Option:**

03 For alleys with restrictive physical conditions and vehicle usage that limits installation of the minimum size sign (or the Conventional Road size sign if no Minimum size is shown), both the sign height and the sign width may be decreased by up to 6 inches.

**Guidance:**

04 *The sizes shown in the Freeway and Expressway columns in the various sign size tables in this Manual should be used on freeways and expressways, and for other higher-speed applications based upon engineering judgment, to provide larger signs for increased visibility and recognition.*

05 *The sizes shown in the Oversized columns in the various sign size tables in this Manual size should be used for those special applications where speed, volume, or other factors result in conditions where increased emphasis, improved recognition, or increased legibility is needed, as determined by engineering judgment or study.*

06 *Increases above the prescribed sizes should be used where greater legibility or emphasis is needed. If signs larger than the prescribed sizes are used, the overall sign dimensions should be increased in 6-inch increments.*

**Standard:**

07 **Where engineering judgment determines that sizes that are different than the prescribed dimensions are appropriate for use, standard shapes and colors shall be used and standard proportions shall be retained as much as practical.**

**Guidance:**

08 *When supplemental plaques are installed with larger sized signs, a corresponding increase in the size of the plaque and its legend should also be made. The resulting plaque size should be approximately in the same relative proportion to the larger sized sign as the conventional sized plaque is to the conventional sized sign.*

## **Section 2A.12 Symbols**

**Standard:**

01 **Symbol designs shall in all cases be unmistakably similar to those shown in this Manual, California MUTCD, California Sign Specifications and in the "Standard Highway Signs and Markings" book (see Section 1A.11).**

**Support:**

02 New symbol designs are adopted by the Federal Highway Administration based on research evaluations to determine road user comprehension, sign conspicuity, and sign legibility.

02a **Use of symbols to word messages is preferred. However, care needs to be taken so as not to mix the individual symbols.**

03 Sometimes a change from word messages to symbols requires significant time for public education and transition. Therefore, this Manual sometimes includes the practice of using educational plaques to accompany new symbol signs.

**Guidance:**

04 *New warning or regulatory symbol signs not readily recognizable by the public should be accompanied by an educational plaque.*

**Option:**

05 Educational plaques may be left in place as long as they are in serviceable condition.

06 State and/or local highway agencies may conduct research studies to determine road user comprehension, sign conspicuity, and sign legibility.

*Guidance:*

*07 Although most standard symbols are oriented facing left, mirror images of these symbols should be used where the reverse orientation might better convey to road users a direction of movement.*

**Standard:**

**08 A symbol used for a given category of signs (regulatory, warning, or guide) shall not be used for a different category of signs, except as specifically authorized in this Manual.**

**09 Except as provided in Paragraph 11, a recreational and cultural interest area symbol (see Chapter 2M) shall not be used on streets or highways outside of recreational and cultural interest areas.**

**10 A recreational and cultural interest area guide sign symbol (see Chapter 2M) shall not be used on any regulatory or warning sign on any street, road, or highway.**

*Option:*

*11 A recreational and cultural interest area guide sign symbol (see Section 2M.04) may be used on a highway guide sign outside of a recreational and cultural interest area to supplement a comparable word message for which there is no approved symbol for that message in Chapters 2B through 2I or 2N.*

*Support:*

*12 Section 2M.07 contains provisions for the use of recreational and cultural interest area symbols to indicate prohibited activities or items in non-road applications.*

### **Section 2A.13 Word Messages**

**Standard:**

**01 Except as provided in Section 2A.06, all word messages shall use standard wording and letters as shown in this Manual and in the “Standard Highway Signs and Markings” book (see Section 1A.11).**

*Guidance:*

*02 Word messages should be as brief as possible and the lettering should be large enough to provide the necessary legibility distance. A minimum specific ratio of 1 inch of letter height per 30 feet of legibility distance should be used.*

*03 Abbreviations (see Section 1A.15) should be kept to a minimum.*

*04 Word messages should not contain periods, apostrophes, question marks, ampersands, or other punctuation or characters that are not letters, numerals, or hyphens unless necessary to avoid confusion.*

*05 The solidus (slanted line or forward slash) is intended to be used for fractions only and should not be used to separate words on the same line of legend. Instead, a hyphen should be used for this purpose, such as “TRUCKS - BUSES.”*

**Standard:**

**06 Fractions shall be displayed with the numerator and denominator diagonally arranged about the solidus (slanted line or forward slash). The overall height of the fraction is measured from the top of the numerator to the bottom of the denominator, each of which is vertically aligned with the upper and lower ends of the solidus. The overall height of the fraction shall be determined by the height of the numerals within the fraction, and shall be 1.5 times the height of an individual numeral within the fraction.**

*Support:*

*07 The “Standard Highway Signs and Markings” book (see Section 1A.11) contains details regarding the layouts of fractions on signs.*

*Guidance:*

*08 When initials are used to represent an abbreviation for separate words (such as “U S” for a United States route), the initials should be separated by a space of between 1/2 and 3/4 of the letter height of the initials.*

*09 When an Interstate route is displayed in text form instead of using the route shield, a hyphen should be used for clarity, such as “I-50.”*

**Standard:**

**10 All sign lettering shall be in upper-case letters as provided in the “Standard Highway Signs and Markings” book (see Section 1A.11), unless otherwise provided in this Manual for a particular sign or type of message.**

**11 The sign lettering for names of places, streets, and highways shall be composed of a combination of lower-case letters with initial upper-case letters.**



**Support:**

<sup>12</sup> Letter height is expressed in terms of the height of an upper-case letter. For mixed-case legends (those composed of an initial upper-case letter followed by lower-case letters), the height of the lower-case letters is derived from the specified height of the initial upper-case letter based on a prescribed ratio. Letter heights for mixed-case legends might be expressed in terms of both the upper- and lower-case letters, or in terms of the initial upper-case letter alone. When the height of a lower-case letter is specified or determined from the prescribed ratio, the reference is to the nominal loop height of the letter. The term loop height refers to the portion of a lower-case letter that excludes any ascending or descending stems or tails of the letter, such as with the letters “d” or “q.” The nominal loop height is equal to the actual height of a non-rounded lower-case letter whose form does not include ascending or descending stems or tails, such as the letter “x.” The rounded portions of a lower-case letter extend slightly above and below the baselines projected from the top and bottom of such a non-rounded letter so that the appearance of a uniform letter height within a word is achieved. The actual loop height of a rounded lower-case letter is slightly greater than the nominal loop height and this additional height is excluded from the expression of the lower-case letter height.

**Standard:**

<sup>13</sup> **When a mixed-case legend is used, the height of the lower-case letters shall be 3/4 of the height of the initial upper-case letter.**

<sup>14</sup> **The unique letter forms for each of the Standard Alphabet series shall not be stretched, compressed, warped, or otherwise manipulated.**

**Support:**

<sup>15</sup> Section 2D.04 contains information regarding the acceptable methods of modifying the length of a word for a given letter height and series.

## **Section 2A.14 Sign Borders**

**Standard:**

<sup>01</sup> **Unless otherwise provided, each sign illustrated in this Manual shall have a border of the same color as the legend, at or just inside the edge.**

<sup>02</sup> **The corners of all sign borders shall be rounded, except for STOP signs.**

*Guidance:*

<sup>03</sup> *A dark border on a light background should be set in from the edge, while a light border on a dark background should extend to the edge of the sign. A border for 30-inch signs with a light background should be from 1/2 to 3/4 inch in width, 1/2 inch from the edge. For similar signs with a light border, a width of 1 inch should be used. For other sizes, the border width should be of similar proportions, but should not exceed the stroke-width of the major lettering of the sign. On signs exceeding 72 x 120 inches in size, the border should be 2 inches wide, or on larger signs, 3 inches wide. Except for STOP signs and as otherwise provided in Section 2E.16, the corners of the sign should be rounded to a radius that is concentric with that of the border.*

## **Section 2A.15 Enhanced Conspicuity for Standard Signs**

**Option:**

<sup>01</sup> Based upon engineering judgment, where the improvement of the conspicuity of a standard regulatory, warning, or guide sign is desired, any of the following methods may be used, as appropriate, to enhance the sign's conspicuity (see Figure 2A-1):

- A. Increasing the size of a standard regulatory, warning, or guide sign.
- B. Doubling-up of a standard regulatory, warning, or guide sign by adding a second identical sign on the left-hand side of the roadway.
- C. Adding a solid yellow or fluorescent yellow rectangular “header panel” above a standard regulatory sign, with the width of the panel corresponding to the width of the standard regulatory sign. A legend of “NOTICE,” “STATE LAW,” or other appropriate text may be added in black letters within the header panel for a period of time determined by engineering judgment.
- D. Adding a NEW plaque (see Section 2C.62) above a new standard regulatory or warning sign, for a period of time determined by engineering judgment, to call attention to the new sign.

- E. Adding one or more red or orange flags (cloth or retroreflective sheeting) above a standard regulatory or warning sign, with the flags oriented so as to be at 45 degrees to the vertical.
- F. Adding a solid yellow, a solid fluorescent yellow, or a diagonally striped black and yellow (or black and fluorescent yellow) strip of retroreflective sheeting at least 3 inches wide around the perimeter of a standard warning sign. This may be accomplished by affixing the standard warning sign on a background that is 6 inches larger than the size of the standard warning sign.
- G. Adding a warning beacon (see Section 4L.03) to a standard regulatory (other than a STOP or a Speed Limit sign), warning, or guide sign.
- H. Adding a speed limit sign beacon (see Section 4L.04) to a standard Speed Limit sign.
- I. Adding a stop beacon (see Section 4L.05) to a STOP sign.
- J. Adding light emitting diode (LED) units within the symbol or legend of a sign or border of a standard regulatory, warning, or guide sign, as provided in Section 2A.07.
- K. Adding a strip of retroreflective material to the sign support in compliance with the provisions of Section 2A.21.
- L. Using other methods that are specifically allowed for certain signs as described elsewhere in this Manual.
- M. For applicable sign types and colors, using a sign with its color in a fluorescent version. See Section 2A.10.

Support:

<sup>02</sup> Sign conspicuity improvements can also be achieved by removing non-essential and illegal signs from the right-of-way (see Section 1A.08), and by relocating signs to provide better spacing.

**Standard:**

- <sup>03</sup> **The NEW plaque (see Section 2C.62) shall not be used alone.**
- <sup>04</sup> **Strobe lights shall not be used to enhance the conspicuity of highway signs.**

## **Section 2A.16 Standardization of Location**

Support:

<sup>01</sup> Standardization of position cannot always be attained in practice. Examples of heights and lateral locations of signs for typical installations are illustrated in Figure 2A-2, and examples of locations for some typical signs at intersections are illustrated in Figures 2A-3 and 2A-4.

<sup>02</sup> Examples of advance signing on an intersection approach are illustrated in Figure 2A-4. Chapters 2B, 2C, and 2D contain provisions regarding the application of regulatory, warning, and guide signs, respectively.

**Guidance:**

<sup>03</sup> *Signs requiring separate decisions by the road user ~~shall~~ should be spaced sufficiently far apart for the appropriate decisions to be made.*

**Standard:**

<sup>03</sup> **One of the factors considered when determining the appropriate spacing shall be the posted or 85<sup>th</sup>-percentile speed.**

**Guidance:**

<sup>04</sup> *Signs should be located on the right-hand side of the roadway where they are easily recognized and understood by road users. Signs in other locations should be considered only as supplementary to signs in the normal locations, except as otherwise provided in this Manual.*

<sup>05</sup> *Signs should be individually installed on separate posts or mountings except where:*

- A. *One sign supplements another;*
- B. *Route or directional signs are grouped to clarify information to motorists;*
- C. *~~Regulatory~~ Signs that do not conflict with each other are grouped, such as turn prohibition signs posted with one way signs or a parking regulation sign posted with ~~a speed limit~~ another sign; or*
- D. *Street name signs are posted with a stop or yield sign.*

<sup>06</sup> *Signs should be located so that they:*

- A. *Are outside the clear zone unless placed on a breakaway or yielding support (see Section 2A.19),*
- B. *Optimize nighttime visibility,*
- C. *Minimize the effects of mud splatter and debris,*
- D. *Do not obscure each other,*

- E. Do not obscure the sight distance to approaching vehicles on the major street for drivers who are stopped on minor-street approaches, and
- F. Are not hidden from view.

Support:

<sup>07</sup> The clear zone is the total roadside border area, starting at the edge of the traveled way, available for use by errant vehicles. The width of the clear zone is dependent upon traffic volumes, speeds, and roadside geometry. Additional information can be found in AASHTO's "Roadside Design Guide" (see Section 1A.11).

Guidance:

<sup>08</sup> With the increase in traffic volumes and the desire to provide road users regulatory, warning, and guidance information, an order of priority for sign installation should be established.

Support:

<sup>09</sup> An order of priority is especially critical where space is limited for sign installation and there is a demand for several different types of signs. Overloading road users with too much information is not desirable.

Guidance:

<sup>10</sup> Because regulatory and warning information is more critical to the road user than guidance information, regulatory and warning signing whose location is critical should be displayed rather than guide signing in cases where conflicts occur. Community wayfinding and acknowledgment guide signs should have a lower priority as to placement than other guide signs. Information of a less critical nature should be moved to less critical locations or omitted.

Option:

<sup>11</sup> Under some circumstances, such as on curves to the right, signs may be placed on median islands or on the left-hand side of the road. A supplementary sign located on the left-hand side of the roadway may be used on a multi-lane road where traffic in a lane to the right might obstruct the view to the right.

Guidance:

<sup>12</sup> ~~In urban areas where crosswalks exist, signs should not be placed within 4 feet in advance of the crosswalk (see Drawing D in Figure 2A-3).~~

<sup>13</sup> The installation of signs, including route shields, on signal standards should be avoided unless they directly affect traffic movements in the intersection.

<sup>14</sup> A minimum spacing of 200 feet between guide signs should be maintained on conventional highways.

<sup>15</sup> A minimum spacing of 800 feet between guide signs should be maintained on freeways and expressways.

Support:

<sup>16</sup> Figure 2A-2(CA) shows height and lateral location of signs for typical installations.

## Section 2A.17 Overhead Sign Installations

Guidance:

<sup>01</sup> Overhead signs should be used on freeways and expressways, at locations where some degree of lane-use control is desirable, and at locations where space is not available at the roadside.

Support:

<sup>02</sup> The operational requirements of the present highway system are such that overhead signs have value at many locations. The factors to be considered for the installation of overhead sign displays are not definable in specific numerical terms.

Option:

<sup>03</sup> The following conditions (not in priority order) may be considered in an engineering study to determine if overhead signs would be beneficial:

- A. Traffic volume at or near capacity,
- B. Complex interchange design,
- C. Three or more lanes in each direction,
- D. Restricted sight distance,
- E. Closely-spaced interchanges,
- F. Multi-lane exits,
- G. Large percentage of trucks,
- H. Street lighting background,

- I. High-speed traffic,
- J. Consistency of sign message location through a series of interchanges,
- K. Insufficient space for post-mounted signs,
- L. Junction of two freeways, and
- M. Left exit ramps.
- N. "Exit Only" lanes and lane drops.
- O. Necessity to have a sign message directly over the lane to which it refers.

<sup>04</sup> Over-crossing structures may be used to support overhead signs.

**Support:**

<sup>05</sup> Under some circumstances, the use of over-crossing structures as sign supports might be the only practical solution that will provide adequate viewing distance. The use of such structures as sign supports might eliminate the need for the foundations and sign supports along the roadside.

<sup>06</sup> Refer to Caltrans' Standard Plans publication for standard application of overhead signs. See Section 1A.11 for information regarding this publication.

**Guidance:**

<sup>07</sup> *Whenever there is a deviation from the standards, a structural analysis should be considered. On State highways, all signs of this type should be referred to Caltrans' Division of Engineering Services, Office of Structure Design Services.*

<sup>08</sup> *Signs mounted on overcrossing structures should not project above the bridge rail by more than 1 foot.*

**Option:**

<sup>09</sup> Structure mounted signs may be placed parallel with the structures for skews up to 10°. At greater angles of skew, position the sign as close to 10° from the normal as possible.

**Standard:**

<sup>10</sup> **If the skew is so great that this is not practical, separate sign structures shall be used.**

## **Section 2A.18 Mounting Height**

**Standard:**

<sup>01</sup> **The provisions of this Section shall apply unless specifically stated otherwise for a particular sign or object marker elsewhere in this Manual.**

**Support:**

<sup>02</sup> The mounting height requirements for object markers are provided in Chapter 2C.

<sup>03</sup> In addition to the provisions of this Section, information affecting the minimum mounting height of signs as a function of crash performance can be found in AASHTO's "Roadside Design Guide" (see Section 1A.11).

**Standard:**

<sup>04</sup> **The minimum height, measured vertically from the bottom of the sign to the elevation of the near edge of the pavement, of signs installed at the side of the road in rural areas shall be 5 feet (see Figure 2A-2).**

<sup>05</sup> **The minimum height, measured vertically from the bottom of the sign to the top of the curb, or in the absence of curb, measured vertically from the bottom of the sign to the elevation of the near edge of the traveled way, of signs installed at the side of the road in business, commercial, or residential areas where parking or pedestrian movements are likely to occur, or where the view of the sign might be obstructed, shall be 7 feet (see Figure 2A-2).**

**Option:**

<sup>06</sup> The height to the bottom of a secondary sign mounted below another sign may be 1 foot less than the height specified in Paragraphs 4 and 5.

**Standard:**

<sup>07</sup> **The minimum height, measured vertically from the bottom of the sign to the sidewalk, of signs installed above sidewalks shall be 7 feet.**

<sup>08</sup> **If the bottom of a secondary sign that is mounted below another sign is mounted lower than 7 feet above a pedestrian sidewalk or pathway (see Section 6D.02), the secondary sign shall not project more than 4 inches into the pedestrian facility.**

Option:

09 Signs that are placed 30 feet or more from the edge of the traveled way may be installed with a minimum height of 5 feet, measured vertically from the bottom of the sign to the elevation of the near edge of the pavement.

**Standard:**

10 **Directional signs on freeways and expressways shall be installed with a minimum height of 7 feet, measured vertically from the bottom of the sign to the elevation of the near edge of the pavement. All route signs, warning signs, and regulatory signs on freeways and expressways shall be installed with a minimum height of 7 feet, measured vertically from the bottom of the sign to the elevation of the near edge of the pavement. If a secondary sign is mounted below another sign on a freeway or expressway, the major sign shall be installed with a minimum height of 8 feet and the secondary sign shall be installed with a minimum height of 5 feet, measured vertically from the bottom of the sign to the elevation of the near edge of the pavement.**

11 **Where large signs having an area exceeding 50 square feet are installed on multiple breakaway posts, the clearance from the ground to the bottom of the sign shall be at least 7 feet.**

Option:

12 A route sign assembly consisting of a route sign and auxiliary signs (see Section ~~2D.34~~ 2D.12) may be treated as a single sign for the purposes of this Section.

13 The mounting height may be adjusted when supports are located near the edge of the right-of-way on a steep backslope in order to avoid the sometimes less desirable alternative of placing the sign closer to the roadway.

**Standard:**

14 **Overhead signs shall provide a vertical clearance of not less than 17 feet to the sign, light fixture, or sign bridge over the entire width of the pavement and shoulders except where the structure on which the overhead signs are to be mounted or other structures along the roadway near the sign structure have a lesser vertical clearance.**

**14a The bottom of the overhead sign truss frame located over a roadway shall be at least 18 feet and 6 inches on State highways. Refer to Caltrans' Standard Plans publication. See Section 1A.11 for information regarding this publication.**

Option:

15 If the vertical clearance of other structures along the roadway near the sign structure is less than 16 feet, the vertical clearance to an overhead sign structure or support may be as low as 1 foot higher than the vertical clearance of the other structures in order to improve the visibility of the overhead signs.

16 In special cases it may be necessary to reduce the clearance to overhead signs because of substandard dimensions in tunnels and other major structures such as double-deck bridges.

Support:

17 Figure 2A-2 illustrates some examples of the mounting height requirements contained in this Section.

18 **Exceptions to the mounting heights are the FREEWAY ENTRANCE (D13-3) and DO NOT ENTER (R5-1) sign packages which are mounted lower to avoid sight restrictions and be most responsive to headlights.**

*Guidance:*

*19 The FREEWAY ENTRANCE (D13-3) and DO NOT ENTER (R5-1) sign packages should be mounted with the bottom of the lower sign 2 feet above the edge of the pavement. The ONE WAY (R6-1) signs should be mounted 1.5 foot above the edge of the pavement.*

*20 Overhead signs should provide a vertical clearance of not less than 18 feet over the entire width of the pavement and shoulders, except where a lesser vertical clearance is used for the design of other structures. The vertical clearance to overhead sign structures or supports need not be greater than 1 foot in excess of the minimum design clearance of other structures.*

Option:

21 In special cases it may be necessary to reduce the clearance still further because of substandard dimensions in tunnels and other major structures such as double-deck bridges.

Support:

22 Figure 2A-2(CA) shows height and lateral location of signs for typical installations.

## Section 2A.19 Lateral Offset

### Standard:

01 For overhead sign supports, the minimum lateral offset from the edge of the shoulder (or if no shoulder exists, from the edge of the pavement) to the near edge of overhead sign supports (cantilever or sign bridges) shall be 6 feet. Overhead sign supports shall have a barrier or crash cushion to shield them if they are within the clear zone.

02 Post-mounted sign and object marker supports shall be crashworthy (breakaway, yielding, or shielded with a longitudinal barrier or crash cushion) if within the clear zone.

### Guidance:

03 For post-mounted signs, the minimum lateral offset should be 12 feet from the edge of the traveled way. If a shoulder wider than 6 feet exists, the minimum lateral offset for post-mounted signs should be 6 feet from the edge of the shoulder.

### Support:

04 The minimum lateral offset requirements for object markers are provided in Chapter 2C.

05 The minimum lateral offset is intended to keep trucks and cars that use the shoulders from striking the signs or supports.

### Guidance:

06 All supports should be located as far as practical from the edge of the shoulder. Advantage should be taken to place signs behind existing roadside barriers, on over-crossing structures, or other locations that minimize the exposure of the traffic to sign supports.

### Option:

07 Where permitted, signs may be placed on existing supports used for other purposes, such as highway traffic signal supports, highway lighting supports, and utility poles.

### Standard:

08 If signs are placed on existing supports, they shall meet other placement criteria contained in this Manual.

### Option:

09 Lesser lateral offsets may be used on connecting roadways or ramps at interchanges, but not less than 6 feet from the edge of the traveled way.

10 On conventional roads in areas where it is impractical to locate a sign with the lateral offset prescribed by this Section, a lateral offset of at least 2 feet may be used.

11 A lateral offset of at least 1 foot from the face of the curb may be used in business, commercial or residential areas where sidewalk width is limited or where existing poles are close to the curb.

### Guidance:

12 Overhead sign supports and post-mounted sign and object marker supports should not intrude into the usable width of a sidewalk or other pedestrian facility.

### Support:

13 Figures 2A-2 and 2A-3 illustrate some examples of the lateral offset requirements contained in this Section.

14 Refer to Caltrans' Highway Design Manual Section 309.1 for horizontal clearances. See Section 1A.11 for information regarding this publication.

### Guidance:

15 On freeways, expressways, and in interchange areas, and on rural highways where practicable, warning and regulatory signs should be placed a minimum of 12 feet and a maximum of 30 feet from the edge of traveled way.

### Standard:

16 When clear roadside recovery areas are provided, guide signs on overhead sign supports shall be placed as far from the edge of traveled way as is practical, up to a maximum of 30 feet.

### Guidance:

17 When possible, they should be located in protected areas or placed behind guardrails, crash cushions, barriers, etc.

### Standard:

18 Overhead signs placed in unprotected locations shall be placed on cantilever structures to provide the maximum possible horizontal clearance to the sign support.

**Support:**

<sup>19</sup> Overcrossing structures can often serve for the support for overhead signs, and may be the only practical location that will provide adequate viewing distance. Use of these structures, as sign supports will minimize the need for sign supports along the roadway. Where overhead crossings are closely spaced and the proximity of other structures does not limit visibility, it is desirable to place signs on the bridges for economy, to reduce fixed objects and to enhance safety.

**Guidance:**

<sup>20</sup> Where a freeway or an expressway median is 12 feet or less in width, consideration should be given to spanning both roadways without a center support. Butterfly-type signs or other overhead sign supports should not be erected in neutral areas (gores) or other exposed locations.

**Standard:**

<sup>21</sup> **Guardrail protection shall be provided for overhead sign supports if they are located within the clear recovery area.**

<sup>22</sup> **In cuts steeper than 4:1, where there are no recovery areas, the sign supports shall be placed on the slopes a minimum of 4 feet vertically from the hinge point. In fill sections, sign supports shall be protected by a minimum of 50 feet of guardrail plus the breakaway end anchor. The supports shall be placed over the hinge point approximately 4 feet from the face of the guard rail.**

<sup>23</sup> **The median support on overhead sign bridges shall be centered in medians 60 feet or less in width and shall be placed 30 feet from the edge of the traveled way in wider medians. Unless there are protected locations, sign bridge supports shall not be placed in medians 22 feet or less in width.**

**Guidance:**

<sup>24</sup> *Overhead signs should be placed at least 30 feet from light standards.*

## **Section 2A.20 Orientation**

**Guidance:**

<sup>01</sup> *Unless otherwise provided in this Manual, signs should be vertically mounted at right angles to the direction of, and facing, the traffic that they are intended to serve.*

<sup>02</sup> *Where mirror reflection from the sign face is encountered to such a degree as to reduce legibility, the sign should be turned slightly away from the road. Signs that are placed 30 feet or more from the pavement edge should be turned toward the road. On curved alignments, the angle of placement should be determined by the direction of approaching traffic rather than by the roadway edge at the point where the sign is located.*

**Option:**

<sup>03</sup> On grades, sign faces may be tilted forward or back from the vertical position to improve the viewing angle.

## **Section 2A.21 Posts and Mountings**

**Standard:**

<sup>01</sup> **Sign posts, foundations, and mountings shall be so constructed as to hold signs in a proper and permanent position, and to resist swaying in the wind or displacement by vandalism.**

**Support:**

<sup>02</sup> The latest edition of AASHTO's "Specifications for Structural Supports for Highway Signs, Luminaires, and Traffic Signals" contains additional information regarding posts and mounting (see Page i for AASHTO's address).

**Option:**

<sup>03</sup> Where engineering judgment indicates a need to draw attention to the sign during nighttime conditions, a strip of retroreflective material may be used on regulatory and warning sign supports.

**Standard:**

<sup>04</sup> **If a strip of retroreflective material is used on the sign support, it shall be at least 2 inches in width, it shall be placed for the full length of the support from the sign to within 2 feet above the edge of the roadway, and its color shall match the background color of the sign, except that the color of the strip for the YIELD and DO NOT ENTER signs shall be red.**

**Support:**

<sup>05</sup> Refer to Caltrans' Highway Design Manual Section 309.1 for horizontal clearances. See Section 1A.11 for information regarding this publication.

*Guidance:*

*06 In areas where ground mounted sign supports cannot be sufficiently offset from the pavement edge, sign supports of a suitable breakaway or yielding design should be considered.*

**Standard:**

**07 Breakaway or yielding supports shall be used on freeways and expressways unless the sign supports are adequately shielded by guardrail, crash cushions, or similar devices.**

*Support:*

*08 In some cases, especially in urban areas, essential signs can be placed on existing supports used for other purposes, such as traffic signals or street lights, thereby saving expense and minimizing sidewalk obstruction.*

*Option:*

*09 When needed for emphasis to facilitate traffic safety on streets with speed limits of 35 mph or less, small plastic signs not exceeding 12 inch in width may be mounted on channelizers, cones or portable delineators to be placed on lane lines and/or centerlines.*

**Standard:**

**10 When installed, they shall supplement permanently mounted standard signs and shall use standard legends, sign colors and retroreflectivity, but in a smaller, proportional format. If the device is used on lane lines, there shall be an engineering study, which documents the limited potential of the device to be struck due to lane changing.**

## **Section 2A.22 Maintenance**

*Guidance:*

*01 Maintenance activities should consider proper position, cleanliness, legibility, and daytime and nighttime visibility (see Section ~~2A.09~~ 2A.08). Damaged or deteriorated signs, gates, or object markers should be replaced.*

*02 To assure adequate maintenance, a schedule for inspecting (both day and night), cleaning, and replacing signs, gates, and object markers should be established. Employees of highway, law enforcement, and other public agencies whose duties require that they travel on the roadways should be encouraged to report any damaged, deteriorated, **missing** or obscured signs, gates, or object markers at the first opportunity.*

*03 Steps should be taken to see that weeds, trees, shrubbery, and construction, maintenance, and utility materials and equipment do not obscure the face of any sign or object marker.*

*04 A regular schedule of replacement of lighting elements for illuminated signs should be maintained.*

## **Section 2A.23 Median Opening Treatments for Divided Highways with Wide Medians**

*Guidance:*

*01 Where divided highways are separated by median widths at the median opening itself of 30 feet or more, median openings should be signed as two separate intersections.*

*Option:*

*02 Additional signs may be placed where the median width is 30 feet or more.*

*03 Standard directional or wrong way arrow pavement markings may be placed in each approach lane of each roadway in advance of a grade intersection and at other selected locations to indicate the direction of traffic flow.*

*04 At locations which are determined to have special need, other standard warning or prohibitive methods and devices may be used as a deterrent to the wrong way movement.*

*Support:*

*05 See Section 2E.53, Wrong-Way Traffic Control at Interchange Ramps.*

## **Section 2A.101(CA) Signs Off the State Right-of-Way**

*Support:*

*01 CVC 21350 permits Caltrans, with the consent of the local authorities, to place and maintain along city streets and county roads appropriate signs as may be necessary or desirable to direct traffic to State highways.*

*Guidance:*

*02 Where a sign beyond the right-of-way line is required for the proper operation of a State highway, such sign should be placed and maintained at State expense.*



**Figure 2A-1. Examples of Enhanced Conspicuity for Signs**

A – W16-15P plaque above a regulatory or warning sign if the regulation or condition is new



B – Red or orange flags above a regulatory, warning, or guide sign



C – W16-18P plaque above a regulatory sign



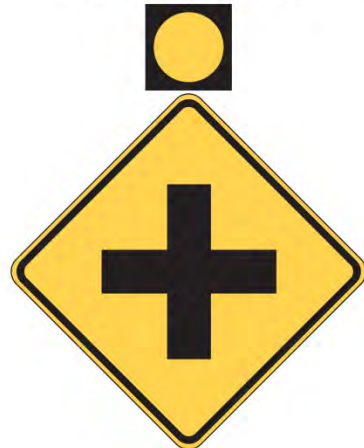
D – Solid yellow, solid fluorescent yellow, or diagonally striped black and yellow (or black and fluorescent yellow) strip of retroreflective sheeting around a warning sign



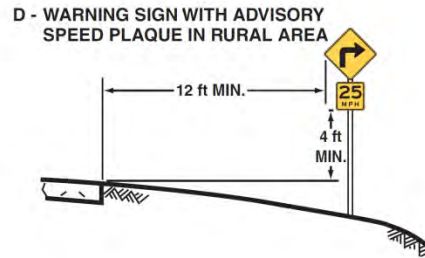
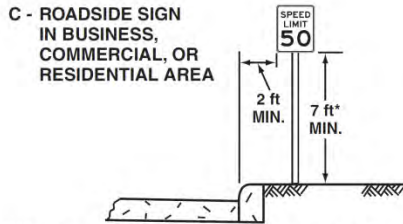
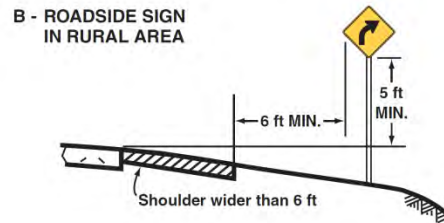
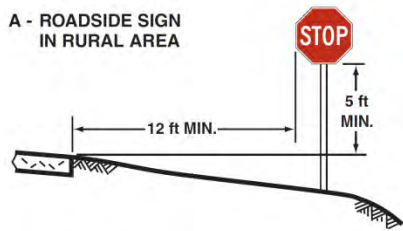
E – Vertical retroreflective strip on sign support



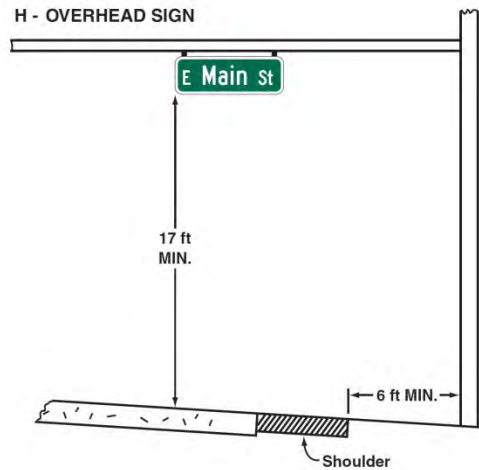
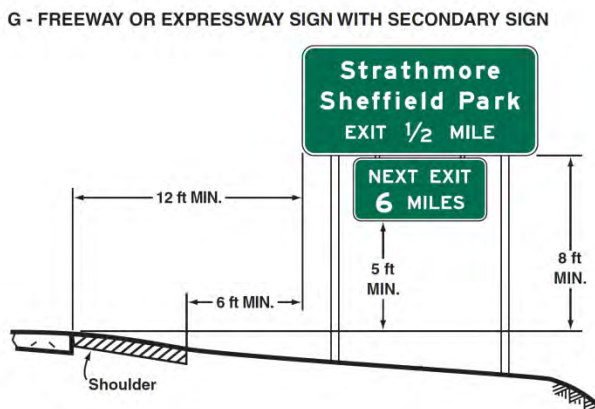
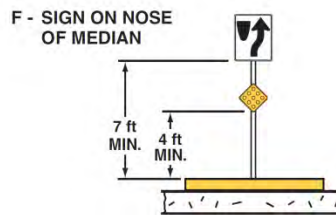
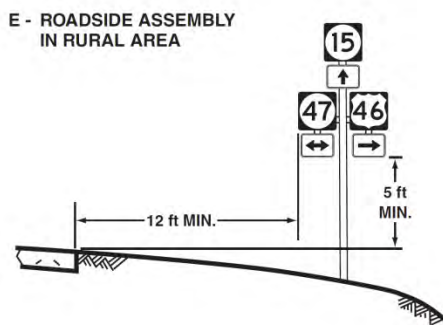
F – Supplemental beacon



**Figure 2A-2. Examples of Heights and Lateral Locations of Sign Installations**



\*Where parking or pedestrian movements are likely to occur



Note:  
 See Section 2A.19 for reduced lateral offset distances that may be used in areas where lateral offsets are limited, and in business, commercial, or residential areas where sidewalk width is limited or where existing poles are close to the curb.

**Figure 2A-2 (CA). Examples of Heights and Lateral Locations of Sign Installations**

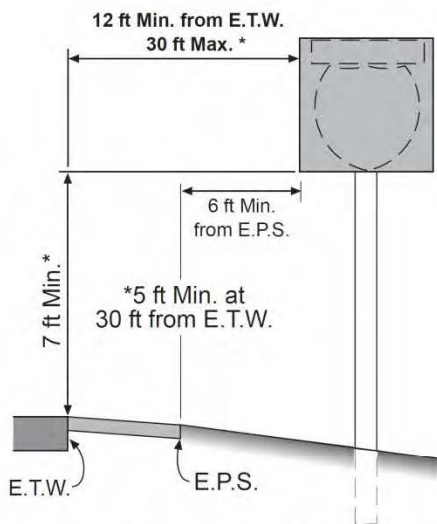
**NOTES:**

These sign positions are typical and should be considered a standard. When physical conditions require deviation from these typicals, they should be documented. When clear roadside recovery areas are provided, signs shall be placed as far from the traveled way as possible, up to 30 ft. When possible, they should be placed in protected locations.

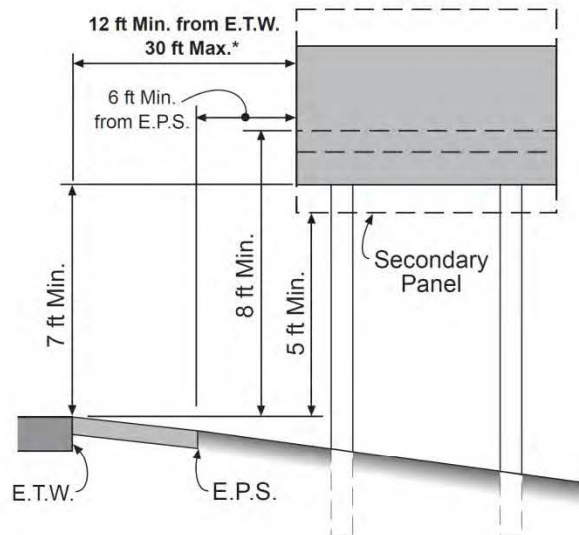
Signs in medians shall be placed at midpoint of median, and should not be closer than 6 ft from the edge of a paved shoulder, or if none, 12 ft from the edge of the traveled way. When appropriate, signs for opposing directions shall be placed back to back.

E.T.W. = Edge of Traveled Way  
 E.P.S. = Edge of Paved Shoulder

**FREEWAY AND EXPRESSWAY LOCATIONS**

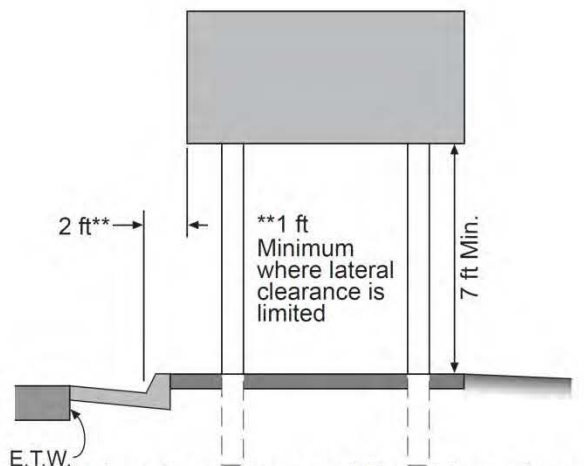


**ROUTE SHIELDS  
 REGULATORY AND WARNING SIGNS**

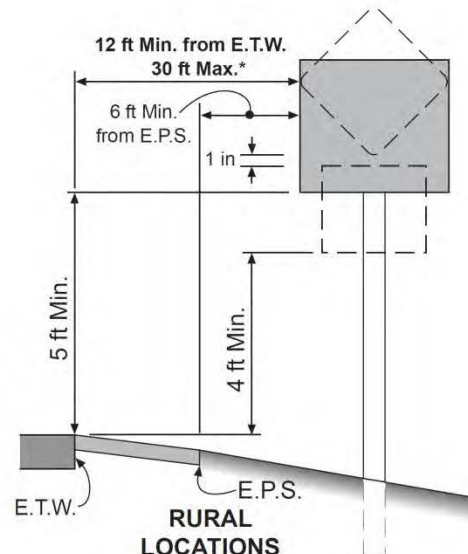


**GUIDE SIGNS**

**CONVENTIONAL HIGHWAYS AND INTERCHANGE AREAS**

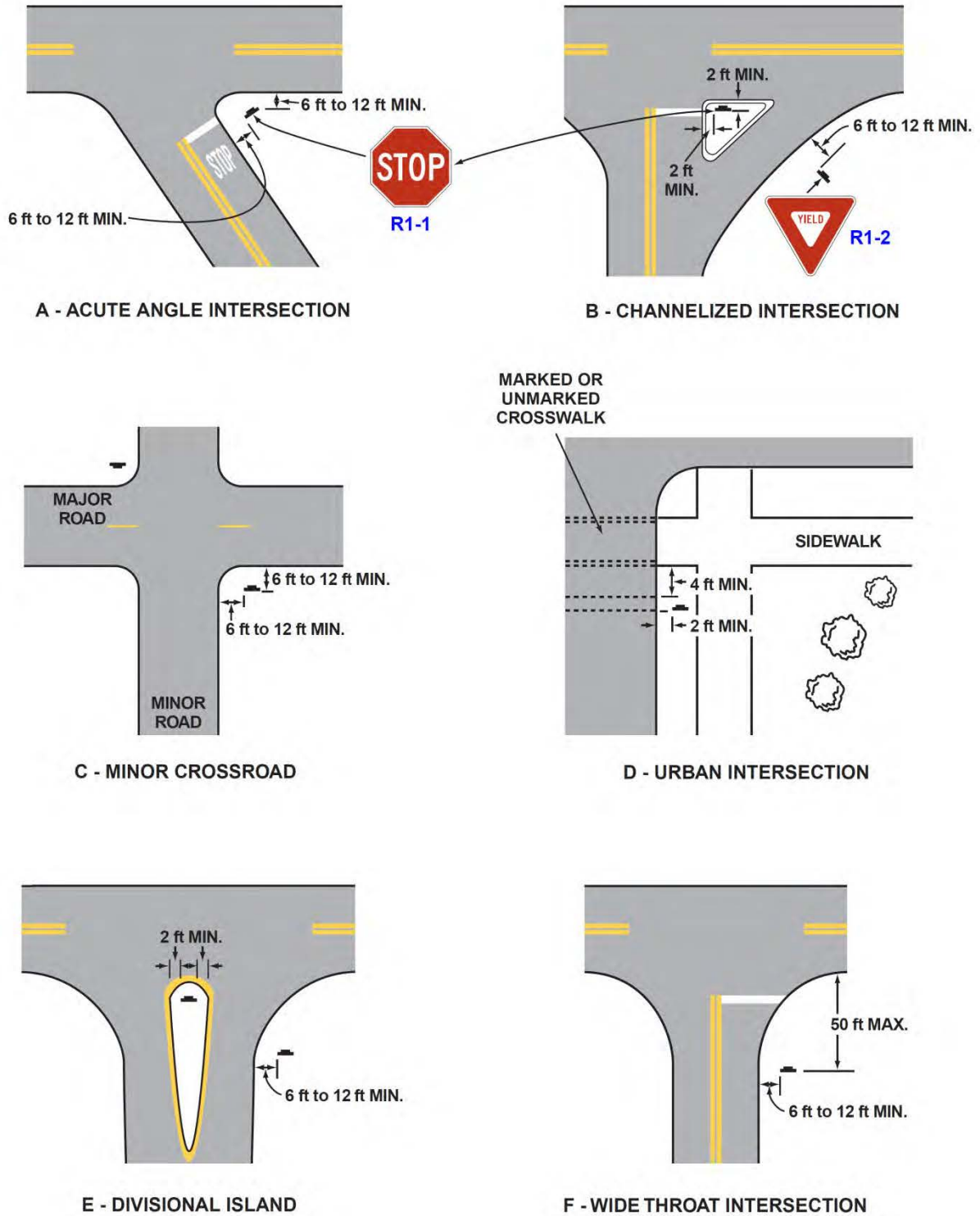


**Urban Locations and Rural Locations  
 with Sidewalk**



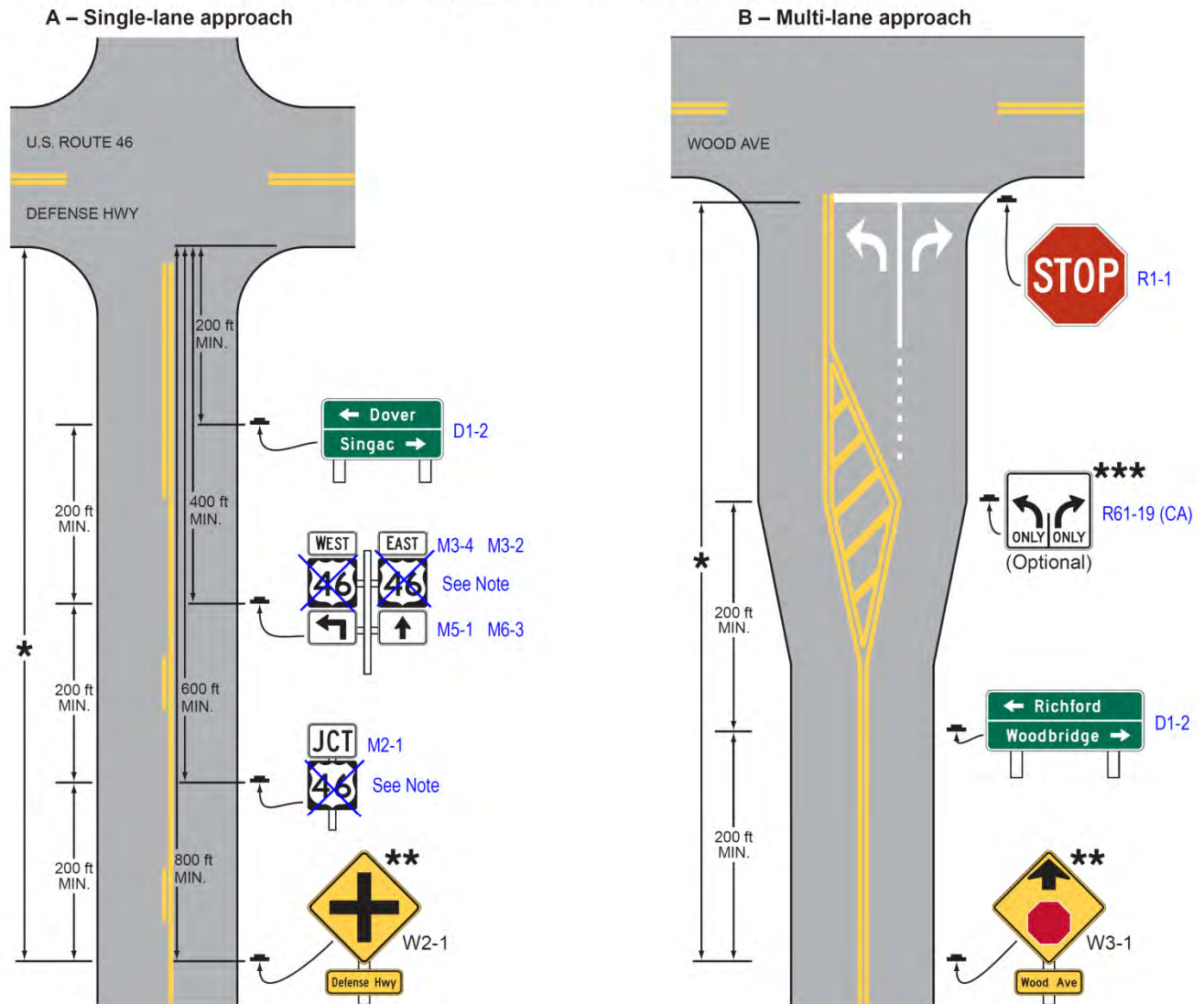
**RURAL  
 LOCATIONS**

**Figure 2A-3. Examples of Locations for Some Typical Signs at Intersections**



Note: Lateral offset is a minimum of 6 feet measured from the edge of the shoulder, or 12 feet measured from the edge of the traveled way. See Section 2A.19 for lower minimums that may be used in urban areas, or where lateral offset space is limited.

**Figure 2A-4. Relative Locations of Regulatory, Warning, and Guide Signs on an Intersection Approach**



Note: See Chapter 2D for information on guide signs and Part 3 for information on pavement markings  
 Use G26-2(CA) in lieu of M1-4 signs.



- \* See Table 2C-4 for the recommended minimum distance
- \*\* See Section 2C.46 for the application of the W2-1 sign and Section 2C.36 for the application of the W3-1 sign
- \*\*\* See Section 2B.22 for the application of Intersection Lane Control signs

**Table 2A-1. Illumination of Sign Elements**

| Means of Illumination   | Sign Element to be Illuminated   |
|---|--|
| Light behind the sign face  | <ul style="list-style-type: none"> <li>• Symbol or word message</li> <li>• Background</li> <li>• Symbol, word message, and background (through a translucent material)</li> </ul>        |
| Attached or independently mounted light source designed to direct essentially uniform illumination onto the sign face   | <ul style="list-style-type: none"> <li>• Entire sign face</li> </ul>   |
| Light emitting diodes (LEDs)  | <ul style="list-style-type: none"> <li>• Border of regulatory or warning signs</li> <li>• <del>Symbol or word message</del></li> <li>• <del>Portions of the sign border</del></li> </ul> |
| Other devices, or treatments that highlight the sign shape, color, or message:<br>Luminous tubing<br>Fiber optics<br>Incandescent light bulbs<br>Luminescent panels | <ul style="list-style-type: none"> <li>• Symbol or word message</li> <li>• Entire sign face</li> </ul>   |

**Table 2A-2. Retroreflection of Sign Elements**

| Means of Retroreflection   | Sign Element                                   |
|--|--|
| Reflector "buttons" or similar units   | Symbol<br>Word message<br>Border               |
| A material that has a smooth, sealed outer surface over a microstructure that reflects light | Symbol<br>Word message<br>Border<br>Background |

**Table 2A-3. Minimum Maintained Retroreflectivity Levels<sup>1</sup>**

| Sign Color  | Sheeting Type (ASTM D4956-04) |  |            |   | Additional Criteria |
|---|-------------------------------|--|------------|---|---------------------|
|   | Beaded Sheeting               |  |            | Prismatic Sheeting  |                     |
|   | I                             | II   | III        | III, IV, VI, VII, VIII, IX, X   |                     |
| White on Green  | W*; G ≥ 7                     | W*; G ≥ 15   | W*; G ≥ 25 | W ≥ 250; G ≥ 25   | Overhead            |
|   | W*; G ≥ 7                     | W ≥ 120; G ≥ 15  |            |   | Post-mounted        |
| Black on Yellow or Black on Orange  | Y*; O*                        | Y ≥ 50; O ≥ 50   |            |   | 2                   |
|   | Y*; O*                        | Y ≥ 75; O ≥ 75   |            |   | 3                   |
| White on Red  | W ≥ 35; R ≥ 7                 |  |            |   | 4                   |
| Black on White  | W ≥ 50                        |  |            |   | –                   |
| <sup>1</sup> The minimum maintained retroreflectivity levels shown in this table are in units of cd/lx/m <sup>2</sup> measured at an observation angle of 0.2° and an entrance angle of -4.0°.  |                               |  |            |   |                     |
| <sup>2</sup> For text and fine symbol signs measuring at least 48 inches and for all sizes of bold symbol signs   |                               |  |            |   |                     |
| <sup>3</sup> For text and fine symbol signs measuring less than 48 inches   |                               |  |            |   |                     |
| <sup>4</sup> Minimum sign contrast ratio ≥ 3:1 (white retroreflectivity ÷ red retroreflectivity)  |                               |  |            |   |                     |
| * This sheeting type shall not be used for this color for this application.   |                               |  |            |   |                     |
| Bold Symbol Signs   |                               |  |            |   |                     |
| <ul style="list-style-type: none"> <li>• W1-1,2 – Turn and Curve</li> <li>• W1-3,4 – Reverse Turn and Curve</li> <li>• W1-5 – Winding Road</li> <li>• W1-6,7 – Large Arrow</li> <li>• W1-8 – Chevron</li> <li>• W1-10 – Intersection in Curve</li> <li>• W1-11 – Hairpin Curve</li> <li>• W1-15 – 270 Degree Loop</li> <li>• W2-1 – Cross Road</li> <li>• W2-2,3 – Side Road</li> <li>• W2-4,5 – T and Y Intersection</li> <li>• W2-6 – Circular Intersection</li> <li>• W2-7,8 – Double Side Roads</li> </ul>  |                               | <ul style="list-style-type: none"> <li>• W3-1 – Stop Ahead</li> <li>• W3-2 – Yield Ahead</li> <li>• W3-3 – Signal Ahead</li> <li>• W4-1 – Merge</li> <li>• W4-2 – Lane Ends</li> <li>• W4-3 – Added Lane</li> <li>• W4-5 – Entering Roadway Merge</li> <li>• W4-6 – Entering Roadway Added Lane</li> <li>• W6-1,2 – Divided Highway Begins and Ends</li> <li>• W6-3 – Two-Way Traffic</li> <li>• W10-1,2,3,4,11,12 – Grade Crossing Advance Warning</li> </ul> |            | <ul style="list-style-type: none"> <li>• W11-2 – Pedestrian Crossing</li> <li>• W11-3,4,16-22 – Large Animals</li> <li>• W11-5 – Farm Equipment</li> <li>• W11-6 – Snowmobile Crossing</li> <li>• W11-7 – Equestrian Crossing</li> <li>• W11-8 – Fire Station</li> <li>• W11-10 – Truck Crossing</li> <li>• W12-1 – Double Arrow</li> <li>• W16-5P,6P,7P – Pointing Arrow Plaques</li> <li>• W20-7 – Flagger</li> <li>• W21-1 – Worker</li> </ul> |                     |
| Fine Symbol Signs (symbol signs not listed as bold symbol signs)  |                               |  |            |   |                     |
| Special Cases   |                               |  |            |   |                     |
| <ul style="list-style-type: none"> <li>• W3-1 – Stop Ahead: Red retroreflectivity ≥ 7</li> <li>• W3-2 – Yield Ahead: Red retroreflectivity ≥ 7; White retroreflectivity ≥ 35</li> <li>• W3-3 – Signal Ahead: Red retroreflectivity ≥ 7; Green retroreflectivity ≥ 7</li> <li>• W3-5 – Speed Reduction: White retroreflectivity ≥ 50</li> <li>• For non-diamond shaped signs, such as W14-3 (No Passing Zone), W4-4P (Cross Traffic Does Not Stop), or W13-1P,2,3,6,7 (Speed Advisory Plaques), use the largest sign dimension to determine the proper minimum retroreflectivity level.</li> </ul> |                               |  |            |   |                     |

**Table 2A-4. Use of Sign Shapes**

| Shape   | Signs  |
|---|--|
| Octagon   | Stop*  |
| Equilateral Triangle (1 point down)                       | Yield*   |
| Circle  | Grade Crossing Advance Warning*  |
| Pennant Shape/Isosceles Triangle (longer axis horizontal) | No Passing*  |
| Pentagon (pointed up)                                     | School Advance Warning Sign (squared bottom corners)*<br>County Route Sign (tapered bottom corners)* |
| Crossbuck (two rectangles in an "X" configuration)        | Grade Crossing*  |
| Diamond   | Warning Series   |
| Rectangle (including square)                              | Regulatory Series<br>Guide Series**<br>Warning Series  |
| Trapezoid   | Recreational and Cultural Interest Area Series<br>National Forest Route Sign                         |

\* This sign shall be exclusively the shape shown.

\*\* Guide series includes general service, specific service, tourist-oriented directional, general information, recreational and cultural interest area, and emergency management signs.



**Table 2A-5. Common Uses of Sign Colors**

| Type of Sign                | Legend |       |      |       |        |        |                          |                  |       | Background |       |       |         |      |       |         |        |                          |                  |
|-----------------------------|--------|-------|------|-------|--------|--------|--------------------------|------------------|-------|------------|-------|-------|---------|------|-------|---------|--------|--------------------------|------------------|
|                             | Black  | Green | Red  | White | Yellow | Orange | Fluorescent Yellow-Green | Fluorescent Pink | Black | Blue       | Brown | Green | Orange* | Red* | White | Yellow* | Purple | Fluorescent Yellow-Green | Fluorescent Pink |
| Regulatory                  | X      |       | X    | X     |        |        |                          |                  | X     |            |       |       |         | X    | X     |         |        |                          |                  |
| Prohibitive                 |        |       | X    | X     |        |        |                          |                  |       |            |       |       |         | X    | X     |         |        |                          |                  |
| Permissive                  |        | X     |      |       |        |        |                          |                  |       |            |       |       |         |      | X     |         |        |                          |                  |
| Warning                     | X      |       |      |       |        |        |                          |                  |       |            |       |       |         |      |       | X       |        |                          |                  |
| Pedestrian                  | X      |       |      |       |        |        |                          |                  |       |            |       |       |         |      |       | X       |        | X                        |                  |
| Bicycle                     | X      |       |      |       |        |        |                          |                  |       |            |       |       |         |      |       | X       |        | X                        |                  |
| Guide                       |        |       |      | X     |        |        |                          |                  |       |            |       | X     |         |      |       |         |        |                          |                  |
| Interstate Route            |        |       |      | X     |        |        |                          |                  |       | X          |       |       |         | X    |       |         |        |                          |                  |
| State Route                 | X      |       |      |       |        |        |                          |                  |       |            |       |       |         |      | X     |         |        |                          |                  |
| U.S. Route                  | X      |       |      |       |        |        |                          |                  |       |            |       |       |         |      | X     |         |        |                          |                  |
| County Route                |        |       |      |       | X      |        |                          |                  |       | X          |       |       |         |      |       |         |        |                          |                  |
| Forest Route                |        |       |      | X     |        |        |                          |                  |       | X          |       |       |         |      |       |         |        |                          |                  |
| Street Name                 |        |       |      | X     |        |        |                          |                  |       |            |       | X     |         |      |       |         |        |                          |                  |
| Destination                 |        |       |      | X     |        |        |                          |                  |       |            |       | X     |         |      |       |         |        |                          |                  |
| Reference Location          |        |       |      | X     |        |        |                          |                  |       |            |       | X     |         |      |       |         |        |                          |                  |
| Information                 |        |       |      | X     |        |        |                          |                  |       | X          |       | X     |         |      |       |         |        |                          |                  |
| Evacuation Route            |        |       |      | X     |        |        |                          |                  |       | X          |       |       |         |      |       |         |        |                          |                  |
| Road User Service           |        |       |      | X     |        |        |                          |                  |       | X          |       |       |         |      |       |         |        |                          |                  |
| Recreational                |        |       |      | X     |        |        |                          |                  |       |            | X     | X     |         |      |       |         |        |                          |                  |
| Temporary Traffic Control   | X      |       |      |       |        |        |                          |                  |       |            |       | X     |         |      |       |         |        |                          |                  |
| Incident Management         | X      |       |      |       |        |        |                          |                  |       |            |       | X     |         |      |       |         |        |                          | X                |
| School                      | X      |       |      |       |        |        |                          |                  |       |            |       |       |         |      |       |         |        | X                        |                  |
| ETC-Account Only            | X      |       |      |       |        |        |                          |                  |       |            |       |       |         |      |       |         | X****  |                          |                  |
| Changeable Message Signs    |        |       |      |       |        |        |                          |                  |       |            |       |       |         |      |       |         |        |                          |                  |
| Regulatory                  |        |       | X*** | X     |        |        |                          |                  | X     |            |       |       |         |      |       |         |        |                          |                  |
| Warning                     |        |       |      |       | X      |        |                          |                  | X     |            |       |       |         |      |       |         |        |                          |                  |
| Temporary Traffic Control   |        |       |      |       | X      | X      |                          |                  | X     |            |       |       |         |      |       |         |        |                          |                  |
| Guide                       |        |       |      | X     |        |        |                          |                  | X     |            |       | X**   |         |      |       |         |        |                          |                  |
| Motorist Services           |        |       |      | X     |        |        |                          |                  | X     | X**        |       |       |         |      |       |         |        |                          |                  |
| Incident Management         |        |       |      |       | X      |        |                          | X                | X     |            |       |       |         |      |       |         |        |                          |                  |
| School, Pedestrian, Bicycle |        |       |      |       | X      |        | X                        |                  | X     |            |       |       |         |      |       |         |        |                          |                  |

\* Fluorescent versions of these background colors may also be used.  
 \*\* These alternative background colors would be provided by blue or green lighted pixels such that the entire CMS would be lighted, not just the legend.  
 \*\*\* Red is used only for the circle and slash or other red elements of a similar static regulatory sign.  
 \*\*\*\* The use of the color purple on signs is restricted per the provisions of Paragraph 1 of Section 2F.03.

**Table 2A-5 (CA). Common Uses of Sign Colors**

Items shown in gray are unique to California standards. All other items are adopted per FHWA 2009 MUTCD.

| Type of Sign              | Legend |       |     |       |        |       |        |                          |                  |       | Background |       |       |        |     |       |        |                          |                  |       |      |            |        |
|---------------------------|--------|-------|-----|-------|--------|-------|--------|--------------------------|------------------|-------|------------|-------|-------|--------|-----|-------|--------|--------------------------|------------------|-------|------|------------|--------|
|                           | Black  | Green | Red | White | Yellow | Brown | Orange | Fluorescent Yellow-Green | Fluorescent Pink | Black | Blue       | Brown | Green | Orange | Red | White | Yellow | Fluorescent Yellow-Green | Fluorescent Pink | Cream | Teal | Light Blue | Purple |
| <b>Regulatory</b>         | x      |       | x   | x     |        |       |        |                          |                  | x     |            |       |       |        | x   | x     |        |                          |                  |       |      |            |        |
| Prohibitive               |        |       | x   | x     |        |       |        |                          |                  |       |            |       |       |        | x   | x     |        |                          |                  |       |      |            |        |
| Permissive                |        | x     |     | x     |        |       |        |                          |                  |       | x          |       |       |        |     | x     |        |                          |                  |       |      |            |        |
| <b>Warning</b>            | x      |       |     |       |        |       |        |                          |                  |       |            |       |       |        |     |       | x      |                          |                  |       |      |            |        |
| Pedestrian                | x      |       |     |       |        |       |        |                          |                  |       |            |       |       |        |     |       | x      | x                        |                  |       |      |            |        |
| Bicycle                   | x      |       |     |       |        |       |        |                          |                  |       |            |       |       |        |     |       | x      | x                        |                  |       |      |            |        |
| Playground                | x      |       |     |       |        |       |        |                          |                  |       |            |       |       |        |     |       | x      | x                        |                  |       |      |            |        |
| School                    | x      |       |     |       |        |       |        |                          |                  |       |            |       |       |        |     |       |        | x                        |                  |       |      |            |        |
| <b>Guide</b>              |        |       |     | x     |        |       |        |                          |                  |       |            |       | x     |        |     |       |        |                          |                  |       |      |            |        |
| Interstate Route          |        |       |     | x     |        |       |        |                          |                  |       | x          |       |       |        | x   |       |        |                          |                  |       |      |            |        |
| Interstate Business Route |        |       |     | x     |        |       |        |                          |                  |       |            |       |       |        |     |       |        |                          |                  |       |      |            |        |
| State Route               |        |       |     | x     |        |       |        |                          |                  |       |            |       |       |        |     |       |        |                          |                  |       |      |            |        |
| US Route                  | x      |       |     |       |        |       |        |                          |                  |       |            |       |       |        |     | x     |        |                          |                  |       |      |            |        |
| County Route              |        |       |     |       | x      |       |        |                          |                  |       | x          |       |       |        |     |       |        |                          |                  |       |      |            |        |
| Forest Route              |        |       |     | x     |        |       |        |                          |                  |       |            | x     |       |        |     |       |        |                          |                  |       |      |            |        |
| Scenic Route              |        |       |     | x     |        |       |        |                          |                  |       |            |       |       |        |     |       |        |                          |                  |       |      |            | x      |
| Bicycle route             |        |       |     | x     |        |       |        |                          |                  |       |            |       |       |        |     |       |        |                          |                  |       |      |            |        |
| Historic Route            | x      |       |     |       |        |       |        |                          |                  |       |            |       |       |        |     |       |        |                          |                  |       |      |            |        |
| Reference Location        |        |       |     | x     |        |       |        |                          |                  |       |            |       |       |        |     |       |        |                          |                  |       |      |            |        |
| <b>Information</b>        |        |       |     | x     |        |       |        |                          |                  |       |            |       |       |        |     |       |        |                          |                  |       |      |            |        |
| Milepost                  |        |       |     | x     |        |       |        |                          |                  |       |            |       |       |        |     |       |        |                          |                  |       |      |            |        |
| Evacuation route          |        |       |     | x     |        |       |        |                          |                  |       |            |       |       |        |     |       |        |                          |                  |       |      |            |        |
| Road User Service         |        |       |     | x     |        |       |        |                          |                  |       |            |       |       |        |     |       |        |                          |                  |       |      |            |        |
| Recreational              |        |       |     | x     |        |       |        |                          |                  |       |            |       |       |        |     |       |        |                          |                  |       |      |            |        |
| Street Name               |        |       |     | x     |        |       |        |                          |                  |       |            |       |       |        |     |       |        |                          |                  |       |      |            |        |
| Destination               |        |       |     | x     |        |       |        |                          |                  |       |            |       |       |        |     |       |        |                          |                  |       |      |            |        |
| Boundary                  |        |       |     | x     |        |       |        |                          |                  |       |            |       |       |        |     |       |        |                          |                  |       |      |            |        |
| State Boundary            | x      |       |     |       | x      |       |        |                          |                  |       |            |       |       |        |     |       |        |                          |                  |       |      |            | x      |
| Place Name                |        |       |     | x     |        |       |        |                          |                  |       |            |       |       |        |     |       |        |                          |                  |       |      |            |        |
| Structure Identification  | x      |       |     |       |        |       |        |                          |                  |       |            |       |       |        |     |       |        |                          |                  |       |      |            |        |
| Historical Landmark       |        |       |     |       |        |       | x      |                          |                  |       |            |       |       |        |     |       |        |                          |                  |       |      |            | x      |
| Memorial                  |        |       |     | x     |        |       |        |                          |                  |       |            |       |       |        |     |       |        |                          |                  |       |      |            |        |
| Call Box                  |        |       |     | x     |        |       |        |                          |                  |       |            |       |       |        |     |       |        |                          |                  |       |      |            |        |
| Victims Memorial          |        |       |     | x     |        |       |        |                          |                  |       |            |       |       |        |     |       |        |                          |                  |       |      |            |        |
| Adopt-A-Highway           |        |       |     | x     |        |       |        |                          |                  |       |            |       |       |        |     |       |        |                          |                  |       |      |            | x      |
| Temporary Traffic Control | x      |       |     |       |        |       |        |                          |                  |       |            |       |       |        |     |       |        |                          |                  |       |      |            | xx     |
| Incident Management       | x      |       |     |       |        |       |        |                          |                  |       |            |       |       |        |     |       |        |                          |                  |       |      |            | x      |
| ETC-Account Only          | x      |       |     |       |        |       |        |                          |                  |       |            |       |       |        |     |       |        |                          |                  |       |      |            |        |
| Changeable Message Signs* |        |       |     |       | x      | x     |        |                          |                  | x     |            |       |       |        |     |       |        |                          |                  |       |      |            | x      |

\* Reverse colors or fluorescent yellow-green pixels may also be used on changeable message signs.

## CHAPTER 2B. REGULATORY SIGNS, BARRICADES, AND GATES

### Section 2B.01 Application of Regulatory Signs

**Standard:**

**01 Regulatory signs shall be used to inform road users of selected traffic laws or regulations and indicate the applicability of the legal requirements.**

**02 Regulatory signs shall be installed at or near where the regulations apply. The signs shall clearly indicate the requirements imposed by the regulations and shall be designed and installed to provide adequate visibility and legibility in order to obtain compliance.**

**03 Regulatory signs shall be retroreflective or illuminated (see Section 2A.07) to show the same shape and similar color by both day and night, unless specifically stated otherwise in the text discussion in this Manual for a particular sign or group of signs.**

**04 The requirements for sign illumination shall not be considered to be satisfied by street or highway lighting.**

**Support:**

**05 Section 1A.09 contains information regarding the assistance that is available to jurisdictions that do not have engineers on their staffs who are trained and/or experienced in traffic control devices.**

**Standard:**

**06 Orders, ordinances and resolutions by local authorities which affect State highways shall be approved by Caltrans.**

**Support:**

**07 Signs required for enforcement are normally placed by, and at the expense of, the authority establishing the regulation.**

**08 Refer to CVC 21461 for failure to obey a regulatory sign.**

### Section 2B.02 Design of Regulatory Signs

**Standard:**

**01 Regulatory signs shall be rectangular unless specifically designated otherwise. Regulatory signs shall be designed in accordance with the sizes, shapes, colors, and legends contained in the “Standard Highway Signs and Markings” book and Caltrans’ California Sign Specifications (see Section 1A.11).**

**Option:**

**02 Regulatory word message signs other than those classified and specified in this Manual and the “Standard Highway Signs and Markings” book (see Section 1A.11) may be developed to aid the enforcement of other laws or regulations.**

**03 Except for symbols on regulatory signs, minor modifications may be made to the design provided that the essential appearance characteristics are met.**

**Support:**

**04 The use of educational plaques to supplement symbol signs is described in Section 2A.12.**

**Guidance:**

**05 Changeable message signs displaying a regulatory message incorporating a prohibitory message that includes a red circle and slash on a static sign should display a red symbol that approximates the same red circle and slash as closely as possible.**

### Section 2B.03 Size of Regulatory Signs

**Standard:**

**01 Except as provided in Section 2A.11, the sizes for regulatory signs shall be as shown in Table 2B-1 and 2B-1(CA).**

**Support:**

**02 Section 2A.11 contains information regarding the applicability of the various columns in Table 2B-1 and 2B-1(CA).**

**Standard:**

**03 Except as provided in Paragraphs 4 and 5, the minimum sizes for regulatory signs facing traffic on multi-lane conventional roads shall be as shown in the Multi-lane column of Table 2B-1 and 2B-1(CA).**

**Option:**

**04** Where the posted speed limit is 35 mph or less on a multi-lane highway or street, other than for a STOP sign, the minimum size shown in the Single Lane column in Table 2B-1 and 2B-1(CA) may be used.

**05** Where a regulatory sign, other than a STOP sign, is placed on the left-hand side of a multi-lane roadway in addition to the installation of the same regulatory sign on the right-hand side or the roadway, the size shown in the Single Lane column in Table 2B-1 and 2B-1(CA) may be used for both the sign on the right-hand side and the sign on the left-hand side of the roadway.

**Standard:**

**06 A minimum size of 36 x 36 inches shall be used for STOP signs that face multi-lane approaches.**

**07 Where side roads intersect a multi-lane street or highway that has a speed limit of 45 mph or higher, the minimum size of the STOP signs facing the side road approaches, even if the side road only has one approach lane, shall be 36 x 36 inches.**

**08 Where side roads intersect a multi-lane street or highway that has a speed limit of 40 MPH or lower, the minimum size of the STOP signs facing the side road approaches shall be as shown in the Single Lane or Multi-lane columns of Table 2B-1 and 2B-1(CA) based on the number of approach lanes on the side street approach.**

**Guidance:**

**09** *The minimum sizes for regulatory signs facing traffic on exit and entrance ramps should be as shown in the column of Table 2B-1 and 2B-1(CA) that corresponds to the mainline roadway classification (Expressway or Freeway). If a minimum size is not provided in the Freeway column, the minimum size in the Expressway column should be used. If a minimum size is not provided in the Freeway or Expressway Column, the size in the Oversized column should be used.*

**Section 2B.04 Right-of-Way at Intersections**

**Support:**

**01** State or local laws written in accordance with the “Uniform Vehicle Code” (see Section 1A.11) establish the right-of-way rule at intersections having no regulatory traffic control signs such that the driver of a vehicle approaching an intersection must yield the right-of-way to any vehicle or pedestrian already in the intersection. When two vehicles approach an intersection from different streets or highways at approximately the same time, the right-of-way rule requires the driver of the vehicle on the left to yield the right-of-way to the vehicle on the right. The right-of-way can be modified at through streets or highways by placing YIELD (R1-2) signs (see Sections 2B.08 and 2B.09) or STOP (R1-1) signs (see Sections 2B.05 through 2B.07) on one or more approaches.

**Guidance:**

**02** *Engineering judgment should be used to establish intersection control. The following factors should be considered:*

- A. Vehicular, bicycle, and pedestrian traffic volumes on all approaches;*
- B. Number and angle of approaches;*
- C. Approach speeds;*
- D. Sight distance available on each approach; and*
- E. Reported crash experience.*

**03** *YIELD or STOP signs should be used at an intersection if one or more of the following conditions exist:*

- A. An intersection of a less important road with a main road where application of the normal right-of-way rule would not be expected to provide reasonable compliance with the law;*
- B. A street entering a designated through highway or street; and/or*
- C. An unsignalized intersection in a signalized area.*

**04** *In addition, the use of YIELD or STOP signs should be considered at the intersection of two minor streets or local roads where the intersection has more than three approaches and where one or more of the following conditions exist:*

- A. *The combined vehicular, bicycle, and pedestrian volume entering the intersection from all approaches averages more than 2,000 units per day;*
  - B. *The ability to see conflicting traffic on an approach is not sufficient to allow a road user to stop or yield in compliance with the normal right-of-way rule if such stopping or yielding is necessary; and/or*
  - C. *Crash records indicate that five or more crashes that involve the failure to yield the right-of-way at the intersection under the normal right-of-way rule have been reported within a 3-year period, or that three or more such crashes have been reported within a 2-year period.*
- <sup>05</sup> *YIELD or STOP signs should not be used for speed control.*

**Support:**

<sup>06</sup> Section 2B.07 contains provisions regarding the application of multi-way STOP control at an intersection.

**Guidance:**

<sup>07</sup> *Once the decision has been made to control an intersection, the decision regarding the appropriate roadway to control should be based on engineering judgment. In most cases, the roadway carrying the lowest volume of traffic should be controlled.*

<sup>08</sup> *A YIELD or STOP sign should not be installed on the higher volume roadway unless justified by an engineering study.*

**Support:**

<sup>09</sup> The following are considerations that might influence the decision regarding the appropriate roadway upon which to install a YIELD or STOP sign where two roadways with relatively equal volumes and/or characteristics intersect:

- A. Controlling the direction that conflicts the most with established pedestrian crossing activity or school walking routes;
- B. Controlling the direction that has obscured vision, dips, or bumps that already require drivers to use lower operating speeds; and
- C. Controlling the direction that has the best sight distance from a controlled position to observe conflicting traffic.

**Standard:**

<sup>10</sup> **Because the potential for conflicting commands could create driver confusion, YIELD or STOP signs shall not be used in conjunction with any traffic control signal operation., except in the following cases:**

- ~~A. If the signal indication for an approach is a flashing red at all times;~~**
- ~~B. If a minor street or driveway is located within or adjacent to the area controlled by the traffic control signal, but does not require separate traffic signal control because an extremely low potential for conflict exists; or~~**
- ~~C. If a channelized turn lane is separated from the adjacent travel lanes by an island and the channelized turn lane is not controlled by a traffic control signal.~~**

<sup>10a</sup> **STOP signs shall not be erected at any entrance to an intersection controlled by traffic signals. Refer to CVC 21355(a).**

**Option:**

<sup>10b</sup> **YIELD or STOP signs may be used at a channelized turn lane if it is separated from the adjacent travel lanes moving in same direction by an island and the channelized turn lane is not controlled by a traffic control signal.**

**Standard:**

<sup>11</sup> **Except as provided in Section 2B.09, STOP signs and YIELD signs shall not be installed on different approaches to the same unsignalized intersection if those approaches conflict with or oppose each other.**

<sup>12</sup> **Portable or part-time STOP or YIELD signs shall not be used except for emergency and temporary traffic control zone purposes.**

<sup>13</sup> **A portable or part-time (folding) STOP sign that is manually placed into view and manually removed from view shall not be used during a power outage to control a signalized approach unless the maintaining agency establishes that the signal indication that will first be displayed to that approach upon restoration of power is a flashing red signal indication and that the portable STOP sign will be manually removed from view prior to stop-and-go operation of the traffic control signal.**

Option:

<sup>14</sup> A portable or part-time (folding) STOP sign that is electrically or mechanically operated such that it only displays the STOP message during a power outage and ceases to display the STOP message upon restoration of power may be used during a power outage to control a signalized approach.

Support:

<sup>15</sup> Section 9B.03 contains provisions regarding the assignment of priority at a shared-use path/ roadway intersection.

## **Section 2B.05 STOP Sign (R1-1) and ALL WAY Plaque (R1-3P)**

### **Standard:**

<sup>01</sup> **When it is determined that a full stop is always required on an approach to an intersection, a STOP (R1-1) sign (see Figure 2B-1) shall be used.**

<sup>02</sup> **The STOP sign shall be an octagon with a white legend and border on a red background.**

<sup>03</sup> **Secondary legends shall not be used on STOP sign faces.**

<sup>04</sup> **At intersections where all approaches are controlled by STOP signs (see Section 2B.07), an ALL WAY supplemental plaque (R1-3P) shall be mounted below each STOP sign. The ALL WAY plaque (see Figure 2B-1) shall have a white legend and border on a red background.**

<sup>05</sup> **The ALL WAY plaque shall only be used if all intersection approaches are controlled by STOP signs.**

<sup>06</sup> **Supplemental plaques with legends such as 2-WAY, 3-WAY, 4-WAY, or other numbers of ways shall not be used with STOP signs.**

### **Support:**

<sup>07</sup> The use of the CROSS TRAFFIC DOES NOT STOP (W4-4P) plaque (and other plaques with variations of this word message) is described in Section 2C.59.

### *Guidance:*

<sup>08</sup> *Plaques with the appropriate alternative messages of TRAFFIC FROM LEFT (RIGHT) DOES NOT STOP (W4-4aP) or ONCOMING TRAFFIC DOES NOT STOP (W4-4bP) should be used at intersections where STOP signs control all but one approach to the intersection, unless the only non-stopped approach is from a one-way street.*

### **Option:**

<sup>09</sup> An EXCEPT RIGHT TURN (R1-10P) plaque (see Figure 2B-1) may be mounted below the STOP sign if an engineering study determines that a special combination of geometry and traffic volumes is present that makes it possible for right-turning traffic on the approach to be permitted to enter the intersection without stopping.

### **Support:**

<sup>10</sup> The design and application of Stop Beacons are described in Section 4L.05.

<sup>11</sup> A STOP (R1-1) sign is not a "cure-all" and is not a substitute for other traffic control devices. Often, the need for a STOP (R1-1) sign can be eliminated if the sight distance is increased by removing obstructions.

## **Through Highways**

### **Option:**

<sup>12</sup> STOP (R1-1) signs may be installed either at or near the entrance to a State highway, except at signalized intersections, or at any location so as to control traffic within an intersection. Refer to CVC 21352 and 21355. See Section 1A.11 for information regarding this publication.

### **Support:**

<sup>13</sup> When STOP (R1-1) signs or traffic control signals have been erected at all entrances, a highway constitutes a through highway. Refer to CVC 600.

<sup>14</sup> Authority to place STOP (R1-1) signs facing State highway traffic is delegated to the Caltrans District Directors.

### **Option:**

<sup>15</sup> Local authorities may designate any highway under their jurisdiction as a through highway and install STOP (R1-1) signs in a like manner. Refer to CVC 21354.

### **Standard:**

<sup>16</sup> **No local authority shall erect or maintain any STOP (R1-1) sign or other traffic control device requiring a stop, on any State highway, except by permission of Caltrans. Refer to CVC 21353.**

**Support:**

<sup>17</sup> Caltrans will grant such permission only when an investigation indicates that the STOP (R1-1) sign will benefit traffic.

**Section 2B.06 STOP Sign Applications**

*Guidance:*

<sup>01</sup> At intersections where a full stop is not necessary at all times, consideration should first be given to using less restrictive measures such as YIELD signs (see Sections 2B.08 and 2B.09).

<sup>02</sup> The use of STOP signs on the minor-street approaches should be considered if engineering judgment indicates that a stop is always required because of one or more of the following conditions:

- A. The vehicular traffic volumes on the through street or highway exceed 6,000 vehicles per day;
- B. A restricted view exists that requires road users to stop in order to adequately observe conflicting traffic on the through street or highway; and/or
- C. Crash records indicate that three or more crashes that are susceptible to correction by the installation of a STOP sign have been reported within a 12-month period, or that five or more such crashes have been reported within a 2-year period. Such crashes include right-angle collisions involving road users on the minor-street approach failing to yield the right-of-way to traffic on the through street or highway.

**Support:**

<sup>03</sup> The use of STOP signs at grade crossings is described in Sections 8B.04 and 8B.05.

**Section 2B.07 Multi-Way Stop Applications**

**Support:**

<sup>01</sup> Multi-way stop control can be useful as a safety measure at intersections if certain traffic conditions exist. Safety concerns associated with multi-way stops include pedestrians, bicyclists, and all road users expecting other road users to stop. Multi-way stop control is used where the volume of traffic on the intersecting roads is approximately equal.

<sup>02</sup> The restrictions on the use of STOP signs described in Section 2B.04 also apply to multi-way stop applications.

*Guidance:*

<sup>03</sup> The decision to install multi-way stop control should be based on an engineering study.

<sup>04</sup> The following criteria should be considered in the engineering study for a multi-way STOP sign installation:

- A. Where traffic control signals are justified, the multi-way stop is an interim measure that can be installed quickly to control traffic while arrangements are being made for the installation of the traffic control signal.
- B. Five or more reported crashes in a 12-month period that are susceptible to correction by a multi-way stop installation. Such crashes include right-turn and left-turn collisions as well as right-angle collisions.
- C. Minimum volumes:
  - 1. The vehicular volume entering the intersection from the major street approaches (total of both approaches) averages at least 300 vehicles per hour for any 8 hours of an average day; and
  - 2. The combined vehicular, pedestrian, and bicycle volume entering the intersection from the minor street approaches (total of both approaches) averages at least 200 units per hour for the same 8 hours, with an average delay to minor-street vehicular traffic of at least 30 seconds per vehicle during the highest hour; but
  - 3. If the 85<sup>th</sup>-percentile approach speed of the major-street traffic exceeds 40 mph, the minimum vehicular volume warrants are 70 percent of the values provided in Items 1 and 2.
- D. Where no single criterion is satisfied, but where Criteria B, C.1, and C.2 are all satisfied to 80 percent of the minimum values. Criterion C.3 is excluded from this condition.

**Option:**

<sup>05</sup> Other criteria that may be considered in an engineering study include:

- A. The need to control left-turn conflicts;
- B. The need to control vehicle/pedestrian conflicts near locations that generate high pedestrian volumes;
- C. Locations where a road user, after stopping, cannot see conflicting traffic and is not able to negotiate the intersection unless conflicting cross traffic is also required to stop; and

- D. An intersection of two residential neighborhood collector (through) streets of similar design and operating characteristics where multi-way stop control would improve traffic operational characteristics of the intersection.

### **Section 2B.08 YIELD Sign (R1-2)**

**Standard:**

**01 The YIELD (R1-2) sign (see Figure 2B-1) shall be a downward-pointing equilateral triangle with a wide red border and the legend YIELD in red on a white background.**

**Support:**

**02 The YIELD sign assigns right-of-way to traffic on certain approaches to an intersection. Vehicles controlled by a YIELD sign need to slow down to a speed that is reasonable for the existing conditions or stop when necessary to avoid interfering with conflicting traffic.**

### **Section 2B.09 YIELD Sign Applications**

**Option:**

**01 YIELD signs may be installed:**

- A. On the approaches to a through street or highway where conditions are such that a full stop is not always required.
- B. At the second crossroad of a divided highway, where the median width at the intersection is 30 feet or greater. In this case, a STOP or YIELD sign may be installed at the entrance to the first roadway of a divided highway, and a YIELD sign may be installed at the entrance to the second roadway.
- C. For a channelized turn lane that is separated from the adjacent travel lanes by an island, even if the adjacent lanes at the intersection are controlled by a highway traffic control signal or by a STOP sign.
- D. At an intersection where a special problem exists and where engineering judgment indicates the problem to be susceptible to correction by the use of the YIELD sign.
- E. Facing the entering roadway for a merge-type movement if engineering judgment indicates that control is needed because acceleration geometry and/or sight distance is not adequate for merging traffic operation.

**Standard:**

**02 A YIELD (R1-2) sign shall be used to assign right-of-way at the entrance to a roundabout. YIELD signs at roundabouts shall be used to control the approach roadways and shall not be used to control the circulatory roadway.**

**03 Other than for all of the approaches to a roundabout, YIELD signs shall not be placed on all of the approaches to an intersection.**

### **Section 2B.10 STOP Sign or YIELD Sign Placement**

**Standard:**

**01 The STOP or YIELD sign shall be installed on the near side of the intersection on the right-hand side of the approach to which it applies. When the STOP or YIELD sign is installed at this required location and the sign visibility is restricted, a Stop Ahead sign (see Section 2C.36) shall be installed in advance of the STOP sign or a Yield Ahead sign (see Section 2C.36) shall be installed in advance of the YIELD sign.**

**02 The STOP or YIELD sign shall be located as close as practical to the intersection it regulates, while optimizing its visibility to the road user it is intended to regulate.**

**02a YIELD signs shall not be erected upon the approaches to more than one of the intersecting streets. Refer to CVC 21356.**

**03 STOP signs and YIELD signs shall not be mounted on the same post.**

**04 No items other than inventory stickers, sign installation dates, and bar codes shall be affixed to the fronts of STOP or YIELD signs, and the placement of these items shall be in the border of the sign.**

**05 No items other than official traffic control signs, inventory stickers, sign installation dates, anti-vandalism stickers, and bar codes shall be mounted on the backs of STOP or YIELD signs.**

**06 No items other than retroreflective strips (see Section 2A.21) or official traffic control signs shall be mounted on the fronts or backs of STOP or YIELD signs supports.**



**06a If other signs are grouped with a STOP sign, except for ONE WAY (R6-1 & R6-2) signs and Street Name (D3-1 or G7-1(CA)) signs (see Sections 2B.40 & 2D.43), they shall be installed below the STOP sign.**

*Guidance:*

*07 STOP or YIELD signs should not be placed farther than 50 feet from the edge of the pavement of the intersected roadway (see Drawing F in Figure 2A-3).*

*08 A sign that is mounted back-to-back with a STOP or YIELD sign should stay within the edges of the STOP or YIELD sign. If necessary, the size of the STOP or YIELD sign should be increased so that any other sign installed back-to-back with a STOP or YIELD sign remains within the edges of the STOP or YIELD sign.*

**Standard:**

**08a When a required stop is to apply at the entrance to an intersection from a one-way street with a roadway of 30 feet or more in width, stop signs shall be erected both on the left and the right sides of the one-way street at or near the entrance to the intersection. Refer to CVC 21355.**

*Option:*

*09 Where drivers proceeding straight ahead must yield to traffic approaching from the opposite direction, such as at a one-lane bridge, a TO ONCOMING TRAFFIC (R1-2aP) plaque may be mounted below the YIELD sign.*

**Standard:**

**09a The TO ONCOMING TRAFFIC (R1-2a) sign when used, shall be mounted on the same post and immediately below a YIELD (R1-2) sign.**

*Guidance:*

*09b The width of the R1-2a sign should be equal to the width of the YIELD (R1-2) sign.*

*Support:*

*10 Figure 2A-3 shows examples of some typical placements of STOP signs and YIELD signs. 11 Section 2A.16 contains additional information about separate and combined mounting of other signs with STOP or YIELD signs.*

*Guidance:*

*12 Stop lines that are used to supplement a STOP sign should be located as described in Section 3B.16. Yield lines that are used to supplement a YIELD sign should be located as described in Section 3B.16.*

*13 Where there is a marked crosswalk at the intersection, the STOP sign should be installed in advance of the crosswalk line nearest to the approaching traffic.*

*14 Except at roundabouts, where there is a marked crosswalk at the intersection, the YIELD sign should be installed in advance of the crosswalk line nearest to the approaching traffic.*

*15 Where two roads intersect at an acute angle, the STOP or YIELD sign should be positioned at an angle, or shielded, so that the legend is out of view of traffic to which it does not apply.*

*16 If a raised splitter island is available on the left-hand side of a multi-lane roundabout approach, an additional YIELD sign should be placed on the left-hand side of the approach.*

*Option:*

*17 If a raised splitter island is available on the left-hand side of a single lane roundabout approach, an additional YIELD sign may be placed on the left-hand side of the approach.*

*18 At wide-throat intersections or where two or more approach lanes of traffic exist on the signed approach, observance of the right-of-way control may be improved by the installation of an additional STOP or YIELD sign on the left-hand side of the road and/or the use of a stop or yield line. At channelized intersections or at divided roadways separated by a median, the additional STOP or YIELD sign may be placed on a channelizing island or in the median. An additional STOP or YIELD sign may also be placed overhead facing the approach at the intersection to improve observance of the right-of-way control.*

**Standard:**

**19 More than one STOP sign or more than one YIELD sign shall not be placed on the same support facing in the same direction.**

*Option:*

*20 For a yield-controlled channelized right-turn movement onto a roadway without an acceleration lane and for an entrance ramp onto a freeway or expressway without an acceleration lane, a NO MERGE AREA (W4-5P) supplemental plaque (see Section 2C.40) may be mounted below a Yield Ahead (W3-2) sign and/or below a YIELD (R1-2) sign when engineering judgment indicates that road users would expect an acceleration lane to be present.*

## **Section 2B.11 Yield Here To Pedestrians Signs and Stop Here For Pedestrians Signs (R1-5 Series)**

### **Standard:**

**~~01 Yield Here To (Stop Here For) Pedestrians (R1-5, R1-5a, R1-5b, or R1-5e) signs (see Figure 2B-2) shall be used if yield (stop) lines are used in advance of a marked crosswalk that crosses an uncontrolled multi-lane approach. The Stop Here for Pedestrians signs shall only be used where the law specifically requires that a driver must stop for a pedestrian in a crosswalk. The legend STATE LAW may be displayed at the top of the R1-5, R1-5a, R1-5b, and R1-5e signs, if applicable.~~**

### **Support:**

~~01a The Stop Here for Pedestrian signs (R1-5b and R1-5c) are deleted as a stop is not required in California per CVC 21950.~~

### **Guidance:**

~~02 If yield (stop) lines and Yield Here To (Stop Here For) Pedestrians signs are used in advance of a crosswalk that crosses an uncontrolled multi-lane approach, they should be placed 20 to 50 feet in advance of the nearest crosswalk line (see Section 3B.16 and Figure 3B-17), and parking should be prohibited in the area between the yield (stop) line and the crosswalk.~~

~~03 Yield (stop) lines and Yield Here To (Stop Here For) Pedestrians signs should not be used in advance of crosswalks that cross an approach to or departure from a roundabout.~~

### **Option:**

~~04 Yield Here To (Stop Here For) Pedestrians signs may be used in advance of a crosswalk that crosses an uncontrolled multi-lane approach to indicate to road users where to yield (stop) even if yield (stop) lines are not used.~~

~~05 A Pedestrian Crossing (W11-2) warning sign may be placed overhead or may be post-mounted with a diagonal downward pointing arrow (W16-7P) plaque at the crosswalk location where Yield Here To (Stop Here For) Pedestrians signs have been installed in advance of the crosswalk.~~

### **Standard:**

**~~06 If a W11-2 sign has been post-mounted at the crosswalk location where a Yield Here To (Stop Here For) Pedestrians sign is used on the approach, the Yield Here To (Stop Here For) Pedestrians sign shall not be placed on the same post as or block the road user's view of the W11-2 sign.~~**

### **Option:**

~~07 An advance Pedestrian Crossing (W11-2) warning sign with an AHEAD or a distance supplemental plaque may be used in conjunction with a Yield Here To (Stop Here For) Pedestrians sign on the approach to the same crosswalk.~~

~~08 In-Street Pedestrian Crossing signs and Yield Here To (Stop Here For) Pedestrians signs may be used together at the same crosswalk.~~

## **Section 2B.12 In-Street and Overhead Pedestrian Crossing Signs (R1-6, R1-6a, R1-9, and R1-9a)**

### **Option:**

~~01 The In-Street Pedestrian Crossing (R1-6 or R1-6a) sign (see Figure 2B-2) or the Overhead Pedestrian Crossing (R1-9 or R1-9a) sign (see Figure 2B-2) may be used to remind road users of laws regarding right-of-way at an unsignalized pedestrian crosswalk. The legend STATE LAW may be displayed at the top of the R1-6, R1-6a, R1-9, and R1-9a signs, if applicable. On the R1-6 and R1-6a signs, the legends STOP or YIELD may be used instead of the appropriate STOP sign or YIELD sign symbol.~~

~~02 Highway agencies may develop and apply criteria for determining the applicability of In-Street Pedestrian Crossing signs.~~

### **Support:**

~~02a The In-Street Pedestrian crossing (R1-6a) and Overhead Pedestrian Crossing (R1-9a) signs are deleted as a stop is not required in California per CVC 21950.~~

### **Standard:**

**~~03 If used, the In-Street Pedestrian Crossing sign shall be placed in the roadway at the crosswalk location on the center line, on a lane line, or on a median island. The In-Street Pedestrian Crossing sign shall not be post-mounted on the left-hand or right-hand side of the roadway.~~**

**04 If used, the Overhead Pedestrian Crossing sign shall be placed over the roadway at the crosswalk location.**

**05 An In-Street or Overhead Pedestrian Crossing sign shall not be placed in advance of the crosswalk to educate road users about the State law prior to reaching the crosswalk, nor shall it be installed as an educational display that is not near any crosswalk.**

*Guidance:*

*06 If an island (see Chapter 3I) is available, the In-Street Pedestrian Crossing sign, if used, should be placed on the island.*

*Option:*

*07 If a Pedestrian Crossing (W11-2) warning sign is used in combination with an In-Street or an Overhead Pedestrian Crossing sign, the W11-2 sign with a diagonal downward pointing arrow (W16-7P) plaque may be post-mounted on the right-hand side of the roadway at the crosswalk location.*

**Standard:**

**08 The In-Street Pedestrian Crossing sign and the Overhead Pedestrian Crossing sign shall not be used at ~~signalized locations~~ **controlled approaches**.**

**09 The STOP FOR legend shall only be used in States where the State law specifically requires that a driver must stop for a pedestrian in a crosswalk.**

**10 The In-Street Pedestrian Crossing sign shall have a black legend (except for the red STOP or YIELD sign symbols) and border on a white background, surrounded by an outer yellow or fluorescent yellow-green background area (see Figure 2B-2). The Overhead Pedestrian Crossing sign shall have a black legend and border on a yellow or fluorescent yellow-green background at the top of the sign and a black legend and border on a white background at the bottom of the sign (see Figure 2B-2).**

**11 Unless the In-Street Pedestrian Crossing sign is placed on a physical island, the sign support shall be designed to bend over and then bounce back to its normal vertical position when struck by a vehicle.**

*Support:*

*12 The Provisions of Section 2A.18 concerning mounting height are not applicable for the In-Street Pedestrian Crossing sign.*

**Standard:**

**13 The top of an In-Street Pedestrian Crossing sign shall be a maximum of 4 feet above the pavement surface. The top of an In-Street Pedestrian Crossing sign placed in an island shall be a maximum of 4 feet above the island surface.**

*Option:*

*14 The In-Street Pedestrian Crossing sign may be used ~~seasonably~~ **seasonally** to prevent damage in winter because of plowing operations, and may be removed at night if the pedestrian activity at night is minimal.*

*15 In-Street Pedestrian Crossing signs, Overhead Pedestrian Crossing signs, and Yield Here To ~~(Stop Here For)~~ Pedestrians signs may be used together at the same crosswalk.*

## **Section 2B.13 Speed Limit Sign (R2-1)**

*Support:*

*00 The setting of speed limits can be controversial and requires a rational and defensible determination to maintain public confidence. Speed limits are normally set near the 85th-percentile speed that statistically represents one standard deviation above the average speed and establishes the upper limit of what is considered reasonable and prudent. As with most laws, speed limits need to depend on the voluntary compliance of the greater majority of motorists. Speed limits cannot be set arbitrarily low, as this would create violators of the majority of drivers and would not command the respect of the public.*

**Standard:**

**01 Speed zones (other than statutory speed limits) shall only be established on the basis of an engineering **and traffic survey (E&TS)** ~~study~~ that has been performed in accordance with traffic engineering practices. The engineering study shall include an analysis of the current speed distribution of free-flowing vehicles.**

**02 The Speed Limit (R2-1) sign (see Figure 2B-3) shall display the limit established by law, ordinance, regulation, or as adopted by the authorized agency based on the engineering study. The speed limits displayed shall be in multiples of 5 mph.**

**03 Speed Limit (R2-1) signs, indicating speed limits for which posting is required by law, shall be located at the points of change from one speed limit to another.**

**04 At the downstream end of the section to which a speed limit applies, a Speed Limit sign showing the next speed limit shall be installed. Additional Speed Limit signs shall be installed beyond major intersections and at other locations where it is necessary to remind road users of the speed limit that is applicable.**

**05 Speed Limit signs indicating the statutory speed limits shall be installed at entrances to the State and, where appropriate, at jurisdictional boundaries in urban areas.**

Support:

06 In general, the maximum speed limits applicable to rural and urban roads are established:

A. Statutorily – a maximum speed limit applicable to a particular class of road, such as freeways or city streets, that is established by State law; or

B. As altered speed zones – based on engineering studies.

07 State statutory limits might restrict the maximum speed limit that can be established on a particular road, notwithstanding what an engineering study might indicate.

Option:

~~08 If a jurisdiction has a policy of installing Speed Limit signs in accordance with statutory requirements only on the streets that enter a city, neighborhood, or residential area to indicate the speed limit that is applicable to the entire city, neighborhood, or residential area unless otherwise posted, a CITYWIDE (R2-5aP), NEIGHBORHOOD (R2-5bP), or RESIDENTIAL (R2-5cP) plaque may be mounted above the Speed Limit sign and an UNLESS OTHERWISE POSTED (R2-5P) plaque may be mounted below the Speed Limit sign (see Figure 2B-3).~~

Guidance:

09 *A Reduced Speed Limit Ahead (W3-5 or W3-5a) sign (see Section 2C.38) should be used to inform road users of a reduced speed zone where the speed limit is being reduced by more than 10 mph, or where engineering judgment indicates the need for advance notice to comply with the posted speed limit ahead.*

10 *States and local agencies should conduct engineering studies at least once every 5, 7 or 10 years, in compliance with CVC Section 40802 to reevaluate non-statutory speed limits on segments of their roadways that have undergone significant changes since the last review, such as the addition or elimination of parking or driveways, changes in the number of travel lanes, changes in the configuration of bicycle lanes, changes in traffic control signal coordination, or significant changes in traffic volumes.*

11 *No more than three speed limits should be displayed on any one Speed Limit sign or assembly.*

~~12 *When a speed limit within a speed zone is posted, it should be within 5 mph of the 85<sup>th</sup> percentile speed of free-flowing traffic.*~~

**Standard:**

**12a When a speed limit is to be posted, it shall be established at the nearest 5 mph increment of the 85th-percentile speed of free-flowing traffic, except as shown in the two Options below.**

Option:

1. The posted speed may be reduced by 5 mph from the nearest 5 mph increment of the 85th-percentile speed, in compliance with CVC Sections 627 and 22358.5. See Standard below for documentation requirements.
2. For cases in which the nearest 5 mph increment of the 85th-percentile speed would require a rounding up, then the speed limit may be rounded down to the nearest 5 mph increment below the 85th percentile speed, if no further reduction is used. Refer to CVC Section 21400(b).

**Standard:**

**12b If the speed limit to be posted has had the 5 mph reduction applied, then an E&TS shall document in writing the conditions and justification for the lower speed limit and be approved by a registered Civil or Traffic Engineer. The reasons for the lower speed limit shall be in compliance with CVC Sections 627 and 22358.5.**

Support:

12c The following examples are provided to explain the application of these speed limit criteria:

Example 1. Using Option 1 above and first step is to round down: If the 85<sup>th</sup> percentile speed in a speed survey for a location was 37 mph, then the speed limit would be established at 35 mph since it is the closest 5 mph increment to the 37 mph speed. As indicated by the option, this 35 mph established speed limit could be reduced by 5 mph to 30 mph if

the conditions and justification for using this lower speed limit are documented in the E&TS and approved by a registered Civil or Traffic Engineer.

Example 2. Using Option 1 above and first step is to round up: If the 85<sup>th</sup> percentile speed in a speed survey for a location was 33 mph, then the speed limit would be established at 35 mph since it is the closest 5 mph increment to the 33 mph speed. As indicated by the option, this 35 mph speed limit could be reduced by 5 mph to 30 mph if the conditions and justification for using this lower speed limit are documented in the E&TS and approved by a registered Civil or Traffic Engineer.

Example 3. Using Option 2 above and first step is to round up: If the 85<sup>th</sup> percentile speed in a speed survey for a location was 33 mph, instead of rounding up to 35mph, the speed limit can be established at 30mph, but no further reductions can be applied (which is allowed in the two examples above).

**Standard:**

**<sup>12d</sup> Examples 1 and 2 for establishing posted speed limits shall apply to engineering and traffic surveys (E&TS) performed on or after July 1, 2009 in accordance with Caltrans' Traffic Operations Policy Directive Number 09-04 dated June 29, 2009.**

**Option:**

<sup>12e</sup> After January 1, 2012, Example 3 may be used to establish speed limits. Refer to CVC 21400(b).

**Support:**

<sup>12f</sup> Any existing E&TS that was performed before July 1, 2009 in accordance with previous traffic control device standards is not required to comply with the new criteria until it is due for reevaluation per the 5, 7 or 10 year criteria.

<sup>13</sup> *Speed studies for signalized intersection approaches should be taken outside the influence area of the traffic control signal, which is generally considered to be approximately 1/2 mile, to avoid obtaining skewed results for the 85<sup>th</sup>-percentile speed.*

**Support:**

<sup>14</sup> Advance warning signs and other traffic control devices to attract the motorist's attention to a signalized intersection are usually more effective than a reduced speed limit zone.

**Guidance:**

<sup>15</sup> *An advisory speed plaque (see Section 2C.08) mounted below a warning sign should be used to warn road users of an advisory speed for a roadway condition. A Speed Limit sign should not be used for this situation.*

**Option:**

<sup>16</sup> Other factors that may be considered when establishing or reevaluating speed limits are the following:

- A. Road characteristics, shoulder condition, grade, alignment, and sight distance;
- B. The pace;
- C. Roadside development and environment;
- D. Parking practices and pedestrian activity; and
- E. Reported crash experience for at least a 12-month period.

<sup>17</sup> Two types of Speed Limit signs may be used: one to designate passenger car speeds, including any nighttime information or minimum speed limit that might apply; and the other to show any special speed limits for trucks and other vehicles.

<sup>18</sup> A changeable message sign that changes the speed limit for traffic and ambient conditions may be installed provided that the appropriate speed limit is displayed at the proper times.

<sup>19</sup> A changeable message sign that displays to approaching drivers the speed at which they are traveling may be installed in conjunction with a Speed Limit sign.

**Guidance:**

<sup>20</sup> *If a changeable message sign displaying approach speeds is installed, the legend YOUR SPEED XX MPH or such similar legend should be displayed. The color of the changeable message legend should be a yellow legend on a black background or the reverse of these colors.*

**Support:**

<sup>21</sup> Advisory Speed signs and plaques are discussed in Sections 2C.08 and 2C.14. Temporary Traffic Control Zone Speed signs are discussed in Part 6. The WORK ZONE (G20-5aP) plaque intended for installation above a Speed Limit sign is discussed in Section 6F.12. School Speed Limit signs are discussed in Section 7B.15.

<sup>22</sup> Speed limits in California are governed by the California Vehicle Code (CVC), Sections 22348 through 22413; also, pertinent sections are found in Sections 627 and 40802 and others referenced in this section. See Section 1A.11 for information regarding this publication.

<sup>23</sup> Refer to Part 6, Section 6C.01 for speed limit signs in temporary traffic control zones. Refer to Part 7 for speed limit signs in school areas.

### **Engineering and Traffic Survey (E&TS)**

Support:

<sup>24</sup> CVC Section 627 defines the term "Engineering and traffic survey" and lists its requirements.

**Standard:**

<sup>25</sup> **An engineering and traffic survey (E&TS) shall include, among other requirements deemed necessary by Caltrans, consideration of all of the following:**

- A. Prevailing speeds as determined by traffic engineering measurements.**
- B. Collision records.**
- C. Highway, traffic, and roadside conditions not readily apparent to the driver.**

*Guidance:*

<sup>26</sup> *The E&TS should contain sufficient information to document that the required three items of CVC Section 627 are provided and that other conditions not readily apparent to a driver are properly identified.*

<sup>27</sup> *Prevailing speeds are determined by a speed zone survey. A speed zone survey should include:*

- A. The intent of the speed measurements is to determine the actual speed of unimpeded traffic. The speed of traffic should not be altered by concentrated law enforcement, or other means, just prior to, or while taking the speed measurements.*
- B. Only one person is required for the field work. Speeds should be read directly from a radar or other electronic speed measuring devices; or,*
- C. Devices, other than radar, capable of accurately distinguishing and measuring the unimpeded speed of free flowing vehicles may be used.*
- D. A location should be selected where prevailing speeds are representative of the entire speed zone section. If speeds vary on a given route, more than one speed zone section may be required, with separate measurements for each section. Locations for measurements should be chosen so as to minimize the effects of traffic signals or stop signs.*
- E. Speed measurements should be taken during off-peak hours between peak traffic periods on weekdays. If there is difficulty in obtaining the desired quantity, speed measurements may be taken during any period with free flowing traffic.*
- F. The weather should be fair (dry pavement) with no unusual conditions prevailing.*
- G. The surveyor and equipment should not affect the traffic speeds. For this reason, an unmarked car is recommended, and the radar speed meter located as inconspicuously as possible.*
- H. In order for the sample to be representative of the actual traffic flow, the minimum sample should be 100 vehicles in each survey. In no case should the sample contain less than 50 vehicles.*
- I. Short speed zones of less than 0.5 miles should be avoided, except in transition areas.*
- J. Speed zone changes should be coordinated with changes in roadway conditions or roadside development.*
- K. Speed zoning should be in 10 mph increments except in urban areas where 5 mph increments are preferable.*
- L. Speed zoning should be coordinated with adjacent jurisdictions.*

Support:

<sup>28</sup> Physical conditions such as width, curvature, grade and surface conditions, or any other condition readily apparent to the driver, in the absence of other factors, would not require special downward speed zoning. Refer to CVC 22358.5.

Option:

<sup>29</sup> When qualifying an appropriate speed limit, local authorities may also consider all of the following findings:

- A. Residential density, if any of the following conditions exist on the particular portion of highway and the property contiguous thereto, other than a business district:
  - 1. Upon one side of the highway, within 0.25 miles, the contiguous property fronting thereon is occupied by 13 or more separate dwelling houses or business structures.
  - 2. Upon both sides of the highway, collectively, within a distance of 0.25 miles the contiguous property fronting thereon is occupied by 16 or more separate dwelling houses or business structures.

3. The portion of highway is larger than 0.25 miles but has the ratio of separate dwelling houses or business structures to the length of the highway described in either subparagraph 1 or 2 above.

B. Pedestrian and bicyclist safety.

<sup>30</sup> The following two methods of conducting E&TS may be used to establish speed limits:

1. State Highways - The E&TS for State highways is made under the direction of the Caltrans District Traffic Engineer. The data includes:

a. One copy of the Example of Speed Zone Survey Sheet (See Figure 2B-101(CA)) showing:

- A north arrow
- Engineer's station or post mileage
- Limits of the proposed zones
- Appropriate notations showing type of roadside development, such as "scattered business," "solid residential," etc. Schools adjacent to the highway are shown, but other buildings need not be plotted unless they are a factor in the speed recommendation or the point of termination of a speed zone.
- Collision rates for the zones involved
- Average daily traffic volume
- Location of traffic signals, signs and markings
- If the highway is divided, the limits of zones for each direction of travel
- Plotted 85<sup>th</sup> percentile and pace speeds at location taken showing speed profile

b. A report to the District Director that includes:

- The reason for the initiation of speed zone survey.
- Recommendations and supporting reasons.
- The enforcement jurisdictions involved and the recommendations and opinions of those officials.
- The stationing or reference post in mileage at the beginning and ending of each proposed zone and any intermediate equations. Location ties must be given to readily identifiable physical features.

2. City and County Through Highways, Arterials, Collector Roads and Local Streets.

a. The short method of speed zoning is based on the premise that a reasonable speed limit is one that conforms to the actual behavior of the majority of motorists, and that by measuring motorists' speeds, one will be able to select a speed limit that is both reasonable and effective. Other factors that need to be considered include but are not limited to: the most recent two-year collision record, roadway design speed, safe stopping sight distance, superelevation, shoulder conditions, profile conditions, intersection spacing and offsets, commercial driveway characteristics, and pedestrian traffic in the roadway without sidewalks.

b. Determination of Existing Speed Limits - Figures 2B-103(CA) & 2B-104(CA) show examples of data sheets which may be used to record speed observations. Specific types of vehicles may be tallied by use of letter symbols in appropriate squares.

<sup>31</sup> In most situations, the short form for local streets and roads will be adequate; however, the procedure used on State highways may be used at the option of the local agency.

*Guidance:*

<sup>32</sup> *The factors justifying a reduction below the 85<sup>th</sup> percentile speed for the posted speed limit are the same factors mentioned above. Whenever such factors are considered to establish the speed limit, they should be documented on the speed zone survey or the accompanying engineering report.*

<sup>33</sup> *The establishment of a speed limit of more than 5 mph below the 85<sup>th</sup> percentile speed should be done with great care as studies have shown that establishing a speed limit at less than the 85<sup>th</sup> percentile generally results in an increase in collision rates; in addition, this may make violators of a disproportionate number of the reasonable majority of drivers.*

*Support:*

<sup>34</sup> Generally, the most decisive evidence of conditions not readily apparent to the driver surfaces in collision histories.

<sup>35</sup> Speed limits are established at or near the 85<sup>th</sup> percentile speed, which is defined as that speed at or below which 85<sup>th</sup> percent of the traffic is moving. The 85<sup>th</sup> percentile speed is often referred to as the critical speed. Pace speed is defined as the 10 mph increment of speed containing the largest number of vehicles (See Figure 2B-102(CA)). The lower limit of the pace is plotted on the Speed Zone Survey Sheets as an aid in determining the proper zone limits. Speed limits higher than the 85<sup>th</sup>

percentile are not generally considered reasonable and prudent. Speed limits below the 85<sup>th</sup> percentile do not ordinarily facilitate the orderly movement of traffic and require constant enforcement to maintain compliance. Speed limits established on the basis of the 85<sup>th</sup> percentile conform to the consensus of those who drive highways as to what speed is reasonable and prudent, and are not dependent on the judgment of one or a few individuals.

<sup>36</sup> The majority of drivers comply with the basic speed law. Speed limits set at or near the 85<sup>th</sup> percentile speed provide law enforcement officers with a limit to cite drivers who will not conform to what the majority considers reasonable and prudent. Further studies show that establishing a speed limit at less than the 85<sup>th</sup> percentile (Critical Speed) generally results in an increase in collision rates.

Option:

<sup>37</sup> When roadside development results in traffic conflicts and unusual conditions which are not readily apparent to drivers, as indicated in collision records, speed limits somewhat below the 85<sup>th</sup> percentile may be justified. Concurrence and support of enforcement officials are necessary for the successful operation of a restricted speed zone.

Guidance:

<sup>38</sup> *Speed zones of less than 0.5 miles and short transition zones should be avoided.*

## **Signs**

**Standard:**

<sup>39</sup> **The Speed Limit (R2-1) sign shall be used to give notice of a prima facie or maximum speed limit except as provided under Prima Facie Speed Limits in CVC 22352.**

<sup>40</sup> **When used, the TRUCKS, 3 AXLES OR MORE 55 MAXIMUM (R6-3(CA)) sign shall be installed approximately 750 feet following each R2-1 sign.**

<sup>41</sup> **The ALL VEHICLES WHEN TOWING 55 MAXIMUM (R6-4(CA)) sign shall be installed approximately 750 feet following the R6-3(CA) sign.**

Guidance:

<sup>42</sup> *The R6-3(CA) and R6-4(CA) signs should be placed on highway segments where speeds in excess of 55 mph are permitted.*

Option:

<sup>43</sup> The existing AUTOS WITH TRAILERS, TRUCKS 55 MAXIMUM (R6-1(CA)) sign may remain in place until it is knocked down, damaged, stolen, vandalized, or otherwise reaches the end of its useful life.

<sup>44</sup> The local California Highway Patrol office may be consulted to identify highway segments where enforcement is an issue. On these segments early replacement of existing R6-1(CA) signs may be necessary.

Support:

<sup>45</sup> Refer to CVC Section 22406 for types of vehicles subject to the 55 mph maximum speed limit.

Option:

<sup>46</sup> The Speed Zone Ahead (R2-4(CA)) sign (see Figure 2B-3(CA)) may be used to inform the motorist of a reduced speed zone.

**Standard:**

<sup>47</sup> **The R2-4(CA) sign shall always be followed by a Speed Limit (R2-1) sign installed at the beginning of the zone where the reduced speed limit applies.**

<sup>48</sup> **The End Speed Limit (R3(CA)) sign shall only be used to mark the end of a speed zone.**

<sup>49</sup> **The R3(CA) sign shall not be used at a transition into a change in speed limits within a reduced zone.**

Option:

<sup>50</sup> The R3(CA) sign (see Figure 2B-3(CA)) may be used with the TRUCK (M4-4) plaque to mark the end of truck speed zones on descending grades.

**Standard:**

<sup>51</sup> **Speed limit signs shall be placed at the beginning of all restricted speed zones.**

Option:

<sup>52</sup> Where speed zones are longer than 1 mile, intermediate signs may be placed at approximate 1 mile intervals. For three or more lanes in each direction, dual installation may be used.



**Standard:**

<sup>53</sup> **The Speed Limit (R2-1) and End Speed Limit (R3(CA)) signs, as appropriate shall be placed at the end of all restricted speed zones.**

<sup>54</sup> **Freeways with 65 mph and those segments where a speed limit of 70 mph has been approved by Caltrans, with approval by the California Highway Patrol, shall be posted as follows:**

- **At the segment entrance, R2-1 signs shall be installed right of traffic off of the right shoulder.**
- **R2-1 signs shall also be installed off of the right shoulder only, throughout the segment, at a maximum of 25 mile intervals.**

**Option:**

- **The 25 mile interval may be modified to include locations following entrance ramps.**

**Standard:**

- **The R6-3(CA) sign (see Figure 2B-3(CA)) shall be installed approximately 750 feet following each R2-1 sign, both at the beginning and throughout each 60, 65 or 70 mph segment.**
- **The R6-4(CA) sign (see Figure 2B-3(CA)) shall be installed approximately 750 feet following each R6-3(CA) sign.**

**Option:**

- **The SLOWER TRAFFIC KEEP RIGHT (R4-3) signs may be installed at locations where there is a tendency of the motorists to drive in the left-hand lane(s) below the normal speed of traffic.**

**Standard:**

- **Signs shall be placed in protected locations.**
- **At the end of the 70/65 mph segment, R2-1 signs shall be installed off of the right shoulder.**

<sup>55</sup> **Freeway segments where a 55 mph speed limit has been approved by Caltrans, with the approval of the California Highway Patrol, shall be posted as follows:**

- **The beginning of the segment shall be posted with an R2-1 sign installed on the right shoulder and left shoulder where the median is of sufficient width to permit sign maintenance without lane closures.**

**Guidance:**

- *Subsequent signs should then be posted on the right shoulder, on approximate 3 mile intervals, with no more than 3 interchanges between signs.*
- *At the end of the segment, an R2-1 sign with the appropriate number for the next speed limit should be posted on the right shoulder.*

<sup>56</sup> *Conventional highways with 55 mph speed limits should be posted as follows:*

**Standard:**

- **The beginning of the segment shall be posted with an R2-1 sign installed on the right shoulder.**

**Guidance:**

- *Subsequent signs should then be posted on approximate 5 to 10 mile intervals and immediately after locations where significant volumes of traffic enter the segment.*
- *At the end of the segment, an R2-1 sign with the appropriate number for the next speed limit should be posted on the right shoulder.*

*Conventional highways with 65 mph speed limits should be posted as follows:*

- *The beginning of the segment should be posted with an R2-1 sign installed on the right shoulder.*
- *Subsequent signs should then be posted at 5 to 10 mile intervals and after locations where significant volumes of traffic enter the segment.*
- *At the end of the segment, an R2-1 sign with the appropriate number for the next speed limit should be posted on the right shoulder.*

**Option:**

<sup>57</sup> *Pavement markings with appropriate numerals (see Section 3B.21) may be used to supplement speed limit signs.*

**Standard:**

<sup>58</sup> **The R2-1 and R6-3(CA) and R6-4(CA) signs giving maximum statewide speed limits for various types of vehicles shall be installed on all State highways near the points of entrance into California.**

*Guidance:*

<sup>59</sup> *The R2-1 and R6-3(CA) and R6-4(CA) signs should be placed in a location to be most effectively viewed by the approaching motorists.*

**Standard:**

<sup>60</sup> **Speed Limit (R2-1) signs shall be installed throughout segments of freeway with posted speed limits of 65 mph or 70 mph at a maximum of 25 mile intervals.**

*Option:*

<sup>61</sup> The 25 mile interval may be modified to include locations following entrance ramps.

**Standard:**

<sup>62</sup> **Speed Limit (R2-1) signs shall be installed throughout segments of conventional highways with a posted speed limit of 65 mph at 5 mile to 10 mile intervals.**

<sup>63</sup> **Speed Limit (R2-1) signs shall be installed throughout segments of freeway with a posted speed limit of 55 mph at approximately 3 mile intervals with no more than 3 interchanges between signs.**

<sup>64</sup> **Speed Limit (R2-1) signs shall be installed throughout segments of conventional highways with a posted speed limit of 55 mph at 5 mile to 10 mile intervals.**

**Speed Enforced Signs**

*Option:*

<sup>65</sup> The SPEED ENFORCED BY RADAR (R48(CA)) sign (see Figure 2B-3(CA)) may be used where the California Highway Patrol has received authority to use radar and requests such signs.

*Guidance:*

<sup>66</sup> *One sign should be used in each direction at the beginning of the segment of roadway, and at intervening major route intersections, where radar enforcement is in effect.*

*Support:*

<sup>67</sup> The R48(CA) sign is a stand-alone sign intended to alert motorists that speed is enforced by radar on a particular segment of roadway.

*Option:*

<sup>68</sup> The RADAR ENFORCED (R48-1(CA)) sign (see Figure 2B-3(CA)) may be used in combination with the Speed Limit (R2-1) sign on any roadway where law enforcement has the authority to use radar.

*Guidance:*

<sup>69</sup> *When used, the R48-1(CA) sign should be placed below the R2-1 sign, at the beginning of the segment of roadway and at intervening major intersections, where radar enforcement is in effect.*

*Option:*

<sup>70</sup> The SPEED ENFORCED BY AIRCRAFT (R48-2(CA)) sign (see Figure 2B-3(CA)) may be placed, when requested by the California Highway Patrol, on sections of highway regularly patrolled by aircraft.

**Standard:**

<sup>71</sup> **The R48-2(CA) sign shall be used for both directions of travel.**

*Guidance:*

<sup>72</sup> *The R48-2(CA) sign should be placed at the beginning of the section and spaced at 25 mile intervals. See Figure 3B-105(CA).*

**Vehicle Speed Feedback Signs**

*Option:*

<sup>73</sup> A Vehicle Speed Feedback sign that displays to approaching drivers the speed at which they are traveling may be installed in conjunction with a Speed Limit (R2-1) sign.

**Standard:**

<sup>74</sup> **If a Vehicle Speed Feedback sign displaying approach speeds is installed, the legend shall be YOUR SPEED XX. The numerals displaying the speed shall be white, yellow, yellow-green or amber color on black background. When activated, lights shall be steady-burn conforming to the provisions of CVC Sections 21466 and 21466.5. Vehicle Speed Feedback signs shall not alternatively be operated as variable speed limit signs.**

*Guidance:*

<sup>75</sup> *To the degree practical, numerals for displaying approach speeds should be similar font and size as numerals on the corresponding Speed Limit (R2-1) sign.*

*Option:*

<sup>76</sup> When used, the Vehicle Speed Feedback sign may be mounted on either a separate support or on the same support as the Speed Limit (R2-1) sign.

<sup>77</sup> In lieu of lights, legend may be retroreflective film for flip-disk systems.

<sup>78</sup> The legend YOUR SPEED may be white on black plaque located above the changeable speed display.

*Support:*

<sup>79</sup> Driver comprehension may improve when the Vehicle Speed Feedback Sign is mounted on the same support below the Speed Limit (R2-1) sign.

<sup>80</sup> Vehicle Speed Feedback Signs are appropriate for use with advisory speed signs and with temporary signs in temporary traffic control zones.

**Basic Speed Law and Prima Facie Speed Limits – See CVC 22350 & 22352**

*Support:*

<sup>81</sup> The basic speed law states “No person shall drive a vehicle upon a highway at a speed greater than is reasonable or prudent having due regard for weather, visibility, the traffic on, and the surface and width of, the highway, and in no event at a speed which endangers the safety of persons or property.”

**Standard:**

<sup>82</sup> **Prima facie speed limits are specific limits and shall apply unless changed based upon an engineering and traffic survey (E&TS) and signs are posted that display the new speed limit.**

*Option:*

<sup>83</sup> Prima facie speed limits may be preempted by the basic speed law, when roadway, traffic or weather conditions warrant a lower speed.

**Use of Metric System Designations – See CVC 21351.3**

*Option:*

<sup>84</sup> Dual units for speed limits on signs may be placed on local streets and roads in both Metric and English units.

*Guidance:*

<sup>85</sup> *If used, dual unit speed limits should be rounded to the nearest 10 km/h for Metric and 5 mph for English units for posting on signs on local streets and roads.*

*Support:*

<sup>86</sup> Refer to AASHTO's Traffic Engineering Metric Conversion Factors. See Section 1A.11 for information regarding this publication.

**Standard:**

<sup>87</sup> **Metric speed limits shall not be placed on State highways. For use in this California MUTCD, 70 mph shall be shown as a metric equivalent of 110 km/h, neither of which shall be used on any local street or road.**

**Legal Authority for Establishing Speed Limits**

*Support:*

<sup>88</sup> Delegation of legal authority to set speed limits on State highways is given to Caltrans District Directors. The District Director of each transportation district is authorized to issue orders regulating the speed of traffic, up to 65 mph on State highways. The Director of Caltrans retains the authority to approve variable, minimum, and maximum speeds up to 70 mph on State freeways.

**Standard:**

<sup>89</sup> **The speed limits shown in Table 2B-101(CA) shall apply, unless changed upon the basis of an engineering and traffic survey (E&TS).**

*Option:*

<sup>90</sup> The speed limits shown in Table 2B-102(CA) may apply, unless changed upon E&TS.

### **Variable Speed Limits on Freeways - See CVC 22355**

#### Option:

<sup>91</sup> The following speed limits may apply:

- Whenever Caltrans determines based upon an engineering and traffic survey (E&TS) that the safe and orderly movement of traffic upon any freeway segment will be facilitated by the establishment of variable speed limits.
- Caltrans may erect, regulate, and control signs upon the state highway which is a freeway, or any portion thereof, which, if used, signs shall be designed to permit display of different speeds at various times of the day or night.
- Such signs need not conform to the standards & specifications per CVC 21400, but if used, shall be of sufficient size and clarity to give adequate notice of the applicable speed limit.

### **Minimum Speed Limits on State Highways - See CVC 22400**

#### Option:

<sup>92</sup> The following speed limits may apply:

- Whenever Caltrans determines based upon an engineering and traffic survey (E&TS) that slow speeds on any part of a state highway consistently impede the normal and reasonable movement of traffic, Caltrans may determine and declare a minimum speed limit. Appropriate signs giving notice shall then be installed on that segment.
- A motorist can be cited for stopping or impeding the normal and reasonable movement of traffic unless the stop is necessary for safe operation and in compliance with the law.

### **Speed Traps**

#### Support:

<sup>93</sup> Refer to CVC 40802 for Speed Traps.

#### Standard:

<sup>94</sup> **A speed trap shall not apply to a local street, road, or school zone.**

<sup>95</sup> **A section of highway shall be defined as a speed trap if the prima facie speed limit is not justified by an engineering and traffic survey (E&TS) within five years, and the enforcement of the speed limit involves the use of radar or any other electronic device that measures the speed of moving objects.**

<sup>96</sup> **This time provision shall be extended to seven years when using radar and all of the following criteria are met:**

- **The arresting officer has successfully completed a minimum of 24 hours of certified radar operator course training.**
- **The radar used to measure the speed meets or exceeds the minimal operational standards of the National Traffic Highway Safety Administration, and has been calibrated within three years of the alleged violation.**

<sup>97</sup> **This time provision shall be extended to seven years when using laser or other electronic device (other than radar) and all of the following criteria are met:**

- **The arresting officer has successfully completed a minimum of 24 hours of certified radar operator course training.**
- **The arresting officer has successfully completed a minimum of 2 hours of additional approved certified training.**
- **The radar used to measure the speed meets or exceeds the minimal operational standards of the National Traffic Highway Safety Administration, and has been calibrated within three years of the alleged violation.**

#### Option:

<sup>98</sup> This time provision for an E&TS may be extended to ten years when all of the above conditions are met and no significant changes in roadway or traffic conditions have occurred, including changes in adjoining property or land use, roadway width, or traffic volume as determined by a registered engineer.

### **Truck Speed Zone on Descending Grades**

#### Guidance:

<sup>99</sup> *Highway descending grades, if used for posting TRUCK Speed Limit signs (R2-1 and M4-4) for trucks travelling downhill, should have recorded incident history of runaway commercial vehicles. Descending grades shorter than 1 mile should be avoided for posting signs because deceleration of vehicles due to braking action can generally provide sufficient control on descending grades of less than 1 mile.*

Support:

<sup>100</sup> To establish a downhill truck speed limit, a physical profile showing length and gradient and a downhill speed profile for three or more axle commercial vehicles with a gross rating of 10,000 lbs. or more will be provided.

**Standard:**

<sup>101</sup> **Speed profiles for truck speed limits shall be prepared on the same form as other speed surveys. An analysis of collisions involving trucks shall be prepared.**

Guidance:

<sup>102</sup> *Posted speeds should be on the low side of the scale, generally within the pace of loaded commercial vehicles.*

**Standard:**

<sup>103</sup> **If warranted, the Caltrans District Director shall issue a standard speed zone order.**

Support:

<sup>104</sup> Posting of the regulation will be by placement of a standard 36 x 45 inch Speed Limit (R2-1) sign with a TRUCK (M4-4) plate above.

**Standard:**

<sup>105</sup> **A standard End Speed Limit (R3(CA)) sign with TRUCK (M4-4) plate shall be posted at the end of the truck zone when appropriate.**

**Speed Zones in Temporary Traffic Control Areas**

Support:

<sup>106</sup> For signing and establishing speed zones in temporary traffic control areas, refer to Section 6C.01 in Part 6.

**Section 2B.14 Truck Speed Limit Plaque (R2-2P)**

**Standard:**

<sup>01</sup> **Where a special speed limit applies to trucks or other vehicles, the legend TRUCKS XX or such similar legend shall be displayed below the legend Speed Limit XX on the same sign ~~or on a separate R2-2P plaque (see Figure 2B-3) below the standard legend.~~**

<sup>02</sup> **The Truck Speed Limit (R2-2) sign shall not be used in California. The TRUCK (M4-4) plaque placed above the Speed Limit (R2-1) sign shall be used instead.**

<sup>03</sup> **The TRUCK (M4-4) plaque shall be placed above the Speed Limit (R2-1) sign to indicate the truck speed limit. It shall also be placed above the End Speed Limit (R3(CA)) sign to mark the end of truck speed limits.**

Support:

<sup>04</sup> Refer to Section 2B.13 for more details.

**Section 2B.15 Night Speed Limit Plaque (R2-3P)**

**Standard:**

<sup>01</sup> **Where different speed limits are prescribed for day and night, both limits shall be posted.**

Guidance:

<sup>02</sup> *A Night Speed Limit (R2-3P) plaque (see Figure 2B-3) should be reversed using a white retroreflectorized legend and border on a black background.*

Option:

<sup>03</sup> A Night Speed Limit plaque may be combined with or installed below the standard Speed Limit (R2-1) sign.

Support:

<sup>04</sup> Refer to CVC 22355.

**Section 2B.16 Minimum Speed Limit Plaque (R2-4P)**

**Standard:**

<sup>01</sup> **A Minimum Speed Limit (R2-4P) plaque (see Figure 2B-3) shall be displayed only in combination with a Speed Limit sign.**

Option:

<sup>02</sup> Where engineering judgment determines that slow speeds on a highway might impede the normal and reasonable movement of traffic, the Minimum Speed Limit plaque may be installed below a Speed Limit (R2-1)

sign to indicate the minimum legal speed. If desired, the Speed Limit sign and the Minimum Speed Limit plaque may be combined on the R2-4a sign (see Figure 2B-3).

Support:

<sup>03</sup> Refer to CVC 22400.

## Section 2B.17 Higher Fines Signs and Plaque (R2-6P, R2-10, and R2-11)

Standard:

<sup>01</sup> If increased fines are imposed for traffic violations within a designated zone of a roadway, a **BEGIN HIGHER DOUBLE FINES ZONE (R2-10)** sign (see Figure 2B-3) or a **FINES HIGHER DOUBLE (R2-6P)** plaque (see Figure 2B-3) shall be used to provide notice to road users. If used, the **FINES HIGHER DOUBLE** plaque shall be mounted below an applicable regulatory or warning sign in a temporary traffic control zone, a school zone, or other applicable designated zone.

<sup>02</sup> If an **R2-10** sign or an **R2-6P** plaque is posted to provide notice of increased fines for traffic violations, an **END HIGHER DOUBLE FINES ZONE (R2-11)** sign (see Figure 2B-3) shall be installed at the downstream end of the zone to provide notice to road users of the termination of the increased fines zone.

Guidance:

<sup>03</sup> If used, the **BEGIN HIGHER DOUBLE FINES ZONE** sign or **FINES HIGHER DOUBLE** plaque should be located at the beginning of the temporary traffic control zone, school zone, or other applicable designated zone and just beyond any interchanges, major intersections, or other major traffic generators.

Standard:

<sup>04</sup> The **Higher Double Fines** signs and plaque shall have a black legend and border on a white rectangular background. All supplemental plaques mounted below the **Higher Double Fines** signs and plaque shall have a black legend and border on a white rectangular background.

Guidance:

<sup>05</sup> Agencies should limit the use of the **Higher Double Fines** signs and plaque to locations where work is actually underway, or to locations where the roadway, shoulder, or other conditions, including the presence of a school zone and/or a reduced school speed limit zone, require a speed reduction or extra caution on the part of the road user.

Option:

<sup>06</sup> Alternate legends such as **BEGIN (or END) DOUBLE FINES ZONE** may also be used for the **R2-10** and **R2-11** signs.

<sup>07</sup> The legend **FINES HIGHER** on the **R2-6P** plaque may be replaced by **FINES DOUBLE (R2-6aP)**, **\$XX FINE (R2-6bP)**, or another legend appropriate to the specific regulation (see Figure 2B-3).

<sup>08</sup> The following may be mounted below an **R2-10** sign or **R2-6P** plaque:

A. A supplemental plaque specifying the times that the higher fines are in effect (similar to the **S4-1P** plaque shown in Figure 7B-1), or

B. A supplemental plaque **WHEN CHILDREN (WORKERS) ARE PRESENT**, or

C. A supplemental plaque **WHEN FLASHING** (similar to the **S4-4P** plaque shown in Figure 7B-1) if used in conjunction with a yellow flashing beacon.

Support:

<sup>09</sup> Section 6F.12 contains information regarding other signs and plaques associated with increased fines for traffic violations in temporary traffic control zones. Section 7B.10 contains information regarding other signs and plaques associated with increased fines for traffic violations in designated school zones.

<sup>10</sup> In California, as per CVC only doubling of the fines is allowed, not higher fines of other denominations. Refer to Section 6F.12 and CVC 42009 for fines for offenses committed in highway construction or maintenance area.

Standard:

<sup>11</sup> The **SPECIAL DRIVING ZONE BEGINS HERE – DOUBLE FINE ZONE (SR53(CA))** sign (see Figure 2B-3(CA)) shall be placed at the beginning of those portions of highways designated and identified as **Safety Enhancement – Double Fine Zones per CVC 42010**.

<sup>12</sup> The **SPECIAL DRIVING ZONE ENDS HERE (SR55(CA))** sign (see Figure 2B-3(CA)) shall be placed at the end of those portions of highways designated and identified as **Safety Enhancement – Double Fine Zones per CVC 42010**.

**Guidance:**

<sup>13</sup> The **DOUBLE FINE ZONE (SR54(CA)) sign** (see Figure 2B-3(CA)) should be placed at major intersections to those portions of highways designated and identified as Safety Enhancement – Double Fine Zone, per CVC 42010, to advise motorists upon entering the highway that they are in a double fine zone.

**Section 2B.18 Movement Prohibition Signs (R3-1 through R3-4, R3-18, and R3-27)**

**Standard:**

<sup>01</sup> ~~Except as provided in Paragraphs 11 and 13, where specific movements are prohibited, Movement Prohibition signs shall be installed.~~

**Guidance:**

<sup>02</sup> ~~Movement Prohibition signs should be placed where they will be most easily seen by road users who might be intending to make the movement.~~

<sup>03</sup> ~~If No Right Turn (R3-1) signs (see Figure 2B-4) are used, at least one should be placed either over the roadway or at a right hand corner of the intersection.~~

<sup>04</sup> ~~If No Left Turn (R3-2) signs (see Figure 2B-4) are used, at least one should be placed over the roadway, at the far left hand corner of the intersection, on a median, or in conjunction with the STOP sign or YIELD sign located on the near right hand corner.~~

<sup>05</sup> ~~Except as provided in Item C of Paragraph 9 for signalized locations, if NO TURNS (R3-3) signs (see Figure 2B-4) are used, two signs should be used, one at a location specified for a No Right Turn sign and one at a location specified for a No Left Turn sign.~~

<sup>06</sup> ~~If No U Turn (R3-4) signs (see Figure 2B-4) or combination No U Turn/No Left Turn (R3-18) signs (see Figure 2B-4) are used, at least one should be used at a location specified for No Left Turn signs.~~

**Option:**

<sup>07</sup> ~~If both left turns and U turns are prohibited, the combination No U Turn/No Left Turn (R3-18) sign (see Figure 2B-4) may be used instead of separate R3-2 and R3-4 signs.~~

**Guidance:**

<sup>08</sup> ~~If No Straight Through (R3-27) signs (see Figure 2B-4) are used, at least one should be placed either over the roadway or at a location where it can be seen by road users who might be intending to travel straight through the intersection.~~

<sup>09</sup> ~~If turn prohibition signs are installed in conjunction with traffic control signals:~~

*A. The No Right Turn sign should be installed adjacent to a signal face viewed by road users in the right hand lane.*

*B. The No Left Turn (or No U Turn or combination No U Turn/No Left Turn) sign should be installed adjacent to a signal face viewed by road users in the left hand lane.*

*C. A NO TURNS sign should be placed adjacent to a signal face viewed by all road users on that approach, or two signs should be used.*

**Option:**

<sup>10</sup> ~~If turn prohibition signs are installed in conjunction with traffic control signals, an additional Movement Prohibition sign may be post mounted to supplement the sign mounted overhead.~~

<sup>11</sup> ~~Where ONE WAY signs are used (see Section 2B.40), No Left Turn and No Right Turn signs may be omitted.~~

<sup>12</sup> ~~When the movement restriction applies during certain time periods only, the following Movement Prohibition signing alternatives may be used and are listed in order of preference:~~

*A. Changeable message signs, especially at signalized intersections.*

*B. Permanently mounted signs incorporating a supplementary legend showing the hours and days during which the prohibition is applicable.*

*C. Portable signs, installed by proper authority, located off the roadway at each corner of the intersection. The portable signs are only to be used during the time that the movement prohibition is applicable.*

<sup>13</sup> ~~Movement Prohibition signs may be omitted at a ramp entrance to an expressway or a channelized intersection where the design is such as to indicate clearly the one-way traffic movement on the ramp or turning lane.~~

**Support:**

<sup>13a</sup> Motorists can make a semicircular or U-turn on a green signal or green arrow except where such turn is prohibited by signs. Refer to CVC 21451 and 21454.

Option:

<sup>13b</sup> Local authorities, by ordinance, may prohibit the making of any turning movement by any vehicle at any intersection or between any designated intersections. Refer to CVC 22113.

<sup>13c</sup> The symbolic No Right Turn (R3-1), No Left Turn (R3-2), No U-Turn (R3-4), No U-Turn/No Left Turn (R3-18) and No Straight Through (R3-27) signs (see Figure 2B-4), may be used as Activated Blank-Out signs as Shown in Figure 2B-4(CA) for this purpose.

**Standard:**

<sup>13d</sup> **No such ordinance shall be effective with respect to a State highway until approved by Caltrans.**

Option:

<sup>13e</sup> Caltrans may restrict turning movements on State highways. Refer to CVC 21352.

Support:

<sup>13f</sup> A thorough investigation is necessary to determine whether or not the prohibited movements can be satisfactorily made at other locations without undue circuitry of travel.

<sup>13g</sup> Refer to CVC 22101 for Turn Prohibition signs.

**Standard:**

<sup>13h</sup> **The NO TURNS (R3-3) sign shall be used in advance of an intersection to indicate that turns are prohibited.**

*Guidance:*

<sup>13i</sup> *On a two-way street, one sign should be used at the near right corner and one sign at the far right corner, facing approaching traffic. On a one-way street, signs should be placed on the near left and right corners facing approaching traffic.*

**Standard:**

<sup>13j</sup> **The No Right/Left Turn (R3-1/R3-2) sign shall be placed at an intersection to indicate that a right/left turn is prohibited.**

*Guidance:*

<sup>13k</sup> *Turn Prohibition signs should be placed where they will be most easily seen by road users intending to turn.*

**Standard:**

<sup>13l</sup> **The No Right Turn (R3-1) sign shall be placed at the near right corner of the intersection or overhead.**

Option:

<sup>13m</sup> If signals are present, the R3-1 sign may be installed adjacent to a signal face viewed by motorists in the right lane.

**Standard:**

<sup>13n</sup> **On one-way roads, the No Left Turn (R3-2) sign shall be placed at the near left corner facing traffic approaching the intersection.**

Option:

<sup>13o</sup> If signals are present, the R3-2 sign may be placed adjacent to a signal face viewed by motorists in the left lane.

**Standard:**

<sup>13p</sup> **On two-way two lane roads (one lane each direction), the No Left Turn (R3-2) sign shall be placed on the near right corner and far left corner facing traffic approaching the intersection.**

Option:

<sup>13q</sup> If signals are present, the R3-2 sign may be installed adjacent to the signal face viewed by motorists.

*Guidance:*

<sup>13r</sup> *On two-way multi-lane roads, the No Left Turn (R3-2) sign should preferably be placed overhead over the left lanes, in the median adjacent to the left lanes, or at the far left corner facing approaching traffic where they will be most easily seen by road users intending to turn.*

Option:

<sup>13s</sup> When the movement restriction applies during certain time periods only, the following Turn Prohibition signing alternatives may be used and are listed in order of preference:

- A. Changeable message signs or internally illuminated signs that are lighted and made legible only during the restricted hours.
- B. A supplemental plate stating the applicable hours and days prohibited, mounted below the sign. The No Left Turn Specific Hours (R33(CA) and R33A(CA)) signs (see Figure 2B-4(CA)) may be used if left turns are prohibited during certain time periods.



**Standard:**

**<sup>13t</sup> The No U-Turn (R3-4) sign shall be used where U turns are prohibited except when Intersection Lane Control signs (R73(CA) Series) signs are used at signalized intersections with separate left turn phases.**

**<sup>13u</sup> The No U-Turn/No Left Turn (R3-18) sign shall be used where both, left turns and U turns are prohibited.**

**Guidance:**

*<sup>13v</sup> The appropriate R3-4 or R3-18 sign should be placed as follows:*

- A. On undivided roads without traffic signals, place on the near right and far left corners of the intersection.*
- B. On undivided roads with traffic signals, place on the far right and far left corners of the intersection, or on the signal mast arm.*
- C. On divided roads at both signalized and unsignalized intersections, place in the median on the near and far side of the intersection, and on the signal mast arm at signalized intersections.*

**Standard:**

**<sup>14</sup> The No Left Turn (R3-2) sign, the No U-Turn (R3-4) sign, and the combination No U-Turn/No Left Turn (R3-18) sign shall not be used at approaches to roundabouts to prohibit drivers from turning left onto the circulatory roadway of a roundabout.**

**Support:**

<sup>15</sup> At roundabouts, the use of R3-2, R3-4, or R3-18 signs to prohibit left turns onto the circulatory roadway might confuse drivers about the possible legal turning movements around the roundabout. Roundabout Directional Arrow (R6-4 series) signs (see Section 2B.43) and/or ONE WAY (R6-1R or R6-2R) signs are the appropriate signs to indicate the travel direction within a roundabout.

**Section 2B.19 Intersection Lane Control Signs (R3-5 through R3-8)**

**Standard:**

**<sup>01</sup> Intersection Lane Control signs, if used, shall require road users in certain lanes to turn, shall permit turns from a lane where such turns would otherwise not be permitted, shall require a road user to stay in the same lane and proceed straight through an intersection, or shall indicate permitted movements from a lane.**

**<sup>02</sup> Intersection Lane Control signs (see Figure 2B-4) shall have three applications:**

- A. Mandatory Movement Lane Control (R3-5, R3-5a, and R3-7) signs,**
- B. Optional Movement Lane Control (R3-6) sign, and**
- C. Advance Intersection Lane Control (R3-8 series) signs.**

**Guidance:**

*<sup>03</sup> When Intersection Lane Control signs are mounted overhead, each sign should be placed over the lane or a projection of the lane to which it applies.*

*<sup>04</sup> On signalized approaches where through lanes that become mandatory turn lanes, multiple-lane turns that include shared lanes for through and turning movements, or other lane-use regulations are present that would be unexpected by unfamiliar road users, overhead lane control signs should be installed at the signalized location over the appropriate lanes or projections thereof and in advance of the intersection over the appropriate lanes.*

*<sup>05</sup> Where overhead mounting on the approach is impractical for the advance and/or intersection lane-use signs, one of the following alternatives should be employed:*

- A. At locations where through lanes become mandatory turn lanes, a mandatory movement lane control (R3-7) sign should be post-mounted on the left-hand side of the roadway where a through lane is becoming a mandatory left-turn lane on a one-way street or where a median of sufficient width for the signs is available, or on the right-hand side of the roadway where a through lane is becoming a mandatory right-turn lane.*
- B. At locations where a through lane is becoming a mandatory left-turn lane on a two-way street where a median of sufficient width for the signs is not available, and at locations where multiple-lane turns that include shared lanes for through and turning movements are present, an Advance Intersection Lane Control (R3-8 series) sign should be post-mounted in a prominent location in advance of the intersection, and consideration should be given to the use of an oversized version in accordance with Table 2B-1 and 2B-1(CA).*

**Standard:**

**06 Use of an overhead sign for one approach lane shall not require installation of overhead signs for the other lanes of that approach.**

**Option:**

07 Where the number of through lanes on an approach is two or less, the Intersection Lane Control signs (R3-5, R3-6, or R3-8) may be overhead or post-mounted.

08 Intersection Lane Control signs may be omitted where:

- A. A turn bay has been provided by physical construction or pavement markings, and
- B. Only the road users using such turn bays are permitted to make a turn in that direction.

09 At roundabouts, Intersection Lane Control (R3-5, R3-6, and R3-8 series) signs may display any of the arrow symbol options shown in Figure 2B-5.

10 Where all approach lanes are required to turn in the same direction, the Mandatory Movement Lane Control (R3-5, R3-5a) signs may be ground mounted.

11 Where there is only one approach lane, the Optional Movement Lane Control (R3-6) signs may be ground mounted.

12 The Advance Intersection Lane Control (R3-8) signs may be overhead or ground mounted.

**Guidance:**

13 *The Intersection Lane Control (R3-5 through R3-8) signs should be used to indicate the movements for specific lanes at an intersection. The arrows should be selected according to lane requirements.*

**Option:**

14 The Intersection Lane Control (R61(CA) Series and R73(CA) Series) signs (see Figure 2B-4(CA)) may be used to indicate the types of movements permitted at intersections. The R73(CA) Series signs may also be used in lieu of the No U-Turn (R3-4) sign to indicate that U-turns are prohibited, when they are prohibited, at signalized intersections with separate left turn phases.

15 Advance Intersection Lane Control (R3-8, R3-8a, and R3-8b) signs may be installed at the intersection.

**Support:**

16 The R73-1(CA) through R73-4(CA) and R73-8(CA) signs (see Figures 2B-4(CA) and 2B-105(CA)) are typical for overhead mounting either on an overhead mast arm or on lightweight structures. The R73-5(CA) and R73-6(CA) signs are typical for overhead mounting on an overhead mast arm; they can be used for ground mounted installations.

**Section 2B.20 Mandatory Movement Lane Control Signs (R3-5, R3-5a, R3-7, and R3-20)**

**Standard:**

01 **If used, the Mandatory Movement Lane Control (R3-5, R3-5a, and R3-7) sign (see Figure 2B-4) shall indicate only the single vehicle movement that is required from the lane. If used, the Mandatory Movement Lane Control sign shall be located in advance of the intersection, such as near the upstream end of the mandatory movement lane, and/or at the intersection where the regulation applies. When the mandatory movement applies to lanes exclusively designated for HOV traffic, the R3-5cP supplemental plaque shall be used. When the mandatory movement applies to lanes that are not HOV facilities, but are lanes exclusively designated for buses and/or taxis, the word message R3-5dP and/or R3-5gP supplemental plaques shall be used.**

02 **The Mandatory Movement Lane Control (R3-7) sign shall include the legend RIGHT (LEFT) LANE MUST TURN RIGHT (LEFT). The Mandatory Movement Lane Control (R3-5 and R3-5a) symbol signs shall include the legend ONLY.**

03 **The R3-7 word message sign shall be for post-mounting only.**

04 ~~Where the number of lanes available to through traffic on an approach is three or more, Mandatory Movement Lane Control (R3-5 and R3-5a) symbol signs, if used, shall be mounted overhead over the specific lanes to which they apply (see Section 2B.19).~~

04a **If used, the Mandatory Movement Lane Control (R3-5 and R3-5a) signs shall be mounted overhead over the specific lanes to which they apply, unless all approach lanes are required to turn in the same direction (see Section 2B.19).**

*Guidance:*

*05 If the R3-5 or R3-5a sign is post-mounted on an approach with two or fewer through lanes, a supplemental plaque (see Figure 2B-4), such as LEFT LANE (R3-5bP), HOV 2+ (R3-5cP), TAXI LANE (R3-5dP), CENTER LANE (R3-5eP), RIGHT LANE (R3-5fP), BUS LANE (R3-5gP), or BOTH LANES, should be added above the sign to indicate the specific lane to which the mandatory movement applies. If Mandatory Lane Movement Control (R3-5) symbol signs with supplemental R3-5bP or R3-5fP plaques are used, they should be mounted adjacent to and along only the full width portion of the turn lane.*

*06 The use of the Mandatory Movement Lane Control (R3-7) word message sign should be limited to only locations that are adjacent to the full-width portion of a mandatory turn lane. The R3-7 sign should not be installed adjacent to a through lane in advance of a turn bay taper or adjacent to a turn bay taper.*

*07 Mandatory Movement Lane Control signs should be accompanied by lane-use arrow markings, especially where traffic volumes are high, where there is a high percentage of commercial vehicles, or where other distractions exist.*

**Option:**

08 The Straight Through Only (R3-5a) sign may be used to require a road user in a particular lane to proceed straight through an intersection.

09 When the Mandatory Movement Lane Control sign for a left-turn lane is installed back-to-back with a Keep Right (R4-7) sign, the dimensions of the Mandatory Movement Lane Control (R3-5) sign may be the same as the Keep Right sign.

10 The diamond symbol may be used instead of the word message HOV on the R3-5cP supplemental plaque.

11 The BEGIN RIGHT TURN LANE (R3-20R) sign (see Figure 2B-4) may be post-mounted on the right-hand side of the roadway at the upstream end of the turn lane taper of a mandatory right-turn lane. The BEGIN LEFT TURN LANE (R3-20L) sign (see Figure 2B-4) may be post-mounted on a median (or on the left-hand side of the roadway for a one-way street) at the upstream end of the turn lane taper of a mandatory left-turn lane.

**Support:**

12 Refer to CVC 22101 for Mandatory Movement Lane Control signs.

**Option:**

13 The Mandatory Movement Lane Control (R3-5) sign may be used to indicate the type of movement permitted at a major intersection where ground mounted signing is not adequate.

**Standard:**

**14 The RIGHT (LEFT) LANE MUST TURN RIGHT (LEFT) (R3-7) sign shall be used when a turning movement is required, except when a clearly marked additional lane is provided for the mandatory turn. When the additional lane is provided, a pavement arrow marking shall be placed at the beginning of the additional lane.**

*Guidance:*

*15 Signs or markings should be repeated in advance of mandatory turn lanes when necessary to prevent entrapment and to help motorists select the appropriate lane before reaching the end of the line of waiting vehicles.*

*16 The R3-7 sign should be erected on the appropriate side of the road, 150 to 300 feet in advance of the turn.*

**Option:**

17 The THRU TRAFFIC MERGE LEFT (RIGHT) (W74(CA)) sign may be used in advance of the R3-7 sign.

**Standard:**

**18 The RIGHT (LEFT) LANE MUST EXIT (R18A(CA)) sign (see Figure 2B-4(CA)) shall be used to indicate a freeway lane drop. The R18A(CA) sign shall be placed at the beginning of the 8 inch solid white line approaching the exit ramp. The R18A(CA) signs shall not be used at freeway to freeway connectors. See Figure 3B-10(CA) in Part 3 for details.**

*Guidance:*

*19 The RIGHT (LEFT) LANE FREEWAY ONLY (R18B(CA)) sign (see Figure 2B-4(CA)) should be used on non-freeway facilities to indicate that a particular lane only leads to a freeway entrance and on to the freeway. The sign should be used in conjunction with, and at the beginning of, the 8 inch solid white lines indicating that traffic in that lane has a mandatory movement leading to a freeway.*

## Section 2B.21 Optional Movement Lane Control Sign (R3-6)

### Standard:

01 If used, the **Optional Movement Lane Control (R3-6) sign** (see Figure 2B-4) shall be used for two or more movements from a specific lane or to emphasize permitted movements. If used, the **Optional Movement Lane Control sign** shall be located in advance of the intersection, such as near the upstream end of an adjacent mandatory movement lane, and/or at the intersection where the regulation applies.

02 If used, the **Optional Movement Lane Control sign** shall indicate all permissible movements from specific lanes.

03 **Optional Movement Lane Control signs** shall be used for two or more movements from a specific lane where a movement, not normally allowed, is permitted.

04 **The Optional Movement Lane Control sign** shall not be used alone to effect a turn prohibition.

05 ~~Where the number of lanes available to through traffic on an approach is three or more, an **Optional Movement Lane Control (R3-6) sign**, if used, shall be mounted overhead over the specific lane to which it applies (see Section 2B.19).~~

05a If used, the **Optional Movement Lane Control (R3-6) sign** shall be mounted overhead over the specific lane to which it applies, unless all approach lanes are required to turn in the same direction (see Section 2B.19).

### Guidance:

06 *If the **Optional Movement Lane Control sign** is post-mounted on an approach with two or fewer through lanes, a supplemental plaque (see Figure 2B-4), such as **LEFT LANE (R3-5bP)**, **HOV 2+ (R3-5cP)**, **TAXI LANE (R3-5dP)**, **CENTER LANE (R3-5eP)**, **RIGHT LANE (R3-5fP)**, or **BUS LANE (R3-5gP)**, should be added above the R3-6 sign to indicate the specific lane from which the optional movements can be made.*

### Option:

07 The word message OK may be used within the border in combination with the arrow symbols of the R3-6 sign.

### Standard:

08 **Because more than one movement is permitted from the lane, the word message ONLY shall not be used on an Optional Movement Lane Control sign.**

### Option:

09 The **Optional Movement Lane Control (R3-6 and R60B(CA)) signs** (see Figures 2B-4 and 2B-4(CA)) may be used to indicate the type of movement permitted at a major intersection where ground mounted signing is not adequate.

### Guidance:

10 *The R3-6 signs should not be used at signalized intersections with separate left turn phases. The R3-6 signs should be installed on pole mounted mast-arms over the lane to which they apply.*

## Section 2B.22 Advance Intersection Lane Control Signs (R3-8 Series)

### Option:

~~01 **Advance Intersection Lane Control (R3-8, R3-8a, and R3-8b) signs** (see Figure 2B-4) may be used to indicate the configuration of all lanes ahead.~~

### Guidance:

01a ***Advance Intersection Lane Control (R3-8, R3-8a, and R3-8b) signs** (see Figure 2B-4) should be used to indicate the configuration of all lanes ahead where there are optional lanes, mandatory turn lanes without turning bays or unshadowed turn lanes,*

### Option:

02 The word messages ONLY, OK, THRU, ALL, or HOV 2+ may be used within the border in combination with the arrow symbols of the R3-8 sign series. The HOV 2+ (R3-5cP) supplemental plaque may be installed at the top outside border of the R3-8 sign over the applicable lane designation on the sign. The diamond symbol may be used instead of the word message HOV. The minimum allowable vehicle occupancy requirement may vary based on the level established for a particular facility.

### Guidance:

03 *If used, an **Advance Intersection Lane Control sign** should be placed at an adequate distance in advance of the intersection so that road users can select the appropriate lane (see Figure 2A-4). If used, the **Advance Intersection Lane Control sign** should be installed either in advance of the tapers or at the beginning of the turn lane.*

Option:

<sup>03a</sup> Advance Intersection Lane Control (R3-8, R3-8a, and R3-8b) signs may be installed at the intersection.

<sup>04</sup> An Advance Intersection Lane Control sign may be repeated closer to the intersection for additional emphasis.

**Standard:**

<sup>05</sup> **Where three or more approach lanes are available to traffic, Advance Intersection Lane Control (R3-8 series) signs, if used, shall be post-mounted in advance of the intersection and shall not be mounted overhead (see Section 2B.19).**

### **Section 2B.23 RIGHT (LEFT) LANE MUST EXIT Sign (R3-33)**

Option:

<sup>01</sup> A RIGHT (LEFT) LANE MUST EXIT (R3-33) sign (see Figure 2B-4) may be used to supplement an overhead EXIT ONLY guide sign to inform road users that traffic in the right-hand (left-hand) lane of a roadway that is approaching a grade-separated interchange is required to depart the roadway on the exit ramp at the next interchange.

Support:

<sup>02</sup> Section 2C.43 contains information regarding a warning sign that can be used in advance of lane drops at grade-separated interchanges.

### **Section 2B.24 Two-Way Left Turn Only Signs (R3-9a, R3-9b)**

*Guidance:*

Option:

<sup>01</sup> Two-Way Left Turn Only (R3-9a or R3-9b) signs (see Figure 2B-6) ~~should~~ **may** be used in conjunction with the required pavement markings where a non-reversible lane is reserved for the exclusive use of left-turning vehicles in either direction and is not used for passing, overtaking, or through travel.

Option:

<sup>02</sup> The post-mounted R3-9b sign may be used as an alternate to or a supplement to the overhead R3-9a sign. The legend BEGIN or END may be used within the border of the main sign itself, or on an R3-9cP or R3-9dP plaque (see Figure 2B-6) mounted immediately above it.

Support:

<sup>03</sup> Signing is especially helpful to drivers in areas where the two-way left turn only maneuver is new, in areas subject to environmental conditions that frequently obscure the pavement markings, and on peripheral streets with two-way left turn only lanes leading to an extensive system of routes with two-way left turn only lanes.

Option:

<sup>04</sup> The Two-Way Left Turn Only (R3-9a or R3-9b) signs (see Figure 2B-6) may be installed in locations to indicate that a lane near the center of the highway is set aside for use by vehicles making left turns in both directions from or into the highway.

Support:

<sup>05</sup> See Figures 3A-108(CA) and 3B-7 (CA) for pavement marking applications for Two-Way Left Turn Lanes.

### **Section 2B.25 BEGIN and END Plaques (R3-9cP, R3-9dP)**

Option:

<sup>01</sup> The BEGIN (R3-9cP) or END (R3-9dP) plaque (see Figure 2B-6) may be used to supplement a regulatory sign to inform road users of the location where a regulatory condition begins or ends.

**Standard:**

<sup>02</sup> **If used, the BEGIN or END plaque shall be mounted directly above a regulatory sign.**

### **Section 2B.26 Reversible Lane Control Signs (R3-9e through R3-9i)**

Option:

<sup>01</sup> A reversible lane may be used for through traffic (with left turns either permitted or prohibited) in alternating directions during different periods of the day, and the lane may be used for exclusive left turns in one or both directions during other periods of the day as well. Reversible Lane Control (R3-9e through R3-9i) signs (see Figure 2B-6) may be either static type or changeable message type. These signs may be either post-mounted or overhead.

**Standard:**

**02 Post-mounted Reversible Lane Control signs shall be used only as a supplement to overhead signs or signals. Post-mounted signs shall be identical in design to the overhead signs and an additional legend such as CENTER LANE shall be added to the sign (R3-9f) to indicate which lane is controlled. For both word messages and symbols, this legend shall be at the top of the sign.**

**03 Where it is determined by an engineering study that lane-use control signals or physical barriers are not necessary, the lane shall be controlled by overhead Reversible Lane Control signs (see Figure 2B-7).**

**Option:**

**04 Reversing traffic flow may be controlled with pavement markings and Reversible Lane Control signs (without the use of lane control signals), when all of the following conditions are met:**

- A. Only one lane is being reversed,
- B. An engineering study indicates that the use of Reversible Lane Control signs alone would result in an acceptable level of safety and efficiency, and
- C. There are no unusual or complex operations in the reversible lane pattern.

**Standard:**

**05 Reversible Lane Control signs shall contain the legend or symbols designating the allowable uses of the lane and the time periods such uses are allowed. Where symbols and legends are used, their meanings shall be as shown in Table 2B-2.**

**06 Reversible Lane Control signs shall consist of a white background with a black legend and border, except for the ~~R3-9d~~ R3-9e sign, where the color red is used.**

**07 Symbol signs, such as the ~~R3-9d~~ R3-9e sign, shall consist of the appropriate symbol in the upper portion of the sign with the appropriate times of the day and days of the week below it. All times of the day and days of the week shall be accounted for on the sign to eliminate confusion to the road user.**

**08 In situations where more than one message is conveyed to the road user, such as on the ~~R3-9d~~ R3-9e sign, the sign legend shall be arranged as follows:**

- A. The prohibition or restriction message is the primary legend and shall be on the top for word message signs and to the far left for symbol signs,
- B. The permissive use message shall be displayed as the second legend, and
- C. The OTHER TIMES message shall be displayed at the bottom for word message signs and to the far right for symbol signs.

**Option:**

**09 The symbol signs may also include a downward pointing arrow with the legend THIS LANE. The term OTHER TIMES may be used for either the symbol or word message sign.**

**Standard:**

**10 A Reversible Lane Control sign shall be mounted over the center of the lane that is being reversed and shall be perpendicular to the roadway alignment.**

**11 If the vertical or horizontal alignment is curved to the degree that a driver would be unable to see at least one sign, and preferably two signs, then additional overhead signs shall be installed. The placement of the signs shall be such that the driver will have a definite indication of the lanes specifically reserved for use at any given time. Special consideration shall be given to major generators introducing traffic between the normal sign placement.**

**12 Transitions at the entry to and exit from a section of roadway with reversible lanes shall be carefully reviewed, and advance signs shall be installed to notify or warn drivers of the boundaries of the reversible lane controls. The R3-9g or R3-9h signs shall be used for this purpose.**

**Option:**

**13 More than one sign may be used at the termination of the reversible lane to emphasize the importance of the message (R3-9i).**

**Standard:**

**14 Flashing beacons, if used to accentuate the overhead Reversible Lane Control signs, shall comply with the applicable requirements for flashing beacons in Chapter 4L.**

**15 When used in conjunction with Reversible Lane Control signs, the Turn Prohibition signs (R3-1 to R3-4, R3-18) shall be mounted overhead and separate from the Reversible Lane Control signs. The Turn Prohibition signs shall be designed and installed in accordance with Section 2B.18.**

*Guidance:*

*16 For additional emphasis, a supplemental plaque stating the distance of the prohibition, such as NEXT 1 MILE, should be added to the Turn Prohibition signs that are used in conjunction with Reversible Lane Control signs.*

*17 If used, overhead signs should be located at intervals not greater than 1/4 mile. The bottom of the overhead Reversible Lane Control signs should not be more than 19 feet above the pavement grade.*

*18 Where more than one sign is used at the termination of a reversible lane, they should be at least 250 feet apart. Longer distances between signs are appropriate for streets with speeds over 35 mph, but the separation should not exceed 1,000 feet.*

*19 Because left-turning vehicles have a significant impact on the safety and efficiency of a reversible lane operation, if an exclusive left-turn lane or two-way left-turn lane cannot be incorporated into the lane-use pattern for a particular peak or off-peak period, consideration should be given to prohibiting left turns and U-turns during that time period.*

### **Section 2B.27 Jughandle Signs (R3-23, R3-24, R3-25, and R3-26 Series)**

*Support:*

*01 A jughandle turn is a left-turn or U-turn that because of special geometry is made by initially making a right turn. This type of turn can increase the operational efficiency of a roadway by eliminating the need for exclusive left-turn lanes and can increase the operational efficiency of a traffic control signal by eliminating the need for protected left-turn phases. A jughandle turn can also provide an opportunity for trucks and commercial vehicles to make a U-turn where the median and roadway are not of sufficient width to accommodate a traditional U-turn by these vehicles.*

*02 Figure 2B-8 shows the various signs that can be used for signing jughandle turns. Figure 2B-9 shows examples of regulatory and destination guide signing for various types of jughandle turns.*

**Standard:**

**03 On multi-lane roadways, since road users generally anticipate that they need to be in the left-hand lane when approaching a location where they desire to turn left or make a U-turn, an ALL TURNS FROM RIGHT LANE (R3-23) or a U TURN FROM RIGHT LANE (R3-23a) sign (see Figure 2B-9) shall be installed in advance of the location to inform drivers that left turns and/or U-turns will be made from the right-hand lane.**

*Option:*

*04 Where a median of sufficient width is available, supplemental regulatory or guide signs may also be placed on the left-hand side of the roadway.*

**Standard:**

**05 An R3-24 series sign with an upward diagonal arrow pointing to the right if the jughandle entrance is designed as an exit ramp (see Drawings A and B of Figure 2B-9) or an R3-25 series sign with a horizontal arrow pointing to the right if the jughandle entrance is designed as an intersection shall be installed on the right-hand side of the roadway at the entrance to the jughandle. The legend on the sign shall be ALL TURNS, U TURN, or U AND LEFT TURNS, as appropriate.**

**06 If the jughandle is designed such that the jughandle entrance is downstream of the location where the turn would normally have been made (see Drawing C of Figure 2B-9), an R3-26 series sign with an arrow pointing straight upward shall be installed on the right-hand side of the roadway at the intersection to inform road users that they need to proceed straight through the intersection in order to make a left turn or U-turn. The legend on the sign shall be U TURN or U AND LEFT TURNS, as appropriate.**

*Support:*

*07 The R3-24, R3-25, and R3-26 series of signs are designed to be mounted below conventional guide signs.*

*08 Section 2C.14 contains information regarding the use of advisory exit and ramp speed signs for exit ramps.*

*09 Section 2D.39 contains information regarding the use of guide signs for jughandles.*

### **Section 2B.28 Do Not Pass Sign (R4-1)**

**Option:**

<sup>01</sup> The Do Not Pass (R4-1) sign (see Figure 2B-10) may be used in addition to pavement markings (see Section 3B.02) to emphasize the restriction on passing.

**Standard:**

<sup>01a</sup> **When used, the Do Not Pass sign may shall be used at the beginning of, and at intervals within, a zone through which sight distance is restricted or where other conditions make overtaking and passing inappropriate.**

**Option:**

<sup>02</sup> If signing is needed on the left-hand side of the roadway for additional emphasis, NO PASSING ZONE (W14-3) signs may be used (see Section 2C.45).

**Support:**

<sup>03</sup> Standards for determining the location and extent of no-passing zone pavement markings are set forth in Section 3B.02.

**Support:**

<sup>04</sup> Typical examples of where the R4-1 sign could be applied are shown in Figures 3B-14(CA) and 3B-106(CA).

**Option:**

<sup>05</sup> The R4-1 sign may be used in conjunction with temporary traffic control signs.

### **Section 2B.29 PASS WITH CARE Sign (R4-2)**

**Guidance:**

<sup>01</sup> *The PASS WITH CARE (R4-2) sign (see Figure 2B-10) should be installed at the downstream end of a no-passing zone if a Do Not Pass sign has been installed at the upstream end of the zone.*

### **Section 2B.30 KEEP RIGHT EXCEPT TO PASS Sign (R4-16) and SLOWER TRAFFIC KEEP RIGHT Sign (R4-3)**

**Option:**

<sup>01</sup> The KEEP RIGHT EXCEPT TO PASS (R4-16) sign (see Figure 2B-10) may be used on multi-lane roadways to direct drivers to stay in the right-hand lane except when they are passing another vehicle. [Refer to CVC 21659.](#)

**Guidance:**

<sup>02</sup> *If used, the KEEP RIGHT EXCEPT TO PASS sign should be installed just beyond the beginning of a multi-lane roadway and at selected locations along multi-lane roadways for additional emphasis.*

**Option:**

<sup>03</sup> The SLOWER TRAFFIC KEEP RIGHT (R4-3) sign (see Figure 2B-10) may be used on multi-lane roadways to reduce unnecessary lane changing.

**Guidance:**

<sup>04</sup> *If used, the SLOWER TRAFFIC KEEP RIGHT sign should be installed just beyond the beginning of a multi-lane pavement, and at selected locations where there is a tendency on the part of some road users to drive in the left-hand lane (or lanes) below the normal speed of traffic. This sign should not be used on the approach to an interchange or through an interchange area.*

### **Section 2B.31 TRUCKS USE RIGHT LANE Sign (R4-5)**

**Guidance:**

<sup>01</sup> *If an extra lane has been provided for trucks and other slow-moving traffic, a SLOWER TRAFFIC KEEP RIGHT (R4-3) sign (see Figure 2B-10), TRUCKS USE RIGHT LANE (R4-5) sign (see Figure 2B-10), or other appropriate sign should be installed at the beginning of the lane.*

**Option:**

<sup>01a</sup> The TRUCKS OK (R70(CA)) sign (see Figure 2B-10(CA)) may be used to allow trucks to legally use other than the right lane or lanes, such as in advance of freeway branch connections, lane drop, etc.

**Support:**

<sup>01b</sup> [Refer to CVC 21655. Erect overhead with the arrow directly over the appropriate lane.](#)



**Option:**

<sup>02</sup> The SLOWER TRAFFIC KEEP RIGHT sign may be used as a supplement or as an alternative to the TRUCKS USE RIGHT LANE sign. Both signs may be used on multi-lane roadways to improve capacity and reduce lane changing.

<sup>03</sup> The TRUCKS USE RIGHT LANE (R4-5) sign may be used on multi-lane roadways to reduce unnecessary lane changing.

**Guidance:**

<sup>04</sup> *If an extra lane has been provided for trucks and other slow-moving traffic, a Lane Ends sign (see Section 2C.42) should be installed in advance of the point where the extra lane ends. Appropriate pavement markings should be installed at both the upstream and downstream ends of the extra lane (see Section 3B.09 and Figure 3B-13).*

**Support:**

<sup>05</sup> Section 2D.51 contains information regarding advance information signs for extra lanes that have been provided for trucks and other slow-moving traffic.

**Option:**

<sup>06</sup> The TRUCKS 3 AXLES OR MORE RIGHT 2 LANES ONLY (R6-3A(CA)) sign (see Figure 2B-10(CA)) may be used on divided highways having four or more lanes for traffic in one direction where this type of vehicle, unless designated, is restricted to the two right lanes. See CVC 21655 and 22348(c).

<sup>07</sup> The ALL VEHICLES WHEN TOWING RIGHT 2 LANES ONLY (R6-4A(CA)) sign (see Figure 2B-10(CA)) may be used on divided highways having four or more lanes for traffic in one direction where this type of vehicle, unless designated, is restricted to the two right lanes. See CVC 21655 and 22348(c).

**Standard:**

<sup>08</sup> The END TRUCK LANE (R53A(CA)) sign (see Figure 2B-10(CA)) shall be placed at the end of a truck lane.

<sup>09</sup> The END TRUCK LANE CONTROL (R53E(CA)) sign (see Figure 2B-10(CA)) shall be placed at the end of a segment of roadway in which trucks are restricted to a particular lane.

<sup>10</sup> The TRUCKS RIGHT LANE ONLY (R53B(CA)) sign (see Figure 2B-10(CA)) shall be used when a climbing lane is provided and it is necessary to prohibit trucks from passing slower moving vehicles. Signs shall be placed at the beginning of the restriction and at approximately 0.25 mile intervals. When the restriction is necessary during certain hours, the Specific Hours/Day (R82A(CA)) Plaque (see Figure 2B-10(CA)) shall be placed below the R53B(CA) sign.

<sup>11</sup> A TRUCK LANE (R4-6) sign shall be placed in advance of the truck lane. An END TRUCK LANE (R53A(CA)) sign shall be placed at the end of the restriction. See Figure 3B-14(CA) for signing and marking the end of an extra lane.

**Option:**

<sup>12</sup> The TRUCKS USE RIGHT LANE (R4-5) sign may be placed to advise trucks that they must use the right lane except to pass slow moving vehicles as provided in CVC 21654.

**Standard:**

<sup>13</sup> The YIELD TO UPHILL TRAFFIC (R55(CA)) sign (see Figure 2B-10(CA)) shall be used facing downhill traffic where a climbing lane has been provided and where a one-direction no passing marking has been placed to allow downhill traffic to pass. Refer to CVC 21661. See Section 3B.01 for further details.

<sup>14</sup> The SLOWER TRAFFIC KEEP RIGHT (R4-3) sign shall be used at the beginning of passing lanes. Refer to CVC 21654. See Figure 3B-14(CA) for application of signing and markings for lane reductions.

## **Section 2B.32 Keep Right and Keep Left Signs (R4-7, R4-8)**

**Option:**

<sup>01</sup> The Keep Right (R4-7) sign (see Figure 2B-10) may be used at locations where it is necessary for traffic to pass only to the right-hand side of a roadway feature or obstruction. The Keep Left (R4-8) sign (see Figure 2B-10) may be used at locations where it is necessary for traffic to pass only to the left-hand side of a roadway feature or obstruction.

**Guidance:**

<sup>02</sup> *At locations where it is not readily apparent that traffic is required to keep to the right, a Keep Right sign should be used.*

*03 If used, the Keep Right sign should be installed as close as practical to approach ends of raised medians, parkways, islands, and underpass piers. The sign should be mounted on the face of or just in front of a pier or other obstruction separating opposite directions of traffic in the center of the highway such that traffic will have to pass to the right-hand side of the sign.*

**Standard:**

**04 The Keep Right sign shall not be installed on the right-hand side of the roadway in a position where traffic must pass to the left-hand side of the sign.**

**At an intersection with a divided highway that has a median width at the intersection itself of less than 30 feet, Keep Right (R4-7) signs shall be installed (see Figures 2B-16 and 2B-17).**

**Option:**

~~05 The Keep Right sign may be omitted at intermediate ends of divisional islands and medians.~~

06 Word message KEEP RIGHT (LEFT) with an arrow (R4-7a or R4-7b) signs (see Figure 2B-10) may be used instead of the R4-7 or R4-8 symbol signs.

07 Where the obstruction obscures the Keep Right sign, the minimum placement height may be increased for better sign visibility.

08 A narrow Keep Right (R4-7c) sign (see Figure 2B-10) may be installed on the approach end of a median island that is less than 4 feet wide at the point where the sign is to be located.

**Standard:**

**09 A narrow Keep Right (R4-7c) sign shall not be installed on a median island that has a width of 4 feet or more at the point where the sign is to be located.**

**Guidance:**

*10 At intersections where the left-turn lane treatment results in channelized offset left-turn lanes (e.g., a parallel or tapered left-turn lane between two medians), the size of the Keep Right (R4-7) sign, if used, should be of the next higher roadway classification, if feasible, as shown in Table 2B-1, to reduce the potential for wrong-way maneuvers by road users turning left from a stop-controlled, intersecting minor roadway.*

*11 Hence, per this offset left-turn lanes scenario, if the type of roadway is a conventional road, the R4-7 sign size used, if feasible, should be from the expressway column as 36 x 48 inch, not the 24 x 30 inch size in the conventional road column.*

### **Section 2B.33 STAY IN LANE Sign (R4-9)**

**Option:**

01 A STAY IN LANE (R4-9) sign (see Figure 2B-10) may be used on multi-lane highways to direct road users to stay in their lane until conditions permit shifting to another lane.

**Guidance:**

*02 If a STAY IN LANE sign is used, it should be accompanied by a double solid white lane line(s) to prohibit lane changing.*

### **Section 2B.34 RUNAWAY VEHICLES ONLY Sign (R4-10)**

~~**Guidance:**~~

**Standard:**

**01 A RUNAWAY VEHICLES ONLY (R4-10) sign (see Figure 2B-10) ~~should~~ shall be installed near a truck escape (or runaway truck) ramp entrance to discourage other road users from entering the ramp.**

**02 The NO STOPPING ANY TIME (R26A(S)(CA)) signs (see Figure 2B-24(CA)) shall be placed as required to keep motorists from stopping in the path of runaway trucks.**

### **Section 2B.35 Slow Vehicle Turn-Out Signs (R4-12, R4-13, and R4-14)**

**Support:**

01 On two-lane highways in areas where traffic volumes and/or vertical or horizontal curvature make passing difficult, turn-out areas are sometimes provided for the purpose of giving a group of faster vehicles an opportunity to pass a slow-moving vehicle.

**Option:**

**Standard:**

**02 A SLOW VEHICLES WITH XX 5 OR MORE FOLLOWING VEHICLES MUST USE TURN-OUT (R4-12) sign (see Figure 2B-10) may shall be installed in advance of a the first turn-out area to inform drivers who are driving so slow that they have accumulated a specific number of vehicles behind them that they are required by the traffic laws of that State to use the turn-out to allow the vehicles following them to pass.**

**Refer to CVC 21656.**

**Support:**

**03** The specific number of vehicles displayed on the R4-12 sign provides law enforcement personnel with the information they need to enforce this regulation.

**03a** Refer to CVC 21656 for Turning out of Slow-Moving Vehicles.

**03b** The R4-12 sign is not intended to be used in advance of each individual turnout.

**03c** See Section 3B.101(CA) for more details.

**Option:**

**04** If an R4-12 sign has been installed in advance of a turn-out area, a SLOW VEHICLES MUST USE TURN-OUT AHEAD (R4-13) sign (see Figure 2B-10) may also be installed downstream from the R4-12 sign, but upstream from the turn-out area, to remind slow drivers that they are required to use a turn-out that is a short distance ahead.

**Standard:**

**05** If an R4-12 sign has been installed in advance of a turn-out area, a SLOW VEHICLES MUST TURN OUT (with arrow) (R4-14) sign (see Figure 2B-10) shall be installed at the entry point of the turn-out area.

**Support:**

**06** Section 2D.52 contains information regarding advance information signs for slow vehicle turn-out areas.

**Section 2B.36 DO NOT DRIVE ON SHOULDER Sign (R4-17) and DO NOT PASS ON SHOULDER Sign (R4-18)**

**Option:**

**01** The DO NOT DRIVE ON SHOULDER (R4-17) sign (see Figure 2B-10) may be installed to inform road users that using the shoulder of a roadway as a travel lane is prohibited.

**02** The DO NOT PASS ON SHOULDER (R4-18) sign (see Figure 2B-10) may be installed to inform road users that using the shoulder of a roadway to pass other vehicles is prohibited.

**Section 2B.37 DO NOT ENTER Sign (R5-1)**

**Standard:**

**01** The DO NOT ENTER (R5-1) sign (see Figure 2B-11) shall be used where traffic is prohibited from entering a restricted roadway.

**Guidance:**

**02** The DO NOT ENTER sign, if used, should be placed directly in view of a road user at the point where a road user could wrongly enter a divided highway, one-way roadway, or ramp (see Figure 2B-12(CA)). The sign should be mounted on the right-hand side of the roadway, facing traffic that might enter the roadway or ramp in the wrong direction.

**03** If the DO NOT ENTER sign would be visible to traffic to which it does not apply, the sign should be turned away from, or shielded from, the view of that traffic.

**Option:**

~~**04** The DO NOT ENTER sign may be installed where it is necessary to emphasize the one-way traffic movement on a ramp or turning lane.~~

~~**05** A second DO NOT ENTER sign on the left-hand side of the roadway may be used, particularly where traffic approaches from an intersecting roadway (see Figure 2B-12).~~

**Support:**

**06** Section 2B.41 contains information regarding an optional lower mounting height for DO NOT ENTER signs that are located along an exit ramp facing a road user who is traveling in the wrong direction.

**Standard:**

**07 The DO NOT ENTER (R5-1) sign and WRONG WAY (R5-1a) sign shall be used at the exit end of a one-way road or ramp to inform motorists that an entrance thereto is prohibited.**

**08 The R5-1 and the R5-1a signs shall be placed in the head-on position to a wrong-way movement.**

**Option:**

**09 The DO NOT ENTER (R5-1) and WRONG WAY (R5-1a) signs (see Figure 2B-11), may be used as Activated Blank-Out signs (see Figure 2B-11(CA)) for controlling reversible lanes and for prohibiting turns into reversible lanes.**

**10 The R5-1 and R5-1a Activated Blank-Out signs may also be used to supplement static R5-1 and R5-1a signs.**

**Standard:**

**11 If used for controlling reversible lanes and for prohibiting turns into reversible lanes, the R5-1 and R5-1a Activated Blank-Out signs shall be used in two sets.**

**Guidance:**

**12 At least one set of R5-1 and R5-1a signs should be visible from each decision point on each likely wrong-way approach.**

**Support:**

**13 See section 2E.53 for wrong-way traffic control at interchange ramps and Figures 2B-12(CA) and 3B-14(CA) for examples of signs and lane reduction markings.**

**Guidance:**

**14 On multilane roadways, a minimum size of 36 x 36 inch should be used for the DO NOT ENTER (R5-1) sign.**

**15 At intersections where the left-turn lane treatment results in channelized offset left-turn lanes (e.g., a parallel or tapered left-turn lane between two medians), the size of the DO NOT ENTER (R5-1) sign or WRONG WAY (R5-1a) sign, if used, should be of the next higher roadway classification, if feasible, as shown in Table 2B-1, to reduce the potential for wrong-way maneuvers by road users turning left from a stop-controlled, intersecting minor roadway.**

**16 Hence, per this offset left-turn lanes scenario, if the type of roadway is a conventional road, the R5-1 sign size used, if feasible, should be from the expressway column as 36 x 36 inch, not the 30 x 30 inch size in the conventional road column.**

### **Section 2B.38 WRONG WAY Sign (R5-1a)**

**Option:**

**01 The WRONG WAY (R5-1a) sign (see Figure 2B-11) may be used as a supplement to the DO NOT ENTER sign where an exit ramp intersects a crossroad or a crossroad intersects a one-way roadway in a manner that does not physically discourage or prevent wrong way entry (see Figure 2B-12).**

**Guidance:**

**02 If used, the WRONG WAY sign should be placed at a location along the exit ramp or the one-way roadway farther from the crossroad than the DO NOT ENTER sign (see Section 2B.41).**

**Support:**

**03 Section 2B.41 contains information regarding an optional lower mounting height for WRONG WAY signs that are located along an exit ramp facing a road user who is traveling in the wrong direction.**

**Support:**

**04 Refer to Section 2B.37 for the WRONG WAY (R5-1a) sign.**

### **Section 2B.39 Selective Exclusion Signs**

**Support:**

**01 Selective Exclusion signs (see Figure 2B-11) give notice to road users that State or local statutes or ordinances exclude designated types of traffic from using particular roadways or facilities.**

**Standard:**

**02 If used, Selective Exclusion signs shall clearly indicate the type of traffic that is excluded.**

**Support:**

**03 Typical exclusion messages include:**

**A. No Trucks (R5-2),**

**B. NO MOTOR VEHICLES (R5-3),**

**C. NO COMMERCIAL VEHICLES (R5-4),**

**D. NO TRUCKS (VEHICLES) WITH LUGS (R5-5),**

- E. No Bicycles (R5-6),
- F. NO NON-MOTORIZED TRAFFIC (R5-7),
- G. NO MOTOR-DRIVEN CYCLES (R5-8),
- H. No Pedestrians (R9-3),
- I. No Skaters (R9-13),
- J. No Equestrians (R9-14), and
- K. ~~No Hazardous Material (R14-3)~~ (see Section 2B.62).

**Option:**

<sup>04</sup> Appropriate combinations or groupings of these legends into a single sign, such as NO PEDESTRIANS BICYCLES MOTOR-DRIVEN CYCLES (R5-10a), or NO PEDESTRIANS OR BICYCLES (R5-10b) may be used.

**Guidance:**

<sup>05</sup> *If an exclusion is governed by vehicle weight, a Weight Limit sign (see Section 2B.59) should be used instead of a Selective Exclusion sign.*

<sup>06</sup> *If used on a freeway or expressway ramp, the NO PEDESTRIANS OR BICYCLES (R5-10b) sign should be installed in a location where it is clearly visible to any pedestrian or bicyclist attempting to enter the limited access facility from a street intersecting the exit ramp.*

<sup>07</sup> *The Selective Exclusion sign should be placed on the right-hand side of the roadway at an appropriate distance from the intersection so as to be clearly visible to all road users turning into the roadway that has the exclusion. The NO PEDESTRIANS (R5-10c) or No Pedestrian Crossing (R9-3) sign (see Section 2B.51) should be installed so as to be clearly visible to pedestrians who are at a location where an alternative route is available.*

**Option:**

<sup>08</sup> The NO PEDESTRIANS (R5-10c) or No Pedestrian Crossing (R9-3) sign may also be used at underpasses or elsewhere where pedestrian facilities are not provided.

<sup>09</sup> The NO TRUCKS (R5-2a) word message sign may be used as an alternate to the No Trucks (R5-2) symbol sign.

<sup>10</sup> The AUTHORIZED VEHICLES ONLY (R5-11) sign may be used at median openings and other locations to prohibit vehicles from using the median opening or facility unless they have special permission (such as law enforcement vehicles or emergency vehicles) or are performing official business (such as highway agency vehicles).

**Support:**

<sup>11</sup> Refer to CVC 21101 through 21104, 22402 through 22405 and 35650 through 35755 for Truck Exclusion signs.

<sup>12</sup> The No Trucks (R5-2) sign is used together with a Truck Exclusion (R20D(CA) Series) plaque (see Figure 2B-11(CA) to specify the maximum width or other restrictions in effect.

**Guidance:**

<sup>13</sup> *An alternative route should be evaluated for height, weight and size restrictions. Appropriate signs should be posted along the route to advise motorists of any restrictions.*

**Option:**

<sup>14</sup> Advance signs may be necessary to give trucks an opportunity to turn around and retrace their path or select another route.

**Standard:**

<sup>15</sup> **The R5-2 signs shall be placed at each end of the affected portion of a highway section. They shall be placed at a distance of not more than 500 feet from the ends of an affected bridge or structure.**

<sup>16</sup> **The Bridge Speed and Weight Limit (R21(CA)) sign (see Figure 2B-11(CA)) shall be used to specify the maximum speed permitted on a bridge or structure for vehicles over a specified weight. The R21(CA) sign shall not be erected more than 500 feet in advance of the bridge or structure.**

**Option:**

<sup>17</sup> The R21(CA) sign, when used with the Weight Limit (R12-5) sign, may be placed on the same post.

<sup>18</sup> The Truck Length Limit (R20H(CA)) sign may be used at locations where a semi-truck over 65 feet in length and a semi-truck with trailer over 75 feet in length is prohibited.

<sup>19</sup> The No Trucks Variable Message (R20-1(CA)) sign (see Figure 2B-11(CA)) may be used with an advance guide sign where there is a truck restriction.

**Standard:**

<sup>20</sup> **The NEXT RIGHT (R20-1A(CA)) Plaque (see Figure 2B-11(CA)) shall be used below the R20-1(CA) sign when no advance guide sign is available.**

**Option:**

<sup>21</sup> The AUTOS WITH TRAILERS - TRUCKS – PROHIBITED (R53D(CA)) sign (see Figure 2B-11(CA)) may be used at locations where these vehicles are prohibited from using the roadway.

**Restrictions on Use of Freeways**

**Support:**

<sup>22</sup> CVC Section 21960 authorizes Caltrans and local authorities, with respect to freeways under their respective jurisdictions, to prohibit or restrict the use of freeways by pedestrians, bicycles or other non-motorized traffic or by any person operating a motor-driven cycle or a motorized bicycle.

**Standard:**

<sup>23</sup> **Restrictions on use of a freeway shall be by the order of Caltrans, District Director.**

<sup>24</sup> **No ordinance or resolution of local authorities shall apply to any State highway until the proposed ordinance or resolution has been presented to, and approved in writing by, Caltrans.**

**Support:**

<sup>25</sup> The District Directors have been delegated the authority to issue orders restricting the use of freeways. They are also authorized to approve orders, ordinances or resolutions of local authorities, which would restrict the use of State highways.

<sup>26</sup> It is Caltrans' policy to restrict the use of freeways when a satisfactory alternate route is available.

**Standard:**

<sup>27</sup> **The NO PEDESTRIANS BICYCLES MOTOR-DRIVEN CYCLES (R5-10a) sign shall be used on a freeway at or near the beginning of the section of freeway to which the prohibition applies and on the right side of freeway entrance ramps.**

**Guidance:**

<sup>28</sup> *Prior to placement of the R5-10a sign on State highways, an order signed by the Caltrans District Director should be on file.*

<sup>29</sup> *At the end of freeway sections where both bicycles and pedestrians have been allowed, and on the continuing freeway where such traffic is prohibited, the R5-10a sign should be placed beyond the exit ramp gore.*

**Option:**

<sup>30</sup> The R5-10a sign may be modified by deleting the word BICYCLES at locations where bicycles are permitted on freeway shoulders.

**Standard:**

<sup>31</sup> **The NO PEDESTRIANS (R5-10c) sign shall be used at all freeways exit ramps to inform the public that pedestrians are prohibited.**

**Guidance:**

<sup>32</sup> *The R5-10c sign should be placed on the left facing pedestrian traffic, which might enter a freeway exit ramp. The sign should be placed up the ramp to avoid conflict with the ramp terminal signs.*

**Option:**

<sup>33</sup> Dual installations may be used where pedestrian problems exist.

**Support:**

<sup>34</sup> See 2E.53 for additional details.

**Option:**

<sup>35</sup> The FREEWAY – ACCESS RIGHTS RESTRICTED ON THIS SECTION OF HIGHWAY (S3-1(CA)) sign may be used to identify a right-of-way fence that has been placed to control access.

## Section 2B.40 ONE WAY Signs (R6-1, R6-2)

### Standard:

01 Except as provided in Paragraph 6, the ONE WAY (R6-1 or R6-2) sign (see Figure 2B-13) shall be used to indicate streets or roadways upon which vehicular traffic is allowed to travel in one direction only.

02 ONE WAY signs shall be placed parallel to the one-way street at all alleys and roadways that intersect one-way roadways as shown in Figure 2B-14.

03 At an intersection with a divided highway that has a median width at the intersection itself of 30 feet or more, ONE WAY signs shall be placed, visible to each crossroad approach, on the near right and far left corners of each intersection with the directional roadways (see Figure 2B-15).

~~04 At an intersection with a divided highway that has a median width at the intersection itself of less than 30 feet, Keep Right (R4-7) signs and/or ONE WAY signs shall be installed (see Figures 2B-16 and 2B-17). If Keep Right signs are installed, they shall be placed as close as practical to the approach ends of the medians and shall be visible to traffic on the divided highway and each crossroad approach. If ONE WAY signs are installed, they shall be placed on the near right and far left corners of the intersection and shall be visible to each crossroad approach.~~

04a The ONE WAY (R6-1) sign shall be used on one-way streets, divided highways, ramp terminals and other similar locations to indicate streets or roadways upon which vehicular traffic is required in one direction only.

04b When grouped with STOP (R1-1) sign or with another regulatory sign, the ONE WAY sign shall be placed at the top.

### Option:

04c The R6-1 signs may be placed on the far right and in the median on the left side of traffic entering the highway where the median is more than 30 feet wide as shown in Figure 2B-15.

05 At an intersection with a divided highway that has a median width at the intersection itself of less than 30 feet, ONE WAY signs may also be placed on the far right corner of the intersection as shown in Figures 2B-16 and 2B-17.

05a At an intersection with a divided highway that has a median width at the intersection itself of less than 30 feet, ONE WAY signs may be installed on the near right and far left corners of the intersection. They may also be placed on the far right corners of intersections for added emphasis. See Figures 2B-16 and 2B-17.

06 ONE WAY signs may be omitted on the one-way roadways of divided highways, where the design of interchanges indicates the direction of traffic on the separate roadways.

### Standard:

07 If used at unsignalized intersections with one-way streets, ONE WAY signs shall be placed on the near right and the far left corners of the intersection facing traffic entering or crossing the one-way street (see Figure 2B-14).

08 If used at signalized intersections with one-way streets, ONE WAY signs shall be placed near the appropriate signal faces, on the poles holding the traffic signals, on the mast arm or span wire holding the signals, or at the locations specified for unsignalized intersections.

09 At unsignalized T-intersections where the roadway at the top of the T-intersection is a one-way roadway, ONE WAY signs shall be placed on the near right and the far side of the intersection facing traffic on the stem approach (see Figure 2B-14).

10 At signalized T-intersections where the roadway at the top of the T-intersection is a one-way roadway, ONE WAY signs shall be placed near the appropriate signal faces, on the poles holding the traffic signals, on the mast arm or span wire holding the signals, or at the locations specified for unsignalized intersections.

### Option:

11 Where the central island of a roundabout allows for the installation of signs, ONE WAY signs may be used instead of or in addition to Roundabout Directional Arrow (R6-4 series) signs (see Section 2B.43) to direct traffic counter-clockwise around the central island.

### Guidance:

12 Where used on the central island of a roundabout, the mounting height of a ONE WAY sign should be at least 4 feet, measured vertically from the bottom of the sign to the elevation of the near edge of the traveled way.

Support:

<sup>13</sup> Using ONE WAY signs on the central island of a roundabout might result in some drivers incorrectly concluding that the cross street is a one-way street. Using Roundabout Directional Arrow signs might reduce this confusion. However, using ONE WAY signs might be necessary in States that have defined a roundabout as a series of T-intersections.

Option:

<sup>14</sup> The BEGIN ONE WAY (R6-6) sign (see Figure 2B-13) may be used to notify road users of the beginning point of a one direction of travel restriction on the street or roadway. The END ONE WAY (R6-7) sign (see Figure 2B-13) may be used to notify road users of the ending point of a one direction of travel restriction on the street or roadway.

Option:

<sup>15</sup> Authorities in charge of any highway may designate, by ordinance or resolution, any roadway, part of a roadway, or specific lanes for one-way traffic. Refer to CVC 21657.

**Standard:**

<sup>16</sup> **No such ordinance shall be effective with respect to a State highway until approved by Caltrans.**

Option:

<sup>17</sup> If, by local ordinance, a State highway through a city has been made one of a pair of one-way streets, the Commission may adopt the additional street into the State Highway System. Refer to Streets and Highways Code Section 111.5. See Section 1A.11 for information regarding this publication.

<sup>18</sup> On streets and highways under local jurisdiction where medians are less than 30 feet wide, raised or unpaved, the R6-1 signs may be placed in the median.

Guidance:

<sup>19</sup> *The appropriate height of the R6-1 signs when placed in the median should be 1.5 feet.*

<sup>20</sup> *The R6-1 signs should also be placed parallel to the one-way street at the appropriate far corner to a wrong-way turn.*

*They should also be placed opposite the exits from alleys and other public ways.*

**Standard:**

<sup>21</sup> **At intersections and ramps, the R6-1 signs shall be placed as provided in Section 2E.53.**

Option:

<sup>22</sup> The ONE WAY (R6-2) sign may be used as an alternative to the R6-1 sign where space is limited and the R6-2 sign is more appropriate.

Guidance:

<sup>23</sup> *At intersections where the left-turn lane treatment results in channelized offset left-turn lanes (e.g., a parallel or tapered left-turn lane between two medians), the size of the ONE WAY (R6-1, R6-2) signs, if used, should be of the next higher roadway classification, if feasible, as shown in Table 2B-1, to reduce the potential for wrong-way maneuvers by road users turning left from a stop-controlled, intersecting minor roadway.*

<sup>24</sup> *Hence, per this offset left-turn lanes scenario, if the type of roadway is a conventional road, the R6-1 sign size used, if feasible, should be from the expressway column as 54 x 18 inch, not the 36 x 12 inch size in the conventional road column.*

## **Section 2B.41 Wrong-Way Traffic Control at Interchange Ramps**

**Standard:**

<sup>01</sup> **At interchange exit ramp terminals where the ramp intersects a crossroad in such a manner that wrong-way entry could inadvertently be made, the following signs shall be used (see Figure 2B-18):**

**A. At least one ONE WAY sign for each direction of travel on the crossroad shall be placed where the exit ramp intersects the crossroad.**

~~**B. At least one DO NOT ENTER sign shall be conspicuously placed near the downstream end of the exit ramp in positions appropriate for full view of a road user starting to enter wrongly from the crossroad.**~~

~~**C. At least one WRONG WAY sign shall be placed on the exit ramp facing a road user traveling in the wrong direction.**~~



*Guidance:*

*02 In addition, the following pavement markings should be used (see Figure 2B-18):*

- A. On two-lane paved crossroads at interchanges, double solid yellow lines should be used as a center line for an adequate distance on both sides approaching the ramp intersections.*
- B. Where crossroad channelization or ramp geometrics do not make wrong-way movements difficult, a lane-use arrow should be placed in each lane of an exit ramp near the crossroad terminal where it will be clearly visible to a potential wrong-way road user.*

**Option:**

03 The following traffic control devices may be used to supplement the signs and pavement markings described in Paragraphs 1 and 2:

- A. Additional ONE WAY signs may be placed, especially on two-lane rural crossroads, appropriately in advance of the ramp intersection to supplement the required ONE WAY sign(s).
- B. Additional WRONG WAY signs may be used.
- C. Slender, elongated wrong-way arrow pavement markings (see Figure ~~3B-24~~ 3B-24(CA)) intended primarily to warn wrong-way road users that they are traveling in the wrong direction may be placed upstream from the ramp terminus (see Figure 2B-18) to indicate the correct direction of traffic flow. Wrong-way arrow pavement markings may also be placed on the exit ramp at appropriate locations near the crossroad junction to indicate wrong-way movement. The wrong-way arrow markings may consist of pavement markings or bidirectional red-and-white raised pavement markers or other units that show red to wrong-way road users and white to other road users (see Figure ~~3B-24~~ 3B-24(CA)).
- D. Lane-use arrow pavement markings may be placed on the exit ramp and crossroad near their intersection to indicate the permissive direction of flow.
- E. Freeway entrance signs (see Section 2D.46) may be used.

*Guidance:*

~~04 On interchange entrance ramps where the ramp merges with the through roadway and the design of the interchange does not clearly make evident the direction of traffic on the separate roadways or ramps, a ONE WAY sign visible to traffic on the entrance ramp and through roadway should be placed on each side of the through roadway near the entrance ramp merging point as illustrated in Figure 2B-19.~~

**Option:**

05 At locations where engineering judgment determines that a special need exists, other standard warning or prohibitive methods and devices may be used as a deterrent to the wrong-way movement.

06 Where there are no parked cars, pedestrian activity or other obstructions such as snow or vegetation, and if an engineering study indicates that a lower mounting height would address wrong-way movements on freeway or expressway exit ramps, a DO NOT ENTER sign(s) and/or a WRONG WAY sign(s) that is located along the exit ramp facing a road user who is traveling in the wrong direction may be installed at a minimum mounting height of 3 feet, measured vertically from the bottom of the sign to the elevation of the near edge of the pavement.

**Support:**

07 Section ~~2B-41~~ 2B.42 contains further information on signing to avoid wrong-way movements at at-grade intersections on expressways.

**Standard:**

**08 The DO NOT ENTER (R5-1) sign and WRONG WAY (R5-1a) sign shall be used at the exit end of a one-way road, ramp or other similar locations to inform motorists that an entrance thereto is prohibited.**

**09 The R5-1 and the R5-1a signs shall be placed in the head-on position to a wrong-way movement.**

**Option:**

10 The DO NOT ENTER (R5-1) and WRONG WAY (R5-1a) signs (see Figure 2B-11), may be used as Activated Blank-Out signs (see Figure 2B-11(CA)) for controlling reversible lanes and for prohibiting turns into reversible lanes.

11 The R5-1 and R5-1a Activated Blank-Out signs may also be used to supplement static R5-1 and R5-1a signs.

**Standard:**

**12 If used for controlling reversible lanes and for prohibiting turns into reversible lanes, the R5-1 and R5-1a Activated Blank-Out signs shall be used in two sets.**

*Guidance:*

13 *At least one set of R5-1 and R5-1a signs should be visible from each decision point on each likely wrong-way approach.*

*Support:*

14 See section 2E.53 for wrong-way traffic control at interchange ramps and Figures 2B-12(CA) and 3B-14(CA) for examples of signs and lane reduction markings.

*Guidance:*

15 *On multilane roadways, a minimum size of 36 x 36 inch should be used for the DO NOT ENTER (R5-1) sign.*

16 *At intersections where the left-turn lane treatment results in channelized offset left-turn lanes (e.g., a parallel or tapered left-turn lane between two medians), the size of the DO NOT ENTER (R5-1) sign or WRONG WAY (R5-1a) sign, if used, should be of the next higher roadway classification, if feasible, as shown in Table 2B-1, to reduce the potential for wrong-way maneuvers by road users turning left from a stop-controlled, intersecting minor roadway.*

17 *Hence, per this offset left-turn lanes scenario, if the type of roadway is a conventional road, the R5-1 sign size used, if feasible, should be from the expressway column as 36 x 36 inch, not the 30 x 30 inch size in the conventional road (single lane) column.*

*Support:*

18 Ramp terminal signing serves two important functions:

1. A link in the guidance system for traffic moving from the conventional roadway to the freeway.
2. Information to prevent a road user from getting into a wrong-way driving situation.

19 Freeway Entrance package is a vertical arrangement of FREEWAY ENTRANCE (D13-3) sign, cardinal direction, route shield, and arrow signs on a single post in which the D13-3 sign is on top and the arrow is on the bottom.

20 Do Not Enter package is a DO NOT ENTER (R5-1) sign with a WRONG WAY (R5-1a) sign directly beneath it on a single post.

*Guidance:*

21 *Ramp terminal signs should be placed within the area normally illuminated by automobile headlights. Ambient lighting in the vicinity of the signs should also be considered.*

22 *In order to be most responsive to headlights, the Do Not Enter and Freeway Entrance packages should be mounted with the bottom of the lower sign 2 feet above the edge of the pavement. The ONE WAY (R6-1) signs should be mounted at 1.5 feet above the edge of pavement.*

*Support:*

23 This will generally ensure that these arrows are low enough that they will not be a sight restriction to the right-way traffic.

**Standard:**

24 **Standard mounting height for all other signs in the ramp terminal area shall remain at 5 feet.**

*Option:*

25 In locations subject to deep snow, sign heights may be adjusted in accordance with engineering judgment.

*Guidance:*

26 *If installed, the pedestrian prohibition (R5-10a and R5-10c) signs should be placed far enough up the ramp to avoid conflict with signs near the terminal.*

*Support:*

27 The sign locations shown in Figure 2B-18(CA) are approximate.

*Guidance:*

28 *All ramp terminals should be reviewed under both day and night conditions by experienced signing personnel to determine exact locations.*

**Standard:**

29 **At least two large painted pavement arrows shall be placed and maintained in the center of each lane of each exit ramp. At least one Type I arrow, not less than 18 feet in length, shall be positioned in the center of each freeway entrance ramp. Refer to Section 3B.20.**

**On-Ramp Terminal Signing**

*Support:*

30 Lead-in signing directing motorists to on-ramps is important. Care should be taken to ensure that arrows on direction signs couldn't be interpreted as pointing into inappropriate roadways, especially off-ramp terminals.

<sup>31</sup> Partial interchanges may need special attention with respect to lead-in signing. Trailblazing a route from a partial interchange to another interchange may be necessary to ensure proper traffic movements.

*Guidance:*

<sup>32</sup> *Freeway Entrance packages should be placed as near the diverge point between the on-ramp and the intersecting roadway as practicable. The down diagonal arrow should always point toward the onramp pavement.*

<sup>33</sup> *Large Freeway Entrance signs should be used with the Freeway Entrance package unless proper placement requires the smaller Freeway Entrance signs.*

### **Off-Ramp Terminal Signing**

**Standard:**

<sup>34</sup> **The Turn Prohibition signs (See Section 2B.18) shall be placed in suitable locations on the crossing street in advance of the off-ramp.**

*Guidance:*

<sup>35</sup> *The Do Not Enter packages should be placed at off-ramp terminals to meet the following criteria:*

A. *At least one package should be visible to a road user (within the scope of his headlights) at his decision point on each potential approach.*

B. *At least one package should be in the head-on position for the road user turning into the off-ramp from each potential approach.*

<sup>36</sup> *A field decision should be made on whether to use three Do Not Enter packages or four if the off-ramp is split by a traffic island.*

*Support:*

<sup>37</sup> Generally, curbed islands larger than 1000 feet<sup>2</sup> in area indicate the use of four packages. Painted islands can be somewhat larger and still be adequately signed with three packages. Refer to Figure 2B-18(CA) Sheets 3, 4 and 5.

*Guidance:*

<sup>38</sup> *The ONE WAY (R6-1) signs should be placed as close to the crossing street as possible. If there are sidewalks immediately adjacent to the cross street, these signs should be located behind the sidewalk to avoid conflicting with pedestrians.*

*Support:*

<sup>39</sup> A less desirable alternate is relocating the signs above the pedestrian level.

*Guidance:*

<sup>40</sup> *At skewed ramp intersections, where the angle approaches 90°, a second ONE WAY (R6-1) sign should be added on the obtuse side when it would be visible to approaching traffic. Refer to Figure 2B-18(CA) Sheet 1.*

### **Section 2B.42 Divided Highway Crossing Signs (R6-3, R6-3a)**

**Standard:**

<sup>01</sup> **On unsignalized minor-street approaches from which both left turns and right turns are permitted onto a divided highway that has a median width at the intersection itself of 30 feet or more, except as provided in Paragraph 2, a Divided Highway Crossing (R6-3 or R6-3a) sign (see Figure 2B-13) shall be used to advise road users that they are approaching an intersection with a divided highway (see Figure 2B-15).**

*Option:*

<sup>02</sup> If the divided highway that has a median width at the intersection itself of 30 feet or more has a traffic volume of less than 400 AADT and a speed limit of 25 mph or less, the Divided Highway Crossing signs facing the unsignalized minor-street approaches may be omitted.

<sup>03</sup> A Divided Highway Crossing sign may be used on signalized minor-street approaches from which both left turns and right turns are permitted onto a divided highway to advise road users that they are approaching an intersection with a divided highway.

**Standard:**

<sup>04</sup> **If a Divided Highway Crossing sign is used at a four-legged intersection, the R6-3 sign shall be used. If used at a T-intersection, the R6-3a sign shall be used.**

<sup>05</sup> **The Divided Highway Crossing sign shall be located on the near right corner of the intersection, mounted beneath a STOP or YIELD sign or on a separate support.**

**Option:**

06 An additional Divided Highway Crossing sign may be installed on the left-hand side of the approach to supplement the Divided Highway Crossing sign on the near right corner of the intersection.

**Guidance:**

07 *At intersections where the left-turn lane treatment results in channelized offset left-turn lanes (e.g., a parallel or tapered left-turn lane between two medians), the size of the Divided Highway Crossing (R6-3, R6-3a) signs, if used, should be of the next higher roadway classification, if feasible, as shown in Table 2B-1, to reduce the potential for wrong-way maneuvers by road users turning left from a stop-controlled, intersecting minor roadway.*

08 *Hence, per this offset left-turn lanes scenario, if the type of roadway is a conventional road, the R6-3 sign size used, if feasible, should be from the expressway column as 36 x 30 inch, not the 30 x 24 inch size in the conventional road column.*

**Section 2B.43 Roundabout Directional Arrow Signs (R6-4, R6-4a, and R6-4b)**

**Guidance:**

01 *Where the central island of a roundabout allows for the installation of signs, Roundabout Directional Arrow (R6-4 series) signs (see Figure 2B-20) should be used in the central island to direct traffic counter-clockwise around the central island, except as provided in Paragraph 11 in Section 2B.40.*

**Standard:**

02 **The R6-4 sign shall be a horizontal rectangle with two black chevron symbols pointing to the right on a white background. The R6-4a sign shall be a horizontal rectangle with three black chevron symbols pointing to the right on a white background. The R6-4b sign shall be a horizontal rectangle with four black chevron symbols pointing to the right on a white background. No border shall be used on the Roundabout Directional Arrow signs.**

03 **Roundabout Directional Arrow signs shall be used only at roundabouts and other circular intersections.**

**Guidance:**

04 *When used on the central island of a roundabout, the mounting height of a Roundabout Directional Arrow sign should be at least 4 feet, measured vertically from the bottom of the sign to the elevation of the near edge of the traveled way.*

**Option:**

05 More than one Roundabout Directional Arrow sign and/or R6-4a or R6-4b signs may be used facing high-speed approaches, facing approaches with limited visibility, or in other circumstances as determined by engineering judgment where increased sign visibility would be appropriate.

**Section 2B.44 Roundabout Circulation Plaque (R6-5P)**

**Guidance:**

01 *Where the central island of a roundabout does not provide a reasonable place to install a sign, Roundabout Circulation (R6-5P) plaques (see Figure 2B-20) should be placed below the YIELD signs on each approach.*

**Option:**

02 At roundabouts where Roundabout Directional Arrow signs and/or ONE WAY signs have been installed in the central island, Roundabout Circulation plaques may be placed below the YIELD signs on approaches to roundabouts to supplement the central island signs.

03 The Roundabout Circulation plaque may be used at any type of circular intersection.

**Section 2B.45 Examples of Roundabout Signing**

**Support:**

01 Figures 2B-21 through 2B-23 illustrate examples of regulatory and warning signing for roundabouts of various configurations.

02 Section 2D.38 contains information regarding guide signing at roundabouts and Chapter 3C contains information regarding pavement markings at roundabouts.

## **Section 2B.46 Parking, Standing, and Stopping Signs (R7 and R8 Series)**

### Support:

<sup>01</sup> Signs governing the parking, stopping, and standing of vehicles cover a wide variety of regulations, and only general guidance can be provided here. ~~The word "standing" when used on the R7 and R8 series of signs refers to the practice of a driver keeping the vehicle in a stationary position while continuing to occupy the vehicle.~~ CVC Section 463 defines "parking", which involves the standing of a vehicle, whether occupied or not. However, the temporary loading or unloading of merchandise or passengers is not considered parking. CVC Section 587 defines "stopping", which involves the cessation of vehicle movement. Typical examples of parking, stopping, and ~~standing~~ loading signs and plaques (see ~~are shown in~~ Figures 2B-24, 2B-24(CA) and 2B-25.) are as follows:

- ~~1. NO PARKING ANY TIME (R7-1);~~
2. NO PARKING X:XX AM TO X:XX PM (R7-2, R7-2a);
- ~~3. NO PARKING EXCEPT SUNDAYS AND HOLIDAYS (R7-3);~~
- ~~4. NO STANDING ANY TIME (R7-4);~~
- ~~5. XX HOUR PARKING X:XX AM - X:XX PM (R7-5);~~
- ~~6. NO PARKING LOADING ZONE (R7-6);~~
7. NO PARKING BUS STOP (R7-7, R7-107, R7-107a);
- ~~8. RESERVED PARKING for persons with disabilities (R7-8);~~
- ~~9. VAN ACCESSIBLE (R7-8P);~~
10. Pay Station (R7-20);
11. Pay Parking (R7-21, R7-21a, R7-22);
- ~~12. Parking Permitted X:XX AM TO X:XX PM (R7-23);~~
- ~~13. Parking Permitted XX HOUR(S) XX AM - XX PM (R7-23a);~~
14. XX HR PARKING X:XX AM TO X:XX PM (R7-108);
- ~~15. NO PARKING ANYTIME/XX HOUR PARKING X:XX AM - X:XX PM (R7-200, R7-200a);~~
- ~~16. TOW AWAY ZONE (R7-201P, R7-201aP);~~
- ~~17. THIS SIDE OF SIGN (R7-202P);~~
18. EMERGENCY SNOW ROUTE NO PARKING IF OVER XX INCHES (R7-203);
- ~~19. NO PARKING ON PAVEMENT (R8-1);~~
- ~~20. NO PARKING EXCEPT ON SHOULDER (R8-2);~~
- ~~21. No Parking (R8-3, R8-3a);~~
- ~~22. EXCEPT SUNDAYS AND HOLIDAYS (R8-3bP);~~
- ~~23. ON PAVEMENT (R8-3cP);~~
- ~~24. ON BRIDGE (R8-3dP);~~
- ~~25. ON TRACKS (R8-3eP);~~
- ~~26. EXCEPT ON SHOULDER (R8-3fP);~~
- ~~27. LOADING ZONE (R8-3gP);~~
- ~~28. X:XX AM TO X:XX PM (R8-3hP);~~
29. EMERGENCY PARKING ONLY (R8-4);
- ~~30. NO STOPPING ON PAVEMENT (R8-5);~~
- ~~31. NO STOPPING EXCEPT ON SHOULDER (R8-6);~~ and
32. EMERGENCY STOPPING ONLY (R8-7).

<sup>02</sup> Refer to CVC 21112 through 22658 regarding the authorities for the various parking, stopping and loading signs.

### **Parking Regulations**

#### Option:

- <sup>03</sup> Parking on freeways which have full control of access and no crossing at grade may be prohibited under CVC 21960.
- <sup>04</sup> Parking on other State highways may be restricted or prohibited under CVC 22505 and 22506.

#### Support:

<sup>05</sup> The Caltrans District Director is authorized to issue orders prohibiting or restricting the parking of vehicles on State highways. The District Director is also authorized to approve ordinances or resolutions of local authorities prohibiting or restricting parking on State highways.

<sup>06</sup> The delegation of maintenance activities to local authorities is usually exercised under the authority of Streets and Highways Code Section 130. Under a proposal to delegate maintenance and parking regulation authority under CVC Section 22506, Caltrans retains the authority to regulate parking under the three conditions specified in CVC Section 22505(a). The District Director of Transportation is authorized to make this delegation of authority.

### **Policy on Parking Restrictions**

#### *Guidance:*

<sup>07</sup> *No Stopping Any Time* – Stopping should be prohibited at locations where the prohibition would reduce the risk of collisions or where parking would unduly interfere with the movement of traffic.

<sup>08</sup> *No Parking Anytime* – Parking should be prohibited at locations where the prohibition is necessary to accommodate other activities and objectives, such as street sweeping, snow removal, public safety or preferential parking.

#### *Option:*

<sup>09</sup> Major factors that may be considered for No Stopping Anytime include:

- Narrow roadway width.
- Restricted visibility at intersections for pedestrian and vehicular traffic.
- Narrow shoulder width.
- Conversion of a parking lane to a through lane or right-turn lane.

#### *Support:*

<sup>10</sup> Limited Time Parking - Caltrans does not issue orders for limited time parking.

#### *Option:*

<sup>11</sup> On State highways, limited time parking restrictions may be initiated by local authorities and approved by Caltrans. Parking prohibitions between certain hours may also be initiated by local authorities.

#### **Standard:**

<sup>12</sup> **Before time limit parking regulations are approved in rural areas, law enforcement agency shall be consulted.**

### **Special Signs**

#### *Option:*

<sup>13</sup> The OK TO PARK ON BRIDGE (R22(CA)) sign may be used to inform motorists that parking is permitted on a bridge. Refer to CVC 22500(k).

#### *Guidance:*

<sup>14</sup> *The PARK PARALLEL (R24(CA)) sign should only be used where diagonal parking is prevalent, in violation of CVC 22502.*

#### **Standard:**

<sup>15</sup> **The SCHOOL BUS ONLY w/ Double Arrow (R24A(CA)), TAXICAB ONLY w/ Double Arrow (R24B(CA)) and TOUR BUS ONLY w/ Double Arrow (R24C(CA)) signs shall be used to inform motorists of location of stands for use by school buses, taxicabs and tour buses, respectively. Refer to CVC 21112.**

<sup>16</sup> **The MAIL DEPOSIT ONLY w/ Double Arrow (R24D(CA)) sign shall be used to inform motorists of curb restrictions at locations for depositing mail in an adjacent mailbox. Refer to CVC 21458(a)(3)(B).**

<sup>17</sup> **The BLOCK WHEELS TO CURB (R24E(CA)) sign shall be used to inform motorists when parking on a hill to block the wheels of the vehicle by turning them against the curb, or by other means, when leaving it to stand unattended upon any grade exceeding 3 percent. Refer to CVC 22509.**

#### *Option:*

<sup>18</sup> The PARK OFF PAVEMENT (R25(CA)) sign may be used where it is likely that vehicles may stop on the traveled way and interfere with through traffic. It may also be used as a temporary sign in snow areas where parking is permitted.

#### **Standard:**

<sup>19</sup> **The LOADING ONLY 7AM TO 6PM EXCEPT SUNDAY 30 MINUTE LIMIT w/ Double Arrow (R25A(CA)) sign shall be used to inform motorists of curb restrictions at locations for loading or unloading passengers or freight for the time as specified by local ordinance. Refer to CVC 21458(a)(2).**

<sup>20</sup> **The following signs shall be used to inform motorists of curb restrictions at locations for loading or unloading of passengers for the time as specified by local ordinance. Refer to CVC 21458(a)(3)(A).**

- **Passenger Loading ONLY 5 MINUTE LIMIT w/ Double Arrow (R25B(CA)) sign**
- **PASSENGER LOADING ONLY 5 MINUTE LIMIT w/ Double Arrow (R25C(CA)) sign**

- **School Passenger Loading ONLY 7AM TO 4PM SCHOOL DAYS 5 MINUTE LIMIT w/ Double Arrow (R25D(CA)) sign**
- **PASSENGER LOADING ONLY 7AM TO 4PM SCHOOL DAYS 5 MINUTE LIMIT w/ Double Arrow (R25E(CA)) sign**
- **School Bus Passenger Loading ONLY w/ Double Arrow (R25F(CA)) sign**
- **Tour Bus Passenger Loading ONLY w/ Double Arrow (R25H(CA)) sign**

**21 The CAR SHARE PARKING ONLY PERMIT REQUIRED w/ Double Arrow (R25J(CA)) sign shall be used to designate certain streets or portions of streets for the exclusive parking privilege of vehicles participating in a car share vehicle program or ridesharing program. Refer to CVC 22507.1.**

Option:

**22 The NO PARKING ANY TIME with arrow (R28(CA)) or without arrow (R26(CA)) signs may be used to inform motorists of a parking prohibition at a specific location. The NO PARKING ANY TIME with arrow (R28A(CA)) or without arrow (R26A(CA)) signs may be used where a larger size is desirable.**

**23 CVC Section 21718 prohibits the stopping, parking or leaving of any vehicle upon a freeway. Large NO PARKING ANY TIME (R26(CA)) or EMERGENCY PARKING ONLY (R8-4) signs may be installed on freeways which have full control of access and no crossing at grade to inform traffic that stopping, parking or leaving of any vehicle upon a freeway is prohibited.**

**24 The Tow-Away No Parking (R26K(CA)) sign may be used to inform motorists of a parking prohibition and tow-away zone at a specific location.**

**25 The NO STOPPING FIRE LANE (R26F(CA)) sign may be used to inform motorists of a designated fire lane. Refer to CVC 22500.1.**

**Standard:**

**26 The NO STOPPING ANY TIME (R26(S)(CA)) sign or Tow-Away NO STOPPING ANY TIME (R26L(CA)) sign shall be used to inform motorists of a No Stopping Zone at a specific location where red curb marking is not used.**

**27 The Tow-Away NO STOPPING 4 TO 6 PM (R107(CA)) sign in a tow-away zone shall be used to inform motorists of a stopping restriction at a specific location during specific hours.**

**28 In zones where vehicles can be towed for violating the posted prohibition restriction, the "Tow-Away" message or symbol shall be used. Where the "Tow-Away" symbol is used in a 12-inch width format, it shall be as shown in the R26K(CA) sign. When it is used in an 18-inch width format, it shall be shown in the R107(CA) sign.**

Option:

**29 The NO STOPPING ANY TIME (R26A(S) (CA)) sign may be used where a larger size is desirable.**

**30 The NO PARKING ON BRIDGE (R27(CA)) sign may be used only where parking is prevalent in violation of CVC 22500(k). The NO PARKING ON BRIDGE (R27A(CA)) sign may be used where a larger size is desirable.**

**31 The NO STOPPING ANY TIME with arrow (R28(S)(CA)) sign may be used to inform motorists of no stopping zones. Use only where the beginning and ending points of the prohibition are not otherwise indicated. The NO STOPPING ANY TIME with arrow (R28A(S)(CA)) sign may be used where a larger size is desirable.**

**Standard:**

**32 The NO STOPPING BUS ONLY w/ Arrow (R28C(CA)) sign shall be used to inform motorists of no stopping zones at bus stops.**

**33 On State highways, the NO PARKING VEHICLES OVER 6' HIGH w/ Double Arrow (R28D(CA)) or NO STOPPING VEHICLES OVER 6' HIGH w/ Double Arrow (R28D(S)(CA)) sign shall be used to inform motorists of a parking or stopping prohibition, which applies only to vehicles 6 feet or more in height. Refer to CVC 22505.**

Option:

**34 The R28D(CA) or R28D(S)(CA)) sign may be installed within 100 feet of an intersection to improve the visibility of the motorists in accordance with CVC 22507, except where parking would obstruct the applicable sight distance as determined by a qualified engineer.**

**Standard:**

**35 The NO PUBLIC PARKING SUBJECT TO CITATION AND REMOVAL AT OWNER'S EXPENSE (R28E(CA)) sign shall be used to inform motorists of a parking prohibition on private property. Refer to CVC 22658.**

**36 The No Parking VEHICLES OVER 5 TONS (R28F(CA)) sign shall be used to inform motorists of a parking prohibition in a residential district for commercial vehicles having a manufacturer's gross vehicle weight rating of 5 tons or more. Refer to CVC 22507.5.**

**37 The No Stopping/No Parking Specific Hours (R29(CA)) sign shall be used to inform motorists of a stopping and parking prohibition during certain hours at a specific location.**

**38 The No Parking Specific Hours (R30(CA) and R30A(CA)) signs shall be used to inform motorists of a parking restriction during certain hours at a specific location.**

**39 The No Parking 10AM TO 12 PM WEDNESDAY STREET SWEEPING (R30B(CA)) sign shall be used to inform motorists of a parking prohibition for the purpose of street sweeping. Refer to CVC 22507.6.**

**40 The No Parking 2AM TO 6AM EXCEPT BY PERMIT (R30C(CA)) or No Parking 2AM TO 6 AM CITYWIDE EXCEPT BY PERMIT (R30D(CA)) sign shall be used to inform motorists of a parking prohibition between the hours of 2 a.m. and 6 a.m. Refer to CVC 22507.5.**

*Guidance:*

*41 When used, the R30D(CA) sign should be posted below the City Limit (G9-5(CA)) sign or downstream from a freeway off-ramp. Refer to CVC 22507.5.*

**Standard:**

**42 The No Parking w/Double Arrow (R30E(CA)) sign shall be used to inform motorists of a parking restriction at a specific location.**

**43 The No Stopping Specific Hours School Days (R30F(CA)) sign shall be used to inform motorists of a stopping prohibition during certain hours at a specific location in a school zone area.**

*Option:*

*44 The No Parking/Parking Specific Hours (R31(CA) and R32B(CA)) and No Stopping/Parking Specific Hours (R31(S)(CA)) signs may be used to inform motorists of a stopping/parking prohibition during certain hours and a parking time limit during other hours at a specific location. The R31(S)(CA) sign is used for stopping prohibitions, generally during peak traffic hours.*

*45 The Limited Hour/Minute Parking Specific Hours (R32(CA)) sign may be used to inform motorists of a parking time limit with specific hours and/or minutes during certain hours at a specific location.*

**Standard:**

**46 The 2 HOUR PARKING 8AM TO 6 PM DISTRICT 7 PERMITS EXEMPT (R32C(CA)) sign or 30 MINUTE PARKING 2AM TO 6 AM DISTRICT 3 PERMITS EXEMPT (R32D(CA)) sign shall be used to inform motorists of a parking time limit designation of certain streets upon which preferential parking privileges are given to residents and merchants adjacent to the streets for their use, under which the residents and merchants can be issued a permit or permits that exempt them from the prohibition or restriction. Refer to CVC 22507.**

**47 A combined 2 HOUR PARKING 8AM TO 4 PM – PASSENGER LOADING ONLY 4PM TO MIDNIGHT 5 MINUTE LIMIT w/ Double Arrow (R32E(CA)) sign shall be used to inform motorists of a parking time limit with specific hours and of curb restrictions at locations for loading or unloading of passengers for the time as specified by local ordinance. Refer to CVC 21458(a)(3)(A).**

**48 The 2 HOUR PARKING 8AM TO 6 PM MOTORCYCLE PARKING ONLY w/ Double Arrow (R32F(CA)) sign shall be used to inform motorists of a parking time limit with specific hours for motorcycles. Refer to CVC 22503.5.**

*Option:*

*49 The Tow-Away No Stopping/No Parking Specific Hours (R37(CA)) sign may be used to inform motorists of no stopping and parking prohibitions and tow-away zone at a specific location.*

*50 The Tow-Away No Parking/Limited Hour Parking Specific Hours (R38(CA)) sign may be used to inform motorists of a parking restriction and tow-away zone at a specific location.*

*51 The Tow-Away No Stopping/Limited Hour Parking Specific Hours (R38(S)(CA)) sign may be used for stopping prohibitions, generally during peak hours.*

**Support**

**52 Local agencies are allowed to adopt, by resolution or ordinance, the restriction of parking and the impounding of vehicles for sale, subject to the requirements of CVC Section 22651.9. Under these requirements, a vehicle can be impounded if a parking violation was received within the last 30 days and a warning was issued.**



Option:

<sup>53</sup> The No Parking of Vehicles for Sale (R108(CA)) signs may be posted to inform motorists that the parking of vehicles for sale is prohibited and that vehicles may be impounded, as prescribed in CVC Section 22651.9, and as authorized by a local ordinance or resolution.

Guidance:

<sup>54</sup> If used, the applicable municipal code or county code should be shown on the R108(CA) signs to assist enforcement personnel in identifying the appropriate parking infraction, due to the special requirements prescribed in CVC Section 22651.9.

Standard:

<sup>55</sup> **The combined TOW-AWAY NO STOPPING 7AM TO 9 AM - PASSENGER LOADING ONLY ALL OTHER TIMES 5 MINUTE LIMIT w/ Double Arrow (R38A(CA)) sign shall be used to inform motorists of no stopping and parking prohibitions and tow-away zone at a specific location during specific hours and of curb restrictions at locations for loading or unloading of passengers for the time as specified by local ordinance. Refer to CVC 21458(a)(3)(A).**

Option:

<sup>56</sup> The NO PARKING OF COMMERCIAL VEHICLES EXCEPT BY PERMIT (R39(CA)) sign may be used on any roadway in which local ordinance or resolution per CVC Section 22505 and 22507 has been established to prohibit parking of commercial vehicles.

Standard:

<sup>57</sup> **If used, the R39(CA) sign shall be used to identify only those street or highway locations, either State or local, upon which parking of commercial vehicles is prohibited, except by permit, as established by the local ordinance or resolution.**

<sup>58</sup> **The NO DOUBLE PARKING ANYTIME COMMERCIAL VEHICLES INCLUDED (R39-1(CA) or R39-2(CA)) sign shall be used to inform motorists of a parking prohibition in a business district for commercial vehicles where a local agency has adopted an ordinance per CVC 22502(c).**

Option:

<sup>59</sup> The NO IDLING COMMERCIAL VEHICLES AND ALL BUSES SR62(CA) or NO IDLING All Buses and Commercial Vehicles SR63(CA) symbol sign may be placed to remind commercial vehicle operators that idling is prohibited for commercial vehicles and all buses for a duration greater than 5 minutes.

Support:

<sup>60</sup> Refer to California Code of Regulations, Title 13, Division 3, Chapter 10, Article 1, Sections 2480 and 2485 which prohibits unnecessary idling of commercial vehicles and all buses.

Standard:

<sup>61</sup> **If used, the NO IDLING COMMERCIAL VEHICLES AND ALL BUSES (SR62(CA)) sign or NO IDLING All Buses and Commercial Vehicles (SR63(CA)) symbol sign shall be placed in areas where idling commonly occurs.**

Support:

<sup>62</sup> **CCR Title 13, Sections 2480 and 2485, of the California Code of Regulations prohibit unnecessary idling of commercial vehicles and all buses for a duration greater than 5 minutes. The sign locations will be determined by Air Resources Board representatives and officials of the law enforcement agency responsible for enforcement and the jurisdiction who owns the roadway will install the signs.**

<sup>63</sup> **The Accessible Parking Only (R99(CA)) sign in combination with MINIMUM FINE \$250 (R99B(CA)) plaque; or, Accessible Parking Only Minimum Fine \$250 (R99C(CA)) sign shall be used in on-street and off-street parking facilities to designate stalls for vehicles with a special identification license plate or a distinguishing placard for persons with disabilities.**

Support:

<sup>64</sup> The R99(CA) sign in combination with the R99B(CA) plaque; or, R99C(CA) sign, blue pavement markings and International Symbol of Accessibility Marking, are required for enforcement of these parking areas. Refer to CVC 22511.7 and 22511.8.

Standard:

<sup>65</sup> **The VAN ACCESSIBLE (R7-8b) sign shall be mounted below the Accessible Parking Only (R99(CA)) sign in combination with MINIMUM FINE \$250 (R99B(CA)) plaque; or, Accessible Parking Only Minimum Fine \$250 (R99C(CA))**

**sign of the parking space for persons with disabilities designated as the van accessible space as provided in the California Building Code Section 1129B.**

**Option:**

<sup>66</sup> The TOW-AWAY SPECIAL PLACARD OR LICENSE PLATE REQUIRED (R100A(CA)) sign may be used with the R99(CA) sign in combination with the R99B(CA) plaque; or, R99C(CA) sign to inform motorists that their vehicle will be towed away if they do not have a special identification license plate or a distinguishing placard for persons with disabilities.

**Standard:**

<sup>67</sup> **The Disabled Tow-Away (R100B(CA)) sign shall be placed immediately adjacent to, and visible from, the stall or space, or at each entrance to an off street parking facility to inform motorists that their vehicle will be towed away if they park in designated stalls or spaces without a special identification license plate or a distinguishing placard for persons with disabilities. The sign shall include the address where the towed vehicle can be reclaimed and the telephone number of the local traffic law enforcement agency. Refer to CVC 22511.8 and 22511.9.**

**Option:**

<sup>68</sup> The DISPLAY OF VEHICLES FOR SALE PROHIBITED (SR26(CA)) sign may be used on any roadway in which local ordinance or resolution per Streets and Highway Code, Section 731 has been established to prohibit the display of vehicles for sale.

**Standard:**

<sup>69</sup> **If used, the SR26 (CA) sign shall be used to identify only those street or highway locations, either State or local, upon which display of vehicles for sale is prohibited, as established by the local ordinance or resolution.**

**Option:**

<sup>70</sup> The TOW-AWAY NO PARKING WHEN SNOW REMOVAL CONDITIONS EXIST (SR49(CA)) sign may be used to prohibit or restrict the parking or standing of vehicles on designated streets or highways, or portions thereof, for the purpose of snow removal. Refer to CVC 22510.

**Guidance:**

<sup>71</sup> *The SNOW NOT REMOVED BEYOND HERE (SR20-1(CA)) sign should be erected at the beginning of the snow season and removed in the spring when the road is opened. The SR20-1(CA) sign should be placed at a location that will provide a motorist the opportunity to turn around.*

**Option:**

<sup>72</sup> The CHAIN INSTALLATION ONLY (R74(CA)) sign may be erected where parked vehicles interfere with normal winter operations.

**Guidance:**

<sup>73</sup> *The R74(CA) sign should be turned or covered at the end of the chain requirement season.*

**Standard:**

<sup>74</sup> **The CHAINS REQUIRED (X MILE (X MILES)) AHEAD (R75(CA)) sign shall be used to give advance notice that chains are required ahead.**

<sup>75</sup> **The CHAINS REQUIRED (R76(CA)) sign shall be used at the beginning of chain control areas and intermittently as needed.**

**Support:**

<sup>76</sup> The R76(CA) sign is installed in combination with the Speed Limit (R2-1), R79(CA) and R80(CA) signs.

**Option:**

<sup>77</sup> The ON SINGLE AXLE DRIVE VEHICLE WITH TRAILER (R76-1(CA)) sign may be used when road conditions are such that only single drive vehicles with trailers need chains.

**Standard:**

<sup>78</sup> **When used, the R76-1(CA) sign shall be mounted below the CHAINS REQUIRED (R76(CA)) sign.**

<sup>79</sup> **The NO EXCEPTIONS (R77(CA)) sign shall be used with the Speed Limit (R2-1) and CHAINS REQUIRED (R76(CA)) signs when chains are required with no exceptions.**

<sup>80</sup> **The END CHAIN CONTROL (R78(CA)) sign shall be used to advise the motorist that the chain control area has ended.**

<sup>81</sup> The AUTOS & PICKUPS SNOW TIRES OK – CARRY CHAINS (R79(CA)) sign shall be used with the Speed Limit (R2-1) and CHAINS REQUIRED (R76(CA)) signs when chains are required but autos and pickups with snow tires are excepted from using chains.

<sup>82</sup> The 4-W DRIVE WITH SNOW TIRES OK – CARRY CHAINS (R80-1(CA)) sign shall be used with the Speed Limit (R2-1) and CHAINS REQUIRED (R76(CA)) signs when chains are required.

Support:

<sup>83</sup> Vehicles with four wheel drive and snow tires on all four wheels are exempt from using chains.

### Electric Vehicle Charging Station Signs

Standard:

<sup>84</sup> If used, the Electric Vehicle Charging Station Tow-Away (R112(CA)) sign (see Figure 2B-24(CA)) shall be placed immediately adjacent to, and visible from, the charging station stall or space, or at each entrance to an off-street parking facility to inform motorists that their vehicles will be towed away if parked in designated stalls or spaces without being connected for electric charging purposes. The sign shall include the address where the towed vehicle can be reclaimed and the telephone number of the local traffic law enforcement agency. Refer to CVC 22511.

Option:

<sup>85</sup> Local agencies may, at their discretion, include CVC Section 22511 or local municipal code section, or ordinance number on the Electric Vehicle Charging Station Tow-Away R112(CA) sign.

Standard:

<sup>86</sup> If used, the No Parking (symbol) EXCEPT FOR EV CHARGING (R113(CA)), or the No Parking (symbol) EXCEPT FOR ELECTRIC VEHICLE CHARGING (R113A(CA)) sign (see Figure 2B-24(CA)) shall be placed immediately adjacent to, and visible from, each charging station stall or space.

<sup>87</sup> If used, the \_\_ HOUR EV CHARGING \_\_ AM TO \_\_ PM (R114(CA)), or the \_\_ HOUR ELECTRIC VEHICLE CHARGING \_\_ AM TO \_\_ PM (R114A(CA)) sign (see Figure 2B-24(CA)) shall be placed immediately adjacent to, and visible from, each charging station stall or space to identify the allowable time limit where electric vehicles may be connected, depending upon what time limitations for charging apply to each charging station.

<sup>88</sup> Identification signs and surface markings shall be placed for Van Accessible, Standard Accessible and Ambulatory electric vehicle charging stations, as required by Chapter 11B of the California Building Code. The International Symbol of Accessibility for the Handicapped (D9-6) sign in combination with the VAN ACCESSIBLE (R7-8b) sub plaque shall be placed at Van Accessible electric vehicle charging stations, or, the D9-6 sign shall be placed at standard accessible electric vehicle charging stations (see CBC 11B-812.8; and, Section 3B.20 for surface markings).

Option:

<sup>89</sup> The Rest Area/Vista Point 8 HOUR PARKING (S23(CA)) sign may be used to discourage extended stays in roadside rests or vista points for noncommercial vehicles. The 10 HOUR PARKING COMMERCIAL MOTOR VEHICLES (R39-3(CA)) may be used to allow ten total hours of parking for commercial vehicles. See CVC 22651(s)1 and CVC 22651(s)2.

### Section 2B.47 Design of Parking, Standing, and Stopping Signs

Support:

<sup>01</sup> Discussions of parking signs and parking regulations in this Section apply not only to parking, but also to ~~standing~~ loading and stopping.

Standard:

<sup>02</sup> The legend on parking signs shall state applicable regulations. Parking signs (see Figures 2B-24 and 2B-25) shall comply with the standards of shape, color, and location.

<sup>03</sup> The colors in parking signs shall conform to their associated curb zone colors. Where parking is prohibited at all times or at specific times, the basic design for parking signs shall have a red legend and border on a white background (Parking Prohibition signs), except that the R8-4 and R8-7 signs and the alternate design for the ~~R7-201aP~~ R7-201P plaque shall have a black legend and border on a white background, ~~and the R8-3 sign shall have a black legend and border and a red circle and slash on a white background.~~ Where an exclusive zone is established for passenger loading or mail deposit, the signs shall have a black legend on a white background. Where an exclusive zone is established for freight or passenger loading, the signs shall have a black

**legend on a yellow background. Where an exclusive zone is established for disabled persons, the signs shall have a white legend on a blue background, as shown on the R99(CA) sign.**

**04 Where only limited-time parking or parking in a particular manner are permitted, the signs shall have a green legend and border on a white background (Permissive Parking signs).**

*Guidance:*

05 *Parking signs should display the following information from top to bottom of the sign, in the order listed:*

- A. Any tow-away message or symbol.
- ~~A.~~ B. The restriction or prohibition;
- ~~B.~~ C. The times of the day that it is applicable, if not at all hours; and
- ~~C.~~ D. The days of the week that it is applicable, if not every day.
- E. Qualifying or supplementary information.
- F. Exemptions to the restriction or prohibition.
- G. The appropriate municipal or county code on selected signs, when deemed necessary in order to aid enforcement personnel in identifying the appropriate infraction.
- H. The phone number to call to recover an impounded or towed vehicle.

06 *If the parking restriction applies to a limited area or zone, the limits of the restriction should be shown by arrows ~~or supplemental plaques~~. If arrows are used and if the sign is at the end of a parking zone, there should be either no arrows or a single-headed arrow pointing in the direction that the regulation is in effect. If the sign is at an intermediate point in a zone, there should be a double-headed arrow pointing both ways. When a single sign is used at the transition point between two parking zones, it should display a right and left arrow pointing in the direction that the respective restrictions apply.*

07 *Where special parking restrictions are imposed during heavy snowfall, Emergency Snow Route (R7-203) signs (see Figure 2B-24) should be installed. The legend will vary according to the regulations, but the signs should be vertical rectangles, having a white background with the upper part of the plate a red background.*

**Standard:**

08 **Where parking spaces that are reserved for persons with disabilities are designated to accommodate wheelchair vans, a VAN ACCESSIBLE (R7-8P R7-8b) plaque shall be mounted below the R7-8 R99(CA) sign. The R7-8 R99(CA) sign (see Figure 2B-24 2B-24(CA)) shall have a green blue legend and border and a white wheelchair symbol on a blue square, all on a white background. The R7-8P R7-8b plaque (see Figure 2B-24 2B-24(CA)) shall have a green blue legend and border on a white background. Refer to California Code of Regulations Title 24, Section 1129B.4.**

*Option:*

09 *To minimize the number of parking signs, blanket regulations that apply to a given district may, if legal, be posted at district boundary lines.*

~~10 *As an alternate to the use of arrows to show designated restriction zones, word messages such as BEGIN, END, HERE TO CORNER, HERE TO ALLEY, THIS SIDE OF SIGN, or BETWEEN SIGNS may be used.*~~

11 *Where parking is prohibited during certain hours and time-limited parking or parking in a particular manner is permitted during certain other time periods, the red Parking Prohibition and green Permissive Parking signs may be designed as follows:*

- A. Two 12 x 18-inch parking signs may be used with the red Parking Prohibition sign installed above or to the left of the green Permissive Parking sign; or
- ~~B. The red Parking Prohibition sign and the green Permissive Parking sign may be combined (see Figure 2B-24) to form an R7-200 sign on a single 24 x 18-inch sign, or an R7-200a sign on a single 12 x 30-inch sign.~~

12 *At the transition point between two parking zones, a single sign or two signs mounted side by side may be used.*

12a *On any sign, the words "Tow-Away" may be used interchangeably with the Tow-Away symbol.*

13 *On any sign, the words NO PARKING may be used as an alternative to the No Parking symbol. The supplemental educational plaque, NO PARKING, with a red legend and border on a white background, may be used above signs incorporating the No Parking symbol.*

14 *Alternate designs for the R7-107 sign may be developed such as the R7-107a sign (see Figure 2B-24). Alternate designs may include, on a single sign, a transit logo, an approved bus symbol, a parking prohibition, the words BUS STOP, and an arrow. The preferred bus symbol color is black, but other dark colors may be used.*

Additionally, the transit logo may be displayed on the bus face in the appropriate colors instead of placing the logo separately. The reverse side of the sign may contain bus routing information.

~~15 To make the parking regulations more effective and to improve public relations by giving a definite warning, a TOW AWAY ZONE (R7-201P) plaque (see Figure 2B-24) may be appended to, or incorporated in, any parking prohibition sign. The Tow Away Zone (R7-201aP) symbol plaque may be used instead of the R7-201P word message plaque. The R7-201aP plaque may have either a black or red legend and border on a white background.~~

*Guidance:*

~~16 If a fee is charged for parking and a midblock pay station is used instead of individual parking meters for each parking space, pay parking signs should be used. Pay Parking (R7-22) signs~~ **The R7-108 and PAY AT STATION (R109(CA)) Plaque** (see Figure 2B-24) should be used to define the area where the pay station parking applies. ~~Pay Station (R7-20) signs (see Figure 2B-24) should be used at the pay station or to direct road users to the pay station.~~

**Standard:**

**17 If the pay parking is subject to a maximum time limit, the appropriate time limit (number of hours or minutes) shall be displayed on the Pay Parking (R7-21 or R7-21a) and Pay Station (R7-20) signs.**

*Option:*

~~18 In rural areas (see Figure 2B-25), the legends NO PARKING ON PAVEMENT (R8-1) or NO STOPPING ON PAVEMENT (R8-5) are generally suitable and may be used. If a roadway has paved shoulders, the NO PARKING EXCEPT ON SHOULDER sign (R8-2) or the NO STOPPING EXCEPT ON SHOULDER sign (R8-6) may be used as these signs would be less likely to cause confusion. The R8-3 symbol sign or the word message NO PARKING (R8-3a) sign may be used to prohibit any parking along a given highway. Word message supplemental plaques may be mounted below the R8-3 or R8-3a sign. These word message supplemental plaques may include legends such as EXCEPT SUNDAYS AND HOLIDAYS (R8-3bP), ON PAVEMENT (R8-3cP), ON BRIDGE (R8-3dP), ON TRACKS (R8-3eP), EXCEPT ON SHOULDERS (R8-3fP), LOADING ZONE (with arrow) (R8-3gP), and X:XX AM TO X:XX PM (with arrow) (R8-3hP).~~

~~19 Colors that are in compliance with the provisions of Section 2A.10 may be used for color coding of parking time limits.~~

*Guidance:*

~~20 If colors are used for color coding of parking time limits, the colors green, red, and black should be the only colors that are used.~~

## **Section 2B.48 Placement of Parking, Stopping, and Standing Signs**

*Guidance:*

~~01 When signs with arrows are used to indicate the extent of the restricted zones, the signs should be set at an angle of not less than 30 degrees or more than 45 degrees with the line of traffic flow in order to be visible to approaching traffic.~~

~~02 Spacing of signs should be based on legibility (see Section 2A.13) and sign orientation (see Section 2A.20).~~

~~03 If the zone is unusually long, signs showing a double arrow should be used at intermediate points within the zone.~~

**Standard:**

**04 If the signs are mounted at an angle of 90 degrees to the curb line, two signs shall be mounted back to back at the transition point between two parking zones, ~~each with an appended THIS SIDE OF SIGN (R7-202P) supplemental plaque.~~**

*Guidance:*

~~05 If the signs are mounted at an angle of 90 degrees to the curb line, signs without any arrows or appended plaques should be used at intermediate points within a parking zone, facing in the direction of approaching traffic. Otherwise the standards of placement should be the same as for signs using directional arrows.~~

## **Section 2B.49 Emergency Restriction Signs (R8-4, R8-7, R8-8)**

*Option:*

~~01 The EMERGENCY PARKING ONLY (R8-4) sign (see Figure 2B-25) or the EMERGENCY STOPPING ONLY (R8-7) sign (see Figure 2B-25) may be used to discourage or prohibit shoulder parking, particularly where scenic or other attractions create a tendency for road users to stop temporarily.~~

*Guidance:*

*02 The DO NOT STOP ON TRACKS (R8-8) sign (see Figure 8B-1) ~~may~~ should be used to discourage or prohibit parking or stopping on railroad or light rail transit tracks (see Section 8B.09).*

**Standard:**

*03 Emergency Restriction signs shall be rectangular and shall have a red or black legend and border on a white background.*

*04 The EMERGENCY PARKING ONLY (R8-4) sign shall be used at the beginning of freeways below the BEGIN FREEWAY (R57(CA)) sign. Refer to CVC 21960.*

*05 The BEGIN FREEWAY (R57(CA)) sign (see Figure 2B-25(CA)) shall be used to mark the beginning of a section of freeway on which parking is prohibited.*

**Support:**

*06 Position the R57(CA) sign above the EMERGENCY PARKING ONLY (R8-4) sign. Refer to CVC 21960.*

**Standard:**

*07 The END FREEWAY (R58(CA)) sign (see Figure 2B-25(CA)) shall be used to mark the end of a freeway.*

**Section 2B.50 WALK ON LEFT FACING TRAFFIC and No Hitchhiking Signs (R9-1, R9-4, R9-4a)**

**Option:**

*01 The WALK ON LEFT FACING TRAFFIC (R9-1) sign (see Figure 2B-26) may be used on highways where no sidewalks are provided.*

**Standard:**

*02 If used, the WALK ON LEFT FACING TRAFFIC sign shall be installed on the right-hand side of the road where pedestrians walk on the pavement or shoulder in the absence of pedestrian pathways or sidewalks.*

**Option:**

*03 The No Hitchhiking (R9-4) sign (see Figure 2B-26) may be used to prohibit standing in or adjacent to the roadway for the purpose of soliciting a ride. The R9-4a word message sign (see Figure 2B-26) may be used as an alternate to the R9-4 symbol sign.*

**Section 2B.51 Pedestrian Crossing Signs (R9-2, R9-3)**

**Option:**

*01 Pedestrian Crossing signs (see Figure 2B-26) may be used to limit pedestrian crossing to specific locations.*

**Standard:**

*02 If used, Pedestrian Crossing signs shall be installed to face pedestrian approaches.*

**Option:**

*03 Where crosswalks are clearly defined, the CROSS ONLY AT CROSSWALKS (R9-2) sign may be used to prohibit pedestrians from crossing at locations away from crosswalks.*

*04 The No Pedestrian Crossing (R9-3) sign may be used to prohibit pedestrians from crossing a roadway at an undesirable location or in front of a school or other public building where a crossing is not designated.*

*05 The NO PEDESTRIAN CROSSING (R9-3a) word message sign may be used as an alternate to the R9-3 symbol sign. The USE CROSSWALK (R9-3bP) supplemental plaque, along with an arrow, may be installed below either sign to designate the direction of the crossing. The NO PED CROSSING - USE CROSSWALK (R49(CA)) Sign may be used as an alternate to the combined R9-3 and R9-3b signs.*

**Support:**

*06 One of the most frequent uses of the Pedestrian Crossing signs is at signalized intersections that have three crossings that can be used and one leg that cannot be crossed.*

**Guidance:**

*07 The R9-3bP plaque should not be installed in combination with educational plaques.*

**Support:**

*08 Refer to CVC 21106.*

**Section 2B.52 Traffic Signal Pedestrian and Bicycle Actuation Signs (R10-1 through R10-4, and R10-24 through R10-26)**

**Standard:**

**01 Traffic Signal signs applicable to pedestrian actuation (see Figure 2B-26) or bicyclist actuation (see Figure 9B-2) shall be mounted immediately above or incorporated into the pushbutton detector units (see Section 4E.08).**

Support:

02 Traffic Signal signs applicable to pedestrians include:

- A. CROSS ONLY ON GREEN (symbolic circular green) (R10-1);
- B. CROSS ONLY ON (symbolic walk indication) SIGNAL (R10-2);
- C. Push Button for Walk Signal (R10-3 series); and
- D. Push Button for Green Signal (R10-4 series).

Option:

03 The following signs may be used as an alternate for the R10-3 and R10-4 signs:

- A. Push Button to Cross Street Wait for Walk Signal (R10-3a); or
- B. Push Button to Cross Street Wait for Green Signal (R10-4a).

04 The name of the street to be crossed may be substituted for the word STREET in the legends on the R10-3a and R10-4a signs.

Guidance:

05 *The finger in the pushbutton symbol on the R10-3, R10-3a, R10-4, and R10-4a signs should point in the same direction as the arrow on the sign.*

Option:

06 Where symbol-type pedestrian signal indications are used, an educational sign (R10-3b) may be used instead of the R10-3 sign to improve pedestrian understanding of pedestrian indications at signalized intersections. Where word-type pedestrian signal indications are being retained for the remainder of their useful service life, the legends WALK/ DONT WALK may be substituted for the symbols on the educational sign R10-3b, thus creating educational sign R10-3c. The R10-3d educational sign may be used to inform pedestrians that the pedestrian clearance time is sufficient only for the pedestrian to cross to the median at locations where pedestrians cross in two stages using a median refuge island. The R10-3e educational sign may be used where countdown pedestrian signals have been provided. In order to assist the pedestrian in understanding which pushbutton to push, the R10-3f to R10-3i educational signs that provide the name of the street to be crossed may be used instead of the R10-3b to R10-3e educational signs.

Support

06a Pedestrian pushbuttons are used to actuate pedestrian signal timing, to activate accessible pedestrian signals or both. See Section 4E.09 regarding the application of accessible pedestrian signals and detectors.

Standard

06b **The bottom panels of signs R10-3b through R10-3i shall be eliminated where the pedestrian signal timing is non-actuated and the pedestrian push button is used solely to activate accessible pedestrian signals.**

Option:

07 The R10-24 or R10-26 sign (see Section 9B.11) may be used where a pushbutton detector has been installed exclusively to actuate a green phase for bicyclists.

08 The R10-25 sign (see Figure 2B-26) may be used where a pushbutton detector has been installed for pedestrians to activate In-Roadway Warning Lights (see Chapter 4N) or flashing beacons that have been added to the pedestrian warning signs.

Support:

09 Section 4E.08 contains information regarding the application of the R10-32P plaque.

Standard:

10 **The PUSH BUTTON FOR PEDESTRIAN WARNING LIGHTS – CROSS WITH CAUTION (R62E(CA)) sign (see Figure 2B-26(CA)) shall be mounted immediately above or incorporated in the pedestrian push button unit where In Roadway Warning Lights are installed and a pedestrian actuated system is used.**

## **Section 2B.53 Traffic Signal Signs (R10-5 through R10-30)**

Option:

01 To supplement traffic signal control, Traffic Signal signs R10-5 through R10-30 may be used to regulate road users.

02 Traffic Signal signs (see Figure 2B-27) may be installed at certain locations to clarify signal control. Among the legends that may be used for this purpose are LEFT ON GREEN ARROW ONLY (R10-5), STOP HERE ON RED (R10-6 ~~or R10-6a~~) for observance of stop lines, DO NOT BLOCK INTERSECTION (R10-7) for avoidance of traffic obstructions, USE LANE(S) WITH GREEN ARROW (R10-8) for obedience to lane-use control signals (see Chapter 4M), LEFT TURN YIELD ON GREEN (symbolic circular green) (R10-12), ~~and LEFT TURN YIELD ON FLASHING RED ARROW AFTER STOP (R10-27).~~

**Support:**

02a Refer to CVC 22526 for the DO NOT BLOCK INTERSECTION (R10-7) sign.

**Option:**

02b Where practical, an additional LEFT TURN YIELD ON GREEN (symbolic green ball) (R10-12) sign ((i.e., in addition to the R10-12 sign adjacent to the signal face) along with an AT SIGNAL (R73-9(CA)) supplemental plaque (see Figure 2B-27(CA)) may be used on the approach to the signalized intersection.

**Guidance:**

02c *If used, the location of this additional R10-12 sign should be in the raised median at the beginning of the left-turn lane, or be based upon Table 2C-4, or as per engineering judgment.*

03 *If used, the LEFT ON GREEN ARROW ONLY (R10-5) sign, the LEFT TURN YIELD ON GREEN (symbolic circular green) (R10-12) sign, ~~or the LEFT TURN YIELD ON FLASHING RED ARROW AFTER STOP (R10-27) sign~~ should be located adjacent to the left-turn signal face.*

**Option:**

04 If needed for additional emphasis, an additional LEFT TURN YIELD ON GREEN (symbolic circular green) (R10-12) sign with an AT SIGNAL (R10-31P) supplemental plaque (see Figure 2B-27) may be installed in advance of the intersection.

04a The LEFT TURN ON GREEN ARROW ONLY – NO U TURN (SR39A(CA)) sign (see Figure 2B-27(CA)) may be used at signalized intersections with separate left turn phases to inform traffic that left turns can only be made on a green arrow in accordance with CVC 21454 and “U” turns are prohibited.

04b The LEFT OR U TURN ON GREEN ARROW ONLY (SR39A(U)(CA)) sign (see Figure 2B-27(CA)) may be used at signalized intersections with separate left turn phases to inform traffic that left turns and “U” turns can only be made on a green arrow in accordance with CVC 21454.

05 In situations where traffic control signals are coordinated for progressive timing, the Traffic Signal Speed (I1-1) sign may be used (see Section 2H.03).

**Standard:**

06 **The CROSSWALK STOP ON RED (symbolic circular red) (R10-23) sign (see Figure 2B-27) shall only be used in conjunction with pedestrian hybrid beacons (see Section 4F.02).**

07 **The EMERGENCY SIGNAL (R10-13) sign (see Figure 2B-27) shall be used in conjunction with emergency-vehicle traffic control signals (see Section 4G.02).**

08 **The EMERGENCY SIGNAL—STOP ON FLASHING RED (R10-14 or R10-14a) sign (see Figure 2B-27) shall be used in conjunction with emergency-vehicle hybrid beacons (see Section 4G.04).**

**Option:**

09 In order to remind drivers who are making turns to yield to pedestrians, a Turning Vehicles Yield to Pedestrians (R10-15) sign (see Figure 2B-27) may be used.

~~10 A U-TURN YIELD TO RIGHT TURN (R10-16) sign (see Figure 2B-27) may be installed near the left turn signal face if U-turns are allowed on a protected left turn movement on an approach from which a right turn GREEN ARROW signal indication is simultaneously being displayed to drivers making a right turn from the conflicting approach to their left.~~

**Guidance:**

~~11 *The U-TURN YIELD TO RIGHT TURN (R10-16) sign is deleted as this condition should not be practiced. The actual movement conflict should be eliminated rather than try to correct it with this sign.*~~

## **Section 2B.54 No Turn on Red Signs (R10-11 Series, R10-17a, and R10-30)**

**Standard:**



**01 Where a right turn on red (or a left turn on red from a one-way street to a one-way street) is to be prohibited, a symbolic NO TURN ON RED (symbolic circular red) (R10-11) sign (see Figure 2B-27) or No Right Turn on Red (R13A(CA)) or No Left Turn on Red (R13B(CA)) signs (see Figure 2B-27(CA)) a NO TURN ON RED (R10-11a, R10-11b) word message sign (see Figure 2B-27) shall be used.**

Support:

01a Refer to CVC 22101 for the No Turn on Red (R10-11 Series and R13A(CA) and R13B(CA)) signs.

Guidance:

02 If used, the No Turn on Red (R10-11, R13A(CA) or R13B(CA)) sign should be installed near the appropriate signal head.

03 A No Turn on Red (R10-11, R13A(CA) or R13B(CA)) sign should be considered when an engineering study finds that one or more of the following conditions exists:

A. Inadequate sight distance to vehicles approaching from the left (or right, if applicable);

B. Geometrics or operational characteristics of the intersection that might result in unexpected conflicts;

C. An exclusive pedestrian phase;

D. An unacceptable number of pedestrian conflicts with right-turn-on-red maneuvers, especially involving children, older pedestrians, or persons with disabilities;

E. More than three right turn on red accidents reported in a 12-month period for the particular approach; or

F. The skew angle of the intersecting roadways creates difficulty for drivers to see traffic approaching from their left.

03a No Right Turn on Red (R13A(CA)) sign or No Left Turn on Red (R13B(CA)) sign (see Figure 2B-27(CA)) should be used on the near right of skewed intersections where the adjacent approach leg to the left intersects the road user's approach leg at an angle of less than 75 degrees.

Option:

03b No Right Turn on Red (R13A(CA)) sign or No Left Turn on Red (R13B(CA)) sign (see Figure 2B-27(CA)) may be used on the near right of extremely wide intersections.

Guidance:

03c When used, the No Right Turn on Red (R13A(CA)) sign should be placed where it will most easily be seen by the road user intending to turn. At least one should be placed overhead, or at a right-hand corner facing approaching traffic.

03d When used, the No Left Turn on Red (R13B(CA)) sign should be placed where it will most easily be seen by the road user intending to turn. At least one should be placed overhead, or at a left-hand corner facing approaching traffic.

Option:

04 A supplemental R10-20aP plaque (see Figure 2B-27) showing times of day (similar to the S4-1P plaque shown in Figure 7B-1) with a black legend and border on a white background may be mounted below a No Turn on Red (R10-11, R13A(CA) or R13B(CA)) sign to indicate that the restriction is in place only during certain times.

05 Alternatively, a an Activated Blank-Out-blank-out sign may be used instead of a static NO TURN ON RED (symbolic circular red) (R10-11) sign, to display either the NO TURN ON RED legend or the No Right Turn symbol or word message, as appropriate, only at certain times during the day or during one or more portion(s) of a particular cycle of the traffic signal.

06 On signalized approaches with more than one right-turn lane, a NO TURN ON RED EXCEPT FROM RIGHT LANE (R10-11c) sign (see Figure 2B-27) may be post-mounted at the intersection or a NO TURN ON RED FROM THIS LANE (with down arrow) (R10-11d) sign (see Figure 2B-27) may be mounted directly over the center of the lane from which turns on red are prohibited.

Guidance:

07 ~~Where turns on red are permitted and the signal indication is a steady RED ARROW, the RIGHT (LEFT) ON RED ARROW AFTER STOP (R10-17a) sign (see Figure 2B-27) should be installed adjacent to the RED ARROW signal indication. A circular red signal face should be used, instead of correcting the condition with this sign.~~

Support:

07a The RIGHT (LEFT) ON RED ARROW AFTER STOP (R10-17a) sign is deleted as it compromises the meaning of the right red arrow.

Option:

08 A RIGHT TURN ON RED MUST YIELD TO U-TURN (R10-30) sign (see Figure 2B-27) may be installed to remind road users that they must yield to conflicting u-turn traffic on the street or highway onto which they are turning right on a red signal after stopping.

### **Section 2B.55 Photo Enforced Signs and Plaques (R10-18, R10-19P, R10-19aP)**

#### **Standard:**

00 A Traffic Signal PHOTO ENFORCED (SR56(CA)) sign shall be posted within 200 feet of a traffic signal on the approaches where the automated traffic enforcement system is being utilized to issue citations. See Figure 2B-3(CA). Refer to CVC 21455.5.

#### **Option:**

01 ~~A TRAFFIC LAWS PHOTO ENFORCED (R10-18) or sign (see Figure 2B-3) may be installed at a jurisdictional boundary to advise road users that some of the traffic regulations within that jurisdiction are being enforced by photographic equipment.~~

01a The RED LIGHT VIOLATION \$ \_\_\_ FINE (SR58(CA)) sign (see Figure 2B-3(CA)) may be used in advance of signalized intersections where a local agency has adopted an ordinance setting a specific fine amount for red light violations within its jurisdiction. The SR58(CA) sign may be placed on State highways when requested by the local agency.

02 ~~A Photo Enforced (R10-19P) plaque or a PHOTO ENFORCED (R10-19aP) word message plaque (see Figure 2B-3) may be mounted below a regulatory sign to advise road users that the regulation is being enforced by photographic equipment.~~

#### **Standard:**

03 ~~If used below a regulatory sign, the Photo Enforced (R10-19P or R10-19aP) plaque shall be a rectangle with a black legend and border on a white background.~~

#### **Support:**

04 Refer to CVC 21455.5 for Traffic Signal Automated Enforcement: Photographic Records.

### **Section 2B.56 Ramp Metering Signs (R10-28 and R10-29)**

#### **Support:**

00a For State highways, see Caltrans' Ramp Metering Design Manual. See Section 1A.11 for information regarding this publication.

00b Refer to Section 2G.102(CA) for regulatory signs for HOV lanes at metered ramps.

#### **Option:**

01 When ramp control signals (see Chapter 4I) are used to meter traffic on a freeway or expressway entrance ramp, regulatory signs with legends appropriate to the control may be installed adjacent to the ramp control signal faces.

02 ~~For entrance ramps with only one controlled lane, an XX VEHICLE(S) PER GREEN (R10-28) sign (see Figure 2B-28) may be used to inform road users of the number of vehicles that are permitted to proceed during each short display of the green signal indication. For entrance ramps with more than one controlled lane, an XX VEHICLE(S) PER GREEN Each Lane (R10-29) (see Figure 2B-28) sign may be used to inform road users of the number of vehicles that are permitted to proceed from each lane during each short display of the green signal indication.~~

#### **Option:**

03 The 1 CAR (2 CARS) PER GREEN (R89(CA)) or 1 CAR (2 CARS) PER GREEN EACH LANE (R89-1(CA)) or 1 CAR (2 CARS) PER GREEN THIS LANE (R89-2(CA)) sign may be used under the lower signal head at freeway ramp meter locations, to indicate the number of vehicle(s) permitted to proceed during each short display of the green signal indication. When used on a signal mast arm, they are respectively placed to the right of the signal head that applies.

04 The RIGHT (LEFT) LANE THIS SIGNAL (R89-3(CA)) sign may be used under the lower signal head at freeway ramp meter locations, where individual signal heads are used for each lane of traffic. When used on a signal mast arm, it is placed to the right of the signal head that applies.

#### **Guidance:**

05 The STOP HERE ON RED (R10-6) sign should be placed on Type 1 standards near the limit line at metered entrance ramps with three or more lanes.

#### **Option:**

<sup>06</sup> The R10-6 sign may also be used at other locations.

Support:

<sup>07</sup> The R10-6 sign is used to emphasize the required observance of the signal limit line, such as the metering signal controlling traffic on metered freeway entrance ramps.

Guidance:

<sup>08</sup> The ALL VEHICLES STOP ON RED (R90-1(CA)) sign should be placed when converting a non-metered HOV preferential lane to a metered one.

Option:

<sup>09</sup> The R90-1(CA) sign may also be used on new installations where potential for confusion exists.

Support:

<sup>10</sup> Refer to Section 2G.102(CA) for signs for HOV lanes at metered ramps.

### **Section 2B.57 KEEP OFF MEDIAN Sign (R11-1)**

Option:

<sup>01</sup> The KEEP OFF MEDIAN (R11-1) sign (see Figure 2B-29) may be used to prohibit driving into or parking on the median.

Guidance:

<sup>02</sup> The KEEP OFF MEDIAN sign should be installed on the left of the roadway within the median at random intervals as needed wherever there is a tendency for encroachment.

### **Section 2B.58 ROAD CLOSED Sign (R11-2) and LOCAL TRAFFIC ONLY Signs (R11-3 Series, R11-4)**

Guidance:

<sup>01</sup> The ROAD CLOSED (R11-2) sign should be installed where roads have been closed to all traffic (except authorized vehicles).

<sup>02</sup> ROAD CLOSED—LOCAL TRAFFIC ONLY (R11-3) or ROAD CLOSED TO THRU TRAFFIC (R11-4) signs should be used where through traffic is not permitted, or for a closure some distance beyond the sign, but where the highway is open for local traffic up to the point of closure.

Standard:

<sup>03</sup> The Road Closed (R11-2, R11-3 series, and R11-4) signs (see Figure 2B-29) shall be designed as horizontal rectangles.

Guidance:

<sup>03a</sup> These signs shall ~~shall~~ **should** be preceded by the applicable Advance Road Closed warning sign with the secondary legend AHEAD and, if applicable, an Advance Detour warning sign (see Section 6F.19).

Option:

<sup>03b</sup> The word RAMP may be substituted for ROAD or STREET where applicable.

<sup>04</sup> An intersecting street name or a well-known destination may be substituted for the XX MILES AHEAD legend in urban areas.

<sup>05</sup> The word message BRIDGE ~~OUT~~ **CLOSED** may be substituted for the ROAD CLOSED legend where applicable.

### **Section 2B.59 Weight Limit Signs (R12-1 through R12-5)**

Option:

<sup>01</sup> ~~The Weight Limit (R12-1) sign carrying the legend WEIGHT LIMIT XX TONS may be used to indicate vehicle weight restrictions including load.~~

<sup>02</sup> ~~Where the restriction applies to axle weight rather than gross load, the legend may be AXLE WEIGHT LIMIT XX TONS or AXLE WEIGHT LIMIT XX LBS (R12-2).~~

<sup>03</sup> ~~To restrict trucks of certain sizes by reference to empty weight in residential areas, the legend may be NO TRUCKS OVER XX TONS EMPTY WT or NO TRUCKS OVER XX LBS EMPTY WT (R12-3).~~

<sup>04</sup> ~~In areas where multiple regulations of the type described in Paragraphs 1 through 3 are applicable, a sign combining the necessary messages on a single sign may be used, such as WEIGHT LIMIT XX TONS PER AXLE, XX TONS GROSS (R12-4).~~

~~05 Posting of specific load limits may be accomplished by use of the Weight Limit symbol sign (R12-5). A sign containing the legend WEIGHT LIMIT on the top two lines, and showing three different truck symbols and their respective weight limits for which restrictions apply may be used, with the weight limits displayed to the right of each symbol as XX T. A bottom line of legend stating GROSS WT may be included if needed for enforcement purposes.~~

~~**Standard:**~~

~~06 If used, the Weight Limit sign (see Figure 2B-29) shall be located in advance of the applicable section of highway or structure.~~

~~*Guidance:*~~

~~07 If used, the Weight Limit sign with an advisory distance ahead legend should be placed at approach road intersections or other points where prohibited vehicles can detour or turn around.~~

~~Support:~~

~~08 Refer to CVC 21101 through 21104 and 35650 through 35755 for Weight Limit signs.~~

~~09 Also refer to Section 2B.39.~~

**Standard:**

**10 The Weight Limit (R12-1, R12-5 and R20A(CA)) signs (see Figures 2B-29 and 2B-29(CA)) shall be used to specify restrictions of trucks on a bridge, structure or highway.**

**Support:**

**11 The No Trucks (R5-2) sign is used together with a Truck Exclusion plaque (R20D(CA) Series) (see Figures 2B-11 and 2B-11(CA)) to specify the maximum weight limit in effect.**

**Standard:**

**12 The weight limit signs shall be placed at each end of the affected portion of a highway section. They shall be placed at a distance of not more than 500 feet from the ends of an affected bridge or structure.**

**Option:**

**13 The Black on Yellow Weight Limit signs (W20(CA) and W20A(CA)) may be used in combination with Distance Ahead Plaque (W34A(CA)), far enough in advance to allow the vehicle operator to select an alternate route.**

**14 The Commercial Vehicle Weight Exclusion (R36(CA)) sign (see Figure 2B-29(CA)) may be used to indicate vehicles over \_\_\_ tons are prohibited from certain streets and highways.**

**Guidance:**

**15 An alternative route should be evaluated for height, weight and size restrictions. Appropriate signs should be posted along the route to advise motorists of any restrictions.**

**Option:**

**16 Advance signs may be necessary to give trucks an opportunity to turn around and retrace their path or select another route.**

## **Section 2B.60 Weigh Station Signs (R13 Series)**

*Guidance:*

~~01 An R13-1 sign with the legend TRUCKS OVER XX TONS MUST ENTER WEIGH STATION NEXT RIGHT (see Figure 2B-30) should be used to direct appropriate traffic into a weigh station.~~

~~02 The R13-1 sign should be supplemented by the D8 series of guide signs (see Section 2D.49).~~

~~02a An SR57(CA) sign with the legend ALL TRUCKS STOP AT SCALES with NO PICKUPS SG8(CA) mounted below (see Figure 2B-30(CA)) should be used to direct appropriate traffic into a weigh station.~~

~~02b The SR57(CA) and SG8(CA) sign combination should be supplemented by the D8 series of guide signs (see Section 2D.49).~~

**Option:**

**03 The reverse color combination, a white legend and border on a black background, may be used for the R13-1 SR57(CA) sign.**

**Support:**

**04 Refer to Figure 2B-30(CA) for Weigh Station Signs.**

**Option:**

05 The WAIT HERE UNTIL SCALE CLEAR (SR6-1(CA)) sign may be used at Weigh Stations to provide guidance to trucks entering the scales.

06 The RELEASE BRAKES WHILE ON SCALE (SR7-1(CA)) sign may be used at Weigh Stations to provide guidance to trucks when they are on the scales.

07 The SET PARKING BRAKES (SR8-1(CA)) sign may be used at Weigh Stations to provide guidance to trucks when they are on the scales.

08 The LOADED (SR9-1(CA)) sign may be used at Weigh Stations to designate the lane loaded trucks are to use when passing through the scales.

09 The EMPTY (SR10-1(CA)) sign may be used at Weigh Stations to designate the lane empty trucks are to use when passing through the scales.

10 The EMPTY 5 MPH (SR11-1(CA)) sign may be used at Weigh Stations to control the speed of empty trucks when passing through scales.

11 The LOADED 3 MPH (SR12-1(CA)) sign may be used at Weigh Stations to control the speed of loaded trucks when passing through scales.

12 The Theft CHP Plaque (SR13-1(CA)) may be used at Weigh Stations to advise scale users that removing any property from the Weigh Station without authorization from the California Highway Patrol is a violation of the Penal Code.

*Guidance:*

13 *The TRUCKS NOT GIVEN BYPASS SIGNAL MUST ENTER OPEN SCALES (SR17(CA)) sign should be used in advance of a truck weigh station that is equipped with a mainline bypass system and weigh-in-motion scales to electronically weigh and verify compliance of commercial trucks as they approach the weigh station.*

14 *The Width Limit (SR40(CA)) sign (see Figure 2B-29(CA)) should be placed at truck weigh stations to direct over width vehicles around the station, if the weigh station lacks adequate width. The California Highway Patrol should be contacted to determine where these signs are needed. Refer to CVC 35790.*

**Standard:**

15 **The ALL BUSES STOP AT SCALES (SR41(CA)) and ALL BUSES with Arrow (SR42(CA)) signs shall be used as a temporary sign for Critical Item Bus Inspections on state highways.**

*Option:*

16 The Weigh Station Repair Service Plaque (S21(CA)) sign may be installed at commercial vehicle inspection facilities on State highways where needed at the request of the California Highway Patrol.

## **Section 2B.61 TRUCK ROUTE Sign (R14-1)**

*Guidance:*

01 *The TRUCK ROUTE (R14-1) sign (see Figure 2B-30) should be used to mark a route that has been designated to allow truck traffic.*

*Option:*

02 On a numbered highway, the TRUCK (M4-4) auxiliary sign may be used (see Section 2D.20).

*Support:*

03 Refer to CVC 21101 through 21104 and 35701 through 35715.

04 Generally, Caltrans is not unilaterally authorized to prohibit truck travel on State highways. Various sections in the California Vehicle Code allow cities and counties to restrict, by ordinance, commercial vehicles subject to the specific conditions in those sections.

**Standard:**

05 **Generally, no such local ordinance shall be effective with respect to any State highway until the ordinance has been approved by Caltrans. This approval shall be made by the Caltrans Director.**

06 **The proposed local ordinance shall designate an unrestricted alternate route, or routes, for use by the prohibited vehicles. Such proposed local ordinances shall not be approved unless the alternate route, or routes, are considered suitable by Caltrans.**

07 **An investigation of designated alternate routes shall be made with special attention being given to the following features:**

**1. Geometrics.**

2. Increase in distance of travel and comparisons in time of travel.
3. Railroad grade crossings.
4. Present traffic and practical capacity of proposed alternates.
5. Structural adequacy of pavement for heavy truck traffic.
6. Heavy grades.
7. Proximity to schools or school routes.
8. Developed residential areas.

## **Section 2B.62 Hazardous Material Signs (R14-2, R14-3)**

Option:

~~01 The Hazardous Material Route (R14-2) sign (see Figure 2B-30) may be used to identify routes that have been designated by proper authority for vehicles transporting hazardous material.~~

~~02 On routes where the transporting of hazardous material is prohibited, the Hazardous Material Prohibition (R14-3) sign (see Figure 2B-30) may be used.~~

*Guidance:*

~~03 If used, the Hazardous Material Prohibition sign should be installed on a street or roadway at a point where vehicles transporting hazardous material have the opportunity to take an alternate route.~~

Support:

04 Refer to Figure 2B-30(CA) for Hazardous Waste/Material signs.

**Standard:**

05 **The Hazardous Waste Prohibited (R102(CA)) sign shall be used to identify those routes, either State or local, upon which the transportation of hazardous waste has been prohibited, as provided in CVC 31303 and 31304.**

Option:

06 On those highways where hazardous waste is permitted, the R102(CA) signs may be placed in advance of their intersection or interchange with the prohibited route.

*Guidance:*

07 *The R102(CA) signs should be placed on the prohibited route for both directions of travel after entry from the above intersection or interchange.*

**Standard:**

08 **The HAZARDOUS WASTE PROHIBITED (R102A(CA)) sign shall be positioned below the R102(CA) sign.**

*Guidance:*

09 *The R102A(CA) sign should be of equal width to the R102(CA) sign.*

Option:

10 The Hazardous Waste Permitted (R103(CA)) sign may be used to guide road users around routes where the transportation of hazardous waste is permitted.

**Standard:**

11 **The HAZARDOUS WASTE PERMITTED (R103A(CA)) sign shall be positioned below the R103(CA) symbol sign.**

*Guidance:*

12 *The R103A(CA) sign should be of equal width to the R103(CA) sign.*

Option:

13 The Hazardous Material Prohibited (R104(CA)) sign may be used to identify those routes, either State or local, upon which the transportation of Hazardous Material has been prohibited. On those highways where Hazardous Material is prohibited, the R105(CA) signs may be placed in advance of their intersection or interchange with the prohibited route.

*Guidance:*

14 *The R104(CA) signs should be placed on the prohibited route for both directions of travel after entry from the above intersection or interchange.*

**Standard:**

15 **The R104(CA) sign shall be used to identify those routes upon which the transportation of Hazardous Materials has been prohibited, as provided in CVC 31303 and 31304.**

16 **The HAZARDOUS MATERIAL PROHIBITED (R104A(CA)) sign shall be positioned below the R104(CA) sign.**

*Guidance:*

<sup>17</sup> *The R104A(CA) sign should be of equal width to the R104(CA) sign.*

*Option:*

<sup>18</sup> The Hazardous Material Permitted (R105(CA)) sign may be used to guide road users around routes where the transportation of Hazardous Material is prohibited.

**Standard:**

<sup>19</sup> **The HAZARDOUS MATERIAL PERMITTED (R105A(CA)) sign shall be positioned below the R105 (CA) sign.**

*Guidance:*

<sup>20</sup> *The R105A(CA) sign should be of equal width to the R105(CA) sign.*

<sup>21</sup> *The NO EXPLOSIVES OR FLAMMABLES (SR18(CA)) sign should be placed on highways, structures, tunnels, etc. where vehicles transporting explosives or flammable materials are prohibited. The SR18(CA) sign should be placed at a location that will provide a motorist the opportunity to turn around.*

<sup>22</sup> *The EXPLOSIVES AND CORROSIVES PROHIBITED WITHOUT PERMIT (SR19-1(CA)) sign should be placed on highways, structures, tunnels, etc. where vehicles transporting explosives or corrosive materials are prohibited without a permit. The SR18(CA) sign should be placed at a location that will provide a motorist the opportunity to turn around.*

*Option:*

<sup>23</sup> The TRANSPORTING ILLEGAL FIREWORKS PROHIBITED (SR25(CA)) sign may be used on any roadway upon which the transportation of illegal fireworks have been prohibited by a local ordinance or resolution per California Health & Safety Code Division 11, Part 2, Sections 12500 through 12726.

**Standard:**

<sup>24</sup> **If used, the SR25(CA) sign shall be used to identify only those street or highway locations, either State or local, upon which the transportation of illegal fireworks is prohibited, as established by the local ordinance or resolution.**

## **Section 2B.63 National Network Signs (R14-4, R14-5)**

*Support:*

<sup>01</sup> The signing of the National Network routes for trucking is optional. See Chapter 2I.

**Standard:**

<sup>02</sup> ~~When a National Network route is signed, the National Network (R14-4) sign (see Figure 2B-30) shall be used.~~

*Option:*

<sup>03</sup> ~~The National Network Prohibition (R14-5) sign (see Figure 2B-30) may be used to identify routes, portions of routes, and ramps where trucks are prohibited. The R14-5 sign may also be used to mark the ends of designated routes.~~

## **Section 2B.64 Headlight Use Signs (R16-5 through R16-11)**

*Support:*

<sup>01</sup> Some States require road users to turn on their vehicle headlights under certain weather conditions, as a safety improvement measure on roadways experiencing high crash rates, or in special situations such as when driving through a tunnel.

<sup>01a</sup> Refer to CVC 24400.

<sup>02</sup> Figure 2B-31 shows the various signs that can be used for informing motorists of these requirements.

*Option:*

<sup>03</sup> A LIGHTS ON WHEN USING WIPERS (R16-5) sign or a LIGHTS ON WHEN RAINING (R16-6) sign may be installed to inform road users of State laws regarding headlight use. Although these signs are typically installed facing traffic entering the State just inside the State border, they also may be installed at other locations within the State.

*Guidance:*

<sup>04</sup> *If a particular section of roadway has been designated as a safety improvement zone within which headlight use is required, a TURN ON HEADLIGHTS NEXT XX MILES (R16-7) sign or a BEGIN DAYTIME HEADLIGHT*

*SECTION (R16-10) sign should be installed at the upstream end of the section, and a END DAYTIME HEADLIGHT SECTION (R16-11) sign should be installed at the downstream end of the section.*

Option:

<sup>05</sup> A TURN ON HEADLIGHTS (R16-8) sign may be installed to require road users to turn on their headlights in special situations such as when driving through a tunnel. A CHECK HEADLIGHTS (R16-9) sign may be installed downstream from the special situation to inform drivers that the using their headlights is no longer required.

Option:

<sup>06</sup> Daylight Headlight (S30(CA)) Series signs may be used after a traffic investigation and consultation with the local CHP office and/or law enforcement as a traffic safety improvement measure in high accident locations on two lane highways where there is a potential for head-on collisions.

Support:

<sup>07</sup> Refer to CVC 21461 for enforcement of S30(CA) Series signs.

Guidance:

<sup>08</sup> When used, the DAYLIGHT HEADLIGHT SECTION (S30-1(CA)) sign should be placed approximately 500 feet in advance of a daylight headlight section.

<sup>09</sup> When used, the TURN ON HEADLIGHTS NEXT X MILES (S30-2(CA)) sign should be placed at the beginning of a daylight headlight section.

<sup>10</sup> When used, the END DAYLIGHT HEADLIGHT SECTION (S30-3(CA)) sign should be placed at the end of a daylight headlight section.

<sup>11</sup> When used, the TURN ON HEADLIGHTS (S30-4(CA)) sign should be placed at the entrances from major side roads to a daylight headlight section.

<sup>12</sup> When used, the CHECK HEADLIGHTS (S30-5(CA)) sign should be placed approximately 500 feet beyond the end of a daylight headlight section.

Support:

<sup>13</sup> See Figure 2B-106(CA) for S30(CA) Series signs.

### **Safety Corridor Sign (S33(CA))**

Option:

<sup>14</sup> The Safety Corridor (S33(CA)) sign (see Figure 2B-106(CA)) may be installed at the written request of an official Corridor Safety Task Force on any roadway segment that is designated as a Safety Awareness Zone under the authority of California Streets and Highways Code Section 97.1.

Support:

<sup>15</sup> More information on Highway Safety Corridors and Task Forces is available at:

<http://www.chp.ca.gov/community/corridor.html>

**Standard:**

<sup>16</sup> **The S33(CA) sign shall not be installed on freeways.**

Guidance:

<sup>17</sup> When used, one S33(CA) sign should be posted at each end of the corridor. The S33(CA) sign specifications should be as follows:

1. Size no larger than 8 feet wide and 4 feet high.
2. White background with black text having a primary safety message.

**Standard:**

<sup>18</sup> **A logo and any secondary message (along with colors) shall be agreed upon by the Task Force. The logo and secondary message shall not cover more than 25 percent of the sign's surface area.**

<sup>19</sup> **Caltrans shall purchase and install the S33(CA) sign.**

Guidance:

<sup>20</sup> The Task Force is to advise Caltrans, in writing, as to how long the signs are to remain on the highway, but this time period should not exceed three years.



### **Section 2B.65 FENDER BENDER Sign (R16-4)**

Option:

~~01 A FENDER BENDER MOVE VEHICLES FROM TRAVEL LANES (R16-4)~~ **MINOR CRASH NO INJURIES – SAFELY MOVE VEHICLES FROM TRAVEL LANES (SR61(CA))** sign (see Figure ~~2B-32~~ **2B-32(CA)**) may be installed to require motorists to move their vehicle out of the travel lanes if they have been involved in a **non-injury** crash.

### **Section 2B.66 Seat Belt Symbol**

**Standard:**

**01 When a seat belt symbol is used, the symbol shown in Figure 2B-32 shall be used.**

*Guidance:*

*02 The seat belt symbol should not be used alone. If used, the seat belt symbol should be incorporated into regulatory sign messages for mandatory seat belt use.*

*03 The Seat Belt (SR15(CA)) sign (see Figure 2B-32(CA)) should be placed in each direction on all freeways and other major state routes at approximate 50 mile intervals.*

**Standard:**

**04 The SAFETY BELT LAW ENFORCED (SR15A(CA)) sign (see Figure 2B-32(CA)) shall be placed below each installation of the Seat Belt (SR15(CA)) sign.**

Option:

**05 The Seat Belt (SR15(CA)) and SAFETY BELT LAW ENFORCED (SR15A(CA)) sign combination may also be used on local arterials.**

### **Section 2B.67 Barricades**

Option:

**01 Barricades may be used to mark any of the following conditions:**

- A. A roadway ends,
- B. A ramp or lane closed for operational purposes, or
- C. The permanent or semi-permanent closure or termination of a roadway.

**Standard:**

**02 When used to warn and alert road users of the terminus of a roadway in other than temporary traffic control zones, barricades shall meet the design criteria of Section 6F.68 for a Type 3 Barricade, except that the colors of the stripes shall be retroreflective white and retroreflective red.**

Option:

**03 An end-of-roadway marker or markers may be used as described in Section 2C.66.**

*Guidance:*

*04 Appropriate advance warning signs (see Chapter 2C) should be used.*

### **Section 2B.68 Gates**

Support:

**01 Gates described in this section used for weather or other emergency conditions are typically permanently installed to enable the gate to be immediately deployed as needed to prohibit the entry of traffic to the highway segment(s).**

**02 A gate typically features a gate arm that is moved from a vertical to a horizontal position or is rotated in a horizontal plane from parallel to traffic to perpendicular to traffic. Traffic is obstructed and required to stop when the gate arm is placed in a horizontal position perpendicular to traffic. Another type of gate consists of a segment of fence (usually on rollers) that swings open and closed, or that is retracted to open and then extended to close.**

**03 Gates are sometimes used to enforce a required stop. Some examples of such uses are the following:**

- A. Parking facility entrances and exits,
- B. Private community entrances and exits,
- C. Military base entrances and exits,
- D. Toll plaza lanes,
- E. Movable bridges (see Chapter 4J),
- F. Automated Flagger Assistance Devices (see Chapter 6E), and

G. Grade crossings (see Part 8).

04 Gates are sometimes used to periodically close a roadway or a ramp. Some examples of such uses are the following:

- A. Closing ramps to implement counter-flow operations for evacuations,
- B. Closing ramps that lead to reversible lanes, and
- C. Closing roadways for weather events such as snow, ice, or flooding, or for other emergencies.

**Standard:**

05 **Except as provided in Paragraph 6, gate arms, if used, shall be fully retroreflectorized on both sides, have vertical stripes alternately red and white at 16-inch intervals measured horizontally as shown in Figure 8C-1.**

**Option:**

06 If used on a one-way roadway or ramp, the retroreflectorization may be omitted on the side of the gate facing away from approaching traffic.

07 Where gate arms are used to block off ramps into reversible lanes or to redirect approaching traffic, the red and white striping may be angled such that the stripes slope downward at an angle of 45 degrees toward the side of the gate arm on which traffic is to pass.

**Standard:**

08 **The gate arm shall extend across the approaching lane or lanes of traffic to effectively block motor vehicle and/or pedestrian travel as appropriate.**

09 **When gate arms are in the vertical position or rotated to an open position, the closest part of the gate arm and support shall have a lateral offset of at least 2 feet from the face of the curb or the edge of the traveled way.**

10 **When gate arms that are located in the median or on an island are in the horizontal position or rotated to a closed position, the closest part of the counterweight or its supports shall have a lateral offset of at least 2 feet from the face of the curb or the edge of the traveled way of the open roadway on the opposite side of the median or island.**

*Guidance:*

11 *When a gate that is rotated in a horizontal plane is in the position where it is parallel to traffic (indicating that the roadway is open), the outer end of the gate arm should be rotated to the downstream direction (from the perspective of traffic in the lane adjacent to the gate support) to prevent spearing if the gate is struck by an errant vehicle.*

12 *If a pedestrian route is present and if it is not intended that pedestrian traffic be controlled by the gate, a minimum of 2 feet of lateral offset from supports, posts, counterweights, and gate mechanisms should be provided when the gate arm is in the open position and when the gate arm is in the closed position such that pedestrian travel is not impeded.*

**Option:**

13 Red lights may be attached to traffic gates.

**Standard:**

14 **If red lights are attached to a traffic gate, the red lights shall be steadily illuminated or flashed only during the period when the gate is in the horizontal or closed position and when the gate is in the process of being opened or closed.**

15 **Except as provided in Paragraph 16, rolling sections of fence, if used, shall include either a horizontal strip of retroreflectorized sheeting on both sides of the fence with vertical stripes alternately red and white at 16-inch intervals measured horizontally to simulate the appearance of a gate arm in the horizontal position, or one or more Type 4 object markers (see Section 2C.66), or both. If a horizontal strip of retroreflectorized sheeting is used, the bottom of the sheeting shall be located 3.5 to 4.5 feet above the roadway surface.**

**Option:**

16 If used on a one-way roadway or ramp, the retroreflectorization may be omitted on the side of the fence facing away from approaching traffic.

### **Section 2B.101(CA) NO FISHING (JUMPING) FROM BRIDGE Sign (R23(CA))**

**Option:**

01 The NO FISHING (JUMPING) FROM BRIDGE sign (R23(CA)) (see Figure 2B-106(CA)) may be used when fishing or jumping from a bridge is prevalent and where investigation has shown that fishing or jumping is unsafe or interferes with the orderly movement of traffic.

### **Section 2B.102(CA) TWO WAY TRAFFIC AHEAD Sign (R40(CA))**

**Standard:**

01 The TWO WAY TRAFFIC AHEAD (R40(CA)) sign (see Figure 2B-10(CA)) shall be used to inform motorists that they are leaving a one-way street and entering a two-way street.

**Guidance:**

02 The R40(CA) sign should be placed on both sides of the one-way street approximately 200 feet in advance of the intersection where the two-way traffic begins. Refer to Section 2C.44.

### **Section 2B.103(CA) \$1000 Fine Signs (R47(CA) and R47A(CA))**

**Option:**

01 The \$1000 FINE FOR LITTERING (R47(CA)) sign (see Figure 2B-106(CA)) may be used to inform the public that it is unlawful to dispose of litter on the highway.

**Support:**

02 Refer to Streets and Highway Code Section 101.6 and CVC 23111 through 23113 and 42001.7.

03 The \$1000 FINE FOR ANIMAL ABANDONMENT (R47A(CA)) sign (see Figure 2B-106(CA)) is used to inform the public that the abandonment or dumping of any animal is a criminal offense.

**Guidance:**

04 The R47A(CA) sign should be placed on all major state highways, as close as practicable, following the Welcome to California (G10B(CA)) sign.

### **Section 2B.104(CA) PRIVATE ROAD (PRIVATE PROPERTY) VEHICLE CODE ENFORCED Sign (R101(CA))**

**Standard:**

01 The PRIVATE ROAD VEHICLE CODE ENFORCED (R101(CA)) sign (see Figure 2B-106(CA)) shall be used at the entrance to a privately owned and maintained road when enforcement of vehicle provisions apply, as provided in CVC 21107.7.

02 The alternate message PRIVATE PROPERTY shall be used at each entrance to a privately owned and maintained off-street parking facility when enforcement of vehicle code provisions apply, as provided in CVC 21107.8.

### **Section 2B.105(CA) Rest Area Disclaimer Sign (SR2(CA))**

**Guidance:**

01 The Rest Area Disclaimer (SR2(CA)) sign (see Figure 2B-106(CA)) should be posted in a conspicuous location, as directed by the Caltrans District Landscape Architect, at all State Safety Roadside Rest Areas.

### **Section 2B.106(CA) Garbage Prohibition Signs (SR22-1(CA) and SR23-1(CA))**

**Option:**

01 The DUMPING PROHIBITED (SR22-1(CA)) sign (see Figure 2B-106(CA)) may be placed at State highway facilities where unauthorized dumping of materials or garbage is prevalent.

02 The NO HOUSEHOLD GARBAGE (SR23-1(CA)) sign (see Figure 2B-106(CA)) may be placed at State highway facilities where refuse containers provided for motorist convenience are being used to dispose of excessive amounts of household garbage.

### **Section 2B.107(CA) GOLF CARTS OK DAYLIGHT HOURS Sign (SR43(CA))**

**Standard:**

**01 The GOLF CARTS OK DAYLIGHT HOURS (SR43(CA)) sign (see Figure 2B-106(CA)) shall be placed on roadways which local authorities have designated for combined use in accordance with CVC 21115.**

Option:

**02** The ordinance number may be included on the sign.

### **Section 2B.108(CA) Bus and Truck Registration Sign (SR44(CA))**

Guidance:

**01** *The Bus and Truck Registration (SR44(CA)) sign (see Figure 2B-106(CA)) should be placed at all Border Inspections Stations to relay this information to Interstate carriers.*

### **Section 2B.109(CA) EMERGENCY ACCESS KEEP CLEAR Sign (SR46(CA))**

Option:

**01** The EMERGENCY ACCESS KEEP CLEAR (SR46(CA)) sign (see Figure 2B-106(CA)) may be used where there is traffic back up due to a controlled intersection or cross street that affects access to the driveway of any emergency service facility such as fire, police or ambulance. Refer to CVC 22500(d) and 22526.

Standard:

**02** **The SR46(CA) sign shall be used in conjunction with KEEP CLEAR pavement markings (see Section 3B.17) that delineate the limits of the keep clear area.**

Option:

**03** The SR46(CA) signs may be placed on both ends of the keep clear area.

Guidance:

**04** *However, if only one sign is used, it should be placed on the upstream side.*

### **Section 2B.110(CA) Off Highway Vehicle Signs (SR47(CA) and SR48(CA))**

Guidance:

**01** *The OFF HIGHWAY VEHICLE COMBINED USE NEXT (X MILES) (SR47(CA)) sign (see Figure 2B-106(CA)) should be used to inform motorists of the length of an Off Highway Vehicle Combined Use segment of the highway.*

**02** *The NO OFF HIGHWAY VEHICLES BEYOND THIS POINT (SR48(CA)) sign (see Figure 2B-106(CA)) should be placed at the end of an Off Highway Vehicle Combined Use segment of the highway.*

### **Section 2B.111(CA) State Property Signs (S8(CA) and S20(CA))**

Option:

**01** The STATE PROPERTY – NO DUMPING – NO PARKING – NO TRESPASSING (S8(CA)) sign (see Figure 2B-106(CA)) may be used to identify state property where dumping, parking or trespassing is prohibited.

**02** The STATE PROPERTY – ANY PERSON REMOVING OR MOLESTING SAME WILL BE PROSECUTED (S20(CA)) sign (see Figure 2B-106(CA)) may be used to identify State owned property and materials placed there for future maintenance or construction purposes.

### **Section 2B.112(CA) MOVE OVER OR SLOW FOR STOPPED EMERGENCY AND MAINTENANCE VEHICLES Sign (R110(CA))**

Option:

**01** The MOVE OVER OR SLOW FOR STOPPED EMERGENCY AND MAINTENANCE VEHICLES (R110(CA)) Sign (see Figure 2B-32(CA)) may be used to inform drivers of the State's MOVE OVER Law, CVC 21809. This sign may be used only within freeway facilities.

Figure 2B-1. STOP and YIELD Signs and Plaques



Figure 2B-2. Unsignalized Pedestrian Crosswalk Signs

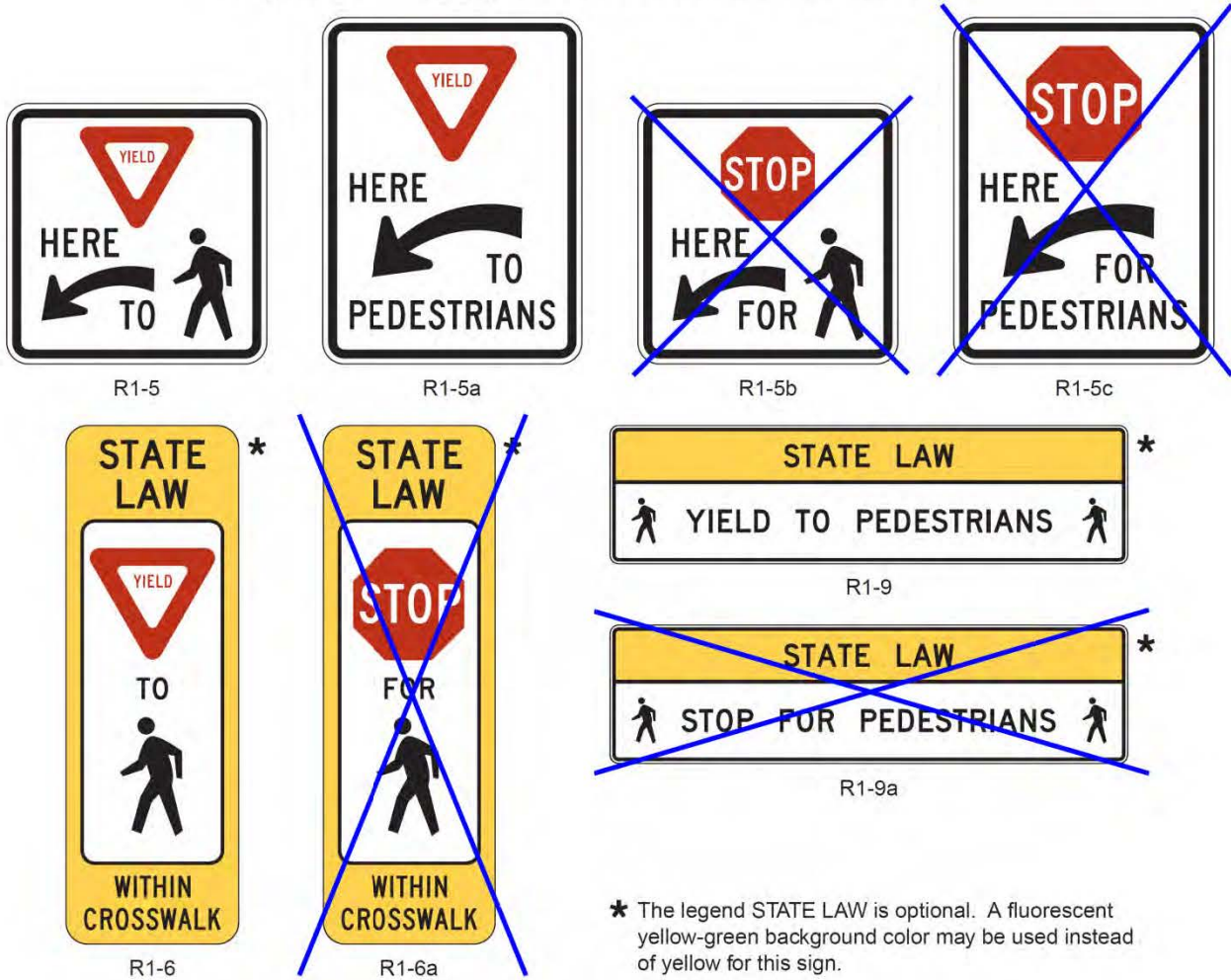
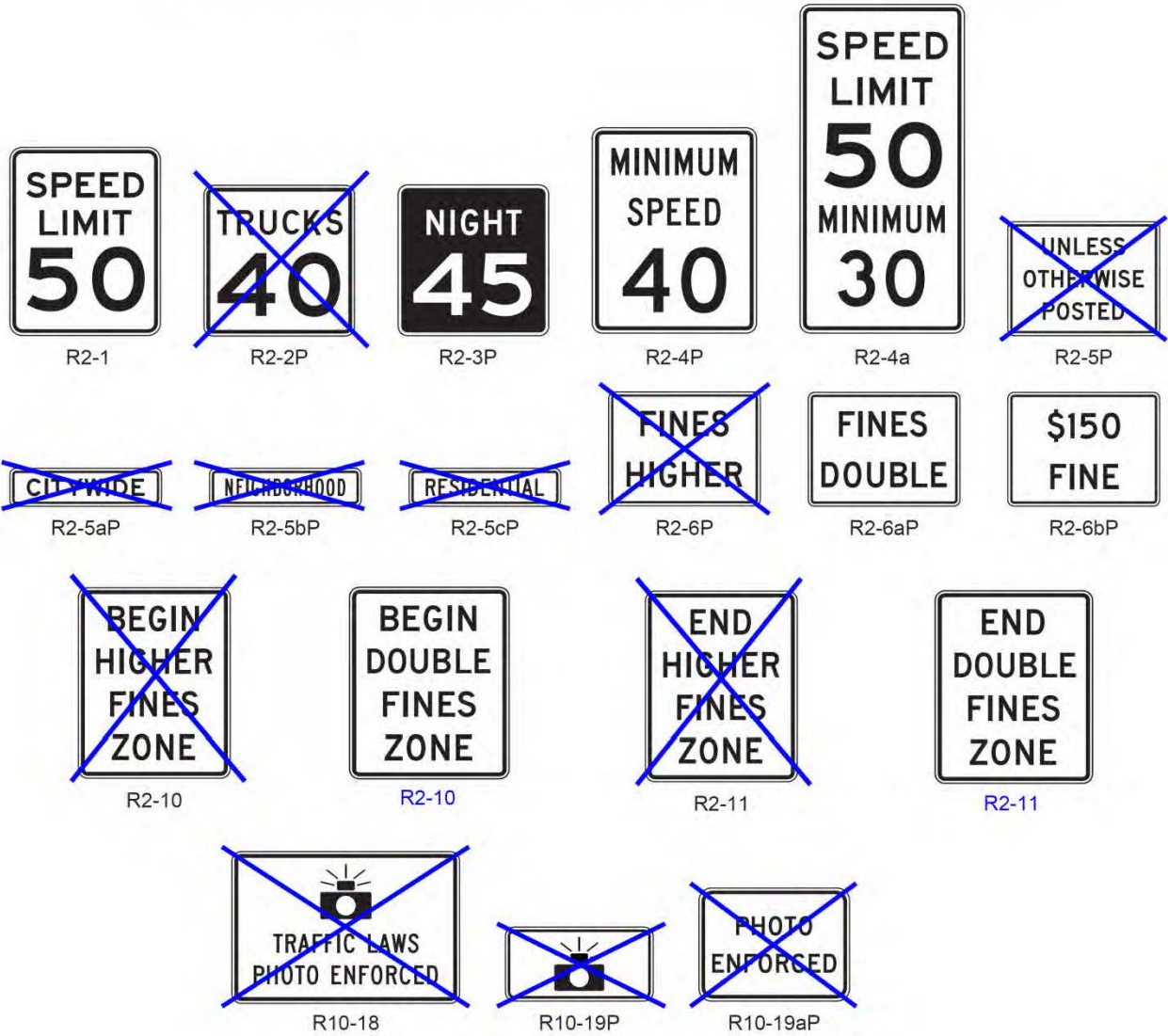
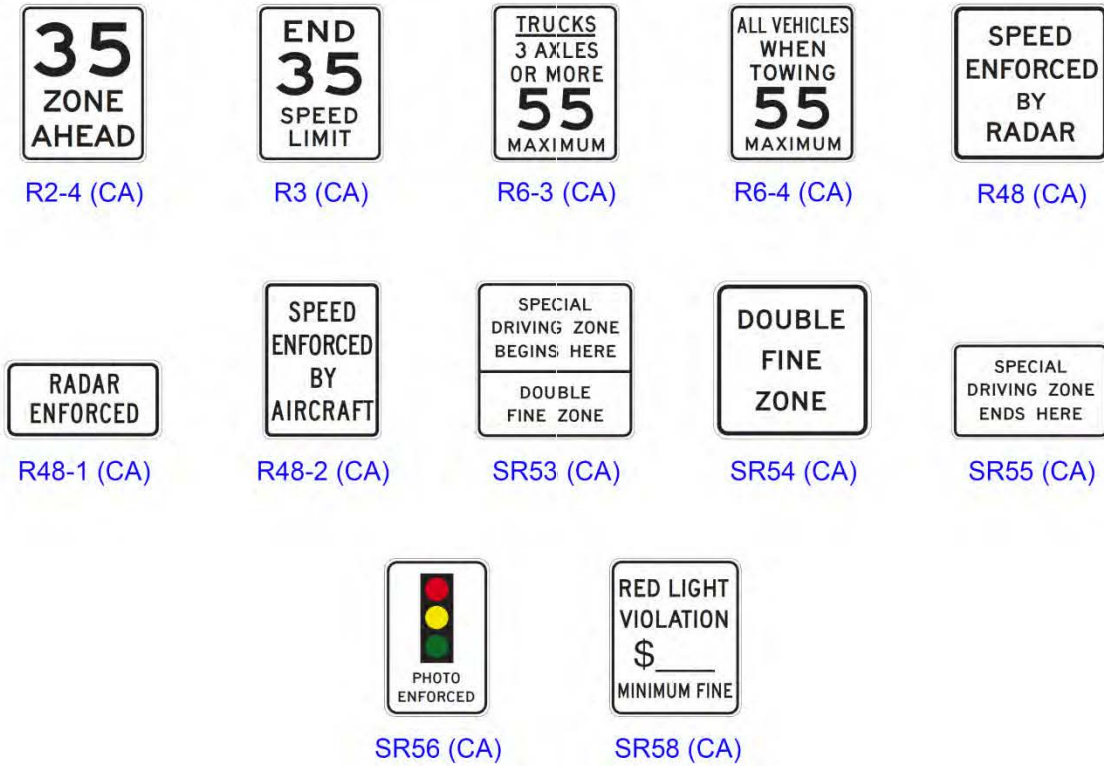


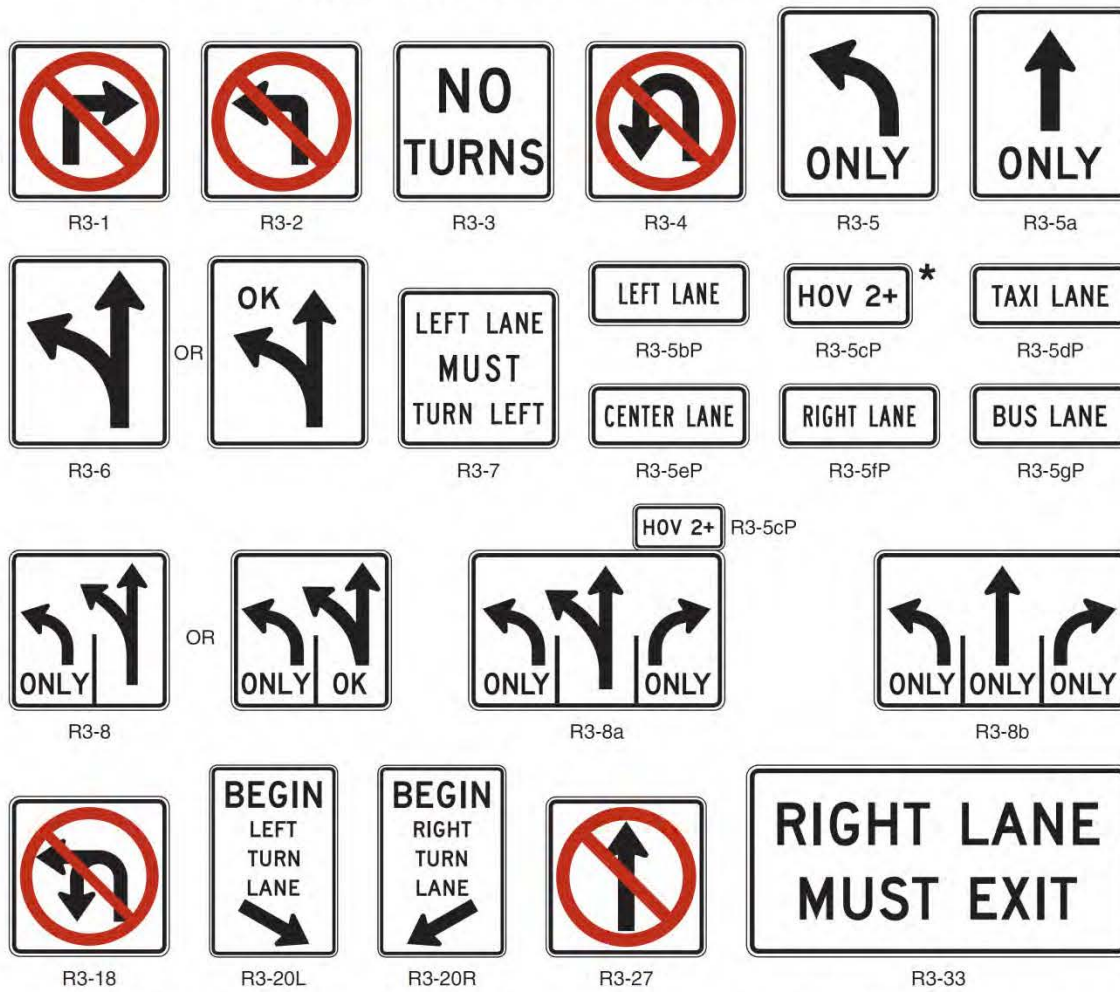
Figure 2B-3. Speed Limit and Photo Enforcement Signs and Plaques



**Figure 2B-3 (CA). Speed Limit and Photo Enforcement Signs and Plaques**



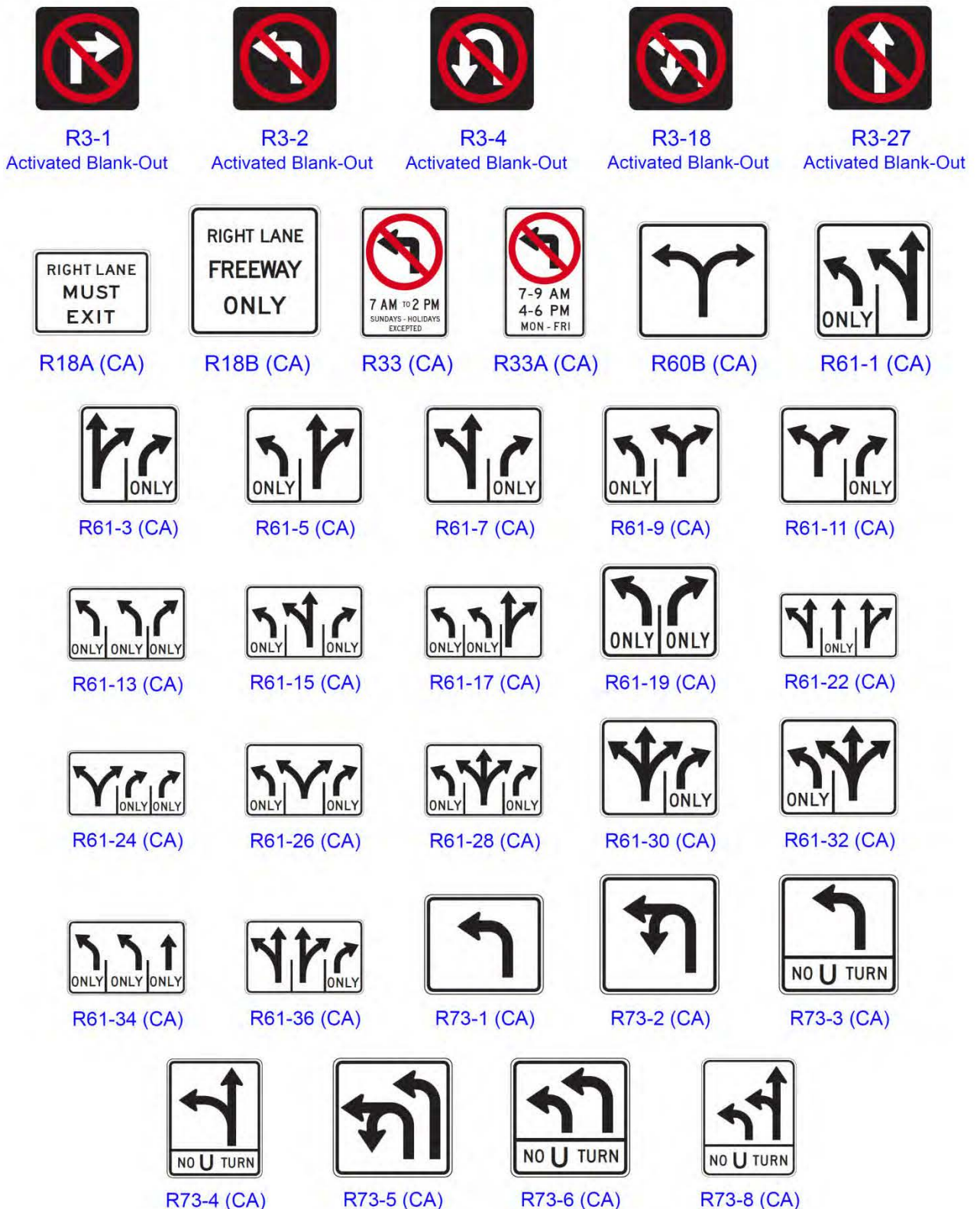
**Figure 2B-4. Movement Prohibition and Lane Control Signs and Plaques**



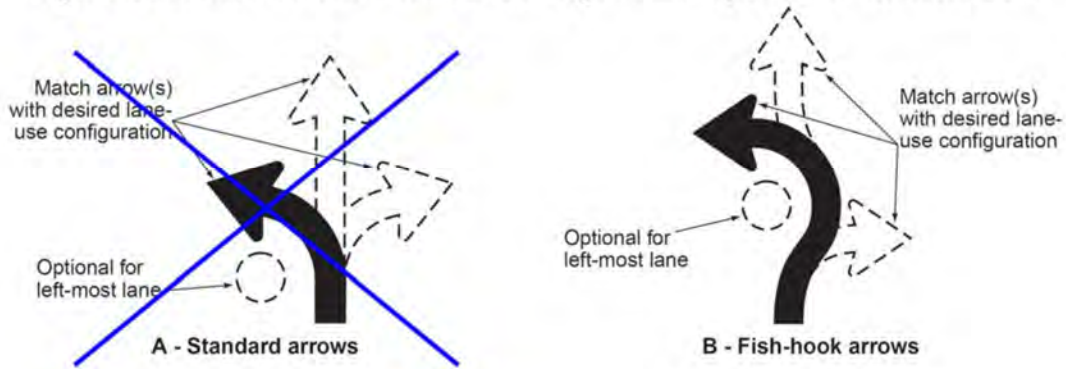
\* The diamond symbol may be used instead of the "HOV" word message. The minimum vehicle occupancy level may vary, such as 2+, 3+, 4+. The words "LANE" or "ONLY" may be used with this sign when appropriate.



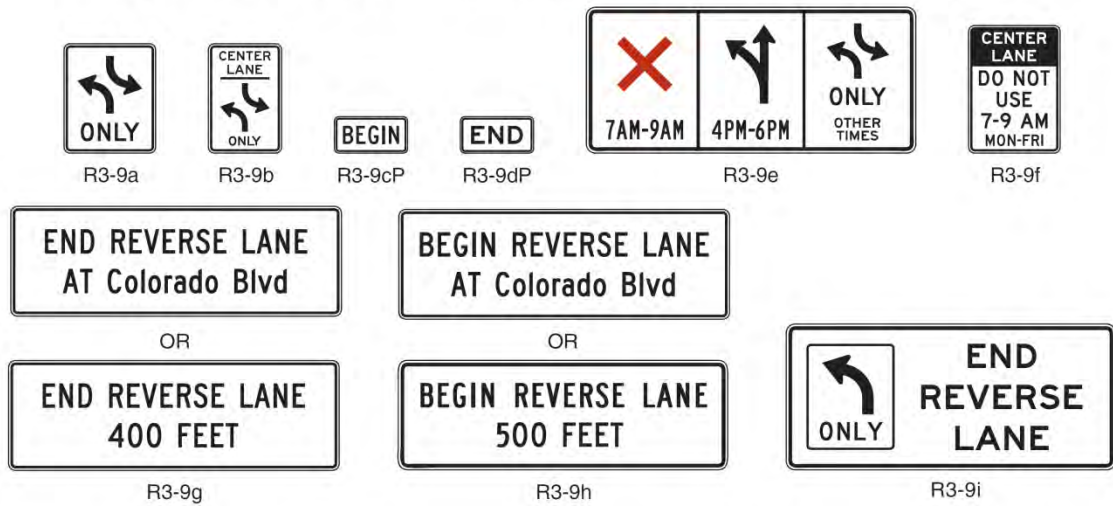
**Figure 2B-4 (CA). Movement Prohibition and Lane Control Signs and Plaques**



**Figure 2B-5. Intersection Lane Control Sign Arrow Options for Roundabouts**



**Figure 2B-6. Center and Reversible Lane Control Signs and Plaques**



**Figure 2B-7. Location of Reversible Two-Way Left-Turn Signs**

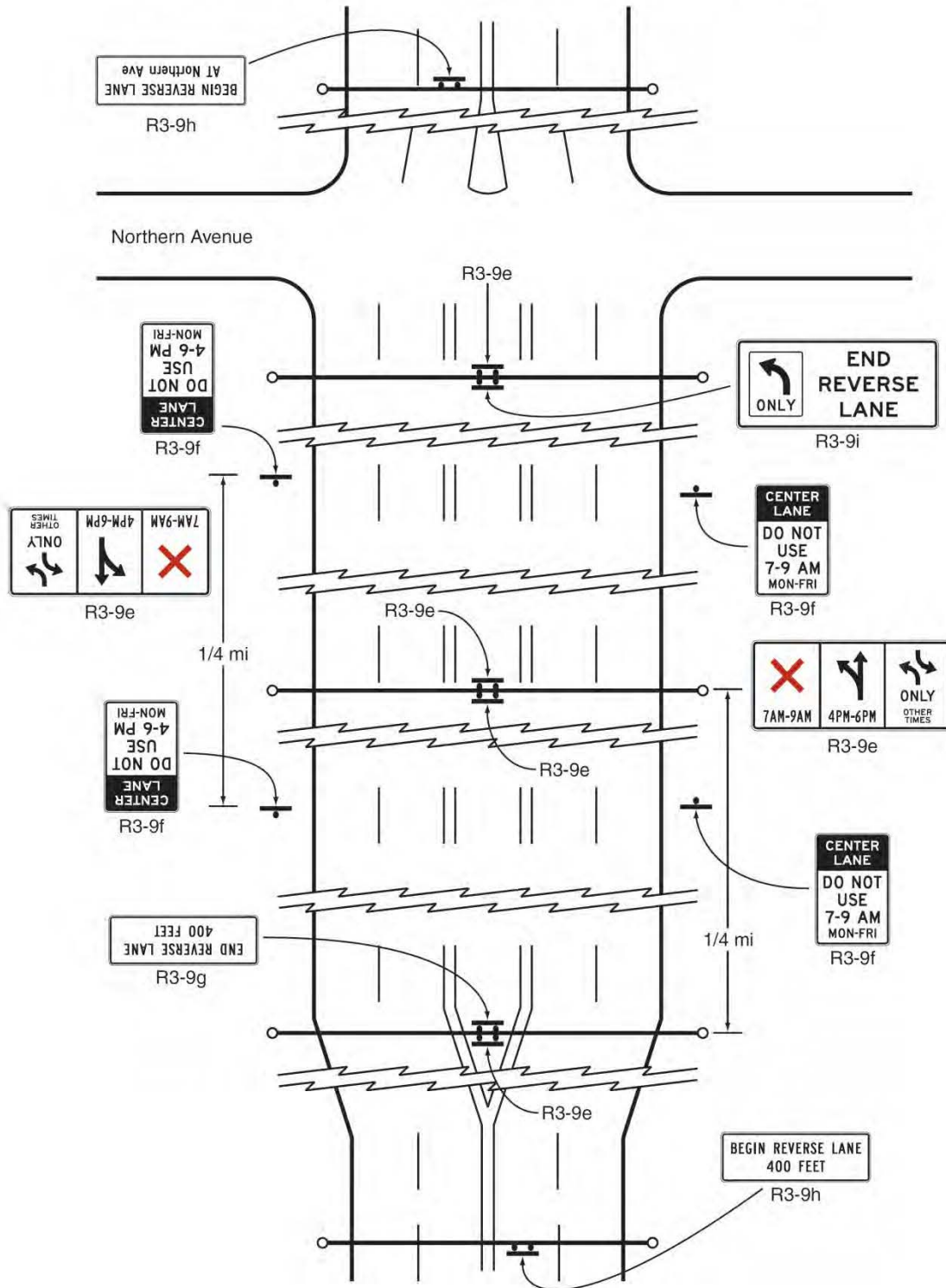
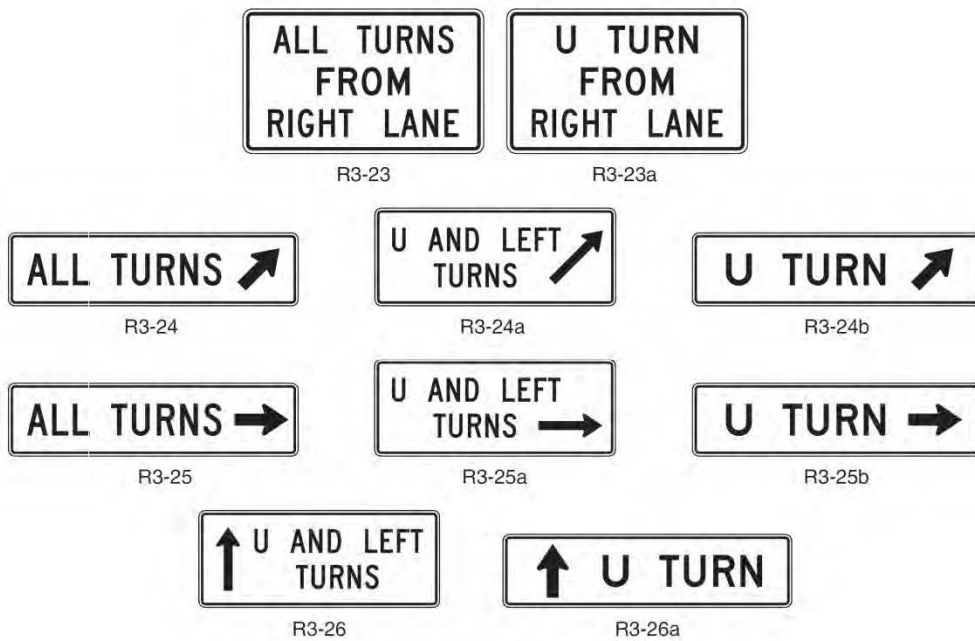
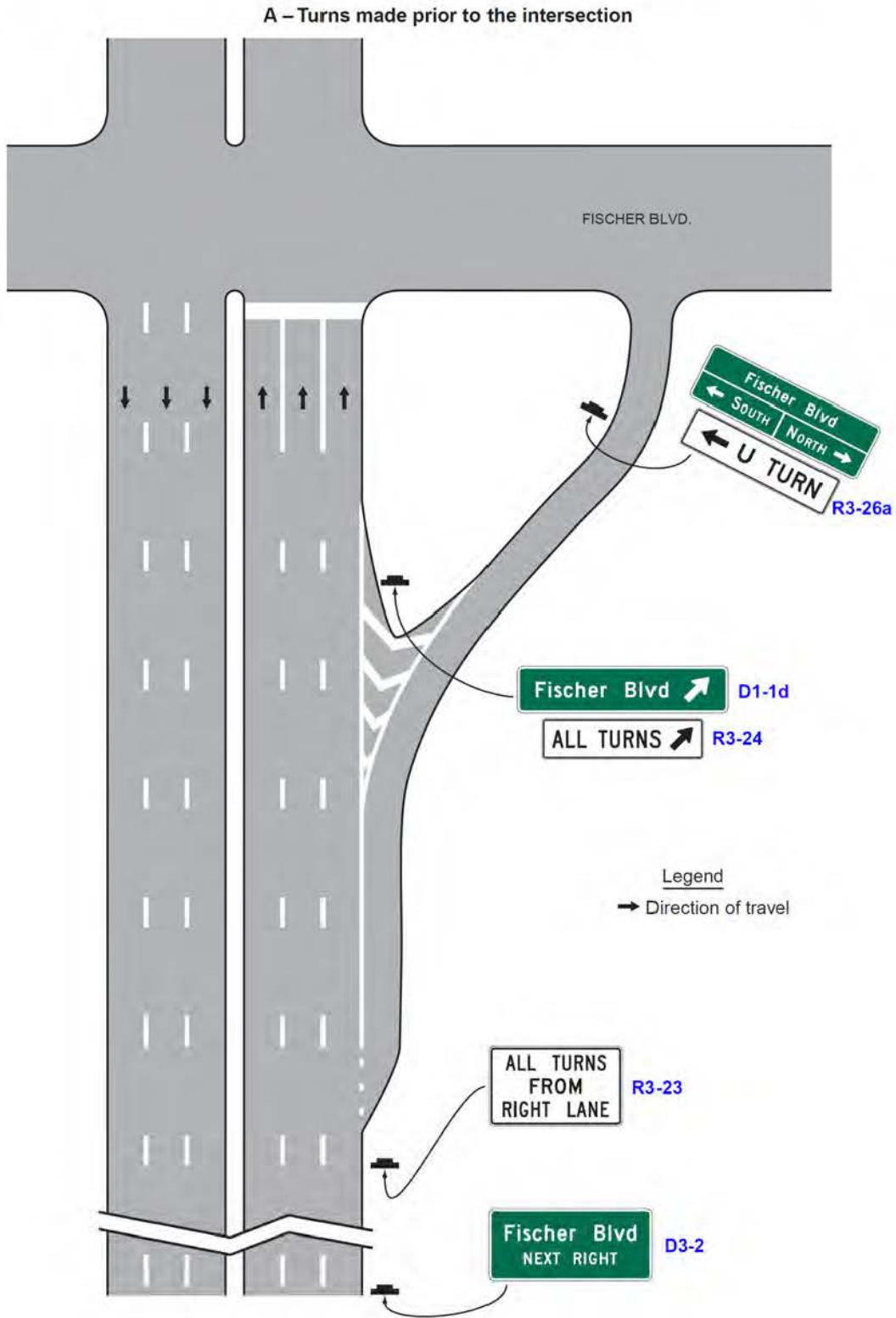


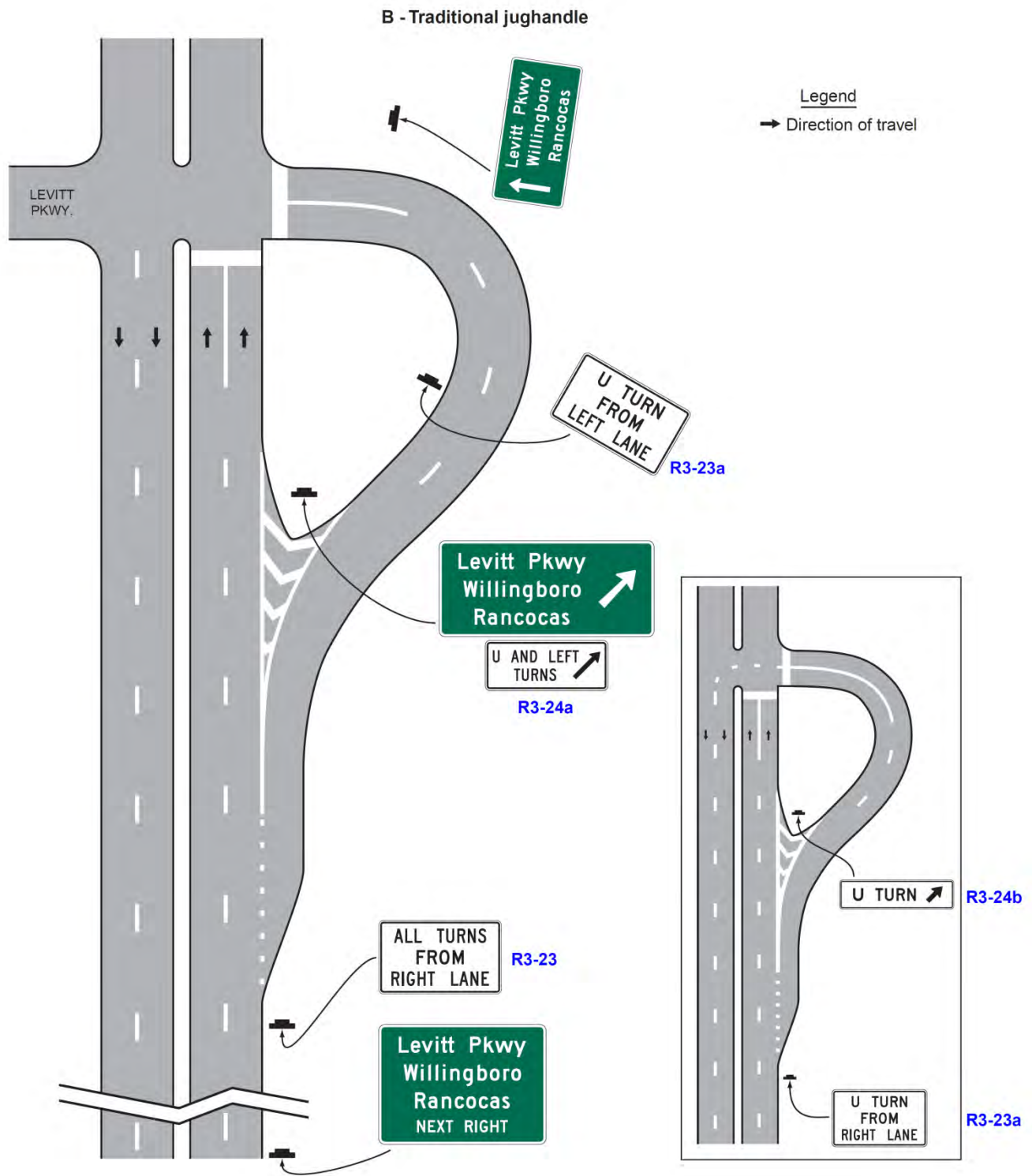
Figure 2B-8. Jughandle Regulatory Signs



**Figure 2B-9. Examples of Applications of Jughandle Regulatory and Guide Signing**  
(Sheet 1 of 3)



**Figure 2B-9. Examples of Applications of Jughandle Regulatory and Guide Signing**  
(Sheet 2 of 3)



**Figure 2B-9. Examples of Applications of Jughandle Regulatory and Guide Signing**  
(Sheet 3 of 3)

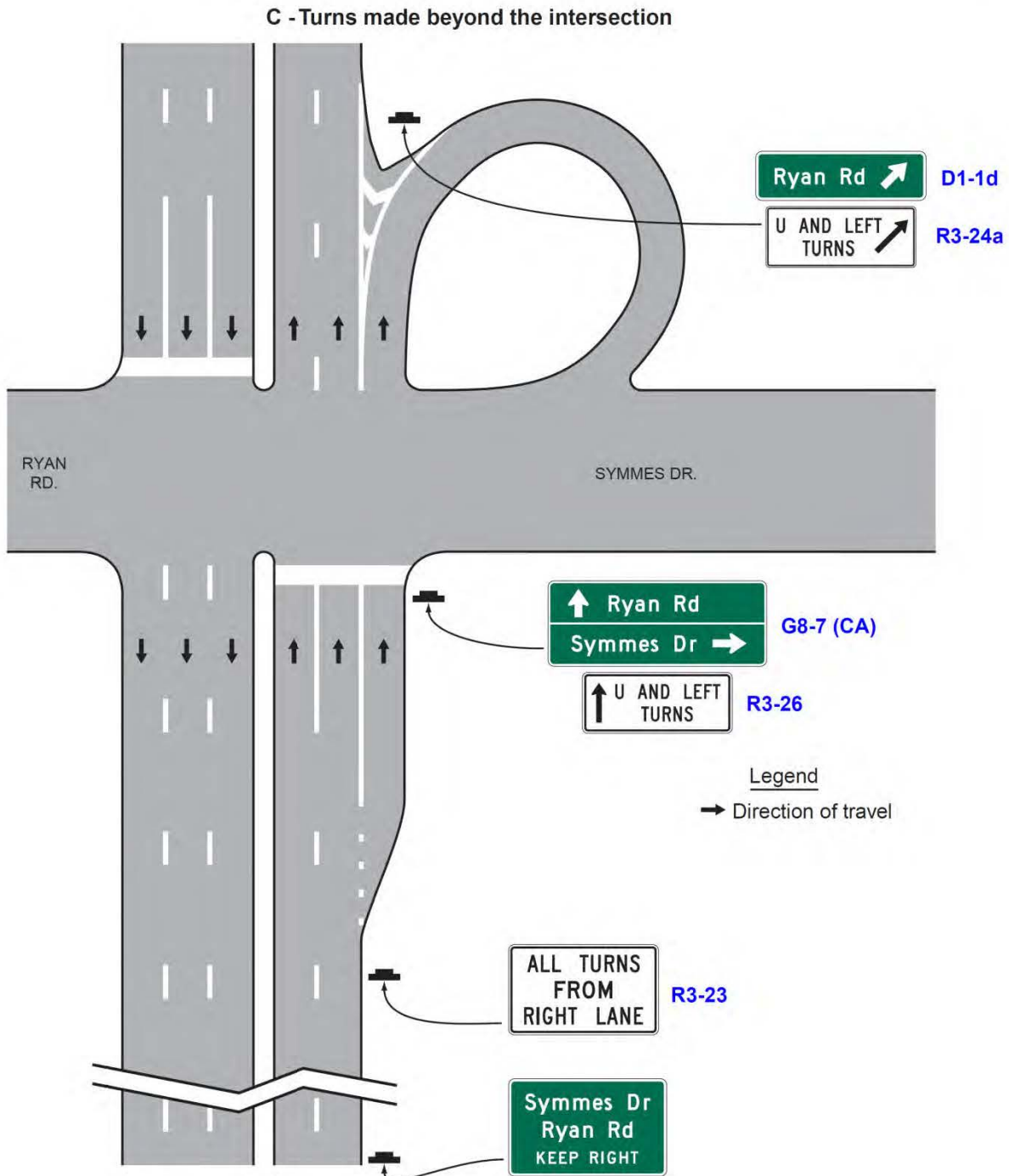
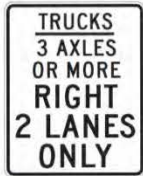


Figure 2B-10. Passing, Keep Right, and Slow Traffic Signs





**Figure 2B-10 (CA). Passing, Keep Right, and Slow Traffic Signs**



R6-3A (CA)



R6-4A (CA)



R40 (CA)



R53A (CA)



R53B (CA)



R53E (CA)



R55 (CA)



R70 (CA)



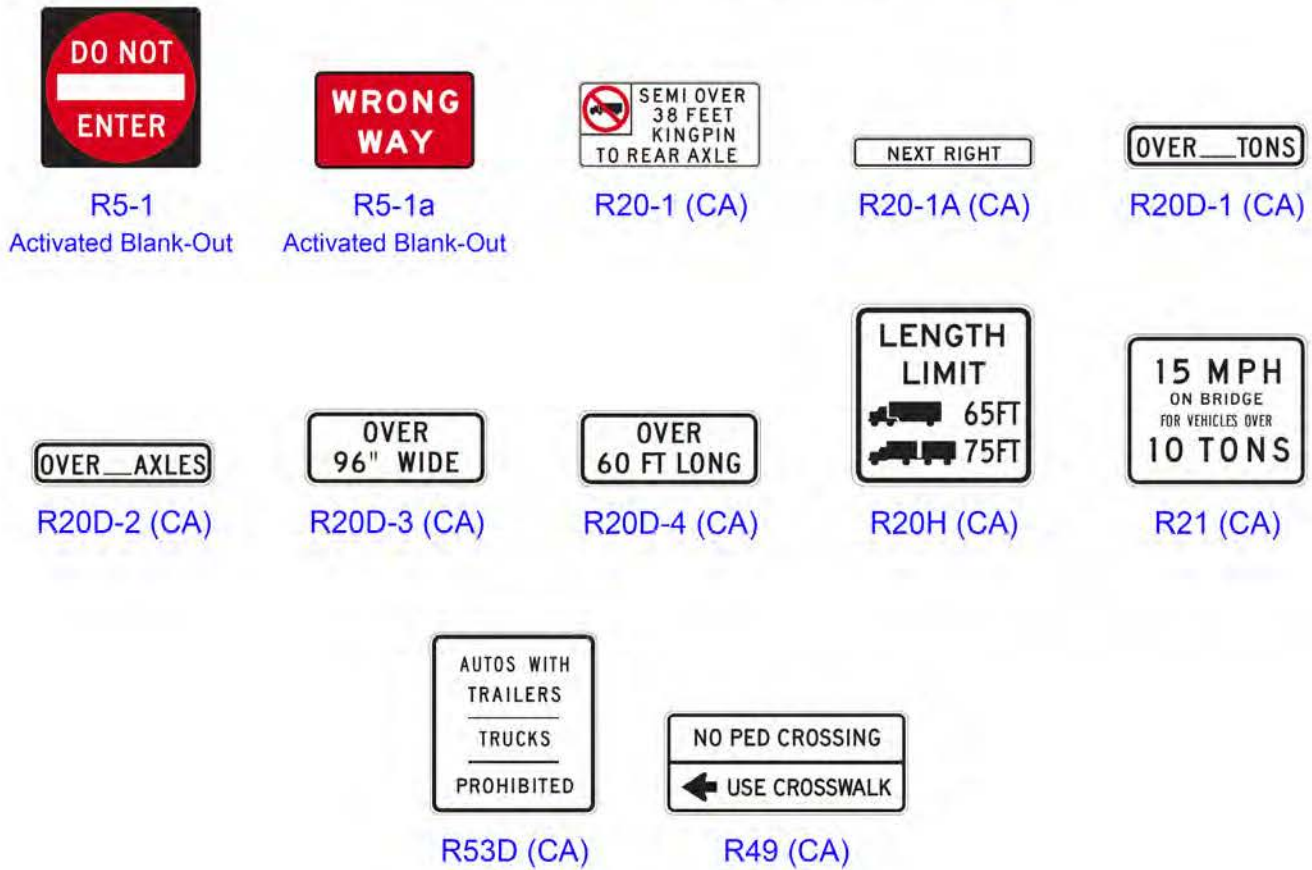
R82A (CA)

Figure 2B-11. Selective Exclusion Signs

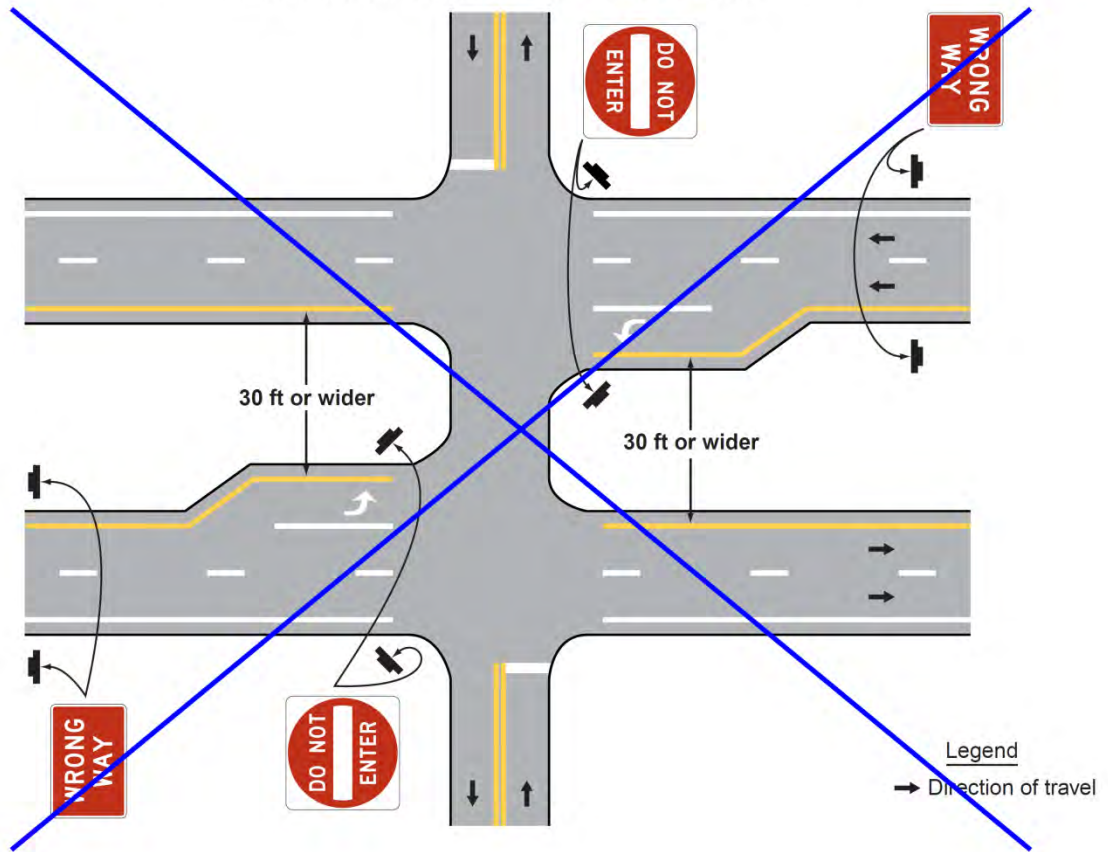


\* An optional word message sign is shown in the "Standard Highway Signs and Markings" book

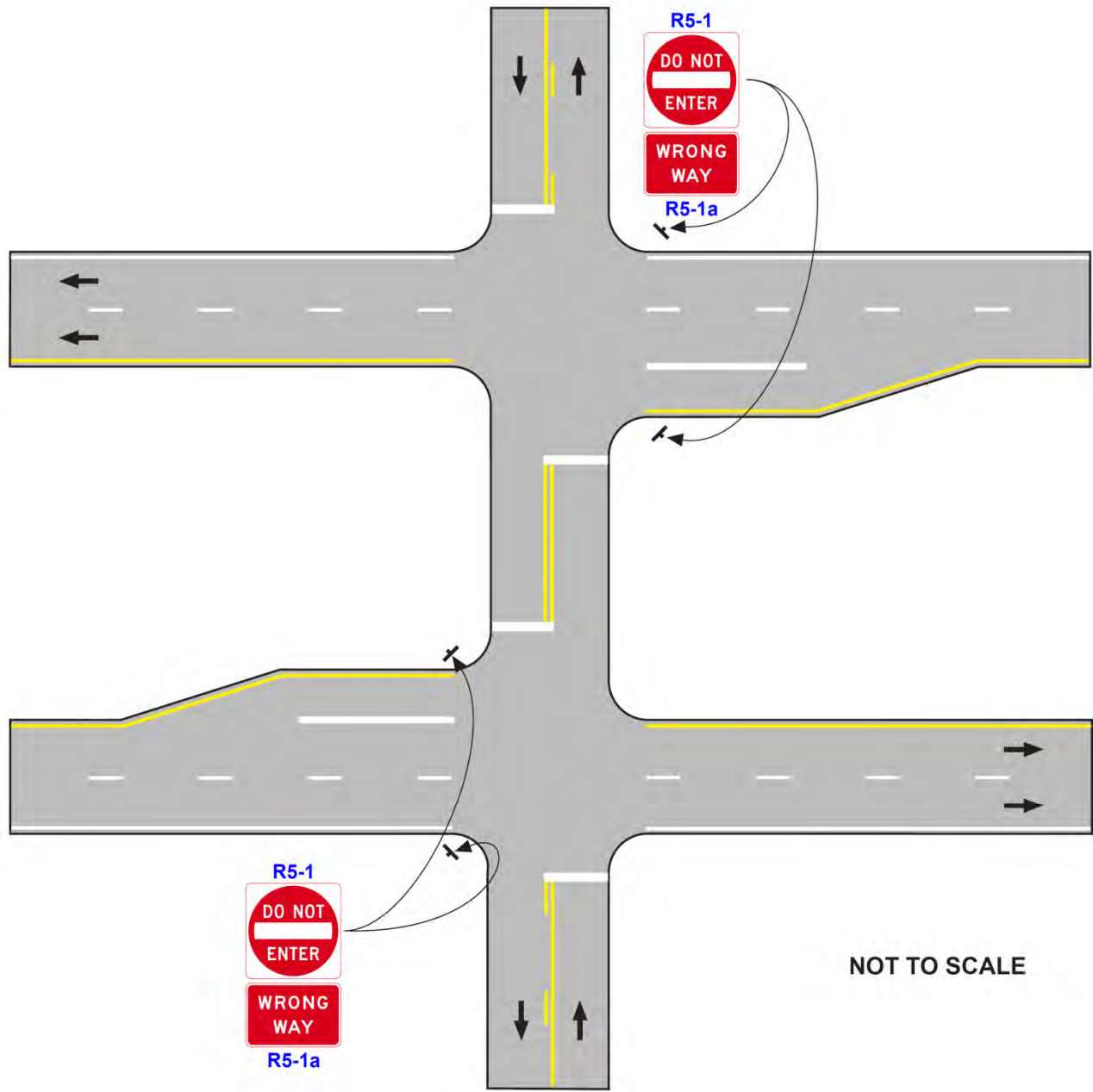
**Figure 2B-11 (CA). Selective Exclusion Signs**



**Figure 2B-12. Locations of Wrong-Way Signing for Divided Highways with Median Widths of 30 Feet or Wider**



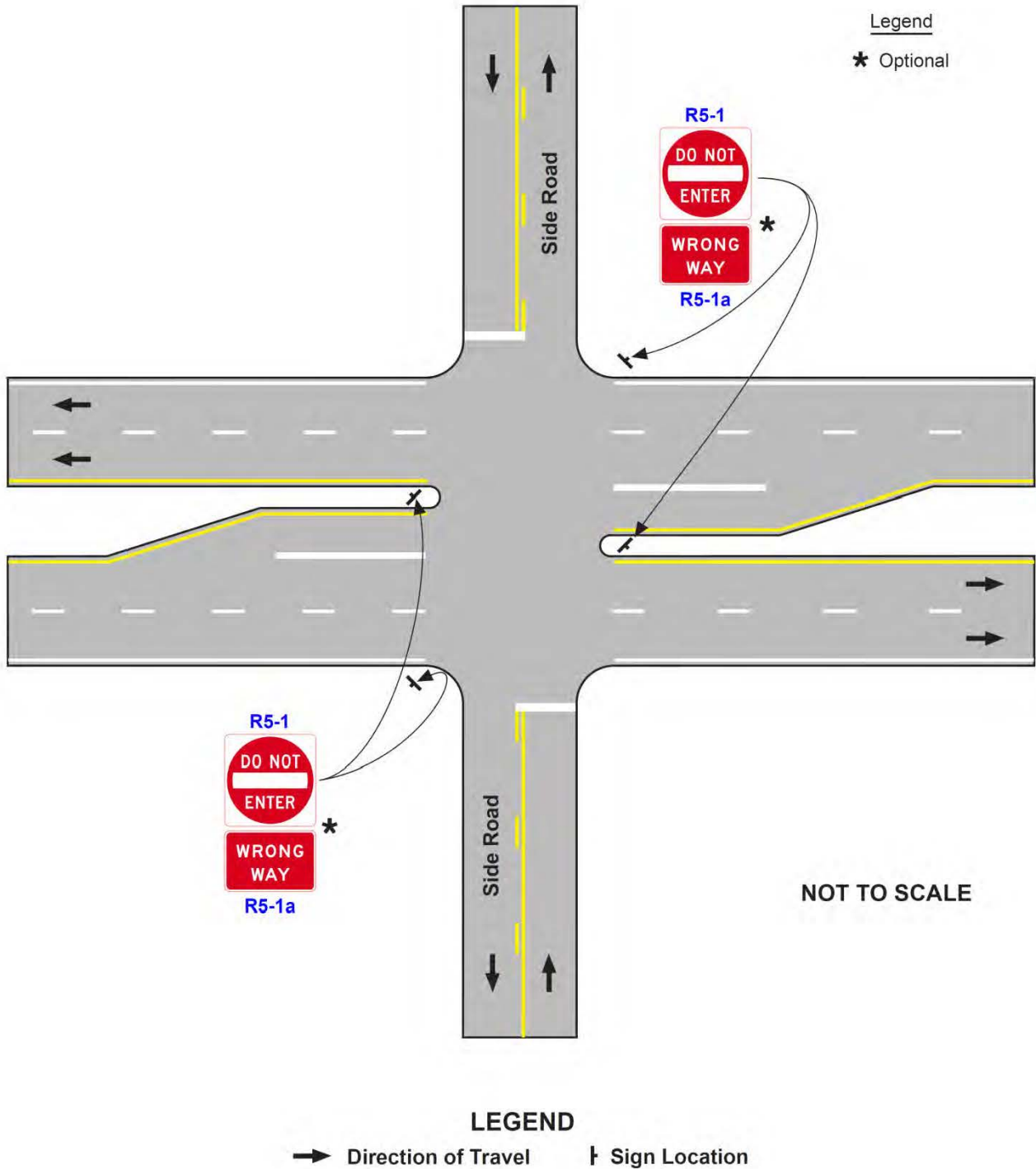
**Figure 2B-12 (CA). Location of Wrong-Way Signing for Divided Highways  
A - with Median Widths of 30 Feet or Wider**



**LEGEND**

- ➔ Direction of Travel
- ‡ Sign Location

**Figure 2B-12 (CA). Location of Wrong-Way Signing for Divided Highways B - with Median Widths Narrower Than 30 Feet**



**Figure 2B-13. ONE WAY and Divided Highway Crossing Signs**

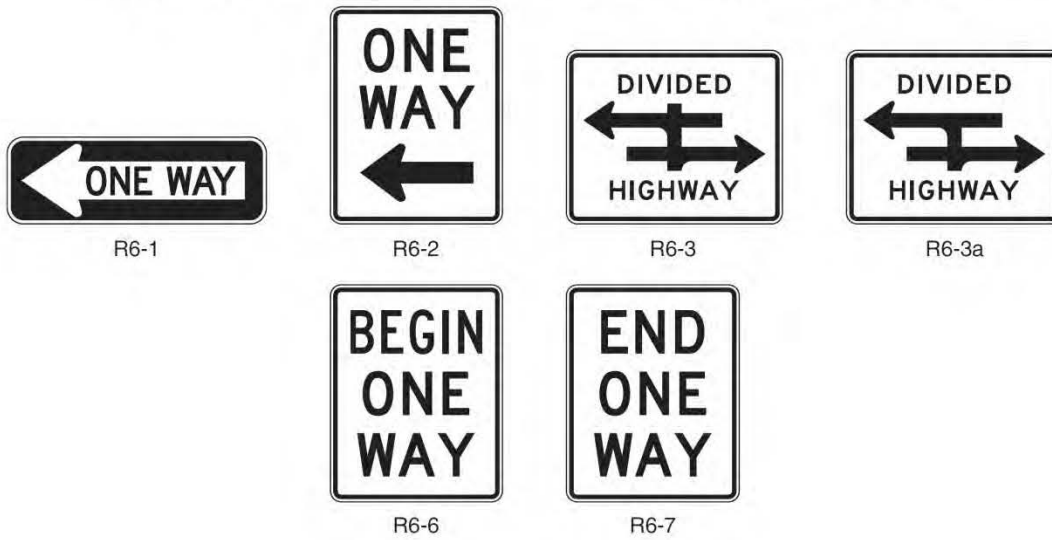
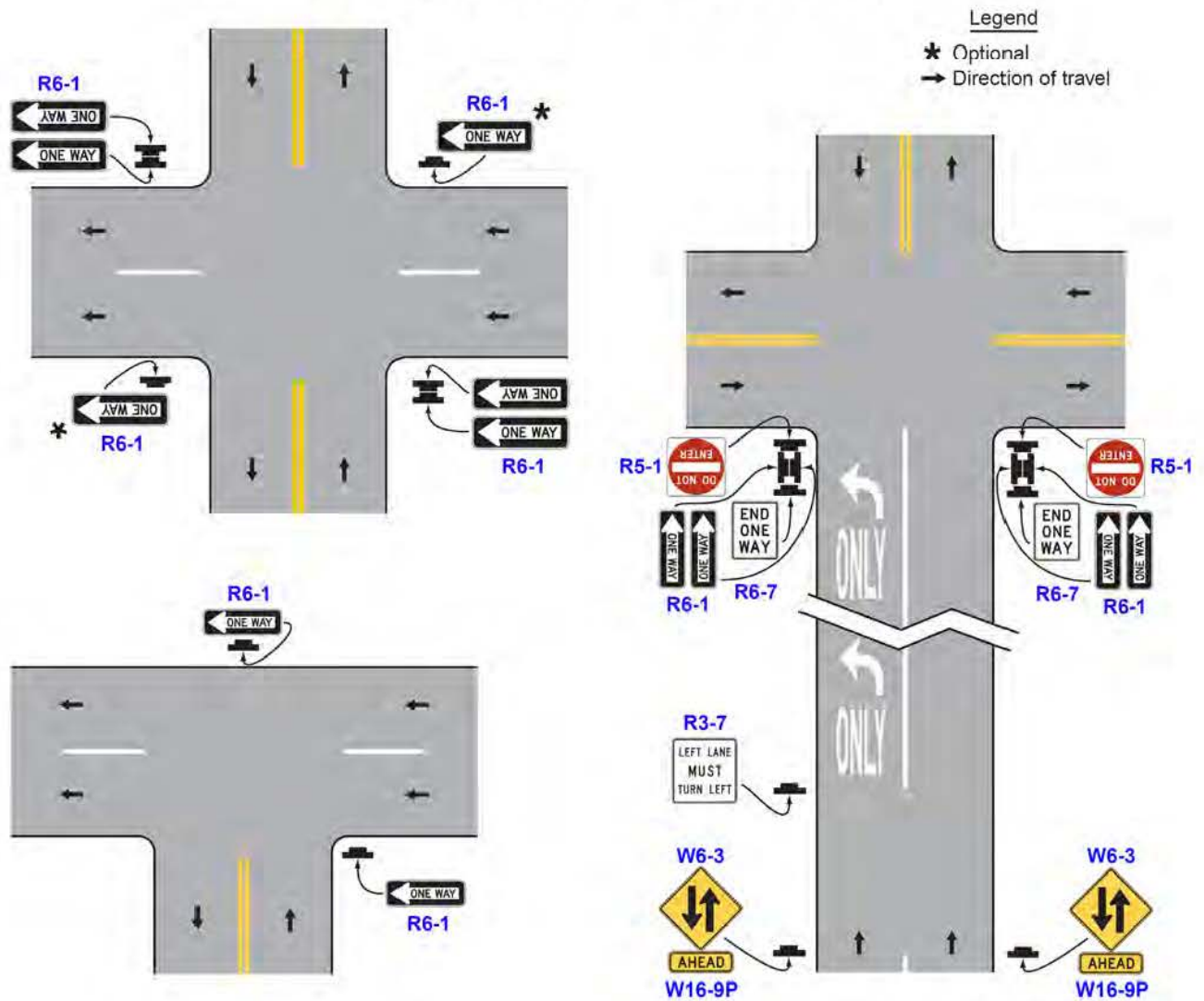
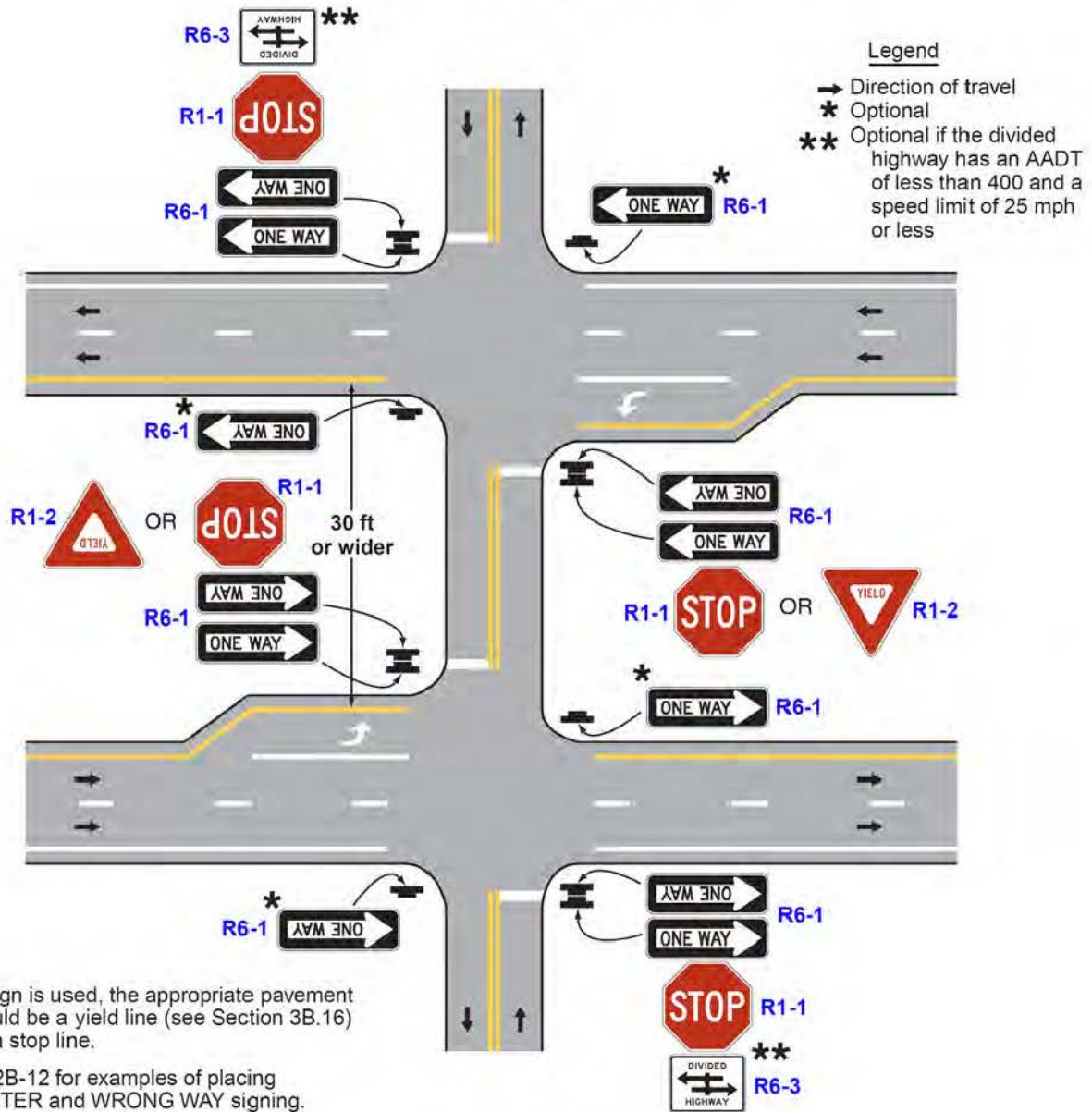


Figure 2B-14. Locations of ONE WAY Signs

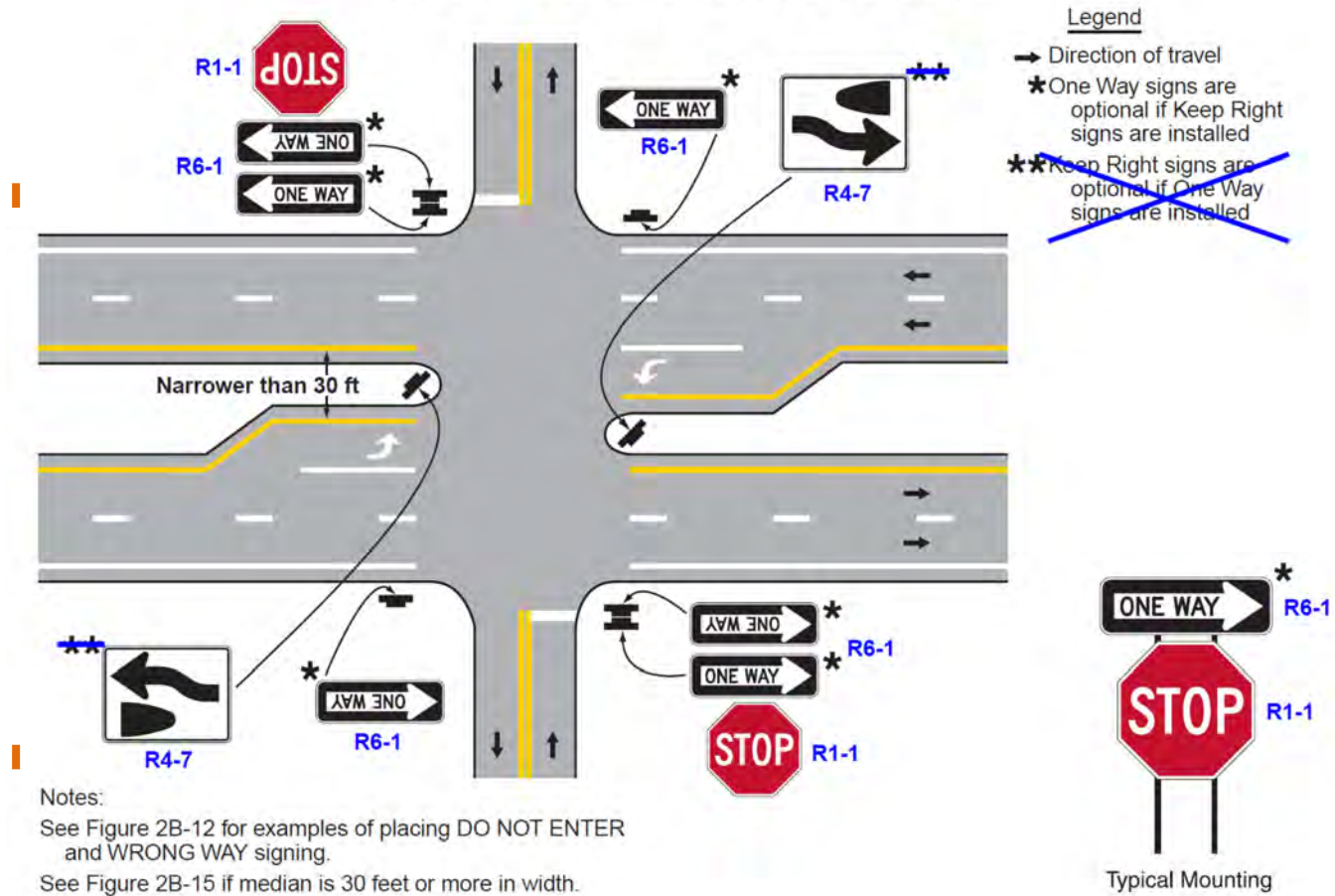




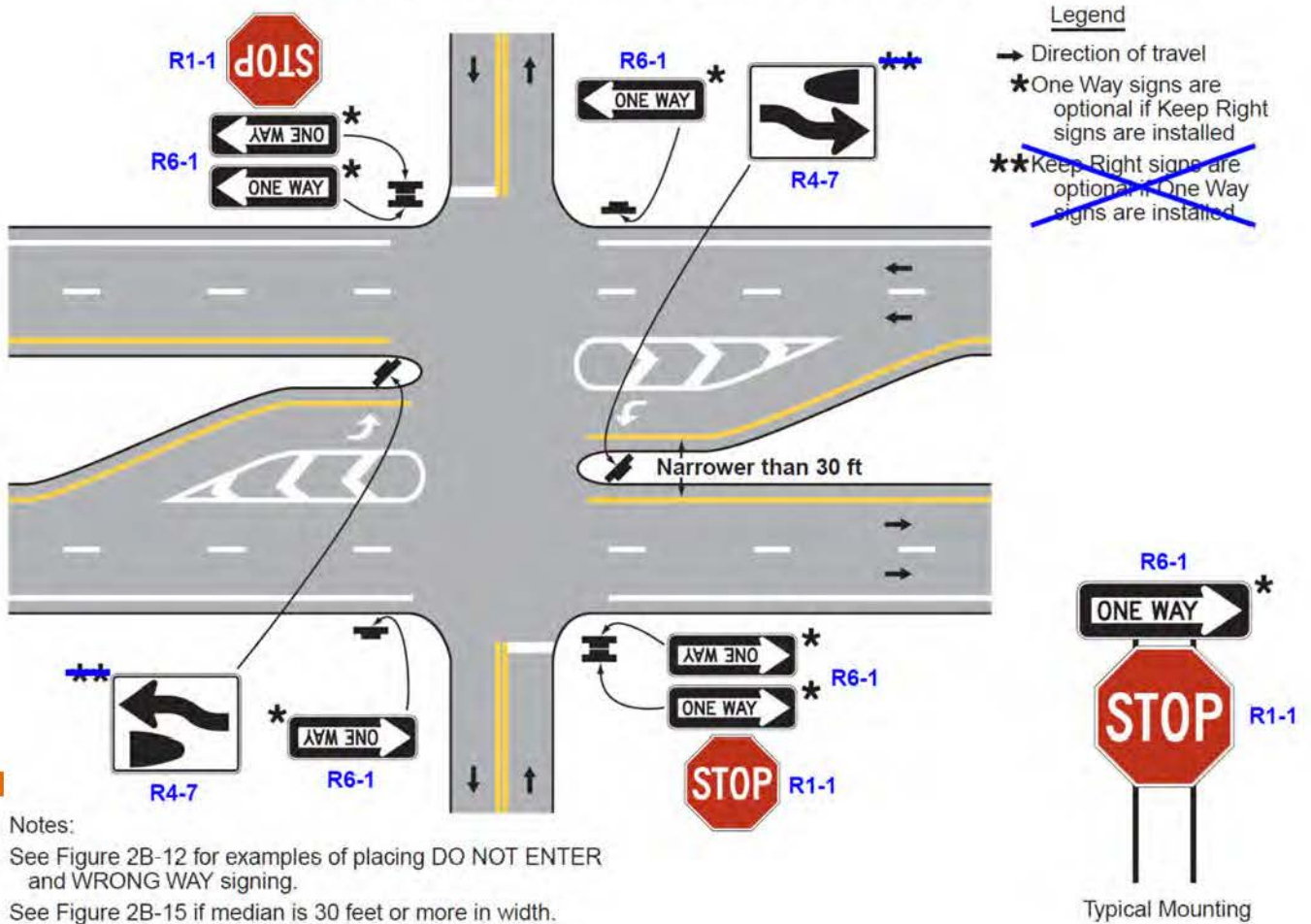
**Figure 2B-15. ONE WAY Signing for Divided Highways with Median Widths of 30 Feet or Wider**



**Figure 2B-16. ONE WAY Signing for Divided Highways with Median Widths Narrower Than 30 Feet**

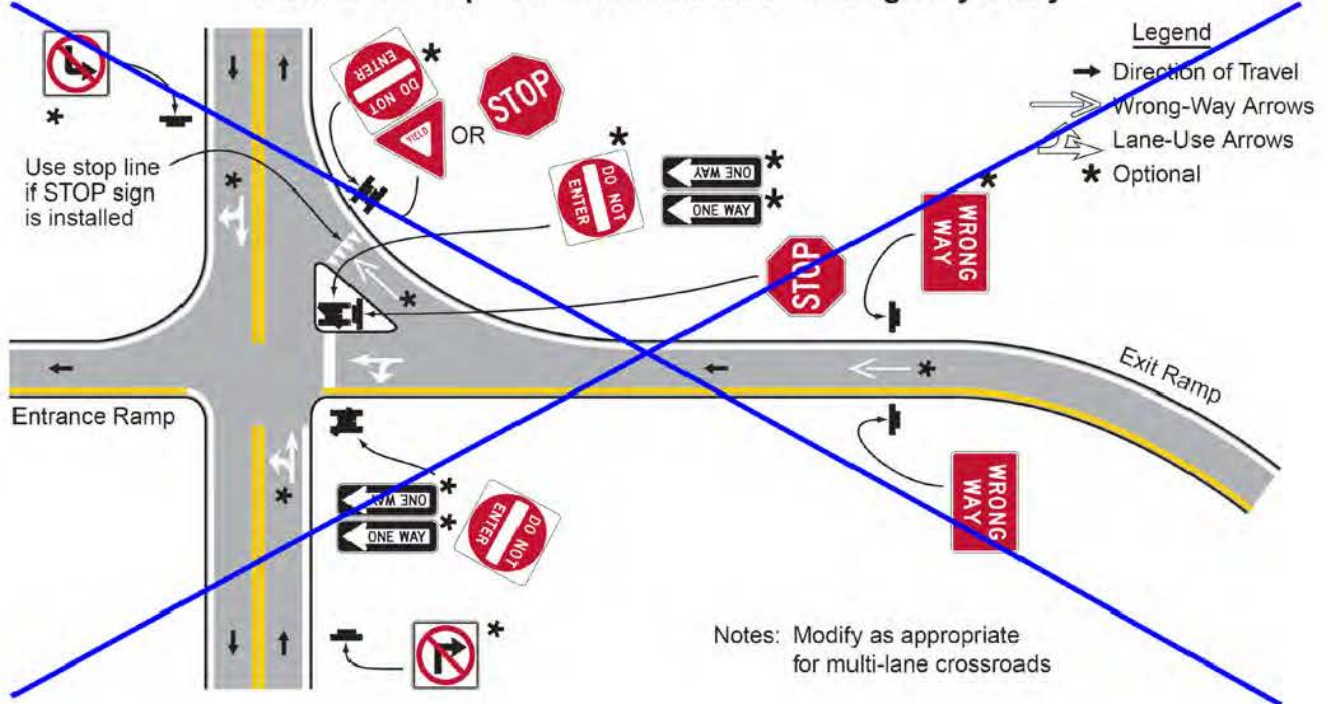


**Figure 2B-17. ONE WAY Signing for Divided Highways with Median Widths Narrower Than 30 Feet and Separated Left-Turn Lanes**

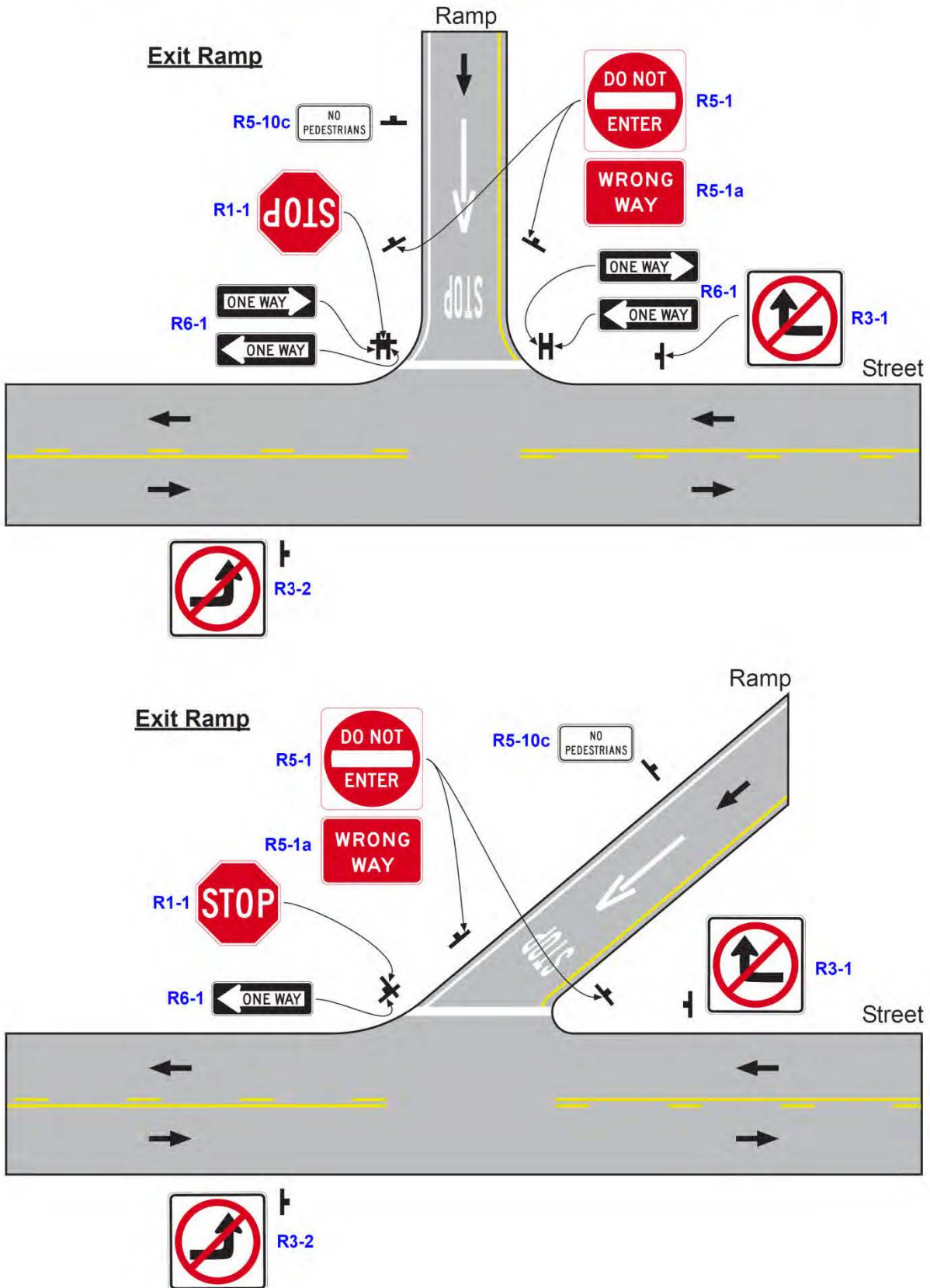


Notes:  
 See Figure 2B-12 for examples of placing DO NOT ENTER and WRONG WAY signing.  
 See Figure 2B-15 if median is 30 feet or more in width.

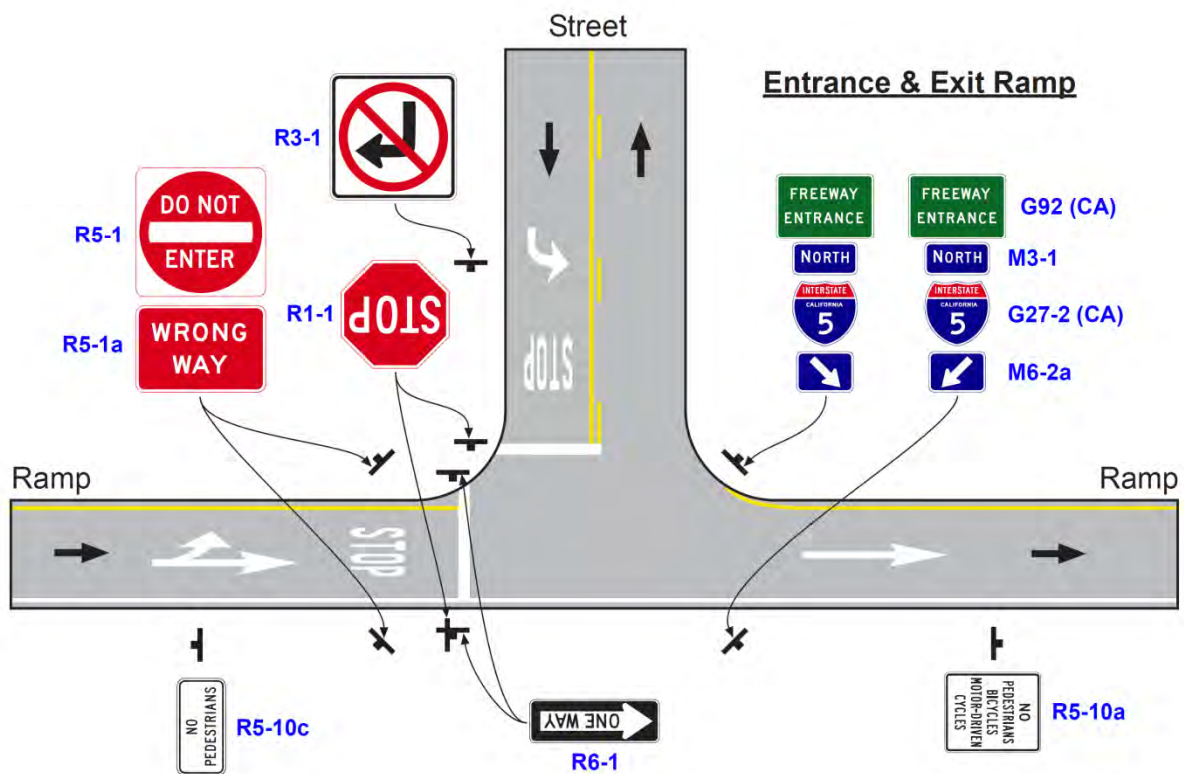
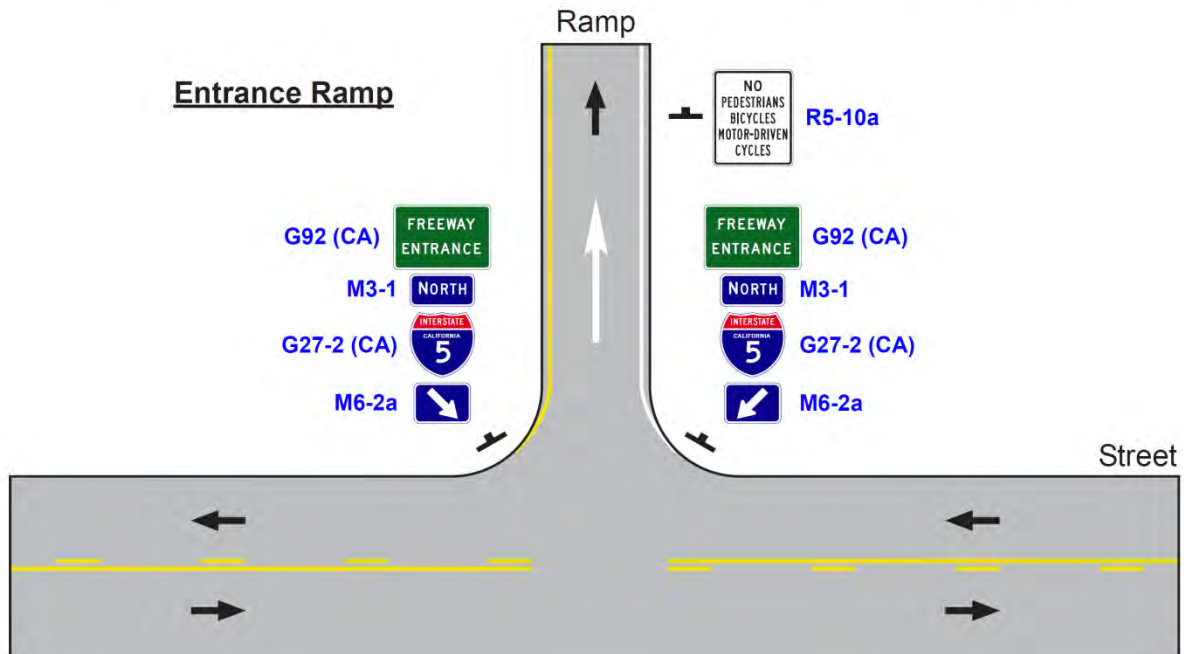
**Figure 2B-18. Example of Application of Regulatory Signing and Pavement Markings at an Exit Ramp Termination to Deter Wrong-Way Entry**



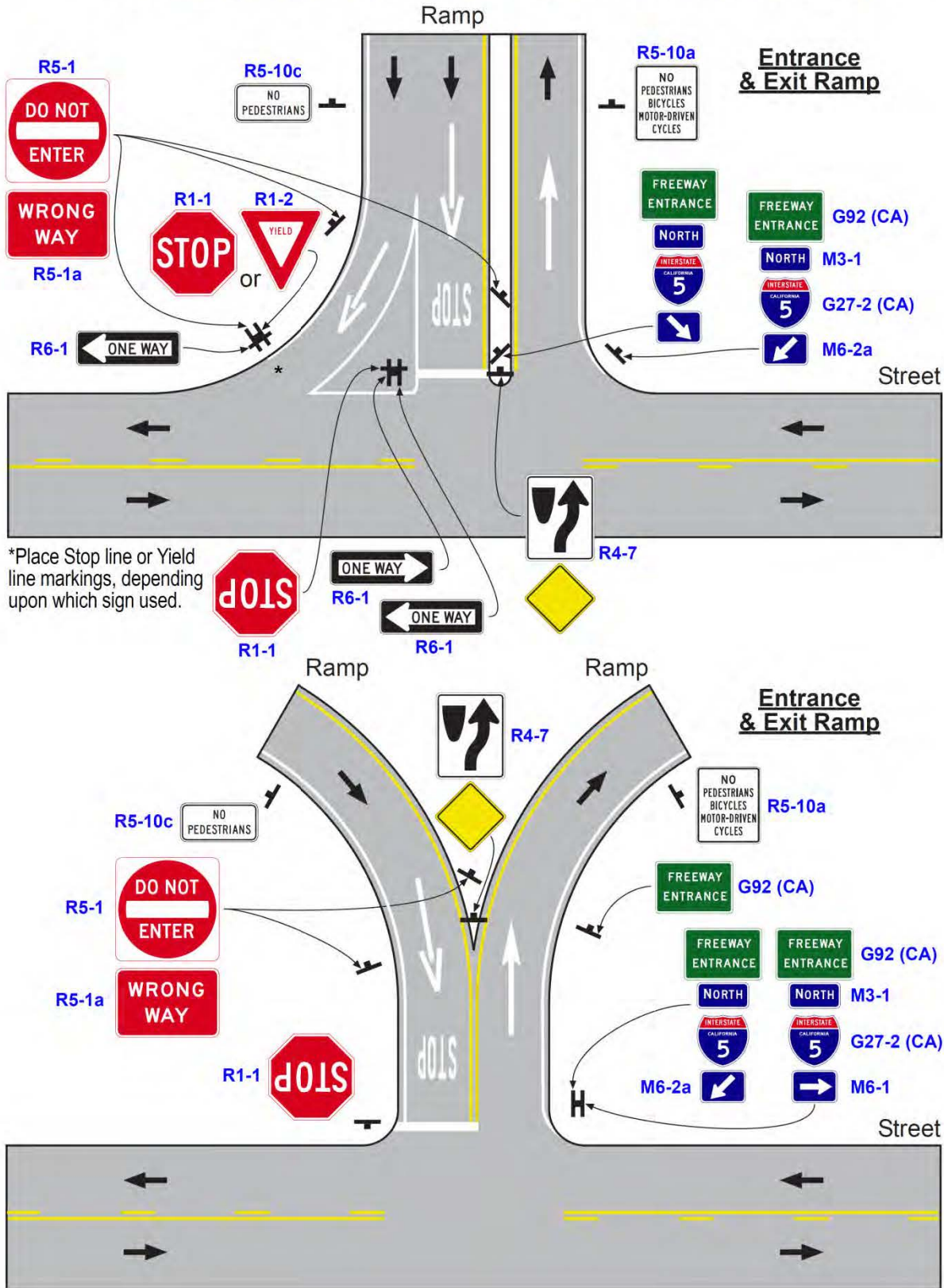
**Figure 2B-18 (CA). Example of Application of Regulatory Signing and Pavement Markings at an Exit Ramp Termination to Deter Wrong-Way Entry (Sheet 1 of 5)**



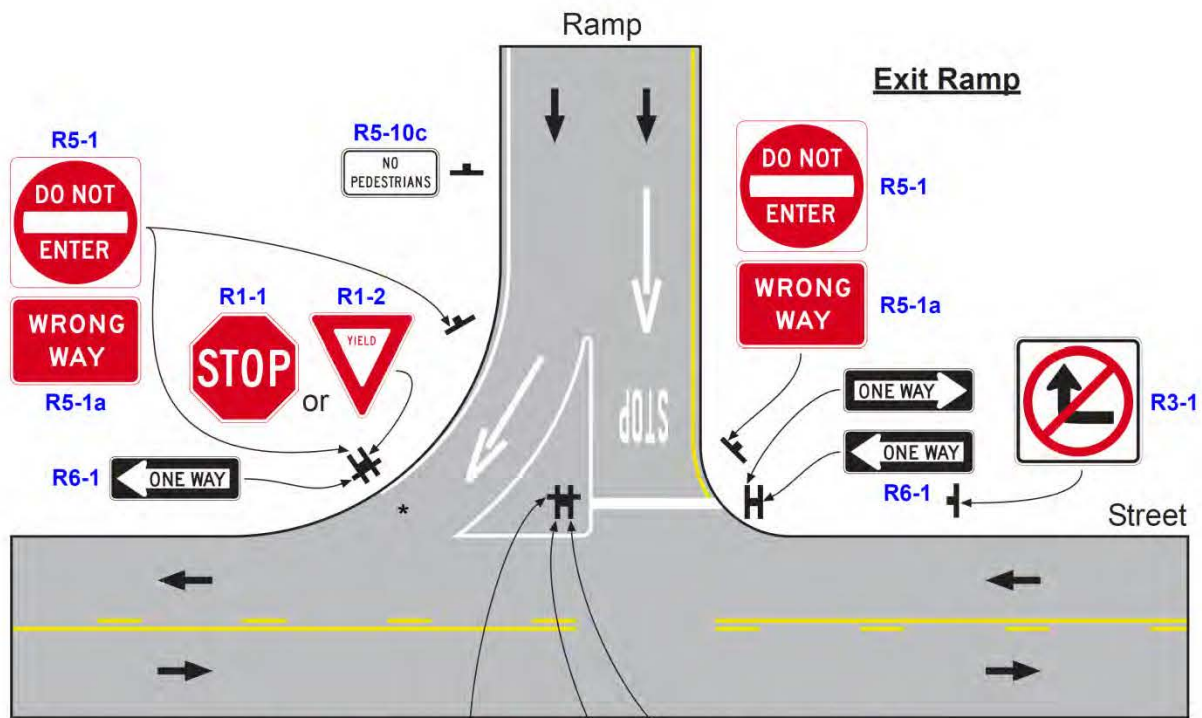
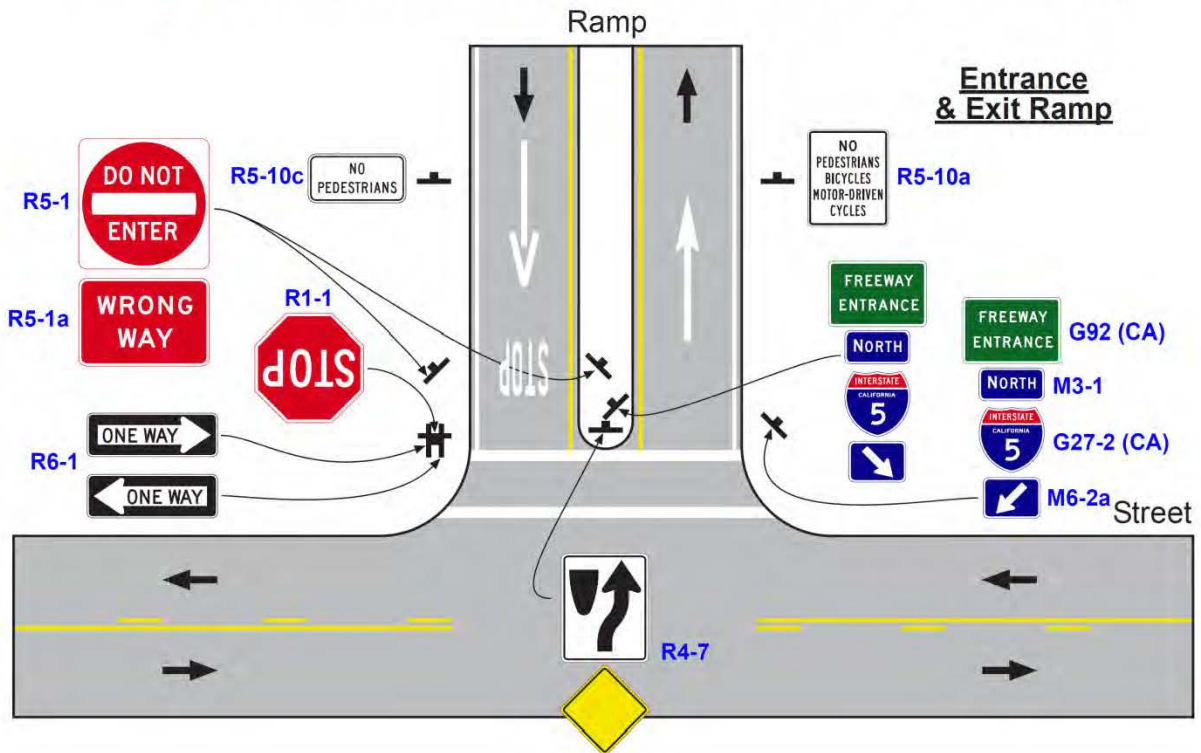
**Figure 2B-18 (CA). Example of Application of Regulatory Signing and Pavement Markings at an Exit Ramp Termination to Deter Wrong-Way Entry (Sheet 2 of 5)**



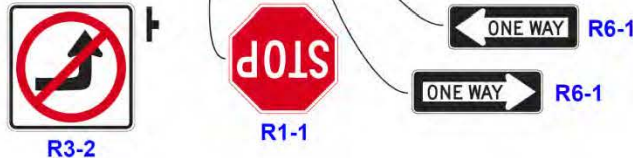
**Figure 2B-18 (CA). Example of Application of Regulatory Signing and Pavement Markings at an Exit Ramp Termination to Deter Wrong-Way Entry (Sheet 3 of 5)**



**Figure 2B-18 (CA). Example of Application of Regulatory Signing and Pavement Markings at an Exit Ramp Termination to Deter Wrong-Way Entry (Sheet 4 of 5)**

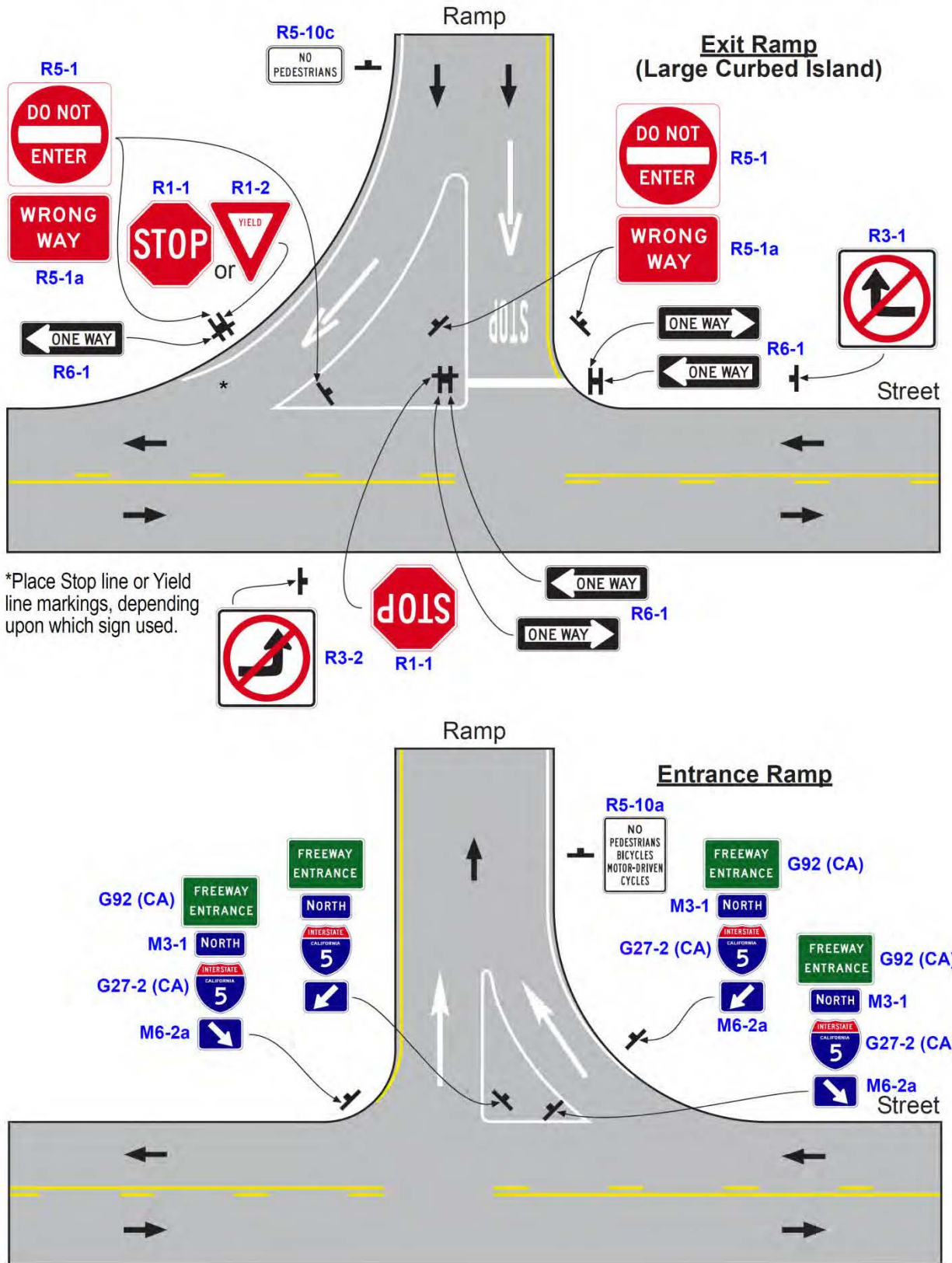


\*Place Stop line or Yield line markings, depending upon which sign is used.

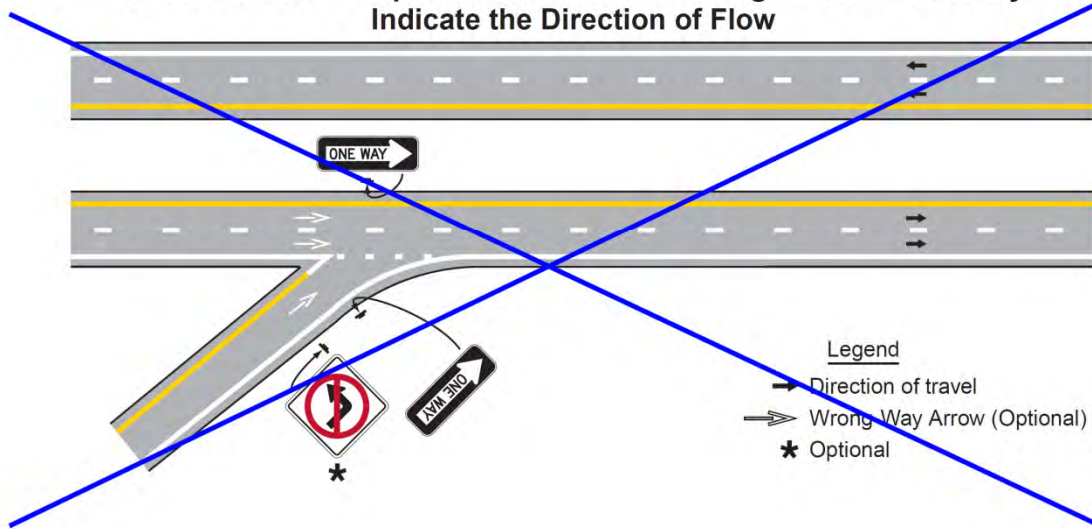




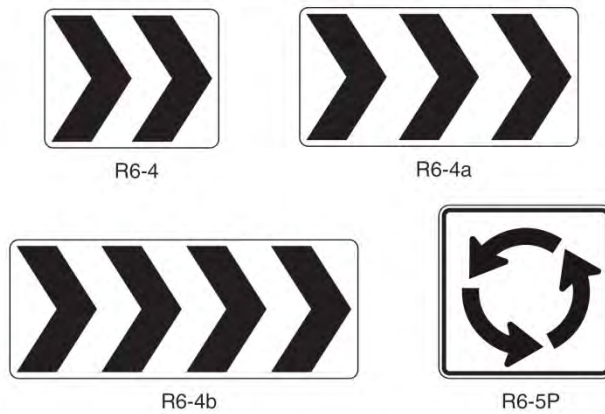
**Figure 2B-18 (CA). Example of Application of Regulatory Signing and Pavement Markings at an Exit Ramp Termination to Deter Wrong-Way Entry (Sheet 5 of 5)**



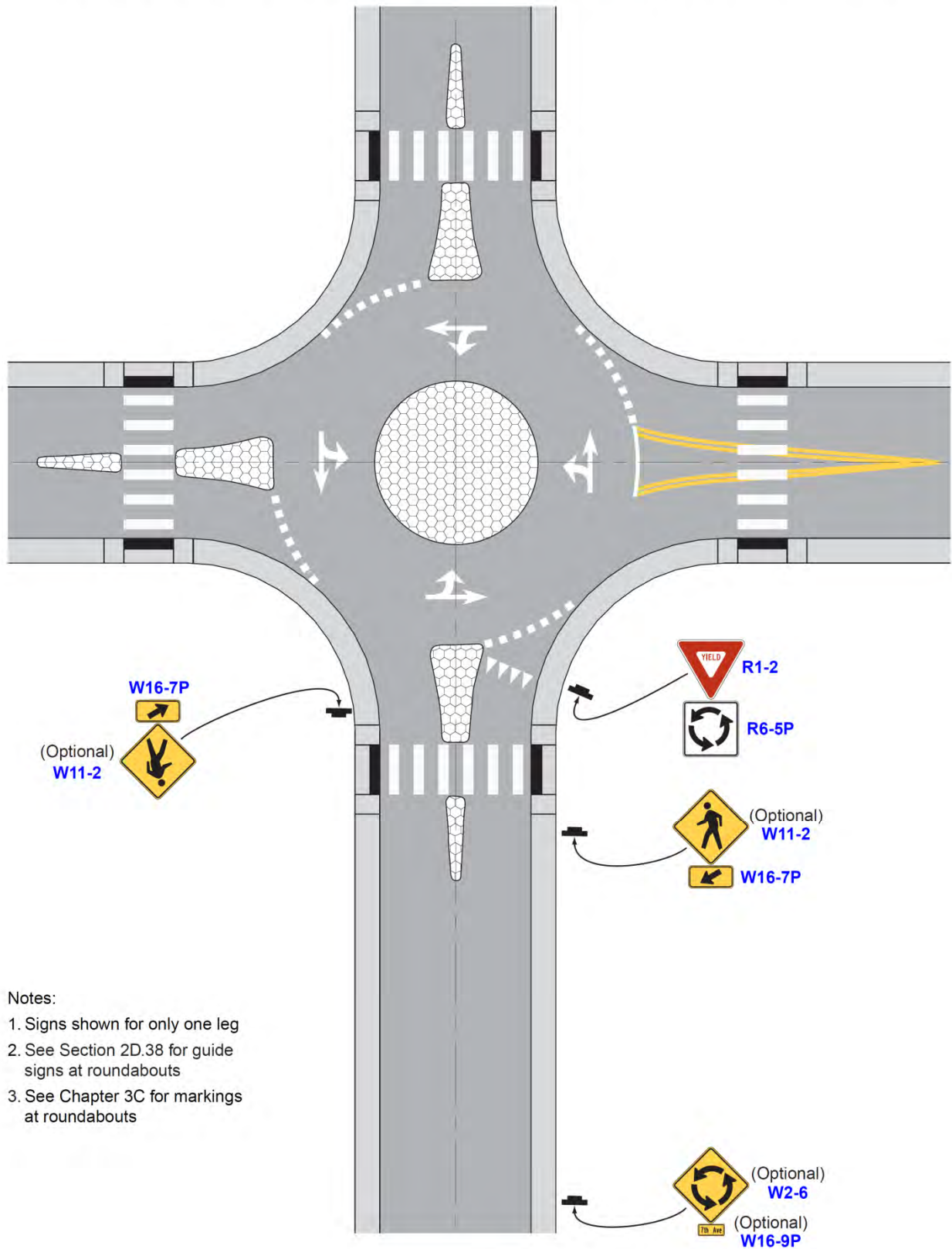
**Figure 2B-19. Example of Application of Regulatory Signing and Pavement Markings at an Entrance Ramp Terminal Where the Design Does Not Clearly Indicate the Direction of Flow**



**Figure 2B-20. Roundabout Signs and Plaques**



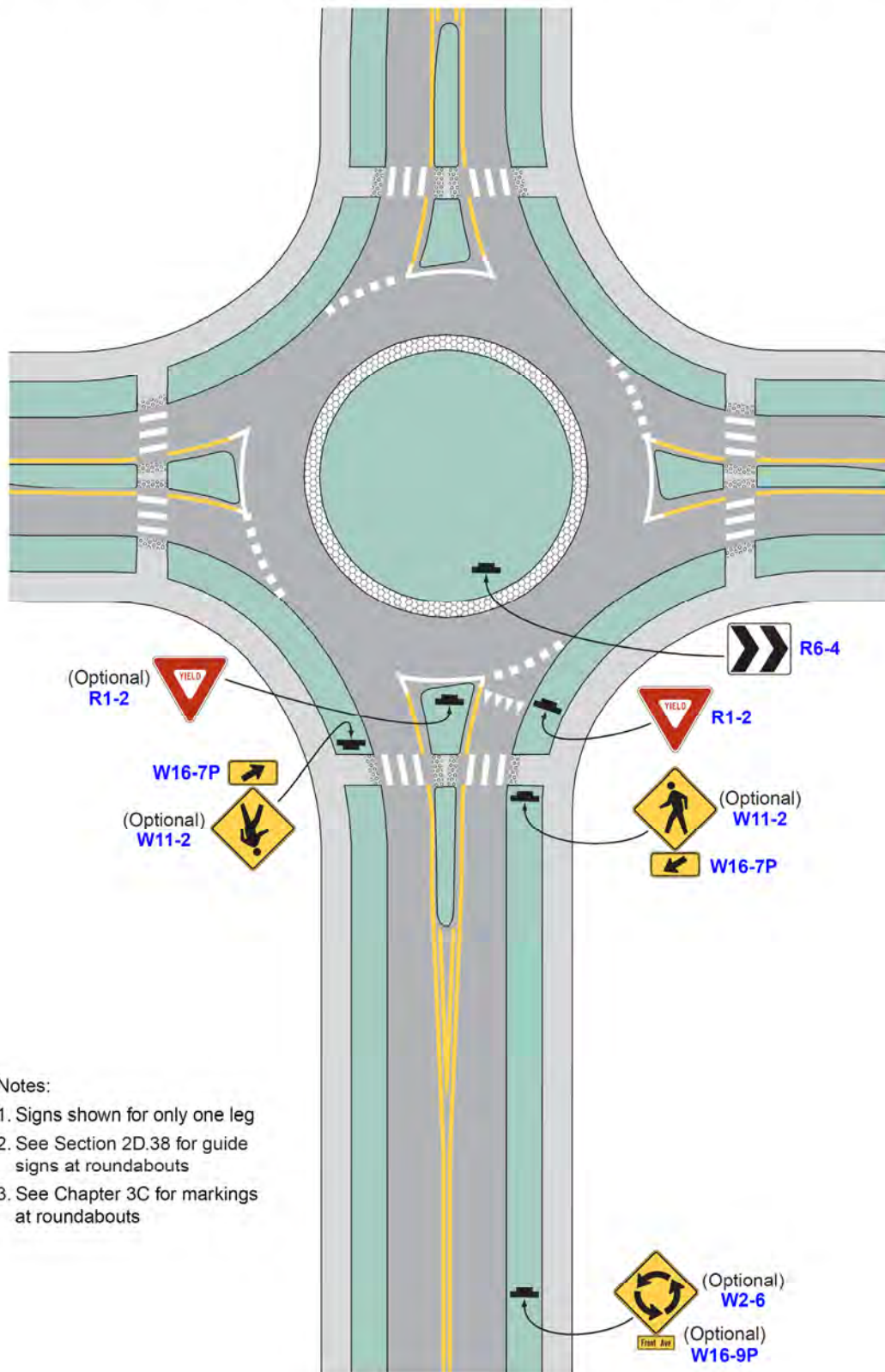
**Figure 2B-21. Example of Regulatory and Warning Signs for a Mini-Roundabout**



Notes:

- 1. Signs shown for only one leg
- 2. See Section 2D.38 for guide signs at roundabouts
- 3. See Chapter 3C for markings at roundabouts

**Figure 2B-22. Example of Regulatory and Warning Signs for a One-Lane Roundabout**



**Figure 2B-23. Example of Regulatory and Warning Signs for a Two-Lane Roundabout with Consecutive Double Lefts**

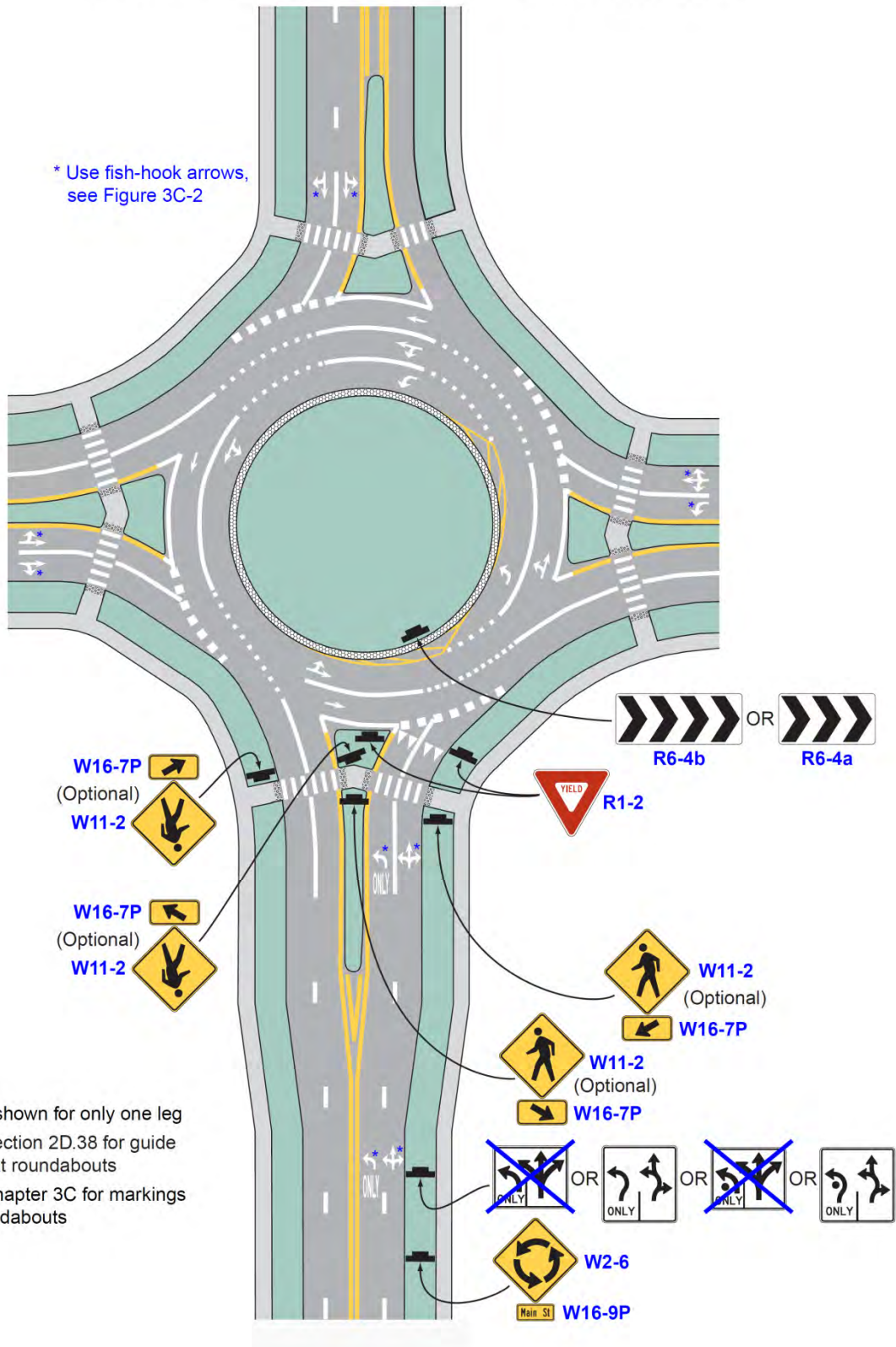
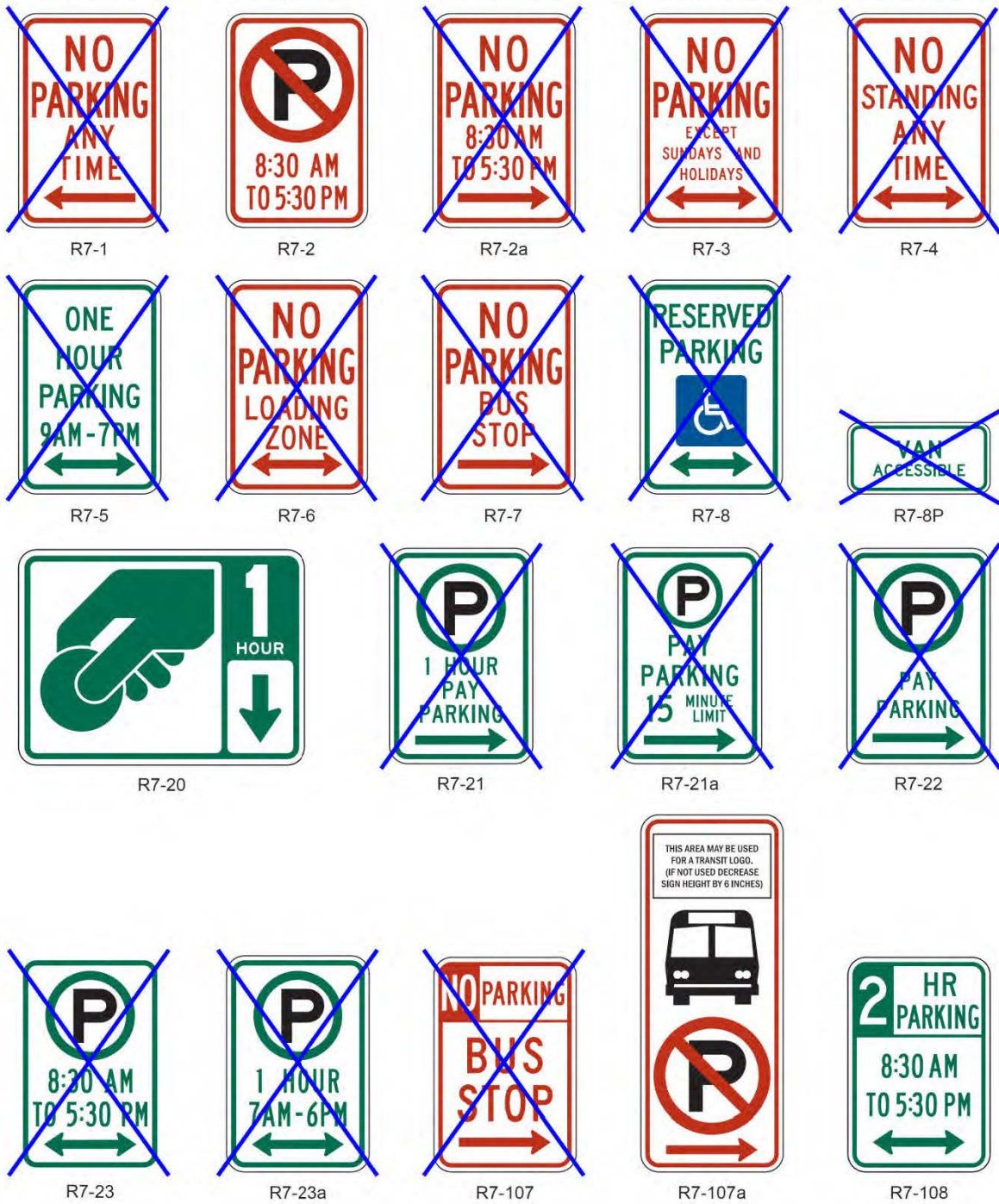
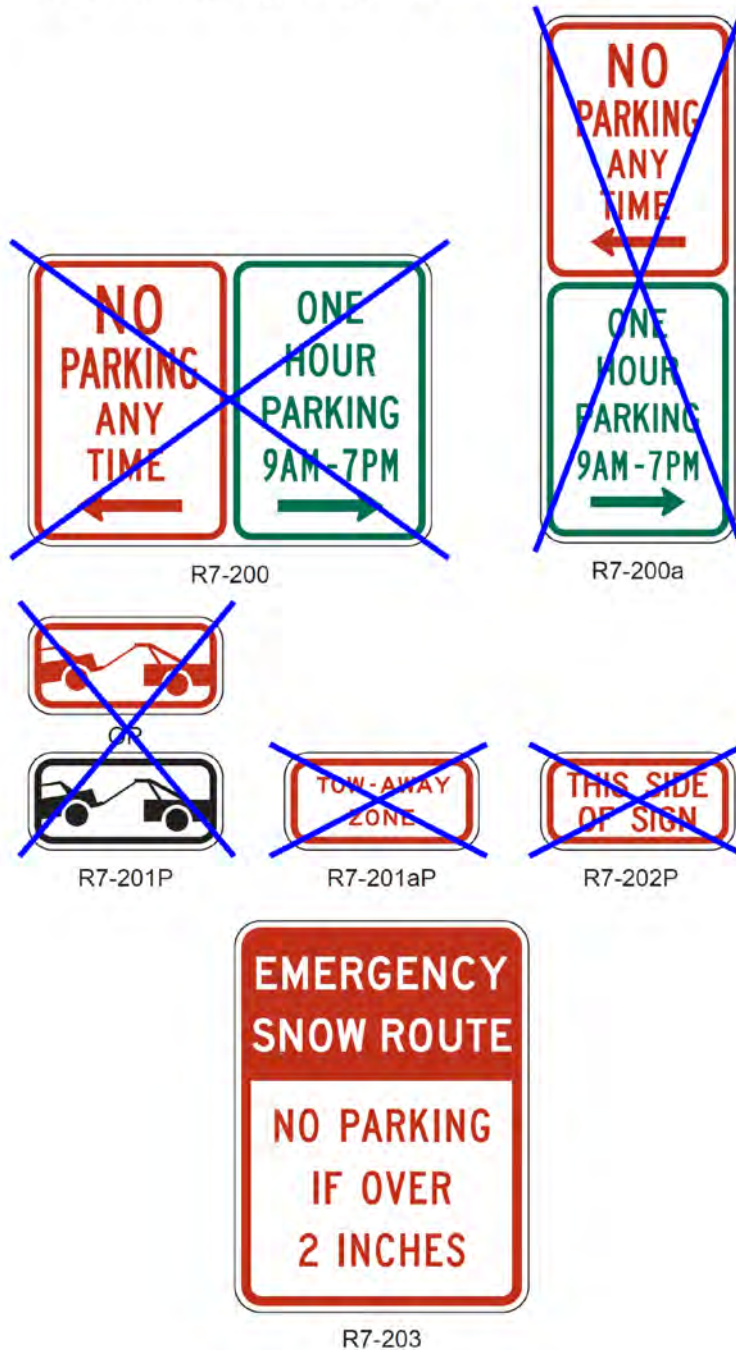


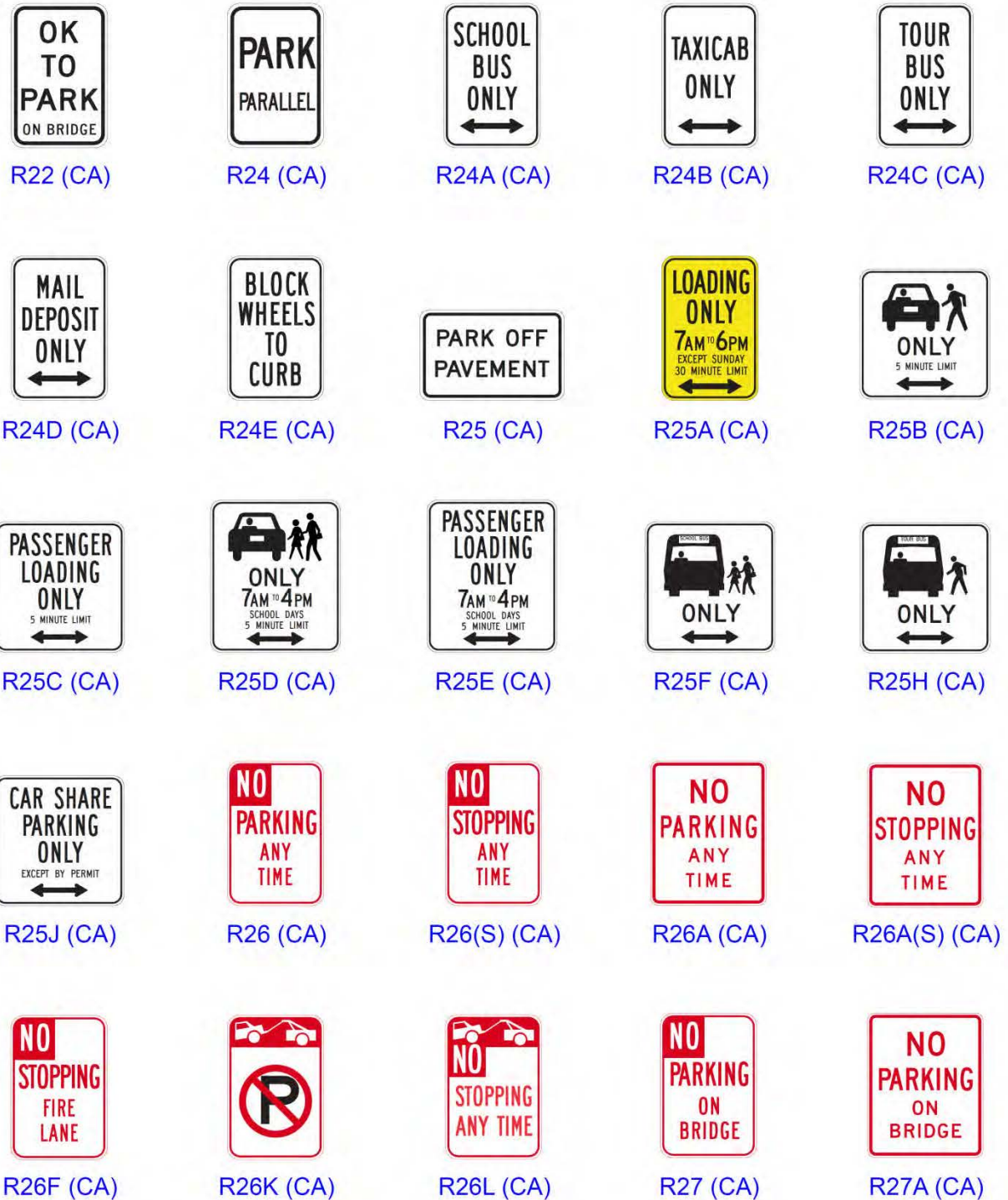
Figure 2B-24. Parking and Standing Signs and Plaques (R7 Series) (Sheet 1 of 2)



**Figure 2B-24. Parking and Standing Signs and Plaques (R7 Series) (Sheet 2 of 2)**



**Figure 2B-24 (CA). Parking and Standing Signs and Plaques (R7 Series) (Sheet 1 of 3)**





**Figure 2B-24 (CA). Parking and Standing Signs and Plaques (R7 Series) (Sheet 2 of 3)**



R28 (CA)



R28(S) (CA)



R28A (CA)



R28A(S) (CA)



R28C (CA)



R28D (CA)



R28D(S) (CA)



R28E (CA)



R28F (CA)



R29 (CA)



R30 (CA)



R30A (CA)



R30B (CA)



R30C (CA)



R30D (CA)



R30E (CA)



R30F (CA)



R31 (CA)



R31(S) (CA)



R32 (CA)



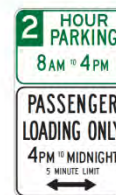
R32B (CA)



R32C (CA)



R32D (CA)

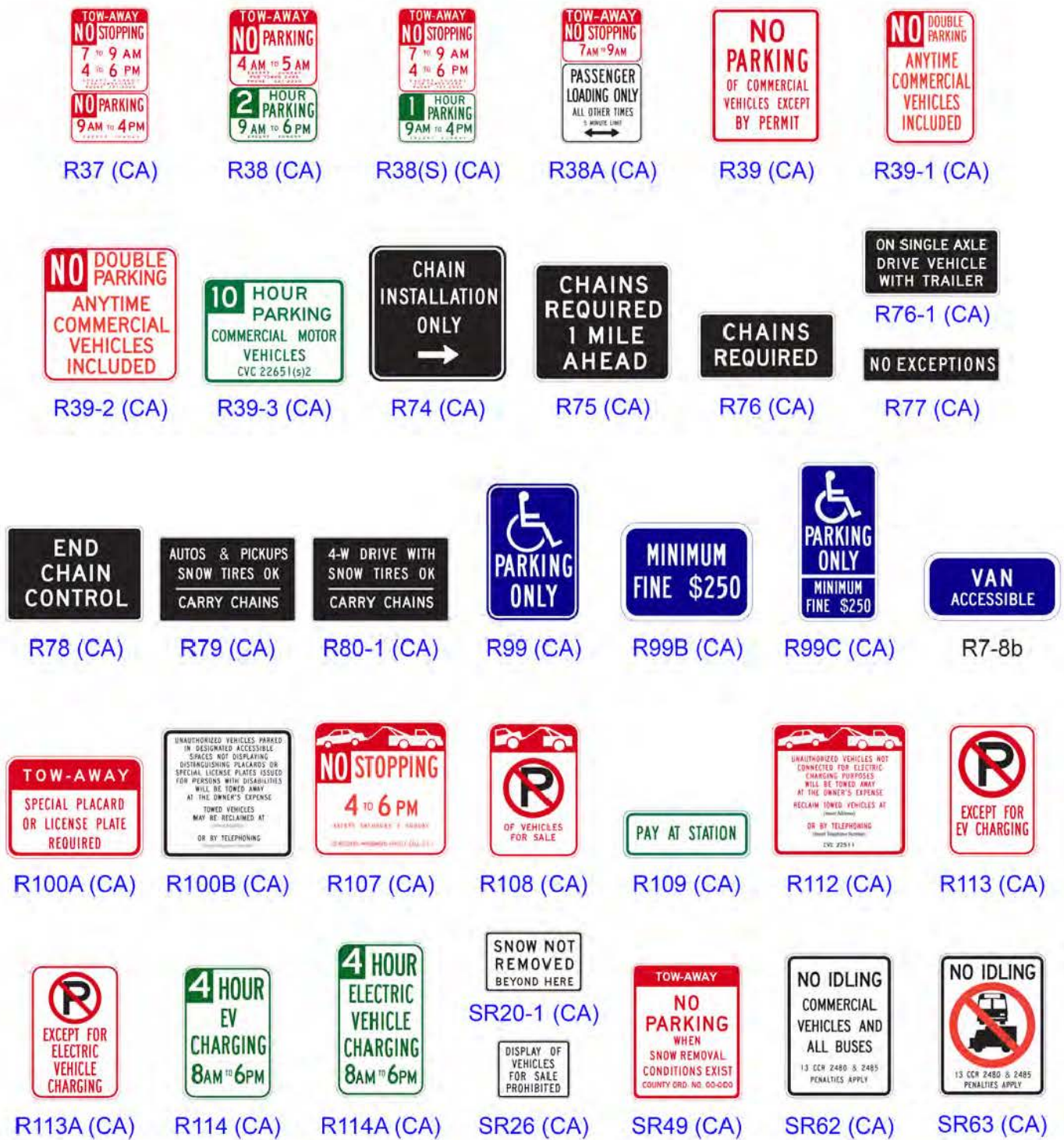


R32E (CA)



R32F (CA)

**Figure 2B-24 (CA). Parking and Standing Signs and Plaques (R7 Series) (Sheet 3 of 3)**



**Figure 2B-25. Parking and Stopping Signs and Plaques (R8 Series)**



**Figure 2B-25 (CA). Parking and Stopping Signs and Plaques (R8 Series)**

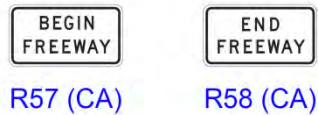


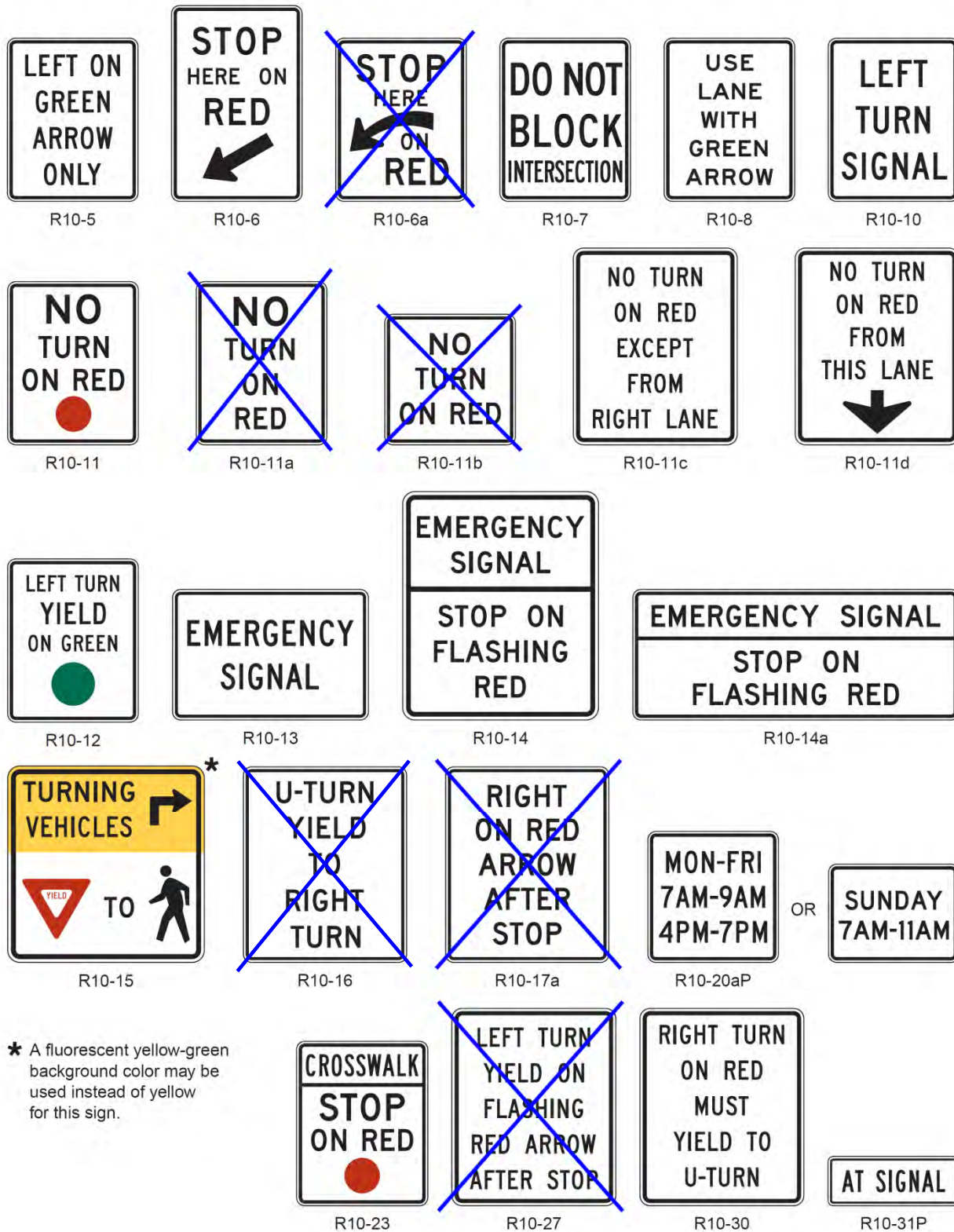
Figure 2B-26. Pedestrian Signs and Plaques (Sheet 1 of 2)



\* The bottom panel shall be eliminated where the pedestrian signal timing is non-actuated and the pedestrian push button is used solely to activate accessible pedestrian signals.



Figure 2B-27. Traffic Signal Signs and Plaques

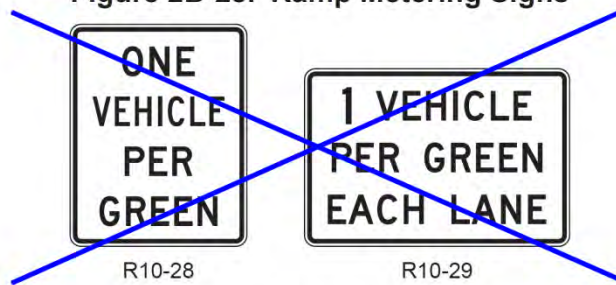


\* A fluorescent yellow-green background color may be used instead of yellow for this sign.

**Figure 2B-27 (CA). Traffic Signal Signs and Plaques**



**Figure 2B-28. Ramp Metering Signs**



**Figure 2B-28 (CA). Ramp Metering Signs**

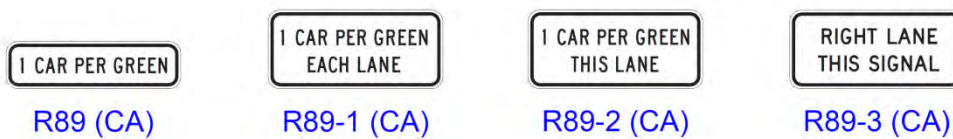


Figure 2B-29. Road Closed and Weight Limit Signs

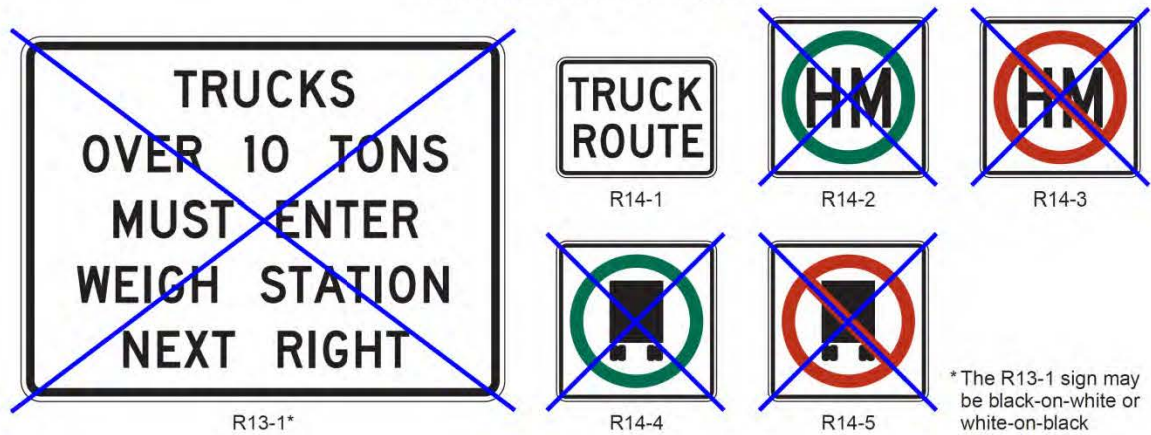


Figure 2B-29 (CA). Road Closed and Weight Limit Signs

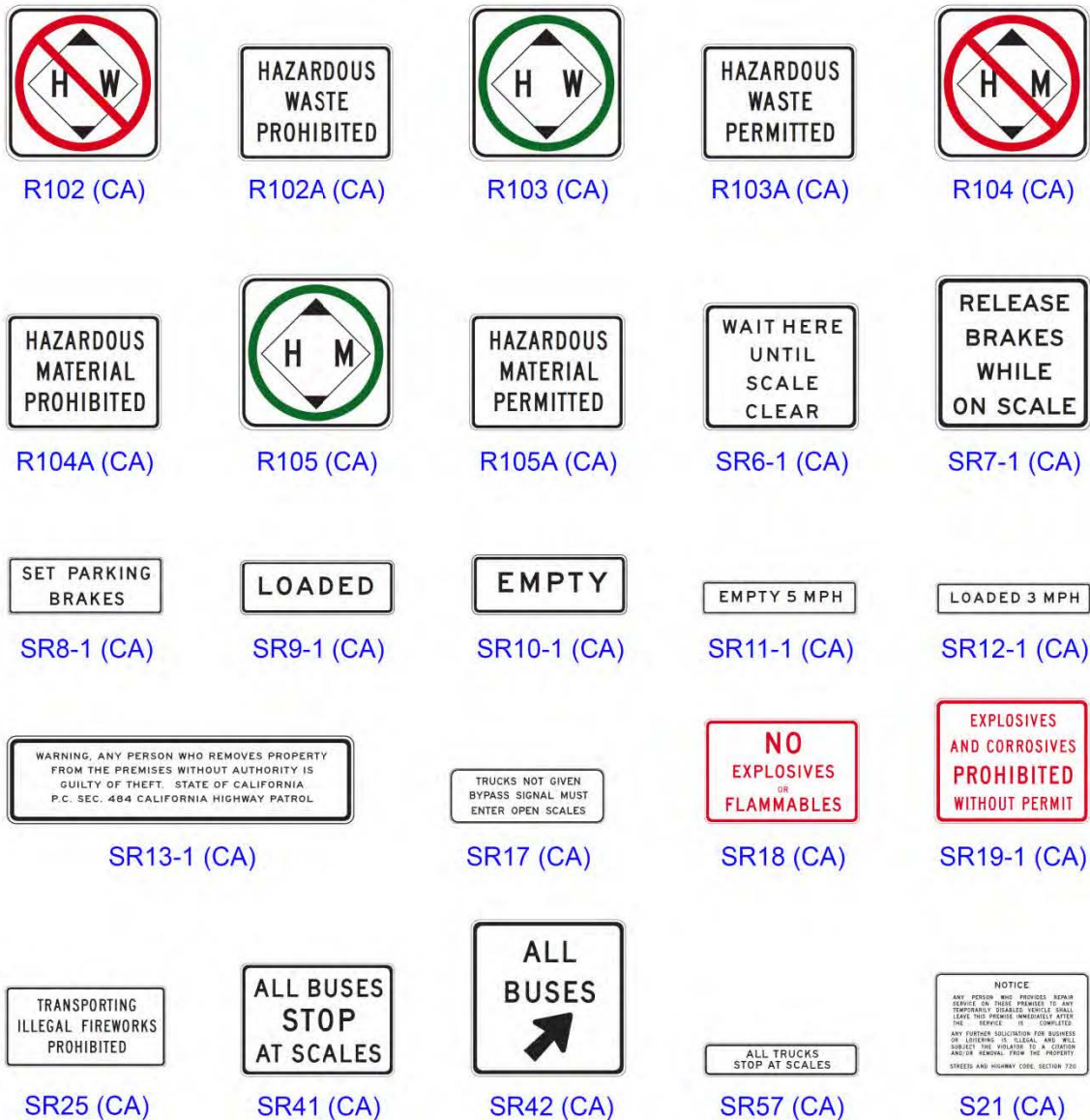




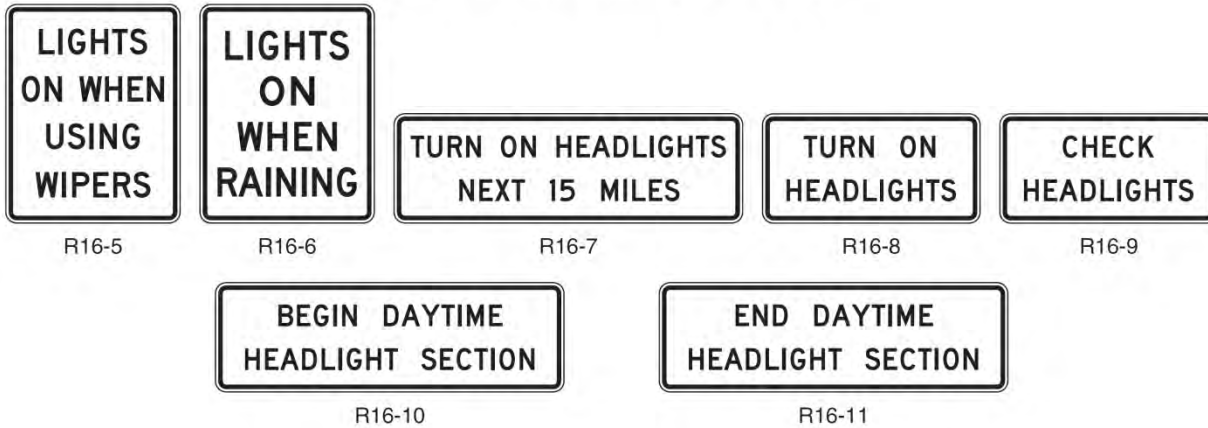
Figure 2B-30. Truck Signs



**Figure 2B-30 (CA). Truck Signs**



**Figure 2B-31. Headlight Use Signs**



**Figure 2B-32. Other Regulatory Signs and Symbols**

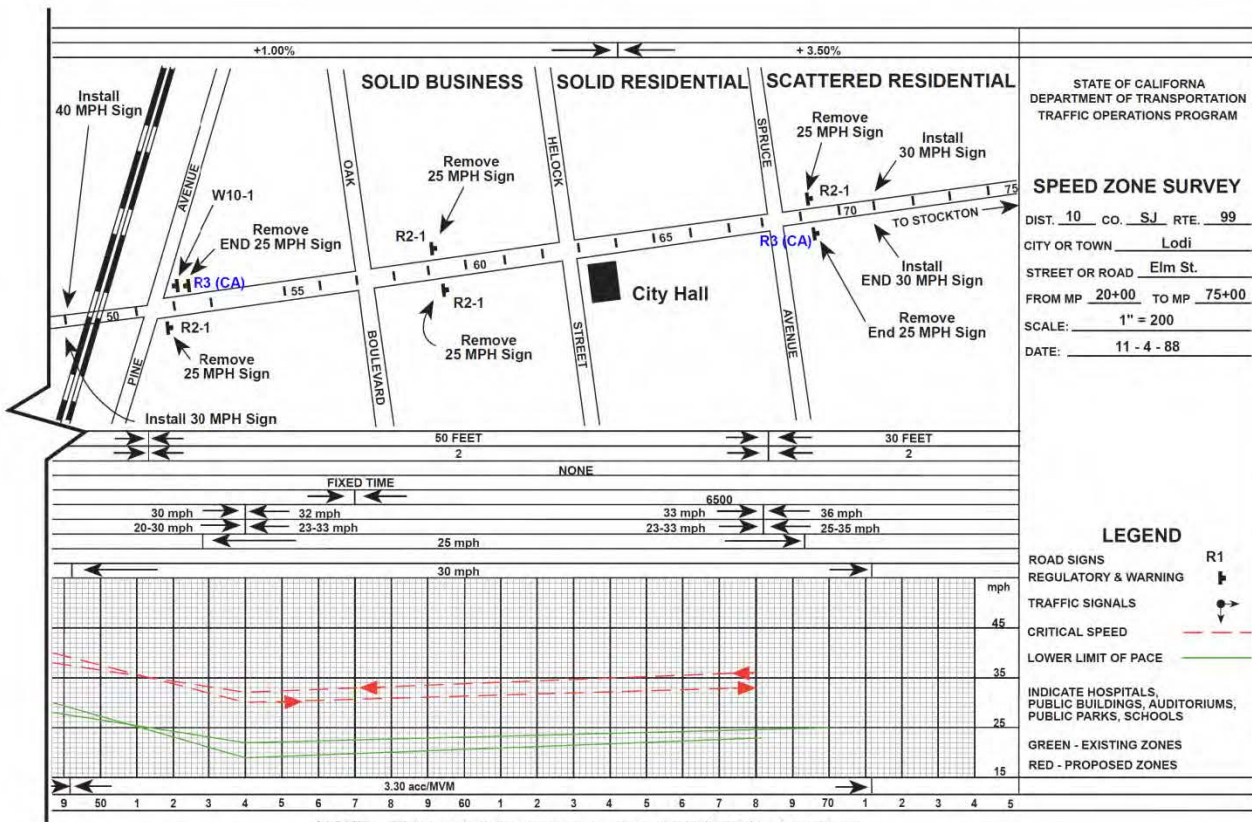
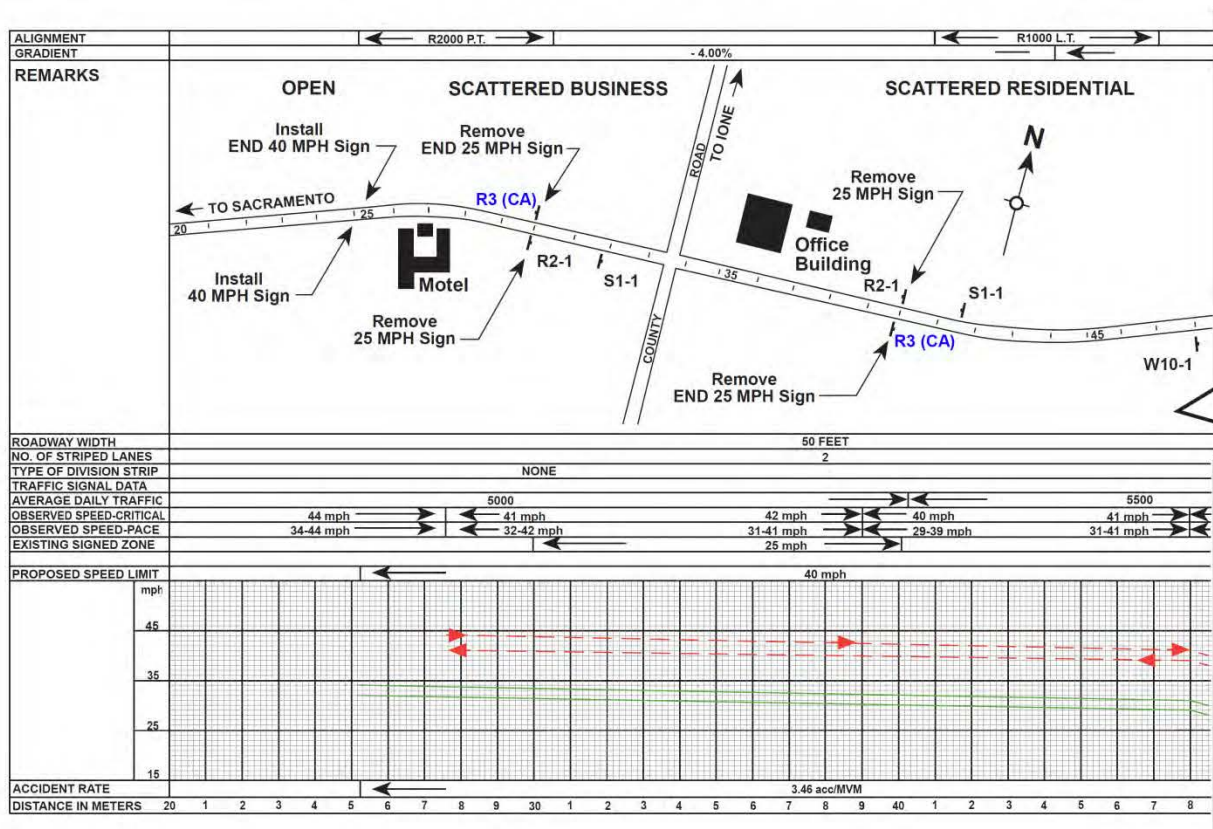


Seat Belt Symbol

**Figure 2B-32 (CA). Other Regulatory Signs and Symbols**

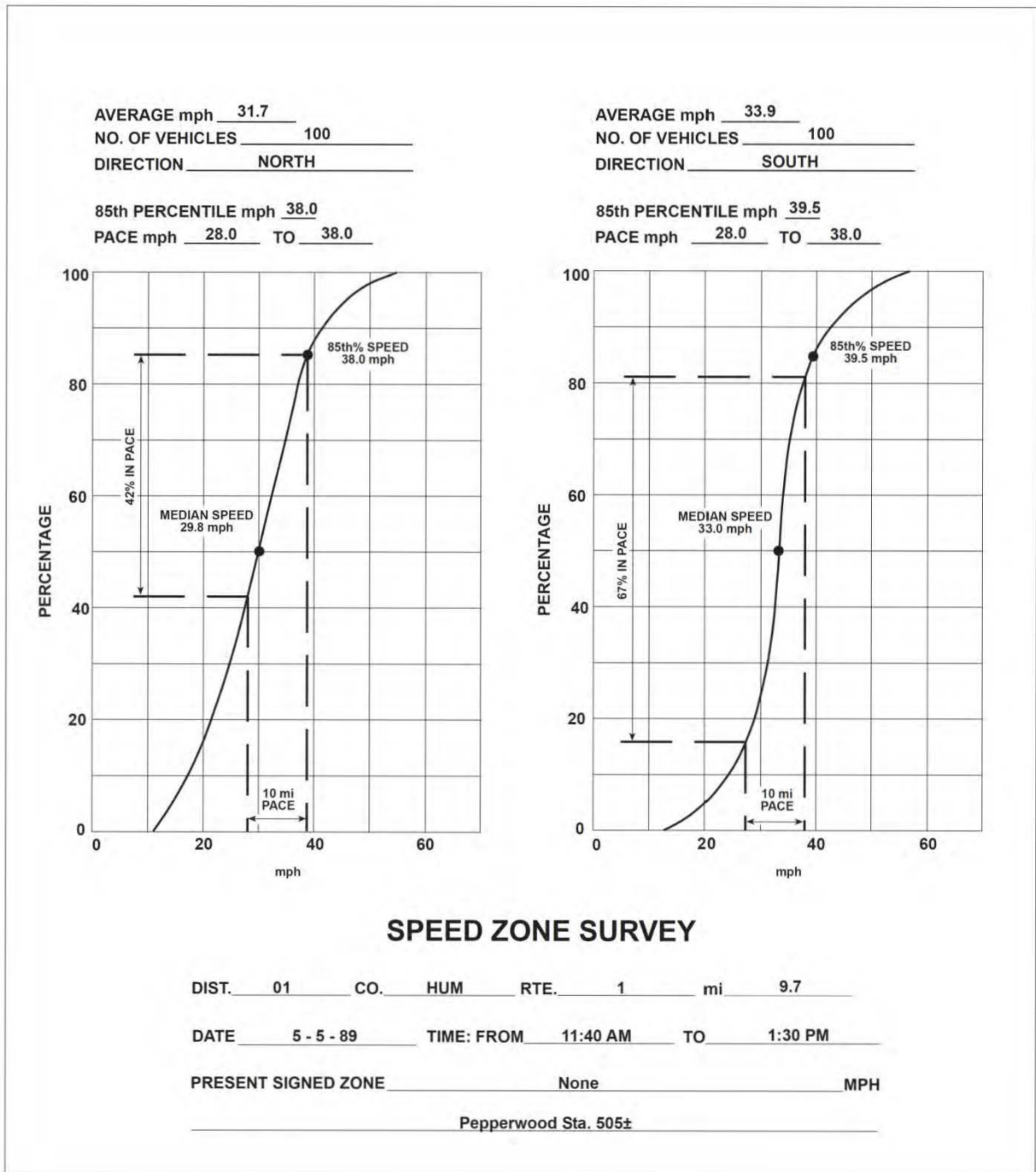


**Figure 2B-101 (CA). Example of Speed Zone Survey Sheet**



NOTE: This scaled figure represents a 11 in X 36 in size sheet.

**Figure 2B-102 (CA). Example of Cumulative Speed Curve Sheet**



**Figure 2B-103 (CA). Example of Vehicle Speed Survey Sheet for City and County Through Highways, Arterials, and Collector Roads**

Jurisdiction \_\_\_\_\_ Date \_\_\_\_\_  
 Location \_\_\_\_\_ Weather \_\_\_\_\_  
 Recorder \_\_\_\_\_ Begin Time \_\_\_\_\_ End Time \_\_\_\_\_

| mph                        | NUMBER OF VEHICLES |    |    |    |    |    | PERCENT OF TOTAL | CUMULATIVE PERCENTAGE |  |
|----------------------------|--------------------|----|----|----|----|----|------------------|-----------------------|--|
|                            | 5                  | 10 | 15 | 20 | 25 | 30 |                  |                       |  |
| 65                         |                    |    |    |    |    |    |                  |                       |  |
| 60                         |                    |    |    |    |    |    |                  |                       |  |
| 55                         |                    |    |    |    |    |    |                  |                       |  |
| 50                         |                    |    |    |    |    |    |                  |                       |  |
| 45                         |                    |    |    |    |    |    |                  |                       |  |
| 40                         |                    |    |    |    |    |    |                  |                       |  |
| 35                         |                    |    |    |    |    |    |                  |                       |  |
| 30                         | X                  | X  | X  |    |    |    | 1                | 100                   |  |
| 29                         | X                  | X  | X  |    |    |    | 5                | 99                    |  |
| 28                         | X                  | X  | X  |    |    |    | 4                | 94                    |  |
| 27                         | X                  | X  | X  |    |    |    | 7                | 91                    |  |
| 26                         | X                  | X  | X  |    |    |    | 7                | 83                    |  |
| 25                         | X                  | X  | X  | X  |    |    | 12               | 76                    |  |
| 24                         | X                  | X  | X  | X  |    |    | 8                | 64                    |  |
| 23                         | X                  | X  | X  | X  |    |    | 8                | 55                    |  |
| 22                         | X                  | X  | X  | X  |    |    | 13               | 47                    |  |
| 21                         | X                  | X  | X  | X  |    |    | 10               | 34                    |  |
| 20                         | X                  | X  | X  | X  |    |    | 7                | 23                    |  |
| 19                         | X                  | X  | X  | X  |    |    | 8                | 17                    |  |
| 18                         | X                  | X  | X  | X  |    |    | 1                | 8                     |  |
| 17                         | X                  | X  | X  | X  |    |    | 5                | 7                     |  |
| 16                         | X                  | X  | X  | X  |    |    | 1                | 3                     |  |
| 15                         | X                  | X  | X  | X  |    |    | 1                | 2                     |  |
|                            |                    |    |    |    |    |    | 1                | 1                     |  |
| TOTAL NUMBER OF VEHICLES = |                    |    |    |    |    |    | 107              | 100 %                 |  |

Other Considerations \_\_\_\_\_  
 Accident History : \_\_\_\_\_  
 Unusual Conditions : \_\_\_\_\_

Signed \_\_\_\_\_ Date \_\_\_\_\_ Title \_\_\_\_\_

**Figure 2B-104 (CA). Example of Vehicle Speed Survey Sheet (For 40 MPH and Under)**

Jurisdiction : \_\_\_\_\_

Residential Area or Subdivision : \_\_\_\_\_

| <b>VEHICLE SPEED DATA</b> |  |  |
|---------------------------|--|--|
| Location : _____          |  | Weather : _____                                  |
| Record : _____            |  | Date : _____ Begin Time : _____ End Time : _____ |
| mph                       | NUMBER OF VEHICLES                       | TOTAL OF EACH SPEED                              |
| 40 & over                 | [Empty grid]                             |  |
| 35                        | [Empty grid]                             |  |
| 30                        | [Empty grid]                             | 1  |
| 25                        | [Empty grid]                             | 1  |
| 20                        | [Empty grid]                             | 2  |
| 15 & under                | [Empty grid]                             | 3  |
| <b>mph</b>                | <b>TOTAL NUMBER OF VEHICLES OBSERVED</b> | <b>54</b>  |

**CRITICAL SPEED CALCULATION**

Total 54 multiplied by 0.15 = 8  
 Count this number of vehicles down from the highest speed observed to determine the critical speed

← **CRITICAL SPEED = 26 mph**

Other Considerations :

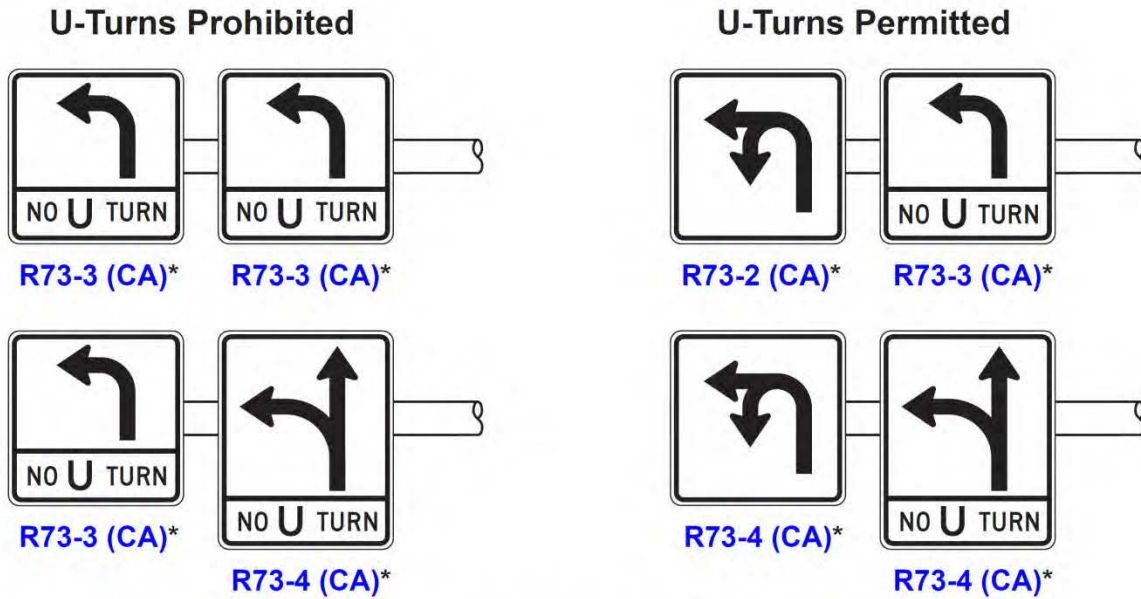
Accident History : \_\_\_\_\_  
 \_\_\_\_\_  
 \_\_\_\_\_

Unusual Conditions : \_\_\_\_\_  
 \_\_\_\_\_  
 \_\_\_\_\_

Date : \_\_\_\_\_ Signed : \_\_\_\_\_ Title : \_\_\_\_\_

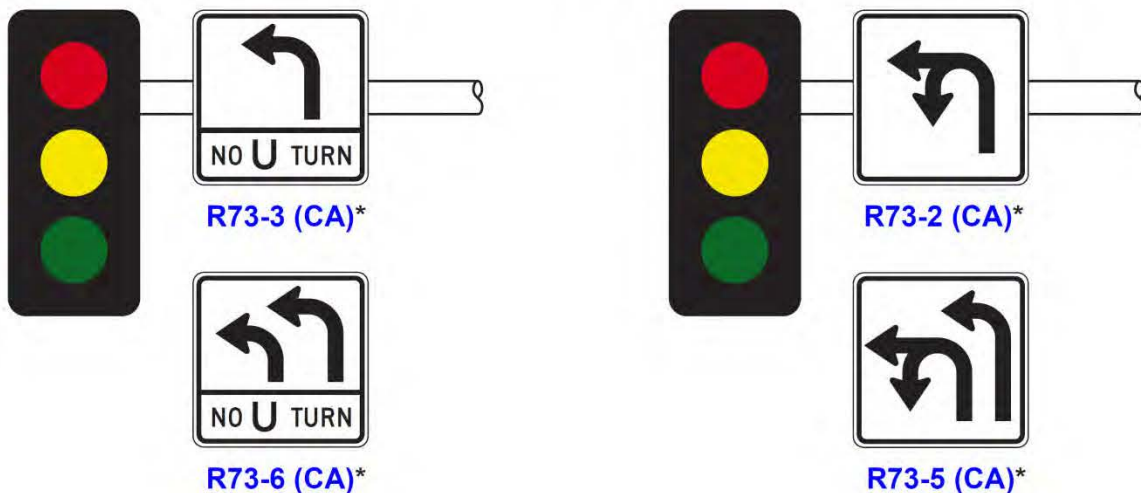
**Figure 2B-105 (CA). U-Turn Signs for Signalized Intersections with Separate Turn Phase**

**TWO LEFT-TURN LANES WITH OVERHEAD U-TURN SIGNS**



See Department of Transportation's Standard Plans for Mounting Details

**SIGNAL MASTARM MOUNTED U-TURN SIGNS**

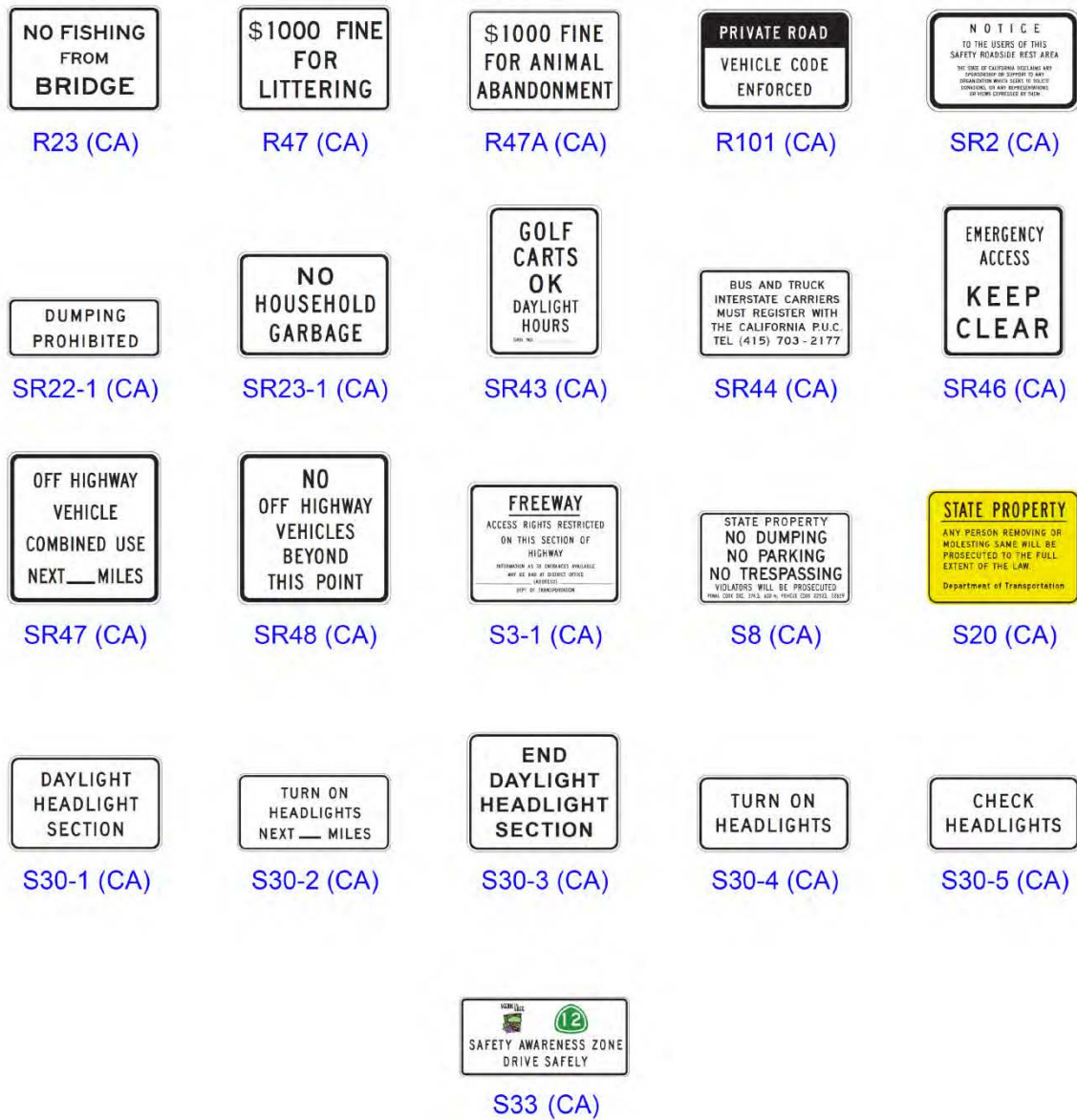


See Department of Transportation's Standard Plans for Mounting Details

\*R73 (CA) Series Signs



**Figure 2B-106 (CA). California Miscellaneous Regulatory Signs**



**Table 2B-1. Regulatory Sign and Plaque Sizes (Sheet 1 of 4)**

| Sign or Plaque                                     | Sign Designation     | Section          | Conventional Road  |                    | Expressway         | Freeway            | Minimum      | Oversized          |
|--|----------------------|------------------|--------------------|--------------------|--------------------|--------------------|--------------|--------------------|
|  |                      |                  | Single Lane        | Multi-Lane         |                    |                    |              |                    |
| Stop   | R1-1                 | 2B.05            | 30 x 30*           | 36 x 36            | 36 x 36            | —                  | 30 x 30*     | 48 x 48            |
| Yield  | R1-2                 | 2B.08            | 36x36x36*          | 48x48x48           | 48x48x48           | 60x60x60           | 30x30x30*    | —                  |
| To Oncoming Traffic (plaque)                       | R1-2aP               | 2B.10            | 24 x 18            | 24 x 18            | 36 x 30            | 48 x 36            | 24 x 18      | —                  |
| All Way (plaque)                                   | R1-3P                | 2B.05            | 18 x 6             | 18 x 6             | —                  | —                  | —            | 30 x 12            |
| Yield Here to Peds                                 | R1-5                 | 2B.11            | —                  | 36 x 36            | —                  | —                  | —            | 36 x 36            |
| Yield Here to Pedestrians                          | R1-5a                | 2B.11            | —                  | 36 x 48            | —                  | —                  | —            | 36 x 48            |
| <del>Stop Here for Peds</del>                      | <del>R1-5b</del>     | <del>2B.11</del> | <del>—</del>       | <del>36 x 36</del> | <del>—</del>       | <del>—</del>       | <del>—</del> | <del>36 x 36</del> |
| <del>Stop Here for Pedestrians</del>               | <del>R1-5c</del>     | <del>2B.11</del> | <del>—</del>       | <del>36 x 48</del> | <del>—</del>       | <del>—</del>       | <del>—</del> | <del>36 x 48</del> |
| In-Street Ped Crossing                             | R1-6,6a              | 2B.12            | 12 x 36            | 12 x 36            | —                  | —                  | —            | —                  |
| Overhead Ped Crossing                              | R1-9,9a              | 2B.12            | 90 x 24            | 90 x 24            | —                  | —                  | —            | —                  |
| Except Right Turn (plaque)                         | R1-10P               | 2B.05            | 24 x 18            | 24 x 18            | —                  | —                  | —            | —                  |
| Speed Limit  | R2-1                 | 2B.13            | 24 x 30*           | 30 x 36            | 36 x 48            | 48 x 60            | 18 x 24*     | 30 x 36            |
| <del>Truck Speed Limit (plaque)</del>              | <del>R2-2P</del>     | <del>2B.14</del> | <del>24 x 24</del> | <del>24 x 24</del> | <del>36 x 36</del> | <del>48 x 48</del> | <del>—</del> | <del>36 x 36</del> |
| Night Speed Limit (plaque)                         | R2-3P                | 2B.15            | 24 x 24            | 24 x 24            | 36 x 36            | 48 x 48            | —            | 36 x 36            |
| Minimum Speed Limit (plaque)                       | R2-4P                | 2B.16            | 24 x 30            | 24 x 30            | 36 x 48            | 48 x 60            | —            | 36 x 48            |
| Combined Speed Limit                               | R2-4a                | 2B.16            | 24 x 48            | 24 x 48            | 36 x 72            | 48 x 96            | —            | 36 x 72            |
| <del>Unless Otherwise Posted (plaque)</del>        | <del>R2-5P</del>     | <del>2B.13</del> | <del>24 x 18</del> | <del>24 x 18</del> | <del>—</del>       | <del>—</del>       | <del>—</del> | <del>—</del>       |
| <del>Citywide (plaque)</del>                       | <del>R2-5aP</del>    | <del>2B.13</del> | <del>24 x 6</del>  | <del>24 x 6</del>  | <del>—</del>       | <del>—</del>       | <del>—</del> | <del>—</del>       |
| <del>Neighborhood (plaque)</del>                   | <del>R2-5bP</del>    | <del>2B.13</del> | <del>24 x 6</del>  | <del>24 x 6</del>  | <del>—</del>       | <del>—</del>       | <del>—</del> | <del>—</del>       |
| <del>Residential (plaque)</del>                    | <del>R2-5cP</del>    | <del>2B.13</del> | <del>24 x 6</del>  | <del>24 x 6</del>  | <del>—</del>       | <del>—</del>       | <del>—</del> | <del>—</del>       |
| <del>Fines Higher (plaque)</del>                   | <del>R2-6P</del>     | <del>2B.17</del> | <del>24 x 18</del> | <del>24 x 18</del> | <del>36 x 24</del> | <del>48 x 36</del> | <del>—</del> | <del>36 x 24</del> |
| Fines Double (plaque)                              | R2-6aP               | 2B.17            | 24 x 18            | 24 x 18            | 36 x 24            | 48 x 36            | —            | 36 x 24            |
| \$XX Fine (plaque)                                 | R2-6bP               | 2B.17            | 24 x 18            | 24 x 18            | 36 x 24            | 48 x 36            | —            | 36 x 24            |
| <del>Begin Higher Fines Zone</del>                 | <del>R2-10</del>     | <del>2B.17</del> | <del>24 x 30</del> | <del>24 x 30</del> | <del>36 x 48</del> | <del>48 x 60</del> | <del>—</del> | <del>36 x 48</del> |
| <del>End Higher Fines Zone</del>                   | <del>R2-11</del>     | <del>2B.17</del> | <del>24 x 30</del> | <del>24 x 30</del> | <del>36 x 48</del> | <del>48 x 60</del> | <del>—</del> | <del>36 x 48</del> |
| Movement Prohibition                               | R3-1,2,3,4,18,27     | 2B.18            | 24 x 24*           | 36 x 36            | 36 x 36            | —                  | —            | 48 x 48            |
| Mandatory Movement Lane Control                    | R3-5,5a              | 2B.20            | 30 x 36            | 30 x 36            | —                  | —                  | —            | —                  |
| Left Lane (plaque)                                 | R3-5bP               | 2B.20            | 30 x 12            | 30 x 12            | —                  | —                  | —            | —                  |
| HOV 2+ (plaque)                                    | R3-5cP               | 2B.20            | 24 x 12            | 24 x 12            | —                  | —                  | —            | —                  |
| Taxi Lane (plaque)                                 | R3-5dP               | 2B.20            | 30 x 12            | 30 x 12            | —                  | —                  | —            | —                  |
| Center Lane (plaque)                               | R3-5eP               | 2B.20            | 30 x 12            | 30 x 12            | —                  | —                  | —            | —                  |
| Right Lane (plaque)                                | R3-5fP               | 2B.20            | 30 x 12            | 30 x 12            | —                  | —                  | —            | —                  |
| Bus Lane (plaque)                                  | R3-5gP               | 2B.20            | 30 x 12            | 30 x 12            | —                  | —                  | —            | —                  |
| Optional Movement Lane Control                     | R3-6                 | 2B.21            | 30 x 36            | 30 x 36            | —                  | —                  | —            | —                  |
| Right (Left) Lane Must Turn Right (Left)           | R3-7                 | 2B.20            | 30 x 30*           | 36 x 36            | —                  | —                  | —            | —                  |
| Advance Intersection Lane Control                  | R3-8,8a,8b           | 2B.22            | Varies x 30        | Varies x 30        | —                  | —                  | —            | Varies x 36        |
| Two-Way Left Turn Only (overhead)                  | R3-9a                | 2B.24            | 30 x 36            | 30 x 36            | —                  | —                  | —            | —                  |
| Two-Way Left Turn Only (post-mounted)              | R3-9b                | 2B.24            | 24 x 36            | 24 x 36            | —                  | —                  | —            | 36 x 48            |
| BEGIN  | R3-9cP               | 2B.25            | 30 x 12            | 30 x 12            | —                  | —                  | —            | —                  |
| END  | R3-9dP               | 2B.25            | 30 x 12            | 30 x 12            | —                  | —                  | —            | —                  |
| Reversible Lane Control (symbol)                   | R3-9e                | 2B.26            | 108 x 48           | 108 x 48           | —                  | —                  | —            | —                  |
| Reversible Lane Control (post-mounted)             | R3-9f                | 2B.26            | 30 x 42*           | 36 x 54            | —                  | —                  | —            | —                  |
| Advance Reversible Lane Control Transition Signing | R3-9g,9h             | 2B.26            | 108 x 36           | 108 x 36           | —                  | —                  | —            | —                  |
| End Reverse Lane                                   | R3-9i                | 2B.26            | 108 x 48           | 108 x 48           | —                  | —                  | —            | —                  |
| Begin Right (Left) Turn Lane                       | R3-20                | 2B.20            | 24 x 36            | 24 x 36            | —                  | —                  | —            | —                  |
| All Turns (U Turn) from Right Lane                 | R3-23,23a            | 2B.27            | 60 x 36            | 60 x 36            | —                  | —                  | —            | —                  |
| All Turns (U Turn) with arrow                      | R3-24,24b,25,25b,26a | 2B.27            | 72 x 18            | 72 x 18            | —                  | —                  | —            | —                  |
| U and Left Turns with arrow                        | R3-24a,25a,26        | 2B.27            | 60 x 24            | 60 x 24            | —                  | —                  | —            | —                  |
| Right Lane Must Exit                               | R3-33                | 2B.23            | —                  | —                  | 78 x 36            | 78 x 36            | —            | —                  |

**Table 2B-1. Regulatory Sign and Plaque Sizes (Sheet 2 of 4)**

| Sign or Plaque   | Sign Designation  | Section          | Conventional Road  |                    | Expressway   | Freeway      | Minimum      | Oversized    |
|--|---|------------------|--------------------|--------------------|--------------|--------------|--------------|--------------|
|  |   |                  | Single Lane        | Multi-Lane         |              |              |              |              |
| Do Not Pass  | R4-1  | 2B.28            | 24 x 30            | 24 x 30            | 36 x 48      | 48 x 60      | 18 x 24      | 36 x 48      |
| Pass With Care   | R4-2  | 2B.29            | 24 x 30            | 24 x 30            | 36 x 48      | 48 x 60      | 18 x 24      | 36 x 48      |
| Slower Traffic Keep Right  | R4-3  | 2B.30            | 24 x 30            | 24 x 30            | 36 x 48      | 48 x 60      | 18 x 24      | 36 x 48      |
| Trucks Use Right Lane  | R4-5  | 2B.31            | 24 x 30            | 24 x 30            | 36 x 48      | 48 x 60      | —            | 36 x 48      |
| Keep Right   | R4-7,7a,7b  | 2B.32            | 24 x 30            | 24 x 30            | 36 x 48      | 48 x 60      | 18 x 24      | 36 x 48      |
| Narrow Keep Right  | R4-7c   | 2B.32            | 18 x 30            | 18 x 30            | —            | —            | —            | —            |
| Keep Left  | R4-8,8a,8b  | 2B.32            | 24 x 30            | 24 x 30            | 36 x 48      | 48 x 60      | 18 x 24      | 36 x 48      |
| Narrow Keep Left   | R4-8c   | 2B.32            | 18 x 30            | 18 x 30            | —            | —            | —            | —            |
| Stay in Lane   | R4-9  | 2B.33            | 24 x 30            | 24 x 30            | 36 x 48      | 48 x 60      | 18 x 24      | 36 x 48      |
| Runaway Vehicles Only  | R4-10   | 2B.34            | 48 x 48            | 48 x 48            | —            | —            | —            | —            |
| Slow Vehicles with XX or More Following Vehicles Must Use Turn-Out | R4-12   | 2B.35            | 42 x 24            | 42 x 24            | —            | —            | —            | —            |
| Slow Vehicles Must Use Turn-Out Ahead                              | R4-13   | 2B.35            | 42 x 24            | 42 x 24            | —            | —            | —            | —            |
| Slow Vehicles Must Turn Out  | R4-14   | 2B.35            | 30 x 42            | 30 x 42            | —            | —            | —            | —            |
| Keep Right Except to Pass  | R4-16   | 2B.30            | 24 x 30            | 24 x 30            | 36 x 48      | 48 x 60      | 18 x 24      | 36 x 48      |
| Do Not Drive on Shoulder   | R4-17   | 2B.36            | 24 x 30            | 24 x 30            | 36 x 48      | 48 x 60      | 18 x 24      | 36 x 48      |
| Do Not Pass on Shoulder  | R4-18   | 2B.36            | 24 x 30            | 24 x 30            | 36 x 48      | 48 x 60      | 18 x 24      | 36 x 48      |
| Do Not Enter   | R5-1  | 2B.37            | 30 x 30*           | 36 x 36            | 36 x 36      | 48 x 48      | —            | 36 x 36      |
| Wrong Way  | R5-1a   | 2B.38            | 36 x 24*           | 42 x 30            | 36 x 24*     | 42 x 30      | 30 x 18*     | 42 x 30      |
| No Trucks  | R5-2,2a   | 2B.39            | 24 x 24            | 24 x 24            | 30 x 30      | 36 x 36      | —            | 36 x 36      |
| No Motor Vehicles  | R5-3  | 2B.39            | 24 x 24            | 24 x 24            | —            | —            | 24 x 24      | —            |
| No Commercial Vehicles   | R5-4  | 2B.39            | 24 x 30            | 24 x 30            | 36 x 48      | 36 x 48      | —            | —            |
| No Vehicles with Lugs  | R5-5  | 2B.39            | 24 x 30            | 24 x 30            | 36 x 48      | 48 x 60      | —            | —            |
| No Bicycles  | R5-6  | 2B.39            | 24 x 24            | 24 x 24            | 30 x 30      | 36 x 36      | 24 x 24      | 48 x 48      |
| No Non-Motorized Traffic   | R5-7  | 2B.39            | 30 x 24            | 30 x 24            | 42 x 24      | 48 x 30      | —            | 42 x 24      |
| No Motor-Driven Cycles   | R5-8  | 2B.39            | 30 x 24            | 30 x 24            | 42 x 24      | 48 x 30      | —            | 42 x 24      |
| No Pedestrians, Bicycles, Motor-Driven Cycles                      | R5-10a  | 2B.39            | 30 x 36            | 30 x 36            | —            | —            | —            | —            |
| No Pedestrians or Bicycles   | R5-10b  | 2B.39            | 30 x 18            | 30 x 18            | —            | —            | —            | —            |
| No Pedestrians   | R5-10c  | 2B.39            | 24 x 12            | 24 x 12            | —            | —            | —            | —            |
| Authorized Vehicles Only   | R5-11   | 2B.39            | 30 x 24            | 30 x 24            | —            | —            | —            | —            |
| One Way  | R6-1  | 2B.40            | 36 x 12*           | 54 x 18            | 54 x 18      | 54 x 18      | —            | 54 x 18      |
| One Way  | R6-2  | 2B.40            | 24 x 30*           | 30 x 36            | 36 x 48      | 48 x 60      | 18 x 24*     | 36 x 48      |
| Divided Highway Crossing   | R6-3,3a   | 2B.42            | 30 x 24            | 30 x 24            | 36 x 30      | —            | —            | 36 x 30      |
| Roundabout Directional (2 chevrons)                                | R6-4  | 2B.43            | 30 x 24            | 30 x 24            | —            | —            | —            | —            |
| Roundabout Directional (3 chevrons)                                | R6-4a   | 2B.43            | 48 x 24            | 48 x 24            | —            | —            | —            | —            |
| Roundabout Directional (4 chevrons)                                | R6-4b   | 2B.43            | 60 x 24            | 60 x 24            | —            | —            | —            | —            |
| Roundabout Circulation (plaque)                                    | R6-5P   | 2B.44            | 30 x 30            | 30 x 30            | —            | —            | —            | —            |
| BEGIN ONE WAY  | R6-6  | 2B.40            | 24 x 30            | 30 x 36            | —            | —            | —            | —            |
| END ONE WAY  | R6-7  | 2B.40            | 24 x 30            | 30 x 36            | —            | —            | —            | —            |
| Parking Restrictions   | <del>R7-1</del><br><del>2,2a,3,4,5,6,7,8,</del><br><del>21,21a,22,23,</del><br><del>23a,407,408</del> | 2B.46            | 12 x 18            | 12 x 18            | —            | —            | —            | —            |
| Van Accessible (plaque)  | <del>R7-8P</del>  | <del>2B.46</del> | <del>18 x 0</del>  | <del>18 x 0</del>  | <del>—</del> | <del>—</del> | <del>—</del> | <del>—</del> |
| Fee Station  | R7-20   | 2B.46            | 24 x 18            | 24 x 18            | —            | —            | —            | —            |
| No Parking (with transit logo)                                     | R7-107a   | 2B.46            | 12 x 30            | 12 x 30            | —            | —            | —            | —            |
| <del>No Parking/Restricted Parking (combined sign)</del>           | <del>R7-200</del>   | <del>2B.46</del> | <del>24 x 18</del> | <del>24 x 18</del> | <del>—</del> | <del>—</del> | <del>—</del> | <del>—</del> |
| <del>No Parking/Restricted Parking (combined sign)</del>           | <del>R7-200a</del>  | <del>2B.46</del> | <del>12 x 30</del> | <del>12 x 30</del> | <del>—</del> | <del>—</del> | <del>—</del> | <del>—</del> |
| <del>Tow Away Zone (plaque)</del>                                  | <del>R7-201P,201aP</del>  | <del>2B.46</del> | <del>12 x 6</del>  | <del>12 x 6</del>  | <del>—</del> | <del>—</del> | <del>—</del> | <del>—</del> |
| <del>This Side of Sign (plaque)</del>                              | <del>R7-202P</del>  | <del>2B.46</del> | <del>12 x 6</del>  | <del>12 x 6</del>  | <del>—</del> | <del>—</del> | <del>—</del> | <del>—</del> |

**Table 2B-1. Regulatory Sign and Plaque Sizes (Sheet 3 of 4)**

| Sign or Plaque                                     | Sign Designation         | Section | Conventional Road |            | Expressway | Freeway | Minimum  | Oversized |
|--|--------------------------|---------|-------------------|------------|------------|---------|----------|-----------|
|  |                          |         | Single Lane       | Multi-Lane |            |         |          |           |
| Emergency Snow Route                               | R7-203                   | 2B.46   | 18 x 24           | 18 x 24    | —          | —       | —        | 24 x 30   |
| No Parking on Pavement                             | R8-1                     | 2B.46   | 24 x 30           | 24 x 30    | 36 x 48    | 48 x 60 | —        | 36 x 48   |
| No Parking Except on Shoulder                      | R8-2                     | 2B.46   | 24 x 30           | 24 x 30    | 36 x 48    | 48 x 60 | —        | 36 x 48   |
| No Parking (symbol)                                | R8-3                     | 2B.46   | 24 x 24*          | 30 x 30    | 36 x 36    | 48 x 48 | 12 x 12* | 36 x 36   |
| No Parking   | R8-3a                    | 2B.46   | 24 x 30           | 24 x 30    | 36 x 36    | 48 x 48 | 18 x 24  | 36 x 36   |
| Except Sundays and Holidays (plaque)               | R8-3bP                   | 2B.46   | 24 x 18           | 24 x 18    | —          | —       | 12 x 0   | 30 x 24   |
| On Pavement (plaque)                               | R8-3eP                   | 2B.46   | 24 x 18           | 24 x 18    | —          | —       | 12 x 0   | 30 x 24   |
| On Bridge (plaque)                                 | R8-3dP                   | 2B.46   | 24 x 18           | 24 x 18    | —          | —       | 12 x 0   | 30 x 24   |
| On Tracks (plaque)                                 | R8-3cP                   | 2B.46   | 12 x 0            | 12 x 0     | —          | —       | —        | 30 x 24   |
| Except on Shoulder (plaque)                        | R8-3fP                   | 2B.46   | 24 x 18           | 24 x 18    | —          | —       | 12 x 0   | 30 x 24   |
| Loading Zone (plaque)                              | R8-3gP                   | 2B.46   | 24 x 18           | 24 x 18    | —          | —       | 12 x 0   | 30 x 24   |
| Times of Day (plaque)                              | R8-3hP                   | 2B.46   | 24 x 18           | 24 x 18    | —          | —       | 12 x 0   | 30 x 24   |
| Emergency Parking Only                             | R8-4                     | 2B.49   | 30 x 24           | 30 x 24    | 30 x 24    | 48 x 36 | —        | 48 x 36   |
| No Stopping on Pavement                            | R8-5                     | 2B.46   | 24 x 30           | 24 x 30    | 36 x 48    | 48 x 60 | —        | 36 x 48   |
| No Stopping Except on Shoulder                     | R8-6                     | 2B.46   | 24 x 30           | 24 x 30    | 36 x 48    | 48 x 60 | —        | 36 x 48   |
| Emergency Stopping Only                            | R8-7                     | 2B.49   | 30 x 24           | 30 x 24    | 48 x 36    | 48 x 36 | —        | 48 x 36   |
| Walk on Left Facing Traffic                        | R9-1                     | 2B.50   | 18 x 24           | 18 x 24    | —          | —       | —        | —         |
| Cross Only at Crosswalks                           | R9-2                     | 2B.51   | 12 x 18           | 12 x 18    | —          | —       | —        | —         |
| No Pedestrian Crossing (symbol)                    | R9-3                     | 2B.51   | 18 x 18           | 18 x 18    | 24 x 24    | 30 x 30 | —        | 30 x 30   |
| No Pedestrian Crossing                             | R9-3a                    | 2B.51   | 12 x 18           | 12 x 18    | —          | —       | —        | —         |
| Use Crosswalk (plaque)                             | R9-3bP                   | 2B.51   | 18 x 12           | 18 x 12    | —          | —       | —        | —         |
| No Hitchhiking (symbol)                            | R9-4                     | 2B.50   | 18 x 18           | 18 x 18    | —          | —       | —        | 24 x 24   |
| No Hitchhiking                                     | R9-4a                    | 2B.50   | 18 x 24           | 18 x 24    | —          | —       | 12 x 18  | —         |
| No Skaters   | R9-13                    | 2B.39   | 18 x 18           | 18 x 18    | 24 x 24    | 30 x 30 | —        | 30 x 30   |
| No Equestrians                                     | R9-14                    | 2B.39   | 18 x 18           | 18 x 18    | 24 x 24    | 30 x 30 | —        | 30 x 30   |
| Cross Only On Green                                | R10-1                    | 2B.52   | 12 x 18           | 12 x 18    | —          | —       | —        | —         |
| Pedestrian Signs and Plaques                       | R10-2, 3,3b,3c,3d,4      | 2B.52   | 9 x 12            | 9 x 12     | —          | —       | —        | —         |
| Pedestrian Signs                                   | R10-3a,3e,3f,3g,3h,3i,4a | 2B.52   | 9 x 15            | 9 x 15     | —          | —       | —        | —         |
| Left on Green Arrow Only                           | R10-5                    | 2B.53   | 30 x 36           | 30 x 36    | 48 x 60    | —       | 24 x 30  | 48 x 60   |
| Stop Here on Red                                   | R10-6                    | 2B.53   | 24 x 36           | 24 x 36    | —          | —       | —        | 36 x 48   |
| Stop Here on Red                                   | R10-6a                   | 2B.53   | 24 x 30           | 24 x 30    | —          | —       | —        | 36 x 42   |
| Do Not Block Intersection                          | R10-7                    | 2B.53   | 24 x 30           | 24 x 30    | —          | —       | —        | —         |
| Use Lane with Green Arrow                          | R10-8                    | 2B.53   | 36 x 42           | 36 x 42    | 36 x 42    | —       | —        | 60 x 72   |
| Left (Right) Turn Signal                           | R10-10                   | 2B.53   | 30 x 36           | 30 x 36    | —          | —       | —        | —         |
| No Turn on Red                                     | R10-11                   | 2B.54   | 24 x 30*          | 36 x 48    | —          | —       | —        | 36 x 48   |
| No Turn on Red                                     | R10-11a                  | 2B.54   | 30 x 36*          | 36 x 48    | —          | —       | —        | —         |
| No Turn on Red                                     | R10-11b                  | 2B.54   | 36 x 36           | 36 x 36    | —          | —       | —        | —         |
| No Turn on Red Except From Right Lane              | R10-11c                  | 2B.54   | 30 x 42           | 30 x 42    | —          | —       | —        | —         |
| No Turn on Red From This Lane                      | R10-11d                  | 2B.54   | 30 x 42           | 30 x 42    | —          | —       | —        | —         |
| Left Turn Yield on Green                           | R10-12                   | 2B.53   | 30 x 36           | 30 x 36    | —          | —       | —        | —         |
| Emergency Signal                                   | R10-13                   | 2B.53   | 42 x 30           | 42 x 30    | —          | —       | —        | —         |
| Emergency Signal - Stop on Flashing Red            | R10-14                   | 2B.53   | 36 x 42           | 36 x 42    | —          | —       | —        | —         |
| Emergency Signal - Stop on Flashing Red (overhead) | R10-14a                  | 2B.53   | 60 x 24           | 60 x 24    | —          | —       | —        | —         |
| Turning Vehicles Yield to Peds                     | R10-15                   | 2B.53   | 30 x 30           | 30 x 30    | —          | —       | —        | —         |
| U Turn Yield to Right Turn                         | R10-16                   | 2B.53   | 30 x 36           | 30 x 36    | —          | —       | —        | —         |
| Right on Red Arrow After Stop                      | R10-17a                  | 2B.54   | 36 x 48           | 36 x 48    | —          | —       | —        | —         |
| Traffic Laws Photo Enforced                        | R10-18                   | 2B.55   | 36 x 24           | 36 x 24    | 48 x 30    | 54 x 36 | —        | 54 x 36   |
| Photo Enforced (symbol/plaque)                     | R10-19P                  | 2B.55   | 24 x 12           | 24 x 12    | 36 x 10    | 48 x 24 | —        | 40 x 24   |
| Photo Enforced (plaque)                            | R10-19aP                 | 2B.55   | 24 x 18           | 24 x 18    | 36 x 30    | 48 x 36 | —        | 48 x 36   |
| MON—FRI (and times) (3 lines) (plaque)             | R10-20aP                 | 2B.53   | 24 x 24           | 24 x 24    | —          | —       | —        | —         |

**Table 2B-1. Regulatory Sign and Plaque Sizes (Sheet 4 of 4)**

| Sign or Plaque                                    | Sign Designation   | Section          | Conventional Road  |                    | Expressway         | Freeway             | Minimum | Oversized          |
|---|--------------------|------------------|--------------------|--------------------|--------------------|---------------------|---------|--------------------|
|   |                    |                  | Single Lane        | Multi-Lane         |                    |                     |         |                    |
| SUNDAY (and times) (2 lines) (plaque)             | R10-20aP           | 2B.53            | 24 x 18            | 24 x 18            | —                  | —                   | —       | —                  |
| Crosswalk, Stop on Red                            | R10-23             | 2B.53            | 24 x 30            | 24 x 30            | —                  | —                   | —       | —                  |
| Push Button To Turn On Warning Lights             | R10-25             | 2B.52            | 9 x 12             | 9 x 12             | —                  | —                   | —       | —                  |
| Left Turn Yield on Flashing Red Arrow After Stop  | R10-27             | 2B.53            | 30 x 36            | 30 x 36            | —                  | —                   | —       | —                  |
| XX Vehicles Per Green                             | R10-28             | 2B.56            | 24 x 30            | 24 x 30            | —                  | —                   | —       | —                  |
| XX Vehicles Per Green Each Lane                   | R10-29             | 2B.56            | 36 x 24            | 36 x 24            | —                  | —                   | —       | —                  |
| Right Turn on Red Must Yield to U-Turn            | R10-30             | 2B.54            | 30 x 36            | 30 x 36            | —                  | —                   | —       | —                  |
| At Signal (plaque)                                | R10-31P            | 2B.53            | 24 x 9             | 24 x 9             | —                  | —                   | —       | —                  |
| Push Button for 2 Seconds for Extra Crossing Time | R10-32P            | 2B.52            | 9 x 12             | 9 x 12             | —                  | —                   | —       | —                  |
| Keep Off Median                                   | R11-1              | 2B.57            | 24 x 30            | 24 x 30            | —                  | —                   | —       | —                  |
| Road Closed                                       | R11-2              | 2B.58            | 48 x 30            | 48 x 30            | —                  | —                   | —       | —                  |
| Road Closed - Local Traffic Only                  | R11-3a,3b,4        | 2B.58            | 60 x 30            | 60 x 30            | —                  | —                   | —       | —                  |
| Weight Limit                                      | R12-1,2            | 2B.59            | 24 x 30            | 24 x 30            | 36 x 48            | —                   | —       | 36 x 48            |
| <del>Weight Limit</del>                           | <del>R12-3</del>   | <del>2B.59</del> | <del>24 x 36</del> | <del>24 x 36</del> |                    |                     |         |                    |
| <del>Weight Limit</del>                           | <del>R12-4</del>   | <del>2B.59</del> | <del>36 x 24</del> | <del>36 x 24</del> |                    |                     |         |                    |
| Weight Limit                                      | R12-5              | 2B.59            | 24 x 36            | 24 x 36            | 36 x 48            | 48 x 60             | —       | —                  |
| <del>Weigh Station</del>                          | <del>R13-1</del>   | <del>2B.60</del> | <del>72 x 54</del> | <del>72 x 54</del> | <del>96 x 72</del> | <del>120 x 90</del> |         |                    |
| Truck Route                                       | R14-1              | 2B.61            | 24 x 18            | 24 x 18            | —                  | —                   | —       | —                  |
| <del>Hazardous Material</del>                     | <del>R14-2,3</del> | <del>2B.62</del> | <del>24 x 24</del> | <del>24 x 24</del> | <del>30 x 30</del> | <del>36 x 36</del>  |         | <del>42 x 42</del> |
| <del>National Network</del>                       | <del>R14-4,5</del> | <del>2B.63</del> | <del>30 x 30</del> | <del>30 x 30</del> | <del>36 x 36</del> | <del>36 x 36</del>  |         | <del>42 x 42</del> |
| <del>Fender Bender Move Vehicles</del>            | <del>R16-4</del>   | <del>2B.65</del> | <del>36 x 24</del> | <del>36 x 24</del> | <del>48 x 36</del> | <del>60 x 48</del>  |         | <del>48 x 36</del> |
| Lights On When Using Wipers or Raining            | R16-5,6            | 2B.64            | 24 x 30            | 24 x 30            | 36 x 48            | 48 x 60             | —       | 36 x 48            |
| Turn On Headlights Next XX Miles                  | R16-7              | 2B.64            | <u>60 x 18</u>     | <u>60 x 18</u>     | <u>96 x 30</u>     | <u>132 x 36</u>     | —       | <u>96 x 30</u>     |
| Turn On, Check Headlights                         | R16-8,9            | 2B.64            | <u>42 x 18</u>     | <u>42 x 18</u>     | <u>60 x 30</u>     | <u>78 x 36</u>      | —       | <u>60 x 30</u>     |
| Begin, End Daytime Headlight Section              | R16-10,11          | 2B.64            | <u>60 x 18</u>     | <u>60 x 18</u>     | <u>96 x 30</u>     | <u>120 x 36</u>     | —       | <u>96 x 30</u>     |

\* See Table 9B-1 for minimum size required for signs on bicycle facilities

- Notes: 1. Larger signs may be used when appropriate  
 2. Dimensions in inches are shown as width x height

**Table 2B-1(CA). California Regulatory Sign and Plaque Sizes (Sheet 1 of 7)**

| Sign or Plaque  | Sign Designation | Section | Conventional Road |            | Expressway | Freeway  | Minimum | Oversized |
|---|------------------|---------|-------------------|------------|------------|----------|---------|-----------|
|   |                  |         | Single Lane       | Multi-Lane |            |          |         |           |
| Speed Zone Ahead  | R2-4(CA)         | 2B.13   | 24 x 30           | 24 x 30    | 36 x 45    | 48 x 60  | 24 x 30 | ---       |
| End Speed Limit   | R3(CA)           | 2B.13   | 24 x 30           | 24 x 30    | 36 x 45    | 48 x 60  | 24 x 30 | ---       |
| TRUCKS, 3 AXLES OR MORE<br>55 MAXIMUM   | R6-3(CA)         | 2B.13   | 48 x 60           | 48 x 60    | 48 x 60    | 48 x 60  | ---     | ---       |
| TRUCKS 3 AXLES OR MORE<br>RIGHT 2 LANES ONLY  | R6-3A(CA)        | 2B.13   | 54 x 66           | 54 x 66    | 54 x 66    | 54 x 66  | ---     | ---       |
| ALL VEHICLES WHEN TOWING<br>55 MAXIMUM  | R6-4(CA)         | 2B.13   | 48 x 60           | 48 x 60    | 48 x 60    | 48 x 60  | ---     | ---       |
| ALL VEHICLES WHEN TOWING<br>RIGHT 2 LANES ONLY  | R6-4A(CA)        | 2B.31   | 54 x 66           | 54 x 66    | 54 x 66    | 54 x 66  | ---     | ---       |
| No Right Turn on Red  | R13A(CA)         | 2B.54   | 18 x 30           | 24 x 36    | 30x 48     | 30x 48   | 18 x 30 | ---       |
| No Left Turn on Red   | R13B(CA)         | 2B.54   | 18 x 30           | 24 x 36    | 30x 48     | 30x 48   | 18 x 30 | ---       |
| RIGHT (LEFT) LANE MUST EXIT   | R18A(CA)         | 2B.20   | ---               | ---        | 66 x48     | 66 x48   | ---     | ---       |
| RIGHT (LEFT) LANE FREEWAY<br>ONLY   | R18B(CA)         | 2B.20   | 36 x 36           | 36 x 36    | ---        | ---      | ---     | ---       |
| No Trucks Variable Message  | R20-1(CA)        | 2B.39   | ---               | ---        | 102 x 48   | 102 x 48 | ---     | ---       |
| NEXT RIGHT plaque   | R20-1A(CA)       | 2B.39   | ---               | ---        | 102 x 18   | 102 x 18 | ---     | ---       |
| Weight Limit  | R20A(CA)         | 2B.59   | 30 x 30           | 30 x 30    | 36 x 40    | ---      | ---     | ---       |
| Truck Exclusion plaque  | R20D-1(CA)       | 2B.59   | 24 x 6            | 30 x 9     | 36 x 12    | ---      | 24 x 6  | ---       |
| Truck Exclusion plaque  | R20D-2(CA)       | 2B.59   | 24 x 6            | 30 x 9     | 36 x 12    | ---      | 24 x 6  | ---       |
| Truck Exclusion plaque  | R20D-3(CA)       | 2B.59   | 24 x 6            | 30 x 9     | 36 x 12    | ---      | 24 x 6  | ---       |
| Truck Exclusion plaque  | R20D-4(CA)       | 2B.59   | 24 x 6            | 30 x 9     | 36 x 12    | ---      | 24 x 6  | ---       |
| Truck Length Limit  | R20H(CA)         | 2B.39   | 36 x 36           | 36 x 36    | 42 x 42    | ---      | 36 x 36 | ---       |
| Bridge Speed and Weight Limit   | R21(CA)          | 2B.39   | 36 X 30           | 36 X 30    | ---        | ---      | ---     | ---       |
| OK TO PARK ON BRIDGE  | R22(CA)          | 2B.46   | 12 X 18           | 12 X 18    | ---        | ---      | ---     | ---       |
| NO FISHING (JUMPING) FROM<br>BRIDGE   | R23(CA)          | 2B.101  | 26 X 18           | 26 X 18    | ---        | ---      | ---     | ---       |
| PARK PARALLEL   | R24(CA)          | 2B.46   | 12 X 18           | 12 X 18    | ---        | ---      | ---     | ---       |
| SCHOOL BUS ONLY w/Double<br>Arrow   | R24A(CA)         | 2B.46   | 12 X 18           | 12 X 18    | ---        | ---      | ---     | ---       |
| TAXI CAB ONLY w/Double Arrow  | R24B(CA)         | 2B.46   | 12 X 18           | 12 X 18    | ---        | ---      | ---     | ---       |
| TOUR BUS ONLY w/ Double<br>Arrow  | R24C(CA)         | 2B.46   | 12 X 18           | 12 X 18    | ---        | ---      | ---     | ---       |
| MAIL DEPOSIT ONLY w/ Double<br>Arrow  | R24D(CA)         | 2B.46   | 12 X 18           | 12 X 18    | ---        | ---      | ---     | ---       |
| BLOCK WHEELS TO CURB  | R24E(CA)         | 2B.46   | 12 X 18           | 12 X 18    | ---        | ---      | ---     | ---       |
| PARK OFF PAVEMENT   | R25(CA)          | 2B.46   | 24 x 15           | 24 x 15    | ---        | ---      | ---     | ---       |
| LOADING ONLY 7AM TO 6PM<br>EXCEPT SUNDAY 30 MINUTE<br>LIMIT w/ Double Arrow               | R25A(CA)         | 2B.46   | 12 X 18           | 12 X 18    | ---        | ---      | ---     | ---       |
| Passenger Loading ONLY 5<br>MINUTE LIMIT w/ Double Arrow                                  | R25B(CA)         | 2B.46   | 18 x 18           | 18 x 18    | ---        | ---      | ---     | ---       |
| PASSENGER LOADING ONLY 5<br>MINUTE LIMIT w/ Double Arrow                                  | R25C(CA)         | 2B.46   | 18 x 18           | 18 x 18    | ---        | ---      | ---     | ---       |
| School Passenger Loading ONLY<br>7AM TO 4PM SCHOOL DAYS 5<br>MINUTE LIMIT w/ Double Arrow | R25D(CA)         | 2B.46   | 18 x 21           | 18 x 21    | ---        | ---      | ---     | ---       |
| PASSENGER LOADING ONLY<br>7AM TO 4PM SCHOOL DAYS 5<br>MINUTE LIMIT w/ Double Arrow        | R25E(CA)         | 2B.46   | 18 x 21           | 18 x 21    | ---        | ---      | ---     | ---       |
| School Bus Passenger Loading<br>ONLY w/ Double Arrow                                      | R25F(CA)         | 2B.46   | 18 x 18           | 18 x 18    | ---        | ---      | ---     | ---       |
| Tour Bus Passenger Loading<br>ONLY w/ Double Arrow  | R25H(CA)         | 2B.46   | 18 x 18           | 18 x 18    | ---        | ---      | ---     | ---       |

**Table 2B-1(CA). California Regulatory Sign and Plaque Sizes (Sheet 2 of 7)**

| Sign or Plaque   | Sign Designation | Section | Conventional Road |            | Expressway | Freeway | Minimum | Oversized |
|--|------------------|---------|-------------------|------------|------------|---------|---------|-----------|
|  |                  |         | Single Lane       | Multi-Lane |            |         |         |           |
| CAR SHARE PARKING ONLY PERMIT REQUIRED w/ Double Arrow               | R25J(CA)         | 2B.46   | 18 x 18           | 18 x 18    | ---        | ---     | ---     | ---       |
| NO PARKING ANY TIME  | R26(CA)          | 2B.46   | 12 x 18           | 12 x 18    | ---        | ---     | ---     | ---       |
| NO STOPPING ANY TIME   | R26(S)(CA)       | 2B.46   | 12 x 18           | 12 x 18    | ---        | ---     | ---     | ---       |
| NO PARKING ANY TIME  | R26A(CA)         | 2B.46   | 24 x 30           | 24 x 30    | 24 x 30    | ---     | ---     | ---       |
| NO STOPPING ANY TIME   | R26A(S)(CA)      | 2B.46   | 24 x 30           | 24 x 30    | 24 x 30    | ---     | ---     | ---       |
| NO STOPPING FIRE LANE  | R26F(CA)         | 2B.46   | 12 x 18           | 12 x 18    | 24 x 30    | ---     | 12 x 18 | ---       |
| Tow-Away No Parking  | R26K(CA)         | 2B.46   | 12 x 18           | 12 x 18    | ---        | ---     | ---     | ---       |
| Tow-Away NO STOPPING ANY TIME  | R26L(CA)         | 2B.46   | 12 x 18           | 12 x 18    | ---        | ---     | ---     | ---       |
| NO PARKING ON BRIDGE   | R27(CA)          | 2B.46   | 12 x 18           | 12 x 18    | ---        | ---     | ---     | ---       |
| NO PARKING ON BRIDGE   | R27A(CA)         | 2B.46   | 24 x 30           | 24 x 30    | 24 x 30    | ---     | ---     | ---       |
| NO PARKING ANY TIME with Arrow                                       | R28(CA)          | 2B.46   | 12 x 18           | 12 x 18    | ---        | ---     | ---     | ---       |
| NO STOPPING ANY TIME with Arrow                                      | R28(S)(CA)       | 2B.46   | 12 x 18           | 12 x 18    | ---        | ---     | ---     | ---       |
| NO PARKING ANY TIME with Arrow                                       | R28A(CA)         | 2B.46   | 24 x 30           | 24 x 30    | 24 x 30    | ---     | ---     | ---       |
| NO STOPPING ANY TIME with Arrow                                      | R28A(S)(CA)      | 2B.46   | 24 x 30           | 24 x 30    | 24 x 30    | ---     | ---     | ---       |
| NO STOPPING BUS ONLY w/ Arrow  | R28C(CA)         | 2B.46   | 12 x 18           | 12 x 18    | ---        | ---     | ---     | ---       |
| NO PARKING VEHICLES OVER 6' HIGH w/ Double Arrow                     | R28D(CA)         | 2B.46   | 18 x 18           | 18 x 18    | ---        | ---     | ---     | ---       |
| NO STOPPING VEHICLES OVER 6' HIGH w/ Double Arrow                    | R28D(S)(CA)      | 2B.46   | 18 x 18           | 18 x 18    | ---        | ---     | ---     | ---       |
| NO PUBLIC PARKING SUBJECT TO CITATION AND REMOVAL AT OWNER'S EXPENSE | R28E(CA)         | 2B.46   | 18 x 24           | 18 x 24    | ---        | ---     | ---     | ---       |
| No Parking VEHICLES OVER 5 TONS                                      | R28F(CA)         | 2B.46   | 12 x 18           | 12 x 18    | ---        | ---     | ---     | ---       |
| No Stopping/No Parking Specific Hours                                | R29(CA)          | 2B.46   | 18 x 30           | 18 x 30    | ---        | ---     | ---     | ---       |
| No Parking Specific Hours  | R30(CA)          | 2B.46   | 12 x 18           | 12 x 18    | ---        | ---     | ---     | ---       |
| No Parking Specific Hours  | R30A(CA)         | 2B.46   | 12 x 18           | 12 x 18    | ---        | ---     | ---     | ---       |
| No Parking 10AM TO 12PM WEDNESDAY STREET SWEEPING                    | R30B(CA)         | 2B.46   | 12 x 18           | 12 x 18    | ---        | ---     | ---     | ---       |
| No Parking 2AM TO 6AM EXCEPT BY PERMIT                               | R30C(CA)         | 2B.46   | 12 x 18           | 12 x 18    | ---        | ---     | ---     | ---       |
| No Parking 2AM TO 6AM CITYWIDE EXCEPT BY PERMIT                      | R30D(CA)         | 2B.46   | 18 x 30           | 18 x 30    | ---        | ---     | ---     | ---       |
| No Parking w/ Double Arrow   | R30E(CA)         | 2B.46   | 12 x 18           | 12 x 18    | ---        | ---     | ---     | ---       |
| No Stopping Specific Hours School Days                               | R30F(CA)         | 2B.46   | 12 x 18           | 12 x 18    | ---        | ---     | ---     | ---       |
| No Parking/Parking Specific Hours                                    | R31(CA)          | 2B.46   | 14 x 20.5         | 14 x 20.5  | ---        | ---     | ---     | ---       |
| No Stopping/Parking Specific Hours                                   | R31(S)(CA)       | 2B.46   | 18 x 30           | 18 x 30    | ---        | ---     | ---     | ---       |
| Limited Hour/Minute Parking Specific Hours                           | R32(CA)          | 2B.46   | 12 x 18           | 12 x 18    | ---        | ---     | ---     | ---       |
| The No Parking/Parking Specific Hours                                | R32B(CA)         | 2B.46   | 12 x 30           | 12 x 30    | ---        | ---     | ---     | ---       |
| 2 HOUR PARKING 8AM TO 6PM DISTRICT 7 PERMITS EXEMPT                  | R32C(CA)         | 2B.46   | 12 x 18           | 12 x 18    | ---        | ---     | ---     | ---       |

**Table 2B-1(CA). California Regulatory Sign and Plaque Sizes (Sheet 3 of 7)**

| Sign or Plaque   | Sign Designation | Section         | Conventional Road |            | Expressway | Freeway | Minimum | Oversized |
|--|------------------|-----------------|-------------------|------------|------------|---------|---------|-----------|
|  |                  |                 | Single Lane       | Multi-Lane |            |         |         |           |
| 30 MINUTE PARKING 2AM TO 6AM<br>DISTRICT 3 PERMITS EXEMPT  | R32D(CA)         | 2B.46           | 12 x 18           | 12 x 18    | ---        | ---     | ---     | ---       |
| 2 HOUR PARKING 8AM TO 4PM -<br>PASSENGER LOADING ONLY 4PM TO<br>MIDNIGHT 5 MINUTE LIMIT w/ Double<br>Arrow       | R32E(CA)         | 2B.46           | 18 x 30           | 18 x 30    | ---        | ---     | ---     | ---       |
| 2 HOUR PARKING 8AM TO 6PM<br>MOTORCYCLE PARKING ONLY w/<br>Double Arrow  | R32F(CA)         | 2B.46           | 12 x 18           | 12 x 18    | ---        | ---     | ---     | ---       |
| NO LEFT TURN Specific Hours  | R33(CA)          | 2B.18           | 24 x 36           | 24 x 36    | ---        | ---     | ---     | ---       |
| NO LEFT TURN Specific Hours  | R33A(CA)         | 2B.18           | 30 x 48           | 30 x 48    | 30 x 48    | ---     | ---     | ---       |
| Commercial Vehicle Weight Exclusion  | R36(CA)          | 2B.59           | 24 x 24           | 24 x 24    | ---        | ---     | ---     | ---       |
| Tow-Away No Stopping/Limited Hour<br>Parking Specific Hours  | R37(CA)          | 2B.46           | 18 x 31           | 18 x 31    | ---        | ---     | ---     | ---       |
| Tow-Away No Parking/Limited Hour<br>Parking Specific Hours   | R38(CA)          | 2B.46           | 14 x 20.5         | 14 x 20.5  | ---        | ---     | ---     | ---       |
| Tow-Away No Stopping/Limited Hour<br>Parking Specific Hours  | R38(S)(CA)       | 2B.46           | 18 x 31           | 18 x 31    | ---        | ---     | ---     | ---       |
| TOW-AWAY NO STOPPING 7AM TO<br>9AM - PASSENGER LOADING ONLY<br>ALL OTHER TIMES 5 MINUTE LIMIT w/<br>Double Arrow | R38A(CA)         | 2B.46           | 18 x 30           | 18 x 30    | ---        | ---     | ---     | ---       |
| NO PARKING OF COMMERCIAL<br>VEHICLES EXCEPT BY PERMIT  | R39(CA)          | 2B.46           | 24 x 30           | 24 x 30    | ---        | ---     | ---     | ---       |
| NO DOUBLE PARKING ANYTIME<br>COMMERCIAL VEHICLES INCLUDED  | R39-1(CA)        | 2B.46           | 12 x 18           | 12 x 18    | ---        | ---     | ---     | ---       |
| NO DOUBLE PARKING ANYTIME<br>COMMERCIAL VEHICLES INCLUDED  | R39-2(CA)        | 2B.46           | 18 x 18           | 18 x 18    | ---        | ---     | ---     | ---       |
| 10 HOUR PARKING COMMERCIAL<br>MOTOR VEHICLES   | R39-3(CA)        | 2B.46,<br>2I.05 | 24 x 18           | 24 x 18    | ---        | ---     | ---     | ---       |
| TWO WAY TRAFFIC AHEAD  | R40(CA)          | 2B.102          | 24 x 30           | 24 x 30    | ---        | ---     | ---     | ---       |
| \$1000 FINE FOR LITTERING  | R47(CA)          | 2B.103          | 52 x 36           | 52 x 36    | 52 x 36    | 52 x 36 | ---     | ---       |
| \$1000 FINE FOR ANIMAL<br>ABANDONMENT  | R47A(CA)         | 2B.103          | 54 x 36           | 54 x 36    | 54 x 36    | 54 x 36 | ---     | ---       |
| SPEED ENFORCED BY RADAR  | R48(CA)          | 2B.110          | 24 x 30           | 24 x 30    | 36 x 48    | 48 x 60 | 18 x 24 | ---       |
| RADAR ENFORCED   | R48-1(CA)        | 2B.13           | 36 x 18           | 36 x 18    | 48 x 24    | 48 x 24 | 24 x 12 | ---       |
| SPEED ENFORCED BY AIRCRAFT   | R48-2(CA)        | 2B.13           | 24 x 30           | 24 x 30    | 36 x 48    | 48 x 60 | 18 x 24 | ---       |
| NO PED CROSSING, USE<br>CROSSWALK  | R49(CA)          | 2B.51           | 42 x 18           | 42 x 18    | ---        | ---     | ---     | ---       |
| END TRUCK LANE   | R53A(CA)         | 2B.31           | 36 x 36           | 36 x 36    | 48 x 48    | 48 x 48 | 24 x 24 | ---       |
| TRUCKS RIGHT LANE ONLY   | R53B(CA)         | 2B.31           | 36 x 48           | 36 x 48    | 48 x 60    | 48 x 60 | 24 x 30 | ---       |
| AUTOS WITH TRAILERS - TRUCKS -<br>PROHIBITED   | R53D(CA)         | 2B.39           | ---               | ---        | 66 x 72    | 66 x 72 | ---     | ---       |
| END TRUCK LANE CONTROL   | R53E(CA)         | 2B.31           | 36 x 48           | 36 x 48    | 48 x 60    | 48 x 60 | 24 x 30 | ---       |
| YIELD TO UPHILL TRAFFIC  | R55(CA)          | 2B.31           | ---               | ---        | 48 x 54    | 48 x 54 | ---     | ---       |
| BEGIN FREEWAY  | R57(CA)          | 2B.49           | ---               | ---        | 48 x 26    | 48 x 26 | ---     | ---       |
| END FREEWAY  | R58(CA)          | 2B.48           | ---               | ---        | 48 x 26    | 48 x 26 | ---     | ---       |
| Optional Movement Lane Control   | R60B(CA)         | 2B.21           | 54 x 48           | 54 x 48    | ---        | ---     | ---     | ---       |
| Intersection Lane Control  | R61-1(CA)        | 2B.19           | 30 x 30           | 45 x 45    | ---        | ---     | 30 x 30 | ---       |
| Intersection Lane Control  | R61-3(CA)        | 2B.19           | 30 x 30           | 45 x 45    | ---        | ---     | 30 x 30 | ---       |
| Intersection Lane Control  | R61-5(CA)        | 2B.19           | 36 x 30           | 54 x 45    | ---        | ---     | 36 x 30 | ---       |
| Intersection Lane Control  | R61-7(CA)        | 2B.19           | 36 x 30           | 54 x 45    | ---        | ---     | 36 x 30 | ---       |



**Table 2B-1(CA). California Regulatory Sign and Plaque Sizes (Sheet 4 of 7)**

| Sign or Plaque   | Sign Designation | Section | Conventional Road |            | Expressway | Freeway | Minimum | Oversized |
|--|------------------|---------|-------------------|------------|------------|---------|---------|-----------|
|  |                  |         | Single Lane       | Multi-Lane |            |         |         |           |
| Intersection Lane Control                                      | R61-9(CA)        | 2B.19   | 36 x 30           | 54 x 45    | ---        | ---     | 36 x 30 | ---       |
| Intersection Lane Control                                      | R61-11(CA)       | 2B.19   | 36 x 30           | 54 x 45    | ---        | ---     | 36 x 30 | ---       |
| Intersection Lane Control                                      | R61-13(CA)       | 2B.19   | 48 x 30           | 72 x 45    | ---        | ---     | 48 x 30 | ---       |
| Intersection Lane Control                                      | R61-15(CA)       | 2B.19   | 48 x 30           | 72 x 45    | ---        | ---     | 48 x 30 | ---       |
| Intersection Lane Control                                      | R61-17(CA)       | 2B.19   | 48 x 30           | 72 x 45    | ---        | ---     | 48 x 30 | ---       |
| Intersection Lane Control                                      | R61-19(CA)       | 2B.19   | 36 x 30           | 48 x 36    | ---        | ---     | 30 x 24 | ---       |
| Intersection Lane Control                                      | R61-22(CA)       | 2B.19   | 54 x 30           | 78 x 45    | ---        | ---     | 54 x 30 | ---       |
| Intersection Lane Control                                      | R61-24(CA)       | 2B.19   | 54 x 30           | 78 x 45    | ---        | ---     | 54 x 30 | ---       |
| Intersection Lane Control                                      | R61-26(CA)       | 2B.19   | 48 x 30           | 72 x 45    | ---        | ---     | 48 x 30 | ---       |
| Intersection Lane Control                                      | R61-28(CA)       | 2B.19   | 48 x 30           | 72 x 45    | ---        | ---     | 48 x 30 | ---       |
| Intersection Lane Control                                      | R61-30(CA)       | 2B.19   | 36 x 30           | 54 x 45    | ---        | ---     | 36 x 30 | ---       |
| Intersection Lane Control                                      | R61-32(CA)       | 2B.19   | 36 x 30           | 54 x 45    | ---        | ---     | 36 x 30 | ---       |
| Intersection Lane Control                                      | R61-34(CA)       | 2B.19   | 48 x 30           | 72 x 45    | ---        | ---     | 48 x 30 | ---       |
| Intersection Lane Control                                      | R61-36(CA)       | 2B.19   | 48 x 30           | 72 x 45    | ---        | ---     | 48 x 30 | ---       |
| PUSH BUTTON FOR PEDESTRIAN WARNING LIGHTS - CROSS WITH CAUTION | R62E(CA)         | 2B.52   | 5 x 7.5           | 5 x 7.5    | ---        | ---     | 5 x 7.5 | 9 x 12    |
| TRUCKS OK  | R70(CA)          | 2B.31   | ---               | ---        | ---        | 96 x 70 | ---     | ---       |
| Intersection Lane Control                                      | R73-1(CA)        | 2B.19   | 36 x 30           | 36 x 30    | ---        | ---     | 24 x 20 | 45 x 36   |
| Intersection Lane Control                                      | R73-2(CA)        | 2B.19   | 36 x 36           | 36 x 36    | ---        | ---     | 24 x 24 | 45 x 45   |
| Intersection Lane Control                                      | R73-3(CA)        | 2B.19   | 36 x 36           | 36 x 36    | ---        | ---     | 24 x 24 | 45 x 45   |
| Intersection Lane Control                                      | R73-4(CA)        | 2B.19   | 36 x 45           | 36 x 45    | ---        | ---     | 36 x 45 | ---       |
| Intersection Lane Control                                      | R73-5(CA)        | 2B.19   | 36 x 36           | 36 x 36    | ---        | ---     | 24 x 24 | ---       |
| Intersection Lane Control                                      | R73-6(CA)        | 2B.19   | 36 x 36           | 36 x 36    | ---        | ---     | 24 x 24 | ---       |
| Intersection Lane Control                                      | R73-8(CA)        | 2B.19   | 36 x 45           | 36 x 45    | ---        | ---     | 24 x 30 | ---       |
| AT SIGNAL plaque   | R73-9(CA)        | 2B.53   | 24 x 9            | 24 x 9     | ---        | ---     | 24 x 9  | ---       |
| CHAIN INSTALLATION ONLY  | R74(CA)          | 2B.46   | 36 x 36           | 36 x 36    | 36 x 36    | 36 x 36 | ---     | ---       |
| CHAINS REQUIRED (X MILE (X MILES)) AHEAD                       | R75(CA)          | 2B.46   | 48 x 42           | 48 x 42    | 48 x 42    | 48 x 42 | ---     | ---       |
| CHAINS REQUIRED  | R76(CA)          | 2B.46   | 48 x 24           | 48 x 24    | 48 x 24    | 48 x 24 | ---     | ---       |
| ON SINGLE AXLE DRIVE VEHICLE WITH TRAILER                      | R76-1(CA)        | 2B.46   | 48 x 24           | 48 x 24    | 48 x 24    | 48 x 24 | ---     | ---       |
| NO EXCEPTIONS  | R77(CA)          | 2B.46   | 48 x 30           | 48 x 30    | 48 x 30    | 48 x 30 | 48 x 12 | ---       |
| END CHAIN CONTROL  | R78(CA)          | 2B.46   | 48 x 34           | 48 x 34    | 48 x 34    | 48 x 34 | ---     | ---       |
| AUTOS & PICKUPS SNOW TIRES OK - CARRY CHAINS                   | R79(CA)          | 2B.46   | 48 x 30           | 48 x 30    | 48 x 30    | 48 x 30 | ---     | ---       |
| 4-W DRIVE WITH SNOW TIRES OK - CARRY CHAINS                    | R80-1(CA)        | 2B.46   | 48 x 30           | 48 x 30    | 48 x 30    | 48 x 30 | ---     | ---       |
| Specific Hours/Days plaque                                     | R82A(CA)         | 2B.31   | 30 x 12           | 30 x 12    | 36 x 18    | 36 x 18 | 30 x 12 | 48 x 24   |
| 1 CAR (2 CARS) PER GREEN                                       | R89(CA)          | 2B.56   | ---               | ---        | 22 x 6     | 36 x 9  | 22 x 6  | ---       |
| 1 CAR (2 CARS) PER GREEN EACH LANE                             | R89-1(CA)        | 2B.56   | ---               | ---        | 22 x 10    | 36 x 16 | 22 x 10 | ---       |
| 1 CAR (2 CARS) PER GREEN THIS LANE                             | R89-2(CA)        | 2B.56   | ---               | ---        | 22 x 10    | 36 x 16 | 22 x 10 | ---       |
| RIGHT (LEFT) LANE THIS SIGNAL                                  | R89-3(CA)        | 2B.56   | ---               | ---        | 22 x 10    | 36 x 16 | 22 x 10 | ---       |
| Accessible Parking Only  | R99(CA)          | 2B.46   | 12 x 18           | 12 x 18    | ---        | ---     | ---     | ---       |
| MINIMUM FINE \$250 plaque                                      | R99B(CA)         | 2B.46   | 12 x 9            | 12 x 9     | ---        | ---     | ---     | ---       |
| Accessible Parking Only Minimum Fine \$250                     | R99C(CA)         | 2B.46   | 12 x 24           | 12 x 24    | ---        | ---     | ---     | ---       |
| TOW-AWAY SPECIAL PLACARD OR LICENSE PLATE REQUIRED             | R100A(CA)        | 2B.46   | 12 x 8            | 12 x 8     | ---        | ---     | ---     | ---       |
| Disabled Tow-Away  | R100B(CA)        | 2B.46   | 24 x 24           | 24 x 24    | ---        | ---     | ---     | ---       |

**Table 2B-1(CA). California Regulatory Sign and Plaque Sizes (Sheet 5 of 7)**

| Sign or Plaque   | Sign Designation | Section    | Conventional Road |            | Expressway | Freeway  | Minimum  | Oversized |
|--|------------------|------------|-------------------|------------|------------|----------|----------|-----------|
|  |                  |            | Single Lane       | Multi-Lane |            |          |          |           |
| PRIVATE ROAD (PRIVATE PROPERTY) VEHICLE CODE ENFORCED            | R101(CA)         | 2B.104     | 36 x 24           | 36 x 24    | ---        | ---      | 24 x 18  | ---       |
| Hazardous Waste Prohibited                                       | R102(CA)         | 2B.62      | 24 x 24           | 24 x 24    | 30 x 30    | 30 x 30  | 18 x 18  | 48 x 48   |
| HAZARDOUS WASTE PROHIBITED                                       | R102A(CA)        | 2B.62      | 24 x 18           | 24 x 18    | 30 x 20    | 30 x 20  | 18 x 12  | 48 x 30   |
| Hazardous Waste Permitted  | R103(CA)         | 2B.62      | 24 x 24           | 24 x 24    | 30 x 30    | 30 x 30  | 18 x 18  | 48 x 48   |
| HAZARDOUS WASTE PERMITTED  | R103A(CA)        | 2B.62      | 24 x 18           | 24 x 18    | 30 x 20    | 30 x 20  | 18 x 12  | 48 x 30   |
| Hazardous Material Prohibited                                    | R104(CA)         | 2B.62      | 24 x 24           | 24 x 24    | 30 x 30    | 30 x 30  | 18 x 18  | 48 x 48   |
| HAZARDOUS MATERIAL PROHIBITED                                    | R104A(CA)        | 2B.62      | 24 x 18           | 24 x 18    | 30 x 20    | 30 x 20  | 18 x 12  | 48 x 30   |
| Hazardous Material Permitted                                     | R105(CA)         | 2B.62      | 24 x 24           | 24 x 24    | 30 x 30    | 30 x 30  | 18 x 18  | 48 x 48   |
| HAZARDOUS MATERIAL PERMITTED                                     | R105A(CA)        | 2B.62      | 24 x 18           | 24 x 18    | 30 x 20    | 30 x 20  | 18 x 12  | 48 x 30   |
| Tow-Away NO STOPPING 4 TO 6 PM                                   | R107(CA)         | 2B.46      | 18 x 18           | 18 x 18    | ---        | ---      | ---      | ---       |
| No Parking of Vehicles for Sale                                  | R108(CA)         | 2B.46      | 12 x 18           | 12 x 18    | ---        | ---      | ---      | ---       |
| PAY AT STATION   | R109(CA)         | 2B.47      | 12 x 6            | 12 x 6     | 12 x 6     | ---      | ---      | ---       |
| MOVE OVER OR SLOW FOR STOPPED EMERGENCY AND MAINTENANCE VEHICLES | R110(CA)         | 2B.112(CA) | ---               | ---        | ---        | 120 x 48 | ---      | ---       |
| Electric Vehicle Charging Station Tow-Away                       | R112(CA)         | 2B.46      | *                 | *          | ---        | ---      | 24 X 24  | ---       |
| No Parking EXCEPT FOR EV CHARGING                                | R113(CA)         | 2B.46      | *                 | *          | ---        | ---      | 12 X 18  | ---       |
| No Parking EXCEPT FOR ELECTRIC VEHICLE CHARGING                  | R113A(CA)        | 2B.46      | *                 | *          | ---        | ---      | 12 X 18  | ---       |
| __ HOUR EV CHARGING __ AM TO __ PM                               | R114(CA)         | 2B.46      | *                 | *          | ---        | ---      | 12 X 18  | ---       |
| __ HOUR ELECTRIC VEHICLE CHARGING __ AM TO __ PM                 | R114A(CA)        | 2B.46      | *                 | *          | ---        | ---      | 12 X 21  | ---       |
| Rest Area Disclaimer   | SR2(CA)          | 2B.46      | 18 x 12           | 18 x 12    | ---        | ---      | ---      | ---       |
| WAIT HERE UNTIL SCALE CLEAR                                      | SR6-1(CA)        | 2B.60      | ---               | ---        | 44 x 36    | 44 x 36  | ---      | ---       |
| RELEASE BRAKES WHILE ON SCALE                                    | SR7-1(CA)        | 2B.60      | ---               | ---        | 42 x 36    | 42 x 36  | ---      | ---       |
| SET PARKING BRAKES   | SR8-1(CA)        | 2B.60      | ---               | ---        | 48 x 20    | 48 x 20  | ---      | ---       |
| LOADED   | SR9-1(CA)        | 2B.60      | ---               | ---        | 68 x 24    | 68 x 24  | ---      | ---       |
| EMPTY  | SR10-1(CA)       | 2B.60      | ---               | ---        | 62 x 24    | 62 x 24  | ---      | ---       |
| EMPTY 5 MPH  | SR11-1(CA)       | 2B.60      | ---               | ---        | 112 x 24   | 112 x 24 | ---      | ---       |
| LOADED 3 MPH   | SR12-1(CA)       | 2B.60      | ---               | ---        | 118 x 24   | 118 x 24 | ---      | ---       |
| Theft CHP plaque   | SR13-1(CA)       | 2B.60      | 48 x 10           | 48 x 10    | ---        | ---      | ---      | ---       |
| Seat Belt  | SR15(CA)         | 2B.66      | 18 x 24           | 18 x 24    | 18 x 24    | 18 x 24  | ---      | ---       |
| SAFETY BELT LAW ENFORCED   | SR15A(CA)        | 2B.66      | 18 x 18           | 18 x 18    | 18 x 18    | 18 x 18  | ---      | ---       |
| TRUCKS NOT GIVEN BYPASS SIGNAL MUST ENTER OPEN SCALES            | SR17(CA)         | 2B.60      | ---               | ---        | 120 x 42   | 144 x 54 | 120 x 42 | ---       |
| NO EXPLOSIVES OR FLAMMABLES                                      | SR18(CA)         | 2B.62      | 36 x 24           | 36 x 24    | ---        | ---      | ---      | ---       |
| EXPLOSIVES AND CORROSIVES PROHIBITED WITHOUT PERMIT              | SR19-1(CA)       | 2B.62      | 60 x 48           | 60 x 48    | ---        | ---      | ---      | ---       |
| SNOW NOT REMOVED BEYOND HERE                                     | SR20-1(CA)       | 2B.46      | 48 x 30           | 48 x 30    | ---        | ---      | ---      | ---       |
| DUMPING PROHIBITED   | SR22-1(CA)       | 2B.106     | 30 x 14           | 30 x 14    | ---        | ---      | ---      | ---       |

**Table 2B-1(CA). California Regulatory Sign and Plaque Sizes (Sheet 6 of 7)**

| Sign or Plaque  | Sign Designation | Section      | Conventional Road |            | Expressway | Freeway  | Minimum | Oversized |
|---|------------------|--------------|-------------------|------------|------------|----------|---------|-----------|
|   |                  |              | Single Lane       | Multi-Lane |            |          |         |           |
| NO HOUSEHOLD GARBAGE  | SR23-1(CA)       | 2B.106       | 26 x 18           | 26 x 18    | ---        | ---      | ---     | ---       |
| TRANSPORTING ILLEGAL FIREWORKS PROHIBITED                                 | SR25(CA)         | 2B.63        | 84 x 42           | 84 x 42    | 108 x 54   | 108 x 54 | 84 x 42 | ---       |
| DISPLAY OF VEHICLES FOR SALE PROHIBITED                                   | SR26(CA)         | 2B.46        | 30 x 24           | 30 x 24    | ---        | ---      | ---     | ---       |
| LEFT TURN ON GREEN ARROW ONLY - NO U TURN                                 | SR39A(CA)        | 2B.53        | 36 x 48           | 36 x 48    | ---        | ---      | ---     | ---       |
| LEFT OR U TURN ON GREEN ARROW ONLY  | SR39A(U)(CA)     | 2B.53        | 42 x 24           | 42 x 24    | ---        | ---      | ---     | ---       |
| Width Limit   | SR40(CA)         | 2B.60        | ---               | ---        | 60 x 78    | 60 x 78  | 48 x 60 | ---       |
| ALL BUSES STOP AT SCALES  | SR41(CA)         | 2B.60        | ---               | ---        | 84 x 48    | 84 x 48  | ---     | ---       |
| ALL BUSES with Arrow  | SR42(CA)         | 2B.60        | ---               | ---        | 54 x 54    | 54 x 54  | ---     | ---       |
| GOLF CARTS OK DAYLIGHT HOURS  | SR43(CA)         | 2B.107       | 18 x 24           | 18 x 24    | ---        | ---      | ---     | ---       |
| Bus and Truck Registration  | SR44(CA)         | 2B.108       | 72 x 42           | 72 x 42    | ---        | ---      | ---     | ---       |
| EMERGENCY ACCESS KEEP CLEAR   | SR46(CA)         | 2B.109       | 24 x 30           | 24 x 30    | ---        | ---      | ---     | ---       |
| OFF HIGHWAY VEHICLES COMBINED USE NEXT (X) MILES                          | SR47(CA)         | 2B.110       | 48 x 48           | 48 x 48    | ---        | ---      | ---     | ---       |
| NO OFF HIGHWAY VEHICLES BEYOND THIS POINT                                 | SR48(CA)         | 2B.110       | 48 x 48           | 48 x 48    | ---        | ---      | ---     | ---       |
| TOW-AWAY NO PARKING WHEN SNOW REMOVAL CONDITIONS EXIST                    | SR49(CA)         | 2B.46        | 36 x 45           | 36 x 45    | ---        | ---      | 18 x 24 | ---       |
| SPECIAL DRIVING ZONE BEGINS HERE - DOUBLE FINE ZONE                       | SR53(CA)         | 2B.17        | 48 x 48           | 48 x 48    | 72 x 72    | 72 x 72  | 48 x 48 | ---       |
| DOUBLE FINE ZONE  | SR54(CA)         | 2B.17        | 30 x 30           | 30 x 30    | 42 x 42    | 42 x 42  | 30 x 30 | ---       |
| SPECIAL DRIVING ZONE ENDS HERE  | SR55(CA)         | 2B.17        | 48 x 30           | 48 x 30    | 72 x 42    | 72 x 42  | 48 x 30 | ---       |
| Traffic Signal PHOTO ENFORCED   | SR56(CA)         | 2B.55        | 36 x 54           | 36 x 54    | 48 x 72    | 48 x 72  | 30 x 42 | ---       |
| ALL TRUCKS - 2 AXLE AND MORE - STOP AT SCALE                              | SR57(CA)         | 2B.60        | 84 x 18           | 84 x 18    | 120 x 30   | 144 x 36 | 84 x 18 | ---       |
| RED LIGHT VIOLATION \$___ FINE  | SR58(CA)         | 2B.55        | 30 x 36           | 30 x 36    | 36 x 48    | 36 x 48  | 30 x 36 | ---       |
| MINOR CRASH NO INJURIES - SAFELY MOVE VEHICLES FROM TRAVEL LANES          | SR61(CA)         | 2B.65        | 96 x 66           | 96 x 66    | 96 x 66    | 96 x 66  | 96 x 66 | ---       |
| NO IDLING COMMERCIAL VEHICLES AND ALL BUSES                               | SR62 (CA)        | 2B.55        | 18 x 24           | 18 x 24    | ---        | ---      | ---     | ---       |
| NO IDLING All Buses and Commercial Vehicles                               | SR63 (CA)        | 2B.55        | 18 x 24           | 18 x 24    | ---        | ---      | ---     | ---       |
| FREEWAY - ACCESS RIGHTS RESTRICTED ON THIS SECTION OF HIGHWAY             | S3-1(CA)         | 2B.39        | 30 x 24           | 30 x 24    | ---        | ---      | ---     | ---       |
| STATE PROPERTY - NO DUMPING - NO PARKING - NO TRESPASSING                 | S8(CA)           | 2B.111       | 36 x 22           | 36 x 22    | ---        | ---      | ---     | ---       |
| STATE PROPERTY - ANY PERSON REMOVING OR MOLESTING SAME WILL BE PROSECUTED | S20(CA)          | 2B.111       | 24 x 18           | 24 x 18    | ---        | ---      | ---     | ---       |
| Weigh Station Repair Service plaque                                       | S21(CA)          | 2B.60        | 36 x 24           | 36 x 24    | ---        | ---      | ---     | ---       |
| Rest Area/Vista Point 8 HOUR PARKING                                      | S23(CA)          | 2B.46, 2I.05 | 24 x 24           | 24 x 24    | ---        | ---      | ---     | ---       |

**Table 2B-1(CA). California Regulatory Sign and Plaque Sizes (Sheet 7 of 7)**

| Sign or Plaque                  | Sign Designation | Section | Conventional Road |            | Expressway | Freeway | Minimum | Oversized |
|---------------------------------|------------------|---------|-------------------|------------|------------|---------|---------|-----------|
|                                 |                  |         | Single Lane       | Multi-Lane |            |         |         |           |
| DAYLIGHT HEADLIGHT SECTION      | S30-1(CA)        | 2B.64   | 84 x 54           | 84 x 54    | ---        | ---     | ---     | ---       |
| TURN ON HEADLIGHTS NEXT X MILES | S30-2(CA)        | 2B.64   | 108 x 54          | 108 x 54   | ---        | ---     | ---     | ---       |
| END DAYLIGHT HEADLIGHT SECTION  | S30-3(CA)        | 2B.64   | 84 x 66           | 84 x 66    | ---        | ---     | ---     | ---       |
| TURN ON HEADLIGHTS              | S30-4(CA)        | 2B.64   | 84 x 42           | 84 x 42    | ---        | ---     | ---     | ---       |
| CHECK HEADLIGHTS                | S30-5(CA)        | 2B.64   | 84 x 42           | 84 x 42    | ---        | ---     | ---     | ---       |
| Safety Corridor Sign            | S33(CA)          | 2B.64   | 102 x 48          | 102 x 48   | ---        | ---     | ---     | ---       |

**Table 2B-2. Meanings of Symbols and Legends on Reversible Lane Control Signs**

| Symbol / Word Message   | Meaning  |
|---|--|
| Red X on white background   | Lane closed  |
| Upward pointing black arrow on white background (if left turns are permitted, the arrow shall be modified to show left / through arrow) | Lane open for through travel and any turns not otherwise prohibited                                  |
| Black two-way left-turn arrows on white background and legend ONLY  | Lane may be used only for left turns in either direction (i.e., as a two-way left-turn lane)         |
| Black single left-turn arrow on white background and legend ONLY  | Lane may be used only for left turns in one direction (without opposing left turns in the same lane) |

**Table 2B-101(CA) Standard Application of Speed Limits per California Vehicle Code (Sheet 1 of 2)**

| Speed       | Determined by            | Roadway Facility   | CVC Section         |
|-------------|--------------------------|--|---------------------|
| 15 mph      | State or local authority | <ul style="list-style-type: none"> <li>▪ Railroad grade crossing with obstructed view</li> <li>▪ Uncontrolled highway intersection with obstructed view</li> <li>▪ An alley</li> </ul>   | 22352.a.1           |
| 15 & 20 mph | State or local authority | Where the prima facie speed of 25 mph is more than is reasonable or safe <ul style="list-style-type: none"> <li>▪ Narrow street not exceeding 25 feet other than a State Highway in a business or residential area or in a public park</li> <li>▪ Road near a school or senior center facility</li> </ul>  | 22358.3 & 22358.4   |
| 25 mph      | State or local authority | <ul style="list-style-type: none"> <li>▪ Any highway other than a State highway in any business or residential district</li> <li>▪ A street contiguous to senior citizen facility other than a State highway</li> <li>▪ Adjacent to a children's playground in a public park, but only during particular hours or days when children are expected to use facilities</li> </ul> | 22352.a.2 & 22357.1 |

**Table 2B-102(CA) Optional Application of Speed Limits per California Vehicle Code (Sheet 2 of 2)**

| Speed                              | Determined by  | Roadway facility  | CVC Section            |
|------------------------------------|--|---|------------------------|
| 25 to 60 mph                       | Caltrans   | State highway, based on an E&TS where the limit of 65 mph is more than is reasonable or safe  | 22354                  |
| 25 to 60 mph                       | Local city council or county board of supervisors for Caltrans | State highway, local entities may conduct a public hearing on proposed increases or decreases and the State Department of Transportation shall take into consideration the results of the public hearing  | 22354.5                |
| 25 to 65 mph                       | Local authority  | Any street other than a State highway, by ordinance, may post a prima facie speed limit based on an E&TS where a speed > 25 mph would facilitate the orderly movement of vehicular traffic and would be reasonable and safe   | 22357                  |
| 20 to 50 mph for Trucks            | State or local authority                                       | Highways under their respective jurisdiction where 55 mph is more than is reasonable or safe for vehicles mentioned in CVC 22406 (Trucks and other large vehicles)  | 22407                  |
| Maximum Speed 55 mph               | State or local authority                                       | <ul style="list-style-type: none"> <li>• Two-lane, undivided highway</li> <li>• Any highway if driving any of the following vehicles: <ul style="list-style-type: none"> <li>a. Motortruck or truck tractor with &gt; 3 axles</li> <li>b. Passenger vehicle or bus towing any other vehicle</li> <li>c. School bus transporting any school pupil</li> <li>d. A farm labor vehicle when transporting passengers</li> <li>e. A vehicle transporting explosives</li> <li>f. A trailer bus</li> </ul> </li> </ul> | 22349.b & .c and 22406 |
| Maximum Speed Limit of 65 mph      | State or local authority                                       | Any highway, posted at 65 mph based upon an E&TS, for vehicles not subject to CVC 22406   | 22349(a) & 22349       |
| Maximum Freeway Speed Limit 70 mph | Caltrans   | Freeways, after consultation with the California Highway Patrol, based upon an E&TS, or upon the basis of appropriate designs standards and projected traffic volumes in the case of newly constructed freeway segments, for vehicles not subject to CVC 22406  | 22356                  |



## CHAPTER 2C. WARNING SIGNS AND OBJECT MARKERS

### Section 2C.01 Function of Warning Signs

Support:

01 Warning signs call attention to unexpected conditions on or adjacent to a highway, street, or private roads open to public travel (see definition in Section 1A.13) and to situations that might not be readily apparent to road users. Warning signs alert road users to conditions that might call for a reduction of speed or an action in the interest of safety and efficient traffic operations.

### Section 2C.02 Application of Warning Signs

Standard:

01 **The use of warning signs shall be based on an engineering study or on engineering judgment.**

Guidance:

02 *The use of warning signs should be kept to a minimum as the unnecessary use of warning signs tends to breed disrespect for all signs. In situations where the condition or activity is seasonal or temporary, the warning sign should be removed or covered when the condition or activity does not exist.*

Option:

03 Consistent with the provisions of Chapter 2L, changeable message signs may be used to display a warning message.

04 Consistent with the provisions of Chapter 4L, a Warning Beacon may be used in combination with a standard warning sign.

Support:

05 The categories of warning signs are shown in Table 2C-1.

06 Warning signs provided in this Manual cover most of the conditions that are likely to be encountered. Additional warning signs for low-volume roads (as defined in Section 5A.01), temporary traffic control zones, school areas, grade crossings, and bicycle facilities are discussed in Parts 5 through 9, respectively.

07 Section 1A.09 contains information regarding the assistance that is available to jurisdictions that do not have engineers on their staffs who are trained and/or experienced in traffic control devices.

### Section 2C.03 Design of Warning Signs

Standard:

01 **Except as provided in Paragraph 2 or unless specifically designated otherwise, all warning signs shall be diamond-shaped (square with one diagonal vertical) with a black legend and border on a yellow background. Warning signs shall be designed in accordance with the sizes, shapes, colors, and legends contained in the "Standard Highway Signs and Markings" book and Caltrans' California Sign Specifications (see Section 1A.11).**

Option:

02 A warning sign that is larger than the size shown in the Oversized column in Table 2C-2 and 2C-2(CA) for that particular sign may be diamond-shaped or may be rectangular or square in shape.

03 Except for symbols on warning signs, minor modifications may be made to the design provided that the essential appearance characteristics are met. Modifications may be made to the symbols shown on combined horizontal alignment/intersection signs (see Section 2C.11) and intersection warning signs (see Section 2C.46) in order to approximate the geometric configuration of the intersecting roadway(s).

04 Word message warning signs other than those provided in this Manual may be developed by Caltrans (via CTDC process) and installed by State and/or local highway agencies. See Section 2A.06.

04a **Warning signs may be supplemented with a yellow flashing beacon.**

05 Warning signs regarding conditions associated with pedestrians, bicyclists, and playgrounds may have a black legend and border on a yellow or fluorescent yellow-green background.

**Standard:**

**06 Warning signs regarding conditions associated with school buses and schools and their related supplemental plaques shall have a black legend and border on a fluorescent yellow-green background (see Section 7B.07).**

**07 The use of educational plaques to supplement symbol signs is described in Section 2A.12.**

**Section 2C.04 Size of Warning Signs**

**Standard:**

**01 Except as provided in Section 2A.11, the sizes for warning signs shall be as shown in Table 2C-2 and 2C-2(CA).**

**Support:**

**02 Section 2A.11 contains information regarding the applicability of the various columns in Table 2C-2 and 2C-2(CA).**

**Standard:**

**03 Except as provided in Paragraph 5, the minimum size for all diamond-shaped warning signs facing traffic on a multi-lane conventional road where the posted speed limit is higher than 35 mph shall be 36 x 36 inches.**

**04 The minimum size for supplemental warning plaques that are not included in Table 2C-2 and 2C-2(CA) shall be as shown in Table 2C-3.**

**Option:**

**05 If a diamond-shaped warning sign is placed on the left-hand side of a multi-lane roadway to supplement the installation of the same warning sign on the right-hand side of the roadway, the minimum size identified in the Single Lane column in Table 2C-2 and 2C-2(CA) may be used.**

**06 Signs and plaques larger than those shown in Tables 2C-2 and 2C-3 may be used (see Section 2A.11).**

**Guidance:**

*07 The minimum size for all diamond-shaped warning signs facing traffic on exit and entrance ramps should be the size identified in Table 2C-2 and 2C-2(CA) for the mainline roadway classification (Expressway or Freeway). If a minimum size is not provided in the Freeway Column, the Expressway size should be used. If a minimum size is not provided in the Freeway or the Expressway Column, the Oversized size should be used.*

**Section 2C.05 Placement of Warning Signs**

**Support:**

**01 For information on placement of warning signs, see Sections 2A.16 to 2A.21.**

**02 The time needed for detection, recognition, decision, and reaction is called the Perception-Response Time (PRT). Table 2C-4 is provided as an aid for determining warning sign location. The distances shown in Table 2C-4 can be adjusted for roadway features, other signing, and to improve visibility.**

**Guidance:**

*03 Warning signs should be placed so that they provide an adequate PRT. The distances contained in Table 2C-4 are for guidance purposes and should be applied with engineering judgment. Warning signs should not be placed too far in advance of the condition, such that drivers might tend to forget the warning because of other driving distractions, especially in urban areas.*

*04 Minimum spacing between warning signs with different messages should be based on the estimated PRT for driver comprehension of and reaction to the second sign.*

*05 The effectiveness of the placement of warning signs should be periodically evaluated under both day and night conditions.*

**Option:**

**06 Warning signs that advise road users about conditions that are not related to a specific location, such as Deer Crossing or SOFT SHOULDER, may be installed in an appropriate location, based on engineering judgment, since they are not covered in Table 2C-4.**

**Standard:**

**07 Warning signs shall be installed in accordance with the general requirements for sign placement as described in Sections 2A.16 to 2A.21 and as shown in Figure 2A-3.**



## **Section 2C.06 Horizontal Alignment Warning Signs**

### **Support:**

<sup>01</sup> A variety of horizontal alignment warning signs (see Figure 2C-1), pavement markings (see Chapter 3B), and delineation (see Chapter 3F) can be used to advise motorists of a change in the roadway alignment. Uniform application of these traffic control devices with respect to the amount of change in the roadway alignment conveys a consistent message establishing driver expectancy and promoting effective roadway operations. The design and application of horizontal alignment warning signs to meet those requirements are addressed in Sections 2C.06 through 2C.15.

### **Standard:**

<sup>02</sup> **In advance of horizontal curves on freeways, on expressways, and on roadways with more than 1,000 AADT that are functionally classified as arterials or collectors, horizontal alignment warning signs shall be used in accordance with Table 2C-5 based on the speed differential between the roadway's posted or statutory speed limit or 85th-percentile speed, whichever is higher, or the prevailing speed on the approach to the curve, and the horizontal curve's advisory speed.**

### **Option:**

<sup>03</sup> Horizontal Alignment Warning signs may also be used on other roadways or on arterial and collector roadways with less than 1,000 AADT based on engineering judgment.

## **Section 2C.07 Horizontal Alignment Signs (W1-1 through W1-5, W1-11, W1-15)**

### **Standard:**

<sup>01</sup> **If Table 2C-5 indicates that a horizontal alignment sign (see Figure 2C-1) is required, recommended, or allowed, the sign installed in advance of the curve shall be a Curve (W1-2) sign unless a different sign is recommended or allowed by the provisions of this Section.**

<sup>02</sup> **A Turn (W1-1) sign shall be used instead of a Curve sign in advance of curves that have advisory speeds of 30 mph or less (see Figure 2C-2).**

### **Guidance:**

<sup>03</sup> *Where there are two changes in roadway alignment in opposite directions that are separated by a tangent distance of less than 600 feet, the Reverse Turn (W1-3) sign should be used instead of multiple Turn (W1-1) signs and the Reverse Curve (W1-4) sign should be used instead of multiple Curve (W1-2) signs.*

### **Support:**

<sup>03a</sup> Refer to Section 2C.10 for Reverse Turn/Advisory Speed (W4-1(CA)) sign or Reverse Curve/Advisory Speed (W4-18(CA)) signs (see Figure 2C-1(CA)).

### **Option:**

<sup>04</sup> A Winding Road (W1-5) sign may be used instead of multiple Turn (W1-1) or Curve (W1-2) signs where there are three or more changes in roadway alignment each separated by a tangent distance of less than 600 feet.

### **Guidance:**

<sup>04a</sup> *The Winding Road (W1-5) sign should be used where there is a series of turns or curves which requires driving caution, and where curve or turn signs would be too numerous to be effective. This sign should be erected in advance of the second curve of the winding section of highway. The first curve should be marked with a curve or turn sign and an Advisory Speed (W13-1P) plaque. Where the winding road is 1 mile or more in length, a Next Distance (W7-3a) plaque should supplement the W1-5 sign. Where any of the curves has an advisory speed that is 10 mph or more below that of the first curve then it should be posted with a curve or turn sign and an Advisory Speed (W13-1P) plaque.*

### **Option:**

<sup>04b</sup> The WINDING LEVEE ROAD (SW22-1(CA)) sign (see Figure 2C-1(CA)) may be used to warn road users of the roadway alignment where the use of curve warning signs have been determined not to be appropriate.

<sup>04c</sup> The Speed/Distance (SW22-1A(CA)) plaque (see Figure 2C-1(CA)) may be installed below the SW22-1(CA) sign. The Next Distance (W7-3a) plaque may be used when there is no advisory speed.

### **Standard:**

<sup>04d</sup> **If used, the Speed/Distance (SW22-1A(CA)) plaque shall be installed below the SW22-1(CA) sign.**

<sup>05</sup> A NEXT XX MILES (W7-3aP) supplemental distance plaque (see Section 2C.55) may be installed below the Winding Road sign where continuous roadway curves exist for a specific distance.

06 If the curve has a change in horizontal alignment of 135 degrees or more, the Hairpin Curve (W1-11) sign may be used instead of a Curve or Turn sign.

07 If the curve has a change of direction of approximately 270 degrees, such as on a cloverleaf interchange ramp, the 270-degree Loop (W1-15) sign may be used instead of a Curve or Turn sign.

**Support:**

07a Refer to Section 2C.10 for Hairpin Curve /Advisory Speed (W4-10(CA)) sign, 270-degree Loop/Advisory Speed (W4-14(CA)) sign and combination Truck Rollover Warning /Advisory Speed (W4-22(CA)) sign (see Figure 2C-1(CA)).

**Guidance:**

08 When the Hairpin Curve sign or the 270-degree Loop sign is installed, either a One-Direction Large Arrow (W1-6) sign or Chevron Alignment (W1-8) signs should be installed on the outside of the turn or curve.

**Option:**

09 The TRACTOR-SEMIS OVER \_\_\_ FEET KINGPIN TO REAR AXLE NOT ADVISED (SW48(CA)) sign (see Figure 2C-5(CA)) may be used on certain specified conventional highways and freeways that have restricted turning radii.

**Standard:**

10 **At freeway off-ramps to restricted conventional highways, the freeway sign shall be installed with a NEXT EXIT (SW 48-1(CA)) sign.**

**Guidance:**

11 The SW48(CA) sign should be located far enough in advance of the restricted area to allow the vehicle operator time to select an alternate route.

**Option:**

12 The NEXT EXIT (SW48-1(CA)) sign (see Figure 2C-5(CA)) or Next Distance (W7-3a) plaque may supplement the SW48(CA) sign, as appropriate. Alternate messages for the SW 48-1(CA) sign may be NEXT RIGHT, SECOND EXIT, SECOND RIGHT, NEXT LEFT or SECOND LEFT.

## **Section 2C.08 Advisory Speed Plaque (W13-1P)**

**Option:**

01 The Advisory Speed (W13-1P) plaque (see Figure 2C-1) may be used to supplement any warning sign to indicate the advisory speed for a condition.

**Standard:**

02 **The use of the Advisory Speed plaque for horizontal curves shall be in accordance with the information shown in Table 2C-5. The Advisory Speed plaque shall also be used where an engineering study indicates a need to advise road users of the advisory speed for other roadway conditions.**

03 **If used, the Advisory Speed plaque shall carry the message XX MPH. The speed displayed shall be a multiple of 5 mph.**

04 **Except in emergencies or when the condition is temporary, an Advisory Speed plaque shall not be installed until the advisory speed has been determined by an engineering study.**

05 **The Advisory Speed plaque shall only be used to supplement a warning sign and shall not be installed as a separate sign installation.**

06 **The advisory speed shall be determined by an engineering study that follows established engineering practices.**

**Support:**

07 Among the established engineering practices that are appropriate for the determination of the recommended advisory speed for a horizontal curve are the following:

- A. An accelerometer that provides a direct determination of side friction factors
- B. A design speed equation
- C. A traditional ball-bank indicator using the following criteria:
  - 1. 16 degrees of ball-bank for speeds of 20 mph or less
  - 2. 14 degrees of ball-bank for speeds of 25 to 30 mph
  - 3. 12 degrees of ball-bank for speeds of 35 mph and higher

08 The 16, 14, and 12 degrees of ball-bank criteria are comparable to the current AASHTO horizontal curve design guidance. Research has shown that drivers often exceed existing posted advisory curve speeds by 7 to 10 mph.

*Guidance:*

*09 The advisory speed should be determined based on free-flowing traffic conditions.*

*10 Because changes in conditions, such as roadway geometrics, surface characteristics, or sight distance, might affect the advisory speed, each location should be evaluated periodically or when conditions change.*

**Standard:**

**11 If used, the speed shown on the W13-1P plaque shall not be in excess of the posted or maximum speed limit.**

**The advisory speed shall be determined in accordance with this section.**

**12 The Advisory Speed plaque shall not be used in conjunction with any sign other than a warning sign, nor shall it be used alone. When used, it shall be positioned below the warning sign.**

*Guidance:*

*13 In determining the need for curve or turn warning signs, consideration should be given to driver expectancy based on the driving environment. If the curve can be driven at legal speed without discomfort, there is normally no need for a sign. A curve warning sign should be considered in advance of any curve that produces a reading of 10 degrees on a Ball Bank Indicator at speeds lower than the approach speed. If a curve warning sign is needed, it should be supplemented with an advisory speed message.*

*14 A mechanical or electronic Ball Indicator should be used to determine the advisory speed for curves.*

**Support:**

**15 This speed is shown on the Horizontal Alignment signs (see Section 2C.06), Combination Horizontal Alignment/Advisory Speed Signs (see Section 2C.10), Advisory Exit and Ramp Speed Signs (see Section 2C.14), Combination Horizontal Alignment/Advisory Exit and Ramp Speed Signs (see Section 2C.15) and Advisory Speed Plaque.**

**Option:**

**16 The Advisory Speed (W13-1P) plaque may also be used with a number of other warning signs.**

**Support:**

**17 One method of determining the advisory speed is to drive the curve at several selected uniform speeds and plot the Ball Bank Indicator readings as shown in Figure 2C-101(CA).**

*Guidance:*

*18 A minimum of three speed runs should be made in each direction.*

**Support:**

**19 The limiting Ball Bank Indicator value for comfort is 16° for speeds of 20 mph or less, approximately 14° for speeds of 25 to 30 mph, inclusive and 12° for speeds of 35 mph or higher.**

**Standard:**

**20 The speeds shown on the sign shall be in mph.**

*Guidance:*

*21 The speed shown on the sign should be in 5 mph increments to the lowest appropriate speed found for the condition.*

**Option:**

**22 A changeable message sign that displays to approaching drivers the speed at which they are traveling may be installed on the same post and in conjunction with any horizontal alignment sign that has an advisory speed.**

**23 Any horizontal alignment that has an advisory speed may be supplemented with a changeable message sign that displays the horizontal alignment sign, advisory speed and the approaching driver's speed.**

**Standard:**

**24 If a changeable message sign is installed, the legend YOUR SPEED XX (MPH) or such similar legend shall be shown.**

**25 The color of the changeable message sign shall be a yellow legend on a black background or the reverse of these colors.**

## **Section 2C.09 Chevron Alignment Sign (W1-8)**

**Standard:**

**01 The use of the Chevron Alignment (W1-8) sign (see Figures 2C-1 and 2C-2) to provide additional emphasis and guidance for a change in horizontal alignment shall be in accordance with the information shown in Table 2C-5.**

**Option:**

**02 When used, Chevron Alignment signs may be used instead of or in addition to standard delineators.**

**Standard:**

**03 The Chevron Alignment sign shall be a vertical rectangle. No border shall be used on the Chevron Alignment sign.**

**04 If used, a minimum of three Chevron Alignment signs shall be installed on the outside of a turn or curve, in line with and at approximately a right angle to approaching traffic. Chevron Alignment signs shall be installed at a minimum height of 4 feet, measured vertically from the bottom of the sign to the elevation of the near edge of the traveled way.**

*Guidance:*

*05 The approximate spacing of Chevron Alignment signs on the turn or curve measured from the point of curvature (PC) should be as shown in Table 2C-6.*

*06 If used, Chevron Alignment signs should be visible for a sufficient distance to provide the road user with adequate time to react to the change in alignment.*

**Standard:**

**07 Chevron Alignment signs shall not be placed on the far side of a T-intersection facing traffic on the stem approach to warn drivers that a through movement is not physically possible, as this is the function of a Two-Direction (or One-Direction) Large Arrow sign.**

**08 Chevron Alignment signs shall not be used to mark obstructions within or adjacent to the roadway, including the beginning of guardrails or barriers, as this is the function of an object marker (see Section 2C.63).**

**Section 2C.10 Combination Horizontal Alignment/Advisory Speed Signs (W1-1a, W1-2a)**

**Option:**

**01 The Turn (W1-1) sign or the Curve (W1-2) sign may be combined with the Advisory Speed (W13-1P) plaque (see Section 2C.08) to create a combination Turn/Advisory Speed (W1-1a) sign or combination Curve/Advisory Speed (W1-2a) sign (see Figure 2C-1).**

**01a The Reverse Turn (W1-3) sign or the Reverse Curve (W1-4) sign may be combined with the Advisory Speed (W13-1P) plaque (see Section 2C.08) to create a combination Reverse Turn/Advisory Speed (W4-1(CA)) sign (see Figure 2C-1(CA)), or combination Reverse Curve/Advisory Speed (W4-18(CA)) sign (see Figure 2C-1(CA)).**

**01b The Hairpin Curve (W1-11) sign or the 270-degree Loop (W1-15) sign may be combined with the Advisory Speed (W13-1P) plaque (see Section 2C.08) to create a combination Hairpin Curve /Advisory Speed (W4-10(CA)) sign (see Figure 2C-1(CA)), or combination 270-degree Loop/Advisory Speed (W4-14(CA)) sign (see Figure 2C-1(CA)).**

**01c The Truck Rollover Warning (W1-13) sign may be combined with the Advisory Speed (W13-1P) plaque (see Section 2C.08) to create a combination Truck Rollover Warning /Advisory Speed (W4-22(CA)) sign (see Figure 2C-1(CA)).**

**02 The combination Horizontal Alignment/Advisory Speed sign may be used to supplement the advance Horizontal Alignment warning sign and Advisory Speed plaque based upon an engineering study.**

**Standard:**

**03 If used, the combination Horizontal Alignment/Advisory Speed sign shall not be used alone and shall not be used as a substitute for a Horizontal Alignment warning sign and Advisory Speed plaque at the advance warning location. The combination Horizontal Alignment/Advisory Speed sign shall only be used as a supplement to the advance Horizontal Alignment warning sign.**

*Guidance:*

*03a If used, the combination Horizontal Alignment/Advisory Speed sign ~~shall~~ should be installed at the beginning of the turn or curve.*

**Support:**

**03b The combination Turn/Advisory Speed (W1-1a) sign or combination Curve/Advisory Speed (W1-2a) sign (see Figure 2C-1) is used at problem locations where the Horizontal Alignment (W1-1 through W1-5) signs have not proven to be effective.**

**Standard:**

**03c When used, combination Turn/Advisory Speed (W1-1a) sign or combination Curve/Advisory Speed (W1-2a) sign (see Figure 2C-1) shall be used in the head-on position (left side) and/or at the beginning of the turn or curve (right side).**

**Guidance:**

<sup>03d</sup> When used, the square shape should be used in the head-on position (left side) for combination Turn/Advisory Speed (W1-1a) sign or combination Curve/Advisory Speed (W1-2a) sign (see Figure 2C-1).

<sup>03e</sup> When used, the diamond shape should be used in the beginning of the turn or curve (right side) for the combination Turn/Advisory Speed (W1-1a) sign or combination Curve/Advisory Speed (W1-2a) sign (see Figure 2C-1).

<sup>03f</sup> Existing pavement markings should also be evaluated.

**Standard:**

<sup>03g</sup> **The advisory speed shall be determined in accordance with Section 2C.08.**

**Guidance:**

<sup>04</sup> The advisory speed displayed on the combination Horizontal Alignment/Advisory Speed sign should be based on the advisory speed for the horizontal curve using recommended engineering practices (see Section 2C.08).

### **Section 2C.11 Combination Horizontal Alignment/Intersection Signs (W1-10 Series)**

**Option:**

<sup>01</sup> The Turn (W1-1) sign or the Curve (W1-2) sign may be combined with the Cross Road (W2-1) sign or the Side Road (W2-2 or W2-3) sign to create a combination Horizontal Alignment/Intersection (W1-10 series) sign (see Figure 2C-1) that depicts the condition where an intersection occurs within or immediately adjacent to a turn or curve.

**Guidance:**

<sup>02</sup> Elements of the combination Horizontal Alignment/Intersection sign related to horizontal alignment should comply with the provisions of Section 2C.07, and elements related to intersection configuration should comply with the provisions of Section 2C.46. The symbol design should approximate the configuration of the intersecting roadway(s). No more than one Cross Road or two Side Road symbols should be displayed on any one combination Horizontal Alignment/Intersection sign.

**Standard:**

<sup>03</sup> **The use of the combination Horizontal Alignment/Intersection sign shall be in accordance with the appropriate Turn or Curve sign information shown in Table 2C-5.**

### **Section 2C.12 One-Direction Large Arrow Sign (W1-6)**

**Option:**

<sup>01</sup> A One-Direction Large Arrow (W1-6) sign (see Figure 2C-1) may be used either as a supplement or alternative to Chevron Alignment signs in order to delineate a change in horizontal alignment (see Figure 2C-2).

<sup>02</sup> A One-Direction Large Arrow (W1-6) sign may be used to supplement a Turn or Reverse Turn sign (see Figure 2C-2) to emphasize the abrupt curvature.

**Standard:**

<sup>03</sup> **The One-Direction Large Arrow sign shall be a horizontal rectangle with an arrow pointing to the left or right.**

<sup>04</sup> **The use of the One-Direction Large Arrow sign shall be in accordance with the information shown in Table 2C-5.**

<sup>05</sup> **If used, the One-Direction Large Arrow sign shall be installed on the outside of a turn or curve in line with and at approximately a right angle to approaching traffic.**

<sup>06</sup> **The One-Direction Large Arrow sign shall not be used where there is no alignment change in the direction of travel, such as at the beginnings and ends of medians or at center piers.**

<sup>07</sup> **The One-Direction Large Arrow sign directing traffic to the right shall not be used in the central island of a roundabout.**

**Guidance:**

<sup>08</sup> If used, the One-Direction Large Arrow sign should be visible for a sufficient distance to provide the road user with adequate time to react to the change in alignment.

<sup>09</sup> Type N-1(CA) (OM1-3) object marker should be used below and on the same post as the W1-6 sign. See Section 2C.65.

### **Section 2C.13 Truck Rollover Warning Sign (W1-13)**

**Option:**

01 A Truck Rollover Warning (W1-13) sign (see Figure 2C-1) may be used to warn drivers of vehicles with a high center of gravity, such as trucks, tankers, and recreational vehicles, of a curve or turn where geometric conditions might contribute to a loss of control and a rollover as determined by an engineering study.

**Support:**

02 Among the established engineering practices that are appropriate for the determination of the truck rollover potential of a horizontal curve are the following:

- A. An accelerometer that provides a direct determination of side friction factors
- B. A design speed equation
- C. A traditional ball-bank indicator using 10 degrees of ball-bank (see Figure 2C-101(CA)).

**Standard:**

03 **If a Truck Rollover Warning (W1-13) sign is used, it shall be accompanied by an Advisory Speed (W13-1P) plaque indicating the recommended speed for vehicles with a higher center of gravity.**

**Option:**

04 The Truck Rollover Warning sign may be displayed as a static sign, as a static sign supplemented by a flashing warning beacon, or as a changeable message sign activated by the detection of an approaching vehicle with a high center of gravity that is traveling in excess of the recommended speed for the condition.

**Support:**

05 The curved arrow on the Truck Rollover Warning sign shows the direction of roadway curvature. The truck tips in the opposite direction.

### **Section 2C.14 Advisory Exit and Ramp Speed Signs (W13-2 and W13-3)**

**Standard:**

01 **Advisory Exit Speed (W13-2) and Advisory Ramp Speed (W13-3) signs (see Figure 2C-1) shall be vertical rectangles. The use of Advisory Exit Speed and Advisory Ramp Speed signs on freeway and expressway ramps shall be in accordance with the information shown in Table 2C-5.**

*Guidance:*

*02 If used, the Advisory Exit Speed sign should be installed along the deceleration lane and the advisory speed displayed should be based on an engineering study. When a Truck Rollover (W1-13) sign (see Section 2C.13) is also installed for the ramp, the advisory exit speed should be based on the truck advisory speed for the horizontal alignment using recommended engineering practices.*

*03 If used, the Advisory Exit Speed sign should be visible in time for the road user to decelerate and make an exiting maneuver.*

**Support:**

04 Table 2C-4 lists recommended advance sign placement distances for deceleration to various advisory speeds.

*Guidance:*

*05 If used, the Advisory Ramp Speed sign should be installed on the ramp to confirm the ramp advisory speed.*  
2009 Edition Page 115

*06 If used, Chevron Alignment (W1-8) signs and/or One Direction Large Arrow (W1-6) signs should be installed on the outside of the exit curve as described in Sections 2C.09 and 2C.12.*

**Option:**

07 Where there is a need to remind road users of the recommended advisory speed, a horizontal alignment warning sign with an advisory speed plaque may be installed at or beyond the beginning of the exit curve or on the outside of the curve, provided that it is apparent that the sign applies only to exiting traffic. These signs may also be used at intermediate points along the ramp, especially if the ramp curvature changes and the subsequent curves on the ramp have a different advisory speed than the initial ramp curve.

**Support:**

08 Figure 2C-3 shows an example of advisory speed signing for an exit ramp.

**Guidance:**

*09 The Advisory Exit Speed (W13-2) sign (see Figure 2C-1) should be placed on the right of exit ramps just beyond the neutral area (gore) to advise motorists of the speed at which the exit ramp can be comfortably negotiated. Consideration should also be given to the speed at which traffic can enter the surface street at the end of the ramp if a stop is not required.*

**Support:**

*10 The W13-2 sign is not necessary for an exit ramp that has tangent alignment and terminates at a stop sign or a signal.*

**Guidance:**

*11 The Advisory Ramp Speed (W13-3) sign (see Figure 2C-1) should be placed on the right of the freeway to freeway connector ramps just beyond the neutral area (gore) where the ramps cannot be comfortably negotiated by motorists at approach speeds.*

*12 Where additional warning is needed for ramp curvature beyond the neutral area (gore), a curve warning sign and an advisory speed should be posted.*

**Standard:**

**13 The advisory speed shall be determined in accordance with Section 2C.08.**

### **Section 2C.15 Combination Horizontal Alignment/Advisory Exit and Ramp Speed Signs (W13-6 and W13-7)**

**Option:**

*01 A horizontal alignment sign (see Section 2C.07) may be combined with an Advisory Exit Speed or Advisory Ramp Speed sign to create a combination Horizontal Alignment/Advisory Exit Speed (W13-6) sign or a combination Horizontal Alignment/Advisory Ramp Speed (W13-7) sign (see Figure 2C-1). These combination signs may be used where the severity of the exit ramp curvature might not be apparent to road users in the deceleration lane or where the curvature needs to be specifically identified as being on the exit ramp rather than on the mainline.*

### **Section 2C.16 Hill Signs (W7-1, W7-1a)**

**Guidance:**

*01 The Hill (W7-1) sign (see Figure 2C-4) should be used in advance of a downgrade where the length, percent of grade, horizontal curvature, and/or other physical features require special precautions on the part of road users.*

*02 The Hill sign and supplemental grade (W7-3P) plaque (see Section 2C.57) used in combination, or the W7-1a sign used alone, should be installed in advance of downgrades for the following conditions:*

- A. 5% grade that is more than 3,000 feet in length,*
- B. 6% grade that is more than 2,000 feet in length,*
- C. 7% grade that is more than 1,000 feet in length,*
- D. 8% grade that is more than 750 feet in length, or*
- E. 9% grade that is more than 500 feet in length.*

*03 These signs should also be installed for steeper grades or where crash experience and field observations indicate a need.*

*04 Supplemental plaques (see Section 2C.57) and larger signs should be used for emphasis or where special hill characteristics exist. On longer grades, the use of the Hill sign with a distance (W7-3aP) plaque or the combination distance/grade (W7-3bP) plaque at periodic intervals of approximately 1-mile spacing should be considered.*

**Standard:**

**05 If the percent grade is displayed on a supplemental plaque, the plaque shall be placed below the Hill (W7-1) sign.**

**Option:**

*06 A USE LOW GEAR (W7-2P) or TRUCKS USE LOWER GEAR (W7-2bP) supplemental plaque (see Figure 2C-4) may be used to indicate a situation where downshifting as well as braking might be advisable.*

*07 The SLOW TRUCKS (W51(CA)) sign (see Figure 2C-4(CA)) may be used to inform drivers that slow moving trucks substantially interfere with the flow of traffic. The Next Distance (W7-3a) plaque may be used with the W51(CA) sign.*

### **Section 2C.17 Truck Escape Ramp Signs (W7-4 Series)**

*Guidance:*

01 *Where applicable, truck escape (or runaway truck) ramp advance warning signs (see Figure 2C-4) should be located approximately 1 mile, and 1/2 mile in advance of the grade, and of the ramp. A sign also should be placed at the gore. A RUNAWAY VEHICLES ONLY (R4-10) sign (see Section 2B.35) should be installed near the ramp entrance to discourage other road users from entering the ramp. ~~No Parking (R8-3) signs should be placed near the ramp entrance.~~ NO STOPPING ANYTIME (R26A(S)(CA)) signs should be placed to keep motorists from stopping in the path of runaway trucks.*

**Standard:**

02 **When truck escape ramps are installed, at least one of the W7-4 series signs shall be used.**

*Option:*

03 A SAND (W7-4dP), GRAVEL (W7-4eP), or PAVED (W7-4fP) supplemental plaque (see Figure 2C-4) may be used to describe the ramp surface. ~~State and local highway agencies~~ Caltrans (via CTCDC process, see Section 2A.06) may develop appropriate word message signs for the specific situation.

**Standard:**

04 **The DEEP GRAVEL (W30B(CA)) sign (see Figure 2C-4(CA)) shall be placed on all truck escape ramps.**

*Guidance:*

05 *The W30B(CA) sign should be placed near the outside edge of the paved ramp prior to the beginning of the gravel bed. See Figure 3F-103(CA) for Runaway Truck Ramp sign and marking details.*

06 *The RIGHT (LEFT) EXIT (W30C(CA)) sign (see Figure 2C-4(CA)) should be used to indicate a right or left exit to a truck escape ramp.*

*Support:*

07 *Erect the W30C(CA) sign below and on the same post with the first W7-4 sign.*

### **Section 2C.18 HILL BLOCKS VIEW Sign (W7-6)**

*Option:*

01 A HILL BLOCKS VIEW (W7-6) sign (see Figure 2C-4) may be used in advance of a crest vertical curve to advise road users to reduce speed as they approach and traverse the hill as only limited stopping sight distance is available.

*Guidance:*

02 *When a HILL BLOCKS VIEW sign is used, it should be supplemented by an Advisory Speed (W13-1P) plaque indicating the recommended speed for traveling over the hillcrest based on available stopping sight distance.*

### **Section 2C.19 ROAD NARROWS Sign (W5-1)**

*Guidance:*

01 *Except as provided in Paragraph 2, a ROAD NARROWS (W5-1) sign (see Figure 2C-5) should be used in advance of a transition on two-lane roads where the pavement width is reduced abruptly to a width such that vehicles traveling in opposite directions cannot simultaneously travel through the narrow portion of the roadway without reducing speed.*

*Option:*

02 The ROAD NARROWS (W5-1) sign may be omitted on low-volume local streets that have speed limits of 30 mph or less.

03 Additional emphasis may be provided by the use of object markers and delineators (see Sections ~~2B.63~~ 2C.63 through ~~2B.65~~ 2C.65 and Chapter 3F). The Advisory Speed (W13-1P) plaque (see Section 2C.08) may be used to indicate the recommended speed.

04 *The Downward Arrow (SW44(CA)) sign (see Figure 2C-5(CA)) may be used where object markers (see Sections 2C.63 and 2C.65) may be ineffective, with the downward arrow either left or right, to mark obstructions in the roadway where traffic is permitted to pass on one side only.*



### **Section 2C.20 NARROW BRIDGE Sign (W5-2)**

*Guidance:*

01 A *NARROW BRIDGE (W5-2)* sign (see Figure 2C-5) should be used in advance of any bridge or culvert having a two-way roadway clearance width of 16 to ~~18~~ 28 feet, or any bridge or culvert having a roadway clearance less than the width of the approach travel lanes.

02 Additional emphases should be provided by the use of object markers, delineators, and/or pavement markings.

*Option:*

03 A *NARROW BRIDGE* sign may be used in advance of a bridge or culvert on which the approach shoulders are narrowed or eliminated.

*Support:*

04 See Figure 3F-104(CA) for narrow bridge sign and marking details.

*Option:*

05 The *TUNNEL (SW37(CA))* sign (see Figure 2C-5(CA)) may be used to warn road user that there is a tunnel ahead.

### **Section 2C.21 ONE LANE BRIDGE Sign (W5-3)**

*Guidance:*

01 A *ONE LANE BRIDGE (W5-3)* sign (see Figure 2C-5) should be used on two-way roadways in advance of any bridge or culvert:

A. Having a clear roadway width of less than 16 feet, or

B. Having a clear roadway width of less than 18 feet when commercial vehicles constitute a high proportion of the traffic, or

C. Having a clear roadway width of 18 feet or less where the sight distance is limited on the approach to the structure.

02 Additional emphases should be provided by the use of object markers, delineators, and/or pavement markings.

### **Section 2C.22 Divided Highway Sign (W6-1)**

*Guidance:*

01 A *Divided Highway (W6-1)* sign (see Figure 2C-5) should be used on the approaches to a section of highway (not an intersection or junction) where the opposing flows of traffic are separated by a median or other physical barrier.

**Standard:**

02 **The Divided Highway (W6-1) sign shall not be used instead of a Keep Right (R4-7 series) sign on the approach end of a median island.**

*Support:*

03 See Figure 3B-14(CA) for signing and marking applications for lane reductions.

### **Section 2C.23 Divided Highway Ends Sign (W6-2)**

*Guidance:*

01 A *Divided Highway Ends (W6-2)* sign (see Figure 2C-5) should be used in advance of the end of a section of physically divided highway (not an intersection or junction) as a warning of two-way traffic ahead.

02 The *Two-Way Traffic (W6-3)* sign (see Section 2C.44) should be used to give warning and notice of the transition to a two-lane, two-way section.

*Support:*

03 See Figure 3B-14(CA) for signing and marking applications for lane reductions.

### **Section 2C.24 Freeway or Expressway Ends Signs (W19 Series)**

*Option:*

01 A *FREEWAY ENDS XX MILES (W19-1)* sign or a *FREEWAY ENDS (W19-3)* sign (see Figure 2C-5) may be used in advance of the end of a freeway.

02 An EXPRESSWAY ENDS XX MILES (W19-2) sign or an EXPRESSWAY ENDS (W19-4) sign (see Figure 2C-5) may be used in advance of the end of an expressway.

03 The rectangular W19-1 and W19-2 signs may be post-mounted or may be mounted overhead for increased emphasis.

**Guidance:**

04 *If the reason that the freeway is ending is that the next portion of the freeway is not yet constructed and as a result all traffic must use an exit ramp to leave the freeway, an ALL TRAFFIC MUST EXIT (W19-5) sign (see Figure 2C-5) should be used in addition to the Freeway Ends signs in advance of the downstream end of the freeway.*

### **Section 2C.25 Double Arrow Sign (W12-1)**

**Option:**

01 The Double Arrow (W12-1) sign (see Figure 2C-5) may be used to advise road users that traffic is permitted to pass on either side of an island, obstruction, or gore in the roadway. Traffic separated by this sign may either rejoin or change directions.

**Guidance:**

02 *If used on an island, the Double Arrow sign should be mounted near the approach end.*

03 *If used in front of a pier or obstruction, the Double Arrow sign should be mounted on the face of, or just in front of, the obstruction. Where stripe markings are used on the obstruction, they should be discontinued to leave a 3-inch space around the outside of the sign.*

### **Section 2C.26 DEAD END/NO OUTLET Signs (W14-1, W14-1a, W14-2, W14-2a)**

**Option:**

01 The DEAD END (W14-1) sign (see Figure 2C-5) may be used at the entrance of a single road or street that terminates in a dead end or cul-de-sac. The NO OUTLET (W14-2) sign (see Figure 2C-5) may be used at the entrance to a road or road network from which there is no other exit.

02 DEAD END (W14-1a) or NO OUTLET (W14-2a) signs (see Figure 2C-5) may be used in combination with Street Name (D3-1) signs (see Section 2D.43) to warn turning traffic that the cross street ends in the direction indicated by the arrow.

03 At locations where the cross street does not have a name, the W14-1a or W14-2a signs may be used alone in place of a street name sign.

**Standard:**

04 **The DEAD END (W14-1a) and NO OUTLET (W14-2a) signs shall be horizontal rectangles with an arrow pointing to the left or right.**

05 **When the W14-1 or W14-2 sign is used, the sign shall be posted as near as practical to the entry point or at a sufficient advance distance to permit the road user to avoid the dead end or no outlet condition by turning at the nearest intersecting street.**

06 **The DEAD END (W14-1a) or NO OUTLET (W14-2a) signs shall not be used instead of the W14-1 or W14-2 signs where traffic can proceed straight through the intersection into the dead end street or no outlet area.**

**Option:**

07 **The END (W31(CA)) sign (see Figure 2C-5(CA)) may be used where a street or highway ends.**

08 **The ROAD ENDS ----- FT (W31A(CA)) sign (see Figure 2C-5(CA)) may be used in advance of the END (W31(CA)) sign.**

**Support:**

09 **Install in a head-on position (left side) in combination with an end-of-roadway marker. See Section 2C.66.**

10 **See Figure 2C-13 and 2C-13(CA) for examples of object markers and more details.**

### **Section 2C.27 Low Clearance Signs (W12-2 and W12-2a)**

**Standard:**

01 **The Low Clearance (W12-2) sign (see Figure 2C-5) shall be used to warn road users of clearances less than 12 inches above the statutory maximum vehicle height.**

*Guidance:*

*02 The actual clearance should be displayed on the Low Clearance sign to the nearest 1 inch not exceeding the actual clearance. However, in areas that experience changes in temperature causing frost action, a reduction, not exceeding 3 inches, should be used for this condition.*

*03 Where the clearance is less than the legal maximum vehicle height, the W12-2 sign with a supplemental distance plaque should be placed at the nearest intersecting road or wide point in the road at which a vehicle can detour or turn around.*

*04 In the case of an arch or other structure under which the clearance varies greatly, two or more signs should be used as necessary on the structure itself to give information as to the clearances over the entire roadway.*

*05 Clearances should be evaluated periodically, particularly when resurfacing operations have occurred.*

*Option:*

*06 The Low Clearance sign may be installed on or in advance of the structure. If a sign is placed on the structure, it may be a rectangular shape (W12-2a) with the appropriate legend (see Figure 2C-5).*

**Standard:**

**07 The Low Clearance (W12-2) sign shall be used to warn motorists of low structure clearances.**

**08 For clearance 15 feet 6 inch or less, in addition to the W12-2a, two advance Low Clearance signs shall be installed on the right side of the roadway. The first W12-2 sign shall be placed in advance of the nearest intersecting street or highway or wide point in the road at which a motorist can detour or safely turn around.**

*Guidance:*

*09 A Distance Ahead (W34A(CA)) plaque should be placed below the W12-2 sign at this location.*

**Standard:**

**10 The second W12-2 sign shall be placed in advance of the structure.**

*Support:*

*11 No W34A(CA) plaque is needed at the second location.*

**Standard:**

**12 The W12-2 sign shall display the same clearance as shown on the W12-2a plaque.**

*Guidance:*

*13 The Distance Ahead (W34A(CA)) plaque when used, should be placed below a W12-2 sign.*

**Standard:**

**14 The \_\_\_ FT \_\_\_ IN plaque (W12-2a) shall be used to warn motorists of structural clearance 15 feet 6 inch or less.**

*Guidance:*

*15 The W12-2a plaque should be centered over the traveled way on the approach side of all underpasses, overheads, viaducts, overcrossings, undercrossings, and grade separations for State highways.*

**Standard:**

**16 The W12-2a plaque shall not encroach over the shoulder area.**

**17 The W12-2a plaque shall display the minimum vertical clearance to the nearest inch, not exceeding the measured value.**

**18 The CAUTION, VERTICAL CLEARANCE \_\_\_' \_\_\_" Arrow (W34C(CA)) sign (see Figure 2C-5(CA)) shall be used on all blind approaches to structures with clearances 15 feet 6 inch or less.**

*Support:*

*19 The W34C(CA) sign is used to warn motorists of low structure clearance around corners.*

*Guidance:*

*20 The W34C(CA) sign should be placed at a location where the motorist can detour or safely turn around before making the turn.*

**Standard:**

**21 The W34C(CA) sign shall display the same clearance as shown on the W12-2a plaque.**

## **Section 2C.28 BUMP and DIP Signs (W8-1, W8-2)**

*Guidance:*

*01 BUMP (W8-1) and DIP (W8-2) signs (see Figure 2C-6) should be used to give warning of a sharp rise or depression in the profile of the road.*

**Standard:**

**01a When used at a cattle guard, the BUMP (W8-1) or DIP (W8-2) signs shall be supplemented with a diagonal downward pointing arrow (W16-7p) plaque showing the location of the cattle guard.**

**Option:**

02 These signs may be supplemented with an Advisory Speed plaque (see Section 2C.08).

**Standard:**

**03 The DIP sign shall not be used at a short stretch of depressed alignment that might momentarily hide a vehicle.**

**Guidance:**

04 *A short stretch of depressed alignment that might momentarily hide a vehicle should be treated as a no-passing zone when center line striping is provided on a two-lane or three-lane road (see Section 3B.02).*

**Section 2C.29 SPEED HUMP Sign (W17-1)**

**Guidance:**

01 *The SPEED HUMP (W17-1) sign (see Figure 2C-6) should be used to give warning of a vertical deflection in the roadway that is designed to limit the speed of traffic.*

02 *If used, the SPEED HUMP sign should be supplemented by an Advisory Speed plaque (see Section 2C.08).*

**Option:**

03 If a series of speed humps exists in close proximity, an Advisory Speed plaque may be eliminated on all but the first SPEED HUMP sign in the series.

04 The legend SPEED BUMP may be used instead of the legend SPEED HUMP on the W17-1 sign.

**Option:**

04a *If a series of speed humps exist in close proximity, a SPEED HUMPS AHEAD (W84(CA)) sign (see Figure 2C-6(CA)) may replace the first SPEED HUMP sign in the series, provided additional warning of speed humps are provided through signs or pavement markings at the speed humps.*

04b *If speed humps exist on a network of streets within an area accessible by a limited number of access points to the area, an optional SPEED HUMP AREA (W85(CA)) sign (see Figure 2C-6(CA)) may be placed at each access point to the area, provided additional warning of speed humps are provided through signs or markings at the speed humps.*

**Support:**

05 Speed humps generally provide more gradual vertical deflection than speed bumps. Speed bumps limit the speed of traffic more severely than speed humps. Other forms of speed humps include speed tables and raised intersections. However, these differences in engineering terminology are not well known by the public, so for signing purposes these terms are interchangeable.

**Section 2C.30 PAVEMENT ENDS Sign (W8-3)**

**Guidance:**

01 *A PAVEMENT ENDS (W8-3) word message sign (see Figure 2C-6) should be used where a paved surface changes to either a gravel treated surface or an earth road surface.*

**Option:**

02 An Advisory Speed plaque (see Section 2C.08) may be used when the change in roadway condition requires a reduced speed.

**Section 2C.31 Shoulder Signs (W8-4, W8-9, W8-17, W8-23, and W8-25)**

**Option:**

01 The SOFT SHOULDER (W8-4) sign (see Figure 2C-6) may be used to warn of a soft shoulder condition.

02 The LOW SHOULDER (W8-9) sign (see Figure 2C-6) may be used to warn of a shoulder condition where there is an elevation difference of less than 3 inches between the shoulder and the travel lane.

**Guidance:**

03 *The Shoulder Drop Off (W8-17) sign (see Figure 2C-6) should be used where an unprotected shoulder drop-off, adjacent to the travel lane, exceeds 3 inches in depth for a significant continuous length along the roadway, based on engineering judgment.*

**Option:**

<sup>04</sup> A SHOULDER DROP-OFF (W8-17P) supplemental plaque (see Figure 2C-6) may be mounted below the W8-17 sign.

<sup>05</sup> The NO SHOULDER (W8-23) sign (see Figure 2C-6) may be used to warn road users that a shoulder does not exist along a portion of the roadway.

<sup>06</sup> The SHOULDER ENDS (W8-25) sign (see Figure 2C-6) may be used to warn road users that a shoulder is ending.

**Standard:**

<sup>07</sup> **When used, shoulder signs shall be placed in advance of the condition (see Table 2C-4).**

*Guidance:*

<sup>08</sup> *Additional shoulder signs should be placed at appropriate intervals along the road where the condition continually exists.*

**Support:**

<sup>09</sup> The low shoulder condition (elevation difference up to 3 inches) between shoulder and the travel lane) is not treated as a permanent condition on State highways.

**Standard:**

<sup>10</sup> **The black on yellow background LOW SHOULDER (W8-9) sign shall not be used on State highways.**

**Option:**

<sup>11</sup> The black on orange background LOW SHOULDER (W8-9) sign may be used on State highways to warn of a shoulder condition where there is an elevation difference of less than 3 inch between the shoulder and the travel lane. See Section 6F.44.

**Section 2C.32 Surface Condition Signs (W8-5, W8-7, W8-8, W8-11, W8-13, and W8-14)**

**Option:**

<sup>01</sup> The Slippery When Wet (W8-5) sign (see Figure 2C-6) may be used to warn of unexpected slippery conditions. Supplemental plaques with legends such as ICE, WHEN WET, STEEL DECK, or EXCESS OIL may be used with the W8-5 sign to indicate the reason that the slippery conditions might be present.

**Standard:**

<sup>01a</sup> **When used at a cattle guard, the Slippery When Wet (W8-5) signs shall be supplemented with a diagonal downward pointing arrow (W16-7p) plaque showing the location of the cattle guard.**

**Option:**

<sup>02</sup> The LOOSE GRAVEL (W8-7) sign (see Figure 2C-6) may be used to warn of loose gravel on the roadway surface.

<sup>03</sup> The ROUGH ROAD (W8-8) sign (see Figure 2C-6) may be used to warn of a rough roadway surface. It may be desirable to supplement this sign with an Advisory Speed (W13-1P) plaque. Where the rough road is 1 mile or more in length, the W8-8 sign may be supplemented with a Next Distance (W7-3a) plaque.

<sup>04</sup> An UNEVEN LANES (W8-11) sign (see Figure 2C-6) may be used to warn of a difference in elevation between travel lanes.

<sup>05</sup> The BRIDGE ICES BEFORE ROAD (W8-13) sign (see Figure 2C-6) may be used in advance of bridges to advise bridge users of winter weather conditions. The BRIDGE ICES BEFORE ROAD sign may be removed or covered during seasons of the year when its message is not relevant.

**Guidance:**

<sup>06</sup> *The ~~FALLEN ROCKS (W8-14) sign (see Figure 2C-6) may~~ Rock Slide Area symbol (W50-1(CA)) sign (see Figure 2C-6(CA)) should be used in advance of an area that is adjacent to a hillside, mountain, or cliff where rocks frequently fall onto the roadway.*

**Guidance:**

<sup>07</sup> *When used, Surface Condition signs should be placed in advance of the beginning of the affected section (see Table 2C-4), and additional signs should be placed at appropriate intervals along the road where the condition exists.*

**Option:**

<sup>08</sup> The SLIDE AREA (W38(CA)) sign (see Figure 2C-6(CA)) may be used in advance of where slides on the highway could be expected.

<sup>09</sup> The SNOW SLIDE AREA (SW41(CA)) sign (see Figure 2C-6(CA)) may be used in areas of known snow slide or avalanche activity.

<sup>10</sup> The Next Distance (W7-3a) plaque may be used below the W38(CA), W50-1(CA) and SW41(CA) signs.

<sup>11</sup> The DRIFTING SAND (SW32(CA)) sign (see Figure 2C-6(CA)) may be used to warn traffic of drifting sand on the roadway.

<sup>12</sup> The WATCH FOR SNOW SLIPPERY (SW46(CA)) sign (see Figure 2C-6(CA)) may be used to warn road users of conditions where snow may be on the roadway surface, but chains are not yet required. The SW46(CA) sign may be placed in advance of areas where such conditions may exist, and intermittently as needed where such conditions may exist for long sections of highways.

<sup>13</sup> The SW46(CA) sign may be displayed when weather conditions are such that it would be reasonable to assume that snow on the roadway would be a possibility.

**Guidance:**

<sup>14</sup> *The SW46(CA) sign should be removed when such conditions are no longer present.*

### **Section 2C.33 Warning Signs and Plaques for Motorcyclists (W8-15, W8-15P, and W8-16)**

**Support:**

<sup>01</sup> The signs and plaques described in this Section are intended to give motorcyclists advance notice of surface conditions that might adversely affect their ability to maintain control of their motorcycle under wet or dry conditions. The use of some of the advance surface condition warning signs described in Section 2C.32, such as Slippery When Wet, LOOSE GRAVEL, or ROUGH ROAD, can also be helpful to motorcyclists if those conditions exist.

**Option:**

<sup>02</sup> If a portion of a street or highway features a roadway pavement surface that is grooved or textured instead of smooth, such as a grooved skid resistance treatment for a horizontal curve or a brick pavement surface, a GROOVED PAVEMENT (W8-15) sign (see Figure 2C-6) may be used to provide advance warning of this condition to motorcyclists, bicyclists, and other road users. Alternate legends such as TEXTURED PAVEMENT or BRICK PAVEMENT may also be used on the W8-15 sign.

<sup>03</sup> If a bridge or a portion of a bridge includes a metal or grated surface, a METAL BRIDGE DECK (W8-16) sign (see Figure 2C-6) may be used to provide advance warning of this condition to motorcyclists, bicyclists, and other users.

<sup>04</sup> A Motorcycle (W8-15P) plaque (see Figure 2C-6) may be mounted below or above a W8-15 or W8-16 sign if the warning is intended to be directed primarily to motorcyclists.

### **Section 2C.34 NO CENTER LINE Sign (W8-12)**

**Option:**

<sup>01</sup> The NO CENTER LINE (W8-12) sign (see Figure 2C-6) may be used to warn of a roadway without center line pavement markings.

### **Section 2C.35 Weather Condition Signs (W8-18, W8-19, W8-21, and W8-22)**

**Option:**

<sup>01</sup> The ROAD MAY FLOOD (W8-18) sign (see Figure 2C-6) may be used to warn road users that a section of roadway is subject to frequent flooding. A Depth Gauge (W8-19) sign (see Figure 2C-6) may also be installed within a roadway section that frequently floods.

**Standard:**

<sup>02</sup> **If used, the Depth Gauge sign shall be in addition to the ROAD MAY FLOOD sign and shall indicate the depth of the water at the deepest point on the roadway.**

**Guidance:**

<sup>02a</sup> *The FLOODED (W55(CA)) sign (see Figure 2C-6(CA)) should be used in advance of locations where the highway is flooded.*

**Standard:**

**02b The W55(CA) signs shall be removed or covered when the condition no longer exists.**

**Option:**

**02c The FLASH FLOOD AREA (SW35(CA)) sign (see Figure 2C-6(CA)) may be used in advance of depressions in the highway alignment that are subject to flash flooding.**

**Option:**

**03 The GUSTY WINDS AREA (W8-21) sign (see Figure 2C-6) may be used to warn road users that wind gusts frequently occur along a section of highway that are strong enough to impact the stability of trucks, recreational vehicles, and other vehicles with high centers of gravity. A NEXT XX MILES (W7-3a) supplemental plaque may be mounted below the W8-21 sign to inform road users of the length of roadway that frequently experiences strong wind gusts.**

**04 The FOG AREA (W8-22) sign (see Figure 2C-6) may be used to warn road users that foggy conditions frequently reduce visibility along a section of highway. A NEXT XX MILES (W7-3a) supplemental plaque may be mounted below the W8-22 sign to inform road users of the length of roadway that frequently experiences foggy conditions.**

**Support:**

**05 The Federal Highway Administration has encouraged use of the phrase WHEN FLOODED TURN AROUND DON'T DROWN as an official warning sign.**

**Option:**

**06 WHEN FLOODED TURN AROUND DON'T DROWN (W87(CA)) sign (see Figure 2C-6(CA)) may be installed at low-water crossings or at bridges or culverts which cannot pass high flood flows.**

**Guidance:**

**07 If used, WHEN FLOODED TURN AROUND DON'T DROWN W87(CA) sign should be installed at locations where stream waters flooding across a road have made passage unsafe.**

## **Section 2C.36 Advance Traffic Control Signs (W3-1, W3-2, W3-3, W3-4)**

**Standard:**

**01 The Advance Traffic Control symbol signs (see Figure 2C-6) include the Stop Ahead (W3-1), Yield Ahead (W3-2), and Signal Ahead (W3-3) signs. These signs shall be installed on an approach to a primary traffic control device that is not visible for a sufficient distance to permit the road user to respond to the device (see Table 2C-4). The visibility criteria for a traffic control signal shall be based on having a continuous view of at least two signal faces for the distance specified in Table 4D-2.**

**Support:**

**02 Figure 2A-4 shows the typical placement of an Advance Traffic Control sign.**

**03 Permanent obstructions causing the limited visibility might include roadway alignment or structures. Intermittent obstructions might include foliage or parked vehicles.**

**Guidance:**

**04 Where intermittent obstructions occur, engineering judgment should determine the treatment to be implemented.**

**Option:**

**05 An Advance Traffic Control sign may be used for additional emphasis of the primary traffic control device, even when the visibility distance to the device is satisfactory.**

**06 An advance street name plaque (see Section 2C.58) may be installed above or below an Advance Traffic Control sign.**

**07 A warning beacon may be used with an Advance Traffic Control sign.**

**07a A BE PREPARED TO STOP (W3-4) sign (see Figure 2C-6) may be used in advance of a traffic control device that could require motorists to stop, such as a traffic control signal or a STOP sign.**

**08 A BE PREPARED TO STOP (W3-4) sign (see Figure 2C-6) WATCH FOR STOPPED VEHICLES (SW60(CA)) sign (see Figure 2C-6(CA)) may be used to warn motorists of stopped traffic caused by a traffic control signal or such as in advance of a section of roadway that regularly experiences traffic congestion.**

**Standard:**

09 **When a BE PREPARED TO STOP sign is used in advance of a traffic control signal, it shall be used in addition to a Signal Ahead sign and shall be placed downstream from the Signal Ahead (W3-3) sign.**

**Option:**

10 The BE PREPARED TO STOP (W3-4) sign or WATCH FOR STOPPED VEHICLES (SW60(CA)) sign may be supplemented with a warning beacon (see Section 4L.03).

**Guidance:**

~~11 When the warning beacon is interconnected with a traffic control signal or queue detection system, the BE PREPARED TO STOP sign should be supplemented with a WHEN FLASHING (W16-13P) plaque (see Figure 2C-12).~~

**Support:**

12 Section 2C.40 contains information regarding the use of a NO MERGE AREA (W4-5P) supplemental plaque in conjunction with a Yield Ahead sign.

**Standard:**

13 **WHEN FLASHING (W16-13P) plaque shall not be used to supplement the BE PREPARED TO STOP (W3-4) sign or WATCH FOR STOPPED VEHICLES (SW60(CA)) sign.**

**Support:**

14 Studies indicate that the W16-13P plaque is generally not effective as a warning device for motorists approaching signalized intersections. Not using the W16-13P plaque also addresses the situation when a warning beacon is inoperative for any reason.

**Guidance:**

15 *The Stop Ahead sign (W3-1) should not be used in the approach to an intersection where there is channelization and the majority of the traffic turns to the right without being required to stop.*

**Option:**

16 The STOP AHEAD pavement markings may be placed in accordance with Section 3B.20.

17 The SIGNAL/STOP AHEAD Arrow sign (SW26(CA)) may be used in the head-on position (left side) where W3-1 and W3-3 signs have proven ineffective.

**Guidance:**

18 *The W3-1 and W3-3 signs should be left in place when the SW26(CA) sign is placed.*

**Section 2C.37 Advance Ramp Control Signal Signs (W3-7 and W3-8)**

**Support:**

00 For State highways, see Caltrans' Ramp Metering Design Manual. See Section 1A.11 for information regarding this publication.

**Option:**

01 A RAMP METER AHEAD (W3-7) sign (see Figure 2C-6) may be used to warn road users that a freeway entrance ramp is metered and that they will encounter a ramp control signal (see Chapter 4I).

**Guidance:**

02 *When the ramp control signals are in operation ~~operated only during certain periods of the day~~, a RAMP METERED WHEN FLASHING (W3-8) sign (see Figure 2C-6), or an overhead Activated Blank-Out "METER ON" (W88-2(CA), W88-3(CA)) message sign, or "PREPARE TO STOP" (W89(CA)) message sign should be installed in advance of the ramp control signal near the entrance to the ramp, or on the arterial on the approach to the ramp, to alert road users to the presence and operation of ramp meters. See Figure 2C-06(CA).*

**Standard:**

03 **The RAMP METERED WHEN FLASHING sign shall be supplemented with a warning beacon (see Section 4L.03) that flashes when the ramp control signal is in operation.**

**Section 2C.38 Reduced Speed Limit Ahead Signs (W3-5, W3-5a)**

**Guidance:**

01 *A Reduced Speed Limit Ahead (W3-5 or W3-5a) sign (see Figure 2C-7) should be used to inform road users of a reduced speed zone where the speed limit is being reduced by more than 10 mph, or where engineering judgment indicates the need for advance notice to comply with the posted speed limit ahead.*



**Standard:**

02 If used, Reduced Speed Limit Ahead signs shall be followed by a Speed Limit (R2-1) sign installed at the beginning of the zone where the speed limit applies.

03 The speed limit displayed on the Reduced Speed Limit Ahead sign shall be identical to the speed limit displayed on the subsequent Speed Limit sign.

**Option:**

04 The TRAILERS-CAMPERS-GUSTY WIND AREA NEXT \_\_\_ MILES (SW17-1(CA)) sign (see Figure 2C-6(CA)) may be used where known or potential wind collision problems exist.

**Section 2C.39 DRAW BRIDGE Sign (W3-6)**

**Standard:**

01 A DRAW BRIDGE (W3-6) sign (see Figure 2C-6) shall be used in advance of movable bridge signals and gates (see Section 4J.02) to give warning to road users, except in urban conditions where such signing would not be practical.

**Guidance:**

02 Where physical conditions prevent a motorist driving at the legal speed limit from having a continuous view of at least one signal indication before reaching the stop line, an auxiliary device should be provided in advance of movable bridge signals and gates.

**Option:**

03 This device may be either a supplemental signal or the mandatory DRAW BRIDGE (W3-6) sign to which has been added a flashing yellow beacon interconnected with movable bridge control.

**Support:**

04 See Figure 3F-104(CA) for narrow bridge sign and marking details.

**Section 2C.40 Merge Signs (W4-1, W4-5)**

**Option:**

01 A Merge (W4-1) sign (see Figure 2C-8) may be used to warn road users on the major roadway that merging movements might be encountered in advance of a point where lanes from two separate roadways converge as a single traffic lane and no turning conflict occurs.

02 A Merge sign may also be installed on the side of the entering roadway to warn road users on the entering roadway of the merge condition.

**Guidance:**

03 The Merge sign should be installed on the side of the major roadway where merging traffic will be encountered and in such a position as to not obstruct the road user's view of entering traffic.

04 Where two roadways of approximately equal importance converge, a Merge sign should be placed on each roadway.

05 When a Merge sign is to be installed on an entering roadway that curves before merging with the major roadway, such as a ramp with a curving horizontal alignment as it approaches the major roadway, the Entering Roadway Merge (W4-5) sign (see Figure 2C-8) should be used to better portray the actual geometric conditions to road users on the entering roadway.

06 The Merge sign should not be used where two roadways converge and merging movements are not required.

07 The Merge sign should not be used in place of a Lane Ends sign (see Section 2C.42) where lanes of traffic moving on a single roadway must merge because of a reduction in the actual or usable pavement width.

**Option:**

08 An Entering Roadway Merge (W4-5) sign with a NO MERGE AREA (W4-5P) supplemental plaque (see Figure 2C-8) mounted below it may be used to warn road users on an entering roadway that they will encounter an abrupt merging situation without an acceleration lane at the downstream end of the ramp.

09 A Merge (W4-1) sign with a NO MERGE AREA (W4-5P) supplemental plaque mounted below it may be used to warn road users on the major roadway that traffic on an entering roadway will encounter an abrupt merging situation without an acceleration lane at the downstream end of the ramp.

<sup>10</sup> For a yield-controlled channelized right-turn movement onto a roadway without an acceleration lane, a NO MERGE AREA (W4-5P) supplemental plaque may be mounted below a Yield Ahead (W3-2) sign and/or below a YIELD (R1-2) sign when engineering judgment indicates that road users would expect an acceleration lane to be present.

**Guidance:**

<sup>11</sup> When installed at freeway entrance ramps, the W4-1 sign should be installed in advance of the paved gore area.

**Option:**

<sup>12</sup> On expressways, the THRU TRAFFIC MERGE LEFT (RIGHT) (W74(CA)) sign (see Figure 2C-8(CA)) may be used in advance of the RIGHT(LEFT) LANE MUST TURN RIGHT(LEFT) sign (R3-7).

**Guidance:**

<sup>13</sup> On conventional highways, the RIGHT(LEFT) LANE TURNS RIGHT(LEFT) AHEAD (W73A(CA)) sign (see Figure 2C-8(CA)) and/or the THRU TRAFFIC MERGE LEFT (RIGHT) sign (W74(CA)) should be used in advance of the RIGHT(LEFT) LANE MUST TURN RIGHT(LEFT) sign (R3-7).

**Support:**

<sup>14</sup> See Figure 3B-14(CA) for signs and lane reduction markings.

**Standard:**

<sup>15</sup> **The THRU TRAFFIC MERGE LEFT (RIGHT) (W74(CA)) sign shall be used on freeways and expressways to inform motorists that the outside or inside lane is being dropped at the next exit, and through traffic must merge into the adjacent lane.**

**Guidance:**

<sup>16</sup> The W74(CA) sign should not be used for a lane reduction.

**Option:**

<sup>17</sup> The W74(CA) signs may also be used on conventional highways.

**Support:**

<sup>18</sup> See Figure 3B-10(CA) for lane drop signing and markings at exit ramps.

**Option:**

<sup>19</sup> The RIGHT(LEFT) LANE TURNS RIGHT(LEFT) AHEAD (W73A(CA)) sign (see Figure 2C-8(CA)) and/or the THRU TRAFFIC MERGE LEFT (RIGHT) (W74(CA)) sign may be used in black on orange version for temporary traffic control zones.

**Support:**

<sup>20</sup> See Figures 6H-22, 6H-24 and 6H-25 for merge signs used for temporary traffic controls.

### **Section 2C.41 Added Lane Signs (W4-3, W4-6)**

**Guidance:**

<sup>01</sup> The Added Lane (W4-3) sign (see Figure 2C-8) should be installed in advance of a point where two roadways converge and merging movements are not required. When possible, the Added Lane sign should be placed such that it is visible from both roadways; if this is not possible, an Added Lane sign should be placed on the side of each roadway.

<sup>02</sup> When an Added Lane sign is to be installed on a roadway that curves before converging with another roadway that has a tangent alignment at the point of convergence, the Entering Roadway Added Lane (W4-6) sign (see Figure 2C-8) should be used to better portray the actual geometric conditions to road users on the curving roadway.

<sup>03</sup> When installed at freeway entrance ramps, the sign should be installed in advance of the paved gore area.

### **Section 2C.42 Lane Ends Signs (W4-2, W9-1, W9-2)**

**Guidance:**

<sup>01</sup> The ~~LANE ENDS MERGE LEFT (RIGHT) (W9-2) sign~~ or the Lane Ends (W4-2) sign should be used to warn of the reduction in the number of traffic lanes in the direction of travel on a multi-lane highway (see Figure 2C-8).

**Standard:**

<sup>01a</sup> **For consistency, the LANE ENDS MERGE LEFT (RIGHT) (W9-2) sign is deleted, only Lane Ends (W4-2) symbol sign shall be used.**

Option:

02 The RIGHT (LEFT) LANE ENDS (W9-1) sign (see Figure 2C-8) may be used in advance of the Lane Ends (W4-2) sign or the LANE ENDS MERGE LEFT (RIGHT) (W9-2) sign as additional warning or to emphasize that the traffic lane is ending and that a merging maneuver will be required.

Guidance:

03 If used, the ~~RIGHT (LEFT) LANE ENDS (W9-1)~~ Lane Ends (W4-2) sign should be installed adjacent to the Lane-Reduction Arrow pavement markings.

Option:

04 On one-way streets or on divided highways where the width of the median will permit, two Lane Ends signs may be placed facing approaching traffic, one on the right-hand side and the other on the left-hand side or median.

Support:

05 Section 3B.09 contains information regarding the use of pavement markings in conjunction with a lane reduction.

Guidance:

06 Where an extra lane has been provided for slower moving traffic (see Section 2B.31), a Lane Ends word sign or a Lane Ends (W4-2) symbol sign should be installed in advance of the downstream end of the extra lane.

07 Lane Ends signs should not be installed in advance of the downstream end of an acceleration lane.

Standard:

08 In dropped lane situations, regulatory signs (see Section 2B.20) shall be used to inform road users that a through lane is becoming a mandatory turn lane. The W4-2, W9-1, and W9-2 signs shall not be used in dropped lane situations.

Guidance:

09 The RIGHT (LEFT) LANE ENDS sign (W9-1) should be used in conjunction with the Lane Ends (W4-2) sign.

Support:

10 The W9-2 or W4-2 sign is not to be used for a lane drop at an exit.

11 See Figure 3B-14(CA) for signing and marking applications for lane reductions.

Standard:

12 The RIGHT (LEFT) LANE EXITS AHEAD (W73(CA)) sign (see Figure 2C-8(CA)) shall be placed between the THRU TRAFFIC MERGE LEFT (RIGHT) (W74(CA)) sign (see Figure 2C-8(CA)) and the RIGHT (LEFT) LANE MUST EXIT sign (R18A(CA)), at locations where overhead Exit Only signs (E11-1 Series or W61(CA) Series) are not in place for lane drops at freeway exit ramps.

Guidance:

13 On expressways, the RIGHT(LEFT) LANE TURNS RIGHT(LEFT) AHEAD (W73A(CA)) sign (see Figure 2C-8(CA)) should be used in advance of the RIGHT(LEFT) LANE MUST TURN RIGHT(LEFT) sign (R3-7).

14 On conventional highways, the RIGHT(LEFT) LANE TURNS RIGHT(LEFT) AHEAD (W73A(CA)) sign and/or the THRU TRAFFIC MERGE LEFT (RIGHT) (W74(CA)) sign (see Figure 2C-8(CA)) should be used in advance of the RIGHT(LEFT) LANE MUST TURN RIGHT(LEFT) sign (R3-7).

Support:

15 See Figure 3B-10(CA) for lane drop signing and markings at exit ramps.

16 See Figure 3B-14(CA) for signs and lane reduction markings.

### Section 2C.43 RIGHT (LEFT) LANE EXIT ONLY AHEAD Sign (W9-7)

Option:

01 The RIGHT (LEFT) LANE EXIT ONLY AHEAD (W9-7) sign (see Figure 2C-8) may be used to provide advance warning to road users that traffic in the right-hand (left-hand) lane of a roadway that is approaching a grade-separated interchange will be required to depart the roadway on an exit ramp at the next interchange.

Standard:

02 The W9-7 sign shall be a horizontal rectangle with a black legend and border on a yellow background.

*Guidance:*

*03 If used, the W9-7 sign should be installed upstream from the first overhead guide sign that contains an EXIT ONLY sign panel or upstream from the first RIGHT (LEFT) LANE MUST EXIT (R3-33) regulatory sign, whichever is farther upstream from the exit.*

**Support:**

04 Section 2B.23 contains information regarding a regulatory sign that can also be used for lane drops at grade-separated interchanges.

### **Section 2C.44 Two-Way Traffic Sign (W6-3)**

*Guidance:*

*01 A Two-Way Traffic (W6-3) sign (see Figure 2C-8) should be used to warn road users of a transition from a multi-lane divided section of roadway to a two-lane, two-way section of roadway.*

*02 A Two-Way Traffic (W6-3) sign with an AHEAD (W16-9P) plaque (see Figure 2C-12) should be used to warn road users of a transition from a one-way street to a two-lane, two-way section of roadway (see Figure 2B-14).*

**Option:**

03 The Two-Way Traffic sign may be used at intervals along a two-lane, two-way roadway and may be used to supplement the Divided Highway (Road) Ends (W6-2) sign discussed in Section 2C.23.

*Guidance:*

*04 The Two-Way Traffic (W6-3) sign should also be used at locations where motorists could perceive that they are on a one-way roadway when, in fact, they are on a two lane, two-way highway. Following are some typical situations:*

- A. Construction sites where a two-lane highway is being converted to a freeway or an expressway.*
- B. Two-lane, two-way highways where ultimate freeway or expressway right-of-way has been purchased and grading for the full width has been completed.*
- C. Two-lane, two-way highways following long sections of multi-lane freeway or expressway.*
- D. Two-way highway with edge lines but with no centerlines.*

**Standard:**

05 **The TWO WAY TRAFFIC (W44A(CA)) plaque (see figure 2C-8(CA)), if used, shall be positioned below the W6-3 sign.**

06 **The Black on Yellow PASS WITH CARE (W83(CA)) sign (see figure 2C-8(CA)), when used, shall be positioned below the Two Way Traffic (W6-3) sign where two-way traffic is being routed over a single roadway of a divided highway and passing is permitted.**

**Support:**

07 See Figure 3B-14(CA) for signing and marking applications for lane reductions.

08 Typical example of W6-3 sign application is shown in Figure 3B-104(CA).

### **Section 2C.45 NO PASSING ZONE Sign (W14-3)**

**Standard:**

01 **The NO PASSING ZONE (W14-3) sign (see Figure 2C-8) shall be a pennant-shaped isosceles triangle with its longer axis horizontal and pointing to the right. When used, the NO PASSING ZONE sign shall be installed on the left side of the roadway at the beginning of no-passing zones identified by pavement markings or DO NOT PASS signs or both (see Sections 2B.28 and 3B.02).**

**Option:**

02 The NO PASSING ZONE (W14-3) sign may be used at the beginning of no-passing zones identified by either pavement markings or DO NOT PASS signs or both (see Sections 2B.28 and 3B.02).

### **Section 2C.46 Intersection Warning Signs (W2-1 through W2-8)**

**Option:**

01 A Cross Road (W2-1) symbol, Side Road (W2-2 or W2-3) symbol, T-Symbol (W2-4), or Y-Symbol (W2-5) sign (see Figure 2C-9) may be used in advance of an intersection to indicate the presence of an intersection and the possibility of turning or entering traffic.

02 The Circular Intersection (W2-6) symbol sign (see Figure 2C-9) may be installed in advance of a circular intersection (see Figures 2B-21 through 2B-23).

*Guidance:*

*03 If an approach to a roundabout has a statutory or posted speed limit of 40 mph or higher, the Circular Intersection (W2-6) symbol sign should be installed in advance of the circular intersection.*

*Option:*

*04 An educational plaque (see Figure 2C-9) with a legend such as ROUNDABOUT (W16-17P) or TRAFFIC CIRCLE (W16-12P) may be mounted below a Circular Intersection symbol sign.*

*05 The relative importance of the intersecting roadways may be shown by different widths of lines in the symbol.*

*06 An advance street name plaque (see Section 2C.58) may be installed above or below an Intersection Warning sign.*

*Guidance:*

*07 The Intersection Warning sign should illustrate and depict the general configuration of the intersecting roadway, such as cross road, side road, T-intersection, or Y-intersection.*

*08 Intersection Warning signs, other than the Circular Intersection (W2-6) symbol sign and the T-intersection (W2-4) symbol sign should not be used on approaches controlled by STOP signs, YIELD signs, or signals.*

*09 If an Intersection Warning sign is used where the side roads are not opposite of each other, the Offset Side Roads (W2-7) symbol sign (see Figure 2C-9) should be used instead of the Cross Road symbol sign.*

*10 If an Intersection Warning sign is used where two closely-spaced side roads are on the same side of the highway, the Double Side Roads (W2-8) symbol sign (see Figure 2C-9) should be used instead of the Side Road symbol sign.*

*11 No more than two side road symbols should be displayed on the same side of the highway on a W2-7 or W2-8 symbol sign, and no more than three side road symbols should be displayed on a W2-7 or W2-8 symbol sign.*

*Support:*

*12 Figure 2A-4 shows the typical placement of an Intersection Warning sign.*

*Option:*

*13 A bulb shape may be placed on the appropriate leg of the Cross Road (W2-1), Side Road (W2-2 or W2-3), T-Symbol (W2-4), or Y-Symbol (W2-5) advance intersection signs to indicate a "Dead End" condition. See Section 2C.26 for DEAD END (W14-1) sign.*

*Guidance:*

*14 The END FREEWAY \_\_\_\_\_ MI (W69(CA)) sign (see Figure 2C-9(CA)) should be used at locations where traffic leaving the freeway comes into a lower standard roadway. At problem locations dual installations with yellow flashing beacons or overhead installations should be considered. The W69(CA) sign should also be used at transitions from freeways to expressways.*

*Option:*

*15 The END FREEWAY (SW36(CA)) sign (see Figure 2C-9(CA)) may be used at locations where traffic leaving the freeway comes into a lower standard roadway. It may also be used where additional emphasis is needed for the W69(CA) sign.*

*Guidance:*

*16 The CROSS TRAFFIC AHEAD (W70(CA)) sign (see Figure 2C-9(CA)) should be used at locations where traffic leaves a freeway section and enters an expressway section to warn motorists that crossing at grade may be expected.*

*Option:*

*17 Where two sections of freeway are connected by a section of expressway of a relatively short distance, the Next Distance (W7-3a) plaque may be installed below the W70(CA) sign.*

## **Section 2C.47 Two-Direction Large Arrow Sign (W1-7)**

**Standard:**

**01 The Two-Direction Large Arrow (W1-7) sign (see Figure 2C-9) shall be a horizontal rectangle.**

**02 If used, it shall be installed on the far side of a T-intersection in line with, and at approximately a right angle to, traffic approaching from the stem of the T-intersection.**

**03 The Two-Direction Large Arrow sign shall not be used where there is no change in the direction of travel such as at the beginnings and ends of medians or at center piers.**

**04 The Two-Direction Large Arrow sign directing traffic to the left and right shall not be used in the central island of a roundabout.**

*Guidance:*

*05 The Two-Direction Large Arrow sign should be visible for a sufficient distance to provide the road user with adequate time to react to the intersection configuration.*

*06 Type N-1(CA) (OM1-3) object marker should be used below and on the same post as the W1-7 sign. See Section 2C.65.*

### **Section 2C.48 Traffic Signal Signs (W25-1, W25-2)**

**Standard:**

~~**01 At locations where either a W25-1 or a W25-2 sign is required based on the provisions in Section 4D.05, the W25-1 or W25-2 sign (see Figure 2C-9) shall be installed near the left-most signal head. The W25-1 and W25-2 signs shall be vertical rectangles.**~~

*Guidance:*

*02 The "yellow trap" should be eliminated rather than trying to correct it with these signs. See Part 4.*

### **Section 2C.49 Vehicular Traffic Warning Signs (W8-6, W11-1, W11-5, W11-5a, W11-8, W11-10, W11-11, W11-12P, W11-14, W11-15, and W11-15a)**

**Option:**

**01 Vehicular Traffic Warning (W8-6, W11-1, W11-5, W11-5a, W11-8, W11-10, W11-11, W11-12P, W11-14, W11-15, and W11-15a) signs (see Figure 2C-10) may be used to alert road users to locations where unexpected entries into the roadway by trucks, bicyclists, farm vehicles, emergency vehicles, golf carts, horse-drawn vehicles, or other vehicles might occur. The TRUCK CROSSING (W8-6) word message sign may be used as an alternate to the Truck Crossing (W11-10) symbol sign.**

**Support:**

**02 These locations might be relatively confined or might occur randomly over a segment of roadway.**

*Guidance:*

*03 Vehicular Traffic Warning signs should be used only at locations where the road user's sight distance is restricted, or the condition, activity, or entering traffic would be unexpected.*

*04 If the condition or activity is seasonal or temporary, the Vehicular Traffic Warning sign should be removed or covered when the condition or activity does not exist.*

**Option:**

**05 The combined Bicycle/Pedestrian (W11-15) sign may be used where both bicyclists and pedestrians might be crossing the roadway, such as at an intersection with a shared-use path. A TRAIL X-ING (W11-15P) supplemental plaque (see Figure 2C-10) may be mounted below the W11-15 sign. The TRAIL CROSSING (W11-15a) sign may be used to warn of shared-use path crossings where pedestrians, bicyclists, and other user groups might be crossing the roadway.**

**06 The W11-1, W11-15, and W11-15a signs and their related supplemental plaques may have a fluorescent yellow-green background with a black legend and border.**

**07 Supplemental plaques (see Section 2C.53) with legends such as AHEAD, XX FEET, NEXT XX MILES, or SHARE THE ROAD may be mounted below Vehicular Traffic Warning signs to provide advance notice to road users of unexpected entries.**

*Guidance:*

*08 If used in advance of a pedestrian and bicycle crossing, a W11-15 or W11-15a sign should be supplemented with an AHEAD or XX FEET plaque to inform road users that they are approaching a point where crossing activity might occur.*

**Standard:**

**09 If a post-mounted W11-1, W11-11, W11-15, or W11-15a sign is placed at the location of the crossing point where golf carts, pedestrians, bicyclists, or other shared-use path users might be crossing the roadway, a diagonal downward pointing arrow (W16-7P) plaque (see Figure 2C-12) shall be mounted below the sign. If the W11-1, W11-11, W11-15, or W11-15a sign is mounted overhead, the W16-7P supplemental plaque shall not be used.**

**Option:**

**10 The crossing location identified by a W11-1, W11-11, W11-15, or W11-15a sign may be defined with crosswalk markings (see Section 3B.18).**

**Standard:**

**11 The Emergency Vehicle (W11-8) sign (see Figure 2C-10) with the EMERGENCY SIGNAL AHEAD (W11-12P) supplemental plaque (see Figure 2C-10) shall be placed in advance of all emergency-vehicle traffic control signals (see Chapter 4G).**

**Option:**

~~12 The Emergency Vehicle (W11-8) sign, or a word message sign indicating the type of emergency vehicle (such as rescue squad), may be used in advance of the emergency vehicle station when no emergency vehicle traffic control signal is present.~~

**Standard:**

**12a The Emergency Vehicle (W11-8) sign or the EMERGENCY VEHICLES (SW52(CA)) sign (see Figure 2C-10(CA)) shall be used for all types of emergency vehicles.**

**Guidance:**

*12b Vehicular Traffic signs should not be placed on the highway where the unexpected entry is located on an intersecting roadway.*

**Option:**

13 A Warning Beacon (see Section 4L.03) may be used with any Vehicular Traffic Warning sign to indicate specific periods when the condition or activity is present or is likely to be present, or to provide enhanced sign conspicuity.

~~14 A supplemental WHEN FLASHING (W16-13P) plaque (see Figure 2C-12) may be used with any Vehicular Traffic Warning sign that is supplemented with a Warning Beacon to indicate specific periods when the condition or activity is present or is likely to be present.~~

**Standard:**

**15 WHEN FLASHING (W16-13P) plaque shall not be used to supplement any Vehicular Traffic Warning sign.**

**Support:**

16 Studies indicate that the W16-13P plaque is generally not effective as a warning device for motorists approaching signalized intersections. Not using the W16-13P plaque also addresses the situation when a warning beacon is inoperative for any reason.

**Option:**

17 The Snowmobile (W11-6) and Golf Cart (W11-11) signs may be used to alert road users to locations where unexpected entries into the roadway by snowmobiles or golf carts might occur, such as at snowmobile or golf cart crossings. Refer to CVC 38025. Also refer to CVC 21115.1.

18 The W11-11 sign may also be used in combination with the SHARE THE ROAD (W16-1) sign at locations where a local agency permits the sharing of the roadway with slower moving golf carts. Refer to CVC 21115.

19 The OFF HIGHWAY VEHICLES (SW47(CA)) sign (see Figure 2C-10(CA)) may be used in advance of a segment of highway that permits the use of regular vehicular traffic and also the driving of off highway motor vehicles on that portion of the highway.

**Guidance:**

*20 A Next Distance (W7-3a) plaque should supplement this sign.*

**Option:**

21 The WATCH FOR SNOW REMOVAL EQUIPMENT (SW58(CA)) sign (see Figure 2C-10(CA)) may be used on highways leading to snow areas.

**Guidance:**

*22 The SW58(CA) sign should be covered or removed during the summer season.*

**Support:**

23 The SW58(CA) sign is normally placed at lower elevations where the first snow is usually encountered.

**Section 2C.50 Non-Vehicular Warning Signs (W11-2, W11-3, W11-4, W11-6, W11-7, W11-9, and W11-16 through W11-22)**

**Option:**

01 Non-Vehicular Warning (W11-2, W11-3, W11-4, W11-6, W11-7, W11-9, and W11-16 through W11-22) signs (see Figure 2C-11) may be used to alert road users in advance of locations where unexpected entries into the roadway might occur or where shared use of the roadway by pedestrians, animals, or equestrians might occur.

**Support:**

<sup>02</sup> These conflicts might be relatively confined, or might occur randomly over a segment of roadway.

**Guidance:**

<sup>03</sup> *If used in advance of a pedestrian, snowmobile, or equestrian crossing, the W11-2, W11-6, W11-7, and W11-9 signs should be supplemented with plaques (see Section 2C.55) with the legend AHEAD or XX FEET to inform road users that they are approaching a point where crossing activity might occur.*

**Standard:**

<sup>04</sup> **If a post-mounted W11-2, W11-6, W11-7, or W11-9 sign is placed at the location of the crossing point where pedestrians, snowmobilers, or equestrians might be crossing the roadway, a diagonal downward pointing arrow (W16-7P) plaque (see Figure 2C-12) shall be mounted below the sign. If the W11-2, W11-6, W11-7, or W11-9 sign is mounted overhead, the W16-7P plaque shall not be used.**

**Option:**

<sup>05</sup> A Pedestrian Crossing (W11-2) sign may be placed overhead or may be post-mounted with a diagonal downward pointing arrow (W16-7P) plaque at the crosswalk location where Yield Here To ~~(Stop Here For)~~ Pedestrians signs (see Section 2B.11) have been installed in advance of the crosswalk.

**Standard:**

<sup>06</sup> **If a W11-2 sign has been post-mounted at the crosswalk location where a Yield Here To ~~(Stop Here For)~~ Pedestrians sign is used on the approach, the Yield Here To ~~(Stop Here For)~~ Pedestrians sign shall not be placed on the same post as or block the road user's view of the W11-2 sign.**

**Option:**

<sup>07</sup> An advance Pedestrian Crossing (W11-2) sign with an AHEAD or a distance supplemental plaque may be used in conjunction with a Yield Here To ~~(Stop Here For)~~ Pedestrians sign on the approach to the same crosswalk.

<sup>08</sup> The crossing location identified by a W11-2, W11-6, W11-7, or W11-9 sign may be defined with crosswalk markings (see Section 3B.18).

<sup>09</sup> The W11-2 and W11-9 signs and their related supplemental plaques may have a fluorescent yellow-green background with a black legend and border.

**Support:**

<sup>09a</sup> Refer to CVC 21364 and 21365 for the Cattle (W11-4) sign.

<sup>09b</sup> Refer to CVC 21805 for the Equestrian (W11-7) sign.

**Guidance:**

<sup>09c</sup> *The Deer Crossing (W11-3) sign should be used only after confirmation from a Department of Fish and Wildlife warden having jurisdiction in the area that a substantial problem exists.*

**Option:**

<sup>09d</sup> The Migrating Bears (SW59(CA)) sign (see Figure 2C-11(CA)) may be used in advance of an area known to be inhabited by bear and there have been reported instances where bears are crossing the roadway.

**Guidance:**

<sup>09e</sup> *If used, the NEXT XX MILES supplemental plaque should be placed at approximately 5 mile intervals, or when intersecting major traffic generators.*

**Option:**

<sup>09f</sup> The DEAF CHILDREN NEAR (SW38(CA)) sign (see Figure 2C-11(CA)) may be used on city streets or county roads to indicate that a deaf child is near. Refer to CVC 21351.7.

<sup>09g</sup> The SENIOR ZONE (SW50-1P(CA)) plaque or SENIOR (SW50-2P(CA)) plaque (see Figure 2C-11(CA)) may be used in combination, above the Speed Limit (R2-1 (25,20 or 15)) sign on any street or road, other than a State highway, with a speed limit greater than 25 mph that is adjacent to a senior citizen facility. Refer to CVC 22352 and 22358.4.

**Guidance:**

<sup>10</sup> *When a fluorescent yellow-green background is used, a systematic approach featuring one background color within a zone or area should be used. The mixing of standard yellow and fluorescent yellow-green backgrounds within a selected site area should be avoided.*



Option:

<sup>11</sup> A Warning Beacon (see Section 4L.03) may be used with any Non-Vehicular Warning sign to indicate specific periods when the condition or activity is present or is likely to be present, or to provide enhanced sign conspicuity.

~~<sup>12</sup> A supplemental WHEN FLASHING (W16-13P) plaque (see Figure 2C-12) may be used with any Non-Vehicular Warning sign that is supplemented with a Warning Beacon to indicate specific periods when the condition or activity is present or is likely to be present.~~

**Standard:**

<sup>13</sup> **WHEN FLASHING (W16-13P) plaque shall not be used to supplement any Non-Vehicular Warning sign.**

Support:

<sup>14</sup> Studies indicate that the W16-13P plaque is generally not effective as a warning device for motorists approaching signalized intersections. Not using the W16-13P plaque also addresses the situation when a warning beacon is inoperative for any reason.

### **Section 2C.51 Playground Sign (W15-1)**

Option:

<sup>01</sup> The Playground (W15-1) sign (see Figure 2C-11) may be used to give advance warning of a designated children's playground that is located adjacent to the road.

<sup>02</sup> The Playground sign may have a fluorescent yellow-green background with a black legend and border.

*Guidance:*

<sup>03</sup> *If the access to the playground area requires a roadway crossing, the application of crosswalk pavement markings (see Section 3B.18) and Non-Vehicular Warning signs (see Section 2C.50) should be considered.*

<sup>04</sup> *The PLAYGROUND (SW49(CA)) sign (see Figure 2C-11(CA)) should not be used alone.*

Option:

<sup>05</sup> The SW49(CA) sign may be used in combination above the Speed Limit (R2-1 (25)) sign and WHEN CHILDREN ARE PRESENT (S4-2) sign on any street or road, other than a State highway, with a speed limit greater than 25 mph that is adjacent to a children's playground within a public park. Refer to CVC 22357.1.

### **Section 2C.52 NEW TRAFFIC PATTERN AHEAD Sign (W23-2)**

Option:

<sup>01</sup> A NEW TRAFFIC PATTERN AHEAD (W23-2) sign (see Figure 2C-6) may be used on the approach to an intersection or along a section of roadway to provide advance warning of a change in traffic patterns, such as revised lane usage, roadway geometry, or signal phasing.

*Guidance:*

<sup>02</sup> *The NEW TRAFFIC PATTERN AHEAD sign should be removed when the traffic pattern returns to normal, when the changed pattern is no longer considered to be new, or within six months.*

### **Section 2C.53 Use of Supplemental Warning Plaques**

Option:

<sup>01</sup> A supplemental warning plaque (see Figure 2C-12) may be displayed with a warning or regulatory sign when engineering judgment indicates that road users require additional warning information beyond that contained in the main message of the warning or regulatory sign.

**Standard:**

<sup>02</sup> **Supplemental warning plaques shall be used only in combination with warning or regulatory signs. They shall not be mounted alone or displayed alone. If used, a supplemental warning plaque shall be installed on the same post(s) as the warning or regulatory sign that it supplements.** <sup>03</sup> **Unless otherwise provided in this Manual for a particular plaque, supplemental warning plaques shall be mounted below the sign they supplement.**

### **Section 2C.54 Design of Supplemental Warning Plaques**

#### **Standard:**

01 **A supplemental warning plaque used with a warning sign shall have the same legend, border, and background color as the warning sign with which it is displayed. A supplemental warning plaque used with a regulatory sign shall have a black legend and border on a yellow background.**

02 **Supplemental warning plaques shall be square or rectangular.**

### **Section 2C.55 Distance Plaques (W16-2 Series, W16-3 Series, W16-4P, W7-3aP)**

#### **Option:**

01 The Distance Ahead (W16-2 series and W16-3 series) plaques (see Figure 2C-12) may be used to inform the road user of the distance to the condition indicated by the warning sign.

02 The Next Distance (W7-3aP and W16-4P) plaques (see Figures 2C-4 and 2C-12) may be used to inform road users of the length of roadway over which the condition indicated by the warning sign exists.

03 The Distance Ahead (W34A(CA)) plaque (see Figure 2C-12(CA)) may be used to inform the road user of the distance to the condition indicated by the warning sign.

#### **Guidance:**

04 *When the distance is in miles, the mileage shown should be to the nearest 1/4 mile for a distance of less than 1 mile and to the nearest mile for distances over one mile. The text "MILE" should be used for a distance of one mile or less. The text "MILES" should be used for distances over one mile.*

### **Section 2C.56 Supplemental Arrow Plaques (W16-5P, W16-6P)**

#### **Guidance:**

01 *If the condition indicated by a warning sign is located on an intersecting road and the distance between the intersection and condition is not sufficient to provide adequate advance placement of the warning sign, a Supplemental Arrow (W16-5P or W16-6P) plaque (see Figure 2C-12) should be used below the warning sign.*

#### **Standard:**

02 **Supplemental Arrow plaques shall have the same legend design as the Advance Turn Arrow and Directional Arrow auxiliary signs (see Sections 2D.26 and 2D.28) except that they shall have a black legend and border on a yellow or fluorescent yellow-green background, as appropriate.**

### **Section 2C.57 Hill-Related Plaques (W7-2 Series, W7-3 Series)**

#### **Guidance:**

01 *Hill-Related (W7-2 series, W7-3 series) plaques (see Figure 2C-4) or other appropriate legends and larger signs should be used for emphasis or where special hill characteristics exist.*

02 *On longer grades, the use of the distance plaque (W7-3aP or W7-3bP) at periodic intervals of approximately 1-mile spacing should be considered.*

#### **Option:**

03 *The WATCH DOWNHILL SPEED (SW4-1(CA)) sign (see Figure 2C-4(CA)) may be used on long downhill grades to remind motorists to maintain the posted speed.*

### **Section 2C.58 Advance Street Name Plaque (W16-8P, W16-8aP)**

#### **Option:**

01 An Advance Street Name (W16-8P or W16-8aP) plaque (see Figure 2C-12) may be used with any Intersection sign (W2 series, W10-2, W10-3, or W10-4) or Advance Traffic Control (W3 series) sign to identify the name of the intersecting street.

#### **Standard:**

02 **The lettering on Advance Street Name plaques shall be composed of a combination of lower-case letters with initial upper-case letters.**

03 **If two street names are used on the Advance Street Name plaque, a directional arrow pointing in the direction of the street shall be placed next to each street name. Arrows pointing to the left shall be placed to the left of the street name, and arrows pointing to the right shall be placed to the right of the street name.**

*Guidance:*

*04 If two street names are used on the Advance Street Name plaque, the street names and associated arrows should be displayed in the following order:*

*A. For a single intersection, the name of the street to the left should be displayed above the name of the street to the right; or*

*B. For two sequential intersections, such as where the plaque is used with an Offset Side Roads (W2-7) or a Double Side Road (W2-8) symbol sign, the name of the first street encountered should be displayed above the name of the second street encountered, and the arrow associated with the second street encountered should be an advance arrow, such as the arrow shown on the W16-6P arrow plaque (see Figure 2C-12).*

### **Section 2C.59 CROSS TRAFFIC DOES NOT STOP Plaque (W4-4P)**

**Option:**

**01** The CROSS TRAFFIC DOES NOT STOP (W4-4P) plaque (see Figure 2C-9) may be used in combination with a STOP sign when engineering judgment indicates that conditions are present that are causing or could cause drivers to misinterpret the intersection as an all-way stop.

**02** Alternative messages (see Figure 2C-9) such as TRAFFIC FROM LEFT (RIGHT) DOES NOT STOP (W4-4aP) or ONCOMING TRAFFIC DOES NOT STOP (W4-4bP) may be used when such messages more accurately describe the traffic controls established at the intersection.

*Guidance:*

*02a The CROSS TRAFFIC DOES NOT STOP (W4-4p) plaque should be used in combination with a STOP sign at two-way stop-controlled intersections when a conversion from four-way stop to two-way stop operation is implemented.*

*03 Plaques with the appropriate alternative messages of TRAFFIC FROM LEFT (RIGHT) DOES NOT STOP or ONCOMING TRAFFIC DOES NOT STOP should be used at intersections where STOP signs control all but one approach to the intersection, unless the only non-stopped approach is from a one-way street.*

**Standard:**

**04 If a W4-4P plaque or a plaque with an alternative message is used, it shall be mounted below the STOP sign.**

### **Section 2C.60 SHARE THE ROAD Plaque (W16-1P)**

**Option:**

**01** In situations where there is a need to warn drivers to watch for other slower forms of transportation traveling along the highway, such as bicycles, golf carts, horse-drawn vehicles, or farm machinery, a SHARE THE ROAD (W16-1P) plaque (see Figure 2C-12) may be used.

**Standard:**

**02 A W16-1P plaque shall not be used alone. If a W16-1P plaque is used, it shall be mounted below either a Vehicular Traffic Warning sign (see Section 2C.49) or a Non-Vehicular Warning sign (see Section 2C.50). The background color of the W16-1P plaque shall match the background color of the warning sign with which it is displayed.**

**Support:**

**03 Refer to Section 9B.06 for Bicycles May Use Full Lane (R4-11) sign.**

**04 Refer to Section 9B.102 for PASS Bicycle 3 FT MIN (R117(CA)) sign.**

### **Section 2C.61 Photo Enforced Plaque (W16-10P)**

**Option:**

**01** A Photo Enforced (W16-10P) plaque or a PHOTO ENFORCED (W16-10aP) word message plaque (see Figure 2C-12) may be mounted below a warning sign to advise road users that the regulations associated with the condition being warned about (such as a traffic control signal or a toll plaza) are being enforced by photographic equipment.

**Standard:**

**02 If used below a warning sign, the Photo Enforced (W16-10P or W16-10aP) plaque shall be a rectangle with a black legend and border on a yellow background.**

### **Section 2C.62 NEW Plaque (W16-15P)**

**Option:**

01 A NEW (W16-15P) plaque (see Figure 2C-12) may be mounted above a regulatory sign when a new regulation takes effect in order to alert road users to the new traffic regulation. A NEW plaque may also be mounted above an advance warning sign (such as a Signal Ahead sign for a newly-installed traffic control signal) for a new traffic regulation.

**Standard:**

- 02 **The NEW plaque shall not be used alone.**
- 03 **The NEW plaque shall be removed no later than 6 months after the regulation has been in effect.**

### **Section 2C.63 Object Marker Design and Placement Height**

**Support:**

01 Type 1, 2, and 3 object markers are used to mark obstructions within or adjacent to the roadway. Type 4 object markers are used to mark the end of a roadway.

**Standard:**

02 **When used, object markers (see Figure 2C-13) shall not have a border and shall consist of an arrangement of one or more of the following types:**

**Type 1**—a diamond-shaped sign, at least 18 inches on a side, consisting of either a yellow (OM1-1) or black (OM1-2) sign with nine yellow retroreflective devices, each with a minimum diameter of 3 inches, mounted symmetrically on the sign, or an all-yellow retroreflective sign (OM1-3).

**Type 2**—either a marker (OM2-1V or OM2-1H) consisting of three yellow retroreflective devices, each with a minimum diameter of 3 inches, arranged either horizontally or vertically on a white sign measuring at least 6 x 12 inches; or an all-yellow horizontal or vertical retroreflective sign (OM2-2V or OM2-2H), measuring at least 6 x 12 inches.

**Type 3**—a striped marker, 12 x 36 inches, consisting of a vertical rectangle with alternating black and retroreflective yellow stripes sloping downward at an angle of 45 degrees toward the side of the obstruction on which traffic is to pass. The minimum width of the yellow and black stripes shall be 3 inches.

**Type 4**—a diamond-shaped sign, at least 18 inches on a side, consisting of either a red (OM4-1) or black (OM4-2) sign with nine red retroreflective devices, each with a minimum diameter of 3 inches, mounted symmetrically on the sign, or an all-red retroreflective sign (OM4-3).

**Type L(CA) Utility Pole marker (see Figure 2C-13(CA)) shall be yellow retroreflective material consisting of three 2 x 12 inch horizontal rectangles arranged vertically on a utility pole.**

**Type Q(CA) object marker (see Figure 2C-13(CA)) shall be a vertical tubular marker, with a height of 18 to 24 inch and a minimum cross sectional dimension of 2 ¼ inch. The yellow retroreflective material shall consist of three bands, each 3 inch in height or a single band 9 inch in height.**

**Type R(CA) (OM-3C) object marker (see Figure 2C-13(CA)) size shall be 24 x 30 inch.**

**Support:**

02a *A cross-reference of object markers is shown in Table 2C-101(CA).*

03 A better appearance can be achieved if the black stripes are wider than the yellow stripes.

04 Type 3 object markers with stripes that begin at the upper right side and slope downward to the lower left side are designated as right object markers (OM3-R). Object markers with stripes that begin at the upper left side and slope downward to the lower right side are designated as left object markers (OM3-L).

**Guidance:**

05 *When used for marking obstructions within the roadway or obstructions that are 8 feet or less from the shoulder or curb, the minimum mounting height, measured from the bottom of the object marker to the elevation of the near edge of the traveled way, should be 4 feet.*

06 *When used to mark obstructions more than 8 feet from the shoulder or curb, the clearance from the ground to the bottom of the object marker should be at least 4 feet.*

07 *Object markers should not present a vertical or horizontal clearance obstacle for pedestrians.*

**Standard:**

07a **Figure 2C-13(CA) shall be used for mounting height of object markers.**

Option:

08 When object markers or markings are applied to an obstruction that by its nature requires a lower or higher mounting, the vertical mounting height may vary according to need.

Support:

09 Section 9B.26 contains information regarding the use of object markers on shared-use paths.

### **Section 2C.64 Object Markers for Obstructions Within the Roadway**

**Standard:**

01 **Obstructions within the roadway shall be marked with a Type 1 or Type 3 object marker. In addition to markers on the face of the obstruction, warning of approach to the obstruction shall be given by appropriate pavement markings (see Section 3B.10).**

Option:

02 To provide additional emphasis, a Type 1 or Type 3 object marker may be installed at or near the approach end of a median island.

03 To provide additional emphasis, large surfaces such as bridge piers may be painted with diagonal stripes, 12 inches or greater in width, similar in design to the Type 3 object marker.

**Standard:**

04 **The alternating black and retroreflective yellow stripes (OM3-L, OM3-R) shall be sloped down at an angle of 45 degrees toward the side on which traffic is to pass the obstruction. If traffic can pass to either side of the obstruction, the alternating black and retroreflective yellow stripes (OM3-C) shall form chevrons that point upwards.**

Option:

05 Appropriate signs (see Sections 2B.32 and 2C.25) directing traffic to one or both sides of the obstruction may be used instead of the object marker.

06 Objects in a paved area within 8 feet of the traveled way may be marked with a Type P(CA) (OM-3L, OM-3R) or Type R(CA) (OM-3C) object marker.

07 The Type Q(CA) object marker may be used to emphasize objects within the roadway, for example, curb noses, where it is desirable that the marker be visible from all directions.

*Guidance:*

08 *If any object marker is located behind the guard rail, all of the marker panel should be visible to approaching traffic.*

09 *The Type P(CA) (OM-3L, OM-3R) object marker should be in line with the inner edge of the obstruction.*

### **Section 2C.65 Object Markers for Obstructions Adjacent to the Roadway**

Support:

01 Obstructions not actually within the roadway are sometimes so close to the edge of the road that they need a marker. These include underpass piers, bridge abutments, handrails, ends of traffic barriers, utility poles, and culvert headwalls. In other cases there might not be a physical object involved, but other roadside conditions exist, such as narrow shoulders, drop-offs, gores, small islands, and abrupt changes in the roadway alignment, that might make it undesirable for a road user to leave the roadway, and therefore would create a need for a marker.

**Standard:**

02 **If a Type 2 or Type 3 object marker is used to mark an obstruction adjacent to the roadway, the edge of the object marker that is closest to the road user shall be installed in line with the closest edge of the obstruction.**

03 **Where Type 3 object markers are applied to the approach ends of guardrail and other roadside appurtenances, sheeting without a substrate shall be directly affixed to the approach end of the guardrail in a rectangular shape conforming to the size of the approach end of the guardrail with alternating black and retroreflective yellow stripes sloping downward at a angle of 45 degrees toward the side of the obstruction on which traffic is to pass.**

04 **Type 1 and Type 4 object markers shall not be used to mark obstructions adjacent to the roadway.**

*Guidance:*

05 *Standard warning signs in this Chapter should also be used where applicable.*

Option:

06 Objects outside of the paved shoulder, within 12 feet of the traveled way, may be marked with Type L(CA) object markers.

07 The Type L(CA) (OM2-2V and OM2-2H) object markers may be placed in front of, alongside of, or attached to the object. Where objects are very close to each other, only the first object may need to be marked.

08 The Type L(CA) Utility Pole marker may be used to mark a utility pole.

**Standard:**

09 **If used on State highways, Type L-1(CA) (OM2-2V) object marker shall be used instead of Type L-2(CA) (OM2-2V).**

*Guidance:*

10 *If used, the utility company should be responsible for installing and maintaining the Type L(CA) Utility Pole marker.*

Support:

11 See Section 2C.12 and 2C.47 for use of Type N-1(CA) (OM1-3) object markers in conjunction with One-Directional Large Arrow (W1-6) and Two-Direction Large Arrow (W1-7) signs for abrupt changes in the roadway alignment.

12 See Section 6F.105(CA) for use of Type N(CA), P(CA) and R(CA) object markers for temporary traffic control.

Option:

13 If engineering judgment indicates that the exit gore at an interchange cannot be negotiated in a reasonable manner, then in addition to the Type F and G delineators, Type R(CA) (OM-3C) object marker may be used as shown in Figure 3F-102(CA).

## **Section 2C.66 Object Markers for Ends of Roadways**

Support:

01 The Type 4 object marker is used to warn and alert road users of the end of a roadway in other than construction or maintenance areas.

**Standard:**

02 **If an object marker is used to mark the end of a roadway, a Type 4 object marker shall be used.**

Option:

~~03 The Type 4 object marker may be used in instances where there are no alternate vehicular paths.~~

**Standard:**

03a **The end-of-roadway marker shall be used at the end of a road or cul-de-sac street where there is no alternate vehicular path.**

04 Where conditions warrant, more than one marker, or a larger marker with or without a Type 3 Barricade (see Section 2B.67), may be used at the end of the roadway.

**Standard:**

~~05 The minimum mounting height, measured vertically from the bottom of a Type 4 object marker to the elevation of the near edge of the traveled way, shall be 4 feet.~~

05a **Figure 2C-13(CA) shall be used for mounting height of the end-of-the-roadway marker.**

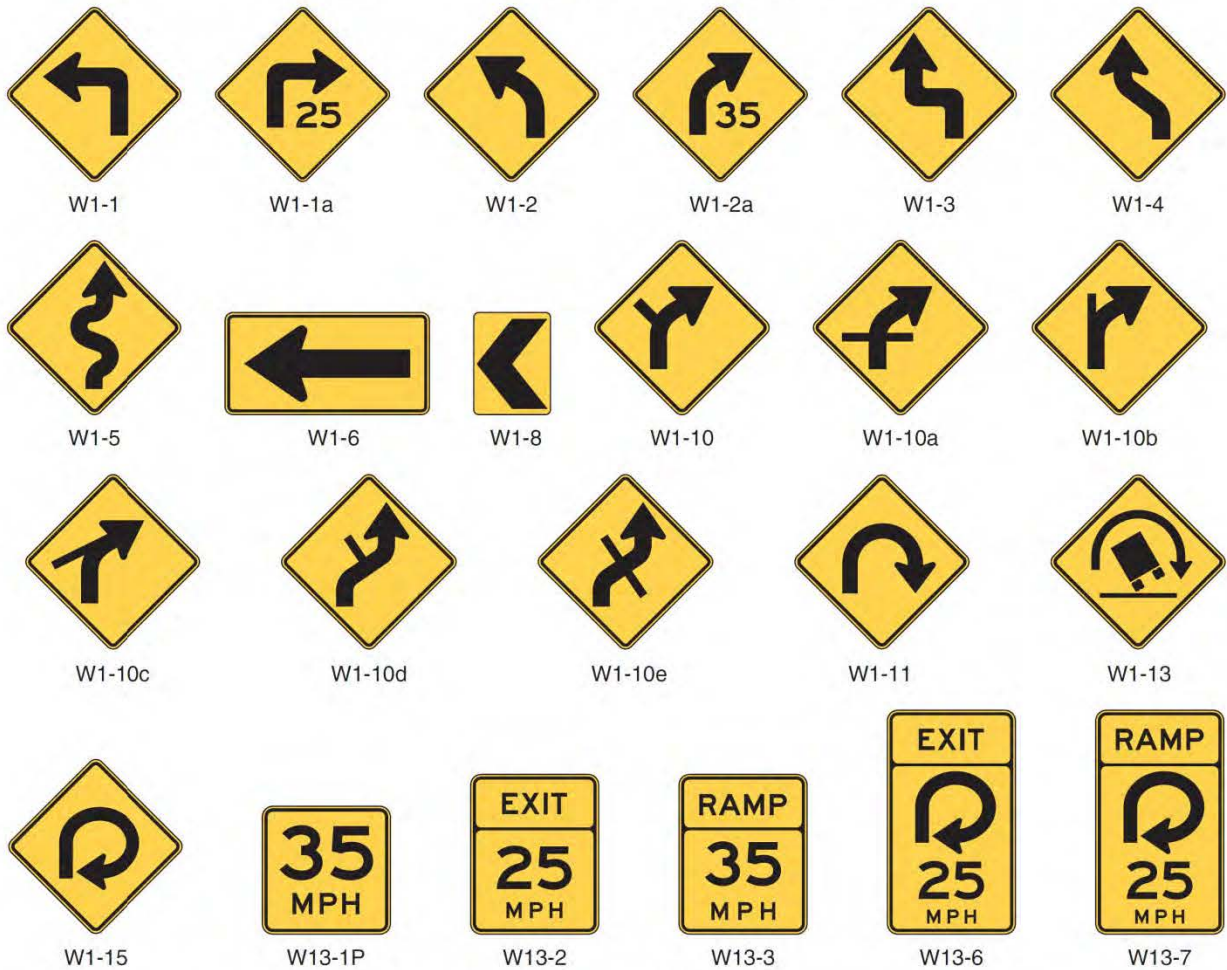
*Guidance:*

06 *Appropriate advance warning signs in this Chapter should be used.*

Support:

07 See Section 2C.26 for use of end-of-roadway marker in conjunction with END (W31(CA)) sign.

**Figure 2C-1. Horizontal Alignment Signs and Plaques**



Note: Turn arrows and reverse turn arrows may be substituted for the curve arrows and reverse curve arrows on the W1-10 series signs where appropriate.

**Figure 2C-1 (CA). Horizontal Alignment Signs and Plaques**



W4-1 (CA)



W4-10 (CA)



W4-14 (CA)



W4-18 (CA)



W4-22 (CA)



SW22-1 (CA)



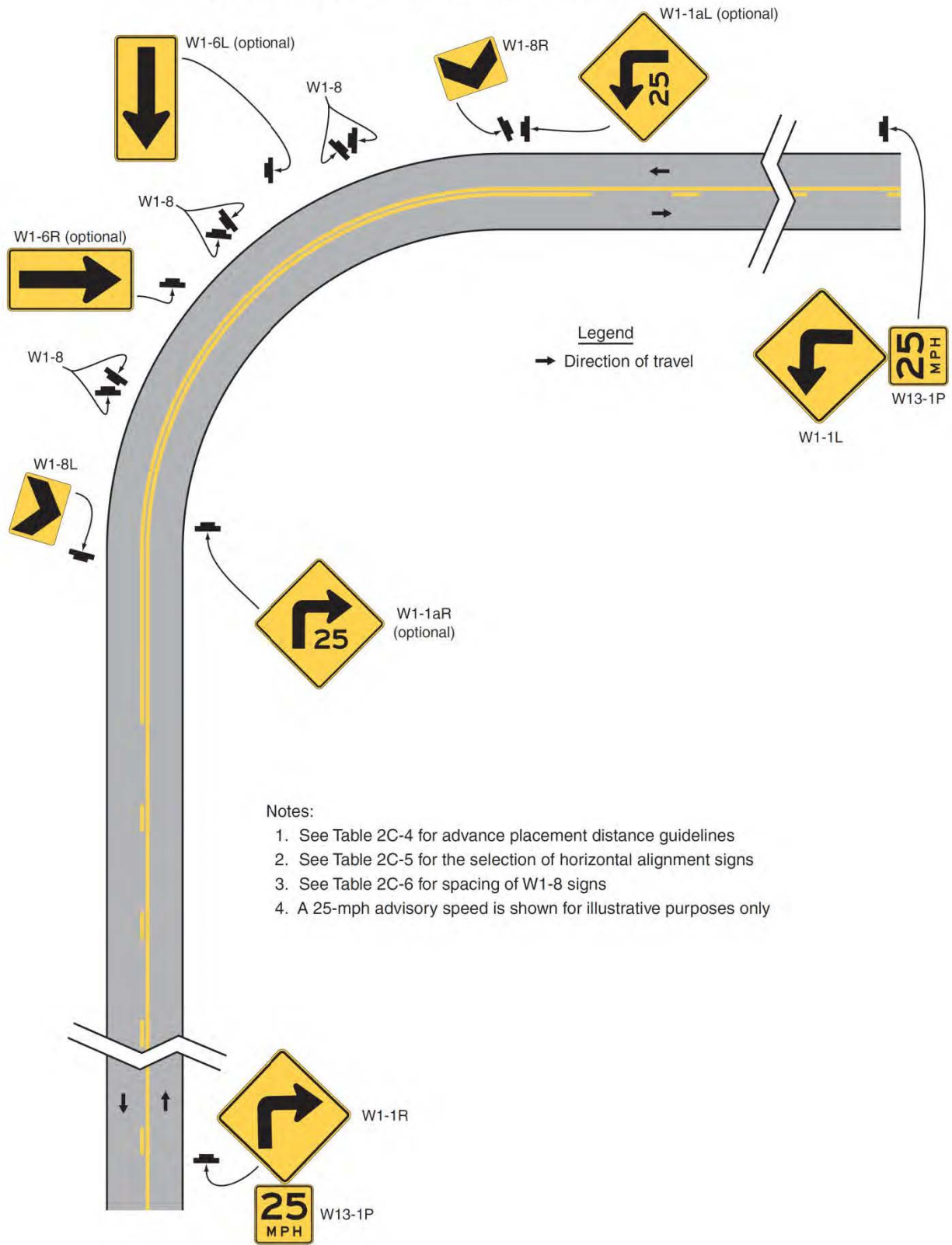
SW22-1A (CA)



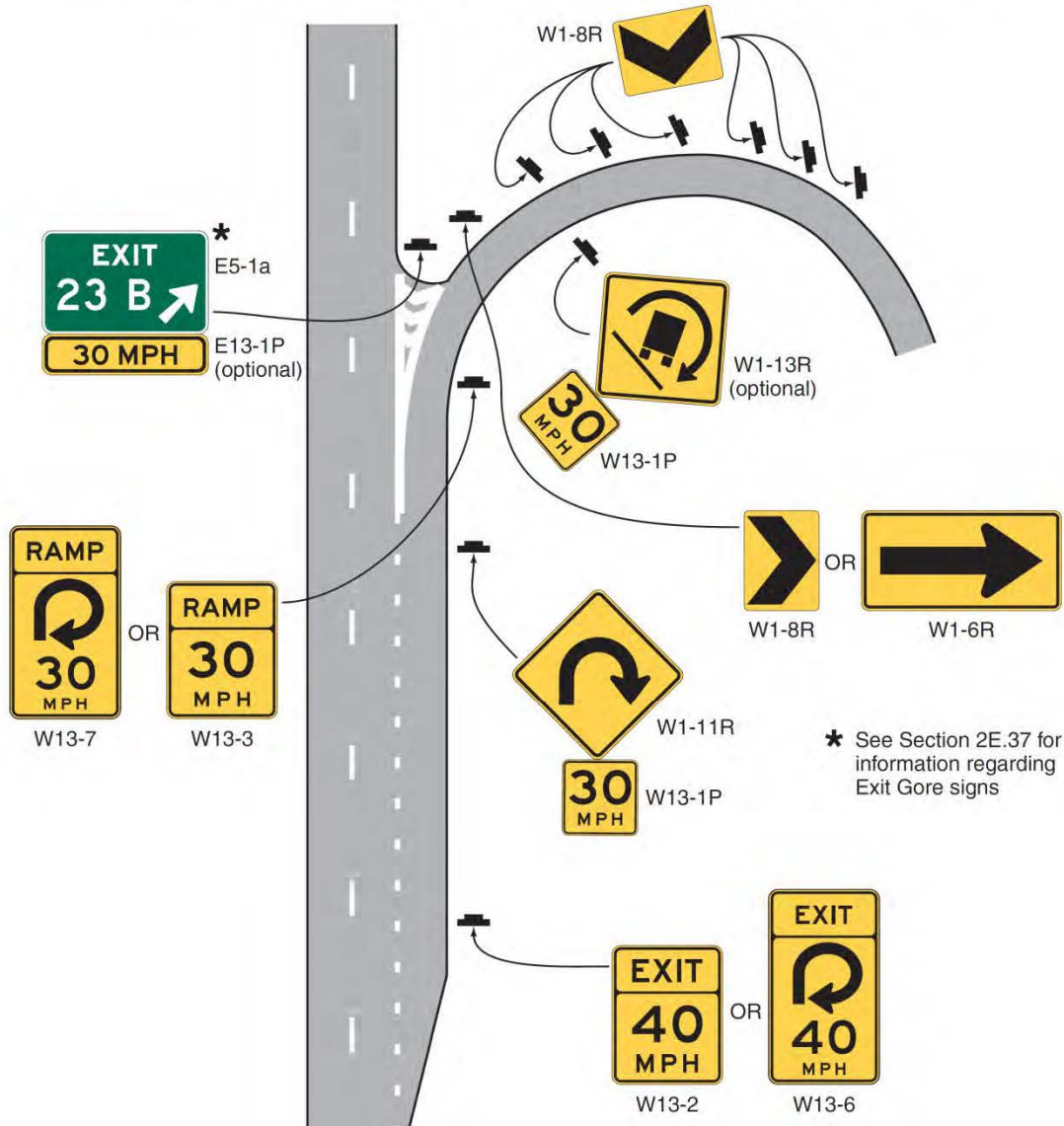
Vehicle Speed Feedback Sign  
(Assembly example shown with W1-2a)



**Figure 2C-2. Example of Warning Signs for a Turn**

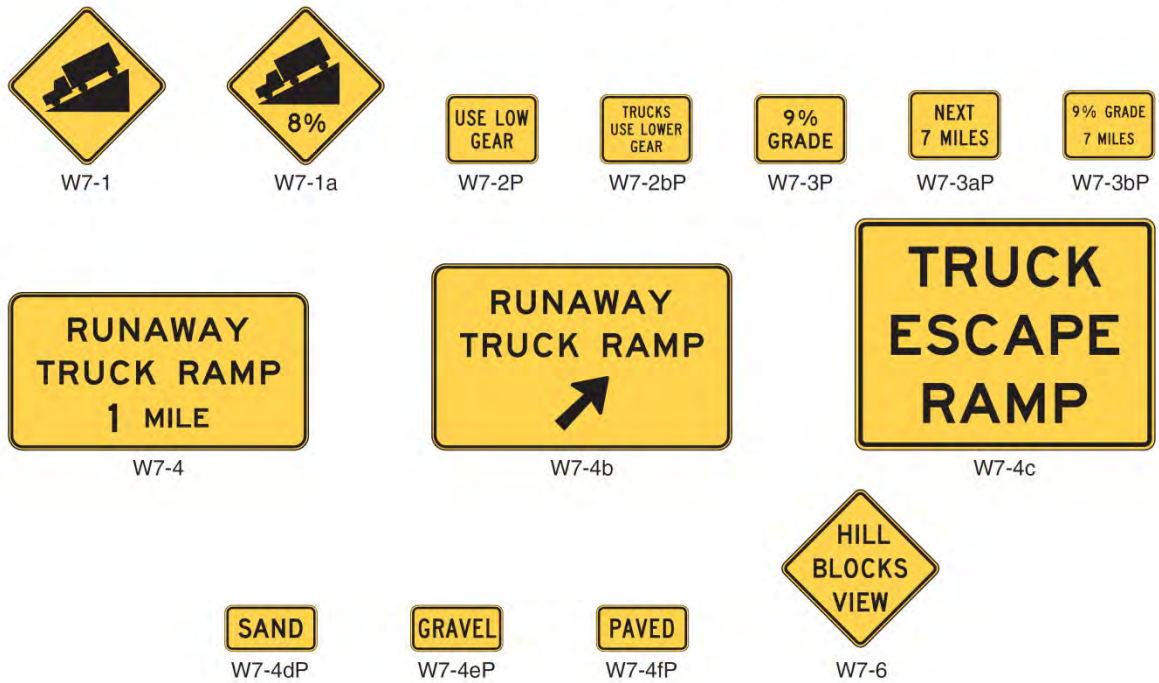


**Figure 2C-3. Example of Advisory Speed Signing for an Exit Ramp**

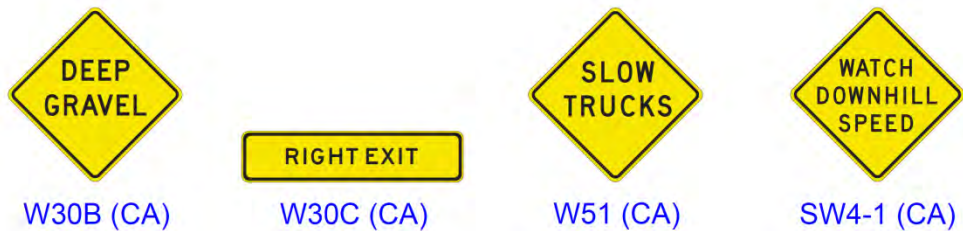


- Notes:
1. See Table 2C-4 for advance placement distance guidelines
  2. See Table 2C-5 for the selection of horizontal alignment signs
  3. See Table 2C-6 for spacing of W1-8 signs
  4. A 30-mph ramp advisory speed and 40-mph exit advisory speed are shown for illustrative purposes only

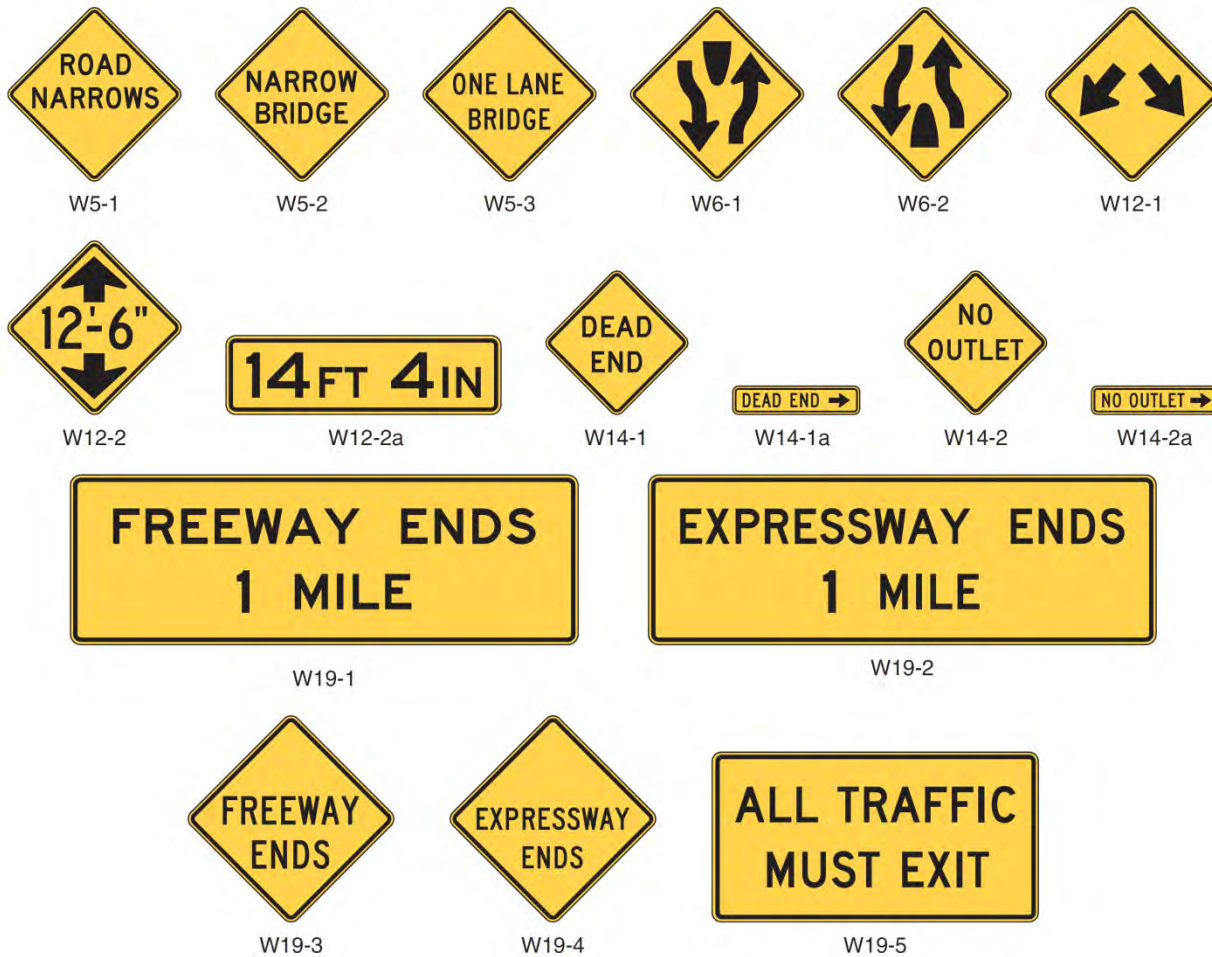
**Figure 2C-4. Vertical Grade Signs and Plaques**



**Figure 2C-4 (CA). Vertical Grade Signs and Plaques**



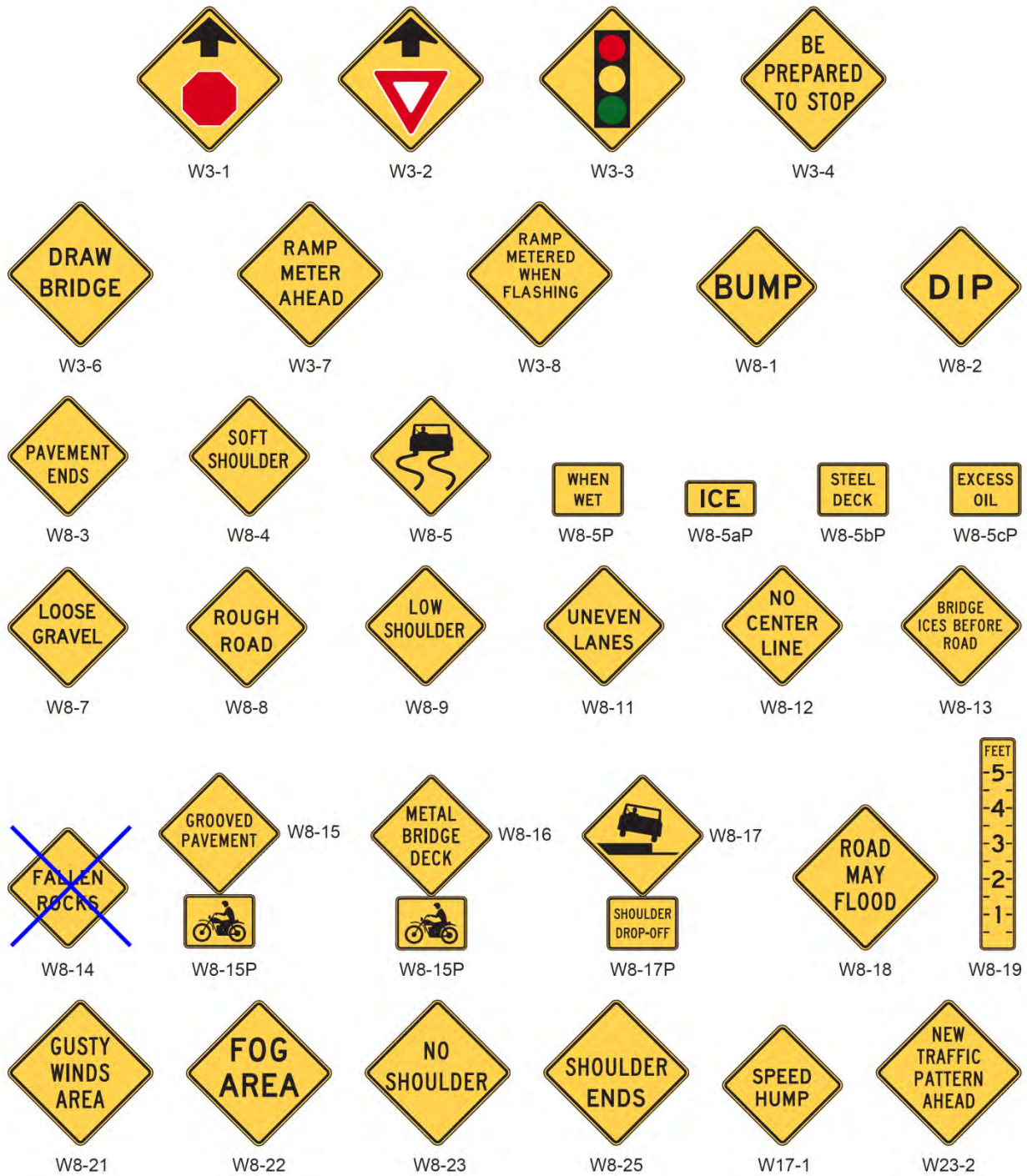
**Figure 2C-5. Miscellaneous Warning Signs**



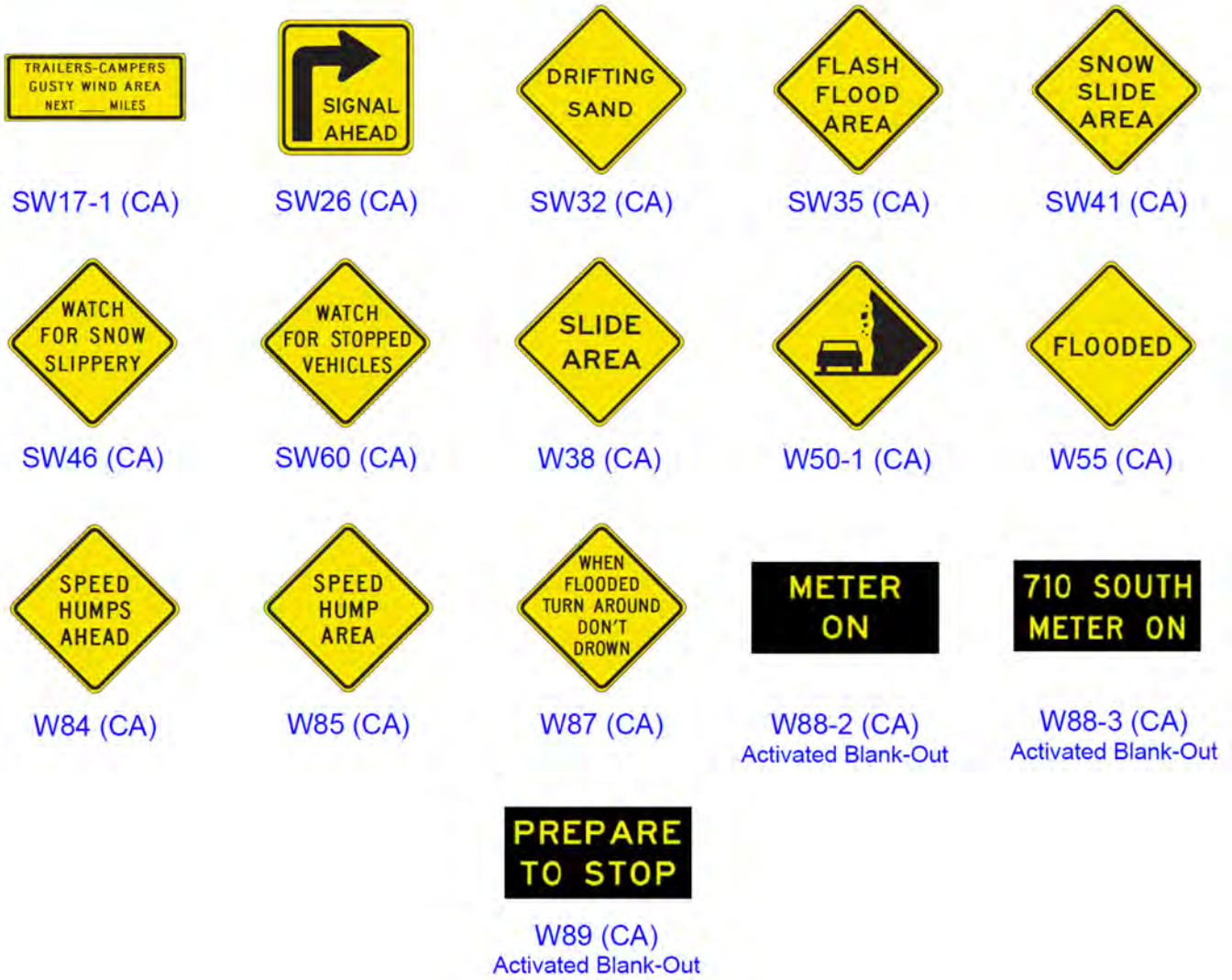
**Figure 2C-5 (CA). Miscellaneous Warning Signs**



**Figure 2C-6. Roadway and Weather Condition and Advance Traffic Control Signs and Plaques**



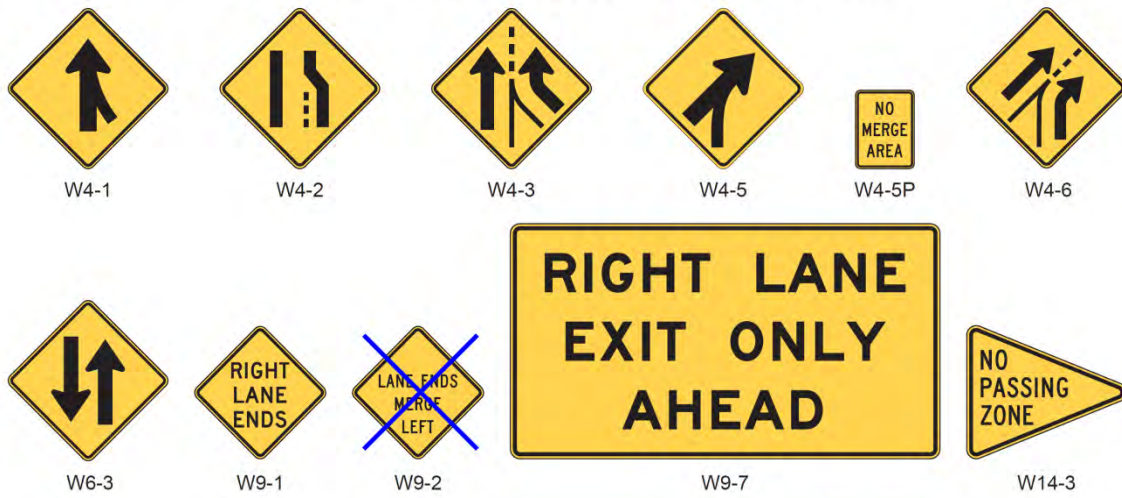
**Figure 2C-6 (CA). Roadway and Weather Condition and Advance Traffic Control Signs and Plaques**



**Figure 2C-7. Reduced Speed Limit Ahead Signs**



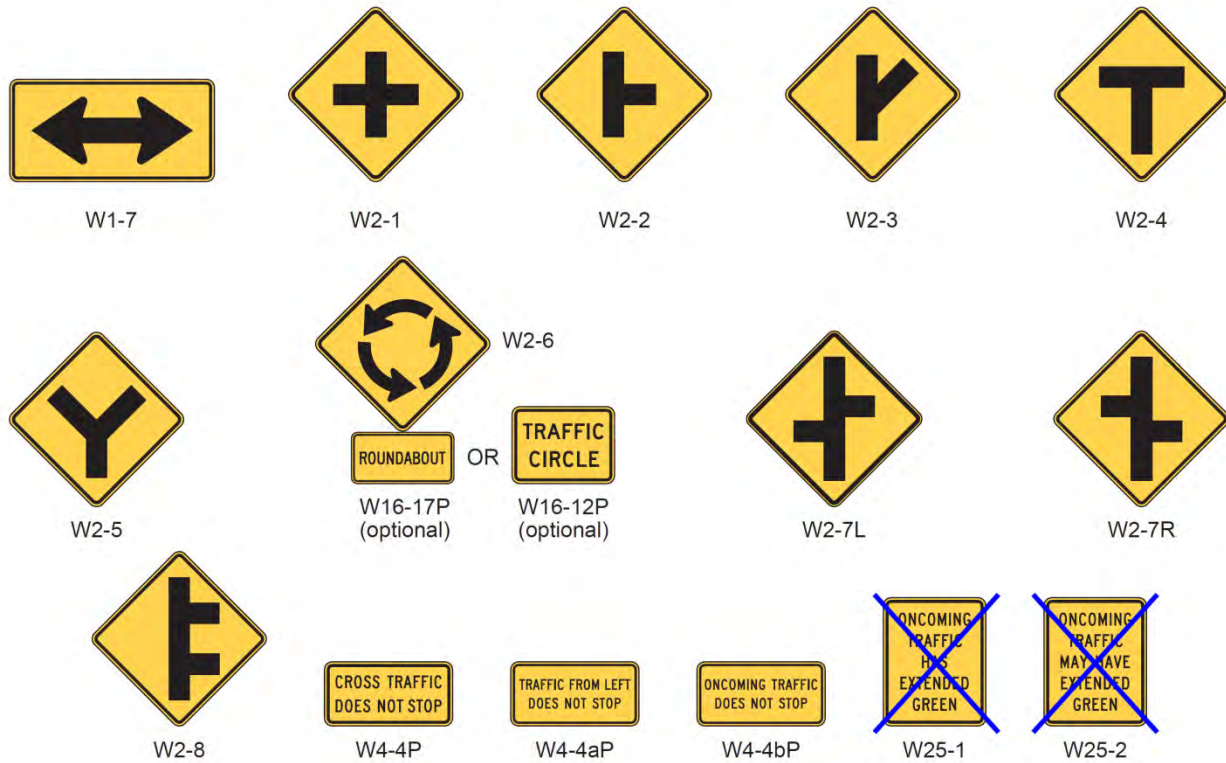
**Figure 2C-8. Merging and Passing Signs and Plaques**



**Figure 2C-8 (CA). Merging and Passing Signs and Plaques**



**Figure 2C-9. Intersection Warning Signs and Plaques**

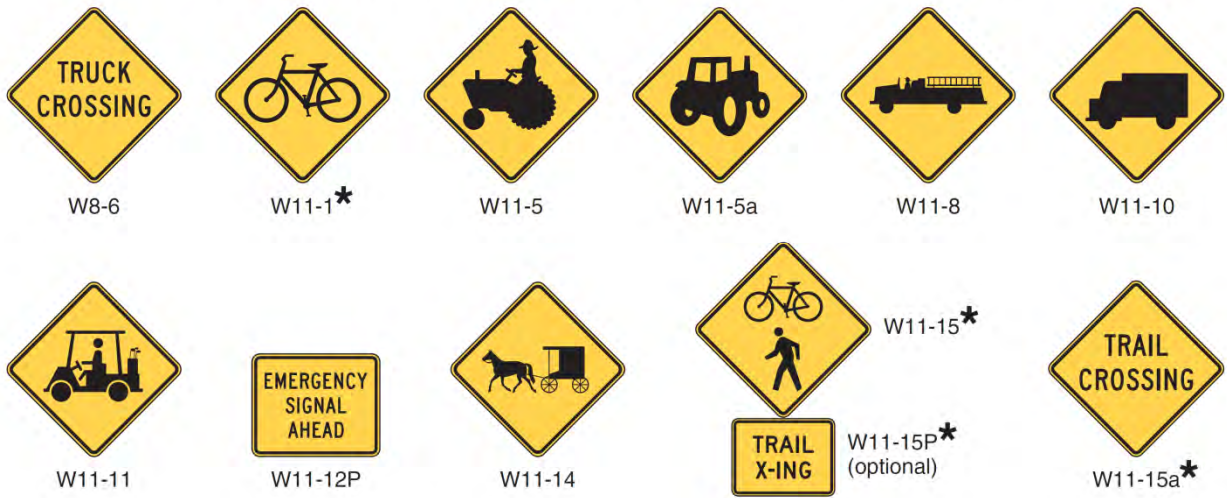


**Figure 2C-9 (CA). Intersection Warning Signs and Plaques**





**Figure 2C-10. Vehicular Traffic Warning Signs and Plaques**



\* A fluorescent yellow-green background color may be used for this sign or plaque.

**Figure 2C-10 (CA). Vehicular Traffic Warning Signs and Plaques**



**Figure 2C-11. Non-Vehicular Warning Signs**

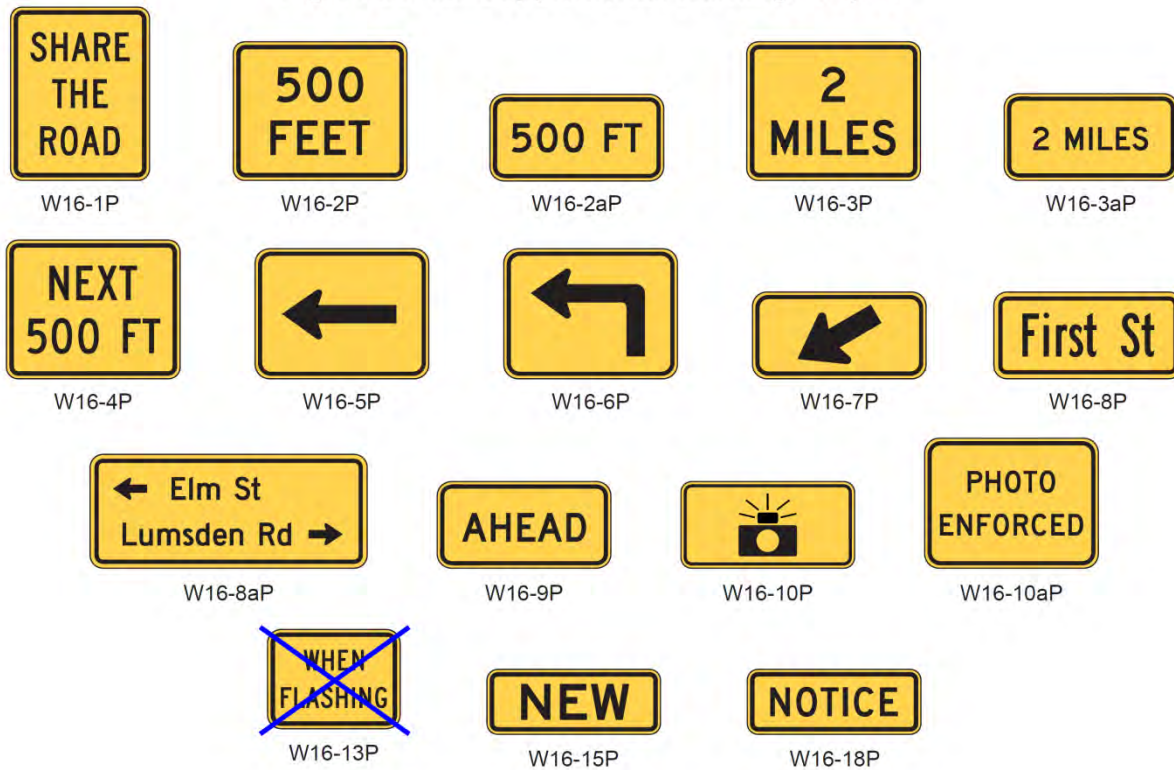


\* A fluorescent yellow-green background color may be used for this sign or plaque.

**Figure 2C-11 (CA). Non-Vehicular Warning Signs**



**Figure 2C-12. Supplemental Warning Plaques**

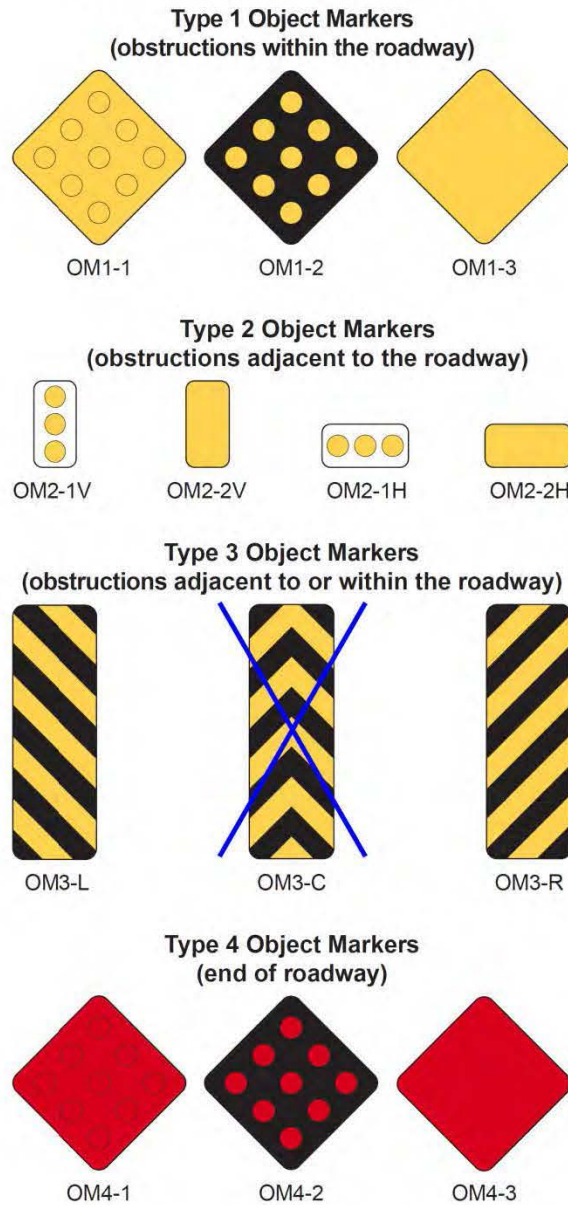


**Figure 2C-12 (CA). Supplemental Warning Plaques**



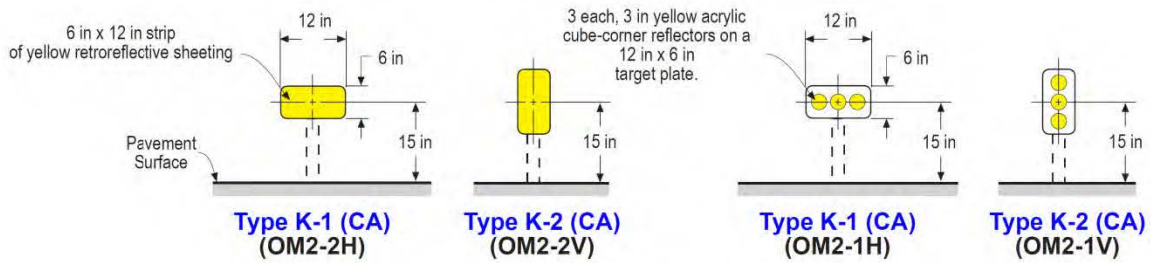
W34A (CA)

**Figure 2C-13. Object Markers**

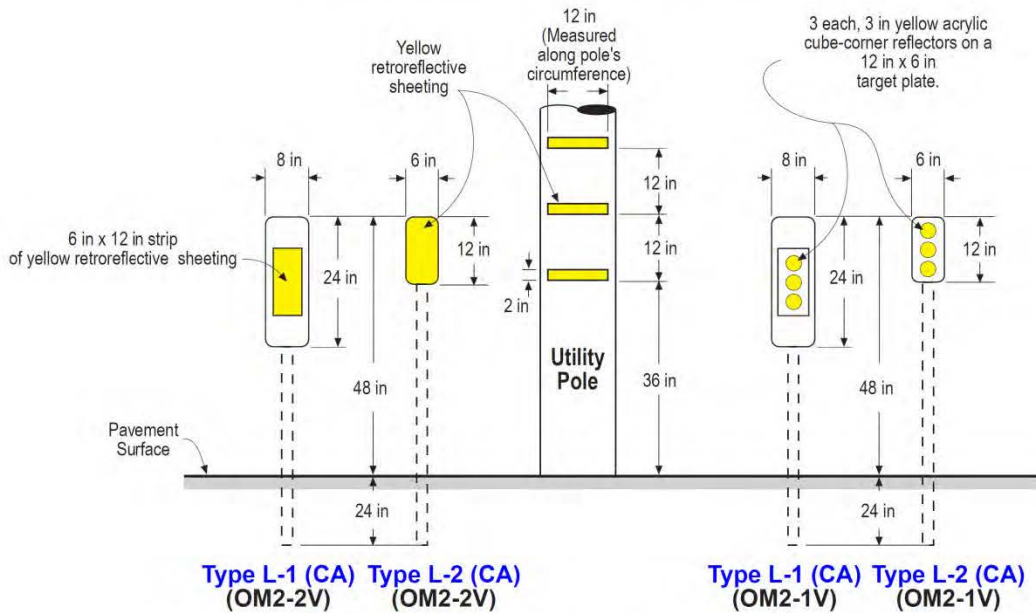


**Figure 2C-13 (CA). California Object Markers (Sheet 1 of 2)**

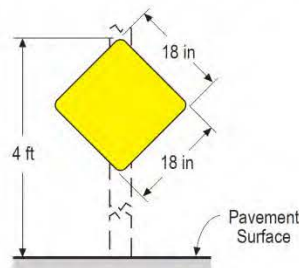
**Type K (CA) Object Marker (Type 2)  
 (obstructions adjacent to the roadway)**



**Type L (CA) Object Marker (Type 2)  
 (obstructions adjacent to the roadway)**



**Type N (CA) Object Marker (Type 1 or Type 4)  
 (obstructions within the roadway or end of roadway)**

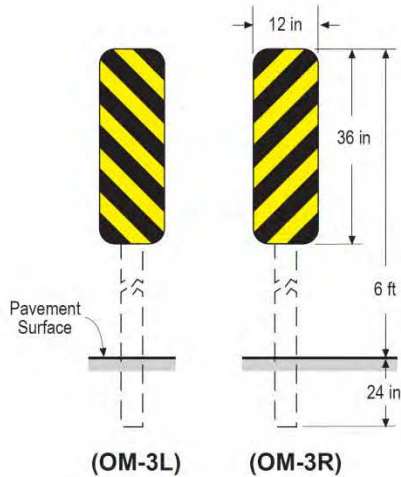


**Type N-1 (CA) (OM1-3), Type N-2 (CA) (OM4-3)**

NOT TO SCALE

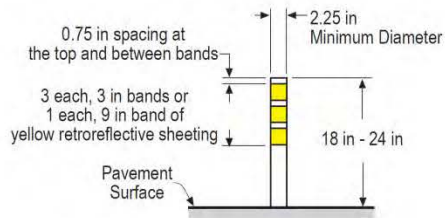
**Figure 2C-13 (CA). California Object Markers (Sheet 2 of 2)**

**Type P (CA) Object Marker (Type 3)  
 (obstructions adjacent to the roadway)**

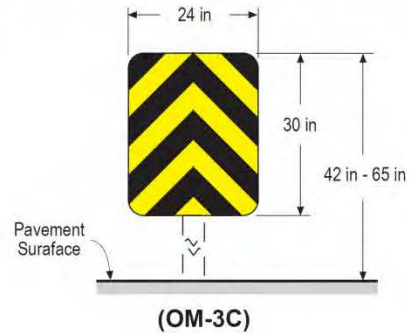


NOT TO SCALE

**Type Q (CA) Object Marker (Type 1)  
 (obstructions within the roadway)**

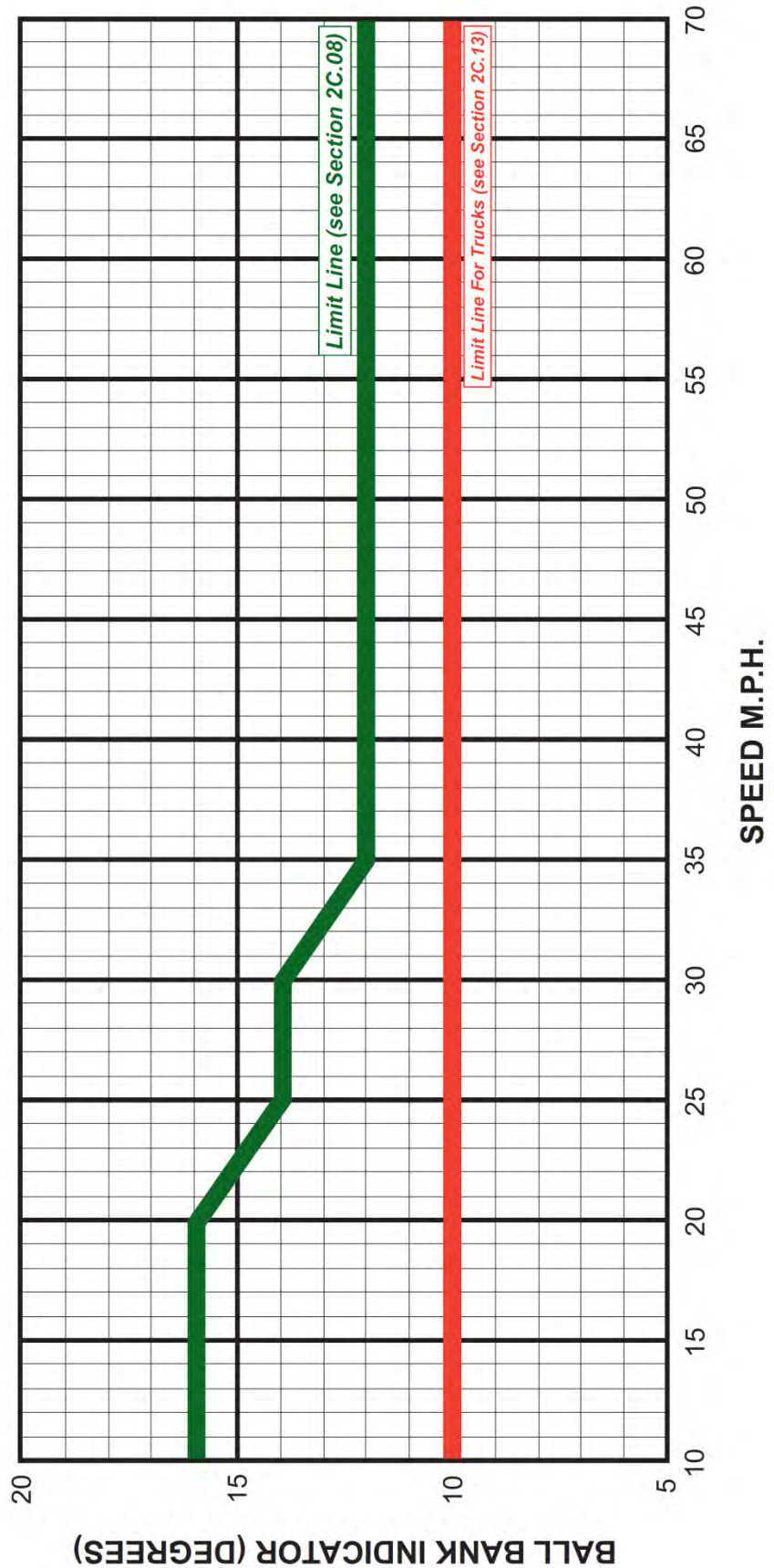


**Type R (CA) Object Marker (Type 1)  
 (obstructions within the roadway)**



**Figure 2C-101 (CA). Determination of Comfortable Speed From Ball Bank Indicator Readings**

Driver \_\_\_\_\_ Co. \_\_\_\_\_ Rte. \_\_\_\_\_ PM \_\_\_\_\_  
 Observer \_\_\_\_\_ Sta. \_\_\_\_\_ To \_\_\_\_\_  
 Vehicle \_\_\_\_\_ Min. Sight Dist. Thru Curve \_\_\_\_\_ Direction \_\_\_\_\_  
 Date \_\_\_\_\_ Approach Speed \_\_\_\_\_ Weather \_\_\_\_\_  
 (Estimated or Observed) \_\_\_\_\_



**Table 2C-1. Categories of Warning Signs and Plaques**

| Category                   | Group                           | Section  | Signs or Plaques  | Sign Designations  |
|----------------------------|---------------------------------|--|---|--|
| Roadway Related            | Changes in Horizontal Alignment | 2C.07  | Turn, Curve, Reverse Turn, Reverse Curve, Winding Road, Hairpin Curve, 270-Degree Curve                             | W1-1,2,3,4,5,11,15   |
|                            |                                 | 2C.08  | Advisory Speed  | W13-1P   |
|                            |                                 | 2C.09  | Chevron Alignment   | W1-8   |
|                            |                                 | 2C.10  | Combination Horizontal Alignment/Advisory Speed   | W1-1a,2a   |
|                            |                                 | 2C.11  | Combination Horizontal Alignment/Intersection   | W1-10,10a,10b,10c,10d  |
|                            |                                 | 2C.12  | Large Arrow (one direction)   | W1-6   |
|                            |                                 | 2C.13  | Truck Rollover  | W1-13  |
|                            |                                 | 2C.14  | Advisory Exit or Ramp Speed   | W13-2,3  |
|                            | Vertical Alignment              | 2C.15  | Combination Horizontal Alignment/Advisory Exit or Ramp Speed  | W13-6,7  |
|                            |                                 | 2C.16  | Hill  | W7-1,1a,2P,2bP,3P,3aP,3bP                                      |
|                            |                                 | 2C.17  | Truck Escape Ramp   | W7-4,4b,4c,4dP,4eP,4fP   |
|                            | Cross Section                   | 2C.18  | Hill Blocks View  | W7-6   |
|                            |                                 | 2C.19  | Road Narrows  | W5-1   |
|                            |                                 | 2C.20,21   | Narrow Bridge, One Lane Bridge  | W5-2,3   |
|                            |                                 | 2C.22,23,25  | Divided Highway, Divided Highway Ends, Double Arrow   | W6-1,2; W12-1  |
|                            |                                 | 2C.24  | Freeway or Expressway Ends, All Traffic Must Exit   | W19-1,2,3,4,5  |
|                            |                                 | 2C.26  | Dead End, No Outlet   | W14-1,1a,2,2a  |
|                            | Roadway Surface Condition       | 2C.27  | Low Clearance   | W12-2,2a   |
|                            |                                 | 2C.28,29   | Bump, Dip, Speed Hump   | W8-1,2; W17-1  |
|                            |                                 | 2C.30  | Pavement Ends   | W8-3   |
| 2C.31                      |                                 | Shoulder, Uneven Lanes   | W8-4,9,11,17,17P,23,25  |  |
| 2C.32                      |                                 | Slippery When Wet, Loose Gravel, Rough Road, Bridge Ices Before Road, Fallen Rocks | W8-5,7,8,13,14  |  |
| Weather                    | 2C.33                           | Grooved Pavement, Metal Bridge Deck  | W8-15,15P,16  |  |
|                            | 2C.34                           | No Center Line   | W8-12   |  |
|                            | 2C.35                           | Road May Flood, Flood Gauge, Gusty Winds Area, Fog Area                            | W8-18,19,21,22  |  |
| Traffic Related            | Advance Traffic Control         | 2C.36-39   | Stop Ahead, Yield Ahead, Signal Ahead, Be Prepared To Stop, Speed Reduction, Drawbridge Ahead, Ramp Meter Ahead     | W3-1,2,3,4,5,5a,6,7,8  |
|                            | Traffic Flow                    | 2C.40-45   | Merge, No Merge Area, Lane Ends, Added Lane, Two-Way Traffic, Right Lane Exit Only Ahead, No Passing Zone           | W4-1,2,3,5,5P,6; W6-3; W9-1,2,7; W14-3                         |
|                            | Intersections                   | 2C.46  | Cross Road, Side Road, T, Y, Circular Intersection, Side Roads  | W2-1,2,3,4,5,6,7,8; W16-12P,17P                                |
|                            |                                 | 2C.47  | Large Arrow (two directions)  | W1-7   |
|                            |                                 | <del>2C.48</del>   | <del>Oncoming Extended Green</del>  | <del>W25-1,2</del>   |
|                            | Vehicular Traffic               | 2C.49  | Truck Crossing, Truck (symbol), Emergency Vehicle, Tractor, Bicycle, Golf Cart, Horse-Drawn Vehicle, Trail Crossing | W8-6; W11-1,5,5a,8,10,11,12P,14,15,15P,15a; <del>W16-13P</del> |
|                            | Non-Vehicular                   | 2C.50,51   | Pedestrian, Deer, Cattle, Snowmobile, Equestrian, Wheelchair, Large Animals, Playground                             | W11-2,3,4,6,7,9,16,17,18,19,20,21,22; W15-1; W16-13P           |
| New                        | 2C.52                           | New Traffic Pattern Ahead  | W23-2   |  |
| Other Supplemental Plaques | Location                        | 2C.53  | Downward Diagonal Arrow, Ahead  | W16-7P,9P  |
|                            | HOV                             | 2C.53  | High-Occupancy Vehicle  | W16-11P  |
|                            | Distance                        | 2C.55  | XX Feet, XX Miles, Next XX Feet, Next XX Miles  | W7-3aP; W16-2P,2aP,3P,3aP,4P                                   |
|                            | Arrow                           | 2C.56  | Advance Arrow, Directional Arrow  | W16-5P,6P  |
|                            | Street Name Plaque              | 2C.58  | Advance Street Name   | W16-8P,8aP   |
|                            | Intersection                    | 2C.59  | Cross Traffic Does Not Stop   | W4-4P,4aP,4bP  |
|                            | Share The Road                  | 2C.60  | Share The Road  | W16-1P   |
|                            | Photo Enforced                  | 2C.61  | Photo Enforced  | W16-10P,10aP   |
| New                        | 2C.62                           | New  | W16-15P   |  |



**Table 2C-2. Warning Sign and Plaque Sizes (Sheet 1 of 3)**

| Sign or Plaque                                   | Sign Designation          | Section | Conventional Road |            | Expressway | Freeway | Minimum  | Oversized |
|--|---------------------------|---------|-------------------|------------|------------|---------|----------|-----------|
|  |                           |         | Single Lane       | Multi-Lane |            |         |          |           |
| Horizontal Alignment                             | W1-1,2,3,4,5              | 2C.07   | 30 x 30*          | 36 x 36    | 36 x 36    | 36 x 36 | —        | 48 x 48   |
| Combination Horizontal Alignment/Advisory Speed  | W1-1a,2a                  | 2C.10   | 36 x 36           | 36 x 36    | 48 x 48    | 48 x 48 | —        | 48 x 48   |
| One-Direction Large Arrow                        | W1-6                      | 2C.12   | 48 x 24           | 48 x 24    | 60 x 30    | 60 x 30 | —        | 60 x 30   |
| Two-Direction Large Arrow                        | W1-7                      | 2C.47   | 48 x 24           | 48 x 24    | —          | —       | —        | 60 x 30   |
| Chevron Alignment                                | W1-8                      | 2C.09   | 18 x 24           | 18 x 24    | 30 x 36    | 36 x 48 | —        | 24 x 30   |
| Combination Horizontal Alignment/Intersection    | W1-10,10a,10b,10c,10d,10e | 2C.11   | 36 x 36           | 36 x 36    | 36 x 36    | 48 x 48 | —        | —         |
| Hairpin Curve                                    | W1-11                     | 2C.07   | 30 x 30           | 30 x 30    | 36 x 36    | 48 x 48 | —        | 48 x 48   |
| Truck Rollover                                   | W1-13                     | 2C.13   | 36 x 36           | 36 x 36    | 36 x 36    | 48 x 48 | —        | 36 x 36   |
| 270-degree Loop                                  | W1-15                     | 2C.07   | 30 x 30           | 30 x 30    | 36 x 36    | 48 x 48 | —        | 48 x 48   |
| Intersection Warning                             | W2-1,2,3,4,5,6,7,8        | 2C.46   | 30 x 30           | 30 x 30    | 36 x 36    | —       | 24 x 24  | 48 x 48   |
| Advanced Traffic Control                         | W3-1,2,3                  | 2C.36   | 30 x 30           | 30 x 30    | 48 x 48    | 48 x 48 | 30 x 30  | —         |
| Be Prepared to Stop                              | W3-4                      | 2C.36   | 36 x 36           | 36 x 36    | 48 x 48    | 48 x 48 | 30 x 30  | —         |
| Reduced Speed Limit Ahead                        | W3-5                      | 2C.38   | 36 x 36           | 36 x 36    | 48 x 48    | 48 x 48 | —        | —         |
| XX MPH Speed Zone Ahead                          | W3-5a                     | 2C.38   | 36 x 36           | 36 x 36    | 48 x 48    | 48 x 48 | —        | —         |
| Draw Bridge                                      | W3-6                      | 2C.39   | 36 x 36           | 36 x 36    | 48 x 48    | —       | —        | 60 x 60   |
| Ramp Meter Ahead                                 | W3-7                      | 2C.37   | 36 x 36           | 36 x 36    | —          | —       | —        | —         |
| Ramp Metered When Flashing                       | W3-8                      | 2C.37   | 36 x 36           | 36 x 36    | —          | —       | —        | —         |
| Merge  | W4-1                      | 2C.40   | 36 x 36           | 36 x 36    | 48 x 48    | 48 x 48 | 30 x 30* | —         |
| Lane Ends  | W4-2                      | 2C.42   | 36 x 36           | 36 x 36    | 48 x 48    | 48 x 48 | 30 x 30* | —         |
| Added Lane                                       | W4-3                      | 2C.41   | 36 x 36           | 36 x 36    | 48 x 48    | 48 x 48 | 30 x 30* | —         |
| Cross Traffic Does Not Stop (plaque)             | W4-4P                     | 2C.59   | 24 x 12           | 24 x 12    | 36 x 18    | —       | —        | 48 x 24   |
| Traffic From Left (Right) Does Not Stop (plaque) | W4-4aP                    | 2C.59   | 24 x 12           | 24 x 12    | 36 x 18    | —       | —        | 48 x 24   |
| Oncoming Traffic Does Not Stop (plaque)          | W4-4bP                    | 2C.59   | 24 x 12           | 24 x 12    | 36 x 18    | —       | —        | 48 x 24   |
| Entering Roadway Merge                           | W4-5                      | 2C.40   | 36 x 36           | 36 x 36    | 48 x 48    | —       | —        | —         |
| No Merge Area (plaque)                           | W4-5P                     | 2C.40   | 18 x 24           | 18 x 24    | 24 x 30    | —       | —        | —         |
| Entering Roadway Added Lane                      | W4-6                      | 2C.41   | 36 x 36           | 36 x 36    | 48 x 48    | —       | —        | —         |
| Road Narrows                                     | W5-1                      | 2C.19   | 36 x 36           | 36 x 36    | 48 x 48    | 48 x 48 | 30 x 30* | —         |
| Narrow Bridge                                    | W5-2                      | 2C.20   | 36 x 36           | 36 x 36    | 48 x 48    | 48 x 48 | 30 x 30* | —         |
| One Lane Bridge                                  | W5-3                      | 2C.21   | 36 x 36           | 36 x 36    | 48 x 48    | 48 x 48 | 30 x 30* | —         |
| Divided Highway                                  | W6-1                      | 2C.22   | 36 x 36           | 36 x 36    | 48 x 48    | 48 x 48 | —        | —         |
| Divided Highway Ends                             | W6-2                      | 2C.23   | 36 x 36           | 36 x 36    | 48 x 48    | 48 x 48 | —        | —         |
| Two-Way Traffic                                  | W6-3                      | 2C.44   | 36 x 36           | 36 x 36    | 48 x 48    | 48 x 48 | —        | —         |
| Hill   | W7-1                      | 2C.16   | 30 x 30*          | 36 x 36    | 36 x 36    | 36 x 36 | 24 x 24* | 48 x 48   |
| Hill with Grade                                  | W7-1a                     | 2C.16   | 30 x 30*          | 36 x 36    | 36 x 36    | 36 x 36 | 24 x 24* | 48 x 48   |
| Use Low Gear (plaque)                            | W7-2P                     | 2C.57   | 24 x 18           | 24 x 18    | —          | —       | —        | —         |
| Trucks Use Lower Gear (plaque)                   | W7-2bP                    | 2C.57   | 24 x 18           | 24 x 18    | —          | —       | —        | —         |
| XX% Grade (plaque)                               | W7-3P                     | 2C.57   | 24 x 18           | 24 x 18    | —          | —       | —        | —         |
| Next XX Miles (plaque)                           | W7-3aP                    | 2C.55   | 24 x 18           | 24 x 18    | —          | —       | —        | —         |
| XX% Grade, XX Miles (plaque)                     | W7-3bP                    | 2C.57   | 24 x 18           | 24 x 18    | —          | —       | —        | —         |
| Runaway Truck Ramp XX Miles                      | W7-4                      | 2C.17   | 78 x 48           | 78 x 48    | 78 x 48    | 78 x 48 | —        | —         |
| Runaway Truck Ramp (with arrow)                  | W7-4b                     | 2C.17   | 78 x 60           | 78 x 60    | 78 x 60    | 78 x 60 | —        | —         |
| Truck Escape Ramp                                | W7-4c                     | 2C.17   | 78 x 60           | 78 x 60    | 78 x 60    | 78 x 60 | —        | —         |
| Sand, Gravel, Paved (plaques)                    | W7-4dP, 4eP, 4fP          | 2C.17   | 24 x 12           | 24 x 12    | 24 x 12    | 24 x 12 | —        | —         |
| Hill Blocks View                                 | W7-6                      | 2C.18   | 30 x 30*          | 36 x 36    | 36 x 36    | —       | —        | 48 x 48   |
| Bump or Dip                                      | W8-1,2                    | 2C.28   | 30 x 30*          | 36 x 36    | 36 x 36    | 48 x 48 | 24 x 24* | 48 x 48   |

**Table 2C-2. Warning Sign and Plaque Sizes (Sheet 2 of 3)**

| Sign or Plaque   | Sign Designation             | Section          | Conventional Road   |                    | Expressway         | Freeway            | Minimum             | Oversized          |
|--|------------------------------|------------------|---------------------|--------------------|--------------------|--------------------|---------------------|--------------------|
|  |                              |                  | Single Lane         | Multi-Lane         |                    |                    |                     |                    |
| Pavement Ends  | W8-3                         | 2C.30            | 36 x 36             | 36 x 36            | 48 x 48            | —                  | 30 x 30*            | —                  |
| Soft Shoulder  | W8-4                         | 2C.31            | 36 x 36             | 36 x 36            | 48 x 48            | 48 x 48            | 24 x 24*            | 48 x 48            |
| Slippery When Wet  | W8-5                         | 2C.32            | 30 x 30*            | 36 x 36            | 36 x 36            | 48 x 48            | 24 x 24*            | 48 x 48            |
| Road Condition (plaques)                                     | W8-5P,5bP,5cP                | 2C.32            | 24 x 18             | 24 x 18            | 30 x 24            | 36 x 30            | —                   | 36 x 30            |
| Ice  | W8-5aP                       | 2C.32            | 24 x 12             | 24 x 12            | 30 x 18            | 30 x 18            | —                   | —                  |
| Truck Crossing   | W8-6                         | 2C.49            | 36 x 36             | 36 x 36            | 36 x 36            | 48 x 48            | 24 x 24*            | 48 x 48            |
| Loose Gravel   | W8-7                         | 2C.32            | 36 x 36             | 36 x 36            | 36 x 36            | —                  | 24 x 24*            | 48 x 48            |
| Rough Road   | W8-8                         | 2C.32            | 36 x 36             | 36 x 36            | 36 x 36            | 48 x 48            | 24 x 24*            | 48 x 48            |
| Low Shoulder   | W8-9                         | 2C.31            | 36 x 36             | 36 x 36            | 36 x 36            | 48 x 48            | 24 x 24*            | 48 x 48            |
| Uneven Lanes   | W8-11                        | 2C.32            | 36 x 36             | 36 x 36            | 36 x 36            | 48 x 48            | —                   | 48 x 48            |
| No Center Line   | W8-12                        | 2C.34            | 36 x 36             | 36 x 36            | 36 x 36            | 48 x 48            | —                   | —                  |
| Bridge Ices Before Road                                      | W8-13                        | 2C.32            | 36 x 36             | 36 x 36            | 36 x 36            | 48 x 48            | 24 x 24*            | 48 x 48            |
| <del>Fallen Rocks</del>                                      | <del>W8-14</del>             | <del>2C.32</del> | <del>36 x 36*</del> | <del>36 x 36</del> | <del>36 x 36</del> | <del>48 x 48</del> | <del>24 x 24*</del> | <del>48 x 48</del> |
| Grooved Pavement   | W8-15                        | 2C.33            | 30 x 30*            | 36 x 36            | 36 x 36            | 48 x 48            | 24 x 24*            | 48 x 48            |
| Motorcycle (plaque)  | W8-15P                       | 2C.33            | 24 x 18             | 24 x 18            | 30 x 24            | 36 x 30            | —                   | 36 x 30            |
| Metal Bridge Deck  | W8-16                        | 2C.33            | 30 x 30*            | 36 x 36            | 36 x 36            | 48 x 48            | 24 x 24*            | 48 x 48            |
| Shoulder Drop Off (symbol)                                   | W8-17                        | 2C.31            | 30 x 30*            | 36 x 36            | 36 x 36            | 48 x 48            | 24 x 24*            | 48 x 48            |
| Shoulder Drop-Off (plaque)                                   | W8-17P                       | 2C.31            | 24 x 18             | 24 x 18            | 30 x 24            | 36 x 30            | —                   | 36 x 30            |
| Road May Flood   | W8-18                        | 2C.35            | 36 x 36             | 36 x 36            | 36 x 36            | 48 x 48            | 24 x 24*            | 48 x 48            |
| Flood Gauge  | W8-19                        | 2C.35            | 12 x 72             | 12 x 72            | —                  | —                  | —                   | —                  |
| Gusty Winds Area   | W8-21                        | 2C.35            | 36 x 36             | 36 x 36            | 36 x 36            | 48 x 48            | 24 x 24*            | 48 x 48            |
| Fog Area   | W8-22                        | 2C.35            | 36 x 36             | 36 x 36            | 36 x 36            | 48 x 48            | 24 x 24*            | 48 x 48            |
| No Shoulder  | W8-23                        | 2C.31            | 36 x 36             | 36 x 36            | 36 x 36            | 48 x 48            | 24 x 24*            | 48 x 48            |
| Shoulder Ends  | W8-25                        | 2C.31            | 30 x 30*            | 36 x 36            | 36 x 36            | 48 x 48            | 24 x 24*            | 48 x 48            |
| Left (Right) Lane Ends                                       | W9-1                         | 2C.42            | 36 x 36             | 36 x 36            | 36 x 36            | 48 x 48            | 30 x 30*            | 48 x 48            |
| <del>Lane Ends Merge Left (Right)</del>                      | <del>W8-2</del>              | <del>2C.42</del> | <del>36 x 36</del>  | <del>36 x 36</del> | <del>36 x 36</del> | <del>48 x 48</del> | <del>30 x 30*</del> | <del>48 x 48</del> |
| Right (Left) Lane Exit Only Ahead                            | W9-7                         | 2C.43            | 132 x 72            | 132 x 72           | 132 x 72           | 132 x 72           | —                   | —                  |
| Bicycle  | W11-1                        | 2C.49            | 30 x 30             | 30 x 30            | 36 x 36            | —                  | 24 x 24*            | 48 x 48            |
| Pedestrian   | W11-2                        | 2C.50            | 30 x 30*            | 36 x 36            | 36 x 36            | —                  | 24 x 24*            | 48 x 48            |
| Large Animals  | W11-3,4,16,17,18,19,20,21,22 | 2C.50            | 30 x 30*            | 36 x 36            | 36 x 36            | —                  | 24 x 24*            | 48 x 48            |
| Farm Vehicle   | W11-5,5a                     | 2C.49            | 30 x 30*            | 36 x 36            | 36 x 36            | —                  | 24 x 24*            | 48 x 48            |
| Snowmobile   | W11-6                        | 2C.50            | 30 x 30*            | 36 x 36            | 36 x 36            | —                  | 24 x 24*            | 48 x 48            |
| Equestrian   | W11-7                        | 2C.50            | 30 x 30*            | 36 x 36            | 36 x 36            | —                  | 24 x 24*            | 48 x 48            |
| Emergency Vehicle  | W11-8                        | 2C.49            | 30 x 30*            | 36 x 36            | 36 x 36            | —                  | 24 x 24*            | 48 x 48            |
| Handicapped  | W11-9                        | 2C.50            | 30 x 30*            | 36 x 36            | 36 x 36            | —                  | —                   | 48 x 48            |
| Truck  | W11-10                       | 2C.49            | 30 x 30*            | 36 x 36            | 36 x 36            | —                  | 24 x 24*            | 48 x 48            |
| Golf Cart  | W11-11                       | 2C.49            | 30 x 30*            | 36 x 36            | 36 x 36            | —                  | 24 x 24*            | 48 x 48            |
| Emergency Signal Ahead (plaque)                              | W11-12P                      | 2C.49            | 36 x 30             | 36 x 30            | 36 x 30            | —                  | —                   | —                  |
| Horse-Drawn Vehicle  | W11-14                       | 2C.49            | 30 x 30*            | 36 x 36            | 36 x 36            | —                  | 24 x 24*            | 48 x 48            |
| Bicycle / Pedestrian   | W11-15                       | 2C.49            | 30 x 30*            | 36 x 36            | 36 x 36            | —                  | 24 x 24*            | 48 x 48            |
| Trail Crossing   | W11-15a                      | 2C.49            | 30 x 30*            | 36 x 36            | 36 x 36            | —                  | 24 x 24*            | 48 x 48            |
| Trail X-ing (plaque)   | W11-15P                      | 2C.49            | 24 x 18             | 24 x 18            | 30 x 24            | —                  | —                   | 36 x 30            |
| Double Arrow   | W12-1                        | 2C.25            | 30 x 30*            | 36 x 36            | 36 x 36            | —                  | —                   | —                  |
| Low Clearance (with arrows)                                  | W12-2                        | 2C.27            | 36 x 36             | 36 x 36            | 48 x 48            | 48 x 48            | 30 x 30*            | —                  |
| Low Clearance  | W12-2a                       | 2C.27            | 78 x 24             | 78 x 24            | —                  | —                  | —                   | —                  |
| Advisory Speed (plaque)                                      | W13-1P                       | 2C.08            | 18 x 18             | 18 x 18            | 24 x 24            | 30 x 30            | —                   | 30 x 30            |
| Advisory Exit or Ramp Speed                                  | W13-2,3                      | 2C.14            | 24 x 30             | 24 x 30            | 36 x 48            | 36 x 48            | —                   | 48 x 60            |
| Combination Horizontal Alignment/Advisory Exit or Ramp Speed | W13-6,7                      | 2C.15            | 24 x 42             | 24 x 42            | 36 x 60            | 36 x 60            | —                   | 48 x 84            |
| Dead End, No Outlet  | W14-1,2                      | 2C.26            | 30 x 30*            | 36 x 36            | 36 x 36            | —                  | 24 x 24*            | 48 x 48            |

**Table 2C-2. Warning Sign and Plaque Sizes (Sheet 3 of 3)**

| Sign or Plaque                           | Sign Designation   | Section          | Conventional Road  |                    | Expressway | Freeway  | Minimum      | Oversized    |
|--|--------------------|------------------|--------------------|--------------------|------------|----------|--------------|--------------|
|  |                    |                  | Single Lane        | Multi-Lane         |            |          |              |              |
| Dead End, No Outlet (with arrow)         | W14-1a,2a          | 2C.26            | 36 x 8             | 36 x 8             | —          | —        | —            | —            |
| No Passing Zone (pennant)                | W14-3              | 2C.45            | 48 x 48 x 36       | 48 x 48 x 36       | —          | —        | 40 x 40 x 30 | 64 x 64 x 48 |
| Playground                               | W15-1              | 2C.51            | 30 x 30*           | 36 x 36            | 36 x 36    | —        | 24 x 24*     | 48 x 48      |
| Share the Road (plaque)                  | W16-1P             | 2C.60            | 18 x 24            | 18 x 24            | 24 x 30    | —        | —            | 24 x 30      |
| XX Feet                                  | W16-2P             | 2C.55            | 24 x 18            | 24 x 18            | —          | —        | —            | 30 x 24      |
| XX Ft                                    | W16-2aP            | 2C.55            | 24 x 12            | 24 x 12            | —          | —        | —            | 30 x 18      |
| XX Miles (2-line plaque)                 | W16-3P             | 2C.55            | 30 x 24            | 30 x 24            | —          | —        | —            | —            |
| XX Miles (1-line plaque)                 | W16-3aP            | 2C.55            | 30 x 12            | 30 x 12            | —          | —        | —            | —            |
| Next XX Feet (plaque)                    | W16-4P             | 2C.55            | 30 x 24            | 30 x 24            | —          | —        | —            | —            |
| Supplemental Arrow (plaque)              | W16-5P,6P          | 2C.56            | 24 x 18            | 24 x 18            | —          | —        | —            | —            |
| Downward Diagonal Arrow (plaque)         | W16-7P             | 2C.50            | 24 x 12            | 24 x 12            | —          | —        | —            | 30 x 18      |
| Advance Street Name (1-line plaque)      | W16-8P             | 2C.58            | Varies x 8         | Varies x 8         | —          | —        | —            | —            |
| Advance Street Name (2-line plaque)      | W16-8aP            | 2C.58            | Varies x 15        | Varies x 15        | —          | —        | —            | —            |
| Ahead (plaque)                           | W16-9P             | 2C.50            | 24 x 12            | 24 x 12            | 30 x 18    | —        | —            | —            |
| Photo Enforced (symbol plaque)           | W16-10P            | 2C.61            | 24 x 12            | 24 x 12            | 36 x 18    | —        | —            | 48 x 24      |
| Photo Enforced (plaque)                  | W16-10aP           | 2C.61            | 24 x 18            | 24 x 18            | 36 x 30    | —        | —            | 48 x 36      |
| HOV (plaque)                             | W16-11P            | 2G.09            | 24 x 12            | 24 x 12            | 30 x 18    | —        | —            | 30 x 18      |
| Traffic Circle (plaque)                  | W16-12P            | 2C.46            | 24 x 18            | 24 x 18            | —          | —        | —            | —            |
| <del>When Flashing (plaque)</del>        | <del>W16-13P</del> | <del>2C.50</del> | <del>24 x 18</del> | <del>24 x 18</del> |            |          |              |              |
| New (plaque)                             | W16-15P            | 2C.62            | 24 x 12            | 24 x 12            | —          | —        | —            | —            |
| Roundabout (plaque)                      | W16-17P            | 2C.46            | 24 x 12            | 24 x 12            | —          | —        | —            | —            |
| NOTICE                                   | W16-18P            | 2A.15            | 24 x 12            | 24 x 12            | —          | —        | —            | —            |
| Speed Hump                               | W17-1              | 2C.29            | 30 x 30*           | 36 x 36            | —          | —        | 24 x 24*     | 48 x 48      |
| Freeway Ends XX Miles                    | W19-1              | 2C.24            | —                  | —                  | —          | 144 x 48 | —            | —            |
| Expressway Ends XX Miles                 | W19-2              | 2C.24            | —                  | —                  | 144 x 48   | —        | —            | —            |
| Freeway Ends                             | W19-3              | 2C.24            | —                  | —                  | —          | 48 x 48  | —            | —            |
| Expressway Ends                          | W19-4              | 2C.24            | —                  | —                  | 48 x 48    | —        | —            | —            |
| All Traffic Must Exit                    | W19-5              | 2C.24            | —                  | —                  | 90 x 48    | 90 x 48  | —            | —            |
| New Traffic Pattern Ahead                | W23-2              | 2C.52            | 36 x 36            | 36 x 36            | —          | —        | —            | —            |
| <del>Traffic Signal Extended Green</del> | <del>W25-1,2</del> | <del>2C.48</del> | <del>24 x 30</del> | <del>24 x 30</del> |            |          |              |              |

**Table 2C-2(CA). California Warning Sign and Plaque Sizes (Sheet 1 of 2)**

| Sign or Plaque                                    | Sign Designation | Section             | Conventional Road |            | Expressway | Freeway       | Minimum | Oversized      |
|---|------------------|---------------------|-------------------|------------|------------|---------------|---------|----------------|
|   |                  |                     | Single Lane       | Multi-Lane |            |               |         |                |
| Combination Reverse Turn/Advisory Speed           | W4-1(CA)         | 2C.07, 2C.10        | 48X48             | 48X48      | 60X60      | 60X60         | ---     | 72X72<br>96X96 |
| Combination Hairpin Curve/Advisory Speed          | W4-10(CA)        | 2C.07, 2C.10        | 48X48             | 48X48      | 60X60      | 60X60         | ---     | 72X72<br>96X96 |
| Combination 270-degree Loop/Advisory Speed        | W4-14(CA)        | 2C.07               | 48X48             | 48X48      | 60X60      | 60X60         | ---     | 72X72<br>96X96 |
| Combination Reverse Curve/Advisory Speed          | W4-18(CA)        | 2C.07, 2C.10        | 48X48             | 48X48      | 60X60      | 60X60         | ---     | 72X72<br>96X96 |
| Combination Truck Rollover Warning/Advisory Speed | W4-22(CA)        | 2C.07, 2C.10        | 72X72             | 72X72      | 72X72      | 72X72         | ---     | 96X96          |
| Weight Limit                                      | W20(CA)          | 2B.59               | 30X36             | 30X36      | 36X48      | 36X48         | ---     | ---            |
| Weight Limit                                      | W20A(CA)         | 2B.59               | 30X30             | 30X30      | 36X40      | 36X40         | ---     | ---            |
| DEEP GRAVEL                                       | W30B(CA)         | 2C.17               | 36X36             | 36X36      | 36X36      | 36X36         | ---     | ---            |
| RIGHT(LEFT) EXIT                                  | W30C(CA)         | 2C.17               | ---               | ---        | 114X24     | 114X24        | 78X18   | ---            |
| END   | W31(CA)          | 2C.26, 2C.66        | 30X30             | 30X30      | 30X30      | 30X30         | 24X24   | ---            |
| ROAD ENDS ___ FT                                  | W31A(CA)         | 2C.26               | 30X30             | 30X30      | 36X36      | 36X36         | 24X24   | ---            |
| Distance Ahead plaque                             | W34A(CA)         | 2C.27, 2C.55        | 36X30             | 36X30      | 48X36      | 48X36         | ---     | 60X48          |
| CAUTION VERTICAL CLEARANCE ___' ___" Arrow        | W34C(CA)         | 2C.27               | 36X54             | 36X54      | 48X72      | 48X72         | ---     | ---            |
| SLIDE AREA  | W38(CA)          | 2C.32               | 30X30             | 30X30      | 48X48      | 48X48         | ---     | ---            |
| TWO WAY TRAFFIC plaque                            | W44A(CA)         | 2C.44               | 36X24             | 36X24      | ---        | ---           | ---     | ---            |
| Rock Slide Area                                   | W50-1(CA)        | 2C.32               | 36X36             | 36X36      | 48X48      | 48X48         | ---     | ---            |
| SLOW TRUCKS                                       | W51(CA)          | 2C.16               | 48X48             | 48X48      | 48X48      | 48X48         | ---     | 72X72          |
| FLOODED   | W55(CA)          | 2C.35               | 30X30             | 30X30      | 36X36      | 36X36         | ---     | ---            |
| END FREEWAY _____ MI                              | W69(CA)          | 2C.46               | ---               | ---        | ---        | 60X60         | ---     | ---            |
| CROSS TRAFFIC AHEAD                               | W70(CA)          | 2C.46               | ---               | ---        | 60X60      | ---           | ---     | ---            |
| RIGHT(LEFT) LANE EXITS AHEAD                      | W73(CA)          | 2C.42               | ---               | ---        | 48X48      | 48X48         | 36X36   | 60X60          |
| RIGHT(LEFT) LANE TURNS RIGHT(LEFT) AHEAD          | W73A(CA)         | 2C.40, 2C.42        | 36X36             | 36X36      | 48X48      | ---           | ---     | 60X60          |
| THRU TRAFFIC MERGE LEFT (RIGHT)                   | W74(CA)          | 2B.20, 2C.40, 2C.42 | 36X36             | 36X36      | 48X48      | 48X48         | ---     | 60X60          |
| PASS WITH CARE                                    | W83(CA)          | 2C.44               | 24X30             | 24X30      | 36X45      | 36X45         | ---     | ---            |
| SPEED HUMPS AHEAD                                 | W84(CA)          | 2C.29               | 36X36             | 36X36      | ---        | ---           | 30X30   | ---            |
| SPEED HUMP AREA                                   | W85(CA)          | 2C.29               | 36X36             | 36X36      | ---        | ---           | 30X30   | ---            |
| WHEN FLOODED TURN AROUND DON'T DROWN              | W87(CA)          | 2C.35               | 48X48             | 48X48      | ---        | ---           | 48X48   | ---            |
| "METER ON" Activated Blank-Out                    | W88-2(CA)        | 2C.37               | ---               | ---        | 96X48      | 96X48         | ---     | ---            |
| "_____ METER ON" Activated Blank-Out              | W88-3(CA)        | 2C.37               | ---               | ---        | 96X48      | 96X48         | ---     | ---            |
| "PREPARE TO STOP" Activated Blank-Out             | W89(CA)          | 2C.37               | ---               | ---        | 96X48      | 96X48         | ---     | ---            |
| WATCH DOWNHILL SPEED                              | SW4-1(CA)        | 2C.57               | 72X72             | 72X72      | 72X72      | 72X72         | ---     | ---            |
| TRAILERS-CAMPERS-GUSTY WIND AREA NEXT ___ MILES   | SW17-1(CA)       | 2C.38               | 132X48            | 132X48     | 132X48     | 132X48        | ---     | ---            |
| WINDING LEVEE ROAD                                | SW22-1(CA)       | 2C.07               | 42X42             | 42X42      | ---        | ---           | ---     | ---            |
| Speed/Distance plaque                             | SW22-1A(CA)      | 2C.07               | 30X18             | 30X18      | 30X18      | 30X18         | ---     | ---            |
| SIGNAL/STOP AHEAD Arrow                           | SW26(CA)         | 2C.36               | 60X60             | 72X72      | 72X72      | 72X72 (ramps) | ---     | 96X96          |
| DRIFTING SAND                                     | SW32(CA)         | 2C.32               | 36X36             | 36X36      | 48X48      | 48X48         | 30X30   | ---            |

**Table 2C-2(CA). California Warning Sign and Plaque Sizes (Sheet 2 of 2)**

| Sign or Plaque   | Sign Designation | Section | Conventional Road |            | Expressway | Freeway | Minimum | Oversized |
|--|------------------|---------|-------------------|------------|------------|---------|---------|-----------|
|  |                  |         | Single Lane       | Multi-Lane |            |         |         |           |
| FLASH FLOOD AREA   | SW35(CA)         | 2C.35   | 36X36             | 36X36      | 36X36      | 36X36   | ---     | ---       |
| END FREEWAY  | SW36(CA)         | 2C.46   | 48X48             | 48X48      | 48X48      | 48X48   | ---     | ---       |
| TUNNEL   | SW37(CA)         | 2C.20   | 30X30             | 30X30      | 30X30      | 30X30   | ---     | ---       |
| DEAF CHILDREN NEAR   | SW38(CA)         | 2C.50   | 30X30             | 30X30      | 30X30      | ---     | 24X24   | ---       |
| SNOW SLIDE AREA  | SW41(CA)         | 2C.32   | 36X36             | 36X36      | 48X48      | 48X48   | 30X30   | ---       |
| Downward Arrow   | SW44(CA)         | 2C.19   | 36X36             | 36X36      | 48X48      | 48X48   | 30X30   | ---       |
| WATCH FOR SNOW SLIPPERY                                      | SW46(CA)         | 2C.32   | 36X36             | 36X36      | 48X48      | 48X48   | ---     | ---       |
| OFF HIGHWAY VEHICLES   | SW47(CA)         | 2C.49   | 36X36             | 36X36      | 36X36      | ---     | 30X30   | ---       |
| TRACTOR-SEMIS OVER ___ FEET KINGPIN TO REAR AXLE NOT ADVISED | SW48(CA)         | 2C.07   | 48X36             | 48X36      | 72X54      | 72X54   | ---     | ---       |
| NEXT RIGHT   | SW48-1(CA)       | 2C.07   | 48X12             | 48X12      | 72X18      | 72X18   | ---     | ---       |
| PLAYGROUND   | SW49(CA)         | 2C.51   | 36X12             | 36X12      | 36X12      | ---     | ---     | ---       |
| SENIOR ZONE  | SW50-1P(CA)      | 2C.50   | 24X18             | 24X18      | 24X18      | ---     | ---     | ---       |
| SENIOR   | SW50-2P(CA)      | 2C.50   | 24X8              | 24X8       | 24X8       | ---     | ---     | ---       |
| EMERGENCY VEHICLES   | SW52(CA)         | 2C.49   | 42X42             | 42X42      | 48X48      | 48X48   | 30X30   | ---       |
| WATCH FOR SNOW REMOVAL EQUIPMENT                             | SW58(CA)         | 2C.49   | 36X36             | 36X36      | 54X48      | 54X48   | ---     | ---       |
| Migrating Bears  | SW59(CA)         | 2C.50   | 36X36             | 36X36      | 48X48      | 48X48   | 30X30   | ---       |
| WATCH FOR STOPPED VEHICLES                                   | SW60(CA)         | 2C.36   | 36X36             | 36X36      | 48X48      | 48X48   | ---     | ---       |

**Table 2C-3. Minimum Size of Supplemental Warning Plaques**

| Size of Warning Sign | Size of Supplemental Plaque |         |         |         |
|----------------------|-----------------------------|---------|---------|---------|
|                      | Rectangular                 |         |         | Square  |
|                      | 1 Line                      | 2 Lines | Arrow   |         |
| 24 x 24              | 24 x 12                     | 24 x 18 | 24 x 12 | 18 x 18 |
| 30 x 30              |                             |         |         |         |
| 36 x 36              | 30 x 18                     | 30 x 24 | 30 x 18 | 24 x 24 |
| 48 x 48              |                             |         |         |         |

Notes: 1. Larger supplemental plaques may be used when appropriate  
 2. Dimensions in inches are shown as width x height

**Table 2C-4. Guidelines for Advance Placement of Warning Signs**

| Posted or 85th-Percentile Speed | Advance Placement Distance <sup>1</sup>                                      |  |                     |                     |                     |                     |                     |                     |                     |
|---------------------------------|--|--|---------------------|---------------------|---------------------|---------------------|---------------------|---------------------|---------------------|
|                                 | Condition A: Speed reduction and lane changing in heavy traffic <sup>2</sup> | Condition B: Deceleration to the listed advisory speed (mph) for the condition |                     |                     |                     |                     |                     |                     |                     |
|                                 |  | 0 <sup>3</sup>   | 10 <sup>4</sup>     | 20 <sup>4</sup>     | 30 <sup>4</sup>     | 40 <sup>4</sup>     | 50 <sup>4</sup>     | 60 <sup>4</sup>     | 70 <sup>4</sup>     |
| 20 mph                          | 225 ft   | 100 ft <sup>6</sup>  | N/A <sup>5</sup>    | —                   | —                   | —                   | —                   | —                   | —                   |
| 25 mph                          | 325 ft   | 100 ft <sup>6</sup>  | N/A <sup>5</sup>    | N/A <sup>5</sup>    | —                   | —                   | —                   | —                   | —                   |
| 30 mph                          | 460 ft   | 100 ft <sup>6</sup>  | N/A <sup>5</sup>    | N/A <sup>5</sup>    | —                   | —                   | —                   | —                   | —                   |
| 35 mph                          | 565 ft   | 100 ft <sup>6</sup>  | N/A <sup>5</sup>    | N/A <sup>5</sup>    | N/A <sup>5</sup>    | —                   | —                   | —                   | —                   |
| 40 mph                          | 670 ft   | 125 ft   | 100 ft <sup>6</sup> | 100 ft <sup>6</sup> | N/A <sup>5</sup>    | —                   | —                   | —                   | —                   |
| 45 mph                          | 775 ft   | 175 ft   | 125 ft              | 100 ft <sup>6</sup> | 100 ft <sup>6</sup> | N/A <sup>5</sup>    | —                   | —                   | —                   |
| 50 mph                          | 885 ft   | 250 ft   | 200 ft              | 175 ft              | 125 ft              | 100 ft <sup>6</sup> | —                   | —                   | —                   |
| 55 mph                          | 990 ft   | 325 ft   | 275 ft              | 225 ft              | 200 ft              | 125 ft              | N/A <sup>5</sup>    | —                   | —                   |
| 60 mph                          | 1,100 ft   | 400 ft   | 350 ft              | 325 ft              | 275 ft              | 200 ft              | 100 ft <sup>6</sup> | —                   | —                   |
| 65 mph                          | 1,200 ft   | 475 ft   | 450 ft              | 400 ft              | 350 ft              | 275 ft              | 200 ft              | 100 ft <sup>6</sup> | —                   |
| 70 mph                          | 1,250 ft   | 550 ft   | 525 ft              | 500 ft              | 450 ft              | 375 ft              | 275 ft              | 150 ft              | —                   |
| 75 mph                          | 1,350 ft   | 650 ft   | 625 ft              | 600 ft              | 550 ft              | 475 ft              | 375 ft              | 250 ft              | 100 ft <sup>6</sup> |

<sup>1</sup> The distances are adjusted for a sign legibility distance of 180 feet for Condition A. The distances for Condition B have been adjusted for a sign legibility distance of 250 feet, which is appropriate for an alignment warning symbol sign. For Conditions A and B, warning signs with less than 6-inch legend or more than four words, a minimum of 100 feet should be added to the advance placement distance to provide adequate legibility of the warning sign.

<sup>2</sup> Typical conditions are locations where the road user must use extra time to adjust speed and change lanes in heavy traffic because of a complex driving situation. Typical signs are Merge and Right Lane Ends. The distances are determined by providing the driver a PRT of 14.0 to 14.5 seconds for vehicle maneuvers (2005 AASHTO Policy, Exhibit 3-3, Decision Sight Distance, Avoidance Maneuver E) minus the legibility distance of 180 feet for the appropriate sign.

<sup>3</sup> Typical condition is the warning of a potential stop situation. Typical signs are Stop Ahead, Yield Ahead, Signal Ahead, and Intersection Warning signs. The distances are based on the 2005 AASHTO Policy, Exhibit 3-1, Stopping Sight Distance, providing a PRT of 2.5 seconds, a deceleration rate of 11.2 feet/second<sup>2</sup>, minus the sign legibility distance of 180 feet.

<sup>4</sup> Typical conditions are locations where the road user must decrease speed to maneuver through the warned condition. Typical signs are Turn, Curve, Reverse Turn, or Reverse Curve. The distance is determined by providing a 2.5 second PRT, a vehicle deceleration rate of 10 feet/second<sup>2</sup>, minus the sign legibility distance of 250 feet.

<sup>5</sup> No suggested distances are provided for these speeds, as the placement location is dependent on site conditions and other signing. An alignment warning sign may be placed anywhere from the point of curvature up to 100 feet in advance of the curve. However, the alignment warning sign should be installed in advance of the curve and at least 100 feet from any other signs.

<sup>6</sup> The minimum advance placement distance is listed as 100 feet to provide adequate spacing between signs.

**Table 2C-5. Horizontal Alignment Sign Selection**

| Type of Horizontal Alignment Sign   | Difference Between Speed Limit and Advisory Speed<br>(See Section 2C.06) |             |             |          |                |
|---|--|-------------|-------------|----------|----------------|
|   | 5 mph  | 10 mph      | 15 mph      | 20 mph   | 25 mph or more |
| Turn (W1-1), Curve (W1-2), Reverse Turn (W1-3), Reverse Curve (W1-4), Winding Road (W1-5), and Combination Horizontal Alignment/Intersection (W1-10) (see Section 2C.07 to determine which sign to use) | Recommended  | Required    | Required    | Required | Required       |
| Advisory Speed Plaque (W13-1P)  | Recommended  | Required    | Required    | Required | Required       |
| Chevrons (W1-8) and/or One Direction Large Arrow (W1-6)   | Optional   | Recommended | Required    | Required | Required       |
| Exit Speed (W13-2) and Ramp Speed (W13-3) on exit ramp  | Optional   | Optional    | Recommended | Required | Required       |

**Table 2C-6. Typical Spacing of Chevron Alignment Signs on Horizontal Curves**

| Advisory Speed   | Curve Radius         | Sign Spacing |
|------------------|----------------------|--------------|
| 15 mph or less   | Less than 200 feet   | 40 feet      |
| 20 to 30 mph     | 200 to 400 feet      | 80 feet      |
| 35 to 45 mph     | 401 to 700 feet      | 120 feet     |
| 50 to 60 mph     | 701 to 1,250 feet    | 160 feet     |
| More than 60 mph | More than 1,250 feet | 200 feet     |

Note: The relationship between the curve radius and the advisory speed shown in this table should not be used to determine the advisory speed.

**Table 2C-101(CA). California Object Markers**

| Object Marker                   | California Designation | MUTCD Designation | Section                                       |
|---------------------------------|------------------------|-------------------|---|
| Typical CA Type K Object Marker | K-1(CA)                | OM2-2H            | 2C.63, 2C.65                                  |
| Typical CA Type K Object Marker | K-2(CA)                | OM2-2V            | 2C.63, 2C.65                                  |
| Typical CA Type L Object Marker | L-1(CA)                | OM2-2V            | 2C.63, 2C.65                                  |
| Typical CA Type L Object Marker | L-2(CA)                | OM2-2V            | 2C.63, 2C.65                                  |
| Typical CA Type N Object Marker | N-1(CA)                | OM1-3             | 2C.12, 2C.47, 2C.63, 2C.64, 2C.65, 6F.105(CA) |
| Typical End-of-Roadway Marker   | N-2(CA)                | OM4-3             | 2C.26, 2C.66                                  |
| Typical CA Type P Object Marker | P(CA)                  | OM-3L and OM-3R   | 2C.63, 2C.64, 6F.105(CA)                      |
| Typical CA Type Q Object Marker | Q(CA)                  | None              | 2C.63, 2C.64                                  |
| Typical CA Type R Object Marker | R(CA)                  | OM-3C             | 2C.63, 2C.64                                  |
| Typical CA Type L Object Marker | Utility Pole           | None              | 2C.63, 2C.65                                  |





## CHAPTER 2D. GUIDE SIGNS—CONVENTIONAL ROADS

### Section 2D.01 Scope of Conventional Road Guide Sign Standards

**Standard:**

01 **The provisions of this Chapter shall apply to expressways, freeways, any road or street other than low-volume roads (as defined in Section 5A.01), ~~expressways, and freeways~~ and except as provided for under Chapter 2E.**

### Section 2D.02 Application

**Support:**

01 Guide signs are essential to direct road users along streets and highways, to inform them of intersecting routes, to direct them to cities, towns, villages, or other important destinations, to identify nearby rivers and streams, parks, forests, and historical sites, and generally to give such information as will help them along their way in the most simple, direct manner possible.

02 Chapter 2A addresses placement, location, and other general criteria for signs.

03 *Guide signs are not intended to replace maps or substitute for adequate trip planning by road users.*

### Section 2D.03 Color, Retroreflection, and Illumination

**Support:**

01 Requirements for illumination, retroreflection, and color are stated under the specific headings for individual guide signs or groups of signs. General provisions are given in Sections 2A.07, 2A.08, and 2A.10.

**Standard:**

02 **Except where otherwise provided in this Manual for individual signs or groups of signs, guide signs on streets and highways shall have a white message and border on a green background. All messages, borders, and legends shall be retroreflective and all backgrounds shall be retroreflective or illuminated.**

**Support:**

03 Color coding is sometimes used to help road users distinguish between multiple potentially confusing destinations. Examples of valuable uses of color coding include guide signs for roadways approaching or inside an airport property with multiple terminals serving multiple airlines, and community wayfinding guide signs for various traffic generator destinations within a community or area.

**Standard:**

04 **Except where otherwise provided in this Manual, different color sign backgrounds shall not be used to provide color coding of destinations. The color coding shall be accomplished by the use of different colored square or rectangular sign panels on the face of the guide signs.**

**Option:**

05 The different colored sign panels may include a black or white (whichever provides the better contrast with the panel color) letter, numeral, or other appropriate designation to identify an airport terminal or other destination.

**Support:**

06 Two examples of color-coded sign assemblies are shown in Figure 2D-1. Section 2D.50 contains specific provisions regarding Community Wayfinding guide signs.

### Overhead Guide Sign Illumination Policy

*Guidance:*

07 *Fixed-lighting should be used to illuminate signs unless retroreflective luminance from headlights provides effective nighttime legibility. The type of fixed-lighting chosen should provide effective and reasonably uniform illumination of the sign face and message.*

**Standard:**

08 **In conjunction with the requirement for retroreflective backgrounds, the Overhead Guide Sign Illumination policy shall apply to all existing and new overhead guide signs.**

Support:

<sup>09</sup> In all applications of the policy, engineering judgment must be exercised. The purpose of the policy is to provide for uniform application of signs statewide. The intent is to make signs conspicuous (target value) and legible to motorists. The policy is consistent with federal requirements.

**Existing Overhead Signs**

Guidance:

<sup>10</sup> *Currently lighted signs with opaque backgrounds should remain lighted.*

Option:

<sup>11</sup> Currently unlighted opaque signs may be lighted. Retrofit-walkways for fixed –lighting systems need to be checked for proper clearance to the roadway.

**Standard:**

<sup>12</sup> **Signs with opaque backgrounds shall be replaced with new signs with retroreflective backgrounds, legends and borders when the old signs have reached the end of their useful life or are replaced for other reasons.**

Guidance:

<sup>13</sup> *Fixed-lighting should be used to illuminate signs with retroreflective backgrounds, legends and borders unless retroreflective luminance from headlights provides effective nighttime legibility*

**New Overhead Signs**

**Standard:**

<sup>14</sup> **Signs shall have retroreflective backgrounds, legends and borders.**

Guidance:

<sup>15</sup> *Fixed-lighting should be used to illuminate signs unless retroreflective luminance from headlights provides effective nighttime legibility.*

**Standard:**

<sup>16</sup> **Basic components for fixed-lighting systems shall be provided even if lights are not planned initially.**

Guidance:

<sup>17</sup> *Signs should be designed and mounted as if lights were installed, as it could be necessary to provide fixed-lighting for the sign at some future date.*

**Fixed-lighting Systems**

Guidance:

<sup>18</sup> *Energy conservation systems should be considered for fixed-lighting.*

**Engineering Considerations**

Guidance:

<sup>19</sup> *The following criteria should be considered in determining which signs should be lighted:*

- A. *Signs skewed or otherwise positioned relative to traffic so as to render retroreflective luminance from headlights ineffective.*
- B. *Signs that for some other reason are not legible when illuminated by vehicle headlights.*
- C. *Signs adjacent to other signs requiring or having fixed-lighting.*
- D. *Signs in advance of ramps in urban areas with heavy traffic during the evening peak period.*

**Energy Conservation Measures for Guide Signs**

Guidance:

<sup>20</sup> *All non-action guide sign lighting (Interchange Sequence (G23(CA) Series) signs) should be turned off, except in special situations where motorist safety could be affected.*

<sup>21</sup> *Following are some situations where engineering judgment should be used to determine if illumination should be maintained:*

- A. *Locations prone to heavy fog or poor visibility.*
- B. *Signs in work zones or in the proximity of work zones.*
- C. *Non-action guide signs adjacent to other signs that must be lighted.*

<sup>22</sup> *All G21(CA) Series, G24(CA) Series, G83(CA) Series, G85(CA) Series and G86(CA) Series and other action guide signs should remain lighted on highways.*

<sup>23</sup> *When illuminated, lights should be replaced with energy efficient fixtures on highways.*

**Standard:**

**<sup>24</sup> New overhead guide sign structure designs shall include appropriate conduit, pull boxes, and fixture attachment points for the future installation of sign lighting, if and when needed.**

**Section 2D.04 Size of Signs**

**Standard:**

**<sup>01</sup> Except as provided in Section 2A.11, the sizes of conventional road guide signs that have standardized designs shall be as shown in Table 2D-1 and 2D-1(CA).**

**Support:**

<sup>02</sup> Section 2A.11 contains information regarding the applicability of the various columns in Table 2D-1 and 2D-1(CA).

**Option:**

<sup>03</sup> Signs larger than those shown in Table 2D-1 and 2D-1(CA) may be used (see Section 2A.11).

**Support:**

<sup>04</sup> For other guide signs, the legends are so variable that a standardized design or size is not appropriate. The sign size is determined primarily by the length of the message, and the size of lettering and spacing necessary for proper legibility.

**Option:**

<sup>05</sup> Reduced letter height, reduced interline spacing, and reduced edge spacing may be used on guide signs if sign size must be limited by factors such as lane width or vertical or lateral clearance.

**Guidance:**

<sup>06</sup> *Reduced spacing between the letters or words on a line of legend should not be used as a means of reducing the overall size of a guide sign, except where determined necessary by engineering judgment to meet unusual lateral space constraints. In such cases, the legibility distance of the sign legend should be the primary consideration in determining whether to reduce the spacing between the letters or the words or between the words and the sign border, or to reduce the letter height.*

<sup>07</sup> *When a reduction in the prescribed size is necessary, the design used should be as similar as possible to the design for the standard size.*

**Support:**

<sup>08</sup> Sign design details are contained in FHWA's "Standard Highway Signs and Markings" book and Caltrans' California Sign Specifications. See Section 1A.11 for information regarding these publications.

**Section 2D.05 Lettering Style**

**Standard:**

**<sup>01</sup> The design of upper-case letters, lower-case letters, numerals, route shields, and spacing shall be as provided in the "Standard Highway Signs and Markings" book (see Section 1A.11).**

**<sup>02</sup> The lettering for names of places, streets, and highways on conventional road guide signs shall be a combination of lower-case letters with initial upper-case letters (see Section 2A.13). The nominal loop height of the lower-case letters shall be 3/4 the height of the initial upper-case letter. When a mixed-case legend letter height is specified referring only to the initial upper-case letter, the height of the lower-case letters that follow shall be determined by this proportion. When the height of a lower-case letter is referenced, the reference is made to the nominal loop height and the height of the initial upper-case letter shall also be determined by this proportion.**

**<sup>03</sup> All other word legends on conventional road guide signs shall be in upper-case letters.**

**<sup>04</sup> The unique letter forms for each of the Standard Alphabet series shall not be stretched, compressed, warped, or otherwise manipulated. Modifications to the length of a word for a given letter height and series shall be accomplished only by the methods described in Section 2D.04.**

**Section 2D.06 Size of Lettering**

**Support:**

<sup>01</sup> Sign legibility is a direct function of letter size and spacing. Legibility distance has to be sufficient to give road users enough time to read and comprehend the sign. Under optimum conditions, a guide sign message can

be read and understood in a brief glance. The legibility distance takes into account factors such as inattention, blocking of view by other vehicles, unfavorable weather, inferior eyesight, or other causes for delayed or slow reading. Where conditions permit, repetition of guide information on successive signs gives the road user more than one opportunity to obtain the information needed.

**Standard:**

**02 Design layouts for conventional road guide signs showing interline spacing, edge spacing, and other specification details shall be as shown in the “Standard Highway Signs and Markings” book (see Section 1A.11).**

**03 The principal legend on guide signs shall be in letters and numerals at least 6 inches in height for all upper-case letters, or a combination of 6 inches in height for upper-case letters and 4.5 inches in height for lower-case letters. On low-volume roads (as defined in Section 5A.01) with speeds of 25 mph or less, and on urban streets with speeds of 25 mph or less, the principal legend shall be in letters at least 4 inches in height for all upper-case letters, or a combination of 4 inches in height for upper-case letters and 3 inches in height for lower-case letters.**

*Guidance:*

*04 Lettering sizes should be consistent on any particular class of highway.*

*05 The minimum lettering sizes provided in this Manual should be exceeded where conditions indicate a need for greater legibility.*

**Standard:**

**06 Design layouts for conventional road guide signs showing interline spacing, edge spacing, and other specification details shall be as shown in FHWA's “Standard Highway Signs and Markings” book and Caltrans' California Sign Specifications. See Section 1A.11 for information regarding these publications.**

## **Section 2D.07 Amount of Legend**

**Support:**

**01 The longer the legend on a guide sign, the longer it will take road users to comprehend it, regardless of letter size.**

*Guidance:*

*02 Except where otherwise provided in this Manual, guide signs should be limited to no more than three lines of destinations, which include place names, route numbers, street names, and cardinal directions. Where two or more signs are included in the same overhead display, the amount of legend should be further minimized. Where appropriate, a distance message or action information, such as an exit number, NEXT RIGHT, or directional arrows, should be provided on guide signs in addition to the destinations.*

## **Section 2D.08 Arrows**

**Support:**

**01 Arrows are used for lane assignment and to indicate the direction toward designated routes or destinations. Figure 2D-2 and 2D-2(CA) shows the various standard arrow designs that have been approved for use on guide signs. Detailed drawings and standardized sizes based on ranges of letter heights are shown for these arrows in the “Standard Highway Signs and Markings” book (see Section 1A.11) and in Figure 2D-2(CA).**

**Standard:**

**02 On overhead signs where it is desirable to indicate a lane to be followed, a down arrow shall be positioned approximately over the center of the lane and shall point vertically downward toward the approximate center of that lane. Down arrows shall be used only on overhead guide signs that restrict the use of specific lanes to traffic bound for the destination(s) and/or route(s) indicated by these arrows. Down arrows shall not be used unless an arrow can be located over and pointed to the approximate center of each lane that can be used to reach the destination displayed on the sign.**

**03 If down arrows are used, having more than one down arrow pointing to the same lane on a single overhead sign (or on multiple signs on the same overhead sign structure) shall not be permitted. 04 Where a roadway is leaving the through lanes, a directional arrow shall point upward at an angle that approximates the alignment of the exit roadway.**

**Option:**

<sup>05</sup> Curved-stem arrows (see Figure 2D-8) that represent the intended driver paths to destinations involving left-turn movements may be used on guide signs on approaches to circular intersections.

**Standard:**

<sup>06</sup> **Curved-stem arrows shall not be used on any sign that is not associated with a circular intersection.**

**Guidance:**

<sup>07</sup> *If curved-stem arrows are used, the principles set forth in Sections 2D.26 through 2D.29 should be followed.*

<sup>08</sup> *The Type A directional arrow should be used on guide signs on freeways, expressways, and conventional roads to indicate the direction to a specific destination or group of destinations, except as otherwise provided in this Section and in Section 2E.19.*

<sup>09</sup> *When a directional arrow in a vertical, upward-pointing orientation is placed to the side of a group of destinations to indicate a through movement, the Type A directional arrow should be used. When a directional arrow in a vertical, upward-pointing orientation is placed to the side of a single destination or under a destination or group of destinations, the Type B directional arrow should be used.*

<sup>10</sup> *The Type B directional arrow should be used on guide signs on conventional roads when placed at any angle to the side of a single destination or when placed in a horizontal orientation to the side of a group of destinations.*

<sup>11</sup> *The Type C advance turn directional arrow should be used on conventional road guide signs placed in advance of an intersection where a turn must be made to reach a posted destination or group of destinations.*

<sup>12</sup> *The Type D directional arrow should be used primarily for sign applications other than guide signs, except as provided in Paragraph ~~15~~ 16.*

**Option:**

<sup>13</sup> The Type A-Extended directional arrow may be used on guide signs where additional emphasis regarding the direction is needed relative to the amount of legend on the sign.

<sup>14</sup> The Type C directional arrow may be used to the side of the legend of an overhead guide sign to accentuate a sharp turn exit maneuver from a mainline roadway (see Section 2E.36 for additional information regarding Exit Direction signs for low advisory ramp speeds).

<sup>15</sup> On conventional roads on the approach to an intersection where the Combination Lane-Use/Destination overhead guide sign (see Section 2D.33) is not used, the Type C advance turn directional arrow may be used beneath the legend of an overhead guide sign to indicate the fact that a turn must be made from a mandatory movement lane over which the sign is placed to reach the destination or destinations displayed on the sign.

<sup>16</sup> The Type D directional arrow may be used on post-mounted guide signs on conventional roads with lower operating speeds if the height of the text on the sign is 8 inches or less.

<sup>17</sup> The directional and down arrows shown in Figure 2D-2 and 2D-2(CA) may be used on signs other than guide signs for the purposes of providing directional guidance and lane assignment.

**Guidance:**

<sup>18</sup> *Arrows used on guide signs to indicate the directions toward designated routes or destinations should be pointed at the appropriate angle to clearly convey the direction to be taken. A horizontally oriented directional arrow design should be used at right-angle intersections.*

<sup>19</sup> *On a post-mounted guide sign, a directional arrow for a straight-through movement should point upward. Except as provided in Section 2D.46, for a turn, the arrow on a guide sign should point horizontally or at an upward angle that approximates the sharpness of the turn.*

<sup>20</sup> *At an exit, an arrow should be placed at the side of the sign that will reinforce the movement of exiting traffic. The directional arrow design should be used.*

**Option:**

<sup>21</sup> Arrows may be placed below the principal sign legend or on the appropriate side of the legend.

<sup>22</sup> On a post-mounted sign at an exit where placement of the arrow to the side of the legend farthest from the roadway would create an unusually wide sign that limits the road user's view of the arrow, the directional arrow may be placed at the bottom portion of the sign, centered under the legend.

**Guidance:**

<sup>23</sup> *The width across the arrowhead for the Types A, B, and C directional arrows should be between 1.5 and 1.75 times the height of the upper-case letters of the principal legend on the sign. The width across the arrowhead for the Type D directional arrow should be at least equal to the height of the upper-case letters of the principal*

*legend on the sign. For down arrows used on overhead signs, the width across the arrowhead should be approximately two times the height of the upper-case letters of the principal legend on the sign.*

*<sup>24</sup> Arrows used in Overhead Arrow-per-Lane and Diagrammatic guide signing, if used on conventional roads, except for signs on approaches to roundabouts, should follow the principles set forth in Section 2E.19. Arrows used in Diagrammatic guide signing on approaches to roundabouts should follow the principles set forth in Section 2D.38.*

Support:

<sup>25</sup> The "Standard Highway Signs and Markings" book (see Section 1A.11) contains design details and standardized sizes of the various arrows based on ranges of letter heights of principal legends.

## **Section 2D.09 Numbered Highway Systems**

Support:

<sup>01</sup> The purpose of numbering and signing highway systems is to identify routes and facilitate travel.

<sup>02</sup> The Interstate and United States (U.S.) highway systems are numbered by the American Association of State Highway and Transportation Officials (AASHTO) upon recommendations of the State highway organizations because the respective States own these systems. State and county road systems are numbered by the appropriate authorities.

<sup>03</sup> The basic policy for numbering the Interstate and U.S. highway systems is contained in the following Purpose and Policy statements published by AASHTO (see Page i for AASHTO's address):

A. "Establishment and Development of United States Numbered Highways," and

B. "Establishment of a Marking System of the Routes Comprising the National System of Interstate and Defense Highways."

Guidance:

<sup>04</sup> *The principles of these policies should be followed in establishing the highway systems described in Paragraph 2 and any other systems, with effective coordination between adjacent jurisdictions. Care should be taken to avoid the use of numbers or other designations that have been assigned to Interstate, U.S., or State routes in the same geographic area. Overlapping numbered routes should be kept to a minimum.*

**Standard:**

<sup>05</sup> **Route systems shall be given preference in this order: Interstate, United States, State, and county. The preference shall be given by installing the highest-priority legend on the top or the left of the sign.**

Support:

<sup>06</sup> Section 2D.53 contains information regarding the signing of unnumbered highways to enhance route guidance and facilitate travel.

Support:

<sup>07</sup> The California Legislature designates all State highway routes and assigns route numbers. General descriptions and route numbers are listed in Chapter 2, Article 3, of the California Streets and Highways Code. The route numbers are used for all administrative purposes.

<sup>08</sup> It is the intent of the Legislature that the numbers on the route guide signs is the same as the designated route number. The routes are described with a general directional convention from south to north and from west to east. The direction and Legislative Route number are used in the State Highway Log, which is distributed annually by Caltrans' Division of Traffic Operations.

<sup>09</sup> A specific location on any State highway is described by Post Mile designation. Post Mile information is available in the State Highway Log and is shown on Post Mile Maps distributed by Caltrans' Division of Transportation System Information. Note that California has adopted a policy of metrication of all engineering plans and specifications. However, a decision has not yet been made to use metric kilometer posts in the Highway Log.

<sup>10</sup> California has three route sign systems on State highways. Each system uses distinctive route signs and shields to inform motorists and to facilitate public travel. These route sign systems are shown on the State Highway Map published by Caltrans. Route numbers in one system will not be duplicated on another system. However, to inform the traveling public, route signs from the State Sign system are posted on the other sign route systems to provide guidance when a break occurs in the State Sign Route.

- A. Interstate System: A network of planned Interstate freeways of national importance are owned and operated by the State. The American Association of State Highway and Transportation Officials (AASHTO) developed the numbering of Interstate routes with the concurrence of the States. Renumbering of a route requires the approval of AASHTO, which assures conformity with established numbering procedures. Renumbering is a system action that must be approved by the Federal Highway Administrator.
- B. United States Numbered Highway Routes: A network of highways of national importance that was created in 1926. These State highways are not necessarily freeways. An U. S. Numbered Route has no connection with Federal control. However, the U. S. Routes are eligible for federal-aid funding according to the route's functional classification. The AASHTO Special Committee on U. S. Route Numbering has full authority for numbering U. S. Routes, with the concurrence of the States.
- C. State Sign Routes: State maintained highways, other than the above-signed routes, are distinctively signed to serve intra-State and interstate travel.

<sup>11</sup> State Business Routes and Interstate Loops are established by Caltrans District Directors.

<sup>12</sup> A Business Route generally is a local street or road in a city or urban area, designated by the same route number as the through Interstate, U.S., or State highway to which it is connected, with the words "Business Route" attached to the identifying route shields. The Business Route designation provides guidance for the traveling public to leave the main highway at one end of a city or urban area, patronize local businesses, and continue on to rejoin the main route at the opposite end of the city or urban area. The Caltrans Division of Transportation System Information is responsible for approval of Business Route designations.

<sup>13</sup> U.S. and Interstate Business Routes require AASHTO approval.

Option:

<sup>14</sup> Applications may be made by memorandum.

**Standard:**

<sup>15</sup> **Applications for Business Route designation and signing shall be made by written request from the local government agency to Caltrans' Division of Transportation System Information. Applications shall include a written request for the route from those local agencies within and whose boundaries the route traverses.**

Guidance:

<sup>16</sup> *A sketch, preferably on letter size stationary, showing the highway relocation and the business route or loop, should be included.*

**Standard:**

<sup>17</sup> **Submission for AASHTO approval shall be made Caltrans, Headquarters. Continuous business route signing shall be provided through the bypassed area and back to the highway. If a business route is approved prior to relinquishment, Caltrans shall install BUSINESS (M4-3) auxiliary signs or Off-Interstate Business Loop (M1-2) markers. After relinquishment, they shall be installed by the local agency involved.**

## **Section 2D.10 Route Signs and Auxiliary Signs**

**Standard:**

<sup>01</sup> **All numbered highway routes shall be identified by route signs and auxiliary signs.**

<sup>02</sup> **The signs for each system of numbered highways, which are distinctive in shape and color, shall be used only on that system and the approaches thereto.**

Option:

<sup>03</sup> Route signs and auxiliary signs may be proportionally enlarged where greater legibility is needed.

Support:

<sup>04</sup> Route signs are typically mounted in assemblies with auxiliary signs.

<sup>05</sup> Section 2D.55 contains information regarding the signing for National Scenic Byways.

<sup>06</sup> Section 2H.07 contains information regarding the signing for Auto Tour Routes.

## Section 2D.11 Design of Route Signs

### Standard:

<sup>01</sup> The “Standard Highway Signs and Markings” book (see Section 1A.11) shall be used for designing route signs. Other route sign designs shall be established by the authority having jurisdiction.

<sup>02</sup> Interstate Route signs (see Figure 2D-3) shall consist of a cutout shield, with the route number in white letters on a blue background, the word INTERSTATE in white upper-case letters on a red background, and a white border. This sign shall be used on all Interstate routes and in connection with route sign assemblies on intersecting highways.

### Guidance:

<sup>03</sup> A 24 x 24-inch minimum sign size ~~shall~~ **should** be used for Interstate route numbers with one or two digits, and a 30 x 24-inch minimum sign size ~~shall~~ **should** be used for Interstate route numbers having three digits.

### Support:

<sup>03a</sup> Route shield sizes shown in Table 2D-101(CA) are lower than the above sizes.

### Option:

<sup>04</sup> Interstate Route signs may contain the State name in white upper-case letters on a blue background.

### Standard:

<sup>05</sup> Off-Interstate Business Route signs (see Figure 2D-3) shall consist of a cutout shield carrying the number of the connecting Interstate route and the words BUSINESS and either LOOP or SPUR in upper-case letters. The legend and border shall be white on a green background, and the shield shall be the same shape and dimensions as the Interstate Route sign. In no instance shall the word INTERSTATE appear on the Off-Interstate Business Route sign.

### Option:

<sup>06</sup> The Off-Interstate Business Route sign may be used on a major highway that is not a part of the Interstate system, but one that serves the business area of a city from an interchange on the system.

<sup>07</sup> When used on a green guide sign, a white square or rectangle may be placed behind the shield to improve contrast.

### Standard:

~~<sup>08</sup> U.S. Route signs (see Figure 2D-3) shall consist of black numerals on a white shield surrounded by a rectangular black background without a border. This sign shall be used on all U.S. routes and in connection with route sign assemblies on intersecting highways.~~

~~<sup>09</sup> A 24 x 24-inch minimum sign size shall be used for U.S. route numbers with one or two digits, and a 30 x 24-inch minimum sign size shall be used for U.S. route numbers having three digits.~~

<sup>09a</sup> The U. S. Route Shield (G26-1(CA)) or U. S. Route Marker (G26-2(CA)) shall be used instead with sizes as shown in Table 2D-101(CA).

<sup>10</sup> State Route signs shall be designed by the individual State highway agencies.

### Guidance:

~~<sup>11</sup> State Route signs (see Figure 2D-3) should be rectangular and should be approximately the same size as the U.S. Route sign. State Route signs should also be similar to the U.S. Route sign by containing approximately the same size black numerals on a white area surrounded by a rectangular black background without a border. The shape of the white area should be circular in the absence of any determination to the contrary by the individual State concerned.~~

<sup>11a</sup> The State Route Shield (G28-1(CA)) or State Route Marker (G28-2(CA)) shall be used instead with sizes as shown in Table 2D-101(CA).

### Guidance:

<sup>12</sup> Where U.S. or State Route signs are used as components of guide signs, only the distinctive shape of the shield itself and the route numerals within should be used. The rectangular background upon which the distinctive shape of the shield is mounted, such as the black area around the outside of the shields on the M1-4 and standard M1-5 signs, should not be included on the guide sign. Where U.S. or State Route signs are used as components of other signs of non-contrasting background colors, the rectangular background should be used so that recognition of the distinctive shape of the shield can be maintained.



**Standard:**

13 **If county road authorities elect to establish and identify a special system of important county roads, a statewide policy for such signing shall be established that includes a uniform numbering system to uniquely identify each route. The County Route (M1-6) sign (see Figure 2D-3) shall consist of a pentagon shape with a yellow county name and route number and border on a blue background. County Route signs displaying two digits or the equivalent (letter and numeral, or two letters) shall be a minimum size of 18 x 18 inches; those carrying three digits or the equivalent shall be a minimum size of 24 x 24 inches.**

14 **If a jurisdiction uses letters instead of numbers to identify routes, all references to numbered routes in this Chapter shall be interpreted to also include lettered routes.**

*Guidance:*

15 *If used with other route signs in common assemblies, the County Route sign should be of a size compatible with that of the other route signs.*

*Option:*

16 *When used on a green guide sign, a yellow square or rectangle may be placed behind the County Route sign to improve contrast.*

**Standard:**

17 **Route signs (see Figure 2D-3) for park and forest roads shall be designed with adequate distinctiveness and legibility and of a size compatible with other route signs used in common assemblies.**

*Support:*

18 *The Route Shields are used on the face of guide signs. The Route Markers are used as stand-alone installations.*

*Guidance:*

19 *The U. S. Route Shield (G26-1(CA)), Interstate Route Shield (M1-1 or G27-1(CA)) or the State Route Shield (G28-1(CA)) should be used when they are placed on the face of a guide sign. These Route Shields should not be used for stand-alone installations.*

20 *The U. S. Route Marker (G26-2(CA)), Interstate CALIFORNIA Route Marker (G27-2(CA)) or the State Route Marker (G28-2(CA)) should be used for stand-alone installations as route markers. These Route Markers should not be used on the face of guide signs.*

*Support:*

21 *For Route Shield sizes, see Table 2D-101(CA).*

22 *For Route Shield and Marker sketches, see Figure 2D-3(CA).*

23 *The design details for Route Shields and Markers are contained in Caltrans' California Sign Specifications. See Section 1A.11 for information regarding these publications.*

*Option:*

24 *The EISENHOWER INTERSTATE SYSTEM (M1-10) sign may be placed on Interstate Highways on the right near the State boundary facing traffic entering the State and at rest areas and vista points on the Interstate Highway System.*

**Section 2D.12 Design of Route Sign Auxiliaries**

**Standard:**

01 **Route sign auxiliaries carrying word legends, except the JCT sign, shall have a standard size of 24 x 12 inches. Those carrying arrow symbols, or the JCT sign, shall have a standard size of 21 x 15 inches. All route sign auxiliaries shall match the color combination of the route sign that they supplement.**

*Guidance:*

02 *With route signs of larger heights, auxiliary signs should be suitably enlarged, but not such that they exceed the width of the route sign.*

03 *The background, legend, and border of a route sign auxiliary should have the same colors as those of the route sign with which the auxiliary is mounted in a route sign assembly (see Section 2D.29). For a route sign design that uses multiple background colors, such as the Interstate route sign, the background color of the corresponding auxiliary should be that of the background area on which the route number is placed on the route sign.*

*Option:*

04 *A route sign and any auxiliary signs used with it may be combined on a single sign as a guide sign.*

*Guidance:*

*05 If a route sign and its auxiliary signs are combined to form a single guide sign, the background color of the sign should be green and the design should comply with the basic principles for the design of guide signs.*

**Standard:**

**06 If a route sign and its auxiliary signs are combined on a single sign with a green background, the auxiliary messages shall be white legends placed directly on the green background. Auxiliary signs shall not be mounted directly to a guide sign or other type of sign.**

**Support:**

07 Chapter 2F contains information regarding auxiliary signs for toll highways.

**Option:**

08 The NEXT RIGHT/LEFT (G58(CA)) Auxiliary sign may be used on freeways, expressways or conventional highways in conjunction with, and placed below a route sign.

### **Section 2D.13 Junction Auxiliary Sign (M2-1)**

**Standard:**

**01 The Junction (M2-1) auxiliary sign (see Figure 2D-4) shall carry the abbreviated legend JCT and shall be mounted at the top of an assembly (see Section 2D.30) directly above the route sign, the sign for an alternative route (see Section 2D.17) that is part of the route designation, or the Cardinal Direction auxiliary sign where access is available only to one direction of the intersected route. The minimum size of the Junction auxiliary sign shall be 21 x 15 inches for compatibility with auxiliary signs carrying arrow symbols.**

### **Section 2D.14 Combination Junction Sign (M2-2)**

**Option:**

01 As an alternative to the standard Junction assembly where more than one route is to be intersected or joined, a rectangular guide sign may be used carrying the word JUNCTION above the route numbers.

**Standard:**

**02 The Combination Junction (M2-2) sign (see Figure 2D-4) shall have a green background with white border and lettering for the word JUNCTION.**

*Guidance:*

*03 The Combination Junction sign should comply with the specific provisions of Section 2D.11 regarding the incorporation of the route signs as components of guide signs.*

*04 Although the size of the Combination Junction sign will depend on the number of routes involved, the numerals should be large enough for clear legibility and should be of a size comparable with those in the individual route signs.*

### **Section 2D.15 Cardinal Direction Auxiliary Signs (M3-1 through M3-4)**

*Guidance:*

*01 Cardinal Direction auxiliary signs (see Figure 2D-4) carrying the legend NORTH, EAST, SOUTH, or WEST should be used to indicate the general direction of the entire route.*

**Standard:**

**02 To improve the readability and recognition of the cardinal directions, the first letter of the cardinal direction words shall be ten percent larger, rounded up to the nearest whole number size.**

**03 If used, the Cardinal Direction auxiliary sign shall be mounted directly above a route sign or, if used, an auxiliary sign for an alternative route.**

**Option:**

04 Cardinal Direction auxiliary signs may be placed to the right of the route shield, if used on the face of a guide sign.

**Support:**

05 For application of Cardinal Direction auxiliary signs in freeway entrance sign packages, refer to Section 2E.53.

### **Section 2D.16 Auxiliary Signs for Alternative Routes (M4 Series)**

**Option:**

01 Auxiliary signs, carrying legends such as ALTERNATE, BY-PASS, BUSINESS, or TRUCK, may be used to indicate an alternate route of the same number between two points on that route.

**Standard:**

02 **If used, the auxiliary signs for alternative routes shall be mounted directly above a route sign.**

### **Section 2D.17 ALTERNATE Auxiliary Signs (M4-1, M4-1a)**

**Option:**

01 The ALTERNATE (M4-1) or the ALT (M4-1a) auxiliary sign (see Figure 2D-4) may be used to indicate an officially designated alternate routing of a numbered route between two points on that route.

**Standard:**

02 **If used, the ALTERNATE or ALT auxiliary sign shall be mounted directly above a route sign.**

**Guidance:**

03 *The shorter (time or distance) or better-constructed route should retain the regular route number, and the longer or worse-constructed route should be designated as the alternate route.*

### **Section 2D.18 BY-PASS Auxiliary Sign (M4-2)**

**Option:**

01 The BY-PASS (M4-2) auxiliary sign (see Figure 2D-4) may be used to designate a route that branches from the numbered route through a city, bypasses a part of the city or congested area, and rejoins the numbered route beyond the city.

**Standard:**

02 **If used, the BY-PASS auxiliary sign shall be mounted directly above a route sign.**

### **Section 2D.19 BUSINESS Auxiliary Sign (M4-3)**

**Option:**

01 The BUSINESS (M4-3) auxiliary sign (see Figure 2D-4) may be used to designate an alternate route that branches from a numbered route, passes through the business portion of a city or unincorporated area, and rejoins the numbered route beyond that area.

**Standard:**

02 **If used, the BUSINESS auxiliary sign shall be mounted directly above a route sign.**

**Option:**

03 The ROUTE \_\_\_ BUSINESS (G76(CA)) sign (see Figure 2D-4(CA)) may be used to direct motorists to an established U. S. or State numbered business route or an interstate business loop from a State highway.

**Guidance:**

04 *The G76(CA) sign should be installed below an advance ground-mounted directional sign.*

**Option:**

05 *The G76(CA) sign may be placed separately in advance of the business route if it is necessary. A NEXT RIGHT/LEFT message may be used. Refer to Section 2D.09 for establishing business routes.*

### **Section 2D.20 TRUCK Auxiliary Sign (M4-4)**

**Option:**

01 The TRUCK (M4-4) auxiliary sign (see Figure 2D-4) may be used to designate an alternate route that branches from a numbered route, when it is desirable to encourage or require commercial vehicles to use the alternate route.

**Standard:**

02 **If used, the TRUCK auxiliary sign shall be mounted directly above a route sign.**

### **Section 2D.21 TO Auxiliary Sign (M4-5)**

**Option:**

01 The TO (M4-5) auxiliary sign (see Figure 2D-4) may be used to provide directional guidance to a particular road facility from other highways in the vicinity (see Section 2D.35).

**Standard:**

02 **If used, the TO auxiliary sign shall be mounted directly above a route sign or an auxiliary sign for an alternative route. If a Cardinal Direction auxiliary sign is also included in the assembly, the TO auxiliary sign shall be mounted directly above the Cardinal Direction auxiliary sign.**

### **Section 2D.22 END Auxiliary Sign (M4-6)**

*Guidance:*

01 *The END (M4-6) auxiliary sign (see Figure 2D-4) should be used where the route being traveled ends, usually at a junction with another route.*

**Standard:**

02 **If used, the END auxiliary sign shall be mounted either directly above a route sign or above a sign for an alternative route that is part of the designation of the route being terminated.**

### **Section 2D.23 BEGIN Auxiliary Sign (M4-14)**

**Option:**

01 The BEGIN (M4-14) auxiliary sign (see Figure 2D-4) may be used where a route begins, usually at a junction with another route.

**Standard:**

02 **If used, the BEGIN auxiliary sign shall be mounted at the top of the first Confirming assembly (see Section 2D.34) for the route that is beginning.**

*Guidance:*

03 *If a BEGIN auxiliary sign is included in the first Confirming assembly, a Cardinal Direction auxiliary sign should also be included in the assembly.*

**Standard:**

04 **If a Cardinal Direction auxiliary sign is also included in the assembly, the BEGIN auxiliary sign shall be mounted directly above the Cardinal Direction auxiliary sign.**

### **Section 2D.24 TEMPORARY Auxiliary Signs (M4-7, M4-7a)**

**Option:**

01 The TEMPORARY (M4-7) or the TEMP (M4-7a) auxiliary sign (see Figure 2D-4) may be used for an interim period to designate a section of highway that is not planned as a permanent part of a numbered route, but that connects completed portions of that route.

**Standard:**

02 **If used, the TEMPORARY or TEMP auxiliary sign shall be mounted directly above the route sign, above a Cardinal Direction sign, or above a sign for an alternate route that is a part of the route designation.**

03 **TEMPORARY or TEMP auxiliary signs shall be promptly removed when the temporary route is abandoned.**

### **Section 2D.25 Temporary Detour and Auxiliary Signs**

**Support:**

01 Chapter 6F contains information regarding Temporary Detour and Auxiliary signs.

### **Section 2D.26 Advance Turn Arrow Auxiliary Signs (M5-1, M5-2, and M5-3)**

#### **Standard:**

**01 If used, the Advance Turn Arrow auxiliary sign (see Figure 2D-5) shall be mounted directly below the route sign in Advance Route Turn assemblies, and displays a right or left arrow, the shaft of which is bent at a 90-degree angle (M5-1) or at a 45-degree angle (M5-2).**

**02 If used, the curved-stem Advance Turn Arrow auxiliary (M5-3) sign shall be used only on the approach to a circular intersection to depict a movement along the circulatory roadway around the central island and to the left, relative to the approach roadway and entry into the intersection.**

#### *Guidance:*

*03 If the M5-3 sign is used, then this arrow type should also be used consistently on any regulatory lane-use signs (see Chapter 2B), Destination signs (see Section 2D.37), and pavement markings (see Part 3) for a particular destination or movement.*

#### *Option:*

*04 The Advance Turn (G22(CA)) sign (see Figure 2D-5(CA)) may be used to give advance notice of a turnoff on expressways and high speed two-lane roads.*

#### *Guidance:*

*05 The G22(CA) sign should not be used on freeways. The G22(CA) sign should be placed on the right approximately 0.25 to 0.5 miles in advance of the turnoff.*

#### *Option:*

*06 A route shield may be used on the G22(CA) sign.*

### **Section 2D.27 Lane Designation Auxiliary Signs (M5-4, M5-5, and M5-6)**

#### *Option:*

*01 A Lane Designation (M5-4, M5-5, or M5-6) auxiliary sign (see Figure 2D-5) may be mounted directly below the route sign in an Advance Route Turn assembly on multi-lane roadways to allow road users to move into the appropriate lane prior to reaching the intersection or interchange.*

#### **Standard:**

**02 If used, the Lane Designation auxiliary signs shall be used only where the designated lane is a mandatory movement lane and shall be located adjacent to the full-width portion of the mandatory movement lane. The Lane Designation auxiliary signs shall not be installed adjacent to a through lane in advance of a lane that is being added or along the taper for a lane that is being added.**

### **Section 2D.28 Directional Arrow Auxiliary Signs (M6 Series)**

#### **Standard:**

**01 If used, the Directional Arrow auxiliary sign (see Figure 2D-5) shall be mounted below the route sign and any other auxiliary signs in Directional assemblies (see Section 2D.32), and displays a single- or double-headed arrow pointing in the general direction that the route follows.**

**02 A Directional Arrow auxiliary sign that displays a double-headed arrow shall not be mounted in any Directional assembly in advance of or at a circular intersection.**

#### *Option:*

*03 The downward pointing diagonal arrow auxiliary (M6-2a) sign may be used in a Directional assembly at the far corner of an intersection to indicate the immediate entry point to a freeway or expressway entrance ramp (see Section 2D.46).*

#### **Standard:**

**04 The M6-2a sign shall not be used on the approach to or on the near side of an intersection, such as to designate an approach lane.**

#### *Option:*

*05 The Directional Arrow auxiliary (G33-1(CA)) sign (see Figure 2D-5(CA)) may be used in lieu of the Directional Arrow auxiliary (M6 Series) signs.*

## **Section 2D.29 Route Sign Assemblies**

### **Standard:**

01 **A Route Sign assembly shall consist of a route sign and auxiliary signs that further identify the route and indicate the direction. Route Sign assemblies shall be installed on all approaches to numbered routes that intersect with other numbered routes.**

02 **Where two or more routes follow the same section of highway, the route signs for Interstate, U.S., State, and county routes shall be mounted in that order from the left in horizontal arrangements and from the top in vertical arrangements. Subject to this order of precedence, route signs for lower-numbered routes shall be placed at the left or top.**

03 **Within groups of assemblies, information for routes intersecting from the left shall be mounted at the left in horizontal arrangements and at the top or center of vertical arrangements. Similarly, information for routes intersecting from the right shall be at the right or bottom, and for straight-through routes at the center in horizontal arrangements or top in vertical arrangements.**

04 **Route Sign assemblies shall be mounted in accordance with the general specifications for signs (Chapter 2A), with the lowest sign in the assembly at the height prescribed for single signs.**

### *Guidance:*

05 *Assemblies for two or more routes, or for different directions on the same route, should be mounted in groups on a common support.*

### *Option:*

06 *Route Sign assemblies may be installed on the approaches to numbered routes on unnumbered roads and streets that carry an appreciable amount of traffic destined for the numbered route.*

07 *The diagrammatic route guide sign format, such as the D1-5 and D1-5a signs shown in Figure 2D-8, may be used on approaches to roundabouts.*

08 *If engineering judgment indicates that groups of assemblies that include overlapping routes or multiple turns might be confusing, route signs or auxiliary signs may be omitted or combined, provided that clear directions are given to road users.*

### *Support:*

09 *Figure 2D-6 shows typical placements of route signs.*

### **Standard:**

10 **The larger shields shall be used on freeways and expressways.**

### *Option:*

11 *The smaller shields may be used on conventional highways, in interchange areas, at entrances to State highways and for all trailblazer assemblies.*

### *Guidance:*

12 *The sign assemblies should be placed on the right.*

### **Standard:**

13 **On freeways, shields shall be installed beyond the end of the acceleration lane of all entrances to freeway to freeway interchanges and at intermediate locations at 3 to 5 mile intervals.**

### *Guidance:*

14 *On conventional highways, they should be installed at important urban and rural intersections and at intermediate locations at 3 to 5 mile intervals in rural areas.*

15 *The Off-Interstate Business Loop Marker (M1-2) should not be placed on the interstate route itself. The ROUTE \_\_\_ BUSINESS (G76(CA)) plaque should be used for advance signing on the interstate route.*

## **Section 2D.30 Junction Assembly**

### **Standard:**

01 **A Junction assembly shall consist of a Junction auxiliary sign and a route sign. The route sign shall carry the number of the intersected or joined route.**

02 **The Junction assembly shall be installed in advance of every intersection where a numbered route is intersected or joined by another numbered route.**

*Guidance:*

*03 In urban areas, the Junction assembly should be installed in the block preceding the intersection. In urban areas where speeds are low, the Junction assembly should not be installed more than 300 feet in advance of the intersection.*

*04 In rural areas, the Junction assembly should be installed at least 400 feet in advance of the intersection. In rural areas, the minimum distance between a Junction assembly and either a Destination sign or an Advance Route Turn assembly should be 200 feet.*

*05 Where speeds are high, greater spacings should be used.*

**Option:**

*06 Where two or more routes are to be indicated, a single Junction auxiliary sign may be used for the assembly and all route signs grouped in a single mounting, or a Combination Junction (M2-2) sign (see Section 2D.14) may be used.*

### **Section 2D.31 Advance Route Turn Assembly**

**Standard:**

**01 An Advance Route Turn assembly shall consist of a route sign, an Advance Turn Arrow or word message auxiliary sign, and a Cardinal Direction auxiliary sign, if needed. It shall be installed in advance of an intersection where a turn must be made to remain on the indicated route.**

**Option:**

*02 The Advance Route Turn assembly may be used to supplement the required Junction assembly in advance of intersecting routes.*

*Guidance:*

**Standard:**

**03 Where a multiple-lane highway approaches an interchange or intersection with a numbered route, the Advance Route Turn assembly ~~should~~ **shall** be used to pre-position turning vehicles in the correct lanes from which to make their turn.**

**Option:**

*04 Lane Designation auxiliary signs (see Section 2D.27) may be used in Advance Route Turn Assemblies in place of the Advance Turn Arrow auxiliary signs where engineering judgment indicates that specific lane information associated with each route is needed and overhead signing is not practical and the designated lane is a mandatory movement lane. An assembly with the Lane Designation auxiliary signs may supplement or substitute for an assembly with Advance Turn Arrow auxiliary signs.*

*Guidance:*

*05 In low-speed areas, the Advance Route Turn assembly should be installed not less than 200 feet in advance of the turn. In high-speed areas, the Advance Route Turn assembly should be installed not less than 300 feet in advance of the turn. In rural areas, the minimum distance between an Advance Route Turn assembly and either a Destination sign or a Junction assembly should be 200 feet.*

**Standard:**

**06 An assembly that includes an Advance Turn Arrow auxiliary sign shall not be placed where there is an intersection between it and the designated turn.**

*Guidance:*

*07 Sufficient distance should be allowed between the assembly and any preceding intersection that could be mistaken for the indicated turn.*

**Support:**

*08 See Figures 2E-34(CA) through 2E-40(CA) in Chapter 2E for typical freeway signing.*

**Standard:**

**09 The Advance Lane Assignment (G20(CA) Series or G21(CA) Series) or Interchange Guide (G77(CA) Series) signs (see Figure 2D-5(CA)) shall be used on multilane cross streets approaching a freeway interchange to indicate the proper lane for the desired freeway entrance. The principal message shall be route and cardinal direction.**

**Option:**

*10 Names of major or control cities may be used in addition to cardinal directions.*

Support:

<sup>11</sup> The Advance Lane Assignment (G21(CA) Series) signs are available in a stacked format for use where space is limited.

Guidance:

<sup>12</sup> When stacked format is used, the top message should indicate the first freeway entrance.

<sup>13</sup> The Interchange Guide (G77(CA)) sign should be used on two-lane cross streets at interchange areas to direct motorists from the cross street to the freeway ramp entrances.

Option:

<sup>14</sup> The G77(CA) sign may also be used at an exit ramp split to direct motorists to the cross street.

<sup>15</sup> The Interchange Guide (G78(CA) Series) signs (see Figure 2D-5(CA)) may be used to direct motorists to a single cardinal direction or destination.

Support:

<sup>16</sup> The G78 Series(CA) signs are ordinarily used as a follow-up to the G77(CA) sign.

<sup>17</sup> The FREEWAY with Arrow (G82(CA)) sign (see Figure 2D-5(CA)) may be used to direct motorists to a freeway from a business route or from a community served by a single freeway.

<sup>18</sup> The G82(CA) sign is available with the freeway name and with vertical, diagonal, or horizontal arrows on either side of the message.

Option:

<sup>19</sup> The G82(CA) signs may be placed at appropriate locations to guide traffic to the freeway.

## Section 2D.32 Directional Assembly

### Standard:

**01 A Directional assembly shall consist of a Cardinal Direction auxiliary sign, if needed; a route sign; and a Directional Arrow auxiliary sign. The various uses of Directional assemblies shall be as provided in Items A through D:**

**A. Turn movements (indicated in advance by an Advance Route Turn assembly) shall be marked by a Directional assembly with a route sign displaying the number of the turning route and a singleheaded arrow pointing in the direction of the turn.**

**B. The beginning of a route (indicated in advance by a Junction assembly) shall be marked by a Directional assembly with a route sign displaying the number of that route and a single-headed arrow pointing in the direction of the route.**

**C. An intersected route (indicated in advance by a Junction assembly) on a crossroad where the route is designated on both legs shall be designated by:**

**1. Two Directional assemblies, each with a route sign displaying the number of the intersected route, a Cardinal Direction auxiliary sign, and a single-headed arrow pointing in the direction of movement on that route; or**

**2. A Directional assembly with a route sign displaying the number of the intersected route and a double-headed arrow, pointing at appropriate angles to the left, right, or ahead.**

**D. An intersected route (indicated in advance by a Junction assembly) on a side road or on a crossroad where the route is designated only on one of the legs shall be designated by a Directional assembly with a route sign displaying the number of the intersected route, a Cardinal Direction auxiliary sign, and a single-headed arrow pointing in the direction of movement on that route.**

### Guidance:

<sup>02</sup> *Straight-through movements should be indicated by a Directional assembly with a route sign displaying the number of the continuing route and a vertical arrow. A Directional assembly should not be used for a straight-through movement in the absence of other assemblies indicating right or left turns, as the Confirming assembly sign beyond the intersection normally provides adequate guidance.*

<sup>03</sup> *Directional assemblies should be located on the near right corner of the intersection. At major intersections and at Y or offset intersections, additional Directional assemblies should be installed on the far right or left corner to confirm the near-side assemblies. When the near-corner position is not practical for Directional assemblies, the far right corner should be the preferred alternative, with oversized signs, if necessary, for*



*legibility. Where unusual conditions exist, the location of a Directional assembly should be determined by engineering judgment with the goal being to provide the best possible combination of view and safety.*

Support:

04 It is more important that guide signs be readable, and that the information and direction displayed thereon be readily understood, at the appropriate time and place than to be located with absolute uniformity.

05 Figure 2D-6 shows typical placements of Directional assemblies.

### **Section 2D.33 Combination Lane-Use/Destination Overhead Guide Sign (D15-1)**

Option:

01 At complex intersection approaches involving multiple turn lanes and destinations, a Combination Lane-Use/Destination (D15-1) overhead guide sign that combines a lane-use regulatory sign with destination information such as a cardinal direction, a route number, a street name, and/or a place name may be used.

Support:

02 At such locations, the combined information on the D15-1 signs can be even more effective than separate lane-use and guide signs for conveying to unfamiliar drivers which lane or lanes to use for a particular destination.

03 Figure 2D-7 shows an example of a D15-1 sign that combines lane-use and route number information and an example of a D15-1 sign that combines lane-use and street name information.

**Standard:**

04 **The Combination Lane-Use/Destination (D15-1) overhead guide sign shall be used only where the designated lane is a mandatory movement lane. The D15-1 sign shall not be used for lanes with optional movements.**

05 **The D15-1 sign shall have a green background with a white border. As shown in Figure 2D-7, the lane-use sign (see Chapter 2B) shall be placed near the bottom of the sign and the destination information shall be placed near the top of the sign. The D15-1 sign shall be located approximately over the center of the lane to which it applies.**

### **Section 2D.34 Confirming or Reassurance Assemblies**

**Standard:**

01 **If used, Confirming or Reassurance assemblies shall consist of a Cardinal Direction auxiliary sign and a route sign. Where the Confirming or Reassurance assembly is for an alternative route, the appropriate auxiliary sign for an alternative route (see Section 2D.16) shall also be included in the assembly.**

*Guidance:*

02 *A Confirming assembly should be installed just beyond intersections of numbered routes. It should be placed 25 to 200 feet beyond the far shoulder or curb line of the intersected highway.*

03 *If used, Reassurance assemblies should be installed between intersections in urban areas as needed, and beyond the built-up area of any incorporated city or town.*

04 *Route signs for either confirming or reassurance purposes should be spaced at such intervals as necessary to keep road users informed of their routes.*

### **Section 2D.35 Trailblazer Assembly**

Support:

01 Trailblazer assemblies provide directional guidance to a particular road facility from other highways in the vicinity. This guidance is accomplished by installing Trailblazer assemblies at strategic locations to indicate the direction to the nearest or most convenient point of access. The use of the word TO indicates that the road or street where the sign is posted is not a part of the indicated route, and that a road user is merely being directed progressively to the route.

**Standard:**

02 **A Trailblazer assembly shall consist of a TO auxiliary sign, a route sign for a numbered or named highway (see Section 2D.53) or an Auto Tour Route sign (see Section 2H.07), and a single-headed Directional Arrow auxiliary sign pointing in the direction leading to the route. Where the Trailblazer**

**assembly is for an alternative route, the appropriate auxiliary sign for an alternative route (see Section 2D.16) shall also be included in the assembly.**

Option:

<sup>03</sup> A Cardinal Direction auxiliary sign may be used with a Trailblazer assembly.

Guidance:

<sup>04</sup> *The TO auxiliary sign, Cardinal Direction auxiliary sign, and Directional Arrow auxiliary sign should be of the standard size provided for auxiliary signs of their respective type. The route sign should be the size provided in Section 2D.11.*

Option:

<sup>05</sup> Trailblazer assemblies may be installed with other Route Sign assemblies, or alone, in the immediate vicinity of the designated facilities.

<sup>06</sup> CVC 21350 provides that the State may, with the consent of the local authorities, place and maintain along city streets and county roads, appropriate signs directing traffic to State highways.

Guidance:

<sup>07</sup> *Cooperation with local authorities should be sought in placing trailblazer signs.*

**Standard:**

<sup>08</sup> **Permission shall be obtained from the appropriate local agency for all signs placed outside the State highway right-of-way.**

Support:

<sup>09</sup> For all signs placed outside of the State right of way refer to Section 2A.101(CA).

Option:

<sup>10</sup> In metropolitan areas, the freeway name may be used only if it is well known, in common use, and its deletion would be confusing to motorists.

**Standard:**

<sup>11</sup> **The format shall include the appropriate route shield.**

## **Section 2D.36 Destination and Distance Signs**

Support:

<sup>01</sup> In addition to guidance by route numbers, it is desirable to supply the road user information concerning the destinations that can be reached by way of numbered or unnumbered routes. This is done by means of Destination signs and Distance signs.

<sup>01a</sup> See Figure 2D-7(CA) for G1(CA) Series, G8(CA) Series and G86(CA) Series California Destination and Distance Signs.

Option:

<sup>02</sup> Route shields and cardinal directions may be included on the Destination sign with the destinations and arrows.

Guidance:

<sup>03</sup> *If Route shields and cardinal directions are included on a Destination sign, the height of the route shields should be at least two times the height of the upper-case letters of the principal legend and not less than 18 inches, and the cardinal directions should be in all upper-case letters that are at least the minimum height specified for these signs.*

## **Section 2D.37 Destination Signs (D1 Series)**

**Standard:**

<sup>01</sup> **Except on approaches to interchanges (see Section 2D.45), the Destination (D1-1 through D1-3) sign (see Figure 2D-7), if used, shall be a horizontal rectangle displaying the name of a city, town, village, or other traffic generator, and a directional arrow.**

Option:

<sup>02</sup> The distance (see Section 2D.41) to the place named may also be displayed on the Destination (D1-1a through D1-3a) sign (see Figure 2D-7). If several destinations are to be displayed at a single point, the several names may be placed on a single sign with an arrow (and the distance, if desired) for each name. If more than one destination lies in the same direction, a single arrow may be used for such a group of destinations.

*Guidance:*

03 *Adequate separation should be made between any destinations or group of destinations in one direction and those in other directions by suitable design of the arrow, spacing of lines of legend, heavy lines entirely across the sign, or separate signs.*

**Support:**

04 Separation of destinations by direction by the use of a horizontal separator line can enhance the readability of a Destination sign by relating an arrow and its corresponding destination(s) and by eliminating the need for multiple arrows that point in the same direction and excessive space between lines of legend.

**Standard:**

05 **Except as otherwise provided in this Manual, an arrow pointing to the right shall be at the extreme right of the sign, and an arrow pointing left or up shall be at the extreme left. The distance numerals, if used, shall be placed to the right of the destination names.**

**Option:**

06 An arrow pointing up may be placed at the extreme right of the sign when the sign is mounted to the left of the traffic to which it applies.

*Guidance:*

07 *Unless a sloping arrow will convey a clearer indication of the direction to be followed, the directional arrows should be horizontal or vertical.*

08 *If several individual name signs are assembled into a group, all signs in the assembly should be of the same horizontal width.*

09 *Destination signs should be used:*

*A. At the intersections of U.S. or State numbered routes with Interstate, U.S., or State numbered routes; and*

*B. At points where they serve to direct traffic from U.S. or State numbered routes to the business section of towns, or to other destinations reached by unnumbered routes.*

**Standard:**

10 **Where a total of three or less destinations are provided on the Advance Guide (see Section 2E.33) and Supplemental Guide (see Section 2E.35) signs, no more than three destination names shall be used on a Destination sign. Where four destinations are provided by the Advance Guide and Supplemental Guide signs, no more than four destination names shall be used on a Destination sign.**

*Guidance:*

11 *If space permits, four destinations should be displayed as two separate signs at two separate locations.*

**Option:**

12 Where space does not permit, or where all four destinations are in one direction, a single sign may be used. Where a single sign is used and all destinations are in the same direction, the arrow may be placed below the destinations for the purpose of enhancing the conspicuity of the arrow.

**Standard:**

13 **Where a single four-name sign assembly is used, a heavy line entirely across the sign or separate signs shall be used to separate destinations by direction.**

*Guidance:*

14 *The closest destination lying straight ahead should be at the top of the sign or assembly, and below it the closest destinations to the left and to the right, in that order. The destination displayed for each direction should ordinarily be the next county seat or the next principal city, rather than a more distant destination. In the case of overlapping routes, only one destination should be displayed in each direction for each route.*

**Standard:**

15 **If more than one destination is displayed in the same direction, the name of a nearer destination shall be displayed above the name of a destination that is further away.**

**Support:**

16 Refer to Section 2E.13 for the designation of destinations and control cities.

**Standard:**

17 **If there are more eligible destinations at a given intersection than can be accommodated (under the limitations mentioned in this section) they shall compete for signs on the basis of traffic volumes to these destinations.**

*Guidance:*

18 *Destinations should be signed to by the route requiring the least amount of time to travel from the nearest State highway.*

**Standard:**

19 **Criteria for supplemental destination signs shall be as shown in Table 2D-102(CA).**

20 **Signs shall not be provided for privately owned, profit making enterprises regardless of their size.**

*Option:*

21 If unusual operational or safety issues become apparent that would be mitigated by signing to the private enterprise, signs on State highways may be used with the approval of Caltrans' Division of Traffic Operations.

**Standard:**

22 **Signs to shopping centers shall not be allowed.**

23 **When a street or facility name change is made on an existing sign on a State highway primarily for the benefit of the requestor, with no, or only minor, improvement of traffic flow, the costs of materials and labor for said change, plus the current overhead assessment rate as determined by the Accounting Service Center to cover administrative overhead, shall be paid by the requestor. Such changes shall require approval of the Caltrans District Director.**

*Option:*

24 Street name changes on signs on State highways which are clearly in the best interest of the motorists and the State may also be approved by the Caltrans District Director.

**Standard:**

25 **New signs, if warranted, shall be installed at State expense.**

*Option:*

26 Signs to a public or nonprofit facility may be installed and maintained on conventional State highways in a "city street" configuration, by local governmental bodies under an encroachment permit.

**Standard:**

27 **Deviations from the signing policies shall not be allowed unless a documented engineering study describes a substantial traffic problem that would be alleviated by increased signing.**

*Option:*

28 The Veterans National Cemetery (G86-14(CA)) or the Veterans Home of California (G86-16(CA)) Signs may be placed, one in each direction of travel from and on the nearest State highway, based upon a request from the Federal Department of Veterans Affairs.

**Supplemental Signing for City Civic Center Areas**

*Option:*

29 Signs to City Civic Center areas may be installed on State highways for incorporated cities.

**Standard:**

30 **The city shall be incorporated and contiguous with the State highway right-of-way.**

31 **The city shall adopt a resolution requesting installation of signs on specific State highways for the purpose of guiding motorists to the city's civic center area, otherwise commonly referred to as downtown, central business district, city center, or city hall. The resolution shall include the appropriate wording for the legend on the sign.**

32 **The route from State highways to City hall shall not be more than 3 miles.**

*Option:*

33 When requested by resolution, signs may be placed on all State highways, which are within 3 miles of City hall.

**Standard:**

34 **Only one sign shall be installed in each direction of travel for each State highway so requested. If any portion of the route from a State highway to the Civic Center area is under the jurisdiction of another city, both cities shall agree (in writing) that signs can be installed on the State highway.**

*Guidance:*

35 *Trailblazer signs should be in place on local streets and roads prior to installation of signs on State highways.*

*Option:*

36 The legend may be "(city name) Civic Center," "Downtown (city name)," "(city name) Central Business District," "(city name) City Center," "(city name) City Hall," or a very similar message.

**Standard:**

**37 Only one legend shall be selected and used on all corresponding State highways for a particular Civic Center area.**

**Guidance:**

*38 Signs should be roadside signs. Where possible, signs should be supplemental plaques mounted on existing roadside Supplemental Destination (G86(CA) Series) signs and NEXT X EXITS (E9) signs.*

**Option:**

*39 When this is not reasonable, signs may be separate roadside signs.*

*40 Signs may be mounted overhead if there is no reasonable roadside alternative.*

**Standard:**

**41 The city shall have the signs installed under an encroachment permit and shall pay all costs for fabrication, and installation of the signs. Caltrans shall maintain these signs.**

**42 Signs shall comply with applicable Caltrans policies, specifications and standards.**

**Bypassed Communities**

**43 Section 100.9 of the Streets and Highways Code provides that appropriate directional signs shall be installed directing to bypassed cities and business districts. This law requires that all signs, except route shields, be left in place on the old highway, regardless of its status as a business route.**

**Guidance:**

*44 When relinquishing any bypassed highway, the city or county concerned should be advised regarding continued maintenance of such signs by the local agencies.*

**Signing for Indian Reservations and Rancherias**

**Standard:**

**45 Indian Reservations and Rancherias shall be signed in a like manner as cities and unincorporated communities for supplemental destination and miscellaneous guide signs. Only the official name of the federally recognized Indian Tribe, Reservation, or Rancheria shall be used on signs. The signs shall be white with retroreflective legend and border on green retroreflective background.**

**46 The signs and sign messages shall conform to the requirements of the California Outdoor Advertising Act, which prohibits advertising displays within the right-of-way of any State highway.**

**Section 2D.38 Destination Signs at Circular Intersections**

**Standard:**

**01 Destination signs that are used at circular intersections shall comply with the provisions of Section 2D.37, except as provided in this Section.**

**Option:**

*02 Exit destination (D1-1d, D1-1e) signs (see Figure 2D-8) with diagonal upward-pointing arrows or Directional assemblies (see Section 2D.32) may be used to designate a particular exit from a circular intersection.*

*03 Exit destination (D1-2d, D1-3d) signs (see Figure 2D-8) with curved-stem arrows may be used on approaches to circular intersections to represent the left-turn movements.*

*04 Curved-stem arrows on circular intersection destination signs may point in diagonal directions to depict the location of an exit relative to the approach roadway and entry into the intersection.*

*05 Exit destination (D1-5 or D1-5a) signs (see Figure 2D-8) with a diagram of the circular intersection may be used on approaches to circular intersections.*

**Guidance:**

*06 If curved-stem arrows are used on destination signs, then this arrow type should also be used consistently on any regulatory lane-use signs (see Chapter 2B), Directional assemblies (see Section 2D.32), and pavement markings (see Part 3) for a particular destination or movement.*

**Support:**

*07 Figure 2D-9 illustrates two examples of guide signing for circular intersections.*

*08 Diagrammatic guide signs might be preferable where space is available and where the geometry of the circular intersection is non-typical, such as where more than four legs are present or where the legs are not at approximately 90-degree angles to each other.*

**Standard:**

**<sup>09</sup> If used, diagrammatic guide signs for circular intersections shall not depict the number of lanes within the intersection circulatory roadway, or on its approaches or exits, through the use of lane lines, multiple arrow shafts for the same movement, or other methods.**

**Support:**

<sup>10</sup> Chapter 2B contains information regarding regulatory signs at circular intersections, Chapter 2C contains information regarding warning signs at circular intersections, and Chapter 3C contains information regarding pavement markings at circular intersections.

**Section 2D.39 Destination Signs at Jughandles**

**Standard:**

**<sup>01</sup> Destination signs that are used at jughandles shall comply with the provisions of Section 2D.37, except as provided in this Section.**

**Option:**

<sup>02</sup> If engineering judgment indicates that standard destination signs alone are insufficient to direct road users to their destinations at a jughandle, a diagrammatic guide sign depicting the appropriate geometry may be used to supplement the normal destination signs.

**Support:**

<sup>03</sup> Section 2B.27 contains information regarding regulatory signs for jughandle turns. Figure 2B-9 shows examples of regulatory and destination guide signing for various types of jughandle turns.

**Section 2D.40 Location of Destination Signs**

*Guidance:*

<sup>01</sup> *When used in high-speed areas, Destination signs should be located 200 feet or more in advance of the intersection, and following any Junction or Advance Route Turn assemblies that might be required. In rural areas, the minimum distance between a Destination sign and either an Advance Route Turn assembly or a Junction assembly should be 200 feet.*

**Option:**

<sup>02</sup> In urban areas, shorter advance distances may be used.

<sup>03</sup> Because the Destination sign is of lesser importance than the Junction, Advance Route Turn, or Directional assemblies, the Destination sign may be eliminated when sign spacing is critical.

**Support:**

<sup>04</sup> Figure 2D-6 shows typical placements of Destination signs.

**Section 2D.41 Distance Signs (D2 Series)**

**Standard:**

**<sup>01</sup> If used, the Distance (D2-1 through D2-3) sign (see Figure 2D-7) shall be a horizontal rectangle of a size appropriate for the required legend, carrying the names of no more than three cities, towns, junctions, or other traffic generators, and the distance (to the nearest mile) to those places.**

**<sup>02</sup> The distance numerals shall be placed to the right of the destination names as shown in Figure 2D-7.**

*Guidance:*

<sup>03</sup> *The distance displayed should be selected on a case-by-case basis by the jurisdiction that owns the road or by statewide policy. A well-defined central area or central business district should be used where one exists. In other cases, the layout of the community should be considered in relation to the highway being signed and the decision based on where it appears that most drivers would feel that they are in the center of the community in question.*

<sup>04</sup> *The top name on the Distance sign should be that of the next place on the route having a post office or a railroad station, a route number or name of an intersected highway, or any other significant geographical identity. The bottom name on the sign should be that of the next major destination or control city. If three destinations are displayed, the middle line should be used to indicate communities of general interest along the route or important route junctions.*

**Option:**

<sup>05</sup> The choice of names for the middle line may be varied on successive Distance signs to give road users additional information concerning communities served by the route.

**Guidance:**

<sup>06</sup> *The control city should remain the same on all successive Distance signs throughout the length of the route until that city is reached.*

**Option:**

<sup>07</sup> If more than one distant point may properly be designated, such as where the route divides at some distance ahead to serve two destinations of similar importance, and if these two destinations cannot appear on the same sign, the two names may be alternated on successive signs.

**Guidance:**

<sup>08</sup> *On a route continuing into another State, destinations in the adjacent State ~~may~~ should be displayed.*

**Support:**

<sup>09</sup> Refer to Section 2E.13 for the designation of destinations and control cities.

### **Section 2D.42 Location of Distance Signs**

**Guidance:**

<sup>01</sup> *If used, Distance signs should be installed on important routes leaving municipalities and just beyond intersections of numbered routes in rural areas. If used, they should be placed just outside the municipal limits or at the edge of the built-up area if it extends beyond the limits.*

<sup>02</sup> *Where overlapping routes separate a short distance from the municipal limits, the Distance sign at the municipal limits should be omitted. The Distance sign should be installed approximately 300 feet beyond the separation of the two routes.*

<sup>03</sup> *Where, just outside of an incorporated municipality, two routes are concurrent and continue concurrently to the next incorporated municipality, the top name on the Distance sign should be that of the place where the routes separate; the bottom name should be that of the city to which the greater part of the through traffic is destined.*

**Support:**

<sup>04</sup> Figure 2D-6 shows typical placements of Distance signs.

**Guidance:**

<sup>05</sup> *The Distance (G5(CA) Series) signs should be placed at approximate 10 mile intervals, unless the destinations have changed. Distances to the same destinations should not be shown more frequently than at 5 mile intervals.*

**Option:**

<sup>06</sup> *The Destination and Street Name with Arrow (G8(CA) Series) signs may be used in advance of conventional highway intersections.*

### **Section 2D.43 Street Name Signs (D3-1 or D3-1a)**

**Guidance:**

<sup>01</sup> *Street Name (D3-1 or D3-1a or G7-1(CA)) signs (see Figure 2D-10 and 2D-10(CA)) should be installed in urban areas at all street intersections regardless of other route signs that might be present and should be installed in rural areas to identify important roads that are not otherwise signed.*

**Support:**

<sup>01a</sup> Refer to Section 9B.20 for signage at street and Class I bikeway intersections.

**Option:**

<sup>02</sup> For streets that are part of a U.S., State, or county numbered route, a D3-1a Street Name sign (see Figure 2D-10) that incorporates a route shield may be used to assist road users who might not otherwise be able to associate the name of the street with the route number.

**Standard:**

<sup>03</sup> **The lettering for names of streets and highways on Street Name signs shall be composed of a combination of lower-case letters with initial upper-case letters (see Section 2A.13).**

**Guidance:**

*04 Lettering on post-mounted Street Name signs should be composed of initial upper-case letters at least 6 inches in height and lower-case letters at least 4.5 inches in height.*

*05 On multi-lane streets with speed limits greater than 40 mph, the lettering on post-mounted Street Name signs should be composed of initial upper-case letters at least 8 inches in height and lower-case letters at least 6 inches in height.*

Option:

*06 For local roads with speed limits of 25 mph or less, the lettering on post-mounted Street Name signs may be composed of initial upper-case letters at least 4 inches in height and lower-case letters at least 3 inches in height.*

Guidance:

*07 If overhead Street Name signs are used, the lettering should be composed of initial upper-case letters at least 12 inches in height and lower-case letters at least 9 inches in height.*

Support:

*08 The recommended minimum letter heights for Street Name signs are summarized in Table 2D-2.*

Option:

*09 Supplementary lettering to indicate the type of street (such as Street, Avenue, or Road) or the section of the city (such as NW) on the D3-1 and D3-1a signs may be in smaller lettering, composed of initial upper-case letters at least 3 inches in height and lower-case letters at least 2.25 inches in height. Conventional abbreviations (see Section 1A.15) may be used except for the street name itself.*

*10 A pictograph (see definition in Section 1A.13) may be used on a D3-1 sign.*

**Standard:**

**11 Pictographs shall not be displayed on D3-1a or Advance Street Name (D3-2) signs (see Section 2D.44).**

**12 If a pictograph is used on a D3-1 sign, the height and width of the pictograph shall not exceed the upper-case letter height of the principal legend of the sign.**

Guidance:

*13 The pictograph should be positioned to the left of the street name.*

**Standard:**

**14 The Street Name sign shall be retroreflective or illuminated to show the same shape and similar color both day and night. The color of the legend (and border, if used) shall contrast with the background color of the sign.**

Option:

*15 The border may be omitted from a Street Name sign.*

*16 An alternative background color other than the normal guide sign color of green may be used for Street Name (D3-1 or D3-1a) signs where the highway agency determines this is necessary to assist road users in determining jurisdictional authority for roads.*

**Standard:**

**17 Alternative background colors shall not be used for Advance Street Name (D3-2) signs (see Section 2D.44).**

**18 The only acceptable alternative background colors for Street Name (D3-1 or D3-1a) signs shall be blue, brown, or white. Regardless of whether green, blue, or brown is used as the background color for Street Name (D3-1 or D3-1a) signs, the legend (and border, if used) shall be white. For Street Name signs that use a white background, the legend (and border, if used) shall be black.**

Guidance:

*19 An alternative background color for Street Name signs, if used, should be applied to the Street Name (D3-1 or D3-1a) signs on all roadways under the jurisdiction of a particular highway agency.*

*20 In business or commercial areas and on principal arterials, Street Name signs should be placed at least on diagonally opposite corners. In residential areas, at least one Street Name sign should be mounted at each intersection. Signs naming both streets should be installed at each intersection.*

**Standard:**

**They ~~should~~ shall be mounted with their faces parallel to the streets they name.**

Option:

*21 To optimize visibility, Street Name signs may be mounted overhead. Street Name signs may also be placed above a regulatory or STOP or YIELD sign with no required vertical separation.*



*Guidance:*

*22 In urban or suburban areas, especially where Advance Street Name signs for signalized and other major intersections are not used, the use of overhead Street Name signs should be strongly considered.*

*Option:*

23 At intersection crossroads where the same road has two different street names for each direction of travel, both street names may be displayed on the same sign along with directional arrows.

*Support:*

24 Information regarding the use of street names on supplemental plaques for use with intersection-related warning signs is contained in Section 2C.58.

**Standard:**

**25 Street Name signs shall be placed, clearly visible to traffic approaching from all directions, at all signalized intersections. Refer to CVC 21366.**

*Option:*

26 If structurally adequate luminaire poles are available, the street name signs may be mounted on them at a height of approximately 15 feet. Refer to Caltrans' Standard Plans publication. See Section 1A.11 for information regarding this publication.

### **Section 2D.44 Advance Street Name Signs (D3-2)**

*Support:*

01 Advance Street Name (D3-2) signs (see Figure 2D-10) identify an upcoming intersection. Although this is often the next intersection, it could also be several intersections away in cases where the next signalized intersection is referenced.

**Standard:**

**02 Advance Street Name (D3-2) signs, if used, shall supplement rather than be used instead of the Street Name (D3-1) signs at the intersection.**

*Option:*

03 Advance Street Name (D3-2) signs may be installed in advance of signalized or unsignalized intersections to provide road users with advance information to identify the name(s) of the next intersecting street to prepare for crossing traffic and to facilitate timely deceleration and/or lane changing in preparation for a turn.

*Guidance:*

**Standard:**

**04 On arterial highways in rural areas, Advance Street Name signs ~~should~~ shall be used in advance of all signalized intersections and in advance of all intersections with exclusive turn lanes.**

*Guidance:*

05 *In urban areas, Advance Street Name signs should be used in advance of all signalized intersections on major arterial streets, except where signalized intersections are so closely spaced that advance placement of the signs is impractical.*

06 *The heights of the letters on Advance Street Name signs should be the same as those used for Street Name signs (see Section 2D.43).*

**Standard:**

**07 If used, Advance Street Name signs shall have a white legend and border on a green background.**

**08 If used, Advance Street Name signs shall provide the name(s) of the intersecting street(s) on the top line(s) of the legend and the distance to the intersecting streets or messages such as NEXT SIGNAL, NEXT INTERSECTION, NEXT ROUNDABOUT, or directional arrow(s) on the bottom line of the legend.**

**09 Pictographs shall not be displayed on Advance Street Name signs.**

*Option:*

10 Directional arrow(s) may be placed to the right or left of the street name or message such as NEXT SIGNAL, as appropriate, rather than on the bottom line of the legend. Curved-stem arrows may be used on Advance Street Name signs on approaches to circular intersections.

11 For intersecting crossroads where the same road has a different street name for each direction of travel, the different street names may be displayed on the same Advance Street Name sign along with directional arrows.

12 In advance of two closely-spaced intersections where it is not practical to install separate Advance Street Name signs, the Advance Street Name sign may include the street names for both intersections along with appropriate supplemental legends for both street names, such as NEXT INTERSECTION, 2ND INTERSECTION, or NEXT LEFT and NEXT RIGHT, or directional arrows.

*Guidance:*

13 *If two street names are used on the Advance Street Name sign, the street names should be displayed in the following order:*

*A. For a single intersection where the same road has a different street name for each direction of travel, the name of the street to the left should be displayed above the name of the street to the right; or*

*B. For two closely-spaced intersections, the name of the first street encountered should be displayed above the name of the second street encountered, and the arrow associated with the second street encountered should be an advance arrow, such as the arrow shown on the W16-6P arrow plaque (see Figure 2C-12).*

*Option:*

14 An Advance Street Name (W16-8P or W16-8aP) plaque (see Section 2C.58) with black legend on a yellow background, installed supplemental to an Intersection (W2 series) or Advance Traffic Control (W3 series) warning sign may be used instead of an Advance Street Name guide sign.

15 [The Destination and Street Name with Arrow \(G8\(CA\) Series\) signs may be used in advance of conventional highway intersections.](#)

## **Section 2D.45 Signing on Conventional Roads on Approaches to Interchanges**

**Support:**

01 Because there are a number of different ramp configurations that are commonly used at interchanges with conventional roads, drivers on the conventional road cannot reliably predict whether they will be required to turn left or right in order to enter the correct ramp to access the freeway or expressway in the desired direction of travel. Consistently applied signing for conventional road approaches to freeway or expressway interchanges is highly desirable.

**Standard:**

02 **On multi-lane conventional roads approaching an interchange, guide signs shall be provided to identify which direction of turn is to be made and/or which specific lane to use for ramp access to each direction of the freeway or expressway.**

*Guidance:*

03 *The signing of conventional roads with one lane of traffic approaching an interchange should consist of a sequence containing the following signs (see Figure 2D-11):*

*A. Junction Assembly*

*B. Destination sign*

*C. Directional Assembly or Entrance Direction sign for the first ramp*

*D. Advance Route Turn Assembly or Advance Entrance Direction sign with an advance turn arrow*

*E. Directional Assembly or Entrance Direction sign for the second ramp*

**Standard:**

04 **If used, the Entrance Direction sign shall consist of a white legend and border on a green background. It shall contain the freeway or expressway route shield(s), cardinal direction, and directional arrow(s).**

**Option:**

05 The Entrance Direction sign may contain a destination(s) and/or an action message such as NEXT RIGHT.

06 At minor interchanges, the following sequence of signs may be used (see Figure 2D-12):

A. Junction Assembly

B. Directional Assembly for the first ramp

C. Directional Assembly for the second ramp

*Guidance:*

07 *On multi-lane conventional roads approaching an interchange, the sign sequence should contain the following signs (see Figures 2D-13 through 2D-15):*

*A. Junction Assembly*

- B. Advance Entrance Direction sign(s) for both directions (if applicable) of travel on the freeway or expressway*
- C. Entrance Direction sign for first ramp*
- D. Advance Turn Assembly*
- E. Entrance Direction sign for the second ramp*

Support:

<sup>08</sup> Advance Entrance Direction signs are used to direct road users to the appropriate lane(s).

**Standard:**

<sup>09</sup> **The Advance Entrance Direction sign shall consist of a white legend and border on a green background. It shall contain the freeway or expressway route shield(s) and cardinal direction(s).**

Option:

<sup>10</sup> The Advance Entrance Direction sign may have destinations, directional arrows, and/or an action message such as KEEP LEFT, NEXT LEFT, or SECOND RIGHT. Signs in this sequence may be mounted overhead to improve visibility as shown in Figures 2D-13 through 2D-15.

<sup>10a</sup> [Contact Caltrans' Division of Traffic Operations for further guidance regarding Figures 2D-11 through 2D-15.](#)

Support:

<sup>11</sup> A post-mounted Advance Entrance Direction diagrammatic guide sign (see Figure 2D-16), within the sequence of approach guide signing described in Paragraphs 3, 6, and 7, might be helpful in depicting the location of a freeway or expressway entrance ramp that is in close proximity to an intervening intersection on the same side of the approach roadway and where signing for only the ramp might cause confusion to road users.

**Standard:**

<sup>12</sup> **If used, the post-mounted Advance Entrance Direction diagrammatic guide sign shall display only the two successive turns from the same side of the roadway, one of which shall be the entrance ramp. The post-mounted Advance Entrance Direction sign shall depict only the successive turns and shall not depict lane use with lane lines, multiple arrow shafts for the approach roadway, action messages, or other representations.**

Support:

<sup>13</sup> Section 2D.46 contains information regarding the use of a Directional assembly or a FREEWAY ENTRANCE sign to mark the entrance to a freeway or expressway at the far corner of an intersection.

## **Section 2D.46 Freeway Entrance Signs (D13-3 and D13-3a)**

Option:

<sup>01</sup> FREEWAY ENTRANCE (D13-3) signs or FREEWAY ENTRANCE with downward pointing diagonal arrow (D13-3a) signs (see Figure 2D-14) may be used on entrance ramps near the crossroad to inform road users of the freeway or expressway entrance, as appropriate.

<sup>02</sup> The D13-3 and D13-3a signs may display an alternate legend in place of FREEWAY, such as EXPRESSWAY or PARKWAY, as appropriate, or may display the name of an unnumbered highway.

<sup>03</sup> A Directional assembly (see Section 2D.32) with a downward pointing diagonal arrow auxiliary (M6-2a) sign (see Section 2D.28) may be used at the far left-hand corner of an intersection with a freeway or expressway entrance ramp as an alternative to the D13-3a sign, facing left-turning traffic on the conventional road approach to indicate the immediate point of entry to the freeway or expressway and distinguish the entrance ramp from an adjoining exit ramp terminal at the same intersection with the conventional road (see Figure 2D-14). A similar Directional assembly may be used at the far right-hand corner of an intersection with a freeway or expressway entrance ramp where the entrance ramp and a crossroad or side road follow one another in close succession on the conventional road approach and the point of entry to the freeway or expressway might be difficult for the road user to distinguish from the crossroad or side road on the conventional road approach (see Figure 2D-14).

Support:

<sup>04</sup> Section 2B.41 contains information regarding the use of regulatory signs to deter wrong-way movements at intersections of freeway or expressway ramps with conventional roads, and in the area where entrance ramps intersect with the mainline lanes.

### **Section 2D.47 Parking Area Guide Sign (D4-1)**

**Option:**

01 The Parking Area (D4-1) guide sign (see Figure 2D-10) may be used to show the direction to a nearby public parking area or parking facility.

**Standard:**

02 **If used, the Parking Area (D4-1) guide sign shall be a horizontal rectangle with a standard size of 30 x 24 inches, or with a smaller size of 18 x 15 inches for minor, low-speed streets. It shall carry the word PARKING, with the letter P five times the height of the remaining letters, and a directional arrow. The legend and border shall be green on a retroreflectorized white background.**

*Guidance:*

03 *If used, the Parking Area guide sign should be installed on major thoroughfares at the nearest point of access to the parking facility and where it can advise drivers of a place to park. The sign should not be used more than four blocks from the parking area.*

### **Section 2D.48 PARK - RIDE Sign (D4-2)**

**Option:**

01 PARK - RIDE (D4-2) signs (see Figure 2D-10) may be used to direct road users to park - ride facilities.

**Standard:**

02 **The signs shall contain the word message PARK - RIDE and direction information (arrow or word message).**

**Option:**

03 PARK - RIDE signs may contain the local transit pictograph and/or carpool symbol on the sign.

**Standard:**

04 **If used, the local transit pictograph and/or carpool symbol shall be located in the top part of the sign above the message PARK - RIDE. In no case shall the vertical dimension of the local transit pictograph and/or carpool symbol exceed 18 inches.**

*Guidance:*

05 *If the function of the parking facility is to provide parking for persons using public transportation, the local transit pictograph should be used on the guide sign. If the function of the parking facility is to serve carpool riders, the carpool symbol should be used on the guide sign. If the parking facility serves both functions, both the pictograph and carpool symbol should be used.*

**Standard:**

06 **These signs shall have a retroreflective white legend and border on a rectangular green background. The carpool symbol shall be as shown for the D4-2 sign. The color of the local transit pictograph shall be selected by the local transit authority.**

**Option:**

07 To increase the target value and contrast of the local transit pictograph, and to allow the local transit pictograph to retain its distinctive color and shape, the pictograph may be included within a white border or placed on a white background.

08 The PARK - RIDE (G95A(CA)) sign (see Figure 2D-10(CA)) may be used below the Advance Guide (G83(CA) Series) signs on freeways and expressways for directions to ride sharing parking lots.

09 The PARK - RIDE NEXT RIGHT (G95B(CA)) sign (see Figure 2D-10(CA)) may be used as a separate installation on freeways and expressways where it is not possible to use the G95A(CA) sign.

*Guidance:*

10 *The Park - Ride Courtesy Plaque (G95B-1(CA)) (see Figure 2D-10(CA)) when used, should be used in conjunction with, and mounted below the PARK - RIDE NEXT RIGHT (G95B(CA)) sign.*

**Standard:**

11 **The following criteria shall be met in order for a private concern to qualify for this type of signing:**

- A. The parking area must have reasonably convenient access to the major transportation facility that it is intended to serve.**
- B. The Park and Ride Facility must be accessible 24 hours a day, 7 days a week.**
- C. A minimum of 50 spaces must be contributed.**

**D. If needed, "Follow-Up" signing shall be provided between the exit point of the major transportation system and the Park and Ride Facility by placing a PARK - RIDE (D4-2) sign at the appropriate locations prior to the installation of the G95B(CA) and G95B-1(CA) signs on the major transportation system.**

Option:

<sup>12</sup> The BUS SERVICE (G95D(CA)) Plaque (see Figure 2D-10(CA)) may be placed below the G95A(CA) or G95B(CA) signs at locations where bus service is available at a particular Park and Ride Facility.

<sup>13</sup> The Park - Ride (G95E(CA)) Plaque (see Figure 2D-10(CA)) may be used below the existing Advance Guide (G83(CA) Series) signs on freeways and expressways for direction to ridesharing parking lots.

Guidance:

<sup>14</sup> If both transit and carpool parking are available, the local transit logo or symbol should be used to the left of the standard carpool symbol shown. If transit parking only, the local transit symbol or logo should be used in lieu of the carpool symbol.

Option:

<sup>15</sup> The NO LOITERING, CAMPING, VENDING OR PARKING OF VEHICLES 30 FEET OR LONGER (S22(CA)) sign (see Figure 2D-10(CA)) may be placed at fringe and transportation corridor parking facilities constructed, maintained, or operated by Caltrans for the purpose of ridesharing. Refer to CVC Section 22518.

### **Section 2D.49 Weigh Station Signing (D8 Series)**

Support:

<sup>01</sup> The general concept for Weigh Station signing is similar to Rest Area signing (see Section 2I.05) because in both cases traffic using either area remains within the right-of-way.

**Standard:**

<sup>02</sup> **The standard installation for Weigh Station signing shall include three basic signs:**

- A. Advance sign (D8-1),**
- B. Exit Direction sign (D8-2), and**
- C. Exit Gore sign (D8-3).**

Support:

<sup>03</sup> Example locations of these signs are shown in Figure 2D-17 and 2D-17(CA).

Option:

<sup>04</sup> Where State law requires a regulatory sign (~~R13-1~~) in advance of the Weigh Station, a fourth sign (see Section 2B.60) may be located following the Advance sign.

Guidance:

<sup>05</sup> The Exit Direction sign (D8-2) or the Advance sign (D8-1) should display, either within the sign border or on a supplemental plaque or sign panel, the changeable message OPEN or CLOSED.

Option:

<sup>06</sup> The NO PICKUPS (SG8(CA)) sign may be used at problem locations to warn motorists that pickups are not allowed at weigh stations.

<sup>07</sup> The ALL TRUCKS – 2 AXLE AND MORE – STOP AT SCALE (SR57(CA)) sign may be placed in combination, below the Weigh Station Exit Direction (D8-2) sign to inform operators of small trucks to stop at the weigh station.

<sup>08</sup> On State highways, an extinguishable message sign may be used in lieu of the OPEN/CLOSED supplemental panel.

<sup>09</sup> The VEHICLE INSPECTION ONLY NO LOITERING OR CAMPING (S22-1(CA)) sign may be placed at problem locations in the area designated for brake check or safety inspection at weigh stations.

### **Section 2D.50 Community Wayfinding Signs**

Support:

<sup>01</sup> Community wayfinding guide signs are part of a coordinated and continuous system of signs that direct tourists and other road users to key civic, cultural, visitor, and recreational attractions and other destinations within a city or a local urbanized or downtown area.

<sup>02</sup> Community wayfinding guide signs are a type of destination guide sign for conventional roads with a common color and/or identification enhancement marker for destinations within an overall wayfinding guide sign plan for an area.

03 Figures 2D-18 through 2D-20 illustrate various examples of the design and application of community wayfinding guide signs.

**Standard:**

04 **The use of community wayfinding guide signs shall be limited to conventional roads. Community wayfinding guide signs shall not be installed on freeway or expressway mainlines or ramps. Direction to community wayfinding destinations from a freeway or expressway shall be limited to the use of a Supplemental Guide sign (see Section 2E.35) on the mainline and a Destination sign (see Section 2D.37) on the ramp to direct road users to the area or areas within which community wayfinding guide signs are used. The individual wayfinding destinations shall not be displayed on the Supplemental Guide and Destination signs except where the destinations are in accordance with the State or agency policy on Supplemental Guide signs.**

05 **Community wayfinding guide signs shall not be used to provide direction to primary destinations or highway routes or streets. Destination or other guide signs shall be used for this purpose as described elsewhere in this Chapter and shall have priority over any community wayfinding sign in placement, prominence, and conspicuity.**

06 **Because regulatory, warning, and other guide signs have a higher priority, community wayfinding guide signs shall not be installed where adequate spacing cannot be provided between the community wayfinding guide sign and other higher priority signs. Community wayfinding guide signs shall not be installed in a position where they would obscure the road users' view of other traffic control devices.**

07 **Community wayfinding guide signs shall not be mounted overhead.**

*Guidance:*

08 *If used, a community wayfinding guide sign system should be established on a local municipal or equivalent jurisdictional level or for an urbanized area of adjoining municipalities or equivalent that form an identifiable geographic entity that is conducive to a cohesive and continuous system of signs. Community wayfinding guide signs should not be used on a regional or statewide basis where infrequent or sparse placement does not contribute to a continuous or coordinated system of signing that is readily identifiable as such to the road user. In such cases, Destination or other guide signs detailed in this Chapter should be used to direct road users to an identifiable area in which the type of eligible destination described in Paragraph 1 is located.*

08a *On State highways, community wayfinding guide signs should be placed under an encroachment permit from Caltrans.*

**Standard:**

08b **Placement of the community wayfinding guide signs shall be by the jurisdiction or agency making the request through the normal permit process as a fee exempt permit.**

08c **These signs shall be installed in accordance with Caltrans' Standard Plans publication. See Section 1A.11 for more information regarding this publication.**

*Guidance:*

08d *These signs should be limited to areas where they do not block or interfere with other signs necessary for safe and efficient operation of the highway. The sign panels should be clearly marked as to the ownership.*

**Support:**

09 The specific provisions of this Section regarding the design of community wayfinding sign legends apply to vehicular community wayfinding signs and do not apply to those signs that are intended only to provide information or direction to pedestrians or other users of a sidewalk or roadside area.

*Guidance:*

10 *Because pedestrian wayfinding signs typically use smaller legends that are inadequately sized for viewing by vehicular traffic and because they can provide direction to pedestrians that might conflict with that appropriate for vehicular traffic, wayfinding signs designed for and intended to provide direction to pedestrians or other users of a sidewalk or other roadside area should be located to minimize their conspicuity to vehicular traffic. Such signs should be located as far as practical from the street, such as at the far edge of the sidewalk. Where locating such signs farther from the roadway is not practical, the pedestrian wayfinding signs should have their conspicuity to vehicular traffic minimized by employing one or a combination of the following methods:*

- A. *Locating signs away from intersections where high-priority traffic control devices are present.*
- B. *Facing the pedestrian message toward the sidewalk and away from the street.*

*C. Cantilevering the sign over the sidewalk if the pedestrian wayfinding sign is mounted at a height consistent with vehicular traffic signs, removing the pedestrian wayfinding signs from the line of sight in a sequence of vehicular signs.*

*11 To further minimize their conspicuity to vehicular traffic during nighttime conditions, pedestrian wayfinding signs should not be retroreflective.*

Support:

*12 Color coding is sometimes used on community wayfinding guide signs to help road users distinguish between multiple potentially confusing traffic generator destinations located in different neighborhoods or subareas within a community or area.*

Option:

*13 At the boundaries of the geographical area within which community wayfinding guide signing is used, an informational guide sign (see Figures 2D-18 and 2D-20) may be posted to inform road users about the presence of wayfinding signing and to identify the meanings of the various color codes or pictographs that are being used.*

**Standard:**

**14 These informational guide signs shall have a white legend and border on a green background and shall have a design similar to that illustrated in Figures 2D-1 and 2D-18 and shall be consistent with the basic design principles for guide signs. These informational guide signs shall not be installed on freeway or expressway mainlines or ramps.**

**15 The color coding or a pictograph of the identification enhancement markers of the community wayfinding guide signing system shall be included on the informational guide sign posted at the boundary of the community wayfinding guide signing area. The color coding or pictographs shall apply to a specific, identifiable neighborhood or geographical subarea within the overall area covered by the community wayfinding guide signing. Color coding or pictographs shall not be used to distinguish between different types of destinations that are within the same designated neighborhood or subarea. The color coding shall be accomplished by the use of different colored square or rectangular panels on the face of the informational guide sign, each positioned to the left of the neighborhood or named geographic area to which the color-coding panel applies. The height of the colored square or rectangular panels shall not exceed two times the height of the upper-case letters of the principal legend on the sign.**

Option:

*16 The different colored square or rectangular panels may include either a black or a white (whichever provides the better contrast with the color of the panel) letter, numeral, or other appropriate designation to identify the destination.*

*17 Except for the informational guide sign posted at the boundary of the wayfinding guide sign area, community wayfinding guide signs may use background colors other than green in order to provide a color identification for the wayfinding destinations by geographical area within the overall wayfinding guide signing system. Color-coded community wayfinding guide signs may be used with or without the boundary informational guide sign displaying corresponding color-coding panels described in Paragraphs 13 through 16. Except as provided in Paragraphs 18 and 19, in addition to the colors that are approved in this Manual for use on official traffic control signs (see Section 2A.10), other background colors may also be used for the color coding of community wayfinding guide signs.*

**Standard:**

**18 The standard colors of red, orange, yellow, purple, or the fluorescent versions thereof, fluorescent yellow-green, and fluorescent pink shall not be used as background colors for community wayfinding guide signs, in order to minimize possible confusion with critical, higher-priority regulatory and warning sign color meanings readily understood by road users.**

**19 The minimum luminance ratio of legend to background for community wayfinding guide signs shall be 3:1.**

**20 All messages, borders, legends, and backgrounds of community wayfinding guide signs and any identification enhancement markers shall be retroreflective (see Sections 2A.07 and 2A.08).**

*Guidance:*

*21 Community wayfinding guide signs, exclusive of any identification enhancement marker used, should be rectangular in shape. Simplicity and uniformity in design, position, and application as described in Section 2A.06*

*are important and should be incorporated into the community wayfinding guide sign design and location plans for the area.*

*22 Community wayfinding guide signs should be limited to three destinations per sign (see Section 2D.07).*

*23 Abbreviations (see Section 1A.15) should be kept to a minimum, and should include only those that are commonly recognized and understood.*

*24 Horizontal lines of a color that contrasts with the sign background color should be used to separate groups of destinations by direction from each other.*

Support:

25 The basic requirement for all highway signs, including community wayfinding signs, is that they be legible to those for whom they are intended and that they be understandable in time to permit a proper response. Section 2A.06 contains additional information on the design of signs, including desirable attributes of effective designs.

Guidance:

26 *Word messages should be as brief as practical and the lettering should be large enough to provide the necessary legibility distance.*

**Standard:**

27 **The minimum specific ratio of letter height to legibility distance shall comply with the provisions of Section 2A.13. The size of lettering used for destination and directional legends on community wayfinding signs shall comply with the provisions of minimum letter heights as provided in Section 2D.06.**

28 **Interline and edge spacing shall comply with the provisions of Section 2D.06.**

29 **Except as provided in Paragraph 31, the lettering style used for destination and directional legends on community wayfinding guide signs shall comply with the provisions of Section 2D.05.**

30 **The lettering for destinations on community wayfinding guide signs shall be a combination of lower-case letters with initial upper-case letters (see Section 2D.05). All other word messages on community wayfinding guide signs shall be in all upper-case letters.**

Option:

31 A lettering style other than the Standard Alphabets provided in the "Standard Highway Signs and Markings" book may be used on community wayfinding guide signs if an engineering study determines that the legibility and recognition values for the chosen lettering style meet or exceed the values for the Standard Alphabets for the same legend height and stroke width.

**Standard:**

32 **Except for signs that are intended to be viewed only by pedestrians, bicyclists stopped out of the flow of traffic, or occupants of parked vehicles, Internet and e-mail addresses, including domain names and uniform resource locators (URL), shall not be displayed on any community wayfinding guide sign or sign assembly.**

33 **The arrow location and priority order of destinations shall follow the provisions described in Sections 2D.08 and 2D.37. Arrows shall be of the designs provided in Section 2D.08.**

Option:

34 Pictographs (see definition in Section 1A.13) may be used on community wayfinding guide signs.

**Standard:**

35 **If a pictograph is used, its height shall not exceed two times the height of the upper-case letters of the principal legend on the sign.**

36 **Except for pictographs, symbols that are not approved in this Manual for use on guide signs shall not be used on community wayfinding guide signs.**

37 **Business logos, commercial graphics, or other forms of advertising (see Section 1A.01) shall not be used on community wayfinding guide signs or sign assemblies.**

Option:

38 Other graphics that specifically identify the wayfinding system, including identification enhancement markers, may be used on the overall sign assembly and sign supports.

Support:

39 An enhancement marker consists of a shape, color, and/or pictograph that is used as a visual identifier for the community wayfinding guide signing system for an area. Figure 2D-18 shows examples of identification enhancement marker designs that can be used with community wayfinding guide signs.



Option:

40 An identification enhancement marker may be used in a community wayfinding guide sign assembly, or may be incorporated into the overall design of a community wayfinding guide sign, as a means of visually identifying the sign as part of an overall system of community wayfinding signs and destinations.

**Standard:**

41 **The sizes and shapes of identification enhancement markers shall be smaller than the community wayfinding guide signs themselves. Identification enhancement markers shall not be designed to have an appearance that could be mistaken by road users as being a traffic control device.**

*Guidance:*

42 *The area of the identification enhancement marker should not exceed 1/5 of the area of the community wayfinding guide sign with which it is mounted in the same sign assembly.*

**Section 2D.51 Truck, Passing, or Climbing Lane Signs (D17-1 and D17-2)**

*Guidance:*

01 *If an extra lane has been provided for trucks and other slow-moving traffic, a NEXT TRUCK LANE XX MILES (D17-1) sign and/or a TRUCK LANE XX MILES (D17-2) sign (see Figure 2D-21) should be installed in advance of the lane.*

Option:

02 Alternative legends such as PASSING LANE or CLIMBING LANE may be used instead of TRUCK LANE.

03 Section 2B.31 contains information regarding regulatory signs for these types of lanes.

Option:

04 The DIVIDED ROAD (X MILES) AHEAD (G68(CA)) sign (see Figure 2D-101(CA)) may be used to indicate the distance to the next section of divided highway.

*Guidance:*

05 *The mileage shown should be to the nearest one-fourth mile, and to the nearest mile for distances over one mile.*

Option:

06 The G68(CA) sign may be used on a two-lane highway in advance of a divided section of highway to encourage passing in the divided section.

07 The PASSING LANE (X MILES) or AHEAD (G69(CA)) sign (see Figure 2D-21(CA)) may be used to inform motorists on a two-lane highway that an additional lane is available ahead for passing slower traffic.

Support:

08 See Section 3B.05 for signing and marking of passing and truck lanes.

**Section 2D.52 Slow Vehicle Turn-Out Sign (D17-7)**

*Guidance:*

01 *If a slow vehicle turn-out area has been provided for slow-moving traffic, a SLOW VEHICLE TURN-OUT XX MILES (D17-7) sign (see Figure 2D-21) should be installed in advance of the turn-out area.*

Option:

02 Section 2B.35 contains information regarding regulatory signs for slow vehicle turn-out areas.

**Section 2D.53 Signing of Named Highways**

Option:

01 Guide signs may contain street or highway names if the purpose is to enhance driver communication and guidance; however, they are to be considered as supplemental information to route numbers.

**Standard:**

02 **Highway names shall not replace official numeral designations.**

03 **Memorial names (see Section 2M.10) shall not appear on supplemental signs or on any other information sign on or along the highway or its intersecting routes.**

04 **The use of route signs shall be restricted to signs officially used for guidance of traffic in accordance with this Manual and the "Purpose and Policy" statement of the American Association of State Highway**

**and Transportation Officials that applies to Interstate and U.S. numbered routes (see Page i for AASHTO's address).**

Option:

05 Unnumbered routes having major importance to proper guidance of traffic may be signed if carried out in accordance with the aforementioned policies. For unnumbered highways, a name to enhance route guidance may be used where the name is applied consistently throughout its length.

Guidance:

06 *Only one name should be used to identify any highway, whether numbered or unnumbered.*

### **Section 2D.54 Crossover Signs (D13-1 and D13-2)**

Option:

01 Crossover signs may be installed on divided highways to identify median openings not otherwise identified by warning or other guide signs.

**Standard:**

02 **A CROSSOVER (D13-1) sign (see Figure 2D-21) shall not be used to identify a median opening that is permitted to be used only by official or authorized vehicles. If used, the sign shall be a horizontal rectangle of appropriate size to carry the word CROSSOVER and a horizontal directional arrow. The CROSSOVER sign shall have a white legend and border on a green background.**

Guidance:

03 *If used, the CROSSOVER sign should be installed immediately beyond the median opening, either on the right-hand side of the roadway or in the median.*

Option:

04 The Advance Crossover (D13-2) sign (see Figure 2D-21) may be installed in advance of the CROSSOVER sign to provide advance notice of the crossover.

**Standard:**

05 **If used, the Advance Crossover sign shall be a horizontal rectangle of appropriate size to carry the word CROSSOVER and the distance to the median opening. The sign shall have white legend and border on a green background.**

Guidance:

06 *The distance displayed on the Advance Crossover sign should be 1 MILE, 1/2 MILE, or 1/4 MILE, unless unusual conditions require some other distance. If used, the sign should be installed either on the right-hand side of the roadway or in the median at approximately the distance displayed on the sign.*

### **Section 2D.55 National Scenic Byways Signs (D6-4, D6-4a)**

Support:

01 Certain roads have been designated by the U.S. Secretary of Transportation as National Scenic Byways or All-American Roads based on their archeological, cultural, historic, natural, recreational, or scenic qualities.

Option:

02 State and local highway agencies may install the National Scenic Byways (D6-4 or D6-4a) signs at entrance points to a route that has been recognized by the U.S. Secretary of Transportation as a National Scenic Byway or an All-American Road. The D6-4 or D6-4a sign may be installed on route sign assemblies (see Figure 2D-22) or as part of larger roadside structures. National Scenic Byways signs may also be installed at periodic intervals along the designated route and at intersections where the designated route turns or follows a different numbered highway. At locations where roadside features have been developed to enhance the traveler's experience such as rest areas, historic sites, interpretive facilities, or scenic overlooks, the National Scenic Byways sign may be placed on the associated sign assembly to inform travelers that the site contributes to the byway travel experience.

**Standard:**

03 **When a National Scenic Byways sign is installed on a National Scenic Byway or an All-American Road, the design shown for the D6-4 or D6-4a sign in Figure 2D-22 shall be used. Use of this design shall be limited to routes that have been designated as a National Scenic Byway or All-American Road by the U.S. Secretary of Transportation.**

**04 If used, the D6-4 or D6-4a sign shall be placed such that the roadway route signs have primary visibility for the road user.**

### **Scenic Route Signs (G30(CA) Series)**

Support:

05 A scenic route is defined as an officially designated portion of the State Highway System traversing areas of outstanding scenic beauty, which together with the adjacent scenic corridors requires special scenic conservation treatment. Refer to California Streets and Highway Codes 260 through 263.8.

**Standard:**

**06 The Scenic Route (G30(CA)) sign shall be used to identify routes, which have been designated as official State Scenic Highways. The G30(CA) sign shall be installed on the right at the beginning of the scenic route.**

*Guidance:*

07 *The Scenic Route (G30A(CA) and G30B(CA)) signs, when used, should be used on State and county routes, respectively, and placed below and on the same post with the route shield signs.*

Option:

08 The Begin plate (G30C(CA)) may be placed above the Scenic Route sign, and the End plate (G30D(CA)) may be placed below the scenic route signs.

Support:

09 See Figure 2D-101(CA) for G30(CA) series signs.

### **Section 2D.101(CA) Inventory Markers**

Option:

01 The Inventory Markers (G11-1(CA), G11-2(CA), G11-4(CA) and G11-5(CA)) may be used at major rivers or creeks to identify bridges or structures.

02 The Inventory Markers (G11-6(CA)) may be used to identify bridges or structures at locations where the official name and number is not needed for motorist orientation.

03 The Inventory Markers (G11-10(CA)) may be used to mark the limits of an environmentally sensitive area within the State highway right of way.

04 The Memorial Bridge and Inventory Marker (G11-8(CA) and G11-9(CA)) combination signs may be placed when an appropriate authority has requested that a highway facility be designated as a memorial facility.

Support:

05 See Figure 2D-101(CA) for G11(CA) series signs.

*Guidance:*

06 *The Inventory Markers should be placed at each end of a structure, with the bottom of the sign even with the top of the bridge rail.*

Support:

07 The official name and number of structures on State highways are determined by Caltrans' Office of Structures Design.

Option:

08 The Inventory Marker (Survey) (S2(CA)) may be used as an accessory or witness marker to aid in the protection, location and identification of Caltrans' survey monuments that are to be perpetuated.

Support:

09 The S2(CA) marker is to be placed on a metal guide post, which is driven 12 to 18 inches away from the monument.

### **Mile Post Markers (G11-7(CA)) on State Highways:**

Support:

10 Refer to Caltrans' TASAS Manual for more details on this topic. See Section 1A.11 for information regarding this publication.

11 The existing markers in the field are in English units (miles). Installation of new markers, replacement of missing markers and correction (relocation) of existing markers will be done in English units (miles).

12 The mile post markers in the field are used by traffic officers, maintenance forces and others to locate specific incidents or features with reference to the mile post marker system. The mile post marker is integral to the mile post marker system and shall not be used for additional marker functions. Other types of markers shall not be used as mile post markers.

**Standard:**

**13 The mile post marker shall indicate the route, county, and mile post marker of the installation; only mile post markers shall contain the route and county designation.**

**Placement**

**Support:**

**A - Rural Areas.**

1. Two-Lane Roads - Markers are placed 1 mile apart on both sides of the highway, staggered by 0.5 miles.
2. Divided Roads - Markers are placed 1 mile apart on both sides of the highway at the same mile post marker location.

**B - Urban Areas.**

1. Two-Lane Roads - Markers are placed 0.5 miles apart on each side of the highway, staggered by 0.25 miles.
2. Divided Roads - Markers are placed 0.5 miles apart on each side of the highway at the same mile post marker location.
3. See sub-heading 'D' below.

**Option:**

**C - Maximum Spacing.**

When a regular marker falls within 0.25 miles of a landmark (bridge, etc.), the 1 mile or 0.5 mile marker may be omitted. The intent is to have mile post markers spaced no farther apart than 1 mile on rural highways, or 0.5 miles on urban highways. This is a maximum spacing. Additional markers may be placed in areas where it is desired to have additional highway reference points.

**D - Incorporated or Suburban Areas.**

Mile post markers may be omitted in communities with city-street characteristics of curb, gutter, sidewalks and local development. In these areas, intersecting streets would be used as reference points in lieu of markers.

**Support:**

**E - Mile Post Marker at County Lines.**

At county lines, the county names and mile post marker information are delineated on separate markers and mounted side-by-side on separate posts, facing both directions of traffic.

**F - Mile Post Marker Equation.**

1. Mile post marker equation with a difference in value of 0.02 miles or more shall be posted on the highway.
2. Each side of the equation is shown on separate markers and mounted side-by-side on separate posts, both facing the direction of traffic.
3. Current mile post marker letter prefix and suffix codes are listed in the State Highway Log. They are also defined in the TASAS Manuals. All prefix letters shall be shown on the mile post markers. The suffix letter E identifies a mile post marker equation. In the field, the letter E is replaced with BK (Back) and AH (Ahead) on separate markers, placed side-by-side.

**Mile Post Markers for Structures**

1. Mile Post Markers.

**Standard:**

**Mile post marker or G11(CA) signs shall be mounted on, or placed at bridge abutments and at the beginning of bridge rails.**

**Support:**

On skewed structures the mile post marker will not necessarily be identical on each side of the highway. The mile post marker on each side of the highway is the mile point of the centerline opposite the marker location.

2. Highway Log Mile Post Marker Values.

**a. Overcrossing and Underpass.**

The Highway Log mile post marker for an overcrossing or underpass is measured from the structure centerline where it intersects the highway centerline. The Post Marker will reflect that value, plus or minus the structure width, and direction of travel. This rule applies to all structures crossing over the highway regardless of the skew.

**b. Undercrossings, Overheads and Bridges.**

Single Structure: The Highway Log mile post marker value is measured along the highway centerline. A post marker value is assigned to the paving notch at the end of the structure and the paved roadbed in each direction of travel.

14 Divided or Separated Structures on Divided Highways: The Highway Log mile post marker value is measured along the centerline of each roadbed. The post marker value is assigned to the paving notch at the end of the structure and the paved roadbed in each direction of travel. Depending on the width of the median and the skew, two mile post marker values may be assigned to each end.

#### **Placement**

##### **Standard:**

15 **The preparation of plans for placement of Mile post markers on State highways shall be the responsibility of Caltrans' District Traffic Branch.**

##### **Support:**

16 Dimensions, lettering and positioning standards are included in Caltrans' Standard Plans and California Sign Specifications publications. See Section 1A.11 for information regarding these publications.

##### **Standard:**

17 **Mile post markers shall not be reflectorized. If a mile post marker should fall within a line of guide markers, it shall be placed in a manner that will not interfere with the guide marker pattern. Mile post markers shall not to be used as guide markers, clearance markers, culvert markers, etc.**

#### **Installation and Verification**

##### **Standard:**

18 **Mile post markers shall be placed a minimum of 2 feet and not more than 12 feet beyond the edge of shoulder on the right side of the highway facing traffic.**

##### **Guidance:**

19 *Generally, they should be placed in such a position as to minimize interference with maintenance.*

##### **Standard:**

20 **When installed behind guardrail, the marker shall be placed so that the entire legend is legible from the road.**

##### **Option:**

21 Stenciling of the mile post marker on concrete median barriers may be in addition to, but not in place of the regular mile post markers. This is an additional aid for maintenance and collision investigation.

##### **Standard:**

22 **All markers shall be located to an accuracy of 50 foot on the ground. The value shown on the marker shall be to the nearest 0.001 miles or 50 feet, and shall reflect the mile point of the centerline opposite the marker location.**

23 **Caltrans' District Traffic Branch shall have the responsibility to verify the accuracy of the placement of mile post markers on State highways. Any markers found to be more than 50 feet from the intended location shall be relocated.**

### **Section 2D.102(CA) Intersection Number (G98(CA)) Sign**

##### **Option:**

01 The Intersection Number (G98(CA)) Sign (see Figure 2D-101(CA)) may be installed on any section of a highway route to number an intersection to assist road users in estimating their progress, and to provide a means for identifying the location on the highway.

02 The intersection numbering may be reference location numbering or consecutive numbering.

##### **Support:**

Reference location numbering is preferred over consecutive numbering for two reasons:

- A. if new intersections are added on a route, the highway agencies do not have to change the numbering sequence; and
- B. reference location numbering assists road users in determining their destination distances and travel mileage.

03 The G98(CA) signs are used to provide a simple method for tourists to find their way safely and efficiently along the highway route upon which a great number of tourist destinations are located on or in close proximity.

##### **Guidance:**

04 *If used, the G98(CA) signs should be ground-mounted or placed on the traffic signal poles at signalized intersections.*

##### **Standard:**

05 **The G98(CA) signs shall not be installed on a highway unless the intersection numbers are published in a tourist map.**

### **Section 2D.103(CA) State Property Signs (SG26(CA), S1-1(CA), and S27(CA))**

**Option:**

**01** The Caltrans Facility Entrance (SG26(CA)) sign (see Figure 2D-101(CA)) may be placed at Caltrans' facilities where necessary to identify the facility and serve a public need.

**02** The STATE PROPERTY (S1-1(CA)) (see Figure 2D-101(CA)) sign may be used to identify materials placed on or near Caltrans' right-of-way for maintenance or construction purposes.

**Standard:**

**03** The Caltrans CONSTRUCTION FIELD OFFICE (S27(CA)) (see Figure 2D-101(CA)) sign shall be placed to identify a facility where offices are provided for the construction projects resident engineer and staff. Refer to Caltrans' Construction Manual, Chapter 1, Section 402. See Section 1A.11 for information regarding this publication.

**Figure 2D-1. Examples of Color-Coded Destination Guide Signs**

**A - Freeway or Expressway – Airport Terminals**

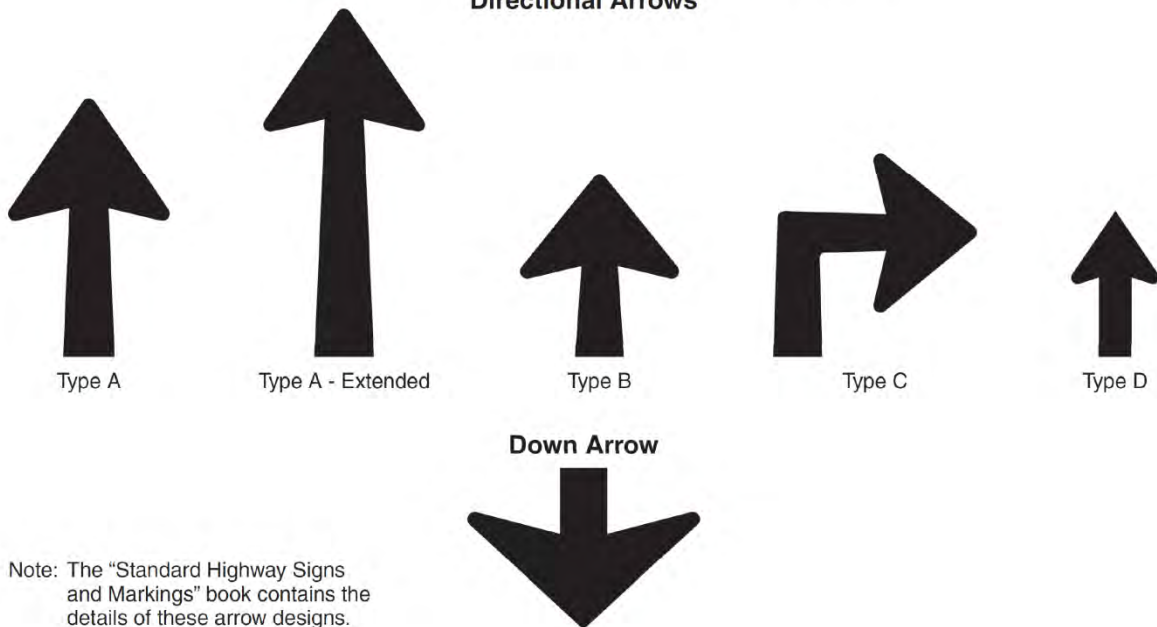


**B - Conventional Road or Street – Urban Areas**



**Figure 2D-2. Arrows for Use on Guide Signs**

**Directional Arrows**

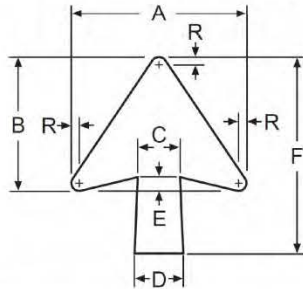


Note: The "Standard Highway Signs and Markings" book contains the details of these arrow designs.

**Figure 2D-2 (CA). Arrows for Use on Guide Signs (Sheet 1 of 2)**

**Standard Arrows for Directional Signs**

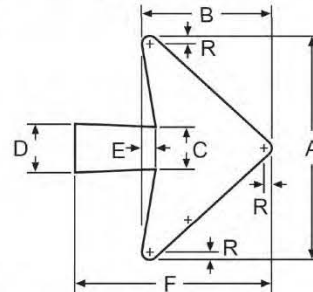
**1 Line Horizontal, Vertical, or Diagonal Arrow**



ENGLISH UNITS

| Letter Sizes        | A      | B       | C       | D       | E      | F      | R    |
|---------------------|--------|---------|---------|---------|--------|--------|------|
| 4UC(EM), 4UC(E)     | 5-5/8  | 3-5/8   | 1-9/16  | 1-15/16 | 7/16   | 6-3/8  | 5/16 |
| 5UC(E)              | 7-1/16 | 4-9/16  | 1-15/16 | 2-7/16  | 9/16   | 8-1/16 | 3/8  |
| 6UC(EM)             | 8-7/16 | 5-7/16  | 2-5/16  | 2-15/16 | 5/8    | 9-9/16 | 1/2  |
| 6UC(E), 8UC(EM)     | 11-1/4 | 7-1/4   | 3-1/8   | 3-7/8   | 7/8    | 12-3/4 | 5/8  |
| 8UC(E), 10.67UC(EM) | 14-1/4 | 9-13/16 | 3-3/8   | 4-1/2   | 1-5/16 | 17-1/4 | 3/4  |
| 10UC(E)             | 14     | 9       | 4       | 5       | 7/8    | 16     | 7/8  |
| 12UC(E), 13.3UC(EM) | 17-1/2 | 11-3/4  | 4-3/8   | 5-5/8   | 1-1/2  | 20-1/4 | 7/8  |
| 15UC(E), 16UC(EM)   | 21-7/8 | 14-1/4  | 5       | 6-3/4   | 1-3/4  | 25     | 1    |

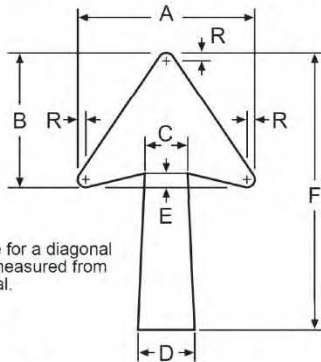
**2 (or more) Line Horizontal Arrow**



ENGLISH UNITS

| Letter Sizes              | A        | B        | C       | D       | E      | F      | R     |
|---------------------------|----------|----------|---------|---------|--------|--------|-------|
| 4UC(EM), 4UC(E)           | 7-1/8    | 4-1/8    | 1-9/16  | 1-15/16 | 7/16   | 6-3/8  | 5/16  |
| 5UC(E)                    | 9        | 5-3/16   | 1-15/16 | 2-7/16  | 9/16   | 8-1/16 | 3/8   |
| 6UC(EM)                   | 10-11/16 | 6-3/16   | 2-5/16  | 2-15/16 | 5/8    | 9-9/16 | 1/2   |
| 6UC(E), 8UC(EM)           | 14-1/4   | 8-1/4    | 3-1/8   | 3-7/8   | 7/8    | 12-3/4 | 5/8   |
| 8UC(E), 10.67UC(EM)       | 18-3/4   | 10-7/8   | 3-3/4   | 5       | 1-5/16 | 17-1/4 | 13/16 |
| 10 or 12UC(E), 13.3UC(EM) | 23-13/16 | 13-13/16 | 4-1/2   | 6       | 1-1/2  | 20-1/4 | 3/4   |
| 15UC(E), 16UC(EM)         | 28-1/2   | 16-1/2   | 5-3/8   | 7-1/8   | 1-3/4  | 25     | 1     |

**2 (or more) Line Vertical or Diagonal Arrow**

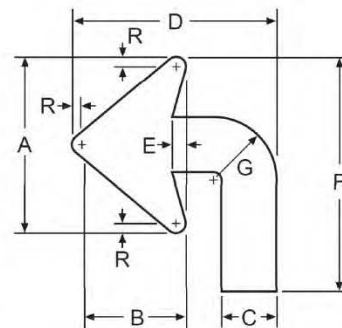


NOTE:  
 The angle for a diagonal arrow is measured from the vertical.

ENGLISH UNITS

| Letter Sizes              | A      | B       | C       | D       | E      | F        | R     |
|---------------------------|--------|---------|---------|---------|--------|----------|-------|
| 4UC(EM), 4UC(E)           | 5-5/8  | 4-3/8   | 1-9/16  | 1-15/16 | 7/16   | 9-1/8    | 5/16  |
| 5UC(E)                    | 7-1/16 | 5-1/2   | 1-15/16 | 2-7/16  | 9/16   | 11-1/2   | 3/8   |
| 6UC(EM)                   | 8-7/16 | 6-9/16  | 2-5/16  | 2-15/16 | 5/8    | 13-11/16 | 1/2   |
| 6UC(E), 8UC(EM)           | 11-1/4 | 8-3/4   | 3-1/8   | 3-7/8   | 7/8    | 18-1/4   | 5/8   |
| 8UC(E), 10.67UC(EM)       | 15-1/8 | 11-9/16 | 3-3/4   | 5       | 1-5/16 | 24-1/4   | 13/16 |
| 10 or 12UC(E), 13.3UC(EM) | 18-1/4 | 14      | 4-1/2   | 6       | 1-1/2  | 29-1/4   | 3/4   |
| 15UC(E), 16UC(EM)         | 22-1/4 | 17      | 5-3/8   | 7-1/8   | 1-3/4  | 35-5/8   | 1     |

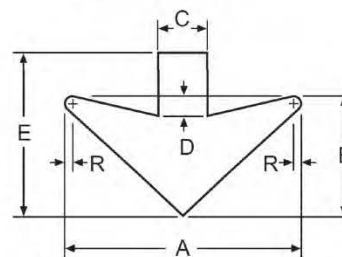
**Advance Arrow (Left or Right Turn)**



ENGLISH UNITS

| Letter Sizes    | A      | B      | C     | D     | E   | F      | G  | R   |
|-----------------|--------|--------|-------|-------|-----|--------|----|-----|
| 6UC(EM)         | 8-7/16 | 5-7/16 | 2-5/8 | 9-3/4 | 5/8 | 11-1/4 | 3R | 1/2 |
| 6UC(E), 8UC(EM) | 11-1/4 | 7-1/4  | 3-1/2 | 13    | 7/8 | 15     | 4R | 5/8 |

**Vertical Down Arrow**



ENGLISH UNITS

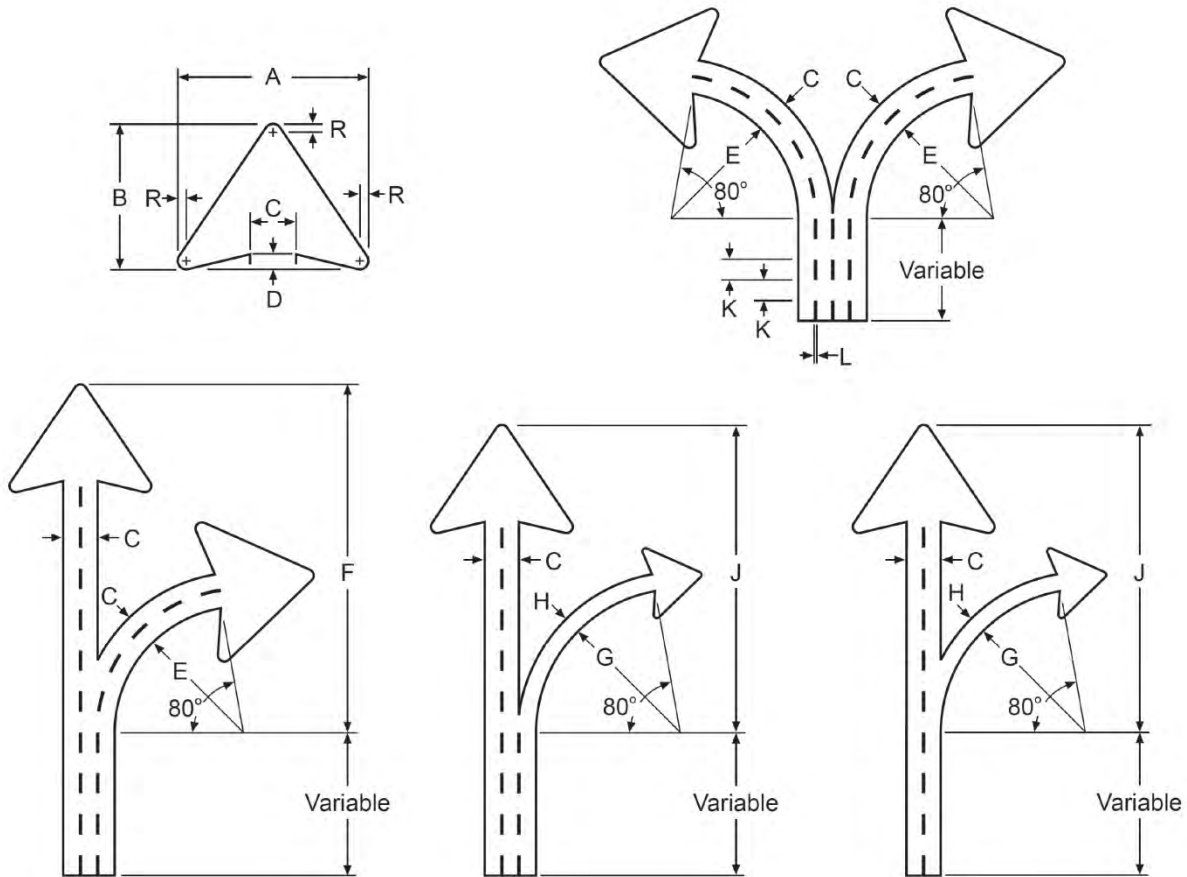
| A  | B  | C     | D | E      | R   |
|----|----|-------|---|--------|-----|
| 24 | 12 | 5     | 2 | 16-1/2 | 3/4 |
| 32 | 16 | 6-1/2 | 3 | 22     | 1   |

2/28/08



**Figure 2D-2 (CA). Arrows for Use on Guide Signs (Sheet 2 of 2)**

**Standard Arrows for Diagrammatic Signs**



ENGLISH UNITS

| Letter Sizes | A     | B     | C   | D    | E    | F   | G    | H    | J  | K    | L    | R     |
|--------------|-------|-------|-----|------|------|-----|------|------|----|------|------|-------|
| 13.3UC(EM)   | 29    | 19    | 6.5 | 2.25 | 24   | 66  | 27.5 | 3.25 | 60 | 4    | .625 | 1.375 |
| 16UC(EM)     | 35    | 22.75 | 8   | 2.75 | 29.5 | 84  | 33.5 | 4    | 72 | 4.75 | .75  | 1.625 |
| 20UC(EM)     | 43.75 | 28.5  | 10  | 3.5  | 37   | 102 | 42   | 5    | 90 | 6    | 1    | 2     |

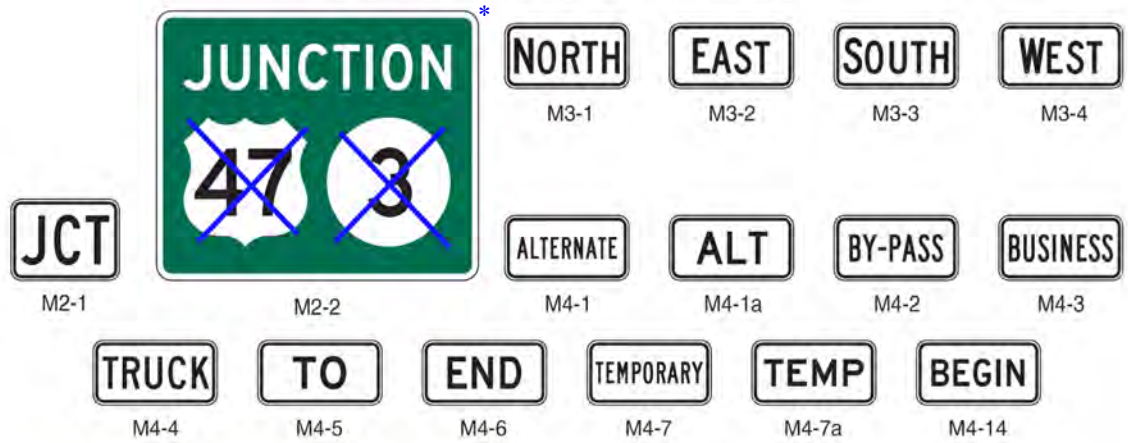
**Figure 2D-3. Route Signs**



**Figure 2D-3 (CA). California Route Signs**



Figure 2D-4. Route Sign Auxiliaries



\* Note: For Combination Junction Assembly (M2-2) and other Guide Sign Assemblies use California State Route (G28-1(CA)) and US Route (G26-1(CA)) shields.

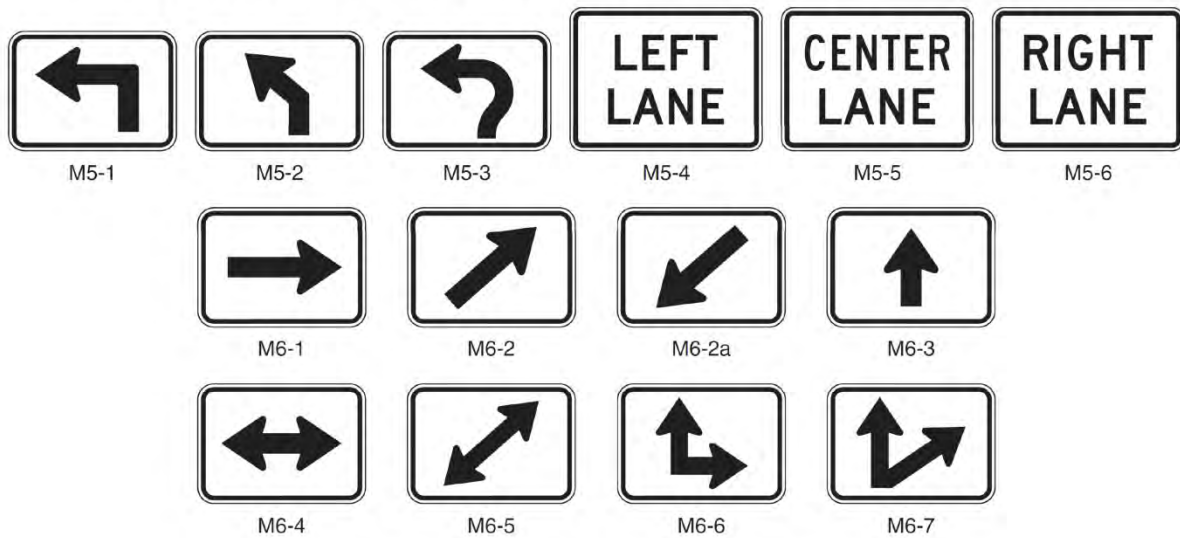


Figure 2D-4 (CA). California Route Sign Auxiliaries

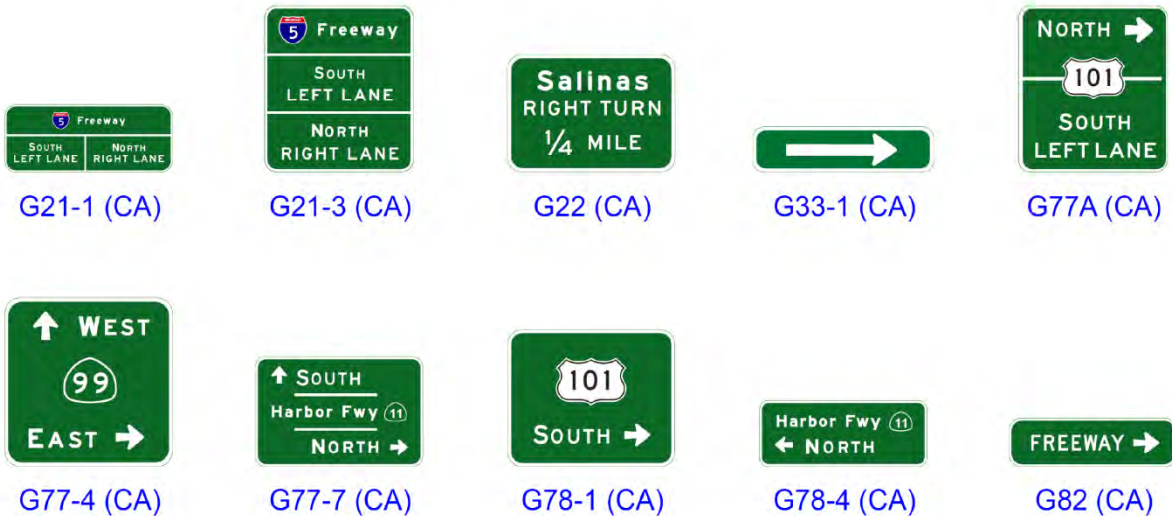


G76 (CA)

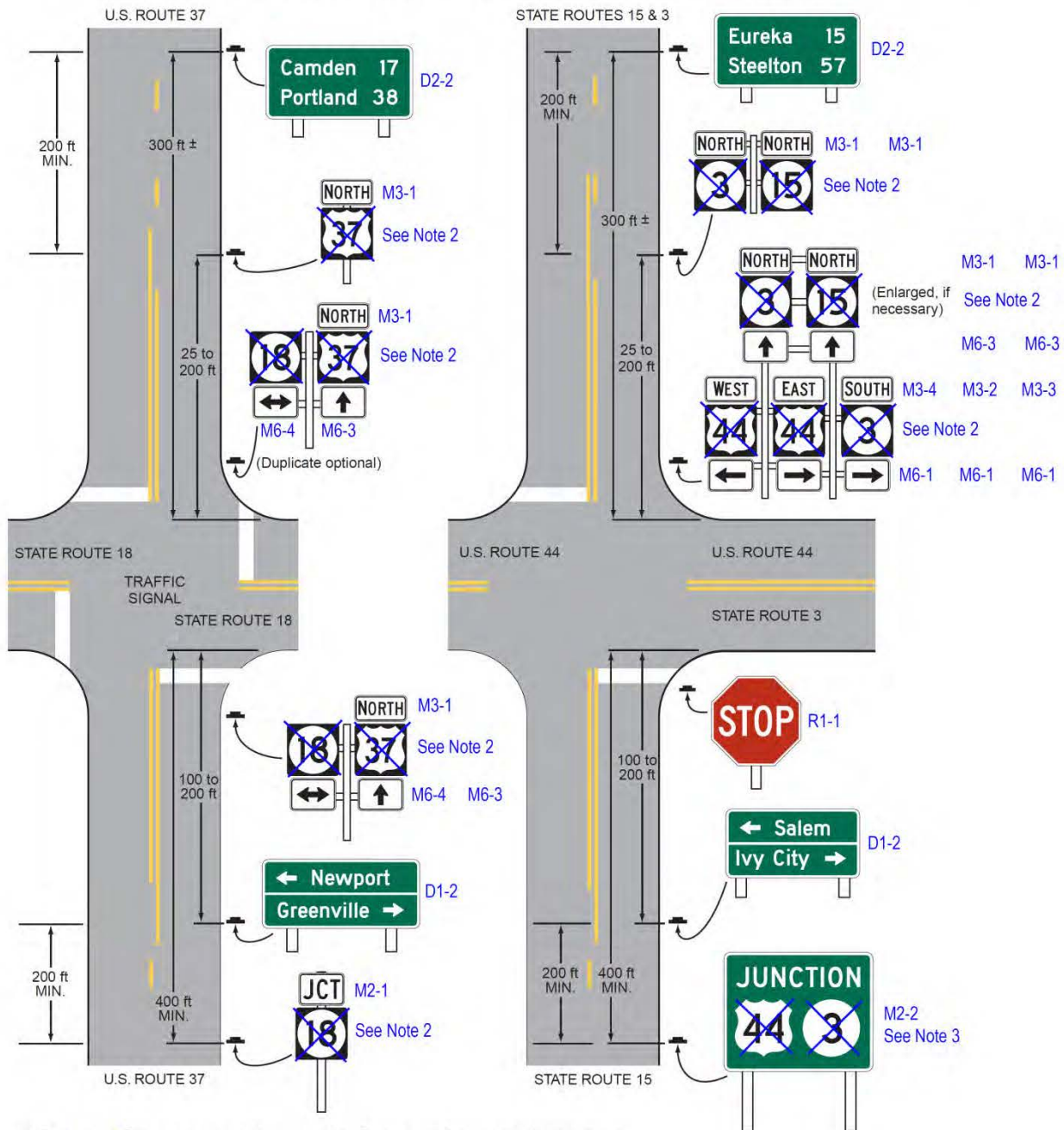
**Figure 2D-5. Advance Turn and Directional Arrow Auxiliary Signs**



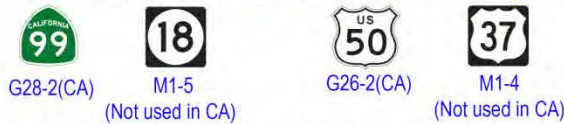
**Figure 2D-5 (CA). Advance Turn and Directional Arrow Auxiliary Signs**



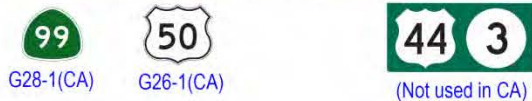
**Figure 2D-6. Illustration of Directional Assemblies and Other Route Signs (for One Direction of Travel Only) (Sheet 1 of 4)**



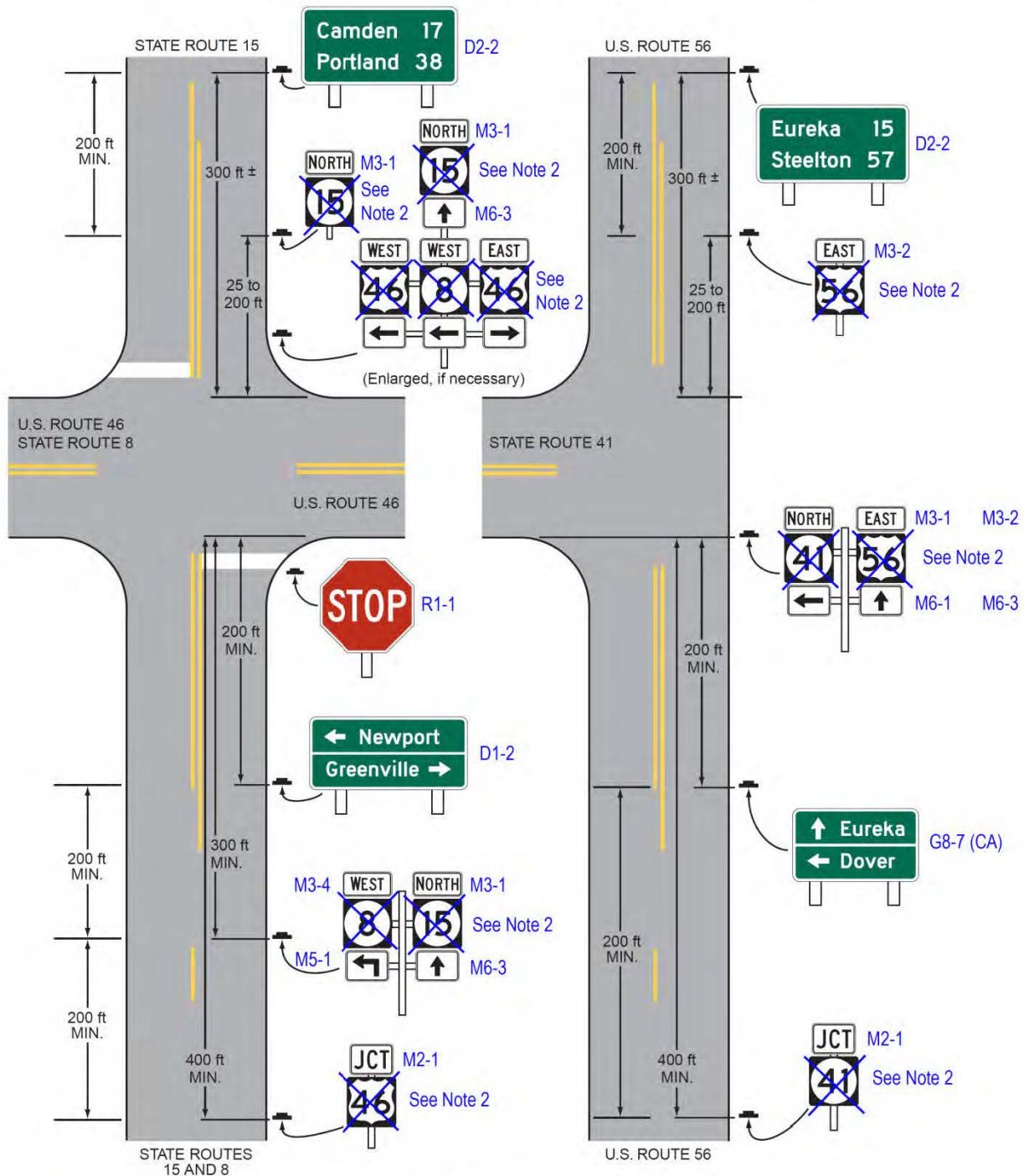
- Notes: 1. The spacings shown on this figure are for rural intersections. See Sections 2D.29, 2D.30, 2D.32, 2D.34, 2D.40, and 2D.42 for low-speed and/or urban conditions.  
 2. Use G28-2(CA) in lieu of M1-5 and G26-2(CA) in lieu of M1-4 signs.



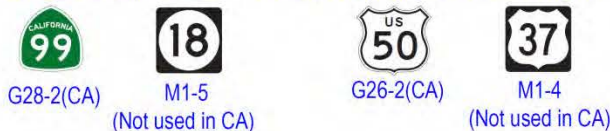
3. For Combination Junction Assembly (M2-2) and other Guide Sign Assemblies use California State Route (G28-1(CA)) and US Route (G26-1(CA)) shields.



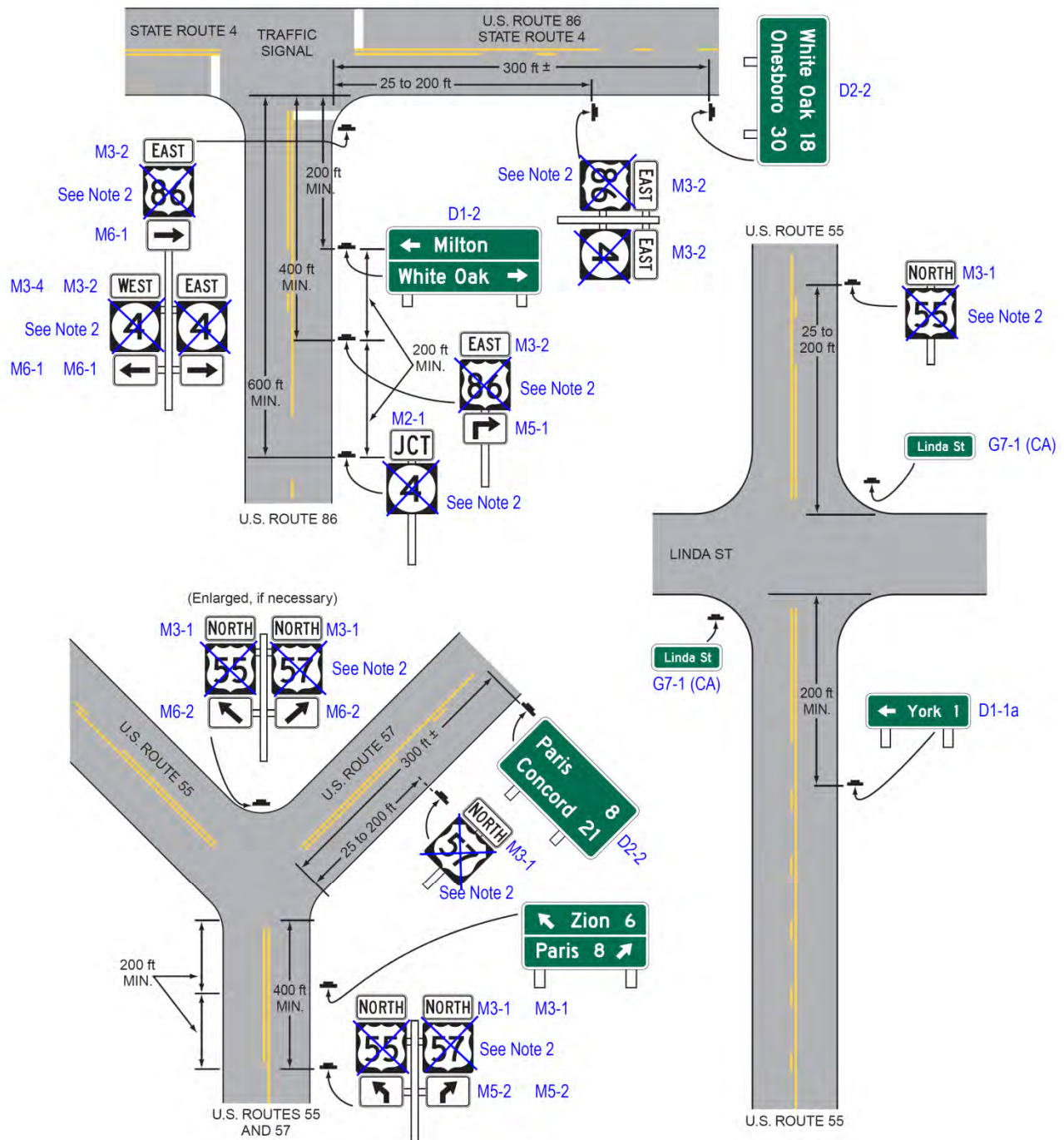
**Figure 2D-6. Illustration of Directional Assemblies and Other Route Signs (for One Direction of Travel Only) (Sheet 2 of 4)**



- Notes: 1. The spacings shown on this figure are for rural intersections. See Sections 2D.29, 2D.30, 2D.32, 2D.34, 2D.40, and 2D.42 for low-speed and/or urban conditions.  
 2. Use G28-2(CA) in lieu of M1-5 and G26-2(CA) in lieu of M1-4 signs.



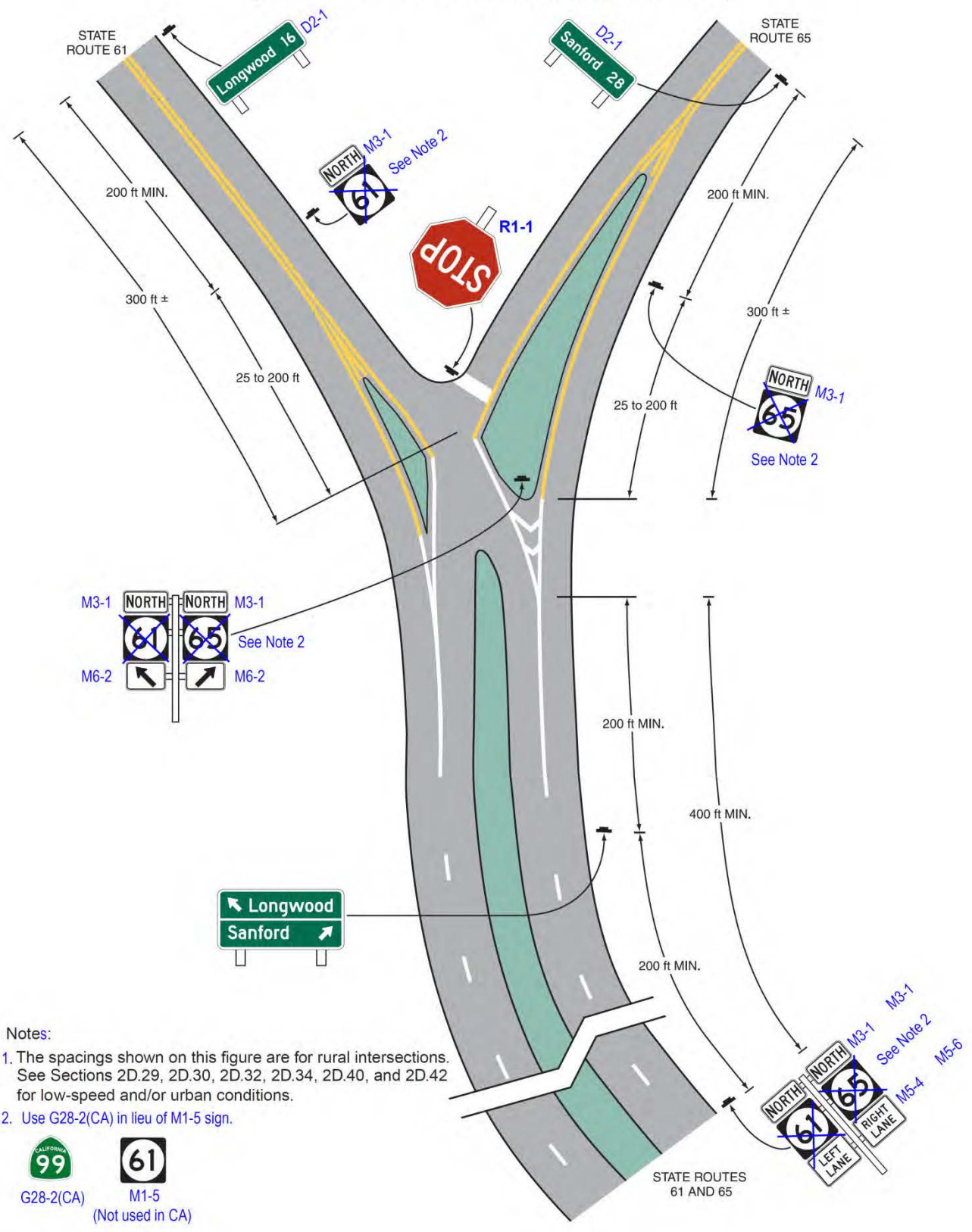
**Figure 2D-6. Illustration of Directional Assemblies and Other Route Signs  
 (for One Direction of Travel Only) (Sheet 3 of 4)**



- Notes: 1. The spacings shown on this figure are for rural intersections. See Sections 2D.29, 2D.30, 2D.32, 2D.34, 2D.40, and 2D.42 for low-speed and/or urban conditions.  
 2. Use G28-2(CA) in lieu of M1-5 and G26-2(CA) in lieu of M1-4 signs.



**Figure 2D-6. Illustration of Directional Assemblies and Other Route Signs (for One Direction of Travel Only) (Sheet 4 of 4)**



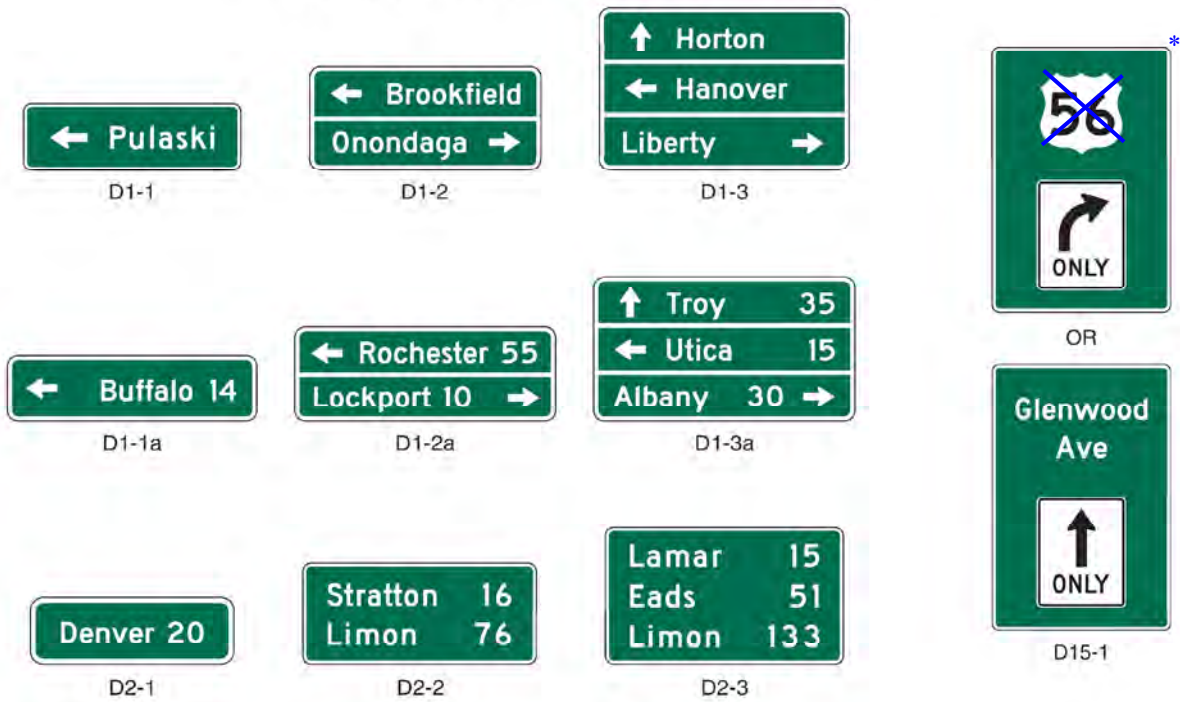
**Notes:**

1. The spacings shown on this figure are for rural intersections. See Sections 2D.29, 2D.30, 2D.32, 2D.34, 2D.40, and 2D.42 for low-speed and/or urban conditions.
2. Use G28-2(CA) in lieu of M1-5 sign.





**Figure 2D-7. Destination and Distance Signs**



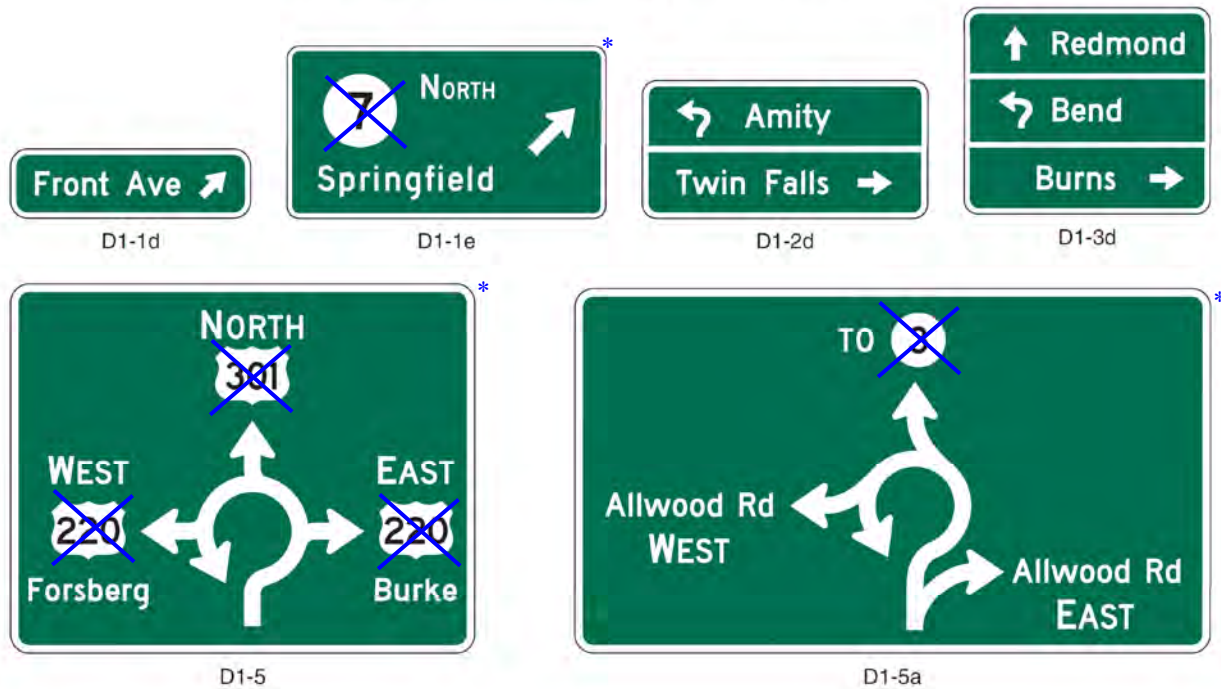
\*Note: For Guide Sign Assemblies use California State Route (G28-1(CA)) and US Route (G26-1(CA)) shields.



**Figure 2D-7 (CA). California Destination and Distance Signs**



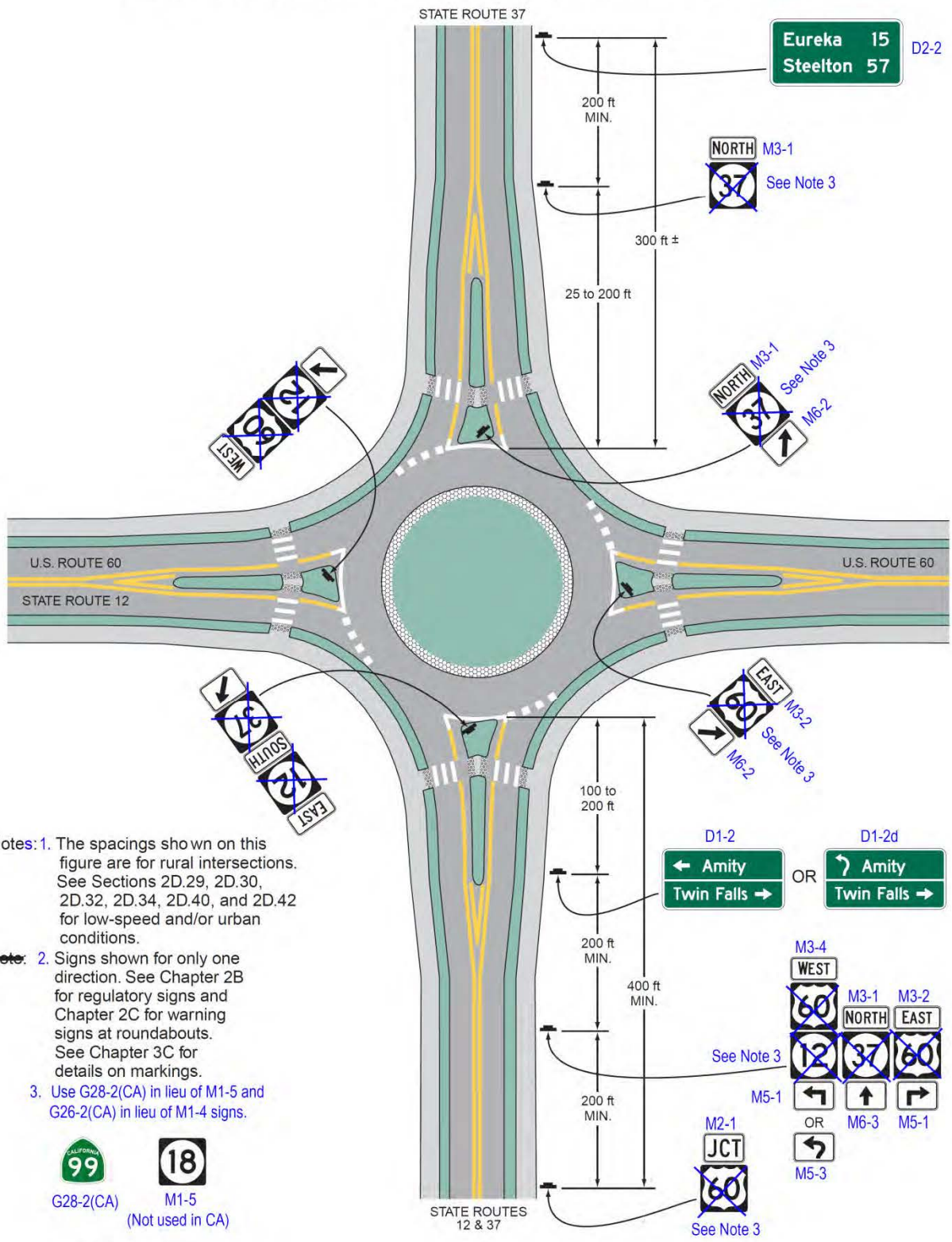
**Figure 2D-8. Destination Signs for Roundabouts**



\*Note: For Guide Sign Assemblies use California State Route (G28-1(CA)) and US Route (G26-1(CA)) shields.



Figure 2D-9. Examples of Guide Signs for Roundabouts (Sheet 1 of 2)



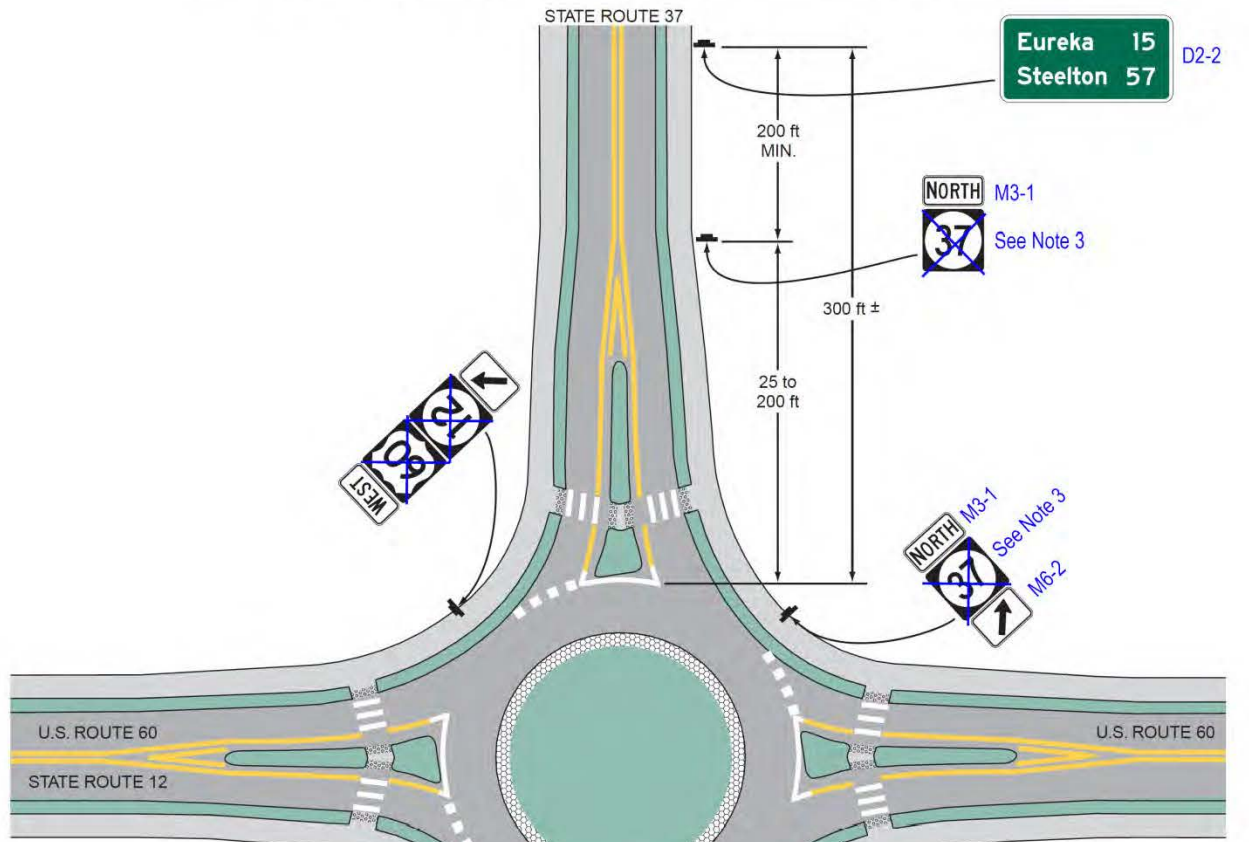
Notes: 1. The spacings shown on this figure are for rural intersections. See Sections 2D.29, 2D.30, 2D.32, 2D.34, 2D.40, and 2D.42 for low-speed and/or urban conditions.

Note: 2. Signs shown for only one direction. See Chapter 2B for regulatory signs and Chapter 2C for warning signs at roundabouts. See Chapter 3C for details on markings.

3. Use G28-2(CA) in lieu of M1-5 and G26-2(CA) in lieu of M1-4 signs.

-  G28-2(CA)
-  M1-5  
(Not used in CA)
-  G26-2(CA)
-  M1-4  
(Not used in CA)

**Figure 2D-9. Examples of Guide Signs for Roundabouts (Sheet 2 of 2)**



Notes: 1. The spacings shown on this figure are for rural intersections. See Sections 2D.29, 2D.30, 2D.32, 2D.34, 2D.40, and 2D.42 for low-speed and/or urban conditions.

Note: 2. Signs shown for only one direction. See Chapter 2B for regulatory signs and Chapter 2C for warning signs at roundabouts. See Chapter 3C for details on markings.

3. Use G28-2(CA) in lieu of M1-5 and G26-2(CA) in lieu of M1-4 signs.



G28-2(CA)



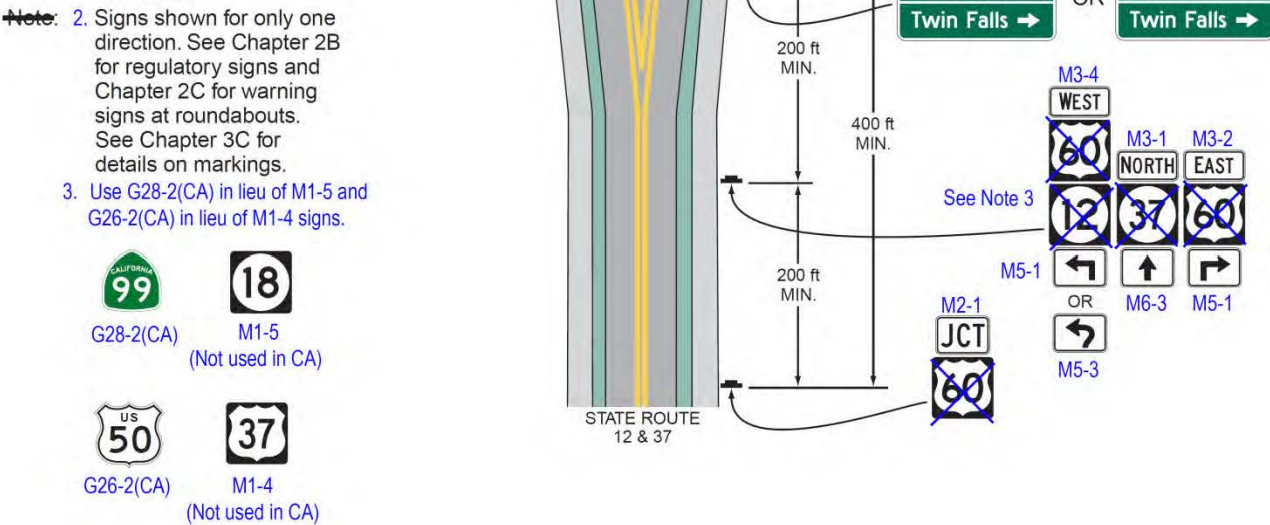
M1-5  
(Not used in CA)



G26-2(CA)



M1-4  
(Not used in CA)



**Figure 2D-10. Street Name and Parking Signs**



\*Note: Use California State Route (G28-1(CA)) or US Route (G26-1(CA)) shields.



**Figure 2D-10 (CA). Street Name and Parking Signs**

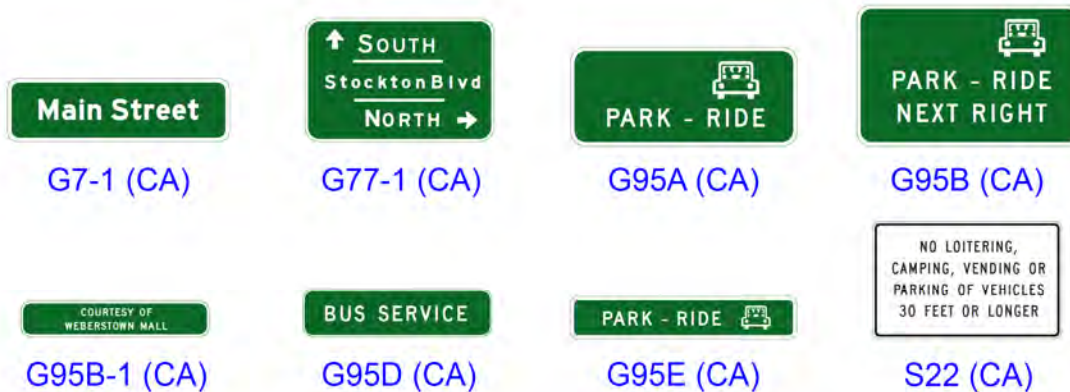
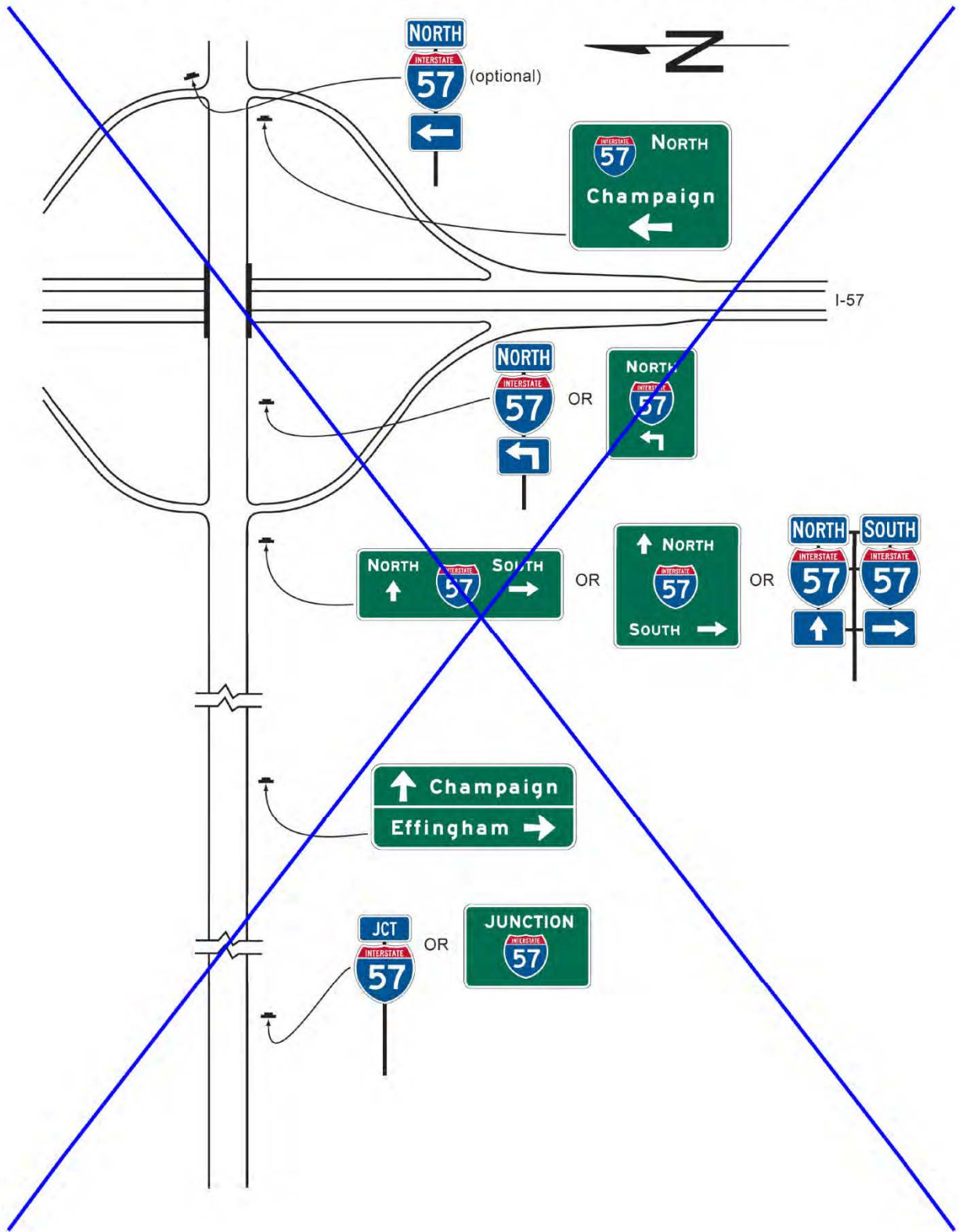
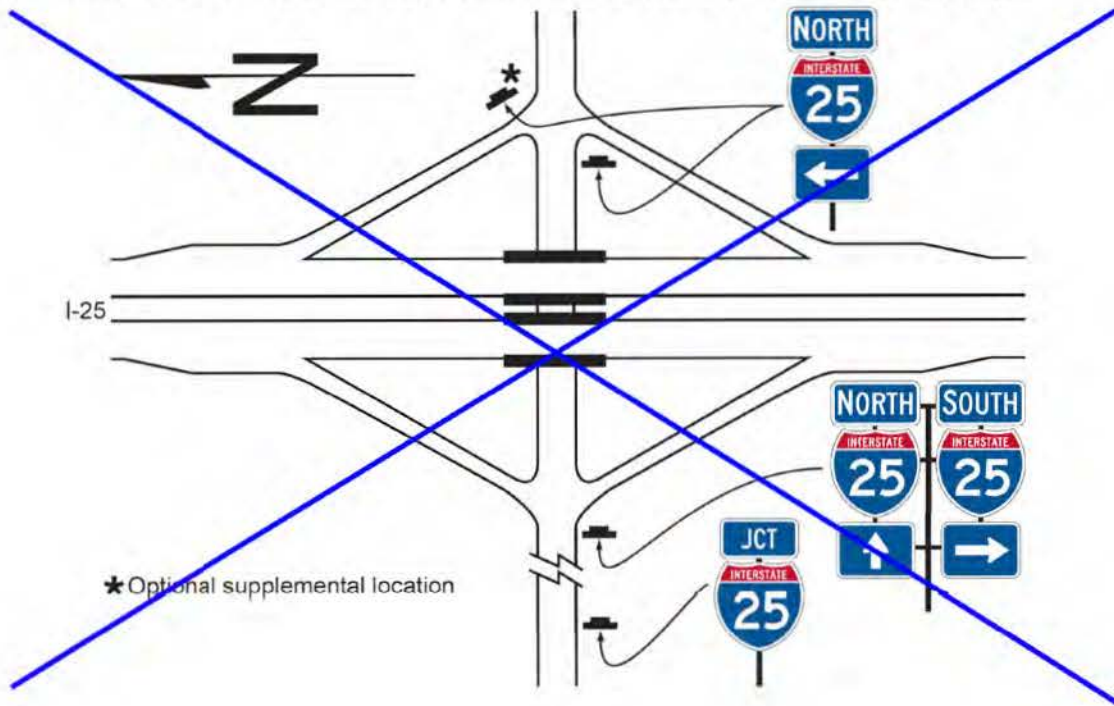


Figure 2D-11. Example of Interchange Crossroad Signing for a One-Lane Approach



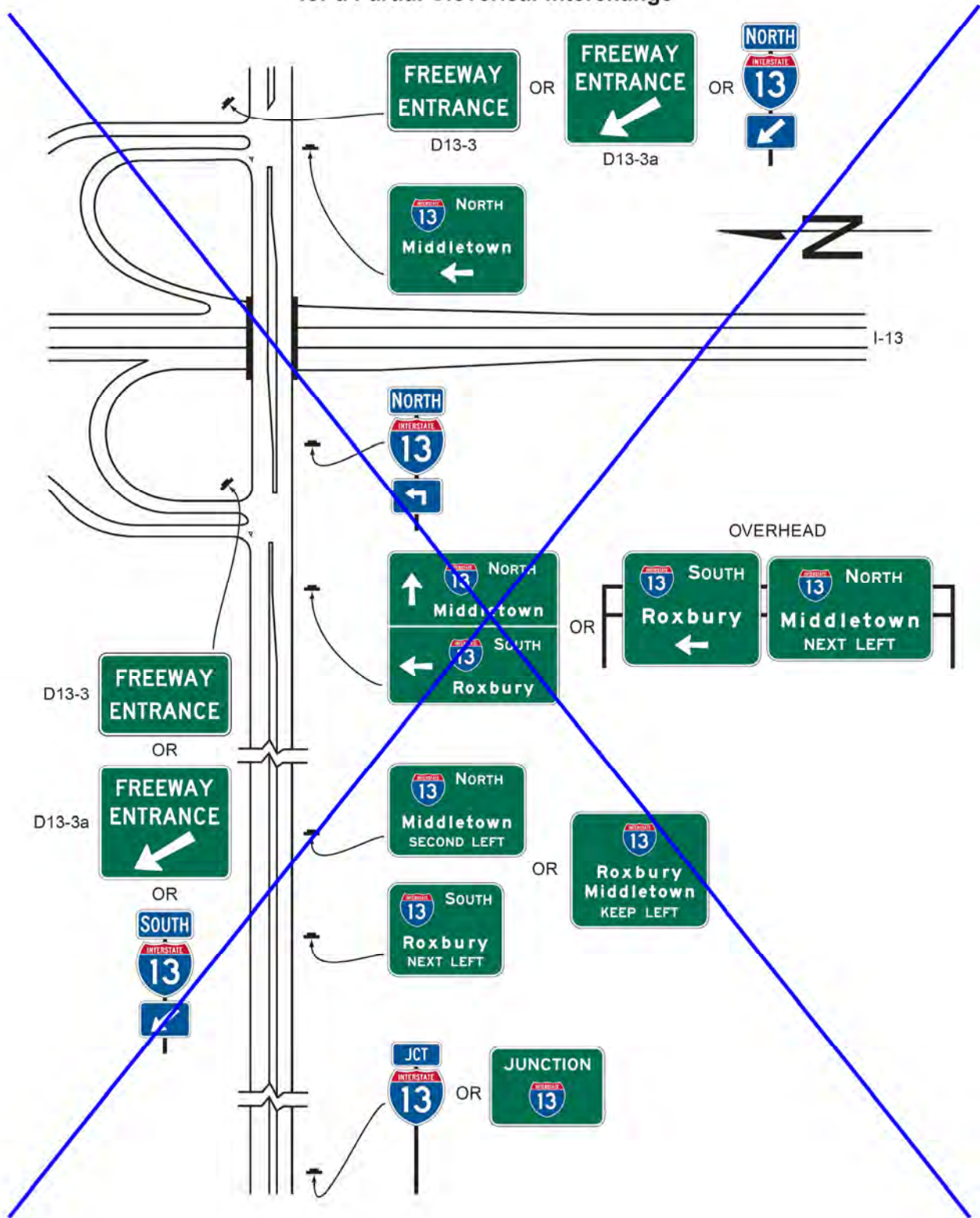
**Figure 2D-12. Example of Minor Interchange Crossroad Signing**



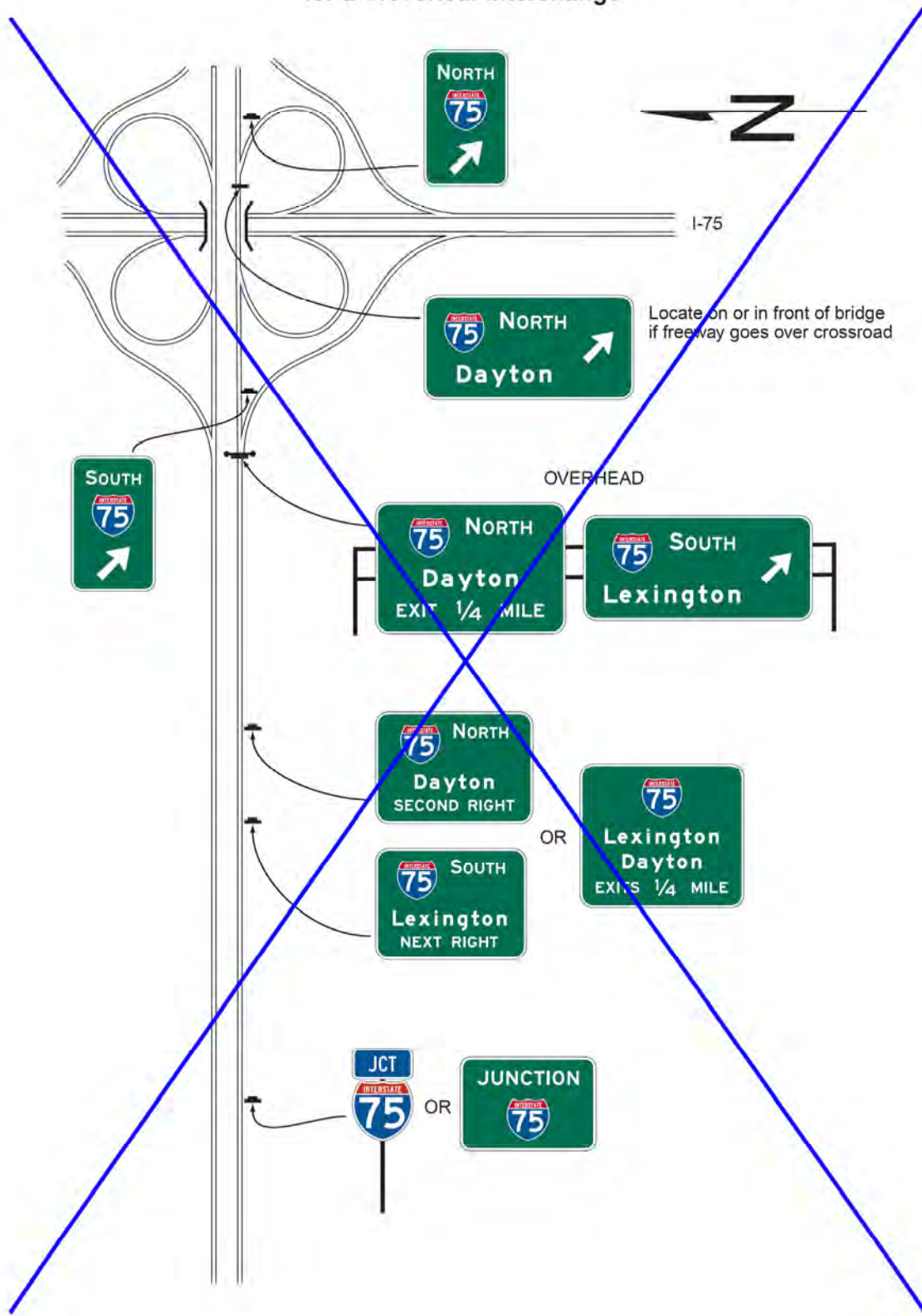




**Figure 2D-14. Examples of Multi-Lane Crossroad Signing for a Partial Cloverleaf Interchange**



**Figure 2D-15. Examples of Multi-Lane Crossroad Signing for a Cloverleaf Interchange**



**Figure 2D-16. Example of Crossroad Signing for an Entrance Ramp with a Nearby Frontage Road**

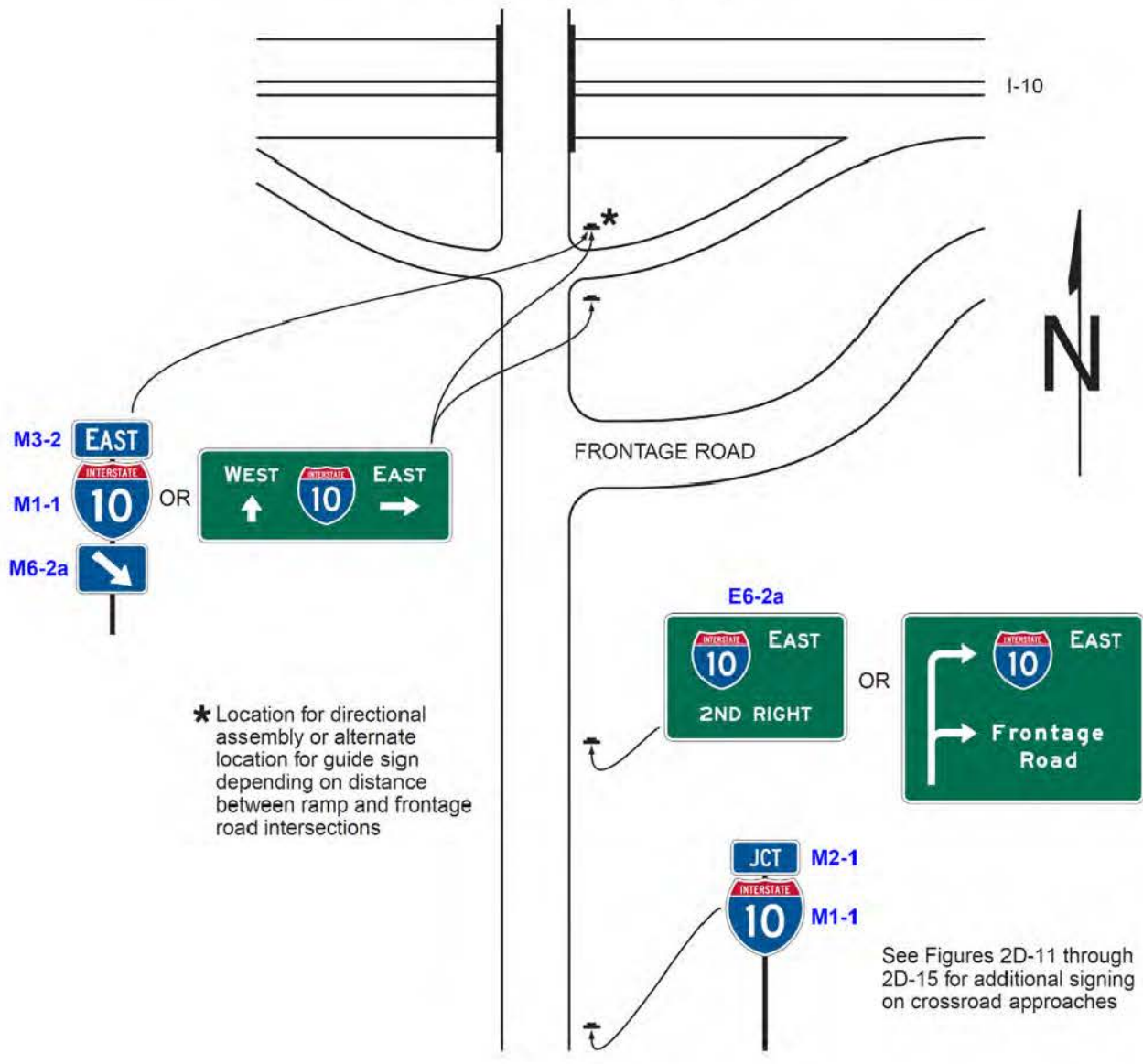
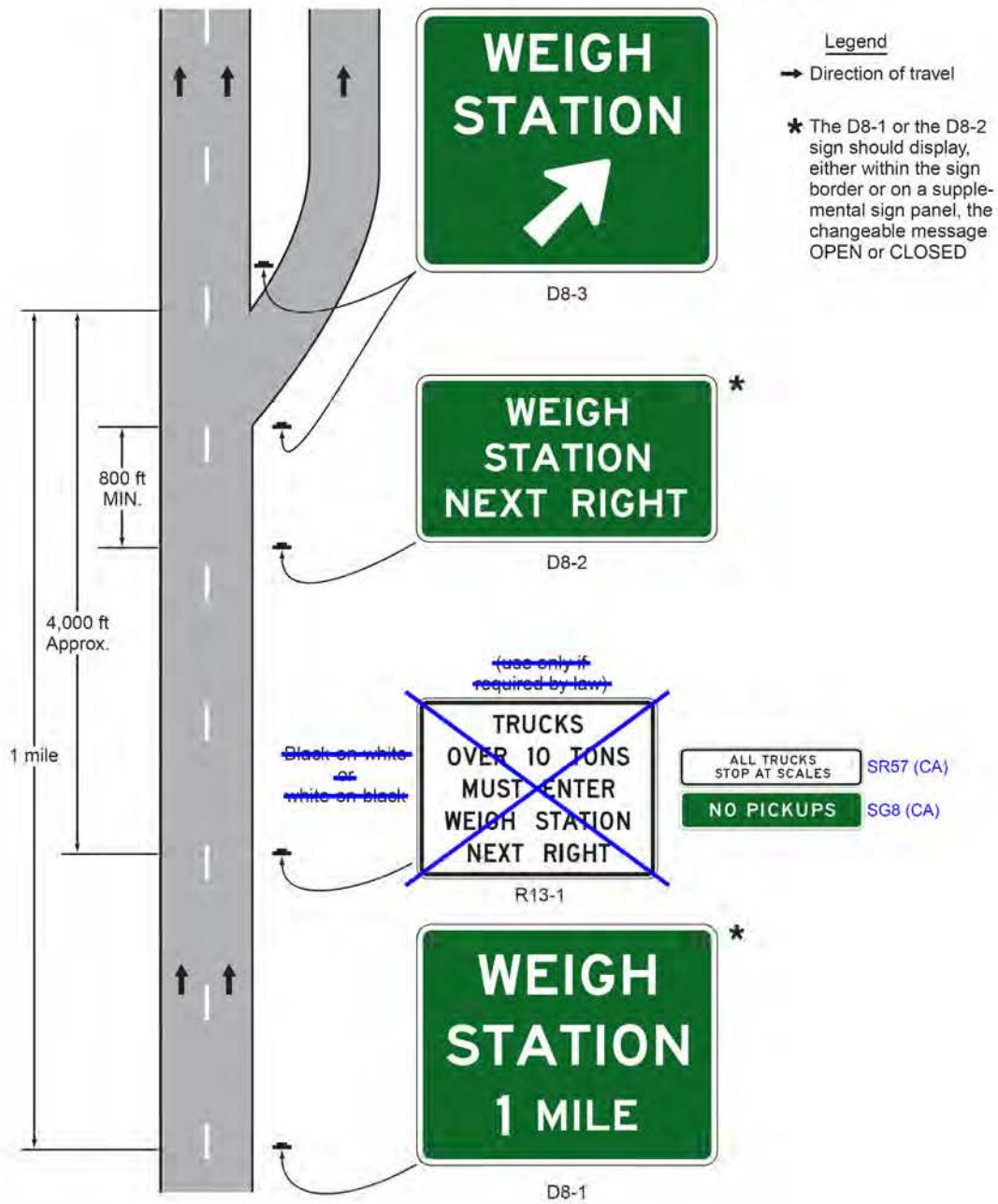


Figure 2D-17. Example of Weigh Station Signing



**Figure 2D-17 (CA). Example of Weigh Station Signing**



**Figure 2D-18. Examples of Community Wayfinding Guide Signs**

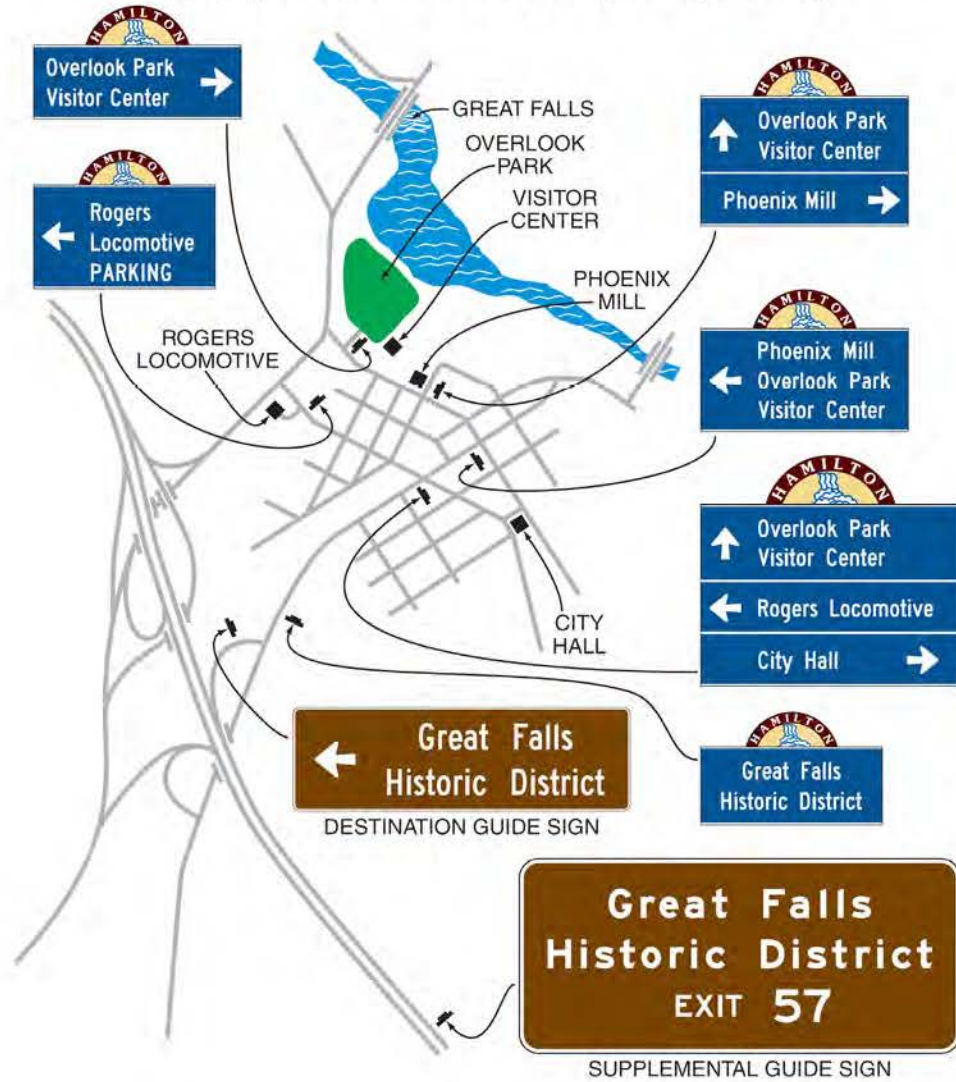
**A - Community Wayfinding Guide Signs with Enhancement Markers**



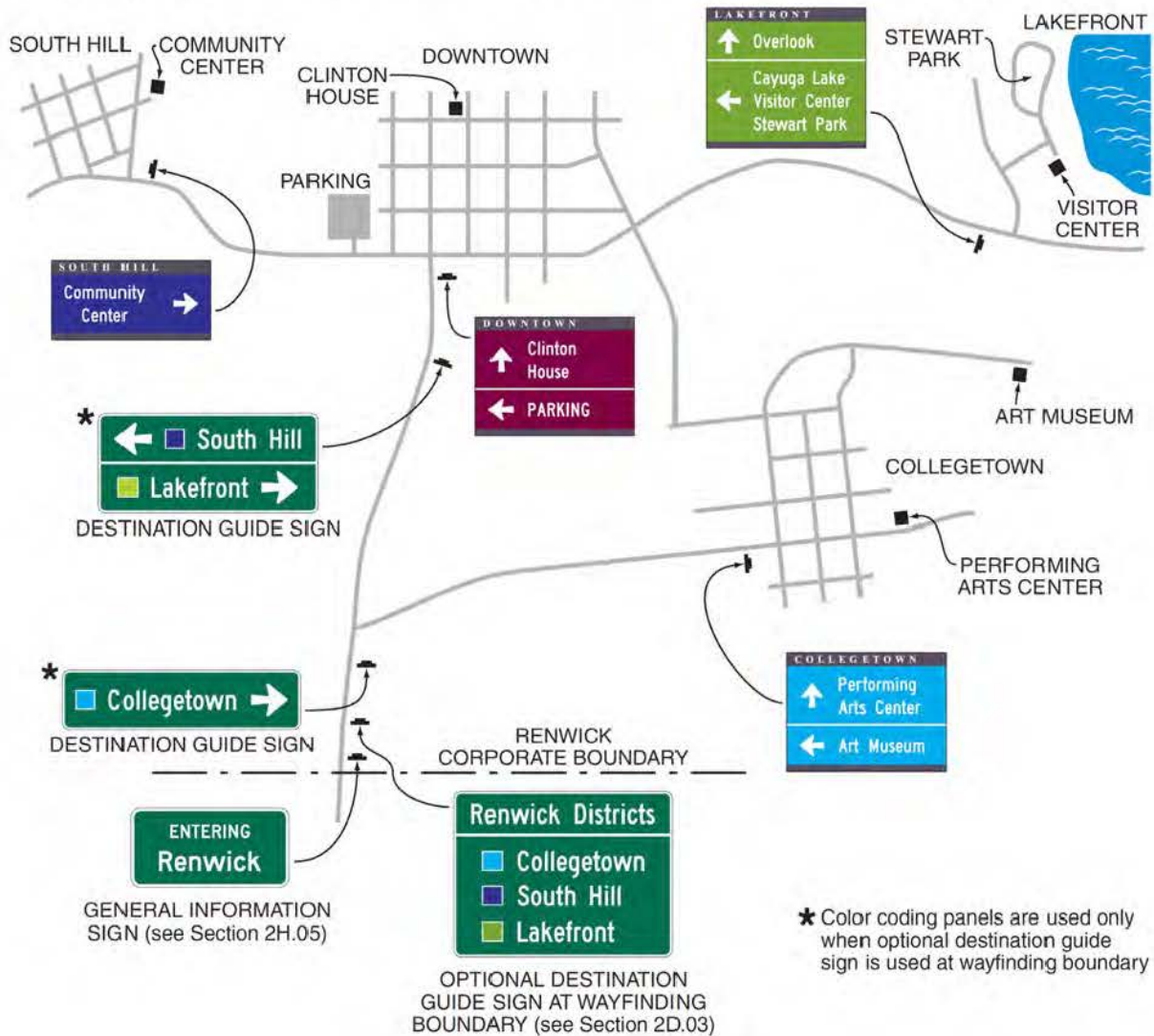
**B - Destination Guide Signs for Color-Coded Community Wayfinding System**



**Figure 2D-19. Example of a Community Wayfinding Guide Sign System Showing Direction from a Freeway or Expressway**

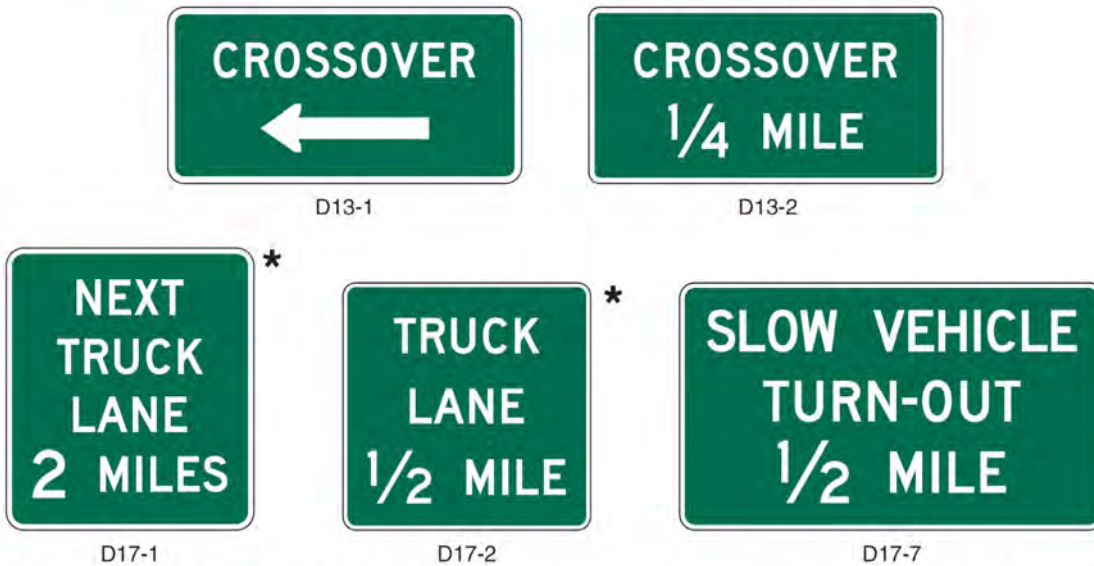


**Figure 2D-20. Example of a Color-Coded Community Wayfinding Guide Sign System**





**Figure 2D-21. Crossover, Truck Lane, and Slow Vehicle Signs**



\* The words PASSING or CLIMBING may be substituted for the word TRUCK on the D17-1 and D17-2 signs.

**Figure 2D-21 (CA). Crossover, Truck Lane, and Slow Vehicle Signs**



G69 (CA)

**Figure 2D-22. Examples of Use of the National Scenic Byways Sign**



\*\*Note: Use California State Route (G28-2(CA)) or US Route (G26-2(CA)) signs.



**Figure 2D-101 (CA). California Miscellaneous Guide Signs**



**Table 2D-1. Conventional Road Guide Sign Sizes**

| Sign  | Sign Designation    | Section | Conventional Road | Minimum     | Oversized   |
|---|---------------------|---------|-------------------|-------------|-------------|
| Interstate Route Sign (1 or 2 digits)       | M1-1                | 2D.11   | 24 x 24           | 24 x 24     | 36 x 36     |
| Interstate Route Sign (3 digits)            | M1-1                | 2D.11   | 30 x 24           | 30 x 24     | 45 x 36     |
| Off-Interstate Route Sign (1 or 2 digits)   | M1-2,3              | 2D.11   | 24 x 24           | 24 x 24     | 36 x 36     |
| Off-Interstate Route Sign (3 digits)        | M1-2,3              | 2D.11   | 30 x 24           | 30 x 24     | 45 x 36     |
| U.S. Route Sign (4 or 2 digits)             | M1-4                | 2D.11   | 24 x 24           | 24 x 24     | 36 x 36     |
| U.S. Route Sign (6 digits)                  | M1-4                | 2D.11   | 36 x 24           | 36 x 24     | 45 x 36     |
| State Route Sign (1 or 2 digits)            | M1-5                | 2D.11   | 24 x 24           | 24 x 24     | 36 x 36     |
| State Route Sign (6 digits)                 | M1-5                | 2D.11   | 36 x 24           | 36 x 24     | 45 x 36     |
| County Route Sign (1, 2, or 3 digits)       | M1-6                | 2D.11   | 24 x 24           | 24 x 24     | 36 x 36     |
| Forest Route (1, 2, or 3 digits)            | M1-7                | 2D.11   | 24 x 24           | 18 x 18     | 36 x 36     |
| Junction                                    | M2-1                | 2D.13   | 21 x 15           | 21 x 15     | 30 x 21     |
| Combination Junction (2 route signs)        | M2-2                | 2D.14   | 60 x 48*          | —           | —           |
| Cardinal Direction                          | M3-1,2,3,4          | 2D.15   | 24 x 12           | 24 x 12     | 36 x 18     |
| Alternate                                   | M4-1,1a             | 2D.17   | 24 x 12           | 24 x 12     | 36 x 18     |
| By-Pass                                     | M4-2                | 2D.18   | 24 x 12           | 24 x 12     | 36 x 18     |
| Business                                    | M4-3                | 2D.19   | 24 x 12           | 24 x 12     | 36 x 18     |
| Truck                                       | M4-4                | 2D.20   | 24 x 12           | 24 x 12     | 36 x 18     |
| To  | M4-5                | 2D.21   | 24 x 12           | 24 x 12     | 36 x 18     |
| End   | M4-6                | 2D.22   | 24 x 12           | 24 x 12     | 36 x 18     |
| Temporary                                   | M4-7,7a             | 2D.24   | 24 x 12           | 24 x 12     | 36 x 18     |
| Begin                                       | M4-14               | 2D.23   | 24 x 12           | 24 x 12     | 36 x 18     |
| Advance Turn Arrow                          | M5-1,2,3            | 2D.28   | 21 x 15           | 21 x 15     | —           |
| Lane Designation                            | M5-4,5,6            | 2D.33   | 24 x 18           | 24 x 18     | 36 x 24     |
| Directional Arrow                           | M6-1,2,2a,3,4,5,6,7 | 2D.29   | 21 x 15           | 21 x 15     | 30 x 21     |
| Destination (1 line)                        | D1-1                | 2D.39   | Varies x 18       | Varies x 18 | —           |
| Destination and Distance (1 line)           | D1-1a               | 2D.39   | Varies x 18       | Varies x 18 | —           |
| Circular Intersection Destination (1 line)  | D1-1d               | 2D.40   | Varies x 18       | Varies x 18 | —           |
| Circular Intersection Departure Guide       | D1-1e               | 2D.40   | Varies x 42*      | —           | —           |
| Destination (2 lines)                       | D1-2                | 2D.39   | Varies x 30       | Varies x 30 | —           |
| Destination and Distance (2 lines)          | D1-2a               | 2D.39   | Varies x 30       | Varies x 30 | —           |
| Circular Intersection Destination (2 lines) | D1-2d               | 2D.40   | Varies x 30       | Varies x 30 | —           |
| Destination (3 lines)                       | D1-3                | 2D.39   | Varies x 42       | Varies x 42 | —           |
| Destination and Distance (3 lines)          | D1-3a               | 2D.39   | Varies x 42       | Varies x 42 | —           |
| Circular Intersection Destination (3 lines) | D1-3d               | 2D.40   | Varies x 42       | Varies x 42 | —           |
| Distance (1 line)                           | D2-1                | 2D.43   | Varies x 18       | Varies x 18 | —           |
| Distance (2 lines)                          | D2-2                | 2D.43   | Varies x 30       | Varies x 30 | —           |
| Distance (3 lines)                          | D2-3                | 2D.43   | Varies x 42       | Varies x 42 | —           |
| Street Name (1 line)                        | D3-1,1a             | 2D.45   | Varies x 12       | Varies x 8  | Varies x 18 |
| Advance Street Name (2 lines)               | D3-2                | 2D.46   | Varies x 30*      | —           | —           |
| Advance Street Name (3 lines)               | D3-2                | 2D.46   | Varies x 42*      | —           | —           |
| Advance Street Name (4 lines)               | D3-2                | 2D.46   | Varies x 60*      | —           | —           |
| Parking Area                                | D4-1                | 2D.49   | 30 x 24           | 18 x 15     | —           |
| Park - Ride                                 | D4-2                | 2D.50   | 30 x 36           | 24 x 30     | 36 x 48     |
| National Scenic Byways                      | D6-4                | 2D.56   | 24 x 24           | 24 x 24     | —           |
| National Scenic Byways                      | D6-4a               | 2D.56   | 24 x 12           | 24 x 12     | —           |
| Weigh Station XX Miles                      | D8-1                | 2D.51   | 78 x 60           | 60 x 48     | 96 x 72     |
| Weigh Station Next Right                    | D8-2                | 2D.51   | 84 x 72           | 66 x 54     | 108 x 90    |
| Weigh Station (with arrow)                  | D8-3                | 2D.51   | 66 x 60           | 48 x 42     | 84 x 78     |
| Crossover                                   | D13-1,2             | 2D.55   | 60 x 30           | 60 x 30     | 78 x 42     |
| Freeway Entrance                            | D13-3               | 2D.48   | 48 x 30           | 48 x 30     | —           |
| Freeway Entrance (with arrow)               | D13-3a              | 2D.48   | 48 x 42           | 48 x 42     | —           |
| Combination Lane Use / Destination          | D15-1               | 2D.35   | Varies x 96       | Varies x 96 | —           |
| Next Truck Lane XX Miles                    | D17-1               | 2D.53   | 42 x 48           | 42 x 48     | 60 x 66     |
| Truck Lane XX Miles                         | D17-2               | 2D.53   | 42 x 42           | 42 x 42     | 60 x 54     |
| Slow Vehicle Turn-Out XX Miles              | D17-7               | 2D.54   | 72 x 42           | 72 x 42     | 96 x 54     |

\*The size shown is for a typical sign. The size should be appropriately based on the amount of legend required for the sign.

- Notes: 1. Larger signs may be used when appropriate  
 2. Dimensions in inches are shown as width x height

**Table 2D-1(CA). California Conventional Road Guide Sign Sizes (Sheet 1 of 2)**

| Sign or Plaque                         | Sign Designation | Section    | Conventional Road | Minimum     | Oversized |
|--|------------------|------------|-------------------|-------------|-----------|
| Destination                            | G1-1(CA)         | 2D.36      | VAR x 18          | VAR x 12    | VAR x 24  |
| Destination                            | G1-4(CA)         | 2D.36      | VAR x 30          | VAR x 18    | VAR x 42  |
| Destination                            | G1-7(CA)         | 2D.36      | VAR x 36          | VAR x 24    | VAR x 48  |
| Destination                            | G1-10(CA)        | 2D.36      | VAR x 48          | VAR x 30    | VAR x 60  |
| Destination                            | G1-13(CA)        | 2D.36      | VAR x 48          | VAR x 30    | VAR x 60  |
| Destination                            | G1-16(CA)        | 2D.36      | VAR x 48          | VAR x 36    | VAR x 72  |
| Destination                            | G1-19(CA)        | 2D.36      | VAR x 42          | VAR x 30    | VAR x 54  |
| Distance                               | G5(CA)           | 2D.42      | VAR x 42          | VAR x 30    | VAR x 54  |
| Street Name                            | G7-1(CA)         | 2D.43      | VAR x 18          | VAR x 6     | VAR x 24  |
| Advance Street Name plaque             | G7-2(CA)         | 2D.44      | VAR x 18          | VAR x 12    | VAR x 24  |
| Destination and Street Name with Arrow | G8-1(CA)         | 2D.42      | VAR x 18          | VAR x 12    | VAR x 24  |
| Destination and Street Name with Arrow | G8-4(CA)         | 2D.42      | VAR x 30          | VAR x 18    | VAR x 42  |
| Destination and Street Name with Arrow | G8-7(CA)         | 2D.42      | VAR x 36          | VAR x 24    | VAR x 48  |
| Destination and Street Name with Arrow | G8-10(CA)        | 2D.42      | VAR x 48          | VAR x 30    | VAR x 60  |
| Destination and Street Name with Arrow | G8-13(CA)        | 2D.42      | VAR x 48          | VAR x 30    | VAR x 60  |
| Destination and Street Name with Arrow | G8-16(CA)        | 2D.42      | VAR x 48          | VAR x 36    | VAR x 72  |
| Destination and Street Name with Arrow | G8-19(CA)        | 2D.42      | VAR x 42          | VAR x 30    | VAR x 54  |
| Destination and Street Name with Arrow | G8-22(CA)        | 2D.42      | VAR x 30          | VAR x 18    | VAR x 42  |
| Inventory Marker                       | G11-1(CA)        | 2D.101(CA) | 36 x 18           | ---         | ---       |
| Inventory Marker                       | G11-2(CA)        | 2D.101(CA) | 36 x 21           | ---         | ---       |
| Inventory Marker                       | G11-4(CA)        | 2D.101(CA) | 44 x 18           | ---         | ---       |
| Inventory Marker                       | G11-4A(CA)       | 2D.101(CA) | 44 x 18           | ---         | ---       |
| Inventory Marker                       | G11-4B(CA)       | 2D.101(CA) | 44 x 24           | ---         | ---       |
| Inventory Marker                       | G11-5(CA)        | 2D.101(CA) | 44 x 24           | ---         | ---       |
| Inventory Marker                       | G11-6(CA)        | 2D.101(CA) | 12 x 24           | ---         | ---       |
| Inventory Marker                       | G11-7(CA)        | 2D.101(CA) | 8 x 24            | ---         | ---       |
| Inventory Marker                       | G11-10(CA)       | 2D.101(CA) | 8 x 30            | ---         | ---       |
| Advance Lane Assignment                | G21-1(CA)        | 2D.31      | VAR x 60          | VAR x 60    | VAR x 72  |
| Advance Lane Assignment                | G21-3(CA)        | 2D.31      | VAR x 90          | VAR x 90    | VAR x 108 |
| Advance Turn                           | G22(CA)          | 2D.26      | VAR x 48          | ---         | ---       |
| U.S. Route Shield                      | G26-1(CA)        | 2D.11      | 11.625 x 10       | 11.625 x 10 | 35 x 30   |
| U.S. Route Marker                      | G26-2(CA)        | 2D.11      | 21 x 18           | 21 x 18     | 35 x 30   |
| Interstate Route Shield                | G27-1(CA)        | 2D.11      | 14 x 12           | 14 x 12     | 36 x 36   |
| Interstate Route Marker                | G27-2(CA)        | 2D.11      | 21 x 18           | 21 x 18     | 36 x 36   |
| State Route Shield                     | G28-1(CA)        | 2D.11      | 10.5 x 9          | 10.5 x 9    | 35 x 32   |
| State Route Marker                     | G28-2(CA)        | 2D.11      | 21 x 18           | 21 x 18     | 35 x 32   |
| Scenic Route                           | G30(CA)          | 2D.55      | 48 x 26           | ---         | ---       |
| Scenic Route                           | G30A(CA)         | 2D.55      | 12 x 18           | 12 x 18     | 18 x 27   |
| Scenic Route                           | G30B(CA)         | 2D.55      | 18 x 18           | 18 x 18     | 24 x 24   |
| Directional Arrow Auxiliary            | G33-1(CA)        | 2D.28      | 24 x 6            | 18 x 5      | 30 x 8    |
| DIVIDED ROAD (X MILES AHEAD)           | G68(CA)          | 2D.51      | 114 x 60          | ---         | ---       |
| PASSING LANE (X MILES) or AHEAD        | G69(CA)          | 2D.51      | 48 x 36           | ---         | ---       |
| ROUTE ____ BUSINESS                    | G76(CA)          | 2D.19      | VAR x 30          | ---         | ---       |
| Interchange Guide                      | G77-1(CA)        | 2D.31      | VAR x 48          | VAR x 48    | VAR x 72  |
| Interchange Guide                      | G77-4(CA)        | 2D.31      | VAR x 54          | VAR x 54    | VAR x 72  |
| Interchange Guide                      | G77-7(CA)        | 2D.31      | VAR x 54          | VAR x 54    | VAR x 72  |
| Interchange Guide                      | G77A(CA)         | 2D.31      | VAR x 66          | VAR x 66    | VAR x 90  |
| Interchange Guide                      | G78-1(CA)        | 2D.31      | VAR x 42          | VAR x 42    | VAR x 54  |
| Interchange Guide                      | G78-4(CA)        | 2D.31      | VAR x 42          | VAR x 42    | VAR x 48  |
| FREEWAY with Arrow                     | G82(CA)          | 2D.31      | 42 x 12           | 42 x 12     | 54 x 15   |
| Supplemental Destination               | G86-1(CA)        | 2D.37      | VAR x 54          | VAR x 54    | VAR x 66  |
| Supplemental Destination               | G86-3(CA)        | 2D.37      | VAR x 96          | VAR x 96    | VAR x 110 |
| Supplemental Destination               | G86-5(CA)        | 2D.37      | VAR x 90          | VAR x 90    | VAR x 108 |
| Supplemental Destination               | G86-7(CA)        | 2D.37      | VAR x 90          | VAR x 90    | VAR x 96  |

**Table 2D-1(CA). California Conventional Road Guide Sign Sizes (Sheet 2 of 2)**

| Sign or Plaque  | Sign Designation | Section    | Conventional Road | Minimum  | Oversized |
|---|------------------|------------|-------------------|----------|-----------|
| Exit Numbered Supplemental Destination                                  | G86-13(CA)       | 2D.37      | VAR x 78          | VAR x 78 | VAR x 90  |
| Veterans National Cemetery Sign   | G86-14(CA)       | 2D.37      | VAR x 66          | ---      | ---       |
| Veterans Home of California   | G86-16(CA)       | 2D.37      | VAR x 66          | ---      | ---       |
| PARK - RIDE   | G95A(CA)         | 2D.48      | 96 x 42           | 96 x 42  | 108 x 48  |
| PARK - RIDE NEXT RIGHT  | G95B(CA)         | 2D.48      | 96 x 60           | 96 x 60  | 108 x 72  |
| Park - Ride Courtesy Plaque   | G95B-1(CA)       | 2D.48      | 96 x 18           | 96 x 18  | 108 x 24  |
| BUS SERVICE Plaque  | G95D(CA)         | 2D.48      | 96 x 24           | 96 x 24  | 108 x 30  |
| Park - Ride Plaque  | G95E(CA)         | 2D.48      | 96 x 18           | 96 x 18  | 120 x 24  |
| Intersection Number   | G98(CA)          | 2D.102(CA) | 18 x 12           | ---      | ---       |
| NO PICKUPS  | SG8(CA)          | 2D.49      | 84 x 18           | 84 x 18  | 120 x 24  |
| Caltrans Facility Entrance  | SG26(CA)         | 2D.103(CA) | 72 x 36           | ---      | ---       |
| STATE PROPERTY  | S1-1(CA)         | 2D.103(CA) | 21 x 15           | ---      | ---       |
| Inventory Marker (Survey)   | S2(CA)           | 2D.101(CA) | 3.5 x 12          | ---      | ---       |
| NO LOITERING, CAMPING, VENDING OR PARKING OF VEHICLES 30 FEET OR LONGER | S22(CA)          | 2D.48      | 24x24             | 24x24    | ---       |
| VEHICLE INSPECTION ONLY, NO LOITERING OR CAMPING                        | S22-1(CA)        | 2D.49      | 48 x 15           | ---      | ---       |
| Caltrans CONSTRUCTION FIELD OFFICE                                      | S27(CA)          | 2D.103(CA) | 36 x 24           | ---      | ---       |

**Table 2D-2. Recommended Minimum Letter Heights on Street Name Signs**

| Type of Mounting | Type of Street or Highway | Speed Limit      | Recommended Minimum Letter Height |             |
|------------------|---------------------------|------------------|-----------------------------------|-------------|
|                  |                           |                  | Initial Upper-Case                | Lower-Case  |
| Overhead         | All types                 | All speed limits | 12 inches                         | 9 inches    |
| Post-mounted     | Multi-lane                | More than 40 mph | 8 inches                          | 6 inches    |
| Post-mounted     | Multi-lane                | 40 mph or less   | 6 inches                          | 4.5 inches  |
| Post-mounted     | 2-lane                    | All speed limits | 6 inches*                         | 4.5 inches* |

\* On local two-lane streets with speed limits of 25 mph or less, 4-inch initial upper-case letters with 3-inch lower-case letters may be used.

**Table 2D-101 (CA). Route Shield Sizes for Guide Signs**

| Guide Sign Letter Size                     | State Route Shield Size | Interstate Route Shield Size | U.S. Route Shield Size | Quantity of Numerals | Shield Numeral Size       |
|--|-------------------------|------------------------------|------------------------|----------------------|---------------------------|
| 4" & 5" Caps                               | 10-1/2" x 9"            |                              |                        | 1 or 2               | 4"                        |
| 4" & 5" Caps                               | 15" x 11"               |                              |                        | 3                    | 4"                        |
| 4" & 5" Caps                               |                         | 14" x 12"                    |                        | 1 or 2               | 4"                        |
| 4" & 5" Caps                               |                         | 16" x 14"                    |                        | 3                    | 4"                        |
| 4" & 5" Caps                               |                         |                              | 11-1/2" x 10"          | 1 or 2               | 4"                        |
| 4" & 5" Caps                               |                         |                              | 14-1/2" x 10"          | 3                    | 4"                        |
| 8" U.C. & 6" L.C. or 6" U.C. & 4-1/2" L.C. | 21" x 18"               | 21" x 18"                    | 21" x 18"              | 1 or 2               | 8"                        |
| 8" U.C. & 6" L.C. or 6" U.C. & 4-1/2" L.C. | 24" x 18"               |                              |                        | 3                    | 6" without the numeral 1  |
| 8" U.C. & 6" L.C. or 6" U.C. & 4-1/2" L.C. | 24" x 18"               |                              |                        | 3                    | 8" with the numeral 1     |
| 8" U.C. & 6" L.C. or 6" U.C. & 4-1/2" L.C. |                         | 21" x 18"                    |                        | 3                    | 6" with the numeral 1     |
| 8" U.C. & 6" L.C. or 6" U.C. & 4-1/2" L.C. |                         | 24" x 24"                    |                        | 3                    | 6" without the numeral 1  |
| 8" U.C. & 6" L.C. or 6" U.C. & 4-1/2" L.C. |                         |                              | 27" x 18"              | 3                    | 8"                        |
| 10.67" U.C. & 8" L.C.                      | 28" x 25"               |                              |                        | 1 or 2               | 10"                       |
| 10.67" U.C. & 8" L.C.                      | 32" x 25"               |                              |                        | 3                    | 10"                       |
| 10.67" U.C. & 8" L.C.                      |                         | 24" x 24"                    |                        | 1 or 2               | 10"                       |
| 10.67" U.C. & 8" L.C.                      |                         | 30" x 25"                    |                        | 3                    | 8" without the numeral 1  |
| 10.67" U.C. & 8" L.C.                      |                         | 30" x 25"                    |                        | 3                    | 10" with the numeral 1    |
| 10.67" U.C. & 8" L.C.                      |                         |                              | 28" x 24"              | 1 or 2               | 10"                       |
| 10.67" U.C. & 8" L.C.                      |                         |                              | 36" x 24"              | 3                    | 10"                       |
| 13.3" U.C. & 10" L.C.                      | 35" x 32"               |                              |                        | 1 or 2               | 12"                       |
| 13.3" U.C. & 10" L.C.                      | 40" x 32"               |                              |                        | 3                    | 12"                       |
| 13.3" U.C. & 10" L.C.                      |                         | 36" x 36"                    |                        | 1 or 2               | 12"                       |
| 13.3" U.C. & 10" L.C.                      |                         | 36" x 36"                    |                        | 3                    | 12" with the numeral 1    |
| 13.3" U.C. & 10" L.C.                      |                         | 45" x 38"                    |                        | 3                    | 12" without the numeral 1 |
| 13.3" U.C. & 10" L.C.                      |                         |                              | 35" x 30"              | 1 or 2               | 12"                       |
| 13.3" U.C. & 10" L.C.                      |                         |                              | 45" x 30"              | 3                    | 12"                       |
| 16" U.C. & 12" L.C.                        | 36" x 36"               | 36" x 36"                    |                        | 1 or 2               | 15"                       |
| 16" U.C. & 12" L.C.                        | 45" x 36"               |                              |                        | 3                    | 12" without the numeral 1 |
| 16" U.C. & 12" L.C.                        | 45" x 36"               |                              |                        | 3                    | 15" with the numeral 1    |
| 16" U.C. & 12" L.C.                        |                         | 45" x 38"                    |                        | 3                    | 12" without the numeral 1 |
| 16" U.C. & 12" L.C.                        |                         | 45" x 38"                    |                        | 3                    | 15" with the numeral 1    |
| 16" U.C. & 12" L.C.                        |                         |                              | 42" x 36"              | 1 or 2               | 15"                       |
| 16" U.C. & 12" L.C.                        |                         |                              | 54" x 36"              | 3                    | 15"                       |
| 20" U.C. & 15" L.C.                        | 42" x 42"               |                              |                        | 1 or 2               | 18"                       |
| 20" U.C. & 15" L.C.                        | 54" x 42"               |                              |                        | 3                    | 18"                       |
| 20" U.C. & 15" L.C.                        |                         | 48" x 48"                    |                        | 1 or 2               | 18"                       |
| 20" U.C. & 15" L.C.                        |                         | 58" x 51"                    |                        | 3                    | 18"                       |
| 20" U.C. & 15" L.C.                        |                         |                              | 49" x 42"              | 1 or 2               | 18"                       |
| 20" U.C. & 15" L.C.                        |                         |                              | 63" x 42"              | 3                    | 18"                       |

**Exceptions:**

1. For **G23 Signs**, use the 10" Numeral Size Shields.
2. For **G77 & G78 signs**, use the 10" Numeral Size Shields. However, when the shield is in line with the word message, the shield's numeral size should match the lower case letter height.

**Table 2D-102 (CA). Criteria for Supplemental Destination Signs**

| Type of Destination  | Specific Criteria  | Major Metropolitan Areas | Urbanized Areas | Rural Areas  |
|--|--|--------------------------|-----------------|--------------|
| Post Secondary School, Public or Private                                   | Minimum Enrollment (Single Campus Locations, See Note 5).<br>Maximum Miles from a Freeway ( See Note 6).   | 1,000<br>2               | 1,000<br>4      | 1,000<br>5   |
| Museum, Zoo, Stadium or Sports Arena                                       | Public Owned and Non-Profit.<br>Minimum Annual Attendance.<br>Maximum Miles from Highway (See Note 2).   | 1,000,000<br>2           | 500,000<br>2    | 200,000<br>3 |
| Convention Center  | Public Owned and Non-Profit.<br>Minimum Annual Attendance.<br>Maximum Miles from Highway (See Note 2).   | 500,000<br>3             | 250,000         | --           |
| Military Base  | Number of Employees and Permanent Garrison.<br>Maximum Miles from Highway.   | 5,000<br>2               | 5,000<br>4      | 5,000<br>7   |
| National Guard Armory  | Only Emergency Center in the Area.<br>Easy Access to Primary Evacuation Route.<br>(See Note 2).  | --                       | --              | --           |
| Fairgrounds  | Publicly Owned and Operated.<br>Temporary Sign Only, Unless There are Year Round Activities.<br>Minimum Annual Attendance.<br>Maximum Miles from Highway (See Note 2). | 500,000<br>2             | 200,000<br>4    | 200,000<br>5 |
| Federal or State Hospitals, Prisons, National Cemeteries and Veterans Home | Maximum Miles from Highway (See Note 2).   | 1                        | 3               | 5            |
| Government Centers   | Number of Employees.<br>Maximum Miles from Highway (See Note 2).   | 5,000<br>2               | 2,000<br>3      | 1,000<br>5   |
| California Welcome Centers   | Easy Access from Nearest State Highway.<br>(See Notes 2 and 7)   | --                       | --              | --           |
| Airports   | Maximum Miles from Highway (See Note 2).   | 1                        | 3               | 5            |
| Rail and Light Rail Stations   | Easy Access from Nearest State Highway.<br>(See Note 2).   | --                       | --              | --           |

NOTES: 1. Meeting the above criteria does not guarantee placement of a sign. Limitations on the spacing between sign and the number of messages permitted, specified in Sections 2A.16, 2D.07 and 2D.40, shall be observed and eligible destinations must compete for signing on the basis of traffic service.

2. Follow-up signing, if necessary, shall be installed by local agencies before signs are placed on the State Highway.

3. If a stadium is located at a school campus for which signs are already provided, separate stadium sign will not be placed.

4. Definitions of Area Classifications:

A. MAJOR METROPOLITAN AREA - An urbanized area, population density of at least 1,000 inhabitants per 2.6 km<sup>2</sup> (1 mi<sup>2</sup>), not necessarily related to county boundaries, with a total population of at least 1,000,000 and an included central city with a population of at least 250,000.

B. URBANIZED AREA - An urbanized area with a total population of at least 50,000 and an included central city with no minimum population.

C. RURAL AREA - All areas outside of an urbanized area.

5. Public or private postsecondary education institution shall have an enrollment of either 1,000 or more full-time students or an equivalent in part-time students. Refer to CVC Section 21375.

6. No signs to school will be erected until funds from private sources covering the cost of the signs and their installation. If a school, which previously had signs, relocates to contribute to the improvement of the school (as determined by the California Department of Transportation), signs will be erected at the new location at no cost to the school.

7. The California Department of Transportation will charge the Welcome Center directly for the cost of the signs and their installation on the State highway. Cost for sign installation on local roads is the responsibility of the Welcome Center and the local agency.





## CHAPTER 2E. GUIDE SIGNS – FREEWAYS AND EXPRESSWAYS

### Section 2E.01 Scope of Freeway and Expressway Guide Sign Standards

Support:

01 The provisions of this Chapter provide a uniform and effective system of signing for high-volume, high-speed motor vehicle traffic on freeways and expressways. The requirements and specifications for expressway signing exceed those for conventional roads (see Chapter 2D), but are less than those for freeway signing. Since there are many geometric design variables to be found in existing roads, a signing concept commensurate with prevailing conditions is the primary consideration. Section 1A.13 includes definitions of freeway and expressway.

02 Guide signs for freeways and expressways are primarily identified by the name of the sign rather than by an assigned sign designation. Guidelines for the design of guide signs for freeways and expressways are provided in the “Standard Highway Signs and Markings” book (see Section 1A.11).

**Standard:**

03 **The provisions of this Chapter shall apply to any highway that meets the definition of freeway or expressway facilities.**

### Section 2E.02 Freeway and Expressway Signing Principles

Support:

01 The development of a signing system for freeways and expressways is approached on the premise that the signing is primarily for the benefit and direction of road users who are not familiar with the route or area. The signing furnishes road users with clear instructions for orderly progress to their destinations. Sign installations are an integral part of the facility and, as such, are best planned concurrently with the development of highway location and geometric design. For optimal results, plans for signing are analyzed during the earliest stages of preliminary design, and details are correlated as final design is developed. The excessive signing found on many major highways usually is the result of using a multitude of signs that are too small and that are poorly designed and placed to accomplish the intended purpose.

02 Freeway and expressway signing is to be considered and developed as a planned system of installations. An engineering study is sometimes necessary for proper solution of the problems of many individual locations, but, in addition, consideration of an entire route is necessary.

*Guidance*

03 *Road users should be guided with consistent signing on the approaches to interchanges, when they drive from one State to another, and when driving through rural or urban areas. Because geographical, geometric, and operating factors regularly create significant differences between urban and rural conditions, the signing should take these conditions into account.*

04 *Guide signs on freeways and expressways should serve distinct functions as follows:*

- A. Give directions to destinations, or to streets or highway routes, at intersections or interchanges;*
- B. Furnish advance notice of the approach to intersections or interchanges;*
- C. Direct road users into appropriate lanes in advance of diverging or merging movements;*
- D. Identify routes and directions on those routes;*
- E. Show distances to destinations;*
- F. Indicate access to general motorist services, rest, scenic, and recreational areas; and*
- G. Provide other information of value to the road user.*

### Section 2E.03 Guide Sign Classification

Support:

01 Freeway and expressway guide signs are classified and treated in the following categories:

- A. Route signs and Trailblazer Assemblies (see Section 2E.27),
- B. At-Grade Intersection signs (see Section 2E.29),
- C. Interchange signs (see Sections 2E.30 through 2E.39),
- D. Interchange Sequence signs (see Section 2E.40),

- E. Community Interchanges Identification signs (see Section 2E.41),
- F. NEXT XX EXITS signs (see Section 2E.42),
- G. Weigh Station signing (see Section 2E.54),
- H. Miscellaneous Information signs (see Section 2H.04)
- I. Reference Location signs (see Section 2H.05),
- J. General Service signs (see Chapter 2I),
- K. Rest and Scenic Area signs (see Section 2I.05),
- L. Tourist Information and Welcome Center signs (see Section 2I.08),
- M. Radio Information signing (see Section 2I.09)
- N. Carpool and Ridesharing signing (see Section 2I.11),
- O. Specific Service signs (see Chapter 2J), and
- P. Recreational and Cultural Interest Area signs (see Chapter 2M).

### **Section 2E.04 General**

**Support:**

01 Signs are designed so that they are legible to road users approaching them and readable in time to permit proper responses. Desired design characteristics include: (a) long visibility distances, (b) large lettering, symbols, and arrows, and (c) short legends for quick comprehension.

**Standard:**

02 **Standard shapes and colors shall be used so that traffic signs can be promptly recognized by road users.**

### **Section 2E.05 Color of Guide Signs**

**Standard:**

01 **Guide signs on freeways and expressways, except as otherwise provided in this Manual, shall have white letters, symbols, arrows, and borders on a green background.**

**Support:**

02 Color requirements for route signs and trailblazers, signs with blank-out or changeable messages, signs for services, rest areas, park and recreational areas, and for certain miscellaneous signs are provided in the individual Sections dealing with the particular sign or sign group.

### **Section 2E.06 Retroreflection or Illumination**

**Standard:**

01 **Letters, numerals, symbols, arrows, and borders of all guide signs shall be retroreflectorized. The background of all guide signs that are not independently illuminated shall be retroreflective.**

**Support:**

02 Where there is no serious interference from extraneous light sources, retroreflectorized post-mounted signs usually provide adequate nighttime visibility.

03 On freeways and expressways where much driving at night is done with low-beam headlights, the amount of headlight illumination incident to an overhead sign display is relatively small.

**Guidance:**

04 *Overhead sign installations should be illuminated unless an engineering study shows that retroreflectorization alone will perform effectively. The type of illumination chosen should provide effective and reasonably uniform illumination of the sign face and message.*

### **Section 2E.07 Characteristics of Urban Signing**

**Support:**

01 Urban conditions are characterized not so much by city limits or other arbitrary boundaries, as by the following features:

- A. Mainline roadways with more than two lanes in each direction;
- B. High traffic volumes on the through roadways;
- C. High volumes of traffic entering and leaving interchanges;

- D. Interchanges closely spaced;
- E. Roadway and interchange lighting;
- F. Three or more interchanges serving the major city;
- G. A loop, circumferential, or spur serving a sizable portion of the urban population; and
- H. Visual clutter from roadside development.

<sup>02</sup> Operating conditions and road geometrics on urban freeways and expressways usually make special sign treatments desirable, including:

- A. Use of Interchange Sequence signs (see Section 2E.40);
- B. Use of sign spreading to the maximum extent possible (see Section 2E.11);
- C. Elimination of General or Specific Service signing (see Chapters 2I and 2J);
- D. Reduction to a minimum of post-interchange signs (see Section 2E.38);
- E. Display of advance signs at distances closer to the interchange, with appropriate adjustments in the legend (see Section 2E.33);
- F. Use of overhead signs on roadway structures and independent sign supports (see Section 2E.25);
- G. Use of Overhead Arrow-per-Lane or Diagrammatic guide signs in advance of intersections and interchanges (see Sections 2E.21 and 2E.22); and
- H. Frequent use of street names as the principal message in guide signs.

<sup>03</sup> Lower speeds which are often characteristic of urban operations do not justify lower signing standards. Typical traffic patterns are more complex for the road user to negotiate, and large, easy-to-read legends are, therefore, just as necessary as on rural highways.

### **Section 2E.08 Characteristics of Rural Signing**

Support:

<sup>01</sup> Rural areas ordinarily have greater distances between interchanges, which permits adequate spacing for the sequences of signs on the approach to and departure from each interchange. However, the absence of traffic in adjoining lanes and on entering or exiting ramps often adds monotony or inattention to rural driving. This increases the importance of signs that call for decisions or actions.

*Guidance:*

<sup>02</sup> *Where there are long distances between interchanges and the alignment is relatively unchanging, signs should be positioned for their best effect on road users. The tendency to group all signing in the immediate vicinity of rural interchanges should be avoided by considering the entire route in the development of signing plans. Extra effort should be given to the placement of signs at natural target locations to command the attention of the road user, particularly when the message requires an action by the road user.*

### **Section 2E.09 Signing of Named Highways**

Support:

<sup>01</sup> Section 2D.53 contains information, which is also applicable to freeways and expressways, regarding the use of highway names on the signing for unnumbered highways to enhance route guidance and facilitate travel.

<sup>02</sup> Section 2M.10 contains information regarding memorial signing of routes, bridges, or highway components.

### **Section 2E.10 Amount of Legend on Guide Signs**

*Guidance:*

<sup>01</sup> *No more than two destination names or street names should be displayed on any Advance Guide sign or Exit Direction sign. A city name and street name on the same sign should be avoided. Where two or three signs are placed on the same supports, destinations or names should be limited to one per sign, or to a total of three in the display. Sign legends should not exceed three lines of copy, exclusive of the exit number and action or distance information.*

### **Section 2E.11 Number of Signs at an Overhead Installation and Sign Spreading**

*Guidance:*

<sup>01</sup> *If overhead signs are warranted, as set forth in Section 2A.17, the number of signs at these locations should be limited to only those essential in communicating pertinent destination information to the road user. Exit*

*Direction signs for a single exit and the Advance Guide signs should have only one sign with one or two destinations. Regulatory signs, such as speed limits, should not be used in conjunction with overhead guide sign installations. Because road users have limited time to read and comprehend sign messages, there should not be more than three guide signs displayed at any one location either on the overhead structure or its support.*

**Option:**

<sup>02</sup> At overhead locations, more than one sign may be installed to advise of a multiple exit condition at an interchange. If the roadway ramp or crossing roadway has complex or unusual geometrics, additional signs with confirming messages may be provided to properly guide the road user.

**Support:**

<sup>03</sup> Sign spreading is a concept where major overhead signs are spaced so that road users are not overloaded with a group of signs at a single location. Figure 2E-1 illustrates an example of sign spreading.

**Guidance:**

<sup>04</sup> *Where overhead signing is used, sign spreading should be used at all single exit interchanges and to the extent possible at multi-exit interchanges. Sign spreading should be accomplished by use of the following:*

- A. The Exit Direction sign should be the only sign used in the vicinity of the gore (other than the Exit Gore sign). It should be located overhead near the theoretical gore and generally on an overhead sign support structure.*
- B. The Advance Guide sign to indicate the next interchange exit should be placed near the crossroad location. If the crossroad goes over the mainline, the Advance Guide sign should be placed on the overcrossing structure or on a separate structure immediately in front of the overcrossing structure.*

## **Section 2E.12 Pull-Through Signs (E6-2, E6-2a)**

**Support:**

<sup>01</sup> Pull-Through (E6-2, E6-2a) signs (see Figure 2E-2 and 2E-2(CA)) are overhead guide signs intended for through traffic.

<sup>01a</sup> See Figures 2E-34(CA), 2E-35(CA) and 2E-37(CA) through 2E-40(CA) for typical freeway signing and use of the Pull-Through (G24(CA) Series) signs.

**Guidance:**

<sup>02</sup> *Pull-Through signs should be used where the geometrics of a given interchange are such that it is not clear to the road user as to which is the through roadway, or where additional route guidance is desired. Pull-Through signs with down arrows should be used where the alignment of the through lanes is curved and the exit direction is straight ahead, where the number of through lanes is not readily evident, and at multi-lane exits where there is a reduction in the number of through lanes.*

**Support:**

<sup>03</sup> Sections 2E.20 through 2E.24 contain information regarding the use of Overhead Arrow-per-Lane or Diagrammatic guide signs at multi-lane exits where there is a reduction in the number of through lanes and a through lane becomes an interior option lane for through or exiting traffic.

## **Section 2E.13 Designation of Destinations**

**Standard:**

<sup>01</sup> **The direction of a freeway and the major destinations or control cities along it shall be clearly identified through the use of appropriate destination legends (see Section 2D.37). Successive freeway guide signs shall provide continuity in destination names and consistency with available map information. At any decision point, a given destination shall be indicated by way of only one route.**

**Guidance:**

- <sup>02</sup> *Control city legends should be used in the following situations along a freeway:*
  - A. At interchanges between freeways;*
  - B. At separation points of overlapping freeway routes;*
  - C. On directional signs on intersecting routes, to guide traffic entering the freeway;*
  - D. On Pull-Through signs; and*
  - E. On the bottom line of post-interchange distance signs.*

**Support:**

<sup>03</sup> Continuity of destination names is also useful on expressways serving long-distance or intrastate travel.

<sup>04</sup> The determination of major destinations or control cities is important to the quality of service provided by the freeway. Control cities on freeway guide signs are selected by the States and are contained in the "Guidelines for the Selection of Supplemental Guide Signs for Traffic Generators Adjacent to Freeways, 4th Edition/Guide Signs, Part II: Guidelines for Airport Guide Signing/Guide Signs, Part III: List of Control Cities for Use in Guide Signs on Interstate Highways," published by and available from the American Association of State and Highway Transportation Officials (see Section 1A.11).

**Guidance:**

<sup>05</sup> *Each Caltrans District should determine its list of control cities in cooperation with adjacent districts and states to achieve continuity of signing for through traffic on State highways. Any given route should have the same control cities (in both directions of travel).*

## **Section 2E.14 Size and Style of Letters and Signs**

**Standard:**

<sup>01</sup> **Except as provided in Section 2A.11, the sizes of freeway and expressway guide signs that have standardized designs shall be as shown in Table 2E-1.**

**Support:**

<sup>02</sup> Section 2A.11 contains information regarding the applicability of the various columns in Table 2E-1.

**Option:**

<sup>03</sup> Signs larger than those shown in Table 2E-1 may be used (see Section 2A.11).

**Standard:**

<sup>04</sup> **For all freeway and expressway signs that do not have a standardized design, the message dimensions shall be determined first, and the outside sign dimensions secondarily. Word messages in the legend of expressway guide signs shall be in letters at least 8 inches high. Larger lettering shall be used for major guide signs at or in advance of interchanges and for all overhead signs. Minimum numeral and letter sizes for expressway guide signs according to interchange classification, type of sign, and component of sign legend shall be as shown in Tables 2E-2 and 2E-3. Minimum numeral and letter sizes for freeway guide signs according to interchange classification, type of sign, and component of sign legend shall be as shown in Tables 2E-4 and 2E-5. All names of places, streets, and highways on freeway and expressway guide signs shall be composed of lower-case letters with initial upper-case letters. The letters and the numerals used shall be Series E(M) of the "Standard Highway Signs and Markings" book (see Section 1A.11). The nominal loop height of the lower-case letters shall be 3/4 of the height of the initial upper-case letter (see Paragraph 2 of Section 2D.05 for additional information on the specification of letter heights). Other word legends shall be composed of upper-case letters. Interline and edge spacing shall be as provided in Section 2E.15.**

<sup>05</sup> **Lettering size on freeway and expressway signs shall be the same for both rural and urban conditions.**

**Support:**

<sup>06</sup> Sign size is determined primarily in terms of the length of the message and the size of the lettering necessary for proper legibility. Letter style and height, and arrow design have been standardized for freeway and expressway signs to assure uniform and effective application.

<sup>07</sup> Designs for upper-case and lower-case alphabets together with Tables of recommended letter spacing, are shown in the "Standard Highway Signs and Markings" book (see Section 1A.11).

**Guidance:**

<sup>08</sup> *Freeway lettering sizes (see Tables 2E-4 and 2E-5) should be used when expressway geometric design is comparable to freeway standards.*

<sup>09</sup> *Other sign letter size requirements not specifically identified elsewhere in this Manual should be guided by these specifications. Abbreviations (see Section 2E.17) should be kept to a minimum.*

**Support:**

<sup>10</sup> A sign mounted over a particular roadway lane to which it applies might have to be limited in horizontal dimension to the width of the lane, so that another sign can be placed over an adjacent lane. The necessity to

maintain proper vertical clearance might also place a further limitation on the size of the overhead sign and the legend that can be accommodated.

**Standard:**

**<sup>11</sup> All capital letters shall be Standard Alphabet Series D 2000.**

**Support:**

<sup>12</sup> Standard Alphabets for traffic control devices are contained in FHWA's "Standard Highway Signs and Markings" book. See Section 1A.11 for information regarding this publication.

<sup>13</sup> Sections 2D.04, 2D.05 and 2D.06 also apply to freeways and expressways.

### **Section 2E.15 Interline and Edge Spacing**

*Guidance:*

<sup>01</sup> *Interline spacing of upper-case letters should be approximately three-fourths the average of upper-case letter heights in adjacent lines of letters.*

<sup>02</sup> *The spacings to the top and bottom borders should be equal to the average of the letter height of the adjacent line of letters. The lateral spacing to the vertical borders should be essentially the same as the height of the largest letter.*

### **Section 2E.16 Sign Borders**

**Standard:**

**<sup>01</sup> Signs shall have a border of the same color as the legend in order to outline their distinctive shape and thereby give them easy recognition and a finished appearance.**

*Guidance:*

<sup>02</sup> *For guide signs larger than 120 x 72 inches, the border should have a width of 2 inches. For smaller guide signs, a border width of 1.25 inches should be used, but the width should not exceed the stroke width of the lettering of the principal legend on the sign.*

<sup>03</sup> *Corner radii of sign borders should be 1/8 of the minimum sign dimension on guide signs, except that the radii should not exceed 12 inches on any sign.*

**Option:**

<sup>04</sup> The sign material in the area outside of the corner radius may be trimmed.

**Support:**

<sup>05</sup> Sign border details are contained in FHWA's "Standard Highway Signs and Markings" book and Caltrans' California Sign Specifications. See Section 1A.11 for information regarding these publications.

### **Section 2E.17 Abbreviations**

*Guidance:*

<sup>01</sup> *Abbreviations should be kept to a minimum; however, they are useful when complete destination messages produce excessively long signs. If used, abbreviations should be unmistakably recognized by road users (see Section 1A.15). Longer commonly used words that are not part of a proper name and are readily recognizable, such as Street, Boulevard, and Avenue, should be abbreviated to expedite recognition of the sign legend by reducing the amount and complexity of the legend.*

<sup>02</sup> *Periods, apostrophes, question marks, ampersands, or other punctuation or characters that are not letters, numerals, or hyphens should not be used in abbreviations, unless necessary to avoid confusion.*

<sup>03</sup> *The solidus (slanted line or forward slash) is intended to be used for fractions only and should not be used to separate words on the same line of legend. Instead, a hyphen should be used for this purpose, such as "CARS – TRUCKS."*

**Standard:**

**<sup>04</sup> The words NORTH, SOUTH, EAST, and WEST shall not be abbreviated when used with route signs to indicate cardinal directions on guide signs.**

## **Section 2E.18 Symbols**

### **Standard:**

**01 Symbol designs shall be unmistakably like those shown in this Manual and in the “Standard Highway Signs and Markings” book (see Section 1A.11).**

### *Guidance:*

**02 A special effort should be made to balance legend components for maximum legibility of the symbol with the rest of the sign.**

### *Option:*

**03 Educational plaques may be used below symbol signs where needed.**

## **Section 2E.19 Arrows for Interchange Guide Signs**

### **Standard:**

**01 Arrows used on interchange guide signs shall be of the types shown in Figure 2D-2 and 2D-2(CA) and shall comply with the provisions of this Section and Section 2D.08.**

**02 Except on Overhead Arrow-per-Lane guide signs (see Section 2E.21) and on Exit Direction signs for lane drops (see Section 2E.24), and except as provided in Paragraphs 3 and 4, directional arrows on all overhead and post-mounted Exit Direction signs shall point diagonally upward and shall be located on the side of the sign consistent with the direction of the exiting movement.**

### *Option:*

**03 On post-mounted Exit Direction signs that are located where a directional arrow to the side of the legend farthest from the roadway might create an unusually wide sign that limits the road user's view of the arrow, the directional arrow may be placed at the bottom portion of the sign, centered under the legend.**

### **Standard:**

**04 Directional arrows on guide signs for multi-lane exits shall be positioned below the legend approximately over the center of each lane to which the arrow applies (see Figures 2E-4 and 2E-8).**

**05 On overhead signs where down arrows are used to indicate a lane to be followed, a down arrow shall be positioned approximately over the center of each lane and shall point vertically downward toward the use of specific lanes to traffic bound for the destination(s) and/or route(s) indicated by these arrows. Down arrows shall not be used unless an arrow can be located over and pointed to the approximate center of each lane that can be used to reach the destination displayed on the sign.**

**06 If down arrows are used, having more than one down arrow pointing to the same lane on a single overhead sign (or on multiple signs on the same overhead sign structure) shall not be permitted.**

### *Support:*

**07 Directional and down arrows for use on guide signs are shown in Figure 2D-2. Detailed drawings and standardized sizes based on ranges of letter heights for these arrows are provided in the “Standard Highway Signs and Markings” book (see Section 1A.11). Information on the dimensions for arrows used in Overhead Arrow-per-Lane and Diagrammatic guide signing is also provided in the “Standard Highway Signs and Markings” book.**

## **Section 2E.20 Signing for Option Lanes at Splits and Multi-Lane Exits**

### *Support:*

**01 Some freeway and expressway splits or multi-lane exit interchanges contain an interior option lane serving both movements in which traffic can either leave the route or remain on the route, or choose either destination at a split, from the same lane.**

### **Standard:**

**02 On freeways and expressways, either the Overhead Arrow-per-Lane or Diagrammatic guide sign designs as provided in Sections 2E.21 and 2E.22 shall be used for all multi-lane exits at major interchanges (see Section 2E.32) that have an optional exit lane that also carries the through route (see Figures 2E-4, 2E-5, 2E-8, and 2E-9) and for all splits that include an option lane (see Figures 2E-6 and 2E-10). Overhead Arrow-per-Lane or Diagrammatic guide signs shall not be used on freeways and expressways for any other types of exits or splits, including single-lane exits and splits that do not have an option lane.**

*Guidance:*

*03 The Overhead Arrow-per-Lane guide sign design (see Section 2E.21) should also be considered for multi-lane exits with an option lane at intermediate interchanges (see Section 2E.32) based on such factors as the extent of the need to optimize the mainline operation by maximizing the usage of the option lane, the extent of the period(s) of the day during which the exiting volumes warrant the multi-lane exit arrangement, and the nature of the traffic that primarily uses the option lane during the high-volume periods.*

*04 Signing for multi-lane exits at minor interchanges (see Section 2E.32) that have an optional exit lane or at intermediate interchanges that have an optional exit lane at which it has been determined that the Overhead Arrow-per-Lane guide sign design is not warranted should use a combination of conventional guide signing and regulatory lane-use signing, in accordance with the provisions of Section 2E.23.*

## **Section 2E.21 Design of Overhead Arrow-per-Lane Guide Signs for Option Lanes**

**Support:**

**01** Overhead Arrow-per-Lane guide signs (see Figure 2E-3) are used where an option lane is present at freeway and expressway multi-lane exit interchanges and splits. They display an upward-pointing arrow above each lane that conveys the direction(s) of travel that the lane serves at the point of departure. At locations where an option lane is present at a multi-lane exit or split, Overhead Arrow-per-Lane guide signs have been shown to be superior to either conventional guide signs or Diagrammatic guide signs because they convey positive direction about which destination and direction each approach lane serves, particularly for the option lane, which is otherwise difficult to clearly sign.

**Standard:**

**02** Overhead Arrow-per-Lane guide signs shall be used on all new or reconstructed freeways and expressways as described in Section 2E.20.

**03** Where used, the Overhead Arrow-per-Lane guide sign at the exit or split shall be located at or in the immediate vicinity of the point where the exiting lanes begin to diverge from the through lanes or, for a split, at the point where the approach lanes begin to diverge from one another, preserving the relation of the arrows displayed on the sign to their respective lanes. The Overhead Arrow-per-Lane guide sign at the exit shall not be located at or near the theoretical gore.

**Option:**

**04** At existing or non-reconstructed locations where Exit Direction and Pull-Through signs exist at the theoretical gore, the existing sign support structure may remain in place, continuing to use Exit Direction and Pull-Through signs, in conjunction with a replacement of the advance signs using the Overhead Arrow-per-Lane guide sign design.

**Standard:**

**05** If existing Exit Direction and Pull-Through signs are being retained at an interchange as provided in Paragraph 4, an Overhead Arrow-per-Lane guide sign shall not be used at the location of the Exit Direction and Pull-Through signs at or in the vicinity of the theoretical gore. New installations of Exit Direction and Pull-Through signs shall not be permitted in conjunction with Overhead Arrow-per-Lane guide signs on new or reconstructed facilities.

*Guidance:*

*06 Overhead Arrow-per-Lane guide signs should be located at approximately 1/2 mile and 1 mile in advance of the exit or split, and at approximately 2 miles in advance of the exit or split where space is available and conditions allow.*

**Standard:**

**07** Overhead Arrow-per-Lane guide signs used on freeways and expressways shall include one arrow above each lane and shall be designed in accordance with the following criteria:

- A.** The sign shall include an upward-pointing arrow for each lane of the approach to the split or exit, and the shaft of each arrow shall be located approximately over the center of the lane to which it applies.
- B.** Arrows for continuing through lanes shall be vertically upward pointing (see Figure 2E-4) unless those lanes are on a significantly curved alignment beyond the theoretical gore, in which case the arrows for the continuing through lanes shall indicate the approximate degree of curvature (see Figure 2E-5).



- C. The arrow for a lane that must exit shall be curved in the direction of the exit and shall be accompanied by black-on-yellow EXIT (E11-1a) and ONLY (E11-1b) sign panels adjacent to the lower end of the arrow shaft. The E11-1a and E11-1b sign panels shall not be used for a split of two overlapping routes where neither of the diverging routes is designated as an exit. Where the through lanes curve and the exit continues on a straight alignment, upward-pointing vertical arrows shall be used for the exiting movement and curved arrows for the through movement.**
- D. The arrow for an optional exit lane that also carries the through route shall have a single shaft that bifurcates into a vertically upward-pointing arrow and a curving arrow corresponding to the configuration of the through and exit lanes.**
- E. For splits with an option lane, the arrow for the lane from which either direction of the split can be accessed shall have a single shaft that bifurcates into two upward-pointing curving arrows showing the approximate degrees of curvature of the two roadways beyond the theoretical gore (see Figure 2E-6).**
- F. A vertical white line shall be used to separate the route shields and destinations for the two diverging movements from each other.**
- G. The distance to the exit or split shall be displayed below the off-movement destination on the advance signs at the 1-mile and 2-mile locations.**
- H. The number of lanes displayed on a sign shall correspond to the number of lanes at the location of that sign. An advance sign shall not depict lanes that are added downstream of a sign location.**
- I. For numbered exits, the Exit Number (E1-5P) or Left Exit Number (E1-5bP) plaque shall be used at the top of the sign in accordance with Section 2E.31. For unnumbered left exits, the LEFT (E1-5aP) plaque shall be used at the top left edge of the sign.**

*Guidance:*

*08 Overhead Arrow-per-Lane guide signs used on freeways and expressways should be designed in accordance with the following additional criteria:*

- A. No more than one destination should be displayed for each movement, and no more than two destinations should be displayed per sign.*
- B. The arrowhead(s) for the diverging movement should be positioned lower on the sign than the arrowhead(s) for the movement that continues straight ahead, independent of which movement carries the through route. Where the movements are freeway or expressway splits rather than exits, the arrowheads should be positioned at approximately the same height on the sign.*
- C. Route shields, cardinal directions, and destinations should be positioned on the sign such that they are clearly related to the arrowhead(s) for the movement to which they apply.*
- D. The cardinal direction should be placed adjacent to the route shield for exits or splits leading in a single cardinal direction.*
- E. The vertical white line that is used to separate the route shields and destinations for the two diverging movements from each other should not descend below the top of the arrowheads for the through lanes, and should be positioned approximately halfway between the diverging arrowheads for the optional movement lane (see Figure 2E-3).*

**Standard:**

**09 Overhead Arrow-per-Lane guide signs shall not be used to depict a downstream split of an exit ramp on a sign located on the mainline.**

**Support:**

*10 Specific guidelines for more detailed design of Overhead Arrow-per-Lane guide signs are contained in the "Standard Highway Signs and Markings" book (see Section 1A.11).*

**Option:**

*11 Where extra emphasis of an especially low advisory ramp speed is needed, an EXIT XX MPH (E13-2) sign panel (see Figure 2E-27) may be placed below the applicable destination legend to supplement, but not to replace, the exit or ramp advisory speed warning signs.*

## **Section 2E.22 Design of Freeway and Expressway Diagrammatic Guide Signs for Option Lanes**

### **Support:**

<sup>01</sup> Diagrammatic guide signs (see Figure 2E-7) are guide signs that show a simplified graphic view of the exit arrangement in relationship to the main highway. While the use of such guide signs might be helpful for the purpose of conveying relative direction of each movement, Diagrammatic guide signs have been shown to be less effective than conventional or Overhead Arrow-per-Lane guide signs at conveying the destination or direction(s) that each approach lane serves, regardless of whether dedicated or option lanes are present.

### **Standard:**

<sup>02</sup> **Diagrammatic guide signs used where an option lane is present at a freeway or expressway split or multi-lane exit shall be designed in accordance with the following criteria:**

- A. The graphic legend shall be of a plan view showing the off-ramp arrangement.**
- B. No other symbols or route shields shall be used as a substitute for arrowheads.**
- C. They shall not be installed at the Exit Direction sign location (see Section 2E.36).**
- D. The EXIT ONLY sign panel shall not be used on diagrammatic guide signs in advance of the interchange.**
- E. For numbered exits, the Exit Number (E1-5P) or Left Exit Number (E1-5bP) plaque shall be used at the top of the sign in accordance with Section 2E.31. For unnumbered left exits, the LEFT (E1-5aP) plaque shall be used at the top left edge of the sign.**
- F. The EXIT ONLY (E11-1e or E11-1f) sign panels shall be used on the Exit Direction sign at the theoretical gore, except at splits of two overlapping routes where neither of the routes is designated as an exit.**

### **Guidance:**

<sup>03</sup> *Diagrammatic guide signs used on freeways and expressways should be designed in accordance with the following additional criteria:*

- A. The graphic should not depict deceleration lanes.*
- B. No more than one destination should be displayed for each movement, and no more than two destinations should be displayed per sign.*
- C. The arrowhead for the diverging movement should be positioned lower on the sign than the arrowhead for the movement that continues straight ahead, independent of which movement carries the through route (see Figures 2E-8 and 2E-9). Where the movements are freeway or expressway splits rather than exits, the arrowheads should be positioned at approximately the same height on the sign (see Figure 2E-10).*
- D. ~~Arrow shafts should contain lane lines.~~ Arrow shafts should match the number of lanes.*
- E. Route shields, cardinal directions, and destinations should be positioned on the sign such that they are clearly related to the arrowhead(s), and the arrowhead for the off movement should point toward the route shield for the off movement.*
- F. For exits or splits leading in a single direction, the cardinal direction should be placed adjacent to the route shield, and the destination should be placed below the route shield and cardinal direction.*

### **Standard:**

<sup>04</sup> **Diagrammatic guide signs shall not be used at cloverleaf interchanges for the purpose of depicting successive departures from the mainline or separate downstream departures from a collector-distributor roadway. The use of Diagrammatic guide signs at cloverleaf interchanges shall be limited to the following cases:**

- A. Where the outer (non-loop) exit ramp of the cloverleaf is a multi-lane exit having an optional exit lane that also carries the through route; and**
- B. At cloverleaf interchanges that include collector-distributor roadways, ~~such as those illustrated in Figure 2E-36,~~ that are accessed from the mainline by a multi-lane exit having an optional exit lane that also carries the through route. In this case, the Diagrammatic guide sign shall only show the configuration of the lanes at the exit point to the collector-distributor roadway and not the entire interchange configuration.**

### **Support:**

<sup>05</sup> Specific guidelines for more detailed design of Diagrammatic guide signs are contained in the "Standard Highway Signs and Markings" book (see Section 1A.11).

<sup>05a</sup> Refer to Section 3B.05 for lane drop markings.

Option:

<sup>06</sup> Where extra emphasis of an especially low advisory ramp speed is needed, an EXIT XX MPH (E13-2) sign panel (see Figure 2E-27) may be placed below the applicable destination legend to supplement, but not to replace, the exit or ramp advisory speed warning signs.

### **Section 2E.23 Signing for Intermediate and Minor Interchange Multi-Lane Exits with an Option Lane**

Support:

<sup>01</sup> Intermediate and minor multi-lane exits might have an operational need for the presence of an option lane for only the peak period during which excessive queues might otherwise develop if the option lane were not available. In such cases, the Overhead Arrow-per-Lane or Diagrammatic guide signing described for option lanes in Sections 2E.21 and 2E.22 might not be practical, depending on the level of use of the option lane and the spacing of nearby interchanges, particularly in non-rural areas.

Guidance:

<sup>02</sup> *Signing for an intermediate or minor interchange that has a multi-lane exit with an option lane that also carries the through route should use the same basic principles as those for a conventional exit. In such cases, the option lane is not signed on the Advance Guide signs. For such exits that involve the addition of an auxiliary lane that is not present at the Advance Guide sign locations, but do not involve a lane drop (see Figure 2E-12), a sequence of post-mounted or overhead-mounted Advance Guide signs should be used, located in accordance with the interchange classification (see Section 2E.32). The Exit Direction sign should be located at the theoretical gore and display a diagonally upward-pointing directional arrow above each lane that departs from the mainline alignment. The Exit Direction sign should not contain the EXIT ONLY legend.*

<sup>03</sup> *For such interchanges that also have a lane drop (see Figure 2E-11), the Advance Guide and Exit Direction signs should follow the provisions of Section 2E.24. The Exit Direction sign should be located at the theoretical gore and should contain the EXIT ONLY (E11-1e) sign panel.*

<sup>04</sup> *The presence of the option lane should be conveyed by the use of post-mounted lane-use (R3-8 Series) signs (see Section 2B.22). When used, the R3-8 signs should be of an appropriate size for their application to optimize their conspicuity. The signs should be located in succession with the Advance Guide signs, where the option and exit lanes have developed (see Figure 2E-11). In cases where the exiting lane or lanes have not developed and the option lane is created by the addition of an auxiliary lane that exits, the R3-8 signs should be located only adjacent to where the lanes have been fully developed and not in advance of the lane or along its transition (see Figure 2E-12).*

Support:

<sup>05</sup> The use of a down arrow on overhead freeway or expressway guide signs has been shown to be misinterpreted by road users as an indication of a dedicated lane.

**Standard:**

<sup>06</sup> **Advance Guide signs that are mounted overhead shall not display a down arrow over an option lane.**

### **Section 2E.24 Signing for Interchange Lane Drops**

**Standard:**

<sup>01</sup> **The provisions of this Section shall only apply to lane drops at exits that do not have an optional exit lane. At exits that have an optional exit lane in addition to the dropped lane, the provisions of Sections 2E.20 through 2E.23 shall apply.**

<sup>02</sup> **Major guide signs for all lane drops at interchanges shall be mounted overhead. An EXIT ONLY sign panel shall be used for all interchange lane drops at which the through route is carried on the mainline.**

<sup>03</sup> **Except on Overhead Arrow-per-Lane and Diagrammatic guide signs (See Sections 2E.20 through 2E.22), the EXIT ONLY (down arrow) (E11-1 or E11-1f) sign panel (see Figure 2E-13) shall be used on all signing of lane drops on all overhead Advance Guide signs (see Figures 2E-14 through 2E-16). The number of arrows on each sign shall correspond to the number of dropped lanes at the location of each sign.**

**Placement of the down arrow shall comply with the provisions of Section 2E.19.**

**04 For lane drops, the Exit Direction sign (see Section 2E.36 and Figure 2E-26) shall be of the format shown in Figures 2E-15 and 2E-16. The bottom portion of the Exit Direction sign shall be yellow with a black border and shall include a diagonally upward-pointing black directional arrow (left or right) for each lane dropped at the exit, with the sign designed and placed so that each arrow is located over the approximate center of each lane being dropped. The words EXIT and ONLY shall be positioned to the left and right, respectively, of the arrow on the E11-1d sign panel for a single-lane drop. For a two-lane drop, the words EXIT ONLY shall be located between the two arrows on the E11-1e sign panel. The number of arrows on the sign shall correspond to the number of dropped lanes at the location of the sign.**

**Option:**

**04a** The Exit Only (W61A(CA), W61B(CA), W61C(CA), W61D(CA), W61E(CA) and W61H(CA)) panels may be used on overhead directional signs to identify lane/lanes that enter or exit a freeway where the E11 series panel does not fit due to space needed to identify destination and it is technically infeasible to place a larger overhead structure. See Figure 2E-13(CA).

**04b** The Only (W61F(CA), W61G(CA) and W61H(CA)) panels may be used on overhead directional signs to identify lane/lanes that become a freeway to freeway connector where the E11 series panel does not fit due to space needed to identify destination and it is technically infeasible to place a larger overhead structure. See Figure 2E-13(CA).

**05** EXIT ONLY messages of either the combination of E11-1a and E11-1b, or E11-1c formats may be used to retrofit existing signing to warn of a lane drop situation ahead.

**Standard:**

**06** If used to retrofit an existing Advance Guide sign, the E11-1a and E11-1b sign panels (see Figure 2E-13) shall be placed on either side of a white down arrow. The E11-1c sign panel, if used to retrofit an existing sign, shall be placed between the lower destination message and the white down arrow.

**Guidance:**

**07** Except as provided in Paragraph 8 for an auxiliary lane, Advance Guide signs for lane drops within 1 mile of the interchange should not contain the distance message.

**08** Where the dropped lane is an auxiliary lane that is provided between successive entrance and exit ramps of two separate interchanges and the distance between the two ramps is less than 1 mile, the first Advance Guide sign in the sequence downstream from the entrance ramp should contain the distance message.

**09** Wherever the dropped lane carries the through route, signs should be used without the EXIT ONLY sign panel.

**Support:**

**10** Sections 2E.20 through 2E.23 contain information on the signing of lane drops at exits that also have an option lane.

**11** Section 2B.23 contains information regarding regulatory signs that can also be used for freeway lane drop situations and Section ~~2C.42~~ **2C.43** contains information regarding warning signs that can also be used for freeway lane drop situations.

## **Section 2E.25 Overhead Sign Installations**

**Support:**

**01** Specifications for the design and construction of structural supports for signs have been standardized by the American Association of State Highway and Transportation Officials (AASHTO). Overcrossing structures can often serve for the support of overhead signs, and might in some cases be the only practical location that will provide adequate viewing distance. Use of these structures as sign supports will eliminate the need for additional sign supports along the roadside. Factors justifying the installation of overhead signs are given in Section 2A.17. Vertical clearance of overhead signs is discussed in Section 2A.18.

## Section 2E.26 Lateral Offset

### Standard:

**01 The minimum lateral offset outside the usable roadway shoulder for post-mounted freeway and expressway signs or for overhead sign supports, either to the right-hand or left-hand side of the roadway, shall be 6 feet. This minimum clearance shall also apply outside of a curb. If located within the clear zone, the signs shall be mounted on crashworthy supports or shielded by appropriate crashworthy barriers.**

### Guidance:

*02 Where practical, a sign should not be less than ~~10~~ 12 feet from the edge of the nearest traffic lane. Large guide signs especially should be farther removed, preferably 30 feet or more from the nearest traffic lane.*

*03 Where an expressway median is 12 feet or less in width, consideration should be given to spanning both roadways without a center support.*

*04 Where overhead sign supports cannot be placed sufficiently far away from the line of traffic or in an otherwise protected site, they should either be designed to minimize the impact forces, or be adequately shielded by a traffic barrier of suitable design.*

### Standard:

**05 Butterfly-type sign supports and other overhead non-crashworthy sign supports shall not be installed in gores or other unshielded locations within the clear zone.**

### Option:

**06 Lesser clearances, but not generally less than 6 feet, may be used on connecting roadways or ramps at interchanges.**

### Support:

*07 Also refer to Section 2A.19 for more information on this topic.*

## Section 2E.27 Route Signs and Trailblazer Assemblies

### Standard:

**01 The official Route sign for the Interstate Highway System shall be the red, white, and blue retroreflective distinctive shield adopted by the American Association of State Highway and Transportation Officials (see Section 2D.11).**

### Guidance:

*02 Route signs (see Figure 2E-17) should be incorporated as cut-out shields or other distinctive shapes on large directional guide signs. Where the Interstate shield is displayed in an assembly or on the face of a guide sign with U.S. or State Route signs, the Interstate numeral should be at least equal in size to the numerals on the other Route signs. The use of independent Route signs should be limited primarily to route confirmation assemblies.*

*03 Route signs and auxiliary signs showing junctions and turns should be used for guidance on approach roads, for route confirmation just beyond entrances and exits, and for reassurance along the freeway or expressway. When used along the freeway or expressway, the Route signs should be enlarged to a 36 x 36-inch minimum size for routes with one or two digits and to a 45 x 36-inch minimum size for routes with three digits as shown in the "Standard Highway Signs and Markings" book (see Section 1A.11). When independently mounted Route signs are used in place of Pull-Through signs, they should be located just beyond the exit.*

### Option:

**04 The standard Trailblazer Assembly (see Section 2D.35) may be used on roads leading to the freeway or expressway. Component messages of the Trailblazer Assembly may be included on a single sign in accordance with the provisions of Section 2D.12. Independently mounted Route signs may be used instead of Pull-Through signs (see Section 2E.12) as confirmation information.**

### Support:

**05 Section 2H.07 contains information regarding the design of signs for Auto Tour Routes.**

### Option:

**06 The commonly used name or trailblazer route sign for a toll highway (see Chapter 2F) may be displayed on non-toll sections of the Interstate Highway System at:**

**A. The last exit before entering a toll Section of the Interstate Highway System;**

- B. The interchange or connection with a toll highway, whether or not the toll highway is a part of the Interstate Highway System; and
- C. Other locations within a reasonable approach distance of toll highways when the name or trailblazer symbol for the toll highway would provide better guidance to road users unfamiliar with the area than would place names and route numbers.

07 The toll highway name or route sign may be included as a part of the guide sign installations on intersecting highways and approach roads to indicate the interchange with a toll Section of an Interstate route. Where needed for the proper direction of traffic, a trailblazer for a toll highway that is part of the Interstate Highway System may be displayed with the Interstate Trailblazer Assembly.

Support:

- 08 Chapter 2F contains additional information regarding signing for toll highways.

### **Section 2E.28 Eisenhower Interstate System Signs (M1-10, M1-10a)**

Option:

01 The Eisenhower Interstate System (M1-10 and M1-10a) signs (see Figure 2E-18) may be used on Interstate highways at periodic intervals and in rest areas, scenic overlooks, or other similar roadside facilities on the Interstate Highway System.

Guidance:

02 *If used, the M1-10a sign should be used only in rest areas or other similar facilities where the sign can be viewed by occupants of parked vehicles or by pedestrians. The M1-10a sign should not be installed on Interstate highway mainlines, ramps, or other roadways where it can be viewed by vehicular traffic.*

Standard:

03 **The M1-10 and M1-10a signs shall not be used as part of a Junction, Advance Route Turn, Directional, or Trailblazer Assembly or as part of a guide sign or similar assembly providing direction to a route or destination.**

### **Section 2E.29 Signs for Intersections at Grade**

Guidance:

01 *If there are intersections at grade within the limits of an expressway, guide sign types provided in Chapter 2D should be used. However, such signs should be of a size compatible with the size of other signing on the expressway.*

Option:

02 Advance Guide signs for intersections at grade may take the form of diagrammatic layouts depicting the geometrics of the intersection along with essential directional information.

### **Section 2E.30 Interchange Guide Signs**

Standard:

Guidance:

01 *The signs at interchanges and on their approaches shall should include Advance Guide signs and Exit Direction signs.*

Standard:

**Consistent destination messages shall be displayed on these signs.**

Guidance:

02 *New destination information should not be introduced into the major sign sequence for one interchange, nor should destination information be dropped.*

03 *Reference should be made to Section 2E.11 and Sections 2E.33 through 2E.42 for a detailed description of the signs in the order that they should appear at the approach to and beyond each interchange. Guide signs placed in advance of an interchange deceleration lane should be spaced at least 800 feet apart.*

04 *Supplemental guide signing should be used sparingly as provided in Section 2E.35.*

Support:

- 05 Also refer to Section 2D.31.

*Guidance:*

*06 The exits should be identified on signs by street names and/or route markers.*

*07 Community names should not be included on street name exit signs. If the interchange provides more than one exit to the street, cardinal directions should be included on the sign.*

*Option:*

*08 The Destination and Street Name with Arrow (G8(CA) Series) signs may be used in freeway interchange areas.*

*Support:*

*09 Typical use of the G8 Series (CA) signs in freeway interchange areas is shown in Figures 2E-34(CA), 2E-35(CA) and 2E-37(CA) through 2E-40(CA) for typical freeway signing.*

## **Section 2E.31 Interchange Exit Numbering**

**Support:**

01 Interchange exit numbering provides valuable orientation for the road user on a freeway or expressway. The feasibility of numbering interchanges or exits on an expressway will depend largely on the extent to which grade separations are provided. Where there is appreciable continuity of interchange facilities, interrupted only by an occasional intersection at grade, the numbering will be helpful to the expressway user.

**Standard:**

02 **Interchange numbering shall be used in signing each freeway interchange exit. Interchange exit numbers shall be displayed with each Advance Guide sign, Exit Direction sign, and Exit Gore sign. The exit number shall be displayed on a separate plaque at the top of the Advance Guide or Exit Direction sign. The exit number (E1-5P) plaque (see Figure 2E-22) shall be 30 inches in height and shall include the word EXIT and the appropriate exit number in a single-line format. Suffix letters shall be used for exit numbering at a multi-exit interchange. The suffix letter shall also be included on the exit number plaque and shall be separated from the exit number by a space having a width of between 1/2 and 3/4 of the height of the suffix letter. Exit numbers shall not include the cardinal initials corresponding to the directions of the cross route. Minimum numeral and letter sizes are given in Tables 2E-2 through 2E-5. If used, the interchange numbering system for expressways shall comply with the provisions prescribed for freeways.**

03 **At a multi-exit interchange where suffix letters are used for exit numbering, an exit of the same number without a suffix letter shall not be used on the same route in the same direction. For example, if an exit is designated as EXIT 256 A, then there shall not be an exit designated as EXIT 256 on the same route in the same direction.**

04 **Interchange exit numbering shall use the reference location sign exit numbering method. The consecutive exit numbering method shall not be used.**

**Support:**

05 Reference location sign exit numbering assists road users in determining their destination distances and travel mileage, and assists highway agencies because the exit numbering sequence does not have to be changed if new interchanges are added to a route.

**Option:**

06 Exit numbers may also be used with Supplemental Guide signs and Motorist Service signs.

*Guidance:*

*07 Exit number (E1-5P) plaques should be added to the top right-hand edge of the sign for an exit to the right.*

**Standard:**

08 **Because road users might not expect an exit to the left and might have difficulty in maneuvering to the left, a left exit number (E1-5bP) plaque (see Figure 2E-22) shall be added to the top left-hand edge of the sign for all left-hand exits (see Figures 2E-14 and 2E-15). The word LEFT on the E1-5bP plaque shall be a black legend on a yellow rectangular sign panel and shall be centered above the word EXIT.**

**Support:**

09 Example exit number plaque designs are shown in Figure 2E-22 and 2E-22(CA). Figures 2E-3, 2E-7, 2E-22, 2E-22(CA), 2E-26, 2E-26(CA) and 2E-27 illustrate the incorporation of exit number plaques on guide signs.

10 The general plan for numbering interchange exits is shown in Figures 2E-19 through 2E-21. Figure 2E-19 shows a circumferential route, which is a route that makes a complete circle around a city or town and usually has two interchanges (one on each side of the city or town) with each of the mainline routes that travel through the

city or town. Figure 2E-20 shows a loop route, which is a route that departs from a mainline route and then rejoins the same mainline route at a subsequent point downstream, and a spur route, which is a route that departs from a mainline route and never rejoins the same mainline route. Figure 2E-21 shows two mainline routes that overlap each other.

**Standard:**

**11 Regardless of whether a mainline route originates within a State or crosses into a State from another State, the southernmost or westernmost terminus within that State shall be the beginning point for interchange numbering.**

**12 For circumferential routes, interchange numbering shall be in a clockwise direction. The numbering shall begin with the first interchange west of the south end of an imaginary north-south line bisecting the circumferential route, at a radial freeway or other Interstate route, or some other conspicuous landmark in the circumferential route near a south polar location (see Figure 2E-19).**

**13 The interchange numbers on loop routes shall begin at the loop interchange nearest the south or west mainline junction and increase in magnitude toward the north or east mainline junction (see Figure 2E-20).**

**14 Spur route interchanges shall be numbered in ascending order starting at the interchange where the spur leaves the mainline route (see Figure 2E-20).**

**15 If a circumferential, loop, or spur route crosses State boundaries, the numbering sequence shall be coordinated by the States to provide continuous interchange numbering.**

**16 Where numbered routes overlap, continuity of interchange numbering shall be established for only one of the routes (see Figure 2E-21). If one of the routes is an Interstate and the other route is not an Interstate, the Interstate route shall maintain continuity of interchange numbering.**

*Guidance:*

*17 The route chosen for continuity of interchange numbering should also have reference location sign continuity (see Figure 2E-21).*

**Standard:**

**18 Caltrans shall utilize mileage based interchange exit numbering to identify the location of each interchange exit on the California Freeway System. The following web site shall provide the statewide listing of freeway exit numbers indexed by route and direction:**

<http://www.dot.ca.gov/hq/traffops/engineering/calnexus/index.htm>

**19 The placement and location of interchange exit numbering on State highways shall conform to the database maintained by Caltrans' Division of Traffic Operations for reference posts. This database is different from the TASAS Highway database.**

**20 Interchange numbering shall be used in signing each freeway interchange exit. Each freeway interchange exit shall include a minimum of two numbered exit signs:**

- 1. One Advance Guide (G83(CA) Series) sign with exit number.**
- 2. One Exit Gore (E5-1 or G84-2(CA) or G84-3(CA)) sign with exit number and arrow or, if not available, an exit number shall be installed on an adjacent Exit Direction (G85-11(CA)) sign at the gore.**

**21 To the extent practical, interchange exit numbers shall be displayed with each Advance Guide sign, Exit Direction sign, and Gore sign on freeways.**

**22 Exit numbers shall not include the cardinal initials corresponding to the directions of the cross route.**

*Guidance:*

*23 The exit number signs should take advantage of existing roadside and overhead signs. Where possible, add-on plaques or panels should be used. In areas where maximum wind loads or existing legends do not permit placement of an add-on plaque or panel, a new sign should be installed.*

*Support:*

*24 For new sign installations or if the existing sign is due for replacement, consider ordering a new sign with the exit number included as part of the sign.*

**Standard:**

**25 Rest areas, vista points, weigh stations, HOV facility exits or HOV to HOV system connector ramps are not considered interchange exits and shall not be signed with exit numbers.**



Support:

<sup>26</sup> Where one or more lanes of traffic diverge from the main line at a single exit, the exit is numbered and signed at the main line diverge as one exit. Generally, there is adequate information displayed on guide signs downstream of the main line diverge to direct a road user to the desired destination, route or street.

Option:

<sup>27</sup> A multiple exit number add-on sign (such as E1-5 with message EXITS 33 A-B in Figure 2E-22) may be placed at the mainline diverge.

Guidance:

<sup>28</sup> *The multiple exit number add-on sign should only be placed when further clarification is needed to guide road users to the desired destination.*

**Standard:**

<sup>29</sup> **If multiple exit number add-on sign is used, exit numbers with the appropriate suffix letters shall be placed on guide signs downstream of the mainline diverge.**

Support:

<sup>30</sup> Exit numbers are not required for exits from auxiliary lanes, connectors or collector-distributors.

Option:

<sup>31</sup> The single line EXIT XX panel (G70-2(CA)) may be attached to an existing Advance Guide sign, Exit Direction sign, or Supplemental Guide sign that identifies an interchange that has been assigned a one or two digit exit number/suffix.

<sup>32</sup> The single line EXIT XXXX panel (G70-3(CA)) may be attached to an existing Advance Guide sign, Exit Direction sign, or Supplemental Guide sign that identifies an interchange that has been assigned a three or four digit exit number/suffix.

<sup>33</sup> The two line EXIT XX panel (G70-4(CA)) may be used as an alternate to the single line EXIT XX panel (G70-2(CA)) when an existing sign cannot accommodate the single line format. It may be attached to an existing Advance Guide sign, Exit Direction sign, or Supplemental Guide sign that identifies an interchange that has been assigned a one or two digit exit number/suffix.

<sup>34</sup> The two line EXIT XXXX panel (G70-5(CA)) may be used as an alternate to the single line EXIT XXXX panel (G70-3(CA)) when an existing sign cannot accommodate the single line format. It may be attached to an existing Advance Guide sign, Exit Direction sign, or Supplemental Guide sign that identifies an interchange that has been assigned a three or four digit exit number/suffix.

Guidance:

<sup>35</sup> *The EXIT panels (G70-2(CA), G70-3(CA), G70-4(CA) and G70-5(CA)) should be located toward the top left edge of the sign for a left exit and toward the top right edge for right exits.*

Option:

<sup>36</sup> The Exit Numbered Advance Guide (G83-5(CA)) sign with a single border may be used as an alternate to the G83-4(CA) when the sign message requires additional space on the sign.

**Standard:**

<sup>37</sup> **If used, G83-5(CA) sign shall be placed on freeways to give motorists advance notice of the exit point to the principal destination served by the next interchange that has been assigned an exit number/suffix, and the distance to that interchange.**

<sup>38</sup> **The Exit Gore (E5-1) sign shall be used at exit ramp gores from expressways, from freeway to freeway connectors, and from collector distributors to identify the exiting point.**

<sup>39</sup> **The EXIT XX with Arrow Gore (G84-2(CA)) sign shall be used at exit ramp gores on freeways to identify the exiting point at an interchange that has been assigned a one or two digit exit number/suffix.**

<sup>40</sup> **The EXIT XXXX with Arrow Gore (G84-3(CA)) sign shall be used at exit ramp gores on freeways to identify the exiting point at an interchange that has been assigned a three or four digit exit number/suffix.**

Guidance:

<sup>41</sup> *On the Exit Gore (E5-1 and G84-2(CA) and G84-3(CA)) signs, the arrow should be aligned to approximate the angle of departure.*

**Standard:**

<sup>42</sup> **The Exit Gore (E5-1 and G84-2(CA) and G84-3(CA)) signs shall be placed in the area between the main roadway and the exit ramp.**

Option:

<sup>43</sup> The Exit Numbered Exit Direction (G85-11(CA)) sign with a single border may be used as an alternate to the G85-10(CA) sign when the sign message requires additional space on the sign.

**Standard:**

<sup>44</sup> **If used, G85-11(CA) sign shall be placed on freeways to direct motorists to the exit ramp of an interchange that has been assigned an exit number/suffix.**

*Guidance:*

<sup>45</sup> *The G85-11(CA) sign should be placed in the area at the beginning of the deceleration lane of the exit ramp.*

Option:

<sup>46</sup> The Exit Numbered Supplemental Guide (G86-13(CA)) sign with a single border may be used when the sign message requires additional space on the sign.

<sup>47</sup> The G86-13(CA) sign may be placed on freeways to give motorists advance notice of the exit point to the principal destination served by the next interchange that has been assigned an exit number/suffix.

### **Section 2E.32 Interchange Classification**

Support:

<sup>01</sup> For signing purposes, interchanges are classified as major, intermediate, and minor. The minimum alphabet sizes contained in Tables 2E-2 and 2E-4 are based on this classification. Descriptions of these classifications are as follows:

A. Major interchanges are subdivided into two categories: (a) interchanges with other expressways or freeways, or (b) interchanges with high-volume multi-lane highways, principal urban arterials, or major rural routes where the volume of interchanging traffic is heavy or includes many road users unfamiliar with the area.

B. Intermediate interchanges are those with urban and rural routes not in the category of major or minor interchanges.

C. Minor interchanges include those where traffic is local and very light, such as interchanges with land service access roads. Where the sum of exit volumes is estimated to be lower than 100 vehicles per day in the design year, the interchange is classified as minor.

### **Section 2E.33 Advance Guide Signs**

Support:

<sup>01</sup> An Advance Guide sign (see Figure 2E-22 and 2E-22(CA)) gives notice well in advance of the exit point of the principal destinations served by the next interchange and the distance to that interchange.

*Guidance:*

<sup>02</sup> *For major and intermediate interchanges (see Section 2E.32), Advance Guide signs should be placed at 1/2 mile and at 1 mile in advance of the exit with a third Advance Guide sign placed at 2 miles in advance of the exit if spacing permits. At minor interchanges, only one Advance Guide sign should be used. It should be located 1/2 to 1 mile from the exit gore. If the sign is located less than 1/2 mile from the exit, the distance displayed should be to the nearest 1/4 mile. Fractions of a mile, rather than decimals, should be displayed in all cases.*

**Standard:**

<sup>03</sup> **For numbered exits to the left, a left exit number (E1-5bP) plaque (see Figure 2E-22) shall be added to the top left-hand edge of the sign.**

<sup>04</sup> **For non-numbered exits to the left, a LEFT (E1-5aP) plaque (see Figure 2E-22) shall be added to the top left-hand edge of the sign.**

Support:

<sup>05</sup> Section 2E.31 contains additional information regarding exit numbering.

**Standard:**

<sup>06</sup> **Advance Guide signs for multi-lane exits having an optional exit lane that also carries the through route (see Figures 2E-4, 2E-5, 2E-8, and 2E-9) and for splits with an option lane (see Figures 2E-6 and 2E-**

**10) shall be Overhead Arrow-per-Lane or diagrammatic signs designed in accordance with Sections 2E.20 through 2E.22.**

**07 Except as provided in Section 2E.24, Advance Guide signs, if used, shall contain the distance message. ~~Except as provided in Paragraph 8 of this Section, the legend on the Advance Guide signs shall be the same as the legend on the Exit Direction sign, except that the last line shall read EXIT XX MILES. If the interchange has two or more exit roadways, the bottom line shall read EXITS XX MILES.~~**

*Guidance:*

*08 Where interchange exit numbers are used, the word EXIT(S) should be omitted from the bottom line.*

**Option:**

**09** Where the distance between interchanges is more than 1 mile, but less than 2 miles, the first Advance Guide sign may be closer than 2 miles, but not placed so as to overlap the signing for the previous exit. Duplicate Advance Guide signs or Interchange Sequence Series signs may be placed in the median on the opposite side of the roadway and are not included in the minimum requirements of interchange signing.

*Guidance:*

*10 Where there is less than 800 feet between interchanges, Interchange Sequence Series signs (see Section 2E.40) should be used instead of Advance Guide signs for the affected interchanges.*

*11 The Advance Guide signs for the last exit from a highway before it becomes a facility on which toll payments are required should include the LAST EXIT BEFORE TOLL (W16-16P) plaque (see Section 2F.10 and Figure 2F-3). The plaque should be installed above the Advance Guide signs.*

**Option:**

**12** If there is insufficient space above the Advance Guide sign because of the presence of an exit number plaque, the W16-16P plaque may be installed below the Advance Guide sign.

**Standard:**

**13 Where the distance between interchanges is less than 2 miles, the Advance Guide (G83(CA) Series) sign shall be placed at the first available location with the mileage adjusted to the nearest 1/4 mile. The word EXIT (with distance) on the bottom line shall be used if the sign is the advance notice for an interchange with distance destinations.**

*Guidance:*

*14 In all other cases, the word EXIT should be omitted.*

*15 For major and intermediate interchanges (see Section 2E.32), two and preferably three Advance Guide signs should be used. At minor interchanges, only one Advance Guide sign should be used.*

*16 If only one Advance Guide sign is used, it should be placed 1 mile in advance of the exit.*

*17 If two Advance Guide signs are used, they should be placed 1 mile and 2 miles in advance of the exit.*

*18 If three Advance Guide signs are used, they should be placed 0.5 miles, 1 mile and 2 miles in advance of the exit.*

**Support:**

*19 See in Figures 2E-34(CA), 2E-35(CA) and 2E-37(CA) through 2E-40(CA) for typical freeway signing.*

### **Section 2E.34 Next Exit Plaques**

**Option:**

**01** Where the distance to the next interchange is unusually long, a Next Exit plaque (see Figure 2E-23) may be installed to inform road users of the distance to the next interchange.

*Guidance:*

*02 The Next Exit plaque should not be used unless the distance between successive interchanges is more than 5 miles.*

**Standard:**

**03 The Next Exit plaque shall carry the legend NEXT EXIT XX MILES. If the Next Exit plaque is used, it shall be placed below the Advance Guide sign nearest the interchange. It shall be mounted so as to not adversely affect the breakaway feature of the sign support structure.**

**Option:**

**04** The legend for the Next Exit plaque may be displayed in either one or two lines as shown in Figure 2E-23.

Support:

05 The one-line message on the Next Exit plaque is the more desirable choice unless the message causes the sign to have a horizontal dimension greater than that of the Advance Guide sign.

### **Section 2E.35 Other Supplemental Guide Signs**

Support:

01 Supplemental Guide signs can be used to provide information regarding destinations accessible from an interchange, other than places displayed on the standard interchange signing. However, such Supplemental Guide signing can reduce the effectiveness of other more important guide signing because of the possibility of overloading the road user's capacity to receive visual messages and make appropriate decisions. "The AASHTO Guidelines for the Selection of Supplemental Guide Signs for Traffic Generators Adjacent to Freeways" is incorporated by reference in this Section (see Page i for AASHTO's address).

Guidance:

02 *No more than one Supplemental Guide sign should be used on each interchange approach.*

03 *A Supplemental Guide sign (see Figure 2E-24) should not list more than two destinations. Destination names should be followed by the interchange number (and suffix), or if interchanges are not numbered, by the legend NEXT RIGHT or SECOND RIGHT or both, as appropriate. The Supplemental Guide sign should be installed as an independent guide sign assembly.*

04 *Where two or more Advance Guide signs are used, the Supplemental Guide sign should be installed approximately midway between two of the Advance Guide signs. If only one Advance Guide sign is used, the Supplemental Guide sign should follow it by at least 800 feet. If the interchanges are numbered, the interchange number should be used for the action message.*

05 *States and other agencies should adopt an appropriate policy for installing supplemental signs using "The AASHTO Guidelines for the Selection of Supplemental Guide Signs for Traffic Generators Adjacent to Freeways." In developing policies for such signing, such items as population, amount of traffic generated, distance from the route, and the significance of the destination should be taken into account.*

**Standard:**

06 **Guide signs directing drivers to park - ride facilities shall be considered as Supplemental Guide signs (see Figure 2E-25).**

Option:

07 A pictograph (see definition in Section 1A.13) may be used on a Supplemental Guide sign in conjunction with a destination that is associated with governmental agencies, military bases, universities, or other government-approved institutions.

**Standard:**

08 **The maximum dimension (height or width) of a pictograph shall not exceed two times the upper-case letter height of the destination legend and shall not exceed the size of a route shield on the guide sign. If used, the pictograph shall be located to the left of the destination legend it represents, except as provided in Paragraph 9 for the park-ride Supplemental Guide sign.**

09 **When a transit pictograph is displayed on the park-ride Supplemental Guide sign, it shall be located on the same line as the carpool symbol, if used, above the word legend.**

10 **A pictograph representing a State, county, or municipal corporation or other incorporated or unincorporated community shall not be displayed on a Supplemental Guide sign.**

11 **Pictographs shall otherwise comply with the provisions of Section 2A.06.**

Support:

12 Section 2D.37 also applies to freeways and expressways.

Option:

13 The Supplemental Destination (G86(CA) Series) signs may be omitted at low traffic volume interchanges or at major interchanges that are spaced 0.5 miles or less apart. They may also be omitted where interchanges are 1 mile or less apart and Interchange Sequence (G23(CA) Series) signs are used.

## Section 2E.36 Exit Direction Signs

### Support:

01 The Exit Direction sign (see Figure 2E-26 and 2E-26(CA)) repeats the route and destination information that was displayed on the Advance Guide sign(s) for the next exit, and thereby assures road users of the destination served and indicates whether they exit to the right or left for that destination.

### Standard:

02 **Exit Direction signs shall be used at major and intermediate interchanges. Populations or other similar information shall not be displayed on Exit Direction signs.**

### Guidance:

03 *Exit Direction signs should be used at minor interchanges.*

04 *post-mounted Exit Direction signs should be installed at the beginning of the deceleration lane. If there is less than 300 feet from the upstream end of the deceleration lane to the theoretical gore (see Figure ~~3B-8~~ 3B-8(CA)), the Exit Direction sign should be installed overhead over the exiting lane in the vicinity of the theoretical gore.*

### Standard:

05 **Except where Overhead Arrow-per-Lane guide signs are used (see Section 2E.21 and Paragraph 6 of this Section), where a through lane is being terminated (dropped) at an exit, the Exit Direction sign shall be placed overhead at the theoretical gore (see Figures ~~2E-8 through 2E-11~~, and 2E-14 through 2E-16).**

06 **Except as provided in Paragraph 4 in Section 2E.21, where Overhead Arrow-per-Lane guide signs are used for the Advance Guide sign(s) for a multi-lane exit having an optional exit lane that also carries the through route or for a split with an option lane (see Section 2E.21), an Overhead Arrow-per-Lane guide sign shall also be used instead of the Exit Direction sign. This Overhead Arrow-per-Lane guide sign shall include the appropriate exit number (E1-5P or E1-5bP) plaque (if a numbered exit) and it shall be located near, but not downstream from, the point where the outside edge of the dropped lane begins to diverge from the mainline (see Figures 2E-4 through 2E-6).**

07 **The following provisions shall govern the design and application of overhead Exit Direction signs: A. The sign shall carry the exit number (if exit numbering is used), the route number, cardinal direction, and destination, as applicable, with a diagonally upward-pointing directional arrow (see Figure 2E-26 and 2E-22(CA)).**

**B. The message EXIT ONLY in black on a yellow sign panel (E11-1d or E11-1e) shall be used on the overhead Exit Direction sign to advise road users of a lane drop situation (see Figures ~~2E-8 through 2E-11~~). The sign shall comply with the provisions of Section 2E.24.**

### Guidance:

08 *For numbered exits to the right, an exit number (E1-5P) plaque (see Figure 2E-22) should be added to the top right-hand edge of the sign.*

### Standard:

09 **For numbered exits to the left, a left exit number (E1-5bP) plaque (see Figure 2E-22) shall be added to the top left-hand edge of the sign.**

10 **For non-numbered exits to the left, a LEFT (E1-5aP) plaque (see Figure 2E-22) shall be added to the top left-hand edge of the sign.**

### Support:

11 Section 2E.31 contains additional information regarding exit numbering.

### Option:

12 In some cases, principally in urban areas, where restricted sight distance because of structures or unusual alignment make it impossible to locate the Exit Direction sign without violating the required minimum spacing (see Section 2E.33) between major guide signs, Interchange Sequence signs (see Section 2E.40) may be substituted for an Advance Guide sign.

### Guidance:

13 *At multi-exit interchanges, the Exit Direction sign should be located directly over the exiting lane for the first exit. At the same location, and normally over the right-hand through lane, an Advance Guide sign for the second exit should be located. Only for those conditions where the through movement is not evident should a confirmatory message (Pull-Through sign as shown in Figure 2E-2) be used over the left lane(s) to guide road*

*users traveling through an interchange. In the interest of sign spreading, three signs on one structure should not be used. When the freeway or expressway is on an overpass, the Exit Direction sign should be installed on an overhead support over the exit lane in advance of the gore point.*

Option:

<sup>14</sup> If the second exit is beyond an underpass, the Exit Direction sign may be mounted on the face of the overhead structure.

<sup>15</sup> Where extra emphasis of an especially low advisory ramp speed is needed, an EXIT XX MPH (E13-2) sign panel (see Figure 2E-27) may be placed at the bottom of the Exit Direction sign to supplement, but not to replace, the exit or ramp advisory speed warning signs.

Guidance:

<sup>16</sup> *At the last exit from a highway before it becomes a facility on which toll payments are required, the LAST EXIT BEFORE TOLL (W16-16P) plaque (see Section 2F.10 and Figure 2F-3) should be installed above the Exit Direction sign.*

Option:

<sup>17</sup> If there is insufficient space above the Exit Direction sign because of the presence of an Exit Number (E1-5P) plaque, the W16-16P plaque may be mounted below the Exit Direction sign.

Support:

<sup>18</sup> See in Figures 2E-34(CA), 2E-35(CA) and 2E-37(CA) through 2E-40(CA) for typical freeway signing.

### **Section 2E.37 Exit Gore Signs (E5-1 Series)**

Support:

<sup>01</sup> The Exit Gore (E5-1 or E5-1a) sign (see Figure 2E-28 and 2E-28(CA)) in the gore indicates the exiting point or the place of departure from the main roadway. Consistent application of this sign at each exit is important.

**Standard:**

<sup>02</sup> **The gore shall be defined as the area located between the main roadway and the ramp just beyond where the ramp branches from the main roadway. The Exit Gore sign shall be located in the gore and shall carry the word EXIT or EXIT XX (if interchange numbering is used) and an appropriate upward slanting arrow. If suffix letters are used for exit numbering at a multi-exit interchange, the suffix letter shall also be included on the Exit Gore sign and shall be separated from the exit number by a space having a width of between 1/2 and 3/4 of the height of the suffix letter. Breakaway or yielding supports shall be used.**

Guidance:

<sup>03</sup> *The arrow should be aligned to approximate the angle of departure. Each gore should be treated similarly, whether the interchange has one exit roadway or multiple exits.*

Option:

<sup>04</sup> Where extra emphasis of an especially low advisory ramp speed is needed, an E13-1P plaque indicating the advisory speed may be mounted below the Exit Gore sign (see Figure 2E-28 and 2E-28(CA)) to supplement, but not to replace, the exit or ramp advisory speed warning signs.

<sup>05</sup> To improve the visibility of the gore for exiting drivers, a Type 1 object marker (see Chapter 2C) may be installed on each sign support below the Exit Gore sign.

~~<sup>06</sup> An Exit Number (E5-1bP) plaque (see Figure 2E-22) may be installed above an existing Exit Gore (E5-1) sign when a non-numbered exit is converted to a numbered exit.~~

**Standard:**

<sup>07</sup> **An Exit Gore (E5-1a) sign shall be used when the replacement of an existing assembly of an E5-1 sign and an E5-1bP plaque becomes necessary.**

Option:

<sup>08</sup> The Narrow Exit Gore (E5-1c) sign may be used in gore areas of limited width where the width of the Exit Gore (E5-1a) sign would not permit sufficient lateral offset (see Section 2A.19), such as for ramp departures that are nearly parallel to the mainline roadway where the Exit Gore sign would be mounted on a narrow island or barrier. Where the E5-1c sign is mounted at a height of 14 feet or more from the roadway, the directional arrow may point diagonally downward.

*Guidance:*

*09 The E5-1c should not be used in gore areas where an E5-1a sign could be installed with sufficient lateral offset.*

### **Section 2E.38 Post-Interchange Signs**

*Guidance:*

*01 If space between interchanges permits, as in rural areas, and where undue repetition of messages will not occur, a fixed sequence of signs should be displayed beginning 500 feet beyond the downstream end of the acceleration lane. At this point a Route sign assembly should be installed followed by a Speed Limit sign and a Distance sign, each at a spacing of 1,000 feet.*

*02 If space between interchanges does not permit placement of these three post-interchange signs without encroaching on or overlapping the Advance Guide signs necessary for the next interchange, or in rural areas where the interchanging traffic is primarily local, one or more of the post-interchange signs should be omitted.*

*Option:*

*03 Usually the Distance sign will be of less importance than the other two signs and may be omitted, especially if Interchange Sequence signs are used. If the sign for through traffic on an overhead assembly already contains the route sign, the post-interchange route sign assembly may also be omitted.*

### **Section 2E.39 Post-Interchange Distance Signs**

**Standard:**

**01 If used, the Post-Interchange Distance sign shall consist of a two- or three-line sign carrying the names of significant destination points and the distances to those points. The top line of the sign shall identify the next meaningful interchange with the name of the community ~~near or~~ through which the route passes, or if there is no community, the route number or name of the intersected highway (see Figure 2E-29).**

*Support:*

*02 The minimum sizes of the route shields identifying a significant destination point are prescribed in Tables 2E-3 and 2E-5.*

*Option:*

*03 The text identification of a route may be displayed instead of a route shield, such as "US XX," "State Route XX," or "County Route XX."*

*Guidance:*

*04 If a second line is used, it should be reserved for communities of general interest that are located on or immediately adjacent to the route or for major traffic generators along the route.*

*Option:*

*05 The choice of names for the second line, if it is used, may be varied on successive Distance signs to give road users maximum information concerning communities served by the route.*

**Standard:**

**06 The third, or bottom line, shall contain the name and distance to a control city (if any) that has national significance for travelers using the route.**

*Guidance:*

*07 Distances to the same destinations should not be shown more frequently than at 5-mile intervals. The distances displayed on these signs should be the actual distance to the destination points and not to the exit from the freeway or expressway. The distance displayed for each community should comply with the provisions of Section 2D.41.*

*08 The Distance (G5(CA) Series) signs should be placed at approximate 10 mile intervals, unless the destinations have changed.*

### **Section 2E.40 Interchange Sequence Signs**

*Option:*

*01 If interchanges are closely spaced, particularly through large urban areas, so that guide signs cannot be adequately spaced, Interchange Sequence signs identifying the next two or three interchanges may be used.*

*Guidance:*

*02 If used, Interchange Sequence signs should be used over the entire length of a route in an urban area. Except as provided in Paragraph 3, they should not be used on a single interchange basis.*

*03 If there is less than 800 feet between interchanges, Interchange Sequence signs should be used instead of the Advance Guide signs for the affected interchanges.*

**Support:**

04 Interchange Sequence signs are generally supplemental to Advance Guide signs. Signing of this type is illustrated in Figures 2E-30 and 2E-31 and 2E-31(CA), and is compatible with the sign spreading concept described in Paragraph 3 of Section 2E.11.

05 These signs are installed in a series and display the next two or three interchanges by name or route number with distances to the nearest 1/4 mile.

**Standard:**

**06 If used, the first sign in the series shall be located in advance of the first Advance Guide sign for the first interchange.**

**07 Where the exit direction is to the left, a LEFT (E11-2) sign panel (see Figure 2E-13) shall be displayed on the same line immediately to the right of the interchange name or route number.**

**08 Interchange Sequence signs shall not be substituted for Exit Direction signs.**

*Guidance:*

*09 Interchange Sequence signs should be located in the median. After the first of the series, Interchange Sequence signs should be placed approximately midway between interchanges.*

**Standard:**

**10 Interchange Sequence signs located in the median shall be installed at overhead sign height (see Section 2A.18).**

**Option:**

~~11 Interchange numbers may be displayed to the left of the interchange name or route number.~~

**Support:**

12 See in Figures 2E-34(CA), 2E-35(CA) and 2E-37(CA) through 2E-40(CA) for typical freeway signing.

**Standard:**

**13 If a destination name is used, it shall be followed by the word EXIT (for instance, SACRAMENTO EXIT).**

**Option:**

14 When two exit names are required at an interchange with a cross street named differently on opposite sides of a freeway, both names may be shown with a single distance; and, four messages may be used on the sign at these locations.

15 The Interchange Sequence (G23(CA) Series) signs may include four lines where two exit names are required for a single interchange.

## **Section 2E.41 Community Interchanges Identification Signs**

**Support:**

~~01 For suburban or rural communities served by two or three interchanges, Community Interchanges Identification signs are useful (see Figure 2E-32).~~

*Guidance:*

~~02 In these cases, the name of the community followed by the word Exits should be displayed on the top line; the lines below should display the destination, road name or route number, and the corresponding distances to the nearest 1/4 mile.~~

~~03 The sign should be located in advance of the first Advance Guide sign for the first interchange within the community.~~

**Option:**

~~04 If interchanges are not conveniently identifiable or if there are more than three interchanges to be identified, the NEXT XX EXITS sign (see Section 2E.42) may be used.~~

**Support:**

05 Use Interchange Sequence (Section 2E.40 and Figures 2E-31 and 2E-31(CA)) and NEXT X EXITS (Section 2E.42 and Figure 2E-33) signs, instead.



## **Section 2E.42 NEXT XX EXITS Sign**

### **Support:**

01 Many freeways or expressways pass through historical or recreational regions, or urban areas served by a succession of several interchanges.

### **Option:**

02 Such regions or areas may be indicated by a NEXT XX EXITS (G87(CA)) sign (see Figure 2E-33 and 2E-33(CA)) located in advance of the Advance Guide sign or signs for the first interchange.

### **Guidance:**

03 *The sign legend should identify the region or area followed by the words NEXT XX EXITS.*

## **Section 2E.43 Signing by Type of Interchange**

### **Support:**

01 Road users need signs to help identify the location of the exit, as well as to obtain route, direction, and destination information for specific exit ramps. Figures ~~2E-34 through 2E-40~~ 2E-34(CA), 2E-35(CA) and 2E-37(CA) through 2E-40(CA) show examples of guide signs for common types of interchanges. The interchange layouts shown in most of the figures illustrate only the major guide signs for one direction of traffic on the freeway and on the exit ramps. Section 2D.45 contains information regarding the signing of the crossroad approaches and connecting roadways to freeways and expressways.

### **Standard:**

02 **Interchange guide signing shall be consistent for each type of interchange along a route.**

### **Guidance:**

03 *The signing layout for all interchanges having only one exit ramp in the direction of travel should be similar, regardless of the interchange type. For the sake of uniform application, the significant features of the signing plan for each of the more frequent kinds of interchanges (illustrated in Figures ~~2E-34 through 2E-40~~ 2E-34(CA), 2E-35(CA) and 2E-37(CA) through 2E-40(CA)) should be followed as closely as possible. Even when unusual geometric features exist, variations in signing layout should be held to a minimum.*

## **Section 2E.44 Freeway-to-Freeway Interchange**

### **Support:**

01 Freeway-to-freeway interchanges are major decision points where the effect of taking a wrong ramp cannot be easily corrected. Reversing direction on the connecting freeway or reentering to continue on the intended course is usually not possible. Figure ~~2E-34~~ 2E-34(CA) shows examples of guide signs at a freeway-to-freeway interchange.

### **Guidance:**

02 *The sign messages should contain only the route shield, cardinal direction, and the name of the next control city on the route. Arrows should point as indicated in Section 2D.08, except where Overhead Arrow-per-Lane or Diagrammatic signs are used in accordance with the provisions of Sections 2E.20 through 2E.22.*

### **Support:**

03 At splits where the off-route movement is to the left or where there is an optional lane split, expectancy problems usually result.

### **Standard:**

04 **At splits where the off-route movement is to the left, the Left Exit Number (E1-5bP) plaque shall be added at the top left-hand edge of the guide sign (see Section 2E.31). Overhead Arrow-per-Lane or Diagrammatic guide signs (see Sections 2E.21 and 2E.22) shall be used for freeway splits with an option lane and for multi-lane freeway-to-freeway exits having an option lane.**

05 **Overhead signs shall be used at a distance of 1 mile and at the theoretical gore of each connecting ramp. When Overhead Arrow-per-Lane or Diagrammatic guide signs are used, they shall comply with the provisions of Sections 2E.21 and 2E.22.**

### **Option:**

06 Overhead signs may also be used at the 1/2-mile and 2-mile locations.

07 The arrow and/or the name of the control city may be omitted on signs that indicate the straight-ahead continuation of a route on a Pull-Through sign (see Section 2E.12).

08 An Advisory Exit Speed sign may be used where an engineering study shows that it is necessary to display a speed reduction message for ramp signing (see Section 2C.14).

09 Where extra emphasis of an especially low advisory ramp speed is needed, an EXIT XX MPH (E13-2) sign panel (see Figure 2E-27) may be placed at the bottom of the Exit Direction sign to supplement, but not to replace, the exit or ramp advisory speed warning signs.

### **Section 2E.45 Cloverleaf Interchange**

Support:

01 A cloverleaf interchange has two exits for each direction of travel. The exits are closely spaced and have common Advance Guide signs. Examples of guide signs for cloverleaf interchanges are shown in Figure ~~2E-35~~ 2E-35(CA).

Guidance:

02 *The Advance Guide signs should include two place names, one corresponding to each exit ramp, with the name of the place served by the first exit on the upper line.*

**Standard:**

03 **An overhead guide sign shall be placed at the theoretical gore of the first exit ramp, with a diagonally upward-pointing directional arrow on the Exit Direction sign for that exit and the message XX MILES, or EXIT XX MILES if interchange numbering is not used, on the Advance Guide sign for the second exit, as shown in Figure ~~2E-35~~ 2E-35(CA). The second exit shall be indicated by an overhead Exit Direction sign over the auxiliary lane. An Exit Gore sign shall also be used at each gore (see Section 2E.37).**

04 **Interchanges with more than one exit from the main line shall be numbered as described in Section 2E.31 with an appropriate suffix.**

05 **Diagrammatic signs shall not be used for cloverleaf interchanges except as otherwise provided in Section 2E.22.**

Guidance:

06 *Where the mainline passes under the crossroad and the exit roadway is located beyond the overcrossing structure, the overhead Exit Direction sign for the second exit should be placed either on the overcrossing structure (see Figure ~~2E-35~~ 2E-35(CA)) or on a separate structure located immediately in front of the overcrossing structure.*

### **Section 2E.46 Cloverleaf Interchange with Collector-Distributor Roadways**

Support:

01 ~~Examples of guide signs for full cloverleaf interchanges with collector-distributor roadways are shown in Figure 2E-36. Contact Caltrans' Division of Traffic Operations for further guidance regarding this figure.~~

Guidance:

02 *Signing on the collector-distributor roadways should be the same as the signing on the mainline of a cloverleaf interchange.*

**Standard:**

03 **Guide signs at exits from the collector-distributor roadways shall be overhead and located at the theoretical gore of the collector-distributor roadway and the exit ramp.**

Option:

04 ~~Exits from the collector-distributor roadways may be numbered with an appropriate suffix. If the exits from a collector-distributor roadway are numbered with suffixes, the Advance Guide signs on the mainline may include two place names and their corresponding exit numbers with the plural EXITS. If only the exit from the mainline is numbered or if interchange numbering is not used, the Advance Guide signs on the mainline may use the singular EXIT. Refer to Sections 2E.31 and 2E.33.~~

05 ~~The Advance Guide signs may include two place names and their corresponding exit numbers.~~

### **Section 2E.47 Partial Cloverleaf Interchange**

Support:

01 ~~Examples of guide signs for partial cloverleaf interchanges are shown in Figure 2E-37~~ 2E-37(CA).

*Guidance:*

02 *Where the mainline passes under the crossroad and the exit roadway is located beyond the overcrossing structure, the overhead Exit Direction sign should be placed either on the overcrossing structure (see Figure ~~2E-37~~ 2E-37(CA)) or on a separate structure located immediately in front of the overcrossing structure.*

**Standard:**

03 **A post-mounted Exit Gore sign shall also be installed in the ramp gore.**

**Support:**

04 Partial cloverleaf interchanges with successive exit ramps from the same direction of travel are signed the same as cloverleaf interchanges for that direction of travel (see Section 2E.45).

### **Section 2E.48 Diamond Interchange**

**Support:**

01 Examples of guide signs for diamond interchanges are shown in Figure ~~2E-38~~ 2E-38(CA).

**Standard:**

02 **For numbered exits, the singular message EXIT shall be used on the Exit Number plaques (see Section 2E.31) with the Advance Guide and Exit Direction signs. For non-numbered exits, the singular message EXIT shall be used as part of the distance message on the Advance Guide signs.**

**Support:**

03 The typical diamond interchange ramp departs from the mainline roadway such that a speed reduction generally is not necessary in order for a driver to negotiate an exit maneuver from the mainline onto the ramp roadway.

*Guidance:*

04 *When a speed reduction is not necessary, an exit speed sign should not be used.*

**Option:**

05 An Advisory Exit Speed sign may be used where an engineering study shows that it is necessary to display a speed reduction message for ramp signing (see Section 2C.14).

*Guidance:*

06 *The Advisory Exit Speed sign should be located along the deceleration lane or along the ramp such that it is visible to the driver far enough in advance to allow the driver to decelerate before reaching the curve associated with the exiting maneuver.*

**Option:**

07 A Stop Ahead or Signal Ahead warning sign may be placed, where engineering judgment indicates a need, along the ramp in advance of the cross street, to give notice to the driver (see Section 2C.36).

*Guidance:*

08 *When used on two-lane ramps, Stop Ahead or Signal Ahead signs should be used in pairs with one sign on each side of the ramp.*

### **Section 2E.49 Diamond Interchange in Urban Area**

**Support:**

01 Examples of guide signs for diamond interchanges in an urban area are shown in Figure ~~2E-39~~ 2E-39(CA). This example includes the use of the Community Interchanges Identification sign (see Section 2E.41), which might be useful if two or more interchanges serve the same community.

02 In urban areas, street names are often displayed as the principal message in destination signs.

**Option:**

03 If interchanges are too closely spaced to properly locate the Advance Guide signs, they may be placed closer to the exit with the distances displayed adjusted accordingly.

### **Section 2E.50 Closely-Spaced Interchanges**

**Support:**

01 Section 2E.11 contains information regarding sign spreading where the Exit Direction sign and the Advance Guide sign for the next interchange are mounted overhead. Sign spreading is particularly beneficial where

interchanges are closely spaced and overhead signing is used in conjunction with Interchange Sequence signs as provided in Paragraph 2.

*Guidance:*

02 *Interchange Sequence signs (see Section 2E.40) should be used at closely-spaced interchanges. When used, they should identify and show street names and distances for the next two or three exits as shown in Figure 2E-30.*

**Standard:**

03 **Advance Guide signs for closely-spaced interchanges shall show information for only one interchange.**

### **Section 2E.51 Minor Interchange**

*Option:*

01 Less signing may be used for minor interchanges because such interchanges customarily serve low volumes of local traffic.

*Support:*

02 Examples of guide signs for minor interchanges are shown in Figure ~~2E-40~~ 2E-40(CA).

**Standard:**

03 **At least one Advance Guide sign and an Exit Gore sign shall be used at a minor interchange.**

*Guidance:*

04 *An Exit Direction sign should also be used.*

### **Section 2E.52 Signing on Conventional Road Approaches and Connecting Roadways**

*Support:*

01 Section 2D.45 contains information regarding the signing on conventional roads on the approaches to interchanges and the signing on connecting roadways.

### **Section 2E.53 Wrong-Way Traffic Control at Interchange Ramps**

*Support:*

01 Section 2B.41 contains information regarding the use of regulatory signs to deter wrong-way movements at intersections of freeway or expressway ramps with conventional roads, and in the area where entrance ramps intersect with the mainline lanes.

02 Section 2D.46 contains information regarding the use of a Directional assembly or a guide sign to mark the entrance to a freeway or expressway from a conventional road.

### **Section 2E.54 Weigh Station Signing**

**Standard:**

01 **Weigh Station signing on freeways and expressways shall be the same as that provided in Section 2D.49, except for lettering size and the advance posting distance for the Exit Direction sign, which shall be located a minimum of 1,500 feet in advance of the gore.**

*Support:*

02 Weigh Station sign layouts for freeway and expressway applications are shown in the "Standard Highway Signs and Markings" book (see Section 1A.11).

Figure 2E-1. Example of Guide Sign Spreading

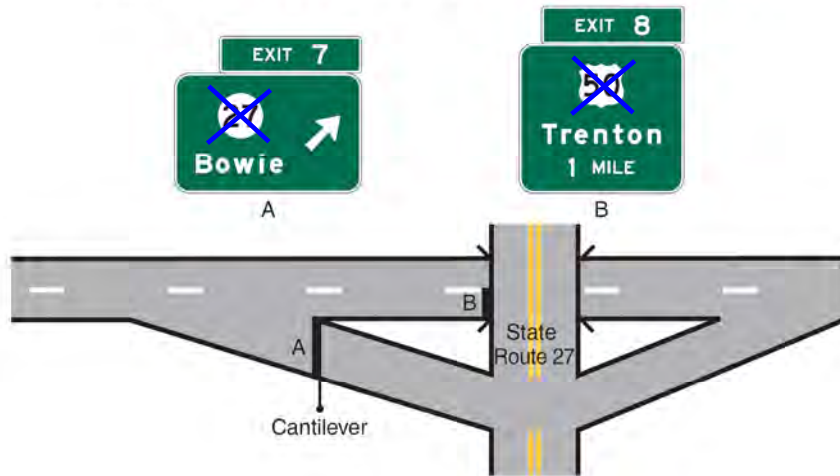


Figure 2E-2. Pull-Through Signs



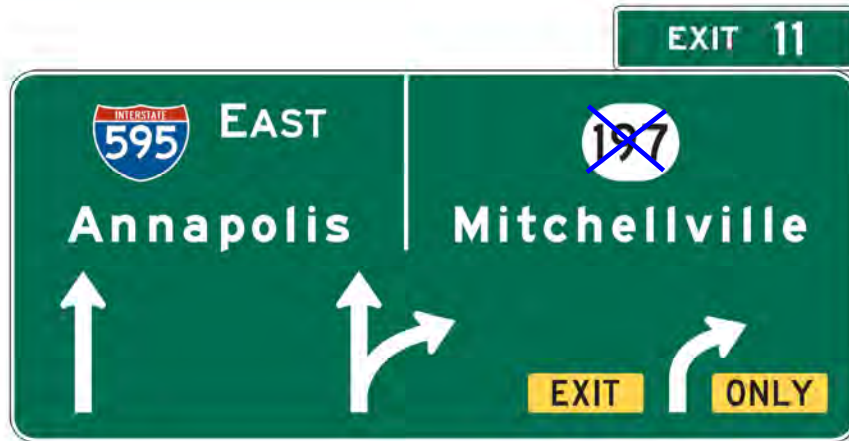
Note: For Guide Sign Assemblies use California State Route (G28-1(CA)) and US Route (G26-1(CA)) shields.



**Figure 2E-2 (CA). California Pull-Through Signs**



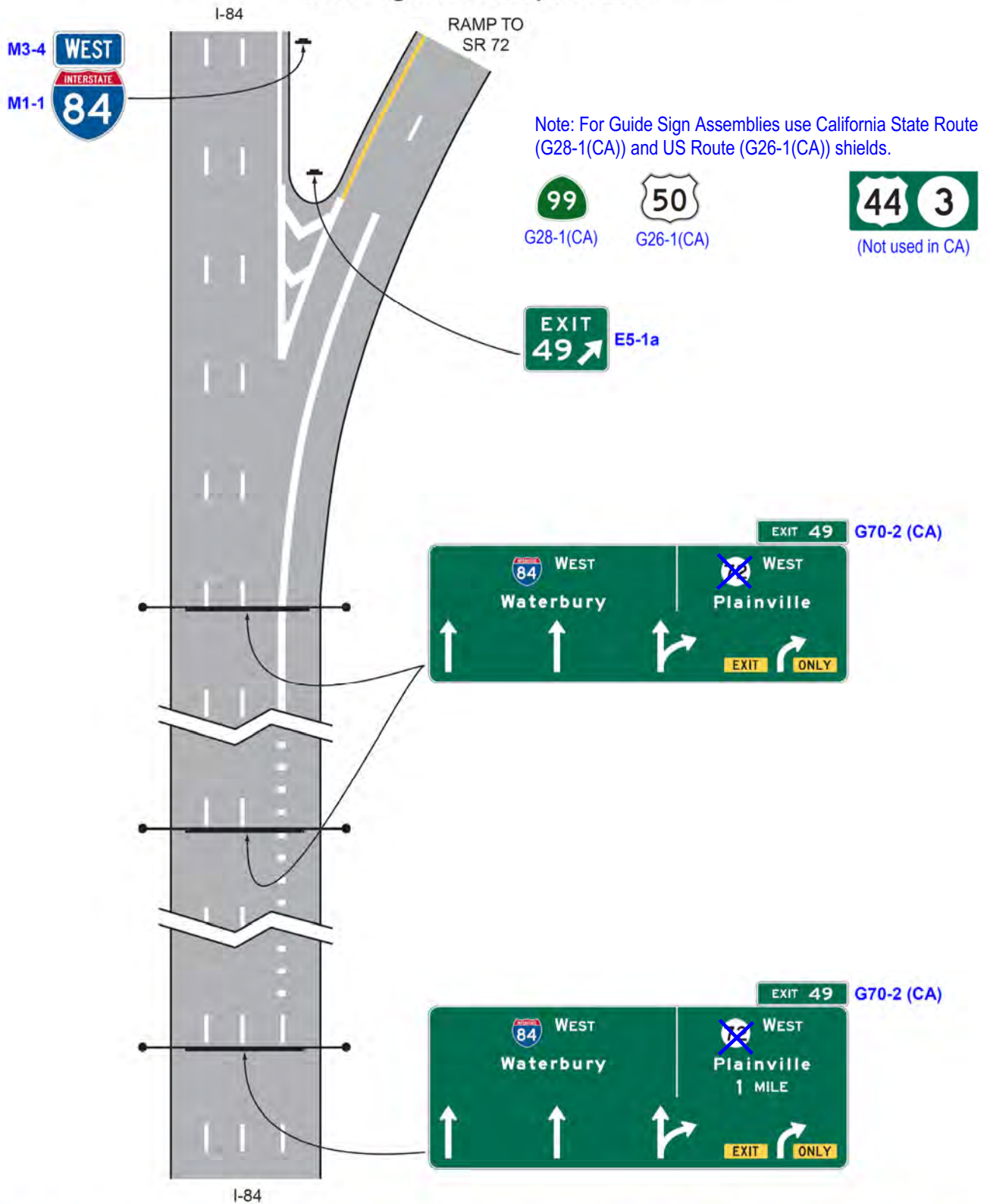
**Figure 2E-3. Overhead Arrow-per-Lane Guide Sign for a Multi-Lane Exit with an Option Lane**



NOTE: The black-on-yellow EXIT (E11-1a) and ONLY (E11-1b) sign panels are used to retrofit existing signs. See Section 2E.24.  
 For Guide Sign Assemblies use California State Route (G28-1(CA)) and US Route (G26-1(CA)) shields.

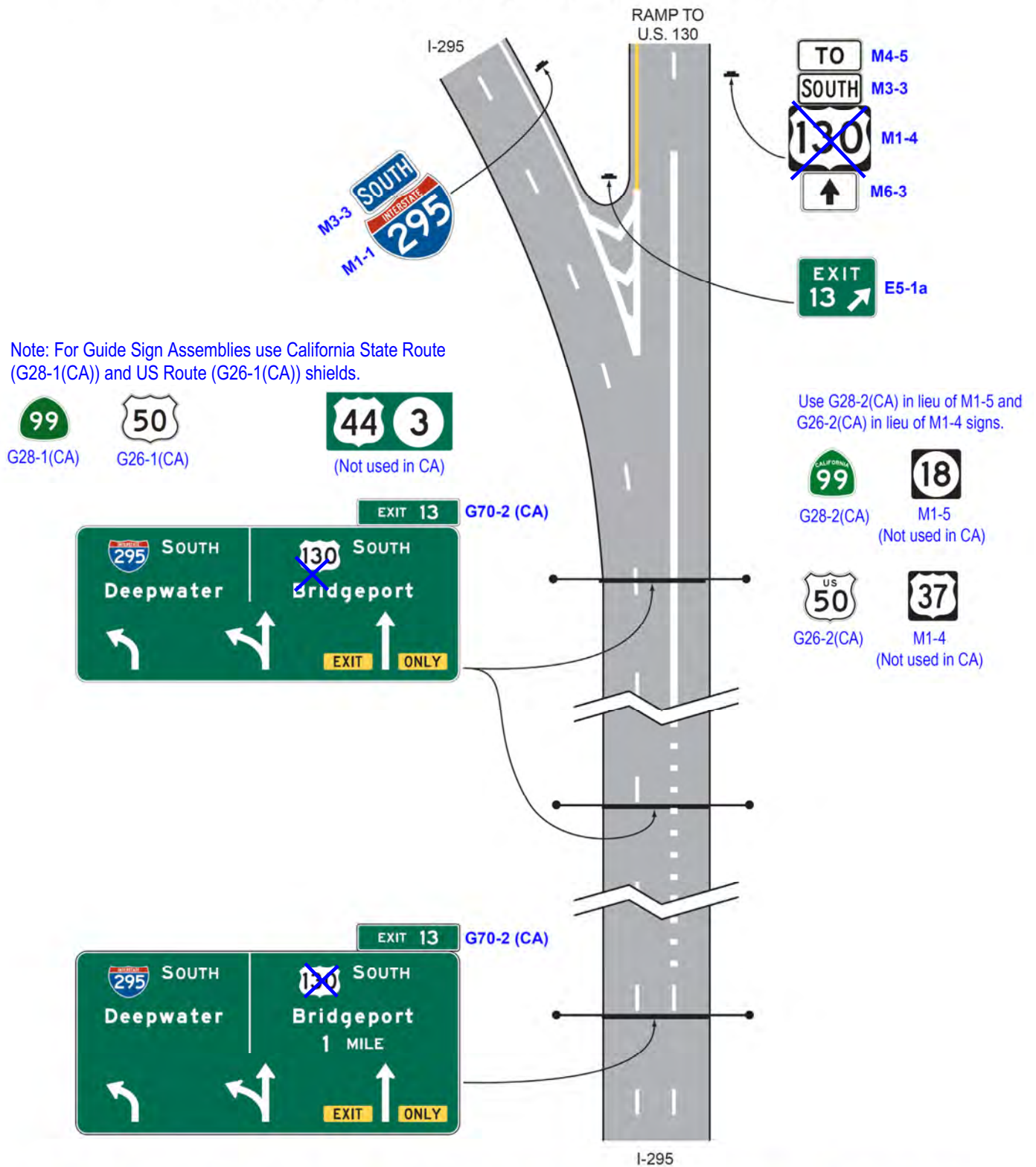


**Figure 2E-4. Overhead Arrow-per-Lane Guide Signs for a Two-Lane Exit to the Right with an Option Lane**



NOTE: The black-on-yellow EXIT (E11-1a) and ONLY (E11-1b) sign panels are used to retrofit existing signs. See Section 2E.24.

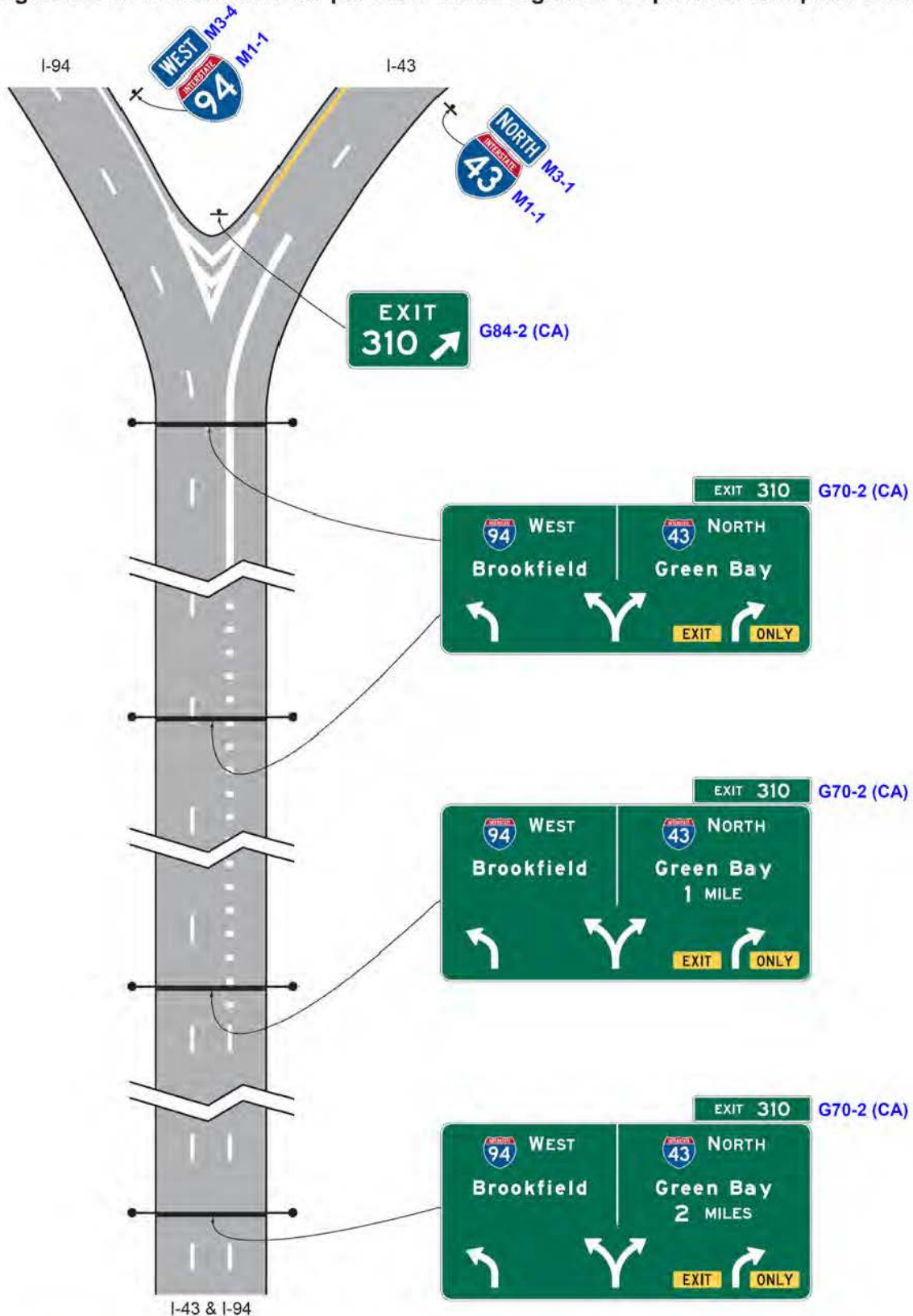
**Figure 2E-5. Overhead Arrow-per-Lane Guide Signs for a Two-Lane Exit to the Right with an Option Lane (Through Lanes Curve to the Left)**



NOTE: The black-on-yellow EXIT (E11-1a) and ONLY (E11-1b) sign panels are used to retrofit existing signs. See Section 2E.24.



**Figure 2E-6. Overhead Arrow-per-Lane Guide Signs for a Split with an Option Lane**



NOTE: The black-on-yellow EXIT (E11-1a) and ONLY (E11-1b) sign panels are used to retrofit existing signs. See Section 2E.24.

**Figure 2E-7. Diagrammatic Guide Sign for a Multi-Lane Exit with an Option Lane**



**Figure 2E-8. Diagrammatic Guide Signs for a Two-Lane Exit to the Right with an Option Lane**



**Figure 2E-9. Diagrammatic Guide Signs for a Two-Lane Exit to the Right with an Option Lane (Through Lanes Curve to the Left)**

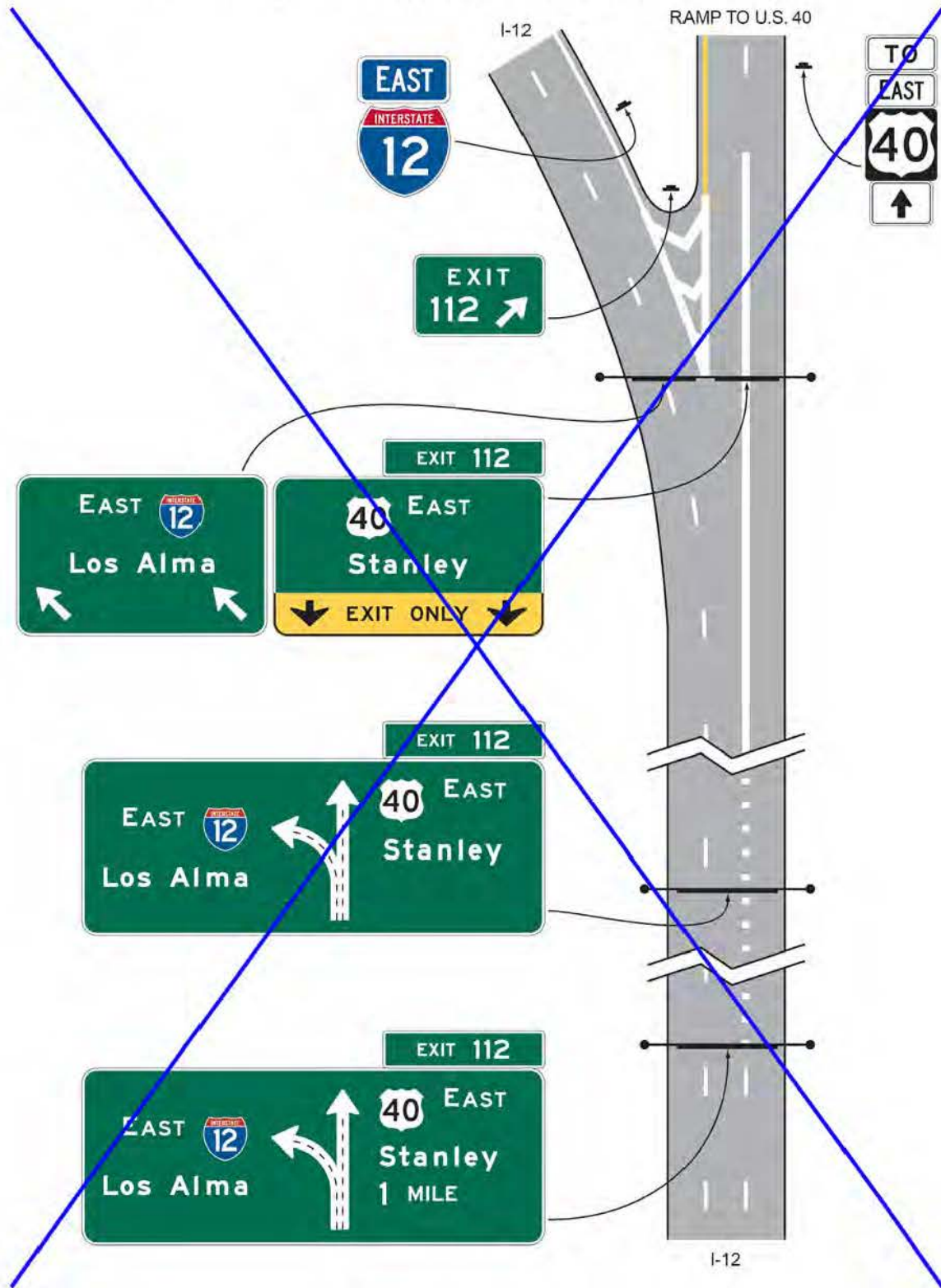
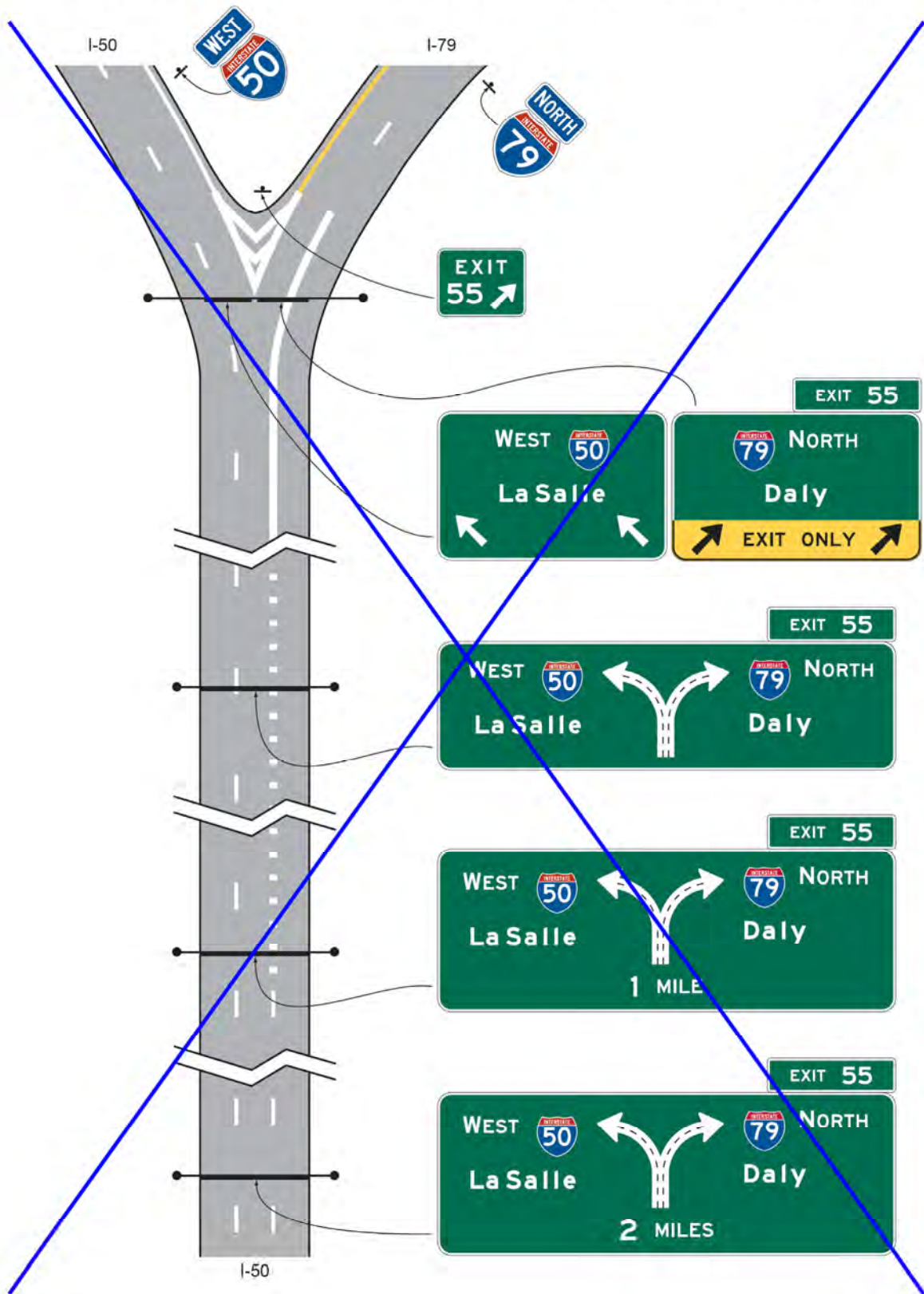
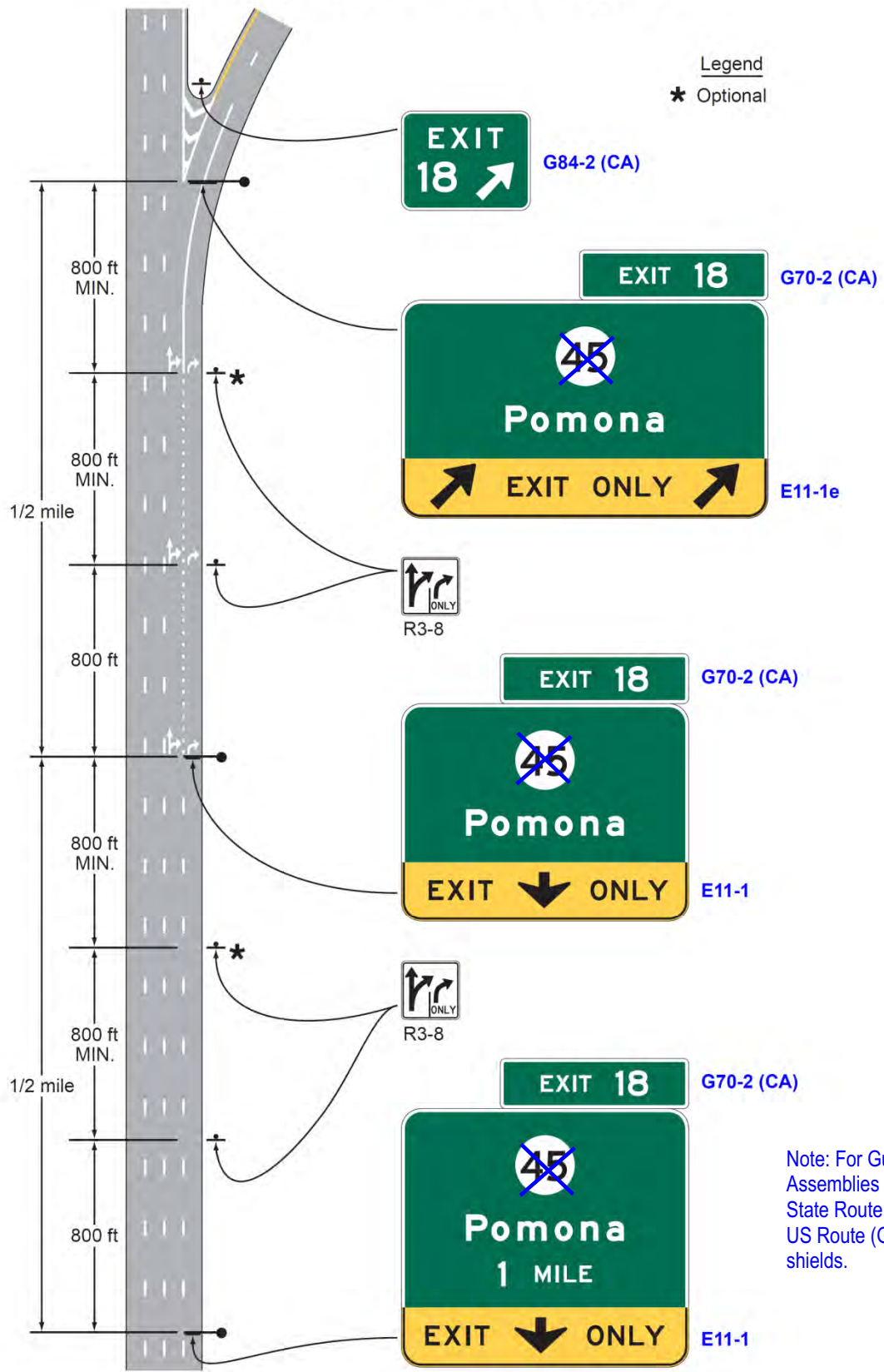


Figure 2E-10. Diagrammatic Guide Signs for a Split with an Option Lane

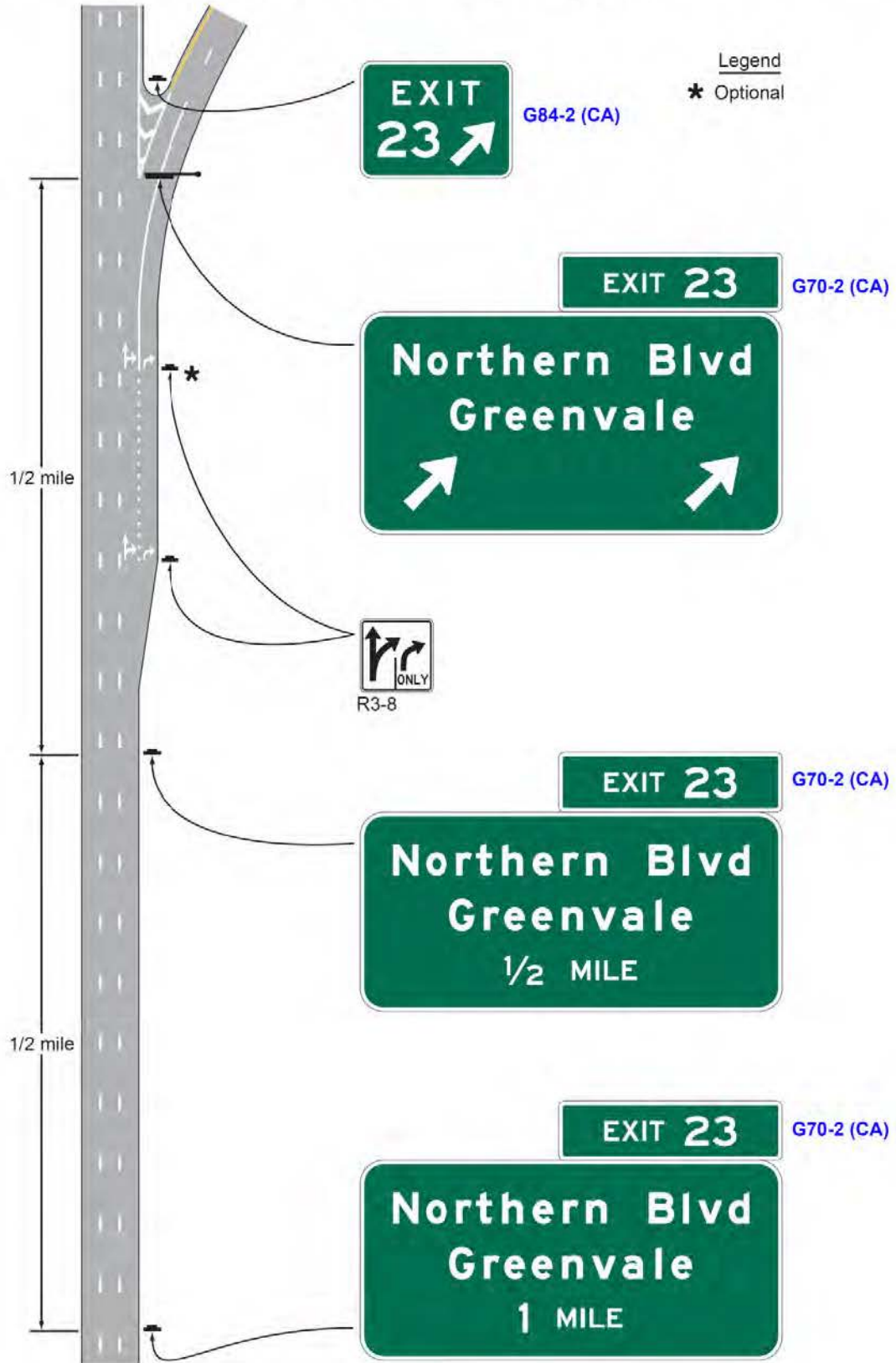


**Figure 2E-11. Example of Signing for a Two-Lane Intermediate or Minor Interchange Exit with an Option Lane and a Dropped Lane**

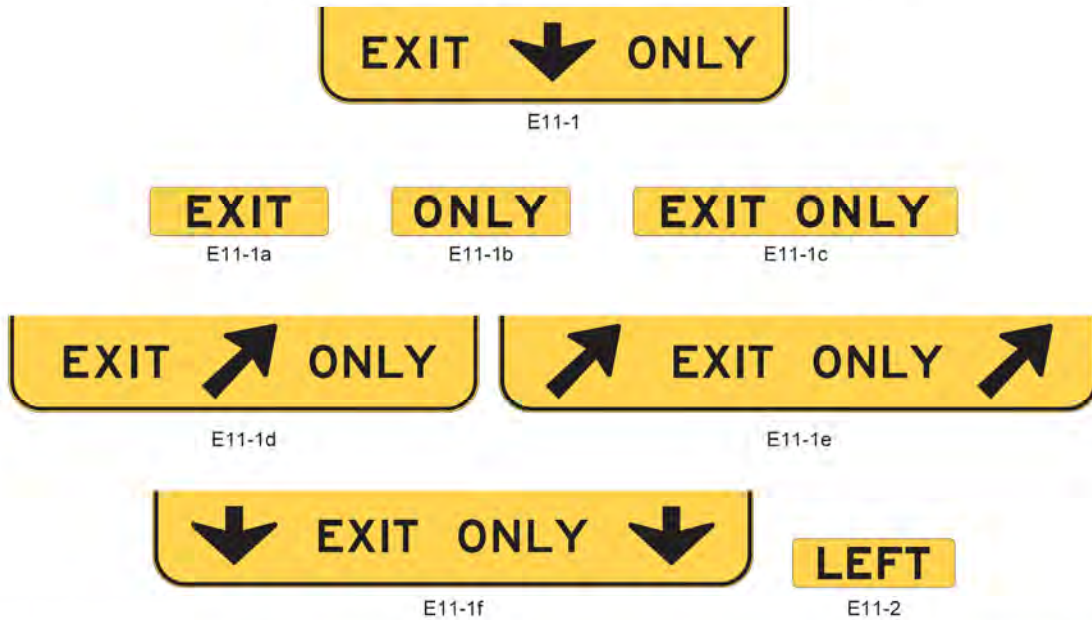


Note: For Guide Sign Assemblies use California State Route (G28-1(CA)) and US Route (G26-1(CA)) shields.

**Figure 2E-12. Example of Signing for a Two-Lane Intermediate or Minor Interchange Exit with Option and Auxiliary Lanes**



**Figure 2E-13. EXIT ONLY and LEFT Sign Panels**



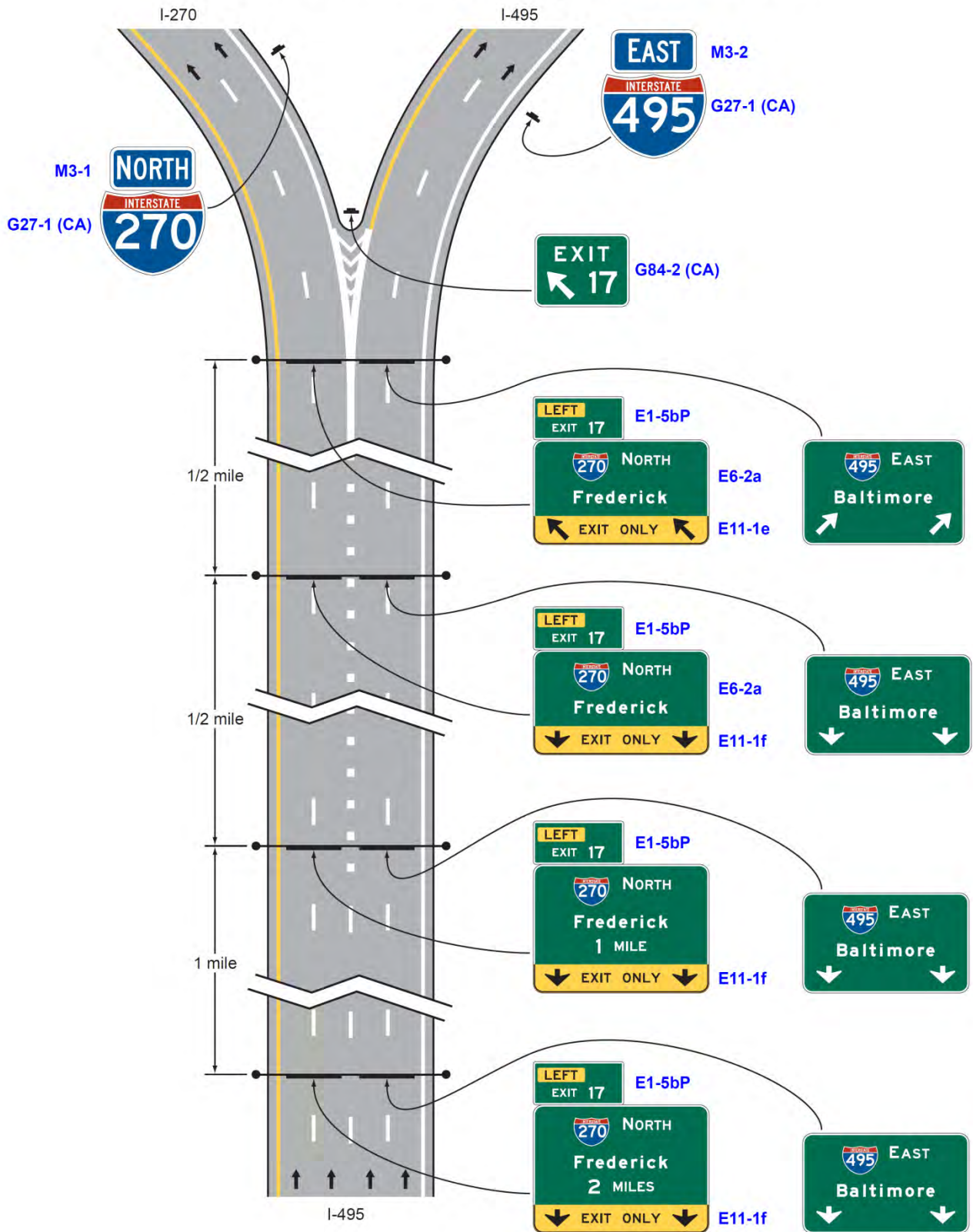
NOTE: The black-on-yellow EXIT (E11-1a) and ONLY (E11-1b) sign panels are used to retrofit existing signs. See Section 2E.24.

**Figure 2E-13 (CA). EXIT ONLY and LEFT Sign Panels**

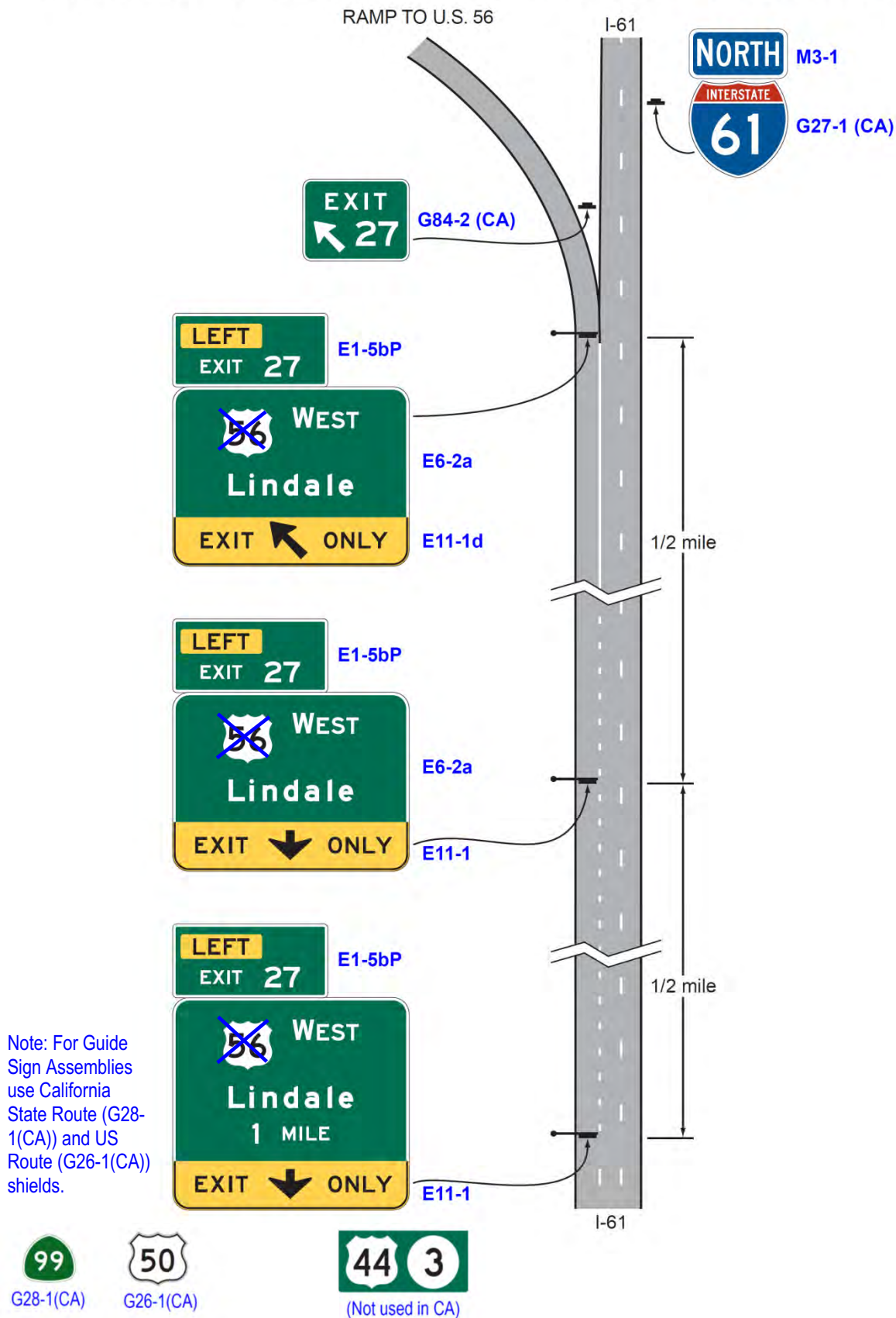




**Figure 2E-14. Guide Signs for a Split with Dedicated Lanes**

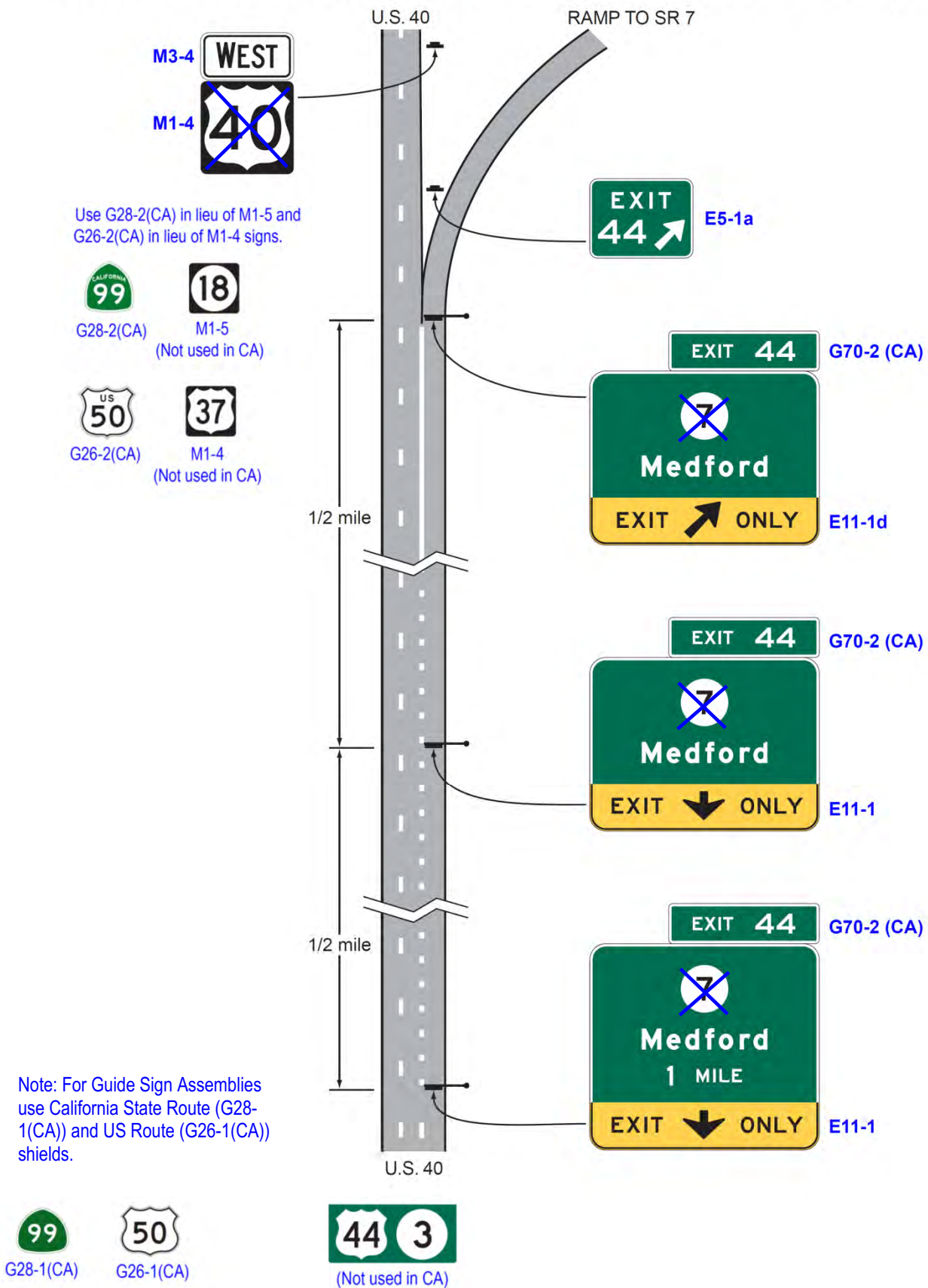


**Figure 2E-15. Guide Signs for a Single-Lane Exit to the Left with a Dropped Lane**

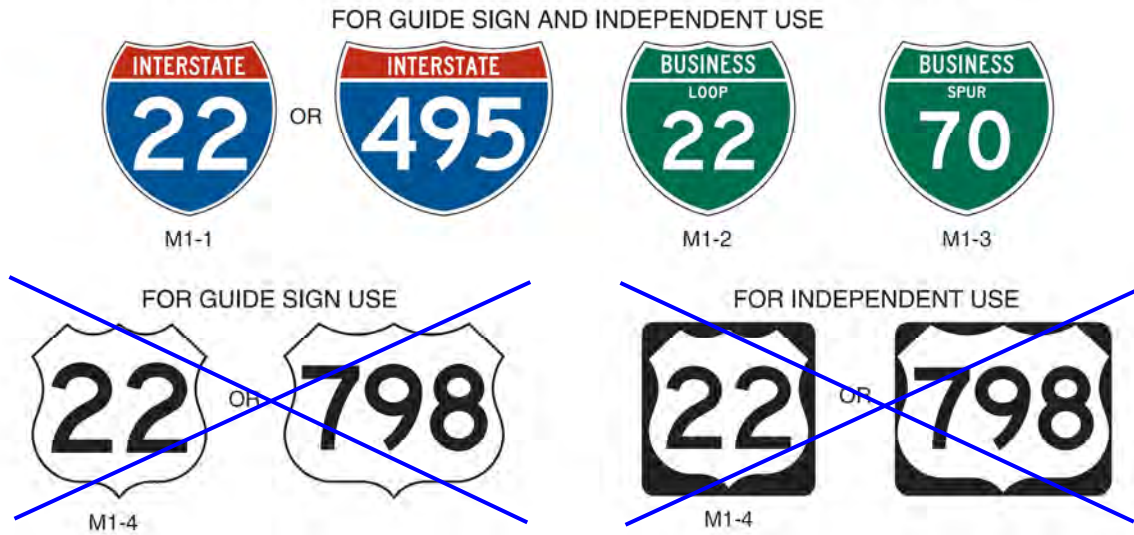


Note: For Guide Sign Assemblies use California State Route (G28-1(CA)) and US Route (G26-1(CA)) shields.

**Figure 2E-16. Guide Signs for a Single-Lane Exit to the Right with a Dropped Lane**



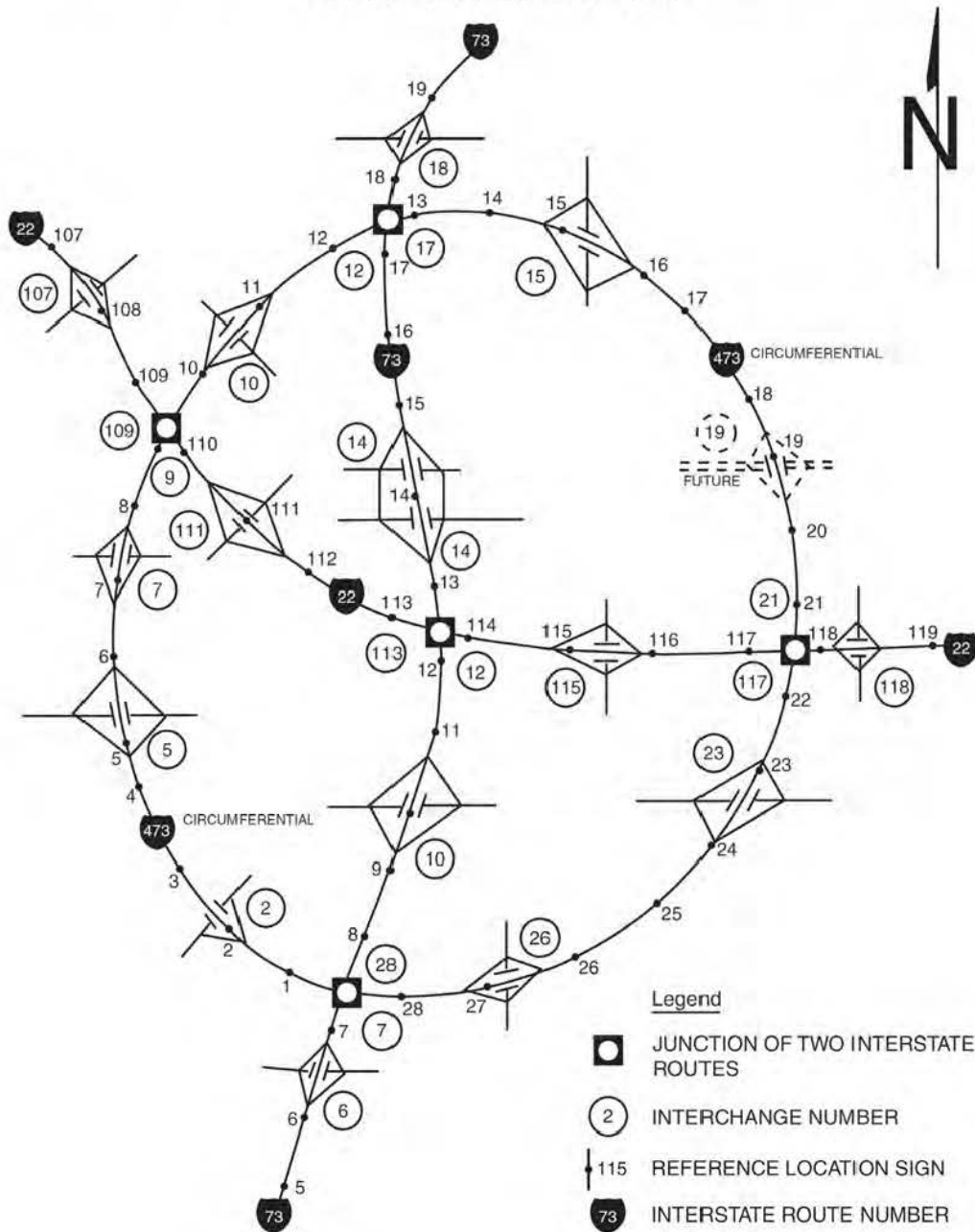
**Figure 2E-17. Interstate, Off-Interstate, and U.S. Route Signs**



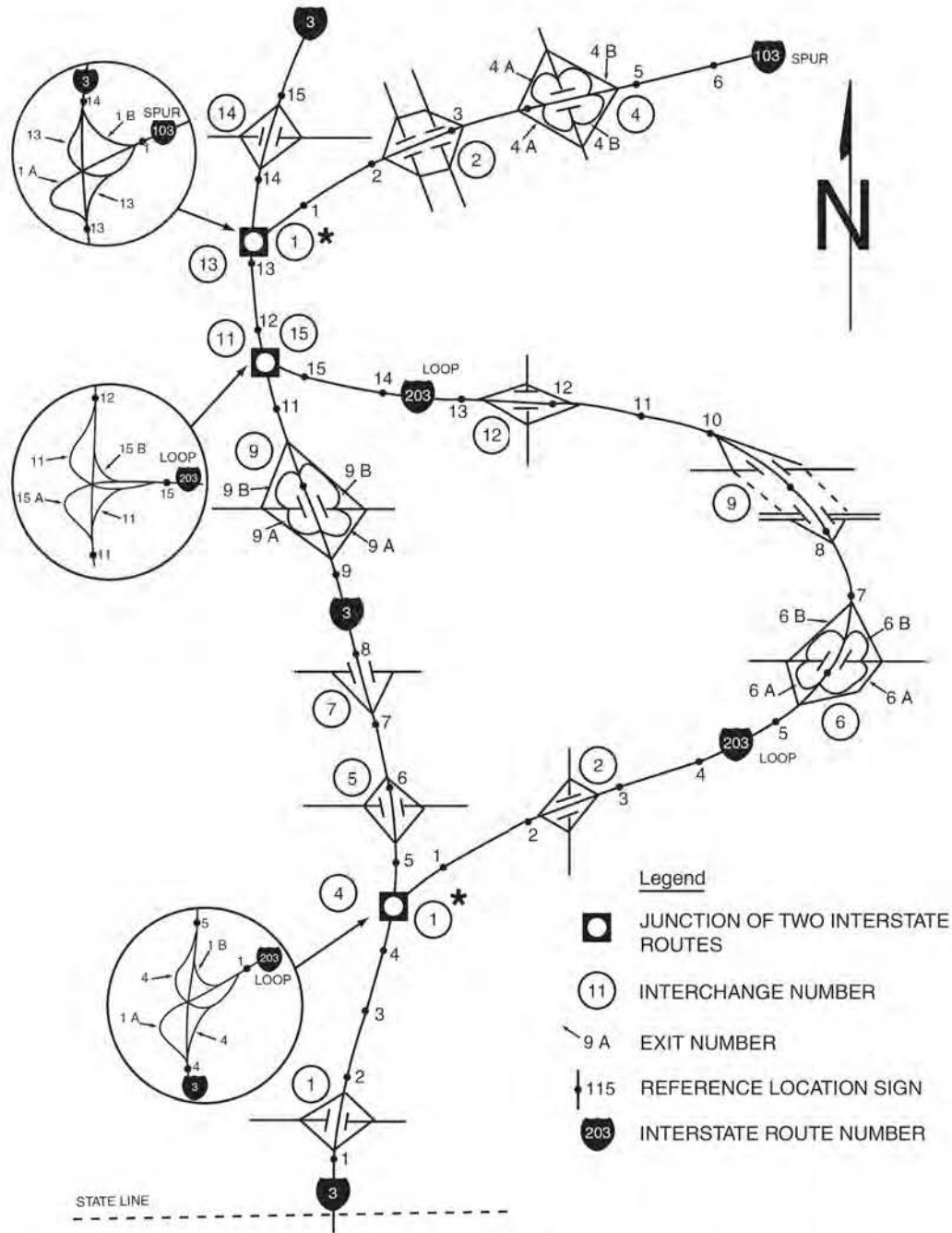
**Figure 2E-18. Eisenhower Interstate System Signs**



**Figure 2E-19. Example of Interchange Numbering for Mainline and Circumferential Routes**

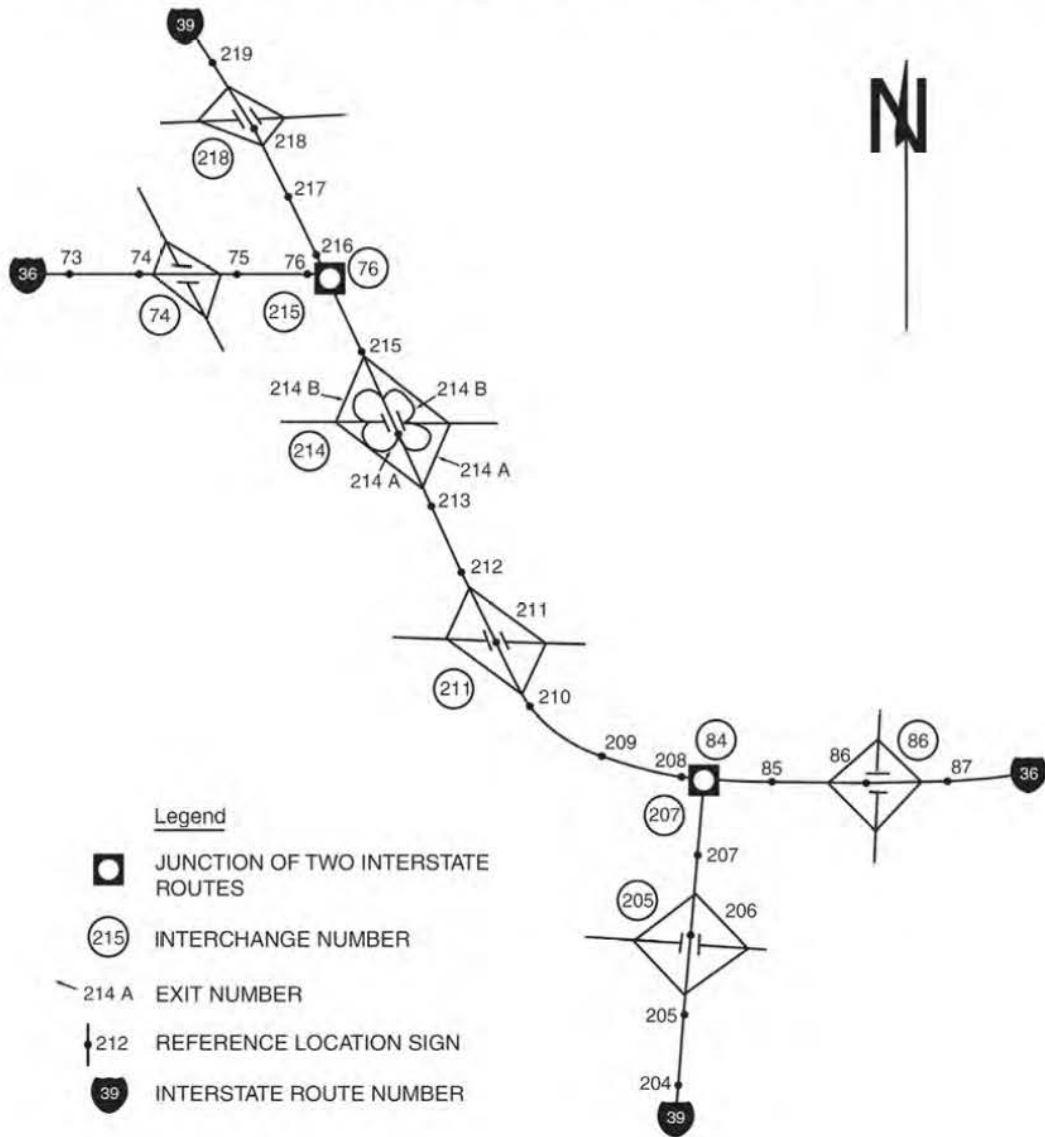


**Figure 2E-20. Example of Interchange Numbering for Mainline, Loop, and Spur Routes**



★ The freeway/freeway interchange where the beginning of the loop or spur route intersects with the mainline route may be called either Exit 1 or Exit 0 on the loop or spur route.

**Figure 2E-21. Example of Interchange Numbering for Overlapping Routes**



**Figure 2E-22. Examples of Interchange Advance Guide Signs, Exit Number Plaques, and LEFT Plaque**



Note: For Guide Sign Assemblies use California State Route (G28-1(CA)) and US Route (G26-1(CA)) shields.





**Figure 2E-22 (CA). Examples of Interchange Advance Guide Signs, Exit Number Plaques, and LEFT Plaque**



**Figure 2E-23. Next Exit Plaques**



**Figure 2E-24. Supplemental Guide Sign for a Multi-Exit Interchange**



**Figure 2E-25. Supplemental Guide Sign for a Park – Ride Facility**

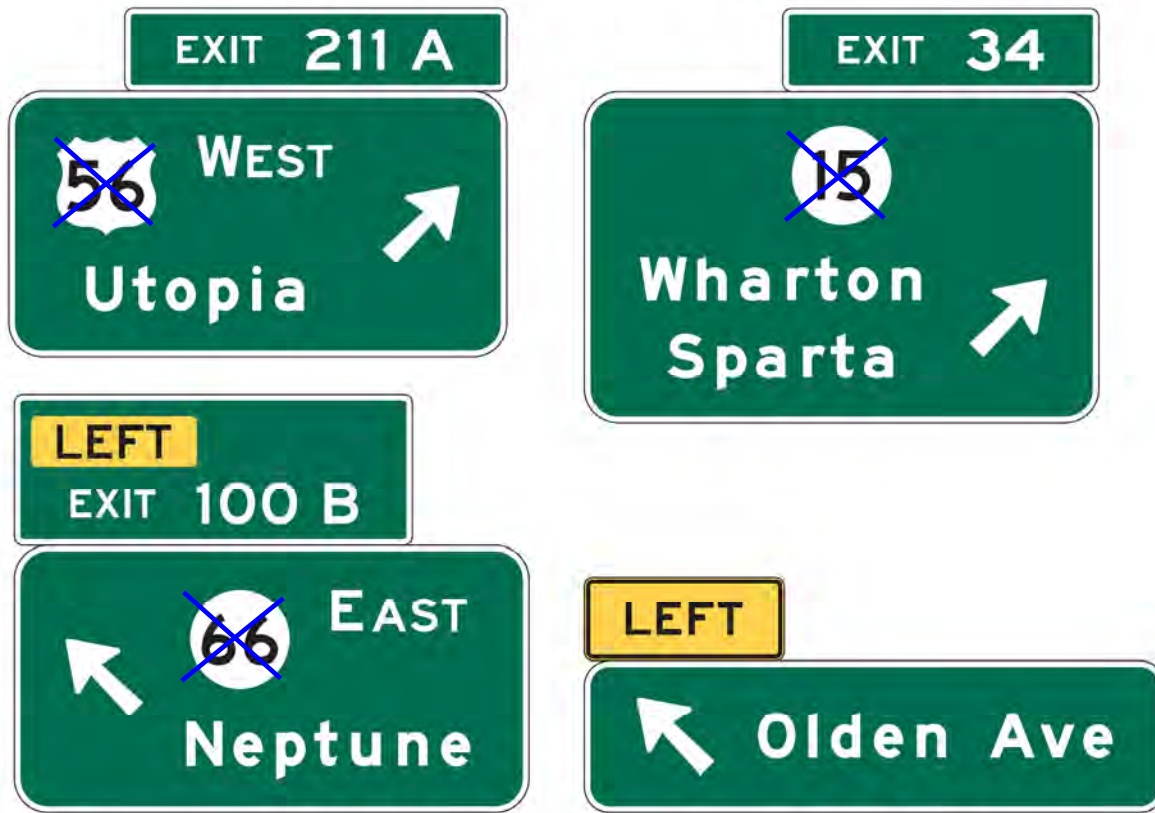
A – ROUTE WITHOUT EXIT NUMBERING



B – ROUTE WITH EXIT NUMBERING



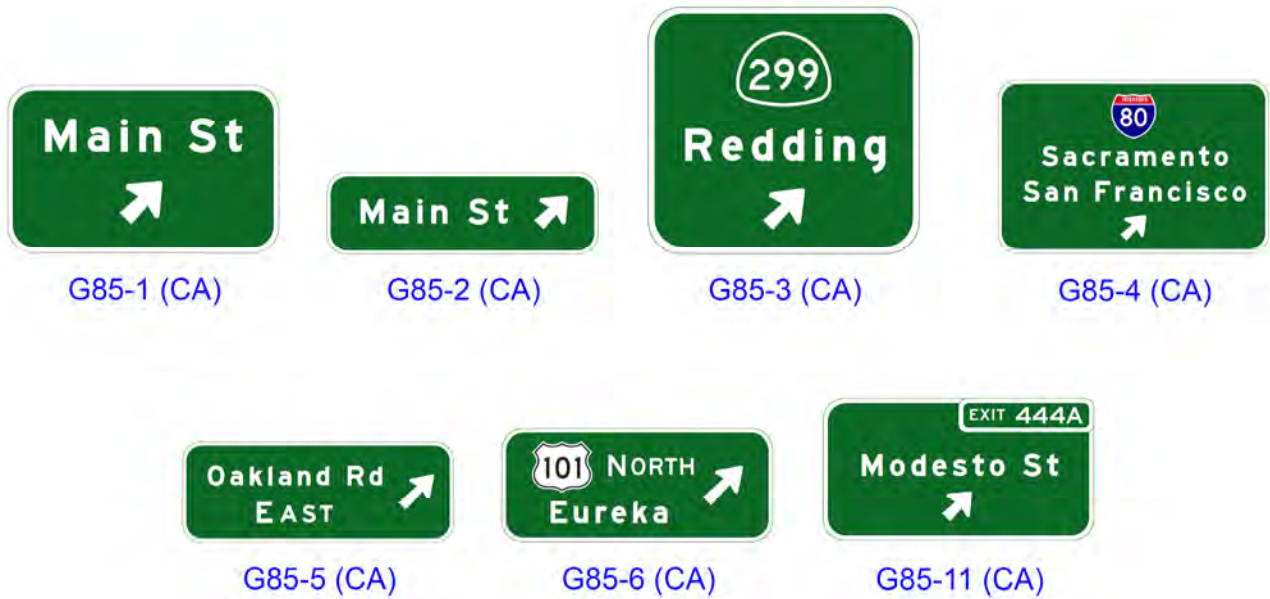
Figure 2E-26. Examples of Interchange Exit Direction Signs



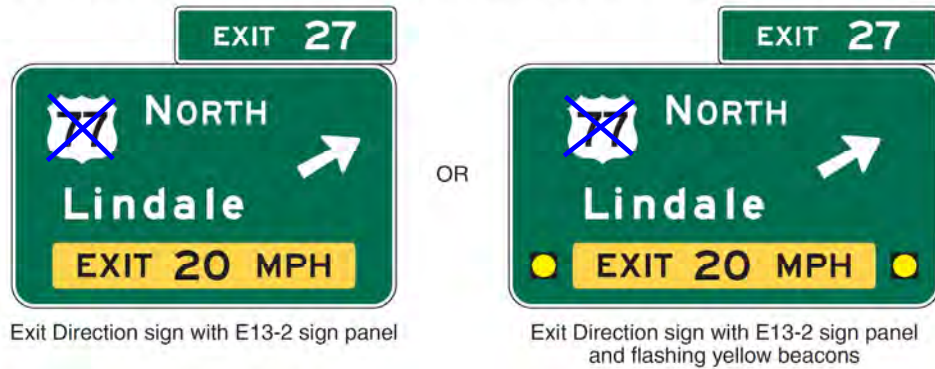
Note: For Guide Sign Assemblies use California State Route (G28-1(CA)) and US Route (G26-1(CA)) shields.



**Figure 2E-26 (CA). Examples of Interchange Exit Direction Signs**



**Figure 2E-27. Interchange Exit Direction Sign with an Advisory Speed Panel**



Exit Direction sign with E13-2 sign panel

Exit Direction sign with E13-2 sign panel and flashing yellow beacons

Note: For Guide Sign Assemblies use California State Route (G28-1(CA)) and US Route (G26-1(CA)) shields.



**Figure 2E-28. Exit Gore Signs**



**Figure 2E-28 (CA). Exit Gore Signs**



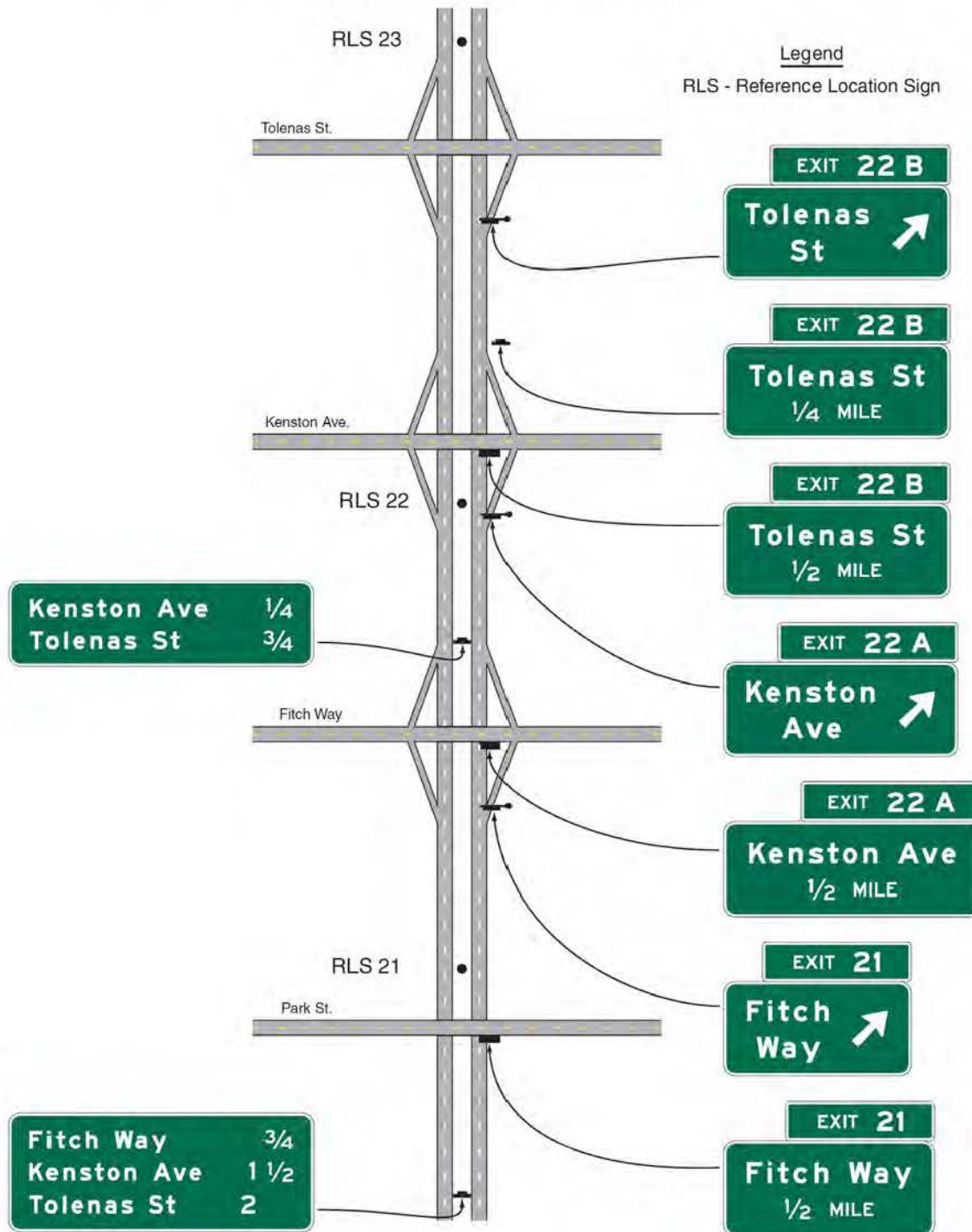
**Figure 2E-29. Post-Interchange Distance Sign**



Note: For Guide Sign Assemblies use California State Route (G28-1(CA)) and US Route (G26-1(CA)) shields.



**Figure 2E-30. Example of Using an Interchange Sequence Sign for Closely-Spaced Interchanges**



**Figure 2E-31. Interchange Sequence Sign**



*Figure 2E-31 (CA). Interchange Sequence Signs*



G23-1 (CA)



G23-2 (CA)



G23-3 (CA)



G23-4 (CA)



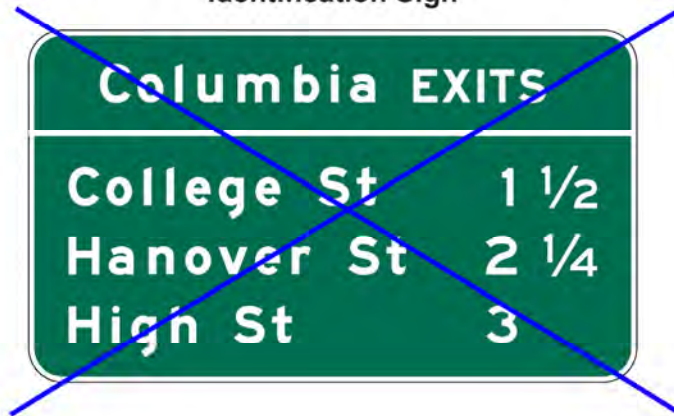
G23-5 (CA)



G23-6 (CA)



**Figure 2E-32. Community Interchanges Identification Sign**



---

**Figure 2E-33. NEXT EXITS Sign**



---

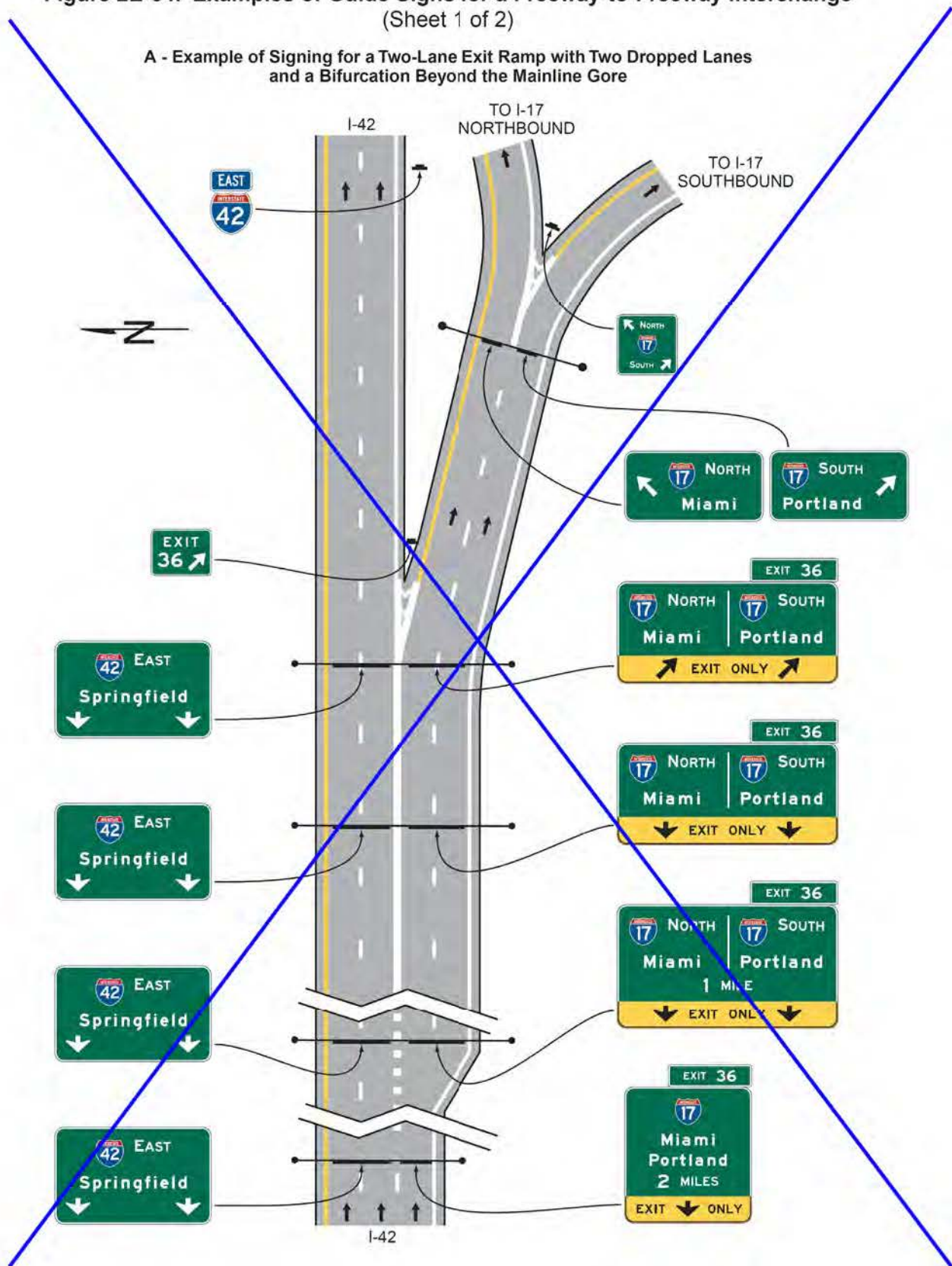
*Figure 2E-33 (CA). NEXT EXITS Sign*



G87 (CA)

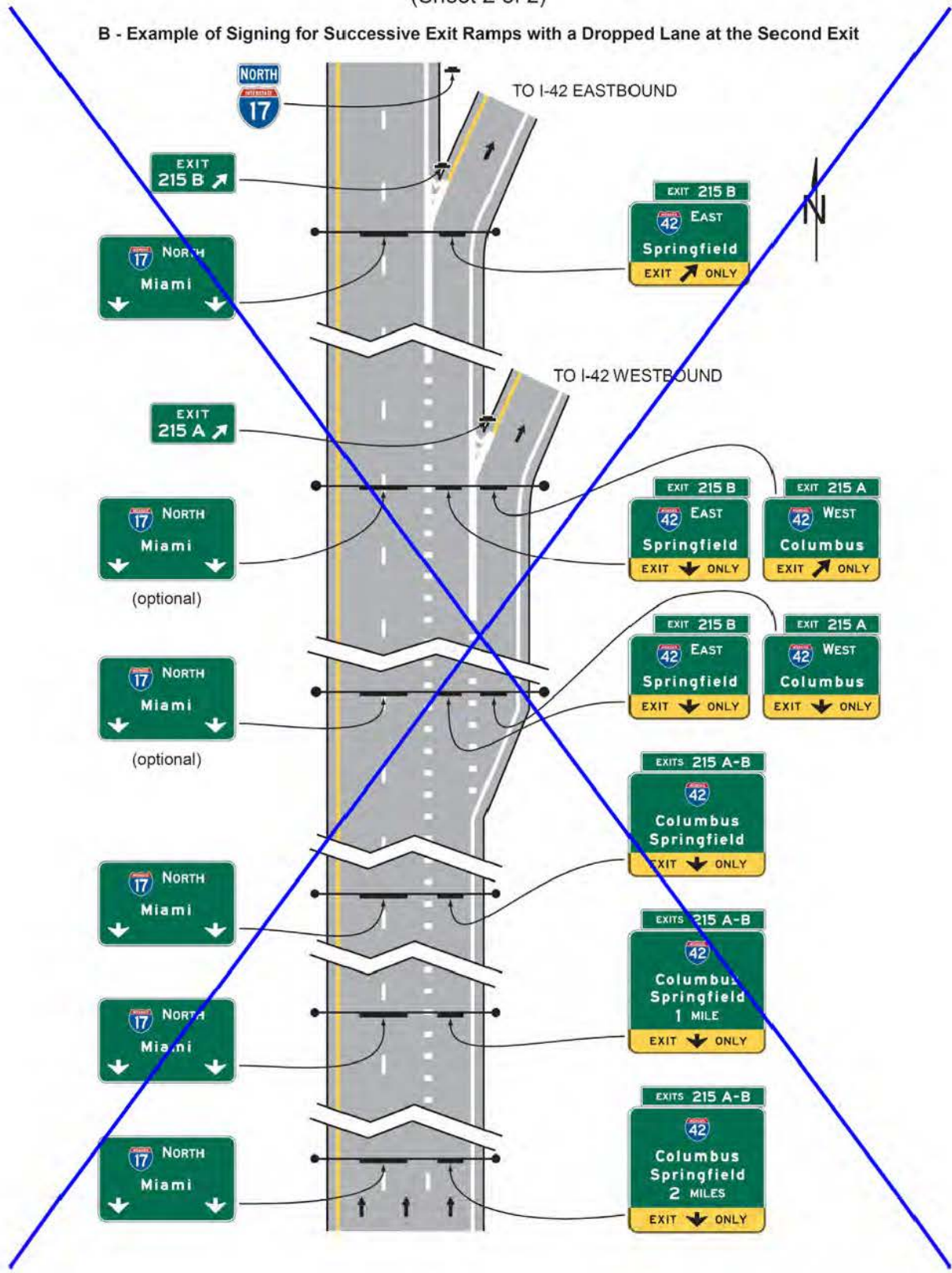
**Figure 2E-34. Examples of Guide Signs for a Freeway-to-Freeway Interchange**  
(Sheet 1 of 2)

**A - Example of Signing for a Two-Lane Exit Ramp with Two Dropped Lanes and a Bifurcation Beyond the Mainline Gore**



**Figure 2E-34. Examples of Guide Signs for a Freeway-to-Freeway Interchange**  
(Sheet 2 of 2)

**B - Example of Signing for Successive Exit Ramps with a Dropped Lane at the Second Exit**



**Figure 2E-34 (CA). Examples of Guide Signs for a Freeway-to-Freeway Interchange**

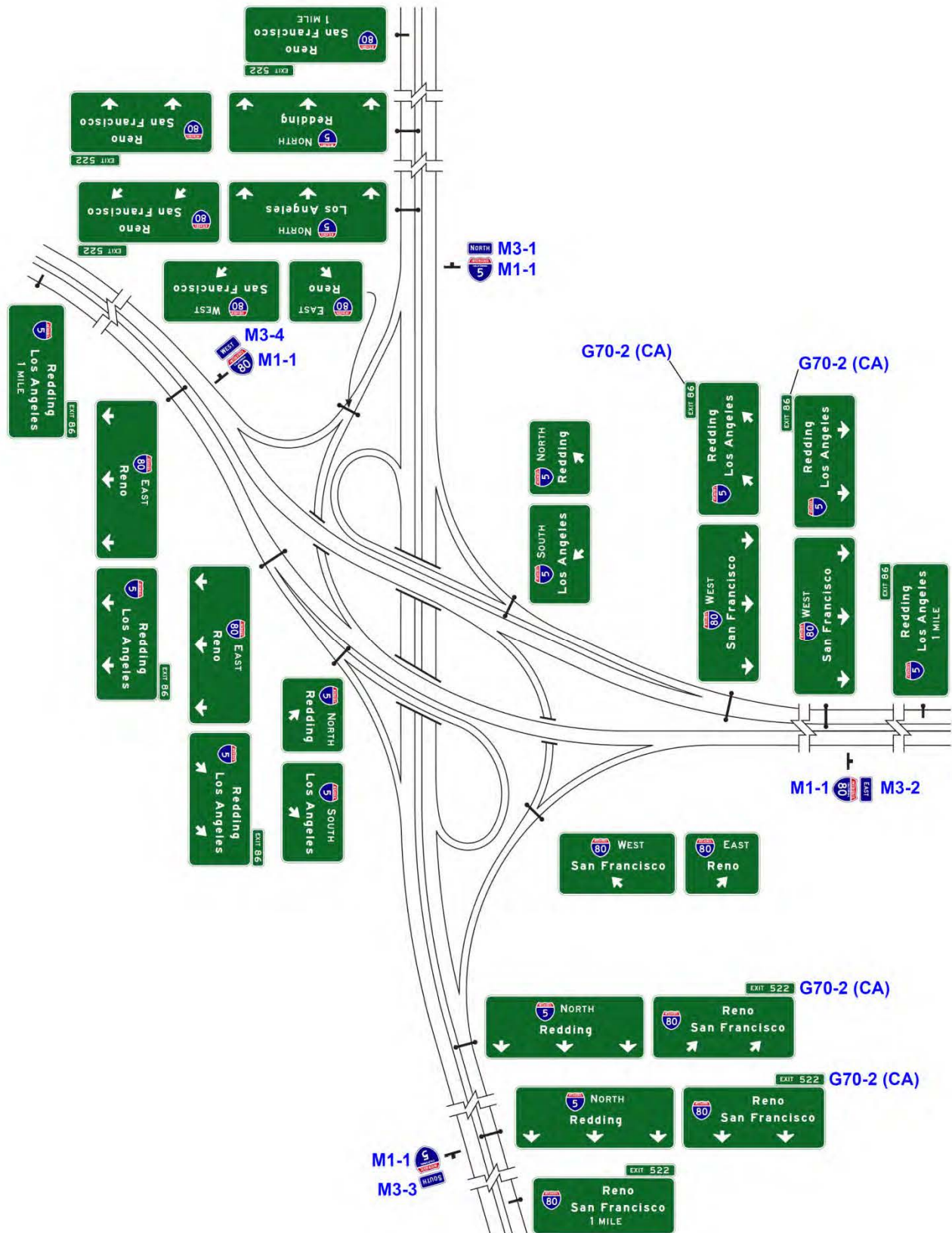
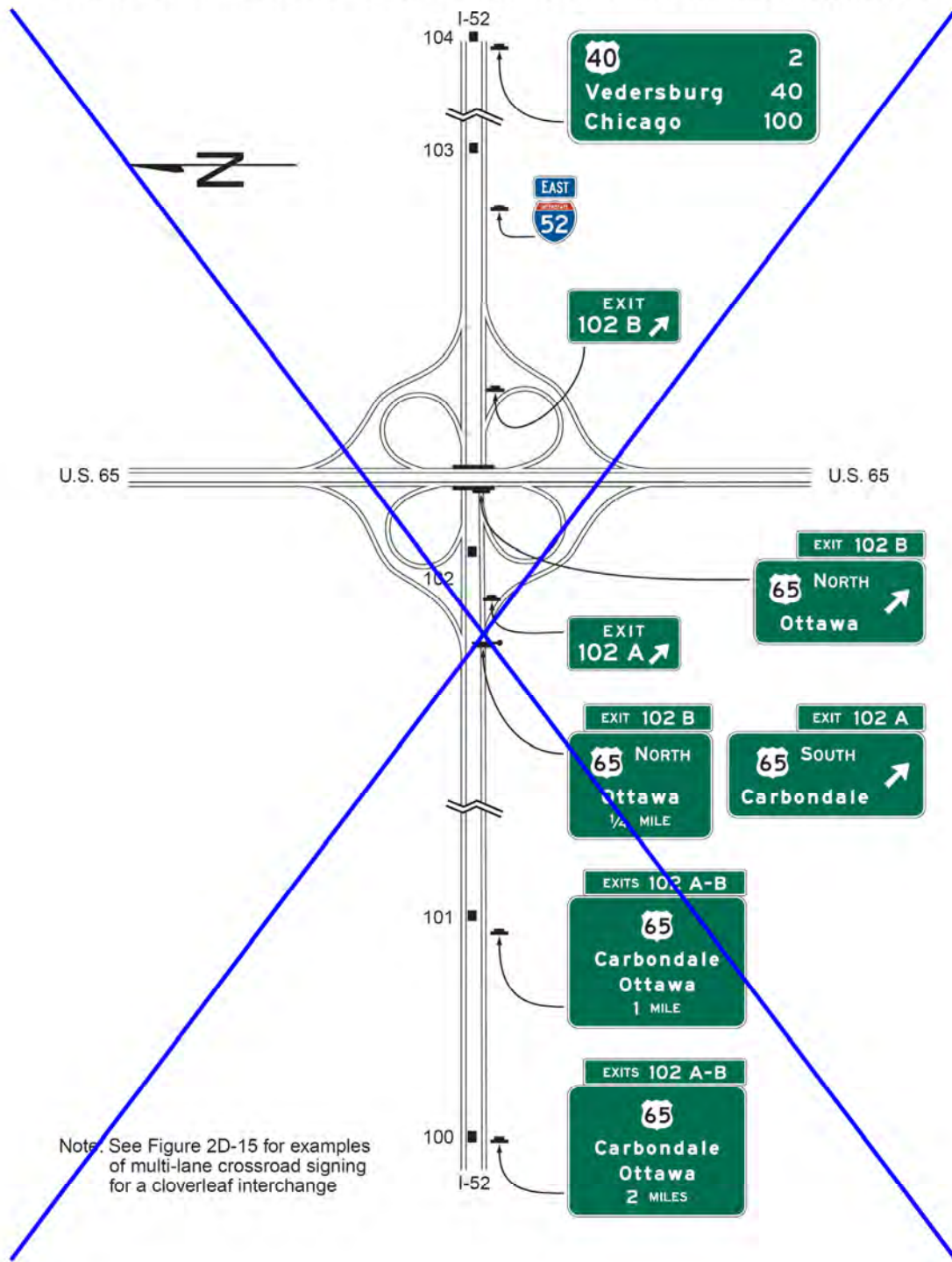


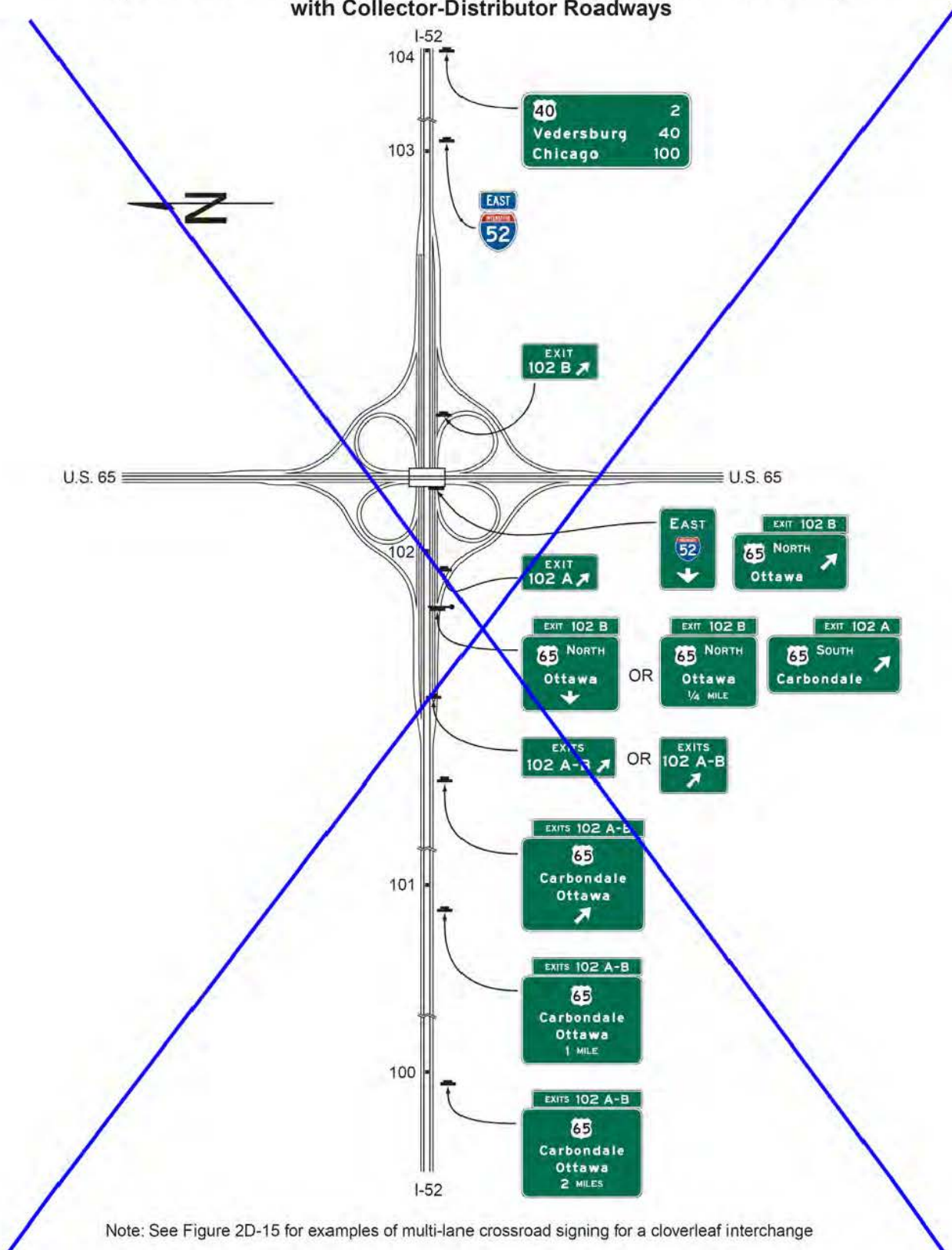
Figure 2E-35. Examples of Guide Signs for a Full Cloverleaf Interchange



Note: See Figure 2D-15 for examples of multi-lane crossroad signing for a cloverleaf interchange

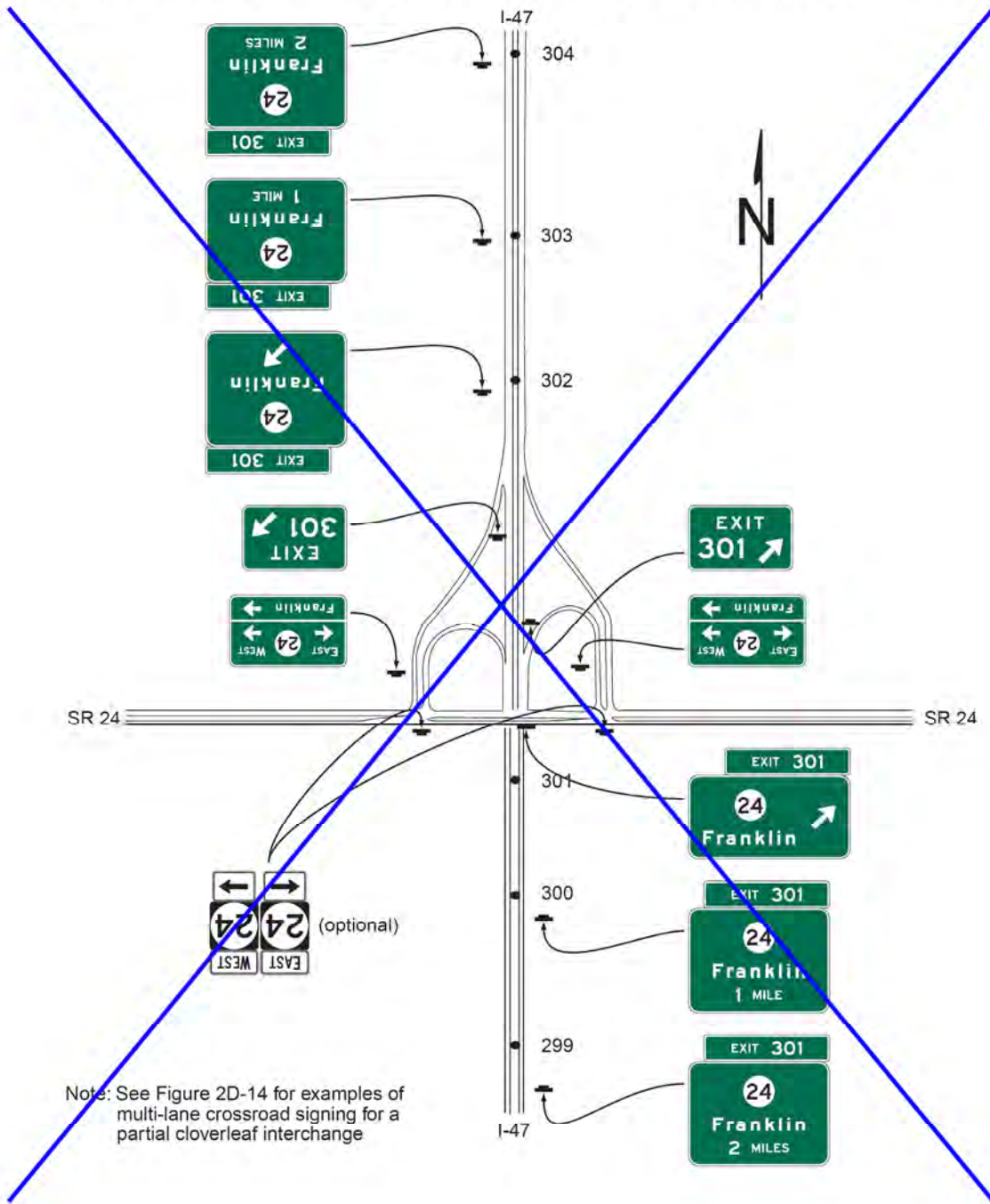


**Figure 2E-36. Examples of Guide Signs for a Full Cloverleaf Interchange with Collector-Distributor Roadways**



Note: See Figure 2D-15 for examples of multi-lane crossroad signing for a cloverleaf interchange

Figure 2E-37. Examples of Guide Signs for a Partial Cloverleaf Interchange





**Figure 2E-37 (CA). Examples of Guide Signs for a Partial Cloverleaf Interchange**

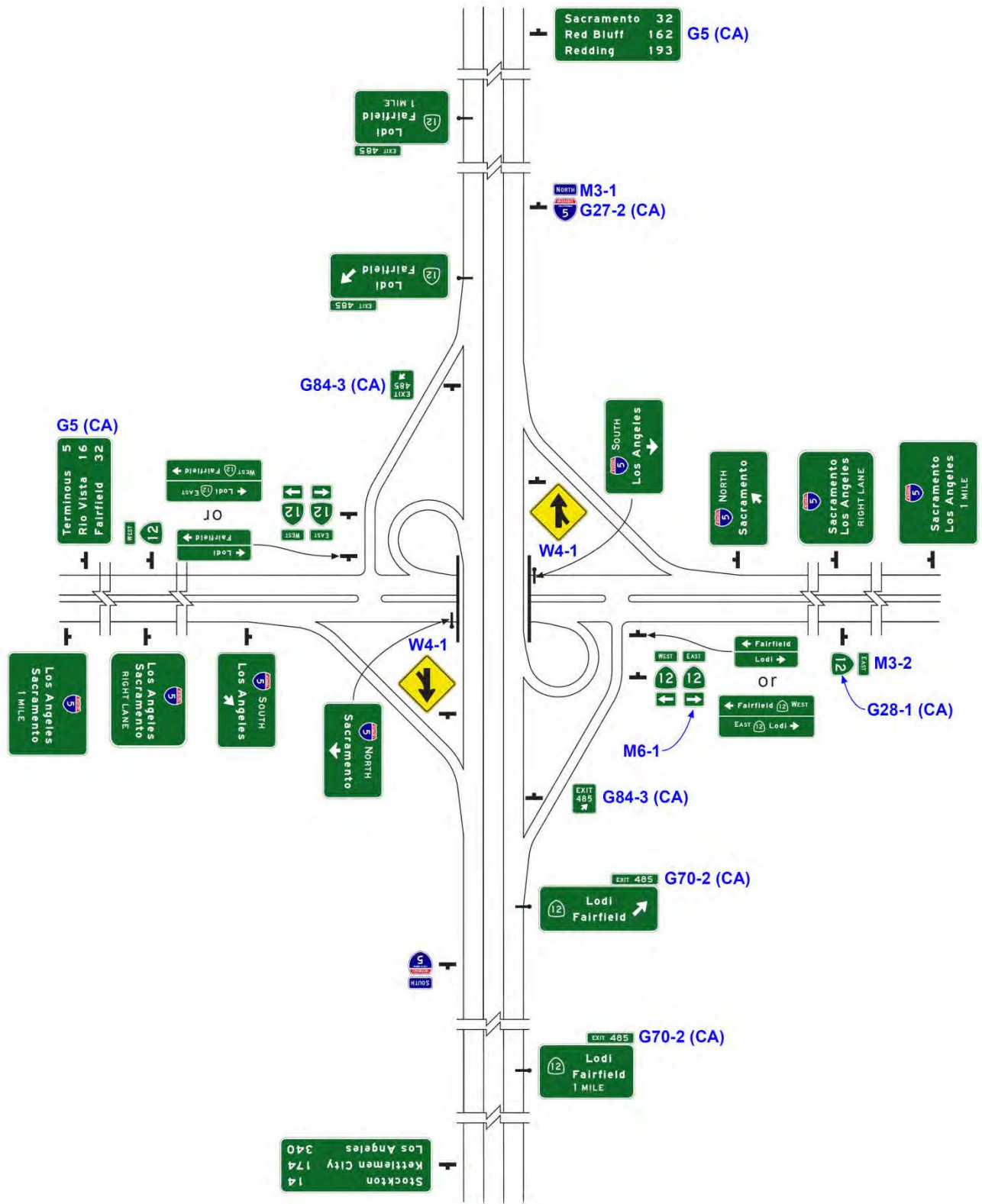
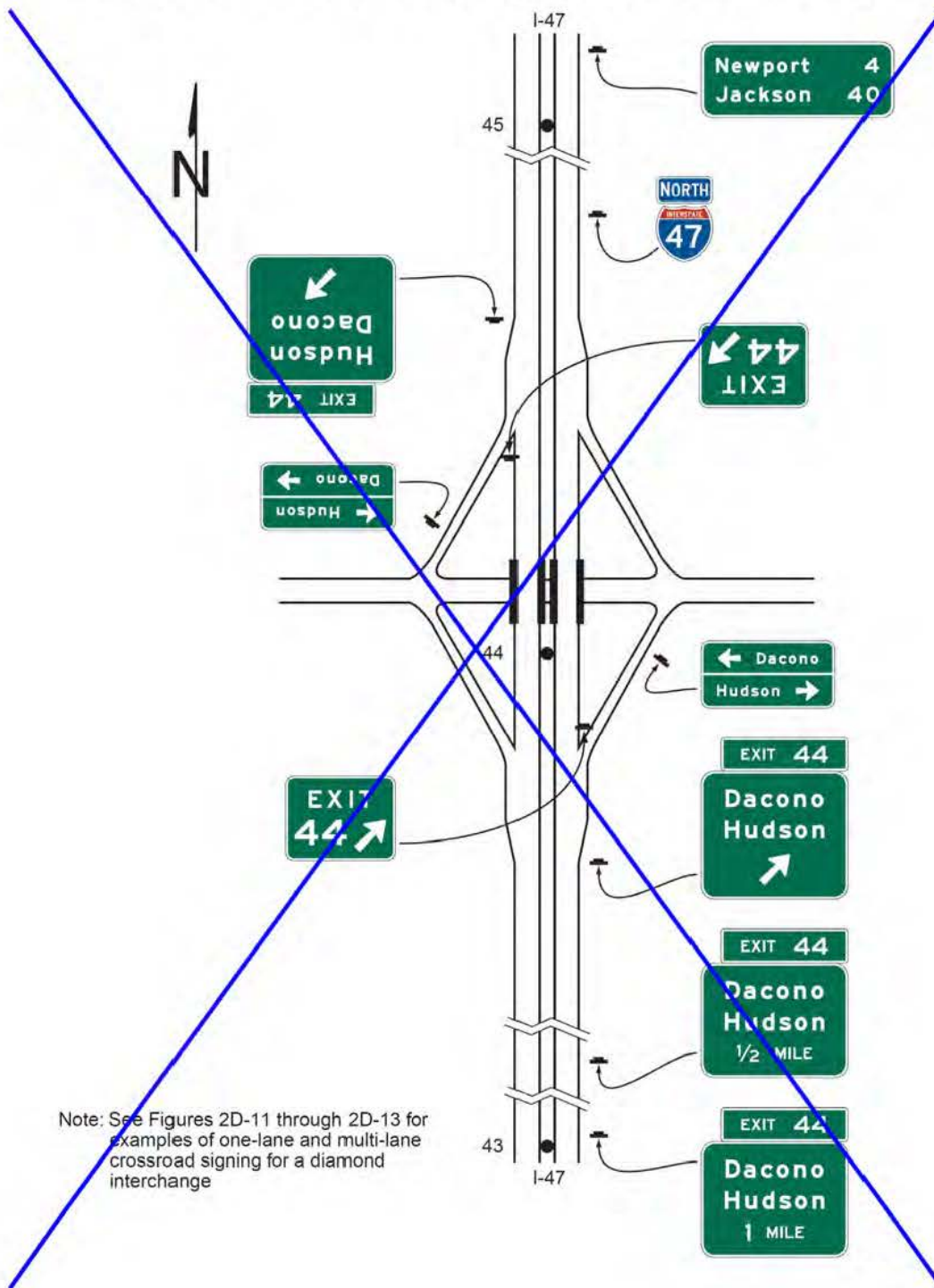
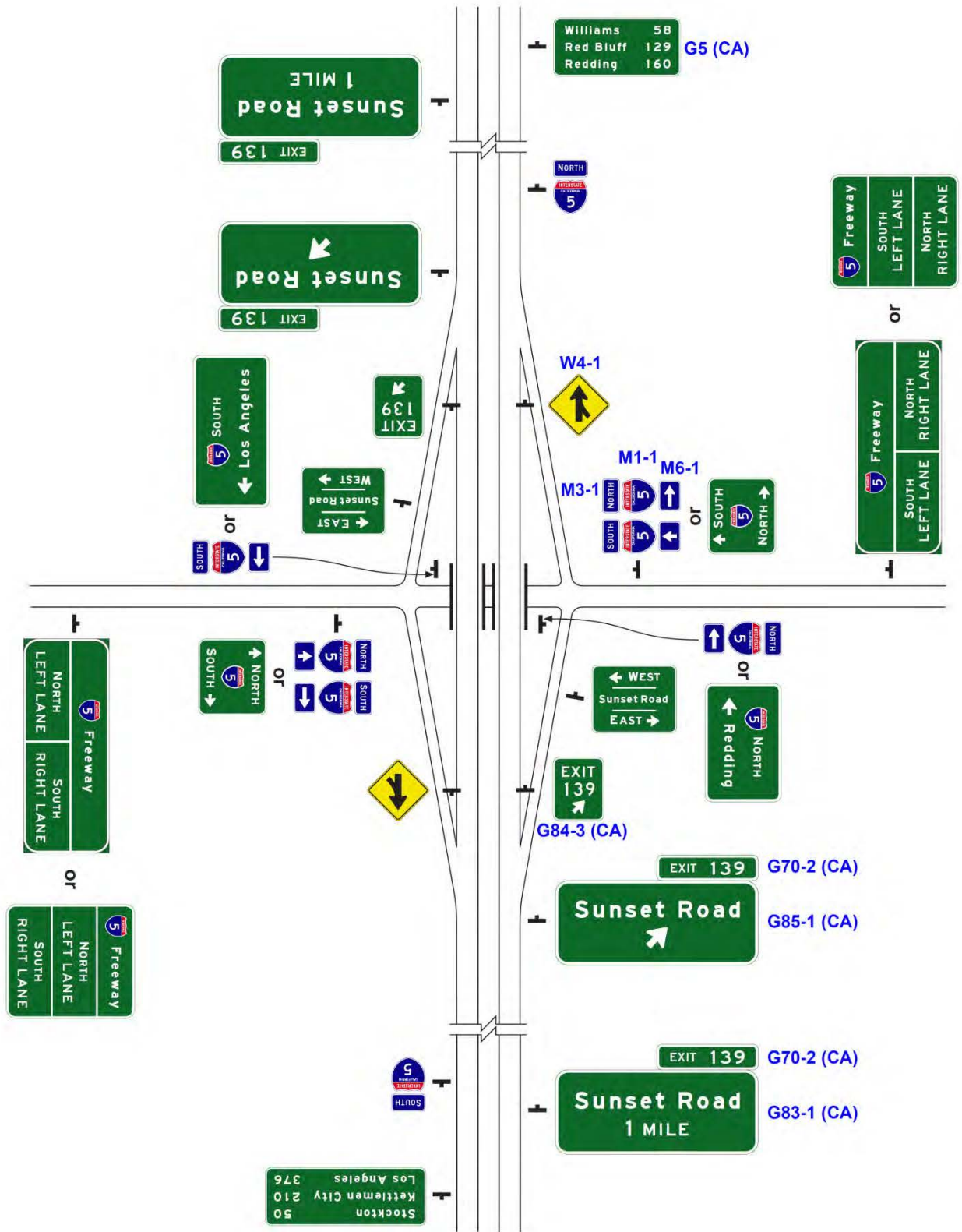


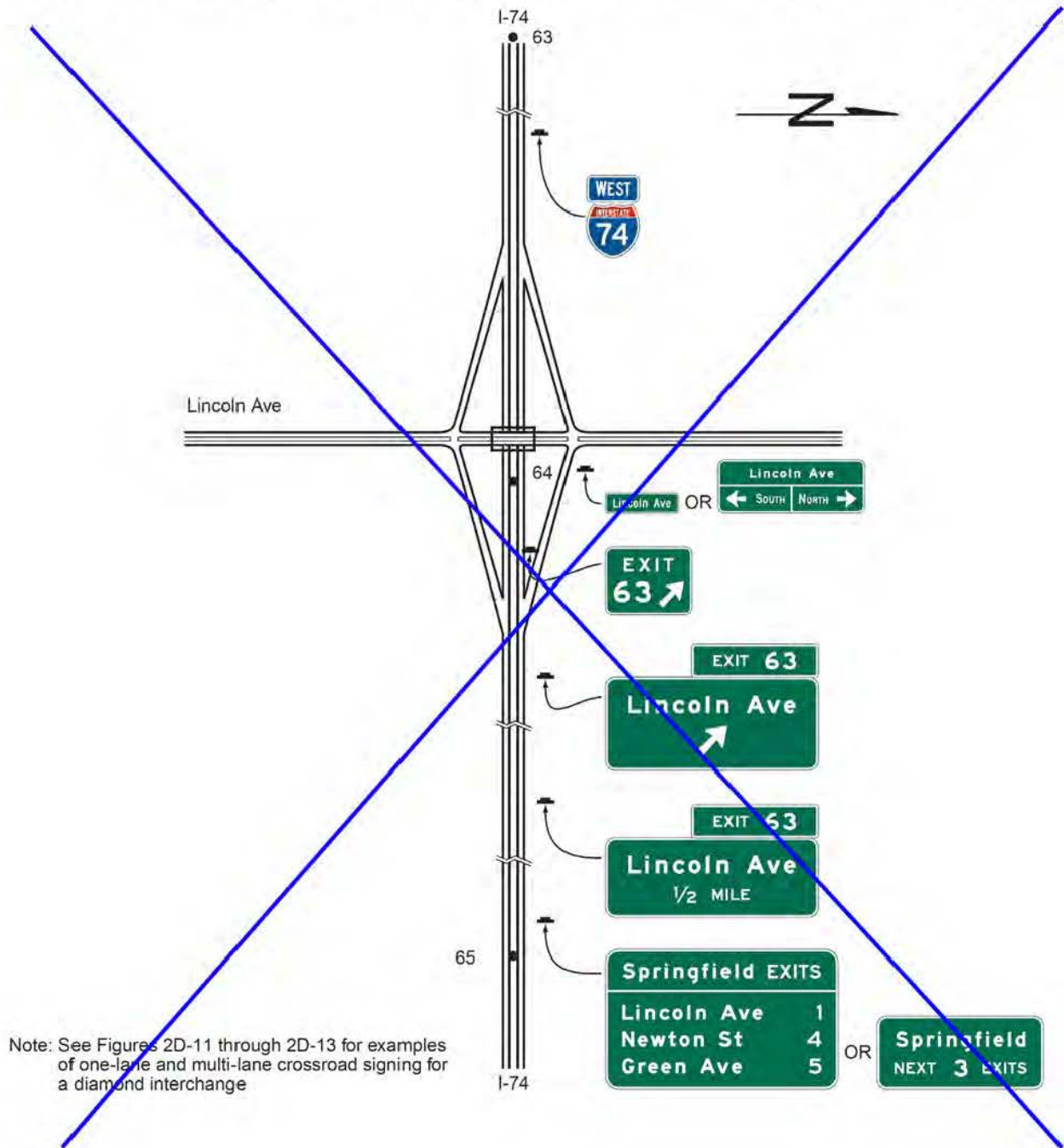
Figure 2E-38. Examples of Guide Signs for a Diamond Interchange



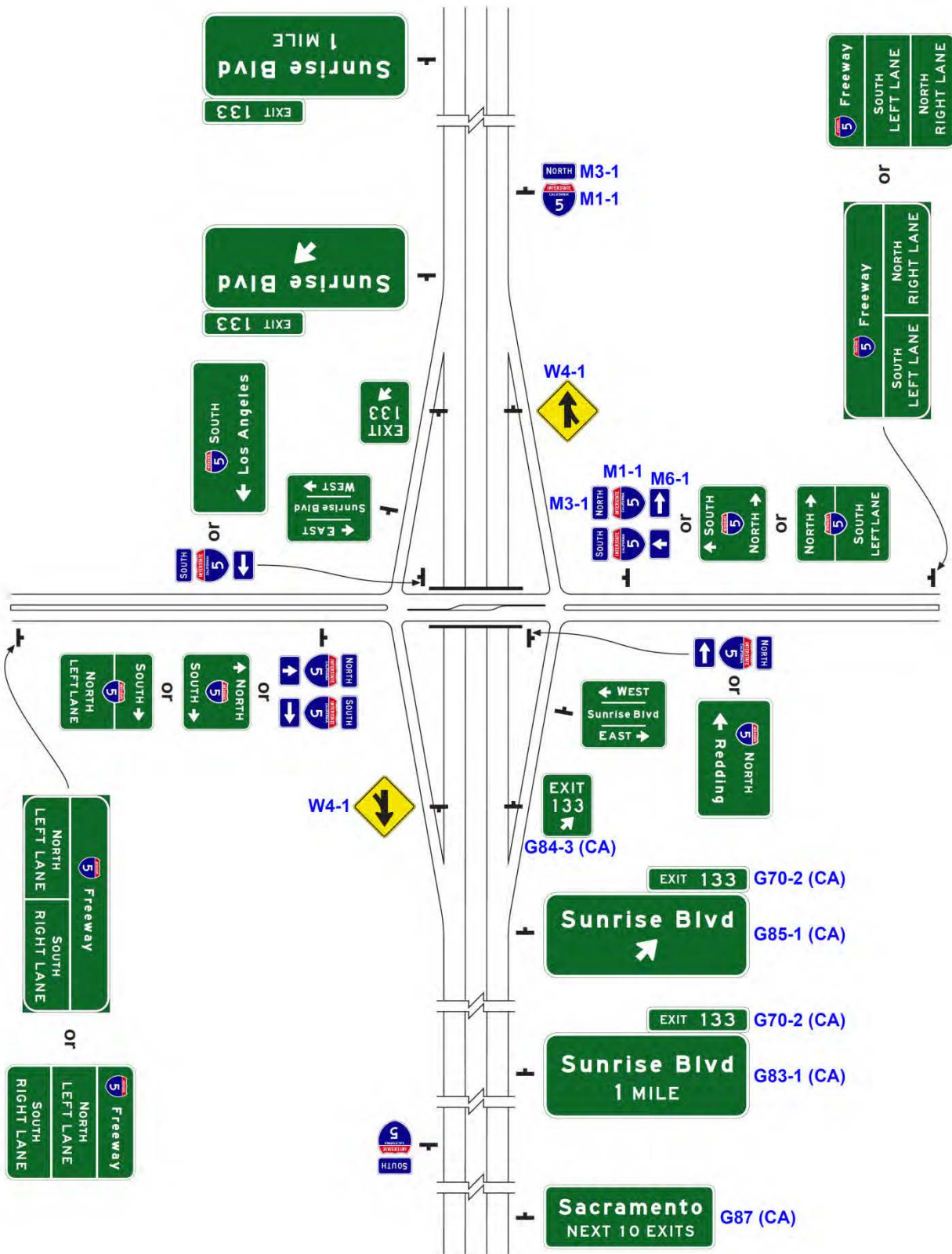
**Figure 2E-38 (CA). Examples of Guide Signs for a Diamond Interchange**



**Figure 2E-39. Examples of Guide Signs for a Diamond Interchange in an Urban Area**

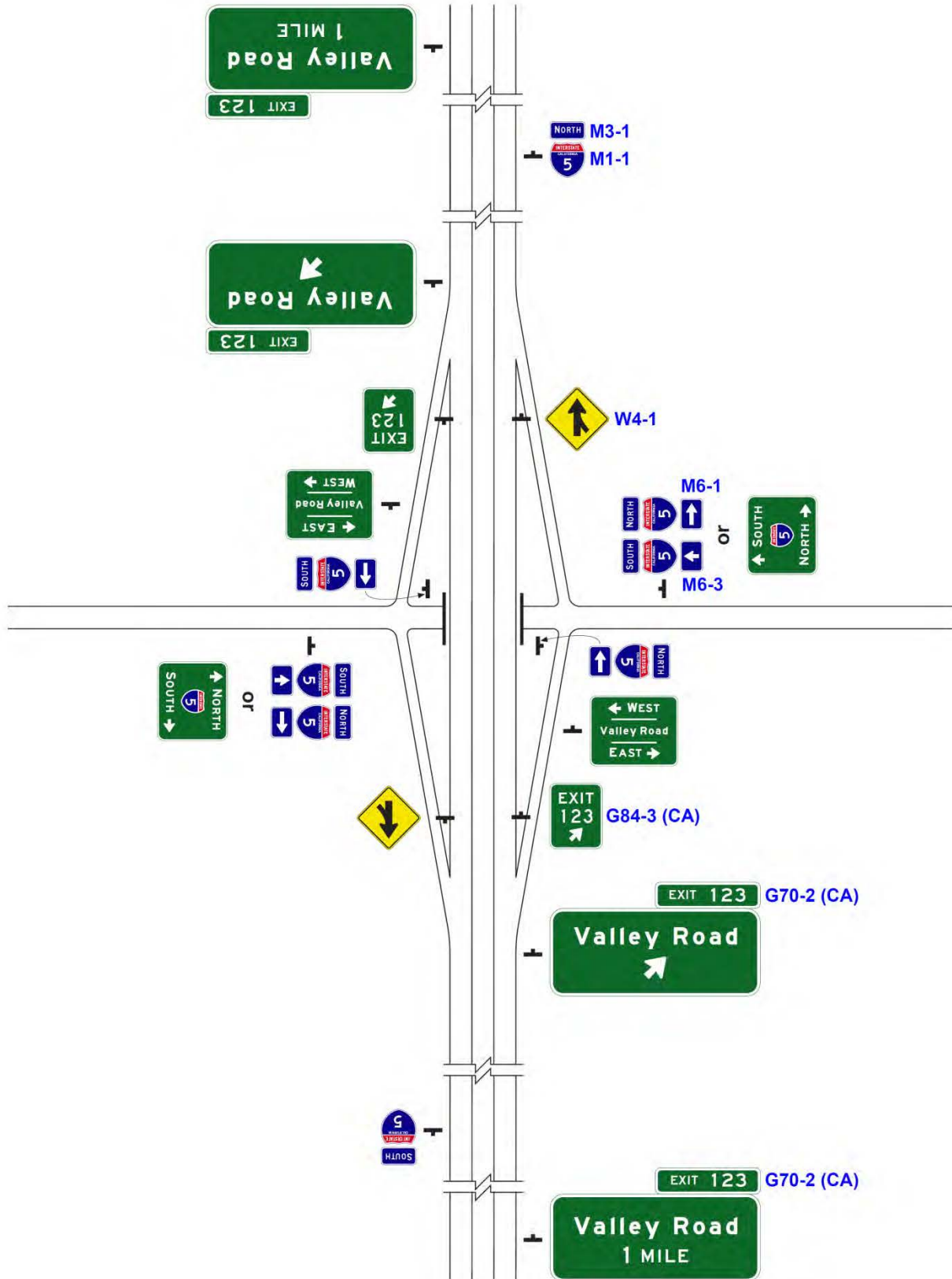


**Figure 2E-39 (CA). Examples of Guide Signs for a Diamond Interchange in an Urban Area**





**Figure 2E-40 (CA). Examples of Guide Signs for a Minor Interchange**



**Table 2E-1. Freeway or Expressway Guide Sign and Plaque Sizes (Sheet 1 of 2)**

| Sign or Plaque  | Sign Designation | Section          | Minimum Size       |
|---|------------------|------------------|--------------------|
| <b>Exit Number (plaque)</b>                             |                  |                  |                    |
| 1-, 2-Digit Exit Number                                 | E1-5P            | 2E.31            | 114 x 30           |
| 3-Digit Exit Number                                     | E1-5P            | 2E.31            | 132 x 30           |
| 1-, 2-Digit Exit Number (with single letter suffix)     | E1-5P            | 2E.31            | 138 x 30           |
| 3-Digit Exit Number (with single letter suffix)         | E1-5P            | 2E.31            | 156 x 30           |
| 1-, 2-Digit Exit Number (with dual letter suffix)       | E1-5P            | 2E.31            | 168 x 30           |
| 3-Digit Exit Number (with dual letter suffix)           | E1-5P            | 2E.31            | 186 x 30           |
| Left (plaque)   | E1-5aP           | 2E.33            | 72 x 30            |
| <b>Left Exit Number (plaque)</b>                        |                  |                  |                    |
| 1-, 2-Digit Exit Number                                 | E1-5bP           | 2E.31            | 114 x 54           |
| 3-Digit Exit Number                                     | E1-5bP           | 2E.31            | 132 x 54           |
| 1-, 2-Digit Exit Number (with single letter suffix)     | E1-5bP           | 2E.31            | 138 x 54           |
| 3-Digit Exit Number (with single letter suffix)         | E1-5bP           | 2E.31            | 156 x 54           |
| 1-, 2-Digit Exit Number (with dual letter suffix)       | E1-5bP           | 2E.31            | 168 x 54           |
| 3-Digit Exit Number (with dual letter suffix)           | E1-5bP           | 2E.31            | 186 x 54           |
| Next Exit XX Miles (1 line)                             | —                | 2E.34            | Varies x 24        |
| Next Exit XX Miles (2 lines)                            | —                | 2E.34            | Varies x 36        |
| Exit Gore (no exit number)                              | E5-1             | 2E.37            | 72 x 60            |
| <b>Exit Gore (with exit number)</b>                     |                  |                  |                    |
| 1-, 2-Digit Exit Number                                 | E5-1a            | 2E.37            | 78 x 60            |
| 3-Digit Exit Number                                     | E5-1a            | 2E.37            | 96 x 60            |
| 1-Digit Exit Number (with single letter suffix)         | E5-1a            | 2E.37            | 90 x 60            |
| 2-Digit Exit Number (with single letter suffix)         | E5-1a            | 2E.37            | 108 x 60           |
| 3-Digit Exit Number (with single letter suffix)         | E5-1a            | 2E.37            | 126 x 60           |
| 1-Digit Exit Number (with dual letter suffix)           | E5-1a            | 2E.37            | 120 x 60           |
| 2-Digit Exit Number (with dual letter suffix)           | E5-1a            | 2E.37            | 138 x 60           |
| 3-Digit Exit Number (with dual letter suffix)           | E5-1a            | 2E.37            | 156 x 60           |
| <b>Exit Number (plaque)</b>                             |                  |                  |                    |
| 1-, 2-Digit Exit Number                                 | E5-1bP           | 2E.37            | 42 x 30            |
| 3-Digit Exit Number                                     | E5-1bP           | 2E.37            | 60 x 30            |
| 1-Digit Exit Number (with single letter suffix)         | E5-1bP           | 2E.37            | 48 x 30            |
| 1-Digit Exit Number (with dual letter suffix)           | E5-1bP           | 2E.37            | 72 x 30            |
| 2-Digit Exit Number (with single or dual letter suffix) | E5-1bP           | 2E.37            | 72 x 30            |
| 3-Digit Exit Number (with single or dual letter suffix) | E5-1bP           | 2E.37            | 72 x 30            |
| Narrow Exit Gore  | E5-1c            | 2E.37            | 60 x 90*           |
| Pull-Through  | E6-2             | 2E.12            | Varies x 120*      |
| Pull-Through  | E6-2a            | 2E.12            | Varies x 90*       |
| Exit Only (with arrow)                                  | E11-1,1d         | 2E.24            | 174** x 36         |
| Exit  | E11-1a           | 2E.24            | 66 x 18            |
| Only  | E11-1b           | 2E.24            | 66 x 18            |
| Exit Only   | E11-1c           | 2E.24            | 120 x 18           |
| Exit Only (with two arrows)                             | E11-1e,1f        | 2E.24            | 222** x 36         |
| Left  | E11-2            | 2E.40            | 60 x 18            |
| Exit Gore Advisory Speed (plaque)                       | E13-1P           | 2E.37            | 72 x 24            |
| Exit Direction Advisory Speed                           | E13-2            | 2E.36            | 162 x 24           |
| Interstate Route Sign (1 or 2 digits)                   | M1-1             | 2E.27            | 36 x 36            |
| Interstate Route Sign (3 digits)                        | M1-1             | 2E.27            | 45 x 36            |
| Off-Interstate Route Sign (1 or 2 digits)               | M1-2,3           | 2E.27            | 36 x 36            |
| Off-Interstate Route Sign (3 digits)                    | M1-2,3           | 2E.27            | 45 x 36            |
| <del>U.S. Route Sign (1 or 2 digits)</del>              | <del>M1-4</del>  | <del>2E.27</del> | <del>36 x 36</del> |
| <del>U.S. Route Sign (3 digits)</del>                   | <del>M1-4</del>  | <del>2E.27</del> | <del>45 x 36</del> |
| <del>State Route Sign (1 or 2 digits)</del>             | <del>M1-5</del>  | <del>2E.11</del> | <del>36 x 36</del> |



**Table 2E-1. Freeway or Expressway Guide Sign and Plaque Sizes (Sheet 2 of 2)**

| Sign or Plaque                         | Sign Designation    | Section          | Minimum Size             |
|--|---------------------|------------------|--------------------------|
| <del>State Route Sign (8 digits)</del> | <del>M1-5</del>     | <del>2D.11</del> | <del>45 x 86</del>       |
| County Route Sign (1, 2, or 3 digits)  | M1-6                | 2D.11            | 36 x 36                  |
| Forest Route (1, 2, or 3 digits)       | M1-7                | 2D.11            | 36 x 36                  |
| Eisenhower Interstate System Junction  | M1-10,10a           | 2E.28            | 36 x 36                  |
| Combination Junction (2 route signs)   | M2-1                | 2D.13            | 30 x 21                  |
| Cardinal Direction                     | M2-2                | 2D.14            | 60 x 48*                 |
| Alternate                              | M3-1,2,3,4          | 2D.15            | 36 x 18                  |
| By-Pass                                | M4-1,1a             | 2D.17            | 36 x 18                  |
| Business                               | M4-2                | 2D.18            | 36 x 18                  |
| Truck                                  | M4-3                | 2D.19            | 36 x 18                  |
| To                                     | M4-4                | 2D.20            | 36 x 18                  |
| End                                    | M4-5                | 2D.21            | 36 x 18                  |
| Temporary                              | M4-6                | 2D.22            | 36 x 18                  |
| Begin                                  | M4-7,7a             | 2D.24            | 36 x 18                  |
| Advance Turn Arrow                     | M4-14               | 2D.23            | 36 x 18                  |
| Lane Designation                       | M5-1,2,3            | 2D.26            | 30 x 21                  |
| Directional Arrow                      | M5-4,5,6            | 2D.27            | 36 x 24                  |
| Destination (1 line)                   | M6-1,2,2a,3,4,5,6,7 | 2D.28            | 30 x 21                  |
| Destination (1 line)                   | D1-1                | 2D.37            | Varies x 30              |
| Destination and Distance (1 line)      | D1-1a               | 2D.37            | Varies x 30              |
| Destination (2 lines)                  | D1-2                | 2D.37            | Varies x 54              |
| Destination and Distance (2 lines)     | D1-2a               | 2D.37            | Varies x 54              |
| Destination (3 lines)                  | D1-3                | 2D.37            | Varies x 72              |
| Destination and Distance (3 lines)     | D1-3a               | 2D.37            | Varies x 72              |
| Distance (1 line)                      | D2-1                | 2D.41            | Varies x 30              |
| Distance (2 lines)                     | D2-2                | 2D.41            | Varies x 54              |
| Distance (3 lines)                     | D2-3                | 2D.41            | Varies x 72              |
| Street Name                            | D3-1,1a             | 2D.43            | Varies x 18              |
| Advance Street Name (2 lines)          | D3-2                | 2D.44            | Varies x 42*             |
| Advance Street Name (3 lines)          | D3-2                | 2D.44            | Varies x 66*             |
| Advance Street Name (4 lines)          | D3-2                | 2D.44            | Varies x 84*             |
| Park - Ride                            | D4-2                | 2D.48            | 36 x 48                  |
| National Scenic Byways                 | D6-4                | 2D.55            | 24 x 24                  |
| National Scenic Byways                 | D6-4a               | 2D.55            | 24 x 12                  |
| Weigh Station XX Miles                 | D8-1                | 2E.54            | 96 x 72 (F) 78 x 60 (E)  |
| Weigh Station Next Right               | D8-2                | 2E.54            | 108 x 90 (F) 84 x 72 (E) |
| Weigh Station (with arrow)             | D8-3                | 2E.54            | 84 x 78 (F) 66 x 60 (E)  |
| Crossover                              | D13-1,2             | 2D.54            | 78 x 42                  |
| Freeway Entrance                       | D13-3               | 2D.46            | 48 x 30                  |
| Freeway Entrance (with arrow)          | D13-3a              | 2D.46            | 48 x 42                  |
| Combination Lane Use / Destination     | D15-1               | 2D.33            | Varies x 96              |
| Next Truck Lane XX Miles               | D17-1               | 2D.51            | 60 x 66                  |
| Truck Lane XX Miles                    | D17-2               | 2D.51            | 60 x 54                  |
| Slow Vehicle Turn-Out XX Miles         | D17-7               | 2D.52            | 96 x 54                  |

\* The size shown is for a typical sign as illustrated in the figures in Chapters 2D and 2E. The size should be determined based on the amount of legend required for the sign.

\*\* The width shown represents the minimum dimension. The width shall be increased as appropriate to match the width of the guide sign.

- Notes: 1. Larger signs may be used when appropriate  
 2. Dimensions in inches are shown as width x height  
 3. Where two sizes are shown, the larger size is for freeways (F) and the smaller size is for expressways (E)

**Table 2E-1(CA). California Freeway or Expressway Guide Sign and Plaque Sizes**

| Sign or Plaque               | Sign Designation | Section      | Minimum   |
|------------------------------|------------------|--------------|-----------|
| Advance Lane Assignment      | G20-1(CA)        | 2D.31        | VAR x 30  |
| Advance Lane Assignment      | G20-3(CA)        | 2D.31        | VAR x 42  |
| Advance Lane Assignment      | G20-5(CA)        | 2D.31        | VAR x 54  |
| Advance Lane Assignment      | G20-7(CA)        | 2D.31        | VAR x 60  |
| Interchange Sequence         | G23-1(CA)        | 2E.35, 2E.40 | VAR x 90  |
| Interchange Sequence         | G23-2(CA)        | 2E.35, 2E.40 | VAR x 100 |
| Interchange Sequence         | G23-3(CA)        | 2E.35, 2E.40 | VAR x 100 |
| Interchange Sequence         | G23-4(CA)        | 2E.35, 2E.40 | VAR x 100 |
| Interchange Sequence         | G23-5(CA)        | 2E.35, 2E.40 | VAR x 120 |
| Interchange Sequence         | G23-6(CA)        | 2E.35, 2E.40 | VAR x 90  |
| Pull-Through                 | G24-1(CA)        | 2D.03, 2E.12 | VAR x 80  |
| Pull-Through                 | G24-3(CA)        | 2D.03, 2E.12 | VAR x 110 |
| Pull-Through                 | G24-4(CA)        | 2D.03, 2E.12 | VAR x 120 |
| Pull-Through                 | G24-5(CA)        | 2D.03, 2E.12 | VAR x 110 |
| Pull-Through                 | G24-6(GA)        | 2D.03, 2E.12 | VAR x 110 |
| Single Line EXIT XX          | G70-2(CA)        | 2E.31        | 36 x 12   |
| Single Line EXIT XXXX        | G70-3(CA)        | 2E.31        | 48 x 12   |
| Two Line EXIT XX             | G70-4(CA)        | 2E.31        | 24 x 24   |
| Two Line EXIT XXXX           | G70-5(CA)        | 2E.31        | 36 x 24   |
| Advance Guide                | G83-1(CA)        | 2E.33        | VAR x 78  |
| Advance Guide                | G83-2(CA)        | 2E.33        | VAR x 110 |
| Exit Numbered Advance Guide  | G83-5(CA)        | 2E.31, 2E.33 | VAR x 78  |
| EXIT (XX) with Arrow         | G84-2(CA)        | 2E.31, 2E.33 | 54 x 48   |
| EXIT (XXX) with Arrow        | G84-3(CA)        | 2E.31, 2E.33 | 48 x 60   |
| Exit Direction               | G85-1(CA)        | 2D.03, 2E.36 | VAR x 78  |
| Exit Direction               | G85-2(CA)        | 2D.03, 2E.36 | VAR x 48  |
| Exit Direction               | G85-3(CA)        | 2D.03, 2E.36 | VAR x 114 |
| Exit Direction               | G85-4(CA)        | 2D.03, 2E.36 | VAR x 138 |
| Exit Direction               | G85-5(CA)        | 2D.03, 2E.36 | VAR x 80  |
| Exit Direction               | G85-6(CA)        | 2D.03, 2E.36 | VAR x 80  |
| Exit Numbered Exit Direction | G85-11(CA)       | 2D.03, 2E.31 | VAR x 84  |
| NEXT XX EXITS                | G87(CA)          | 2E.42        | VAR x 54  |
| Exit Only                    | W61A(CA)         | 2E.24        | 44 x 20   |
| Exit Only                    | W61B(CA)         | 2E.24        | 44 x 20   |
| Exit Only                    | W61C(CA)         | 2E.24        | 84 x 20   |
| Exit Only                    | W61D(CA)         | 2E.24        | 126 x 20  |
| Exit Only                    | W61E(CA)         | 2E.24        | 174 x 20  |
| Only                         | W61F(CA)         | 2E.24        | 84 x 20   |
| Only                         | W61G(CA)         | 2E.24        | 174 x 20  |
| Exit Only                    | W61H(CA)         | 2E.24        | 44 x 20   |

**Table 2E-2. Minimum Letter and Numeral Sizes for Expressway Guide Signs According to Interchange Classification**

| Type of Sign   | Type of Interchange (see Section 2E.32) |            |              |         | Overhead |
|--|---|------------|--------------|---------|----------|
|  | Major                                   |            | Intermediate | Minor   |          |
|  | Category a                              | Category b |              |         |          |
| <b>A. Advance Guide, Exit Direction, and Overhead Guide Signs</b>          |   |            |              |         |          |
| Exit Number Plaques  |   |            |              |         |          |
| Words  | 10                                      | 10         | 10           | 8       | 10       |
| Numerals & Letters   | 15                                      | 15         | 15           | 12      | 15       |
| Interstate Route Signs   |   |            |              |         |          |
| Numerals   | 18                                      | —          | —            | —       | 18       |
| 1- or 2-Digit Shields  | 36 x 36                                 | —          | —            | —       | 36 x 36  |
| 3-Digit Shields  | 45 x 36                                 | —          | —            | —       | 45 x 36  |
| U.S. or State Route Signs  |   |            |              |         |          |
| Numerals   | 18                                      | 18         | 18           | 12      | 18       |
| 1- or 2-Digit Shields  | 36 x 36                                 | 36 x 36    | 36 x 36      | 24 x 24 | 36 x 36  |
| 3-Digit Shields  | 45 x 36                                 | 45 x 36    | 45 x 36      | 30 x 24 | 45 x 36  |
| U.S. or State Route Text Identification (Example: US 56)                   |   |            |              |         |          |
| Numerals & Letters   | 18                                      | 15         | 15           | 12      | 15       |
| Cardinal Directions  |   |            |              |         |          |
| First Letters  | 18                                      | 15         | 12           | 10      | 15       |
| Rest of Words  | 15                                      | 12         | 10           | 8       | 12       |
| Auxiliary and Alternative Route Legends (Examples: JCT, TO, ALT, BUSINESS) |   |            |              |         |          |
| Words  | 15                                      | 12         | 10           | 8       | 12       |
| Names of Destinations  |   |            |              |         |          |
| Upper-Case Letters   | 20                                      | 16         | 13.33        | 10.67   | 16       |
| Lower-Case Letters   | 15                                      | 12         | 10           | 8       | 12       |
| Distance Numbers   | 18                                      | 15         | 12           | 10      | 15       |
| Distance Fraction Numerals   | 12                                      | 10         | 10           | 8       | 10       |
| Distance Words   | 12                                      | 10         | 10           | 8       | 10       |
| Action Message Words   | 10                                      | 10         | 10           | 8       | 10       |
| <b>B. Gore Signs</b>   |   |            |              |         |          |
| Words  | 10                                      | 10         | 10           | 8       | —        |
| Numerals & Letters   | 12                                      | 12         | 12           | 10      | —        |

Note: Sizes are shown in inches and where applicable are shown as width x height

**Table 2E-3. Minimum Letter and Numeral Sizes for Expressway Guide Signs According to Sign Type**

| Type of Sign  | Minimum Size |
|---|--------------|
| <b>A. Pull-Through Signs</b>  |              |
| Destinations — Upper-Case Letters   | 13.33        |
| Destinations — Lower-Case Letters   | 10           |
| Route Signs   |              |
| 1- or 2-Digit Shields   | 36 x 36      |
| 3-Digit Shields   | 45 x 36      |
| Cardinal Directions — First Letters   | 12           |
| Cardinal Directions — Rest of Word  | 10           |
| <b>B. Supplemental Guide Signs</b>  |              |
| Exit Number — Words   | 8            |
| Exit Number — Numerals and Letters  | 12           |
| Place Names — Upper-Case Letters  | 10.67        |
| Place Names — Lower-Case Letters  | 8            |
| Action Messages   | 8            |
| Route Signs   |              |
| Numerals  | 12           |
| 1- or 2-Digit Shield  | 24 x 24      |
| 3-Digit Shield  | 30 x 24      |
| <b>C. Interchange Sequence or Community Interchanges Identification Signs</b> |              |
| Words — Upper-Case Letters  | 10.67        |
| Words — Lower-Case Letters  | 8            |
| Numerals  | 10.67        |
| Fraction Numerals   | 8            |
| Route Signs   |              |
| Numerals  | 12           |
| 1- or 2-Digit Shield  | 24 x 24      |
| 3-Digit Shield  | 30 x 24      |
| <b>D. Next XX Exits Sign</b>  |              |
| Place Names — Upper-Case Letters  | 10.67        |
| Place Names — Lower-Case Letters  | 8            |
| NEXT XX EXITS — Words   | 8            |
| NEXT XX EXITS — Number  | 12           |

| Type of Sign   | Minimum Size |
|--|--------------|
| <b>E. Distance Signs</b>   |              |
| Words — Upper-Case Letters   | 8            |
| Words — Lower-Case Letters   | 6            |
| Numerals   | 8            |
| Route Signs  |              |
| Numerals   | 9            |
| 1- or 2-Digit Shield   | 18 x 18      |
| 3-Digit Shield   | 22.5 x 18    |
| <b>F. General Services Signs (see Chapter 2I)</b>                          |              |
| Exit Number — Words  | 8            |
| Exit Number — Numerals and Letters   | 12           |
| Services   | 8            |
| <b>G. Rest Area, Scenic Area, and Roadside Area Signs (see Chapter 2I)</b> |              |
| Words  | 10           |
| Distance Numerals  | 12           |
| Distance Fraction Numerals   | 8            |
| Distance Words   | 8            |
| Action Message Words   | 10           |
| <b>H. Reference Location Signs (see Chapter 2H)</b>                        |              |
| Words  | 4            |
| Numerals   | 10           |
| <b>I. Boundary and Orientation Signs (see Chapter 2H)</b>                  |              |
| Words — Upper-Case Letters   | 8            |
| Words — Lower-Case Letters   | 6            |
| <b>J. Next Exit and Next Services Signs</b>                                |              |
| Words and Numerals   | 8            |
| <b>K. Exit Only Signs</b>  |              |
| Words  | 12           |
| <b>L. Overhead Arrow-Per-Lane and Diagrammatic Signs</b>                   |              |
| See Table 2E-5   |              |

Note: Sizes are shown in inches and where applicable are shown as width x height

**Table 2E-4. Minimum Letter and Numeral Sizes for Freeway Guide Signs According to Interchange Classification**

| Type of Sign   | Type of Interchange (see Section 2E.32) |            |              |         | Overhead |
|--|---|------------|--------------|---------|----------|
|  | Major                                   |            | Intermediate | Minor   |          |
|  | Category a                              | Category b |              |         |          |
| <b>A. Advance Guide, Exit Direction, and Overhead Guide Signs</b>          |   |            |              |         |          |
| Exit Number Plaques  |   |            |              |         |          |
| Words  | 10                                      | 10         | 10           | 10      | 10       |
| Numerals & Letters   | 15                                      | 15         | 15           | 15      | 15       |
| Interstate Route Signs   |   |            |              |         |          |
| Numerals   | 24/18                                   | —          | —            | —       | 18       |
| 1- or 2-Digit Shields  | 48 x 48/<br>36 x 36                     | —          | —            | —       | 36 x 36  |
| 3-Digit Shields  | 60 x 48/<br>45 x 36                     | —          | —            | —       | 45 x 36  |
| U.S. or State Route Signs  |   |            |              |         |          |
| Numerals   | 24/18                                   | 18         | 18           | 12      | 18       |
| 1- or 2-Digit Shields  | 48 x 48/<br>36 x 36                     | 36 x 36    | 36 x 36      | 24 x 24 | 36 x 36  |
| 3-Digit Shields  | 60 x 48/<br>45 x 36                     | 45 x 36    | 45 x 36      | 30 x 24 | 45 x 36  |
| U.S. or State Route Text Identification (Example: US 56)                   |   |            |              |         |          |
| Numerals & Letters   | 18                                      | 18/15      | 15           | 12      | 15       |
| Cardinal Directions  |   |            |              |         |          |
| First Letters  | 18                                      | 15         | 15           | 10      | 15       |
| Rest of Words  | 15                                      | 12         | 12           | 8       | 12       |
| Auxiliary and Alternative Route Legends (Examples: JCT, TO, ALT, BUSINESS) |   |            |              |         |          |
| Words  | 15                                      | 12         | 12           | 8       | 12       |
| Names of Destinations  |   |            |              |         |          |
| Upper-Case Letters   | 20                                      | 20         | 16           | 13.33   | 16       |
| Lower-Case Letters   | 15                                      | 15         | 12           | 10      | 12       |
| Distance Numbers   | 18                                      | 18/15      | 15           | 12      | 15       |
| Distance Fraction Numerals   | 12                                      | 12/10      | 10           | 8       | 10       |
| Distance Words   | 12                                      | 12/10      | 10           | 8       | 10       |
| Action Message Words   | 12                                      | 12/10      | 10           | 8       | 10       |
| <b>B. Gore Signs</b>   |   |            |              |         |          |
| Words  | 12                                      | 12         | 12           | 8       | —        |
| Numerals & Letters   | 18                                      | 18         | 18           | 12      | —        |

Notes: 1. Sizes are shown in inches and where applicable are shown as width x height  
 2. Slanted line (/) signifies separation of desirable and minimum sizes

**Table 2E-5. Minimum Letter and Numeral Sizes for Freeway Guide Signs According to Sign Type**

| Type of Sign  | Minimum Size |
|---|--------------|
| <b>A. Pull-Through Signs</b>  |              |
| Destinations — Upper-Case Letters   | 16           |
| Destinations — Lower-Case Letters   | 12           |
| Route Signs   |              |
| 1- or 2-Digit Shields   | 36 x 36      |
| 3-Digit Shields   | 45 x 36      |
| Cardinal Directions — First Letter  | 15           |
| Cardinal Directions — Rest of Word  | 12           |
| <b>B. Supplemental Guide Signs</b>  |              |
| Exit Number Words   | 10           |
| Exit Number Numerals and Letters  | 15           |
| Place Names — Upper-Case Letters  | 13.33        |
| Place Names — Lower-Case Letters  | 10           |
| Action Messages   | 8            |
| Route Signs   |              |
| Numerals  | 12           |
| 1- or 2-Digit Shield  | 24 x 24      |
| 3-Digit Shield  | 30 x 24      |
| <b>C. Interchange Sequence or Community Interchanges Identification Signs</b> |              |
| Words — Upper-Case Letters  | 13.33        |
| Words — Lower-Case Letters  | 10           |
| Numerals  | 13.33        |
| Fraction Numerals   | 10           |
| Route Signs   |              |
| Numerals  | 12           |
| 1- or 2-Digit Shield  | 24 x 24      |
| 3-Digit Shield  | 30 x 24      |
| <b>D. Next XX Exits Sign</b>  |              |
| Place Names — Upper-Case Letters  | 13.33        |
| Place Names — Lower-Case Letters  | 10           |
| NEXT XX EXITS — Words   | 10           |
| NEXT XX EXITS — Number  | 15           |
| <b>E. Distance Signs</b>  |              |
| Words — Upper-Case Letters  | 8            |
| Words — Lower-Case Letters  | 6            |
| Numerals  | 8            |
| Route Signs   |              |
| Numerals  | 9            |
| 1- or 2-Digit Shield  | 18 x 18      |
| 3-Digit Shield  | 22.5 x 18    |
| <b>F. General Services Signs (see Chapter 2I)</b>                             |              |
| Exit Number Words   | 10           |
| Exit Number Numerals and Letters  | 15           |
| Services  | 10           |

| Type of Sign   | Minimum Size |
|--|--------------|
| <b>G. Rest Area, Scenic Area, and Roadside Area Signs (see Chapter 2I)</b>   |              |
| Words  | 12           |
| Distance Numerals  | 15           |
| Distance Fraction Numerals   | 10           |
| Distance Words   | 10           |
| Action Message Words   | 12           |
| <b>H. Reference Location Signs (see Chapter 2H)</b>                          |              |
| Words  | 4            |
| Numerals   | 10           |
| <b>I. Boundary and Orientation Signs (see Chapter 2H)</b>                    |              |
| Words — Upper-Case Letters   | 8            |
| Words — Lower-Case Letters   | 6            |
| <b>J. Next Exit and Next Services Signs</b>                                  |              |
| Words and Numerals   | 8            |
| <b>K. Exit Only Signs</b>  |              |
| Words  | 12           |
| <b>L. Overhead Arrow-Per-Lane Signs</b>                                      |              |
| Arrowhead (Type D Directional Arrow)   | 21.625       |
| Arrow Shaft Width  | 8            |
| Arrow Height   |              |
| Through  | 72           |
| Left Only  | 48           |
| Right Only   | 48           |
| Optional-Diverge (Through with Left or Right)                                | 72           |
| Optional-Split (Left and Right)  | 66           |
| Vertical Separator Width   | 2            |
| Vertical Space between Vertical Separator and Top of Nearest Arrow           | 8            |
| Horizontal Space between Vertical Separator and Top of Nearest Through Arrow | 15           |
| Horizontal Space between Arrow Shaft and EXIT and ONLY plaques               | 10           |
| EXIT and ONLY Panels   | 60 x 18      |
| <b>M. Diagrammatic Signs</b>   |              |
| Arrowhead (Type D Directional Arrow)   | 13.5*        |
| Lane Widths  | 5            |
| Lane Line Segments   | 1 x 6        |
| Spacing between Lane Line Segments   | 6            |
| Stem Height to Upper Point of Departure                                      | 30           |
| Horizontal Space between Arrowhead and Route Shield or Destination           | 12           |

\* The size shown is the arrowhead width per lane depicted on the corresponding arrow shaft

Note: Sizes are shown in inches and where applicable are shown as width x height

## CHAPTER 2F. TOLL ROAD SIGNS

### Section 2F.01 Scope

**Support:**

<sup>01</sup> Toll highways are typically limited-access freeway or expressway facilities. A portion of or an entire route might be a toll highway, or a bridge, tunnel, or other crossing point might be the only toll portion of a highway. A toll highway might be a conventional road. The general signing requirements for toll roads will depend on the type of facility and access (freeway, expressway, or conventional road). The provisions of Chapters 2D and 2E will generally apply for guide signs along the toll facility that direct road users within and off the facility where exit points and geometric configurations are not dependent specifically on the collection of tolls. The aspect of tolling and the presence of toll plazas or collection points necessitate additional considerations in the typical signing needs. The notification of the collection of tolls in advance of and at entry points to the toll highway also necessitate additional modifications to the typical signing.

<sup>02</sup> The scope of this Section applies to a route or facility on which all lanes are tolled. Chapter 2G contains provisions for the signing of managed lanes within an otherwise non-toll facility that employ tolling or pricing as an operational strategy to manage congestion levels.

**Standard:**

<sup>03</sup> **Except where specifically provided in this Chapter, the provisions of other Chapters in Part 2 shall apply to toll roads.**

### Section 2F.02 Sizes of Toll Road Signs

**Standard:**

<sup>01</sup> **Except as provided in Section 2A.11, the sizes of toll road signs that have standardized designs shall be as shown in Table 2F-1.**

**Support:**

<sup>02</sup> Section 2A.11 contains information regarding the applicability of the various columns in Table 2F-1.

**Option:**

<sup>03</sup> Signs larger than those shown in Table 2F-1 may be used (see Section 2A.11).

### Section 2F.03 Use of Purple Backgrounds and Underlay Panels with ETC Account Pictographs

**Standard:**

<sup>01</sup> **Use of the color purple on any sign shall comply with the provisions of Sections 1A.12 and 2A.10. Except as provided in Sections 2F.12 and 2F.16, purple as a background color shall be used only when the information associated with the appropriate ETC account is displayed on that portion of the sign. The background color of the remaining portion of such signs shall comply with the provisions of Sections 1A.12 and 2A.10 as appropriate for a regulatory, warning, or guide sign. Purple shall not be used as a background color to display a destination, action message, or other legend that is not a display of the requirement for all vehicles to have a registered ETC account.**

<sup>02</sup> **If only vehicles with registered ETC accounts are allowed to use a highway lane, a toll plaza lane, an open-road tolling lane, or all lanes of a toll highway or connection, the signs for such lanes or highways shall incorporate the pictograph (see Chapter 2A) adopted by the toll facility's ETC payment system and the regulatory message ONLY. Except for ETC pictographs whose predominant background color is purple, if incorporated within the green background of a guide sign, the ETC pictograph shall be on a white rectangular or square panel set on a purple underlay panel with a white border. For rectangular ETC pictographs whose predominant background color is purple, a white border shall be used at the outer edges of the purple rectangle to provide contrast between the pictograph and the sign background color.**

<sup>03</sup> **If an ETC pictograph is used on a separate plaque with a guide sign or on a header panel within a guide sign, the plaque or the header panel shall have a purple background with a white border and the ETC pictograph shall have a white border to provide contrast between the pictograph and the background of the plaque or header panel.**

**04 Purple underlay panels for ETC pictographs or purple backgrounds for plaques and header panels shall only be used in the manner described in Paragraphs 1 through 3 to convey the requirement of a registered ETC account on signs for lanes reserved exclusively for vehicles with such an account and on directional signs to an ETC account-only facility from a non-toll facility or from a toll facility that accepts multiple payment forms.**

Support:

05 Figure 2F-1 shows examples of ETC account pictographs, their use with various background colors, and modifications involving underlay panels.

06 Section 2F.04 contains provisions regarding the size of pictographs for ETC accounts.

## **Section 2F.04 Size of ETC Pictographs**

**Standard:**

**01 The ETC pictograph (see Chapter 2A) shall be of a size that makes it a prominent feature of the sign legend as necessary for conspicuity for those road users with registered ETC accounts seeking such direction, as well as for those road users who do not have ETC accounts so that it is clear to them to avoid such direction when applicable.**

*Guidance:*

02 *An ETC pictograph that is in the shape of a horizontal rectangle should have a minimum height between approximately 1.5 and 2 times the upper-case letter height of the principal legend on the sign. The width of an ETC pictograph in the shape of a horizontal rectangle should be between approximately two and three times the height of the pictograph. When the pictograph is the principal legend on the sign, such as for advance guide signs for open-road tolling lanes (see Section 2F.15), the minimum height of a horizontal rectangular ETC pictograph should be consistent with that of a route shield prescribed for the particular application and type of sign.*

03 *For ETC pictographs whose shape is square, circular, or otherwise similar in height and width, or is a vertical rectangle, the same basic principles for conspicuity and placement should be followed. ETC pictographs whose shape is not in that of a horizontal rectangle should be suitably sized to facilitate conspicuity as described in Paragraph 1 and should be of a similar approximate area as the horizontal rectangular pictographs designed in accordance with the height and width as provided in Paragraph 2.*

## **Section 2F.05 Regulatory Signs for Toll Plazas**

Support:

01 Toll plaza operations often include lane-specific restrictions on vehicle type, forms of payment accepted, and speed limits or required stops. Vehicles are typically required to come to a stop to pay the toll or receive a toll ticket in the attended and exact change or automatic lanes. Electronic toll collection (ETC) lanes with favorable geometrics typically allow vehicles to move through the toll plaza without stopping, but usually within a set regulatory speed limit or advisory speed. In some ETC lanes and in most lanes that accommodate non-ETC vehicles, a stop might be required while the ETC payment is processed because of geometric or other conditions.

*Guidance:*

02 *Regulatory signs applicable only to a particular lane or lanes should be located in a position that makes their applicability clear to road users approaching the toll plaza.*

03 *Regulatory signs, or regulatory panels within guide signs, indicating restrictions on vehicle type and forms of toll payment accepted at a specific toll plaza lane should be installed over the applicable lane either on the toll plaza canopy or on a separate structure immediately in advance of the canopy located in a manner such that each sign is clearly related to an individual toll lane.*

Support:

04 Section 2F.13 contains information regarding the incorporation of regulatory messages into guide signs for toll plazas.

05 Section 2F.16 contains information regarding the design and use of toll plaza canopy signs.

*Guidance:*

06 *One or more Speed Limit (R2-1) signs (see Section 2B.13) should be installed in the locations provided in Paragraph 8 for an ETC-Only lane at a toll plaza in which an enforceable regulatory speed limit is established for a lane in which it is intended that vehicles move through the toll plaza without stopping while toll payments*



*requiring stops occur in other lanes at the toll plaza. The speed limit displayed on the signs should be based on an engineering study taking into account the geometry of the plaza and the lanes and other appropriate safety and operational factors.*

*07 A Speed Limit (R2-1) sign should not be installed for a toll plaza lane that is controlled by a STOP (R1-1) sign or where a stop is required.*

Option:

08 Speed limit signs may be installed over the applicable lane on the toll plaza canopy, on the approach end of the toll booth island, on the toll booth itself, or on a vertical element of the canopy structure. Down arrows or diagonally downward-pointing directional arrows may be used to supplement the speed limit signs if an engineering study or engineering judgment indicates that the arrow is needed to clarify the applicability of a sign to a specific lane or to improve compliance.

**Standard:**

**09 A STOP (R1-1) sign shall not be installed for a toll plaza lane that is operated as an ETC-Only lane and that is designed for tolls to be collected while vehicles continue moving.**

Option:

10 A STOP (R1-1) sign may be installed to require vehicles to come to a complete stop to pay a toll in an attended or exact change lane, even if that lane is also available for optional use by vehicles with registered ETC accounts. A PAY TOLL (R3-29P) or TAKE TICKET (R3-30P) plaque (see Figure 2F-2), as appropriate to the operation, may be installed directly under the STOP (R1-1) sign for a toll plaza lane, if needed.

11 The mounting height of the STOP sign and any supplemental plaque may be less than the normal mounting height requirements if constrained by the physical features of the toll island or toll plaza.

12 The lateral offset of a STOP or other regulatory sign located within a toll plaza island may be reduced to a minimum of 1 foot from the face of the toll island or raised barrier to the nearest edge of the sign.

Guidance:

*13 If used, a STOP (R1-1) sign for a toll plaza cash payment lane should be located in a longitudinal position as near as practical to the point where a vehicle is expected to stop to pay the toll or take a ticket.*

Option:

14 A Toll Rate (R3-28) sign (see Figure 2F-2) may be installed in advance of the toll plaza to indicate the toll applicable to the various vehicle types.

Guidance:

*15 If used, the Toll Rate (R3-28) sign should be located between the toll plaza and the first advance sign informing road users of the toll plaza.*

*16 The R3-28 sign should not contain more than three lines of legend. Each line that shows a toll amount should display only a single toll amount.*

Option:

17 Additional toll rate information exceeding three lines of legend may be displayed on the toll booth adjacent to the payment window of an attended lane or the payment receptacle of an exact change or automatic lane where it is visible to a road user who has stopped to pay the toll, but is not visible to approaching road users who have not yet entered the toll lane.

## **Section 2F.06 Pay Toll Advance Warning Sign (W9-6)**

**Standard:**

**01 The Pay Toll Advance Warning (W9-6) sign shall be a horizontal rectangle with a black legend and border on a yellow background. The legend shall include the distance to the toll plaza and, except for toll-ticket facilities, the toll for passenger or 2-axle vehicles (see Figure 2F-3). Where the toll for passenger or 2-axle vehicles is variable by time of day, a changeable message element shall be incorporated into the W9-6 sign to display the toll in effect. For toll plazas where road users entering a toll-ticket facility are issued a toll ticket, the legend PAY TOLL shall be replaced with a suitable legend such as TAKE TICKET.**

Guidance:

*02 The Pay Toll Advance Warning sign should be installed overhead at approximately 1 mile and 1/2 mile in advance of mainline toll plazas at which some or all lanes are required to come to a stop to pay a toll (see Sections 2F.14 and 2F.15).*

Option:

03 If there is insufficient space for the W9-6 sign at the 1-mile or 1/2-mile advance locations, the Pay Toll Advance Warning (W9-6P) plaque (see Section 2F.07) may be installed at those advance locations above the appropriate guide sign(s) that relate to toll payment types.

04 An additional W9-6 sign may be installed approximately 2 miles in advance of a mainline toll plaza. This sign may be either overhead or post-mounted.

05 If the visibility of a ramp toll plaza at which some or all lanes are required to come to a stop to pay a toll is limited, the W9-6 sign may also be installed in advance of the ramp toll plaza.

**Section 2F.07 Pay Toll Advance Warning Plaque (W9-6P)**

Option:

01 The Pay Toll Advance Warning (W9-6P) plaque (see Figure 2F-3) may be installed above the appropriate guide sign(s) relating to toll payment types at the 1-mile and/or 1/2-mile advance locations on the approach to a toll plaza if there is insufficient space for the W9-6 sign (see Section 2F.06) at those advance locations.

**Standard:**

02 **The W9-6P plaque shall be a horizontal rectangle with black legend and border on a yellow background. The legend shall include the distance to the toll plaza and, except for toll-ticket facilities, the toll for passenger or 2-axle vehicles. Where the toll for passenger or 2-axle vehicles is variable by time of day, a changeable message element shall be incorporated into the W9-6P plaque to display the toll in effect. For toll plazas where road users entering a toll-ticket facility are issued a toll ticket, the legend PAY TOLL shall be replaced with a suitable legend such as TAKE TICKET.**

Option:

03 The distance to the toll plaza may be omitted from the W9-6P plaque if the distance is displayed on the guide sign that the plaque accompanies.

04 The toll for passenger or 2-axle vehicles may be omitted from the W9-6P plaque if the toll information is displayed on the guide sign that the plaque accompanies.

**Section 2F.08 Stop Ahead Pay Toll Warning Sign (W9-6a)**

**Standard:**

01 **The Stop Ahead Pay Toll (W9-6a) sign shall be a horizontal rectangle with a black legend and border on a yellow background. The legend shall include STOP AHEAD PAY TOLL and, except for toll-ticket facilities, the toll for passenger or 2-axle vehicles (see Figure 2F-3). Where the toll for passenger or 2-axle vehicles is variable by time of day, a changeable message element shall be incorporated into the W9-6a sign to display the toll in effect. For toll plazas where road users entering a toll-ticket facility are issued a toll ticket, the legend PAY TOLL shall be replaced with a suitable legend such as TAKE TICKET.**

*Guidance:*

02 *The Stop Ahead Pay Toll sign should be installed overhead downstream from the W9-6 sign that is 1/2 mile in advance of a mainline toll plaza where some or all of the lanes are required to come to a stop to pay a toll (see Sections 2F.14 and 2F.15). The location of the overhead sign should coincide with the approximate location where the mainline lanes begin to widen on the approach to the toll plaza lanes.*

03 *Where open-road tolling is used in addition to a toll plaza at a particular location, the W9-6a sign should be located such that the message is clearly related to the lanes that access the toll plaza and not to the open-road tolling lanes.*

Option:

04 If there is insufficient space for the W9-6a sign at the recommended location, the Stop Ahead Pay Toll (W9-6aP) plaque (see Section 2F.09) may be installed at that location above the appropriate guide sign that relates to toll payment types.

05 If the visibility of a ramp toll plaza at which some or all lanes are required to come to a stop to pay a toll is limited, the W9-6a sign may also be installed in advance of the ramp toll plaza.

### **Section 2F.09 Stop Ahead Pay Toll Warning Plaque (W9-6aP)**

**Option:**

01 The Stop Ahead Pay Toll (W9-6aP) plaque (see Figure 2F-3) may be installed above the appropriate guide sign at the location specified for the Stop Ahead Pay Toll (W9-6a) sign (see Section 2F.08) if there is insufficient space for the W9-6a sign at that location.

**Standard:**

02 **The W9-6aP plaque shall be a horizontal rectangle with black legend and border on a yellow background. The legend shall include STOP AHEAD PAY TOLL and, except for toll-ticket facilities, the toll for passenger or 2-axle vehicles. Where the toll for passenger or 2-axle vehicles is variable by time of day, a changeable message element shall be incorporated into the W9-6aP plaque to display the toll in effect. For toll plazas where road users entering a toll-ticket facility are issued a toll ticket, the legend PAY TOLL shall be replaced with a suitable legend such as TAKE TICKET.**

**Option:**

03 The toll for passenger or 2-axle vehicles may be omitted from the W9-6aP plaque if the toll information is displayed on the guide sign that the plaque accompanies.

### **Section 2F.10 LAST EXIT BEFORE TOLL Warning Plaque (W16-16P)**

**Guidance:**

01 *The LAST EXIT BEFORE TOLL (W16-16P) plaque (see Figure 2F-3) should be used to notify road users of the last exit from a highway before it becomes a facility on which toll payments are required. The plaque should be installed above or below the appropriate guide signs for the exit (see Sections ~~2E.30~~ 2E.33 and ~~2E.33~~ 2E.36).*

**Standard:**

02 **The W16-16P plaque shall have a black legend and border on a yellow background.**

### **Section 2F.11 TOLL Auxiliary Sign (M4-15)**

**Standard:**

01 **The TOLL (M4-15) auxiliary sign (see Figure 2F-4) shall have a black legend and border on a yellow background and shall be mounted directly above the route sign of a numbered toll highway or, if used, above the cardinal direction and alternative route auxiliary signs, in any route sign assembly providing directions from a non-toll highway to the toll highway or to a segment of a highway on which the payment of a toll is required.**

### **Section 2F.12 Electronic Toll Collection (ETC) Account-Only Auxiliary Signs (M4-16 and M4-20)**

**Standard:**

01 **In any route sign assembly providing directions from a non-toll highway to a toll facility, or to a tolled segment of a highway, where electronic toll collection (ETC) is the only payment method accepted and all vehicles are required to have a registered ETC account, the ETC Account-Only (M4-20) auxiliary sign (see Figure 2F-4) shall be mounted directly below the route sign of the numbered or named toll facility. The M4-20 auxiliary sign shall have a white border and purple background and incorporate the pictograph adopted by the toll facility's ETC payment system and the word ONLY in black letters on a white panel set on the purple background of the sign.**

**Option:**

02 The NO CASH (M4-16) auxiliary sign (see Figure 2F-4) with a black legend and border on a white background may be used in a route sign assembly directly below the M4-20 auxiliary sign.

### **Section 2F.13 Toll Facility and Toll Plaza Guide Signs – General**

**Support:**

01 Toll plazas are used on many toll highways, bridges, and tunnels for collection of tolls from road users. Electronic toll collection and/or open-road tolling might also be used on such facilities, either in addition to or in place of collecting toll payments at toll plazas.

02 Chapter 2G contains information regarding signs for preferential and managed lanes that are applicable to toll roads.

<sup>03</sup> Chapter 3E contains information regarding pavement markings for certain toll plaza applications.

**Standard:**

<sup>04</sup> **Directional assemblies for entrances to a toll highway or to a road leading directly to a toll highway with no opportunity to exit before paying or being charged a toll, shall clearly indicate that the facility is a toll facility. The TOLL (M4-15) auxiliary sign (see Section 2F.11) shall be used above the route sign of a numbered toll facility in any route sign assembly that provides directions to the toll route from another highway.**

<sup>05</sup> **A rectangular panel with the black legend TOLL on a yellow background shall be incorporated into the guide signs leading road users to a toll highway (see Figure 2F-5).**

<sup>06</sup> **Guide signs for toll highways, toll plazas, and tolled or priced managed lanes (see Chapter 2G) shall have white legends and borders on green backgrounds, except as specifically provided by Sections 2F.13 through 2F.16.**

**Option:**

<sup>07</sup> Where conditions do not permit separate signs, or where it is important to associate a particular regulatory or warning message with specific guidance information, regulatory and/or warning messages may be combined with guide signs for toll plazas using plaques, header panels, or rectangular regulatory or warning panels incorporated within the guide signs, as long as the proper legend and background colors are preserved.

**Standard:**

<sup>08</sup> **When regulatory messages are incorporated within a guide sign, they shall be on a rectangular panel with black legend on a white background. When warning messages are incorporated within a guide sign, they shall be on a rectangular panel with black legend on a yellow background.**

**Support:**

<sup>09</sup> Figure 2F-5 shows examples of guide signs for entrances to various types of toll highways and for ETC account-only entrances to non-toll highways.

**Standard:**

<sup>10</sup> **Signing for entrances to toll highways where ETC is employed only through license plate character recognition such that road users are not required to establish a toll account or register their vehicle equipment shall comply with the provisions of Paragraphs 4 and 5 (see Figure 2F-6).**

<sup>11</sup> **If only vehicles with registered ETC accounts are allowed to use a toll highway, the guide signs for entrances to such facilities shall incorporate the pictograph adopted by the toll facility's ETC payment system and the regulatory message ONLY (see Figures 2F-1, 2F-5, and 2F-6). The use, size, and placement of the ETC pictograph shall comply with the provisions of Sections 2F.03 and 2F.04.**

**Support:**

<sup>12</sup> Sections 2F.11, 2F.12, and 2F.17 contain additional provisions regarding signs for toll highways that only accept ETC payments.

<sup>13</sup> Sections 2G.16 through 2G.18 contain additional provisions regarding signs for priced managed lanes that only accept ETC payments.

**Option:**

<sup>14</sup> Where a toll highway on which tolls are collected only electronically also accepts payments from registered toll account users and those road users not registered in a toll account program are assessed a nominal surcharge in addition to the toll, or registered toll account users are assessed a discounted toll, such information may be displayed on a separate information sign near the entrance to such a facility (see Figure 2F-6).

**Support:**

<sup>15</sup> Figure 2F-7 shows an example of guide signs for alternative toll and non-toll ramp connections to a non-toll highway.

<sup>16</sup> Many different ETC payment systems are used by the various toll facility operators. Some of these systems accept payment from other systems' accounts.

**Option:**

<sup>17</sup> Where a facility will accept payments from other systems' accounts in addition to its primary ETC-account payment system, such information may be displayed on a separate information sign near the entrances to such a facility or in advance of a toll plaza or open-road tolling lanes, as space allows between primary signs.

*Guidance:*

<sup>18</sup> *Guide signs for toll plazas should be designed in accordance with the general principles of guide signs and the specific provisions of Chapter 2E.*

<sup>19</sup> *Signs for toll plazas should systematically provide road users with advance and toll plaza lane-specific information regarding:*

- A. The amount of the toll, the types of payment accepted, and the type(s) of registered ETC accounts accepted for payment;*
- B. Which lane or lanes are required or allowed to be used for each available payment type; and*
- C. Restrictions on the use of a toll plaza lane or lanes by certain types of vehicles (such as cars only or no trucks).*

**Standard:**

<sup>20</sup> **Signs for attended lanes at toll plazas shall include word messages such as FULL SERVICE, CASH, CHANGE, or RECEIPTS (see Figures 2F-8 through 2F-11).**

**Option:**

<sup>21</sup> Signs for Attended lanes at toll plazas may incorporate the Toll Taker (M4-17) symbol (see Figures 2F-8 and 2F-9), in a size that makes the symbol the predominant feature of the sign, to supplement the required word message.

**Standard:**

<sup>22</sup> **Signs for Exact Change lanes at toll plazas shall incorporate an appropriate word message, such as EXACT CHANGE and the amount of the toll for passenger vehicles (see Figures 2F-8 through 2F-11).**

**Option:**

<sup>23</sup> Signs for Exact Change lanes at toll plazas may include the Exact Change (M4-18) symbol (see Figures 2F-8 and 2F-9), in a size that makes the symbol the predominant feature of the sign, to supplement the required word message.

**Standard:**

<sup>24</sup> **If used, the M4-17 and M4-18 symbols shall be used only as panels within guide signs that accompany the required word messages. The M4-17 and M4-18 symbols shall not be used as an independent sign or within a sign assembly.**

<sup>25</sup> **If only vehicles with registered ETC accounts are allowed to use a toll plaza lane, the signs for such lanes shall incorporate the pictograph adopted by the toll facility's ETC payment system and the regulatory message ONLY (see Figures 2F-1, 2F-8, 2F-9, and 2F-11). The use, size, and placement of the ETC pictograph shall comply with the provisions of Sections 2F.03 and 2F.04.**

**Option:**

<sup>26</sup> The ETC payment system's pictograph, without a purple underlay or purple header panel, may be used on signs for Exact Change or attended lanes at toll plazas to indicate that vehicles with registered ETC accounts may also use those lanes (see Figure 2F-9).

## **Section 2F.14 Advance Signs for Conventional Toll Plazas**

*Guidance:*

<sup>01</sup> *For conventional toll plazas (those without a divergence onto a separate alignment from mainline-aligned open-road tolling or ETC-Only lanes), one or more sets of overhead advance guide signs complying with the provisions of this Section should be provided. The advance guide signs for multi-lane toll plazas should provide information regarding which lanes to use for all of the toll payment methods accepted at the toll plaza. These signs should include toll plaza lane numbers (if used), or action messages or lane-use information such as LEFT LANE(S), CENTER LANE(S), RIGHT LANE(S), or down arrows over the approximate center of each applicable lane. These signs should also incorporate regulatory messages indicating any restrictions or prohibitions on the use of the lanes associated with the various types of payment methods by certain types of vehicles. For mainline toll plazas, these signs should be at least 1/2 mile in advance of the toll plaza, and farther if practical.*

<sup>02</sup> *Additional guide signs with lane information for the toll payment types should be provided between approximately 1/4 mile and 800 feet in advance of the toll plaza at a location that avoids or minimizes obstruction of toll plaza canopy signs (see Section 2F.16) and lane-use control signals.*

*03 The number, mounting, and/or spacing of sets of advance signs for approaches to toll plazas on ramps, toll bridges, or tunnels, to accommodate a limited distance to the plaza from an intersection or from the start of the approach road to the bridge or tunnel, should be based on an engineering study or engineering judgment.*

Support:

*04 Figure 2F-10 shows examples of advance signs for a conventional toll plaza.*

### **Section 2F.15 Advance Signs for Toll Plazas on Diverging Alignments from Open-Road ETC Account-Only Lanes**

Support:

*01 Open-Road ETC lanes are sometimes located on the normal mainline alignment while the lanes for other toll payment methods are located at a toll plaza on a separate alignment (see Figure 2F-11). Since road users paying cash tolls must diverge from the mainline alignment, similar to a movement for an exit, it is important that the guide signs in advance of and at the point of divergence clearly indicate the required lane use and/or movements.*

*Guidance:*

*02 For toll plazas located on a separate alignment that diverges from mainline-aligned Open-Road ETC lanes where vehicles are required to have a registered ETC account to use the Open-Road Tolling lanes, overhead advance signs should be provided at approximately 1 mile and 1/2 mile in advance of the divergence point. Both the 1-mile and 1/2-mile advance signs should include:*

- A. The ETC (pictograph) Account-Only guide sign (see Figures 2F-8 and 2F-11) with a down arrow over the center of each lane that will become an Open-Road ETC lane;*
- B. For the lane or lanes which will diverge to a toll plaza, guide signs conforming to the provisions of Section 2F.13, indicating which lane or lanes will diverge to the toll plaza for the various cash toll payment methods; and*
- C. Regulatory signs, plaques, or panels within the guide signs, indicating any restrictions or prohibitions of certain types of vehicles from toll plaza lanes associated with the various types of payment methods.*

*03 At or near the theoretical gore of the divergence point, an additional set of overhead guide signs should be provided and should include:*

- A. The ETC (pictograph) Account-Only guide sign (see Figures 2F-8 and 2F-11) with a down arrow over the center of each Open-Road ETC lane;*
- B. Guide signs conforming to the provisions of Section 2F.13, with diagonally upward-pointing directional arrow(s) over the approximate center of each lane indicating the direction of the divergence, and providing lane information for all types of payment methods accepted at the toll plaza; and*
- C. Regulatory signs, plaques, or panels within the guide signs, indicating any restrictions or prohibitions on the use of the toll plaza lanes associated with the various types of payment methods by certain types of vehicles.*

*04 Approximately 800 feet in advance of the toll plaza at a location that avoids or minimizes any obstruction of the toll plaza canopy signs (see Section 2F.16) and lane-use control signals, an additional set of overhead advance signs with lane information for the toll payment types should be provided.*

**Standard:**

**05 The use of down and directional arrows on the signs at the locations described in Paragraphs 2 through 4 shall comply with the provisions of Section 2D.08.**

Support:

*06 Figure 2F-11 shows an example of advance signs for toll plazas on a diverging alignment from Open-Road ETC Account-Only Lanes.*

*07 Section 4K.02 contains information regarding the use of lane-use control signals for Open-Road ETC lanes for temporary lane closure purposes.*

### **Section 2F.16 Toll Plaza Canopy Signs**

**Standard:**

**01 A sign complying with the provisions of Section 2F.13 shall be provided above the center of each lane that is not an Open-Road ETC lane, mounted on or suspended from the toll plaza canopy, or on a separate structure immediately in advance of the plaza located such that each sign is clearly related to an individual toll lane, indicating the payment type(s) accepted in the lane and any restrictions or prohibitions of certain**

**types of vehicles that apply to the lane. Except for toll-ticket systems, the toll for passenger or 2-axle vehicles shall be included on the canopy sign or on a separate sign mounted on the upstream side of the tollbooth.**

**02 The background color of a canopy sign for an ETC Account-Only toll plaza lane shall be purple (see Figure 2F-9).**

Option:

03 Where vehicles are required to have a registered ETC account to use the lane, one or two flashing yellow beacons (see Section 4K.04) may supplement a canopy sign over an ETC Account-Only lane to call special attention to the location of the ETC Account-Only lane within the plaza.

04 The canopy sign for an ETC-Only toll plaza lane in which a regulatory speed limit is not posted and in which vehicles are not required to stop may display an advisory speed within a horizontal rectangular panel with a black legend and yellow background within the bottom portion of the canopy sign.

**Standard:**

**05 Flashing beacons supplementing a canopy sign over an ETC Account-Only lane shall be mounted directly above or alongside the sign in a manner that is separated from any lane-use control signals for that lane (see Figure 2F-9).**

**06 For multi-lane toll plazas, lane-use control signals (see Section 4K.02) shall be provided above the center of each toll plaza lane that is not an Open-Road ETC lane to indicate the open or closed status of each lane. Lane-use control signals shall not be used to call attention to a lane for a specific toll payment type such as ETC Account-Only lanes.**

Support:

07 Part 6 contains information regarding the closing of a lane for temporary traffic control purposes.

08 Figure 2F-9 shows examples of toll plaza canopy signs.

### **Section 2F.17 Guide Signs for Entrances to ETC Account-Only Facilities**

Support:

01 Some toll highways, bridges, and tunnels are restricted to use only by vehicles with a specific registered ETC account.

**Standard:**

**02 Where vehicles are required to have a registered ETC account to use an ETC Account-Only facility, guide signs for the facility shall comply with the applicable provisions of Chapter 2E and specifically with the applicable provisions of Section 2F.13.**

**03 Guide signs for the entrance ramps to such ETC Account-Only facilities shall incorporate the pictograph of the toll facility's ETC payment system and the word ONLY in a header panel or plaque designed in accordance with the provisions of Section 2F.13 (see Figure 2F-5).**

Support:

04 Section 2F.12 contains information regarding ETC-Only auxiliary signs for use with route signs in route sign assemblies.

### **Section 2F.18 ETC Program Information Signs**

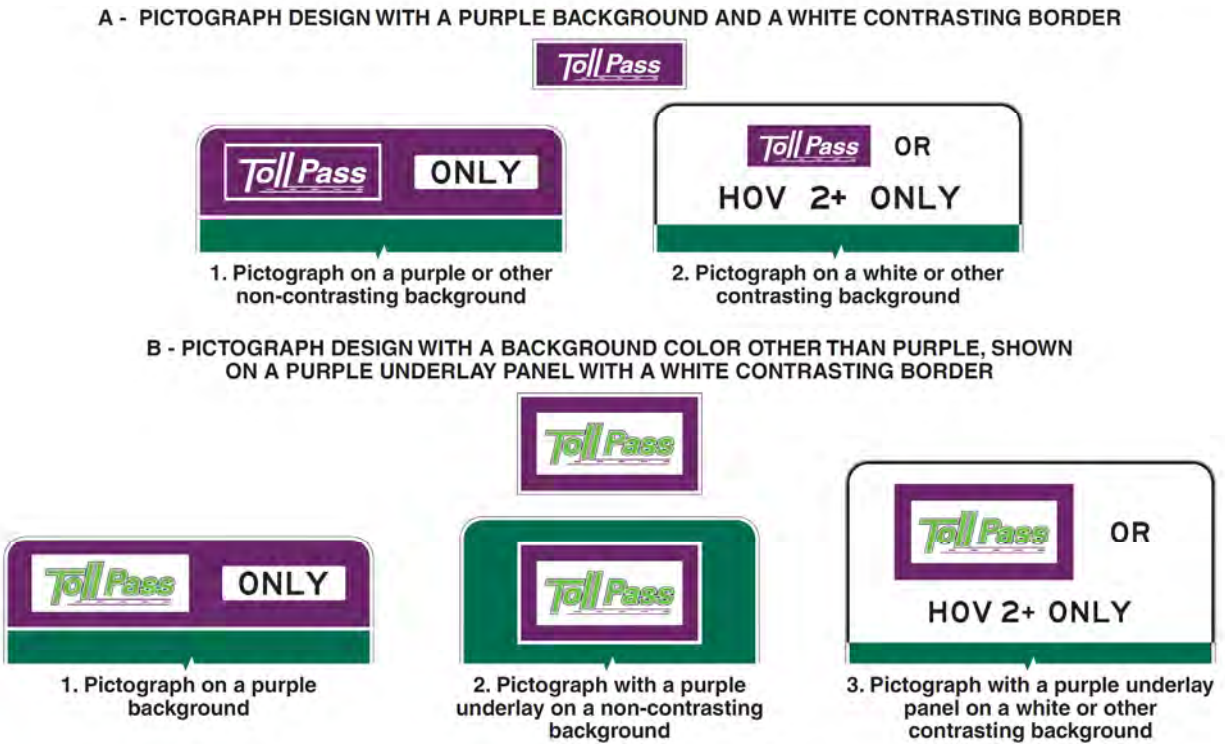
**Standard:**

**01 Except as provided in Paragraph 2, signs that inform road users of telephone numbers, Internet addresses, including domain names and uniform resource locators (URLs), or e-mail addresses for enrolling in an ETC program of a toll facility or managed lane, obtaining an ETC transponder, and/or obtaining ETC program information shall only be installed in rest areas, parking areas, or similar roadside facilities where the signs are viewed only by pedestrians or occupants of parked vehicles.**

Option:

02 ETC program information signs displaying telephone numbers that have no more than four characters may be installed on roadways in locations where they will not obscure the road user's view of higher priority traffic control devices and that are removed from key decision points where the road user's view is more appropriately focused on other traffic control devices, roadway geometry, or traffic conditions, including exit and entrance ramps, intersections, toll plazas, temporary traffic control zones, and areas of limited sight distance.

**Figure 2F-1. Examples of ETC Account Pictographs and Use of Purple Backgrounds and Underlay Panels**



**Figure 2F-2. Toll Plaza Regulatory Signs and Plaques**

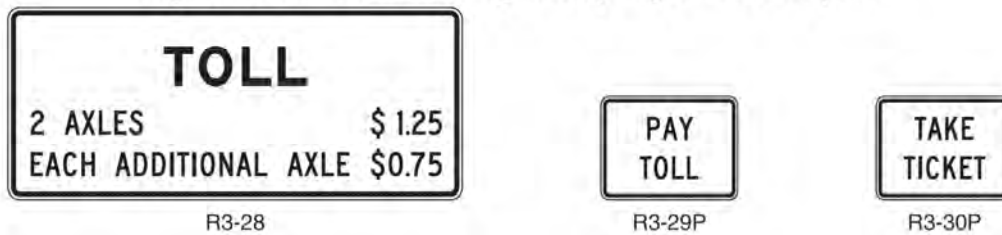




Figure 2F-3. Toll Plaza Warning Signs and Plaques

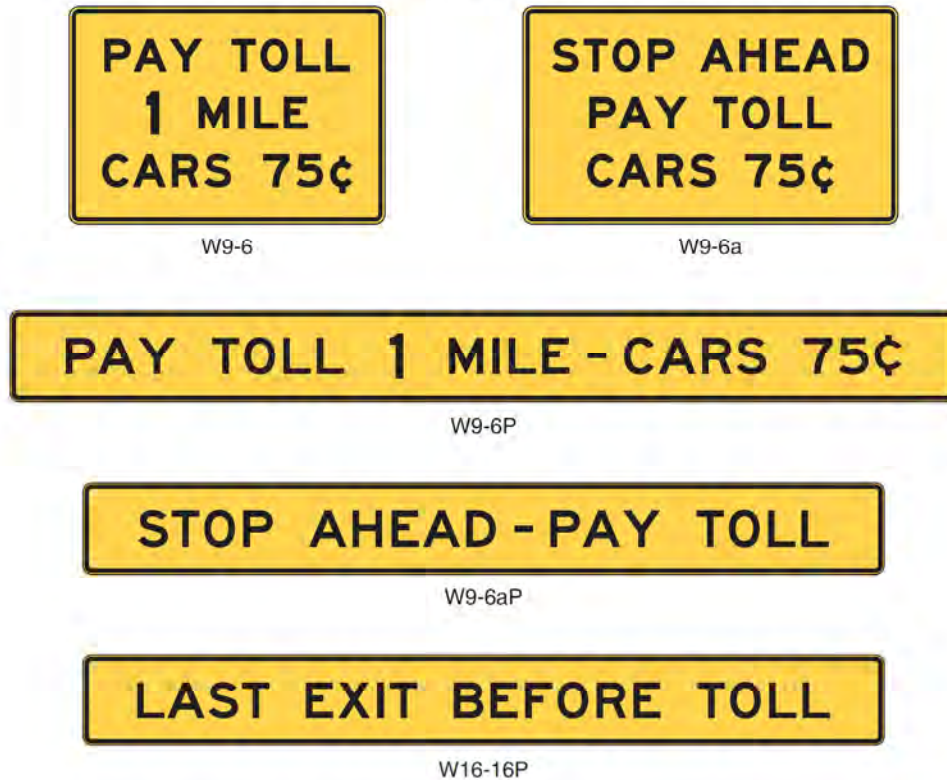
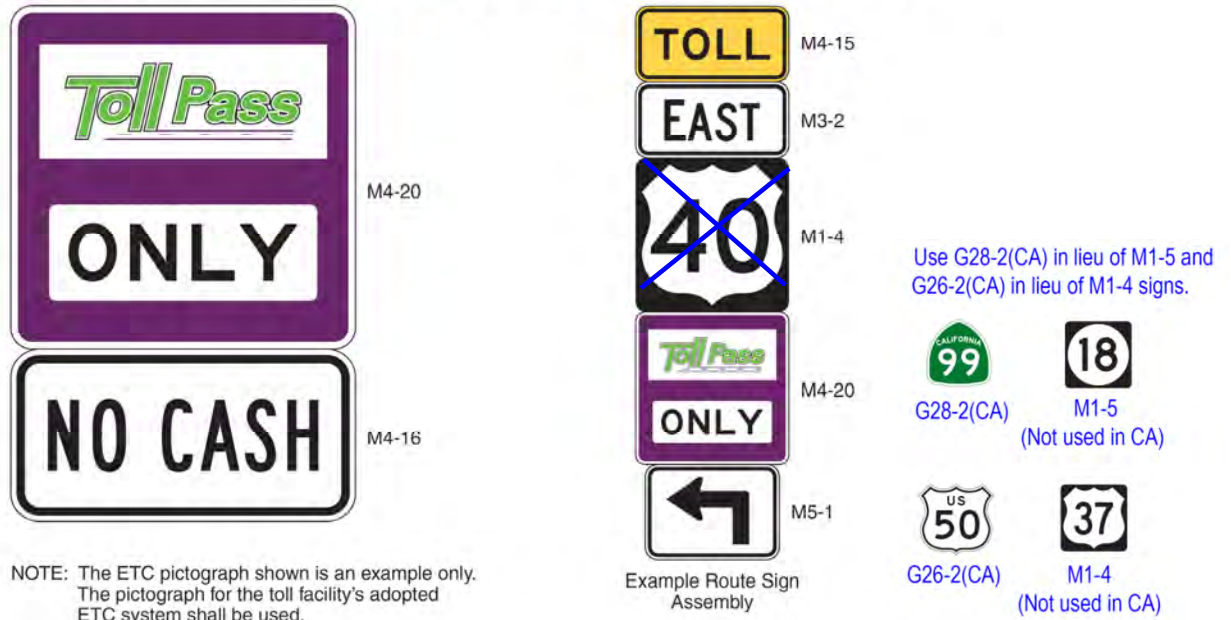


Figure 2F-4. ETC Account-Only Auxiliary Signs for Use in Route Sign Assemblies



**Figure 2F-5. Examples of Guide Signs for Entrances to Toll Highways or Ramps**

**A - ENTRANCE TO A TOLL HIGHWAY ON WHICH REGISTRATION IN A TOLL ACCOUNT PROGRAM IS NOT REQUIRED**



**B - ENTRANCE TO AN ETC ACCOUNT-ONLY TOLL HIGHWAY OR ENTRANCE TO A TOLL HIGHWAY VIA AN ETC ACCOUNT-ONLY RAMP**



**C - ENTRANCE TO A NON-TOLL HIGHWAY VIA AN ETC ACCOUNT-ONLY TOLL ENTRANCE RAMP**



(the toll entrance is the only connection provided in the vicinity)



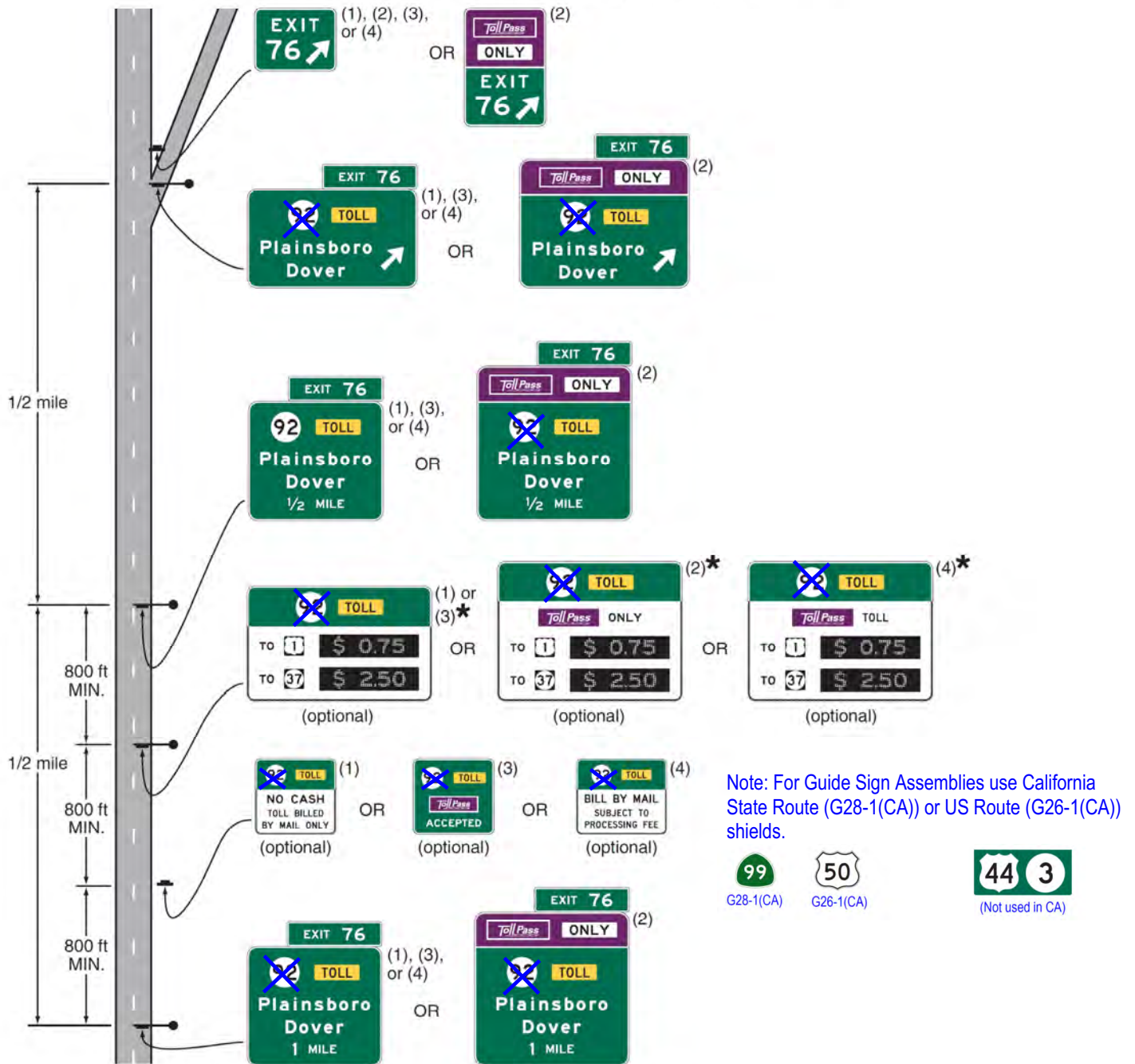
(an alternate non-toll entrance is provided in the vicinity)

Note: The ETC pictographs shown are examples only. The pictograph for the toll facility's adopted ETC system shall be used.

For Guide Sign Assemblies use California State Route (G28-1(CA)) or US Route (G26-1(CA)) shields.

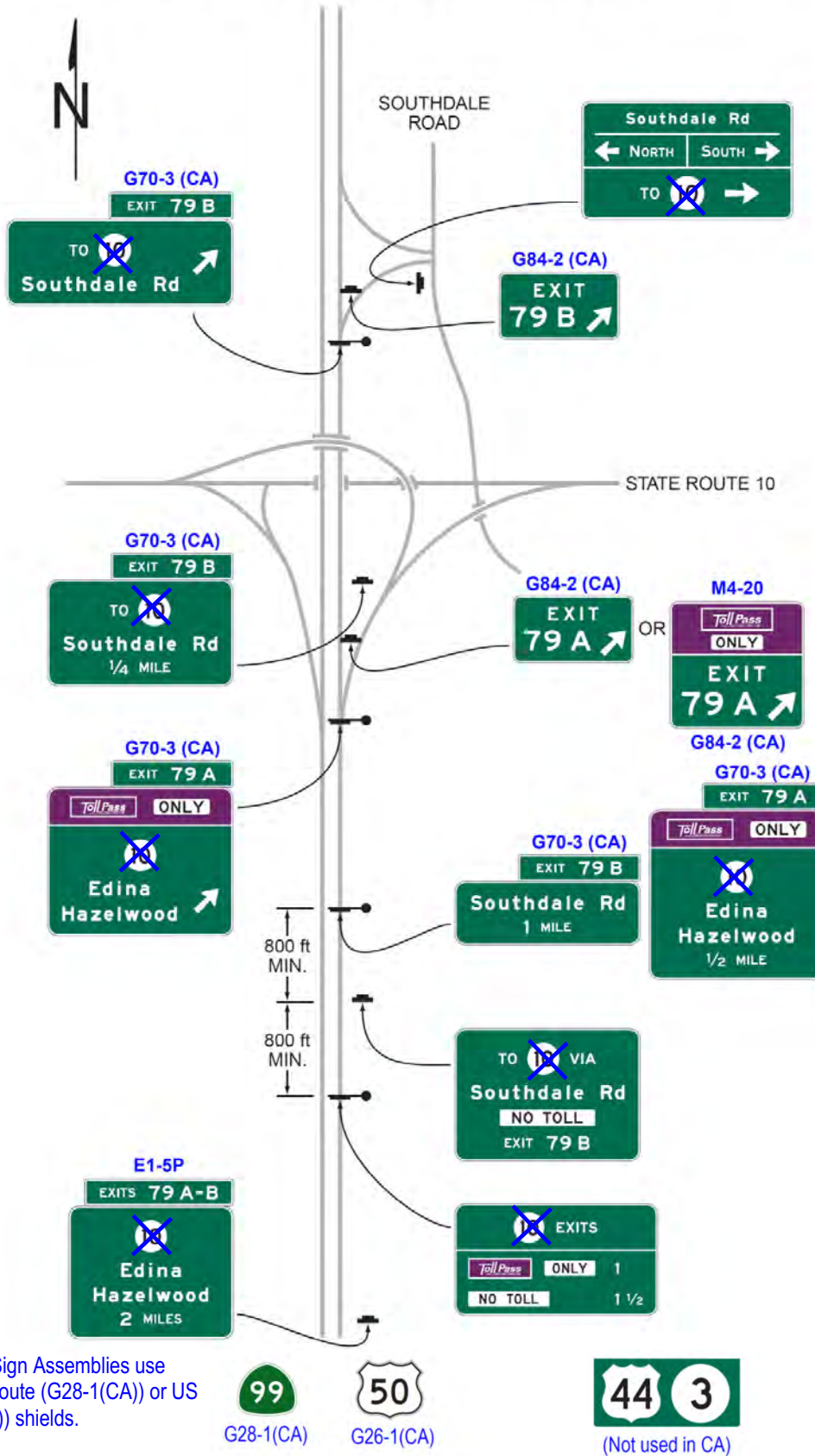


**Figure 2F-6. Examples of Guide Signs for the Entrance to a Toll Highway on which Tolls are Collected Electronically Only**



- (1) All tolls are billed through license plate recognition only. A registered toll account or ETC device is not needed.
  - (2) All tolls are billed through registered toll accounts only. All vehicles must be registered in an ETC account program.
  - (3) Toll payments are also accepted from registered toll accounts. Registered toll accounts might receive a discount from the toll amount displayed on the signs.
  - (4) Toll payments are also accepted from registered toll accounts. Vehicles not registered in a toll account program are assessed a nominal processing fee in addition to the toll amount displayed on the signs.
- \* For managed toll highways only (see Chapter 2G)

**Figure 2F-7. Examples of Guide Signs for Alternative Toll and Non-Toll Ramp Connections to a Non-Toll Highway**



**Figure 2F-8. Examples of Conventional Toll Plaza Advance Signs**



Notes:

1. The M4-17 symbol is optional for an attended lane.
2. The M4-18 symbol is optional for an exact change lane.
3. The ETC pictograph that is shown is only an example. The pictograph for the toll facility's adopted ETC system shall be used.

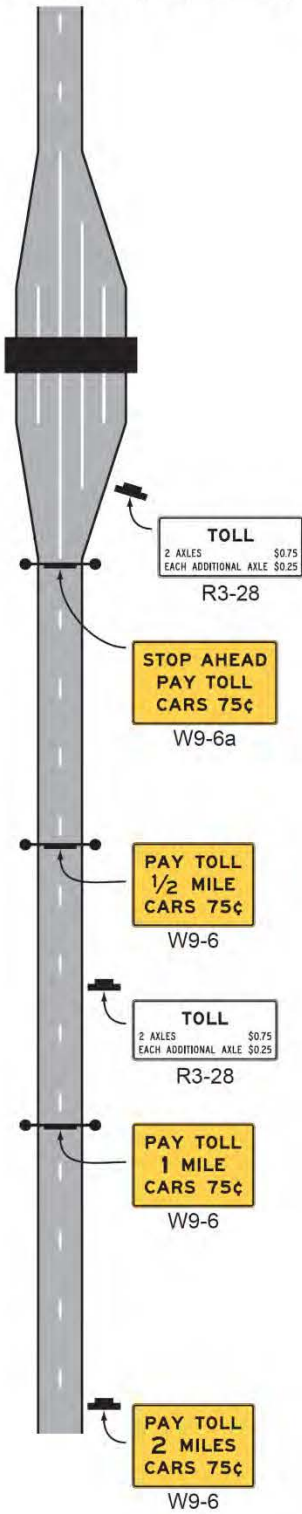
**Figure 2F-9. Examples of Toll Plaza Canopy Signs**



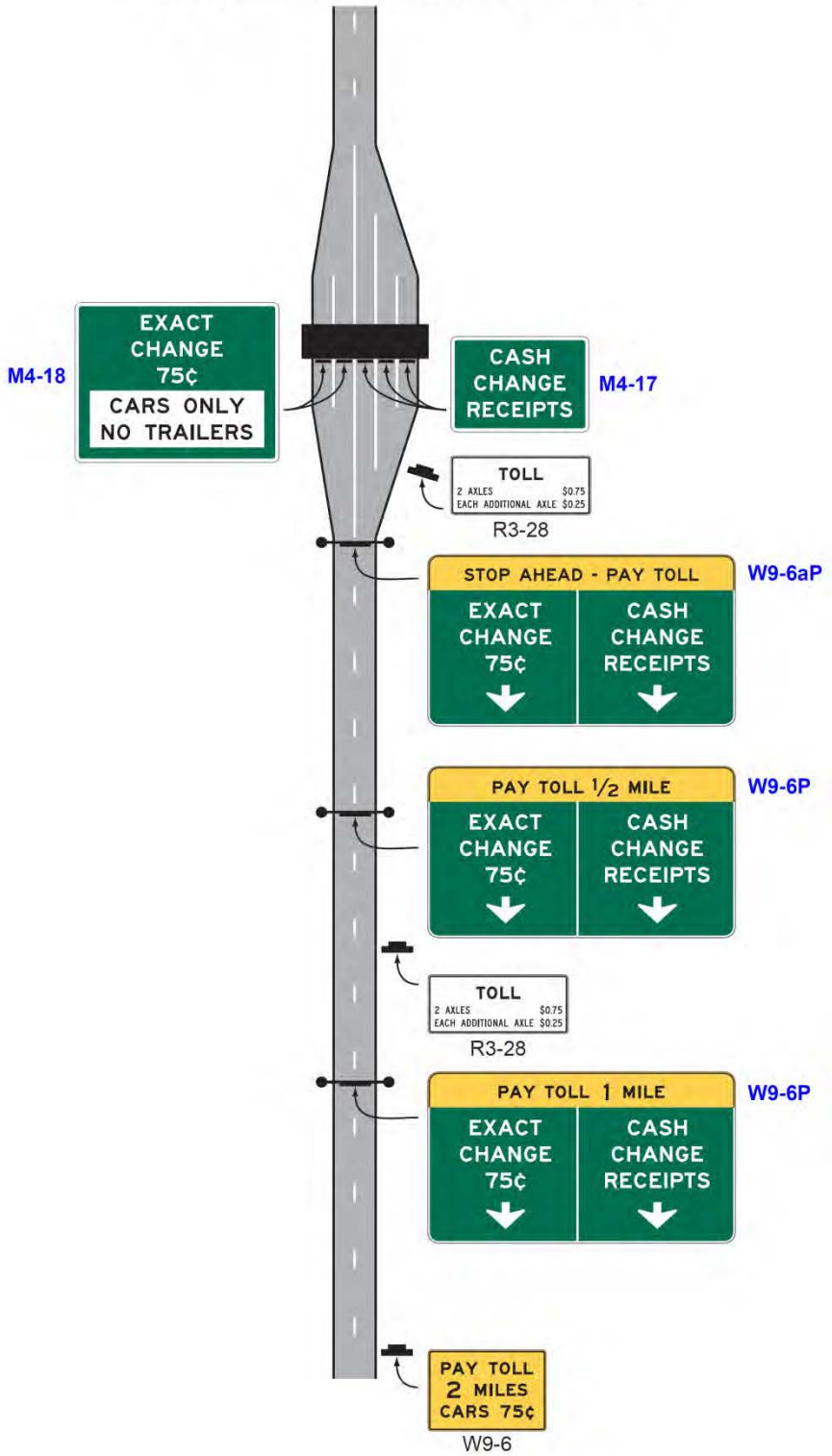
- \* Optional flashing yellow beacons that are separated from any lane-use control signals for the lane (see Section 2F.16)
- \*\* The ETC pictographs that are shown are only examples. The pictograph for the toll facility's adopted ETC system shall be used.

**Figure 2F-10. Examples of Mainline Toll Plaza Approach and Canopy Signing**

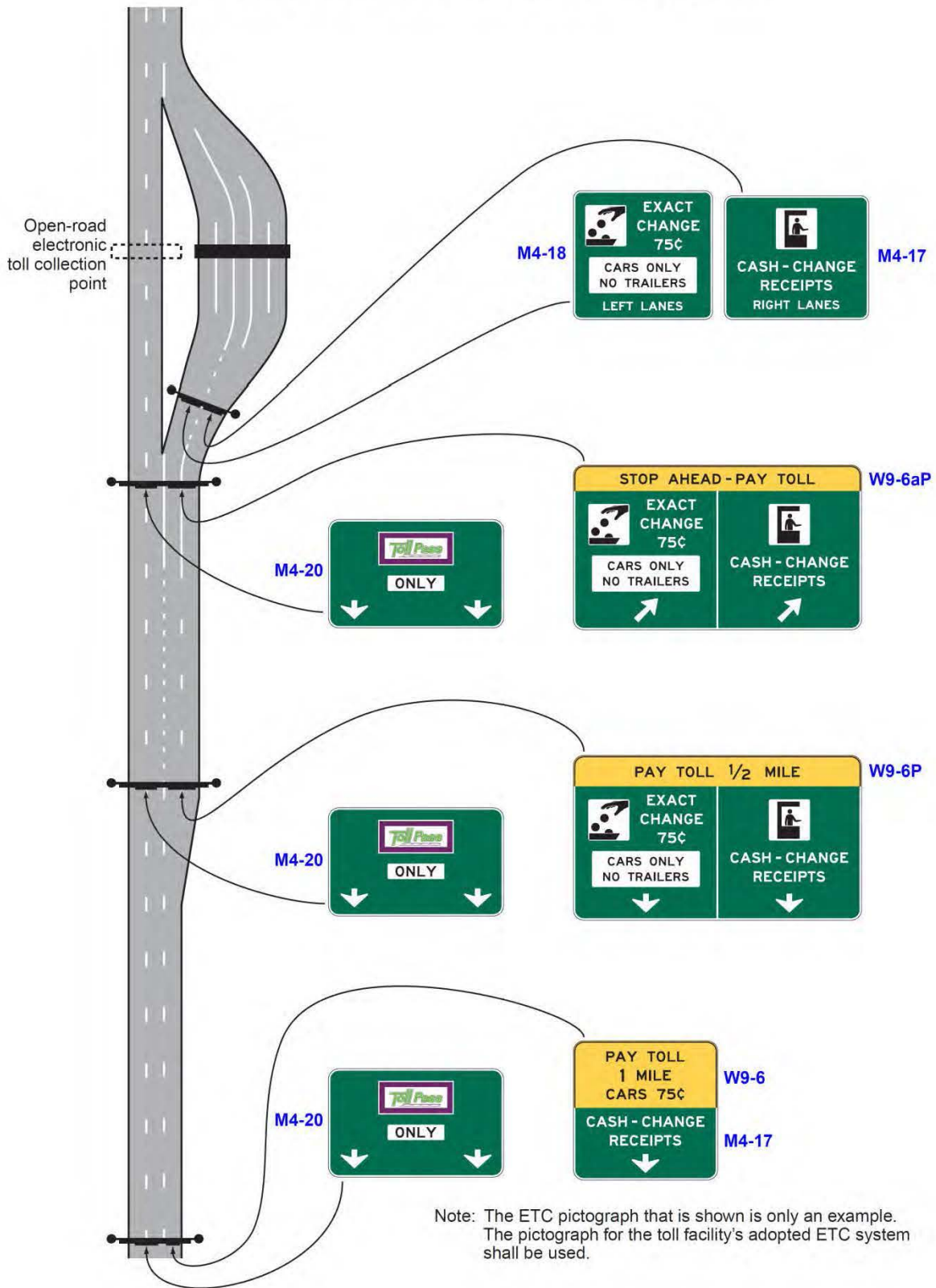
**A - ALL TOLL PLAZA LANES ATTENDED  
 (NO AUTOMATIC OR ELECTRONIC  
 COLLECTION EQUIPMENT)**



**B - EXACT CHANGE AND ATTENDED TOLL LANES**



**Figure 2F-11. Examples of Guide Signs for a Mainline Toll Plaza on a Diverging Alignment from Open-Road ETC Lanes**



**Table 2F-1. Toll Road Sign and Plaque Minimum Sizes**

| Sign or Plaque                          | Sign Designation | Section | Conventional Road |            | Expressway | Freeway   | Minimum | Oversized |
|---|------------------|---------|-------------------|------------|------------|-----------|---------|-----------|
|   |                  |         | Single Lane       | Multi-Lane |            |           |         |           |
| Toll Rate                               | R3-28            | 2F.05   | —                 | —          | 114 x 48   | 114 x 48  | —       | —         |
| Pay Toll (plaque)                       | R3-29P           | 2F.05   | —                 | —          | 24 x 18    | 24 x 18   | —       | —         |
| Take Ticket (plaque)                    | R3-30P           | 2F.05   | —                 | —          | 24 x 18    | 24 x 18   | —       | —         |
| Pay Toll XX Miles Cars (price)          | W9-6             | 2F.06   | 96 x 66           | 96 x 66    | 96 x 66    | 96 x 66   | —       | —         |
| Pay Toll XX Miles Cars (price) (plaque) | W9-6P            | 2F.07   | 288* x 36         | 288* x 36  | 288* x 36  | 288* x 36 | —       | —         |
| Stop Ahead Pay Toll Cars (price)        | W9-6a            | 2F.08   | 114 x 66          | 114 x 66   | 114 x 66   | 114 x 66  | —       | —         |
| Stop Ahead Pay Toll (plaque)            | W9-6aP           | 2F.09   | 252* x 36         | 252* x 36  | 252* x 36  | 252* x 36 | —       | —         |
| Last Exit Before Toll (plaque)          | W16-16P          | 2F.10   | —                 | —          | 252* x 36  | 252* x 36 | —       | —         |
| Toll                                    | M4-15            | 2F.11   | 24 x 12           | 24 x 12    | 36 x 18    | 36 x 18   | 24 x 12 | 36 x 18   |
| No Cash                                 | M4-16            | 2F.12   | 24 x 12           | 24 x 12    | 36 x 18    | 36 x 18   | 24 x 12 | 36 x 18   |
| Toll Collector Symbol                   | M4-17            | 2F.13   | —                 | —          | 48 x 48    | 48 x 48   | —       | —         |
| Exact Change Symbol                     | M4-18            | 2F.13   | —                 | —          | 48 x 48    | 48 x 48   | —       | —         |
| ETC Only                                | M4-20            | 2F.12   | 24 x 24           | 24 x 24    | 36 x 36    | 36 x 36   | 24 x 24 | 36 x 36   |

\* The width shown represents the minimum dimension. The width shall be increased as appropriate to match the width of the guide sign.

- Notes: 1. Larger signs may be used when appropriate  
 2. Dimensions in inches are shown as width x height



## CHAPTER 2G. PREFERENTIAL AND MANAGED LANE SIGNS

### Section 2G.01 Scope

**Support:**

01 Preferential lanes are lanes designated for special traffic uses such as high-occupancy vehicles (HOVs), light rail, buses, taxis, or bicycles. Preferential lane treatments might be as simple as restricting a turning lane to a certain class of vehicles during peak periods, or as sophisticated as providing a separate roadway system within a highway corridor for certain vehicles.

02 Preferential lanes might be barrier-separated (on a separate alignment or physically separated from the other travel lanes by a barrier or median), buffer-separated (separated from the adjacent general-purpose lanes only by a narrow buffer area created with longitudinal pavement markings), or contiguous (separated from the adjacent general-purpose lanes only by a lane line). Preferential lanes might allow continuous access with the adjacent general-purpose lanes or restrict access only to designated locations. Preferential lanes might be operated in a constant direction or operated as reversible lanes. Some reversible preferential lanes on a divided highway might be operated counter-flow to the direction of traffic on the immediately adjacent general-purpose lanes.

03 Preferential lanes might be operated on a 24-hour basis, for extended periods of the day, during peak travel periods only, during special events, or during other activities.

04 Open-road tolling lanes and toll plaza lanes that segregate traffic based on payment method are not considered preferential lanes. Chapter 2F contains information regarding signing of open-road tolling lanes and toll plaza lanes.

05 Managed lanes typically restrict access with the adjacent general-purpose lanes to designated locations only.

06 Under certain operational strategies, such as the occupancy requirement of an HOV lane changing in response to actual congestion levels, a managed lane is a special type of preferential lane (see Sections 2G.03 through 2G.07).

07 A managed lane operated on a real-time basis in response to changing conditions might be operated as an HOV lane for a period of time as needed to manage congestion levels.

08 Sections 2G.16 through 2G.18 contain additional information regarding signs for managed lanes that use tolling or pricing as a management strategy.

09 Section 9B.04 contains information regarding Preferential Lane signs for bike lanes.

### Section 2G.02 Sizes of Preferential and Managed Lane Signs

**Standard:**

01 **Except as provided in Section 2A.11, the sizes of preferential and managed lane signs that have standardized designs shall be as shown in Table 2G-1.**

**Support:**

02 Section 2A.11 contains information regarding the applicability of the various columns in Table 2G-1.

**Option:**

03 Signs larger than those shown in Table 2G-1 may be used (see Section 2A.11).

### Section 2G.03 Regulatory Signs for Preferential Lanes – General

**Standard:**

01 **When a preferential lane is established, the Preferential Lane regulatory signs (see Figure 2G-1) and pavement markings (see Chapter 3D) for these lanes shall be used to advise road users.**

**Support:**

02 Preferential Lane (~~R3-10 series~~ [R3-11 series](#) through R3-15 series, [R82B\(CA\) through R88\(CA\)](#), [R91\(CA\) series through R94\(CA\)](#), [SR50\(CA\) series](#) and the [SR60\(CA\) series](#)) regulatory signs consist of several different general types of regulatory signs as follows (see Figure 2G-1 and [Figure 2G-1\(CA\)](#)):

A. Vehicle Occupancy Definition signs define the vehicle occupancy requirements applicable to an HOV lane (such as “2 OR MORE PERSONS PER VEHICLE”) or types of vehicles not meeting the minimum occupancy requirement (such as motorcycles or ILEVVs) that are allowed to use an HOV lane (see Section 2G.04).

- B. Periods of Operation signs notify road users of the days and hours during which the preferential restrictions are in effect (see Section 2G.05).
- C. Preferential Lane Advance signs notify road users that a preferential lane restriction begins ahead (see Section 2G.06).
- D. Preferential Lane Ends signs notify users of the termination point of the preferential lane restrictions (see Section 2G.07).

**Standard:**

**03 Regulatory signs applicable only to a preferential lane shall be distinguished from regulatory signs applicable to general-purpose lanes by the inclusion of the applicable symbol(s) and/or word(s) (see Figure 2G-1 and Figure 2G-1(CA)).**

**Support:**

04 The symbol and word message displayed on a particular Preferential Lane regulatory sign will vary based on the specific type of allowed traffic and on other related operational constraints that have been established for a particular lane, such as an HOV lane, a bus lane, or a taxi lane.

**Option:**

05 Changeable message signs may supplement, substitute for, or be incorporated into static Preferential Lane regulatory signs where travel conditions change or where multiple types of operational strategies (such as variable occupancy requirements or vehicle types) are used and varied throughout the day or week, or on a real-time basis, to manage the use of, control of, or access to preferential lanes.

**Support:**

06 Figure 2G-1 illustrates examples of changeable messages incorporated into static Preferential Lane regulatory signs.

**Standard:**

**07 When changeable message signs (see Chapter 2L) are used as regulatory signs for preferential lanes, they shall be the required sign size and shall display the required letter height and legend format that corresponds to the type of roadway facility and design speed.**

**Guidance:**

08 *When Preferential Lane regulatory signs are used on conventional roads, the decision regarding whether to use a post-mounted or overhead version of a particular type of sign should be based on an engineering study that considers the available space, the existing signs for the adjacent general-purpose traffic lanes, roadway and traffic characteristics, the proximity to existing overhead signs, the ability to install overhead signs, and any other unique local factors.*

09 *If overhead regulatory signs applicable only to a preferential lane are located in approximately the same longitudinal position along the highway as overhead signs applicable only to the general-purpose lanes, the signs for the preferential lane should be separated laterally from the signs for the general-purpose lanes to the maximum extent practical to minimize conflicting information, while maintaining their visual relationship to the lanes below necessitated by specific legend or arrows indicating lane assignment.*

**Standard:**

**10 If used, overhead Preferential Lane (R3-13 series, R3-14 series, and R3-15 series, and R87(CA) series) regulatory signs shall be installed on the side of the roadway where the entrance to the preferential lane is located and any appropriate adjustments shall be made to the sign message.**

**Option:**

11 Where a median of sufficient width is available, the R3-13 series and R3-15 series signs may be post-mounted.

**Support:**

12 The sizes for Preferential Lane regulatory signs will differ to reflect the design speeds for each type of roadway facility. Table 2G-1 provides sizes for each type of roadway facility.

**Guidance:**

13 *The edges of Preferential Lane regulatory signs that are post-mounted on a median barrier should not project beyond the outer edges of the barrier, including in areas where lateral clearance is limited.*

**Option:**

14 Where lateral clearance is limited, Preferential Lane regulatory signs that are post-mounted on a median barrier and that are 72 inches or less in width may be skewed up to 45 degrees in order to fit within the barrier

width or may be mounted higher, such that the vertical clearance to the bottom of the sign, light fixture, or structural support, whichever is lowest, is not less than 14 feet above any portion of the pavement and shoulders.

**Standard:**

**15 Where lateral clearance is limited, Preferential Lane regulatory signs that are post-mounted on a median barrier and that are wider than 72 inches shall be mounted with a vertical clearance that complies with the provisions of Section 2A.18 for overhead mounting.**

*Guidance:*

*16 On conventional roadways, Preferential Lane regulatory sign spacing should be determined by engineering judgment based on speed, block length, distances from adjacent intersections, and other site-specific considerations.*

*Support:*

17 Sections 2G.04 and 2G.05 contain provisions regarding the placement of Preferential Lane regulatory signs on freeways and expressways.

**Standard:**

**18 The signs illustrated in Figure 2G-1 and Figure 2G-1(CA) that incorporate the diamond symbol shall be used exclusively with preferential lanes for high-occupancy vehicles to indicate the particular occupancy requirement and time restrictions applying to that lane. The signs illustrated in Figure 2G-1 that do not have a diamond symbol shall be used with preferential lanes that are not HOV lanes, but are designated for use by other types of vehicles (such as bus and/or taxi use).**

*Option:*

19 Agencies may select from either the HOV abbreviation or the diamond symbol, or use both, to reference the HOV lane designation.

**Standard:**

**20 When the diamond symbol (or HOV abbreviation) is used without text on the post-mounted Preferential Lane (~~R3-10 series~~, R3-11 series, and R3-12 series, **R93-2(CA)**, and **SR50-2(CA)**) regulatory signs, it shall be centered on the top line of the sign. When the diamond symbol (or HOV abbreviation) is used with associated text on the post-mounted Preferential Lane (~~R3-10 series~~, R3-11 series, and R3-12 series, **R82-1(CA)**, **R84-2(CA)**, **R86(CA) series**, **R88(CA)**, and **R91(CA) series**) regulatory signs, it shall appear to the left of the associated text. When the diamond symbol is used on the overhead Preferential Lane (R3-13, R3-13a, R3-14, and R3-14a, and **R87(CA) series**) regulatory signs, it shall appear in the top left quadrant. The diamond symbol for the R3-15, R3-15a, R3-15b, and R3-15c, and **SR50-1(CA)** signs shall appear on the left side of the sign. The diamond symbol shall not be used on the bus, taxi, or bicycle Preferential Lane signs.**

**21 Vehicle Occupancy Definition, Periods of Operation, and Preferential Lane Advance regulatory signs for HOV lanes shall display the minimum allowable vehicle occupancy requirement established for each HOV lane, displayed immediately after the word message HOV or the diamond symbol.**

*Support:*

22 The agencies that own and operate HOV lanes have the authority and responsibility to determine how they are operated and the minimum occupancy requirements. Information about federal requirements for certain types of vehicles not meeting the minimum occupancy requirement to be eligible to use HOV lanes that receive Federal-aid program funding and about requirements associated with proposed significant changes to the operation of an existing HOV lane and certain vehicles are contained in the "Federal-Aid Highway Program Guidance on High Occupancy Vehicle (HOV) Lanes" (see Section 1A.11).

**Standard:**

**23 The provisions of Sections 2G.03 through 2G.07 regarding regulatory signs for Preferential lanes shall apply to managed lanes operated at all times or at certain times by varying vehicle occupancy requirements (HOV) or by using vehicle type restrictions as a congestion management strategy. Such managed lanes shall use changeable message signs or changeable message elements within static signs to display the appropriate regulatory sign messages only when they are in effect.**

**24 When certain types of vehicles (such as trucks) are prohibited from using a managed lane or when a managed lane is restricted to use by only certain types of vehicles during certain operational strategies, regulatory signs or regulatory panels within the appropriate guide signs that include changeable message elements shall be used to display the open/closed status of the managed lane for such vehicle types.**

**25 When the vehicle occupancy required for use of an HOV lane is varied as a part of a managed lane operational strategy, regulatory signs that include changeable message elements shall be used to display the required vehicle occupancy in effect.**

Support:

26 See Section 2G.17 for regulatory signs for managed lanes that use tolling or pricing as a congestion management strategy, either exclusively or with other management strategies.

27 Figures 2G-2 and 2G-3 illustrate the use of regulatory signs for the beginning, along the length, and at the end of contiguous or buffer-separated preferential lanes that provide continuous access with the adjacent general-purpose lanes.

Support:

28 For State highways, see Caltrans' High Occupancy Vehicle (HOV) Guidelines. See Section 1A.11 for information regarding this publication.

29 Refer to CVC 21655.5 for Exclusive- or Preferential-Use Lanes for High Occupancy Vehicles.

30 Refer to Figure 2G-1(CA) for Preferential Lane Regulatory Signs and Plaques.

### **Section 2G.04 Preferential Lane Vehicle Occupancy Definition Regulatory Signs (R3-10 Series and R3-13 Series)**

**Standard:**

**01 The ~~R3-10, R3-13, and R3-13a~~, and **R93-2(CA)** Vehicle Occupancy Definition signs (see Figure 2G-1 and **Figure 2G-1(CA)**) shall be used where agencies determine that it is appropriate to provide a sign that defines the minimum occupancy of vehicles that are allowed to use an HOV lane.**

*Guidance:*

*02 The ~~Inherently Low Emission Vehicle (ILEV) (R3-10a) sign (see Figure 2G-1) should be used when it is permissible for a properly labeled and certified ILEV, regardless of the number of occupants, to use an HOV lane. When used, the ILEV signs should be post-mounted in advance of and at intervals along the HOV lane based upon engineering judgment and the placement of other Preferential Lane regulatory signs. The R3-10a sign is only applicable to HOV lanes and should not to be used with other preferential lane applications.~~*

Support:

03 ILEVs are defined by the Environmental Protection Agency (EPA) as vehicles having no fuel vapor (hydrocarbon) emissions and are certified by the EPA as meeting the emissions standards and requirements specified in 40 CFR 88.311-93 and 40 CFR 88.312-93(e).

*Guidance:*

*03a The **VEHICLES WITH DMV CLEAN AIR DECALOK (R93A(CA))** sign should be used when it is permissible for a properly labeled and certified low or zero emission vehicle, regardless of the number of occupants, to use an HOV lane. Refer to CVC 21655.9.*

*03b The **R93A(CA)** should be used in advance of and at intervals along the HOV lane based on engineering judgment.*

**Standard:**

**03c When used, the **R93A(CA)** sign shall be placed below the **R93-2(CA)** sign.**

**Option:**

03d The **AUTOS/PICKUPS 2 SEATERS WITH 2 PERSONS OK (R91B(CA))** sign may be placed below the **R93-2(CA)** sign for preferential lane facilities at toll plazas that require 3 or more persons per vehicle but can also be utilized by vehicles designed by the manufacturer to be occupied by no more than 2 persons. Refer to Streets & Highways Code, Section 30101.8.

*Guidance:*

*04 The legend format of the ~~R3-10 and R3-13~~ signs should have the following sequence:*

*A. Top Line: "HOV 2+ ONLY" (or 3+ or 4+ if appropriate)*

*B. Bottom Lines: "2 OR MORE PERSONS PER VEHICLE" (or 3 or 4 if appropriate)*

*05 The legend format of the **R3-13a** sign should have the following sequence:*

*A. Top Line: "HOV 2+ ONLY" (or 3+ or 4+ if appropriate)*

*B. Middle Lines: "2 OR MORE PERSONS PER VEHICLE" (or 3 or 4 if appropriate)*

*C. Bottom Lines: Times and days the occupancy restriction is in effect*

05a *The legend format of the R93-2(CA) sign should have the following sequence:*

A. *Top Line: "HOV 2+ IS" (or 3+ or 4+ if appropriate)*

B. *Bottom Lines: " 2 OR MORE PERSONS PER VEHICLE" (or 3 or 4 if appropriate)*

Support:

06 Section 2G.17 contains information regarding the legends of Vehicle Occupancy Definition signs for a priced managed lane that has an occupancy requirement for non-toll travel.

**Standard:**

07 **For barrier- or buffer-separated or contiguous preferential lanes where access between the preferential and general-purpose lanes is restricted to designated locations, an overhead Vehicle Occupancy Definition (R3-13 or R3-13a) sign shall be installed at least 1/2 mile in advance of the beginning of or initial entry point to an HOV lane. ~~These signs shall only be displayed in advance of the beginning of or initial entry point to HOV lanes.~~**

*Guidance:*

07a *The R3-13 or R3-13a sign should be installed at least 1/4 mile in advance of any intermediate access points or gaps in the barrier where vehicles are allowed to legally access the access-restricted preferential lanes.*

Option:

08 For barrier-separated HOV lanes, the sequence of a post-mounted Periods of Operation (R3-11a or R86(CA) series) sign followed by a post-mounted Vehicle Occupancy Definition (~~R3-10~~) (R93-2(CA)) sign may be located at intervals of approximately 1/2 mile along the length of the HOV lane, at intermediate entry points, and at ~~designated enforcement areas as defined by the operating agency~~ *downstream of direct access ramps.*

**Standard:**

09 **For buffer-separated or contiguous HOV lanes where access is restricted to designated locations, the sequence of a post-mounted Periods of Operation (R3-11a or R86(CA) series) sign followed by a post-mounted Vehicle Occupancy Definition (~~R3-10~~) (R93-2(CA)) sign shall be located at intervals not greater than 1/2 mile along the length of the access-restricted HOV lane, at designated gaps where vehicles are allowed to legally access the HOV lane, and ~~within designated enforcement areas as defined by the operating agency.~~ *downstream of direct access ramps.***

10 **~~For buffer-separated or contiguous HOV lanes where continuous access with the adjacent general-purpose lanes is provided, the sequence of a post-mounted Periods of Operation (R3-11a or R86(CA) series) sign followed by a post-mounted Vehicle Occupancy Definition (~~R3-10~~) (R93-2(CA)) sign, and ILEV (~~R3-10a~~) signs if appropriate, shall be located at intervals not greater than 1/2 mile along the length of the HOV lane.~~**

*Guidance:*

11 *The signs within each Preferential Lane regulatory sign sequence should be separated by a minimum distance of 800 feet and a maximum distance of 1,000 feet.*

**Standard:**

12 **For all types of direct access ramps that provide access to or lead to HOV lanes, a post-mounted Vehicle Occupancy Definition (~~R3-10~~) (R93-2(CA)) sign, ~~and an ILEV (~~R3-10a~~) sign if appropriate,~~ shall be used at the beginning or initial entry point for the direct access ramp.**

Option:

12a *The (HOV) NO TRUCKS 3 AXLES OR MORE – NO VEHICLES WITH TRAILERS (R91-4(CA)) sign may be placed adjacent to the HOV lane, as needed, where incidences of trucks or vehicles with trailers in the HOV lanes have commonly occurred and on surface streets approaching direct access ramps that provide access to or lead to HOV lanes.*

## **Section 2G.05 Preferential Lane Periods of Operation Regulatory Signs (R3-11 Series and R3-14 Series)**

*Guidance:*

01 *The sizes of post-mounted Periods of Operation (R3-11 series, R86(CA) series, and SR60-3(CA) through SR60-7(CA)) signs should remain consistent to accommodate any manual addition or removal of a single line of text for each sign.*

**Support:**

<sup>02</sup> Consistent sign sizes are beneficial for agencies when ordering sign materials, as well as when making text changes to existing signs if changes occur to operating times or occupancy restrictions in the future. For example, the R3-11e sign has space for one line located below "24 HOURS" if an agency determines that it is appropriate to display additional information (such as "MON-FRI"), yet the R3-11e sign has the same dimensions as the other R3-11 series signs.

**Standard:**

<sup>03</sup> When used, the post-mounted Periods of Operation (R3-11 series, R86(CA) series, and SR60-3(CA) through SR60-7(CA)) signs shall be located adjacent to the preferential lane, and the overhead Periods of Operation (R3-14 series, R3-14c, R87-3(CA), SR60-8(CA) and SR60-9(CA)) signs shall be mounted directly over the lane.

<sup>04</sup> The legend format of the post-mounted Periods of Operation (R3-11 series, R86(CA) series, and SR60-3(CA) through SR60-7(CA)) signs shall have the following sequence:

- A. Top Lines: Lanes applicable, such as "RIGHT LANE" or "2 RIGHT LANES" or "THIS LANE"
- B. Middle Lines: Eligible uses, such as "HOV 2+ ONLY" (or 3+ or 4+ if appropriate) or "BUSES ONLY" or other applicable uses or eligible turning movements
- C. Bottom Lines: Applicable times and days, such as "7 AM – 9 AM" or "6:30 AM – 9:30 AM, MON-FRI" or "24 HOURS".

<sup>05</sup> The legend format of the overhead Periods of Operation (R3-14 series and R87-3(CA)) signs shall have the following sequence:

- A. Top Line: Eligible uses, such as "HOV 2+ ONLY" (or 3+ or 4+ if appropriate) or "BUSES ONLY" or other applicable uses or eligible turning movements
- B. Bottom Lines: Applicable times and days, with the time and day placed above the down arrow, such as "7 AM – 9 AM" or "6:30 AM – 9:30 AM, MON-FRI". (When the operating periods exceed the available line width, the hours and days of the week shall be stacked as shown for the R3-14a sign in Figure 2G-1.)

<sup>06</sup> For preferential lanes that are in effect on a full-time basis, either the full-time Periods of Operation (R3-11b and R3-14b R3-14b, R86-4(CA) and SR60-4(CA) through SR60-6(CA)) signs shall be used, or the legends of the part-time Periods of Operations (R3-11, R3-11a, R3-14, R3-14a) signs shall be modified to display the legend 24 HOURS. The R3-11a, R3-14, R3-14a, R3-14c, R86-3(CA), R87-3(CA), and SR60-3(CA) signs shall be used for preferential lanes that are in effect on a part-time basis.

<sup>07</sup> The full-time Periods of Operation (R3-14b R3-14c, R86-4(CA) and SR60-4(CA) through SR60-6(CA)) signs shall not be used where the preferential lane is in effect only on a part-time basis.

**Option:**

<sup>08</sup> Where additional movements are permitted from a preferential lane on an approach to an intersection, the format and words used in the legend in the middle lines on the post-mounted Periods of Operation (R3-11 series and R86(CA) series) signs and on the top line of the overhead Periods of Operation (R3-14 series and R87-3(CA)) signs may be modified to accommodate the permitted movements (such as "HOV 2+ AND RIGHT TURNS ONLY").

<sup>08a</sup> The Mandatory/Optional HOV Movement Lane Control (R94(CA)) sign may be installed on local streets when one of the mandatory turn lanes (left or right) is designated as a HOV only lane.

<sup>09</sup> A MOTORCYCLES ALLOWED (R3-11P) plaque may be used where motorcycles, regardless of the number of occupants, are allowed to use an HOV lane.

**Standard:**

<sup>10</sup> If used, the MOTORCYCLES ALLOWED plaque shall be mounted below a post-mounted Preferential Lane Periods of Operation (R3-11, R3-11a, or R3-11e) sign.

<sup>11</sup> For all barrier- or buffer-separated or contiguous preferential lanes where access is restricted to designated locations, an overhead Periods of Operation (R3-14 series, R87-3(CA), SR60-8(CA) or SR60-9(CA)) sign shall be used at the beginning or initial entry point, and at any intermediate entry points or gaps in the barrier where vehicles are allowed to legally access the access-restricted preferential lanes. For all barrier-separated and buffer-separated preferential lanes, post-mounted Periods of Operation (R3-11 series, R86(CA) series and SR60-3(CA) through SR60-7(CA)) signs shall be used only as a supplement to the overhead

**signs at the beginning or initial entry point, or at any intermediate entry points or gaps in the barrier or buffer.**

**12 For ~~buffer-separated or~~ contiguous preferential lanes where continuous access with the adjacent general-purpose lanes is provided, including those where a preferential lane is added to the roadway (see Figure 2G-2 for HOV lanes) and those where a general-purpose lane transitions into a preferential lane (see Figure 2G-3 for HOV lanes), an overhead Periods of Operation (R3-14 series or R87-3(CA)) sign shall be used at the beginning or initial entry point of the preferential lane.**

*Guidance:*

**Option:**

**13 Overhead (R3-14 series, R87-3(CA), SR60-8(CA) and SR60-9(CA)) or post-mounted (R3-11 series, R86(CA) series and SR60-3(CA) through SR60-7(CA)) Periods of Operation signs ~~should~~ may be installed at periodic intervals along the length of a contiguous ~~or buffer-separated~~ preferential lane where continuous access with the adjacent general-purpose lanes is provided.**

**Option:**

**14 Additional overhead (R3-14 series, R87-3(CA), SR60-8(CA) and SR60-9(CA)) or post-mounted (R3-11 series, R86(CA) series and SR60-3(CA) through SR60-7(CA)) Periods of Operation signs may be provided along the length of any type of preferential lane.**

**15 On conventional roads, the overhead Periods of Operation (R3-14 series, R87-3(CA), SR60-8(CA) and SR60-9(CA)) signs may be installed at the beginning or entry points and/or at intermediate points along preferential lanes in any geometric configuration.**

**Standard:**

**16 For all types of direct access ramps that provide access to or lead to preferential lanes, ~~a post-mounted~~ an overhead Periods of Operation (R3-11 series R87-4(CA) or R87-5(CA)) sign shall be used at the beginning or initial entry point of the direct access ramp.**

**Option:**

**~~17 For direct access ramps to preferential lanes, an overhead Periods of Operation (R3-14 series) sign may be used at the beginning or initial entry point to supplement the required post-mounted signs.~~**

**18 Lane-use control signals (see Chapter 4M) may be used at access points to preferential lanes to indicate that a ramp or access roadway leading to the preferential lane or facility, or one or more specific lanes of the facility, are open or closed (see Figure 2G-14).**

## **Section 2G.06 Preferential Lane Advance Regulatory Signs (R3-12, R3-12e, R3-12f, R3-15, R3-15a, and R3-15d)**

*Guidance:*

**Standard:**

**01 The Preferential Lane Advance (R3-12, R3-12f, R3-15, and R3-15d, SR60-1(CA) and SR60-2(CA)) signs ~~should~~ shall be used for advance notification of a ~~barrier-separated, buffer-separated, or~~ contiguous preferential lane that is added to the general-purpose lanes and continuous access with the adjacent general-purpose lanes is provided (see Figure ~~2G-12~~ 2G-2).**

**02 The Preferential Lane Advance (R3-12e and R3-15a) signs ~~should~~ shall be used for advance notification of a general-purpose lane that becomes a preferential lane and continuous access with the adjacent general-purpose lanes is provided (see Figure ~~2G-13~~ 2G-3).**

**Option:**

**03 The legends on the R3-12f and R3-15d signs may be modified to suit the type of preferential lane.**

*Guidance:*

**04 On conventional roads, for general-purpose lanes that become preferential lanes, a post-mounted (R3-12e) or overhead (R3-15a) Preferential Lane Advance sign should be installed in advance of the beginning of or initial entry point to the preferential lane at a distance determined by engineering judgment based on speed, traffic characteristics, and other site-specific considerations. The distance selected should provide adequate opportunity for ineligible vehicles to vacate the lane prior to the beginning of the restriction.**

*05 On freeways and expressways, for general-purpose lanes that become preferential lanes, an overhead Preferential Lane Advance (R3-15a) sign should be installed at least 1 mile in advance of the beginning of the preferential lane restriction.*

Option:

*06 Additional post-mounted or overhead Preferential Lane Advance signs may be placed farther in advance of or closer to the beginning or initial entry points to a preferential lane.*

**Standard:**

**07 A Specific Hours/Days (R82A(CA) or R82B(CA)) Plaque shall be used to designate the periods of operation for preferential lanes that operate on a part-time basis.**

Guidance:

*08 The Specific Hours/Days plaque, when used, should be placed below the R3-12, R3-12e, R3-12f, SR60-1(CA), and SR60-2(CA) signs.*

### **Section 2G.07 Preferential Lane Ends Regulatory Signs (R3-12a, R3-12b, R3-12c, R3-12d, R3-12g, R3-12h, R3-15b, R3-15c, and R3-15e)**

**Standard:**

**01 A post-mounted Preferential Lane Ends (R3-12b or R3-12h) sign shall be installed at least 1/2 mile in advance of the termination of a preferential lane.**

**02 Except as provided in Paragraph 6, a post-mounted Preferential Lane Ends (R3-12a or R3-12g or SR60-7(CA)) sign shall be installed at the point where a preferential lane and restriction end and traffic must merge into the general-purpose lanes.**

**03 A post-mounted Preferential Lane Ends (R3-12d) sign shall be installed at least 1/2 mile in advance of the point where a preferential lane restriction ends and the lane becomes a general-purpose lane.**

**04 Except as provided in Paragraph 7, a post-mounted Preferential Lane Ends (R3-12c) sign shall be installed at the point where a preferential lane restriction ends and the lane becomes a general-purpose lane.**

Option:

*05 The legends on the R3-12g and R3-15e signs may be modified to suit the type of preferential lane.*

*06 An overhead Preferential Lane Ends (R3-15b or R3-15e) sign may be installed instead of or in addition to a post-mounted R3-12a or R3-12g sign at the point where a preferential lane and restriction ends and traffic must merge into the general-purpose lanes.*

*07 An overhead Preferential Lane Ends (R3-15c) sign may be installed instead of or in addition to a post-mounted R3-12c sign at the point where the preferential lane restriction ends and the lane becomes a general-purpose lane.*

### **Section 2G.08 Warning Signs on Median Barriers for Preferential Lanes**

Option:

*01 When a warning sign applicable only to a preferential lane is installed on a median barrier with limited lateral clearance to the adjacent travel lanes or shoulders, the warning sign may have a vertical rectangular shape. For a High Occupancy Vehicle lane, such signs may be used instead of using the HOV Plaque (W16-11P) (see Section 2G.09) with a standard diamond-shaped warning sign.*

**Standard:**

**02 When a vertical rectangular-shaped warning sign applicable only to a preferential lane is installed on a median barrier, the top portion of the sign shall be comprised of a white symbol or legend denoting the type of preferential lane (such as the diamond symbol for HOV or the legend BUS LANE) on a black background with a white border, and the bottom portion of the sign shall be comprised of the standard word message or symbol of the standard warning sign as a black legend on a yellow background with a black border (see Figure 2G-4).**

Guidance:

*03 Where lateral clearance is limited, such as when a post-mounted warning sign applicable only to a preferential lane is installed on a median barrier, the edges of the sign should not project beyond the outer edges of the barrier.*



Option:

04 Where lateral clearance is limited, warning signs applicable only to a preferential lane that are post-mounted on a median barrier and that are 72 inches or less in width may be skewed up to 45 degrees in order to fit within the barrier width or may be mounted higher, such that the vertical clearance to bottom of the sign, light fixture, or its structural support, whichever is lowest, is not less than 14 feet above any portion of the pavement and shoulders.

**Standard:**

05 **Where lateral clearance is limited, Preferential Lane warning signs that are post-mounted on a median barrier and that are wider than 72 inches shall be mounted with a vertical clearance that complies with the provisions of Section 2A.18 for overhead mounting.**

*Guidance:*

06 *The HOV Lane Reduction (W11-1(CA)) sign (see Figure 2G-4(CA)) should be used to warn of a reduction in the number of HOV lanes.*

07 *The HOV Merge (W59-1(CA)) sign (see Figure 2G-4(CA)) should be used in advance of locations where HOV lanes converge. This includes HOV direct access ramps where high speeds and volumes prevail and merging or weaving must be accomplished in a relatively short distance.*

08 *The HOV Advisory Exit (Ramp) Speed (W72B(CA)) sign when used, should be placed on the left of an HOV drop ramp or freeway to freeway connector to advise motorists of the speed at which the drop ramp or freeway to freeway connector can be comfortably negotiated.*

09 *The HOV THRU TRAFFIC MERGE LEFT (RIGHT) (W74-1(CA)) sign (see Figure 2G-4(CA)) should be used to inform motorists that the outside or inside lane of an HOV facility with two or more directional HOV lanes is being dropped at the next exit and through HOV traffic must merge into the adjacent HOV lane. This sign should not be used for a lane reduction.*

Option

10 *The HOV Lane Selection SW54(CA) and SW54-1(CA) signs (see Figure 2G-4(CA)) may be used as an advance warning that motorists will have to choose whether or not to be in an HOV lane. These signs may be used where geometrics make entrapment likely or where there is a history of vehicles being entrapped in an HOV lane.*

*Guidance:*

11 *The SW54(CA) and SW54-1(CA) signs should not be used at the entrance of an HOV lane.*

12 *The SW54C(CA) sign (see Figure 2G-4(CA)) should be used in conjunction with the Lane Selection sign so that motorists can determine if they are eligible to use the HOV lane.*

### **Section 2G.09 High-Occupancy Vehicle (HOV) Plaque (W16-11P)**

Option:

01 In situations where there is a need to warn drivers in an HOV lane of a specific condition, a HOV (W16-11P) plaque (see Figure 2G-4) may be used above a warning sign. The HOV plaque may be used to differentiate a warning sign specific for HOV lanes when the sign is also visible to traffic on the adjacent general-purpose roadway. Among the warning signs that may be possible applications of the HOV plaque are the Advisory Exit Speed, Added Lane, and Merge signs.

02 The diamond symbol may be used instead of the word message HOV on the W16-11P plaque. When appropriate, the words LANE or ONLY may be used on this plaque.

Support:

03 Section 2G.08 contains information regarding warning signs that can be mounted on barriers for HOV or other types of preferential lanes.

### **Section 2G.10 Preferential Lane Guide Signs – General**

Support:

01 Preferential lanes are used on freeways, expressways, and conventional roads. Except as otherwise provided, Sections 2G.10 through 2G.15 apply only to guide signs for preferential lanes on freeways and expressways.

*Guidance:*

02 *On conventional roads, guide signs applicable only to preferential lanes are ordinarily not needed, but if used they should comply with the provisions for guide signs in Chapter 2D and any principles for Preferential*

*Lane guide signs in Sections 2G.10 through 2G.15 that engineering judgment finds to be appropriate for the conditions.*

**Support:**

03 Consistency in signs and pavement markings for preferential lanes plays a critical role in building public awareness, understanding, and acceptance, and makes enforcement more effective.

04 Additional guidance and standards related to the designation, operational considerations, signs, pavement markings, and other considerations for preferential lanes is provided in Sections 2G.03 through 2G.07, and 2G.09, and Chapter 3D.

**Guidance:**

05 *The appropriate combinations of pavement markings and standard overhead and post-mounted regulatory, warning, and guide signs for a specific preferential lane application should be selected based on an engineering study.*

06 *If overhead signs applicable only to a preferential lane are located in approximately the same longitudinal position along the highway as overhead signs applicable only to the general-purpose lanes, the signs for the preferential lane should be separated laterally from the signs for the general-purpose lanes to the maximum extent practical to minimize conflicting information.*

07 *The Preferential Lane signs should be designed and located to avoid overloading the road user. Based on the importance of the sign, regulatory signs should be given priority over guide signs. The order of priority of guide signs should be Advance Guide, Preferential Lane Entrance Direction, and finally Preferential Lane Exit Destination supplemental guide signs.*

**Standard:**

08 **Signs applicable only to a preferential lane shall be distinguished from signs applicable to general-purpose lanes by the inclusion of the applicable symbol(s) and/or word(s).**

**Support:**

09 The symbol and/or word message that appears on a particular guide sign applicable only to a preferential lane will vary based on the specific type of allowed traffic and on other related operational constraints that have been established for a particular lane, such as an HOV lane, a bus lane, or a taxi lane.

**Standard:**

10 **For HOV lanes, the diamond symbol shall appear on each Advance Guide sign, Preferential Lane Entrance Direction sign, and Preferential Lane Entrance Gore sign, as shown in Figures 2G-5 through 2G-7 for the designated entry and exit points for barrier- and buffer-separated geometric configurations and direct access ramps to or from such lanes. The diamond symbol shall not be used with preferential lanes for other types of traffic, such as bus lanes or taxi lanes.**

11 **Signing for an HOV lane that is managed by means of varying the occupancy requirement in response to changing conditions shall also comply with these provisions.**

12 **The diamond symbol shall be displayed in the legend of each Preferential Lane guide sign at the designated entry and exit points for all types of HOV lanes (including barrier- and buffer-separated, contiguous, and direct access ramps) in order to alert motorists that there is a minimum allowable vehicle occupancy requirement for vehicles to use the HOV lanes. Guide signs shall not display the occupancy requirement for the preferential lane.**

13 **A combination of guide and regulatory signs shall be used in advance of and at the initial entry point and all intermediate entry points from general-purpose lanes or facilities to contiguous, barrier-separated, and buffer-separated preferential lanes where access between the preferential and general-purpose lanes is restricted to designated locations. The regulatory signs shall comply with the provisions of Sections 2G.03 through 2G.07.**

14 **Regulatory signs alone shall be used in advance of, at the beginning of, and at periodic intervals along contiguous or buffer-separated preferential lanes that provide continuous access between the adjacent general-purpose lanes and the preferential lane (see Figures 2G-12 and 2G-13). The design and placement of the regulatory signs shall comply with the provisions of Sections 2G.03 through 2G.07.**

15 **Except as otherwise provided in Sections 2G.10 through 2G.13, guide signs applicable to a preferential lane with a vehicle occupancy requirement shall be distinguished from those applicable to general-purpose lanes by displaying the white diamond symbol on a black background at the left-hand edge of these signs.**

Option:

<sup>16</sup> When post-mounted guide signs applicable only to a preferential lane are installed on a median barrier with limited lateral clearance to the adjacent travel lanes or shoulders, the guide signs may have a vertical rectangular shape.

**Standard:**

<sup>17</sup> **When vertical rectangular shaped guide signs applicable only to a preferential lane are installed on a median barrier, the top portion of the signs shall be comprised of the applicable white symbol or white word message that identifies the type of preferential lane (such as the diamond symbol for an HOV lane) on a black background with a white border, and the bottom portion of the sign shall be comprised of the appropriate guide sign legend on a green background with a white border (see Figures 2G-3, 2G-6, and 2G-7).**

*Guidance:*

<sup>18</sup> *Where lateral clearance is limited, such as when a post-mounted Preferential Lane guide sign is installed on a median barrier, the edges of the sign should not project beyond the outer edges of the barrier.*

Option:

<sup>19</sup> Where lateral clearance is limited, Preferential Lane guide signs that are 72 inches or less in width may be skewed up to 45 degrees in order to fit within the barrier width or may be mounted higher, such that the vertical clearance to the bottom of the sign, light fixture, or its structural support, whichever is lowest, is not less than 14 feet above any portion of the pavement and shoulders.

**Standard:**

<sup>20</sup> **Where lateral clearance is limited, Preferential Lane guide signs that are post-mounted on a median barrier and that are wider than 72 inches shall be mounted with a vertical clearance that complies with the provisions of Section 2A.18 for overhead mounting.**

Option:

<sup>21</sup> Lane-use control signals (see Chapter 4M) may be used at access points to preferential lanes to indicate that a ramp or access roadway leading to or from the preferential lane or facility, or one or more specific lanes of the facility, are open or closed.

<sup>22</sup> Changeable message signs may supplement, substitute for, or be incorporated into static guide signs where travel conditions change or where multiple types of operational strategies (such as variable occupancy requirements, vehicle types, or pricing policies) are used and varied throughout the day or week to manage the use of, control of, or access to preferential lanes.

**Standard:**

<sup>23</sup> **When changeable message signs (see Chapter 2L) are used as guide signs for preferential lanes, they shall be the required sign size and shall display the required letter height and legend format that corresponds to the type of roadway facility and design speed.**

<sup>24</sup> **Advance Guide signs, Preferential Lane Entrance Direction signs, and Preferential Lane Entrance Gore signs for the initial entry point and intermediate entry points into a preferential lane from the general-purpose lanes on the same designated route shall not identify the entry point as an exit by using the word "EXIT" on the sign or on a plaque.**

*Guidance:*

<sup>25</sup> *Advance Guide signs and Preferential Lane Entrance Direction signs for initial and intermediate entry points into a preferential lane should use the word "ENTRANCE," such as "HOV LANE ENTRANCE" (see Figures 2G-5 and 2G-6) to convey the fact that vehicles are not leaving the designated route.*

<sup>26</sup> *Preferential Lane Entrance Gore signs (see Figure 2G-7) at the initial entry point to a preferential lane should use the word "ENTRANCE." Preferential Lane Entrance Gore signs at intermediate entry points to a barrier-separated preferential lane where the sign would be located immediately adjacent to and directly viewed by traffic in the preferential lane should not use the word "ENTRANCE."*

**Standard:**

<sup>27</sup> **When the entry point is on the left-hand side of the general-purpose lanes, a LEFT (E1-5aP) plaque (see Figure 2E-22) shall be added to the top left edge of the Advance Guide and Preferential Lane Entrance Direction signs. The LEFT plaque shall not be used on a preferential lane regulatory sign.**

## **Section 2G.11 Guide Signs for Initial Entry Points to Preferential Lanes**

### **Standard:**

**01 Except where a ~~buffer-separated or~~ contiguous preferential lane is added or where a general-purpose lane becomes a ~~buffer-separated or~~ contiguous preferential lane, and provides continuous access with the adjacent general-purpose lanes as illustrated in Figures 2G-2 and 2G-3, an Advance Guide sign shall be provided at least 1/2 mile prior to the initial entry point to all types of preferential lanes in any type of geometric configuration. A Preferential Lane Entrance Direction sign shall also be provided at the initial entry point. Advance Guide and Preferential Lane Entrance Direction signs for such entry points shall not include the word "EXIT" (see Section 2G.10).**

### *Guidance:*

#### **Option:**

**02 An Advance Guide sign ~~should~~ may also be installed and located approximately 1 mile in advance of the initial entry point to a preferential lane that restricts access with the adjacent general-purpose lanes to designated locations.**

#### **Option:**

**03 An Advance Guide sign may also be installed and located approximately 2 miles in advance of the initial entry point to a preferential lane that restricts access with the adjacent general-purpose lanes to designated locations.**

### **Standard:**

**04 For barrier-separated, buffer-separated, or contiguous preferential lanes where entry is restricted to only designated points, the Advance Guide and Preferential Lane Entrance Direction signs shall be mounted overhead.**

### *Guidance:*

#### **Option:**

**05 Preferential Lane Exit Destination guide signs, identifying final destination and downstream exit locations accessible from the preferential lane (see Figures 2G-8, ~~2G-13~~, 2G-14, and 2G-16), ~~should~~ may be installed in advance of the initial entry points to access-restricted preferential lanes (such as barrier- and buffer-separated).**

### *Guidance:*

*These Preferential Lane Exit Destination guide signs should be located based on the priority of the message, the available space, the existing signs on adjacent general-purpose traffic lanes, roadway and traffic characteristics, the proximity to existing overhead signs, the ability to install overhead signs, and other unique local factors.*

### **Standard:**

**06 Advance destination guide signs for preferential lanes shall include an upper section displaying a black legend that includes the type of preferential lane and the word "EXITS," such as "HOV EXITS," on a white background. For preferential lanes that incorporate a vehicle occupancy requirement, the white diamond symbol on a black background shall be displayed at the left edge of this upper section (see Figure 2G-8). Advance destination guide signs for preferential lanes shall only list direct exits from the preferential lane to another highway.**

### **Support:**

**07 Figure 2G-8 shows an example of signs for the initial entry point to a preferential lane.**

## **Section 2G.12 Guide Signs for Intermediate Entry Points to Preferential Lanes**

### **Standard:**

**01 For barrier-separated, buffer-separated, and contiguous preferential lanes where entry is restricted only to designated points, an overhead Preferential Lane Entrance Direction sign shall be provided at intermediate entry points to the preferential lane from the general-purpose lanes.**

### *Guidance:*

*02 For barrier- and buffer-separated preferential lanes where intermediate entry from the general-purpose lanes is provided via a separate lane or ramp (see Figure 2G-9), at least one Advance Guide sign should be provided in addition to the Preferential Lane Entrance Direction sign.*

*03 For access-restricted preferential lanes where intermediate entrance and egress are at the same designated access location, the Preferential Lane Entrance Direction sign should be located between 1/2 and 1/4 of the length of the designated entry area, as measured from the downstream end of the entry area (see Figure 2G-10).*

**Standard:**

**04 The Advance Guide signs, if used for intermediate entry points to a preferential lane from the general purpose lanes, shall be overhead.**

**Option:**

*05 Advance Guide signs may be provided at approximately 1/2 mile, 1 mile, and 2 miles in advance of intermediate entry points from the general-purpose lanes to a preferential lane.*

**Standard:**

**06 Advance Guide and Preferential Lane Entrance Direction signs for intermediate entry points shall not include the word "EXIT" (see Section 2G.10).**

*Guidance:*

**Option:**

*07 Exit Destination guide signs, identifying the final destination and downstream exit locations accessible from the preferential lane, should may be installed in advance of intermediate entry points from the general-purpose lanes to access-restricted preferential lanes.*

**Support:**

*08 Section 2G.11 contains information on the design and placement of Preferential Lane Exit Destination guide signs.*

*09 Figures 2G-9 and 2G-10 show examples of signs for various geometric configurations of intermediate entry to a barrier- or buffer-separated preferential lane where access is restricted to designated locations.*

## **Section 2G.13 Guide Signs for Egress from Preferential Lanes to General-Purpose Lanes**

**Standard:**

**01 For barrier-separated, buffer-separated, and contiguous preferential lanes where egress is restricted only to designated points, post-mounted Advance Guide and post-mounted Intermediate Egress Direction signs (see Figure 2G-11) shall be installed in the median or on median barriers that separate two directions of traffic prior to and at the intermediate exit points from the preferential lanes to the general-purpose lanes (see Figure 2G-9).**

**02 The legends of these signs shall refer to the next exit or exits from the general-purpose lanes by displaying the appropriate destination information, exit number(s), or both. The Intermediate Egress Direction signs for egress from the preferential lanes to the general-purpose lanes shall not refer to the egress as an exit.**

**Support:**

*03 Section 2G.10 contains information on the design of post-mounted guide signs applicable to a preferential lane when installed on a median barrier. Figures 2G-9 and 2G-12 show examples of signs for various geometric configurations of intermediate egress from a barrier- or buffer-separated preferential lane where access is restricted to designated locations.*

*Guidance:*

*04 Where two or more adjacent preferential lanes are present in a single direction, consideration should be given to the use of overhead guide signs to display the information related to egress from the preferential lanes.*

*05 For barrier-separated and buffer-separated preferential lanes where egress from a preferential lane to the general-purpose lanes is restricted only to designated points via a separate lane or ramp, the Advance Guide and Intermediate Egress Direction signs for the egress should be mounted overhead and a Pull-Through sign should be mounted with the Intermediate Egress Direction sign (see Figure 2G-12).*

**Standard:**

**06 For preferential lanes that incorporate a vehicle occupancy requirement, the design of the overhead Advance Guide and Egress Direction signs for intermediate egress from the preferential lanes to the general-purpose lanes shall display a white diamond symbol on a black background at the left-hand edge of the signs.**

**07 The design of Pull-Through signs when used in conjunction with an Egress Direction sign at an intermediate egress from the preferential lanes to the general-purpose lanes shall be distinguished from those applicable to general-purpose lanes by inclusion of an upper section with the applicable black legend on a white background, such as HOV LANE. For preferential lanes that incorporate a vehicle occupancy requirement, the white diamond symbol on a black background shall be displayed at the left-hand edge of this upper section.**

### **Section 2G.14 Guide Signs for Direct Entrances to Preferential Lanes from Another Highway**

#### **Standard:**

**01 For direct access ramps to preferential lanes from a transit facility (such as a park - ride lot or a transit station or terminal) that is accessible from surface streets, advance guide signs shall be provided along the adjoining surface streets to direct traffic into and through the transit facility to the preferential lane (see Figure 2G-13).**

**01a The HOV Advance Lane Assignment (G20-9(CA)) sign (see Figure 2G-6(CA)) shall be used on a multilane cross street approaching a direct access ramp to an HOV lane to direct traffic into the proper lane to access the ramp.**

**01b The HOV LANE ENTRANCE (G92-1(CA)) sign (see Figure 2G-6(CA)) shall be used at the entrance to a direct access ramp to an HOV lane. The G92-1(CA) sign is similar to the FREEWAY ENTRANCE (D13-3)) sign and shall be installed similarly. Refer to Section 2A18 and 2B.41.**

#### **Support:**

**02 Figure 2G-14 2G-13 provides examples of recommended uses and layouts of signs for HOV lanes for direct access ramps, park - ride lots, and access from surface streets.**

### **Section 2G.15 Guide Signs for Direct Exits from Preferential Lanes to Another Highway**

#### **Standard:**

**01 For contiguous preferential lanes on the left-hand side of the roadway, Advance Guide signs, Exit Direction signs, and Exit Gore signs (see Figure 2G-14 and Figure 2G-14(CA)) specifically applicable to the preferential lanes shall be used for exits to direct access ramps, such as HOV lane ramps (see Figure 2G-15 2G-15(CA)) or ramps to park - ride facilities.**

**02 The design of Advance Guide, Exit Direction, and Pull-Through signs for direct exits from preferential lanes shall be distinguished from those applicable to general-purpose lanes by inclusion of an upper section with the applicable black legend on a white background, such as HOV LANE (for Pull-Through signs) or HOV EXIT (for Advance Guide and Exit Direction signs). For preferential lanes that incorporate a vehicle occupancy requirement, the white diamond symbol on a black background shall be displayed at the left-hand edge of this upper section (see Figures 2G-15 2G-15(CA) and 2G-16).**

**02a The HOV Supplemental Destination (G86-15(CA)) and HOV Advance Guide (G83-6(CA)) signs shall be used for Advance Guide signs for exits to direct access ramps from an HOV lane.**

**02b The HOV Exit Direction (G85-12(CA)) sign shall be used as the Exit Direction sign for exits to direct access ramps from an HOV lane.**

#### **Option:**

**02c If an auxiliary lane is not used in advance of the direct access ramp, the G83-6(CA) sign and the W61C(CA) panel on the G85-12(CA) sign may be eliminated.**

#### **Standard:**

**02d The HOV Exit with Arrow (E8-4) sign shall be used as the Exit Gore sign for exits to direct access ramps from an HOV lane.**

#### **Guidance:**

**02e The arrow on the E8-4 sign should be aligned to approximately the angle of departure and should be positioned to avoid confusion that the exit may serve general purpose traffic.**

**03 Advance Guide ~~and Exit Direction~~ signs for exits to direct access ramps from a preferential lane should be mounted overhead. A Pull-Through sign should be used with the Exit Direction sign at exits to direct access ramps.**

#### **Standard:**

**03a Exit Direction signs for exits to direct access ramps from a preferential lane shall be mounted overhead.**

**04 Post-mounted guide signs in a vertical rectangular shape installed on a median barrier shall not be used for the ~~Advance Guide and Exit Direction~~ signs for exits to direct access ramps.**

**05 Because direct access ramps for preferential lanes at interchanges connecting two freeways are typically left-hand side exits and typically have design speeds similar to the preferential lane, overhead Advance Guide signs and overhead Exit Direction signs shall be provided in advance of and at the entry point to each freeway-to-freeway preferential lane ramp (see Figure 2G-16).**

*Guidance:*

*06 The use of guide signs for preferential lanes at freeway interchanges should comply with the provisions for guide signs established in this Manual.*

**Support:**

**07 Guide signs for direct access ramps for preferential lanes at interchanges connecting two freeways are similar to those for a connecting ramp between two freeway facilities.**

## **Section 2G.16 Signs for Priced Managed Lanes – General**

**Support:**

**01 A priced managed lane is a managed lane that employs tolling or pricing, typically through electronic toll collection, to manage congestion levels and maintain a certain level of service for users of the facility. A priced managed facility typically provides a less congested alternative to adjacent lanes along the same designated route, or to a nearby facility, that experience recurring congestion during peak periods. A priced managed lane might allow non-toll travel by certain vehicles based on occupancy or other criteria. A variety of operational management strategies might be used in conjunction with tolling or pricing.**

**02 The number and combination of operational strategies that are applied to a managed lane to manage congestion or improve efficiency might be practically limited by the amount of information that can be legibly displayed on signs or in signing sequences and still be readily comprehended by road users. Such factors to consider when evaluating alternatives for managed lanes are locations of signs for general-purpose interchanges and for other roadway conditions, the number of intermediate access points between the managed and general-purpose lanes and the need to repeat the operational information, and the distance over which a signing sequence that displays all of the eligibility requirements can be displayed.**

**03 Because managed lanes have the capability to employ a variety of operational strategies on a changing basis, it is not practical to assign a naming convention to such lanes for the purpose of signing based on the specific operational management strategies, as is more readily accomplished with other types of preferential lanes, such as HOV, Bus, or Bike lanes. Instead, the various requirements, restrictions, and eligibility criteria are more appropriately conveyed through a sequence of regulatory and guide signs with a more encompassing designation for the purpose of providing directional information.**

**04 As priced managed lanes become more prevalent as an operational strategy, it will be important to establish a uniform naming convention to distinguish those lanes that are an alternative to travel on adjacent general-purpose lanes on the same designated route to effectively communicate to motorists the range of basic requirements for similar facilities in different regions.**

**Standard:**

**05 Priced managed lanes that are adjacent to general-purpose lanes along the same designated route shall be signed using the legend EXPRESS or EXPRESS LANE(S). This provision shall apply when any of the following operational strategies is used for a managed lane:**

- A. All users of the managed lane are charged a fixed or variable toll;**
- B. General-purpose traffic using the managed lane is charged a fixed or variable toll, but HOV traffic is allowed to travel without being charged a toll on either a full- or part-time basis;**
- C. General-purpose traffic using the managed lane is charged a fixed or variable toll, but HOV traffic is offered a discounted toll on either a full- or part-time basis; or**
- D. General-purpose traffic using the managed lane is charged a fixed or variable toll, but HOV traffic registered with a local program travels at a discounted toll or without being charged a toll on either a full- or part-time basis (a transponder or other identifier is typically required of HOVs to indicate registration in conjunction with electronic or visual enforcement and verification of vehicle occupancy).**

**06 The legends EXPRESS and EXPRESS LANE(S) shall not be used on signs for entrances to highways on which all lanes are managed and there are no adjacent general-purpose lanes on the same designated route. The legends EXPRESS and EXPRESS LANE(S) shall not be used on signs for a managed ramp connection that provides an alternative to a general-purpose ramp connection (see Figure 2F-7), except where the ramp leads directly to a managed lane as described in Section 2G.14. The legends EXPRESS and EXPRESS LANE(S) shall not be used on signs for open-road tolling lanes that bypass a conventional toll plaza (see Chapter 2F).**

**07 The diamond symbol shall be reserved exclusively for preferential lanes whose operational strategy is occupancy-based only (see Sections 2G.03 through 2G.14) and shall not be used to designate a managed lane in which other operational strategies, such as tolling and pricing, are employed to allow general-purpose traffic to use the lane.**

## **Section 2G.17 Regulatory Signs for Priced Managed Lanes**

### **Standard:**

**01 Except as otherwise provided in this Section, the provisions of Sections 2G.03 through 2G.07 regarding regulatory signs for Preferential lanes shall apply to priced managed lanes operated at all times or at certain times with a toll payment requirement of some or all vehicles to use the lane(s). Such managed lanes shall use changeable message signs or changeable message elements within static signs to display the appropriate regulatory sign messages only when they are in effect.**

**02 Regulatory signs for preferential lanes shall be appropriately modified for adaptation to a priced managed lane, where applicable, as shown in Figure 2G-17.**

**03 Regulatory signs shall be used to indicate the toll charged. If the toll varies, regulatory signs that include changeable message elements, such as the R3-48 and R3-48a signs that are shown in Figure 2G-17, shall be used to display the actual toll amount in effect at any given time.**

**04 When only vehicles with a registered ETC account are allowed to use a managed lane where some or all vehicles are charged a toll, regulatory signs to indicate such a restriction shall be provided and shall incorporate the pictograph adopted by the toll facility's ETC payment system and the word ONLY (see Section 2G.18 for the incorporation of such regulatory legends into the guide signs for the entrances to such facilities). The display of the ETC system pictograph shall comply with the provisions of Sections 2F.03 and 2F.04 as shown in Figures 2G-17 and 2G-18.**

**05 When HOV traffic is allowed to use a priced managed lane without paying a toll and registration in a local program is not required to receive the toll exemption, the Vehicle Occupancy Definition (R3-10 (R93-2(CA)) or R3-13) signs (see Section 2G.04) shall be modified to delete the diamond symbol to create priced managed lane Vehicle Occupancy Definition (R3-40 and R3-43) signs to indicate the minimum occupancy related to the management strategy (see Figure 2G-17).**

**06 A priced managed lane Periods of Operation (R3-44 or R3-44a) sign (see Figure 2G-17) shall be installed at the beginning or initial entry point, and at any intermediate entry points where vehicles are allowed to legally enter an access-restricted priced managed lane.**

**07 When the vehicle occupancy required for non-toll use of a managed lane is varied as a part of a priced managed lane operational strategy, regulatory signs that include changeable message elements shall be used to display the required vehicle occupancy in effect for non-toll travel.**

### **Option:**

**08 Where registration in a local program or ETC account is required for HOV traffic to travel in a priced managed lane without being charged a toll or by being charged a discounted toll, such information may be displayed on a separate sign within the sequence of the required regulatory and guide signs.**

### **Guidance:**

*08a No more than two destinations should be shown on the R3-48 or R3-48a sign. If multiple destinations are used, one of these destinations should be the furthest destination on the facility; the other destination(s) should be an intermediate interchange. The particular intermediate interchange to be shown on the R3-48 or R3-48a sign should be determined on a case-by-case basis, depending upon local factors including the relative importance of the intermediate interchanges.*



**Standard:**

**09 R3-42 Series and R3-45 Series signs (see Figure 2G-17) shall be installed in accordance with the provisions of Section 2G.07 to indicate the termination of a priced managed lane or restriction. The R3-42, R3-42a, and R3-45 signs shall be used only where the managed lane and restriction end and traffic must merge into the general-purpose lanes. The R3-42b, R3-42c, and R3-45a signs shall be used only where the managed lane restriction ends and the lane becomes a general-purpose lane.**

**Section 2G.18 Guide Signs for Priced Managed Lanes**

**Standard:**

**01 Except as otherwise provided in this Section, guide signs for barrier-separated, buffer-separated, and contiguous managed lanes shall follow the specific provisions for Preferential Lane guide signs contained in Sections 2G.10 through 2G.15. Except as otherwise provided in this Section, guide signs for highways on which all lanes are managed shall follow the general provisions for freeway and expressway guide signs as contained in Chapter 2E as a whole. Guide signs for highways on which all lanes are managed and tolling or pricing is used as a management strategy shall follow the applicable provisions for toll road guide signs as contained in Chapter 2F, in addition to the general provisions of Chapter 2E.**

**02 If fixed or variable tolls are used as an operational strategy for a managed lane, the guide signs shall comply with the provisions of Sections 2F.03, 2F.04, and 2F.17 regarding the use, size, and placement of ETC-account pictographs.**

**Support:**

**03 Figure 2G-18 shows examples of Guide signs for entrances to priced managed lanes and other ETC account-only toll facilities that incorporate header panels with ETC account pictographs and regulatory legends.**

***Guidance:***

***Option:***

**04 Exit Destination supplemental guide signs, identifying final destination and downstream exit locations accessible from the managed lane (see Figure 2G-19), ~~should~~ **may** be installed in advance of the initial entry points to priced managed lanes. ~~These signs should be located in accordance with the provisions of Paragraph 5 of Section 2G.11.~~**

***Guidance:***

**04a *Exit Destination supplemental guide signs should be located in accordance with the provisions of Paragraphs 5 and 6 of Section 2G.11.***

***Option:***

**05 For managed lanes that are available as an alternative to travel on adjacent general-purpose lanes on the same designated route, changeable message signs indicating the comparative travel times or congestion levels using the managed lanes versus the general-purpose lanes (see Figure 2G-20) ~~should~~ **may** be installed in advance of the initial and intermediate entry points to the managed lanes.**

***Option:***

**06 Changeable message signs may also be used on non-managed highways to display comparative travel times or congestion levels for a nearby managed highway.**

**Standard:**

**07 Guide signs at the initial and intermediate entry points to a priced managed lane in which all general-purpose passenger vehicles are allowed shall include the legend EXPRESS or EXPRESS LANE(S). The guide signs shall incorporate the pictograph of the ETC account system into a header panel within the guide sign in accordance with Sections 2F.03, 2F.04, and 2F.17. For a priced managed lane that allows non-toll travel by HOV traffic without registration in a local program, the header panel shall be modified to a regulatory format to display both the pictograph of the ETC account system and the minimum occupancy requirement for non-toll travel with a black legend on a white background (see Figure 2G-19).**

**08 Guide signs at the initial and intermediate entry points to a managed lane that allows only HOV traffic with either a fixed or variable occupancy requirement shall follow the provisions of Sections 2G.10 through 2G.12 and 2G.14.**

**Support:**

<sup>09</sup> Figures 2G-21 through 2G-24 show examples of guide signs for various configurations of initial and intermediate entrances to a priced managed lane.

**Standard:**

<sup>10</sup> **The use and locations of guide signs for intermediate egress locations and direct exits from a priced managed lane (see Figures 2G-24 through 2G-27) shall comply with the provisions of Sections 2G.13 and 2G.15. The signs shall be suitably modified to display header messages of white legend on a green background that relate the guide sign legends to the managed lane(s) as appropriate in accordance with the following:**

- A. Post-mounted or overhead-mounted Advance Guide signs for intermediate egress to the general-purpose lanes shall include the legend LOCAL EXITS in a header panel within the guide signs, destination information or the exit number(s) for the next exit(s) accessible from the general-purpose lanes, and the appropriate distance information to the location of the egress (see Figures 2G-24 and 2G-25).**
- B. Post-mounted or overhead-mounted Intermediate Egress Direction signs shall include the legend LOCAL EXITS in a header panel within the signs, the destination information or the exit number(s) of the next exit(s) accessible from the general-purpose lanes, and a diagonally upward-pointing directional arrow (see Figures 2G-24 and 2G-25).**
- C. For direct exits to another roadway, the legend EXPRESS EXIT shall be used on the Advance Guide and Exit Direction signs (see Figure 2G-26).**
- D. For pull-through signs, the legend EXPRESS LANE(S) shall be used, either as a header panel within the pull-through sign or as the principal legend of the sign without a header panel (see Figures 2G-25, 2G-26, and 2G-27).**

**Support:**

<sup>11</sup> Section 2G.13 contains information on the use of overhead-mounted guide signs for intermediate egress to the general-purpose lanes.

<sup>12</sup> Figures 2G-28 and 2G-29 show examples of guide signing for direct entrances to a priced managed lane from a crossroad or surface street.

**Standard:**

<sup>12a</sup> **The G92-1(CA) sign shall be used for direct entrances to a priced managed lane from a crossroad or surface street. When used for this purpose the sign shall be modified in accordance with the provisions of this section.**

## **Section 2G.101(CA) Preferential Lane Enforcement Signing (SR50(CA)) series**

*Guidance:*

<sup>01</sup> *The HOV VIOLATION \$\_\_ MINIMUM FINE (SR50-2(CA)) sign should be placed near the beginning of all HOV facilities and may be placed at intermediate entry point or gaps in the barrier or buffer for all barrier- or buffer-separated HOV lanes.*

<sup>02</sup> *The SR50-2(CA) sign should also be used on priced managed lane facilities that charge HOV users no toll or a discounted toll.*

*Option:*

<sup>03</sup> *The SR50-2(CA) sign may be repeated at 2-mile intervals or as needed at locations experiencing high violation rates.*

<sup>04</sup> *The HOV VIOLATION \$\_\_ MINIMUM FINE (SR50-1(CA)) sign may be used to supplement the SR50-2(CA) sign on HOV facilities or priced managed lane facilities where violation rates are particularly high.*

**Support:**

<sup>05</sup> *The SR50-1(CA) is normally placed onto an existing overhead sign structure if it can adequately support the additional sign.*

**Standard:**

<sup>06</sup> **These signs shall be modified to delete the diamond symbol when utilized on priced managed lanes.**

## **Section 2G.102(CA) Regulatory Signs for Preferential Lanes at Metered On-Ramps**

**Support:**

<sup>01</sup> *For State highways, see Caltrans' Ramp Metering Design Manual. See Section 1A.11 for information regarding this publication.*

- 02 Refer to CVC 21655.5 for Exclusive- or Preferential-Use Lanes for High Occupancy Vehicles.
- 03 Refer to Section 2B.56 for additional regulatory signs to be used at metered on-ramps.

*Guidance:*

04 *The No Left Turn Specific Hours EXCEPT BUSES AND HOV \_\_+(R33B(CA)) sign should be installed on local streets (with concurrence of local agency) whenever left turns are restricted to buses and high-occupancy vehicles only during peak hours. The No Left Turn WHEN METERED EXCEPT BUSES AND HOV \_\_+ (R33C(CA)) sign should be installed on local streets (with concurrence of local agency) whenever left turns are restricted to buses and high-occupancy vehicles only during periods of ramp metering.*

**Standard:**

05 **The LEFT (RIGHT OR CENTER) LANE DO NOT STOP (BUSES ONLY) (R88(CA)) sign shall be used for preferential lanes at metered on-ramps to indicate that the preferential lane is not required to stop.**

- 06 **The diamond symbol shall not be utilized on the R88(CA) if the preferential lane is not for HOV usage.**

*Guidance:*

- 07 *The R88(CA) sign should be placed on the same side as the preferential lane, upstream of the meter.*
- 08 *The ALL VEHICLES STOP ON RED (R90-1(CA)) sign should be placed when converting a non-metered preferential lane to a metered operation.*

*Option:*

- 09 *The R90-1(CA) sign may also be used on new installations where potential for confusion exists.*

**Standard:**

10 **The LEFT (RIGHT OR CENTER) HOV \_\_+ \_\_ OR MORE ONLY WHEN METERED (R91-1(CA)) sign shall be used for preferential lanes at metered on-ramps to clearly indicate the lane and number of persons per vehicle required to use the lane.**

11 **The message "24 HOURS" shall be used instead of "WHEN METERED" if the preferential lane is in effect on a full-time basis.**

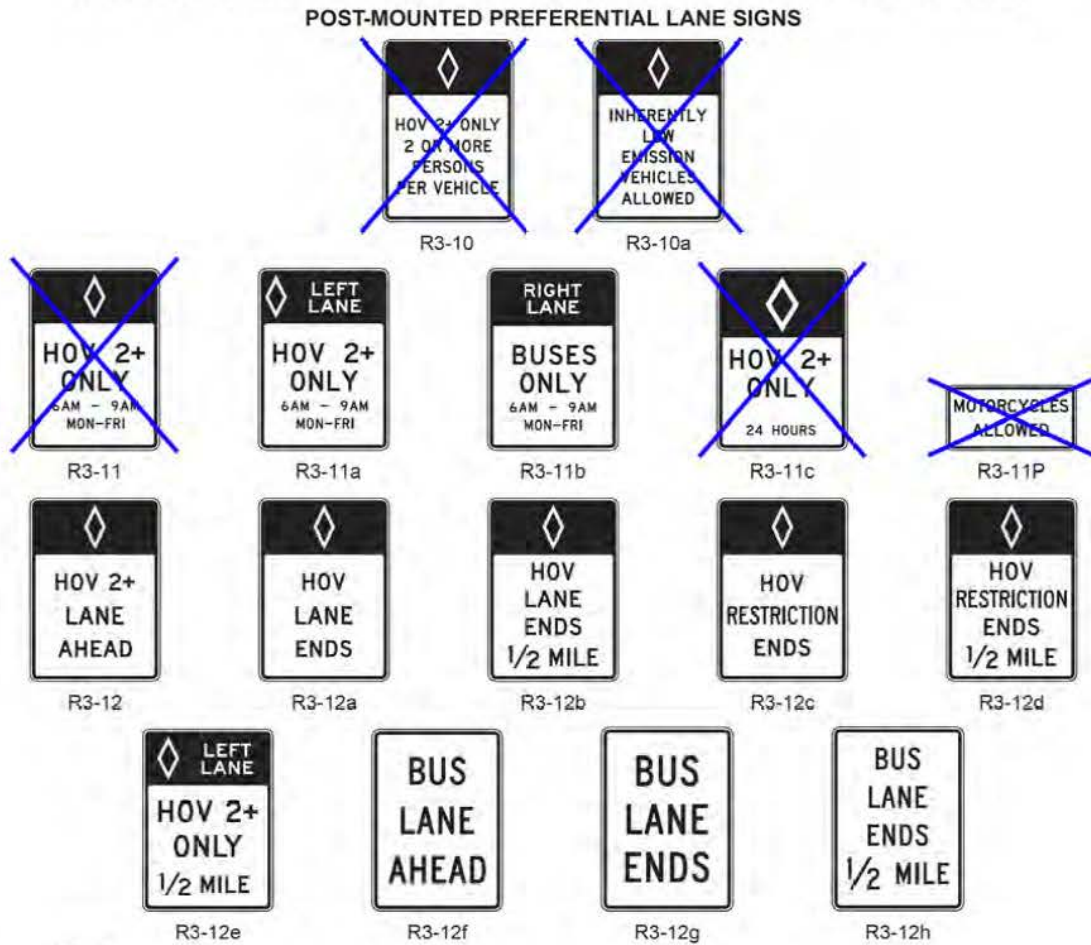
*Option:*

12 *An alternate 1 line message, such as "BUSES OK" may also be used in place of "WHEN METERED" on line 6 of the R91-1(CA) sign.*

*Guidance:*

- 13 *When used, the R91-1(CA) sign should be placed near a diamond symbol pavement marking.*

**Figure 2G-1. Preferential Lane Regulatory Signs and Plaques (Sheet 1 of 2)**

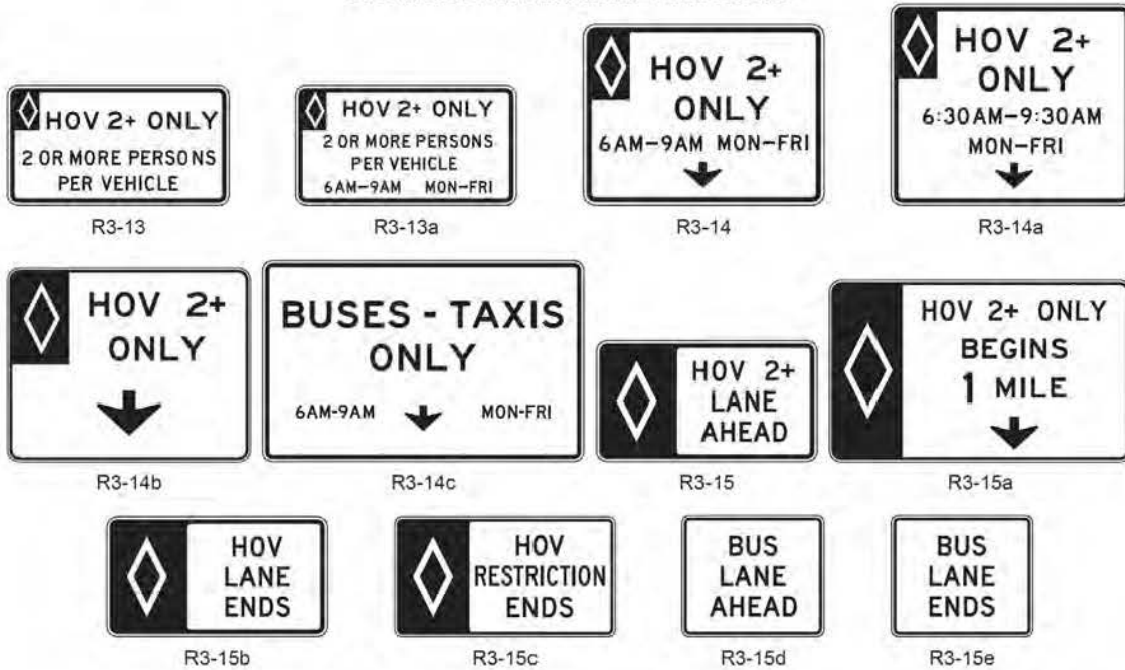


**Notes:**

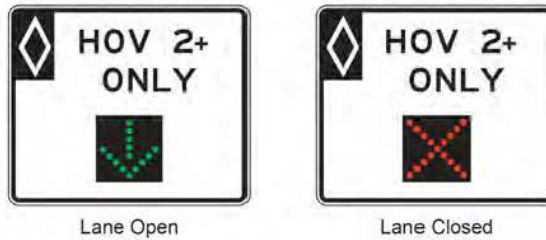
1. The minimum vehicle occupancy requirement may vary for each facility (such as 2+, 3+, 4+).
2. The occupancy requirement may be added to the first line of the R3-12a, R3-12b, R3-12c, and R3-12d signs.
3. Some of the legends shown on these signs are for example purposes only. The specific legend for a particular application should be based upon local conditions, ordinances, and State statutes.

**Figure 2G-1. Preferential Lane Regulatory Signs and Plaques (Sheet 2 of 2)**

**OVERHEAD PREFERENTIAL LANE SIGNS**



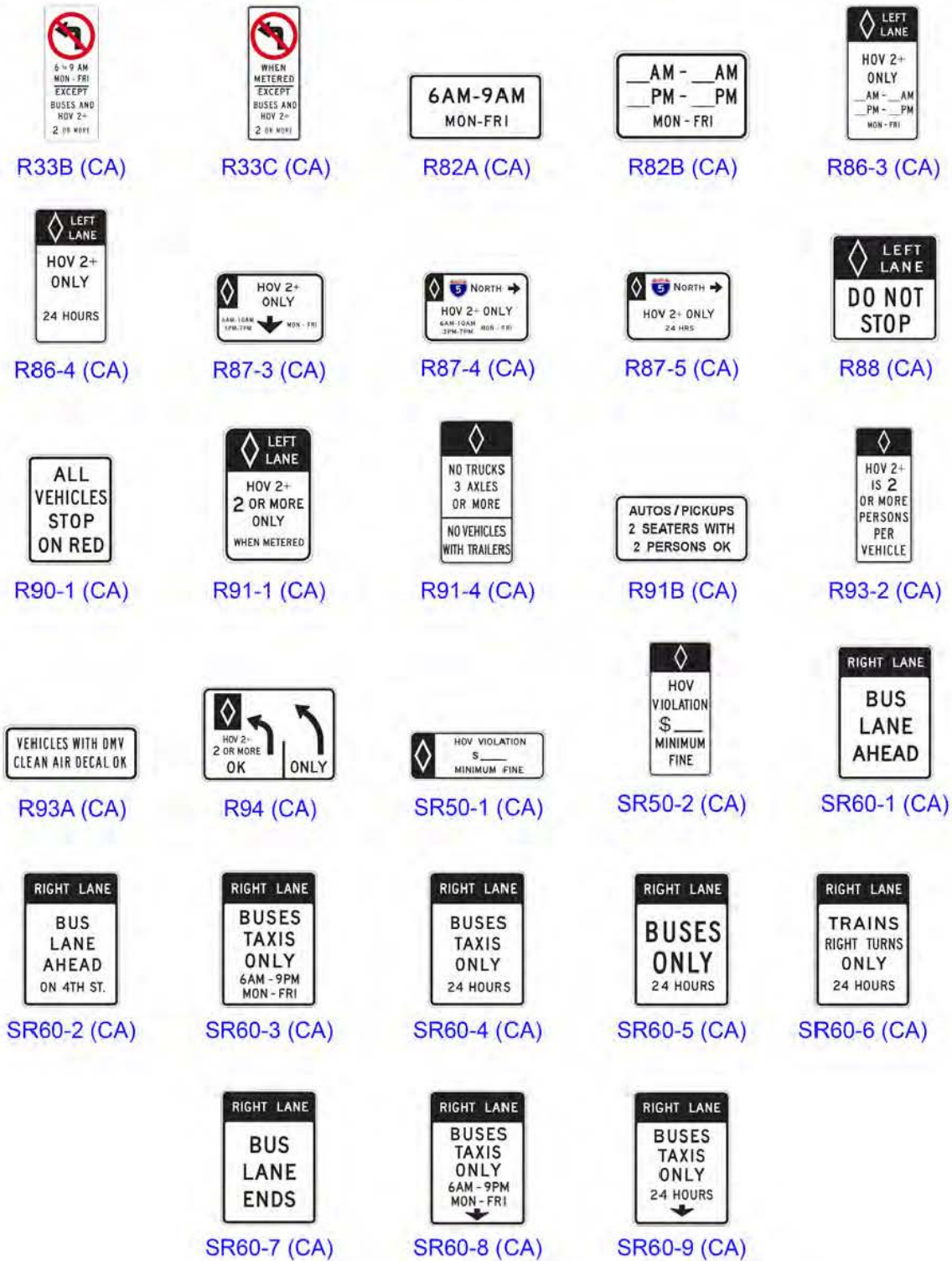
A lane-use control signal may be incorporated into an overhead preferential lane regulatory sign to indicate the status of a reversible operation as shown in the following example:



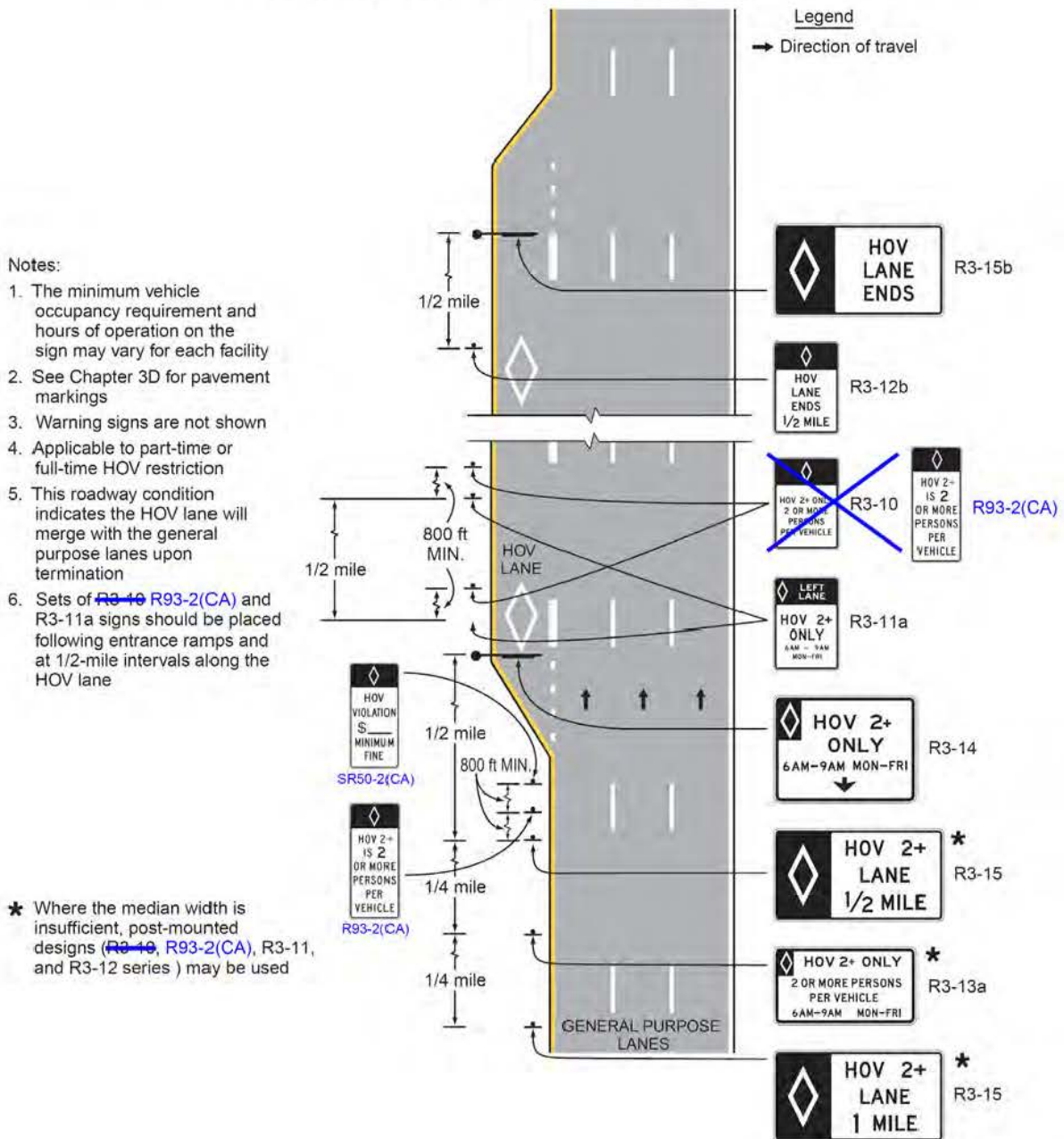
**Notes:**

1. The minimum vehicle occupancy requirement may vary for each facility (such as 2+, 3+, 4+).
2. The occupancy requirement may be added to the first line of the R3-15b and R3-15c signs.
3. Some of the legends shown on these signs are for example purposes only. The specific legend for a particular application should be based upon local conditions, ordinances, and State statutes.
4. Where sufficient median width is available, the R3-13 series and R3-15 series signs may be post-mounted.

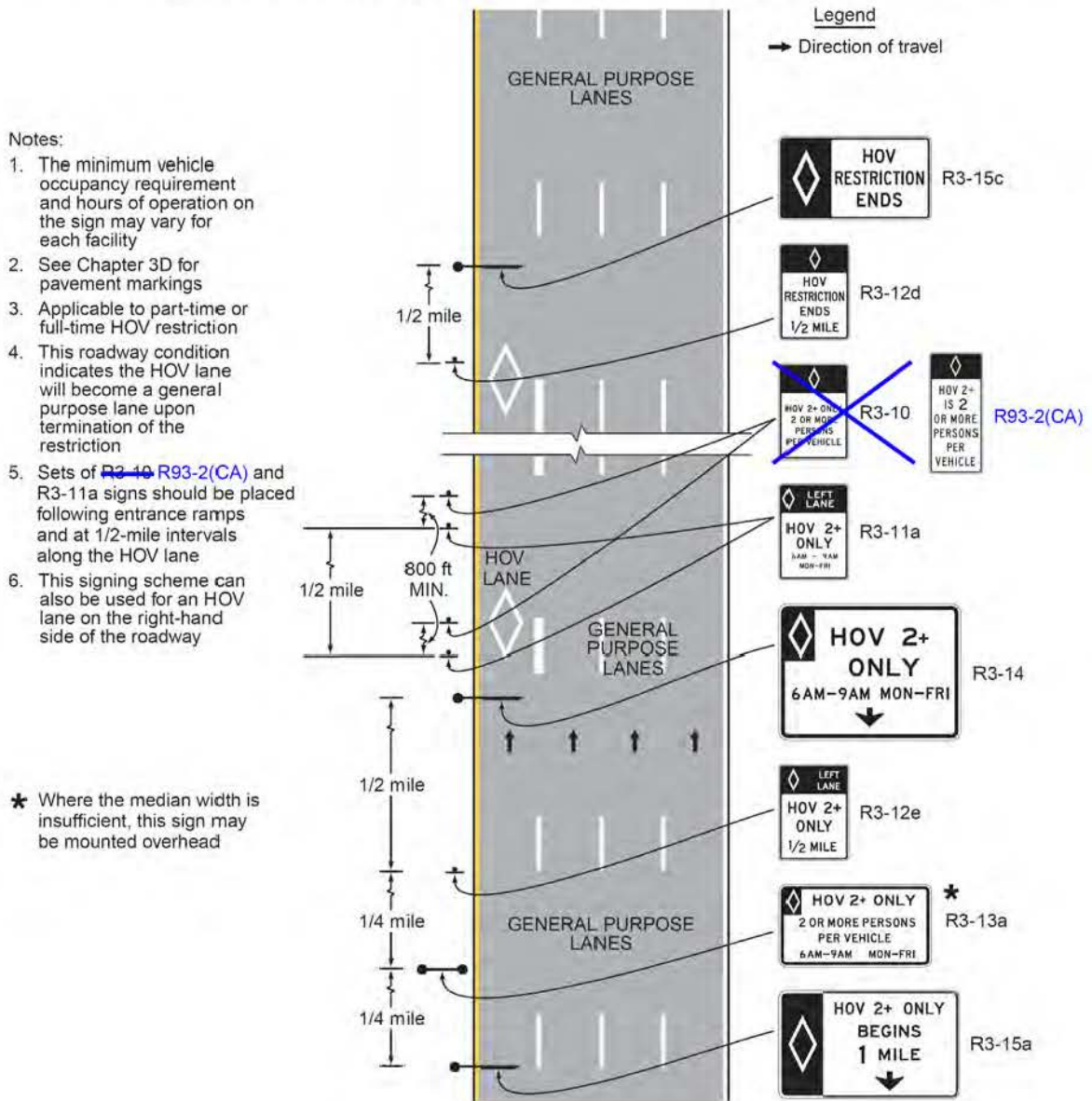
**Figure 2G-1 (CA). Preferential Lane Regulatory Signs and Plaques**



**Figure 2G-2. Example of Signing for an Added Continuous-Access Contiguous or Buffer-Separated HOV Lane**



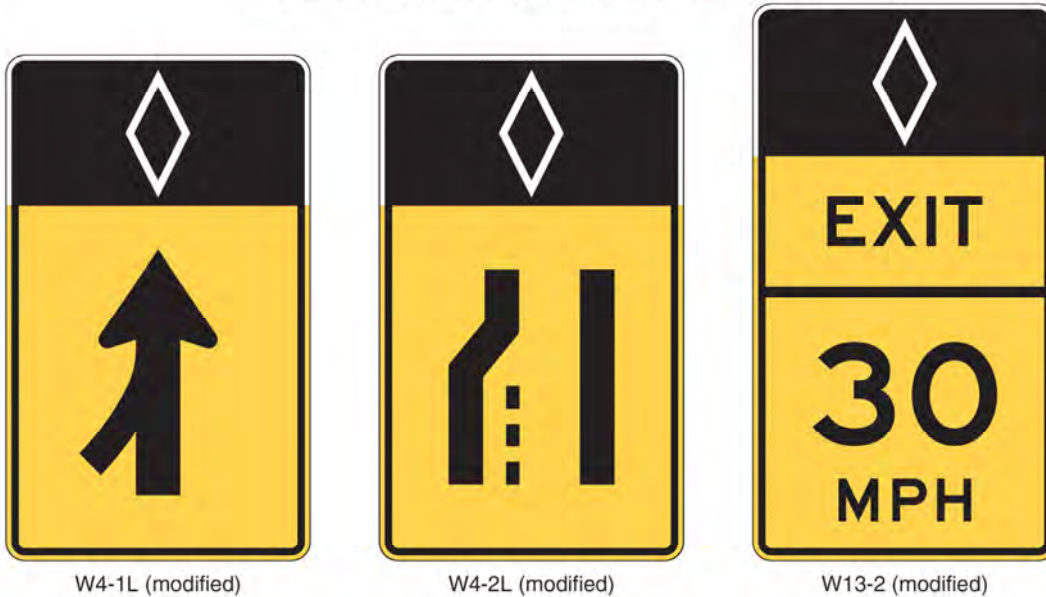
**Figure 2G-3. Example of Signing for a General-Purpose Lane that Becomes a Continuous-Access Contiguous or Buffer-Separated HOV Lane**





**Figure 2G-4. Examples of Warning Signs and Plaques Applicable Only to Preferential Lanes**

**A - BARRIER-MOUNTED RECTANGULAR WARNING SIGNS**



**B - WARNING PLAQUE FOR USE ABOVE STANDARD DIAMOND-SHAPED WARNING SIGNS**



W16-11P

Note: An HOV lane example (diamond symbol) is illustrated. For other types of preferential lanes, the appropriate symbol or word message (see Section 2G.03) shall be displayed in white on the black background of the top portion of these signs.

**Figure 2G-4 (CA). Examples of Warning Signs and Plaques Applicable Only to Preferential Lanes**



**Figure 2G-5. Example of an Overhead Advance Guide Sign for a Preferential Lane Entrance**



E8-3

Note: An example of an HOV Lane (diamond symbol) sign is illustrated. For other types of preferential lanes, the appropriate symbol or word message (see Section 2G.03) is displayed in white on the black background of the left-hand portion of this sign.

**Figure 2G-6. Examples of Overhead or Post-Mounted Preferential Lane Entrance Direction Signs**



E8-2  
(overhead only)



E8-2a  
(post-mounted only)

A changeable message sign may be incorporated into an overhead preferential lane guide sign to indicate the status of a reversible operation as shown in the following example:



Lane Open



Lane Closed

Note: Examples of HOV Lane (diamond symbol) signs are illustrated. For other types of preferential lanes, the appropriate symbol or word message (see Section 2G.03) is displayed in white on the black background of the top left-hand portion of these signs.

**Figure 2G-6 (CA). Guide Signs for Direct Entrances to Preferential Lanes From Another Highway**



G92-1 (CA)



G20-9 (CA)

---

**Figure 2G-7. Entrance Gore Signs for Barrier-Separated Preferential Lanes**



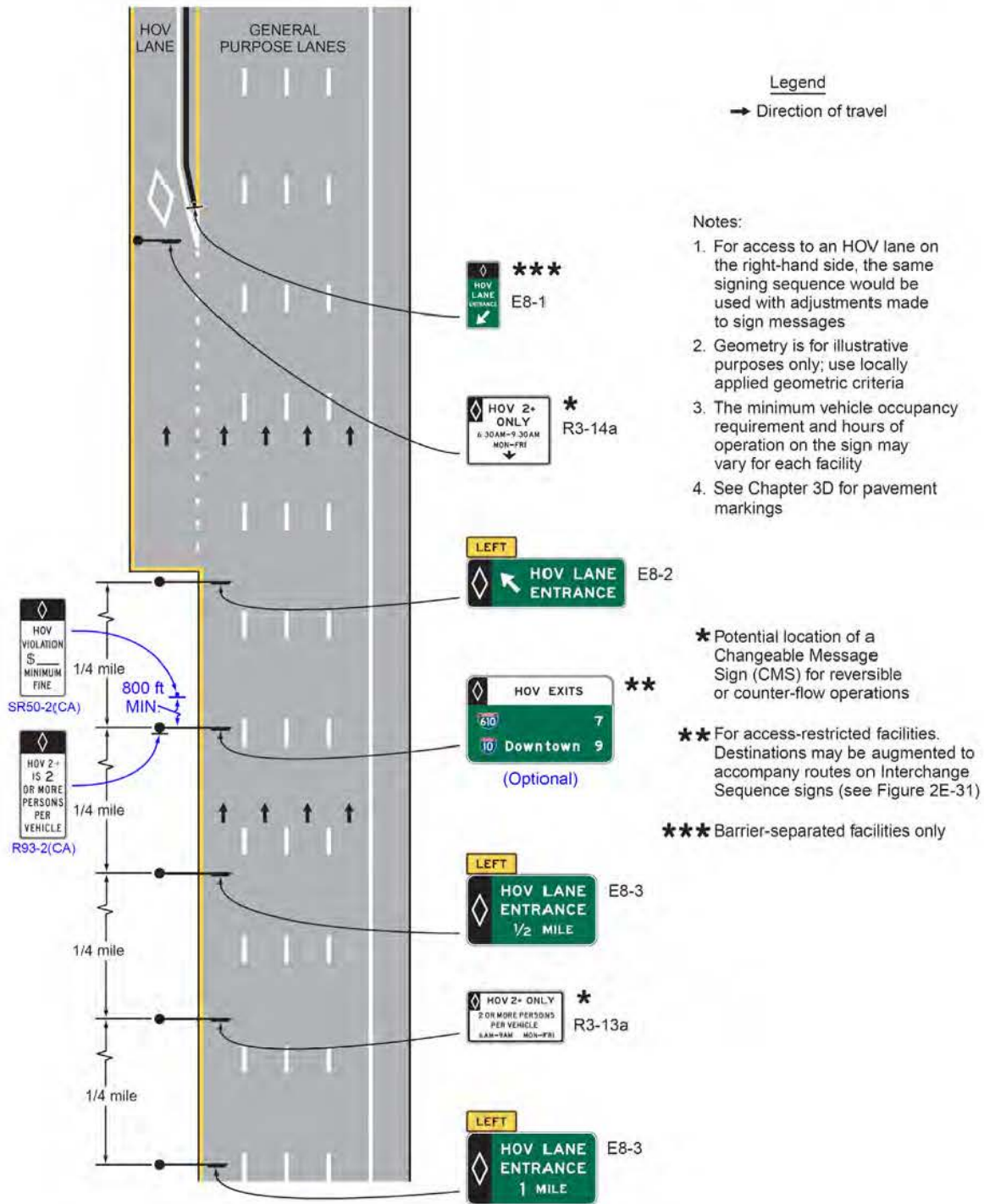
E8-1



E8-1a

Note: Examples of HOV Lane (diamond symbol) signs are illustrated. For other types of preferential lanes, the appropriate symbol or word message (see Section 2G.03) is displayed in white on the black background of the top portion of these signs.

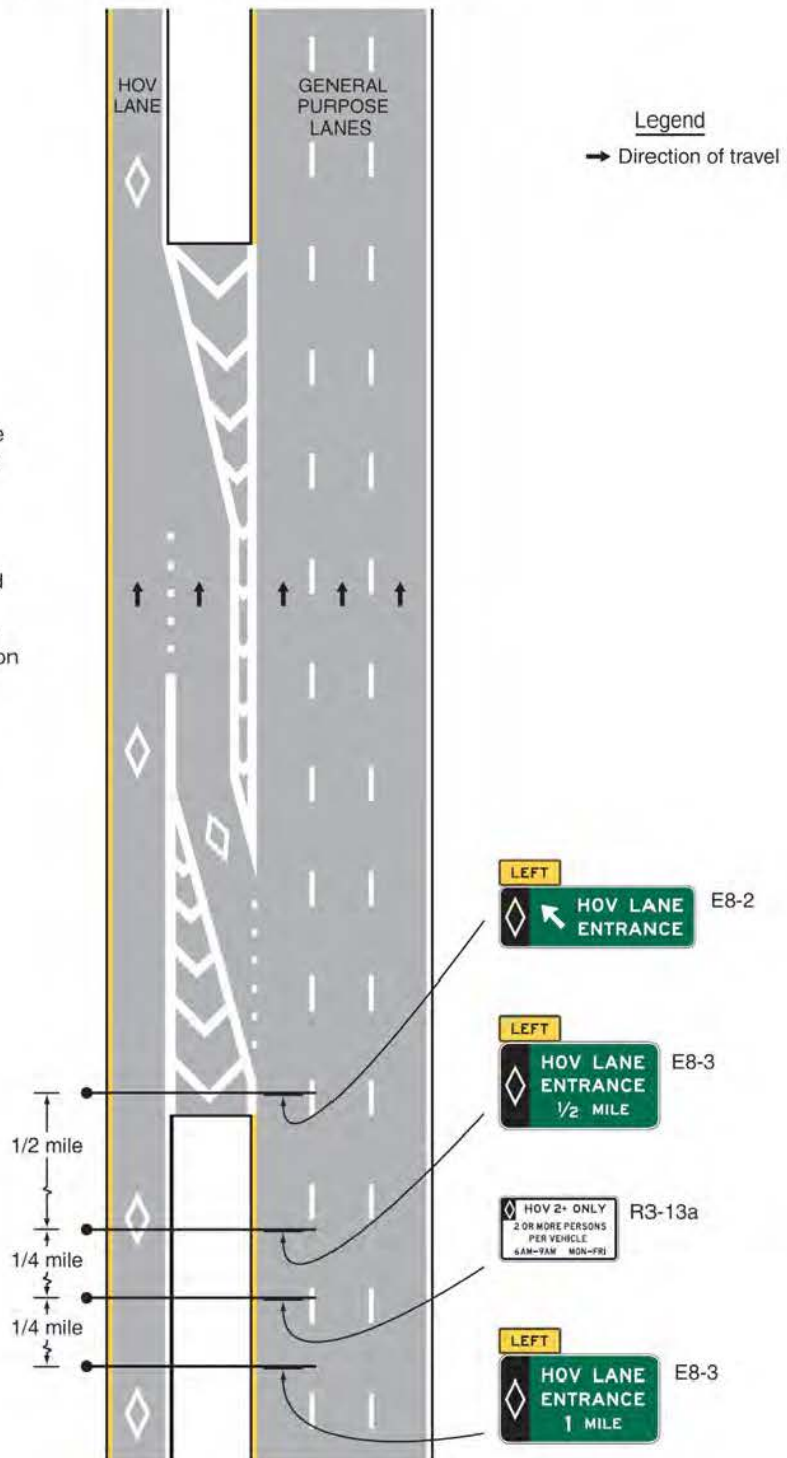
**Figure 2G-8. Example of Signing for an Entrance to Access-Restricted HOV Lanes**



**Figure 2G-9. Example of Signing for an Intermediate Entry to a Barrier- or Buffer-Separated HOV Lane**

**Notes:**

1. For access to an HOV lane on the right-hand side, the same signing sequence would be used with adjustments made to sign messages
2. Geometry is for illustrative purposes only; use locally applied geometric criteria
3. The minimum vehicle occupancy requirement and hours of operation on the sign may vary for each facility
4. See Chapter 3D for pavement markings.
5. Warning signs are not shown

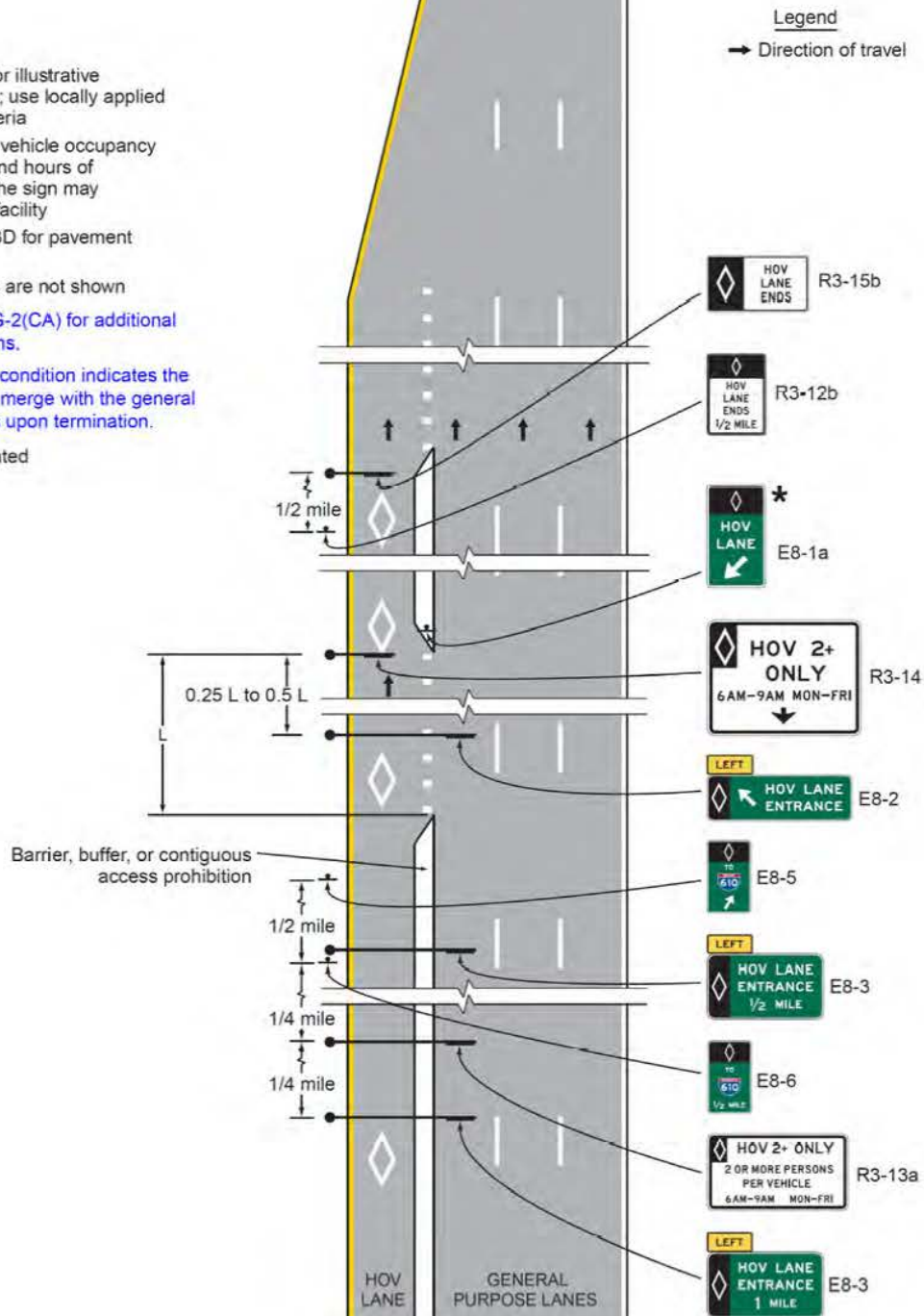


**Figure 2G-10. Example of Signing for the Intermediate Entry to, Egress from, and End of Access-Restricted HOV Lanes**

Notes:

1. Geometry is for illustrative purposes only; use locally applied geometric criteria
2. The minimum vehicle occupancy requirement and hours of operation on the sign may vary for each facility
3. See Chapter 3D for pavement markings
4. Warning signs are not shown
5. See Figure 2G-2(CA) for additional regulatory signs.
6. This roadway condition indicates the HOV lane will merge with the general purpose lanes upon termination.

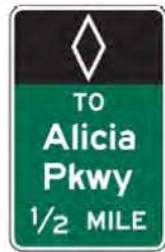
\* Barrier-separated facilities only



**Figure 2G-11. Examples of Barrier-Mounted Guide Signs for an Intermediate Egress from Preferential Lanes**



E8-5



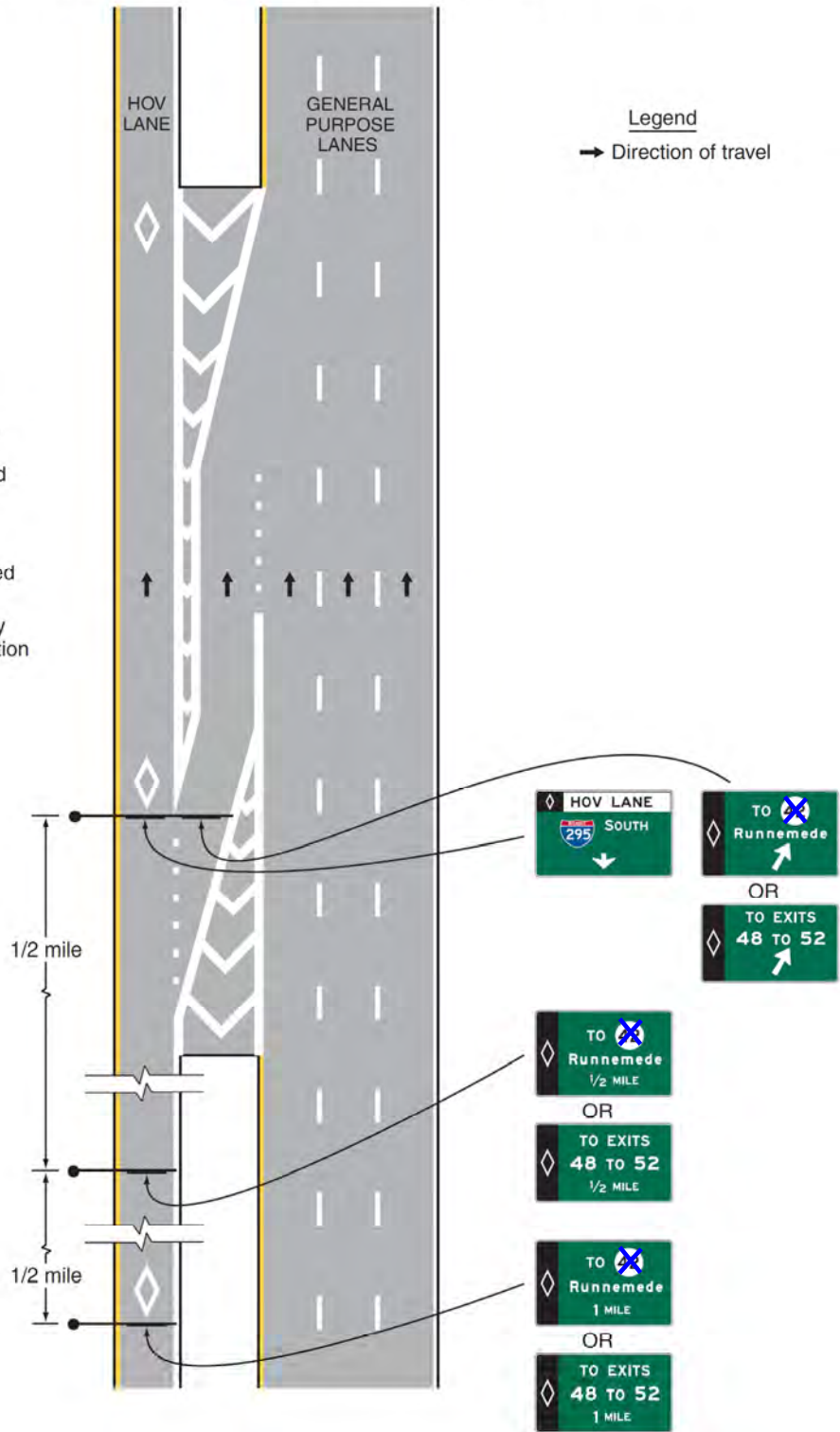
E8-6

Note: Examples of HOV Lane (diamond symbol) signs are illustrated. For other types of preferential lanes, the appropriate symbol or word message (see Section 2G.03) is displayed in white on the black background of the top portion of these signs.

**Figure 2G-12. Examples of Signs for an Intermediate Egress from a Barrier- or Buffer-Separated HOV Lane**

Notes:

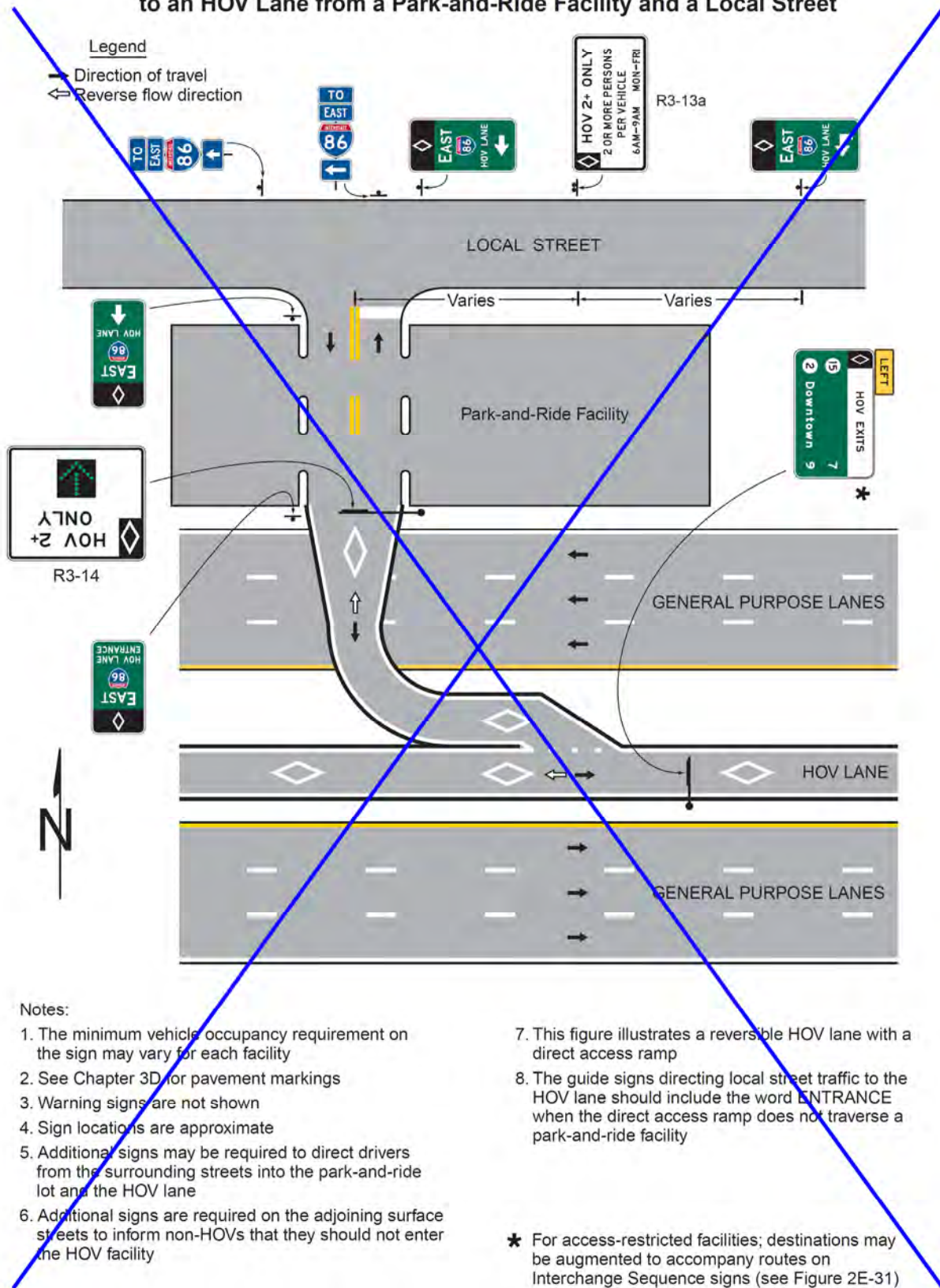
1. For an exit on the left-hand side from an HOV lane, the same signing sequence would be used with adjustments made to sign messages
2. Geometry is for illustrative purposes only; use locally applied geometric criteria
3. The minimum vehicle occupancy requirement and hours of operation on the sign may vary for each facility
4. See Sections Chapter 3D for pavement markings
5. Warning signs are not shown



Note: For Guide Sign Assemblies use California State Route (G28-1(CA)) and US Route (G26-1(CA)) shields.



**Figure 2G-13. Example of Signing for a Direct Entrance Ramp to an HOV Lane from a Park-and-Ride Facility and a Local Street**



**Figure 2G-14. Exit Gore Sign for a Direct Exit from a Preferential Lane**



E8-4

Note: An example of an HOV Lane (diamond symbol) sign is illustrated. For other types of preferential lanes, the appropriate symbol or word message (see Section 2G.03) is displayed in white on the black background of the top portion of this sign.

**Figure 2G-14 (CA). Advanced Guide and Exit Direction Sign for a Direct Exit from a Preferential lane**



G83-6 (CA)

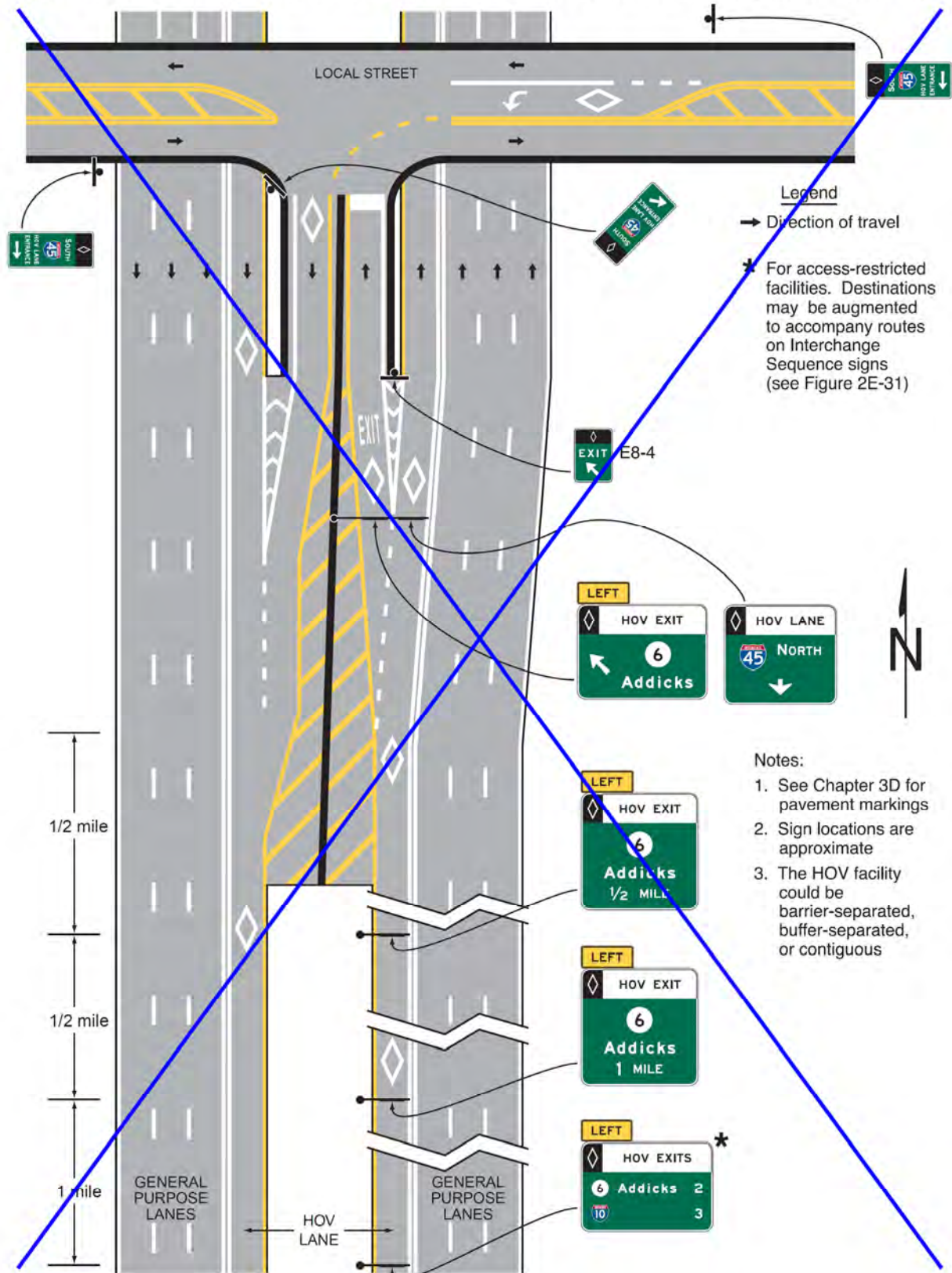


G85-12 (CA)

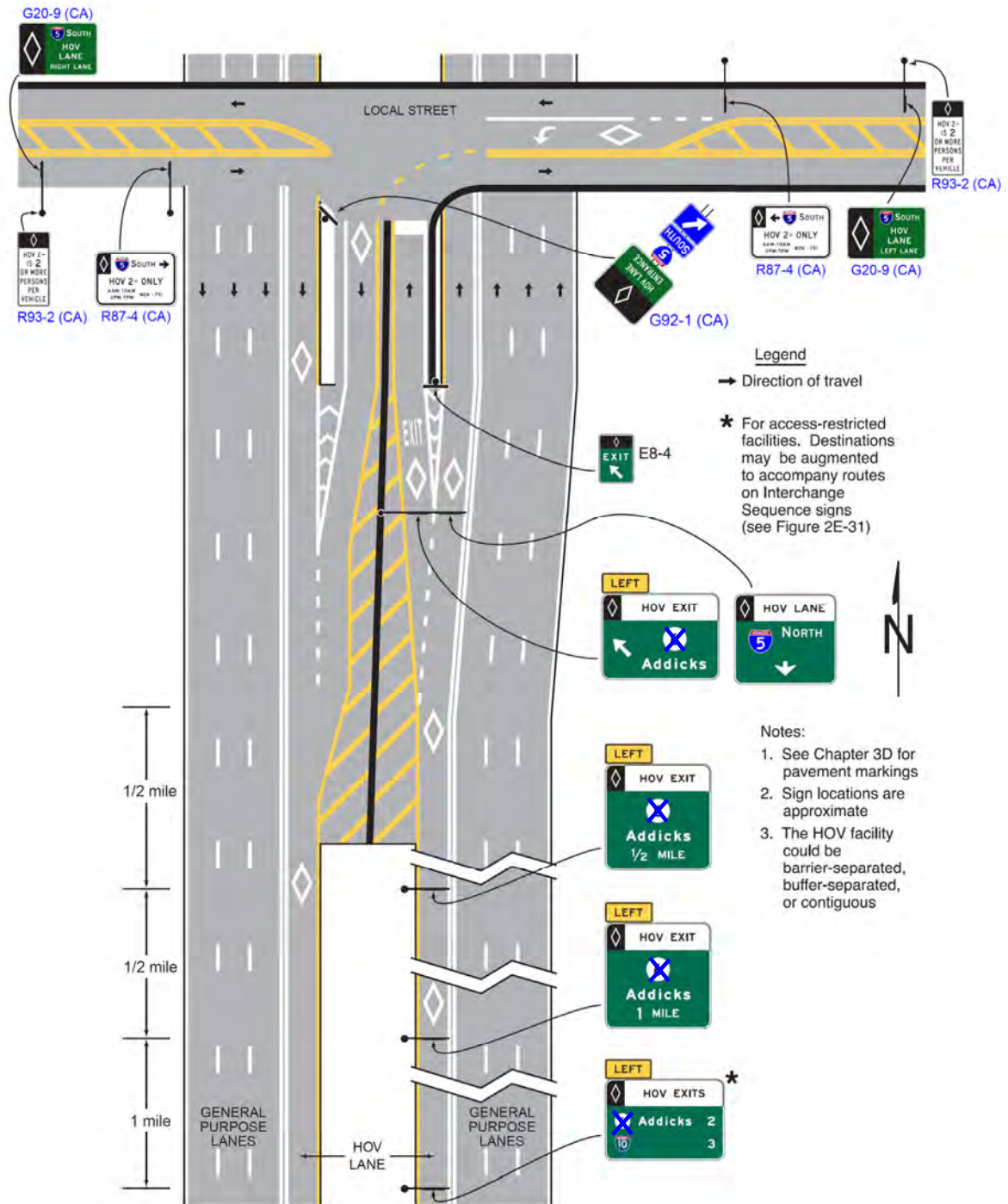


G86-15 (CA)

**Figure 2G-15. Examples of Guide Signs for Direct HOV Lane Entrance and Exit Ramps**

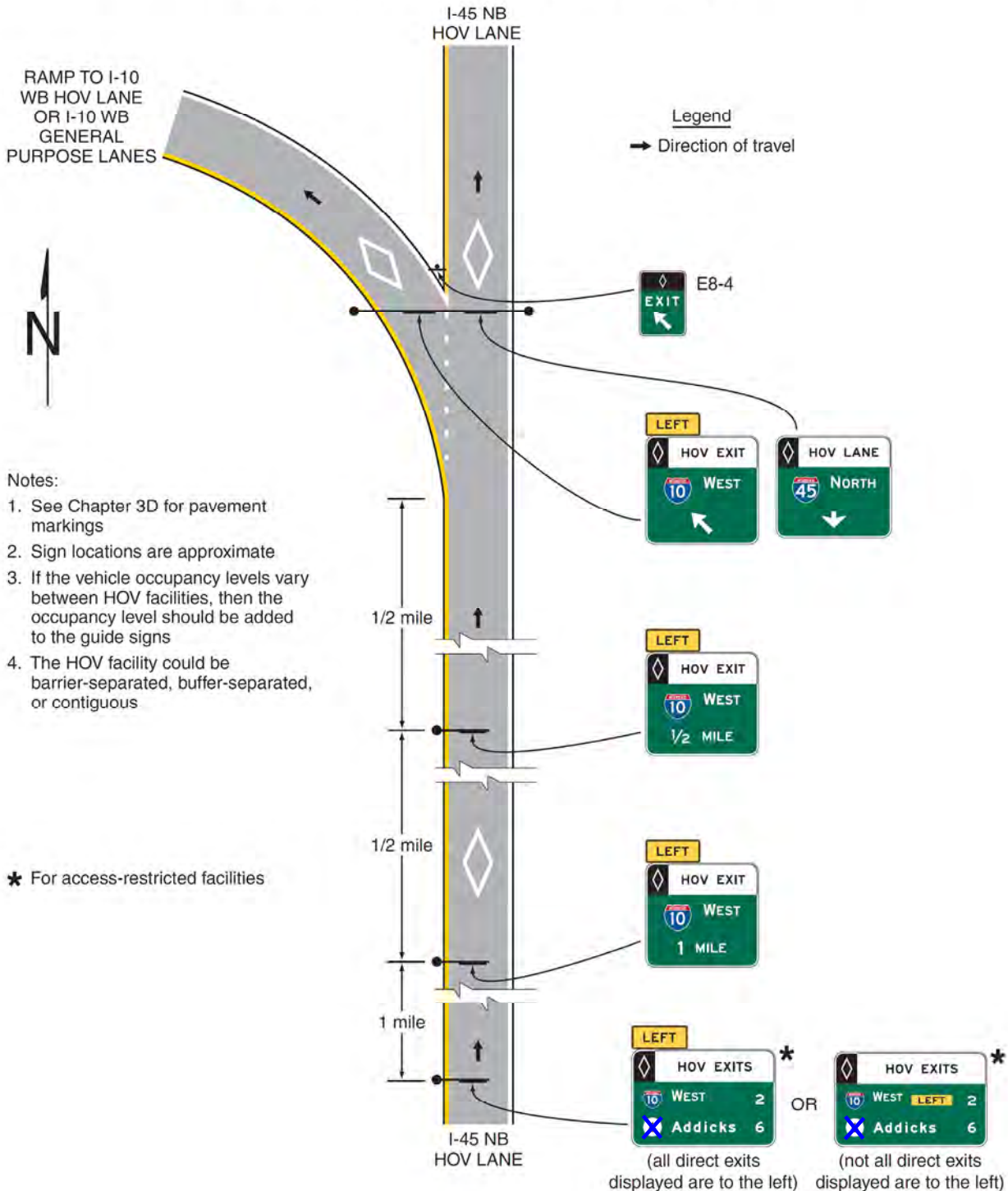


**Figure 2G-15 (CA). Example of Guide Signs for Direct HOV Lane Entrance and Exit Ramps**



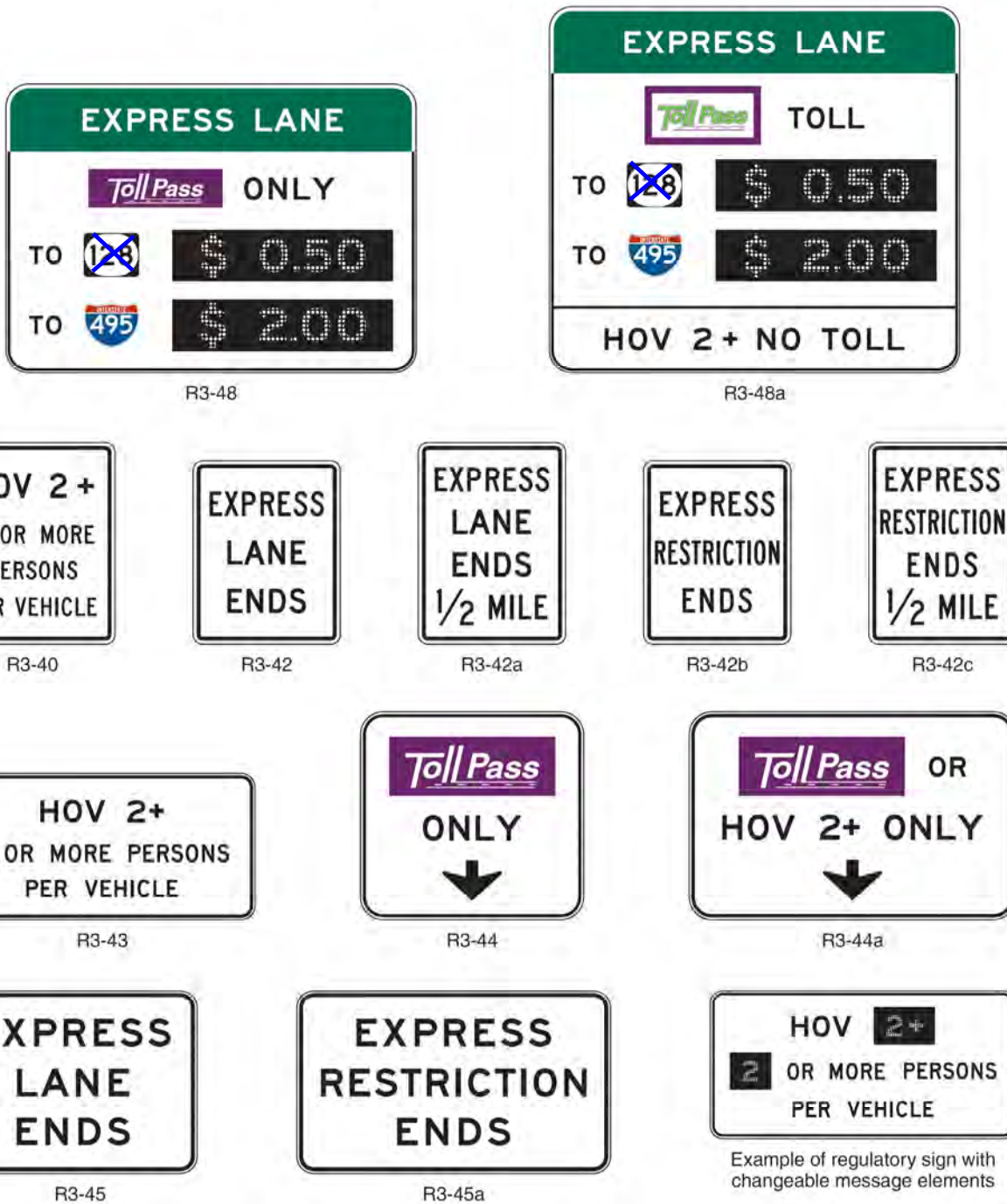
Note: For Guide Sign Assemblies use California State Route (G28-1(CA)) or US Route (G26-1(CA)) shields.

**Figure 2G-16. Examples of Guide Signs for a Direct Access Ramp between HOV Lanes on Separate Freeways**



Note: For Guide Sign Assemblies use California State Route (G28-1(CA)) or US Route (G26-1(CA)) shields.

**Figure 2G-17. Regulatory Signs for Managed Lanes**



Notes:

1. The ETC pictograph shown is an example only. The pictograph for the toll facility's adopted ETC system shall be used.
2. Changeable message sign elements shall be used for the numerals displayed for the variable tolls.
3. For Guide Sign Assemblies use California State Route (G28-1(CA)) or US Route (G26-1(CA)) shields.

**Figure 2G-18. Examples of Guide Signs for Entrances to Priced Managed Lanes**

**A - ENTRANCE TO A PRICED MANAGED LANE FROM A GENERAL PURPOSE LANE**



**B - DIRECT ENTRANCE TO A PRICED MANAGED LANE FROM A CROSSROAD**



Note: 1. The ETC pictographs shown are examples only. The pictograph for the toll facility's adopted ETC system shall be used.  
 2. The examples shown are for facilities on which registration in a toll account program is required for toll payments.

**Figure 2G-19. Example of an Exit Destinations Sign for a Managed Lane**



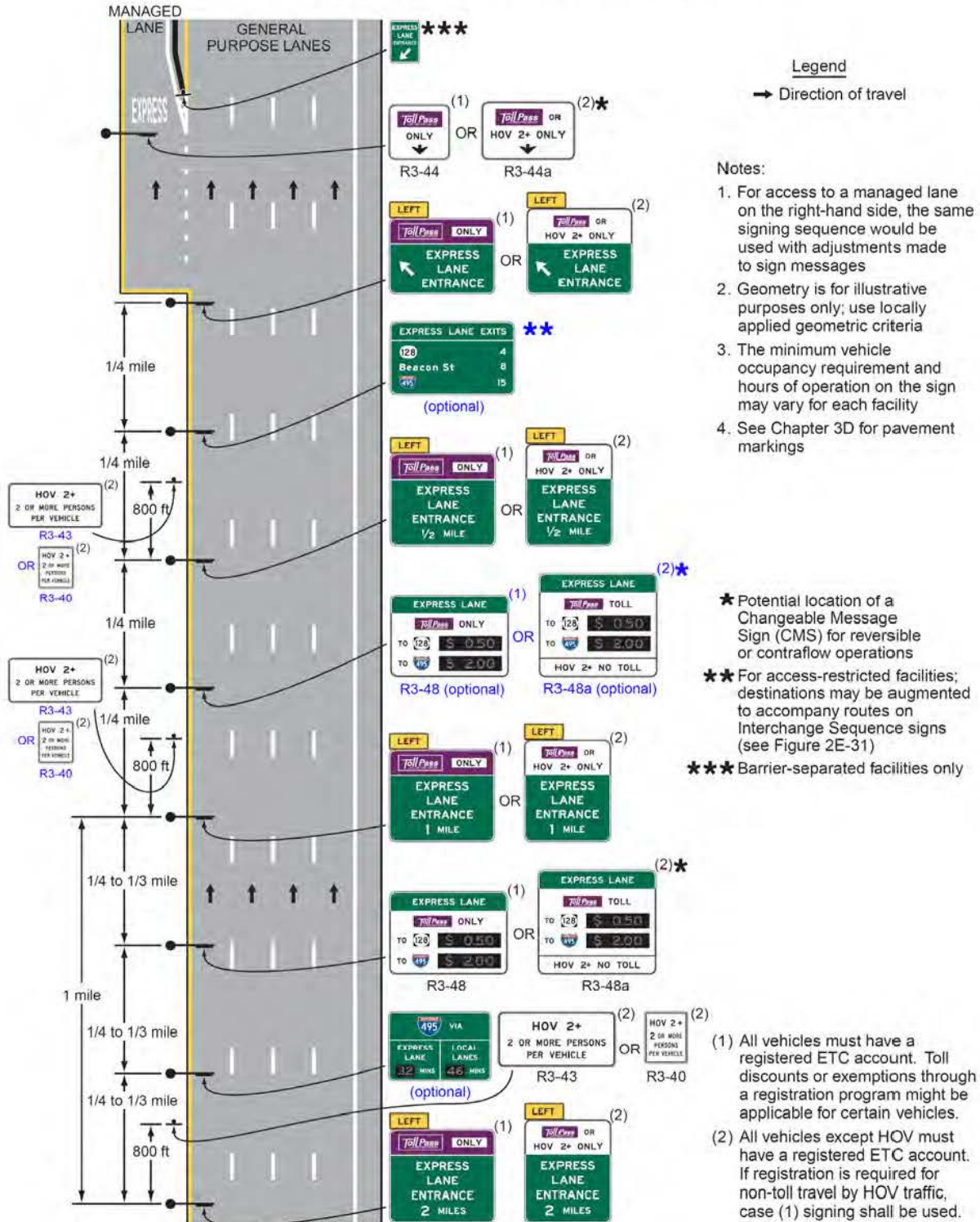
**Figure 2G-20. Example of a Comparative Travel Time Information Sign for Preferential or Managed Lanes**



Notes:

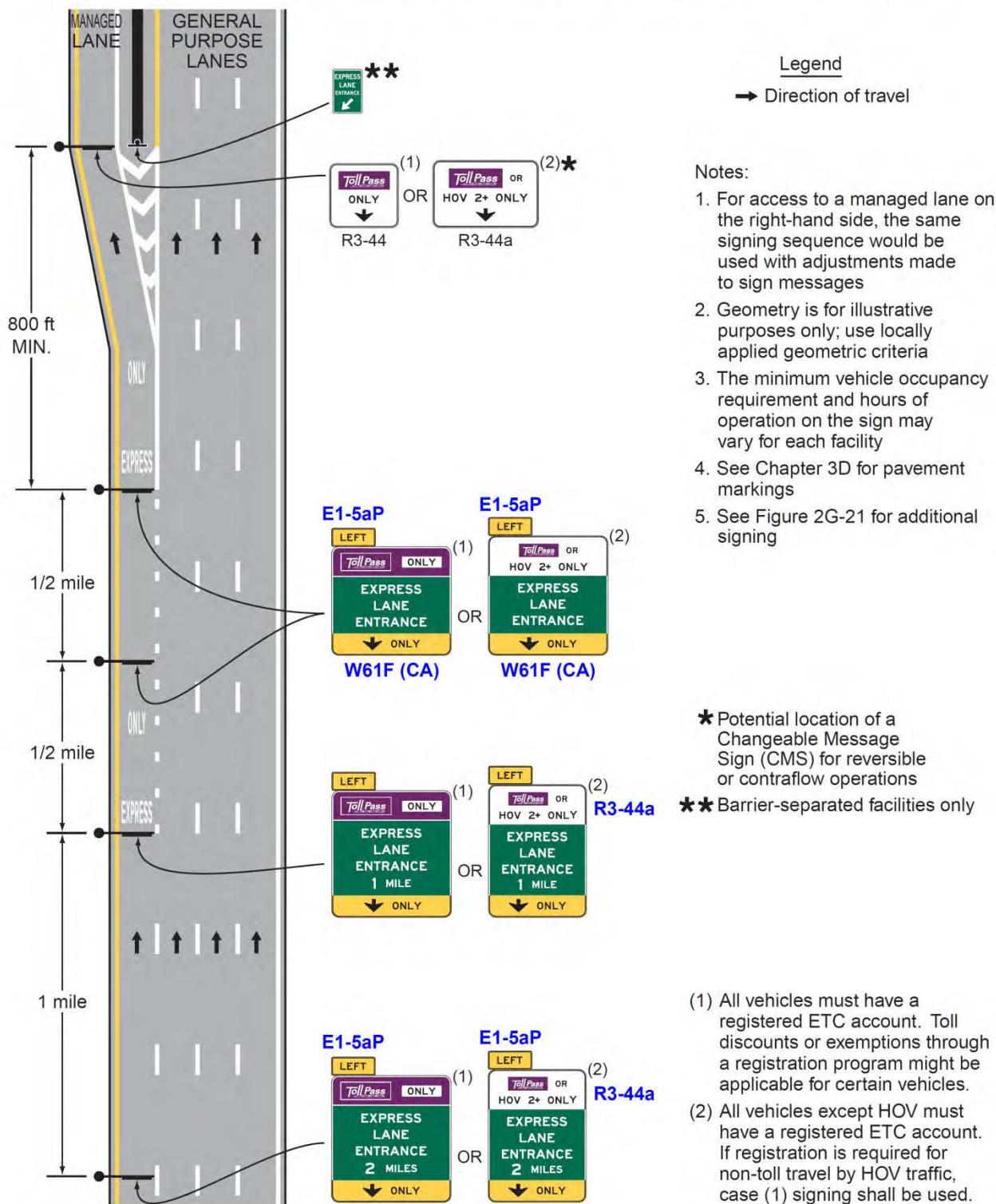
1. The ETC pictograph shown is an example only. The pictograph for the toll facility's adopted ETC system shall be used.
2. CMS elements shall be used for the numerals displayed for the estimated travel times.

**Figure 2G-21. Example of Signing for the Entrance to an Access-Restricted Priced Managed Lane**

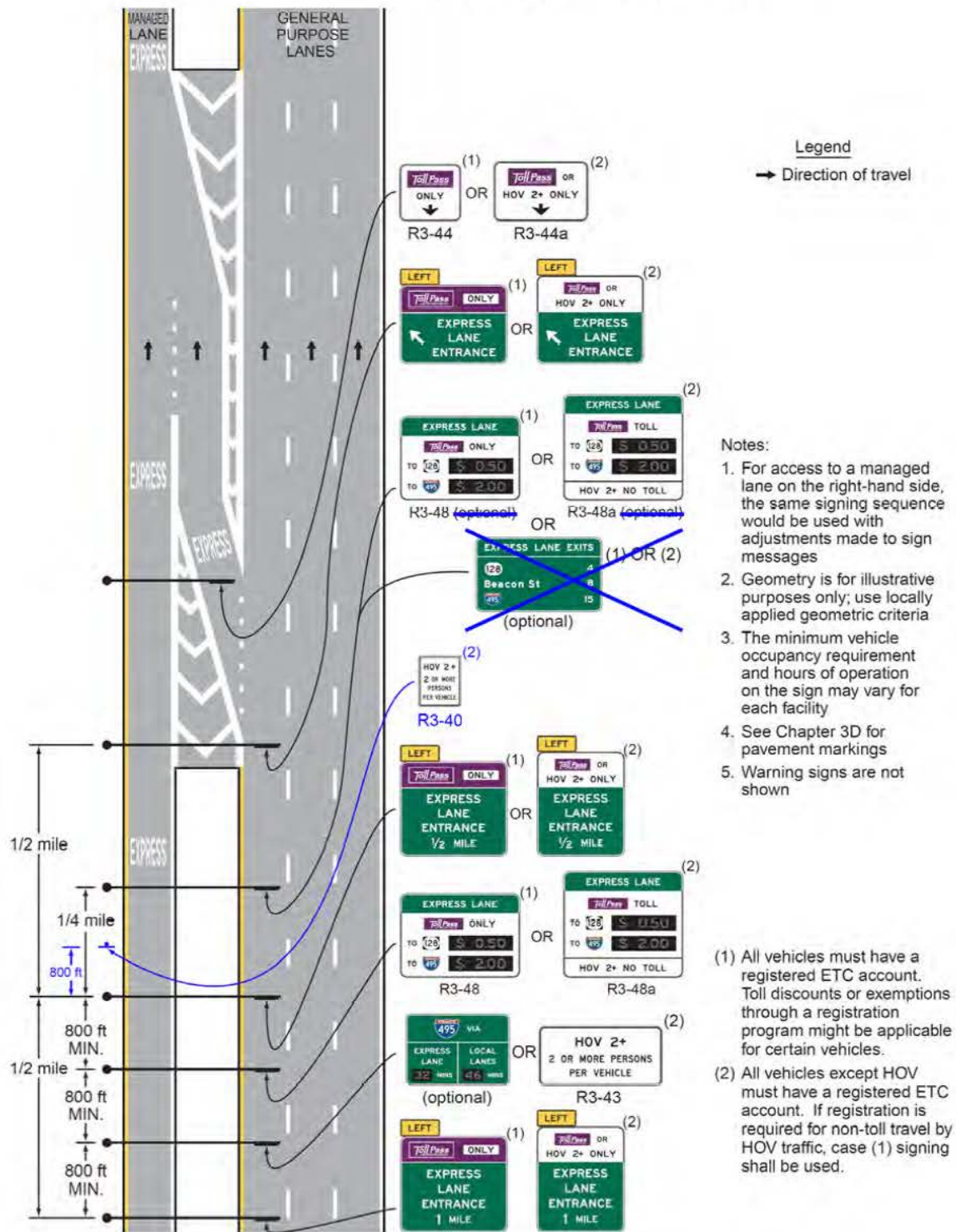




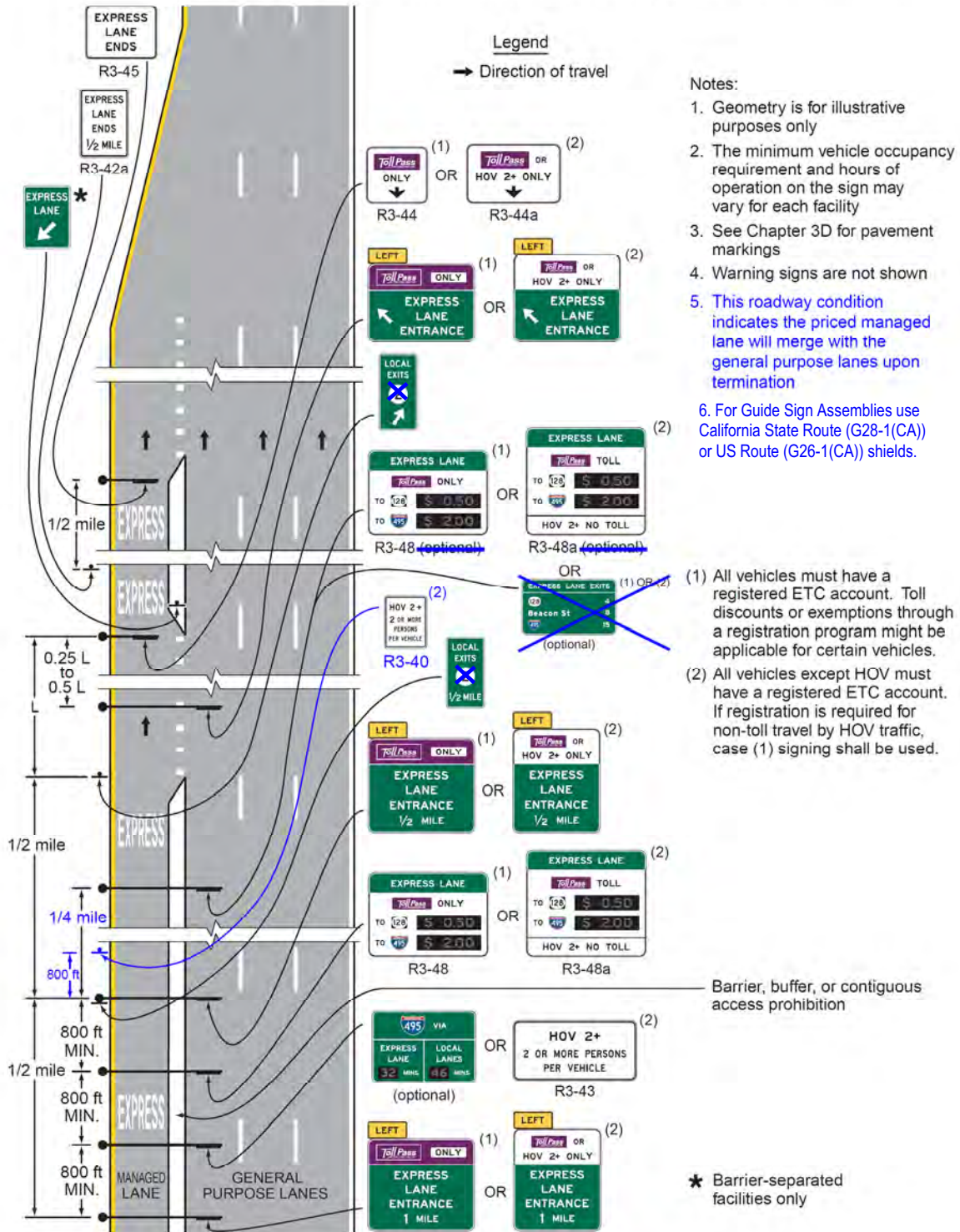
**Figure 2G-22. Example of Signing for the Entrance to an Access-Restricted Priced Managed Lane Where a General-Purpose Lane Becomes the Managed Lane**



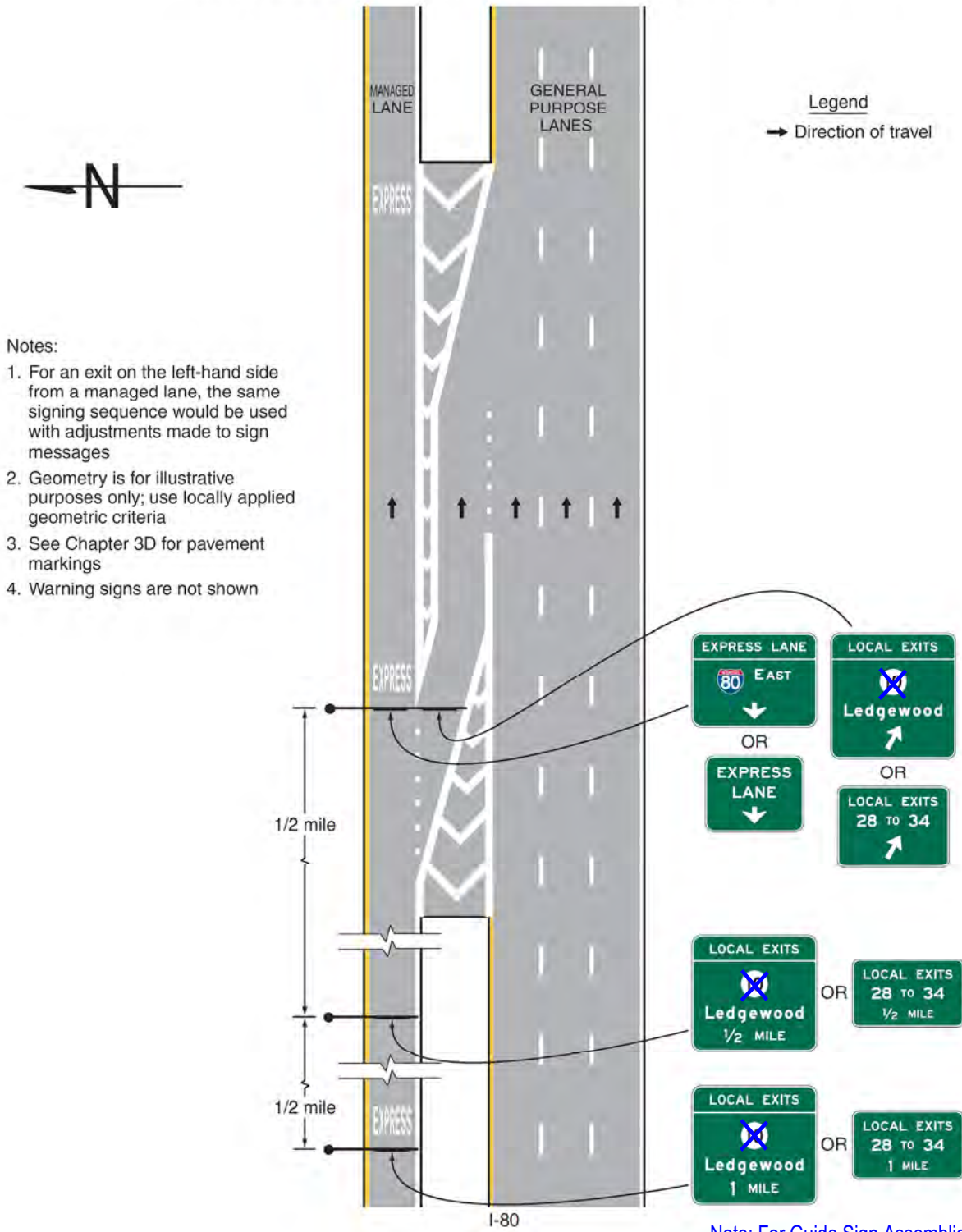
**Figure 2G-23. Example of Signing for an Intermediate Entry to a Barrier- or Buffer-Separated Priced Managed Lane**



**Figure 2G-24. Example of Signing for the Intermediate Entry to, Egress from, and End of Access-Restricted Priced Managed Lanes**

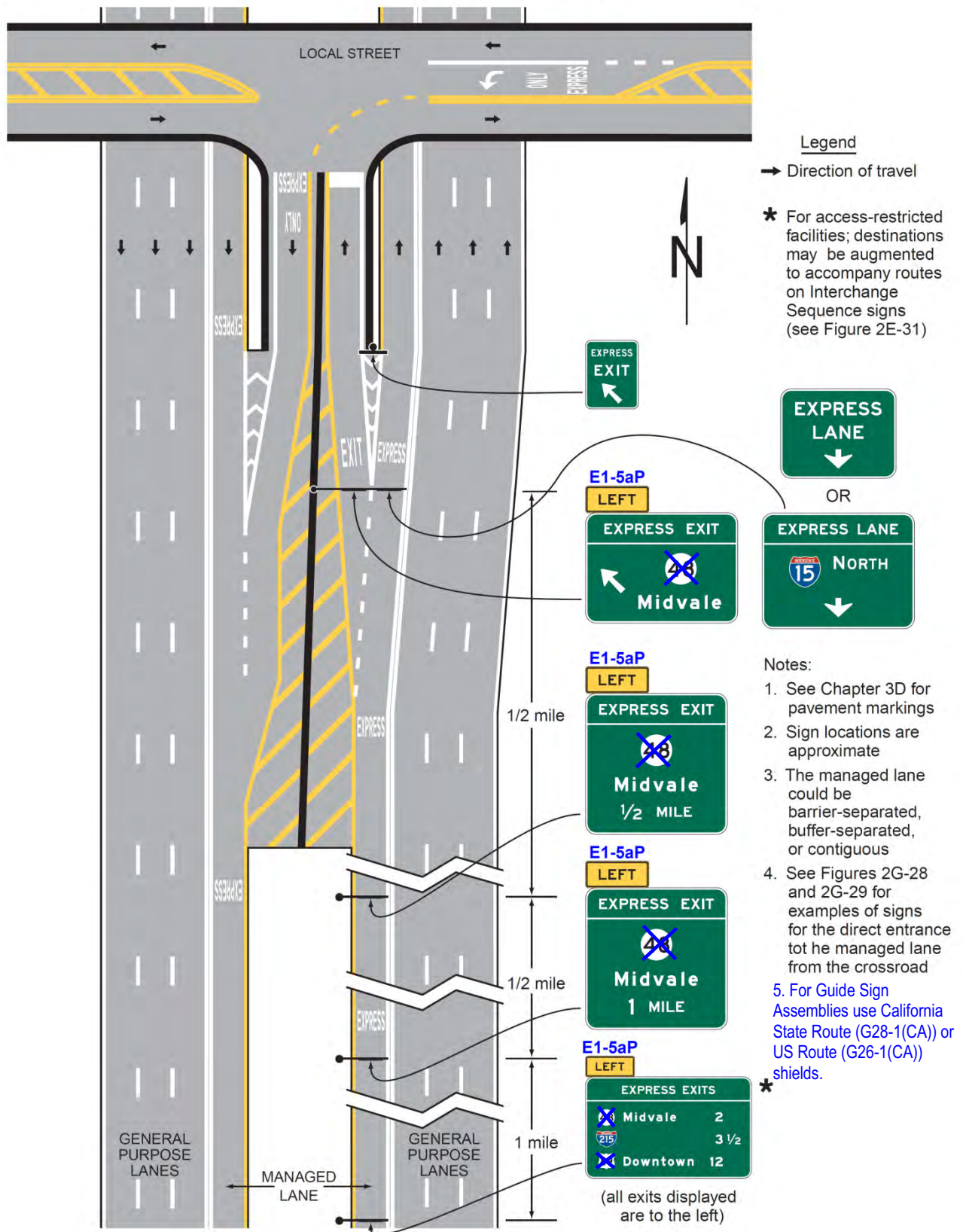


**Figure 2G-25. Examples of Guide Signs for an Intermediate Egress from a Barrier- or Buffer-Separated Managed Lane**

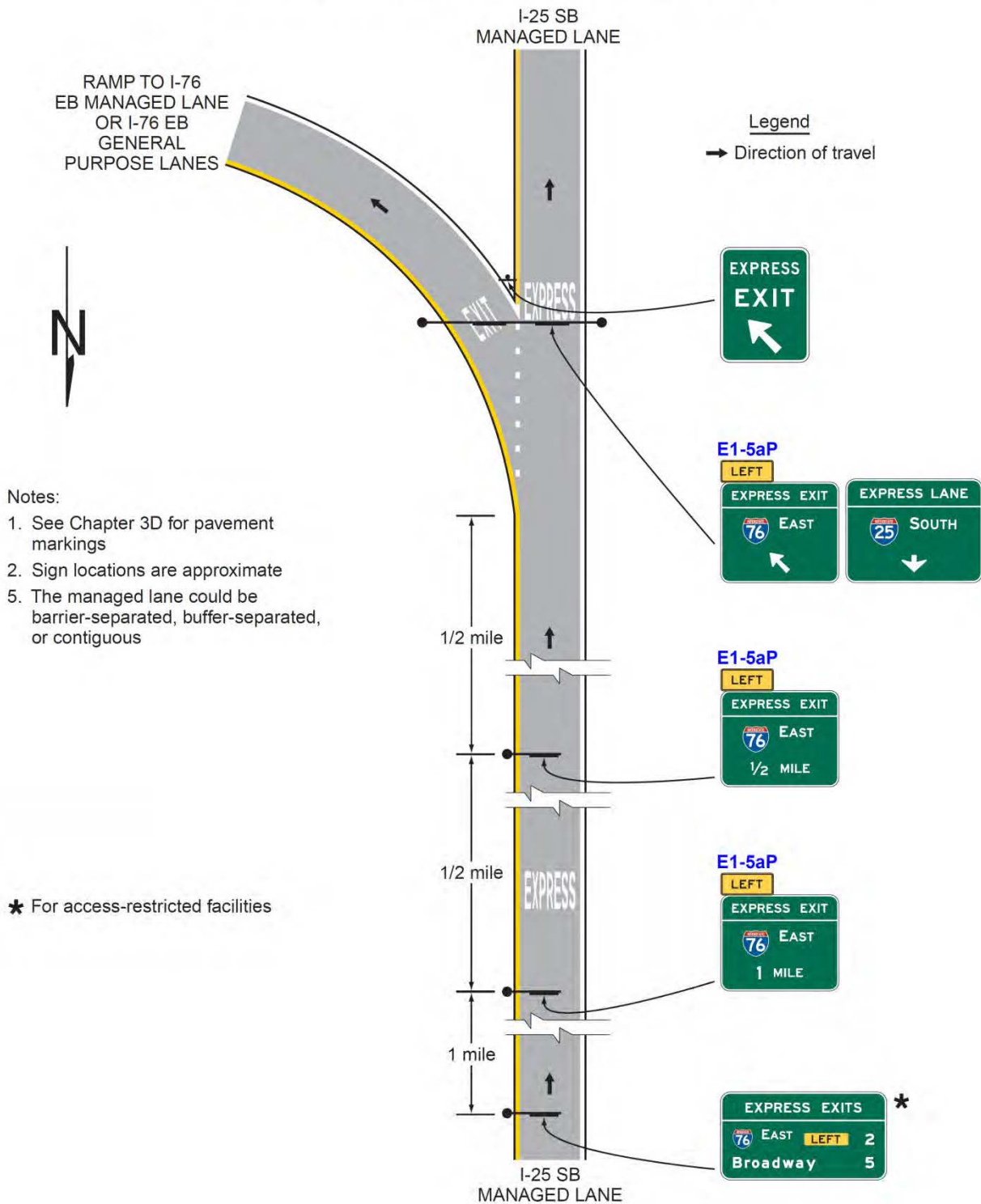


Note: For Guide Sign Assemblies use California State Route (G28-1(CA)) or US Route (G26-1(CA)) shields.

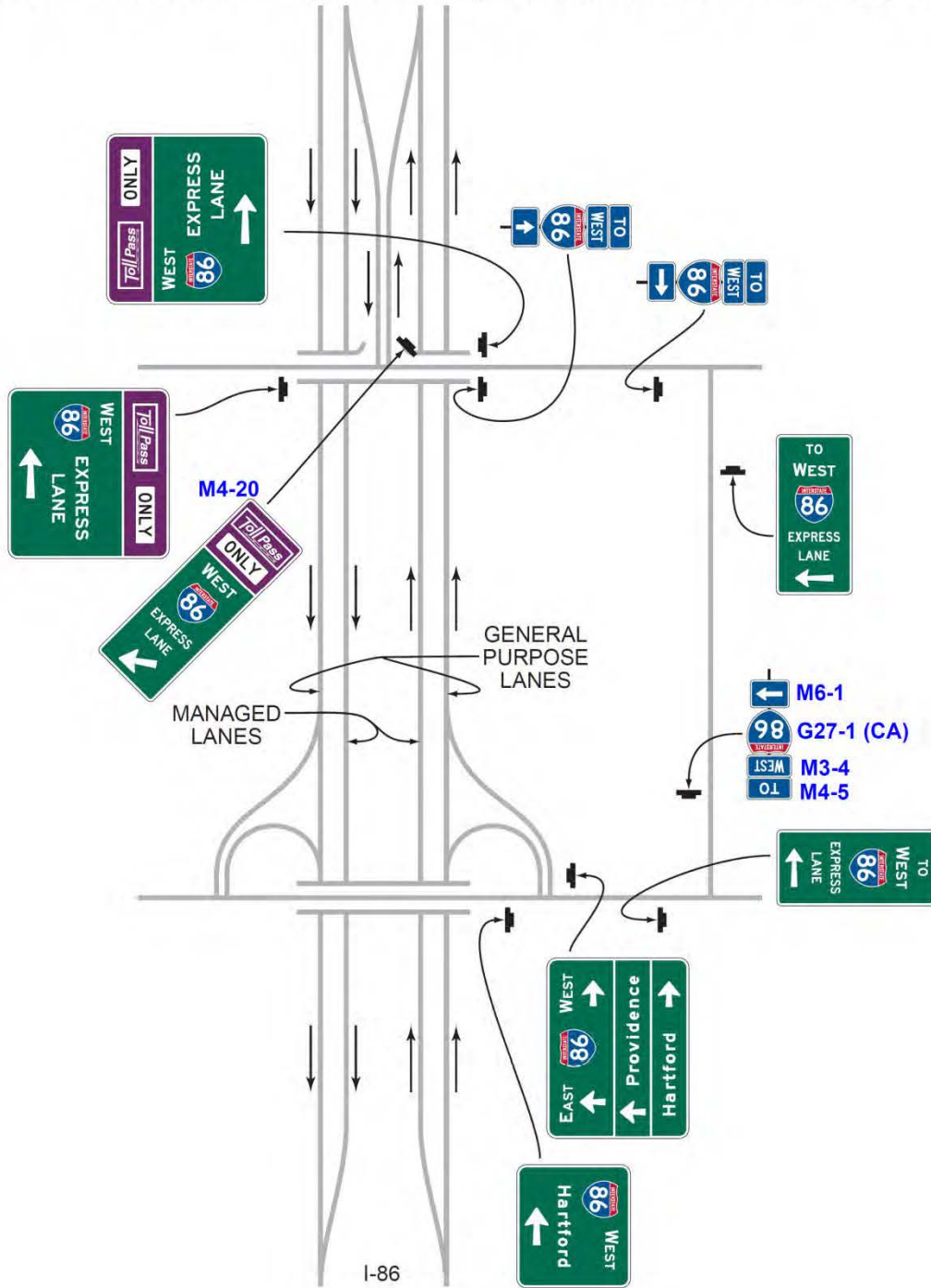
**Figure 2G-26. Examples of Guide Signs for Direct Managed Lane Entrance and Exit Ramps**



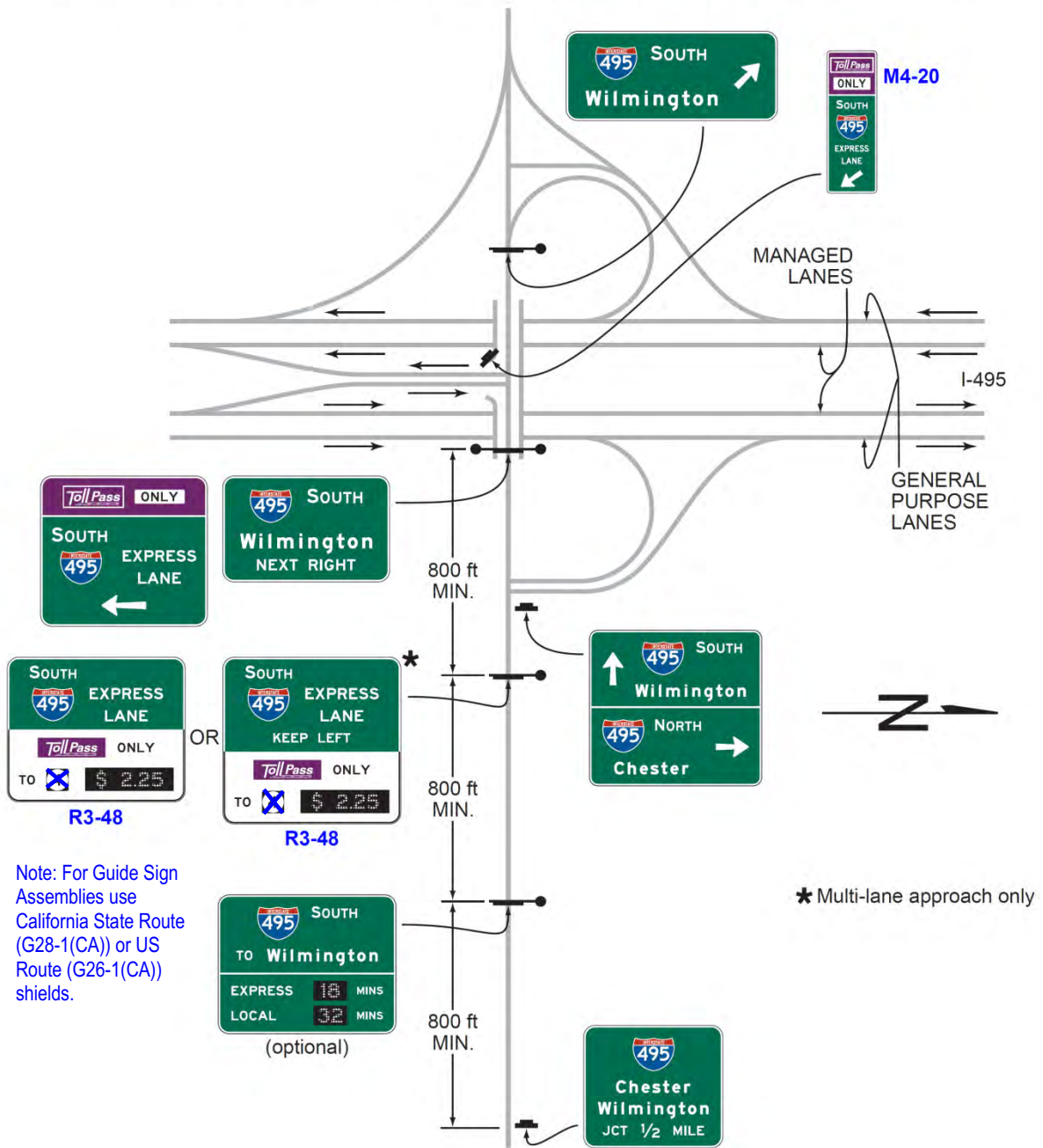
**Figure 2G-27. Examples of Guide Signs for a Direct Access Ramp between Managed Lanes on Separate Freeways**



**Figure 2G-28. Examples of Guide Signs for a Direct Entrance Ramp to a Priced Managed Lane and Trailblazing to a Nearby Entrance to the General-Purpose Lanes**



**Figure 2G-29. Examples of Guide Signs for Separate Entrance Ramps to General-Purpose and Priced Managed Lanes from the Same Crossroad**



Note: For Guide Sign Assemblies use California State Route (G28-1(CA)) or US Route (G26-1(CA)) shields.



**Table 2G-1. Managed and Preferential Lanes Sign and Plaque Minimum Sizes**

| Sign or Plaque   | Sign Designation     | Section          | Conventional Road  |                    | Expressway         | Freeway                       | Oversized          |
|--|----------------------|------------------|--------------------|--------------------|--------------------|-------------------------------|--------------------|
|  |                      |                  | Single Lane        | Multi-Lane         |                    |                               |                    |
| <del>Preferential Lane Vehicle Occupancy Definition (post-mounted)</del> | <del>R3-10,10e</del> | <del>2G-04</del> | <del>30 x 42</del> | <del>30 x 42</del> | <del>36 x 60</del> | <del>70 x 96</del>            | <del>78 x 96</del> |
| Preferential Lane Periods of Operation (post-mounted)                    | R3-11 series         | 2G.05            | 30 x 42            | 30 x 42            | 36 x 60            | <del>70 x 96</del><br>36 x 60 | 78 x 96            |
| <del>Motorcycles Allowed (plaque)</del>                                  | <del>R3-11P</del>    | <del>2G-05</del> | <del>30 x 42</del> | <del>30 x 42</del> | <del>36 x 60</del> | <del>70 x 96</del>            | <del>78 x 96</del> |
| Preferential Lane Ahead or Ends (post-mounted)                           | R3-12 series         | 2G.06            | 30 x 42            | 30 x 42            | 36 x 60            | <del>70 x 96</del><br>36 x 60 | 48 x 84            |
| Preferential Lane Vehicle Occupancy Definition (overhead)                | R3-13,13a            | 2G.04            | 66 x 36            | 66 x 36            | 84 x 48            | 144 x 78                      | 144 x 78           |
| HOV Lane Periods of Operation (overhead)                                 | R3-14,14a,14b        | 2G.05            | 72 x 60            | 72 x 60            | 96 x 72            | 144 x 108                     | 144 x 108          |
| Preferential Lane Periods of Operation (overhead)                        | R3-14c               | 2G.05            | 90 x 60            | 90 x 60            | 108 x 72           | 156 x 102                     | 168 x 102          |
| HOV Lane Ahead (overhead)  | R3-15                | 2G.06            | 66 x 36            | 66 x 36            | 84 x 48            | 102 x 60                      | 102 x 60           |
| HOV Lane Begins XX Miles (overhead)                                      | R3-15a               | 2G.06            | 78 x 42            | 78 x 42            | 102 x 54           | 132 x 72                      | 132 x 72           |
| HOV Lane Ends (overhead)   | R3-15b,15c           | 2G.07            | 66 x 36            | 66 x 36            | 84 x 48            | 102 x 60                      | 102 x 60           |
| Preferential Lane Ahead or Ends (overhead)                               | R3-15d,15e           | 2G.07            | 42 x 36            | 42 x 36            | 54 x 48            | 72 x 60                       | 72 x 60            |
| Priced Managed Lane Vehicle Occupancy Definition (post-mounted)          | R3-40                | 2G.17            | —                  | —                  | 54 x 66            | 54 x 66                       | 66 x 78            |
| Priced Managed Lane Ends (post-mounted)                                  | R3-42,42b            | 2G.17            | —                  | —                  | 48 x 60            | 48 x 60                       | 60 x 78            |
| Priced Managed Lane Ends Advance (post-mounted)                          | R3-42a,42c           | 2G.17            | —                  | —                  | 48 x 66            | 48 x 66                       | 60 x 84            |
| Priced Managed Lane Vehicle Occupancy Definition                         | R3-43                | 2G.17            | —                  | —                  | 138 x 66           | 138 x 66                      | —                  |
| Priced Managed Lane Periods of Operation (overhead)                      | R3-44                | 2G.17            | —                  | —                  | 90 x 84            | 90 x 84                       | —                  |
| Priced Managed Lane Periods of Operation (overhead)                      | R3-44a               | 2G.17            | —                  | —                  | 132 x 84           | 132 x 84                      | —                  |
| Priced Managed Lane Ends (overhead)                                      | R3-45                | 2G.17            | —                  | —                  | 90 x 66            | 90 x 66                       | —                  |
| Priced Managed Lane Ends (overhead)                                      | R3-45a               | 2G.17            | —                  | —                  | 114 x 66           | 114 x 66                      | —                  |
| Priced Managed Lane Toll Rate  | R3-48                | 2G.17            | —                  | —                  | Varies             | Varies                        | —                  |
| Priced Managed Lane Toll Rate  | R3-48a               | 2G.17            | —                  | —                  | Varies             | Varies                        | —                  |
| HOV (plaque)   | W16-11P              | 2G.09            | 24 x 12            | 24 x 12            | 30 x 18            | 30 x 18                       | 30 x 18            |
| Preferential Lane Entrance Gore  | E8-1                 | 2G.10            | —                  | —                  | 48 x 96            | 48 x 96                       | —                  |
| Preferential Lane Intermediate Entrance Gore                             | E8-1a                | 2G.10            | —                  | —                  | 48 x 84            | 48 x 84                       | —                  |
| Preferential Lane Entrance Direction (overhead)                          | E8-2                 | 2G.11            | —                  | —                  | 222 x 72           | 222 x 72                      | —                  |
| Preferential Lane Entrance Direction (post-mounted)                      | E8-2a                | 2G.11            | —                  | —                  | 186 x 108          | 186 x 108                     | —                  |
| Preferential Lane Entrance Advance                                       | E8-3                 | 2G.11            | —                  | —                  | 186 x 96           | 186 x 96                      | —                  |
| Preferential Lane Direct Exit Gore                                       | E8-4                 | 2G.15            | —                  | —                  | 60 x 78            | 60 x 78                       | —                  |
| Preferential Lane Intermediate Egress Direction                          | E8-5                 | 2G.13            | —                  | —                  | Varies x 90        | Varies x 90                   | —                  |
| Preferential Lane Intermediate Egress Advance                            | E8-6                 | 2G.13            | —                  | —                  | Varies x 84        | Varies x 84                   | —                  |

Notes: 1. Larger signs may be used when appropriate  
 2. Dimensions in inches are shown as width x height

**Table 2G-1(CA). California Managed and Preferential Lanes Sign and Plaque Minimum Sizes (Sheet 1 of 2)**

| Sign or Plaque  | Sign Designation | Section    | Conventional Road |            | Expressway | Freeway  | Oversized |
|---|------------------|------------|-------------------|------------|------------|----------|-----------|
|   |                  |            | Single Lane       | Multi-Lane |            |          |           |
| HOV Advance Lane Assignment   | G20-9(CA)        | 2G.14      | 108 x 72          | 108 x 72   | 108 x 72   | ---      | ---       |
| HOV Advance Guide   | G83-6(CA)        | 2G.15      | ---               | ---        | ---        | ---      | ---       |
| HOV Exit Direction  | G85-12(CA)       | 2G.15      | ---               | ---        | ---        | ---      | ---       |
| HOV Supplemental Destination  | G86-15(CA)       | 2G.15      | ---               | ---        | ---        | ---      | ---       |
| HOV LANE ENTRANCE   | G92-1(CA)        | 2G.14      | 36 x 36           | 36 x 36    | 48 x 42    | ---      | ---       |
| No Left Turn Specific Hours EXCEPT BUSES AND HOV ___+                         | R33B(CA)         | 2G.102(CA) | 24 x 60           | 24 x 60    | ---        | ---      | ---       |
| No Left Turn WHEN METERED EXCEPT BUSES AND HOV ___+                           | R33C(CA)         | 2G.102(CA) | 24 x 60           | 24 x 60    | ---        | ---      | ---       |
| Specific Hours/Days Plaque  | R82A(CA)         | 2G.06      | 30 x 12           | 30 x 12    | 36 x 18    | 36 x 18  | 48 x 24   |
| Specific Hours/Days Plaque  | R82B(CA)         | 2G.06      | 30 x 24           | 30 x 24    | 36 x 24    | 36 x 24  | 48 x 36   |
| LEFT LANE HOV ___+ ONLY Specific Hours/Days                                   | R86-3(CA)        | 2G.05      | 30 x 66           | 30 x 66    | 36 x 66    | 36 x 66  | 48 x 78   |
| LEFT LANE HOV ___+ ONLY 24 HOURS  | R86-4(CA)        | 2G.05      | 30 x 66           | 30 x 66    | 36 x 66    | 36 x 66  | 48 x 78   |
| HOV ___+ ONLY Specific Hours/Days   | R87-3(CA)        | 2G.05      | 90 x 60           | 90 x 60    | 108 x 70   | 108 x 70 | 108 x 70  |
| Route Shield HOV ___+ ONLY Specific Hours/Days                                | R87-4(CA)        | 2G.05      | 104 x 70          | 104 x 70   | ---        | ---      | ---       |
| Route Shield HOV ___+ ONLY 24 HOURS   | R87-5(CA)        | 2G.05      | 104 x 70          | 104 x 70   | ---        | ---      | ---       |
| LEFT (CENTER OR RIGHT) LANE DO NOT STOP (BUSES ONLY)                          | R88(CA)          | 2G.102(CA) | 30 x 30           | 30 x 30    | ---        | ---      | ---       |
| ALL VEHICLES STOP ON RED  | R90-1(CA)        | 2G.102(CA) | 24 x 30           | 24 x 30    | ---        | ---      | ---       |
| LEFT (CENTER OR RIGHT) LANE HOV ___+ ___ OR MORE ONLY WHEN METERED (24 HOURS) | R91-1(CA)        | 2G.102(CA) | 30 x 54           | 30 x 54    | ---        | ---      | ---       |
| (HOV) NO TRUCKS 3 AXLES OR MORE - NO VEHICLES WITH TRAILERS                   | R91-4(CA)        | 2G.04      | 36 x 66           | 36 x 66    | 36 x 66    | 36 x 66  | 48 x 78   |
| AUTOS/PICKUPS 2 SEATERS WITH 2 PERSONS OK                                     | R91B(CA)         | 2G.04      | 30 x 18           | 36 x 18    | 36 x 18    | 36 x 18  | 48 x 24   |
| HOV ___+ IS ___ OR MORE PERSONS PER VEHICLE                                   | R93-2(CA)        | 2G.04      | 30 x 72           | 30 x 72    | 36 x 84    | 36 x 84  | ---       |
| VEHICLES WITH DMV CLEAN AIR DECAL OK  | R93A(CA)         | 2G.04      | 30 x 12           | 30 x 12    | 36 x 15    | 36 x 15  | ---       |
| Mandatory/Optional HOV Movement Lane Control                                  | R94(CA)          | 2G.05      | 60 x 42           | 60 x 42    | ---        | ---      | ---       |
| HOV VIOLATION \$ ___ MINIMUM FINE   | SR50-1(CA)       | 2G.101(CA) | ---               | ---        | 192 x 70   | 192 x 70 | ---       |
| HOV VIOLATION \$ ___ MINIMUM FINE   | SR50-2(CA)       | 2G.101(CA) | 30 x 66           | 30 x 66    | 36 x 78    | 36 x 78  | 48 x 96   |
| RIGHT LANE BUS LANE AHEAD   | SR60-1(CA)       | 2G.06      | 30 x 42           | 30 x 42    | 30 x 42    | ---      | ---       |
| RIGHT LANE BUS LANE AHEAD ON X ST.  | SR60-2(CA)       | 2G.06      | 30 x 42           | 30 x 42    | 30 x 42    | ---      | ---       |
| RIGHT LANE BUSES TAXIS ONLY Specific Hours/Days                               | SR60-3(CA)       | 2G.05      | 30 x 42           | 30 x 42    | 30 x 42    | ---      | ---       |
| RIGHT LANE BUSES TAXIS ONLY 24 HOURS  | SR60-4(CA)       | 2G.05      | 30 x 42           | 30 x 42    | 30 x 42    | ---      | ---       |
| RIGHT LANE BUSES ONLY 24 HOURS  | SR60-5(CA)       | 2G.05      | 30 x 42           | 30 x 42    | 30 x 42    | ---      | ---       |
| RIGHT LANE TRAINS RIGHT TURNS ONLY 24 HOURS                                   | SR60-6(CA)       | 2G.05      | 30 x 42           | 30 x 42    | 30 x 42    | ---      | ---       |
| RIGHT LANE BUS LANE ENDS  | SR60-7(CA)       | 2G.07      | 30 x 42           | 30 x 42    | 30 x 42    | ---      | ---       |
| RIGHT LANE BUSES TAXIS ONLY Specific Hours/Days w/Downward Arrow              | SR60-8(CA)       | 2G.05      | 30 x 42           | 30 x 42    | 30 x 42    | ---      | ---       |
| RIGHT LANE BUSES TAXIS ONLY 24 HOURS w/Downward Arrow                         | SR60-9(CA)       | 2G.05      | 30 x 42           | 30 x 42    | 30 x 42    | ---      | ---       |
| (HOV) Lane Reduction  | W11-1(CA)        | 2G.08      | 30 x 60           | 30 x 60    | 36 x 60    | 36 x 60  | 48 x 72   |
| (HOV) Merge   | W59-1(CA)        | 2G.08      | 30 x 60           | 30 x 60    | 36 x 60    | 36 x 60  | 48 x 72   |
| (HOV) Advisory Exit(Ramp) Speed   | W72B(CA)         | 2G.08      | 36 x 66           | 36 x 66    | 48 x 78    | 48 x 78  | 60 x 102  |

**Table 2G-1(CA). California Managed and Preferential Lanes Sign and Plaque Minimum Sizes (Sheet 2 of 2)**

| Sign or Plaque   | Sign Designation | Section | Conventional Road |            | Expressway | Freeway | Oversized |
|--|------------------|---------|-------------------|------------|------------|---------|-----------|
|  |                  |         | Single Lane       | Multi-Lane |            |         |           |
| (HOV) THRU TRAFFIC MERGE LEFT (RIGHT)                        | W74-1(CA)        | 2G.08   | 30 x 60           | 30 x 60    | 36 x 60    | 36 x 60 | 48 x 72   |
| (HOV) Lane Selection (Left or Right Arrow)                   | SW54(CA)         | 2G.08   | 36 x 36           | 36 x 36    | 48 x 48    | ---     | ---       |
| (HOV) Lane Selection (Left or Right and Vertical Arrow)      | SW54-1(CA)       | 2G.08   | 36 x 36           | 36 x 36    | 48 x 48    | ---     | ---       |
| HOV ___ + IS ___ OR MORE PER VEHICLE WHEN METERED (24 HOURS) | SW54C(CA)        | 2G.08   | 30 x 30           | 30 x 30    | 36 x 36    | ---     | ---       |



## CHAPTER 2H. GENERAL INFORMATION SIGNS

### Section 2H.01 Sizes of General Information Signs

**Standard:**

**01 Except as provided in Section 2A.11, the sizes of General Information signs that have a standardized design shall be as shown in Table 2H-1.**

**Support:**

02 Section 2A.11 contains information regarding the applicability of the various columns in Table 2H-1.

**Option:**

03 Signs larger than those shown in Table 2H-1 may be used (see Section 2A.11).

### Section 2H.02 General Information Signs (I Series)

**Support:**

01 Of interest to the traveler, though not directly necessary for guidance, are numerous kinds of information that can properly be conveyed by General Information signs (see Figure 2H-1 and 2H-1(CA)) or miscellaneous information signs (see Section 2H.04). They include such items as State lines, city limits, other political boundaries, time zones, stream names, elevations, landmarks, and similar items of geographical interest, and safety and transportation-related messages. Chapter 2M contains recreational and cultural interest area symbol signs that are sometimes used in combination with General Information signs.

**Guidance:**

02 *General Information signs should not be installed within a series of guide signs or at other equally critical locations, unless there are specific reasons for orienting the road user or identifying control points for activities that are clearly in the public interest. On all such signs, the designs should be simple and dignified, devoid of any advertising, and in general compliance with other guide signing.*

**Standard:**

**03 Except for political boundary signs, General Information signs shall have white legends and borders on green rectangular-shaped backgrounds.**

**Option:**

04 An information symbol sign (I-5 through I-9 and SG60(CA)) may be used to identify a route leading to a transportation or general information facility, or to provide additional guidance to the facility. The symbol sign may be supplemented by an educational plaque where necessary; also, the name of the facility may be used if needed to distinguish between similar facilities.

05 The Advance Turn (M5 series) or Directional Arrow (M6 series) auxiliary signs shown in Figure 2H-1 with white arrows on green backgrounds may be used with General Information symbol signs to create a General Information Directional Assembly.

06 Guide signs for commercial service airports and non-carrier airports may be provided from the nearest Interstate, other freeway, or conventional highway intersection directly to the airport, normally not to exceed 15 miles. The Airport (I-5) symbol sign along with a supplemental plaque may be used to indicate the specific name of the airport. An Airport symbol sign, with or without a supplemental name plaque or the word AIRPORT, and an arrow may be used as a trailblazer.

**Standard:**

**07 Adequate trailblazer signs shall be in place prior to installing the ~~airport~~ transportation or general information facility guide signs.**

**Support:**

08 Location and placement of all ~~airport~~ transportation or general information facility guide signs depends upon the availability of longitudinal spacing on highways.

**Option:**

08a The POST OFFICE SG60(CA) sign with Symbol and Arrow may be used to indicate direction to a local post office which is located off the arterial network.

09 The Recycling Collection Center (I-11) symbol sign may be used to direct road users to recycling collection centers.

*Guidance:*

<sup>10</sup> *The Recycling Collection Center symbol sign should not be used on freeways and expressways.*

**Standard:**

<sup>11</sup> **If used on freeways or expressways, the Recycling Collection Center symbol sign shall be considered one of the supplemental sign destinations.**

<sup>12</sup> **When a sign is used to display a safety or transportation-related message, the display format shall not be of a type that would be considered similar to advertising displays. Messages and symbols that resemble any official traffic control device shall not be used on safety or transportation-related message signs.**

*Option:*

<sup>13</sup> The pictograph of a political jurisdiction (such as a State, county, or municipal corporation) may be displayed on a political boundary General Information sign.

**Standard:**

<sup>14</sup> **If used, the height of a pictograph on a political boundary General Information sign shall not exceed two times the height of the upper-case letters of the principal legend on the sign. The pictograph shall comply with the provisions of Section 2A.06.**

**Unincorporated Community and City Limit (G9-2(CA) and G9-5(CA)) Signs**

**Standard:**

<sup>15</sup> **The Unincorporated Community (G9-2(CA)) and City Limit (G9-5(CA)) signs shall be used to mark the limits of cities and to identify unincorporated towns. Refer to S&H Section 101.1.**

*Guidance:*

<sup>16</sup> *The G9-2(CA) signs should be placed on the right, as close as practical to the outer town limits of unincorporated towns, facing traffic entering the named town.*

<sup>17</sup> *The G9-5(CA) sign should be placed on the right, as close as practical to the outer city limits of incorporated cities, facing traffic entering the named city.*

*Option:*

<sup>18</sup> The population may be obtained from:

- A. Federal census
- B. California Dept. of Finance
- C. County Board of Supervisors
- D. County Planning Commission

<sup>19</sup> The elevation shown may be that of the courthouse, post office, railroad station, or benchmark in the central district of the city.

**Standard:**

<sup>20</sup> **See Section 101.1 of the Streets and Highways Code, which makes these changes mandatory, and Section 101.2 and 101.4, which provides that Caltrans, under certain conditions, shall replace any city limit signs.**

*Guidance:*

<sup>21</sup> *If a city or community desires to install a distinctive type city limits or "Welcome" sign on conventional highways at its city limits in place of the standard G9-5(CA) sign, the following criteria should be followed:*

**Standard:**

- A. **The signs shall be installed by local authorities at no expense to the State, and an approved encroachment permit will be obtained prior to installation. They shall be maintained by the permittee to the satisfaction of the permitter.**
- B. **Such signs shall be installed in accordance with current Caltrans practices.**
- C. **Signs shall be of reasonable size and proportional to other guide signs in the area.**
- D. **Signs shall be positioned so they do not obstruct the view of official traffic control devices.**
- E. **No moving or flashing displays or advertising of any kind will be permitted.**
- F. **No sign shall encroach over the highway.**

Option:

- G. Political jurisdiction logos may be displayed on the city limit signs, but the predominant characteristics of the sign will be white legend on a green rectangular shaped background. Distinctive type city limit signs not conforming to the above may remain in place until normal replacement is required.

**County Line (G10(CA)) Sign**

Guidance:

- 22 *The County Line (G10(CA)) sign should be used at the point where the county boundary line crosses the State highway.*
- 23 *The G10(CA) sign should be placed on the right, as close as practical to the outer limits of the county, facing traffic entering the named county.*

Option:

- 24 The County Line (G10-3(CA)) sign may be used in lieu of G10(CA) sign to include wording "WHERE WE HONOR VETERANS". The WHERE WE HONOR VETERANS (G10-4(CA)) sign may be used below the G10(CA) sign. Refer to Streets & Highways Code, Section 1978.

**Welcome to California (G10B(CA)) Sign**

Guidance:

- 25 *The Welcome to California (G10B(CA)) sign should be used to indicate the California State line. The sign should be placed on the right near the State boundary facing traffic entering the State.*

**River Name (I-3) Sign**

Option:

- 26 The River Name (I-3) sign may be used to identify bridges or structures across rivers and creeks and provide motorist orientation that is not otherwise included in the primary signing.

Guidance:

- 27 *The I-3 sign should be used on freeways to identify major river crossings.*

Option:

- 28 The Watershed Boundary (S36(CA)) sign may be installed to identify the boundary of recognized watershed areas, by its appropriate name (before "WATERSHED"). The sign assembly may provide road user orientation with the directional information plaque, ENTERING (S36A(CA)), or LEAVING (S36B(CA)), as appropriate, included above the S36(CA) sign.

Support:

- 29 The Watershed Boundary (S36(CA)) sign provides information for road users to be aware of the geographic boundary of the geographically-named watershed, as recognized by the United States Geological Survey, and promotes environmental stewardship of watersheds by the community. The purpose of the sign is to serve as a reminder to road users that they are traveling through a watershed, and to promote awareness that the responsibility of preserving the cleanliness of our watersheds is shared by all in the community.

**Standard:**

- 30 **The agency installing the Watershed Boundary (S36(CA)) sign, with or without the ENTERING (S36A(CA)) or LEAVING (S36B(CA)) supplemental plaque, shall be responsible for furnishing, installing, maintaining and replacing the signs, as needed. The agency installing the signs shall receive approval from the agency having jurisdiction of the roadway prior to installation of these signs.**

**Elevation (G16(CA) and G17(CA)) Signs**

Option:

- 31 The Mountain Pass Elevation (G16(CA)) sign may be used at the summit to inform the public of a mountain pass name and elevation.

Guidance:

- 32 *The G16(CA) sign should be placed facing traffic in each direction on the right.*

Option:

- 33 The Elevation (G17(CA)) sign may be used to inform motorists of changes in elevation. Feet will be shown in multiples of 1,000 feet above sea level, and multiples of 100 feet below sea level.

Guidance:

- 34 *The G17(CA) sign should be placed facing traffic in each direction on the right.*

### **Conventional Airport (G94-1(CA)) Sign**

**Support:**

<sup>35</sup> The Conventional Airport (G94-1(CA)) sign typifies smaller conventional type aircraft.

**Guidance:**

<sup>36</sup> *The G94-1(CA) sign should be used in lieu of the Airport (I-5) sign to direct to airports, which do not accommodate large commercial jet aircraft.*

### **Coastal Access (SG28(CA)) Sign**

**Option:**

<sup>37</sup> The Coastal Access (SG28(CA)) sign may be used to identify only those improved coastal access points selected by the Coastal Commission in accordance with the agreement between the California Coastal Commission and Caltrans dated April, 30, 1980.

### **USING RECYCLED WATER (S28(CA)) Sign**

**Standard:**

<sup>38</sup> **The USING RECYCLED WATER (S28(CA)) sign shall be placed to identify locations where recycled water is being used for irrigating landscaped areas and other maintenance operations. Refer to Caltrans' Maintenance Manual Chapter 8, Section 8.45. See Section 1A.11 for information regarding this publication.**

## **Section 2H.03 Traffic Signal Speed Sign (I1-1)**

**Option:**

<sup>01</sup> The Traffic Signal Speed (I1-1) sign (see Figure 2H-1), reading SIGNALS SET FOR XX MPH, may be used to indicate a section of street or highway on which the traffic control signals are coordinated into a progressive system timed for a specified speed at all hours during which they are operated in a coordinated mode.

<sup>02</sup> If different system progression speeds are set for different times of the day, a changeable message element may be used for the numerals of the Traffic Signal Speed (I1-1) sign. If the system is operated in coordinated mode only during certain times, a blank-out version of the Traffic Signal Speed (I1-1) sign may be used to display the message only during those times.

**Guidance:**

<sup>03</sup> *If used, the sign should be mounted as near as practical to each intersection where the timed speed changes, and at intervals of several blocks throughout any section where the timed speed remains constant.*

**Standard:**

<sup>04</sup> **The Traffic Signal Speed sign shall be a minimum of 24 x 36 inches with the longer dimension vertical. It shall have a white message and border on a green background.**

**Option:**

<sup>05</sup> The local authorities may set traffic signal timing for speeds in slight variance from the posted speed limits.

**Guidance:**

<sup>06</sup> *The Traffic Signal Speed (I1-1) sign should not display a speed above the posted speed limit because of the enticement to exceed that posted speed limit. Refer to CVC 22401.*

## **Section 2H.04 Miscellaneous Information Signs**

**Support:**

<sup>01</sup> Miscellaneous information are used to point out geographical features, such as rivers and summits, and other jurisdictional boundaries (see Section 2H.02). Figure 2H-1 and 2H-1(CA) shows examples of miscellaneous information (I-2 and I-3) signs.

**Option:**

<sup>02</sup> Miscellaneous information signs may be used if they do not interfere with signing for interchanges or other critical points.

**Guidance:**

<sup>03</sup> *Miscellaneous information signs should not be installed unless there are specific reasons for orienting the road users or identifying control points for activities that are clearly in the public interest. If Miscellaneous information signs are to be of value to the road user, they should be consistent with other guide signs in design*



*and legibility. On all such signs, the design should be simple and dignified, devoid of any ~~tendency toward flamboyant~~ advertising, and in general compliance with other signing.*

## **Section 2H.05 Reference Location Signs (D10-1 through D10-3) and Intermediate Reference Location Signs (D10-1a through D10-3a)**

### **Support:**

01 There are two types of reference location signs:

A. Reference Location (D10-1, 2, and 3) signs show an integer distance point along a highway, and

B. Intermediate Reference Location (D10-1a, 2a, and 3a) signs also show a decimal between integer distance points along a highway.

### **Standard:**

#### **Option:**

02 ~~Except when Enhanced Reference Location signs (see Section 2H.06) are used instead,~~ Reference Location (D10-1 through D10-3) signs shall **may** be placed on all expressway facilities that are located on a route where there is reference location sign continuity and on all freeway facilities to assist road users in estimating their progress, to provide a means for identifying the location of emergency incidents and traffic crashes, and to aid in highway maintenance and servicing.

#### **Option:**

03 Reference Location (D10-1 to D10-3) signs (see Figure 2H-2) may be installed along any section of a highway route or ramp to assist road users in estimating their progress, to provide a means for identifying the location of emergency incidents and traffic crashes, and to aid in highway maintenance and servicing **on the highway.**

04 To augment the reference location sign system, Intermediate Reference Location (D10-1a to D10-3a) signs (see Figure 2H-3), which show the tenth of a mile with a decimal point, may be installed at one tenth of a mile intervals, or at some other regular spacing.

### **Standard:**

05 **When Intermediate Reference Location (D10-1a to D10-3a) signs are used to augment the reference location sign system, the reference location sign at the integer mile point shall display a decimal point and a zero numeral.**

06 **When placed on freeways or expressways, reference location signs shall contain 10-inch white numerals on a 12-inch wide green background with a white border. The signs shall be 24, 36, or 48 inches in height for one, two, or three digits, respectively, and shall contain the word MILE in 4-inch white letters.**

07 **When placed on conventional roads, reference location signs shall contain 6-inch white numerals on a green background that is at least 10 inches wide with a white border. The signs shall contain the word MILE in 4-inch white letters.**

08 **Reference location signs shall have a minimum mounting height of 4 feet, measured vertically from the bottom of the sign to the elevation of the near edge of the roadway, and shall not be governed by the mounting height requirements prescribed in Section 2A.18.**

09 **The distance numbering shall be continuous for each route within a State, except where overlaps occur (see Section 2E.31). Where routes overlap, reference location sign continuity shall be established for only one of the routes. If one of the overlapping routes is an Interstate route, that route shall be selected for continuity of distance numbering.**

### **Guidance:**

10 *The route selected for continuity of distance numbering should also have continuity in interchange exit numbering (see Section 2E.31).*

11 *On a route without reference location sign continuity, the first reference location sign beyond the overlap should indicate the total distance traveled on the route so that road users will have a means of correlating their travel distance between reference location signs with that shown on their odometer.*

### **Standard:**

12 **For divided highways, the distance measurement shall be made on the northbound and eastbound roadways. The reference location signs for southbound or westbound roadways shall be set at locations directly opposite the reference location signs for the northbound or eastbound roadways.**

*Guidance:*

<sup>13</sup> Zero distance should begin at the south and west State lines, or at the south and west terminus points where routes begin within a State.

**Standard:**

<sup>14</sup> **Except as provided in Paragraph 15, reference location signs shall be installed on the right-hand side of the roadway.**

*Option:*

<sup>15</sup> Where conditions limit or restrict the use of reference location signs on the right-hand side of the roadway, they may be installed in the median. On two-lane conventional roadways, reference location signs may be installed on one side of the roadway only and may be installed back-to-back. Reference location signs may be placed up to 30 feet from the edge of the pavement.

<sup>16</sup> If a reference location sign cannot be installed in the correct location, it may be moved in either direction as much as 50 feet.

*Guidance:*

<sup>17</sup> If a reference location sign cannot be placed within 50 feet of the correct location, it should be omitted.

**Standard:**

<sup>18</sup> **In California, reference posts shall be mileage based.**

<sup>19</sup> **Reference posts shall be mounted so that the bottom of the sign is a minimum of 2 feet above the near roadway edge. For lateral position, see Section 2A.16, 2A.19 and Figure 2A-2(CA).**

<sup>20</sup> **The placement and location of reference posts on State highways shall conform to the database maintained by Caltrans' Division of Traffic Operations for reference posts. This database is different from the TASAS Highway database.**

## **Section 2H.06 Enhanced Reference Location Signs (D10-4, D10-5)**

*Support:*

<sup>01</sup> There are two types of enhanced reference location signs:

- A. Enhanced Reference Location signs (D10-4), and
- B. Intermediate Enhanced Reference Location signs (D10-5).

*Option:*

<sup>02</sup> Enhanced Reference Location (D10-4) signs (see Figure 2H-4), which enhance the reference location sign system by identifying the route, may be placed on freeways or expressways (instead of Reference Location signs) or on conventional roads.

<sup>03</sup> To augment an enhanced reference location sign system, Intermediate Enhanced Reference Location (D10-5) signs (see Figure 2H-4), which show the tenth of a mile with a decimal point, may be installed along any section of a highway route or ramp at one tenth of a mile intervals, or at some other regular spacing.

**Standard:**

<sup>04</sup> **If enhanced reference location signs are used, they shall be vertical signs having blue or green backgrounds with white numerals, letters, and borders, except for the route shield, which shall be the standard color and shape. The top line shall consist of the cardinal direction for the roadway. The second line shall consist of the applicable route shield for the roadway. The third line shall identify the mile reference for the location and the bottom line of the Intermediate Enhanced Reference Location sign shall give the tenth of a mile reference for the location. The bottom line of the Intermediate Enhanced Reference Location sign shall contain a decimal point. The height of the legend on enhanced reference location signs shall be a minimum of 6 inches. The height of the route shield on enhanced reference location signs shall be a minimum of 12 inches.**

<sup>05</sup> **The background color shall be the same for all enhanced reference location signs within a jurisdiction.**

*Support:*

<sup>06</sup> The provisions in Section 2H.05 regarding mounting height, distance numbering and measurements, sign continuity, and placement with respect to the right-hand shoulder and/or median for reference location signs also apply to enhanced reference location signs.

## **Section 2H.07 Auto Tour Route Signs**

### **Support:**

01 Auto Tour Route signs are informational signs, plaques, or shields designed to provide road users with route guidance in following an auto tour route of particular cultural, historical, or educational significance.

02 Signed auto tour routes are used in some cases to generally follow the historical route of a trail, such as the National Historic Trails administered by the National Park Service. Examples include auto tour routes that parallel the Lewis and Clark National Historic Trail, the Oregon National Historic Trail, and the Santa Fe National Historic Trail.

### **Guidance:**

03 *If shields or other similar signs are used to provide route guidance in following an auto tour route, they should be designed in accordance with the sizes and other design principles for route signs, such as those described in Sections 2D.10 through 2D.12.*

### **Option:**

04 Auto Tour Route signs may be installed on a highway if they have been approved by the appropriate transportation agency.

### **Standard:**

05 **Auto Tour Route signs shall not be installed on freeways or expressways, except as necessary to provide continuity between discontinuous segments of conventional roadways that are designated as auto tour routes, for which the freeway or expressway provides the only connection between the segments. If installed on freeways or expressways, Auto Tour Route signs shall be installed as independent trailblazer assemblies (see Sections 2D.35 and 2E.27) and shall not be installed with other Route signs or confirmation assemblies or on guide signs. If installed on freeways or expressways, Auto Tour Route trailblazer assemblies shall be installed at less frequent intervals than route confirmation assemblies.**

## **Section 2H.08 Acknowledgment Signs**

### **Support:**

01 Acknowledgment signs are a way of recognizing ~~a company, business, or volunteer group~~ **an entity** that provides a highway-related service. Acknowledgment signs include ~~sponsorship~~ **courtesy** signs for **Caltrans' adopt-a-highway program, litter removal programs, maintenance of a parkway or interchange, and other highway maintenance or beautification sponsorship programs.**

### **Guidance:**

02 *A State or local highway agency that elects to have an acknowledgment sign program should develop an acknowledgment sign policy. The policy should require that eligible sponsoring organizations comply with State laws prohibiting discrimination based on race, religion, color, age, sex, national origin, and other applicable laws. The acknowledgment sign policy should include all of the provisions regarding sign placement and sign design that are described in this Section.*

### **Standard:**

03 **Because regulatory, warning, and guide signs have a higher priority, acknowledgment signs shall only be installed where adequate spacing is available between the acknowledgment sign and other higher priority signs. Acknowledgment signs shall not be installed in a position where they would obscure the road users' view of other traffic control devices.**

04 **Acknowledgment signs shall not be installed at any of the following locations:**

- A. On the front or back of, adjacent to, or around any other traffic control device, including traffic signs, highway traffic signals, and changeable message signs;**
- B. On the front or back of, adjacent to, or around the supports or structures of other traffic control devices, or bridge piers; or**
- C. At key decision points where a road user's attention is more appropriately focused on other traffic control devices, roadway geometry, or traffic conditions, including exit and entrance ramps, intersections, grade crossings, toll plazas, temporary traffic control zones, and areas of limited sight distance.**

*Guidance:*

<sup>05</sup> *The minimum spacing between acknowledgment signs and any other traffic control signs, except parking regulation signs, should be:*

- A. 150 feet on roadways with speed limits of less than 30 mph,
- B. 200 feet on roadways with speed limits of 30 to 45 mph, and
- C. 500 feet on roadways with speed limits greater than 45 mph.

<sup>06</sup> *If the placement of a newly-installed higher-priority traffic control device, such as a higher-priority sign, a highway traffic signal, or a temporary traffic control device, conflicts with an existing acknowledgment sign, the acknowledgment sign should be relocated, covered, or removed.*

*Option:*

<sup>07</sup> State or local highway agencies may develop their own acknowledgment sign designs and may also use their own pictograph (see definition in Section 1A.13) and/or a brief jurisdiction-wide program slogan as part of any portion of the acknowledgment sign, provided that the signs comply with the provisions for shape, color, and lettering style in this Chapter and in Chapter 2A.

*Guidance:*

<sup>08</sup> *Acknowledgment signs should clearly indicate the type of highway services provided by the sponsor.*

**Standard:**

<sup>09</sup> **In addition to the general provisions for signs described in Chapter 2A and the sign design principles covered in the “Standard Highway Signs and Markings” book (see Section 1A.11), acknowledgment sign designs developed by State or local highway agencies shall comply with the following provisions:**

- A. Neither the sign design nor the sponsor acknowledgment logo shall contain any contact information, directions, slogans (other than a brief jurisdiction-wide program slogan, if used), telephone numbers, or Internet addresses, including domain names and uniform resource locators (URL);**

*Option:*

Entities that operate exclusively on the Internet and whose legal name is the same as appears in their Internet web address' domain name, may be permitted to display their name on their recognition panel.

**Standard:**

- B. Except for the lettering, if any, on the sponsor acknowledgment logo, all of the lettering shall be in upper-case letters or a combination of lower-case letters with initial upper-case letters as provided in the “Standard Highway Signs and Markings” book or Caltrans' California Sign Specifications (see Section 1A.11). Combining large and small upper-case letters or displaying some letters in all uppercase and some in upper- and lowercase shall not be permitted.;**
- C. In order to keep the main focus on the highway-related service and not on the sponsor acknowledgment logo, the area reserved for the sponsor acknowledgment logo shall not exceed 1/3 of the total area of the sign and shall be a maximum of 8 square feet, and shall not be located at the top of the sign;**
- D. The entire sign display area shall not exceed 24 square feet;**
- E. The sign shall not contain any messages, lights, symbols, or trademarks that resemble any official traffic control devices;**
- F. The sign shall not contain any external or internal illumination, light-emitting diodes, luminous tubing, fiber optics, luminescent panels, or other flashing, moving, or animated features; and**
- G. The sign shall not distract from official traffic control messages such as regulatory, warning, or guidance messages.**

*Support:*

<sup>10</sup> Examples of acknowledgment sign designs are shown in Figure 2H-5 and Adopt-A-Highway program signs are shown in Figure 2H-5(CA).

**Adopt-A-Highway Program Signs (S32(CA) Series)**

*Support:*

<sup>11</sup> Refer to Streets and Highways Code Section 91.5 and Caltrans' Maintenance Manual. See Section 1A.11 for information regarding this publication.

Option:

<sup>12a</sup> The Adopt-A-Highway (S32(CA)) sign (see Figure 2H-5(CA)) may be installed near the beginning of each section of State highway that is being maintained under Caltrans' Encroachment Permit (Adopt-A-Highway), form TR-0121.

<sup>12b</sup> The Adopt-A-Bike Path (S32(CA) alternate) sign (see Figure 2H-5(CA)) may be installed near the beginning of each section of Class I (Bike Path) constructed adjacent to State Highways or other roadways that are being maintained under Caltrans' Encroachment Permit (Adopt-A-Highway), form TR-0121 or under a similar action allowed by a local agency for bike paths that do not require a Caltrans Encroachment Permit.

**Standard:**

<sup>13</sup> **The Adopt-A-Highway Symbol (S32A(CA)) sign shall be installed on the Adopt-A-Highway (S32(CA)) sign, and Adopt-A-Bike Path (S32(CA) alternate) signs.**

Support:

<sup>14</sup> The 10 x 12 inch symbol size is used on the 36 x 30 inch size S32(CA) sign and the 15 x 18 inch symbol size is used on the 54 x 42 inch size S32(CA) sign. Bike Paths will only use the 36 x 30 inch size S32(CA) alternate sign.

<sup>15</sup> The Adopt-A-Highway, or Adopt-A-Bike Path Recognition Panel (S32B(CA)) with a participant's name and/or logo is placed over the information area of the S32(CA) sign when a section of State highway or Bike Path has been adopted

**Standard:**

<sup>16</sup> **When used, the Litter Removal (S32-1(CA)), Wildflower Planting (S32-2(CA)), Tree Planting (S32-3(CA)), Graffiti Removal (S32-4(CA)) or Vegetation Control (S32-5(CA)) signs shall be placed below the S32(CA) sign.**

**Figure 2H-1. General Information and Miscellaneous Information Signs**



**Figure 2H-1 (CA). General Information and Miscellaneous Information Signs**



**Figure 2H-2. Reference Location Signs**



---

**Figure 2H-3. Intermediate Reference Location Signs**



**Figure 2H-4. Enhanced Reference  
Location Signs**



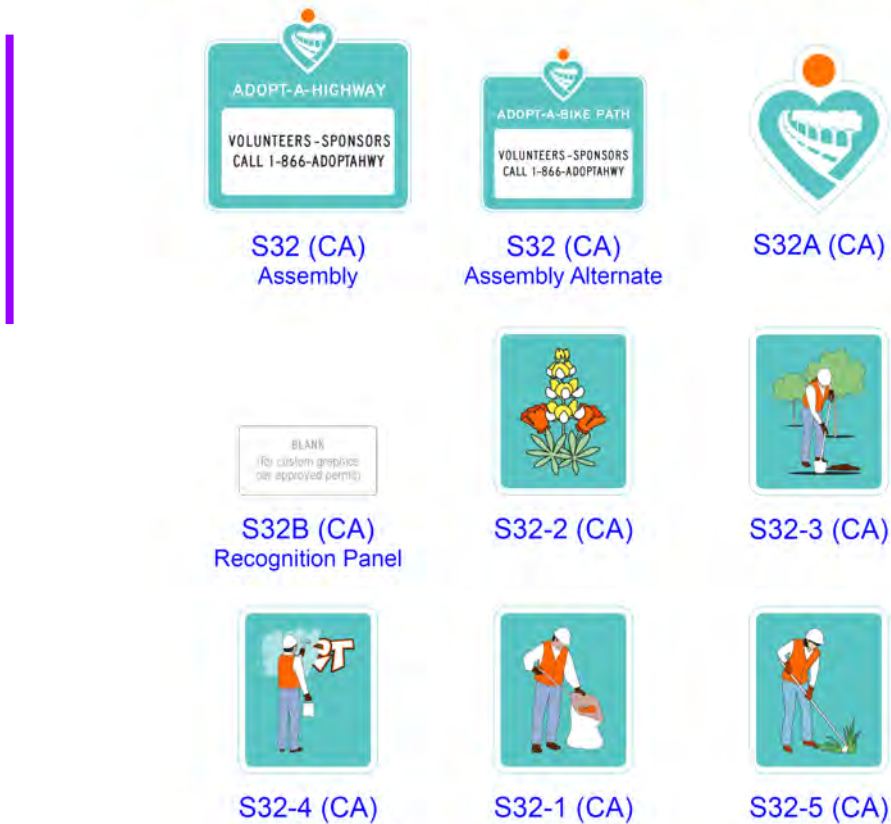
Note: Use California State Route (G28-1(CA)) or US Route (G26-1(CA)) shields.



**Figure 2H-5. Examples of Acknowledgment Sign Designs**



**Figure 2H-5 (CA). Examples of Adopt-A-Highway Sign Designs**



**Table 2H-1. General Information Sign Sizes**

| Sign                                       | Sign Designation | Section | Conventional Road | Freeway or Expressway |
|--|------------------|---------|-------------------|-----------------------|
| Reference Location (1 digit)               | D10-1            | 2H.05   | 10 x 18           | 12 x 24               |
| Intermediate Reference Location (2 digits) | D10-1a           | 2H.05   | 10 x 27           | 12 x 36               |
| Reference Location (2 digits)              | D10-2            | 2H.05   | 10 x 27           | 12 x 36               |
| Intermediate Reference Location (3 digits) | D10-2a           | 2H.05   | 10 x 36           | 12 x 48               |
| Reference Location (3 digits)              | D10-3            | 2H.05   | 10 x 36           | 12 x 48               |
| Intermediate Reference Location (4 digits) | D10-3a           | 2H.05   | 10 x 48           | 12 x 60               |
| Enhanced Reference Location                | D10-4            | 2H.06   | 18 x 54           | 18 x 54               |
| Intermediate Enhanced Reference Location   | D10-5            | 2H.06   | 18 x 60           | 18 x 60               |
| Acknowledgement                            | D14-1            | 2H.08   | 36 x 30*          | 72 x 48*              |
| Acknowledgement                            | D14-2            | 2H.08   | 36 x 30*          | 72 x 48*              |
| Acknowledgement                            | D14-3            | 2H.08   | 42 x 24*          | 96 x 36*              |
| Signals Set for XX MPH                     | I1-1             | 2H.03   | 24 x 36           | —                     |
| Jurisdictional Boundary                    | I-2              | 2H.04   | Varies x 18**     | Varies x 36**         |
| Geographical Features                      | I-3              | 2H.04   | Varies x 18**     | Varies x 36**         |
| Airport                                    | I-5              | 2H.02   | 24 x 24           | 30 x 30               |
| Bus Station                                | I-6              | 2H.02   | 24 x 24           | 30 x 30               |
| Train Station                              | I-7              | 2H.02   | 24 x 24           | 30 x 30               |
| Library                                    | I-8              | 2H.02   | 24 x 24           | 30 x 30               |
| Vehicle Ferry Terminal                     | I-9              | 2H.02   | 24 x 24           | 30 x 30               |
| Recycling Collection Center                | I-11             | 2H.02   | 30 x 48           | —                     |
| Light Rail Transit Station                 | I-12             | 2H.02   | 24 x 24           | —                     |

\* The size shown is the maximum size for the corresponding roadway classification. The size of the sign and acknowledgement logo should be appropriately reduced where shorter legends are used.

\*\* The size shown is for the typical sign illustrated in the figure. The size should be determined based on the amount of legend required for the sign.

Notes: 1. Larger signs may be used when appropriate, except for the D14 series signs  
 2. Dimensions in inches are shown as width x height

**Table 2H-1(CA). California General Information Sign Sizes**

| Sign or Plaque                    | Sign Designation  | Section | Conventional Road | Freeway or Expressway |
|-----------------------------------|-------------------|---------|-------------------|-----------------------|
| Unincorporated Community          | G9-2(CA)          | 2H.02   | VAR x 18          | VAR x 30              |
| City Limit                        | G9-5(CA)          | 2H.02   | VAR x 24          | VAR x 42              |
| County Line                       | G10(CA)           | 2H.02   | VAR x 24          | VAR x 36              |
| Welcome To California             | G10B(CA)          | 2H.02   | 60 x 36           | 132 x 84              |
| County Line                       | G10-3(CA)         | 2H.02   | 60 x 30           | 90 x 42               |
| WHERE WE HONOR VETERANS           | G10-4(CA)         | 2H.02   | 60 x 9            | 90 x 12               |
| Mountain Pass Elevation           | G16(CA)           | 2H.02   | VAR x 18          | VAR x 36              |
| Elevation                         | G17(CA)           | 2H.02   | 36 x 18           | 72 x 36               |
| Conventional Airport              | G94-1(CA)         | 2H.02   | 24 x 24           | 30 x 30               |
| Coastal Access                    | SG28(CA)          | 2H.02   | 30 x 30           | 48 x 48               |
| POST OFFICE with Symbol and Arrow | SG60(CA)          | 2H.02   | 42 x 30           | ---                   |
| USING RECYCLED WATER              | S28(CA)           | 2H.02   | 36 x 24           | 54 x 36               |
| Watershed Boundary                | S36(CA)           | 2H.02   | 48 x 54           | 48 x 54               |
| ENTERING                          | S36A(CA)          | 2H.02   | 48 x 12           | 48 x 12               |
| LEAVING                           | S36B(CA)          | 2H.02   | 48 x 12           | 48 x 12               |
| Adopt-A-Highway                   | S32(CA)           | 2H.08   | 36 x 30*          | 54 x 42*              |
| Adopt-A-Bike Path                 | S32(CA) Alternate | 2H.08   | 36 x 30*          | ---                   |
| Adopt-A-Highway Symbol            | S32A(CA)          | 2H.08   | 10 x 12*          | 15 x 18*              |
| Adopt-A-Highway Recognition Panel | S32B(CA)          | 2H.08   | 30 x 15*          | 45 x 21*              |
| Litter Removal                    | S32-1(CA)         | 2H.08   | 15 x 18*          | 15 x 18*              |
| Wildflower Planting               | S32-2(CA)         | 2H.08   | 15 x 18*          | 15 x 18*              |
| Tree Planting                     | S32-3(CA)         | 2H.08   | 15 x 18*          | 15 x 18*              |
| Graffiti Removal                  | S32-4(CA)         | 2H.08   | 15 x 18*          | 15 x 18*              |
| Vegetation Control                | S32-5(CA)         | 2H.08   | 15 x 18*          | 15 x 18*              |

\* The size shown is the maximum size for the corresponding roadway classification. The size of the sign and Adopt-A-Highway logo should be appropriately reduced where shorter legends are used.



## CHAPTER 2I. GENERAL SERVICE SIGNS

### Section 2I.01 Sizes of General Service Signs

**Standard:**

01 Except as provided in Section 2A.11, the sizes of General Service signs that have a standardized design shall be as shown in Table 2I-1.

**Support:**

02 Section 2A.11 contains information regarding the applicability of the various columns in Table 2I-1.

**Option:**

03 Signs larger than those shown in Table 2I-1 may be used (see Section 2A.11).

### Section 2I.02 General Service Signs for Conventional Roads

**Support:**

01 On conventional roads, commercial services such as gas-fuel, food, and lodging generally are within sight and are available to the road user at reasonably frequent intervals along the route. Consequently, on this class of road there usually is no need for special signs calling attention to these services. Moreover, General Service signing is usually not required in urban areas except for hospitals, law enforcement assistance, tourist information centers, and camping.

**Option:**

02 General Service signs (see Figure 2I-1 and 2I-1(CA)) may be used where such services are infrequent and are found only on an intersecting highway or crossroad.

**Standard:**

03 All General Service signs and supplemental sign panels shall have white letters, symbols, arrows, and borders on a blue background.

**Guidance:**

04 General Service signs should be installed at a suitable distance in advance of the turn-off point or intersecting highway.

05 States that elect to provide General Service signing should establish a statewide policy or warrant for its use, and criteria for the availability of services. Local jurisdictions electing to use such signing should follow State policy for the sake of uniformity.

**Option:**

06 Individual States may sign for whatever alternative fuels are available at appropriate locations.

**Standard:**

07 General Service signs, if used at intersections, shall be accompanied by a directional message.

**Option:**

08 The Advance Turn (M5 series) or Directional Arrow (M6 series) auxiliary signs with white arrows on blue backgrounds as shown in Figure 2I-1 may be used with General Service symbol signs to create a General Service Directional Assembly.

08a The NEXT RIGHT/LEFT (G58(CA)) Auxiliary sign may also be used in conjunction with the General Service signs.

09 The General Service sign legends may be either symbols or word messages.

**Standard:**

10 ~~Symbols and word message General Service legends shall not be intermixed on the same sign. The Pharmacy (D9-20) sign shall only be used to indicate the availability of a pharmacy that is open, with a State-licensed pharmacist present and on duty, 24 hours per day, 7 days per week, and that is located within 3 miles of an interchange on the Federal-aid system. The D9-20 sign shall have a 24 HR (D9-20aP) plaque mounted below it.~~

**Support:**

11 Formats for displaying different combinations of these services are described in Section 2I.03.

**Option:**

12 If the distance to the next point at which services are available is 10 miles or more, a NEXT SERVICES XX MILES (D9-17P) plaque (see Figure 2I-2) may be installed below the General Service sign.

13 The International Symbol of Accessibility for the Handicapped (D9-6) sign may be used beneath General Service signs where paved ramps and rest room facilities accessible to, and usable by, the physically handicapped are provided.

*Guidance:*

14 *When the D9-6 sign is used in accordance with Paragraph 13, and van-accessible parking is available at the facility, a VAN ACCESSIBLE (D9-6P) plaque (see Figure 2I-1) should be mounted below the D9-6 sign.*

*Option:*

15 The Recreational Vehicle Sanitary Station (D9-12) sign may be used as needed to indicate the availability of facilities designed for the use of dumping wastes from recreational vehicle holding tanks.

16 The Litter Container (D9-4) sign may be placed in advance of roadside turnouts or rest areas, unless it distracts the driver's attention from other more important regulatory, warning, or directional signs.

17 The Emergency Medical Services (D9-13) symbol sign may be used to identify medical service facilities that have been included in the Emergency Medical Services system under a signing policy developed by the State and/ or local highway agency.

**Standard:**

18 **The Emergency Medical Services symbol sign shall not be used to identify services other than qualified hospitals, ambulance stations, and qualified free-standing emergency medical treatment centers. If used, the Emergency Medical Services symbol sign shall be supplemented by a sign identifying the type of service provided.**

*Option:*

19 The Emergency Medical Services symbol sign may be used above the HOSPITAL (D9-13aP) sign plaque or Hospital (D9-2) symbol sign or above a sign with the legend AMBULANCE STATION (D9-13bP), EMERGENCY MEDICAL CARE (D9-13cP), or TRAUMA CENTER (D9-13dP). The Emergency Medical Services symbol sign may also be used to supplement Telephone (D9-1), Channel 9 Monitored (D12-3), or POLICE (D9-14) signs.

**Standard:**

20 **The legend EMERGENCY MEDICAL CARE shall not be used for services other than qualified free-standing emergency medical treatment centers.**

*Guidance:*

21 *Each State should develop guidelines for the implementation of the Emergency Medical Services symbol sign.*

22 *The State should consider the following guidelines in the preparation of its policy:*

**A. AMBULANCE**

1. *24-hour service, 7 days per week.*
2. *Staffed by two State-certified persons trained at least to the basic level.*
3. *Vehicular communications with a hospital emergency department.*
4. *Operator should have successfully completed an emergency-vehicle operator training course.*

**B. HOSPITAL**

1. *24-hour service, 7 days per week.*
2. *Emergency department facilities with a physician (or emergency care nurse on duty within the emergency department with a physician on call) trained in emergency medical procedures on duty.*
3. *Licensed or approved for definitive medical care by an appropriate State authority.*
4. *Equipped for radio voice communications with ambulances and other hospitals.*

**C. Channel 9 Monitored**

1. *Provided by either professional or volunteer monitors.*
2. *Available 24 hours per day, 7 days per week.*
3. *The service should be endorsed, sponsored, or controlled by an appropriate government authority to guarantee the level of monitoring.*

### **Section 2I.03 General Service Signs for Freeways and Expressways**

**Support:**

01 General Service (D9-18 series) signs (see Figure 2I-3) are generally not appropriate at major interchanges (see definition in Section 2E.32) and in urban areas.

**Standard:**

**02 General Service signs shall have white letters, symbols, arrows, and borders on a blue background. Letter and numeral sizes shall comply with the minimum requirements of Tables 2E-2 through 2E-5. All approved symbols shall be permitted as alternatives to word messages, but symbols and word service messages shall not be intermixed. If the services are not visible from the ramp of a single-exit interchange, the service signing shall be repeated in smaller size at the intersection of the exit ramp and the crossroad. Such service signs shall use arrows to indicate the direction to the services.**

**Option:**

**03** For numbered interchanges, the exit number may be incorporated within the sign legend (D9-18b) or displayed on an Exit Number (E1-5P) plaque (see Section 2E.31).

**Guidance:**

*04 Distance to services should be displayed on General Service signs where distances are more than  $\pm$  0.5 miles.*

*05 General Service signing should only be provided at locations where the road user can return to the freeway or expressway and continue in the same direction of travel.*

*06 Only services that fulfill the needs of the road user should be displayed on General Service signs. If State or local agencies elect to provide General Service signing, there should be a statewide policy for such signing and criteria for the availability of the various types of services. The criteria should consider the following:*

*A. ~~Gas-Fuel~~, Diesel, LP ~~Gas-Fuel~~, EV Charging, and/or other alternative fuels if all of the following are available:*

- 1. Vehicle services such as ~~gas fuel~~, oil, and water;*
- 2. Modern sanitary facilities and drinking water;*
- 3. Continuous operations at least 16 hours per day, 7 days per week; and*
- 4. Public telephone.*

*B. Food if all of the following are available:*

- 1. Licensing or approval, where required;*
- 2. Continuous operation to serve at least two meals per day, at least 6 days per week;*
- 3. Public telephone; and*
- 4. Modern sanitary facilities.*

*C. Lodging if all of the following are available:*

- 1. Licensing or approval, where required;*
- 2. Adequate sleeping accommodations;*
- 3. Public telephone; and*
- 4. Modern sanitary facilities.*

*D. Public Telephone if continuous operation, 7 days per week is available.*

*E. Hospital if continuous emergency care capability, with a physician on duty 24 hours per day, 7 days per week is available. A physician on duty would include the following criteria and should be signed in accordance with the priority as follows:*

- 1. Physician on duty within the emergency department;*
- 2. Registered nurse on duty within the emergency department, with a physician in the hospital on call; or*
- 3. Registered nurse on duty within the emergency department, with a physician on call from office or home.*

*F. 24-Hour Pharmacy if a pharmacy is open, with a State-licensed pharmacist present and on duty, 24 hours per day, 7 days per week and is located within 3 miles of an interchange on the Federal-aid system.*

*G. Camping if all of the following are available:*

- 1. Licensing or approval, where required;*
- 2. Adequate parking accommodations; and*
- 3. Modern sanitary facilities and drinking water.*

**Standard:**

**07 For any service that is operated on a seasonal basis only, the General Service signs shall be removed or covered during periods when the service is not available.**

~~**08 The General Service signs shall be mounted in an effective location, between the Advance Guide sign and the Exit Direction sign, in advance of the exit leading to the available services.**~~

**Option:**

08a The General Service signs may be located between the Advance Guide sign and the Exit Direction sign, in advance of the exit leading to the available services.

**Guidance:**

09 The General Service sign should contain the interchange number, if any, as shown in Figure 2I-3.

**Option:**

10 If the distance to the next point where services are available is greater than 10 miles, a NEXT SERVICES XX MILES (D9-17P) plaque (see Figure 2I-2) may be installed below the ~~Exit Direction sign~~ Advance Guide sign.

10a The NEXT RIGHT/LEFT (G58(CA)) Auxiliary sign may also be used in conjunction with the General Service signs.

**Standard:**

11 Signs for services shall comply with the format for General Service signs (see Section 2I.02) and as provided in this Manual. No more than six general road user services shall be displayed on one sign, which includes any appended supplemental signs or plaques. General Service signs shall carry the legends for one or more of the following services: Food, Gas Fuel, Lodging, Camping, Phone, Hospital, ~~24-Hour Pharmacy~~, or Tourist Information.

12 The qualified services available shall be displayed at specific locations on the sign.

13 To provide flexibility for the future when the service might become available, the sign space normally reserved for a given service symbol or word shall be left blank when that service is not present.

**Guidance:**

14 The standard display of word messages should be FOOD and PHONE in that order on the top line, and GAS FUEL and LODGING on the second line. If used, HOSPITAL and CAMPING should be on separate lines (see Figure 2I-3).

**Option:**

15 Signing for DIESEL, LP-Gas Fuel, or other alternative fuel services may be substituted for any of the general services or appended to such signs. The International Symbol of Accessibility for the Handicapped (D9-6) sign (see Figure 2I-1) may be used for facilities that qualify.

**Guidance:**

16 When symbols are used for the road user services, they should be displayed as follows:

A. Six services:

1. Top row—GAS FUEL, FOOD, and LODGING
2. Bottom row—PHONE, HOSPITAL, and CAMPING

B. Four services:

1. Top row—GAS FUEL and FOOD
2. Bottom row—LODGING and PHONE

C. Three services:

1. Top row—GAS FUEL, FOOD, and LODGING

**Option:**

17 Substitutions of other services for any of the services described in Paragraph 16 may be made by placing the substitution in the lower right (four or six services) or extreme right (three services) portion of the sign. An action message or an interchange number may be used for symbol signs in the same manner as they are used for word message signs. The Diesel Fuel (D9-11) symbol or the LP-Gas Fuel (D9-15) symbol may be substituted for the symbol representing fuel or appended to such assemblies. The Tourist Information (D9-10) symbol or the ~~24-Hour Pharmacy (D9-20 and D9-20aP) symbol~~ may be substituted on any of the configurations provided in Paragraph 16.

**Guidance:**

18 At rural interchange areas where limited road user services are available and where it is unlikely that additional services will be provided within the near future, a supplemental plaque displaying one to three services (words or symbols) ~~may~~ should be appended below a post-mounted interchange guide sign.

**Standard:**

19 ~~If more than three services become available at rural interchange areas where limited road user services were anticipated, the appended supplemental plaque described in Paragraph 18 shall be removed and replaced with an independently mounted General Service sign as described in this Section.~~



**19a If more than four services become available, any appended sign panel shall be removed and replaced with an independently mounted General Service sign as described in this Section.**

**Option:**

20 A separate Telephone Service (D9-1) sign (see Figure 2I-1) may be installed if telephone facilities are located adjacent to the route at places where public telephones would not normally be expected.

21 The Recreational Vehicle Sanitary Station (D9-12) sign (see Figure 2I-1) may be used as needed to indicate the availability of facilities designed for dumping wastes from recreational vehicle holding tanks.

22 In some locations, signs may be used to indicate that services are not available.

23 A separate Truck Parking (D9-16) sign (see Figure 2I-1) may be mounted below the other general road user services to direct truck drivers to designated parking areas.

**Option:**

24 General Service signs may be placed where appropriate, on freeways and expressways and for bypassed communities reasonably accessible from the highway.

**Guidance:**

25 *General Service signs should be considered only when there is an easy route for the road user to return to the freeway from the service facility.*

**Support:**

26 General Service signs are not normally used on conventional highways except in rural areas where the service facilities are not visible from the highway or where commercial services are infrequent and the road users may need the information to enable them to plan their stops. Service signing is intended to be a service to the road user and not to be advertising for individual businesses. When private advertising for a service is provided, there is no need to place General Service signs.

27 In urban areas, commercial services (such as fuel, food and lodging) are generally within sight and available to the road user at reasonably frequent intervals along the route. However, they can be desirable or necessary where services are infrequent or in areas that are predominately residential or industrial where such services are not readily apparent. Also, if the visibility of the private advertising signs have impaired or eliminated either by sound-walls or other items constructed on State right-of-way, or by landscaping or other vegetation that cannot be trimmed or removed, the location can qualify for General Service signing.

**Standard:**

28 **The following criteria shall apply to General Service signs:**

1. **The business shall be within 1,000 feet of the intersection.**
2. **Only Fuel, Food and Lodging symbol (G66(CA)) signs shall be used.**
3. **All other qualifying criteria for Fuel, Food and Lodging listed below shall be met.**
4. **New installations shall be mounted on existing sign supports.**

**Support:**

29 Except for the conditions stated above, General Service signing will not normally be provided in urban areas except for signs directing to a hospital and camping.

**Standard:**

30 **General Service signs shall have a white retroreflective symbol or legend and border on a blue retroreflective background. Letter and numeral sizes shall conform to the minimum requirements of Table 2E-1 through 2E-5. Approved symbol signs shall be used in lieu of word messages, but symbol and word service message shall not be intermixed.**

31 **Follow-up signing, if necessary, shall be placed by local jurisdictions before General Service signs are placed on the State highway.**

**Guidance:**

32 *Whenever possible, General Service signs should be placed below the ground mounted Advance Guide (G83(CA) Series) signs. No more than four symbols should be mounted beneath a single advance directional sign.*

**Option:**

33 If there are no ground mounted Advance Guide (G83(CA) Series) signs available, the General Service signs may be placed as separate installations with a Directional Arrow Auxiliary (M6 Series) sign or NEXT RIGHT/LEFT (G58(CA)) plaque.

*Guidance:*

<sup>34</sup> To avoid misleading the road user, those services that are more than 0.5 miles from the access point on the major route to the service, should have a Distance with Arrow (G66-21A(CA)) plaque installed below the service sign.

*Support:*

<sup>35</sup> Accordingly, it would be a disservice to the traveler to lead them off on to a minor road to a business providing a service when that same service can be obtained in a shorter distance by remaining on the major road.

*Guidance:*

<sup>36</sup> General Service signing should only be provided at locations where the road user can return to the freeway or expressway and continue in the same direction of travel.

<sup>37</sup> Only services that fulfill the needs of the road user should be shown on General Service signs.

**Standard:**

<sup>38</sup> **Symbol signs shall be used for all new installations of the General Service signs and for all routine maintenance replacements.**

*Guidance:*

<sup>39</sup> The symbols should be placed below the first ground mounted Advance Guide (G83(CA) Series) sign.

*Option:*

<sup>40</sup> Where it is not possible to place them below an existing guide sign, they may be used individually on conventional highways or at the terminus of exit ramps.

*Guidance:*

<sup>41</sup> If placed separately, the NEXT RIGHT/LEFT (G58(CA)) auxiliary sign should be used with the symbol sign.

**Fuel (Gasoline, Diesel and Alternative Fuels) Signs (D9-7, D9-11, G66-11(CA), G66-11A(CA), G66-22A(CA), G66-22B(CA), G66-22C(CA), G66-22D(CA), G66-22E(CA), G66-22F(CA), G66-22G(CA), G66-22H(CA), G66-22J(CA), G66-22K(CA) and G81-52(CA))**

**Standard:**

- 1. The maximum distance to a service station shall be 0.5 miles and have reasonably direct access from and return to the highway.**

*Option:*

2. Service may be signed to in bypassed communities, if the distance to the service is less than the distance to the next service on the through route.

**Standard:**

- 3. Fuel, oil, compressed air, air gauge, radiator water, drinking water, telephone and restrooms shall be available during all service hours.**

*Guidance:*

4. The station should be open at least 12 hours a day.

**Standard:**

- 5. Where gasoline is available, the Gas (D9-7) symbol sign shall be used.**
- 6. Where gasoline and diesel is available, the Diesel Fuel (D9-11) symbol sign (with a superimposed "D") shall be used.**

*Option:*

7. The DIESEL (G66-12A(CA)) plaque may be used in addition to other appropriate service signs. Where neat (B100) Biodiesel (BD) fuel is available, the Biodiesel (G66-22C(CA)) symbol sign and BIODIESEL (G66-22D(CA)) supplemental plaque may be used in addition to the other appropriate signs.
8. Where liquefied petroleum gas is available; a LP GAS (G81-52(CA)) plaque may be used below either D9-7 or D9-11 sign.
9. Where methanol fuel is available, the Methanol Fuel (G66-11(CA)) symbol sign and METHANOL (G66-11A(CA)) plaque may be used in addition to other appropriate service signs.
10. The Compressed Natural Gas (G66-22A(CA)) sign may be used for Compressed Natural Gas Refueling Stations within 3 miles of a State highway and be available to the public at least 16 hours a day.
11. The Liquefied Natural Gas (G66-22B(CA)) sign may be used for Liquefied Natural Gas Refueling Stations within 3 miles of a State highway and be available to the public at least 16 hours a day.

12. Where ethanol E85 fuel is available, the Ethanol E85 (G66-22E(CA)) symbol sign and ETHANOL (G66-22F(CA)) supplemental plaque may be used in addition to the other appropriate signs.
13. Where hydrogen (HYD) fuel is available, the Hydrogen (G66-22G(CA)) symbol sign and HYDROGEN (G66-22H(CA)) supplemental plaque may be used within 3 miles of a State highway and be available to the public at least 16 hours a day, in addition to the other appropriate signs.
14. Where only alternative fuels are available and gasoline and diesel fuels are not, the Alternative ALT (G66-22J(CA)) symbol sign (with superimposed "ALT") may be used with an Alternative Fuels (G66-22K(CA)) supplemental plaque mounted below.
15. Beneath the standard fuel symbol sign, per #5 or #6 above, or, the Alternative-ALT (G66-22J(CA)) symbol sign, the Alternative Fuels (G66-22K(CA)) supplemental plaque may list alternative fuels available with one fuel name or abbreviation per line. This supplemental plaque height may vary from 2 to 6 lines of text; and, may intentionally leave space(s) for an alternate fuel legend overlay(s) to be added at a future time.

**Standard:**

16. **Follow-up signing, if necessary, shall be placed by local agencies before signs are placed on the State highway.**

**Support:**

42 Caltrans may develop signs for future requests for alternative fuel signs, then share the signs with the California Traffic Control Devices Committee (CTCDC) in a subsequent meeting for informational purposes.

**Electric Vehicle Charging Station Signs (G66-21(CA))**

**Option:**

43 The ELECTRIC VEHICLE CHARGING STATION (G66-21(CA)) sign may be used for Electric Vehicle Charging Stations within 3 miles of a State highway and be available to the public at least 16 hours a day.

**Standard:**

- 44 **Follow-up signing, if necessary, shall be placed by local agencies before signs are placed on the State highway.**

**Option:**

45 The Distance with Arrow (G66-21A(CA)) plaque may be used to supplement the G66-21(CA) sign to provide distance and directional information to the motorist. It may also be used with other general service signs (See Paragraph 34).

46 The FAST (G66-21C(CA)) header plaque may be used to supplement the G66-21(CA) sign to indicate that a Fast Electric Vehicle Charging Station is located off the State highway.

**Support:**

47 A Fast Electric Vehicle Charging Station is where the rate of battery electric charging is at least 20 kWh in a 30-minute period. Fast charging stations include direct current (DC) fast charging and battery switching.

**Food or Lodging Signs (D9-8 and D9-9)**

**Standard:**

48 **To qualify for food signs, single establishments shall be open to serve at least two meals a day. Both food and lodging establishments shall score at least 10 points in the following categories, including at least one point in Category 4, to qualify for signs.**

1. **Maximum distance from the highway exit to the first service facility:**

|                   |          |
|-------------------|----------|
| 0 – 1 mile        | 3 Points |
| 1 – 2 miles       | 2 Points |
| 2 – 5 miles       | 1 Point  |
| More than 5 miles | 0 Points |

2. **Number of traffic control devices (signals or stop signs) between the exit and the facility:**

|               |          |
|---------------|----------|
| 0 - 1 Devices | 3 Points |
| 2 – 3 Devices | 2 Points |
| 4 – 4 Devices | 1 Point  |
| More than 5   | 0 Points |

- 3. Number of seats available in food facilities:**
  - 50 or more 3 Points
  - 30 – 49 2 Points
  - 15 – 29 1 Point
  - Less than 15 0 Points
- 4. Number of rooms available with private baths at lodging facilities:**
  - 30 or more 3 Points
  - 10 – 30 2 Points
  - 2 – 10 1 Point
  - Less than 2 0 Points
- 5. Distance to the next highway exit served by a food or lodging establishment:**
  - 15 miles or more 3 Points
  - 7 – 15 miles 2 Points
  - 3 – 7 miles 1 Point
  - 3 miles or less 0 Points

*Guidance:*

- 6. *Judgment factors include comfort, appearance, scope of service provided, etc., should be scored 0 to 3 points by the inspecting official.*

**Camping Signs (D9-3 and D9-3a)**

*Option:*

<sup>49</sup> The Camping (D9-3 and D9-3a) signs may be placed for campgrounds providing individual service and utility hookups for one-night stops for travel trailers, campers and other recreational vehicles.

***Standard:***

- <sup>50</sup> **To qualify for Camping (D9-3 and D9-3a) signs, the facility shall meet all the following criteria:**
  - 1. It shall be licensed for private operation or be operated by a governmental agency.
  - 2. It shall be accessible to and capable of handling all types of recreational vehicles.
  - 3. It shall be open to the public for 24 hours each day during the time the signs are in place.
  - 4. It shall be no more than 10 miles from the highway exit designated by the sign.
  - 5. It shall be equipped to handle a minimum of 25 travel trailers, campers, and other recreational vehicles for overnight stops, including individual service, utility hook-ups and individual sewer connections or a central sewer holding tank.
  - 6. Follow-up signing shall be installed and maintained by local agencies where required for the logical direction of traffic.

**Hospital Sign (D9-2 and D9-13)**

*Option:*

<sup>49</sup> Hospitals, as defined in California Code of Regulations, Title 22, Division 5, Chapter 1, Article 1, Section 70005 and licensed by the Department of Health Services, which provide 24 hour inpatient care, in urban and rural areas which are located in close proximity to a highway and provide specified medical services, may qualify for the Hospital (D9-2) symbol sign.

<sup>50</sup> The D9-2 signs may be provided for hospitals in urban areas within 1 mile of a highway, accept emergency cases and have a medical doctor in attendance 24 hours a day.

<sup>51</sup> The D9-2 signs may be provided for hospitals in rural areas within 3 miles of a highway, accept emergency cases and have a doctor on call 24 hours a day.

<sup>52</sup> Exceptions to the distance requirement may be made in areas where hospitals are a great distance apart.

**Telephone Signs (D9-1, D9-1a and D9-1b)**

*Option:*

<sup>53</sup> The Telephone (D9-1, D9-1a and D9-1b) signs are placed where a telephone is available 24 hours a day and is located in a remote area where it would not be expected.

### **STAA Truck Service and Terminal Access Signs (G66-55(CA) and G66-56(CA))**

Option:

<sup>54</sup> The STAA Truck Service (G66-55(CA)) and STAA Truck Terminal Access (G66-56(CA)) signs may be placed by Caltrans on the National Network of Highways to identify locations where STAA trucks may leave the National Network to access services and terminals per CVC 35401.5(c) and (d). The G66-55(CA) and G66-56(CA) signs may also be used on Terminal Access routes to indicate turns and access ending points.

Support:

<sup>55</sup> More information on the National Network and State Terminal Access routes is available from the Office of Traffic Engineering in Caltrans' Division of Traffic Operations. Some of this information can also be accessed on the Internet at the following web site:

<http://www.dot.ca.gov/hq/traffops/engineering/trucks/>

### **STAA Definitions**

Support:

- **STAA** - Surface Transportation Assistance Act of 1982, federal funding authorization that declared, among other things;
  1. Semitrailers up to and including 48 feet in length are exempt from state kingpin to rear axle (KPRI) and overall combination length limits,
  2. Semitrailers over 48 feet long and up to and including 53 feet in length are exempt from state overall length limits. (These semitrailers are subject to state KPRI limits in California.),
  3. Double trailers in combination where each does not exceed 28.5 feet in length are exempt from any state overall length limits.
  4. Federal length rules apply to these combination vehicles only when operating on a federally declared system of highways called the National Network and the state and local determined terminal access and service access highways.

Note: Four buses up to 45 feet long (motorcoaches) were added to the federal regulations under the Intermodal Surface Transportation Efficiency Act of 1991 (ISTEA). Motorhomes (housecars) up to 45 feet in length were legalized in California in October 2001. Although highway restrictions apply to both these vehicle types, they may operate beyond the STAA Network. However, the Motorcoach and Motorhome Network map defines highway access restrictions imposed at the limits of turning performance (i.e., the 45 feet vehicles would need to cross centerlines).

- **National Network** – federally designated state highways for STAA vehicles as defined and listed in the Federal Code of Regulations, Title 23, Part 658 (23CFR658) and 658.23 Appendix A.
- **Terminal Access** – state and local agency highways designated for “reasonable access” to/from the National Network by STAA vehicles as provided for in the CVC 35401.5(c) and (d). All transitions (egress) from National Network to Terminal Access highways, critical decision points (all turns) and Terminal Access end points should be so designated with a G66-56(CA) sign.
- **STAA Network** – the California network of Terminal Access and National Network highways. A map and Truck Route List identifying the STAA Network (includes State highway system only, does not include local streets and roads) are available from Office of Traffic Engineering in Caltrans' Division of Traffic Operations.
- **Service Access (SA)** – state and local agency highways identified for service use by STAA vehicles. Service access is limited to 1 mile off the STAA network and must be “identified.” Identification may include a map indicating service access for STAA vehicles, an approved list, or by G66-55(CA) signs.
- **STAA trucks** – are truck tractor-semi-trailer combinations, or doubles with a long length configuration such that the vehicles may operate legally only on the STAA Network and SA routes.

### **STAA Truck Service (G66-55(CA)) Sign**

Option:

<sup>56</sup> The STAA Truck Service (G66-55(CA)) Sign may be placed on the STAA Network to identify locations where STAA trucks may exit the network to obtain services as provided for by CVC 35401.5(c) and (d).

Standard:

<sup>57</sup> **STAA trucks shall not exit the STAA Network to obtain services unless the G66-55(CA) sign indicates egress.**

<sup>58</sup> **STAA Truck Service (G66-55(CA)) signs shall be provided as follows:**

1. **Access – All the following requirements shall be met:**

- Fuel, food, lodging and/or repair facilities shall be located within 1 mile of the point of ingress and egress from the designated system.
  - Ramps, intersections and streets shall have adequate turning radii and lane widths to safely accommodate STAA trucks.
  - The service being made accessible shall have parking provisions for STAA trucks, or alternative parking within 1 mile shall be identified.
2. Facilities – Two of the four services - fuel, food, lodging & repair - shall be provided:
- Fuel (Diesel) - Fuel is available at least 12 hours during the working day.
  - Food - Conforms to requirements for Food (D9-8) signs in this section.
  - Lodging - Conforms to requirements for Lodging (D9-9) signs in this section.
  - Repair Services - Oil, tire repair, engine and brake services are available.
3. Concurrence:
- The proposal for G66-55(CA) signing has written concurrence by the local jurisdiction(s) having responsibility for maintenance of the roadways within 1 mile of ingress/egress.
4. Sign Placement:
- The G66-55(CA) sign on the STAA Network shall be displayed in advance of the ramp or intersection.
  - Although no follow-up signing is required, trailblazer signs may be used where applicable.

#### STAA Truck Terminal Access (G66-56(CA)) Sign

##### Option:

<sup>59</sup> STAA Truck Terminal Access (G66-56(CA)) signs may be placed to identify Terminal Access routes leading from the National Network as trailblazers and to indicate the end of a Terminal Access route. STAA trucks can exit the National Network onto Terminal Access routes only where indicated by a G66-56(CA) sign. (Note: In California, no signs indicate the National Network routes.) State routes may be designated Terminal Access only if the curves, ramps, and intersections meet the geometric criteria for STAA trucks, including adequate turning radii and lane width.

##### Support:

<sup>60</sup> The geometric criteria for using the STAA design vehicle to design or analyze the intersection, ramp, or curve are described in Topic 404 in the Caltrans Highway Design Manual. If the Terminal Access route ends without connecting to another STAA route, then the geometric criteria also include ensuring that an adequate turn-around location is available for all STAA vehicles 24 hours per day, 7 days per week.

##### Standard:

<sup>61</sup> STAA Truck Terminal Access (G66-56(CA)) signs shall be provided as follows:

1. On State Routes:
  - State route segments under consideration for Terminal Access shall meet all geometric criteria (see Paragraph 60) for STAA trucks.
  - The end of any Terminal Access route segment shall be signed as such.
  - Trail-blazing signs shall be placed at decision points indicating direction(s) a STAA truck may proceed.
  - The G66-56(CA) sign shall be placed in advance of the ramp or intersection where a STAA truck may exit the National Network or the designated Terminal Access routes.
2. On Local Routes:
  - Signing of egress from a State Terminal Access route to a local Terminal Access route shall be done by Caltrans, only if:
    - a) The local agency has requested that Caltrans place the sign and,
    - b) the local agency has informed Caltrans in writing that the local roads and intersections on the proposed local Terminal Access route meet all geometric criteria for STAA trucks and,
    - c) where the proposed Terminal Access route passes through more than one local jurisdiction, each affected agency has informed Caltrans in writing that the local roads and intersections on the proposed local Terminal Access route meet all geometric criteria for STAA trucks and,
    - d) Caltrans has verified that the State highway ramps or intersections meet all geometric criteria for STAA trucks.

- After steps a) through d) have been completed in item 2 “On Local Routes,” the local agency or agencies shall place G66-56(CA) signs at every critical decision point on the Terminal Access route in their respective jurisdictions, including a G66-56(CA) sign with END Auxiliary (M4-6) sign at the 24-hour turn-around location where the Terminal Access route ends if it does not connect to another STAA route.
- After the local agency or agencies have placed all the required signs on the local Terminal Access routes, Caltrans shall place a G66-56(CA) sign on the State route in advance of the ramp or intersection to the local Terminal Access route.

*Guidance:*

- Local agencies should furnish Terminal Access route information to the Office of Traffic Engineering for web publication. Some examples are available on the following web site:  
<http://www.dot.ca.gov/hq/traffops/engineering/trucks/truckmap/local-truck-routes.htm>

**NEXT EXIT OK Sign (G66-56A(CA))**

Option:

<sup>61</sup> The NEXT EXIT OK (G66-56A(CA)) sign may be used below the appropriate G66-55(CA) or G66-56(CA) signs.

**Law Enforcement Signs (G66-57(CA), G66-61(CA) and G66-62(CA))**

Option:

<sup>62</sup> The Highway Patrol (G66-57(CA)) signs may be placed for California Highway Patrol offices located within 1 mile of a highway.

<sup>63</sup> The Sheriff (G66-61(CA)) sign may be placed for a sheriff office located within 1 mile of a highway.

<sup>64</sup> The Police (G66-62(CA)) sign may be placed for a police station located within 1 mile of a highway.

**Emergency Services Signs**

Option:

<sup>65</sup> Emergency Service signs, such as DRINKING WATER, RADIATOR WATER; etc. may be placed when appropriate.

**Call Box Signs (SG25(CA), SG25A(CA) and SG41(CA))**

Support:

<sup>66</sup> The Call Box (SG25(CA)) sign is used to designate call boxes on the county SAFE (Service Authority for Freeway Emergencies) Call Box System. The special sign sizes are intended for use only on scenic highways, within designated coastal zones and National or State parks, to keep signing compatible with scenic values.

<sup>67</sup> The call box identification number is established by using the route number to the left of the hyphen. The first two numbers to the right of the hyphen are the post mile numbers (or three numbers if applicable); the last number locates the call box within the post mile.

<sup>68</sup> For northbound and eastbound routes, this number will be 2 for the call box in the first quarter mile; 4 for the call box between one quarter and one half mile; 6 for the call box between one half and three quarter mile; and 8 for the call box between three quarter and one mile, within a given post mile. 0 will be used for infills or for call boxes at the post mile.

<sup>69</sup> For southbound and westbound routes, this number will be 3 for the call box in the first quarter mile; 5 for the call box between one quarter and one half mile; 7 for the call box between one half and three quarter mile; and 9 for the call box between three quarter and one mile, within a given post mile. 1 will be used for infills or for call boxes at the post mile.

Option:

- A letter code may precede the post mile (R for realignment, etc.).

**Standard:**

- Call boxes located in the median shall be designated by the letter “M” following the post mile.
- Call boxes located on a transition or connector shall be designated by the letter “T” following the post mile.
- Call boxes located at a park and ride lot shall be designated by the letter “A” following the post mile.
- Call boxes located on a carpool lane shall be designated by the letter “P” following the post mile.
- Call boxes located on a split (i.e. Cypress) shall be designated by the letter “S” following the post mile.

Option:

<sup>70</sup> The Call Box Adoption Plaque (SG25A(CA)) may be used to inform motorists on highways, that have the SAFE Call Box System, that a particular call box location or segment of highway has been adopted by an individual, organization or company.

**Standard:**

<sup>71</sup> **When used, the SG25A(CA) sign shall be placed below the SG25(CA) sign.**

Option:

<sup>72</sup> The END CALL BOXES (SG41(CA)) sign may be used to inform motorists of the end of the SAFE Call Box System for a particular segment of highway.

**CAL Fire Station Signs (SG38(CA) and SG39(CA))**

Option:

<sup>73</sup> The CAL FIRE STATION NEXT RIGHT (SG38(CA)) sign may be used on freeways in rural areas to give advance notice of an exit to a California Department of Forestry Fire Station which is within 0.5 miles of the exit and is open 24 hours each day of the year.

<sup>74</sup> The CAL FIRE STATION with Arrow (SG39(CA)) sign may be used in rural areas on expressways, conventional highways and freeway ramp terminals in advance of the turn off to a California Department of Forestry Fire Station which is within 0.5 miles of the exit and is open 24 hours each day of the year.

**Fire Hydrant Signs (S9(CA) and S10(CA))**

<sup>75</sup> The Fire Hydrant Street Name (S9(CA)) or Fire Hydrant with Distance and Arrow (S10(CA)) sign may be used to mark the location of off right-of-way fire hydrants adjacent to freeways. A public entity may place blue reflective pavement markers on a State highway after first obtaining an encroachment permit from Caltrans. Refer to Health and Safety Code Section 13060. In many locations the off right-of-way fire hydrants may be out of view from the freeway. Some fire districts may want to install the S9(CA) and S10(CA) signs to identify the hydrant. These S9(CA) and S10(CA) sign installations are optional and at the discretion of the Caltrans District Engineer.

**Section 2I.04 Interstate Oasis Signing**

Support:

<sup>01</sup> An Interstate Oasis is a facility near an Interstate highway that provides products and services to the public, 24-hour access to public restrooms, and parking for automobiles and heavy trucks. Interstate Oasis guide signs inform road users on Interstate highways as to the presence of an Interstate Oasis at an interchange and which businesses have been designated by the State within which they are traveling as having met the eligibility criteria of the Federal Highway Administration's Interstate Oasis policy. The FHWA's policy, which is dated October 18, 2006, and which can be viewed on the MUTCD website at <http://mutcd.fhwa.dot.gov/res-policy.htm>, provides a more detailed definition of an Interstate Oasis and specifies the eligibility criteria for an Interstate Oasis designation in compliance with the requirements of laws enacted by Congress.

Guidance:

<sup>02</sup> *If a State elects to provide or allow Interstate Oasis signing (see Figure 2I-4), there should be a statewide policy, program, procedures, and criteria for the designation and signing of a facility as an Interstate Oasis that complies with FHWA's policy and with the provisions of this Section.*

<sup>03</sup> *States electing to provide or allow Interstate Oasis signing should use the following signing practices on the freeway for any given exit to identify the availability of a designated Interstate Oasis:*

- A. If adequate sign spacing allows, a separate Interstate Oasis (D5-12) sign should be installed in an effective location with spacing of at least 800 feet from other adjacent guide signs, including any Specific Service signs. This Interstate Oasis sign should be located upstream from the Advance Guide sign or between the Advance Guide sign and the Exit Direction sign for the exit leading to the Interstate Oasis. The Interstate Oasis sign should have a white legend with a letter height of at least 10 inches and a white border on a blue background and should contain the words INTERSTATE OASIS and the exit number or, for an unnumbered interchange, an action message such as NEXT RIGHT. The names or logos of the businesses designated as Interstate Oases should not be included on this sign.*
- B. If the spacing of the other guide signs precludes the use of a separate sign as described in Item A, an INTERSTATE OASIS (D5-12P) supplemental plaque with a letter height of at least 10 inches and with a*



*white legend and border on a blue background should be appended above or below an existing D9-18 series General Service sign for the interchange.*

04 *If a separate Interstate Oasis (D5-12) sign is installed, an Interstate Oasis sign panel should be incorporated into the design of the sign (see Figure 2I-4).*

**Standard:**

05 **The Interstate Oasis sign panel shall only be used on the separate Interstate Oasis sign where it is accompanied by the words INTERSTATE OASIS and shall not be used independently without the words.**  
Option:

06 *If Specific Service signing is provided at the interchange, a business designated as an Interstate Oasis and having a business logo sign panel on the Food and/or Gas Specific Service signs may use the bottom portion of the business logo sign panel to display the word OASIS.*

**Standard:**

07 **If Specific Services signs containing the OASIS legend as a part of the business logo(s) are not used on the ramp and if the Interstate Oasis is not clearly visible and identifiable from the exit ramp, a sign with a white INTERSTATE OASIS legend with a letter height of at least 6 inches and a white border on a blue background shall be provided on the exit ramp to indicate the direction and distance to the Interstate Oasis.**

08 **If needed, additional trailblazer guide signs shall be used along the crossroad to guide road users to an Interstate Oasis.**

## **Section 2I.05 Rest Area and Other Roadside Area Signs**

**Standard:**

01 **Rest Area signs (see Figure 2I-5 and 2I-5(CA)) shall have a retroreflective white legend and border on a blue background.**

02 **Signs that include the legend REST AREA shall be used only where parking and restroom facilities are available.**

*Guidance:*

03 *A roadside area that does not contain restroom facilities should be signed to indicate the major road user service that is provided. For example, the sign legends for an area with only parking should use the words PARKING AREA instead of REST AREA. The sign legends for an area with only picnic tables and parking should use words such as PICNIC AREA, ROADSIDE TABLE, or ROADSIDE PARK instead of REST AREA.*

04 *Rest areas that have tourist information and welcome centers should be signed as discussed in Section 2I.08.*

05 *Scenic area signing should be consistent with that provided for rest areas, except that the legends should use words such as SCENIC AREA, SCENIC VIEW, or SCENIC OVERLOOK instead of REST AREA.*

06 *If a rest area or other roadside area is provided on a conventional road, a D5-1 and/or ~~D5-1b~~ D5-1a sign should be installed in advance of the rest area or other roadside area to permit the driver to reduce speed in preparation for leaving the highway. A D5-5 sign (or a D5-2 sign if an exit ramp is provided) should be installed at the turnoff point where the driver needs to leave the highway to access the rest area or other roadside area.*

07 *If a rest area or other roadside area is provided on a freeway or expressway, a D5-1 sign should be placed 1 mile and/or 2 miles in advance of the rest area.*

**Standard:**

08 **A ~~D5-2~~ D5-2a sign shall be placed at the rest area or other roadside area exit gore.**

**Option:**

09 **A ~~D5-1b~~ D5-1a sign may be placed between the D5-1 sign and the exit gore on a freeway or expressway. A second D5-1 sign may be used in place of the D5-1b sign with a distance to the nearest 1/2 or 1/4 mile displayed as a fraction rather than a decimal for distances of less than 1 mile.**

10 **To provide the road user with information on the location of succeeding rest areas, a NEXT REST AREA XX MILES (D5-6) sign (see Figure 2I-5) may be installed independently or as a supplemental sign mounted below one of the REST AREA advance guide signs.**

**Standard:**

**11 All signs on freeways and expressways for rest and other roadside areas shall have letter and numeral sizes that comply with the minimum requirements of Tables 2E-2 through 2E-5. The sizes for General Service signs that have standardized designs shall be as shown in Table 2I-1.**

**Option:**

12 If the rest area has facilities for the physically impaired (see Section 2I.02), the International Symbol of Accessibility for the Handicapped (D9-6) sign (see Figure 2I-1) may be placed with or beneath the REST AREA advance guide sign.

13 If telecommunication devices for the deaf (TDD) are available at the rest area, the TDD (D9-21) symbol sign (see Figure 2I-1) may be used to supplement the advance guide signs for the rest area.

14 If wireless Internet services are available at the rest area, the Wi-Fi (D9-22) symbol sign (see Figure 2I-1) may be used to supplement the advance guide signs for the rest area.

15 The alternate message VISTA POINT may be used on D5-1 signs in advance of a vista point.

16 When several rest areas are provided (or planned) on the same route, generally within one hour's drive, a NEXT REST (X MILE) Plaque (G79A(CA)) may be placed below the REST AREA (X MILE) (D5-1) sign.

17 The PATROLLED BY HIGHWAY PATROL (G80B(CA)) sign may be used below the REST AREA (D5-2) sign where the California Highway Patrol has made an agreement with Caltrans to patrol a specific rest area.

**Support:**

18 Until all of a planned series of roadside rests are constructed, it will be appropriate to sign to rest areas greater than one hour's drive ahead.

**Guidance:**

19 *The REST AREA w/Arrow (D5-2b) sign should be placed, as a supplement to REST AREA (X MILE) (D5-1) sign, at the beginning of the deceleration lane leading to a roadside rest area. The sign should be used in lieu of an EXIT with Arrow (E5-1) sign at roadside rests.*

**Option:**

20 The Opposite Sex Attendant (S19(CA)) sign may be used for the use of restroom facilities at Safety Roadside Rest Areas to indicate that it is permissible for a disabled person to be accompanied in the restroom by his or her attendant, who may be a person of the opposite sex, to assist the disabled person. Refer to Streets and Highways Code Section 223.5.

21 The Highway Patrol PARKING ONLY (S34(CA)) sign may be used in a Safety Roadside Rest Area to designate a parking stall(s) dedicated for California Highway Patrol Vehicles only. The S34(CA) sign may be supplemented with a "CHP" pavement marking.

**Guidance:**

22 *When used, the pavement marking should be located so that it is visible when a vehicle is parked in the space.*

**Option:**

23 The Rattlesnakes Caution (S26(CA)) sign may be used in locations such as vista points and rest areas where pedestrians are present and rattlesnakes have been known to inhabit the area.

24 The Rest Area/Vista Point 8 HOUR PARKING (S23(CA)) sign may be used to discourage extended stays in roadside rests or vista points for noncommercial vehicles. The 10 HOUR PARKING COMMERCIAL MOTOR VEHICLES (R39-3(CA)) may be used to allow ten total hours for parking for commercial vehicles. See CVC 22651(s)1 and CVC 22651(s)2.

25 The NO SOLICITING (S24(CA)) sign may be used to prohibit the vending of merchandise, foodstuff, or services and the soliciting of money within any roadside rest areas or vista points. Refer to Streets and Highways Code 225.5. See Section 1A.11 for information regarding this publication.

26 The VENDING MACHINES (G81-63(CA)) sign may be placed below the REST AREA X MILE (D5-1) sign at those rest areas which provide vending machine services to the motorists on a 24 hour basis.

**Guidance:**

27 *The G81-63(CA) sign should be installed similar to the General Service (G66(CA) Series) signs in Section 2I.03, below the D5-1 sign.*

**Option:**

28 The REST AREA (X MILE) (D5-1) and REST AREA with Arrow (D5-2) signs may also be used with the message VISTA POINT, where appropriate.

<sup>29</sup> The ALT FUEL VEHICLE PARKING ONLY (R116(CA)) sign may be used in a public parking facility or a park-and-ride lot to designate a parking stall(s) dedicated for alternatively fueled vehicles only.

Support:

<sup>30</sup> Public Resource Code 25722.9 (a) defines "alternatively fueled vehicles" as light-, medium-, and heavy-duty vehicles that reduce petroleum usage and related emissions by using advanced technologies and fuels, including those vehicles described in Section 5205.5 of the Vehicle Code.

### **Section 2I.06 Brake Check Area Signs (D5-13 and D5-14)**

Guidance:

<sup>01</sup> If an area has been provided for drivers to check the brakes on their vehicle, a BRAKE CHECK AREA XX MILES (D5-13) sign (see Figure 2I-6) should be installed in advance of the brake check area, and a D5-14 sign (see Figure 2I-6) should be placed at the entrance to the brake check area.

Support:

<sup>02</sup> The Brake Check Area (G66-58(CA), G66-59(CA) and G66-60(CA)) signs (see Figure 2I-6(CA)) are provided to give notice to motorists, particularly truck operators, of an area provided to allow vehicle operators to stop and check the condition and adjustment of their brakes. These areas are generally provided just prior to a significant downgrade.

### **Section 2I.07 Chain-Up Area Signs (D5-15 and D5-16)**

Guidance:

<sup>01</sup> If an area has been provided for drivers to pull off of the roadway to install chains on their tires, a CHAINUP AREA XX MILES (D5-15) sign (see Figure 2I-6) should be installed in advance of the chain-up area, and a D5-16 sign (see Figure 2I-6) should be placed at the entrance to the chain-up area.

### **Section 2I.08 Tourist Information and Welcome Center Signs**

Support:

<sup>01</sup> Tourist information and welcome centers have been constructed within rest areas on freeways and expressways and are operated by either a State or a private organization. Others have been located within close proximity to these facilities and operated by civic clubs, chambers of commerce, or private enterprise.

Guidance:

<sup>02</sup> An excessive number of supplemental sign panels should not be installed with Tourist Information or Welcome Center signs so as not to overload the road user.

Standard:

<sup>03</sup> Tourist Information or Welcome Center signs (see Figure 2I-7 and 2I-7(CA)) shall have a white legend and border on a blue background. Continuously staffed or unstaffed operation at least 8 hours per day, 7 days per week, shall be required.

<sup>04</sup> If operated only on a seasonal basis, the Tourist Information or Welcome Center signs shall be removed or covered during the off seasons.

Guidance:

<sup>05</sup> For freeway or expressway rest area locations that also serve as tourist information or welcome centers, the following signing criteria should be used:

- A. The locations for tourist information and welcome center Advance Guide, Exit Direction, and Exit Gore signs should meet the General Service signing requirements described in Section 2I.03.
- B. If the signing for the tourist information or welcome center is to be accomplished in conjunction with the initial signing for the rest areas, the message on the Advance Guide (D5-7) sign should be REST AREA, TOURIST INFO CENTER, XX MILES or REST AREA, STATE NAME (optional), WELCOME CENTER XX MILES. On the Exit Direction (D5-8 or D5-11) sign the message should be REST AREA, TOURIST INFO CENTER with a diagonally upward-pointing directional arrow (or NEXT RIGHT), or REST AREA, STATE NAME (optional), WELCOME CENTER with a diagonally upward-pointing directional arrow (or NEXT RIGHT).
- C. If the initial rest area Advance Guide and Exit Direction signing is in place, these signs should include, on supplemental signs, the legend TOURIST INFO CENTER or STATE NAME (optional), WELCOME CENTER.
- D. The Exit Gore sign should contain only the legend REST AREA with the arrow and should not be supplemented with any legend pertaining to the tourist information center or welcome center.

Option:

06 An alternative to the supplemental TOURIST INFO CENTER legend is the Tourist Information (D9-10) sign (see Figure 2I-1), which may be appended beneath the REST AREA advance guide sign.

07 The name of the State or local jurisdiction may appear on the Advance Guide and Exit Direction tourist information/welcome center signs if the jurisdiction controls the operation of the tourist information or welcome center and the center meets the operating criteria set forth in this Manual and is consistent with State policies.

Guidance:

08 *For tourist information centers that are located off the freeway or expressway facility, additional signing criteria should be as follows:*

- A. *Each State should adopt a policy establishing the maximum distance that a tourist information center can be located from the interchange in order to be included on official signs.*
- B. *The location of signing should be in accordance with requirements pertaining to General Service signing (see Section 2I.03).*
- C. *Signing along the crossroad should be installed to guide the road user from the interchange to the tourist information center and back to the interchange.*

Option:

09 As an alternative, the Tourist Information (D9-10) sign (see Figure 2I-1) may be appended to the guide signs for the exit that provides access to the tourist information center. As a second alternative, the Tourist Information sign may be combined with General Service signing.

**Tourist Information Signs (G81-21(CA) and G81-24(CA))**

Option:

10 The TOURIST INFORMATION (G81-21(CA) and G81-24(CA)) signs may be placed directing to off-highway facilities.

**Standard:**

11 **These signed facilities shall have a principal function of providing local tourist information. Those facilities provided by local chamber of commerce (or other official body) representing a group of people or businesses shall be given initial priority for signing.**

Guidance:

12 *The G81-21(CA) or G81-24(CA) signs should be placed on State highways only where privately-owned off-highway signs would not reasonably provide adequate directions to motorists. These signs should be restricted to those facilities which are spaced no closer than 15 miles apart in each direction along any highway. An excessive number of supplemental panels should not be installed with Tourist Information or Welcome Center signs so as not to overload the road user.*

**Standard:**

13 **The TOURIST INFORMATION (G81-21(CA) and G81-24(CA)) signs shall have a white legend and border on a blue background.**

Guidance:

14 *These signs should be placed beneath another primary guide sign.*

Option:

15 If no guide signs are available, the G81-21(CA) or G81-24(CA) signs may be placed as separate installations.

Guidance:

16 *Facilities should be within 0.5 miles of the highway and have reasonably direct access from, and return to, the highway.*

17 *Facilities should provide lighting, telephone and information on a 24-hour basis and cover the entire area served.*

*Information should include area and regional maps, and 24-hour service information including, but not limited to medical, police, fire, restrooms, auto repair service and fuel. Outside maps and displays must be provided at all manned centers for use during periods when the facility is not manned.*

18 *Facilities should have adequate on premise and off right-of-way signing, where necessary, denoting "Tourist Information". Displays should be professionally designed and constructed and provide resistance to fading, chipping and vandalism.*

**Standard:**

19 **If operated only on a seasonal basis, where criteria cannot be met during closed periods, these signs shall be covered or removed.**

*Guidance:*

*20 For freeway or expressway rest area locations that also serve as tourist information centers, the following signing criteria should be used:*

- A. The locations for the Advance Guide (G83(CA) Series), Exit Direction (G85(CA) Series), and Exit Gore (E5-1) signs should meet the General Service signing requirements.*
- B. The TOURIST INFORMATION (G81-21(CA) and G81-24(CA)) signs should be placed beneath the REST AREA (D5-2) sign or other primary guide sign. If no guide signs are available, they may be placed as a separate installation.*
- C. The gore sign should contain only the legend REST AREA with the arrow and should not be supplemented with any legend pertaining to the tourist information.*

*Option:*

*21 As an alternative, the Information Symbol (D9-10) sign may be appended to the guide signs for the exit providing access to the tourist information center. As a second alternative, the D9-10 sign may be combined with General Service signing.*

**California Welcome Center Signs (SG47(CA) Series)**

*Option:*

*22 The CALIFORNIA WELCOME CENTER (SG47(CA) Series) signs may be placed directing to a statewide network of visitor information centers as designated by the California Office of Tourism to encourage tourism in California and provide benefits to the State economy.*

**Standard:**

**23 The facilities signed shall have a principal function of providing statewide tourist information. Centers that can be so designated shall include, but not be limited to, centers operated by convention centers and visitor bureaus, chambers of commerce, federal, state or local governments, or private entities.**

**24 Designation of an entity as a California Welcome Center shall be based on conditions established by the Office of Tourism through written agreement with the entity.**

**25 The SG47(CA) Series signs shall have a yellow welcome center logo, and a white legend and border on a blue background.**

*Guidance:*

*26 The SG47(CA) Series signs should be placed as separate installations with the individual welcome centers being charged directly for the initial and ongoing cost and fees related production, maintenance and permitting of the signs.*

*27 Facilities should be within 3 miles in urban areas and 5 miles of a State highway and have reasonably direct access from, and return to, the highway.*

**Standard:**

**28 Follow-up signing, if necessary, shall be placed by local jurisdictions before these signs are placed on the State highway.**

**29 If operated only on a seasonal basis, where criteria cannot be met during closed periods, signs shall be covered or removed as directed by the Office of Tourism.**

*Option:*

*30 The CALIFORNIA WELCOME CENTER X MILES (SG47A(CA)) sign may be placed on the nearest freeway approximately 2 miles, or more as appropriate, in advance of the exit to a California Welcome Center that has been established under the authority of the California Office of Tourism.*

*31 The CALIFORNIA WELCOME CENTER NEXT RIGHT (SG47B(CA)) sign may be placed on the nearest freeway, at the appropriate exit to a California Welcome Center that has been established under the authority of the California Office of Tourism.*

*32 The CALIFORNIA WELCOME CENTER with Arrow (SG47C(CA)) sign may be placed at a freeway ramp terminal, conventional highway or local road to provide direction to a California Welcome Center that has been established under the authority of the California Office of Tourism.*

*33 The CALIFORNIA WELCOME CENTER X MILES with Arrow (SG47D(CA)) sign may be placed at a freeway ramp terminal to provide direction and distance to a California Welcome Center that has been established under the authority of the California Office of Tourism.*

*Guidance:*

*34 The distance on the SG47D(CA) sign should be no more than 3 miles from the State highway.*

Support:

<sup>35</sup> The Welcome Center will be charged directly for the initial and ongoing cost and fees related to production, maintenance and permitting of the SG47A(CA), SG47B(CA), SG47C(CA) and SG47D(CA) signs.

## Section 2I.09 Radio Information Signing

Option:

<sup>01</sup> Radio-Weather Information (D12-1) signs (see Figure 2I-8) may be used in areas where difficult driving conditions commonly result from weather systems. Radio-Traffic Information signs may be used in conjunction with traffic management systems.

**Standard:**

<sup>02</sup> **Radio-Weather and Radio-Traffic Information signs shall have a white legend and border on a blue background. Only the numerical indication of the radio frequency shall be used to identify a station broadcasting travel-related weather or traffic information. No more than three frequencies shall be displayed on each sign. Only radio stations whose signal will be of value to the road user and who agree to broadcast either of the following two items shall be identified on Radio-Weather and Radio-Traffic Information signs:**

**A. Periodic weather warnings at a rate of at least once every 15 minutes during periods of adverse weather; or**

**B. Driving condition information (affecting the roadway being traveled) at a rate of at least once every 15 minutes, or when required, during periods of adverse traffic conditions, and when supplied by an official agency having jurisdiction.**

<sup>03</sup> **If a station to be considered operates only on a seasonal basis, its signs shall be removed or covered during the off season.**

*Guidance:*

<sup>04</sup> *The radio station should have a signal strength to adequately broadcast 70 miles along the route. Signs should be spaced as needed for each direction of travel at distances determined by an engineering study. The stations to be included on the signs should be selected in cooperation with the association(s) representing major broadcasting stations in the area to provide: (1) maximum coverage to all road users on both AM and FM frequencies; and (2) consideration of 24 hours per day, 7 days per week broadcast capability.*

Option:

<sup>05</sup> In roadway rest area locations, a smaller sign using a greater number of radio frequencies, but of the same general design, may be used.

**Standard:**

<sup>06</sup> **Radio-Weather and Radio-Traffic Information signs installed in rest areas shall be positioned such that they are not visible from the main roadway.**

Option:

<sup>07</sup> A Channel 9 Monitored (D12-3) sign (see Figure 2I-8) may be installed as needed. Official public agencies or their designees may be displayed as the monitoring agency on the sign.

**Standard:**

<sup>08</sup> **Only official public agencies or their designee shall be displayed as the monitoring agency on the Channel 9 Monitored sign.**

<sup>08a</sup> There are three types of radio information signs:

1. Radio – Weather Information (D12-1)
2. Radio – Traffic Information (D12-1)
3. Radio – Recreational Information (G81-65(CA))

**Standard:**

<sup>08b</sup> **Stations shall broadcast on AM or FM frequencies licensed by the Federal Communications Commission (FCC) for traveler information stations.**

### **Radio – Weather Information (D12-1)**

Option:

<sup>08c</sup> The D12-1 sign with alternate “Weather” message may be used on rural highways where weather conditions result in driving conditions less than optimum or to inform motorists of road or traffic conditions for highways and public inter-modal transportation facilities.

<sup>08d</sup> The criteria for D12-1 sign is as follows:

**Standard:**

- 1 Only the numerical indication of the radio frequency shall be used to identify the broadcasting stations.**
- 2 If a station to be considered operates only on a seasonal basis, its signs shall be removed or covered during the off-season.**

*Guidance:*

- 3 The radio stations should have signal strength to adequately serve 70 miles along the roadway.*
- 4 Signs should be spaced according to need, but ordinarily not closer than 30 miles apart for each direction of travel.*
- 5 Only radio stations whose signal will be of value to the traveler and who agree to carry the two items below should be identified on this sign:*
  - a. Periodic weather warnings at no more than 15-minute intervals during periods of adverse weather.*
  - b. Road condition information affecting the roadway being traveled, broadcasted once every half-hour when required, to be supplied by an official agency having jurisdiction.*
- 6 The stations to be included on the signs should be selected in cooperation with the association(s) representing major broadcasting stations in the area to provide:*
  - a. Maximum coverage to all motorists on both AM and FM frequencies, and*
  - b. Consideration of 24 hours a day, 7 days a week broadcast capabilities.*

Option:

- 7 A maximum of three frequencies may be shown on each sign.
- 8 A particular radio frequency may be shown a maximum of twice in one direction along the mainline.

<sup>08e</sup> The WHEN FLASHING (G81-64A(CA)) sign may be used with the D12-1 sign when messages are not broadcast full time and to accommodate “real-time” usage.

*Guidance:*

<sup>08f</sup> *The G81-64A(CA) sign should be placed with flashing yellow beacons, above and on the same posts with the D12-1 sign.*

### **Radio – Traffic Information (D12-1)**

Option:

<sup>08g</sup> The D12-1 sign with alternate “Traffic” message may be used to inform motorists of broadcasts about traffic conditions for highways and public inter-modal transportation facilities.

**Standard:**

<sup>08h</sup> **The radio station shall be operated by the public agency having jurisdiction over the transportation facility. The agency operating the station shall be responsible for monitoring and maintaining the system and changing the message content as situations warrant.**

### **Radio – Recreation Information (G81-65(CA))**

Option:

<sup>08i</sup> The G81-65(CA) sign (see Figure 2I-8(CA)) may be used on rural highways to inform travelers of broadcasts about State or federal parks and recreational facilities.

**Standard:**

<sup>08j</sup> **The G81-65(CA) sign shall have a white legend and border on a brown background. The sign and sign structure shall be free of extraneous messages or logos, and must stand alone with no external lights or flashing beacons. Only the numerical indication of the radio frequency shall be used to identify a station. No more than three frequencies shall be shown on each sign. Only radio stations whose signal will be of value to the road user and who agree to broadcast in accordance with the items below shall be identified on this sign:**

- A. Provides information about State or federal recreational facilities located in rural areas.**
- B. Message content is devoted to public highway purposes.**

**C. Broadcasts operate 24 hours per day and 7 days per week.**

**D. Broadcasts contain no commercial messages.**

<sup>08k</sup> **For installation of G81-65(CA) sign on State highways, the sign shall be installed by the permittee through Caltrans' encroachment permit process. The costs, conditions of operation, and specific message content shall be clearly specified in the encroachment permit subject to the following terms and conditions:**

**A. The permittee is the State or federal agency that owns and/or operates the recreational facility.**

**B. The permittee possesses a valid FCC license to operate the radio station as a traveler information station.**

**C. The permittee is responsible for the accuracy of the message and message content.**

**D. The permittee bears all costs, including but not limited to, FCC approval and licensing; fabrication and installation of signs; and the installation, operation and maintenance of appurtenant radio equipment and facilities.**

Option:

<sup>09</sup> An Emergency CALL XX (D12-4) sign (see Figure 2I-8), along with the appropriate number to call, may be used for cellular phone communications.

### **EMERGENCY CALL 9-1-1 (G81-61(CA) and G81-62(CA)) Signs**

Option:

<sup>10</sup> The EMERGENCY CALL 9-1-1 (G81-61(CA)) sign (see Figure 2I-8(CA)) may be placed below all new Unincorporated Community (G9-2(CA)), City Limit (G9-5(CA)) and County Line (G10(CA)) signs. The G81-61(CA) may also be placed below the existing G9-2(CA), G9-5(CA) and G10(CA) signs when they are changed for other purposes, such as updating population figures. The G81-61(CA) sign panel may be shorter than the G9-2(CA), G9-5(CA) and G10(CA) sign panel under which it is placed.

Guidance:

<sup>11</sup> *The G81-61(CA) sign panel should not be longer than the G9-2(CA), G9-5(CA) and G10(CA) sign panel under which it is placed.*

**Standard:**

<sup>12</sup> **The letter size used in the G81-61(CA) sign shall not exceed that of the words "City Limit" on the G9-5(CA) sign or the words "County Line" on the G10(CA) sign.**

Option:

<sup>13</sup> The EMERGENCY CALL 9-1-1 (G81-62(CA)) sign (see Figure 2I-8(CA)) may be installed on all State highways at state entry points.

Guidance:

<sup>14</sup> *The G81-62(CA) sign should be installed as a separate installation in an appropriate location following the Welcome To California (G10B(CA)) sign.*

Option:

<sup>15</sup> The G81-62(CA) sign (particularly the smaller version) may be used in place of the G81-61(CA) sign in installations requiring a shorter sign panel.

### **REPORT DRUNK DRIVERS CALL 911 (G81-66(CA)) Sign**

Option:

<sup>16</sup> The REPORT DRUNK DRIVERS CALL 911 (G81-66(CA)) Sign (see Figure 2I-8(CA)) may be installed on the roadway for safety enhancement.

## **Section 2I.10 TRAVEL INFO CALL 511 Signs (D12-5 and D12-5a)**

Option:

<sup>01</sup> A TRAVEL INFO CALL 511 (D12-5 or SG49A(CA)) sign (see Figure 2I-8 and 2I-8(CA)) may be installed if a 511 travel information services telephone number is available to road users for obtaining traffic, public transportation, weather, construction, or road condition information.

<sup>02</sup> The pictograph of the transportation agency or the travel information service or program that is providing the travel information may be incorporated within the D12-5 sign either above or below the TRAVEL INFO CALL 511 legend.

**Standard:**



- 03 **The logo of a commercial entity shall not be incorporated within the TRAVEL INFO CALL 511 sign.**
- 04 **The TRAVEL INFO CALL 511 sign shall have a white legend and border on a blue background.**

*Guidance:*

05 *If the pictograph of the transportation agency or the travel information service or program is used, the pictograph's maximum height should not exceed two times the letter height used in the legend of the sign.*

*Option:*

06 A FREEWAY ASSIST CALL ### (SG49C(CA)) sign (see Figure 2I-8(CA)) may be installed if a Service Authority for Freeway Emergencies (SAFE) has established a mobile call box program, which is available to road users for obtaining roadside assistance such as tow service.

07 The pictograph of the SAFE that is providing the roadside assistance may be incorporated within the SG49C(CA) sign either above or below the FREEWAY ASSIST CALL ### legend.

**Standard:**

- 08 **The ### shall be replaced with the mobile call number applicable to the SAFE providing the roadside assistance.**
- 09 **The logo of a commercial entity shall not be incorporated within the FREEWAY ASSIST CALL ### sign**
- 10 **The FREEWAY ASSIST CALL ### sign shall have a white legend and border on a blue background.**

*Guidance:*

11 *If the pictograph of the SAFE is used, the pictograph's maximum height should not exceed two times the letter height used in the legend of the sign.*

12 *A call box identification number (see Section 2I.03, paragraph 66) may be included on the sign for location identification purposes, when the sign has been placed at a location where a call box has been removed.*

### **Section 2I.11 Carpool and Ridesharing Signing**

*Option:*

01 In areas having carpool matching services, Carpool Information (D12-2) signs (see Figure 2I-8) may be provided adjacent to highways with preferential lanes or along any other highway.

02 Carpool Information signs may include an Internet domain name or telephone number of more than four characters within the legend.

*Guidance:*

03 *Because this is an information sign related to road user services, the Carpool Information sign should have a white legend and border on a blue background.*

**Standard:**

04 **If a local transit pictograph or carpool symbol is incorporated into the Carpool Information sign, the maximum vertical dimension of the logo or symbol shall not exceed 18 inches.**

*Option:*

05 The Ridesharing Information (SG19(CA)) sign (see Figure 2I-8(CA)) may be placed at selected locations for incoming traffic in urban areas.

06 The Park & Ride Facility Information (SG20(CA)) sign (see Figure 2I-8(CA)) may be used to identify park and ride facilities provided for the use of car-poolers and transit users.

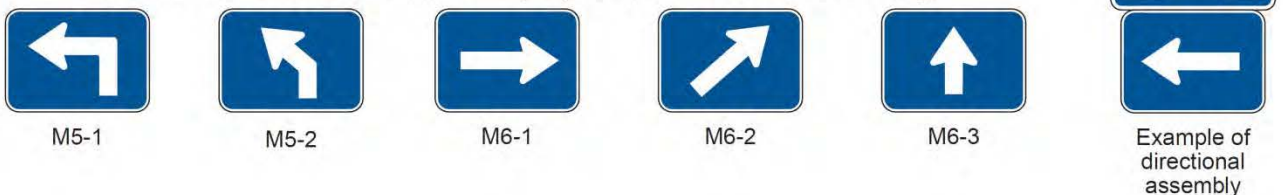
*Guidance:*

07 *For freeways and expressways, the SG19(CA) sign locations should be no closer than 10 miles apart.*

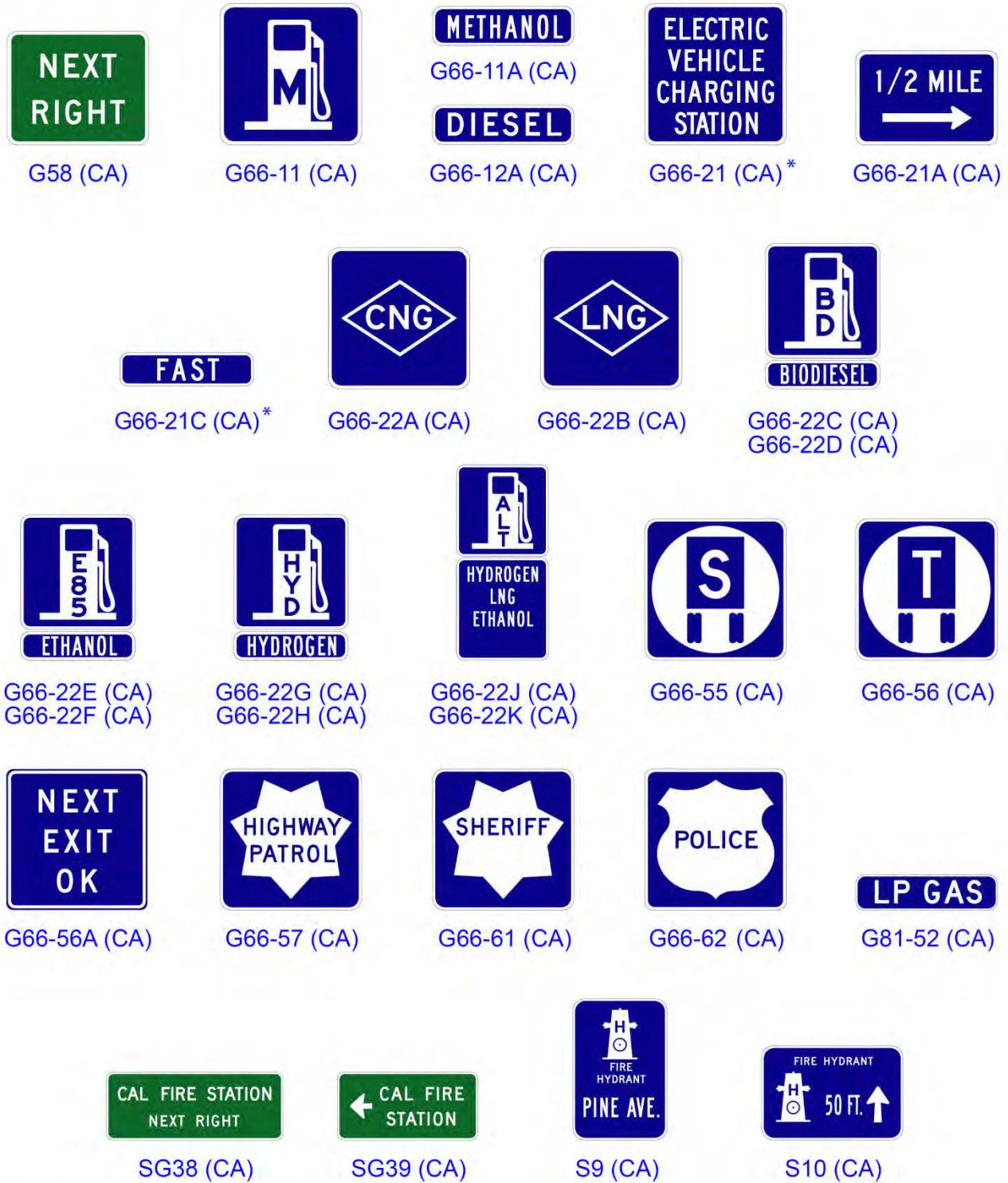
**Figure 2I-1. General Service Signs and Plaques**



Advance Turn and Directional Arrow Auxiliary Signs for use with General Service Signs



**Figure 2I-1 (CA). General Service Signs and Plaques**



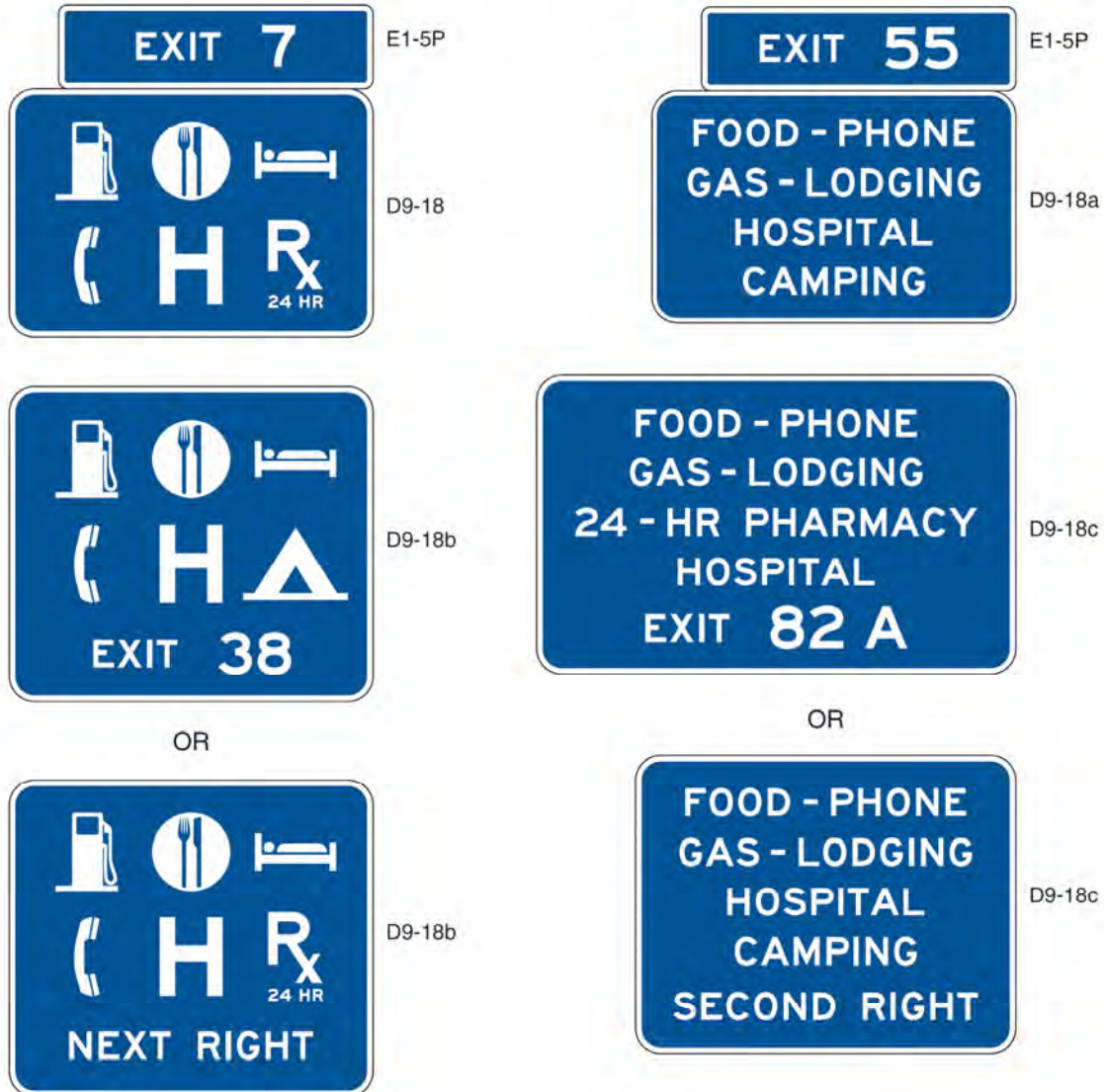
\* Note: Refer to TOPD 13-01 for use on Electric Vehicle Charging Station sign G66-21B(CA)  
<http://www.dot.ca.gov/hq/traffops/engineering/control-devices/policy/13-01.pdf>

**Figure 2I-2. Example of Next Services Plaque**



D9-17P

**Figure 2I-3. Examples of General Service Signs with and without Exit Numbering**



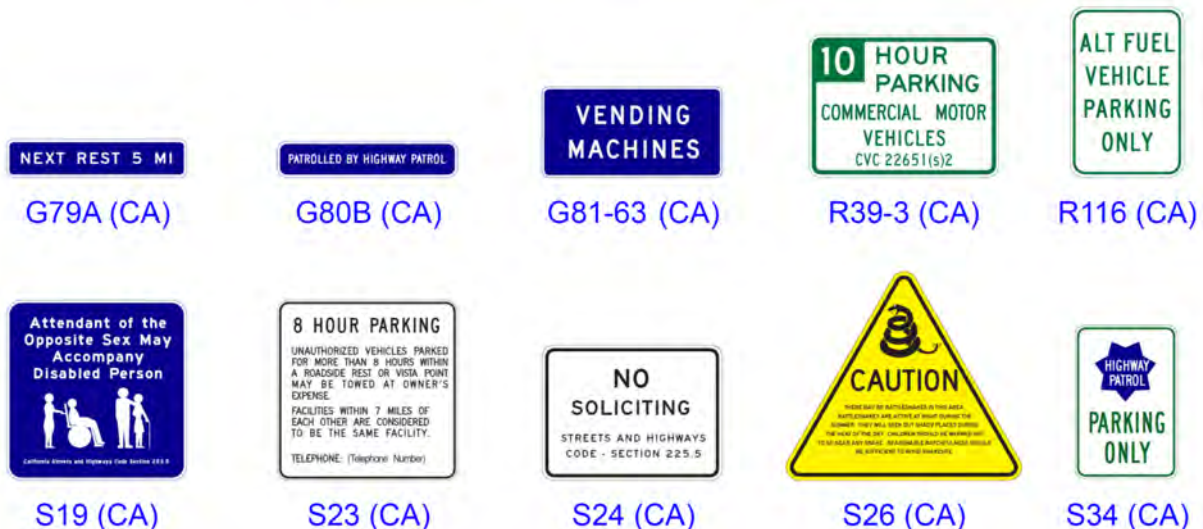
**Figure 2I-4. Examples of Interstate Oasis Signs and Plaques**



**Figure 2I-5. Rest Area and Other Roadside Area Signs**



**Figure 2I-5 (CA). Rest Area and Other Roadside Area Signs**



**Figure 2I-6. Brake Check Area and Chain-Up Area Signs**



**Figure 2I-6 (CA). Brake Check Area and Chain-Up Area Signs**



**Figure 2I-7. Examples of Tourist Information and Welcome Center Signs**



Note: Alternate legends may be substituted for the TOURIST INFO CENTER legend, such as WELCOME CENTER and (State Name) WELCOME CENTER.

**Figure 2I-7 (CA). Examples of Tourist Information and Welcome Center Signs**



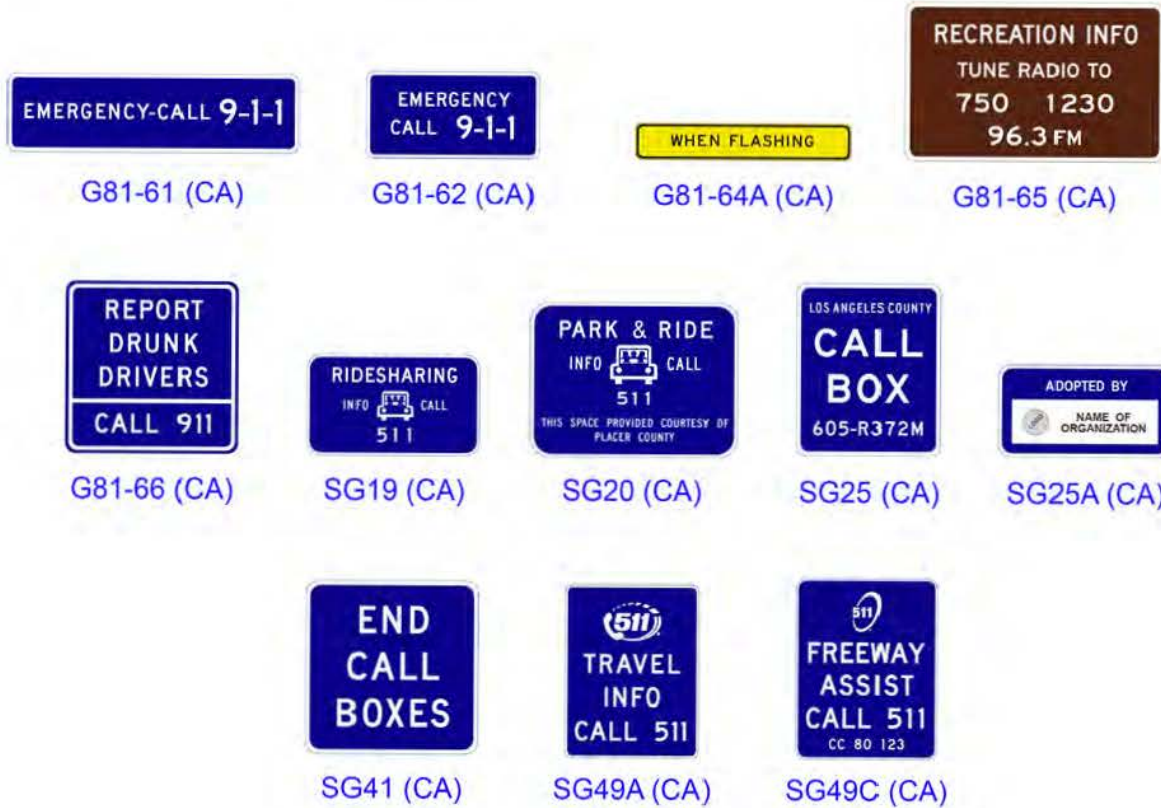
**Figure 2I-8. Radio, Telephone, and Carpool Information Signs**



\* The pictograph of the transportation agency or the travel information service or program may be used in place of the 511 pictograph (see Section 2I.08)



**Figure 2I-8 (CA). Radio, Telephone, and Carpool Information Signs**



**Table 2I-1. General Service Sign and Plaque Sizes (Sheet 1 of 2)**

| Sign or Plaque                                | Sign Designation   | Section          | Conventional Road  | Freeway or Expressway           |
|---|--------------------|------------------|--------------------|---------------------------------|
| Rest Area XX Miles                            | D5-1               | 2I.05            | 66 x 36*           | 96 x 54*                        |
| Rest Area Next Right                          | D5-1a              | 2I.05            | 78 x 36*           | 120 x 60* (F)<br>114 x 48* (E)  |
| Rest Area (with arrow)                        | D5-2               | 2I.05            | 66 x 36*           | 96 x 54*                        |
| Rest Area Gore                                | D5-2a              | 2I.05            | 42 x 48*           | 78 x 78* (F)<br>66 x 72* (E)    |
| Rest Area (with horizontal arrow)             | D5-5               | 2I.05            | 42 x 48*           | —                               |
| Next Rest Area XX Miles                       | D5-6               | 2I.05            | 60 x 48*           | 90 x 72*                        |
| Rest Area Tourist Info Center XX Miles        | D5-7               | 2I.08            | 90 x 72*           | 114 x 102* (F)<br>132 x 96* (E) |
| Rest Area Tourist Info Center (with arrow)    | D5-8               | 2I.08            | 84 x 72*           | 120 x 102* (F)<br>120 x 96* (E) |
| Rest Area Tourist Info Center Next Right      | D5-11              | 2I.08            | 90 x 72*           | 144 x 102* (F)<br>132 x 96* (E) |
| Interstate Oasis                              | D5-12              | 2I.04            | —                  | 156 x 78                        |
| Interstate Oasis (plaque)                     | D5-12P             | 2I.04            | —                  | 114 x 48                        |
| Brake Check Area XX Miles                     | D5-13              | 2I.06            | 84 x 48            | 126 x 72                        |
| Brake Check Area (with arrow)                 | D5-14              | 2I.06            | 78 x 60            | 96 x 72                         |
| Chain-Up Area XX Miles                        | D5-15              | 2I.07            | 66 x 48            | 96 x 72                         |
| Chain-Up Area (with arrow)                    | D5-16              | 2I.07            | 72 x 54            | 96 x 66                         |
| Telephone                                     | D9-1               | 2I.02            | 24 x 24            | 30 x 30                         |
| Hospital                                      | D9-2               | 2I.02            | 24 x 24            | 30 x 30                         |
| Camping                                       | D9-3               | 2I.02            | 24 x 24            | 30 x 30                         |
| Trailer Camping                               | D9-3a              | 2I.02            | 24 x 24            | 30 x 30                         |
| Litter Container                              | D9-4               | 2I.02            | 24 x 30            | 36 x 48                         |
| Handicapped                                   | D9-6               | 2I.02            | 24 x 24            | 30 x 30                         |
| Van Accessible (plaque)                       | D9-6P              | 2I.02            | 18 x 9             | —                               |
| Gas   | D9-7               | 2I.02            | 24 x 24            | 30 x 30                         |
| Food  | D9-8               | 2I.02            | 24 x 24            | 30 x 30                         |
| Lodging                                       | D9-9               | 2I.02            | 24 x 24            | 30 x 30                         |
| Tourist Information                           | D9-10              | 2I.02            | 24 x 24            | 30 x 30                         |
| Diesel Fuel                                   | D9-11              | 2I.02            | 24 x 24            | 30 x 30                         |
| Alternative Fuel - Compressed Natural Gas     | D9-11a             | 2I.02            | 24 x 24            | 30 x 30                         |
| <del>Electric Vehicle Charging</del>          | <del>D9-11b</del>  | <del>2I.02</del> | <del>24 x 24</del> | <del>30 x 30</del>              |
| <del>Electric Vehicle Charging (plaque)</del> | <del>D9-11bP</del> | <del>2I.02</del> | <del>24 x 18</del> | <del>30 x 24</del>              |
| Alternative Fuel - Ethanol                    | D9-11c             | 2I.02            | 24 x 24            | 30 x 30                         |
| RV Sanitary Station                           | D9-12              | 2I.02            | 24 x 24            | 30 x 30                         |
| Emergency Medical Services                    | D9-13              | 2I.02            | 24 x 24            | 30 x 30                         |

**Table 2I-1. General Service Sign and Plaque Sizes (Sheet 2 of 2)**

| Sign or Plaque   | Sign Designation   | Section          | Conventional Road  | Freeway or Expressway             |
|--|--------------------|------------------|--------------------|-----------------------------------|
| Hospital (plaque)  | D9-13aP            | 2I.02            | 24 x 12            | 30 x 12                           |
| Ambulance Station (plaque)   | D9-13bP            | 2I.02            | 24 x 12            | 30 x 15                           |
| Emergency Medical Care (plaque)                                    | D9-13cP            | 2I.02            | 24 x 18            | 30 x 24                           |
| Trauma Center (plaque)   | D9-13dP            | 2I.02            | 24 x 12            | 30 x 15                           |
| Police   | D9-14              | 2I.02            | 24 x 24            | 30 x 30                           |
| Propane Gas  | D9-15              | 2I.02            | 24 x 24            | 30 x 30                           |
| Truck Parking  | D9-16              | 2I.02            | 24 x 24            | 30 x 30                           |
| Next Services XX Miles (plaque)                                    | D9-17P             | 2I.02            | 102 x 24           | 156 x 30                          |
| General Services (up to 6 symbols)                                 | D9-18              | 2I.03            | —                  | 96 x 60                           |
| General Services   | D9-18a             | 2I.03            | —                  | 96 x 60                           |
| General Services (up to 6 symbols) with Action or Exit Information | D9-18b             | 2I.03            | 108 x 84           | 132 x 114 (F)<br>132 x 108 (E)    |
| General Services with Action or Exit Information                   | D9-18c             | 2I.03            | 72 x 60**          | 132 x 108** (F)<br>108 x 84** (E) |
| <del>Pharmacy</del>  | <del>D9-20</del>   | <del>2I.02</del> | <del>24 x 24</del> | <del>30 x 30</del>                |
| <del>24 Hour (plaque)</del>  | <del>D9-20aP</del> | <del>2I.02</del> | <del>24 x 12</del> | <del>30 x 12</del>                |
| Telecommunication Device for the Deaf                              | D9-21              | 2I.05            | 24 x 24            | 30 x 30                           |
| Wireless Internet  | D9-22              | 2I.05            | 24 x 24            | 30 x 30                           |
| Weather Information  | D12-1              | 2I.09            | 84 x 48            | 132 x 84                          |
| Carpool Information  | D12-2              | 2I.11            | 60 x 42            | 96 x 66                           |
| Channel 9 Monitored  | D12-3              | 2I.09            | 84 x 48            | 132 x 84                          |
| Emergency Call 911   | D12-4              | 2I.09            | 66 x 30            | 96 x 48                           |
| Travel Info Call 511 (pictograph)                                  | D12-5              | 2I.10            | 42 x 60            | 66 x 78                           |
| Travel Info Call 511   | D12-5a             | 2I.10            | 48 x 36            | 66 x 48                           |

\* The size shown is for a sign with a REST AREA and/or TOURIST INFO CENTER legend. The size should be appropriately adjusted if an alternate legend is used.  
 \*\* The size shown is for a sign with four lines of services. The size should be appropriately adjusted depending on the amount of legend displayed.  
 Notes: 1. Larger signs may be used when appropriate  
 2. Dimensions in inches are shown as width x height  
 3. Where two sizes are shown, the larger size is for freeways (F) and the smaller size is for expressways (E)

**Table 2I-1(CA). California General Service Sign and Plaque Sizes (Sheet 1 of 2)**

| Sign or Plaque                    | Sign Designation | Section      | Conventional Road | Freeway or Expressway |
|-----------------------------------|------------------|--------------|-------------------|-----------------------|
| Next Right/Left                   | G58(CA)          | 2I.02, 2I.03 | 30 x 24           | 30 x 24               |
| Methanol Fuel                     | G66-11(CA)       | 2I.03        | 24 x 24           | 30 x 30               |
| METHANOL                          | G66-11A(CA)      | 2I.03        | 24 x 6            | 30 x 8                |
| DIESEL                            | G66-12A(CA)      | 2I.03        | 24 x 6            | 30 x 8                |
| ELECTRIC VEHICLE CHARGING STATION | G66-21(CA)       | 2I.03        | 24 x 24           | 30 x 30               |
| Distance with Arrow               | G66-21A(CA)      | 2I.03        | 24 x 16           | 30 x 18               |
| FAST (Header Plaque)              | G66-21C(CA)      | 2I.03        | 24 x 6            | 30 x 8                |
| Compressed Natural Gas            | G66-22A(CA)      | 2I.03        | 24 x 24           | 30 x 30               |
| Liquefied Natural Gas             | G66-22B(CA)      | 2I.03        | 24 x 24           | 30 x 30               |
| Biodiesel                         | G66-22C(CA)      | 2I.03        | 24 x 24           | 30 x 30               |
| BIODIESEL                         | G66-22D(CA)      | 2I.03        | 24 x 6            | 30 x 8                |
| Ethanol E85                       | G66-22E(CA)      | 2I.03        | 24 x 24           | 30 x 30               |
| ETHANOL                           | G66-22F(CA)      | 2I.03        | 24 x 6            | 30 x 8                |
| Hydrogen                          | G66-22G(CA)      | 2I.03        | 24 x 24           | 30 x 30               |
| HYDROGEN                          | G66-22H(CA)      | 2I.03        | 24 x 6            | 30 x 8                |
| Alternative ALT                   | G66-22J(CA)      | 2I.03        | 24 x 24           | 30 x 30               |
| Alternative Fuels                 | G66-22K(CA)      | 2I.03        | 24 x 30           | 30 x 36               |
| STAA Truck Service                | G66-55(CA)       | 2I.03        | 24 x 24           | 30 x 30               |
| STAA Truck Terminal Access        | G66-56(CA)       | 2I.03        | 24 x 24           | 30 x 30               |
| NEXT EXIT OK                      | G66-56A(CA)      | 2I.03        | 30 x 30           | 30 x 30               |

**Table 2I-1(CA). California General Service Sign and Plaque Sizes (Sheet 2 of 2)**

| Sign or Plaque                               | Sign Designation | Section         | Conventional Road | Freeway or Expressway |
|--|------------------|-----------------|-------------------|-----------------------|
| Highway Patrol                               | G66-57(CA)       | 2I.03           | 24 x 24           | 30 x 30               |
| BRAKE CHECK AREA                             | G66-58(CA)       | 2I.06           | VAR x 36          | VAR x 42              |
| BRAKE CHECK AREA with Arrow                  | G66-59(CA)       | 2I.06           | VAR x 42          | VAR x 54              |
| BRAKE CHECK AREA (X MILE)                    | G66-60(CA)       | 2I.06           | VAR x 48          | VAR x 66              |
| Sheriff                                      | G66-61(CA)       | 2I.03           | 24 x 24           | 30 x 30               |
| Police                                       | G66-62(CA)       | 2I.03           | 24 x 24           | 30 x 30               |
| NEXT REST (X MILE)                           | G79A(CA)         | 2I.05           | 72 x 12           | 144 x 24              |
| PATROLLED BY HIGHWAY PATROL                  | G80B(CA)         | 2I.05           | 72 x 12           | 144 x 24              |
| TOURIST INFORMATION                          | G81-21(CA)       | 2I.08           | 144 x 24          | 204 x 30              |
| TOURIST INFORMATION                          | G81-24(CA)       | 2I.08           | 96 x 42           | 132 x 48              |
| LP GAS                                       | G81-52(CA)       | 2I.03           | 24 x 6            | 30 x 8                |
| EMERGENCY CALL 9-1-1                         | G81-61(CA)       | 2I.09           | VAR x 6           | VAR x 18              |
| EMERGENCY CALL 9-1-1                         | G81-62(CA)       | 2I.09           | 36 x 18           | 60 x 30               |
| VENDING MACHINES                             | G81-63(CA)       | 2I.05           | 36 x 18           | 48 x 30               |
| WHEN FLASHING                                | G81-64A(CA)      | 2I.09           | 84 x 12           | 108 x 18              |
| Radio-Recreation Information                 | G81-65(CA)       | 2I.09           | 84 x 48           | 108 x 66              |
| REPORT DRUNK DRIVERS CALL 911                | G81-66(CA)       | 2I.09           | 36 x 36           | 48 x 48               |
| ALT FUEL VEHICLE PARKING ONLY                | R116(CA)         | 2I.05           | 12 x 18           | ---                   |
| Ridesharing Information                      | SG19(CA)         | 2I.11           | 48 x 30           | 72 x 42               |
| Park & Ride Facility Information             | SG20(CA)         | 2I.11           | 48 x 36           | 66 x 54               |
| Call Box                                     | SG25(CA)         | 2I.03           | 18 x 24           | 30 x 36               |
| Call Box Adoption Plaque                     | SG25A(CA)        | 2I.03           | 18 x 12           | 30 x 18               |
| CAL FIRE STATION NEXT RIGHT                  | SG38(CA)         | 2I.03           | 78 x 30           | 102 x 36              |
| CAL FIRE STATION with Arrow                  | SG39(CA)         | 2I.03           | 48 x 21           | 60 x 30               |
| END CALL BOXES                               | SG41(CA)         | 2I.03           | 36 x 36           | 48 x 48               |
| CALIFORNIA WELCOME CENTER X MILES            | SG47A(CA)        | 2I.08           | 66 x 48           | 108 x 66              |
| CALIFORNIA WELCOME CENTER NEXT RIGHT         | SG47B(CA)        | 2I.08           | 66 x 48           | 108 x 66              |
| CALIFORNIA WELCOME CENTER with Arrow         | SG47C(CA)        | 2I.08           | 42 x 24           | 54 x 30               |
| CALIFORNIA WELCOME CENTER X MILES with Arrow | SG47D(CA)        | 2I.08           | 42 x 28           | 54 x 36               |
| TRAVEL INFO CALL 511                         | SG49A(CA)        | 2I.10           | 42 x 54           | 54 x 72               |
| Fire Hydrant Street Name                     | S9(CA)           | 2I.03           | 12 x 18           | ---                   |
| Fire Hydrant with Distance and Arrow         | S10(CA)          | 2I.03           | 18 x 12           | ---                   |
| Opposite Sex Attendant                       | S19(CA)          | 2I.05           | 12 x 12           | ---                   |
| Rest Area/Vista Point 8 HOUR PARKING         | S23(CA)          | 2B.46,<br>2I.05 | 24 x 24           | ---                   |
| NO SOLICITING                                | S24(CA)          | 2I.05           | 24 x 18           | ---                   |
| Rattlesnakes Caution                         | S26(CA)          | 2I.05           | 26.75 x 23.5      | ---                   |
| Highway Patrol PARKING ONLY                  | S34(CA)          | 2I.05           | 12 x 18           | ---                   |
| 10 HOUR PARKING COMMERCIAL MOTOR VEHICLES    | R39-3(CA)        | 2B.46,<br>2I.05 | 24 x 18           | -                     |

## CHAPTER 2J. SPECIFIC SERVICE SIGNS

### Section 2J.01 Eligibility

#### Standard:

**01 Specific Service signs shall be defined as guide signs that provide road users with business identification and directional information for services ~~and for eligible attractions~~. Eligible service categories shall be limited to gas, food, lodging, camping, attractions, and 24-hour pharmacies.**

#### Support:

**01a** California Streets and Highways Code, Division 1, Chapter 1, Article 3, Section 101.7 and California Code of Regulations, Title 21, Division 2, Chapter 19, Sections 2100 through 2120, do not include the "attractions" category.

#### ~~Guidance:~~

#### Standard:

**02 The use of Specific Service signs ~~should~~ shall be limited to areas primarily rural in character or to areas where adequate sign spacing can be maintained. Refer California Streets and Highways Code, Division 1, Chapter 1, Article 3, Section 101.7.**

#### Option:

**03** Where an engineering study determines a need, Specific Service signs may be used on any class of highways.

#### Support:

**03a** California Streets and Highways Code, Division 1, Chapter 1, Article 3, Section 101.7 includes the use of specific service signs for freeways only.

#### ~~Guidance:~~

#### Standard:

**04 Specific Service signs ~~should~~ shall not be installed at an interchange where the road user cannot conveniently reenter the freeway or expressway and continue in the same direction of travel.**

#### Support:

**04a** Refer California Code of Regulations, Title 21, Division 2, Chapter 19, Section 2108(d).

#### Standard:

**05 Eligible service facilities shall comply with laws concerning the provisions of public accommodations without regard to race, religion, color, age, sex, or national origin, and laws concerning the licensing and approval of service facilities.**

**06 ~~The attraction services shall include only facilities which have the primary purpose of providing amusement, historical, cultural, or leisure activities to the public.~~**

**07 ~~Distances to eligible 24-hour pharmacies shall not exceed 3 miles in any direction of an interchange on the Federal aid system.~~**

#### ~~Guidance:~~

**08 ~~Except as provided in Paragraph 9, distances to eligible services other than pharmacies should not exceed 3 miles in any direction.~~**

#### Option:

**09 ~~If, within the 3-mile limit, facilities for the services being considered other than pharmacies are not available or choose not to participate in the program, the limit of eligibility may be extended in 3-mile increments until one or more facilities for the services being considered chooses to participate, or until 15 miles is reached, whichever comes first.~~**

#### Guidance:

**10** If State or local agencies elect to provide Specific Service signing, there should be a statewide policy for such signing and criteria for the availability of the various types of services. The criteria should consider the following:

A. To qualify for a **GAS FUEL** logo sign panel, a business should have:

1. Vehicle services including gas and/or alternative fuels, oil, and water;
2. Continuous operation at least 16 hours per day, 7 days per week for freeways and expressways, and continuous operation at least 12 hours per day, 7 days per week for conventional roads;
3. Modern sanitary facilities and drinking water; and

4. Public telephone.
- B. To qualify for a **FOOD** logo sign panel, a business should have:
  1. Licensing or approval, where required;
  2. Continuous operations to serve at least two meals per day, at least 6 days per week;
  3. Modern sanitary facilities; and
  4. Public telephone.
- C. To qualify for a **LODGING** logo sign panel, a business should have:
  1. Licensing or approval, where required;
  2. Adequate sleeping accommodations;
  3. Modern sanitary facilities; and
  4. Public telephone.
- D. To qualify for a **CAMPING** logo sign panel, a business should have:
  1. Licensing or approval, where required;
  2. Adequate parking accommodations; and
  3. Modern sanitary facilities and drinking water.
- E. To qualify for an **ATTRACTION** logo sign panel, a facility should have:
  1. Regional significance, in compliance with the provisions of Paragraph 6; and
  2. Adequate parking accommodations.
- E. To qualify for an **Electric Vehicle Charging (EV CHARGING)** logo sign panel, a business should have:
  1. Availability to the public 16 hours a day.
  2. Location within 3 miles of a freeway interchange.

**Standard:**

~~11 If State or local agencies elect to provide Specific Service signing for pharmacies, both of the following criteria shall be met for a pharmacy to qualify for signing:~~

- ~~A. The pharmacy shall be continuously operated 24 hours per day, 7 days per week, and shall have a State licensed pharmacist present and on duty at all times; and~~
- ~~B. The pharmacy shall be located within 3 miles of an interchange on the Federal aid system.~~

Support:

<sup>12</sup> Section 2I.04 contains information regarding the Interstate Oasis program.

Support:

<sup>13</sup> Refer California Streets and Highways Code, Division 1, Chapter 1, Article 3, Section 101.7 and California Code of Regulations, Title 21, Division 2, Chapter 19, Sections 2100 through 2120 for detailed policies on specific service signs. See Section 1A.11 for information regarding these publications.

**Sign Eligibility Criteria**

**Standard:**

<sup>14</sup> A qualified specific service shall meet the following minimum criteria:

**1. Fuel**

**The business:**

- A. Shall be located not more than 1 mile from the interchange where the Logo Panel is to be displayed according to the State Measured Distance.
- B. Shall provide vehicle services, including but not limited to: fuel, oil, tire repair, battery, and radiator water.
- C. Shall provide public rest room facilities, each containing at least a sink, running water, and a flush toilet.
- D. Shall provide drinking water from a fountain or dispenser for public use.
- E. Shall provide a public telephone.
- F. Shall be open for business, with all of the above services and facilities available, and in a continuous operation, for at least 16 consecutive hours daily, seven (7) days a week, except that the qualified business shall not be considered to be in violation of this requirement when, as a result of a shortage of fuel, the facility is closed or when its hours of operation are reduced.
- G. Shall obtain and display any appropriate license or permit as may be required by law.
- H. A permittee may include the word "Diesel" or a Caltrans approved symbol for diesel, or the letters "LPG" for liquid propane fuel, or any other word or symbol that has been approved by Caltrans which represent a type of fuel on the Logo Panel as specifically provided in the permit.

**2. Food**

The business:

- A. Shall be located not more than 3 miles from the interchange where the Logo Panel is to be displayed according to the State Measured Distance.
- B. Shall accumulate at least seven (7) points from the following four (4) categories, but at least one point must be accumulated from Category 3:

Category 1. If the State Measured Distance is:

- a. 0 to 0.5 miles, inclusive assign 3 points
- b. 0.5 to 1.0 mile, inclusive assign 2 points
- c. Over 1.0 to 3.0 miles, inclusive assign 1 point

Category 2. If the number of traffic control devices consisting of traffic signals or stop signs between said gore and said nearest driveway is:

- a. 0-1 device assign 3 points
- b. 2-3 devices assign 2 points
- c. 4-5 devices assign 1 point
- d. More than 5 devices assign 0 points

Category 3.

a. If the number of indoor seats totals:

- (1) 50 or more seats assign 3 points
- (2) 30 seats to 49 seats assign 2 points
- (3) 15 seats to 29 seats assign 1 point
- (4) Less than 15 seats assign 0 points

Or

b. If the parking facilities for drive-in or drive-through service totals:

- (1) 20 or more spaces assign 3 points
- (2) 11 spaces to 19 spaces assign 2 points
- (3) 5 spaces to 10 spaces assign 1 point
- (4) Less than 5 spaces assign 0 points

Category 4. When the distance as measured from said gore of the interchange where the Logo Panel is to be displayed to the gore of the next exit served by a food establishment which business would qualify for signing is:

- a. Over 10 miles assign 3 points
- b. Over 3 to 10 miles, inclusive assign 2 points
- c. 1 to 3 miles, inclusive assign 1 point
- d. Less than 1 mile assign 0 points

- C. Shall be in compliance with respect to licensing, approval, and regulation by any state agency and/or any political subdivision of the state having or exercising jurisdiction over the business premises. Licenses and permits required and issued by the state or its political subdivisions shall be displayed on the premises.
- D. Shall provide a public telephone.
- E. Shall provide public rest room facilities, each containing at least a sink, running water, and a flush toilet.
- F. Shall be open for business, with all the above services and facilities available, and in continuous operation for at least 12 consecutive hours daily, beginning not later than 7 a.m., six (6) days a week, and serving breakfast, lunch, and dinner.

**3. Lodging**

The business:

- A. Shall be located not more than 3 miles from the interchange where the Logo Panel is to be displayed according to the State Measured Distance.
- B. Shall accumulate at least seven (7) points from the following four (4) categories:

Category 1. If the State Measured Distance is:

- a. 0 to 0.5 miles, inclusive assign 3 points
- b. Over 0.5 to 1.0 mile, inclusive assign 2 points
- c. Over 1.0 to 3.0 miles, inclusive assign 1 point

**Category 2. If the number of traffic control devices consisting of traffic signals or stop signs between said gore and said nearest driveway is:**

- a. 0-1 device assign 3 points
- b. 2-3 devices assign 2 points
- c. 4-5 devices assign 1 point
- d. More than 5 devices assign 0 points

**Category 3. If the number of lodging units, each with private bath facilities, is:**

- (1) 50 or more units assign 3 points
- (2) 30 units to 49 units assign 2 points
- (3) 15 units to 29 units assign 1 point
- (4) Less than 15 units assign 0 points

**Category 4. When the distance as measured from said gore of the interchange where the Logo Panel is to be displayed to the gore of the next exit served by a lodging establishment which would qualify for signing is:**

- a. Over 10 miles assign 3 points
- b. Over 3 to 10 miles, inclusive assign 2 points
- c. 1 to 3 miles, inclusive assign 1 point
- d. Less than 1 mile assign 0 points

- C. Shall be in compliance with respect to licensing, approval, and regulation by any state agency and/or any political subdivision of the state having or exercising jurisdiction over the business premises. Any licenses or permits, which are issued by the state or a local governmental body, shall be displayed on the premises.
- D. Shall provide at least one off-street passenger vehicle parking space for each lodging unit available for rent.
- E. Shall provide a public telephone.
- F. Shall be open for business, with all of the above services and facilities available, and in continuous operation 24 hours a day, seven (7) days a week.

#### **4. Camping**

The business:

- A. Shall be located not more than 10 miles from the interchange where the Logo Panel is to be displayed according to the State Measured Distance.
- B. Shall be in compliance with respect to licensing, approval, and regulation by any state agency and/or any political subdivision of the state having or exercising jurisdiction over the business premises or be operated by a governmental agency. Any license or permits, which are issued by the state or a local governmental body, shall be displayed on the premises.
- C. Must establish eligibility under at least one of the following three criteria:
  - 1. Shall have not less than 25 vehicular overnight camping units or spaces available for rent. Each unit or space must provide individual service and utility hook-ups suitable for travel trailers, campers, and other recreational vehicles. The facility shall be accessible to and capable of accommodating all types of recreational vehicles, travel trailers and campers.
  - 2. Shall have not less than 15 overnight camping units or spaces available, which will accommodate tents, and have at least one vehicle parking space for each unit or space available for rent. Shall have sanitary facilities, and drinking water for the units or spaces, but not necessarily at each individual campsite.
  - 3. Shall have not less than 30 overnight camping units or spaces available, consisting of a combination of the types specified in items A. and B. herein and above.
- D. Shall have an attendant on duty 24 hours a day to manage and maintain the facility while it is open for business.
- E. Shall be open for business and in continuous operation 24 hours a day, seven (7) days a week, except that seasonally the facility may be closed to the public for not more than 150 consecutive days, provided Caltrans has received proper notification together with a request to cover or remove all Logo Panels fastened to the Specific Service Signs.

#### **5. Electric Vehicle Charging**

The business:

- A. Shall be located not more than 3 miles from the interchange where the Logo Panel is to be displayed according to the State Measured Distance.



B. Shall be open for business, with the ability to provide Electric Vehicle Charging, for at least 16 consecutive hours daily, seven (7) days a week, except that the qualified business shall not be considered to be in violation of this requirement when, as a result of a shortage of electricity, the facility is closed or when its hours of operation are reduced.

C. A Logo permittee for Food, Fuel, Lodging or Camping may include the legend "EV CHARGING" which represent this service across the bottom of their permitted Logo sign panel, if they also offer EV CHARGING within 3 miles of a freeway interchange, and make this service available at least 16 hours daily, seven (7) days a week.

6. "Fuel", "Food", "Lodging", "Camping" and "Electric Vehicle Charging"

A Qualified Specific Service Business shall give written assurances of its conformity with all applicable laws concerning the provisions of public accommodations without regard to race, sex, religion, color, or national origin and shall not be in continuing breach of that assurance.

7. Equal Access

A. The order of priority for granting permits to "LODGING", "EV CHARGING" or "CAMPING" businesses for the installation of their Logo Panels on Specific Service (Mainline) Signs or Specific Service (Ramp) Signs, when applications are received from a greater number of Qualified Specific Service Businesses which meet the minimum eligibility criteria than there is space available on the Specific Service Sign, shall be determined based upon the State Measured Distance; with first priority going to the closest business, second priority to the next closest business, and so on until all available space on the Specific Service Sign has been allocated. The same order of priority shall apply when the maximum number of permits has been issued and a new application is received from a Qualified Specific Service Business located closer to the interchange than another qualified business, which is already signed.

B. The order of priority for granting permits to "FOOD" or "FUEL" businesses for the installation of their Logo Panels on Specific Service (Mainline) Signs or Specific Service (Ramp) Signs, when applications are received from a greater number of Qualified Specific Service Businesses which meet the eligibility criteria than there is space available on the Specific Service Sign, shall be based upon the highest point accumulation from the following two (2) categories:

Category 1. If the State Measured Distance is:

- |    |                                  |                 |
|----|----------------------------------|-----------------|
| a. | 0 to 0.5 miles, inclusive        | assign 3 points |
| b. | Over 0.5 to 1.0 mile, inclusive  | assign 2 points |
| c. | Over 1.0 to 3.0 miles, inclusive | assign 1 point  |

Category 2. If the business is open:

- |    |                     |                 |
|----|---------------------|-----------------|
| a. | 20-24 hours per day | assign 3 points |
| b. | 16-20 hours per day | assign 2 points |
| c. | 12-16 hours per day | assign 1 point  |

<sup>15</sup> The same order of priority shall apply when the maximum number of permits has been issued and a new application is received from a Qualified Specific Service Business with a higher point accumulation than another qualified business, which is already signed.

## Section 2J.02 Application

### Standard:

<sup>01</sup> The number of Specific Service signs along an approach to an interchange or intersection, regardless of the number of service types displayed, shall be limited to a maximum of four. In the direction of traffic, successive Specific Service signs shall be for ~~24-hour pharmacy, attraction,~~ **Electric Vehicle Charging** camping, lodging, food, and ~~gas~~ **fuel** services, in that order.

<sup>02</sup> A Specific Service sign shall display the word message ~~GAS FUEL, FOOD, LODGING, CAMPING, ATTRACTION, or 24-HOUR PHARMACY,~~ or **EV CHARGING**, an appropriate directional legend such as the word message EXIT XX, NEXT RIGHT, SECOND RIGHT, or directional arrows, and the related logo sign panels.

<sup>03</sup> No more than ~~three~~ **two** types of services shall be represented on any sign or sign assembly. If ~~three~~ **two** types of services are displayed on one sign, then the logo sign panels shall be limited to ~~two~~ **three** for each service type (for a total of six logo sign panels). Refer California Code of Regulations, Title 21, Division 2, Chapter

**19, Section 2110(f).** If two types of services are displayed on one sign, then the logo sign panels shall be limited to either three for each service type (for a total of six logo sign panels) or four for one service type and two for the other service type (for a total of six logo sign panels). The legend and logo sign panels applicable to a service type shall be displayed such that the road user will not associate them with another service type on the same sign.

<sup>04</sup> No service type shall appear on more than two signs (see Paragraph 6).

<sup>05</sup> The signs shall have a blue background, a white border, and white legends of upper-case letters, numbers, and arrows.

Support:

<sup>05a</sup> California Streets and Highways Code, Division 1, Chapter 1, Article 3, Section 101.7 and California Code of Regulations, Title 21, Division 2, Chapter 19, Sections 2100 through 2120, do not include the "attractions", "24 hour pharmacy", or "electric vehicle charging" categories.

<sup>05b</sup> In California, the generic term FUEL is used for GAS.

Guidance:

<sup>06</sup> Where a service type is displayed on two signs, the signs for that service should follow one another in succession.

<sup>07</sup> The Specific Service signs should be located to take advantage of natural terrain, to have the least impact on the scenic environment, and to avoid visual conflict with other signs within the highway right-of-way.

Option:

<sup>08</sup> General Service signs (see Sections 2I.02 and 2I.03) may be used in conjunction with Specific Service signs for eligible types of services that are not represented by a Specific Service sign.

Support:

<sup>09</sup> Examples of Specific Service signs are shown in Figure 2J-1 and 2J-1(CA). Examples of sign locations are shown in Figure 2J-2.

### **Section 2J.03 Logos and Logo Sign Panels**

**Standard:**

<sup>01</sup> A logo shall be either an identification symbol/trademark or a word message. Each logo shall be placed on a separate logo sign panel that shall be attached to the Specific Service sign. Symbols or trademarks used alone for a logo shall be reproduced in the colors and general shape consistent with customary use, and any integral legend shall be in proportionate size. A logo that resembles an official traffic control device shall not be used.

Guidance:

<sup>02</sup> A word message logo, not using a symbol or trademark, should have a blue background with white legend and border.

Support:

<sup>03</sup> Section 2J.05 contains information regarding the minimum letter heights for logo sign panels.

Option:

<sup>04</sup> Where business identification symbols or trademarks are used alone for a logo, the border may be omitted from the logo sign panel.

<sup>05</sup> A portion of a logo sign panel may be used to display a supplemental message horizontally along the bottom of the logo sign panel, provided that the message displays essential motorist information (see Figure 2J-3 and Figure 2J-3(CA)).

**Standard:**

<sup>06</sup> All supplemental messages shall be displayed within the logo sign panel and shall have letters and numerals that comply with the minimum height requirements shown in Table 2J-1.

Guidance:

<sup>07</sup> A logo sign panel should not display more than one supplemental message.

<sup>08</sup> The supplemental message should be displayed in a color to contrast effectively with the background of the business sign or separated from the other legend or logo by a divider bar.

<sup>09</sup> State or local agencies that elect to allow supplemental messages on logo sign panels should develop a statewide policy for such messages.

**Support:**

<sup>10</sup> Typical supplemental messages might include DIESEL, 24 HOURS, CLOSED and the day of the week when the facility is closed, ALTERNATIVE FUELS (see Section 2I.03), **EV CHARGING** and RV ACCESS.

**Option:**

<sup>11</sup> The RV ACCESS supplemental message may be circular.

**Standard:**

<sup>12</sup> **If the RV ACCESS supplemental message is circular, it shall be the abbreviation RV in black letters inside a yellow circle with a black border and it shall be displayed within the logo sign panel near the lower right-hand corner (see Figure 2J-4).**

*Guidance:*

<sup>13</sup> *If the circular RV ACCESS supplemental message is used, the circle should have a diameter of 10 inches and the letters should have a height of 6 inches.*

<sup>14</sup> *If a State or local agency elects to display the designation of businesses as providing on-premise accommodations for recreational vehicles with the RV ACCESS supplemental message or the RV Access circular message, there should be a statewide policy for such designation and criteria for qualifying businesses. The criteria should include such site conditions as access between the public roadway and the site, on-premise geometry, and parking.*

**Option:**

<sup>15</sup> If a business designated as an Interstate Oasis (see Section 2I.04) has a business logo sign panel on the Food and/or Gas Specific Service signs, the word OASIS may be displayed on the bottom portion of the logo sign panel for that business.

**Standard:**

<sup>16</sup> **A logo sign panel shall not display the symbol/trademark or name of more than one business.**

## **Section 2J.04 Number and Size of Signs and Logo Sign Panels**

*Guidance:*

<sup>01</sup> *Sign sizes should be determined by the amount and height of legend and the number and size of logo sign panels attached to the sign. All logo sign panels on a sign should be the same size.*

**Standard:**

<sup>02</sup> **Each Specific Service sign or sign assembly shall be limited to no more than six logo sign panels. There shall be no more than three logo panels for one of the two service types on the same sign or sign assembly. Refer California Code of Regulations, Title 21, Division 2, Chapter 19, Section 2110(f).**

**Option:**

<sup>03</sup> ~~Where more than six businesses of a specific service type are eligible for logo sign panels at the same interchange, additional logo sign panels of that same specific service type may also be displayed in accordance with the provisions of Paragraph 4. The additional logo sign panels may be displayed either by placing more than one specific service type on the same sign (see Paragraph 3 of Section 2J.02) or by using a second Specific Service sign of that specific service type if the additional sign can be added without exceeding the limit of four Specific Service signs at an interchange or intersection approach (see Paragraph 6 of Section 2J.02).~~

**Standard:**

~~<sup>04</sup> Where logo sign panels for more than six businesses of a specific service type are displayed at the same interchange or intersection approach, the following provisions shall apply:~~

~~**A. No more than 12 logo sign panels of a specific service type shall be displayed on no more than two Specific Service signs or sign assemblies;**~~

~~**B. No more than six logo sign panels shall be displayed on a single Specific Service sign; and**~~

~~**C. No more than four Specific Service signs shall be displayed on the approach.**~~

**Support:**

<sup>05</sup> Section 2J.08 contains information regarding Specific Service signs for double-exit interchanges.

**Standard:**

<sup>06</sup> **Each logo sign panel attached to a Specific Service sign shall have a rectangular shape with a width longer than the height. A logo sign panel on signs for freeways and expressways shall not exceed 60 inches in width and 36 inches in height. A logo sign panel on signs for conventional roads and freeway and**

**expressway ramps shall not exceed 30 inches in width and 18 inches in height. California Streets and Highways Code, Division 1, Chapter 1, Article 3, Section 101.7 includes the use of specific service signs for freeways only. The vertical and horizontal spacing between logo sign panels shall not exceed 8 inches and 12 inches, respectively.**

**06a A logo panel on signs for the mainline shall be 48 inch in width and 36 inch in height.**

**06b A logo panel on signs for the ramps shall be 18 inch in width and 12 inch in height.**

**Support:**

**07 Sections 2A.14, 2E.15, and 2E.16 contain information regarding borders, interline spacing, and edge spacing.**

### **Section 2J.05 Size of Lettering**

**Standard:**

**01 All Specific Service signs and logo sign panels shall have letter and numeral sizes that comply with the minimum requirements of Table 2J-1.**

**Guidance:**

**02 Any legend on a symbol/trademark should be proportional to the size of the symbol/trademark.**

### **Section 2J.06 Signs at Interchanges**

**Standard:**

**01 The Specific Service signs shall be installed between the preceding interchange and at least 800 feet in advance of the Exit Direction sign at the interchange from which the services are available (see Figure 2J-2).**

**Guidance:**

**02 There should be at least an 800 foot spacing between the Specific Service signs, except for Specific Service ramp signs. However, excessive spacing is not desirable. Specific Service ramp signs should be spaced at least 100 feet from the Exit Gore sign, from each other, and from the ramp terminal.**

**Standard:**

**03 Specific Service signs shall be located between the previous interchange and sufficiently in advance of the approaching interchange so that the last sign is at least 0.25 miles in advance of the gore of the approaching interchange with at least 800 foot spacing between all Specific Service signs and between Specific Service signs and guide signs. Refer California Code of Regulations, Title 21, Division 2, Chapter 19, Section 2108(a).**

**Option:**

**04 At the discretion of Caltrans, the location of the Specific Service signs with respect to their distances from the gore may be increased to avoid conflict with existing guide signs.**

### **Section 2J.07 Single-Exit Interchanges**

**Standard:**

**01 At numbered single-exit interchanges, the name of the service type followed by the exit number shall be displayed on one line above the logo sign panels. At unnumbered interchanges, the directional legend NEXT RIGHT (LEFT) shall be used.**

**02 At single-exit interchanges, Specific Service ramp signs shall be installed along the ramp or at the ramp terminal for facilities that have logo sign panels displayed along the main roadway if the facilities are not readily visible from the ramp terminal. Directions to the service facilities shall be indicated by arrows on the ramp signs. Logo sign panels on Specific Service ramp signs shall be duplicates of those displayed on the Specific Service signs located in advance of the interchange, but shall be reduced in size (see Paragraph 6 of Section 2J.04).**

**Guidance:**

**03 Specific Service ramp signs should include distances to the service facilities.**

**Option:**

**04 An exit number plaque (see Section 2E.31) may be used instead of the exit number on the signs located in advance of an interchange.**

**Standard:**

**05 The Single-Exit Interchange (One Service) Mainline sign (SG42-1(CA)) shall be used for the Specific Service Signing Program (Logo Program) where there are at least four qualified facilities available with the possibility of more.**

**06 The Single-Exit Interchange (One Service) Mainline sign (SG42-2(CA)) shall be used for the Specific Service Signing Program (Logo Program) where there are one or two qualified facilities available and it is not likely that there will be more than three.**

**07 At numbered interchanges, the name of the service type followed by the appropriate exit number shall be displayed on one line above the logo panels for SG42-1(CA) and SG42-2(CA) signs.**

**Option:**

**08 At unnumbered interchanges, the directional legend NEXT RIGHT (LEFT), SECOND RIGHT (LEFT), NEXT EXIT, or SECOND EXIT may be used in place of the exit number for SG42-1(CA) and SG42-2(CA) signs.**

**Standard:**

**09 The Single-Exit Interchange (Two Services) Mainline sign (SG42-6(CA)) shall be used for the Specific Service Signing Program (Logo Program) where there are a limited number of services, three or four, in remote rural areas.**

**10 The Single-Exit Interchange (Two Services) Mainline sign (SG42-7(CA)) shall be used for the Specific Service Signing Program (Logo Program) where there are a limited number of services, one or two, in remote rural areas.**

**11 At numbered interchanges, the appropriate exit number shall be displayed on the first line and the name of each service type shall be displayed above the logo panels for SG42-6(CA) and SG42-7(CA) signs.**

**Option:**

**12 At unnumbered interchanges, the directional legend NEXT RIGHT (LEFT), SECOND RIGHT (LEFT), NEXT EXIT, or SECOND EXIT may be used in place of the exit number for SG42-6(CA) and SG42-7(CA) signs.**

**Standard:**

**13 The Single-Exit Interchange (One Service) Mainline sign (SG42-9(CA)) shall be used for the Specific Service Signing Program (Logo Program) where there is only one service, in remote rural areas.**

**14 At numbered interchanges, the name of the service type shall be displayed above the logo panel and the appropriate exit number shall be displayed above the service type.**

**Option:**

**15 At unnumbered interchanges, the directional legend NEXT RIGHT (LEFT), SECOND RIGHT (LEFT), NEXT EXIT, or SECOND EXIT may be used in place of the exit number for the SG42-9(CA) sign.**

**Standard:**

**16 The Single-Exit Interchange (One Service) Mainline sign (SG42-10(CA)) shall be used for the Specific Service Signing Program (Logo Program) where there are at least two qualified facilities and it is not likely that there will be more than four.**

**17 At numbered interchanges, the name of the service type followed by the appropriate exit number shall be displayed on one line above the logo panels for the SG42-10(CA) sign.**

**Option:**

**18 At unnumbered interchanges, the directional legend NEXT RIGHT (LEFT), SECOND RIGHT (LEFT), NEXT EXIT, or SECOND EXIT may be used in place of the exit number for the SG42-10(CA) sign.**

## **Section 2J.08 Double-Exit Interchanges**

*Guidance:*

*01 At double-exit interchanges, the Specific Service signs should consist of two sections, one for each exit (see Figure 2J-1).*

**Standard:**

**02 At a double-exit interchange, the top section shall display the logo sign panels for the first exit and the bottom section shall display the logo sign panels for the second exit. At numbered interchanges, the name of the service type and the exit number shall be displayed above the logo sign panels in each section. At unnumbered interchanges, the word message NEXT RIGHT (LEFT) and SECOND RIGHT (LEFT) shall be used in place of the exit number. The number of logo sign panels on the sign (total of both sections) or the sign assembly shall be limited to six.**

*Guidance:*

*03 At a double-exit interchange, where a service type is displayed on two Specific Service signs in accordance with the provisions of Section 2J.04, one of the signs should display the logo sign panels for that service type for the businesses that are accessible from one of the two exits and the other sign should display the logo sign panels for that service type for the businesses that are accessible from the other exit.*

**Option:**

*04 At a double-exit interchange where there are four logo sign panels to be displayed for one of the exits and one or two logo sign panels to be displayed for the other exit, the logo sign panels may be arranged in three rows with two logo sign panels per row.*

*05 At a double-exit interchange, where a service is to be signed for only one exit, one section of the Specific Service sign may be omitted, or a single exit interchange sign may be used. Signs on ramps and crossroads as described in Section 2J.07 may be used at a double-exit interchange.*

**Standard:**

**06 The Double-Exit Interchange Mainline sign (SG42-3(CA)) shall be used for the Specific Service Signing Program (Logo Program) where there are one or two qualified facilities available from each exit and it is not likely that there will be more than three from each exit.**

**07 At numbered interchanges, the name of the service type followed by the appropriate exit number shall be displayed on one line above the logo panels for the SG42-3(CA) sign.**

**Option:**

*08 At unnumbered interchanges, the directional legend NEXT RIGHT (LEFT), SECOND RIGHT (LEFT), NEXT EXIT, or SECOND EXIT may be used in place of the exit number for the SG42-3(CA) sign.*

**Standard:**

**09 The Double-Exit Interchange Mainline sign (SG42-11(CA)) shall be used for the Specific Service Signing Program (Logo Program) where there is at least one qualified facility available from each exit and it is not likely that there will be more than two from each exit.**

**10 At numbered interchanges, the name of the service type followed by the appropriate exit number shall be displayed on one line above the logo panels for the SG42-11(CA) sign.**

**Option:**

*11 At unnumbered interchanges, the directional legend NEXT RIGHT (LEFT), SECOND RIGHT (LEFT), NEXT EXIT, or SECOND EXIT may be used in place of the exit number for the SG42-11(CA) sign.*

## **Section 2J.09 Specific Service Trailblazer Signs**

**Support:**

*01 Specific Service trailblazer signs (see Figure 2J-5) are guide signs with one to four logo sign panels that display business identification and directional information for services and for eligible attractions. Specific Service trailblazer signs are installed along crossroads for facilities that have logo sign panels displayed along the main roadway and ramp, and that require additional vehicle maneuvers.*

**Standard:**

**02 Specific Service trailblazer signs shall be installed along crossroads where the route to the business requires a direction change, where it is questionable as to which roadway to follow, or where additional guidance is needed. Where it is not feasible or practical to install Specific Service trailblazer signs to such businesses, those businesses shall not be considered eligible for signing from the ramp and main roadway. A Specific Service trailblazer sign shall not be required at the point where the business is visible from the roadway and its access is readily apparent.**

**Guidance:**

*03 If used, a Specific Service trailblazer sign should be located a maximum of 500 feet in advance of any required turn.*

**Standard:**

**04 The location of other traffic control devices shall take precedence over the location of a Specific Service trailblazer sign.**

**05 When used, each Specific Service trailblazer sign or sign assembly shall be limited to no more than four logo sign panels. The logo sign panels on Specific Service trailblazer signs shall be duplicates of those displayed on the Specific Service ramp signs.**

**06 Appropriate legends, such as directional arrows or the word message NEXT RIGHT or SECOND RIGHT, shall be displayed with the logo sign panel to provide proper guidance. The directional legend and border shall be white and shall be displayed on a blue background.**

Option:

07 Specific Service trailblazer signs may contain various types of services on a single sign or on a sign assembly.

08 Specific Service trailblazer signs may be placed farther from the edge of the road than other traffic control signs.

## Section 2J.10 Signs at Intersections

**Standard:**

~~01 Where both tourist-oriented information (see Chapter 2K) and specific service information would be needed at the same intersection, the design of the tourist-oriented directional signs shall be used, and the needed specific service information shall be incorporated.~~

*Guidance:*

~~02 If Specific Service signs are used on conventional roads or at intersections on expressways, they should be installed between the previous interchange or intersection and at least 300 feet in advance of the intersection from which the services are available.~~

~~03 The spacing between signs should be determined on the basis of an engineering study.~~

~~04 Logo sign panels should not be displayed for a type of service for which a qualified facility is readily visible.~~

**Standard:**

~~05 If Specific Service signs are used on conventional roads or at intersections on expressways, the name of each type of service shall be displayed above its logo sign panel(s), together with an appropriate legend, such as NEXT RIGHT (LEFT) or a directional arrow, either displayed on the same line as the name of the type of service or displayed below the logo sign panel(s).~~

Option:

~~06 Signs similar to Specific Service ramp signs as described in Section 2J.07 may be provided on the crossroad.~~

**Standard:**

07 Per California Streets and Highways Code, Division 1, Chapter 1, Article 3, Section 101.7 includes the use of specific service signs for freeways only.

08 The tourist-oriented information and specific service information signs shall be separate installations. Refer California Streets and Highways Code, Division 1, Chapter 1.5, Article 3, Section 229.285.

## Section 2J.11 Signing Policy

*Guidance:*

01 Each highway agency that elects to use Specific Service signs should establish a signing policy that includes, as a minimum, the guidelines of Section 2J.01 and at least the following criteria:

A. Selection of eligible businesses;

B. Distances to eligible services;

C. The use of logo sign panels, legends, and signs conforming with this Manual and State design requirements;

D. Removal or covering of logo sign panels during off seasons for businesses that operate on a seasonal basis;

E. The circumstances, if any, under which Specific Service signs are permitted to be used in non-rural areas;  
and

F. Determination of the costs to businesses for initial permits, installations, annual maintenance, and removal of logo sign panels.

**Support:**

02 California Streets and Highways Code, Division 1, Chapter 1, Article 3, Section 101.7 provides for placement of Specific Service Signs (Logo Sign Program) on all rural freeways in California. The term "rural" for this purpose means any area outside of an "urban" area. An urban area is an area encompassing a population of 5,000 or more.

03 California Code of Regulations, Title 21, Division 2, Chapter 19, Sections 2100 through 2120 contain standards for the Specific Service Signs (Logo Sign Program).

**Standard:**

**04 No new Specific Service (SG42 Series(CA)) signs shall be installed in a geographic area with a population over 5,000 as identified on maps prepared by Caltrans based on the most recent United States Bureau of Census data.**

**05 When a geographic area exceeds a population of 5,000, Specific Service signs in that area, which were in place prior to the population increase, shall remain in place until new census data shows population levels exceeding 10,000. The Specific Service signs shall then be removed.**

### **Section 2J.101(CA) Signs at Ramps (SG42-4(CA), SG42-5(CA), SG42-8(CA) and SG42-12(CA))**

#### **Standard:**

**01 Specific Service (Ramp) Signs shall be located on, opposite of, or at the terminus of an off-ramp, in the same direction of travel as the Specific Service (Mainline) Signs (See Section 2J.07 and 2J.08). As viewed in the direction of travel, the successive signs shall be those for "EV CHARGING," "CAMPING," "LODGING," "FOOD," and "FUEL" in that order.**

**02 If either the business premises or an On-Site Sign of a Qualified Specific Service Business is not visible from any point on the off-ramp or from the terminus of the off-ramp, the Owner or Responsible Operator shall be required to make application to have a Logo Panel placed on a Specific Service (Ramp) Sign.**

#### **Option:**

**03 If either the business premises or an on-site sign of a Qualified Specific Service Business is visible from any point on the off-ramp or from the terminus of the off-ramp, the Owner or Responsible Operator may apply for placement of a Logo Panel on the Specific Service (Ramp) Sign.**

**04 Caltrans may require that a Logo panel be placed on a Specific Service (Ramp) Sign when either the business premises or an On-Site Sign is visible from the off-ramp or from the terminus of the off-ramp, if a sign is necessary to avoid misdirection of the motorist because of the complexity of the interchange.**

**05 Appropriate trailblazers may be required by Caltrans along other public highways as necessary to adequately direct road users to the business referred to on any Logo Panel.**

#### **Standard:**

**06 The Logo Panels fastened to a Specific Service (Ramp) Sign or a trailblazer sign shall be the same in shape, color, and message as those shown on the Specific Service (Mainline) Signs, but shall be of smaller size.**

#### **Support:**

**07 The Specific Service Ramp sign (SG42-4(CA)) may be used for the Specific Service Signing Program (Logo Program) at an exit ramp where there are one or two qualified facilities available and it is not likely that there will be more than three in each direction.**

**08 The Specific Service Ramp sign (SG42-5(CA)) may be used for the Specific Service Signing Program (Logo Program) at an exit ramp where there are only one or two qualified facilities in only one direction.**

**09 The Specific Service Ramp sign (SG42-12(CA)) may be used for the Specific Service Signing Program (Logo Program) where there is only one qualified facility available and it is not likely that there will ever be more.**

#### **Standard:**

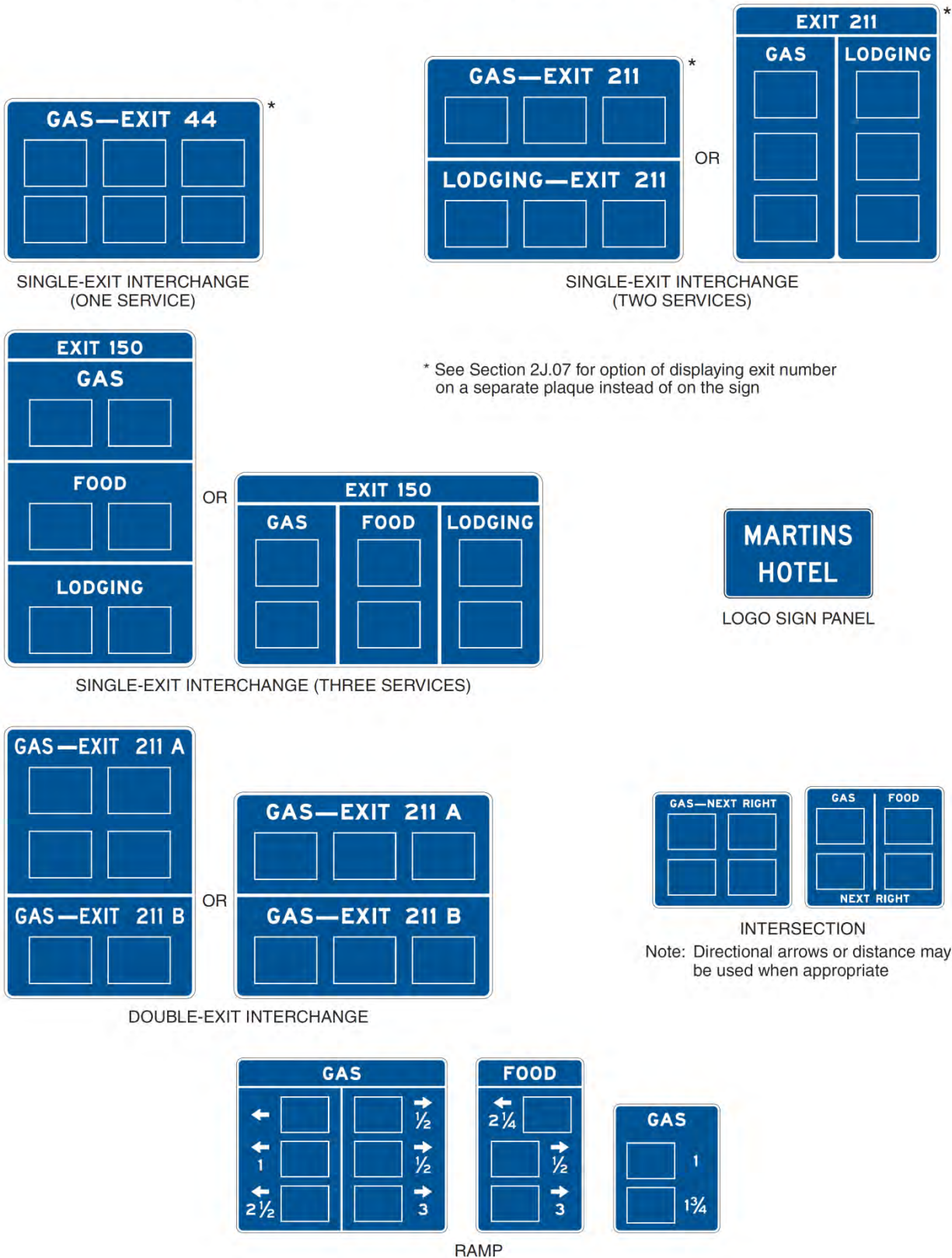
**10 Ramp signs shall be installed along the ramp or at the ramp terminal for facilities that have logo panels displayed along the main roadway if the facilities are not readily visible from the ramp terminal. Directions to the service facilities shall be indicated by arrows on the ramp signs. Logo panels on Specific Service ramp signs shall be duplicates of those displayed on the mainline signs located in advance of the interchange, but shall be reduced in size.**

#### **Support:**

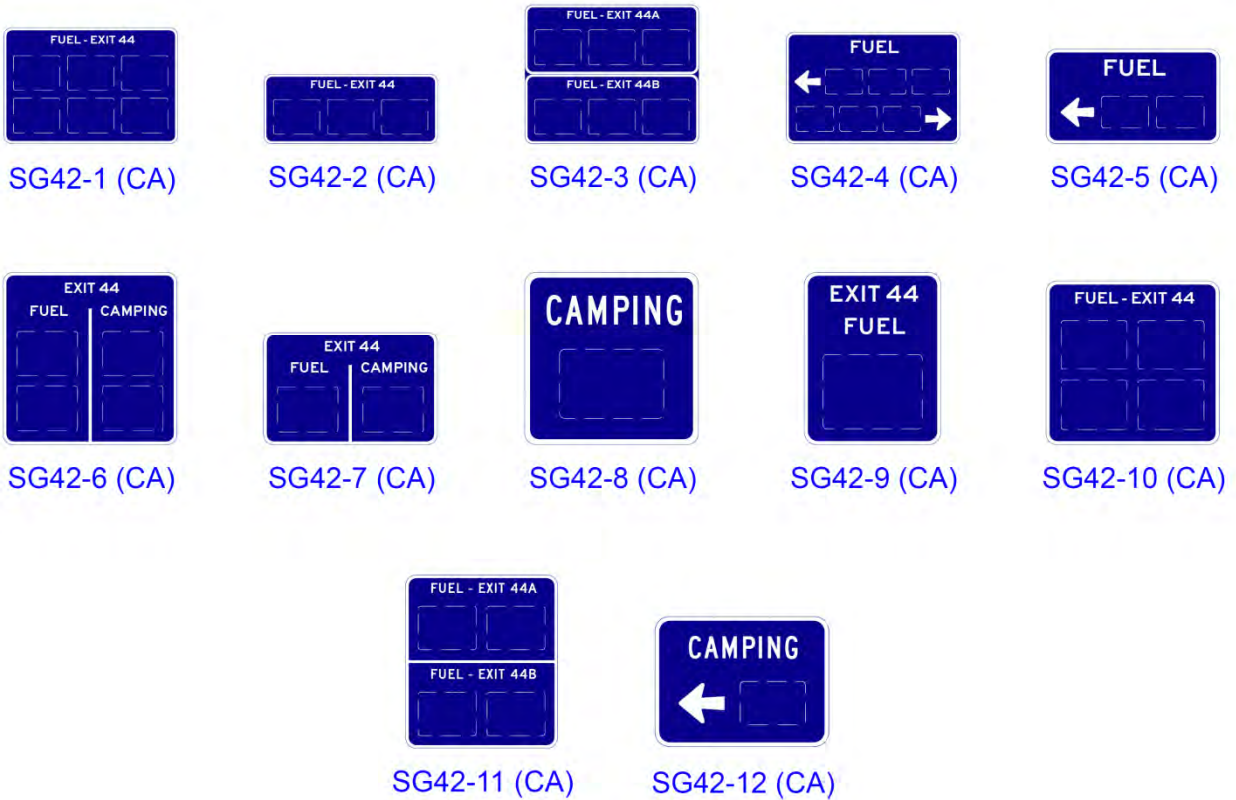
**11 The Specific Service Ramp sign (SG42-8(CA)) may be used for the Specific Service Signing Program (Logo Program) in combination with a Directional Arrow Auxiliary (M6 Series) signs, at an exit ramp terminus, as a follow-up sign to freeway signs. A Mileage Plate may be applied to the sign panel, under the business logo where a business is not visible from the sign's location.**



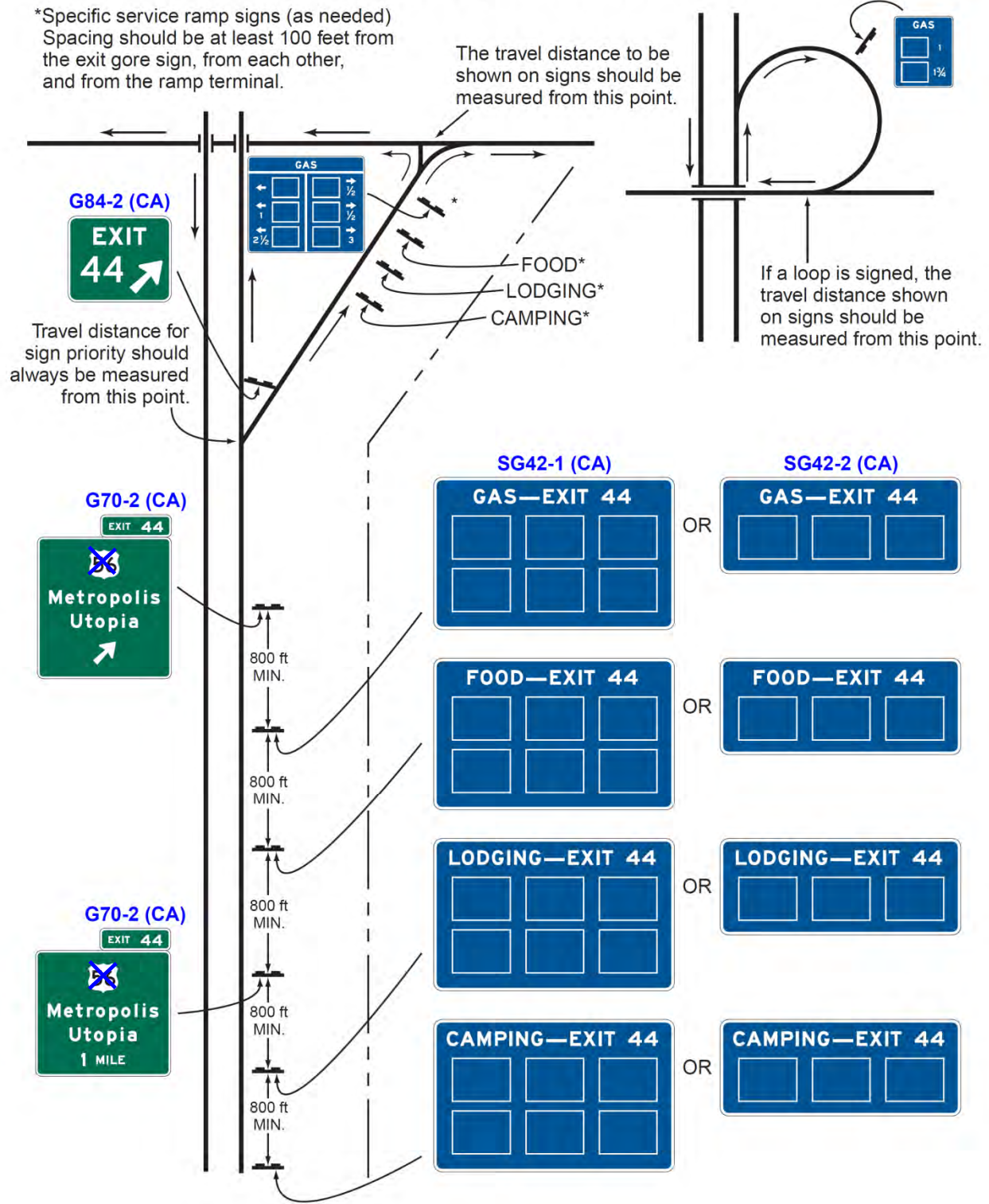
**Figure 2J-1. Examples of Specific Service Signs**



**Figure 2J-1 (CA). Examples of Specific Service Signs**



**Figure 2J-2. Examples of Specific Service Sign Locations**

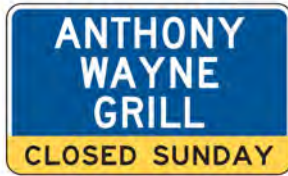


Note: For Guide Sign Assemblies use California State Route (G28-1(CA)) or US Route (G26-1(CA)) shields.



**Figure 2J-3. Example of Supplemental Messages on Logo Sign Panels**

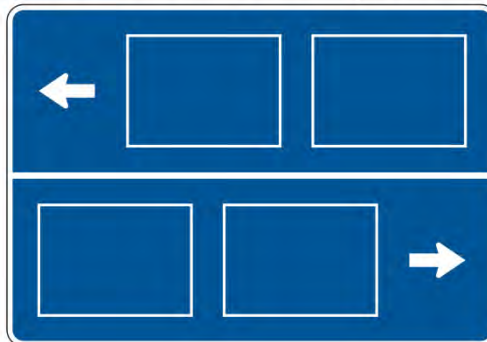
**Figure 2J-3 (CA). Example of Supplemental Messages on Logo Sign Panels**



**Figure 2J-4. Examples of RV Access Supplemental Messages on Logo Sign Panels**



**Figure 2J-5. Examples of Specific Service Trailblazer Signs**



**Table 2J-1. Minimum Letter and Numeral Sizes for Specific Service Signs According to Sign Type**

| Type of Sign                                    | Freeway or Expressway | Conventional Road or Ramp |
|---|-----------------------|---------------------------|
| <b>A. Specific Service Signs</b>                |                       |                           |
| Service Categories                              | 10                    | 6                         |
| Exit Number Words                               | 10                    | —                         |
| Exit Number Numerals and Letters                | 10                    | —                         |
| Action Message Words                            | 10                    | 6                         |
| Distance Numerals                               | —                     | 6                         |
| Distance Fraction Numerals                      | —                     | 4                         |
| <b>B. Logo Sign Panels</b>                      |                       |                           |
| Logo Sign Panels                                | 60 x 36               | 30 x 18                   |
| Words and Numerals (Non-Trademark/Graphic Logo) | 8                     | 4                         |
| Trademark/Graphic Logo                          | Proportional          | Proportional              |
| Supplemental Message Words and Numerals         | 5                     | 2.5                       |

Note: Sizes are shown in inches and where applicable are shown as width x height

**Table 2J-101(CA). California Specific Service Sign and Plaque Sizes**

| Sign or Plaque                                  | Sign Designation | Section    | Conventional Road | Freeway or Expressway |
|---|------------------|------------|-------------------|-----------------------|
| Single-Exit Interchange (One Service) Mainline  | SG42-1(CA)       | 2J.07      | 180 x 120         | 180 x 120             |
| Single-Exit Interchange (One Service) Mainline  | SG42-2(CA)       | 2J.07      | 180 x 72          | 180 x 72              |
| Double-Exit Interchange Mainline                | SG42-3(CA)       | 2J.08      | 180 x 144         | 180 x 144             |
| Specific Service Ramp                           | SG42-4(CA)       | 2J.101(CA) | 84 x 54           | 84 x 54               |
| Specific Service Ramp                           | SG42-5(CA)       | 2J.101(CA) | 66 x 36           | 66 x 36               |
| Single-Exit Interchange (Two Services) Mainline | SG42-6(CA)       | 2J.07      | 138 x 138         | 138 x 138             |
| Single-Exit Interchange (Two Services) Mainline | SG42-7(CA)       | 2J.07      | 138 x 90          | 138 x 90              |
| Specific Service Ramp                           | SG42-8(CA)       | 2J.101(CA) | 30 x 30           | 30 x 30               |
| Single-Exit Interchange (One Service) Mainline  | SG42-9(CA)       | 2J.07      | 66 x 84           | 66 x 84               |
| Single-Exit Interchange (One Service) Mainline  | SG42-10(CA)      | 2J.07      | 126 x 120         | 126 x 120             |
| Double-Exit Interchange Mainline                | SG42-11(CA)      | 2J.08      | 126 x 144         | 126 x 144             |
| Specific Service Ramp                           | SG42-12(CA)      | 2J.101(CA) | 48 x 36           | 48 x 36               |



## CHAPTER 2K. TOURIST-ORIENTED DIRECTIONAL SIGNS

### Section 2K.01 Purpose and Application

**Support:**

<sup>01</sup> Tourist-oriented directional signs are guide signs with one or more sign panels that display the business identification of and directional information for eligible business, service, and activity facilities.

**Standard:**

<sup>02</sup> **A facility shall be eligible for tourist-oriented directional signs only if it derives its major portion of income or visitors during the normal business season from road users not residing in the area of the facility.**

**Option:**

<sup>03</sup> Tourist-oriented directional signs may include businesses involved with seasonal agricultural products.

**Standard:**

<sup>04</sup> **When used, tourist-oriented directional signs shall be used only on rural conventional roads and shall not be used on conventional roads in urban areas or at interchanges on freeways or expressways.**

<sup>05</sup> ~~Where both tourist-oriented directional signs and Specific Service signs (see Chapter 2J) would be needed at the same intersection, the tourist-oriented directional signs shall incorporate the needed information from, and be used in place of, the Specific Service signs.~~ **The tourist-oriented information and specific service information signs shall be separate installations.**

**Support:**

<sup>05a</sup> Refer to California Streets and Highways Code, Division 1, Chapter 1.5, Article 3, Section 229.285.

**Option:**

<sup>06</sup> Tourist-oriented directional signs may be used in conjunction with General Service signs (see Section 2I.02).

**Support:**

<sup>07</sup> Section 2K.07 contains information on the adoption of a State policy for States that elect to use tourist-oriented directional signs.

<sup>08</sup> Refer to California Streets and Highways Code, Division 1, Chapter 1.5 for administration, standards, eligibility, and fees concerning the tourist-oriented directional signs. See Section 1A.11 for information regarding these publications.

### Section 2K.02 Design

**Standard:**

<sup>01</sup> **Tourist-oriented directional signs shall have one or more sign panels for the purpose of displaying the business identification of and directional information for eligible facilities. Each sign panel shall be rectangular in shape and shall have a white legend and border on a blue background.**

<sup>02</sup> **The content of the legend on each sign panel shall be limited to the identification and directional information for no more than one eligible business, service, or activity facility. The legends shall not include promotional advertising.**

**Guidance:**

<sup>03</sup> *Each sign panel should have a maximum of two lines of legend including no more than one symbol, a separate directional arrow, and the distance to the facility displayed beneath the arrow. Arrows pointing to the left or up should be at the extreme left of the sign panel. Arrows pointing to the right should be at the extreme right of the sign panel. Symbols, when used, should be to the left of the word legend or logo sign panel (see Paragraph 7).*

**Option:**

<sup>04</sup> The General Service sign symbols (see Section 2I.02) and the symbols for recreational and cultural interest area signs (see Chapter 2M) may be used.

<sup>05</sup> ~~Logo sign panels (see Section 2J.03) for specific businesses, services, and activities may also be used. Based on engineering judgment, the hours of operation may be displayed on the sign panels.~~

**Standard:**

<sup>05a</sup> **The tourist-oriented information and specific service information signs shall be separate installations.**

Support:

<sup>05b</sup> Refer to California Streets and Highways Code, Division 1, Chapter 1.5, Article 3, Section 229.285.

**Standard:**

<sup>06</sup> When used, symbols and logo sign panels shall be an appropriate size (see Section 2K.04). Logos resembling official traffic control devices shall not be permitted.

Option:

<sup>07</sup> The tourist-oriented directional sign may display the word message TOURIST ACTIVITIES at the top of the sign. The TOURIST ACTIVITIES word message unnecessarily increases the height of the sign.

**Standard:**

~~<sup>08</sup> The TOURIST ACTIVITIES word message shall have a white legend in all upper-case letters and a white border on a blue background. If used, it shall be placed above and in addition to the directional sign panels.~~

Support:

<sup>09</sup> Examples of tourist-oriented directional signs are shown in Figures ~~2K-1 and 2K-2~~ 2K-1(CA).

### Section 2K.03 Style and Size of Lettering

*Guidance:*

~~<sup>01</sup> All letters and numbers on tourist-oriented directional signs, except on the logo sign panels, should be upper-case and at least 6 inches in height. Any legend on a logo should be proportional to the size of the logo.~~

**Standard:**

<sup>02</sup> Design standards for letters, numerals, and spacing shall be as provided in the “Standard Highway Signs and Markings” book (see Section 1A.11).

**Standard:**

<sup>03</sup> Figure 2G-1(CA) and Caltrans' California Sign Specifications for Tourist Oriented Directional (SG44-1(CA) and SG44-2(CA)) signs shall be used for arrangement and size of tourist-oriented directional signs. A single sign arrangement is used in California for tourist-oriented directional signs.

### Section 2K.04 Arrangement and Size of Signs

**Standard:**

~~<sup>01</sup> The size of a tourist-oriented directional sign shall be limited to a maximum height of 6 feet. Additional height shall be allowed to accommodate the addition of the optional TOURIST ACTIVITIES message provided in Section 2K.02 and the action messages provided in Section 2K.05.~~

*Guidance:*

~~<sup>02</sup> The number of intersection approach signs (one sign for tourist-oriented destinations to the left, one for destinations to the right, and one for destinations straight ahead) installed in advance of an intersection should not exceed three. The number of sign panels installed on each sign should not exceed four. The sign panels for right turn, left turn, and straight-through destinations should be on separate signs. The left turn destination sign should be located farthest from the intersection, then the right turn destination sign, with the straight-through destination sign located closest to the intersection (see Figure 2K-2). Signs for facilities in the straight-through direction should be considered only when there are signs for destinations in either the left or right direction.~~

~~<sup>03</sup> If it has been determined to be appropriate to combine the left turn and right turn destination sign panels on a single sign, the left turn destination sign panels should be above the right turn destination sign panels (see Figure 2K-1). When there are multiple destinations in the same direction, they should be in order based on their distance from the intersection. Except as provided in Paragraph 5, a straight-through sign panel should not be combined with a sign displaying left and/or right turn destinations.~~

~~<sup>04</sup> The sign panels should not exceed the size necessary to accommodate two lines of legend without crowding. Symbols and logo sign panels on a directional sign panel should not exceed the height of two lines of a word legend. All directional sign panels and other parts of the sign should be the same width, which should not exceed 6 feet.~~

Option:

~~<sup>05</sup> At intersection approaches where three or fewer facilities are displayed, the left turn, right turn, and straight-through destination sign panels may be combined on the same sign.~~



**Standard:**

**06 Figure 2K-1(CA) and Caltrans' California Sign Specifications for Tourist Oriented Directional (SG44-1(CA) and SG44-2(CA)) signs shall be used for arrangement and size of tourist-oriented directional signs. A single sign arrangement is used in California for tourist-oriented directional signs.**

**Section 2K.05 Advance Signs**

*Guidance:*

~~01 Advance signs should be limited to those situations where sight distance, intersection vehicle maneuvers, or other vehicle operating characteristics require advance notification of the destinations and their directions.~~

~~02 The design of the advance sign should be identical to the design of the intersection approach sign. However, the directional arrows and distances to the destinations should be omitted and the action messages NEXT RIGHT, NEXT LEFT, or AHEAD should be placed on the sign above the business identification sign panels. The action messages should have the same letter height as the other word messages on the directional sign panels (see Figures 2K-1 and 2K-2).~~

**Standard:**

~~03 The action message sign panels shall have a white legend in all upper-case letters and a white border on a blue background.~~

**Option:**

~~04 The legend RIGHT 1/2 MILE or LEFT 1/2 MILE may be used on advance signs when there are intervening minor roads.~~

~~05 The height required to add the directional word messages recommended for the advance sign may be added to the maximum sign height of 6 feet.~~

*Guidance:*

~~06 The optional TOURIST ACTIVITIES message, when used on an advance sign, and the action message should be combined on a single sign panel with TOURIST ACTIVITIES as the top line and the action message as the bottom line (see Figure 2K-2).~~

**Support:**

**07 Advance signs are not used in California for tourist-oriented directional signs.**

**Section 2K.06 Sign Locations**

*Guidance:*

~~01 If used, the intersection approach signs should be located at least 200 feet in advance of the intersection. Signs should be spaced at least 200 feet apart and at least 200 feet from other traffic control devices.~~

~~02 If used, advance signs should be located approximately 1/2 mile from the intersection with 500 feet between these signs. In the direction of travel, the order of advance sign placement should be to show the destinations to the left first, then destinations to the right, and last, the destinations straight ahead. Advance signs are not used in California for tourist-oriented directional signs.~~

~~03 Position, height, and lateral offset of signs should be governed by Chapter 2A except as permitted in this Section.~~

**Option:**

~~04 Tourist-oriented directional signs may be placed farther from the edge of the road than other traffic control signs.~~

**Standard:**

~~05 The location of other traffic control devices shall take precedence over the location of tourist-oriented directional signs.~~

**Section 2K.07 State Policy**

**Standard:**

**01 To be eligible for tourist-oriented directional signing, facilities shall comply with applicable State and Federal laws concerning the provisions of public accommodations without regard to race, religion, color, age, sex, or national origin, and with laws concerning the licensing and approval of service facilities. Each**

**State that elects to use tourist-oriented directional signs shall adopt a policy that complies with these provisions.**

*Guidance:*

*02 The State policy should include:*

- A. A definition of tourist-oriented business, service, and activity facilities.*
- B. Eligibility criteria for signs for facilities.*
- C. Provision for incorporating Specific Service signs into the tourist-oriented directional signs as required by Paragraph 5 of Section 2K.01.*
- D. Provision for covering signs during off seasons for facilities operated on a seasonal basis.*
- E. Provisions for signs to facilities that are not located on the crossroad when such facilities are eligible for signs.*
- F. A definition of the immediate area in compliance with the provisions of Paragraph 2 of Section 2K.01.*
- G. Maximum distances to eligible facilities. The maximum distance should be 5 miles.*
- H. Provision for information centers (plazas) when the number of eligible sign applicants exceeds the maximum permissible number of sign panel installations.*
- I. Provision for limiting the number of signs when there are more applicants than the maximum number of signs permitted.*
- J. Criteria for use at intersections on expressways.*
- K. Provisions for controlling or excluding those businesses which have illegal signs as defined by the Highway Beautification Act of 1965 (23 U.S.C. 131).*
- L. Provisions for States to charge fees to cover the cost of signs through a permit system.*
- M. A definition of the conditions under which the time of operation is displayed.*
- N. Provisions for determining if advance signs will be permitted, and the circumstances under which they will be installed.*

**Option:**

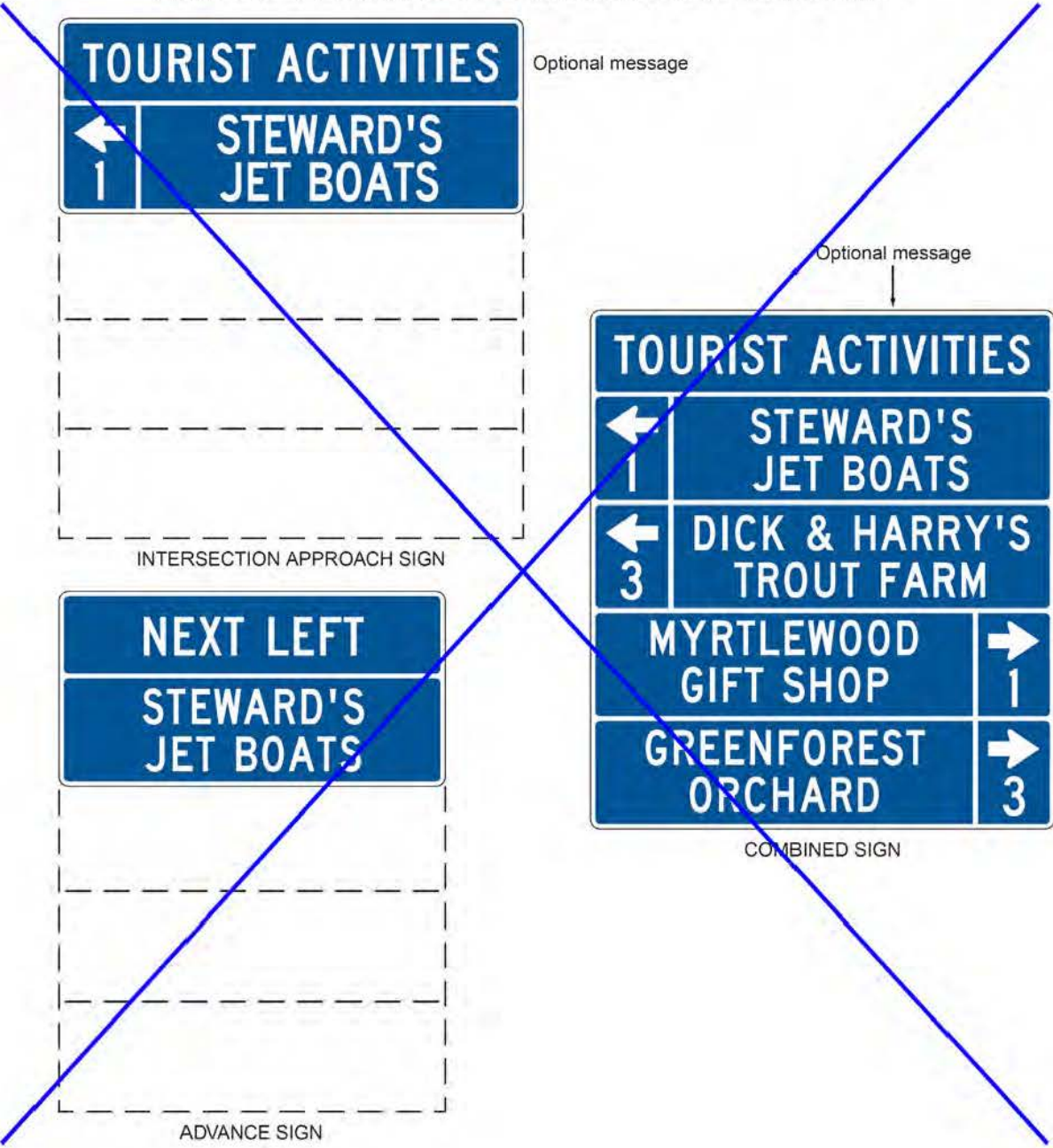
*03 The Tourist Oriented Directional (SG44-1(CA) and SG44-2(CA)) signs may be placed at qualifying conventional rural highway intersections.*

**Support:**

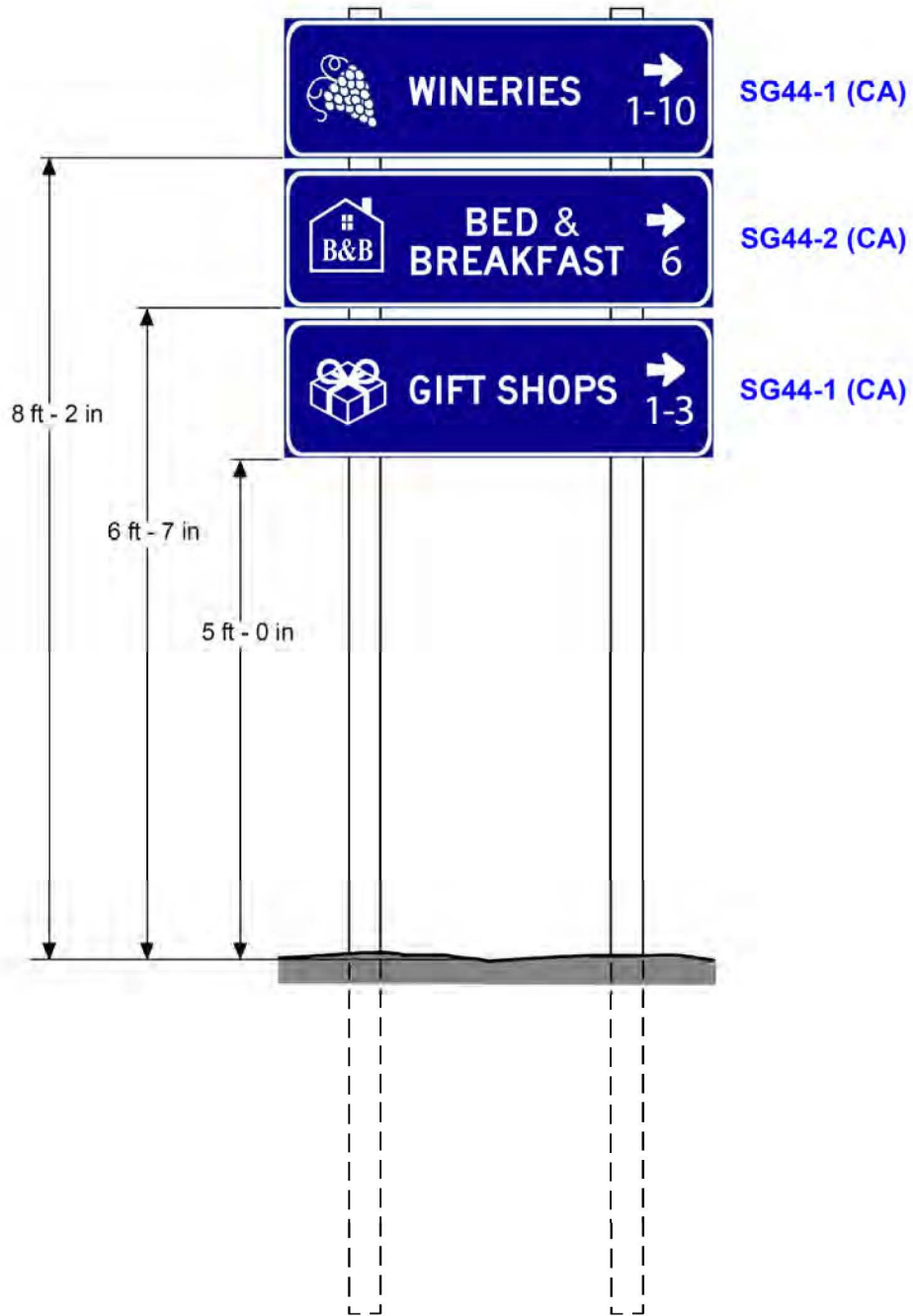
*04 These qualifying intersections are described in Chapter 1.5 of the Streets and Highways Code.*

*05 Refer to California Streets and Highways Code, Division 1, Chapter 1.5 for administration, standards, eligibility, and fees concerning the tourist-oriented directional signs. See Section 1A.11 for information regarding these publications.*

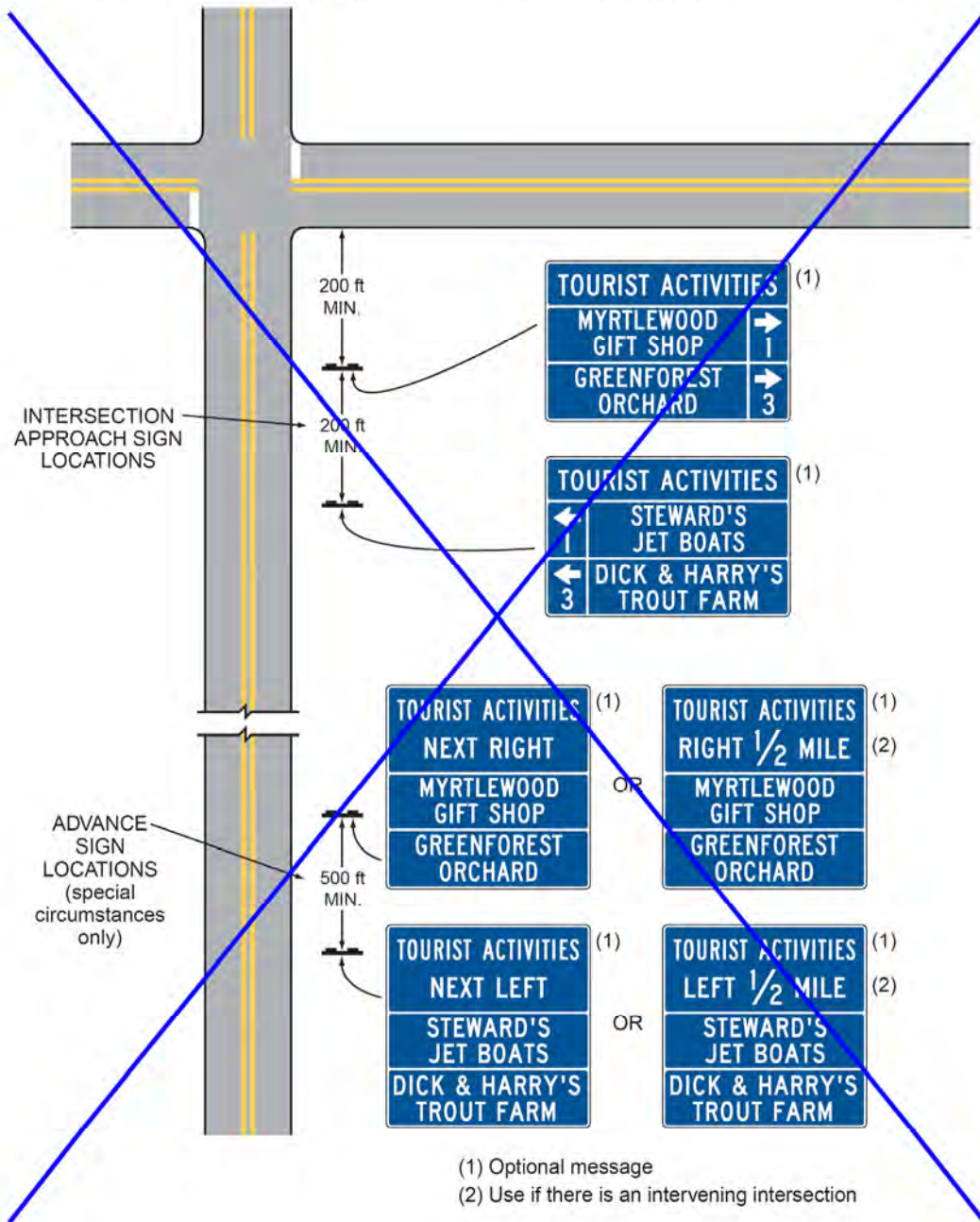
Figure 2K-1. Examples of Tourist-Oriented Directional Signs



**Figure 2K-1 (CA). Examples of Tourist-Oriented Directional Signs**



**Figure 2K-2. Examples of Intersection Approach Signs and Advance Signs for Tourist-Oriented Directional Signs**



**Table 2K-101(CA). California Tourist-Oriented Directional Sign Sizes**

| Sign or Plaque                           | Sign Designation | Section              | Conventional Road |
|--|------------------|----------------------|-------------------|
| Tourist Oriented Directional Sign (TODS) | SG44-1(CA)       | 2K.03, 2K.04 & 2K.07 | 72 x 18           |
| Tourist Oriented Directional Sign (TODS) | SG44-2(CA)       | 2K.03, 2K.04 & 2K.07 | 72 x 18           |



## CHAPTER 2L. CHANGEABLE MESSAGE SIGNS

### Section 2L.01 Description of Changeable Message Signs

#### Support:

<sup>01</sup> A changeable message sign (CMS) is a traffic control device that is capable of displaying one or more alternative messages. Some changeable message signs have a blank mode when no message is displayed, while others display multiple messages with only one of the messages displayed at a time (such as OPEN/CLOSED signs at weigh stations).

<sup>02</sup> The provisions in this Chapter apply to both permanent and portable changeable message signs with electronic displays. Additional provisions that only apply to portable changeable message signs can be found in Section 6F.60. The provisions in this Chapter do not apply to changeable message signs with non-electronic displays that are changed either manually or electromechanically, such as a hinged-panel, rotating-drum, or back-lit curtain or scroll CMS.

#### Standard:

<sup>03</sup> **Except as provided in Paragraph 2 of Section 2L.02, changeable message signs shall display only traffic operational, regulatory, warning, and guidance information. Advertising messages shall not be displayed on changeable message signs or its supports or other equipment.**

<sup>04</sup> **The design of legends for non-electronic display changeable message signs shall comply with the provisions of Chapters 2A through 2K, 2M, and 2N of this Manual. All other changeable message signs shall comply with the design and application principles established in this Chapter and in Chapter 2A.**

#### Guidance:

<sup>05</sup> *Blank-out signs that display only single-phase, predetermined electronic-display legends that are limited by their composition and arrangement of pixels or other illuminated forms in a fixed arrangement (such as a blank-out sign indicating a part-time turn prohibition, a blank-out or changeable lane-use sign, or a changeable OPEN/CLOSED sign for a weigh station) should comply with the provisions of the applicable Section for the specific type of sign, provided that the letter forms, symbols, and other legend elements are duplicates of the static messages as detailed in the "Standard Highway Signs and Markings" book (see Section 1A.11). Because such a sign is effectively an illuminated version of a static sign, the size of its legend elements, the overall size of the sign, and placement of the sign should comply with the applicable provisions for the static version of the sign.*

### Section 2L.02 Applications of Changeable Message Signs

#### Support:

<sup>01</sup> Changeable message signs have a large number of applications including, but not limited to, the following:

- A. Incident management and route diversion
- B. Warning of adverse weather conditions
- C. Special event applications associated with traffic control or conditions
- D. Control at crossing situations
- E. Lane, ramp, and roadway control
- F. Priced or other types of managed lanes
- G. Travel times
- H. Warning situations
- I. Traffic regulations
- J. Speed control
- K. Destination guidance

#### Option:

<sup>02</sup> Changeable message signs may be used by State and local highway agencies to display safety messages, transportation-related messages, emergency homeland security messages, and America's Missing: Broadcast Emergency Response (AMBER) alert messages.

#### Guidance:

<sup>03</sup> *State and local highway agencies should develop and establish a policy regarding the display of the types of messages provided in Paragraph 2. When changeable message signs are used at multiple locations to address a*

*specific situation, the message displays should be consistent along the roadway corridor and adjacent corridors, which might necessitate coordination among different operating agencies.*

Support:

<sup>04</sup> Examples of safety messages include “SEAT BELT BUCKLED?” and “DON'T DRINK AND DRIVE.” Examples of transportation-related messages include “STADIUM EVENT SUNDAY, EXPECT DELAYS NOON TO 4 PM” and “OZONE ALERT CODE RED—USE TRANSIT.”

Guidance:

<sup>05</sup> *When a CMS is used to display a safety or transportation related message, the message should be simple, brief, legible, and clear. A CMS should not be used to display a safety or transportation-related message if doing so would adversely affect respect for the sign. “CONGESTION AHEAD” or other overly simplistic or vague messages should not be displayed alone. These messages should be supplemented with a message on the location or distance to the congestion or incident, delay and travel time, alternative route, or other similar messages.*

**Standard:**

<sup>06</sup> **When a CMS is used to display a safety, transportation-related, emergency homeland security, or AMBER alert message, the display format shall not be of a type that could be considered similar to advertising displays.**

Support:

<sup>07</sup> Section 2B.13 contains information regarding the design of changeable message signs that are used to display variable speed limits that change based on ambient or operational conditions, or that display the speed at which approaching drivers are traveling.

#### **Caltrans' Policy regarding the use of CMS signs for child abduction (AMBER) alert messages on State Highways**

Support:

<sup>08</sup> A primary mission of Caltrans is the safe and orderly movement of traffic. It is the policy of Caltrans to display only real-time information that conveys current traffic safety and congestion information on highway Changeable Message Signs (CMS).

**Standard:**

<sup>09</sup> **An exception to Caltrans policy on the use of CMS signs shall be made only for AMBER Alerts. Only credible real-time information, where it is crucial to the safety of the victim to disseminate the information to the public in the near term, shall be displayed on these CMS signs.**

Support:

<sup>10</sup> Law enforcement activates an Amber Alert when circumstances meet the following criteria: the missing child is of a pre-determined age; the law enforcement agency believes the child has been kidnapped; the agency believes the missing child is under threat of serious bodily harm or death.

**Standard:**

<sup>11</sup> **The California Highway Patrol (CHP) shall consult with the investigating agency prior to requesting any CMS sign activation. Caltrans shall only respond to AMBER alert requests from the CHP. Caltrans' District Traffic Management Center (TMC) staff and local CHP staff shall jointly agree upon the most appropriate CMS sign message content(s). The TMC staff shall also consult with CHP staff regarding the length of time to display messages (initially 2-3 hours), and extent of roadway system to display the messages (i.e. radius and/or directions and specific routes).**

Guidance:

<sup>12</sup> *TMC personnel should discuss with the requester the limitations on message content, the number of signs that can be deployed within a given time period, conflicts with other necessary sign messages etc.*

Support:

<sup>13</sup> There is a concern that messages that are too general in describing vehicles might result in inappropriate vigilantism. The preferred response is to display a radio frequency (thus referring the public elsewhere for details) – Caltrans' Highway Advisory Radios (HAR) or appropriate commercial radio. Alternatively, a license plate number (or partial number) might be displayed along with a vehicle description. The display of any contact phone number is discouraged.

<sup>14</sup> Nothing in this policy suggests a requirement to pre-empt true road users safety messages, e.g. unexpected “end of queue” motorist alerts, severe weather advisories (fog, smoke), road closure and detour information etc.

Option:

<sup>15</sup> It may be necessary to turn off an AMBER alert sign that creates a traffic hazard.



**Support:**

<sup>16</sup> This policy primarily applies to the use of permanently installed overhead CMS signs. Should the use of mobile CMS signs be necessary and appropriate at a specific location(s); Caltrans can expect CHP assistance with mobile sign deployment as needed.

**Guidance:**

<sup>17</sup> *The TMCs should notify Caltrans' HQ Communications Center when responding to an AMBER alert request. The TMCs should monitor and save traffic data in order to determine if unintended consequences of displaying such a message occurred on the highway.*

**Standard:**

<sup>18</sup> **A joint debriefing of Caltrans and CHP personnel shall follow every event.**

<sup>19</sup> **In all cases, messages shall maintain the credibility of the CMS system.**

### **Section 2L.03 Legibility and Visibility of Changeable Message Signs**

**Support:**

<sup>01</sup> The maximum distance at which a driver can first correctly identify letters and words on a sign is called the legibility distance of the sign. Legibility distance is affected by the characteristics of the sign design and the visual capabilities of drivers. Visual capabilities, and thus legibility distances, vary among drivers.

<sup>02</sup> For the more common types of changeable message signs, the longest measured legibility distances on sunny days occur during mid-day when the sun is overhead. Legibility distances are much shorter when the sun is behind the sign face, when the sun is on the horizon and shining on the sign face, or at night.

<sup>03</sup> Visibility is the characteristic that enables a CMS to be seen. Visibility is associated with the point where the CMS is first detected, whereas legibility is the point where the message on the CMS can be read. Environmental conditions such as rain, fog, and snow impact the visibility of changeable message signs and can reduce the available legibility distances. During these conditions, there might not be enough viewing time for drivers to read the message.

**Guidance:**

<sup>04</sup> *Changeable message signs used on roadways with speed limits of 55 mph or higher should be visible from 1/2 mile under both day and night conditions. The message should be designed to be legible from a minimum distance of 600 feet for nighttime conditions and 800 feet for normal daylight conditions. When environmental conditions that reduce visibility and legibility are present, or when the legibility distances stated in the previous sentences in this paragraph cannot be practically achieved, messages composed of fewer units of information should be used and consideration should be given to limiting the message to a single phase (see Section 2L.05 for information regarding the lengths of messages displayed on changeable message signs).*

### **Section 2L.04 Design Characteristics of Changeable Message Signs**

**Standard:**

<sup>01</sup> **Changeable message signs shall not include advertising, animation, rapid flashing, dissolving, exploding, scrolling, or other dynamic elements.**

**Support:**

<sup>02</sup> Section 6F.61 contains information regarding the use of arrow boards that use flashing or sequential displays for lane closures.

**Guidance:**

<sup>03</sup> *Except in the case of a limited-legend CMS (such as a blank-out or electronic-display changeable message regulatory sign) that is used in place of a static regulatory sign or an activated blank-out warning sign that supplements a static warning sign at a separate location, changeable message signs should be used as a supplement to and not as a substitute for conventional signs and markings.*

<sup>04</sup> *CMS should be limited to no more than three lines, with no more than 20 characters per line.*

<sup>05</sup> *The spacing between characters in a word should be between 25 to 40 percent of the letter height. The spacing between words in a message should be between 75 and 100 percent of the letter height. Spacing between the message lines should be between 50 and 75 percent of the letter height.*

<sup>06</sup> *Except as provided in Paragraph 18, word messages on changeable message signs should be composed of all upper-case letters. The minimum letter height should be 18 inches for changeable message signs on roadways*

*with speed limits of 45 mph or higher. The minimum letter height should be 12 inches for changeable message signs on roadways with speed limits of less than 45 mph.*

**Support:**

07 Using letter heights of more than 18 inches will not result in proportional increases in legibility distance.

**Guidance:**

08 *The width-to-height ratio of the sign characters should be between 0.7 and 1.0. The stroke width-to-height ratio should be 0.2.*

**Support:**

09 The width-to-height ratio is commonly accomplished using a minimum font matrix density of five pixels wide by seven pixels high.

**Standard:**

**10 Changeable message signs shall automatically adjust their brightness under varying light conditions to maintain legibility.**

**Guidance:**

11 *The luminance of changeable message signs should meet industry criteria for daytime and nighttime conditions. Luminance contrast should be between 8 and 12 for all conditions.*

12 *Contrast orientation of changeable message signs should always be positive, that is, with luminous characters on a dark or less luminous background.*

**Support:**

13 Legibility distances for negative-contrast changeable message signs are likely to be at least 25 percent shorter than those of positive-contrast messages. In addition, the increased light emitted by negative-contrast changeable message signs has not been shown to improve detection distances.

**Standard:**

**14 The colors used for the legends and backgrounds on changeable message signs shall be as provided in Table 2A-5 2A-5(CA).**

**Guidance:**

15 *If a black background is used, the color used for the legend on a changeable message sign should match the background color that would be used on a standard sign for that type of legend, such as white for regulatory, yellow for warning, orange for temporary traffic control, red for stop or yield, fluorescent pink for incident management, and fluorescent yellow-green for bicycle, pedestrian, and school warning.*

**Standard:**

**16 If a green background is used for a guide message on a CMS or if a blue background is used for a motorist services message on a CMS, the background color shall be provided by green or blue lighted pixels such that the entire CMS would be lighted, not just the white legend.**

**Support:**

17 Some CMS that employ newer technologies have the capability to display an exact duplicate of a standard sign or other sign legend using standard symbols, the Standard Alphabets and letter forms, route shields, and other typical sign legend elements with no apparent loss of resolution or recognition to the road user when compared with a static version of the same sign legend. Such signs are of the full-matrix type and can typically display full-color legends. Use of such technologies for new CMS is encouraged for greater legibility of their displays and enhanced recognition of the message as it pertains to regulatory, warning, or guidance information.

**Guidance:**

18 *If used, the CMS described in the preceding paragraph should not display symbols or route shields unless they can do so in the appropriate color combinations. For a single-phase message where the Standard Alphabets and other legend elements of standard designs are used, the lettering style, size, and line spacing should comply with the applicable provisions for the type of message displayed as provided elsewhere in this Manual. For two-phase messages, larger legend heights should be used as described previously in this Section because of the need for such messages to be legible at a greater distance. Regardless of the number of phases, the CMS should comply with the legibility and visibility provisions of Section 2L.03.*

## **Section 2L.05 Message Length and Units of Information**

### *Guidance:*

*01 The maximum length of a message should be dictated by the number of units of information contained in the message, in addition to the size of the CMS. A unit of information, which is a single answer to a single question that a driver can use to make a decision, should not be more than four words.*

### **Support:**

*02 In order to illustrate the concept of units of information, Table 2L-1 shows an example message that is comprised of four units of information.*

*03 The maximum allowable number of units of information in a CMS message is based on the principles described in this Section, the current highway operating speed, the legibility characteristics of the CMS, and the lighting conditions.*

### **Standard:**

**04 Each message shall consist of no more than two phases. A phase shall consist of no more than three lines of text. Each phase shall be understood by itself regardless of the sequence in which it is read. Messages shall be centered within each line of legend. Except for signs located on toll plaza structures or other facilities with a similar booth-lane arrangement, if more than one CMS is visible to road users, then only one sign shall display a sequential message at any given time.**

**05 Techniques of message display such as fading, rapid flashing, exploding, dissolving, or moving messages shall not be used. The text of the message shall not scroll or travel horizontally or vertically across the face of the sign.**

### *Guidance:*

*06 When designing and displaying messages on changeable message signs, the following principles relative to message design should be used:*

- A. The minimum time that an individual phase is displayed should be based on 1 second per word or 2 seconds per unit of information, whichever produces a lesser value. The display time for a phase should never be less than 2 seconds.*
- B. The maximum cycle time of a two-phase message should be 8 seconds.*
- C. The duration between the display of two phases should not exceed 0.3 seconds.*
- D. No more than three units of information should be displayed on a phase of a message.*
- E. No more than four units of information should be in a message when the traffic operating speeds are 35 mph or more.*
- F. No more than five units of information should be in a message when the traffic operating speeds are less than 35 mph.*
- G. Only one unit of information should appear on each line of the CMS.*
- H. Compatible units of information should be displayed on the same message phase.*

### **Option:**

*07 A unit of information consisting of more than one word may be displayed on more than one line. An additional changeable message sign at a downstream location may be used for the purpose of allowing the entire message to be read twice.*

### *Guidance:*

*08 If more than two phases would be needed to display the necessary information, additional changeable message signs should be used to display this information as a series of two distinct, independent messages with a maximum of two phases at each location, in accordance with the provisions of Paragraph 4.*

*09 When the message on a CMS includes an abbreviation, the provisions of Section 1A.15 should be used.*

**Section 2L.06 Installation of Permanent Changeable Message Signs**

*Guidance:*

01 A CMS that is used in place of a static sign (such as a blank-out or variable legend regulatory sign) should be located in accordance with the provisions of Chapter 2A. The following factors should be considered when installing other permanent changeable message signs:

- A. Changeable message signs should be located sufficiently upstream of known bottlenecks and high crash locations to enable road users to select an alternate route or take other appropriate action in response to a recurring condition.
- B. Changeable message signs should be located sufficiently upstream of major diversion decision points, such as interchanges, to provide adequate distance over which road users can change lanes to reach one destination or the other.
- C. Changeable message signs should not be located within an interchange except for toll plazas or managed lanes.
- D. Changeable message signs should not be positioned at locations where the information load on drivers is already high because of guide signs and other types of information.
- E. Changeable message signs should not be located in areas where drivers frequently perform lane-changing maneuvers in response to static guide sign information, or because of merging or weaving conditions.

**Support:**

02 Information regarding the design and application of portable changeable message signs in temporary traffic control zones is contained in Section 6F.60.

**Section 2L.101(CA) Extinguishable Message Signs**

**Support:**

01 Extinguishable message signs are designed to have one or more messages that can be displayed or deleted as required. Such a sign can be changed manually, by remote control, or by automatic controls that can “sense” the conditions that require special sign messages.

02 It is recognized that due to technological limitations, many extinguishable message signs cannot conform to the exact sign shape, color, and dimensions specified in these standards. Nevertheless, it is essential that extinguishable message signs ascribe to the principles established in this California MUTCD, and to the extent practicable, with the design and applications prescribed herein.

**Table 2L-1. Example of Units of Information**

| Question                 | Answer                      | Number of Information Units |
|--------------------------|-----------------------------|-----------------------------|
| What happened?           | MAJOR CRASH                 | 1                           |
| Where?                   | AT EXIT 12                  | 1                           |
| Who is the advisory for? | Drivers Heading TO NEW YORK | 1                           |
| What is advised?         | USE ROUTE 46                | 1                           |

Note: The following is an example of a two-phase message that could be developed from the four information units shown in this table:

**MAJOR CRASH  
AT EXIT 12**

Phase 1

**USE ROUTE 46  
TO NEW YORK**

Phase 2

## CHAPTER 2M. RECREATIONAL AND CULTURAL INTEREST AREA SIGNS

### Section 2M.01 Scope

Support:

01 Recreational or cultural interest areas are attractions or traffic generators that are open to the general public for the purpose of play, amusement, or relaxation. Recreational attractions include such facilities as parks, campgrounds, gaming facilities, and ski areas, while examples of cultural attractions include museums, art galleries, and historical buildings or sites.

02 The purpose of recreation and cultural interest area signs is to guide road users to a general area and then to specific facilities or activities within the area.

Option:

03 Recreational and cultural interest area guide signs directing road users to significant traffic generators may be used on freeways and expressways where there is direct access to these areas as provided in Section 2M.09.

04 Recreational and cultural interest area signs may be used off the road network, as appropriate.

### Section 2M.02 Application of Recreational and Cultural Interest Area Signs

Support:

01 Provisions for signing recreational or cultural interest areas are subdivided into two different types of signs: (1) symbol signs and (2) destination guide signs.

Guidance:

02 *When highway agencies decide to provide recreational and cultural interest area signing, these agencies should have a policy for such signing. The policy should establish signing criteria for the eligibility of the various types of services, accommodations, and facilities. These signs should not be used where they might be confused with other traffic control signs.*

Option:

03 Recreational and cultural interest area guide signs may be used on any road to direct persons to facilities, structures, and places, and to identify various services available to the general public. These guide signs may also be used in recreational or cultural interest areas for signing non-vehicular events and amenities such as trails, structures, and facilities.

Support:

04 Section 2A.12 contains information regarding the use of recreational and cultural interest area symbols on other types of signs.

Support:

05 The recreational and cultural interest area signs are supplemental signs and are subject to the same spacing and number of messages limitations set forth in Chapters 2A, 2D and 2E. Under these limitations, the supplemental destination, recreational and cultural interest area signs compete for signing on the basis of traffic service.

Guidance:

06 *Recreational area signs to National Parks and State Parks should normally include the name of the area. County and City Park signs should not normally include the name.*

Option:

07 Recreational area signs may be placed for the following facilities:

- A. National Parks or Monuments.
- B. State Parks, when located within 5 miles of the highway.
- C. County Parks, when located within 3 miles of the highway.
- D. In urban areas, City Parks within 1 mile may be signed from conventional highways. Normally, City Parks will not be signed to or from metropolitan freeways.
- E. Campgrounds in National Forests or State Parks may be signed from conventional highways when the entrances are located on the highway. An advance sign reading "Campground 1/4 mile" may be placed. Signs at the immediate entrance will be placed by the agency having jurisdiction over the campground.

- F. Major rural recreational areas may be signed by name. When a recreational area is served by more than a single exit, the appropriate colored NEXT X EXITS (E9) sign may be used. Normally, the sign will include the name of the area and the text "RECREATIONAL AREA".
- G. In rural recreational areas, guide signs may be supplemented with white on brown symbol signs mounted below indicating recreational facilities available to the road users.

*Guidance:*

*08 On State highways, signs to major rural recreational areas that include a jurisdictional logo or are unique in shape should be placed under an encroachment permit from Caltrans.*

**Standard:**

**09 Placement of these signs to major rural recreational areas shall be by the jurisdiction or agency making the request through the normal permit process as a fee exempt permit.**

**10 These signs shall be installed in accordance with Caltrans' Standard Plans publication. See Section 1A.11 for more information regarding this publication.**

*Guidance:*

*11 These signs to major rural recreational areas should be limited to areas where they do not block or interfere with other signs necessary for safe and efficient operation of the highway. The sign panels should be clearly marked as to the ownership.*

**Standard:**

**12 The use of the following symbol signs shall conform to the warrants shown here and in Chapter 2I:**

**General Information**

*Option:*

*13 The Automobile (RG-010) sign indicates that automobiles may use the signed facility within a recreation area.*

**Standard:**

**14 The RG-010 sign shall not be used on State highways.**

*Option:*

*15 The Lookout Tower (RS-006) sign may be used for lookout facilities that are publicly owned, within 3 miles of the highway, and open for visitors at least 8 hours per day, 180 days per year.*

**Standard:**

**16 Follow up signs to the RS-006 sign, where required, shall be installed by the local authority having jurisdiction in the area.**

*Option:*

*17 The Lighthouse (RS-007) sign may be used for lighthouse facilities that are within 3 miles of the highway and open for visitors at least 8 hours per day, 180 days per year.*

*18 The Dam (RS-009) sign may be used to indicate dams, located within 1 mile of the highway, that have recreational activities with parking, water access, power plant tours and picnicking, which do not meet warrants for other recreational symbols.*

*19 The Fish Hatchery (RS-010) sign may be used to indicate publicly administered hatcheries that are within 3 miles of the highway and open for visitors at least 8 hours per day, 180 days per year.*

*20 The Deer Viewing Area (RS-011) sign may be placed to indicate an area which is determined by the Department of Fish and Wildlife to be particularly well suited for viewing deer and other wild life. This area should have adequate parking and be within 1 mile of the highway, via a well-maintained road.*

*21 The Drinking Water (RS-013) sign may be used to indicate free public drinking water within 0.25 miles of the highway where no other publicly accessible drinking water is available within 10 miles.*

*22 The Information (D9-10) sign may be used to indicate publicly operated informational facilities that are located within 1 mile of the highway and open all year.*

*Option:*

*23 The Ranger Station (RS-015) sign may be used for public agency ranger stations that are within 1 mile of the highway and open all year.*

*24 The Truck (RG-190) sign indicates that trucks may use the signed facility within a recreation area.*

**Standard:**

**25 The RG-190 sign shall not be used on State highways.**

Option:

26 The Wildlife Viewing (RS-076) sign may be used to direct road users to the Wildlife Viewing Areas as published in the California Watchable Viewing Guide.

Support:

27 Refer to the following web link for more information:

<http://www.cawatchablewildlife.org>

**Standard:**

28 **The WILDLIFE VIEWING (G200-81A(CA)) sign shall be placed below the Wildlife Viewing (RS-076) sign.**

Option:

29 The Botanical Management Area (G200-82(CA)) sign may be used to identify areas along the State highway right-of-way that are environmentally significant natural remnants of California's botanical diversity, as designated by the Office of State Landscape Architecture.

Guidance:

30 *The G200-82(CA) sign should be placed in combination with the BOTANICAL MANAGEMENT AREA (G200-82A(CA)) plaque.*

31 *The G200-82A(CA) plaque should be placed below the G200-82(CA) sign.*

**Road User Services**

Option:

32 The Camping (Tent) (D9-3) sign may be used for campsite facilities, either public or private, located within 3 miles of the highway.

**Standard:**

33 **For the use of D9-3 sign, a minimum of 15 campsites shall be provided. Water and sanitary facilities shall be available, but not necessarily at each individual campsite.**

Option:

34 The Trailer Site (RS-040) sign may be used to indicate trailer site facilities within a public recreation area, located within 3 miles of the highway.

**Standard:**

35 **For the use of RS-040 sign, a minimum of 15 trailer sites shall be provided. Water and sanitary facilities shall be available.**

Option:

36 The Ferry (RM-030) sign may be used to indicate recreational ferry operations within 2 miles of the highway.

37 The Food Service (D9-8) sign may be used to sign for food service facilities in public recreation areas which meet the criteria for food (D9-8) signs in Chapter 2I. On State highways, only the D9-8 sign is used, where appropriate, to sign for food service facilities.

38 The Gas (D9-7) sign may be used to indicate fuel stations in public recreation areas, which meet the criteria for Gas (D9-7) signs in Chapter 2I. On State highways, only the D9-7 sign may be used where appropriate.

39 The Grocery Store (RS-020) sign may be used within public recreation areas for facilities within 1 mile of the highway that provide standard grocery items such as eggs, bread, milk and fruit, provided there are no other similar facilities within 10 miles.

**Standard:**

40 **For the use of RS-020 sign, services shall be available at least 12 hours per day.**

Option:

41 The Handicapped (D9-6) sign may be used in public recreation areas where paved ramps and rest room facilities accessible to, and usable by, the physically handicapped are provided. On State highways and at other State facilities, only the International Symbol of Accessibility for the Handicapped (D9-6) sign is to be used.

42 The Lodging (D9-9) sign may be used to indicate lodging facilities in public recreation areas, which meet the criteria for lodging (D9-9) signs in Section 2D.45. On State highways, only the D9-9 sign is used, where appropriate, to sign to lodging facilities.

43 The Mechanic (RS-027) sign may be used to indicate facilities in public recreation areas with automotive repair capability.

**Standard:**

44 **The RS-027 sign shall not be used on State highways.**

Option:

45 The Picnic Area (RS-044) sign may be used for picnic areas, either public or private, located within 1 mile of the highway.

**Standard:**

46 **For the use of RS-044 sign, a minimum of 10 sites with tables shall be provided. Water and sanitary facilities shall be available.**

Option:

47 The Rest Room (RS-022) sign may be used to indicate free public access to a restroom within 0.25 miles of the highway where no other publicly accessible restroom is available within 10 miles.

48 The Telephone (D9-1) sign may be used within public recreation areas where a public telephone is available 24 hours a day and it is located in a remote area where it is not expected. On State highways, only the Telephone (D9-1) sign is used, where appropriate, to indicate the availability of a telephone.

49 The Trailer Sanitary Station (RS-041) sign may be used to indicate dump stations where recreational vehicles may dispose of their holding tank waste.

**Standard:**

50 **For the use of RS-041 sign, the station shall be located within a public recreation area and within 1 mile of the highway.**

Option:

51 The Viewing Area (RS-036) sign may be used to direct road users to public recreation area sites, located within 0.25 miles of the highway, which have significant views.

*Guidance:*

52 *For the use of RS-036 sign, the sites should have adequate parking and well maintained access. On freeways, the VISTA POINT (D5-1) sign should be used where appropriate. Refer to Chapter 2I.*

### **Accommodation Services**

Option:

53 The Airport (I-5) sign may be used in public recreation areas to direct road users to airports, which meet the criteria, specified for Airport (I-5) signs. Only the I-5 and Conventional Airport (G94-1(CA)) signs may be used on State highways to indicate nearby airports.

54 The Parking (RS-034) sign may be used to indicate public parking facilities less than 0.25 miles from a highway in recreation areas.

*Guidance:*

55 *Use of RS-034 signs should be restricted to locations outside of urbanized zones, where the Parking Area (D4-1) sign is inappropriate.*

### **Land Recreation**

Option:

56 The Amphitheater (RS-070) sign may be used to identify an amphitheater facility within 1 mile of the highway.

57 The Playground (W15-1) sign may be used to identify playgrounds within a recreation area and not more than 1 mile from the highway.

58 The Trail (Bicycle) (D11-1) sign may be used for identifying bicycle trails located within public recreation areas.

*Guidance:*

59 *On State highways, the Bike Lane (R81(CA)) or the Bike Route (D11-1) signs should be used.*

Option:

60 The Trail (Hiking) (RS-068) sign may be used for marked and maintained hiking trails.

**Standard:**

61 **For the use of RS-068 sign, the trailhead shall be within 1 mile of the highway, with sufficient parking to accommodate normal demand.**

Option:

62 The Trail (Horse) (RS-064) sign may be used for identifying horse trails located within public recreation areas.

*Guidance:*

63 *For the use of RS-064 sign, the trailhead should be within 3 miles of the highway.*

Option:

64 The Trail (4WD Vehicle) (RS-067) sign may be used to identify recreation vehicle trails located within public recreation areas.



*Guidance:*

<sup>65</sup> For the use of RS-067 sign, the trailhead should be 3 miles or less from the highway. For this application, the term "recreation vehicle" is synonymous with "off highway vehicle" (OHV), which includes vehicles with two or more wheels. The OHV TRAIL (S12(CA)) sign should be used at points where off-highway vehicle trails intersect highways.

*Option:*

<sup>66</sup> The Trail (Trail Bike) (RL-150) sign may be used to identify trail bike trails located within public recreation areas.

*Guidance:*

<sup>67</sup> For the use of RL-150 sign, the trailhead should be 3 miles or less from the highway. The OHV TRAIL (S12(CA)) sign should be used where the trail intersects the highway.

*Option:*

<sup>68</sup> The Tramway (RS-071) sign may be used to identify recreational tramways or gondolas that provide year-round service and are located within 5 miles of the highway.

<sup>69</sup> The Golf Course (G200-80(CA)) sign may be used to identify a 9 hole or more golf course within 3 miles on a conventional highway which does not have its main entrance adjacent to the highway. The G200-80(CA) signs may be installed under permit by local agencies only.

**Standard:**

<sup>70</sup> **The G200-80(CA) signs shall not be used at driving ranges or miniature golf courses.**

*Option:*

<sup>71</sup> The OHV TRAIL (S12(CA)) sign may be used to direct off highway vehicle operators to the location of a OHV trail. The S12(CA) sign may be supplemented by a white on brown Directional Arrow Auxiliary (M6 Series) sign.

**Water Recreation**

*Option:*

<sup>72</sup> The Canoeing (RS-079) sign may be used to indicate where canoeing facilities and services are available within 3 miles of the highway.

<sup>73</sup> The Diving (RS-062) sign may be used to indicate a diving facility within a recreational area.

<sup>74</sup> The Diving (Scuba) (RS-060) sign may be used to indicate areas suitable for scuba diving within 3 miles of the highway.

<sup>75</sup> The Fishing (RS-063) sign may be used to indicate a fishing area, either public or private, within 3 miles of the highway.

<sup>76</sup> The Marina (RS-053) sign may be used to indicate an area where boats can be anchored and serviced within 3 miles of the highway.

<sup>77</sup> The Motorboating (RS-055) sign may be used to indicate areas where motorboating facilities and services are available within 3 miles of the highway.

<sup>78</sup> The Ramp (Launch) (RS-054) sign may be used to indicate boat launching facilities, either public or private, located within 3 miles of the highway.

<sup>79</sup> The Rowboating (RS-057) sign may be used to indicate areas where Rowboating facilities and services are available within 3 miles of the highway.

<sup>80</sup> The Sailboating (RW-056) sign may be used to indicate areas where Sailboating facilities and services are available within 3 miles of the highway.

<sup>81</sup> The Skiing (Water) (RW-058) sign may be used to indicate areas where water-skiing facilities and services are available within 3 miles of the highway.

<sup>82</sup> The Surfing (RS-059) sign may be used to indicate areas suitable for surfing within 3 miles of the highway.

*Guidance:*

<sup>83</sup> For the use of RS-059 sign, adequate parking should also be available.

*Option:*

<sup>84</sup> The Swimming (RS-061) sign may be used to indicate a swimming facility within a recreational area.

**Winter Recreation**

*Option:*

<sup>85</sup> The Skating (Ice) (RS-050) sign may be used to indicate ice skating facilities within 5 miles of the highway.

<sup>86</sup> The Ski Jumping (RS-048) sign may be used to indicate ski jumping facilities within 5 miles of the highway.

<sup>87</sup> The Skiing (Bobbing) (RS-030) sign may be used to indicate ski bobbing facilities within 1 mile of the highway.

*Guidance:*

<sup>88</sup> For the use of RS-030 sign, there should be sufficient parking to accommodate normal demand.

Option:

<sup>89</sup> The Skiing (Cross Country) (RS-046) sign may be used to indicate cross country skiing facilities within 1 mile of the highway.

Guidance:

<sup>90</sup> *For the use of RS-046 sign, there should be sufficient parking to accommodate normal demand.*

Option:

<sup>91</sup> The Skiing (Downhill) (RS-047) sign may be used to indicate down hill skiing facilities located within 5 miles of the highway.

<sup>92</sup> The Sledding (RS-049) sign may be used to indicate sledding facilities within 1 mile of the highway.

Guidance:

<sup>93</sup> *For the use of RS-049 sign, there should be sufficient parking to accommodate normal demand.*

Option:

<sup>94</sup> The Snowmobiling (RS-052) sign may be used to indicate Snowmobiling facilities within 1 mile of the highway.

Guidance:

<sup>95</sup> *For the use of RS-052 sign, there should be a paved loading area at any such facility which is at least 20 feet wide (measured perpendicular to the traveled way) and sufficient parking to accommodate normal demand. Parking spaces should be sized for vehicles with small trailers.*

Option:

<sup>96</sup> The Snowshoeing (RS-078) sign may be used to indicate an area within 1 mile of the highway where special facilities or services are available for Snowshoeing.

Guidance:

<sup>97</sup> *For the use of RS-078 sign, there should be sufficient parking to accommodate normal demand.*

Option:

<sup>98</sup> The Winter Recreation Area (RS-077) sign may be used to indicate a winter recreation area within 1 mile of the highway when other recreation symbols are not appropriate.

Guidance:

<sup>99</sup> *For the use of RS-077 sign, there should be sufficient parking to accommodate normal demand.*

### **Sno-Park Signs**

Option:

<sup>100</sup> Only those specific parking areas designated by the Department of Parks and Recreation may be signed as Sno-Park parking areas. Parking is by permit only.

<sup>101</sup> The SNO-PARK X MILE (SG30(CA)) sign may be used on expressways or conventional highways to give advance notice of a snow plowed parking area. The SNO-PARK with Arrow (SG32(CA)) sign may be used on expressways or conventional highways in advance of a turn off to a snow plowed parking area.

<sup>102</sup> The SNO-PARK NEXT RIGHT (SG31(CA)) sign may be used on freeways to give advance notice of an exit to a snow plowed parking area. The SNO-PARK (SG34(CA)) sign may be placed below an existing Advance Guide (G83(CA) Series) or Supplemental Destination (G86(CA) Series) sign on freeways to indicate an exit to a snow plowed parking area.

**Standard:**

<sup>103</sup> **If the SG31(CA) or SG34(CA) sign is used, a SNO-PARK with Arrow (SG33(CA)) sign shall be placed at the ramp terminal.**

Guidance:

<sup>104</sup> *If used, the PERMIT REQUIRED (SG35(CA)) sign should be placed below the SG30(CA) or SG31(CA) sign and the PERMIT REQUIRED NOV 1 TO MAY 30 (SG35-1(CA)) sign should be placed below the SG32(CA) or SG33(CA) sign. Placement should be under the sign, which is nearest to the Sno-Park entrance.*

<sup>105</sup> *Between November 1 and May 30, during periods when snow is not available for recreational activities, the SG35(CA) and SG35-1(CA) signs should be covered.*

**Standard:**

<sup>105</sup> **At the end of the Sno-Park season, May 30, the SG35(CA) and SG35-1(CA) signs shall be covered or removed.**

### **Section 2M.03 Regulatory and Warning Signs**

#### **Standard:**

**01 All regulatory and warning signs installed on public roads and streets within recreational and cultural interest areas shall comply with the requirements of Chapters 2A, 2B, 2C, 7B, 8B, and 9B.**

### **Section 2M.04 General Design Requirements for Recreational and Cultural Interest Area Symbol Guide Signs**

#### **Standard:**

**01 Recreational and cultural interest area symbol guide signs shall be square or rectangular in shape and shall have a white symbol or message and white border on a brown background. The symbols shall be grouped into the following usage and series categories:**

- A. General Applications,**
- B. Accommodations,**
- C. Services,**
- D. Land Recreation,**
- E. Water Recreation, and**
- F. Winter Recreation.**

#### **Support:**

**02 Table 2M-1 contains a listing of the symbols within each series category. Drawings showing the design details for these symbols are found in the "Standard Highway Signs and Markings" book (see Section 1A.11).**

#### **Option:**

**03 Mirror images of symbols may be used where the reverse image will better convey the message.**

### **Section 2M.05 Symbol Sign Sizes**

#### *Guidance:*

*01 Recreational and cultural interest area symbol signs should be 24 x 24 inches. Where greater visibility or emphasis is needed, larger sizes should be used. Symbol sign enlargements should be in 6-inch increments.*

*02 Recreational and cultural interest area symbol signs should be 30 x 30 inches when used on guide signs on freeways or expressways.*

#### **Option:**

**03 A smaller size of 18 x 18 inches may be used on low-speed, low-volume roadways and on non-road applications.**

### **Section 2M.06 Use of Educational Plaques**

#### *Guidance:*

*01 Educational plaques should accompany all initial installations of recreational and cultural interest area symbol signs. The educational plaque should remain in place for at least 3 years after the initial installation. If used, the educational plaque should be the same width as the symbol sign.*

#### **Option:**

**02 Symbol signs that are readily recognizable by the public may be installed without educational plaques.**

#### **Support:**

**03 Figure 2M-1 illustrates some examples of the use of educational plaques.**

### **Section 2M.07 Use of Prohibitive Circle and Diagonal Slash for Non-Road Applications**

#### **Standard:**

**01 Where it is necessary to indicate a prohibition of an activity or an item within a recreational or cultural interest area for non-road use and a standard regulatory sign for such a prohibition is not provided in Chapter 2B, the appropriate recreational and cultural interest area symbol shall be used in combination with a red prohibitive circle and red diagonal slash. The recreational and cultural interest area symbol and the sign border shall be black and the sign background shall be white. The symbol shall be scaled proportionally to fit completely within the circle and the diagonal slash shall be oriented from the upper left to the lower right portions of the circle as shown in Figure 2M-1 and Figure 2M-102(CA).**

**02 Requirements for retroreflection of the red circle and red diagonal slash shall be the same as those requirements for backgrounds, legends, symbols, arrows, and borders.**

**03 If used, Figure 2M-102(CA), Table 2M-1 (with annotations), and Table 2M-1(CA) shall identify eligible Prohibited Symbol (PS- (CA) series) signs for use in California.**

Option:

**04 If used, Figure 2M-102(CA), Table 2M-1 (with annotations), and Table 2M-1(CA) may identify eligible Prohibited Recreation Educational Plaque (PREP- (CA) series) for optional use in California.**

## **Section 2M.08 Placement of Recreational and Cultural Interest Area Symbol Signs**

**Standard:**

**01 If used, recreational and cultural interest area symbol signs shall be placed in accordance with the general requirements contained in Chapter 2A. The symbol(s) shall be placed as sign panels in the uppermost part of the sign and the directional information shall be placed below the symbol(s).**

**02 Except as provided in Paragraph 3, if the name of the recreational or cultural interest area facility or activity is displayed on a destination guide sign (see Section 2M.09) and a symbol is used, the symbol shall be placed below the name (see Figure 2M-2).**

Option:

**03** When the legend Wildlife Viewing Area is displayed with the RS-076 symbol on a destination guide sign, the symbol may be placed to the left or right of the legend and the arrow may be placed below the symbol (see Figure 2M-2).

**04** The symbols displayed with the facility or activity name may be placed below the destination guide sign as illustrated in Figure 2M-2 instead of as sign panels placed with the destination guide sign.

**05** Secondary symbols of a smaller size (18 x 18 inches) may be placed beneath the primary symbols (see Drawing A in Figure 2M-1), where needed.

**Standard:**

**06 Recreational and cultural interest area symbols installed for non-road use shall be placed in accordance with the general sign position requirements of the authority having jurisdiction.**

Support:

**07** Figure 2M-3 illustrates typical height and lateral mounting positions. Figure 2M-4 illustrates some examples of the placement of symbol signs within a recreational or cultural interest area. Figures 2M-5 through 2M-10, and 2M-5(CA) and 2M-8(CA) illustrate some of the symbols that can be used.

Guidance:

**08** *The number of symbols used in a single sign assembly should not exceed four.*

Option:

**09** The Advance Turn (M5 series) or Directional Arrow (M6 series) auxiliary signs with white arrows on brown backgrounds shown in Figure 2D-5 may be used with Recreational and Cultural Area Interest symbol guide signs to create a Recreational and Cultural Interest Area Directional Assembly. The symbols may be used singularly, or in groups of two, three, or four on a single sign assembly (see Figures 2M-1, 2M-3, and 2M-4).

Guidance:

**10** *The symbol signs should be placed below the first advance ground-mounted directional sign.*

Option:

**11** The NEXT RIGHT/LEFT (G58(CA)) Auxiliary sign (see Figure 2M-1(CA)) may also be used in conjunction with the recreational and cultural interest area signs.

## **Section 2M.09 Destination Guide Signs**

Guidance:

**01** *When recreational or cultural interest area destinations are displayed on supplemental guide signs, the sign should be rectangular or trapezoidal in shape. The order of preference for use of shapes and colors should be as follows: (1) rectangular with a white legend and border on a green background; (2) rectangular with a white legend and border on a brown background; or (3) trapezoidal with a white legend and border on a brown background.*

**Standard:**

**02** **Whenever the trapezoidal shape is used, the color combination shall be a white legend and border on a brown background.**

**Option:**

03 Destination guide signs with a white legend and border on a brown background may be posted at the first point where an access or crossroad intersects a highway where recreational or cultural interest areas are a significant destination along conventional roads, expressways, or freeways. Supplemental guide signs with a white legend and border on a brown background may be used along conventional roads, expressways, or freeways to direct road users to recreational or cultural interest areas. Where access or crossroads lead exclusively to the recreational or cultural interest area, the advance guide sign and the exit direction sign may have a white legend and border on a brown background.

**Standard:**

04 **All Exit Gore (E5-1 and E5-1a) signs (see Section 2E.37) shall have a white legend and border on a green background. The background color of the interchange Exit Number (E1-5P and E1-5bP) plaque (see Section 2E.31) shall match the background color of the guide sign. Design characteristics of conventional road, expressway, or freeway guide signs shall comply with Chapter 2D or 2E except as provided in this Section for color combination.**

05 **The advance guide sign and the Exit Direction sign shall retain the white-on-green color combination where the crossroad leads to a destination other than a recreational or cultural interest area.**

**Support:**

06 Figure 2M-2, and 2M-2(CA) illustrates destination guide signs commonly used for identifying recreational or cultural interest areas or facilities.

07 The name of a community that is culturally unique and historically significant can be used on supplemental guide signs in accordance with California Streets and Highways Code Section 101.12.

**Option:**

08 The Historic District Supplemental Destination (G86-11(CA)) signs may be placed directing traffic to a commercial or residential area that is of historic significance to a community and is recognized as such in the National Register of Historic Places.

**Standard:**

09 **For a Historic District to be signed from a State highway, its boundaries shall be within 3 miles of the highway. Only one sign, for each direction shall be allowed and it will be from the nearest State highway. The type of sign, whether it is a supplemental plate under an existing Supplemental Destination (G86(CA) Series) sign or a stand alone sign shall be determined by Caltrans. Any follow-up signs, if needed, shall be in place before the highway signs are installed.**

10 **The requesting local agency shall be responsible for consulting with the Department of Parks and Recreation, Office of Historic Preservation to verify the Historic District's official name and to insure there are no conflicts with existing historic landmarks or points of historical interest signs which may already be in place.**

11 **When the above requirements are met, the requesting agency shall adopt a resolution, requesting Caltrans to place the signs. The cost of these signs and their installation shall be the responsibility of the requesting agency.**

## **Section 2M.10 Memorial or Dedication Signing**

**Support:**

01 Legislative bodies will occasionally adopt an act or resolution memorializing or dedicating a highway, bridge, or other component of the highway.

**Guidance:**

~~02 Such memorial or dedication names should not appear on or along a highway, or be placed on bridges or other highway components. If a route, bridge, or highway component is officially designated as a memorial or dedication, and if notification of the memorial or dedication is to be made on the highway right-of-way, such notification should consist of installing a memorial or dedication marker in a rest area, scenic overlook, recreational area, or other appropriate location where parking is provided with the signing inconspicuously located relative to vehicle operations along the highway.~~

**Option:**

~~03 If the installation of a memorial or dedication marker off the main roadway is not practical, memorial or dedication signs may be installed on the mainline.~~

*Guidance:*

*04 Memorial or dedication signs should have a white legend and border on a brown background.*

**Standard:**

**05 Where such memorial or dedication signs are installed on the mainline, (1) memorial or dedication names shall not appear on directional guide signs, (2) memorial or dedication signs shall not interfere with the placement of any other necessary signing, and (3) memorial or dedication signs shall not compromise the safety or efficiency of traffic flow. The memorial or dedication signing shall be limited to one sign at an appropriate location in each route direction, each as an independent sign installation.**

**06 Memorial or dedication signs shall be rectangular in shape. The legend displayed on memorial or dedication signs shall be limited to the name of the person or entity being recognized and a simple message preceding or following the name, such as "Dedicated to" or "Memorial Parkway." Additional legend, such as biographical information, shall not be displayed on memorial or dedication signs. Decorative or graphical elements, pictographs, logos, or symbols shall not be displayed on memorial or dedication signs. All letters and numerals displayed on memorial or dedication signs shall be as provided in the "Standard Highway Signs and Markings" book (see Section 1A.11). The route number or officially mapped name of the highway shall not be displayed on the memorial or dedication sign.**

**07 Memorial or dedication names shall not appear on supplemental signs or on any other information sign on or along the highway or its intersecting routes.**

**Option:**

**08 The lettering for the name of the person or entity being recognized may be composed of a combination of lower-case letters with initial upper-case letters.**

*Guidance:*

*09 Freeways and expressways should not be signed as memorial or dedicated highways.*

**Support:**

**10 Named highways are officially designated and shown on official maps and serve the purpose of providing route guidance, primarily on unnumbered highways. A highway designated as a memorial or dedication is not considered to be a named highway. Section 2D.53 contains provisions for the signing of named highways.**

*Guidance:*

*11 Route numbers and cardinal directions should be used in signing to freeways in metropolitan areas.*

**Option:**

**12 At freeway to freeway interchanges, overhead signing by freeway name may be included in primary directional signs only when the freeway name is well recognized and space permits. At other than freeway to freeway interchanges, Interchange Guide (G77(CA) and G78(CA) series) signs including both the freeway name and appropriate route shield may be used to direct to the named freeway.**

**13 Ground-mounted freeway name signs in rural areas may be installed beyond major freeway interchanges and at approximate 10 mile intervals.**

*Guidance:*

*14 Freeway names should not be used on signs directing to freeways in rural areas.*

**Option:**

**15 The Legislature, by legislative action, may designate names for State highways and bridges. The Legislature may request memorial named highway facilities to be designated with signs instead of a plaque and specify that the signs are to be furnished and installed "at no cost to the State".**

**Support:**

**16 Caltrans is authorized to expend reasonable sums for plaques.**

**Standard:**

**17 When highway facilities are named by the Legislature, the following guidelines shall apply according to the type of facility:**

- 1. Bridges. One sign shall be placed at the approach ends of the bridge, underpass, tunnel or other structure with the name of the memorialized individual. Normally this would consist of an additional plate attached to the existing Memorial Bridge (G11(CA) series) sign. The color and size of the plate shall match the sign. The memorial name shall be smaller so that it does not dominate the G11(CA) sign.**

2. **Freeways and Highways.** One sign shall be placed at each terminal. Signs shall be white on green. When used, the Memorial Highway (G12-1(CA) & G12-2(CA)) signs (see Figure 2M-101(CA)) shall be placed at the beginning of the highway segment memorialized by the Legislature.
3. **Rest Areas.** One sign shall be placed in advance of each named rest area. Normally a one line message would be placed above the REST AREA (X MILE) (D5-1) sign. The sign shall be white on blue.
4. **Interchanges.** One bronze plaque shall be installed at each legislatively named interchange. Memorial name signs shall not be erected at interchanges.
5. **Vista Points.** One bronze plaque shall be installed at each legislatively named vista point. Memorial name signs shall not be installed in advance of vista points.

*Guidance:*

<sup>18</sup> *The size, color, and retroreflectorization of memorial named signs should match existing signs associated with the facility.*

**Standard:**

<sup>19</sup> **Standard letter size, type and stroke widths shall be used.**

*Support:*

<sup>20</sup> The word "memorial" is not normally included on the sign.

*Guidance:*

<sup>21</sup> *Bronze plaques normally should bear the name in 1 inch letters. However, the plaque should be no larger than 30 x 30 inches.*

<sup>22</sup> *When the highway is a State facility, the following procedure should be followed when legislation includes a provision that either memorial signs or plaques be purchased and installed at no cost to the State.*

<sup>23</sup> *The District Director will:*

- A. *Contact the sponsor of the legislation to determine appropriate wording for the signs or plaques.*
- B. *Prepare an estimate of cost for the signs or plaque installation, and submit the estimate to the sponsor.*
- C. *After receipt of the funds from the sponsor, purchase and install the signs or plaque.*
- D. *Notify the author and sponsor when the memorial signs or plaque are ready so that a dedication can be arranged.*
- E. *Maintain all signs and plaques within the right-of-way.*

<sup>24</sup> *The sponsor will:*

- A. *Collect donations from individuals who appreciated the services provided by the memorialized individual.*
- B. *Submit advance payment for the signs or plaque and installation to Caltrans.*
- C. *Arrange for suitable public dedication.*

*Support:*

<sup>25</sup> When legislation does not include the "at no cost to the State" provision, signs and plaques will continue to be furnished and installed at State expense.

<sup>26</sup> Existing named highway facilities that have been designated with a bronze plaque are exempt from the above provisions and no signs are required.

*Option:*

<sup>27</sup> The Memorial Bridge (G11-4A(CA) and G11-4B(CA)) signs (see Figure 2M-101(CA)) may be placed above an existing Inventory Marker (G11-1(CA), G11-2(CA), G11-4(CA) or G11-5(CA)) when an appropriate authority has requested that a highway facility be designated as a memorial facility.

<sup>28</sup> The Memorial Bridge and Inventory Marker (G11-8(CA) and G11-9(CA)) combination signs (see Figure 2M-101(CA)) may be placed when an appropriate authority has requested that a highway facility be designated as a memorial facility.

*Guidance:*

<sup>29</sup> *The Inventory Markers should be placed at each end of a structure, with the bottom of the sign even with the top of the bridge rail.*

*Support:*

<sup>30</sup> The official name and number of structures on State highways are determined by Caltrans' Office of Structures Design.

*Option:*

<sup>31</sup> The Named State Highway (SG1(CA)) sign may be used to identify a named State highway when required by legislation or when determined necessary to provide traveler information.

### **Victims Memorial Program Signs (S35(CA) Series)**

**Support:**

<sup>32</sup> Refer to Streets and Highways Code Section 101.10.

**Option:**

<sup>33</sup> The PLEASE DON'T DRINK AND DRIVE (S35(CA)) sign (see Figure 2M-101(CA)) may be placed on any state highway upon request from an immediate family member of a person who was killed by a driver intoxicated with drugs or alcohol, in memory of the victim.

**Standard:**

<sup>34</sup> The **IN MEMORY OF XXX – 1 PERSON (S35-1(CA)), IN MEMORY OF XXX – 2 PERSONS (S35-2(CA)) or IN MEMORY OF XXX – 3 PERSONS (S35-3(CA))** sign (see Figure 2M-101(CA)) shall be placed below the S35(CA) sign.

<sup>35</sup> The following conditions shall be satisfied to qualify for a S35(CA) sign on a state highway:

- 1 At least one of the deceased victim's immediate family members requests a memorial sign. An immediate family member is a spouse, child, stepchild, brother, stepbrother, sister, stepsister, mother, stepmother, father or stepfather.**
- 2 The accident occurred on or after January 1, 1991.**
- 3 Either (a) or (b) is true:**
  - a. The intoxicated driver was convicted of second degree murder, or gross vehicular manslaughter, or vehicular manslaughter.**
  - b. The intoxicated driver died or could not be prosecuted because of mental incompetence.**
- 4 Note: An intoxicated driver who died does NOT qualify as a victim.**

<sup>36</sup> The placement of the S35(CA) sign on state highways shall be per the following requirements:

- 1. Signs will be installed in accordance with applicable Caltrans policies and standards for signs. This includes posts, hardware, materials, vertical, longitudinal, and lateral positioning.**
- 2. Caltrans will NOT install or maintain a memorial sign if there is written opposition from any immediate family member.**
- 3. Only one sign will be installed in one direction of travel on the right side of the state highway in close proximity to where the accident occurred at a location where it is safe and practical to do so.**
- 4. Caltrans will maintain the sign for 7 years or until the condition of the sign has deteriorated to a point where it is no longer serviceable, whichever occurs first.**
- 5. Only one sign will be installed per accident. Multiple victim names may appear on the sign.**
- 6. A sign will NOT be installed in the median of any state highway.**

### **Section 2M.101(CA) Historical Landmark Signs (G13-1(CA), G13-2(CA) and G14(CA))**

**Standard:**

<sup>01</sup> The **Historical Landmark (G13-1(CA) and G13-2(CA))** signs and the **Advance Historical Landmark (G14(CA))** sign shall have a brown legend and border on a cream colored background.

**Option:**

<sup>02</sup> The G13-1(CA), G13-2(CA) and G14(CA) signs may be in addition to the normal compliment of signs, but minimum spacing will be maintained.

<sup>03</sup> The G13-1(CA), G13-2(CA) and G14(CA) signs may be placed directing to Historical Landmarks that are registered with the Department of Parks and Recreation.

**Standard:**

<sup>04</sup> **On freeways, the G13-1(CA), G13-2(CA) and G14(CA) signs shall be limited to those more important and better known landmarks where some physical evidence remains, such as missions, forts, state monuments, etc., rather than mere sites of former buildings or happenings.**

<sup>05</sup> **The Office of Historic Preservation within the Department of Parks and Recreation (or the Resource Protection Division in the case of State Historic Park sites) shall be notified prior to the removal of existing G13-1(CA), G13-2(CA) and G14(CA) signs.**



*Guidance:*

*06 The Historical Landmark (G13-1(CA)) sign should be used on conventional highways to guide road users by the most direct route to registered historical landmarks which are located within 5 miles of the highway. The sign should be placed not more than 150 feet in advance of the intersection on the right.*

*07 The Historical Landmark (G13-2(CA)) sign should be used on freeways to guide road users to the original 21 California Missions and other important well-known historical landmarks. See Section 123.5 of the Streets and Highways Code for signing to Missions. The G13-2(CA) sign should also be used on freeways to guide road users to historical landmarks that have a profound impact on the history of California as a whole.*

*Option:*

*08 Supplemental Destination (G86(CA) Series) signs (white text on green background) may be used on freeways where the landmark generates considerable traffic.*

**Standard:**

**09 These G86(CA) Series signs shall be followed up by standard Historical Landmark signs on the next exit ramps.**

*Guidance:*

*10 The Advance Historical Landmark (G14(CA)) sign should be used in advance of a registered historical landmark monument or plaque within or adjacent to the right of way. The sign should be placed 500 to 1500 feet in advance of the landmark or monument on the right, depending on the approach speed of traffic.*

**Section 2M.102(CA) POINT OF HISTORICAL INTEREST Sign (G15(CA))**

**Standard:**

**01 The POINT OF HISTORICAL INTEREST (G15(CA)) sign shall have a cream legend on a brown background.**

**02 The G15(CA) sign shall not be used on freeways.**

*Option:*

*03 The POINT OF HISTORICAL INTEREST (G15(CA)) sign may be used to direct the public to a historical point of interest that has been registered with the Office of Historic Preservation, Department of Parks and Recreation. The G15(CA) sign may be used on the right on city streets or conventional rural highways.*

*Support:*

*04 The G15(CA) sign is placed when requested by local authorities, after markers or other identification have been placed at the location and follow-up signs, if necessary, have been installed.*

**Section 2M.103(CA) Historic Route Signs (SG2(CA), SG2A(CA), S18(CA) and S25(CA))**

*Guidance:*

*01 The EL CAMINO REAL (SG2(CA)) sign should be used in combination with the Mission Bell assembly, to identify the original route of El Camino Real.*

*02 The HISTORIC EL CAMINO REAL (SG2A(CA)) sign should be used in combination with the Mission Bell assembly, to identify Historic El Camino Real.*

*Option:*

*03 The Historic Route (S18(CA)) sign may be used to identify a "Historic Route" when directed by the Legislature.*

*Support:*

*04 Caltrans and local agencies with portions of Historic Routes under their jurisdiction, upon application by an interested local agency or private group and receiving donations from non-State sources for the cost of the sign and their installation, will place these signs as requested.*

*05 The Historic Route 99 (S25(CA)) sign is used to identify "Historic Route 99".*

*06 Caltrans and local agencies with portions of former U.S. Route 99 currently under their jurisdiction, upon application by an interested local agency or private group and receiving donations from non-State sources for the cost of the sign and their installation, will place these signs as requested.*

*Guidance:*

*07 Suggested placement should be staggered in each direction at approximately 10 mile intervals on conventional highways and 25 mile intervals on freeways for the S18(CA) and S25(CA) signs.*

## **Section 2M.104(CA) Historic Bridge Signs (S29(CA), S29-1(CA) and S29-2(CA))**

### *Guidance:*

*01 The Historic Bridge (S29(CA) and S29-1(CA)) sign should be used to identify 280 bridges in the State that are of historical significance and appear in Caltrans' publication titled "Historical Highway Bridges of California". See Section 1A.11 for information regarding this publication.*

*02 The Advance Historic Bridge (S29-2(CA)) sign should be used in advance of a historic bridge to direct the public to the historic bridge.*

### *Support:*

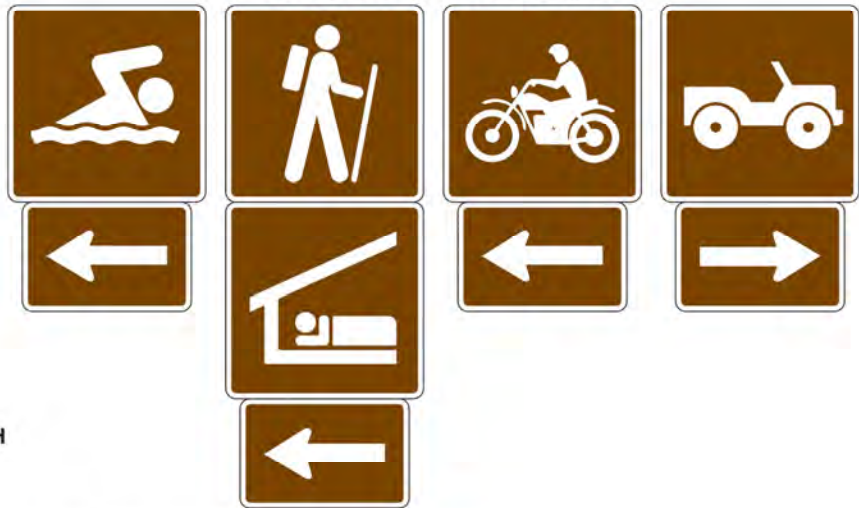
*03 The initial installation of the Historic Bridge signs was through a grant provided under the ISTEA Enhancement Program and administered by Caltrans' Environmental Program. Maintenance for the existing signs is borne by the agency responsible for the bridge.*

**Figure 2M-1. Examples of Use of Arrows, Educational Plaques, and Prohibitive Slashes**

**A - DIRECTIONAL SIGNS**



**B - DIRECTIONAL ASSEMBLIES**



**C - DIRECTIONAL ASSEMBLY WITH EDUCATIONAL PLAQUE**



**D - PROHIBITED ACTIVITIES AND EDUCATIONAL PLAQUE FOR NON-ROAD USE\***



\* Standard regulatory signs shall be used where provided elsewhere in this Manual

*Figure 2M-1 (CA). Examples of Use of Arrows, Educational Plaques, and Prohibitive Slashes*



G58 (CA)

**Figure 2M-2. Examples of Recreational and Cultural Interest Area Guide Signs**

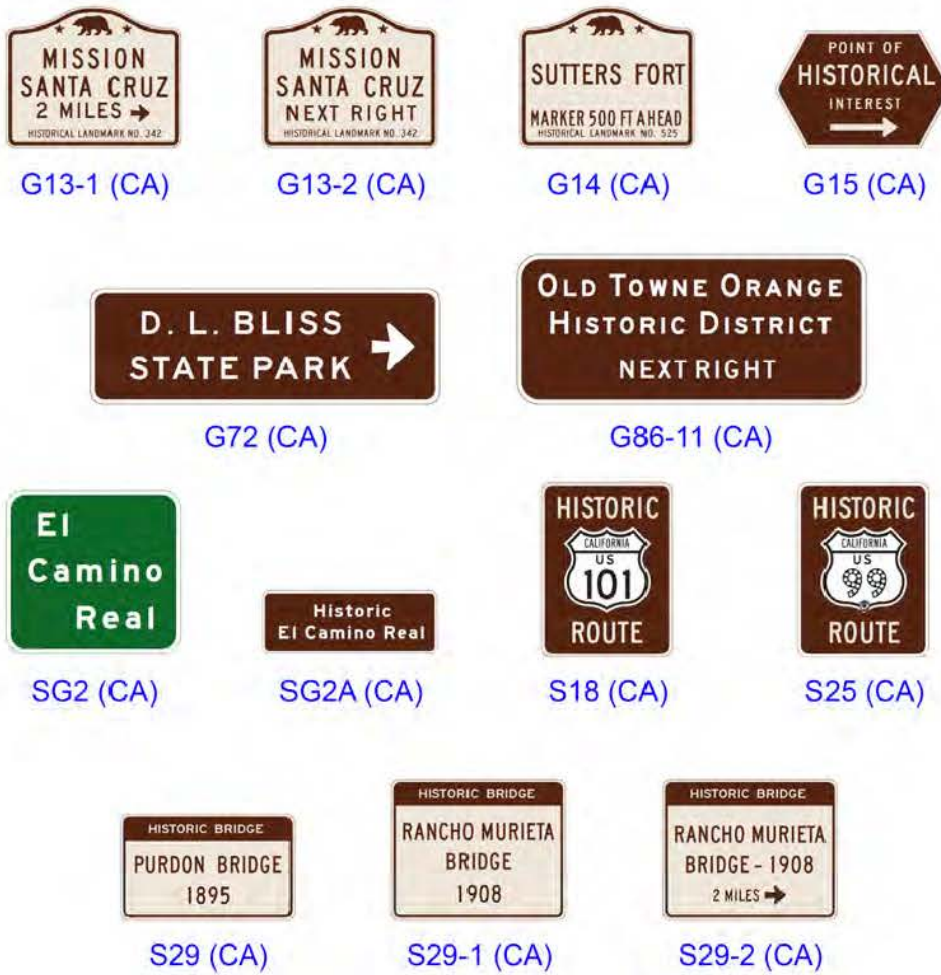


\* Optional shape

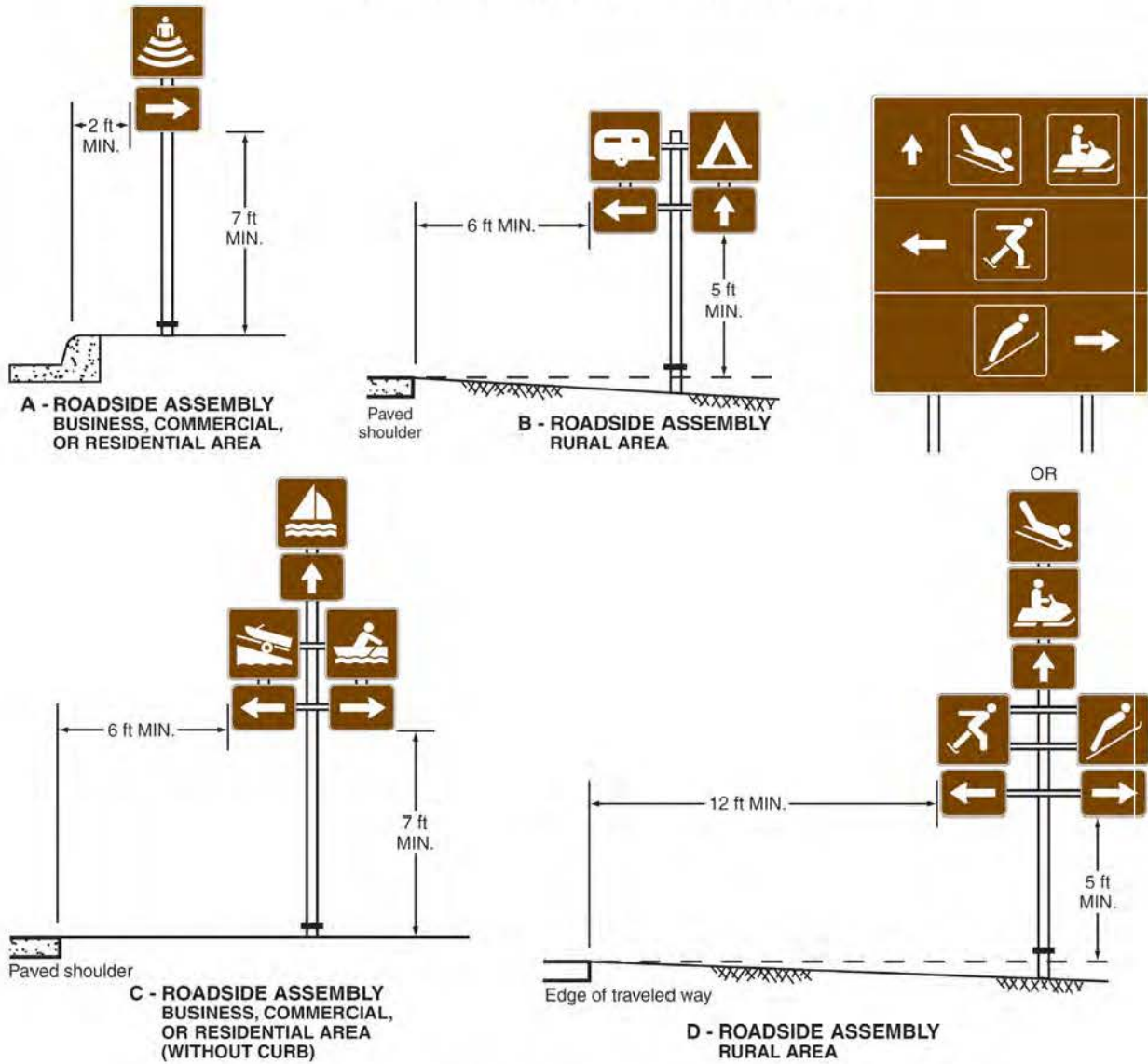
**B - EXPRESSWAYS AND FREEWAYS**



**Figure 2M-2 (CA). Examples of Recreational and Cultural Interest Area Guide Signs**

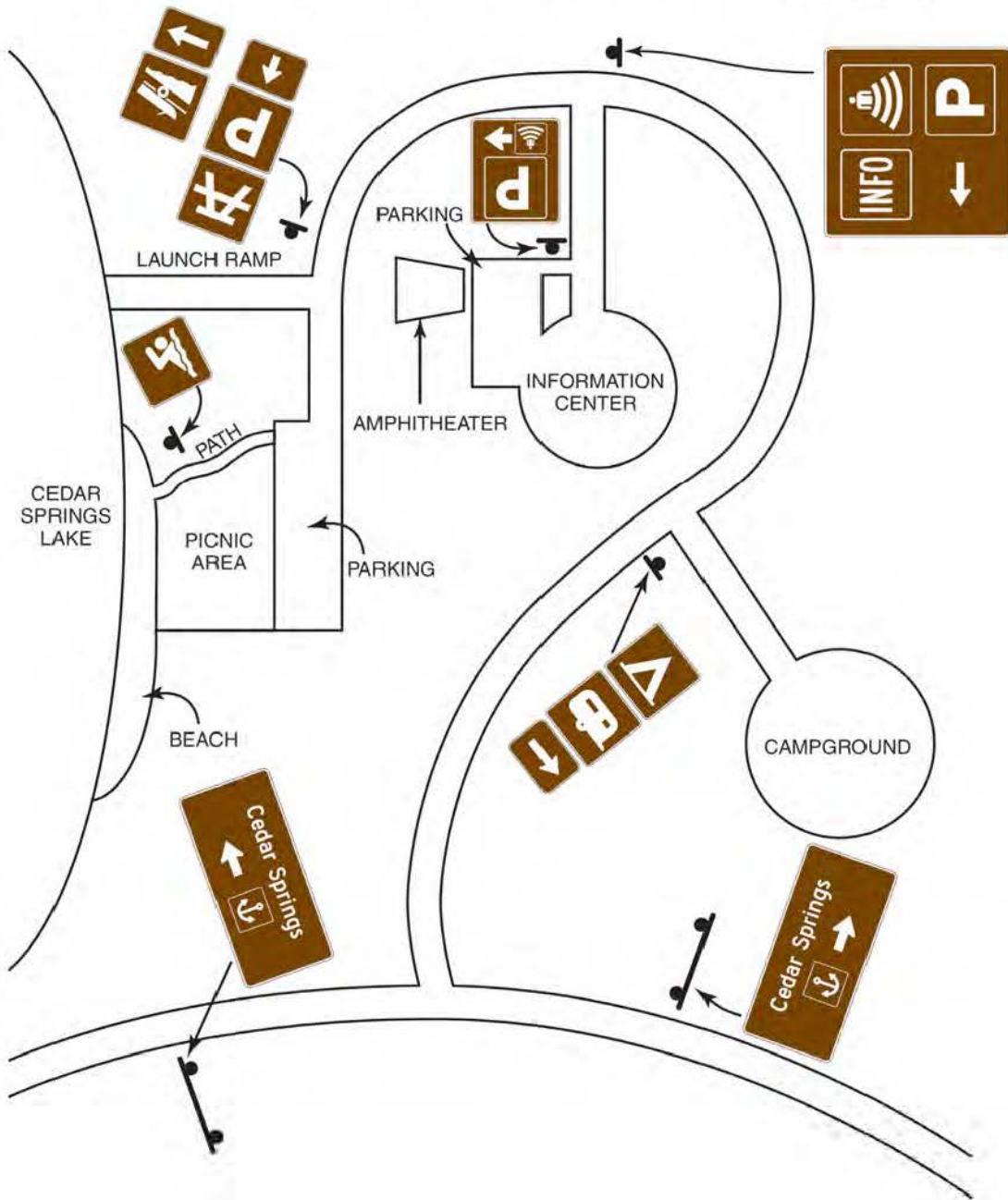


**Figure 2M-3. Arrangement, Height, and Lateral Position of Signs Located Within Recreational and Cultural Interest Areas**



Note: See Section 2A.19 for reduced lateral offset distances that may be used in areas where lateral offsets are limited, and in urban areas where sidewalk width is limited or where existing poles are close to the curb.

Figure 2M-4. Examples of Symbol and Destination Guide Signing Layout

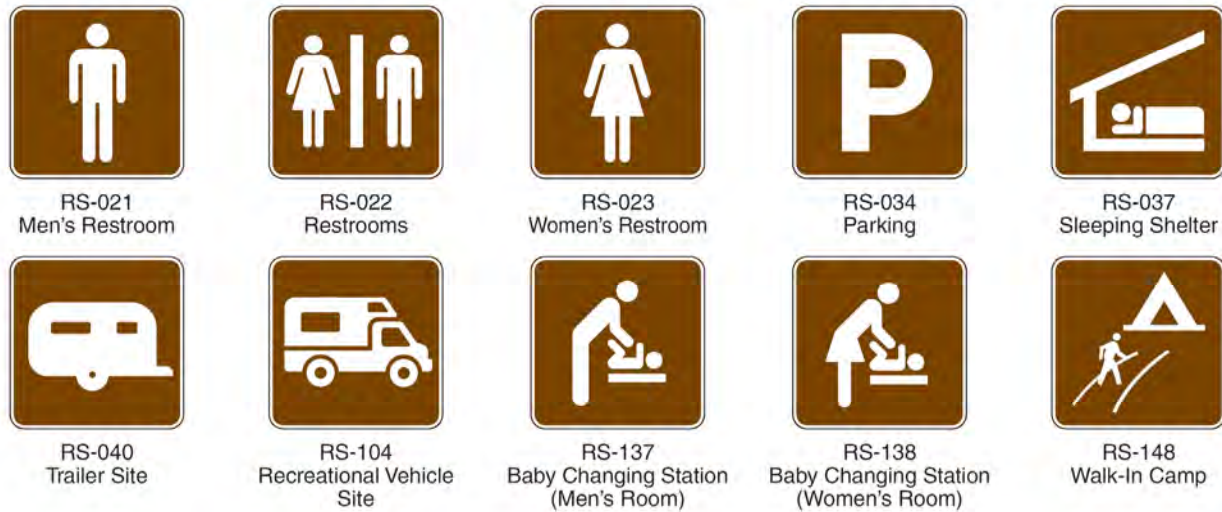


**Figure 2M-5. Recreational and Cultural Interest Area Symbol Signs for General Applications**





**Figure 2M-6. Recreational and Cultural Interest Area Symbol Signs for Accommodations**



**Figure 2M-7. Recreational and Cultural Interest Area Symbol Signs for Services**



**Figure 2M-8. Recreational and Cultural Interest Area Symbol Signs for Land Recreation**



**Figure 2M-8 (CA). Recreational and Cultural Interest Area Symbol Signs for Land Recreation**



**Figure 2M-9. Recreational and Cultural Interest Area Symbol Signs for Water Recreation**



**Figure 2M-10. Recreational and Cultural Interest Area Symbol Signs for Winter Recreation**



**Figure 2M-10 (CA). Recreational and Cultural Interest Area Symbol Signs for Winter Recreation**



**Figure 2M-101 (CA). Memorial or Dedication Signing**



**Figure 2M-102 (CA). Prohibited Recreational and Cultural Interest Area  
 Symbol Signs and Educational Plaque**



PS - Prohibited [Recreation Series] Symbol

PREP - Prohibited Recreational [Series] Educational Plaque

**Table 2M-1. Category Chart for Recreational and Cultural Interest Area Symbols**

| General                |        |
|------------------------|--------|
| Bear Viewing Area      | RS-012 |
| Bus Stop               | RS-031 |
| Campfires *            | RS-042 |
| Cans or Bottles *      | RS-101 |
| Cultural Interest Area | RS-142 |
| Dam                    | RS-009 |
| Deer Viewing Area      | RS-011 |
| Falling Rocks *        | RS-008 |
| Fire Extinguisher *    | RS-090 |
| Lighthouse             | RS-007 |
| Lookout Tower          | RS-006 |
| Nature Study Area      | RS-141 |
| Pets on Leash *        | RS-017 |
| Pick-Up Trucks         | RS-140 |
| Point of Interest      | RS-080 |
| Radios *               | RS-103 |
| Rattlesnakes *         | RS-099 |
| Recycling *            | RS-200 |
| Sea Plane              | RS-115 |
| Smoking *              | RS-002 |
| Snack Bar *            | RS-102 |
| Stay on Trail *        | RS-123 |
| Strollers *            | RS-111 |
| Tunnel                 | RS-005 |
| Viewing Area           | RS-036 |
| Walk on Boardwalk *    | RS-122 |
| Wood Gathering *       | RS-120 |

| Accommodations                       |        |
|--------------------------------------|--------|
| Baby Changing Station (Men's Room)   | RS-137 |
| Baby Changing Station (Women's Room) | RS-138 |
| Men's Restroom                       | RS-021 |
| Parking                              | RS-034 |
| Recreational Vehicle Site            | RS-104 |
| Restrooms                            | RS-022 |
| Sleeping Shelter *                   | RS-037 |
| Trailer Site                         | RS-040 |
| Walk-In Camp                         | RS-148 |
| Women's Restroom                     | RS-023 |

| Services           |        |
|--------------------|--------|
| Drinking Water ^   | RS-013 |
| Electrical Hook-Up | RS-150 |
| Firewood Cutting * | RS-112 |
| First Aid          | RS-024 |
| Grocery Store      | RS-020 |
| Kennel             | RS-045 |
| Laundromat         | RS-085 |
| Litter Receptacle  | RS-086 |
| Lockers/Storage *  | RS-030 |
| Mechanic           | RS-027 |
| Picnic Shelter     | RS-039 |
| Picnic Site        | RS-044 |
| Post Office        | RS-026 |
| Ranger Station     | RS-015 |
| Sanitary Station   | RS-041 |
| Showers *          | RS-035 |
| Stable             | RS-073 |
| Theater            | RS-109 |
| Trail Shelter *    | RS-043 |
| Tramway            | RS-071 |
| Trash Dumpster     | RS-091 |

| Land                    |        |
|-------------------------|--------|
| All-Terrain Trail       | RS-095 |
| Amphitheater            | RS-070 |
| Archery                 | RS-116 |
| Baseball *              | RS-096 |
| Climbing *              | RS-082 |
| Corral                  | RS-149 |
| Driving Tour            | RS-113 |
| Exercise/Fitness        | RS-097 |
| Golfing *               | RS-128 |
| Hang Gliding            | RS-126 |
| Hiking Trail            | RS-068 |
| Horse Trail             | RS-064 |
| In-Line Skating         | RS-125 |
| Interpretive Trail      | RS-114 |
| Off-Road Vehicle Trail  | RS-067 |
| Rock Collecting *       | RS-083 |
| Skateboarding *         | RS-098 |
| Spelunking/Caves        | RS-084 |
| Technical Rock Climbing | RS-081 |
| Tennis                  | RS-129 |
| Wildlife Viewing        | RS-076 |

| Water                         |        |
|-------------------------------|--------|
| Beach                         | RS-145 |
| Boat Motor ^                  | RS-147 |
| Boat Ramp                     | RS-054 |
| Canoeing                      | RS-079 |
| Diving                        | RS-062 |
| Fish Cleaning *               | RS-093 |
| Fish Hatchery                 | RS-010 |
| Fish Ladder *                 | RS-089 |
| Fishing Area                  | RS-063 |
| Fishing Pier                  | RS-119 |
| Hand Launch/Small Boat Launch | RS-117 |
| Jet Ski/Personal Watercraft   | RS-121 |
| Kayaking                      | RS-118 |
| Lifejackets *                 | RS-094 |
| Marina                        | RS-053 |
| Motorboating                  | RS-055 |
| Rafting                       | RS-146 |
| Rowboating                    | RS-057 |
| Sailing                       | RS-056 |
| Scuba Diving                  | RS-060 |
| Seal Viewing                  | RS-106 |
| Surfing                       | RS-059 |
| Swimming                      | RS-061 |
| Tour Boat                     | RS-087 |
| Wading                        | RS-088 |
| Waterskiing                   | RS-058 |
| Whale Viewing                 | RS-107 |
| Wind Surfing                  | RS-108 |

| Winter                   |        |
|--------------------------|--------|
| Chair Lift/Ski Lift      | RS-105 |
| Cross Country Skiing     | RS-046 |
| Dog Sledding             | RS-143 |
| Downhill Skiing          | RS-047 |
| Ice Fishing              | RS-092 |
| Ice Skating              | RS-050 |
| Ski Jumping              | RS-048 |
| Sledding                 | RS-049 |
| Snow Tubing              | RS-144 |
| Snowboarding             | RS-127 |
| Snowmobiling             | RS-052 |
| Snowshoeing              | RS-078 |
| Winter Recreational Area | RS-077 |

\* For non-road use only

⊘ Eligible for Prohibited Symbol sign

^ For use, as needed, in California

[⊘] Prohibited Word Message or Symbol Sign in Chapter 2B

**Table 2M-1(CA). California Category Chart for Recreational and Cultural Interest Area Symbols**

| General RS- Series  | Sign        | PS- (CA) Series      | Sign        | PREP- (CA) Series  | Sign         |
|---------------------|-------------|----------------------|-------------|--------------------|--------------|
| Title               | Designation | Title                | Designation | Legend             | Designation  |
| Campfires *         | ⊘ RS-042    | No Campfires *       | PS-042(CA)  | NO CAMPFIRES       | PREP-042(CA) |
| Cans or Bottles *   | ⊘ RS-101    | No Bottles or Cans * | PS-101(CA)  | NO BOTTLES OR CANS | PREP-101(CA) |
| Pets on Leash *     | ⊘ RS-017    | No Pets * (no leash) | PS-017(CA)  | NO PETS            | PREP-017(CA) |
| Pick-Up Trucks      | [⊘] RS-140  |                      |             | NO PICKUPS         | SG8(CA)      |
| Radios *            | ⊘ RS-103    | No Radios *          | PS-103(CA)  | NO RADIOS          | PREP-103(CA) |
| Smoking *           | ⊘ RS-002    | No Smoking *         | PS-002(CA)  | NO SMOKING         | PREP-002(CA) |
| Stay on Trail *     | ⊘ RS-123    | No Step *            | PS-123(CA)  | NO STEP            | PREP-123(CA) |
| Strollers *         | ⊘ RS-111    | No Baby Strollers*   | PS-111(CA)  | NO BABY STROLLERS  | PREP-111(CA) |
| Walk on Boardwalk * | ⊘ RS-122    | Stay on Boardwalk *  | PS-122(CA)  | STAY ON BOARDWALK  | PREP-122(CA) |
| Wood Gathering *    | ⊘ RS-120    | No Wood Gathering *  | RS-120(CA)  | NO WOOD GATHERING  | PREP-120(CA) |

| Services RS- Series | Sign        | PS- (CA) Series    | Sign        | PREP- (CA) Series | Sign         |
|---------------------|-------------|--------------------|-------------|-------------------|--------------|
| Title               | Designation | Title              | Designation | Legend            | Designation  |
| Drinking Water ^    | ⊘ RS-013    | Do Not Drink ^     | PS-013(CA)  | DO NOT DRINK      | PREP-013(CA) |
| Firewood Cutting *  | ⊘ RS-112    | No Wood Chopping * | PS-112(CA)  | NO WOOD CHOPPING  | PREP-112(CA) |

| Land RS- Series   | Sign        | PS- (CA) Series      | Sign        | PREP- (CA) Series  | Sign         |
|-------------------|-------------|----------------------|-------------|--------------------|--------------|
| Title             | Designation | Title                | Designation | Legend             | Designation  |
| Baseball *        | ⊘ RS-096    | No Ball Playing *    | PS-096(CA)  | NO BALL PLAYING    | PREP-096(CA) |
| Climbing *        | ⊘ RS-082    | No Climbing *        | PS-082(CA)  | NO CLIMBING        | PREP-082(CA) |
| Golfing *         | ⊘ RS-128    | No Golfing *         | PS-128(CA)  | NO GOLFING         | PREP-128(CA) |
| Hiking Trail      | [⊘] RS-068  | No Pedestrians       | R9-3        | NO PEDESTRIANS     | R5-10c       |
| Horse Trail       | [⊘] RS-064  | No Equestrians       | R9-14       | NO EQUESTRIANS     | PREP-064(CA) |
| In-Line Skating   | [⊘] RS-125  | No Skaters           | R9-13       | NO SKATERS         | PREP-125(CA) |
| Rock Collecting * | ⊘ RS-083    | No Rock Collecting * | PS-083(CA)  | NO ROCK COLLECTING | PREP-083(CA) |
| Skateboarding *   | ⊘ RS-098    | No Skateboarding *   | PS-098(CA)  | NO SKATEBOARDING   | PREP-098(CA) |

| Water RS- Series | Sign        | PS- (CA) Series    | Sign        | PREP- (CA) Series | Sign         |
|------------------|-------------|--------------------|-------------|-------------------|--------------|
| Title            | Designation | Title              | Designation | Legend            | Designation  |
| Boat Motor ^     | ⊘ RS-147    | No Boat Motor ^    | PS-147(CA)  | NO BOAT MOTOR     | PREP-147(CA) |
| Fish Cleaning *  | ⊘ RS-093    | No Fish Cleaning * | PS-093(CA)  | NO FISH CLEANING  | PREP-093(CA) |

| Related Recreation Activities or Services | Sign Designation | Related Recreation Activities or Services | Sign Designation | PREP- (CA) Series Legend  | Sign Designation |
|---|------------------|---|------------------|---|------------------|
| Bicycles Permitted                        | [⊘] D11-1a       | No Bicycles                               | R5-6             | NO BICYCLES   | PREP-R5-6(CA)    |
| Camping                                   | [⊘] D9-3         |   |                  | NO LOITERING, CAMPING, VENDING OR PARKING OF VEHICLES 30 FEET OR LONGER | S22(CA)          |
|   |                  |   |                  | VEHICLE INSPECTION ONLY, NO LOITERING OR CAMPING                        | S22-1(CA)        |

\* For non-road use only  
 ^ For use, as needed, in California  
 ⊘ Eligible for Prohibited Symbol Sign  
 [⊘] Prohibited Word Message or Symbol Sign in Chapter 2B  
 PS - Prohibited [Recreational Series] Symbol  
 PREP - Prohibited Recreational [Series] Educational Plaque



**Table 2M-101(CA). California Recreational and Cultural Interest Area Sign and Plaque Sizes**

| Sign or Plaque                             | Sign Designation | Section    | Conventional Road | Freeway or Expressway |
|--|------------------|------------|-------------------|-----------------------|
| Memorial Bridge                            | G11-4A(CA)       | 2M.10      | 44 x 18           | 44x18                 |
| Memorial Bridge                            | G11-4B(CA)       | 2M.10      | 44 x 24           | 44 x 24               |
| Memorial Bridge and Inventory Marker       | G11-8(CA)        | 2M.10      | 44 x 36           | 44 x 36               |
| Memorial Bridge and Inventory Marker       | G11-9(CA)        | 2M.10      | 44 x 42           | 44 x 42               |
| Memorial Highway                           | G12-1(CA)        | 2M.10      | VAR x 18          | VAR x 24              |
| Memorial Highway                           | G12-2(CA)        | 2M.10      | VAR x 30          | VAR x 42              |
| Historical Landmark                        | G13-1(CA)        | 2M.101(CA) | 36 x 30           | 36 x 30               |
| Historical Landmark                        | G13-2(CA)        | 2M.101(CA) | 72 x 60           | 72 x 60               |
| Advance Historical Landmark                | G14(CA)          | 2M.101(CA) | 36 x 30           | 36 x 30               |
| POINT OF HISTORICAL INTEREST               | G15(CA)          | 2M.102(CA) | 15 x 9            | 36 x 20               |
| NEXT RIGHT/LEFT                            | G58(CA)          | 2M.08      | 30 x 24           | 30 x 24               |
| National/State Park (X MILES)              | G72(CA)          | 2M.09      | VAR x 18          | VAR x 30              |
| Historic District Supplemental Destination | G86-11(CA)       | 2M.09      | VAR x 42          | VAR x 54              |
| Golf Course                                | G200-80(CA)      | 2M.02      | 24 x 24           | 30 x 30               |
| WILDLIFE VIEWING                           | G200-81A(CA)     | 2M.02      | 24 x 12           | 30 x 18               |
| Botanical Management Area                  | G200-82(CA)      | 2M.02      | 24 x 24           | 30 x 30               |
| BOTANICAL MANAGEMENT AREA                  | G200-82A(CA)     | 2M.02      | 24 x 18           | 30 x 24               |
| Named State Highway                        | SG1(CA)          | 2M.10      | VAR x 20          | VAR x 30              |
| EL CAMINO REAL                             | SG2(CA)          | 2M.103(CA) | 30 x 28           | 48 x 40               |
| HISTORIC EL CAMINO REAL                    | SG2A(CA)         | 2M.103(CA) | 42 x 15           | 42 x 15               |
| SNO-PARK X MILE                            | SG30(CA)         | 2M.02      | 60 x 30           | 60 x 30               |
| SNO-PARK NEXT RIGHT                        | SG31(CA)         | 2M.02      | 60 x 30           | 60 x 30               |
| SNO-PARK with Arrow                        | SG32(CA)         | 2M.02      | 60 x 30           | 60 x 30               |
| SNO-PARK with Arrow                        | SG33(CA)         | 2M.02      | VAR x 12          | VAR x 18              |
| SNO-PARK                                   | SG34(CA)         | 2M.02      | 96 x 24           | 120 x 30              |
| PERMIT REQUIRED                            | SG35(CA)         | 2M.02      | 60 x 12           | 60 x 12               |
| PERMIT REQUIRED NOV 1 TO MAY 30            | SG35-1(CA)       | 2M.02      | 60 x 18           | 60 x 18               |
| OHV TRAIL                                  | S12(CA)          | 2M.02      | 24 x 18           | 24 x 18               |
| Historic Route                             | S18(CA)          | 2M.103(CA) | 12 x 18           | 24 x 36               |
| Historic Route 99                          | S25(CA)          | 2M.103(CA) | 12 x 18           | 24 x 36               |
| Historic Bridge                            | S29(CA)          | 2M.104(CA) | VAR x 18          | VAR x 36              |
| Historic Bridge                            | S29-1(CA)        | 2M.104(CA) | VAR x 24          | VAR x 48              |
| Advance Historic Bridge                    | S29-2(CA)        | 2M.104(CA) | VAR x 24          | VAR x 48              |
| PLEASE DON'T DRINK AND DRIVE               | S35(CA)          | 2M.10      | 36 x 30           | 36 x 30               |
| IN MEMORY OF XXX - 1 PERSON                | S35-1(CA)        | 2M.10      | 36 x 12           | 36 x 12               |
| IN MEMORY OF XXX - 2 PERSONS               | S35-2(CA)        | 2M.10      | 36 x 15           | 36 x 15               |
| IN MEMORY OF XXX - 3 PERSONS               | S35-3(CA)        | 2M.10      | 36 x 18           | 36 x 18               |

## CHAPTER 2N. EMERGENCY MANAGEMENT SIGNING

### Section 2N.01 Emergency Management

#### Guidance:

01 *Contingency planning for an emergency evacuation should be considered by all State and local jurisdictions and should consider the use of all applicable roadways.*

02 *In the event of a disaster where highways that cannot be used will be closed, a successful contingency plan should account for the following elements: a controlled operation of certain designated highways, the establishment of traffic operations for the expediting of essential traffic, and the provision of emergency centers for civilian aid.*

### Section 2N.02 Design of Emergency Management Signs

#### Standard:

01 **Emergency Management signs shall be used to guide and control highway traffic during an emergency.**

02 **Emergency Management signs shall not permanently displace any of the standard signs that are normally applicable.**

03 **Advance planning for transportation operations' emergencies shall be the responsibility of State and local authorities. The Federal Government shall provide guidance to the States as necessitated by changing circumstances.**

04 **Except as provided in Section 2A.11, the sizes for Emergency Management signs shall be as shown in Table 2N-1.**

#### Support:

05 Section 2A.11 contains information regarding the applicability of the various columns in Table 2N-1.

#### Option:

06 Signs larger than those shown in Table 2N-1 may be used (see Section 2A.11).

#### Guidance:

07 *As conditions permit, the Emergency Management signs should be replaced or augmented by standard signs.*

08 *The background of Emergency Management signs should be retroreflective.*

09 *Because Emergency Management signs might be needed in large numbers for temporary use during an emergency, consideration should be given to their fabrication from any light and economical material that can serve through the emergency period.*

#### Option:

10 Any Emergency Management sign that is used to mark an area that is contaminated by biological or chemical warfare agents or radioactive fallout may be accompanied by the standard symbol that is illustrated in the upper left corner of the EM-7c and EM-7d signs in Figure 2N-1.

### Section 2N.03 Evacuation Route Signs (EM-1 and EM-1a)

#### Standard:

01 **The Evacuation Route (EM-1 and EM-1a) signs shall display a blue circular symbol on a white square sign without a border as shown in Figure 2N-1. The EM-1 sign shall include a white directional arrow (except as provided in Paragraph 3) and a white legend EVACUATION ROUTE within the blue circular symbol. The EM-1a sign shall include a white EVACUATION ROUTE legend and the tsunami symbol within the blue circular symbol. The EM-1 and EM-1a signs shall be retroreflective.**

02 **An Advance Turn Arrow (M5 series) or Directional Arrow (M6 series) auxiliary sign as shown in Figure 2D-5, but with a white arrow on a blue background instead of a black arrow on a white background, shall be installed below the EM-1a sign.**

#### Option:

03 Instead of including a directional arrow within the blue circular symbol on the EM-1 sign, an Advance Turn Arrow (M5 series) or Directional Arrow (M6 series) auxiliary sign as shown in Figure 2D-5, but with a white arrow on a blue background instead of a black arrow on a white background, may be installed below the EM-1 sign.

04 If desired, the word HURRICANE, or a word that describes some other type of evacuation route, may be added as a third line of text above the white EVACUATION ROUTE legend within the blue circular symbol on the EM-1 sign.

05 An approved Emergency Management symbol with a diameter of 3.5 inches may appear near the bottom of an Evacuation Route sign.

**Standard:**

06 **The arrow designs, if used, on the EM-1 sign shall include a straight, vertical arrow pointing upward, a straight horizontal arrow pointing to the left or right, or a bent arrow pointing to the left or right for advance warning of a turn.**

07 **If used, the Evacuation Route sign, with the appropriate arrow, shall be installed 150 to 300 feet in advance of, and at, any turn in an approved evacuation route. The sign shall also be installed elsewhere for straight-ahead confirmation where needed.**

08 **If used in urban areas, the Evacuation Route sign shall be mounted at the right-hand side of the roadway, not less than 7 feet above the top of the curb, and at least 1 foot back from the face of the curb. If used in rural areas, the Evacuation Route sign shall be mounted at the right-hand side of the roadway, not less than 7 feet above the pavement and not less than 6 feet or more than 10 feet to the right of the right-hand roadway edge.**

09 **Evacuation Route signs shall not be placed where they will conflict with other signs. Where conflict in placement would occur between the Evacuation Route sign and a standard regulatory sign, the regulatory sign shall take precedence.**

**Option:**

10 In case of conflict with guide or warning signs, the Evacuation Route sign may take precedence.

**Guidance:**

11 *Placement of Evacuation Route signs should be made under the supervision of the officials having jurisdiction over the placement of other traffic signs. Coordination with Emergency Management authorities and agreement between contiguous political entities should occur to assure continuity of routes.*

## **Section 2N.04 AREA CLOSED Sign (EM-2)**

**Standard:**

01 **The AREA CLOSED (EM-2) sign (see Figure 2N-1) shall be used to close a roadway in order to prohibit traffic from entering the area. It shall be installed on the shoulder as near as practical to the right-hand edge of the roadway, or preferably, on a portable mounting or barricade partly or entirely in the roadway.**

**Guidance:**

02 *For best visibility, particularly at night, the sign height should not exceed 4 feet measured vertically from the pavement to the bottom of the sign. Unless adequate advance warning signs are used, it should not be placed to create a complete and unavoidable blocked route. Where feasible, the sign should be located at an intersection that provides a detour route.*

## **Section 2N.05 TRAFFIC CONTROL POINT Sign (EM-3)**

**Standard:**

01 **The TRAFFIC CONTROL POINT (EM-3) sign (see Figure 2N-1) shall be used to designate a location where an official traffic control point has been set up to impose such controls as are necessary to limit congestion, expedite emergency traffic, exclude unauthorized vehicles, or protect the public.**

02 **The sign shall be installed in the same manner as the AREA CLOSED sign (see Section 2N.04), and at the point where traffic must stop to be checked.**

03 **The standard STOP (R1-1) sign shall be used in conjunction with the TRAFFIC CONTROL POINT sign. The TRAFFIC CONTROL POINT sign shall consist of a black legend and border on a retroreflectorized white background.**

**Guidance:**

04 *The TRAFFIC CONTROL POINT sign should be mounted directly below the STOP sign.*

### **Section 2N.06 MAINTAIN TOP SAFE SPEED Sign (EM-4)**

**Option:**

<sup>01</sup> The MAINTAIN TOP SAFE SPEED (EM-4) sign (see Figure 2N-1) may be used on highways where conditions are such that it is prudent to evacuate or traverse an area as quickly as possible.

<sup>02</sup> Where an existing Speed Limit (R2-1) sign is in a suitable location, the MAINTAIN TOP SAFE SPEED sign may conveniently be mounted directly over the face of the speed limit sign that it supersedes.

**Support:**

<sup>03</sup> Since any speed zoning would be impractical under such emergency conditions, no minimum speed limit can be prescribed by the MAINTAIN TOP SAFE SPEED sign in numerical terms. Where traffic is supervised by a traffic control point, official instructions will usually be given verbally, and the sign will serve as an occasional reminder of the urgent need for maintaining the proper speed.

**Guidance:**

<sup>04</sup> *The sign should be installed as needed, in the same manner as other standard speed signs.*

**Standard:**

<sup>05</sup> **If used in rural areas, the MAINTAIN TOP SAFE SPEED sign shall be mounted on the right-hand side of the road at a horizontal distance of not less than 6 feet or more than 10 feet from the roadway edge, and at a minimum height, measured vertically from the bottom of the sign to the elevation of the near edge of the traveled way, of 5 feet. If used in urban areas, the minimum height, measured vertically from the bottom of the sign to the top of the curb, or in the absence of curb, measured vertically from the bottom of the sign to the elevation of the near edge of the traveled way, shall be 7 feet, and the nearest edge of the sign shall be not less than 1 foot back from the face of the curb.**

### **Section 2N.07 ROAD (AREA) USE PERMIT REQUIRED FOR THRU TRAFFIC Sign (EM-5)**

**Support:**

<sup>01</sup> The intent of the ROAD (AREA) USE PERMIT REQUIRED FOR THRU TRAFFIC (EM-5) sign (see Figure 2N-1) is to notify road users of the presence of the traffic control point so that those who do not have priority permits issued by designated authorities can take another route, or turn back, without making a needless trip and without adding to the screening load at the post. Local traffic, without permits, can proceed as far as the traffic control post.

**Standard:**

<sup>02</sup> **If used, the ROAD (AREA) USE PERMIT REQUIRED FOR THRU TRAFFIC (EM-5) sign shall be used at an intersection that is an entrance to a route on which a traffic control point is located.** <sup>03</sup> **If used, the sign shall be installed in a manner similar to that of the MAINTAIN TOP SAFE SPEED sign (see Section 2N.06).**

### **Section 2N.08 Emergency Aid Center Signs (EM-6 Series)**

**Standard:**

<sup>01</sup> **In the event of emergency, State and local authorities shall establish various centers for civilian relief, communication, medical service, and similar purposes. To guide the public to such centers a series of directional signs shall be used.**

<sup>02</sup> **Emergency Aid Center (EM-6 series) signs (see Figure 2N-1) shall carry the designation of the center and an arrow indicating the direction to the center. They shall be installed as needed, at intersections and elsewhere, on the right-hand side of the roadway, in urban areas at a minimum height, measured vertically from the bottom of the sign to the top of the curb, or in the absence of curb, measured vertically from the bottom of the sign to the elevation of the near edge of the traveled way, of 7 feet, and not less than 1 foot back from the face of the curb, and in rural areas at a minimum height, measured vertically from the bottom of the sign to the elevation of the near edge of the traveled way, of 5 feet, and at a horizontal distance of not less than 6 feet or more than 10 feet from the roadway edge.**

<sup>03</sup> **Emergency Aid Center signs shall carry one of the following legends, as appropriate, or others designating similar emergency facilities:**

- A. MEDICAL CENTER (EM-6a),**
- B. WELFARE CENTER (EM-6b),**

**C. REGISTRATION CENTER (EM-6c), or  
D. DECONTAMINATION CENTER (EM-6d).**

**04 The Emergency Aid Center sign shall be a horizontal rectangle. Except as provided in Paragraph 5, the identifying word and the word CENTER, the directional arrow, and the border shall be black on a white background.**

Option:

**05** When Emergency Aid Center signs are used in an incident situation, such as during the aftermath of a nuclear or biological attack, the background color may be fluorescent pink (see Chapter 6I).

**Section 2N.09 Shelter Directional Signs (EM-7 Series)**

**Standard:**

**01 Shelter Directional (EM-7 series) signs (see Figure 2N-1) shall be used to direct the public to selected shelters that have been licensed and marked for emergency use.**

**02 The installation of Shelter Directional signs shall comply with established signing standards. Where used, the signs shall not be installed in competition with other necessary highway guide, warning, and regulatory signs.**

**03 The Shelter Directional sign shall be a horizontal rectangle. Except as provided in Paragraph 4, the identifying word and the word SHELTER, the directional arrow, the distance to the shelter, and the border shall be black on a white background.**

Option:

**04** When Shelter Directional signs are used in an incident situation, such as during the aftermath of a nuclear or biological attack, the background color may be fluorescent pink (see Chapter 6I).

**05** The distance to the shelter may be omitted from the sign when appropriate.

**06** Shelter Directional signs may carry one of the following legends, or others designating similar emergency facilities:

- A. EMERGENCY (EM-7a),
- B. HURRICANE (EM-7b),
- C. FALLOUT (EM-7c), or
- D. CHEMICAL (EM-7d).

**07** If appropriate, the name of the facility may be used.

**08** The Shelter Directional signs may be installed on the Interstate Highway System or any other major highway system when it has been determined that a need exists for such signs as part of a State or local shelter plan.

**09** The Shelter Directional signs may be used to identify different routes to a shelter to provide for rapid movement of large numbers of persons.

*Guidance:*

**10** *The Shelter Directional sign should be used sparingly and only in conjunction with approved plans of State and local authorities.*

**11** *The Shelter Directional sign should not be posted more than 5 miles from a shelter.*

**Figure 2N-1. Emergency Management Signs**



\* HURRICANE is an example of one type of evacuation route. Legends for other types may also be used, or this line of text may be omitted.

**Table 2N-1. Emergency Management Sign Sizes**

| Sign or Plaque          | Sign Designation | Section | Minimum Size |
|-------------------------|------------------|---------|--------------|
| Evacuation Route        | EM-1, EM-1a      | 2N.03   | 24 x 24'     |
| Area Closed             | EM-2             | 2N.04   | 30 x 24      |
| Traffic Control Point   | EM-3             | 2N.05   | 30 x 24      |
| Maintain Top Safe Speed | EM-4             | 2N.06   | 24 x 30      |
| Permit Required         | EM-5             | 2N.07   | 24 x 30      |
| Emergency Aid Center    | EM-6a to EM-6d   | 2N.08   | 30 x 24      |
| Shelter Directional     | EM-7a to EM-7d   | 2N.09   | 30 x 24      |

\* A minimum size of 18 x 18 may be used on low-volume roadways or roadways with speeds of 25 mph or less

Notes: 1. Larger signs may be used when appropriate  
 2. Dimensions in inches are shown as width x height

# PART 3

## MARKINGS

### CHAPTER 3A. GENERAL

#### Section 3A.01 Functions and Limitations

Support:

01 Markings on highways and on private roads open to public travel (see definition in Section 1A.13) have important functions in providing guidance and information for the road user. Major marking types include pavement and curb markings, delineators, colored pavements, channelizing devices, and islands. In some cases, markings are used to supplement other traffic control devices such as signs, signals, and other markings. In other instances, markings are used alone to effectively convey regulations, guidance, or warnings in ways not obtainable by the use of other devices.

02 Markings have limitations. Visibility of the markings can be limited by snow, debris, and water on or adjacent to the markings. Marking durability is affected by material characteristics, traffic volumes, weather, and location. However, under most highway conditions, markings provide important information while allowing minimal diversion of attention from the roadway.

#### Section 3A.02 Standardization of Application

Standard:

01 Each standard marking shall be used only to convey the meaning prescribed for that marking in this Manual. When used for applications not described in this Manual, markings shall conform in all respects to the principles and standards set forth in this Manual.

Guidance:

02 Before any new highway, private road open to public travel (see definition in Section 1A.13), paved detour, or temporary route is opened to public travel, all necessary markings should be in place.

Standard:

03 Markings that must be visible at night shall be retroreflective unless ambient illumination assures that the markings are adequately visible. All markings on Interstate highways shall be retroreflective.

03a All longitudinal pavement markings shall be retroreflective except non-reflective pavement markers and directional markings for tourists. Refer to CVC 21374.

04 Markings that are no longer applicable for roadway conditions or restrictions and that might cause confusion for the road user shall be removed or obliterated to be unidentifiable as a marking as soon as practical.

Option:

05 Until they can be removed or obliterated, markings may be temporarily masked with tape that is approximately the same color as the pavement.

Guidance:

06 If used, the masking tape should match the pavement surface color and not provide undue contrast.

Support:

07 Use of black tape for temporary "masking" is effective for new Asphalt Concrete pavement. However, for faded Asphalt Concrete pavement or Portland Cement Concrete pavements, black "masking" pavement markings could appear as a stripe in low light conditions and result in confusion to road users.

#### Section 3A.03 Maintaining Minimum Pavement Marking Retroreflectivity

(This Section is reserved for future text based on FHWA rulemaking.)

### Section 3A.04 Materials

#### Support:

<sup>01</sup> Pavement and curb markings are commonly placed by using paints or thermoplastics; however, other suitable marking materials, including raised pavement markers and colored pavements, are also used. Delineators and channelizing devices are visibly placed in a vertical position similar to signs above the roadway.

<sup>02</sup> Some marking systems consist of clumps or droplets of material with visible open spaces of bare pavement between the material droplets. These marking systems can function in a manner that is similar to the marking systems that completely cover the pavement surface and are suitable for use as pavement markings if they meet the other pavement marking requirements of the highway agency.

#### Guidance:

<sup>03</sup> *The materials used for markings should provide the specified color throughout their useful life.*

<sup>04</sup> *Consideration should be given to selecting pavement marking materials that will minimize tripping or loss of traction for road users, including pedestrians, bicyclists, and motorcyclists.*

<sup>05</sup> *Delineators should not present a vertical or horizontal clearance obstacle for pedestrians.*

### Section 3A.05 Colors

#### Standard:

<sup>01</sup> Markings shall be yellow, white, red, blue, green or purple. The colors for markings shall conform to the standard highway colors. Black in conjunction with one of the colors mentioned in the first sentence of this paragraph shall be a usable color.

<sup>01a</sup> **The color of curb markings shall conform to CVC 21458. Refer to CVC 21374 for exceptions.**

<sup>02</sup> When used, white markings for longitudinal lines shall delineate:

**A. The separation of traffic flows in the same direction, or**

**B. The right-hand edge of the roadway.**

<sup>03</sup> When used, yellow markings for longitudinal lines shall delineate:

**A. The separation of traffic traveling in opposite directions,**

**B. The left-hand edge of the roadways of divided highways and one-way streets or ramps, or**

**C. The separation of two-way left-turn lanes and reversible lanes from other lanes.**

<sup>04</sup> When used, red raised pavement markers or delineators shall delineate:

**A. Truck escape ramps, or**

**B. One-way roadways, ramps, or travel lanes that shall not be entered or used in the direction from which the markers are visible.**

#### Support:

<sup>04a</sup> Red pavement markers are used to alert possible wrong way drivers on freeways as shown in Figure 3A-102(CA), Details 14 and 14A.

<sup>05</sup> When used, blue markings shall supplement white markings for parking spaces for persons with disabilities.

<sup>06</sup> When used, purple markings shall supplement lane line or edge line markings for toll plaza approach lanes that are restricted to use only by vehicles with registered electronic toll collection accounts.

#### Option:

<sup>07</sup> Colors used for official route shield signs (see Section 2D.11) may be used as colors of symbol markings to simulate route shields on the pavement (see Section 3B.20.)

<sup>08</sup> Black may be used in combination with the colors mentioned in the first sentence of Paragraph 1 where a light-colored pavement does not provide sufficient contrast with the markings.

<sup>08a</sup> *If the material used for centerline marking is paint, a 3-inch wide black line may be placed between the 4-inch wide yellow lines on streets and highways under local jurisdiction.*

#### Standard:

<sup>08b</sup> **If the material used for centerline marking is paint, a 3-inch wide black line shall be placed between the 4-inch wide yellow lines on State highways.**

#### Support:

<sup>09</sup> When used in combination with other colors, black is not considered a marking color, but only a contrast-enhancing system for the markings.



### **Section 3A.06 Functions, Widths, and Patterns of Longitudinal Pavement Markings**

#### **Standard:**

**01 The general functions of longitudinal lines shall be:**

- A. A double line indicates maximum or special restrictions,**
- B. A solid line discourages or prohibits crossing (depending on the specific application),**
- C. A broken line indicates a permissive condition, and**
- D. A dotted line provides guidance or warning of a downstream change in lane function.**

**02 The widths and patterns of longitudinal lines shall be as follows:**

- A. Normal line—4 to 6 inches wide.**
- B. Wide line—at least twice the width of a normal line.**
- C. Double line—two parallel lines separated by a discernible space.**
- D. Broken line—normal line segments separated by gaps.**
- E. Dotted line—noticeably shorter line segments separated by shorter gaps than used for a broken line.**

**The width of a dotted line extension shall be at least the same as the width of the line it extends.**

#### **Support:**

**03 The width of the line indicates the degree of emphasis.**

#### ***Guidance:***

~~*04 Broken lines should consist of 10-foot line segments and 30-foot gaps, or dimensions in a similar ratio of line segments to gaps as appropriate for traffic speeds and need for delineation.*~~

#### **Support:**

**05 Patterns for dotted lines depend on the application (see Sections 3B.04 and 3B.08.)**

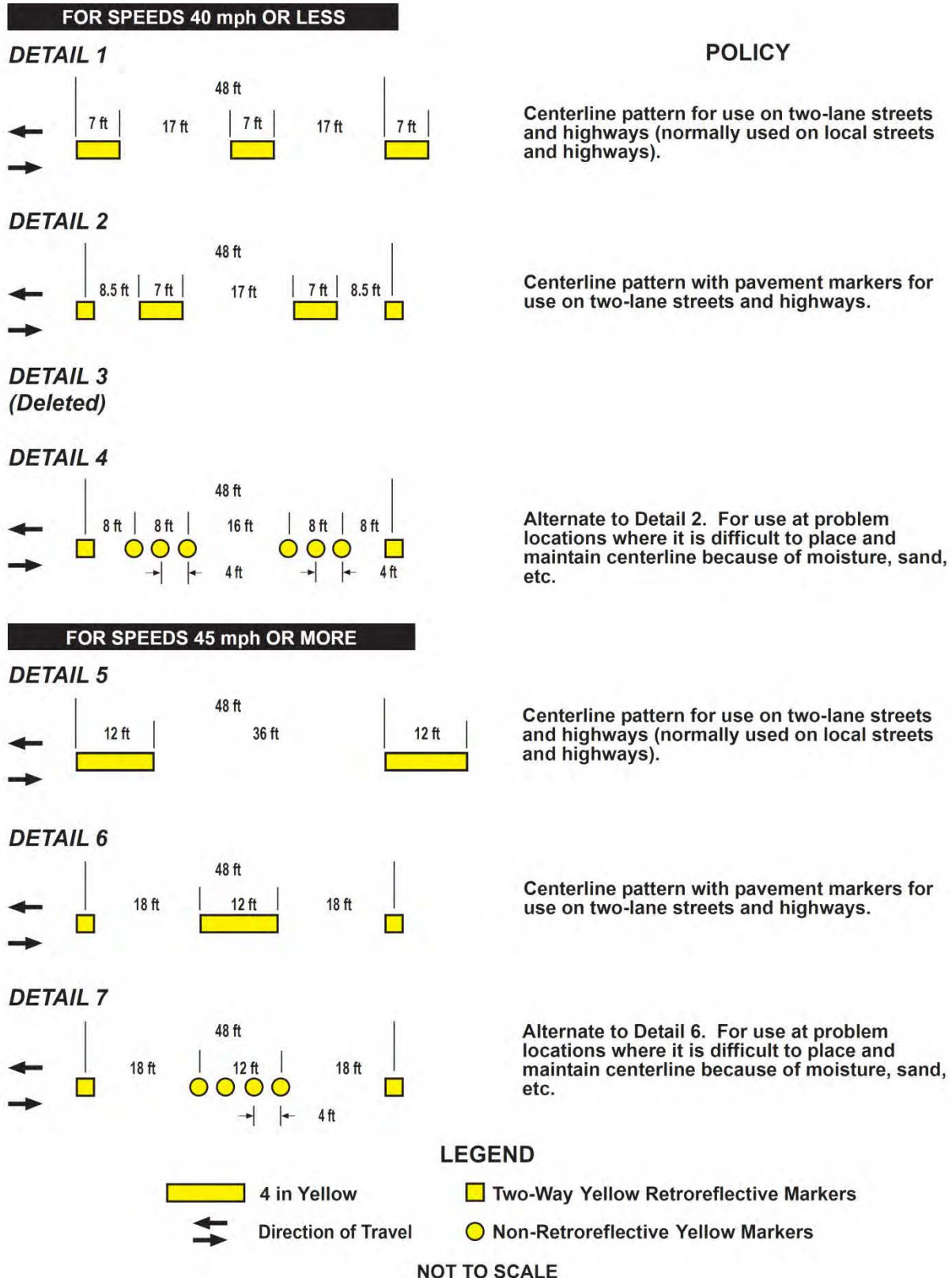
#### ***Guidance:***

~~*06 A dotted line for line extensions within an intersection or taper area should consist of 2-foot line segments and 2 to 6-foot gaps. A dotted line used as a lane line should consist of 3-foot line segments and 9-foot gaps.*~~

#### **Standard:**

**07 The widths and patterns of longitudinal lines shall conform to the details shown in Figures 3A-101(CA) through 3A-113(CA).**

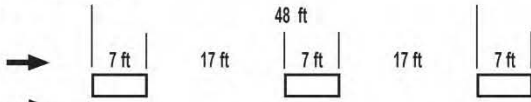
**Figure 3A-101 (CA). Centerlines - 2 Lane Highways**



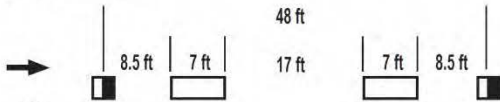
**Figure 3A-102 (CA). Lane Lines - Multilane Highways**

**FOR SPEEDS 40 mph OR LESS**

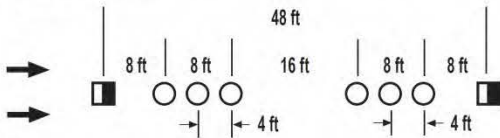
**DETAIL 8**



**DETAIL 9**

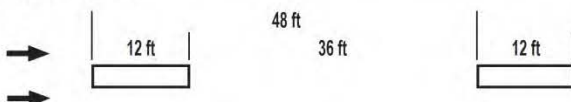


**DETAIL 10**

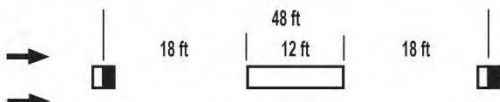


**FOR SPEEDS 45 mph OR MORE**

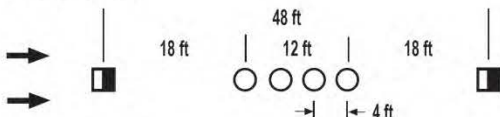
**DETAIL 11**



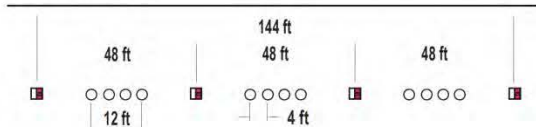
**DETAIL 12**



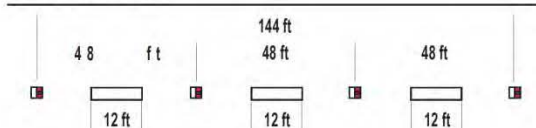
**DETAIL 13**



**DETAIL 14**



**DETAIL 14A**



**POLICY**

Lane Line pattern for use on multilane streets and highways (normally used on local streets and highways).

Lane Line pattern with pavement markers for use on multilane streets, highways and freeway ramps.

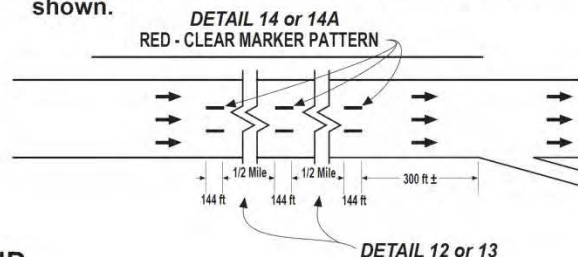
Lane Line pattern with pavement markers for use on multilane streets, highways and freeway ramps.

Lane Line pattern for use on multilane streets and highways (normally used on local streets and highways).

Lane Line pattern with pavement markers for use on multilane conventional streets and highways, State freeways, expressways, freeway ramps, freeway to freeway connectors and collector roads. See Detail 14A.

Lane Line pattern with pavement markers for use on State freeways, expressways, freeway ramps, freeway to freeway connectors and collector roads. See Detail 14.

Lane Line pattern with red-clear pavement markers shall be used on freeways approaching exit ramps. Detail 14 is used with Detail 13 and Detail 14A is used with Detail 12, in a pattern of four red-clear pavement markers, at intervals as shown.

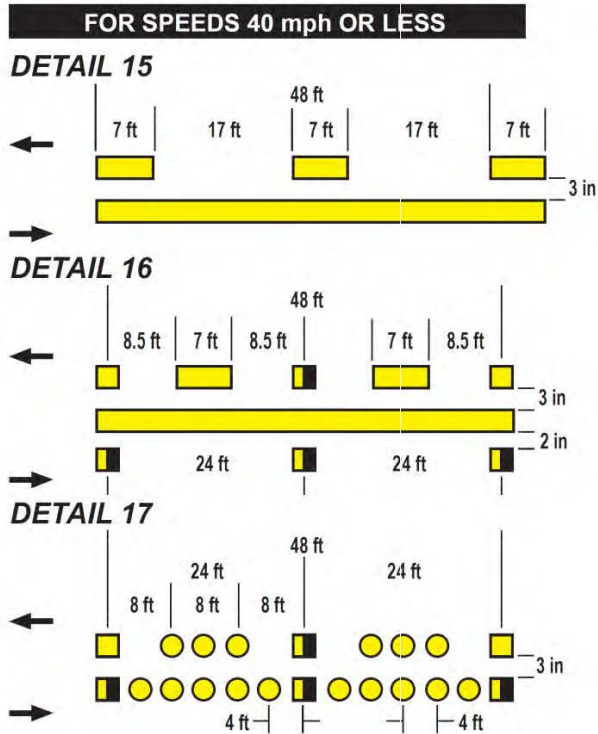


**LEGEND**

- 4 in White
- One-Way Clear Retroreflective Markers
- Non-Retroreflective White Markers
- Red-Clear Retroreflective Markers
- Direction of Travel

NOT TO SCALE

**Figure 3A-103 (CA). No Passing Zones - One Direction**

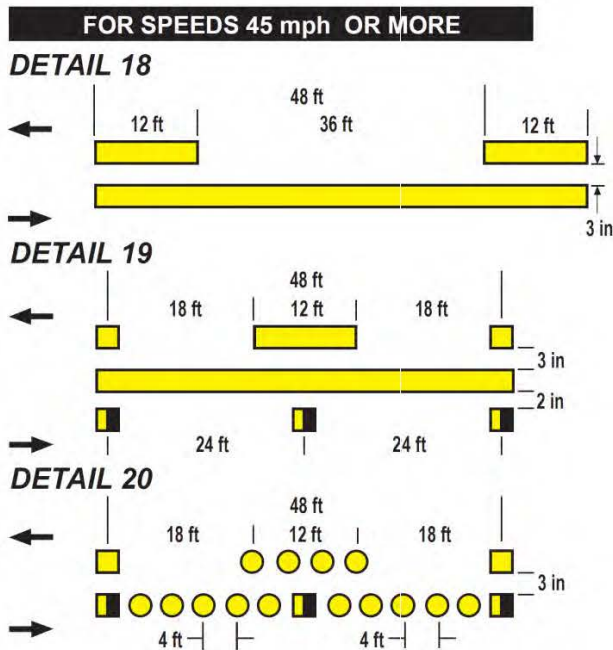


**POLICY**

One direction no-passing pattern for use on two-lane streets and highways (normally used on local streets and highways). See Note 2.

One direction no-passing pattern with pavement markers for use on two-lane streets and highways. See Notes 1 and 2.

Alternate to Detail 16. For use with Detail 4.








One direction no-passing pattern for use on two-lane streets and highways (normally used on local streets and highways). See Note 2.

One direction no-passing pattern with pavement markers for use on two-lane streets and highways. See Notes 1 and 2.

Alternate to Detail 19. For use with Detail 7.

- NOTES:** 1. Pavement markers shown off the solid line in Details 16 and 19 may be placed on the line.  
 2. If the material used for centerline marking is paint, a 3 in black line shall be placed between the 4 in yellow lines on State highways and may be placed on streets and highways under local jurisdiction.

**LEGEND**

|   |  |  |
|---|--|--|
|  4 in Yellow         |  Two-Way Yellow Retroreflective Markers |  Non-Retroreflective Yellow Markers |
|  Direction of Travel |  One-Way Yellow Retroreflective Markers | NOT TO SCALE   |

**Figure 3A-104 (CA). No Passing Zones - Two Direction**

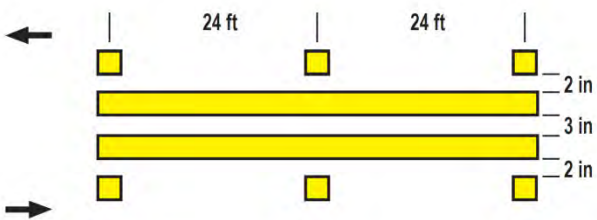
**DETAIL 21**



**POLICY**

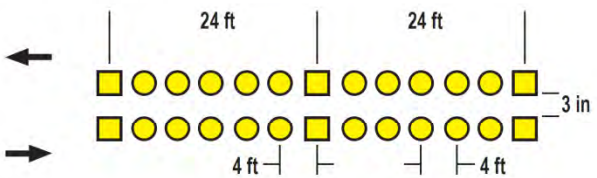
Two-direction no-passing pattern for use on two-lane streets and highways (normally used on local streets and highways). See Note 2.

**DETAIL 22**



Two-direction no-passing pattern with pavement markers for use on two-lane streets and highways. See Notes 1 and 2.

**DETAIL 23**



Alternate to Detail 22. For use with either Detail 4 or Detail 7.

- NOTES:**
1. Pavement markers shown off the solid line in Detail 22 may be placed on the line.
  2. If the material used for centerline marking is paint, a 3 in black line shall be placed between the 4 in yellow lines on State highways and may be placed on streets and highways under local jurisdiction.

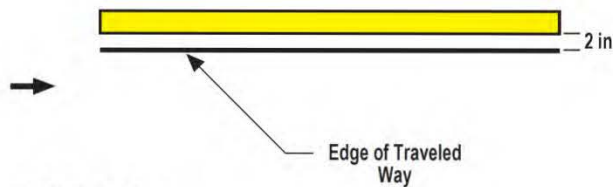
**LEGEND**

- 4 in Yellow
- Two-Way Yellow Retroreflective Markers
- Direction of Travel
- Non-Retroreflective Yellow Markers

NOT TO SCALE

**Figure 3A-105 (CA). Left Edge Lines for Divided Highways**

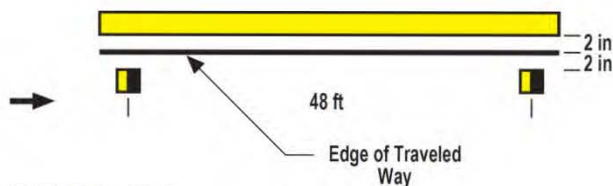
**DETAIL 24**



**POLICY**

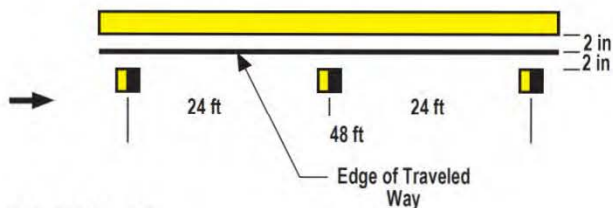
Left Edge Line pattern for use on streets and highways (normally used on local streets and highways).

**DETAIL 25**



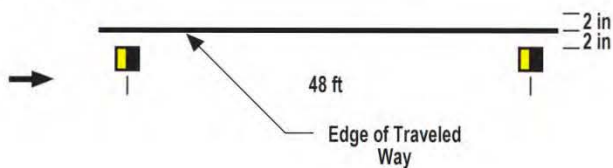
Left Edge Line for use on State highways.

**DETAIL 25A**



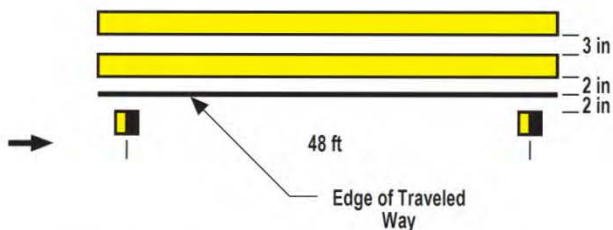
Left Edge Line for use on freeway ramps and connectors.

**DETAIL 26**



Alternate to Details 24 and 25 when there is adequate contrast between travelled way and shoulder.



**DETAIL 27**




Alternate to Detail 25. A double solid yellow line may be used for more emphasis when motorists tend to use the shoulder for a through lane, or where encroachments onto the shoulder occasionally occur. See Note 1.

**NOTE: 1.** If the material used for centerline marking is paint, a 3 in black line shall be placed between the 4 in yellow lines on State highways and may be placed on streets and highways under local jurisdiction.

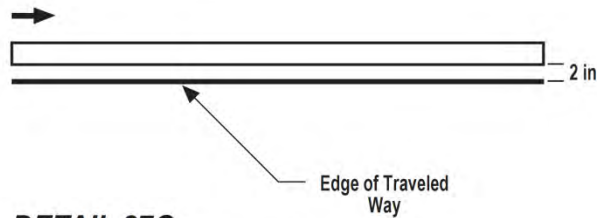
**LEGEND**

 4 in Yellow  
 Direction of Travel

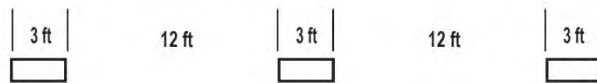
 One-Way Yellow Retroreflective Markers  
 NOT TO SCALE

**Figure 3A-106 (CA). Right Edge Line and Right Edge Line Extension Through Intersections**

**DETAIL 27B**  
**Right Edge Line**



**DETAIL 27C**  
**Right Edge Line Extension**  
**Through Intersections**



**POLICY**

Right Edge Line pattern for use on all State highways may be used on local streets and highways. It is generally dropped at the beginning of the intersection flares on conventional highways. See also Detail 27C. On freeways, it may be flared in advance of the exit ramp as shown in Figure 3B-8 (CA).

Right Edge Line Extension Through Intersections pattern for use to extend the right edgeline through an intersection where climatic conditions, such as areas of heavy fog, may require additional guidance.

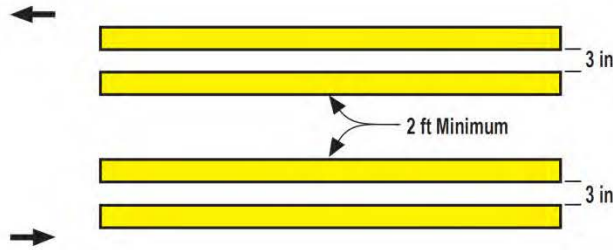
**LEGEND**



NOT TO SCALE

**Figure 3A-107 (CA). Median Islands**

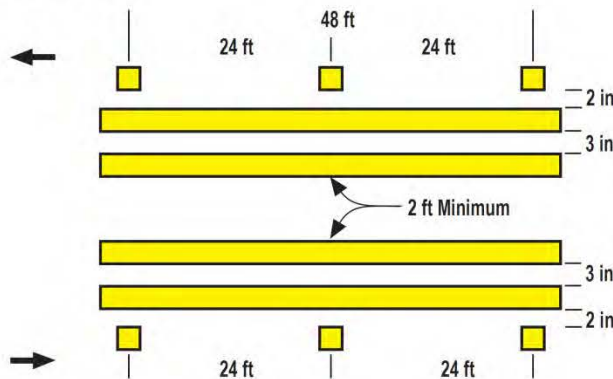
**DETAIL 28**



**POLICY**

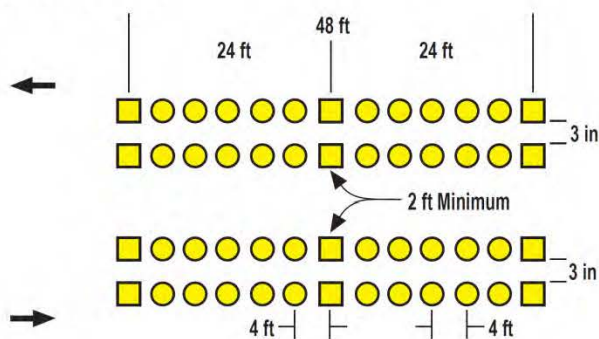
Double Left Edge Line pattern for use on all-paved sections of streets and highways (normally used on local streets and highways). See Note 2.

**DETAIL 29**



Double Left Edge Line pattern with pavement markers for use on all-paved sections of streets and highways. See Notes 1 and 2.

**DETAIL 30**



Alternate to Detail 29. For use at problem locations where it is difficult to place and maintain lines because of moisture, sand, etc.

- NOTES:** 1. Pavement markers shown off the solid line in Detail 29 may be placed on the line.  
 2. If the material used for centerline marking is paint, a 3 in black line shall be placed between the 4 in yellow lines on State highways and may be placed on streets and highways under local jurisdiction.

**LEGEND**

- 4 in Yellow
- Two-Way Yellow Retroreflective Markers
- Direction of Travel
- Non-Retroreflective Yellow Markers

NOT TO SCALE

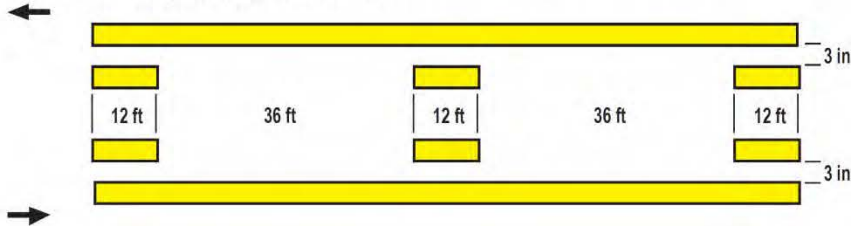


**Figure 3A-108 (CA). Two-Way Left-Turn Lanes**

**DETAIL 31**

**POLICY**

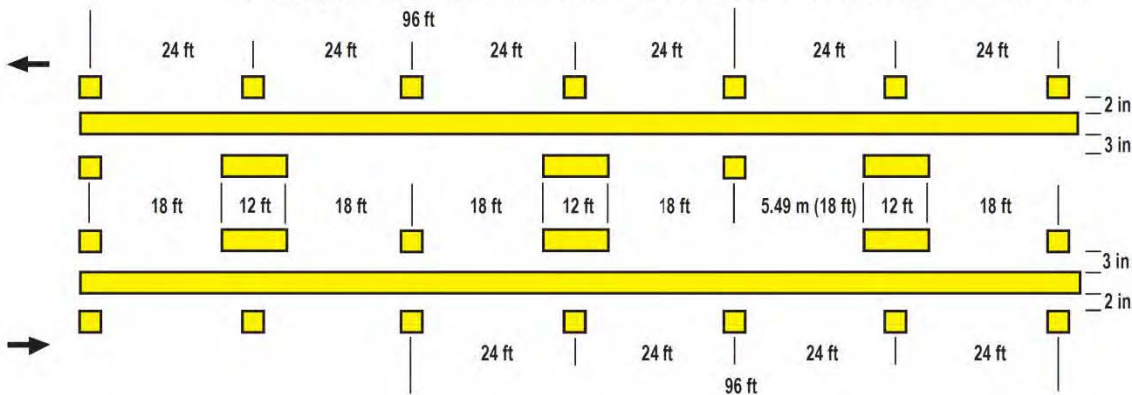
Two-way left-turn lane pattern for use on streets and highways (normally used on local streets and highways). See Note 2.



**DETAIL 32**

**POLICY**

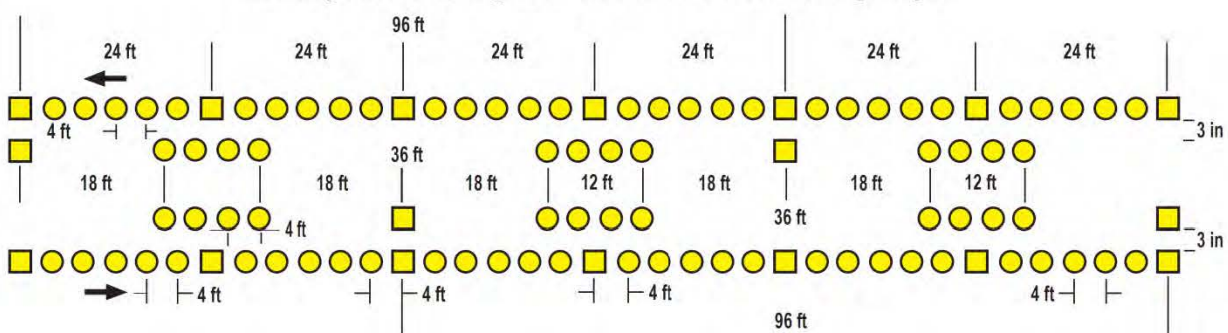
Two-way left-turn lane pattern for use on streets and highways. See Note 2.



**DETAIL 33**

**POLICY**

Two-way left-turn lane pattern for use on streets and highways.



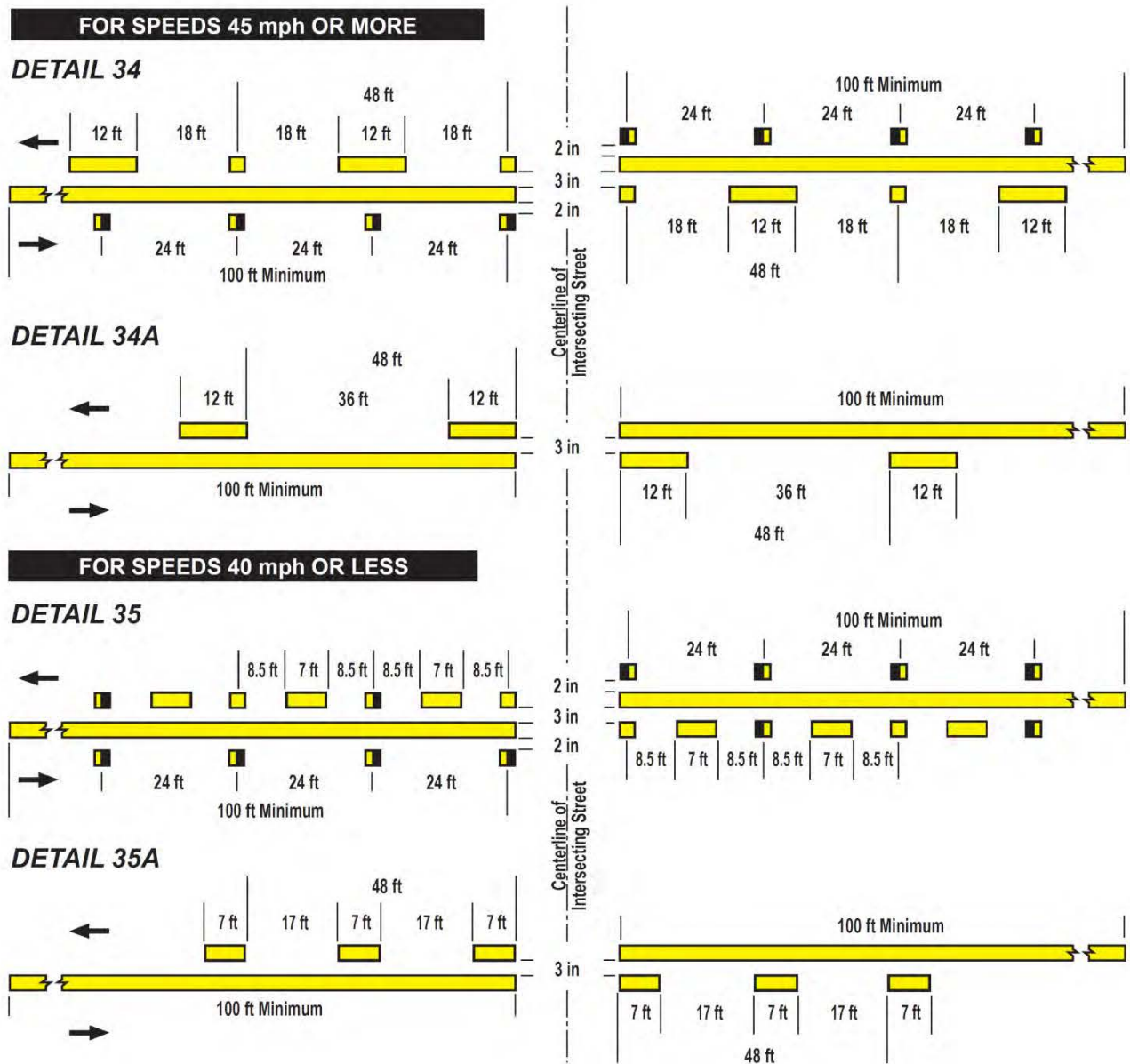
- NOTES: 1. Pavement markers shown off the solid line in Detail 32 may be placed on the line.  
 2. If the material used for centerline marking is paint, a 3 in black line shall be placed between the 4 in yellow lines on State highways and may be placed on streets and highways under local jurisdiction.

**LEGEND**

- 4 in Yellow
- Two-Way Yellow Retroreflective Markers
- Direction of Travel
- Non-Retroreflective Yellow Markers

NOT TO SCALE

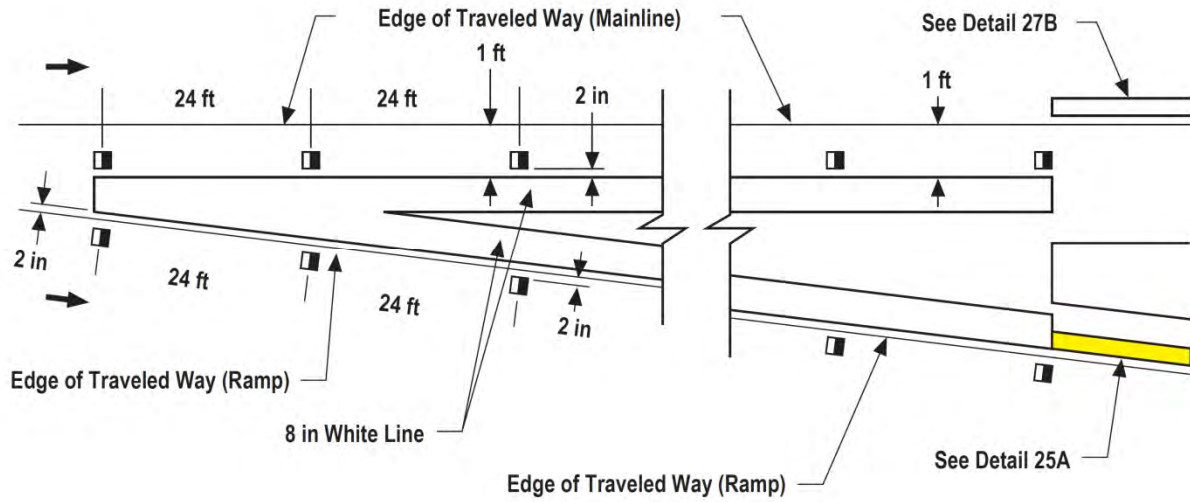
**Figure 3A-109 (CA). Intersection Markings**







- NOTES:**
1. Raised Pavement Markers are optional on non-state highways.
  2. Raised Pavement Markers shown off the solid line may be placed on the line.
  3. If the material used for centerline marking is paint, a 3 in black line shall be placed between the 4 in yellow lines on State highways and may be placed on streets and highways under local jurisdiction.

**Figure 3A-110 (CA). Freeway Exit and Entrance Ramp Channelizing Line (Sheet 1 of 2)**

**DETAIL 36 - Exit Ramp Neutral Area (Gore) Channelizing Lines (See Figure 3B-8 (CA), Sheet 2 of 2)**



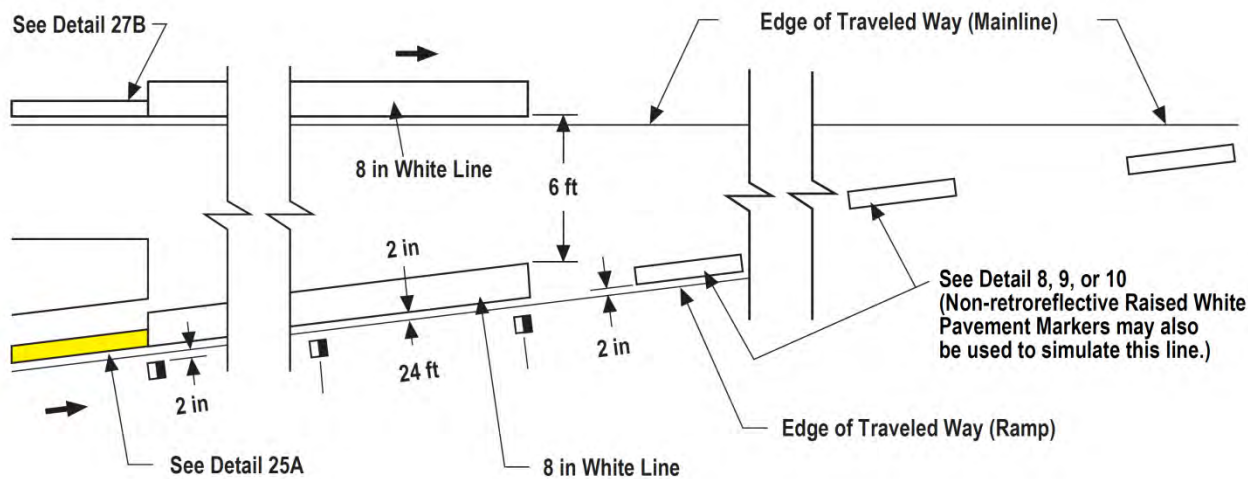
**LEGEND**

-  4 in White
-  4 in Yellow
-  One-Way Clear Retroreflective Markers
-  Direction of Travel

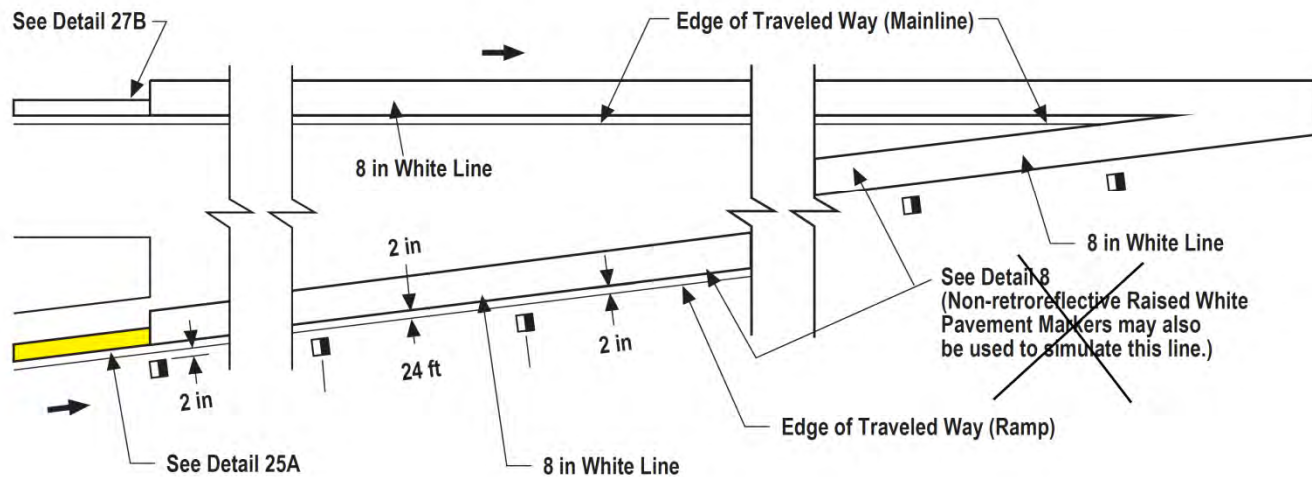
NOT TO SCALE

**Figure 3A-110 (CA). Freeway Exit and Entrance Ramp Channelizing Lines (Sheet 2 of 2)**





**DETAIL 36A - Entrance Ramp Neutral Area (Merge) Channelizing Lines**  
 (See Figure 3B-9 (CA), Sheet 1 of 2)



**DETAIL 36B - Entrance Ramp Neutral Area (Acceleration Lane) Channelizing Lines**  
 (See Figure 3B-8 (CA), Sheet 3 of 3)



**LEGEND**

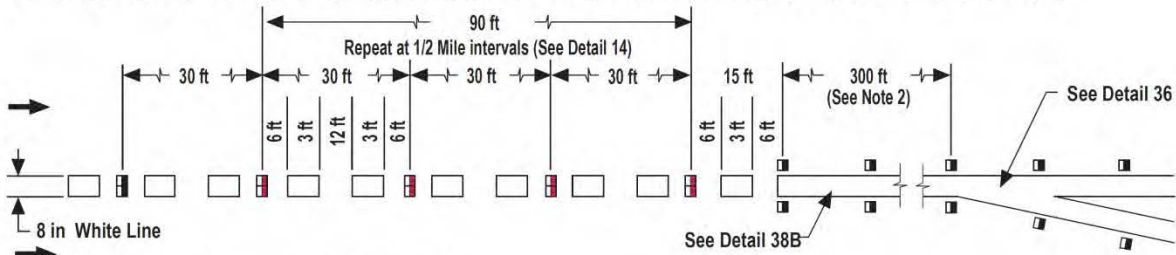
-  4 in White
-  4 in Yellow
-  One-Way Clear Retroreflective Markers
-  Direction of Travel

NOT TO SCALE

**Figure 3A-111 (CA). Lane Drop Markings**

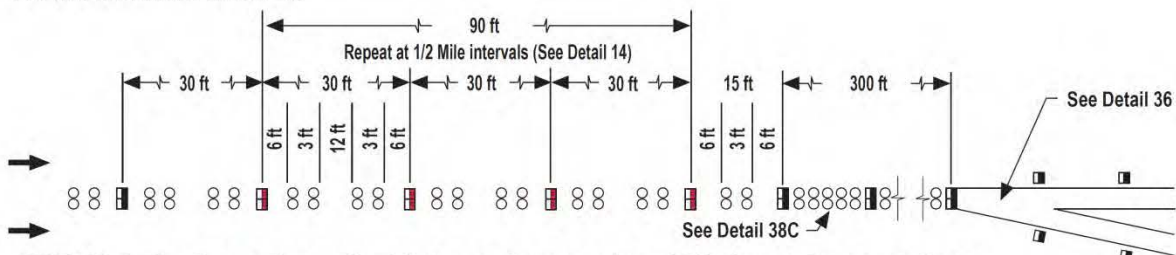
**DETAIL 37 - Lane Drop Markings at Exit Ramps**

Marking pattern for use on mandatory lane drops at freeway exit ramps and freeway to freeway connectors.



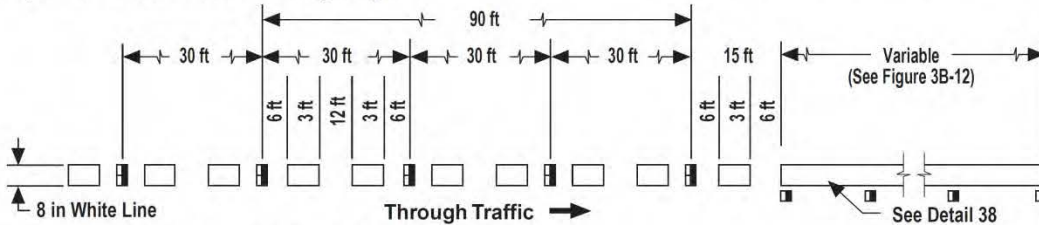
**DETAIL 37A - Alternate to Detail 37**

For use with Detail 10 and 13.



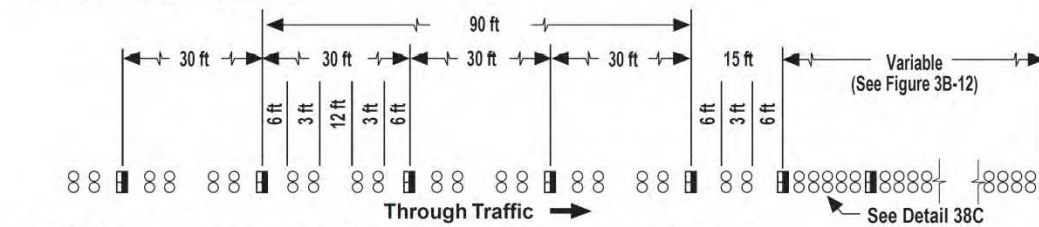
**DETAIL 37B - Lane Drop Markings at Conventional Highway Intersections**

Marking pattern for use on mandatory turn lanes at intersections. Pavement markers shown are optional on local streets and highways.



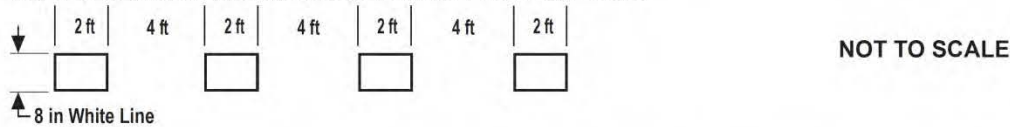
**DETAIL 37C - Alternate to Detail 37B**

For use with Detail 10 and 13.



**DETAIL 37D - Lane Drop Line For Two-Lane Roundabouts**

For use on mandatory exiting lanes from two-lane roundabouts.



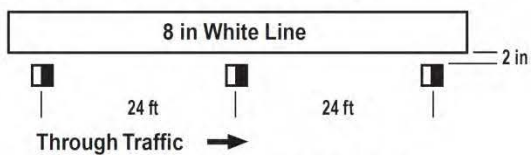
- NOTES:**
1. Pavement markers shown off the solid line in Detail 37 may be placed on the line.
  2. The Solid Channelizing Line shown in Detail 37 and 37A may be omitted on short auxiliary lanes where weaving length is critical.

**LEGEND**

- 88 Non-Retroreflective White Markers
- ➔ Direction of Travel
- One-Way Clear Retroreflective Markers
- Red-Clear Retroreflective Markers

**Figure 3A-112 (CA). Channelizing Line and Lane Line/Centerline Extensions**

**DETAIL 38 - Channelizing Line**



**POLICY**

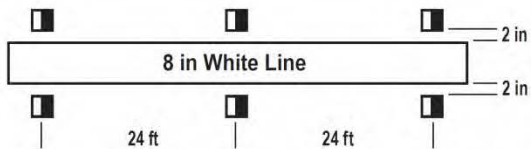
Typical channelizing line for use on Left-Turn or Right-Turn lanes on State highways. Pavement Markers when used should be placed on the through traffic side only.

**DETAIL 38A - Channelizing Line**



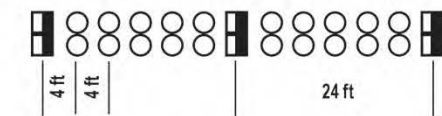
Typical channelizing line for use on Left-Turn or Right-Turn lanes on local streets and highways and freeway off-ramp terminals.

**DETAIL 38B - Channelizing Line at Exit Ramps**



Typical channelizing line for use on Exit Ramps. Pavement Markers as shown may also be placed on the line.

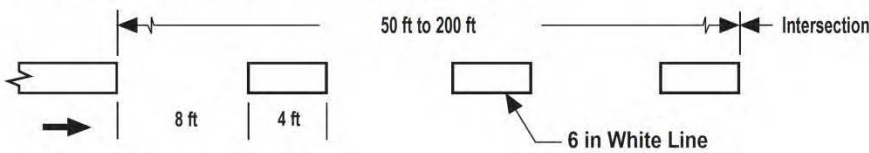
**DETAIL 38C - Alternate to Detail 38 and 38B**



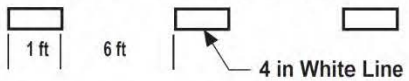
**DETAIL 39 - Bike Lane Line**



**DETAIL 39A - Bike Lane Intersection Line**

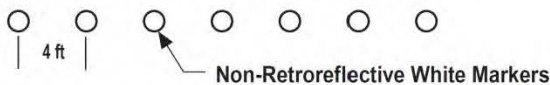


**DETAIL 40 - Lane Line Extension Through Intersections**

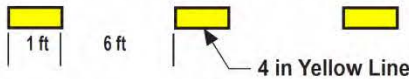


The Lane Line Extension Through Intersections line is used to extend the lane line through an intersection that might otherwise be confusing to the motorist.

**DETAIL 40A - Alternate to Detail 40**



**DETAIL 41 - Centerline Extension Through Intersections**



The Centerline Extension Through Intersections line is used to extend the centerline through an intersection that might otherwise be confusing to the motorist.

**DETAIL 41A - Alternate to Detail 41**



NOT TO SCALE

**LEGEND**

|   |  |   |
|---|--|---|
|  White Line  |  Non-Retroreflective White Markers  |  Direction of Travel                   |
|  Yellow Line |  Non-Retroreflective Yellow Markers |  One-Way Clear Retroreflective Markers |

**Figure 3A-113 (CA). Examples of Preferential Lane Lines**

**DETAIL 42 - Contiguous, Continuous Access**

**POLICY**



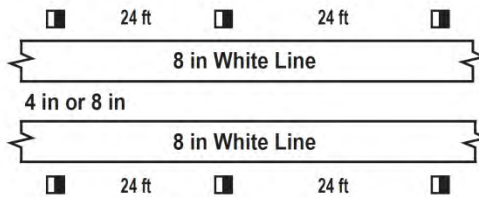
See Figure 3D-3.C

**DETAIL 43 - Contiguous, Access Discouraged**



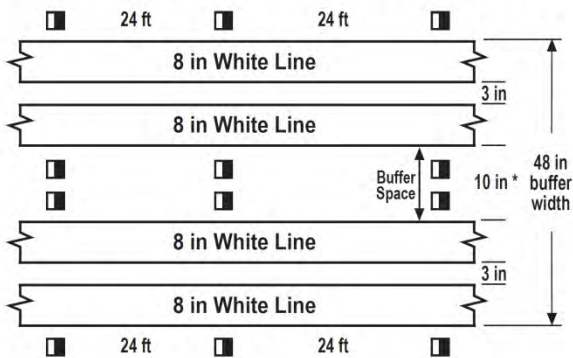
See Figure 3D-3.B

**DETAIL 44 - Contiguous, Access Prohibited**



See Figure 3D-3.A. An 8 inch separation creates a 2 foot buffer width.

**DETAIL 45 - Buffer-Separated, Access Prohibited**



See Figure 3D-2.A

\* If buffer space is wider than 4 feet, then chevron markings are required (see Figure 3D.2(A) and Section 3B-24).

NOT TO SCALE

**LEGEND**

-  White Line
-  One-Way Clear Retroreflective Markers





## CHAPTER 3B. PAVEMENT AND CURB MARKINGS

### Section 3B.01 Yellow Center Line Pavement Markings and Warrants

#### Standard:

**01 Center line pavement markings, when used, shall be the pavement markings used to delineate the separation of traffic lanes that have opposite directions of travel on a roadway and shall be yellow.**

#### Option:

**02 Center line pavement markings may be placed at a location that is not the geometric center of the roadway.**

**03 On roadways without continuous center line pavement markings, short sections may be marked with center line pavement markings to control the position of traffic at specific locations, such as around curves, over hills, on approaches to grade crossings, at grade crossings, and at bridges.**

#### Standard:

**04 The center line markings on two-lane, two-way roadways shall be one of the following as shown in Figure 3B-1:**

**A. Two-direction passing zone markings consisting of a normal broken yellow line where crossing the center line markings for passing with care is permitted for traffic traveling in either direction;**

**B. One-direction no-passing zone markings consisting of a double yellow line, one of which is a normal broken yellow line and the other is a normal solid yellow line, where crossing the center line markings for passing with care is permitted for the traffic traveling adjacent to the broken line, but is prohibited for traffic traveling adjacent to the solid line; or**

**C. Two-direction no-passing zone markings consisting of two normal solid yellow lines where crossing the center line markings for passing is prohibited for traffic traveling in either direction.**

**05 A single solid yellow line shall not be used as a center line marking on a two-way roadway.**

**06 The center line markings on undivided two-way roadways with four or more lanes for moving motor vehicle traffic always available shall be the two-direction no-passing zone markings consisting of a solid double yellow line as shown in Figure 3B-2.**

#### Guidance:

*07 On two-way roadways with three through lanes for moving motor vehicle traffic, two lanes should be designated for traffic in one direction by using one- or two-direction no-passing zone markings as shown in Figure 3B-3.*

#### Support:

*08 Sections 11-301(e) and 11-311(e) of the "Uniform Vehicle Code (UVC)" contain information regarding left turns across center line no-passing zone markings and paved medians, respectively. The UVC can be obtained from the National Committee on Uniform Traffic Laws and Ordinances at the address shown on Page i.*

#### Standard:

**09 Center line markings shall be placed on all paved urban arterials and collectors that have a traveled way of 20 feet or more in width and an ADT of 6,000 vehicles per day or greater. Center line markings shall also be placed on all paved two-way streets or highways that have three or more lanes for moving motor vehicle traffic.**

#### Guidance:

*10 Center line markings should be placed on paved urban arterials and collectors that have a traveled way of 20 feet or more in width and an ADT of 4,000 vehicles per day or greater. Center line markings should also be placed on all rural arterials and collectors that have a traveled way of 18 feet or more in width and an ADT of 3,000 vehicles per day or greater. Center line markings should also be placed on other traveled ways where an engineering study indicates such a need.*

*11 Engineering judgment should be used in determining whether to place center line markings on traveled ways that are less than 16 feet wide because of the potential for traffic encroaching on the pavement edges, traffic being affected by parked vehicles, and traffic encroaching into the opposing traffic lane.*

#### Option:

**12 Center line markings may be placed on other paved two-way traveled ways that are 16 feet or more in width.**

13 If a traffic count is not available, the ADTs described in this Section may be estimates that are based on engineering judgment.

**Standard:**

14 **Centerline patterns shall be selected from those shown in Figures 3A-101(CA) and 3A-104(CA).**

15 **Raised retroreflective pavement markers shall be used to supplement the centerline markings on State highways, except in snow areas.**

**Support:**

16 On horizontal curves with radii less than 3280 feet and without street lighting, Detail 22 instead of Detail 21 can be helpful in improving the delineation for centerline markings as it includes retroreflective raised pavement markers. Detail 22 can be applied in advance of the approach to the curve per Table 2C-4 and continued throughout the length of the curve.

17 Refer to CVC 21460 for Double Lines.

18 Refer to CVC 21460.5 for Two-Way Left-Turn Lanes.

**Standard:**

19 **A left edge line shall consist of a minimum 4 inch wide solid yellow line, yellow reflective pavement markers or a combination of line and markers as shown in Figure 3A-105(CA).**

**Option:**

20 Two normal solid yellow lines may be used as a left edge line on a divided roadway for more emphasis when motorists tend to use the shoulder for a through lane or where encroachments onto the shoulder occasionally occur.

**Support:**

21 Left edge line patterns for median islands are shown in Figure 3A-107(CA).

**Standard:**

22 **When a passing lane is provided, a two-direction no passing marking (see Figure 3A-104(CA)) shall be used when the Average Daily Traffic (ADT) exceeds 3,000. See Figure 3B-106(CA).**

**Option:**

23 Passing in both directions may be provided by alternating the direction of the middle lane at about 1 mile intervals.

24 A one-direction no passing marking (see Figure 3A-103(CA)) with one or more YIELD TO UPHILL TRAFFIC (R55(CA)) signs may be used when the ADT is 3,000 or less.

### **Section 3B.02 No-Passing Zone Pavement Markings and Warrants**

**Standard:**

01 **No-passing zones shall be marked by either the one direction no-passing zone pavement markings or the two-direction no-passing zone pavement markings described in Section 3B.01 and shown in Figures 3B-1 and 3B-3.**

02 **When center line markings are used, no-passing zone markings shall be used on two-way roadways at lane-reduction transitions (see Section 3B.09) and on approaches to obstructions that must be passed on the right (see Section 3B.10).**

03 **On two-way, two- or three-lane roadways where center line markings are installed, no-passing zones shall be established at vertical and horizontal curves and other locations where an engineering study indicates that passing must be prohibited because of inadequate sight distances or other special conditions.**

04 **On roadways with center line markings, no-passing zone markings shall be used at horizontal or vertical curves where the passing sight distance is less than the minimum shown in Table 3B-1 for the 85<sup>th</sup>-percentile speed or the posted or statutory speed limit. The passing sight distance on a vertical curve is the distance at which an object 3.5 feet above the pavement surface can be seen from a point 3.5 feet above the pavement (see Figure 3B-4). Similarly, the passing sight distance on a horizontal curve is the distance measured along the center line (or right-hand lane line of a three-lane roadway) between two points 3.5 feet above the pavement on a line tangent to the embankment or other obstruction that cuts off the view on the inside of the curve (see Figure 3B-4).**

**Support:**

05 The upstream end of a no-passing zone at point "a" in Figure 3B-4 is that point where the sight distance first becomes less than that specified in Table 3B-1. The downstream end of the no-passing zone at point "b" in Figure 3B-4 is that point at which the sight distance again becomes greater than the minimum specified.

06 The values of the minimum passing sight distances that are shown in Table 3B-1 are for operational use in

marking no-passing zones and are less than the values that are suggested for geometric design by the AASHTO Policy on Geometric Design of Streets and Highways (see Section 1A.11).

**Guidance:**

~~07 Where the distance between successive no-passing zones is less than 400 feet, no-passing markings should connect the zones.~~

**Standard:**

**07a If the gap between successive no-passing zones is less than the sight distance for the prevailing speed shown in Table 3B-1, the no-passing zone shall be continuous.**

**08 Where center line markings are used, no-passing zone markings shall be used on approaches to grade crossings in compliance with Section 8B.27.**

**Option:**

09 In addition to pavement markings, no-passing zone signs (see Sections 2B.28, 2B.29, and 2C.45) may be used to emphasize the existence and extent of a no-passing zone.

**Support:**

10 Section 11-307 of the "Uniform Vehicle Code (UVC)" contains further information regarding required road user behavior in no-passing zones. The UVC can be obtained from the National Committee on Uniform Traffic Laws and Ordinances at the address shown on Page i.

**Standard:**

**11 On three-lane roadways where the direction of travel in the center lane transitions from one direction to the other, a no-passing buffer zone shall be provided in the center lane as shown in Figure 3B-5. A lane-reduction transition (see Section 3B.09) shall be provided at each end of the buffer zone.**

**12 The buffer zone shall be a flush median island formed by two sets of double yellow center line markings that is at least 50 feet in length.**

**Option:**

13 Yellow diagonal crosshatch markings (see Section 3B.24) may be placed in the flush median area between the two sets of no-passing zone markings as shown in Figure 3B-5.

**Guidance:**

14 For three-lane roadways having a posted or statutory speed limit of 45 mph or greater, the lane transition taper length should be computed by the formula  $L = WS$ . For roadways where the posted or statutory speed limit is less than 45 mph, the formula  $L = WS^2/60$  should be used to compute the taper length.

**Support:**

15 Under both formulas, L equals the taper length in feet, W equals the width of the center lane or offset distance in feet, and S equals the 85<sup>th</sup>-percentile speed or the posted or statutory speed limit, whichever is higher.

**Guidance:**

16 The minimum lane transition taper length should be 100 feet in urban areas and 200 feet in rural areas.

**Support:**

17 Refer to CVC 21750 through 21759 for overtaking and passing.

18 Refer to CVC 21460 for Double Lines.

19 CVC 21752 restricts passing (driving on left side of a two-way roadway) when approaching within 100 feet of or when traversing any intersection or railroad grade crossing. CVC 21752 also restricts passing (driving on left side of a two-way roadway) when the view is obstructed upon approaching within 100 feet of any bridge, viaduct, or tunnel. The patterns and policy for intersection markings are shown in Figure 3A-109(CA).

**Standard:**

**20 No-passing zone patterns shall be selected from those shown in Figures 3A-103(CA) and 3A-104(CA).**

**Guidance:**

21 The no-passing zone markings at intersections, when used, should be between 100 feet and 300 feet in length at the approach to an intersection and placed in a pattern as shown in Figure 3A-109(CA).

### **Section 3B.03 Other Yellow Longitudinal Pavement Markings**

#### **Standard:**

**01 If reversible lanes are used, the lane line pavement markings on each side of reversible lanes shall consist of a normal broken double yellow line to delineate the edge of a lane in which the direction of travel is reversed from time to time, such that each of these markings serve as the center line markings of the roadway during some period (see Figure 3B-6).**

**02 Signs (see Section 2B.26), lane-use control signals (see Chapter 4M), or both shall be used to supplement reversible lane pavement markings.**

**03 If a two-way left-turn lane that is never operated as a reversible lane is used, the lane line pavement markings on each side of the two-way left-turn lane shall consist of a normal broken yellow line and a normal solid yellow line to delineate the edges of a lane that can be used by traffic in either direction as part of a left-turn maneuver. These markings shall be placed with the broken line toward the two-way left-turn lane and the solid line toward the adjacent traffic lane as shown in Figure 3B-7.**

#### *Guidance:*

#### *Option:*

**04 White two-way left-turn lane-use arrows (see Figure 3B-7), ~~should~~ **may** be used in conjunction with the longitudinal two-way left-turn markings at the locations described in Section 3B.20.**

**05 Signs ~~should~~ **may** be used in conjunction with the two-way left turn markings (see Section 2B.24).**

#### **Standard:**

**06 If a continuous flush median island formed by pavement markings separating travel in opposite directions is used, two sets of solid double yellow lines shall be used to form the island as shown in Figures 3B-2 and 3B-5. Other markings in the median island area shall also be yellow, except crosswalk markings which shall be white (see Section 3B.18).**

**07 On State highways, reversible lanes shall be separated by physical barriers or delineators.**

#### *Support:*

**08 A two-way left-turn lane is a lane reserved in the center of a highway for exclusive use of left or U-turning vehicles. Refer to CVC 21460.5. It is normally used where there are many points of access.**

#### **Standard:**

**09 The two-way left-turn lane markings shall be selected from those shown in Figure 3A-108(CA).**

#### *Option:*

**10 Optional treatments at signalized, major and minor intersections as shown in Figure 3B-7(CA) may be used.**

**11 Two-way opposing pavement arrows may be used as shown in Figure 3B-7(CA). The arrows may be supplemented by Two-Way Left Turn Lane (R3-9a or R3-9b) sign at new installations and problem locations.**

#### *Guidance:*

**12 A gap in the markings should be made at all intersections.**

#### *Support:*

**13 For left turn channelization, see Figure 3B-101(CA) and Caltrans' Highway Design Manual, Section 405.2. See Section 1A.11 for information regarding this publication.**

**14 Channelized left-turn lanes in combination with continuous raised-curb medians are used instead of two-way left-turn lanes (TWLTL) if one or more of the following conditions exist:**

- A. Average daily traffic volumes exceed 20,000 vehicles per day**
- B. For remediation where there is a demonstrated crash problem,**
- C. Wherever a need is demonstrated through engineering study.**

**15 Refer to CVC 21460.5 for Two-Way Left-Turn Lanes.**

**16 For details of two-way left-turn lanes, see Figure 3B-7(CA). For left turn channelization, see Figure 3B-101(CA) and Caltrans' Highway Design Manual, Section 405.2. See Section 1A.11 for information regarding this publication.**

#### **Standard:**

**17 Left-turn or right-turn lanes shall be separated from the through lanes by a single solid 8 inch wide white line as shown in Figure 3A-112(CA) except as provided in paragraph 18.**

#### *Option:*

**18 Left-turn or right-turn lanes may be separated from the through lanes by multiple solid 8 inch wide white lines or two longitudinal solid 8 inch wide lines with diagonal lines used for crosshatch markings.**

### **Section 3B.04 White Lane Line Pavement Markings and Warrants**

#### **Standard:**

**01 When used, lane line pavement markings delineating the separation of traffic lanes that have the same direction of travel shall be white.**

**02 Lane line markings shall be used on all freeways and Interstate highways.**

#### *Guidance:*

*03 Lane line markings should be used on all roadways that are intended to operate with two or more adjacent traffic lanes in the same direction of travel, except as otherwise required for reversible lanes. Lane line markings should also be used at congested locations where the roadway will accommodate more traffic lanes with lane line markings than without the markings.*

#### *Support:*

*04 Examples of lane line markings are shown in Figures 3B-2, 3B-3, and 3B-7 through 3B-13.*

#### **Standard:**

**05 Except as provided in Paragraph 6, where crossing the lane line markings with care is permitted, the lane line markings shall consist of a normal broken white line.**

**06 A dotted white line marking shall be used as the lane line to separate a through lane that continues beyond the interchange or intersection from an adjacent lane for any of the following conditions:**

**A. A deceleration or acceleration lane,**

**B. A through lane that becomes a mandatory exit or turn lane,**

**C. An auxiliary lane 2 miles or less in length between an entrance ramp and an exit ramp, or**

**D. An auxiliary lane 1 mile or less in length between two adjacent intersections.**

**07 For exit ramps with a parallel deceleration lane, a normal width dotted white lane line shall be installed from the upstream end of the full-width deceleration lane to the theoretical gore or to the upstream end of a solid white lane line, if used, that extends upstream from the theoretical gore as shown in ~~Drawings A and C of Figure 3B-8~~ **3B-8(CA)**.**

#### *Option:*

*08 For exit ramps with a parallel deceleration lane, a normal width dotted white line extension may be installed in the taper area upstream from the full-width deceleration lane as shown in ~~Drawings A and C of Figure 3B-8~~ **3B-8(CA)**.*

*09 For an exit ramp with a tapered deceleration lane, a normal width dotted white line extension may be installed from the theoretical gore through the taper area such that it meets the edge line at the upstream end of the taper as shown in ~~Drawing B of Figure 3B-8~~ **3B-8(CA)**.*

#### **Standard:**

**10 For entrance ramps with a parallel acceleration lane, a normal width dotted white lane line shall be installed from the theoretical gore or from the downstream end of a solid white lane line, if used, that extends downstream from the theoretical gore, to a point at least one-half the distance from the theoretical gore to the downstream end of the acceleration taper, as shown in ~~Drawing A of Figure 3B-9~~ **3B-9(CA)**.**

#### *Option:*

*11 For entrance ramps with a parallel acceleration lane, a normal width dotted white line extension may be installed from the downstream end of the dotted white lane line to the downstream end of the acceleration taper, as shown in ~~Drawing A of Figure 3B-9~~ **3B-9(CA)**.*

*12 For entrance ramps with a tapered acceleration lane, a normal width dotted white line extension may be installed from the downstream end of the channelizing line adjacent to the through lane to the downstream end of the acceleration taper, as shown in ~~Drawings B and C of Figure 3B-9~~ **3B-9(CA)**.*

#### **Standard:**

**13 A wide dotted white lane line shall be used:**

**A. As a lane drop marking in advance of lane drops at exit ramps to distinguish a lane drop from a normal exit ramp (see ~~Drawings A, B, and C of Figure 3B-10~~ **3B-10(CA)**),**

**B. In advance of freeway route splits with dedicated lanes (see ~~Drawing D of Figure 3B-10~~ **3B-10(CA)**),**

**C. To separate a through lane that continues beyond an interchange from an adjacent auxiliary lane between an entrance ramp and an exit ramp (see ~~Drawing E of Figure 3B-10~~ **3B-10(CA)**),**

- D. As a lane drop marking in advance of lane drops at intersections to distinguish a lane drop from an intersection through lane (see Drawing A of Figure 3B-11), and**
- E. To separate a through lane that continues beyond an intersection from an adjacent auxiliary lane between two intersections (see Drawing B of Figure 3B-11).**

*Guidance:*

*14 Lane drop markings used in advance of lane drops at freeway and expressway exit ramps should begin at least 1/2 mile in advance of the theoretical gore.*

*14a If the dropped lane is an auxiliary lane 1/2 mile or less in length, the lane drop line should extend throughout the entire length.*

*15 On the approach to a multi-lane exit ramp having an optional exit lane that also carries through traffic, lane line markings should be used as illustrated in ~~Drawing B of Figure 3B-10~~ 3B-10(CA). In this case, if the right-most exit lane is an added lane such as a parallel deceleration lane, the lane drop marking should begin at the upstream end of the full-width deceleration lane, as shown in ~~Drawing C of Figure 3B-8~~ 3B-8(CA).*

*16 lane drop markings used in advance of lane drops at intersections should begin a distance in advance of the intersection that is determined by engineering judgment as suitable to enable drivers who do not desire to make the mandatory turn to move out of the lane being dropped prior to reaching the queue of vehicles that are waiting to make the turn. The lane drop marking should begin no closer to the intersection than the most upstream regulatory or warning sign associated with the lane drop.*

*17 The dotted white lane lines that are used for lane drop markings and that are used as a lane line separating through lanes from auxiliary lanes should consist of line segments that are 3 feet in length separated by 9-foot gaps.*

**Standard:**

**17a The lane drop line pattern shall be as shown in Figure 3A-111(CA).**

**Support:**

**17b See Figures 3A-111(CA), 3B-8(CA), 3B-9(CA), 3B-10(CA), 3B-14(CA) and 3B-106(CA) for further details of markings and signing.**

**Option:**

**17c A 8 inch wide single solid white line preceded by a 8 inch wide dotted white line may be placed in advance of an intersection where the outside lane is dropped at the intersection, and as a result, creates a mandatory turn lane.**

**Standard:**

**17d If used, diagonal lines shall be the same color as the edge line.**

**Support:**

**18 Section 3B.20 contains information regarding other markings that are associated with lane drops, such as lane-use arrow markings and ONLY word markings.**

**19 Section 3B.09 contains information about the lane line markings that are to be used for transition areas where the number of through lanes is reduced.**

**Standard:**

**20 Where crossing the lane line markings is discouraged, the lane line markings shall consist of a normal or wide solid white line, except as provided in paragraph 5.**

**Option:**

**21 Where it is intended to discourage lane changing on the approach to an exit ramp, a wide solid white lane line may extend upstream from the theoretical gore or, for multi-lane exits, as shown in ~~Drawing B of Figure 3B-10~~ 3B-10(CA), for a distance that is determined by engineering judgment.**

**22 Where lane changes might cause conflicts, a wide or normal solid white lane line may extend upstream from an intersection.**

**23 In the case of a lane drop at an exit ramp or intersection, such a solid white line may replace a portion, but not all of the length of the wide dotted white lane line.**

**Support:**

**24 Section 3B.09 contains information about the lane line markings that are to be used for transition areas where the number of through lanes is reduced.**

*Guidance:*

*25 On approaches to intersections, a solid white lane line marking should be used to separate a through lane from an added mandatory turn lane.*

Option:

26 On approaches to intersections, solid white lane line markings may be used to separate adjacent through lanes or adjacent mandatory turn lanes from each other.

27 Where the median width allows the left-turn lanes to be separated from the through lanes to give drivers on opposing approaches a less obstructed view of opposing through traffic, white pavement markings may be used to form channelizing islands as shown in Figure 2B-17.

28 Solid white lane line markings may be used to separate through traffic lanes from auxiliary lanes, such as an added uphill truck lane or a preferential lane (see Section 3D.02).

29 Wide solid lane line markings may be used for greater emphasis.

**Standard:**

30 **Where crossing the lane line markings is prohibited, the lane line markings shall consist of a solid double white line (see Figure 3B-12).**

31 **Lane line patterns shall be selected from those shown in Figure 3A-102(CA). Detail 9 or 10 (40 mph or less) or Detail 12 or 13 (45 mph or more) shall be used on State freeways, expressways, freeway ramps, freeway to freeway connectors and collector roads, except when used in snow areas, the raised pavement markers, if used, shall be recessed; otherwise, use Detail 8 or 11.**

32 **When a climbing lane is provided on an upgrade and it is necessary to prohibit trucks from passing slower moving vehicles, an 8 inch solid white line shall be used in place of the standard lane line stripe. See Section 2B.31 for truck lane control signs.**

### **Section 3B.05 Other White Longitudinal Pavement Markings**

**Standard:**

01 **A channelizing line shall be a wide or double solid white line.**

Option:

02 Channelizing lines may be used to form channelizing islands where traffic traveling in the same direction is permitted on both sides of the island.

**Standard:**

03 **Other pavement markings in the channelizing island area shall be white.**

Support:

04 Examples of channelizing line applications are shown in Figures ~~3B-8~~ 3B-8(CA), ~~3B-9~~ 3B-9(CA), and ~~3B-10~~ 3B-10(CA), and in Drawing C of Figure 3B-15.

05 Channelizing lines at exit ramps as shown in Figures ~~3B-8~~ 3B-8(CA) and ~~3B-10~~ 3B-10(CA) define the neutral area, direct exiting traffic at the proper angle for smooth divergence from the main lanes into the ramp, and reduce the probability of colliding with objects adjacent to the roadway.

06 Channelizing lines at entrance ramps as shown in Figures ~~3B-9~~ 3B-9(CA) and ~~3B-10~~ 3B-10(CA) promote orderly and efficient merging with the through traffic.

**Standard:**

07 **For all exit ramps and for entrance ramps with parallel acceleration lanes, channelizing lines shall be placed on both sides of the neutral area (see Figures ~~3B-8~~ 3B-8(CA) and ~~3B-10~~ 3B-10(CA) and ~~Drawing A of Figure 3B-9~~ 3B-9(CA)).**

08 **For entrance ramps with tapered acceleration lanes, channelizing lines shall be placed along both sides of the neutral area to a point at least one-half of the distance to the theoretical gore (see ~~Drawing C of Figure 3B-9~~ 3B-9(CA)).**

Option:

09 For entrance ramps with tapered acceleration lanes, the channelizing lines may extend to the theoretical gore as shown in ~~Drawing B of Figure 3B-9~~ 3B-9(CA).

10 White chevron crosshatch markings (see Section 3B.24) may be placed in the neutral area of exit ramp and entrance ramp gores for special emphasis as shown in Figures ~~3B-8~~ and ~~3B-10~~ and ~~Drawing A of Figure 3B-9~~. The channelizing lines and the optional chevron crosshatch markings at exit ramp and entrance ramp gores may be supplemented with white retroreflective or internally illuminated raised pavement markers (see Sections 3B.11 and 3B.13) for enhanced nighttime visibility.

### **Section 3B.06 Edge Line Pavement Markings**

#### **Standard:**

- 01 If used, edge line pavement markings shall delineate the right or left edges of a roadway.**
- 02 Except for dotted edge line extensions (see Section 3B.08), edge line markings shall not be continued through intersections or major driveways.**
- 03 If used on the roadways of divided highways or one-way streets, or on any ramp in the direction of travel, left edge line pavement markings shall consist of a normal solid yellow line to delineate the left-hand edge of a roadway or to indicate driving or passing restrictions left of these markings.**
- 04 If used, right edge line pavement markings shall consist of a normal solid white line to delineate the right-hand edge of the roadway.**

#### *Guidance:*

- 05 Edge line markings should not be broken for minor driveways.*

#### *Support:*

- 06 Edge line markings have unique value as visual references to guide road users during adverse weather and visibility conditions.*

#### *Option:*

- 07 Wide solid edge line markings may be used for greater emphasis.*

#### **Standard:**

- 08 A right edge line shall consist of a minimum 4 inch wide solid white line.**

#### *Guidance:*

- 09 The edge line should be placed 2 inch in from the edge of traveled way, approximately 12 feet from the lane line or centerline on highway mainlines, ramps, and connectors. See Figure 3A-106(CA).*

- 10 Generally, the solid edge line should be dropped at the beginning of intersection flares.*

#### *Option:*

- 11 In heavy fog areas, or locations where additional guidance would be beneficial, a dotted 4 inch wide white right edge line may be continued across an intersection.*

#### *Support:*

- 12 Edge line is not used at turnouts. See Figure 3B-107(CA).*

#### **Standard:**

- 13 Exit and entrance ramps, including freeway connectors, shall be marked with a yellow edge line supplemented with yellow reflective pavement markers on the left and a white edge line on the right. See Figure 3A-105(CA).**

### **Section 3B.07 Warrants for Use of Edge Lines**

#### **Standard:**

- 01 Edge line markings shall be placed on paved streets or highways with the following characteristics:**
  - A. Freeways,**
  - B. Expressways, and**
  - C. Rural arterials with a traveled way of 20 feet or more in width and an ADT of 6,000 vehicles per day or greater.**

#### *Guidance:*

- 02 Edge line markings should be placed on paved streets or highways with the following characteristics:*

- A. Rural arterials and collectors with a traveled way of 20 feet or more in width and an ADT of 3,000 vehicles per day or greater.*

- B. ~~At~~ On other paved streets and highways where an engineering study indicates a need for edge line markings.*

- 03 Edge line markings should not be placed where an engineering study or engineering judgment indicates that providing them is likely to decrease safety.*

#### *Option:*

- 04 Edge line markings may be placed on streets and highways with or without center line markings.*

- 05 Edge line markings may be excluded, based on engineering judgment, for reasons such as if the traveled way edges are delineated by curbs, parking, or other markings.*

- 06 If a bicycle lane is marked on the outside portion of the traveled way, the edge line that would mark the outside edge of the bicycle lane may be omitted.*



07 Edge line markings may be used where edge delineation is desirable to minimize unnecessary driving on paved shoulders or on refuge areas that have lesser structural pavement strength than the adjacent roadway.

**Standard:**

08 **Edge lines shall be used on all State highways, except urban type streets with curbs and parking provisions.**

**Option:**

09 The Two-Way Traffic (W6-3) sign may be used in conjunction with edge lines at locations where road users could perceive that they are on a one-way roadway when, in fact, they are on a two lane, two-way highway. See Section 2C.44 for W6-3 sign.

### **Section 3B.08 Extensions Through Intersections or Interchanges**

**Standard:**

01 **Except as provided in Paragraph 2, pavement markings extended into or continued through an intersection or interchange area shall be the same color and at least the same width as the line markings they extend (see Figure 3B-13).**

**Option:**

02 A normal line may be used to extend a wide line through an intersection.

**Guidance:**

03 *Where highway design or reduced visibility conditions make it desirable to provide control or to guide vehicles through an intersection or interchange, such as at offset, skewed, complex, or multi-legged intersections, on curved roadways, where multiple turn lanes are used, or where offset left turn lanes might cause driver confusion, dotted line extension markings consisting of 2-foot line segments and 2- to 6-foot gaps should be used to extend longitudinal line markings through an intersection or interchange area.*

**Option:**

04 Dotted edge line extensions may be placed through intersections or major driveways.

**Guidance:**

05 *Where greater restriction is required, solid lane lines or channelizing lines should be extended into or continued through intersections or major driveways.*

**Standard:**

06 **Solid lines shall not be used to extend edge lines into or through intersections or major driveways.**

**Guidance:**

07 *Where a double line is extended through an intersection, a single line of equal width to one of the lines of the double line should be used.*

08 *To the extent possible, pavement marking extensions through intersections should be designed in a manner that minimizes potential confusion for drivers in adjacent or opposing lanes.*

**Support:**

09 See Figure 3A-112(CA), Detail 40 and 40A for lane line extensions.

### **Section 3B.09 Lane-Reduction Transition Markings**

**Support:**

01 Lane-reduction transition markings are used where the number of through lanes is reduced because of narrowing of the roadway or because of a section of on-street parking in what would otherwise be a through lane. Lane-reduction transition markings are not used for lane drops.

**Standard:**

02 **Except as provided in Paragraph 3, where pavement markings are used, lane-reduction transition markings shall be used to guide traffic through transition areas where the number of through lanes is reduced, as shown in Figure 3B-14 3B-14(CA). On two-way roadways, no-passing zone markings shall be used to prohibit passing in the direction of the convergence, and shall continue through the transition area.**

**Option:**

03 On low-speed urban roadways where curbs clearly define the roadway edge in the lane-reduction transition, or where a through lane becomes a parking lane, the edge line and/or delineators shown in Figure 3B-14 3B-14(CA) may be omitted as determined by engineering judgment.

*Guidance:*

*04 For roadways having a posted or statutory speed limit of 45 mph or greater, the transition taper length for a lane-reduction transition should be computed by the formula  $L = WS$ . For roadways where the posted or statutory speed limit is less than 45 mph, the formula  $L = WS^2/60$  should be used to compute the taper length.*

*Support:*

*05 Under both formulas, L equals the taper length in feet, W equals the width of the offset distance in feet, and S equals the 85<sup>th</sup>-percentile speed or the posted or statutory speed limit, whichever is higher.*

*Guidance:*

*06 Where observed speeds exceed posted or statutory speed limits, longer tapers should be used.*

*Option:*

*07 On new construction, where no posted or statutory speed limit has been established, the design speed may be used in the transition taper length formula.*

*Guidance:*

*08 Lane line markings should be discontinued one-quarter of the distance between the Lane Ends sign (see Section 2C.42) and the point where the transition taper begins.*

*09 Except as provided in Paragraph 3 for low-speed urban roadways, the edge line markings shown in Figure 3B-14 3B-14(CA) should be installed from the location of the Lane Ends warning sign to beyond the beginning of the narrower roadway.*

*Support:*

*10 Pavement markings at lane-reduction transitions supplement the standard signs. See Section 3B.20 for provisions regarding use of lane-reduction arrows.*

*11 Typical lane reduction transitions (four lane to two lane) and transitions from two lanes to four lanes are shown in Figure 3B-14(CA).*

### **Section 3B.10 Approach Markings for Obstructions**

**Standard:**

**01 Pavement markings shall be used to guide traffic away from fixed obstructions within a paved roadway. Approach markings for bridge supports, refuge islands, median islands, toll plaza islands, and raised channelization islands shall consist of a tapered line or lines extending from the center line or the lane line to a point 1 to 2 feet to the right-hand side, or to both sides, of the approach end of the obstruction (see Figure 3B-15).**

*Support:*

*02 See Chapter 3E for additional information on approach markings for toll plaza islands.*

*Guidance:*

*03 For roadways having a posted or statutory speed limit of 45 mph or greater, the taper length of the tapered line markings should be computed by the formula  $L = WS$ . For roadways where the posted or statutory speed limit is less than 45 mph, the formula  $L = WS^2/60$  should be used to compute the taper length.*

*Support:*

*04 Under both formulas, L equals the taper length in feet, W equals the width of the offset distance in feet, and S equals the 85<sup>th</sup>-percentile speed or the posted or statutory speed limit, whichever is higher.*

*Guidance:*

*05 The minimum taper length should be 100 feet in urban areas and 200 feet in rural areas.*

*Support:*

*06 Examples of approach markings for obstructions in the roadway are shown in Figure 3B-15.*

**Standard:**

**07 If traffic is required to pass only to the right of the obstruction, the markings shall consist of a two-direction no-passing zone marking at least twice the length of the diagonal portion as determined by the appropriate taper formula (see Drawing A of Figure 3B-15).**

*Option:*

*08 If traffic is required to pass only to the right of the obstruction, yellow diagonal crosshatch markings (see Section 3B.24) may be placed in the flush median area between the no-passing zone markings as shown in Drawings A and B of Figure 3B-15. Other markings, such as yellow delineators, yellow channelizing devices,*

yellow raised pavement markers, and white crosswalk pavement markings, may also be placed in the flush median area.

**Standard:**

**09 If traffic can pass either to the right or left of the obstruction, the markings shall consist of two channelizing lines diverging from the lane line, one to each side of the obstruction. In advance of the point of divergence, a wide solid white line or normal solid double white line shall be extended in place of the broken lane line for a distance equal to the length of the diverging lines (see Drawing C of Figure 3B-15).**

**Option:**

10 If traffic can pass either to the right or left of the obstruction, additional white chevron crosshatch markings (see Section 3B.24) may be placed in the flush median area between the channelizing lines as shown in Drawing C of Figure 3B-15. Other markings, such as white delineators, white channelizing devices, white raised pavement markers, and white crosswalk markings may also be placed in the flush median area.

**Section 3B.11 Raised Pavement Markers – General**

**Standard:**

**01 The color of raised pavement markers under both daylight and nighttime conditions shall conform to the color of the marking for which they serve as a positioning guide, or for which they supplement or substitute.**

**Option:**

02 The side of a raised pavement marker that is visible to traffic proceeding in the wrong direction may be red (see Section 3A.05).

03 Retroreflective or internally illuminated raised pavement markers may be used in the roadway immediately adjacent to curbed approach ends of raised medians and curbs of islands, or on top of such curbs (see Section 3B.23).

**Support:**

04 Retroreflective and internally illuminated raised pavement markers are available in mono-directional and bidirectional configurations. The bidirectional marker is capable of displaying the applicable color for each direction of travel.

05 Blue raised pavement markers are sometimes used in the roadway to help emergency personnel locate fire hydrants.

**Standard:**

**06 When used, internally illuminated raised pavement markers shall be steadily illuminated and shall not be flashed.**

**Support:**

07 Flashing raised pavement markers are considered to be In-Roadway Lights (see Chapter 4N).

**Guidance:**

08 *Non-retroreflective raised pavement markers should not be used alone, without supplemental retroreflective or internally illuminated markers, as a substitute for other types of pavement markings.*

09 *Directional configurations should be used to maximize correct information and to minimize confusing information provided to the road user. Directional configurations also should be used to avoid confusion resulting from visibility of markers that do not apply to the road user.*

10 *The spacing of raised pavement markers used to supplement or substitute for other types of longitudinal markings should correspond with the pattern of broken lines for which the markers supplement or substitute.*

**Standard:**

~~11 The value of N cited in Sections 3B.12 through 3B.14 for the spacing of raised pavement markers shall equal the length of one line segment plus one gap of the broken lines used on the highway.~~

**11a The widths and patterns of raised pavement markers shall conform to the details shown in Figures 3A-101(CA) through 3A-112(CA). See Section 3A.06.**

**Option:**

12 For additional emphasis, retroreflective raised pavement markers may be spaced closer than described in Sections 3B.12 through 3B.14, as determined by engineering judgment or engineering study.

**Support:**

<sup>13</sup> Figures 9-20 through 9-22 in the "Traffic Control Devices Handbook" (see Section 1A.11) contain additional information regarding the spacing of raised pavement markers on longitudinal markings.

**Support:**

<sup>14</sup> Raised pavement markers are not normally placed where snow plows would damage the markers and require an unusual amount of replacement.

**Guidance:**

<sup>15</sup> *When used in these areas, they should be recessed, as shown in Caltrans' Standard Plan A20-D. See Section 1A.11 for information regarding this publication.*

**Advance Markers**

**Option:**

<sup>16</sup> Advance Markers at exit ramps may be used to help motorists locate exit ramps in heavy fog areas.

**Support:**

<sup>17</sup> The Advance Markers consist of a 3-2-1 countdown pattern of one-way clear reflective pavement markers. The pattern consists of three markers placed on the right shoulder 2100 feet in advance of the neutral area (gore), two markers at 1400 feet and one marker at 700 feet. The markers are placed on a line perpendicular to the lane line at 1 foot spacing beginning 2 inch off the edge of traveled way.

**Location Markers for Fire Hydrants**

**Option:**

<sup>18</sup> Blue raised reflective pavement markers, may be placed on a highway, street, or road, to mark fire hydrant and/or water supply locations.

**Standard:**

<sup>19</sup> **The blue raised reflective pavement markers shall not be used for any other purpose.**

<sup>20</sup> **Local agencies shall not place blue reflective pavement markers on a State highway unless they first obtain an encroachment permit from Caltrans. The agency responsible for the placement shall also be responsible for the maintenance and replacement. See Section 13060, of the Health and Safety Code. See Section 1A.11 for information regarding this publication.**

**Guidance:**

<sup>21</sup> *In general, the blue reflective pavement markers should be placed 6 inch from the centerline stripe, or approximate center of the pavement where there is no centerline stripe, on the side nearest the fire hydrant.*

<sup>22</sup> *When placed on expressways, freeways and freeway ramps, they should be placed on the shoulder, 1 foot to the right of the edge line, opposite the fire hydrant. Typical marker locations are shown on Figure 3B-102(CA).*

**Option:**

<sup>23</sup> Because fire hydrants adjacent to freeways may be out of the right-of-way and, in many locations, out of view from the freeway, some fire districts may want to install small supplemental signs (S9(CA) and S10(CA)) or markings to identify the hydrant number or distance to the hydrant. These installations are optional and at the discretion of Caltrans' Districts.

**Section 3B.12 Raised Pavement Markers as Vehicle Positioning Guides with Other Longitudinal Markings**

**Option:**

<sup>01</sup> Retroreflective or internally illuminated raised pavement markers may be used as positioning guides with longitudinal line markings without necessarily conveying information to the road user about passing or lane-use restrictions. In such applications, markers may be positioned in line with or immediately adjacent to a single line marking, or positioned between the two lines of a double center line or double lane line marking.

**Guidance:**

<sup>02</sup> ~~*The spacing for such applications should be 2N, where N equals the length of one line segment plus one gap (see Section 3B.11).*~~

**Option:**

<sup>03</sup> Where it is desired to alert the road user to changes in the travel path, such as on sharp curves or on transitions that reduce the number of lanes or that shift traffic laterally, the spacing ~~may be reduced to N or less~~ shown in Details 16, 17, 19, 20, 22 or 23 may be used.

~~04 On freeways and expressways, the spacing may be increased to 3N for relatively straight and level roadway segments where engineering judgment indicates that such spacing will provide adequate delineation under wet night conditions.~~

**Standard:**

**05 The widths and patterns of raised pavement markers shall conform to the details shown in Figures 3A-101(CA) through 3A-112(CA). See Section 3A.06.**

### **Section 3B.13 Raised Pavement Markers Supplementing Other Markings**

*Guidance:*

01 *The use of retroreflective or internally illuminated raised pavement markers for supplementing longitudinal line markings should comply with the following:*

*A. Lateral Positioning*

- 1. When supplementing double line markings, pairs of raised pavement markers placed laterally in line with or immediately outside of the two lines should be used.*
- 2. When supplementing wide line markings, pairs of raised pavement markers placed laterally adjacent to each other should be used.*

*B. Longitudinal Spacing*

- 1. When supplementing solid line markings, raised pavement markers at a spacing no greater than N (see Section 3B.11) should be used, except that when supplementing channelizing lines or edge line markings, a spacing of no greater than N/2 should be used.*
- 2. When supplementing broken line markings, a spacing no greater than 3N should be used. However, when supplementing broken line markings identifying reversible lanes, a spacing of no greater than N should be used.*
- 3. When supplementing dotted lane line markings, a spacing appropriate for the application should be used.*
- 4. When supplementing longitudinal line extension markings through at-grade intersections, one raised pavement marker for each short line segment should be used.*
- 5. When supplementing line extensions through freeway interchanges, a spacing of no greater than N should be used.*

02 *Raised pavement markers should not supplement right-hand edge lines unless an engineering study or engineering judgment indicates the benefits of enhanced delineation of a curve or other location would outweigh possible impacts on bicycles using the shoulder, and the spacing of raised pavement markers on the right-hand edge is close enough to avoid misinterpretation as a broken line during wet night conditions.*

*Option:*

03 *Raised pavement markers also may be used to supplement other markings such as channelizing islands, gore areas, approaches to obstructions, or wrong-way arrows.*

04 *To improve the visibility of horizontal curves, center lines may be supplemented with retroreflective or internally illuminated raised pavement markers for the entire curved section as well as for a distance in advance of the curve that approximates 5 seconds of travel time.*

**Standard:**

**05 The widths and patterns of raised pavement markers shall conform to the details shown in Figures 3A-101(CA) through 3A-112(CA). See Section 3A.06.**

### **Section 3B.14 Raised Pavement Markers Substituting for Pavement Markings**

*Option:*

01 *Retroreflective or internally illuminated raised pavement markers, or non-retroreflective raised pavement markers supplemented by retroreflective or internally illuminated markers, may be substituted for markings of other types.*

*Guidance:*

02 *If used, the pattern of the raised pavement markers should simulate the pattern of the markings for which they substitute.*

**Standard:**

**03 If raised pavement markers are used to substitute for broken line markings, a group of three to five markers equally spaced at a distance no greater than  $N/8$  (see Section 3B.11) shall be used. If  $N$  is other than 40 feet, the markers shall be equally spaced over the line segment length (at 1/2 points for three markers, at 1/3 points for four markers, and at 1/4 points for five markers). At least one retroreflective or internally illuminated marker per group shall be used or a retroreflective or internally illuminated marker shall be installed midway in each gap between successive groups of non-retroreflective markers.**

~~04 When raised pavement markers substitute for solid line markings, the markers shall be equally spaced at no greater than  $N/4$ , with retroreflective or internally illuminated units at a spacing no greater than  $N/2$ .~~

**04a The widths and patterns of raised pavement markers shall conform to the details shown in Figures 3A-101(CA) through 3A-112(CA). See Section 3A.06.**

*Guidance:*

*05 Raised pavement markers should not substitute for right-hand edge line markings unless an engineering study or engineering judgment indicates the benefits of enhanced delineation of a curve or other location would outweigh possible impacts on bicycles using the shoulder, and the spacing of raised pavement markers on the right-hand edge line is close enough to avoid misinterpretation as a broken line during wet night conditions.*

**Standard:**

~~06 When raised pavement markers substitute for dotted lines, they shall be spaced at no greater than  $N/4$ , with not less than one raised pavement marker per dotted line segment. At least one raised marker every  $N$  shall be retroreflective or internally illuminated.~~

*Option:*

*07 When substituting for wide lines, raised pavement markers may be placed laterally adjacent to each other to simulate the width of the line.*

**Standard:**

**08 If used on State highways, internally-illuminated raised pavement markers shall be installed by an encroachment permit and include a maintenance agreement as a provision of the permit for the service life of the markers.**

### **Section 3B.15 Transverse Markings**

**Standard:**

**01 Transverse markings, which include shoulder markings, word and symbol markings, arrows, stop lines, yield lines, crosswalk lines, speed measurement markings, speed reduction markings, speed hump markings, parking space markings, and others, shall be white unless otherwise provided in this Manual.**

**01a Crosswalk markings near schools shall be yellow. Refer to CVC 21368 and Part 7.**

*Guidance:*

*02 Because of the low approach angle at which pavement markings are viewed, transverse lines should be proportioned to provide visibility at least equal to that of longitudinal lines.*

*Support:*

*03 Refer to Caltrans' Standard Plans for pavement marking letters, numerals and symbols. See Section 1A.11 for information regarding this publication*

### **Section 3B.16 Stop and Yield Lines**

*Guidance:*

*01 Stop lines, if used, should be used to indicate the point behind which vehicles are required to stop in compliance with a traffic control signal.*

*Option:*

*02 Stop lines may be used to indicate the point behind which vehicles are required to stop in compliance with a STOP (R1-1) sign, a Stop Here For Pedestrians (R1-5b or R1-5c) sign, or some other traffic control device that requires vehicles to stop, except YIELD signs that are not associated with passive grade crossings.*

*03 Yield lines may be used to indicate the point behind which vehicles are required to yield in compliance with a YIELD (R1-2) sign or a Yield Here To Pedestrians (R1-5 or R1-5a) sign.*

**Standard:**

<sup>04</sup> Except as provided in Section 8B.28, stop lines shall not be used at locations where drivers are required to yield in compliance with a YIELD (R1-2) sign or a Yield Here To Pedestrians (R1-5 or R1-5a) sign or at locations on uncontrolled approaches where drivers are required by State law to yield to pedestrians.

<sup>05</sup> Yield lines shall not be used at locations where drivers are required to stop in compliance with a STOP (R1-1) sign, a ~~Stop Here For Pedestrians (R1-5b or R1-5c) sign~~, a traffic control signal, or some other traffic control device.

<sup>06</sup> Stop lines shall consist of solid white lines extending across approach lanes to indicate the point at which the stop is intended or required to be made.

<sup>07</sup> Yield lines (see Figure 3B-16) shall consist of a row of solid white isosceles triangles pointing toward approaching vehicles extending across approach lanes to indicate the point at which the yield is intended or required to be made.

*Guidance:*

<sup>08</sup> Stop lines should be 12 to 24 inches wide.

<sup>09</sup> The individual triangles comprising the yield line should have a base of 12 to 24 inches wide and a height equal to 1.5 times the base. The space between the triangles should be 3 to 12 inches.

<sup>10</sup> If used, stop and yield lines should be placed a minimum of 4 feet in advance of the nearest crosswalk line at controlled intersections, except for yield lines at roundabouts as provided for in Section 3C.04 and at midblock crosswalks. In the absence of a marked crosswalk, the stop line or yield line should be placed at the desired stopping or yielding point, but should not be placed more than 30 feet or less than 4 feet from the nearest edge of the intersecting traveled way.

<sup>11</sup> Stop lines at midblock signalized locations should be placed at least 40 feet in advance of the nearest signal indication (see Section 4D.14).

<sup>12</sup> If yield ~~or stop~~ lines are used at a crosswalk that crosses an uncontrolled multi-lane approach, the yield lines ~~or stop lines~~ should be placed 20 to 50 feet in advance of the nearest crosswalk line, and parking should be prohibited in the area between the yield ~~or stop~~ line and the crosswalk (see Figure 3B-17).

**Standard:**

<sup>13</sup> If yield (~~stop~~) lines are used at a crosswalk that crosses an uncontrolled multi-lane approach, Yield Here To (~~Stop Here For~~) Pedestrians (R1-5 series) signs (see Section 2B.11) shall be used.

*Guidance:*

<sup>14</sup> Yield (~~stop~~) lines and Yield Here To (~~Stop Here For~~) Pedestrians signs should not be used in advance of crosswalks that cross an approach to or departure from a roundabout.

**Support:**

<sup>15</sup> When drivers yield or stop too close to crosswalks that cross uncontrolled multi-lane approaches, they place pedestrians at risk by blocking other drivers' views of pedestrians and by blocking pedestrians' views of vehicles approaching in the other lanes.

**Option:**

<sup>16</sup> Stop and yield lines may be staggered longitudinally on a lane-by-lane basis (see Drawing D of Figure 3B-13).

**Support:**

<sup>17</sup> Staggered stop lines and staggered yield lines can improve the driver's view of pedestrians, provide better sight distance for turning vehicles, and increase the turning radius for left-turning vehicles.

<sup>18</sup> Section 8B.28 contains information regarding the use of stop lines and yield lines at grade crossings.

**Support:**

<sup>19</sup> As defined in CVC 377, a "limit line" is a solid white line not less than 12 inch nor more than 24 inch wide, extending across a roadway or any portion thereof to indicate the point at which traffic is required to stop in compliance with legal requirements.

**Standard:**

<sup>20</sup> For all purposes, limit line(s) as defined per CVC 377 shall mean stop line(s). See Paragraph 5.

*Guidance:*

<sup>21</sup> If a sidewalk exists, the limit line should be placed in advance of an unmarked crosswalk area.

Option:

<sup>22</sup> A limit line may be placed in advance of a crosswalk where vehicles are required to stop, in compliance with a STOP (R1-1) sign, traffic control signal or some other traffic control device.

Support:

<sup>23</sup> If a marked crosswalk is in place, it would normally function as a limit line.

<sup>24</sup> Typical limit line markings are shown in Figure 3B-103(CA).

### **Section 3B.17 Do Not Block Intersection Markings**

Support:

<sup>00</sup> Refer to CVC 22526 for entering intersection, rail crossing or marked crosswalk.

Option:

<sup>01</sup> Do Not Block Intersection markings may be used to mark the edges of an intersection area that is in close proximity to a signalized intersection, railroad crossing, or other nearby traffic control that might cause vehicles to stop within the intersection and impede other traffic entering the intersection. If authorized by law, Do Not Block Intersection markings with appropriate signs may also be used at other locations.

**Standard:**

<sup>02</sup> **If used, Do Not Block Intersection markings (see Figure 3B-18 3B-18(CA)) shall consist of one of the following alternatives:**

~~A. Wide solid white lines that outline the intersection area that vehicles must not block;~~

**B. Wide solid white lines that outline the intersection area that vehicles must not block and a white word message such as DO NOT BLOCK or KEEP CLEAR;**

~~C. Wide solid white lines that outline the intersection area that vehicles must not block and white cross-hatching within the intersection area; or~~

**D. A white word message, such as DO NOT BLOCK or KEEP CLEAR, within the intersection area that vehicles must not block.**

<sup>03</sup> **Do Not Block Intersection markings shall be accompanied by one or more DO NOT BLOCK INTERSECTION (DRIVEWAY) (CROSSING) (R10-7) signs (see Section 2B.53), one or more DO NOT STOP ON TRACKS (R8-8) signs (see Section 8B.09), or one or more similar signs.**

### **Section 3B.18 Crosswalk Markings**

Support:

<sup>01</sup> Crosswalk markings provide guidance for pedestrians who are crossing roadways by defining and delineating paths on approaches to and within signalized intersections, and on approaches to other intersections where traffic stops.

<sup>02</sup> In conjunction with signs and other measures, crosswalk markings help to alert road users of a designated pedestrian crossing point across roadways at locations that are not controlled by traffic control signals or STOP or YIELD signs.

<sup>03</sup> At non-intersection locations, crosswalk markings legally establish the crosswalk.

**Standard:**

<sup>04</sup> **When crosswalk lines are used, they shall consist of solid white lines that mark the crosswalk. They shall not be less than 6 1/2 inches or greater than 24 inches in width.**

*Guidance:*

<sup>05</sup> *If transverse lines are used to mark a crosswalk, the gap between the lines should not be less than 6 feet. If diagonal or longitudinal lines are used without transverse lines to mark a crosswalk, the crosswalk should be not less than 6 feet wide.*



*06 Crosswalk lines, if used on both sides of the crosswalk, should extend across the full width of pavement or to the edge of the intersecting crosswalk to discourage diagonal walking between crosswalks (see Figures 3B-17 and 3B-19).*

*07 At locations controlled by traffic control signals or on approaches controlled by STOP or YIELD signs, crosswalk lines should be installed where engineering judgment indicates they are needed to direct pedestrians to the proper crossing path(s).*

*08 Crosswalk lines should not be used indiscriminately. An engineering study should be performed before a marked crosswalk is installed at a location away from a traffic control signal or an approach controlled by a STOP or YIELD sign. The engineering study should consider the number of lanes, the presence of a median, the distance from adjacent signalized intersections, the pedestrian volumes and delays, the average daily traffic (ADT), the posted or statutory speed limit or 85<sup>th</sup>-percentile speed, the geometry of the location, the possible consolidation of multiple crossing points, the availability of street lighting, and other appropriate factors.*

*09 New marked crosswalks **across uncontrolled roadways should include alone, without other measures designed to reduce traffic speeds, shorten crossing distances, enhance driver awareness of the crossing, and/or provide active warning of pedestrian presence, should not be installed across uncontrolled roadways where the speed limit exceeds 40 mph and either:***

- A. The roadway has four or more lanes of travel without a raised median or pedestrian refuge island and an ADT of 12,000 vehicles per day or greater; or*
- B. The roadway has four or more lanes of travel with a raised median or pedestrian refuge island and an ADT of 15,000 vehicles per day or greater.*

*09a If a marked crosswalk exists across an uncontrolled roadway where the speed limit exceeds 40 mph and the roadway has four or more lanes of travel and an ADT of 12,000 vehicles per day or greater, advanced yield lines with associated Yield Here to Pedestrians (R1-5, R1-5a) signs should be placed 20 to 50 ft in advance of the crosswalk, adequate visibility should be provided by parking prohibitions, pedestrian crossing (W11-2) warning signs with diagonal downward pointing arrow (W16-7p) plaques should be installed at the crosswalk, and a high-visibility crosswalk marking pattern should be used (See Figure 3B-17(CA)).*

Support:

*10 Chapter 4F contains information on Pedestrian Hybrid Beacons. Section 4L.03 contains information regarding Warning Beacons to provide active warning of a pedestrian's presence. Section 4N.02 contains information regarding In-Roadway Warning Lights at crosswalks. Chapter 7D contains information regarding school crossing supervision.*

Guidance:

*11 Because non-intersection pedestrian crossings are generally unexpected by the road user, warning signs (see Section 2C.50) should be installed for all marked crosswalks at non-intersection locations and adequate visibility should be provided by parking prohibitions.*

Support:

*12 Section 3B.16 contains information regarding placement of stop line markings near crosswalk markings.*

Option:

*13 For added visibility, the area of the crosswalk may be marked with white diagonal lines at a 45-degree angle to the line of the crosswalk or with white longitudinal lines parallel to traffic flow as shown in Figure 3B-19.*

*14 When diagonal or longitudinal lines are used to mark a crosswalk, the transverse crosswalk lines may be omitted*

Guidance:

*14a This type of marking should be used at locations where substantial numbers of pedestrians cross without any other traffic control device, at locations where physical conditions are such that added visibility of the crosswalk is desired, or at places where a pedestrian crosswalk might not be expected.*

*15 If used, the diagonal or longitudinal lines should be 12 to 24 inches wide and separated by gaps of 12 to 60 inches. The design of the lines and gaps should avoid the wheel paths if possible, and the gap between the lines should not exceed 2.5 times the width of the diagonal or longitudinal lines.*

Option:

*16 When an exclusive pedestrian phase that permits diagonal crossing of an intersection is provided at a traffic control signal, a marking as shown in Figure 3B-20 may be used for the crosswalk.*

*Guidance:*

*17 Crosswalk markings should be located so that the curb ramps are within the extension of the crosswalk markings.*

*Support:*

*18 Detectable warning surfaces mark boundaries between pedestrian and vehicular ways where there is no raised curb. Detectable warning surfaces are required by 49 CFR, Part 37 and by the Americans with Disabilities Act (ADA) where curb ramps are constructed at the junction of sidewalks and the roadway, for marked and unmarked crosswalks. Detectable warning surfaces contrast visually with adjacent walking surfaces, either light-on-dark, or dark-on-light. The "Americans with Disabilities Act Accessibility Guidelines for Buildings and Facilities (ADAAG)" (see Section 1A.11) contains specifications for design and placement of detectable warning surfaces.*

**Standard:**

**19 Crosswalk markings near schools shall be yellow as provided in CVC 21368. See Part 7.**

*Option:*

*20 Pedestrian crosswalk markings may be placed at intersections, representing extensions of the sidewalk lines, or on any portion of the roadway distinctly indicated for pedestrian crossing. Refer to CVC 275.*

*Guidance:*

*21 In general, crosswalks should not be marked at intersections unless they are intended to channelize pedestrians. Emphasis is placed on the use of marked crosswalks as a channelization device.*

*22 The following factors may be considered in determining whether a marked crosswalk should be used:*

- A. Vehicular approach speeds from both directions.*
- B. Vehicular volume and density.*
- C. Vehicular turning movements.*
- D. Pedestrian volumes.*
- E. Roadway width.*
- F. Day and night visibility by both pedestrians and road users.*
- G. Channelization is desirable to clarify pedestrian routes for sighted or sight impaired pedestrians.*
- H. Discouragement of pedestrian use of undesirable routes.*
- I. Consistency with markings at adjacent intersections or within the same intersection.*

*Option:*

*23 Crosswalk markings may be established between intersections (mid-block) in accordance with CVC 21106(a).*

*Guidance:*

*24 Mid-block pedestrian crossings are generally unexpected by the motorist and should be discouraged unless, in the opinion of the engineer, there is strong justification in favor of such installation. Particular attention should be given to roadways with two or more traffic lanes in one direction as a pedestrian may be hidden from view by a vehicle yielding the right-of-way to a pedestrian.*

*Option:*

*25 When diagonal or longitudinal lines are used to mark a crosswalk, the transverse crosswalk lines may be omitted.*

**Standard:**

**26 However, when the factor that determined the need to mark a crosswalk is the clarification of pedestrian routes for sight-impaired pedestrians, the transverse crosswalk lines shall be marked.**

*Option:*

*27 At controlled approaches, limit lines (stop lines) help to define pedestrian paths and are therefore a factor the engineer may consider in deciding whether or not to mark the crosswalk.*

*28 Where it is desirable to remove a marked crosswalk, the removal may be accomplished by repaving or surface treatment.*

*Guidance:*

*29 A marked crosswalk should not be eliminated by allowing it to fade out or be worn away.*

*Support:*

*30 The worn or faded crosswalk retains its prominent appearance to the pedestrian at the curb, but is less visible to the approaching road user.*

**Standard:**

**31 Notification to the public shall be given at least 30 days prior to the scheduled removal of an existing marked crosswalk. The notice of proposed removal shall inform the public how to provide input related to the scheduled removal and shall be posted at the crosswalk identified for removal. Refer to CVC 21950.5**

Option:

<sup>32</sup> Signs may be installed at or adjacent to an intersection directing that pedestrians shall not cross in a crosswalk indicated at the intersection in accordance with CVC 21106(b).

<sup>33</sup> White PED XING pavement markings may be placed in each approach lane to a marked crosswalk, except at intersections controlled by traffic signals or STOP or YIELD signs.

### **Section 3B.19 Parking Space Markings**

Support:

<sup>01</sup> Marking of parking space boundaries encourages more orderly and efficient use of parking spaces where parking turnover is substantial. Parking space markings tend to prevent encroachment into fire hydrant zones, bus stops, loading zones, approaches to intersections, curb ramps, and clearance spaces for islands and other zones where parking is restricted. Examples of parking space markings are shown in Figure ~~3B-21~~ 3B-21(CA).

**Standard:**

<sup>02</sup> **Parking space markings shall be white.**

Option:

<sup>03</sup> Blue lines may supplement white parking space markings of each parking space designated for use only by persons with disabilities.

Support:

<sup>04</sup> Additional parking space markings for the purpose of designating spaces for use only by persons with disabilities are discussed in Section 3B.20 and illustrated in Figure ~~3B-22~~ 3B-22(CA). The design and layout of accessible parking spaces for persons with disabilities is provided in the "Americans with Disabilities Act Accessibility Guidelines (ADAAG)" (see Section 1A.11).

Support:

<sup>05</sup> Refer to CVC 22500 through 22522 for parking space markings.

<sup>06</sup> Refer to Section 2B.39 for Parking Regulations.

### **Policy on Parking Restrictions**

Option:

<sup>07</sup> Local authorities may, by ordinance, provide for the establishment of parking meter zones and cause streets and highways to be marked with white lines designating parking spaces. Refer to CVC Section 22508.

**Standard:**

<sup>08</sup> **Where the proposed zones are on State highways, the ordinances shall be approved by Caltrans.**

<sup>09</sup> **Local authorities shall furnish a sketch or map showing the definite location of all parking meter stalls on State highways before Caltrans approval is given.**

Support:

<sup>10</sup> The District Directors have been delegated the authority to approve such ordinances.

<sup>11</sup> The desirable dimensions of parking meter stalls are 8 feet by 24 feet with a minimum length of 20 feet.

Guidance:

<sup>12</sup> *At all intersections, one stall length on each side measured from the crosswalk or end of curb return should have parking prohibited. A clearance of 6 feet measured from the curb return should be provided at alleys and driveways.*

<sup>13</sup> *At signalized intersections parking should be prohibited for a minimum of 30 feet on the near side and one stall length on the far side. See Figure 3B-21(CA).*

**Standard:**

<sup>14</sup> **The departmental approval for the installation of the parking meters shall be covered by an encroachment permit.**

### **Section 3B.20 Pavement Word, Symbol, and Arrow Markings**

**Support:**

<sup>01</sup> Word, symbol, and arrow markings on the pavement are used for the purpose of guiding, warning, or regulating traffic. These pavement markings can be helpful to road users in some locations by supplementing signs and providing additional emphasis for important regulatory, warning, or guidance messages, because the markings do not require diversion of the road user's attention from the roadway surface. Symbol messages are preferable to word messages. Examples of standard word and arrow pavement markings are shown in Figures ~~3B-23~~ **3B-23(CA)** and ~~3B-24~~ **3B-24(CA)**.

<sup>01a</sup> Normally, pavement word and symbol markings supplement standard signing.

**Option:**

<sup>02</sup> Word, symbol, and arrow markings, including those contained in the "Standard Highway Signs and Markings" book (see Section 1A.11), may be used as determined by engineering judgment to supplement signs and/or to provide additional emphasis for regulatory, warning, or guidance messages. Among the word, symbol, and arrow markings that may be used are the following:

A. Regulatory:

1. STOP
2. YIELD
3. RIGHT (LEFT) TURN ONLY
4. 25 MPH
5. Lane-use and wrong-way arrows
6. Diamond symbol for HOV lanes
7. Other preferential lane word markings

B. Warning:

1. STOP AHEAD
2. YIELD AHEAD
3. YIELD AHEAD triangle symbol
4. SCHOOL XING
5. SIGNAL AHEAD
6. PED XING
7. SCHOOL
8. R X R
9. BUMP
10. HUMP
11. Lane-reduction arrows
12. TRAIL XING

C. Guide:

1. Route numbers (route shield pavement marking symbols and/or words such as I-81, US 40, STATE 135, or ROUTE 10)
2. Cardinal directions (NORTH, SOUTH, EAST, or WEST)
3. TO
4. Destination names or abbreviations thereof

**Standard:**

<sup>03</sup> **Word, symbol, and arrow markings shall be white, except as otherwise provided in this Section.**

<sup>04</sup> **Pavement marking letters, numerals, symbols, and arrows shall be installed in accordance with the design details in the Pavement Markings chapter of the "Standard Highway Signs and Markings" book (see Section 1A.11).**

*Guidance:*

<sup>05</sup> *Letters and numerals should be 6 feet or more in height.*

<sup>06</sup> *Word and symbol markings should not exceed three lines of information.*

<sup>07</sup> *If a pavement marking word message consists of more than one line of information, it should read in the direction of travel. The first word of the message should be nearest to the road user.*

<sup>08</sup> Except for the two opposing arrows of a two-way left-turn lane marking (see Figure 3B-7), the longitudinal space between word or symbol message markings, including arrow markings, should be at least four times the height of the characters for low-speed roads, but not more than ten times the height of the characters under any conditions.

<sup>09</sup> The number of different word and symbol markings used should be minimized to provide effective guidance and avoid misunderstanding.

<sup>10</sup> Except for the SCHOOL word marking (see Section 7C.03), pavement word, symbol, and arrow markings should be no more than one lane in width.

Option:

<sup>11</sup> Pavement word, symbol, and arrow markings ~~should~~ **may** be proportionally ~~scaled~~ **spaced** to fit within the width of the facility upon which they are applied.

Option:

<sup>12</sup> On narrow, low-speed shared-use paths, the pavement words, symbols, and arrows may be smaller than suggested, but to the relative scale.

<sup>13</sup> Pavement markings simulating Interstate, U.S., State, and other official highway route shield signs (see Figure 2D-3) with appropriate route numbers, but elongated for proper proportioning when viewed as a marking, may be used to guide road users to their destinations (see Figure 3B-25).

**Standard:**

<sup>14</sup> **Except at the ends of aisles in parking lots, the word STOP shall not be used on the pavement unless accompanied by a stop line (see Section 3B.16) and STOP sign (see Section 2B.05). At the ends of aisles in parking lots, the word STOP shall not be used on the pavement unless accompanied by a stop line.**

<sup>15</sup> **The word STOP shall not be placed on the pavement in advance of a stop line, unless every vehicle is required to stop at all times.**

Guidance:

<sup>15a</sup> *A STOP pavement marking should be placed on all but minor approaches to State highways not controlled by signals.*

Option:

<sup>15b</sup> *Pavement markings with appropriate figures may be used to supplement speed limit signs. See Section 2B.13.*

Option:

<sup>16</sup> A yield-ahead triangle symbol (see Figure 3B-26) or YIELD AHEAD word pavement marking may be used on approaches to intersections where the approaching traffic will encounter a YIELD sign at the intersection.

**Standard:**

<sup>17</sup> **The yield-ahead triangle symbol or YIELD AHEAD word pavement marking shall not be used unless a YIELD sign (see Section 2B.08) is in place at the intersection. The yield-ahead symbol marking shall be as shown in Figure 3B-26.**

~~Guidance:~~

~~<sup>18</sup> **The International Symbol of Accessibility parking space marking (see Figure 3B-22) should be placed in each parking space designated for use by persons with disabilities.**~~

~~Option:~~

~~<sup>18</sup> **The International Symbol of Accessibility (ISA) parking space marking shall be placed in each off-street parking space (see Figure 3B.22(CA)).**~~

~~Guidance:~~

~~<sup>18a</sup> *The ISA parking space marking (3B-22(CA)) should be placed in each on-street parking space designated for use by persons with disabilities.*~~

~~**Standard:**~~

~~<sup>19</sup> **A blue background with white border ~~may~~ **shall** supplement the wheelchair symbol as shown in Figure ~~3B-22~~ **3B-22(CA).****~~

~~<sup>19a</sup> **If used, new construction of accessible off-street parking spaces, and, loading and unloading areas shall include pavement marking details shown on Figure 3B-22 (CA), or as shown on Caltrans' Standard Plan A90A. The loading and unloading area shall be marked by a border and hatched lines. The border shall be painted blue and the hatched lines shall be painted a suitable contrasting color to the parking space (blue or white paint is preferred).**~~

**19b If used, new construction of accessible on-street parking shall include a blue painted curb, as shown on Caltrans' Standard Plan A90B. If on-street parking designated and designed for persons with disabilities includes a loading and unloading area, it shall be marked by a border and hatched lines. The border shall be painted blue and the hatched lines shall be painted a suitable contrasting color to the parking space (blue or white paint is preferred).**

**19c Loading and unloading areas shall include the words "NO PARKING" within the blue border and shall be painted in white letters no less than 12 inch high (See detail in Figure 3B-22 (CA)). Refer to California Code of Regulations Title 24, Section 1129B.4.**

Support:

**20 Lane-use arrow markings (see Figure ~~3B-24~~ 3B-24(CA)) are used to indicate the mandatory or permissible movements in certain lanes (see Figure 3B-27) and in two-way left-turn lanes (see Figure 3B-7).**

Guidance:

**21 Lane-use arrow markings (see Figure ~~3B-24~~ 3B-24(CA)) should be used in lanes designated for the exclusive use of a turning movement, including turn bays, except where engineering judgment determines that physical conditions or other markings (such as a dotted extension of the lane line through the taper into the turn bay) clearly discourage unintentional use of a turn bay by through vehicles. Lane-use arrow markings should also be used in lanes from which movements are allowed that are contrary to the normal rules of the road (see Drawing B of Figure 3B-13). When used in turn lanes, at least two arrows should be used, one at or near the upstream end of the full-width turn lane and one an appropriate distance upstream from the stop line or intersection (see Drawing A of Figure 3B-11).**

Option:

**22 An additional arrow or arrows may be used in a turn lane. When arrows are used for a short turn lane, the second (downstream) arrow may be omitted based on engineering judgment.**

Guidance:

**23 Where opposing offset channelized left-turn lanes exist, lane-use arrow markings should be placed near the downstream terminus of the offset left-turn lanes to reduce wrong-way movements (see Figure 2B-17).**

Support:

**24 An arrow at the downstream end of a turn lane can help to prevent wrong way movements.**

**Standard:**

**25 Where through lanes approaching an intersection become mandatory turn lanes, lane-use arrow markings (see Figure ~~3B-24~~ 3B-24(CA)) shall be used and shall be accompanied by standard signs.**

#### **Arrows:**

**Standard:**

**25a Where a turning movement is mandatory, an arrow marking accompanied by a regulatory sign shall be used. However, when an additional clearly marked lane is provided for the approach to the turning movement, the sign is not required. Refer to CVC 22101.**

Support:

**25b Examples of entrance/exit ramp terminal signs and pavement markings are shown in Figure 3B-24(CA).**

Guidance:

**25c The Type V arrows and warning signs, as shown in Figure 3B-104(CA), should be used at locations where road users could perceive that they are on a one-way roadway when, in fact, they are on a two lane, two-way highway. Following are some typical situations:**

- A. Construction sites where a two-lane highway is being converted to a freeway or an expressway.**
- B. Two-lane, two-way highways where ultimate freeway or expressway right-of-way has been purchased and grading for the full width has been completed.**
- C. Two-lane, two-way highways following long sections of multi-lane freeway or expressway.**

#### **Exit Ramp Arrows:**

**Standard:**

**25d A minimum of two pavement arrows shall be placed on each freeway exit ramp lane.**

**25e A Type V arrow shall be the first arrow, on the ramp, in the direction of travel when exiting the freeway.**

**25f Where a mandatory movement is required, a Type I, II, III, IV, VII, or VIII arrow shall be placed with its point approximately 20 feet preceding the limit line, crosswalk or "STOP" pavement legend. Where no mandatory movement is required, a Type V arrow shall be used at this location.**

**25g All other additional arrows, when used, shall be a minimum of 24 feet in length.**

<sup>25h</sup> **All arrows shall be placed in the center of the lane and spaced approximately 100 feet to 300 feet apart.**

*Guidance:*

<sup>25i</sup> *The actual position and spacing should be determined in the field to provide the optimum visibility for traffic that may attempt to enter the exit ramp in the wrong direction.*

*Support:*

<sup>25j</sup> See Figure 3B-24(CA).

**Entrance Ramp Arrows:**

**Standard:**

<sup>25k</sup> **A minimum of one Type I arrow, not less than 18 feet in length, shall be positioned in the center of each freeway entrance ramp lane so that it is clearly in view of a right-way road user.**

*Guidance:*

<sup>25l</sup> *The distance between arrows, when more than one per lane is needed, should be 100 feet to 300 feet. The Type V arrow should not be used on entrance ramps.*

*Support:*

<sup>25m</sup> See Figure 3B-24(CA).

<sup>25n</sup> Additional information on signing of ramp terminals is shown in Section 2E.53.

**Turn Lane Arrows:**

**Standard:**

<sup>25o</sup> **One directional arrow, a minimum of 8 feet in length, shall be placed in the center of each turning lane near the point of entrance.**

*Option:*

<sup>25p</sup> High approach speeds may justify the use of a longer arrow. Two or more arrows may be placed in long turning lanes.

*Support:*

<sup>25q</sup> See Figures 3B-7(CA) and 3B-101(CA).

<sup>25r</sup> Refer to Section 2B.41 and 2E.53 for Wrong-Way Traffic Control at Interchange Ramps.

*Guidance:*

<sup>26</sup> *Where through lanes approaching an intersection become mandatory turn lanes, ONLY word markings (see Figure ~~3B-23~~ 3B-23(CA)) should be used in addition to the required lane-use arrow markings and signs (see Sections 2B.19 and 2B.20). These markings and signs should be placed well in advance of the turn and should be repeated as necessary to prevent entrapment and to help the road user select the appropriate lane in advance of reaching a queue of waiting vehicles (see Drawing A of Figure 3B-11).*

*Option:*

<sup>27</sup> On freeways or expressways where a through lane becomes a mandatory exit lane, lane-use arrow markings may be used on the approach to the exit in the dropped lane and in an adjacent optional through-or-exit lane if one exists.

*Guidance:*

<sup>28</sup> *A two-way left-turn lane-use arrow pavement marking, with opposing arrows spaced as shown in Figure 3B-7, should be used at or just downstream from the beginning of a two-way left-turn lane.*

*Option:*

<sup>29</sup> Additional two-way left-turn lane-use arrow markings may be used at other locations along a two-way left-turn lane where engineering judgment determines that such additional markings are needed to emphasize the proper use of the lane.

**Standard:**

<sup>30</sup> **A single-direction lane-use arrow shall not be used in a lane bordered on both sides by yellow two-way left-turn lane longitudinal markings.**

<sup>31</sup> **Lane-use, lane-reduction, and wrong-way arrow markings shall be designed as shown in Figure 3B-24 3B-24(CA) and in the “Standard Highway Signs and Markings” book (see Section 1A.11).**

*Option:*

<sup>32</sup> The ONLY word marking (see Figure ~~3B-23~~ 3B-23(CA)) may be used to supplement the lane-use arrow markings in lanes that are designated for the exclusive use of a single movement (see Figure 3B-27) or to supplement a preferential lane word or symbol marking (see Section 3D.01).

**Standard:**

**33 The ONLY word marking shall not be used in a lane that is shared by more than one movement.**

*Guidance:*

*34 Where a lane-reduction transition occurs on a roadway with a speed limit of 45 mph or more, the lane-reduction arrow markings shown in Drawing f in Figure ~~3B-24~~ 3B-24(CA) should be used (see Figure ~~3B-14~~ 3B-14(CA)). Except for acceleration lanes, where a lane-reduction transition occurs on a roadway with a speed limit of less than 45 mph, the lane-reduction arrow markings shown in Drawing f in Figure ~~3B-24~~ 3B-24(CA) should be used if determined to be appropriate based on engineering judgment.*

*Option:*

*35 Lane-reduction arrow markings may be used in long acceleration lanes based on engineering judgment.*

*Guidance:*

*36 Where crossroad channelization or ramp geometrics do not make wrong-way movements difficult, the appropriate lane-use arrow should be placed in each lane of an exit ramp near the crossroad terminal where it will be clearly visible to a potential wrong-way road user (see Figure 2B-18).*

*Option:*

*37 The wrong-way arrow markings shown in Drawing D in Figure ~~3B-24~~ 3B-24(CA) may be placed near the downstream terminus of a ramp as shown in Figures 2B-18 and ~~2B-19~~, or at other locations where lane-use arrows are not appropriate, to indicate the correct direction of traffic flow and to discourage drivers from traveling in the wrong direction.*

*38 Electric vehicle charging stations in off-street locations may be marked with white, twelve-inch high EV CHARGING ONLY pavement marking (See Figure 3B-108(CA)) to supplement Electric Vehicle Charging Station signs in sections 2B.46 and 2I.03.*

**Standard:**

**39 Each electric vehicle charging station designated for Van Accessible, Standard Accessible and Ambulatory electric vehicle charging stations shall be marked with a white, twelve-inch high EV CHARGING ONLY pavement marking (See Figure 3B-108(CA) to supplement signs, per CBC, Chapter 11B, Section 812.9, and Figure 11B-812.9).**

### **Section 3B.21 Speed Measurement Markings**

**Support:**

*01 A speed measurement marking is a transverse marking placed on the roadway to assist the enforcement of speed regulations.*

**Standard:**

**02 Speed measurement markings, if used, shall be white, and shall not be greater than 24 inches in width.**

**Option:**

*03 Speed measurement markings may extend 24 inches on either side of the center line or 24 inches on either side of edge line markings at 1/4-mile intervals over a 1-mile length of roadway. When paved shoulders of sufficient width are available, the speed measurement markings may be placed entirely on these shoulders (see ~~Drawing A of Figure 3B-10~~ 3B-105(CA)). Advisory signs may be used in conjunction with these markings.*

**Support:**

*04 The California Highway Patrol patrols certain highways with both helicopters and fixed-wing aircraft. The purpose of the patrol is to monitor traffic, provide motorist assistance and initiate appropriate enforcement action.*

*05 In order to make the air patrol effective, the California Highway Patrol and Caltrans have agreed upon markings and signs as shown in Figure 3B-105(CA).*

**Option:**

*06 Speed measurement markings may be placed on the right shoulder in areas patrolled by aircraft as requested by the California Highway Patrol.*

**Standard:**

**07 Where there is an equation of more than 100 feet in a 1 mile posting, a white 'X' pavement marking shall be placed at each end of the section to indicate the markings are less than 1 mile apart.**

**Support:**

*08 An equation is a place where post mile on a linear feature, such as a highway or rail line, fail to increase normally, usually due to realignment or changes in planned alignment.*



*Guidance:*

*09 The SPEED ENFORCED BY AIRCRAFT (R48-2(CA)) sign should be used for both directions of travel and should be spaced at 25 mile intervals.*

*10 Pavement marking should be placed on the shoulder in one direction only, except where the opposing roadway is widely separated.*

*Option:*

*11 In areas where identifying features are widely separated, white 3 feet high post mile numbers may be placed at 5 mile points where needed for aircraft reference.*

**Standard:**

**12 Markings shall not be on the traveled way.**

*Option:*

*13 If routes with narrow shoulders are requested for marking, the standard marking shape may be modified to provide an equivalent area without encroaching on the traveled way or the Alternate Marking System described.*

*Support:*

*14 The Alternate Marking System is an 8 inch wide solid white longitudinal line, 20 feet in length and in line with the right edge line. It is preceded and followed by a 20 feet gap in the right edge line.*

### **Section 3B.22 Speed Reduction Markings**

*Support:*

*01 Speed reduction markings (see Figure 3B-28) are transverse markings that are placed on the roadway within a lane (along both edges of the lane) in a pattern of progressively reduced spacing to give drivers the impression that their speed is increasing. These markings might be placed in advance of an unexpectedly severe horizontal or vertical curve or other roadway feature where drivers need to decelerate prior to reaching the feature and where the desired reduction in speeds has not been achieved by the installation of warning signs and/or other traffic control devices.*

*Guidance:*

*02 If used, speed reduction markings should be reserved for unexpected curves and should not be used on long tangent sections of roadway or in areas frequented mainly by local or familiar drivers, (e.g., school zones). If used, speed reduction markings should supplement the appropriate warning signs and other traffic control devices and should not substitute for these devices.*

**Standard:**

**03 If used, speed reduction markings shall be a series of white transverse lines on both sides of the lane that are perpendicular to the center line, edge line, or lane line. The longitudinal spacing between the markings shall be progressively reduced from the upstream to the downstream end of the marked portion of the lane.**

*Guidance:*

*04 Speed reduction markings should not be greater than 12 inches in width, and should not extend more than 18 inches into the lane.*

**Standard:**

**05 Speed reduction markings shall not be used in lanes that do not have a longitudinal line (center line, edge line, or lane line) on both sides of the lane.**

### **Section 3B.23 Curb Markings**

*Support:*

*01 Curb markings are most often used to indicate parking regulations or to delineate the curb.*

**Standard:**

**02 Where curbs are marked to convey parking regulations in areas where curb markings are frequently obscured by snow and ice accumulation, signs shall be used with the curb markings except as provided in Paragraph 4.**

*Guidance:*

*03 Except as provided in Paragraph 4, when curb markings are used without signs to convey parking regulations, a legible word marking regarding the regulation (such as "No Parking" or "No Standing") should be placed on the curb.*

Option:

*04 Curb markings without word markings or signs may be used to convey a general prohibition by statute of parking within a specified distance of a stop sign, YIELD sign, driveway, fire hydrant, or crosswalk.*

*05 Local highway agencies may prescribe special colors for curb markings to supplement standard signs for parking regulation.*

Support:

*06 Since yellow and white curb markings are frequently used for curb delineation and visibility, it is advisable to establish parking regulations through the installation of standard signs (see Sections 2B.46 through 2B.48).*

**Standard:**

**07 Where curbs are marked for delineation or visibility purposes, the colors shall comply with the general principles of markings (see Section 3A.05).**

Guidance:

*08 Retroreflective solid yellow markings should be placed on the approach ends of raised medians and curbs of islands that are located in the line of traffic flow where the curb serves to channel traffic to the right of the obstruction.*

*09 Retroreflective solid white markings should be used when traffic is permitted to pass on either side of the island.*

Support:

*09a Refer to Sections 2C.63 through 2C.66 for marking noses of raised medians and curbs of islands with object markers.*

Support:

*10 Where the curbs of the islands become parallel to the direction of traffic flow, it is not necessary to mark the curbs unless an engineering study indicates the need for this type of delineation.*

*11 Curbs at openings in a continuous median island need not be marked unless an engineering study indicates the need for this type of marking.*

Option:

*12 Retroreflective or internally illuminated raised pavement markers of the appropriate color may be placed on the pavement in front of the curb and/or on the top of curbed noses of raised medians and curbs of islands, as a supplement to or substitute for retroreflective curb markings used for delineation.*

Support:

*13 Refer to Section 2B.46 for Parking Regulations.*

*14 In California, curb markings are not used for delineating traffic. They are mainly used for parking regulations.*

**Standard:**

**15 The color of curb markings shall conform to CVC 21458 quoted below:**

**(a) Whenever local authorities enact local parking regulations and indicate them by the use of paint upon curbs, the following colors only shall be used, and the colors indicate as follows:**

**(1) Red indicates no stopping, standing, or parking, whether the vehicle is attended or unattended, except that a bus may stop in a red zone marked or sign posted as a bus loading zone.**

**(2) Yellow indicates stopping only for the purpose of loading or unloading passengers or freight for the time as may be specified by local ordinance.**

**(3) White indicates stopping for either of the following purposes:**

**(A) Loading or unloading of passengers for the time as may be specified by local ordinance.**

**(B) Depositing mail in an adjacent mailbox.**

**(4) Green indicates time limit parking specified by local ordinance.**

**(5) Blue indicates parking limited exclusively to the vehicles of disabled persons and disabled veterans.**

**(b) Regulations adopted pursuant to subdivision (a) shall be effective on days and during hours or times as prescribed by local ordinances.**

**16 Parking regulations shall be covered by ordinance or order of the authority having jurisdiction over the street or highway.**

Option:

*17 Curb markings may supplement standard signs.*

<sup>18</sup> Prohibitions or restrictions enacted by local authorities under Sections 22506 or 22507 may be indicated by marking curbs as prescribed by CVC Section 21458.

### **Policy on Parking Restrictions**

Support:

<sup>19</sup> Loading Zones - Local authorities are authorized by Section 21112 of the CVC to license and regulate the location of stands on streets and highways for use of taxicabs and other public carriers for hire. Where such stands are located on State highways, and highway maintenance is not delegated to the local authority, the approval of Caltrans is required. The District Directors have been delegated authority to approve local ordinances establishing such stands.

<sup>20</sup> Loading zone ordinances restricted for certain segments of traffic such as "hotel patrons only" will not be approved. Bus stand ordinances are generally approved.

**Standard:**

<sup>21</sup> **Whenever practicable, bus stands shall be located on the far side of the intersection.**

### **Section 3B.24 Chevron and Diagonal Crosshatch Markings**

Option:

<sup>01</sup> Chevron and diagonal crosshatch markings may be used to discourage travel on certain paved areas, such as shoulders, gore areas, flush median areas between solid double yellow center line markings or between white channelizing lines approaching obstructions in the roadway (see Section 3B.10 and Figure 3B-15), between solid double yellow center line markings forming flush medians or channelized travel paths at intersections (see Figures 3B-2 and 3B-5), buffer spaces between preferential lanes and general-purpose lanes (see Figures 3D-2 and 3D-4), and at grade crossings (see Part 8).

**Standard:**

<sup>02</sup> **When crosshatch markings are used in paved areas that separate traffic flows in the same general direction, they shall be white and they shall be shaped as chevron markings, with the point of each chevron facing toward approaching traffic, as shown in Figure 3B-8 3B-8(CA), Drawing A of Figure 3B-9 3B-9(CA), Figure 3B-10 3B-10(CA), and Drawing C of Figure 3B-15.**

<sup>03</sup> **When crosshatch markings are used in paved areas that separate opposing directions of traffic, they shall be yellow diagonal markings that slant away from traffic in the adjacent travel lanes, as shown in Figures 3B-2 and 3B-5 and Drawings A and B of Figure 3B-15.**

<sup>04</sup> **When crosshatch markings are used on paved shoulders, they shall be diagonal markings that slant away from traffic in the adjacent travel lane. The diagonal markings shall be yellow when used on the left-hand shoulders of the roadways of divided highways and on the left-hand shoulders of one-way streets or ramps. The diagonal markings shall be white when used on right-hand shoulders.**

*Guidance:*

<sup>05</sup> *The chevrons and diagonal lines used for crosshatch markings should be at least 12 inches wide for roadways having a posted or statutory speed limit of 45 mph or greater, and at least 8 inches wide for roadways having posted or statutory speed limit of less than 45 mph. The longitudinal spacing of the chevrons or diagonal lines should be determined by engineering judgment considering factors such as speeds and desired visual impacts. The chevrons and diagonal lines should form an angle of approximately 30 to 45 degrees with the longitudinal lines that they intersect.*

<sup>06</sup> *Diagonal and chevron markings should be used, when in the opinion of an engineer, it is necessary to add emphasis or to discourage vehicular travel upon a paint-formed roadway feature such as an unusually wide shoulder area, a pedestrian refuge island, or a traffic divisional or channelization island.*

<sup>07</sup> *Diagonal lines, when used, should be installed between an edge line and traffic island, or between pairs of double yellow lines.*

<sup>08</sup> *Chevron markings, when used, should be installed between channelizing lines for traffic flows in the same direction.*

Support:

<sup>09</sup> The applicable channelizing lines for chevron markings are shown in Figure 3A-110(CA), Details 36, 36A and 36B and pairs of lines shown in Figure 3A-112(CA), Details 38 and 38A.

<sup>10</sup> The diagonal lines or chevron markings are normally 12 inch wide.

**Standard:**

**11 Diagonal lines and chevrons shall be the same color as the line or lines to which they connect and shall point at a 45-degree forward angle.**

**12 Diagonal lines or chevrons, if used, shall be the same color as the edge line.**

Option:

**13 The spacing between these lines may vary from 1 foot in a pedestrian crosswalk to 200 feet for vehicular traffic.**

### **Section 3B.25 Speed Hump Markings**

**Standard:**

**01 If speed hump markings are used, they shall be a series of white markings placed on a speed hump to identify its location. If markings are used for a speed hump that does not also function as a crosswalk or speed Table, the markings shall comply with Option A, B, or C shown in Figure 3B-29. If markings are used for a speed hump that also functions as a crosswalk or speed Table, the markings shall comply with Option A or B shown in Figure 3B-30.**

Support:

**02 Per CVC 440, speed humps or bumps are not official traffic control devices.**

### **Section 3B.26 Advance Speed Hump Markings**

Option:

**01 Advance speed hump markings (see Figure 3B-31) may be used in advance of speed humps or other engineered vertical roadway deflections such as dips where added visibility is desired or where such deflection is not expected.**

**02 Advance pavement wording such as BUMP or HUMP (see Section 3B.20) may be used on the approach to a speed hump either alone or in conjunction with advance speed hump markings. Appropriate advance warning signs may be used in compliance with Section 2C.29.**

**Standard:**

**03 If advance speed hump markings are used, they shall be a series of eight white 12-inch transverse lines that become longer and are spaced closer together as the vehicle approaches the speed hump or other deflection. If advance markings are used, they shall comply with the detailed design shown in Figure 3B-31.**

Guidance:

**04 If used, advance speed hump markings should be installed in each approach lane.**

### **Section 3B.101(CA) Turnouts**

Guidance:

**01 Paved turnouts should be marked with a 8 inch wide single solid white line between the through lane and the turnout. The line should not extend through the entry and exit areas. See Figure 3B-107(CA) and Caltrans' Highway Design Manual, Section 204.5 (4). See Section 1A.11 for information regarding this publication.**

**02 Turnouts should be 200 feet to 500 feet in length including a short taper of 50 feet at each end. Turnouts should not be longer than 500 feet.**

**03 The right edge line should be dropped throughout the length of the turnout.**

Option:

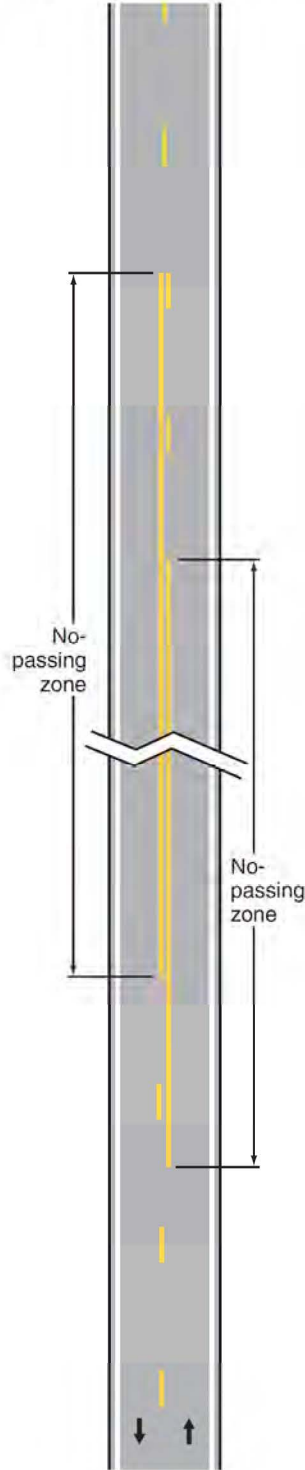
**04 Turnout length may be increased 100 feet on down grades over 3%.**

**Figure 3B-1. Examples of Two-Lane, Two-Way Marking Applications**

**A - Typical two-lane, two-way marking with passing permitted in both directions**

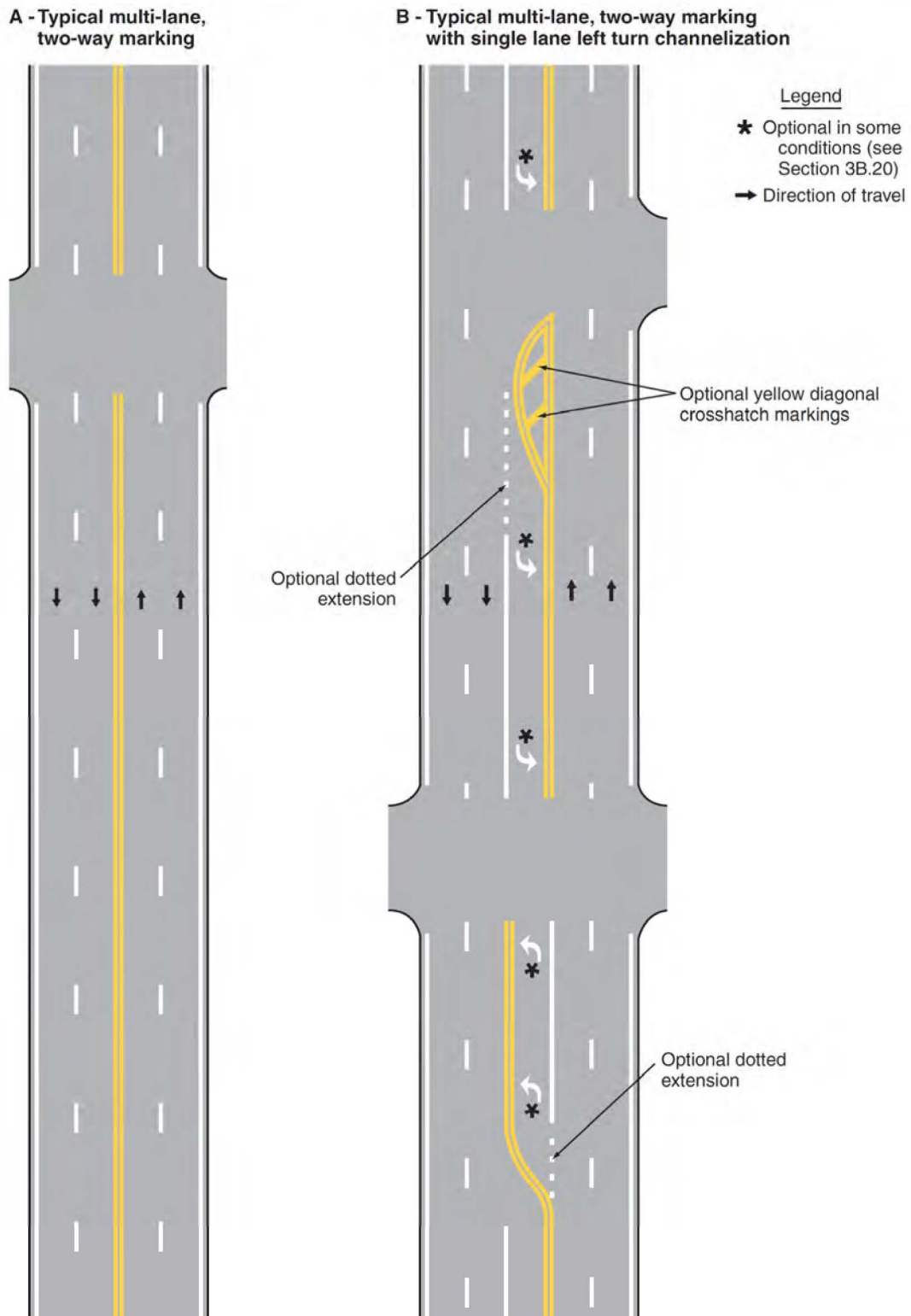


**B - Typical two-lane, two-way marking with no-passing zones**

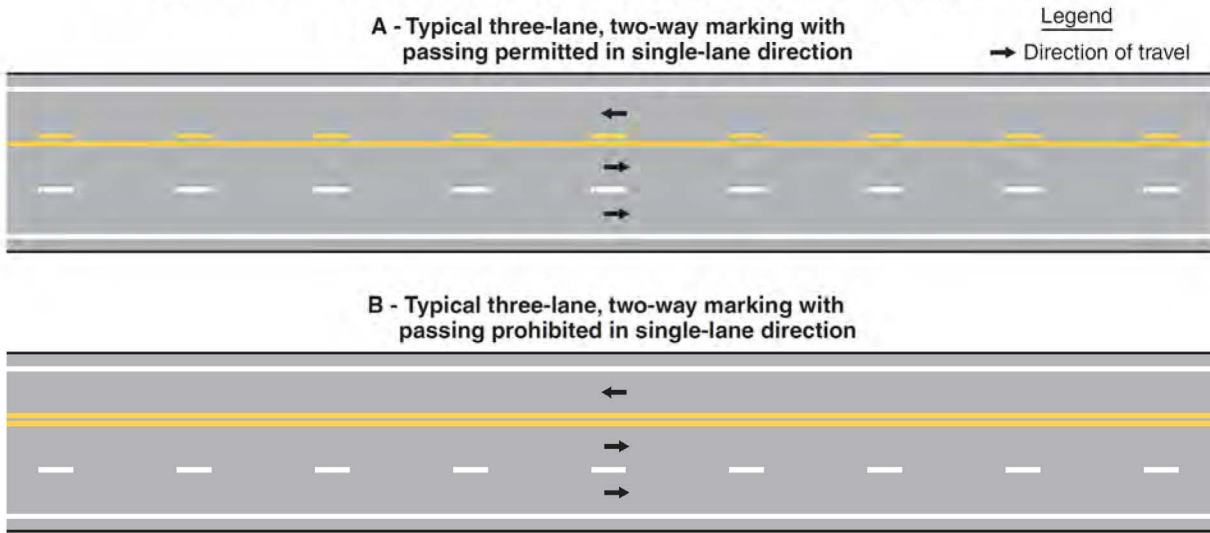


Legend  
→ Direction of travel

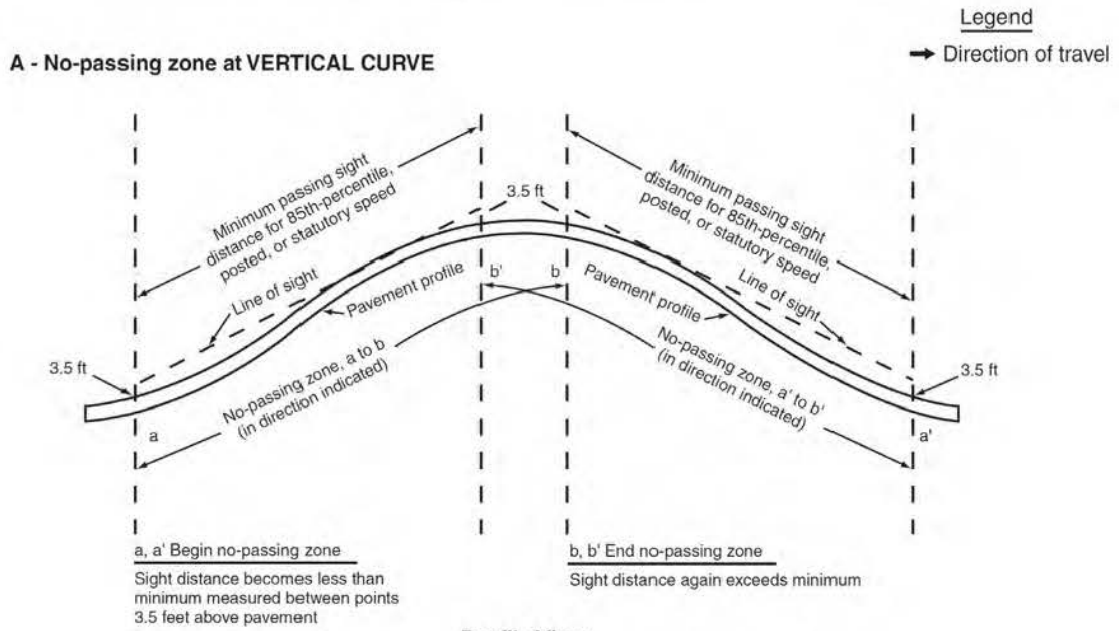
**Figure 3B-2. Examples of Four-or-More Lane, Two-Way Marking Applications**



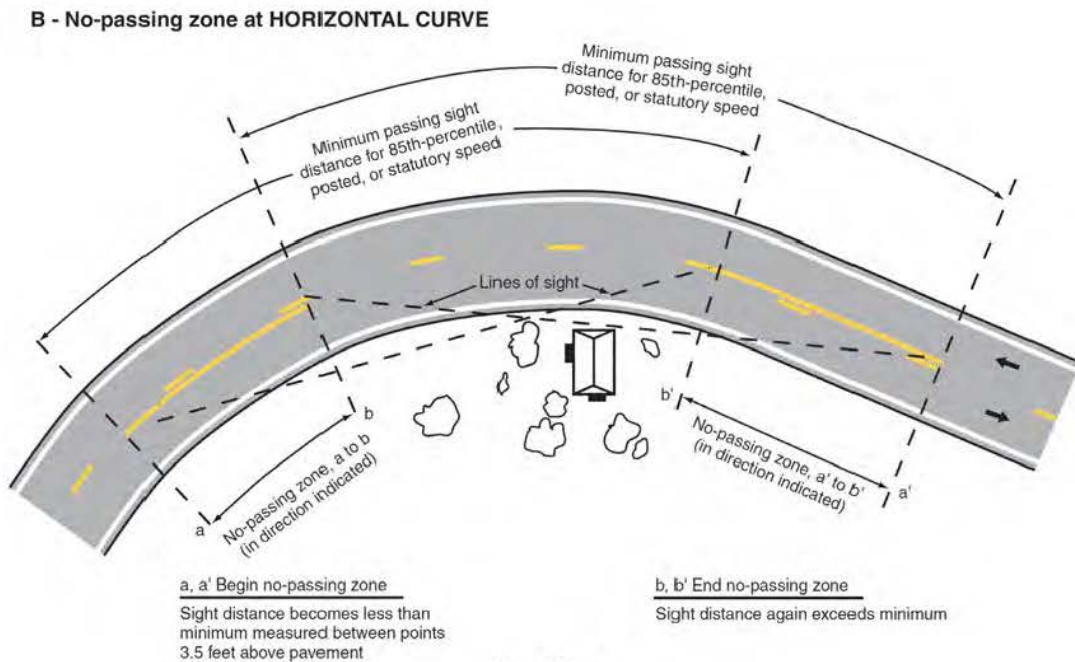
**Figure 3B-3. Examples of Three-Lane, Two-Way Marking Applications**



**Figure 3B-4. Method of Locating and Determining the Limits of No-Passing Zones at Curves**



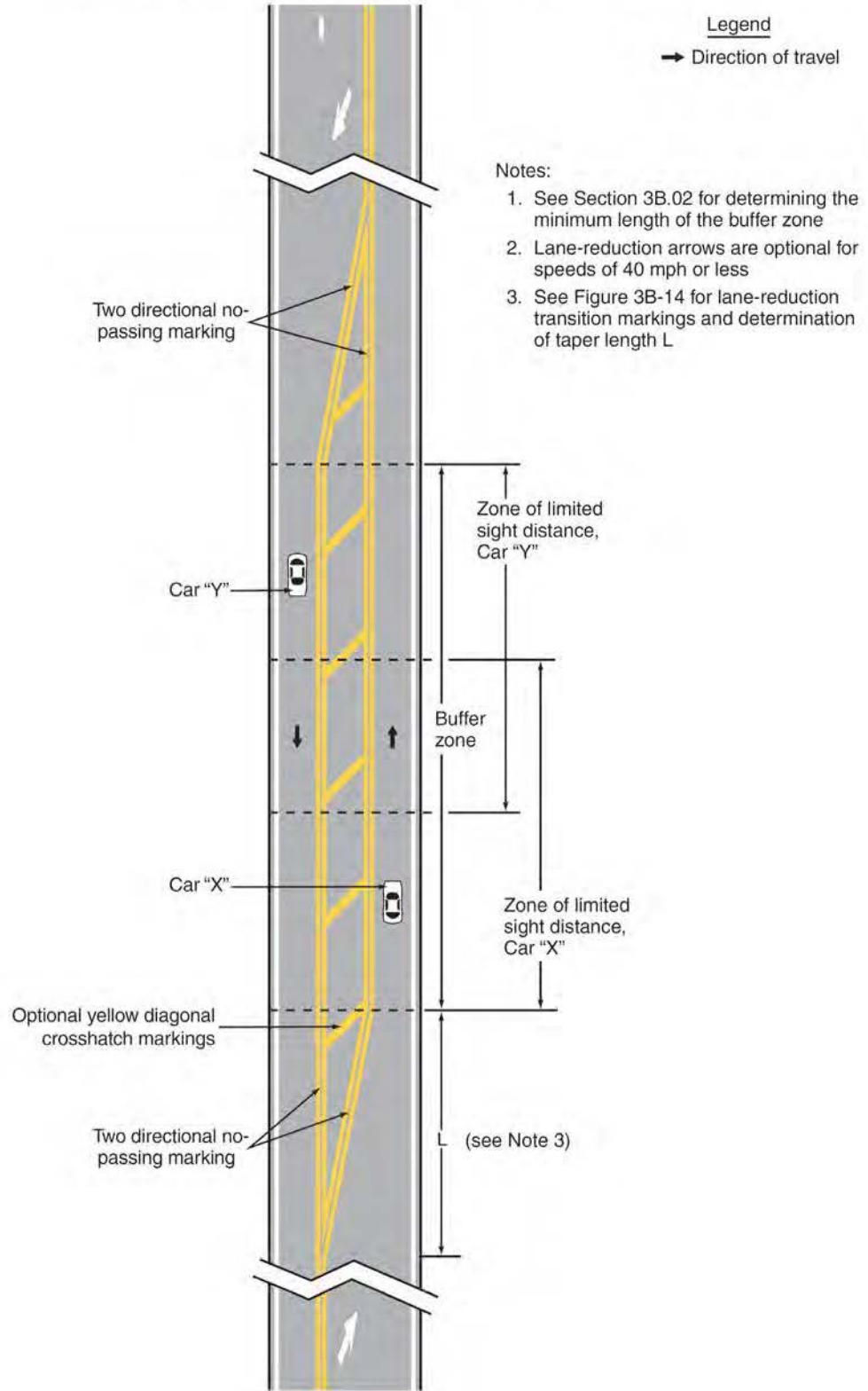
Note: No-passing zones in opposite directions may or may not overlap, depending on alignment



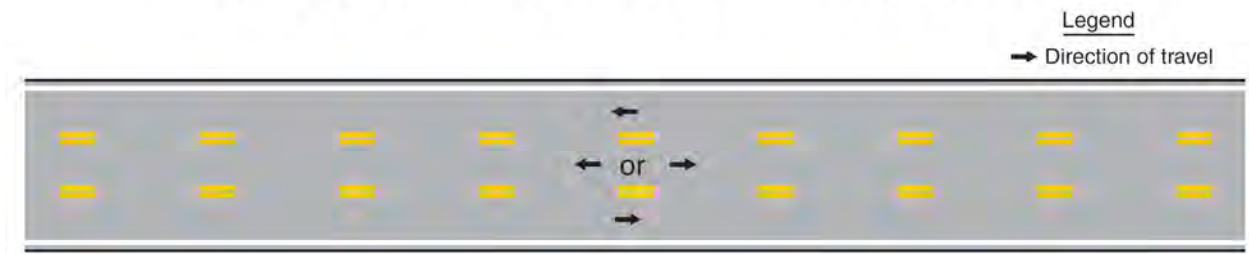
Note: No-passing zones in opposite directions may or may not overlap, depending on alignment



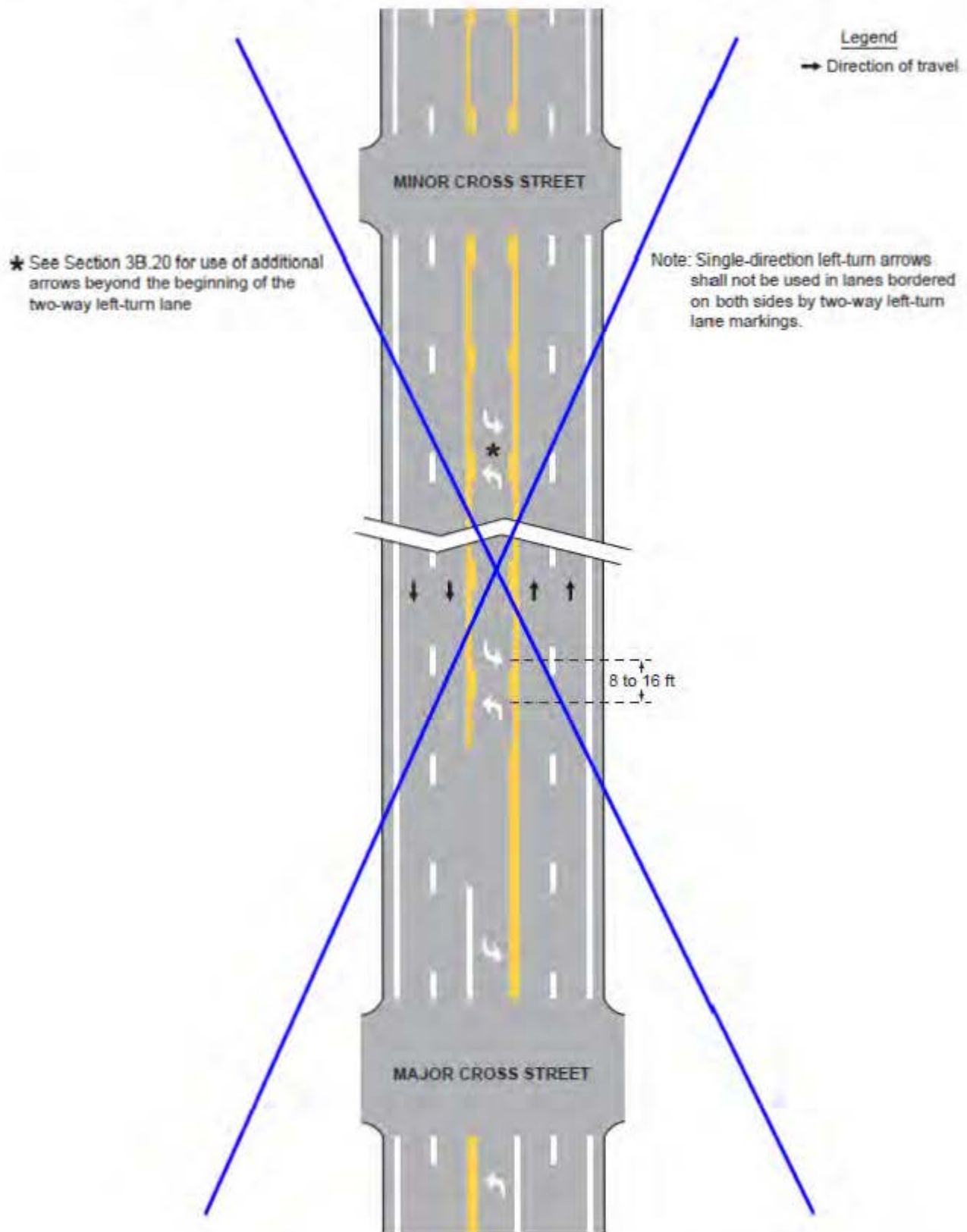
**Figure 3B-5. Example of Application of Three-Lane, Two-Way Marking for Changing Direction of the Center Lane**



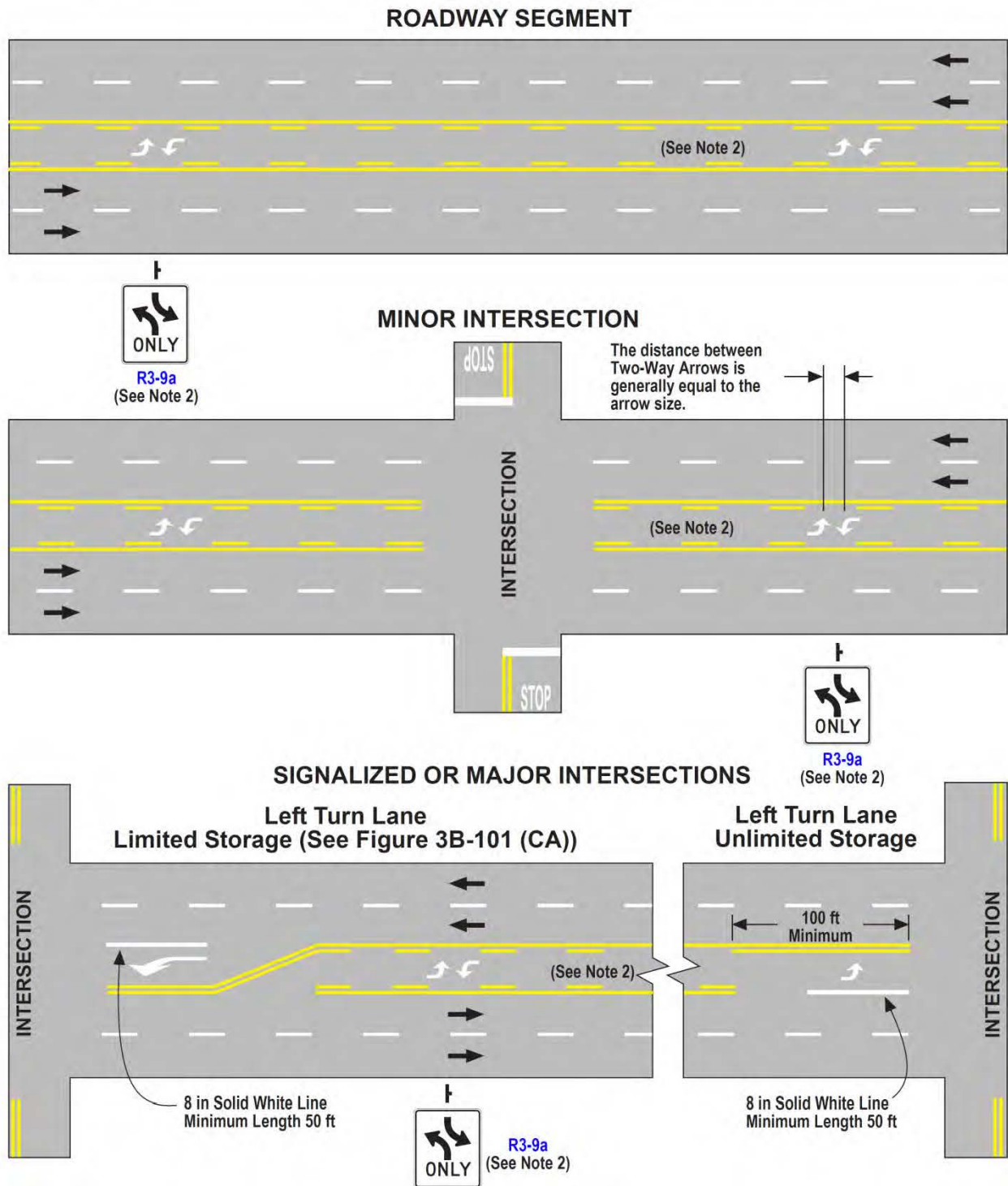
**Figure 3B-6. Example of Reversible Lane Marking Application**



**Figure 3B-7. Example of Two-Way Left-Turn Lane marking Applications**



**Figure 3B-7 (CA). Example of Two-Way Left-Turn Lane Marking Applications**



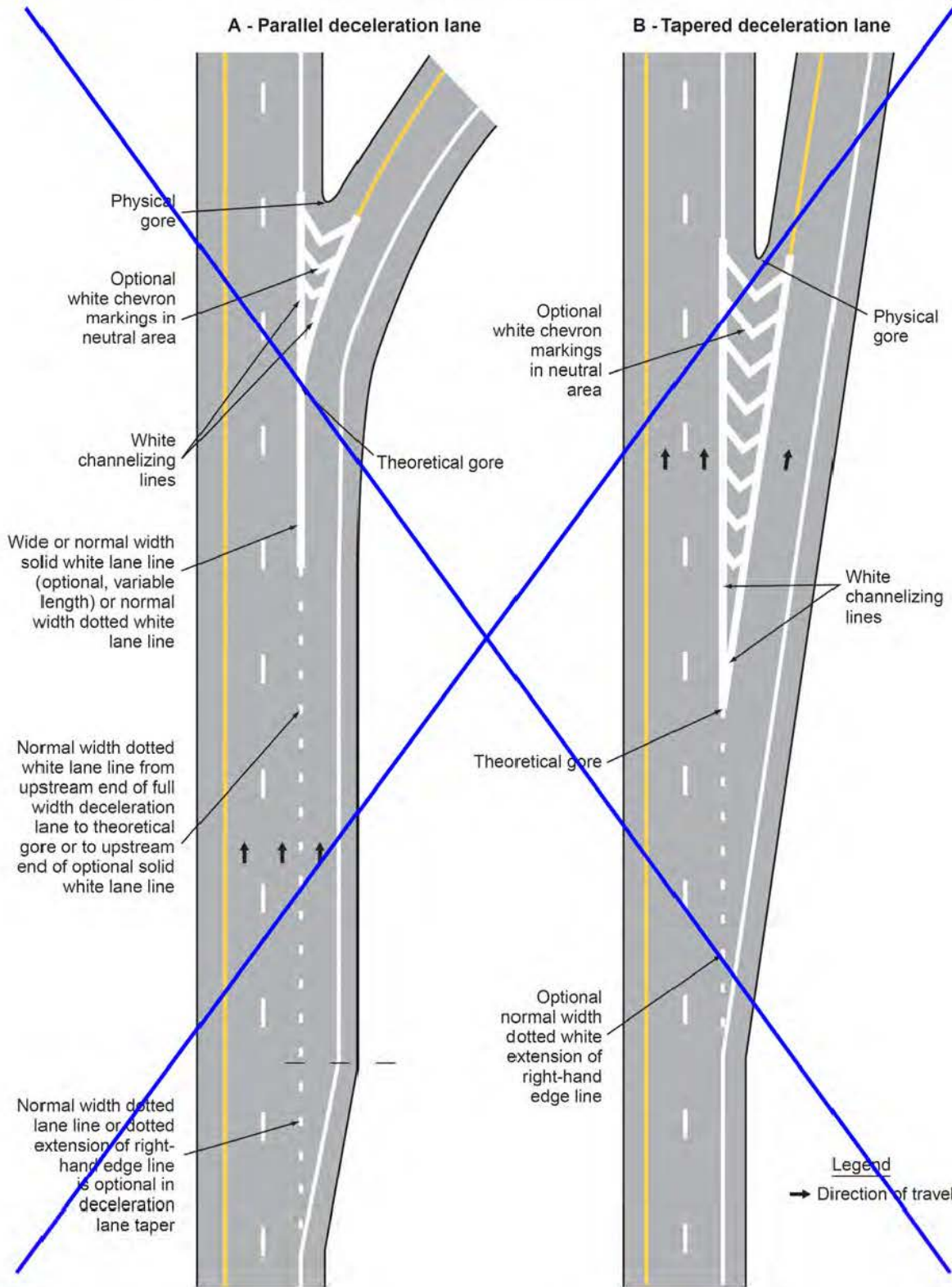
- NOTES: 1. See Figure 3A-108 (CA) for Two-Way Left-Turn Lane line markings.  
 2. Two-Way Pavement Arrows and the R3-9a sign are optional.

**LEGEND**

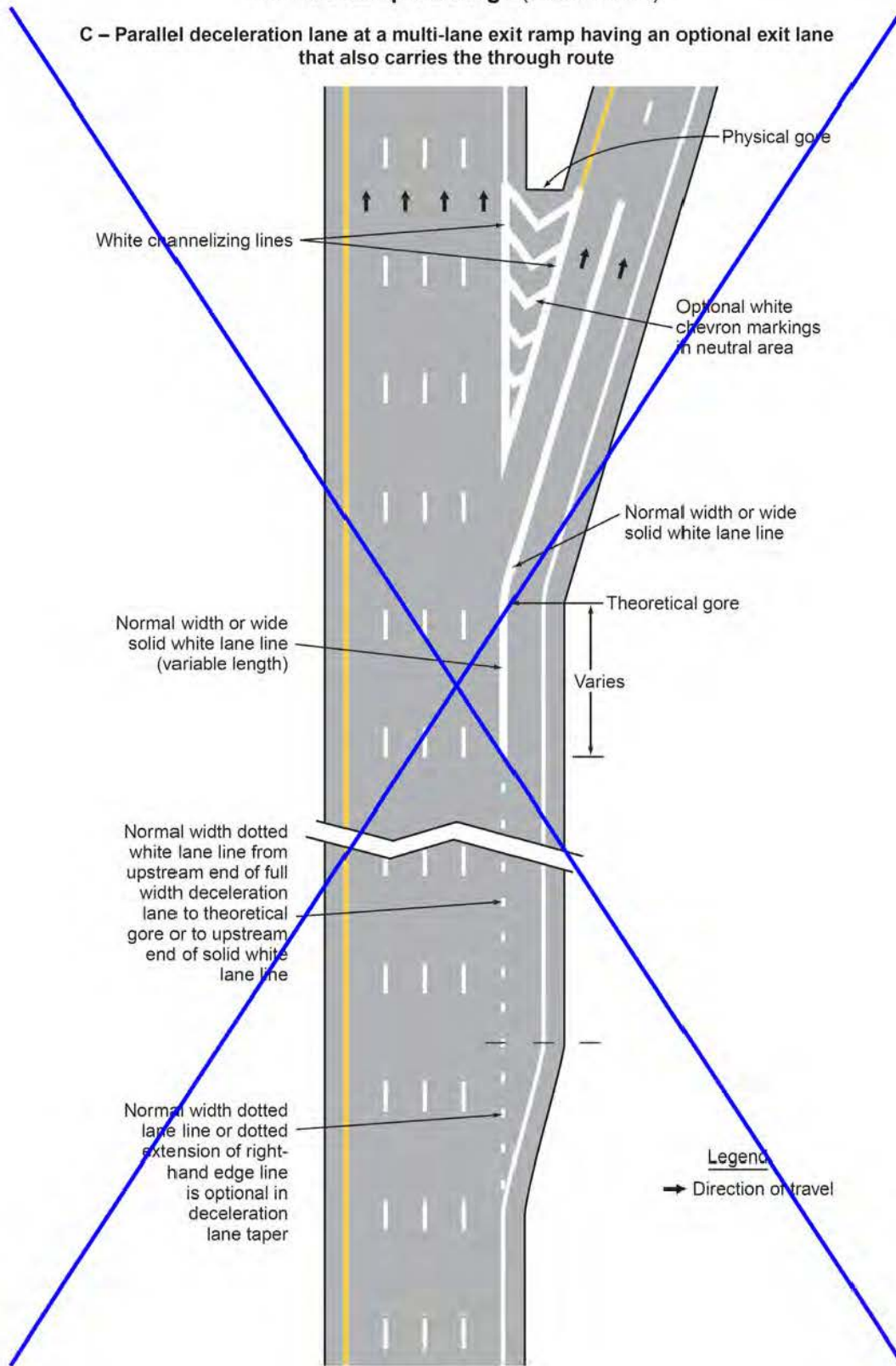
➔ Direction of Travel       Two-Way Pavement Arrows

NOT TO SCALE

**Figure 3B-8. Examples of Dotted Line and Channelizing Line Applications for Exit Ramp Markings (Sheet 1 of 2)**

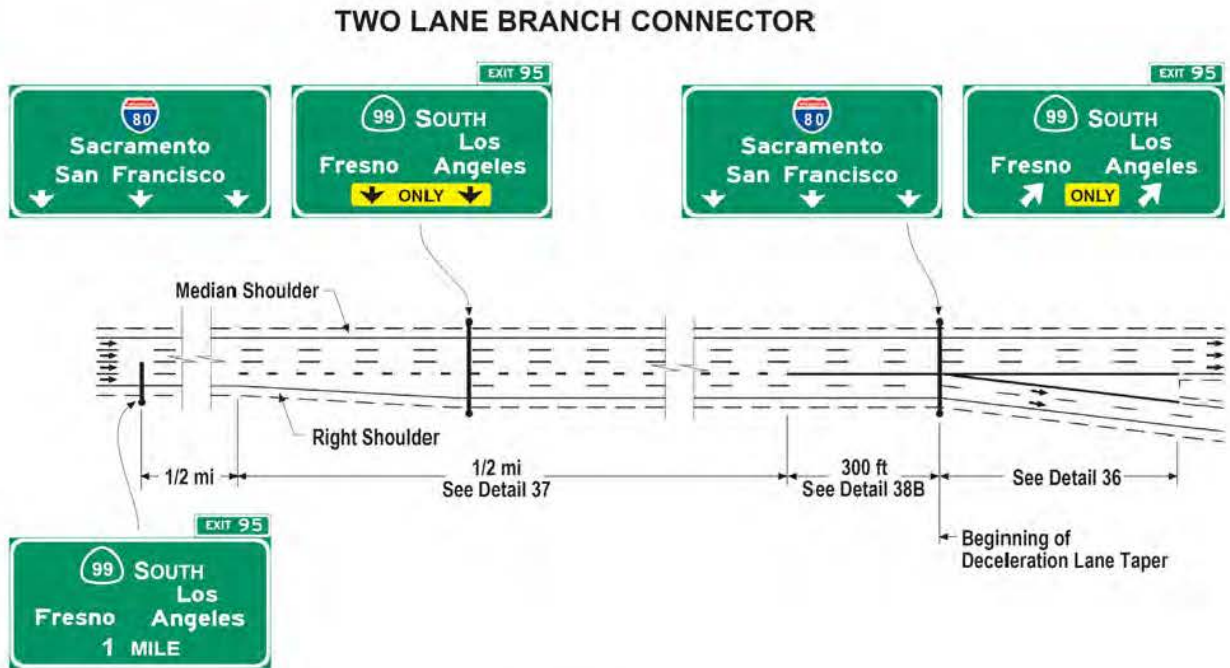
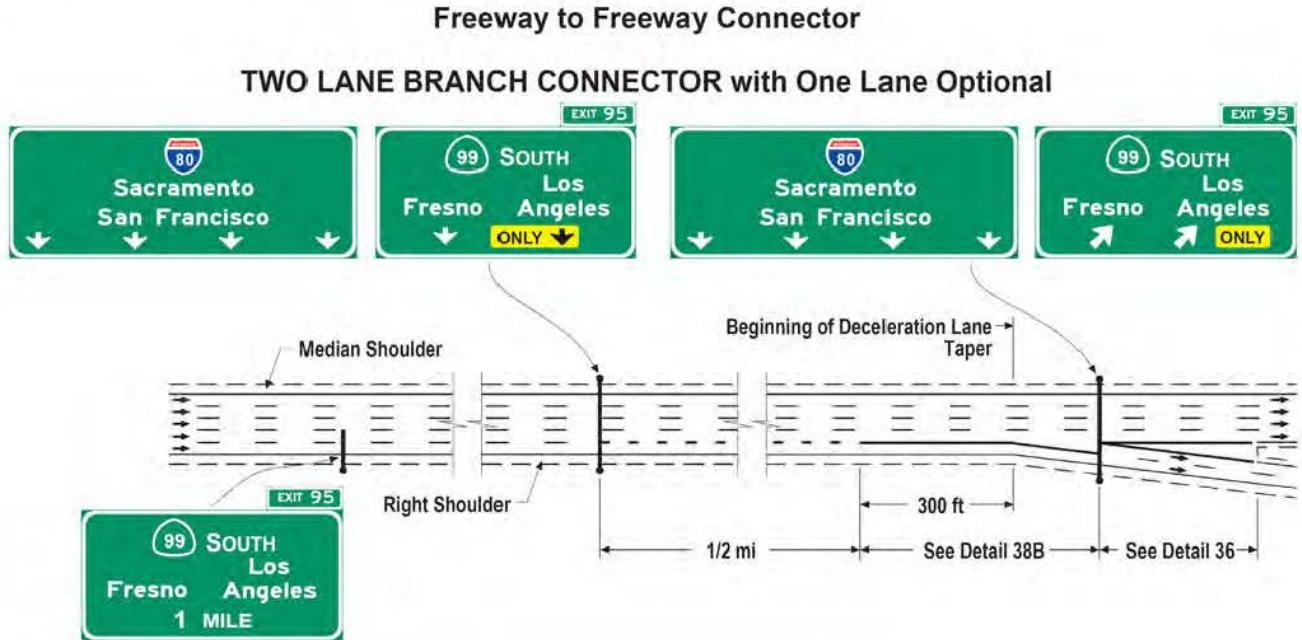


**Figure 3B-8. Examples of Dotted Line and Channelizing Line Applications for Exit Ramp Markings (Sheet 2 of 2)**



**Figure 3B-8 (CA). Examples of Dotted Line and Channelizing Line Applications for Exit Ramp Markings (Sheet 1 of 3)**

a - Parallel deceleration lane

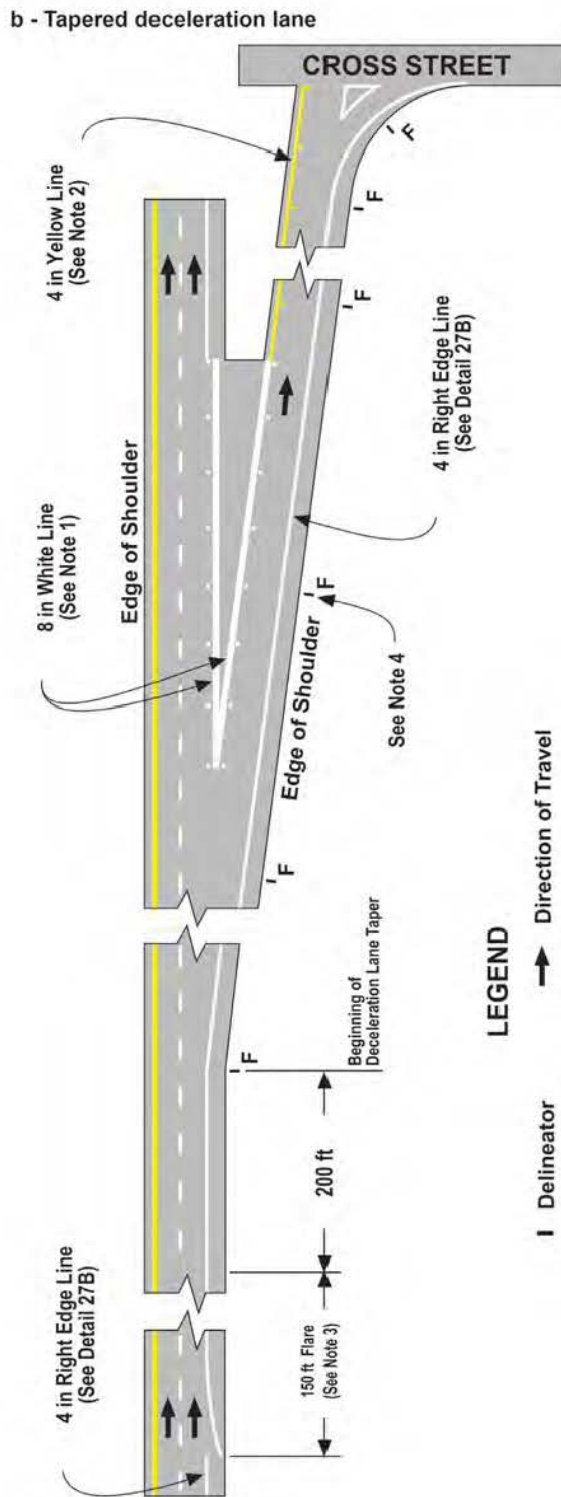


**LEGEND**

➔ Direction of Travel    - - - Lane Drop Pattern

NOT TO SCALE

**Figure 3B-8 (CA). Examples of Dotted Line and Channelizing Line Applications for Exit Ramp Markings (Sheet 2 of 3)**



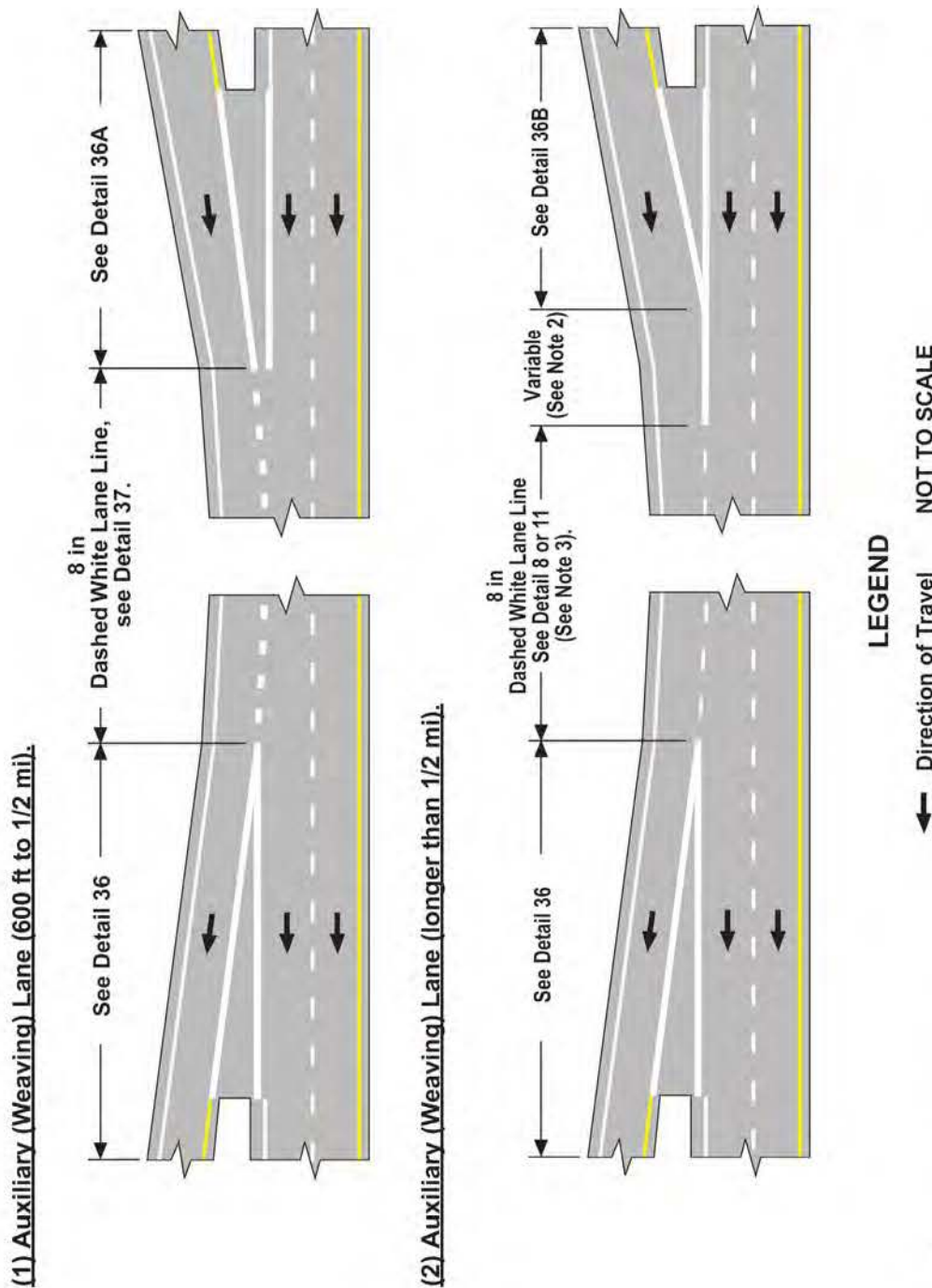
**NOTES:**

1. Place a 8 in Solid White Line and One-Way Clear Retroreflective Markers on 24 ft centers. See Detail 36.
2. Place a 4 in Solid Yellow Left Edge Line and One-Way Yellow Retroreflective Pavement Markers on 24 ft centers. See Detail 25A.
3. A flared Right Edge Line 150 ft in advance of an exit ramp, is recommended where climatic conditions, such as areas that experience heavy fog, may require additional guidance. In areas that normally do not experience these conditions, a continuous edge line may be used. See also Section 3B.11, Advance Markers - Exit Ramps.
4. Place delineators 2 ft to 6 ft outside edge of paved shoulder, approximately 200 ft apart with a minimum of 3 delineators per tangent. For additional details on delineator locations and spacing, see Figure 3F-1 and 3F-102 (CA).
5. See Figure 3B-22 (CA) for Ramp Terminal Markings and Section 2B.41.



**Figure 3B-8 (CA). Examples of Dotted Line and Channelizing Line Applications for Exit Ramp Markings (Sheet 3 of 3)**

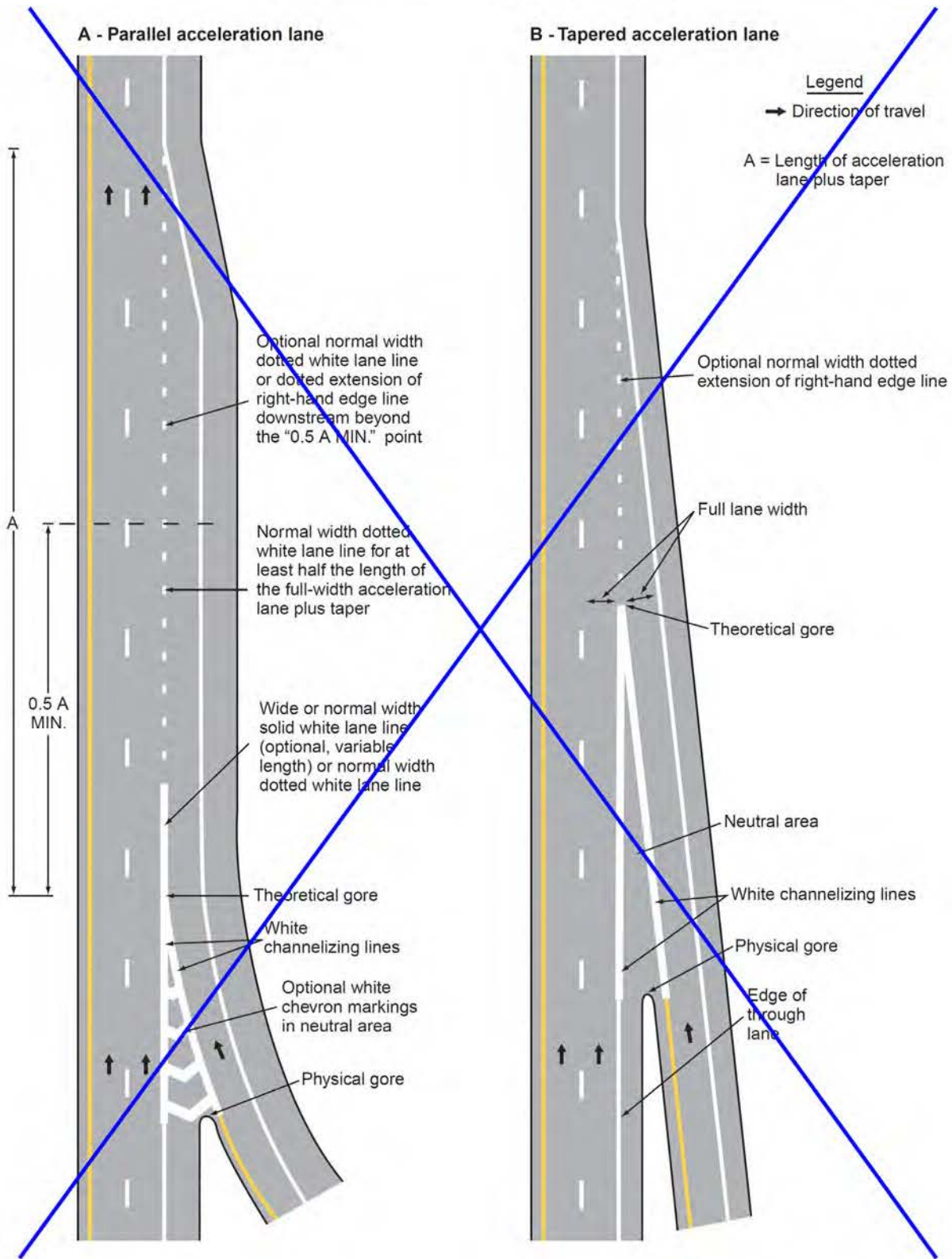
**c - Auxiliary (Weaving) Lane, such as at Cloverleaf Interchange**



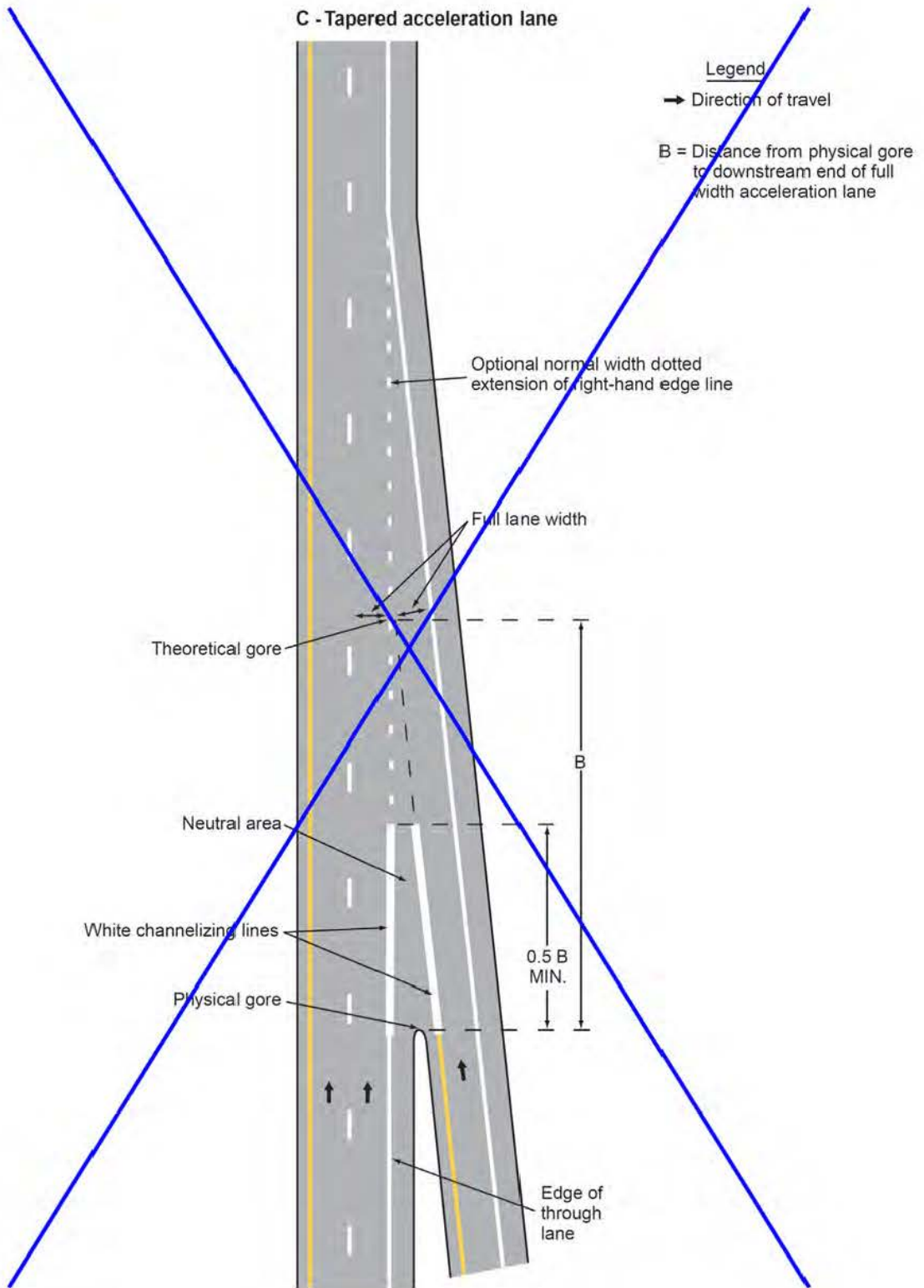
**NOTES:**

1. Auxiliary (Weaving) Lanes less than 600 ft are normally marked as Exit Ramps (see Sheets 1 and 2) and Entrance Ramps (see Figure 3B-9(CA)).
2. An 8 in Solid White Channelizing Line should be continued for approximately one-tenth the length of the acceleration lane beyond the tangent point. See Detail 38A.
3. A 4 in Dashed White Lane Line (Detail 8 or 11) is normally used for the remaining length of the lane. However, in those locations where the lane may give the appearance of an added lane and to discourage its use by through traffic, an 8 in Dashed White Channelizing Line (Detail 37) may be considered.

**Figure 3B-9. Examples of Dotted Line and Channelizing Line Applications for Entrance Ramp Markings (Sheet 1 of 2)**

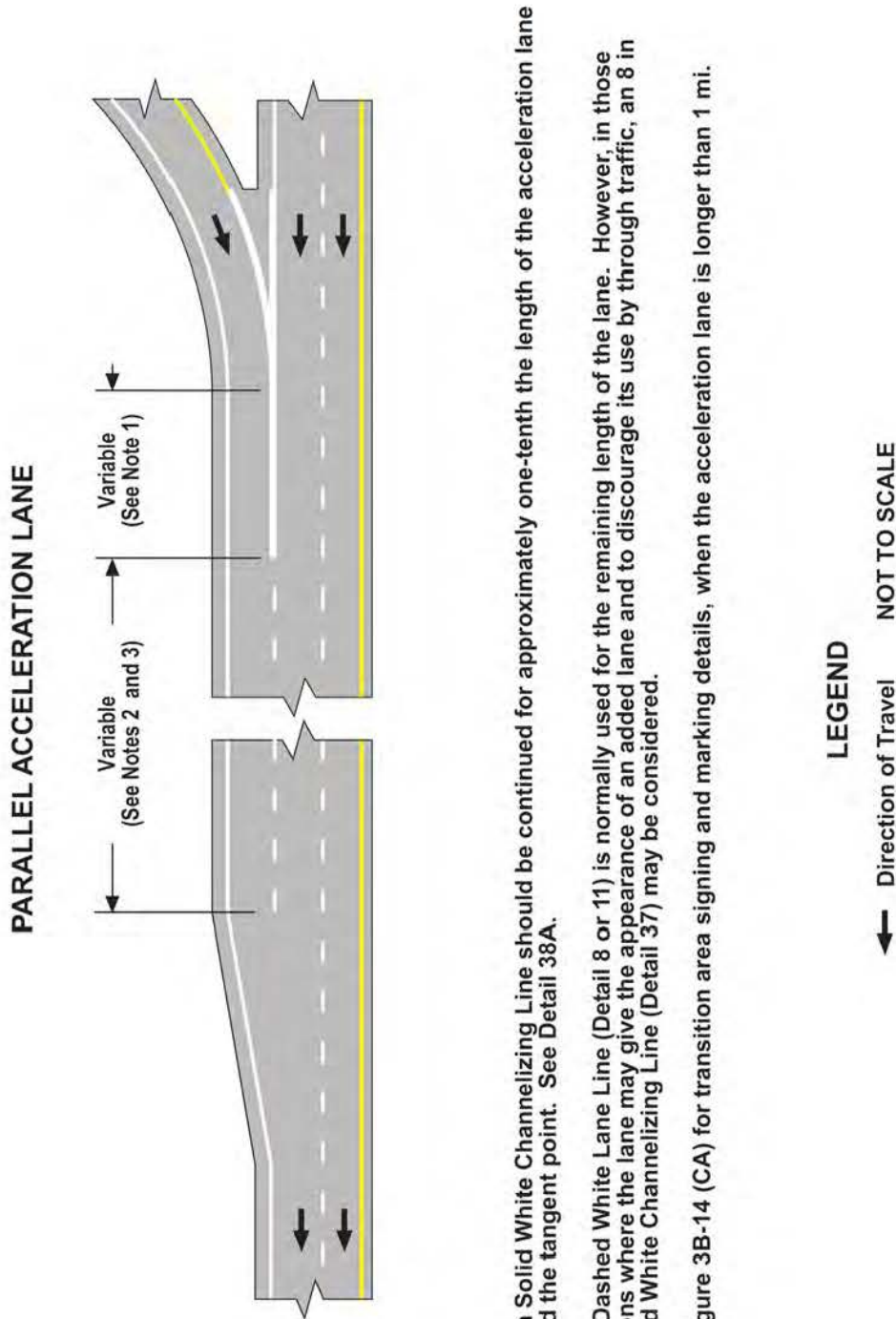


**Figure 3B-9. Examples of Dotted Line and Channelizing Line Applications for Entrance Ramp Markings (Sheet 2 of 2)**





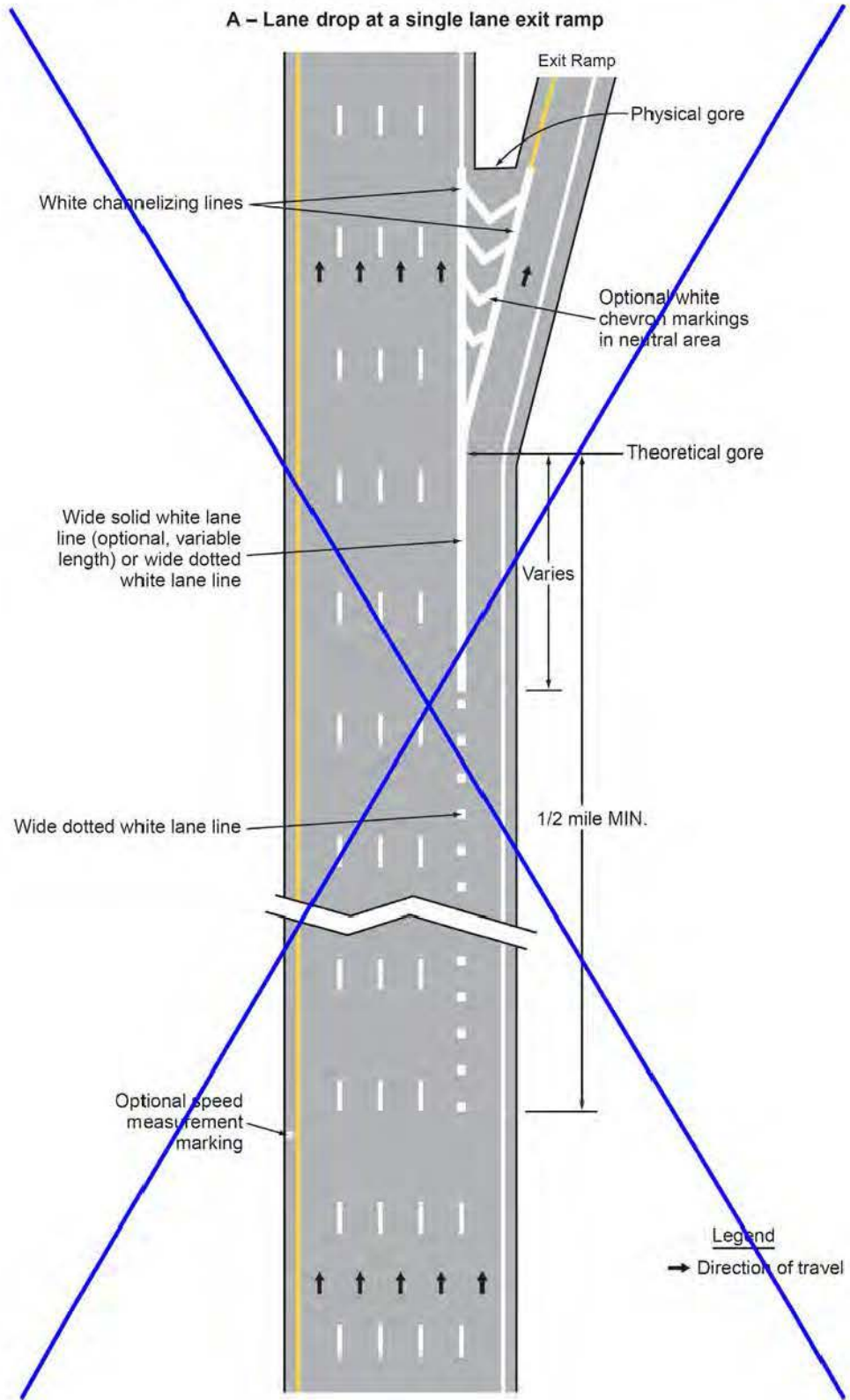
**Figure 3B-9 (CA). Examples of Dotted Line and Channelizing Line Applications for Entrance Ramp Markings (Sheet 2 of 2)**



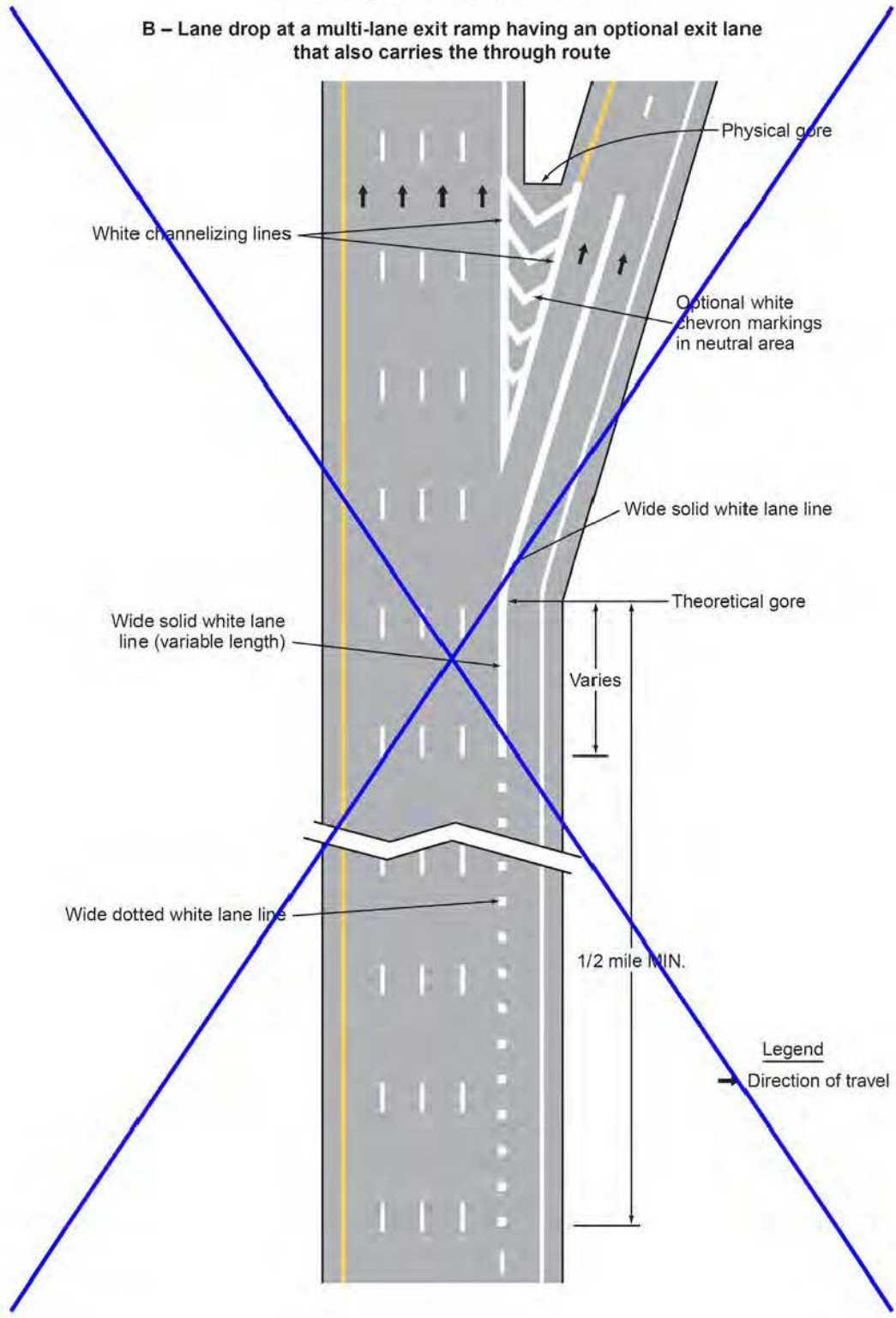
**NOTES:**

1. An 8 in Solid White Channelizing Line should be continued for approximately one-tenth the length of the acceleration lane beyond the tangent point. See Detail 38A.
2. A 4 in Dashed White Lane Line (Detail 8 or 11) is normally used for the remaining length of the lane. However, in those locations where the lane may give the appearance of an added lane and to discourage its use by through traffic, an 8 in Dashed White Channelizing Line (Detail 37) may be considered.
3. See Figure 3B-14 (CA) for transition area signing and marking details, when the acceleration lane is longer than 1 mi.

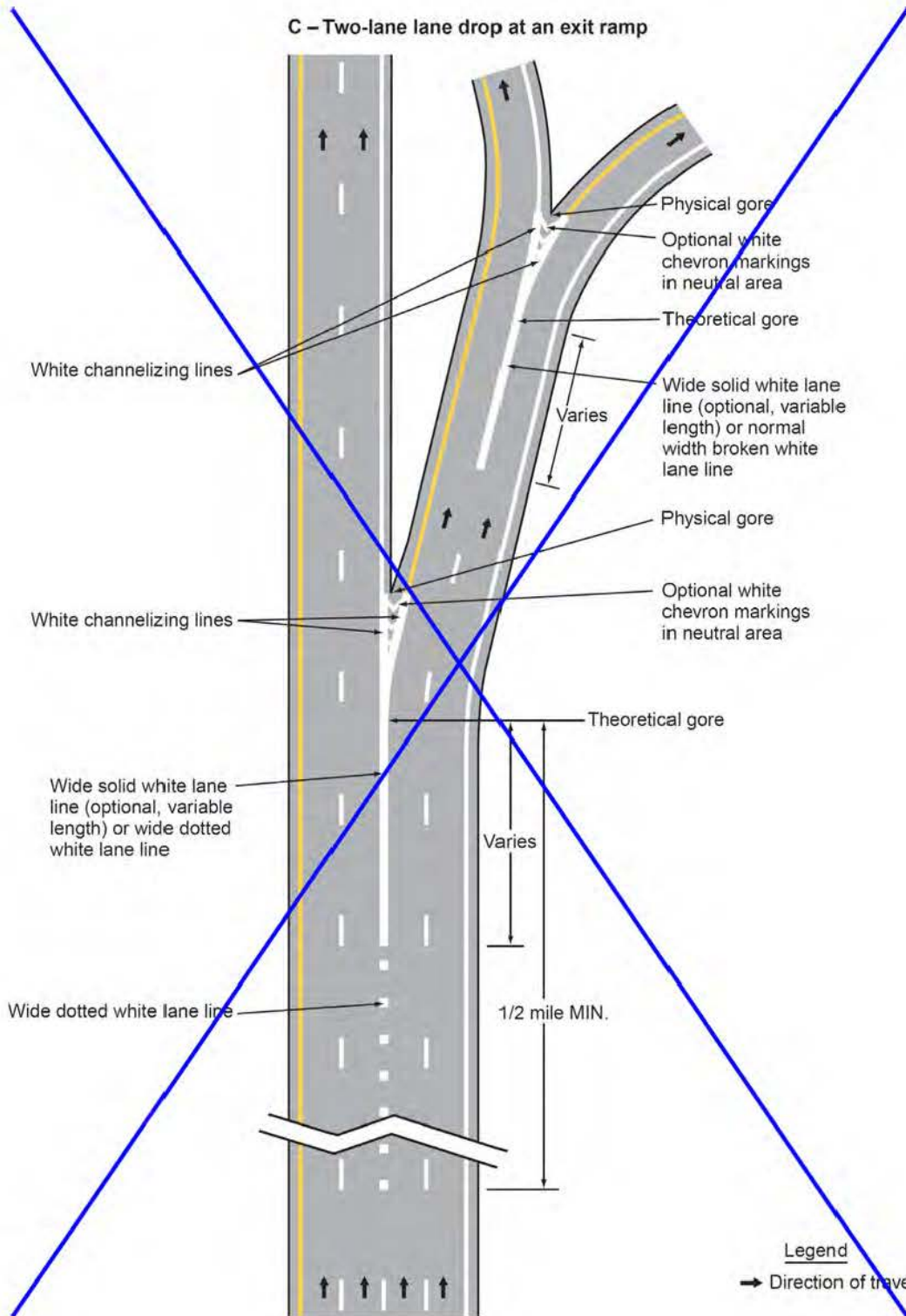
**Figure 3B-10. Examples of Applications of Freeway and Expressway Lane-Drop Markings (Sheet 1 of 5)**



**Figure 3B-10. Examples of Applications of Freeway and Expressway Lane-Drop Markings (Sheet 2 of 5)**

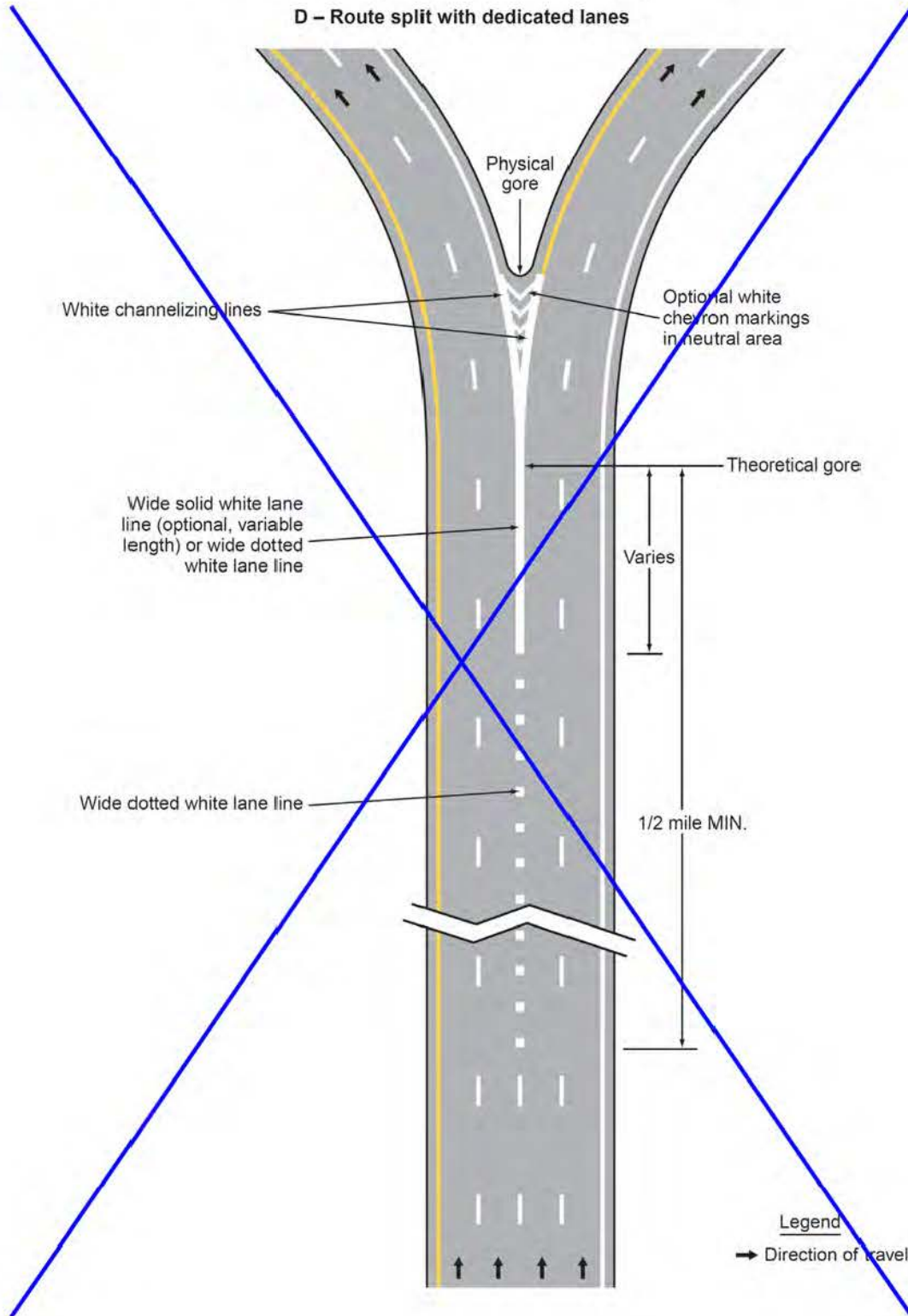


**Figure 3B-10. Examples of Applications of Freeway and Expressway Lane-Drop Markings (Sheet 3 of 5)**

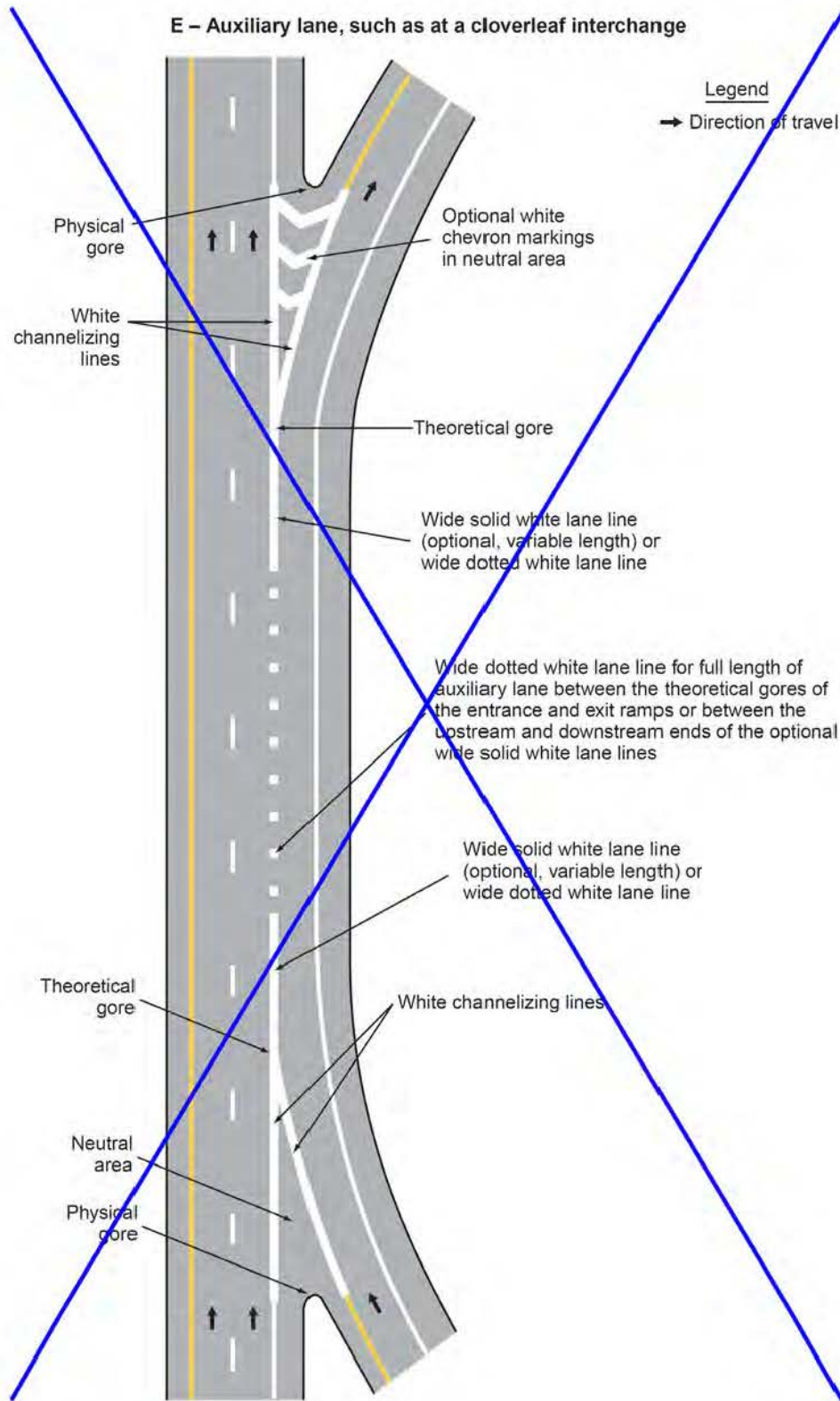




**Figure 3B-10. Examples of Applications of Freeway and Expressway Lane-Drop Markings (Sheet 4 of 5)**

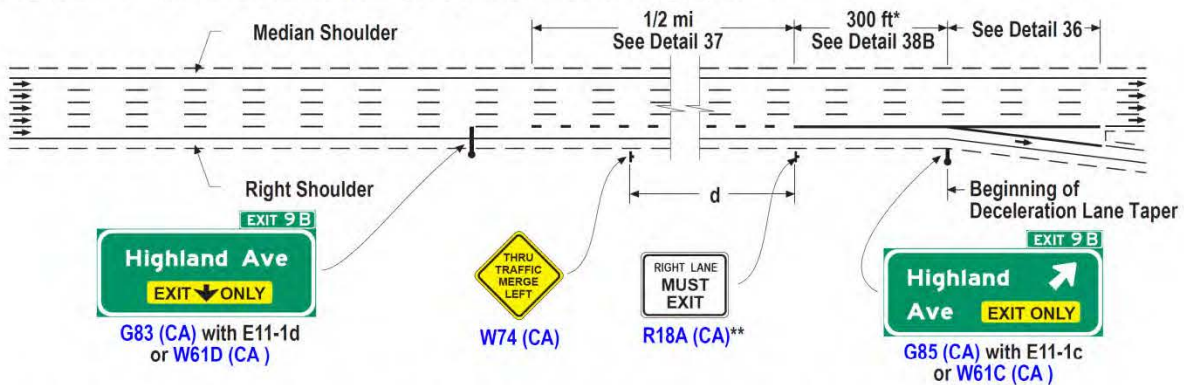


**Figure 3B-10. Examples of Applications of Freeway and Expressway Lane-Drop Markings (Sheet 5 of 5)**

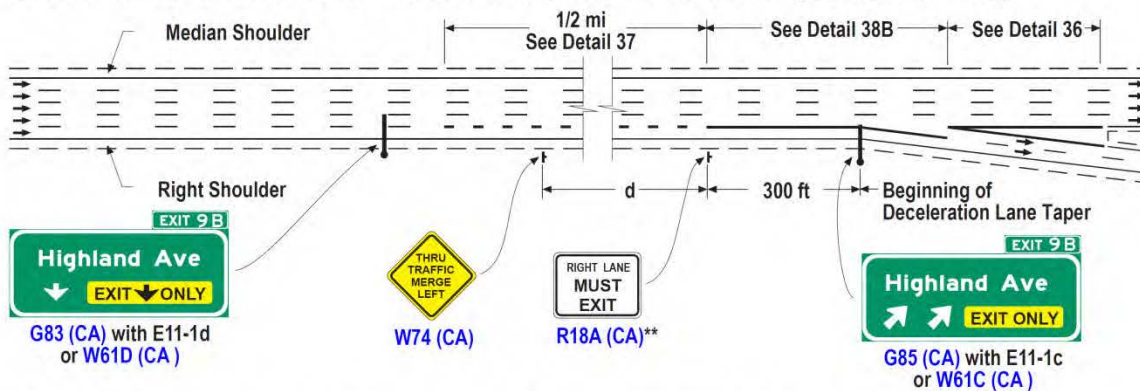


**Figure 3B-10 (CA). Examples of Applications of Freeway and Expressway Lane-Drop Markings**

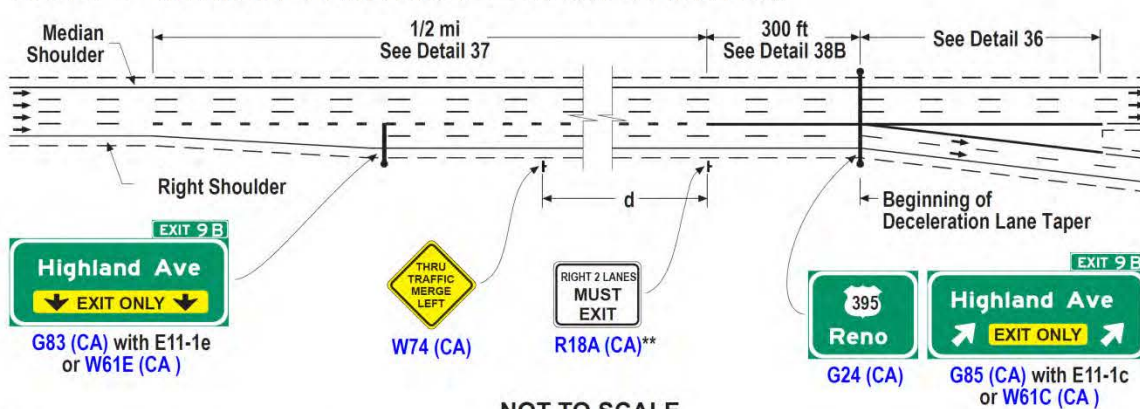
**CASE: 1 - MAINLINE LANE DROP TO A ONE LANE EXIT**



**CASE: 2 - MAINLINE LANE DROP TO A TWO LANE EXIT (Optional Lane)**



**CASE: 3 - MAINLINE LANE DROP TO A TWO LANE EXIT**



NOT TO SCALE

Notes:

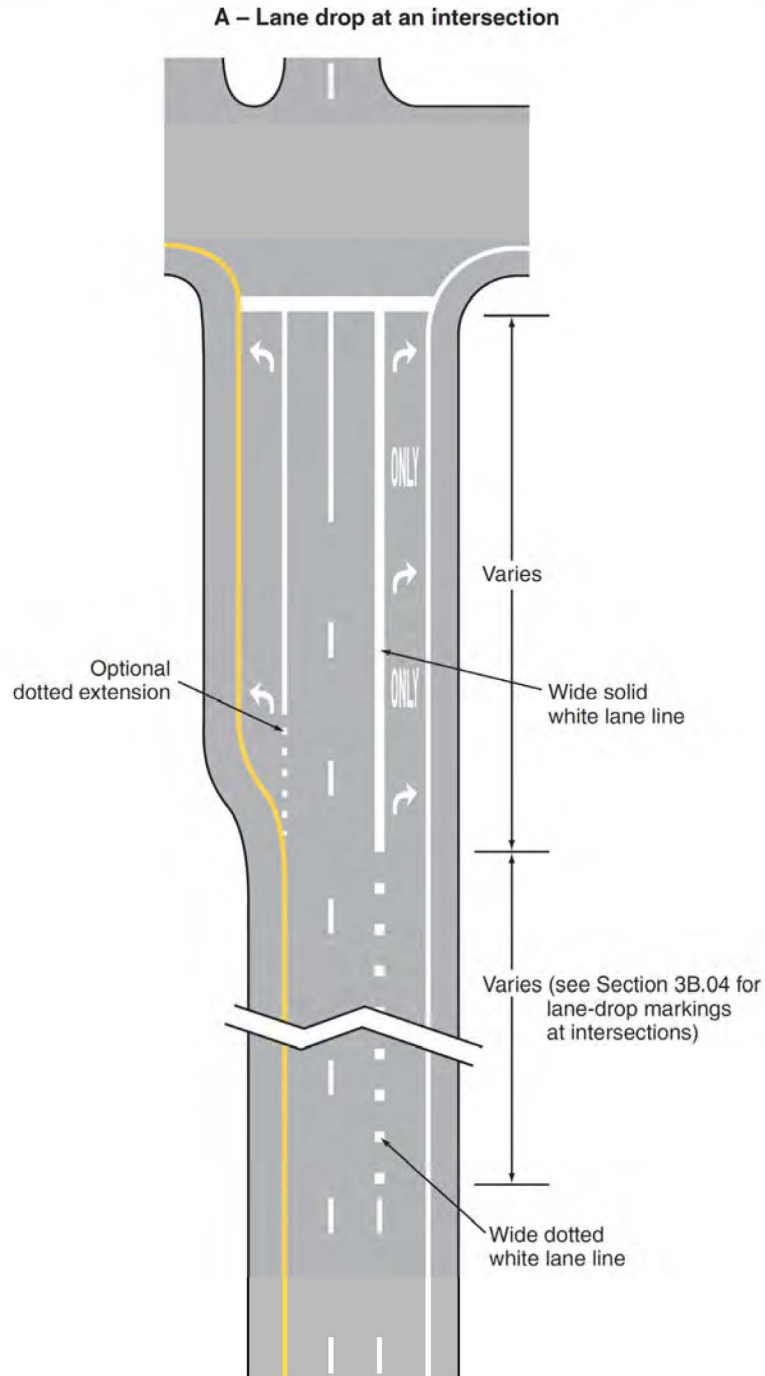
\* The solid line may be eliminated where additional weaving distance is needed. When it is eliminated, a RIGHT LANE EXITS AHEAD, W73 (CA) sign shall be used in lieu of the R18A (CA) sign.

\*\* At locations where the overhead EXIT ONLY (E11-1 Series or W61 (CA) Series) signs are not in place, a RIGHT LANE EXITS AHEAD, W73 (CA) sign shall be placed, approximately midway between the W74 (CA) and the R18A (CA) signs.

**LEGEND**

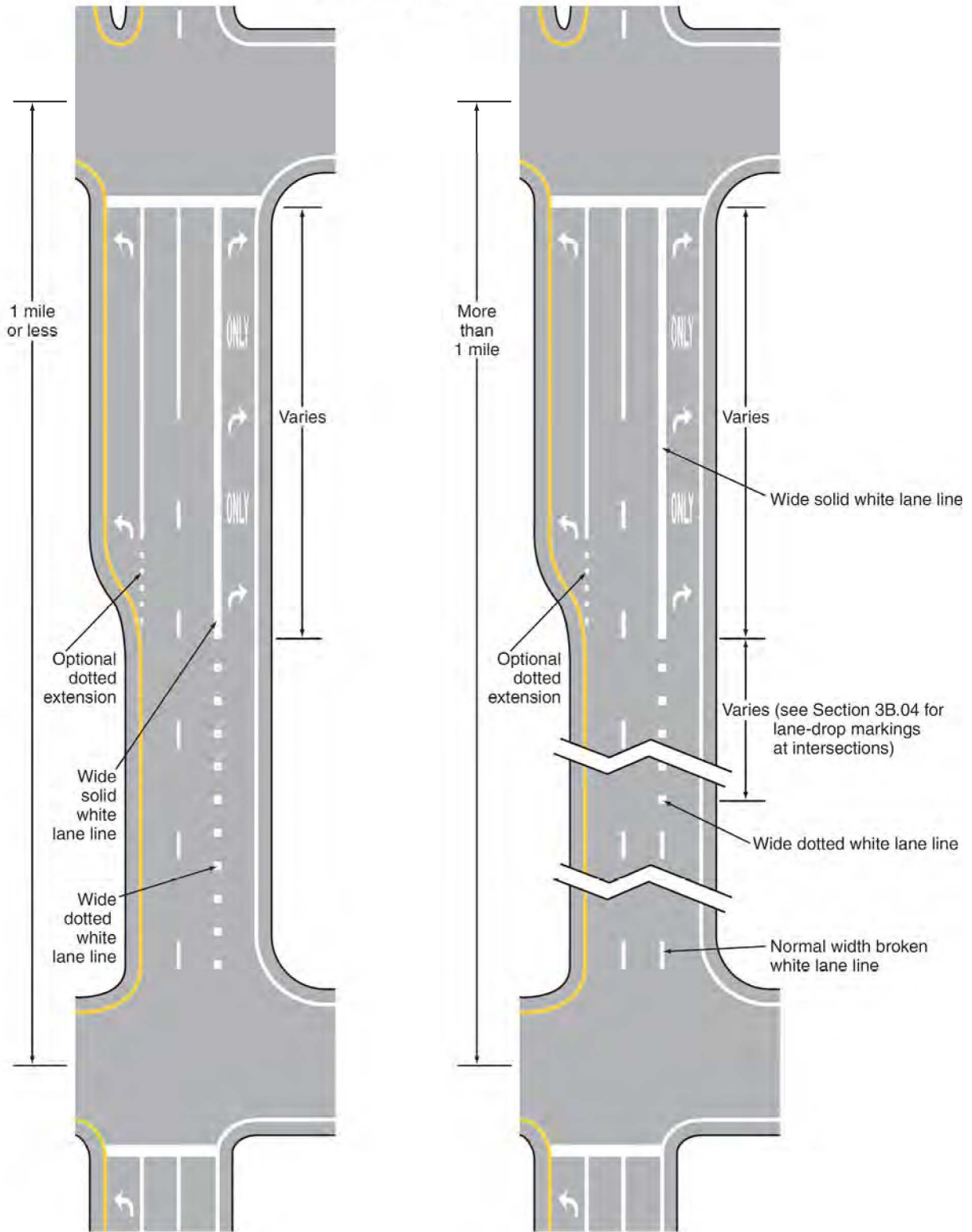
- d = Advance Placement Distance (see Section 2C.05)
- ➔ Direction of Travel    - - - Lane Drop Pattern

**Figure 3B-11. Examples of Applications of Conventional Road Lane-Drop Markings**  
(Sheet 1 of 2)

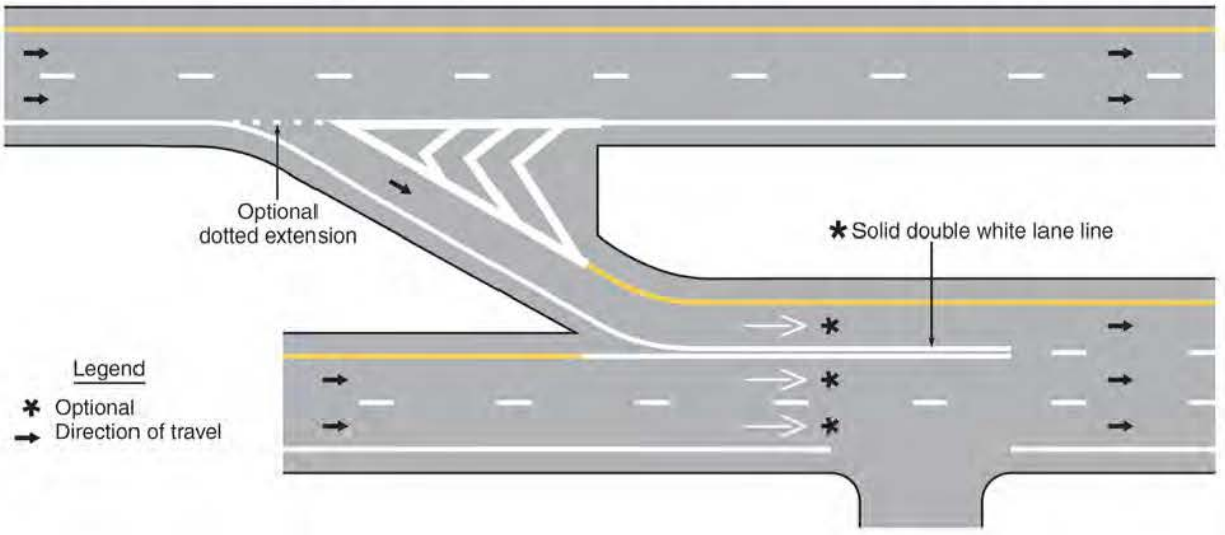


**Figure 3B-11. Examples of Applications of Conventional Road Lane-Drop Markings**  
(Sheet 2 of 2)

**B – Auxiliary lane between intersections**

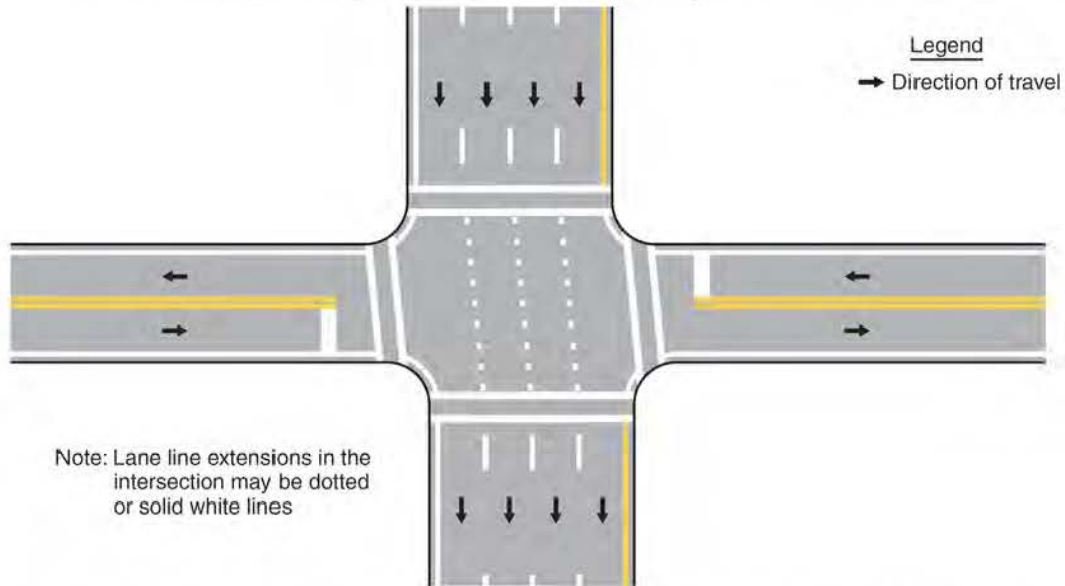


**Figure 3B-12. Example of Solid Double White Lines Used to Prohibit Lane Changing**

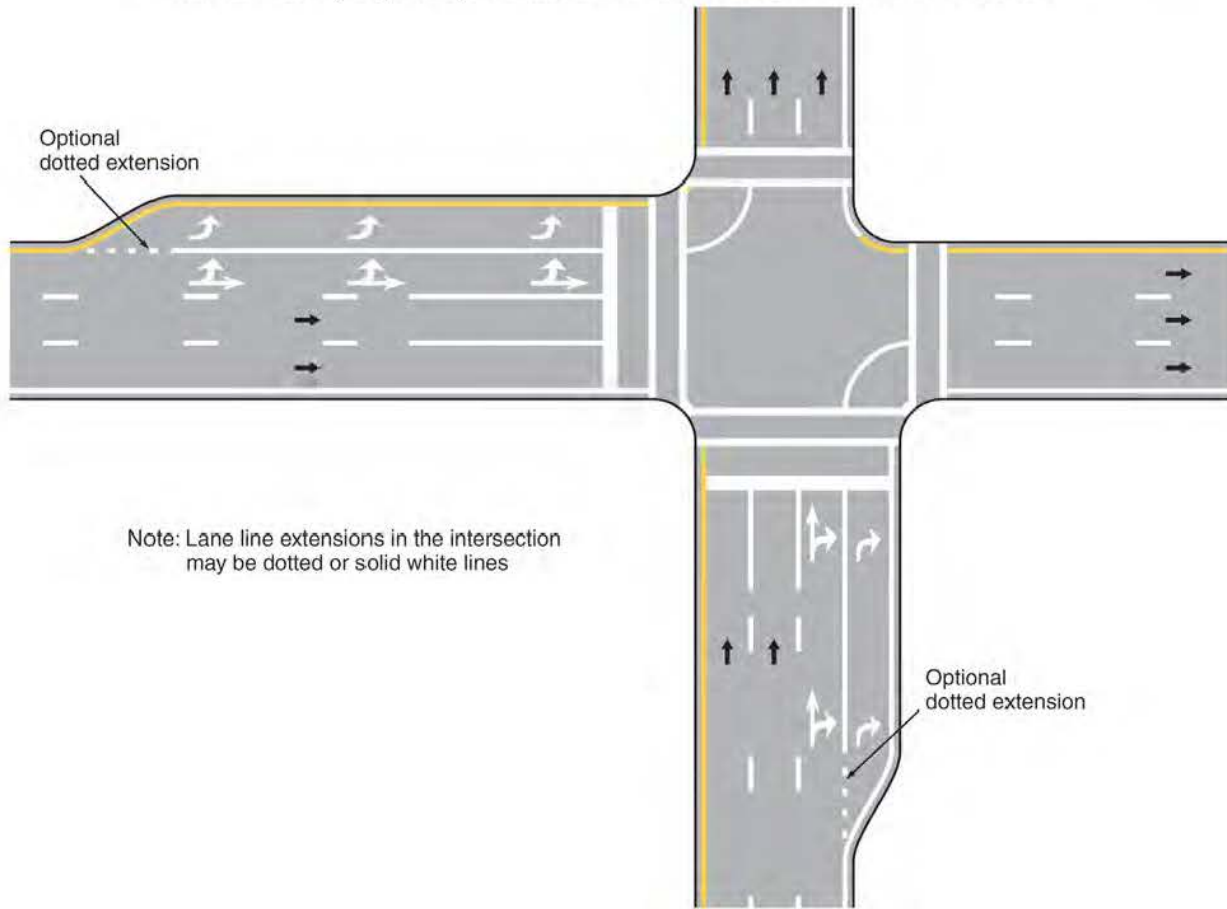


**Figure 3B-13. Examples of Line Extensions through Intersections (Sheet 1 of 2)**

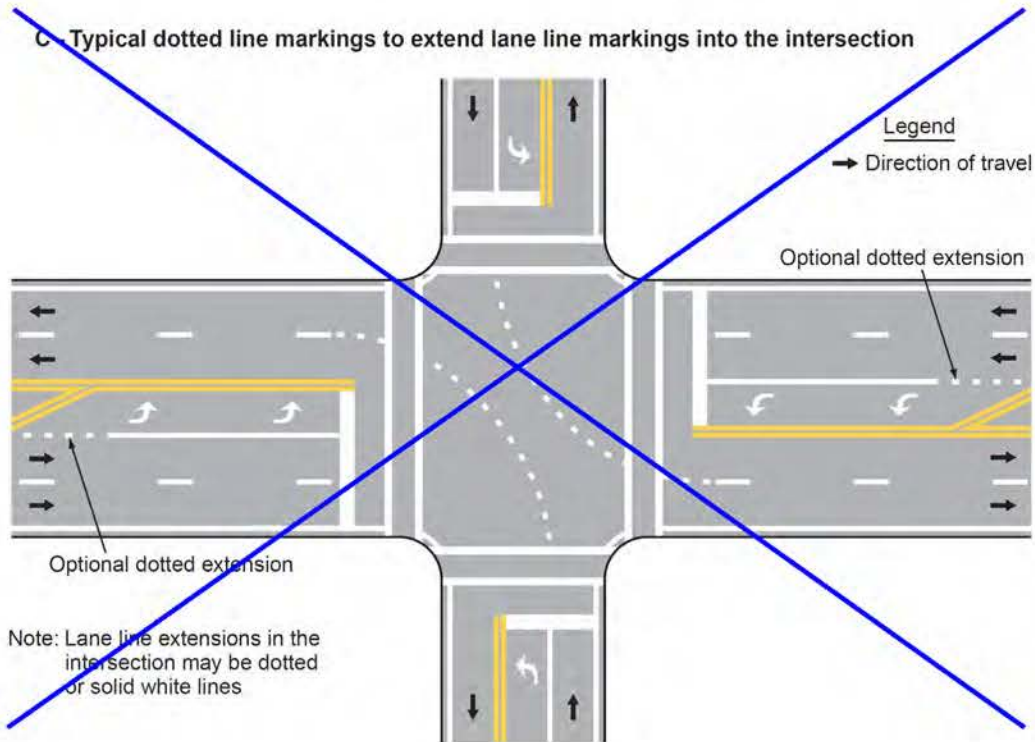
**A - Typical pavement markings with offset lane lines continued through the intersection and optional crosswalk lines and stop lines**



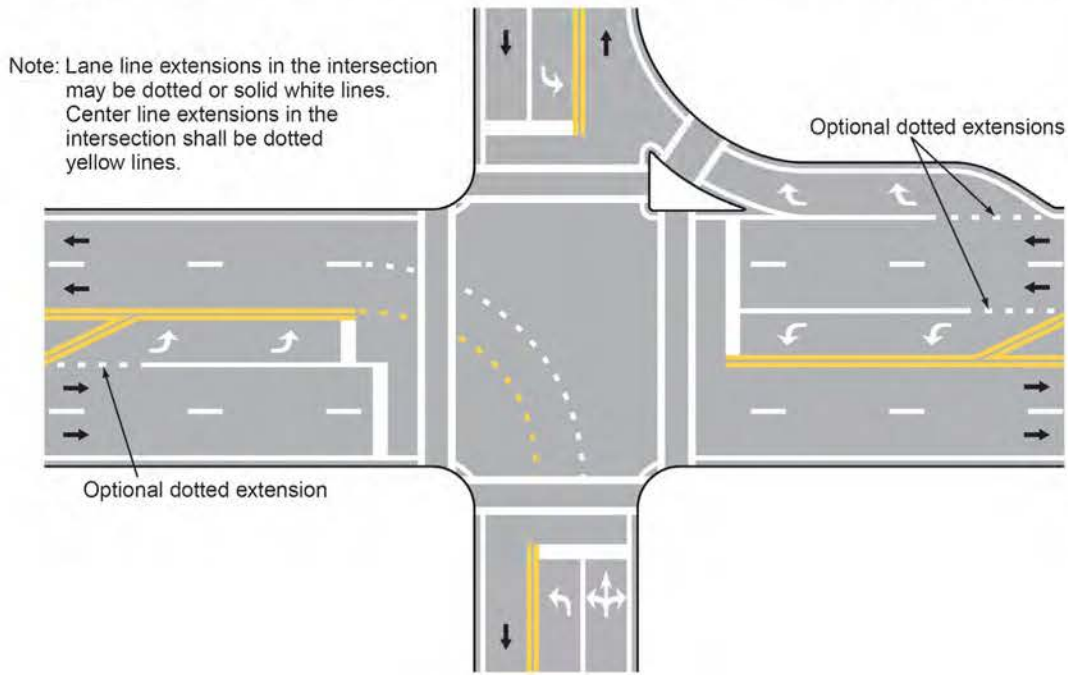
**B - Typical pavement markings with double-turn lanes, lane-use turn arrows, and optional crosswalk lines, stop lines, and line extensions into intersection for double turns**



**Figure 3B-13. Examples of Line Extensions through Intersections (Sheet 2 of 2)**

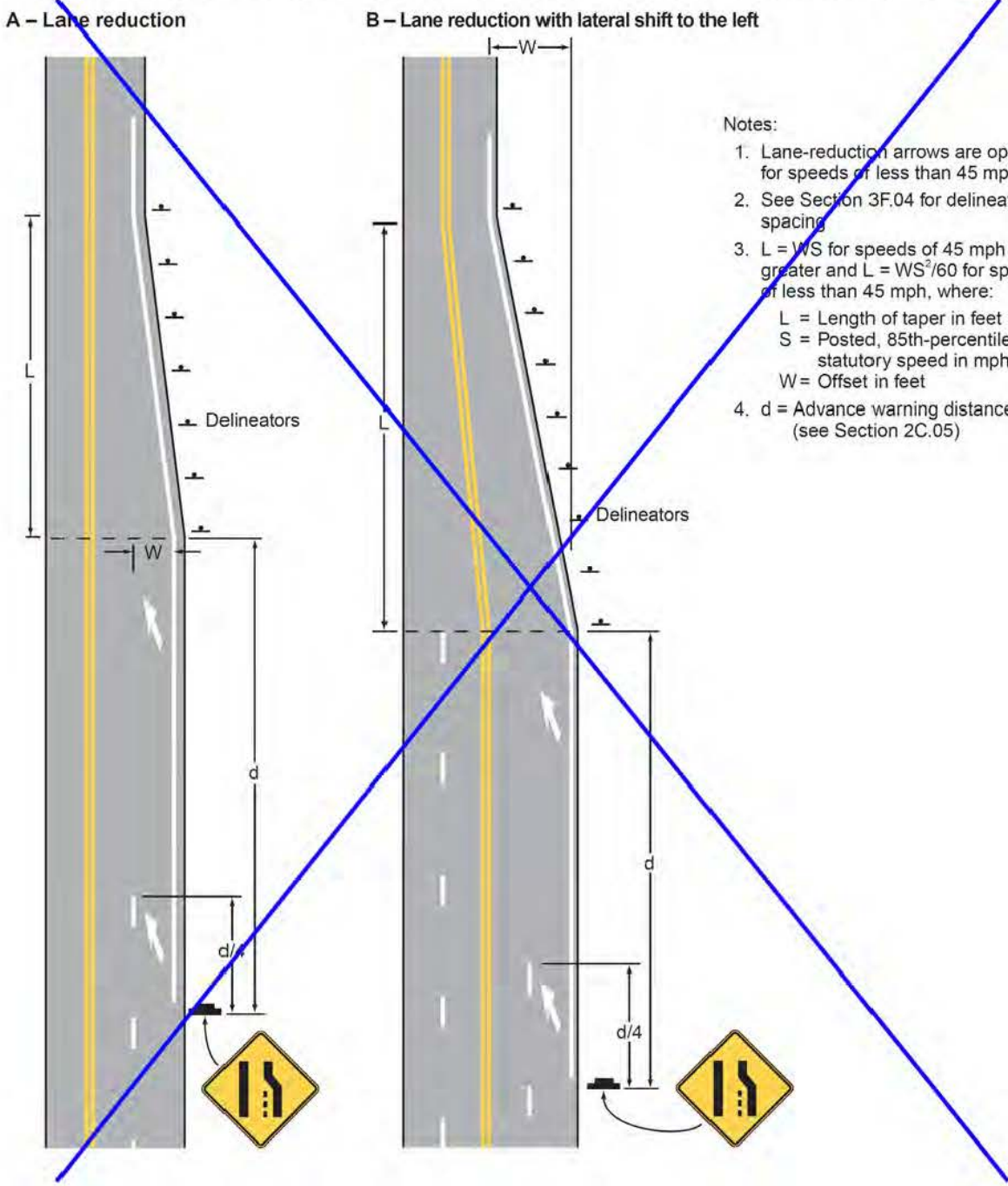


**D - Typical dotted line markings to extend center line and lane line markings into the intersection**

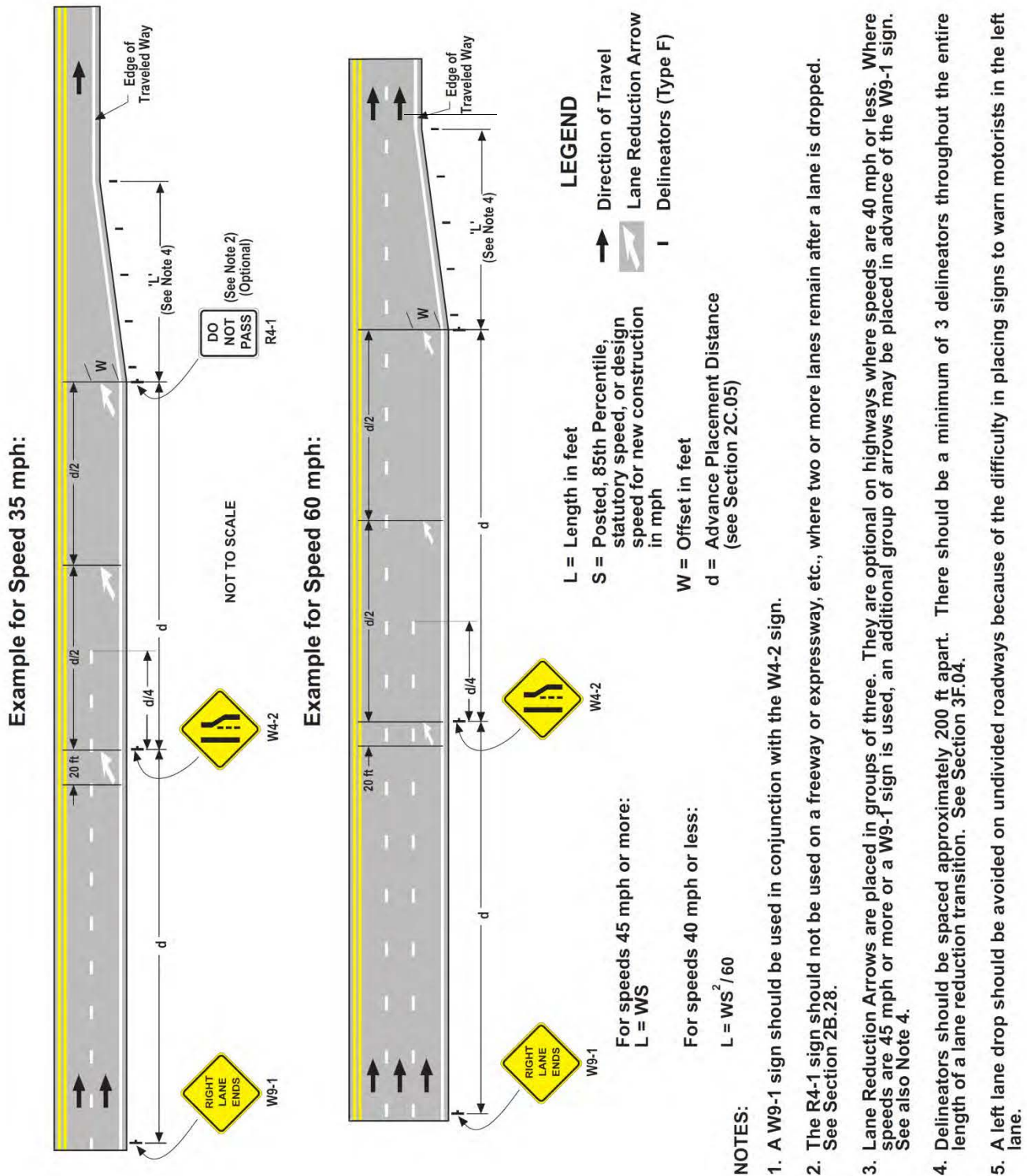




**Figure 3B-14. Examples of Applications of Lane-Reduction Transition Markings**

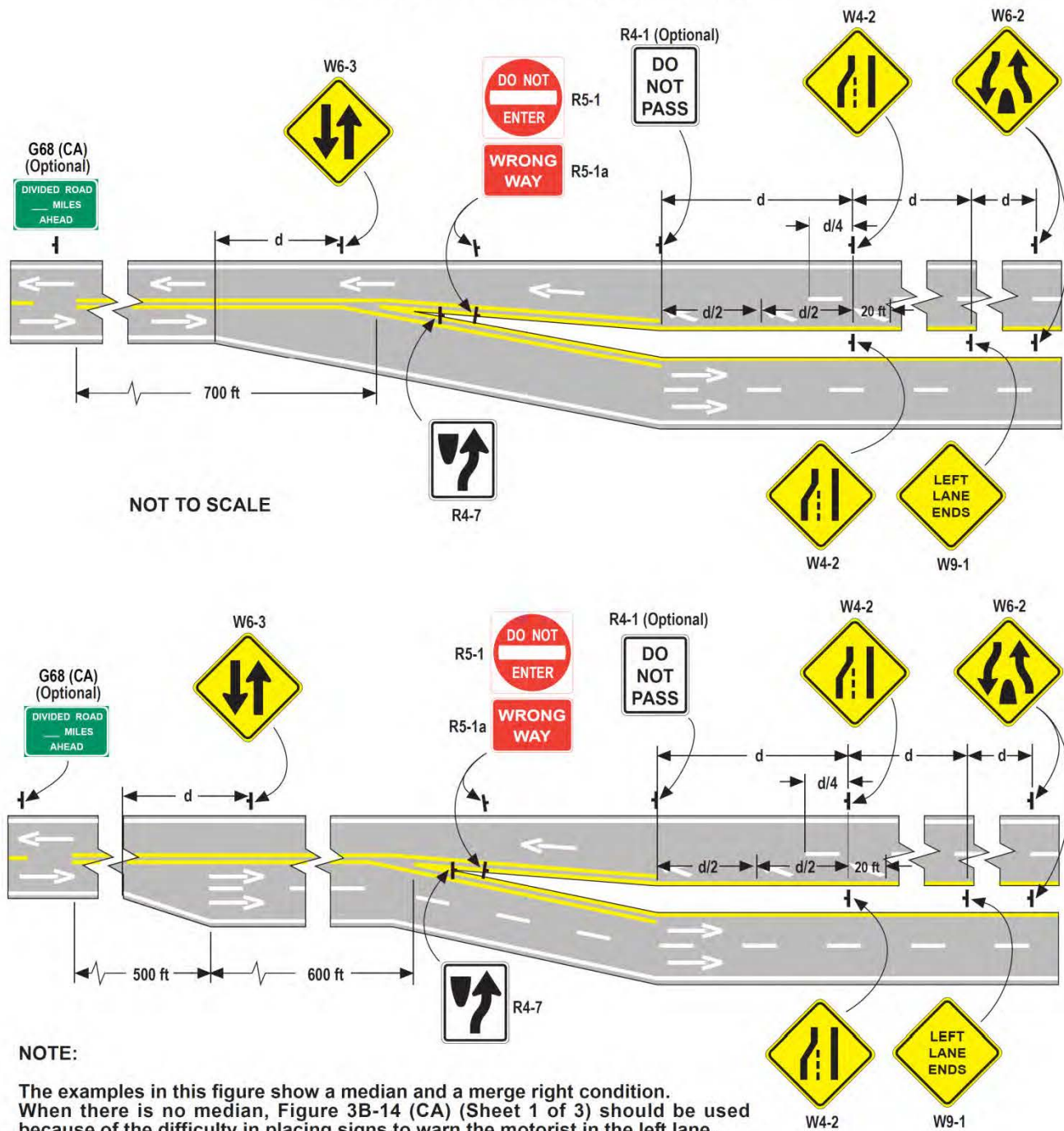


**Figure 3B-14 (CA). Examples of Applications of Lane-Reduction Transition Markings (Sheet 1 of 3)**



**Figure 3B-14 (CA). Examples of Applications of Lane-Reduction Transition Markings (Sheet 2 of 3)**

**From 4 lanes to 2 lanes (With Median)**

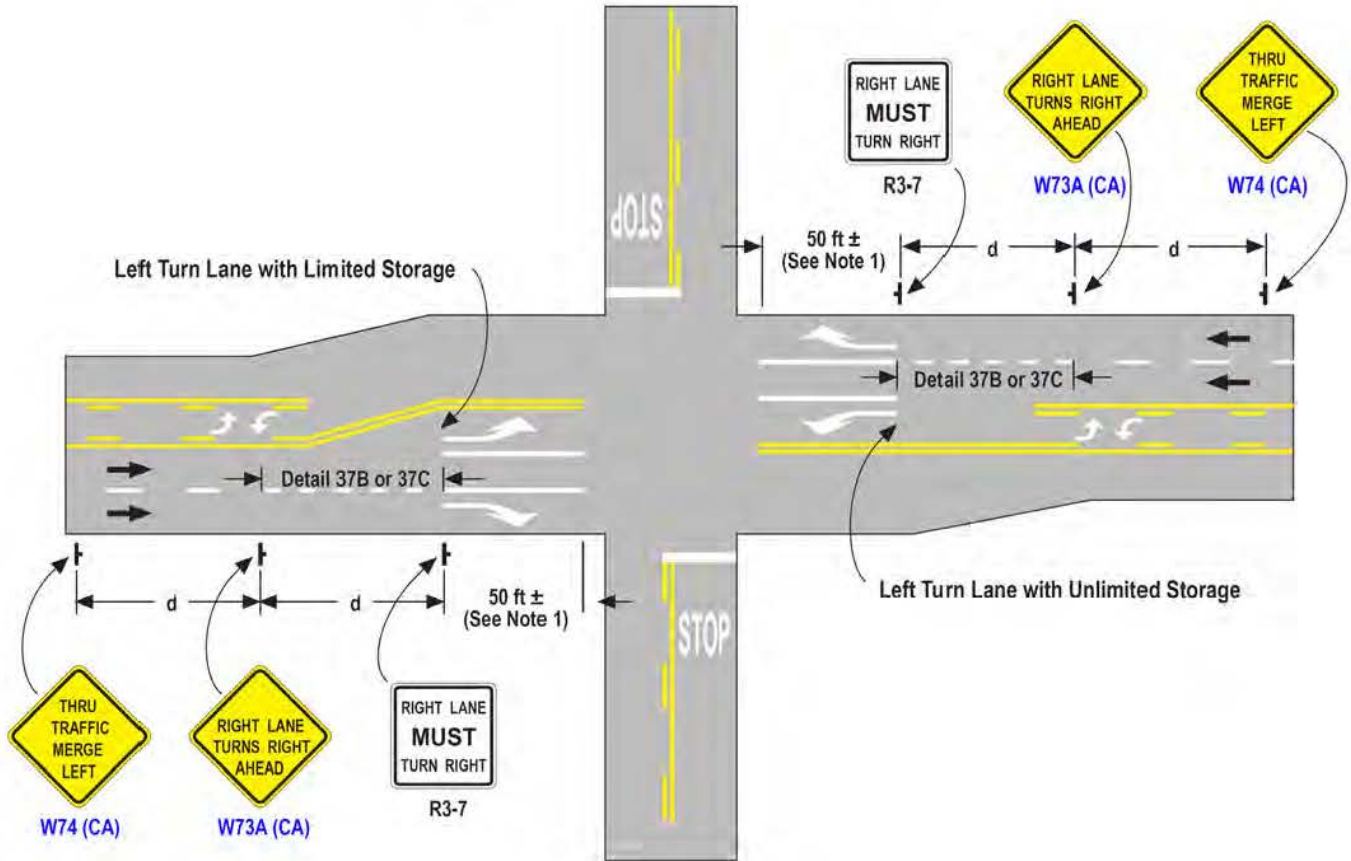


**LEGEND**

- d = Advance Placement Distance (see Section 2C.05)
- † Sign Location
-  Lane Reduction Arrow
-  Wrong Way Arrow

**Figure 3B-14 (CA). Examples of Applications of Lane-Reduction Transition Markings (Sheet 3 of 3)**

**Conventional Highway Intersections**



**NOTES:**

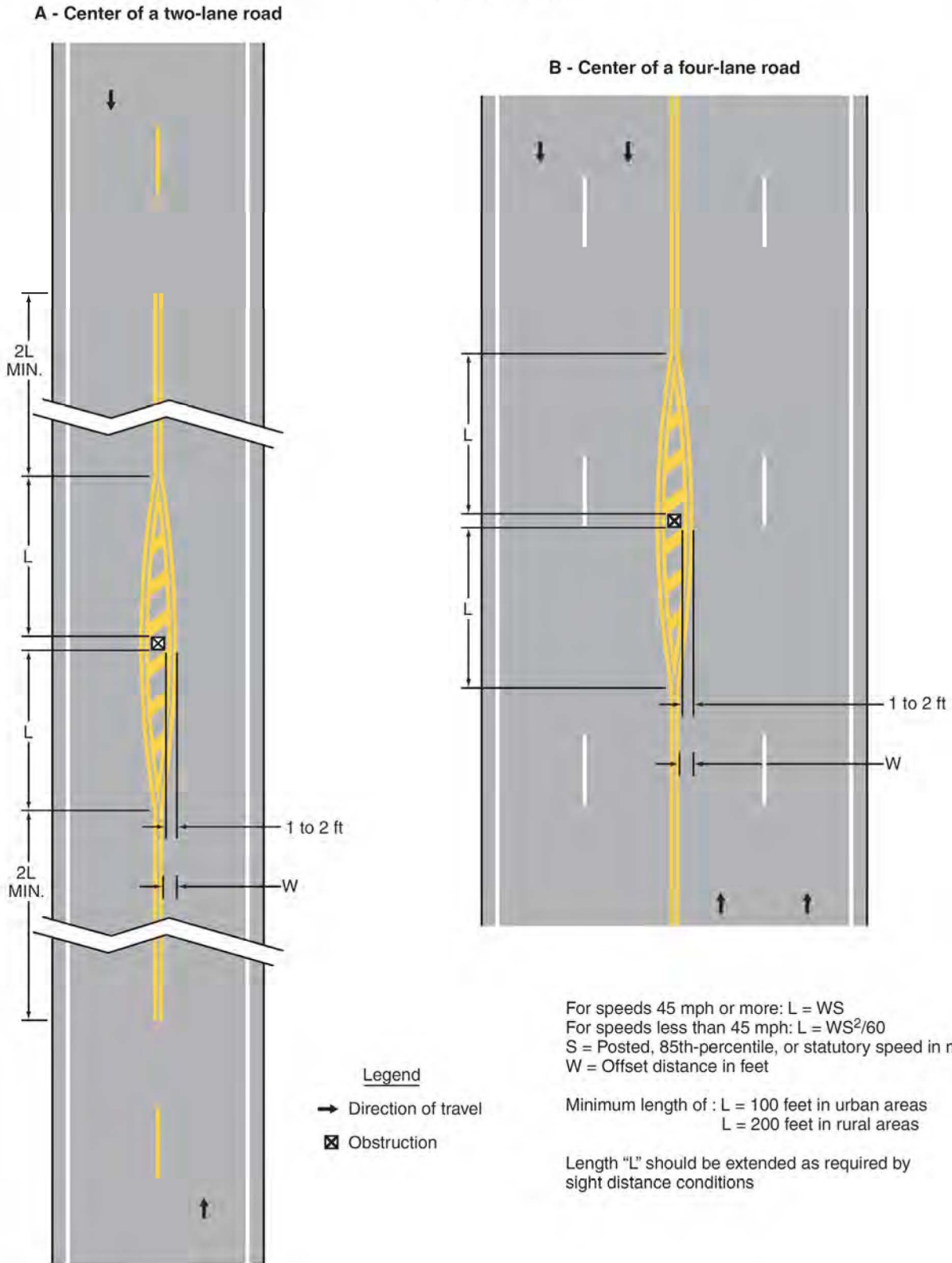
1. See Figure 3B-101 for taper and storage lengths. See Detail 37B and 37C for lane drop markings. The minimum length of solid channelizing line is 50 ft. However, if using Detail 37C, the minimum length will be 48 ft.
2. The RIGHT LANE TURNS RIGHT AHEAD, (W73A CA) sign should be placed in conjunction with the RIGHT LANE MUST TURN RIGHT (R3-7) sign and the appropriate lane line and markings. A THRU TRAFFIC MERGE LEFT (W74 CA) sign may be placed in advance of the W73A CA sign. However, adequate sight distance or proximity to a freeway ramp, cross road, etc., may dictate the need and location of additional signs and the length of the turn lane.

**LEGEND**

- ➔ Direction of Travel
- ▬ Pavement Arrows
- ⊥ Sign Location
- d = Advance Placement Distance (see Section 2C.05)

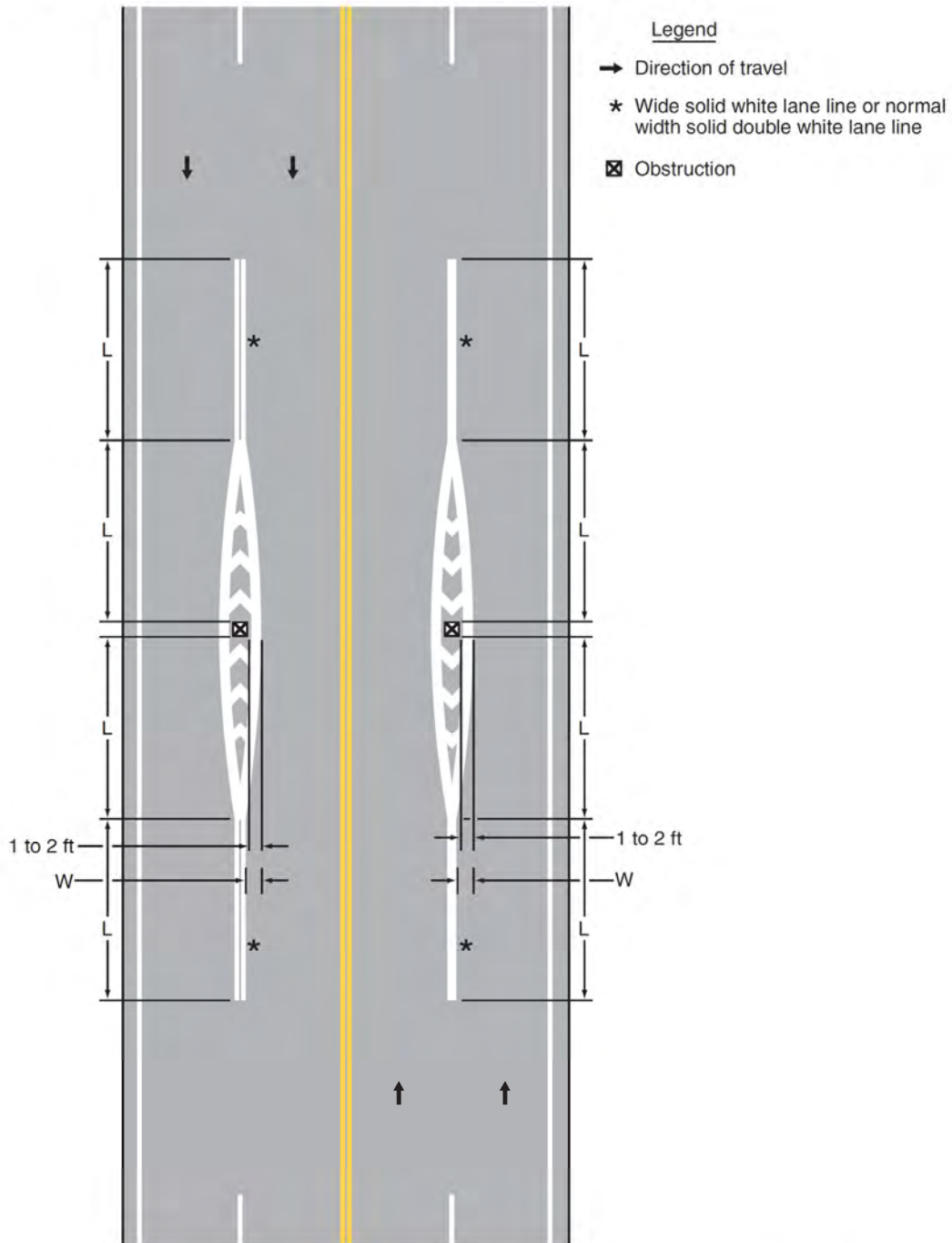
NOT TO SCALE

**Figure 3B-15. Examples of Applications of Markings for Obstructions in the Roadway**  
 (Sheet 1 of 2)



**Figure 3B-15. Examples of Applications of Markings for Obstructions in the Roadway**  
 (Sheet 2 of 2)

**C - Traffic passing in the same direction on both sides of an obstruction**

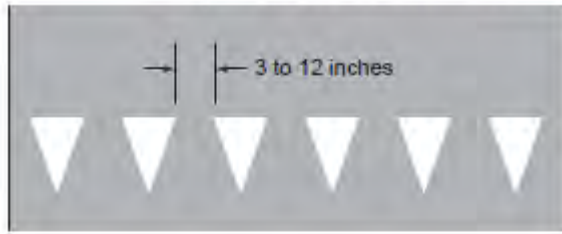


For speeds of 45 mph or more:  $L = WS$   
 For speeds of less than 45 mph:  $L = WS^2/60$   
 S = Posted, 85th-percentile, or statutory speed in mph  
 W = Offset distance in feet

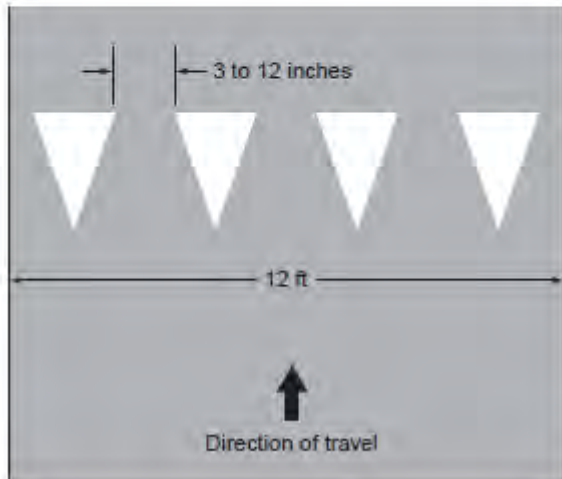
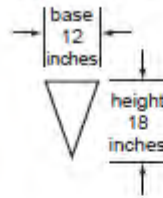
Minimum length of: L = 100 feet in urban areas  
 L = 200 feet in rural areas

Length "L" should be extended as required by sight distance conditions

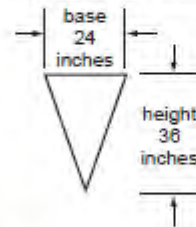
**Figure 3B-16. Recommended Yield Line Layouts**



(a) Minimum Dimensions



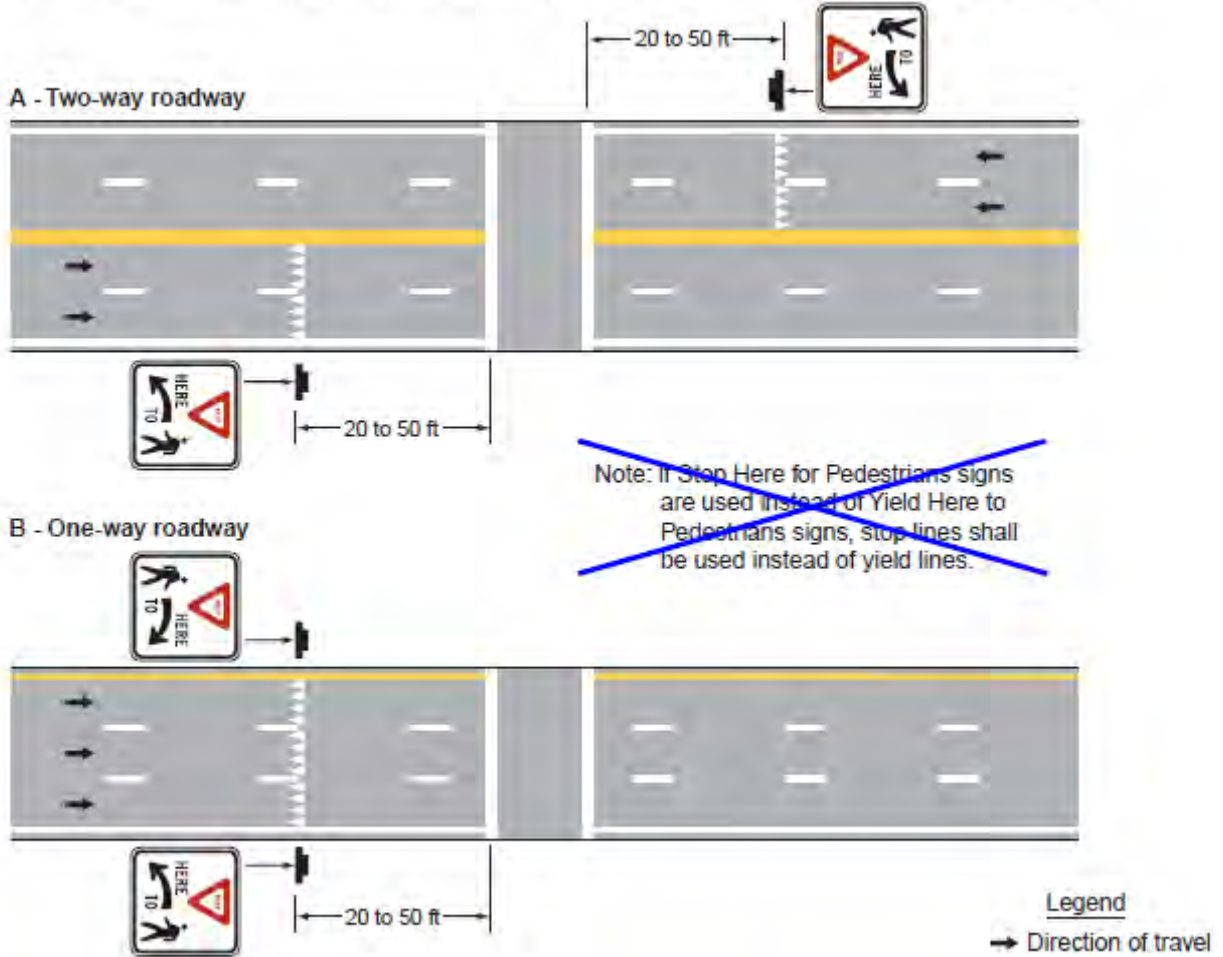
(b) Maximum Dimensions



Notes:  
Triangle height is equal to 1.5 times the base dimension.

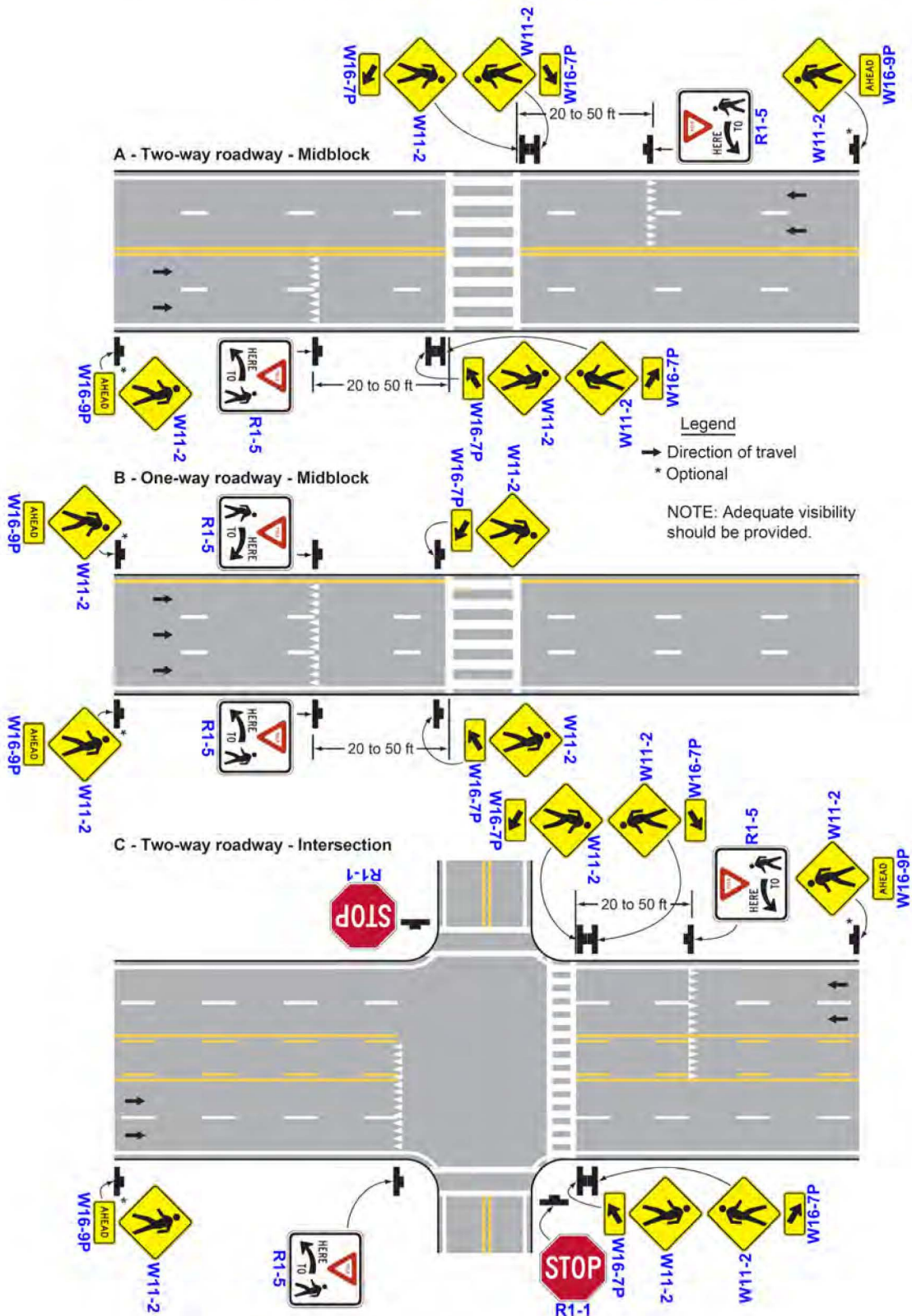
Yield lines may be smaller than suggested when installed on much narrower, slow-speed facilities such as shared-use paths.

Figure 3B-17. Examples of Yield Lines at Unsignalized Midblock Crosswalks

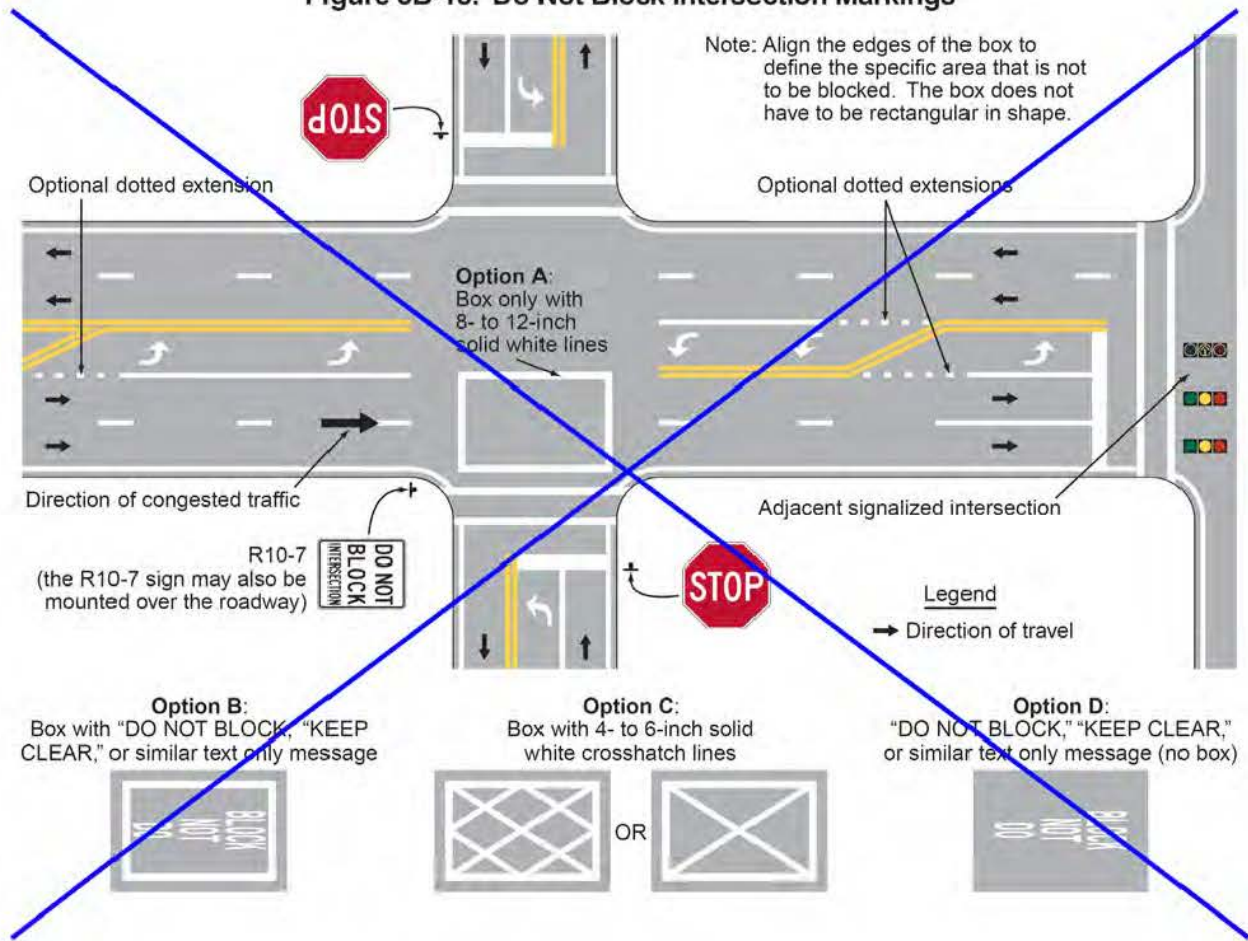




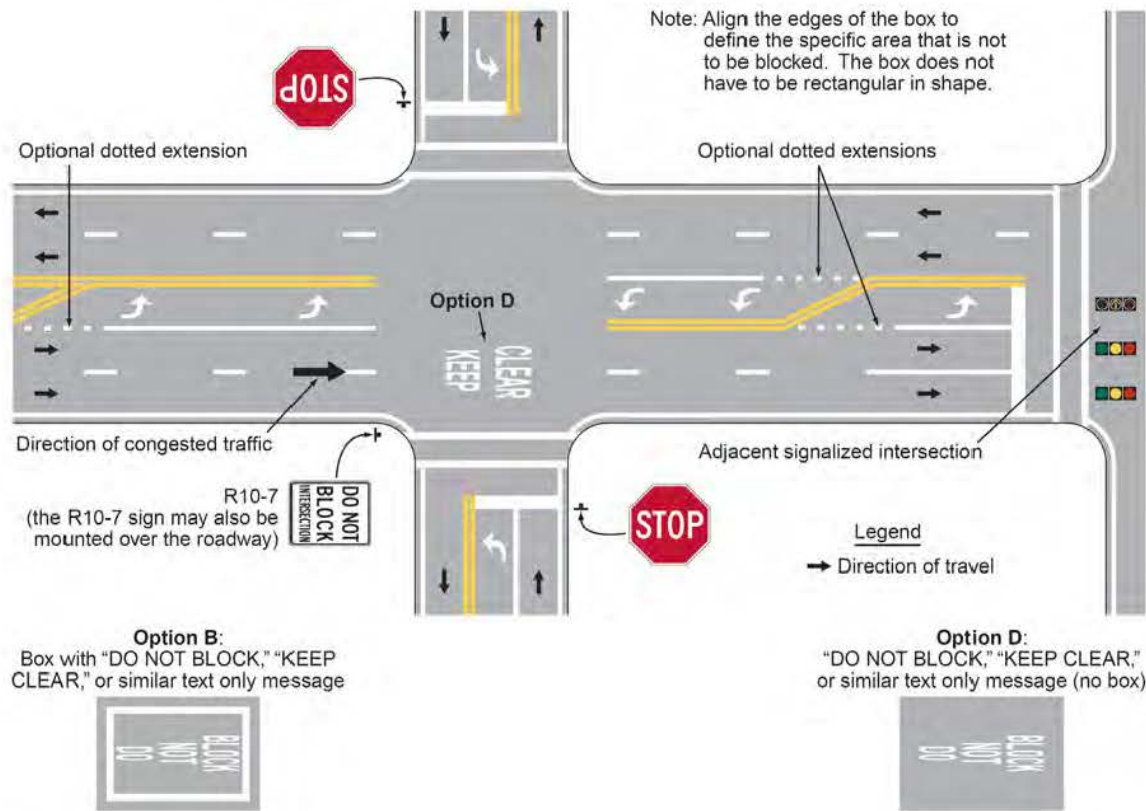
**Figure 3B-17 (CA). Examples of Crosswalk Enhancements at Uncontrolled Multilane Approaches**



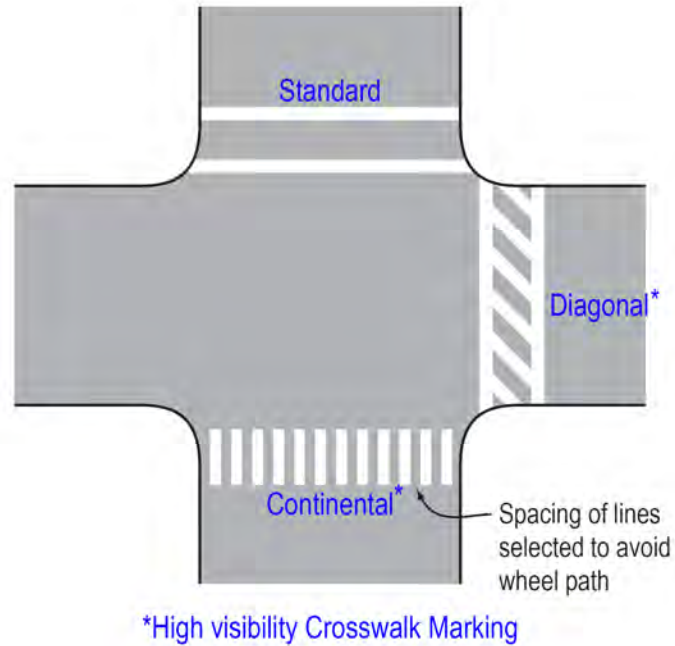
**Figure 3B-18. Do Not Block Intersection Markings**



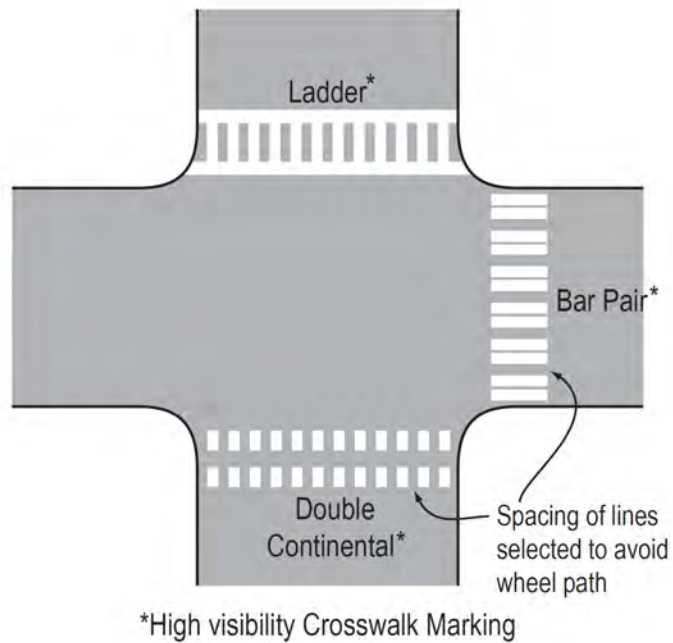
**Figure 3B-18 (CA). Do Not Block Intersection Markings**



**Figure 3B-19. Examples of Crosswalk Markings**



**Figure 3B-19 (CA). Examples of Crosswalk Markings**



**Figure 3B-20. Example of Crosswalk Markings for an Exclusive Pedestrian Phase that Permits Diagonal Crossing**

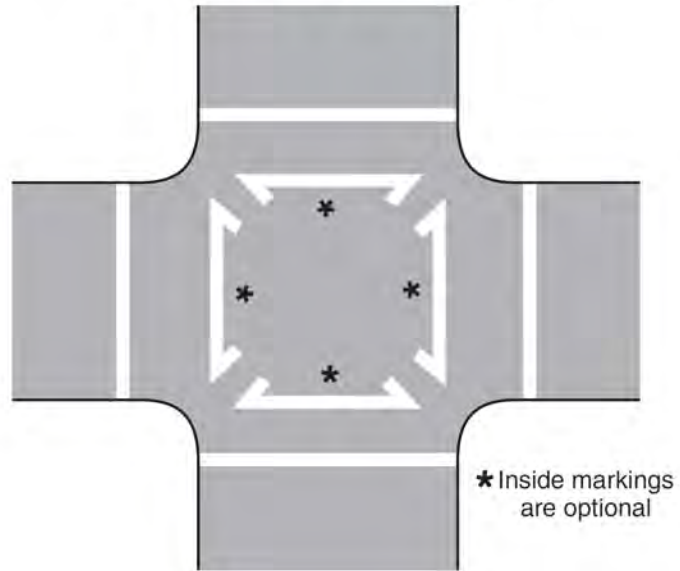
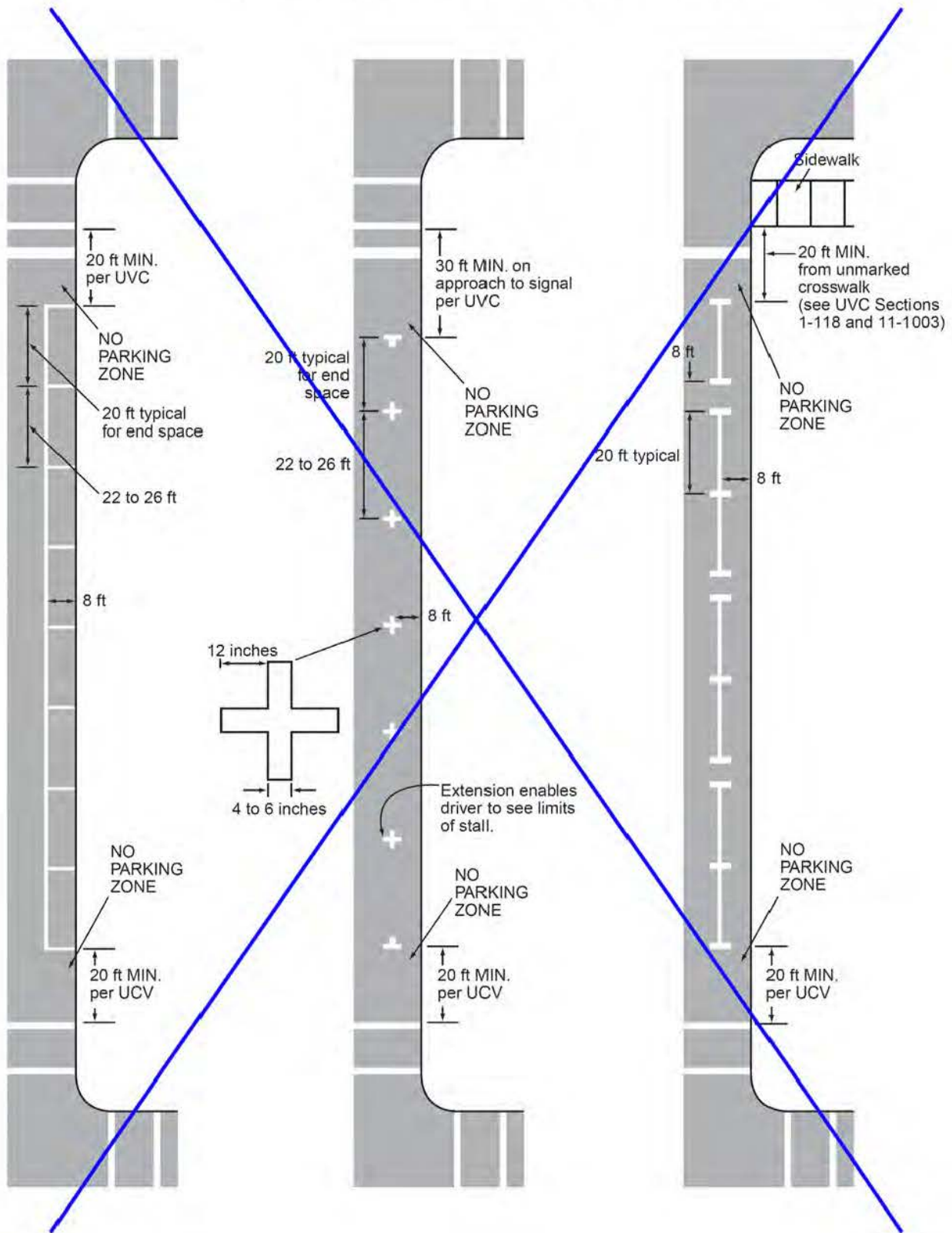
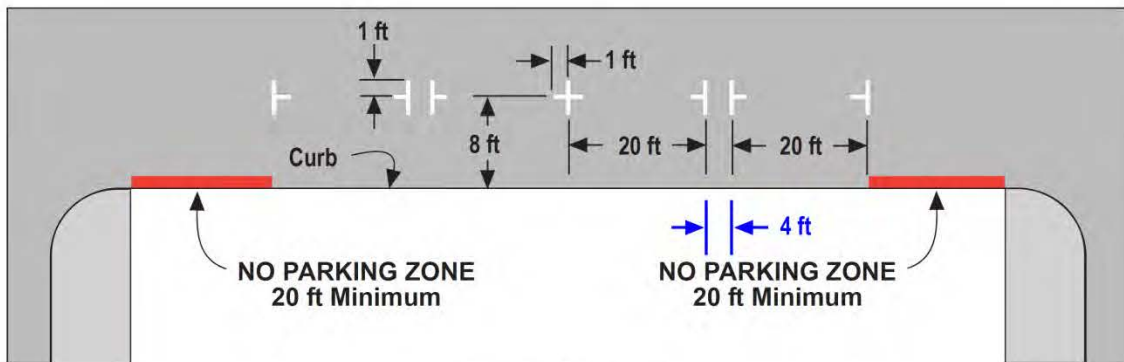
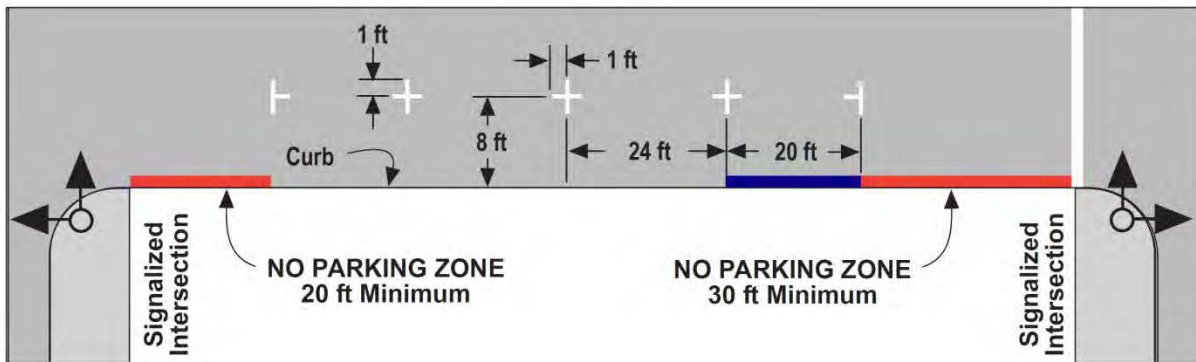
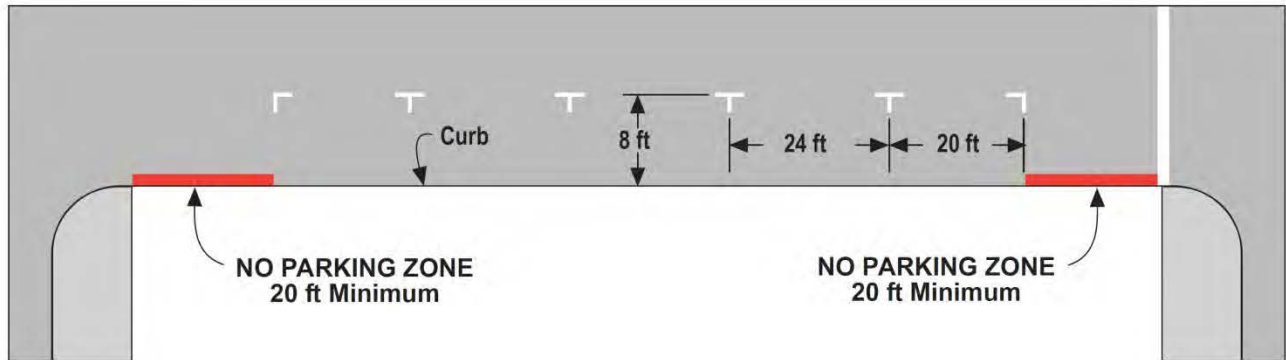


Figure 3B-21. Examples of Parking Space Markings



**Figure 3B-21 (CA). Examples of Parking Space Markings**

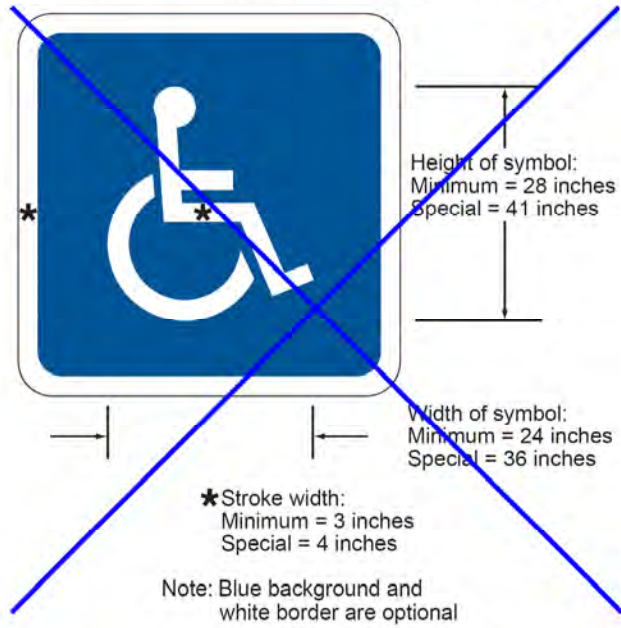


NOT TO SCALE

**NOTES:**

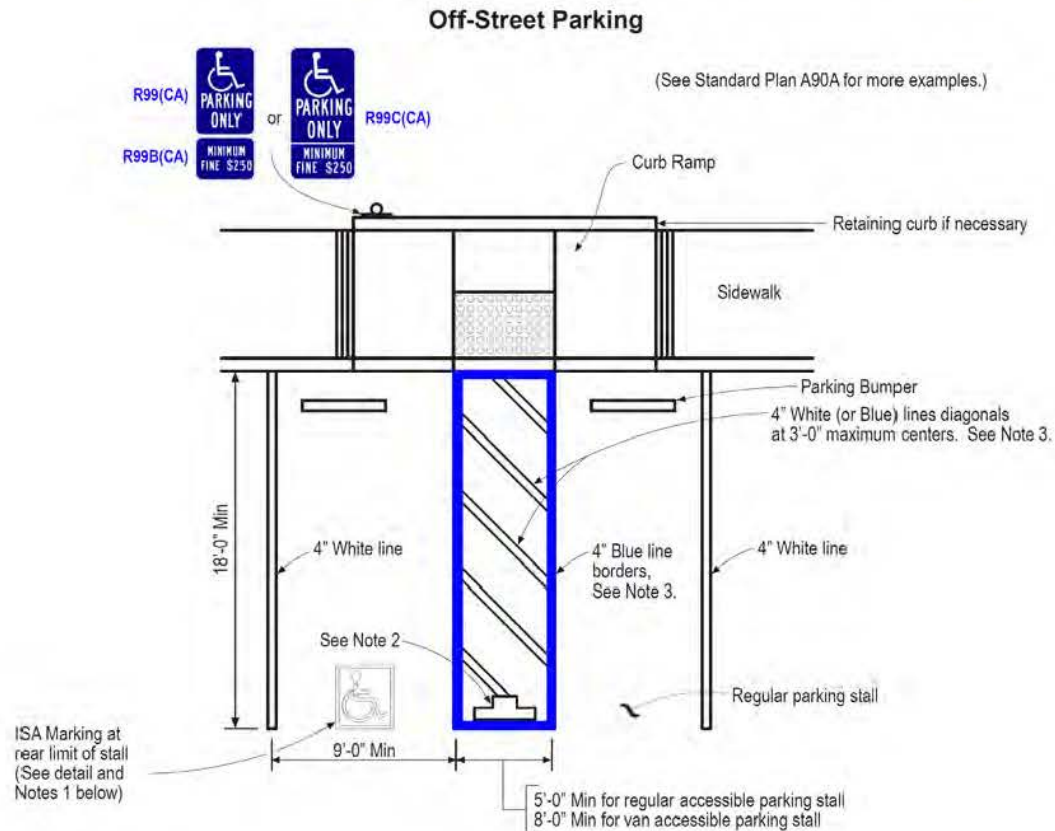
1. For Parking Stalls along the left side curb on one-way streets, markings may be placed on the curb delineating the ends of the individual stalls.
2. All stall markings are made with 4 in wide white lines. The shape is optional.
3. The parking stall cross line, 8 ft from the curb, may be continuous longitudinally.

**Figure 3B-22. International Symbol of Accessibility Parking Space Marking**

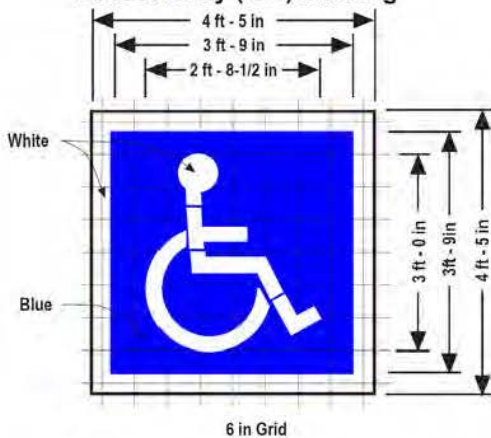




**Figure 3B-22 (CA). Examples of Disabled Persons Parking Symbol, Legend and Related Markings (Sheet 1 of 2)**



**International Symbol of Accessibility (ISA) Marking**



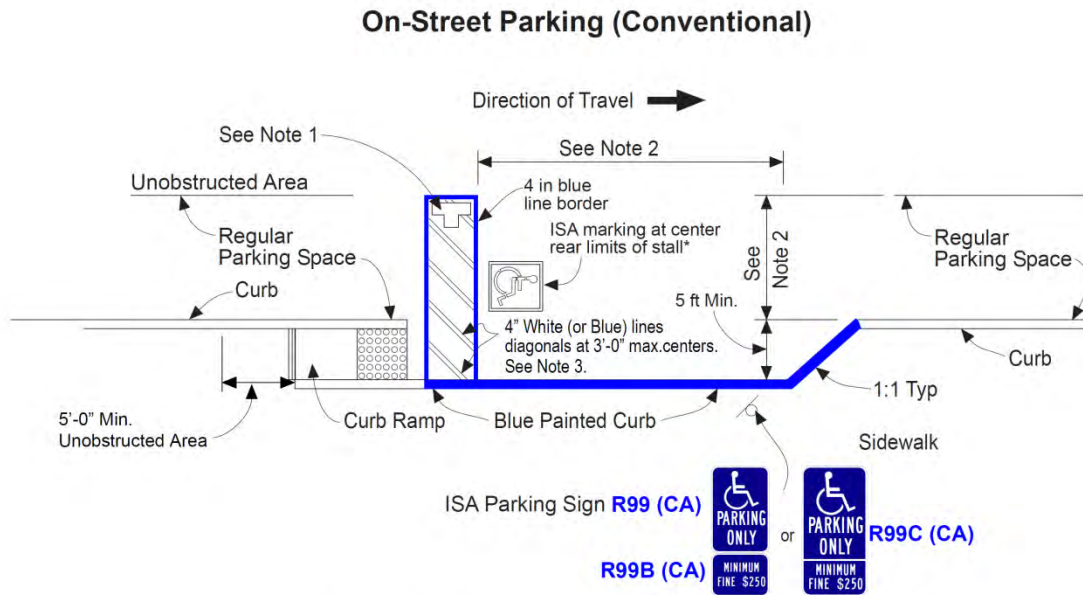
**Loading and Unloading Area Pavement Marking Legend**



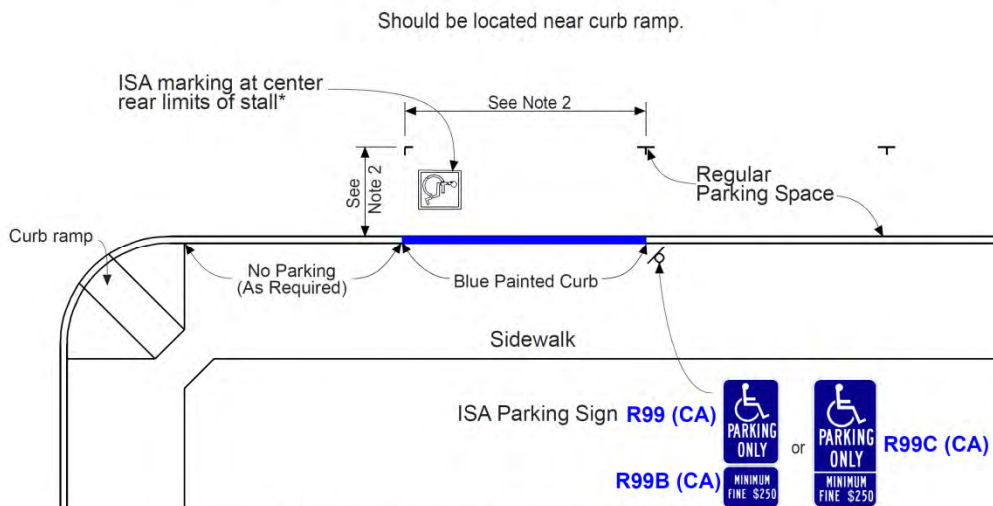
**NOTES:**

1. The design details for this symbol, legends, and related markings are shown in the Department of Transportation's Standard Plans. See Standard Plan A24C for square unit area for the ISA marking.
2. The words "NO PARKING" shall be painted in the loading and unloading area in white letters no less than 12 in high on a contrasting background and located so that it is visible to traffic enforcement officials. See Standard Plan A24E for square unit area for "NO PARKING" legend.
3. Loading and unloading area border shall be marked in blue paint. The hatched lines shall be painted a suitable contrasting color to the parking space. Blue or white paint is preferred.

**Figure 3B-22 (CA). Examples of Disabled Persons Parking Symbol, Legend and Related Markings (Sheet 2 of 2)**



### On-Street Parking (Restricted Right of Way Width)

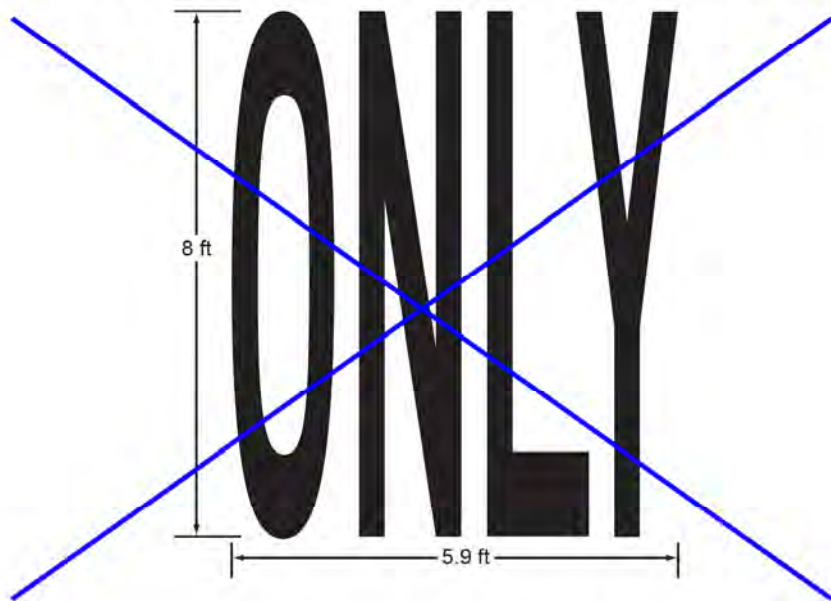


\* ISA marking is optional for On-Street accessible parking.

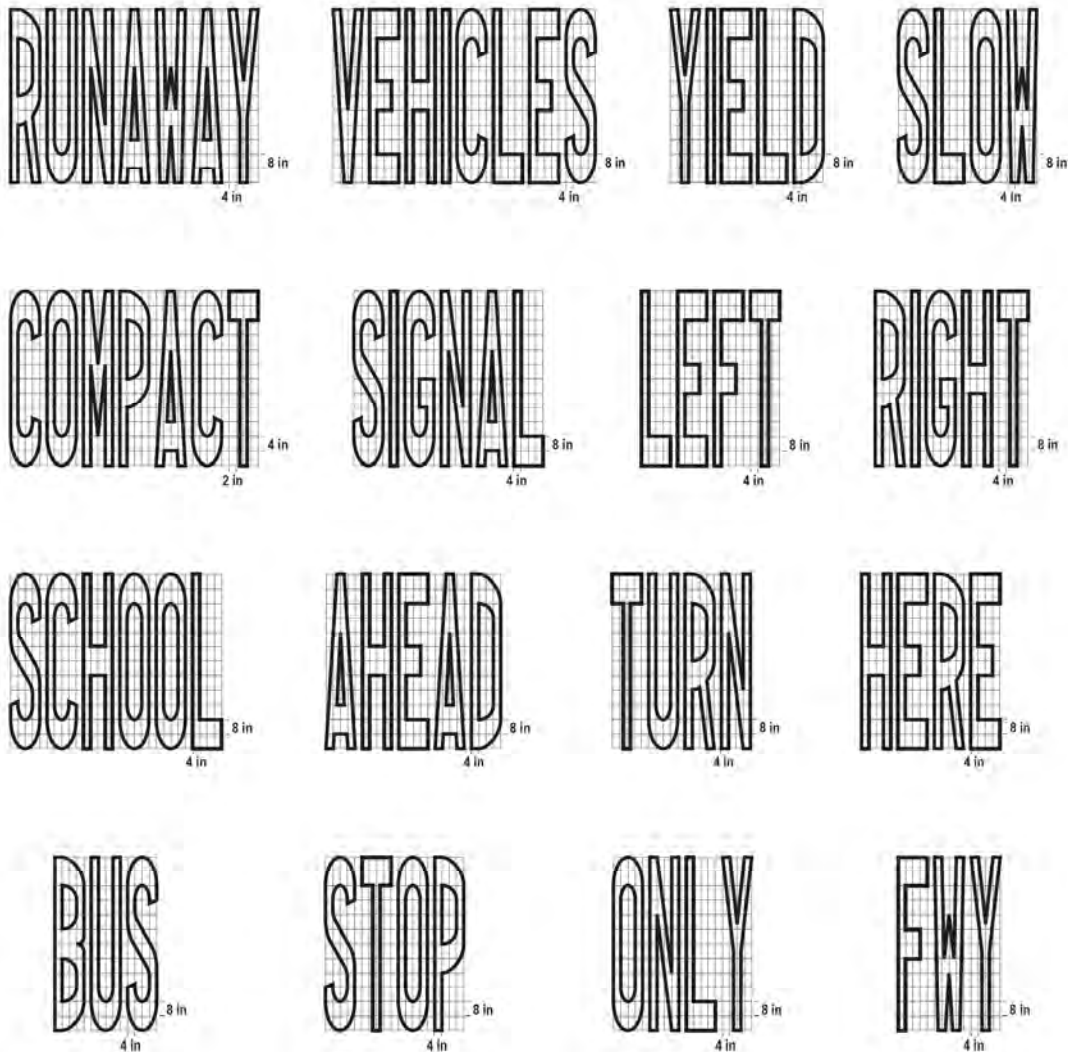
**NOTES:**

1. The words "NO PARKING", shall be painted in white letters no less than 12 in high on a contrasting background and located so that it is visible to traffic enforcement officials. See Standard Plan A24E for square unit area for painting the legend "NO PARKING".
2. Accessible on-street parking spaces shall not be smaller in length or width than that specified by the local jurisdiction for other parking spaces, but not less than 20 ft in length and not less than 8 ft in width.
3. The hatched lines shall be painted a suitable contrasting color to the parking space. Blue or white paint is preferred.
4. Actual dimensions and curb geometry may differ from that shown. See Standard Plan A90B for additional details.

**Figure 3B-23. Example of Elongated Letters for Word Pavement Markings**



**Figure 3B-23 (CA). Examples of Elongated Letters for Word Pavement Markings (Sheet 1 of 2)**

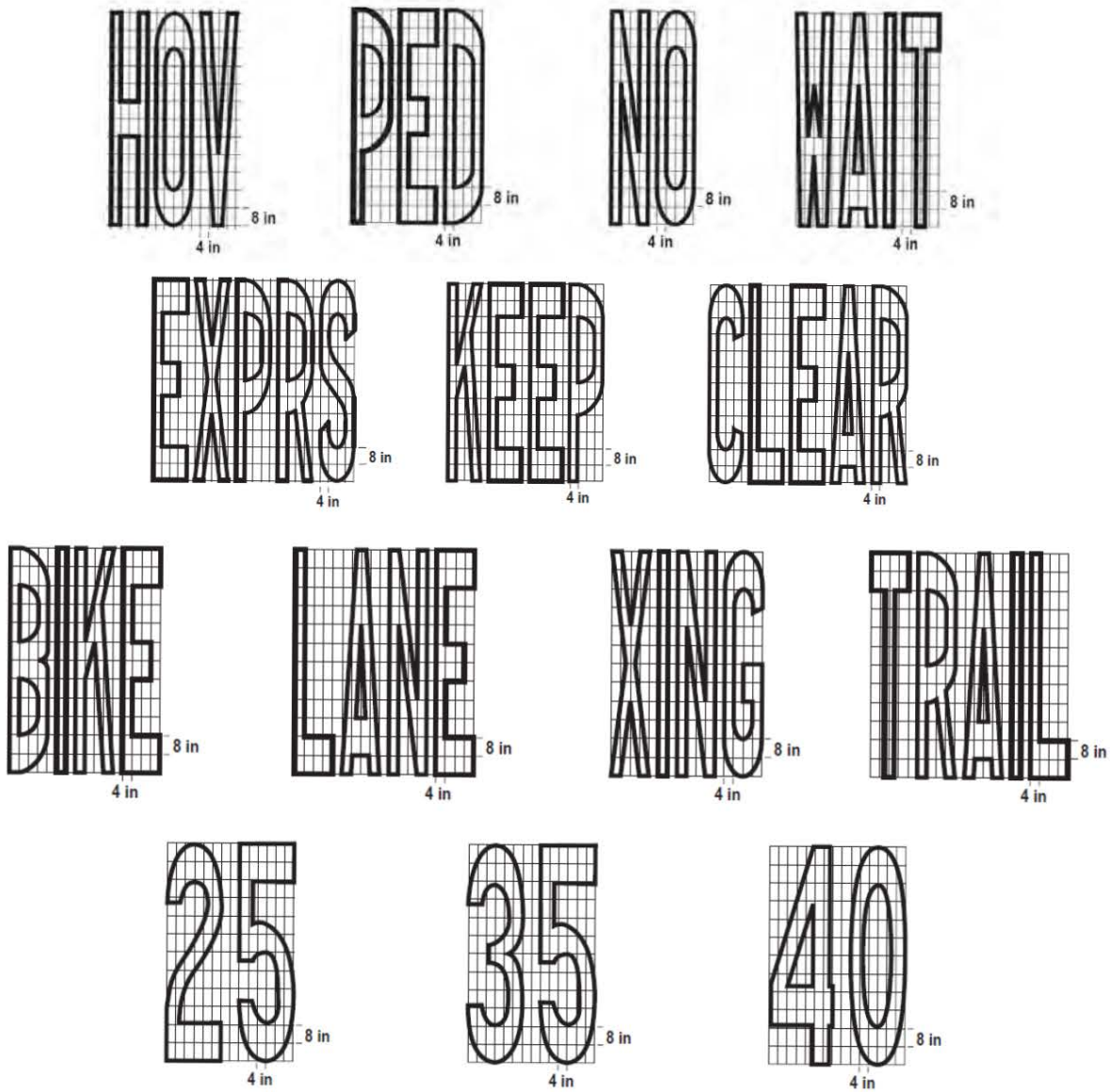


NOT TO SCALE

**NOTES:**

1. All letters and numerals should be in conformance with the standard alphabets for highway signs and pavement markings approved by Department of Transportation.
2. The design details for various words are also shown in Department of Transportation's Standard Plans.

**Figure 3B-23 (CA). Examples of Elongated Letters for Word Pavement Markings (Sheet 2 of 2)**

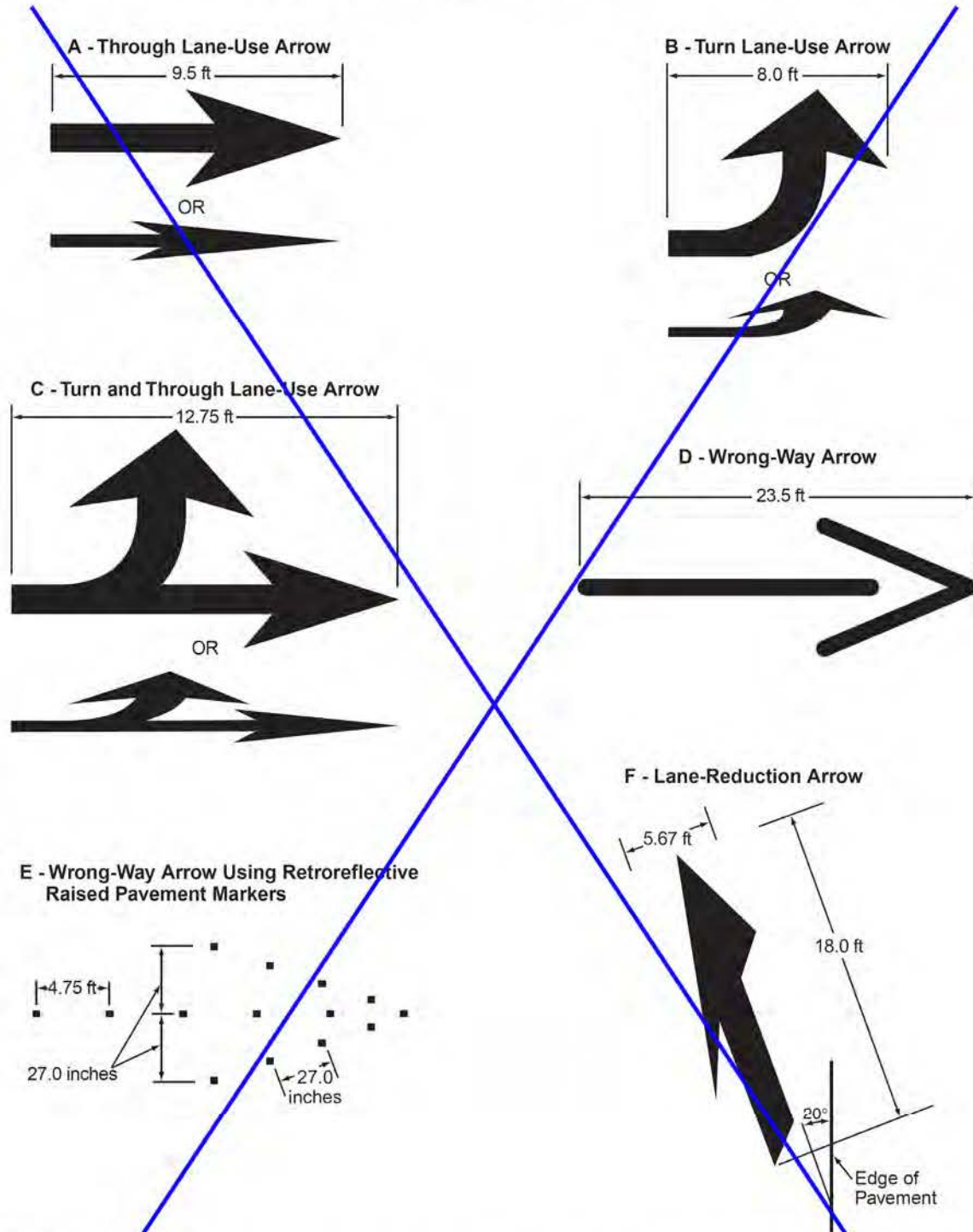


NOT TO SCALE

**NOTES:**

1. All letters and numerals should be in conformance with the standard alphabets for highway signs and pavement markings approved by Department of Transportation.
2. The design details for various words are also shown in Department of Transportation's Standard Plans.

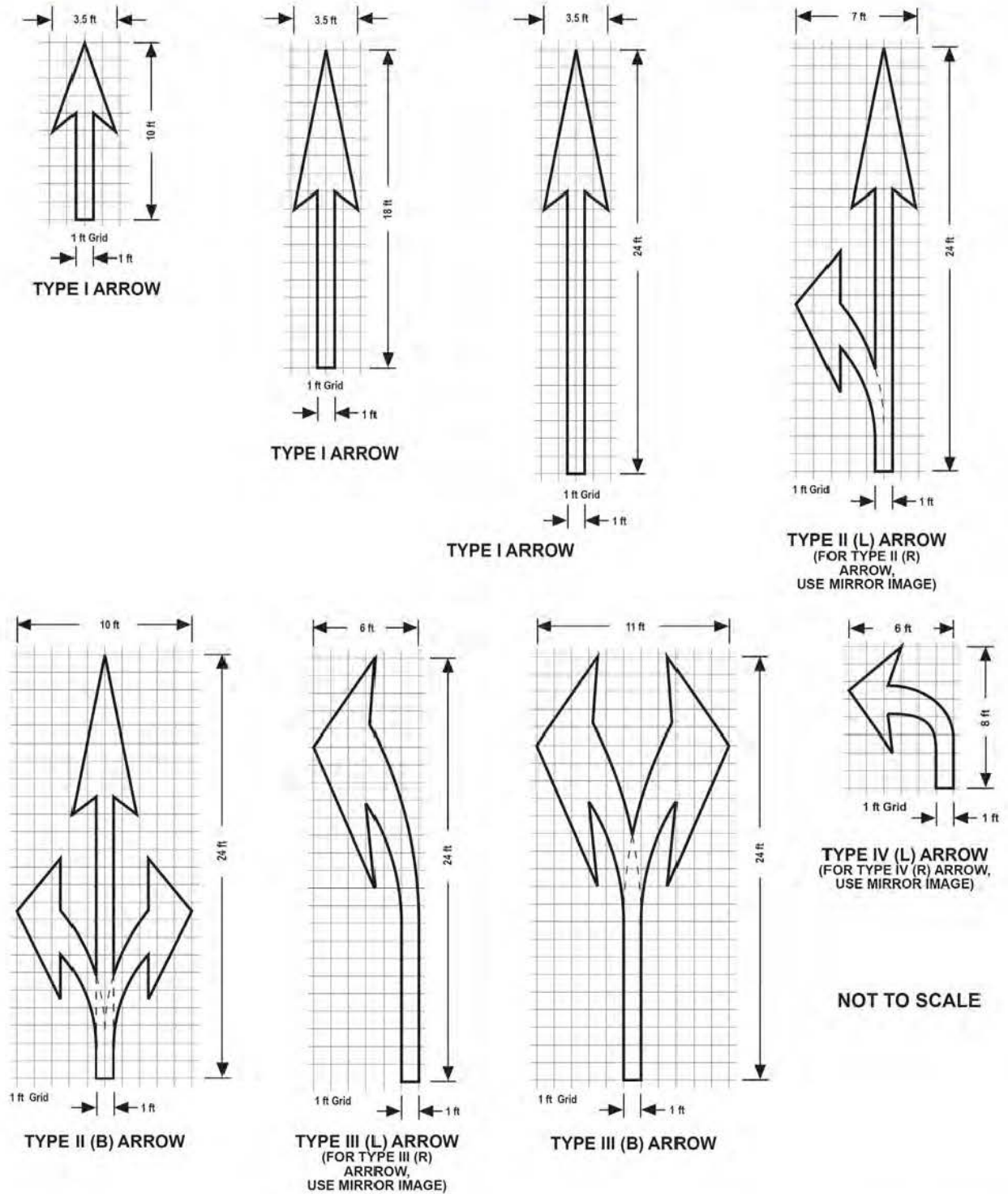
**Figure 3B-24. Examples of Standard Arrows for Pavement Markings**



**Notes:**

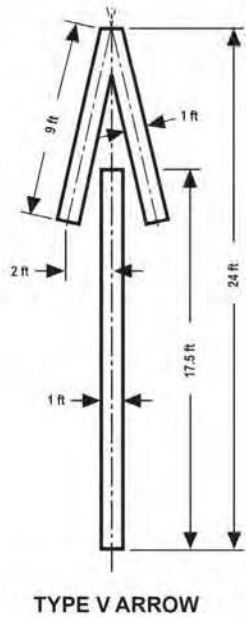
1. Typical sizes for normal installation; sizes may be reduced approximately one-third for low-speed urban conditions; larger sizes may be needed for freeways, above average speeds, and other critical locations.
2. The narrow elongated arrow designs shown in Drawings A, B, and C are optional.
3. For proper proportion, see the Pavement Markings chapter of the "Standard Highway Signs and Markings" book (see Section 1A.11).

**Figure 3B-24 (CA). Examples of Standard Arrows for Pavement Markings (Sheet 1 of 8)**

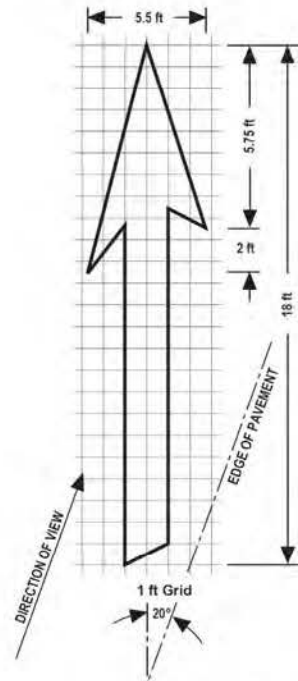


**NOTE:** The design details for various arrows are also shown in Department of Transportation's Standard Plans.

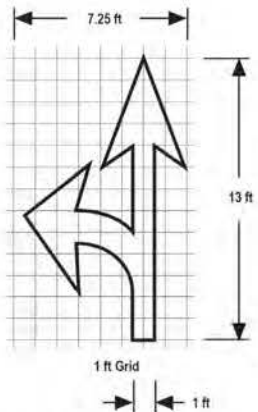
**Figure 3B-24 (CA). Examples of Standard Arrows for Pavement Markings (Sheet 2 of 8)**



**TYPE V ARROW**

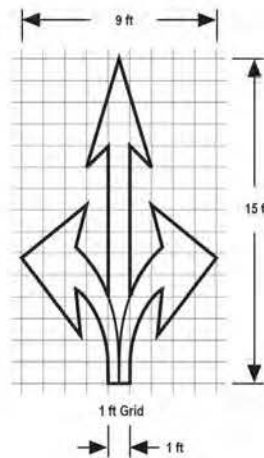


**TYPE VI ARROW**  
 RIGHT LANE DROP ARROW  
 (FOR LEFT LANE, USE MIRROR IMAGE)



**TYPE VII (L) ARROW**  
 (FOR TYPE (R) ARROW, USE MIRROR IMAGE)

**NOT TO SCALE**

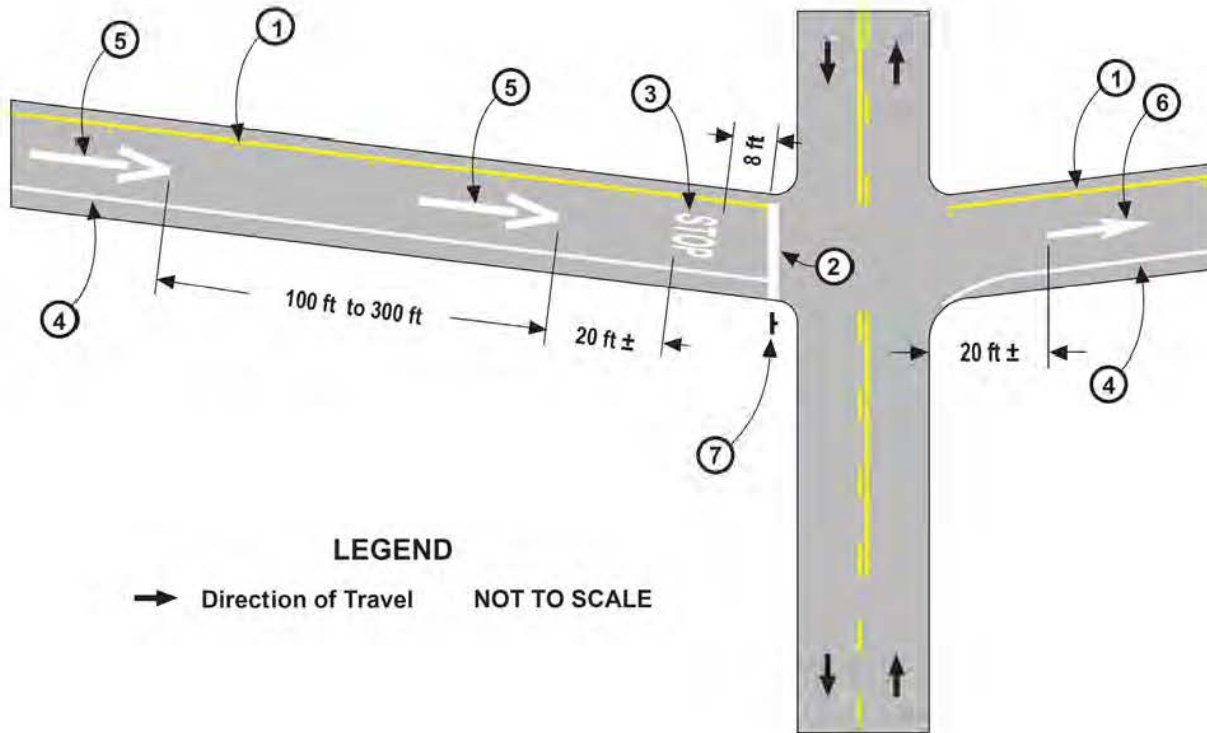


**TYPE VIII ARROW**

**NOTE:** The design details for various arrows are also shown in Department of Transportation's Standard Plans.



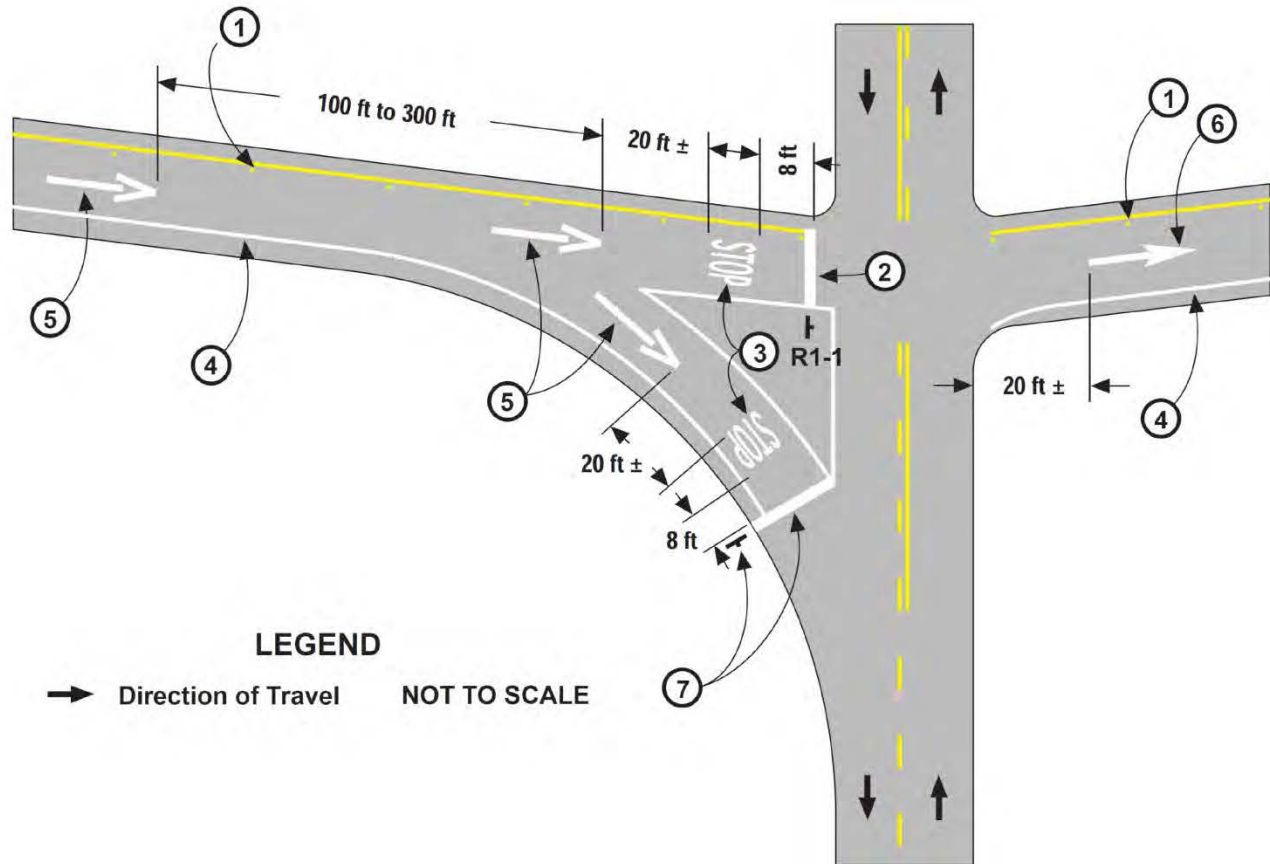
**Figure 3B-24 (CA). Examples of Standard Arrows for Pavement Markings (Sheet 3 of 8)**



**NOTES:**

1. Place 4 in Solid Yellow Left Edge Line and One-Way Yellow Retroreflective Pavement Markers on 24 ft centers as shown. See Edge Line Detail 25A.
2. Place Limit Line as shown. See also Note 7 and Section 3B.16.
3. Place "STOP" legend as shown. See Section 3B.16.
4. Place 4 in Solid White Right Edge Line, flared end optional, as shown. See Edge Line Detail 27B.
5. Place Type V Arrows, in pairs, as shown. See Section 3B.19.
6. Place Type I Arrow as shown. See Section 3B.19.
7. A "YIELD" (R1-2) sign, Yield Line and "YIELD" pavement legend may be used in lieu of the "STOP" (R1-1) sign, Limit Line and "STOP" pavement legend on low volume roads.

**Figure 3B-24 (CA). Examples of Standard Arrows for Pavement Markings (Sheet 4 of 8)**

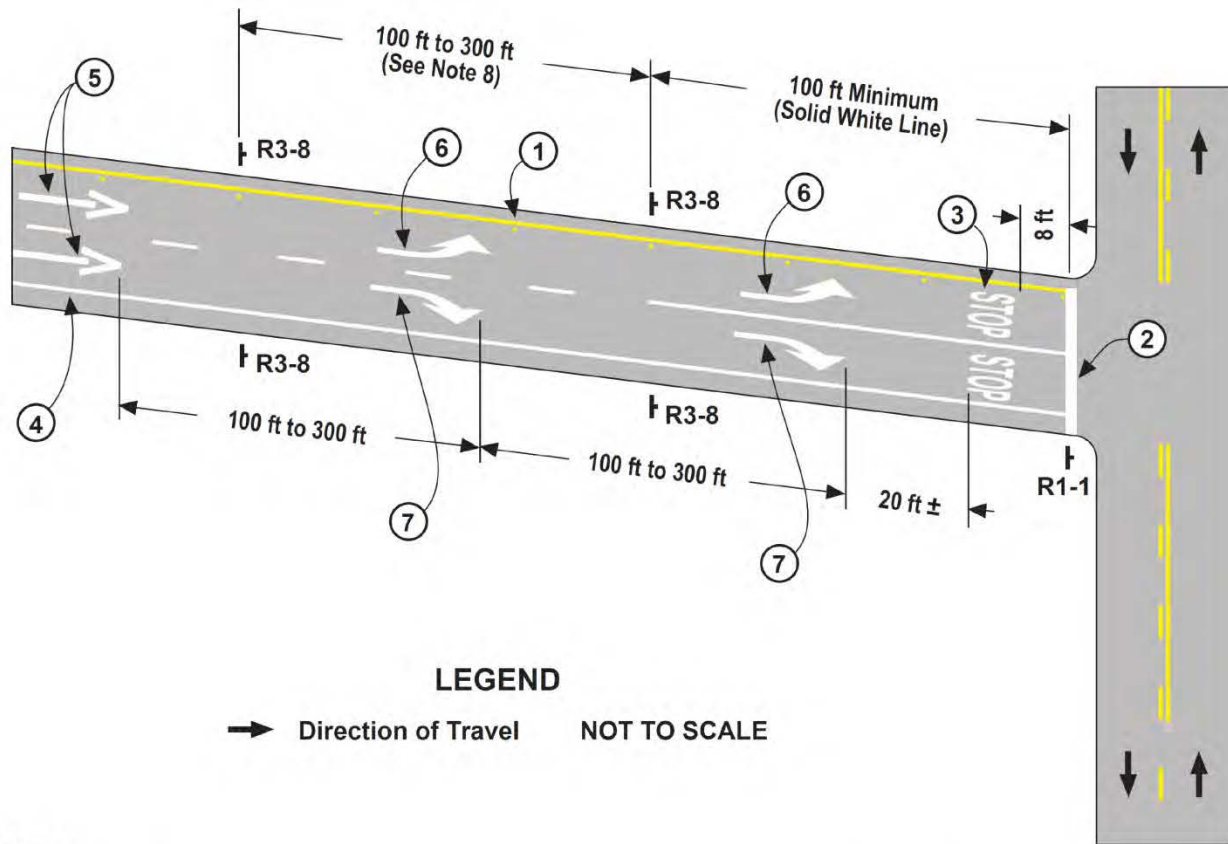


**LEGEND**  
 → Direction of Travel      NOT TO SCALE

**NOTES:**

1. Place 4 in Solid Yellow Left Edge Line and One-Way Yellow Retroreflective Pavement Markers on 24 ft centers as shown. See Edge Line Detail 25A.
2. Place Limit Line as shown. See Section 3B.16.
3. Place "STOP" legend as shown. See Section 3B.16.
4. Place 4 in Solid White Right Edge Line, flared end optional, as shown. See Edge Line Detail 27B.
5. Place Type V Arrows, in pairs, as shown. See Section 3B.20.
6. Place Type I Arrow as shown. See Section 3B.20.
7. A "YIELD" (R1-2) sign, Yield Line and "YIELD" pavement legend may be used in lieu of the "STOP" (R1-1) sign, Limit Line and "STOP" pavement legend on low volume roads.

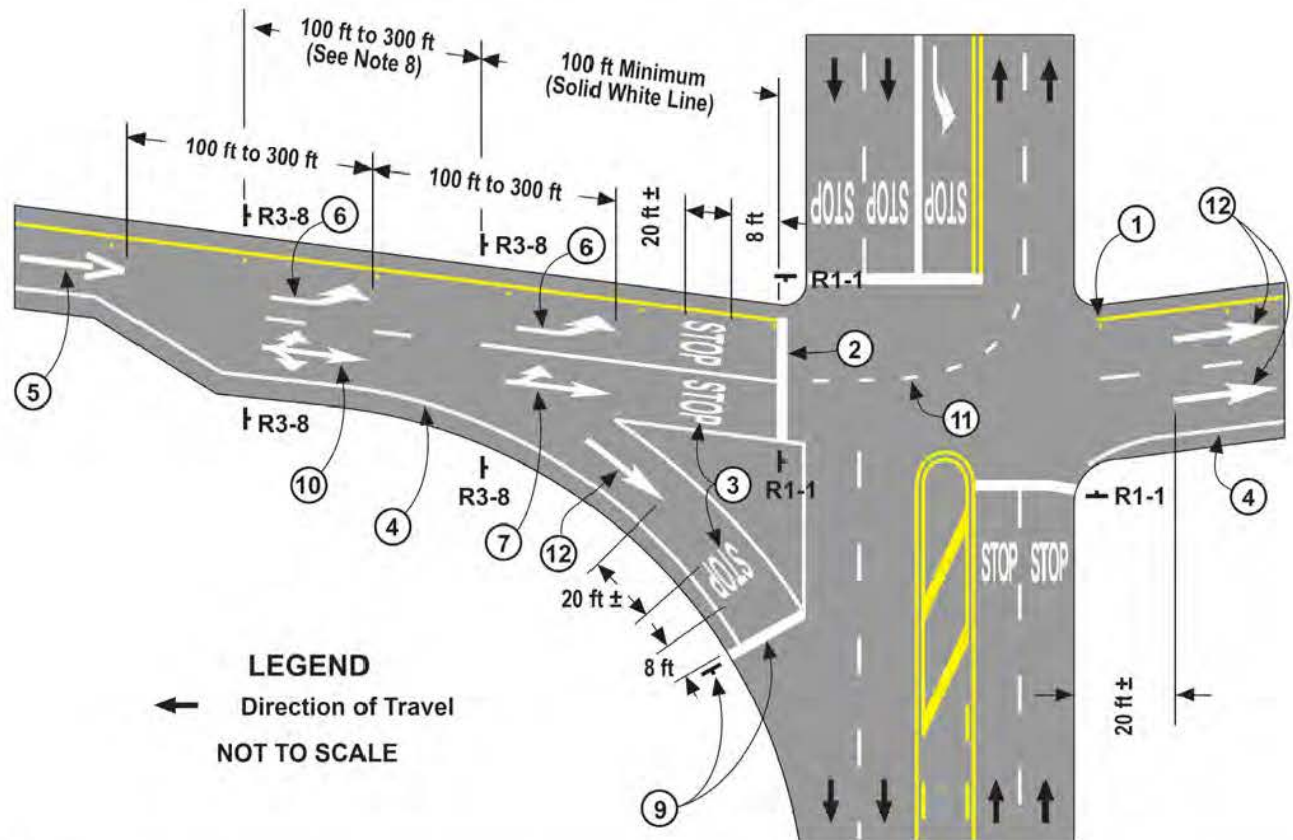
**Figure 3B-24 (CA). Examples of Standard Arrows for Pavement Markings (Sheet 5 of 8)**



**NOTES:**

1. Place 4 in Solid Yellow Left Edge Line and One-Way Yellow Retroreflective Pavement Markers on 24 ft centers as shown. See Edge Line Detail 25A.
2. Place Limit Line as shown. See Section 3B.16.
3. Place "STOP" legend as shown. See Section 3B.16.
4. Place 4 in Solid White Right Edge Line, flared end optional, as shown. See Edge Line Detail 27B.
5. Place Type V Arrows as shown. See Section 3B.20.
6. Place Type III (L) Arrows, in pairs, as shown when distance permits. See Section 3B.20.
7. Place Type III (R) Arrows, in pairs, as shown when distance permits. See Section 3B.20.
8. Lane Use Control (R3-8) signs should be placed on both sides of the exit ramp, at the beginning of the Solid White Line. An additional set should also be placed in advance where distance permits, to alert the motorist of lane use controls ahead.

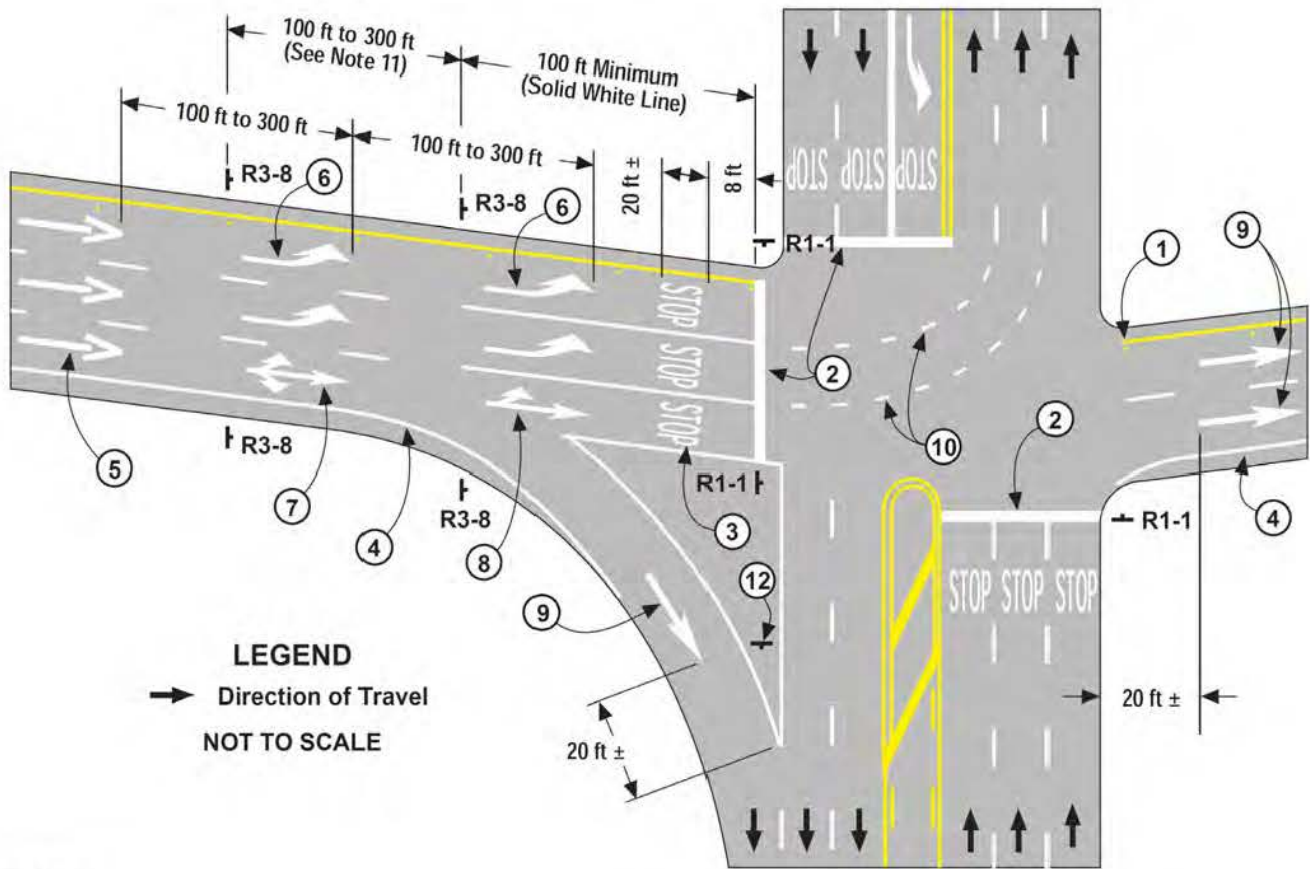
**Figure 3B-24 (CA). Examples of Standard Arrows for Pavement Markings (Sheet 6 of 8)**



**NOTES:**

1. Place 4 in Solid Yellow Left Edge Line and One-Way Yellow Retroreflective Pavement Markers on 24 ft centers as shown. See Edge Line Detail 25A.
2. Place Limit Line as shown. See Section 3B.16.
3. Place "STOP" legend as shown. See Section 3B.16.
4. Place 4 in Solid White Right Edge Line, flared end optional, as shown. See Edge Line Detail 27B.
5. Place Type V Arrow as shown. See Section 3B.20.
6. Place Type III(L) Arrows, in pairs, as shown where distance permits. See Section 3B.20.
7. Place Type II(L) Arrow, as shown where distance permits. See Section 3B.20.
8. Lane-Use Control (R3-8) signs should be place on both sides of the exit ramp, at the beginning of the Solid White Line. An additional set should also be placed in advance where distance permits, to alert the motorist of lane use controls ahead.
9. A "YIELD" (R1-2) sign, Yield Line and "YIELD" pavement legend may be used in lieu of the "STOP" (R1-1) sign, Limit Line and "STOP" pavement legend on low volume roads.
10. Place Type II(B) Arrow, as shown. See Section 3B.20.
11. Lane Line Extensions through the intersection may be used, as shown. See Lane Line Detail 40.
12. Place Type I [24 ft] Arrows as shown. See Section 3B.20.

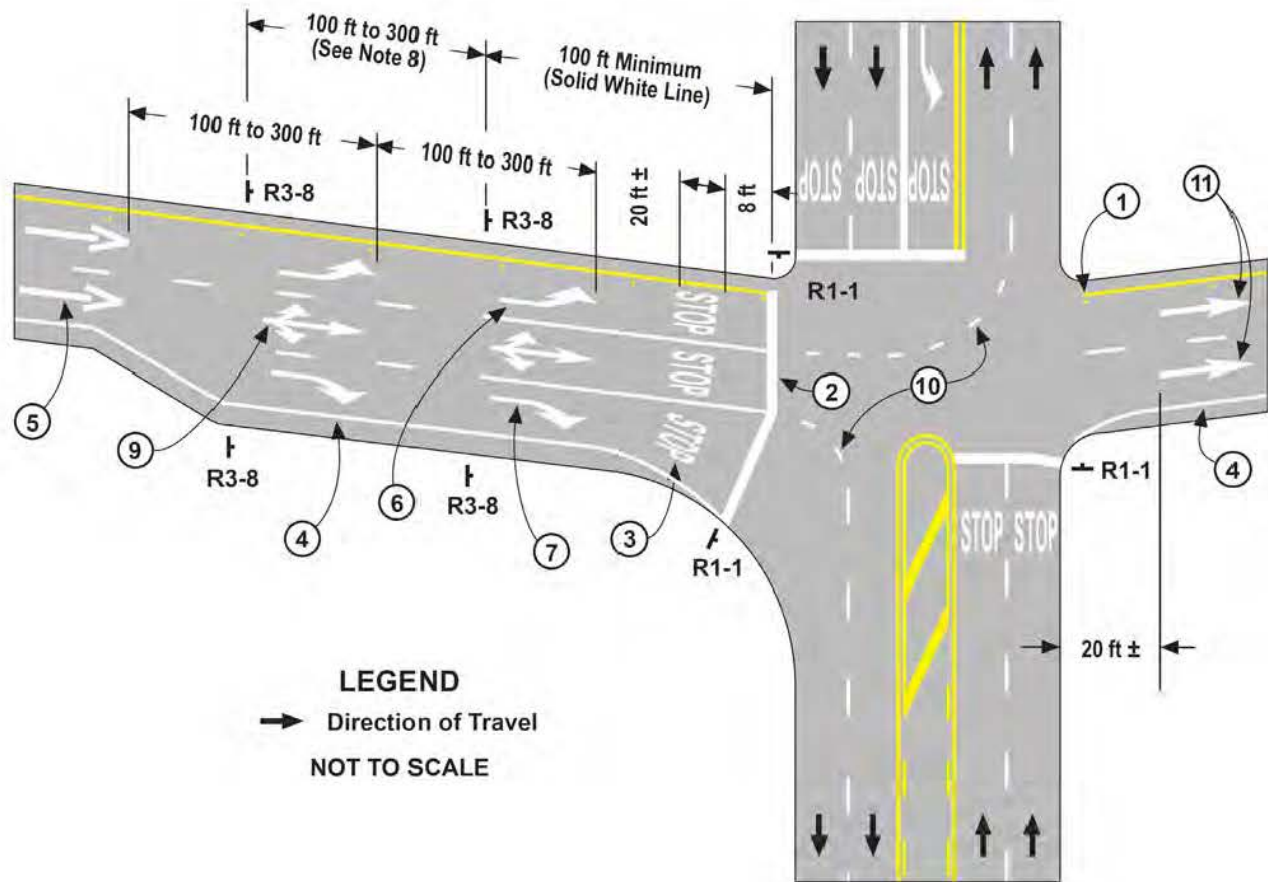
**Figure 3B-24 (CA). Examples of Standard Arrows for Pavement Markings (Sheet 7 of 8)**



**NOTES:**

1. Place 4 in Solid Yellow Left Edge Line and One-Way Yellow Retroreflective Pavement Markers on 24 ft centers as shown. See Edge Line Detail 25A.
2. Place Limit Line as shown. See Section 3B.16.
3. Place "STOP" legend as shown. See Section 3B.16.
4. Place 4 in Solid White Right Edge Line, flared end optional, as shown. See Edge Line Detail 27B.
5. Place Type V Arrows as shown. See Section 3B.20.
6. Place Type III(L) Arrows, in pairs, as shown where distance permits. See Section 3B.20.
7. Place Type II(B) Arrow, as shown where distance permits. See Section 3B.20.
8. Place Type II(L) Arrow, as shown. See Section 3B.20.
9. Place Type I [24 ft] Arrow as shown. See Section 3B.20.
10. Lane Line Extensions through the intersection may be used, as shown. See Lane Line Detail 40.
11. Lane-Use Control (R3-8) signs should be placed on both sides of the exit ramp, at the beginning of the Solid White Line. An additional set should also be placed in advance where distance permits, to alert the motorist of lane use controls ahead.
12. The Added Lane Symbol (W4-3) sign should be used in lieu of the Merge Symbol (W4-1) sign, when an extra lane is provided of more than 1/2 Mile in length.

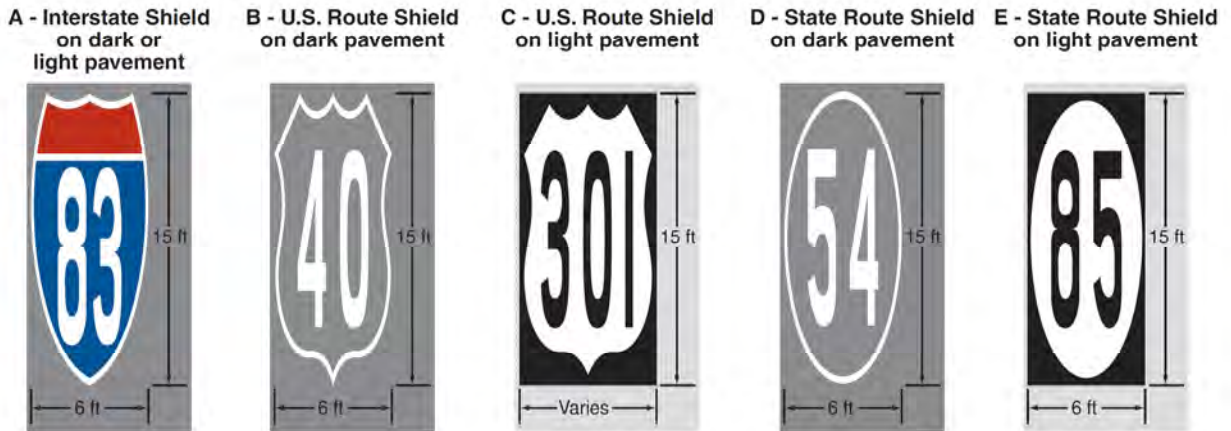
**Figure 3B-24 (CA). Examples of Standard Arrows for Pavement Markings (Sheet 8 of 8)**



**NOTES:**

1. Place 4 in Solid Yellow Left Edge Line and One-Way Yellow Retroreflective Pavement Markers on 24 ft centers as shown. See Edge Line Detail 25A.
2. Place Limit Line as shown. See Section 3B.16.
3. Place "STOP" legend as shown. See Section 3B.16.
4. Place 4 in Solid White Right Edge Line, flared end optional, as shown. See Edge Line Detail 27B.
5. Place Type V Arrows as shown. See Section 3B.20.
6. Place Type III(L) Arrows, in pairs, as shown where distance permits. See Section 3B.20.
7. Place Type III(R) Arrows, in pairs, as shown where distance permits. See Section 3B.20.
8. Lane-Use Control (R3-8) signs should be place on both sides of the exit ramp, at the beginning of the Solid White Line. An additional set should also be placed in advance where distance permits, to alert the motorist of lane use controls ahead.
9. Place Type II(B) Arrows, in pairs, as shown where distance permits. See Section 3B.20.
10. Lane Line Extensions through the intersection may be used, as shown. See Lane Line Detail 40.
11. Place Type I [24 ft] Arrows as shown. See Section 3B.20.

**Figure 3B-25. Examples of Elongated Route Shields for Pavement Markings**

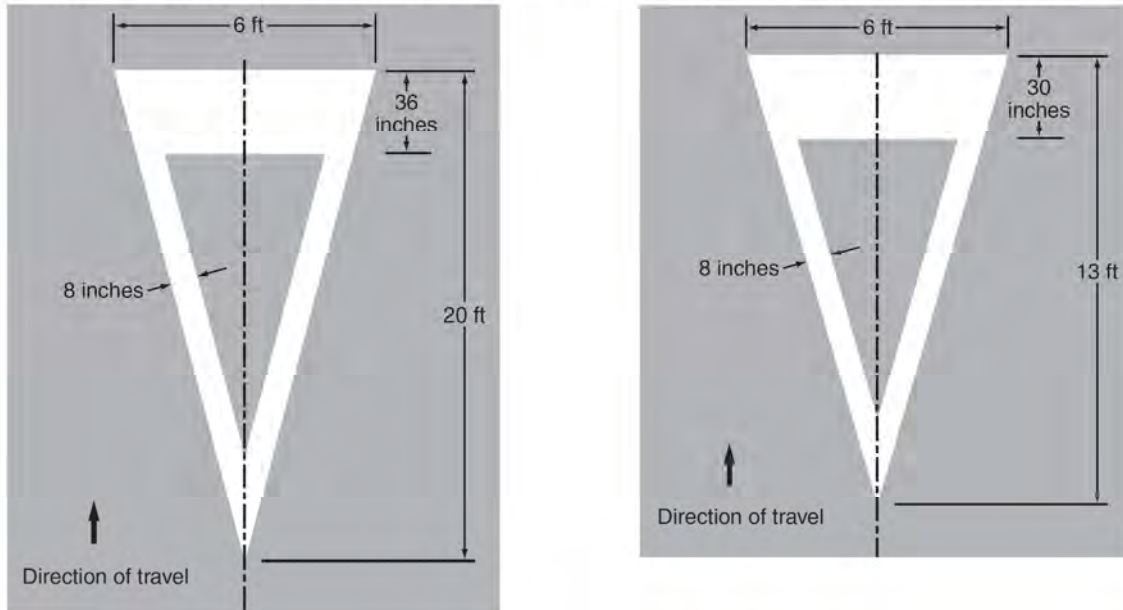


**Notes:**

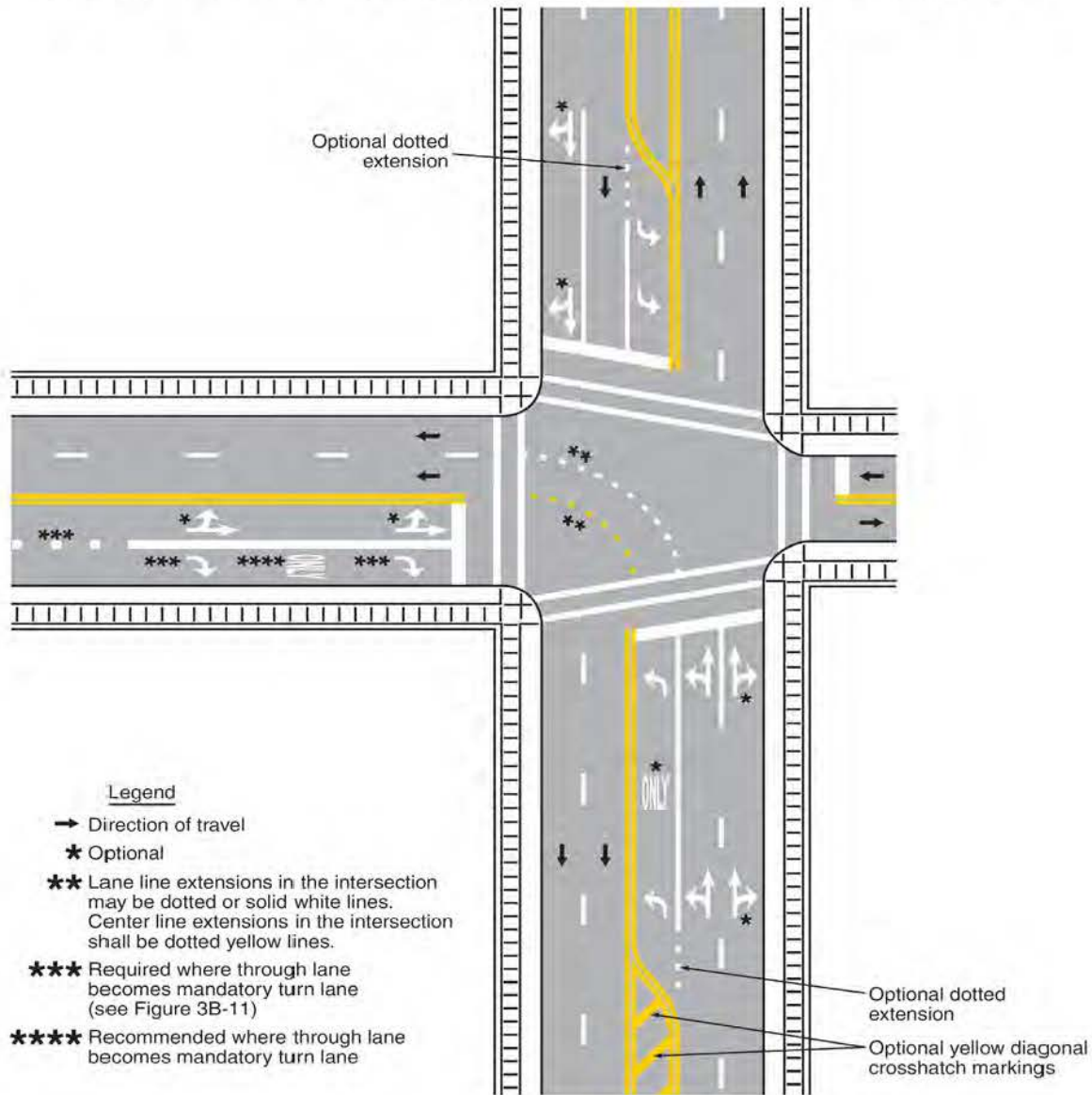
1. See the "Standard Highway Signs and Markings" book for other sizes and details
2. Colors and elongated shapes simulating State route shield signs may be used for route shield pavement markings where appropriate

**Figure 3B-26. Yield Ahead Triangle Symbols**

**A - Posted or Statutory Speed Limit of 45 mph or greater**      **B - Posted or Statutory Speed Limit of less than 45 mph**

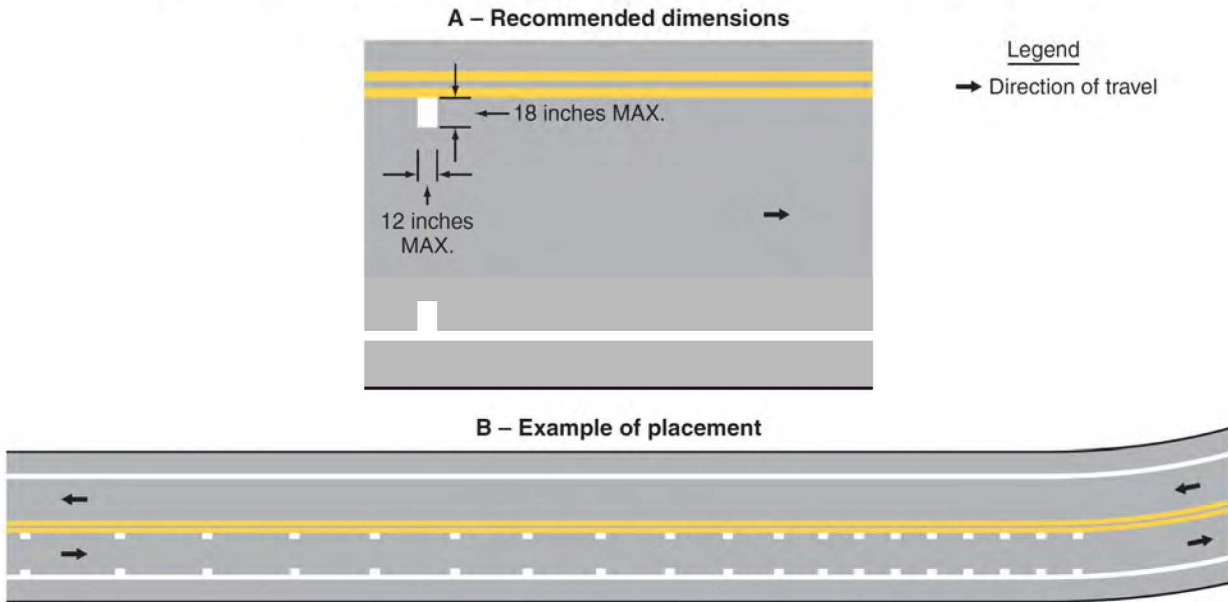


**Figure 3B-27. Examples of Lane-Use Control Word and Arrow Pavement Markings**

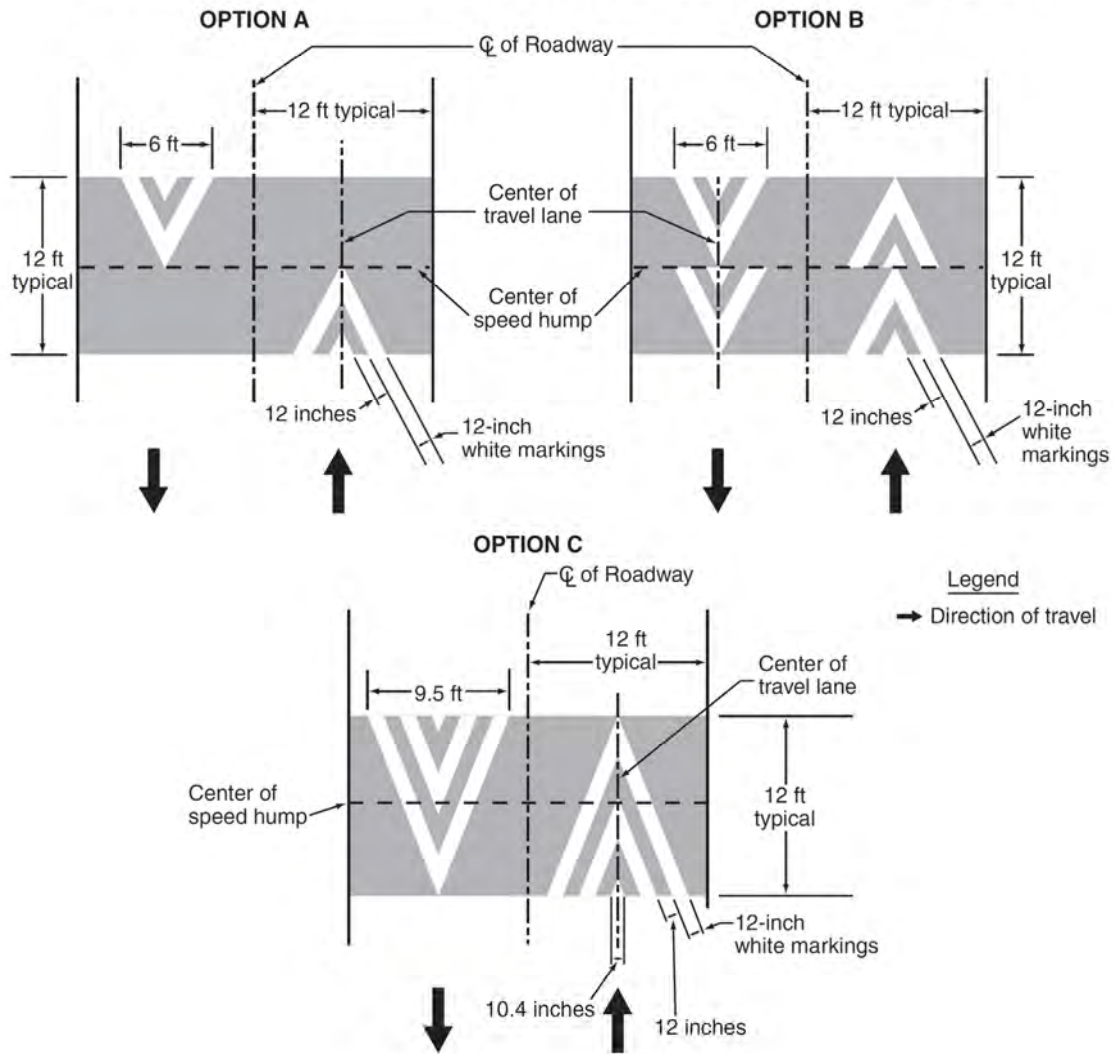




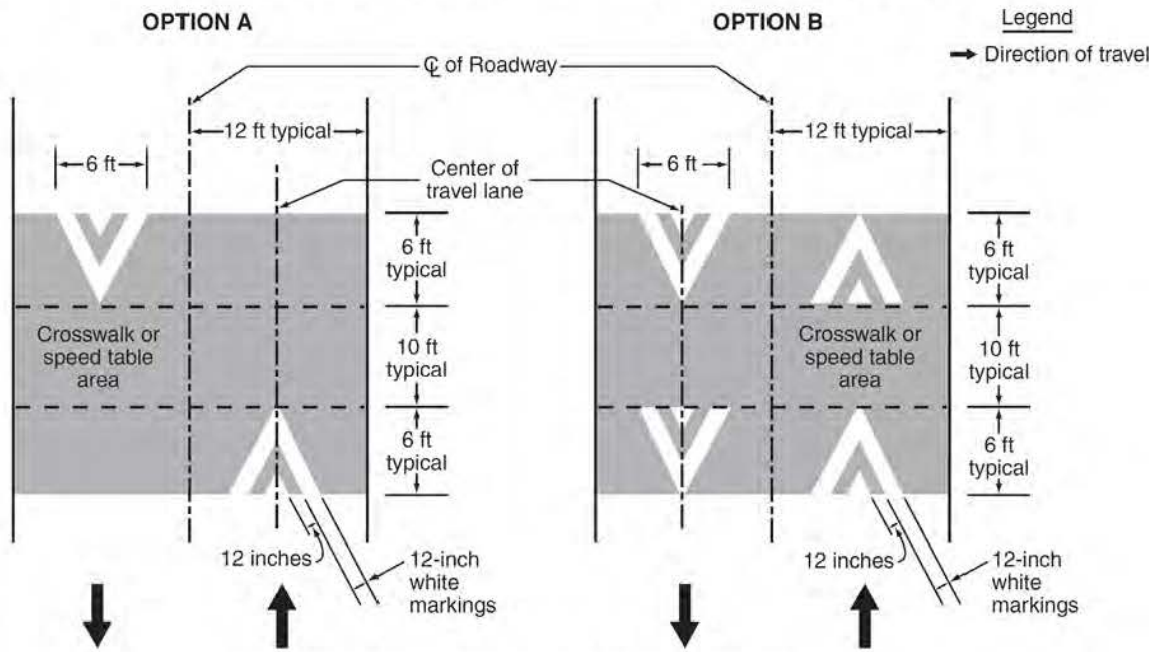
**Figure 3B-28. Example of the Application of Speed Reduction Markings**



**Figure 3B-29. Pavement Markings for Speed Humps without Crosswalks**

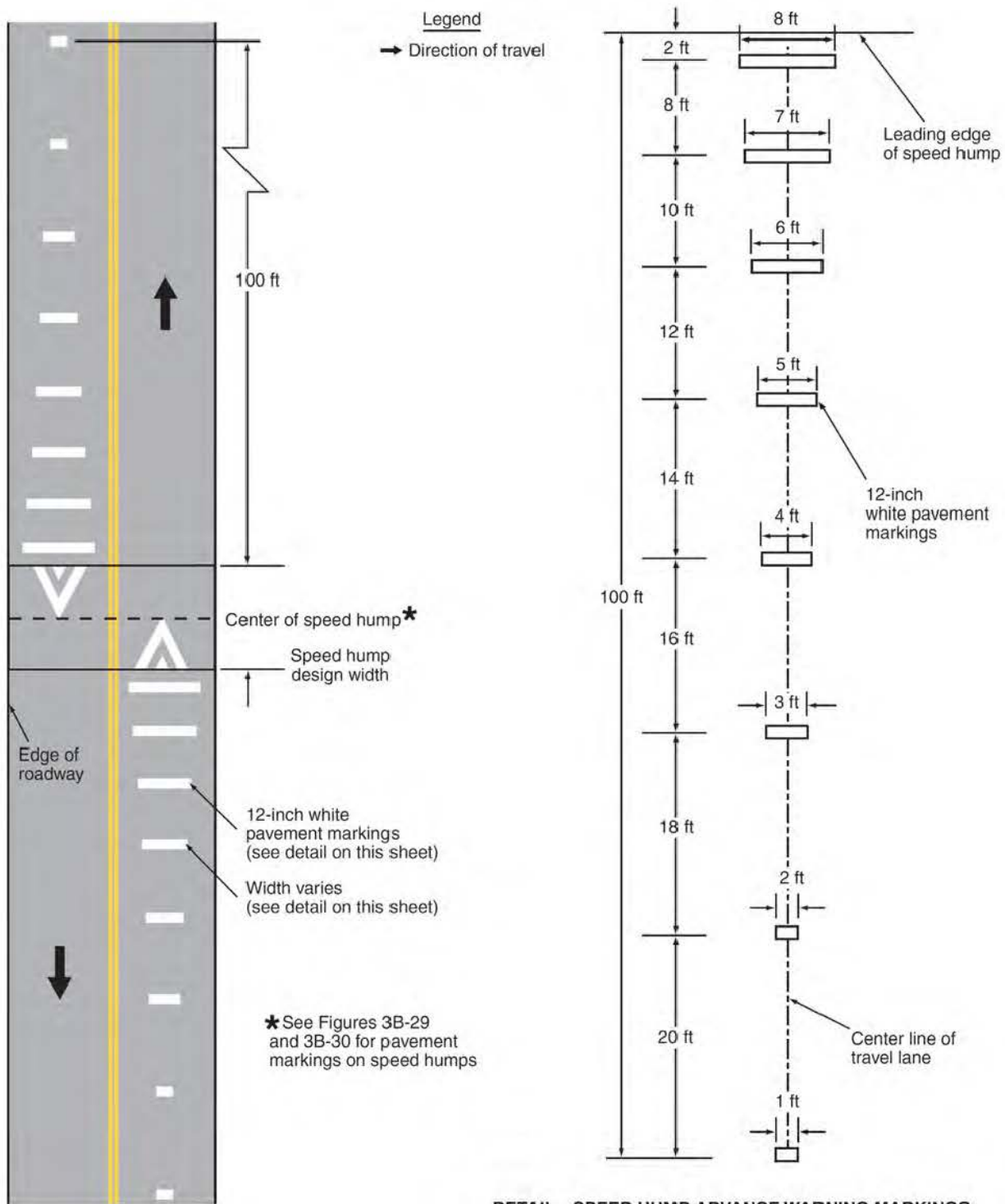


**Figure 3B-30. Pavement Markings for Speed Tables or Speed Humps with Crosswalks**

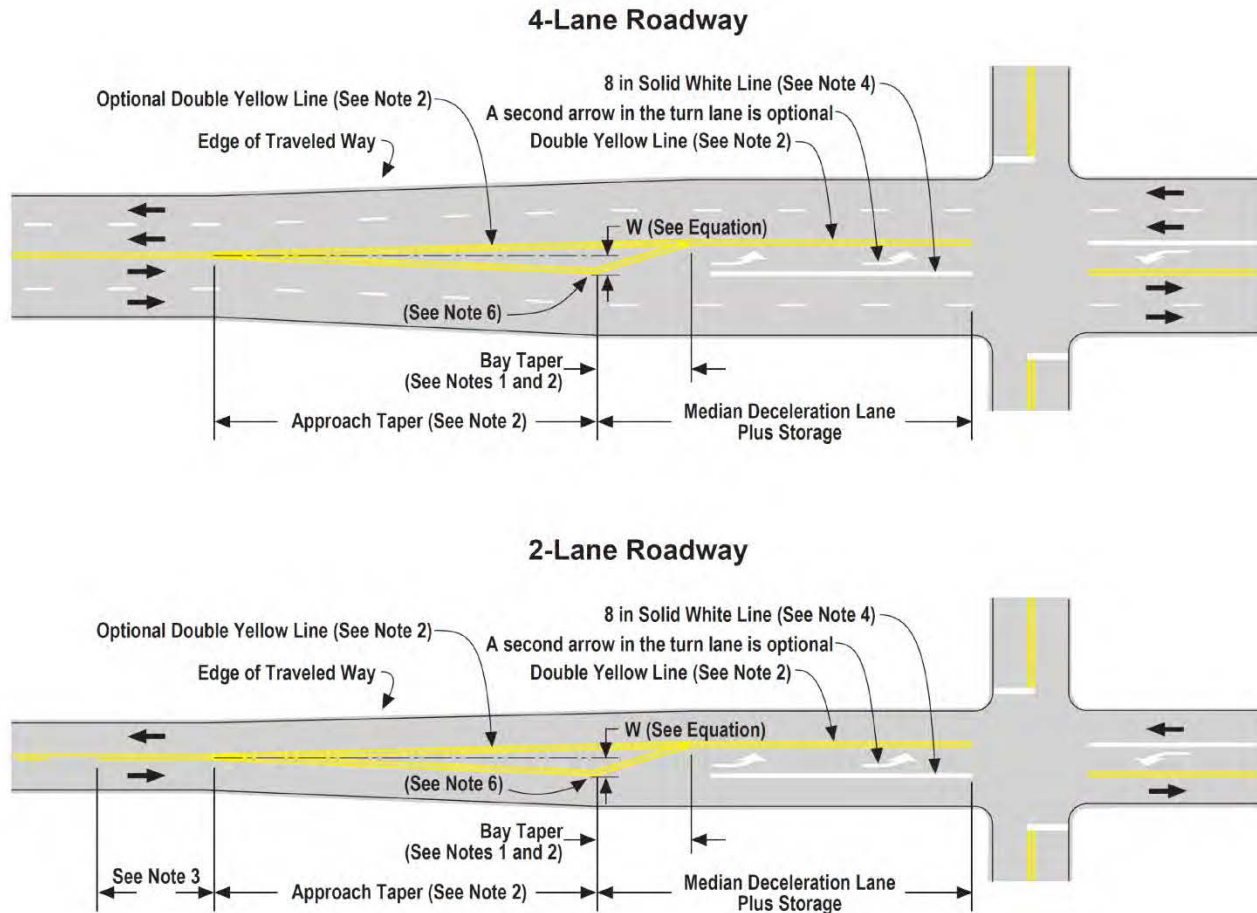


Note: Optional crosswalk lines are not shown in this figure

**Figure 3B-31. Advance Warning Markings for Speed Humps**



**Figure 3B-101 (CA). Examples of Left-Turn Channelization Markings**



NOT TO SCALE

$$\text{Approach Taper} = \frac{WS^2}{60} \text{ for speeds of 40 mph or less and } WS \text{ for speeds of 45 mph or more.}$$

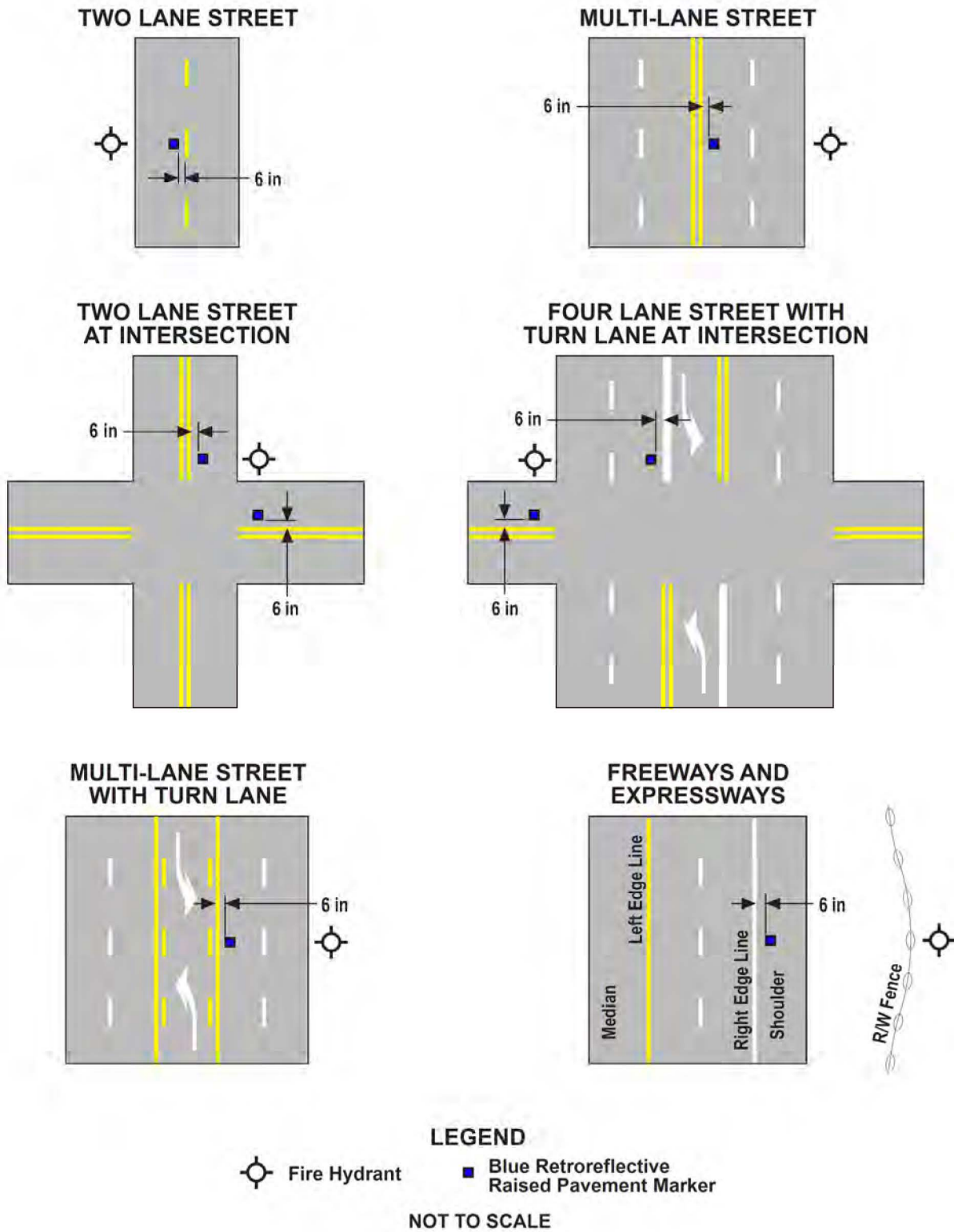
Where S = Off Peak 85th Percentile Speed in mph.

W = Width of Lateral Traffic Shift in feet.

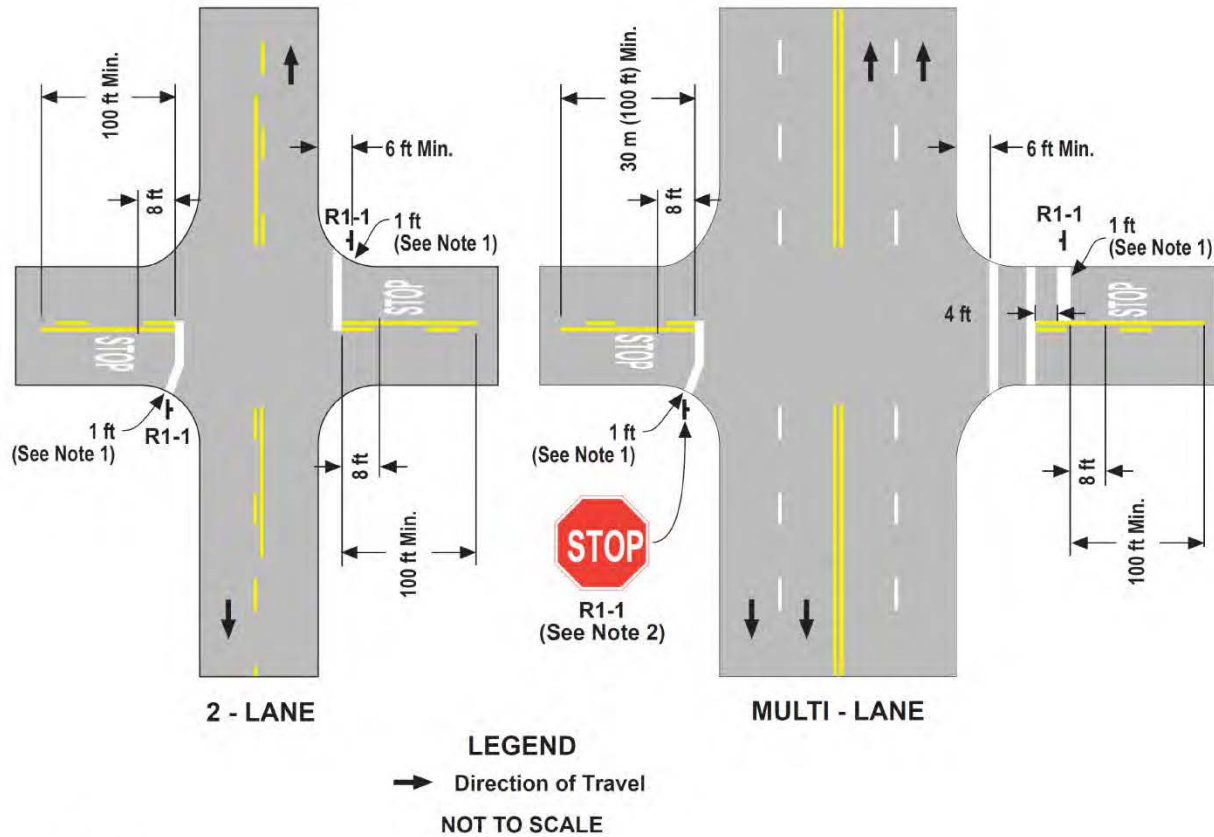
NOTES:

1. Bay taper length = 60 ft or 90 ft for Business, Residential and Urban Areas and 120 ft for high speed Rural Areas.
2. See Striping Details 21 through 23 or 28 through 30.
3. On two lane roads, use Striping Details 21 through 23 for one half (1/2) of the passing sight distance for the prevailing speed.
4. See Striping Detail 38, use a minimum storage length of 50 ft.
5. See Highway Design Manual, Section 405.2 for design details.
6. Based on engineering judgement, intersection of the Approach and Bay Tapers may be located within the width of the left-turn lane.

**Figure 3B-102 (CA). Examples of Fire Hydrant Location Pavement Markers**



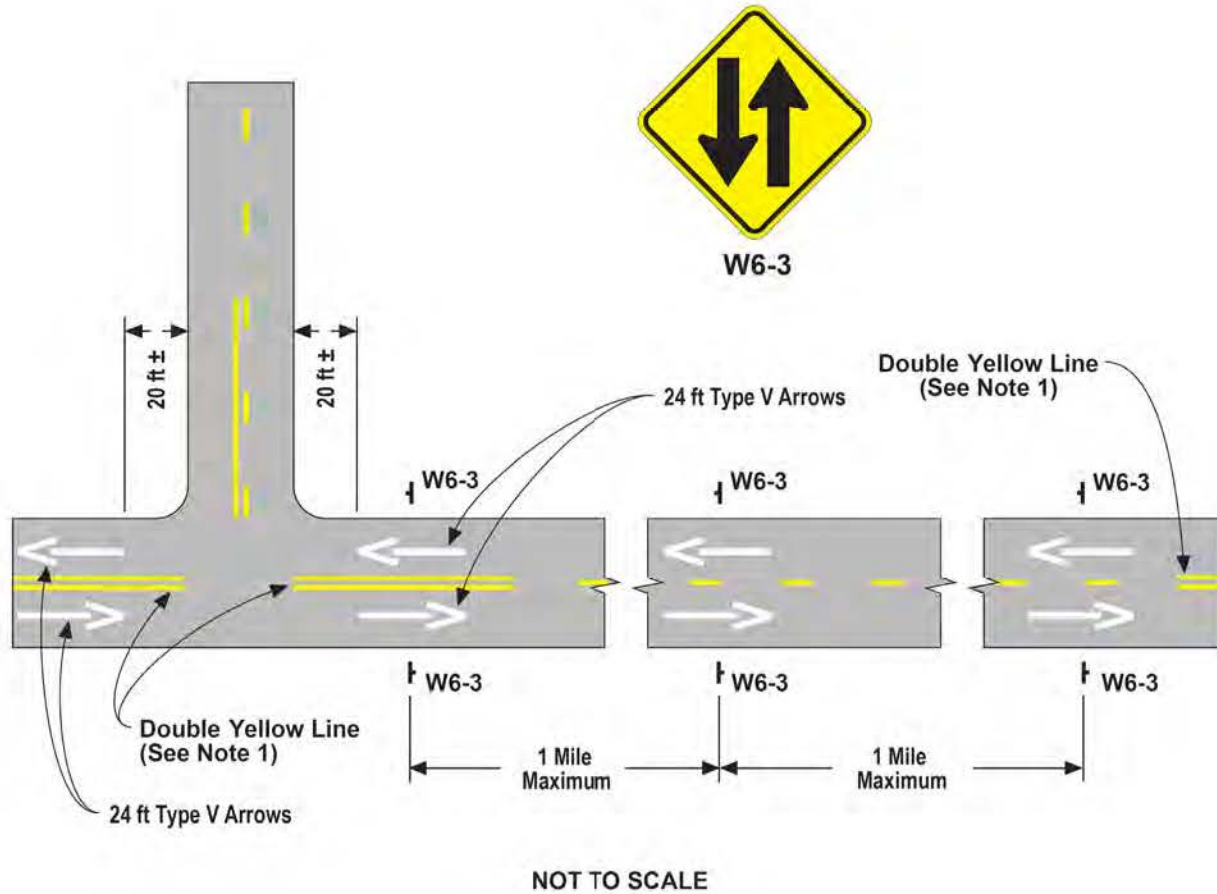
**Figure 3B-103 (CA). Examples of Intersection Markings**



**NOTES:**

1. The Limit Line is optional, refer to Section 3B.16. The Limit Line on wide side roads on long radius corners may be bent at a  $45^{\circ} \pm$  angle for traffic making a right turn.
2. When a Stop Ahead (W3-1) or STOP AHEAD (W3-1a) sign is used, a STOP AHEAD pavement marking may be placed to supplement the sign according to Section 3B.20.

**Figure 3B-104 (CA). Treatment for Divided Highway Illusion**

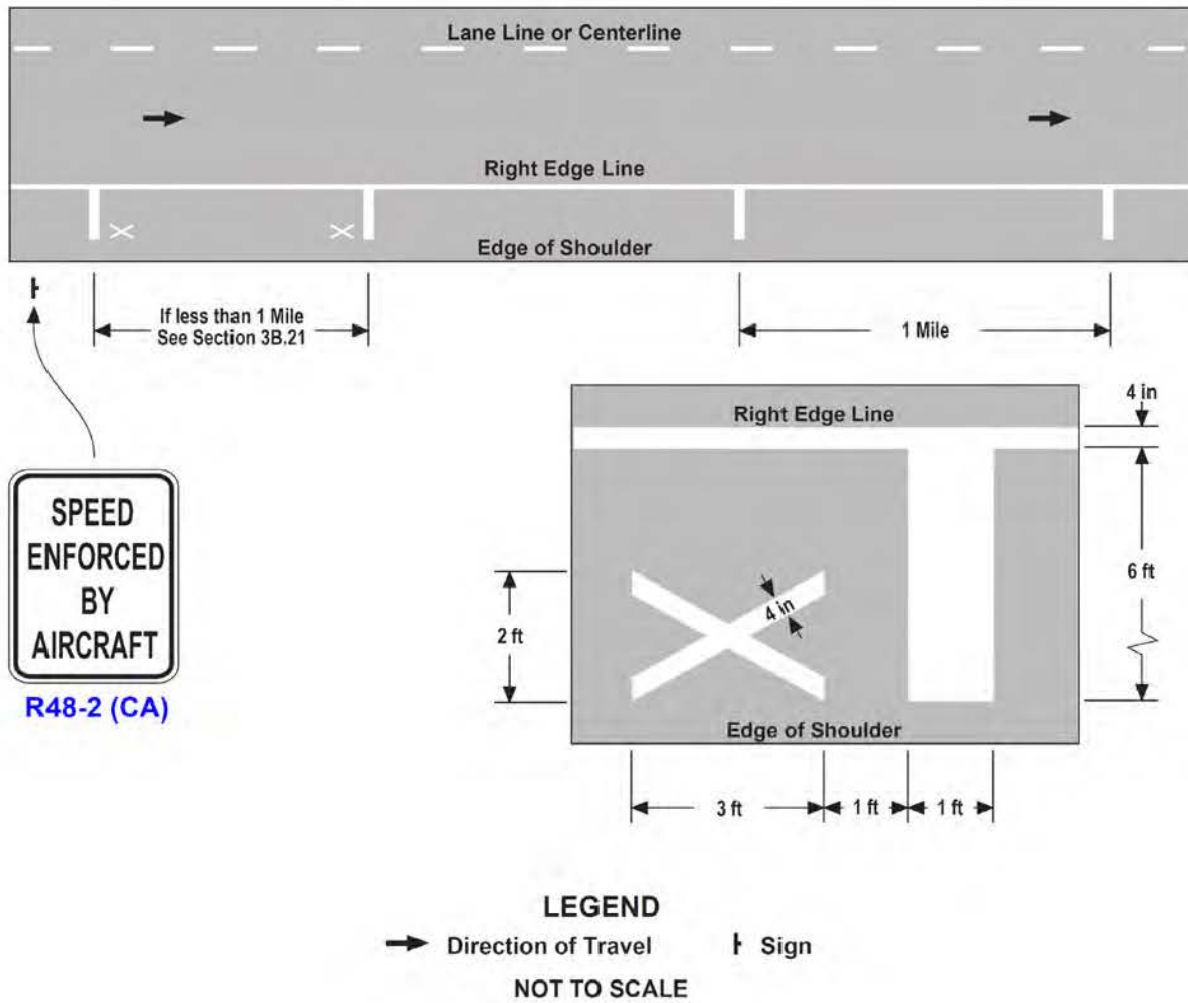


**NOTE:**

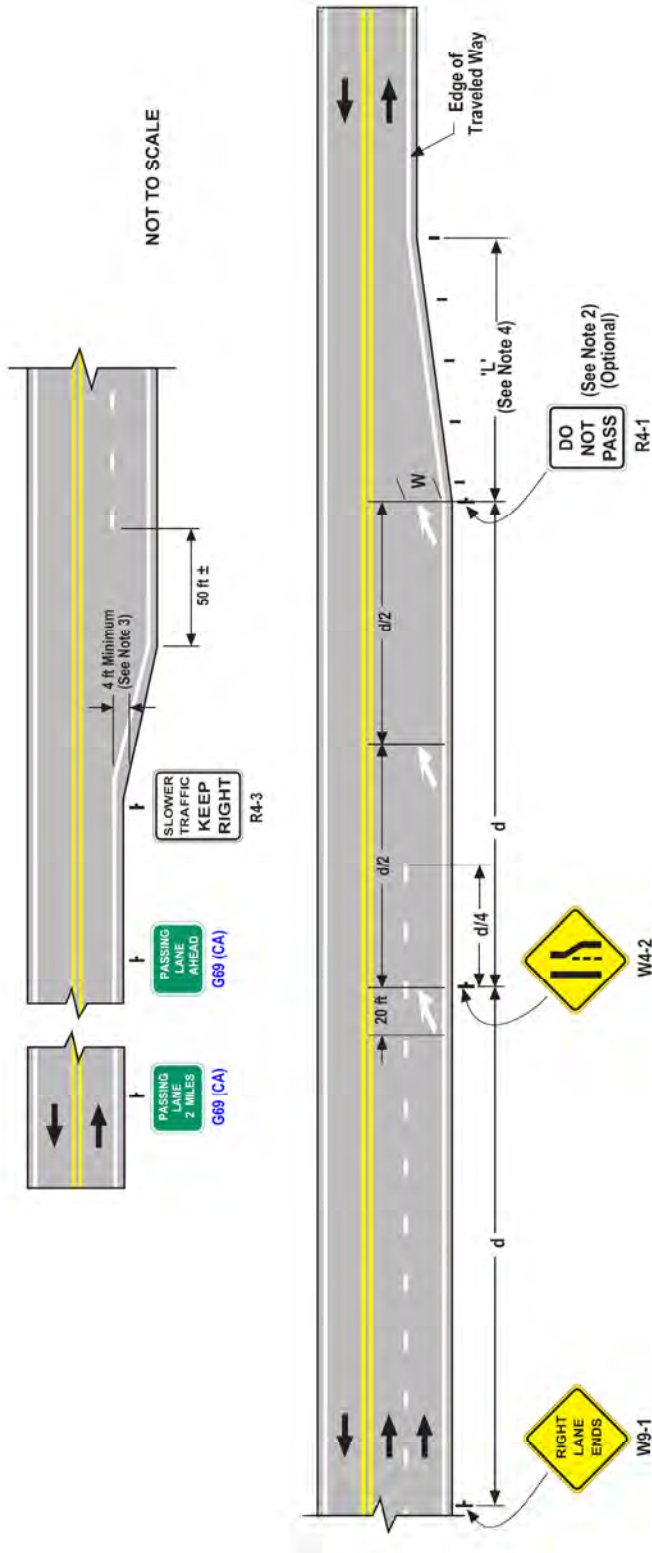
1. Use a Double Yellow Line (Two Direction - No Passing) to discourage wrong way movements at critical locations, such as entering roads or approaches to transitions.



**Figure 3B-105 (CA). Examples of Signs and Markings for Highways Where Speed is Enforced by Aircraft**



**Figure 3B-106 (CA). Passing Lanes**



**NOTES:**

1. For taper lengths, sign and delineator placement at different speeds, see Figure 3B-14 (CA) (Sheet 1 of 3).
2. The R4-1 sign should not be used on a freeway or expressway, etc., where two or more lanes remain after a lane is dropped. See Section 2B.28.
3. To discourage vehicular travel off the traveled way, the Right Edge Line should be continued until there is at least 4 ft between the beginning of the edge line taper and the edge of the traveled way.
4. Delineators should be spaced approximately 200 ft apart. There should be a minimum of 3 delineators throughout the entire length of a lane reduction transition. See Section 3F.04.
5. Lane Reduction Arrows may be placed when a passing lane is 1 mi or more in length.

**LEGEND**

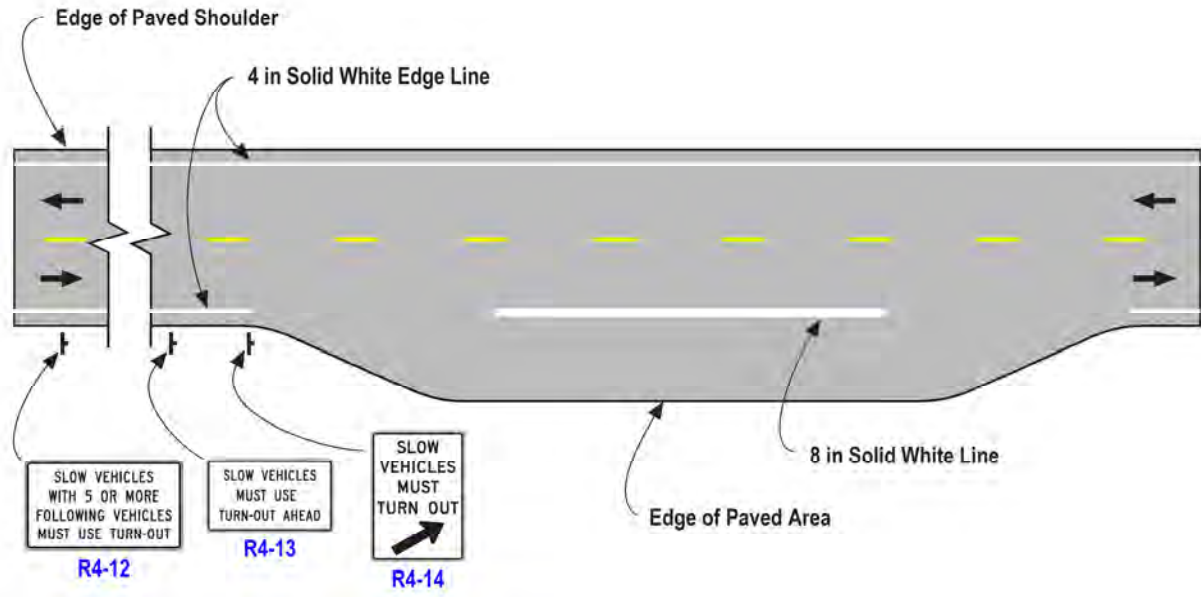
**L = Length in feet**  
**S = Posted, 85th Percentile, statutory speed, or design speed for new construction in mph**  
**W = Offset in feet**  
**d = Advance Placement Distance (see Section 2C.05)**

**For speeds 45 mph or more:**  
 $L=WS$

**For speeds 40 mph or less:**  
 $L=WS^2 / 60$

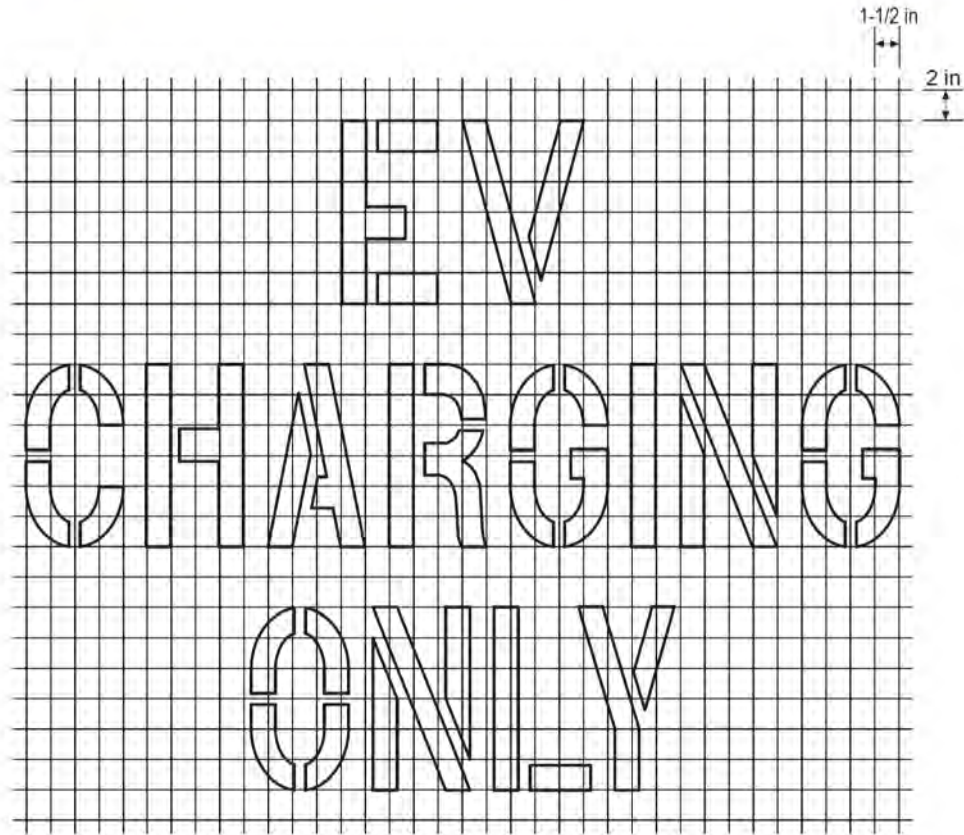
Direction of Travel  
 Lane Reduction Arrow  
 Delineators (Type F)  
 Sign Location

**Figure 3B-107 (CA). Examples of Signing and Marking Turnouts**



**LEGEND**  
┆ Sign Location      ➔ Direction of Travel  
NOT TO SCALE

**Figure 3B-108 (CA). Electric Vehicle Charging Station Pavement Marking Detail**



**Table 3B-1. Minimum Passing Sight Distances for No-Passing Zone Markings**

| <b>85th-Percentile or Posted or Statutory Speed Limit</b> | <b>Minimum Passing Sight Distance</b> |
|---|---------------------------------------|
| 25 mph  | 450 feet                              |
| 30 mph  | 500 feet                              |
| 35 mph  | 550 feet                              |
| 40 mph  | 600 feet                              |
| 45 mph  | 700 feet                              |
| 50 mph  | 800 feet                              |
| 55 mph  | 900 feet                              |
| 60 mph  | 1,000 feet                            |
| 65 mph  | 1,100 feet                            |
| 70 mph  | 1,200 feet                            |



## CHAPTER 3C. ROUNDABOUT MARKINGS

### Section 3C.01 General

Support:

01 A roundabout (see definition in Section 1A.13) is a specific type of circular intersection designed to control speeds and having specific traffic control features.

Guidance:

02 *Pavement markings and signing for a roundabout should be integrally designed to correspond to the geometric design and intended lane use of a roundabout.*

03 *Markings on the approaches to a roundabout and on the circular roadway should be compatible with each other to provide a consistent message to road users and should facilitate movement through the roundabout such that vehicles do not have to change lanes within the circulatory roadway in order to exit the roundabout in a given direction.*

Support:

04 Figure 3C-1 provides an example of the pavement markings for approach and circulatory roadways at a roundabout. Figure 3C-2 shows the options that are available for lane-use pavement marking arrows on approaches to roundabouts. Figures 3C-3 through 3C-14 illustrate examples of markings for roundabouts of various geometric and lane-use configurations.

05 Traffic control signals or pedestrian hybrid beacons (see Part 4) are sometimes used at roundabouts to facilitate the crossing of pedestrians or to meter traffic.

06 Section 8C.12 contains information about roundabouts that contain or are in close proximity to grade crossings.

### Section 3C.02 White Lane Line Pavement Markings for Roundabouts

Standard:

01 **Multi-lane approaches to roundabouts shall have lane lines.**

02 **A through lane on a roadway that becomes a dropped lane (mandatory turn lane) at a roundabout shall be marked with a dotted white lane line in accordance with Section 3B.04. See Detail 37D as shown in Figure 3A-111(CA).**

Guidance:

03 *Multi-lane roundabouts should have lane line markings within the circulatory roadway to channelize traffic to the appropriate exit lane.*

Standard:

04 **Continuous concentric lane lines shall not be used within the circulatory roadway of roundabouts.**

Support:

05 Section 9C.04 contains information regarding bicycle lane markings at roundabouts.

### Section 3C.03 Edge Line Pavement Markings for Roundabout Circulatory Roadways

Guidance:

01 *A white edge line should be used on the outer (right-hand) side of the circulatory roadway.*

02 *Where a white edge line is used for the circulatory roadway, it should be as follows (see Figure 3C-1):*

*A. A solid line adjacent to the splitter island, and*

*B. A wide dotted line across the lane(s) entering the roundabout.*

Standard:

03 **Edge lines and edge line extensions shall not be placed across the exits from the circulatory roadway at roundabouts.**

Option:

04 A yellow edge line may be placed around the inner (left-hand) edge of the circulatory roadway (see Figure 3C-1) and may be used to channelize traffic (see Drawing B of Figure 3C-4).

### **Section 3C.04 Yield Lines for Roundabouts**

**Option:**

01 A yield line (see Section 3B.16) may be used to indicate the point behind which vehicles are required to yield at the entrance to a roundabout (see Figure 3C-1).

### **Section 3C.05 Crosswalk Markings at Roundabouts**

**Standard:**

01 **Pedestrian crosswalks shall not be marked to or from the central island of roundabouts.**

**Guidance:**

02 *If pedestrian facilities are provided, crosswalks (see Section 3B.18) should be marked across roundabout entrances and exits to indicate where pedestrians are intended to cross.*

03 *Crosswalks should be a minimum of 20 feet from the edge of the circulatory roadway.*

**Support:**

04 Various arrangements of crosswalks at roundabouts are illustrated in the figures in this Chapter.

### **Section 3C.06 Word, Symbol, and Arrow Pavement Markings for Roundabouts**

**Option:**

01 Lane-use arrows may be used on any approach to and within the circulatory roadway of any roundabout.

02 YIELD (word) and YIELD AHEAD (symbol or word) pavement markings (see Figure 3C-1) may be used on approaches to roundabouts.

03 Word and/or route shield pavement markings may be used on an approach to or within the circulatory roadway of a roundabout to provide route and/or destination guidance information to road users (see Figure 3C-14).

**Guidance:**

04 *Within the circulatory roadway of multi-lane roundabouts, normal lane-use arrows (see Section 3B.20 and Figure ~~3B-24~~ 3B-24(CA)) should be used.*

05 *On multi-lane approaches with double left-turn and/or double right-turn lanes, lane-use arrows as shown in Figures 3C-7 and 3C-8 should be used.*

**Option:**

06 If used on approaches to a roundabout, lane-use arrows may be either normal or (fish-hook arrows only), either with or without an oval symbolizing the central island, as shown in Figure 3C-2.

### **Section 3C.07 Markings for Other Circular Intersections**

**Support:**

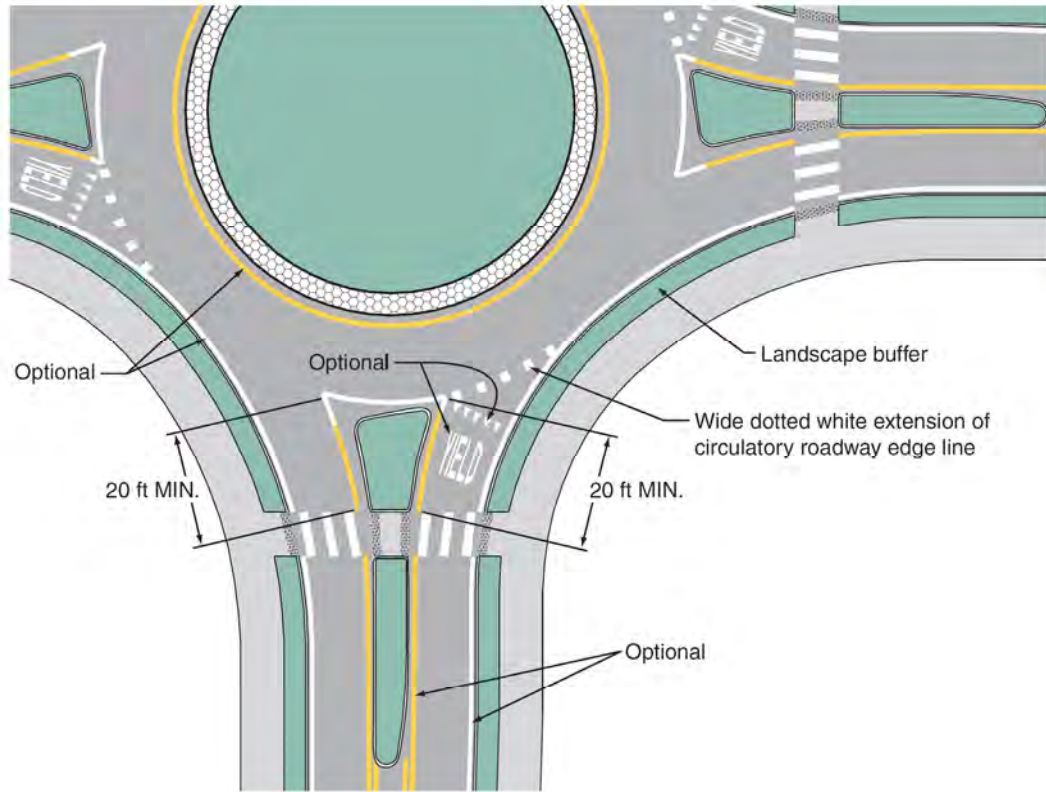
01 Other circular intersections include, but are not limited to, rotaries, traffic circles, and residential traffic calming designs.

**Option:**

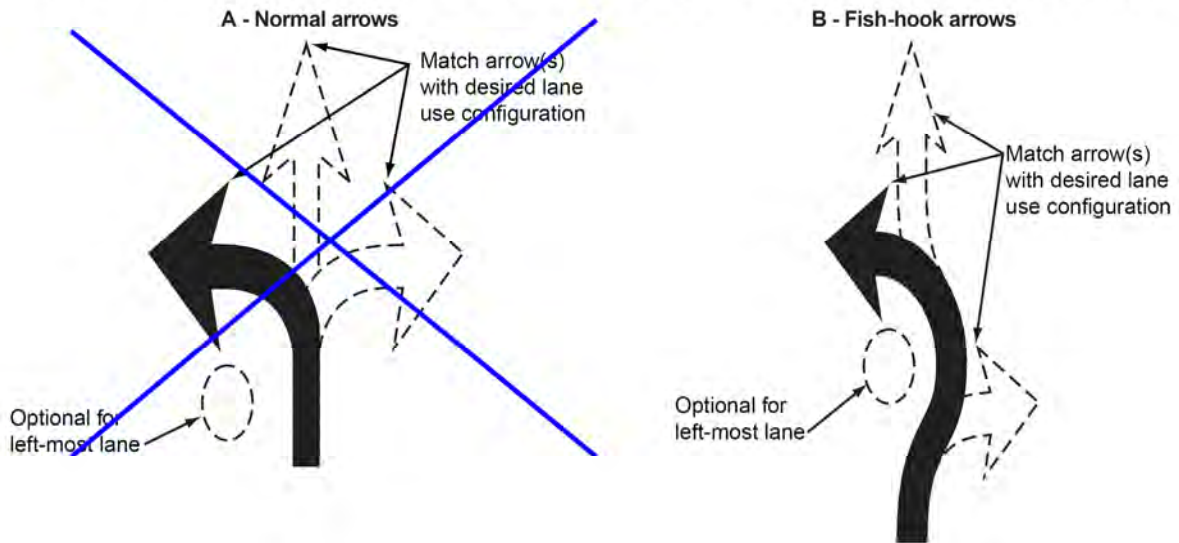
02 The markings shown in this Chapter may be used at other circular intersections if engineering judgment indicates that their presence will benefit drivers, pedestrians, or other road users.



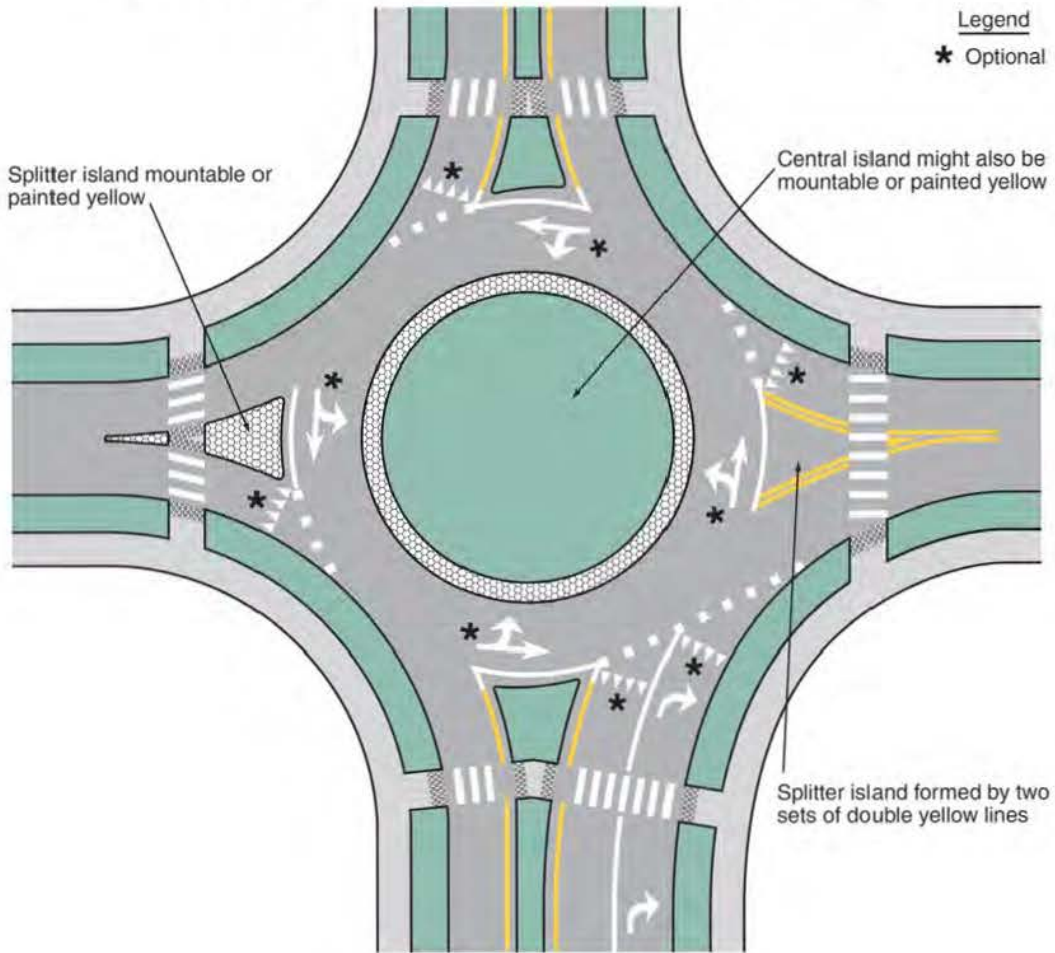
**Figure 3C-1. Example of Markings for Approach and Circulatory Roadways at a Roundabout**



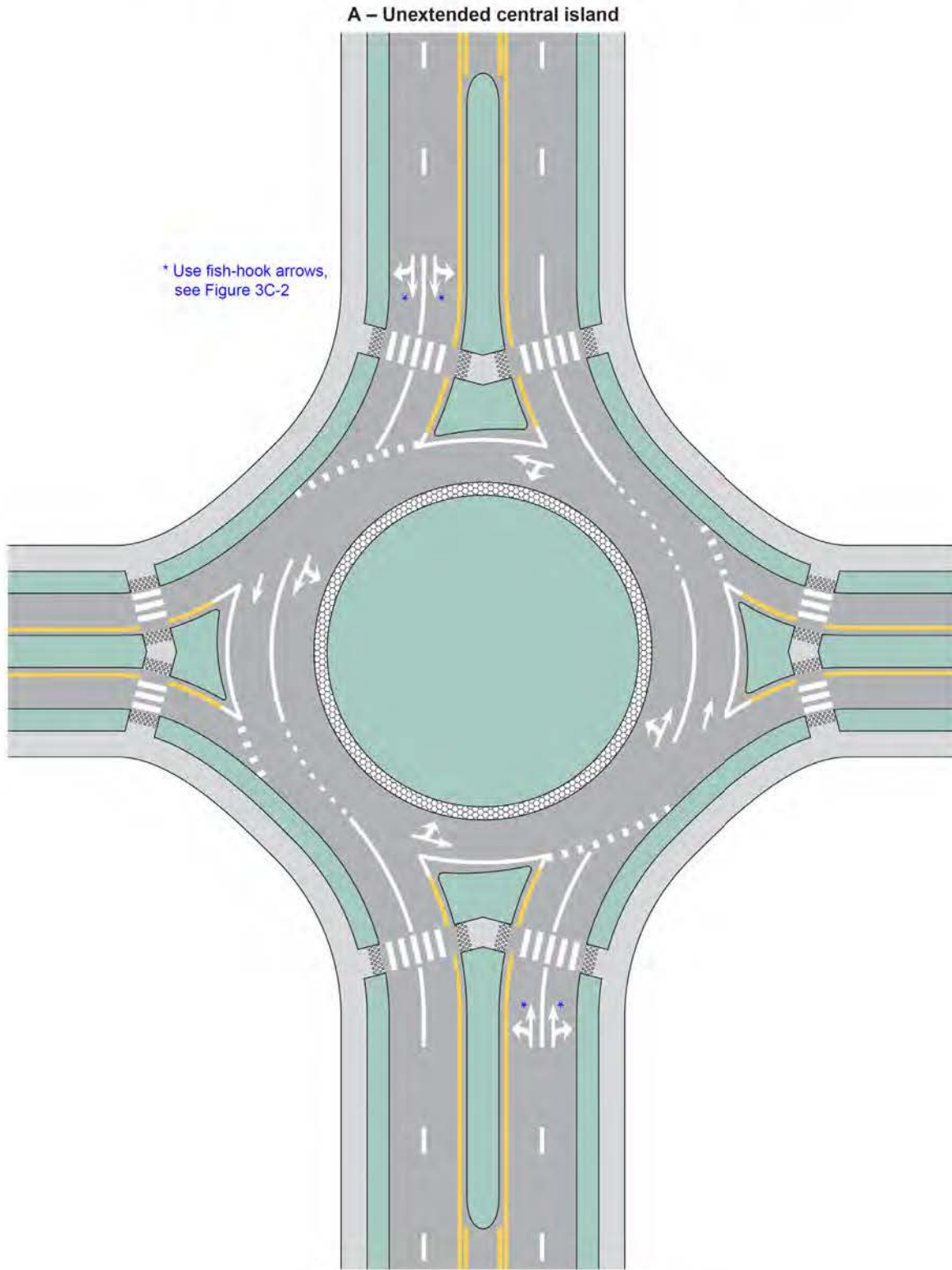
**Figure 3C-2. Lane-Use Arrow Pavement Marking Options for Roundabout Approaches**



**Figure 3C-3. Example of Markings for a One-Lane Roundabout**

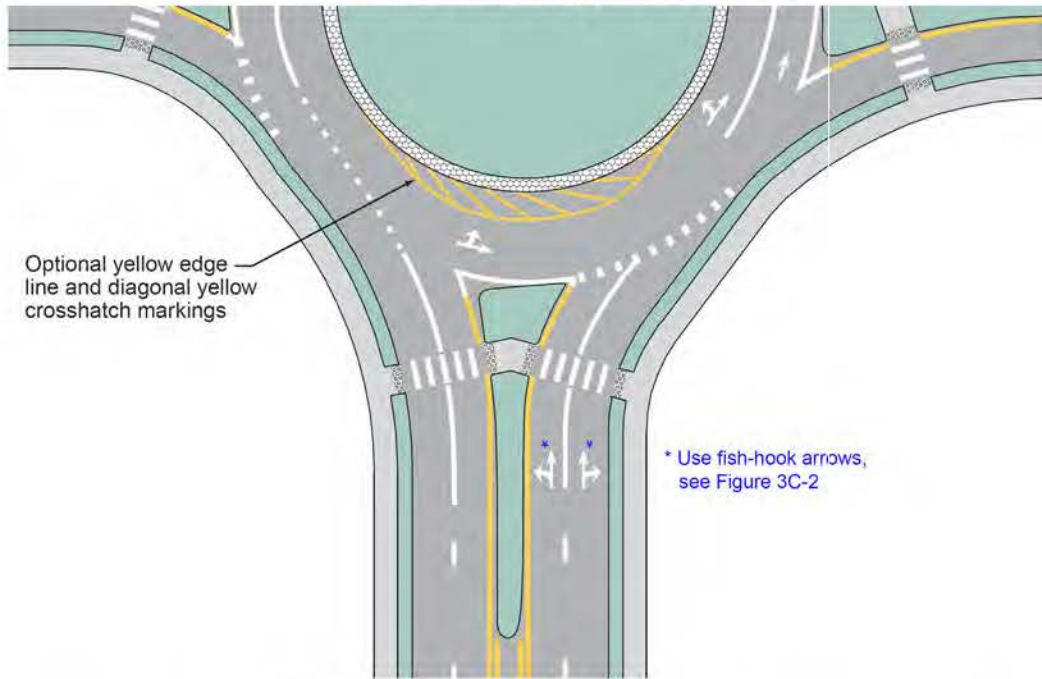


**Figure 3C-4. Example of Markings for a Two-Lane Roundabout with One- and Two-Lane Approaches (Sheet 1 of 2)**

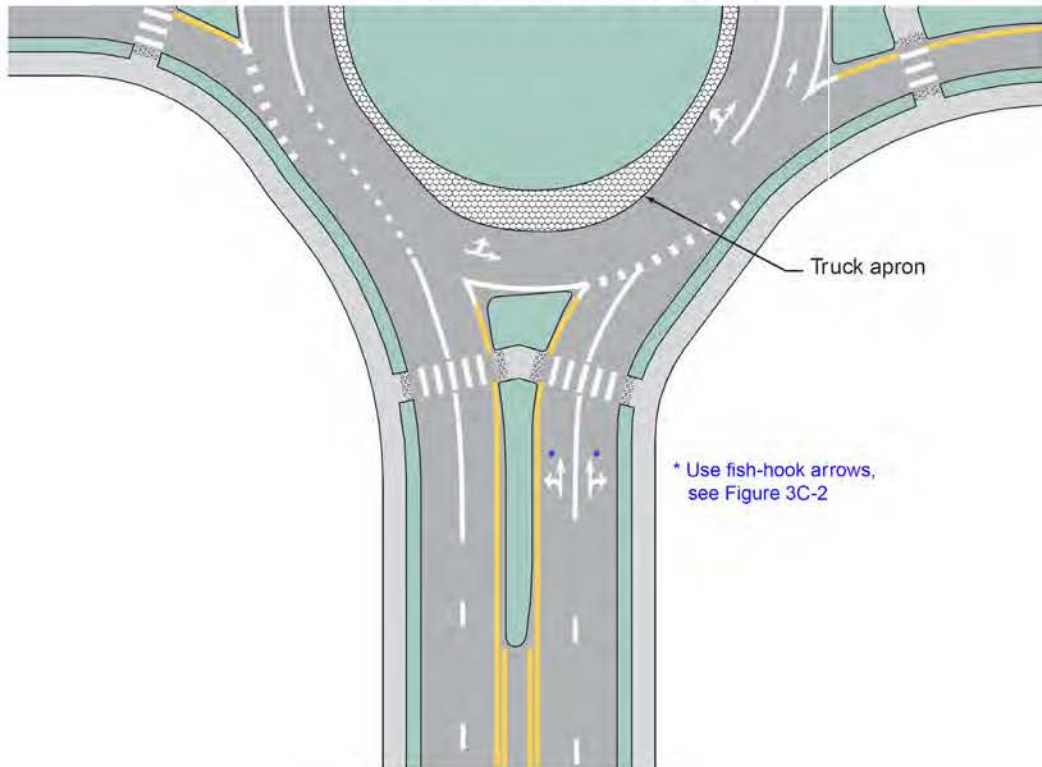


**Figure 3C-4. Example of Markings for a Two-Lane Roundabout with One- and Two-Lane Approaches (Sheet 2 of 2)**

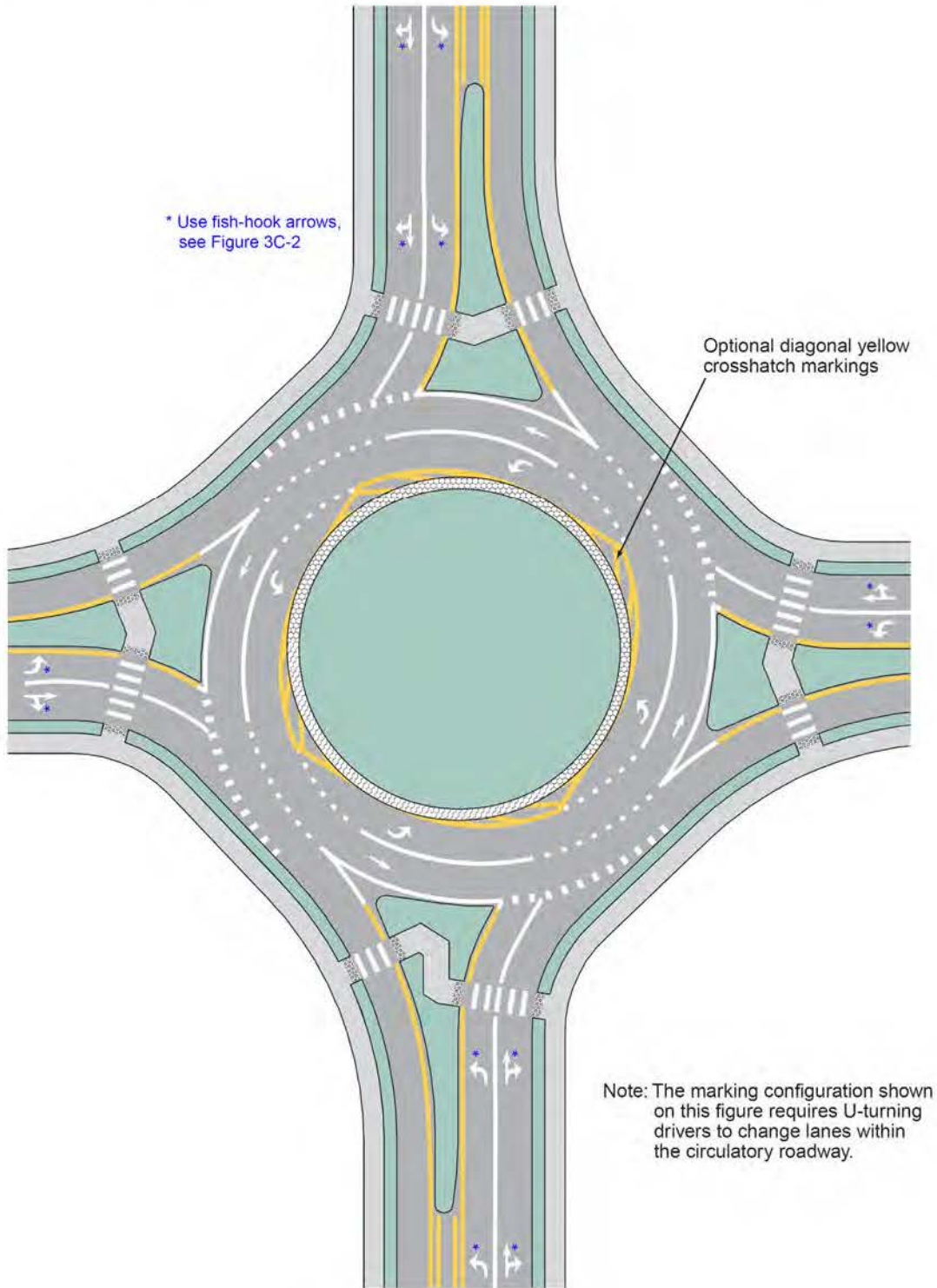
**B – Central island extended by pavement markings**



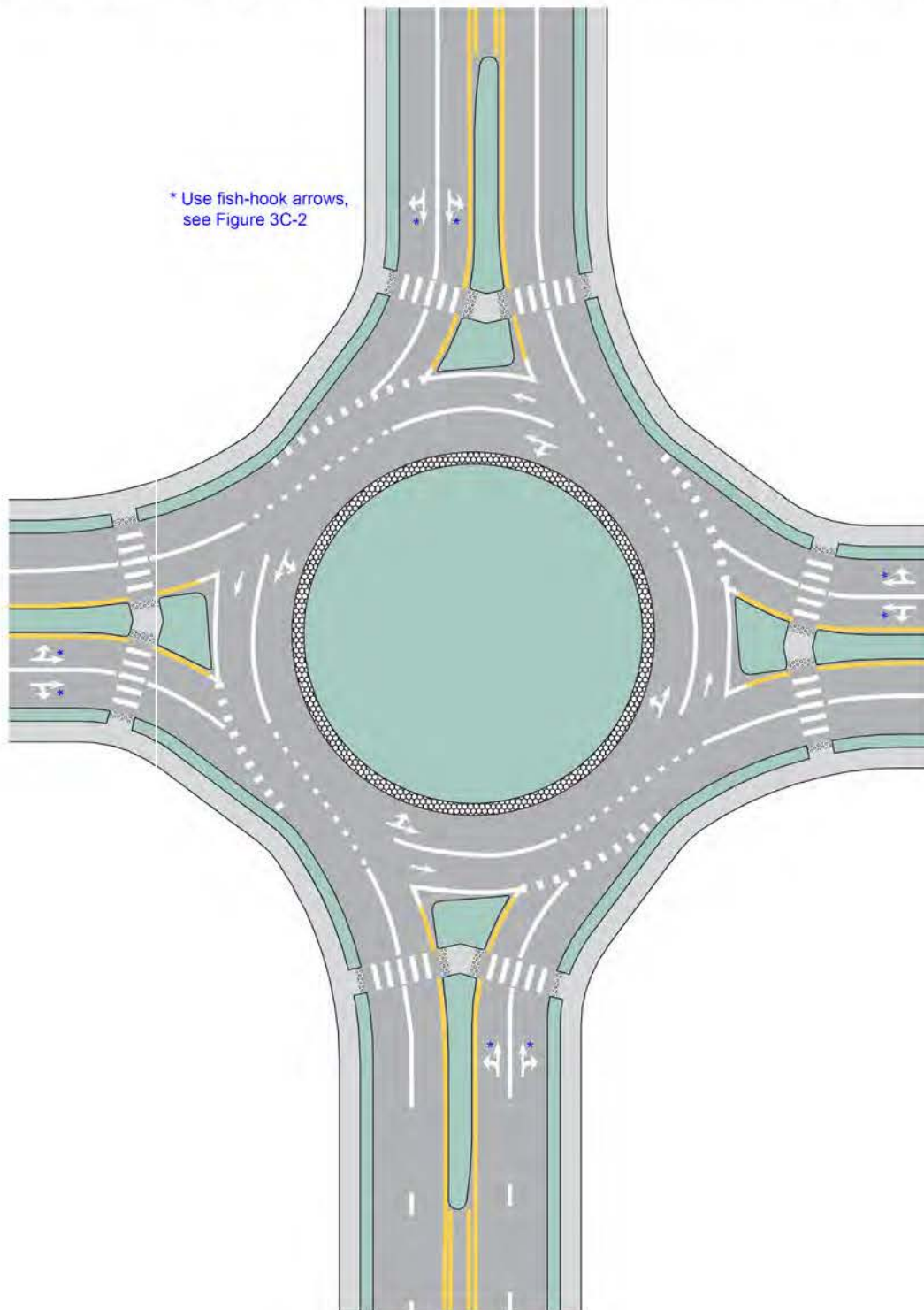
**C – Central island extended by a truck apron**



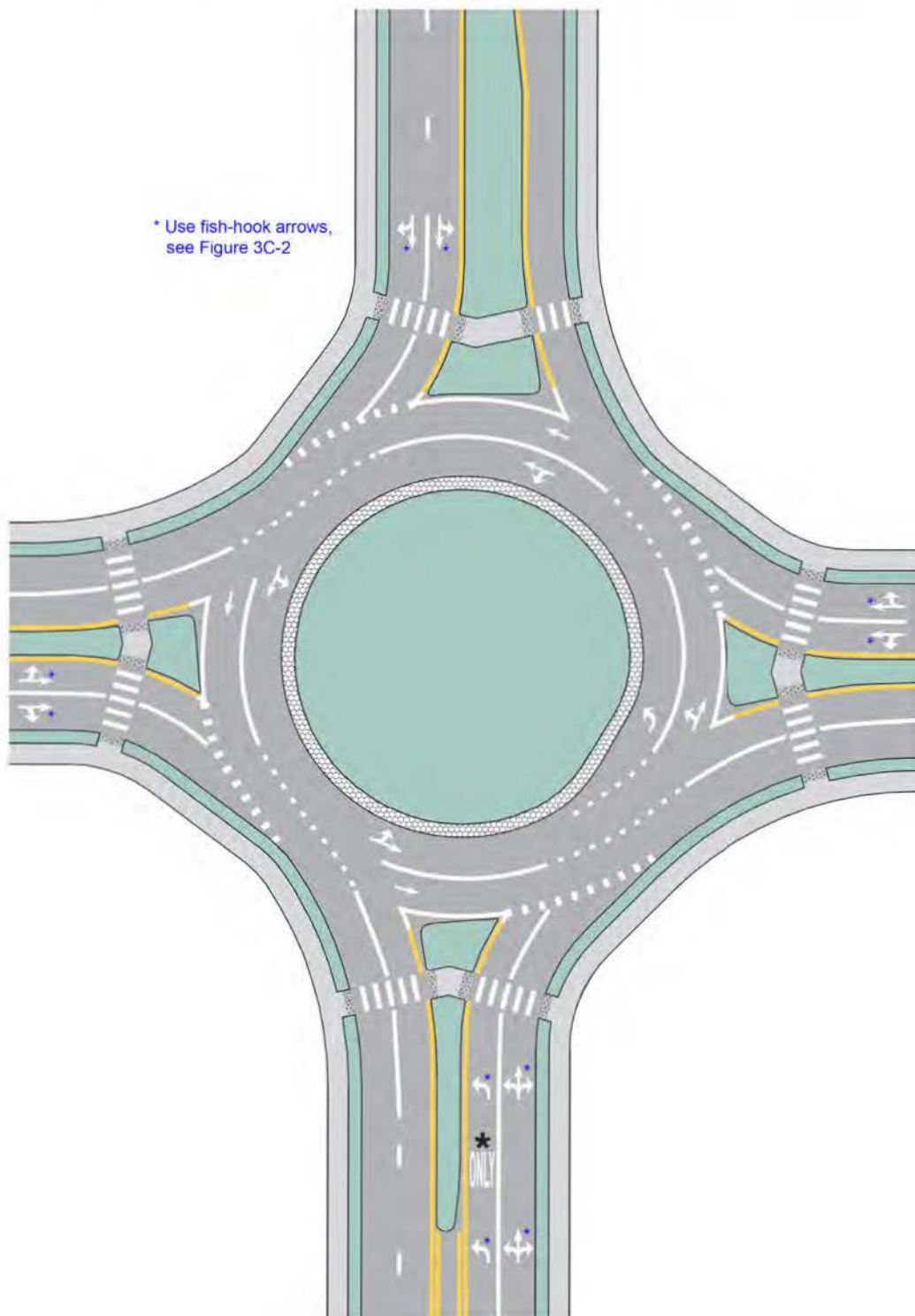
**Figure 3C-5. Example of Markings for a Two-Lane Roundabout with One-Lane Exits**



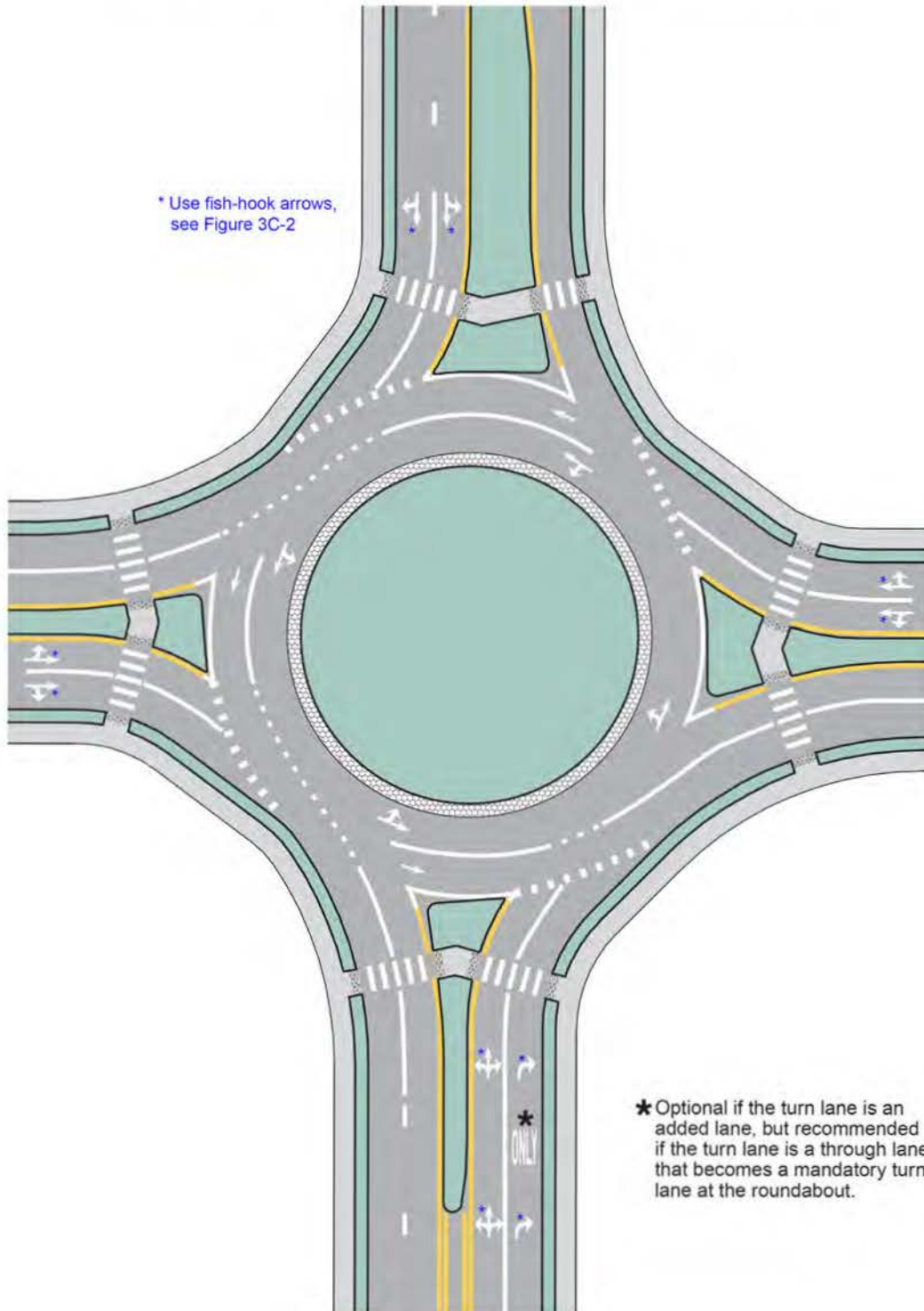
**Figure 3C-6. Example of Markings for a Two-Lane Roundabout with Two-Lane Exits**



**Figure 3C-7. Example of Markings for a Two-Lane Roundabout with a Double Left Turn**

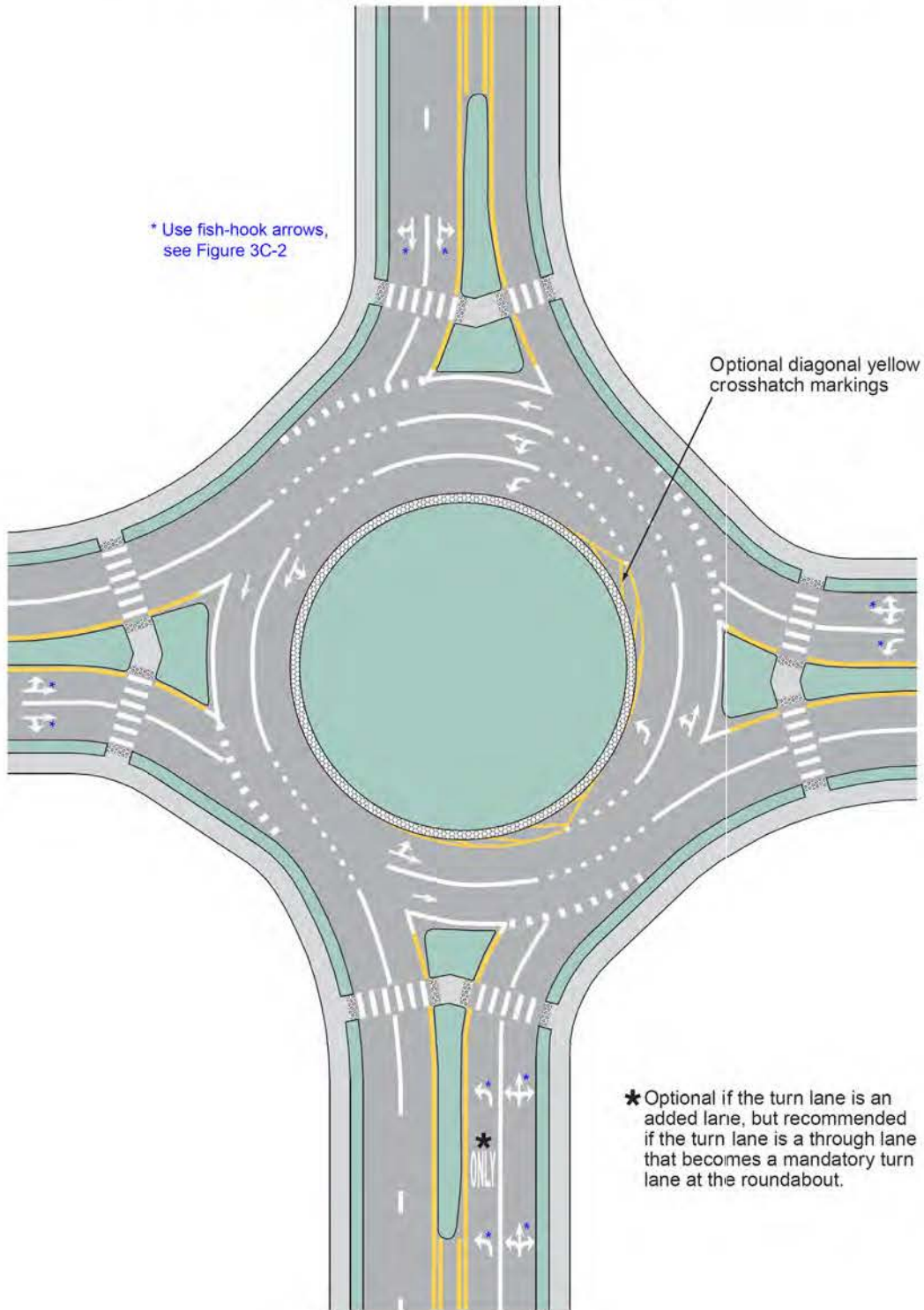


**Figure 3C-8. Example of Markings for a Two-Lane Roundabout with a Double Right Turn**

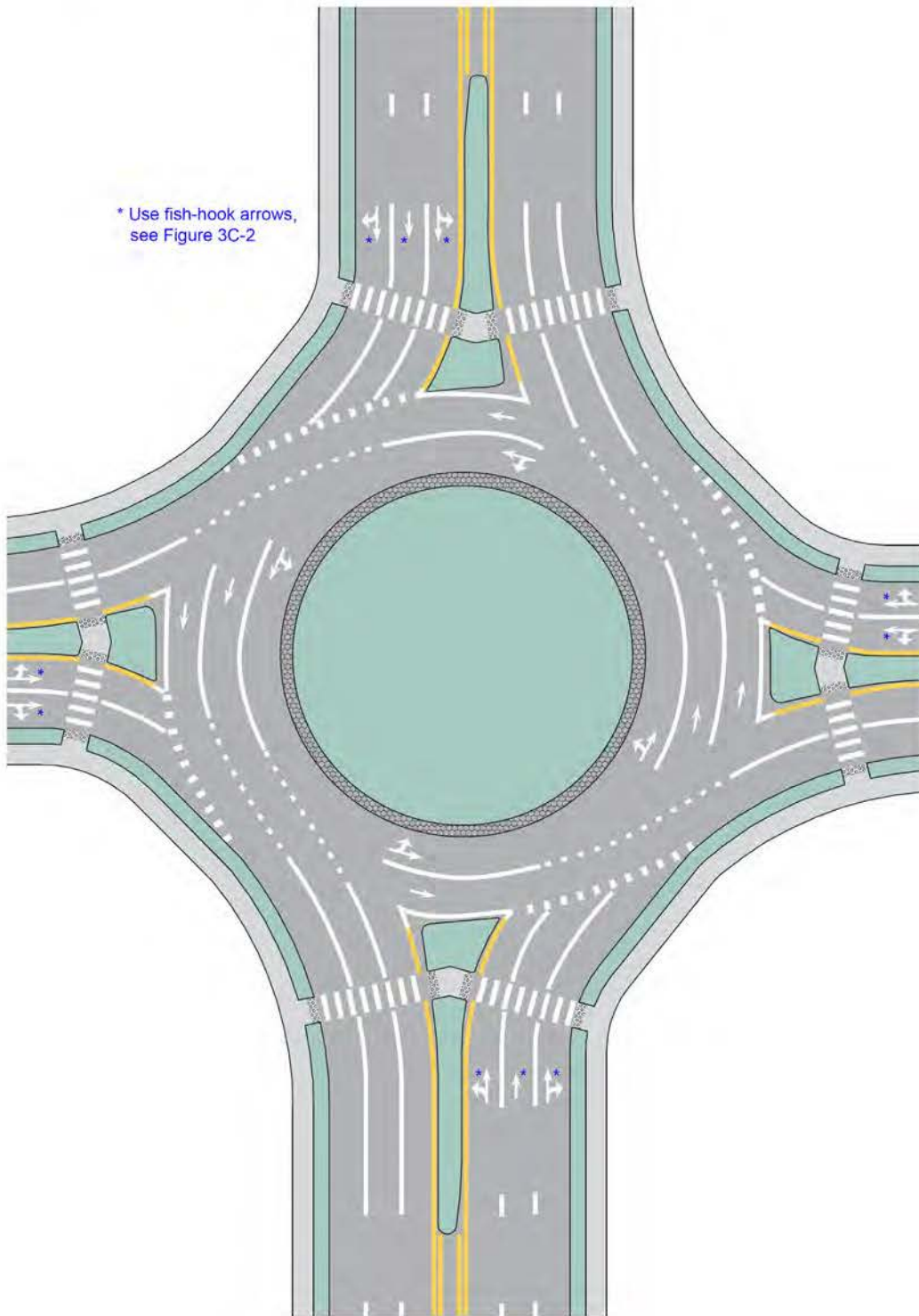




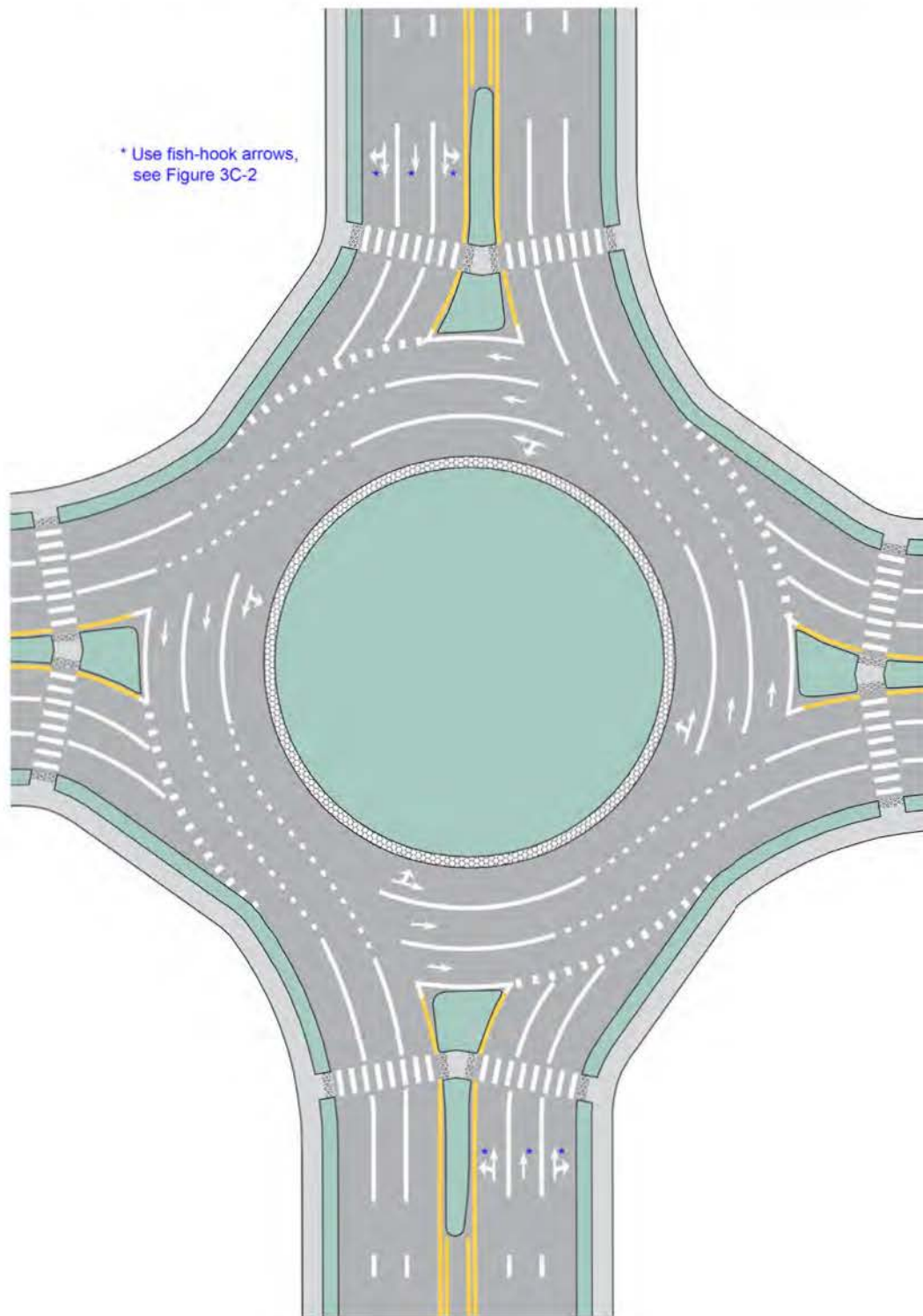
**Figure 3C-9. Example of Markings for a Two-Lane Roundabout with Consecutive Double Left Turns**



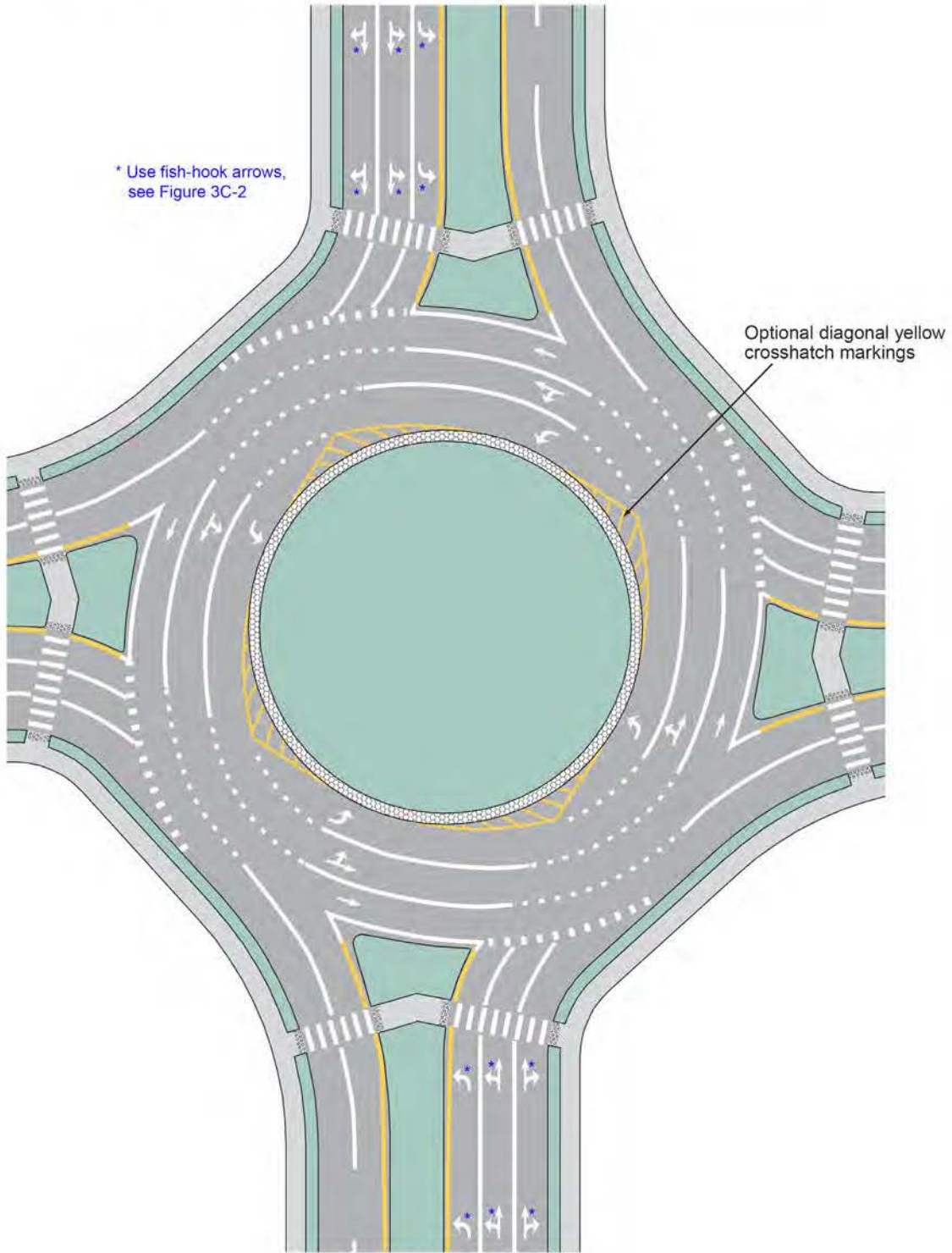
**Figure 3C-10. Example of Markings for a Three-Lane Roundabout with Two- and Three-Lane Approaches**



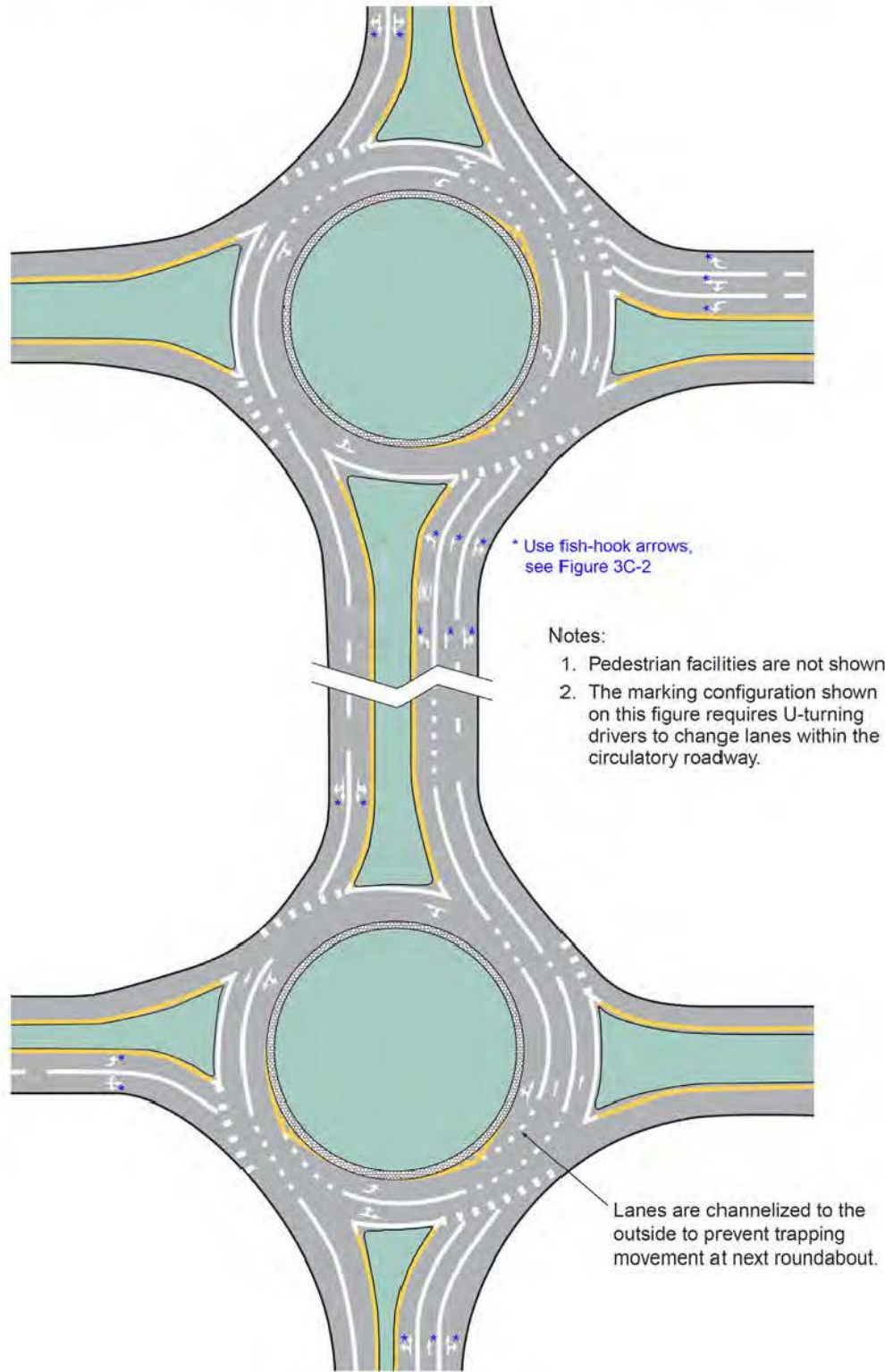
**Figure 3C-11. Example of Markings for a Three-Lane Roundabout with Three-Lane Approaches**



**Figure 3C-12. Example of Markings for a Three-Lane Roundabout with Two-Lane Exits**



**Figure 3C-13. Example of Markings for Two Linked Roundabouts**





## CHAPTER 3D. MARKINGS FOR PREFERENTIAL LANES

### Section 3D.01 Preferential Lane Word and Symbol Markings

#### Support:

<sup>01</sup> Preferential lanes are established for one or more of a wide variety of special uses, including, but not limited to, high-occupancy vehicle (HOV) lanes, ETC lanes, ~~high-occupancy toll (HOT)~~ priced managed lanes, bicycle lanes, bus only lanes, taxi only lanes, and light rail transit only lanes.

#### Standard:

<sup>02</sup> When a lane is assigned full or part time to a particular class or classes of vehicles, the preferential lane word and symbol markings described in this Section and the preferential lane longitudinal markings described in Section 3D.02 shall be used.

<sup>03</sup> All longitudinal pavement markings, as well as word and symbol pavement markings, associated with a preferential lane shall end where the Preferential Lane Ends (R3-12a or R3-12c) sign (see Section 2G.07) designating the downstream end of the preferential only lane restriction is installed.

<sup>04</sup> Static or changeable message regulatory signs (see Sections 2G.03 to 2G.07) shall be used with preferential lane word or symbol markings.

<sup>05</sup> All preferential lane word and symbol markings shall be white and shall be positioned laterally in the center of the preferential lane.

<sup>06</sup> Where a preferential lane use exists contiguous to a general-purpose lane or is separated from a general-purpose lane by a flush buffered space that can be traversed by motor vehicles, the preferential lane shall be marked with one or more of the following symbol or word markings for the preferential lane use specified:

- A. HOV lane—the preferential lane-use marking for high-occupancy vehicle lanes shall consist of white lines formed in a diamond shape symbol or the word message HOV. The diamond shall be at least 2.5 feet wide and 12 feet in length. The lines shall be at least 6 inches in width. See Figures 3B-23(CA) and 3D-101(CA).
- ~~B. HOT lane or ETC Account Only lane—except as provided in Paragraph 8, the preferential lane-use marking for a HOT lane or an ETC Account Only lane shall consist of a word marking using the name of the ETC payment system required for use of the lane, such as E-Z PASS ONLY.~~
- B. Priced managed lane – the preferential lane-use marking for a priced managed lane shall consist of the word marking EXPRS LANE. See Figure 3B-23(CA).
- C. Bicycle lane—the preferential lane-use marking for a bicycle lane shall consist of a bicycle symbol or the word marking BIKE LANE (see Chapter 9C and Figures 9C-1 and 9C-3 through 9C-6).
- D. Bus only lane—the preferential lane-use marking for a bus only lane shall consist of the word marking BUS ONLY.
- E. Taxi only lane—the preferential lane-use marking for a taxi only lane shall consist of the word marking TAXI ONLY.
- F. Light rail transit lane—the preferential lane-use marking for a light rail transit lane shall consist of the word marking LRT ONLY.
- G. Other type of preferential lane—the preferential lane-use markings shall consist of a word marking appropriate to the restriction.

<sup>07</sup> If two or more preferential lane uses are permitted in a single lane, the symbol or word marking for each preferential lane use shall be installed.

#### Option:

<sup>08</sup> Preferential lane-use symbol or word markings may be omitted at toll plazas where physical conditions preclude the use of the markings (see Section 3E.01).

#### Guidance:

<sup>09</sup> *The spacing of the markings should be based on engineering judgment that considers the prevailing speed, block lengths, distance from intersections, and other factors that affect clear communication to the road user.*

**Support:**

<sup>10</sup> Markings spaced as close as 80 feet apart might be appropriate on city streets, while markings spaced as far as ~~1,000~~ 500 feet apart might be appropriate for freeways (Refer to HOV Guidelines publication) and 180 feet for onramps (Refer to Ramp Meter Design Manual). See Section 1A.11 for information regarding these publications.

**Guidance:**

<sup>11</sup> In addition to a regular spacing interval, the preferential lane marking should be placed at strategic locations such as major decision points, direct exit ramp departures from the preferential lane, and along access openings to and from adjacent general-purpose lanes. At decision points, the preferential lane marking should be placed on all applicable lanes and should be visible to approaching traffic for all available departures. At direct exits from preferential lanes where extra emphasis is needed, the use of word markings (such as "EXIT" or "EXIT ONLY") in the deceleration lane for the direct exit and/or on the direct exit ramp itself just beyond the exit gore should be considered.

**Option:**

~~<sup>12</sup> A numeral indicating the vehicle occupancy requirements established for a high occupancy vehicle lane may be included in sequence after the diamond symbol or HOV word message.~~

**Guidance:**

<sup>13</sup> Engineering judgment should determine the need for supplemental devices such as tubular markers, traffic cones, or other channelizing devices (see Chapter 3H).

**Support:**

<sup>14</sup> For State highways, see Caltrans' High Occupancy Vehicle (HOV) Guidelines and Ramp Meter Design Manual. See Section 1A.11 for information regarding these publications.

### **Section 3D.02 Preferential Lane Longitudinal Markings for Motor Vehicles**

**Support:**

<sup>01</sup> Preferential lanes can take many forms depending on the level of usage and the design of the facility. They might be barrier-separated or buffer-separated from the adjacent general-purpose lanes, or they might be contiguous with the adjacent general-purpose lanes. Barrier-separated preferential lanes might be operated in a constant direction or be operated as reversible lanes. Some reversible preferential lanes on a divided highway might be operated counter-flow to the direction of traffic on the immediately adjacent general-purpose lanes. See Section 1A.13 for definitions of terms.

<sup>02</sup> Preferential lanes might be operated full-time (24 hours per day on all days), for extended periods of the day, part-time (restricted usage during specific hours on specified days), or on a variable basis (such as a strategy for a managed lane).

**Standard:**

<sup>03</sup> **Longitudinal pavement markings for preferential lanes shall be as follows (these same requirements are presented in tabular form in Table 3D-1):**

- A. Barrier-separated, non-reversible preferential lane—the longitudinal pavement markings for preferential lanes that are physically separated from the other travel lanes by a barrier or median shall consist of a normal solid single yellow line at the left-hand edge of the travel lane(s), and a normal solid single white line at the right-hand edge of the travel lane(s) (see Drawing A in Figure 3D-1).**
- B. Barrier-separated, reversible preferential lane—the longitudinal pavement markings for reversible preferential lanes that are physically separated from the other travel lanes by a barrier or median shall consist of a normal solid single white line at both edges of the travel lane(s) (see Drawing B in Figure 3D-1).**
- C. Buffer-separated (left-hand side) preferential lane—the longitudinal pavement markings for a full-time or part-time preferential lane on the left-hand side of and separated from the other travel lanes by a neutral buffer space shall consist of a normal solid single yellow line at the left-hand edge of the preferential travel lane(s) and one of the following at the right-hand edge of the preferential travel**



- lane(s):
- ~~1. A wide solid double white line along both edges of the buffer space where crossing the buffer space is prohibited (see Drawing A in Figure 3D-2).~~
  1. Two sets of wide solid double white lines where crossing the buffer space is prohibited and the buffer width is 4 feet or greater (see Drawing A in Figure 3D-2 and Detail 45 in Figure 3A-113(CA)).
  - ~~2. A wide solid single white line along both edges of the buffer space where crossing the buffer space is discouraged (see Drawing B in Figure 3D-2).~~
  2. A set of wide solid double white lines where crossing the buffer space is prohibited and the buffer width is 2 feet (see Drawing A in Figure 3D-2 and Detail 44 in Figure 3A-113(CA)).
  3. ~~A wide broken single white line along both edges of the buffer space, or a~~ A wide broken single white lane line within the allocated buffer space (resulting in wider lanes), where crossing the buffer space is permitted (see [bottom half of Drawing C in Figure 3D-2](#) and [Detail 42 in Figure 3A-113\(CA\)](#)).
- D. Buffer-separated (right-hand side) preferential lane—the longitudinal pavement markings for a full-time or part-time preferential lane on the right-hand side of and separated from the other travel lanes by a neutral buffer space shall consist of a normal solid single white line at the right-hand edge of the preferential travel lane(s) if warranted (see Section 3B.07) and one of the following at the left-hand edge of the preferential travel lane(s) (see Drawing D in Figure 3D-2):
- ~~1. A wide solid double white line along both edges of the buffer space where crossing the buffer space is prohibited.~~
  1. Two sets of wide solid double white lines where crossing the buffer space is prohibited and the buffer width is 4 feet or greater (see [Detail 45 in Figure 3A-113\(CA\)](#)).
  - ~~2. A wide solid single white line along both edges of the buffer space where crossing of the buffer space is discouraged.~~
  2. A set of wide solid double white lines where crossing the buffer space is prohibited and the buffer width is 2 feet (see [Detail 44 in Figure 3A-113\(CA\)](#)).
  3. ~~A wide broken single white line along both edges of the buffer space, or a~~ A wide broken single white line within the allocated buffer space (resulting in wider lanes), where crossing the buffer space is permitted (see [Detail 42 in Figure 3A-113\(CA\)](#)).
  4. A wide dotted single white lane line within the allocated buffer space (resulting in wider lanes) where crossing the buffer space is permitted for any vehicle to perform a right-turn maneuver (see [Detail 37 in Figure 3A-111\(CA\)](#)).
- E. Contiguous (left-hand side) preferential lane—the longitudinal pavement markings for a full-time or part-time preferential lane on the left-hand side of and contiguous to the other travel lanes shall consist of a normal solid single yellow line at the left-hand edge of the preferential travel lane(s) and one of the following at the right-hand edge of the preferential travel lane(s):
1. A wide solid double white lane line where crossing is prohibited (see [Drawing A in Figure 3D-3](#) and [Detail 44 in Figure 3A-113\(CA\)](#)).
  2. A wide solid single white lane line where crossing is discouraged (see [Drawing B in Figure 3D-3](#) and [Detail 43 in Figure 3A-113\(CA\)](#)).
  3. A wide ~~solid~~ broken single white lane line where crossing is permitted (see [Drawing C in Figure 3D-3](#) and [Detail 42 in Figure 3A-113\(CA\)](#)).
  4. A normal broken white line where crossing is permitted on preferential lanes that operate for only certain periods of the day. In these cases, markings shall conform to the purpose the lane serves a majority of the time.
- F. Contiguous (right-hand side) preferential lane—the longitudinal pavement markings for a full-time or part-time preferential lane on the right-hand side of and contiguous to the other travel lanes shall consist of a normal solid single white line at the right-hand edge of the preferential travel lane(s) if warranted (see Section 3B.07) and one of the following at the left-hand edge of the preferential travel lane(s) (see Drawing D in Figure 3D-3):
1. A wide solid double white lane line where crossing is prohibited (see [Detail 44 in Figure 3A-113\(CA\)](#)).
  2. A wide solid single white lane line where crossing is discouraged (see [Detail 43 in Figure 3A-113\(CA\)](#)).

3. A wide broken single white lane line where crossing is permitted (see Detail 42 in Figure 3A-113(CA)).
4. A wide dotted single white lane line where crossing is permitted for any vehicle to perform a right-turn maneuver (see Detail 37 in Figure 3A-111(CA)).
5. A normal broken white line where crossing is permitted on preferential lanes that operate for only certain periods of the day. In these cases, markings shall conform to the purpose the lane serves a majority of the time.

*Guidance:*

<sup>04</sup> Where preferential lanes and other travel lanes are separated by a buffer space wider than 4 feet and crossing the buffer space is prohibited, chevron markings (see Section 3B.24) should be placed in the buffer area (see Drawing A in Figure 3D-2). The chevron spacing should be 100 feet or greater.

<sup>04a</sup> Buffer widths between 4 feet and 12 feet (see Figure 3A-113(CA), Detail 45) should be avoided, except when transitioning between narrow and wide buffer areas.

*Option:*

<sup>05</sup> If a full-time or part-time contiguous preferential lane is separated from the other travel lanes by a wide broken single white line (see Drawing C in Figure 3D-3), the spacing or skip pattern of the line may be reduced and the width of the line may be increased.

**Standard:**

<sup>06</sup> If there are two or more preferential lanes for traffic moving in the same direction, the lane lines between the preferential lanes shall be normal broken white lines.

<sup>07</sup> Preferential lanes for motor vehicles shall also be marked with the appropriate word or symbol pavement markings in accordance with Section 3D.01 and shall have appropriate regulatory signs in accordance with Sections 2G.03 through 2G.07.

*Guidance:*

<sup>08</sup> At direct exits from a preferential lane, dotted white line markings should be used to separate the tapered or parallel deceleration lane for the direct exit (including the taper) from the adjacent continuing preferential through lane, to reduce the chance of unintended exit maneuvers.

**Standard:**

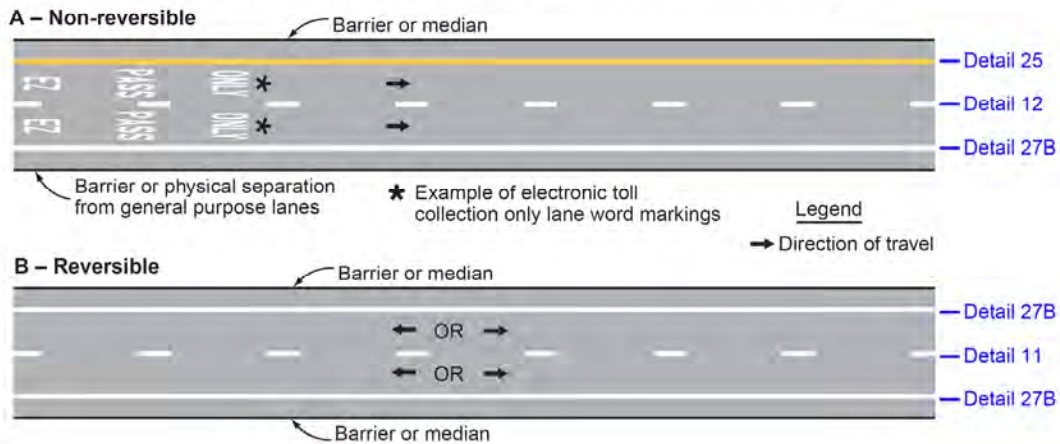
<sup>09</sup> On a divided highway, a part-time counter-flow preferential lane that is contiguous to the travel lanes in the opposing direction shall be separated from the opposing direction lanes by the standard reversible lane longitudinal marking, a normal width broken double yellow line (see Section 3B.03 and Drawing A of Figure 3D-4). ~~If a buffer space is provided between the part-time counter-flow preferential lane and the opposing direction lanes, a normal width broken double yellow line shall be placed along both edges of the buffer space (see Drawing B of Figure 3D-4).~~ Signs (see Section 2B.26), lane-use control signals (see Chapter 4M), or both shall be used to supplement the reversible lane markings.

<sup>10</sup> On a divided highway, a full-time counter-flow preferential lane that is contiguous to the travel lanes in the opposing direction shall be separated from the opposing direction lanes by a solid double yellow center line marking (see Drawing C of Figure 3D-4). If a buffer space is provided between the full-time counter-flow preferential lane and the opposing direction lanes, a normal width solid double yellow line shall be placed along both edges of the buffer space (see Drawing D of Figure 3D-4).

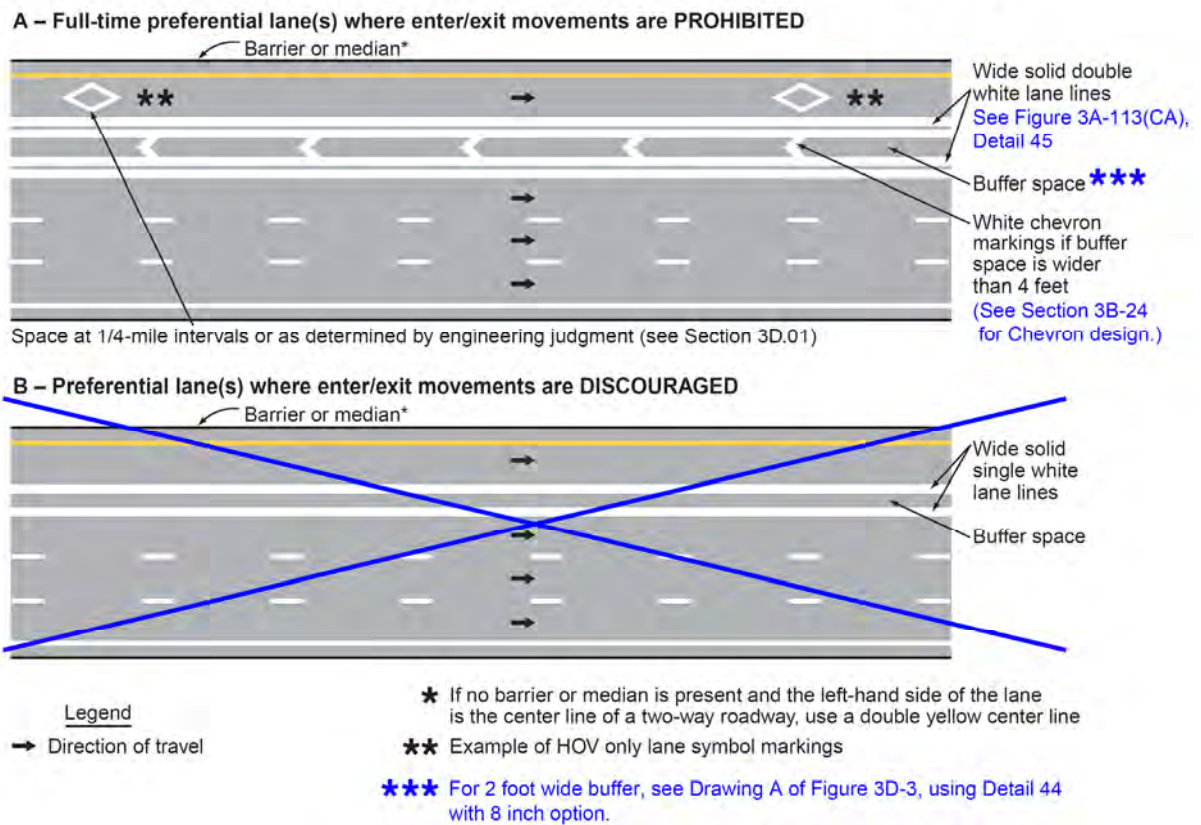
*Option:*

<sup>11</sup> Cones, tubular markers, or other channelizing devices (see Chapter 3H) may also be used to separate the opposing lanes when a counter-flow preferential lane operation is in effect.

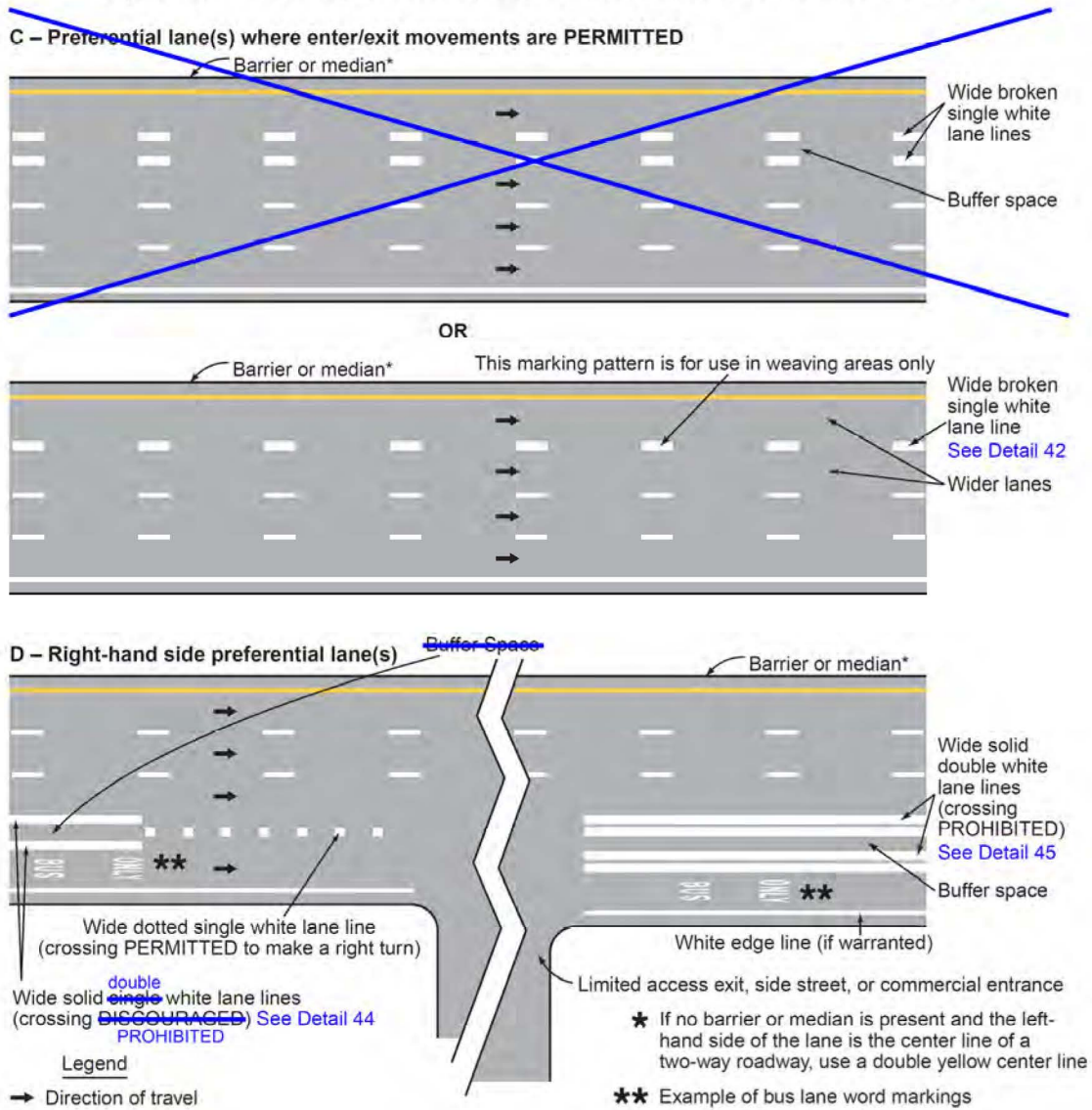
**Figure 3D-1. Markings for Barrier-Separated Preferential Lanes**



**Figure 3D-2. Markings for Buffer-Separated Preferential Lanes (Sheet 1 of 2)**

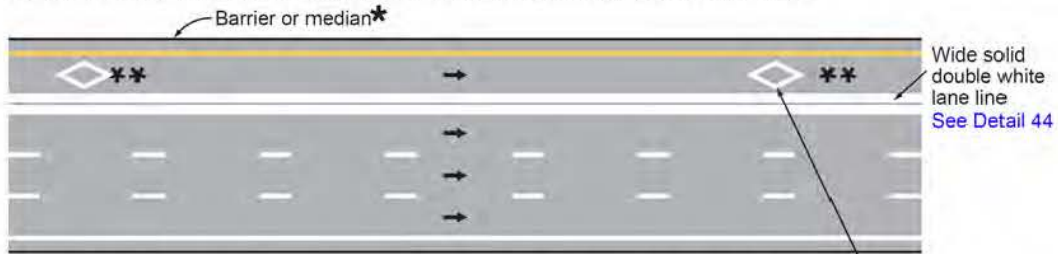


**Figure 3D-2. Markings for Buffer-Separated Preferential Lanes (Sheet 2 of 2)**

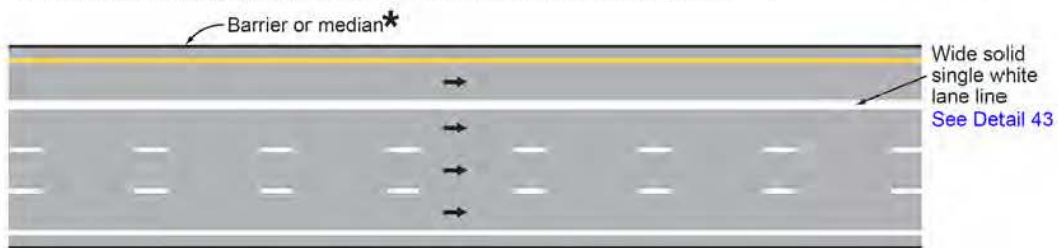


**Figure 3D-3. Markings for Contiguous Preferential Lanes**

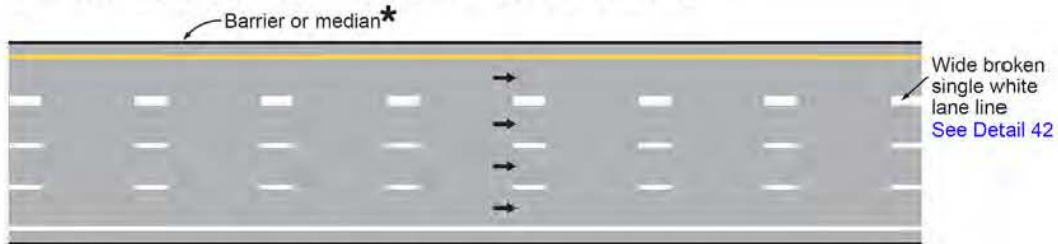
**A – Full-time preferential lane(s) where enter/exit movements are PROHIBITED**



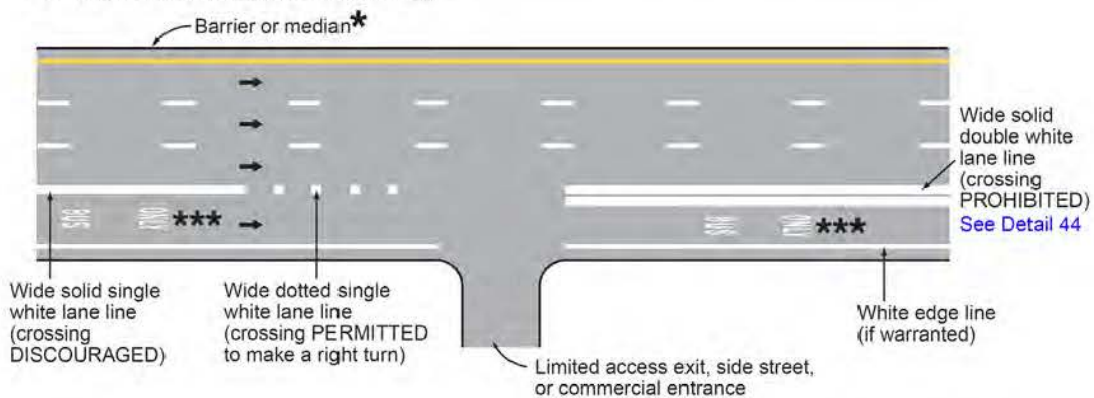
**B – Preferential lane(s) where enter/exit movements are DISCOURAGED** Space at 1/4-mile intervals



**C – Preferential lane(s) where enter/exit movements are PERMITTED**



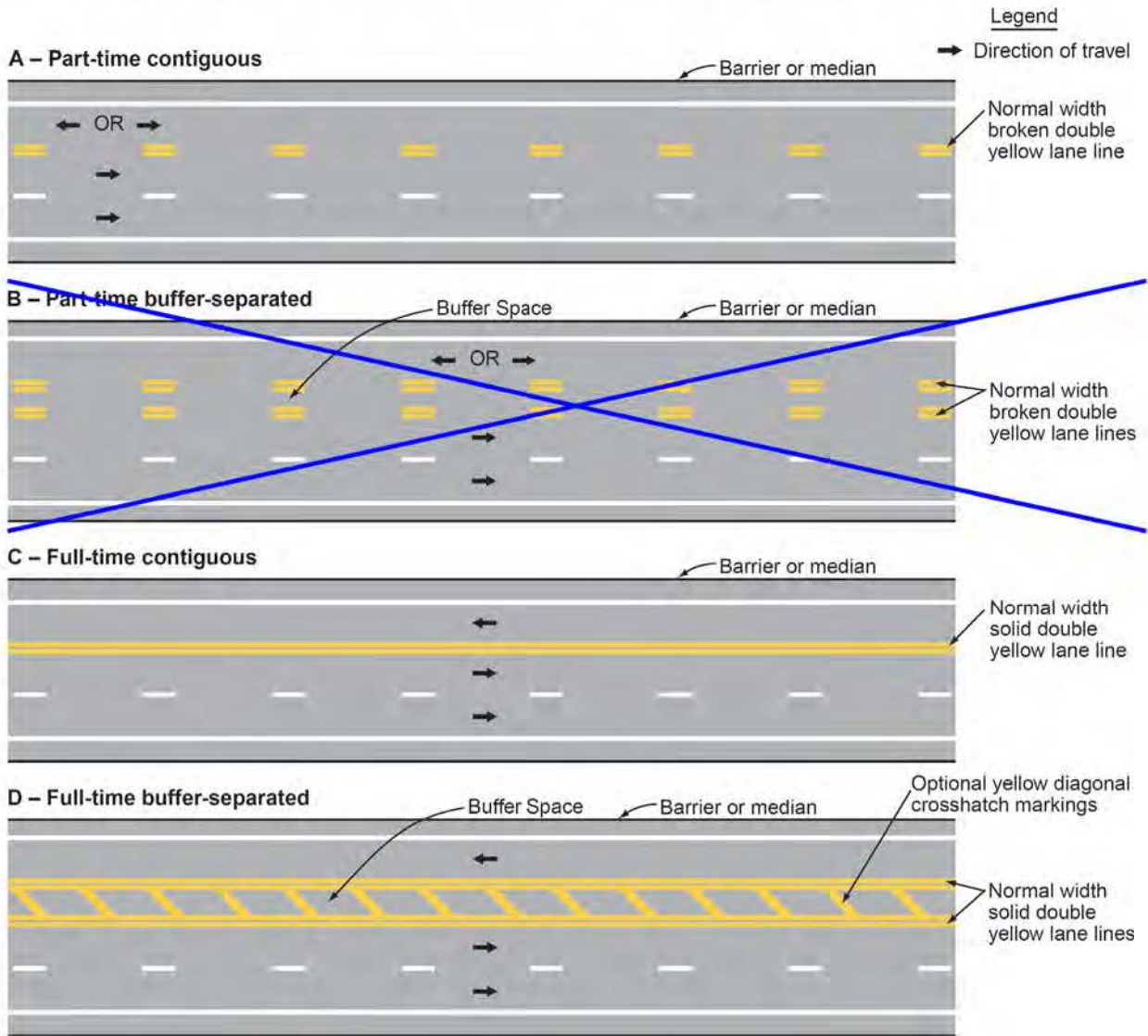
**D – Right-hand side preferential lane(s)**



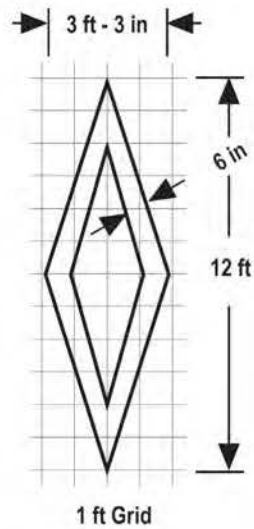
**Legend**  
 → Direction of travel

- \* If no barrier or median is present and the left-hand side of the lane is the center line of a two-way roadway, use a double yellow center line
- \*\* Example of HOV only lane symbol markings
- \*\*\* Example of bus lane word markings

**Figure 3D-4. Markings for Counter-Flow Preferential Lanes on Divided Highways**



**Figure 3D-101 (CA). Diamond Symbol (HOV Lane)**



**NOTE:** The design detail for this symbol is also shown in the Department of Transportation's Standard Plans.

**Table 3D-1. Standard Edge Line and Lane Line Markings for Preferential Lanes**

| Type of Preferential Lane         | Left-Hand Edge Line  | Right-Hand Edge Line   |
|-----------------------------------|--|--|
| Barrier-Separated, Non-Reversible | A normal solid single yellow line  | A normal solid single white line (see Drawing A of Figure 3D-1)  |
| Barrier-Separated, Reversible     | A normal solid single white line   | A normal solid single white line (see Drawing B of Figure 3D-1)  |
| Buffer-Separated, Left Hand Side  | A normal solid single yellow line  | A wide solid double white line along both edges of the buffer space where crossing is prohibited (see Drawing A of Figure 3D-2 and Detail 44)<br><del>A wide solid single white line along both edges of the buffer space (less than 4 feet) where crossing is discouraged prohibited (see Drawing B of Figure 3D-2)</del><br><del>A wide broken single white line along both edges of the buffer space, or a wide broken single white line within the buffer space (resulting in wider lanes), where crossing is permitted (see Drawing C of Figure 3D-2)</del> |
| Buffer-Separated, Right-Hand Side | A wide solid double white line along both edges of the buffer space where crossing is prohibited (see Drawing D of Figure 3D-2 and Detail 44)<br><del>A wide solid single white line along both edges of the buffer space (less than 4 feet) where crossing is discouraged prohibited (see Drawing D of Figure 3D-2)</del><br><del>A wide broken single white line along both edges of the buffer space, or a wide broken single white line within the buffer space (resulting in wider lanes), where crossing is permitted (see Drawing D of Figure 3D-2)</del><br>A wide dotted single white line within the buffer space (resulting in wider lanes) where crossing is permitted for any vehicle to perform a right-turn maneuver (see Drawing D of Figure 3D-2) | A normal solid single white line (if warranted)  |
| Contiguous, Left-Hand Side        | A normal solid single yellow line  | A wide solid double white line where crossing is prohibited (see Drawing A of Figure 3D-3)<br>A wide solid single white line where crossing is discouraged (see Drawing B of Figure 3D-3)<br>A wide broken single white line where crossing is permitted (see Drawing C of Figure 3D-3)  |
| Contiguous, Right-Hand Side       | A wide solid double white line where crossing is prohibited (see Drawing D of Figure 3D-3)<br>A wide solid single white line where crossing is discouraged (see Drawing D of Figure 3D-3)<br>A wide broken single white line where crossing is permitted (see Drawing D of Figure 3D-3)<br>A wide dotted single white line where crossing is permitted for any vehicle to perform a right-turn maneuver (see Drawing D of Figure 3D-3)   | A normal solid single white line   |

- Notes: 1. If there are two or more preferential lanes, the lane lines between the preferential lanes shall be normal broken white lines.  
 2. The standard lane markings listed in this table are provided in a tabular format for reference.  
 3. This information is also described in Paragraph 3 of Section 3D.02.



## CHAPTER 3E. MARKINGS FOR TOLL PLAZAS

### Section 3E.01 Markings for Toll Plazas

#### Support:

<sup>01</sup> At toll plazas, pavement markings help road users identify the proper lane(s) to use for the type of toll payment they plan to use, to channelize movements into the various lanes, and to delineate obstructions in the roadway.

#### Standard:

<sup>02</sup> **When a lane on the approach to a toll plaza is restricted to use only by vehicles with registered ETC accounts, the ETC Account-Only lane word markings described in Section 3D.01 and the preferential lane longitudinal markings described in Section 3D.02 shall be used. When one or more ORT lanes that are restricted to use only by vehicles with registered ETC accounts bypass a mainline toll plaza on a separate alignment, these word markings and longitudinal markings shall be used on the approach to the point where the ORT lanes diverge from the lanes destined for the mainline toll plaza.**

#### Option:

<sup>03</sup> Preferential lane-use symbol or word markings may be omitted at toll plazas where physical conditions preclude the use of the markings.

#### Guidance:

<sup>04</sup> *If an ORT lane that is immediately adjacent to a mainline toll plaza is not separated from adjacent cash payment toll plaza lanes by a curb or barrier, then channelizing devices (see Section 3H.01), and/or longitudinal pavement markings that discourage or prohibit lane changing should be used to separate the ORT lane from the adjacent cash payment lane. This separation should begin on the approach to the mainline toll plaza at approximately the point where the vehicle speeds in the adjacent cash lanes drop below 30 mph during off-peak periods and should extend downstream beyond the toll plaza approximately to the point where the vehicles departing the toll plaza in the adjacent cash lanes have accelerated to 30 mph.*

#### Option:

<sup>05</sup> For a toll plaza approach lane that is restricted to use only by vehicles with registered ETC accounts, the solid white lane line or edge line on the right-hand side of the ETC Account-Only lane and the solid white lane line or solid yellow edge line on the left-hand side of the ETC Account-Only lane may be supplemented with purple solid longitudinal markings placed contiguous to the inside edges of the lines defining the lane.

#### Standard:

<sup>06</sup> **If used, the purple solid longitudinal marking described in the previous paragraph shall be a minimum of 3 inches in width and a maximum width equal to the width of the line it supplements, and ETC Account-Only preferential lane word markings (see Section 3D.01) shall be installed within the lane.** <sup>07</sup> **Toll booths and the islands on which they are located are considered to be obstructions in the roadway and they shall be provided with markings that comply with the provisions of Section 3B.10 and Chapter 3G.**

#### Option:

<sup>08</sup> Longitudinal pavement markings may be omitted alongside toll booth islands between the approach markings and any departure markings.



## CHAPTER 3F. DELINEATORS

### Section 3F.01 Delineators

Support:

<sup>01</sup> Delineators are particularly beneficial at locations where the alignment might be confusing or unexpected, such as at lane-reduction transitions and curves. Delineators are effective guidance devices at night and during adverse weather. An important advantage of delineators in certain locations is that they remain visible when the roadway is wet or snow covered.

<sup>02</sup> Delineators are considered guidance devices rather than warning devices.

Option:

<sup>03</sup> Delineators may be used on long continuous sections of highway or through short stretches where there are changes in horizontal alignment.

### Section 3F.02 Delineator Design

Standard:

<sup>01</sup> **Delineators shall consist of retroreflective devices that are capable of clearly retroreflecting light under normal atmospheric conditions from a distance of 1,000 feet when illuminated by the high beams of standard automobile lights.**

<sup>02</sup> **Retroreflective elements for delineators shall have a minimum dimension of 3 inches.**

Support:

<sup>03</sup> Within a series of delineators along a roadway, delineators for a given direction of travel at a specific location are referred to as single delineators if they have one retroreflective element for that direction, double delineators if they have two identical retroreflective elements for that direction mounted together, or vertically elongated delineators if they have a single retroreflective element with an elongated vertical dimension to approximate the vertical dimension of two separate single delineators.

Option:

<sup>04</sup> A vertically elongated delineator of appropriate size may be used in place of a double delineator.

Support:

<sup>05</sup> There are two classes of delineator posts and several types of retroreflectorization as shown in Figure 3F-101(CA).

### Section 3F.03 Delineator Application

Standard:

<sup>01</sup> **The color of delineators shall comply with the color of edge lines stipulated in Section 3B.06, except for the use of red at truck escape ramps.**

<sup>02</sup> **A series of single delineators shall be provided on the right-hand side of freeways and expressways and on at least one side of interchange ramps, except when either Condition A or Condition B is met, as follows:**

**A. On tangent sections of freeways and expressways when both of the following conditions are met:**

- 1. Raised pavement markers are used continuously on lane lines throughout all curves and on all tangents to supplement pavement markings, and**
- 2. Roadside delineators are used to lead into all curves.**

**B. On sections of roadways where continuous lighting is in operation between interchanges.**

Option:

<sup>03</sup> Delineators may be provided on other classes of roads. A series of single delineators may be provided on the left-hand side of roadways.

Standard:

<sup>04</sup> **Delineators on the left-hand side of a two-way roadway shall be white (see Figure 3F-1).**

Guidance:

<sup>05</sup> *A series of single delineators should be provided on the outside of curves on interchange ramps.*

06 *Where median crossovers are provided for official or emergency use on divided highways and where these crossovers are to be marked, a double yellow delineator should be placed on the left-hand side of the through roadway on the far side of the crossover for each roadway.*

~~07 *Double or vertically elongated delineators should be installed at 100-foot intervals along acceleration and deceleration lanes.*~~

08 *A series of delineators should be used wherever guardrail or other longitudinal barriers are present along a roadway or ramp.*

Option:

~~09 *Red delineators may be used on the reverse side of any delineator where it would be viewed by a road user traveling in the wrong direction on that particular ramp or roadway.*~~ In California, except at truck escape ramps, red markers are used for wrong-way traffic, not delineators.

10 *Delineators of the appropriate color may be used to indicate a lane-reduction transition where either an outside or inside lane merges into an adjacent lane.*

Guidance:

11 *When used for lane-reduction transitions, the delineators should be installed adjacent to the lane or lanes reduced for the full length of the transition and should be so placed and spaced to show the reduction (see Figure ~~3B-14~~ 3B-14(CA)).*

Support:

12 *Delineators are not necessary for traffic moving in the direction of a wider pavement or on the side of the roadway where the alignment is not affected by the lane-reduction transition.*

Guidance:

13 *On a highway with continuous delineation on either or both sides, delineators should be carried through transitions.*

Option:

14 *On a highway with continuous delineation on either or both sides, the spacing between a series of delineators may be closer.*

**Standard:**

15 **When used on a truck escape ramp, delineators shall be red.**

Guidance:

16 *Red delineators should be placed on both sides of truck escape ramps. The delineators should be spaced at 50-foot intervals for a distance sufficient to identify the ramp entrance. Delineator spacing beyond the ramp entrance should be adequate for guidance according to the length and design of the escape ramp.*

Option:

17 *Where delineation is required within a paved area, surface mounted channelizers may be used. See Section 3H.01.*

Support:

18 *Examples of the use of delineators are shown in Figure 3F-101(CA). Color exceptions are shown in Figure 3F-103(CA) and 3F-104(CA).*

19 *Following are typical delineators and their uses:*

- A. *Type E - White Retroreflector (2 Sided). For use on the left or right of 2-lane 2-way streets and highways when it is desirable to have a reflector on the front and one on the back of the delineator facing the opposite direction of traffic.*
- B. *Type F - White Retroreflector (1 Sided). For use on the right of freeways and expressways. They may also be used on 2-lane 2-way streets and highways when the Type E is not needed.*
- C. *Type G - Yellow Retroreflector (1 Sided). For use on the left of divided highways and 2-lane highway intersections as shown in Figure 3F-102(CA).*
- D. *Type J - Red Retroreflector (1 Sided). For placement on both sides of Truck Escape Ramps as shown in Figure 3F-103(CA).*

### **Section 3F.04 Delineator Placement and Spacing**

Guidance:

01 *Delineators should be mounted on suitable supports at a mounting height, measured vertically from the bottom of the lowest retroreflective device to the elevation of the near edge of the roadway, of approximately 4 feet.*

Option:

02 When mounted on the face of or on top of guardrails or other longitudinal barriers, delineators may be mounted at a lower elevation than the normal delineator height recommended in Paragraph 1.

Guidance:

03 *Delineators should be placed 2 to & 6 feet outside the outer edge of the shoulder, or if appropriate, in line with the roadside barrier that is 8 feet or less outside the outer edge of the shoulder.*

04 *Delineators should be placed at a constant distance from the edge of the roadway, except that where an obstruction intrudes into the space between the pavement edge and the extension of the line of the delineators, the delineators should be transitioned to be in line with or inside the innermost edge of the obstruction. If the obstruction is a guardrail or other longitudinal barrier, the delineators should be transitioned to be just behind, directly above (in line with), or on the innermost edge of the guardrail or longitudinal barrier.*

~~05 Delineators should be spaced 200 to 530 feet apart on mainline tangent sections. Delineators should be spaced 100 feet apart on ramp tangent sections.~~

05a *Delineators should be spaced 530 feet apart on mainline tangent sections. Delineators should be spaced 200 feet apart on ramp tangent sections.*

Support:

06 Examples of delineator installations are shown in Figure 3F-1.

Option:

07 When uniform spacing is interrupted by such features as driveways and intersections, delineators which would ordinarily be located within the features may be relocated in either direction for a distance not exceeding one quarter of the uniform spacing. Delineators still falling within such features may be eliminated.

08 Delineators may be transitioned in advance of a lane transition or obstruction as a guide for oncoming traffic.

Guidance:

09 *The spacing of delineators should be adjusted on approaches to and throughout horizontal curves so that several delineators are always simultaneously visible to the road user. The approximate spacing shown in Table 3F-1 should be used.*

Option:

10 When needed for special conditions, delineators of the appropriate color may be mounted in a closely-spaced manner on the face of or on top of guardrails or other longitudinal barriers to form a continuous or nearly continuous "ribbon" of delineation.

Guidance:

11 *If used, delineators should be placed as follows:*

- A. *On the outsides of highway curves of 3000 feet radius or less (including medians in divided highways), freeway exit and entrance ramps and connectors. Exception to this is where a median barrier is delineated as shown in the Median Barrier Delineation Detail in Figure 3F-105(CA). Delineator spacing on curves is shown in Figure 3F-1 and Table 3F-1.*
- B. *On the right of tangent sections of freeway entrance and exit ramps, collector roads, freeway connectors and lane reduction transition sections at 200 feet spacing.*
- C. *On embankments higher than 10 feet and with side slopes steeper than 4:1. The spacing of tangent sections is approximately 525 feet. For spacing on curves, see Figure 3F-1 and Table 3F-1.*
- D. *On approaches to narrow bridges as shown in Figure 3F-104(CA).*
- E. *On tangent sections of rural State highways where there are no reflective pavement markers, such as in snow areas. Delineator spacing is approximately 525 feet.*
- F. *On all new guardrail or bridge rail installations, or when maintenance is required on existing guardrail or bridge rail, within 12 feet of the edge of traveled way and curves of 3000 feet radius or less. The spacing on tangent sections is approximately 525 feet. For spacing on curves, see Figure 3F-1 and Table 3F-1.*

Option:

14 *Delineators may also be placed as follows:*

- A. *At intersections, road approaches, and median openings, as shown in Figure 3F-102(CA).*
- B. *On sections of highway with non-standard shoulder width.*

15 *If the exit gore at an interchange is not illuminated or is partially illuminated, delineators may be placed as shown in Figure 3F-102(CA) per the following details:*

- A. Type F - White Retroreflectors (1 Sided) on the right side, beginning at a distance > 5S from the theoretical gore point at 100 feet spacing.
- B. Type G - Yellow Retroreflectors (1 Sided) on the left side of the exit at 10 feet spacing and then shifting to 100 feet spacing.
- C. Type F - White Retroreflectors (1 Sided) on the right side of the mainline, downstream of the exit at 10 feet spacing.

Support:

<sup>16</sup> Refer to Table 3F-1 for formula to calculate value of S.

### **Section 3F.101(CA) Culvert Markers**

Support:

<sup>01</sup> Culvert markers are placed as a convenience to maintenance crews in marking locations of culvert openings. Such marking is sometimes necessary to protect culvert ends from damage from adjacent operations as well as to serve as an aid in locating culverts during storm conditions.

<sup>02</sup> Refer to Caltrans' Maintenance Manual, Chapter M5 (Traffic Safety Devices) for more information on culvert markers. See Section 1A.11 for information regarding this publication.

Option:

<sup>03</sup> Culvert markers may be placed on both sides of the highway at those culverts where they are necessary.

Guidance:

<sup>04</sup> *Culvert markers should be so placed as not to interfere with a line of delineators.*

**Standard:**

<sup>05</sup> **Culvert markers shall not be retroreflective, or contain kilometer post marker information.**

### **Section 3F.102(CA) Emergency Passageway Marker**

Support:

<sup>01</sup> Except for emergency passageways in median barriers, median openings are not allowed on freeways.

<sup>02</sup> Refer to Caltrans' Traffic Manual, Section 7-04.7 for design considerations of emergency passageways. See Section 1A.11 for information regarding this publication.

Guidance:

<sup>03</sup> *Where freeway median passageways are provided for emergency vehicles, delineation for the crossover should be as follows:*

- A. *At a point, 1/5 mile in advance of the crossover, one Class 1 Delineator, with a yellow post and two 3 x 12 inch white retroreflectors stacked vertically (24 inch of white retroreflectance), should be placed on the left side of the through roadway facing approaching traffic.*
- B. *At a point, 1/10 mile in advance of the crossover, one Class 1 Delineator, with a yellow post and two 3 x 12 inch yellow retroreflectors stacked vertically, should be placed on the left side as in A.*
- C. *At the far side of the crossover, one Class 1 Delineator, with a yellow post and one 3 x 12 inch white retroreflector over one 3 x 12 inch yellow retroreflector stacked vertically, should be placed on the left side as in A.*

### **Section 3F.103(CA) Narrow Bridge Signing and Marking**

Support:

<sup>01</sup> The placement of warning signs, object markers, delineators, and edge lines at narrow bridges is dependent upon the width of the bridge and approach roadway.

**Standard:**

<sup>02</sup> **Narrow bridge signing and marking shall conform to the details shown in Figure 3F-104(CA).**

### **Section 3F.104(CA) Median Barrier Delineation**

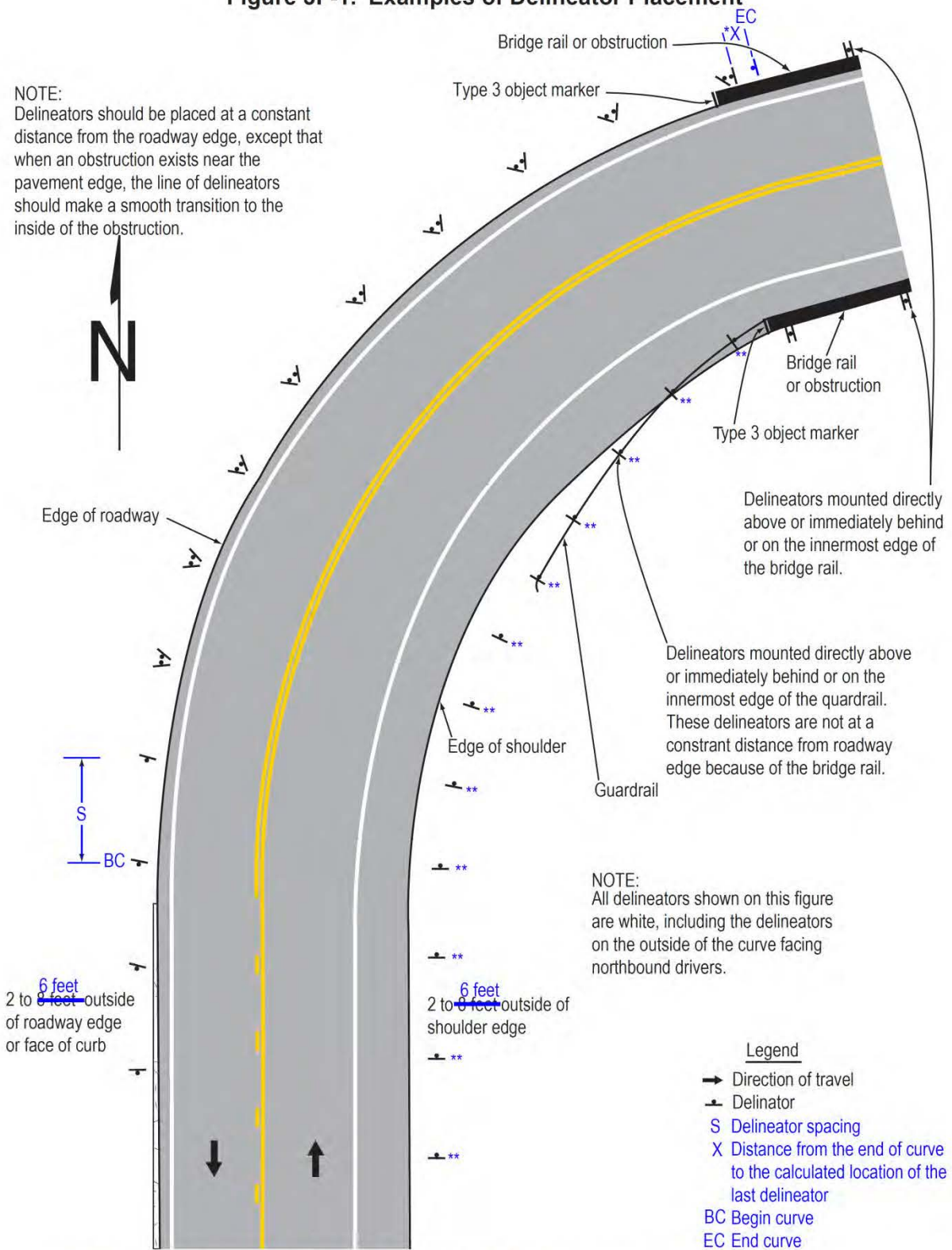
*Guidance:*

*01 Median barriers should be delineated when the clearance between the barrier and the edge of traveled way is less than 8 feet.*

*02 In general, when delineated, it should be with an approved median barrier marker, the same color as the left edge line. They should be placed on top of the barrier at 48 foot centers.*

*03 Markers placed on the sides of barriers, near the splash zone, should be avoided because of the tendency to collect dirt which reduces their effectiveness. See Figure 3F-105(CA).*

**Figure 3F-1. Examples of Delineator Placement**



NOTE:  
 Delineators should be placed at a constant distance from the roadway edge, except that when an obstruction exists near the pavement edge, the line of delineators should make a smooth transition to the inside of the obstruction.

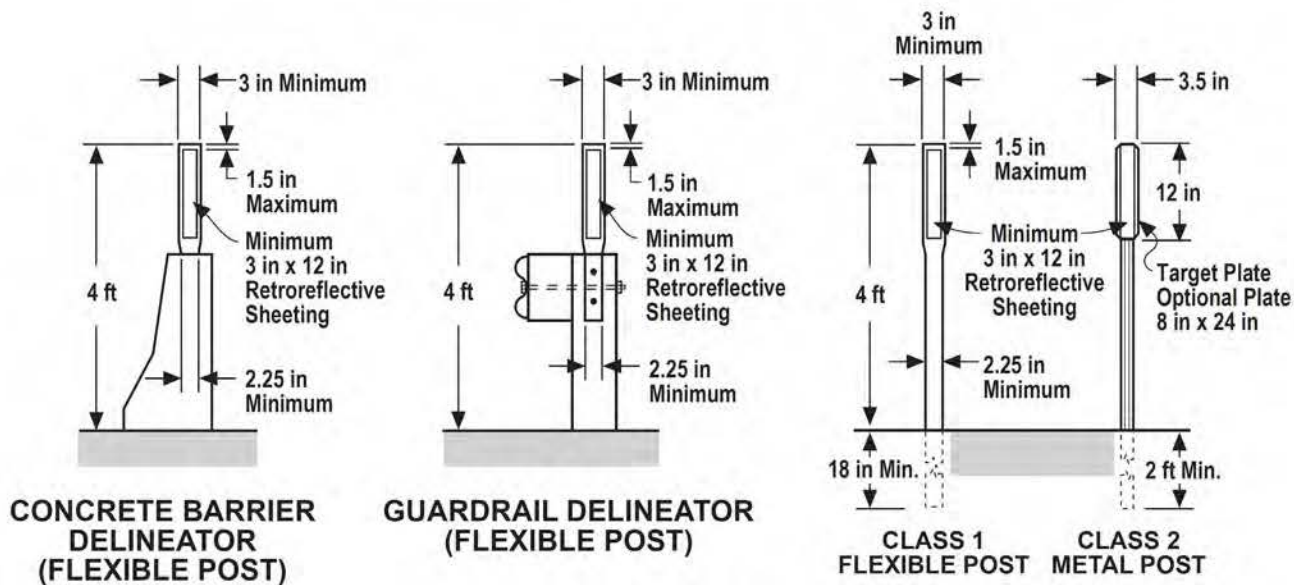
2 to 6 feet outside of roadway edge or face of curb

2 to 6 feet outside of shoulder edge

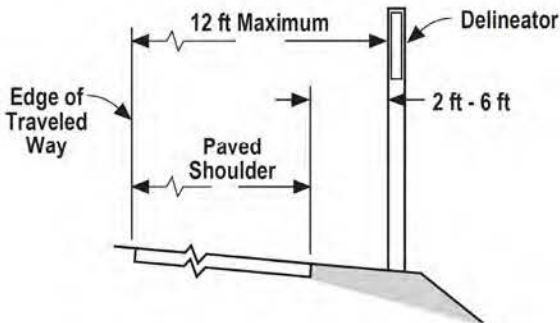
\* Prorate distance "X" among all spacing so the delineator falls at the end of the curve.  
 \*\* See Section 3F.03 Paragraph 8 for use of delineators when guardrail or other longitudinal barriers are present along a roadway.



**Figure 3F-101 (CA). Examples of Delineators**



NOT TO SCALE



**TYPICAL DELINEATOR PLACEMENT**

**TYPES OF DELINEATORS**

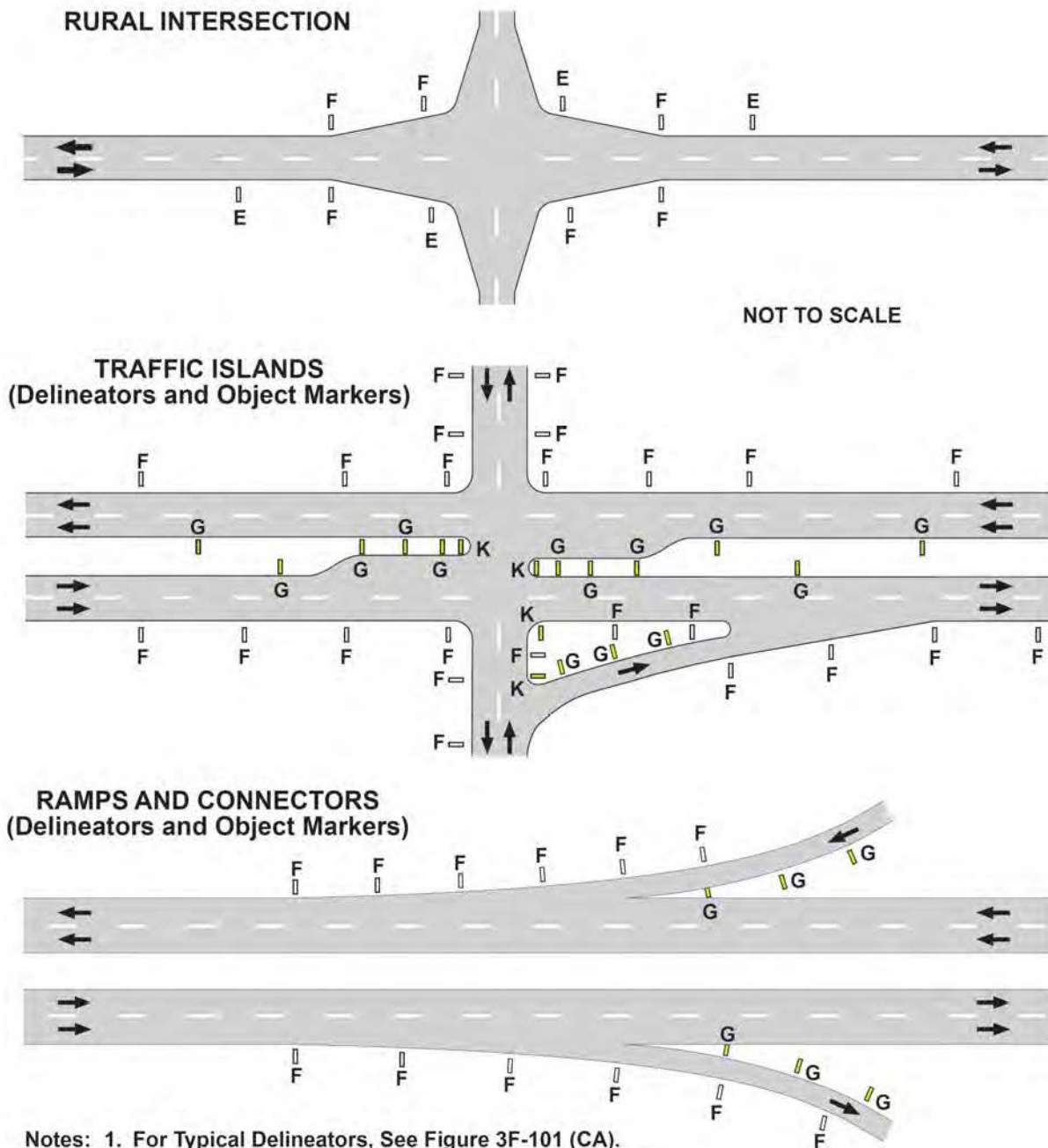
| TYPE | RETROREFLECTOR COLOR |       |
|------|----------------------|-------|
|      | FRONT                | BACK* |
| E    | WHITE                | WHITE |
| F    | WHITE                | NONE  |
| G    | YELLOW               | NONE  |
| J    | RED                  | NONE  |

\*Back Retroreflector:  
 Class 1 Delineator - 3 in ± square of retroreflective sheeting.  
 Class 2 Delineator - 3 in ± acrylic cube-corner retroreflective element.

**Notes:**

1. Class 1 (Flexible Post) Delineators are standard on State highways, except for certain locations, e.g., snow or protected areas behind guardrail, etc. The color of the post is white.
2. Class 1 (Flexible Post) Delineators used in construction or maintenance zones shall be orange with white retroreflective sheeting. However, if the delineators are to remain in place as a permanent roadway feature after the construction or maintenance period, the color of the post shall be white with the appropriate color of retroreflective sheeting as specified in Section 3F.03.
3. The Type of Retroreflective Element and Class of Post is designated as E-1, F-2, etc.

**Figure 3F-102 (CA). Examples of Delineator Placement When Used at Intersections, Islands, Ramps, and Connectors (Sheet 1 of 2)**



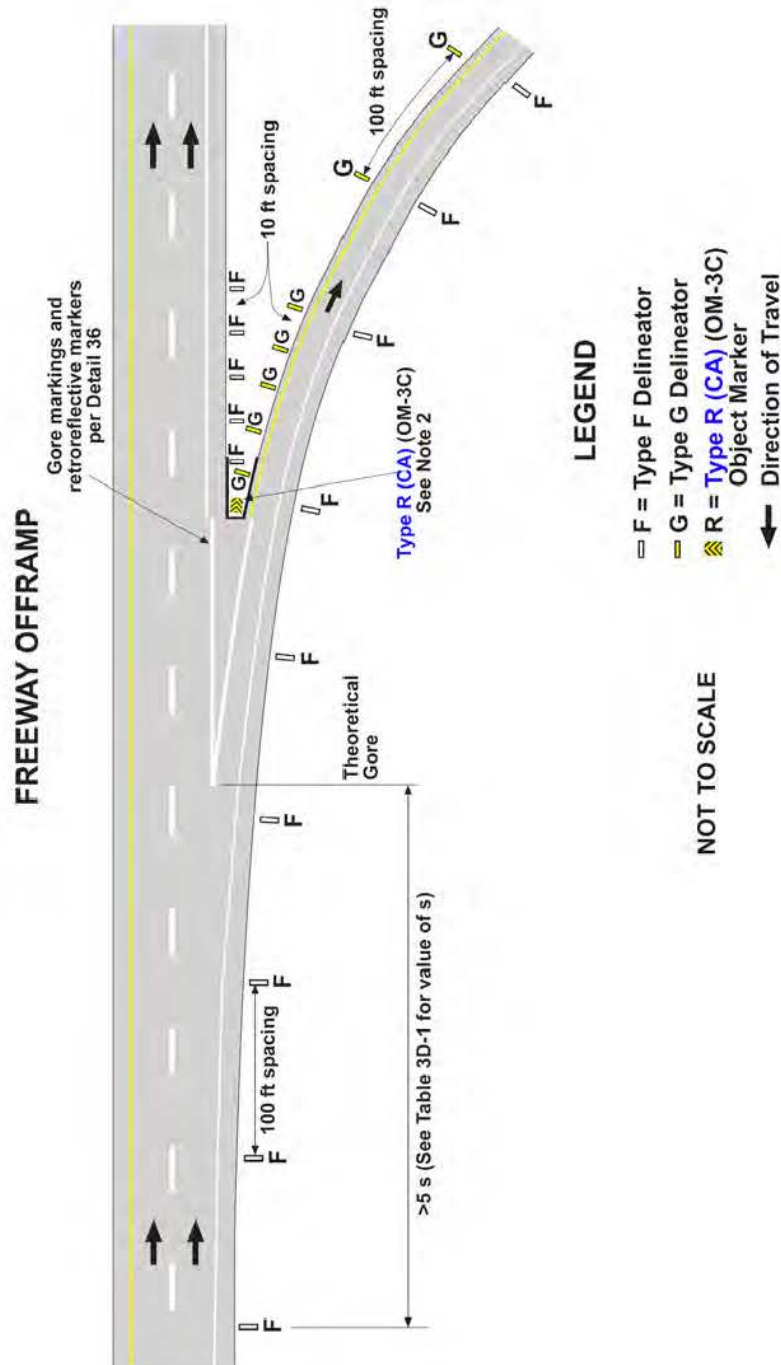
NOT TO SCALE

- Notes: 1. For Typical Delineators, See Figure 3F-101 (CA).  
 2. For Delineator Spacing on Curves, See Figure 3F-1.  
 3. For Typical Object Markers, See Figure 2C-13 and 2C-13 (CA).

**LEGEND**

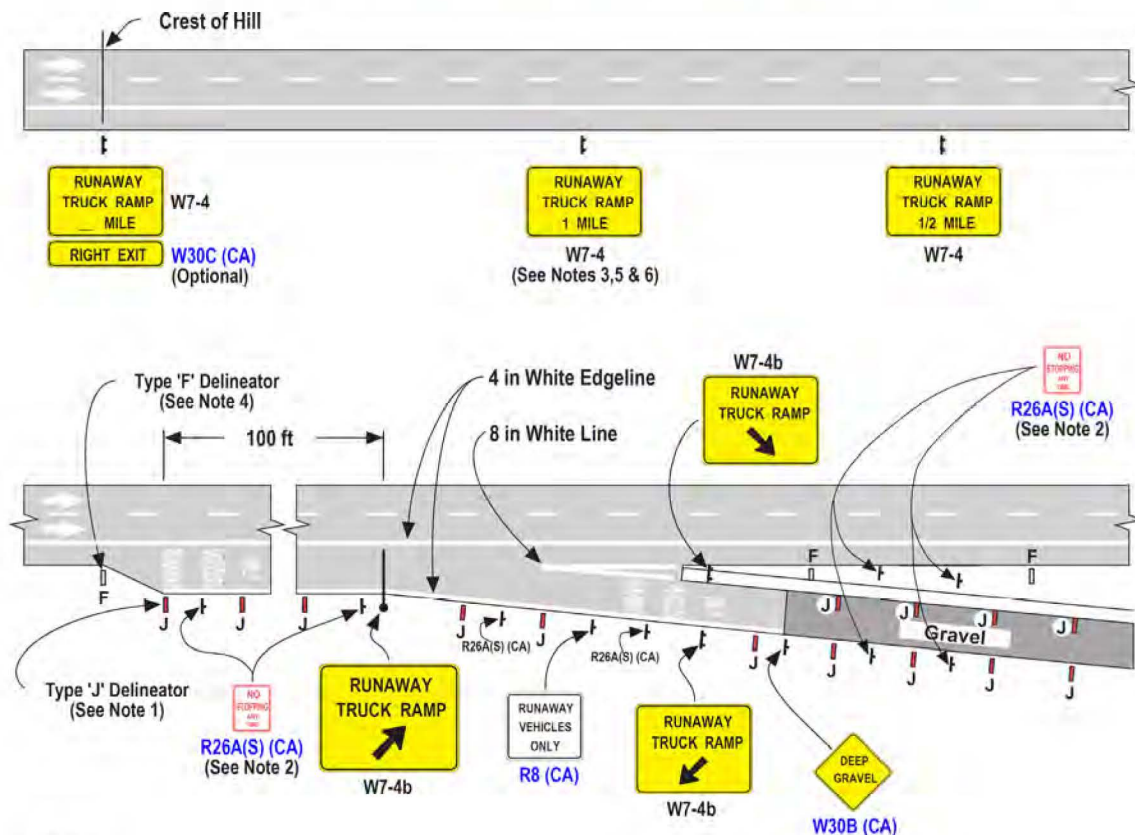
- ▮ E & F = Types of Delineators
- ▮ G = Type of Delineator
- ▮ K = Type K (CA) Object Marker
- ← Direction of Travel

**Figure 3F-102 (CA). Examples of Delineator Placement When Used at Intersections, Islands, Ramps, and Connectors (Sheet 2 of 2)**



**NOTE:**  
 1. Optional delineation if exit gore area is not illuminated or is partially illuminated. See Section 3F.04.  
 2. To be used if the exit gore can not be negotiated in a reasonably safe manner. See Section 2C.65.

**Figure 3F-103 (CA). Examples of Runaway Truck Ramp Signs and Markings**



**Notes:**

1. Place Type 'J' Delineators at 50 ft centers. See Figure 3F-101 (CA).
2. Place NO STOPPING ANY TIME, R26A(S) (CA) signs at 250 ft centers.
3. Additional RUNAWAY TRUCK RAMP 1 MILE and RUNAWAY TRUCK RAMP 1/2 MILE, W7-4 signs may also be placed in the median on a one-way roadway.
4. Place 3 - Type 'F' Delineators at 500 ft centers, preceding and following the Runaway Truck Ramp. See Figure 3F-101 (CA).
5. Additional advance RUNAWAY TRUCK RAMP (2 MILES, 3 MILES, etc.) W7-4 signs may be added as necessary.
6. Overhead signs may be substituted for ground mounted signs.

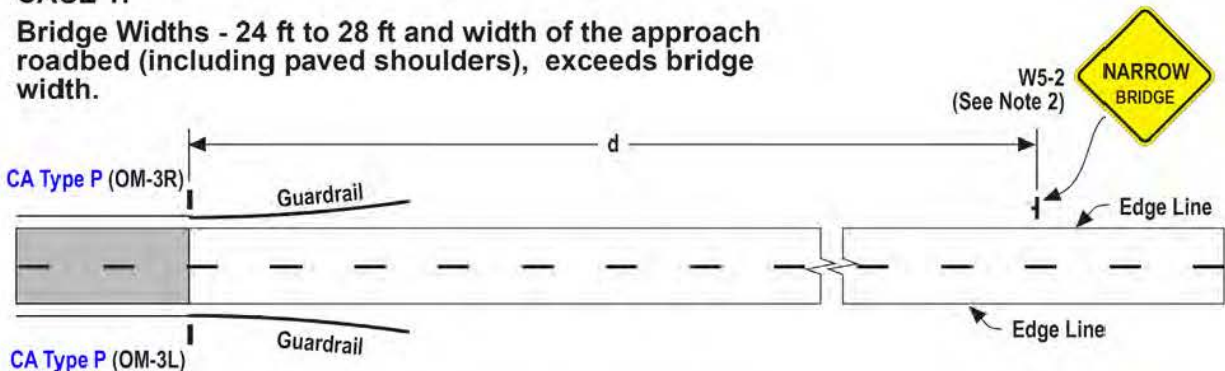
**LEGEND**

- ▭ F = Type of Delineator
  - ▭ J = Type of Delineator
  - ← Direction of Travel
- NOT TO SCALE

**Figure 3F-104 (CA). Narrow Bridge Signs and Markings  
 (One-Way and Two-Way Roadways)**

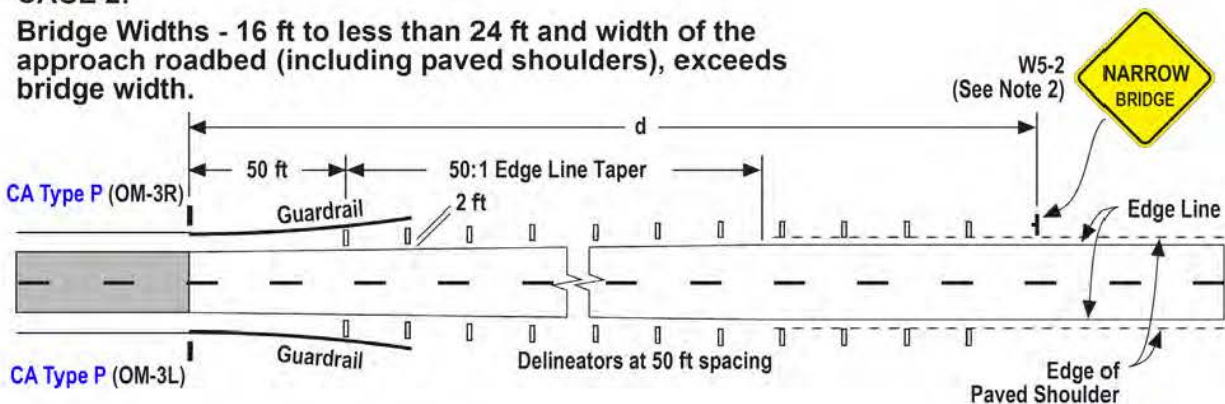
**CASE 1:**

**Bridge Widths - 24 ft to 28 ft and width of the approach roadbed (including paved shoulders), exceeds bridge width.**



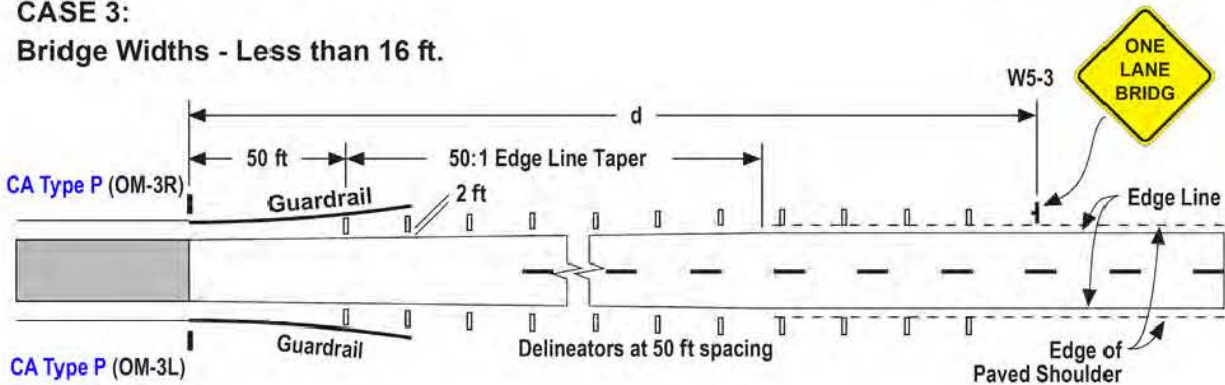
**CASE 2:**

**Bridge Widths - 16 ft to less than 24 ft and width of the approach roadbed (including paved shoulders), exceeds bridge width.**



**CASE 3:**

**Bridge Widths - Less than 16 ft.**



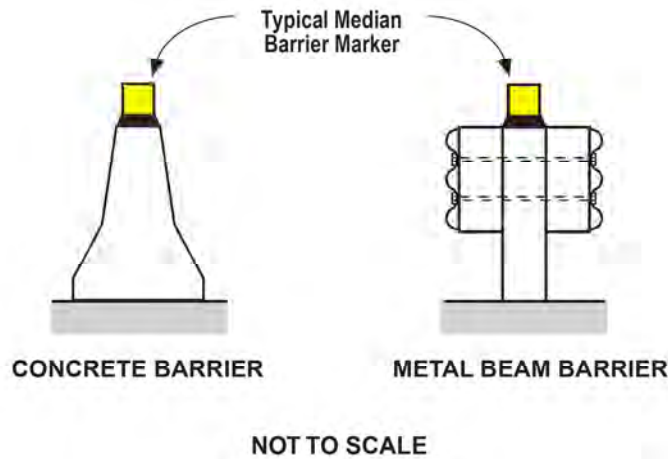
NOT TO SCALE

- Notes: 1. The Edge Line shall be continued across all bridges on State highways.  
 2. The NARROW BRIDGE (W5-2) sign should be erected on the right and in the median on a one-way roadway.  
 3. Delineators shall be continued across the bridge in Cases 2 and 3.

**LEGEND**

- █ = CA Type P Object Marker. See Figure 2C-13 (CA).
- d = Advance Placement Distance (see Section 2C.05)
- ▤ = Delineators (Type "F" for One-Way Roadways and Type "E" for Two-Way Roadways). See Figure 3F-101 (CA).

**Figure 3F-105 (CA). Examples of Median Barrier Delineation**



**Table 3F-1. Approximate Spacing for Delineators on Horizontal Curves**

| Radius (R) of Curve | Approximate Spacing (S) on Curve |
|---------------------|----------------------------------|
| 50 feet             | 20 feet                          |
| 115 feet            | 25 feet                          |
| 180 feet            | 35 feet                          |
| 250 feet            | 40 feet                          |
| 300 feet            | <del>50 feet</del> 40 feet       |
| 400 feet            | <del>55 feet</del> 40 feet       |
| 500 feet            | <del>65 feet</del> 40 feet       |
| 600 feet            | <del>70 feet</del> 40 feet       |
| 700 feet            | 75 feet                          |
| 800 feet            | 80 feet                          |
| 900 feet            | 85 feet                          |
| 1,000 feet          | 90 feet                          |

- Notes:
1. Spacing for specific radii may be interpolated from table.
  2. The minimum spacing should be 20 feet.
  3. The spacing on curves should not exceed 300 feet.
  4. In advance of or beyond a curve, and proceeding away from the end of the curve, the spacing of the first delineator is 2S, the second 3S, and the third 6S, but not to exceed 300 feet.
  5. S refers to the delineator spacing for specific radii computed from the formula  $S=3\sqrt{R-50}$ .
  6. The distances for S shown in the table above were rounded to the nearest 5 feet.

## CHAPTER 3G. COLORED PAVEMENTS

### Section 3G.01 General

#### Support:

<sup>01</sup> Colored pavements consist of differently colored road paving materials, such as colored asphalt or concrete, or paint or other marking materials applied to the surface of a road or island to simulate a colored pavement.

<sup>02</sup> If non-retroreflective colored pavement, including bricks and other types of patterned surfaces, is used as a purely aesthetic treatment and is not intended to communicate a regulatory, warning, or guidance message to road users, the colored pavement is not considered to be a traffic control device, even if it is located between the lines of a crosswalk.

#### Standard:

<sup>03</sup> **If colored pavement is used within the traveled way, on flush or raised islands, or on shoulders to regulate, warn, or guide traffic or if retroreflective colored pavement is used, the colored pavement is considered to be a traffic control device and shall be limited to the following colors and applications:**

**A. Yellow pavement color shall be used only for flush or raised median islands separating traffic flows in opposite directions or for left-hand shoulders of roadways of divided highways or one-way streets or ramps.**

**B. White pavement color shall be used for flush or raised channelizing islands where traffic passes on both sides in the same general direction or for right-hand shoulders.**

<sup>04</sup> **Colored pavements shall not be used as a traffic control device, unless the device is applicable at all times.**

#### Guidance:

<sup>05</sup> *Colored pavements used as traffic control devices should be used only where they contrast significantly with adjoining paved areas.*

<sup>06</sup> *Colored pavement located between crosswalk lines should not use colors or patterns that degrade the contrast of white crosswalk lines, or that might be mistaken by road users as a traffic control application.*





## CHAPTER 3H. CHANNELIZING DEVICES USED FOR EMPHASIS OF PAVEMENT MARKING PATTERNS

### Section 3H.01 Channelizing Devices

#### Option:

~~01 Channelizing devices, as described in Sections 6F.63 through 6F.73, and 6F.75, and as shown in Figure 6F-7, such as cones, tubular markers, vertical panels, drums, lane separators, and raised islands, may be used for general traffic control purposes such as adding emphasis to reversible lane delineation, channelizing lines, or islands. Channelizing devices may also be used along a center line to preclude turns or along lane lines to preclude lane changing, as determined by engineering judgment.~~

#### Standard:

~~02 Except for color, the design of channelizing devices, including but not limited to retroreflectivity, minimum dimensions, and mounting height, shall comply with the provisions of Chapter 6F.~~

~~03 The color of channelizing devices used outside of temporary traffic control zones shall be either orange or the same color as the pavement marking that they supplement, or for which they are substituted.~~

~~04 For nighttime use, channelizing devices shall be retroreflective (as described in Part 6) or internally illuminated. On channelizing devices used outside of temporary traffic control zones, retroreflective sheeting or bands shall be white if the devices separate traffic flows in the same direction and shall be yellow if the devices separate traffic flows in the opposite direction or are placed along the left hand edge line of a one-way roadway or ramp.~~

#### Support:

~~04a In California, cones are used for temporary traffic control, not as permanent channelizing devices.~~

#### Guidance:

~~05 Channelizing devices should be kept clean and bright to maximize target value.~~

#### Support:

~~06 Channelizers are flexible retroreflective devices for installation within the roadway to discourage road users from crossing a line or area of the roadway. Unlike delineators, which indicate the roadway alignment, channelizers are intended to provide additional guidance and/or restriction to traffic by supplementing pavement markings and delineation.~~

#### Option:

~~07 Channelizers may be used for additional emphasis to discourage median crossings at traffic islands and at lane separations.~~

#### Standard:

~~08 The design of a channelizer shall be as shown in Figure 3H-101(CA) and Figure 6F-102(CA).~~

~~09 The retroreflective unit used on channelizers shall be a minimum of 3 x 12 inch. The 3 x 24 inch minimum retroreflective unit shall be visible at 1000 feet at night under illumination of legal high beam headlights, by persons with vision of or corrected to 20/20. Refer to Caltrans' Standard Specifications Section 12-3.07. See Section 1A.11 for information regarding this publication.~~

~~10 The post shall be flexible with a 2 ¼ inch minimum width, except that the portion containing the retroreflective unit shall be a minimum width of 3 inch. The post shall be a minimum height of 36 inch above the pavement.~~

~~11 Channelizer posts used for temporary traffic control shall be orange with white reflectors. See Section 6F.101(CA).~~

~~12 If the channelizers are to remain in place as a permanent roadway feature, the post shall be white and the color of the reflector shall conform to that of the pavement markings it supplements with the following exceptions:~~

~~A. Retroreflective units used in narrow bridge shoulder tapers shall be yellow as shown in Figure 3F-104(CA).~~

~~B. Retroreflective units shall be white when used in construction and maintenance zones (posts shall be orange). See Section 6F.101(CA).~~

#### Option:

~~13 At locations where speeds are 40 mph or less a minimum post height of 28 inch may be used.~~

Support:

14 Since channelizers require closer spacing, their post size requirements differ from those of delineators.

15 There are two basic types of channelizers: one attaches to the pavement and the other attaches to an anchoring device imbedded in the pavement. Both the base and anchor systems are designed to permit replacement of the channelizer post. See Figure 3H-101(CA).

Guidance:

16 Channelizers should be placed a minimum of 2 feet from the traffic line, away from traffic, to allow for future maintenance of the line.

Option:

17 Space limitations may dictate exceptions to this criterion. At certain locations, placement directly on the traffic line may be required.

Support:

18 Spacing of the channelizers depends on the type of facility where they are to be used, the speed and volume of traffic, and the alignment to be channelized. Spacing which results in a visual fence/barrier effect is a key factor in channelizer installation.

Guidance:

19 The maximum post spacing should be 100 feet on carpool lanes where channelizers are used primarily to delineate the separation between the carpool lane and the main facility.

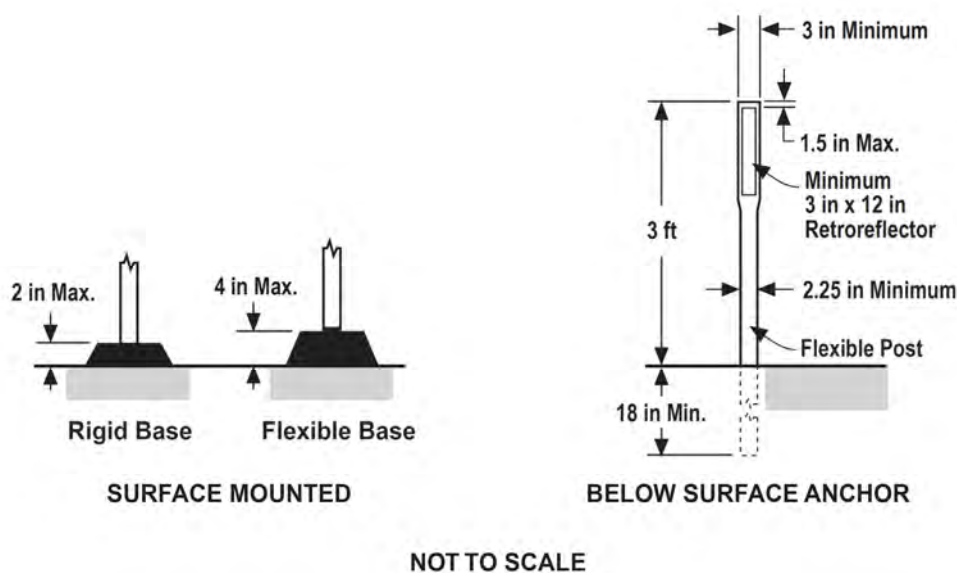
20 In locations where a relatively high number of violations occur, the post spacing should be 25 feet.

Option:

21 Where barrier violations are relatively minimal, a post spacing of 50 feet may be adequate. However, spacing in excess of 50 feet is of negligible value as a deterrent to intentional barrier violations.

22 Post spacing closer than 25 feet may be considered on lower speed roads, urban streets and at specific locations such as traffic islands.

**Figure 3H-101 (CA). Example of Channelizers**



## CHAPTER 3I. ISLANDS

### Section 3I.01 General

**Support:**

01 This Chapter addresses the characteristics of islands (see definition in Section 1A.13) as traffic-control devices. Criteria for the design of islands are set forth in "A Policy on Geometric Design of Highways and Streets" (see Section 1A.11).

**Option:**

02 An island may be designated by curbs, pavement edges, pavement markings, channelizing devices, or other devices.

**Support:**

03 Raised channelization with sloping (mountable) curbed medians are used instead of channelization accomplished through the use of pavement markings (flush), for the following operating conditions:

- A. Left- and right-turn lane treatments at intersections on all roadways with operating speeds of less than 40 mph.
- B. Right-turn treatments on roadways with operating speeds equal to or greater than 40 mph.

04 On State highways, criteria for the design of islands are set forth in Caltrans' Highway Design Manual. See Section 1A.11 for information regarding this publication.

### Section 3I.02 Approach-End Treatment

**Guidance:**

01 *The ends of islands first approached by traffic should be preceded by diverging longitudinal pavement markings on the roadway surface, to guide vehicles into desired paths of travel along the island edge.*

**Support:**

~~02 The neutral area between approach-end markings that can be readily crossed even at considerable speed sometimes contains slightly raised (usually less than 1 inch high) sections of coarse aggregate or other suitable materials to create rumble sections that provide increased visibility of the marked areas and that produce an audible warning to road users traveling across them. For additional discouragement to driving in the neutral area, bars or buttons projecting 1 to 3 inches above the pavement surface are sometimes placed in the neutral area. These bars or buttons are designed so that any wheel encroachment within the area will be obvious to the vehicle operator, but will result in only minimal effects on control of the vehicle. Such bars or buttons are sometimes preceded by rumble sections or their height is gradually increased as approached by traffic.~~

**Guidance:**

~~03 *When raised bars or buttons are used in these neutral areas, they should be marked with white or yellow retroreflective materials, as determined by the direction or directions of travel they separate.*~~

**Standard:**

04 **Channelizing devices, when used in advance of islands having raised curbs, shall not be placed in such a manner as to constitute an unexpected obstacle.**

**Option:**

~~05 Pavement markings may be used with raised bars to better designate the island area.~~

### Section 3I.03 Island Marking Application

**Standard:**

01 **Markings, as related to islands, shall consist only of pavement and curb markings, channelizing devices, and delineators.**

**Guidance:**

**Option:**

02 Pavement markings as described in Section 3B.10 for the approach to an obstruction may be omitted on the approach to a particular island based on engineering judgment.

**Standard:**

**03 Double solid 4 inch wide yellow lines shall be used to delineate the edge of a median island where the median is an all-paved, at-grade section of the highway. The island formed by double yellow lines shall be at least 2 foot in width, as shown in Figure 3A-107(CA).**

**04 When used, other markings in the median island area shall be yellow.**

**Support:**

05 This treatment is not intended for freeways or other highways with a positive barrier in the median. Single solid yellow left edge line and markers as shown in Figure 3A-105(CA) are standard.

06 The use of channelizing lines are shown in Figure 3A-112(CA) and no-passing markings are shown in Figures 3A-104(CA) and 3B-15.

**Section 3I.04 Island Marking Colors**

*Guidance:*

01 *Islands outlined by curbs or pavement markings should be marked with retroreflective white or yellow material as determined by the direction or directions of travel they separate (see Section 3A.05).*

02 *The retroreflective area should be of sufficient length to denote the general alignment of the edge of the island along which vehicles travel, including the approach end, when viewed from the approach to the island.*

*Option:*

03 On long islands, curb retroreflection may be discontinued such that it does not extend for the entire length of the curb, especially if the island is illuminated or marked with delineators or edge lines.

**Section 3I.05 Island Delineation**

**Standard:**

~~01 Delineators installed on islands shall be the same colors as the related edge lines except that, when facing wrong-way traffic, they shall be red (see Section 3F.03).~~

**01a Delineators installed on islands shall be the same colors as the related edge lines.**

**Support:**

01b In California, red markers are used for wrong-way traffic, not delineators.

**Standard:**

**02 Each roadway through an intersection shall be considered separately in positioning delineators to assure maximum effectiveness.**

*Option:*

03 Retroreflective or internally illuminated raised pavement markers of the appropriate color may be placed on the pavement in front of the curb and/or on the top of curbed approach ends of raised medians and curbs of islands, as a supplement to or as a substitute for retroreflective curb markings.

**Section 3I.06 Pedestrian Islands and Medians**

**Support:**

01 Raised islands or medians of sufficient width that are placed in the center area of a street or highway can serve as a place of refuge for pedestrians who are attempting to cross at a midblock or intersection location. Center islands or medians allow pedestrians to find an adequate gap in one direction of traffic at a time, as the pedestrians are able to stop, if necessary, in the center island or median area and wait for an adequate gap in the other direction of traffic before crossing the second half of the street or highway. The minimum widths for accessible refuge islands and for design and placement of detectable warning surfaces are provided in the "Americans with Disabilities Act Accessibility Guidelines for Buildings and Facilities (ADAAG)" (see Section 1A.11).

## CHAPTER 3J. RUMBLE STRIP MARKINGS

### Section 3J.01 Longitudinal Rumble Strip Markings

Support:

<sup>01</sup> Longitudinal rumble strips consist of a series of rough-textured or slightly raised or depressed road surfaces intended to alert inattentive drivers through vibration and sound that their vehicle has left the travel lane. Shoulder rumble strips are typically installed along the shoulder near the travel lane. On divided highways, rumble strips are sometimes installed on the median side (left-hand side) shoulder as well as on the outside (right-hand side) shoulder. On two-way roadways, rumble strips are sometimes installed along the center line.

<sup>02</sup> This Manual contains no provisions regarding the design and placement of longitudinal rumble strips. The provisions in this Manual address the use of markings in combination with a longitudinal rumble strip.

Option:

<sup>03</sup> An edge line or center line may be located over a longitudinal rumble strip to create a rumble stripe.

**Standard:**

<sup>04</sup> **The color of an edge line or center line associated with a longitudinal rumble stripe shall be in accordance with Section 3A.05.**

<sup>05</sup> **An edge line shall not be used in addition to a rumble stripe that is located along a shoulder.**

Support:

<sup>06</sup> Figure 3J-1 illustrates markings used with or near longitudinal rumble strips.

### Section 3J.02 Transverse Rumble Strip Markings

Support:

<sup>01</sup> Transverse rumble strips consist of intermittent narrow, transverse areas of rough-textured or slightly raised or depressed road surface that extend across the travel lanes to alert drivers to unusual vehicular traffic conditions. Through noise and vibration, they attract the attention of road users to features such as unexpected changes in alignment and conditions requiring a reduction in speed or a stop.

<sup>02</sup> This Manual contains no provisions regarding the design and placement of transverse rumble strips that approximate the color of the pavement. The provisions in this Manual address the use of markings in combination with a transverse rumble strip.

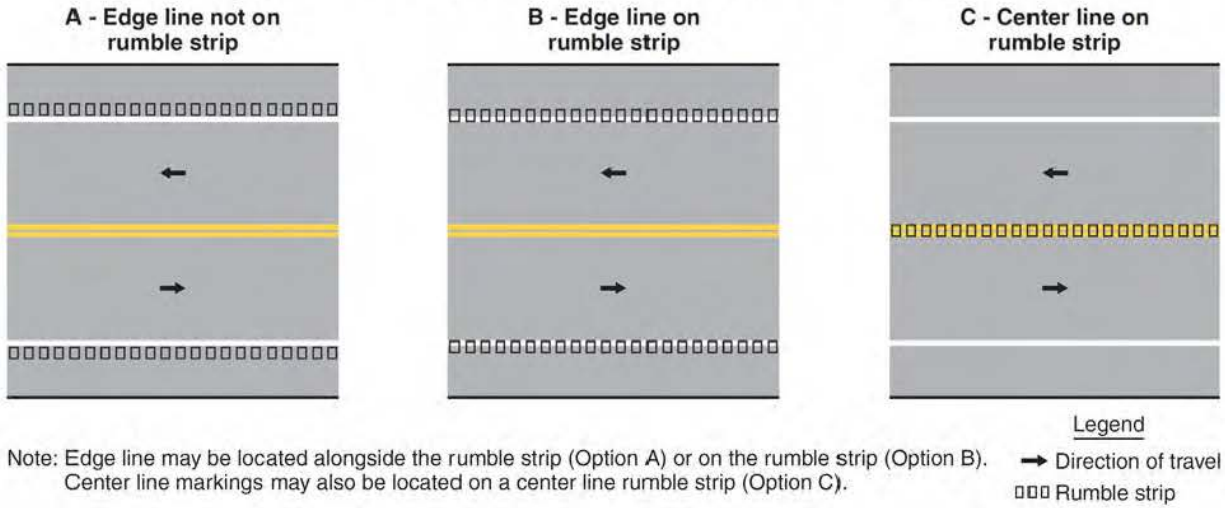
**Standard:**

<sup>03</sup> **Except as otherwise provided in Section 6F.87 for TTC zones, if the color of a transverse rumble strip used within a travel lane is not the color of the pavement, the color of the transverse rumble strip shall be either black or white.**

*Guidance:*

<sup>04</sup> *White transverse rumble strips used in a travel lane should not be placed in locations where they could be confused with other transverse markings such as stop lines or crosswalks.*

**Figure 3J-1. Examples of Longitudinal Rumble Strip Markings**



# PART 4

## HIGHWAY TRAFFIC SIGNALS

### CHAPTER 4A. GENERAL

#### **Section 4A.01 Types**

Support:

<sup>01</sup> The following types and uses of highway traffic signals are discussed in Part 4: traffic control signals; pedestrian signals; hybrid beacons; emergency-vehicle signals; traffic control signals for one-lane, two-way facilities; traffic control signals for freeway entrance ramps; traffic control signals for movable bridges; toll plaza traffic signals; flashing beacons; lane-use control signals; and in-roadway lights.

#### **Section 4A.02 Definitions Relating to Highway Traffic Signals**

Support:

<sup>01</sup> Definitions and acronyms pertaining to Part 4 are provided in Sections 1A.13 and 1A.14.





## CHAPTER 4B. TRAFFIC CONTROL SIGNALS—GENERAL

### Section 4B.01 General

Support:

01 Words such as pedestrians and bicyclists are used redundantly in selected Sections of Part 4 to encourage sensitivity to these elements of “traffic.”

02 Standards for traffic control signals are important because traffic control signals need to attract the attention of a variety of road users, including those who are older, those with impaired vision, as well as those who are fatigued or distracted, or who are not expecting to encounter a signal at a particular location.

### Section 4B.02 Basis of Installation or Removal of Traffic Control Signals

Guidance:

01 *The selection and use of traffic control signals should be based on an engineering study of roadway, traffic, and other conditions.*

Support:

02 A careful analysis of traffic operations, pedestrian and bicyclist needs, and other factors at a large number of signalized and unsignalized locations, coupled with engineering judgment, has provided a series of signal warrants, described in Chapter 4C, that define the minimum conditions under which installing traffic control signals might be justified.

Guidance:

03 *Engineering judgment should be applied in the review of operating traffic control signals to determine whether the type of installation and the timing program meet the current requirements of all forms of traffic.*

04 *If changes in traffic patterns eliminate the need for a traffic control signal, consideration should be given to removing it and replacing it with appropriate alternative traffic control devices, if any are needed.*

05 *If the engineering study indicates that the traffic control signal is no longer justified, and a decision is made to remove the signal, removal should be accomplished using the following steps:*

A. *Determine the appropriate traffic control to be used after removal of the signal.*

B. *Remove any sight-distance restrictions as necessary.*

C. *Inform the public of the removal study.*

D. *Flash or cover the signal heads for a minimum of 90 days, and install the appropriate stop control or other traffic control devices.*

E. *Remove the signal if the engineering data collected during the removal study period confirms that the signal is no longer needed.*

Option:

06 Because Items C, D, and E in Paragraph 5 are not relevant when a temporary traffic control signal (see Section 4D.32) is removed, a temporary traffic control signal may be removed immediately after Items A and B are completed.

07 Instead of total removal of a traffic control signal, the poles, controller cabinet, and cables may remain in place after removal of the signal heads for continued analysis.

**Standard:**

08 **Once a traffic signal at an intersection or pedestrian crossing has been energized, it shall not be turned off unless arrangements have been made for temporary control by traffic officers, temporary stop signs or an approved temporary signal.**

### Section 4B.03 Advantages and Disadvantages of Traffic Control Signals

Support:

01 When properly used, traffic control signals are valuable devices for the control of vehicular and pedestrian traffic. They assign the right-of-way to the various traffic movements and thereby profoundly influence traffic flow.

02 Traffic control signals that are properly designed, located, operated, and maintained will have one or more of the following advantages:

- A. They provide for the orderly movement of traffic.
  - B. They increase the traffic-handling capacity of the intersection if:
    - 1. Proper physical layouts and control measures are used, and
    - 2. The signal operational parameters are reviewed and updated (if needed) on a regular basis (as engineering judgment determines that significant traffic flow and/or land use changes have occurred) to maximize the ability of the traffic control signal to satisfy current traffic demands.
  - C. They reduce the frequency and severity of certain types of crashes, especially right-angle collisions.
  - D. They are coordinated to provide for continuous or nearly continuous movement of traffic at a definite speed along a given route under favorable conditions.
  - E. They are used to interrupt heavy traffic at intervals to permit other traffic, vehicular or pedestrian, to cross.
- <sup>03</sup> Traffic control signals are often considered a panacea for all traffic problems at intersections. This belief has led to traffic control signals being installed at many locations where they are not needed, adversely affecting the safety and efficiency of vehicular, bicycle, and pedestrian traffic.
- <sup>04</sup> Traffic control signals, even when justified by traffic and roadway conditions, can be ill-designed, ineffectively placed, improperly operated, or poorly maintained. Improper or unjustified traffic control signals can result in one or more of the following disadvantages:
- A. Excessive delay,
  - B. Excessive disobedience of the signal indications,
  - C. Increased use of less adequate routes as road users attempt to avoid the traffic control signals, and
  - D. Significant increases in the frequency of collisions (especially rear-end collisions).

#### **Section 4B.04 Alternatives to Traffic Control Signals**

*Guidance:*

<sup>01</sup> *Since vehicular delay and the frequency of some types of crashes are sometimes greater under traffic signal control than under STOP sign control, consideration should be given to providing alternatives to traffic control signals even if one or more of the signal warrants has been satisfied.*

*Option:*

- <sup>02</sup> These alternatives may include, but are not limited to, the following:
- A. Installing signs along the major street to warn road users approaching the intersection;
  - B. Relocating the stop line(s) and making other changes to improve the sight distance at the intersection;
  - C. Installing measures designed to reduce speeds on the approaches;
  - D. Installing a flashing beacon at the intersection to supplement STOP sign control;
  - E. Installing flashing beacons on warning signs in advance of a STOP sign controlled intersection on major and/ or minor-street approaches;
  - F. Adding one or more lanes on a minor-street approach to reduce the number of vehicles per lane on the approach;
  - G. Revising the geometrics at the intersection to channelize vehicular movements and reduce the time required for a vehicle to complete a movement, which could also assist pedestrians;
  - H. Revising the geometrics at the intersection to add pedestrian median refuge islands and/or curb extensions;
  - I. Installing roadway lighting if a disproportionate number of crashes occur at night;
  - J. Restricting one or more turning movements, perhaps on a time-of-day basis, if alternate routes are available;
  - K. If the warrant is satisfied, installing multi-way STOP sign control;
  - L. Installing a pedestrian hybrid beacon (see Chapter 4F) or In-Roadway Warning Lights (see Chapter 4N) if pedestrian safety is the major concern;
  - M. Installing a roundabout; and
  - N. Employing other alternatives, depending on conditions at the intersection.

#### **Section 4B.05 Adequate Roadway Capacity**

*Support:*

<sup>01</sup> The delays inherent in the alternating assignment of right-of-way at intersections controlled by traffic control signals can frequently be reduced by widening the major roadway, the minor roadway, or both roadways. Widening the minor roadway often benefits the operations on the major roadway, because it reduces the green

time that must be assigned to minor-roadway traffic. In urban areas, the effect of widening can be achieved by eliminating parking on intersection approaches. It is desirable to have at least two lanes for moving traffic on each approach to a signalized location. Additional width on the departure side of the intersection, as well as on the approach side, will sometimes be needed to clear traffic through the intersection effectively.

*Guidance:*

*02 Adequate roadway capacity should be provided at a signalized location. Before an intersection is widened, the additional green time pedestrians need to cross the widened roadways should be considered to determine if it will exceed the green time saved through improved vehicular flow.*

*03 Other methods of increasing the roadway capacity at signalized locations that do not involve roadway widening, such as revisions to the pavement markings and the careful evaluation of proper lane-use assignments (including varying the lane use by time of day), should be considered where appropriate. Such consideration should include evaluation of any impacts that changes to pavement markings and lane assignments will have on bicycle travel.*

### **Section 4B.101(CA) Traffic Signal Development Procedures – Introduction**

**Support:**

*01 General requirements for the development of traffic signal, lighting and electrical systems projects are noted in Caltrans' Project Development Procedures Manual. See Section 1A.11 for information regarding this publication. The cost of traffic signals on Federal Aid highway projects is eligible for federal participation under certain conditions.*

**Option:**

*02 The preparation of a Project Study Report may be required for major traffic signal, lighting and/or electrical system projects for scoping and programming purposes.*

**Guidance:**

*03 Caltrans' Project Development Procedures Manual and the appropriate Program Advisor should be consulted to determine specific reporting requirements.*

### **Section 4B.102(CA) Project Report**

**Standard:**

*01 The Caltrans' District shall prepare a project report of the investigation of conditions at locations where a new traffic signal is to be installed, an existing traffic signal is to be modified or an existing traffic signal is to be removed on the State highway. Caltrans District Directors are authorized to approve project reports in accordance with the current departmental policies contained in the Project Development Procedures Manual. Three copies of the District-approved project report shall be forwarded to Caltrans' Chief, State and Local Project Development. A project report shall be prepared whether the work is performed by the State or by others, if the traffic signal is located on the State highway.*

**Guidance:**

*02 General requirements for project reports are noted in Caltrans' Project Development Procedures Manual. A project report for the installation, modification (except for upgrading projects involving specific equipment) or removal of a traffic signal should include the following specific information:*

**1. Traffic Counts.**

- a) Both pedestrian and vehicular traffic counts should include the periods of the average day when the signals would appear to be needed most. The counts should be at least eight hours in duration, not necessarily consecutive, but including a.m. and p.m. peak hours.*
- b) Traffic counts for a new signal shall be shown on appropriate Traffic Signal Warrant Sheets and a Directional Traffic Count Sheet. See Figures 4C-101(CA) thru 4C-103(CA).*
- c) Where pedestrian volumes are significant, show the volume on each crosswalk for the same periods as the vehicle count.*
- d) When estimated traffic volumes are used in establishing traffic signal warrants, they should be prepared on Form TS-10D. See Figure 4C-103(CA).*

**2. Collision Diagram.**

*A collision diagram for the intersection covering the recent collision experience history. The diagram should cover a 3-year interval.*

3. *Condition Diagram.*  
*A condition diagram showing existing roadway conditions. Any railroad grade crossing within 200 feet of the intersection should be shown.*
4. *Improvement Diagram.*  
*A diagram showing existing and proposed signals, phasing, channelization and other proposed improvements. This may be combined with 1, 2 and/or 3 on a single plan.*
5. *Estimate.*  
*An estimate of the cost of the project (including State furnished materials) and the proposed method of financing.*
6. *Other Specialized Data When Appropriate:*
  - a. *Classification of Vehicles.* *The classification is required when it is a significant factor in affecting intersection capacity.*
  - b. *Critical Speed (85th percentile) of Approaching Vehicles.* *This is the speed at a point unaffected by existing controls.*
  - c. *Time-Space Diagram.* *When the project involves a coordinated traffic signal system.*

### **Section 4B.103(CA) Submittals**

**Support:**

<sup>01</sup> General requirements for the submittal of plans, specifications and estimates are noted in the Caltrans' Project Development Procedures Manual and the Ready to List and Construction Contract Award Guide. See Section 1A.11 for information regarding these publications.

**Standard:**

- <sup>02</sup> **All electrical plans shall bear the following: "Note: This plan accurate for electrical work only."**

### **Section 4B.104(CA) Financing**

**Guidance:**

<sup>01</sup> *Unless previously budgeted, the financing of a project should be considered only after receipt of the PS&E Report and cooperative agreements.*

**Support:**

<sup>02</sup> Normally, the costs of a new traffic signal or the modification of a signal or signal system are to be shared with a local agency.

**Option:**

<sup>03</sup> In situations where a new traffic signal or a modification to an existing traffic signal or traffic signal system is urgently needed to improve safety or traffic flow on the State highway and the local agencies are unable to finance their prorated share of the cost, the State may accept a lesser participation, or even no participation, by the local authorities.

**Standard:**

- <sup>04</sup> **The definition of "urgently needed" shall be made by the Caltrans District Director.**
- <sup>05</sup> **The cost of small projects such as modifications to existing traffic signals (detectors, signal heads, mast arms, etc.) where the prorated share of the local agency is \$3,000 or less, shall be at 100% State expense.**

### **Section 4B.105(CA) Design Cost**

**Standard:**

<sup>01</sup> **The following criteria shall apply in determining the amount of participation in the design cost by the State and a local agency:**

- A. Where the State prepares plans for the installation or modification of a traffic signal or a traffic signal system on a State highway, the design costs should be shared with the local agency. Where the local agency is to prepare the plans, the State may participate in the design costs. Participation should be the same as construction cost participation and be covered by a cooperative agreement.**

**Guidance:**

- B. Estimated design costs should be determined on the basis of an agreed fixed percentage of the total project costs. The fixed percentage should be based on historical design costs for projects in the price range concerned.**

**Standard:**

- C. Where the State is requested by a local agency to prepare plans and specifications for a traffic signal project that does not involve State participation in the construction costs, the design costs shall be borne entirely by the local agency or others. The State may, however, assume the design engineering costs and the construction engineering costs, where the local agency agrees to pay all of the construction costs for a warranted project and where all of the costs would normally be shared on a prorated basis.**

**Section 4B.106(CA) Construction Costs - Conventional Highways**

**Standard:**

- 01 The following criteria shall apply in determining the amount of the construction costs by the State and local agency for a traffic signal, safety lighting, and channelization or widening project on conventional State highways.**
- 02 Channelization and/or Widening Costs. On cooperatively financed projects, the channelization and/or widening costs shall be shared as follows:**
  - A. Channelization on and/or widening of the State highway shall be at 100% State expense.**
  - B. Channelization on and/or widening of the local street shall be at 100% local agency expense.**
  - C. Where the local agency's portion of the channelization or widening is a minor part of the channelization or widening being constructed by the State and the local agency's share of the work amounts to \$3,000, or less, the State may assume the entire cost of the channelization or widening.**
- 03 Channelization and/or widening required, as a part of the conditions of a permit by a private party shall be at 100% expense of the private party.**
- 04 In Cases A, B, and D listed below, the costs of constructing the electrical facilities are to be shared by the State and local agencies. The costs shall be shared on a prorated basis in the same ratio as the number of legs in the intersection under each agency's jurisdiction bears to the total number of legs.**
  - Case A. Installation or Modification of a Traffic Signal and/or Safety Lighting at an Existing Intersection. When a traffic signal and/or safety lighting is to be installed or modified at the intersection of a State highway and a local road, local agency participation in the installation or modification costs shall be sought.**

**Guidance:**

- Case B. Existing Driveways at Existing Signalized Intersections. A private driveway that constitutes a leg at an existing signalized intersection should be treated as follows:*
  - 1. If the driveway does not generate appreciable traffic, no control is required.*
  - 2. If the driveway serves an area that generates sufficient traffic to constitute a problem, it should be controlled. One example of control is the use of a red flashing beacon and/or a Right Turn ONLY (R3-5R) sign to control egress from the private driveway. Another would be to provide signal indications for the private driveway.*

**Standard:**

- 3. Costs shall be as in Case D.**
- Case C. A New Road or Driveway at an Existing Signalized Intersection. Where a new road or driveway is to be constructed to enter an existing "T" intersection, the cost of necessary right-of-way, traffic signal and/or safety lighting shall be at 100% local agency or permittee expense. The cost shall include the signal faces and detectors for the new approach and signal faces and detectors for left turns into the new approach and channelization, if necessary.**
- Case D. Installation of a Traffic Signal and/or Safety Lighting at an existing intersection with a Driveway. Where a traffic signal and/or safety lighting is to be installed at an existing intersection serving an area which generates sufficient traffic to constitute a problem that includes a private driveway as the fourth approach, the cost of signal and lighting equipment for the driveway approach shall be included in the cost of the entire installation.**
  - Where one or more legs of the intersection are under the jurisdiction of a local agency, the construction costs shall be shared with the local agency. The cost of the driveway leg shall be included with the local agency's share. It shall be the responsibility of the local agency to obtain the right-of-way, right-of-entry or easement necessary to install and maintain the signal equipment to be located on private property.**
- Case E. Reconstruction of a Conventional State Highway. When it is necessary to widen or reconstruct a State highway, the reconstruction and relocation of traffic control devices and safety lighting systems, shall be at 100% State expense. Local participation for purposes of expediting a project should be accepted. Additional**

**traffic control devices installed in connection with reconstruction of a conventional highway are to be treated as in Case A.**

**Case F. Relocation of a Conventional State Highway.** When an existing State highway is relocated, the State will install warranted traffic control devices and safety lighting at State expense. Local participation will not be required. If, however, a local authority wishes to participate in a project in order to expedite it, local participation should be accepted.

**Case G. Installation of a Traffic Signal and/or Safety Lighting at a Private Driveway or Privately Owned Street.** The cost of a new traffic signal and/or safety lighting installed at a private driveway or privately owned street (i.e., not under the jurisdiction of a city or county) shall be entirely at the expense of the property owner or developer.

The permittee shall grant the State access rights to the private property at any time for the purpose of maintaining or timing the signal and lighting.

Upon installation, all rights, title and interest in the traffic signal equipment shall be granted to the State by the permittee. In the event that the State finds it advisable for the signals to be removed, the State will remove and salvage the equipment.

**Case H. Reconstruction of Existing Facilities.** When affected by State highway construction, existing roadway lighting, police and fire alarm systems, and similar systems owned by a city, county or publicly owned service district shall be relocated at the sole expense of the owner, unless prior rights can be established.

**Case I. School Traffic Signals and Flashing Beacons.** Where traffic signals and/or flashing beacons are justified only by the School Area Traffic Signal Warrant on a State highway, the installation shall be at 100% State expense. When any other warrant is met also, the cost is shared in the usual manner.

#### **Section 4B.107(CA) Construction Costs – Freeways**

##### **Standard:**

**01 The installation of electrical work and channelization at an intersection of a freeway ramp and a local road shall be at 100% State expense if such improvements are warranted at the time the freeway is to be opened to traffic, or if they are estimated to be warranted within five years after the date the freeway is opened to traffic.**

##### **Support:**

**02 It can be difficult to accurately predict the traffic pattern at interchanges at the time of the freeway design. Therefore, the need for signals at the ramp connections to local roads cannot always be anticipated.**

##### **Standard:**

**03 If within five years after the date of completion of the freeway, the interchange does not operate in the manner intended, and signal warrants are met, it shall be the policy to provide signals, lighting, channelization or roadway widening as necessary to facilitate the flow of traffic through the interchange. This work shall be done entirely at State expense in the same manner as it would have been done had it been planned in the original freeway project. This shall include widening of roadway approaches to proposed signalized ramp intersections in accordance with present design practice entirely at State expense.**

**04 After the five-year period, the cost of installation shall be financed in the same manner as for existing intersections.**

##### **Guidance:**

**05 Approval by local agencies should be obtained for changes to roads under their jurisdiction.**

##### **Option:**

**06 In lieu of treating each ramp intersection individually and sharing the costs on the basis of the number of legs under each jurisdiction, the concept of the overall facility as described in Caltrans' Maintenance Manual may be used. See Section 1A.11 for information regarding this publication.**

##### **Standard:**

**07 Frontage roads or portions of frontage roads, which serve as connections between ramps to or from the freeway and existing public roads and which are retained under State jurisdiction, shall be considered as freeway ramps and electrical work at the intersections shall be financed as described above.**

**08 Any time the interchange is revised by adding or relocating ramps, it is considered a new interchange and the cost of signals at the ramp terminals and/or the connection to the local road shall be at 100% State expense.**

### **Section 4B.108(CA) Roadway Improvements by Local Agencies**

**Standard:**

**01 Any new connection of a local street to a State highway, including any electrical work, widening and/or channelization required within the State highway right of way, shall be at 100% local agency expense.**

**02 At existing intersections any relocation or improvement of electrical facilities due to widening and/or channelization of the local street shall be at 100% local agency expense.**

### **Section 4B.109(CA) Cooperative Agreements**

**Support:**

**01 When a local agency participates in the various project costs, a cooperative agreement is required.**

**Standard:**

**02 Each agreement shall include a statement of ownership, maintenance and operation.**

**Support:**

**03 Pre-approved agreement forms and procedure details are available.**

### **Section 4B.110(CA) Engineering Services for Local Agencies**

**Standard:**

**01 Contracts with local agencies for the State to provide traffic signal control system engineering services shall include a clause relating to "Legal Relationships and Responsibilities".**

**Support:**

**02 Pre-approved wording is available.**

### **Section 4B.111(CA) Salvaged Electrical Equipment**

**Support:**

**01 A construction project sometimes includes the removal of traffic signal, lighting or other electrical equipment that is not to be reused on the particular project.**

**Guidance:**

**02 *The determination as to whether particular electrical equipment is salvable should be made at the Caltrans District level. The determination as to whether or not to salvage existing equipment should be made on the basis of the economic benefit to the State and on the conservation of energy and/or materials that would result from salvaging and/or reinstatement. Equipment should be salvaged if it falls within one of the following categories:***

- A. *It is an item for which there is a foreseeable use.***
- B. *It is part of an electrical installation owned jointly with another agency and the other agency has requested the salvaged equipment.***
- C. *It is usable in some other Caltrans District.***
- D. *It can be immediately disposed of by other means.***

**Standard:**

**03 All electrical equipment removed and determined not to be salvable shall become the property of the contractor.**

**04 Equipment determined to be salvable shall be disposed of as follows:**

- A. If the electrical installation is jointly owned by the State and one or more local agencies, each of the owners shall share in the salvage value. The local agencies shall be given first choice in obtaining the salvaged equipment. The agency obtaining the salvaged equipment shall reimburse the other agency in accordance with the proportionate ownership.**
- B. Where the State or local agency is replacing existing electrical equipment without the other agency participating in the cost of the new equipment, the salvaged equipment shall belong to the party or parties who bore the cost of the new equipment unless otherwise specified in an agreement or encroachment permit.**

**05 The salvage value shall be determined at the Caltrans District level during preparation of the preliminary report.**

**Guidance:**

**06 *The salvage value should be such that if the equipment were taken into State storage it could be used economically for maintenance or as State-furnished material on contracts. The estimated salvage value should make the equipment more attractive to local agencies than the money representing the other partner's share of the salvage value. Wire and wiring***

*supplies such as conduit, junction boxes, and connectors, and other materials should be considered as a lot at no value, or in any case, not more than the nominal sum of \$1.*

Support:

*07 Often, salvaged electrical equipment is available for use on new installations; in many cases this will result in considerable savings.*

#### **Section 4B.112(CA) Encroachment Permits**

**Standard:**

**01 Encroachment permits shall be required for a local agency or a private party to install or modify traffic signals and roadway lighting on a State highway.**

*Guidance:*

*02 Plans and Specifications prepared by Permittees should conform to State Standard Specifications, Standard Plans and be submitted to the Caltrans District for review and approval.*

**Standard:**

**03 In each case, a statement of ownership, maintenance and operation shall be included in the permit.**

Support:

*04 A Permit Engineering Evaluation Report (PEER) may be prepared in lieu of a project report for all projects estimated to cost \$1,000,000 or less, as part of the encroachment permit review process. Instructions for PEER's are found in Caltrans' Project Development Procedures Manual and the Encroachment Permits Manual. See Section 1A.11 for information regarding these publications.*

**Standard:**

**05 All projects financed, in whole or in part, from retail transactions and use taxes and projects costing more than \$1,000,000 requires a cooperative agreement.**

#### **Section 4B.113(CA) Modifications of Existing Signals**

*Guidance:*

*01 Where existing signals are to be modified, construction plans should include a separate plan of the existing system as well as a plan showing the modifications.*

Option:

*02 It may also be necessary to include a tabulation on the plan showing such appurtenances as backplates and special signal faces that may be difficult to discern on a complicated plan.*

*Guidance:*

*03 The design of any signal modification project should include adequate consideration for keeping the existing signals in operation while the modification work is being done.*

#### **Section 4B.114(CA) Signals on Poles Owned by Others**

Option:

*01 Traffic signal equipment may be attached to poles owned by utility companies or other agencies when it is desired to keep the number of poles at an intersection to a minimum.*

*Guidance:*

*02 In such cases, the Agency should enter into an agreement with the owner of the pole. The agreement should be written to hold the owner of the pole free of liability relative to operation of the traffic signal or damage to the pole and to make the State or Local Transportation Agency responsible for moving the equipment in the event the pole is removed or relocated.*



## CHAPTER 4C. TRAFFIC CONTROL SIGNAL NEEDS STUDIES

### Section 4C.01 Studies and Factors for Justifying Traffic Control Signals

**Standard:**

**01 An engineering study of traffic conditions, pedestrian characteristics, and physical characteristics of the location shall be performed to determine whether installation of a traffic control signal is justified at a particular location.**

**01a On State highways, the engineering study shall include consideration of a roundabout (yield control). If a roundabout is determined to provide a viable and practical solution, it shall be studied in lieu of, or in addition to a traffic control signal.**

*Guidance:*

*01b On local streets and highways, the engineering study should include consideration of a roundabout (yield control). If a roundabout is determined to provide a viable and practical solution, it should be studied in lieu of, or in addition to a traffic control signal.*

*Support:*

*01c Refer to Caltrans' website (<http://www.dot.ca.gov/hq/traffops/liaisons/ice.html>) for more information on the Traffic Operations Policy Directive 13-02, Intersection Control Evaluation (ICE), and other resources for the evaluation of intersection traffic control strategies.*

**02 The investigation of the need for a traffic control signal shall include an analysis of factors related to the existing operation and safety at the study location and the potential to improve these conditions, and the applicable factors contained in the following traffic signal warrants:**

**Warrant 1, Eight-Hour Vehicular Volume**

**Warrant 2, Four-Hour Vehicular Volume**

**Warrant 3, Peak Hour**

**Warrant 4, Pedestrian Volume**

**Warrant 5, School Crossing**

**Warrant 6, Coordinated Signal System**

**Warrant 7, Crash Experience**

**Warrant 8, Roadway Network**

**Warrant 9, Intersection Near a Grade Crossing**

**03 The satisfaction of a traffic signal warrant or warrants shall not in itself require the installation of a traffic control signal.**

*Support:*

*04 Sections 8C.09 and 8C.10 contain information regarding the use of traffic control signals instead of gates and/ or flashing-light signals at highway-rail grade crossings and highway-light rail transit grade crossings, respectively.*

*Guidance:*

*05 A traffic control signal should not be installed unless one or more of the factors described in this Chapter are met.*

*06 A traffic control signal should not be installed unless an engineering study indicates that installing a traffic control signal will improve the overall safety and/or operation of the intersection.*

*07 A traffic control signal should not be installed if it will seriously disrupt progressive traffic flow.*

*08 The study should consider the effects of the right-turn vehicles from the minor-street approaches.*

*Engineering judgment should be used to determine what, if any, portion of the right-turn traffic is subtracted from the minor-street traffic count when evaluating the count against the signal warrants listed in Paragraph 2.*

*09 Engineering judgment should also be used in applying various traffic signal warrants to cases where approaches consist of one lane plus one left-turn or right-turn lane. The site-specific traffic characteristics should dictate whether an approach is considered as one lane or two lanes. For example, for an approach with one lane for through and right-turning traffic plus a left-turn lane, if engineering judgment indicates that it should be considered a one-lane approach because the traffic using the left-turn lane is minor, the total traffic volume approaching the intersection should be applied against the signal warrants as a one-lane approach. The*

*approach should be considered two lanes if approximately half of the traffic on the approach turns left and the left-turn lane is of sufficient length to accommodate all left-turn vehicles.*

*10 Similar engineering judgment and rationale should be applied to a street approach with one through/left-turn lane plus a right-turn lane. In this case, the degree of conflict of minor-street right-turn traffic with traffic on the major street should be considered. Thus, right-turn traffic should not be included in the minor-street volume if the movement enters the major street with minimal conflict. The approach should be evaluated as a one-lane approach with only the traffic volume in the through/left-turn lane considered.*

*11 At a location that is under development or construction and where it is not possible to obtain a traffic count that would represent future traffic conditions, hourly volumes should be estimated as part of an engineering study for comparison with traffic signal warrants. Except for locations where the engineering study uses the satisfaction of Warrant 8 to justify a signal, a traffic control signal installed under projected conditions should have an engineering study done within 1 year of putting the signal into stop-and-go operation to determine if the signal is justified. If not justified, the signal should be taken out of stop-and-go operation or removed.*

*12 For signal warrant analysis, a location with a wide median, even if the median width is greater than 30 feet, should be considered as one intersection.*

Option:

*13 At an intersection with a high volume of left-turn traffic from the major street, the signal warrant analysis may be performed in a manner that considers the higher of the major-street left-turn volumes as the "minor-street" volume and the corresponding single direction of opposing traffic on the major street as the "major street" volume. ~~volume volume of the major-street left-turn volumes plus the higher volume minor-street approach as the "minor street" volume and both approaches of the major street minus the higher of the major-street left-turn volume as "major street" volume.~~*

*14 For signal warrants requiring conditions to be present for a certain number of hours in order to be satisfied, any four sequential 15-minute periods may be considered as 1 hour if the separate 1-hour periods used in the warrant analysis do not overlap each other and both the major-street volume and the minor-street volume are for the same specific one-hour periods.*

*15 For signal warrant analysis, bicyclists may be counted as either vehicles or pedestrians.*

Support:

*16 When performing a signal warrant analysis, bicyclists riding in the street with other vehicular traffic are usually counted as vehicles and bicyclists who are clearly using pedestrian facilities are usually counted as pedestrians.*

Option:

*17 Engineering study data may include the following:*

- A. The number of vehicles entering the intersection in each hour from each approach during 12 hours of an average day. It is desirable that the hours selected contain the greatest percentage of the 24-hour traffic volume.
- B. Vehicular volumes for each traffic movement from each approach, classified by vehicle type (heavy trucks, passenger cars and light trucks, public-transit vehicles, and, in some locations, bicycles), during each 15-minute period of the 2 hours in the morning and 2 hours in the afternoon during which total traffic entering the intersection is greatest.
- C. Pedestrian volume counts on each crosswalk during the same periods as the vehicular counts in Item B and during hours of highest pedestrian volume. Where young, elderly, and/or persons with physical or visual disabilities need special consideration, the pedestrians and their crossing times may be classified by general observation.
- D. Information about nearby facilities and activity centers that serve the young, elderly, and/or persons with disabilities, including requests from persons with disabilities for accessible crossing improvements at the location under study. These persons might not be adequately reflected in the pedestrian volume count if the absence of a signal restrains their mobility.
- E. The posted or statutory speed limit or the 85<sup>th</sup>-percentile speed on the uncontrolled approaches to the location.
- F. A condition diagram showing details of the physical layout, including such features as intersection geometrics, channelization, grades, sight-distance restrictions, transit stops and routes, parking conditions,

pavement markings, roadway lighting, driveways, nearby railroad crossings, distance to nearest traffic control signals, utility poles and fixtures, and adjacent land use.

G. A collision diagram showing crash experience by type, location, direction of movement, severity, weather, time of day, date, and day of week for at least 1 year.

<sup>18</sup> The following data, which are desirable for a more precise understanding of the operation of the intersection, may be obtained during the periods described in Item B of Paragraph 17:

A. Vehicle-hours of stopped time delay determined separately for each approach.

B. The number and distribution of acceptable gaps in vehicular traffic on the major street for entrance from the minor street.

C. The posted or statutory speed limit or the 85<sup>th</sup>-percentile speed on controlled approaches at a point near to the intersection but unaffected by the control.

D. Pedestrian delay time for at least two 30-minute peak pedestrian delay periods of an average weekday or like periods of a Saturday or Sunday.

E. Queue length on stop-controlled approaches.

**Standard:**

<sup>19</sup> **Delay, congestion, approach conditions, driver confusion, future land use or other evidence of the need for right of way assignment beyond that which could be provided by stop sign shall be demonstrated.**

Support:

<sup>20</sup> Figure 4C-101(CA) and 4C-103(CA) are examples of warrant sheets.

Guidance:

<sup>21</sup> *Figure 4C-103(CA) should be used only for new intersections or other locations where it is not reasonable to count actual traffic volumes.*

**Section 4C.02 Warrant 1, Eight-Hour Vehicular Volume**

Support:

<sup>01</sup> The Minimum Vehicular Volume, Condition A, is intended for application at locations where a large volume of intersecting traffic is the principal reason to consider installing a traffic control signal.

<sup>02</sup> The Interruption of Continuous Traffic, Condition B, is intended for application at locations where Condition A is not satisfied and where the traffic volume on a major street is so heavy that traffic on a minor intersecting street suffers excessive delay or conflict in entering or crossing the major street.

<sup>03</sup> It is intended that Warrant 1 be treated as a single warrant. If Condition A is satisfied, then Warrant 1 is satisfied and analyses of Condition B and the combination of Conditions A and B are not needed. Similarly, if Condition B is satisfied, then Warrant 1 is satisfied and an analysis of the combination of Conditions A and B is not needed.

**Standard:**

<sup>04</sup> **The need for a traffic control signal shall be considered if an engineering study finds that one of the following conditions exist for each of any 8 hours of an average day:**

**A. The vehicles per hour given in both of the 100 percent columns of Condition A in Table 4C-1 exist on the major-street and the higher-volume minor-street approaches, respectively, to the intersection; or**

**B. The vehicles per hour given in both of the 100 percent columns of Condition B in Table 4C-1 exist on the major-street and the higher-volume minor-street approaches, respectively, to the intersection.**

**In applying each condition the major-street and minor-street volumes shall be for the same 8 hours. On the minor street, the higher volume shall not be required to be on the same approach during each of these 8 hours.**

Option:

<sup>05</sup> If the posted or statutory speed limit or the 85<sup>th</sup>-percentile speed on the major street exceeds 40 mph, or if the intersection lies within the built-up area of an isolated community having a population of less than 10,000, the traffic volumes in the 70 percent columns in Table 4C-1 may be used in place of the 100 percent columns.

Guidance:

<sup>06</sup> *The combination of Conditions A and B is intended for application at locations where Condition A is not satisfied and Condition B is not satisfied and should be applied only after an adequate trial of other alternatives that could cause less delay and inconvenience to traffic has failed to solve the traffic problems.*

**Standard:**

- 07 The need for a traffic control signal shall be considered if an engineering study finds that both of the following conditions exist for each of any 8 hours of an average day:**
- A. The vehicles per hour given in both of the 80 percent columns of Condition A in Table 4C-1 exist on the major-street and the higher-volume minor-street approaches, respectively, to the intersection; and**
  - B. The vehicles per hour given in both of the 80 percent columns of Condition B in Table 4C-1 exist on the major-street and the higher-volume minor-street approaches, respectively, to the intersection.**
- These major-street and minor-street volumes shall be for the same 8 hours for each condition; however, the 8 hours satisfied in Condition A shall not be required to be the same 8 hours satisfied in Condition B. On the minor street, the higher volume shall not be required to be on the same approach during each of the 8 hours.**

**Option:**

**08 If the posted or statutory speed limit or the 85th-percentile speed on the major street exceeds 40 mph, or if the intersection lies within the built-up area of an isolated community having a population of less than 10,000, the traffic volumes in the 56 percent columns in Table 4C-1 may be used in place of the 80 percent columns.**

**Section 4C.03 Warrant 2, Four-Hour Vehicular Volume**

**Support:**

**01 The Four-Hour Vehicular Volume signal warrant conditions are intended to be applied where the volume of intersecting traffic is the principal reason to consider installing a traffic control signal.**

**Standard:**

**02 The need for a traffic control signal shall be considered if an engineering study finds that, for each of any 4 hours of an average day, the plotted points representing the vehicles per hour on the major street (total of both approaches) and the corresponding vehicles per hour on the higher-volume minor-street approach (one direction only) all fall above the applicable curve in Figure 4C-1 for the existing combination of approach lanes. On the minor street, the higher volume shall not be required to be on the same approach during each of these 4 hours.**

**Option:**

**03 If the posted or statutory speed limit or the 85th-percentile speed on the major street exceeds 40 mph, or if the intersection lies within the built-up area of an isolated community having a population of less than 10,000, Figure 4C-2 may be used in place of Figure 4C-1.**

**Section 4C.04 Warrant 3, Peak Hour**

**Support:**

**01 The Peak Hour signal warrant is intended for use at a location where traffic conditions are such that for a minimum of 1 hour of an average day, the minor-street traffic suffers undue delay when entering or crossing the major street.**

**Standard:**

**02 This signal warrant shall be applied only in unusual cases, such as office complexes, manufacturing plants, industrial complexes, or high-occupancy vehicle facilities that attract or discharge large numbers of vehicles over a short time.**

**03 The need for a traffic control signal shall be considered if an engineering study finds that the criteria in either of the following two categories are met:**

- A. If all three of the following conditions exist for the same 1 hour (any four consecutive 15-minute periods) of an average day:**
  - 1. The total stopped time delay experienced by the traffic on one minor-street approach (one direction only) controlled by a STOP sign equals or exceeds: 4 vehicle-hours for a one-lane approach or 5 vehicle-hours for a two-lane approach; and**
  - 2. The volume on the same minor-street approach (one direction only) equals or exceeds 100 vehicles per hour for one moving lane of traffic or 150 vehicles per hour for two moving lanes; and**

**3. The total entering volume serviced during the hour equals or exceeds 650 vehicles per hour for intersections with three approaches or 800 vehicles per hour for intersections with four or more approaches.**

**B. The plotted point representing the vehicles per hour on the major street (total of both approaches) and the corresponding vehicles per hour on the higher-volume minor-street approach (one direction only) for 1 hour (any four consecutive 15-minute periods) of an average day falls above the applicable curve in Figure 4C-3 for the existing combination of approach lanes.**

Option:

<sup>04</sup> If the posted or statutory speed limit or the 85th-percentile speed on the major street exceeds 40 mph, or if the intersection lies within the built-up area of an isolated community having a population of less than 10,000, Figure 4C-4 may be used in place of Figure 4C-3 to evaluate the criteria in the second category of the Standard.

<sup>05</sup> If this warrant is the only warrant met and a traffic control signal is justified by an engineering study, the traffic control signal may be operated in the flashing mode during the hours that the volume criteria of this warrant are not met.

*Guidance:*

<sup>06</sup> *If this warrant is the only warrant met and a traffic control signal is justified by an engineering study, the traffic control signal should be traffic-actuated.*

### **Section 4C.05 Warrant 4, Pedestrian Volume**

Support:

<sup>01</sup> The Pedestrian Volume signal warrant is intended for application where the traffic volume on a major street is so heavy that pedestrians experience excessive delay in crossing the major street.

**Standard:**

<sup>02</sup> **The need for a traffic control signal at an intersection or midblock crossing shall be considered if an engineering study finds that one of the following criteria is met:**

**A. For each of any 4 hours of an average day, the plotted points representing the vehicles per hour on the major street (total of both approaches) and the corresponding pedestrians per hour crossing the major street (total of all crossings) all fall above the curve in Figure 4C-5; or**

**B. For 1 hour (any four consecutive 15-minute periods) of an average day, the plotted point representing the vehicles per hour on the major street (total of both approaches) and the corresponding pedestrians per hour crossing the major street (total of all crossings) falls above the curve in Figure 4C-7.**

Option:

<sup>03</sup> If the posted or statutory speed limit or the 85th-percentile speed on the major street exceeds 35 mph, or if the intersection lies within the built-up area of an isolated community having a population of less than 10,000, Figure 4C-6 may be used in place of Figure 4C-5 to evaluate Criterion A in Paragraph 2, and Figure 4C-8 may be used in place of Figure 4C-7 to evaluate Criterion B in Paragraph 2.

**Standard:**

<sup>04</sup> **The Pedestrian Volume signal warrant shall not be applied at locations where the distance to the nearest traffic control signal or STOP sign controlling the street that pedestrians desire to cross is less than 300 feet, unless the proposed traffic control signal will not restrict the progressive movement of traffic.**

<sup>05</sup> **If this warrant is met and a traffic control signal is justified by an engineering study, the traffic control signal shall be equipped with pedestrian signal heads complying with the provisions set forth in Chapter 4E.**

*Guidance:*

<sup>06</sup> *If this warrant is met and a traffic control signal is justified by an engineering study, then:*

*A. If it is installed at an intersection or major driveway location, the traffic control signal should also control the minor-street or driveway traffic, should be traffic-actuated, and should include pedestrian detection.*

*B. If it is installed at a non-intersection crossing, the traffic control signal should be installed at least 100 feet from side streets or driveways that are controlled by STOP or YIELD signs, and should be pedestrian-actuated. If the traffic control signal is installed at a non-intersection crossing, at least one of the signal faces should be over the traveled way for each approach, parking and other sight obstructions should be prohibited for at least 100 feet in advance of and at least 20 feet beyond the crosswalk or site*

*accommodations should be made through curb extensions or other techniques to provide adequate sight distance, and the installation should include suitable standard signs and pavement markings.*

*C. Furthermore, if it is installed within a signal system, the traffic control signal should be coordinated.*

Option:

07 The criterion for the pedestrian volume crossing the major street may be reduced as much as 50 percent if the 15th-percentile crossing speed of pedestrians is less than 3.5 feet per second.

08 A traffic control signal may not be needed at the study location if adjacent coordinated traffic control signals consistently provide gaps of adequate length for pedestrians to cross the street.

#### **Section 4C.06 Warrant 5, School Crossing**

Support:

01 The School Crossing signal warrant is intended for application where the fact that schoolchildren cross the major street is the principal reason to consider installing a traffic control signal. For the purposes of this warrant, the word "schoolchildren" includes elementary through high school students.

**Standard:**

02 **The need for a traffic control signal shall be considered when an engineering study of the frequency and adequacy of gaps in the vehicular traffic stream as related to the number and size of groups of schoolchildren at an established school crossing across the major street shows that the number of adequate gaps in the traffic stream during the period when the schoolchildren are using the crossing is less than the number of minutes in the same period (see Section 7A.03) and there are a minimum of 20 schoolchildren during the highest crossing hour.**

03 **Before a decision is made to install a traffic control signal, consideration shall be given to the implementation of other remedial measures, such as warning signs and flashers, school speed zones, school crossing guards, or a grade-separated crossing.**

04 **The School Crossing signal warrant shall not be applied at locations where the distance to the nearest traffic control signal along the major street is less than 300 feet, unless the proposed traffic control signal will not restrict the progressive movement of traffic.**

Guidance:

05 *If this warrant is met and a traffic control signal is justified by an engineering study, then:*

*A. If it is installed at an intersection or major driveway location, the traffic control signal should also control the minor-street or driveway traffic, should be traffic-actuated, and should include pedestrian detection.*

*B. If it is installed at a non-intersection crossing, the traffic control signal should be installed at least 100 feet from side streets or driveways that are controlled by STOP or YIELD signs, and should be pedestrian-actuated. If the traffic control signal is installed at a non-intersection crossing, at least one of the signal faces should be over the traveled way for each approach, parking and other sight obstructions should be prohibited for at least 100 feet in advance of and at least 20 feet beyond the crosswalk or site accommodations should be made through curb extensions or other techniques to provide adequate sight distance, and the installation should include suitable standard signs and pavement markings.*

*C. Furthermore, if it is installed within a signal system, the traffic control signal should be coordinated.*

#### **Section 4C.07 Warrant 6, Coordinated Signal System**

Support:

01 Progressive movement in a coordinated signal system sometimes necessitates installing traffic control signals at intersections where they would not otherwise be needed in order to maintain proper platooning of vehicles.

**Standard:**

02 **The need for a traffic control signal shall be considered if an engineering study finds that one of the following criteria is met:**

**A. On a one-way street or a street that has traffic predominantly in one direction, the adjacent traffic control signals are so far apart that they do not provide the necessary degree of vehicular platooning.**

**B. On a two-way street, adjacent traffic control signals do not provide the necessary degree of platooning and the proposed and adjacent traffic control signals will collectively provide a progressive operation.**

*Guidance:*

*03 The Coordinated Signal System signal warrant should not be applied where the resultant spacing of traffic control signals would be less than 1,000 feet.*

**Section 4C.08 Warrant 7, Crash Experience**

**Support:**

01 The Crash Experience signal warrant conditions are intended for application where the severity and frequency of crashes are the principal reasons to consider installing a traffic control signal.

**Standard:**

02 **The need for a traffic control signal shall be considered if an engineering study finds that all of the following criteria are met:**

- A. Adequate trial of alternatives with satisfactory observance and enforcement has failed to reduce the crash frequency; and**
- B. Five or more reported crashes, of types susceptible to correction by a traffic control signal, have occurred within a 12-month period, each crash involving personal injury or property damage apparently exceeding the applicable requirements for a reportable crash; and**
- C. For each of any 8 hours of an average day, the vehicles per hour (vph) given in both of the 80 percent columns of Condition A in Table 4C-1 (see Section 4C.02), or the vph in both of the 80 percent columns of Condition B in Table 4C-1 exists on the major-street and the higher-volume minor-street approach, respectively, to the intersection, or the volume of pedestrian traffic is not less than 80 percent of the requirements specified in the Pedestrian Volume warrant. These major-street and minor-street volumes shall be for the same 8 hours. On the minor street, the higher volume shall not be required to be on the same approach during each of the 8 hours.**

**Option:**

03 If the posted or statutory speed limit or the 85th-percentile speed on the major street exceeds 40 mph, or if the intersection lies within the built-up area of an isolated community having a population of less than 10,000, the traffic volumes in the 56 percent columns in Table 4C-1 may be used in place of the 80 percent columns.

**Section 4C.09 Warrant 8, Roadway Network**

**Support:**

01 Installing a traffic control signal at some intersections might be justified to encourage concentration and organization of traffic flow on a roadway network.

**Standard:**

02 **The need for a traffic control signal shall be considered if an engineering study finds that the common intersection of two or more major routes meets one or both of the following criteria:**

- A. The intersection has a total existing, or immediately projected, entering volume of at least 1,000 vehicles per hour during the peak hour of a typical weekday and has 5-year projected traffic volumes, based on an engineering study, that meet one or more of Warrants 1, 2, and 3 during an average weekday; or**
- B. The intersection has a total existing or immediately projected entering volume of at least 1,000 vehicles per hour for each of any 5 hours of a non-normal business day (Saturday or Sunday).**

03 **A major route as used in this signal warrant shall have at least one of the following characteristics:**

- A. It is part of the street or highway system that serves as the principal roadway network for through traffic flow.**
- B. It includes rural or suburban highways outside, entering, or traversing a city.**
- C. It appears as a major route on an official plan, such as a major street plan in an urban area traffic and transportation study.**

**Section 4C.10 Warrant 9, Intersection Near a Grade Crossing**

**Support:**

01 The Intersection Near a Grade Crossing signal warrant is intended for use at a location where none of the conditions described in the other eight traffic signal warrants are met, but the proximity to the intersection of a

grade crossing on an intersection approach controlled by a STOP or YIELD sign is the principal reason to consider installing a traffic control signal.

*Guidance:*

*02 This signal warrant should be applied only after adequate consideration has been given to other alternatives or after a trial of an alternative has failed to alleviate the safety concerns associated with the grade crossing. Among the alternatives that should be considered or tried are:*

- A. Providing additional pavement that would enable vehicles to clear the track or that would provide space for an evasive maneuver, or*
- B. Reassigning the stop controls at the intersection to make the approach across the track a non-stopping approach.*

**Standard:**

**03 The need for a traffic control signal shall be considered if an engineering study finds that both of the following criteria are met:**

- A. A grade crossing exists on an approach controlled by a STOP or YIELD sign and the center of the track nearest to the intersection is within 140 feet of the stop line or yield line on the approach; and**
- B. During the highest traffic volume hour during which rail traffic uses the crossing, the plotted point representing the vehicles per hour on the major street (total of both approaches) and the corresponding vehicles per hour on the minor-street approach that crosses the track (one direction only, approaching the intersection) falls above the applicable curve in Figure 4C-9 or 4C-10 for the existing combination of approach lanes over the track and the distance D, which is the clear storage distance as defined in Section 1A.13.**

*Guidance:*

*04 The following considerations apply when plotting the traffic volume data on Figure 4C-9 or 4C-10:*

- A. Figure 4C-9 should be used if there is only one lane approaching the intersection at the track crossing location and Figure 4C-10 should be used if there are two or more lanes approaching the intersection at the track crossing location.*
- B. After determining the actual distance D, the curve for the distance D that is nearest to the actual distance D should be used. For example, if the actual distance D is 95 feet, the plotted point should be compared to the curve for D = 90 feet.*
- C. If the rail traffic arrival times are unknown, the highest traffic volume hour of the day should be used.*

**Option:**

**05 The minor-street approach volume may be multiplied by up to three adjustment factors as provided in Paragraphs 6 through 8.**

**06 Because the curves are based on an average of four occurrences of rail traffic per day, the vehicles per hour on the minor-street approach may be multiplied by the adjustment factor shown in Table 4C-2 for the appropriate number of occurrences of rail traffic per day.**

**07 Because the curves are based on typical vehicle occupancy, if at least 2% of the vehicles crossing the track are buses carrying at least 20 people, the vehicles per hour on the minor-street approach may be multiplied by the adjustment factor shown in Table 4C-3 for the appropriate percentage of high-occupancy buses.**

**08 Because the curves are based on tractor-trailer trucks comprising 10% of the vehicles crossing the track, the vehicles per hour on the minor-street approach may be multiplied by the adjustment factor shown in Table 4C-4 for the appropriate distance and percentage of tractor-trailer trucks.**

**Standard:**

**09 If this warrant is met and a traffic control signal at the intersection is justified by an engineering study, then:**

- A. The traffic control signal shall have actuation on the minor street;**
- B. Preemption control shall be provided in accordance with Sections 4D.27, 8C.09, and 8C.10; and**
- C. The grade crossing shall have flashing-light signals (see Chapter 8C).**

*Guidance:*

*10 If this warrant is met and a traffic control signal at the intersection is justified by an engineering study, the grade crossing should have automatic gates (see Chapter 8C).*



## **Section 4C.101(CA) Criterion for School Crossing Traffic Signals**

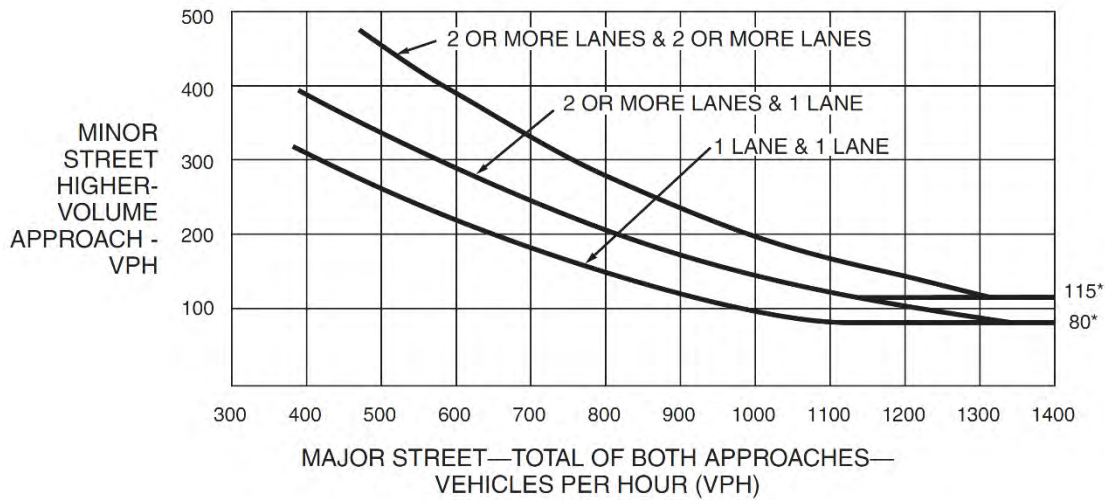
### **<sup>01</sup> Standard:**

- A. The signal shall be designed for full-time operation.**
- B. Pedestrian signal faces of the International Symbol type shall be installed at all marked crosswalks at signalized intersections along the "Suggested Route to School."**
- C. If an intersection is signalized under this guideline for school pedestrians, the entire intersection shall be signalized.**
- D. School area traffic signals shall be traffic actuated type with push buttons or other detectors for pedestrians.**

### **Option:**

- <sup>02</sup> Non-intersection school pedestrian crosswalk locations may be signalized when justified.**

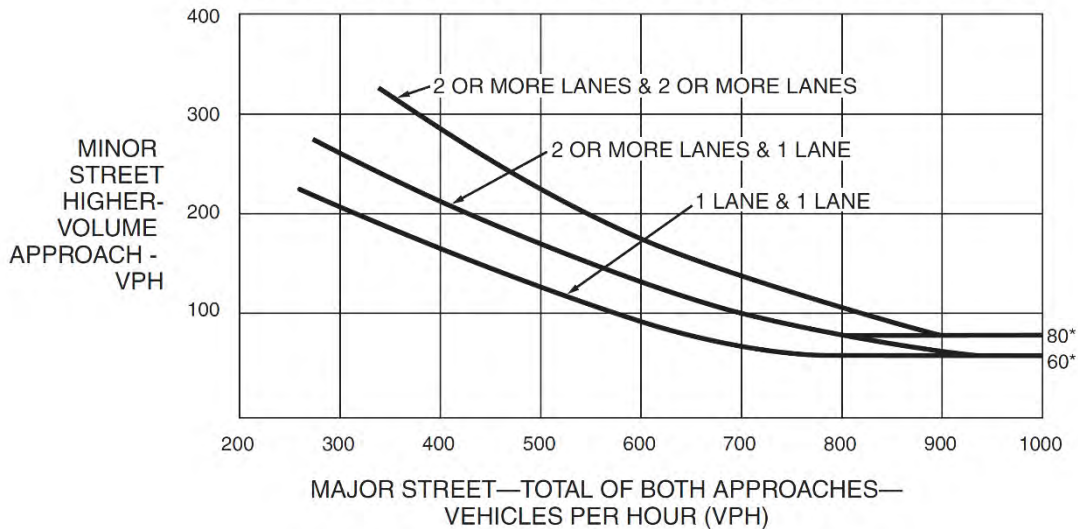
**Figure 4C-1. Warrant 2, Four-Hour Vehicular Volume**



\*Note: 115 vph applies as the lower threshold volume for a minor-street approach with two or more lanes and 80 vph applies as the lower threshold volume for a minor-street approach with one lane.

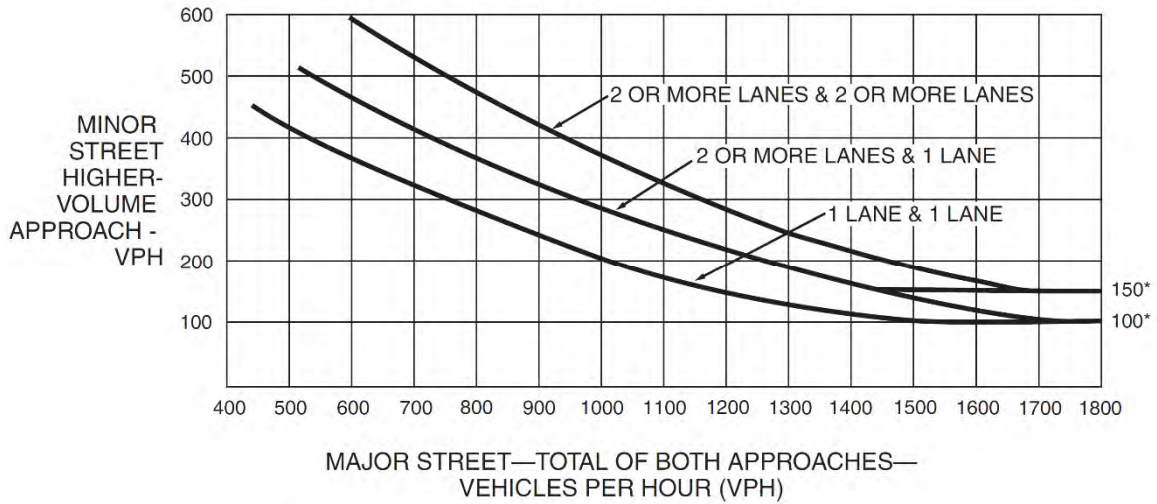
**Figure 4C-2. Warrant 2, Four-Hour Vehicular Volume (70% Factor)**

(COMMUNITY LESS THAN 10,000 POPULATION OR ABOVE 40 MPH ON MAJOR STREET)



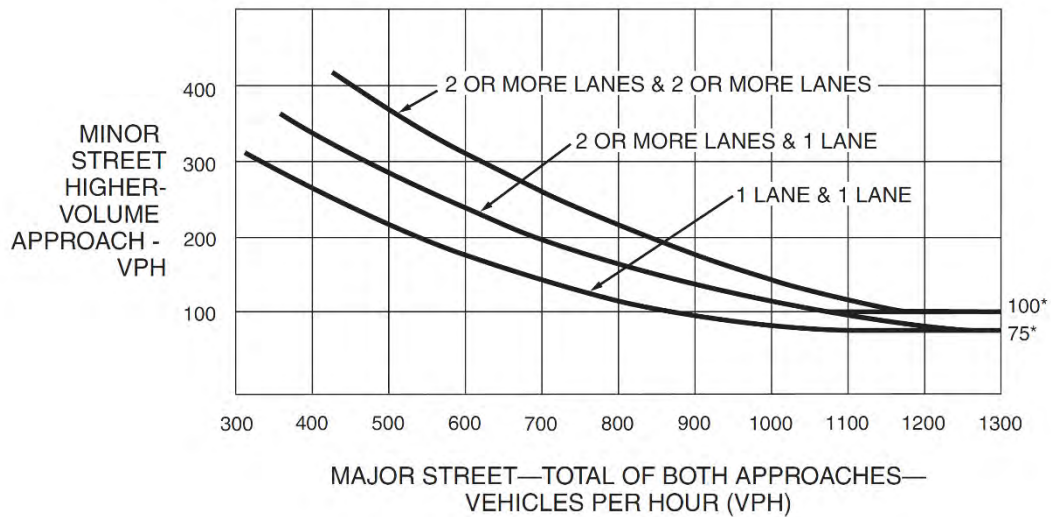
\*Note: 80 vph applies as the lower threshold volume for a minor-street approach with two or more lanes and 60 vph applies as the lower threshold volume for a minor-street approach with one lane.

**Figure 4C-3. Warrant 3, Peak Hour**



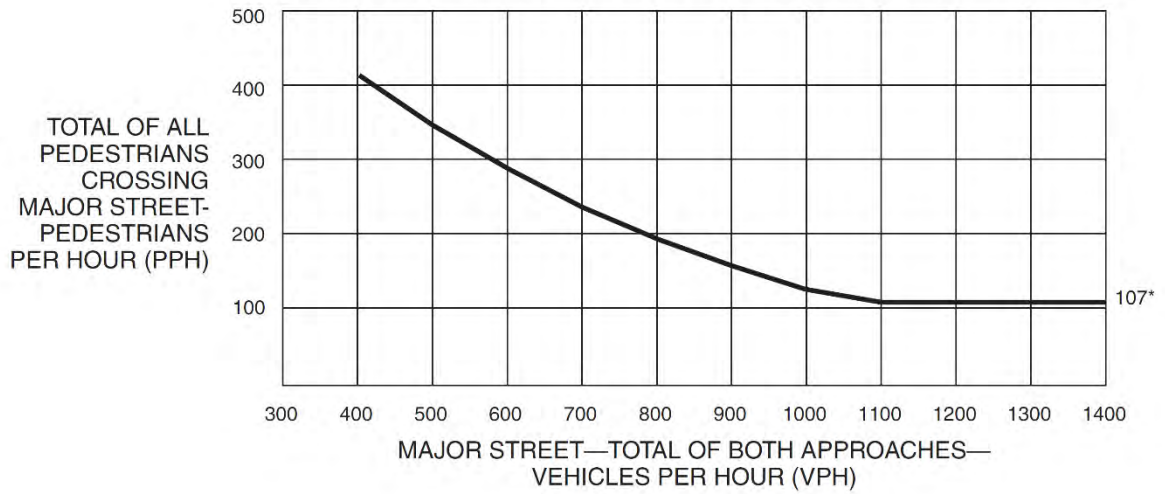
\*Note: 150 vph applies as the lower threshold volume for a minor-street approach with two or more lanes and 100 vph applies as the lower threshold volume for a minor-street approach with one lane.

**Figure 4C-4. Warrant 3, Peak Hour (70% Factor)**  
 (COMMUNITY LESS THAN 10,000 POPULATION OR ABOVE 40 MPH ON MAJOR STREET)



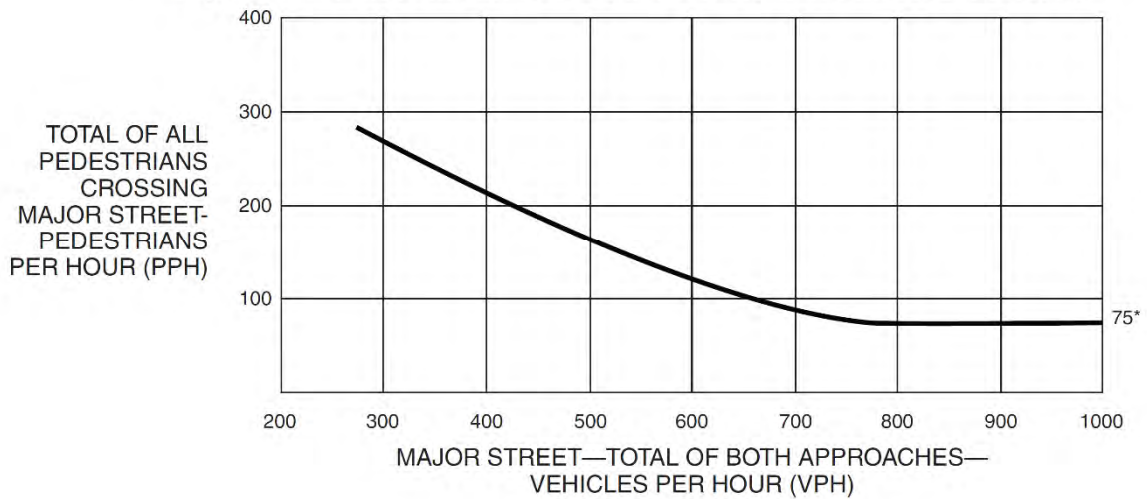
\*Note: 100 vph applies as the lower threshold volume for a minor-street approach with two or more lanes and 75 vph applies as the lower threshold volume for a minor-street approach with one lane.

**Figure 4C-5. Warrant 4, Pedestrian Four-Hour Volume**



\*Note: 107 pph applies as the lower threshold volume.

**Figure 4C-6. Warrant 4, Pedestrian Four-Hour Volume (70% Factor)**



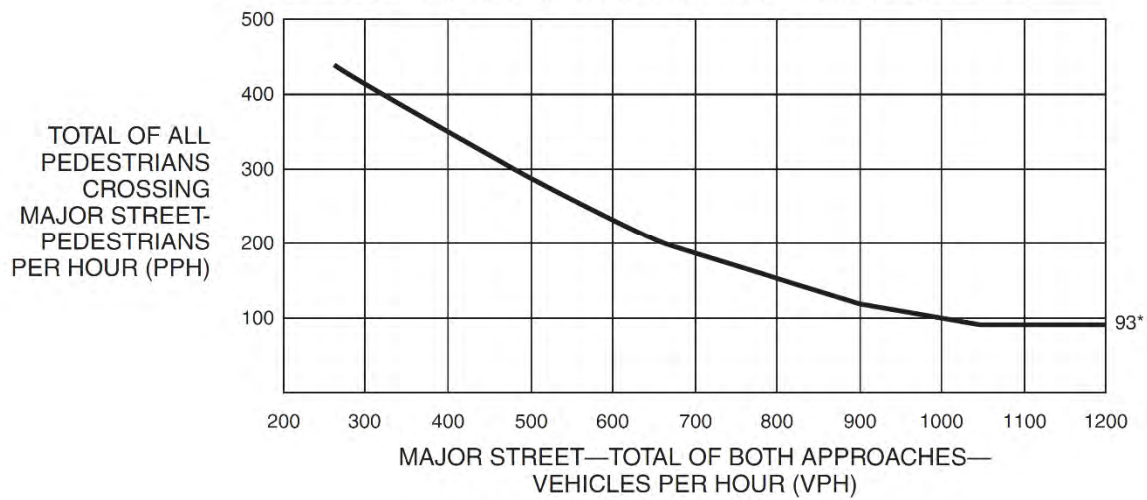
\*Note: 75 pph applies as the lower threshold volume.

**Figure 4C-7. Warrant 4, Pedestrian Peak Hour**



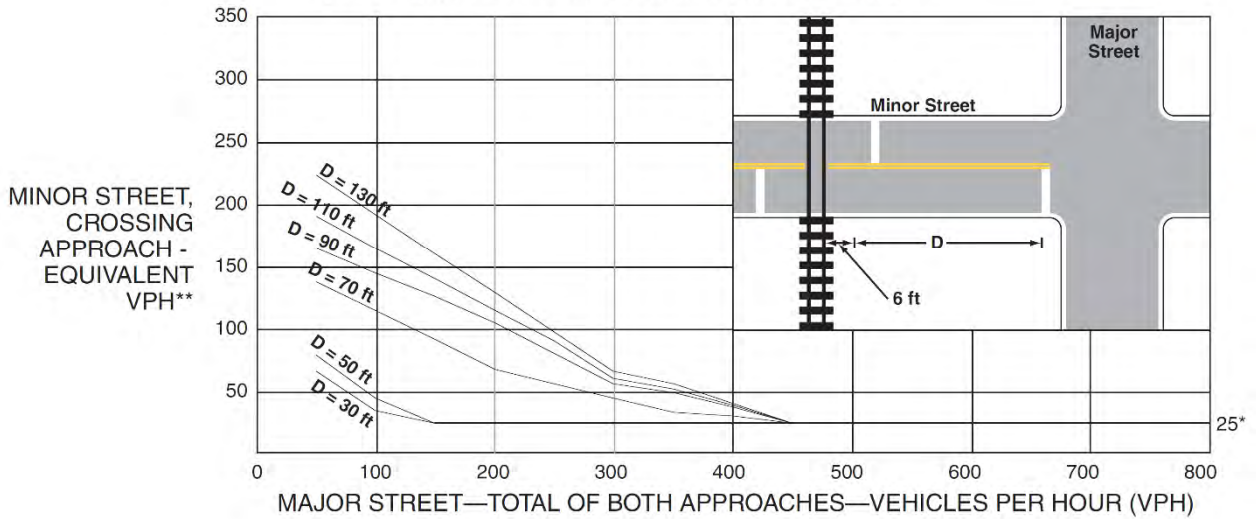
\*Note: 133 pph applies as the lower threshold volume.

**Figure 4C-8. Warrant 4, Pedestrian Peak Hour (70% Factor)**



\*Note: 93 pph applies as the lower threshold volume.

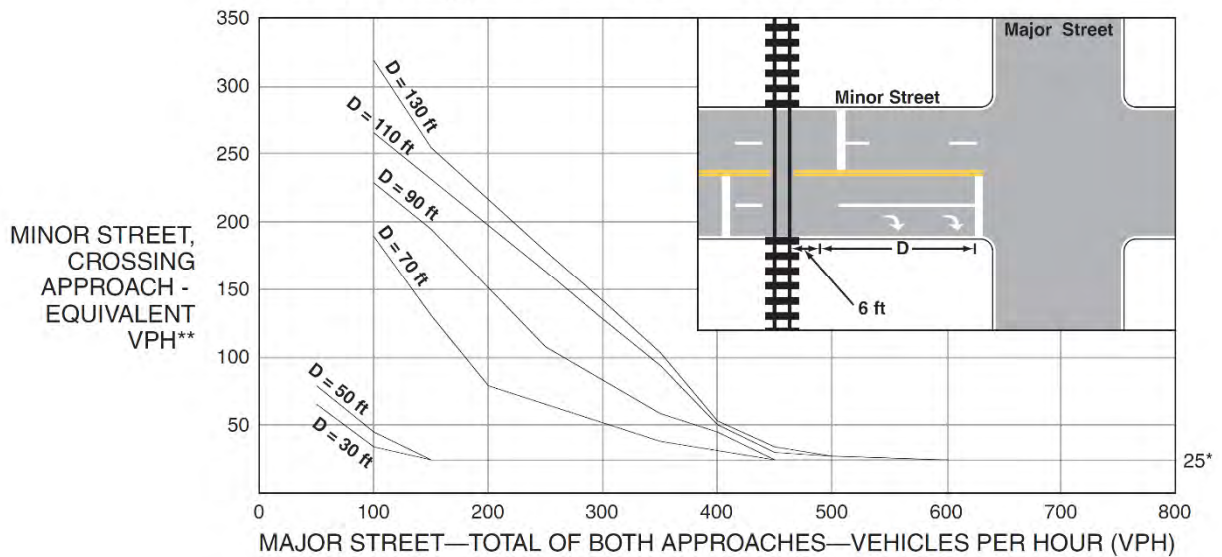
**Figure 4C-9. Warrant 9, Intersection Near a Grade Crossing  
 (One Approach Lane at the Track Crossing)**



\* 25 vph applies as the lower threshold volume

\*\* VPH after applying the adjustment factors in Tables 4C-2, 4C-3, and/or 4C-4, if appropriate

**Figure 4C-10. Warrant 9, Intersection Near a Grade Crossing  
 (Two or More Approach Lanes at the Track Crossing)**



\* 25 vph applies as the lower threshold volume

\*\* VPH after applying the adjustment factors in Tables 4C-2, 4C-3, and/or 4C-4, if appropriate

**Figure 4C-101 (CA). Traffic Signal Warrants Worksheet (Sheet 1 of 5)**

COUNT DATE \_\_\_\_\_

CALC \_\_\_\_\_ DATE \_\_\_\_\_

CHK \_\_\_\_\_ DATE \_\_\_\_\_

DIST \_\_\_\_\_ CO \_\_\_\_\_ RTE \_\_\_\_\_ PM \_\_\_\_\_

Major St: \_\_\_\_\_ Critical Approach Speed \_\_\_\_\_ mph

Minor St: \_\_\_\_\_ Critical Approach Speed \_\_\_\_\_ mph

Speed limit or critical speed on major street traffic > 40 mph.....  or  } **RURAL (R)**

In built up area of isolated community of < 10,000 population.....  } **URBAN (U)**

**WARRANT 1 - Eight Hour Vehicular Volume** SATISFIED YES  NO   
 (Condition A or Condition B or combination of A and B must be satisfied)

**Condition A - Minimum Vehicle Volume** 100% SATISFIED YES  NO   
 80% SATISFIED YES  NO

| APPROACH LANES                | MINIMUM REQUIREMENTS (80% SHOWN IN BRACKETS) |              |              |              |                                 |  |  |  |  |  |  |  |  |  |  |  |  |  |
|-------------------------------|--|--------------|--------------|--------------|---------------------------------|--|--|--|--|--|--|--|--|--|--|--|--|--|
|                               | U  | R            | U            | R            |                                 |  |  |  |  |  |  |  |  |  |  |  |  |  |
|                               | 1  |              | 2 or More    |              | / / / / / / / / / / / / / / / / |  |  |  |  |  |  |  |  |  |  |  |  |  |
| Both Approaches Major Street  | 500<br>(400)                                 | 350<br>(280) | 600<br>(480) | 420<br>(336) |                                 |  |  |  |  |  |  |  |  |  |  |  |  |  |
| Highest Approach Minor Street | 150<br>(120)                                 | 105<br>(84)  | 200<br>(160) | 140<br>(112) |                                 |  |  |  |  |  |  |  |  |  |  |  |  |  |

**Condition B - Interruption of Continuous Traffic** 100% SATISFIED YES  NO   
 80% SATISFIED YES  NO

| APPROACH LANES                | MINIMUM REQUIREMENTS (80% SHOWN IN BRACKETS) |              |              |              |                                 |  |  |  |  |  |  |  |  |  |  |  |  |  |
|-------------------------------|--|--------------|--------------|--------------|---------------------------------|--|--|--|--|--|--|--|--|--|--|--|--|--|
|                               | U  | R            | U            | R            |                                 |  |  |  |  |  |  |  |  |  |  |  |  |  |
|                               | 1  |              | 2 or More    |              | / / / / / / / / / / / / / / / / |  |  |  |  |  |  |  |  |  |  |  |  |  |
| Both Approaches Major Street  | 750<br>(600)                                 | 525<br>(420) | 900<br>(720) | 630<br>(504) |                                 |  |  |  |  |  |  |  |  |  |  |  |  |  |
| Highest Approach Minor Street | 75<br>(60)                                   | 53<br>(42)   | 100<br>(80)  | 70<br>(56)   |                                 |  |  |  |  |  |  |  |  |  |  |  |  |  |

**Combination of Conditions A & B** SATISFIED YES  NO

| REQUIREMENT  | CONDITION                                  | ✓ | FULFILLED  |
|--|--|---|--|
| TWO CONDITIONS SATISFIED 80%   | A. MINIMUM VEHICULAR VOLUME                |   | Yes <input type="checkbox"/> No <input type="checkbox"/> |
|  | AND, B. INTERRUPTION OF CONTINUOUS TRAFFIC |   |  |
| AND, AN ADEQUATE TRIAL OF OTHER ALTERNATIVES THAT COULD CAUSE LESS DELAY AND INCONVENIENCE TO TRAFFIC HAS FAILED TO SOLVE THE TRAFFIC PROBLEMS |  |   | Yes <input type="checkbox"/> No <input type="checkbox"/> |

The satisfaction of a traffic signal warrant or warrants shall not in itself require the installation of a traffic control signal.

**Figure 4C-101 (CA). Traffic Signal Warrants Worksheet (Sheet 2 of 5)**

**WARRANT 2 - Four Hour Vehicular Volume**

**SATISFIED\*** YES  NO

Record hourly vehicular volumes for any four hours of an average day.

| APPROACH LANES                 | One |  | 2 or More |  | Hour |
|--------------------------------|-----|--|-----------|--|------|
|                                |     |  |           |  |      |
| Both Approaches - Major Street |     |  |           |  |      |
| Higher Approach - Minor Street |     |  |           |  |      |

|  |                              |                             |
|--|------------------------------|-----------------------------|
| *All plotted points fall above the applicable curve in Figure 4C-1. (URBAN AREAS)            | Yes <input type="checkbox"/> | No <input type="checkbox"/> |
| <u>OR</u> , All plotted points fall above the applicable curve in Figure 4C-2. (RURAL AREAS) | Yes <input type="checkbox"/> | No <input type="checkbox"/> |

**WARRANT 3 - Peak Hour  
 (Part A or Part B must be satisfied)**

**SATISFIED** YES  NO

**PART A**

**SATISFIED** YES  NO

(All parts 1, 2, and 3 below must be satisfied for the same one hour, for any four consecutive 15-minute periods)

|   |                              |                             |
|---|------------------------------|-----------------------------|
| 1. The total delay experienced by traffic on one minor street approach (one direction only) controlled by a STOP sign equals or exceeds four vehicle-hours for a one-lane approach, or five vehicle-hours for a two-lane approach; <u>AND</u> | Yes <input type="checkbox"/> | No <input type="checkbox"/> |
| 2. The volume on the same minor street approach (one direction only) equals or exceeds 100 vph for one moving lane of traffic or 150 vph for two moving lanes; <u>AND</u>   | Yes <input type="checkbox"/> | No <input type="checkbox"/> |
| 3. The total entering volume serviced during the hour equals or exceeds 800 vph for intersections with four or more approaches or 650 vph for intersections with three approaches.  | Yes <input type="checkbox"/> | No <input type="checkbox"/> |

**PART B**

**SATISFIED** YES  NO

| APPROACH LANES                 | One |  | 2 or More |  | Hour |
|--------------------------------|-----|--|-----------|--|------|
|                                |     |  |           |  |      |
| Both Approaches - Major Street |     |  |           |  |      |
| Higher Approach - Minor Street |     |  |           |  |      |

|  |                              |                             |
|--|------------------------------|-----------------------------|
| The plotted point falls above the applicable curve in Figure 4C-3. (URBAN AREAS)             | Yes <input type="checkbox"/> | No <input type="checkbox"/> |
| <u>OR</u> , The plotted point falls above the applicable curve in Figure 4C-4. (RURAL AREAS) | Yes <input type="checkbox"/> | No <input type="checkbox"/> |

The satisfaction of a traffic signal warrant or warrants shall not in itself require the installation of a traffic control signal.



**Figure 4C-101 (CA). Traffic Signal Warrants Worksheet (Sheet 3 of 5)**

**WARRANT 4 - Pedestrian Volume  
 (Parts 1 and 2 Must Be Satisfied)**

SATISFIED YES  NO

**Part 1 (Parts A or B must be satisfied)**

Hours - - ->

|    |                                      |  |  |  |  |
|----|--------------------------------------|--|--|--|--|
| A. | Vehicles per hour for any 4 hours    |  |  |  |  |
|    | Pedestrians per hour for any 4 hours |  |  |  |  |

Figure 4C-5 or Figure 4C-6  
 SATISFIED YES  NO

Hours - - ->

|    |                                     |  |  |  |  |
|----|-------------------------------------|--|--|--|--|
| B. | Vehicles per hour for any 1 hour    |  |  |  |  |
|    | Pedestrians per hour for any 1 hour |  |  |  |  |

Figure 4C-7 or Figure 4C-8  
 SATISFIED YES  NO

**Part 2**

SATISFIED YES  NO

|  |                              |                             |
|--|------------------------------|-----------------------------|
| <u>AND</u> , The distance to the nearest traffic signal along the major street is greater than 300 ft      | Yes <input type="checkbox"/> | No <input type="checkbox"/> |
| <u>OR</u> , The proposed traffic signal will not restrict progressive traffic flow along the major street. | Yes <input type="checkbox"/> | No <input type="checkbox"/> |

**WARRANT 5 - School Crossing  
 (Parts A and B Must Be Satisfied)**

SATISFIED YES  NO

**Part A  
 Gap/Minutes and # of Children**

SATISFIED YES  NO

|   |                                 |  |      |
|---|---------------------------------|--|------|
| Gaps vs Minutes                             | Minutes Children Using Crossing |  | Hour |
|   | Number of Adequate Gaps         |  |      |
| School Age Pedestrians Crossing Street / hr |                                 |  |      |

Gaps < Minutes YES  NO   
AND Children > 20/hr YES  NO

|  |                              |                             |
|--|------------------------------|-----------------------------|
| <u>AND</u> , Consideration has been given to less restrictive remedial measures. | Yes <input type="checkbox"/> | No <input type="checkbox"/> |
|--|------------------------------|-----------------------------|

**Part B**

SATISFIED YES  NO

|  |                              |                             |
|--|------------------------------|-----------------------------|
| The distance to the nearest traffic signal along the major street is greater than 300 ft | Yes <input type="checkbox"/> | No <input type="checkbox"/> |
| <u>OR</u> , The proposed signal will not restrict the progressive movement of traffic.   | Yes <input type="checkbox"/> | No <input type="checkbox"/> |

The satisfaction of a traffic signal warrant or warrants shall not in itself require the installation of a traffic control signal.

**Figure 4C-101 (CA). Traffic Signal Warrants Worksheet (Sheet 4 of 5)**

**WARRANT 6 - Coordinated Signal System  
 (All Parts Must Be Satisfied)**

**SATISFIED YES  NO**

|  |  |  |
|--|--|--|
| MINIMUM REQUIREMENTS   | DISTANCE TO NEAREST SIGNAL                     |  |
| ≥ 1000 ft  | N _____ ft, S _____ ft, E _____ ft, W _____ ft | Yes <input type="checkbox"/> No <input type="checkbox"/> |
| On a one-way street or a street that has traffic predominantly in one direction, the adjacent traffic control signals are so far apart that they do not provide the necessary degree of vehicular platooning.        |  | Yes <input type="checkbox"/> No <input type="checkbox"/> |
| OR, On a two-way street, adjacent traffic control signals do not provide the necessary degree of platooning and the proposed and adjacent traffic control signals will collectively provide a progressive operation. |  |  |

**WARRANT 7 - Crash Experience Warrant  
 (All Parts Must Be Satisfied)**

**SATISFIED YES  NO**

|   |  |  |   |
|---|--|--|---|
| Adequate trial of alternatives with satisfactory observance and enforcement has failed to reduce the crash frequency. |  | Yes <input type="checkbox"/> No <input type="checkbox"/> |   |
| REQUIREMENTS  | Number of crashes reported within a 12 month period susceptible to correction by a traffic signal, and involving injury or damage exceeding the requirements for a reportable crash. | Yes <input type="checkbox"/> No <input type="checkbox"/> |   |
| 5 OR MORE   |  |  |   |
| REQUIREMENTS  | CONDITIONS   | Yes <input type="checkbox"/> No <input type="checkbox"/> |   |
| ONE CONDITION SATISFIED 80%   | Warrant 1, Condition A - Minimum Vehicular Volume  |  | ✓ |
|   | OR, Warrant 1, Condition B - Interruption of Continuous Traffic  |  |   |
|   | OR, Warrant 4, Pedestrian Volume Condition Ped Vol ≥ 80% of Figure 4C-5 through Figure 4C-8  |  |   |

**WARRANT 8 - Roadway Network  
 (All Parts Must Be Satisfied)**

**SATISFIED YES  NO**

|  |   |               |  |
|--|---|---------------|--|
| MINIMUM VOLUME REQUIREMENTS  | ENTERING VOLUMES - ALL APPROACHES   | ✓             | FULFILLED  |
| 1000 Veh/Hr  | During Typical Weekday Peak Hour _____ Veh/Hr and has 5-year projected traffic volumes that meet one or more of Warrants 1, 2, and 3 during an average weekday. |               | Yes <input type="checkbox"/> No <input type="checkbox"/> |
|  | OR<br>During Each of Any 5 Hrs. of a Sat. or Sun _____ Veh/Hr   |               |  |
| CHARACTERISTICS OF MAJOR ROUTES                                      |   | MAJOR ROUTE A | MAJOR ROUTE B  |
| Hwy. System Serving as Principal Network for Through Traffic         |   |               |  |
| Rural or Suburban Highway Outside Of, Entering, or Traversing a City |   |               |  |
| Appears as Major Route on an Official Plan                           |   |               |  |
| Any Major Route Characteristics Met, Both Streets                    |   |               | Yes <input type="checkbox"/> No <input type="checkbox"/> |

The satisfaction of a traffic signal warrant or warrants shall not in itself require the installation of a traffic control signal.

**Figure 4C-101 (CA). Traffic Signal Warrants Worksheet (Sheet 5 of 5)**

**WARRANT 9 - Intersection Near a Grade Crossing  
 (Both Parts A and B Must Be Satisfied)**

**SATISFIED YES  NO**

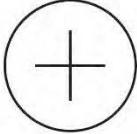
|   |   |
|---|---|
| <p><b><u>PART A</u></b></p> <p>A grade crossing exists on an approach controlled by a STOP or YIELD sign and the center of the track nearest to the intersection is within 140 feet of the stop line or yield line on the approach. Track Center Line to Limit Line _____ ft</p>  | <p>Yes <input type="checkbox"/> No <input type="checkbox"/></p> |
| <p><b><u>PART B</u></b></p> <p><b>There is one minor street approach lane at the track crossing</b> - During the highest traffic volume hour during which rail traffic uses the crossing, the plotted point falls above the applicable curve in Figure 4C-9.</p> <p>Major Street - Total of both approaches: _____ VPH<br/>                 Minor Street - Crosses the track (one direction only, approaching the intersection): _____ VPH X AF (Use Tables 4C-2, 3, &amp; 4 below to calculate AF) = _____ VPH</p> | <p>Yes <input type="checkbox"/> No <input type="checkbox"/></p> |
| <p><b><u>OR</u>, There are two or more minor street approach lanes at the track crossing</b> - During the highest traffic volume hour during which rail traffic uses the crossing, the plotted point falls above the applicable curve in Figure 4C-10.</p> <p>Major Street - Total of both approaches : _____ VPH<br/>                 Minor Street - Crosses the track (one direction only, approaching the intersection): _____ VPH X AF (Use Tables 4C-2, 3, &amp; 4 below to calculate AF) = _____ VPH</p>      | <p>Yes <input type="checkbox"/> No <input type="checkbox"/></p> |

The minor street approach volume may be multiplied by up to three following adjustment factors (AF) as described in Section 4C.10.

- 1- Number of Rail Traffic per Day \_\_\_\_\_ Adjustment factor from table 4C-2 \_\_\_\_\_
- 2- Percentage of High-Occupancy Buses on Minor Street Approach \_\_\_\_\_ Adjustment factor from table 4C-3 \_\_\_\_\_
- 3- Percentage of Tractor-Trailer Trucks on Minor Street Approach \_\_\_\_\_ Adjustment factor from table 4C-4 \_\_\_\_\_

NOTE: If no data is available or known, then use AF = 1 (no adjustment)

**Figure 4C-102 (CA). Traffic Count Worksheet**



Insert North Point

**Not to Scale**

|                 |             |        |
|-----------------|-------------|--------|
| Number of Lanes | Pedestrians |        |
|                 | Total*      | Peak   |
| AM Peak         | PM Peak     | Total* |
| ( )             | ( )         | ( )    |

|         |         |        |
|---------|---------|--------|
| AM Peak | PM Peak | Total* |
| ( )     | ( )     | ( )    |

|         |         |        |
|---------|---------|--------|
| AM Peak | PM Peak | Total* |
| ( )     | ( )     | ( )    |

|         |         |        |
|---------|---------|--------|
| AM Peak | PM Peak | Total* |
| ( )     | ( )     | ( )    |

|         |         |        |
|---------|---------|--------|
| AM Peak | PM Peak | Total* |
| ( )     | ( )     | ( )    |

|                 |             |        |
|-----------------|-------------|--------|
| Number of Lanes | Pedestrians |        |
|                 | Total*      | Peak   |
| AM Peak         | PM Peak     | Total* |
| ( )             | ( )         | ( )    |

**\*Entire Count Period**

**DIRECTIONAL TRAFFIC COUNT**

Dist \_\_\_\_\_ Co \_\_\_\_\_ Rte \_\_\_\_\_ PM \_\_\_\_\_

Intersection Give Name \_\_\_\_\_

City \_\_\_\_\_

Day \_\_\_\_\_ Date \_\_\_\_\_

Hour \_\_\_\_\_ to Hour \_\_\_\_\_

Total Volume \_\_\_\_\_

AM Peak \_\_\_\_\_

Hour \_\_\_\_\_ Volume \_\_\_\_\_

PM Peak \_\_\_\_\_

Hour \_\_\_\_\_ Volume \_\_\_\_\_



**Table 4C-1. Warrant 1, Eight-Hour Vehicular Volume**

**Condition A—Minimum Vehicular Volume**

| Number of lanes for moving traffic on each approach |              | Vehicles per hour on major street (total of both approaches) |                  |                  |                  | Vehicles per hour on higher-volume minor-street approach (one direction only) |                  |                  |                  |
|---|--------------|--|------------------|------------------|------------------|---|------------------|------------------|------------------|
| Major Street  | Minor Street | 100% <sup>a</sup>  | 80% <sup>b</sup> | 70% <sup>c</sup> | 56% <sup>d</sup> | 100% <sup>a</sup>   | 80% <sup>b</sup> | 70% <sup>c</sup> | 56% <sup>d</sup> |
| 1   | 1            | 500  | 400              | 350              | 280              | 150   | 120              | 105              | 84               |
| 2 or more   | 1            | 600  | 480              | 420              | 336              | 150   | 120              | 105              | 84               |
| 2 or more   | 2 or more    | 600  | 480              | 420              | 336              | 200   | 160              | 140              | 112              |
| 1   | 2 or more    | 500  | 400              | 350              | 280              | 200   | 160              | 140              | 112              |

**Condition B—Interruption of Continuous Traffic**

| Number of lanes for moving traffic on each approach |              | Vehicles per hour on major street (total of both approaches) |                  |                  |                  | Vehicles per hour on higher-volume minor-street approach (one direction only) |                  |                  |                  |
|---|--------------|--|------------------|------------------|------------------|---|------------------|------------------|------------------|
| Major Street  | Minor Street | 100% <sup>a</sup>  | 80% <sup>b</sup> | 70% <sup>c</sup> | 56% <sup>d</sup> | 100% <sup>a</sup>   | 80% <sup>b</sup> | 70% <sup>c</sup> | 56% <sup>d</sup> |
| 1   | 1            | 750  | 600              | 525              | 420              | 75  | 60               | 53               | 42               |
| 2 or more   | 1            | 900  | 720              | 630              | 504              | 75  | 60               | 53               | 42               |
| 2 or more   | 2 or more    | 900  | 720              | 630              | 504              | 100   | 80               | 70               | 56               |
| 1   | 2 or more    | 750  | 600              | 525              | 420              | 100   | 80               | 70               | 56               |

<sup>a</sup> Basic minimum hourly volume

<sup>b</sup> Used for combination of Conditions A and B after adequate trial of other remedial measures

<sup>c</sup> May be used when the major-street speed exceeds 40 mph or in an isolated community with a population of less than 10,000

<sup>d</sup> May be used for combination of Conditions A and B after adequate trial of other remedial measures when the major-street speed exceeds 40 mph or in an isolated community with a population of less than 10,000

**Table 4C-2. Warrant 9, Adjustment Factor for Daily Frequency of Rail Traffic**

| Rail Traffic per Day | Adjustment Factor |
|----------------------|-------------------|
| 1                    | 0.67              |
| 2                    | 0.91              |
| 3 to 5               | 1.00              |
| 6 to 8               | 1.18              |
| 9 to 11              | 1.25              |
| 12 or more           | 1.33              |

**Table 4C-3. Warrant 9, Adjustment Factor for Percentage of High-Occupancy Buses**

| % of High-Occupancy Buses* on Minor-Street Approach | Adjustment Factor |
|---|-------------------|
| 0%  | 1.00              |
| 2%  | 1.09              |
| 4%  | 1.19              |
| 6% or more  | 1.32              |

\* A high-occupancy bus is defined as a bus occupied by at least 20 people.

**Table 4C-4. Warrant 9, Adjustment Factor for Percentage of Tractor-Trailer Trucks**

| % of Tractor-Trailer Trucks on Minor-Street Approach | Adjustment Factor   |                      |
|--|---------------------|----------------------|
|  | D less than 70 feet | D of 70 feet or more |
| 0% to 2.5%   | 0.50                | 0.50                 |
| 2.6% to 7.5%   | 0.75                | 0.75                 |
| 7.6% to 12.5%  | 1.00                | 1.00                 |
| 12.6% to 17.5%                                       | 2.30                | 1.15                 |
| 17.6% to 22.5%                                       | 2.70                | 1.35                 |
| 22.6% to 27.5%                                       | 3.28                | 1.64                 |
| More than 27.5%                                      | 4.18                | 2.09                 |





## CHAPTER 4D. TRAFFIC CONTROL SIGNAL FEATURES

### Section 4D.01 General

#### Support:

01 The features of traffic control signals of interest to road users are the location, design, and meaning of the signal indications. Uniformity in the design features that affect the traffic to be controlled, as set forth in this Manual, is especially important for the safety and efficiency of operations.

02 Traffic control signals can be operated in pre-timed, semi-actuated, or full-actuated modes. For isolated (non-interconnected) signalized locations on rural high-speed highways, full-actuated mode with advance vehicle detection on the high-speed approaches is typically used. These features are designed to reduce the frequency with which the onset of the yellow change interval is displayed when high-speed approaching vehicles are in the "dilemma zone" such that the drivers of these high-speed vehicles find it difficult to decide whether to stop or proceed.

#### Standard:

03 **When a traffic control signal is not in operation, such as before it is placed in service, during seasonal shutdowns, or when it is not desirable to operate the traffic control signal, the signal faces shall be covered, turned, or taken down to clearly indicate that the traffic control signal is not in operation.**

#### Support:

04 Seasonal shutdown is a condition in which a permanent traffic signal is turned off or otherwise made non-operational during a particular season when its operation is not justified. This might be applied in a community where tourist traffic during most of the year justifies the permanent signalization, but a seasonal shutdown of the signal during an annual period of lower tourist traffic would reduce delays; or where a major traffic generator, such as a large factory, justifies the permanent signalization, but the large factory is shut down for an annual factory vacation for a few weeks in the summer.

#### Standard:

05 **A traffic control signal shall control traffic only at the intersection or midblock location where the signal faces are placed.**

06 **Midblock crosswalks shall not be signalized if they are located within 300 feet from the nearest traffic control signal, unless the proposed traffic control signal will not restrict the progressive movement of traffic.**

#### Guidance:

07 *A midblock crosswalk location should not be controlled by a traffic control signal if the crosswalk is located within 100 feet from side streets or driveways that are controlled by STOP signs or YIELD signs.*

08 *Engineering judgment should be used to determine the proper phasing and timing for a traffic control signal. Since traffic flows and patterns change, phasing and timing should be reevaluated regularly and updated if needed.*

09 *Traffic control signals within 1/2 mile of one another along a major route or in a network of intersecting major routes should be coordinated, preferably with interconnected controller units. Where traffic control signals that are within 1/2 mile of one another along a major route have a jurisdictional boundary or a boundary between different signal systems between them, coordination across the boundary should be considered.*

#### Support:

10 Signal coordination need not be maintained between control sections that operate on different cycle lengths.

11 For coordination with grade crossing signals and movable bridge signals, see Sections 4D.27, 4J.03, 8C.09, and 8C.10.

### Section 4D.02 Responsibility for Operation and Maintenance

#### Guidance:

01 *Prior to installing any traffic control signal, the responsibility for the maintenance of the signal and all of the appurtenances, hardware, software, and the timing plan(s) should be clearly established. The responsible agency should provide for the maintenance of the traffic control signal and all of its appurtenances in a competent manner.*

*02 To this end the agency should:*

- A. Keep every controller assembly in effective operation in accordance with its predetermined timing schedule; check the operation of the controller assembly frequently enough to verify that it is operating in accordance with the predetermined timing schedule; and establish a policy to maintain a record of all timing changes and that only authorized persons are permitted to make timing changes;*
- B. Clean the optical system of the signal sections and replace the light sources as frequently as experience proves necessary;*
- C. Clean and service equipment and other appurtenances (i.e. cameras and preemption devices) as frequently as experience proves necessary;*
- D. Provide for alternate operation of the traffic control signal during a period of failure, using flashing mode or manual control, or manual traffic direction by proper authorities as might be required by traffic volumes or congestion, or by erecting other traffic control devices;*
- E. Have properly skilled maintenance personnel available without undue delay for all signal malfunctions and signal indication failures;*
- F. Provide spare equipment to minimize the interruption of traffic control signal operation as a result of equipment failure;*
- G. Provide for the availability of properly skilled maintenance personnel for the repair of all components; and*
- H. Maintain the appearance of the signal displays and equipment.*

**Support:**

*03 Caltrans is responsible for the operation of all State highway traffic signals, regardless of whether the signal is maintained by the State or by others.*

**Standard:**

*04 State highway traffic signals shall include, but are not necessarily limited to, all signals on a State highway and at ramp connections to local streets.*

*05 Maintenance and operation of highway traffic signals involving State Highways by an agency other than Caltrans shall require a jointly approved written agreement.*

### **Section 4D.03 Provisions for Pedestrians**

**Support:**

*01 Chapter 4E contains additional information regarding pedestrian signals and Chapter 4F contains additional information regarding pedestrian hybrid beacons.*

**Standard:**

*02 The design and operation of traffic control signals shall take into consideration the needs of pedestrian as well as vehicular traffic.*

*03 If engineering judgment indicates the need for provisions for a given pedestrian movement, signal faces conveniently visible to pedestrians shall be provided by pedestrian signal heads (see Chapter 4E) or a vehicular signal face(s) for a concurrent vehicular movement.*

**Guidance:**

*04 Accessible pedestrian signals (see Sections 4E.09 through 4E.13) that provide information in non-visual formats (such as audible tones, speech messages, and/or vibrating surfaces) should be provided where determined appropriate by engineering judgment.*

*05 Where pedestrian movements regularly occur, pedestrians should be provided with sufficient time to cross the roadway by adjusting the traffic control signal operation and timing to provide sufficient crossing time every cycle or by providing pedestrian detectors.*

*06 If it is necessary or desirable to prohibit certain pedestrian movements at a traffic control signal location, No Pedestrian Crossing (R9-3) signs (see Section 2B.51) should be used if it is not practical to provide a barrier or other physical feature to physically prevent the pedestrian movements.*

## **Section 4D.04 Meaning of Vehicular Signal Indications**

### **Support:**

<sup>01</sup> The “Uniform Vehicle Code” (see Section 1A.11) is the primary source for the standards for the meaning of vehicular signal indications to both vehicle operators and pedestrians as provided in this Section, and the standards for the meaning of separate pedestrian signal head indications as provided in Section 4E.02.

<sup>02</sup> The physical area that is defined as being “within the intersection” is dependent upon the conditions that are described in the definition of intersection in Section 1A.13.

### **Standard:**

<sup>03</sup> **The following meanings shall be given to highway traffic signal indications for vehicles and pedestrians:**

#### **A. Steady green signal indications shall have the following meanings:**

- 1. Vehicular traffic facing a CIRCULAR GREEN signal indication is permitted to proceed straight through or turn right or left or make a U-turn movement except as such movement is modified by lane-use signs, turn prohibition signs, lane markings, roadway design, separate turn signal indications, or other traffic control devices.**

Such vehicular traffic, including vehicles turning right or left or making a U-turn movement, shall yield the right-of-way to:

- (a) Pedestrians lawfully within an associated crosswalk, and**
- (b) Other vehicles lawfully within the intersection.**

In addition, vehicular traffic turning left or making a U-turn movement to the left shall yield the right-of-way to other vehicles approaching from the opposite direction so closely as to constitute an immediate hazard during the time when such turning vehicle is moving across or within the intersection.

- 2. Vehicular traffic facing a GREEN ARROW signal indication, displayed alone or in combination with another signal indication, is permitted to cautiously enter the intersection only to make the movement indicated by such arrow, or such other movement as is permitted by other signal indications displayed at the same time.**

Such vehicular traffic, including vehicles turning right or left or making a U-turn movement, shall yield the right-of-way to:

- (a) Pedestrians lawfully within an associated crosswalk, and**
- (b) Other vehicles lawfully within the intersection.**

- 3. Pedestrians facing a CIRCULAR GREEN signal indication, unless otherwise directed by a pedestrian signal indication or other traffic control device, are permitted to proceed across the roadway within any marked or unmarked associated crosswalk. The pedestrian shall yield the right-of-way to vehicles lawfully within the intersection or so close as to create an immediate hazard at the time that the green signal indication is first displayed.**

- 4. Pedestrians facing a GREEN ARROW signal indication, unless otherwise directed by a pedestrian signal indication or other traffic control device, shall not cross the roadway.**

#### **B. Steady yellow signal indications shall have the following meanings:**

- 1. Vehicular traffic facing a steady CIRCULAR YELLOW signal indication is thereby warned that the related green movement or the related flashing arrow movement is being terminated or that a steady red signal indication will be displayed immediately thereafter when vehicular traffic shall not enter the intersection. The rules set forth concerning vehicular operation under the movement(s) being terminated shall continue to apply while the steady CIRCULAR YELLOW signal indication is displayed.**
- 2. Vehicular traffic facing a steady YELLOW ARROW signal indication is thereby warned that the related GREEN ARROW movement or the related flashing arrow movement is being terminated. The rules set forth concerning vehicular operation under the movement(s) being terminated shall continue to apply while the steady YELLOW ARROW signal indication is displayed.**
- 3. Pedestrians facing a steady CIRCULAR YELLOW or YELLOW ARROW signal indication, unless otherwise directed by a pedestrian signal indication or other traffic control device shall not start to cross the roadway.**

**C. Steady red signal indications shall have the following meanings:**

- 1. Vehicular traffic facing a steady CIRCULAR RED signal indication, unless entering the intersection to make another movement permitted by another signal indication, shall stop at a clearly marked stop line; but if there is no stop line, traffic shall stop before entering the crosswalk on the near side of the intersection; or if there is no crosswalk, then before entering the intersection; and shall remain stopped until a signal indication to proceed is displayed, or as provided below. Except when a traffic control device is in place prohibiting a turn on red or a steady RED ARROW signal indication is displayed, vehicular traffic facing a steady CIRCULAR RED signal indication is permitted to enter the intersection to turn right, or to turn left from a one-way street into a one-way street, after stopping. The right to proceed with the turn shall be subject to the rules applicable after making a stop at a STOP sign.**
- 2. Vehicular traffic facing a steady RED ARROW signal indication shall not enter the intersection to make the movement indicated by the arrow and, unless entering the intersection to make another movement permitted by another signal indication, shall stop at a clearly marked stop line; but if there is no stop line, before entering the crosswalk on the near side of the intersection; or if there is no crosswalk, then before entering the intersection; and shall remain stopped until a signal indication or other traffic control device permitting the movement indicated by such RED ARROW is displayed.**

~~When a traffic control device is in place permitting a turn on a steady RED ARROW signal indication, vehicular traffic facing a steady RED ARROW signal indication is permitted to enter the intersection to make the movement indicated by the arrow signal indication, after stopping. The right to proceed with the turn shall be limited to the direction indicated by the arrow and shall be subject to the rules applicable after making a stop at a STOP sign.~~ **The R10-17a sign shall not be used in California. Turning on a steady red arrow is not permitted in California.**

- 3. Unless otherwise directed by a pedestrian signal indication or other traffic control device, pedestrians facing a steady CIRCULAR RED or steady RED ARROW signal indication shall not enter the roadway.**

**D. A flashing green signal indication has no meaning and shall not be used.**

**E. Flashing yellow signal indications shall have the following meanings:**

- 1. Vehicular traffic, on an approach to an intersection, facing a flashing CIRCULAR YELLOW signal indication is permitted to cautiously enter the intersection to proceed straight through or turn right or left or make a U-turn except as such movement is modified by lane-use signs, turn prohibition signs, lane markings, roadway design, separate turn signal indications, or other traffic control devices.**

Such vehicular traffic, including vehicles turning right or left or making a U-turn, shall yield the right-of-way to:

- (a) Pedestrians lawfully within an associated crosswalk, and**
- (b) Other vehicles lawfully within the intersection.**

In addition, vehicular traffic turning left or making a U-turn to the left shall yield the right-of-way to other vehicles approaching from the opposite direction so closely as to constitute an immediate hazard during the time when such turning vehicle is moving across or within the intersection.

- 2. Vehicular traffic, on an approach to an intersection, facing a flashing YELLOW ARROW signal indication, displayed alone or in combination with another signal indication, is permitted to cautiously enter the intersection only to make the movement indicated by such arrow, or other such movement as is permitted by other signal indications displayed at the same time.**

Such vehicular traffic, including vehicles turning right or left or making a U-turn, shall yield the right-of-way to:

- (a) Pedestrians lawfully within an associated crosswalk, and**
- (b) Other vehicles lawfully within the intersection.**

In addition, vehicular traffic turning left or making a U-turn to the left shall yield the right-of-way to other vehicles approaching from the opposite direction so closely as to constitute an

**immediate hazard during the time when such turning vehicle is moving across or within the intersection.**

- 3. Pedestrians facing any flashing yellow signal indication at an intersection, unless otherwise directed by a pedestrian signal indication or other traffic control device, are permitted to proceed across the roadway within any marked or unmarked associated crosswalk. Pedestrians shall yield the right-of-way to vehicles lawfully within the intersection at the time that the flashing yellow signal indication is first displayed.**
  - 4. When a flashing CIRCULAR YELLOW signal indication(s) is displayed as a beacon (see Chapter 4L) to supplement another traffic control device, road users are notified that there is a need to pay extra attention to the message contained thereon or that the regulatory or warning requirements of the other traffic control device, which might not be applicable at all times, are currently applicable.**
- F. Flashing red signal indications shall have the following meanings:**
- 1. Vehicular traffic, on an approach to an intersection, facing a flashing CIRCULAR RED signal indication shall stop at a clearly marked stop line; but if there is no stop line, before entering the crosswalk on the near side of the intersection; or if there is no crosswalk, at the point nearest the intersecting roadway where the driver has a view of approaching traffic on the intersecting roadway before entering the intersection. The right to proceed shall be subject to the rules applicable after making a stop at a STOP sign.**
  - 2. Vehicular traffic, on an approach to an intersection, facing a flashing RED ARROW signal indication if intending to turn in the direction indicated by the arrow shall stop at a clearly marked stop line; but if there is no stop line, before entering the crosswalk on the near side of the intersection; or if there is no crosswalk, at the point nearest the intersecting roadway where the driver has a view of approaching traffic on the intersecting roadway before entering the intersection. The right to proceed with the turn shall be limited to the direction indicated by the arrow and shall be subject to the rules applicable after making a stop at a STOP sign.**
  - 3. Pedestrians facing any flashing red signal indication at an intersection, unless otherwise directed by a pedestrian signal indication or other traffic control device, are permitted to proceed across the roadway within any marked or unmarked associated crosswalk. Pedestrians shall yield the right-of-way to vehicles lawfully within the intersection at the time that the flashing red signal indication is first displayed.**
  - 4. When a flashing CIRCULAR RED signal indication(s) is displayed as a beacon (see Chapter 4L) to supplement another traffic control device, road users are notified that there is a need to pay extra attention to the message contained thereon or that the regulatory requirements of the other traffic control device, which might not be applicable at all times, are currently applicable. Use of this signal indication shall be limited to supplementing STOP (R1-1), DO NOT ENTER (R5-1), or WRONG WAY (R5-1a) signs, and to applications where compliance with the supplemented traffic control device requires a stop at a designated point.**

#### **Section 4D.05 Application of Steady Signal Indications**

##### **Standard:**

- 01 When a traffic control signal is being operated in a steady (stop-and-go) mode, at least one indication in each signal face shall be displayed at any given time.**
- 02 A signal face(s) that controls a particular vehicular movement during any interval of a cycle shall control that same movement during all intervals of the cycle.**
- 03 Steady signal indications shall be applied as follows:**
  - A. A steady CIRCULAR RED signal indication:**
    - 1. Shall be displayed when it is intended to prohibit traffic, except pedestrians directed by a pedestrian signal head, from entering the intersection or other controlled area. Turning after stopping is permitted as stated in Item C.1 in Paragraph 3 of Section 4D.04.**
    - 2. Shall be displayed with the appropriate GREEN ARROW signal indications when it is intended to permit traffic to make a specified turn or turns, and to prohibit traffic from proceeding straight ahead through the intersection or other controlled area, except in protected only mode operation**

(see Sections 4D.19 and 4D.23), or in protected/permissive mode operation with separate turn signal faces (see Sections 4D.20 and 4D.24).

**B. A steady CIRCULAR YELLOW signal indication:**

1. Shall be displayed following a CIRCULAR GREEN or straight-through GREEN ARROW signal indication in the same signal face.
2. Shall not be displayed in conjunction with the change from the CIRCULAR RED signal indication to the CIRCULAR GREEN signal indication.
3. Shall be followed by a CIRCULAR RED signal indication except that, when entering preemption operation, the return to the previous CIRCULAR GREEN signal indication shall be permitted following a steady CIRCULAR YELLOW signal indication (see Section 4D.27).
4. Shall not be displayed to an approach from which drivers are turning left permissively or making a U-turn to the left permissively unless one of the following conditions exists:
  - (a) A steady CIRCULAR YELLOW signal indication is also simultaneously being displayed to the opposing approach;
  - (b) ~~An engineering study has determined that, because of unique intersection conditions, the condition described in Item (a) cannot reasonably be implemented without causing significant operational or safety problems and that the volume of impacted left-turning or U-turning traffic is relatively low, and those left-turning or U-turning drivers are advised that a steady CIRCULAR YELLOW signal indication is not simultaneously being displayed to the opposing traffic if this operation occurs continuously by the installation near the left-most signal head of a W25-1 sign (see Section 2C.48) with the legend ONCOMING TRAFFIC HAS EXTENDED GREEN; or W25-1 sign shall not be used in California.~~
  - (c) ~~Drivers are advised of the operation if it occurs only occasionally, such as during a preemption sequence, by the installation near the left-most signal head of a W25-2 sign (see Section 2C.48) with the legend ONCOMING TRAFFIC MAY HAVE EXTENDED GREEN. W25-2 sign shall not be used in California~~

**C. A steady CIRCULAR GREEN signal indication shall be displayed only when it is intended to permit traffic to proceed in any direction that is lawful and practical.**

**D. A steady RED ARROW signal indication shall be displayed when it is intended to prohibit traffic, except pedestrians directed by a pedestrian signal head, from entering the intersection or other controlled area to make the indicated turn. ~~Except as described in Item C.2 in Paragraph 3 of Section 4D.04,~~ turning on a steady RED ARROW signal indication shall not be permitted.**

**E. A steady YELLOW ARROW signal indication:**

1. Shall be displayed in the same direction as a GREEN ARROW signal indication following a GREEN ARROW signal indication in the same signal face, unless:
  - (a) The GREEN ARROW signal indication and a CIRCULAR GREEN (or straight-through GREEN ARROW) signal indication terminate simultaneously in the same signal face, or
  - (b) The green arrow is a straight-through GREEN ARROW (see Item B.1).
2. Shall be displayed in the same direction as a flashing YELLOW ARROW signal indication or flashing RED ARROW signal indication following a flashing YELLOW ARROW signal indication or flashing RED ARROW signal indication in the same signal face, when the flashing arrow indication is displayed as part of a steady mode operation, if the signal face will subsequently display a steady red signal indication.
3. Shall not be displayed in conjunction with the change from a steady RED ARROW, flashing RED ARROW, or flashing YELLOW ARROW signal indication to a GREEN ARROW signal indication, except when entering preemption operation as provided in Item 5(a).
4. Shall not be displayed when any conflicting vehicular movement has a green or yellow signal indication (~~except for the situation regarding U-turns to the left provided in Paragraph 4~~) or any conflicting pedestrian movement has a WALKING PERSON (symbolizing WALK) or flashing UPRAISED HAND (symbolizing DONT WALK) signal indication, except that a steady left-turn (or U-turn to the left) YELLOW ARROW signal indication used to terminate a flashing left-turn (or U-turn to the left) YELLOW ARROW or a flashing left-turn (or U-turn to the left) RED ARROW signal indication in a signal face controlling a permissive left-turn (or U-turn to the left)

movement as described in Sections 4D.18 and 4D.20 shall be permitted to be displayed when a CIRCULAR YELLOW signal indication is displayed for the opposing through movement. Vehicles departing in the same direction shall not be considered in conflict if, for each turn lane with moving traffic, there is a separate departing lane, and pavement markings or raised channelization clearly indicate which departure lane to use.

5. Shall not be displayed to terminate a flashing arrow signal indication on an approach from which drivers are turning left permissively or making a U-turn to the left permissively unless one of the following conditions exists:
  - (a) A steady CIRCULAR YELLOW or CIRCULAR RED signal indication is also simultaneously being displayed to the opposing approach;
  - ~~(b) An engineering study has determined that, because of unique intersection conditions, the condition described in Item (a) cannot reasonably be implemented without causing significant operational or safety problems and that the volume of impacted left-turning or U-turning traffic is relatively low, and those left-turning or U-turning drivers are advised that a steady CIRCULAR YELLOW signal indication is not simultaneously being displayed to the opposing traffic if this operation occurs continuously by the installation near the left-most signal head of a W25-1 sign (see Section 2C.48) with the legend ONCOMING TRAFFIC HAS EXTENDED GREEN; or W25-1 sign shall not be used in California.~~
  - ~~(c) Drivers are advised of the operation if it occurs only occasionally, such as during a preemption sequence, by the installation near the left-most signal head of a W25-2 sign (see Section 2C.48) with the legend ONCOMING TRAFFIC MAY HAVE EXTENDED GREEN. W25-2 sign shall not be used in California.~~
6. Shall be terminated by a RED ARROW signal indication for the same direction or a CIRCULAR RED signal indication except:
  - (a) When entering preemption operation, the display of a GREEN ARROW signal indication or a flashing arrow signal indication shall be permitted following a steady YELLOW ARROW signal indication.
  - (b) When the movement controlled by the arrow is to continue on a permissive mode basis during an immediately following CIRCULAR GREEN or flashing YELLOW ARROW signal indication.

**F. A steady GREEN ARROW signal indication:**

1. Shall be displayed only to allow vehicular movements, in the direction indicated, that are not in conflict with other vehicles moving on a green or yellow signal indication and are not in conflict with pedestrians crossing in compliance with a WALKING PERSON (symbolizing WALK) or flashing UPRAISED HAND (symbolizing DONT WALK) signal indication. Vehicles departing in the same direction shall not be considered in conflict if, for each turn lane with moving traffic, there is a separate departing lane, and pavement markings or raised channelization clearly indicate which departure lane to use.
2. Shall be displayed on a signal face that controls a left-turn movement when said movement is not in conflict with other vehicles moving on a green or yellow signal indication (except for the situation regarding U-turns provided in Paragraph 4) and is not in conflict with pedestrians crossing in compliance with a WALKING PERSON (symbolizing WALK) or flashing UPRAISED HAND (symbolizing DONT WALK) signal indication. Vehicles departing in the same direction shall not be considered in conflict if, for each turn lane with moving traffic, there is a separate departing lane, and pavement markings or raised channelization clearly indicate which departure lane to use.
3. Shall not be required on the stem of a T-intersection or for turns from a one-way street.

**Option:**

~~04 If U-turns are permitted from the approach and a right-turn GREEN ARROW signal indication is simultaneously being displayed to road users making a right turn from the conflicting approach to the left, road users making a U-turn may be advised of the operation by the installation near the left-turn signal face of a U-TURN YIELD TO RIGHT TURN (R10-16) sign (see Section 2B.53).~~

**Standard:**

**<sup>04a</sup> When a RIGHT TURN ARROW controls the Right Turn movement, a conflicting U-turn approach shall be prohibited.**

**Option:**

<sup>05</sup> If not otherwise prohibited, a steady straight-through green arrow signal indication may be used instead of a circular green signal indication in a signal face on an approach intersecting a one-way street to discourage wrong-way turns.

<sup>06</sup> If not otherwise prohibited, steady red, yellow, and green turn arrow signal indications may be used instead of steady circular red, yellow, and green signal indications in a signal face on an approach where all traffic is required to turn or where the straight-through movement is not physically possible.

**Support:**

<sup>07</sup> Section 4D.25 contains information regarding the signalization of approaches that have a shared left-turn/right-turn lane and no through movement.

**Standard:**

<sup>08</sup> **If supplemental signal faces are used, the following limitations shall apply:**

**A. Left-turn arrows and U-turn arrows to the left shall not be used in near-right signal faces.**

**B. Right-turn arrows and U-turn arrows to the right shall not be used in far-left signal faces. A far-side median-mounted signal face shall be considered a far-left signal for this application.**

<sup>09</sup> **A straight-through RED ARROW signal indication or a straight-through YELLOW ARROW signal indication shall not be displayed on any signal face, either alone or in combination with any other signal indication.**

<sup>10</sup> **The following combinations of signal indications shall not be simultaneously displayed on any one signal face:**

**A. CIRCULAR RED with CIRCULAR YELLOW;**

**B. CIRCULAR GREEN with CIRCULAR RED; or**

**C. Straight-through GREEN ARROW with CIRCULAR RED;**

<sup>11</sup> **Additionally, the above combinations shall not be simultaneously displayed on an approach as a result of the combination of displays from multiple signal faces unless the display is created by a signal face(s) devoted exclusively to the control of a right-turning movement and:**

**A. The signal face(s) controlling the right-turning movement is visibility-limited from the adjacent through movement or positioned to minimize potential confusion to approaching road users, or**

**B. A RIGHT TURN SIGNAL (R10-10) sign (see Sections 4D.21 through 4D.24) is mounted adjacent to the signal face(s) controlling the right-turning movement.**

<sup>12</sup> **The following combinations of signal indications shall not be simultaneously displayed on any one signal face or as a result of the combination of displays from multiple signal faces on an approach:**

**A. CIRCULAR GREEN with CIRCULAR YELLOW;**

**B. Straight-through GREEN ARROW with CIRCULAR YELLOW;**

**C. GREEN ARROW with YELLOW ARROW pointing in the same direction;**

**D. RED ARROW with YELLOW ARROW pointing in the same direction; or**

**E. GREEN ARROW with RED ARROW pointing in the same direction.**

<sup>13</sup> **Except as otherwise provided in Sections 4F.03 and 4G.04, the same signal section shall not be used to display both a flashing yellow and a steady yellow indication during steady mode operation. Except as otherwise provided in Sections 4D.18, 4D.20, 4D.22, and 4D.24, the same signal section shall not be used to display both a flashing red and a steady red indication during steady mode operation.**

**Guidance:**

<sup>14</sup> *No movement that creates an unexpected crossing of pathways of moving vehicles or pedestrians should be allowed during any green or yellow interval, except when all three of the following conditions are met:*

*A. The movement involves only slight conflict, and*

*B. Serious traffic delays are substantially reduced by permitting the conflicting movement, and*

*C. Drivers and pedestrians subjected to the unexpected conflict are effectively warned thereof by a sign.*



## **Section 4D.06 Signal Indications – Design, Illumination, Color, and Shape**

### **Standard:**

- 01 Each signal indication, except those used for pedestrian signal heads and lane-use control signals, shall be circular or arrow.**
- 02 Letters or numbers (including those associated with countdown displays) shall not be displayed as part of a vehicular signal indication.**
- 03 Strobes shall not be used within or adjacent to any signal indication.**
- 04 Except for the flashing signal indications and the pre-emption confirmation lights that are expressly allowed by the provisions of this Chapter, flashing displays shall not be used within or adjacent to any signal indications.**
- 05 Each circular signal indication shall emit a single color: red, yellow, or green.**
- 06 Each arrow signal indication shall emit a single color: red, yellow, or green except that the alternate display (dual-arrow signal section) of a GREEN ARROW and a YELLOW ARROW signal indication, both pointing in the same direction, shall be permitted, provided that they are not displayed simultaneously.**
- 07 The arrow, which shall show only one direction, shall be the only illuminated part of an arrow signal indication.**
- 08 Arrows shall be pointed:**
  - A. Vertically upward to indicate a straight-through movement, or**
  - B. Horizontally in the direction of the turn to indicate a turn at approximately or greater than a right angle, or**
  - C. Upward with a slope at an angle approximately equal to that of the turn if the angle of the turn is substantially less than a right angle, or**
  - D. In a manner that directs the driver through the turn if a U-turn arrow is used (see Figure 4D-1).**
- 09 Except as provided in Paragraph 10, the requirements of the publication entitled “Vehicle Traffic Control Signal Heads” (see Section 1A.11) that pertain to the aspects of the signal head design that affect the display of the signal indications shall be met.**

### *Guidance:*

*10 The intensity and distribution of light from each illuminated signal lens should comply with the publications entitled “Vehicle Traffic Control Signal Heads” and “Traffic Signal Lamps” (see Section 1A.11).*

### **Standard:**

- 11 References to signal lenses in this section shall not be used to limit signal optical units to incandescent lamps within optical assemblies that include lenses.**

### *Support:*

*12 Research has resulted in signal optical units that are not lenses, such as, but not limited to, light emitting diode (LED) traffic signal modules. Some units are practical for all signal indications, and some are practical for specific types such as visibility-limited signal indications.*

### *Guidance:*

*13 If a signal indication is so bright that it causes excessive glare during nighttime conditions, some form of automatic dimming should be used to reduce the brilliance of the signal indication.*

## **Section 4D.07 Size of Vehicular Signal Indications**

### **Standard:**

- 01 There shall be two nominal diameter sizes for vehicular signal indications: 8 inches and 12 inches.**
- 02 Except as provided in Paragraph 3 below, 12-inch signal indications shall be used for all signal sections in all new signal faces.**

### *Option:*

- 03 Eight-inch circular signal indications may be used in new signal faces only for:*
  - A. The green or flashing yellow signal indications in an emergency-vehicle traffic control signal (see Section 4G.02);*
  - B. The circular indications in signal faces controlling the approach to the downstream location where two adjacent signalized locations are close to each other and it is not practical because of factors such as high*

approach speeds, horizontal or vertical curves, or other geometric factors to install visibility-limited signal faces for the downstream approach;

- C. The circular indications in a signal face that is located less than 120 feet from the stop line on a roadway with a posted or statutory speed limit of 30 mph or less;
- D. The circular indications in a supplemental near-side signal face;
- E. The circular indications in a supplemental signal face installed for the sole purpose of controlling pedestrian movements (see Section 4D.03) rather than vehicular movements; and
- F. The circular indications in a signal face installed for the sole purpose of controlling a bikeway or a bicycle movement.

<sup>04</sup> Existing 8-inch circular signal indications that are not included in Items A through F in Paragraph 3 may be retained for the remainder of their useful service life.

### **Section 4D.08 Positions of Signal Indications Within a Signal Face – General**

Support:

<sup>01</sup> Standardization of the number and arrangements of signal sections in vehicular traffic control signal faces enables road users who are color vision deficient to identify the illuminated color by its position relative to other signal sections.

**Standard:**

<sup>02</sup> **Unless otherwise provided in this Manual for a particular application, each signal face at a signalized location shall have three, four, or five signal sections. Unless otherwise provided in this Manual for a particular application, if a vertical signal face includes a cluster (see Section 4D.09), the signal face shall have at least three vertical positions.**

<sup>03</sup> **A single-section signal face shall be permitted at a traffic control signal if it consists of a continuously-displayed GREEN ARROW signal indication that is being used to indicate a continuous movement.**

<sup>04</sup> **The signal sections in a signal face shall be arranged in a vertical or horizontal straight line, except as otherwise provided in Section 4D.09.**

<sup>05</sup> **The arrangement of adjacent signal sections in a signal face shall follow the relative positions listed in Sections 4D.09 or 4D.10, as applicable.**

<sup>06</sup> **If a signal section that displays a CIRCULAR YELLOW signal indication is used, it shall be located between the signal section that displays the red signal indication and all other signal sections.**

<sup>07</sup> **If a U-turn arrow signal section is used in a signal face for a U-turn to the left, its position in the signal face shall be the same as stated in Sections 4D.09 and 4D.10 for a left-turn arrow signal section of the same color. If a U-turn arrow signal section is used in a signal face for a U-turn to the right, its position in the signal face shall be the same as stated in Sections 4D.09 and 4D.10 for a right-turn arrow signal section of the same color.**

<sup>08</sup> **A U-turn arrow signal indication pointing to the left shall not be used in a signal face that also contains a left-turn arrow signal indication. A U-turn arrow signal indication pointing to the right shall not be used in a signal face that also contains a right-turn arrow signal indication.**

Option:

<sup>09</sup> Within a signal face, two identical CIRCULAR RED or RED ARROW signal indications may be displayed immediately horizontally adjacent to each other in a vertical or horizontal signal face (see Figure 4D-2) for emphasis.

<sup>10</sup> Horizontally-arranged and vertically-arranged signal faces may be used on the same approach provided they are separated to meet the lateral separation spacing required in Section 4D.13.

Support:

<sup>11</sup> Figure 4D-2 illustrates some of the typical arrangements of signal sections in signal faces that do not control separate turning movements. Figures 4D-6 through 4D-12 illustrate the typical arrangements of signal sections in left-turn signal faces. Figures 4D-13 through 4D-19 illustrate the typical arrangements of signal sections in right-turn signal faces.

**Standard:**

- <sup>12</sup> **There shall be at least two signal faces for each movement on each signal-controlled approach.**

*Guidance:*

*13 Supplemental signal faces should be considered if any of the following conditions exist:*

- A. The area is rural.*
- B. The area is urban and the signal is the first one on a particular highway.*
- C. The roadway is striped for two or more approach lanes.*
- D. Where visibility of the signal is affected by alignment or obstructions.*

*Support:*

*14 On an undivided roadway, the signal faces for each through approach of an intersection are usually placed at the far right and far left corners.*

*Option:*

*15 The signal faces for two or more approaches may be combined on a single standard.*

*Support:*

*16 It is generally desirable to locate the signal faces on separate standards at curb returns. This practice will tend to maximize the visibility of the signal faces for the controlled approach while minimizing the visibility of the signal faces intended for the cross-street approach.*

*Guidance:*

*17 Separate standards should be considered whenever the curb return radius is greater than 10 feet.*

*18 The preferred locations for new installations of signal faces for fully-protected left turn movements at a typical intersection are on a mast arm of sufficient length to place one signal face as nearly as practical in line with the left turn lane and to place the second face on a standard at the far left corner.*

*Option:*

*19 Unusual roadway geometrics, wide medians, wide roadways, more than one left turn lane in the same direction or other factors may require the left turn signal face(s) to be mounted on standard(s) located in a median to satisfy visibility requirements.*

*20 A signal face, containing a circular green indication, may be located in a far median only when:*

- A. The signal phasing provides a protected left turn movement; or*
- B. The signal face is provided with some type of visibility control so that the indications are not visible to traffic in the left turn storage lane; or*
- C. It is not facing a left turn storage lane; or*
- D. LEFT TURN YIELD ON GREEN (symbolic circular green) (R10-12) sign is installed below the said signal face.*

*21 A signal face containing a circular green indication may be located in the near median where there is a left turn storage lane and there is no associated left turn phase.*

*22 Supplemental signal faces may be placed at a near side location or suspended from a mast arm.*

#### **Section 4D.09 Positions of Signal Indications Within a Vertical Signal Face**

**Standard:**

**01 In each vertically-arranged signal face, all signal sections that display red signal indications shall be located above all signal sections that display yellow and green signal indications.**

**02 In vertically-arranged signal faces, each signal section that displays a YELLOW ARROW signal indication shall be located above the signal section that displays the GREEN ARROW signal indication to which it applies.**

**03 The relative positions of signal sections in a vertically-arranged signal face, from top to bottom, shall be as follows:**

**CIRCULAR RED**

**Steady and/or flashing left-turn RED ARROW**

**Steady and/or flashing right-turn RED ARROW**

**CIRCULAR YELLOW**

**CIRCULAR GREEN**

**Straight-through GREEN ARROW**

**Steady left-turn YELLOW ARROW**

**Flashing left-turn YELLOW ARROW**

**Left-turn GREEN ARROW**

**Steady right-turn YELLOW ARROW**  
**Flashing right-turn YELLOW ARROW**  
**Right-turn GREEN ARROW**

<sup>04</sup> If a dual-arrow signal section (capable of alternating between the display of a GREEN ARROW and a YELLOW ARROW signal indication) is used in a vertically-arranged signal face, the dual-arrow signal section shall occupy the same position relative to the other sections as the signal section that displays the GREEN ARROW signal indication in a vertically-arranged signal face would occupy.

Option:

<sup>05</sup> In a vertically-arranged signal face, signal sections that display signal indications of the same color may be arranged horizontally adjacent to each other at right angles to the basic straight line arrangement to form a clustered signal face (see Figures 4D-2, 4D-8, 4D-9, 4D-11, 4D-15, 4D-16, and 4D-18, and 4D-20).

**Standard:**

<sup>06</sup> Such clusters shall be limited to the following:

- A. Two identical signal sections,
- B. Two or three different signal sections that display signal indications of the same color, or
- C. For only the specific case described in Section 4D.25 (see Drawing B of Figure 4D-20), two signal sections, one of which displays a GREEN ARROW signal indication and the other of which displays a flashing YELLOW ARROW signal indication.

<sup>07</sup> The signal section that displays a flashing yellow signal indication during steady mode operation:

- A. Shall not be placed in the same vertical position as the signal section that displays a steady yellow signal indication, and
- B. Shall be placed below the signal section that displays a steady yellow signal indication.

Support:

<sup>08</sup> Sections 4F.02 and 4G.04 contain exceptions to the provisions of this Section that are applicable to hybrid beacons.

**Section 4D.10 Positions of Signal Indications Within a Horizontal Signal Face**

**Standard:**

<sup>01</sup> In each horizontally-arranged signal face, all signal sections that display red signal indications shall be located to the left of all signal sections that display yellow and green signal indications.

<sup>02</sup> In horizontally-arranged signal faces, each signal section that displays a YELLOW ARROW signal indication shall be located to the left of the signal section that displays the GREEN ARROW signal indication to which it applies.

<sup>03</sup> The relative positions of signal sections in a horizontally-arranged signal face, from left to right, shall be as follows:

**CIRCULAR RED**

**Steady and/or flashing left-turn RED ARROW**  
**Steady and/or flashing right-turn RED ARROW**

**CIRCULAR YELLOW**

**Steady left-turn YELLOW ARROW**  
**Flashing left-turn YELLOW ARROW**  
**Left-turn GREEN ARROW**

**CIRCULAR GREEN**

**Straight-through GREEN ARROW**  
**Steady right-turn YELLOW ARROW**  
**Flashing right-turn YELLOW ARROW**  
**Right-turn GREEN ARROW**

<sup>04</sup> If a dual-arrow signal section (capable of alternating between the display of a GREEN ARROW and a YELLOW ARROW signal indication) is used in a horizontally-arranged signal face, the signal section that displays the dual left-turn arrow signal indication shall be located immediately to the right of the signal section that displays the CIRCULAR YELLOW signal indication, the signal section that displays the straight-through GREEN ARROW signal indication shall be located immediately to the right of the signal

**section that displays the CIRCULAR GREEN signal indication, and the signal section that displays the dual right-turn arrow signal indication shall be located to the right of all other signal sections.**

**05 The signal section that displays a flashing yellow signal indication during steady mode operation:**

- A. Shall not be placed in the same horizontal position as the signal section that displays a steady yellow signal indication, and**
- B. Shall be placed to the right of the signal section that displays a steady yellow signal indication.**

#### **Section 4D.11 Number of Signal Faces on an Approach**

**Standard:**

**01 The signal faces for each approach to an intersection or a midblock location shall be provided as follows:**

- A. If a signalized through movement exists on an approach, a minimum of two primary signal faces shall be provided for the through movement. If a signalized through movement does not exist on an approach, a minimum of two primary signal faces shall be provided for the signalized turning movement that is considered to be the major movement from the approach (also see Section 4D.25).**
- B. See Sections 4D.17 through 4D.20 for left-turn (and U-turn to the left) signal faces.**
- C. See Sections 4D.21 through 4D.24 for right-turn (and U-turn to the right) signal faces.**

**Option:**

**02 Where a movement (or a certain lane or lanes) at the intersection never conflicts with any other signalized vehicular or pedestrian movement, a continuously-displayed single-section GREEN ARROW signal indication may be used to inform road users that the movement is free-flow and does not need to stop.**

**Support:**

**03 In some circumstances where the through movement never conflicts with any other signalized vehicular or pedestrian movement at the intersection, such as at T-intersections with appropriate geometrics and/or pavement markings and signing, an engineering study might determine that the through movement (or certain lanes of the through movement) can be free-flow and not signalized.**

**Guidance:**

**04 If two or more left-turn lanes are provided for a separately controlled protected only mode left-turn movement, or if a left-turn movement represents the major movement from an approach, two or more primary left-turn signal faces should be provided.**

**05 If two or more right-turn lanes are provided for a separately controlled right-turn movement, or if a right-turn movement represents the major movement from an approach, two or more primary right-turn signal faces should be provided.**

**Support:**

**06 Locating primary signal faces overhead on the far side of the intersection has been shown to ~~provide safer~~ **improve** operation by reducing intersection entries late in the yellow interval and by reducing red signal violations, as compared to post-mounting signal faces at the roadside or locating signal faces overhead within the intersection on a diagonally-oriented mast arm or span wire. On approaches with two or more lanes for the through movement, one signal face per through lane, centered over each through lane, has ~~also been shown to provide safer operation~~ **be effective in reducing excessive red signal violations.****

**Guidance:**

**07 If the posted or statutory speed limit or the 85th-percentile speed on an approach to a signalized location is 45 mph or higher, signal faces should be provided as follows for ~~all~~ **new or reconstructed** signal installations, **where there is a documented pattern of excessive red signal violations** (see Figure 4D-3):**

- A. The minimum number and location of primary (non-supplemental) signal faces for through traffic should be provided in accordance with Table 4D-1.**
- B. If the number of overhead primary signal faces for through traffic is equal to the number of through lanes on an approach, one overhead signal face should be located approximately over the center of each through lane.**
- C. Except for shared left-turn and right-turn signal faces, any primary signal face required by Sections 4D.17 through 4D.25 for an exclusive turn lane should be located overhead approximately over the center of each exclusive turn lane.**

*D. All primary signal faces should be located on the far side of the intersection.*

*E. In addition to the primary signal faces, one or more supplemental pole-mounted or overhead signal faces should be considered to provide added visibility for approaching traffic that is traveling behind large vehicles.*

*F. All signal faces should have backplates.*

*08 This layout of signal faces should also be considered for any major urban or suburban arterial street with four or more lanes and for other approaches with speeds of less than 45 mph.*

## **Section 4D.12 Visibility, Aiming, and Shielding of Signal Faces**

### **Standard:**

**01 The primary consideration in signal face placement, aiming, and adjustment shall be to optimize the visibility of signal indications to approaching traffic.**

**02 Road users approaching a signalized intersection or other signalized area, such as a midblock crosswalk, shall be given a clear and unmistakable indication of their right-of-way assignment.**

**03 The geometry of each intersection to be signalized, including vertical grades, horizontal curves, and obstructions as well as the lateral and vertical angles of sight toward a signal face, as determined by typical driver-eye position, shall be considered in determining the vertical, longitudinal, and lateral position of the signal face.**

### *Guidance:*

*04 The two primary signal faces required as a minimum for each approach should be continuously visible to traffic approaching the traffic control signal, from a point at least the minimum sight distance provided in Table 4D-2 in advance of and measured to the stop line. This range of continuous visibility should be provided unless precluded by a physical obstruction or unless another signalized location is within this range.*

*05 There should be legal authority to prohibit the display of any unauthorized sign, signal, marking, or device that interferes with the effectiveness of any official traffic control device (see Section 11-205 of the "Uniform Vehicle Code").*

*06 At signalized midblock crosswalks, at least one of the signal faces should be over the traveled way for each approach.*

### **Standard:**

**07 If approaching traffic does not have a continuous view of at least two signal faces for at least the minimum sight distance shown in Table 4D-2, a sign (see Section 2C.36) shall be installed to warn approaching traffic of the traffic control signal.**

### *Option:*

*08 If a sign is installed to warn approaching road users of the traffic control signal, the sign may be supplemented by a Warning Beacon (see Section 4L.03).*

*09 A Warning Beacon used in this manner may be interconnected with the traffic signal controller assembly in such a manner as to flash yellow during the period when road users passing this beacon at the legal speed for the roadway might encounter a red signal indication (or a queue resulting from the display of the red signal indication) upon arrival at the signalized location.*

*10 If the sight distance to the signal faces for an approach is limited by horizontal or vertical alignment, supplemental signal faces aimed at a point on the approach at which the signal indications first become visible may be used.*

### *Guidance:*

*11 Supplemental signal faces should be used if engineering judgment has shown that they are needed to achieve intersection visibility both in advance and immediately before the signalized location.*

*12 If supplemental signal faces are used, they should be located to provide optimum visibility for the movement to be controlled.*

### **Standard:**

**13 In cases where irregular street design necessitates placing signal faces for different street approaches with a comparatively small angle between their respective signal indications, each signal indication shall, to the extent practical, be visibility-limited by signal visors, signal louvers, or other means so that an**

**approaching road user's view of the signal indication(s) controlling movements on other approaches is minimized.**

**14 Signal visors exceeding 12 inches in length shall not be used on free-swinging signal faces.**

*Guidance:*

*15 Signal visors should be used on signal faces to aid in directing the signal indication specifically to approaching traffic, as well as to reduce "sun phantom," which can result when external light enters the lens.*

*16 The use of signal visors, or the use of signal faces or devices that direct the light without a reduction in intensity, should be considered as an alternative to signal louvers because of the reduction in light output caused by signal louvers.*

*Option:*

*17 Special signal faces, such as visibility-limited signal faces, may be used such that the road user does not see signal indications intended for other approaches before seeing the signal indications for their own approach, if simultaneous viewing of both signal indications could cause the road user to be misdirected.*

*Guidance:*

*18 If the posted or statutory speed limit or the 85th-percentile speed on an approach to a signalized location is 45 mph or higher, signal backplates should be used on all of the signal faces that face the approach. Signal backplates should also be considered for use on signal faces on approaches with posted or statutory speed limits or 85th-percentile speeds of less than 45 mph where sun glare, bright sky, and/or complex or confusing backgrounds indicate a need for enhanced signal face target value.*

*Support:*

*19 The use of backplates enhances the contrast between the traffic signal indications and their surroundings for both day and night conditions, which is also helpful to older drivers.*

**Standard:**

**20 The inside of signal visors (hoods), the entire surface of louvers and fins, and the front surface of backplates shall have a dull black finish to minimize light reflection and to increase contrast between the signal indication and its background.**

*Option:*

*21 A yellow retroreflective strip with a minimum width of 1 inch and a maximum width of 3 inches may be placed along the perimeter of the face of a signal backplate to project a rectangular appearance at night.*

#### **Section 4D.13 Lateral Positioning of Signal Faces**

**Standard:**

**01 At least one and preferably both of the minimum of two primary signal faces required for the through movement (or the major turning movement if there is no through movement) on the approach shall be located between two lines intersecting with the center of the approach at a point 10 feet behind the stop line, one making an angle of approximately 20 degrees to the right of the center of the approach extended, and the other making an angle of approximately 20 degrees to the left of the center of the approach extended. The signal face that satisfies this requirement shall simultaneously satisfy the longitudinal placement requirement described in Section 4D.14 (see Figure 4D-4).**

**02 If both of the minimum of two primary signal faces required for the through movement (or the major turning movement if there is no through movement) on the approach are post-mounted, they shall both be on the far side of the intersection, one on the right and one on the left of the approach lane(s).**

**03 The required signal faces for through traffic on an approach shall be located not less than 8 feet apart measured horizontally perpendicular to the approach between the centers of the signal faces.**

**04 If more than one separate turn signal face is provided for a turning movement and if one or both of the separate turn signal faces are located over the roadway, the signal faces shall be located not less than 8 feet apart measured horizontally perpendicular to the approach between the centers of the signal faces.**

*Guidance:*

*05 If a signal face controls a specific lane or lanes of an approach, its position should make it readily visible to road users making that movement.*

**Support:**

<sup>06</sup> Section 4D.11 contains additional provisions regarding lateral positioning of signal faces for approaches having a posted or statutory speed limit or an 85th-percentile speed of 45 mph or higher.

**Standard:**

<sup>07</sup> **If an exclusive left-turn, right-turn, or U-turn lane is present on an approach and if a primary separate turn signal face controlling that lane is mounted over the roadway, the primary separate turn signal face shall not be positioned any further to the right than the extension of the right-hand edge of the exclusive turn lane or any further to the left than the extension of the left-hand edge of the exclusive turn lane.**

<sup>08</sup> **Supplemental turn signal faces mounted over the roadway shall not be subject to the positioning requirements in the previous paragraph.**

*Guidance:*

<sup>09</sup> *For new or reconstructed signal installations, on an approach with an exclusive turn lane(s) for a left-turn (or U-turn to the left) movement and with opposing vehicular traffic, signal faces that display a CIRCULAR GREEN signal indication should not be post-mounted on the far-side median or mounted overhead above the exclusive turn lane(s) or the extension of the lane(s).*

**Standard:**

<sup>10</sup> **If supplemental ~~post-mounted~~ signal faces are used, the following limitations shall apply:**

- A. Left-turn arrows and U-turn arrows to the left shall not be used in near-right signal faces.**
- B. Right-turn arrows and U-turn arrows to the right shall not be used in far-left signal faces. A far-side median-mounted signal face shall be considered a far-left signal for this application.**

#### **Section 4D.14 Longitudinal Positioning of Signal Faces**

**Standard:**

<sup>01</sup> **Except where the width of an intersecting roadway or other conditions make it physically impractical, the signal faces for each approach to an intersection or a midblock location shall be provided as follows:**

**A. A signal face installed to satisfy the requirements for primary left-turn signal faces (see Sections 4D.17 through 4D.20) and primary right-turn signal faces (see Sections 4D.21 through 4D.24), and at least one and preferably both of the minimum of two primary signal faces required for the through movement (or the major turning movement if there is no through movement) on the approach shall be located:**

- 1. No less than 40 feet beyond the stop line,**
- 2. No more than 180 feet beyond the stop line unless a supplemental near-side signal face is provided, and**
- 3. As near as practical to the line of the driver's normal view, if mounted over the roadway. The primary signal face that satisfies this requirement shall simultaneously satisfy the lateral placement requirement described in Section 4D.13 (see Figure 4D-4).**

**B. Where the nearest signal face is located between 150 and 180 feet beyond the stop line, engineering judgment of the conditions, including the worst-case visibility conditions, shall be used to determine if the provision of a supplemental near-side signal face would be beneficial.**

**Support:**

<sup>02</sup> Section 4D.11 contains additional provisions regarding longitudinal positioning of signal faces for approaches having a posted or 85th-percentile speed of 45 mph or higher.

*Guidance:*

<sup>03</sup> *Supplemental near-side signal faces should be located as near as practical to the stop line.*

#### **Section 4D.15 Mounting Height of Signal Faces**

**Standard:**

<sup>01</sup> **The top of the signal housing of a vehicular signal face located over any portion of a highway that can be used by motor vehicles shall not be more than 25.6 feet above the pavement.**

<sup>02</sup> **For viewing distances between 40 and 53 feet from the stop line, the maximum mounting height to the top of the signal housing shall be as shown in Figure 4D-5.**



**03 The bottom of the signal housing and any related attachments to a vehicular signal face located over any portion of a highway that can be used by motor vehicles shall be at least 15 feet above the pavement.**

**Guidance:**

*03a The bottom of the signal housing and any related attachments to a vehicular signal face located over a roadway should be at least 17 feet. Refer to Caltrans' Standard Plans publication. See Section 1A.11 for information regarding this publication.*

**Standard:**

**04 The bottom of the signal housing (including brackets) of a vehicular signal face that is vertically arranged and not located over a roadway:**

- A. Shall be a minimum of 8 feet and a maximum of 19 feet above the sidewalk or, if there is no sidewalk, above the pavement grade at the center of the roadway.**
- B. Shall be a minimum of 4.5 feet and a maximum of 19 feet above the median island grade of a center median island if located on the near side of the intersection.**

**05 The bottom of the signal housing (including brackets) of a vehicular signal face that is horizontally arranged and not located over a roadway:**

- A. Shall be a minimum of 8 feet and a maximum of 22 feet above the sidewalk or, if there is no sidewalk, above the pavement grade at the center of the roadway.**
- B. Shall be a minimum of 4.5 feet and a maximum of 22 feet above the median island grade of a center median island if located on the near side of the intersection.**

#### **Section 4D.16 Lateral Offset (Clearance) of Signal Faces**

**Standard:**

**01 Signal faces mounted at the side of a roadway with curbs at less than 15 feet from the bottom of the housing and any related attachments shall have a horizontal offset of not less than 2 feet from the face of a vertical curb, or if there is no curb, not less than 2 feet from the edge of a shoulder.**

#### **Section 4D.17 Signal Indications for Left-Turn Movements – General**

**Standard:**

**01 In Sections 4D.17 through 4D.20, provisions applicable to left-turn movements and left-turn lanes shall also apply to signal indications for U-turns to the left that are provided at locations where left turns are prohibited or not geometrically possible.**

**Support:**

**02 Left-turning traffic is controlled by one of four modes as follows:**

- A. Permissive Only Mode—turns made on a CIRCULAR GREEN signal indication, a flashing left-turn YELLOW ARROW signal indication, or a flashing left-turn RED ARROW signal indication after yielding to pedestrians, if any, and/or opposing traffic, if any.**
- B. Protected Only Mode—turns made only when a left-turn GREEN ARROW signal indication is displayed.**
- C. Protected/Permissive Mode—both modes can occur on an approach during the same cycle.**
- D. Variable Left-Turn Mode—the operating mode changes among the protected only mode and/or the protected/permissive mode and/or the permissive only mode during different periods of the day or as traffic conditions change.**

**Option:**

**03 In areas having a high percentage of older drivers, special consideration may be given to the use of protected only mode left-turn phasing, when appropriate.**

**Standard:**

**04 During a permissive left-turn movement, the signal faces for through traffic on the opposing approach shall simultaneously display green or steady yellow signal indications. If pedestrians crossing the lane or lanes used by the permissive left-turn movement to depart the intersection are controlled by pedestrian signal heads, the signal indications displayed by those pedestrian signal heads shall not be limited to any particular display during the permissive left-turn movement.**

**05 During a protected left-turn movement, the signal faces for through traffic on the opposing approach shall simultaneously display steady CIRCULAR RED signal indications. If pedestrians crossing the lane or**

**lanes used by the protected left-turn movement to depart the intersection are controlled by pedestrian signal heads, the pedestrian signal heads shall display a steady UPRAISED HAND (symbolizing DONT WALK) signal indication during the protected left-turn movement.**

**06 A protected only mode left-turn movement that does not begin and terminate at the same time as the adjacent through movement shall not be provided on an approach unless an exclusive left-turn lane exists.**

**07 A yellow change interval for the left-turn movement shall not be displayed when the status of the left-turn operation is changing from permissive to protected within any given signal sequence.**

**08 If the operating mode changes among the protected only mode and/or the protected/permissive mode and/or the permissive only mode during different periods of the day or as traffic conditions change, the requirements in Sections 4D.18 through 4D.20 that are appropriate to that mode of operation shall be met, subject to the following:**

**A. The CIRCULAR GREEN and CIRCULAR YELLOW signal indications shall not be displayed when operating in the protected only mode.**

**B. The left-turn GREEN ARROW and left-turn YELLOW ARROW signal indications shall not be displayed when operating in the permissive only mode.**

Option:

**09 Additional static signs or changeable message signs may be used to meet the requirements for the variable left-turn mode or to inform drivers that left-turn green arrows will not be available during certain times of the day.**

Support:

**10 Sections 4D.17 through 4D.20 describe the use of the following two types of signal faces for controlling left-turn movements:**

**A. Shared signal face – This type of signal face controls both the left-turn movement and the adjacent movement (usually the through movement) and can serve as one of the two required primary signal faces for the adjacent movement. A shared signal face always displays the same color of circular indication that is displayed by the signal face or faces for the adjacent movement. If a shared signal face that provides protected/permissive mode left turns is mounted overhead at the intersection, it is usually positioned over or slightly to the right of the extension of the lane line separating the left-turn lane from the adjacent lane.**

**B. Separate left-turn signal face – This type of signal face controls only the left-turn movement and cannot serve as one of the two required primary signal faces for the adjacent movement (usually the through movement) because it displays signal indications that are applicable only to the left-turn movement. If a separate left-turn signal face is mounted overhead at the intersection, it is positioned over the extension of the left-turn lane. In a separate left-turn signal face, a flashing left-turn YELLOW ARROW signal indication or a flashing left-turn RED ARROW signal indication is used to control permissive left-turning movements.**

**11 Section 4D.13 contains provisions regarding the lateral positioning of signal faces that control left-turn movements.**

**12 It is not necessary that the same mode of left-turn operation or same type of left-turn signal face be used on every approach to a signalized location. Selecting different modes and types of left-turn signal faces for the various approaches to the same signalized location is acceptable.**

Option:

**13 A signal face that is shared by left-turning and right-turning traffic may be provided for a shared left-turn/right-turn lane on an approach that has no through traffic (see Section 4D.25).**

## **Section 4D.18 Signal Indications for Permissive Only Mode Left-Turn Movements**

**Standard:**

**01 If a shared signal face is provided for a permissive only mode left turn, it shall meet the following requirements (see Figure 4D-6):**

**A. It shall be capable of displaying the following signal indications: steady CIRCULAR RED, steady CIRCULAR YELLOW, and CIRCULAR GREEN. Only one of the three indications shall be displayed at any given time.**

**B. During the permissive left-turn movement, a CIRCULAR GREEN signal indication shall be displayed.**

- C. A permissive only shared signal face, regardless of where it is positioned and regardless of how many adjacent through signal faces are provided, shall always simultaneously display the same color of circular indication that the adjacent through signal face or faces display.**
- D. If the permissive only mode is not the only left-turn mode used for the approach, the signal face shall be the same shared signal face that is used for the protected/permissive mode (see Section 4D.20) except that the left-turn GREEN ARROW and left-turn YELLOW ARROW signal indications shall not be displayed when operating in the permissive only mode.**

<sup>02</sup> If a separate left-turn signal face is being operated in a permissive only left-turns mode, a CIRCULAR GREEN signal indication shall not be used in that face.

<sup>03</sup> If a separate left-turn signal face is being operated in a permissive only left-turn mode and a flashing left-turn YELLOW ARROW signal indication is provided, it shall meet the following requirements (see Figure 4D-7):

- A. It shall be capable of displaying the following signal indications: steady left-turn RED ARROW, steady left-turn YELLOW ARROW, and flashing left-turn YELLOW ARROW. Only one of the three indications shall be displayed at any given time.**
- B. During the permissive left-turn movement, a flashing left-turn YELLOW ARROW signal indication shall be displayed.**
- C. A steady left-turn YELLOW ARROW signal indication shall be displayed following the flashing left-turn YELLOW ARROW signal indication.**
- D. It shall be permitted to display a flashing left-turn YELLOW ARROW signal indication for a permissive left-turn movement while the signal faces for the adjacent through movement display steady CIRCULAR RED signal indications and the opposing left-turn signal faces display left-turn GREEN ARROW signal indications for a protected left-turn movement.**
- E. During steady mode (stop-and-go) operation, the signal section that displays the steady left-turn YELLOW ARROW signal indication during change intervals shall not be used to display the flashing left-turn YELLOW ARROW signal indication for permissive left turns.**
- F. During flashing mode operation (see Section 4D.30), the display of a flashing left-turn YELLOW ARROW signal indication shall be only from the signal section that displays a steady left-turn YELLOW ARROW signal indication during steady mode (stop-and-go) operation.**
- G. If the permissive only mode is not the only left-turn mode used for the approach, the signal face shall be the same separate left-turn signal face with a flashing YELLOW ARROW signal indication that is used for the protected/permissive mode (see Section 4D.20) except that the left-turn GREEN ARROW signal indication shall not be displayed when operating in the permissive only mode.**

Option:

<sup>04</sup> A separate left-turn signal face with a flashing left-turn RED ARROW signal indication during the permissive left-turn movement may be used for unusual geometric conditions, such as wide medians with offset left-turn lanes, but only when an engineering study determines that each and every vehicle must successively come to a full stop before making a permissive left turn.

**Standard:**

<sup>05</sup> If a separate left-turn signal face is being operated in a permissive only left-turn mode and a flashing left-turn RED ARROW signal indication is provided, it shall meet the following requirements (see Figure 4D-8):

- A. It shall be capable of displaying the following signal indications: steady or flashing left-turn RED ARROW, steady left-turn YELLOW ARROW, and left-turn GREEN ARROW. Only one of the three indications shall be displayed at any given time. The GREEN ARROW indication is required in order to provide a three-section signal face, but shall not be displayed during the permissive only mode.**
- B. During the permissive left-turn movement, a flashing left-turn RED ARROW signal indication shall be displayed, thus indicating that each and every vehicle must successively come to a full stop before making a permissive left turn.**
- C. A steady left-turn YELLOW ARROW signal indication shall be displayed following the flashing left-turn RED ARROW signal indication.**
- D. It shall be permitted to display a flashing left-turn RED ARROW signal indication for a permissive left-turn movement while the signal faces for the adjacent through movement display steady**

**CIRCULAR RED signal indications and the opposing left-turn signal faces display left-turn GREEN ARROW signal indications for a protected left-turn movement.**

**E. A supplementary sign shall not be required. ~~If used, it shall be a LEFT TURN YIELD ON FLASHING RED ARROW AFTER STOP (R10-27) sign (see Figure 2B-27).~~**

Option:

<sup>06</sup> The requirements of Item A in Paragraph 5 may be met by a vertically-arranged signal face with a horizontal cluster of two left-turn RED ARROW signal indications, the left-most of which displays a steady indication and the right-most of which displays a flashing indication (see Figure 4D-8).

#### **Section 4D.19 Signal Indications for Protected Only Mode Left-Turn Movements**

**Standard:**

<sup>01</sup> **A shared signal face shall not be used for protected only mode left turns unless the CIRCULAR GREEN and left-turn GREEN ARROW signal indications always begin and terminate together. If a shared signal face is provided for a protected only mode left turn, it shall meet the following requirements (see Figure 4D-9):**

- A. It shall be capable of displaying the following signal indications: steady CIRCULAR RED, steady CIRCULAR YELLOW, CIRCULAR GREEN, and left-turn GREEN ARROW. Only one of the three colors shall be displayed at any given time.**
- B. During the protected left-turn movement, the shared signal face shall simultaneously display both a CIRCULAR GREEN signal indication and a left-turn GREEN ARROW signal indication.**
- C. The shared signal face shall always simultaneously display the same color of circular indication that the adjacent through signal face or faces display.**
- D. If the protected only mode is not the only left-turn mode used for the approach, the signal face shall be the same shared signal face that is used for the protected/permissive mode (see Section 4D.20).**

Option:

<sup>02</sup> A straight-through GREEN ARROW signal indication may be used instead of the CIRCULAR GREEN signal indication in Items A and B in Paragraph 1 on an approach where right turns are prohibited and a straight-through GREEN ARROW signal indication is also used instead of a CIRCULAR GREEN signal indication in the other signal face(s) for through traffic.

**Standard:**

<sup>03</sup> **If a separate left-turn signal face is provided for a protected only mode left turn, it shall meet the following requirements (see Figure 4D-10):**

- A. It shall be capable of displaying, the following signal indications: steady left-turn RED ARROW, steady left-turn YELLOW ARROW, and left-turn GREEN ARROW. Only one of the three indications shall be displayed at any given time. A signal instruction sign shall not be required with this set of signal indications. If used, it shall be a LEFT ON GREEN ARROW ONLY (R10-5) sign (see Figure 2B-27).**
- B. During the protected left-turn movement, a left-turn GREEN ARROW signal indication shall be displayed.**
- C. A steady left-turn YELLOW ARROW signal indication shall be displayed following the left-turn GREEN ARROW signal indication.**
- D. If the protected only mode is not the only left-turn mode used for the approach, the signal face shall be the same separate left-turn signal face that is used for the protected/permissive mode (see Section 4D.20 and Figures 4D-8 and 4D-12) except that the flashing left-turn YELLOW ARROW or flashing left-turn RED ARROW signal indication shall not be displayed when operating in the protected only mode.**

*Guidance:*

<sup>04</sup> *Since separate signal phases for protected left turns will reduce the green time available for other phases, alternate means of handling left turn conflicts should be considered first.*

Support:

<sup>05</sup> The most likely possibilities are:

1. Prohibition of left turns. This can be done only if there are convenient alternate means of making the movement. Typical alternate means are:
  - a. A series of right and/or left turns around a block to permit getting to the desired destination; or
  - b. Making the left turn at an adjacent unsignalized intersection during gaps in the opposing through traffic.
2. Geometric changes to eliminate the left turn. An effective change would be a complete separation or a complete or partial "clover leaf" at grade. Any of these, while eliminating left turns, requires additional cost and right of way.
3. Provide protected-permissive or permissive-protected left turn operation. The protected left turn interval may be prohibited during certain periods of the day to allow only permissive intervals for left turn movement in order to increase the green time available for other phases. Refer to Section 4D.20 for the requirements of protected-permissive or permissive-protected left turn operation.

Guidance:

<sup>06</sup> Protected left turn phases should be considered where such alternatives couldn't be utilized, and one or more of the following conditions exist:

1. Collisions - Five or more left turn collisions for a particular left turn movement during a recent 12-month period.
2. Delay - Left-turn delay of one or more vehicles, which were waiting at the beginning of the green interval and are still remaining in the left turn lane after at least 80% of the total number of cycles for one hour.
3. Volume - At new intersections where only estimated volumes are available, the following criteria may be used. For pre-timed signal or a background-cycle-controlled actuated signal, a left turn volume of more than two vehicles per approach per cycle for a peak hour; or for a traffic-actuated signal, 50 or more left turning vehicles per hour in one direction with the product of the turning and conflicting through traffic during the peak hour of 100,000 or more.
4. Miscellaneous. Other factors that might be considered include but are not limited to: impaired sight distance due to horizontal or vertical curvature, or where there are a large percentage of buses and trucks.

## **Section 4D.20 Signal Indications for Protected/Permissive Mode Left-Turn Movements**

**Standard:**

<sup>01</sup> **If a shared signal face is provided for a protected/permissive mode left turn, it shall meet the following requirements (see Figure 4D-11):**

- A. It shall be capable of displaying the following signal indications: steady CIRCULAR RED, steady CIRCULAR YELLOW, CIRCULAR green, steady left-turn YELLOW ARROW, and left-turn GREEN ARROW. Only one of the three circular indications shall be displayed at any given time. Only one of the two arrow indications shall be displayed at any given time. If the left-turn GREEN ARROW signal indication and the CIRCULAR GREEN signal indication(s) for the adjacent through movement are always terminated together, the steady left-turn YELLOW ARROW signal indication shall not be required.**
- B. During the protected left-turn movement, the shared signal face shall simultaneously display a left-turn GREEN ARROW signal indication and a circular signal indication that is the same color as the signal indication for the adjacent through lane on the same approach as the protected left turn.**
- C. A steady left-turn YELLOW ARROW signal indication shall be displayed following the left-turn GREEN ARROW signal indication, unless the left-turn GREEN ARROW signal indication and the CIRCULAR GREEN signal indication(s) for the adjacent through movement are being terminated together. When the left-turn GREEN ARROW and CIRCULAR GREEN signal indications are being terminated together, the required display following the left-turn GREEN ARROW signal indication shall be either the display of a CIRCULAR YELLOW signal indication alone or the simultaneous display of the CIRCULAR YELLOW and left-turn YELLOW ARROW signal indications.**
- D. During the permissive left-turn movement, the shared signal face shall display only a CIRCULAR GREEN signal indication.**
- E. A protected/permissive shared signal face, regardless of where it is positioned and regardless of how many adjacent through signal faces are provided, shall always simultaneously display the same color of circular indication that the adjacent through signal face or faces display.**

**F. A supplementary sign shall not be required. If used, it shall be a LEFT TURN YIELD ON GREEN (symbolic circular green) (R10-12) sign (see Figure 2B-27).**

<sup>02</sup> **If a separate left-turn signal face is being operated in a protected/permissive left-turn mode, a CIRCULAR GREEN signal indication shall not be used in that face.**

<sup>03</sup> **If a separate left-turn signal face is being operated in a protected/permissive left-turn mode and a flashing left-turn yellow arrow signal indication is provided, it shall meet the following requirements (see Figure 4D-12):**

**A. It shall be capable of displaying the following signal indications: steady left-turn RED ARROW, steady left-turn YELLOW ARROW, flashing left-turn YELLOW ARROW, and left-turn GREEN ARROW. Only one of the four indications shall be displayed at any given time.**

**B. During the protected left-turn movement, a left-turn GREEN ARROW signal indication shall be displayed.**

**C. A steady left-turn YELLOW ARROW signal indication shall be displayed following the left-turn GREEN ARROW signal indication.**

**D. During the permissive left-turn movement, a flashing left-turn YELLOW ARROW signal indication shall be displayed.**

**E. A steady left-turn YELLOW ARROW signal indication shall be displayed following the flashing left-turn YELLOW ARROW signal indication if the permissive left-turn movement is being terminated and the separate left-turn signal face will subsequently display a steady left-turn RED ARROW indication.**

**F. It shall be permitted to display a flashing left-turn YELLOW ARROW signal indication for a permissive left-turn movement while the signal faces for the adjacent through movement display steady CIRCULAR RED signal indications and the opposing left-turn signal faces display left-turn GREEN ARROW signal indications for a protected left-turn movement.**

**G. When a permissive left-turn movement is changing to a protected left-turn movement, a left-turn GREEN ARROW signal indication shall be displayed immediately upon the termination of the flashing left-turn YELLOW ARROW signal indication. A steady left-turn YELLOW ARROW signal indication shall not be displayed between the display of the flashing left-turn YELLOW ARROW signal indication and the display of the steady left-turn GREEN ARROW signal indication.**

**H. The display shall be a four-section signal face except that a three-section signal face containing a dual-arrow signal section shall be permitted where signal head height limitations (or lateral positioning limitations for a horizontally-mounted signal face) will not permit the use of a four-section signal face. The dual-arrow signal section, where used, shall display a GREEN ARROW for the protected left-turn movement and a flashing YELLOW ARROW for the permissive left-turn movement.**

**I. During steady mode (stop-and-go) operation, the signal section that displays the steady left-turn YELLOW ARROW signal indication during change intervals shall not be used to display the flashing left-turn YELLOW ARROW signal indication for permissive left turns.**

**J. During flashing mode operation (see Section 4D.30), the display of a flashing left-turn YELLOW ARROW signal indication shall be only from the signal section that displays a steady left-turn YELLOW ARROW signal indication during steady mode (stop-and-go) operation.**

Option:

<sup>04</sup> A separate left-turn signal face with a flashing left-turn RED ARROW signal indication during the permissive left-turn movement may be used for unusual geometric conditions, such as wide medians with offset left-turn lanes, but only when an engineering study determines that each and every vehicle must successively come to a full stop before making a permissive left turn.

**Standard:**

<sup>05</sup> **If a separate left-turn signal face is being operated in a protected/permissive left-turn mode and a flashing left-turn RED arrow signal indication is provided, it shall meet the following requirements (see Figure 4D-8):**

**A. It shall be capable of displaying the following signal indications: steady or flashing left-turn RED ARROW, steady left-turn YELLOW ARROW, and left-turn GREEN ARROW. Only one of the three indications shall be displayed at any given time.**

- B. During the protected left-turn movement, a left-turn GREEN ARROW signal indication shall be displayed.**
- C. A steady left-turn YELLOW ARROW signal indication shall be displayed following the left-turn GREEN ARROW signal indication.**
- D. During the permissive left-turn movement, a flashing left-turn RED ARROW signal indication shall be displayed.**
- E. A steady left-turn YELLOW ARROW signal indication shall be displayed following the flashing left-turn RED ARROW signal indication if the permissive left-turn movement is being terminated and the separate left-turn signal face will subsequently display a steady left-turn RED ARROW indication.**
- F. When a permissive left-turn movement is changing to a protected left-turn movement, a left-turn GREEN ARROW signal indication shall be displayed immediately upon the termination of the flashing left-turn RED ARROW signal indication. A steady left-turn YELLOW ARROW signal indication shall not be displayed between the display of the flashing left-turn RED ARROW signal indication and the display of the steady left-turn GREEN ARROW signal indication.**
- G. It shall be permitted to display a flashing left-turn RED ARROW signal indication for a permissive left-turn movement while the signal faces for the adjacent through movement display steady CIRCULAR RED signal indications and the opposing left-turn signal faces display left-turn GREEN ARROW signal indications for a protected left-turn movement.**
- H. A supplementary sign shall not be required. ~~If used, it shall be a LEFT TURN YIELD ON FLASHING RED ARROW AFTER STOP (R10-27) sign (see Figure 2B-27).~~**

Option:

<sup>06</sup> The requirements of Item A in Paragraph 5 may be met by a vertically-arranged signal face with a horizontal cluster of two left-turn RED ARROW signal indications, the left-most of which displays a steady indication and the right-most of which displays a flashing indication (see Figure 4D-8).

**Standard:**

<sup>07</sup> **Protected/permissive mode left-turn shall not be used for left turn movements that oppose phases that require preemption for rail traffic.**

#### **Section 4D.21 Signal Indications for Right-Turn Movements – General**

**Standard:**

<sup>01</sup> **In Sections 4D.21 through 4D.24, provisions applicable to right-turn movements and right-turn lanes shall also apply to signal indications for U-turns to the right that are provided at locations where right turns are prohibited or not geometrically possible.**

Support:

<sup>02</sup> Right-turning traffic is controlled by one of four modes as follows:

- A. Permissive Only Mode—turns made on a CIRCULAR GREEN signal indication, a flashing right-turn YELLOW ARROW signal indication, or a flashing right-turn RED ARROW signal indication after yielding to pedestrians, if any.
- B. Protected Only Mode—turns made only when a right-turn GREEN ARROW signal indication is displayed.
- C. Protected/Permissive Mode—both modes occur on an approach during the same cycle.
- D. Variable Right-Turn Mode—the operating mode changes among the protected only mode and/or the protected/permissive mode and/or the permissive only mode during different periods of the day or as traffic conditions change.

**Standard:**

<sup>03</sup> **During a permissive right-turn movement, the signal faces, if any, that exclusively control U-turn traffic that conflicts with the permissive right-turn movement (see Item F.1 in Section 4D.05) shall simultaneously display steady U-turn RED ARROW signal indications. If pedestrians crossing the lane or lanes used by the permissive right-turn movement to depart the intersection are controlled by pedestrian signal heads, the signal indications displayed by those pedestrian signal heads shall not be limited to any particular display during the permissive right-turn movement.**

<sup>04</sup> **During a protected right-turn movement, the signal faces for left-turn traffic, if any, on the opposing approach shall not simultaneously display a steady left-turn GREEN ARROW or steady left-turn**

**YELLOW ARROW signal indication, and signal faces, if any, that exclusively control U-turn traffic that conflicts with the protected right-turn movement (see Item F.1 in Section 4D.05) shall simultaneously display steady U-turn RED ARROW signal indications. If pedestrians crossing the lane or lanes used by the protected right-turn movement to depart the intersection are controlled by pedestrian signal heads, the pedestrian signal heads shall display a steady UPRAISED HAND (symbolizing DONT WALK) signal indication during the protected right-turn movement.**

**<sup>05</sup> A protected only mode right-turn movement that does not begin and terminate at the same time as the adjacent through movement shall not be provided on an approach unless an exclusive right-turn lane exists.**

**<sup>06</sup> A yellow change interval for the right-turn movement shall not be displayed when the status of the right-turn operation is changing from permissive to protected within any given signal sequence.**

**<sup>07</sup> If the operating mode changes among the protected only mode and/or the protected/permissive mode and/or the permissive only mode during different periods of the day or as traffic conditions change, the requirements in Sections 4D.22 through 4D.24 that are appropriate to that mode of operation shall be met, subject to the following:**

**A. The CIRCULAR GREEN and CIRCULAR YELLOW signal indications shall not be displayed when operating in the protected only mode.**

**B. The right-turn GREEN ARROW and right-turn YELLOW ARROW signal indications shall not be displayed when operating in the permissive only mode.**

Option:

<sup>08</sup> Additional static signs or changeable message signs may be used to meet the requirements for the variable right-turn mode or to inform drivers that right-turn green arrows will not be available during certain times of the day.

Support:

<sup>09</sup> Sections 4D.21 through 4D.24 describe the use of the following two types of signal faces for controlling right-turn movements:

A. Shared signal face – This type of signal face controls both the right-turn movement and the adjacent movement (usually the through movement) and can serve as one of the two required primary signal faces for the adjacent movement. A shared signal face always displays the same color of circular indication that is displayed by the signal face or faces for the adjacent movement.

B. Separate right-turn signal face – This type of signal face controls only the right-turn movement and cannot serve as one of the two required primary signal faces for the adjacent movement (usually the through movement) because it displays signal indications that are applicable only to the right-turn movement. If a separate right-turn signal face is mounted overhead at the intersection, it is positioned over the extension of the right-turn lane. In a separate right-turn signal face, a flashing right-turn YELLOW ARROW signal indication or a flashing right-turn RED ARROW signal indication is used to control permissive right-turning movements.

<sup>10</sup> Section 4D.13 contains provisions regarding the lateral positioning of signal faces that control right-turn movements.

<sup>11</sup> It is not necessary that the same mode of right-turn operation or same type of right-turn signal face be used on every approach to a signalized location. Selecting different modes and types of right-turn signal faces for the various approaches to the same signalized location is acceptable.

Option:

<sup>12</sup> A signal face that is shared by left-turning and right-turning traffic may be provided for a shared left-turn/right-turn lane on an approach that has no through traffic (see Section 4D.25).

*Guidance:*

<sup>13</sup> *A right-turn green arrow should be considered for use only when there is an exclusive right-turn lane or it is the only movement that traffic is permitted to make or when the right-turn volume exceeds 200 vehicles per hour.*



## **Section 4D.22 Signal Indications for Permissive Only Mode Right-Turn Movements**

### **Standard:**

**01 If a shared signal face is provided for a permissive only mode right turn, it shall meet the following requirements (see Figure 4D-13):**

- A. It shall be capable of displaying the following signal indications: steady CIRCULAR RED, steady CIRCULAR YELLOW, and CIRCULAR GREEN. Only one of the three indications shall be displayed at any given time.**
- B. During the permissive right-turn movement, a CIRCULAR GREEN signal indication shall be displayed.**
- C. A permissive only shared signal face, regardless of where it is positioned and regardless of how many adjacent through signal faces are provided, shall always simultaneously display the same color of circular indication that the adjacent through signal face or faces display.**
- D. If the permissive only mode is not the only right-turn mode used for the approach, the signal face shall be the same shared signal face that is used for the protected/permissive mode (see Section 4D.24) except that the right-turn GREEN ARROW and right-turn YELLOW ARROW signal indications shall not be displayed when operating in the permissive only mode.**

**02 If a separate right-turn signal face is being operated in a permissive only right-turn mode, a CIRCULAR GREEN signal indication shall not be used in that face.**

**03 If a separate right-turn signal face is being operated in a permissive only right-turn mode and a flashing right-turn yellow arrow signal indication is provided, it shall meet the following requirements (see Figure 4D-14):**

- A. It shall be capable of displaying one of the following sets of signal indications:**
  - 1. Steady right-turn RED ARROW, steady right-turn YELLOW ARROW, and flashing right-turn YELLOW ARROW. Only one of the three indications shall be displayed at any given time.**
  - 2. Steady CIRCULAR RED, steady right-turn YELLOW ARROW, and flashing right-turn YELLOW ARROW. Only one of the three indications shall be displayed at any given time. If the CIRCULAR RED signal indication is sometimes displayed when the signal faces for the adjacent through lane(s) are not displaying a CIRCULAR RED signal indication, a RIGHT TURN SIGNAL (R10-10R) sign (see Figure 2B-27) shall be used unless the CIRCULAR RED signal indication in the separate right-turn signal face is shielded, hooded, louvered, positioned, or designed such that it is not readily visible to drivers in the through lane(s).**
- B. During the permissive right-turn movement, a flashing right-turn YELLOW ARROW signal indication shall be displayed.**
- C. A steady right-turn YELLOW ARROW signal indication shall be displayed following the flashing right-turn YELLOW ARROW signal indication.**
- D. When the separate right-turn signal face is providing a message to stop and remain stopped, a steady right-turn RED ARROW signal indication shall be displayed if it is intended that right turns on red not be permitted (except when a traffic control device is in place permitting a turn on a steady RED ARROW signal indication) or a steady CIRCULAR RED signal indication shall be displayed if it is intended that right turns on red be permitted.**
- E. It shall be permitted to display a flashing right-turn YELLOW ARROW signal indication for a permissive right-turn movement while the signal faces for the adjacent through movement display steady CIRCULAR RED signal indications.**
- F. During steady mode (stop-and-go) operation, the signal section that displays the steady right-turn YELLOW ARROW signal indication during change intervals shall not be used to display the flashing right-turn YELLOW ARROW signal indication for permissive right turns.**
- G. During flashing mode operation (see Section 4D.30), the display of a flashing right-turn YELLOW ARROW signal indication shall be only from the signal section that displays a steady right-turn YELLOW ARROW signal indication during steady mode (stop-and-go) operation.**
- H. If the permissive only mode is not the only right-turn mode used for the approach, the signal face shall be the same separate right-turn signal face with a flashing YELLOW ARROW signal indication**

**that is used for the protected/permissive mode (see Section 4D.24) except that the right-turn GREEN ARROW signal indication shall not be displayed when operating in the permissive only mode.**

Option:

<sup>04</sup> When an engineering study determines that each and every vehicle must successively come to a full stop before making a permissive right turn, a separate right-turn signal face with a flashing right-turn RED ARROW signal indication during the permissive right-turn movement may be used.

**Standard:**

<sup>05</sup> **If a separate right-turn signal face is being operated in a permissive only right-turn mode and a flashing right-turn RED arrow signal indication is provided, it shall meet the following requirements (see Figure 4D-15):**

**A. It shall be capable of displaying one of the following sets of signal indications:**

- 1. Steady or flashing right-turn RED ARROW, steady right-turn YELLOW ARROW, and right-turn GREEN ARROW. Only one of the three indications shall be displayed at any given time. The GREEN ARROW indication is required in order to provide a three-section signal face, but shall not be displayed during permissive only mode.**
- 2. Steady CIRCULAR RED on the left and steady right-turn RED ARROW on the right of the top position, steady right-turn YELLOW ARROW in the middle position, and right-turn GREEN ARROW in the bottom position. Only one of the four indications shall be displayed at any given time. The GREEN ARROW indication is required in order to provide three vertical positions, but shall not be displayed during permissive only mode. If the CIRCULAR RED signal indication is sometimes displayed when the signal faces for the adjacent through lane(s) are not displaying a CIRCULAR RED signal indication, a RIGHT TURN SIGNAL (R10-10R) sign (see Figure 2B-27) shall be used unless the CIRCULAR RED signal indication in the separate right-turn signal face is shielded, hooded, louvered, positioned, or designed such that it is not readily visible to drivers in the through lane(s).**

**B. During the permissive right-turn movement, a flashing right-turn RED ARROW signal indication shall be displayed, thus indicating that each and every vehicle must successively come to a full stop before making a permissive right turn.**

**C. A steady right-turn YELLOW ARROW signal indication shall be displayed following the flashing right-turn RED ARROW signal indication.**

**D. When the separate right-turn signal face is providing a message to stop and remain stopped, a steady right-turn RED ARROW signal indication shall be displayed if it is intended that right turns on red not be permitted (except when a traffic control device is in place permitting a turn on a steady RED ARROW signal indication) or a steady CIRCULAR RED signal indication shall be displayed if it is intended that right turns on red be permitted.**

**E. The display of a flashing right-turn RED ARROW signal indication for a permissive right-turn movement while the signal faces for the adjacent through movement display steady CIRCULAR RED signal indications and the opposing left-turn signal faces display left-turn GREEN ARROW signal indications for a protected left-turn movement shall be permitted.**

**F. A supplementary sign shall not be required. ~~If used, it shall be a RIGHT TURN YIELD ON FLASHING RED ARROW AFTER STOP (R10-27) sign (see Figure 2B-27).~~**

Option:

<sup>06</sup> The requirements of Item A.1 in Paragraph 5 may be met by a vertically-arranged signal face with a horizontal cluster of two right-turn RED ARROW signal indications, the left-most of which displays a steady indication and the right-most of which displays a flashing indication (see Figure 4D-15).

### **Section 4D.23 Signal Indications for Protected Only Mode Right-Turn Movements**

**Standard:**

<sup>01</sup> **A shared signal face shall not be used for protected only mode right turns unless the CIRCULAR GREEN and right-turn GREEN ARROW signal indications always begin and terminate together. If a shared signal face is provided for a protected only right turn, it shall meet the following requirements (see Figure 4D-16):**

- A. It shall be capable of displaying the following signal indications: steady CIRCULAR RED, steady CIRCULAR YELLOW, CIRCULAR GREEN, and right-turn GREEN ARROW. Only one of the three colors shall be displayed at any given time.**
- B. During the protected right-turn movement, the shared signal face shall simultaneously display both a CIRCULAR GREEN signal indication and a right-turn GREEN ARROW signal indication.**
- C. The shared signal face shall always simultaneously display the same color of circular indication that the adjacent through signal face or faces display.**
- D. If the protected only mode is not the only right-turn mode used for the approach, the signal face shall be the same shared signal face that is used for the protected/permissive mode (see Section 4D.24).**

Option:

<sup>02</sup> A straight-through GREEN ARROW signal indication may be used instead of the CIRCULAR GREEN signal indication in Items A and B in Paragraph 1 on an approach where left turns are prohibited and a straight-through GREEN ARROW signal indication is also used instead of a CIRCULAR GREEN signal indication in the other signal face(s) for through traffic.

**Standard:**

<sup>03</sup> **If a separate right-turn signal face is provided for a protected only mode right turn, it shall meet the following requirements (see Figure 4D-17):**

- A. It shall be capable of displaying one of the following sets of signal indications:**
  - 1. Steady right-turn RED ARROW, steady right-turn YELLOW ARROW, and right-turn GREEN ARROW. Only one of the three indications shall be displayed at any given time. A signal instruction sign shall not be required with this set of signal indications. If used, it shall be a RIGHT ON GREEN ARROW ONLY (R10-5a) sign (see Figure 2B-27).**
  - 2. Steady CIRCULAR RED, steady right-turn YELLOW ARROW, and right-turn GREEN ARROW. Only one of three indications shall be displayed at any given time. If the CIRCULAR RED signal indication is sometimes displayed when the signal faces for the adjacent through lane(s) are not displaying a CIRCULAR RED signal indication, a RIGHT TURN SIGNAL (R10-10R) sign (see Figure 2B-27) shall be used unless the CIRCULAR RED signal indication is shielded, hooded, louvered, positioned, or designed such that it is not readily visible to drivers in the through lane(s).**
- B. During the protected right-turn movement, a right-turn GREEN ARROW signal indication shall be displayed.**
- C. A steady right-turn YELLOW ARROW signal indication shall be displayed following the right-turn GREEN ARROW signal indication.**
- D. When the separate signal face is providing a message to stop and remain stopped, a steady right-turn RED ARROW signal indication shall be displayed if it is intended that right turns on red not be permitted (except when a traffic control device is in place permitting a turn on a steady RED ARROW signal indication) or a steady CIRCULAR RED signal indication shall be displayed if it is intended that right turns on red be permitted.**
- E. If the protected only mode is not the only right-turn mode used for the approach, the signal face shall be the same separate right-turn signal face that is used for the protected/permissive mode (see Section 4D.24 and Figure 4D-19) except that a flashing right-turn YELLOW ARROW or flashing right-turn RED ARROW signal indication shall not be displayed when operating in the protected only mode.**

#### **Section 4D.24 Signal Indications for Protected/Permissive Mode Right-Turn Movements**

**Standard:**

<sup>01</sup> **If a shared signal face is provided for a protected/permissive mode right turn, it shall meet the following requirements (see Figure 4D-18):**

- A. It shall be capable of displaying the following signal indications: steady CIRCULAR RED, steady CIRCULAR YELLOW, CIRCULAR green, steady right-turn YELLOW ARROW, and right-turn GREEN ARROW. Only one of the three circular indications shall be displayed at any given time. Only one of the two arrow indications shall be displayed at any given time. If the right-turn GREEN ARROW signal indication and the CIRCULAR GREEN signal indication(s) for the adjacent through**

movement are always terminated together, the steady right-turn YELLOW ARROW signal indication shall not be required.

**B. During the protected right-turn movement, the shared signal face shall simultaneously display a right-turn GREEN ARROW signal indication and a circular signal indication that is the same color as the signal indication for the adjacent through lane on the same approach as the protected right turn.**

**C. A steady right-turn YELLOW ARROW signal indication shall be displayed following the right-turn GREEN ARROW signal indication, unless the right-turn GREEN ARROW signal indication and the CIRCULAR GREEN signal indication(s) for the adjacent through movement are being terminated together. When the right-turn GREEN ARROW and CIRCULAR GREEN signal indications are being terminated together, the required display following the right-turn GREEN ARROW signal indication shall be either the display of a CIRCULAR YELLOW signal indication alone or the simultaneous display of the CIRCULAR YELLOW and right-turn YELLOW ARROW signal indications.**

**D. During the permissive right-turn movement, the shared signal face shall display only a CIRCULAR GREEN signal indication.**

**E. A protected/permissive shared signal face, regardless of where it is positioned and regardless of how many adjacent through signal faces are provided, shall always simultaneously display the same color of circular indication that the adjacent through signal face or faces display.**

<sup>02</sup> If a separate right-turn signal face is being operated in a protected/permissive right-turn mode, a CIRCULAR GREEN signal indication shall not be used in that face.

<sup>03</sup> If a separate right-turn signal face is being operated in a protected/permissive right-turn mode and a flashing right-turn yellow arrow signal indication is provided, it shall meet the following requirements (see Figure 4D-19):

**A. It shall be capable of displaying one of the following sets of signal indications:**

- 1. Steady right-turn RED ARROW, steady right-turn YELLOW ARROW, flashing right-turn YELLOW ARROW, and right-turn GREEN ARROW. Only one of the four indications shall be displayed at any given time.**
- 2. Steady CIRCULAR RED, steady right-turn YELLOW ARROW, flashing right-turn YELLOW ARROW, and right-turn GREEN ARROW. Only one of the four indications shall be displayed at any given time. If the CIRCULAR RED signal indication is sometimes displayed when the signal faces for the adjacent through lane(s) are not displaying a CIRCULAR RED signal indication, a RIGHT TURN SIGNAL (R10-10R) sign (see Figure 2B-27) shall be used unless the CIRCULAR RED signal indication in the separate right-turn signal face is shielded, hooded, louvered, positioned, or designed such that it is not readily visible to drivers in the through lane(s).**

**B. During the protected right-turn movement, a right-turn GREEN ARROW signal indication shall be displayed.**

**C. A steady right-turn YELLOW ARROW signal indication shall be displayed following the right-turn GREEN ARROW signal indication.**

**D. During the permissive right-turn movement, a flashing right-turn YELLOW ARROW signal indication shall be displayed.**

**E. A steady right-turn YELLOW ARROW signal indication shall be displayed following the flashing right-turn YELLOW ARROW signal indication if the permissive right-turn movement is being terminated and the separate right-turn signal face will subsequently display a steady red indication.**

**F. When a permissive right-turn movement is changing to a protected right-turn movement, a right-turn GREEN ARROW signal indication shall be displayed immediately upon the termination of the flashing right-turn YELLOW ARROW signal indication. A steady right-turn YELLOW ARROW signal indication shall not be displayed between the display of the flashing right-turn YELLOW ARROW signal indication and the display of the steady right-turn GREEN ARROW signal indication.**

**G. When the separate right-turn signal face is providing a message to stop and remain stopped, a steady right-turn RED ARROW signal indication shall be displayed if it is intended that right turns on red not be permitted (except when a traffic control device is in place permitting a turn on a steady RED**

**ARROW signal indication) or a steady CIRCULAR RED signal indication shall be displayed if it is intended that right turns on red be permitted.**

- H. It shall be permitted to display a flashing right-turn YELLOW ARROW signal indication for a permissive right-turn movement while the signal faces for the adjacent through movement display steady CIRCULAR RED signal indications.**
- I. A signal face containing a dual-arrow signal section in place of separate flashing right-turn YELLOW ARROW and right-turn GREEN ARROW signal sections shall be permitted where signal head height limitations (or lateral positioning limitations for a horizontally-mounted signal face) are a concern. The dual-arrow signal section, where used, shall display a GREEN ARROW for the protected right-turn movement and a flashing YELLOW ARROW for the permissive right-turn movement.**
- J. During steady mode (stop-and-go) operation, the signal section that displays the steady right-turn YELLOW ARROW signal indication during change intervals shall not be used to display the flashing right-turn YELLOW ARROW signal indication for permissive right turns.**
- K. During flashing mode operation (see Section 4D.30), the display of a flashing right-turn YELLOW ARROW signal indication shall be only from the signal section that displays a steady right-turn YELLOW ARROW signal indication during steady mode (stop-and-go) operation.**

Option:

<sup>04</sup> When an engineering study determines that each and every vehicle must successively come to a full stop before making a permissive right turn, a separate signal face that has a flashing right-turn RED ARROW signal indication during the permissive right-turn movement may be used.

**Standard:**

<sup>05</sup> **If a separate right-turn signal face is being operated in a protected/permissive right-turn mode and a flashing right-turn RED arrow signal indication is provided, it shall meet the following requirements (see Figure 4D-15):**

- A. It shall be capable of displaying one of the following sets of signal indications:**
  - 1. Steady or flashing right-turn RED ARROW, steady right-turn YELLOW ARROW, and right-turn GREEN ARROW. Only one of the three indications shall be displayed at any given time.**
  - 2. Steady CIRCULAR RED on the left and steady or flashing right-turn RED ARROW on the right of the top position, steady right-turn YELLOW ARROW in the middle position, and right-turn GREEN ARROW in the bottom position. Only one of the four indications shall be displayed at any given time. If the CIRCULAR RED signal indication is sometimes displayed when the signal faces for the adjacent through lane(s) are not displaying a CIRCULAR RED signal indication, a RIGHT TURN SIGNAL (R10-10R) sign (see Figure 2B-27) shall be used unless the CIRCULAR RED signal indication in the separate right-turn signal face is shielded, hooded, louvered, positioned, or designed such that it is not readily visible to drivers in the through lane(s).**
- B. During the protected right-turn movement, a right-turn GREEN ARROW signal indication shall be displayed.**
- C. A steady right-turn YELLOW ARROW signal indication shall be displayed following the right-turn GREEN ARROW signal indication.**
- D. During the permissive right-turn movement, the separate right-turn signal face shall display a flashing right-turn RED ARROW signal indication.**
- E. A steady right-turn YELLOW ARROW signal indication shall be displayed following the flashing right-turn RED ARROW signal indication if the permissive right-turn movement is being terminated and the separate right-turn signal face will subsequently display a steady red indication.**
- F. When a permissive right-turn movement is changing to a protected right-turn movement, a right-turn GREEN ARROW signal indication shall be displayed immediately upon the termination of the flashing right-turn RED ARROW signal indication. A steady right-turn YELLOW ARROW signal indication shall not be displayed between the display of the flashing right-turn RED ARROW signal indication and the display of the steady right-turn GREEN ARROW signal indication.**
- G. When the separate right-turn signal face is providing a message to stop and remain stopped, a steady right-turn RED ARROW signal indication shall be displayed if it is intended that right turns on red not be permitted (except when a traffic control device is in place permitting a turn on a steady RED**

**ARROW signal indication) or a steady CIRCULAR RED signal indication shall be displayed if it is intended that right turns on red be permitted.**

**H. It shall be permitted to display a flashing right-turn RED ARROW signal indication for a permissive right-turn movement while the signal faces for the adjacent through movement display steady CIRCULAR RED signal indications and the opposing left-turn signal faces display left-turn GREEN ARROW signal indications for a protected left-turn movement.**

**I. A supplementary sign shall not be required. ~~If used, it shall be a RIGHT TURN YIELD ON FLASHING RED ARROW AFTER STOP (R10-27) sign (see Figure 2B-27).~~**

Option:

<sup>06</sup> The requirements of Item A.1 in Paragraph 5 may be met by a vertically-arranged signal face with a horizontal cluster of two right-turn RED ARROW signal indications, the left-most of which displays a steady indication and the right-most of which displays a flashing indication (see Figure 4D-15).

### **Section 4D.25 Signal Indications for Approaches With Shared Left-Turn/Right-Turn Lanes and No Through Movement**

Support:

<sup>01</sup> A lane that is shared by left-turn and right-turn movements is sometimes provided on an approach that has no through movement, such as the stem of a T-intersection or where the opposite approach is a one-way roadway in the opposing direction.

**Standard:**

<sup>02</sup> **When a shared left-turn/right-turn lane exists on a signalized approach, the left-turn and right-turn movements shall start and terminate simultaneously and the red signal indication used in each of the signal faces on the approach shall be a CIRCULAR RED.**

Support:

<sup>03</sup> This requirement for the use of CIRCULAR RED signal indications in signal faces for approaches having a shared lane for left-turn and right-turn movements is a specific exception to other provisions in this Chapter that would otherwise require the use of RED ARROW signal indications.

**Standard:**

<sup>04</sup> **The signal faces provided for an approach with a shared left-turn/right-turn lane and no through movement shall be one of the following:**

**A. Two or more signal faces, each capable of displaying CIRCULAR RED, CIRCULAR YELLOW, and CIRCULAR GREEN signal indications, shall be provided for the approach. This display shall be permissible regardless of number of exclusive left-turn and/or right-turn lanes that exist on the approach in addition to the shared left-turn/right-turn lane and regardless of whether or not there are pedestrian or opposing vehicular movements that conflict with the left-turn or right-turn movements. However, if there is an opposing approach and the signal phasing protects the left-turn movement on the approach with the shared left-turn/right-turn lane from conflicts with the opposing vehicular movements and any signalized pedestrian movements, a left-turn GREEN ARROW signal indication shall also be included in the left-most signal face and shall be displayed simultaneously with the CIRCULAR GREEN signal indication.**

**B. If the approach has one or more exclusive turn lanes in addition to the shared left-turn/right-turn lane and there is no conflict with a signalized vehicular or pedestrian movement, and GREEN ARROW signal indications are used in place of CIRCULAR GREEN signal indications on the approach, the signal faces for the approach shall be:**

**1. A signal face(s) capable of displaying CIRCULAR RED, YELLOW ARROW, and GREEN ARROW signal indications for the exclusive turn lane(s), with the arrows pointing in the direction of the turn, and**

**2. A shared left-turn/right-turn signal face capable of displaying CIRCULAR RED, left-turn YELLOW ARROW, left-turn GREEN ARROW, right-turn YELLOW ARROW, and right-turn GREEN ARROW signal indications, in an arrangement of signal sections that complies with the provisions of Section 4D.09 or 4D.10.**

**C. If the approach has one or more exclusive turn lanes in addition to the shared left-turn/right-turn lane and there is a conflict with a signalized vehicular or pedestrian movement, and flashing YELLOW ARROW signal indications are used in place of CIRCULAR GREEN signal indications on the approach, the signal faces for the approach shall be as described in Items B.1 and B.2, except that flashing YELLOW ARROW signal indications shall be used in place of the GREEN ARROW signal indications for the turning movement(s) that conflicts with the signalized vehicular or pedestrian movement.**

Support:

<sup>05</sup> Figure 4D-20 illustrates application of these Standards on approaches that have only a shared left-turn/right-turn lane, and on approaches that have one or more exclusive turn lanes in addition to the shared left-turn/right-turn lane.

Option:

<sup>06</sup> If the lane-use regulations on an approach are variable such that at certain times all of the lanes on the approach are designated as exclusive turn lanes and no lane is designated as a shared left-turn/right-turn lane:

- A. During the times that no lane is designated as a shared left-turn/right-turn lane, the left-turn and right-turn movements may start and terminate independently, and the left-turn and right-turn movements may be operated in one or more of the modes of operation as described in Sections 4D.17 through 4D.24; and
- B. If a protected-permissive mode is used, the shared left-turn/right-turn signal face provided in Paragraph 4 may be modified to include a dual-arrow signal section capable of displaying both a GREEN ARROW signal indication and a flashing YELLOW ARROW signal indication for a turn movement(s) in order to not exceed the maximum of five sections per signal face provided in Section 4D.08.

#### **Section 4D.26 Yellow Change and Red Clearance Intervals**

**Standard:**

<sup>01</sup> **A steady yellow signal indication shall be displayed following every CIRCULAR GREEN or GREEN ARROW signal indication and following every flashing YELLOW ARROW or flashing RED ARROW signal indication displayed as a part of a steady mode operation. This requirement shall not apply when a CIRCULAR GREEN, a flashing YELLOW ARROW, or a flashing RED ARROW signal indication is followed immediately by a GREEN ARROW signal indication.**

<sup>02</sup> **The exclusive function of the yellow change interval shall be to warn traffic of an impending change in the right-of-way assignment.**

<sup>03</sup> **The duration of the yellow change interval shall be determined using engineering practices.**

Support:

<sup>04</sup> Section 4D.05 contains provisions regarding the display of steady CIRCULAR YELLOW signal indications to approaches from which drivers are allowed to make permissive left turns.

*Guidance:*

<sup>05</sup> *When indicated by the application of engineering practices, the yellow change interval should be followed by a red clearance interval to provide additional time before conflicting traffic movements, including pedestrians, are released.*

**Standard:**

<sup>06</sup> **When used, the duration of the red clearance interval shall be determined using engineering practices.**

Support:

<sup>07</sup> Engineering practices for determining the duration of yellow change and red clearance intervals can be found in ITE's "Traffic Control Devices Handbook" and in ITE's "Manual of Traffic Signal Design" (see Section 1A.11).

**Standard:**

<sup>08</sup> **The durations of yellow change intervals and red clearance intervals shall be consistent with the determined values within the technical capabilities of the controller unit.**

<sup>09</sup> **The duration of a yellow change interval shall not vary on a cycle-by-cycle basis within the same signal timing plan.**

<sup>10</sup> **Except as provided in Paragraph 12, the duration of a red clearance interval shall not be decreased or omitted on a cycle-by-cycle basis within the same signal timing plan.**

Option:

<sup>11</sup> The duration of a red clearance interval may be extended from its predetermined value for a given cycle based upon the detection of a vehicle that is predicted to violate the red signal indication.

<sup>12</sup> When an actuated signal sequence includes a signal phase for permissive/protected (lagging) left-turn movements in both directions, the red clearance interval may be shown during those cycles when the lagging left-turn signal phase is skipped and may be omitted during those cycles when the lagging left-turn signal phase is shown.

<sup>13</sup> The duration of a yellow change interval or a red clearance interval may be different in different signal timing plans for the same controller unit.

Guidance:

<sup>14</sup> *A yellow change interval should have a minimum duration of 3 seconds and a maximum duration of 6 seconds. The longer intervals should be reserved for use on approaches with higher speeds. Practitioners should exercise engineering judgment for determination of the minimum yellow change interval. Judgment should be based on numerous factors including, but not limited to, field observation of traffic behavior, intersection geometrics, downhill grade, perception-reaction time of drivers in the area, and actually driving the protected left-turn or protected right-turn movements to assess the need for longer yellow change intervals. Particular attention should be paid where setting minimum yellow change interval timing when exclusive turn lane exceeds 150 feet in length excluding the transition. Refer to Table 4D-102(CA).*

Support:

<sup>14a</sup> The purpose of the yellow signal indication is to warn traffic approaching a traffic signal that the related green movement is ending or that a steady red indication will be exhibited immediately thereafter and traffic will be required to stop when the red signal is exhibited.

Standard:

<sup>14b</sup> **The minimum yellow change interval for through traffic movement shall be determined by using the 85th percentile speed of free-flow traffic rounded up to the next 5 mph increment. Where the posted or prima facie speed limit is higher than the rounded value, use the posted or prima facie speed limit for determination of the minimum yellow change interval for the through traffic movement. See Table 4D-102(CA) sub-heading "a".**

<sup>14c</sup> **If the 85th percentile speed data is not available, the minimum yellow change interval for through traffic movements shall be determined by adding 7 miles per hour to the posted or prima facie speed limits of 30 mph or higher, and by adding 10 miles per hour to the posted or prima facie speed limits of 25 mph or less. See Table 4D-102(CA) sub-heading "b".**

Option:

<sup>14d</sup> The minimum yellow change interval for the through movement and the protected left-turn or protected right-turn may be increased based on appropriate engineering judgment.

<sup>15</sup> *Except when clearing a one-lane, two-way facility (see Section 4H.02) or when clearing an exceptionally wide intersection, a red clearance interval should have a duration not exceeding 6 seconds.*

Support:

<sup>15a</sup> When used, red clearance intervals normally range from 0.1 to 2.0 seconds.

Standard:

<sup>16</sup> **Except for warning beacons mounted on advance warning signs on the approach to a signalized location (see Section 2C.36), signal displays that are intended to provide a "pre-yellow warning" interval, such as flashing green signal indications, vehicular countdown displays, or other similar displays, shall not be used at a signalized location.**

Support:

<sup>17</sup> The use of signal displays (other than warning beacons mounted on advance warning signs) that convey a "pre-yellow warning" have been found by research to increase the frequency of crashes.



## **Section 4D.27 Preemption and Priority Control of Traffic Control Signals**

### **Option:**

<sup>01</sup> Traffic control signals may be designed and operated to respond to certain classes of approaching vehicles by altering the normal signal timing and phasing plan(s) during the approach and passage of those vehicles. The alternative plan(s) may be as simple as extending a currently displayed green interval or as complex as replacing the entire set of signal phases and timing.

### **Support:**

<sup>02</sup> Preemption control (see definition in Section 1A.13) is typically given to trains, boats, emergency vehicles, and light rail transit vehicles.

<sup>03</sup> Examples of preemption control include the following:

- A. The prompt displaying of green signal indications at signalized locations ahead of fire vehicles, law enforcement vehicles, ambulances, and other official emergency vehicles;
- B. A special sequence of signal phases and timing to expedite and/or provide additional clearance time for vehicles to clear the tracks prior to the arrival of rail traffic; and
- C. A special sequence of signal phases to display a steady red indication to prohibit turning all movements toward the tracks during the approach or passage of rail traffic.

<sup>04</sup> Priority control (see definition in Section 1A.13) is typically given to certain non-emergency vehicles such as light-rail transit vehicles operating in a mixed-use alignment and buses.

<sup>05</sup> Examples of priority control include the following:

- A. The displaying of early or extended green signal indications at an intersection to assist public transit vehicles in remaining on schedule, and
- B. Special phasing to assist public transit vehicles in entering the travel stream ahead of the platoon of traffic.

<sup>06</sup> Some types or classes of vehicles supersede others when a traffic control signal responds to more than one type or class. In general, a vehicle that is more difficult to control supersedes a vehicle that is easier to control.

### **Option:**

<sup>07</sup> Preemption or priority control of traffic control signals may also be a means of assigning priority right-of-way to specified classes of vehicles at certain non-intersection locations such as on approaches to one-lane bridges and tunnels, movable bridges, highway maintenance and construction activities, metered freeway entrance ramps, and transit operations.

### **Standard:**

<sup>08</sup> **During the transition into preemption control:**

- A. **The yellow change interval, and any red clearance interval that follows, shall not be shortened or omitted.**
- B. **The shortening or omission of any pedestrian walk interval and/or pedestrian change interval shall be permitted.**
- C. **The return to the previous green signal indication shall be permitted following a steady yellow signal indication in the same signal face, omitting the red clearance interval, if any.**

<sup>09</sup> **During preemption control and during the transition out of preemption control:**

- A. **The shortening or omission of any yellow change interval, and of any red clearance interval that follows, shall not be permitted.**
- B. **A signal indication sequence from a steady yellow signal indication to a green signal indication shall not be permitted.**

<sup>10</sup> **During priority control and during the transition into or out of priority control:**

- A. **The shortening or omission of any yellow change interval, and of any red clearance interval that follows, shall not be permitted.**
- B. **The shortening of any pedestrian walk interval below that time described in Section 4E.06 shall not be permitted.**
- C. **The omission of a pedestrian walk interval and its associated change interval shall not be permitted unless the associated vehicular phase is also omitted or the pedestrian phase is exclusive.**
- D. **The shortening or omission of any pedestrian change interval shall not be permitted.**
- E. **A signal indication sequence from a steady yellow signal indication to a green signal indication shall not be permitted.**

*Guidance:*

*11 Except for traffic control signals interconnected with light rail transit systems, traffic control signals with railroad preemption or coordinated with flashing-light signal systems should be provided with a back-up power supply.*

*12 When a traffic control signal that is returning to a steady mode from a dark mode (typically upon restoration from a power failure) receives a preemption or priority request, care should be exercised to minimize the possibility of vehicles or pedestrians being misdirected into a conflict with the vehicle making the request.*

*Option:*

*13 During the change from a dark mode to a steady mode under a preemption or priority request, the display of signal indications that could misdirect road users may be prevented by one or more of the following methods:*

- A. Having the traffic control signal remain in the dark mode,*
- B. Having the traffic control signal remain in the flashing mode,*
- C. Altering the flashing mode,*
- D. Executing the normal start-up routine before responding, or*
- E. Responding directly to initial or dwell period.*

*Guidance:*

*14 If a traffic control signal is installed near or within a grade crossing or if a grade crossing with active traffic control devices is within or near a signalized highway intersection, Chapter 8C should be consulted.*

*15 Traffic control signals operating under preemption control or under priority control should be operated in a manner designed to keep traffic moving.*

*16 Traffic control signals that are designed to respond under preemption or priority control to more than one type or class of vehicle should be designed to respond in the relative order of importance or difficulty in stopping the type or class of vehicle. The order of priority should be: train, boat, heavy vehicle (fire vehicle, emergency medical service), light vehicle (law enforcement), light rail transit, rubber-tired transit.*

*Option:*

*17 A distinctive indication may be provided at the intersection to show that an emergency vehicle has been given control of the traffic control signal (see Section 11-106 of the "Uniform Vehicle Code"). In order to assist in the understanding of the control of the traffic signal, a common distinctive indication may be used where drivers from different agencies travel through the same intersection when responding to emergencies.*

*18 If engineering judgment indicates that light rail transit signal indications would reduce road user confusion that might otherwise occur if standard traffic signal indications were used to control these movements, light rail transit signal indications complying with Section 8C.11 and as illustrated in Figure 8C-3 8C-3(CA) may be used for preemption or priority control of the following exclusive movements at signalized intersections:*

- A. Public transit buses in "queue jumper" lanes, and*
- B. Bus rapid transit in semi-exclusive or mixed-use alignments.*

*Guidance:*

*19 Traffic control signals within 200 feet of a highway-rail crossing should be operated during railroad pre-emption in a manner that minimizes delay and potential conflicts. These alternatives include steady all-red, all-red flash, limited service or special sequential signal phasing.*

*Option:*

*20 Activated Blank-Out or changeable message regulatory signs and/or appropriate red traffic control signal indications that are visible only during railroad or light rail transit pre-emption may be used to prohibit movements from a signalized location toward a highway-rail crossing. Examples of applicable regulatory signs that may be used in Activated Blank-Out format include the R3-1, R3-2 and R3-27 signs.*

*Support:*

*21 Left turns from a nearby signalized intersection toward a highway-rail crossing can be prohibited during railroad or light rail transit pre-emption by use of a red-left arrow display or an Activated Blank-Out R3-2 sign. Likewise, right turns from a nearby signalized intersection toward such a crossing can be prohibited by use of a red right arrow display or an Activated Blank-Out R3-1 sign. Through movements from a nearby signalized intersection toward a highway-rail crossing can be prohibited by a circular red display or an Activated Blank-Out R3-27 sign.*

*22 Where the highway-rail crossing impacts two streets near a signalized intersection, then steady all red operation may be appropriate during railroad or light rail transit pre-emption.*

23 Where the typical pre-emption period tends to be short, such as for light rail vehicles or commuter trains, a single pre-emption signal phase that serves some vehicular movements and prohibits others may be appropriate. So-called "limited-service" operation, which provides a steady circular green to traffic except for the movements that approach the highway-rail crossing, is one such example.

24 Where the pre-emption period tends to be long, such as for some freight train movements, all-red flash or special sequential phases that alternate among movements that do not approach the highway-rail crossing, possibly in combination with Activated Blank-Out signs, may be appropriate to provide alternating right-of-way.

25 Where there are exclusive turn lanes that accommodate turns toward the highway-rail crossing, then it becomes practical to prohibit those moves during railroad pre-emption.

26 Where exclusive turn lanes or special sequential phases are not feasible, then all-red flash may be desirable to allow movements to be made after road users stop to assess the railroad or light rail transit pre-emption operation.

27 The desirability of prohibiting movements toward the highway-rail crossing during railroad or light rail transit pre-emption increases as:

- 1) the distance between the signalized intersection and the highway-rail crossing decreases; and,
- 2) the volume that likely would enter increases.

### **Railroad Preemption**

Support:

28 Railroad preemption results in a special traffic signal operation depending on the relation of the railroad tracks to the intersection, the number of phases in the traffic signal and other traffic conditions. Railroad preemption is normally initiated by a notification from the railroad grade crossing warning equipment.

Guidance:

29 *Typical circumstances where railroad preemption is required, the following type of signal operation should be provided during preemption:*

1. *Where a railroad grade crossing, provided with grade crossing warning equipment, is within 200 feet of a signalized intersection, preemption of the traffic signal should provide the following sequence of operation:*

**Standard:**

- a. **A yellow change interval and any required red clearance interval for any signal phase that is green or yellow when preemption is initiated and which will be red during the track clearance interval. The length of yellow change and red clearance intervals shall not be altered by preemption. Phases, which are in the green interval when preemption is initiated, and which will be green during the track clearance interval, shall remain green. Any pedestrian walk or clearance interval, in effect when preemption is initiated, shall immediately be terminated and all pedestrian signal faces shall display steady UPRAISED HAND.**
- b. **A track clearance interval for the signal phase or phases controlling the approach that crosses the railroad tracks.**

Option:

The signal indication for the clearance interval may be either green or flashing red.

Guidance:

- c. *A yellow change interval if green signal indications were provided during the track clearance interval.*
- d. *Depending on traffic requirements and phasing of the traffic signal controller, the traffic signal may then do one of the following:*
  - (1) *Go into flashing operation, with flashing red or flashing yellow indications for the approaches parallel to the railroad tracks and flashing red indications for all other approaches.*

**Standard:**

**Pedestrian signals shall be extinguished. If flashing red is used for all approaches, an all-red or other clearance interval shall be provided prior to returning to normal operation.**

- (2) **Revert to limited operation with those signal indications controlling through and left turn approaches towards the railroad tracks displaying steady red. Permitted pedestrian signal phases shall operate normally. This operation shall be used only if the grade crossing warning equipment includes gates.**

**e. The traffic signal shall return to normal operation following release of preemption control.**

Guidance:

2. *Where the railroad tracks run within a roadway and train speeds exceed 10 mph, preemption of the traffic signal should provide the following sequence of operation.*

- a. *A yellow change interval and any required red clearance interval for all signal phases that are green or yellow when preemption is initiated and which will be red during the preemption period.*

**Standard:**

**The length of yellow change and red clearance intervals shall not be altered by preemption. Phases, which are in the green interval when preemption is initiated, and which will be green during the preemption period, shall remain green. Any walk or pedestrian clearance intervals in effect when preemption is initiated shall be immediately terminated and all pedestrian signal faces shall display UPRAISED HAND.**

- b. **All signal faces controlling traffic movements parallel to the railroad tracks will display green or flashing yellow indications. All other vehicle signal faces will display steady red indications; pedestrian signal faces will display UPRAISED HAND.**

**Option:**

3. Where the railroad tracks run along a roadway of a signalized intersection and train speeds do not exceed 10 mph, trains may be controlled by the vehicle signal indications. This type of train control requires approval from the railroad, the Public Utilities Commission and the Director of Transportation.
4. Unusual or unique track or roadway configurations may require other solutions than those described above.

**Emergency Vehicle Preemption**

<sup>30</sup> Authorized emergency vehicles may preempt traffic signals. The purpose of such preemption is to provide the right of way to the emergency vehicle as soon as practical. The preemption may be controlled by one of the following means:

1. By direct wire, modulated light or radio from a remote location such as a fire house; and
2. By modulated light or radio from an emergency vehicle.

**Guidance:**

<sup>31</sup> *Emergency vehicle equipment should be capable of encoding IDs.*

<sup>32</sup> *Emergency vehicle preemption should provide the following sequence of operation:*

1. *A yellow change interval and any required red clearance interval for any signal phase that is green or yellow when preemption is initiated and which will be red during the preemption interval.*

**Standard:**

**The length of the yellow change and red clearance intervals shall not be altered by preemption. Phases, which are in the green interval when preemption is initiated, and which will be green during the preemption period shall remain green. Any pedestrian walk interval in effect when preemption is initiated shall be immediately terminated. The normal pedestrian clearance interval may be abbreviated.**

2. **An all-red intersection preemption display shall not be used.**
3. **The traffic signal shall return to normal operation upon termination of the demand for preemption or the termination of the assured green interval.**

<sup>33</sup> **At a traffic signal provided with both emergency vehicle preemption and railroad preemption, the railroad preemption shall have priority. In the event of a demand for an emergency vehicle preemption during the time that the intersection is operating on railroad preemption, the railroad preemption sequence shall continue unaffected until completion. In the event of a demand for railroad preemption during emergency vehicle preemption operation, railroad preemption shall immediately assume control of the intersection.**

<sup>34</sup> **When control of emergency vehicle preemption is by means of a radio or modulated light source, the following shall apply:**

1. **The transmitter shall be permanently mounted on the emergency vehicle or building and shall operate at a range sufficient to permit a normal yellow change interval and any required clearance intervals to take place prior to the arrival of the emergency vehicle. The normal pedestrian clearance interval may be abbreviated.**
2. **The preemption system may provide an indication (such as a special signal) to the driver of an emergency vehicle that preemption of the traffic signal has been effected. If a special signal light is used, the color shall not be red, yellow, or green.**
3. **The system shall be designed to prevent simultaneous preemption by two or more emergency vehicles on separate approaches to the intersection.**

<sup>35</sup> **When performed by a local agency, the installation of emergency vehicle preemption equipment shall be covered by an Encroachment Permit issued by the Caltrans District Director.**

**The permit shall state the applicable requirements from those listed above and the following:**

1. It should be understood that the permit for the installation might be revoked or changed as deemed advisable or necessary by Caltrans.
2. The programming of the preemption equipment shall be as approved in advance by Caltrans and shall not be changed without written permission. The Permittee shall make any changes in programming, requested by Caltrans.
3. The Permittee shall assume all liability for the claims, which arise due to or because of the permit.

Support:

<sup>36</sup> Normally emergency vehicle preemption equipment is installed, operated, and maintained at no cost to the State. An exception is where the equipment is installed for use by vehicles of another State agency.

**Standard:**

<sup>37</sup> The State shall maintain the preemption equipment at the traffic signal when the signal is maintained by the State. The costs of such maintenance shall be at 100% local agency expense.

#### **Bus/Transit Vehicle Priority**

Support:

<sup>38</sup> The requirements for bus/transit vehicle priority insofar as installation, encroachment permit, maintenance and funding are the same as stated above for emergency vehicle preemption.

**Standard:**

<sup>39</sup> The equipment and operation requirements for bus/transit vehicle priority shall be similar to those above for emergency vehicle priority. Some exceptions to these requirements are:

1. Equipment requirements for the transmitter are set forth in CVC Section 25352.
2. Any pedestrian interval in effect when priority is initiated shall not have its timing affected.

*Guidance:*

3. *Normally, bus/transit priority should not occur more than once every other signal cycle.*

#### **Section 4D.28 Flashing Operation of Traffic Control Signals – General**

**Standard:**

<sup>01</sup> The light source of a flashing signal indication shall be flashed continuously at a rate of not less than 50 or more than 60 times per minute.

<sup>02</sup> The displayed period of each flash shall be a minimum of 1/2 and a maximum of 2/3 of the total flash cycle.

<sup>03</sup> Flashing signal indications shall comply with the requirements of other Sections of this Manual regarding visibility-limiting or positioning of conflicting signal indications, except that flashing yellow signal indications for through traffic shall not be required to be visibility-limited or positioned to minimize visual conflict for road users in separately controlled turn lanes.

<sup>04</sup> Each traffic control signal shall be provided with an independent flasher mechanism that operates in compliance with this Section.

<sup>05</sup> The flashing operation shall not be terminated by removal or turn off of the controller unit or of the conflict monitor (malfunction management unit) or both.

<sup>06</sup> A manual switch, a conflict monitor (malfunction management unit) circuit, and, if appropriate, automatic means shall be provided to initiate the flashing mode.

Option:

<sup>07</sup> Based on engineering study or engineering judgment, traffic control signals may be operated in the flashing mode on a scheduled basis during one or more periods of the day rather than operated continuously in the steady (stop-and-go) mode.

Support:

<sup>08</sup> Sections 4E.06 and 4E.09 contain information regarding the operation of pedestrian signal heads and accessible pedestrian signal detector pushbutton locator tones, respectively, during flashing operation.

### **Section 4D.29 Flashing Operation – Transition Into Flashing Mode**

#### **Standard:**

- 01 The transition from steady (stop-and-go) mode to flashing mode, if initiated by a conflict monitor (malfunction management unit) or by a manual switch, shall be permitted to be made at any time.**
- 02 Programmed changes from steady (stop-and-go) mode to flashing mode shall be made under either of the following circumstances:**
  - A. At the end of the common major-street red interval (such as just prior to the start of the green in both directions on the major street), or**
  - B. Directly from a CIRCULAR GREEN signal indication to a flashing CIRCULAR YELLOW signal indication, or from a GREEN ARROW signal indication to a flashing YELLOW ARROW signal indication, or from a flashing YELLOW ARROW signal indication (see Sections 4D.17 to 4D.24) to a flashing YELLOW ARROW signal indication in a different signal section.**
- 03 During programmed changes into flashing mode, no green signal indication or flashing yellow signal indication shall be terminated and immediately followed by a steady red or flashing red signal indication without first displaying the steady yellow signal indication.**

### **Section 4D.30 Flashing Operation – Signal Indications During Flashing Mode**

#### *Guidance:*

- 01 When a traffic control signal is operated in the flashing mode, a flashing yellow signal indication should be used for the major street and a flashing red signal indication should be used for the other approaches unless flashing red signal indications are used on all approaches.*

#### **Standard:**

- 02 When a traffic control signal is operated in the flashing mode, all of the green signal indications at the signalized location shall be dark (non-illuminated) and shall not be displayed in either a steady or flashing manner, except for single-section GREEN ARROW signal indications as provided elsewhere in this Section.**
- 03 Flashing yellow signal indications shall be used on more than one approach to a signalized location only if those approaches do not conflict with each other.**
- 04 Except as provided in Paragraph 5, when a traffic control signal is operated in the flashing mode, one and only one signal indication in every signal face at the signalized location shall be flashed.**

#### *Option:*

- 05 If a signal face has two identical CIRCULAR RED or RED ARROW signal indications (see Section 4D.08), both of those identical signal indications may be flashed simultaneously.*

#### **Standard:**

- 06 No steady indications, other than a single-section signal face consisting of a continuously-displayed GREEN ARROW signal indication that is used alone to indicate a continuous movement in the steady (stop-and-go) mode, shall be displayed at the signalized location during the flashing mode. A single-section GREEN ARROW signal indication shall remain continuously-displayed when the traffic control signal is operated in the flashing mode.**
- 07 If a signal face includes both circular and arrow signal indications of the color that is to be flashed, only the circular signal indication shall be flashed.**
- 08 All signal faces that are flashed on an approach shall flash the same color, either yellow or red, except that separate turn signal faces (see Sections 4D.17 and 4D.21) shall be permitted to flash a RED ARROW signal indication when the adjacent through movement signal indications are flashed yellow. Shared signal faces (see Sections 4D.17 and 4D.21) for turn movements shall not be permitted to flash a CIRCULAR RED signal indication when the adjacent through movement signal indications are flashed yellow.**
- 09 The appropriate RED ARROW or YELLOW ARROW signal indication shall be flashed when a signal face consists entirely of arrow indications. A signal face that consists entirely of arrow indications and that provides a protected only turn movement during the steady (stop-and-go) mode or that provides a flashing yellow arrow or flashing red arrow signal indication for a permissive turn movement during the steady (stop-and-go) mode shall be permitted to flash the YELLOW ARROW signal indication during the flashing mode if the adjacent through movement signal indications are flashed yellow and if it is intended**

**that a permissive turn movement not requiring a full stop by each turning vehicle be provided during the flashing mode.**

#### **Section 4D.31 Flashing Operation – Transition Out of Flashing Mode**

**Standard:**

**01 All changes from flashing mode to steady (stop-and-go) mode shall be made under one of the following procedures:**

- A. Yellow-red flashing mode: Changes from flashing mode to steady (stop-and-go) mode shall be made at the beginning of the major-street green interval (when a green signal indication is displayed to through traffic in both directions on the major street), or if there is no common major-street green interval, at the beginning of the green interval for the major traffic movement on the major street.**
- B. Red-red flashing mode: Changes from flashing mode to steady (stop-and-go) mode shall be made by changing the flashing red indications to steady red indications followed by appropriate green indications to begin the steady mode cycle. These green indications shall be the beginning of the major-street green interval (when a green signal indication is displayed to through traffic in both directions on the major street) or if there is no common major-street green interval, at the beginning of the green interval for the major traffic movement on the major street.**

*Guidance:*

*02 The steady red clearance interval provided during the change from red-red flashing mode to steady (stop-and-go) mode should have a duration of 6 seconds.*

*03 When changing from the yellow-red flashing mode to steady (stop-and-go) mode, if there is no common major-street green interval, the provision of a steady red clearance interval for the other approaches before changing from a flashing yellow or a flashing red signal indication to a green signal indication on the major approach should be considered.*

**Standard:**

**04 During programmed changes out of flashing mode, no flashing yellow signal indication shall be terminated and immediately followed by a steady red or flashing red signal indication without first displaying the steady yellow signal indication.**

**Option:**

**05 Because special midblock signals that rest in flashing circular yellow in the position normally occupied by the green signal indication do not have a green signal indication in the signal face, these signals may go directly from flashing circular yellow (in the position normally occupied by the green signal indication) to steady yellow without going first to a green signal indication.**

#### **Section 4D.32 Temporary and Portable Traffic Control Signals**

**Support:**

**01 A temporary traffic control signal is generally installed using methods that minimize the costs of installation, relocation, and/or removal. Typical temporary traffic control signals are for specific purposes, such as for one-lane, two-way facilities in temporary traffic control zones (see Chapter 4H), for a haul-road intersection, or for access to a site that will have a permanent access point developed at another location in the near future.**

**Standard:**

- 02 Advance signing shall be used when employing a temporary traffic control signal.**
- 03 A temporary traffic control signal shall:**
  - A. Meet the physical display and operational requirements of a conventional traffic control signal.**
  - B. Be removed when no longer needed.**
  - C. Be placed in the flashing mode when not being used if it will be operated in the steady mode within 5 working days; otherwise, it shall be removed.**
  - D. Be placed in the flashing mode during periods when it is not desirable to operate the signal, or the signal heads shall be covered, turned, or taken down to indicate that the signal is not in operation.**
  - E. Each temporary signals plan shall include the equipment details.**
  - F. Signal faces, detectors and control equipment shall be kept in good operating condition at all times.**
  - G. Timing of the signals shall be determined by the agency having jurisdiction.**

- H. A Signal Ahead (W3-3) sign (and flashing beacon, if required) shall be placed on each approach of the highway in advance of the signal.
- I. Haul road signals shall be operated using manual control or vehicle detectors. The operation shall provide a green indication to the haul road only if the contractor's equipment is approaching the crossing.
- J. The all-red clearance interval shall permit a vehicle to travel the length of the one-way lane before a green indication is shown to opposing traffic.
- K. Failure to comply with any of the above or other specified conditions shall be justification for revoking the permit.

*Guidance:*

- 04 A temporary traffic control signal should be used only if engineering judgment indicates that installing the signal will improve the overall safety and/or operation of the location.*
- 05 The use of temporary traffic control signals by a work crew on a regular basis in their work area should be subject to the approval of the jurisdiction having authority over the roadway.*
- 06 A temporary traffic control signal should not operate longer than 30 days unless associated with a longer-term temporary traffic control zone project.*
- 07 For use of temporary traffic control signals in temporary traffic control zones, reference should be made to Section 6F.84.*

*Option:*

- 08 One-way traffic control signals may utilize semi- or fully-traffic-actuated controller units, or may be manually controlled.*
- 09 Temporary signals for traffic control at the intersection of a State highway and a haul road, or to provide one-way traffic control through a construction zone, may be either the fixed or portable type. Such signals are normally installed by a contractor and may require an Encroachment Permit.*

### **Section 4D.33 Lateral Offset of Signal Supports and Cabinets**

*Guidance:*

- 01 The following items should be considered when placing signal supports and cabinets:*
  - A. Reference should be made to the American Association of State Highway and Transportation Officials (AASHTO) "Roadside Design Guide" (see Section 1A.11) and to the "Americans with Disabilities Act Accessibility Guidelines for Buildings and Facilities (ADAAG)" (see Section 1A.11).*
  - B. Signal supports should be placed as far as practical from the edge of the traveled way without adversely affecting the visibility of the signal indications.*
  - C. Where supports cannot be located based on the recommended AASHTO clearances, consideration should be given to the use of appropriate safety devices.*
  - D. No part of a concrete base for a signal support should extend more than 4 inches above the ground level at any point. This limitation does not apply to the concrete base for a rigid support.*
  - E. In order to minimize hindrance to the passage of persons with physical disabilities, a signal support or controller cabinet should not obstruct the sidewalk, or access from the sidewalk to the crosswalk.*
  - F. Controller cabinets should be located as far as practical from the edge of the roadway.*
  - G. On medians, the minimum clearances provided in Items A through E for signal supports should be obtained if practical.*

*Guidance:*

- 02 Normally, controller cabinets should be located in accordance with the following:*
  - A. It should not be vulnerable to traffic.*
  - B. Traffic movements at the intersection should be visible from the controller timing position.*
  - C. The doors of the cabinet should open away from the curb or traveled way.*
  - D. It should be possible to park a maintenance truck close to the cabinet.*
  - E. It should not be located in a drainage ditch, in an area which could be under water or where subjected to water from sprinklers.*
  - F. It should not obstruct sidewalks, wheelchair ramps, or store entrances.*
  - G. It should be placed so as not to obstruct pedestrian or road user visibility.*



Support:

03 Refer to Figures 4D-102(CA) through 4D-108(CA) for typical signal layouts for various intersections.

**Standard:**

04 **Upon requests, keys for the police panel on traffic signal controller cabinets shall be furnished to the California Highway Patrol offices or local enforcement agencies.**

**Section 4D.34 Use of Signs at Signalized Locations**

Support:

01 Traffic signal signs are sometimes used at highway traffic signal locations to instruct or guide pedestrians, bicyclists, or motorists. Among the signs typically used at or on the approaches to signalized locations are movement prohibition signs (see Section 2B.18), lane control signs (see Sections 2B.19 to 2B.22), pedestrian crossing signs (see Section 2B.51), pedestrian actuation signs (see Section 2B.52), traffic signal signs (see Sections 2B.53 and 2C.48), Signal Ahead warning signs (see Section 2C.36), Street Name signs (see Section 2D.43), and Advance Street Name signs (see Section 2D.44).

Guidance:

02 *Regulatory, warning, and guide signs should be used at traffic control signal locations as provided in Part 2 and as specifically provided elsewhere in Part 4.*

03 *Traffic signal signs should be located adjacent to the signal face to which they apply.*

Support:

04 Section 2B.19 contains information regarding the use of overhead lane control signs on signalized approaches where lane drops, multiple-lane turns involving shared through-and-turn lanes, or other lane-use regulations that would be unexpected by unfamiliar road users are present.

**Standard:**

05 **If used, illuminated traffic signal signs shall be designed and mounted in such a manner as to avoid glare and reflections that seriously detract from the signal indications. Traffic control signal faces shall be given dominant position and brightness to maximize their priority in the overall display.**

06 **The minimum vertical clearance and horizontal offset of the total assembly of traffic signal signs (see Section 2B.53) shall comply with the provisions of Sections 4D.15 and 4D.16.**

07 **Because the potential for conflicting commands could create driver confusion, YIELD or STOP signs shall not be used in conjunction with any traffic control signal operation, ~~except in either of the following cases:~~**

**~~A. If the signal indication for an approach is a flashing red at all times, or~~**

**~~B. If a minor street or driveway is located within or adjacent to the area controlled by the traffic control signal, but does not require separate traffic signal control because an extremely low potential for conflict exists.~~**

08 **STOP signs shall not be erected at any entrance to an intersection controlled by traffic signals. Refer to CVC 21355(a).**

Option:

09 YIELD or STOP signs may be used at a channelized turn lane if it is separated from the adjacent travel lanes moving in same direction by an island and the channelized turn lane is not controlled by a traffic control signal.

**Section 4D.35 Use of Pavement Markings at Signalized Locations**

Support:

01 Pavement markings (see Part 3) that clearly communicate the operational plan of an intersection to road users play an important role in the effective operation of traffic control signals. By designating the number of lanes, the use of each lane, the length of additional lanes on the approach to an intersection, and the proper stopping points, the engineer can design the signal phasing and timing to best match the goals of the operational plan.

Guidance:

02 *Pavement markings should be used at traffic control signal locations as provided in Part 3. If the road surface will not retain pavement markings, signs should be installed to provide the needed road user information.*

### **Section 4D.101(CA) Traffic Signal Design and Operations**

**Support:**

- 01 The design of traffic signals by Caltrans is based upon the following publications:
  - A. Standard Specifications.
  - B. Standard Plans.
  - C. Signal and Lighting Design Guide.
  - D. Ramp Meter Design Manual.
  - E. Highway Design Manual.
- 02 Additional references that can be used include:
  - A. Traffic Engineering Handbook.
  - B. Manual of Traffic Signal Design.
  - C. Traffic Control Systems Standards.
  - D. Traffic Control Devices Handbook.
- 03 See Section 1A.11 for information regarding these publications.

### **Section 4D.102(CA) Signal Plan Schedules**

**Guidance:**

- 01 *The traffic signal plans for the installation of a new signal or the major modification of an existing signal should include the following schedules:*
  - A. Pole and Equipment Schedule: A pole and equipment schedule shows the types of standards, mast arm lengths, types and mounting for vehicle and pedestrian signal faces, and other equipment. See Table 4D-105(CA) and the Standard Plans.
  - B. Conductors and Conduit Schedule: A conductor and conduit schedule shows the size of each conduit run, and the size, type and number of conductors or cables in each conduit run. See Table 4D-106(CA).

**Support:**

- 02 Dimensions of conductors and conduit and data for determining conduit size are shown in Tables 4D-107(CA) and 4D-108(CA).

### **Section 4D.103(CA) Vehicle Detectors**

**Support:**

- 01 The proper operation of a traffic-actuated signal is dependent upon the appropriate type and proper placement of detectors. The types and applications of vehicle detectors currently used include the following:
  - A. Inductive Loop - The inductive loop detector, because of its presence feature, detects a standing vehicle as well as a moving one. The detection area is roughly that enclosed by the loop.
  - B. Magnetometer- The magnetometer detector detects a standing vehicle, as well as a moving one, and has a detection area up to 3.3 feet in diameter over each sensing element.
  - C. Magnetic- The magnetic detector detects only vehicles moving in excess of 5 mph. One sensing element covers one or two traffic lanes.
  - D. Video Detection- Detects vehicles passing through the field of view of a CCTV camera or image sensor. They are useful during construction or other temporary situations when lanes change frequently in width and location as well as where the installation of conduit and detector loops is expensive or difficult. Care is necessary to avoid locations and conditions which could obscure the detector's visibility such as extreme weather, sun glare and moving shadows.
  - E. Pressure Sensitive.

**Standard:**

- 02 **No new pressure sensitive installations shall be made. Existing units shall be replaced with other types of detectors loop when:**
  - A. They require relocation;**
  - B. The traffic signal is to be modified; or**
  - C. The roadway is to be resurfaced.**

Support:

<sup>03</sup> The normal installation of inductive loop and magnetic detectors requires sound pavement if the detector is to operate reliably.

Guidance:

<sup>04</sup> *If the pavement on an approach in which these detectors are to be installed is cracked, the project should include resurfacing of the areas where the detectors and lead-in cables are to be placed.*

Support:

<sup>05</sup> Typical installation details for inductive loop and magnetic detectors are shown on the Standard Plans. The longitudinal location (setback) of detectors relative to the limit line depends on the speed of traffic and the type of detector operation desired. See Table 4D-101(CA) for suggested setback from Limit lines.

### **Section 4D.104(CA) Optional Use of Bicycle Signal Faces**

Support:

<sup>01</sup> A bicycle signal (see Figure 4D-112(CA)) is an electrically powered traffic control device that uses bicycle signal faces and directs bicyclists to take specific actions. Use of bicycle signal faces is analogous to using pedestrian signal heads where implementation is based on engineering judgment. Refer to Table 1A-101(CA) for information on FHWA's Interim Approval for Optional Use of a Bicycle Signal Face (IA-16). See FHWA's memorandum: INFORMATION: MUTCD – Official Ruling 9(09)-47(I) – Clarification of the Interim Approval for the Optional Use of a Bicycle Signal Face (IA-16). Refer to CVC 21450 and 21456.3.

Option:

<sup>02</sup> Existing signalized locations may be retrofitted with additional signal heads that include bicycle signal faces if the engineer determines that it would be advantageous or beneficial to have the signalized location implement bicycle signal faces.

**Standard:**

<sup>03</sup> **If used, bicycle signal faces shall only be used at signalized locations. Signal phasing shall be such that while bicycles are moving on a green or yellow bicycle indication, they are not in conflict with any simultaneous motor vehicle movements at the signalized location, including right (or left) turns on red.**

Guidance:

<sup>04</sup> *Before existing signalized intersections are retrofitted with bicycle signal faces, alternative means of handling conflicts between bicycles and motor vehicles should be considered.*

<sup>05</sup> *Two alternatives that should be considered are:*

- A. *Striping to direct a bicyclist to a lane adjacent to a traffic lane such as a bike lane to left of a right-turn-only lane.*
- B. *Redesigning the intersection to direct a bicyclist from an off-street path to a bicycle lane at a point removed from the signalized intersection.*

### **Section 4D.105(CA) Bicycle/Motorcycle Detection**

**Standard:**

<sup>01</sup> **All new limit line detector installations and modifications to the existing limit line detection on a public or private road or driveway intersecting a public road (see Section 1A.13 for definitions) shall either provide a Limit Line Detection Zone in which the Reference Bicycle-Rider is detected or be placed on permanent recall or fixed time operation. Refer to CVC 21450.5.**

<sup>02</sup> **All new and modified bike path approaches to a signalized intersection shall be equipped with either a Limit Line Detection Zone or a bicyclist pushbutton, or else the phase serving the bike path shall be placed on permanent recall or fixed time operation. A bicyclist pushbutton, if used, shall be located on the right side of the bike path and where it can be reached from the bike path. See Section 9B.11 for bicycle regulatory signs.**

<sup>03</sup> **At new signalized intersections or when the advance detection is being replaced at existing signalized intersections, phases with advance detection only shall be placed on permanent recall.**

Support:

<sup>04</sup> The requirement to detect the Reference Bicycle-Rider in the Limit Line Detection Zone is technology-neutral.

Option:

<sup>05</sup> The detection zone in a bike lane may be narrower than 6 feet. See Figure 4D-111(CA).

<sup>06</sup> A Bicycle Detector Symbol may be used. See Sections 9B.13 and 9C.05.

<sup>07</sup> A bicyclist pushbutton may be used to supplement the required limit line detection.

Support:

<sup>08</sup> See Section 9B.10 for bicycle regulatory signs.

Guidance:

<sup>09</sup> If more than 50% of the limit line detectors need to be replaced at a signalized intersection, then the entire intersection should be upgraded so that every lane has a Limit Line Detection Zone.

<sup>10</sup> The Reference Bicycle-Rider or the equivalent should be used to confirm bicycle detection under the following situations:

- A. A new detection system has been installed; or
- B. The detection configuration has been modified.

Support:

<sup>11</sup> CVC Section 21202(a) requires bicyclists traveling "at a speed less than the normal speed of traffic" to ride "as close as practicable to the right-hand curb or edge of the roadway" with exceptions, including when the bicyclist is "approaching a place where a right turn is authorized." This exception was intended to provide the bicyclist the flexibility to avoid having to ride against the right hand curb or edge of the road where a potential conflict would be created with a right turning road user.

<sup>12</sup> A Limit Line Detection Zone provides for the detection of both bicycles and vehicles, including motorcycles.

Guidance:

<sup>13</sup> Where a Limit Line Detection Zone that detects the Reference Bicycle-Rider has been provided, minimum bicycle timing should be provided as follows:

<sup>14</sup> For all phases, the sum of the minimum green, plus the yellow change interval, plus any red clearance interval should be sufficient to allow a bicyclist riding a bicycle 6 feet long to clear the last conflicting lane at a speed of 14.7 feet/sec plus an additional effective start-up time of 6 seconds, according to the formula

$$G_{min} + Y + R_{clear} \geq 6 \text{ sec} + (W+6 \text{ feet})/14.7 \text{ feet/sec,}$$

Where:

$G_{min}$  = Length of minimum green interval (sec)

$Y$  = Length of yellow interval (sec)

$R_{clear}$  = Length of red clearance interval (sec)

$W$  = Distance from limit line to far side of last conflicting lane (feet)

Support:

<sup>15</sup> Bicyclist crossing times are shown in Table 4D-109(CA). The speed of 14.7 feet/sec represents the final crossing speed and the effective start-up time of 6 seconds represents the time lost in reacting to the green light and then accelerating to full speed.

Option:

<sup>16</sup> A limit line detection system that can discriminate between bicyclists and vehicles may be used to extend the length of the minimum green.

<sup>17</sup> Supplemental Reference Bicycle-Rider detection zones, new technology, or various signal controller settings may be utilized to adjust the time ( $G_{min} + Y + R_{clear}$ ) and/or travel distance ( $W$ ) that bicyclists are exposed to conflicting vehicular traffic.

## **Section 4D.106(CA) Selection of Traffic Signal Operation**

Guidance:

<sup>01</sup> A prime factor to be considered in selection of the type of traffic signal operation is adequacy. Even though a sophisticated signal control should operate satisfactorily at any intersection, the intersection should not be provided with a type of control that is unnecessarily complex and expensive.

Support:

<sup>02</sup> The type of traffic signal operation to be used is dependent upon the variations in traffic demand. The two general types of signal operation are pre-timed and traffic-actuated. Traffic-actuated operation can be further classified as full-traffic-actuated or semi-traffic-actuated. With full-traffic-actuated operation, all traffic movements or phases are provided with detectors. In semi-traffic-actuated operation, certain phases (usually the coordinated phases) do not have detectors.

Guidance:

<sup>03</sup> Pre-timed and semi-traffic-actuated operation should be used in coordinated systems only. They should not be installed at isolated intersections (more than 1 mile) from the closest signalized intersection).

<sup>04</sup> Where the distance between signalized intersections is 0.5 mile or less, coordination of signals should be considered, including the preparation of a time-space diagram and an evaluation of the cost-effectiveness of coordination.

<sup>05</sup> Discretion should be used with phasing at offset intersections as it may introduce operational problems, which should be recognized and avoided. The most critical of these problems is where one approach right-of-way is terminated while the opposing approach continues with a green indication.

### **Section 4D.107(CA) Selection of Left-Turn Phasing**

**Support:**

01 There are various methods to signalize left turn movements. See Figure 4D-101(CA).

**Guidance:**

02 *If the left turn volume is 300 or more vehicles per hour, or if delays to traffic at the intersection can be significantly reduced, consideration should be given to a two-lane left turn.*

### **Section 4D.108(CA) Dual Left-Turn Phasing**

**Support:**

01 This method is most effective during free or isolated operation and is traffic-actuated. It is the most efficient means of providing protected left turn movements since the various phases and combinations of phases appear only on demand. A through movement is allowed to go with its associated left turn movement when there is no opposing left turn traffic. See Figure 4D-101(CA).

### **Section 4D.109(CA) Lead-Lag Left-Turn Phasing**

**Guidance:**

01 *This operation can be either pre-timed or traffic-actuated. Normally, "Lead-Lag Left-Turn" phasing should be considered for coordinated signals when the offset timing determined by the system time-space diagram results in the arrival of the two directions of traffic at different times during a cycle. This will provide the most efficient progressive band. See Figure 4D-101(CA).*

### **Section 4D.110(CA) Opposite or Opposing (Six Phase Opposing Operation)**

**Guidance:**

01 *Opposing operation should be used where the left turn volume per lane is very high in either direction and is about equal to or greater than the companion through movement.*

**Support:**

02 This method is especially useful when one of the through lanes must be used as an optional turning lane or where a separate left turn lane cannot be provided. See Figure 4D-106(CA).

### **Section 4D.111(CA) Permissive Left-Turn Phasing**

**Guidance:**

01 *When a protected-permissive or permissive-protected left-turn phasing operation is used for a signal system, no information sign is necessary.*

**Standard:**

02 **If a sign is used, it shall be a LEFT TURN YIELD ON GREEN (Green Ball symbol) (R10-12) sign.**

**Option:**

03 Public agencies having jurisdiction may use an Activated Blank-Out message sign on local roads in place of the R10-12 sign on their local roads that are not part of an intersection with a State highway.

**Standard:**

04 **The Activated Blank-Out sign shall say LEFT TURN YIELD in at least 6 inch high letters. The light source shall be designed and constructed so that when illuminated, the message shall be white and remain dark when not in use. The message shall be illuminated only when the green permissive ball is lighted.**

05 **The following apply to permissive left-turn phasing:**

- 1. This operation shall not be initiated where the left turn collision warrant is satisfied.**
- 2. Both directions of through traffic shall be terminated simultaneously except where opposing left turns or opposing U-turns are prohibited.**

**Guidance:**

3. *Signal faces should not be placed in a median facing a left turn lane.*

- The signal face is provided with some type of visibility control so that the indications are not visible to traffic in the left turn storage lane; or*
- A LEFT TURN YIELD ON GREEN (symbolic circular green) (R10-12) sign is installed below the said signal face.*

Support:

4. Signs are not required for this operation unless U-turns are to be prohibited.

### **Section 4D.112(CA) Signals at Interchanges**

Support:

<sup>01</sup> Signals at freeway interchanges require special consideration as to phasing and timing to minimize backup of traffic onto the freeway lanes. In addition, signals at diamond-type interchanges require phasing and timing to provide the necessary turning movements from the cross street to and from the ramps, without a backup of traffic between the ramps.

Guidance:

<sup>02</sup> *Figures 4D-109(CA) and 4D-110(CA) are guides and should be used to determine the timing of traffic signals at diamond interchanges. These figures should be used in conjunction with Table 4D-103(CA) to determine the timing of the splits and offsets for diamond interchange signals.*

Support:

<sup>03</sup> The decision whether to use pre-timed or traffic-actuated operation is dependent not only upon traffic conditions in the interchange area, but also upon traffic conditions along the cross street. For example, a coordinated traffic signal system along the cross street may require that the signals at the interchange be coordinated with the cross street progression.

### **Section 4D.113(CA) Timing of Green Intervals**

Guidance:

<sup>01</sup> *The proportion of green time, or split, allotted to each phase or combination of phases during a signal cycle, should be as close as practicable to the proportion of critical lane traffic volumes on the respective approaches. In traffic-actuated operation, this proportioning is done automatically and continuously as a result of vehicle detector inputs to the controller unit.*

Option:

<sup>02</sup> Factors that may modify this proportioning are the time required for pedestrian intervals and the requirements of a coordinated system.

Support:

<sup>03</sup> In the usual signal operation, predetermined splits can be selected by time-of-day or traffic-responsive equipment. In coordinated signal systems, the cycle length and the split can be varied by command from the system master controller.

### **Section 4D.114(CA) Review of Traffic Signal Operations**

Guidance:

<sup>01</sup> *All traffic signals should be periodically reviewed for proper operation. The traffic signal operation should be observed during morning and evening peak traffic periods and during off-peak periods. If an operating deficiency is observed, the reason for the deficiency should be determined. If there is a malfunction, Maintenance unit should be notified, and after corrective work is done, further surveillance should be conducted to be sure no deficiency remains. If a need for a design change is observed, an analysis should be made to determine what improvement might be necessary to improve the design.*

<sup>02</sup> *Improvements to consider are:*

1. *Timing of:*
  - a. *Maximums or Force Offs*
  - b. *Gap Interval*
  - c. *Offsets*
  - d. *Cycle Length*
2. *Time-of-Day or Traffic Responsive Settings*
3. *Signal Phasing or Phase Sequence*
4. *Type of Operation*
5. *Coordination of Signals*
6. *Signs, Striping and/or Pavement Markings*
7. *Roadway Improvements*

**Standard:**

<sup>03</sup> **Timing and phasing of traffic signals and any subsequent changes in timing shall be approved by the public agency having jurisdiction. Timing records shall be kept by the agency responsible for the maintenance and/or**

operation and be readily available to the maintenance and traffic operations staffs and other agencies, where appropriate.

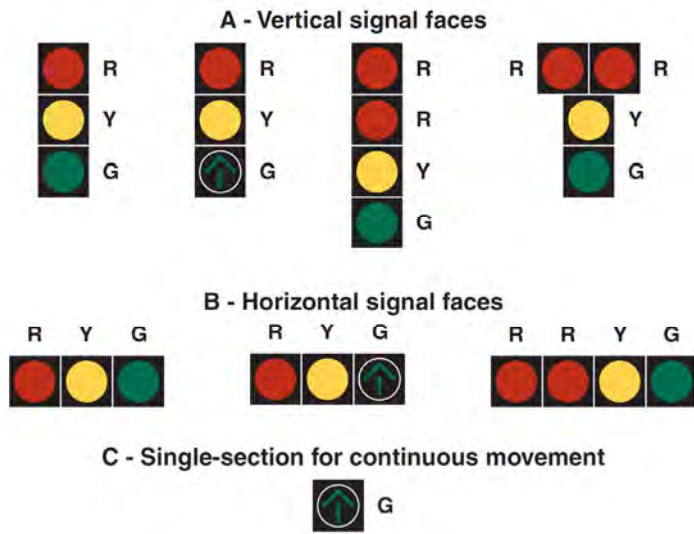
Support:

04 Aids for timing are shown in Tables 4D-103(CA) and 4D-104(CA).

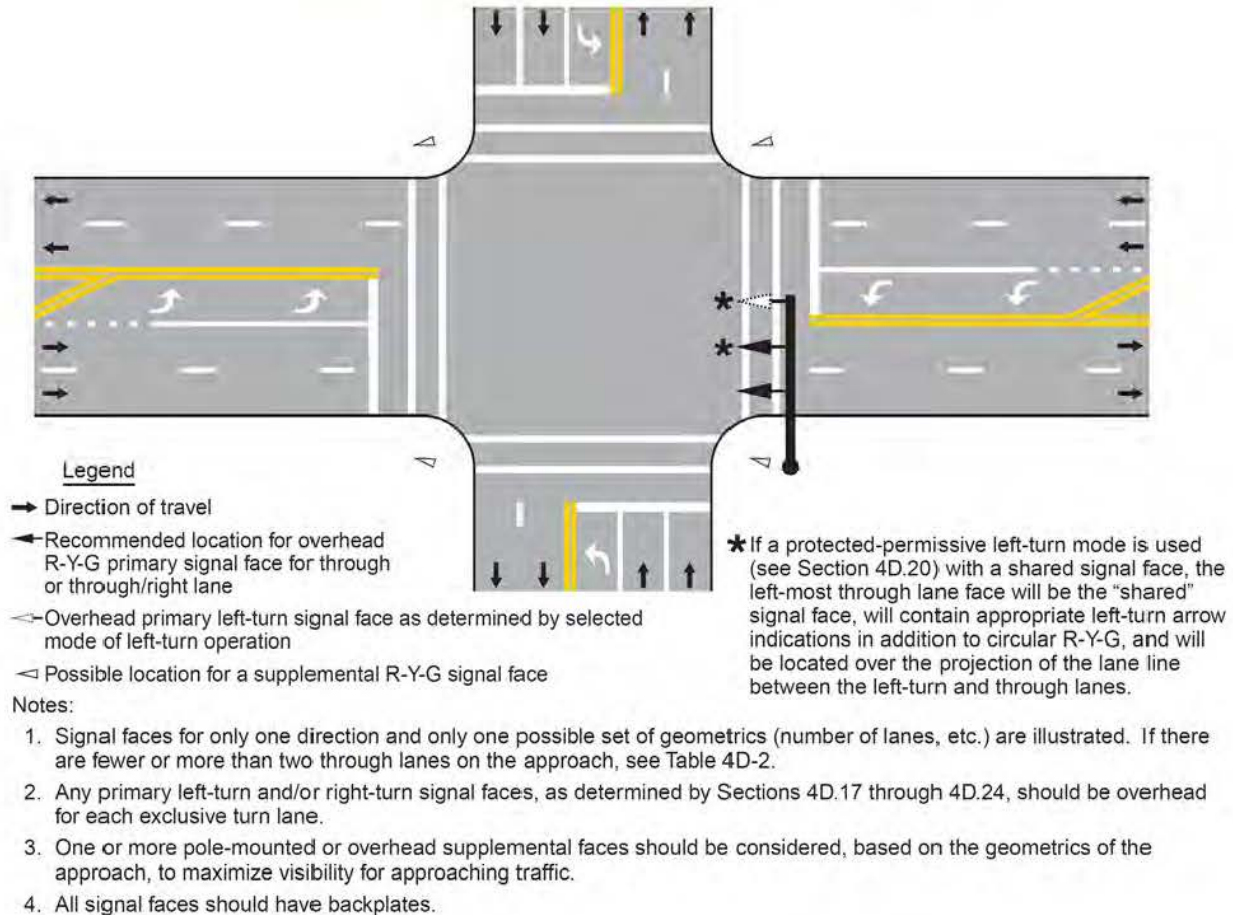
**Figure 4D-1. Example of U-Turn Signal Face**



**Figure 4D-2. Typical Arrangements of Signal Sections in Signal Faces That Do Not Control Turning Movements**

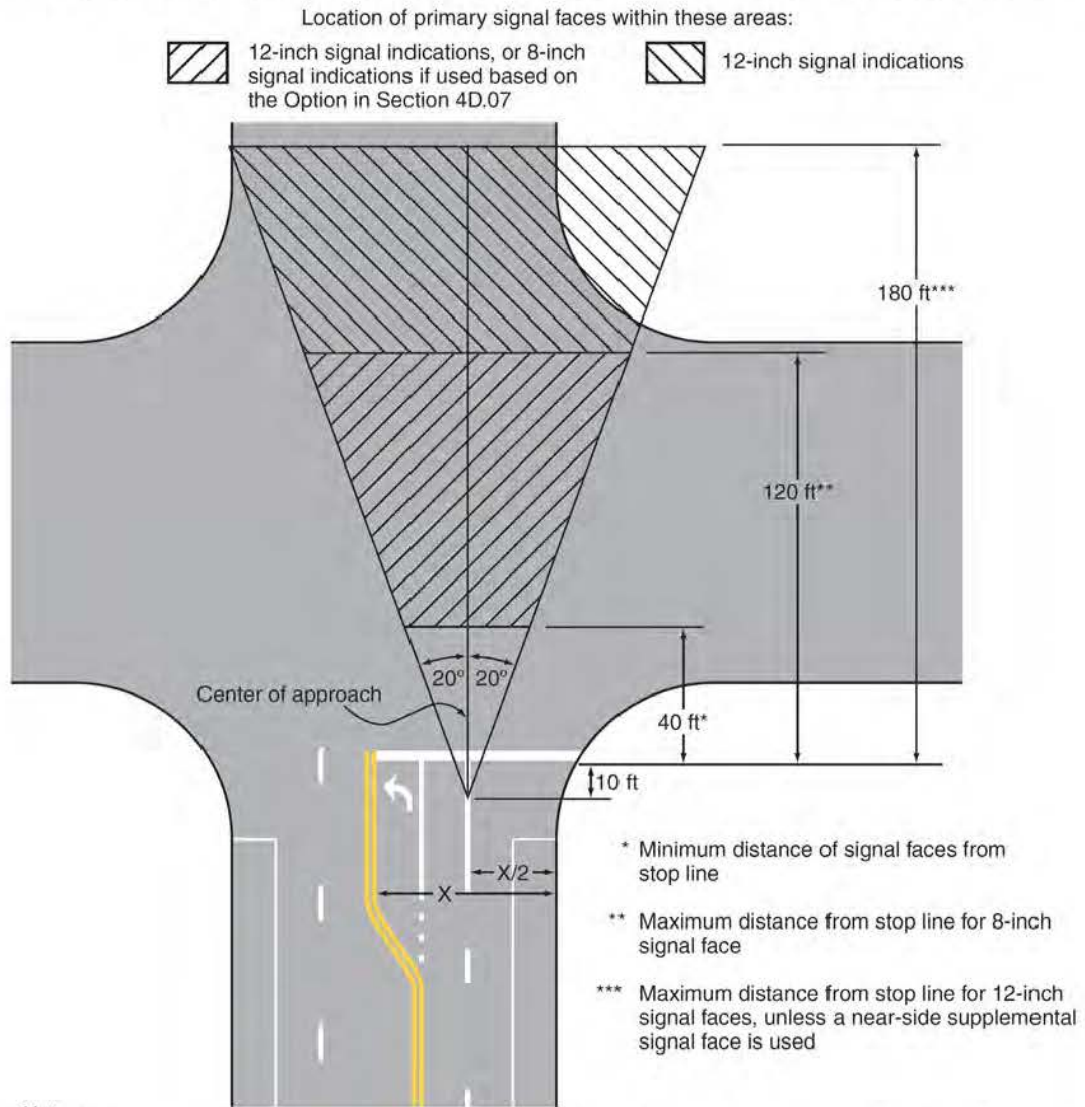


**Figure 4D-3. Recommended Vehicular Signal Faces for Approaches with Posted, Statutory, or 85<sup>th</sup>-Percentile Speed of 45 mph or Higher  
 (Where there are Excessive Red Signal Violations)**





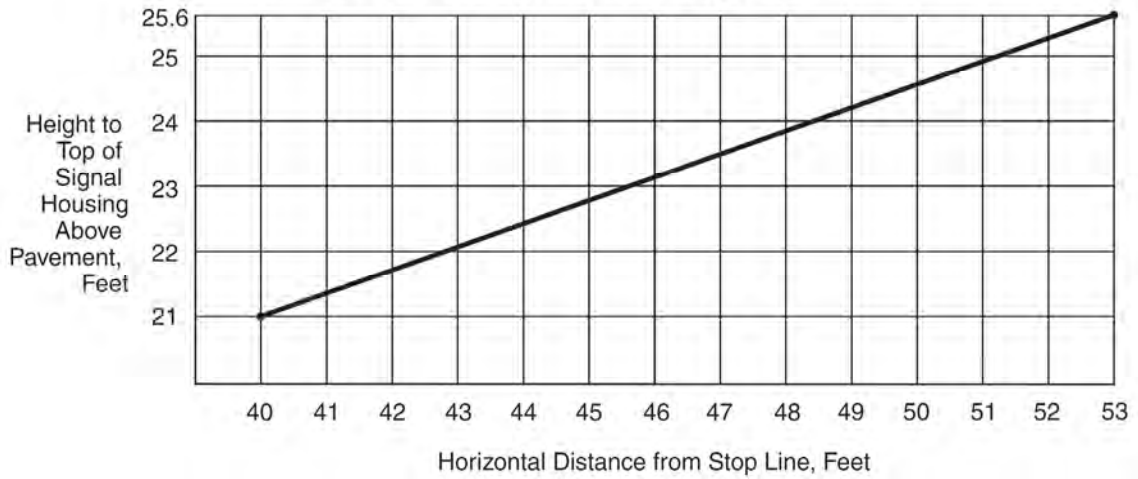
**Figure 4D-4. Lateral and Longitudinal Location of Primary Signal Faces**



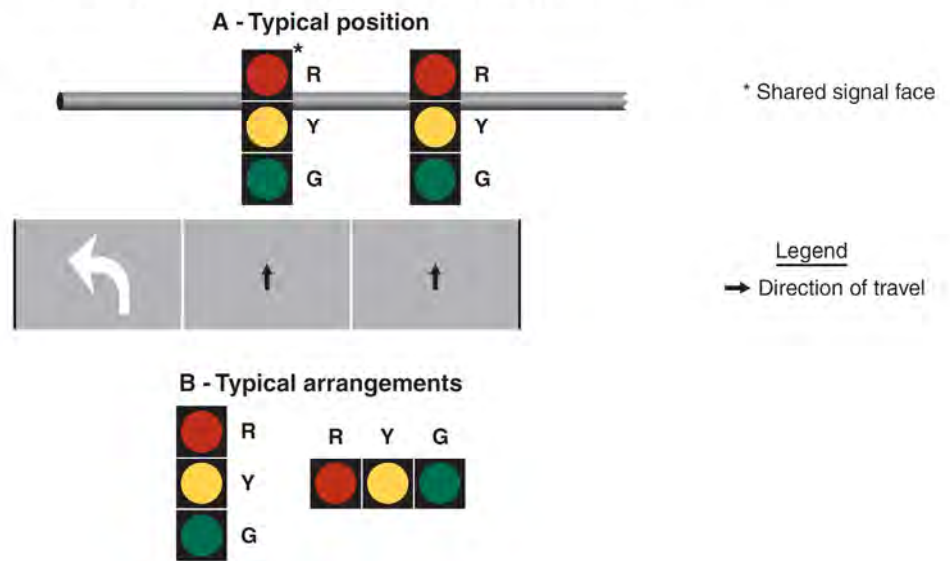
**Notes:**

1. See Section 4D.11 for approaches with posted, statutory, or 85th-percentile speeds of 45 mph or higher
2. See Section 4D.13 regarding location of signal faces that display a CIRCULAR GREEN signal indication for a permissive left-turn movement on approaches with an exclusive left-turn lane or lanes

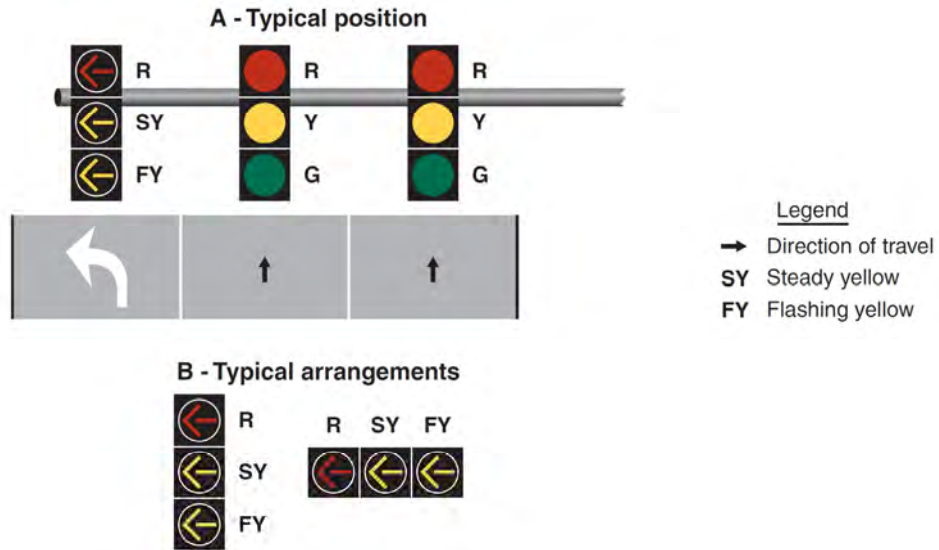
**Figure 4D-5. Maximum Mounting Height of Signal Faces Located Between 40 Feet and 53 Feet from Stop Line**



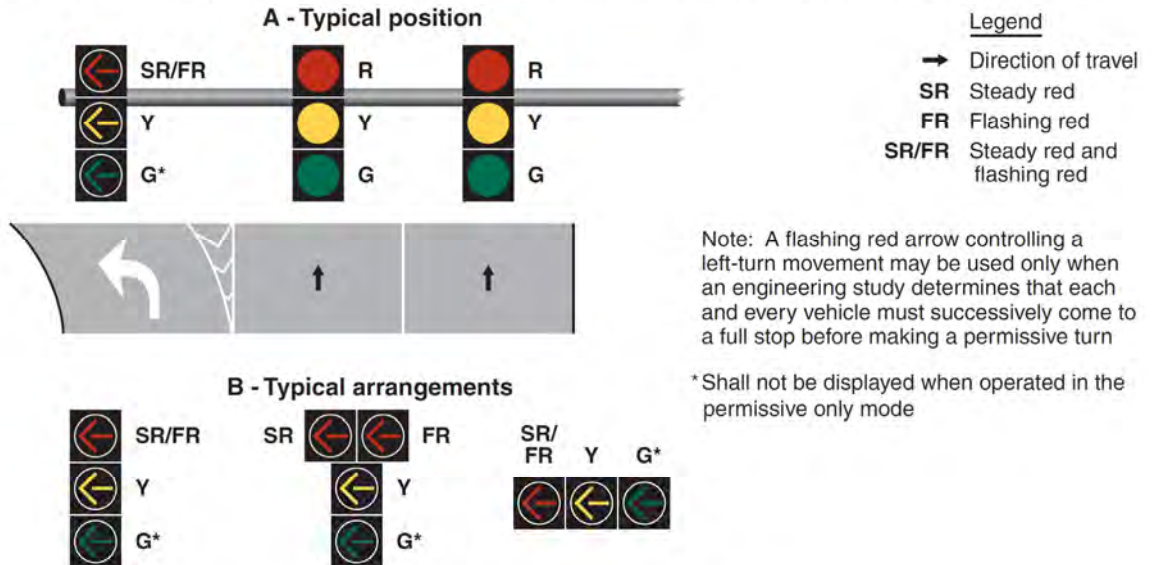
**Figure 4D-6. Typical Position and Arrangements of Shared Signal Faces for Permissive Only Mode Left Turns**



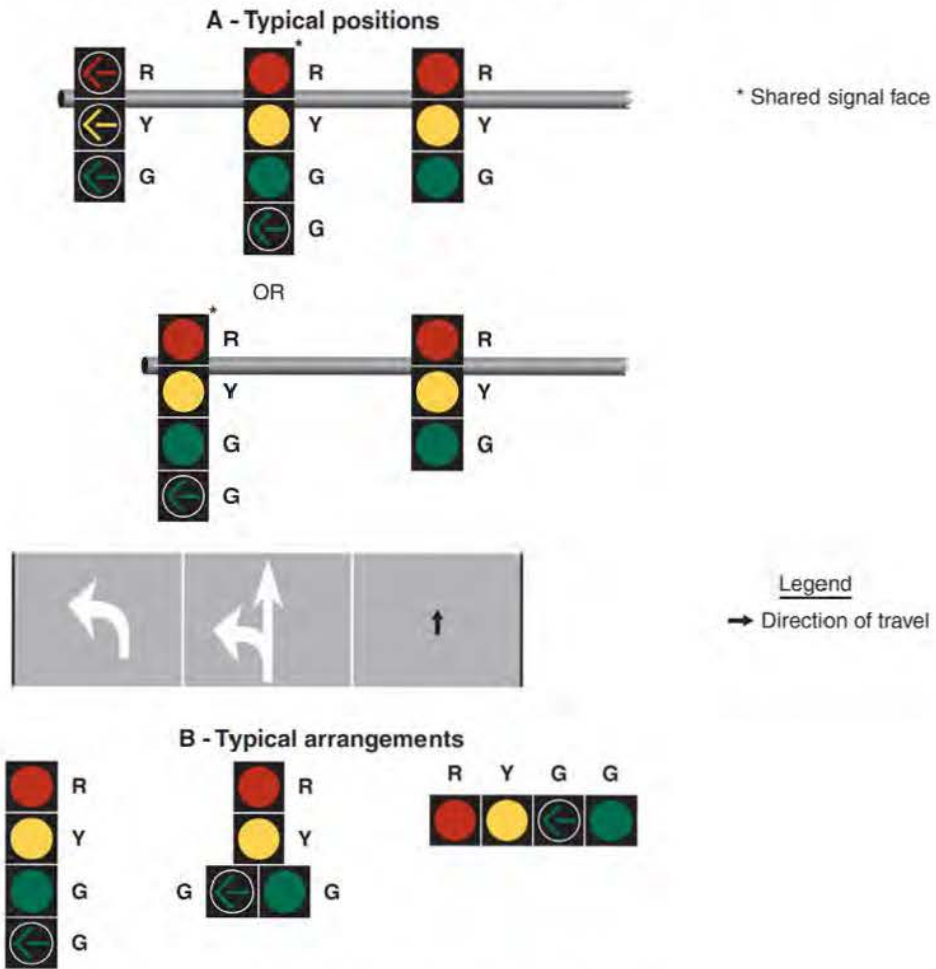
**Figure 4D-7. Typical Position and Arrangements of Separate Signal Faces with Flashing Yellow Arrow for Permissive Only Mode Left Turns**



**Figure 4D-8. Typical Position and Arrangements of Separate Signal Faces with Flashing Red Arrow for Permissive Only Mode and Protected/Permissive Mode Left Turns**

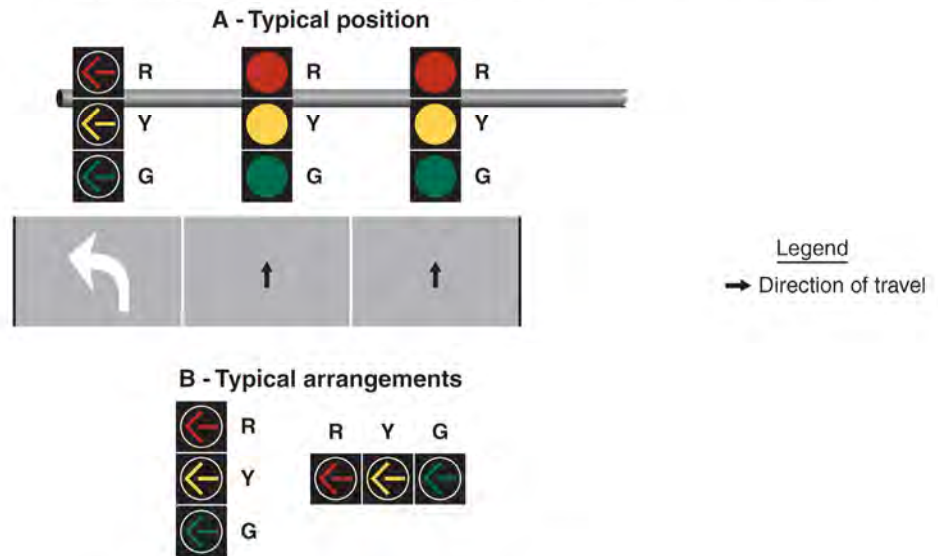


**Figure 4D-9. Typical Positions and Arrangements of Shared Signal Faces for Protected Only Mode Left Turns**

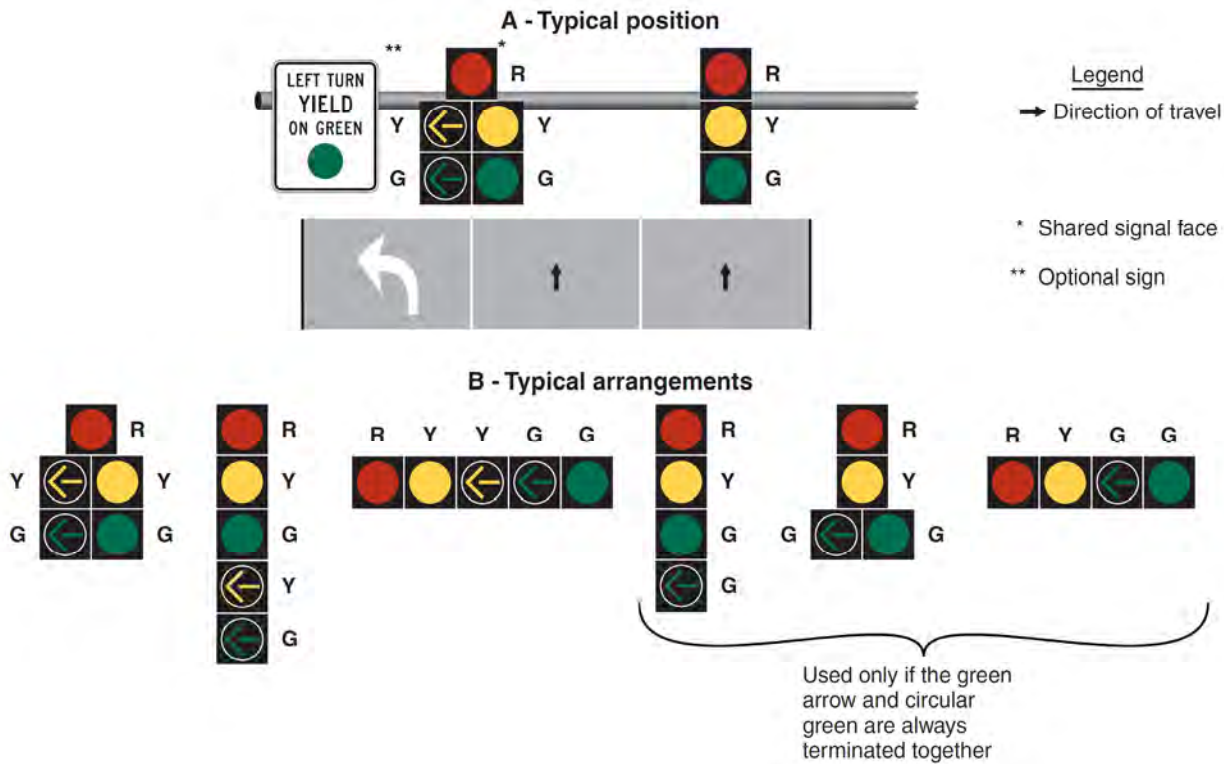


Note: Shared signal faces shall only be used for a protected-only mode left turn if the circular green and green left-turn arrow indications always begin and terminate together

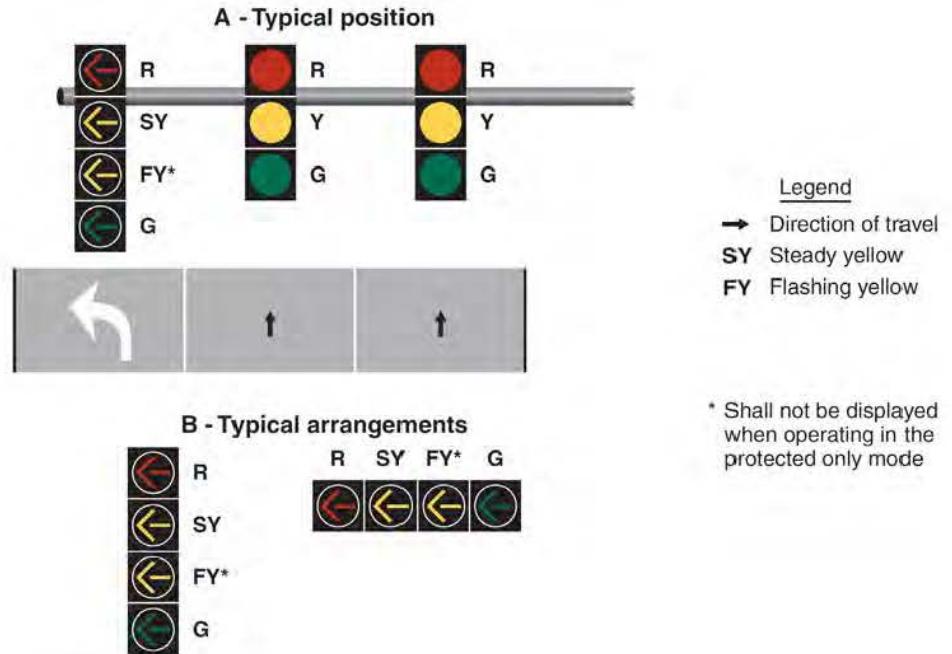
**Figure 4D-10. Typical Position and Arrangements of Separate Signal Faces for Protected Only Mode Left Turns**



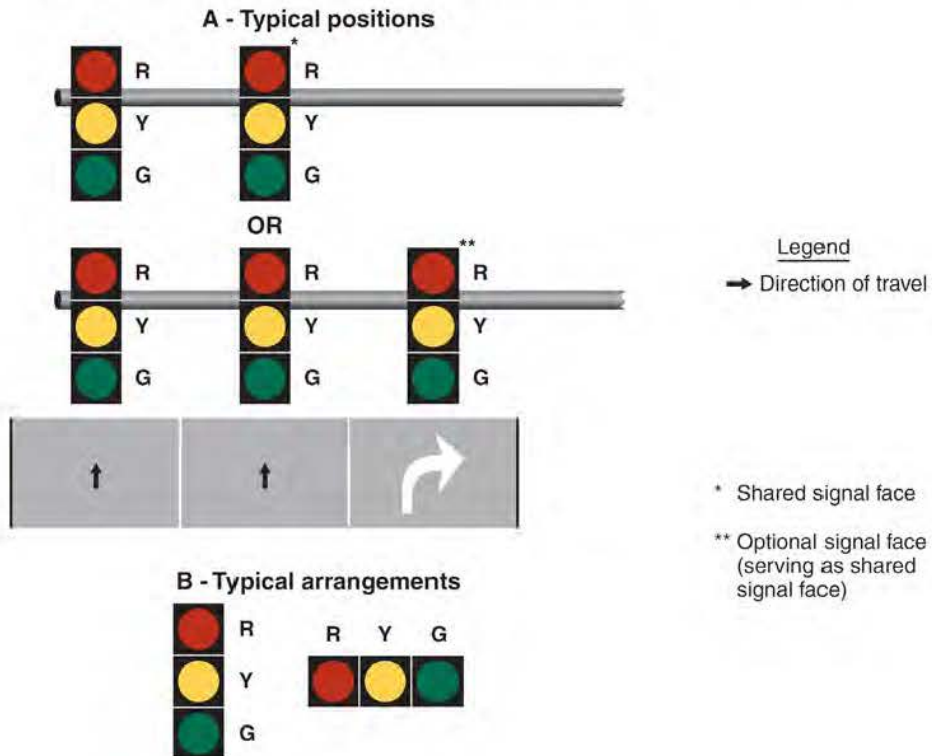
**Figure 4D-11. Typical Position and Arrangements of Shared Signal Faces for Protected/Permissive Mode Left Turns**



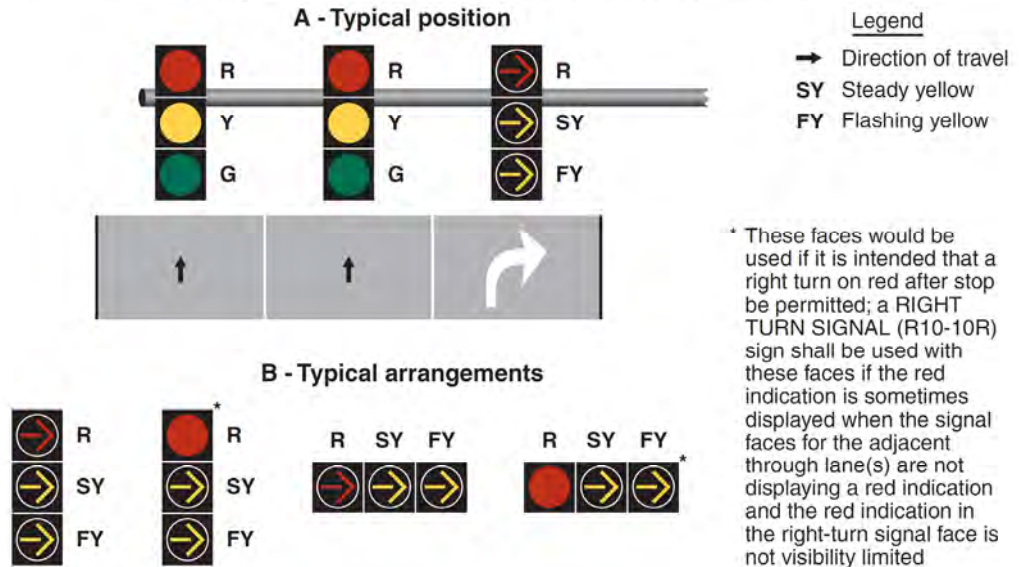
**Figure 4D-12. Typical Position and Arrangements of Separate Signal Faces with Flashing Yellow Arrow for Protected/Permissive Mode and Protected Only Mode Left Turns**



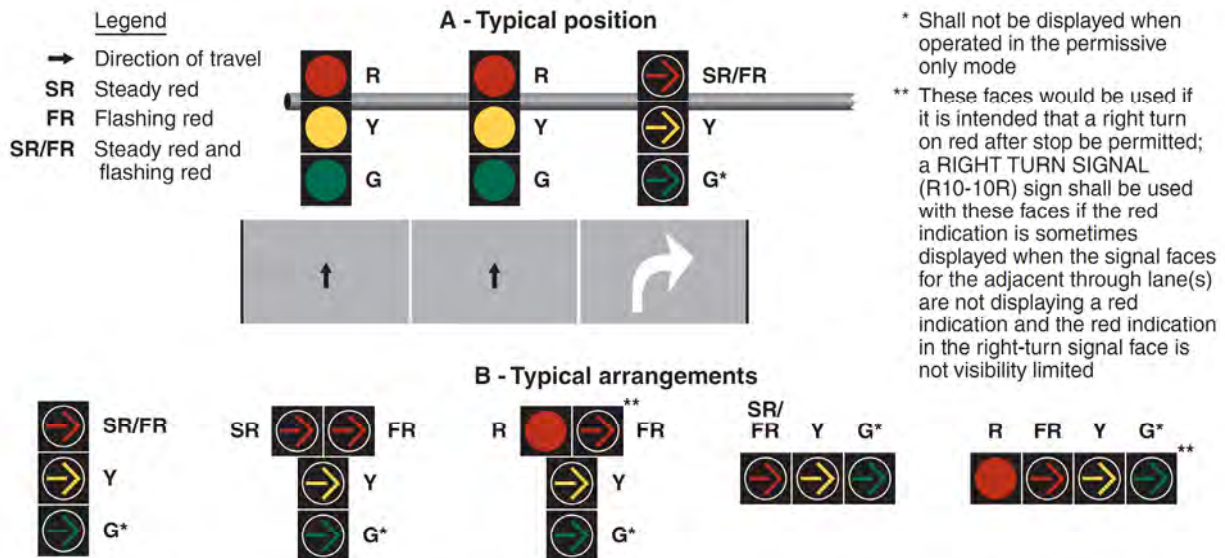
**Figure 4D-13. Typical Positions and Arrangements of Shared Signal Faces for Permissive Only Mode Right Turns**



**Figure 4D-14. Typical Position and Arrangements of Separate Signal Faces with Flashing Yellow Arrow for Permissive Only Mode Right Turns**

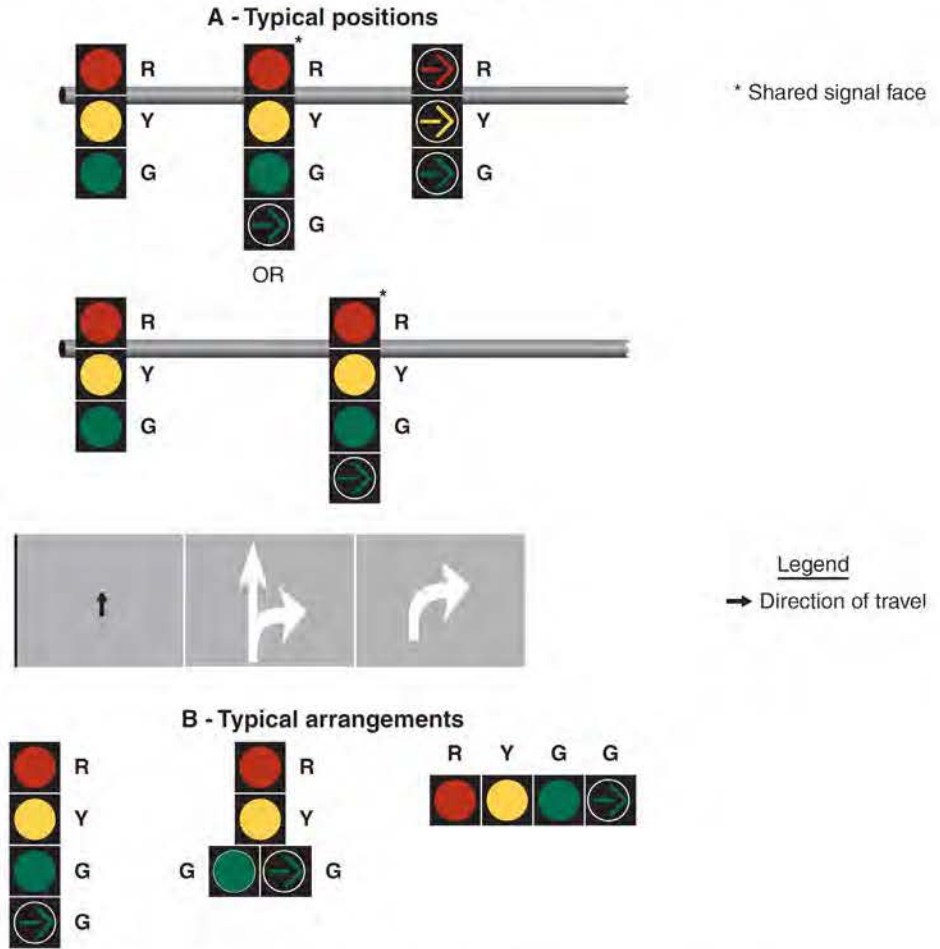


**Figure 4D-15. Typical Position and Arrangements of Separate Signal Faces with Flashing Red Arrow for Permissive Only Mode and Protected/Permissive Mode Right Turns**



Note: A flashing red arrow controlling a right-turn movement may be used only when an engineering study determines that each and every vehicle must successively come to a full stop before making a permissive turn

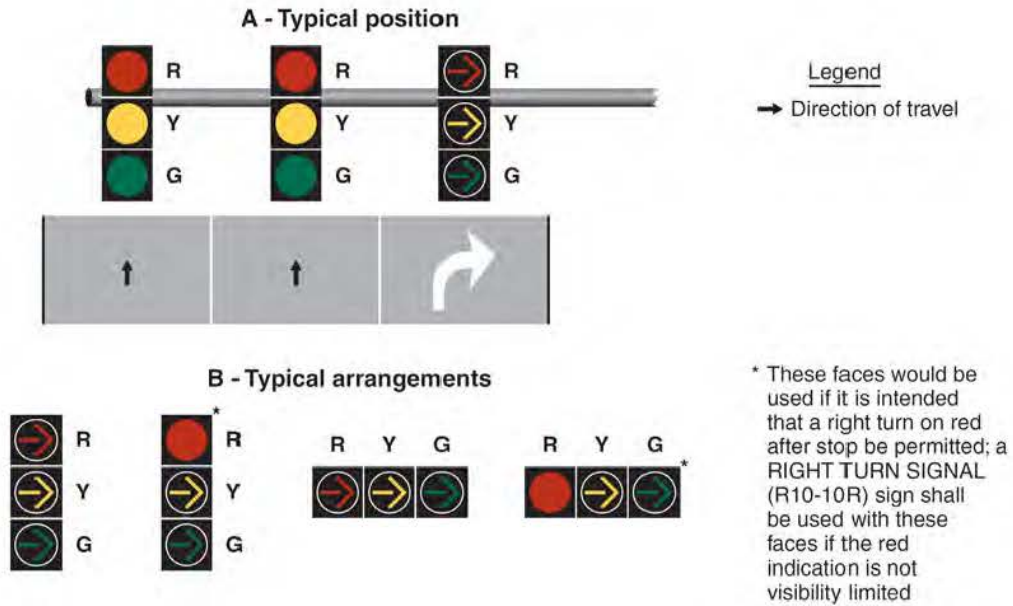
**Figure 4D-16. Typical Positions and Arrangements of Shared Signal Faces for Protected Only Mode Right Turns**



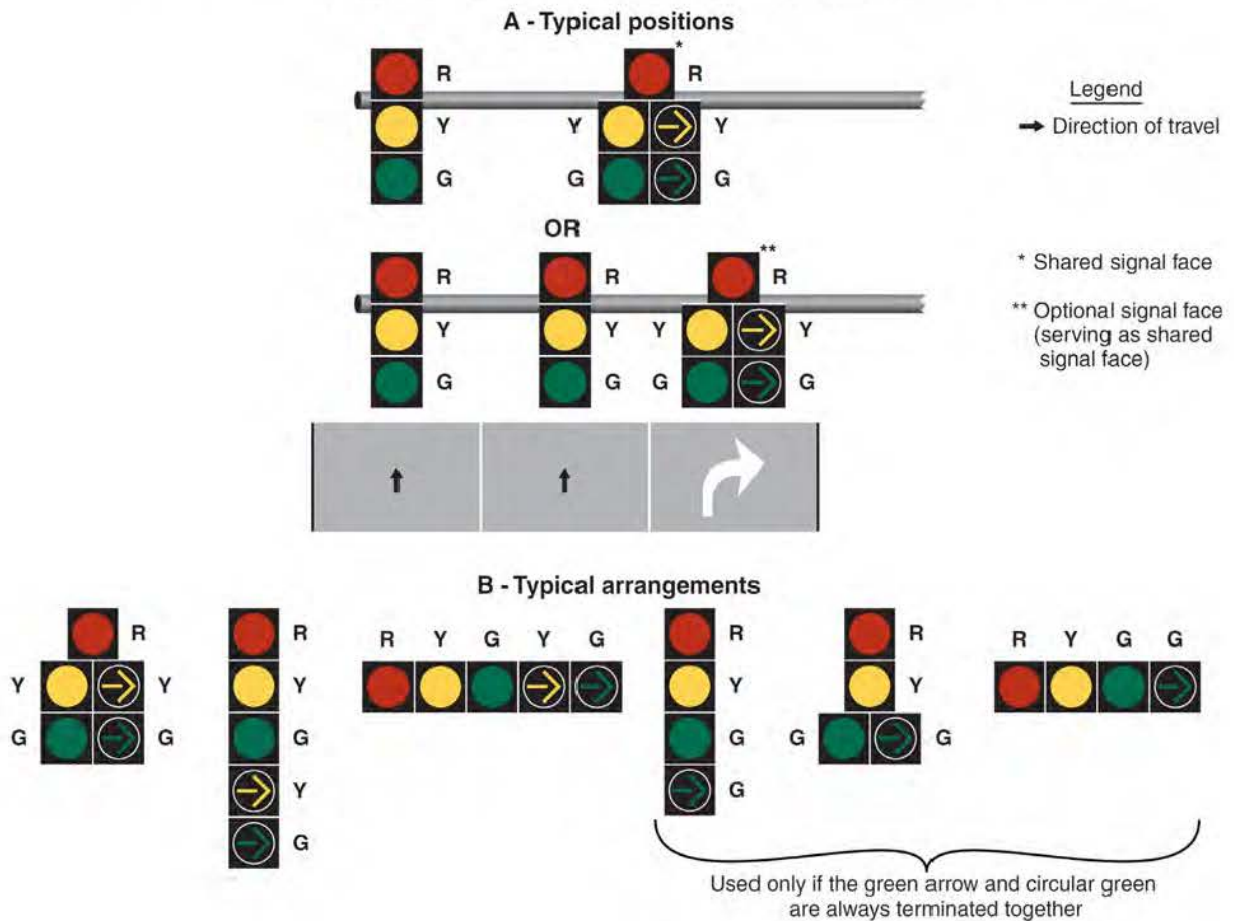
Note: Shared signal faces shall only be used for a protected-only mode right turn if the circular green and green right-turn arrow indications always begin and terminate together



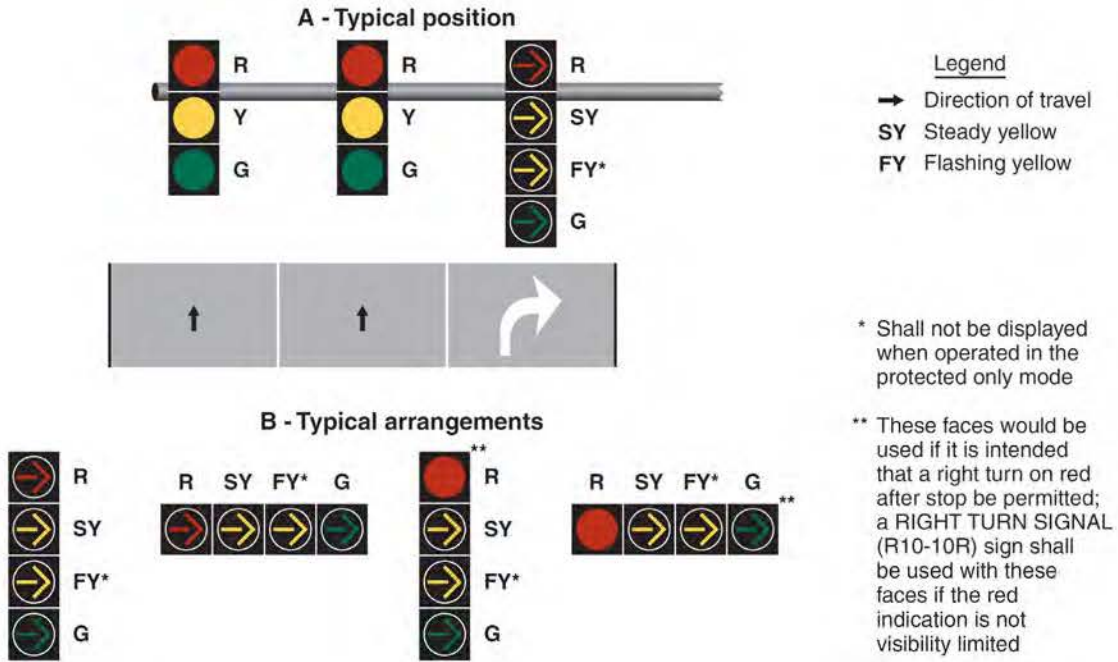
**Figure 4D-17. Typical Position and Arrangements of Separate Signal Faces for Protected Only Mode Right Turns**



**Figure 4D-18. Typical Positions and Arrangements of Shared Signal Faces for Protected/Permissive Mode Right Turns**

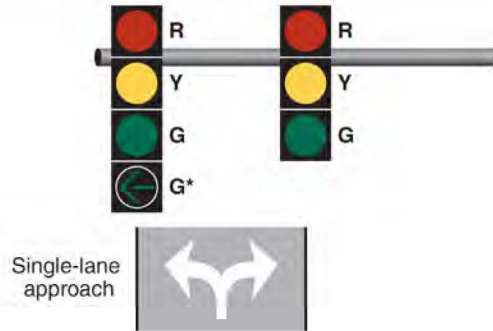


**Figure 4D-19. Typical Position and Arrangements of Separate Signal Faces with Flashing Yellow Arrow for Protected/Permissive Mode and Protected Only Mode Right Turns**



**Figure 4D-20. Signal Indications for Approaches with a Shared Left-Turn/Right-Turn Lane and No Through Movement (Sheet 1 of 3)**

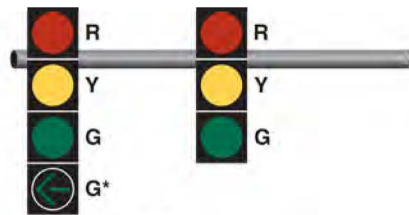
**A - No conflicting vehicular or pedestrian movements**



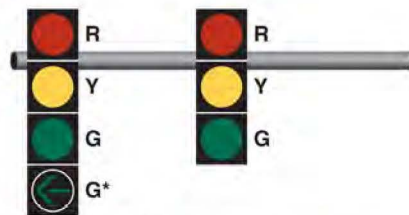
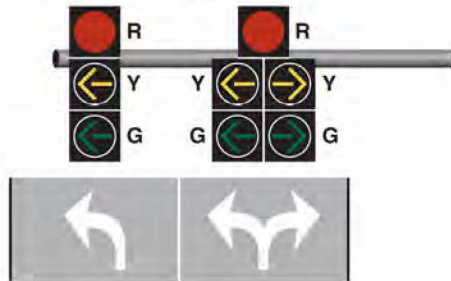
\* Left-turn GREEN ARROW section shall be included if there is an opposing one-way approach and the signal phasing eliminates conflicts.

Notes:

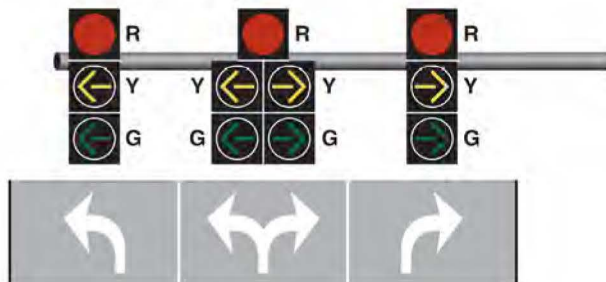
1. Horizontally-aligned signal faces may also be used.
2. Shared signal faces may also be 5 sections in a vertical straight line instead of a cluster.



OR

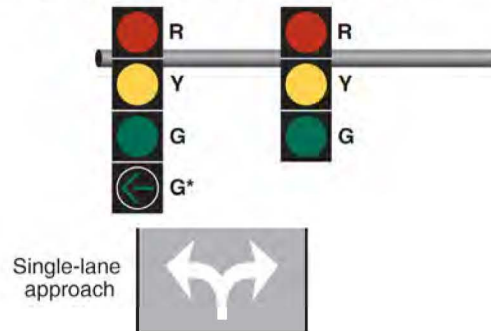


OR



**Figure 4D-20. Signal Indications for Approaches with a Shared Left-Turn/Right-Turn Lane and No Through Movement (Sheet 2 of 3)**

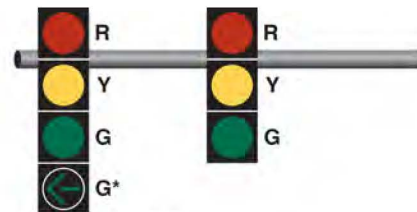
**B - Pedestrian or vehicular conflict with one turn movement**



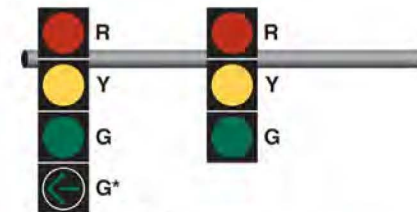
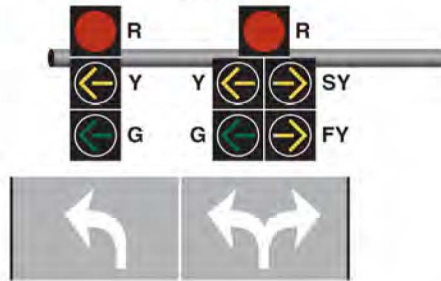
\* Left-turn GREEN ARROW section shall be included if there is an opposing one-way approach and the signal phasing eliminates conflicts.

**Notes:**

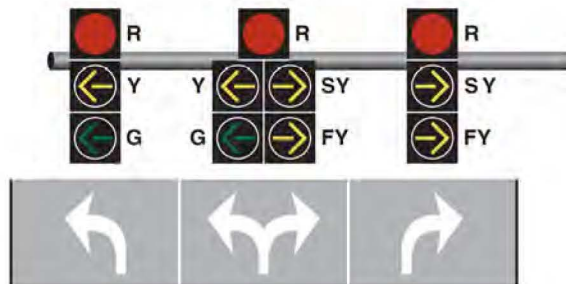
1. A conflict with the right-turn movement is illustrated.
2. Horizontally-aligned signal faces may also be used.
3. Shared signal faces may also be 5 sections in a vertical straight line instead of a cluster.



OR

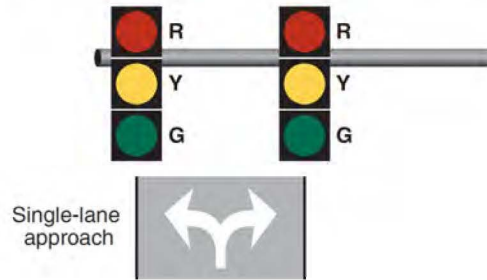


OR



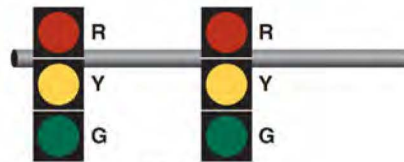
**Figure 4D-20. Signal Indications for Approaches with a Shared Left-Turn/Right-Turn Lane and No Through Movement (Sheet 3 of 3)**

**C - Pedestrian or vehicular conflicts with both turn movements**

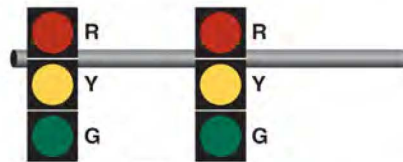
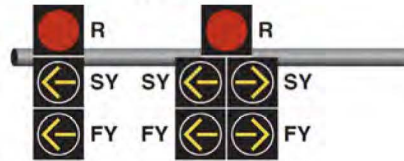


**Notes:**

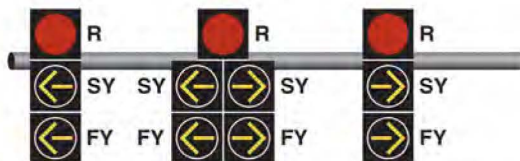
1. Horizontally-aligned signal faces may also be used.
2. Shared signal faces may also be 5 sections in a vertical straight line instead of a cluster.



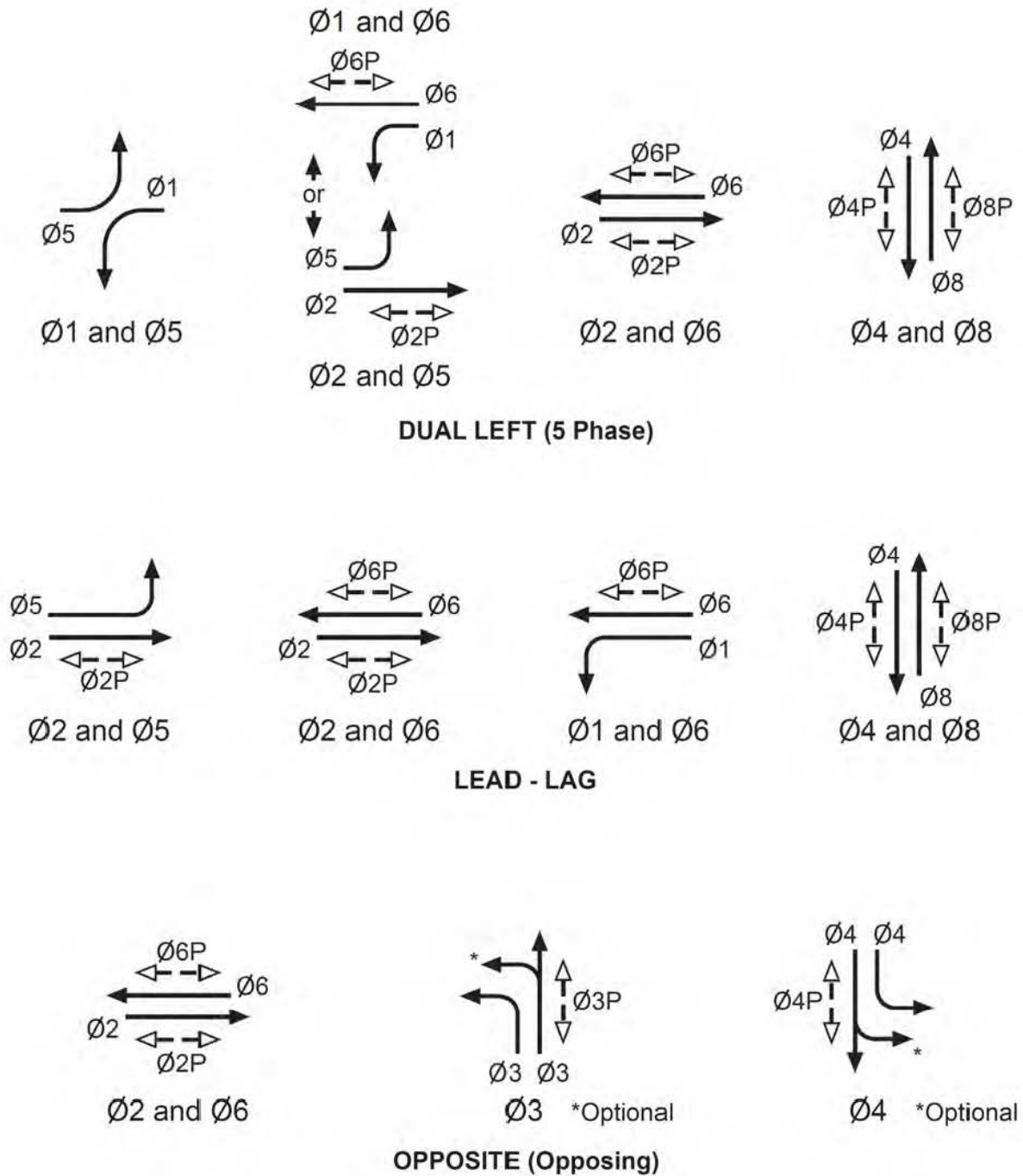
OR



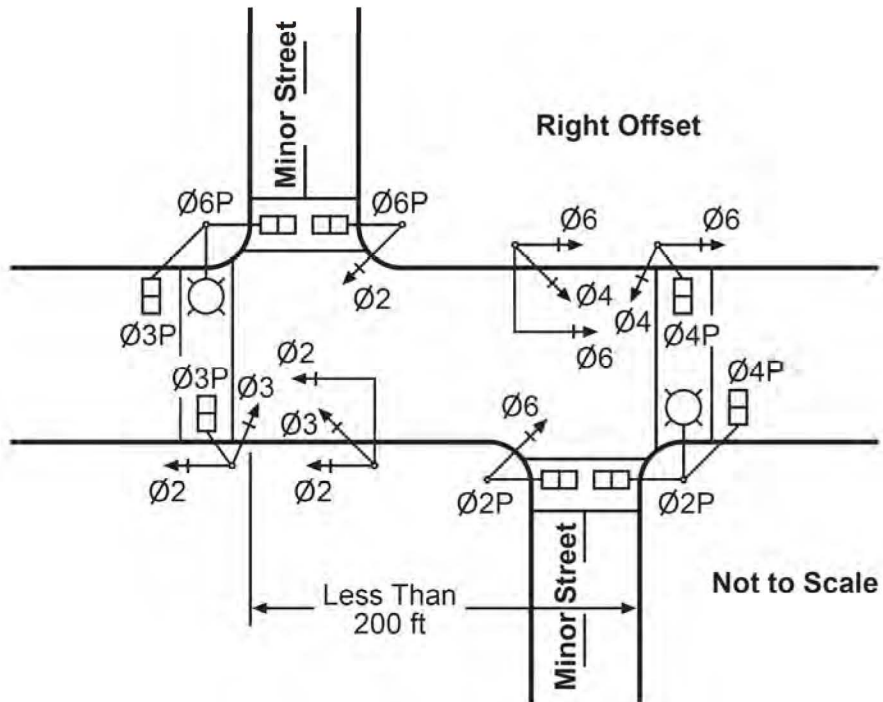
OR



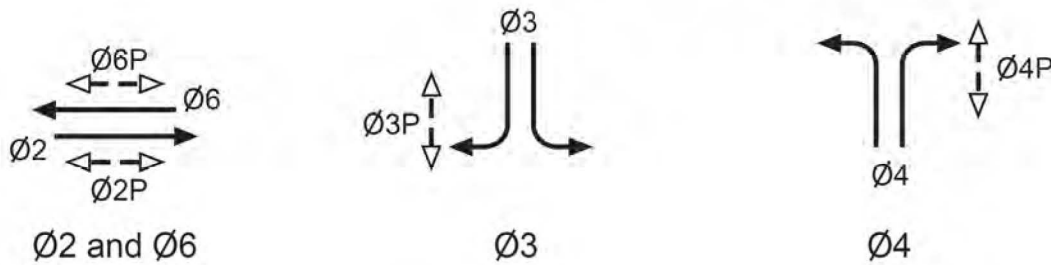
**Figure 4D-101 (CA). Left-Turn Phasing Methods(Phase Diagrams)**



**Figure 4D-102 (CA). Typical Signal Layout at Offset Intersections, Signalized and Marked as a Single Intersection (Sheet 1 of 4)**

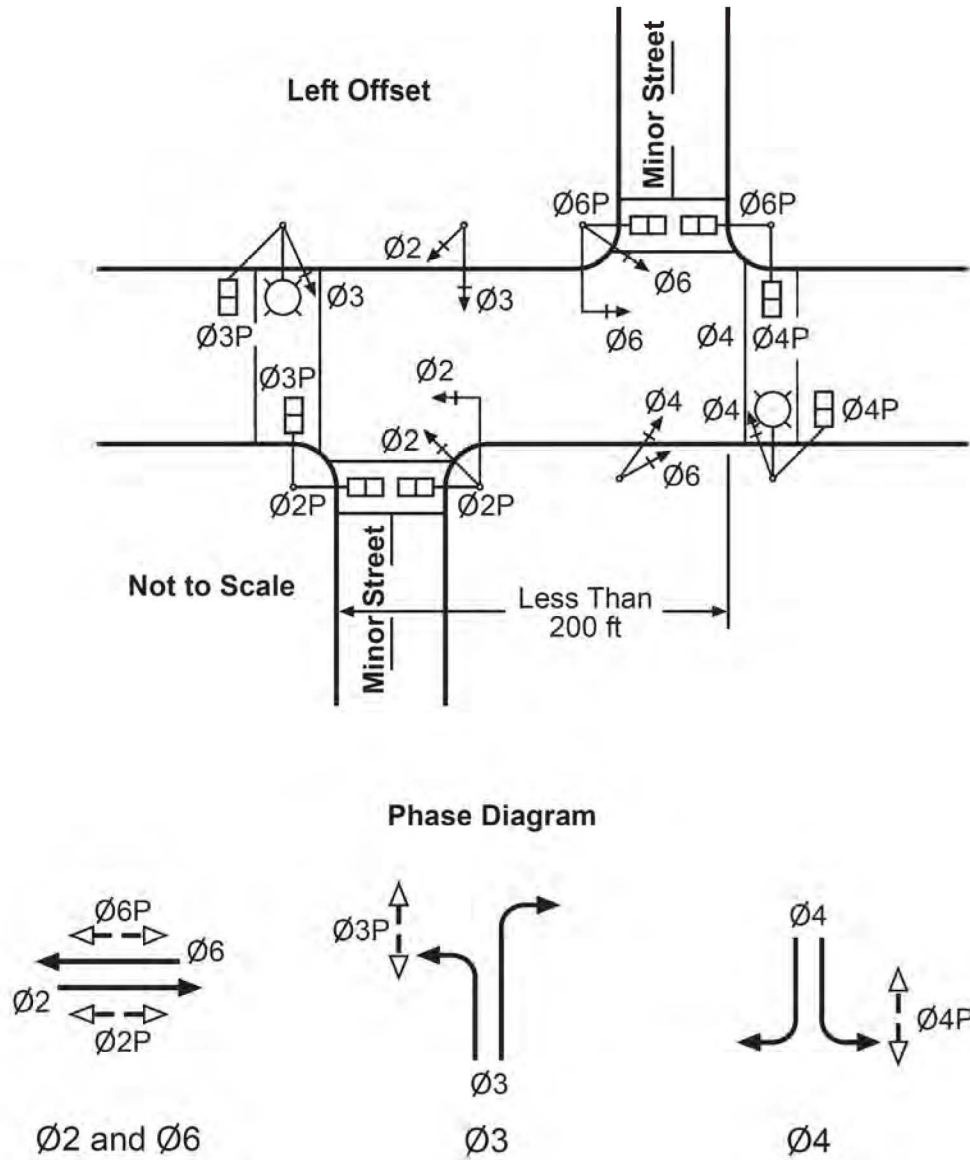


**Phase Diagram**

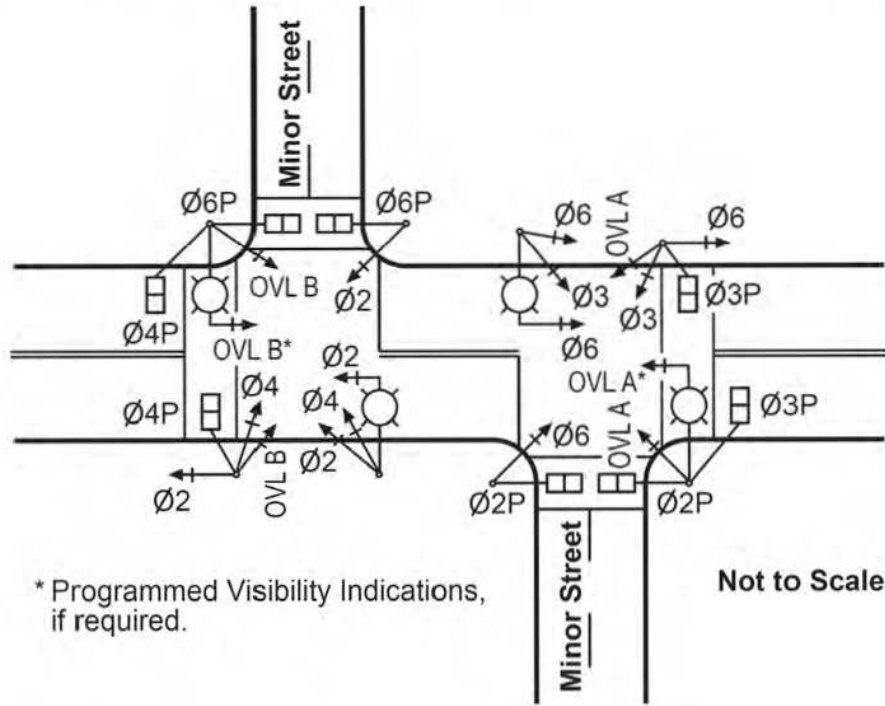
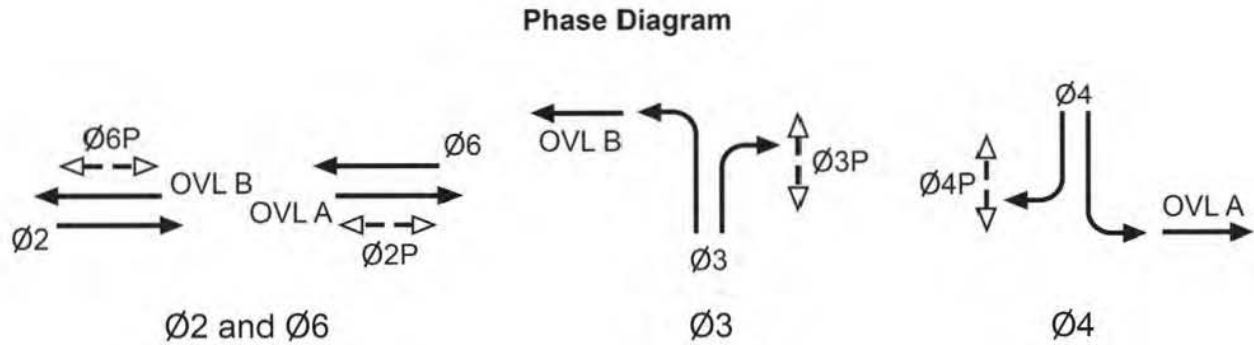




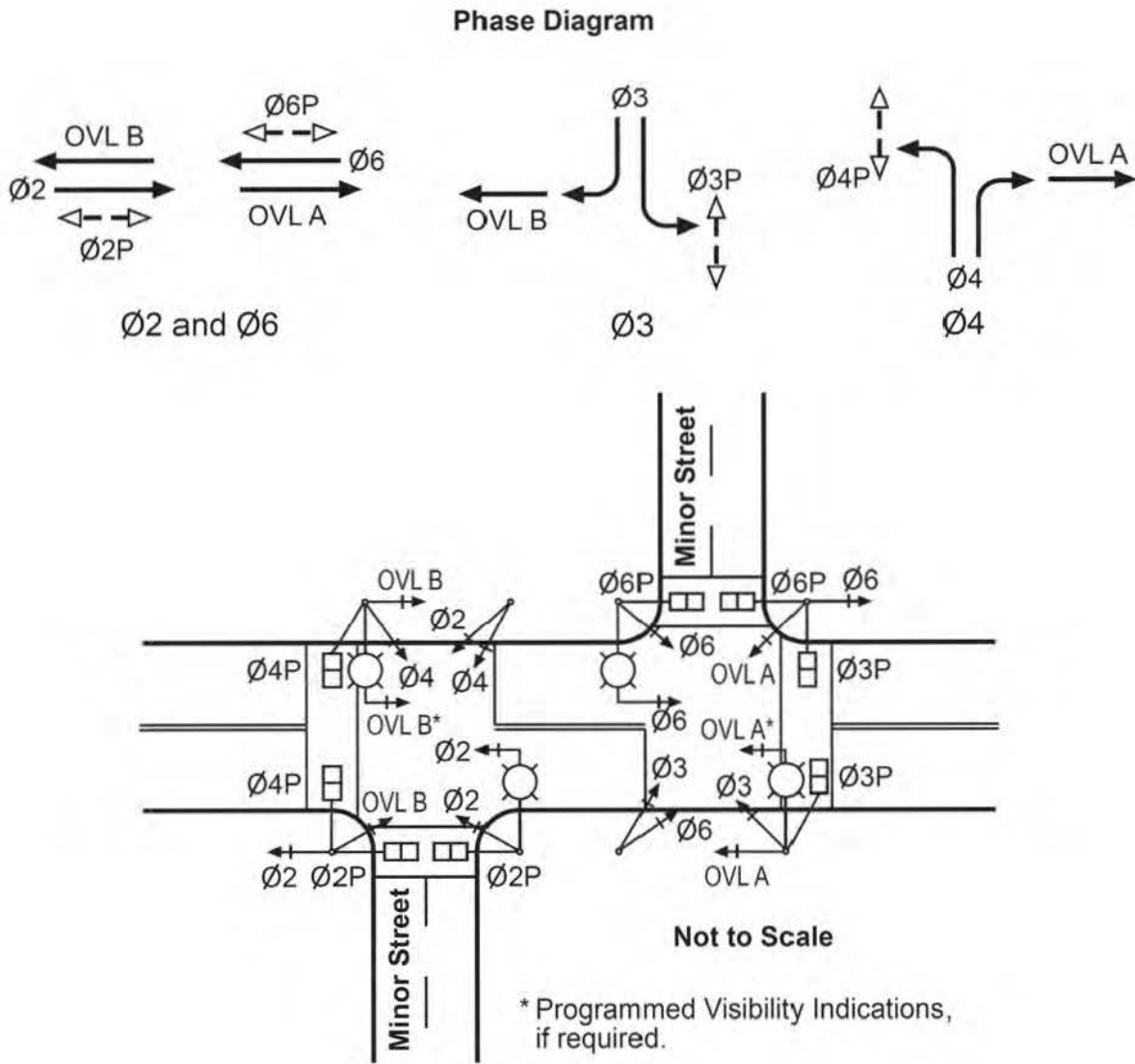
**Figure 4D-102 (CA). Typical Signal Layout at Offset Intersections, Signalized and Marked as a Single Intersection (Sheet 2 of 4)**



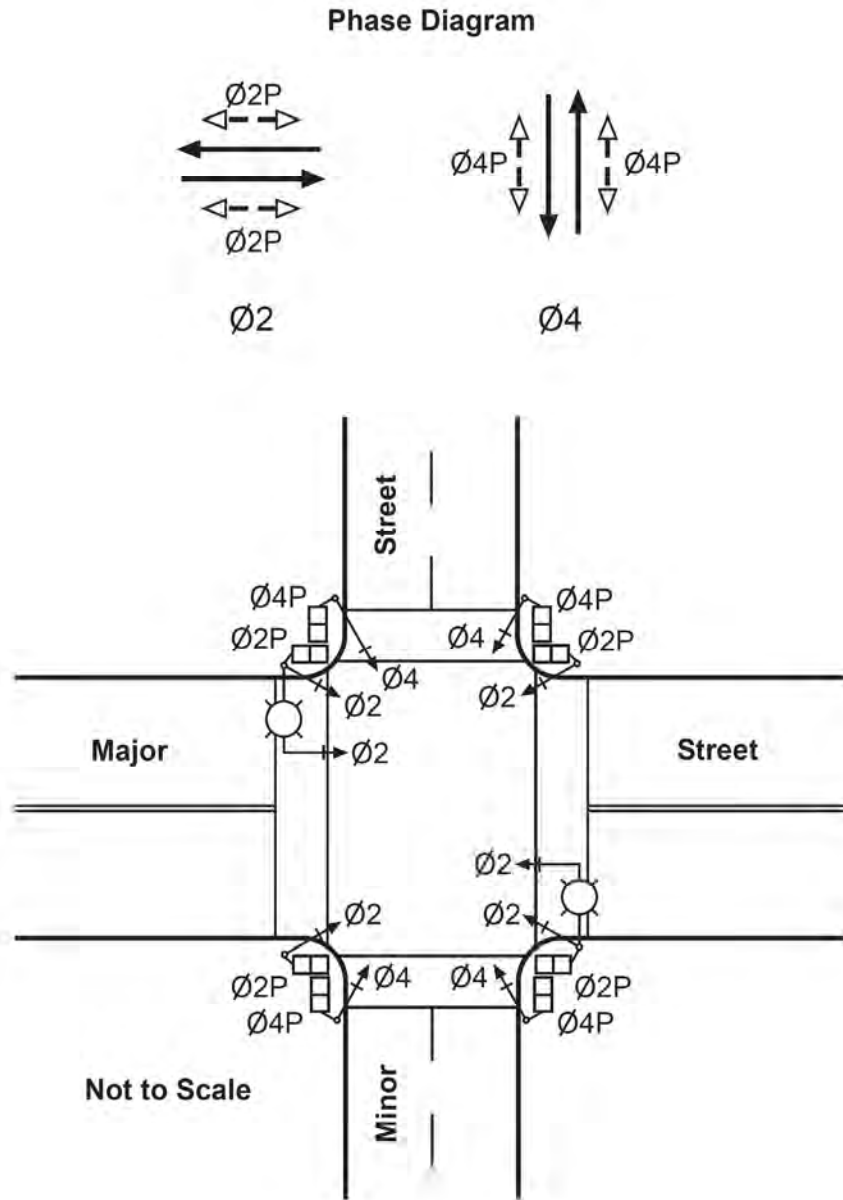
**Figure 4D-102 (CA). Typical Signal Layout at Offset Intersections, Signalized and Marked as Separate Intersections (Sheet 3 of 4)**



**Figure 4D-102 (CA). Typical Signal Layout at Offset Intersections, Signalized and Marked as Separate Intersections (Sheet 4 of 4)**



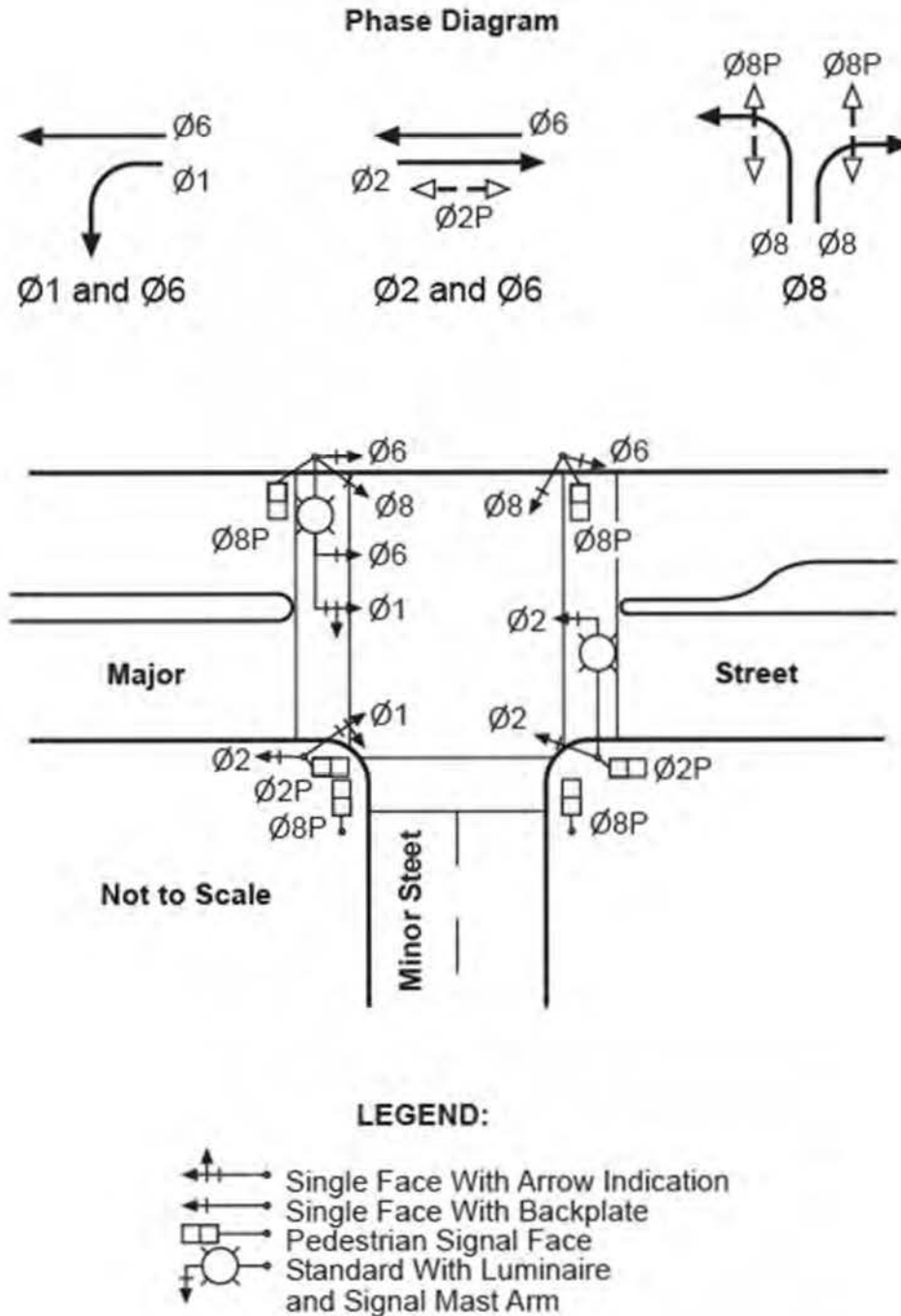
**Figure 4D-103 (CA). Typical Signal Layout (Two Phase Operation)**



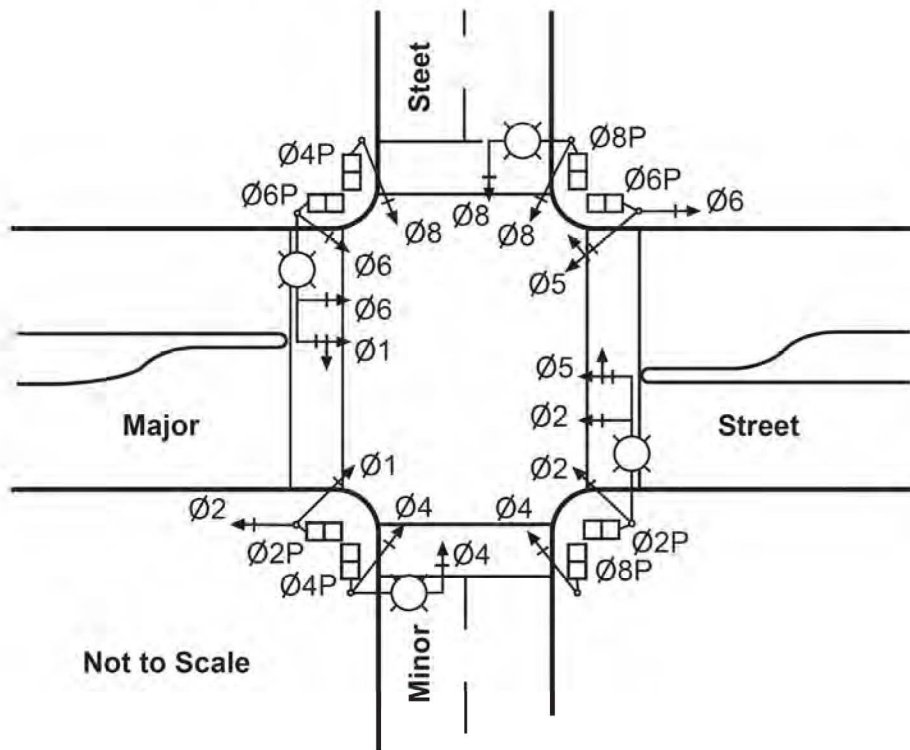
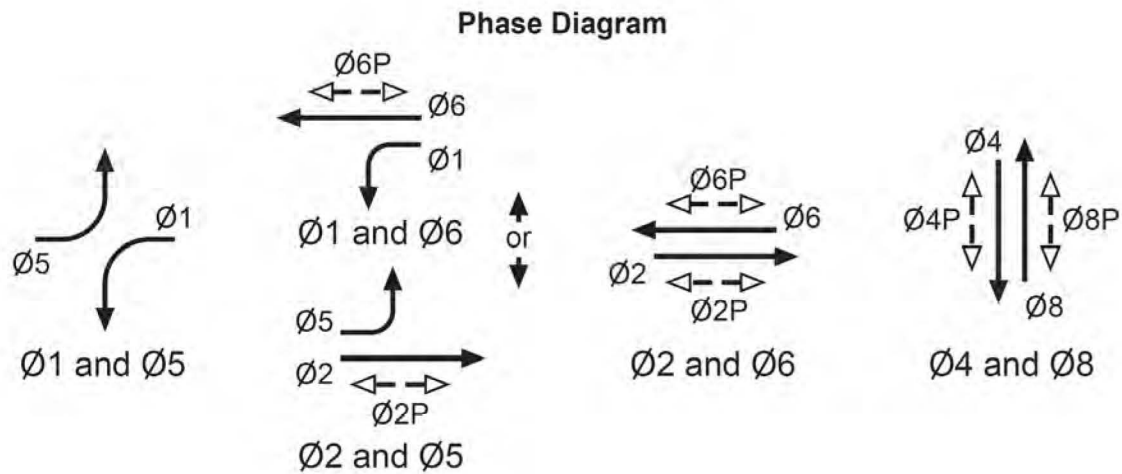
**LEGEND:**

- Single Face With Backplate
- Pedestrian Signal Face
- Standard With Luminaire and Signal Mast Arm

**Figure 4D-104 (CA). Typical Signal Layout (Three Phase Operation)**



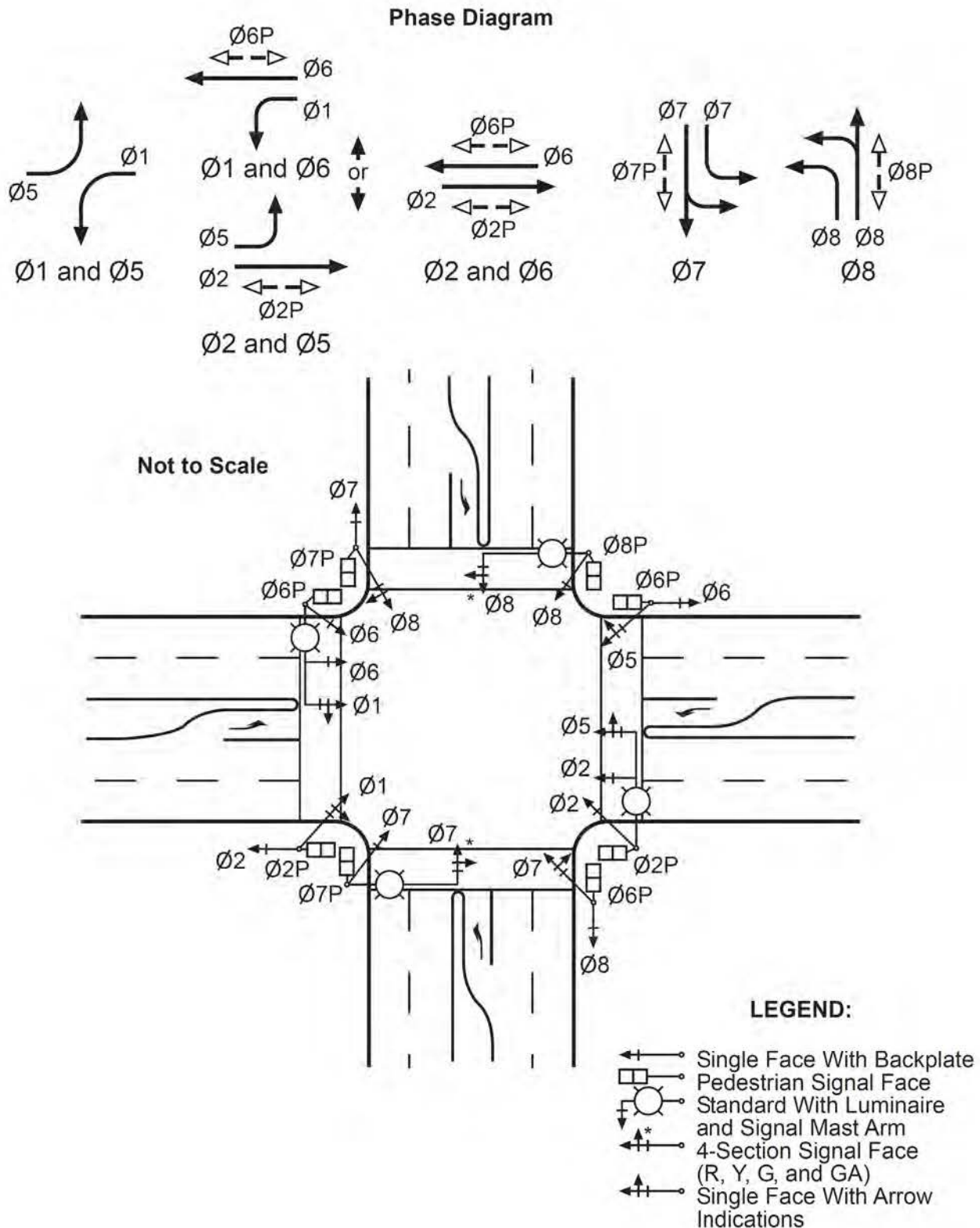
**Figure 4D-105 (CA). Typical Signal Layout (Five Phase "Dual Left" Operation)**



**LEGEND:**

- Single Face With Arrow Indication
- Single Face With Backplate
- Pedestrian Signal Face
- Standard With Luminaire and Signal Mast Arm

**Figure 4D-106 (CA). Typical Signal Layout (Six Phase "Opposing" Operation)**



**Figure 4D-107 (CA). Typical Signal Layout (Eight Phase "Quad Left" Operation)**

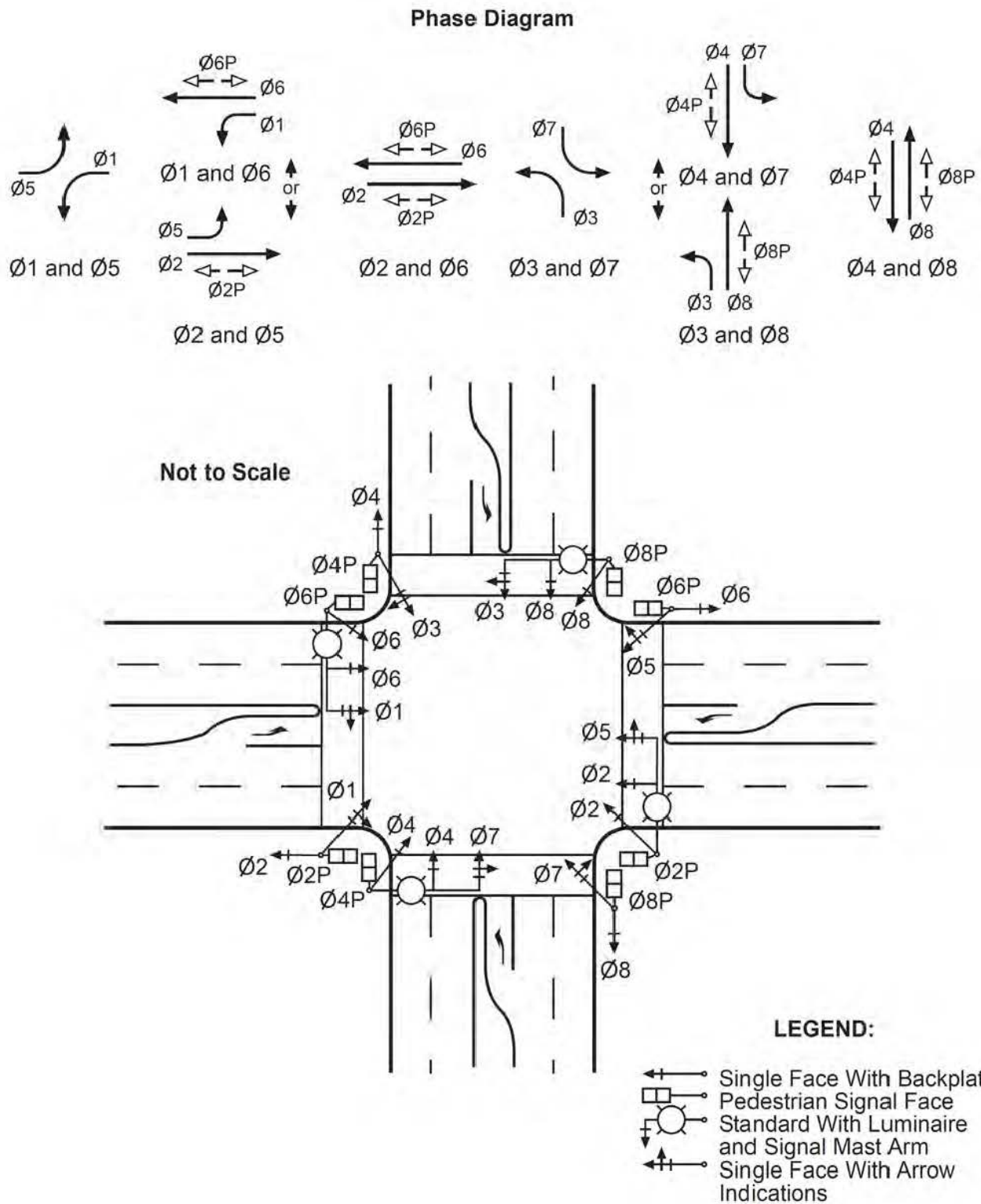
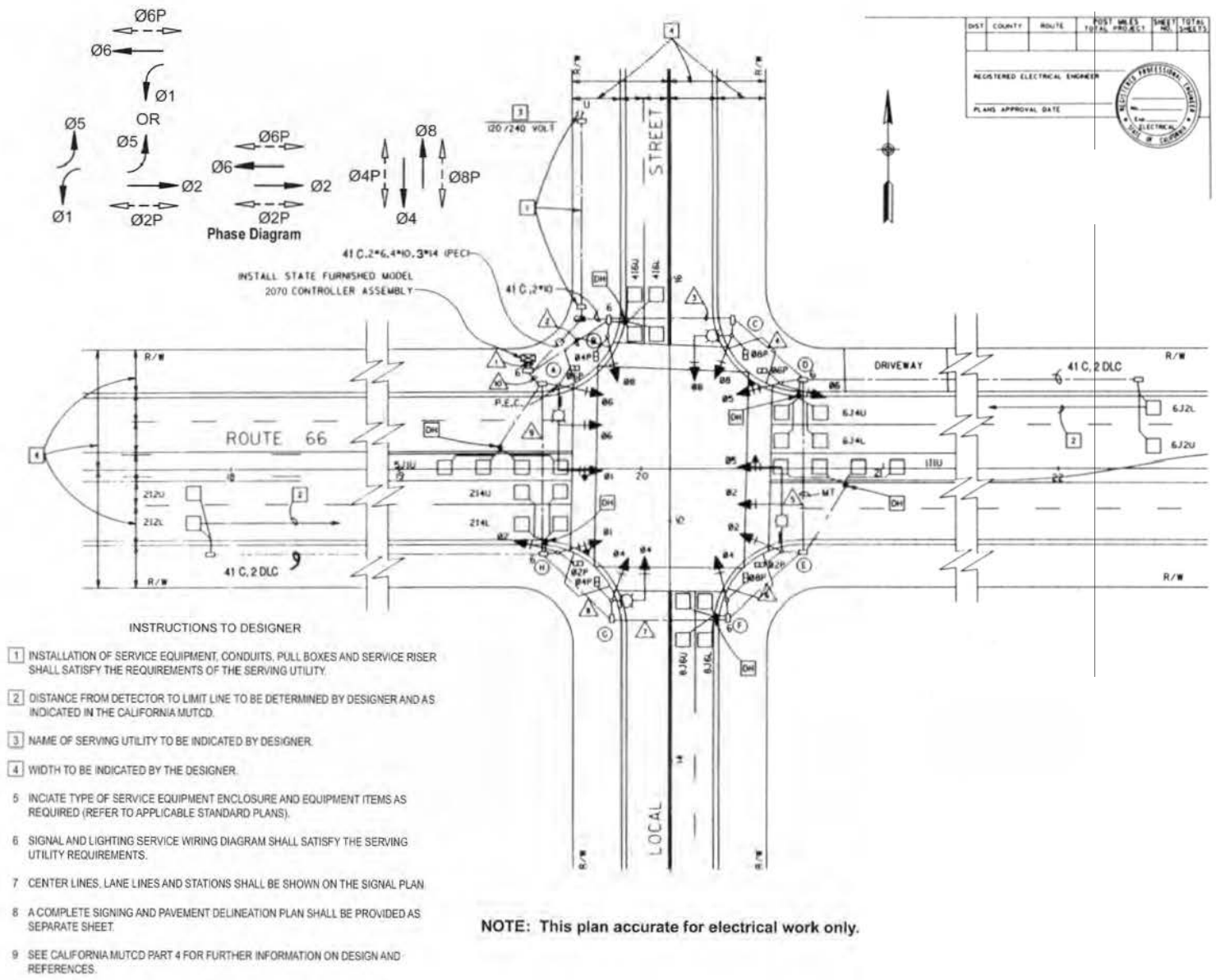
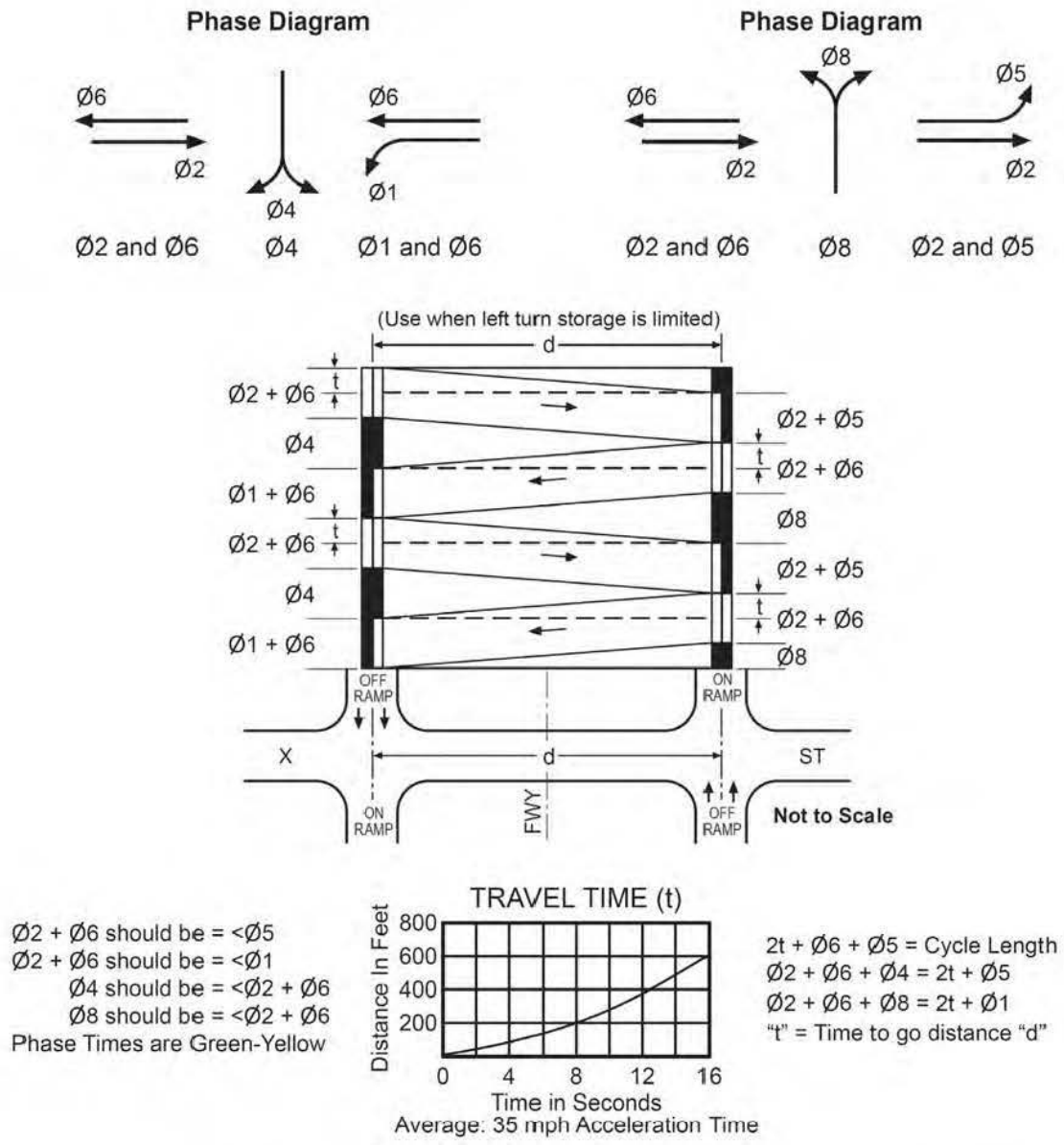




Figure 4D-108 (CA). Typical Traffic Signal Installation

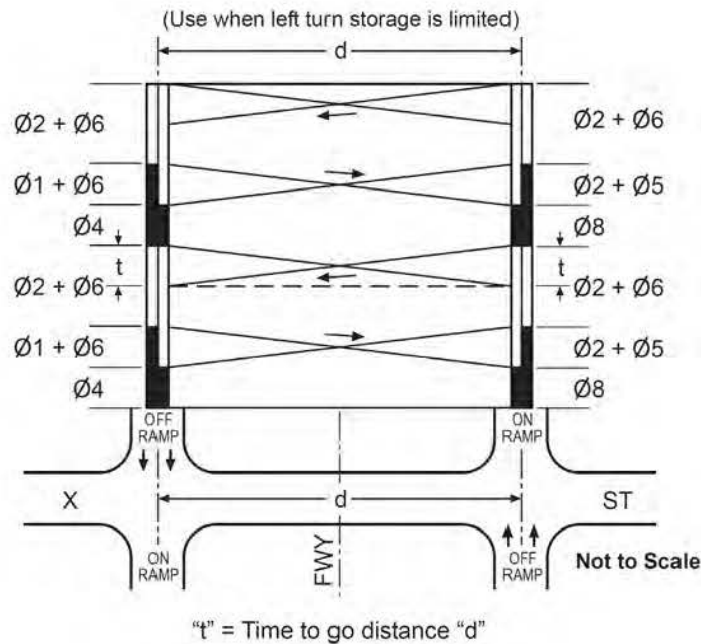
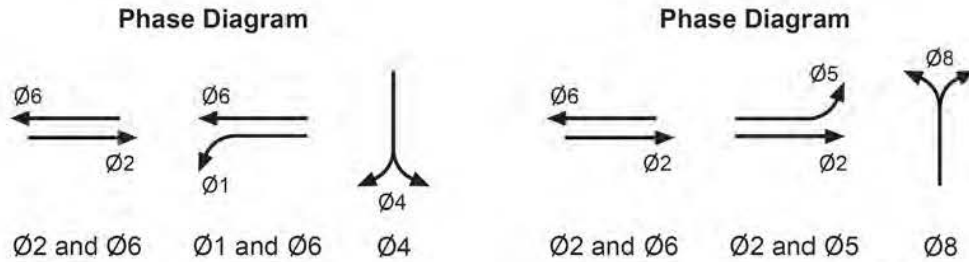


**Figure 4D-109 (CA). Diamond Interchange Timing Chart  
 (Heavy Left-Turn - 200 vphpl or More - Using Two Controllers)**



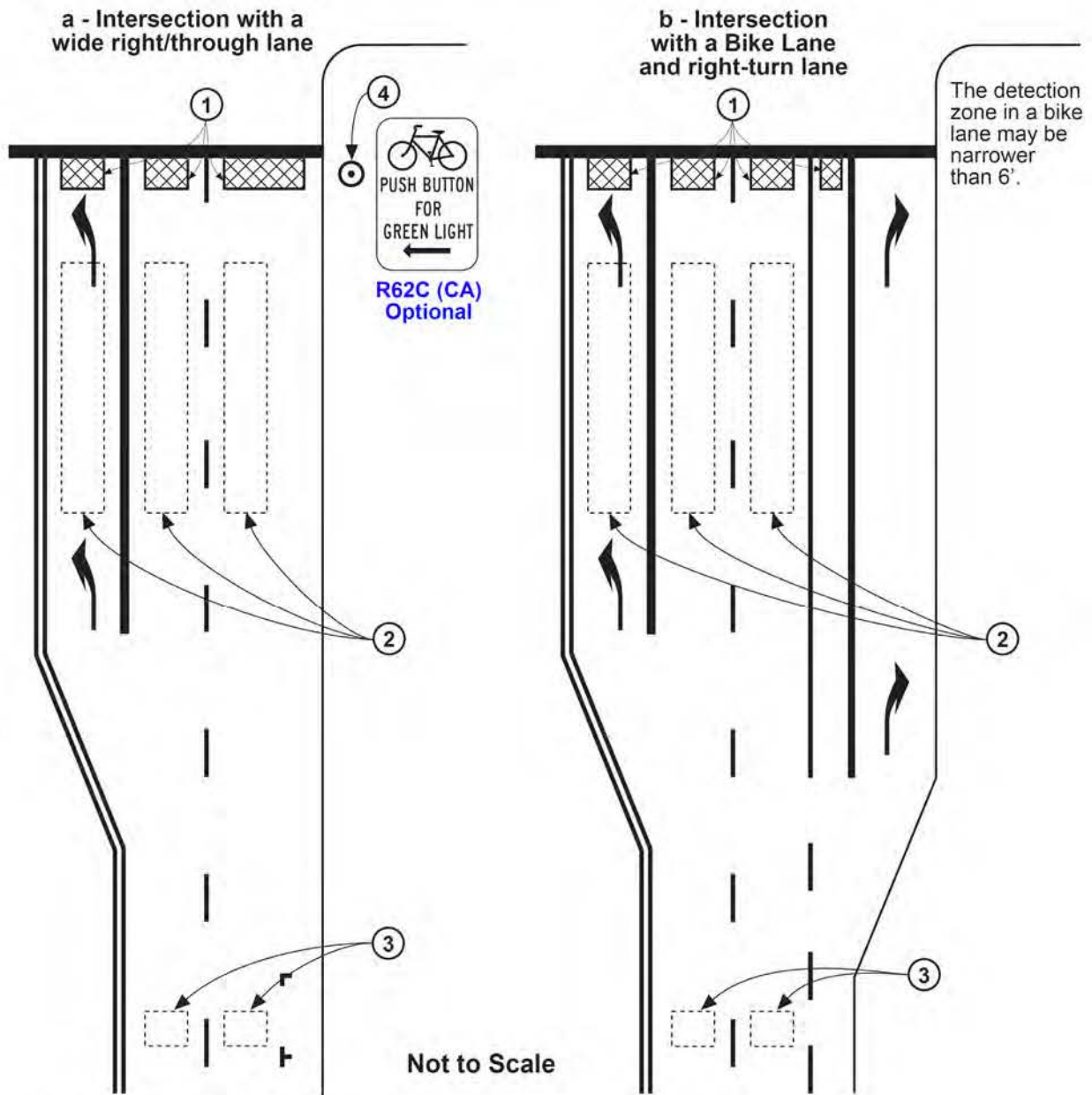
NOTE: These timing guidelines are ideal. Variations in timing may be necessary to provide proper splits to meet volume demands (See Table 4D-103 (CA)).

**Figure 4D-110 (CA). Diamond Interchange Timing Chart  
 (Light Left-Turn - 200 vphpl or Less - Using Two Controllers)**



- NOTES: 1. These timing guidelines are ideal. Variations in timing may be necessary to provide proper splits to meet volume demands (See Table 4D-103 (CA)).  
 2. The Green-Yellow interval for phases 1, 4, 5 or 8 should equal time "t".

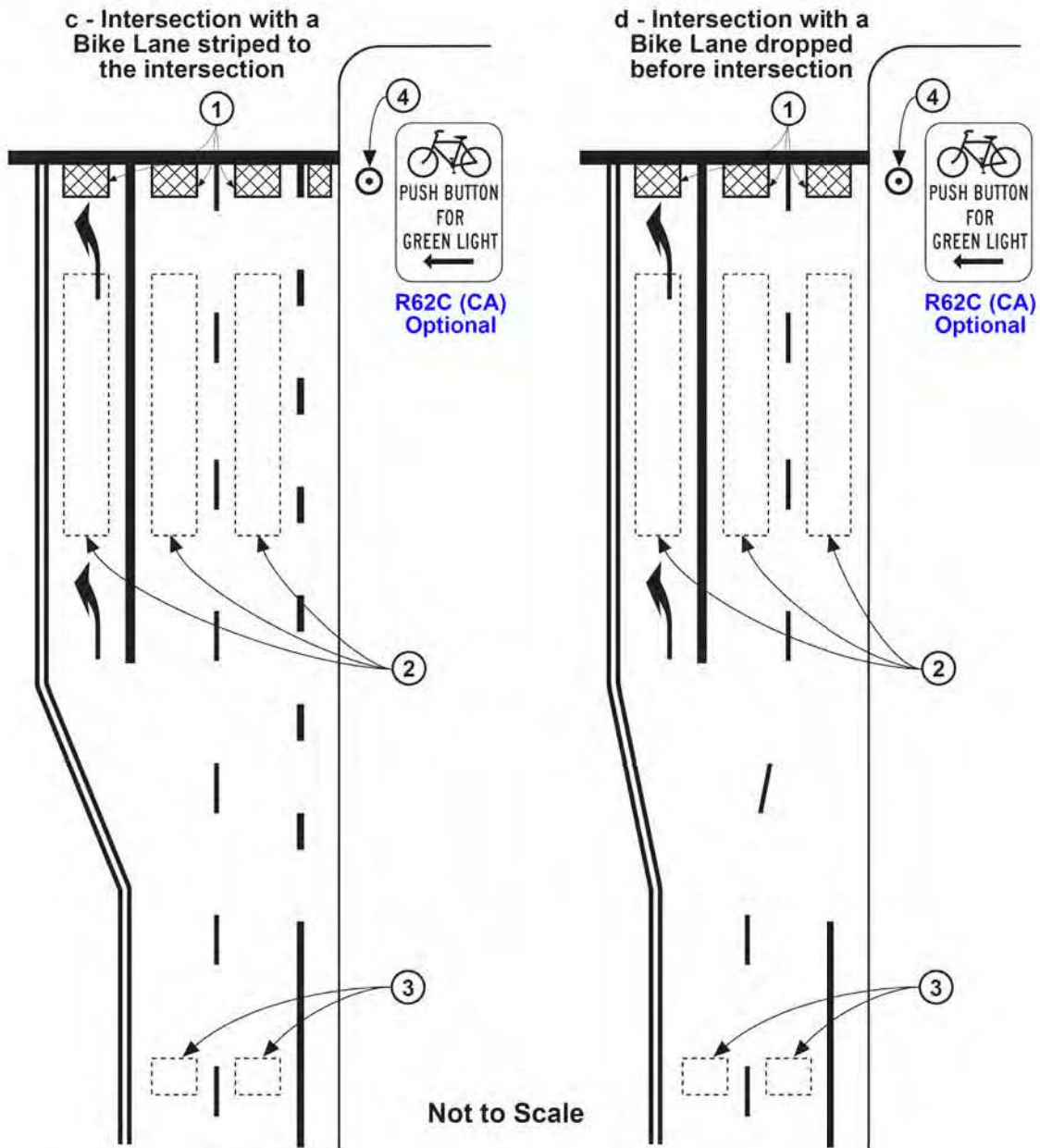
**Figure 4D-111 (CA). Examples of Detection Systems (Sheet 1 of 3)**



**NOTES:**

1. Typical technology-neutral limit line detection locations. See Section 4D.105 (CA).
2. Typical presence detection locations. See Section 4D.103 (CA).
3. Typical advance detection locations.
4. A bicyclist pushbutton may be used to activate a traffic signal to supplement the required limit line detection. A pushbutton should be located so it is convenient to use by bicyclists. See Section 9B.11 for bicycle regulatory signs.

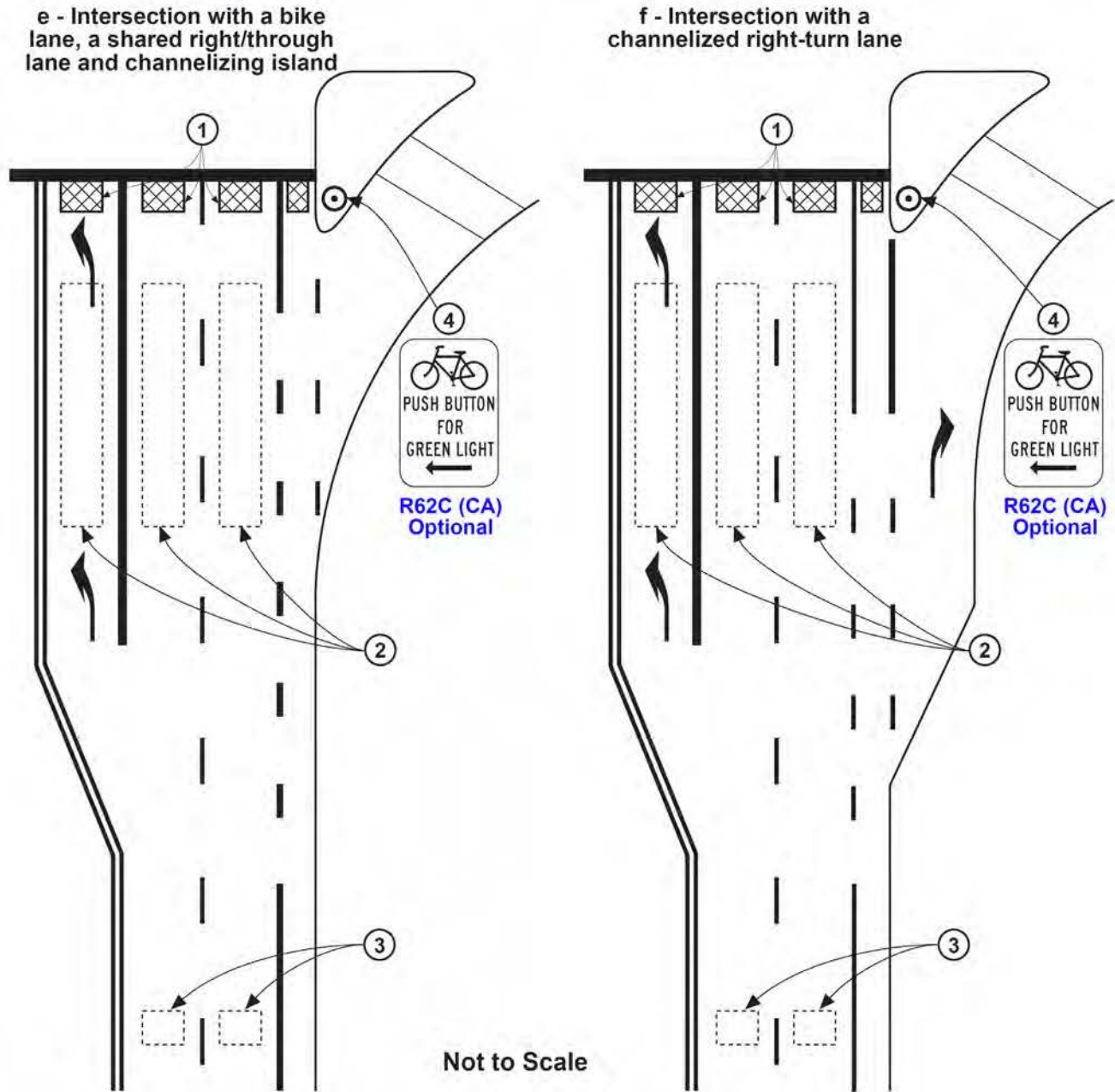
**Figure 4D-111 (CA). Examples of Detection Systems (Sheet 2 of 3)**



**NOTES:**

1. Typical technology-neutral limit line detection locations. See Section 4D.105 (CA).
2. Typical presence detection locations. See Section 4D.103 (CA).
3. Typical advance detection locations.
4. A bicyclist pushbutton may be used to activate a traffic signal to supplement the required limit line detection. A pushbutton should be located so it is convenient to use by bicyclists. See Section 9B.11 for bicycle regulatory signs.

**Figure 4D-111 (CA). Examples of Detection Systems (Sheet 3 of 3)**



**NOTES:**

1. Typical technology-neutral limit line detection locations. See Section 4D.105 (CA).
2. Typical presence detection locations. See Section 4D.103 (CA).
3. Typical advance detection locations.
4. A bicyclist pushbutton may be used to activate a traffic signal to supplement the required limit line detection. A pushbutton should be located so it is convenient to use by bicyclists. See Section 9B.11 for bicycle regulatory signs.

**Figure 4D-112 (CA). Example of Bicycle Signal Face**



**Table 4D-1. Recommended Minimum Number of Primary Signal Faces for Through Traffic on Approaches with Posted, Statutory, or 85<sup>th</sup>-Percentile Speed of 45 mph or Higher**

| Number of Through Lanes on Approach | Total Number of Primary Through Signal Faces for Approach* | Minimum Number of Overhead-Mounted Primary Through Signal Faces for Approach |
|-------------------------------------|--|--|
| 1                                   | 2  | 1  |
| 2                                   | 2  | 1  |
| 3                                   | 3  | 2**  |
| 4 or more                           | 4 or more  | 3**  |

NOTES: \* A minimum of two through signal faces is always required (See Section 4D.11). These recommended numbers of through signal faces may be exceeded. Also, see cone of vision requirements otherwise indicated in Section 4D.13.

\*\* If practical, all of the recommended number of primary through signal faces should be located overhead.

**Table 4D-2. Minimum Sight Distance for Signal Visibility**

| 85th-Percentile Speed | Minimum Sight Distance |
|-----------------------|------------------------|
| 20 mph                | 175 feet               |
| 25 mph                | 215 feet               |
| 30 mph                | 270 feet               |
| 35 mph                | 325 feet               |
| 40 mph                | 390 feet               |
| 45 mph                | 460 feet               |
| 50 mph                | 540 feet               |
| 55 mph                | 625 feet               |
| 60 mph                | 715 feet               |

Note: Distances in this table are derived from stopping sight distance plus an assumed queue length for shorter cycle lengths (60 to 75 seconds).



**Table 4D-101 (CA). Suggested Detector Setbacks From Limit Line**

Deceleration Rate  $d = 10 \text{ ft/sec}^2$

Reaction Time  $t_R = 1.00 \text{ sec}$

Reaction Distance =  $Vt_R$

Deceleration Distance =  $\frac{1}{2}dt^2$  or  $\frac{1}{2}Vt$  or  $\frac{V^2}{2d}$

Deceleration Time =  $\frac{V}{d}$

Detector Setback = Deceleration Distance + Reaction Distance =  $\frac{V^2}{2d} + Vt_R$

$V$  = Deceleration Speed (ft/sec)

$t_D$  = Deceleration Time (sec)

Note: Speed must be expressed in feet per second and the Deceleration Setback will be measured in feet.

| SPEED |        | DEC. TIME | DECELERATION DISTANCE | TOTAL TIME | DETECTOR SETBACK |                   |
|-------|--------|-----------|-----------------------|------------|------------------|-------------------|
| mph   | feet/s | Seconds   | Feet                  | Seconds    | ACTUAL<br>Feet   | SUGGESTED<br>Feet |
| 25    | 36.68  | 3.67      | 66.93                 | 4.67       | 103.90           | 105               |
| 30    | 44.00  | 4.40      | 96.82                 | 5.40       | 140.80           | 140               |
| 35    | 51.35  | 5.13      | 131.80                | 6.13       | 183.10           | 185               |
| 40    | 58.69  | 5.87      | 172.10                | 6.87       | 230.80           | 230               |
| 45    | 66.04  | 6.60      | 217.80                | 7.60       | 283.90           | 285               |
| 50    | 73.36  | 7.33      | 268.90                | 8.33       | 342.30           | 345               |
| 55    | 80.71  | 8.06      | 325.40                | 9.06       | 406.10           | 405               |
| 60    | 88.00  | 8.80      | 387.30                | 9.80       | 475.30           | 475               |
| 65    | 95.37  | 9.53      | 454.50                | 10.53      | 549.90           | 550               |
| 70    | 102.7  | 10.27     | 526.60                | 11.27      | 629.30           | 630               |

**Table 4D-102 (CA). Minimum Yellow Change Interval Timing**

$$\text{Yellow Time} = \frac{\text{Detector Setback Distance}}{\text{Speed}}$$

$$T = \frac{D}{V} = \text{The minimum yellow change interval (sec)}$$

V = Speed (ft/sec)

d = Deceleration Rate (10 ft/sec<sup>2</sup>)

t<sub>R</sub> = Reaction Time (1 sec)

Reaction Distance = Vt<sub>R</sub>

Deceleration Distance =  $\frac{1}{2}dt^2$  or  $\frac{1}{2}Vt$  or  $\frac{V^2}{2d}$

D = Detector Setback = Deceleration Distance + Reaction Distance =  $\frac{V^2}{2d} + Vt_R$

$$T = \frac{\frac{V^2}{2d} + Vt_R}{V}$$

$$T = \frac{V}{2d} + t_R$$

**a - For Speed determined by 85th Percentile**

| SPEED<br>(Determined by<br>85th Percentile Speed)* | MINIMUM<br>YELLOW INTERVAL |
|--|----------------------------|
| mph  | Seconds                    |
| 25 or less   | 3.0                        |
| 30   | 3.2                        |
| 35   | 3.6                        |
| 40   | 3.9                        |
| 45   | 4.3                        |
| 50   | 4.7                        |
| 55   | 5.0                        |
| 60   | 5.4                        |
| 65   | 5.8                        |

\*See Section 4D.26 Standard under paragraph 14b

**b - For Posted or Prima Facie Speed**

| POSTED SPEED or<br>UNPOSTED PRIMA<br>FACIE SPEED | MINIMUM<br>YELLOW INTERVAL * | MINIMUM<br>YELLOW INTERVAL * |
|--|------------------------------|------------------------------|
| mph  | Seconds                      | Seconds                      |
| 15   | N/A                          | 3.0                          |
| 20   | N/A                          | 3.2                          |
| 25   | N/A                          | 3.6                          |
| 30   | 3.7                          | N/A                          |
| 35   | 4.1                          | N/A                          |
| 40   | 4.4                          | N/A                          |
| 45   | 4.8                          | N/A                          |
| 50   | 5.2                          | N/A                          |
| 55   | 5.5                          | N/A                          |
| 60 or higher                                     | 5.9                          | N/A                          |

\*Speed values for Table 4D-102b (CA) are inclusive of the 7 MPH added for speeds equal to 30 MPH or higher and 10 MPH for speeds equal to or lower than 25 MPH for determining the minimum values of the yellow intervals.

**Table 4D-103 (CA). Traffic Signal Timing Analysis Chart**

| Number of Cars | Min. Time in Seconds Req. for Cars | Length of Stopped Queue<br>Feet | Length of Moving Queue<br>Feet (30 mph) | Moving Queue Time (Bond Width in Seconds) | NUMBER OF VEHICLES PER HOUR LANE AT INDICATED CYCLE LENGTH |         |         |         |         |          |          |          |          |          |
|----------------|------------------------------------|---------------------------------|---|---|--|---------|---------|---------|---------|----------|----------|----------|----------|----------|
|                |                                    |                                 |   |   | 50 Sec.  | 60 Sec. | 70 Sec. | 80 Sec. | 90 Sec. | 100 Sec. | 120 Sec. | 150 Sec. | 180 Sec. | 240 Sec. |
| 1              | 4                                  | 25                              | 0                                       | 2   | 70   | 60      | 50      | 45      | 40      | 35       | 30       | 25       | 20       | 15       |
| 2              | 7                                  | 50                              | 88                                      | 4   | 145  | 120     | 100     | 90      | 80      | 70       | 60       | 50       | 40       | 30       |
| 3              | 9                                  | 75                              | 176                                     | 6   | 215  | 180     | 150     | 135     | 120     | 110      | 90       | 70       | 60       | 45       |
| 4              | 11                                 | 100                             | 264                                     | 8   | 290  | 240     | 205     | 180     | 160     | 145      | 120      | 95       | 80       | 60       |
| 5              | 13                                 | 125                             | 352                                     | 10  | 360  | 360     | 255     | 225     | 200     | 180      | 150      | 120      | 100      | 75       |
| 6              | 15                                 | 150                             | 440                                     | 12  | 430  | 420     | 310     | 270     | 240     | 215      | 180      | 145      | 120      | 90       |
| 7              | 17                                 | 175                             | 528                                     | 14  | 505  | 480     | 360     | 315     | 280     | 250      | 210      | 170      | 140      | 105      |
| 8              | 19                                 | 200                             | 616                                     | 16  | 575  | 540     | 410     | 360     | 320     | 290      | 240      | 190      | 160      | 120      |
| 9              | 21                                 | 225                             | 704                                     | 18  | 650  | 600     | 460     | 405     | 360     | 320      | 270      | 215      | 180      | 135      |
| 10             | 23                                 | 250                             | 792                                     | 20  | 720  | 660     | 510     | 450     | 400     | 360      | 300      | 240      | 200      | 150      |
| 11             | 25                                 | 275                             | 880                                     | 22  | 790  | 720     | 560     | 495     | 440     | 400      | 330      | 265      | 220      | 165      |
| 12             | 27                                 | 300                             | 968                                     | 24  | 865  | 780     | 610     | 540     | 480     | 430      | 360      | 290      | 240      | 180      |
| 13             | 29                                 | 325                             | 1056                                    | 26  | 935  | 840     | 665     | 585     | 520     | 470      | 390      | 315      | 260      | 195      |
| 14             | 31                                 | 350                             | 1144                                    | 28  | 1020   | 900     | 715     | 630     | 560     | 500      | 420      | 340      | 280      | 210      |
| 15             | 33                                 | 375                             | 1232                                    | 30  | 1080   | 960     | 765     | 675     | 600     | 540      | 450      | 365      | 300      | 225      |
| 16             | 35                                 | 400                             | 1320                                    | 32  | 1150   | 1020    | 815     | 720     | 640     | 580      | 480      | 385      | 320      | 240      |
| 17             | 37                                 | 425                             | 1408                                    | 34  | 1225   | 1080    | 865     | 765     | 680     | 610      | 510      | 410      | 340      | 255      |
| 18             | 39                                 | 450                             | 1496                                    | 36  | 1295   | 1140    | 920     | 810     | 720     | 650      | 540      | 430      | 360      | 270      |
| 19             | 41                                 | 475                             | 1584                                    | 38  |  | 1200    | 970     | 855     | 760     | 680      | 570      | 455      | 380      | 285      |
| 20             | 43                                 | 500                             | 1672                                    | 40  |  | 1260    | 1020    | 900     | 800     | 720      | 600      | 480      | 400      | 300      |
| 21             | 45                                 | 525                             | 1760                                    | 42  |  | 1320    | 1070    | 945     | 840     | 760      | 630      | 505      | 420      | 315      |
| 22             | 47                                 | 550                             | 1848                                    | 44  |  | 1380    | 1120    | 990     | 880     | 790      | 660      | 530      | 440      | 330      |
| 23             | 49                                 | 575                             | 1936                                    | 46  |  | 1440    | 1175    | 1035    | 920     | 830      | 690      | 550      | 460      | 345      |
| 24             | 51                                 | 600                             | 2024                                    | 48  |  |         | 1225    | 1080    | 960     | 860      | 720      | 575      | 480      | 360      |
| 25             | 53                                 | 625                             | 2112                                    | 50  |  |         | 1275    | 1125    | 1000    | 900      | 750      | 600      | 500      | 375      |
| 26             | 55                                 | 650                             | 2200                                    | 52  |  |         | 1325    | 1170    | 1040    | 930      | 780      | 625      | 520      | 390      |
| 27             | 57                                 | 675                             | 2288                                    | 54  |  |         | 1375    | 1215    | 1080    | 960      | 810      | 650      | 540      | 405      |
| 28             | 59                                 | 700                             | 2376                                    | 56  |  |         | 1430    | 1260    | 1120    | 990      | 840      | 670      | 560      | 420      |
| 29             | 61                                 | 725                             | 2464                                    | 58  |  |         |         | 1305    | 1160    | 1020     | 870      | 700      | 580      | 435      |

**Table 4D-104 (CA). Signal Operations - Vehicular Speed**

| SECONDS |        | 10                        | 15      | 20      | 25      | 30      | 35      | 40      | 45      | 50      | 55      | 60       |
|---------|--------|---------------------------|---------|---------|---------|---------|---------|---------|---------|---------|---------|----------|
| mph     | ft/s   | DISTANCE TRAVELED IN FEET |         |         |         |         |         |         |         |         |         |          |
| 1       | 1.46   | 14.6                      | 21.9    | 29.3    | 36.6    | 44.0    | 51.3    | 58.6    | 66.0    | 73.3    | 80.6    | 88.0     |
| 2       | 2.93   | 29.3                      | 44.0    | 58.6    | 73.3    | 88.0    | 102.6   | 117.3   | 132.0   | 146.6   | 161.3   | 176.0    |
| 3       | 4.40   | 44.0                      | 66.0    | 88.0    | 110.0   | 132.0   | 154.0   | 176.0   | 198.0   | 220.0   | 242.0   | 264.0    |
| 4       | 5.86   | 58.6                      | 88.0    | 117.3   | 146.6   | 176.0   | 205.3   | 234.6   | 264.0   | 293.3   | 322.6   | 352.0    |
| 5       | 7.30   | 73.0                      | 110.0   | 147.0   | 183.0   | 220.0   | 257.0   | 293.0   | 330.0   | 367.0   | 403.0   | 440.0    |
| 10      | 14.60  | 146.0                     | 220.0   | 293.0   | 366.0   | 440.0   | 513.0   | 587.0   | 660.0   | 733.0   | 807.0   | 880.0    |
| 15      | 22.00  | 220.0                     | 330.0   | 440.0   | 550.0   | 660.0   | 770.0   | 880.0   | 990.0   | 1,100.0 | 1,210.0 | 1,320.0  |
| 20      | 29.30  | 293.0                     | 440.0   | 587.0   | 733.0   | 880.0   | 1,027.0 | 1,173.0 | 1,320.0 | 1,467.0 | 1,613.0 | 1,760.0  |
| 25      | 36.70  | 367.0                     | 550.0   | 733.0   | 917.0   | 1,100.0 | 1,283.0 | 1,467.0 | 1,650.0 | 1,833.0 | 2,017.0 | 2,200.0  |
| 30      | 44.00  | 440.0                     | 660.0   | 880.0   | 1,100.0 | 1,320.0 | 1,540.0 | 1,760.0 | 1,980.0 | 2,200.0 | 2,420.0 | 2,640.0  |
| 35      | 51.30  | 513.0                     | 770.0   | 1,027.0 | 1,283.0 | 1,540.0 | 1,797.0 | 2,053.0 | 2,310.0 | 2,567.0 | 2,823.0 | 3,080.0  |
| 40      | 58.70  | 587.0                     | 880.0   | 1,173.0 | 1,467.0 | 1,760.0 | 2,053.0 | 2,347.0 | 2,640.0 | 2,933.0 | 3,227.0 | 3,520.0  |
| 45      | 66.00  | 660.0                     | 990.0   | 1,320.0 | 1,650.0 | 1,980.0 | 2,310.0 | 2,640.0 | 2,970.0 | 3,300.0 | 3,630.0 | 3,960.0  |
| 50      | 73.30  | 733.0                     | 1,100.0 | 1,467.0 | 1,833.0 | 2,200.0 | 2,567.0 | 2,933.0 | 3,300.0 | 3,667.0 | 4,033.0 | 4,400.0  |
| 55      | 80.70  | 807.0                     | 1,210.0 | 1,613.0 | 2,017.0 | 2,420.0 | 2,823.0 | 3,227.0 | 3,630.0 | 4,033.0 | 4,437.0 | 4,840.0  |
| 60      | 88.00  | 880.0                     | 1,320.0 | 1,760.0 | 2,200.0 | 2,640.0 | 3,080.0 | 3,520.0 | 3,960.0 | 4,400.0 | 4,840.0 | 5,280.0  |
| 65      | 95.30  | 953.0                     | 1,430.0 | 1,907.0 | 2,383.0 | 2,860.0 | 3,337.0 | 3,813.0 | 4,290.0 | 4,767.0 | 5,243.0 | 5,720.0  |
| 70      | 102.70 | 1,027.0                   | 1,540.0 | 2,053.0 | 2,567.0 | 3,080.0 | 3,593.0 | 4,107.0 | 4,620.0 | 5,133.0 | 5,647.0 | 6,160.0  |
| 75      | 110.00 | 1,100.0                   | 1,650.0 | 2,200.0 | 2,750.0 | 3,300.0 | 3,850.0 | 4,400.0 | 4,950.0 | 5,500.0 | 6,050.0 | 6,600.0  |
| 80      | 117.30 | 1,173.0                   | 1,760.0 | 2,347.0 | 2,933.0 | 3,520.0 | 4,107.0 | 4,693.0 | 5,280.0 | 5,867.0 | 6,453.0 | 7,040.0  |
| 85      | 124.70 | 1,247.0                   | 1,870.0 | 2,493.0 | 3,117.0 | 3,740.0 | 4,363.0 | 4,987.0 | 5,610.0 | 6,233.0 | 6,858.0 | 7,480.0  |
| 90      | 132.00 | 1,320.0                   | 1,980.0 | 2,640.0 | 3,300.0 | 3,960.0 | 4,620.0 | 5,280.0 | 5,940.0 | 6,600.0 | 7,260.0 | 7,920.0  |
| 95      | 139.30 | 1,393.0                   | 2,090.0 | 2,787.0 | 3,483.0 | 4,180.0 | 4,877.0 | 5,573.0 | 6,270.0 | 6,967.0 | 7,663.0 | 8,360.0  |
| 100     | 146.70 | 1,467.0                   | 2,200.0 | 2,933.0 | 3,667.0 | 4,400.0 | 5,133.0 | 5,867.0 | 6,600.0 | 7,333.0 | 8,067.0 | 8,800.0  |
| 105     | 154.00 | 1,540.0                   | 2,310.0 | 3,080.0 | 3,850.0 | 4,620.0 | 5,390.0 | 6,160.0 | 6,930.0 | 7,700.0 | 8,470.0 | 9,240.0  |
| 110     | 161.30 | 1,613.0                   | 2,420.0 | 3,227.0 | 4,033.0 | 4,840.0 | 5,647.0 | 6,453.0 | 7,260.0 | 8,067.0 | 8,873.0 | 9,680.0  |
| 115     | 168.60 | 1,686.0                   | 2,530.0 | 3,373.0 | 4,217.0 | 5,060.0 | 5,903.0 | 6,747.0 | 7,590.0 | 8,434.0 | 9,277.0 | 10,120.0 |
| 120     | 176.00 | 1,760.0                   | 2,640.0 | 3,520.0 | 4,400.0 | 5,280.0 | 6,160.0 | 7,040.0 | 7,920.0 | 8,800.0 | 9,680.0 | 10,560.0 |

**Table 4D-105 (CA). Pole and Equipment Schedule**

|   | STANDARD          |                 |                    | VEHICLE SIGNAL MAST |        | PED. SIGNAL MTG. | PPB |       | HPS LUM. | SPECIAL REQUIREMENTS                                    |
|---|-------------------|-----------------|--------------------|---------------------|--------|------------------|-----|-------|----------|---|
|   | TYPE              | SIGNAL MAST ARM | LUMINAIRE MAST ARM | MAST                | POLE   |                  | Ø   | ARROW |          |   |
|   | Wind Velocity mph | Feet            | Feet               |                     |        |                  |     |       |          |   |
| A | 24-4-100          | 35              | 12                 | MAT MAS             | SV-1-T | SP-1-T           | 4   | ←     | 200W     | Internally Illuminated Street Name Sign "Local Streets" |
| B | 1A                |                 |                    |                     | TV-1-T | SP-1-T           | 6   | →     |          |   |
| C | 19-1-100          | 15              | 12                 | MAS                 | SV-1-T | SP-1-T           | 6   | ←     | 200W     |   |
| D | 1A                |                 |                    |                     | TV-2-T | SP-1-T           | 8   | →     |          |   |
| E | 24-4-100          | 35              | 12                 | MAT MAS             | SV-1-T | SP-1-T           | 8   | ←     | 200W     | Internally Illuminated Street Name Sign "Local Streets" |
| F | 1A                |                 |                    |                     | TV-1-T | SP-1-T           | 2   | →     |          |   |
| G | 19-1-100          | 15              | 12                 | MAS                 | SV-1-T | SP-1-T           | 2   | ←     | 200W     |   |
| H | 1A                |                 |                    |                     | TV-2-T | SP-1-T           | 4   | →     |          |   |

**Table 4D-106 (CA). Conductor and Conduit Schedule**

| AWG<br>or<br>CABLE            | CONDUCTOR RUN                           | 1                        | 2                    | 3                      | 4                    | 5                    | 6                    | 7                      | 8                      | 9                    | 10                   |   |
|-------------------------------|---|--------------------------|----------------------|------------------------|----------------------|----------------------|----------------------|------------------------|------------------------|----------------------|----------------------|---|
| # 14                          | Ø1                                      | 3                        |                      |                        |                      |                      |                      |                        |                        | 3                    | 3                    |   |
|                               | Ø2                                      | 3                        |                      |                        |                      |                      | 3                    | 3                      | 3                      | 3                    | 3                    |   |
|                               | Ø4                                      | 3                        |                      |                        |                      |                      |                      | 3                      | 3                      | 3                    | 3                    |   |
|                               | Ø5                                      | 6                        | 3                    | 3                      | 3                    |                      | 3                    | 3                      | 3                      | 3                    | 3                    |   |
|                               | Ø6                                      | 6                        | 3                    | 3                      | 3                    |                      |                      |                        |                        |                      | 3                    |   |
|                               | Ø8                                      | 3                        | 3                    | 3                      |                      |                      |                      |                        |                        |                      |                      |   |
|                               | Ø2P                                     | 2                        |                      |                        |                      |                      | 2                    | 2                      | 2                      | 2                    | 2                    |   |
|                               | Ø4P                                     | 4                        | 2                    |                        |                      |                      |                      |                        | 2                      | 2                    | 2                    |   |
|                               | Ø6P                                     | 4                        | 2                    | 2                      | 2                    |                      |                      |                        |                        |                      | 2                    |   |
|                               | Ø8P                                     | 4                        | 2                    | 2                      |                      |                      |                      | 2                      | 2                      | 2                    | 2                    |   |
|                               | Ø2PPB                                   | 1                        |                      |                        |                      |                      |                      |                        | 1                      | 1                    | 1                    |   |
|                               | Ø4PPB                                   | 1                        |                      |                        |                      |                      |                      |                        |                        |                      | 1                    |   |
|                               | Ø6PPB                                   | 1                        | 1                    | 1                      |                      |                      |                      |                        |                        |                      |                      |   |
|                               | Ø8PPB                                   | 2                        | 1                    | 1                      | 1                    |                      | 1                    | 1                      | 1                      | 1                    | 1                    |   |
|                               | PPB Common                              | 2                        | 1                    | 1                      | 1                    |                      | 1                    | 1                      | 1                      | 1                    | 1                    |   |
|                               | P.E.C.                                  |                          |                      |                        |                      |                      |                      |                        |                        |                      |                      | 3 |
|                               | Spares                                  | 6                        | 3                    | 3                      | 3                    |                      | 3                    | 3                      | 3                      | 3                    | 3                    |   |
| <b>Total # 14</b>             |   | <b>51</b>                | <b>21</b>            | <b>19</b>              | <b>13</b>            |                      | <b>13</b>            | <b>19</b>              | <b>21</b>              | <b>25</b>            | <b>35</b>            |   |
| # 10                          | Internally Illuminated Street Name Sign |                          |                      |                        |                      |                      | 2                    | 2                      | 2                      | 2                    | 2                    |   |
|                               | Luminaires                              |                          |                      | 2                      |                      |                      | 2                    | 2                      | 2                      | 2                    | 2                    |   |
|                               | Signal Common                           | 2                        | 1                    | 1                      | 1                    |                      | 1                    | 1                      | 1                      | 1                    | 1                    |   |
|                               | <b>Total # 10</b>                       | <b>2</b>                 | <b>1</b>             | <b>3</b>               | <b>1</b>             |                      | <b>5</b>             | <b>5</b>               | <b>5</b>               | <b>5</b>             | <b>5</b>             |   |
| # 6                           | Signal Service                          | 2                        |                      |                        |                      |                      |                      |                        |                        |                      |                      |   |
| Detector-<br>Lead-In<br>Cable | Ø 1 Detectors                           | 1                        |                      |                        |                      |                      | 1                    | 1                      | 1                      | 1                    | 1                    |   |
|                               | Ø 2 Detectors                           | 4                        |                      |                        |                      |                      |                      |                        |                        | 4                    | 4                    |   |
|                               | Ø 4 Detectors                           | 2                        | 2                    |                        |                      |                      |                      |                        |                        |                      |                      |   |
|                               | Ø 5 Detectors                           | 1                        |                      |                        |                      |                      |                      |                        |                        |                      | 1                    |   |
|                               | Ø 6 Detectors                           | 4                        | 4                    | 4                      | 4                    |                      |                      |                        |                        |                      |                      |   |
|                               | Ø 8 Detectors                           | 2                        |                      |                        |                      |                      |                      | 2                      | 2                      | 2                    | 2                    |   |
|                               | <b>TOTAL DLC</b>                        | <b>14</b>                | <b>6</b>             | <b>4</b>               | <b>4</b>             |                      | <b>1</b>             | <b>3</b>               | <b>3</b>               | <b>7</b>             | <b>8</b>             |   |
| <b>CONDUIT SIZE</b>           |   | <b>2-78C</b><br>(2-3 in) | <b>78C</b><br>(3 in) | <b>63C</b><br>(2.5 in) | <b>53C</b><br>(2 in) | <b>78C</b><br>(3 in) | <b>53C</b><br>(2 in) | <b>63C</b><br>(2.5 in) | <b>63C</b><br>(2.5 in) | <b>78C</b><br>(3 in) | <b>78C</b><br>(3 in) |   |

**Table 4D-107 (CA). Available Conduit Area**

| SQUARE INCHES |                 |      |      |      |       |
|---------------|-----------------|------|------|------|-------|
| CONDUIT SIZE  | PERCENT OF FILL |      |      |      |       |
|               | 26%             | 35%  | 40%  | 50%  | 100%  |
| 1"            | 0.23            | 0.30 | 0.35 | 0.43 | 0.86  |
| 1-1/2"        | 0.53            | 0.72 | 0.82 | 1.02 | 2.04  |
| 2"            | 0.87            | 1.18 | 1.34 | 1.68 | 3.36  |
| 2-1/2"        | 1.24            | 1.68 | 1.92 | 2.45 | 4.79  |
| 3"            | 1.92            | 2.58 | 2.96 | 3.69 | 7.38  |
| 3-1/2"        | 2.57            | 3.47 | 3.96 | 4.95 | 9.90  |
| 4"            | 3.31            | 4.45 | 5.09 | 6.36 | 12.72 |

As a practical limit, projects for new installations should be designed to the 26% fill limitation. Projects for existing conduit should be designed to the 35% fill limitation.

**Table 4D-108 (CA). Conductor Size**

| ENGLISH UNITS                            |                               |                        |                              |
|--|-------------------------------|------------------------|------------------------------|
| CONDUCTOR SIZE (AWG)                     | TYPES TW, THW, USE, RHH & RHN |                        | D.C. RESISTANCE Ohms/1000 ft |
|  | INSULATION THICKNESS (Inches) | TOTAL AREA (Sq Inches) |                              |
| #14                                      | 0.045                         | 0.021                  | 3.07                         |
| #12                                      | 0.045                         | 0.025                  | 1.93                         |
| #10                                      | 0.045                         | 0.031                  | 1.21                         |
| #8 Stranded                              | 0.060                         | 0.060                  | 0.78                         |
| #6 Stranded                              | 0.060                         | 0.082                  | 0.49                         |
| #4 Stranded                              | 0.060                         | 0.109                  | 0.31                         |
| #2 Stranded                              | 0.060                         | 0.147                  | 0.19                         |
| Type B Loop Detector Lead-in Cable (DLC) |                               | 0.073                  |                              |
| Type C Loop Detector Lead-in Cable (DLC) |                               | 0.064                  |                              |
| Signal Interconnect Cable (3-Pair)       |                               | 0.091                  |                              |
| Signal Interconnect Cable (6-Pair)       |                               | 0.181                  |                              |



**Table 4D-109 (CA). Signal Operations - Minimum Bicycle Timing**

$$G_{min} + Y + R_{clear} \geq 6 \text{ sec} + (w+6 \text{ ft})/14.7 \text{ ft/sec, where}$$

$G_{min}$  = Length of minimum green interval (sec)

$Y$  = Length of yellow interval (sec)

$R_{clear}$  = Length of red clearance interval (sec)

$W$  = distance from limit line to far side of last conflicting lane (ft)

| Distance from limit line to far side of last conflicting lane | Minimum phase length (minimum green plus yellow plus red clearance) |
|---|---|
| Feet  | Seconds   |
| 40  | 9.1   |
| 50  | 9.8   |
| 60  | 10.5  |
| 70  | 11.2  |
| 80  | 11.9  |
| 90  | 12.5  |
| 100   | 13.2  |
| 110   | 13.9  |
| 120   | 14.6  |
| 130   | 15.3  |
| 140   | 15.9  |
| 150   | 16.6  |
| 160   | 17.3  |
| 170   | 18.0  |
| 180   | 18.7  |



## CHAPTER 4E. PEDESTRIAN CONTROL FEATURES

### Section 4E.01 Pedestrian Signal Heads

Support:

<sup>01</sup> Pedestrian signal heads provide special types of traffic signal indications exclusively intended for controlling pedestrian traffic. These signal indications consist of the illuminated symbols of a WALKING PERSON (symbolizing WALK) and an UPRAISED HAND (symbolizing DONT WALK).

Guidance:

<sup>02</sup> *Engineering judgment should determine the need for separate pedestrian signal heads (see Section 4D.03) and accessible pedestrian signals (see Section 4E.09).*

Support:

<sup>03</sup> Chapter 4F contains information regarding the use of pedestrian hybrid beacons and Chapter 4N contains information regarding the use of In-Roadway Warning Lights at unsignalized marked crosswalks.

**Standard:**

<sup>04</sup> **Signal design shall provide for or prohibit pedestrian movements.**

### Section 4E.02 Meaning of Pedestrian Signal Head Indications

**Standard:**

<sup>01</sup> **Pedestrian signal head indications shall have the following meanings:**

- A. A steady WALKING PERSON (symbolizing WALK) signal indication means that a pedestrian facing the signal indication is permitted to start to cross the roadway in the direction of the signal indication, possibly in conflict with turning vehicles. The pedestrian shall yield the right-of-way to vehicles lawfully within the intersection at the time that the WALKING PERSON (symbolizing WALK) signal indication is first shown.**
- B. A flashing UPRAISED HAND (symbolizing DONT WALK) signal indication means that a pedestrian shall not start to cross the roadway in the direction of the signal indication, but that any pedestrian who has already started to cross on a steady WALKING PERSON (symbolizing WALK) signal indication shall proceed to the far side of the traveled way of the street or highway, unless otherwise directed by a traffic control device to proceed only to the median of a divided highway or only to some other island or pedestrian refuge area.**
- C. A steady UPRAISED HAND (symbolizing DONT WALK) signal indication means that a pedestrian shall not enter the roadway in the direction of the signal indication.**
- D. A flashing WALKING PERSON (symbolizing WALK) signal indication has no meaning and shall not be used.**

### Section 4E.03 Application of Pedestrian Signal Heads

**Standard:**

<sup>01</sup> **Pedestrian signal heads shall be used in conjunction with vehicular traffic control signals under any of the following conditions:**

- A. If a traffic control signal is justified by an engineering study and meets either Warrant 4, Pedestrian Volume or Warrant 5, School Crossing (see Chapter 4C);**
- B. If an exclusive signal phase is provided or made available for pedestrian movements in one or more directions, with all conflicting vehicular movements being stopped;**
- C. At an established school crossing at any signalized location; or**
- D. Where engineering judgment determines that multi-phase signal indications (as with split-phase timing) would tend to confuse or cause conflicts with pedestrians using a crosswalk guided only by vehicular signal indications.**

Guidance:

<sup>02</sup> *Pedestrian signal heads should be used under any of the following conditions:*

- A. *If it is necessary to assist pedestrians in deciding when to begin crossing the roadway in the chosen direction or if engineering judgment determines that pedestrian signal heads are justified to minimize vehicle-pedestrian conflicts;*
- B. *If pedestrians are permitted to cross a portion of a street, such as to or from a median of sufficient width for pedestrians to wait, during a particular interval but are not permitted to cross the remainder of the street during any part of the same interval; and/or*
- C. *If no vehicular signal indications are visible to pedestrians, or if the vehicular signal indications that are visible to pedestrians starting a crossing provide insufficient guidance for them to decide when to begin crossing the roadway in the chosen direction, such as on one-way streets, at T-intersections, or at multi-phase signal operations.*

Option:

- <sup>03</sup> Pedestrian signal heads may be used under other conditions based on engineering judgment.

#### **Section 4E.04 Size, Design, and Illumination of Pedestrian Signal Head Indications**

**Standard:**

<sup>01</sup> **All new pedestrian signal head indications shall be displayed within a rectangular background and shall consist of symbolized messages (see Figure 4E-1), except that existing pedestrian signal head indications with lettered or outline style symbol messages shall be permitted to be retained for the remainder of their useful service life. The symbol designs that are set forth in the “Standard Highway Signs and Markings” book (see Section 1A.11) shall be used. Each pedestrian signal head indication shall be independently displayed and emit a single color.**

<sup>02</sup> **If a two-section pedestrian signal head is used, the UPRAISED HAND (symbolizing DONT WALK) signal section shall be mounted directly above the WALKING PERSON (symbolizing WALK) signal section. If a one-section pedestrian signal head is used, the symbols shall be either overlaid upon each other or arranged side-by-side with the UPRAISED HAND symbol to the left of the WALKING PERSON symbol, and a light source that can display each symbol independently shall be used.**

<sup>03</sup> **The WALKING PERSON (symbolizing WALK) signal indication shall be white, conforming to the publication entitled “Pedestrian Traffic Control Signal Indications” (see Section 1A.11), with all except the symbol obscured by an opaque material.**

<sup>04</sup> **The UPRAISED HAND (symbolizing DONT WALK) signal indication shall be Portland orange, conforming to the publication entitled “Pedestrian Traffic Control Signal Indications” (see Section 1A.11), with all except the symbol obscured by an opaque material.**

<sup>05</sup> **When not illuminated, the WALKING PERSON (symbolizing WALK) and UPRAISED HAND (symbolizing DONT WALK) symbols shall not be readily visible to pedestrians at the far end of the crosswalk that the pedestrian signal head indications control.**

<sup>06</sup> **For pedestrian signal head indications, the symbols shall be at least 6 inches high.**

<sup>07</sup> **The light source of a flashing UPRAISED HAND (symbolizing DONT WALK) signal indication shall be flashed continuously at a rate of not less than 50 or more than 60 times per minute. The displayed period of each flash shall be a minimum of 1/2 and a maximum of 2/3 of the total flash cycle.**

*Guidance:*

<sup>08</sup> *Pedestrian signal head indications should be conspicuous and recognizable to pedestrians at all distances from the beginning of the controlled crosswalk to a point 10 feet from the end of the controlled crosswalk during both day and night.*

<sup>09</sup> *For crosswalks where the pedestrian enters the crosswalk more than 100 feet from the pedestrian signal head indications, the symbols should be at least 9 inches high.*

<sup>10</sup> *If the pedestrian signal indication is so bright that it causes excessive glare in nighttime conditions, some form of automatic dimming should be used to reduce the brilliance of the signal indication.*

Option:

<sup>11</sup> **An animated eyes symbol may be added to a pedestrian signal head in order to prompt pedestrians to look for vehicles in the intersection during the time that the WALKING PERSON (symbolizing WALK) signal indication is displayed.**

**Standard:**

**12 If used, the animated eyes symbol shall consist of an outline of a pair of white steadily-illuminated eyes with white eyeballs that scan from side to side at a rate of approximately once per second. The animated eyes symbol shall be at least 12 inches wide with each eye having a width of at least 5 inches and a height of at least 2.5 inches. The animated eyes symbol shall be illuminated at the start of the walk interval and shall terminate at the end of the walk interval.**

**Section 4E.05 Location and Height of Pedestrian Signal Heads**

**Standard:**

**01 Pedestrian signal heads shall be mounted with the bottom of the signal housing including brackets not less than 7 feet or more than 10 feet above sidewalk level, and shall be positioned and adjusted to provide maximum visibility at the beginning of the controlled crosswalk.**

**02 If pedestrian signal heads are mounted on the same support as vehicular signal heads, there shall be a physical separation between them.**

**Section 4E.06 Pedestrian Intervals and Signal Phases**

**Standard:**

**01 At intersections equipped with pedestrian signal heads, the pedestrian signal indications shall be displayed except when the vehicular traffic control signal is being operated in the flashing mode. At those times, the pedestrian signal indications shall not be displayed.**

**02 When the pedestrian signal heads associated with a crosswalk are displaying either a steady WALKING PERSON (symbolizing WALK) or a flashing UPRAISED HAND (symbolizing DONT WALK) signal indication, a steady or a flashing red signal indication shall be shown to any conflicting vehicular movement that is approaching the intersection or midblock location perpendicular or nearly perpendicular to the crosswalk.**

**03 When pedestrian signal heads are used, a WALKING PERSON (symbolizing WALK) signal indication shall be displayed only when pedestrians are permitted to leave the curb or shoulder.**

**04 A pedestrian change interval consisting of a flashing UPRAISED HAND (symbolizing DONT WALK) signal indication shall begin immediately following the WALKING PERSON (symbolizing WALK) signal indication **except as provided in Section 4D.27**. Following the pedestrian change interval, a buffer interval consisting of a steady UPRAISED HAND (symbolizing DONT WALK) signal indication shall be displayed for at least 3 seconds prior to the release of any conflicting vehicular movement. The sum of the time of the pedestrian change interval and the buffer interval shall not be less than the calculated pedestrian clearance time (see Paragraphs 7 through 16). The buffer interval shall not begin later than the beginning of the red clearance interval, if used.**

**Option:**

**05 During the yellow change interval, the UPRAISED HAND (symbolizing DON'T WALK) signal indication may be displayed as either a flashing indication, a steady indication, or a flashing indication for an initial portion of the yellow change interval and a steady indication for the remainder of the interval.**

**Support:**

**06 Figure 4E-2 illustrates the pedestrian intervals and their possible relationships with associated vehicular signal phase intervals.**

**Guidance:**

**07 Except as provided in Paragraph 8, the pedestrian clearance time should be sufficient to allow a pedestrian crossing in the crosswalk who left the curb or shoulder at the end of the WALKING PERSON (symbolizing WALK) signal indication to travel at a walking speed of 3.5 feet per second to at least the far side of the traveled way or to a median of sufficient width for pedestrians to wait.**

**Option:**

**08 A walking speed of up to 4 feet per second may be used to evaluate the sufficiency of the pedestrian clearance time at locations where an extended pushbutton press function has been installed to provide slower pedestrians an opportunity to request and receive a longer pedestrian clearance time. Passive pedestrian detection**

may also be used to automatically adjust the pedestrian clearance time based on the pedestrian's actual walking speed or actual clearance of the crosswalk.

<sup>09</sup> The additional time provided by an extended pushbutton press to satisfy pedestrian clearance time needs may be added to either the walk interval or the pedestrian change interval.

*Guidance:*

<sup>10</sup> *Where pedestrians who walk slower than 3.5 feet per second, or pedestrians who use wheelchairs, routinely use the crosswalk, a walking speed of less than 3.5 feet per second should be considered in determining the pedestrian clearance time.*

<sup>10a</sup> *Where older or disabled pedestrians routinely use the crosswalk, a walking speed of 2.8 feet per second should be considered in determining the pedestrian clearance time.*

<sup>11</sup> *Except as provided in Paragraph 12, the walk interval should be at least 7 seconds in length so that pedestrians will have adequate opportunity to leave the curb or shoulder before the pedestrian clearance time begins.*

*Option:*

<sup>12</sup> If pedestrian volumes and characteristics do not require a 7-second walk interval, walk intervals as short as 4 seconds may be used.

*Support:*

<sup>13</sup> The walk interval is intended for pedestrians to start their crossing. The pedestrian clearance time is intended to allow pedestrians who started crossing during the walk interval to complete their crossing. Longer walk intervals are often used when the duration of the vehicular green phase associated with the pedestrian crossing is long enough to allow it.

*Guidance:*

<sup>14</sup> *The total of the walk interval and pedestrian clearance time should be sufficient to allow a pedestrian crossing in the crosswalk who left the pedestrian detector (or, if no pedestrian detector is present, a location 6 feet from the face of the curb or from the edge of the pavement) at the beginning of the WALKING PERSON (symbolizing WALK) signal indication to travel at a walking speed of 3 feet per second to the far side of the traveled way being crossed or to the median if a two-stage pedestrian crossing sequence is used. Any additional time that is required to satisfy the conditions of this paragraph should be added to the walk interval.*

*Option:*

<sup>15</sup> On a street with a median of sufficient width for pedestrians to wait, a pedestrian clearance time that allows the pedestrian to cross only from the curb or shoulder to the median may be provided.

**Standard:**

<sup>16</sup> **Where the pedestrian clearance time is sufficient only for crossing from the curb or shoulder to a median of sufficient width for pedestrians to wait, median-mounted pedestrian signals (with pedestrian detectors if actuated operation is used) shall be provided (see Sections 4E.08 and 4E.09) and signing such as the R10-3d sign (see Section 2B.52) shall be provided to notify pedestrians to cross only to the median to await the next WALKING PERSON (symbolizing WALK) signal indication.**

*Guidance:*

<sup>17</sup> *Where median-mounted pedestrian signals and detectors are provided, the use of accessible pedestrian signals (see Sections 4E.09 through 4E.13) should be considered.*

*Option:*

<sup>18</sup> During the transition into preemption, the walk interval and the pedestrian change interval may be shortened or omitted as described in Section 4D.27.

<sup>19</sup> At intersections with high pedestrian volumes and high conflicting turning vehicle volumes, a brief leading pedestrian interval, during which an advance WALKING PERSON (symbolizing WALK) indication is displayed for the crosswalk while red indications continue to be displayed to parallel through and/or turning traffic, may be used to reduce conflicts between pedestrians and turning vehicles.

*Guidance:*

<sup>20</sup> *If a leading pedestrian interval is used, the use of accessible pedestrian signals (see Sections 4E.09 through 4E.13) should be considered.*

**Support:**

<sup>21</sup> If a leading pedestrian interval is used without accessible features, pedestrians who are visually impaired can be expected to begin crossing at the onset of the vehicular movement when drivers are not expecting them to begin crossing.

**Guidance:**

<sup>22</sup> *If a leading pedestrian interval is used, it should be at least 3 seconds in duration and should be timed to allow pedestrians to cross at least one lane of traffic or, in the case of a large corner radius, to travel far enough for pedestrians to establish their position ahead of the turning traffic before the turning traffic is released.* <sup>23</sup> *If a leading pedestrian interval is used, consideration should be given to prohibiting turns across the crosswalk during the leading pedestrian interval.*

**Support:**

<sup>24</sup> At intersections with pedestrian volumes that are so high that drivers have difficulty finding an opportunity to turn across the crosswalk, the duration of the green interval for a parallel concurrent vehicular movement is sometimes intentionally set to extend beyond the pedestrian clearance time to provide turning drivers additional green time to make their turns while the pedestrian signal head is displaying a steady UPRAISED HAND (symbolizing DONT WALK) signal indication after pedestrians have had time to complete their crossings.

### **Section 4E.07 Countdown Pedestrian Signals**

**Standard:**

<sup>01</sup> **All pedestrian signal heads used at crosswalks where the pedestrian change interval is more than 7 seconds shall include a pedestrian change interval countdown display in order to inform pedestrians of the number of seconds remaining in the pedestrian change interval.**

**Option:**

<sup>02</sup> Pedestrian signal heads used at crosswalks where the pedestrian change interval is 7 seconds or less may include a pedestrian change interval countdown display in order to inform pedestrians of the number of seconds remaining in the pedestrian change interval.

**Standard:**

<sup>03</sup> **Where countdown pedestrian signals are used, the countdown shall always be displayed simultaneously with the flashing UPRAISED HAND (symbolizing DONT WALK) signal indication displayed for that crosswalk.**

<sup>04</sup> **Countdown pedestrian signals shall consist of Portland orange numbers that are at least 6 inches in height on a black opaque background. The countdown pedestrian signal shall be located immediately adjacent to the associated UPRAISED HAND (symbolizing DONT WALK) pedestrian signal head indication (see Figure 4E-1).**

<sup>05</sup> **The display of the number of remaining seconds shall begin only at the beginning of the pedestrian change interval (flashing UPRAISED HAND). After the countdown displays zero, the display shall remain dark until the beginning of the next countdown.**

<sup>06</sup> **The countdown pedestrian signal shall display the number of seconds remaining until the termination of the pedestrian change interval (flashing UPRAISED HAND). Countdown displays shall not be used during the walk interval or during the red clearance interval of a concurrent vehicular phase.**

**Guidance:**

<sup>07</sup> *If used with a pedestrian signal head that does not have a concurrent vehicular phase, the pedestrian change interval (flashing UPRAISED HAND) should be set to be approximately 4 seconds less than the required pedestrian clearance time (see Section 4E.06) and an additional clearance interval (during which a steady UPRAISED HAND is displayed) should be provided prior to the start of the conflicting vehicular phase.*

<sup>08</sup> *For crosswalks where the pedestrian enters the crosswalk more than 100 feet from the countdown pedestrian signal display, the numbers should be at least 9 inches in height.*

<sup>09</sup> *Because some technology includes the countdown pedestrian signal logic in a separate timing device that is independent of the timing in the traffic signal controller, care should be exercised by the engineer when timing changes are made to pedestrian change intervals.*

*10 If the pedestrian change interval is interrupted or shortened as a part of a transition into a preemption sequence (see Section 4E.06), the countdown pedestrian signal display should be discontinued and go dark immediately upon activation of the preemption transition.*

### **Section 4E.08 Pedestrian Detectors**

Option:

*01 Pedestrian detectors may be pushbuttons or passive detection devices.*

Support:

*02 Passive detection devices register the presence of a pedestrian in a position indicative of a desire to cross, without requiring the pedestrian to push a button. Some passive detection devices are capable of tracking the progress of a pedestrian as the pedestrian crosses the roadway for the purpose of extending or shortening the duration of certain pedestrian timing intervals.*

*03 The provisions in this Section place pedestrian pushbuttons within easy reach of pedestrians who are intending to cross each crosswalk and make it obvious which pushbutton is associated with each crosswalk. These provisions also position pushbutton poles in optimal locations for installation of accessible pedestrian signals (see Sections 4E.09 through 4E.13). Information regarding reach ranges can be found in the "Americans with Disabilities Act Accessibility Guidelines for Buildings and Facilities (ADAAG)" (see Section 1A.11).*

Guidance:

*04 If pedestrian pushbuttons are used, they should be capable of easy activation and conveniently located near each end of the crosswalks. Except as provided in Paragraphs 5 and 6, pedestrian pushbuttons should be located to meet all of the following criteria (see Figure 4E-3):*

- A. Unobstructed and adjacent to a level all-weather surface to provide access from a wheelchair;*
- B. Where there is an all-weather surface, a wheelchair accessible route from the pushbutton to the ramp;*
- C. Between the edge of the crosswalk line (extended) farthest from the center of the intersection and the side of a curb ramp (if present), but not greater than 5 feet from said crosswalk line;*
- D. Between 1.5 and 6 feet from the edge of the curb, shoulder, or pavement;*
- E. With the face of the pushbutton parallel to the crosswalk to be used; and*
- F. At a mounting height of approximately 3.5 feet, but no more than 4 feet, above the sidewalk.*

*05 Where there are physical constraints that make it impractical to place the pedestrian pushbutton adjacent to a level all-weather surface, the surface should be as level as feasible.*

*06 Where there are physical constraints that make it impractical to place the pedestrian pushbutton between 1.5 and 6 feet from the edge of the curb, shoulder, or pavement, it should not be farther than 10 feet from the edge of curb, shoulder, or pavement.*

*07 Except as provided in Paragraph 8, where two pedestrian pushbuttons are provided on the same corner of a signalized location, the pushbuttons should be separated by a distance of at least 10 feet.*

Option:

*08 Where there are physical constraints on a particular corner that make it impractical to provide the 10-foot separation between the two pedestrian pushbuttons, the pushbuttons may be placed closer together or on the same pole.*

Support:

*09 Figure 4E-4 shows typical pedestrian pushbutton locations for a variety of situations.*

**Standard:**

***10 Signs (see Section 2B.52) shall be mounted adjacent to immediately above or integral with pedestrian pushbuttons, explaining their purpose and use.***

Option:

*11 At certain locations, a supplemental sign in a more visible location may be used to call attention to the pedestrian pushbutton.*

**Standard:**

***12 The positioning of pedestrian pushbuttons and the legends on the pedestrian pushbutton signs shall clearly indicate which crosswalk signal is actuated by each pedestrian pushbutton.***



**13 If the pedestrian clearance time is sufficient only to cross from the curb or shoulder to a median of sufficient width for pedestrians to wait and the signals are pedestrian actuated, an additional pedestrian detector shall be provided in the median.**

*Guidance:*

*14 The use of additional pedestrian detectors on islands or medians where a pedestrian might become stranded should be considered.*

*15 If used, special purpose pushbuttons (to be operated only by authorized persons) should include a housing capable of being locked to prevent access by the general public and do not need an instructional sign.*

**Standard:**

**16 If used, a pilot light or other means of indication installed with a pedestrian pushbutton shall not be illuminated until actuation. Once it is actuated, the pilot light shall remain illuminated until the pedestrian's green or WALKING PERSON (symbolizing WALK) signal indication is displayed.**

**17 If a pilot light is used at an accessible pedestrian signal location (see Sections 4E.09 through 4E.13), each actuation shall be accompanied by the speech message "wait."**

*Option:*

*18 At signalized locations with a demonstrated need and subject to equipment capabilities, pedestrians with special needs may be provided with additional crossing time by means of an extended pushbutton press.*

**Standard:**

**19 If additional crossing time is provided by means of an extended pushbutton press, a PUSH BUTTON FOR 2 SECONDS FOR EXTRA CROSSING TIME (R10-32P) plaque (see Figure 2B-26) shall be mounted adjacent to or integral with the pedestrian pushbutton.**

## **Section 4E.09 Accessible Pedestrian Signals and Detectors – General**

*Support:*

*01 Accessible pedestrian signals and detectors provide information in non-visual formats (such as audible tones, speech messages, and/or vibrating surfaces).*

*02 The primary technique that pedestrians who have visual disabilities use to cross streets at signalized locations is to initiate their crossing when they hear the traffic in front of them stop and the traffic alongside them begin to move, which often corresponds to the onset of the green interval. The existing environment is often not sufficient to provide the information that pedestrians who have visual disabilities need to cross a roadway at a signalized location.*

*Guidance:*

*03 If a particular signalized location presents difficulties for pedestrians who have visual disabilities to cross the roadway, an engineering study should be conducted that considers the needs of pedestrians in general, as well as the information needs of pedestrians with visual disabilities. The engineering study should consider the following factors:*

*A. Potential demand for accessible pedestrian signals;*

*B. A request for accessible pedestrian signals;*

*C. Traffic volumes during times when pedestrians might be present, including periods of low traffic volumes or high turn-on-red volumes;*

*D. The complexity of traffic signal phasing (such as split phases, protected turn phases, leading pedestrian intervals, and exclusive pedestrian phases); and*

*E. The complexity of intersection geometry.*

*Support:*

*04 The factors that make crossing at a signalized location difficult for pedestrians who have visual disabilities include: increasingly quiet cars, right turn on red (which masks the beginning of the through phase), continuous right-turn movements, complex signal operations, traffic circles, and wide streets. Furthermore, low traffic volumes might make it difficult for pedestrians who have visual disabilities to discern signal phase changes.*

*05 Local organizations, providing support services to pedestrians who have visual and/or hearing disabilities, can often act as important advisors to the traffic engineer when consideration is being given to the installation of devices to assist such pedestrians. Additionally, orientation and mobility specialists or similar staff also might be able to provide a wide range of advice. The U.S. Access Board ([www.access-board.gov](http://www.access-board.gov)) provides technical*

assistance for making pedestrian signal information available to persons with visual disabilities (see Page i for the address for the U.S. Access Board).

**Standard:**

**06 When used, accessible pedestrian signals shall be used in combination with pedestrian signal timing. The information provided by an accessible pedestrian signal shall clearly indicate which pedestrian crossing is served by each device.**

**07 Under stop-and-go operation, accessible pedestrian signals shall not be limited in operation by the time of day or day of week.**

**Option:**

08 Accessible pedestrian signal detectors may be pushbuttons or passive detection devices.

09 At locations with pretimed traffic control signals or non-actuated approaches, pedestrian pushbuttons may be used to activate the accessible pedestrian signals.

**Support:**

10 Accessible pedestrian signals are typically integrated into the pedestrian detector (pushbutton), so the audible tones and/or messages come from the pushbutton housing. They have a pushbutton locator tone and tactile arrow, and can include audible beaconing and other special features.

**Option:**

11 The name of the street to be crossed may also be provided in accessible format, such as Braille or raised print. Tactile maps of crosswalks may also be provided.

**Support:**

12 Specifications regarding the use of Braille or raised print for traffic control devices can be found in the "Americans with Disabilities Act Accessibility Guidelines for Buildings and Facilities (ADAAG)" (see Section 1A.11).

**Standard:**

**13 At accessible pedestrian signal locations where pedestrian pushbuttons are used, each pushbutton shall activate both the walk interval and the accessible pedestrian signals.**

**Standard:**

**14 The tone of the walk signal shall not be similar to the push button locator tones.**

**15 The cost of installing and maintaining Accessible Pedestrian Signals shall be shared with the local agency in the same manner as a traffic signal. See Section 4B.104(CA).**

**Option:**

16 New signalized intersections and planned upgrades to signalized intersections that are equipped with pedestrian crosswalks as well as the following characteristics may be considered for accessible pedestrian signals when the need and viability are confirmed by an engineering study:

- A. Intersections near blind centers and senior centers
- B. Transit terminals
- C. T-type intersections
- D. Wide intersections
- E. Intersections with unusual geometry
- F. Skewed intersections
- G. Mid-block crosswalks
- H. Intersections with exclusive phasing
- I. Intersections with leading pedestrian intervals
- J. Intersections with frequent side street calls, and;
- K. Intersections with high turning volumes

**Option:**

17 The installation of Accessible Pedestrian Signals may be considered when an engineering study and evaluation have been conducted and the following minimum conditions have been met:

- A. The proposed intersection crosswalk must be signalized.
- B. The audible devices should be retrofittable to the existing traffic signal hardware.
- C. The signalized intersection should be equipped with pedestrian push buttons.
- D. The selected crosswalk must be suitable for the installation of audible signals, in terms of surrounding land use and traffic patterns.

- E. There must be a demonstrated need for the audible signals in the form of a request from an individual or group that would use the audible signal.
- F. The individual or group requesting the device should agree to train the visually impaired users of the audible signals.

#### **Section 4E.10 Accessible Pedestrian Signals and Detectors – Location**

Support:

<sup>01</sup> Accessible pedestrian signals that are located as close as possible to pedestrians waiting to cross the street provide the clearest and least ambiguous indication of which pedestrian crossing is served by a device.

*Guidance:*

<sup>02</sup> *Pushbuttons for accessible pedestrian signals should be located in accordance with the provisions of Section 4E.08 and should be located as close as possible to the crosswalk line furthest from the center of the intersection and as close as possible to the curb ramp.*

**Standard:**

<sup>03</sup> **If two accessible pedestrian pushbuttons are placed less than 10 feet apart or on the same pole, each accessible pedestrian pushbutton shall be provided with the following features (see Sections 4E.11 through 4E.13):**

- A. A pushbutton locator tone,**
- B. A tactile arrow,**
- C. A speech walk message for the WALKING PERSON (symbolizing WALK) indication, and**
- D. A speech pushbutton information message.**

<sup>04</sup> **If the pedestrian clearance time is sufficient only to cross from the curb or shoulder to a median of sufficient width for pedestrians to wait and accessible pedestrian detectors are used, an additional accessible pedestrian detector shall be provided in the median.**

#### **Section 4E.11 Accessible Pedestrian Signals and Detectors – Walk Indications**

Support:

<sup>01</sup> Technology that provides different sounds for each non-concurrent signal phase has frequently been found to provide ambiguous information. Research indicates that a rapid tick tone for each crossing coming from accessible pedestrian signal devices on separated poles located close to each crosswalk provides unambiguous information to pedestrians who are blind or visually impaired. Vibrotactile indications provide information to pedestrians who are blind and deaf and are also used by pedestrians who are blind or who have low vision to confirm the walk signal in noisy situations.

**Standard:**

<sup>02</sup> **Accessible pedestrian signals shall have both audible and vibrotactile walk indications.**

<sup>03</sup> **Vibrotactile walk indications shall be provided by a tactile arrow on the pushbutton (see Section 4E.12) that vibrates during the walk interval.**

<sup>04</sup> **Accessible pedestrian signals shall have an audible walk indication during the walk interval only. The audible walk indication shall be audible from the beginning of the associated crosswalk.**

<sup>05</sup> **The accessible walk indication shall have the same duration as the pedestrian walk signal except when the pedestrian signal rests in walk.**

*Guidance:*

<sup>06</sup> *If the pedestrian signal rests in walk, the accessible walk indication should be limited to the first 7 seconds of the walk interval. The accessible walk indication should be recalled by a button press during the walk interval provided that the crossing time remaining is greater than the pedestrian change interval.*

**Standard:**

<sup>07</sup> **Where two accessible pedestrian signals are separated by a distance of at least 10 feet, the audible walk indication shall be a percussive tone. Where two accessible pedestrian signals on one corner are not separated by a distance of at least 10 feet, the audible walk indication shall be a speech walk message.**

<sup>08</sup> **Audible tone walk indications shall repeat at eight to ten ticks per second. Audible tones used as walk indications shall consist of multiple frequencies with a dominant component at 880 Hz.**

*Guidance:*

<sup>09</sup> *The volume of audible walk indications and pushbutton locator tones (see Section 4E.12) should be set to be a maximum of 5 dBA louder than ambient sound, except when audible beaconing is provided in response to an extended pushbutton press.*

**Standard:**

<sup>10</sup> **Automatic volume adjustment in response to ambient traffic sound level shall be provided up to a maximum volume of 100 dBA.**

*Guidance:*

<sup>11</sup> *The sound level of audible walk indications and pushbutton locator tones should be adjusted to be low enough to avoid misleading pedestrians who have visual disabilities when the following conditions exist:*

- A. Where there is an island that allows unsignalized right turns across a crosswalk between the island and the sidewalk.*
- B. Where multi-leg approaches or complex signal phasing require more than two pedestrian phases, such that it might be unclear which crosswalk is served by each audible tone.*
- C. At intersections where a diagonal pedestrian crossing is allowed, or where one street receives a WALKING PERSON (symbolizing WALK) signal indication simultaneously with another street.*

**Option:**

<sup>12</sup> An alert tone, which is a very brief burst of high-frequency sound at the beginning of the audible walk indication that rapidly decays to the frequency of the walk tone, may be used to alert pedestrians to the beginning of the walk interval.

**Support:**

<sup>13</sup> An alert tone can be particularly useful if the walk tone is not easily audible in some traffic conditions.

<sup>14</sup> Speech walk messages communicate to pedestrians which street has the walk interval. Speech messages might be either directly audible or transmitted, requiring a personal receiver to hear the message. To be a useful system, the words and their meaning need to be correctly understood by all users in the context of the street environment where they are used. Because of this, tones are the preferred means of providing audible walk indications except where two accessible pedestrian signals on one corner are not separated by a distance of at least 10 feet.

<sup>15</sup> If speech walk messages are used, pedestrians have to know the names of the streets that they are crossing in order for the speech walk messages to be unambiguous. In getting directions to travel to a new location, pedestrians with visual disabilities do not always get the name of each street to be crossed. Therefore, it is desirable to give users of accessible pedestrian signals the name of the street controlled by the pushbutton. This can be done by means of a speech pushbutton information message (see Section 4D.13 4E.13) during the flashing or steady UPRAISED HAND intervals, or by raised print and Braille labels on the pushbutton housing.

<sup>16</sup> By combining the information from the pushbutton message or Braille label, the tactile arrow aligned in the direction of travel on the relevant crosswalk, and the speech walk message, pedestrians with visual disabilities are able to correctly respond to speech walk messages even if there are two pushbuttons on the same pole.

**Standard:**

<sup>17</sup> **If speech walk messages are used to communicate the walk interval, they shall provide a clear message that the walk interval is in effect, as well as to which crossing it applies. Speech walk messages shall be used only at intersections where it is technically infeasible to install two accessible pedestrian signals at one corner separated by a distance of at least 10 feet.**

<sup>18</sup> **Speech walk messages that are used at intersections having pedestrian phasing that is concurrent with vehicular phasing shall be patterned after the model: “Broadway. Walk sign is on to cross Broadway.”**

<sup>19</sup> **Speech walk messages that are used at intersections having exclusive pedestrian phasing shall be patterned after the model: “Walk sign is on for all crossings.”**

<sup>20</sup> **Speech walk messages shall not contain any additional information, except they shall include designations such as “Street” or “Avenue” where this information is necessary to avoid ambiguity at a particular location.**

*Guidance:*

<sup>21</sup> *Speech walk messages should not state or imply a command to the pedestrian, such as “Cross Broadway now.” Speech walk messages should not tell pedestrians that it is “safe to cross,” because it is always the pedestrian’s responsibility to check actual traffic conditions.*

**Standard:**

**22 A speech walk message is not required at times when the walk interval is not timing, but, if provided:**

**A. It shall begin with the term “wait.”**

**B. It need not be repeated for the entire time that the walk interval is not timing.**

**23 If a pilot light (see Section 4E.08) is used at an accessible pedestrian signal location, each actuation shall be accompanied by the speech message “wait.”**

Option:

**24 Accessible pedestrian signals that provide speech walk messages may provide similar messages in languages other than English, if needed, except for the terms “walk sign” and “wait.”**

**Standard:**

**25 Following the audible walk indication, accessible pedestrian signals shall revert to the pushbutton locator tone (see Section 4E.12) during the pedestrian change interval.**

**Section 4E.12 Accessible Pedestrian Signals and Detectors – Tactile Arrows and Locator Tones**

**Standard:**

**01 To enable pedestrians who have visual disabilities to distinguish and locate the appropriate pushbutton at an accessible pedestrian signal location, pushbuttons shall clearly indicate by means of tactile arrows which crosswalk signal is actuated by each pushbutton. Tactile arrows shall be located on the pushbutton, have high visual contrast (light on dark or dark on light), and shall be aligned parallel to the direction of travel on the associated crosswalk.**

**02 An accessible pedestrian pushbutton shall incorporate a locator tone.**

Support:

**03 A pushbutton locator tone is a repeating sound that informs approaching pedestrians that a pushbutton to actuate pedestrian timing or receive additional information exists, and that enables pedestrians with visual disabilities to locate the pushbutton.**

**Standard:**

**04 Pushbutton locator tones shall have a duration of 0.15 seconds or less, and shall repeat at 1-second intervals.**

**05 Pushbutton locator tones shall be deactivated when the traffic control signal is operating in a flashing mode. This requirement shall not apply to traffic control signals or pedestrian hybrid beacons that are activated from a flashing or dark mode to a stop-and-go mode by pedestrian actuations.**

**06 Pushbutton locator tones shall be intensity responsive to ambient sound, and be audible 6 to 12 feet from the pushbutton, or to the building line, whichever is less.**

Support:

**07 Section 4E.11 contains additional provisions regarding the volume and sound level of pushbutton locator tones.**

**Section 4E.13 Accessible Pedestrian Signals and Detectors – Extended Pushbutton Press Features**

Option:

**01 Pedestrians may be provided with additional features such as increased crossing time, audible beaconing, or a speech pushbutton information message as a result of an extended pushbutton press.**

**Standard:**

**02 If an extended pushbutton press is used to provide any additional feature(s), a pushbutton press of less than one second shall actuate only the pedestrian timing and any associated accessible walk indication, and a pushbutton press of one second or more shall actuate the pedestrian timing, any associated accessible walk indication, and any additional feature(s).**

**03 If additional crossing time is provided by means of an extended pushbutton press, a PUSH BUTTON FOR 2 SECONDS FOR EXTRA CROSSING TIME (R10-32P) plaque (see Figure 2B-26) shall be mounted adjacent to or integral with the pedestrian pushbutton.**

Support:

**04 Audible beaconing is the use of an audible signal in such a way that pedestrians with visual disabilities can home in on the signal that is located on the far end of the crosswalk as they cross the street.**

<sup>05</sup> Not all crosswalks at an intersection need audible beaoning; audible beaoning can actually cause confusion if used at all crosswalks at some intersections. Audible beaoning is not appropriate at locations with channelized turns or split phasing, because of the possibility of confusion.

*Guidance:*

<sup>06</sup> *Audible beaoning should only be considered following an engineering study at:*

- A. Crosswalks longer than 70 feet, unless they are divided by a median that has another accessible pedestrian signal with a locator tone;*
- B. Crosswalks that are skewed;*
- C. Intersections with irregular geometry, such as more than four legs;*
- D. Crosswalks where audible beaoning is requested by an individual with visual disabilities; or*
- E. Other locations where a study indicates audible beaoning would be beneficial.*

**Option:**

<sup>07</sup> Audible beaoning may be provided in several ways, any of which are initiated by an extended pushbutton press.

**Standard:**

<sup>08</sup> **If audible beaoning is used, the volume of the pushbutton locator tone during the pedestrian change interval of the called pedestrian phase shall be increased and operated in one of the following ways:**

- A. The louder audible walk indication and louder locator tone comes from the far end of the crosswalk, as pedestrians cross the street,**
- B. The louder locator tone comes from both ends of the crosswalk, or**
- C. The louder locator tone comes from an additional speaker that is aimed at the center of the crosswalk and that is mounted on a pedestrian signal head.**

**Option:**

<sup>09</sup> Speech pushbutton information messages may provide intersection identification, as well as information about unusual intersection signalization and geometry, such as notification regarding exclusive pedestrian phasing, leading pedestrian intervals, split phasing, diagonal crosswalks, and medians or islands.

**Standard:**

<sup>10</sup> **If speech pushbutton information messages are made available by actuating the accessible pedestrian signal detector, they shall only be actuated when the walk interval is not timing. They shall begin with the term “Wait,” followed by intersection identification information modeled after: “Wait to cross Broadway at Grand.” If information on intersection signalization or geometry is also given, it shall follow the intersection identification information.**

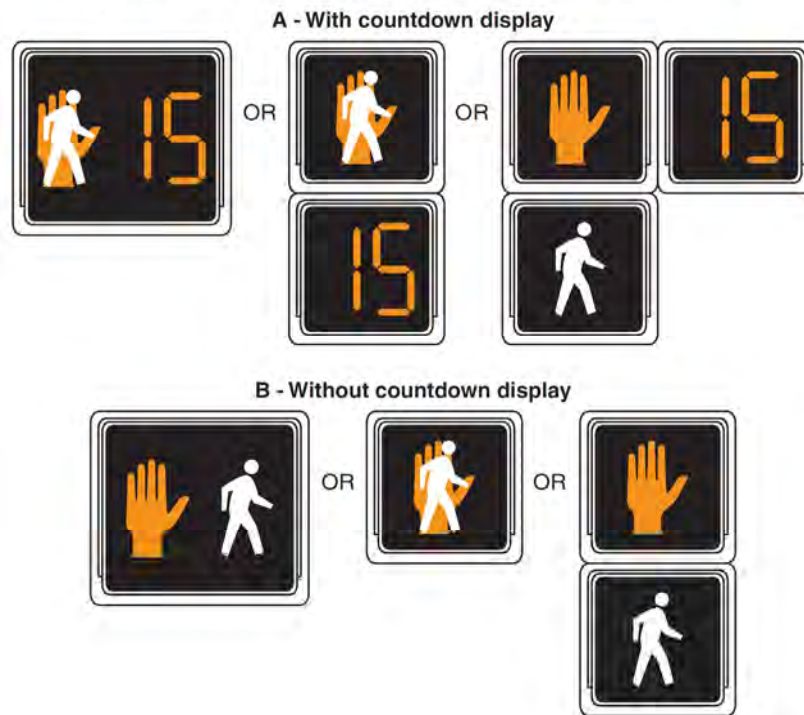
*Guidance:*

<sup>11</sup> *Speech pushbutton information messages should not be used to provide landmark information or to inform pedestrians with visual disabilities about detours or temporary traffic control situations.*

**Support:**

<sup>12</sup> Additional information on the structure and wording of speech pushbutton information messages is included in ITE's “Electronic Toolbox for Making Intersections More Accessible for Pedestrians Who Are Blind or Visually Impaired,” which is available at ITE's website (see Page i).

**Figure 4E-1. Typical Pedestrian Signal Indications**



**Figure 4E-2. Pedestrian Intervals**



**Relationship to associated vehicular phase intervals:**



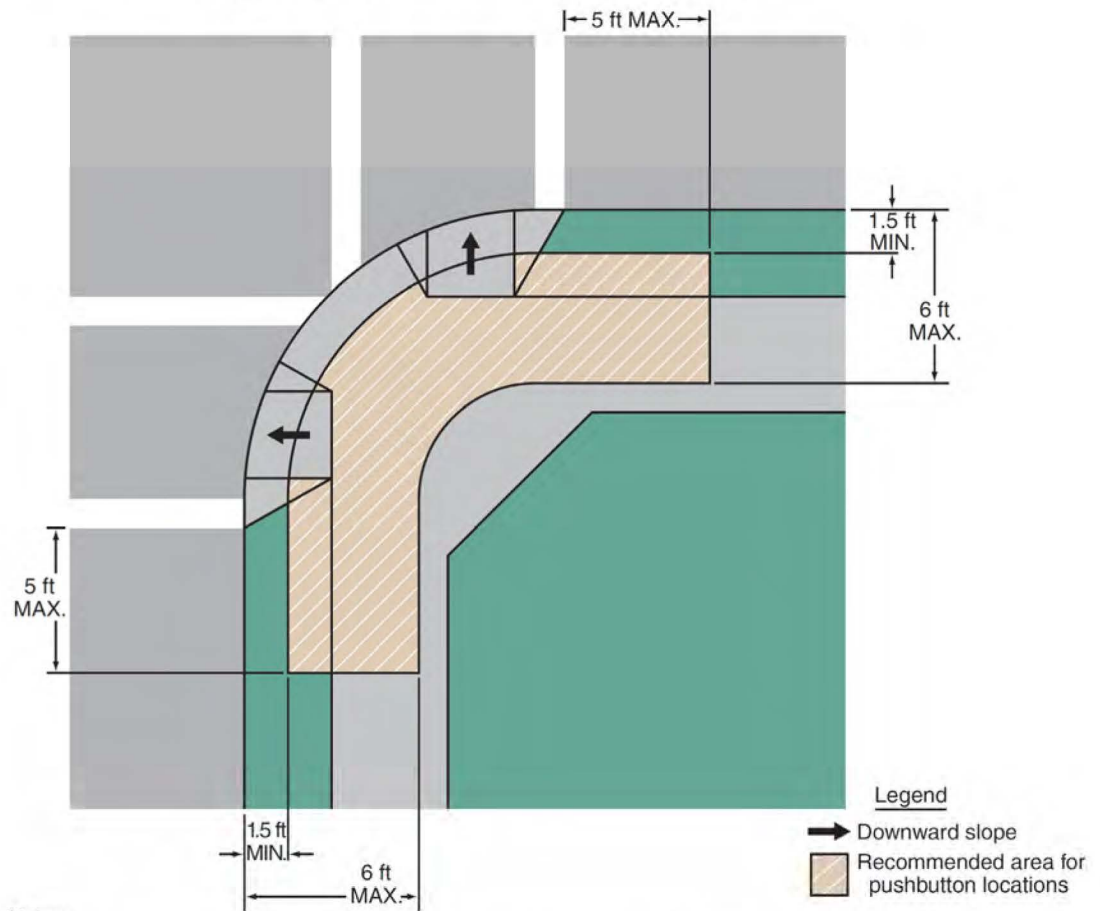
**Legend**

- G** = Green Interval
- Y** = Yellow Change Interval (of at least 3 seconds)
- R** = Red Clearance Interval
- Red** = Red because conflicting traffic has been released

- \* The countdown display is optional for Pedestrian Change Intervals of 7 seconds or less.
- \*\* The Walk Interval may be reduced under some conditions (see Section 4E.06).
- \*\*\* The Buffer Interval, which shall always be provided and displayed, may be used to help satisfy the calculated pedestrian clearance time, or may begin after the calculated pedestrian clearance time has ended.



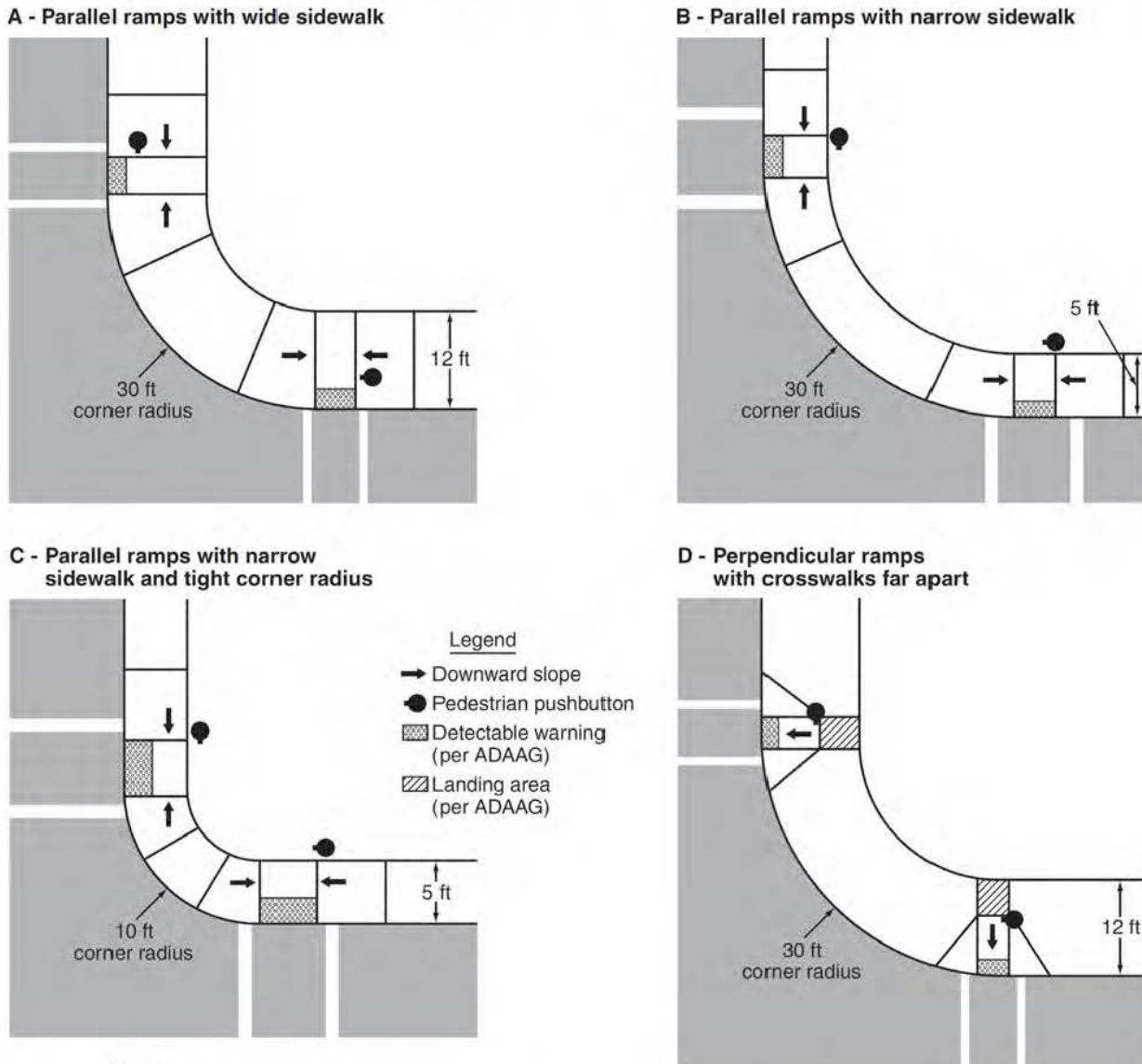
**Figure 4E-3. Pushbutton Location Area**



**Notes:**

1. Where there are constraints that make it impractical to place the pedestrian pushbutton between 1.5 feet and 6 feet from the edge of the curb, shoulder, or pavement, it should not be further than 10 feet from the edge of curb, shoulder, or pavement.
2. Two pedestrian pushbuttons on a corner should be separated by 10 feet.
3. This figure is not drawn to scale.
4. Figure 4E-4 shows typical pushbutton locations.

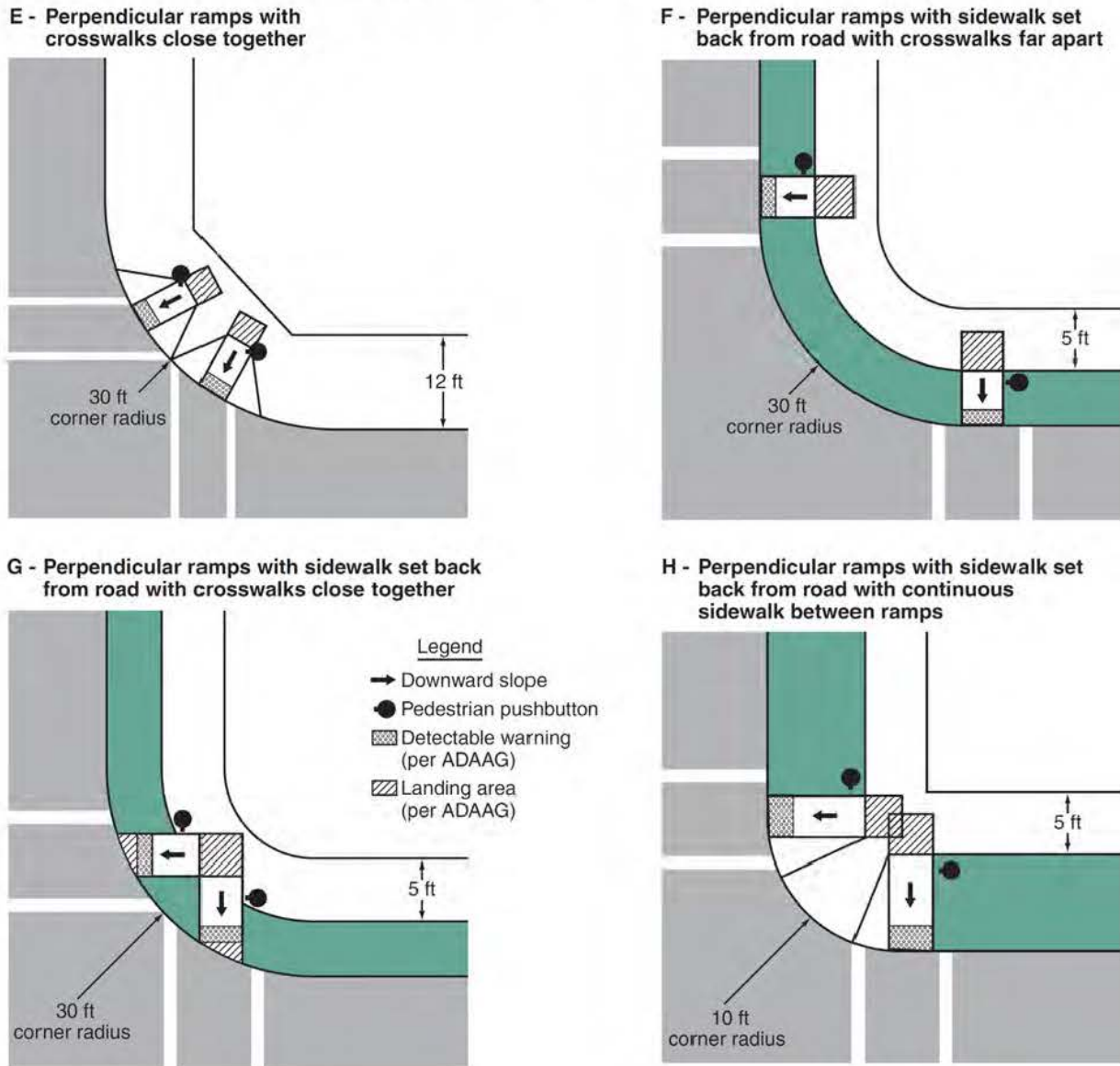
**Figure 4E-4. Typical Pushbutton Locations (Sheet 1 of 2)**



**Notes:**

1. This figure is not drawn to scale.
2. These drawings are intended to describe the typical locations for pedestrian pushbutton installations. They are not intended to be a guide for the design of curb cut ramps.
3. Figure 4E-3 shows the recommended area for pushbutton locations.

**Figure 4E-4. Typical Pushbutton Locations (Sheet 2 of 2)**



**Notes:**

1. This figure is not drawn to scale.
2. These drawings are intended to describe the typical locations for pedestrian pushbutton installations. They are not intended to be a guide for the design of curb cut ramps.
3. Figure 4E-3 shows the recommended area for pushbutton locations.



## CHAPTER 4F. PEDESTRIAN HYBRID BEACONS

### Section 4F.01 Application of Pedestrian Hybrid Beacons

#### Support:

<sup>01</sup> A pedestrian hybrid beacon is a special type of hybrid beacon used to warn and control traffic at an unsignalized location to assist pedestrians in crossing a street or highway at a marked crosswalk.

<sup>01a</sup> A conventional traffic control signal operation with a standard signal face displaying green, yellow and red (steady and/or flashing red) indications, at a mid-block crosswalk is an alternative to the pedestrian hybrid beacon.

#### Option:

<sup>02</sup> A pedestrian hybrid beacon may be considered for installation to facilitate pedestrian crossings at a location that does not meet traffic signal warrants (see Chapter 4C), or at a location that meets traffic signal warrants under Sections 4C.05 and/or 4C.06 but a decision is made to not install a traffic control signal.

#### Standard:

<sup>03</sup> **If used, pedestrian hybrid beacons shall be used in conjunction with signs and pavement markings to warn and control traffic at locations where pedestrians enter or cross a street or highway. A pedestrian hybrid beacon shall only be installed at a marked crosswalk.**

#### Guidance:

<sup>04</sup> *If one of the signal warrants of Chapter 4C is met and a traffic control signal is justified by an engineering study, and if a decision is made to install a traffic control signal, it should be installed based upon the provisions of Chapters 4D and 4E.*

<sup>05</sup> *If a traffic control signal is not justified under the signal warrants of Chapter 4C and if gaps in traffic are not adequate to permit pedestrians to cross, or if the speed for vehicles approaching on the major street is too high to permit pedestrians to cross, or if pedestrian delay is excessive, the need for a pedestrian hybrid beacon should be considered on the basis of an engineering study that considers major-street volumes, speeds, widths, and gaps in conjunction with pedestrian volumes, walking speeds, and delay.*

<sup>06</sup> *For a major street where the posted or statutory speed limit or the 85th-percentile speed is 35 mph or less, the need for a pedestrian hybrid beacon should be considered if the engineering study finds that the plotted point representing the vehicles per hour on the major street (total of both approaches) and the corresponding total of all pedestrians crossing the major street for 1 hour (any four consecutive 15-minute periods) of an average day falls above the applicable curve in Figure 4F-1 for the length of the crosswalk.*

<sup>07</sup> *For a major street where the posted or statutory speed limit or the 85th-percentile speed exceeds 35 mph, the need for a pedestrian hybrid beacon should be considered if the engineering study finds that the plotted point representing the vehicles per hour on the major street (total of both approaches) and the corresponding total of all pedestrians crossing the major street for 1 hour (any four consecutive 15-minute periods) of an average day falls above the applicable curve in Figure 4F-2 for the length of the crosswalk.*

<sup>08</sup> *For crosswalks that have lengths other than the four that are specifically shown in Figures 4F-1 and 4F-2, the values should be interpolated between the curves.*

### Section 4F.02 Design of Pedestrian Hybrid Beacons

#### Standard:

<sup>01</sup> **Except as otherwise provided in this Section, a pedestrian hybrid beacon shall meet the provisions of Chapters 4D and 4E.**

<sup>02</sup> **A pedestrian hybrid beacon face shall consist of three signal sections, with a CIRCULAR YELLOW signal indication centered below two horizontally aligned CIRCULAR RED signal indications (see Figure 4F-3).**

<sup>03</sup> **When an engineering study finds that installation of a pedestrian hybrid beacon is justified, then:**

**A. At least two pedestrian hybrid beacon faces shall be installed for each approach of the major street,**

**B. A stop line shall be installed for each approach to the crosswalk,**

**C. A pedestrian signal head conforming to the provisions set forth in Chapter 4E shall be installed at each end of the marked crosswalk, and**

**D. The pedestrian hybrid beacon shall be pedestrian actuated.**

*Guidance:*

<sup>04</sup> *When an engineering study finds that installation of a pedestrian hybrid beacon is justified, then:*

- A. *The pedestrian hybrid beacon should be installed at an intersection, or at the junction of a roadway with a driveway, or at least 100 feet from side streets or driveways that are controlled by STOP or YIELD signs,*
- B. *Parking and other sight obstructions should be prohibited for at least 100 feet in advance of and at least 20 feet beyond the marked crosswalk, or site accommodations should be made through curb extensions or other techniques to provide adequate sight distance,*
- C. *The installation should include suitable standard signs and pavement markings, and*
- D. *If installed within a signal system, the pedestrian hybrid beacon should be coordinated.*

<sup>05</sup> *On approaches having posted or statutory speed limits or 85th-percentile speeds in excess of 35 mph and on approaches having traffic or operating conditions that would tend to obscure visibility of roadside hybrid beacon face locations, both of the minimum of two pedestrian hybrid beacon faces should be installed over the roadway.*

<sup>06</sup> *On multi-lane approaches having a posted or statutory speed limits or 85th-percentile speeds of 35 mph or less, either a pedestrian hybrid beacon face should be installed on each side of the approach (if a median of sufficient width exists) or at least one of the pedestrian hybrid beacon faces should be installed over the roadway.*

<sup>07</sup> *A pedestrian hybrid beacon should comply with the signal face location provisions described in Sections 4D.11 through 4D.16.*

**Standard:**

<sup>08</sup> **A CROSSWALK STOP ON RED (symbolic circular red) (R10-23) sign (see Section 2B.53) shall be mounted adjacent to a pedestrian hybrid beacon face on each major street approach. If an overhead pedestrian hybrid beacon face is provided, the sign shall be mounted adjacent to the overhead signal face.**

**Option:**

<sup>09</sup> **A Pedestrian (W11-2) warning sign (see Section 2C.50) with an AHEAD (W16-9P) supplemental plaque may be placed in advance of a pedestrian hybrid beacon. A warning beacon may be installed to supplement the W11-2 sign.**

*Guidance:*

<sup>10</sup> *If a warning beacon supplements a W11-2 sign in advance of a pedestrian hybrid beacon, it should be programmed to flash only when the pedestrian hybrid beacon is not in the dark mode.*

**Standard:**

<sup>11</sup> **If a warning beacon is installed to supplement the W11-2 sign, the design and location of the warning beacon shall comply with the provisions of Sections 4L.01 and 4L.03.**

### **Section 4F.03 Operation of Pedestrian Hybrid Beacons**

**Standard:**

<sup>01</sup> **Pedestrian hybrid beacon indications shall be dark (not illuminated) during periods between actuations.**

<sup>02</sup> **Upon actuation by a pedestrian, a pedestrian hybrid beacon face shall display a flashing CIRCULAR yellow signal indication, followed by a steady CIRCULAR yellow signal indication, followed by both steady CIRCULAR RED signal indications during the pedestrian walk interval, followed by alternating flashing CIRCULAR RED signal indications during the pedestrian clearance change interval (see Figure 4F-3). Upon termination of the pedestrian clearance interval, the pedestrian hybrid beacon faces shall revert to a dark (not illuminated) condition.**

<sup>03</sup> **Except as provided in Paragraph 4, the pedestrian signal heads shall continue to display a steady UPRAISED HAND (symbolizing DONT WALK) signal indication when the pedestrian hybrid beacon faces are either dark or displaying flashing or steady CIRCULAR yellow signal indications. The pedestrian signal heads shall display a WALKING PERSON (symbolizing WALK) signal indication when the pedestrian hybrid beacon faces are displaying steady CIRCULAR RED signal indications. The pedestrian signal heads shall display a flashing UPRAISED HAND (symbolizing DONT WALK) signal indication when the pedestrian hybrid beacon faces are displaying alternating flashing CIRCULAR RED signal indications. Upon termination of the pedestrian clearance interval, the pedestrian signal heads shall revert to a steady UPRAISED HAND (symbolizing DONT WALK) signal indication.**

**Option:**

<sup>04</sup> Where the pedestrian hybrid beacon is installed adjacent to a roundabout to facilitate crossings by pedestrians with visual disabilities and an engineering study determines that pedestrians without visual disabilities can be allowed to cross the roadway without actuating the pedestrian hybrid beacon, the pedestrian signal heads may be dark (not illuminated) when the pedestrian hybrid beacon faces are dark.

*Guidance:*

<sup>05</sup> *The duration of the flashing yellow interval should be determined by engineering judgment.*

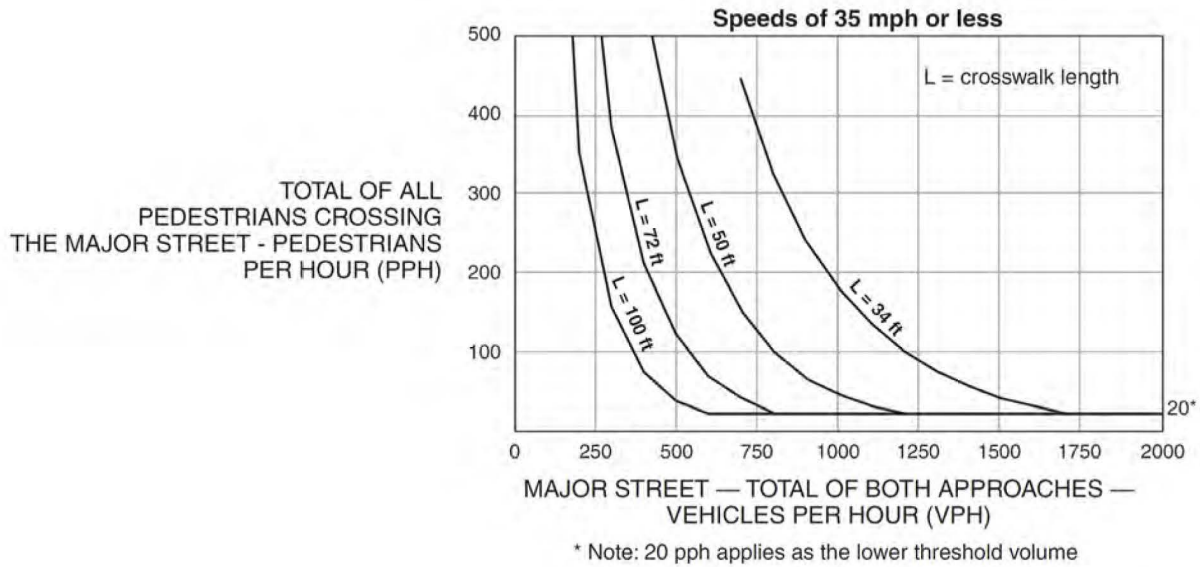
**Standard:**

<sup>06</sup> **The duration of the steady yellow change interval shall be determined using engineering practices.**

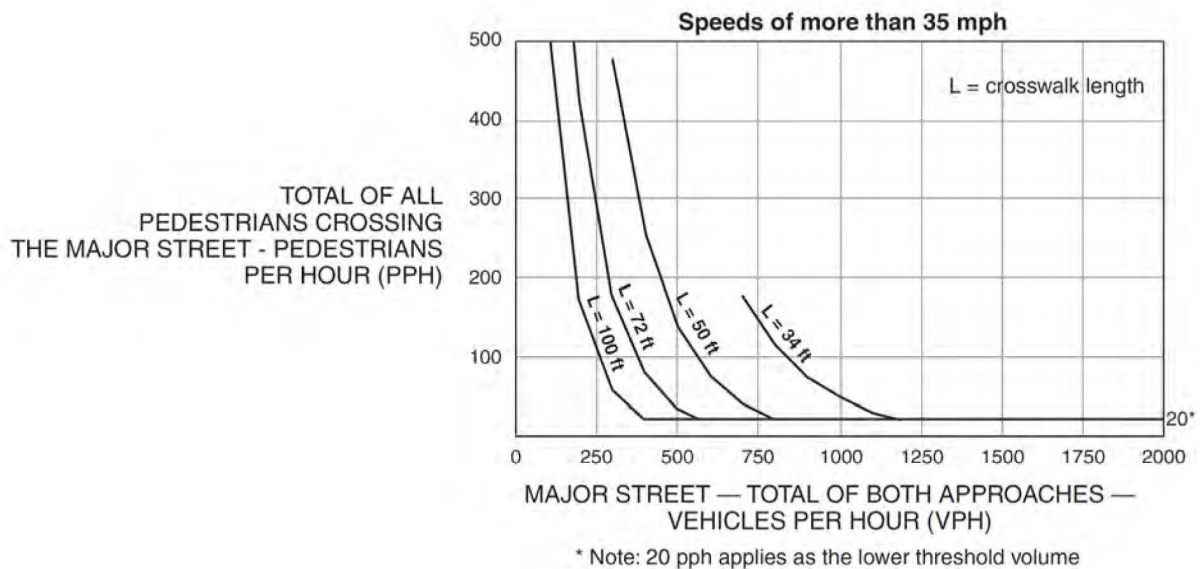
*Guidance:*

<sup>07</sup> *The steady yellow interval should have a minimum duration of 3 seconds and a maximum duration of 6 seconds (see Section 4D.26). The longer intervals should be reserved for use on approaches with higher speeds.*

**Figure 4F-1. Guidelines for the Installation of Pedestrian Hybrid Beacons on Low-Speed Roadways**

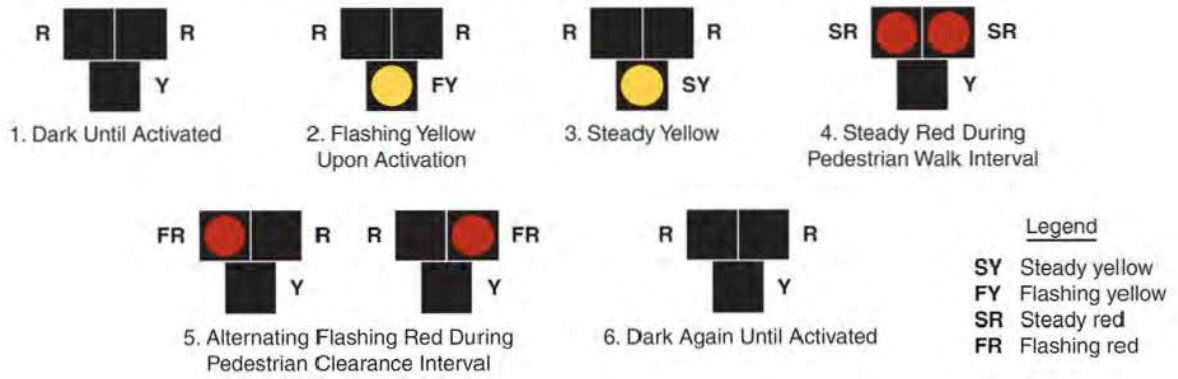


**Figure 4F-2. Guidelines for the Installation of Pedestrian Hybrid Beacons on High-Speed Roadways**





**Figure 4F-3. Sequence for a Pedestrian Hybrid Beacon**





## CHAPTER 4G. TRAFFIC CONTROL SIGNALS AND HYBRID BEACONS FOR EMERGENCY-VEHICLE ACCESS

### **Section 4G.01 Application of Emergency-Vehicle Traffic Control Signals and Hybrid Beacons**

Support:

01 An emergency-vehicle traffic control signal is a special traffic control signal that assigns the right-of-way to an authorized emergency vehicle.

Option:

02 An emergency-vehicle traffic control signal may be installed at a location that does not meet other traffic signal warrants such as at an intersection or other location to permit direct access from a building housing the emergency vehicle.

03 An emergency-vehicle hybrid beacon may be installed instead of an emergency-vehicle traffic control signal under conditions described in Section 4G.04.

Guidance:

04 *If a traffic control signal is not justified under the signal warrants of Chapter 4C and if gaps in traffic are not adequate to permit the timely entrance of emergency vehicles, or the stopping sight distance for vehicles approaching on the major street is insufficient for emergency vehicles, installing an emergency-vehicle traffic control signal should be considered. If one of the signal warrants of Chapter 4C is met and a traffic control signal is justified by an engineering study, and if a decision is made to install a traffic control signal, it should be installed based upon the provisions of Chapter 4D.*

05 *The sight distance determination should be based on the location of the visibility obstruction for the critical approach lane for each street or drive and the posted or statutory speed limit or 85th-percentile speed on the major street, whichever is higher.*

### **Section 4G.02 Design of Emergency-Vehicle Traffic Control Signals**

Standard:

01 **Except as otherwise provided in this Section, an emergency-vehicle traffic control signal shall meet the requirements of this Manual.**

02 **An Emergency Vehicle (W11-8) sign (see Section 2C.49) with an EMERGENCY SIGNAL AHEAD (W11-12P) supplemental plaque shall be placed in advance of all emergency-vehicle traffic control signals. If a warning beacon is installed to supplement the W11-8 sign, the design and location of the beacon shall comply with the Standards of Sections 4L.01 and 4L.03.**

Guidance:

03 *At least one of the two required signal faces for each approach on the major street should be located over the roadway.*

04 *The following size signal indications should be used for emergency-vehicle traffic control signals: 12-inch diameter for steady red and steady yellow circular signal indications and any arrow indications, and 8-inch diameter for green or flashing yellow circular signal indications.*

Standard:

05 **An EMERGENCY SIGNAL (R10-13) sign shall be mounted adjacent to a signal face on each major street approach (see Section 2B.53). If an overhead signal face is provided, the EMERGENCY SIGNAL sign shall be mounted adjacent to the overhead signal face.**

Option:

06 An approach that only serves emergency vehicles may be provided with only one signal face consisting of one or more signal sections.

07 Besides using an 8-inch diameter signal indication, other appropriate means to reduce the flashing yellow light output may be used.

### **Section 4G.03 Operation of Emergency-Vehicle Traffic Control Signals**

#### **Standard:**

- 01 Right-of-way for emergency vehicles at signalized locations operating in the steady (stop-and-go) mode shall be obtained as provided in Section 4D.27.**
- 02 As a minimum, the signal indications, sequence, and manner of operation of an emergency-vehicle traffic control signal installed at a midblock location shall be as follows:**
- A. The signal indication, between emergency-vehicle actuations, shall be either green or flashing yellow. If the flashing yellow signal indication is used instead of the green signal indication, it shall be displayed in the normal position of the green signal indication, while the steady red and steady yellow signal indications shall be displayed in their normal positions.**
  - B. When an emergency-vehicle actuation occurs, a steady yellow change interval followed by a steady red interval shall be displayed to traffic on the major street.**
  - C. A yellow change interval is not required following the green interval for the emergency-vehicle driveway.**
- 03 Emergency-vehicle traffic control signals located at intersections shall either be operated in the flashing mode between emergency-vehicle actuations (see Sections 4D.28 and 4D.30) or be full-actuated or semi-actuated to accommodate normal vehicular and pedestrian traffic on the streets.**
- 04 Warning beacons, if used with an emergency-vehicle traffic control signal, shall be flashed only:**
- A. For an appropriate time in advance of and during the steady yellow change interval for the major street; and**
  - B. During the steady red interval for the major street.**

#### *Guidance:*

*05 The duration of the steady red interval for traffic on the major street should be determined by on-site test-run time studies, but should not exceed 1.5 times the time required for the emergency vehicle to clear the path of conflicting vehicles.*

#### *Option:*

*06 An emergency-vehicle traffic control signal sequence may be initiated manually from a local control point such as a fire station or law enforcement headquarters or from an emergency vehicle equipped for remote operation of the signal.*

### **Section 4G.04 Emergency-Vehicle Hybrid Beacons**

#### **Standard:**

**01 Emergency-vehicle hybrid beacons shall be used only in conjunction with signs to warn and control traffic at an unsignalized location where emergency vehicles enter or cross a street or highway. Emergency-vehicle hybrid beacons shall be actuated only by authorized emergency or maintenance personnel.**

#### *Guidance:*

- 02 Emergency-vehicle hybrid beacons should only be used when all of the following criteria are satisfied:*
- A. The conditions justifying an emergency-vehicle traffic control signal (see Section 4G.01) are met; and*
  - B. An engineering study, considering the road width, approach speeds, and other pertinent factors, determines that emergency-vehicle hybrid beacons can be designed and located in compliance with the requirements contained in this Section and in Section 4L.01, such that they effectively warn and control traffic at the location; and*
  - C. The location is not at or within 100 feet from an intersection or driveway where the side road or driveway is controlled by a STOP or YIELD sign.*

#### **Standard:**

- 03 Except as otherwise provided in this Section, an emergency-vehicle hybrid beacon shall meet the requirements of this Manual.**
- 04 An emergency-vehicle hybrid beacon face shall consist of three signal sections, with a CIRCULAR YELLOW signal indication centered below two horizontally aligned CIRCULAR RED signal indications (see Figure 4G-1).**

**05 Emergency-vehicle hybrid beacons shall be placed in a dark mode (no indications displayed) during periods between actuations.**

**06 Upon actuation by authorized emergency personnel, the emergency-vehicle hybrid beacon faces shall each display a flashing yellow signal indication, followed by a steady yellow change interval, prior to displaying two CIRCULAR RED signal indications in an alternating flashing array for a duration of time adequate for egress of the emergency vehicles. The alternating flashing red signal indications shall only be displayed when it is required that drivers on the major street stop and then proceed subject to the rules applicable after making a stop at a STOP sign. Upon termination of the flashing red signal indications, the emergency-vehicle hybrid beacons shall revert to a dark mode (no indications displayed) condition.**

*Guidance:*

*07 The duration of the flashing yellow interval should be determined by engineering judgment.*

**Standard:**

**08 The duration of the steady yellow change interval shall be determined using engineering practices.**

*Guidance:*

*09 The steady yellow change interval should have a minimum duration of 3 seconds and a maximum duration of 6 seconds (see Section 4D.26). The longer intervals should be reserved for use on approaches with higher speeds.*

*Option:*

*10 A steady red clearance interval may be used after the steady yellow change interval.*

*11 Emergency-vehicle hybrid beacons may be equipped with a light or other display visible to the operator of the egressing emergency vehicle to provide confirmation that the beacons are operating.*

*12 Emergency-vehicle hybrid beacons may be supplemented with an advance warning sign, which may also be supplemented with a Warning Beacon (see Section 4L.03).*

*Guidance:*

*13 If a Warning Beacon is used to supplement the advance warning sign, it should be programmed to flash only when the emergency-vehicle hybrid beacon is not in the dark mode.*

**Standard:**

**14 At least two emergency-vehicle hybrid beacon faces shall be installed for each approach of the major street and a stop line shall be installed for each approach of the major street.**

*Guidance:*

*15 On approaches having posted or statutory speed limits or 85th-percentile speeds in excess of 40 mph, and on approaches having traffic or operating conditions that would tend to obscure visibility of roadside beacon faces, both of the minimum of two emergency-vehicle hybrid beacon faces should be installed over the roadway.*

*16 On multi-lane approaches having posted or statutory speed limits or 85th-percentile speeds of 40 mph or less, either an emergency-vehicle hybrid beacon face should be installed on each side of the approach (if a median of sufficient width exists) or at least one of the emergency-vehicle hybrid beacon faces should be installed over the roadway.*

*17 An emergency-vehicle hybrid beacon should comply with the signal face location provisions described in Sections 4D.11 through 4D.16.*

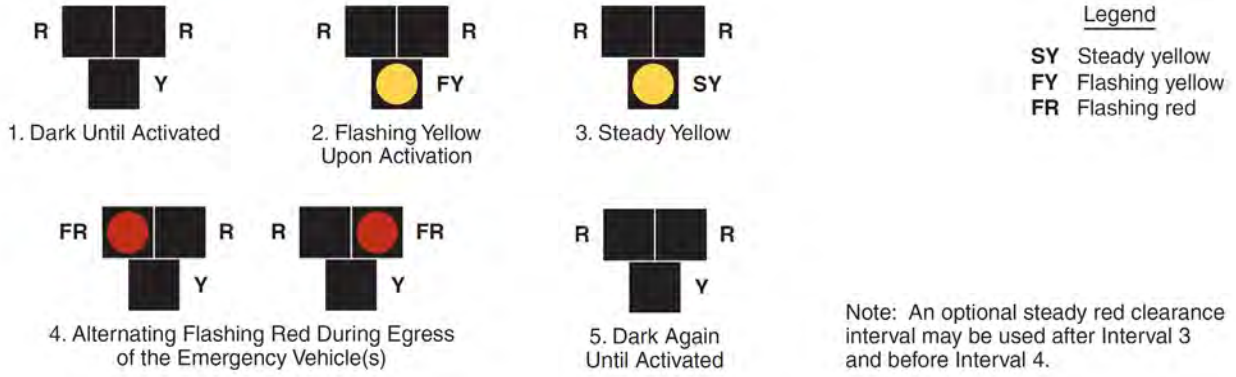
**Standard:**

**18 Stop lines and EMERGENCY SIGNAL—STOP WHEN FLASHING RED (R10-14 or R10-14a) signs (see Section 2B.53 Figure 2B-27) shall be used with emergency-vehicle hybrid beacons.**

*Option:*

*19 If needed for extra emphasis, a STOP HERE ON FLASHING RED (R10-14b) sign (see Section 2B.53) may be installed with an emergency-vehicle hybrid beacon.*

**Figure 4G-1. Sequence for an Emergency-Vehicle Hybrid Beacon**



## **CHAPTER 4H. TRAFFIC CONTROL SIGNALS FOR ONE-LANE, TWO-WAY FACILITIES**

### **Section 4H.01 Application of Traffic Control Signals for One-Lane, Two-Way Facilities**

**Support:**

01 A traffic control signal at a narrow bridge, tunnel, or roadway section is a special signal that assigns the right-of-way for vehicles passing over a bridge or through a tunnel or roadway section that is not of sufficient width for two opposing vehicles to pass.

02 Temporary traffic control signals (see Sections 4D.32 and 6F.84) are the most frequent application of one-lane, two-way facilities.

**Guidance:**

03 *Sight distance across or through the one-lane, two-way facility should be considered as well as the approach speed and sight distance approaching the facility when determining whether traffic control signals should be installed.*

**Option:**

04 At a narrow bridge, tunnel, or roadway section where a traffic control signal is not justified under the conditions of Chapter 4C, a traffic control signal may be used if gaps in opposing traffic do not permit the flow of traffic through the one-lane section of roadway.

### **Section 4H.02 Design of Traffic Control Signals for One-Lane, Two-Way Facilities**

**Standard:**

01 **The provisions of Chapter 4D shall apply to traffic control signals for one-lane, two-way facilities, except that:**

**A. Durations of red clearance intervals shall be adequate to clear the one-lane section of conflicting vehicles.**

**B. Adequate means, such as interconnection, shall be provided to prevent conflicting signal indications, such as green and green, at opposite ends of the section.**

### **Section 4H.03 Operation of Traffic Control Signals for One-Lane, Two-Way Facilities**

**Standard:**

01 **Traffic control signals at one-lane, two-way facilities shall operate in a manner consistent with traffic requirements.**

02 **When in the flashing mode, the signal indications shall flash red.**

**Guidance:**

03 *Adequate time should be provided to allow traffic to clear the narrow facility before opposing traffic is allowed to move. Engineering judgment should be used to determine the proper timing for the signal.*





## CHAPTER 4I. TRAFFIC CONTROL SIGNALS FOR FREEWAY ENTRANCE RAMPS

### Section 4I.01 Application of Freeway Entrance Ramp Control Signals

Support:

01 Ramp control signals are traffic control signals that control the flow of traffic entering the freeway facility. ~~This is often referred to as "ramp metering."~~

02 Freeway entrance ramp control signals are sometimes used if controlling traffic entering the freeway could reduce the total expected delay to traffic in the freeway corridor, including freeway ramps and local streets.

Guidance:

03 *The installation of ramp control signals should be preceded by an engineering study of the physical and traffic conditions on the highway facilities likely to be affected. The study should include the ramps and ramp connections and the surface streets that would be affected by the ramp control, as well as the freeway section concerned.*

Support:

04 Information on conditions that might justify freeway entrance ramp control signals, factors to be evaluated in traffic engineering studies for ramp control signals, design of ramp control signals, and operation of ramp control signals can be found in the FHWA's "Ramp Management and Control Handbook" (see Section 1A.11).

### Section 4I.02 Design of Freeway Entrance Ramp Control Signals

Standard:

01 **Ramp control signals shall meet all of the standard design specifications for traffic control signals, except as otherwise provided in this Section.**

02 **The signal face for freeway entrance ramp control signals shall be ~~either a two-section signal face containing red and green signal indications or~~ a three-section signal face containing red, yellow, and green signal indications.**

03 **If only one lane is present on an entrance ramp or if more than one lane is present on an entrance ramp and the ramp control signals are operated such that green signal indications are always displayed simultaneously to all of the lanes on the ramp, then a minimum of two signal faces per ramp shall face entering traffic. The minimum number of upper signal faces per ramp shall not be less than the total number of lanes at the limit line for viewing by approaching motorists. For side-mounted signals, the same number of lower signal faces shall also be provided for viewing by stopped motorists at the limit line.**

04 ~~If more than one lane is present on an entrance ramp and the ramp control signals are operated such that green signal indications are not always displayed simultaneously to all of the lanes on the ramp, then one signal face shall be provided over the approximate center of each separately-controlled lane.~~

04a **If multiple lanes are present on an entrance ramp and the ramp control faces are operated such that green signal indications are not always displayed simultaneously to all of the lanes on the ramp, then the following shall apply:**

- A. If roadside mounted signal faces are installed, a minimum of two signal faces shall be provided for each of the lanes, with both mounted at the side of the roadway on a single pole (see Paragraphs 9 and 10 below). Roadside mounted signal faces only apply to configurations with 2 separately controlled lanes.**
- B. If overhead mounted signals faces are installed, one signal face shall be provided over the approximate center of each separately-controlled lane.**

Guidance:

05 ~~Additional side-mounted signal faces should be considered for ramps with two or more separately-controlled lanes~~ **overhead mounted signal faces.**

Standard:

06 **Ramp control signals shall be located and designed to minimize their viewing by mainline freeway traffic.**

Option:

07 Ramp control signals may be placed in the dark mode (no indications displayed) when not in use.

08 Ramp control signals may be used to control some, but not all, lanes on a ramp, such as when non-metered HOV ~~bypass~~ lanes are provided on a ramp.

**Standard:**

09 **The required signal faces, if located at the side of the ramp roadway, one for each lane may shall be mounted such that the height above the pavement grade at the center of the ramp roadway to the bottom of the signal housing of the lowest signal face is between 4.5 and 6 feet.**

**Option:**

10 For entrance ramps with only one controlled lane, the two required signal faces may both be mounted at the side of the roadway on a single pole, with one face at the normal mounting height and one face mounted lower as provided in Paragraph 9, as a specific exception to the normal 8-foot minimum lateral separation of signal faces required by Section 4D.13.

**Guidance:**

11 *Regulatory signs with legends appropriate to the control, such as ~~XX Vehicle (S) Per Green or XX VEHICLE(S) PER GREEN Each Lane~~ 1 CAR (2 CARS) PER GREEN (R89(CA)) or 1 CAR (2 CARS) PER GREEN EACH LANE (R89-1(CA)) or 1 CAR (2 CARS) PER GREEN THIS LANE (R89-2(CA)) (see Section 2B.56), should be installed adjacent to the ramp control signal faces. When ramp control signals are installed on a freeway-to-freeway ramp, special consideration should be given to assuring adequate visibility of the ramp control signals, and multiple advance warning signs with flashing warning beacons should be installed to warn road users of the metered operation.*

**Support:**

12 Refer to Section 2G.102(CA) for regulatory signs for HOV lanes at metered ramps.

### **Section 4L.03 Operation of Freeway Entrance Ramp Control Signals**

**Guidance:**

01 *Operational strategies for ramp control signals, such as periods of operation, metering rates and algorithms, and queue management, should be determined by the operating agency prior to the installation of the ramp control signals and should be closely monitored and adjusted as needed thereafter.*

02 *When the ramp control signals are in operation ~~operated only during certain periods of the day~~, a RAMP METERED WHEN FLASHING (W3-8) sign (see Section 2C.37) or an overhead Activated Blank-Out "METER ON" (W88-2(CA), W88-3(CA)) message sign, or an Activated Blank-Out "PREPARE TO STOP" (W89(CA)) message sign should be installed in advance of the ramp control signal near the entrance to the ramp, or on the arterial on the approach to the ramp, to alert road users to the presence and operation of ramp meters. (See Figure 2C-6(CA)).*

**Standard:**

03 **The RAMP METERED WHEN FLASHING sign shall be supplemented with a warning beacon (see Section 4L.03) that flashes when the ramp control signal is in operation.**

## CHAPTER 4J. TRAFFIC CONTROL FOR MOVABLE BRIDGES

### Section 4J.01 Application of Traffic Control for Movable Bridges

#### Support:

<sup>01</sup> Traffic control signals for movable bridges are a special type of highway traffic signal installed at movable bridges to notify road users to stop because of a road closure rather than alternately giving the right-of-way to conflicting traffic movements. The signals are operated in coordination with the opening and closing of the movable bridge, and with the operation of movable bridge warning and resistance gates, or other devices and features used to warn, control, and stop traffic.

<sup>02</sup> Movable bridge warning gates installed at movable bridges decrease the likelihood of vehicles and pedestrians passing the stop line and entering an area where potential hazards exist because of bridge operations.

<sup>03</sup> A movable bridge resistance gate is sometimes used at movable bridges and located downstream of the movable bridge warning gate. A movable bridge resistance gate provides a physical deterrent to road users when placed in the appropriate position. The movable bridge resistance gates are considered a design feature and not a traffic control device; requirements for them are contained in AASHTO's "Standard Specifications for Movable Highway Bridges" (see Page i for AASHTO's address).

#### Standard:

- <sup>04</sup> **Traffic control at movable bridges shall include both signals and gates, except in the following cases:**
- A. Neither is required if other traffic control devices or measures considered appropriate are used under either of the following conditions:**
    - 1. On low-volume roads (roads of less than 400 vehicles average daily traffic), or**
    - 2. At manually operated bridges if electric power is not available.**
  - B. Only signals are required in urban areas if intersecting streets or driveways make gates ineffective.**
  - C. Only movable bridge warning gates are required if a traffic control signal that is controlled as part of the bridge operations exists within 500 feet of the movable bridge resistance gates and no intervening traffic entrances exist.**

### Section 4J.02 Design and Location of Movable Bridge Signals and Gates

#### Standard:

<sup>01</sup> **The signal faces and mountings of movable bridge signals shall comply with the provisions of Chapter 4D except as provided in this Section.**

<sup>02</sup> **Signal faces with 12-inch diameter signal indications shall be used for all new movable bridge signals.**

#### Option:

<sup>03</sup> Existing signal faces with 8-inch diameter lenses may be retained for the remainder of their useful service life.

#### Standard:

<sup>04</sup> **Since movable bridge operations cover a variable range of time periods between openings, the signal faces shall be one of the following types:**

- A. Three-section signal faces with red, yellow, and green signal indications; or**
- B. Two one-section signal faces with red signal indications in a vertical array separated by a STOP HERE ON RED (R10-6) sign (see Section 2B.53).**

<sup>05</sup> **Regardless of which signal type is selected, at least two signal faces shall be provided for each approach to the movable span and a stop line (see Section 3B.16) shall be installed to indicate the point behind which vehicles are required to stop.**

#### Guidance:

<sup>06</sup> *If movable bridge operation is frequent, the use of three-section signal faces should be considered.*

<sup>07</sup> *Insofar as practical, the height and lateral placement of signal faces should comply with the requirements for other traffic control signals in accordance with Chapter 4D. They should be located no more than 50 feet in advance of the movable bridge warning gate.*

Option:

<sup>08</sup> Movable bridge signals may be supplemented with audible warning devices to provide additional warning to drivers and pedestrians.

**Standard:**

<sup>09</sup> **A DRAW BRIDGE (W3-6) sign (see Section 2C.39) shall be used in advance of movable bridge signals and gates to give warning to road users, except in urban conditions where such signing would not be practical.**

<sup>10</sup> **If physical conditions prevent a road user from having a continuous view of at least two signal indications for the distance specified in Table 4D-2, an auxiliary device (either a supplemental signal face or the mandatory DRAW BRIDGE (W3-6) sign to which has been added a warning beacon that is interconnected with the movable bridge controller unit) shall be provided in advance of movable bridge signals and gates.**

Option:

<sup>11</sup> The DRAW BRIDGE (W3-6) sign may be supplemented by a Warning Beacon (see Section 4L.03).

**Standard:**

<sup>12</sup> **If two sets of gates (both a warning and a resistance gate) are used for a single direction, highway traffic signals shall not be required to accompany the resistance gate nearest the span opening.**

<sup>13</sup> **Movable bridge warning gates, if used, shall be at least standard railroad size, striped with 16-inch alternate vertical, fully reflectorized red and white stripes. Flashing red lights in accordance with the Standards for those on railroad gates (see Section 8C.04) shall be included on the gate arm and they shall only be operated if the gate is closed or in the process of being opened or closed. In the horizontal position, the top of the gate shall be approximately 4 feet above the pavement.**

*Guidance:*

<sup>14</sup> *Movable bridge warning gates should be of lightweight construction. In its normal upright position, the gate arm should provide adequate lateral clearance.*

Option:

<sup>15</sup> The movable bridge resistance gates may be delineated, if practical, in a manner similar to the movable bridge warning gate.

**Standard:**

<sup>16</sup> **Movable bridge warning gates, if used, shall extend at least across the full width of the approach lanes if movable bridge resistance gates are used. On divided highways in which the roadways are separated by a barrier median, movable bridge warning gates, if used, shall extend across all roadway lanes approaching the span openings.**

*Guidance:*

<sup>17</sup> *If movable bridge resistance gates are not used on undivided highways, movable bridge warning gates, if used, should extend across the full width of the roadway.*

Option:

<sup>18</sup> A single full-width gate or two half-width gates may be used.

**Support:**

<sup>19</sup> The locations of movable bridge signals and gates are determined by the location of the movable bridge resistance gate (if used) rather than by the location of the movable spans. The movable bridge resistance gates for high-speed highways are preferably located 50 feet or more from the span opening except for bascule and lift bridges, where they are often attached to, or are a part of, the structure.

**Standard:**

<sup>20</sup> **Except where physical conditions make it impractical, movable bridge warning gates shall be located 100 feet or more from the movable bridge resistance gates or, if movable bridge resistance gates are not used, 100 feet or more from the movable span.**

*Guidance:*

<sup>21</sup> *On bridges or causeways that cross a long reach of water and that might be hit by large marine vessels, within the limits of practicality, traffic should not be halted on a section of the bridge or causeway that is subject to impact.*

*22 In cases where it is not practical to halt traffic on a span that is not subject to impact, traffic should be halted at least one span from the opening. If traffic is halted by signals and gates more than 330 feet from the movable bridge warning gates (or from the span opening if movable bridge warning gates are not used), a second set of gates should be installed approximately 100 feet from the gate or span opening.*

*23 If the movable bridge is close to a grade crossing and traffic might possibly be stopped on the crossing as a result of the bridge opening, a traffic control device should notify the road users to not stop on the railroad tracks.*

### **Section 4J.03 Operation of Movable Bridge Signals and Gates**

#### **Standard:**

**01 Traffic control devices at movable bridges shall be coordinated with the movable spans, so that the signals, gates, and movable spans are controlled by the bridge tender through an interlocked control.**

**02 If the three-section type of signal face is used, the green signal indication shall be displayed at all times between bridge openings, except that if the bridge is not expected to open during continuous periods in excess of 5 hours, a flashing yellow signal indication shall be permitted to be used. The signal shall display a steady red signal indication when traffic is required to stop. The duration of the yellow change interval between the display of the green and steady red signal indications, or flashing yellow and steady red signal indications, shall be determined using engineering practices (see Section 4D.26).**

**03 If the vertical array of red signal indications is the type of signal face selected, the red signal indications shall flash alternately only when traffic is required to stop.**

#### *Guidance:*

*04 The yellow change interval should have a minimum duration of 3 seconds and a maximum duration of 6 seconds. The longer intervals should be reserved for use on approaches with higher speeds.*

*05 Traffic control signals on adjacent streets and highways should be interconnected with the drawbridge control if indicated by engineering judgment. When such interconnection is provided, the traffic control signals at adjacent intersections should be preempted by the operation of the movable bridge in the manner described in Section 4D.27.*



## CHAPTER 4K. HIGHWAY TRAFFIC SIGNALS AT TOLL PLAZAS

### Section 4K.01 Traffic Signals at Toll Plazas

**Standard:**

01 **Traffic control signals or devices that closely resemble traffic control signals that use red or green circular indications shall not be used at toll plazas to indicate the open or closed status of the toll plaza lanes.**

*Guidance:*

02 *Traffic control signals or devices that closely resemble traffic control signals that use red or green circular indications should not be used for new or reconstructed installations at toll plazas to indicate the success or failure of electronic toll payments or to alternately direct drivers making cash toll payments to stop and then proceed.*

### Section 4K.02 Lane-Use Control Signals at or Near Toll Plazas

**Standard:**

01 **Lane-use control signals used at toll plazas shall comply with the provisions of Chapter 4M except as otherwise provided in this Section.**

02 **At toll plazas with multiple lanes where one or more lanes is sometimes closed to traffic, a lane-use control signal shall be installed above the center of each toll plaza lane to indicate the open or closed status of the controlled lane.**

*Option:*

03 The bottom of the signal housing of a lane-use control signal above a toll plaza lane having a canopy may be mounted lower than 15 feet above the pavement, but not lower than the vertical clearance of the canopy structure.

04 Lane-use control signals may also be used to indicate the open or closed status of an Open-Road ETC lane as a supplement to other devices used for the temporary closure of a lane (see Part 6).

### Section 4K.03 Warning Beacons at Toll Plazas

**Standard:**

01 **Warning Beacons used at toll plazas shall comply with the provisions of Chapter 4L except as otherwise provided in this Section.**

*Guidance:*

02 *Warning Beacons, if used with a toll plaza canopy sign (see Section 2F.16) to assist drivers of such vehicles in locating the dedicated ETC Account-Only lane(s), should be installed in a manner such that the beacons are distinctly separate from the lane-use control signals (see Section 4M.01) for the toll plaza lane.*

*Option:*

03 Warning Beacons that are mounted on toll plaza islands, behind impact attenuators in front of toll plaza islands, and/or on toll booth pylons (ramparts) to identify them as objects in the roadway may be mounted at a height that is appropriate for viewing in a toll plaza context, even if that height is lower than the normal minimum of 8 feet above the pavement.





## CHAPTER 4L. FLASHING BEACONS

### Section 4L.01 General Design and Operation of Flashing Beacons

**Support:**

<sup>01</sup> A Flashing Beacon is a highway traffic signal with one or more signal sections that operates in a flashing mode. It can provide traffic control when used as an intersection control beacon (see Section 4L.02) or it can provide warning when used in other applications (see Sections 4L.03, 4L.04, and 4L.05).

**Standard:**

<sup>02</sup> **Flashing Beacon units and their mountings shall comply with the provisions of Chapter 4D, except as otherwise provided in this Chapter.**

<sup>03</sup> **Beacons shall be flashed at a rate of not less than 50 or more than 60 times per minute. The illuminated period of each flash shall be a minimum of 1/2 and a maximum of 2/3 of the total cycle.**

<sup>04</sup> **A beacon shall not be included within the border of a sign except for SCHOOL SPEED LIMIT sign beacons (see Sections 4L.04 and 7B.15).**

**Guidance:**

<sup>05</sup> *If used to supplement a warning or regulatory sign, the edge of the beacon signal housing should normally be located no closer than 12 inches outside of the nearest edge of the sign.*

**Option:**

<sup>06</sup> An automatic dimming device may be used to reduce the brilliance of flashing yellow signal indications during night operation.

**Support:**

<sup>07</sup> Typical applications for flashing beacons include the following:

- A. Signal Ahead
- B. Stop Signs
- C. Speed Limit Signs
- D. Other Warning and Regulatory Signs
- E. Schools
- F. Fire Stations
- G. Intersection Control
- H. Freeway Bus Stops
- I. At Intersections where a more visible warning is desired.

<sup>08</sup> Typical uses include:

- A. Obstructions in or immediately adjacent to the roadway.
- B. Supplemental to advance warning signs.
- C. At mid-block crosswalks.
- D. At intersections where a warning is appropriate.

**Option:**

<sup>09</sup> Only warning, regulatory or construction signs may be supplemented by flashing beacons.

**Standard:**

<sup>10</sup> **The cost of installing a Warning or Regulatory Sign Flashing Beacon on a State highway shall be at 100% State expense.**

### Section 4L.02 Intersection Control Beacon

**Standard:**

<sup>01</sup> **An Intersection Control Beacon shall consist of one or more signal faces directed toward each approach to an intersection. Each signal face shall consist of one or more signal sections of a standard traffic signal face, with flashing CIRCULAR YELLOW or CIRCULAR RED signal indications in each signal face. They shall be installed and used only at an intersection to control two or more directions of travel.**

**02 Application of Intersection Control Beacon signal indications shall be limited to the following:**

**A. Yellow on one route (normally the major street) and red for the remaining approaches for existing installations, and**

**B. Red for all approaches at new installations (if the warrant described in Section 2B.07 for a multi-way stop is satisfied).**

**03 Flashing yellow signal indications shall not face conflicting vehicular approaches.**

**04 A STOP sign shall be used on approaches to which a flashing red signal indication is displayed on an Intersection Control Beacon (see Section 2B.04).**

**05 If two horizontally aligned red signal indications are used on an approach for an Intersection Control Beacon, they shall be flashed simultaneously to avoid being confused with grade crossing flashing-light signals. If two vertically aligned red signal indications are used on an approach for an Intersection Control Beacon, they shall be flashed alternately.**

*Guidance:*

*06 An Intersection Control Beacon should not be mounted on a pedestal in the roadway unless the pedestal is within the confines of a traffic or pedestrian island.*

*Option:*

*07 Supplemental signal indications may be used on one or more approaches in order to provide adequate visibility to approaching road users.*

*08 Intersection Control Beacons may be used at intersections where traffic or physical conditions do not justify conventional traffic control signals but crash rates indicate the possibility of a special need.*

*09 An Intersection Control Beacon is generally located over the center of an intersection; however, it may be used at other suitable locations.*

**Standard:**

**10 New installations of overhead intersection control flashing beacon shall consist of red indications for each approach.**

**11 The cost of installing an Intersection Control Beacon and intersection lighting shall be shared with the local agency in the same manner as a traffic signal.**

*Option:*

**12 Yellow flashing beacons may be used with Signal Ahead (W3-3) signs in advance of:**

**A. An isolated traffic signal on either a conventional highway or on an expressway in a rural area.**

**B. The first traffic signal approaching an urban area.**

**C. Any traffic signal with limited approach visibility, or where approach speeds exceed 50 mph.**

**13 On divided highways where the median is 8 feet wide, or greater, the installation may consist of:**

**A. Two Type 1 standards, each with a Signal Ahead (W3-3) sign and a 12-inch signal face, with one standard located in the median and the other off of the right shoulder; or**

**B. A Type 9 cantilever flashing beacon installation with a Signal Ahead (W3-3) sign and two 12-inch signal faces as shown in Caltrans' Standard Plans. See Section 1A.11 for information regarding this publication.**

**14 The above installation designs may result in noncompliance with Caltrans' Highway Design Manual mandatory standards for horizontal clearance and shoulder width, and the advisory design standard for clear recovery zones. If such nonstandard features cannot be avoided, the designer must obtain approval in accordance with Topic 82 of Caltrans' Highway Design Manual and the current instructions pertaining to exceptions from mandatory and advisory design standards. See Section 1A.11 for information regarding this publication.**

**15 On undivided highways or on highways where the median is less than 8 feet wide, the installation may consist of a single standard located off of the right shoulder or Type 9 cantilever flashing beacon installation as described for use on divided highways, or it may be a Type 15-FBS flashing beacon installation.**

*Support:*

**16 The cost of installing a Signal Ahead Flashing Beacon is normally included in the traffic signal project and the cost shared with the local agency.**

### **Section 4L.03 Warning Beacon**

#### **Support:**

01 Typical applications of Warning Beacons include the following:

- A. At obstructions in or immediately adjacent to the roadway;
- B. As supplemental emphasis to warning signs;
- C. As emphasis for midblock crosswalks;
- D. As supplemental emphasis to regulatory signs, except STOP, DO NOT ENTER, WRONG WAY, and SPEED LIMIT signs; and
- E. In conjunction with a regulatory or warning sign that includes the phrase WHEN FLASHING in its legend to indicate that the regulation is in effect or that the condition is present only at certain times.

#### **Standard:**

02 **A Warning Beacon shall consist of one or more signal sections of a standard traffic signal face with a flashing CIRCULAR YELLOW signal indication in each signal section.**

03 **A Warning Beacon shall be used only to supplement an appropriate warning or regulatory sign or marker.**

04 **Warning Beacons, if used at intersections, shall not face conflicting vehicular approaches.**

05 **If a Warning Beacon is suspended over the roadway, the clearance above the pavement shall be a minimum of 15 feet and a maximum of 19 feet.**

#### **Guidance:**

06 *The condition or regulation justifying Warning Beacons should largely govern their location with respect to the roadway.*

07 *If an obstruction is in or adjacent to the roadway, illumination of the lower portion or the beginning of the obstruction or a sign on or in front of the obstruction, in addition to the beacon, should be considered.*

08 *Warning Beacons should be operated only during those periods or times when the condition or regulation exists.*

#### **Option:**

09 Warning Beacons that are actuated by pedestrians, bicyclists, or other road users may be used as appropriate to provide additional warning to vehicles approaching a crossing or other location.

10 If Warning Beacons have more than one signal section, they may be flashed either alternately or simultaneously.

11 A flashing yellow beacon interconnected with a traffic signal controller assembly may be used with a traffic signal warning sign (see Section 2C.36).

### **Section 4L.04 Speed Limit Sign Beacon**

#### **Standard:**

01 **A Speed Limit Sign Beacon shall be used only to supplement a Speed Limit sign.**

02 **A Speed Limit Sign Beacon shall consist of one or more signal sections of a standard traffic control signal face, with a flashing CIRCULAR YELLOW signal indication in each signal section. The signal indications shall have a nominal diameter of not less than 8 inches. If two signal indications are used, they shall be vertically aligned, except that they shall be permitted to be horizontally aligned if the Speed Limit (R2-1) sign is longer horizontally than vertically. If two signal indications are used, they shall be alternately flashed.**

#### **Option:**

03 A Speed Limit Sign Beacon may be used with a fixed or variable Speed Limit sign. If applicable, a flashing Speed Limit Sign Beacon (with an appropriate accompanying sign) may be used to indicate that the displayed speed limit is in effect.

04 ~~A Speed Limit Sign Beacon may be included within the border of a School Speed Limit (S5-1) sign (see Section 7B.15).~~

#### **Guidance:**

05 *When a Speed Limit Sign Flashing Beacon is installed at the request of a local agency, or installed by the local agency under an encroachment permit the costs of installing and maintaining the beacon should be at 100% local agency expense.*

### **Section 4L.05 Stop Beacon**

#### **Standard:**

**01 A Stop Beacon shall be used only to supplement a STOP sign, a DO NOT ENTER sign, or a WRONG WAY sign.**

**02 A Stop Beacon shall consist of one or more signal sections of a standard traffic signal face with a flashing CIRCULAR RED signal indication in each signal section. If two horizontally aligned signal indications are used for a Stop Beacon, they shall be flashed simultaneously to avoid being confused with grade crossing flashing-light signals. If two vertically aligned signal indications are used for a Stop Beacon, they shall be flashed alternately.**

**03 The bottom of the signal housing of a Stop Beacon shall be not less than 12 inches or more than 24 inches above the top of a STOP sign, a DO NOT ENTER sign, or a WRONG WAY sign.**

#### **Support:**

**04 A Stop Sign Flashing Beacon consists of one or two signal sections with a flashing circular red indication in each section.**

#### **Standard:**

**05 The bottom of the housing of a Stop Sign Flashing Beacon shall not be less than 12 inches nor more than 24 inches above the top of the stop sign.**

**06 The cost of installing a Stop Sign Beacon shall be shared with the local agency in the same manner as a traffic signal.**

### **Section 4L.101(CA) Flashing Beacons at School Crosswalks**

#### **Option:**

**01 Flashing beacons at school crosswalks may be installed on State highways in accordance with CVC Sections 21372 and 21373.**

**02 Flashing yellow beacons may be installed to supplement standard school signing and markings for the purpose of providing advanced warning during specified times of operation when justified.**

**03 A flashing yellow beacon may be justified when ALL of the following conditions are fulfilled:**

- A. The uncontrolled school crossing is on the "Suggested Route to School"; and**
- B. At least 40 school pedestrians use the crossing during each of any two hours (not necessarily consecutive) of a normal school day; and**
- C. The crossing is at least 600 feet from the nearest alternate crossing controlled by traffic signals, stop signs or crossing guards; and**
- D. The vehicular volume through the crossing exceeds 200 vehicles per hour in urban areas or 140 vehicles per hour in rural areas during the same hour the students are going to and from school during normal school hours; and**
- E. The critical approach speeds exceeds 35 mph or the approach visibility is less than the stopping sight distance.**

#### **Standard:**

**04 If school authorities are to operate flashing yellow beacon, an inter-agency agreement shall be executed to assure designations of a responsible adult to operate the beacon controls and to provide accessibility for necessary equipment maintenance.**

**05 Where traffic signals and/or flashing beacons are justified only by the School Area Traffic Signal Warrant on a State highway, the installation shall be at 100% State expense. When any other warrant is met also, the cost is shared in the usual manner.**

#### **Support:**

**06 Figure 4L-101(CA) shows the worksheet for flashing beacon at school crossings.**

### **Section 4L.102(CA) Flashing Beacons for Fire Stations**

#### **Option:**

**01 Flashing beacons at fire station driveways or at intersections immediately adjacent to a fire station may be installed on State highways.**

**Standard:**

- 02 The flashing beacon shall be used only to supplement an appropriate warning or regulatory sign. The flashing beacon shall be actuated from a non-illuminated condition by a switch at the fire station.**
- 03 The costs of installing and maintaining the flashing beacon for the fire station shall be at 100% local agency or fire department expense.**

**Section 4L.103(CA) Flashing Beacons at Bus Stops on Freeway Interchanges**

**Option:**

**01 At locations of approved bus stops within interchange areas, a flashing beacon may be provided near the top of a lighting standard to provide a flag stop.**

**Standard:**

- 02 The following design and operational requirements shall be met:**
  - A. A push button shall be provided on the lighting standard with a sign explaining the purpose and operation. The sign shall state that if no bus has arrived within 15 minutes (or other time) after the button has been actuated it will be necessary to actuate it again.**
  - B. The flashing beacon shall consist of a 8-inch, signal section with an uncolored or white lens mounted on the lighting standard in such a position that an approaching bus driver can see it on the freeway.**
  - C. The operation of the control shall be such that the flashing beacon will operate for 15 minutes after the button has been actuated and then go out.**
- 03 The cost of installing and maintaining Flashing Beacons at Bus Stops on Freeway Interchanges shall be 100% State expense.**

**Figure 4L-101 (CA). Flashing Beacon at School Crossings Worksheet**

COUNT DATE \_\_\_\_\_

CALC \_\_\_\_\_ DATE \_\_\_\_\_

CHK \_\_\_\_\_ DATE \_\_\_\_\_

DIST \_\_\_\_\_ CO \_\_\_\_\_ RTE \_\_\_\_\_ PM \_\_\_\_\_

Major St: \_\_\_\_\_ Critical Approach Speed \_\_\_\_\_ mph

Minor St: \_\_\_\_\_ Critical Approach Speed \_\_\_\_\_ mph

Speed limit or critical speed on major street traffic > 40 mph.....  }  
 or } **RURAL (R)**  
 }  
 In built up area of isolated community of < 10,000 population.....  } **URBAN (U)**

**Flashing Yellow Beacon at School Crossings  
 (All Parts Must Be Satisfied)**

**SATISFIED YES  NO**

|  |                 | MINIMUM REQUIREMENTS |     |  |  |
|--|-----------------|----------------------|-----|--|--|
| Part A                                 |                 | U                    | R   |  |  |
| Vehicle Volume                         | Each of 2 Hours | 200                  | 140 |  |  |
| School Age Pedestrians Crossing Street | Each of 2 Hours | 40                   | 40  |  |  |

SATISFIED YES  NO

**AND**

**Part B**

Critical Approach Speed Exceeds 35 mph

SATISFIED YES  NO

**AND**

**Part C**

Is Nearest Controlled Crossing More Than 600 ft away?

SATISFIED YES  NO

## CHAPTER 4M. LANE-USE CONTROL SIGNALS

### Section 4M.01 Application of Lane-Use Control Signals

#### Support:

<sup>01</sup> Lane-use control signals are special overhead signals that permit or prohibit the use of specific lanes of a street or highway or that indicate the impending prohibition of their use. Lane-use control signals are distinguished by placement of special signal faces over a certain lane or lanes of the roadway and by their distinctive shapes and symbols. Supplementary signs are sometimes used to explain their meaning and intent.

<sup>02</sup> Lane-use control signals are most commonly used for reversible-lane control, but are also used in certain non-reversible lane applications and for toll plaza lanes (see Section 4K.02).

#### Guidance:

<sup>03</sup> *An engineering study should be conducted to determine whether a reversible-lane operation can be controlled satisfactorily by static signs (see Section 2B.26) or whether lane-use control signals are necessary. Lane-use control signals should be used to control reversible-lane operations if any of the following conditions are present:*

- A. *More than one lane is reversed in direction;*
- B. *Two-way or one-way left turns are allowed during peak-period reversible operations, but those turns are from a different lane than used during off-peak periods;*
- C. *Other unusual or complex operations are included in the reversible-lane pattern;*
- D. *Demonstrated crash experience occurring with reversible-lane operation controlled by static signs that can be corrected by using lane-use control signals at the times of transition between peak and off-peak patterns; and/or*
- E. *An engineering study indicates that the safety and efficiency of the traffic operations of a reversible-lane system would be improved by lane-use control signals.*

#### Standard:

<sup>04</sup> **Pavement markings (see Section 3B.03) shall be used in conjunction with reversible-lane control signals.**

#### Option:

<sup>05</sup> Lane-use control signals may also be used if there is no intent or need to reverse lanes, but there is a need to indicate the open or closed status of one or more lanes, such as:

- A. On a freeway, if it is desired to close certain lanes at certain hours to facilitate the merging of traffic from a ramp or other freeway;
- B. On a freeway, near its terminus, to indicate a lane that ends;
- C. On a freeway or long bridge, to indicate that a lane may be temporarily blocked by a crash, breakdown, construction or maintenance activities, or similar temporary conditions; and
- D. On a conventional road or driveway, at access or egress points to or from a facility, such as a parking garage, where one or more lanes of the access or egress are opened or closed at various times.

### Section 4M.02 Meaning of Lane-Use Control Signal Indications

#### Standard:

<sup>01</sup> **The meanings of lane-use control signal indications shall be as follows:**

- A. **A steady DOWNWARD GREEN ARROW signal indication (see Figure 4M-101(CA)) shall mean that a road user is permitted to drive in the lane over which the arrow signal indication is located.**
- B. **A steady YELLOW X signal indication (see Figure 4M-101(CA)) shall mean that a road user is to prepare to vacate the lane over which the signal indication is located because a lane control change is being made to a steady RED X signal indication.**
- C. **A steady WHITE TWO-WAY LEFT-TURN ARROW signal indication (see Figure 4M-1) shall mean that a road user is permitted to use a lane over which the signal indication is located for a left turn, but not for through travel, with the understanding that common use of the lane by oncoming road users for left turns is also permitted.**

- D. A steady WHITE ONE WAY LEFT-TURN ARROW signal indication (see Figure 4M-1) shall mean that a road user is permitted to use a lane over which the signal indication is located for a left turn (without opposing turns in the same lane), but not for through travel.**
- E. A steady RED X signal indication (see Figure 4M-101(CA)) shall mean that a road user is not permitted to use the lane over which the signal indication is located and that this signal indication shall modify accordingly the meaning of other traffic controls present.**

### **Section 4M.03 Design of Lane-Use Control Signals**

#### **Standard:**

- 01 All lane-use control signal indications shall be in units with rectangular signal faces and shall have opaque backgrounds. Nominal minimum height and width of each DOWNWARD GREEN ARROW, YELLOW X, and RED X signal face shall be 18 inches for typical applications. The WHITE TWO-WAY LEFT-TURN ARROW and WHITE ONE WAY LEFT-TURN ARROW signal faces shall have a nominal minimum height and width of 30 inches.**
- 02 Each lane to be reversed or closed shall have signal faces with a DOWNWARD GREEN ARROW and a RED X symbol.**
- 03 Each reversible lane that also operates as a two-way or one-way left-turn lane during certain periods shall have signal faces that also include the applicable WHITE TWO-WAY LEFT-TURN ARROW or WHITE ONE WAY LEFT-TURN ARROW symbol.**
- 04 Each non-reversible lane immediately adjacent to a reversible lane shall have signal indications that display a DOWNWARD GREEN ARROW to traffic traveling in the permitted direction and a RED X to traffic traveling in the opposite direction.**
- 05 If in separate signal sections, the relative positions, from left to right, of the signal indications shall be RED X, YELLOW X, DOWNWARD GREEN ARROW, WHITE TWO-WAY LEFT-TURN ARROW, WHITE ONE WAY LEFT-TURN ARROW.**
- 06 The color of lane-use control signal indications shall be clearly visible for 2,300 feet at all times under normal atmospheric conditions, unless otherwise physically obstructed.**
- 07 Lane-use control signal faces shall be located approximately over the center of the lane controlled.**
- 08 If the area to be controlled is more than 2,300 feet in length, or if the vertical or horizontal alignment is curved, intermediate lane-use control signal faces shall be located over each controlled lane at frequent intervals. This location shall be such that road users will at all times be able to see at least one signal indication and preferably two along the roadway, and will have a definite indication of the lanes specifically reserved for their use.**
- 09 All lane-use control signal faces shall be located in a straight line across the roadway approximately at right angles to the roadway alignment.**
- 10 On roadways having intersections controlled by traffic control signals, the lane-use control signal face shall be located sufficiently far in advance of or beyond such traffic control signals to prevent them from being misconstrued as traffic control signals.**
- 11 Except as provided in Paragraph 12, the bottom of the signal housing of any lane-use control signal face shall be a minimum of 15 feet and a maximum of 19 feet above the pavement grade.**

#### **Option:**

- 12 The bottom of a lane-use control signal housing may be lower than 15 feet above the pavement if it is mounted on a canopy or other structure over the pavement, but not lower than the vertical clearance of the structure.**
- 13 Except for lane-use control signals at toll plazas (see Section 4K.02), in areas with minimal visual clutter and with speeds of less than 40 mph, lane-use control signal faces with nominal height and width of 12 inches may be used for the DOWNWARD GREEN ARROW, YELLOW X, and RED X signal faces, and lane-use control signal faces with nominal height and width of 18 inches may be used for the WHITE TWO-WAY LEFT-TURN ARROW and WHITE ONE-WAY LEFT-TURN ARROW signal faces.**
- 14 Other sizes of lane-use control signal faces larger than 18 inches with message recognition distances appropriate to signal spacing may be used for the DOWNWARD GREEN ARROW, YELLOW X, and RED X signal faces.**



<sup>15</sup> Non-reversible lanes not immediately adjacent to a reversible lane on any street so controlled may also be provided with signal indications that display a DOWNWARD GREEN ARROW to traffic traveling in the permitted direction and a RED X to traffic traveling in the opposite direction.

<sup>16</sup> The signal indications provided for each lane may be in separate signal sections or may be superimposed in the same signal section.

*Guidance:*

<sup>17</sup> *The RED X lane-use control signal face and the downward pointing green arrow symbol should consist of a stroke width of 1.5 inches.*

## **Section 4M.04 Operation of Lane-Use Control Signals**

### **Standard:**

<sup>01</sup> All lane-use control signals shall be coordinated so that all the signal indications along the controlled section of roadway are operated uniformly and consistently. The lane-use control signal system shall be designed to reliably guard against showing any prohibited combination of signal indications to any traffic at any point in the controlled lanes.

<sup>02</sup> For reversible-lane control signals, the following combination of signal indications shall not be simultaneously displayed over the same lane to both directions of travel:

A. DOWNWARD GREEN ARROW in both directions,

B. YELLOW X in both directions,

C. WHITE ONE WAY LEFT-TURN ARROW in both directions,

D. DOWNWARD GREEN ARROW in one direction and YELLOW X in the other direction,

E. WHITE TWO-WAY LEFT-TURN ARROW or WHITE ONE WAY LEFT-TURN ARROW in one direction and DOWNWARD GREEN ARROW in the other direction,

F. WHITE TWO-WAY LEFT-TURN ARROW in one direction and WHITE ONE WAY LEFT-TURN ARROW in the other direction, and

G. WHITE ONE WAY LEFT-TURN ARROW in one direction and YELLOW X in the other direction.

<sup>03</sup> A moving condition in one direction shall be terminated either by the immediate display of a RED X signal indication or by a YELLOW X signal indication followed by a RED X signal indication. In either case, the duration of the RED X signal indication shall be sufficient to allow clearance of the lane before any moving condition is allowed in the opposing direction.

<sup>04</sup> Whenever a DOWNWARD GREEN ARROW signal indication is changed to a WHITE TWO-WAY LEFT-TURN ARROW signal indication, the RED X signal indication shall continue to be displayed to the opposite direction of travel for an appropriate duration to allow traffic time to vacate the lane being converted to a two-way left-turn lane.

<sup>05</sup> If an automatic control system is used, a manual control to override the automatic control shall be provided.

*Guidance:*

<sup>06</sup> *The type of control provided for reversible-lane operation should be such as to permit either automatic or manual operation of the lane-use control signals.*

### **Standard:**

<sup>07</sup> If used, lane-use control signals shall be operated continuously, except that lane-use control signals that are used only for special events or other infrequent occurrences and lane-use control signals on non-reversible freeway lanes shall be permitted to be darkened when not in operation. The change from normal operation to non-operation shall occur only when the lane-use control signals display signal indications that are appropriate for the lane use that applies when the signals are not operated. The lane-use control signals shall display signal indications that are appropriate for the existing lane use when changed from non-operation to normal operations. Also, traffic control devices shall clearly indicate the proper lane use when the lane control signals are not in operation.

**Support:**

<sup>08</sup> Section 2B.26 contains additional information concerning considerations involving left-turn prohibitions in conjunction with reversible-lane operations.

**Figure 4M-1. Left-Turn Lane-Use Control Signals**



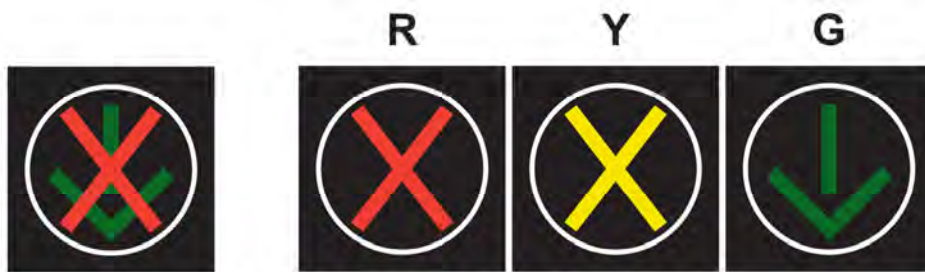
Two-way left-turn arrow



One-way left-turn arrow

White arrows on an opaque 30 x 30-inch background

*Figure 4M-101 (CA). Example of Lane Control Signal Face*



## CHAPTER 4N. IN-ROADWAY LIGHTS

### Section 4N.01 Application of In-Roadway Lights

Support:

<sup>01</sup> In-Roadway Lights are special types of highway traffic signals installed in the roadway surface to warn road users that they are approaching a condition on or adjacent to the roadway that might not be readily apparent and might require the road users to slow down and/or come to a stop. This includes situations warning of marked school crosswalks, marked midblock crosswalks, marked crosswalks on uncontrolled approaches, marked crosswalks in advance of roundabouts as described in Chapter 3C, and other roadway situations involving pedestrian crossings.

**Standard:**

<sup>02</sup> **In-Roadway Lights shall not be used for any application that is not described in this Chapter.**

<sup>03</sup> **If used, In-Roadway Lights shall not exceed a height of 3/4 inch above the roadway surface.**

<sup>04</sup> **When used, In-Roadway Lights shall be flashed and shall not be steadily illuminated.**

Support:

<sup>05</sup> Steadily illuminated lights installed in the roadway surface are considered to be internally illuminated raised pavement markers (see Section 3B.11).

Option:

<sup>06</sup> In-Roadway Lights may be flashed in a manner that includes a continuous flash of varying intensity and time duration that is repeated to provide a flickering effect (see Section 4N.02).

### Section 4N.02 In-Roadway Warning Lights at Crosswalks

Option:

<sup>01</sup> In-roadway lights may be installed at certain marked crosswalks, based on an engineering study or engineering judgment, to provide additional warning to road users.

**Standard:**

<sup>02</sup> **If used, In-Roadway Warning Lights at crosswalks shall be installed only at marked crosswalks with applicable warning signs. They shall not be used at crosswalks controlled by YIELD signs, STOP signs, or traffic control signals.**

<sup>03</sup> **If In-Roadway Warning Lights are used at a crosswalk, the following requirements shall apply:**

**A. Except as provided in Paragraphs 7 and 8, they shall be installed along both sides of the crosswalk and shall span its entire length.**

**B. They shall initiate operation based on pedestrian actuation and shall cease operation at a predetermined time after the pedestrian actuation or, with passive detection, after the pedestrian clears the crosswalk.**

**C. They shall display a flashing yellow light when actuated. The flash rate shall be at least 50, but no more than 60, flash periods per minute. If they are flashed in a manner that includes a continuous flash of varying intensity and time duration that is repeated to provide a flickering effect, the flickers or pulses shall not repeat at a rate that is between 5 and 30 per second to avoid frequencies that might cause seizures.**

**D. They shall be installed in the area between the outside edge of the crosswalk line and 10 feet from the outside edge of the crosswalk.**

**E. They shall face away from the crosswalk if unidirectional, or shall face away from and across the crosswalk if bidirectional.**

<sup>04</sup> **If used on one-lane, one-way roadways, a minimum of two In-Roadway Warning Lights shall be installed on the approach side of the crosswalk. If used on two-lane roadways, a minimum of three In-Roadway Warning Lights shall be installed along both sides of the crosswalk. If used on roadways with more than two lanes, a minimum of one In-Roadway Warning Light per lane shall be installed along both sides of the crosswalk.**

*Guidance:*

05 *If used, In-Roadway Warning Lights should be installed in the center of each travel lane, at the center line of the roadway, at each edge of the roadway or parking lanes, or at other suitable locations away from the normal tire track paths.*

06 *The location of the In-Roadway Warning Lights within the lanes should be based on engineering judgment.*

**Option:**

07 On one-way streets, In-Roadway Warning Lights may be omitted on the departure side of the crosswalk.

08 Based on engineering judgment, the In-Roadway Warning Lights on the departure side of the crosswalk on the left side of a median may be omitted.

09 Unidirectional In-Roadway Warning Lights installed at crosswalk locations may have an optional, additional yellow light indication in each unit that is visible to pedestrians in the crosswalk to indicate to pedestrians in the crosswalk that the In-Roadway Warning Lights are in fact flashing as they cross the street. These yellow lights may flash with and at the same flash rate as the light module in which each is installed.

*Guidance:*

10 *If used, the period of operation of the In-Roadway Warning Lights following each actuation should be sufficient to allow a pedestrian crossing in the crosswalk to leave the curb or shoulder and travel at a walking speed of 3.5 feet per second to at least the far side of the traveled way or to a median of sufficient width for pedestrians to wait. Where pedestrians who walk slower than 3.5 feet per second, or pedestrians who use wheelchairs, routinely use the crosswalk, a walking speed of less than 3.5 feet per second should be considered in determining the period of operation.*

**Standard:**

11 **If pedestrian pushbuttons are used to actuate the in-roadway lights, a Push Button To Turn On Warning Lights (with pushbutton symbol) (R10-25) sign (see Figure 2B-26) shall be mounted adjacent to immediately above or integral with each pedestrian pushbutton.**

12 **Where the period of operation is sufficient only for crossing from a curb or shoulder to a median of sufficient width for pedestrians to wait, median-mounted pedestrian actuators shall be provided.**

13 **In-Roadway Warning Lights (IRWLs) shall not be placed on or within the crosswalk markings. If the In-Roadway Warning Lights are activated by a push button, the PUSH BUTTON FOR PEDESTRIAN WARNING LIGHTS, CROSS WITH CAUTION (R62E(CA)) sign shall be used.**

14 **The following shall be considered when evaluating the need for In-Roadway Warning Lights:**

- A. **Whether the crossing is controlled or uncontrolled.**
- B. **An engineering traffic study to determine if In-Roadway Warning Lights are compatible with the safety and operation of nearby intersections, which may or may not be, controlled by traffic signals or STOP/YIELD signs.**
- C. **Standard traffic signs for crossings and crosswalk pavement markings are provided.**
- D. **At least 40 pedestrians regularly use the crossing during each of any two hours (not necessarily consecutive) during a 24-hour period.**
- E. **The vehicular volume through the crossing exceeds 200 vehicles per hour in urban areas or 140 vehicles per hour in rural areas during peak-hour pedestrian usage.**
- F. **The critical approach speed (85th percentile) is 45 mph or less.**
- G. **In-Roadway Warning Lights are visible to drivers at the minimum stopping sight distance for the posted speed limit.**
- H. **Public education on In-Roadway Warning Lights is conducted for new installations.**

**Option:**

15 **Overhead or roadside Flashing Yellow Beacons may be installed in conjunction with In-Roadway Warning Lights. In-Roadway Warning Lights may be installed independently, but are not necessarily intended to be a substitute for standard flashing beacons. Engineering judgment should be exercised.**

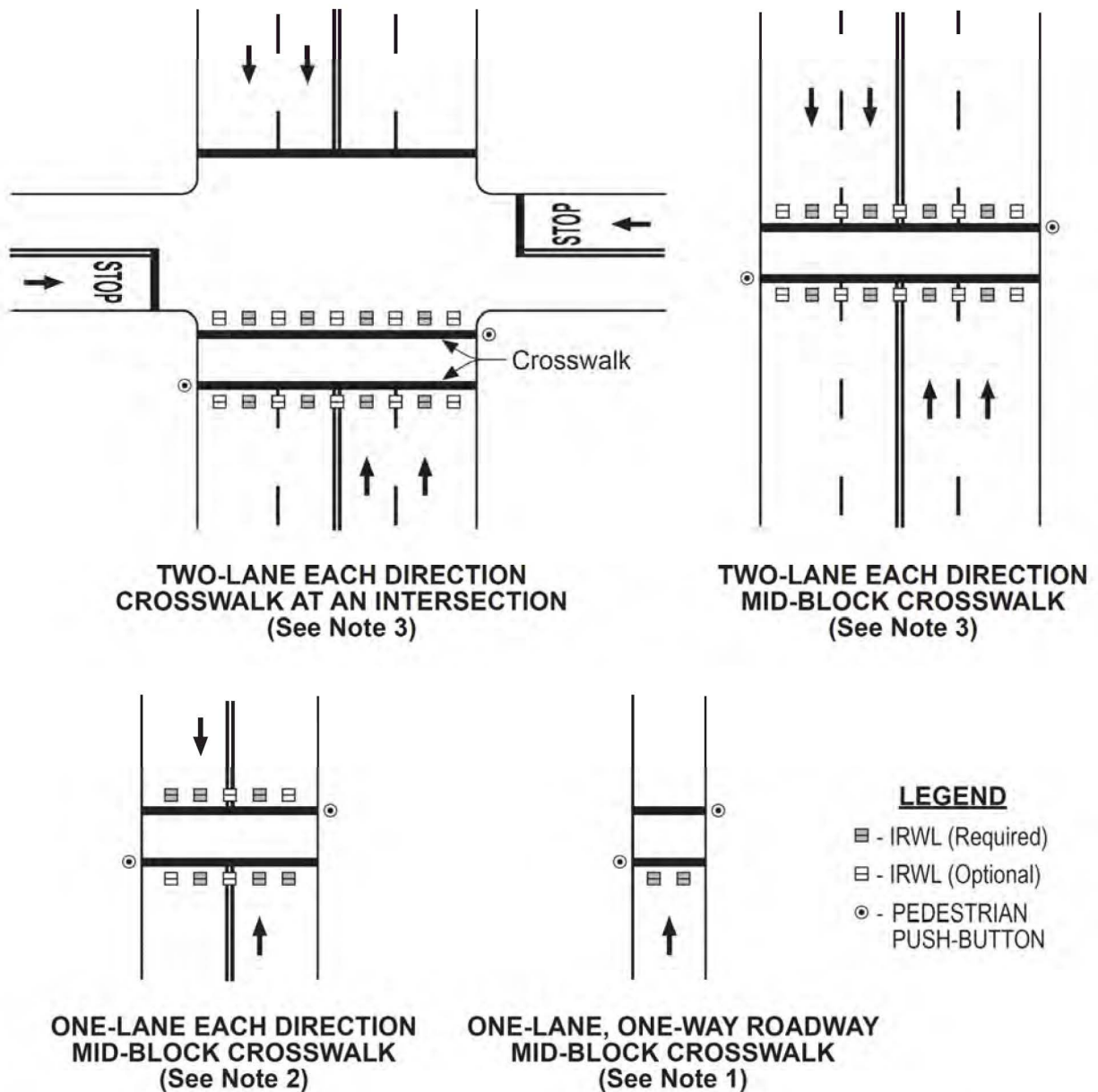
*Guidance:*

16 *Typical applications of In-Roadway Warning Lights are shown in Figure 4N-101(CA).*

**Section 4N.101(CA) In-Roadway Warning Lights at Crosswalks Financing and Maintenance-State Highways Standard:**

**<sup>01</sup> When In-Roadway Warning Lights are proposed by Caltrans on State highways, Caltrans shall pay the costs of installation and maintenance. When In-Roadway Warning Lights are proposed and installed by a local agency on State highways, the installation of In-Roadway Warning Lights shall be covered by an Encroachment Permit issued by the local Caltrans District Director. The local agency shall be responsible for installation and maintenance of the In-Roadway Warning Lights.**

**Figure 4N-101 (CA). Typical Layout for In-Roadway Warning Lights (IRWLs)**



**NOTES:**

1. One-Lane, One-Way Roadways, a minimum of two IRWLs shall be installed on the approach side of the crosswalk.
2. One-Lane each direction, a minimum of three IRWLs shall be installed along both sides of the crosswalk.
3. Two-Lanes each direction, a minimum of one IRWLs per lane, shall be installed along both sides of the crosswalk.
4. IRWLs should be located off the tire tracks.

# PART 5

## TRAFFIC CONTROL DEVICES FOR LOW-VOLUME ROADS

### CHAPTER 5A. GENERAL

#### Section 5A.01 Function

##### Standard:

**01 A low-volume road shall be defined for this Part of the Manual as follows:**

- A. A low-volume road shall be a facility lying outside of built-up areas of cities, towns, and communities, and it shall have a traffic volume of less than 400 AADT.**
- B. A low-volume road shall not be a freeway, an expressway, an interchange ramp, a freeway service road, a road on a designated State highway system, or a residential street in a neighborhood. In terms of highway classification, it shall be a variation of a conventional road or a special purpose road as defined in Section 1A.13.**
- C. A low-volume road shall be classified as either paved or unpaved.**

##### Support:

**02** Low-volume roads typically include agricultural, recreational, resource management and development such as mining and logging and grazing, and local roads in rural areas.

##### Guidance:

**03** The needs of unfamiliar road users for occasional, recreational, and commercial transportation purposes should be considered.

##### Support:

**04** At some locations on low-volume roads, the use of traffic control devices might be needed to provide the road user limited, but essential, information regarding regulation, guidance, and warning.

**05** Other Parts of this Manual contain provisions applicable to all low-volume roads; however, Part 5 specifically supplements and references the provisions for traffic control devices commonly used on low-volume roads.

#### Section 5A.02 Application

##### Support:

**01** It is possible, in many cases, to provide essential information to road users on low-volume roads with a limited number of traffic control devices. The focus might be on devices that:

- A. Warn of conditions not normally encountered,
- B. Prohibit unsafe movements, or
- C. Provide minimal destination guidance.

##### Standard:

**02 The provisions contained in Part 5 shall not prohibit the installation or the full application of traffic control devices on a low-volume road where conditions justify their use.**

##### Guidance:

**03** Additional traffic control devices and provisions contained in other Parts of the Manual should be considered for use on low-volume roads.

##### Support:

**04** Section 1A.09 contains information regarding the assistance that is available to jurisdictions that do not have engineers on their staffs who are trained and/or experienced in traffic control devices.

### **Section 5A.03 Design**

#### **Standard:**

**01 Traffic control devices for use on low-volume roads shall be designed in accordance with the provision contained in Part 5, and where required, in other applicable Parts of this Manual.**

**02 The typical sizes for signs and plaques installed on low-volume roads shall be as shown in Table 5A-1. The sizes in the minimum column shall only be used on low-volume roads where the 85th-percentile speed or posted speed limit is less than 35 mph.**

#### **Guidance:**

**03 The sizes in the oversized column should be used where engineering judgment indicates a need based on high vehicle operating speeds, driver expectancy, traffic operations, or roadway conditions.**

#### **Option:**

**04 Signs and plaques larger than those shown in Table 5A-1 may be used (see Section 2A.11).**

#### **Standard:**

**05 All signs shall be retroreflective or illuminated to show the same shape and similar color both day and night, unless specifically stated otherwise in other applicable Parts of this Manual. The requirements for sign illumination shall not be considered to be satisfied by street, highway, or strobe lighting.**

**06 All markings shall be visible at night and shall be retroreflective unless ambient illumination provides adequate visibility of the markings.**

### **Section 5A.04 Placement**

#### **Standard:**

**01 Except as provided in Paragraph 3, the traffic control devices used on low-volume roads shall be placed and positioned in accordance with the lateral, longitudinal, and vertical placement provisions contained in Part 2 and other applicable Sections of this Manual.**

#### **Guidance:**

**02 The placement of warning signs should comply with the guidance contained in Section 2C.05 and other applicable Sections of this Manual.**

#### **Option:**

**03 A lateral offset of not less than 2 feet from the roadway edge to the roadside edge of a sign may be used where roadside features such as terrain, shrubbery, and/or trees prevent lateral placement in accordance with Section 2A.19.**

#### **Standard:**

**04 If located within a clear zone, post-mounted sign supports shall be yielding, breakaway, or shielded with a longitudinal barrier or crash cushion in Section 2A.19.**



**Table 5A-1. Sign and Plaque Sizes on Low-Volume Roads (Sheet 1 of 2)**

| Sign or Plaque                  | Sign Designation | Section | Sign Sizes   |         |              |
|---------------------------------|------------------|---------|--------------|---------|--------------|
|                                 |                  |         | Typical      | Minimum | Oversized    |
| Stop                            | R1-1             | 5B.02   | 30 x 30      | —       | 36 x 36      |
| Yield                           | R1-2             | 5B.02   | 30 x 30 x 30 | —       | 36 x 36 x 36 |
| Speed Limit (English)           | R2-1             | 5B.03   | 24 x 30      | 18 x 24 | 36 x 48      |
| Do Not Pass                     | R4-1             | 5B.04   | 24 x 30      | —       | 36 x 48      |
| Pass With Care                  | R4-2             | 5B.04   | 24 x 30      | 18 x 24 | 36 x 48      |
| Keep Right                      | R4-7             | 5B.04   | 24 x 30      | 18 x 24 | 36 x 48      |
| Do Not Enter                    | R5-1             | 5B.04   | 30 x 30      | —       | 36 x 36      |
| No Trucks                       | R5-2             | 5B.04   | 24 x 24      | —       | 30 x 30      |
| One Way                         | R6-2             | 5B.04   | 18 x 24      | —       | 24 x 30      |
| No Parking (symbol)             | R8-3             | 5B.05   | 24 x 24      | 18 x 18 | 30 x 30      |
| No Parking                      | R8-3a            | 5B.05   | 18 x 24      | —       | 24 x 30      |
| No Parking (plaque)             | R8-3cP,3dP       | 5B.05   | 24 x 18      | 18 x 12 | 30 x 24      |
| Road Closed                     | R11-2            | 5B.04   | 48 x 30      | —       | —            |
| Road Closed, Local Traffic Only | R11-3a           | 5B.04   | 60 x 30      | —       | —            |
| Bridge Out, Local Traffic Only  | R11-3b           | 5B.04   | 60 x 30      | —       | —            |
| Road Closed to Thru Traffic     | R11-4            | 5B.04   | 60 x 30      | —       | —            |
| Weight Limit                    | R12-1            | 5B.04   | 24 x 30      | —       | 36 x 48      |
| Grade Crossing (Crossbuck)      | R15-1            | 5F.02   | 48 x 9       | —       | —            |
| Number of Tracks (plaque)       | R15-2P           | 5F.02   | 27 x 18      | —       | —            |
| Horizontal Alignment            | W1-1,2,3,4,5     | 5C.02   | 30 x 30      | —       | 36 x 36      |
| One-Direction Large Arrow       | W1-6             | 5C.02   | 36 x 18      | —       | 48 x 24      |
| Two-Direction Large Arrow       | W1-7             | 5C.02   | 36 x 18      | —       | 48 x 24      |
| Chevron Alignment               | W1-8             | 5C.02   | 12 x 18      | —       | 18 x 24      |
| Intersection Warning            | W2-1,2,3,4,5,6   | 5C.03   | 30 x 30      | —       | 36 x 36      |
| Stop Ahead                      | W3-1             | 5C.04   | 30 x 30      | —       | 36 x 36      |
| Yield Ahead                     | W3-2             | 5C.04   | 30 x 30      | —       | 36 x 36      |
| Be Prepared to Stop             | W3-4             | 5G.05   | 36 x 36      | —       | 48 x 48      |
| Narrow Bridge                   | W5-2             | 5C.05   | 30 x 30      | —       | 36 x 36      |
| One Lane Bridge                 | W5-3             | 5C.06   | 30 x 30      | —       | 36 x 36      |
| Hill                            | W7-1             | 5C.07   | 30 x 30      | —       | 36 x 36      |
| XX % Grade (plaque)             | W7-3P            | 5C.07   | 24 x 18      | —       | 30 x 24      |
| Next XX Miles (plaque)          | W7-3aP           | 5C.09   | 24 x 18      | —       | 30 x 24      |
| Pavement Ends                   | W8-3             | 5C.08   | 30 x 30      | —       | 36 x 36      |
| Truck Crossing                  | W8-6             | 5C.09   | 30 x 30      | —       | 36 x 36      |
| Loose Gravel                    | W8-7             | 5G.05   | 30 x 30      | —       | 36 x 36      |
| Rough Road                      | W8-8             | 5G.05   | 30 x 30      | —       | 36 x 36      |
| Road May Flood                  | W8-18            | 5G.05   | 30 x 30      | —       | 36 x 36      |
| Grade Crossing Advance Warning  | W10-1            | 5F.03   | 30 Dia.      | —       | 36 Dia.      |
| Grade Crossing Advance Warning  | W10-2,3,4        | 5F.03   | 30 x 30      | —       | 36 x 36      |
| Trains May Exceed 80 mph        | W10-8            | 5F.06   | 30 x 30      | —       | 36 x 36      |
| Storage Space Symbol            | W10-11           | 5F.06   | 30 x 30      | —       | 36 x 36      |
| Skewed Crossing                 | W10-12           | 5F.06   | 30 x 30      | —       | 36 x 36      |
| Entering/Crossing               | W11 Series       | 5C.09   | 30 x 30      | —       | 36 x 36      |
| Advisory Speed (plaque)         | W13-1P           | 5C.10   | 18 x 18      | —       | 24 x 24      |
| Dead End/No Outlet              | W14-1,2          | 5C.11   | 30 x 30      | —       | 36 x 36      |
| Dead End/No Outlet              | W14-1a,2a        | 5C.11   | 36 x 9       | 24 x 6  | —            |

**Table 5A-1. Sign and Plaque Sizes on Low-Volume Roads (Sheet 2 of 2)**

| Sign or Plaque                 | Sign Designation | Section          | Sign Sizes         |              |                    |
|--------------------------------|------------------|------------------|--------------------|--------------|--------------------|
|                                |                  |                  | Typical            | Minimum      | Oversized          |
| No Passing Zone (pennant)      | W14-3            | 5G.05            | 40 x 40 x 30       | —            | 48 x 48 x 36       |
| Supplemental Distance (plaque) | W16-2P           | 5C.09            | 24 x 18            | 18 x 12      | 30 x 24            |
| Diagonal Arrow (plaque)        | W16-7P           | 5C.09            | 24 x 12            | —            | 30 x 18            |
| Ahead (plaque)                 | W16-9P           | 5C.09            | 24 x 12            | —            | 30 x 18            |
| No Traffic Signs               | W18-1            | 5C.12            | 30 x 30            | 24 x 24      | 36 x 36            |
| Road Work (with distance)      | W20-1            | 5G.05            | 36 x 36            | —            | 48 x 48            |
| Road Closed (with distance)    | W20-3            | 5G.05            | 36 x 36            | —            | 48 x 48            |
| One Lane Road (with distance)  | W20-4            | 5G.05            | 36 x 36            | —            | 48 x 48            |
| Flagger                        | <del>W20-7</del> | <del>5G.05</del> | <del>36 x 36</del> | <del>—</del> | <del>48 x 48</del> |
| Workers                        | W21-1            | 5G.05            | 36 x 36            | —            | 48 x 48            |
| Fresh Oil                      | W21-2            | 5G.05            | 30 x 30            | —            | 48 x 48            |
| Road Machinery Ahead           | W21-3            | 5G.05            | 30 x 30            | —            | 48 x 48            |
| Shoulder Work                  | W21-5            | 5G.05            | 36 x 36            | —            | 48 x 48            |
| Survey Crew                    | W21-6            | 5G.05            | 36 x 36            | —            | 48 x 48            |
| Utility Work (with distance)   | W21-7            | 5G.05            | 36 x 36            | —            | 48 x 48            |

Notes: 1. Larger sizes may be used when appropriate  
 2. Dimensions are shown in inches and are shown as width x height

## CHAPTER 5B. REGULATORY SIGNS

### Section 5B.01 Introduction

Support:

01 The purpose of a regulatory sign is to inform highway users of traffic laws or regulations, and to indicate the applicability of legal requirements that would not otherwise be apparent.

02 The provisions for regulatory signs are contained in Chapter 2B and in other Sections of this Manual. Provisions for regulatory signs that are specific to low-volume roads are contained in this Chapter.

### Section 5B.02 STOP and YIELD Signs (R1-1 and R1-2)

Guidance:

01 *STOP (R1-1) and YIELD (R1-2) signs (see Figure 5B-1) should be considered for use on low-volume roads where engineering judgment or study, consistent with the provisions of Sections 2B.04 to 2B.10, indicates that either of the following conditions applies:*

- A. *An intersection of a less-important road with a main road where application of the normal right-of-way rule might not be readily apparent.*
- B. *An intersection that has restricted sight distance for the prevailing vehicle speeds.*

### Section 5B.03 Speed Limit Signs (R2 Series)

Standard:

01 **If used, Speed Limit (R2 series) signs (see Figure 5B-1) shall display the speed limit established by law, ordinance, regulation, or as adopted by the authorized agency following an engineering study. The displayed speed limits shall be in multiples of 5 mph.**

02 **Speed limits shall be established in accordance with Section 2B.13.**

Option:

03 Speed limit signs may be used on low-volume roads that carry traffic from, onto, or adjacent to higher-volume roads that have posted speed limits.

### Section 5B.04 Traffic Movement and Prohibition Signs (R3, R4, R5, R6, R9, R10, R11, R12, R13, and R14 Series)

Support:

01 The regulatory signs (see Figure 5B-1) in these series inform road users of required, permitted, or prohibited traffic movements involving turn, alignment, exclusion, and pedestrians.

Standard:

02 **If used, signs for traffic prohibitions or restrictions shall be placed in advance of the prohibition or restriction so that traffic can use an alternate route or turn around.**

Guidance:

03 *Signs should be used on low-volume roads to indicate traffic prohibitions and restrictions such as road closures and weight restrictions.*

Option:

04 Signs for traffic prohibitions or restrictions may be used on a low-volume road near and at the intersections or the connections with a higher class of road, and where the regulatory message is essential for transition from the low-volume road to the higher-class facility or vice versa.

### Section 5B.05 Parking Signs (R8 Series)

Support:

00 Provisions for parking signs are contained in Chapter 2B of this Manual.

Option:

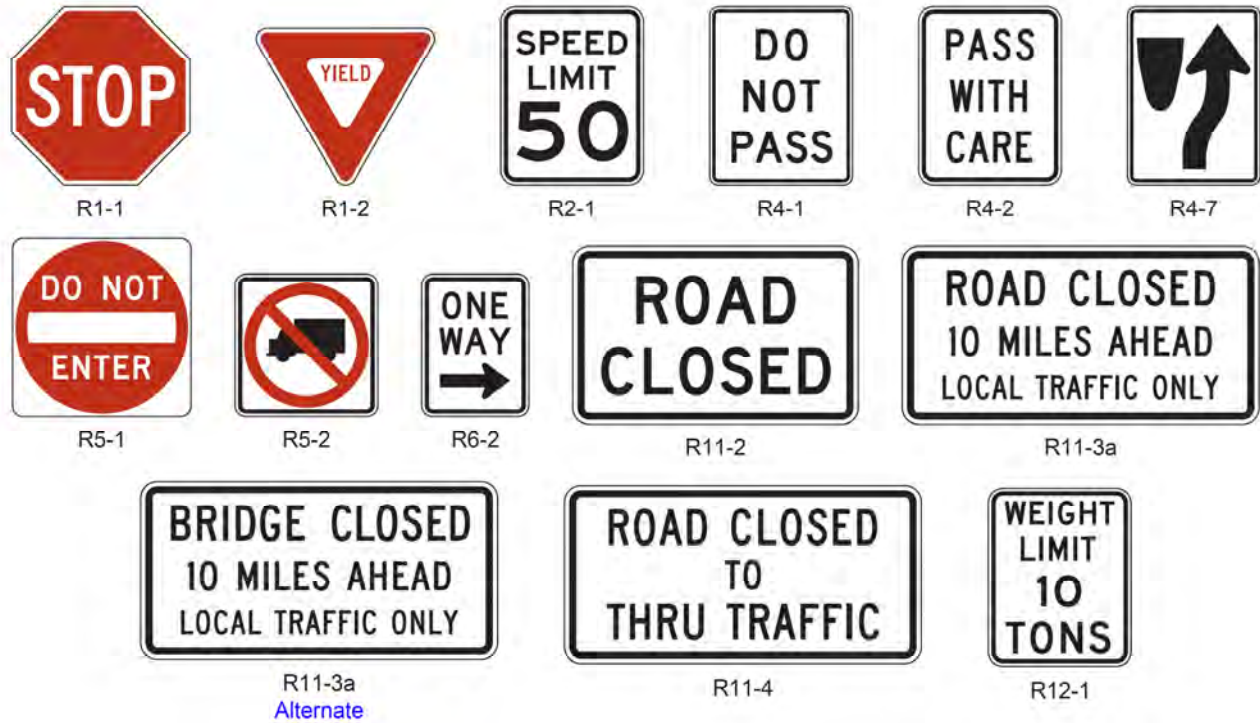
01 Parking signs (see ~~Figure 5B-2~~ [Figure 2B-24\(CA\)](#)) may be installed selectively on low-volume roads with due consideration of enforcement.

**Section 5B.06 Other Regulatory Signs**

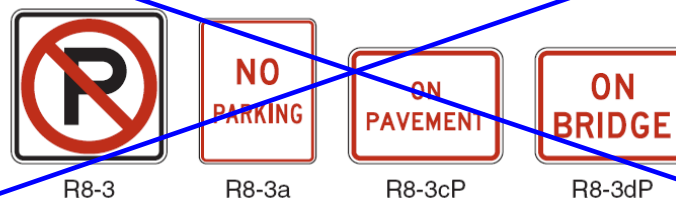
**Standard:**

01 Other regulatory signs used on low-volume roads that are not discussed in Part 5 shall comply with the provisions contained in other Parts of this Manual.

**Figure 5B-1. Regulatory Signs on Low-Volume Roads**



**Figure 5B-2. Parking Signs and Plaques on Low-Volume Roads**



## CHAPTER 5C. WARNING SIGNS

### Section 5C.01 Introduction

Support:

- 01 The purpose of a warning sign is to provide advance warning to the road user of unexpected conditions on or adjacent to the roadway that might not be readily apparent.
- 02 The provisions for warning signs are contained in Chapter 2C and in other Sections of this Manual. Provisions for warning signs that are specific to low-volume roads are contained in this Chapter.

### Section 5C.02 Horizontal Alignment Signs (W1-1 through W1-8)

Support:

- 01 Horizontal Alignment signs (see Sections 2C.06 through 2C.12 and Figure 5C-1) include turn, curve, reverse turn, reverse curve, winding road, large arrow, and chevron alignment signs.

Option:

- 02 Horizontal Alignment signs may be used where engineering judgment indicates a need to inform the road user of a change in the horizontal alignment of the roadway.

### Section 5C.03 Intersection Warning Signs (W2-1 through W2-6)

Support:

- 01 Intersection signs (see Figure 5C-1) include the crossroad, side road, T-symbol, Y-symbol, and circular intersection signs.

Option:

- 02 Intersection signs may be used where engineering judgment indicates a need to inform the road user in advance of an intersection.

### Section 5C.04 Stop Ahead and Yield Ahead Signs (W3-1, W3-2)

Standard:

- 01 **A Stop Ahead (W3-1) sign (see Figure 5C-2) shall be used where a STOP sign is not visible for a sufficient distance to permit the road user to bring the vehicle to a stop at the STOP sign.**
- 02 **A Yield Ahead (W3-2) sign (see Figure 5C-2) shall be used where a YIELD sign is not visible for a sufficient distance to permit the road user to bring the vehicle to a stop, if necessary, at the YIELD sign.**

### Section 5C.05 NARROW BRIDGE Sign (W5-2)

Option:

- 01 The NARROW BRIDGE (W5-2) sign (see Figure 5C-2) may be used on an approach to a bridge or culvert that has a clear width less than that of the approach roadway.

### Section 5C.06 ONE LANE BRIDGE Sign (W5-3)

Guidance:

- 01 *A ONE LANE BRIDGE (W5-3) sign (see Figure 5C-2) should be used on low-volume two-way roadways in advance of any bridge or culvert:*
  - A. *Having a clear roadway width of less than 16 feet, or*
  - B. *Having a clear roadway width of less than 18 feet when commercial vehicles constitute a high proportion of the traffic, or*
  - C. *Having a clear roadway width of 18 feet or less where the approach sight distance is limited on the approach to the structure.*

Option:

- 02 Roadway alignment and additional warning may be provided on the approach to a bridge or culvert by the use of object markers and/or delineators.

*Guidance:*

*03 The ONE LANE BRIDGE FOR TRUCKS AND BUSES (SR27-1(CA)) sign (see Figure 5C-2(CA)) should be used at the approaches to a bridge that is determined to be too narrow to allow trucks or buses in opposing directions to be on the bridge at the same time.*

**Section 5C.07 Hill Sign (W7-1)**

Option:

01 An engineering study of vehicles and road characteristics, such as percent grade and length of grade, may be conducted to determine hill signing requirements.

**Section 5C.08 PAVEMENT ENDS Sign (W8-3)**

Option:

01 A PAVEMENT ENDS (W8-3) sign (see Figure 5C-2) may be used to warn road users where a paved surface changes to a gravel or earth road surface.

**Section 5C.09 Vehicular Traffic Warning and Non-Vehicular Warning Signs (W11 Series and W8-6)**

*Guidance:*

*01 Vehicular Traffic Warning signs (see Figure 5C-2) should be used to alert road users to locations where frequent unexpected entries into the roadway by trucks, bicyclists, farm vehicles, fire trucks, and other vehicles might occur. Such signs should be used only at locations where the road user's sight distance is restricted or the condition, activity, or entering traffic would be unexpected.*

Option:

02 Non-Vehicular Warning signs (see Figure 5C-2) may be used to alert road users in advance of locations where unexpected entries into the roadway or shared use by pedestrians, large animals, or other crossing activities might occur.

03 A W7-3aP, W16-2P, or W16-9P supplemental plaque (see Figure 5C-2), with the legend NEXT XX MILES, XX FEET, or AHEAD may be installed below a Vehicular Traffic Warning or Non-Vehicular Warning sign (see Sections 2C.49 and 2C.50) to inform road users that they are approaching a portion of the roadway or a point where crossing activity might occur.

**Standard:**

**04 When a Non-Vehicular Warning sign is placed at the location of the crossing point, a diagonal downward pointing arrow (W16-7P) plaque (see Figure 5C-2) shall be mounted below the sign.**

*Guidance:*

*05 If the activity is seasonal or temporary, the sign should be removed or covered when the condition or activity does not exist.*

**Section 5C.10 Advisory Speed Plaque (W13-1P)**

Option:

01 An Advisory Speed (W13-1P) plaque (see Figure 5C-1) may be mounted below a warning sign when the condition requires a reduced speed.

**Section 5C.11 DEAD END or NO OUTLET Signs (W14-1, W14-1a, W14-2, W14-2a)**

Option:

01 The DEAD END (W14-1) and NO OUTLET (W14-2) signs (see Figure 5C-2) and the DEAD END (W14-1a) and NO OUTLET (W14-2a) signs (see Figure 5C-2) may be used to warn road users of a road that has no outlet or that terminates in a dead end or cul-de-sac.

*Guidance:*

*02 If used, these signs should be placed at a location that gives drivers of large commercial or recreational vehicles an opportunity to select a different route or turn around.*

### **Section 5C.12 NO TRAFFIC SIGNS Sign (W18-1)**

**Option:**

01 A W18-1 warning sign (see Figure 5C-2) with the legend NO TRAFFIC SIGNS may be used only on unpaved, low-volume roads to advise users that no signs are installed along the distance of the road. If used, the sign may be installed at the point where road users would enter the low-volume road or where, based on engineering judgment, the road user might need this information.

02 A W7-3aP, W16-2P, or W16-9P supplemental plaque (see Figure 5C-2) with the legend NEXT XX MILES, XX FEET, or AHEAD may be installed below the W18-1 sign when appropriate.

### **Section 5C.13 Other Warning Signs**

**Standard:**

01 **Other warning signs used on low-volume roads that are not discussed in Part 5, but are in this Manual, shall comply with the provisions contained in other Parts of this Manual. Warning signs that are not provided in this Manual shall comply with the provisions in Sections 2C.02 and 2C.03.**

### **Section 5C.14 Object Markers and Barricades**

**Support:**

01 The purpose of object markers is to mark obstructions located within or adjacent to the roadway, such as bridge abutments, drainage structures, and other physical objects.

**Guidance:**

02 *The end of a low-volume road should be marked with a Type 4 object marker in compliance with Section 2C.66.*

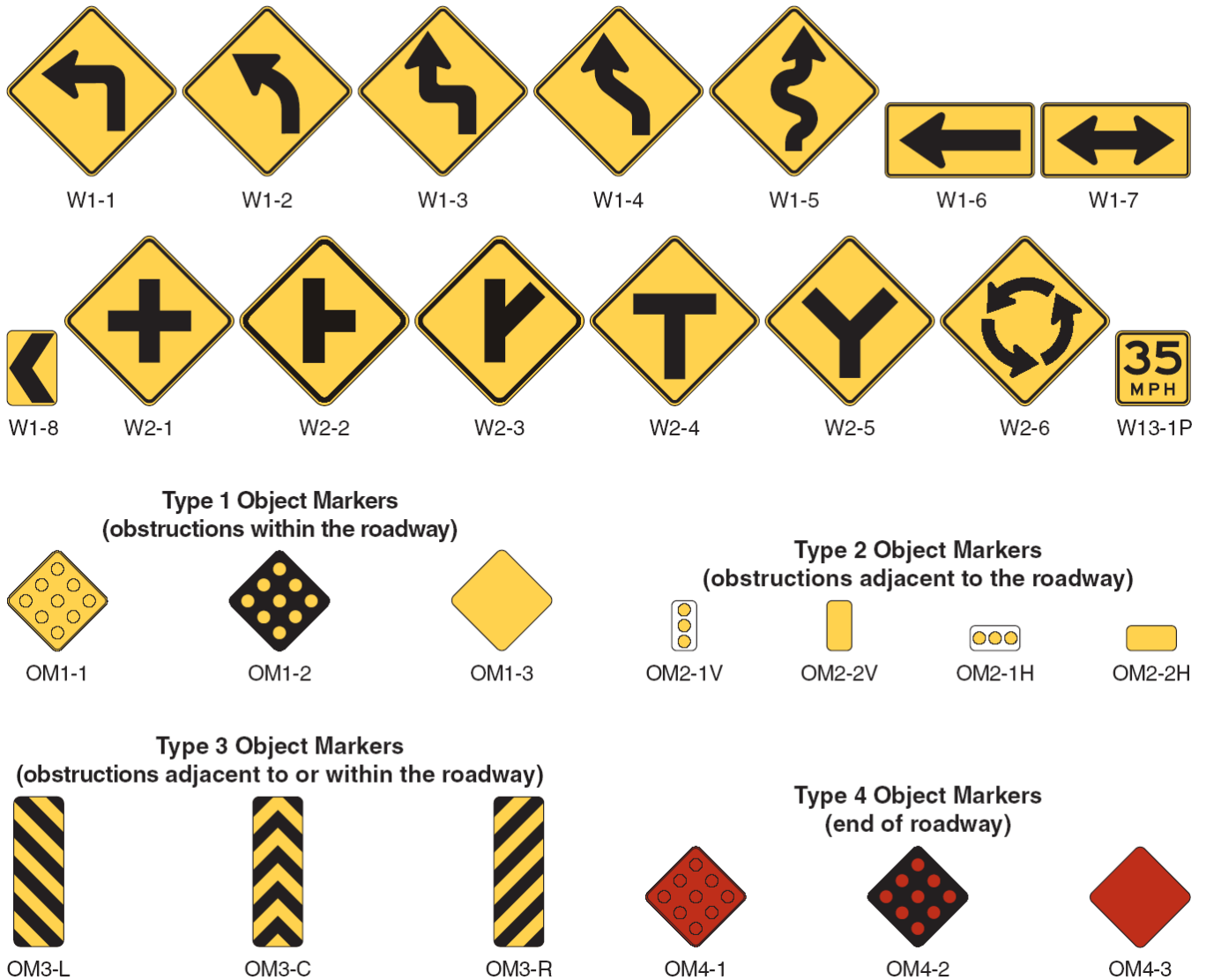
**Option:**

03 A Type 3 Barricade may be used where engineering studies or judgment indicates a need for a more visible end-of-roadway treatment (see Section 2B.67).

**Standard:**

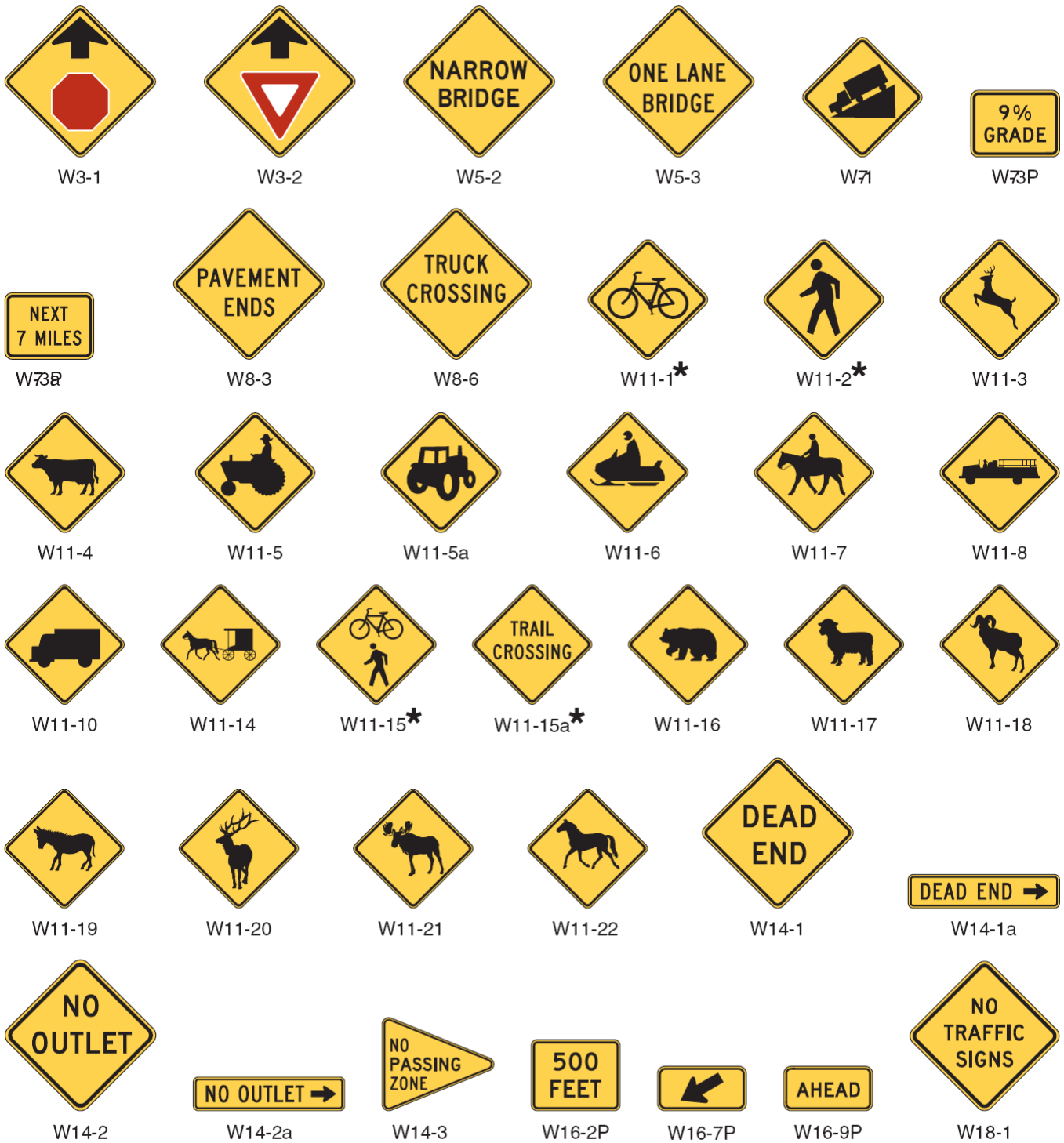
04 **Barricades used on low-volume roads shall comply with the provisions contained in Section 2B.67.**

**Figure 5C-1. Horizontal Alignment and Intersection Warning Signs and Plaques and Object Markers on Low-Volume Roads**





**Figure 5C-2. Other Warning Signs and Plaques on Low-Volume Roads**



\* A fluorescent yellow-green background color may be used for this sign or plaque

**Figure 5C-2 (CA). Other Warning Signs and Plaques on Low-Volume Roads**



SR27-1 (CA)

## CHAPTER 5D. GUIDE SIGNS

### Section 5D.01 Introduction

**Support:**

01 The purpose of a guide sign is to inform road users regarding positions, directions, destinations, and routes.

02 The provisions for guide signs, in general, are contained in Chapters 2D through 2N and in other Sections of this Manual. Provisions for guide signs that are specific to low-volume roads are contained in this Chapter.

**Guidance:**

03 *The familiarity of the road users with the road should be considered in determining the need for guide signs on low-volume roads.*

**Support:**

04 Low-volume roads generally do not require guide signs to the extent that they are needed on higher classes of roads. Because guide signs are typically only beneficial as a navigational aid for road users who are unfamiliar with a low-volume road, guide signs might not be needed on low-volume roads that serve only local traffic.

**Guidance:**

05 *If used, destination names should be as specific and descriptive as possible. Destinations such as campgrounds, ranger stations, recreational areas, and the like should be clearly indicated so that they are not interpreted to be communities or locations with road user services.*

**Option:**

06 Guide signs may be used at intersections to provide information for road users returning to a higher class of roads.



## CHAPTER 5E. MARKINGS

### Section 5E.01 Introduction

Support:

01 The purpose of markings on highways is to provide guidance and information for road users regarding roadway conditions and restrictions.

02 The provisions for markings and delineators, in general, are contained in Part 3 and in other Sections of this Manual. Provisions for markings that are specific to low-volume roads are contained in this Chapter.

### Section 5E.02 Center Line Markings

Standard:

01 **Where center line markings are installed, no-passing zone markings in compliance with Section 3B.02 shall also be installed.**

Guidance:

02 *Center line markings should be used on paved low-volume roads consistent with the principles of this Manual and with the policies and practices of the road agency and on the basis of either an engineering study or the application of engineering judgment.*

Option:

03 Center line markings may be placed on highways with or without edge line markings.

### Section 5E.03 Edge Line Markings

Support:

01 The purpose of edge line markings is to delineate the left-hand or right-hand edge of the roadway.

01a [Refer to Section 3B.06 and 3B.07 edge line markings and warrants for use of edge line markings.](#)

Guidance:

02 *Edge line markings should be considered for use on paved low-volume roads based on engineering judgment or an engineering study.*

Option:

03 Edge line markings may be placed on highways with or without center line markings.

04 Edge line markings may be placed on paved low-volume roads for roadway features such as horizontal curves, narrow bridges, pavement width transitions, curvilinear alignment, and at other locations based on engineering judgment or an engineering study.

05 [If edge line markings are placed without centerline markings, the Two-Way Traffic \(W6-3\) sign may be used where road users could perceive that they are on a one-way roadway when, in fact, they are on a two lane, two-way highway.](#)

### Section 5E.04 Delineators

Support:

01 The purpose of delineators is to enhance driver safety where it is desirable to call attention to a changed or changing condition such as abrupt roadway narrowing or curvature.

01a [Refer to Chapter 3F for more details on delineators.](#)

Option:

02 Delineators may be used on low-volume roads based on engineering judgment, such as for curves, T-intersections, and abrupt changes in the roadway width. In addition, they may be used to mark the location of driveways or other minor roads entering the low-volume road.

### Section 5E.05 Other Markings

Standard:

01 **Other markings, such as stop lines, crosswalks, pavement legends, channelizing devices, and islands, used on low-volume roads shall comply with the provisions contained in this Manual.**



## CHAPTER 5F. TRAFFIC CONTROL FOR HIGHWAY-RAIL GRADE CROSSINGS

### Section 5F.01 Introduction

Support:

01 The provisions for highway-rail grade crossing traffic control devices are contained in Part 8 and in other Sections of this Manual.

02 Traffic control for highway-rail grade crossings includes all signs, signals, markings, illumination, and other warning devices and their supports along roadways either approaching or at highway-rail grade crossings. The purpose of this traffic control is to promote a safer and more efficient operation of both rail and highway traffic at highway-rail grade crossings.

### Section 5F.02 Grade Crossing (Crossbuck) Sign and Number of Tracks Plaque (R15-1, R15-2P)

Support:

01 In most States, the Grade Crossing (Crossbuck) (R15-1) sign (see Figure 5F-1) requires road users to yield the right-of-way to rail traffic at a highway-rail grade crossing.

**Standard:**

02 **The Crossbuck (R15-1) sign shall be used at all highway-rail grade crossings, except as otherwise provided in Section 8B.03. For all low-volume roads, Crossbuck signs shall be used on the right-hand side of each approach. If there are two or more tracks, the supplemental Number of Tracks (R15-2P) plaque (see Figure 5F-1) shall display the number of tracks and shall be installed below the Crossbuck sign.**

03 **A strip of retroreflective white material not less than 2 inches in width shall be used on the back of each blade of each Crossbuck sign for the length of each blade, at all highway-rail grade crossings, except those where Crossbuck signs have been installed back-to-back.**

04 **A vertical strip of retroreflective white material, not less than 2 inches in width, shall be used on each support at passive highway-rail grade crossings for the full length of the front and back of the support from the Crossbuck sign or Number of Tracks plaque to within 2 feet above the ground, except on the side of those supports where a STOP (R1-1) or YIELD (R1-2) sign or flashing lights have been installed or on the back side of supports for Crossbuck signs installed on one-way streets.**

### Section 5F.03 Grade Crossing Advance Warning Signs (W10 Series)

**Standard:**

01 ~~Except as provided in Paragraph 2, a Grade Crossing Advance Warning (W10-1) sign (see Figure 5F-1) shall be used on all low-volume roads in advance of every highway-rail grade crossing.~~

**Option:**

02 ~~The Grade Crossing Advance Warning sign may be omitted for highway-rail grade crossings that are flagged by train crews.~~

03 ~~The W10-2, W10-3, and W10-4 signs (see Figure 5F-1) may be used on low-volume roads that run parallel to railroad tracks to warn road users making a turn that they will encounter a highway-rail grade crossing soon after making the turn.~~

**Standard:**

04 **The Highway-Rail Grade Crossing Advance Warning (W10 Series) signs shall be placed in conformance with Parts 2 and 8 of this Manual.**

### Section 5F.04 STOP and YIELD Signs (R1-1, R1-2)

**Standard:**

01 **The use and application at passive highway-rail grade crossings on low-volume roads of Crossbuck Assemblies with YIELD (R1-2) signs or STOP (R1-1) signs shall comply with the provisions of Section 8B.04.**

02 **At all highway-rail grade crossings where YIELD or STOP signs are installed, Yield Ahead (W3-2) or Stop Ahead (W3-1) signs shall also be installed if the criteria for their installation in Section 2C.36 is met.**

### Section 5F.05 Pavement Markings

*Guidance:*

01 *Pavement markings at highway-rail grade crossings should be used on paved low-volume roads, particularly if they are already deployed at most other highway-rail grade crossings within the immediate vicinity, or when the roadway has center-line markings.*

**Standard:**

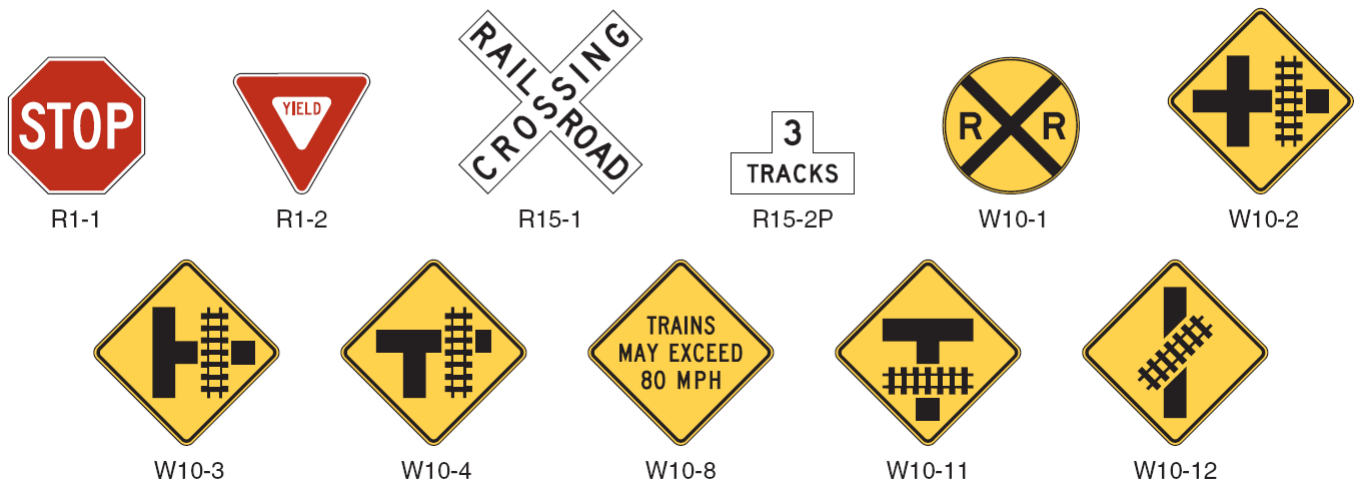
02 **Pavement markings at highway-rail grade crossings shall be placed in conformance with Parts 2 and 8 of this Manual.**

### Section 5F.06 Other Traffic Control Devices

**Standard:**

01 **Other traffic control devices that are used at highway-rail grade crossings on low-volume roads, such as other signs, signals, and illumination that are not in this Chapter, shall comply with the provisions contained in Part 8 and other applicable Parts of this Manual.**

Figure 5F-1. Highway-Rail Grade Crossing Signs and Plaques for Low-Volume Roads





## CHAPTER 5G. TEMPORARY TRAFFIC CONTROL ZONES

### Section 5G.01 Introduction

*Guidance:*

01 *The safety of road users, including pedestrians and bicyclists, as well as personnel in work zones, should be an integral and high priority element of every project in the planning, design, maintenance, and construction phases. Part 6 should be reviewed for additional criteria, specific details, and more complex temporary traffic control zone requirements. The following principles should be applied to temporary traffic control zones:*

*A. Traffic movement should be disrupted as little as possible.*

*B. Road users should be guided in a clear and positive manner while approaching and within construction, maintenance, and utility work areas.*

*C. Routine inspection and maintenance of traffic control elements should be performed both day and night.*

*D. Both the contracting agency and the contractor should assign at least one person on each project to have day-to-day responsibility for assuring that the traffic control elements are operating effectively and any needed operational changes are brought to the attention of their supervisors.*

02 *Traffic control in temporary traffic control zones should be designed on the assumption that road users will only reduce their speeds if they clearly perceive a need to do so, and then only in small increments of speed. Temporary traffic control zones should not present a surprise to the road user. Frequent and/or abrupt changes in geometrics and other features should be avoided. Transitions should be well delineated and long enough to accommodate driving conditions at the speeds vehicles are realistically expected to travel.*

03 *A temporary traffic control plan (see Section 6C.01) should be used for a temporary traffic control zone on a low-volume road to specify particular traffic control devices and features, or to reference typical drawings such as those contained in Part 6.*

*Support:*

04 *Applications of speed reduction countermeasures and enforcement can be effective in reducing traffic speeds in temporary traffic control zones.*

### Section 5G.02 Applications

*Guidance:*

01 *Planned work phasing and sequencing should be the basis for the use of traffic control devices for temporary traffic control zones. Part 6 should be consulted for specific traffic control requirements and examples where construction or maintenance work is planned.*

*Support:*

02 *Maintenance activities might not require extensive temporary traffic control if the traffic volumes and speeds are low.*

*Option:*

03 *The traffic applications shown in Figures 6H-1, ~~6H-10~~ 6H-10(CA), 6H-10A(CA), 6H-11, 6H-13, 6H-15, 6H-16, and 6H-18 of Part 6 are among those that may be used on low-volume roads.*

*Support:*

04 *Table 6H-3 provides distances for the advance placement of the traffic control devices shown in the typical applications.*

*Option:*

05 *For low-volume roadways with speeds of 30 miles per hour or less, a minimum distance of 100 feet may be used for the advance placement distance and the distance between signs shown in the typical applications.*

06 *For temporary traffic control zones on low-volume roads that require flaggers, a single flagger may be adequate if the flagger is visible to approaching traffic from all appropriate directions.*

### Section 5G.03 Channelization Devices

**Standard:**

01 **Channelization devices for nighttime use shall have the same retroreflective requirements as specified for higher-volume roadways.**

Option:

02 To alert, guide, and direct road users through temporary traffic control zones on low-volume roads, tapers may be used to move a road user out of the traffic lane and around the work space using the spacing of devices that is described in Section 6F.63.

**Section 5G.04 Markings**

Guidance:

01 Pavement markings should be considered for temporary traffic control zones on paved low-volume roads, especially roads that had existing pavement markings or that have a surfaced detour or temporary roadway.

Option:

02 Interim pavement markings may be omitted in a temporary traffic control zone if they are not needed based on the criteria for these markings in Section 6F.78.

**Section 5G.05 Other Traffic Control Devices**

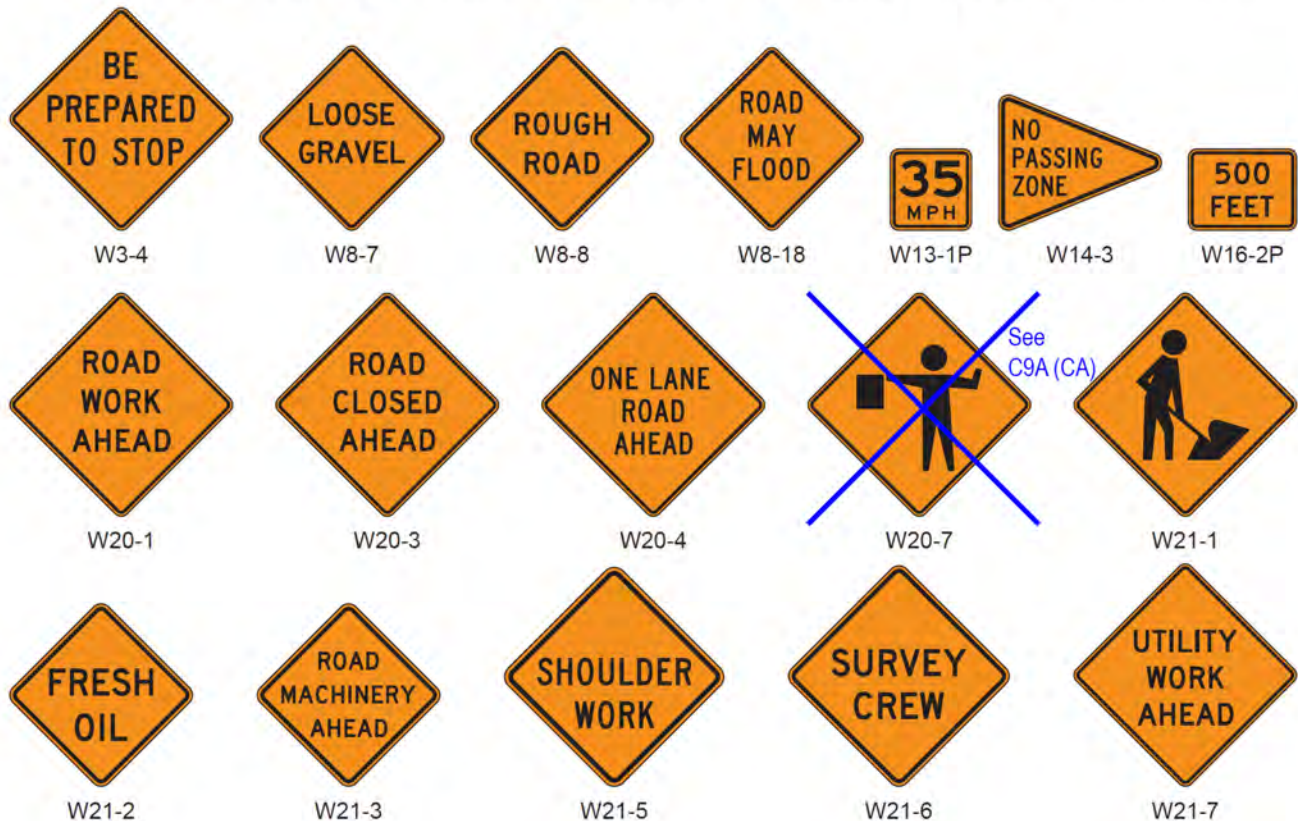
Standard:

01 Other traffic control devices, such as other signs, signals, and illumination that are used on low-volume roads in temporary traffic control zones, but are not described in Part 5, shall comply with the provisions contained in other Parts of this Manual.

Support:

02 Some of the signs that might be applicable in a temporary traffic control zone on a low-volume road are shown in Figure 5G-1.

**Figure 5G-1. Temporary Traffic Control Signs and Plaques on Low-Volume Roads**



## CHAPTER 5H. TRAFFIC CONTROL FOR SCHOOL AREAS

### Section 5H.01 Introduction

Support:

01 The provisions for school traffic control devices are contained in Part 7 of this Manual.

**Standard:**

02 **The sizes of school signs and plaques on low-volume roads shall be in accordance with Section 7B.01 and Table 7B-1.**



# PART 6

## TEMPORARY TRAFFIC CONTROL

### CHAPTER 6A. GENERAL

#### Section 6A.01 General

Support:

<sup>01</sup> Whenever the acronym “TTC” is used in Part 6, it refers to “temporary traffic control.”

**Standard:**

<sup>02</sup> **The needs and control of all road users (motorists, bicyclists, and pedestrians within the highway, or on private roads open to public travel (see definition in Section 1A.13), including persons with disabilities in accordance with the Americans with Disabilities Act of 1990 (ADA), Title II, Paragraph 35.130) through a TTC zone shall be an essential part of highway construction, utility work, maintenance operations, and the management of traffic incidents.**

Support:

<sup>03</sup> When the normal function of the roadway, or a private road open to public travel (see definition in Section 1A.13), is suspended, TTC planning provides for continuity of the movement of motor vehicle, bicycle, and pedestrian traffic (including accessible passage); transit operations; and access (and accessibility) to property and utilities.

<sup>04</sup> The primary function of TTC is to provide for the reasonably safe and effective movement of road users through or around TTC zones while reasonably protecting road users, workers, responders to traffic incidents, and equipment.

<sup>05</sup> Of equal importance to the public traveling through the TTC zone is the safety of workers performing the many varied tasks within the work space. TTC zones present constantly changing conditions that are unexpected by the road user. This creates an even higher degree of vulnerability for the workers and incident management responders on or near the roadway (see Section 6D.03). At the same time, the TTC zone provides for the efficient completion of whatever activity interrupted the normal use of the roadway.

<sup>06</sup> Consideration for road user safety, worker and responder safety, and the efficiency of road user flow is an integral element of every TTC zone, from planning through completion. A concurrent objective of the TTC is the efficient construction and maintenance of the highway and the efficient resolution of traffic incidents.

<sup>07</sup> No one set of TTC devices can satisfy all conditions for a given project or incident. At the same time, defining details that would be adequate to cover all applications is not practical. Instead, Part 6 displays typical applications that depict common applications of TTC devices. The TTC selected for each situation depends on type of highway, road user conditions, duration of operation, physical constraints, and the nearness of the work space or incident management activity to road users.

<sup>08</sup> Improved road user performance might be realized through a well-prepared public relations effort that covers the nature of the work, the time and duration of its execution, the anticipated effects upon road users, and possible alternate routes and modes of travel. Such programs have been found to result in a significant reduction in the number of road users traveling through the TTC zone, which reduces the possible number of conflicts.

<sup>09</sup> Operational improvements might be realized by using intelligent transportation systems (ITS) in work zones. The use in work zones of ITS technology, such as portable camera systems, highway advisory radio, variable speed limits, ramp metering, traveler information, merge guidance, and queue detection information, is aimed at increasing safety for both workers and road users and helping to ensure a more efficient traffic flow. The use in work zones of ITS technologies has been found to be effective in providing traffic monitoring and management, data collection, and traveler information.

**Standard:**

<sup>10</sup> **TTC plans and devices shall be the responsibility of the authority of a public body or official having jurisdiction for guiding road users. There shall be adequate statutory authority for the implementation and enforcement of needed road user regulations, parking controls, speed zoning, and the management of**

**traffic incidents. Such statutes shall provide sufficient flexibility in the application of TTC to meet the needs of changing conditions in the TTC zone.**

**Support:**

<sup>11</sup> Temporary facilities, including pedestrian routes around worksites, are also covered by the accessibility requirements of the Americans with Disabilities Act of 1990 (ADA) (Public Law 101-336, 104 Stat. 327, July 26, 1990, 42 U.S.C. 12101-12213 (as amended)).

**Guidance:**

<sup>12</sup> *The TTC plan should start in the planning phase and continue through the design, construction, and restoration phases. The TTC plans and devices should follow the principles set forth in Part 6. The management of traffic incidents should follow the principles set forth in Chapter 6I.*

**Option:**

<sup>13</sup> TTC plans may deviate from the typical applications described in Chapter 6H to allow for conditions and requirements of a particular site or jurisdiction.

**Support:**

<sup>14</sup> The provisions of Part 6 apply to both rural and urban areas. A rural highway is normally characterized by lower volumes, higher speeds, fewer turning conflicts, and less conflict with pedestrians. An urban street is typically characterized by relatively low speeds, wide ranges of road user volumes, narrower roadway lanes, frequent intersections and driveways, significant pedestrian activity, and more businesses and houses.

<sup>15</sup> The determination as to whether a particular facility at a particular time of day can be considered to be a high-volume roadway or can be considered to be a low-volume roadway is made by the public agency or official having jurisdiction.

<sup>16</sup> Per the provisions of the Construction Safety Orders in the California Code of Regulations (Title 8, Division 1, Chapter 4, Subchapter 4, Article 11, Sections 1598 and 1599), this Part of the California MUTCD is incorporated by reference as part of those regulations.

<sup>17</sup> It is the responsibility of the Contractor or Organization performing work on, or adjacent to, a highway to install and maintain such devices which are necessary to provide passage for the traveling public (including pedestrians and bicyclists) through the work, as well as for the safeguard of workers.

**Standard:**

<sup>18</sup> **Before work begins, traffic control plans, when developed for handling traffic through a construction or maintenance project, shall be approved by the Engineer or the Engineer's designee of the public agency or authority having jurisdiction over the highway.**

**Option:**

<sup>19</sup> When typical applications from Chapter 6H are to be used the Engineer or the Engineer's designee of the public agency or authority having jurisdiction over the highway may approve their use before the work begins to ensure the appropriate plans are used.

**Support:**

<sup>19</sup> The following references from the California Vehicle Code (CVC) relate to TTC:

- Section 112 – Amber.
- Section 165 – Authorized Emergency Vehicle.
- Section 291 – Department of Transportation.
- Section 385 – Local Authorities.
- Section 21351.3 – Use of Metric System Designations.
- Section 21363 – Detour Signs.
- Section 21367 – Traffic Control: Highway Construction.
- Section 21466.5 – Light Impairing Driver's Vision.
- Section 22362 – Speed Limit Where Persons at Work.

## CHAPTER 6B. FUNDAMENTAL PRINCIPLES

### Section 6B.01 Fundamental Principles of Temporary Traffic Control

#### Support:

<sup>01</sup> Construction, maintenance, utility, and incident zones can all benefit from TTC to compensate for the unexpected or unusual situations faced by road users. When planning for TTC in these zones, it can be assumed that it is appropriate for road users to exercise caution. Even though road users are assumed to be using caution, special care is still needed in applying TTC techniques.

<sup>02</sup> Special plans preparation and coordination with transit, other highway agencies, law enforcement and other emergency units, utilities, schools, and railroad companies might be needed to reduce unexpected and unusual road user operation situations.

<sup>03</sup> During TTC activities, commercial vehicles might need to follow a different route from passenger vehicles because of bridge, weight, clearance, or geometric restrictions. Also, vehicles carrying hazardous materials might need to follow a different route from other vehicles. The Hazardous Materials and National Network signs are included in Sections 2B.62 and 2B.63, respectively.

<sup>04</sup> Experience has shown that following the fundamental principles of Part 6 will assist road users and help protect workers in the vicinity of TTC zones.

#### Guidance:

<sup>05</sup> *Road user and worker safety and accessibility in TTC zones should be an integral and high-priority element of every project from planning through design and construction. Similarly, maintenance and utility work should be planned and conducted with the safety and accessibility of all motorists, bicyclists, pedestrians (including those with disabilities), and workers being considered at all times. If the TTC zone includes a grade crossing, early coordination with the railroad company or light rail transit agency should take place.*

#### Support:

<sup>06</sup> Formulating specific plans for TTC at traffic incidents is difficult because of the variety of situations that can arise.

#### Guidance:

<sup>07</sup> *The following are the seven fundamental principles of TTC:*

1. *General plans or guidelines should be developed to provide safety for motorists, bicyclists, pedestrians, workers, enforcement/emergency officials, and equipment, with the following factors being considered:*
  - A. *The basic safety principles governing the design of permanent roadways and roadsides should also govern the design of TTC zones. The goal should be to route road users through such zones using roadway geometrics, roadside features, and TTC devices as nearly as possible comparable to those for normal highway situations.*
  - B. *A TTC plan, in detail appropriate to the complexity of the work project or incident, should be prepared and understood by all responsible parties before the site is occupied.*

#### Standard:

**Any changes in the TTC plan shall be approved by an official who is knowledgeable (for example, trained and/or certified) in proper TTC practices the Engineer or the Engineer's designee of the public agency or authority having jurisdiction over the highway.**

#### Guidance:

2. *Road user movement should be inhibited as little as practical, based on the following considerations:*
  - A. *TTC at work and incident sites should be designed on the assumption that drivers will only reduce their speeds if they clearly perceive a need to do so (see Section 6C.01).*
  - B. *Frequent and abrupt changes in geometrics such as lane narrowing, dropped lanes, or main roadway transitions that require rapid maneuvers, should be avoided.*
  - C. *Work should be scheduled in a manner that minimizes the need for lane closures or alternate routes, while still getting the work completed quickly and the lanes or roadway open to traffic as soon as possible.*
  - D. *Attempts should be made to reduce the volume of traffic using the roadway or freeway to match the restricted capacity conditions. Road users should be encouraged to use alternative routes. For high-*

- volume roadways and freeways, the closure of selected entrance ramps or other access points and the use of signed diversion routes should be evaluated.*
- E. Bicyclists and pedestrians, including those with disabilities, should be provided with access and reasonably safe passage through the TTC zone.*
  - F. If work operations permit, lane closures on high-volume streets and highways should be scheduled during off-peak hours. Night work should be considered if the work can be accomplished with a series of short-term operations.*
  - G. Early coordination with officials having jurisdiction over the affected cross streets and providing emergency services should occur if significant impacts to roadway operations are anticipated.*
3. *Motorists, bicyclists, and pedestrians should be guided in a clear and positive manner while approaching and traversing TTC zones and incident sites. The following principles should be applied:*
- A. Adequate warning, delineation, and channelization should be provided to assist in guiding road users in advance of and through the TTC zone or incident site by using proper pavement marking, signing, or other devices that are effective under varying conditions. Providing information that is in usable formats by pedestrians with visual disabilities should also be considered.*
  - B. TTC devices inconsistent with intended travel paths through TTC zones should be removed or covered. However, in intermediate-term stationary, short-term, and mobile operations, where visible permanent devices are inconsistent with intended travel paths, devices that highlight or emphasize the appropriate path should be used. Providing traffic control devices that are accessible to and usable by pedestrians with disabilities should be considered.*
  - C. Flagging procedures, when used, should provide positive guidance to road users traversing the TTC zone.*
4. *To provide acceptable levels of operations, routine day and night inspections of TTC elements should be performed as follows:*
- A. Individuals who are knowledgeable (for example, trained and/or certified) in the principles of proper TTC should be assigned responsibility for safety in TTC zones. The most important duty of these individuals should be to check that all TTC devices of the project are consistent with the TTC plan and are effective for motorists, bicyclists, pedestrians, and workers.*
  - B. As the work progresses, temporary traffic controls and/or working conditions should be modified, if appropriate, in order to provide mobility and positive guidance to the road user and to provide worker safety. The individual responsible for TTC should have the authority to halt work until applicable or remedial safety measures are taken.*
  - C. TTC zones should be carefully monitored under varying conditions of road user volumes, light, and weather to check that applicable TTC devices are effective, clearly visible, clean, and in compliance with the TTC plan.*
  - D. When warranted, an engineering study should be made (in cooperation with law enforcement officials) of reported crashes occurring within the TTC zone. Crash records in TTC zones should be monitored to identify the need for changes in the TTC zone.*
5. *Attention should be given to the maintenance of roadside safety during the life of the TTC zone by applying the following principles:*
- A. To accommodate run-off-the-road incidents, disabled vehicles, or emergency situations, unencumbered roadside recovery areas or clear zones should be provided where practical.*
  - B. Channelization of road users should be accomplished by the use of pavement markings, signing, and crashworthy, detectable channelizing devices.*
  - C. Work equipment, workers' private vehicles, materials, and debris should be stored in such a manner to reduce the probability of being impacted by run-off-the-road vehicles.*
6. *Each person whose actions affect TTC zone safety, from the upper-level management through the field workers, should receive training appropriate to the job decisions each individual is required to make. Only those individuals who are trained in proper TTC practices and have a basic understanding of the principles (established by applicable standards and guidelines, including those of this Manual) should supervise the selection, placement, and maintenance of TTC devices used for TTC zones and for incident management.*



7. *Good public relations should be maintained by applying the following principles:*

- A. *The needs of all road users should be assessed such that appropriate advance notice is given and clearly defined alternative paths are provided.*
- B. *The cooperation of the various news media should be sought in publicizing the existence of and reasons for TTC zones because news releases can assist in keeping the road users well informed.*
- C. *The needs of abutting property owners, residents, and businesses should be assessed and appropriate accommodations made.*
- D. *The needs of emergency service providers (law enforcement, fire, and medical) should be assessed and appropriate coordination and accommodations made.*
- E. *The needs of railroads and transit should be assessed and appropriate coordination and accommodations made.*
- F. *The needs of operators of commercial vehicles such as buses and large trucks should be assessed and appropriate accommodations made.*

Option:

- G. *Public Information - Improved road user performance may be realized through a well-prepared and complete public relations effort that covers the nature of the work, the time and duration of its execution, its anticipated effects on traffic, and possible alternate routes and modes of travel. Such programs can encourage the use of alternate routes, thus allowing consideration of temporary lane closures for additional buffer space.*

**Standard:**

- 08 Before any new detour or temporary route is opened to traffic, all necessary signs shall be in place.**
- 09 All TTC devices shall be removed as soon as practical when they are no longer needed. When work is suspended for short periods of time, TTC devices that are no longer appropriate shall be removed or covered.**
- 10 On State highways, covers for TTC signs shall be of sufficient size and density to completely block out the message so that it is not visible either during the day or at night. Covers shall be fastened securely to prevent movement caused by wind action. Refer to Caltrans' Standard Specifications Section 12-3.06. See Section 1A.11 for information regarding this publication.**

Support:

- 11 Refer to Caltrans' Highway Design Manual Section 110.7 for Traffic Control Plans. Refer to Caltrans' Transportation Management Plan Guidelines for Temporary Traffic Control Zone Transportation Management Plan. See Section 1A.11 for information regarding these publications.**



## CHAPTER 6C. TEMPORARY TRAFFIC CONTROL ELEMENTS

### Section 6C.01 Temporary Traffic Control Plans

#### Support:

01 A TTC plan describes TTC measures to be used for facilitating road users through a work zone or an incident area. TTC plans play a vital role in providing continuity of effective road user flow when a work zone, incident, or other event temporarily disrupts normal road user flow. Important auxiliary provisions that cannot conveniently be specified on project plans can easily be incorporated into Special Provisions within the TTC plan.

02 TTC plans range in scope from being very detailed to simply referencing typical drawings contained in this Manual, standard approved highway agency drawings and manuals, or specific drawings contained in the contract documents. The degree of detail in the TTC plan depends entirely on the nature and complexity of the situation.

#### Guidance:

03 *TTC plans should be prepared by persons knowledgeable (for example, trained and/or certified) about the fundamental principles of TTC and work activities to be performed. The design, selection, and placement of TTC devices for a TTC plan should be based on engineering judgment.*

04 *Coordination should be made between adjacent or overlapping projects to check that duplicate signing is not used and to check compatibility of traffic control between adjacent or overlapping projects.*

05 *Traffic control planning should be completed for all highway construction, utility work, maintenance operations, and incident management including minor maintenance and utility projects prior to occupying the TTC zone. Planning for all road users should be included in the process.*

06 *Provisions for effective continuity of accessible circulation paths for pedestrians should be incorporated into the TTC process. Where existing pedestrian routes are blocked or detoured, information should be provided about alternative routes that are usable by pedestrians with disabilities, particularly those who have visual disabilities. Access to temporary bus stops, travel across intersections with accessible pedestrian signals (see Section 4E.09), and other routing issues should be considered where temporary pedestrian routes are channelized. Barriers and channelizing devices that are detectable by people with visual disabilities should be provided.*

#### Option:

07 Provisions may be incorporated into the project bid documents that enable contractors to develop an alternate TTC plan.

08 Modifications of TTC plans may be necessary because of changed conditions or a determination of better methods of safely and efficiently handling road users.

#### Guidance:

#### Standard:

09 **This alternate or modified plan ~~should~~ shall have the approval of the Engineer or the Engineer's designee of the public agency or authority having jurisdiction over the highway responsible highway agency prior to implementation.**

#### Guidance:

10 *Provisions for effective continuity of transit service should be incorporated into the TTC planning process because often public transit buses cannot efficiently be detoured in the same manner as other vehicles (particularly for short-term maintenance projects). Where applicable, the TTC plan should provide for features such as accessible temporary bus stops, pull-outs, and satisfactory waiting areas for transit patrons, including persons with disabilities, if applicable (see Section 8A.08 for additional light rail transit issues to consider for TTC).*

11 *Provisions for effective continuity of railroad service and acceptable access to abutting property owners and businesses should also be incorporated into the TTC planning process.*

### Reduced Speed Limits in TTC Zones

#### Guidance:

12 *Reduced speed limits should be used only in the specific portion of the TTC zone where conditions or restrictive features are present. However, frequent changes in the speed limit should be avoided. A TTC plan*

*should be designed so that vehicles can travel through the TTC zone with a speed limit reduction of no more than 10 mph.*

*13 A reduction of more than 10 mph in the speed limit should be used only when required by restrictive features in the TTC zone. Where restrictive features justify a speed reduction of more than 10 mph, additional driver notification should be provided. The speed limit should be stepped down in advance of the location requiring the lowest speed, and additional TTC warning devices should be used.*

*14 Reduced speed zoning (lowering the regulatory speed limit) should be avoided as much as practical because drivers will reduce their speeds only if they clearly perceive a need to do so.*

**Standard:**

**14a The justification for the reduced regulatory speed limit shall be documented in writing. Refer to CVC 21367 and 22362.**

**Option:**

**14b Reduced speed limits in construction zones may be established by an engineering analysis, which may include a traffic and engineering survey.**

**Support:**

**15** Research has demonstrated that large reductions in the speed limit, such as a 30 mph reduction, increase speed variance and the potential for crashes. Smaller reductions in the speed limit of up to 10 mph cause smaller changes in speed variance and lessen the potential for increased crashes. A reduction in the regulatory speed limit of only up to 10 mph from the normal speed limit has been shown to be more effective.

**Support:**

**16** See Section 2B.13 for Regulatory Speed Limit signs and Speed Zones.

**17** See Section 6F.12 for WORK ZONE (G20-5aP) plaque and END WORK ZONE SPEED LIMIT (R2-12) sign.

**18** CVC section 22362 gives the agency having jurisdiction over a highway the authority to regulate the speed of traffic to provide protection for workers when at work on the roadway or within the right-of-way so close thereto as to be endangered by passing traffic.

**19** CVC Section 21367 gives the agency having jurisdiction over a highway the authority to regulate the speed of traffic whenever the traffic would endanger the safety of workers or the work would interfere with or endanger the movement of traffic through the area.

**Guidance:**

**20** *The need for a long-term reduced speed limit within a TTC zone should be a decision made during the project development process. The need for a short-term reduced speed limit within a TTC zone, such as a maintenance activity, should be determined in advance of planned maintenance activities.*

**Option:**

**21** If lowering speed limits for a short-term, such as a maintenance activity, signs lowering the speed limit by 10 mph or less may be placed in work zones that are not protected by a positive barrier and involve workers on foot or on equipment.

**Guidance:**

**22** *Reducing speed limits in TTC zones should be avoided if traffic speeds can be reduced by other means. Speed restrictions should be imposed on the public only when necessary for worker or public safety.*

**Standard:**

**23 Where traffic obstructions exist only during the hours of construction, the speed zone signs shall be covered during non-working hours.**

**Support:**

**24** CVC 22362 applies to "When Workers are Present" condition and signs need to be covered or removed when no work is in progress. As per CVC 21367, agency can "...regulate the movement of traffic...whenever the traffic would endanger the safety of workers or the work would interfere with or endanger the movement of traffic through the area." If obstructions would be present throughout the project duration the signs would not need to be covered or removed. This would also apply to situations where the construction work changes the highway configuration, curvature or elevation, making it necessary to post reduced speed limits.

**Option:**

**25** The Advisory Speed (W13-1P) plaque may be used in combination with various warning type signs to decrease speed at a particular location. See Section 6F.52

*Guidance:*

*26 To preserve the effectiveness of the W13-1P plaque, it should not be used unless the condition to which it applies is immediate and will be experienced by all motorists.*

*Guidance:*

*27 Construction zone speed limits should be reduced in sequential stages and where overall reduction of 15 mph or more is required. The first stage of the sequence should be a reduction of 10 mph and the final stage reduction should be 10 mph or 5 mph, as necessary.*

**Standard:**

**28 The reduced speed limit shall not be less than 25 mph. Refer to CVC 22362.**

**Option:**

**29 As an example, if the project falls within an established 55 mph zone, and a 40 mph speed limit is considered necessary, it may be posted only if the approaching speed limits are lowered in two stages (i.e., first to a 45 mph speed limit followed by a reduction to the desired 40 mph.)**

**Support:**

**30 Documentation for reducing speed limits in TTC zones are ordinarily issued for the entire length of the TTC zones in a project. This avoids the necessity and resulting delay of obtaining new documentation each time the speed restriction signs require relocation to fit the conditions. It is not the intention, however, that the entire length be posted for the duration of the project.**

**Standard:**

**31 Speed limit signs for reduced speed limits shall be posted only in areas where the traveling public is affected by TTC operations.**

**Standard:**

**32 Signs shall be used only during working hours and removed, or covered during non-working hours unless the movement of traffic through the TTC zone is affected during non-working hours as well. Refer to CVC 21367.**

**33 Signs shall be removed immediately following completion of the construction or change in the conditions for which they were installed. When the construction is completed or the speed restriction is no longer necessary, the formal speed zone orders shall be revoked.**

## **Section 6C.02 Temporary Traffic Control Zones**

**Support:**

**01 A TTC zone is an area of a highway where road user conditions are changed because of a work zone, an incident zone, or a planned special event through the use of TTC devices, uniformed law enforcement officers, or other authorized personnel.**

**02 A work zone is an area of a highway with construction, maintenance, or utility work activities. A work zone is typically marked by signs, channelizing devices, barriers, pavement markings, and/or work vehicles. It extends from the first warning sign or high-intensity rotating, flashing, oscillating, or strobe lights on a vehicle to the END ROAD WORK sign or the last TTC device.**

**03 An incident zone is an area of a highway where temporary traffic controls are imposed by authorized officials in response to a traffic incident (see Section 6I.01). It extends from the first warning device (such as a sign, light, or cone) to the last TTC device or to a point where road users return to the original lane alignment and are clear of the incident.**

**04 A planned special event often creates the need to establish altered traffic patterns to handle the increased traffic volumes generated by the event. The size of the TTC zone associated with a planned special event can be small, such as closing a street for a festival, or can extend throughout a municipality for larger events. The duration of the TTC zone is determined by the duration of the planned special event.**

## **Section 6C.03 Components of Temporary Traffic Control Zones**

**Support:**

**01 Most TTC zones are divided into four areas: the advance warning area, the transition area, the activity area, and the termination area. Figure 6C-1 illustrates these four areas. These four areas are described in Sections 6C.04 through 6C.07.**

### **Section 6C.04 Advance Warning Area**

**Support:**

01 The advance warning area is the section of highway where road users are informed about the upcoming work zone or incident area.

**Option:**

02 The advance warning area may vary from a single sign or high-intensity rotating, flashing, oscillating, or strobe lights on a vehicle to a series of signs in advance of the TTC zone activity area.

**Guidance:**

03 *Typical distances for placement of advance warning signs on freeways and expressways should be longer because drivers are conditioned to uninterrupted flow. Therefore, the advance warning sign placement should extend on these facilities as far as 1/2 mile or more.*

04 *On urban streets, the effective placement of the first warning sign in feet should range from 4 to 8 times the speed limit in mph, with the high end of the range being used when speeds are relatively high. When a single advance warning sign is used (in cases such as low-speed residential streets), the advance warning area can be as short as 100 feet. When two or more advance warning signs are used on higher-speed streets, such as major arterials, the advance warning area should extend a greater distance (see Table 6C-1).*

05 *Since rural highways are normally characterized by higher speeds, the effective placement of the first warning sign in feet should be substantially longer—from 8 to 12 times the speed limit in mph. Since two or more advance warning signs are normally used for these conditions, the advance warning area should extend 1,500 feet or more for open highway conditions (see Table 6C-1).*

06 *The distances contained in Table 6C-1 are approximate, are intended for guidance purposes only, and should be applied with engineering judgment. These distances should be adjusted for field conditions, if necessary, by increasing or decreasing the recommended distances.*

**Support:**

07 The need to provide additional reaction time for a condition is one example of justification for increasing the sign spacing. Conversely, decreasing the sign spacing might be justified in order to place a sign immediately downstream of an intersection or major driveway such that traffic turning onto the roadway in the direction of the TTC zone will be warned of the upcoming condition.

**Option:**

08 Advance warning may be eliminated when the activity area is ~~sufficiently removed from the road users' path~~ **behind a barrier, more than 2 feet behind the curb, or 15 feet or more from the edge of the traveled way** so that it does not interfere with the normal flow.

### **Section 6C.05 Transition Area**

**Support:**

01 The transition area is that section of highway where road users are redirected out of their normal path. Transition areas usually involve strategic use of tapers, which because of their importance are discussed separately in detail.

**Standard:**

02 **When redirection of the road users' normal path is required, they shall be directed from the normal path to a new path.**

**Option:**

03 Because it is impractical in mobile operations to redirect the road user's normal path with stationary channelization, more dominant vehicle-mounted traffic control devices, such as arrow boards, portable changeable message signs, and high-intensity rotating, flashing, oscillating, or strobe lights, may be used instead of channelizing devices to establish a transition area.

### **Section 6C.06 Activity Area**

**Support:**

01 The activity area is the section of the highway where the work activity takes place. It is comprised of the work space, the traffic space, and the buffer space.

02 The work space is that portion of the highway closed to road users and set aside for workers, equipment, and material, and a shadow vehicle if one is used upstream. Work spaces are usually delineated for road users by channelizing devices or, to exclude vehicles and pedestrians, by temporary barriers.

Option:

03 The work space may be stationary or may move as work progresses.

Guidance:

04 *Since there might be several work spaces (some even separated by several miles) within the project limits, each work space should be adequately signed to inform road users and reduce confusion.*

Support:

05 The traffic space is the portion of the highway in which road users are routed through the activity area.

06 The buffer space is a lateral and/or longitudinal area that separates road user flow from the work space or an unsafe area, and might provide some recovery space for an errant vehicle.

Guidance:

07 *Neither work activity nor storage of equipment, vehicles, or material should occur within a buffer space.*

Option:

08 Buffer spaces may be positioned either longitudinally or laterally with respect to the direction of road user flow. The activity area may contain one or more lateral or longitudinal buffer spaces.

09 A longitudinal buffer space may be placed in advance of a work space.

Guidance:

10 *The longitudinal buffer space ~~may~~ should also be used to separate opposing road user flows that use portions of the same traffic lane, as shown in Figure 6C-2.*

Option:

11 If a longitudinal buffer space is used, the values shown in Table 6C-2 and Table 6C-101(CA) may be used to determine the length of the longitudinal buffer space.

Support:

12 Typically, the buffer space is formed as a traffic island and defined by channelizing devices.

13 When a shadow vehicle, arrow board, or changeable message sign is placed in a closed lane in advance of a work space, only the area upstream of the vehicle, arrow board, or changeable message sign constitutes the buffer space.

Option:

14 The lateral buffer space may be used to separate the traffic space from the work space, as shown in Figures 6C-1 and 6C-2, or such areas as excavations or pavement edge drop-offs. A lateral buffer space also may be used between two travel lanes, especially those carrying opposing flows.

Guidance:

15 *The width of a lateral buffer space should be determined by engineering judgment.*

Option:

16 When work occurs on a high-volume, highly congested facility, a vehicle storage or staging space may be provided for incident response and emergency vehicles (for example, tow trucks and fire apparatus) so that these vehicles can respond quickly to road user incidents.

### **Section 6C.07 Termination Area**

Support:

01 The termination area is the section of the highway where road users are returned to their normal driving path. The termination area extends from the downstream end of the work area to the last TTC device such as END ROAD WORK signs, if posted.

Option:

02 An END ROAD WORK sign, a Speed Limit sign, or other signs may be used to inform road users that they can resume normal operations.

03 A longitudinal buffer space may be used between the work space and the beginning of the downstream taper.

## Section 6C.08 Tapers

### Option:

01 Tapers may be used in both the transition and termination areas. Whenever tapers are to be used in close proximity to an interchange ramp, crossroads, curves, or other influencing factors, the length of the tapers may be adjusted.

### Support:

02 Tapers are created by using a series of channelizing devices and/or pavement markings to move traffic out of or into the normal path. Types of tapers are shown in Figure 6C-2.

03 Longer tapers are not necessarily better than shorter tapers (particularly in urban areas with characteristics such as short block lengths or driveways) because extended tapers tend to encourage sluggish operation and to encourage drivers to delay lane changes unnecessarily. The test concerning adequate lengths of tapers involves observation of driver performance after TTC plans are put into effect.

### Guidance:

04 *The appropriate taper length (L) should be determined using the criteria shown in Tables 6C-3, 6C-3(CA) and 6C-4.*

05 *The maximum distance in feet between devices in a taper should not exceed 1.0 times the speed limit in mph.*

### Support:

06 A merging taper requires the longest distance because drivers are required to merge into common road space.

### Guidance:

07 *A merging taper should be long enough to enable merging drivers to have adequate advance warning and sufficient length to adjust their speeds and merge into an adjacent lane before the downstream end of the transition.*

### Support:

08 A shifting taper is used when a lateral shift is needed. When more space is available, a longer than minimum taper distance can be beneficial. Changes in alignment can also be accomplished by using horizontal curves designed for normal highway speeds.

### Guidance:

09 *A shifting taper should have a length of approximately 1/2 L (see Tables 6C-3, 6C-3(CA) and 6C-4).*

### Support:

10 A shoulder taper might be beneficial on a high-speed roadway where shoulders are part of the activity area and are closed, or when improved shoulders might be mistaken as a driving lane. In these instances, the same type, but abbreviated, closure procedures used on a normal portion of the roadway can be used.

### Guidance:

11 *If used, shoulder tapers should have a length of approximately 1/3 L (see Tables 6C-3, 6C-3(CA) and 6C-4). If a shoulder is used as a travel lane, either through practice or during a TTC activity, a normal merging or shifting taper should be used.*

### Support:

12 A downstream taper might be useful in termination areas to provide a visual cue to the driver that access is available back into the original lane or path that was closed.

### Guidance:

13 *If used, a downstream taper should have a minimum length of 50 feet and a maximum length of 100 feet with devices placed at a spacing of approximately 20 feet.*

### Support:

14 The one-lane, two-way taper is used in advance of an activity area that occupies part of a two-way roadway in such a way that a portion of the road is used alternately by traffic in each direction.

### Guidance:

15 *Traffic should be controlled by a flagger or temporary traffic control signal (if sight distance is limited), or a STOP or YIELD sign. A short taper having a minimum length of 50 feet and a maximum length of 100 feet with channelizing devices at approximately 20-foot spacing should be used to guide traffic into the one-lane section, and a downstream taper should be used to guide traffic back into their original lane.*

### Support:

16 An example of a one-lane, two-way traffic taper is shown in Figure 6C-3.



**Guidance:**

*<sup>17</sup> On State highways, Caltrans' Standard Plans for Traffic Control Systems (Standard Plans T9 through T17) should be used. See Section 1A.11 for information regarding this publication.*

### **Section 6C.09 Detours and Diversions**

**Support:**

<sup>01</sup> A detour is a temporary rerouting of road users onto an existing highway in order to avoid a TTC zone.

**Guidance:**

<sup>02</sup> Detours should be clearly signed over their entire length so that road users can easily use existing highways to return to the original highway.

**Support:**

<sup>03</sup> A diversion is a temporary rerouting of road users onto a temporary highway or alignment placed around the work area.

**Standard:**

<sup>04</sup> **The detour route shall be evaluated for height, weight, and size restrictions. Appropriate signs shall be posted along the route to advise road users of any restrictions. Refer to CVC 21363 for detour signs.**

**Option:**

<sup>05</sup> Advance signs or changeable message signs (CMS) may be necessary to give trucks an opportunity to turn around and retrace their path or select another route.

### **Section 6C.10 One-Lane, Two-Way Traffic Control**

**Standard:**

<sup>01</sup> **Except as provided in Paragraph 5, when traffic in both directions must use a single lane for a limited distance, movements from each end shall be coordinated.**

**Guidance:**

<sup>02</sup> *Provisions should be made for alternate one-way movement through the constricted section via methods such as flagger control, ~~a flag transfer~~, a pilot car, traffic control signals, or stop or yield control.*

<sup>03</sup> *Control points at each end should be chosen to permit easy passing of opposing lanes of vehicles.*

<sup>04</sup> *If traffic on the affected one-lane roadway is not visible from one end to the other, then flagging procedures, a pilot car with a flagger used as described in Section 6C.13, or a traffic control signal should be used to control opposing traffic flows.*

**Option:**

<sup>05</sup> If the work space on a low-volume street or road is short and road users from both directions are able to see the traffic approaching from the opposite direction through and beyond the worksite, the movement of traffic through a one-lane, two-way constriction may be self-regulating.

**Support:**

<sup>06</sup> See Section 5A.01 and Section 6A.01 for definition of a low-volume road where paragraph 5 is applied.

### **Section 6C.11 Flagger Method of One-Lane, Two-Way Traffic Control**

**Guidance:**

<sup>01</sup> *Except as provided in Paragraph 2, traffic should be controlled by a flagger at each end of a constricted section of roadway. One of the flaggers should be designated as the coordinator. To provide coordination of the control of the traffic, the flaggers should be able to communicate with each other orally, electronically, or with manual signals. These manual signals should not be mistaken for flagging signals.*

**Option:**

<sup>02</sup> When a one-lane, two-way TTC zone is short enough to allow a flagger to see from one end of the zone to the other, traffic may be controlled by either a single flagger or by a flagger at each end of the section.

**Guidance:**

<sup>03</sup> *When a single flagger is used, the flagger should be stationed on the shoulder opposite the constriction or work space, or in a position where good visibility and traffic control can be maintained at all times. When good visibility and traffic control cannot be maintained by one flagger station, traffic should be controlled by a flagger at each end of the section.*

### **Section 6C.12 Flag Transfer Method of One-Lane, Two-Way Traffic Control**

**Support:**

01 The driver of the last vehicle proceeding into the one-lane section is given a red flag (or other token) and instructed to deliver it to the flagger at the other end. The opposite flagger, upon receipt of the flag, then knows that traffic can be permitted to move in the other direction. A variation of this method is to replace the use of a flag with an official pilot car that follows the last road user vehicle proceeding through the section.

**Guidance:**

02 *The flag transfer method should be employed only where the one-way traffic is confined to a relatively short length of a road, usually no more than 1 mile in length.*

**Standard:**

01 **This section is deleted for application and shall not be used in California. See section 6C.10, 6C.11, 6C.13, 6C.14, and 6C.15 for other methods of one-lane, two-way traffic control that are to be used in California.**

### **Section 6C.13 Pilot Car Method of One-Lane, Two-Way Traffic Control**

**Option:**

01 A pilot car may be used to guide a queue of vehicles through the TTC zone or detour.

**Guidance:**

02 *The pilot car should have the name of the contractor or contracting authority prominently displayed.*

**Standard:**

03 **The PILOT CAR FOLLOW ME (G20-4) sign or PILOT CAR DO NOT PASS (R115(CA)) sign (see Section 6F.58) shall be mounted on the rear of the pilot vehicle.**

04 **A flagger shall be stationed on the approach to the activity area to control vehicular traffic until the pilot vehicle is available.**

**Option:**

05 **Two or more pilot cars may be used to guide two-way traffic through a particularly complex detour or TTC zone.**

### **Section 6C.14 Temporary Traffic Control Signal Method of One-Lane, Two-Way Traffic Control**

**Option:**

01 Traffic control signals may be used to control vehicular traffic movements in one-lane, two-way TTC zones (see Figure 6H-12 and Chapter 4H).

### **Section 6C.15 Stop or Yield Control Method of One-Lane, Two-Way Traffic Control**

**Option:**

01 STOP or YIELD signs may be used to control traffic on low-volume roads at a one-lane, two-way TTC zone when drivers are able to see the other end of the one-lane, two-way operation and have sufficient visibility of approaching vehicles.

**Guidance:**

02 *If the STOP or YIELD sign is installed for only one direction, then the STOP or YIELD sign should face road users who are driving on the side of the roadway that is closed for the work activity area.*

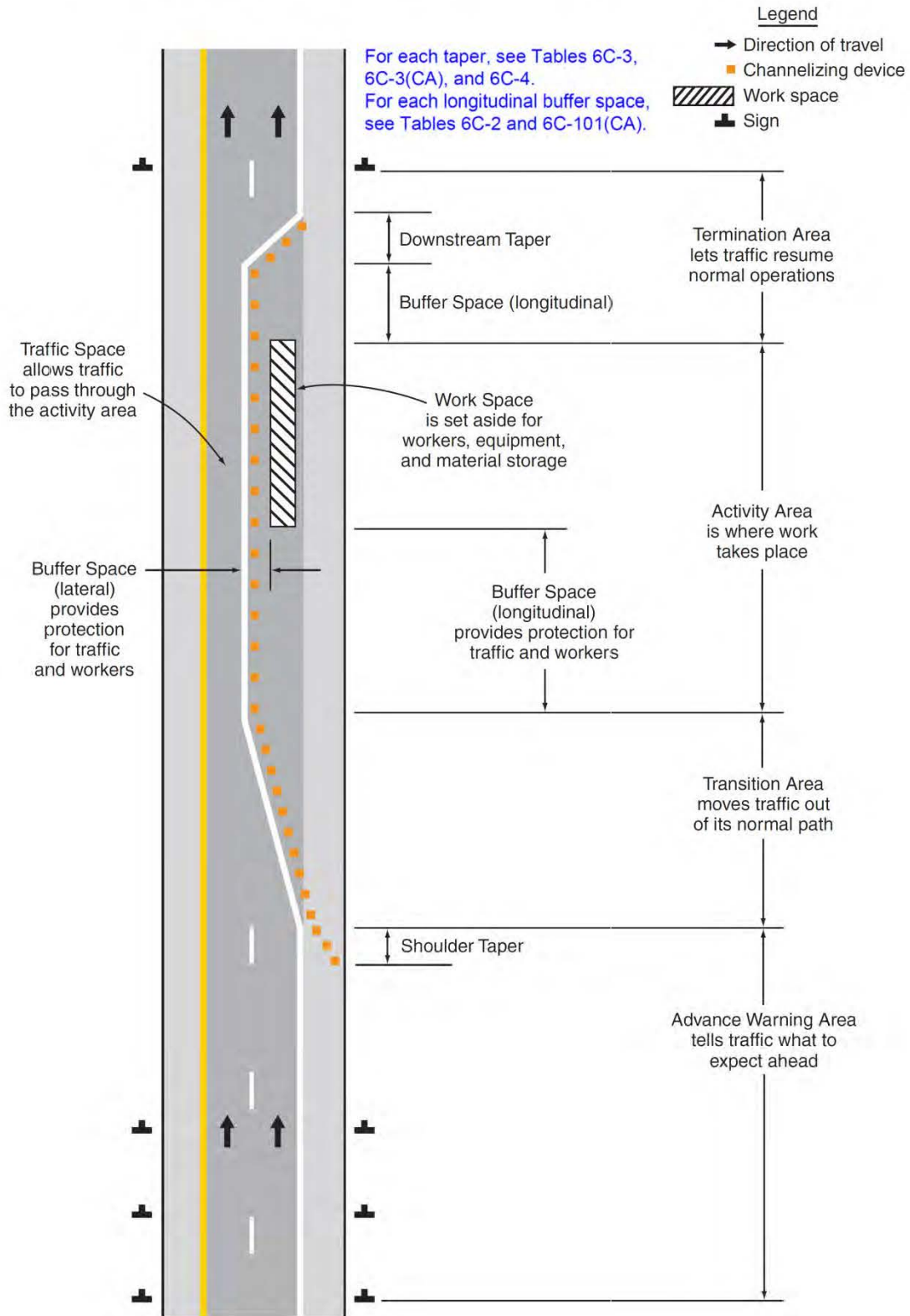
**Standard:**

03 **The approach to the side that is not closed shall be visible (for a distance equal to the safe passing sight distance for that approach) to the driver who must yield or stop.**

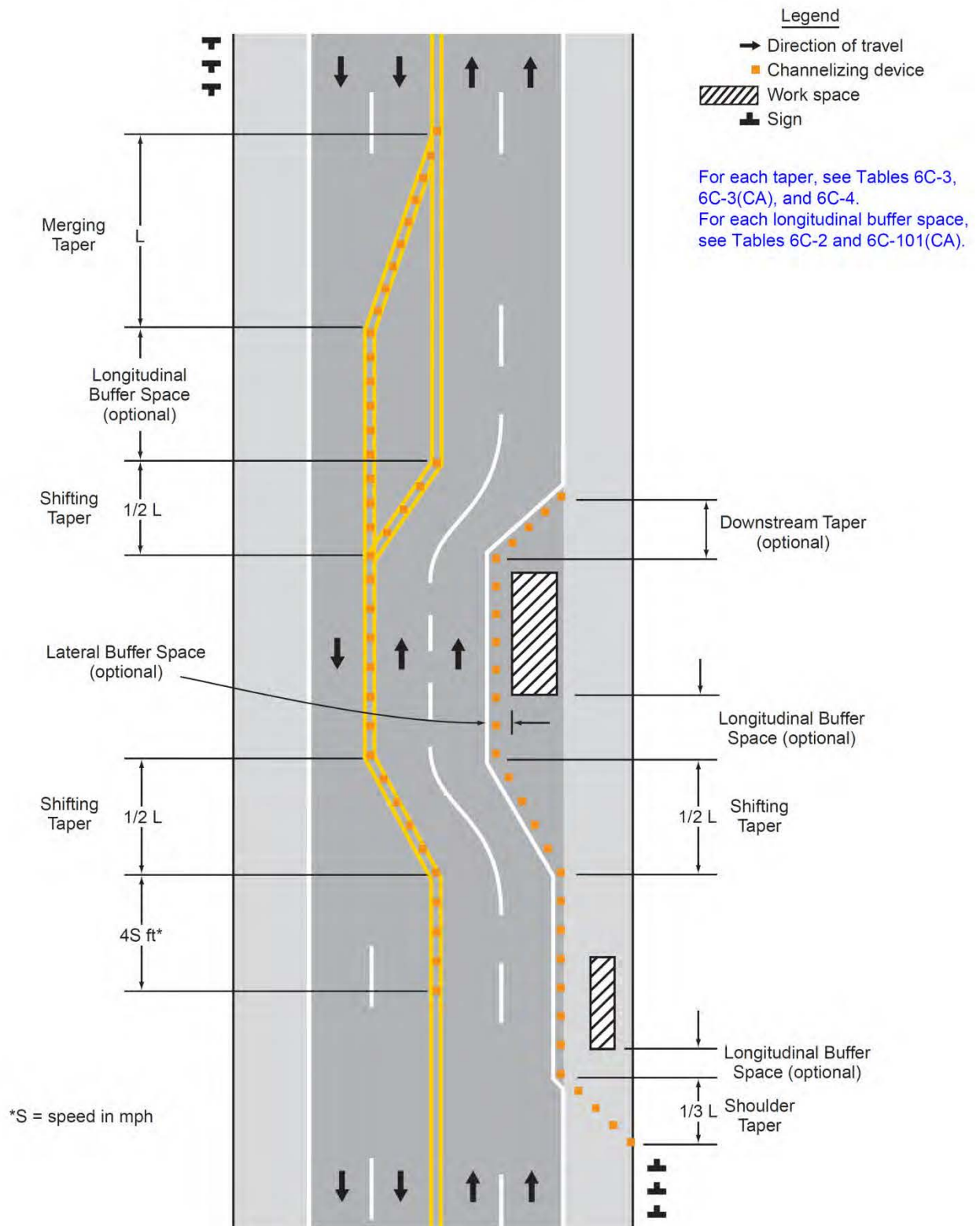
**Support:**

04 See Section 3B.02 and Figure 6H-11.

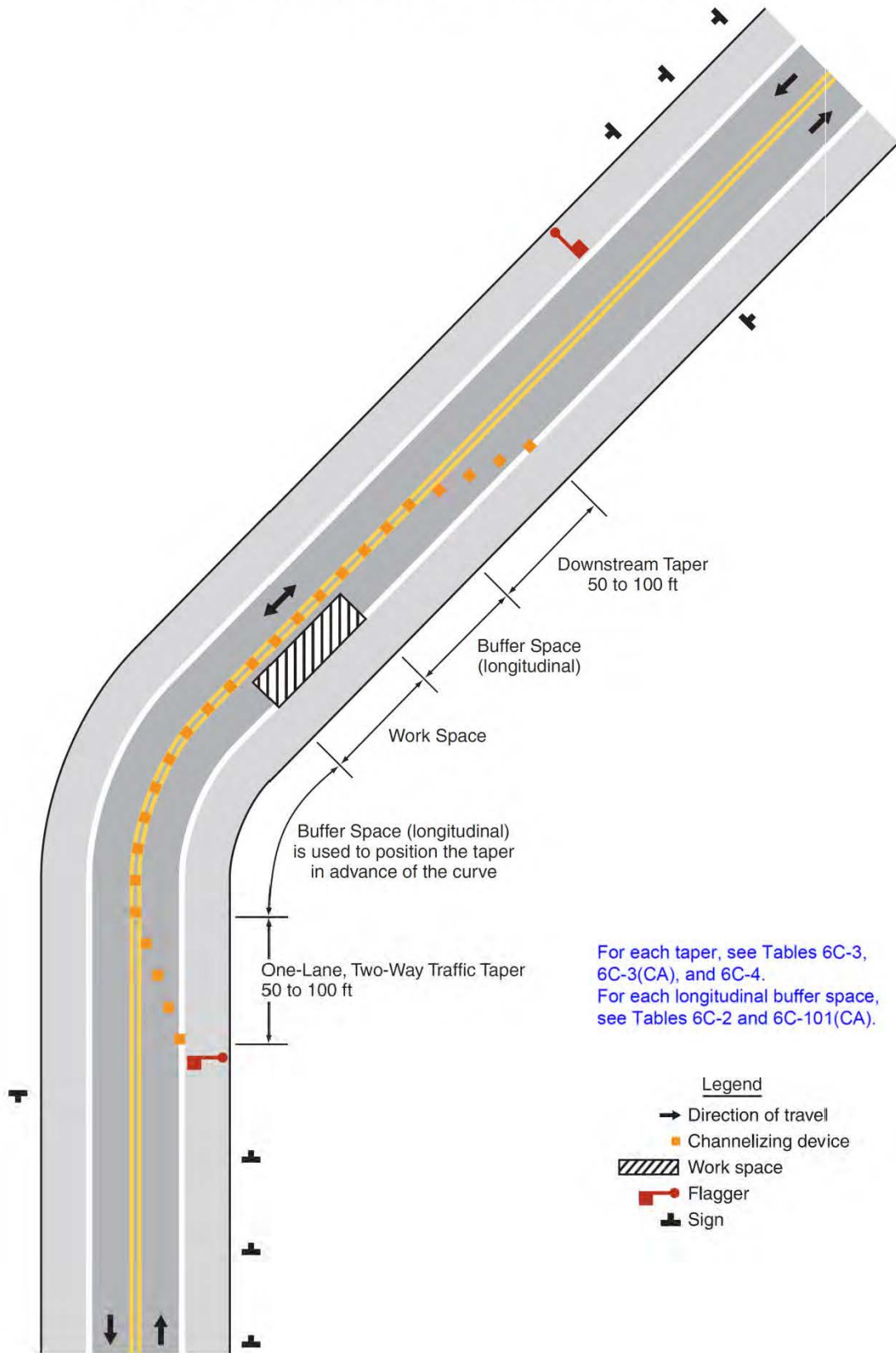
**Figure 6C-1. Component Parts of a Temporary Traffic Control Zone**



**Figure 6C-2. Types of Tapers and Buffer Spaces**



**Figure 6C-3. Example of a One-Lane, Two-Way Traffic Taper**



**Table 6C-1. Recommended Advance Warning Sign ~~Minimum~~ Spacing**

| Road Type   | Distance Between Signs** |            |            |
|---|--------------------------|------------|------------|
|   | A                        | B          | C          |
| Urban ( <del>low speed</del> ) - 25 mph or less***    | 100 feet                 | 100 feet   | 100 feet   |
| Urban - more than 25 mph to 40 mph***                 | 250 feet                 | 250 feet   | 250 feet   |
| Urban ( <del>high speed</del> ) - more than 40 mph*** | 350 feet                 | 350 feet   | 350 feet   |
| Rural   | 500 feet                 | 500 feet   | 500 feet   |
| Expressway / Freeway                                  | 1,000 feet               | 1,500 feet | 2,640 feet |

- \* ~~Speed category to be determined by the highway agency.~~
- \*\* The column headings A, B, and C are the dimensions shown in Figures 6H-1 through 6H-46. The A dimension is the distance from the transition or point of restriction to the first sign. The B dimension is the distance between the first and second signs. The C dimension is the distance between the second and third signs. (The "first sign" is the sign in a three-sign series that is closest to the TTC zone. The "third sign" is the sign that is furthest upstream from the TTC zone.)
- \*\*\* Posted speed limit, off-peak 85th-percentile speed prior to work starting, or other anticipated operating speed in mph.

**Table 6C-2. Stopping Sight Distance as a Function of Speed on Level Roads.  
 (Used as suggested longitudinal buffer space length or location for flagger station)**

| Speed* | Distance |
|--------|----------|
| 20 mph | 115 feet |
| 25 mph | 155 feet |
| 30 mph | 200 feet |
| 35 mph | 250 feet |
| 40 mph | 305 feet |
| 45 mph | 360 feet |
| 50 mph | 425 feet |
| 55 mph | 495 feet |
| 60 mph | 570 feet |
| 65 mph | 645 feet |
| 70 mph | 730 feet |
| 75 mph | 820 feet |

\* Posted speed, off-peak 85th-percentile speed prior to work starting, or the anticipated operating speed in mph.

**Table 6C-3. Taper Length Criteria for Temporary Traffic Control Zones**

| Type of Taper                   | Taper Length                      |
|---------------------------------|-----------------------------------|
| Merging Taper                   | at least L                        |
| Shifting Taper                  | at least 0.5 L                    |
| Shoulder Taper                  | at least 0.33 L                   |
| One-Lane, Two-Way Traffic Taper | 50 feet minimum, 100 feet maximum |
| Downstream Taper                | 50 feet minimum, 100 feet maximum |

Note: Use Table 6C-4 to calculate L

**Table 6C-3(CA). Taper Length Criteria for Temporary Traffic Control Zones  
 (for 12 feet Offset Width)**

| Speed*<br>S<br>(mph) | Minimum Taper Length**<br>for Width of Offset 12 feet (W) |                           |                           |                             |
|----------------------|---|---------------------------|---------------------------|-----------------------------|
|                      | Merging<br>L<br>(feet)                                    | Shifting<br>L/2<br>(feet) | Shoulder<br>L/3<br>(feet) | Down<br>Stream<br>(feet)*** |
| 20                   | 80  | 40                        | 27                        | 50                          |
| 25                   | 125   | 63                        | 42                        | 50                          |
| 30                   | 180   | 90                        | 60                        | 50                          |
| 35                   | 245   | 123                       | 82                        | 50                          |
| 40                   | 320   | 160                       | 107                       | 50                          |
| 45                   | 540   | 270                       | 180                       | 50                          |
| 50                   | 600   | 300                       | 200                       | 50                          |
| 55                   | 660   | 330                       | 220                       | 50                          |
| 60                   | 720   | 360                       | 240                       | 50                          |
| 65                   | 780   | 390                       | 260                       | 50                          |
| 70                   | 840   | 420                       | 280                       | 50                          |
| 75                   | 900   | 450                       | 300                       | 50                          |

\* - Posted speed limit, off-peak 85<sup>th</sup>-percentile speed prior to work starting, or the anticipated operating speed in mph.

\*\* - For other offsets use the following merging taper length formula for L:

For speeds of 40 mph or less,  $L = WS^2/60$

For speeds of 45 mph or more,  $L = WS$

Where: L = taper length in feet  
 W = width of offset in feet  
 S = posted speed limit, off-peak 85<sup>th</sup>-percentile speed prior to work starting, or the anticipated operating speed in mph

\*\*\* - Maximum downstream taper length is 100 feet. See Section 6C.08.

**Table 6C-4. Formulas for Determining  
 Taper Length**

| Speed (S)      | Taper Length (L) in feet |
|----------------|--------------------------|
| 40 mph or less | $L = \frac{WS^2}{60}$    |
| 45 mph or more | $L = WS$                 |

Where: L = taper length in feet  
 W = width of offset in feet  
 S = posted speed limit, or off-peak 85<sup>th</sup>-percentile speed prior to work starting, or the anticipated operating speed in mph

**Table 6C-101(CA). Stopping Sight Distance as a Function of Speed on Downgrades.  
 (Used as suggested longitudinal buffer space length or location for flagger station)**

| Speed<br>(mph) | % Downgrade (Buffer Space) |               |               |
|----------------|----------------------------|---------------|---------------|
|                | -3%<br>(feet)              | -6%<br>(feet) | -9%<br>(feet) |
| 20             | 116                        | 120           | 126           |
| 25             | 158                        | 165           | 173           |
| 30             | 205                        | 215           | 227           |
| 35             | 257                        | 271           | 287           |
| 40             | 315                        | 333           | 354           |
| 45             | 378                        | 400           | 427           |
| 50             | 446                        | 474           | 507           |
| 55             | 520                        | 553           | 593           |
| 60             | 598                        | 638           | 686           |
| 65             | 682                        | 728           | 785           |
| 70             | 771                        | 825           | 891           |
| 75             | 866                        | 927           | 1003          |

\* Exhibit 3-2. A Policy on Geometric Design of Highways and Streets, AASHTO, 2001, p.115.



## CHAPTER 6D. PEDESTRIAN AND WORKER SAFETY

### Section 6D.01 Pedestrian Considerations

#### Support:

01 A wide range of pedestrians might be affected by TTC zones, including the young, elderly, and people with disabilities such as hearing, visual, or mobility. These pedestrians need a clearly delineated and usable travel path. Considerations for pedestrians with disabilities are addressed in Section 6D.02.

#### Standard:

02 **The various TTC provisions for pedestrian and worker safety set forth in Part 6 shall be applied by knowledgeable (for example, trained and/or certified) persons after appropriate evaluation and engineering judgment.**

03 **Advance notification of sidewalk closures shall be provided by the maintaining agency.**

04 **If the TTC zone affects the movement of pedestrians, adequate pedestrian access and walkways shall be provided. If the TTC zone affects an accessible and detectable pedestrian facility, the accessibility and detectability shall be maintained along the alternate pedestrian route.**

#### Option:

05 If establishing or maintaining an alternate pedestrian route is not feasible during the project, an alternate means of providing for pedestrians may be used, such as adding free bus service around the project or assigning someone the responsibility to assist pedestrians with disabilities through the project limits.

#### Support:

06 It must be recognized that pedestrians are reluctant to retrace their steps to a prior intersection for a crossing or to add distance or out-of-the-way travel to a destination.

#### Guidance:

07 *The following three items should be considered when planning for pedestrians in TTC zones:*

*A. Pedestrians should not be led into conflicts with vehicles, equipment, and operations.*

*B. Pedestrians should not be led into conflicts with vehicles moving through or around the worksite.*

*C. Pedestrians should be provided with a convenient and accessible path that replicates as nearly as practical the most desirable characteristics of the existing sidewalk(s) or footpath(s).*

08 *A pedestrian route should not be severed and/or moved for non-construction activities such as parking for vehicles and equipment.*

09 *Consideration should be made to separate pedestrian movements from both worksite activity and vehicular traffic. Unless an acceptable route that does not involve crossing the roadway can be provided, pedestrians should be appropriately directed with advance signing that encourages them to cross to the opposite side of the roadway. In urban and suburban areas with high vehicular traffic volumes, these signs should be placed at intersections (rather than midblock locations) so that pedestrians are not confronted with midblock worksites that will induce them to attempt skirting the worksite or making a midblock crossing.*

#### Support:

10 Figures 6H-28 and 6H-29 show typical TTC device usage and techniques for pedestrian movement through work zones.

#### Guidance:

11 *To accommodate the needs of pedestrians, including those with disabilities, the following considerations should be addressed when temporary pedestrian pathways in TTC zones are designed or modified:*

*A. Provisions for continuity of accessible paths for pedestrians should be incorporated into the TTC plan.*

*B. Access to transit stops should be maintained.*

*C. A smooth, continuous hard surface should be provided throughout the entire length of the temporary pedestrian facility. There should be no curbs or abrupt changes in grade or terrain that could cause tripping or be a barrier to wheelchair use. The geometry and alignment of the facility should meet the applicable requirements of the "Americans with Disabilities Act Accessibility Guidelines for Buildings and Facilities (ADAAG)" (see Section 1A.11).*

*D. The width of the existing pedestrian facility should be provided for the temporary facility if practical. Traffic control devices and other construction materials and features should not intrude into the usable width of the*

*sidewalk, temporary pathway, or other pedestrian facility. When it is not possible to maintain a minimum width of 60 inches throughout the entire length of the pedestrian pathway, a 60 x 60-inch passing space should be provided at least every 200 feet to allow individuals in wheelchairs to pass.*

*E. Blocked routes, alternate crossings, and sign and signal information should be communicated to pedestrians with visual disabilities by providing devices such as audible information devices, accessible pedestrian signals, or barriers and channelizing devices that are detectable to the pedestrians traveling with the aid of a long cane or who have low vision. Where pedestrian traffic is detoured to a TTC signal, engineering judgment should be used to determine if pedestrian signals or accessible pedestrian signals should be considered for crossings along an alternate route.*

*F. When channelization is used to delineate a pedestrian pathway, a continuous detectable edging should be provided throughout the length of the facility such that pedestrians using a long cane can follow it. These detectable edgings should comply with the provisions of Section 6F.74.*

*G. Signs and other devices mounted lower than 7 feet above the temporary pedestrian pathway should not project more than 4 inches into accessible pedestrian facilities.*

**Option:**

<sup>12</sup> Whenever it is feasible, closing off the worksite from pedestrian intrusion may be preferable to channelizing pedestrian traffic along the site with TTC devices.

**Guidance:**

<sup>13</sup> *Fencing should not create sight distance restrictions for road users. Fences should not be constructed of materials that would be hazardous if impacted by vehicles. Wooden railing, fencing, and similar systems placed immediately adjacent to motor vehicle traffic should not be used as substitutes for crashworthy temporary traffic barriers.*

<sup>14</sup> *Ballast for TTC devices should be kept to the minimum amount needed and should be mounted low to prevent penetration of the vehicle windshield.*

<sup>15</sup> *Movement by work vehicles and equipment across designated pedestrian paths should be minimized and, when necessary, should be controlled by flaggers or TTC. Staging or stopping of work vehicles or equipment along the side of pedestrian paths should be avoided, since it encourages movement of workers, equipment, and materials across the pedestrian path.*

<sup>16</sup> *Access to the work space by workers and equipment across pedestrian walkways should be minimized because the access often creates unacceptable changes in grade, and rough or muddy terrain, and pedestrians will tend to avoid these areas by attempting non-intersection crossings where no curb ramps are available.*

**Option:**

<sup>17</sup> A canopied walkway may be used to protect pedestrians from falling debris, and to provide a covered passage for pedestrians.

**Guidance:**

<sup>18</sup> *Covered walkways should be sturdily constructed and adequately lighted for nighttime use.*

<sup>19</sup> *When pedestrian and vehicle paths are rerouted to a closer proximity to each other, consideration should be given to separating them by a temporary traffic barrier.*

<sup>20</sup> *If a temporary traffic barrier is used to shield pedestrians, it should be designed to accommodate site conditions.*

**Support:**

<sup>21</sup> Depending on the possible vehicular speed and angle of impact, temporary traffic barriers might deflect upon impact by an errant vehicle. Guidance for locating and designing temporary traffic barriers can be found in Chapter 9 of AASHTO's "Roadside Design Guide" (see Section 1A.11).

**Standard:**

<sup>22</sup> **Short intermittent segments of temporary traffic barrier shall not be used because they nullify the containment and redirective capabilities of the temporary traffic barrier, increase the potential for serious injury both to vehicle occupants and pedestrians, and encourage the presence of blunt, leading ends. All upstream leading ends that are present shall be appropriately flared or protected with properly installed and maintained crashworthy cushions. Adjacent temporary traffic barrier segments shall be properly connected in order to provide the overall strength required for the temporary traffic barrier to perform properly.**

**23 Normal vertical curbing shall not be used as a substitute for temporary traffic barriers when temporary traffic barriers are needed.**

**Option:**

24 Temporary traffic barriers or longitudinal channelizing devices may be used to discourage pedestrians from unauthorized movements into the work space. They may also be used to inhibit conflicts with vehicular traffic by minimizing the possibility of midblock crossings.

**Support:**

25 A major concern for pedestrians is urban and suburban building construction encroaching onto the contiguous sidewalks, which forces pedestrians off the curb into direct conflict with moving vehicles.

**Guidance:**

26 *If a significant potential exists for vehicle incursions into the pedestrian path, pedestrians should be rerouted or temporary traffic barriers should be installed.*

**Support:**

27 TTC devices, jersey barriers, and wood or chain link fencing with a continuous detectable edging can satisfactorily delineate a pedestrian path.

**Guidance:**

28 *Tape, rope, or plastic chain strung between devices are not detectable, do not comply with the design standards in the "Americans with Disabilities Act Accessibility Guidelines for Buildings and Facilities (ADAAG)" (see Section 1A.11), and should not be used as a control for pedestrian movements.*

29 *In general, pedestrian routes should be preserved in urban and commercial suburban areas. Alternative routing should be discouraged.*

30 *The highway agency in charge of the TTC zone should regularly inspect the activity area so that effective pedestrian TTC is maintained.*

**Support:**

31 *Other laws and requirements are unique to California and need to be followed when providing pedestrian access through or around TTC zones.*

32 *Additional information on this topic can be found in publication titled "Pedestrian Considerations for California Temporary Traffic Control Zones on Caltrans' following web link:*

<http://dot.ca.gov/hq/traffops/engineering/control-devices/pdf/PedBrochure.pdf>

## **Section 6D.02 Accessibility Considerations**

**Support:**

01 Additional information on the design and construction of accessible temporary facilities is found in publications listed in Section 1A.11 (see Publications 12, 38, 39, and 42).

**Guidance:**

02 *The extent of pedestrian needs should be determined through engineering judgment or by the individual responsible for each TTC zone situation. Adequate provisions should be made for pedestrians with disabilities.*

**Standard:**

03 **When existing pedestrian facilities are disrupted, closed, or relocated in a TTC zone, the temporary facilities shall be detectable and include accessibility features consistent with the features present in the existing pedestrian facility. Where pedestrians with visual disabilities normally use the closed sidewalk, a barrier that is detectable by a person with a visual disability traveling with the aid of a long cane shall be placed across the full width of the closed sidewalk.**

**Support:**

04 Maintaining a detectable, channelized pedestrian route is much more useful to pedestrians who have visual disabilities than closing a walkway and providing audible directions to an alternate route involving additional crossings and a return to the original route. Braille is not useful in conveying such information because it is difficult to find. Audible instructions might be provided, but the extra distance and additional street crossings might add complexity to a trip.

**Guidance:**

05 *Because printed signs and surface delineation are not usable by pedestrians with visual disabilities, blocked routes, alternate crossings, and sign and signal information should be communicated to pedestrians with visual*

*disabilities by providing audible information devices, accessible pedestrian signals, and barriers and channelizing devices that are detectable to pedestrians traveling with the aid of a long cane or who have low vision.*

Support:

<sup>06</sup> The most desirable way to provide information to pedestrians with visual disabilities that is equivalent to visual signing for notification of sidewalk closures is a speech message provided by an audible information device. Devices that provide speech messages in response to passive pedestrian actuation are the most desirable. Other devices that continuously emit a message, or that emit a message in response to use of a pushbutton, are also acceptable. signing information can also be transmitted to personal receivers, but currently such receivers are not likely to be carried or used by pedestrians with visual disabilities in TTC zones. Audible information devices might not be needed if detectable channelizing devices make an alternate route of travel evident to pedestrians with visual disabilities.

Guidance:

<sup>07</sup> *If a pushbutton is used to provide equivalent TTC information to pedestrians with visual disabilities, the pushbutton should be equipped with a locator tone to notify pedestrians with visual disabilities that a special accommodation is available, and to help them locate the pushbutton.*

### **Section 6D.03 Worker Safety Considerations**

Support:

<sup>01</sup> Equally as important as the safety of road users traveling through the TTC zone is the safety of workers. TTC zones present temporary and constantly changing conditions that are unexpected by the road user. This creates an even higher degree of vulnerability for workers on or near the roadway.

<sup>02</sup> Maintaining TTC zones with road user flow inhibited as little as possible, and using TTC devices that get the road user's attention and provide positive direction are of particular importance. Likewise, equipment and vehicles moving within the activity area create a risk to workers on foot. When possible, the separation of moving equipment and construction vehicles from workers on foot provides the operator of these vehicles with a greater separation clearance and improved sight lines to minimize exposure to the hazards of moving vehicles and equipment.

Guidance:

<sup>03</sup> *The following are the key elements of worker safety and TTC management that should be considered to improve worker safety:*

- A. Training—all workers should be trained on how to work next to motor vehicle traffic in a way that minimizes their vulnerability. Workers having specific TTC responsibilities should be trained in TTC techniques, device usage, and placement.*
- B. Temporary Traffic Barriers—temporary traffic barriers should be placed along the work space depending on factors such as lateral clearance of workers from adjacent traffic, speed of traffic, duration and type of operations, time of day, and volume of traffic.*
- C. Speed Reduction—reducing the speed of vehicular traffic, mainly through regulatory speed zoning, funneling, lane reduction, or the use of uniformed law enforcement officers or flaggers, should be considered. The use of regulatory speed zone signing tends to be more effective when law enforcement is present. Refer to Section 6C.01.*
- D. Activity Area—planning the internal work activity area to minimize backing-up maneuvers of construction vehicles should be considered to minimize the exposure to risk.*
- E. Worker Safety Planning—a trained person designated by the employer should conduct a basic hazard assessment for the worksite and job classifications required in the activity area. This safety professional should determine whether engineering, administrative, or personal protection measures should be implemented. This plan should be in accordance with the Occupational Safety and Health Act of 1970, as amended, “General Duty Clause” Section 5(a)(1) - Public Law 91-596, 84 Stat. 1590, December 29, 1970, as amended, and with the requirement to assess worker risk exposures for each job site and job classification, as per 29 CFR 1926.20 (b)(2) of “Occupational Safety and Health Administration Regulations, General Safety and Health Provisions” (see Section 1A.11).*

**Standard:**

**04 All workers, including emergency responders, within the right-of-way who are exposed either to traffic (vehicles using the highway for purposes of travel) or to work vehicles and construction equipment within the TTC zone shall wear high-visibility safety apparel that meets the Performance Class 2 or 3 requirements of the ANSI/ISEA 107–2004 publication entitled “American National Standard for High-Visibility Safety Apparel and Headwear” (see Section 1A.11), or equivalent revisions, and labeled as meeting the ANSI 107-2004, or equivalent revisions, standard performance for Class 2 or 3 risk exposure, except as provided in Paragraph 5. A person designated by the employer to be responsible for worker safety shall make the selection of the appropriate class of garment.**

**04a Refer to Construction Safety Order in the California Code of Regulations (Title 8, Division 1, Chapter 4, Subchapter 4, Article 11, Section 1598 and 1599). See Section 1A.11 for information regarding this publication.**

**Option:**

**05 Emergency and incident responders and law enforcement personnel within the TTC zone may wear high-visibility safety apparel that meets the performance requirements of the ANSI/ISEA 207-2006 publication entitled “American National Standard for High-Visibility Public Safety Vests” (see Section 1A.11), or equivalent revisions, and labeled as ANSI 207-2006, or equivalent revisions, in lieu of ANSI/ISEA 107-2004 apparel.**

**Standard:**

**06 When uniformed law enforcement personnel are used to direct traffic, to investigate crashes, or to handle lane closures, obstructed roadways, and disasters, high-visibility safety apparel as described in this Section shall be worn by the law enforcement personnel.**

**07 Except as provided in Paragraph 8, firefighters or other emergency responders working within the right-of-way shall wear high-visibility safety apparel as described in this Section.**

**Option:**

**08 Firefighters or other emergency responders working within the right-of-way and engaged in emergency operations that directly expose them to flame, fire, heat, and/or hazardous materials may wear retroreflective turnout gear that is specified and regulated by other organizations, such as the National Fire Protection Association.**

**09 The following are additional elements of TTC management that may be considered to improve worker safety:**

- A. Shadow Vehicle**—in the case of mobile and constantly moving operations, such as pothole patching and striping operations, a shadow vehicle, equipped with appropriate lights and warning signs, may be used to protect the workers from impacts by errant vehicles. The shadow vehicle may be equipped with a rear-mounted impact attenuator.
- B. Road Closure**—if alternate routes are available to handle road users, the road may be closed temporarily. This may also facilitate project completion and thus further reduce worker vulnerability.
- C. Law Enforcement Use**—in highly vulnerable work situations, particularly those of relatively short duration, law enforcement units may be stationed to heighten the awareness of passing vehicular traffic and to improve safety through the TTC zone.
- D. Lighting**—for nighttime work, the TTC zone and approaches may be lighted.

**Guidance:**

*Care should be taken to ensure that the lighting used for nighttime work does not cause blinding. Refer to CVC 21466.5 for light impairing driver's vision.*

**Support:**

For construction lighting Refer to Construction Safety Order in the California Code of Regulations (Title 8, Division 1, Chapter 4, Subchapter 4, Article 3, Section 1523 - Illumination). See Section 1A.11 for information regarding this publication.

**Option:**

- E. Special Devices**—these include rumble strips, changeable message signs, hazard identification beacons, flags, and warning lights. Intrusion warning devices may be used to alert workers to the approach of errant vehicles.

**Support:**

- F. Public Information** – Well informed public plays an important role in worker safety. See Section 6B.01 for details.

**Support:**

<sup>10</sup> Judicious use of the special devices described in Item E in Paragraph 9 might be helpful for certain difficult TTC situations, but misuse or overuse of special devices or techniques might lessen their effectiveness.

**Section 6D.101(CA) Bicycle Considerations**

**Support:**

<sup>01</sup> There are several considerations in planning for bicyclists in TTC zones on highways and streets:

- A. A travel route that replicates the most desirable characteristics of a wide paved shoulder or bikeway through or around the TTC zone is desirable for bicyclists.
- B. If the TTC zone interrupts the continuity of an existing bikeway system, signs directing bicyclists through or around the zone and back to the bikeway is desirable.
- C. Unless a separate bike path through or around the TTC zone is provided, adequate roadway lane width to allow bicyclists and motor vehicles to travel side by side through or around the TTC zone is desirable.

**Guidance:**

- D. *When the roadway width is inadequate for allowing bicyclists and motor vehicles to travel side by side, warning signs should be used to advise motorists of the presence of bicyclists in the travel way lanes. See Section 6G.05 for more details.*

**Standard:**

- E. **Bicyclists shall not be led into direct conflicts with mainline traffic, work site vehicles, or equipment moving through or around the TTC zone.**

**Support:**

<sup>02</sup> Figures 6H-15, 6H-30, 6H-32(CA), 6H-36(CA), 6H-101(CA), 6H-102(CA), 6H-103(CA), and 6H-104(CA) show typical TTC device usage and techniques for bicycle movement through TTC zones.

## CHAPTER 6E. FLAGGER CONTROL

### Section 6E.01 Qualifications for Flaggers

*Guidance:*

*01 Because flaggers are responsible for public safety and make the greatest number of contacts with the public of all highway workers, they should be trained in safe traffic control practices and public contact techniques.*

*Flaggers should be able to satisfactorily demonstrate the following abilities:*

- A. Ability to receive and communicate specific instructions clearly, firmly, and courteously;*
- B. Ability to move and maneuver quickly in order to avoid danger from errant vehicles;*
- C. Ability to control signaling devices (such as paddles and flags) in order to provide clear and positive guidance to drivers approaching a TTC zone in frequently changing situations;*
- D. Ability to understand and apply safe traffic control practices, sometimes in stressful or emergency situations; and*
- E. Ability to recognize dangerous traffic situations and warn workers in sufficient time to avoid injury.*

**Standard:**

**02 Flaggers shall be trained in the proper fundamentals of flagging moving traffic before being assigned as flaggers. Signaling directions used by flaggers shall conform to Figure 6E-3. The training and instructions shall be based on this Manual and work site conditions and also include the following:**

- (1) flagger equipment which must be used,**
- (2) layout of the work zone and flagging station,**
- (3) methods to signal traffic to stop, proceed or slow down,**
- (4) methods of one-way traffic control,**
- (5) trainee demonstration of proper flagging methodology and operations,**
- (6) emergency vehicles traveling through the work zone,**
- (7) handling emergency situations,**
- (8) methods of dealing with hostile drivers,**
- (9) flagging procedures when a single flagger is used (when applicable),**

**03 Documentation of the training shall be maintained as required by Injury Illness and Prevention Program of the General Industry Safety Order in the California Code of Regulations (Title 8, Division 1, Chapter 4, Subchapter 7, Section 3203).**

**04 Flaggers shall be trained by persons with the qualifications and experience necessary to effectively instruct the employee in the proper fundamentals of flagging moving traffic.**

**Support:**

**05 Refer to Construction Safety Order in the California Code of Regulations (Title 8, Division 1, Chapter 4, Subchapter 4, Article 11, Section 1599 - Flaggers) for flagger training. See Section 1A.11 for information regarding this publication.**

### Section 6E.02 High-Visibility Safety Apparel

**Standard:**

**01 For daytime and nighttime activity, flaggers shall wear high-visibility safety apparel that meets the Performance Class 2 or 3 requirements of the ANSI/ISEA 107–2004 publication entitled “American National Standard for High-Visibility Apparel and Headwear” (see Section 1A.11), or equivalent revisions, and labeled as meeting the ANSI 107-2004, or equivalent revisions, standard performance for Class 2 or 3 risk exposure. The apparel background (outer) material color shall be fluorescent orange-red, fluorescent yellow-green, or a combination of the two as defined in the ANSI standard. The retroreflective material shall be orange, yellow, white, silver, yellow-green, or a fluorescent version of these colors, and shall be visible at a minimum distance of 1,000 feet. The retroreflective safety apparel shall be designed to clearly identify the wearer as a person.**

*Guidance:*

*02 For nighttime activity, high-visibility safety apparel that meets the Performance Class 3 requirements of the ANSI/ISEA 107–2004 publication entitled “American National Standard for High-Visibility Apparel and*

Headwear" (see Section 1A.11), *or equivalent revisions*, and labeled as meeting the ANSI 107-2004, *or equivalent revisions*, standard performance for Class 3 risk exposure should be considered for flagger wear.

**Standard:**

**03 When uniformed law enforcement officers are used to direct traffic within a TTC zone, they shall wear high-visibility safety apparel as described in this Section.**

**Option:**

**04** In lieu of ANSI/ISEA 107-2004, *or equivalent revisions* apparel, law enforcement personnel within the TTC zone may wear high-visibility safety apparel that meets the performance requirements of the ANSI/ISEA 207-2006 publication entitled "American National Standard for High-Visibility Public Safety Vests" (see Section 1A.11), *or equivalent revisions*, and labeled as ANSI 207-2006, *or equivalent revisions*.

**Section 6E.03 Hand-Signaling Devices**

*Guidance:*

**Standard:**

**01 The STOP/SLOW (R1-1/W20-8) paddle ~~should~~ shall be the primary and preferred hand-signaling device because the STOP/SLOW paddle gives road users more positive guidance than red flags. Use of flags ~~should~~ shall be limited to emergency situations.**

**Standard:**

**02 The STOP/SLOW paddle shall have an octagonal shape on a rigid handle. STOP/SLOW paddles shall be at least 18 inches wide with letters at least 6 inches high. The STOP (R1-1) face shall have white letters and a white border on a red *or fluorescent red* background. The SLOW (W20-8) face shall have black letters and a black border on an orange *or fluorescent orange* background. When used at night, the STOP/SLOW paddle shall be retroreflectORIZED.**

**02a The sign retroreflectivity shall be maintained at or above the minimum levels in Table 2A-3.**

*Guidance:*

**03 The STOP/SLOW paddle should be fabricated from light semi-rigid material. The bottom of the STOP/SLOW sign portion of the paddle should be a minimum of 6 feet above the pavement when mounted on a rigid staff.**

**Support:**

**04** The optimum method of displaying a STOP or SLOW message is to place the STOP/SLOW paddle on a rigid staff that is tall enough that when the end of the staff is resting on the ground, the message is high enough to be seen by approaching or stopped traffic.

**Option:**

**04a The 24 x 24 inch size of the STOP/SLOW paddle may be used where greater emphasis is needed and speeds are 30 mph or more.**

**05** The STOP/SLOW paddle may be modified to improve conspicuity by incorporating ~~either white or red~~ flashing lights on the STOP face, and ~~either white or yellow~~ flashing lights on the SLOW face. The flashing lights may be arranged in any of the following patterns:

- A. Two ~~white or red~~ lights, one centered vertically above and one centered vertically below the STOP legend; and/or two ~~white or yellow~~ lights, one centered vertically above and one centered vertically below the SLOW legend;
- B. Two ~~white or red~~ lights, one centered horizontally on each side of the STOP legend; and/or two ~~white or yellow~~ lights, one centered horizontally on each side of the SLOW legend;
- C. One ~~white or red~~ light centered below the STOP legend; and/or one ~~white or yellow~~ light centered below the SLOW legend;
- D. A series of eight or more small ~~white or red~~ lights no larger than 1/4 inch in diameter along the outer edge of the paddle, arranged in an octagonal pattern at the eight corners of the border of the STOP face; and/ or a series of eight or more small ~~white or yellow~~ lights no larger than 1/4 inch in diameter along the outer edge of the paddle, arranged in a diamond pattern along the border of the SLOW face; or
- E. A series of white lights forming the shapes of the letters in the legend.

**Standard:**

**06 If flashing lights are used on the STOP face of the paddle, their colors shall be ~~all white or~~ all red. If flashing lights are used on the SLOW face of the paddle, their colors shall be ~~all white or~~ all yellow.**



**07 If more than eight flashing lights are used, the lights shall be arranged such that they clearly convey the octagonal shape of the STOP face of the paddle and/or the diamond shape of the SLOW face of the paddle.**

**08 If flashing lights are used on the STOP/SLOW paddle, the flash rate shall be at least 50, but not more than 60, flashes per minute.**

**09 Flags, when used (for emergency situations only), shall be red or fluorescent orange/red in color, shall be a minimum of 24 inches square, and shall be securely fastened to a staff that is approximately 36 inches in length.**

*Guidance:*

*10 The free edge of a flag should be weighted so the flag will hang vertically, even in heavy winds.*

**Standard:**

**11 When used at nighttime (for emergency situations only), flags shall be retroreflectorized red.**

**Option:**

**12 When flagging in an emergency situation at night in a non-illuminated flagger station, a flagger may use a traffic baton made of a flashlight with a red glow cone to supplement the STOP/SLOW paddle or flag.**

**Standard:**

**13 When a flashlight is used for flagging in an emergency situation at night in a non-illuminated flagger station, the flagger shall hold the flashlight in the left hand, shall hold the paddle or flag in the right hand as shown in Figure 6E-3, and shall use the flashlight in the following manner to control approaching road users:**

- A. To inform road users to stop, the flagger shall hold the flashlight with the left arm extended and pointed down toward the ground, and then shall slowly wave the flashlight in front of the body in a slow arc from left to right such that the arc reaches no farther than 45 degrees from vertical.**
- B. To inform road users to proceed, the flagger shall point the flashlight at the vehicle's bumper, slowly aim the flashlight toward the open lane, then hold the flashlight in that position. The flagger shall not wave the flashlight.**
- C. To alert or slow traffic, the flagger shall point the flashlight toward oncoming traffic and quickly wave the flashlight in a figure eight motion.**

## **Section 6E.04 Automated Flagger Assistance Devices**

**Support:**

**01 Automated Flagger Assistance Devices (AFADs) enable a flagger(s) to be positioned out of the lane of traffic and are used to control road users through temporary traffic control zones. These devices are designed to be remotely operated either by a single flagger at one end of the TTC zone or at a central location, or by separate flaggers near each device's location.**

**02 There are two types of AFADs:**

- A. An AFAD (see Section 6E.05) that uses a remotely controlled STOP/SLOW sign on either a trailer or a movable cart system to alternately control right-of-way.**
- B. An AFAD (see Section 6E.06) that uses remotely controlled red and yellow lenses and a gate arm to alternately control right-of-way.**

**03 AFADs might be appropriate for short-term and intermediate-term activities (see Section 6G.02). Typical applications include TTC activities such as, but not limited to:**

- A. Bridge maintenance;**
- B. Haul road crossings; and**
- C. Pavement patching.**

**Standard:**

**04 AFADs shall only be used in situations where there is only one lane of approaching traffic in the direction to be controlled.**

**05 When used at night, the AFAD location shall be illuminated in accordance with Section 6E.08.**

*Guidance:*

*06 AFADs should not be used for long-term stationary work (see Section 6G.02).*

**Standard:**

**07 Because AFADs are not traffic control signals, they shall not be used as a substitute for or a replacement for a continuously operating temporary traffic control signal as described in Section 6F.84.**

**08 AFADs shall meet the crashworthy performance criteria contained in Section 6F.01.**

*Guidance:*

*09 If used, AFADs should be located in advance of one-lane, two-way tapers and downstream from the point where approaching traffic is to stop in response to the device.*

**Standard:**

**10 If used, AFADs shall be placed so that all of the signs and other items controlling traffic movement are readily visible to the driver of the initial approaching vehicle with advance warning signs alerting other approaching traffic to be prepared to stop.**

**11 If used, an AFAD shall be operated only by a flagger (see Section 6E.01) who has been trained on the operation of the AFAD. The flagger(s) operating the AFAD(s) shall not leave the AFAD(s) unattended at any time while the AFAD(s) is being used.**

**12 The use of AFADs shall conform to one of the following methods:**

**A. An AFAD at each end of the TTC zone (Method 1), or**

**B. An AFAD at one end of the TTC zone and a flagger at the opposite end (Method 2).**

**13 Except as provided in Paragraph 14, two flaggers shall be used when using either Method 1 or Method 2.**

*Option:*

*14 A single flagger may simultaneously operate two AFADs (Method 1) or may operate a single AFAD on one end of the TTC zone while being the flagger at the opposite end of the TTC zone (Method 2) if both of the following conditions are present:*

*A. The flagger has an unobstructed view of the AFAD(s), and*

*B. The flagger has an unobstructed view of approaching traffic in both directions.*

*Guidance:*

*15 When an AFAD is used, the advance warning signing should include a ROAD WORK AHEAD (W20-1) sign, a ONE LANE ROAD (W20-4) sign, and a BE PREPARED TO STOP (W3-4) sign.*

**Standard:**

**16 When the AFAD is not in use, the signs associated with the AFAD, both at the AFAD location and in advance, shall be removed or covered.**

*Guidance:*

*17 A State or local agency that elects to use AFADs should adopt a policy, based on engineering judgment, governing AFAD applications. The policy should also consider more detailed and/or more restrictive requirements for AFAD use, such as the following:*

*A. Conditions applicable for the use of Method 1 and Method 2 AFAD operation,*

*B. Volume criteria,*

*C. Maximum distance between AFADs,*

*D. Conflicting lenses/indications monitoring requirements,*

*E. Fail safe procedures,*

*F. Additional signing and pavement markings,*

*G. Application consistency,*

*H. Larger signs or lenses to increase visibility, and*

*I. Use of backplates.*

**Section 6E.05 STOP/SLOW Automated Flagger Assistance Devices**

**Standard:**

**01 A STOP/SLOW Automated Flagger Assistance Device (AFAD) (see Section 6E.04) shall include a STOP/SLOW sign that alternately displays the STOP (R1-1) face and the SLOW (W20-8) face of a STOP/SLOW paddle (see Figure 6E-1).**

**02 The AFAD's STOP/SLOW sign shall have an octagonal shape, shall be fabricated of rigid material, and shall be mounted with the bottom of the sign a minimum of 6 feet above the pavement on an**

**appropriate support. The size of the STOP/SLOW sign shall be at least 24 x 24 inches with letters at least 8 inches high. The background of the STOP face shall be red with white letters and border. The background of the SLOW face shall be diamond shaped and orange with black letters and border. Both faces of the STOP/SLOW sign shall be retroreflectorized.**

**03 The AFAD's STOP/SLOW sign shall have a means to positively lock, engage, or otherwise maintain the sign assembly in a stable condition when set in the STOP or SLOW position.**

**04 The AFAD's STOP/SLOW sign shall be supplemented with active conspicuity devices by incorporating either:**

**A. ~~White or~~ red flashing lights within the STOP face and ~~white or~~ yellow flashing lights within the SLOW face meeting the provisions contained in Section 6E.03; or**

**B. A Stop Beacon (see Section 4L.05) mounted a maximum of 24 inches above the STOP face and a Warning Beacon (see Section 4L.03) mounted a maximum of 24 inches above, below, or to the side of the SLOW face. The Stop Beacon shall not be flashed or illuminated when the SLOW face is displayed, and the Warning Beacon shall not be flashed or illuminated when the STOP face is displayed. Except for the mounting locations, the beacons shall comply with the provisions of Chapter 4L.**

Option:

**05 Type B warning light(s) (see Section 6F.83) may be used in lieu of the Warning Beacon during the display of the SLOW face of the AFAD's STOP/SLOW sign.**

**Standard:**

**06 If Type B warning lights are used in lieu of a Warning Beacon, they shall flash continuously when the SLOW face is displayed and shall not be flashed or illuminated when the STOP face is displayed.**

Option:

**07 The faces of the AFAD's STOP/SLOW sign may include louvers to improve the stability of the device in windy or other adverse environmental conditions.**

**Standard:**

**08 If louvers are used, the louvers shall be designed such that the full sign face is visible to approaching traffic at a distance of 50 feet or greater.**

*Guidance:*

*09 The STOP/SLOW AFAD should include a gate arm that descends to a down position across the approach lane of traffic when the STOP face is displayed and then ascends to an upright position when the SLOW face is displayed.*

Option:

**10 In lieu of a stationary STOP/SLOW sign with a separate gate arm, the STOP/SLOW sign may be attached to a mast arm that physically blocks the approach lane of traffic when the STOP face is displayed and then moves to a position that does not block the approach lane when the SLOW face is displayed.**

**Standard:**

**11 Gate arms, if used, shall be fully retroreflectorized on both sides, and shall have vertical alternating red and white stripes at 16-inch intervals measured horizontally as shown in Figure 8C-1. When the arm is in the down position blocking the approach lane:**

**A. The minimum vertical aspect of the arm and sheeting shall be 2 inches; and**

**B. The end of the arm shall reach at least to the center of the lane being controlled.**

**12 A WAIT ON STOP (R1-7) sign (see Figure 6E-1) shall be displayed to road users approaching the AFAD.**

Option:

**13 A GO ON SLOW (R1-8) sign (see Figure 6E-1) may also be displayed to road users approaching the AFAD.**

**Standard:**

**14 The GO ON SLOW sign, if used, and the WAIT ON STOP sign shall be positioned on the same support structure as the AFAD or immediately adjacent to the AFAD such that they are in the same direct line of view of approaching traffic as the sign faces of the AFAD. Both signs shall have black legends and borders on white backgrounds. Each of these signs shall be rectangular in shape and each shall be at least 24 x 30 inches in size with letters at least 6 inches high.**

**15 To inform road users to stop, the AFAD shall display the STOP face and the red ~~or white~~ lights, if used, within the STOP face shall flash or the Stop Beacon shall flash. To inform road users to proceed, the**

**AFAD shall display the SLOW face and the yellow ~~or white~~ lights, if used, within the SLOW face shall flash or the Warning Beacon or the Type B warning lights shall flash.**

**16 If STOP/SLOW AFADs are used to control traffic in a one-lane, two-way TTC zone, safeguards shall be incorporated to prevent the flagger(s) from simultaneously displaying the SLOW face at each end of the TTC zone. Additionally, the flagger(s) shall not display the AFAD's SLOW face until all oncoming vehicles have cleared the one-lane portion of the TTC zone.**

### **Section 6E.06 Red/Yellow Lens Automated Flagger Assistance Devices**

#### **Standard:**

**01 A Red/Yellow Lens Automated Flagger Assistance Device (AFAD) (see Section 6E.04) shall alternately display a steadily illuminated CIRCULAR RED lens and a flashing CIRCULAR YELLOW lens to control traffic without the need for a flagger in the immediate vicinity of the AFAD or on the roadway (see Figure 6E-2).**

**02 Red/Yellow Lens AFADs shall have at least one set of CIRCULAR RED and CIRCULAR YELLOW lenses that are 12 inches in diameter. Unless otherwise provided in this Section, the lenses and their arrangement, CIRCULAR RED on top and CIRCULAR YELLOW below, shall comply with the applicable provisions for traffic signal indications in Part 4. If the set of lenses is post-mounted, the bottom of the housing (including brackets) shall be at least 7 feet above the pavement. If the set of lenses is located over any portion of the highway that can be used by motor vehicles, the bottom of the housing (including brackets) shall be at least 15 feet above the pavement.**

#### **Option:**

**03 Additional sets of CIRCULAR RED and CIRCULAR YELLOW lenses, located over the roadway or on the left-hand side of the approach and operated in unison with the primary set, may be used to improve visibility and/or conspicuity of the AFAD.**

#### **Standard:**

**04 A Red/Yellow Lens AFAD shall include a gate arm that descends to a down position across the approach lane of traffic when the steady CIRCULAR RED lens is illuminated and then ascends to an upright position when the flashing CIRCULAR YELLOW lens is illuminated. The gate arm shall be fully retroreflectorized on both sides, and shall have vertical alternating red and white stripes at 16-inch intervals measured horizontally as shown in Figure 8C-1. When the arm is in the down position blocking the approach lane:**

- A. The minimum vertical aspect of the arm and sheeting shall be 2 inches; and**
- B. The end of the arm shall reach at least to the center of the lane being controlled.**

**05 A Stop Here On Red (R10-6 ~~or R10-6a~~) sign (see Section 2B.53) shall be installed on the right-hand side of the approach at the point at which drivers are expected to stop when the steady CIRCULAR RED lens is illuminated (see Figure 6E-2).**

**06 To inform road users to stop, the AFAD shall display a steadily illuminated CIRCULAR RED lens and the gate arm shall be in the down position. To inform road users to proceed, the AFAD shall display a flashing CIRCULAR YELLOW lens and the gate arm shall be in the upright position.**

**07 If Red/Yellow Lens AFADs are used to control traffic in a one-lane, two-way TTC zone, safeguards shall be incorporated to prevent the flagger(s) from actuating a simultaneous display of a flashing CIRCULAR YELLOW lens at each end of the TTC zone. Additionally, the flagger shall not actuate the AFAD's display of the flashing CIRCULAR YELLOW lens until all oncoming vehicles have cleared the one-lane portion of the TTC zone.**

**08 A change interval shall be provided as the transition between the display of the flashing CIRCULAR YELLOW indication and the display of the steady CIRCULAR RED indication. During the change interval, the CIRCULAR YELLOW lens shall be steadily illuminated. The gate arm shall remain in the upright position during the display of the steadily illuminated CIRCULAR YELLOW change interval.**

**09 A change interval shall not be provided between the display of the steady CIRCULAR RED indication and the display of the flashing CIRCULAR YELLOW indication.**

*Guidance:*

*<sup>10</sup> The steadily illuminated CIRCULAR YELLOW change interval should have a duration of at least 5 seconds, unless a different duration, within the range of durations recommended by Section 4D.26, is justified by engineering judgment.*

### **Section 6E.07 Flagger Procedures**

**Support:**

<sup>01</sup> The use of paddles and flags by flaggers is illustrated in Figure 6E-3.

**Standard:**

<sup>02</sup> **Flaggers shall use a STOP/SLOW paddle, a flag (for emergency situations only), or an Automated Flagger Assistance Device (AFAD) to control road users approaching a TTC zone. The use of hand movements alone without a paddle, flag, or AFAD to control road users shall be prohibited except for law enforcement personnel or emergency responders at incident scenes as described in Section 6I.01.**

<sup>03</sup> **The following methods of signaling with paddles shall be used:**

- A. To stop road users, the flagger shall face road users and aim the STOP paddle face toward road users in a stationary position with the arm extended horizontally away from the body. The free arm shall be held with the palm of the hand above shoulder level toward approaching traffic.**
- B. To direct stopped road users to proceed, the flagger shall face road users with the SLOW paddle face aimed toward road users in a stationary position with the arm extended horizontally away from the body. The flagger shall motion with the free hand for road users to proceed.**
- C. To alert or slow traffic, the flagger shall face road users with the SLOW paddle face aimed toward road users in a stationary position with the arm extended horizontally away from the body.**

**Option:**

<sup>04</sup> To further alert or slow traffic, the flagger holding the SLOW paddle face toward road users may motion up and down with the free hand, palm down.

**Standard:**

<sup>05</sup> **The following methods of signaling with a flag (for emergency situations only) shall be used:**

- A. To stop road users, the flagger shall face road users and extend the flag staff horizontally across the road users' lane in a stationary position so that the full area of the flag is visibly hanging below the staff. The free arm shall be held with the palm of the hand above shoulder level toward approaching traffic.**
- B. To direct stopped road users to proceed, the flagger shall face road users with the flag and arm lowered from the view of the road users, and shall motion with the free hand for road users to proceed. Flags shall not be used to signal road users to proceed.**
- C. To alert or slow traffic, the flagger shall face road users and slowly wave the flag in a sweeping motion of the extended arm from shoulder level to straight down without raising the arm above a horizontal position. The flagger shall keep the free hand down.**

*Guidance:*

*<sup>06</sup> The flagger should stand either on the shoulder adjacent to the road user being controlled or in the closed lane prior to stopping road users. A flagger should only stand in the lane being used by moving road users after road users have stopped. The flagger should be clearly visible to the first approaching road user at all times. The flagger also should be visible to other road users. The flagger should be stationed sufficiently in advance of the workers to warn them (for example, with audible warning devices such as horns or whistles) of approaching danger by out-of-control vehicles. The flagger should stand alone, away from other workers, work vehicles, or equipment.*

**Option:**

<sup>07</sup> At spot lane closures where adequate sight distance is available for the reasonably safe handling of traffic, the use of one flagger may be sufficient.

*Guidance:*

*<sup>08</sup> When a single flagger is used, the flagger should be stationed on the shoulder opposite the spot lane closure or work space, or in a position where good visibility and traffic control can be maintained at all times.*

## **Section 6E.08 Flagger Stations**

### **Standard:**

**01 Flagger stations shall be located such that approaching road users will have sufficient distance to stop at an intended stopping point.**

### **Option:**

02 The distances shown in Table 6E-1, which provides information regarding the stopping sight distance as a function of speed, may be used for the location of a flagger station. These distances may be increased for downgrades ([Table 6E-101\(CA\)](#)) and other conditions that affect stopping distance.

### **Guidance:**

03 *Flagger stations should be located such that an errant vehicle has additional space to stop without entering the work space. The flagger should identify an escape route that can be used to avoid being struck by an errant vehicle.*

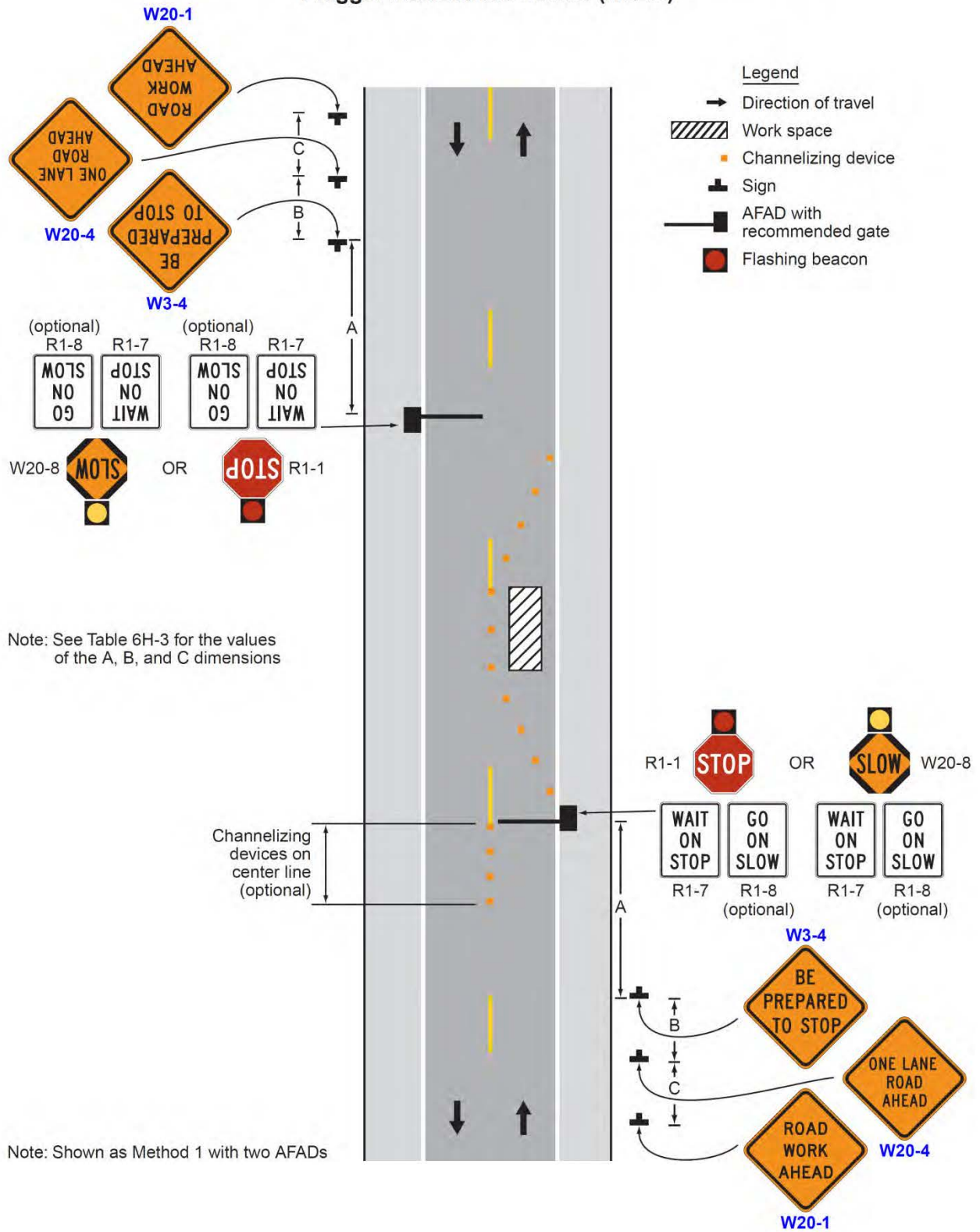
### **Standard:**

**04 Except in emergency situations, flagger stations shall be preceded by an advance warning sign or signs. Except in emergency situations, flagger stations shall be illuminated at night.**

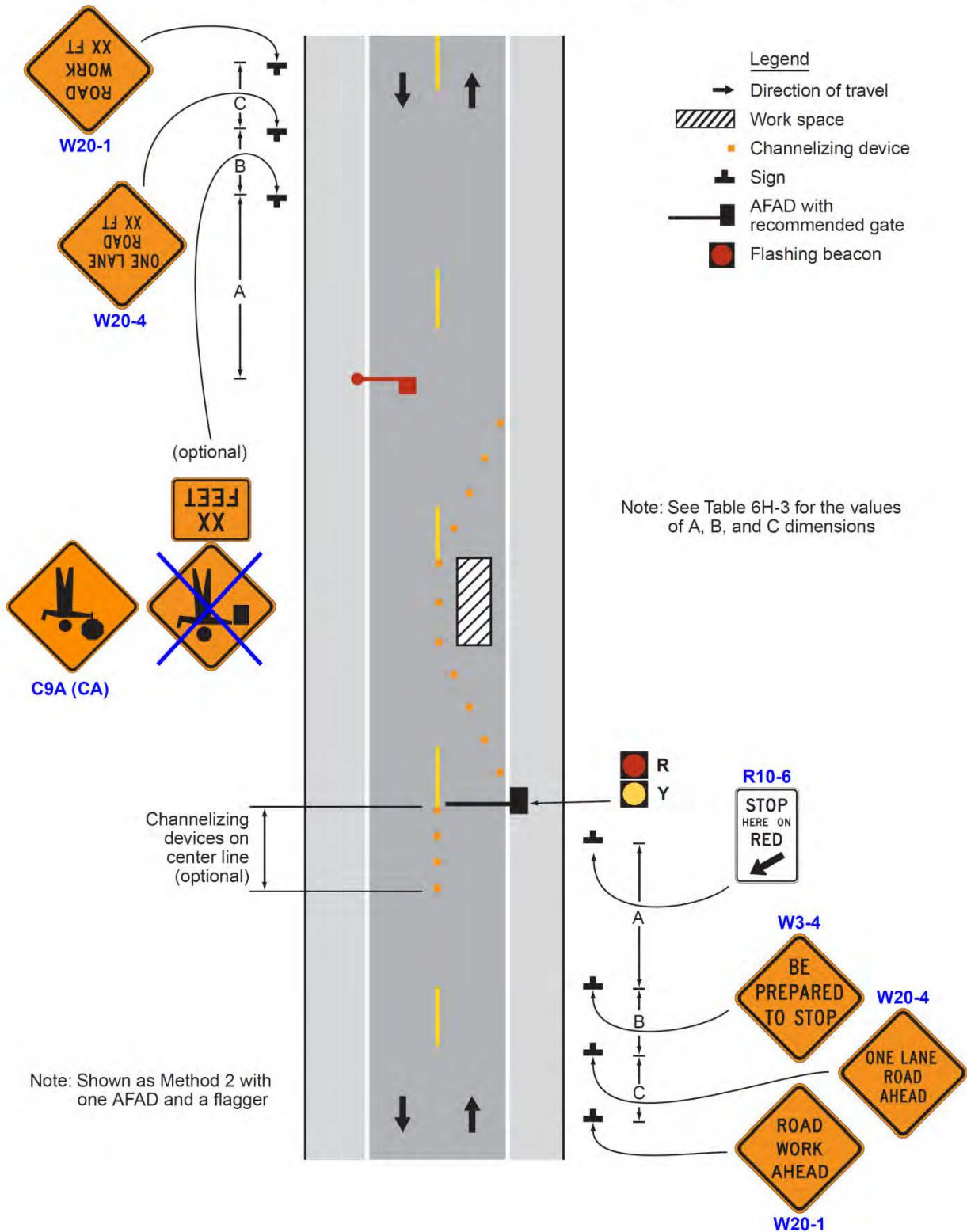
### **Support:**

05 Refer to Construction Safety Orders in the California Code of Regulations (Title 8, Division 1, Chapter 4, Subchapter 4, Article 3, Section 1523 – Illumination and Section 1599 - Flaggers). See Section 1A.11 for information regarding this publication.

**Figure 6E-1. Example of the Use of a STOP/SLOW Automated Flagger Assistance Device (AFAD)**

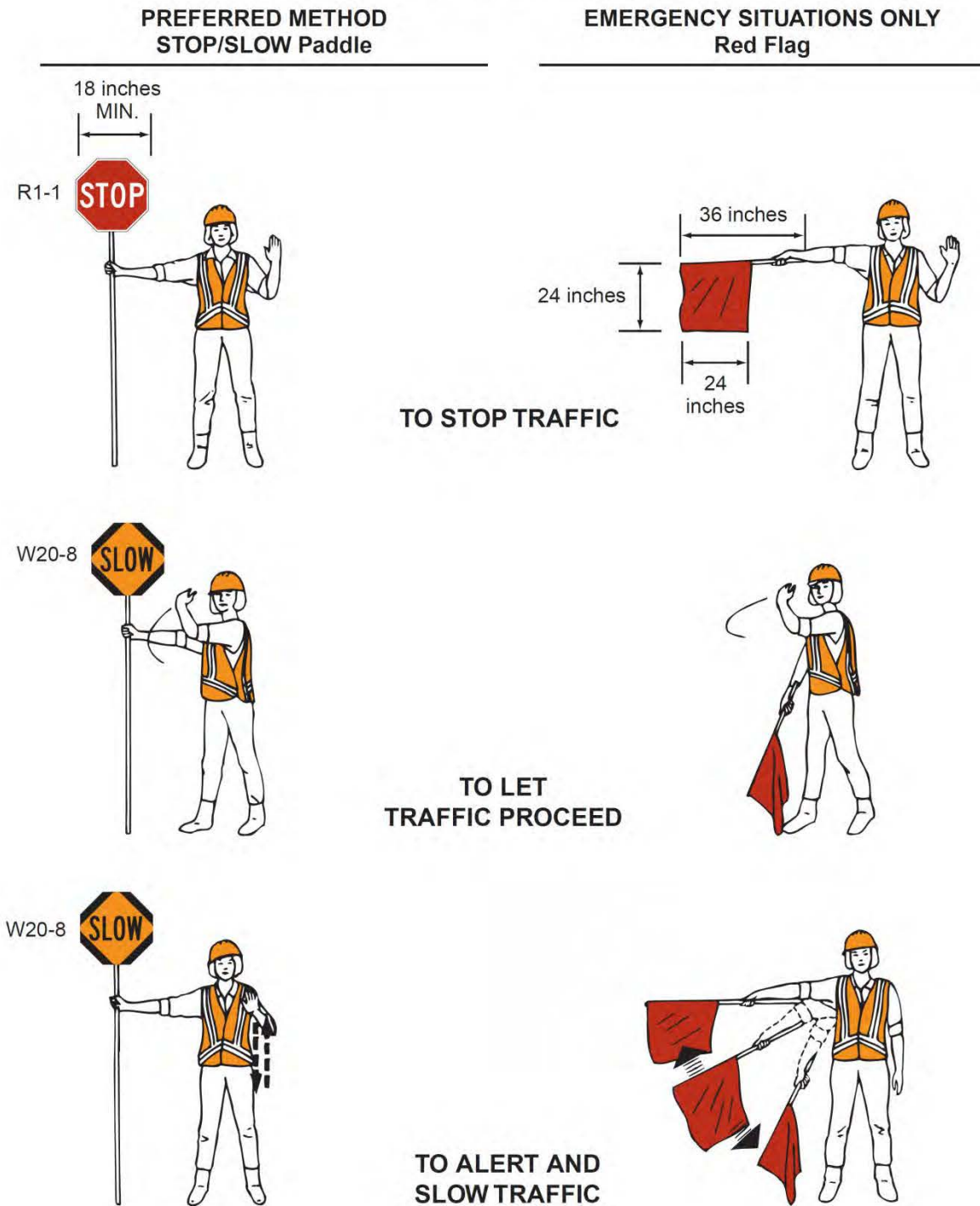


**Figure 6E-2. Example of the Use of a Red/Yellow Lens Automated Flagger Assistance Device (AFAD)**





**Figure 6E-3. Use of Hand-Signaling Devices by Flaggers**



**Table 6E-1. Stopping Sight Distance as a Function of Speed on Level Roads.**  
 (Used as suggested longitudinal buffer space length or location for flagger station)

| Speed* | Distance |
|--------|----------|
| 20 mph | 115 feet |
| 25 mph | 155 feet |
| 30 mph | 200 feet |
| 35 mph | 250 feet |
| 40 mph | 305 feet |
| 45 mph | 360 feet |
| 50 mph | 425 feet |
| 55 mph | 495 feet |
| 60 mph | 570 feet |
| 65 mph | 645 feet |
| 70 mph | 730 feet |
| 75 mph | 820 feet |

\* Posted speed, off-peak 85th-percentile speed prior to work starting, or the anticipated operating speed in mph.

**Table 6E-101(CA). Stopping Sight Distance as a Function of Speed on Downgrades.**  
 (Used as suggested longitudinal buffer space length or location for flagger station)

| Speed (mph) | % Downgrade (Buffer Space) |            |            |
|-------------|----------------------------|------------|------------|
|             | -3% (feet)                 | -6% (feet) | -9% (feet) |
| 20          | 116                        | 120        | 126        |
| 25          | 158                        | 165        | 173        |
| 30          | 205                        | 215        | 227        |
| 35          | 257                        | 271        | 287        |
| 40          | 315                        | 333        | 354        |
| 45          | 378                        | 400        | 427        |
| 50          | 446                        | 474        | 507        |
| 55          | 520                        | 553        | 593        |
| 60          | 598                        | 638        | 686        |
| 65          | 682                        | 728        | 785        |
| 70          | 771                        | 825        | 891        |
| 75          | 866                        | 927        | 1003       |

\* Exhibit 3-2. A Policy on Geometric Design of Highways and Streets, AASHTO, 2001, p.115.

## CHAPTER 6F. TEMPORARY TRAFFIC CONTROL ZONE DEVICES

### Section 6F.01 Types of Devices

#### *Guidance:*

*01 The design and application of TTC devices used in TTC zones should consider the needs of all road users (motorists, bicyclists, and pedestrians), including those with disabilities.*

#### **Support:**

02 FHWA policy requires that all roadside appurtenances such as traffic barriers, barrier terminals and crash cushions, bridge railings, sign and light pole supports, and work zone hardware used on the National Highway System meet the crashworthy performance criteria contained in the National Cooperative Highway Research Program (NCHRP) Report 350, "Recommended Procedures for the Safety Performance Evaluation of Highway Features" or the Manual for Assessing Safety Hardware (MASH). MASH crash testing guidelines were published by the American Association of State and Highway and Transportation Officials on November 20, 2009, and supersede NCHRP Report 350 for roadside safety hardware developed after January 1, 2011. The FHWA website at "<http://safety.fhwa.dot.gov/programs/roadsideHardware.htm>" identifies all such hardware and includes copies of FHWA acceptance letters for each of them. In the case of proprietary items, links are provided to manufacturers' websites as a source of detailed information on specific devices. The website also contains an "Ask the Experts" section where questions on roadside design issues can be addressed.

02a Caltrans adopted the Manual for Assessing Safety Hardware (MASH) crash testing guidelines in 2012 (TOPD 12-02) for testing and evaluating new roadside safety hardware, bridge railings and barriers and appurtenances to those new highway safety features.

03 Various Sections of the MUTCD require certain traffic control devices, their supports, and/or related appurtenances to be crashworthy. Such MUTCD crashworthiness provisions apply to all streets, highways, and private roads open to public travel (see definition in Section 1A.13). Also, State Departments of Transportation and local agencies might have expanded the NCHRP Report 350 crashworthy criteria to apply to certain other roadside appurtenances.

04 Crashworthiness and crash testing information on devices described in Part 6 are found in AASHTO's "Roadside Design Guide" (see Section 1A.11).

05 As defined in Section 1A.13, "crashworthy" is a characteristic of a roadside appurtenance that has been successfully crash tested in accordance with a national standard such as the NCHRP Report 350, "Recommended Procedures for the Safety Performance Evaluation of Highway Features" or MASH crash guidelines.

#### **Standard:**

06 **Traffic control devices shall be defined as all signs, signals, markings, and other devices used to regulate, warn, or guide road users, placed on, over, or adjacent to a street, highway, private roads open to public travel (see definition in Section 1A.13), pedestrian facility, or bikeway by authority of a public body or official having jurisdiction.**

07 **All traffic control devices used for construction, maintenance, utility, or incident management operations on a street, highway, or private road open to public travel (see definition in Section 1A.13) shall comply with the applicable provisions of this Manual.**

08 **Caltrans shall implement NCHRP 350 or MASH criteria for crashworthy TTC devices in TTC zones on all State highways effective as of December 1, 2005. Crashworthiness of TTC devices shall be substantiated. When no longer needed, TTC devices shall be removed from the TTC zone.**

09 **Crashworthiness of TTC devices shall be substantiated as follows:**

10 **Category 1 devices purchased after October 1, 1998 shall be employed based on the vendor's self-certification. Self-certification shall be based on crash testing, crash testing of similar devices, or years of demonstrable safe performance.**

11 **Category 2 devices shall be on FHWA's list of Acceptable Crashworthy Category 2 Hardware for Work Zones which meet NCHRP Report 350 or MASH criteria for crashworthiness. Category 2 devices that have not received FHWA acceptance and were purchased before October 1, 2000, shall not be used. Category 2 devices in use that have received FHWA acceptance shall be labeled with the FHWA acceptance letter number and the name of the**

**manufacturer by the start of the project. The label shall be readable and permanently affixed by the manufacturer. Category 2 devices without a label shall not be used in highway work zones.**

**12 Category 3 devices shall be crash tested in accordance with NCHRP Report 350 or MASH criteria. Caltrans shall include Standard Special Provision (SSP) 12-000, Standard Plans and construction details in all contract documents.**  
Support:

**13 For Category 3, the compliance date was October 1, 1998 for truck mounted attenuators and work zone crash cushions. The compliance date for other Category 3 devices was October 1, 2002.**

## **Section 6F.02 General Characteristics of Signs**

Support:

**01 TTC zone signs convey both general and specific messages by means of words, symbols, and/or arrows and have the same three categories as all road user signs: regulatory, warning, and guide.**

**Standard:**

**02 The colors for regulatory signs shall follow the Standards for regulatory signs in Table 2A-5 2A-5(CA) and Chapter 2B. Warning signs in TTC zones shall have a black legend and border on an orange background, except for the Grade Crossing Advance Warning (W10-1) sign which shall have a black legend and border on a yellow background, and except for signs that are required or recommended in Parts 2 or 7 to have fluorescent yellow-green backgrounds. Colors for guide signs shall follow the Standards in Table 2A-5 2A-5(CA) and Chapter 2D, except for guide signs as otherwise provided in Section 6F.55.**

Option:

**03 Where the color orange is required, the fluorescent orange color may also be used.**

Support:

**04 The fluorescent version of orange provides higher conspicuity than standard orange, especially during twilight.**

Option:

**05 Existing warning signs that are still applicable may remain in place.**

**06 In order to maintain the systematic use of yellow or fluorescent yellow-green backgrounds for pedestrian, bicycle, and school warning signs in a jurisdiction, the yellow or fluorescent yellow-green background for pedestrian, bicycle, and school warning signs may be used in TTC zones.**

**07 Standard orange flags or flashing warning lights may be used in conjunction with signs.**

**Standard:**

**08 When standard orange flags or flashing warning lights are used in conjunction with signs, they shall not block the sign face.**

**09 Except as provided in Section 2A.11, the sizes for TTC signs and plaques shall be as shown in Table 6F-1 and 6F-1(CA). The sizes in the minimum column shall only be used on local streets or roadways where the 85th-percentile speed or posted speed limit is less than 35 mph.**

Option:

**10 The dimensions of signs and plaques shown in Table 6F-1 and 6F-1(CA) may be increased wherever necessary for greater legibility or emphasis.**

**Standard:**

**11 Deviations from standard sizes as prescribed in this Manual shall be in 6-inch increments.**

Support:

**12 Sign design details are contained in the "Standard Highway Signs and Markings" book (see Section 1A.11).**

**13 Section 2A.06 contains additional information regarding the design of signs, including an Option allowing the development of special word message signs if a standard word message or symbol sign is not available to convey the necessary regulatory, warning, or guidance information.**

**Standard:**

**14 All signs used at night shall be either retroreflective with a material that has a smooth, sealed outer surface or illuminated to show the same shape and similar color both day and night.**

**15 The requirement for sign illumination shall not be considered to be satisfied by street, highway, or strobe lighting.**

**15a TTC zone signs used at night shall maintain retroreflectivity at or above the minimum levels in Table 2A-3.**

Option:

- 16 Sign illumination may be either internal or external.
- 17 Signs may be made of rigid or flexible material.

Support:

18 Sign design details are contained in FHWA's "Standard Highway Signs and Markings" book and Caltrans' California Sign Specifications. See Section 1A.11 for information regarding these publications.

### Section 6F.03 Sign Placement

*Guidance:*

- 01 Signs should be located on the right-hand side of the roadway unless otherwise provided in this Manual.

Option:

02 Where special emphasis is needed, signs may be placed on both the left-hand and right-hand sides of the roadway. Signs mounted on portable supports may be placed within the roadway itself. Signs may also be mounted on or above barricades.

Support:

03 The provisions of this Section regarding mounting height apply unless otherwise provided for a particular sign elsewhere in this Manual.

**Standard:**

04 **The minimum height, measured vertically from the bottom of the sign to the elevation of the near edge of the pavement, of signs installed at the side of the road in rural areas shall be 5 feet (see Figure 6F-1).**

05 **The minimum height, measured vertically from the bottom of the sign to the top of the curb, or in the absence of curb, measured vertically from the bottom of the sign to the elevation of the near edge of the traveled way, of signs installed at the side of the road in business, commercial, or residential areas where parking or pedestrian movements are likely to occur, or where the view of the sign might be obstructed, shall be 7 feet (see Figure 6F-1).**

06 **The minimum height, measured vertically from the bottom of the sign to the sidewalk, of signs installed above sidewalks shall be 7 feet.**

Option:

07 The height to the bottom of a secondary sign mounted below another sign may be 1 foot less than the height provided in Paragraphs 4 through 6.

*Guidance:*

08 ~~Neither portable nor permanent sign supports should be located on sidewalks, bicycle facilities, or areas designated for pedestrian or bicycle traffic.~~ Sign supports should be located so as to accommodate pedestrians and bicyclists in areas designated for their use. A minimum lateral width of 4 feet should be maintained for pedestrian pathways. If the bottom of a secondary sign that is mounted below another sign is mounted lower than 7 feet above a pedestrian sidewalk or pathway (see Section 6D.02), the secondary sign should not project more than 4 inches into the pedestrian facility.

**Standard:**

09 **Where it has been determined that the accommodation of pedestrians with disabilities is necessary, signs shall be mounted and placed in accordance with Section 4.4 of the "Americans with Disabilities Act Accessibility Guidelines for Buildings and Facilities (ADAAG)" (see Section 1A.11).**

- 10 **Signs mounted on barricades and barricade/sign combinations shall be crashworthy.**

*Guidance:*

11 *Except as provided in Paragraph 12, signs (see Figures 6F-3, 6F-4 and 6F-5) mounted on portable sign supports that do not meet the minimum mounting heights provided in Paragraphs 4 through 6 should not be used for a duration of more than 3 days.*

Option:

12 The R9-8 through R9-11a series, R11 series, W1-6 through W1-8 series, M4-10, E5-1, ~~or other similar type signs (see Figures 6F-3, 6F-4, and 6F-5)~~ may be used on portable sign supports that do not meet the minimum mounting heights provided in Paragraphs 4 through 6 for longer than 3 days.

Support:

- 13 Methods of mounting signs other than on posts are illustrated in Figure 6F-2.

*Guidance:*

*14 Signs mounted on Type 3 Barricades should not cover more than 50 percent of the top two rails or 33 percent of the total area of the three rails.*

**Standard:**

**15 Sign supports shall be crashworthy. Where large signs having an area exceeding 50 square feet are installed on multiple breakaway posts, the clearance from the ground to the bottom of the sign shall be at least 7 feet.**

**16 The bottom of a sign mounted on a barricade, or other portable support, shall be at least 1 foot above the traveled way.**

**Option:**

17 For mobile operations, a sign may be mounted on a work vehicle, a shadow vehicle, or a trailer stationed in advance of the TTC zone or moving along with it.

**Support:**

18 If alterations are made to specific traffic control device supports that have been successfully crash tested in accordance with NCHRP Report 350 or MASH crash guidelines, the altered supports might not be considered to be crashworthy.

19 Refer to Section 2A.21 for mounting of small plastic signs on channelizers (CA), cones or portable delineators.

**Section 6F.04 Sign Maintenance**

*Guidance:*

01 Signs should be properly maintained for cleanliness, visibility, and correct positioning.

02 Signs that have lost significant legibility should be promptly replaced.

**Support:**

03 Section 2A.08 contains information regarding the retroreflectivity of signs, including the signs that are used in TTC zones.

**Section 6F.05 Regulatory Sign Authority**

**Support:**

01 Regulatory signs such as those shown in Figure 6F-3 inform road users of traffic laws or regulations and indicate the applicability of legal requirements that would not otherwise be apparent.

**Standard:**

**02 Regulatory signs shall be authorized by the public agency or official having jurisdiction and shall conform with Chapter 2B.**

**Support:**

03 Some of the California regulatory signs used in TTC zones are shown in Figure 6F-101(CA) and Table 6F-1(CA).

**Section 6F.06 Regulatory Sign Design**

**Standard:**

**01 TTC regulatory signs shall comply with the Standards for regulatory signs presented in Part 2 and in the FHWA's "Standard Highway Signs and Markings" book (see Section 1A.11).**

**Support:**

02 Regulatory signs are generally rectangular with a black legend and border on a white background. Exceptions include the STOP, YIELD, DO NOT ENTER, WRONG WAY, and ONE WAY signs.

**Option:**

03 The ONE WAY sign may be either a horizontal or vertical rectangular sign.

**Section 6F.07 Regulatory Sign Applications**

**Standard:**

**01 If a TTC zone requires regulatory measures different from those existing, the existing permanent regulatory devices shall be removed or covered and superseded by the appropriate temporary regulatory signs. This change shall be made in compliance with applicable ordinances or statutes of the jurisdiction.**

**Section 6F.08 ROAD (STREET) CLOSED Sign (R11-2)**

*Guidance:*

01 The **ROAD (STREET) CLOSED (R11-2)** sign (see Figure 6F-3) should be used when the roadway is closed to all road users except contractors' equipment or officially authorized vehicles. The R11-2 sign should be accompanied by appropriate warning and detour signing.

Option:

02 The words ~~BRIDGE OUT~~ (or ~~BRIDGE CLOSED~~) may be substituted for **ROAD (STREET) CLOSED** where applicable.

Guidance:

03 The **ROAD (STREET) CLOSED** sign should be installed at or near the center of the roadway on or above a Type 3 Barricade that closes the roadway (see Section 6F.68).

**Standard:**

04 **The ROAD (STREET) CLOSED sign shall not be used where road user flow is maintained through the TTC zone with a reduced number of lanes on the existing roadway or where the actual closure is some distance beyond the sign.**

### **Section 6F.09 Local Traffic Only Signs (R11-3a, R11-4)**

Guidance:

01 The **Local Traffic Only** signs (see Figure 6F-3) should be used where road user flow detours to avoid a closure some distance beyond the sign, but where local road users can use the roadway to the point of closure. These signs should be accompanied by appropriate warning and detour signing.

02 In rural applications, the **Local Traffic Only** sign should have the legend **ROAD CLOSED XX MILES AHEAD, LOCAL TRAFFIC ONLY (R11-3a)**.

Option:

03 In urban areas, the legend **ROAD (STREET) CLOSED TO THRU TRAFFIC (R11-4)** or **ROAD CLOSED, LOCAL TRAFFIC ONLY** may be used.

04 In urban areas, a word message that includes the name of an intersecting street name or well-known destination may be substituted for the words **XX MILES AHEAD** on the R11-3a sign where applicable.

05 The words ~~BRIDGE OUT~~ (or ~~BRIDGE CLOSED~~) may be substituted for the words **ROAD (STREET) CLOSED** on the R11-3a or R11-4 sign where applicable.

Option:

06 The word **RAMP** may be substituted for **ROAD** or **STREET** where applicable.

### **Section 6F.10 Weight Limit Signs (R12-1, R12-2, R12-5)**

**Standard:**

01 A **Weight Limit** sign (see Figure 6F-3), which shows the gross weight ~~or axle weight~~ that is permitted on the roadway or bridge, shall be consistent with State or local regulations and shall not be installed without the approval of the authority having jurisdiction over the highway.

02 When weight restrictions are imposed because of the activity in a TTC zone, a marked detour shall be provided for vehicles weighing more than the posted limit.

### **Section 6F.11 STAY IN LANE Sign (R4-9)**

Option:

01 A **STAY IN LANE (R4-9)** sign (see Figure 6F-3) may be used where a multi-lane shift has been incorporated as part of the TTC on a highway to direct road users around road work that occupies part of the roadway on a multi-lane highway.

### **Section 6F.12 Work Zone and Higher Fines Signs and Plaques**

Option:

01 A **WORK ZONE (G20-5aP)** plaque (see Figure 6F-3) may be mounted above a **Speed Limit (R2-1)** sign to emphasize that a reduced speed limit is in effect within a TTC zone. An **END WORK ZONE SPEED LIMIT (R2-12)** sign (see Figure 6F-3) may be installed at the downstream end of the reduced speed limit zone.

Guidance:

02 A **BEGIN HIGHER DOUBLE FINES ZONE (R2-10)** sign (see Figure 6F-3) should be installed at the upstream end of a work zone where increased fines are imposed for traffic violations, and an **END HIGHER**

*DOUBLE FINES ZONE (R2-11) sign (see Figure 6F-3) should be installed at the downstream end of the work zone.*

**Option:**

03 Alternate legends such as BEGIN (or END) DOUBLE FINES ZONE may also be used for the R2-10 and R2-11 signs.

04 A ~~FINES HIGHER~~, FINES DOUBLE, or ~~\$\$\$ FINE~~ plaque (see Section 2B.17 and Figure 6F-3) may be mounted below the Speed Limit sign if increased fines are imposed for traffic violations within the TTC zone.

05 Individual signs and plaques for work zone speed limits and higher fines may be combined into a single sign or may be displayed as an assembly of signs and plaques.

06 The TRAFFIC FINES DOUBLED IN CONSTRUCTION ZONES (C40(CA)) and TRAFFIC FINES DOUBLED IN WORK ZONES (C40A(CA)) signs may be placed approximately 500 feet in advance of the first required TTC sign(s). The placement of the C40(CA) and C40A(CA) signs is at the discretion of the responsible person(s) in charge of the work zone.

**Support:**

07 Refer to CVC 42009 for fines for offenses committed in highway construction or maintenance area. In California, as per CVC only doubling of the fines is allowed, not higher fines of other denominations.

**Guidance:**

08 *The C40A(CA) sign is intended to be manufactured as a fabric sign and should be used on a short term (daily) basis only. Longer term situations should use the C40(CA) sign.*

**Support:**

09 CVC 22362 applies to "When Workers are Present" condition and signs need to be covered or removed when no work is in progress. However, per CVC 21367, agency can "...regulate the movement of traffic...whenever the traffic would endanger the safety of workers or the work would interfere with or endanger the movement of traffic through the area." If obstructions would be present throughout the project duration the signs would not need to be covered or removed. This would also apply to situations where the construction work changes the highway configuration, curvature or elevation, making it necessary to post reduced speed limits.

**Option:**

10 The Speed Limit (R2-1) sign with a WORK ZONE (G20-5aP) plaque mounted above it may be used for the protection of workers during working hours to reduce speed limit within a TTC zone.

**Standard:**

11 **The R2-1 sign with G20-5aP plaque mounted above it shall only be used in conjunction with appropriate advance warning signs.**

12 **The R2-1 signs with G20-5aP plaques mounted above them shall be removed or covered promptly when no longer applicable.**

**Support:**

14 The R2-1 sign with G20-5aP mounted above it is authorized for use by CVC Section 22362. This section provides authority to post a speed limit of not less than 25 mph at locations where employees of any contractor, or of the agency in charge of the job, are engaged in work upon the roadway.

15 Posting unrealistically low speed limits will result in loss of sign credibility and a high violation rate.

**Guidance:**

16 *Before using a R2-1 sign with G20-5aP plaque mounted above it, work zone conditions should be analyzed to determine what maximum speed limit would be appropriate for that particular location.*

17 *The R2-1 sign with G20-5aP plaque mounted above it should be placed within 400 feet of the zone where workers are on the roadway or so nearly adjacent as to be endangered by traffic.*

**Option:**

18 The R2-1 sign with G20-5aP plaque mounted above it may be provided by the agency having jurisdiction over the street or road.

**Guidance:**

19 *The R2-1 sign with G20-5aP plaque mounted above it should be posted a maximum distance of 400 feet in advance of where, and when workers are present; and the Speed Reduction (W3-5) sign or Speed Zone Ahead (R2-4(CA)) sign informs road users of the reduced speed limit TTC zone.*

20 *As the TTC zone activities change, signs should be moved as appropriate.*



### **Section 6F.13 PEDESTRIAN CROSSWALK Sign (R9-8)**

**Option:**

01 The PEDESTRIAN CROSSWALK (R9-8) sign (see Figure 6F-3) may be used to indicate where a temporary crosswalk has been established.

**Standard:**

02 **If a temporary crosswalk is established, it shall be accessible to pedestrians with disabilities in accordance with Section 6D.02.**

### **Section 6F.14 SIDEWALK CLOSED Signs (R9-9, R9-10, R9-11, R9-11a)**

**Guidance:**

01 *SIDEWALK CLOSED* signs (see Figure 6F-3) should be used where pedestrian flow is restricted. Bicycle/Pedestrian Detour (M4-9a) signs or Pedestrian Detour (M4-9b) signs should be used where pedestrian flow is rerouted (see Section 6F.59).

02 The *SIDEWALK CLOSED* (R9-9) sign should be installed at the beginning of the closed sidewalk, at the intersections preceding the closed sidewalk, and elsewhere along the closed sidewalk as needed.

03 The *SIDEWALK CLOSED, (ARROW) USE OTHER SIDE* (R9-10) sign should be installed at the beginning of the restricted sidewalk when a parallel sidewalk exists on the other side of the roadway.

04 The *SIDEWALK CLOSED AHEAD, (ARROW) CROSS HERE* (R9-11) sign should be used to indicate to pedestrians that sidewalks beyond the sign are closed and to direct them to open crosswalks, sidewalks, or other travel paths.

05 The *SIDEWALK CLOSED, (ARROW) CROSS HERE* (R9-11a) sign should be installed just beyond the point to which pedestrians are being redirected.

**Support:**

06 These signs are typically mounted on a detectable barricade to encourage compliance and to communicate with pedestrians that the sidewalk is closed. Printed signs are not useful to many pedestrians with visual disabilities. A barrier or barricade detectable by a person with a visual disability is sufficient to indicate that a sidewalk is closed. If the barrier is continuous with detectable channelizing devices for an alternate route, accessible signing might not be necessary. An audible information device is needed when the detectable barricade or barrier for an alternate channelized route is not continuous.

### **Section 6F.15 Special Regulatory Signs**

**Option:**

01 Special regulatory signs may be used based on engineering judgment consistent with regulatory requirements.

**Guidance:**

02 *Special regulatory signs should comply with the general requirements of color, shape, and alphabet size and series. The sign message should be brief, legible, and clear.*

### **Section 6F.16 Warning Sign Function, Design, and Application**

**Support:**

01 TTC zone warning signs (see Figure 6F-4) notify road users of specific situations or conditions on or adjacent to a roadway that might not otherwise be apparent.

**Standard:**

02 **TTC warning signs shall comply with the Standards for warning signs presented in Part 2 and in FHWA's "Standard Highway Signs and Markings" book (see Section 1A.11). Except as provided in Paragraph 3, TTC warning signs shall be diamond-shaped with a black legend and border on an orange (or fluorescent orange) background, except for the W10-1 sign which shall have a black legend and border on a yellow (or fluorescent yellow) background, and except for signs that are required or recommended in Parts 2 or 7 to have fluorescent yellow-green backgrounds.**

**Option:**

03 Warning signs used for TTC incident management situations may have a black legend and border on a fluorescent pink background.

04 Mounting or space considerations may justify a change from the standard diamond shape.

05 In emergencies, available warning signs having yellow backgrounds may be used if signs with orange or fluorescent pink backgrounds are not at hand.

*Guidance:*

- 06 *Where roadway or road user conditions require greater emphasis, larger than standard size warning signs should be used, with the symbol or legend enlarged approximately in proportion to the outside dimensions.*
- 07 *Where any part of the roadway is obstructed or closed by work activities or incidents, advance warning signs should be installed to alert road users well in advance of these obstructions or restrictions.*
- 08 *Where road users include pedestrians, the provision of supplemental audible information or detectable barriers or barricades should be considered for people with visual disabilities.*

**Support:**

- 09 *Detectable barriers or barricades communicate very clearly to pedestrians who have visual disabilities that they can no longer proceed in the direction that they are traveling.*

**Option:**

- 10 *Advance warning signs may be used singly or in combination.*
- 11 *Where distances are not displayed on warning signs as part of the message, a supplemental plaque with the distance legend may be mounted immediately below the sign on the same support.*

**Support:**

- 12 *Some of the California warning signs used in TTC zones are shown in Figure 6F-101(CA) and Table 6F-1(CA).*

### **Section 6F.17 Position of Advance Warning Signs**

*Guidance:*

- 01 *Where highway conditions permit, warning signs should be placed in advance of the TTC zone at varying distances depending on roadway type, condition, and posted speed. Table 6C-1 contains information regarding the spacing of advance warning signs. Where a series of two or more advance warning signs is used, the closest sign to the TTC zone should be placed approximately 100 feet for low-speed urban streets to 1,000 feet or more for freeways and expressways.*

- 02 *Where multiple advance warning signs are needed on the approach to a TTC zone, the ROAD WORK AHEAD (W20-1) sign should be the first advance warning sign encountered by road users.*

**Support:**

- 03 *Various conditions, such as limited sight distance or obstructions that might require a driver to reduce speed or stop, might require additional advance warning signs.*

**Option:**

- 04 *As an alternative to a specific distance on advance warning signs, the word AHEAD may be used.*

**Support:**

- 05 *At TTC zones on lightly-traveled roads, all of the advance warning signs prescribed for major construction might not be needed.*

**Option:**

- 06 *Utility work, maintenance, or minor construction can occur within the TTC zone limits of a major construction project, and additional warning signs may be needed.*

*Guidance:*

- 07 *Utility, maintenance, and minor construction signing and TTC should be coordinated with appropriate authorities so that road users are not confused or misled by the additional TTC devices.*

### **Section 6F.18 ROAD (STREET) WORK Sign (W20-1)**

*Guidance:*

- 01 *The ROAD (STREET) WORK (W20-1) sign (see Figure 6F-4), which serves as a general warning of obstructions or restrictions, should be located in advance of the work space or any detour, on the road where the work is taking place.*

- 02 *Where traffic can enter a TTC zone from a crossroad or a major (high-volume) driveway, an advance warning sign should be used on the crossroad or major driveway.*

**Standard:**

- 03 **The ROAD (STREET) WORK (W20-1) sign shall have the legend ROAD (STREET) WORK, XX FEET, XX MILES, or AHEAD.**

Option:

- 04 The RAMP WORK AHEAD (C23(CA)) sign may be substituted for the W20-1 sign where applicable.
- 05 The ROAD (STREET) WORK Informational plaque (C23B(CA)) may be used with the ROAD (STREET) WORK (W20-1) sign.

**Standard:**

06 **The message displayed on the ROAD (STREET) WORK Informational plaque (C23B(CA)) shall be worded in terms common to motorists, as shown in examples below. The height and width of the plate will vary according to the lettering size and message. The width of the plate shall not exceed the overall width of the W20-1 sign.**

Support:

- 07 Following are some example messages:
- A. BRIDGE REPLACEMENT
  - B. BRIDGE WIDENING
  - C. BRIDGE REPAIR
  - D. CURVE IMPROVEMENT
  - E. HIGHWAY REALIGNMENT
  - F. HIGHWAY WIDENING
  - G. HIGHWAY WIDENING AND PAVING
  - H. HIGHWAY REHABILITATION
  - I. STORM REPAIR
  - J. PAVING
  - K. SIGNING IMPROVEMENT
  - L. PAVEMENT MAINTENANCE
  - M. SAFETY IMPROVEMENT

Guidance:

08 *The SPECIAL EVENT AHEAD (SC5(CA)) sign should be used in lieu of the ROAD (STREET) WORK (W20-1) sign for special events, such as bike races, movie filming, etc., where the event is on the travel way or close enough or of such a nature as to have a potential effect on motorists, bicyclists and pedestrians.*

### **Section 6F.19 DETOUR Sign (W20-2)**

*Guidance:*

**Standard:**

01 **The DETOUR (W20-2) sign (see Figure 6F-4) ~~should~~ shall be used in advance of a road user detour over a different roadway or route. Refer to CVC 21363 for detour signs.**

**Standard:**

- 02 **The DETOUR sign shall have the legend DETOUR, XX FEET, XX MILES, or AHEAD.**

### **Section 6F.20 ROAD (STREET) CLOSED Sign (W20-3)**

*Guidance:*

01 *The ROAD (STREET) CLOSED (W20-3) sign (see Figure 6F-4) should be used in advance of the point where a highway is closed to all road users, or to all but local road users.*

**Standard:**

02 **The ROAD (STREET) CLOSED sign shall have the legend ROAD (STREET) CLOSED, XX FEET, XX MILES, or AHEAD.**

### **Section 6F.21 ONE LANE ROAD Sign (W20-4)**

**Standard:**

01 **The ONE LANE ROAD (W20-4) sign (see Figure 6F-4) shall be used only in advance of that point where motor vehicle traffic in both directions must use a common single lane (see Section 6C.10). It shall have the legend ONE LANE ROAD, XX FEET, XX MILES, or AHEAD.**

### **Section 6F.22 Lane(s) Closed Signs (W20-5, W20-5a)**

#### **Standard:**

01 The Lane(s) Closed sign (see Figure 6F-4) shall be used in advance of that point where one or more through lanes of a multi-lane roadway are closed.

02 For a single lane closure, the Lane Closed (W20-5) sign (see Figure 6F-4) shall have the legend RIGHT (LEFT) LANE CLOSED, XX FEET, XX MILES, or AHEAD. Where two adjacent lanes are closed, the W20-5a sign (see Figure 6F-4) shall have the legend XX RIGHT (LEFT) LANES CLOSED, XX FEET, XX MILES, or AHEAD.

#### **Option:**

03 The Lane Closed or LANE(S) CLOSED (W20-5, W20-5a or C20(CA)) sign by itself, or in combination with LEFT (C20A(CA)) plaque and/or Numeral (C20B(CA)) plaque may be used.

04 The LANE CLOSED (C30(CA)) sign may be used within a closed lane of a multilane highway as follow-up information to the appropriate advance warning signs. The C30(CA) sign may be repeated at intervals, throughout long lane closures, as a reminder to motorists.

05 The words RAMP CLOSED may be used as an alternate message on the C30(CA) signs on surface streets to warn that the upcoming freeway/expressway on ramp is closed.

### **Section 6F.23 CENTER LANE CLOSED AHEAD Sign (W9-3)**

#### **Guidance:**

01 The CENTER LANE CLOSED AHEAD (W9-3) sign (see Figure 6F-4) should be used in advance of that point where work occupies the center lane(s) and approaching motor vehicle traffic is directed to the right or left of the work zone in the center lane.

#### **Support:**

02 For moving lane closures on State highways, see Caltrans' Standard Plan T-16. See Section 1A.11 for information regarding this publication.

03 Do not use the CENTER LANE CLOSED AHEAD (W9-3) sign for moving lane closures on State highways.

### **Section 6F.24 Lane Ends Sign (W4-2)**

#### **Option:**

#### **Guidance:**

01 The Lane Ends (W4-2) symbol sign (see Figure 6F-4) ~~may~~ should be used to warn drivers of the reduction in the number of lanes for moving motor vehicle traffic in the direction of travel on a multi-lane roadway.

### **Section 6F.25 ON RAMP Plaque (W13-4P)**

#### **Guidance:**

01 ~~When work is being done on a ramp, but the ramp remains open, the ON RAMP (W13-4P) plaque (see Figure 6F-4) should be used to supplement the advance ROAD WORK sign.~~

#### **Standard:**

02 The ON RAMP (W13-4) plaque shall not be used in California due to the potential for conflict if it is used when the work is being done on an off ramp.

### **Section 6F.26 RAMP NARROWS Sign (W5-4)**

#### **Guidance:**

01 ~~The RAMP NARROWS (W5-4) sign (see Figure 6F-4) should be used in advance of the point where work on a ramp reduces the normal width of the ramp along a part or all of the ramp.~~

#### **Standard:**

02 The RAMP NARROWS (W5-4) sign shall not be used in California. The ROAD NARROWS (W5-1) sign or NARROW LANE(S) (C12(CA)) sign, as appropriate, shall be used instead. See Sections 2C.19 and 6F.102(CA).

### **Section 6F.27 SLOW TRAFFIC AHEAD Sign (W23-1)**

**Option:**

01 The SLOW TRAFFIC AHEAD (W23-1) sign (see Figure 6F-4) may be used on a shadow vehicle, usually mounted on the rear of the most upstream shadow vehicle, along with other appropriate signs for mobile operations to warn of slow moving work vehicles. A ROAD (STREET) WORK (W20-1) sign may also be used with the SLOW TRAFFIC AHEAD sign.

### **Section 6F.28 EXIT OPEN and EXIT CLOSED Signs (E5-2, E5-2a)**

**Option:**

01 An EXIT OPEN (E5-2) or EXIT CLOSED (E5-2a) sign (see Figure 6F-5) may be used to supplement other warning signs where work is being conducted in the vicinity of an exit ramp and where the exit maneuver for vehicular traffic using the ramp is different from the normal condition.

**Guidance:**

02 *When an exit ramp is closed, an EXIT CLOSED sign panel with a black legend and border on an orange background should be placed diagonally across the interchange/intersection guide signs.*

**Standard:**

03 **The RAMP CLOSED (C2(CA)) sign (see Figure 6F-101(CA)) shall be used at the entrance of the on or off ramp that is closed to all road users. The RAMP CLOSED (Not more than one day) (SC6-3(CA)) sign and The RAMP CLOSED (More than one day) (SC6-4(CA)) sign shall not be used in lieu of the C2(CA) sign.**

**Option:**

04 The RAMP CLOSED, USE RAMP AT \_\_ (SC7(CA)) sign may be used in lieu of the RAMP CLOSED (C2(CA)) sign.

**Guidance:**

05 *The RAMP CLOSED AHEAD (C19(CA)) sign (see Figure 6F-101(CA)) should be used in advance of the point where a on or off ramp is closed to all road users.*

**Option:**

06 The USE NEXT EXIT (C38(CA)) sign may be used with the RAMP CLOSED (C2(CA)) sign on freeways if the next exit provides access to destinations from the closed ramp.

**Guidance:**

07 *The RAMP CLOSED (Not more than one day) (SC6-3(CA)) sign should be used to inform motorists of the temporary closing of a freeway or expressway entrance or exit ramp for not more than one day.*

08 *The RAMP CLOSED (More than one day) (SC6-4(CA)) sign should be used to inform motorists of the temporary closing of a freeway or expressway entrance or exit ramp for more than one day.*

09 *The SC6-3(CA) and SC6-4(CA) signs should be removed when the ramp is re-opened to traffic.*

**Standard:**

10 **The SC6-3(CA) and SC6-4(CA) signs shall display the correct day of the week, month, calendar day and times the ramp is closed.**

**Support:**

11 The Day/Month (SC6A(CA)) plaque is used on the RAMP CLOSED (SC6-3(CA) and SC6-4(CA)) signs, to provide the appropriate day of the week and month a freeway or expressway entrance or exit ramp is closed.

12 The Time (SC6B(CA)) plaque is used on the RAMP CLOSED (SC6-3(CA) and SC6-4(CA)) signs, to provide the appropriate time of the day a freeway or expressway entrance or exit ramp is closed.

**Option:**

13 The RAMP CLOSED, USE RAMP AT \_\_ (SC7(CA)) sign may be used in lieu of the combination of the RAMP CLOSED (C2(CA)) sign and USE NEXT EXIT (C38(CA)) sign as shown on Caltrans' Standard Plan T-14 to inform motorists of a closed entrance or exit ramp and to provide an alternate route. See Section 1A.11 for information regarding this publication.

**Guidance:**

14 *The \_\_ EXIT – RAMP CLOSED (SC8(CA)) sign should be used to inform motorists of a closed exit ramp.*

**Standard:**

15 **If used, the SC8(CA) sign shall be placed on the right shoulder, upstream of the preceding exit ramp.**

*Guidance:*

*<sup>16</sup> The EXIT with Arrow (SC18(CA)) sign should be used to inform motorists of the direction to follow for a freeway exit within a work zone.*

**Section 6F.29 EXIT ONLY Sign (E5-3)**

*Option:*

<sup>01</sup> An EXIT ONLY (E5-3) sign (see Figure 6F-5) may be used to supplement other warning signs where work is being conducted in the vicinity of an exit ramp and where the exit maneuver for vehicular traffic using the ramp is different from the normal condition.

**Section 6F.30 NEW TRAFFIC PATTERN AHEAD Sign (W23-2)**

*Option:*

<sup>01</sup> A NEW TRAFFIC PATTERN AHEAD (W23-2) sign (see Figure 6F-4) may be used on the approach to an intersection or along a section of roadway to provide advance warning of a change in traffic patterns, such as revised lane usage, roadway geometry, or signal phasing.

*Guidance:*

<sup>02</sup> *To retain its effectiveness, the W23-2 sign should be displayed for up to 2 weeks, and then it should be covered or removed until it is needed again.*

**Section 6F.31 Flagger Signs (W20-7, W20-7a)**

*Guidance:*

<sup>01</sup> *The Flagger (W20-7) symbol sign (see Figure 6F-4) California Flagger symbol (C9A(CA)) sign (see Figure 6F-101(CA)) should be used in advance of any point where a flagger is stationed to control road users.*

*Option:*

<sup>02</sup> A distance legend may be displayed on a supplemental plaque below the Flagger sign. The sign may be used with appropriate legends or in conjunction with other warning signs, such as the BE PREPARED TO STOP (W3-4) sign (see Figure 6F-4).

<sup>03</sup> The FLAGGER (W20-7a) word message sign with distance legends may be substituted for the ~~Flagger (W20-7) symbol sign~~ California Flagger symbol (C9A(CA)) sign.

**Standard:**

<sup>04</sup> **The MUTCD Flagger symbol (W20-7a) sign shall not be used in California, instead, the California Flagger symbol (C9A(CA)) sign shall be used.**

**Section 6F.32 Two-Way Traffic Sign (W6-3)**

*Guidance:*

<sup>01</sup> *When one roadway of a normally divided highway is closed, with two-way vehicular traffic maintained on the other roadway, the Two-Way Traffic (W6-3) sign (see Figure 6F-4) should be used at the beginning of the two-way vehicular traffic section and at intervals to remind road users of opposing vehicular traffic.*

*Guidance:*

<sup>02</sup> *The Two-Way Traffic (W6-3) sign should also be used at locations where motorists could perceive that they are on a one-way roadway when, in fact, they are on a two lane, two-way highway.*

*Support:*

<sup>03</sup> Following are some typical situations:

- A. Construction sites where a two-lane highway is being converted to a freeway or an expressway.
- B. Two-lane, two-way highways where ultimate freeway or expressway right-of-way has been purchased and grading for the full width has been completed.
- C. Two-lane, two-way highways following long sections of multi-lane freeway or expressway.
- D. Lane-shift as shown in Figure 6H-105(CA).

### **Section 6F.33 Workers Signs (W21-1, W21-1a)**

**Option:**

01 A Workers (W21-1) symbol sign (see Figure 6F-4) may be used to alert road users of workers in or near the roadway.

**Guidance:**

02 *In the absence of other warning devices, a Workers symbol sign should be used when workers are in the roadway.*

**Option:**

03 The WORKERS (W21-1a) word message sign may be used as an alternate to the Workers (W21-1) symbol sign.

### **Section 6F.34 FRESH OIL (TAR) Sign (W21-2)**

**Guidance:**

01 *The FRESH OIL (TAR) (W21-2) sign (see Figure 6F-4) should be used to warn road users of the surface treatment.*

### **Section 6F.35 ROAD MACHINERY AHEAD Sign (W21-3)**

**Option:**

01 The ROAD MACHINERY AHEAD (W21-3) sign (see Figure 6F-4) may be used to warn of machinery operating in or adjacent to the roadway.

### **Section 6F.36 Motorized Traffic Signs (W8-6, W11-10)**

**Option:**

01 Motorized Traffic (W8-6, W11-10 or C44(CA)) signs may be used to alert road users to locations where unexpected travel on the roadway or entries into or departures from the roadway by construction vehicles might occur. The TRUCK CROSSING (W8-6) or TRUCKS ENTERING EXITING (C44(CA)) word message sign may be used as an alternate to the Truck Crossing (W11-10) symbol sign (see Figure 6F-4) where there is an established construction vehicle crossing, **entrance, or exit** of the roadway.

**Support:**

02 These locations might be relatively confined or might occur randomly over a segment of roadway.

### **Section 6F.37 Shoulder Work Signs (W21-5, W21-5a, W21-5b)**

**Support:**

01 Shoulder Work signs (see Figure 6F-4) warn of maintenance, reconstruction, or utility operations on the highway shoulder where the roadway is unobstructed.

**Standard:**

02 **The Shoulder Work sign shall have the legend SHOULDER WORK (W21-5), RIGHT (LEFT) SHOULDER CLOSED (W21-5a), or RIGHT (LEFT) SHOULDER CLOSED XX FT or AHEAD (W21-5b), or SHOULDER WORK AHEAD (C24(CA)), or SHOULDER CLOSED (C30A(CA)).**

**Option:**

03 The Shoulder Work sign may be used in advance of the point on a non-limited access highway where there is shoulder work. It may be used singly or in combination with a ROAD WORK NEXT XX MILES or ROAD WORK AHEAD sign.

**Guidance:**

04 *On freeways and expressways, the RIGHT (LEFT) SHOULDER CLOSED XX FT or AHEAD (W21-5b) sign followed by RIGHT (LEFT) SHOULDER CLOSED (W21-5a) sign should be used in advance of the point where the shoulder work occurs and should be preceded by a ROAD WORK AHEAD sign.*

**Option:**

05 The SHOULDER WORK AHEAD (C24(CA)) sign may be used in advance of the point where shoulder work or utility operations involve the shoulder but the roadway is unobstructed.

06 The SHOULDER CLOSED (C30A(CA)) sign may be used within a shoulder area that has been closed due to work near the traveled way. The C30A(CA) sign is supplemental to appropriate advance warning signs.

### **Section 6F.38 SURVEY CREW Sign (W21-6)**

*Guidance:*

01 *The SURVEY CREW (W21-6) sign (see Figure 6F-4) should be used to warn of surveying crews working in or adjacent to the roadway.*

### **Section 6F.39 UTILITY WORK Sign (W21-7)**

*Option:*

01 The UTILITY WORK (W21-7) sign (see Figure 6F-4) may be used as an alternate to the ROAD (STREET) WORK (W20-1) sign for utility operations on or adjacent to a highway.

*Support:*

02 Typical examples of where the UTILITY WORK sign is used appear in Figures 6H-4, 6H-6, ~~6H-10~~ 6H-10(CA), 6H-10A(CA), 6H-15, 6H-18, 6H-21, 6H-22, 6H-26, and 6H-33.

**Standard:**

03 **The UTILITY WORK sign shall carry the legend UTILITY WORK, XX FEET, XX MILES, or AHEAD.**

### **Section 6F.40 Signs for Blasting Areas**

*Support:*

01 Radio-Frequency (RF) energy can cause the premature firing of electric detonators (blasting caps) used in TTC zones.

**Standard:**

02 **Road users shall be warned to turn off mobile radio transmitters and cellular telephones where blasting operations occur. A sequence of signs shall be prominently displayed to direct operators of mobile radio equipment, including cellular telephones, to turn off transmitters in a blasting area. These signs shall be covered or removed when there are no explosives in the area or the area is otherwise secured.**

### **Section 6F.41 BLASTING ZONE AHEAD Sign (W22-1)**

**Standard:**

01 **The BLASTING ZONE AHEAD (W22-1) sign (see Figure 6F-4) shall be used in advance of any TTC zone where explosives are being used. The TURN OFF 2-WAY RADIO AND CELL PHONE and END BLASTING ZONE signs shall be used in sequence with this sign.**

### **Section 6F.42 TURN OFF 2-WAY RADIO AND CELL PHONE Sign (W22-2)**

**Standard:**

01 **The TURN OFF 2-WAY RADIO AND CELL PHONE (W22-2) sign (see Figure 6F-4) shall follow the BLASTING ZONE AHEAD sign and shall be placed at least 1,000 feet before the beginning of the blasting zone.**

### **Section 6F.43 END BLASTING ZONE Sign (W22-3)**

**Standard:**

01 **The END BLASTING ZONE (W22-3) sign (see Figure 6F-4) shall be placed a minimum of 1,000 feet past the blasting zone.**

*Option:*

02 The END BLASTING ZONE sign may be placed either with or preceding the END ROAD WORK sign.

### **Section 6F.44 Shoulder Signs and Plaque (W8-4, W8-9, W8-17, and W8-17P)**

*Option:*

01 The SOFT SHOULDER (W8-4) sign (see Figure 6F-4) may be used to warn of a soft shoulder condition.

02 The LOW SHOULDER (W8-9) sign (see Figure 6F-4) may be used to warn of a shoulder condition where there is an elevation difference of 3 inches or less between the shoulder and the travel lane.



*Guidance:*

*03 The Shoulder Drop Off (W8-17) sign (see Figure 6F-4) should be used when an unprotected shoulder drop-off, adjacent to the travel lane, exceeds 3 inches in depth for a continuous length along the roadway, based on engineering judgment.*

*Option:*

*04 A SHOULDER DROP-OFF (W8-17P) supplemental plaque (see Figure 6F-4) may be mounted below the W8-17 sign.*

*Option:*

*05 The NO SHOULDER (C31A(CA)) sign may be used where no earth, gravel or paved shoulders are available for vehicles to pull off the roadway.*

### **Section 6F.45 UNEVEN LANES Sign (W8-11)**

*Guidance:*

*01 The UNEVEN LANES (W8-11) sign (see Figure 6F-4) should be used during operations that create a difference in elevation between adjacent lanes that are open to travel.*

*02 The UNEVEN PAVEMENT (C46(CA)) sign (see Figure 6F-101(CA)) should be used during operations that create a difference in elevation in the pavement that is not along a lane line.*

*Support:*

*03 Uneven pavement conditions include elevation difference adjacent to lanes but not at the lane line; between a vehicle lane and a bicycle lane or an unmarked shoulder; and a step in any direction in the pavement. A step is defined as a ridge in the pavement, such as that which might exist between the pavement and a concrete gutter or manhole cover; or that might exist between two pavement blankets when the top level does not extend to the edge of the roadway.*

*Option:*

*04 In situations where there is a need to warn bicyclists or other road users of the uneven pavement condition the UNEVEN PAVEMENT (C46P(CA)) plaque (see Figure 6F-101(CA)) may be used.*

**Standard:**

**05 A C46P(CA) plaque shall not be used alone. If a C46P(CA) plaque is used, it shall be mounted below either a Vehicular Traffic Warning sign (see Section 2C.49) or a Non-Vehicular Warning sign (see Section 2C.50). The background color of the C46P(CA) plaque shall match the background color of the warning sign with which it is displayed.**

*Option:*

*06 When warning is intended to be directed primarily to motorcyclists, use of the UNEVEN LANES (W8-11) sign or UNEVEN PAVEMENT (C46(CA)) sign with motorcycle plaque (W8-15P) may be considered.*

*Support:*

*07 See Table 6F-102 (CA) for pavement surface tolerances for each road user group.*

### **Section 6F.46 STEEL PLATE AHEAD Sign (W8-24)**

*Option:*

*01 A STEEL PLATE AHEAD (W8-24) sign (see Figure 6F-4) may be used to warn road users that the presence of a temporary steel plate(s) might make the road surface uneven and might create slippery conditions during wet weather.*

### **Section 6F.47 NO CENTER LINE Sign (W8-12)**

*Guidance:*

*01 The NO CENTER LINE (W8-12) sign (see Figure 6F-4) should be used when the work obliterates the center line pavement markings and when temporary pavement centerline markings are not provided. This sign should be placed at the beginning of the TTC zone and repeated at 2-mile intervals in long TTC zones.*

*Support:*

*02 Section 6F.78 contains information regarding temporary markings.*

**Standard:**

**03 The NO CENTER STRIPE (W8-12) sign shall not be used on State highways. Whenever construction or maintenance work causes obliteration of center stripe, temporary or permanent center stripe shall be in place prior to opening the State highway to public traffic.**

**Section 6F.48 Reverse Curve Signs (W1-4 Series)**

*Guidance:*

01 *In order to give road users advance notice of a lane shift, a Reverse Curve (W1-4, ~~W1-4b, or W1-4e~~) sign (see Figure 6F-4) should be used when a lane (or lanes) is being shifted to the left or right. If the design speed of the curves is 30 mph or less, a Reverse Turn (W1-3) sign should be used.*

**Standard:**

**02 If a Reverse Curve (or Turn) sign is used, the direction of the reverse curve (or turn) shall be appropriately illustrated. ~~E, except as provided in Paragraph 3, the number of lanes illustrated on the sign shall be the same as the number of through lanes available to road users.~~**

*Option:*

03 Where two or more lanes are being shifted, a W1-4 (or W1-3) sign with an ALL LANES (W24-1cP) plaque (see Figure 6F-4) may be used instead of a sign that illustrates the number of lanes.

04 Where more than three lanes are being shifted, the Reverse Curve (or Turn) sign may be rectangular.

**Section 6F.49 Double Reverse Curve Signs (W24-1 Series)**

*Option:*

01 The Double Reverse Curve (W24-1, ~~W24-1a, or W24-1b~~) sign (see Figure 6F-4) may be used where the tangent distance between two reverse curves is less than 600 feet, thus making it difficult for a second Reverse Curve (W1-4 series) sign to be placed between the curves. If the design speed of the curves is 30 mph or less, Double Reverse Turn signs should be used.

**Standard:**

**02 If a Double Reverse Curve (or Turn) sign is used, the direction of the double reverse curve (or turn) shall be appropriately illustrated. ~~E, except as provided in Paragraph 3, the number of lanes illustrated on the sign shall be the same as the number of through lanes available to road users.~~**

*Option:*

03 Where two or more lanes are being shifted, a W24-1 (or Double Reverse Turn sign showing one lane) sign with an ALL LANES (W24-1cP) plaque (see Figure 6F-4) may be used instead of a sign that illustrates the number of lanes.

04 Where more than three lanes are being shifted, the Double Reverse Curve (or Turn) sign may be rectangular.

**Section 6F.50 Other Warning Signs**

*Option:*

01 Advance warning signs may be used by themselves or with other advance warning signs.

02 Besides the warning signs specifically related to TTC zones, several other warning signs in Part 2 may apply in TTC zones.

**Standard:**

**03 Except as provided in Section 6F.02, other warning signs that are used in TTC zones shall have black legends and borders on an orange background.**

**Section 6F.51 Special Warning Signs**

*Option:*

01 Special warning signs may be used based on engineering judgment.

*Guidance:*

02 *Special warning signs should comply with the general requirements of color, shape, and alphabet size and series. The sign message should be brief, legible, and clear.*

### **Section 6F.52 Advisory Speed Plaque (W13-1P)**

**Option:**

<sup>01</sup> In combination with a warning sign, an Advisory Speed (W13-1P) plaque (see Figure 6F-4) may be used to indicate a recommended speed through the TTC zone.

**Standard:**

<sup>02</sup> **The Advisory Speed plaque shall not be used in conjunction with any sign other than a warning sign, nor shall it be used alone. When used with orange TTC zone signs, this plaque shall have a black legend and border on an orange background. The sign shall be at least 24 x 24 inches in size when used with a sign that is 36 x 36 inches or larger. Except in emergencies, an Advisory Speed plaque shall not be mounted until the recommended speed is determined by the highway agency.**

### **Section 6F.53 Supplementary Distance Plaque (W7-3aP)**

**Option:**

<sup>01</sup> In combination with a warning sign, a Supplementary Distance (W7-3aP) plaque (see Figure 6F-4) with the legend NEXT XX MILES may be used to indicate the length of highway over which a work activity is being conducted, or over which a condition exists in the TTC zone.

<sup>02</sup> In long TTC zones, Supplementary Distance plaques with the legend NEXT XX MILES may be placed in combination with warning signs at regular intervals within the zone to indicate the remaining length of highway over which the TTC work activity or condition exists.

<sup>02a</sup> [The XXXX FT \(C29\(CA\)\) panel may be used on the face of a warning sign to indicate the distance to where the work activity is being conducted, or to where a condition exists in the TTC zone.](#)

**Standard:**

<sup>03</sup> **The Supplementary Distance plaque with the legend NEXT XX MILES shall not be used in conjunction with any sign other than a warning sign, nor shall it be used alone. When used with orange TTC zone signs, this plaque shall have a black legend and border on an orange background. The sign shall be at least 30 x 24 inches in size when used with a sign that is 36 x 36 inches or larger.**

**Guidance:**

<sup>04</sup> *When used in TTC zones, the Supplementary Distance plaque with the legend NEXT XX MILES should be placed below the initial warning sign designating that, within the approaching zone, a temporary work activity or condition exists.*

### **Section 6F.54 Motorcycle Plaque (W8-15P)**

**Option:**

<sup>01</sup> A Motorcycle (W8-15P) plaque (see Figure 6F-4) may be mounted below a LOOSE GRAVEL (W8-7) sign, [an UNEVEN LANES \(W8-11\) sign](#), [an UNEVEN PAVEMENT \(C46\(CA\)\) sign](#), a GROOVED PAVEMENT (W8-15) sign, a METAL BRIDGE DECK (W8-16) sign, or a STEEL PLATE AHEAD (W8-24) sign if the warning is intended to be directed primarily to motorcyclists.

### **Section 6F.55 Guide Signs**

**Support:**

<sup>01</sup> Guide signs along highways provide road users with information to help them along their way through the TTC zone. The design of guide signs is presented in Part 2.

**Guidance:**

<sup>02</sup> *The following guide signs should be used in TTC zones as needed:*

- A. Standard route markings, where temporary route changes are necessary,*
- B. Directional signs and street name signs, and*
- C. Special guide signs relating to the condition or work being done.*

**Standard:**

**03 If additional temporary guide signs are used in TTC zones, they shall have a black legend and border on an orange background.**

**Option:**

04 Guide signs used in TTC incident management situations may have a black legend and border on a fluorescent pink background.

05 When directional signs and street name signs are used in conjunction with detour routing, these signs may have a black legend and border on an orange background.

06 When permanent directional signs or permanent street name signs are used in conjunction with detour signing, they may have a white legend on a green background.

**Section 6F.56 ROAD WORK NEXT XX MILES Sign (G20-1)**

*Guidance:*

01 *The ROAD WORK NEXT XX MILES (G20-1) sign (see Figure 6F-4) should be installed in advance of TTC zones that are more than 2 miles in length.*

**Option:**

02 The ROAD WORK NEXT XX MILES sign may be mounted on a Type 3 Barricade. The sign may also be used for TTC zones of shorter length.

**Standard:**

**03 The distance displayed on the ROAD WORK NEXT XX MILES sign shall be stated to the nearest whole mile.**

**Option:**

04 The word STATE HIGHWAY may be substituted for ROAD, where applicable.

05 The word CONSTRUCTION may be substituted for WORK, where applicable.

**Section 6F.57 END ROAD WORK Sign (G20-2)**

*Guidance:*

01 *When used, the END ROAD WORK (G20-2) sign (see Figure 6F-4) should be placed near the downstream end of the termination area, as determined by engineering judgment.*

**Option:**

02 The END ROAD WORK sign may be installed on the back of a warning sign facing the opposite direction of road users or on the back of a Type 3 Barricade.

03 The END ROAD WORK (G20-2) sign may be omitted if the end of the work zone is obvious to motorists or falls within a larger project's limits.

**Support:**

04 Conditions could be such that posting of END ROAD WORK (G20-2) signs is not helpful. For example, they can be omitted if other TTC zones begin within 1 mile of the end of the workspace in rural areas, or about 0.25 miles within urban areas. For normal daytime maintenance operations, the G20-2 sign is optional.

**Section 6F.58 PILOT CAR FOLLOW ME Sign (G20-4)**

**Standard:**

**01 The PILOT CAR FOLLOW ME (G20-4) sign (see Figure 6F-4) shall be mounted in a conspicuous position on the rear of a vehicle used for guiding one-way vehicular traffic through or around a TTC zone (see Section 6C.13).**

**Option:**

01a Where needed, the PILOT CAR DO NOT PASS (R115(CA)) sign may be used in place of the G20-4 sign.

*Guidance:*

02 *The TRAFFIC CONTROL – WAIT AND FOLLOW PILOT CAR (C37(CA)) sign should be used at intersecting approaches to a work zone when pilot cars are controlling reversible lane traffic. Where vehicular traffic cannot effectively self-regulate, one or two flaggers should be placed at the intersection instead of C37(CA) sign.*

## **Section 6F.59 Detour Signs (M4-8, M4-8a, M4-8b, M4-9, M4-9a, M4-9b, M4-9c, and M4-10)**

### **Standard:**

01 Each detour shall be adequately marked with standard temporary route signs and destination signs.

### **Support:**

01a Refer to CVC 21363 for detour signs.

### **Option:**

02 Detour signs in TTC incident management situations may have a black legend and border on a fluorescent pink background.

03 The Detour Arrow (M4-10) sign (see Figure 6F-5) may be used where a detour route has been established.

04 The DETOUR (M4-8) sign (see Figure 6F-5) may be mounted at the top of a route sign assembly to mark a temporary route that detours from a highway, bypasses a section closed by a TTC zone, and rejoins the highway beyond the TTC zone.

### **Guidance:**

05 The Detour Arrow (M4-10) sign should normally be mounted just below the ROAD CLOSED (R11-2, R11-3a, or R11-4) sign. The Detour Arrow sign should include a horizontal arrow pointed to the right or left as required.

06 The DETOUR (M4-9) sign (see Figure 6F-5) should be used for unnumbered highways, for emergency situations, for periods of short durations, or where, over relatively short distances, road users are guided along the detour and back to the desired highway without route signs.

07 A Street Name sign should be placed above, or the street name should be incorporated into, a DETOUR (M4-9) sign to indicate the name of the street being detoured.

### **Option:**

08 The END DETOUR (M4-8a) or END (M4-8b) sign (see Figure 6F-5) may be used to indicate that the detour has ended.

### **Guidance:**

09 When the END DETOUR sign is used on a numbered highway, the sign should be mounted above a route sign after the downstream end of the detour.

10 The Pedestrian/Bicycle Detour (M4-9a) sign (see Figure 6F-5) should be used where a pedestrian/bicycle detour route has been established because of the closing of a pedestrian/bicycle facility to through traffic.

### **Standard:**

11 If used, the Pedestrian/Bicycle Detour sign shall have an arrow pointing in the appropriate direction.

### **Option:**

12 The arrow on a Pedestrian/Bicycle Detour sign may be on the sign face or on a supplemental plaque.

13 The Pedestrian Detour (M4-9b) sign or Bicycle Detour (M4-9c) sign (see Figure 6F-5) may be used where a pedestrian or bicycle detour route (not both) has been established because of the closing of the pedestrian or bicycle facility to through traffic.

### **Guidance:**

14 The DETOUR (M4-8) sign should be placed on tangent sections at intervals not to exceed 0.25 miles and at major intersections.

### **Option:**

15 In urban areas, the M4-8 signs may be placed at every intersection.

### **Guidance:**

16 The DETOUR with Arrow (SC3(CA)) sign should be used for unnumbered highways, for emergency situations, for periods of short duration, or where, over relatively short distances, road users are guided along the detour and back to the desired highway without route markers.

17 The (FWY) DETOUR with Arrow (SC9(CA)) sign should be used to inform motorists of the direction to follow for a detour. The words FWY DETOUR may be substituted for DETOUR, where applicable.

## **Section 6F.60 Portable Changeable Message Signs**

### **Support:**

01 Portable changeable message signs (PCMS) are TTC devices installed for temporary use with the flexibility to display a variety of messages. In most cases, portable changeable message signs follow the same provisions for design and application as those given for changeable message signs in Chapter 2L. The information in this

Section describes situations where the provisions for portable changeable message signs differ from those given in Chapter 2L.

02 Portable changeable message signs are used most frequently on high-density urban freeways, but have applications on all types of highways where highway alignment, road user routing problems, or other pertinent conditions require advance warning and information.

03 Portable changeable message signs have a wide variety of applications in TTC zones including: roadway, lane, or ramp closures; incident management; width restriction information; speed control or reductions; advisories on work scheduling; road user management and diversion; warning of adverse conditions or special events; and other operational control.

04 The primary purpose of portable changeable message signs in TTC zones is to advise the road user of unexpected situations. Portable changeable message signs are particularly useful as they are capable of:

- A. Conveying complex messages,
- B. Displaying real time information about conditions ahead, and
- C. Providing information to assist road users in making decisions prior to the point where actions must be taken.

05 Some typical applications include the following:

- A. Where the speed of vehicular traffic is expected to drop substantially;
- B. Where significant queuing and delays are expected;
- C. Where adverse environmental conditions are present;
- D. Where there are changes in alignment or surface conditions;
- E. Where advance notice of ramp, lane, or roadway closures is needed;
- F. Where crash or incident management is needed; and/or
- G. Where changes in the road user pattern occur.

*Guidance:*

06 *The components of a portable changeable message sign should include: a message sign, control systems, a power source, and mounting and transporting equipment. The front face of the sign should be covered with a protective material.*

**Standard:**

07 **Portable changeable message signs shall comply with the applicable design and application principles established in Chapter 2A. Portable changeable message signs shall display only traffic operational, regulatory, warning, and guidance information, and shall not be used for advertising messages.**

Support:

08 Section 2L.02 contains information regarding overly simplistic or vague messages that is also applicable to portable changeable message signs.

**Standard:**

09 **The colors used for legends on portable changeable message signs shall comply with those shown in Table 2A-5 2A-5(CA).**

Support:

10 Section 2L.04 contains information regarding the luminance, luminance contrast, and contrast orientation that is also applicable to portable changeable message signs.

*Guidance:*

11 *Portable changeable message signs should be visible from 1/2 mile under both day and night conditions.*

Support:

12 Section 2B.13 contains information regarding the design of portable changeable message signs that are used to display speed limits that change based on operational conditions, or are used to display the speed at which approaching drivers are traveling.

*Guidance:*

13 *A portable changeable message sign should be limited to three lines of eight characters per line or should consist of a full matrix display.*

14 *Except as provided in Paragraph 15, the letter height used for portable changeable message sign messages should be a minimum of 18 inches.*

**Option:**

15 For portable changeable message signs mounted on service patrol trucks or other incident response vehicles, a letter height as short as 10 inches may be used. Shorter letter sizes may also be used on a portable changeable message sign used on low speed facilities provided that the message is legible from at least 650 feet.

16 The portable changeable message sign may vary in size.

**Guidance:**

17 *Messages on a portable changeable message sign should consist of no more than two phases, and a phase should consist of no more than three lines of text. Each phase should be capable of being understood by itself, regardless of the order in which it is read. Messages should be centered within each line of legend. If more than one portable changeable message sign is simultaneously legible to road users, then only one of the signs should display a sequential message at any given time.*

**Support:**

18 Road users have difficulties in reading messages displayed in more than two phases on a typical three-line portable changeable message sign.

**Standard:**

19 **Techniques of message display such as animation, rapid flashing, dissolving, exploding, scrolling, travelling horizontally or vertically across the face of the sign, or other dynamic elements shall not be used.**

**Guidance:**

20 *When a message is divided into two phases, the display time for each phase should be at least 2 seconds, and the sum of the display times for both of the phases should be a maximum of 8 seconds.*

21 *All messages should be designed with consideration given to the principles provided in this Section and also taking into account the following:*

A. *The message should be as brief as possible and should contain three thoughts (with each thought preferably shown on its own line) that convey:*

1. *The problem or situation that the road user will encounter ahead,*
2. *The location of or distance to the problem or situation, and*
3. *The recommended driver action.*

B. *If more than two phases are needed to display a message, additional portable changeable message signs should be used. When multiple portable changeable message signs are needed, they should be placed on the same side of the roadway and they should be separated from each other by a distance of at least 1,000 feet on freeways and expressways, and by a distance of at least 500 feet on other types of highways.*

**Standard:**

22 **When the word messages shown in Tables 1A-1 or 1A-2 need to be abbreviated on a portable changeable message sign, the provisions described in Section 1A.15 shall be followed.**

23 **In order to maintain legibility, portable changeable message signs shall automatically adjust their brightness under varying light conditions.**

24 **The control system shall include a display screen upon which messages can be reviewed before being displayed on the message sign. The control system shall be capable of maintaining memory when power is unavailable.**

25 **Portable changeable message signs shall be equipped with a power source and a battery back-up to provide continuous operation when failure of the primary power source occurs.**

26 **The mounting of portable changeable message signs on a trailer, a large truck, or a service patrol truck shall be such that the bottom of the message sign shall be a minimum of 7 feet above the roadway in urban areas and 5 feet above the roadway in rural areas when it is in the operating mode.**

**Guidance:**

27 *Portable changeable message signs should be used as a supplement to and not as a substitute for conventional signs and pavement markings.*

28 *When portable changeable message signs are used for route diversion, they should be placed far enough in advance of the diversion to allow road users ample opportunity to perform necessary lane changes, to adjust their speed, or to exit the affected highway.*

29 *Portable changeable message signs should be sited and aligned to provide maximum legibility and to allow time for road users to respond appropriately to the portable changeable message sign message.*

*30 Portable changeable message signs should be placed off the shoulder of the roadway and behind a traffic barrier, if practical. Where a traffic barrier is not available to shield the portable changeable message sign, it should be placed off the shoulder and outside of the clear zone. If a portable changeable message sign has to be placed on the shoulder of the roadway or within the clear zone, it should be delineated with retroreflective TTC devices. When used, advanced warning delineation is not needed if the portable changeable message sign is behind a barrier, more than 2 feet behind the curb, or 15 feet or more from the edge of the traveled way (see Section 6C.04). If the portable changeable message sign is placed on shoulder or partially blocking the shoulder (including overhangs), the shoulder should be closed off by a taper of channelizing devices with a length of 1/3 L using the formulas in Tables 6C-3, 6C-3(CA) and 6C-4 (see Section 6C.08). See Figure 6F-104(CA) for typical layout using channelizing devices to delineate a portable changeable message sign on shoulder.*

Option:

*30a For incident management before additional resources are available or for short duration use (see Section 6G.02) or when portable changeable message sign is placed well beyond the shoulder but partially within 15 feet from the edge of the traveled way it may be delineated with a minimum of a 30 feet taper formed by three traffic cones.*

Guidance:

*31 When portable changeable message signs are used in TTC zones, they should display only TTC messages.*

*32 When portable changeable message signs are not being used to display TTC messages, they should be relocated such that they are outside of the clear zone or shielded behind a traffic barrier and turned away from traffic. If relocation or shielding is not practical, they should be delineated with retroreflective TTC devices. If the portable changeable message sign is stored within a shoulder or partially blocking a shoulder, the shoulder should be closed according to Section 6G.07. If the portable changeable message sign is stored well beyond the shoulder but within the clear zone, it should be delineated by a taper of channelizing devices with a length of 1/3 L using the formulas in Tables 6C-3, 6C-3(CA) and 6C-4 (see Section 6C.08). Clear zone is defined by AASHTO's "Roadside Design Guide" (see Section 1A.11). See Figure 6F-104(CA) for typical layout using channelizing devices to delineate a portable changeable message sign on a shoulder.*

*33 Portable changeable message sign trailers should be delineated on a permanent basis by affixing retroreflective material, known as conspicuity material, in a continuous line on the face of the trailer as seen by oncoming road users.*

Standard:

**34 On State highways, the message displayed on Portable Changeable Message signs shall be visible from a distance of 1500 feet and shall be legible from a distance of 750 feet, at noon on a cloudless day, by persons with vision of or corrected to 20/20.**

Guidance:

*35 On local roads, the message displayed on Portable Changeable Message signs should be visible from a distance of 1500 feet and shall be legible from a distance of 750 feet, at noon on a cloudless day, by persons with vision of or corrected to 20/20.*

Support:

*36 Refer to Caltrans' Standard Specifications Section 12-3.32 for visibility criteria cited. See Section 1A.11 for information regarding this publication.*

*37 Refer to Section 2B.13 for Vehicle Speed Feedback Signs.*

## **Section 6F.61 Arrow Boards**

Standard:

**01 An arrow board shall be a sign with a matrix of elements capable of either flashing or sequential displays. This sign shall provide additional warning and directional information to assist in merging and controlling road users through or around a TTC zone.**

Guidance:

*02 An arrow board in the arrow or chevron mode should be used to advise approaching traffic of a lane closure along major multi-lane roadways in situations involving heavy traffic volumes, high speeds, and/or limited sight distances, or at other locations and under other conditions where road users are less likely to expect such lane closures.*



*03 If used, an arrow board should be used in combination with appropriate signs, channelizing devices, or other TTC devices.*

*04 An arrow board should be placed on the shoulder of the roadway or, if practical, farther from the traveled lane. It should be delineated with retroreflective TTC devices. When an arrow board is not being used, it should be removed; if not removed, it should be shielded; or if the previous two options are not feasible, it should be delineated with retroreflective TTC devices.*

*04a If the arrow board is stored within a shoulder or partially blocking a shoulder, the shoulder should be closed according to Section 6G.07. If the arrow board is stored well beyond the shoulder but within the clear zone, it should be delineated by a taper of channelizing devices with a length of 1/3 L using the formulas in Tables 6C-3, 6C-3(CA) and 6C-4 (see Section 6C.08). Clear zone is defined by AASHTO's "Roadside Design Guide" (see Section 1A.11). See Figure 6F-104(CA) for typical layout using channelizing devices to delineate an arrow board on a shoulder.*

**Standard:**

**05 Arrow boards shall meet the minimum size, legibility distance, number of elements, and other specifications shown in Figure 6F-6.**

**Support:**

*06 Type A arrow boards are appropriate for use on low-speed urban streets. Type B or II arrow boards are appropriate for intermediate-speed facilities and for maintenance or mobile operations on high-speed roadways. Type C or I arrow boards are intended to be used on high-speed, high-volume motor vehicle traffic control projects. Type D arrow boards are intended for use on vehicles authorized by the State or local agency.*

**Standard:**

**07 Type A, B or II, and C or I arrow boards shall have solid rectangular appearances. A Type D arrow board shall conform to the shape of the arrow.**

**08 All arrow boards shall be finished in non-reflective black. The arrow board shall be mounted on a vehicle, a trailer, or other suitable support.**

**Guidance:**

*09 The minimum mounting height, measured vertically from the bottom of the board to the roadway below it or to the elevation of the near edge of the roadway, of an arrow board should be 7 feet, except on vehicle-mounted arrow boards, which should be as high as practical.*

*10 A vehicle-mounted arrow board should be provided with remote controls.*

**Standard:**

**11 Arrow board elements shall be capable of at least a 50 percent dimming from full brilliance. The dimmed mode shall be used for nighttime operation of arrow boards.**

**Guidance:**

*12 Full brilliance should be used for daytime operation of arrow boards.*

**Standard:**

**13 The arrow board shall have suitable elements capable of the various operating modes. The color presented by the elements shall be yellow.**

**Guidance:**

*14 If an arrow board consisting of a bulb matrix is used, the elements should be recess-mounted or equipped with an upper hood of not less than 180 degrees.*

**Standard:**

**15 The minimum element on-time shall be 50 percent for the flashing mode, with equal intervals of 25 percent for each sequential phase. The flashing rate shall be not less than 25 or more than 40 flashes per minute.**

**16 An arrow board shall have the following three mode selections:**

- A. A Flashing Arrow, Sequential Arrow, or Sequential Chevron mode;**
- B. A flashing Double Arrow mode; and**
- C. A flashing Caution or Alternating Diamond mode.**

**17 An arrow board in the arrow or chevron mode shall be used only for stationary or moving lane closures on multi-lane roadways.**

**18 For shoulder work, blocking the shoulder, for roadside work near the shoulder, or for temporarily closing one lane on a two-lane, two-way roadway, an arrow board shall be used only in the caution mode.**

*Guidance:*

<sup>19</sup> For a stationary lane closure, the arrow board should be located on the shoulder at the beginning of the merging taper.

<sup>20</sup> Where the shoulder is narrow, the arrow board should be located in the closed lane.

**Standard:**

<sup>20a</sup> **The arrow board shall be located behind channelizing devices used to transition traffic from the closed lane.**

**Support:**

<sup>20b</sup> Caltrans' Standard Specifications for flashing arrow boards are in Section 12-3.03. See Section 1A.11 for information regarding this publication.

**Standard:**

<sup>21</sup> **When arrow boards are used to close multiple lanes, a separate arrow board shall be used for each closed lane.**

*Guidance:*

<sup>22</sup> When arrow boards are used to close multiple lanes, if the first arrow board is placed on the shoulder, the second arrow board should be placed in the first closed lane at the upstream end of the second merging taper (see Figure 6H-37). When the first arrow board is placed in the first closed lane, the second arrow board should be placed in the second closed lane at the downstream end of the second merging taper.

<sup>23</sup> For mobile operations where a lane is closed, the arrow board should be located to provide adequate separation from the work operation to allow for appropriate reaction by approaching drivers.

**Standard:**

<sup>24</sup> **A vehicle displaying an arrow board shall be equipped with high-intensity rotating, flashing, oscillating, or strobe lights.**

<sup>25</sup> **Arrow boards shall only be used to indicate a lane closure. Arrow boards shall not be used to indicate a lane shift.**

**Option:**

<sup>26</sup> A portable changeable message sign may be used to simulate an arrow board display.

**Standard:**

<sup>27</sup> **The minimum legibility distance is the distance at which flashing arrow boards shall be legible at noon on a cloudless day and at night by persons with vision of or corrected to 20/20.**

**Support:**

<sup>28</sup> The minimum legibility distance for each arrow board type is shown in Figure 6F-6.

<sup>29</sup> Refer to Caltrans' Standard Specifications Section 12-3.03 for visibility criteria cited. See Section 1A.11 for information regarding this publication.

## **Section 6F.62 High-Level Warning Devices (Flag Trees)**

**Option:**

<sup>01</sup> A high-level warning device (flag tree) may supplement other TTC devices in TTC zones.

**Support:**

<sup>02</sup> A high-level warning device is designed to be seen over the top of typical passenger cars. A typical high-level warning device is shown in Figure 6F-2.

**Standard:**

<sup>03</sup> **A high-level warning device shall consist of a minimum of two flags with or without a Type B high-intensity flashing warning light. The distance from the roadway to the bottom of the lens of the light and to the lowest point of the flag material shall be not less than 8 feet. The flag shall be 16 inches square or larger and shall be orange or fluorescent red-orange in color.**

**Option:**

<sup>04</sup> An appropriate warning sign may be mounted below the flags.

**Support:**

<sup>05</sup> High-level warning devices are most commonly used in high-density road user situations to warn road users of short-term operations.

## Section 6F.63 Channelizing Devices

### Standard:

01 **Designs of various channelizing devices shall be as shown in Figure 6F-7 and 6F-102(CA). All channelizing devices shall be crashworthy.**

### Support:

02 The function of channelizing devices is to warn road users of conditions created by work activities in or near the roadway and to guide road users. Channelizing devices include cones, tubular markers, [channelizers \(CA\)](#), [portable delineators](#), vertical panels, drums, barricades, and longitudinal channelizing devices.

03 Channelizing devices provide for smooth and gradual vehicular traffic flow from one lane to another, onto a bypass or detour, or into a narrower traveled way. They are also used to channelize vehicular traffic away from the work space, pavement drop-offs, pedestrian or shared-use paths, or opposing directions of vehicular traffic.

### Standard:

04 **Devices used to channelize pedestrians shall be detectable to users of long canes and visible to persons having low vision.**

05 **Where channelizing devices are used to channelize pedestrians, there shall be continuous detectable bottom and top surfaces to be detectable to users of long canes. The bottom of the bottom surface shall be no higher than 2 inches above the ground. The top of the top surface shall be no lower than 32 inches above the ground.**

### Option:

06 A gap not exceeding 2 inches between the bottom rail and the ground surface may be used to facilitate drainage.

### Guidance:

07 *Where multiple channelizing devices are aligned to form a continuous pedestrian channelizer, connection points should be smooth to optimize long-cane and hand trailing.*

08 *The spacing between cones, tubular markers, vertical panels, drums, and barricades should not exceed a distance in feet equal to 1.0 times the speed limit in mph when used for taper channelization, and a distance in feet equal to 2.0 times the speed limit in mph when used for tangent channelization.*

09 *When channelizing devices have the potential of leading vehicular traffic out of the intended vehicular traffic space as shown in Figure 6H-39, the channelizing devices should be extended a distance in feet of 2.0 times the speed limit in mph beyond the downstream end of the transition area.*

09a *The spacing of channelizing devices should not exceed the maximum distances shown in Table 6F-101(CA).*

### Option:

10 Warning lights (see Section 6F.83) may be added to channelizing devices in areas with frequent fog, snow, or severe roadway curvature, or where visual distractions are present.

### Standard:

11 **Warning lights shall flash when placed on channelizing devices used alone or in a cluster to warn of a condition. Except for the sequential flashing warning lights discussed in Paragraphs 12 and 13, warning lights placed on channelizing devices used in a series to channelize road users shall be steady-burn.**

### Option:

12 A series of sequential flashing warning lights may be placed on channelizing devices that form a merging taper in order to increase driver detection and recognition of the merging taper.

### Standard:

13 **When used, the successive flashing of the sequential warning lights shall occur from the upstream end of the merging taper to the downstream end of the merging taper in order to identify the desired vehicle path. Each warning light in the sequence shall be flashed at a rate of not less than 55 nor more than 75 times per minute.**

14 **The retroreflective material used on channelizing devices shall have a smooth, sealed outer surface that will display a similar color day or night.**

### Option:

15 The name and telephone number of the highway agency, contractor, or supplier may be displayed on the non-retroreflective surface of all types of channelizing devices.

**Standard:**

**16 The letters and numbers of the name and telephone number shall be non-retroreflective and not over 2 inches in height.**

*Guidance:*

*17 Particular attention should be given to maintaining the channelizing devices to keep them clean, visible, and properly positioned at all times.*

**Standard:**

**18 Devices that are damaged or have lost a significant amount of their retroreflectivity and effectiveness shall be replaced.**

**Section 6F.64 Cones**

**Standard:**

**01 Cones (see Figure 6F-7) shall be predominantly orange and shall be made of a material that can be struck without causing damage to the impacting vehicle. For daytime and low-speed roadways, cones shall be not less than 18 inches in height. When cones are used on freeways and other high-speed highways or at night on all highways, or when more conspicuous guidance is needed, cones shall be a minimum of 28 inches in height.**

**02 For nighttime use, cones shall be retroreflectorized or equipped with lighting devices for maximum visibility. Retroreflectorization of cones that are 28 to 36 inches in height shall be provided by a 6-inch wide white band located 3 to 4 inches from the top of the cone and an additional 4-inch wide white band located approximately 2 inches below the 6-inch band.**

**03 Retroreflectorization of cones that are more than 36 inches in height shall be provided by horizontal, circumferential, alternating orange and white retroreflective stripes that are 4 to 6 inches wide. Each cone shall have a minimum of two orange and two white stripes with the top stripe being orange. Any non-retroreflective spaces between the orange and white stripes shall not exceed 3 inches in width.**

**Support:**

**03a The 36 inch and 42 inch high cones provide additional conspicuity in visually complex environments and for older road users.**

**Option:**

**04 Traffic cones may be used to channelize road users, divide opposing vehicular traffic lanes, divide lanes when two or more lanes are kept open in the same direction, and delineate short duration maintenance and utility work.**

*Guidance:*

*05 Steps should be taken to minimize the possibility of cones being blown over or displaced by wind or moving vehicular traffic.*

**Option:**

**06 Cones may be doubled up to increase their weight.**

**Support:**

**07 Some cones are constructed with bases that can be filled with ballast. Others have specially weighted bases, or weight such as sandbag rings that can be dropped over the cones and onto the base to provide added stability.**

*Guidance:*

*08 Ballast should be kept to the minimum amount needed.*

**Option:**

**09 Retroreflectorization of 28 inch in height or higher cones may be provided by a 13 inch band (sleeve).**

**Standard:**

**10 On State highways, the retroreflectorized bands shall be visible at 1000 feet at night under illumination of legal high beam headlights, by persons with vision of or corrected to 20/20.**

*Guidance:*

*11 On local roads, the retroreflectorized bands should be visible at 1000 feet at night under illumination of legal high beam headlights, by persons with vision of or corrected to 20/20.*

**Support:**

**12 Refer to Caltrans' Standard Specifications Section 12-3.01A(4) for visibility criteria cited. See Section 1A.11 for information regarding this publication.**

## Section 6F.65 Tubular Markers

### Support:

00a Tubular markers are used to guide and channelize traffic for temporary traffic control. Tubular markers generally have the same circular cross-section throughout their length. Tubular markers may be affixed to the ground or may be portable. There are three types of tubular markers and they are defined as following:

00b The term "tubular marker" is used for a tubular marker that is affixed to the pavement and is cylindrical from top to bottom

00c The term "channelizer (CA)" is a special type of tubular marker that is affixed to the pavement and has a cylindrical lower portion and a flattened upper portion. This term "channelizer (CA)" is not to be confused with the term "channelizing device(s)" in Section 6F.63. Although it is similar to the channelizer for permanent use, as discussed in Section 3H.01 and shown in Figure 3H-101(CA), there are differences. The channelizer (CA) is used for temporary traffic control.

00d The term "portable delineator" is used to describe a tubular marker that is not affixed to the pavement but stabilized by using a weighted base or weights, and is cylindrical from top to bottom. This term "portable delineator" is not to be confused with the term "delineator" in Section 6F.80.

### Standard:

00e **The retroreflectorized bands for tubular markers, channelizers (CA), and portable delineators shall be visible at 1000 feet during night under illumination of legal high beam headlights, by persons with vision of or corrected to 20/20.**

### Support:

00f Refer to Caltrans' Standard Specifications Section 12-3.01A(4) for visibility criteria cited. See Section 1A.11 for information regarding this publication.

## Tubular Marker

### Standard:

01 **Tubular markers (see Figure 6F-7) shall be predominantly orange and shall be not less than 18 inches high and 2 inches wide facing road users. They shall be made of a material that can be struck without causing damage to the impacting vehicle.**

02 **Tubular markers shall be a minimum of 28 inches in height when they are used on freeways and other high-speed highways, on all highways during nighttime, or whenever more conspicuous guidance is needed.**

03 **For nighttime use, tubular markers shall be retroreflectorized. Retroreflectorization of tubular markers that have a height of less than 42 inches shall be provided by two 3-inch wide white bands placed a maximum of 2 inches from the top with a maximum of 6 inches between the bands. Retroreflectorization of tubular markers that have a height of 42 inches or more shall be provided by four 4- to 6-inch wide alternating orange and white stripes with the top stripe being orange.**

### Support:

03a The 42 inch high tubular markers provide additional conspicuity in visually complex environments and for older road users.

### Guidance:

04 *Tubular markers have less visible area than other devices and should be used only where space restrictions do not allow for the use of other more visible devices.*

05 *Tubular markers should be stabilized by affixing them to the pavement, ~~by using weighted bases, or weights such as sandbag rings that can be dropped over the tubular markers and onto the base to provide added stability.~~ Ballast should be kept to the minimum amount needed.*

### Option:

06 Tubular markers may be used effectively to divide opposing lanes of road users, divide vehicular traffic lanes when two or more lanes of moving vehicular traffic are kept open in the same direction, and to delineate the edge of a pavement drop off where space limitations do not allow the use of larger devices.

### Standard:

07 **A tubular marker shall be attached to the pavement to display the minimum 2-inch width to the approaching road users.**

### Portable Delineator

#### **Standard:**

<sup>08</sup> The design of a portable delineator shall be as shown in Figure 6F-102(CA). <sup>09</sup> Portable delineators shall be a minimum of 36 inches in height. The vertical portion of portable delineators shall be fluorescent orange or predominantly orange. The posts shall be not less than 3 inches in width or diameter. Retroreflectorization of portable delineators that have a height of less than 42 inches shall be provided by two 3-inch wide white bands placed a maximum of 2 inches from the top with a maximum of 6 inches between the bands. Retroreflectorization of portable delineators that have a height of 42 inches or more shall be provided by four 4-inch to 6-inch wide alternating orange and white stripes with the top stripe being orange.

#### Support:

<sup>10</sup> The 42 inch or higher portable delineators provide additional conspicuity in visually complex environments and for older road users.

#### Guidance:

<sup>11</sup> Portable delineators have less visible area than other devices and should be used only where space restrictions do not allow for the use of other more visible devices.

<sup>12</sup> Portable delineators should be stabilized by using weighted bases, or weights such as sandbag rings that can be dropped over the portable delineators and onto the base to provide added stability. Ballast should be kept to the minimum amount needed.

#### Option:

<sup>13</sup> Portable delineators may be used effectively to divide opposing lanes of road users, divide vehicular traffic lanes when two or more lanes of moving vehicular traffic are kept open in the same direction, and to delineate the edge of a pavement drop off where space limitations do not allow the use of larger devices.

### Channelizer(CA)

#### **Standard:**

<sup>14</sup> When a channelizer (CA) is used, it shall be attached to the pavement in a manner such that the retroreflectorized bands facing road users meet the minimum visibility requirements.

<sup>15</sup> The design of a channelizer (CA) shall be as shown in Figure 6F-102(CA). The height shall be 36 inch minimum where speeds are above 40 mph. The height shall be 28 inch minimum where speeds are 40 mph or less. The width of the post shall be 2 ¼ inch minimum and the color predominantly orange. Channelizers (CA) shall be affixed with retroreflective white sheeting, 3 by 12 inches in size.

#### Support:

<sup>16</sup> Channelizers (CA) are implanted in the ground or affixed to the pavement, and are not susceptible to displacement, and are capable of normally withstanding numerous vehicular impacts.

<sup>17</sup> Channelizers (CA) are generally used in series to create a visual fence/barrier, to provide additional guidance and/or restriction to traffic.

#### Option:

<sup>18</sup> Channelizers (CA) may be used in lieu of cones, portable delineators, or drums, to channelize traffic or divide opposing lanes of traffic.

## **Section 6F.66 Vertical Panels**

#### **Standard:**

<sup>01</sup> Vertical panels (see Figure 6F-7) shall have retroreflective striped material that is 8 to 12 inches in width and at least 24 inches in height. They shall have alternating diagonal orange and white retroreflective stripes sloping downward at an angle of 45 degrees in the direction vehicular traffic is to pass.

<sup>02</sup> Where the height of the retroreflective material on the vertical panel is 36 inches or more, a stripe width of 6 inches shall be used.

#### Guidance:

<sup>02a</sup> Vertical panels should be a minimum of 12 inch in width.

#### Option:

<sup>03</sup> Where the height of the retroreflective material on the vertical panel is less than 36 inches, a stripe width of 4 inches may be used.

04 Where space is limited, vertical panels may be used to channelize vehicular traffic, divide opposing lanes, or replace barricades.

## **Section 6F.67 Drums**

### **Standard:**

01 **Drums (see Figure 6F-7) used for road user warning or channelization shall be constructed of lightweight, deformable materials. They shall be a minimum of 36 inches in height and have at least an 18-inch minimum width regardless of orientation. Metal drums shall not be used. The markings on drums shall be horizontal, circumferential, alternating orange and white retroreflective stripes 4 to 6 inches wide. Each drum shall have a minimum of two orange and two white stripes with the top stripe being orange. Any non-retroreflectorized spaces between the horizontal orange and white stripes shall not exceed 3 inches wide. Drums shall have closed tops that will not allow collection of construction debris or other debris.**

### **Support:**

02 Drums are highly visible, have good target value, give the appearance of being formidable obstacles and, therefore, command the respect of road users. They are portable enough to be shifted from place to place within a TTC zone in order to accommodate changing conditions, but are generally used in situations where they will remain in place for a prolonged period of time.

### **Option:**

03 Although drums are most commonly used to channelize or delineate road user flow, they may also be used alone or in groups to mark specific locations.

### **Guidance:**

04 *Drums should not be weighted with sand, water, or any material to the extent that would make them hazardous to road users or workers when struck. Drums used in regions susceptible to freezing should have drain holes in the bottom so that water will not accumulate and freeze causing a hazard if struck by a road user.*

### **Standard:**

05 **Ballast shall not be placed on the top of a drum.**

06 **On State highways, the retroreflectorized bands shall be maintained at or above minimum levels in Table 2A-3.**

### **Guidance:**

07 *On local roads, the retroreflectorized bands should be maintained at or above minimum levels in Table 2A-3.*

### **Support:**

08 Refer to Caltrans' Standard Specifications Section 12-3.01A(4) for visibility criteria cited. See Section 1A.11 for information regarding this publication.

## **Section 6F.68 Type 1, 2, or 3 Barricades**

### **Support:**

01 A barricade is a portable or fixed device having from one to three rails with appropriate markings and is used to control road users by closing, restricting, or delineating all or a portion of the right-of-way.

02 As shown in Figure 6F-7, barricades are classified as Type 1, Type 2, or Type 3.

### **Standard:**

03 **Stripes on barricade rails shall be alternating orange and white retroreflective stripes sloping downward at an angle of 45 degrees in the direction road users are to pass. Except as provided in Paragraph 4, the stripes shall be 6 inches wide.**

### **Option:**

04 When rail lengths are less than 36 inches, 4-inch wide stripes may be used.

### **Standard:**

05 **The minimum length for Type 1 and Type 2 Barricades shall be 24 inches, and the minimum length for Type 3 Barricades shall be 48 inches. Each barricade rail shall be 8 to 12 inches wide. Barricades used on freeways, expressways, and other high-speed roadways shall have a minimum of 270 square inches of retroreflective area facing road users.**

### **Support:**

05a The Type I and Type II Barricades, 36 inch in length with each rail 12 inch wide, provide additional conspicuity in visually complex environments and for older road users.

**Standard:**

05b **On State highways, the retroreflectorized bands shall be maintained at or above minimum levels in Table 2A-3.**

**Guidance:**

05c *On local roads, the retroreflectorized bands should be maintained at or above minimum levels in Table 2A-3.*

**Support:**

05d Refer to Caltrans' Standard Specifications Section 12-3.01A(4) for visibility criteria cited. See Section 1A.11 for information regarding this publication.

**Guidance:**

06 *Where barricades extend entirely across a roadway, the stripes should slope downward in the direction toward which road users must turn.*

07 *Where both right and left turns are provided, the barricade stripes should slope downward in both directions from the center of the barricade or barricades.*

08 *Where no turns are intended, the stripes should be positioned to slope downward toward the center of the barricade or barricades.*

09 *Barricade rails should be supported in a manner that will allow them to be seen by the road user, and in a manner that provides a stable support that is not easily blown over or displaced.*

10 *The width of the existing pedestrian facility should be provided for the temporary facility if practical. Traffic control devices and other construction materials and features should not intrude into the usable width of the sidewalk, temporary pathway, or other pedestrian facility. When it is not possible to maintain a minimum width of 60 inches throughout the entire length of the pedestrian pathway, a 60 x 60-inch passing space should be provided at least every 200 feet to allow individuals in wheelchairs to pass.*

11 *Barricade rail supports should not project into pedestrian circulation routes more than 4 inches from the support between 27 and 80 inches from the surface as described in Section 4.4.1 of the "Americans with Disabilities Act Accessibility Guidelines for Buildings and Facilities (ADAAG)" (see Section 1A.11).*

**Option:**

12 For Type 1 Barricades, the support may include other unstriped horizontal rails necessary to provide stability.

**Guidance:**

13 *On high-speed expressways or in other situations where barricades may be susceptible to overturning in the wind, ballasting should be used.*

**Option:**

14 Sandbags may be placed on the lower parts of the frame or the stays of barricades to provide the required ballast.

**Support:**

15 Type 1 or Type 2 Barricades are intended for use in situations where road user flow is maintained through the TTC zone.

**Option:**

16 Barricades may be used alone or in groups to mark a specific condition or they may be used in a series for channelizing road users.

17 Type 1 Barricades may be used on conventional roads or urban streets.

**Guidance:**

18 *Type 2 or Type 3 Barricades should be used on freeways and expressways or other high-speed roadways. Type 3 Barricades should be used to close or partially close a road.*

**Option:**

19 Type 3 Barricades used at a road closure may be placed completely across a roadway or from curb to curb.

**Guidance:**

20 *Where provision is made for access of authorized equipment and vehicles, the responsibility for Type 3 Barricades should be assigned to a person who will provide proper closure at the end of each work day.*

**Support:**

21 When a highway is legally closed but access must still be allowed for local road users, barricades usually are not extended completely across the roadway.

**Standard:**



**22 A sign shall be installed with the appropriate legend concerning permissible use by local road users (see Section 6F.09). Adequate visibility of the barricades from both directions shall be provided.**

Option:

23 Signs may be installed on barricades (see Section 6F.03).

24 Barricades may be used as sign supports if the barricades have been successfully crash tested as one unit with a construction area sign attached.

### **Section 6F.69 Direction Indicator Barricades**

**Standard:**

01 **The Direction Indicator Barricade (see Figure 6F-7) shall consist of a One-Direction Large Arrow (W1-6) sign mounted above a diagonal striped, horizontally aligned, retroreflective rail.**

02 **The One-Direction Large Arrow (W1-6) sign shall be black on an orange background. The stripes on the bottom rail shall be alternating orange and white retroreflective stripes sloping downward at an angle of 45 degrees in the direction road users are to pass. The stripes shall be 4 inches wide. The One-Direction Large Arrow (W1-6) sign shall be 24 x 12 inches. The bottom rail shall have a length of 24 inches and a height of 8 inches.**

Option:

03 The Direction Indicator Barricade may be used in tapers, transitions, and other areas where specific directional guidance to drivers is necessary.

*Guidance:*

04 *If used, Direction Indicator Barricades should be used in series to direct the driver through the transition and into the intended travel lane.*

### **Section 6F.70 Temporary Traffic Barriers as Channelizing Devices**

Support:

01 Temporary traffic barriers are not TTC devices in themselves; however, when placed in a position identical to a line of channelizing devices and marked and/or equipped with appropriate channelization features to provide guidance and warning both day and night, they serve as TTC devices.

**Standard:**

02 **Temporary traffic barriers serving as TTC devices shall comply with requirements for such devices as set forth throughout Part 6.**

03 **Temporary traffic barriers (see Section 6F.85) shall not be used solely to channelize road users, but also to protect the work space. If used to channelize vehicular traffic, the temporary traffic barrier shall be supplemented with delineation, pavement markings, or channelizing devices for improved daytime and nighttime visibility.**

*Guidance:*

04 *Temporary traffic barriers should not be used for a merging taper except in low-speed urban areas.*

05 *When it is necessary to use a temporary traffic barrier for a merging taper in low-speed urban areas or for a constricted/restricted TTC zone, the taper length should be designed to optimize road user operations considering the available geometric conditions.*

**Standard:**

06 **When it is necessary to use a temporary traffic barrier for a merging taper in low-speed urban areas or for a constricted/restricted TTC zone, the taper shall be delineated.**

*Guidance:*

07 *When used for channelization, temporary traffic barriers should be of a light color for increased visibility.*

Option:

08 Side reflectors or top mounted reflectors (facing the road user) may be used on temporary traffic barriers.

*Guidance:*

09 *If used, the spacing of these reflectors should not exceed a distance in feet equal to 1.0 times the speed limit in mph through the TTC zone.*

### **Section 6F.71 Longitudinal Channelizing Devices**

**Support:**

01 Longitudinal channelizing devices are lightweight, deformable devices that are highly visible, have good target value, and can be connected together.

**Standard:**

02 **If used singly as Type 1, 2, or 3 barricades, longitudinal channelizing devices shall comply with the general size, color, stripe pattern, retroreflectivity, and placement characteristics established for the devices described in this Chapter.**

*Guidance:*

03 *If used to channelize vehicular traffic at night, longitudinal channelizing devices should be supplemented with retroreflective material or delineation for improved nighttime visibility.*

**Option:**

04 Longitudinal channelizing devices may be used instead of a line of cones, drums, or barricades.

05 Longitudinal channelizing devices may be hollow and filled with water as a ballast.

06 Longitudinal channelizing devices may be used for pedestrian traffic control.

**Standard:**

07 **If used for pedestrian traffic control, longitudinal channelizing devices shall be interlocked to delineate or channelize flow. The interlocking devices shall not have gaps that allow pedestrians to stray from the channelizing path.**

*Guidance:*

08 *Longitudinal channelizing devices have not met the crashworthy requirements for temporary traffic barriers and should not be used to shield obstacles or provide positive protection for pedestrians or workers.*

### **Section 6F.72 Temporary Lane Separators**

**Option:**

01 Temporary lane separators may be used to channelize road users, to divide opposing vehicular traffic lanes, to divide lanes when two or more lanes are open in the same direction, and to provide continuous pedestrian channelization.

**Standard:**

02 **Temporary lane separators shall be crashworthy. Temporary lane separators shall have a maximum height of 4 inches and a maximum width of 1 foot, and shall have sloping sides in order to facilitate crossover by emergency vehicles.**

**Option:**

03 Temporary lane separators may be supplemented with any of the approved channelizing devices contained in this Chapter, such as tubular markers, vertical panels, and opposing traffic lane dividers.

**Standard:**

04 **If appropriate channelizing devices are used to supplement a temporary lane separator, the channelizing devices shall be retroreflectorized to provide nighttime visibility. If channelizing devices are not used, the temporary lane separator shall contain retroreflectorization to enhance its visibility.**

*Guidance:*

05 *A temporary lane separator should be stabilized by affixing it to the pavement in a manner suitable to its design, while allowing the unit to be shifted from place to place within the TTC zone in order to accommodate changing conditions.*

**Standard:**

06 **At pedestrian crossing locations, temporary lane separators shall have an opening or be shortened to provide a pathway that is at least 60 inches wide for crossing pedestrians.**

### **Section 6F.73 Other Channelizing Devices**

**Option:**

01 Channelizing devices other than those described in this Chapter may be used in special situations based on an engineering study.

*Guidance:*

*02 Other channelizing devices should comply with the general size, color, stripe pattern, retroreflection, and placement characteristics established for the devices described in this Chapter.*

### **Section 6F.74 Detectable Edging for Pedestrians**

**Support:**

**01 Individual channelizing devices, tape or rope used to connect individual devices, other discontinuous barriers and devices, and pavement markings are not detectable by persons with visual disabilities and are incapable of providing detectable path guidance on temporary or realigned sidewalks or other pedestrian facilities.**

*Guidance:*

*02 When it is determined that a facility should be accessible to and detectable by pedestrians with visual disabilities, a continuously detectable edging should be provided throughout the length of the facility such that it can be followed by pedestrians using long canes for guidance. This edging should protrude at least 6 inches above the surface of the sidewalk or pathway, with the bottom of the edging a maximum of ~~2.5~~2.0 inches above the surface. This edging should be continuous throughout the length of the facility except for gaps at locations where pedestrians or vehicles will be turning or crossing. This edging should consist of a prefabricated or formed-in-place curbing or other continuous device that is placed along the edge of the sidewalk or walkway. This edging should be firmly attached to the ground or to other devices. Adjacent sections of this edging should be interconnected such that the edging is not displaced by pedestrian or vehicular traffic or work operations, and such that it does not constitute a hazard to pedestrians, workers, or other road users.*

**Support:**

**03 Examples of detectable edging for pedestrians include:**

- A. Prefabricated lightweight sections of plastic, metal, or other suitable materials that are interconnected and fixed in place to form a continuous edge.
- B. Prefabricated lightweight sections of plastic, metal, or other suitable materials that are interconnected, fixed in place, and placed at ground level to provide a continuous connection between channelizing devices located at intervals along the edge of the sidewalk or walkway.
- C. Sections of lumber interconnected and fixed in place to form a continuous edge.
- D. Formed-in-place asphalt or concrete curb.
- E. Prefabricated concrete curb sections that are interconnected and fixed in place to form a continuous edge.
- F. Continuous temporary traffic barrier or longitudinal channelizing barricades placed along the edge of the sidewalk or walkway that provides a pedestrian edging at ground level.
- G. Chain link or other fencing equipped with a continuous bottom rail.

*Guidance:*

*04 Detectable pedestrian edging should be orange, white, or yellow and should match the color of the adjacent channelizing devices or traffic control devices, if any are present.*

*05 If prefabricated edging is used to separate pedestrians and vehicular traffic, such edging should be certified as crashworthy (see section 6F.01). If section of lumber is used to form a railing system, any part of the railing that is more than 3 feet above pavement should be treated lumber and cause no harm to bare hand touching it.*

### **Section 6F.75 Temporary Raised Islands**

**Standard:**

**01 Temporary raised islands shall be used only in combination with pavement striping and other suitable channelizing devices.**

**Option:**

**02 A temporary raised island may be used to separate vehicular traffic flows in two-lane, two-way operations on roadways having a vehicular traffic volume range of 4,000 to 15,000 average daily traffic (ADT) and on freeways having a vehicular traffic volume range of 22,000 ADT to 60,000 ADT.**

**03 Temporary raised islands also may be used in other than two-lane, two-way operations where physical separation of vehicular traffic from the TTC zone is not required.**

*Guidance:*

*04 Temporary raised islands should have the basic dimensions of 4 inches high by at least 12 inches wide and have rounded or chamfered corners.*

*05 The temporary raised islands should not be designed in such a manner that they would cause a motorist to lose control of the vehicle if the vehicle inadvertently strikes the temporary raised island. If struck, pieces of the island should not be dislodged to the extent that they could penetrate the occupant compartment or involve other vehicles.*

**Standard:**

**06 At pedestrian crossing locations, temporary raised islands shall have an opening or be shortened to provide at least a 60-inch wide pathway for the crossing pedestrian.**

**Section 6F.76 Opposing Traffic Lane Divider and Sign (W6-4)**

**Support:**

*01 Opposing traffic lane dividers are delineation devices used as center lane dividers to separate opposing vehicular traffic on a two-lane, two-way operation.*

**Standard:**

**02 Opposing traffic lane dividers shall not be placed across pedestrian crossings.**

**03 The Opposing Traffic Lane Divider (W6-4) sign (see Figure 6F-4) shall be an upright, retroreflective orange-colored sign placed on a flexible support and sized at least 12 inches wide by 18 inches high.**

**Guidance:**

*04 The Opposing Traffic Lane Divider (W6-4) sign should only be used to supplement a channelizing device that is being used to separate opposing traffic in a TTC zone.*

**Section 6F.77 Pavement Markings**

**Support:**

*01 Pavement markings are installed or existing markings are maintained or enhanced in TTC zones to provide road users with a clearly defined path for travel through the TTC zone in day, night, and twilight periods under both wet and dry pavement conditions.*

**Guidance:**

*02 The work should be planned and staged to provide for the placement and removal of the pavement markings in a way that minimizes the disruption to traffic flow approaching and through the TTC zone during the placement and removal process.*

**Standard:**

**03 Existing pavement markings shall be maintained in all long-term stationary (see Section 6G.02) TTC zones in accordance with Chapters 3A and 3B, except as otherwise provided for temporary pavement markings in Section 6F.78. Pavement markings shall match the alignment of the markings in place at both ends of the TTC zone. Pavement markings shall be placed along the entire length of any paved detour or temporary roadway prior to the detour or roadway being opened to road users.**

**04 For long-term stationary operations, pavement markings in the temporary traveled way that are no longer applicable shall be removed or obliterated as soon as practical. Pavement marking obliteration shall remove the non-applicable pavement marking material, and the obliteration method shall minimize pavement scarring. Painting over existing pavement markings with black paint or spraying with asphalt shall not be accepted as a substitute for removal or obliteration.**

**Option:**

*05 Removable, non-reflective, preformed tape that is approximately the same color as the pavement surface may be used where markings need to be covered temporarily.*

**Guidance:**

*06 Centerlines and lane lines should be placed, replaced, or delineated where appropriate before the roadway is opened to traffic.*

**Standard:**

**07 On State highways, whenever construction or maintenance work causes obliteration of center stripe, temporary or permanent center stripe shall be in place prior to opening the State highway to public traffic.**

## Section 6F.78 Temporary Markings

### Support:

01 Temporary markings are those pavement markings or devices that are placed within TTC zones to provide road users with a clearly defined path of travel through the TTC zone when the permanent markings are either removed or obliterated during the work activities. Temporary markings are typically needed during the reconstruction of a road while it is open to traffic, such as overlays or surface treatments or where lanes are temporarily shifted on pavement that is to remain in place.

### Guidance:

02 *Unless justified based on engineering judgment, temporary pavement markings should not remain in place for more than 14 days after the application of the pavement surface treatment or the construction of the final pavement surface on new roadways or over existing pavements.*

03 *The temporary use of edge lines, channelizing lines, lane-reduction transitions, gore markings, and other longitudinal markings, and the various non-longitudinal markings (such as stop lines, railroad crossings, crosswalks, words, symbols, or arrows) should be in accordance with the State's or highway agency's policy.*

### Standard:

04 **Warning signs, channelizing devices, and delineation shall be used to indicate required road user paths in TTC zones where it is not possible to provide a clear path by pavement markings.**

05 **Except as otherwise provided in this Section, all temporary pavement markings for no-passing zones shall comply with the requirements of Chapters 3A and 3B. All temporary broken-line pavement markings shall use the same cycle length as permanent markings and shall have line segments that are at least 2 feet long.**

### Guidance:

06 *All pavement markings and devices used to delineate road user paths should be reviewed during daytime and nighttime periods.*

### Option:

07 Half-cycle lengths with a minimum of 2-foot stripes may be used on roadways with severe curvature (see Section 3A.06) for broken line center lines in passing zones and for lane lines.

08 For temporary situations of 14 days or less, for a two- or three-lane road, no-passing zones may be identified by using DO NOT PASS (R4-1), PASS WITH CARE (R4-2), and NO PASSING ZONE (W14-3) signs (see Sections 2B.28, 2B.29, and 2C.45) rather than pavement markings. Also, DO NOT PASS, PASS WITH CARE, and NO PASSING ZONE signs may be used instead of pavement markings on roads with low volumes for longer periods in accordance with the State's or highway agency's policy.

### Guidance:

09 *If used, the DO NOT PASS, PASS WITH CARE, and NO PASSING ZONE signs should be placed in accordance with Sections 2B.28, 2B.29, and 2C.45.*

10 *If used, the NO CENTER LINE sign should be placed in accordance with Section 6F.47.*

### Standard:

11 **Temporary lane lines and/or centerlines shall consist of retroreflectorized lines approximately 24 inch long, 4 inch wide, spaced approximately 24 feet apart.**

### Option:

12 Day/night raised retroreflectorized pavement markers, approved by Caltrans, may be used in lieu of 24 inch lines. See Section 6F.79 for spacing requirements.

### Guidance:

13 *Right edge lines should not be simulated with dashed lines or raised pavement markers because they could confuse motorists.*

### Option:

14 Portable delineators, permanent type delineators, etc., may be used where it is considered desirable to enhance the edge of traveled way due to curvilinear alignment, narrowing pavement, etc.

### Standard:

15 **Locations on two-lane conventional highways where no-passing zone centerline delineation has been obliterated shall be posted with a sign package consisting of a ROAD (STREET) WORK (W20-1) sign and WORK ZONE (G20-5aP) plaque in combination with a DO NOT PASS (R4-1) sign.**

*Guidance:*

*<sup>16</sup> The R4-1 sign should be posted at approximate 2000 foot intervals throughout the extended no-pass zone. A PASS WITH CARE (R4-2) sign should also be placed at the end of the zone.*

### **Section 6F.79 Temporary Raised Pavement Markers**

**Option:**

<sup>01</sup> Retroreflective or internally illuminated raised pavement markers, or non-retroreflective raised pavement markers supplemented by retroreflective or internally illuminated markers, may be substituted for markings of other types in TTC zones.

**Standard:**

<sup>02</sup> **If used, the color and pattern of the raised pavement markers shall simulate the color and pattern of the markings for which they substitute.**

~~<sup>03</sup> If temporary raised pavement markers are used to substitute for broken line segments, a group of at least three retroreflective markers shall be equally spaced at no greater than  $N/8$  (see Section 3B.14). The value of  $N$  for a broken or dotted line shall equal the length of one line segment plus one gap.~~

~~<sup>04</sup> If temporary raised pavement markers are used to substitute for solid lines, the markers shall be equally spaced at no greater than  $N/4$ , with retroreflective or internally illuminated units at a spacing no greater than  $N/2$ . The value of  $N$  referenced for solid lines shall equal the  $N$  for the broken or dotted lines that might be adjacent to or might extend the solid lines (see Section 3B.11).~~

<sup>04a</sup> **If raised pavement markers are used to substitute for broken line segments, at least two retroreflective markers shall be placed, one at each end of a segment of 4 feet or less. For segments over 4 feet, a group of at least three retroreflective markers shall be equally spaced. See Section 3A.06 for more details.**

**Option:**

~~<sup>05</sup> Temporary raised pavement markers may be used to substitute for broken line segments by using at least two retroreflective markers placed at each end of a segment of 2 to 5 feet in length, using the same cycle length as permanent markings.~~

*Guidance:*

<sup>06</sup> *Temporary raised pavement markers used on ~~2 to 5-foot~~ 4-foot or less segments to substitute for broken line segments should not be in place for more than 14 days unless justified by engineering judgment.*

<sup>07</sup> *Raised pavement markers should be considered for use along surfaced detours or temporary roadways, and other changed or new travel-lane alignments.*

**Option:**

<sup>08</sup> Retroreflective or internally illuminated raised pavement markers, or non-retroreflective raised pavement markers supplemented by retroreflective or internally illuminated markers, may also be used in TTC zones to supplement markings as prescribed in Chapters 3A and 3B.

### **Section 6F.80 Delineators**

**Standard:**

<sup>01</sup> **When used, delineators shall combine with or supplement other TTC devices. They shall be mounted on crashworthy supports so that the reflecting unit is approximately 4 feet above the near roadway edge. The standard color for delineators used along both sides of two-way streets and highways and the right-hand side of one-way roadways shall be white. Delineators used along the left-hand side of one-way roadways shall be yellow.**

*Guidance:*

<sup>02</sup> *Spacing along roadway curves should be as set forth in Section 3F.04 and should be such that several delineators are constantly visible to the driver.*

**Option:**

<sup>03</sup> Delineators may be used in TTC zones to indicate the alignment of the roadway and to outline the required vehicle path through the TTC zone.

**Standard:**

<sup>04</sup> **The delineators shall be placed 2 feet to 6 feet outside the outer edge of the shoulder. Retroreflection of delineators shall be 3 x 12 inch minimum size.**

### **Section 6F.81 Lighting Devices**

*Guidance:*

- 01 *Lighting devices should be provided in TTC zones based on engineering judgment.*
- 02 *When used to supplement channelization, the maximum spacing for warning lights should be identical to the channelizing device spacing requirements.*

*Option:*

- 03 *Lighting devices may be used to supplement retroreflectorized signs, barriers, and channelizing devices.*
- 04 *During normal daytime maintenance operations, the functions of flashing warning beacons may be provided by high-intensity rotating, flashing, oscillating, or strobe lights on a maintenance vehicle.*

**Standard:**

- 05 **Although vehicle hazard warning lights are permitted to be used to supplement high-intensity rotating, flashing, oscillating, or strobe lights, they shall not be used instead of high-intensity rotating, flashing, oscillating, or strobe lights.**

### **Section 6F.82 Floodlights**

*Support:*

- 01 *Utility, maintenance, or construction activities on highways are frequently conducted during nighttime periods when vehicular traffic volumes are lower. Large construction projects are sometimes operated on a double-shift basis requiring night work (see Section 6G.19).*

*Guidance:*

- 02 *When nighttime work is being performed, floodlights should be used to illuminate the work area, equipment crossings, and other areas.*

**Standard:**

- 02a **Highway construction work lighting shall be as per Construction Safety Order 1523 (California Code of Regulations Title 8, Division 1, Chapter 4, Subchapter 4, Article 3, Section 1523 - Illumination). See Section 1A.11 for information regarding this publication.**

- 03 **Except in emergency situations, flagger stations shall be illuminated at night.**
- 04 **Floodlighting shall not produce a disabling glare condition for approaching road users, flaggers, or workers.**

*Guidance:*

- 05 *The adequacy of the floodlight placement and elimination of potential glare should be determined by driving through and observing the floodlighted area from each direction on all approaching roadways after the initial floodlight setup, at night, and periodically.*

*Support:*

- 06 *Desired illumination levels vary depending upon the nature of the task involved. An average horizontal luminance of ~~5 foot candles~~ **10 foot candles (108 lux)** can be adequate for general activities. Tasks requiring high levels of precision and extreme care can require an average horizontal luminance of 20 foot candles.*

### **Section 6F.83 Warning Lights**

*Support:*

- 01 *Type A, Type B, Type C, and Type D 360-degree warning lights are portable, powered, yellow, lens-directed, enclosed lights.*

**Standard:**

- 02 **Warning lights shall be in accordance with the current ITE “Purchase Specification for Flashing and Steady-Burn Warning Lights” (see Section 1A.11).**
- 03 **When warning lights are used, they shall be mounted on signs or channelizing devices in a manner that, if hit by an errant vehicle, they will not be likely to penetrate the windshield.**

*Guidance:*

- 04 *The maximum spacing for warning lights should be identical to the channelizing device spacing requirements.*

Support:

05 The light weight and portability of warning lights are advantages that make these devices useful as supplements to the retroreflectorization on signs and channelizing devices. The flashing lights are effective in attracting road users' attention.

Option:

06 Warning lights may be used in either a steady-burn or flashing mode.

**Standard:**

07 **Except for the sequential flashing warning lights that are described in Paragraphs 8 and 9, flashing warning lights shall not be used for delineation, as a series of flashers fails to identify the desired vehicle path.**

Option:

08 A series of sequential flashing warning lights may be placed on channelizing devices that form a merging taper in order to increase driver detection and recognition of the merging taper.

**Standard:**

09 **If a series of sequential flashing warning lights is used, the successive flashing of the lights shall occur from the upstream end of the merging taper to the downstream end of the merging taper in order to identify the desired vehicle path. Each flashing warning light in the sequence shall be flashed at a rate of not less than 55 or more than 75 times per minute.**

10 **Type A Low-Intensity Flashing warning lights, Type C Steady-Burn warning lights, and Type D 360-degree Steady-Burn warning lights shall be maintained so as to be capable of being visible on a clear night from a distance of 3,000 feet. Type B High-Intensity Flashing warning lights shall be maintained so as to be capable of being visible on a sunny day when viewed without the sun directly on or behind the device from a distance of 1,000 feet.**

11 **Warning lights shall have a minimum mounting height of 30 inches to the bottom of the lens.**

Support:

12 Type A Low-Intensity Flashing warning lights are used to warn road users during nighttime hours that they are approaching or proceeding in a potentially hazardous area.

Option:

13 Type A warning lights may be mounted on channelizing devices.

Support:

14 Type B High-Intensity Flashing warning lights are used to warn road users during both daylight and nighttime hours that they are approaching a potentially hazardous area.

Option:

15 Type B warning lights are designed to operate 24 hours per day and may be mounted on advance warning signs or on independent supports.

16 Type C Steady-Burn warning lights and Type D 360-degree Steady-Burn warning lights may be used during nighttime hours to delineate the edge of the traveled way.

*Guidance:*

17 *When used to delineate a curve, Type C and Type D 360-degree warning lights should only be used on devices on the outside of the curve, and not on the inside of the curve.*

Support:

18 **Flashing warning beacon is a type of warning light and often used to supplement other TTC devices.**

**Standard:**

19 **Flashing warning beacon shall comply with the provisions of Chapter 4L and Caltrans' standard signal lenses. A flashing warning beacon shall be a flashing yellow light with a minimum nominal diameter of 12 inch. Where flashing warning beacon is required, a Type B warning light shall not be used in its place. When placed within 15 feet of the edge of travel way the beacon and its support shall be certified as crashworthy (see section 6F.01) or the beacon shall meet the lightweight criteria set for Type B warning light and is mounted on a certified crashworthy support. The mounting height shall be between 6 feet and 10 feet, measured from the bottom of the base to the center of the lens.**



## **Section 6F.84 Temporary Traffic Control Signals**

### **Standard:**

**01 Temporary traffic control signals (see Section 4D.32) used to control road user movements through TTC zones and in other TTC situations shall comply with the applicable provisions of Part 4 and for State highways, Caltrans' Standard Plans and/or Special Provisions. See Section 1A.11 for information regarding this publication.**

### **Support:**

02 Temporary traffic control signals are typically used in TTC zones such as temporary haul road crossings; temporary one-way operations along a one-lane, two-way highway; temporary one-way operations on bridges, reversible lanes, and intersections.

### **Standard:**

**03 A temporary traffic control signal that is used to control traffic through a one-lane, two-way section of roadway shall comply with the provisions of Section 4H.02.**

### **Guidance:**

04 *Where pedestrian traffic is detoured to a temporary traffic control signal, engineering judgment should be used to determine if pedestrian signals or accessible pedestrian signals (see Section 4E.09) are needed for crossing along an alternate route.*

05 *When temporary traffic control signals are used, conflict monitors typical of traditional traffic control signal operations should be used.*

### **Option:**

06 Temporary traffic control signals may be portable or temporarily mounted on fixed supports.

### **Guidance:**

07 *Temporary traffic control signals should only be used in situations where temporary traffic control signals are preferable to other means of traffic control, such as changing the work staging or work zone size to eliminate one-way vehicular traffic movements, using flaggers to control one-way or crossing movements, using STOP or YIELD signs, and using warning devices alone.*

### **Support:**

08 Factors related to the design and application of temporary traffic control signals include the following:

- A. Safety and road user needs;
- B. Work staging and operations;
- C. The feasibility of using other TTC strategies (for example, flaggers, providing space for two lanes, or detouring road users, including bicyclists and pedestrians);
- D. Sight distance restrictions;
- E. Human factors considerations (for example, lack of driver familiarity with temporary traffic control signals);
- F. Road-user volumes including roadway and intersection capacity;
- G. Affected side streets and driveways;
- H. Vehicle speeds;
- I. The placement of other TTC devices;
- J. Parking;
- K. Turning restrictions;
- L. Pedestrians;
- M. The nature of adjacent land uses (such as residential or commercial);
- N. Legal authority;
- O. Signal phasing and timing requirements;
- P. Full-time or part-time operation;
- Q. Actuated, fixed-time, or manual operation;
- R. Power failures or other emergencies;
- S. Inspection and maintenance needs;
- T. Need for detailed placement, timing, and operation records; and
- U. Operation by contractors or by others.

09 Although temporary traffic control signals can be mounted on trailers or lightweight portable supports, fixed supports offer superior resistance to displacement or damage by severe weather, vehicle impact, and vandalism.

*Guidance:*

<sup>10</sup> *Other TTC devices should be used to supplement temporary traffic control signals, including warning and regulatory signs, pavement markings, and channelizing devices.*

<sup>11</sup> *Temporary traffic control signals not in use should be covered or removed.*

<sup>12</sup> *If a temporary traffic control signal is located within 1/2 mile of an adjacent traffic control signal, consideration should be given to interconnected operation.*

**Standard:**

<sup>13</sup> **Temporary traffic control signals shall not be located within 200 feet of a grade crossing unless the temporary traffic control signal is provided with preemption in accordance with Section 4D.27, or unless a uniformed officer or flagger is provided at the crossing to prevent vehicles from stopping within the crossing.**

## **Section 6F.85 Temporary Traffic Barriers**

**Support:**

<sup>01</sup> Temporary traffic barriers, including shifting portable or movable barriers, are devices designed to help prevent penetration by vehicles while minimizing injuries to vehicle occupants, and to protect workers, bicyclists, and pedestrians.

<sup>02</sup> The four primary functions of temporary traffic barriers are:

A. To keep vehicular traffic from entering work areas, such as excavations or material storage sites;

B. To separate workers, bicyclists, and pedestrians from motor vehicle traffic;

C. To separate opposing directions of vehicular traffic; and

D. To separate vehicular traffic, bicyclists, and pedestrians from the work area such as false work for bridges and other exposed objects.

**Option:**

<sup>03</sup> Temporary traffic barriers may be used to separate two-way vehicular traffic.

*Guidance:*

<sup>04</sup> *Because the protective requirements of a TTC situation have priority in determining the need for temporary traffic barriers, their use should be based on an engineering study.*

**Standard:**

<sup>05</sup> **Temporary traffic barriers shall be supplemented with standard delineation, pavement markings, or channelizing devices for improved daytime and nighttime visibility if they are used to channelize vehicular traffic. The delineation color shall match the applicable pavement marking color.**

<sup>06</sup> **Temporary traffic barriers, including their end treatments, shall be crashworthy. In order to mitigate the effect of striking the upstream end of a temporary traffic barrier, the end shall be installed in accordance with AASHTO's "Roadside Design Guide" (see Section 1A.11) by flaring until the end is outside the acceptable clear zone or by providing crashworthy end treatments.**

**Option:**

<sup>07</sup> Warning lights or steady-burn lamps may be mounted on temporary traffic barrier installations.

<sup>07a</sup> Side reflectors or top mounted reflectors (facing the road user) may be used on temporary traffic barriers.

*Guidance:*

<sup>07b</sup> *If used, the spacing of these reflectors should not exceed a distance in feet equal to 1.0 times the speed limit in mph through the TTC zone.*

**Support:**

<sup>08</sup> Movable barriers are capable of being repositioned laterally using a transfer vehicle that travels along the barrier. Movable barriers enable short-term closures to be installed and removed on long-term projects. Providing a barrier-protected work space for short-term closures and providing unbalanced flow to accommodate changes in the direction of peak-period traffic flows are two of the advantages of using movable barriers.

<sup>09</sup> Figure 6H-45 shows a temporary reversible lane using movable barriers. The notable feature of the movable barrier is that in both Phase A and Phase B, the lanes used by opposing traffic are separated by a barrier.

<sup>10</sup> Figure 6H-34 shows an exterior lane closure using a temporary traffic barrier. Notes 7 through 9 address the option of using a movable barrier. By using a movable barrier, the barrier can be positioned to close the lane during the off-peak periods and can be relocated to open the lane during peak periods to accommodate peak

traffic flows. With one pass of the transfer vehicle, the barrier can be moved out of the lane and onto the shoulder. Furthermore, if so desired, with a second pass of the transfer vehicle, the barrier could be moved to the roadside beyond the shoulder.

<sup>11</sup> More specific information on the use of temporary traffic barriers is contained in Chapters 8 and 9 of AASHTO's "Roadside Design Guide" (see Section 1A.11).

Support:

<sup>12</sup> More specific information on the use of portable barriers and crash cushions can be obtained from Caltrans' Standard Plans and Standard Specifications. See Section 1A.11 for information regarding this publication.

## **Section 6F.86 Crash Cushions**

Support:

<sup>01</sup> Crash cushions are systems that mitigate the effects of errant vehicles that strike obstacles, either by smoothly decelerating the vehicle to a stop when hit head-on, or by redirecting the errant vehicle. The two types of crash cushions that are used in TTC zones are stationary crash cushions and truck-mounted attenuators. Crash cushions in TTC zones help protect the drivers from the exposed ends of barriers, fixed objects, shadow vehicles, and other obstacles. Specific information on the use of crash cushions can be found in AASHTO's "Roadside Design Guide" (see Section 1A.11).

**Standard:**

<sup>02</sup> **Crash cushions shall be crashworthy. They shall also be designed for each application to stop or redirect errant vehicles under prescribed conditions. Crash cushions shall be periodically inspected to verify that they have not been hit or damaged. Damaged crash cushions shall be promptly repaired or replaced to maintain their crashworthiness.**

Support:

<sup>03</sup> Stationary crash cushions are used in the same manner as permanent highway installations to protect drivers from the exposed ends of barriers, fixed objects, and other obstacles.

**Standard:**

<sup>04</sup> **Stationary crash cushions shall be designed for the specific application intended.**

<sup>05</sup> **Truck-mounted attenuators shall be energy-absorbing devices attached to the rear of shadow trailers or trucks. If used, the shadow vehicle with the attenuator shall be located in advance of the work area, workers, or equipment to reduce the severity of rear-end crashes from errant vehicles.**

Support:

<sup>06</sup> Trucks or trailers are often used as shadow vehicles to protect workers or work equipment from errant vehicles. These shadow vehicles are normally equipped with flashing arrows, changeable message signs, and/or high-intensity rotating, flashing, oscillating, or strobe lights located properly in advance of the workers and/or equipment that they are protecting. However, these shadow vehicles might themselves cause injuries to occupants of the errant vehicles if they are not equipped with truck-mounted attenuators.

*Guidance:*

<sup>07</sup> *The shadow truck should be positioned a sufficient distance in advance of the workers or equipment being protected so that there will be sufficient distance, but not so much so that errant vehicles will travel around the shadow truck and strike the protected workers and/or equipment.*

Support:

<sup>08</sup> Chapter 9 of AASHTO's "Roadside Design Guide" (see Section 1A.11) contains additional information regarding the use of shadow vehicles.

*Guidance:*

<sup>09</sup> *If used, the truck-mounted attenuator should be used in accordance with the manufacturer's specifications.*

Support:

<sup>10</sup> Information about designs and types of crash cushions currently approved for use on State highways is available from Caltrans' Division of Traffic Operations in Sacramento.

## Section 6F.87 Rumble Strips

### Support:

01 Transverse rumble strips consist of intermittent, narrow, transverse areas of rough-textured or slightly raised or depressed road surface that extend across the travel lanes to alert drivers to unusual vehicular traffic conditions. Through noise and vibration they attract the driver's attention to such features as unexpected changes in alignment and to conditions requiring a stop.

### Option:

01a Portable transverse rumble strips may be used for flagging operations, as they are easy to set out, remove and/or relocate.

02 Longitudinal rumble strips consist of a series of rough-textured or slightly raised or depressed road surfaces located along the shoulder to alert road users that they are leaving the travel lanes.

### Standard:

03 **If it is desirable to use a color other than the color of the pavement for a longitudinal rumble strip, the color of the rumble strip shall be the same color as the longitudinal line the rumble strip supplements.**

04 **If the color of a transverse rumble strip used within a travel lane is not the color of the pavement, the color of the rumble strip shall be white, black, or orange.**

04a **The color of a portable transverse rumble strip used within a travel lane shall be black or orange. The height of the portable transverse rumble strip shall be from 5/8 to 3/4 inch, including the height of adhesives, if used. The width of each portable transverse rumble strip shall not be less than 12 inches, nor more than 13 inches. Each portable transverse rumble strip shall be at least 10 feet long and shall have a minimum weight of 105 lbs.**

### Option:

05 Intervals between transverse rumble strips may be reduced as the distance to the approached conditions is diminished in order to convey an impression that a closure speed is too fast and/or that an action is imminent. A RUMBLE STRIPS (C45(CA)) sign warning drivers of the onset of rumble strips may be placed in advance of any transverse rumble strip installation.

### Guidance:

06 *Transverse rumble strips should be placed transverse to vehicular traffic movement. They should not adversely affect overall pavement skid resistance under wet or dry conditions.*

07 *In urban areas, even though a closer spacing might be warranted, transverse rumble strips should be designed in a manner that does not promote unnecessary braking or erratic steering maneuvers by road users.*

08 *Transverse rumble strips should not be placed on sharp horizontal or vertical curves.*

09 *Rumble strips should not be placed through pedestrian crossings or on bicycle routes.*

10 *Transverse rumble strips should not be placed on roadways used by bicyclists unless a minimum clear path of 4 feet is provided at each edge of the roadway or on each paved shoulder as described in AASHTO's "Guide to the Development of Bicycle Facilities" (see Section 1A.11).*

11 *Longitudinal rumble strips should not be placed on the shoulder of a roadway that is used by bicyclists unless a minimum clear path of 4 feet is also provided on the shoulder.*

12 *If used for flagging operation, 2 arrays (1 array is a single group or set) of portable transverse rumble strips should be placed transverse to the vehicular traffic movement in advance of and approach to each flagger station. Each array should consist of 3 rumble strips spaced no less 6 feet and no more than 10 feet apart. The 1st array should be placed adjacent to the ONE LANE ROAD AHEAD (W20-4) sign and the 2nd array should be placed adjacent to the California Flagger symbol (C9A(CA)) sign. See Figure 6H-10A(CA).*

### Standard:

13 **If portable transverse rumble strips are used for flagging operations, the RUMBLE STRIPS (C45(CA)) sign shall be placed half way between the ROAD WORK AHEAD (W20-1) sign and the ONE LANE ROAD AHEAD (W20-4) (see Figure 6H-10A(CA)).**

14 **If the portable transverse rumble strips become out of alignment (skewed) by more than 6 inches, measured from one end to the other, they shall be readjusted to bring the placement back to the original location.**

## **Section 6F.88 Screens**

### **Support:**

01 Screens are used to block the road users' view of activities that can be distracting. Screens might improve safety and motor vehicle traffic flow where volumes approach the roadway capacity because they discourage gawking and reduce headlight glare from oncoming motor vehicle traffic.

### **Guidance:**

02 *Screens should not be mounted where they could adversely restrict road user visibility and sight distance and adversely affect the reasonably safe operation of vehicles.*

### **Option:**

03 Screens may be mounted on the top of temporary traffic barriers that separate two-way motor vehicle traffic.

03a Temporary traffic screen may be mounted on top of temporary traffic barriers, when barriers are used in transition and crossover areas for glare-control on high-volume roadways.

### **Guidance:**

03b *If used, temporary traffic screen panels should be a minimum of 24 inches in height.*

04 *Design of screens should be in accordance with Chapter 9 of AASHTO's "Roadside Design Guide" (see Section 1A.11).*

## **Section 6F.101(CA) LOOSE GRAVEL Sign (W8-7)**

### **Guidance:**

01 *The LOOSE GRAVEL (W8-7) sign should be used on chip seal jobs or other areas to warn motorists that there is loose gravel on the roadway.*

### **Standard:**

02 **When used, the W8-7 sign shall be placed at the beginning of work and at maximum 2000 feet intervals.**

### **Option:**

03 When warning is intended to be directed primarily to motorcyclists, use of the W8-7 sign with motorcycle plaque (W8-15P) may be considered.

04 The Advisory Speed (W13-1P) plaque may be used in combination with the W8-7 sign to indicate the need to decrease speed at a particular location. See Section 6C.01.

### **Guidance:**

05 *The advisory speed should be reasonable or prudent, considering weather, visibility, traffic, surface condition and width of the roadway.*

### **Standard:**

06 **On highways with speed limits of 40 mph or higher for seal coat projects, the W13-1P (35 mph or lower) plaque shall be used to supplement the W8-7 sign during placement and/or brooming of screenings.**

## **Section 6F.102(CA) NARROW LANE(S) Sign (C12(CA))**

### **Option:**

01 The NARROW LANE(S) (C12(CA)) sign may be used, when appropriate, to warn the approaching motorist of a narrow lane condition.

### **Guidance:**

02 *When used, the C12(CA) sign should be used in conjunction with an Advisory Speed (W13-1P) plaque. See Section 6C.01.*

## **Section 6F.103(CA) OPEN TRENCH Sign (C27(CA))**

### **Standard:**

01 **The OPEN TRENCH (C27(CA)) sign shall be used in advance of open trenches in/or adjacent to roadway.**

02 **The edge of the traveled way shall be defined by edge line delineation consisting of appropriate markers or striping. Edge line delineation shall be white when located on the right of traffic and yellow when located on the left of traffic.**

*Guidance:*

*03 Trenches in excess of 0.15 feet in depth but not exceeding 0.25 feet in depth that are less than 8 feet from the edge of traveled way should be identified by LOW SHOULDER (W8-9) signs set in the trench adjacent to the edge of pavement at intervals not to exceed every 2,000 feet.*

*Option:*

*04 Portable delineators may be placed at intervals not to exceed 100 feet in lieu of edge line delineation.*

**Standard:**

**05 Trenches in excess of 0.25 feet but less than 2.5 feet in depth that are less than 8 feet from the edge of traveled way shall be identified by alternating C27(CA) and NO SHOULDER (C31A(CA)) signs set in the trench at intervals not to exceed 2,000 feet.**

*Guidance:*

*06 Channelizers (CA) or portable delineators should be placed 2 feet to 6 feet outside of the edge line at 100 foot intervals for the conditions described above.*

*07 Trenches in excess of 0.25 feet in depth but not exceeding 2.5 feet in depth that are 8 feet to 15 feet from the edge of traveled way should be identified by C27(CA) signs set in the trench at intervals not to exceed every 2,000 feet. Portable delineators should be placed at 200 foot intervals within 2 feet from the edge of the trench and at 100 foot intervals for edge conditions exceeding 0.5 feet in depth.*

*08 Trenches in excess of 0.5 feet in depth but not exceeding 2.5 feet in depth that are more than 15 feet from the edge of traveled way at locations where a recovery area was available prior to construction should be identified by placing delineators at 200 foot intervals within 2 feet from the edge of the trench and by placing C27(CA) signs in the trench at intervals not to exceed 2,000 feet.*

**Standard:**

**09 Signing for trenches in excess of 2.5 feet in depth shall be based upon engineering judgment or studies (as noted in Section 1A.09) to ensure proper visibility of barricades and signing.**

*Support:*

*10 Refer to Tables 6F-101(CA) and 6H-3.*

**Section 6F.104(CA) Moving Lane Closure Signs (W23-1 and SC10(CA), SC11(CA), SC13(CA), SC15(CA))**

**Standard:**

**01 On State highways, the following signs shall be used as shown in Caltrans' Standard Plans T15, T16 and T17 for moving lane closures. See Section 1A.11 for information regarding this publication.**

- A. LANE CLOSED AHEAD or ROAD WORK AHEAD (SC10(CA)).**
- B. LANE CLOSED (SC11(CA)).**
- C. SLOW TRAFFIC AHEAD (W23-1).**
- D. DO NOT PASS (SC13(CA)).**
- E. CAUTION (SC15(CA)).**

**02 The Moving Lane Closure signs shall have a black legend on either a white or an orange background.**

**03 If used, the SC10(CA) sign and a Type II arrow board shall be mounted on the designated sign vehicle.**

**04 The SC11(CA) sign and a Type II arrow board shall be mounted on the designated sign vehicle.**

**05 If used, the W23-1 sign shall be mounted on the rear of the designated sign vehicle.**

**06 The SC13(CA) sign shall be mounted on the rear and/or the front of the designated sign vehicle.**

**07 If used, the SC15(CA) sign shall be mounted on the front of the designated sign vehicle.**

**Section 6F.105(CA) Object Markers**

**Standard:**

**01 When used in work zones, the Type N-3(CA) or OM1-3 object markers shall have an orange or fluorescent orange retroreflective background.**

**02 When used in work zones, the Type P(CA), R(CA), OM-3L, OM-3R and OM-3C object marker shall have alternating retroreflective orange and white stripes.**

*Support:*

*03 Figure 6F-103(CA) shows examples of object markers in TTC zones.*

*04 See Chapter 2C for more details.*

### **Section 6F.106(CA) Slow For The Cone Zone (SC19(CA) and SC20(CA)) Signs**

**Option:**

01 The Slow For The Cone Zone (SC19(CA)) and SLOW FOR THE CONE ZONE (SC20(CA)) signs (see Figures 6H-32(CA), 6H-33 & 6H-36(CA)) may be used to remind motorists to slow down when entering a temporary traffic control (TTC) zone to improve worker and road user safety.

02 If used, SC19(CA) and/or SC20(CA) signs may be used within the advance warning area, transition area, or activity area of a TTC zone.

03 A pictograph may be used on the SC19(CA) sign to identify a governmental jurisdiction, an area of jurisdiction, a governmental agency, a military base or branch of service, a governmental-approved university or college, or a governmental-approved institution.

**Standard:**

04 **If a pictograph is used on the SC19(CA) sign, the maximum dimension (height or width) of a pictograph shall not exceed two times the letter height of the largest legend used on the sign.**

### **Section 6F.107(CA) FRESH CONCRETE (C43(CA)) Sign**

**Option:**

01 The FRESH CONCRETE (C43(CA)) sign (see Figure 6F-101(CA)) may be used to warn road users of the surface treatment.

**Standard:**

02 **When used, the FRESH CONCRETE (C43(CA)) sign shall be placed at the beginning of the pavement work area.**

**Guidance:**

03 *The FRESH CONCRETE (C43(CA)) sign should remain in place during the entire curing period.*

### **Section 6F.108(CA) CAUTION FREQUENT STOPPING AND BACKING STAY BACK 100 FEET (SC21(CA)) Sign and MOVE OVER OR SLOW WHEN AMBER LIGHTS FLASHING (R111(CA)) Sign**

**Option:**

01 For mobile operations, CAUTION FREQUENT STOPPING AND BACKING STAY BACK 100 FEET (SC21(CA)) sign (see Figure 6F-101(CA)) may be mounted on a work vehicle to warn road users and workers of the frequent stopping and backing maneuvers made by the vehicle.

02 On Freeways, lane and/or shoulder closures, incident management, and for short duration work, MOVE OVER OR SLOW WHEN AMBER LIGHTS FLASHING (R111(CA)) sign (see Figure 6F-101(CA)) may be temporarily displayed on the back of a work vehicle to warn and regulate road users to move over and/or slow when passing work vehicles displaying a flashing amber warning light within or adjacent to the highway.

### **Section 6F.109(CA) Construction Project Funding Identification Signs**

**Option:**

01 For use on projects with estimated contract costs of \$750,000 or more and 50 working days or more, or 70 working days minimum when Saturdays or holidays are counted as working days, the Construction Funding Identification (C47(CA) Series) signs may be used to identify funding sources for a highway project. Formats of the sign series are flexible to include federal, state and/or local agency funding sources. See Figure 6F-101(CA).

**Standard:**

02 **If used, header panel shall include local agency pictograph and legend designed to fit within fluorescent orange portion, or shall include legend "Your Tax Dollars AT WORK" with a scaled image of the SLOW FOR THE CONE ZONE (SC19(CA)) sign to fit. Installation shall be placed in advance of temporary traffic control zone signs, one sign installed in each direction on up to two approaches.**

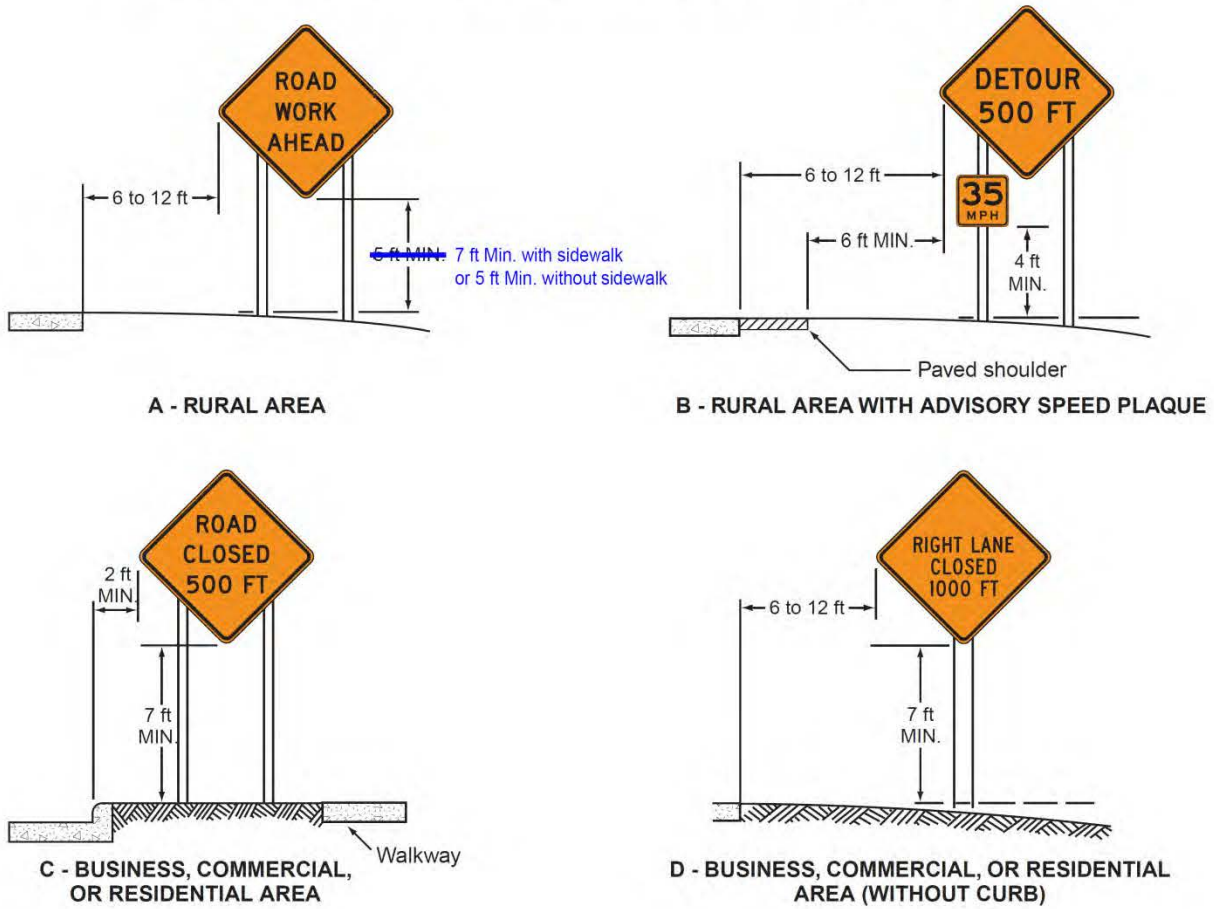
**Guidance:**

03 *Information on the sign should include type of project, such as Highway Construction, Highway Repair, Highway Improvement, Bridge Construction, Bridge Repair, or Roadside Work; types of funding, such as FEDERAL HIGHWAY TRUST FUNDS, STATE HIGHWAY FUNDS, STATE TRANSPORTATION BOND FUNDS, and/or COUNTY (CITY, RTPo, or MPO) TRANSPORTATION FUNDS; and anticipated year of completion, according to established contract completion schedule.*

**Option:**

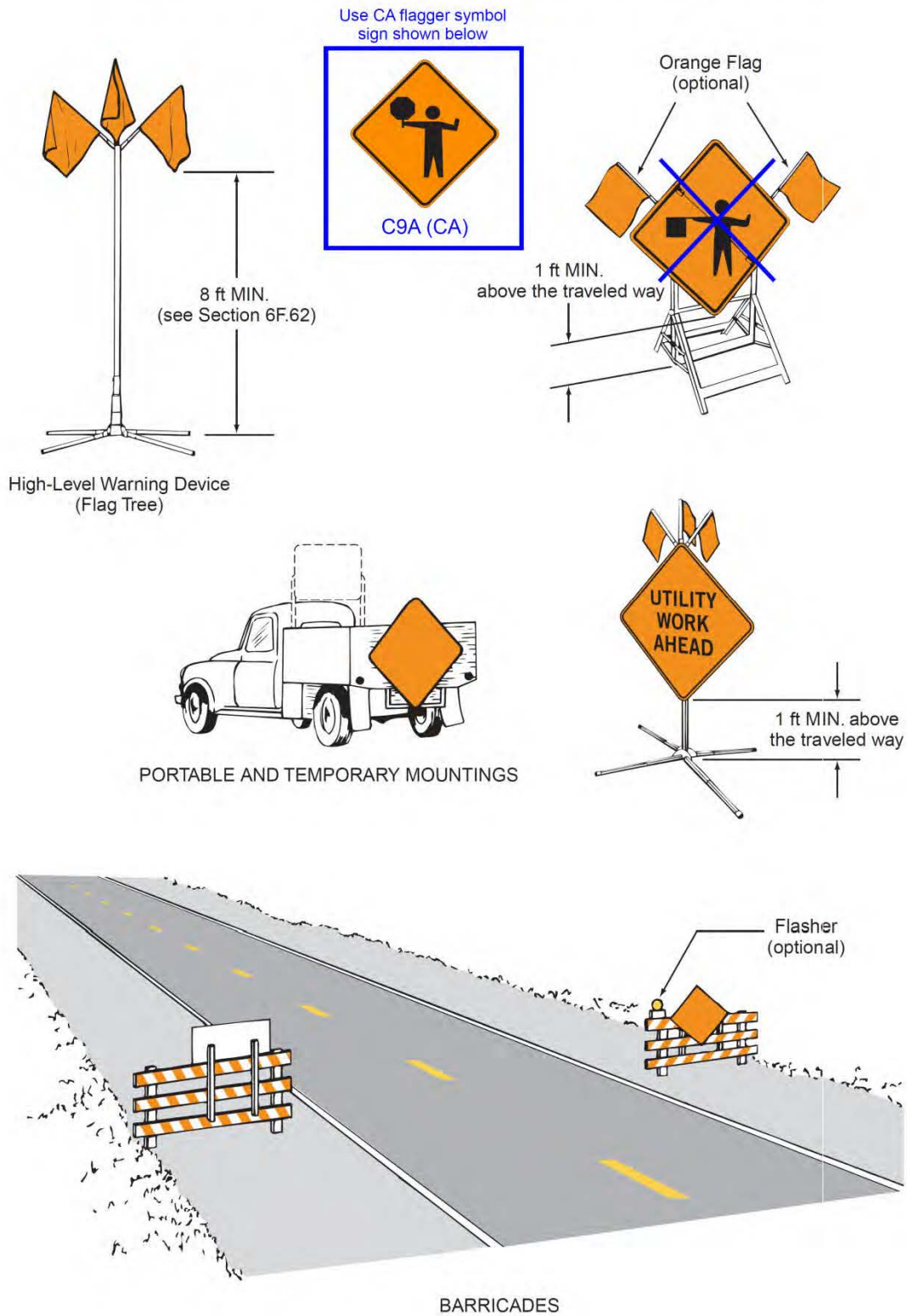
04 The C48 (CA) sign may be used on projects funded by Senate Bill 1. Formats of this sign are flexible to include federal, state and/or local agency funding sources. See Figure 6F-101(CA).

**Figure 6F-1. Height and Lateral Location of Signs—Typical Installations**





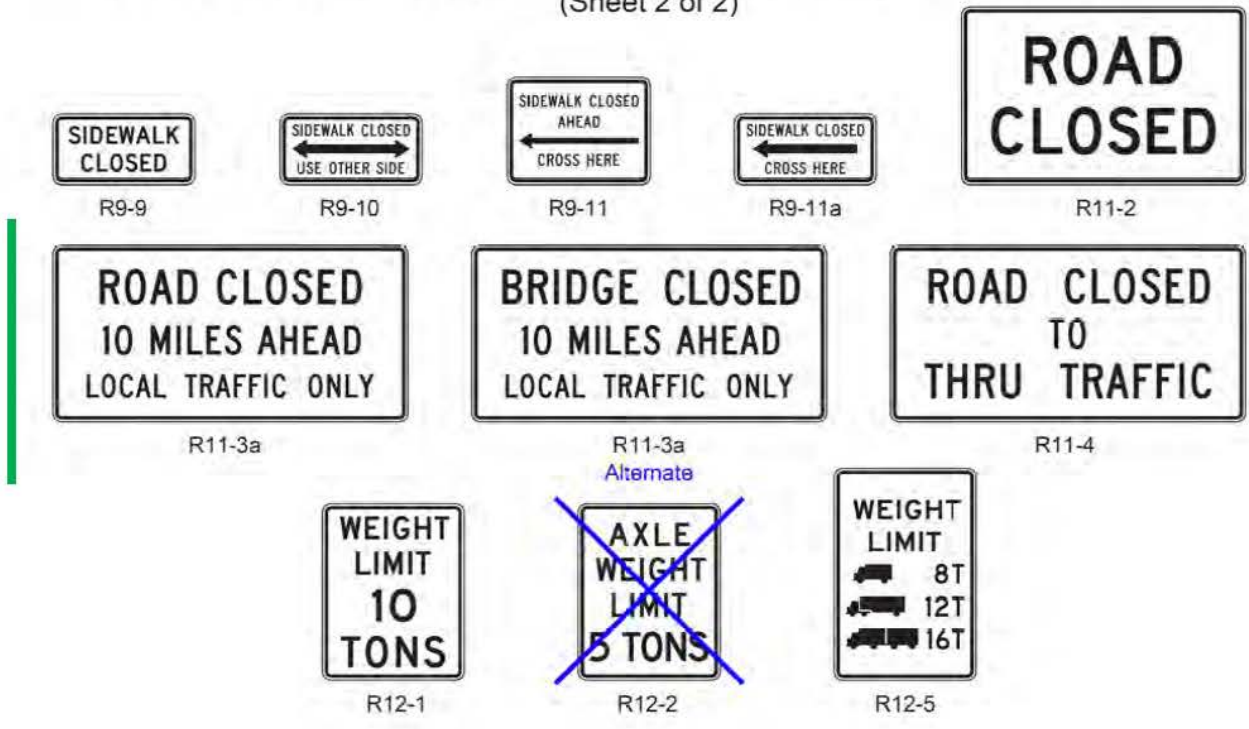
**Figure 6F-2. Methods of Mounting Signs Other Than on Posts**



**Figure 6F-3. Regulatory Signs and Plaques in Temporary Traffic Control Zones**  
 (Sheet 1 of 2)



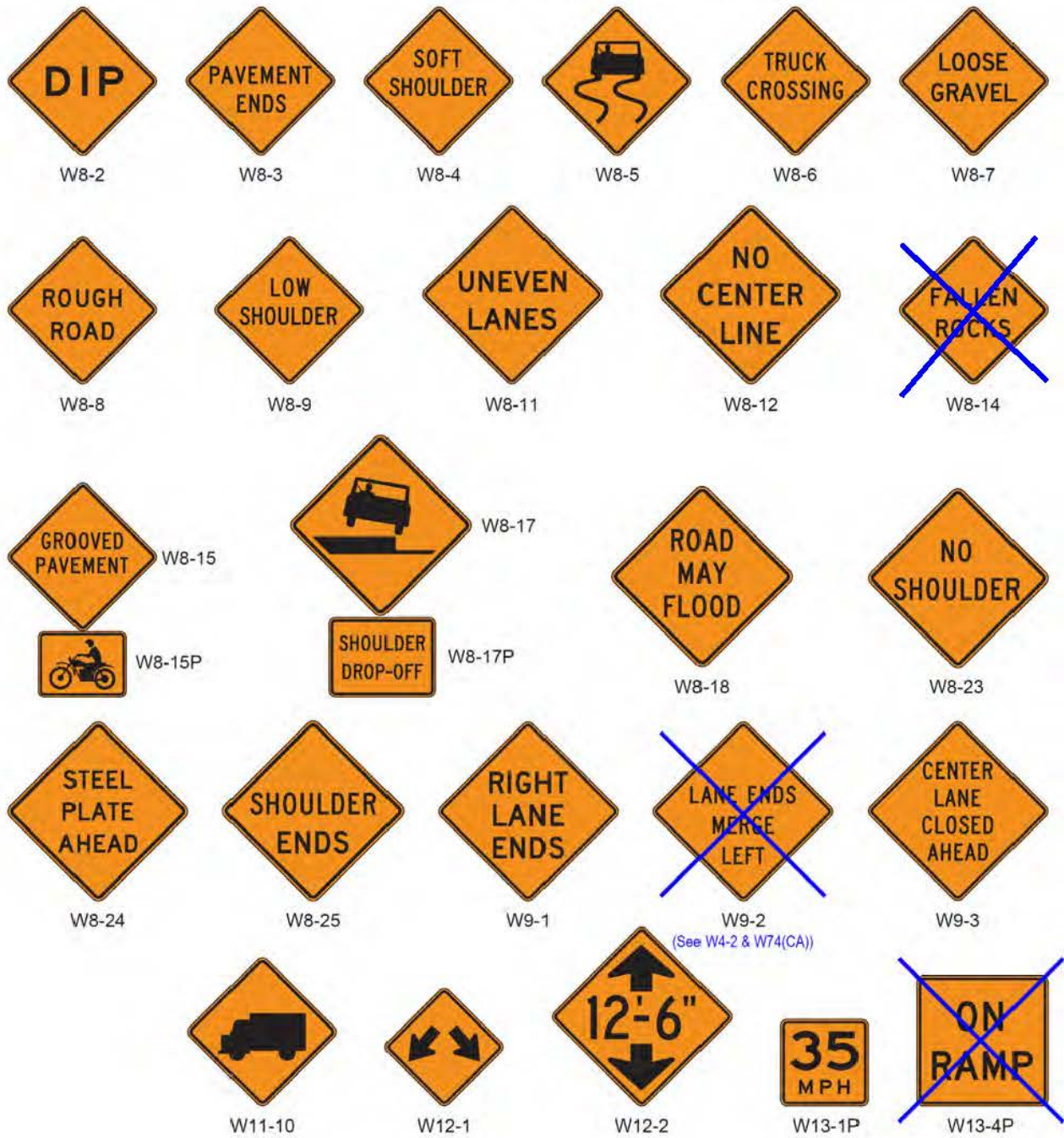
**Figure 6F-3. Regulatory Signs and Plaques in Temporary Traffic Control Zones**  
(Sheet 2 of 2)



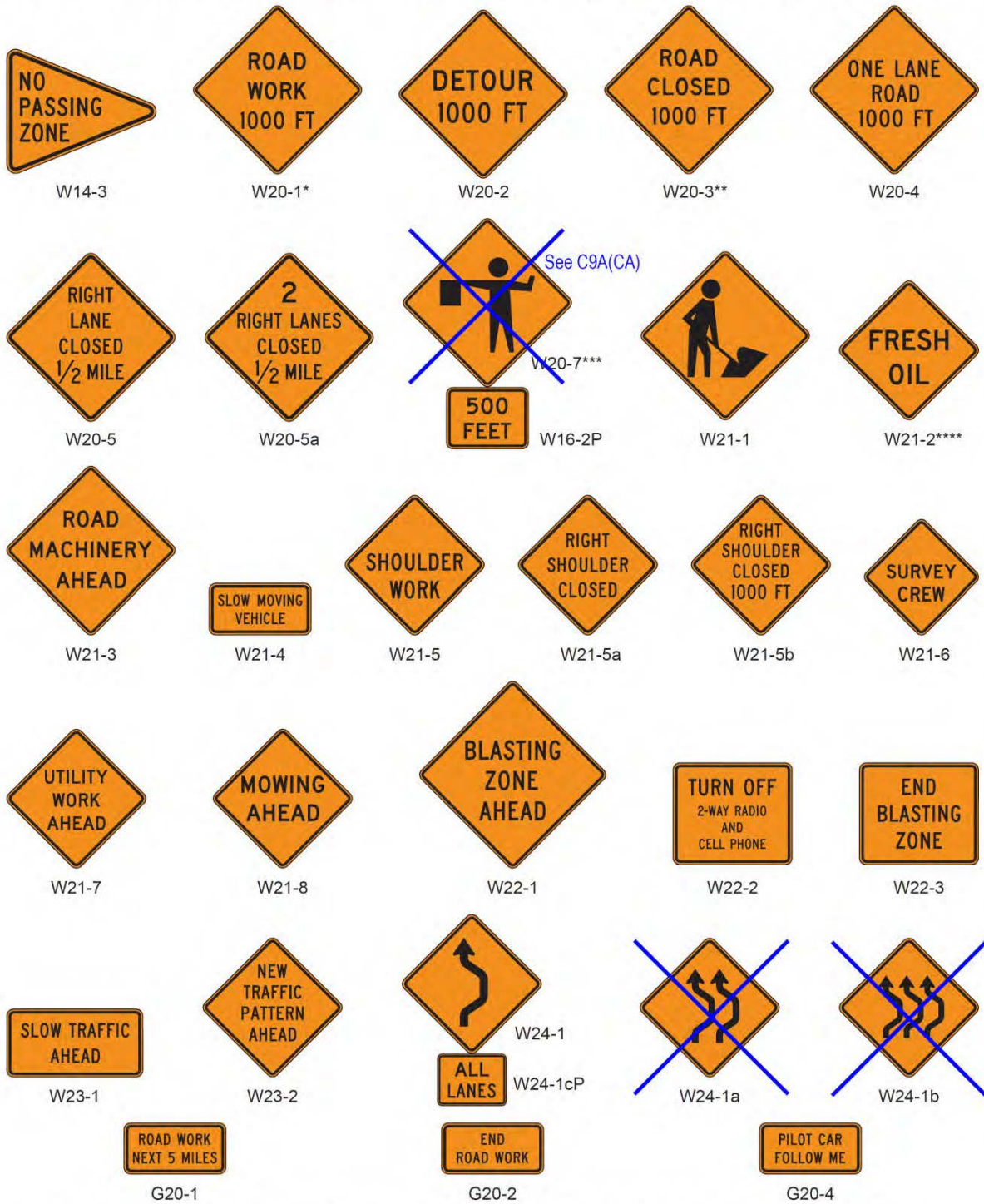
**Figure 6F-4. Warning Signs and Plaques in Temporary Traffic Control Zones**  
 (Sheet 1 of 3)



**Figure 6F-4. Warning Signs and Plaques in Temporary Traffic Control Zones**  
 (Sheet 2 of 3)

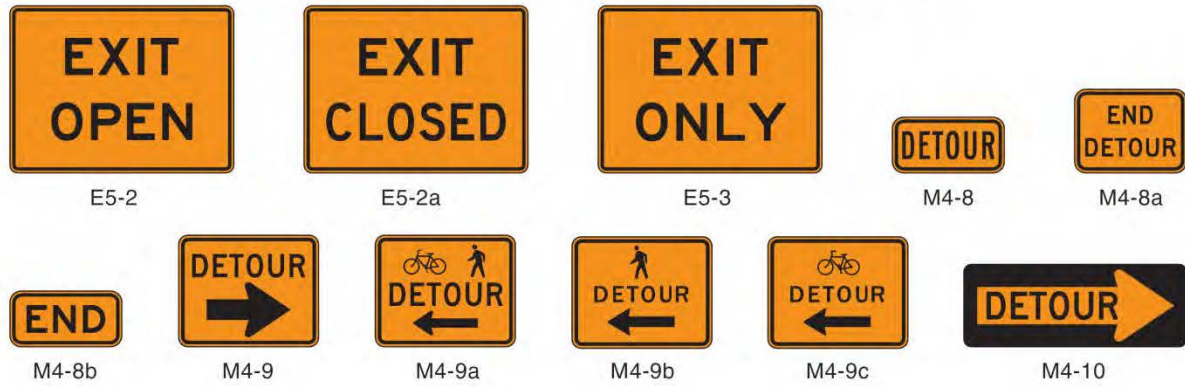


**Figure 6F-4. Warning Signs and Plaques in Temporary Traffic Control Zones (Sheet 3 of 3)**

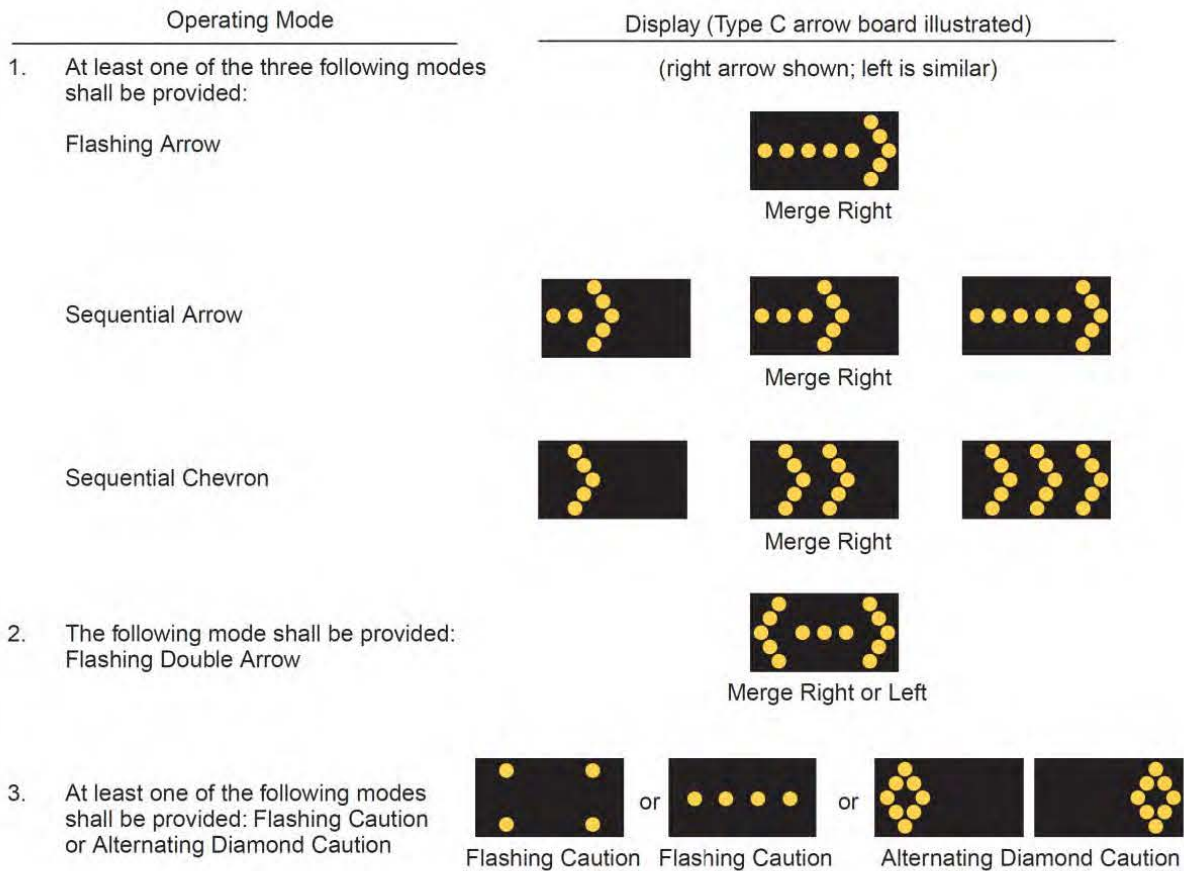


\* An optional STREET WORK word message sign is shown in the "Standard Highway Signs and Markings" book.  
 \*\* An optional STREET CLOSED word message sign is shown in the "Standard Highway Signs and Markings" book.  
 \*\*\* An optional FLAGGER (W20-7a) word message sign is shown in the "Standard Highway Signs and Markings" book.  
 \*\*\*\* An optional FRESH TAR word message sign is shown in the "Standard Highway Signs and Markings" book.

Figure 6F-5. Exit Open and Closed and Detour Signs



**Figure 6F-6. Advance Warning Arrow Board Display Specifications**



| Arrow Board Type | Minimum Size    | Minimum Legibility Distance | Minimum Number of Elements | Appropriate Use***  |
|------------------|-----------------|-----------------------------|----------------------------|---|
| A                | 48 x 24 inches  | 1/2 mile                    | 12                         | Low-speed urban streets   |
| B                | 60 x 30 inches  | 3/4 mile                    | 13                         | Intermediate-speed facilities and maintenance or mobile operations on high-speed roadways |
| II**             | 72 x 36 inches* | 3/4 mile                    | 13                         | Use in place of Type B or C   |
| C or I           | 96 x 48 inches  | 1 mile                      | 15                         | High-speed, high volume roadways  |
| D                | None*           | 1/2 mile                    | 12                         | On authorized vehicles  |

\*Length of arrow equals 48 inches, width of arrowhead equals 24 inches

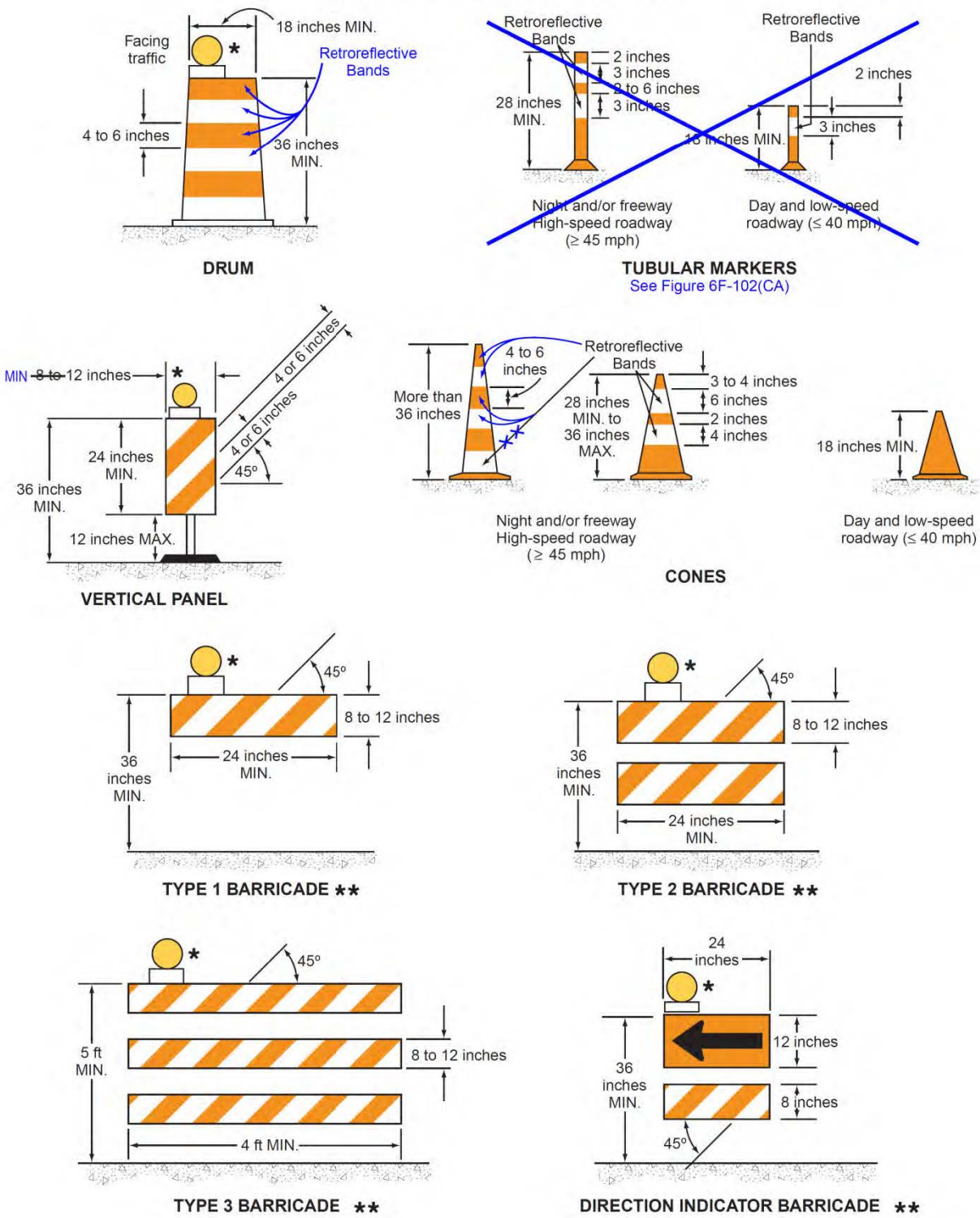
**Standard:**

\*\* For State highways, the panel Type B shall be replaced by Type II.

\*\*\* See Section 6F.61 for more details.

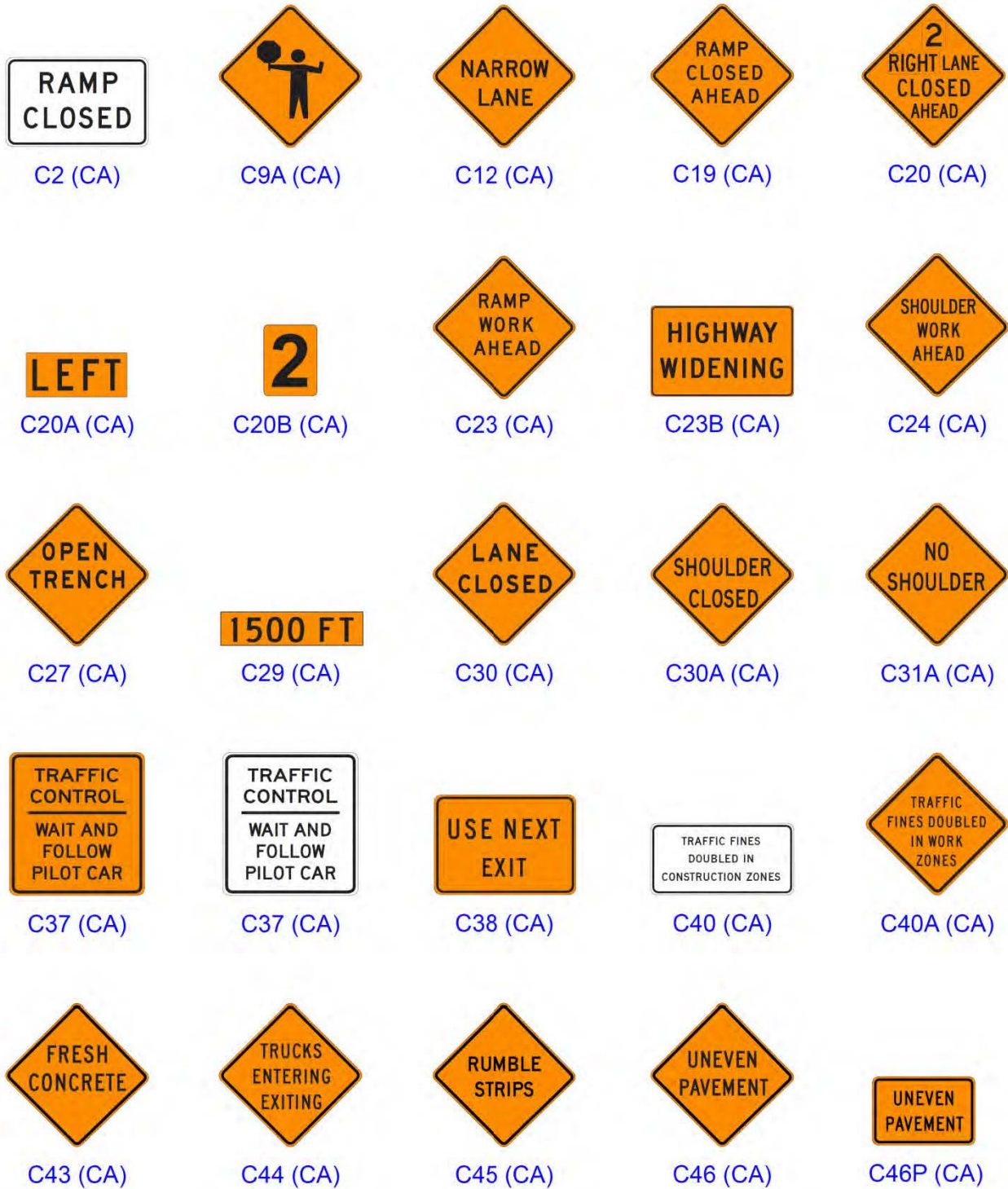


**Figure 6F-7. Channelizing Devices**

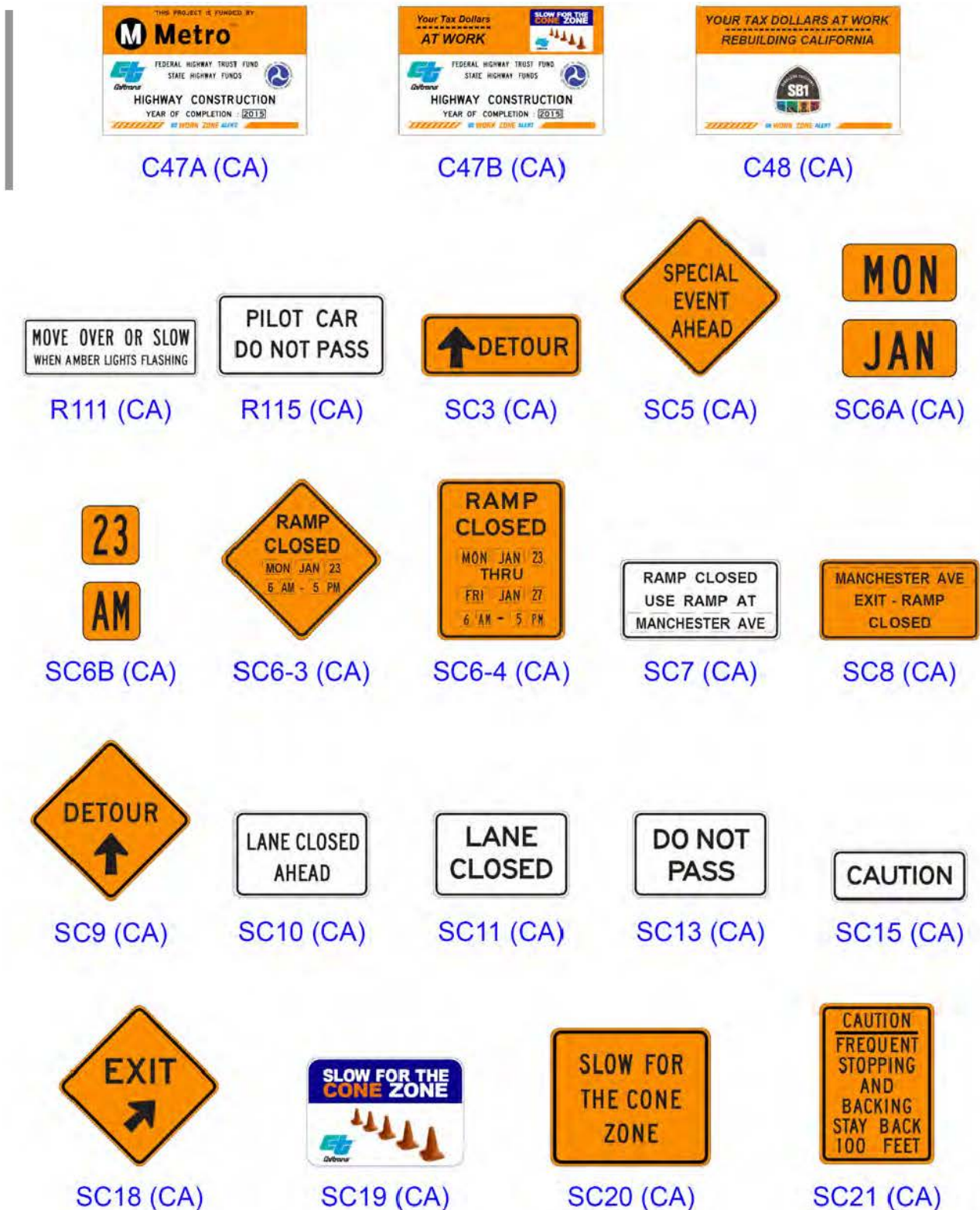


\* Warning lights (optional)  
 \*\* Rail stripe widths shall be 6 inches, except that 4-inch wide stripes may be used if rail lengths are less than 36 inches. The sides of barricades facing traffic shall have retroreflective rail faces.

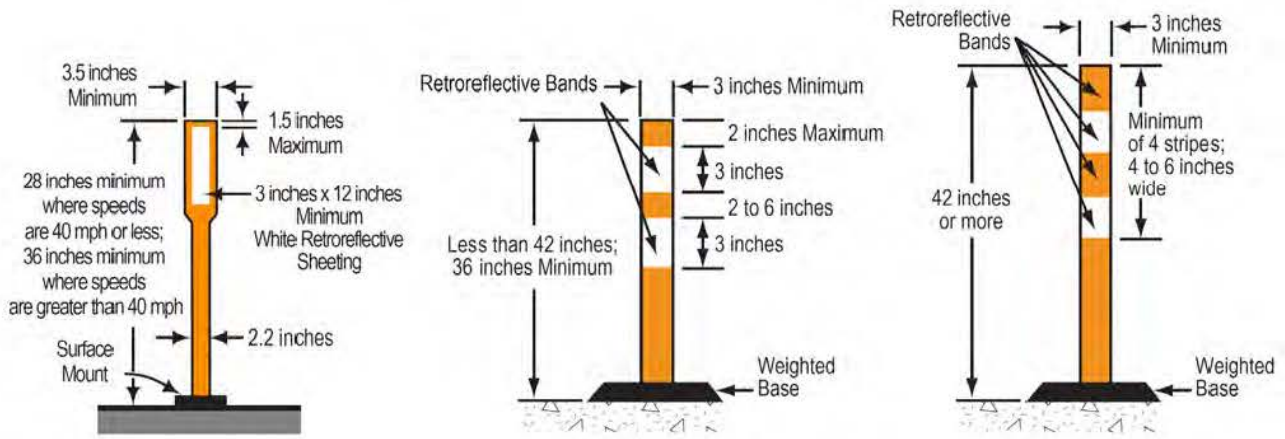
**Figure 6F-101 (CA). California Temporary Traffic Control Signs  
(Sheet 1 of 2)**



**Figure 6F-101 (CA). California Temporary Traffic Control Signs  
 (Sheet 2 of 2)**

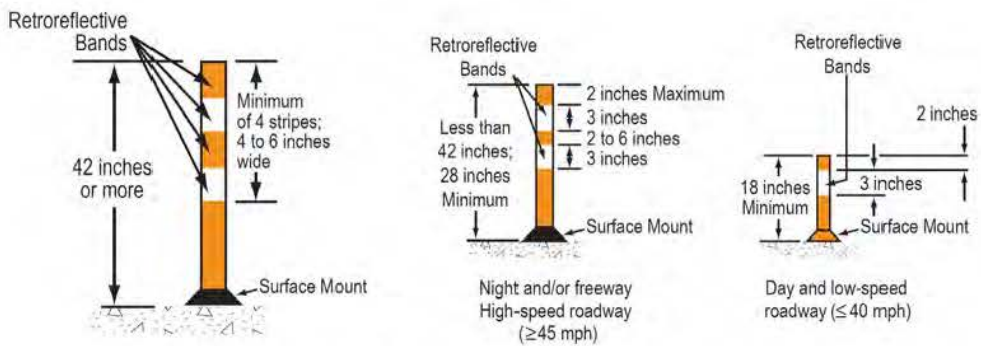


**Figure 6F-102 (CA). Tubular Markers**



**Channelizer (CA)**  
 (Tubular marker with flattened top and affixed to pavement)

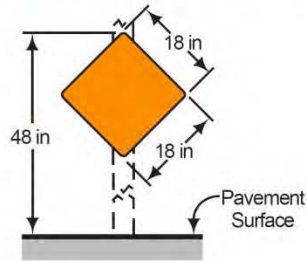
**Portable Delineator**  
 (Tubular marker with weighted base, not affixed to pavement)



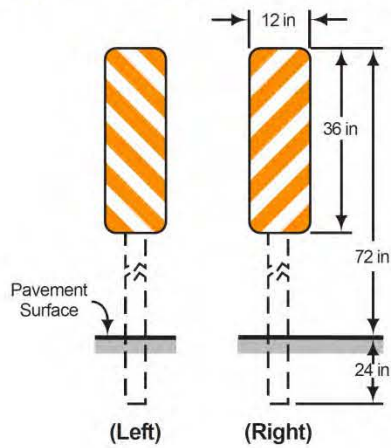
**Tubular Marker (Affixed to pavement)**

**Figure 6F-103 (CA). Examples of Object Markers in Temporary Traffic Control Zones**

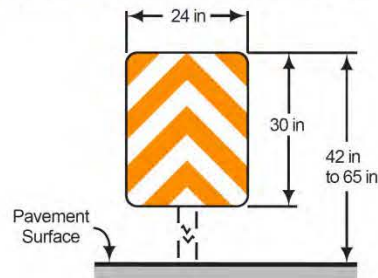
**Type N-3 (CA) Object Marker (OM1-3)**



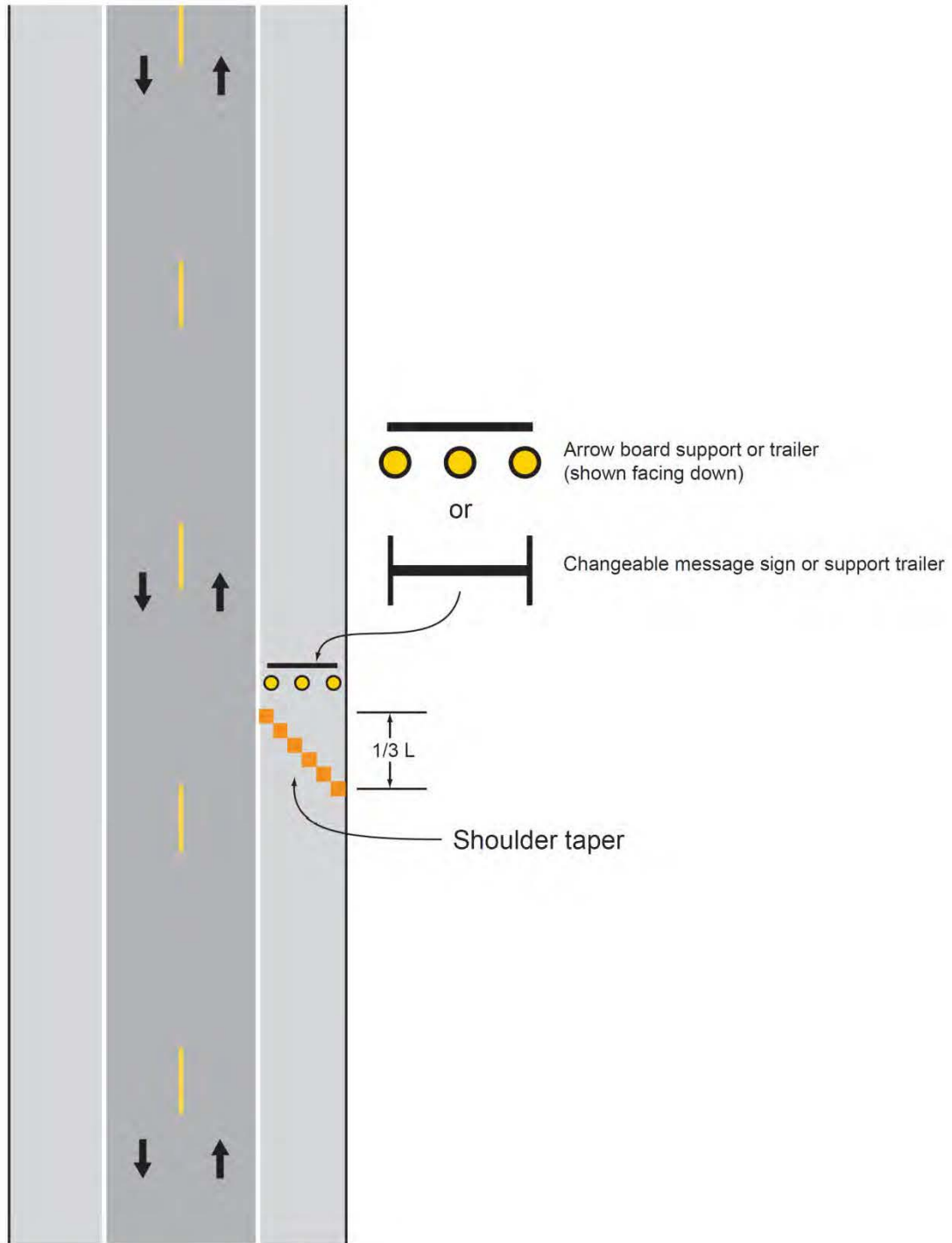
**Type P (CA) Object Markers (OM-3L&R)**



**Type R (CA) Object Marker (OM-3C)**



**Figure 6F-104(CA) Typical Layout Using Channelizing Devices to Delineate a Portable Changeable Message Sign or Arrow Board on Shoulder**



**Table 6F-1. Temporary Traffic Control Zone Sign and Plaque Sizes (Sheet 1 of 3)**

| Sign or Plaque                                       | Sign Designation    | Section          | Conventional Road  | Freeway or Expressway | Minimum            |
|--|---------------------|------------------|--------------------|-----------------------|--------------------|
| Stop   | R1-1                | 6F.06            | 30 x 30*           | —                     | —                  |
| Stop (on Stop/Slow Paddle)                           | R1-1                | 6E.03            | 18 x 18            | —                     | —                  |
| Yield  | R1-2                | 6F.06            | 36 x 36 x 36*      | —                     | 30 x 30 x 30       |
| To Oncoming Traffic (plaque)                         | R1-2aP              | 6F.06            | 36 x 30            | 48 x 36               | 24 x 18            |
| Wait on Stop   | R1-7                | 6E.05            | 24 x 30            | 24 x 30               | —                  |
| Go on Slow   | R1-8                | 6E.05            | 24 x 30            | 24 x 30               | —                  |
| Speed Limit  | R2-1                | 6F.12            | 24 x 30*           | 36 x 48               | —                  |
| <del>Fines Higher (plaque)</del>                     | <del>R2-6P</del>    | <del>6F.12</del> | <del>24 x 18</del> | <del>36 x 24</del>    | —                  |
| Fines Double (plaque)                                | R2-6aP              | 6F.12            | 24 x 18            | 36 x 24               | —                  |
| \$XX Fine (plaque)                                   | R2-6bP              | 6F.12            | 24 x 18            | 36 x 24               | —                  |
| Begin <del>Higher</del> <sup>Double</sup> Fines Zone | R2-10               | 6F.12            | 24 x 30            | 36 x 48               | —                  |
| End <del>Higher</del> <sup>Double</sup> Fines Zone   | R2-11               | 6F.12            | 24 x 30            | 36 x 48               | —                  |
| End Work Zone Speed Limit                            | R2-12               | 6F.12            | 24 x 36            | 36 x 54               | —                  |
| Movement Prohibition                                 | R3-1,2,3,4,18,27    | 6F.06            | 24 x 24*           | 36 x 36               | —                  |
| Mandatory Movement (1 lane)                          | R3-5                | 6F.06            | 30 x 36            | —                     | —                  |
| Optional Movement (1 lane)                           | R3-6                | 6F.06            | 30 x 36            | —                     | —                  |
| Mandatory Movement (text)                            | R3-7                | 6F.06            | 30 x 30*           | —                     | —                  |
| Advance Intersection Lane Control                    | R3-8                | 6F.06            | Varies x 30        | —                     | —                  |
| Do Not Pass  | R4-1                | 6F.06            | 24 x 30            | 36 x 48               | —                  |
| Pass With Care                                       | R4-2                | 6F.06            | 24 x 30            | 36 x 48               | —                  |
| Keep Right   | R4-7                | 6F.06            | 24 x 30            | 36 x 48               | —                  |
| Narrow Keep Right                                    | R4-7c               | 6F.06            | 18 x 30            | —                     | —                  |
| Stay in Lane   | R4-9                | 6F.11            | 24 x 30            | 36 x 48               | —                  |
| Do Not Enter   | R5-1                | 6F.06            | 30 x 30*           | 36 x 36               | —                  |
| Wrong Way  | R5-1a               | 6F.06            | 36 x 24*           | 42 x 30               | —                  |
| One Way  | R6-1                | 6F.06            | 36 x 12*           | 54 x 18               | —                  |
| One Way  | R6-2                | 6F.06            | 24 x 30*           | 36 x 48               | —                  |
| <del>No Parking (symbol)</del>                       | <del>R8-3</del>     | <del>6F.06</del> | <del>24 x 24</del> | <del>36 x 36</del>    | —                  |
| Pedestrian Crosswalk                                 | R9-8                | 6F.13            | 36 x 18            | —                     | —                  |
| Sidewalk Closed                                      | R9-9                | 6F.14            | 24 x 12            | —                     | —                  |
| Sidewalk Closed, Use Other Side                      | R9-10               | 6F.14            | 24 x 12            | —                     | —                  |
| Sidewalk Closed Ahead, Cross Here                    | R9-11               | 6F.14            | 24 x 18            | —                     | —                  |
| Sidewalk Closed, Cross Here                          | R9-11a              | 6F.14            | 24 x 12            | —                     | —                  |
| Road Closed  | R11-2               | 6F.08            | 48 x 30            | —                     | —                  |
| Road Closed - Local Traffic Only                     | R11-3a,3b,4         | 6F.09            | 60 x 30            | —                     | —                  |
| Weight Limit   | R12-1,2             | 6F.10            | 24 x 30            | 36 x 48               | —                  |
| Weight Limit (with symbols)                          | R12-5               | 6F.10            | 24 x 36            | 36 x 48               | —                  |
| Turn and Curve Signs                                 | W1-1,2,3,4          | 6F.16            | 36 x 36            | 48 x 48               | 30 x 30            |
| <del>Reverse Curve (2 or more lanes)</del>           | <del>W1-4b,4c</del> | <del>6F.16</del> | <del>36 x 36</del> | <del>48 x 48</del>    | <del>30 x 30</del> |
| One-Direction Large Arrow                            | W1-6                | 6F.16            | 48 x 24            | 60 x 30               | —                  |
| Chevron  | W1-8                | 6F.16            | 18 x 24            | 30 x 36               | —                  |
| Stop Ahead   | W3-1                | 6F.16            | 36 x 36            | 48 x 48               | 30 x 30            |
| Yield Ahead  | W3-2                | 6F.16            | 36 x 36            | 48 x 48               | 30 x 30            |
| Signal Ahead   | W3-3                | 6F.16            | 36 x 36            | 48 x 48               | 30 x 30            |
| Be Prepared to Stop                                  | W3-4                | 6F.16            | 36 x 36            | 48 x 48               | 30 x 30            |
| Reduced Speed Limit Ahead                            | W3-5                | 6F.16            | 36 x 36            | 48 x 48               | 30 x 30            |

(Also see C2(CA) Sign Size)

(See W1-4 Sign Size)

**Table 6F-1. Temporary Traffic Control Zone Sign and Plaque Sizes (Sheet 2 of 3)**

| Sign or Plaque                 | Sign Designation  | Section          | Conventional Road  | Freeway or Expressway | Minimum            |
|--------------------------------|-------------------|------------------|--------------------|-----------------------|--------------------|
| XX MPH Speed Zone Ahead        | W3-5a             | 6F.16            | 36 x 36            | 48 x 48               | 30 x 30            |
| Merging Traffic                | W4-1,5            | 6F.16            | 36 x 36            | 48 x 48               | 36 x 36            |
| Lane Ends                      | W4-2              | 6F.24            | 36 x 36            | 48 x 48               | 30 x 30            |
| Added Lane                     | W4-3,6            | 6F.16            | 36 x 36            | 48 x 48               | 30 x 30            |
| No Merge Area (plaque)         | W4-5P             | 6F.16            | 18 x 24            | 24 x 30               | —                  |
| Road Narrows                   | W5-1              | 6F.16            | 36 x 36            | 48 x 48               | 30 x 30            |
| Narrow Bridge                  | W5-2              | 6F.16            | 36 x 36            | 48 x 48               | 30 x 30            |
| One Lane Bridge                | W5-3              | 6F.16            | 36 x 36            | 48 x 48               | 30 x 30            |
| <del>Ramp Narrows</del>        | <del>W5-4</del>   | <del>6F.26</del> | <del>36 x 36</del> | <del>48 x 48</del>    | <del>30 x 30</del> |
| Divided Highway                | W6-1              | 6F.16            | 36 x 36            | 48 x 48               | 30 x 30            |
| Divided Highway Ends           | W6-2              | 6F.16            | 36 x 36            | 48 x 48               | 30 x 30            |
| Two-Way Traffic                | W6-3              | 6F.32            | 36 x 36            | 48 x 48               | 30 x 30            |
| Two-Way Traffic                | W6-4              | 6F.76            | 12 x 18            | 12 x 18               | —                  |
| Hill (symbol)                  | W7-1              | 6F.16            | 36 x 36            | 48 x 48               | 30 x 30            |
| Next XX Miles (plaque)         | W7-3aP            | 6F.53            | 24 x 18            | 36 x 30               | —                  |
| Bump                           | W8-1              | 6F.16            | 36 x 36            | 48 x 48               | 30 x 30            |
| Dip                            | W8-2              | 6F.16            | 36 x 36            | 48 x 48               | 30 x 30            |
| Pavement Ends                  | W8-3              | 6F.16            | 36 x 36            | 48 x 48               | 30 x 30            |
| Soft Shoulder                  | W8-4              | 6F.44            | 36 x 36            | 48 x 48               | 30 x 30            |
| Slippery When Wet              | W8-5              | 6F.16            | 36 x 36            | 48 x 48               | 30 x 30            |
| Truck Crossing                 | W8-6              | 6F.36            | 36 x 36            | 48 x 48               | 30 x 30            |
| Loose Gravel                   | W8-7              | 6F.16            | 36 x 36            | 48 x 48               | 30 x 30            |
| Rough Road                     | W8-8              | 6F.16            | 36 x 36            | 48 x 48               | 30 x 30            |
| Low Shoulder                   | W8-9              | 6F.44            | 36 x 36            | 48 x 48               | 30 x 30            |
| Uneven Lanes                   | W8-11             | 6F.45            | 36 x 36            | 48 x 48               | 30 x 30            |
| No Center Line                 | W8-12             | 6F.47            | 36 x 36            | 48 x 48               | 30 x 30            |
| <del>Fallen Rocks</del>        | <del>W8-14</del>  | <del>6F.16</del> | <del>36 x 36</del> | <del>48 x 48</del>    | <del>30 x 30</del> |
| Grooved Pavement               | W8-15             | 6F.16            | 36 x 36            | 48 x 48               | 30 x 30            |
| Motorcycle (plaque)            | W8-15P            | 6F.54            | 24 x 18            | 30 x 24               | —                  |
| Shoulder Drop Off (symbol)     | W8-17             | 6F.44            | 36 x 36            | 48 x 48               | 30 x 30            |
| Shoulder Drop-Off (plaque)     | W8-17P            | 6F.44            | 24 x 18            | 30 x 24               | —                  |
| Road May Flood                 | W8-18             | 6F.16            | 36 x 36            | 48 x 48               | 24 x 24            |
| No Shoulder                    | W8-23             | 6F.16            | 36 x 36            | 48 x 48               | 30 x 30            |
| Steel Plate Ahead              | W8-24             | 6F.46            | 36 x 36            | 48 x 48               | 30 x 30            |
| Shoulder Ends                  | W8-25             | 6F.16            | 36 x 36            | 48 x 48               | 30 x 30            |
| Lane Ends                      | W9-1              | 6F.16            | 36 x 36            | 48 x 48               | 30 x 30            |
| Center Lane Closed Ahead       | W9-3              | 6F.23            | 36 x 36            | 48 x 48               | 30 x 30            |
| Grade Crossing Advance Warning | W10-1             | 6F.16            | 36 dia.            | —                     | —                  |
| Truck                          | W11-10            | 6F.36            | 36 x 36            | 48 x 48               | 30 x 30            |
| Double Arrow                   | W12-1             | 6F.16            | 30 x 30            | —                     | —                  |
| Low Clearance                  | W12-2             | 6F.16            | 36 x 36            | 48 x 48               | 30 x 30            |
| Advisory Speed (plaque)        | W13-1P            | 6F.52            | 24 x 24            | 30 x 30               | 18 x 18            |
| <del>On Ramp (plaque)</del>    | <del>W13-4P</del> | <del>6F.25</del> | <del>36 x 36</del> | <del>36 x 36</del>    | <del>—</del>       |
| No Passing Zone (pennant)      | W14-3             | 6F.16            | 48 x 48 x 36       | 64 x 64 x 48          | 40 x 40 x 30       |
| XX Feet (plaque)               | W16-2P            | 6F.16            | 24 x 18            | 30 x 24               | —                  |
| Road Work (with distance)      | W20-1             | 6F.18            | 36 x 36            | 48 x 48               | 30 x 30            |

(See W5-1 or C12(CA) Sign Sizes)

(See W50-1(CA) Sign)

(See C23(CA) for RAMP WORK AHEAD Sign)



**Table 6F-1. Temporary Traffic Control Zone Sign and Plaque Sizes (Sheet 3 of 3)**

| Sign or Plaque                            | Sign Designation  | Section          | Conventional Road             | Freeway or Expressway         | Minimum            |
|---|-------------------|------------------|-------------------------------|-------------------------------|--------------------|
| Detour (with distance)                    | W20-2             | 6F.19            | 36 x 36                       | 48 x 48                       | 30 x 30            |
| Road (Street) Closed (with distance)      | W20-3             | 6F.20            | 36 x 36                       | 48 x 48                       | 30 x 30            |
| One Lane Road (with distance)             | W20-4             | 6F.21            | 36 x 36                       | 48 x 48                       | 30 x 30            |
| Lane(s) Closed (with distance)            | W20-5,5a          | 6F.22            | 36 x 36                       | 48 x 48                       | 30 x 30            |
| <del>Flagger (symbol)</del>               | <del>W20-7</del>  | <del>6F.31</del> | <del>36 x 36</del>            | <del>48 x 48</del>            | <del>30 x 30</del> |
| Flagger                                   | W20-7a            | 6F.31            | 36 x 36                       | 48 x 48                       | 30 x 30            |
| Slow (on Stop/Slow Paddle)                | W20-8             | 6E.03            | 18 x 18                       | —                             | —                  |
| Workers                                   | W21-1,1a          | 6F.33            | 36 x 36                       | 48 x 48                       | 30 x 30            |
| Fresh Oil (Tar)                           | W21-2             | 6F.34            | 36 x 36                       | 48 x 48                       | 30 x 30            |
| Road Machinery Ahead                      | W21-3             | 6F.35            | 36 x 36                       | 48 x 48                       | 30 x 30            |
| Slow Moving Vehicle                       | W21-4             | 6G.06            | 36 x 18                       | —                             | —                  |
| Shoulder Work                             | W21-5             | 6F.37            | 36 x 36                       | 48 x 48                       | 30 x 30            |
| Shoulder Closed                           | W21-5a            | 6F.37            | 36 x 36                       | 48 x 48                       | 30 x 30            |
| Shoulder Closed (with distance)           | W21-5b            | 6F.37            | 36 x 36                       | 48 x 48                       | 30 x 30            |
| Survey Crew                               | W21-6             | 6F.38            | 36 x 36                       | 48 x 48                       | 30 x 30            |
| Utility Work Ahead                        | W21-7             | 6F.39            | 36 x 36                       | 48 x 48                       | 30 x 30            |
| Mowing Ahead                              | W21-8             | 6G.06            | 36 x 36                       | 48 x 48                       | 30 x 30            |
| Blasting Zone Ahead                       | W22-1             | 6F.41            | 36 x 36                       | 48 x 48                       | 30 x 30            |
| Turn Off 2-Way Radio and Cell Phone       | W22-2             | 6F.42            | 42 x 36                       | 42 x 36                       | —                  |
| End Blasting Zone                         | W22-3             | 6F.43            | 42 x 36                       | 42 x 36                       | 36 x 30            |
| Slow Traffic Ahead                        | W23-1             | 6F.27            | <del>42 x 36</del><br>54 x 30 | <del>48 x 48</del><br>72 x 42 | 48 x 24            |
| New Traffic Pattern Ahead                 | W23-2             | 6F.30            | 36 x 36                       | 48 x 48                       | 30 x 30            |
| Double Reverse Curve (1 lane)             | W24-1             | 6F.49            | 36 x 36                       | 48 x 48                       | 30 x 30            |
| <del>Double Reverse Curve (2 lanes)</del> | <del>W24-1a</del> | <del>6F.49</del> | <del>36 x 36</del>            | <del>48 x 48</del>            | <del>30 x 30</del> |
| <del>Double Reverse Curve (3 lanes)</del> | <del>W24-1b</del> | <del>6F.49</del> | <del>36 x 36</del>            | <del>48 x 48</del>            | <del>30 x 30</del> |
| All Lanes                                 | W24-1cP           | 6F.49            | 24 x <del>24</del> 18         | 30 x <del>30</del> 24         | —                  |
| Road Work (Construction) Next XX Miles    | G20-1             | 6F.56            | <del>36 x 18</del><br>60 x 36 | <del>48 x 24</del><br>90 x 48 | 36 x 18            |
| End Road Work                             | G20-2             | 6F.57            | 36 x 18                       | 48 x 24                       | —                  |
| Pilot Car Follow Me                       | G20-4             | 6F.58            | 36 x 18                       | —                             | —                  |
| Work Zone (plaque)                        | G20-5aP           | 6F.12            | 24 x 18                       | 36 x 24                       | —                  |
| Exit Open                                 | E5-2              | 6F.28            | 48 x 36                       | 48 x 36                       | —                  |
| Exit Closed                               | E5-2a             | 6F.28            | 48 x 36                       | 48 x 36                       | —                  |
| Exit Only                                 | E5-3              | 6F.29            | 48 x 36                       | 48 x 36                       | —                  |
| Detour                                    | M4-8              | 6F.59            | 24 x 12                       | 30 x 15                       | —                  |
| End Detour                                | M4-8a             | 6F.59            | 24 x 18                       | 24 x 18                       | —                  |
| End                                       | M4-8b             | 6F.59            | 24 x 12                       | 24 x 12                       | —                  |
| Detour                                    | M4-9              | 6F.59            | 30 x 24                       | 48 x 36                       | —                  |
| Bike/Pedestrian Detour                    | M4-9a             | 6F.59            | 30 x 24                       | —                             | —                  |
| Pedestrian Detour                         | M4-9b             | 6F.59            | 30 x 24                       | —                             | —                  |
| Bike Detour                               | M4-9c             | 6F.59            | 30 x 24                       | —                             | —                  |
| Detour                                    | M4-10             | 6F.59            | 48 x 18                       | —                             | —                  |

(See C19(CA) for RAMP CLOSED Sign)

(Also See C20(CA) Sign Size)

(Also See C9A(CA) Sign Size)

(See W24-1 Sign Size)

(See W24-1 Sign Size)

\* See Table 2B-1 for minimum size required for signs facing traffic on multi-lane conventional roads

- Notes: 1. Larger signs may be used wherever necessary for greater legibility or emphasis  
 2. Dimensions are shown in inches and are shown as width x height

**Table 6F-1(CA). California Temporary Traffic Control Zone Sign and Plaque Sizes**

| Sign or Plaque   | Sign Designation | Section           | Conventional Road (Minimum) | Expressway | Freeway  | Oversized |
|--|------------------|-------------------|-----------------------------|------------|----------|-----------|
| RAMP CLOSED  | C2(CA)           | 6F.28             | 48 x 30                     | 48 x 30    | 48 x 30  | ---       |
| California Flagger Symbol                                | C9A(CA)          | 6F.31             | 36 x 36                     | 48 x 48    | 48 x 48  | ---       |
| NARROW LANE(S)   | C12(CA)          | 6F.26, 6F.102(CA) | 36 x 36                     | 48 x 48    | 48 x 48  | ---       |
| RAMP CLOSED AHEAD  | C19(CA)          | 6F.28             | 36 x 36                     | 48 x 48    | 48 x 48  | ---       |
| RIGHT LANE CLOSED AHEAD                                  | C20(CA)          | 6F.22             | 36 x 36                     | 48 x 48    | 48 x 48  | 72 x 72   |
| LEFT plaque  | C20A(CA)         | 6F.22             | 16 x 7                      | 19 x 8     | 19 x 8   | 33 x 10   |
| Numeral plaque   | C20B(CA)         | 6F.22             | 6 x 8                       | 8 x 10     | 8 x 10   | 10 x 12   |
| RAMP WORK AHEAD  | C23(CA)          | 6F.18             | 36 x 36                     | 48 x 48    | 48 x 48  | ---       |
| ROAD (STREET) WORK Informational plaque                  | C23B(CA)         | 6F.18             | Var x 18                    | Var x 24   | Var x 24 | ---       |
| SHOULDER WORK AHEAD                                      | C24(CA)          | 6F.37             | 30 x 30                     | 48 x 48    | 48 x 48  | ---       |
| OPEN TRENCH  | C27(CA)          | 6F.103(CA)        | 36 x 36                     | 48 x 48    | 48 x 48  | ---       |
| XXXX FT  | C29(CA)          | 6F.53             | 20 x 7                      | 36 x 9     | 36 x 9   | ---       |
| LANE CLOSED  | C30(CA)          | 6F.22             | 30 x 30                     | 48 x 48    | 48 x 48  | ---       |
| SHOULDER CLOSED  | C30A(CA)         | 6F.37             | 30 x 30                     | 48 x 48    | 48 x 48  | ---       |
| NO SHOULDER  | C31A(CA)         | 6F.44, 6F.103(CA) | 36 x 36                     | 48 x 48    | 48 x 48  | ---       |
| TRAFFIC CONTROL - WAIT AND FOLLOW PILOT CAR              | C37(CA)          | 6F.58             | 36 x 42                     | 36 x 42    | ---      | ---       |
| USE NEXT EXIT  | C38(CA)          | 6F.28             | ---                         | 48 x 36    | 48 x 36  | ---       |
| TRAFFIC FINES DOUBLED IN CONSTRUCTION ZONES              | C40(CA)          | 6F.12             | 108 x 42                    | 144 x 60   | 144 x 60 | ---       |
| TRAFFIC FINES DOUBLED IN WORK ZONES                      | C40A(CA)         | 6F.12             | 36 x 36                     | 48 x 48    | 48 x 48  | ---       |
| FRESH CONCRETE   | C43(CA)          | 6F.107(CA)        | 36 x 36                     | 48 x 48    | 48 x 48  | ---       |
| TRUCKS ENTERING EXITING                                  | C44(CA)          | 6F.36             | 36 x 36                     | 48 x 48    | 48 x 48  | ---       |
| RUMBLE STRIPS  | C45(CA)          | 6F.87             | 36 x 36                     | 48 x 48    | ---      | ---       |
| UNEVEN PAVEMENT  | C46(CA)          | 6F.45             | 36 x 36                     | 48 x 48    | 48 x 48  | ---       |
| UNEVEN PAVEMENT plaque                                   | C46P(CA)         | 6F.45             | 30 x 18                     | 36 x 24    | 36 x 24  | ---       |
| Construction Project Funding Identification Signs        | C47A, B(CA)      | 6F.109(CA)        | 96 x 60                     | 144 x 90   | 144 x 90 | ---       |
| Construction Project Funding Identification Signs        | C48(CA)          | 6F.109(CA)        | 48 x 30                     | 144 x 90   | 144 x 90 | ---       |
| MOVE OVER OR SLOW WHEN AMBER LIGHTS FLASHING             | R111(CA)         | 6F.108(CA)        | 54 x 18                     | 54 x 18    | 54 x 18  | ---       |
| PILOT CAR DO NOT PASS                                    | R115(CA)         | 6F.58             | 36 x 18                     | 36 x 18    | ---      | ---       |
| DETOUR with Arrow  | SC3(CA)          | 6F.59             | 36 x 12                     | 48 x 18    | 48 x 18  | ---       |
| SPECIAL EVENT AHEAD                                      | SC5(CA)          | 6F.18             | 36 x 36                     | 48 x 48    | 48 x 48  | ---       |
| RAMP CLOSED<br>(Not more than one day)                   | SC6-3(CA)        | 6F.28             | 48 x 48                     | 48 x 48    | 48 x 48  | ---       |
| RAMP CLOSED<br>(More than one day)                       | SC6-4(CA)        | 6F.28             | 48 x 60                     | 48 x 60    | 48 x 60  | ---       |
| Day/Month plaque   | SC6A(CA)         | 6F.28             | 12 x 6                      | 12 x 6     | 12 x 6   | ---       |
| Time plaque  | SC6B(CA)         | 6F.28             | 6 x 6                       | 6 x 6      | 6 x 6    | ---       |
| RAMP CLOSED,<br>USE RAMP AT _____                        | SC7(CA)          | 6F.28             | 84 x 42                     | 84 x 42    | 84 x 42  | ---       |
| ____ EXIT - RAMP CLOSED                                  | SC8(CA)          | 6F.28             | ---                         | 84 x 42    | 84 x 42  | ---       |
| (FWY) DETOUR with Arrow                                  | SC9(CA)          | 6F.59             | 36 x 36                     | 48 x 48    | 48 x 48  | ---       |
| LANE CLOSED AHEAD or ROAD WORK AHEAD                     | SC10(CA)         | 6F.104(CA)        | 48 x 30                     | 66 x 36    | 66 x 36  | ---       |
| LANE CLOSED  | SC11(CA)         | 6F.104(CA)        | 42 x 30                     | 54 x 42    | 54 x 42  | ---       |
| DO NOT PASS  | SC13(CA)         | 6F.104(CA)        | 42 x 30                     | 54 x 42    | 54 x 42  | ---       |
| CAUTION  | SC15(CA)         | 6F.104(CA)        | 42 x 18                     | 54 x 24    | 54 x 24  | ---       |
| EXIT with Arrow  | SC18(CA)         | 6F.28             | ---                         | 48 x 48    | 48 x 48  | ---       |
| Slow For The Cone Zone                                   | SC19(CA)         | 6F.106(CA)        | 54 x 36                     | 54 x 36    | 54 x 36  | 114 x 78  |
| SLOW FOR THE CONE ZONE                                   | SC20(CA)         | 6F.106(CA)        | 42 x 36                     | 54 x 48    | 54 x 48  | ---       |
| CAUTION FREQUENT STOPPING AND BACKING STAY BACK 100 FEET | SC21(CA)         | 6F.108(CA)        | 30 x 42                     | 30 x 42    | 30 x 42  | ---       |
| FLOODING AHEAD TURN AROUND DON'T DROWN                   | W86(CA)          | 6I.101(CA)        | 30 x 24                     | ---        | ---      | ---       |
| EMERGENCY SCENE AHEAD                                    | W90(CA)          | 6I.101(CA)        | 36 X 36                     | 48 X 48    | 48 X 48  | ---       |

**Table 6F-101(CA). Maximum Spacing of Channelizing Devices**

| Speed<br>(mph) | Maximum Channelizing Devices Spacing |                   |                      |
|----------------|--------------------------------------|-------------------|----------------------|
|                | Taper*<br>(feet)                     | Tangent<br>(feet) | Conflict**<br>(feet) |
| 20             | 20                                   | 40                | 10                   |
| 25             | 25                                   | 50                | 12                   |
| 30             | 30                                   | 60                | 15                   |
| 35             | 35                                   | 70                | 17                   |
| 40             | 40                                   | 80                | 20                   |
| 45             | 45                                   | 90                | 22                   |
| 50             | 50                                   | 100               | 25                   |
| 55             | 50                                   | 100               | 25                   |
| 60             | 50                                   | 100               | 25                   |
| 65             | 50                                   | 100               | 25                   |
| 70             | 50                                   | 100               | 25                   |
| 75             | 50                                   | 100               | 25                   |

\* Maximum channelizing device spacing for all speeds on one-lane/two-way tapers is 20 feet.

Maximum channelizing device spacing for all speeds on downstream tapers is 20 feet.

All other tapers are as shown.

\*\* Use on intermediate and short-term projects for taper and tangent sections where there are no pavement markings or where there is a conflict between existing pavement markings and channelizing devices.

**Table 6F-102(CA). Pavement Surface Tolerances\***

| Direction of Travel     | Steps **               |                          |
|-------------------------|------------------------|--------------------------|
|                         | Bicycles / Motorcycles | 4 wheeled motor vehicles |
| Parallel to travel      | No more than 3/8" high | No more than 2" high     |
| Perpendicular to travel | No more than 3/4" high | No more than 2" high     |

Notes:

\* Criteria for displaying warning signs. If a step of more than 3" high exists in the pavement, do not open that portion of roadway to traffic.

\*\* Step -- A ridge in the pavement, such as that which might exist between the pavement and a concrete gutter or manhole cover; or that might exist between two pavement blankets when the top level does not extend to the edge of the roadway.

## CHAPTER 6G. TYPE OF TEMPORARY TRAFFIC CONTROL ZONE ACTIVITIES

### Section 6G.01 Typical Applications

Support:

01 Each TTC zone is different. Many variables, such as location of work, highway type, geometrics, vertical and horizontal alignment, intersections, interchanges, road user volumes, road vehicle mix (buses, trucks, and cars), and road user speeds affect the needs of each zone. The goal of TTC in work zones is safety with minimum disruption to road users. The key factor in promoting TTC zone safety is proper judgment.

02 Typical applications (TAs) of TTC zones are organized according to duration, location, type of work, and highway type. Table 6H-1 is an index of these typical applications. These typical applications include the use of various TTC methods, but do not include a layout for every conceivable work situation.

03 Well-designed TTC plans for planned special events will likely be developed from a combination of treatments from several of the typical applications.

Guidance:

04 *For any planned special event that will have an impact on the traffic on any street or highway, a TTC plan should be developed in conjunction with and be approved by the agency or agencies that have jurisdiction over the affected roadways.*

05 *Typical applications should be altered, when necessary, to fit the conditions of a particular TTC zone.*

Option:

06 Other devices may be added to supplement the devices shown in the typical applications, while others may be deleted. The sign spacings and taper lengths may be increased to provide additional time or space for driver response.

Support:

07 Decisions regarding the selection of the most appropriate typical application to use as a guide for a specific TTC zone require an understanding of each situation. Although there are many ways of categorizing TTC zone applications, the four factors mentioned earlier (work duration, work location, work type, and highway type) are used to characterize the typical applications illustrated in Chapter 6H.

### Section 6G.02 Work Duration

Support:

01 Work duration is a major factor in determining the number and types of devices used in TTC zones. The duration of a TTC zone is defined relative to the length of time a work operation occupies a spot location.

Standard:

02 **The five categories of work duration and their time at a location shall be:**

**A. Long-term stationary is work that occupies a location more than 3 days.**

**B. Intermediate-term stationary is work that occupies a location more than one daylight period up to 3 days, or nighttime work lasting more than 1 hour.**

**C. Short-term stationary is daytime work that occupies a location for more than 1 hour within a single daylight period.**

**D. Short duration is work that occupies a location up to 1 hour.**

**E. Mobile is work that moves intermittently or continuously.**

Support:

03 At long-term stationary TTC zones, there is ample time to install and realize benefits from the full range of TTC procedures and devices that are available for use. Generally, larger channelizing devices, temporary roadways, and temporary traffic barriers are used.

Standard:

04 **Since long-term operations extend into nighttime, retroreflective and/or illuminated devices shall be used in long-term stationary TTC zones.**

Guidance:

05 *Inappropriate markings in long-term stationary TTC zones should be removed and replaced with temporary markings.*

**Support:**

06 In intermediate-term stationary TTC zones, it might not be feasible or practical to use procedures or devices that would be desirable for long-term stationary TTC zones, such as altered pavement markings, temporary traffic barriers, and temporary roadways. The increased time to place and remove these devices in some cases could significantly lengthen the project, thus increasing exposure time.

**Standard:**

07 **Since intermediate-term operations extend into nighttime, retroreflective and/or illuminated devices shall be used in intermediate-term stationary TTC zones.**

**Support:**

08 Most maintenance and utility operations are short-term stationary work.

09 As compared to stationary operations, mobile and short-duration operations are activities that might involve different treatments. Devices having greater mobility might be necessary such as signs mounted on trucks. Devices that are larger, more imposing, or more visible can be used effectively and economically. The mobility of the TTC zone is important.

*Guidance:*

10 *Safety in short-duration or mobile operations should not be compromised by using fewer devices simply because the operation will frequently change its location.*

**Option:**

11 Appropriately colored or marked vehicles with high-intensity rotating, flashing, oscillating, or strobe lights may be used in place of signs and channelizing devices for short-duration or mobile operations. These vehicles may be augmented with signs or arrow boards.

**Support:**

12 During short-duration work, it often takes longer to set up and remove the TTC zone than to perform the work. Workers face hazards in setting up and taking down the TTC zone. Also, since the work time is short, delays affecting road users are significantly increased when additional devices are installed and removed.

**Option:**

13 Considering these factors, simplified control procedures may be warranted for short-duration work. A reduction in the number of devices may be offset by the use of other more dominant devices such as high-intensity rotating, flashing, oscillating, or strobe lights on work vehicles.

**Support:**

14 Mobile operations often involve frequent short stops for activities such as litter cleanup, pothole patching, or utility operations, and are similar to short-duration operations.

*Guidance:*

15 *Warning signs and high-intensity rotating, flashing, oscillating, or strobe lights should be used on the vehicles that are participating in the mobile work.*

**Option:**

16 Flags and/or channelizing devices may additionally be used and moved periodically to keep them near the mobile work area.

17 Flaggers may be used for mobile operations that often involve frequent short stops.

**Support:**

18 Mobile operations also include work activities where workers and equipment move along the road without stopping, usually at slow speeds. The advance warning area moves with the work area.

*Guidance:*

19 *When mobile operations are being performed, a shadow vehicle equipped with an arrow board or a sign should follow the work vehicle, especially when vehicular traffic speeds or volumes are high. Where feasible, warning signs should be placed along the roadway and moved periodically as work progresses.*

20 *Under high-volume conditions, consideration should be given to scheduling mobile operations work during off-peak hours.*

21 *If there are mobile operations on a high-speed travel lane of a multi-lane divided highway, arrow boards and/or Portable Changeable Message Signs should be used.*

**Standard:**

**<sup>22</sup> Mobile operations shall have appropriate devices on the equipment (that is, high-intensity rotating, flashing, oscillating, or strobe lights, signs, or special lighting), or shall use a separate vehicle with appropriate warning devices.**

**Option:**

<sup>23</sup> For mobile operations that move at speeds of less than 3 mph, mobile signs or stationary signing that is periodically retrieved and repositioned in the advance warning area may be used.

**Section 6G.03 Location of Work**

**Support:**

<sup>01</sup> Chapter 6D and Sections 6F.74 and 6G.05 contain additional information regarding the steps to follow when pedestrian or bicycle facilities are affected by the worksite.

<sup>02</sup> The choice of TTC needed for a TTC zone depends upon where the work is located. As a general rule, the closer the work is to road users (including bicyclists and pedestrians), the greater the number of TTC devices that are needed. Procedures are described later in this Chapter for establishing TTC zones in the following locations:

- A. Outside the shoulder,
- B. On the shoulder with no encroachment,
- C. On the shoulder with minor encroachment,
- D. Within the median, and
- E. Within the traveled way.

**Standard:**

**<sup>03</sup> When the work space is within the traveled way, except for short-duration and mobile operations, advance warning shall provide a general message that work is taking place and shall supply information about highway conditions. TTC devices shall indicate how vehicular traffic can move through the TTC zone.**

**Section 6G.04 Modifications To Fulfill Special Needs**

**Support:**

<sup>01</sup> The typical applications in Chapter 6H illustrate commonly encountered situations in which TTC devices are employed.

**Option:**

<sup>02</sup> Other devices may be added to supplement the devices provided in the typical applications, and device spacing may be adjusted to provide additional reaction time. When conditions are less complex than those depicted in the typical applications, fewer devices may be needed.

**Guidance:**

<sup>03</sup> *When conditions are more complex, typical applications should be modified by giving particular attention to the provisions set forth in Chapter 6B and by incorporating appropriate devices and practices from the following list:*

*A. Additional devices:*

- 1. Signs*
- 2. Arrow boards*
- 3. More channelizing devices at closer spacing (see Section 6F.74 for information regarding detectable edging for pedestrians)*
- 4. Temporary raised pavement markers*
- 5. High-level warning devices*
- 6. Portable changeable message signs*
- 7. Temporary traffic control signals (including pedestrian signals and accessible pedestrian signals)*
- 8. Temporary traffic barriers*
- 9. Crash cushions*
- 10. Screens*
- 11. Rumble strips*
- 12. More delineation*

- B. Upgrading of devices:*
  - 1. A full complement of standard pavement markings*
  - 2. Brighter and/or wider pavement markings*
  - 3. Larger and/or brighter signs*
  - 4. Channelizing devices with greater conspicuity*
  - 5. Temporary traffic barriers in place of channelizing devices*
- C. Improved geometrics at detours or crossovers*
- D. Increased distances:*
  - 1. Longer advance warning area*
  - 2. Longer tapers*
- E. Lighting:*
  - 1. Temporary roadway lighting*
  - 2. Steady-burn lights used with channelizing devices*
  - 3. Flashing lights for isolated hazards*
  - 4. Illuminated signs*
  - 5. Floodlights*
- F. Pedestrian routes and temporary facilities*
- G. Bicycle diversions and temporary facilities*

### **Section 6G.05 Work Affecting Pedestrian and Bicycle Facilities**

#### **Support:**

<sup>01</sup> It is not uncommon, particularly in urban areas, that road work and the associated TTC will affect existing pedestrian or bicycle facilities. It is essential that the needs of all road users, including pedestrians with disabilities, are considered in TTC zones.

<sup>02</sup> In addition to specific provisions identified in Sections 6G.06 through 6G.14, there are a number of provisions that might be applicable for all of the types of activities identified in this Chapter.

#### **Guidance:**

<sup>03</sup> *Where pedestrian or bicycle usage is high, the typical applications should be modified by giving particular attention to the provisions set forth in Chapter 6D, this Chapter, Section 6F.74, and in other Sections of Part 6 related to accessibility and detectability provisions in TTC zones.*

<sup>04</sup> *Pedestrians should be separated from the worksite by appropriate devices that maintain the accessibility and detectability for pedestrians with disabilities.*

<sup>05</sup> *Bicyclists and pedestrians should not be exposed to unprotected excavations, open utility access, overhanging equipment, or other such conditions.*

<sup>06</sup> *Except for short duration and mobile operations, when a highway shoulder is occupied, a SHOULDER WORK (W21-5) sign, a SHOULDER CLOSED C30A(CA) sign, or other similar signs should be placed in advance of the activity area. When work is performed on a paved shoulder 8 feet or more in width, channelizing devices should be placed on a taper having a length that conforms to the requirements of a shoulder taper. Signs should be placed such that they do not narrow any existing pedestrian passages to less than 48 inches.*

<sup>06a</sup> *When existing accommodations for bicycle travel are disrupted or closed in a long-term duration project (see Section 6G.02), information and devices contained in Figures 6H-101(CA) through 6H-104(CA), as appropriate per situation encountered, should be used in order to replicate existing conditions for the needs and control of bicyclists through a TTC zone.*

<sup>06b</sup> *Except for short durations and mobile operations (see Section 6G.02), when a highway shoulder is occupied and bicyclists would be sharing a lane with vehicular traffic, as a result of the TTC zone, a combination of Bicycle crossing (W11-1) and SHARE THE ROAD (W16-1P) plaque should be placed in advance of the activity area. When work is performed on a paved shoulder 8 feet or more in width, channelizing devices should be placed on a taper having a length that conforms to the requirements of a shoulder taper. Signs should be placed such that they do not block the bicyclist's path of travel and they do not narrow any existing pedestrian passages to less than 48 inches.*

<sup>07</sup> *Pedestrian detours should be avoided since pedestrians rarely observe them and the cost of providing accessibility and detectability might outweigh the cost of maintaining a continuous route. Whenever possible,*



*work should be done in a manner that does not create a need to detour pedestrians from existing routes or crossings.*

**Standard:**

**<sup>08</sup> Where pedestrian routes are closed, alternate pedestrian routes shall be provided.**

**<sup>09</sup> When existing pedestrian facilities are disrupted, closed, or relocated in a TTC zone, the temporary facilities shall be detectable and shall include accessibility features consistent with the features present in the existing pedestrian facility.**

**Option:**

<sup>10</sup> If establishing or maintaining an alternate pedestrian route is not feasible during the project, an alternate means of providing for pedestrians may be used, such as adding free bus service around the project or assigning a person the responsibility to assist pedestrians with disabilities through the project limits. See Section 6D.01 for details.

**Section 6G.06 Work Outside of the Shoulder**

**Support:**

<sup>01</sup> When work is being performed off the roadway (beyond the shoulders, but within the right-of-way), little or no TTC might be needed. TTC generally is not needed where work is confined to an area 15 feet or more from the edge of the traveled way. However, TTC is appropriate where distracting situations exist, such as vehicles parked on the shoulder, vehicles accessing the worksite via the highway, and equipment traveling on or crossing the roadway to perform the work operations (for example, mowing). For work beyond the shoulder, see Figure 6H-1.

**Guidance:**

<sup>02</sup> *Where the situations described in Paragraph 1 exist, a single warning sign, such as ROAD WORK AHEAD (W20-1) or Workers (W21-1) sign, should be used. If the equipment travels on the roadway, the equipment should be equipped with appropriate flags, high-intensity rotating, flashing, oscillating, or strobe lights, and/or a SLOW MOVING VEHICLE (W21-4) sign.*

**Option:**

<sup>03</sup> If work vehicles are on the shoulder, a SHOULDER WORK (W21-5) sign may be used. For mowing operations, the sign MOWING AHEAD (W21-8) may be used.

<sup>04</sup> Where the activity is spread out over a distance of more than 2 miles, the SHOULDER WORK (W21-5) sign may be repeated every 1 mile.

<sup>05</sup> A supplementary plaque with the message NEXT XX MILES (W7-3aP) may be used.

**Guidance:**

<sup>06</sup> *A general warning sign like ROAD MACHINERY AHEAD (W21-3) should be used if workers and equipment must occasionally move onto the shoulder.*

**Section 6G.07 Work on the Shoulder with No Encroachment**

**Support:**

<sup>01</sup> The provisions of this Section apply to short-term through long-term stationary operations.

**Standard:**

**<sup>02</sup> When paved shoulders having a width of 8 feet or more are closed, at least one advance warning sign shall be used. In addition, channelizing devices shall be used to close the shoulder in advance to delineate the beginning of the work space and direct motor vehicle traffic to remain within the traveled way.**

**Guidance:**

<sup>03</sup> *When paved shoulders having a width of 8 feet or more are closed on freeways and expressways, road users should be warned about potential disabled vehicles that cannot get off the traveled way. An initial general warning sign, such as ROAD WORK AHEAD (W20-1), should be used, followed by a RIGHT or LEFT SHOULDER CLOSED (W21-5a) sign. Where the downstream end of the shoulder closure extends beyond the distance that can be perceived by road users, a supplementary plaque bearing the message NEXT XX FEET (W16-4P) or MILES (W7-3aP) should be placed below the SHOULDER CLOSED (W21-5a) sign. On multi-lane, divided highways, signs advising of shoulder work or the condition of the shoulder should be placed only on the side of the affected shoulder.*

*04 When an improved shoulder is closed on a high-speed roadway, it should be treated as a closure of a portion of the road system because road users expect to be able to use it in emergencies. Road users should be given ample advance warning that shoulders are closed for use as refuge areas throughout a specified length of the approaching TTC zone. The sign(s) should read SHOULDER CLOSED (W21-5a) with distances indicated. The work space on the shoulder should be closed off by a taper or channelizing devices with a length of 1/3 L using the formulas in Tables 6C-3, 6C-3(CA) and 6C-4.*

*05 When the shoulder is not occupied but work has adversely affected its condition, the LOW SHOULDER (W8-9) or SOFT SHOULDER (W8-4) sign should be used, as appropriate.*

*06 Where the condition extends over a distance in excess of 1 mile, the sign should be repeated at 1-mile intervals.*

Option:

*07 In addition, a supplementary plaque bearing the message NEXT XX MILES (W7-3aP) may be used. Temporary traffic barriers may be needed to inhibit encroachment of errant vehicles into the work space and to protect workers.*

**Standard:**

**08 When used for shoulder work, arrow boards shall operate only in the caution mode.**

Support:

*09 A typical application for stationary work operations on shoulders is shown in Figure 6H-3. Short duration or mobile work on shoulders is shown in Figure 6H-4. Work on freeway shoulders is shown in Figure ~~6H-5~~ 6H-5(CA).*

### **Section 6G.08 Work on the Shoulder with Minor Encroachment**

Support:

*01 Chapter 6D and Sections 6F.74 and 6G.05 contain additional information regarding the steps to follow when pedestrian or bicycle facilities are affected by the worksite.*

*Guidance:*

*02 When work takes up part of a lane, vehicular traffic volumes, vehicle mix (buses, trucks, cars, and bicycles), speed, and capacity should be analyzed to determine whether the affected lane should be closed. Unless the lane encroachment permits a remaining lane width of 10 feet, the lane should be closed.*

*03 Truck off-tracking should be considered when determining whether the minimum lane width of 10 feet is adequate.*

Option:

*04 Except on State highways, a lane width of 9 feet may be used for short-term stationary work on low-volume, low-speed roadways when vehicular traffic does not include longer and wider heavy commercial vehicles.*

Support:

*05 Figure 6H-6 illustrates a method for handling vehicular traffic where the stationary or short duration work space encroaches slightly into the traveled way.*

### **Section 6G.09 Work Within the Median**

Support:

*01 Chapter 6D and Sections 6F.74 and 6G.05 contain additional information regarding the steps to follow when pedestrian or bicycle facilities are affected by the worksite.*

*Guidance:*

*02 If work in the median of a divided highway is within 15 feet from the edge of the traveled way for either direction of travel, TTC should be used through the use of advance warning signs and channelizing devices.*

### **Section 6G.10 Work Within the Traveled Way of a Two-Lane Highway**

Support:

*01 Chapter 6D and Sections 6F.74 and 6G.05 contain additional information regarding the steps to follow when pedestrian or bicycle facilities are affected by the worksite.*

*02 Detour signs are used to direct road users onto another roadway. At diversions, road users are directed onto a temporary roadway or alignment placed within or adjacent to the right-of-way. Typical applications for detouring*

or diverting road users on two-lane highways are shown in Figures 6H-7, 6H-8, and 6H-9. Figure 6H-7 illustrates the controls around an area where a section of roadway has been closed and a diversion has been constructed. Channelizing devices and pavement markings are used to indicate the transition to the temporary roadway.

**Guidance:**

<sup>03</sup> *When a detour is long, Detour (M4-8, M4-9) signs should be installed to remind and reassure road users periodically that they are still successfully following the detour.*

<sup>04</sup> *When an entire roadway is closed, as illustrated in Figure 6H-8, a detour should be provided and road users should be warned in advance of the closure, which in this example is a closure 10 miles from the intersection. If local road users are allowed to use the roadway up to the closure, the ROAD CLOSED AHEAD, LOCAL TRAFFIC ONLY (R11-3a) sign should be used. The portion of the road open to local road users should have adequate signing, marking, and delineation.*

<sup>05</sup> *Detours should be signed so that road users will be able to traverse the entire detour route and back to the original roadway as shown in Figure 6H-9.*

**Support:**

<sup>06</sup> Techniques for controlling vehicular traffic under one-lane, two-way conditions are described in Section 6C.10.

**Option:**

<sup>07</sup> Flaggers may be used as shown in Figure ~~6H-10~~ 6H-10(CA) and 6H-10A(CA).

<sup>08</sup> STOP/YIELD sign control may be used on roads with low traffic volumes as shown in Figure 6H-11.

<sup>09</sup> A temporary traffic control signal may be used as shown in Figure 6H-12.

**Support:**

<sup>10</sup> Refer to CVC 21363 for detour signs.

## **Section 6G.11 Work Within the Traveled Way of an Urban Street**

**Support:**

<sup>01</sup> Chapter 6D and Sections 6F.74 and 6G.05 contain additional information regarding the steps to follow when pedestrian or bicycle facilities are affected by the worksite.

<sup>02</sup> In urban TTC zones, decisions are needed on how to control vehicular traffic, such as how many lanes are required, whether any turns need to be prohibited at intersections, and how to maintain access to business, industrial, and residential areas.

<sup>03</sup> Pedestrian traffic needs separate attention. Chapter 6D contains information regarding pedestrian movements near TTC zones.

**Standard:**

<sup>04</sup> **If the TTC zone affects the movement of bicyclists, adequate access to the roadway or shared-use paths shall be provided (see Part 9).**

<sup>05</sup> **Where transit stops are affected or relocated because of work activity, both pedestrian and vehicular access to the affected or relocated transit stops shall be provided.**

**Guidance:**

<sup>06</sup> *If a designated bicycle route is closed because of the work being done, a signed alternate route should be provided. Bicyclists should not be directed onto the path used by pedestrians.*

<sup>07</sup> *Worksites within the intersection should be protected against inadvertent pedestrian incursion by providing detectable channelizing devices.*

**Support:**

<sup>08</sup> Utility work takes place both within and outside the roadway to construct and maintain services such as power, gas, light, water, or telecommunications. Operations often involve intersections, since that is where many of the network junctions occur. The work force is usually small, only a few vehicles are involved, and the number and types of TTC devices placed in the TTC zone is usually minimal.

**Standard:**

<sup>09</sup> **All TTC devices shall be retroreflective or illuminated if utility work is performed during nighttime hours.**

*Guidance:*

<sup>10</sup> *As discussed under short-duration projects, however, the reduced number of devices in utility work zones should be offset by the use of high-visibility devices, such as high-intensity rotating, flashing, oscillating, or strobe lights on work vehicles or high-level warning devices.*

**Support:**

<sup>11</sup> Figures 6H-6, ~~6H-10~~ 6H-10(CA), 6H-10A(CA), 6H-15, 6H-18, 6H-21, 6H-22, 6H-22A(CA), 6H-22B(CA), 6H-23, 6H-26, and 6H-33 are examples of typical applications for utility operations. Other typical applications might apply as well.

## **Section 6G.12 Work Within the Traveled Way of a Multi-Lane, Non-Access Controlled Highway**

**Support:**

<sup>01</sup> Chapter 6D and Sections 6F.74 and 6G.05 contain additional information regarding the steps to follow when pedestrian or bicycle facilities are affected by the worksite.

<sup>02</sup> Work on multi-lane (two or more lanes of moving motor vehicle traffic in one direction) highways is divided into right-lane closures, left-lane closures, interior-lane closures, multiple-lane closures, and closures on five-lane roadways.

**Standard:**

<sup>03</sup> **When a lane is closed on a multi-lane road for other than a mobile operation, a transition area containing a merging taper shall be used.**

*Guidance:*

<sup>04</sup> *When justified by an engineering study, temporary traffic barriers (see Section 6F.70) should be used to prevent incursions of errant vehicles into hazardous areas or work space.*

**Support:**

<sup>05</sup> Figure 6H-34 illustrates a lane closure in which temporary traffic barriers are used.

**Option:**

<sup>06</sup> When the right lane is closed, TTC similar to that shown in Figure 6H-33 may be used for undivided or divided four-lane roads.

*Guidance:*

<sup>07</sup> *If morning and evening peak hour vehicular traffic volumes in the two directions are uneven and the greater volume is on the side where the work is being done in the right-hand lane, consideration should be given to closing the inside lane for opposing vehicular traffic and making the lane available to the side with heavier vehicular traffic, as shown in Figure 6H-31.*

<sup>08</sup> *If the larger vehicular traffic volume changes to the opposite direction at a different time of the day, the TTC should be changed to allow two lanes for opposing vehicular traffic by moving the devices from the opposing lane to the center line. When it is necessary to create a temporary center line that is not consistent with the pavement markings, channelizing devices should be used and closely spaced.*

**Option:**

<sup>09</sup> When closing a left lane on a multi-lane undivided road, as vehicular traffic flow permits, the two interior lanes may be closed, as shown in Figure 6H-30, to provide drivers and workers additional lateral clearance and to provide access to the work space.

**Standard:**

<sup>10</sup> **When only the left lane is closed on undivided roads, channelizing devices shall be placed along the center line as well as along the adjacent lane.**

*Guidance:*

<sup>11</sup> *When an interior lane is closed, an adjacent lane should also be considered for closure to provide additional space for vehicles and materials and to facilitate the movement of equipment within the work space.*

<sup>12</sup> *When multiple lanes in one direction are closed, a capacity analysis should be made to determine the number of lanes needed to accommodate motor vehicle traffic needs. Vehicular traffic should be moved over one lane at a time. As shown in Figure 6H-37, the tapers should be separated by a distance of 2L, with L being determined by the formulas in Tables 6C-3, 6C-3(CA) and 6C-4.*

Option:

13 If operating speeds are 40 mph or less and the space approaching the work area does not permit moving traffic over one lane at a time, a single continuous taper may be used.

**Standard:**

14 **When a directional roadway is closed, inapplicable WRONG WAY signs and markings, and other existing traffic control devices at intersections within the temporary two-lane, two-way operations section shall be covered, removed, or obliterated.**

Option:

15 When half the road is closed on an undivided highway, both directions of vehicular traffic may be accommodated as shown in Figure ~~6H-32~~ 6H-32(CA). When both interior lanes are closed, temporary traffic controls may be used as provided in Figure 6H-30. When a roadway must be closed on a divided highway, a median crossover may be used (see Section 6G.16).

Support:

16 TTC for lane closures on five-lane roads is similar to other multi-lane undivided roads. Figure ~~6H-32~~ 6H-32(CA) can be adapted for use on five-lane roads. Figure 6H-35 can be used on a five-lane road for short duration and mobile operations.

### **Section 6G.13 Work Within the Traveled Way at an Intersection**

Support:

01 Chapter 6D and Sections 6F.74 and 6G.05 contain additional information regarding the steps to follow when pedestrian or bicycle facilities are affected by the worksite.

02 The typical applications for intersections are classified according to the location of the work space with respect to the intersection area (as defined by the extension of the curb or edge lines). The three classifications are near side, far side, and in-the-intersection. Work spaces often extend into more than one portion of the intersection. For example, work in one quadrant often creates a near-side work space on one street and a far-side work space on the cross street. In such instances, an appropriate TTC plan is obtained by combining features shown in two or more of the intersection and pedestrian typical applications.

03 TTC zones in the vicinity of intersections might block movements and interfere with normal road user flows. Such conflicts frequently occur at more complex signalized intersections having such features as traffic signal heads over particular lanes, lanes allocated to specific movements, multiple signal phases, signal detectors for actuated control, and accessible pedestrian signals and detectors.

*Guidance:*

04 *The effect of the work upon signal operation should be considered, and temporary corrective actions should be taken, if necessary, such as revising signal phasing and/or timing to provide adequate capacity, maintaining or adjusting signal detectors, and relocating signal heads to provide adequate visibility as described in Part 4.*

**Standard:**

05 **When work will occur near an intersection where operational, capacity, or pedestrian accessibility problems are anticipated, the highway agency having jurisdiction shall be contacted.**

*Guidance:*

06 *For work at an intersection, advance warning signs, devices, and markings should be used on all cross streets, as appropriate. The typical applications depict urban intersections on arterial streets. Where the posted speed limit, the off-peak 85th-percentile speed prior to the work starting, or the anticipated speed exceeds 40 mph, additional warning signs should be used in the advance warning area.*

07 *Pedestrian crossings near TTC sites should be separated from the worksite by appropriate barriers that maintain the accessibility and detectability for pedestrians with disabilities.*

Support:

08 Near-side work spaces, as depicted in Figure 6H-21, are simply handled as a midblock lane closure. A problem that might occur with near-side lane closure is a reduction in capacity, which during certain hours of operation could result in congestion and backups.

Option:

09 When near-side work spaces are used, an exclusive turn lane may be used for through vehicular traffic.

<sup>10</sup> Where space is restricted in advance of near-side work spaces, as with short block spacings, two warning signs may be used in the advance warning area, and a third action-type warning or a regulatory sign (such as Keep Left) may be placed within the transition area.

Support:

<sup>11</sup> Far-side work spaces, as depicted in Figures 6H-22 through 6H-25, involve additional treatment because road users typically enter the activity area by straight-through and left- or right-turning movements.

Guidance:

<sup>12</sup> *When a lane through an intersection must be closed on the far side, it should also be closed on the near-side approach to preclude merging movements within the intersection.*

Option:

<sup>13</sup> If there are a significant number of vehicles turning from a near-side lane that is closed on the far side, the near-side lane may be converted to an exclusive turn lane.

Support:

<sup>14</sup> Figures 6H-26 and 6H-27 provide guidance on applicable procedures for work performed within the intersection.

Option:

<sup>15</sup> If the work is within the intersection, any of the following strategies may be used:

- A. A small work space so that road users can move around it, as shown in Figure 6H-26;
- B. Flaggers or uniformed law enforcement officers to direct road users, as shown in Figure 6H-27;
- C. Work in stages so the work space is kept to a minimum; and
- D. Road closures or upstream diversions to reduce road user volumes.

Guidance:

<sup>16</sup> *Depending on road user conditions, a flagger(s) and/or a uniformed law enforcement officer(s) should be used to control road users.*

## **Section 6G.14 Work Within the Traveled Way of a Freeway or Expressway**

Support:

<sup>01</sup> Problems of TTC might occur under the special conditions encountered where vehicular traffic must be moved through or around TTC zones on high-speed, high-volume roadways. Although the general principles outlined in the previous Sections of this Manual are applicable to all types of highways, high-speed, access-controlled highways need special attention in order to accommodate vehicular traffic while also protecting road users and workers. The road user volumes, road vehicle mix (buses, trucks, cars, and bicycles, if permitted), and speed of vehicles on these facilities require that careful TTC procedures be implemented, for example, to induce critical merging maneuvers well in advance of work spaces and in a manner that creates minimum turbulence and delay in the vehicular traffic stream. These situations often require more conspicuous devices than specified for normal rural highway or urban street use. However, the same important basic considerations of uniformity and standardization of general principles apply for all roadways.

<sup>02</sup> Work under high-speed, high-volume vehicular traffic on a controlled access highway is complicated by the roadway design and operational features. The presence of a median that establishes separate roadways for directional vehicular traffic flow might prohibit the closing of one of the roadways or the diverting of vehicular traffic to the other roadway. Lack of access to and from adjacent roadways prohibits rerouting of vehicular traffic away from the work space in many cases. Other conditions exist where work must be limited to night hours, thereby necessitating increased use of warning lights, illumination of work spaces, and advance warning systems.

<sup>03</sup> TTC for a typical lane closure on a divided highway is shown in Figure 6H-33. Temporary traffic controls for short duration and mobile operations on freeways are shown in Figure 6H-35. A typical application for shifting vehicular traffic lanes around a work space is shown in Figure ~~6H-36~~ [6H-36\(CA\)](#). TTC for multiple ~~and interior~~ lane closures on a freeway is shown in Figures 6H-37 and ~~6H-38~~ [Caltrans' Standard Plan T10, T10A](#). [See Section 1A.11 for information regarding this publication.](#)

Guidance:

<sup>04</sup> *The method for closing an interior lane when the open lanes have the capacity to carry vehicular traffic should be as shown in Figure 6H-37. When the capacity of the other lanes is needed, the method shown in Figure ~~6H-38~~ should be used.*

Support:

05 The temporary traffic controls for short duration and mobile operations on State highways are shown in Caltrans' Standard Plans T15, T16 and T17.

06 A typical layout of closing lanes to direct traffic around a workspace is shown in Caltrans' Standard Plans T10 through T14.

07 See Section 1A.11 for information regarding this publication.

### **Section 6G.15 Two-Lane, Two-Way Traffic on One Roadway of a Normally Divided Highway**

Support:

01 Two-lane, two-way operation on one roadway of a normally divided highway is a typical procedure that requires special consideration in the planning, design, and work phases, because unique operational problems (for example, increasing the risk of head-on crashes) can arise with the two-lane, two-way operation.

**Standard:**

02 **When two-lane, two-way traffic control must be maintained on one roadway of a normally divided highway, opposing vehicular traffic shall be separated with either temporary traffic barriers (concrete safety-shape or approved alternate), channelizing devices, or a temporary raised island throughout the length of the two-way operation. The use of markings and complementary signing, by themselves, shall not be used.**

Support:

03 Figure 6H-39 shows the procedure for two-lane, two-way operation. Treatments for entrance and exit ramps within the two-way roadway segment of this type of work are shown in Figures 6H-40 and 6H-41.

Support:

04 A temporary traffic control zone in the entrance and exit ramps may be handled as shown in Caltrans' Standard Plans T10 and T14. See Section 1A.11 for information regarding this publication.

### **Section 6G.16 Crossovers**

*Guidance:*

01 *The following are considered good guiding principles for the design of crossovers:*

*A. Tapers for lane drops should be separated from the crossovers, as shown in Figure 6H-39.*

*B. Crossovers should be designed for speeds no lower than 10 mph below the posted speed, the off-peak 85th-percentile speed prior to the work starting, or the anticipated operating speed of the roadway, unless unusual site conditions require that a lower design speed be used.*

*C. A good array of channelizing devices, delineators, and full-length, properly placed pavement markings should be used to provide drivers with a clearly defined travel path.*

*D. The design of the crossover should accommodate all vehicular traffic, including trucks and buses.*

Support:

02 Temporary traffic barriers and the excessive use of TTC devices cannot compensate for poor geometric and roadway cross-section design of crossovers.

### **Section 6G.17 Interchanges**

*Guidance:*

01 *Access to interchange ramps on limited-access highways should be maintained even if the work space is in the lane adjacent to the ramps. Access to exit ramps should be clearly marked and delineated with channelizing devices. For long-term projects, conflicting pavement markings should be removed and new ones placed. Early coordination with officials having jurisdiction over the affected cross streets and providing emergency services should occur before ramp closings.*

Option:

02 If access is not possible, ramps may be closed by using signs and Type 3 Barricades. As the work space changes, the access area may be changed, as shown in Figure 6H-42. A TTC zone in the exit ramp may be handled as shown in Figure 6H-43.

03 When a work space interferes with an entrance ramp, a lane may need to be closed on the freeway (see Figure 6H-44). A TTC zone in the entrance ramp may require shifting ramp vehicular traffic (see Figure 6H-44).

Option:

<sup>04</sup> A temporary traffic control zone in the entrance and exit ramps may be handled as shown in Caltrans' Standard Plans T10 and T14. See Section 1A.11 for information regarding this publication.

### **Section 6G.18 Work in the Vicinity of a Grade Crossing**

**Standard:**

<sup>01</sup> When grade crossings exist either within or in the vicinity of a TTC zone, lane restrictions, flagging, or other operations shall not create conditions where vehicles can be queued across the tracks. If the queuing of vehicles across the tracks cannot be avoided, a uniformed law enforcement officer or flagger shall be provided at the crossing to prevent vehicles from stopping on the tracks, even if automatic warning devices are in place.

**Support:**

<sup>02</sup> Figure 6H-46 shows work in the vicinity of a grade crossing.

<sup>03</sup> Section 8A.08 contains additional information regarding temporary traffic control zones in the vicinity of grade crossings.

**Guidance:**

<sup>04</sup> Early coordination with the railroad company or light rail transit agency should occur before work starts.

### **Section 6G.19 Temporary Traffic Control During Nighttime Hours**

**Support:**

<sup>01</sup> Chapter 6D and Sections 6F.74 and 6G.05 contain additional information regarding the steps to follow when pedestrian or bicycle facilities are affected by the worksite.

<sup>02</sup> Conducting highway construction and maintenance activities during night hours could provide an advantage when traditional daytime traffic control strategies cannot achieve an acceptable balance between worker and public safety, traffic and community impact, and constructability. The two basic advantages of working at night are reduced traffic congestion and less involvement with business activities. However, the two basic conditions that must normally be met for night work to offer any advantage are reduced traffic volumes and easy set up and removal of the traffic control patterns on a nightly basis.

<sup>03</sup> Shifting work activities to night hours, when traffic volumes are lower and normal business is less active, might offer an advantage in some cases, as long as the necessary work can be completed and the worksite restored to essentially normal operating conditions to carry the higher traffic volume during non-construction hours.

<sup>04</sup> Although working at night might offer advantages, it also includes safety issues. Reduced visibility inherent in night work impacts the performance of both drivers and workers. Because traffic volumes are lower and congestion is minimized, speeds are often higher at night necessitating greater visibility at a time when visibility is reduced. Finally, the incidence of impaired (alcohol or drugs), fatigued, or drowsy drivers might be higher at night.

<sup>05</sup> Working at night also involves other factors, including construction productivity and quality, social impacts, economics, and environmental issues. A decision to perform construction or maintenance activities at night normally involves some consideration of the advantages to be gained compared to the safety and other issues that might be impacted.

**Guidance:**

<sup>06</sup> Considering the safety issues inherent to night work, consideration should be given to enhancing traffic controls (see Section 6G.04) to provide added visibility and driver guidance, and increased protection for workers.

<sup>07</sup> In addition to the enhancements listed in Section 6G.04, consideration should be given to providing additional lights and retroreflective markings to workers, work vehicles, and equipment.

**Option:**

<sup>08</sup> Where reduced traffic volumes at night make it feasible, the entire roadway may be closed by detouring traffic to alternate facilities, thus removing the traffic risk from the activity area.



*Guidance:*

<sup>09</sup> Consideration should be given to stationing uniformed law enforcement officers and lighted patrol cars at night work locations where there is a concern that high speeds or impaired drivers might result in undue risks for workers or other drivers.

**Standard:**

<sup>10</sup> **Except in emergencies, temporary lighting shall be provided at all flagger stations.**

**Support:**

<sup>10a</sup> Refer to Construction Safety Order in the California Code of Regulations (Title 8, Division 1, Chapter 4, Subchapter 4, Article 11, Section 1599 - Flaggers). See Section 1A.11 for information regarding this publication.

**Support:**

<sup>11</sup> Desired illumination levels vary depending upon the nature of the task involved. ~~An average horizontal luminance of 5 foot candles can be adequate for general activities.~~ An average horizontal luminance of 10 foot candles can be adequate for **general activities and** activities around equipment. Tasks requiring high levels of precision and extreme care can require an average horizontal luminance of 20 foot candles.

**Standard:**

<sup>12</sup> **Highway construction work lighting shall be as per Construction Safety Order 1523 (California Code of Regulations Title 8, Division 1, Chapter 4, Subchapter 4, Article 3, Section 1523 - Illumination). See Section 1A.11 for information regarding this publication.**



## CHAPTER 6H. TYPICAL APPLICATIONS

### Section 6H.01 Typical Applications

#### Support:

<sup>01</sup> Chapter 6G contains discussions of typical TTC activities. This Chapter presents typical applications for a variety of situations commonly encountered. While not every situation is addressed, the information illustrated can generally be adapted to a broad range of conditions. In many instances, an appropriate TTC plan is achieved by combining features from various typical applications. For example, work at an intersection might present a near-side work zone for one street and a far-side work zone for the other street. These treatments are found in two different typical applications, while a third typical application shows how to handle pedestrian crosswalk closures. For convenience in using the typical application diagrams, Tables 6C-1 and 6C-4 are reproduced in this Chapter as Tables 6H-3 and 6H-4, respectively.

<sup>02</sup> Procedures for establishing TTC zones vary with such conditions as road configuration, location of the work, work activity, duration of work, road user volumes, road vehicle mix (buses, trucks, cars, motorcycles, and bicycles), and road user speeds.

<sup>03</sup> In general, the procedures illustrated represent minimum solutions for the situations depicted. Except for the notes (which are clearly classified using headings as being Standard, Guidance, Option, or Support), the information presented in the typical applications can generally be regarded as Guidance.

#### Option:

<sup>04</sup> Other devices may be added to supplement the devices and device spacing may be adjusted to provide additional reaction time or delineation. Fewer devices may be used based on field conditions.

#### Support:

<sup>05</sup> Figures and tables found throughout Part 6 provide information for the development of TTC plans. Also, Table 6H-3 is used for the determination of sign spacing and other dimensions for various area and roadway types.

<sup>06</sup> Table 6H-1 is an index of the 46 typical applications. Typical applications are shown on the right-hand page with notes on the facing page to the left. The legend for the symbols used in the typical applications is provided in Table 6H-2. In many of the typical applications, sign spacings and other dimensions are indicated by letters using the criteria provided in Table 6H-3. The formulas for determining taper lengths are provided in Table 6H-4.

<sup>07</sup> Most of the typical applications show TTC devices for only one direction.

#### Guidance:

<sup>08</sup> *The spacing of channelizing devices should not exceed the maximum distances shown in Table 6F-101(CA).*


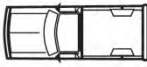





















**Table 6H-1. Index to Typical Applications**

| Typical Application Description  | Typical Application Number |
|--|----------------------------|
| <b>Work Outside of the Shoulder (see Section 6G.06)</b>  |                            |
| Work Beyond the Shoulder   | TA-1                       |
| Blasting Zone  | TA-2                       |
| <b>Work on the Shoulder (see Sections 6G.07 and 6G.08)</b>   |                            |
| Work on the Shoulders  | TA-3                       |
| Short Duration or Mobile Operation on a Shoulder   | TA-4                       |
| Shoulder Closure on a Freeway  | TA-5                       |
| Shoulder Work with Minor Encroachment  | TA-6                       |
| <b>Work Within the Traveled Way of a Two-Lane Highway (see Section 6G.10)</b>                          |                            |
| Road Closed with a Diversion   | TA-7                       |
| Roads Closed with an Off-Site Detour   | TA-8                       |
| Overlapping Routes with a Detour   | TA-9                       |
| Lane Closure on a Two-Lane Road Using Flaggers   | TA-10                      |
| Lane Closure on a Two-Lane Road with Low Traffic Volumes   | TA-11                      |
| Lane Closure on a Two-Lane Road Using Traffic Control Signals  | TA-12                      |
| Temporary Road Closure   | TA-13                      |
| Haul Road Crossing   | TA-14                      |
| Work in the Center of a Road with Low Traffic Volumes  | TA-15                      |
| Surveying Along the Center Line of a Road with Low Traffic Volumes                                     | TA-16                      |
| Mobile Operations on a Two-Lane Road   | TA-17                      |
| <b>Work Within the Traveled Way of an Urban Street (see Section 6G.11)</b>                             |                            |
| Lane Closure on a Minor Street   | TA-18                      |
| Detour for One Travel Direction  | TA-19                      |
| Detour for a Closed Street   | TA-20                      |
| <b>Work Within the Traveled Way at an Intersection and on Sidewalks (see Section 6G.13)</b>            |                            |
| Lane Closure on the Near Side of an Intersection   | TA-21                      |
| Right-Hand Lane Closure on the Far Side of an Intersection   | TA-22                      |
| Left-Hand Lane Closure on the Far Side of an Intersection  | TA-23                      |
| Half Road Closure on the Far Side of an Intersection   | TA-24                      |
| Multiple Lane Closures at an Intersection  | TA-25                      |
| Closure in the Center of an Intersection   | TA-26                      |
| Closure at the Side of an Intersection   | TA-27                      |
| Sidewalk Detour or Diversion   | TA-28                      |
| Crosswalk Closures and Pedestrian Detours  | TA-29                      |
| <b>Work Within the Traveled Way of a Multi-Lane, Non-Access Controlled Highway (see Section 6G.12)</b> |                            |
| Interior Lane Closure on a Multi-Lane Street   | TA-30                      |
| Lane Closure on a Street with Uneven Directional Volumes   | TA-31                      |
| Half Road Closure on a Multi-Lane, High-Speed Highway  | TA-32                      |
| Stationary Lane Closure on a Divided Highway   | TA-33                      |
| Lane Closure with a Temporary Traffic Barrier  | TA-34                      |
| Mobile Operation on a Multi-Lane Road  | TA-35                      |
| <b>Work Within the Traveled Way of a Freeway or Expressway (see Section 6G.14)</b>                     |                            |
| Lane Shift on a Freeway  | TA-36                      |
| Double Lane Closure on a Freeway   | TA-37                      |
| Interior Lane Closure on a Freeway   | TA-38                      |
| Median Crossover on a Freeway  | TA-39                      |
| Median Crossover for an Entrance Ramp  | TA-40                      |
| Median Crossover for an Exit Ramp  | TA-41                      |
| Work in the Vicinity of an Exit Ramp   | TA-42                      |
| Partial Exit Ramp Closure  | TA-43                      |
| Work in the Vicinity of an Entrance Ramp   | TA-44                      |
| Temporary Reversible Lane Using Movable Barriers   | TA-45                      |
| <b>Work in the Vicinity of a Grade Crossing (see Section 6G.18)</b>                                    |                            |
| Work in the Vicinity of a Grade Crossing   | TA-46                      |

**Table 6H-1(CA). Index to Typical Applications**

| Typical Application Description   | Typical Application Number |
|---|----------------------------|
| <b>Work affecting Pedestrian and Bicycle Facilities (see Section 6G.05)</b>                           |                            |
| Shoulder Closure on Urban (Low Speed) Locations to Accommodate Bicyclists                             | TA-101(CA)                 |
| Lane Closure on Freeway, Expressway, Rural and Urban (High Speed) Locations to Accommodate Bicyclists | TA-102(CA)                 |
| Detour for Bike Lane on Roads with Closure of One Travel Direction                                    | TA-103(CA)                 |
| Right Lane and Bike Lane Closure on Far Side of Intersection  | TA-104(CA)                 |
| <b>Work Within the Traveled Way of a Two-Lane Highway (see Section 6G.10)</b>                         |                            |
| Lane Shift on Road with Low Traffic Volumes   | TA-105(CA)                 |

**Table 6H-2. Meaning of Symbols on Typical Application Diagrams**

|   |  |  |                                      |
|---|--|--|--------------------------------------|
|    | Arrow board  |    | Shadow vehicle                       |
|    | Arrow board support or trailer (shown facing down)               |    | Sign (shown facing left)             |
|    | Changeable message sign or support trailer                       |    | Surveyor                             |
|    | Channelizing device  |    | Temporary barrier                    |
|    | Crash cushion  |    | Temporary barrier with warning light |
|  | Direction of temporary traffic detour                            |  | Traffic or pedestrian signal         |
|  | Direction of traffic   |  | Truck-mounted attenuator             |
|  | Flagger  |  | Type 3 barricade                     |
|  | High-level warning device (Flag tree)                            |  | Warning light                        |
|  | Longitudinal channelizing device                                 |  | Work space                           |
|  | Luminaire  |  | Work vehicle                         |
|  | Pavement markings that should be removed for a long-term project |  |                                      |

**Table 6H-3. Recommended Advance Warning Sign ~~Minimum~~ Spacing**

| Road Type   | Distance Between Signs** |            |            |
|---|--------------------------|------------|------------|
|   | A                        | B          | C          |
| Urban <del>(low speed)</del> - 25 mph or less***    | 100 feet                 | 100 feet   | 100 feet   |
| Urban - more than 25 mph to 40 mph***               | 250 feet                 | 250 feet   | 250 feet   |
| Urban <del>(high speed)</del> - more than 40 mph*** | 350 feet                 | 350 feet   | 350 feet   |
| Rural   | 500 feet                 | 500 feet   | 500 feet   |
| Expressway / Freeway                                | 1,000 feet               | 1,500 feet | 2,640 feet |

\* ~~Speed category to be determined by the highway agency.~~

\*\* The column headings A, B, and C are the dimensions shown in Figures 6H-1 through 6H-46. The A dimension is the distance from the transition or point of restriction to the first sign. The B dimension is the distance between the first and second signs. The C dimension is the distance between the second and third signs. (The “first sign” is the sign in a three-sign series that is closest to the TTC zone. The “third sign” is the sign that is furthest upstream from the TTC zone.)

\*\*\* Posted speed limit, off-peak 85th-percentile speed prior to work starting, or other anticipated operating speed in mph.

**Table 6H-4. Formulas for Determining Taper Length**

| Speed (S)      | Taper Length (L) in feet |
|----------------|--------------------------|
| 40 mph or less | $L = \frac{WS^2}{60}$    |
| 45 mph or more | $L = WS$                 |

Where: L = taper length in feet  
 W = width of offset in feet  
 S = posted speed limit, or off-peak 85th-percentile speed prior to work starting, or the anticipated operating speed in mph

**Table 6H-4(CA). Taper Length Criteria for Temporary Traffic Control Zones  
 (for 12 feet Offset Width)**

| Speed*<br>S<br>(mph) | Minimum Taper Length**<br>for Width of Offset 12 feet (W) |                           |                           |                             |
|----------------------|---|---------------------------|---------------------------|-----------------------------|
|                      | Merging<br>L<br>(feet)                                    | Shifting<br>L/2<br>(feet) | Shoulder<br>L/3<br>(feet) | Down<br>Stream<br>(feet)*** |
| 20                   | 80  | 40                        | 27                        | 50                          |
| 25                   | 125   | 63                        | 42                        | 50                          |
| 30                   | 180   | 90                        | 60                        | 50                          |
| 35                   | 245   | 123                       | 82                        | 50                          |
| 40                   | 320   | 160                       | 107                       | 50                          |
| 45                   | 540   | 270                       | 180                       | 50                          |
| 50                   | 600   | 300                       | 200                       | 50                          |
| 55                   | 660   | 330                       | 220                       | 50                          |
| 60                   | 720   | 360                       | 240                       | 50                          |
| 65                   | 780   | 390                       | 260                       | 50                          |
| 70                   | 840   | 420                       | 280                       | 50                          |
| 75                   | 900   | 450                       | 300                       | 50                          |

\* - Posted speed limit, off-peak 85<sup>th</sup>-percentile speed prior to work starting, or the anticipated operating speed in mph.

\*\* - For other offsets use the following merging taper length formula for L:

For speeds of 40 mph or less,  $L=WS^2/60$

For speeds of 45 mph or more,  $L=WS$

Where: L = taper length in feet  
 W = width of offset in feet  
 S = posted speed limit, off-peak 85<sup>th</sup>-percentile speed prior to work starting, or the anticipated operating speed in mph

\*\*\* - Maximum downstream taper length is 100 feet. See Section 6C.08.

### **Notes for Figure 6H-1 —Typical Application 1 Work Beyond the Shoulder**

*Guidance:*

- 1. If the work space is in the median of a divided highway, an advance warning sign should also be placed on the left side of the directional roadway.*

*Option:*

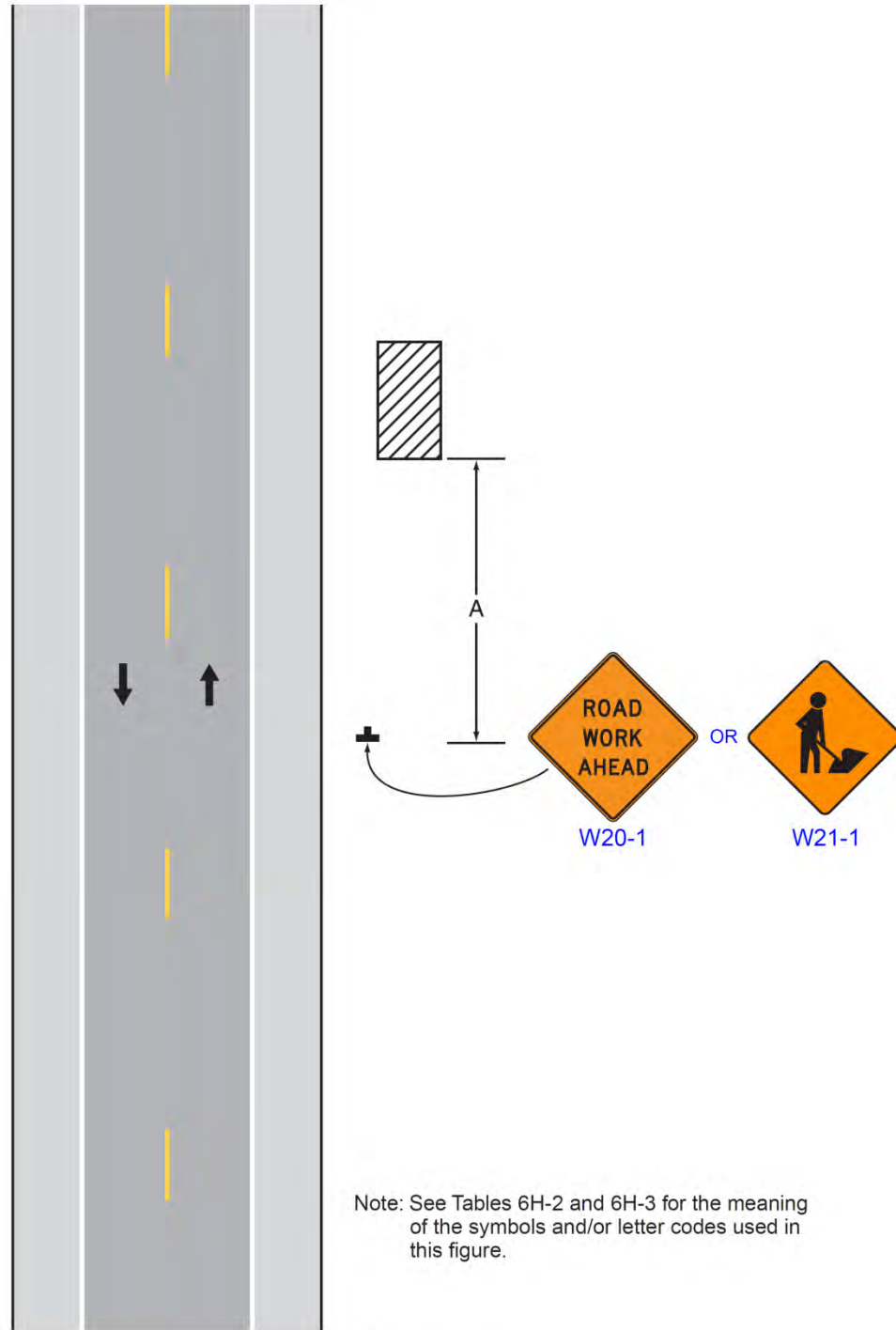
2. The ROAD WORK AHEAD sign or Workers (W21-1a) sign may be replaced with other appropriate signs such as the SHOULDER WORK sign. The SHOULDER WORK sign may be used for work adjacent to the shoulder.
3. The ROAD WORK AHEAD sign or Workers (W21-1a) sign may be omitted where the work space is behind a barrier, more than 24 inches behind the curb, or 15 feet or more from the edge of any roadway.
4. For short-term, short duration or mobile operation, all signs and channelizing devices may be eliminated if a vehicle with activated high-intensity rotating, flashing, oscillating, or strobe lights is used.
5. Vehicle hazard warning signals may be used to supplement high-intensity rotating, flashing, oscillating, or strobe lights.

**Standard:**

- 6. Vehicle hazard warning signals shall not be used instead of the vehicle's high-intensity rotating, flashing, oscillating, or strobe lights.**



**Figure 6H-1. Work Beyond the Shoulder (TA-1)**



Note: See Tables 6H-2 and 6H-3 for the meaning of the symbols and/or letter codes used in this figure.

**Typical Application 1**

## **Notes for Figure 6H-2—Typical Application 2 Blasting Zone**

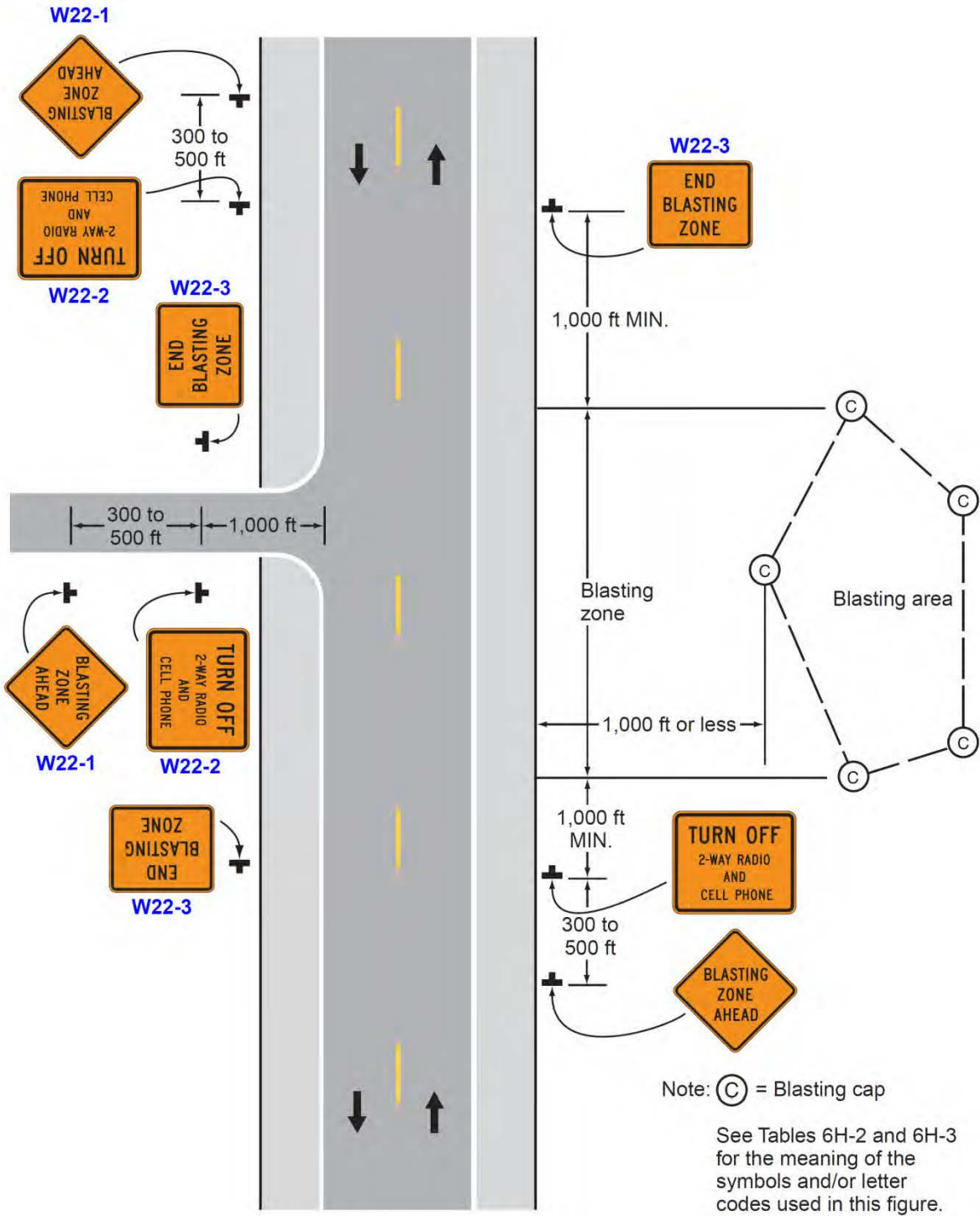
**Standard:**

- 1. Whenever blasting caps are used within 1,000 feet of a roadway, the signing shown shall be used.**
- 2. The signs shall be covered or removed when there are no explosives in the area or the area is otherwise secure.**
- 3. Whenever a side road intersects the roadway between the **BLASTING ZONE AHEAD** sign and the **END BLASTING ZONE** sign, or a side road is within 1,000 feet of any blasting cap, similar signing, as on the mainline, shall be installed on the side road.**
- 4. Prior to blasting, the blaster in charge shall determine whether road users in the blasting zone will be endangered by the blasting operation. If there is danger, road users shall not be permitted to pass through the blasting zone during blasting operations.**

*Guidance:*

- 5. On a divided highway, the signs should be mounted on both sides of the directional roadways.*

**Figure 6H-2. Blasting Zone (TA-2)**



**Typical Application 2**

### **Notes for Figure 6H-3—Typical Application 3 Work on the Shoulders**

*Guidance:*

1. A *SHOULDER WORK* sign should be placed on the left side of the roadway for a divided or one-way street only if the left shoulder is affected.

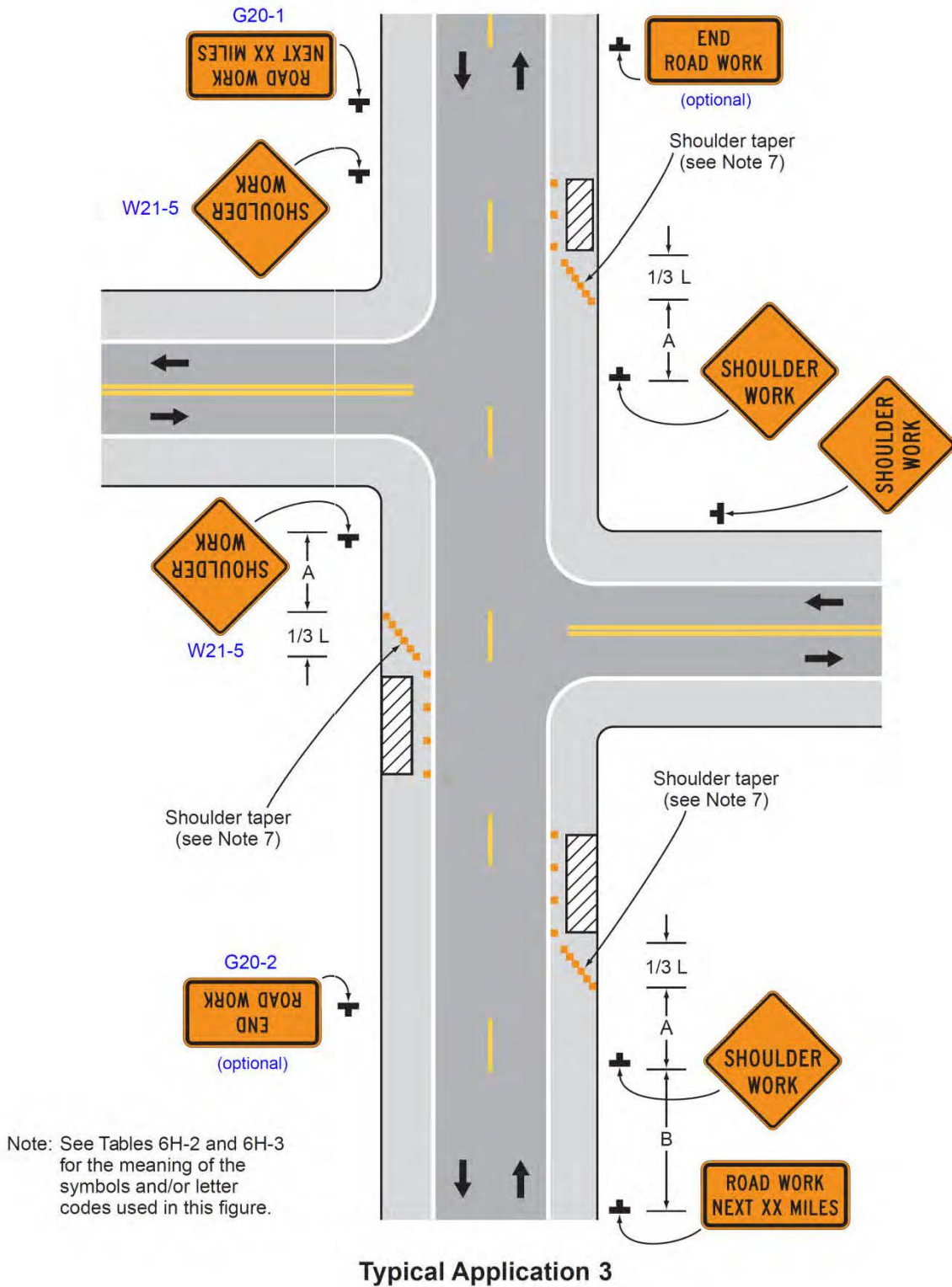
*Option:*

2. The Workers symbol signs may be used instead of SHOULDER WORK signs.
3. The SHOULDER WORK AHEAD sign on an intersecting roadway may be omitted where road users emerging from that roadway will encounter another advance warning sign prior to this activity area.
4. For short duration operations of 60 minutes or less, all signs and channelizing devices may be eliminated if a vehicle with activated high-intensity rotating, flashing, oscillating, or strobe lights is used.
5. Vehicle hazard warning signals may be used to supplement high-intensity rotating, flashing, oscillating, or strobe lights.

**Standard:**

6. **Vehicle hazard warning signals shall not be used instead of the vehicle's high-intensity rotating, flashing, oscillating, or strobe lights.**
7. **When paved shoulders having a width of 8 feet or more are closed, at least one advance warning sign shall be used. In addition, channelizing devices shall be used to close the shoulder in advance to delineate the beginning of the work space and direct vehicular traffic to remain within the traveled way.**

**Figure 6H-3. Work on the Shoulders (TA-3)**



### Notes for Figure 6H-4 —Typical Application 4 Short Duration or Mobile Operation on a Shoulder

**Guidance:**

1. In those situations where multiple work locations within a limited distance make it practical to place stationary signs, the distance between the advance warning sign and the work should not exceed 5 miles.
2. In those situations where the distance between the advance signs and the work is 2 miles to 5 miles, a Supplemental Distance plaque should be used with the ROAD WORK AHEAD sign or SHOULDER WORK AHEAD (C24(CA)) sign.

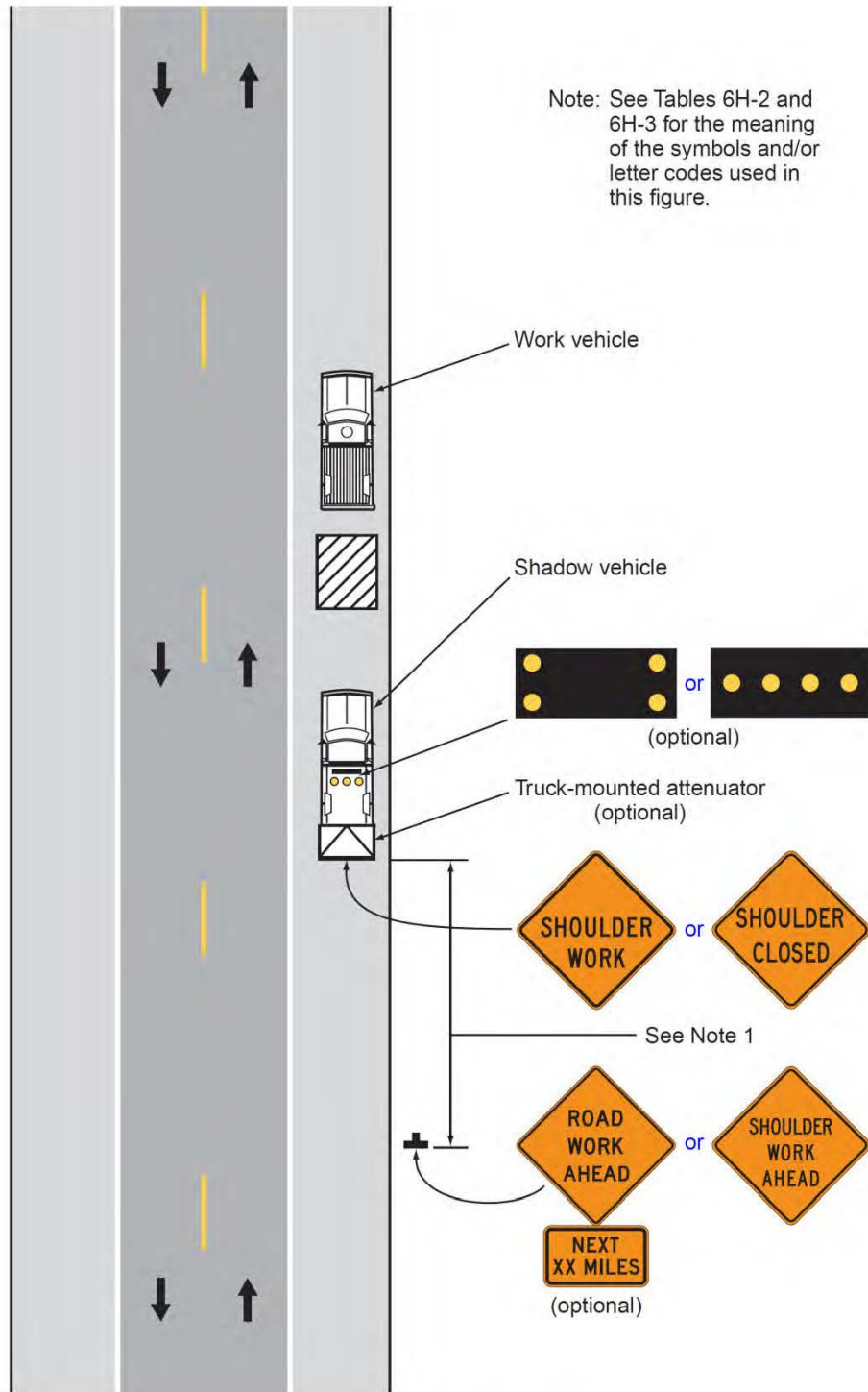
**Option:**

3. The ROAD WORK NEXT XX MILES sign may be used instead of the ROAD WORK AHEAD sign or SHOULDER WORK AHEAD (C24(CA)) sign if the work locations occur over a distance of more than 2 miles.
4. Stationary warning signs may be omitted for short duration or mobile operations if the work vehicle displays high-intensity rotating, flashing, oscillating, or strobe lights.
5. Vehicle hazard warning signals may be used to supplement high-intensity rotating, flashing, oscillating, or strobe lights.

**Standard:**

6. Vehicle hazard warning signals shall not be used instead of the vehicle's high-intensity rotating, flashing, oscillating, or strobe lights.
7. If an arrow board is used for an operation on the shoulder, the caution mode shall be used.
8. Vehicle-mounted signs shall be mounted in a manner such that they are not obscured by equipment or supplies. Sign legends on vehicle-mounted signs shall be covered or turned from view when work is not in progress.

**Figure 6H-4. Short-Duration or Mobile Operation on a Shoulder (TA-4)**



**Typical Application 4**

**Notes for Figure ~~6H-5~~ 6H-5(CA) — Typical Application 5  
Shoulder Closure on a Freeway**

*Guidance:*

1. *SHOULDER CLOSED* signs should be used on limited-access highways where there is no opportunity for disabled vehicles to pull off the roadway.
2. If drivers cannot see a pull-off area beyond the closed shoulder, information regarding the length of the shoulder closure should be provided in feet or miles, as appropriate.
3. The use of a temporary traffic barrier should be based on engineering judgment.

**Standard:**

4. **Temporary traffic barriers, if used, shall comply with the provisions of Section 6F.85.**

**Option:**

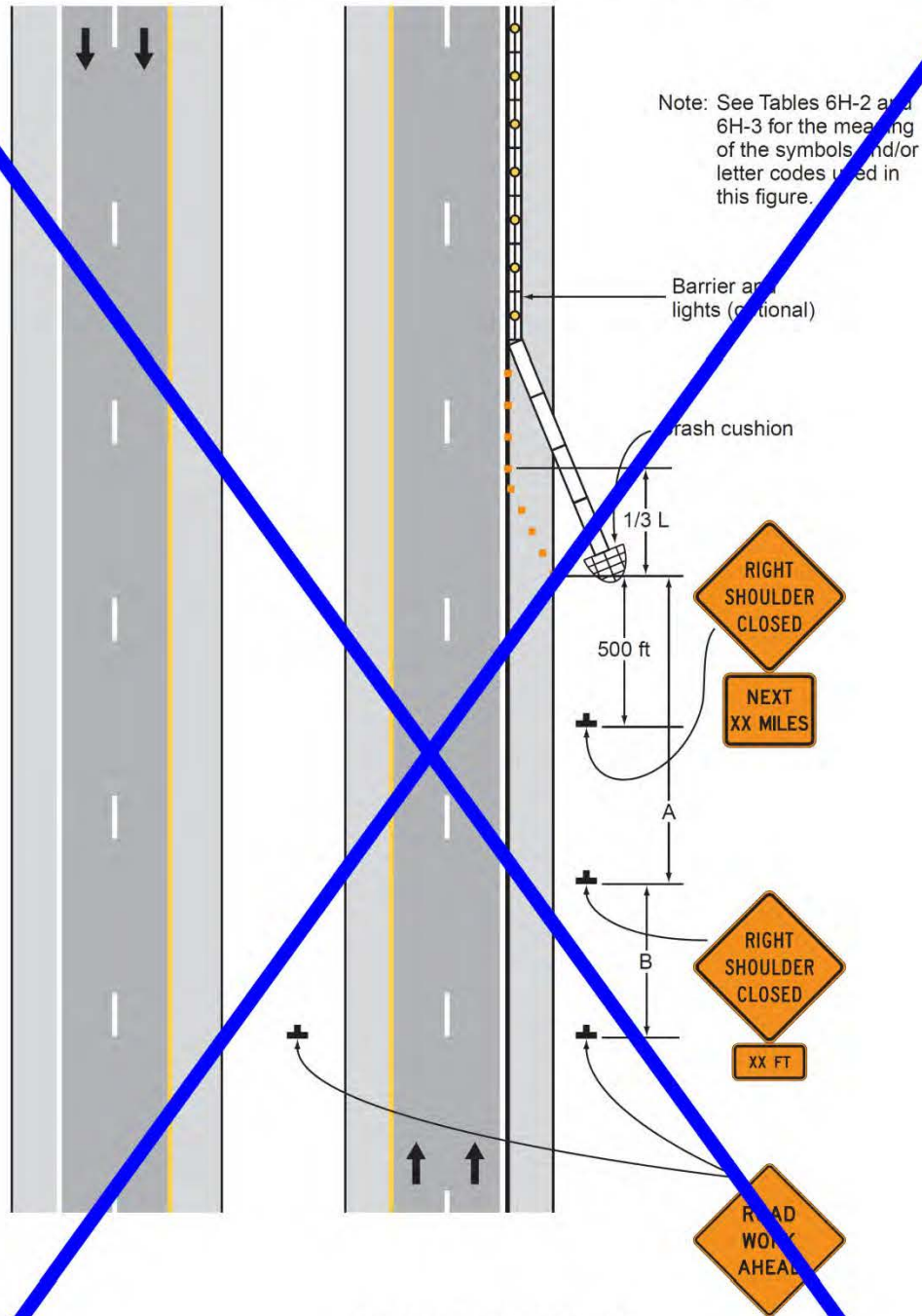
5. The barrier shown in this typical application is an example of one method that may be used to close a shoulder of a long-term project.
6. The warning lights shown on the barrier may be used.

**Standard:**

7. **Temporary traffic barriers, including their end treatments, shall be crashworthy. In order to mitigate the effect of striking the upstream end of a temporary traffic barrier, the end shall be installed in accordance with AASHTO's "Roadside Design Guide" (see Section 1A.11) by flaring until the end is outside the acceptable clear zone or by providing crashworthy end treatments. See Section 6F.85 for more details.**

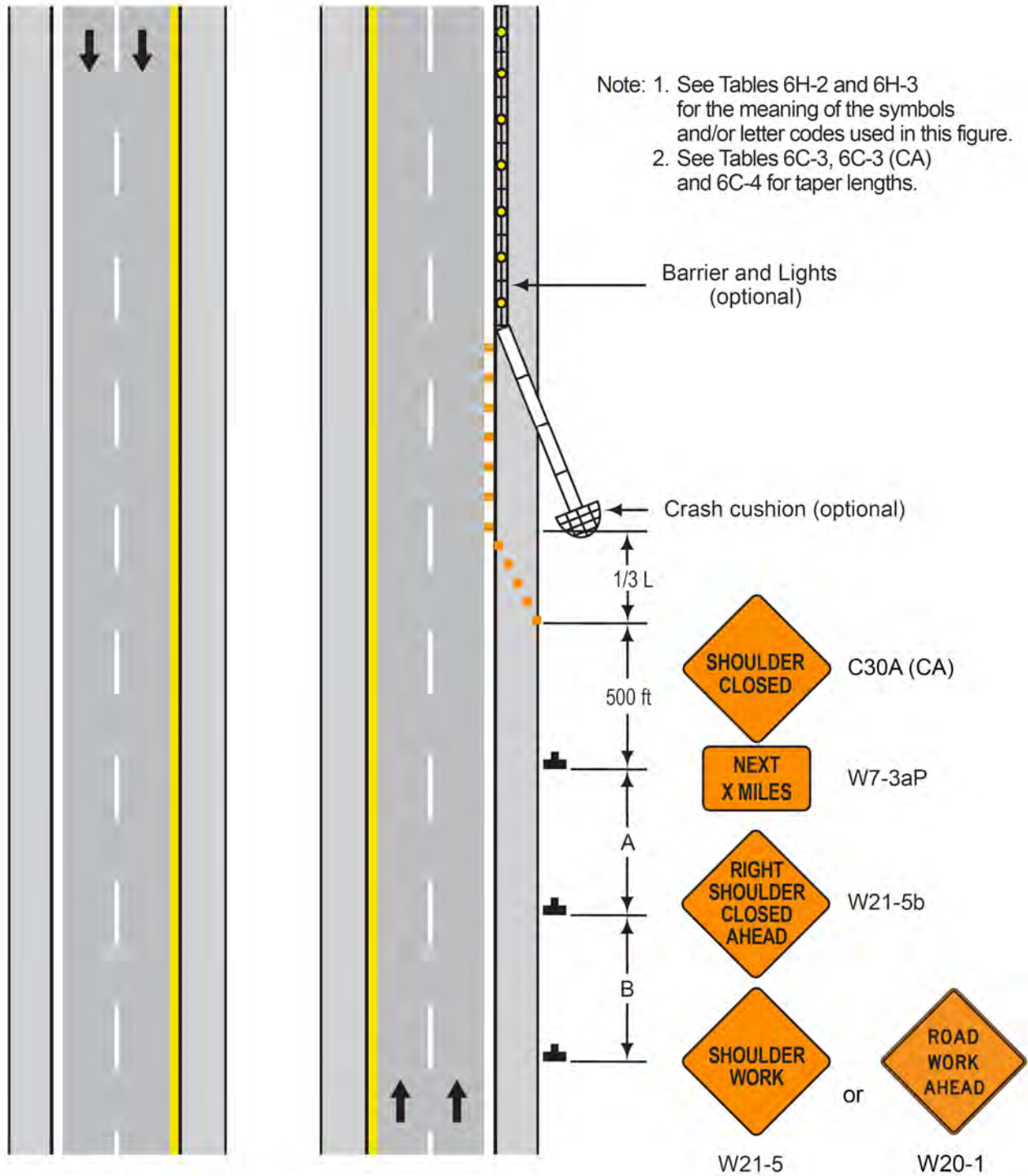


Figure 6H-5. Shoulder Closure on a Freeway (TA-5)



Typical Application 5

**Figure 6H-5 (CA). Shoulder Closure on Freeway (TA-5)**



**Typical Application 5**

## Notes for Figure 6H-6—Typical Application 6 Shoulder Work with Minor Encroachment

### Guidance:

1. All lanes should be a minimum of 10 feet in width as measured to the near face of the channelizing devices.
2. The treatment shown should be used on a minor road having low speeds. For higher-speed traffic conditions, a lane closure should be used.

### Option:

3. For short-term use on low-volume, low-speed roadways with vehicular traffic that does not include longer and wider heavy commercial vehicles, a minimum lane width of 9 feet may be used.
4. Where the opposite shoulder is suitable for carrying vehicular traffic and of adequate width, lanes may be shifted by use of closely-spaced channelizing devices, provided that the minimum lane width of 10 feet is maintained.
5. Additional advance warning may be appropriate, such as a ROAD NARROWS sign.
6. Temporary traffic barriers may be used along the work space.
7. The shadow vehicle may be omitted if a taper and channelizing devices are used.
8. A truck-mounted attenuator may be used on the shadow vehicle.
9. For short-duration work, the taper and channelizing devices may be omitted if a shadow vehicle with activated high-intensity rotating, flashing, oscillating, or strobe lights is used.
10. Vehicle hazard warning signals may be used to supplement high-intensity rotating, flashing, oscillating, or strobe lights.

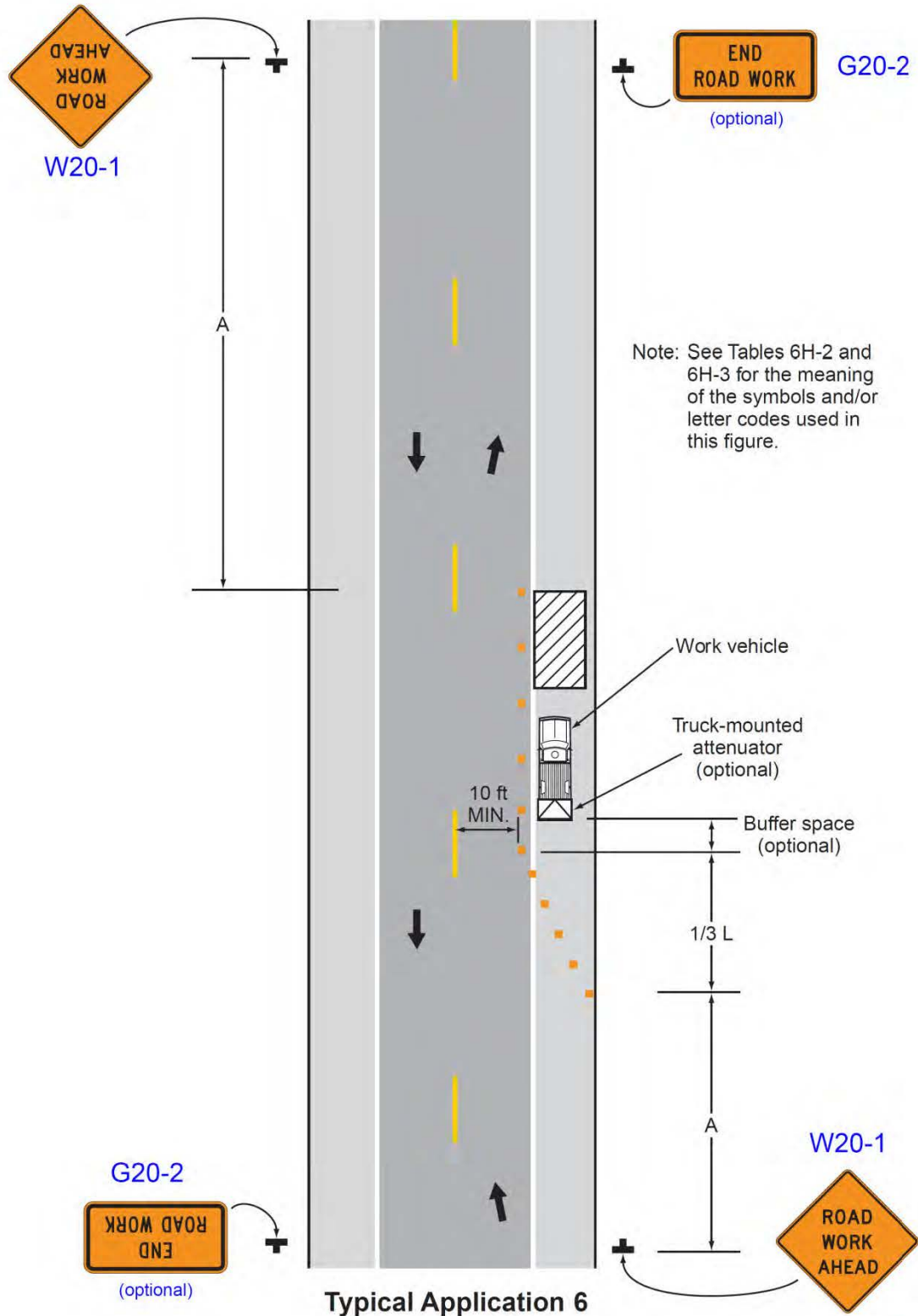
### Standard:

11. **Vehicle-mounted signs shall be mounted in a manner such that they are not obscured by equipment or supplies. Sign legends on vehicle-mounted signs shall be covered or turned from view when work is not in progress.**
12. **Shadow and work vehicles shall display high-intensity rotating, flashing, oscillating, or strobe lights.**
13. **Vehicle hazard warning signals shall not be used instead of the vehicle's high-intensity rotating, flashing, oscillating, or strobe lights.**

### Guidance:

14. *All advance warning signs should be placed so that the path of travel for bicycles is not blocked, while maintaining visibility for road users.*
15. *When existing accommodations for bicycle travel are disrupted or closed in a long-term duration project (see Section 6G.02) and the roadway width is inadequate for allowing bicyclists and motor vehicles to travel side by side, the Bicycle Warning (W11-1) sign and the SHARE THE ROAD (W16-1P) plaque should be used to advise motorists of the presence of bicyclists in the travel way lanes.*
16. *Except for short durations and mobile operations, when a highway shoulder is occupied and bicyclists would be sharing a lane with vehicular traffic, as a result of the TTC zone, speed reduction countermeasures should be used to reduce traffic speeds in the TTC zone. Refer to Sections 6C.01 and 6D.03.*
17. *Except for short durations and mobile operations, when a highway shoulder is occupied and bicyclists would be sharing a lane with vehicular traffic, as a result of the TTC zone, before narrowing the outside lane other measures such as widening the outside shoulder to allow bicyclists and motor vehicles to travel side by side through the TTC zone should be considered.*
18. *If traffic volumes make it feasible, the two left lanes should be merged into one lane to avoid using the shoulder as a traveled way lane and allowing continued use for emergency purposes and bicycle travel.*
19. *When existing accommodations for bicycle travel are disrupted or closed in a long-term duration project (see Section 6G.02) and the roadway width is inadequate for allowing bicyclists and motor vehicles to travel side by side, a separate path should be considered for bicyclists.*

**Figure 6H-6. Shoulder Work with Minor Encroachment (TA-6)**



## Notes for Figure 6H-7 — Typical Application 7 Road Closure with a Diversion

Support:

1. Signs and object markers are shown for one direction of travel only.

**Standard:**

2. **Devices similar to those depicted shall be placed for the opposite direction of travel.**
3. **Pavement markings no longer applicable to the traffic pattern of the roadway shall be removed or obliterated before any new traffic patterns are open to traffic.**
4. **Temporary barriers and end treatments shall be crashworthy.**

*Guidance:*

5. *If the tangent distance along the temporary diversion is more than 600 feet, a Reverse Curve sign, left first, should be used instead of the Double Reverse Curve sign, and a second Reverse Curve sign, right first, should be placed in advance of the second reverse curve back to the original alignment.*
6. *When the tangent section of the diversion is more than 600 feet, and the diversion has sharp curves with recommended speeds of 30 mph or less, Reverse Turn signs should be used.*
7. *Where the temporary pavement and old pavement are different colors, the temporary pavement should start on the tangent of the existing pavement and end on the tangent of the existing pavement.*

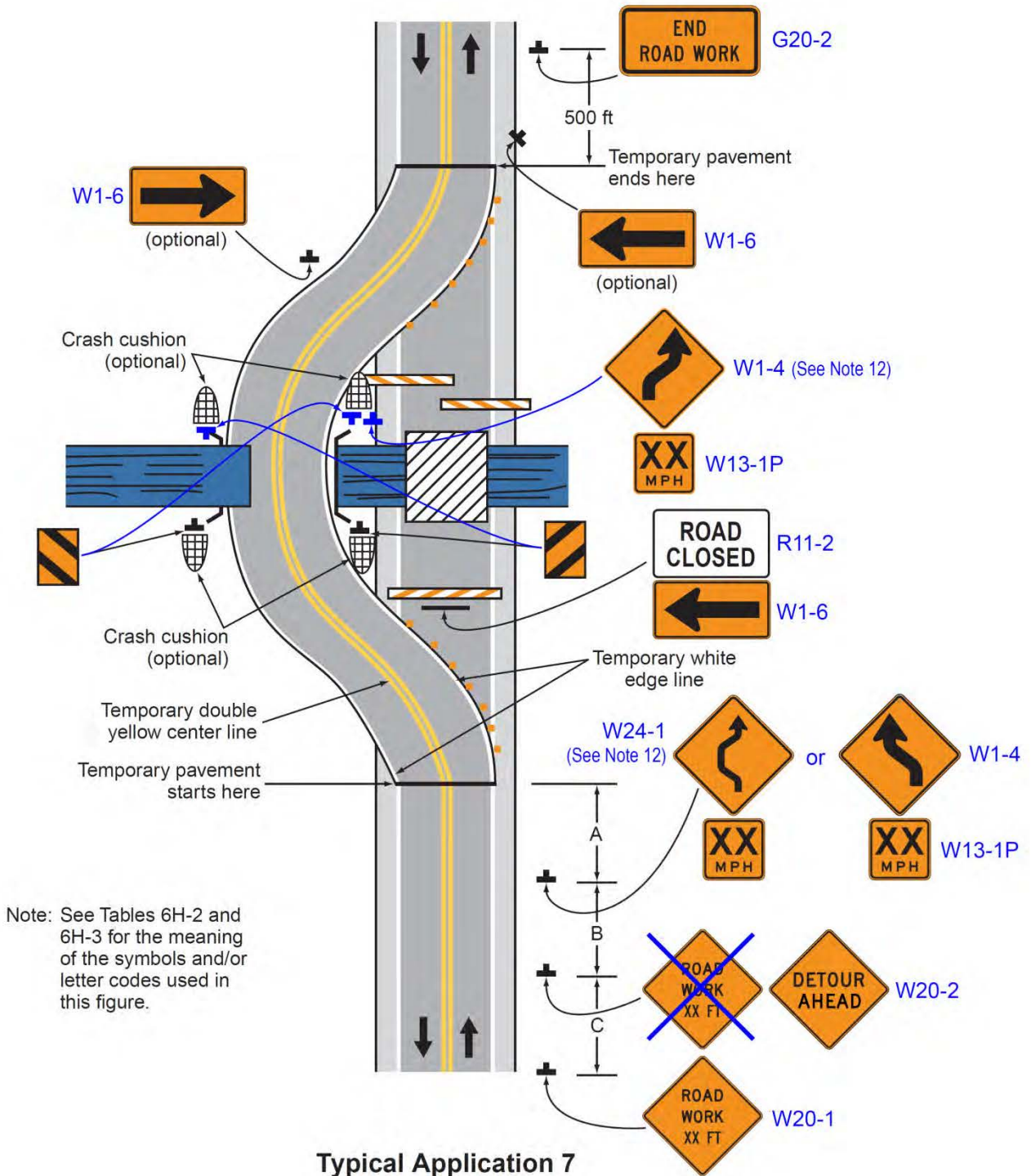
Option:

8. Flashing warning lights and/or flags may be used to call attention to the warning signs.
9. On sharp curves, large arrow signs may be used in addition to other advance warning signs.
10. Delineators or channelizing devices may be used along the diversion.
11. If the tangent distance along the temporary diversion is less than 600 feet, additional One-Direction Large Arrow (W1-6) and Chevron Alignment (W1-8) signs may be used.
12. When recommended speeds are the same for each curve, one Double Reverse Curve (W24-1) sign may be used, instead of two Reverse Curve (W1-4) signs, in advance of the first curve.

Support:

13. Use crash cushions, wherever applicable.

**Figure 6H-7. Road Closure with a Diversion (TA-7)**



### **Notes for Figure 6H-8—Typical Application 8 Road Closure with an Off-Site Detour**

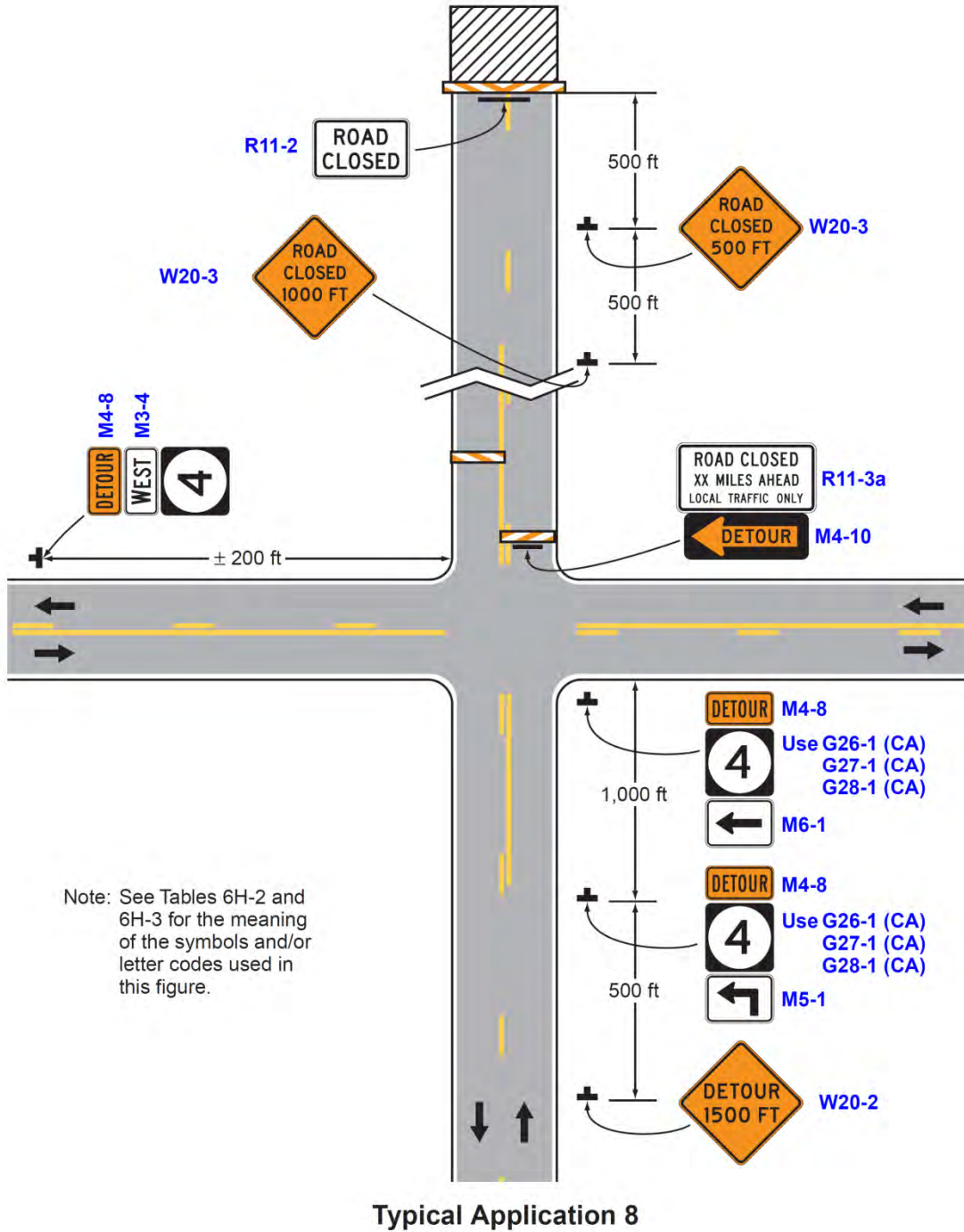
*Guidance:*

- 1. Regulatory traffic control devices should be modified as needed for the duration of the detour.*

**Option:**

2. If the road is opened for some distance beyond the intersection and/or there are significant origin/ destination points beyond the intersection, the ROAD CLOSED and DETOUR signs on Type 3 Barricades may be located at the edge of the traveled way.
3. A Route Sign Directional assembly may be placed on the far left corner of the intersection to augment or replace the one shown on the near right corner.
4. Flashing warning lights and/or flags may be used to call attention to the advance warning signs.
5. Cardinal direction plaques may be used with route signs.

Figure 6H-8. Road Closure with an Off-Site Detour (TA-8)





### **Notes for Figure 6H-9—Typical Application 9 Overlapping Routes with a Detour**

**Support:**

1. TTC devices are shown for one direction of travel only.

**Standard:**

- 2. Devices similar to those depicted shall be placed for the opposite direction of travel.**

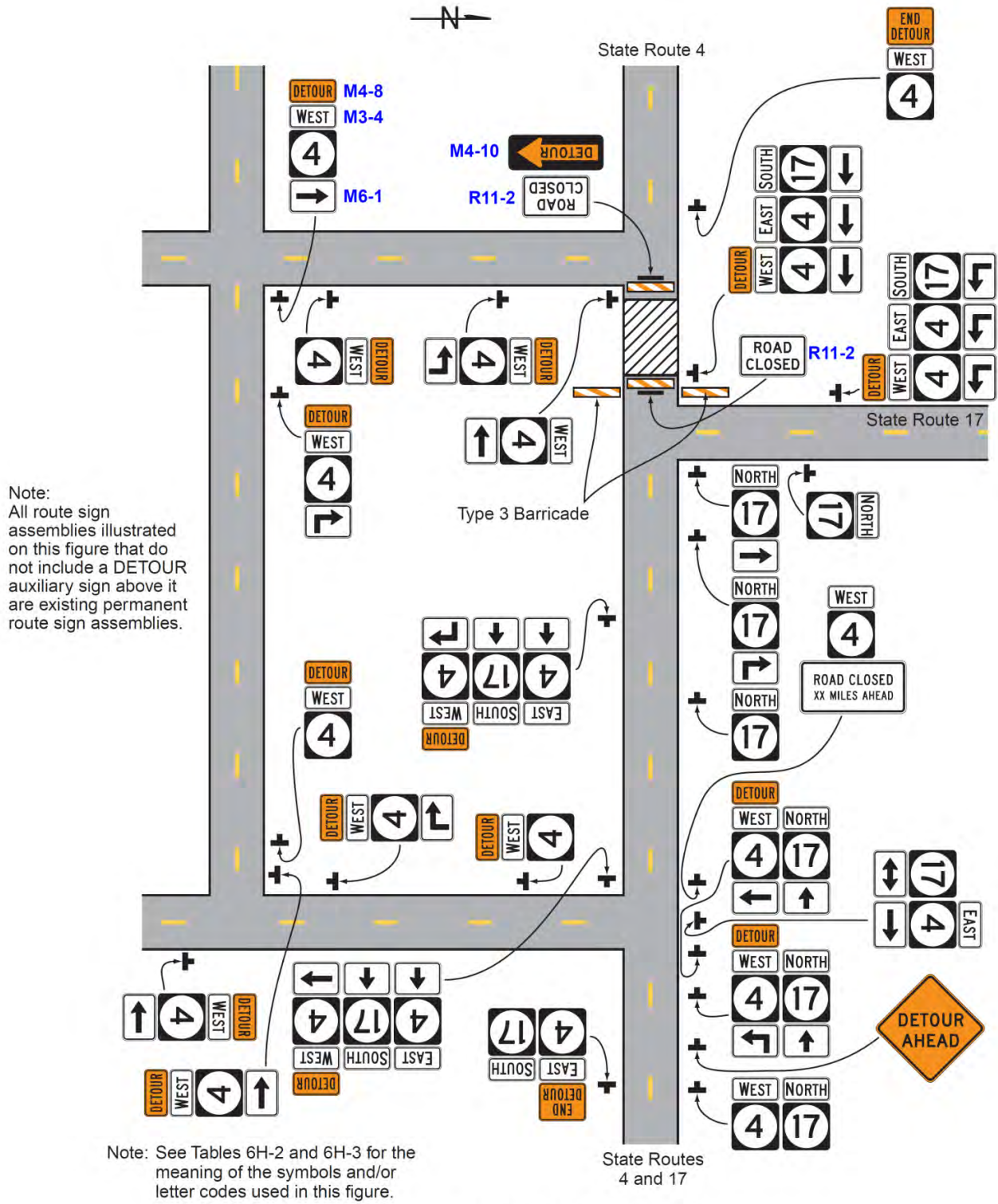
*Guidance:*

- 3. STOP or YIELD signs displayed to side roads should be installed as needed along the temporary route.*

**Option:**

4. Flashing warning lights and/or flags may be used to call attention to the advance warning signs.
5. Flashing warning lights may be used on the Type 3 Barricades.
6. Cardinal direction plaques may be used with route signs.

Figure 6H-9. Overlapping Routes with a Detour (TA-9)



Typical Application 9

### Notes for Figure ~~6H-10~~ 6H-10(CA) and 6H-10A(CA) — Typical Application 10 Lane Closure on a Two-Lane Road Using Flaggers

**Option:**

1. For low-volume (Refer to Part 5, Section 5A.01) situations with short work zones on straight roadways where the flagger is visible to road users approaching from both directions, a single flagger, positioned to be visible to road users approaching from both directions, may be used (see Chapter 6E).
2. The ROAD WORK AHEAD and the END ROAD WORK signs may be omitted for short-duration operations.
3. Flashing warning lights and/or flags may be used to call attention to the advance warning signs. A BE PREPARED TO STOP sign may be added to the sign series.

**Guidance:**

4. *The buffer space should be extended so that the two-way traffic taper is placed before a horizontal (or crest vertical) curve to provide adequate sight distance for the flagger and a queue of stopped vehicles.*

**Standard:**

5. **At night, flagger stations shall be illuminated, except in emergencies.**

**Guidance:**

6. *When used, the BE PREPARED TO STOP sign should be located ~~between~~ after the Flagger sign and the ONE LANE ROAD sign.*
7. *When a grade crossing exists within or upstream of the transition area and it is anticipated that queues resulting from the lane closure might extend through the grade crossing, the TTC zone should be extended so that the transition area precedes the grade crossing.*
8. *When a grade crossing equipped with active warning devices exists within the activity area, provisions should be made for keeping flaggers informed as to the activation status of these warning devices.*
9. *When a grade crossing exists within the activity area, drivers operating on the left-hand side of the normal center line should be provided with comparable warning devices as for drivers operating on the right-hand side of the normal center line.*
10. *Early coordination with the railroad company or light rail transit agency should occur before work starts.*

**Option:**

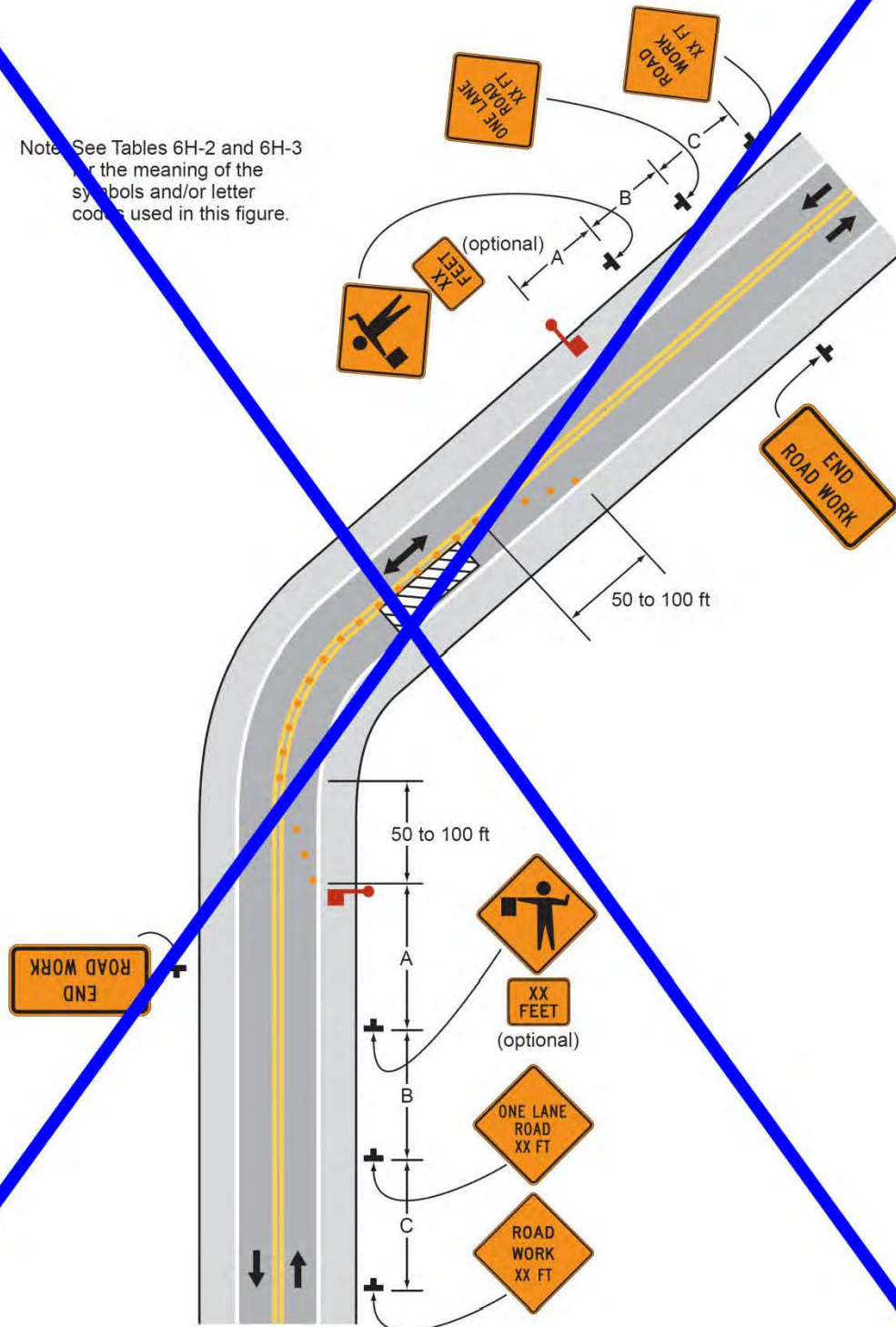
11. A flagger or a uniformed law enforcement officer may be used at the grade crossing to minimize the probability that vehicles are stopped within 15 feet of the grade crossing, measured from both sides of the outside rails.

**Support:**

12. For State highways, see Caltrans' Standard Plan T13. See Section 1A.11 for information regarding this publication.
13. If portable transverse rumble strips are used for flagging operations, refer to Section 6F.87.

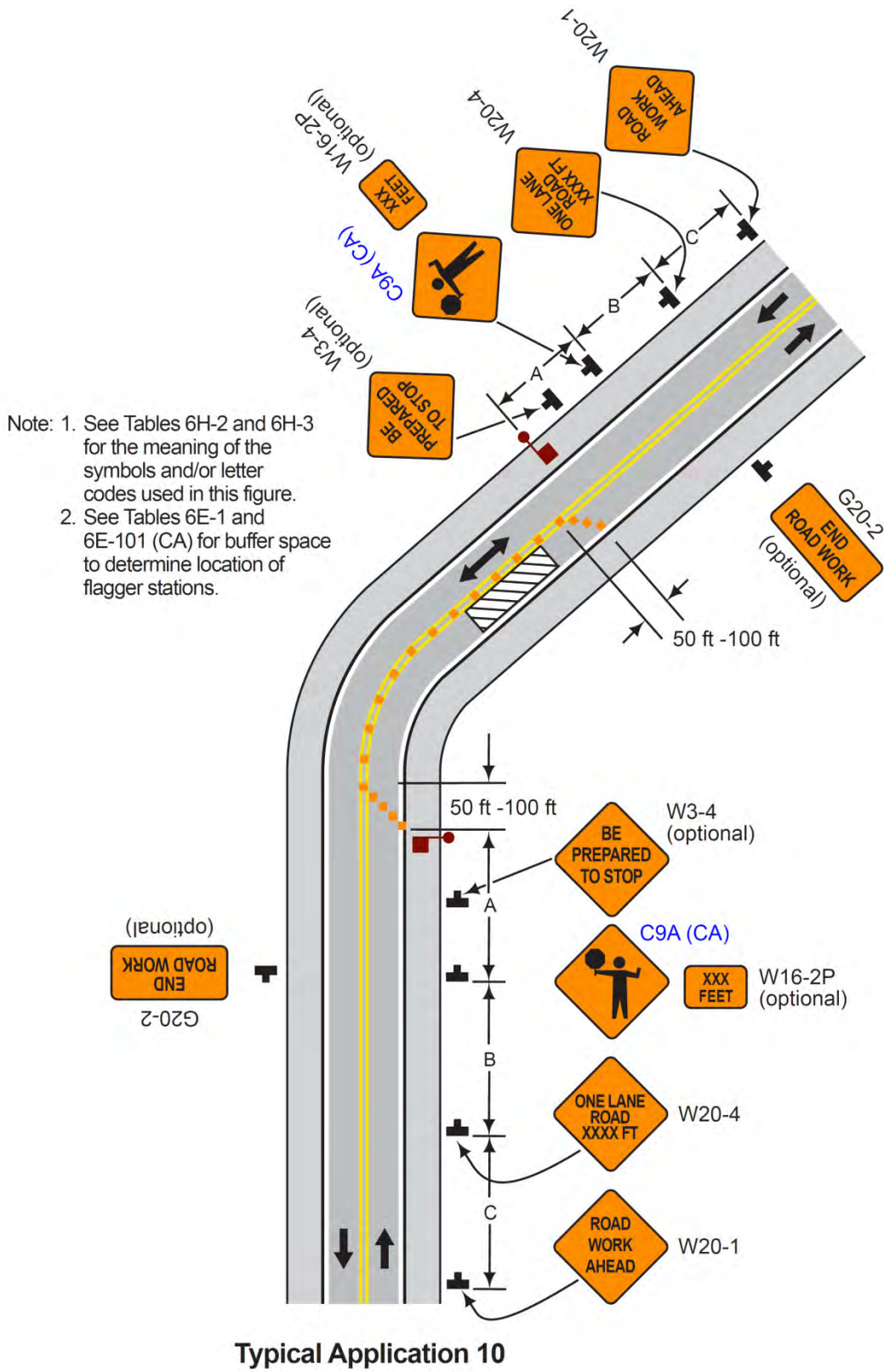
**Figure 6H-10. Lane Closure on a Two-Lane Road Using Flaggers (TA-10)**

Note: See Tables 6H-2 and 6H-3 for the meaning of the symbols and/or letter codes used in this figure.

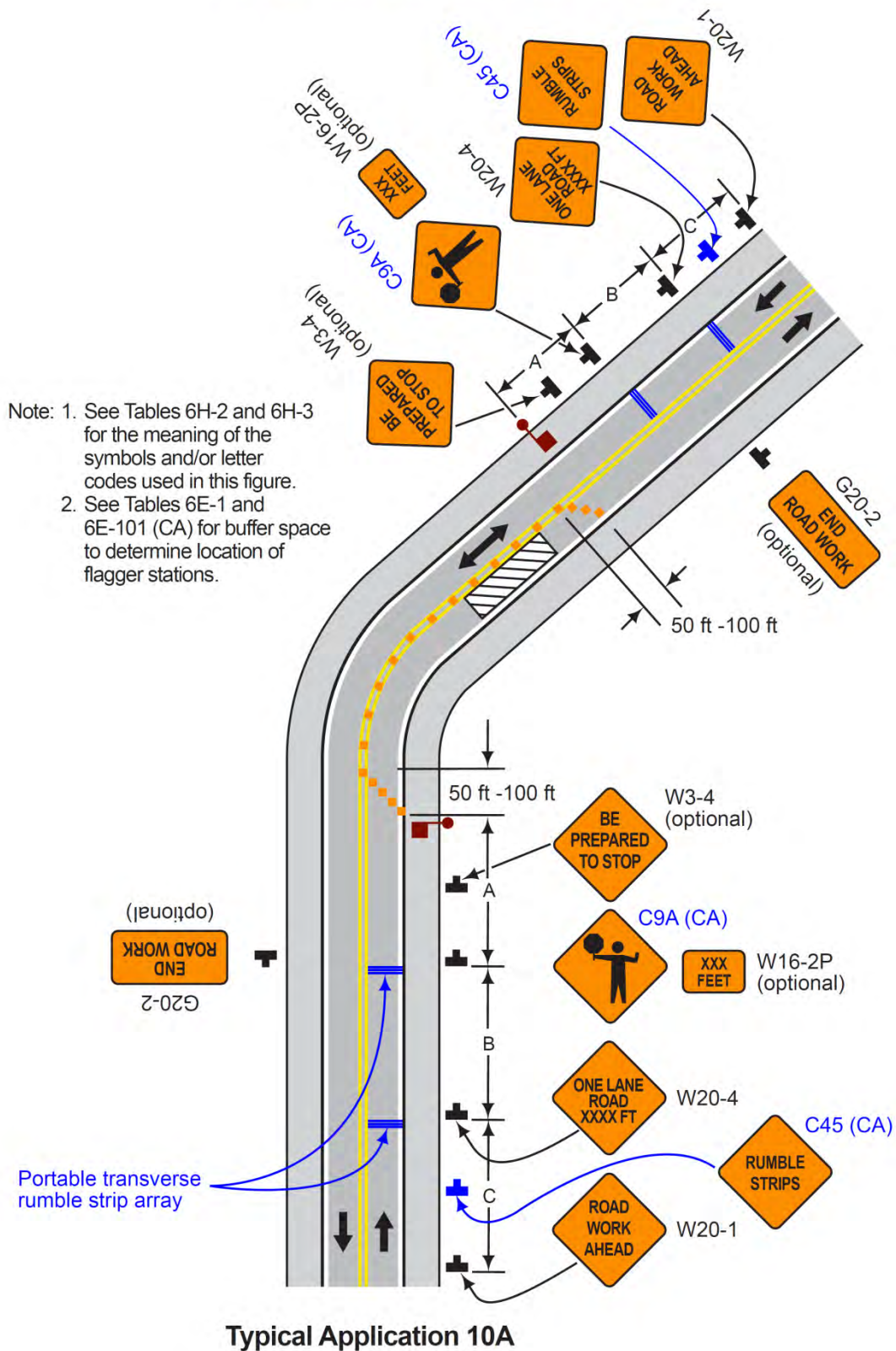


**Typical Application 10**

**Figure 6H-10 (CA). Lane Closure on Two-Lane Road Using Flaggers (TA-10)**



**Figure 6H-10A (CA). Lane Closure on Two-Lane Road Using Flaggers (TA-10A) Using Portable Transverse Rumble Strips**



### **Notes for Figure 6H-11—Typical Application 11 Lane Closure on a Two-Lane Road with Low Traffic Volumes**

**Option:**

1. This TTC zone application may be used as an alternate to the TTC application shown in Figure ~~6H-10~~ **6H-10(CA)** (using flaggers) when the following conditions exist:
  - a. Vehicular traffic volume is such that sufficient gaps exist for vehicular traffic that must yield.
  - b. Road users from both directions are able to see approaching vehicular traffic through and beyond the worksite and have sufficient visibility of approaching vehicles.
2. The Type B flashing warning lights may be placed on the ROAD WORK AHEAD and the ONE LANE ROAD AHEAD signs whenever a night lane closure is necessary.

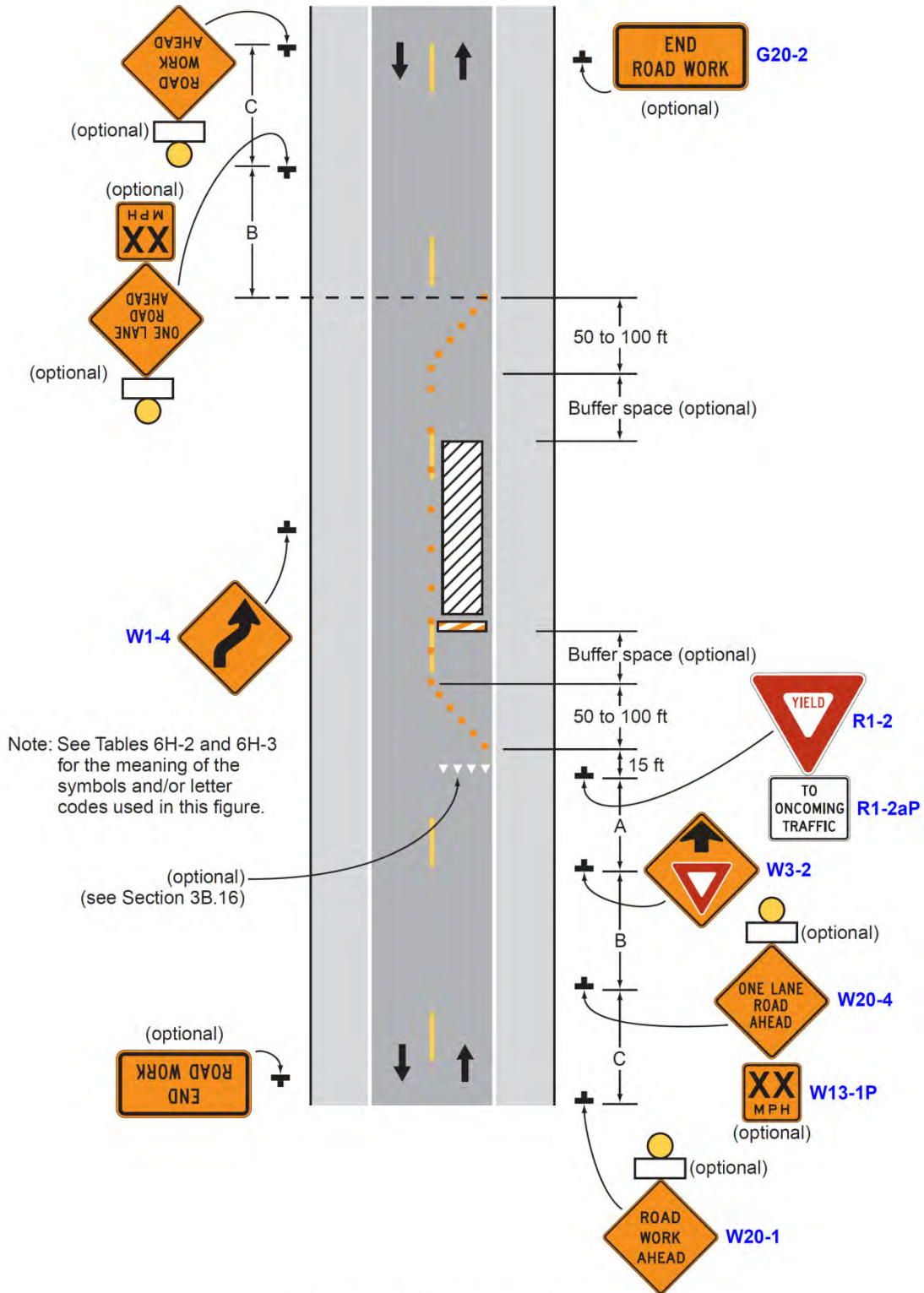
**Standard:**

- 3. The approach to the side that is not closed shall be visible (for a distance equal to the safe passing sight distance for that approach) to the road user who must yield or stop.**

**Support:**

See Section 3B.02 and 6C.15.

**Figure 6H-11. Lane Closure on a Two-Lane Road with Low Traffic Volumes (TA-11)**



**Typical Application 11**



## **Notes for Figure 6H-12 —Typical Application 12 Lane Closure on a Two-Lane Road Using Traffic Control Signals**

**Standard:**

- 1. Temporary traffic control signals shall be installed and operated in accordance with the provisions of Part 4. Temporary traffic control signals shall meet the physical display and operational requirements of conventional traffic control signals.**
- 2. Temporary traffic control signal timing shall be established by authorized officials. Durations of red clearance intervals shall be adequate to clear the one-lane section of conflicting vehicles.**
- 3. When the temporary traffic control signal is changed to the flashing mode, either manually or automatically, red signal indications shall be flashed to both approaches.**
- 4. Stop lines shall be installed with temporary traffic control signals for intermediate and long-term closures. Existing conflicting pavement markings and raised pavement marker reflectors between the activity area and the stop line shall be removed. After the temporary traffic control signal is removed, the stop lines and other temporary pavement markings shall be removed and the permanent pavement markings restored.**
- 5. Safeguards shall be incorporated to avoid the possibility of conflicting signal indications at each end of the TTC zone.**

*Guidance:*

- 6. Where no-passing lines are not already in place, they should be added.*
- 7. Adjustments in the location of the advance warning signs should be made as needed to accommodate the horizontal or vertical alignment of the roadway, recognizing that the distances shown for sign spacings are minimums. Adjustments in the height of the signal heads should be made as needed to conform to the vertical alignment.*

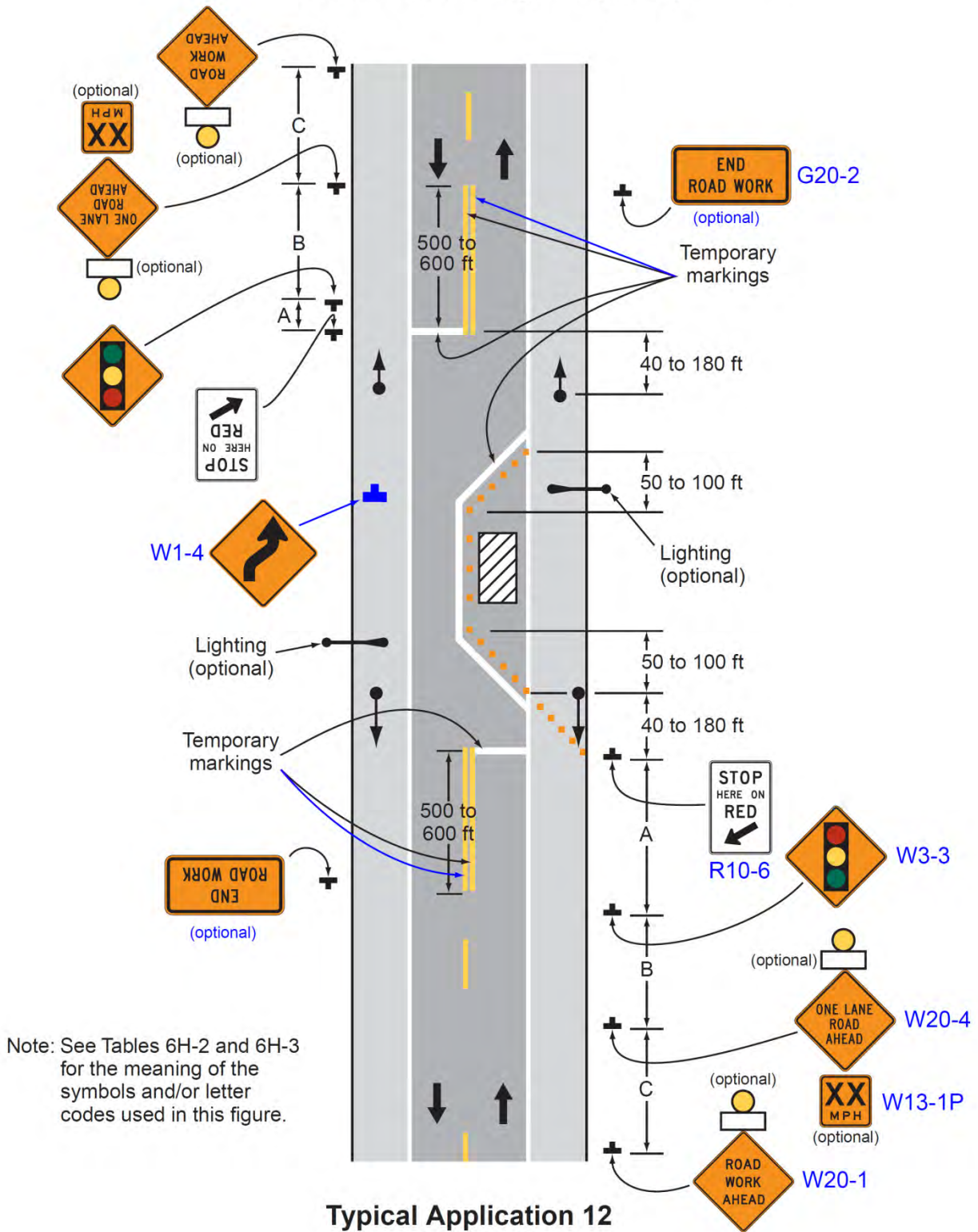
**Option:**

- 8. Flashing warning lights shown on the ROAD WORK AHEAD and the ONE LANE ROAD AHEAD signs may be used.**
- 9. Removable pavement markings may be used.**

**Support:**

- 10. Temporary traffic control signals are preferable to flaggers for long-term projects and other activities that would require flagging at night.**
- 11. The maximum length of activity area for one-way operation under temporary traffic control signal control is determined by the capacity required to handle the peak demand.**

**Figure 6H-12. Lane Closure on a Two-Lane Road Using Traffic Control Signals (TA-12)**



### Notes for Figure 6H-13 —Typical Application 13 Temporary Road Closure

Support:

1. Conditions represented are a planned closure not exceeding 20 minutes during the daytime.

**Standard:**

- 2. A flagger or uniformed law enforcement officer shall be used for this application. The flagger, if used for this application, shall follow the procedures provided in Sections 6E.07 and 6E.08.**

*Guidance:*

- 3. The uniformed law enforcement officer, if used for this application, should follow the procedures provided in Sections 6E.07 and 6E.08.*

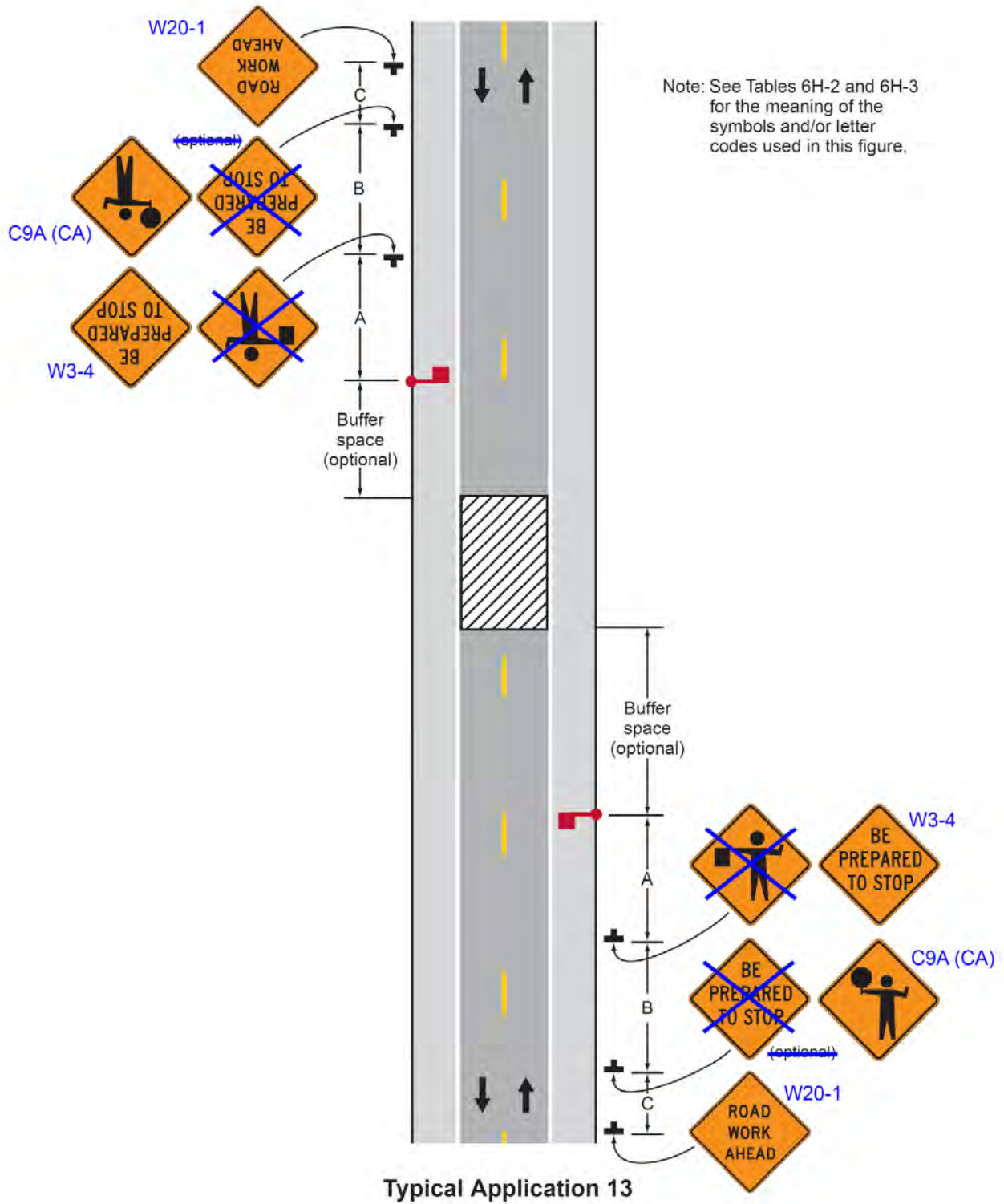
Option:

4. A BE PREPARED TO STOP sign may be added to the sign series.

*Guidance:*

- 5. When used, the BE PREPARED TO STOP sign should be located ~~before~~ after the Flagger symbol sign.*

**Figure 6H-13. Temporary Road Closure (TA-13)**



**Notes for Figure ~~6H-14~~ 6H-14(CA) — Typical Application 14  
Haul Road Crossing**

*Guidance:*

1. Floodlights should be used to illuminate haul road crossings where existing light is inadequate.
2. Where no-passing lines are not already in place, they should be added.

**Standard:**

3. The traffic control method selected shall be used in both directions.

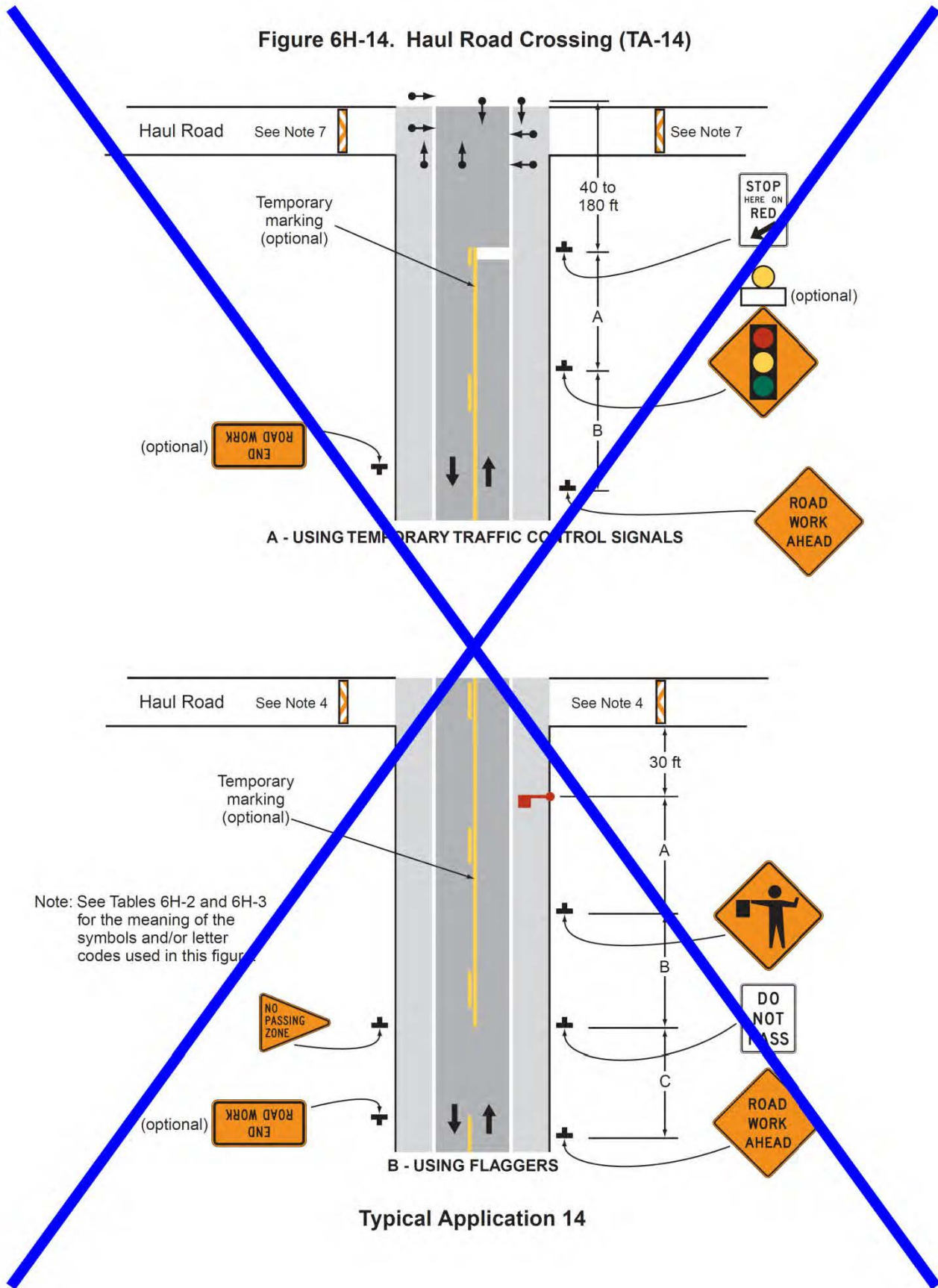
**Flagging Method**

4. When a road used exclusively as a haul road is not in use, the haul road shall be closed with Type 3 Barricades and the Flagger symbol signs covered.
5. The flagger shall follow the procedures provided in Sections 6E.07 and 6E.08.
6. At night, flagger stations shall be illuminated, except in emergencies.

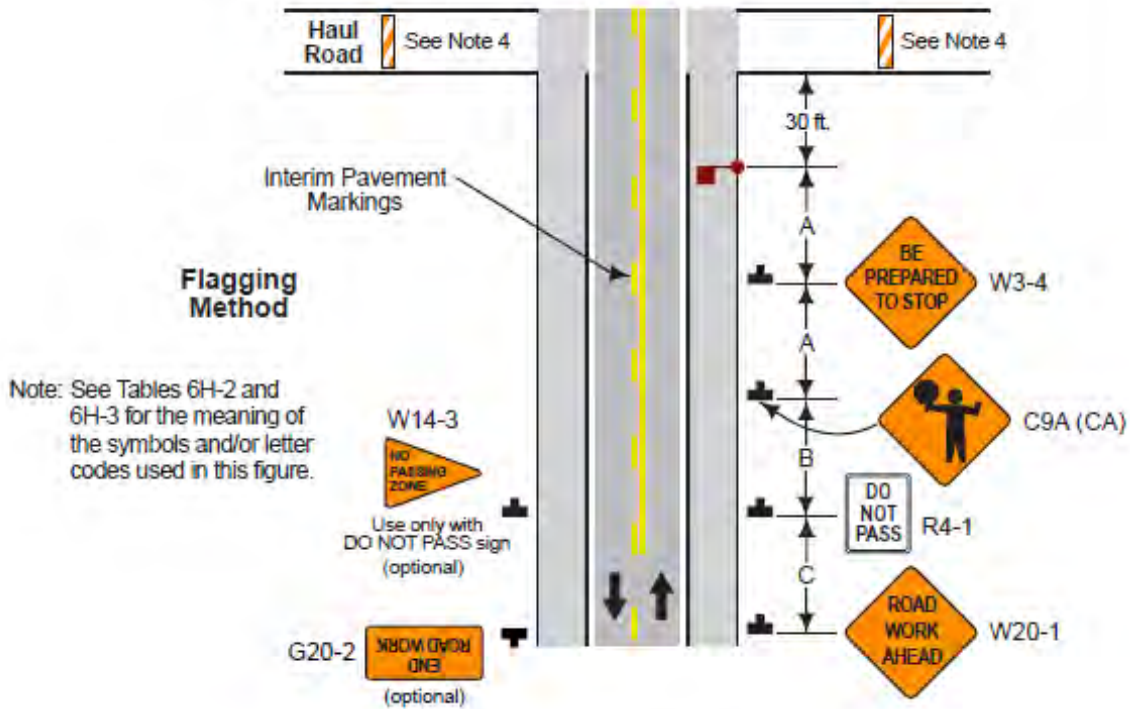
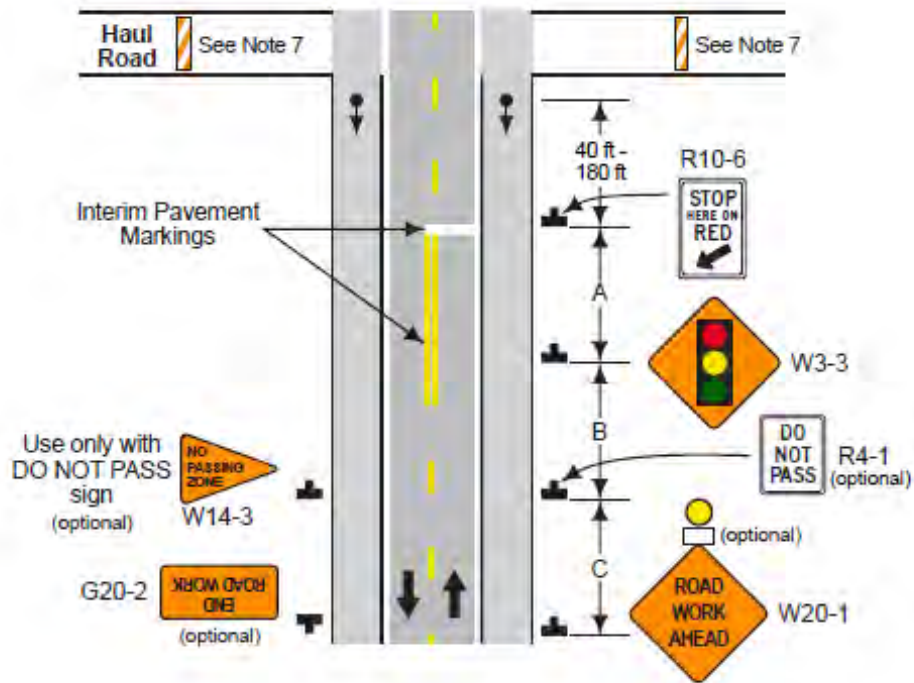
**Signalized Method**

7. When a road used exclusively as a haul road is not in use, the haul road shall be closed with Type 3 Barricades. The signals shall either flash yellow on the main road or be covered, and the Signal Ahead and STOP HERE ON RED signs shall be covered or hidden from view.
8. The temporary traffic control signals shall control both the highway and the haul road and shall meet the physical display and operational requirements of conventional traffic control signals as described in Part 4. Traffic control signal timing shall be established by authorized officials.
9. Stop lines shall be used on existing highway with temporary traffic control signals.
10. Existing conflicting pavements markings between the stop lines shall be removed. After the temporary traffic control signal is removed, the stop lines and other temporary pavement markings shall be removed and the permanent pavement markings restored.

**Figure 6H-14. Haul Road Crossing (TA-14)**



**Figure 6H-14 (CA). Haul Road Crossing (TA-14)**



Note: See Tables 6H-2 and 6H-3 for the meaning of the symbols and/or letter codes used in this figure.

**Flagging Method**

**Typical Application 14**

**Notes for Figure 6H-15—Typical Application 15**  
**Work in the Center of a Road with Low Traffic Volumes**  
**(Refer to Part 5, Section 5A.01)**

*Guidance:*

1. *The lanes on either side of the center work space should have a minimum width of 10 feet as measured from the near edge of the channelizing devices to the edge of the pavement or the outside edge of the paved shoulder.*

*Option:*

2. Flashing warning lights and/or flags may be used to call attention to the advance warning signs.
3. If the closure continues overnight, warning lights may be used on the channelizing devices.
4. A lane width of 9 feet may be used for short-term stationary work on low-volume, low-speed roadways when motor vehicle traffic does not include longer and wider heavy commercial vehicles.
5. A work vehicle displaying high-intensity rotating, flashing, oscillating, or strobe lights may be used instead of the channelizing devices forming the tapers or the high-level warning devices.
6. Vehicle hazard warning signals may be used to supplement high-intensity rotating, flashing, oscillating, or strobe lights.

**Standard:**

- 7. Vehicle hazard warning signals shall not be used instead of the vehicle's high-intensity rotating, flashing, oscillating, or strobe lights.**

*Guidance:*

8. *All advance warning signs should be placed so that the path of travel for bicycles is not blocked while maintaining visibility for road users.*
9. *When existing accommodations for bicycle travel are disrupted or closed in a long-term duration project (see Section 6G.02) and the roadway width is inadequate for allowing bicyclists and motor vehicles to travel side by side, the Bicycle Crossing (W11-1) sign and the SHARE THE ROAD (W16-1P) plaque should be used to advise motorists of the presence of bicyclists in the travel way lanes.*
10. *When existing accommodations for bicycle travel are disrupted or closed in a long-term duration project (see Section 6G.02), the temporary white edge line should be used on the shoulder to indicate the use of a portion of the shoulder as a traveled way lane.*





**Notes for Figure 6H-16—Typical Application 16**  
**Surveying Along the Center Line of a Road with Low Traffic Volumes**  
**(Refer to Part 5, Section 5A.01)**

*Guidance:*

1. *The lanes on either side of the center work space should have a minimum width of 10 feet as measured from the near edge of the channelizing devices to the edge of the pavement or the outside edge of the paved shoulder.*
2. *Cones should be placed 6 to 12 inches on either side of the center line.*
3. *A flagger should be used to warn workers who cannot watch road users.*

**Standard:**

4. **For surveying on the center line of a high-volume road, one lane shall be closed using the information illustrated in Figure ~~6H-10~~ 6H-10(CA).**

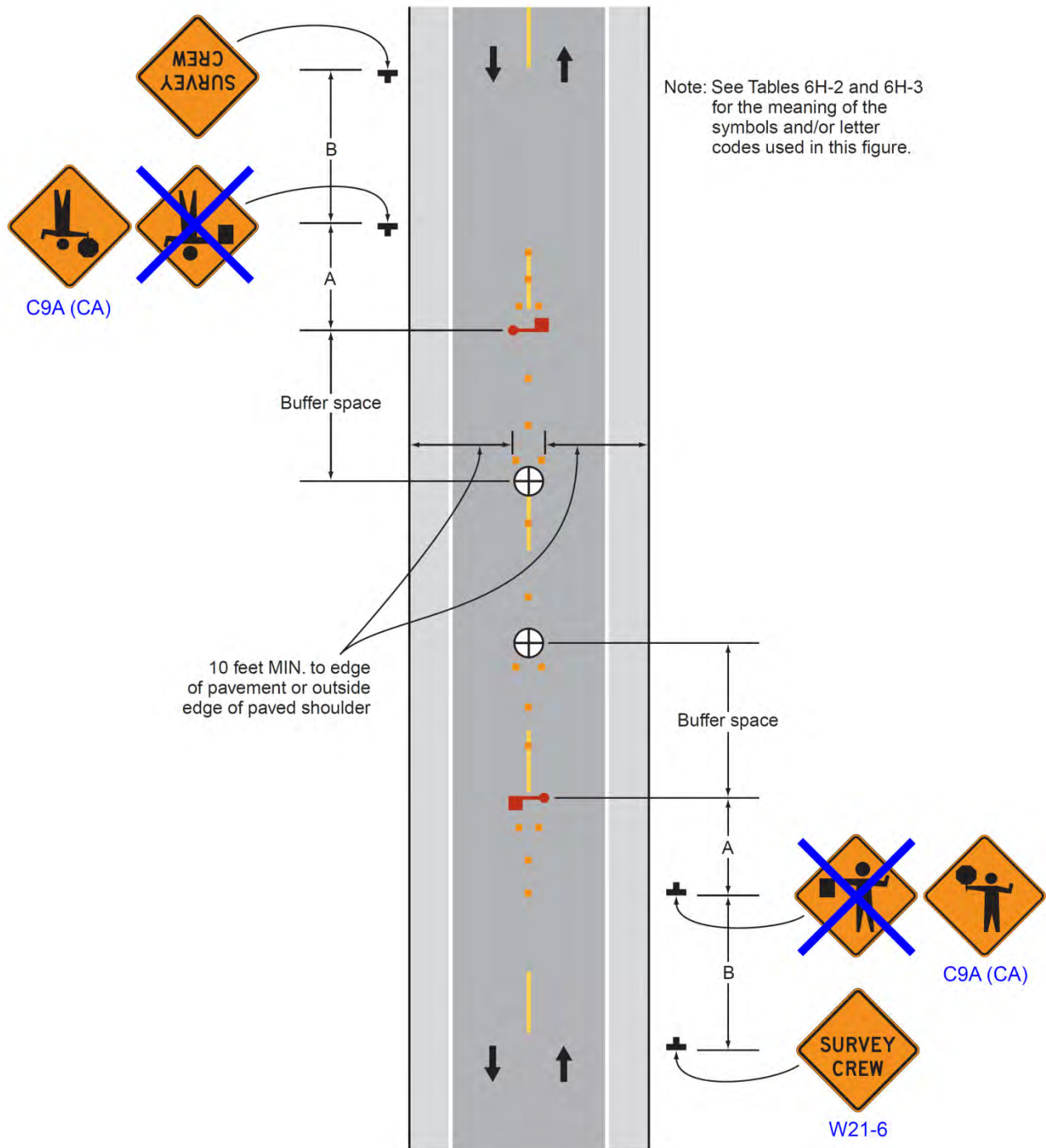
*Option:*

5. A high-level warning device may be used to protect a surveying device, such as a target on a tripod.
6. Cones may be omitted for a cross-section survey.
7. ROAD WORK AHEAD signs may be used in place of the SURVEY CREW AHEAD signs.
8. Flags may be used to call attention to the advance warning signs.
9. If the work is along the shoulder, the flagger may be omitted.
10. For a survey along the edge of the road or along the shoulder, cones may be placed along the edge line.
11. A BE PREPARED TO STOP sign may be added to the sign series.

*Guidance:*

12. *When used, the BE PREPARED TO STOP sign should be located ~~before~~ after the Flagger symbol sign.*

**Figure 6H-16. Surveying Along the Center Line of a Road with Low Traffic Volumes (TA-16)**



**Typical Application 16**

### Notes for Figure 6H-17—Typical Application 17 Mobile Operations on a Two-Lane Road

**Standard:**

- 1. Vehicle-mounted signs shall be mounted in a manner such that they are not obscured by equipment or supplies. Sign legends on vehicle-mounted signs shall be covered or turned from view when work is not in progress.**
- 2. Shadow and work vehicles shall display high-intensity rotating, flashing, oscillating, or strobe lights.**
- 3. If an arrow board is used, it shall be used in the caution mode.**

*Guidance:*

- 4. Where practical and when needed, the work and shadow vehicles should pull over periodically to allow vehicular traffic to pass.*
- 5. Whenever adequate stopping sight distance exists to the rear, the shadow vehicle should maintain the minimum distance from the work vehicle and proceed at the same speed. The shadow vehicle should slow down in advance of vertical or horizontal curves that restrict sight distance.*
- 6. The shadow vehicles should also be equipped with two high-intensity flashing lights mounted on the rear, adjacent to the sign.*

*Option:*

- 7. The distance between the work and shadow vehicles may vary according to terrain, paint drying time, and other factors.*
- 8. Additional shadow vehicles to warn and reduce the speed of oncoming or opposing vehicular traffic may be used. Law enforcement vehicles may be used for this purpose.*
- 9. A truck-mounted attenuator may be used on the shadow vehicle or on the work vehicle.*
- 10. If the work and shadow vehicles cannot pull over to allow vehicular traffic to pass frequently, a DO NOT PASS sign may be placed on the rear of the vehicle blocking the lane.*

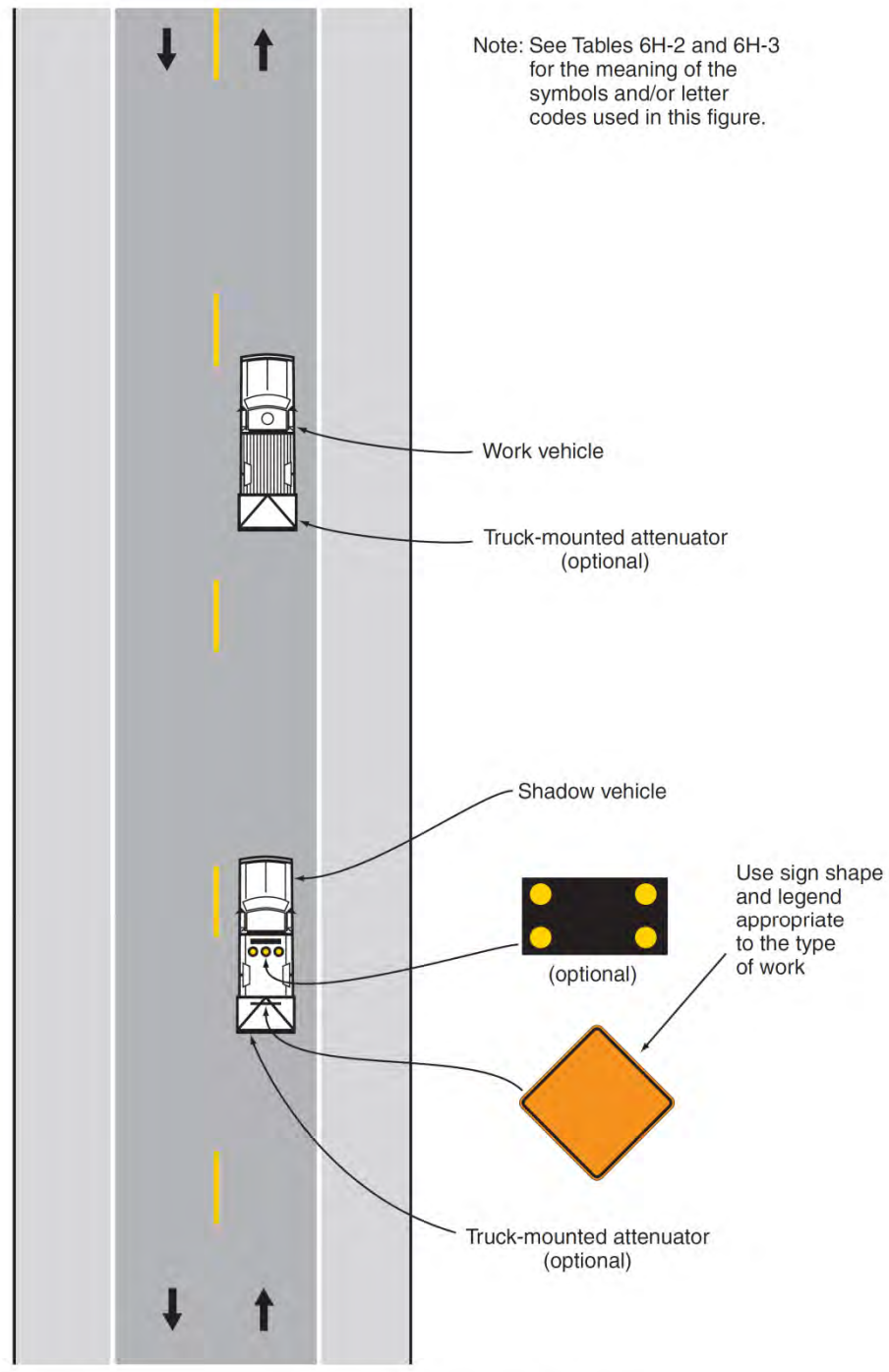
*Support:*

- 11. Shadow vehicles are used to warn motor vehicle traffic of the operation ahead.*

**Standard:**

- 12. Vehicle hazard warning signals shall not be used instead of the vehicle's high-intensity rotating, flashing, oscillating, or strobe lights.**
- 13. This typical application shall not be used on State highways, Caltrans' Standard Plan T17 for moving lane closure shall be used instead. See Section 1A.11 for information regarding this publication.**

**Figure 6H-17. Mobile Operations on a Two-Lane Road (TA-17)**



**Typical Application 17**

### **Notes for Figure 6H-18—Typical Application 18 Lane Closure on a Minor Street**

**Standard:**

- 1. This TTC shall be used only for low-speed facilities having low traffic volumes (Refer to Part 5, Section 5A.01).**

**Option:**

2. Where the work space is short, where road users can see the roadway beyond, and where volume is low, vehicular traffic may be self-regulating.

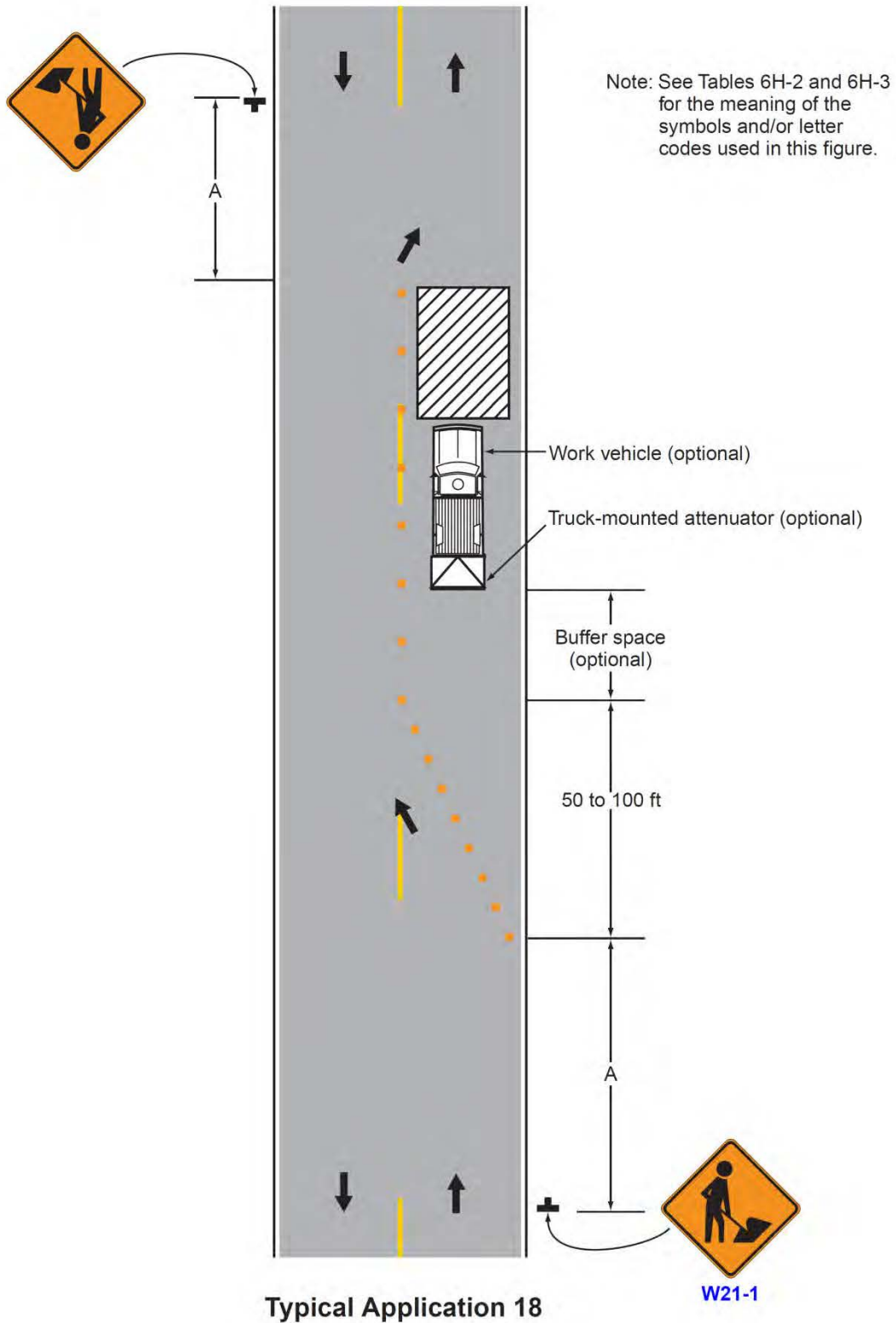
**Standard:**

- 3. Where vehicular traffic cannot effectively self-regulate, one or two flaggers shall be used as illustrated in Figure ~~6H-10~~ 6H-10(CA).**

**Option:**

4. Flashing warning lights and/or flags may be used to call attention to the advance warning signs.
5. A truck-mounted attenuator may be used on the work vehicle and the shadow vehicle.

**Figure 6H-18. Lane Closure on a Minor Street (TA-18)**



### **Notes for Figure 6H-19—Typical Application 19 Detour for One Travel Direction**

*Guidance:*

1. *This plan should be used for streets without posted route numbers.*
2. *On multi-lane streets, Detour signs with an Advance Turn Arrow should be used in advance of a turn.*

*Option:*

3. The STREET CLOSED legend may be used in place of ROAD CLOSED.
4. Additional DO NOT ENTER signs may be used at intersections with intervening streets.
5. Warning lights may be used on Type 3 Barricades.
6. Detour signs may be located on the far side of intersections.
7. A Street Name sign may be mounted with the Detour sign. The Street Name sign may be either white on green or black on orange.

**Standard:**

8. **When used, the Street Name sign shall be placed above the Detour sign.**

*Guidance:*

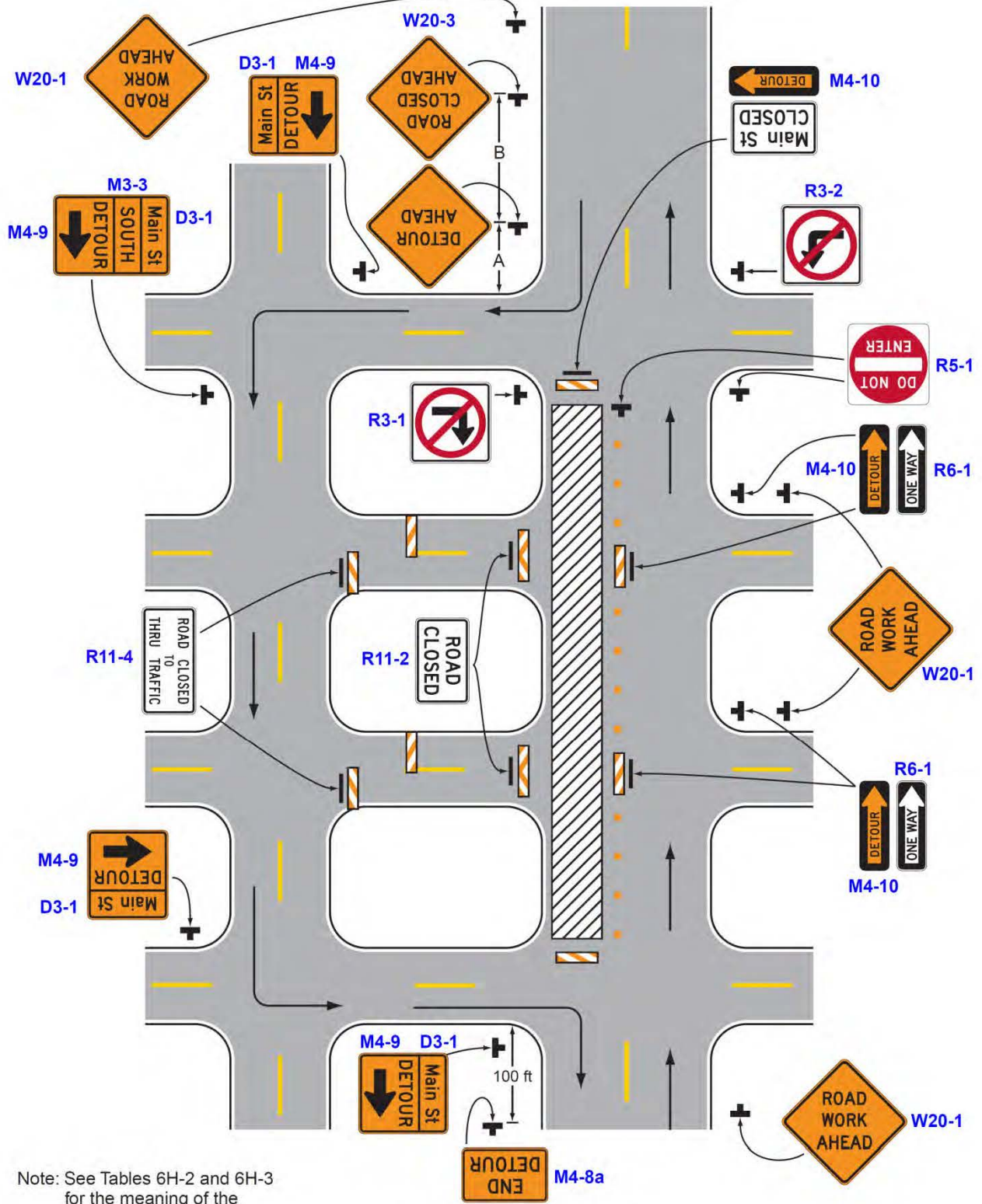
9. *The DETOUR (M4-8) sign should be placed on tangent sections at intervals not to exceed 1300 feet and at major intersections.*

*Option:*

10. *In urban areas, the M4-8 signs may be placed at every intersection.*



Figure 6H-19. Detour for One Travel Direction (TA-19)



Note: See Tables 6H-2 and 6H-3 for the meaning of the symbols and/or letter codes used in this figure.

Typical Application 19

### **Notes for Figure 6H-20—Typical Application 20 Detour for a Closed Street**

*Guidance:*

- 1. This plan should be used for streets without posted route numbers.*
- 2. On multi-lane streets, Detour signs with an Advance Turn Arrow should be used in advance of a turn.*

*Option:*

3. Flashing warning lights and/or flags may be used to call attention to the advance warning signs.
4. Flashing warning lights may be used on Type 3 Barricades.
5. Detour signs may be located on the far side of intersections. A Detour sign with an advance arrow may be used in advance of a turn.
6. A Street Name sign may be mounted with the Detour sign. The Street Name sign may be either white on green or black on orange.

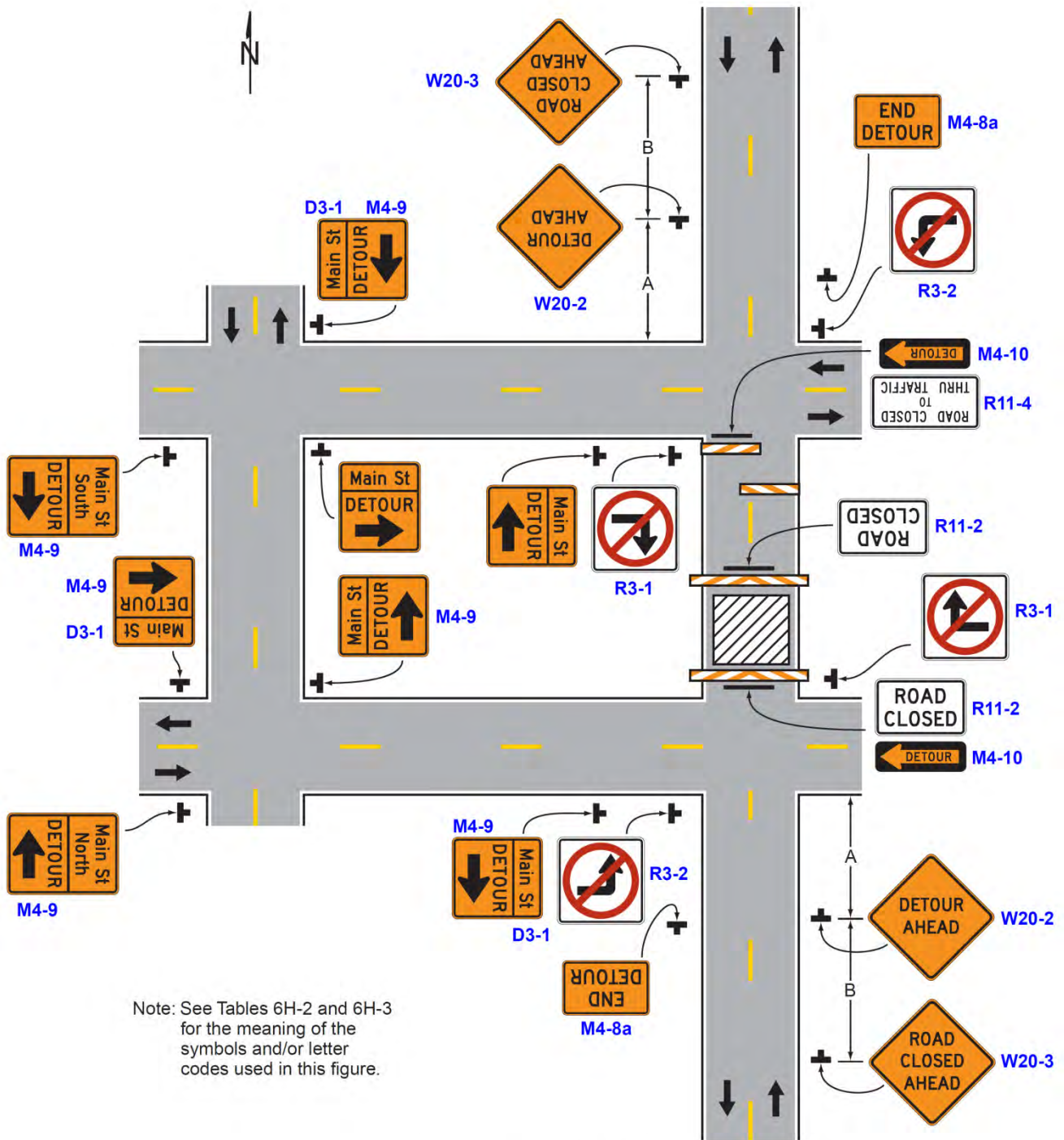
**Standard:**

- 7. When used, the Street Name sign shall be placed above the Detour sign.**

*Support:*

8. See Figure 6H-9 for the information for detouring a numbered highway.

Figure 6H-20. Detour for a Closed Street (TA-20)



Note: See Tables 6H-2 and 6H-3 for the meaning of the symbols and/or letter codes used in this figure.

Typical Application 20

### **Notes for Figure 6H-21—Typical Application 21 Lane Closure on the Near Side of an Intersection**

**Standard:**

- 1. The merging taper shall direct vehicular traffic into either the right-hand or left-hand lane, but not both.**

*Guidance:*

- 2. In this typical application, a left taper should be used so that right-turn movements will not impede through motor vehicle traffic. However, the reverse should be true for left-turn movements.*
- 3. If the work space extends across a crosswalk, the crosswalk should be closed using the information and devices shown in Figure 6H-29.*

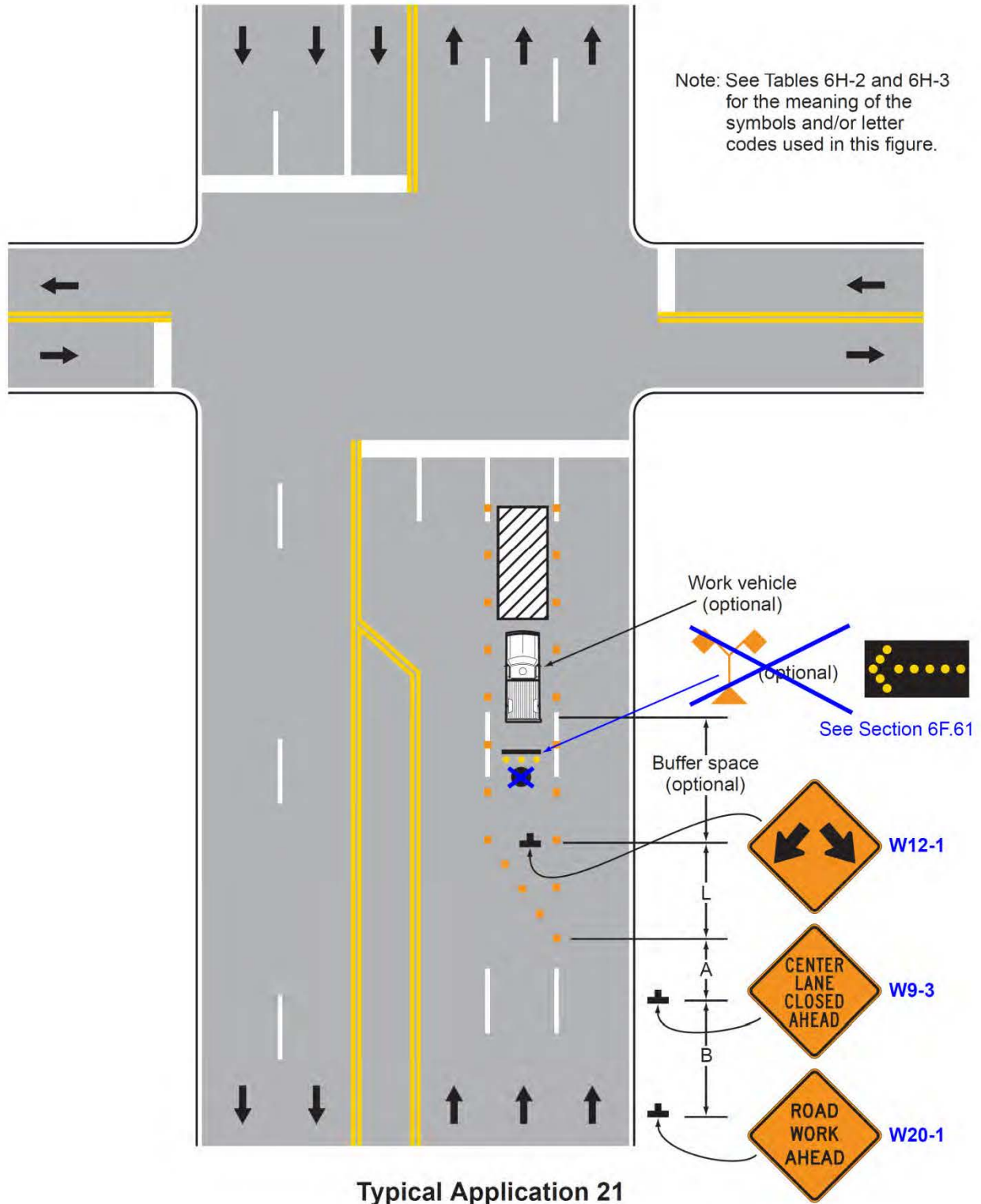
*Option:*

4. Flashing warning lights and/or flags may be used to call attention to the advance warning signs.
5. A shadow vehicle with a truck-mounted attenuator may be used.
6. A work vehicle with high-intensity rotating, flashing, oscillating, or strobe lights may be used with the ~~high-level warning device~~ **arrow board**.
7. Vehicle hazard warning signals may be used to supplement high-intensity rotating, flashing, oscillating, or strobe lights.

**Standard:**

- 8. Vehicle hazard warning signals shall not be used instead of the vehicle's high-intensity rotating, flashing, oscillating, or strobe lights.**

**Figure 6H-21. Lane Closure on the Near Side of an Intersection (TA-21)**



## Notes for Figure 6H-22, 6H-22A(CA) and 6H-22B(CA) —Typical Application 22 Right-Hand Lane Closure on the Far Side of an Intersection

### Guidance:

1. *If the work space extends across a crosswalk, the crosswalk should be closed using the information and devices shown in Figure 6H-29.*

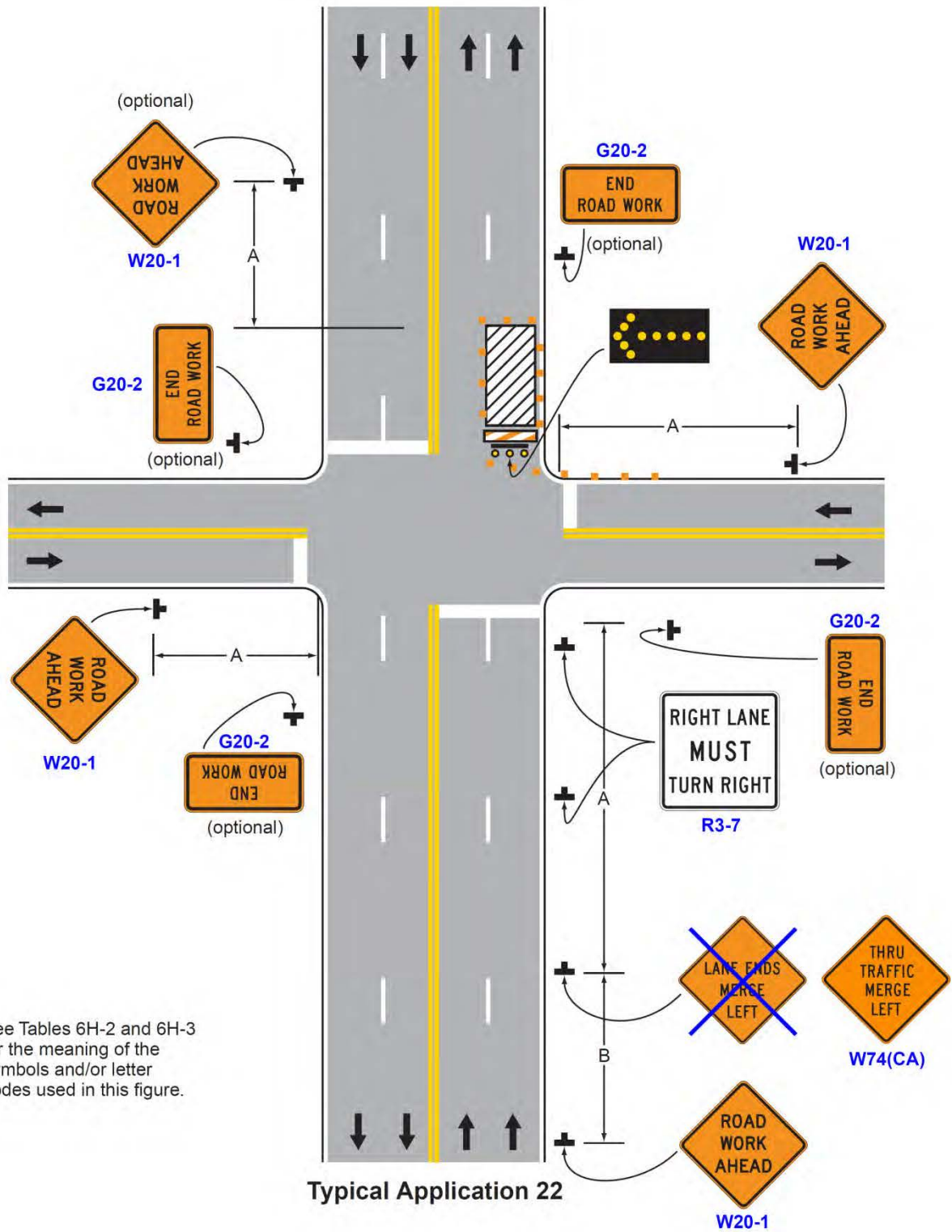
### Option:

2. The normal procedure is to close on the near side of the intersection any lane that is not carried through the intersection. However, when this results in the closure of a right-hand lane having significant right turning movements, then the right-hand lane may be restricted to right turns only, as shown. This procedure increases the through capacity by eliminating right turns from the open through lane.
3. For intersection approaches reduced to a single lane, left-turning movements may be prohibited to maintain capacity for through vehicular traffic.
4. Flashing warning lights and/or flags may be used to call attention to the advance warning signs.
5. Where the turning radius is large, it may be possible to create a right-turn island using channelizing devices or pavement markings.
6. See Figure 3B-14(CA) Page 3 of 3 for lane reduction markings. See Section 2C.40 for merge signs.

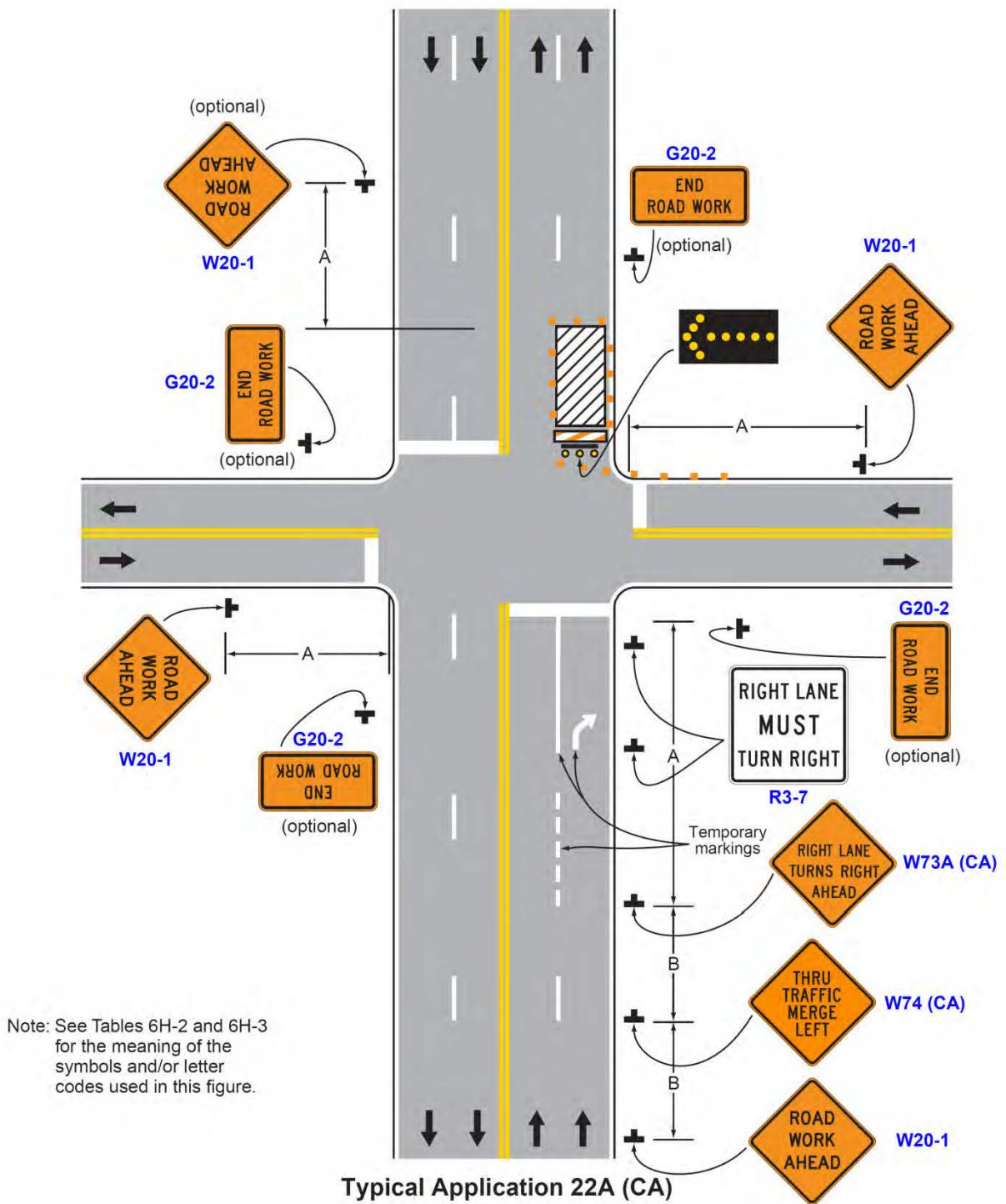
### Support:

7. Figure 6H-22 is appropriate for short-term and intermediate-term duration where it is not appropriate to install temporary markings.
8. Figure 6H-22A(CA) is appropriate for long-term duration.
9. Figure 6H-22B(CA) is appropriate to avoid through movements from the right lane by first closing the right lane and then reopening it as a turn bay.

**Figure 6H-22. Right-Hand Lane Closure on the Far Side of an Intersection (TA-22)**

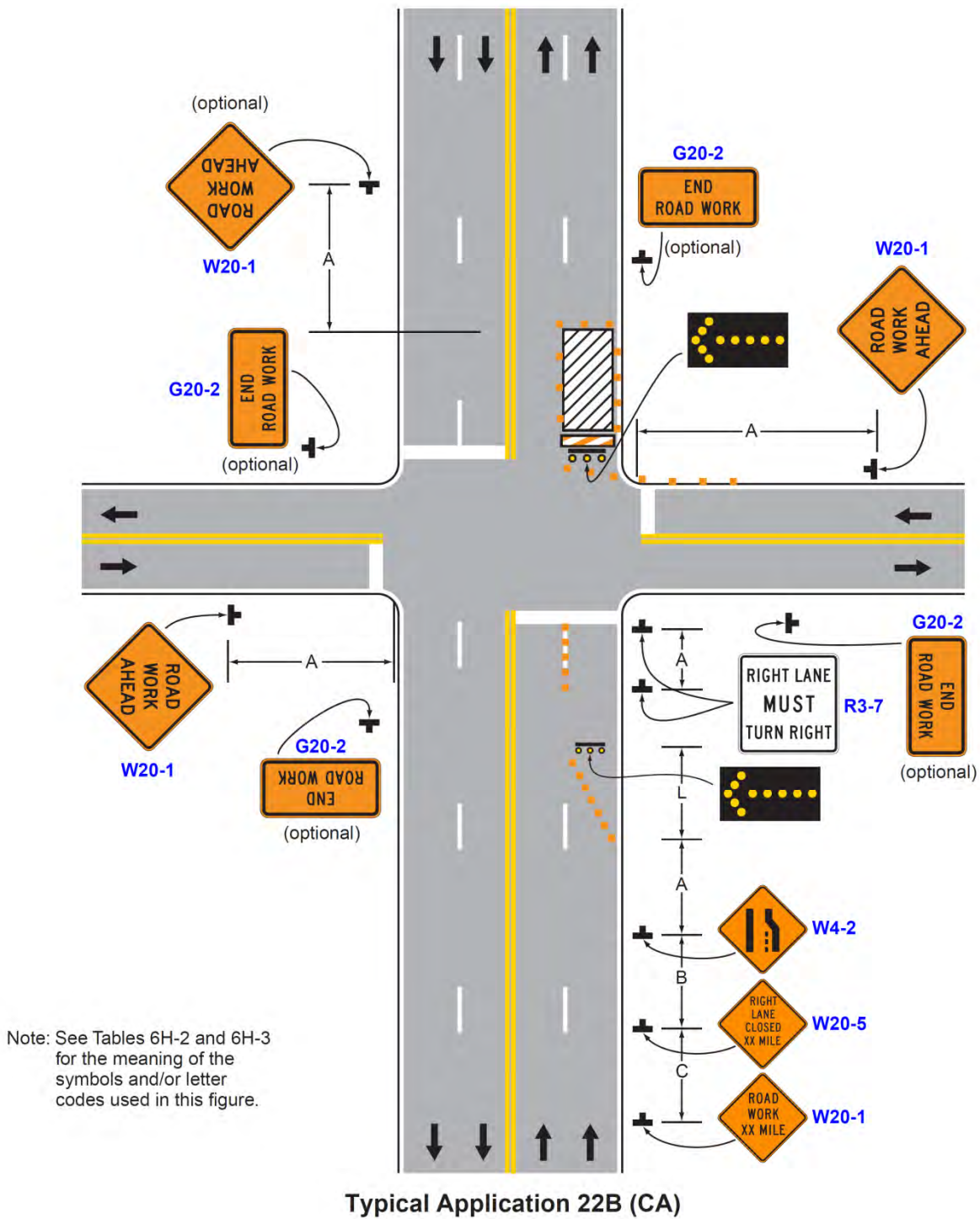


**Figure 6H-22A(CA). Right-Hand Lane Closure on the Far Side of an Intersection (TA-22A (CA))**





**Figure 6H-22B(CA). Right-Hand Lane Closure on the Far Side of an Intersection (TA-22B (CA))**



### **Notes for Figure 6H-23—Typical Application 23 Left-Hand Lane Closure on the Far Side of an Intersection**

*Guidance:*

1. *If the work space extends across a crosswalk, the crosswalk should be closed using the information and devices shown in Figure 6H-29.*

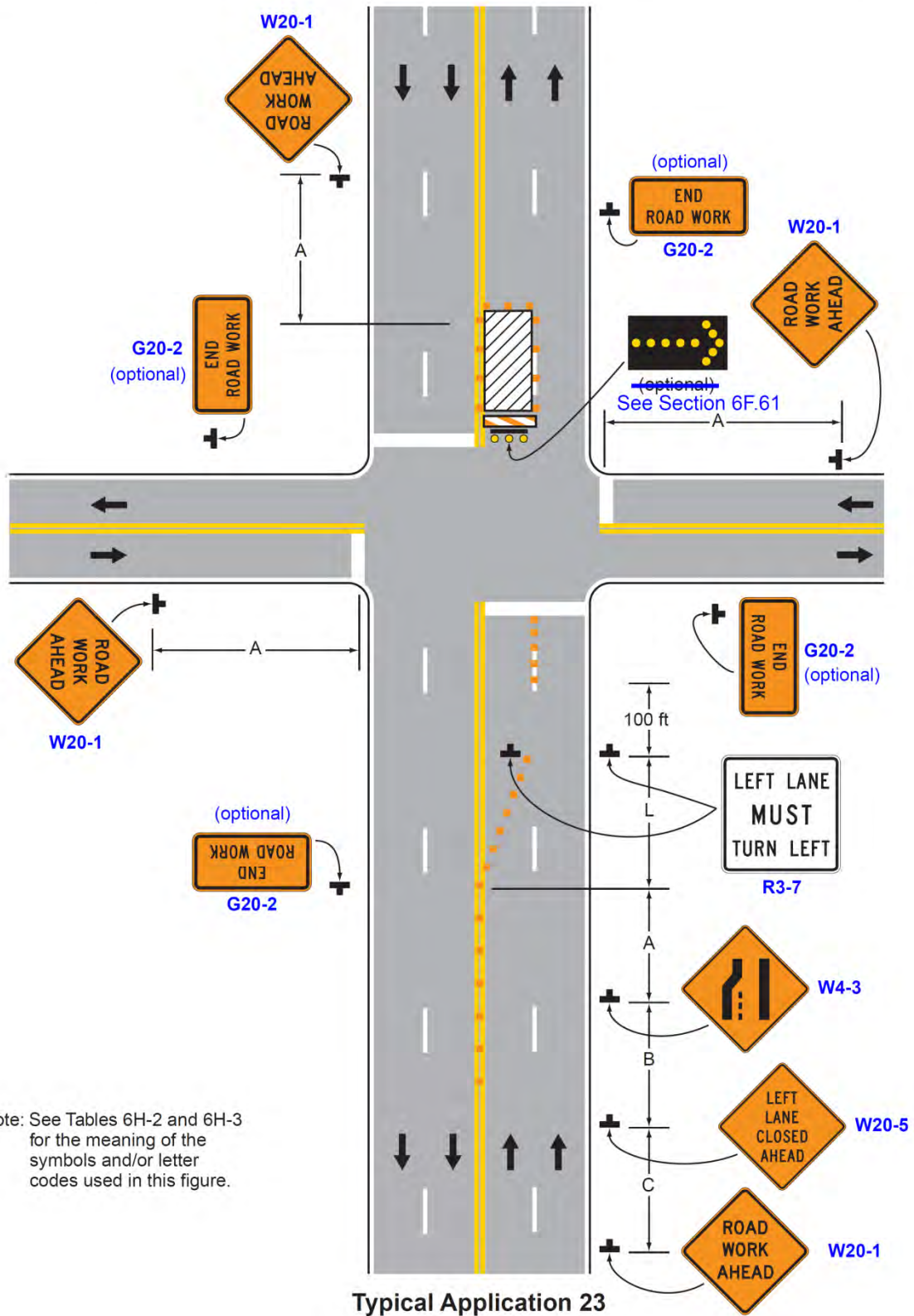
*Option:*

2. Flashing warning lights and/or flags may be used to call attention to the advance warning signs.
3. The normal procedure is to close on the near side of the intersection any lane that is not carried through the intersection. However, when this results in the closure of a left lane having significant left-turning movements, then the left lane may be reopened as a turn bay for left turns only, as shown.

*Support:*

4. By first closing off the left lane and then reopening it as a turn bay, the left-turn bay allows storage of turning vehicles so that the movement of through traffic is not impeded. A left-turn bay that is long enough to accommodate all turning vehicles during a traffic signal cycle will provide the maximum benefit for through traffic. Also, an island is created with channelizing devices that allows the LEFT LANE MUST TURN LEFT sign to be repeated on the left adjacent to the lane that it controls.

**Figure 6H-23. Left-Hand Lane Closure on the Far Side of an Intersection (TA-23)**



### **Notes for Figure 6H-24 and 6H-24A(CA) —Typical Application 24 Half Road Closure on the Far Side of an Intersection**

*Guidance:*

- 1. If the work space extends across a crosswalk, the crosswalk should be closed using the information and devices shown in Figure 6H-29.*
- 2. When turn prohibitions are implemented, two turn prohibition signs should be used, one on the near side and, space permitting, one on the far side of the intersection.*

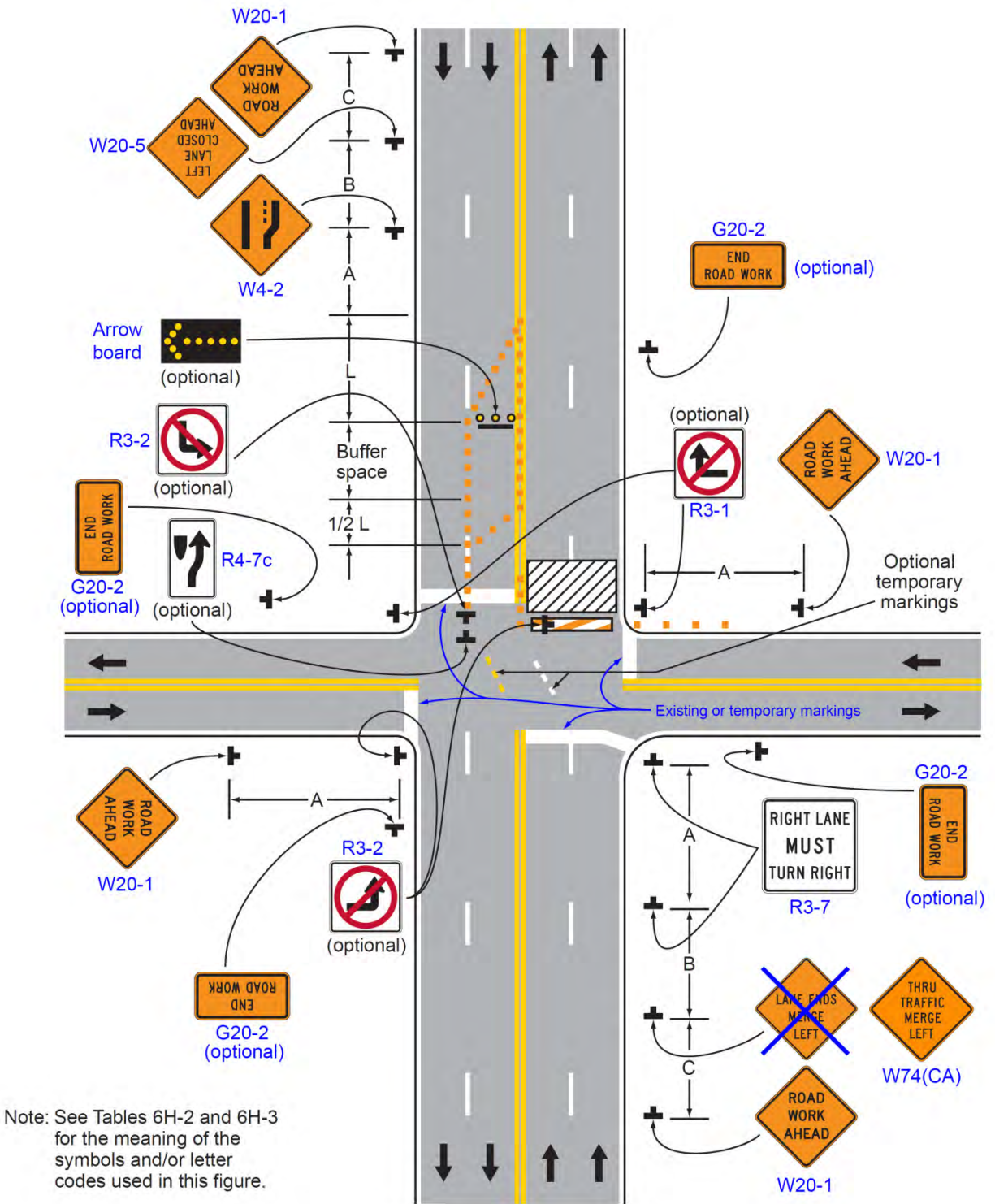
*Option:*

3. A buffer space may be used between opposing directions of vehicular traffic as shown in this application.
4. The normal procedure is to close on the near side of the intersection any lane that is not carried through the intersection. However, if there is a significant right-turning movement, then the right-hand lane may be restricted to right turns only, as shown.
5. Where the turning radius is large, a right-turn island using channelizing devices or pavement markings may be used.
6. There may be insufficient space to place the back-to-back Keep Right sign and No Left Turn symbol signs at the end of the row of channelizing devices separating opposing vehicular traffic flows. In this situation, the No Left Turn symbol sign may be placed on the right and the Keep Right sign may be omitted.
7. For intersection approaches reduced to a single lane, left-turning movements may be prohibited to maintain capacity for through vehicular traffic.
8. Flashing warning lights and/or flags may be used to call attention to advance warning signs.
9. Temporary pavement markings may be used to delineate the travel path through the intersection.

*Support:*

10. Keeping the right-hand lane open increases the through capacity by eliminating right turns from the open through lane.
11. A temporary turn island reinforces the nature of the temporary exclusive right-turn lane and enables a second RIGHT LANE MUST TURN RIGHT sign to be placed in the island.
12. Figure 6H-24 is appropriate for situations where the approach is stop-controlled (Stop sign and/or red flashing beacons) due to the abrupt transition through the intersection.
13. Figure 6H-24A(CA) is appropriate for situations where the approach is uncontrolled or controlled by traffic signals.

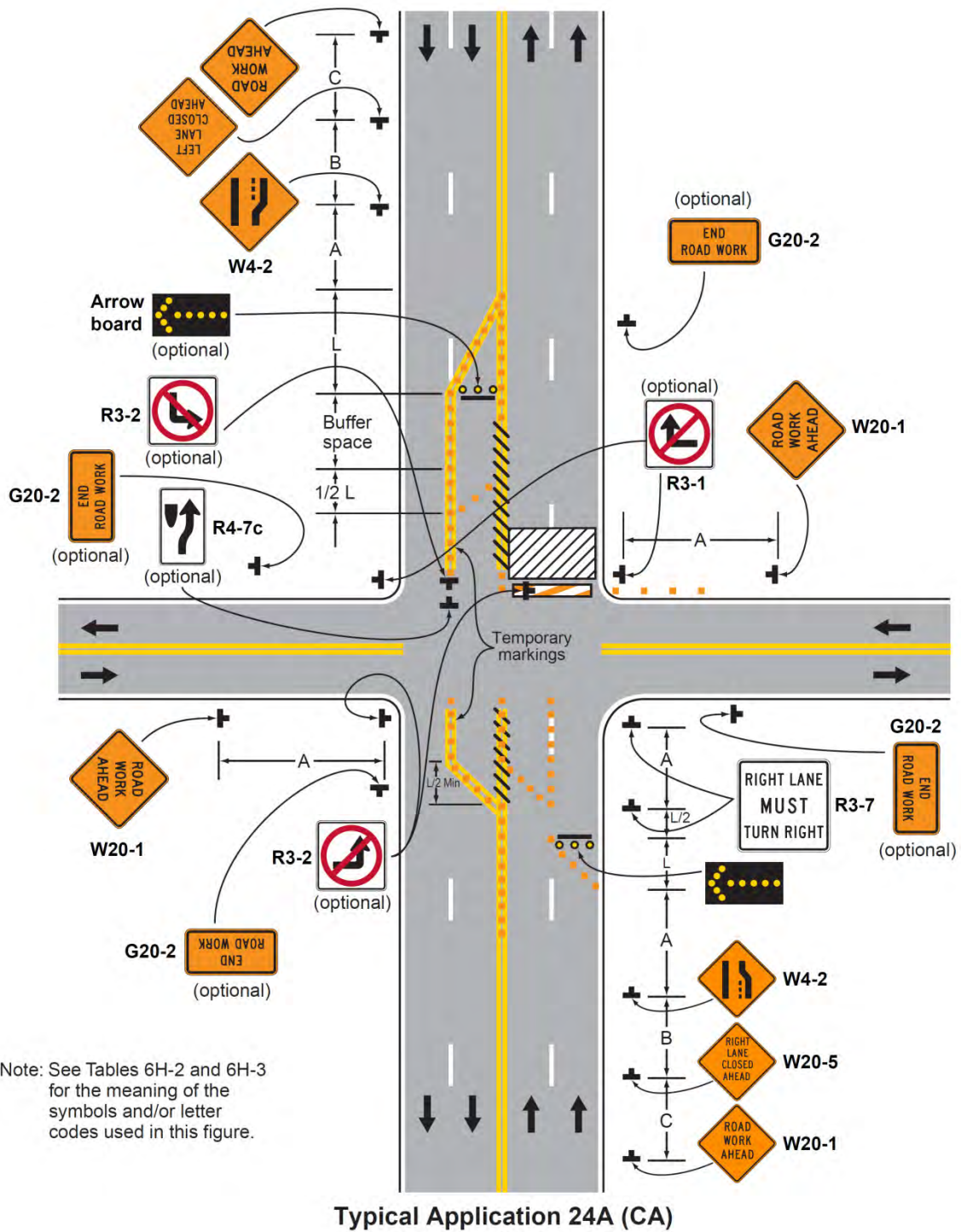
**Figure 6H-24. Half Road Closure on the Far Side of an Intersection (TA-24)**



Note: See Tables 6H-2 and 6H-3 for the meaning of the symbols and/or letter codes used in this figure.

**Typical Application 24**

**Figure 6H-24A (CA). Half Road Closure on the Far Side of an Intersection (TA-24A(CA))**



### **Notes for Figure 6H-25 and 6H-25A(CA) —Typical Application 25 Multiple Lane Closures at an Intersection**

*Guidance:*

- 1. If the work space extends across a crosswalk, the crosswalk should be closed using the information and devices shown in Figure 6H-29.*
- 2. If the left through lane is closed on the near-side approach, the LEFT LANE MUST TURN LEFT sign should be placed in the median to discourage through vehicular traffic from entering the left-turn bay.*

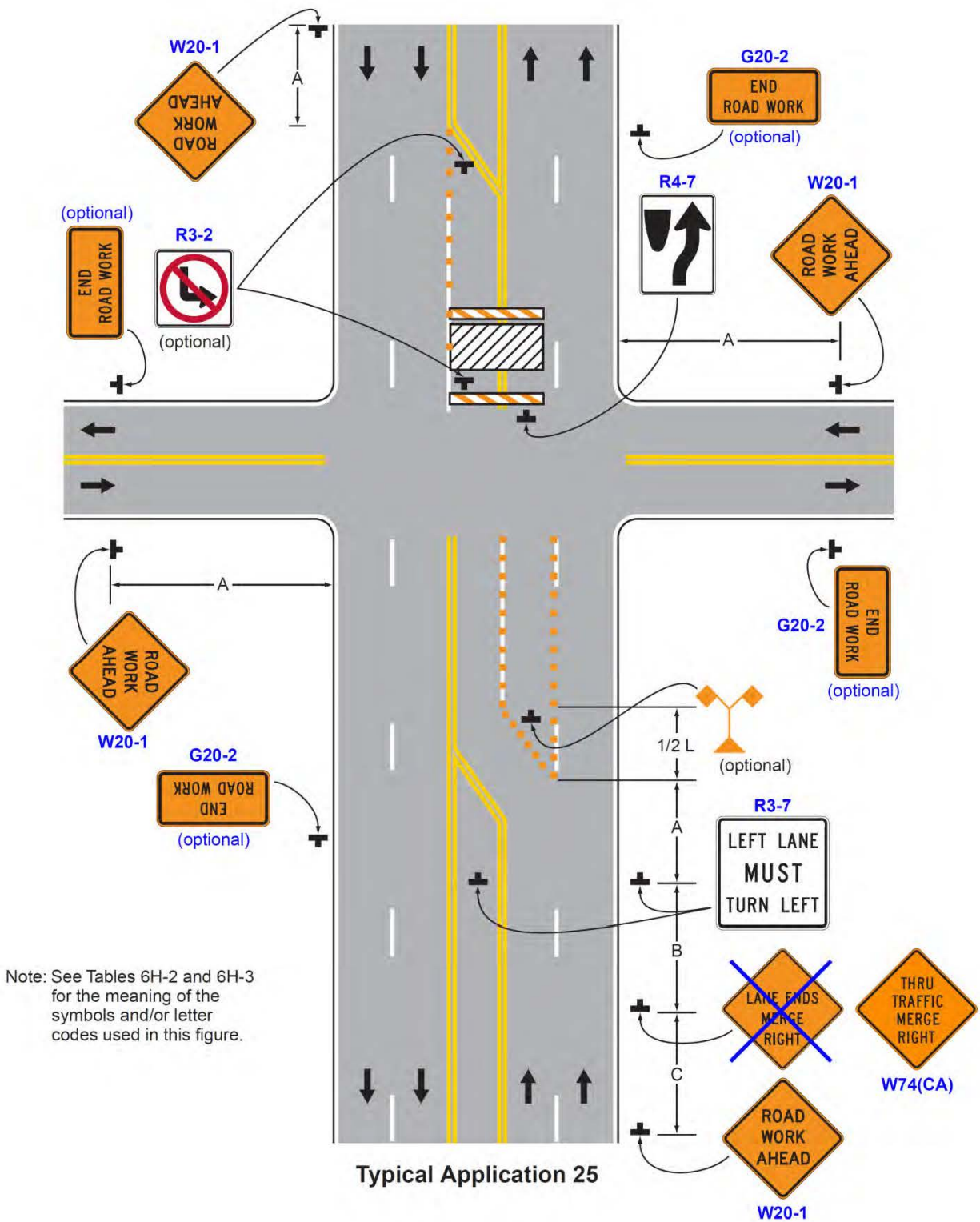
*Support:*

- 3. The normal procedure is to close on the near side of the intersection any lane that is not carried through the intersection (see Figure 6H-25A(CA)).*

*Option:*

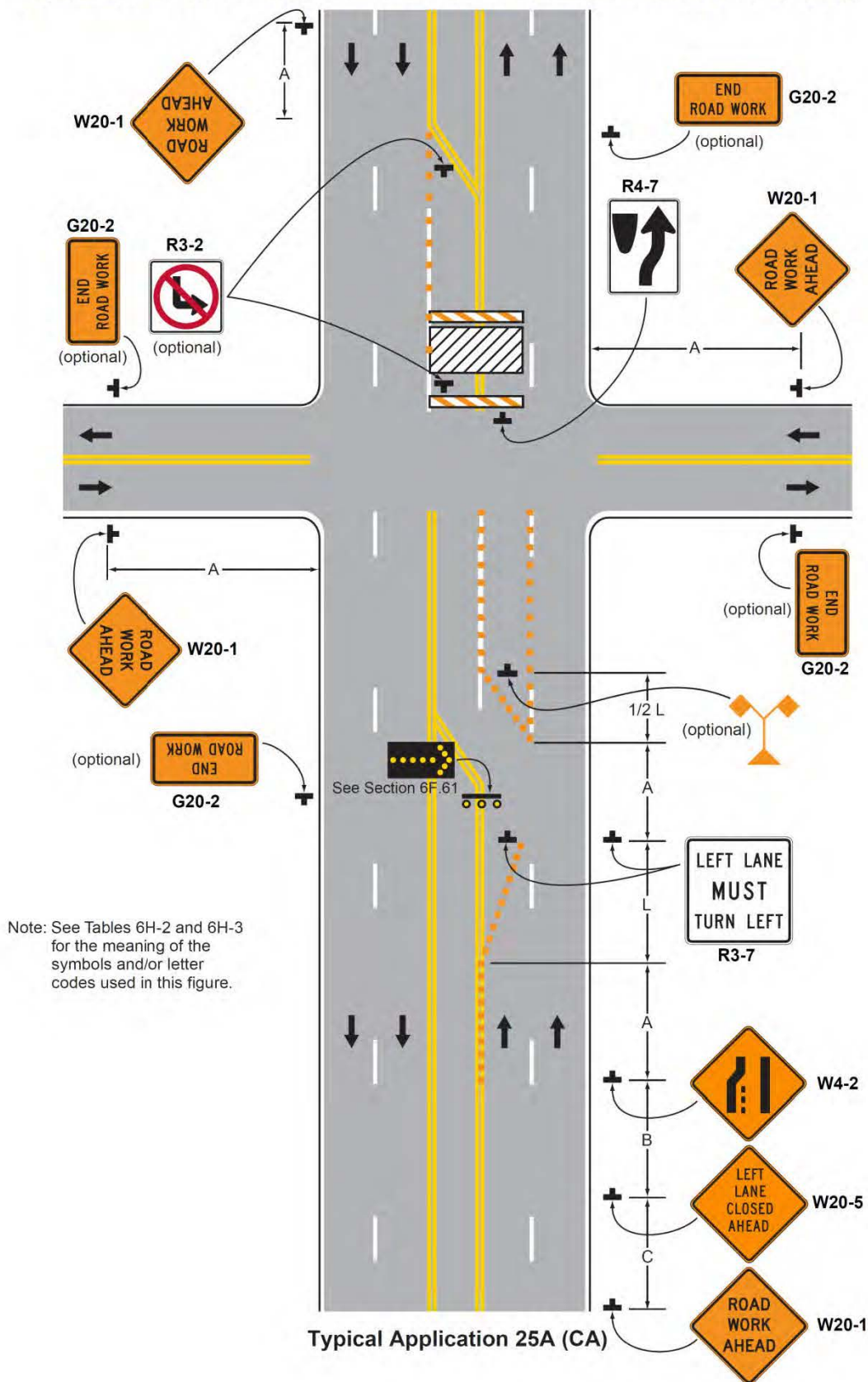
- 4. If the left-turning movement that normally uses the closed turn bay is small and/or the gaps in opposing vehicular traffic are frequent, left turns may be permitted on that approach.*
- 5. Flashing warning lights and/or flags may be used to call attention to the advance warning signs.*

**Figure 6H-25. Multiple Lane Closures at an Intersection (TA-25)**





**Figure 6H-25A (CA). Multiple Lane Closures at an Intersection (TA-25A(CA))**



### **Notes for Figure 6H-26—Typical Application 26 Closure in the Center of an Intersection**

*Guidance:*

1. All lanes should be a minimum of 10 feet in width as measured to the near face of the channelizing devices.

*Option:*

2. A high-level warning device may be placed in the work space, if there is sufficient room.
3. For short-term use on low-volume, low-speed roadways with vehicular traffic that does not include longer and wider heavy commercial vehicles, a minimum lane width of 9 feet may be used.
4. Flashing warning lights and/or flags may be used to call attention to advance warning signs.
5. Unless the streets are wide, it may be physically impossible to turn left, especially for large vehicles. Left turns may be prohibited as required by geometric conditions. If used, No Left Turn (R3-2) signs may be placed on left side of approaching traffic. If space is limited, the R3-2 signs may be placed on right side of approaching traffic.
6. For short-duration work operations, the channelizing devices may be eliminated if a vehicle displaying high-intensity rotating, flashing, oscillating, or strobe lights is positioned in the work space.
7. Vehicle hazard warning signals may be used to supplement high-intensity rotating, flashing, oscillating, or strobe lights.

**Standard:**

- 8. Vehicle hazard warning signals shall not be used instead of the vehicle's high-intensity rotating, flashing, oscillating, or strobe lights.**



### Notes for Figure 6H-27—Typical Application 27 Closure at the Side of an Intersection

*Guidance:*

1. *The situation depicted can be simplified by closing one or more of the intersection approaches. If this cannot be done, and/or when capacity is a problem, through vehicular traffic should be directed to other roads or streets.*
2. *Depending on road user conditions, flagger(s) or uniformed law enforcement officer(s) should be used to direct road users within the intersection.*

**Standard:**

3. **At night, flagger stations shall be illuminated, except in emergencies.**

*Option:*

4. Flashing warning lights and/or flags may be used to call attention to the advance warning signs.
5. For short-duration work operations, the channelizing devices may be eliminated if a vehicle displaying high-intensity rotating, flashing, oscillating, or strobe lights is positioned in the work space.
6. A BE PREPARED TO STOP sign may be added to the sign series.

*Guidance:*

7. *When used, the BE PREPARED TO STOP sign should be located ~~before~~ after the Flagger symbol sign.*
8. *ONE LANE ROAD AHEAD signs should also be used to provide adequate advance warning.*

*Support:*

9. Turns can be prohibited as required by vehicular traffic conditions. Unless the streets are wide, it might be physically impossible to make certain turns, especially for large vehicles.

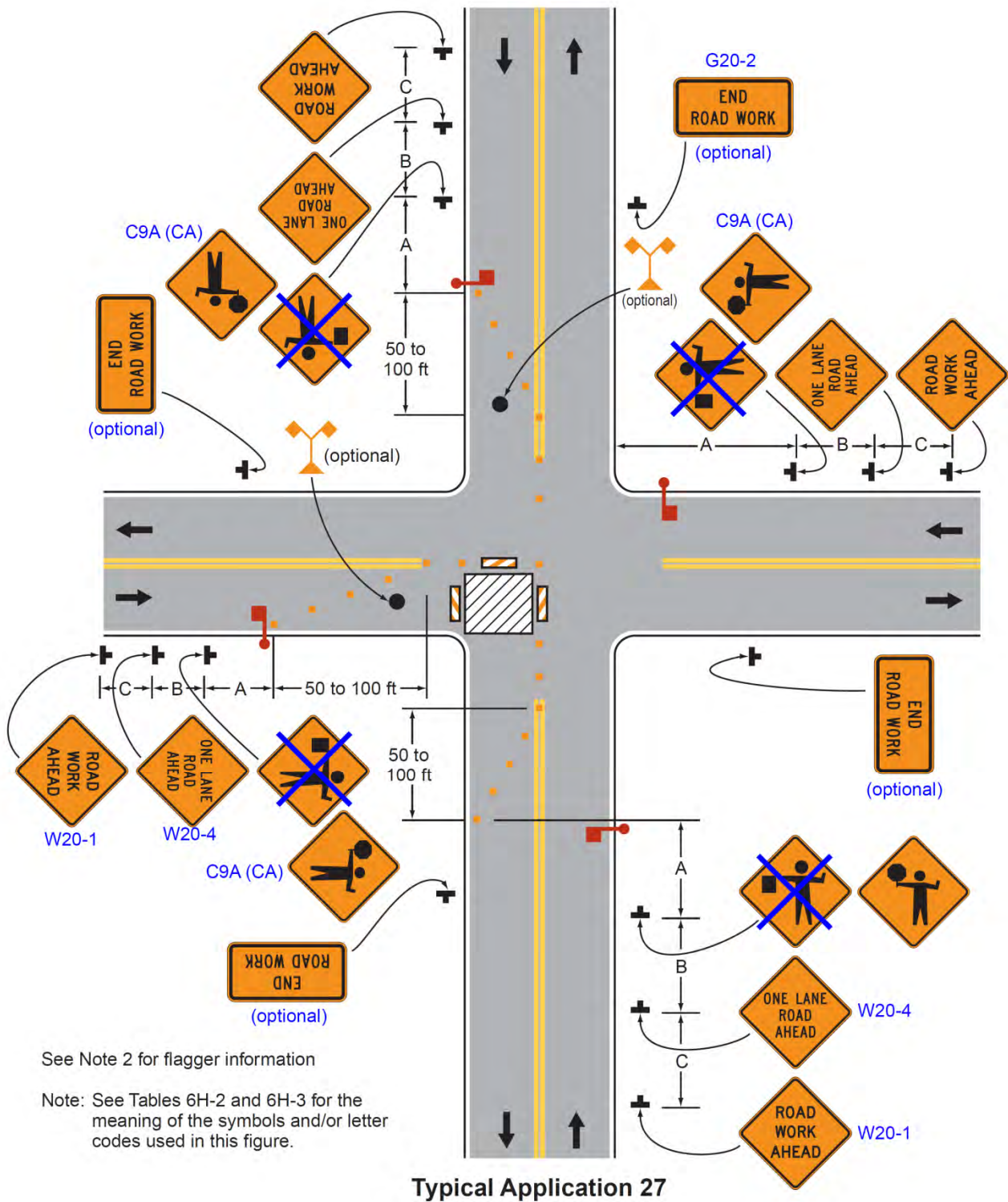
*Option:*

10. Vehicle hazard warning signals may be used to supplement high-intensity rotating, flashing, oscillating, or strobe lights.

**Standard:**

11. **Vehicle hazard warning signals shall not be used instead of the vehicle's high-intensity rotating, flashing, oscillating, or strobe lights.**

**Figure 6H-27. Closure at the Side of an Intersection (TA-27)**



### **Notes for Figure 6H-28—Typical Application 28 Sidewalk Detour or Diversion**

**Standard:**

- 1. When crosswalks or other pedestrian facilities are closed or relocated, temporary facilities shall be detectable and shall include accessibility features consistent with the features present in the existing pedestrian facility.**

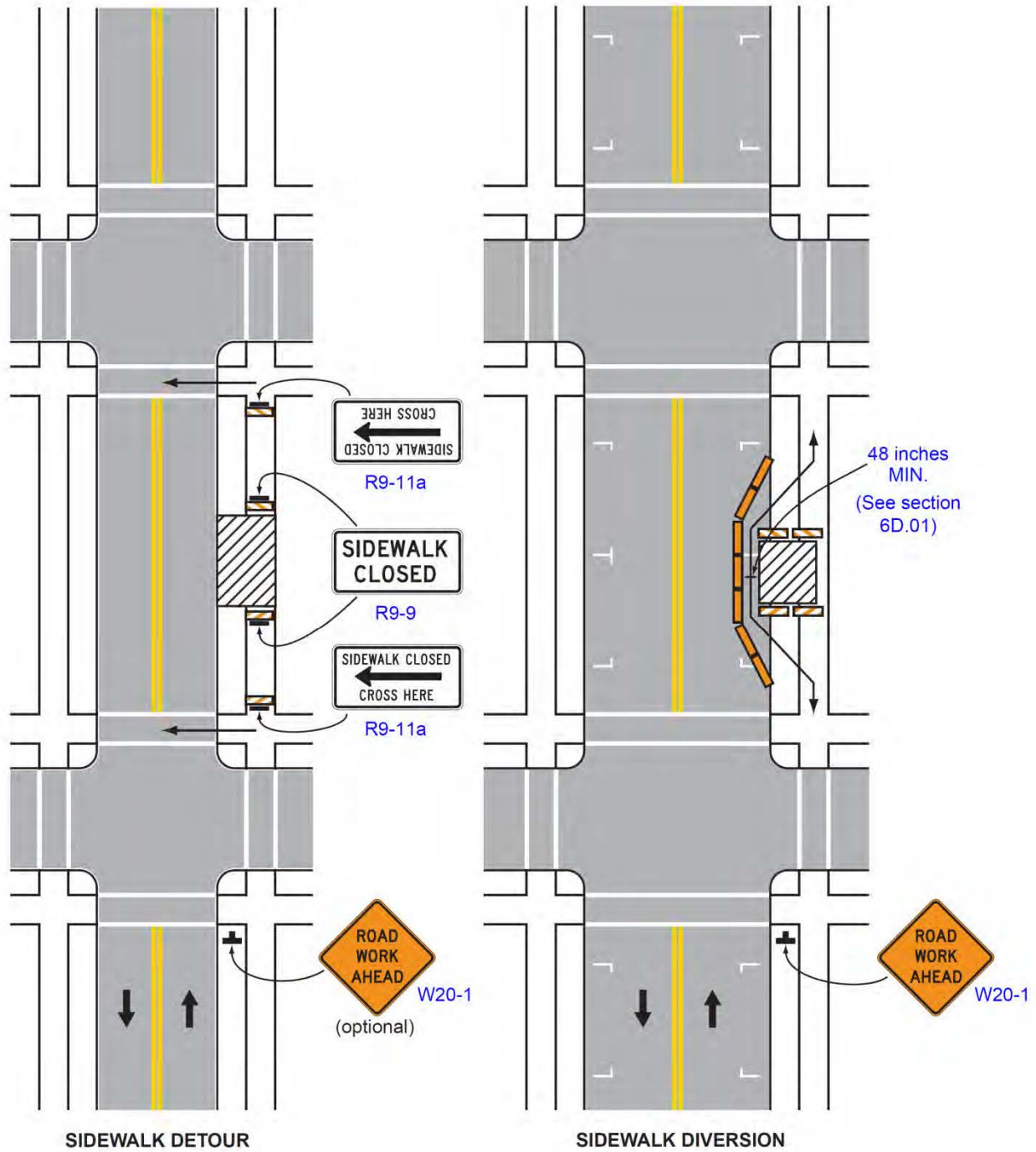
*Guidance:*

- 2. Where high speeds are anticipated, a temporary traffic barrier and, if necessary, a crash cushion should be used to separate the temporary sidewalks from vehicular traffic.*
- 3. Audible information devices should be considered where midblock closings and changed crosswalk areas cause inadequate communication to be provided to pedestrians who have visual disabilities.*

*Option:*

4. Street lighting may be considered.
5. Only the TTC devices related to pedestrians are shown. Other devices, such as lane closure signing or ROAD NARROWS signs, may be used to control vehicular traffic.
6. For nighttime closures, Type A Flashing warning lights may be used on barricades that support signs and close sidewalks.
7. Type C Steady-Burn or Type D 360-degree Steady-Burn warning lights may be used on channelizing devices separating the temporary sidewalks from vehicular traffic flow.
8. Signs, such as KEEP RIGHT (LEFT), may be placed along a temporary sidewalk to guide or direct pedestrians.

**Figure 6H-28. Sidewalk Detour or Diversion (TA-28)**



**Typical Application 28**

Note: See Tables 6H-2 and 6H-3 for the meaning of the symbols and/or letter codes used in this figure.

## Notes for Figure 6H-29—Typical Application 29 Crosswalk Closures and Pedestrian Detours

### Standard:

1. When crosswalks or other pedestrian facilities are closed or relocated, temporary facilities shall be detectable and shall include accessibility features consistent with the features present in the existing pedestrian facility.
2. ~~Curb parking shall be prohibited for at least 50 feet in advance of the midblock crosswalk.~~

### Guidance:

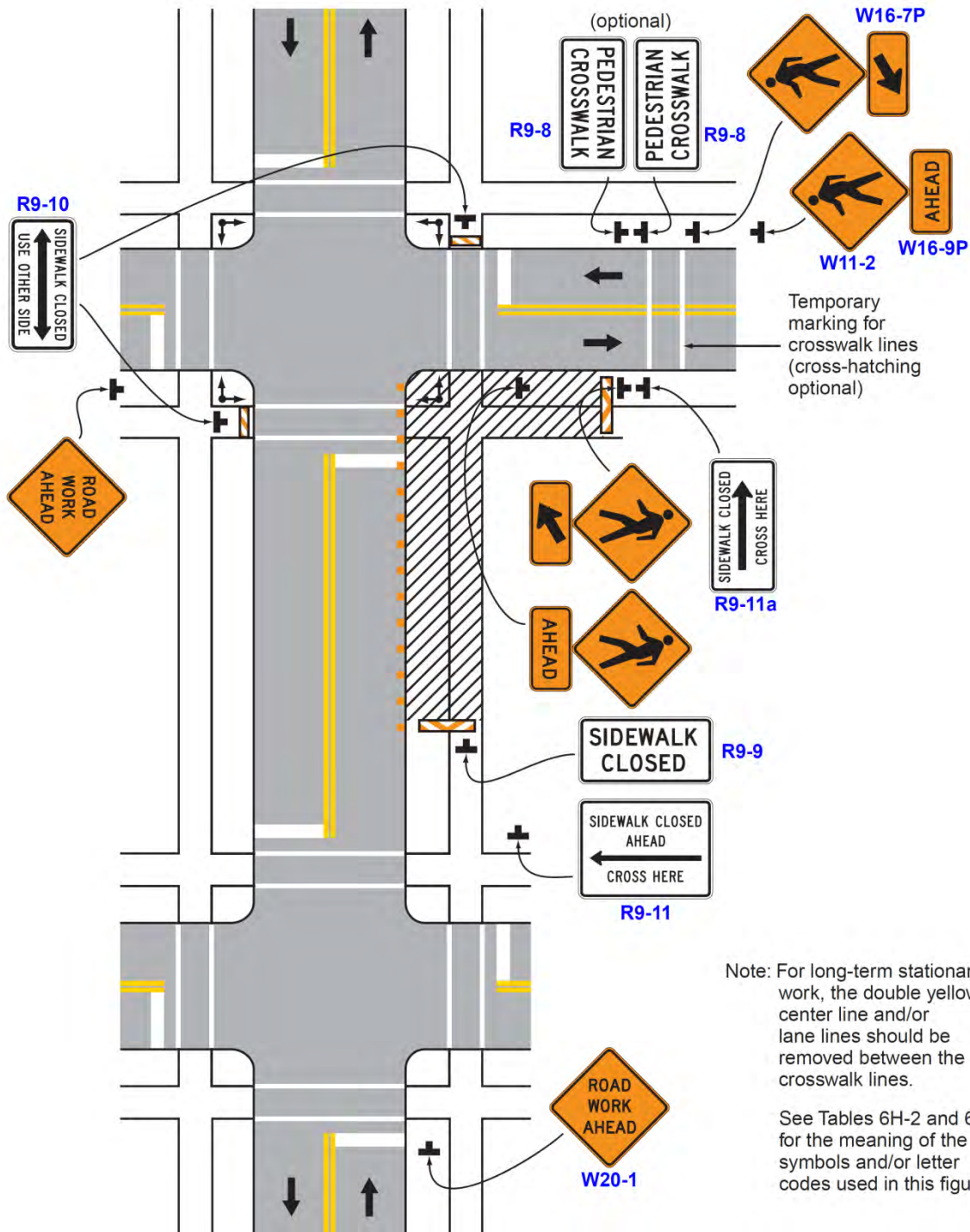
2. *Parking should be prohibited in advance of mid-block crosswalks. Mid-block crosswalks should be avoided, when possible. See Section 3B.18.*
3. *Audible information devices should be considered where midblock closings and changed crosswalk areas cause inadequate communication to be provided to pedestrians who have visual disabilities.*
4. *Pedestrian traffic signal displays controlling closed crosswalks should be covered or deactivated.*

### Option:

5. Street lighting may be considered.
6. Only the TTC devices related to pedestrians are shown. Other devices, such as lane closure signing or ROAD NARROWS signs, may be used to control vehicular traffic.
7. For nighttime closures, Type A Flashing warning lights may be used on barricades supporting signs and closing sidewalks.
8. Type C Steady-Burn or Type D 360-degree Steady-Burn warning lights may be used on channelizing devices separating the work space from vehicular traffic.
9. In order to maintain the systematic use of the fluorescent yellow-green background for pedestrian, bicycle, and school warning signs in a jurisdiction, the fluorescent yellow-green background for pedestrian, bicycle, and school warning signs may be used in TTC zones.



**Figure 6H-29. Crosswalk Closures and Pedestrian Detours (TA-29)**



Note: For long-term stationary work, the double yellow center line and/or lane lines should be removed between the crosswalk lines.

See Tables 6H-2 and 6H-3 for the meaning of the symbols and/or letter codes used in this figure.

**Typical Application 29**

### **Notes for Figure 6H-30—Typical Application 30 Interior Lane Closure on a Multi-Lane Street**

*Guidance:*

- 1. This information applies to low-speed, low-volume urban streets. Where speed or volume is higher, additional signing such as LEFT LANE CLOSED XX FT should be used between the signs shown.*

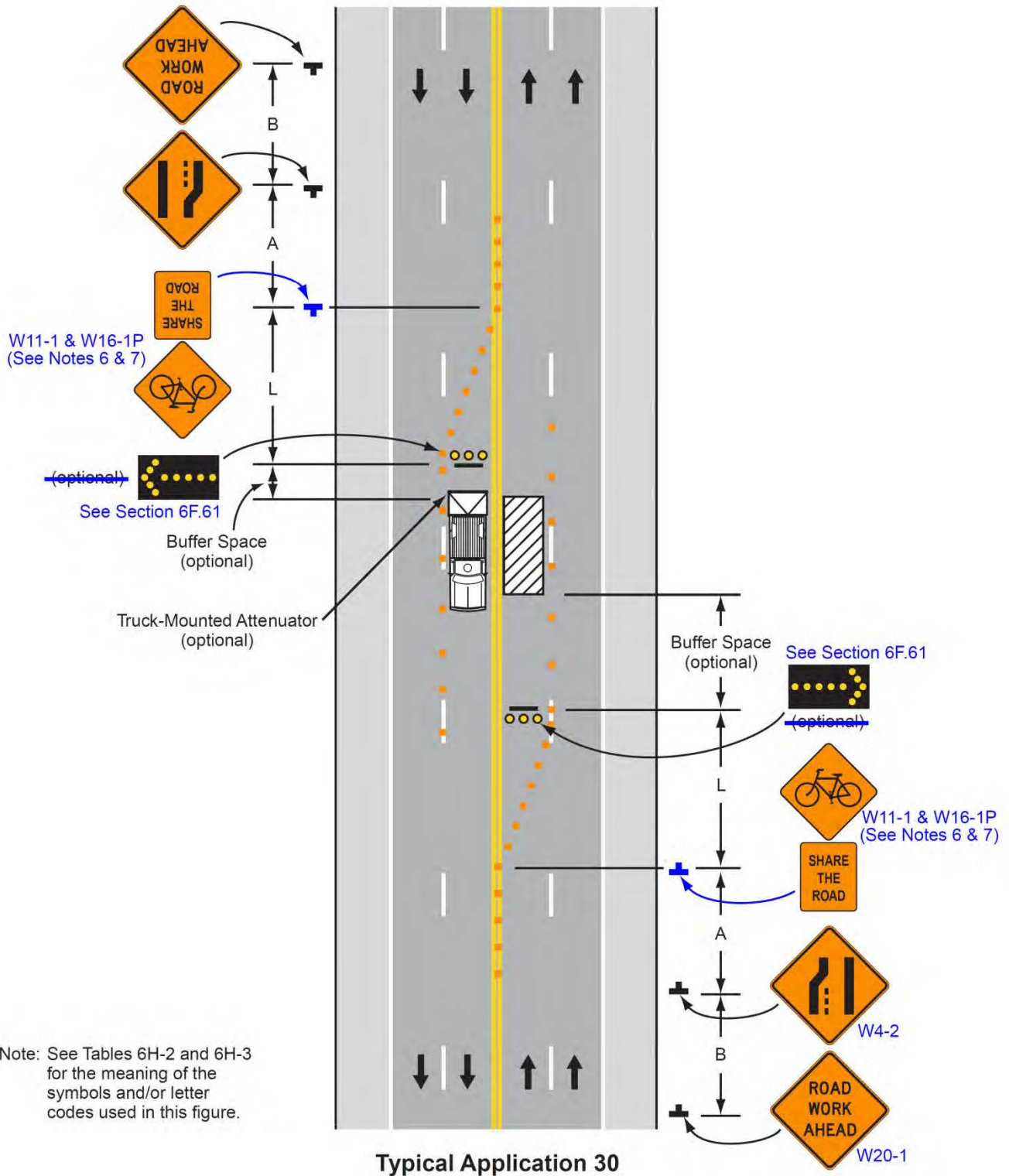
*Option:*

- 2. The closure of the adjacent interior lane in the opposing direction may not be necessary, depending upon the activity being performed and the work space needed for the operation.*
- 3. Shadow vehicles with a truck-mounted attenuator may be used.*
- 4. The RIGHT (LEFT) LANE(S) CLOSED (W20-5 or C20(CA)) sign may be used instead of the Lane Reduction (W4-2) sign.*

*Guidance:*

- 5. All advance warning signs should be placed so that the path of travel for bicycles is not blocked, while maintaining visibility for road users.*
- 6. When existing accommodations for bicycle travel are disrupted or closed in a long-term duration project (see Section 6G.02) and the roadway width is inadequate for allowing bicyclists and motor vehicles to travel side by side, the Bicycle Crossing (W11-1) sign and the SHARE THE ROAD (W16-1P) plaque should be used to advise motorists of the presence of bicyclists in the travel way lanes.*
- 7. If bicyclists are able to use the shoulder throughout the TTC zone, the Bicycle Crossing (W11-1) sign and the SHARE THE ROAD (W16-1P) plaque should be omitted.*

**Figure 6H-30. Interior Lane Closure on Multi-lane Street (TA-30)**



### Notes for Figure 6H-31 — Typical Application 31 Lane Closure on a Street with Uneven Directional Volumes

**Standard:**

1. The illustrated information shall be used only when the vehicular traffic volume indicates that two lanes of vehicular traffic shall be maintained in the direction of travel for which one lane is closed.

**Option:**

2. The procedure may be used during a peak period of vehicular traffic and then changed to provide two lanes in the other direction for the other peak.

**Guidance:**

3. For high speeds, a *LEFT LANE CLOSED XX FT* sign should be added for vehicular traffic approaching the lane closure, as shown in Figure ~~6H-32~~ 6H-32(CA).
4. Conflicting pavement markings should be removed for long-term projects. For short-term and intermediate-term projects where this is not practical, the channelizing devices in the area where the pavement markings conflict should be placed at a maximum spacing of  $1/2 S$  feet where  $S$  is the speed in mph. Temporary markings should be installed where needed. The spacing of channelizing devices should not exceed the maximum distances shown in Table 6F-101(CA). Refer to Section 6F.63 for spacing of channelizing devices.
5. If the lane shift has curves with recommended speeds of 30 mph or less, Reverse Turn signs should be used.
6. Where the shifted section is long, a Reverse Curve sign should be used to show the initial shift and a second sign should be used to show the return to the normal alignment.
7. If the tangent distance along the temporary diversion is less than 600 feet, the Double Reverse Curve sign should be used at the location of the first Two Lane Reverse Curve sign. The second Two Lane Reverse Curve sign should be omitted. Use the Reverse Curve (W1-4) signs for both locations instead of the Double Reverse Curve or Two Lane Reverse Curve signs.

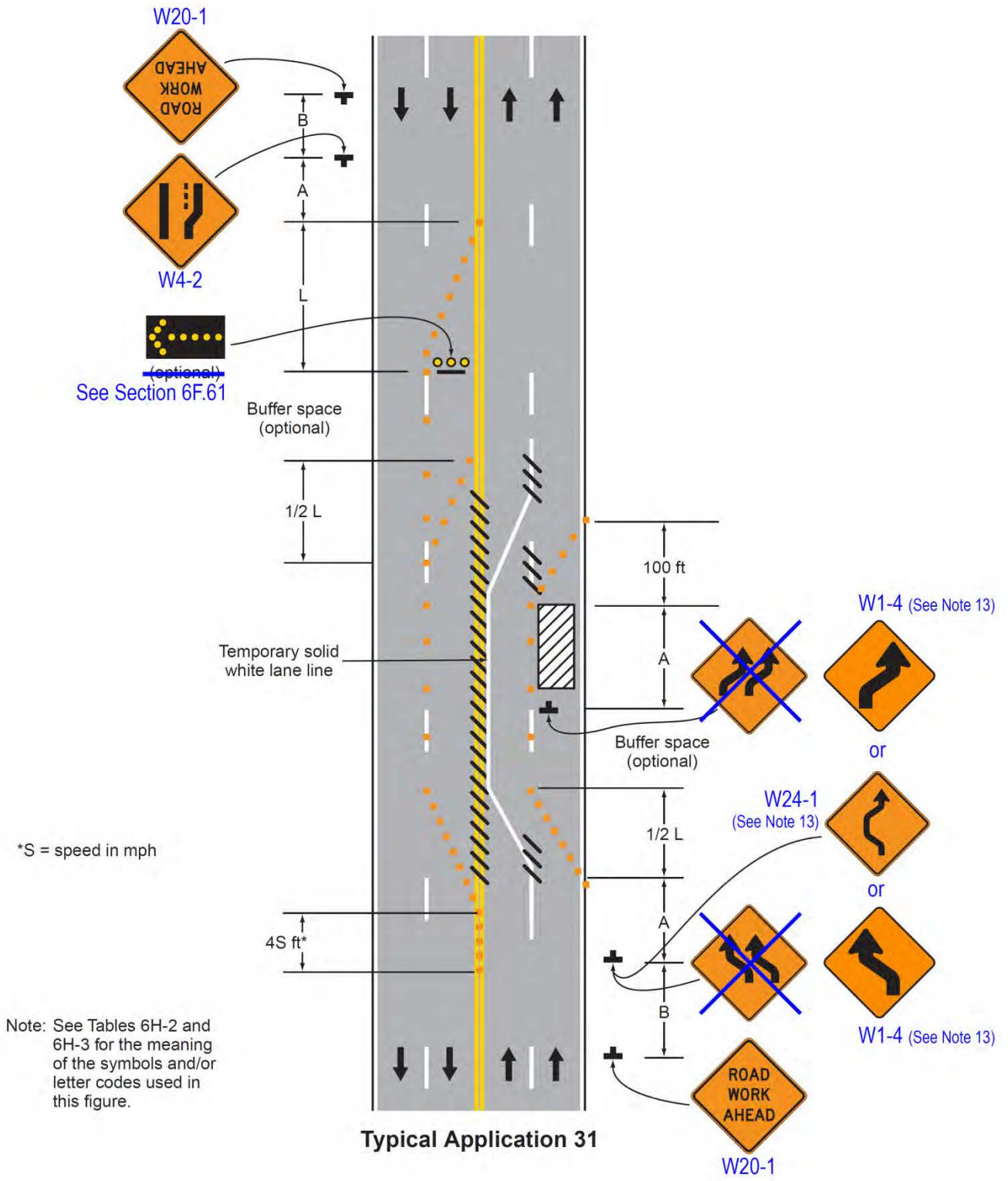
**Standard:**

8. ~~The number of lanes illustrated on the Reverse Curve or Double Reverse Curve signs shall be the same as the number of through lanes available to road users, and the direction of the reverse curves shall be appropriately illustrated.~~ Curve warning signs with multiple arrows shall not be used in California. Only W1-3, W1-4 and W24-1 signs shall be used.

**Option:**

9. A longitudinal buffer space may be used in the activity area to separate opposing vehicular traffic.
10. Where two or more lanes are being shifted, a W1-4 (or W1-3) sign with an ALL LANES (W24-1cP) plaque (see Figure 6F-4) may be used instead of a sign that illustrates the number of lanes.
11. Where more than three lanes are being shifted, the Reverse Curve (or Turn) sign may be rectangular.
12. A work vehicle or a shadow vehicle may be equipped with a truck-mounted attenuator.
13. When recommended speeds are the same for each curve, one Double Reverse Curve (W24-1) sign may be used, instead of two Reverse Curve (W1-4) signs, in advance of the first curve.

**Figure 6H-31. Lane Closures on a Street with Uneven Directional Volumes (TA-31)**



## Notes for Figure ~~6H-32~~ 6H-32(CA) — Typical Application 32 Half Road Closure on a Multi-Lane, High-Speed Highway

### Standard:

1. Pavement markings no longer applicable shall be removed or obliterated as soon as practical. Except for intermediate-term and short-term situations, temporary markings shall be provided to clearly delineate the temporary travel path. For short-term and intermediate-term situations where it is not feasible to remove and restore pavement markings, channelization shall be made dominant by using a very close device spacing.

### Guidance:

2. When paved shoulders having a width of 8 feet or more are closed, channelizing devices should be used to close the shoulder in advance of the merging taper to direct vehicular traffic to remain within the traveled way.
3. Where channelizing devices are used instead of pavement markings, the maximum spacing should be  $1/2 S$  feet where  $S$  is the speed in mph. The spacing of channelizing devices should not exceed the maximum distances shown in Table 6F-101(CA). Refer to Section 6F.63 for spacing of channelizing devices.
4. If the tangent distance along the temporary diversion is less than 600 feet, a Double Reverse Curve sign should be used instead of the first Reverse Curve sign, and the second Reverse Curve sign should be omitted.

### Option:

5. Warning lights may be used to supplement channelizing devices at night.
6. A truck-mounted attenuator may be used on the work vehicle and/or the shadow vehicle.

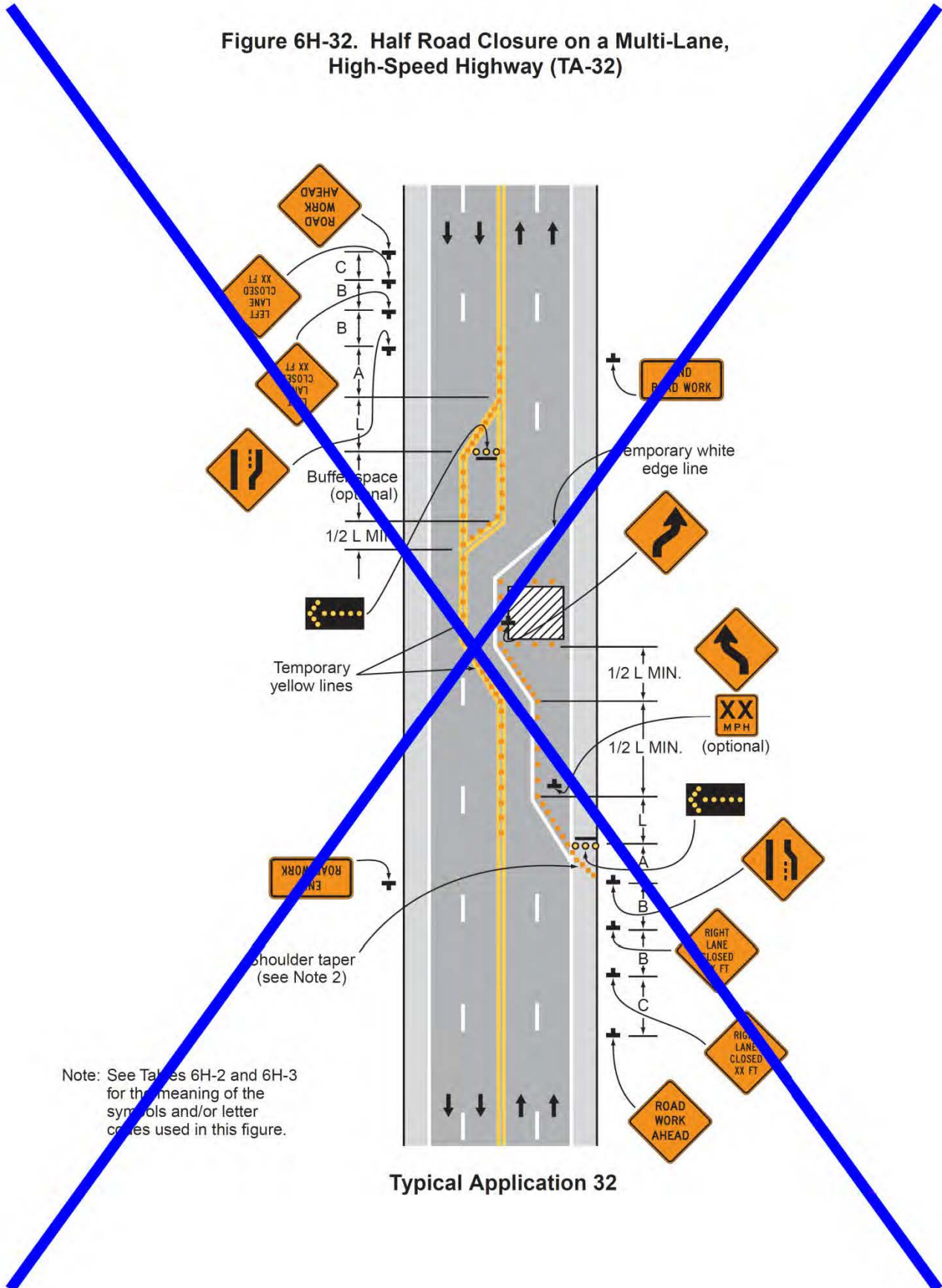
### Support:

7. See Section 6F.106(CA) for use of the Slow For The Cone Zone (SC19(CA) and SC20(CA)) Signs.

### Guidance:

8. All advance warning signs should be placed so that the path of travel for bicycles is not blocked, while maintaining visibility for road users.
9. If bicyclists are able to use the shoulder throughout the TTC zone, the Bicycle Crossing (W11-1) sign should be used and the SHARE THE ROAD (W16-1P) plaque should be omitted.
10. The speeds used for the shoulder taper calculations should be of bicyclists in the project vicinity or if a special event such as a bike race, the expected speed of bicyclists approaching the TTC zone.
11. If bicyclists are sharing the traveled way lanes with motorists, speed reduction countermeasures should be used to reduce traffic speeds in the TTC zone. Refer to Sections 6C.01 and 6D.03.
12. When existing accommodations for bicycle travel are disrupted or closed in a long-term duration project (see Section 6G.02) and the roadway width is inadequate for allowing bicyclists and motor vehicles to travel side by side, the Bicycle Crossing (W11-1) sign and the SHARE THE ROAD (W16-1P) plaque should be used to advise motorists of the presence of bicyclists in the travel way lanes.

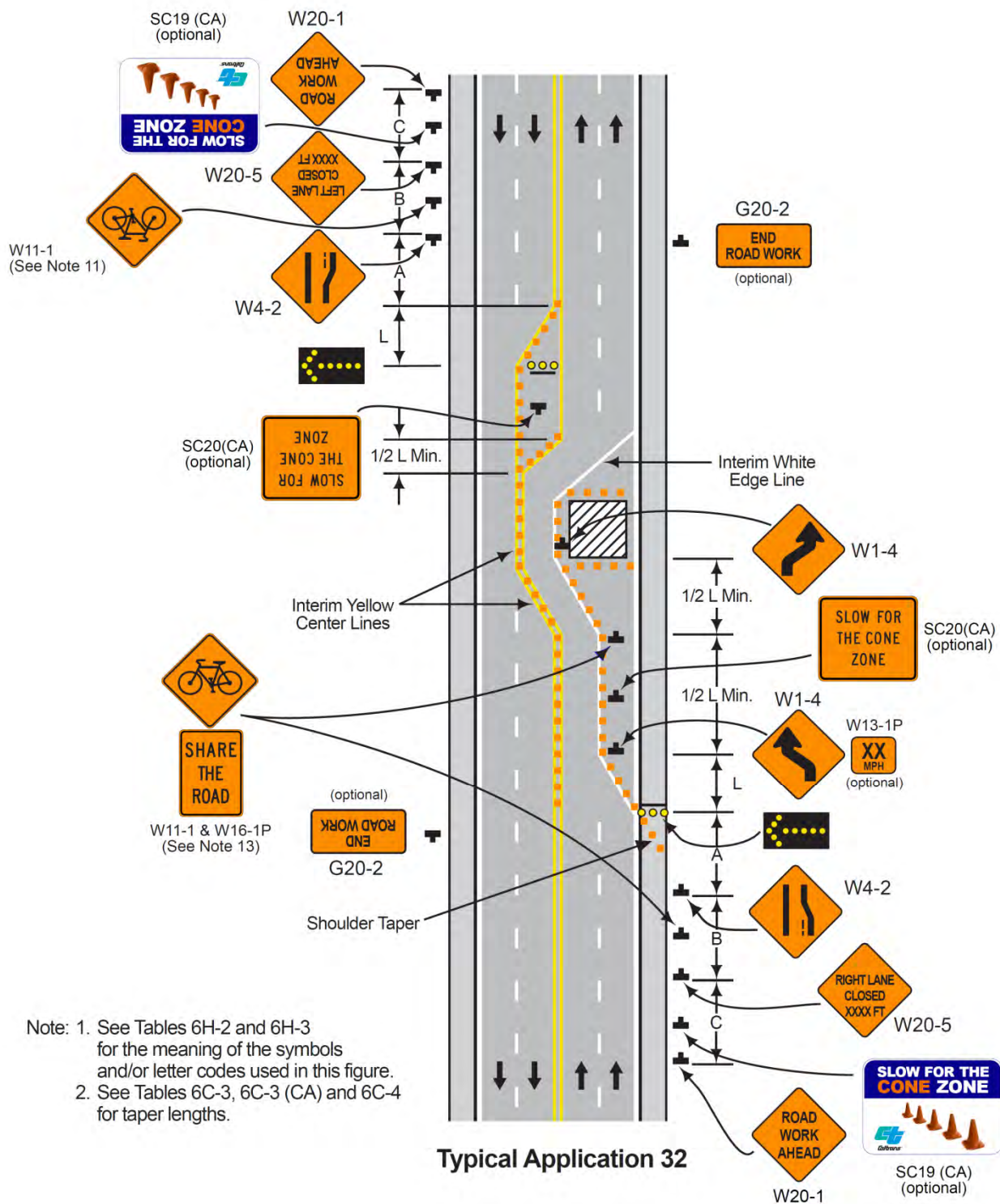
**Figure 6H-32. Half Road Closure on a Multi-Lane, High-Speed Highway (TA-32)**



Note: See Tables 6H-2 and 6H-3 for the meaning of the symbols and/or letter codes used in this figure.

**Typical Application 32**

**Figure 6H-32 (CA). Half Road Closure on a Multilane, High-Speed Highway (TA-32)**





### **Notes for Figure 6H-33 —Typical Application 33 Stationary Lane Closure on a Divided Highway**

**Standard:**

- 1. This information also shall be used when work is being performed in the lane adjacent to the median on a divided highway. In this case, the LEFT LANE CLOSED signs and the corresponding Lane Ends signs shall be substituted.**
- 2. When a side road intersects the highway within the TTC zone, additional TTC devices shall be placed as needed.**

*Guidance:*

- 3. When paved shoulders having a width of 8 feet or more are closed, channelizing devices should be used to close the shoulder in advance of the merging taper to direct vehicular traffic to remain within the traveled way.*

*Option:*

- 4. A truck-mounted attenuator may be used on the work vehicle and/or shadow vehicle.*

*Support:*

- 5. Where conditions permit, restricting all vehicles, equipment, workers, and their activities to one side of the roadway might be advantageous.*

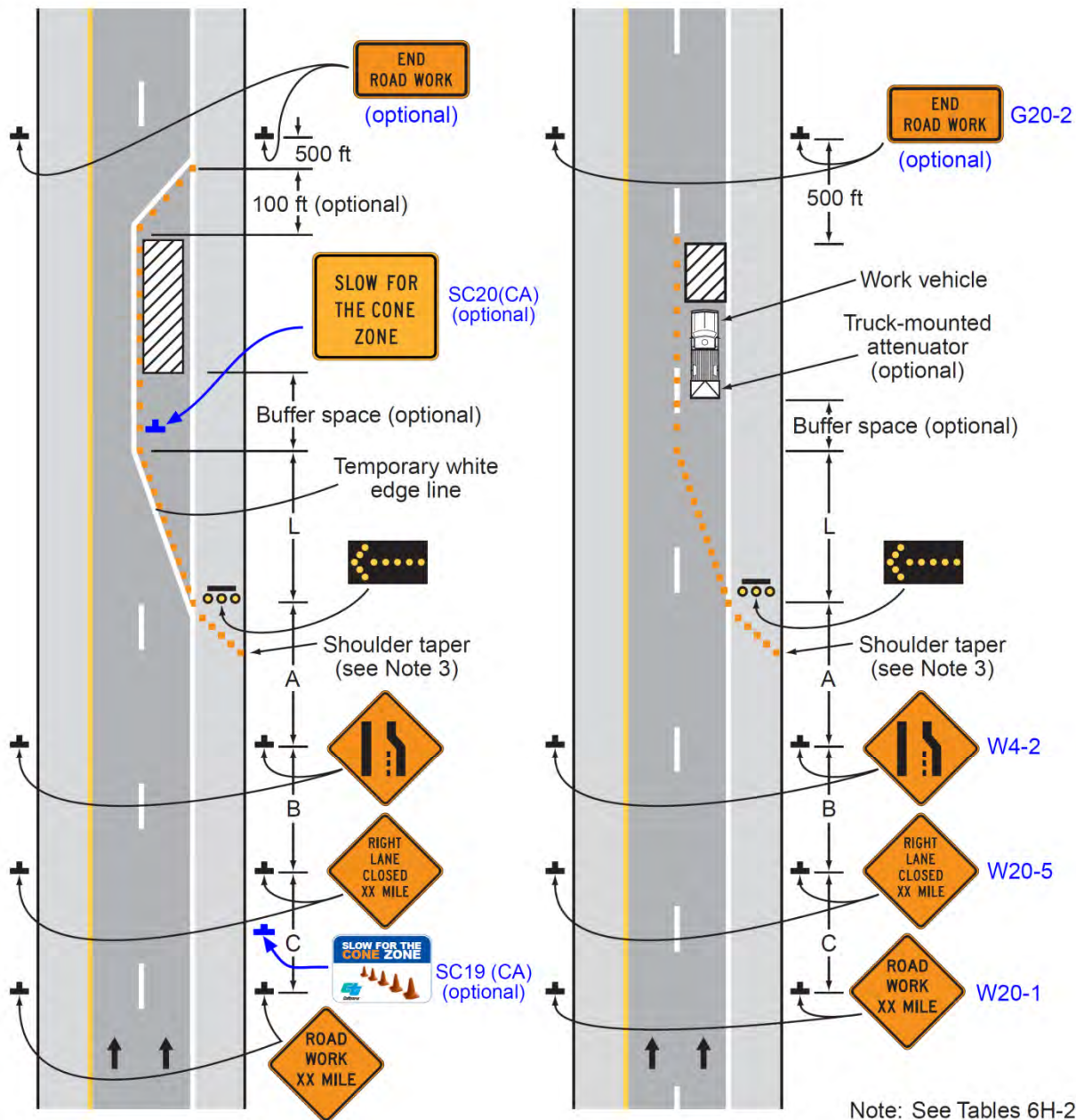
**Standard:**

- 6. An arrow board shall be used when a freeway lane is closed. When more than one freeway lane is closed, a separate arrow board shall be used for each closed lane.**

*Support:*

- 7. See Section 6F.106(CA) for use of the Slow For The Cone Zone (SC19(CA) and SC20(CA)) Signs.*

**Figure 6H-33. Stationary Lane Closure on a Divided Highway (TA-33)**



Note: See Tables 6H-2 and 6H-3 for the meaning of the symbols and/or letter codes used in this figure.

**Typical Application 33**

### Notes for Figure 6H-34—Typical Application 34 Lane Closure with a Temporary Traffic Barrier

**Standard:**

- 1. This information also shall be used when work is being performed in the lane adjacent to the median on a divided highway. In this case, the LEFT LANE CLOSED signs and the corresponding Lane Ends signs shall be substituted.**

*Guidance:*

- 2. For long-term lane closures on facilities with permanent edge lines, a temporary edge line should be installed from the upstream end of the merging taper to the downstream end of the downstream taper, and conflicting pavement markings should be removed.*
- 3. The use of a barrier should be based on engineering judgment.*

**Standard:**

- 4. Temporary traffic barriers, if used, shall comply with the provisions of Section 6F.85.**
- 5. The barrier shall not be placed along the merging taper. The lane shall first be closed using channelizing devices and pavement markings.**

*Option:*

- 6. Type C Steady-Burn warning lights may be placed on channelizing devices and the barrier parallel to the edge of pavement for nighttime lane closures.*
- 7. The barrier shown in this typical application is an example of one method that may be used to close a lane for a long-term project. If the work activity permits, a movable barrier may be used and relocated to the shoulder during non-work periods or peak-period vehicular traffic conditions, as appropriate.*

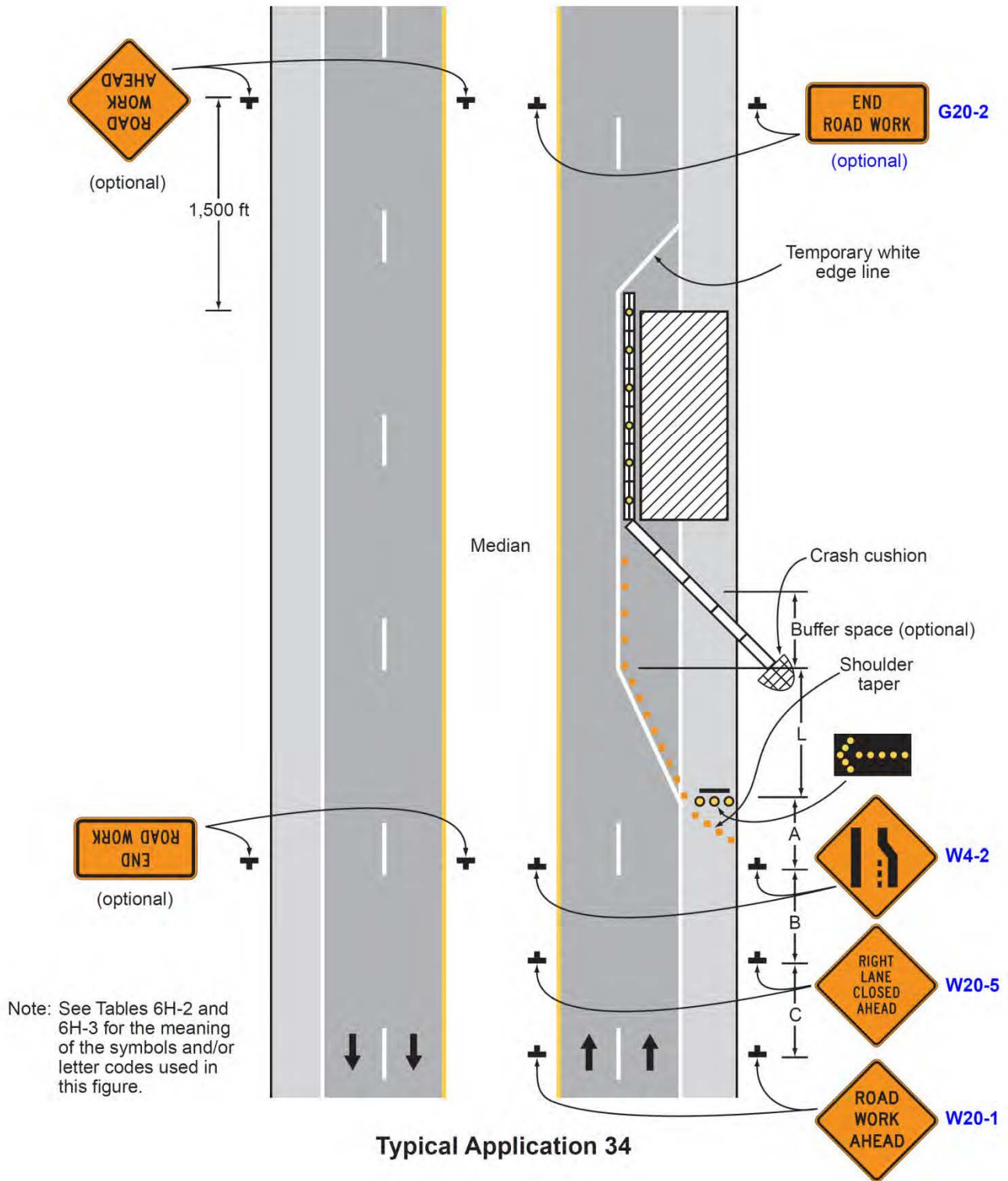
**Standard:**

- 8. If a movable barrier is used, the temporary white edge line shown in the typical application shall not be used. During the period when the right-hand lane is opened, the sign legends and the channelization shall be changed to indicate that only the shoulder is closed, as illustrated in Figure ~~6H-5~~ 6H-5(CA). The arrow board, if used, shall be placed at the downstream end of the shoulder taper and shall display the caution mode.**

*Guidance:*

- 9. If a movable barrier is used, the shift should be performed in the following manner. When closing the lane, the lane should be initially closed with channelizing devices placed along a merging taper using the same information employed for a stationary lane closure. The lane closure should then be extended with the movable-barrier transfer vehicle moving with vehicular traffic. When opening the lane, the movable barrier transfer vehicle should travel against vehicular traffic from the termination area to the transition area. The merging taper should then be removed using the same information employed for a stationary lane closure.*

**Figure 6H-34. Lane Closure with a Temporary Traffic Barrier (TA-34)**



### Notes for Figure 6H-35—Typical Application 35 Mobile Operation on a Multi-Lane Road

**Standard:**

1. Arrow boards shall, as a minimum, be Type B, with a size of 60 x 30 inches. For State highways, the arrow boards shall, as a minimum, be type II, with a size of 72 x 36 inch. Refer to Caltrans' Standard Specifications Section 12-3.03 for minimum size and type of arrow panels cited above. See Section 1A.11 for information regarding this publication.
2. Vehicle-mounted signs shall be mounted in a manner such that they are not obscured by equipment or supplies. Sign legends on vehicle-mounted signs shall be covered or turned from view when work is not in progress.
3. Shadow and work vehicles shall display high-intensity rotating, flashing, oscillating, or strobe lights.
4. An arrow board shall be used when a freeway lane is closed. When more than one freeway lane is closed, a separate arrow board shall be used for each closed lane.

*Guidance:*

5. Vehicles used for these operations should be made highly visible with appropriate equipment, such as flags, signs, or arrow boards.
6. Shadow Vehicle 1 should be equipped with an arrow board and truck-mounted attenuator.
7. Shadow Vehicle 2 should be equipped with an arrow board. An appropriate lane closure sign should be placed on Shadow Vehicle 2 so as not to obscure the arrow board.
8. Shadow Vehicle 2 should travel at a varying distance from the work operation so as to provide adequate sight distance for vehicular traffic approaching from the rear.
9. The spacing between the work vehicles and the shadow vehicles, and between each shadow vehicle should be minimized to deter road users from driving in between.
10. Work should normally be accomplished during off-peak hours.
11. When the work vehicle occupies an interior lane (a lane other than the far right or far left) of a directional roadway having a right-hand shoulder 10 feet or more in width, Shadow Vehicle 2 should drive the right-hand shoulder with a sign indicating that work is taking place in the interior lane.

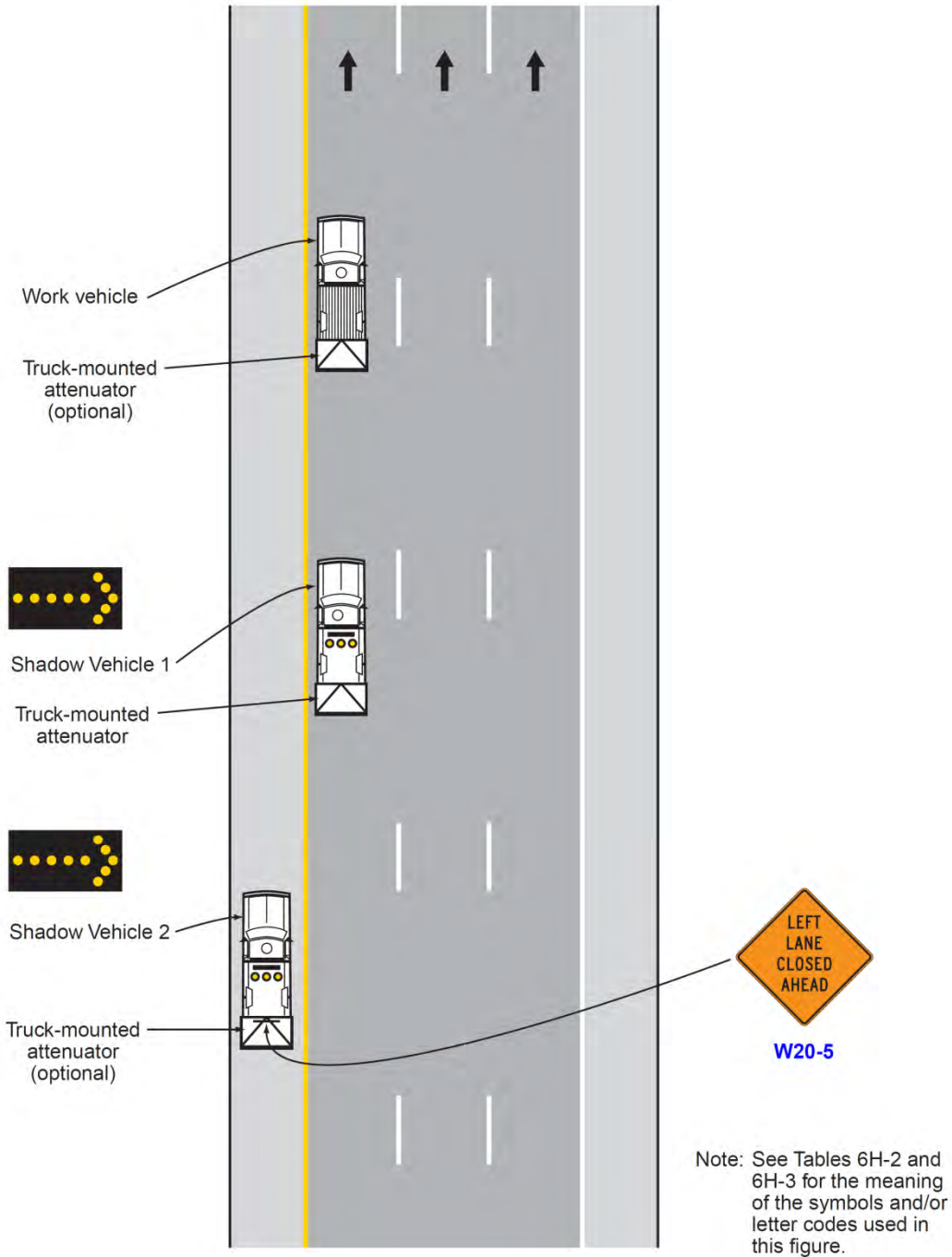
*Option:*

12. A truck-mounted attenuator may be used on Shadow Vehicle 2.
13. On high-speed roadways, a third shadow vehicle (not shown) may be used with Shadow Vehicle 1 in the closed lane, Shadow Vehicle 2 straddling the edge line, and Shadow Vehicle 3 on the shoulder.
14. Where adequate shoulder width is not available, Shadow Vehicle 3 may also straddle the edge line.

*Support:*

15. For State highways, see Caltrans' Standard Plan T15 and T16. See Section 1A.11 for information regarding this publication.

**Figure 6H-35. Mobile Operation on a Multi-Lane Road (TA-35)**



**Typical Application 35**

## Notes for Figure ~~6H-36~~ **6H-36(CA)** — Typical Application 36 Lane Shift on a Freeway

**Guidance:**

1. The lane shift should be used when the work space extends into either the right-hand or left-hand lane of a divided highway and it is not practical, for capacity reasons, to reduce the number of available lanes.

**Support:**

2. When a lane shift is accomplished by using
  - (1) geometry that meets the design speed at which the permanent highway was designed,
  - (2) full normal cross-section (full lane width and full shoulders), and
  - (3) complete pavement markings, then only the initial general work-zone warning sign is required.

**Guidance:**

3. When the conditions in Note 2 are not met, the information shown in the typical application should be employed and all the following notes apply.

**Standard:**

4. Temporary traffic barriers, if used, shall comply with the provisions of Section 6F.85.
5. The barrier shall not be placed along the shifting taper. The lane shall first be shifted using channelizing devices and pavement markings.

**Guidance:**

6. A warning sign should be used to show the changed alignment.

**Standard:**

7. ~~The number of lanes illustrated on the Reverse Curve signs shall be the same as the number of through lanes available to road users, and the direction of the reverse curves shall be appropriately illustrated.~~

**Option:**

8. Where two or more lanes are being shifted, a W1-4 (or W1-3) sign with an ALL LANES (W24-1cP) plaque (see Figure 6F-4) ~~may~~ **shall** be used instead of a sign that illustrates the number of lanes. **The Reverse Curve (W1-4) sign shall be used instead of the Reverse Curve (W1-4a & W1-4b) signs which show the number of lanes.**

**Option:**

9. Where more than three lanes are being shifted, the Reverse Curve (or Turn) sign may be rectangular.

**Guidance:**

10. Where the shifted section is longer than 600 feet, one set of Reverse Curve signs should be used to show the initial shift and a second set should be used to show the return to the normal alignment. If the tangent distance along the temporary diversion is less than 600 feet, a Double Reverse Curve sign should be used instead of the first Reverse Curve sign, and the second Reverse Curve sign should be omitted. **Use the Reverse Curve (W1-4) signs for both locations instead of the Double Reverse Curve (W24-1) sign.**
11. If a STAY IN LANE sign is used, then solid white lane lines should be used.

**Standard:**

12. The minimum width of the shoulder lane shall be 10 feet.
13. For long-term stationary work, existing conflicting pavement markings shall be removed and temporary markings shall be installed before traffic patterns are changed.

**Option:**

14. For short-term stationary work, lanes may be delineated by channelizing devices or removable pavement markings instead of temporary markings.

**Guidance:**

15. If the shoulder cannot adequately accommodate trucks, trucks should be directed to use the travel lanes.
16. The use of a barrier should be based on engineering judgment.

**Option:**

17. Type C Steady-Burn warning lights may be placed on channelizing devices and the barrier parallel to the edge of the pavement for nighttime lane closures.

Option:

18. Detail 11 (see Figure 3A-102(CA)) may be used instead of the temporary solid white lane line, which is shown in Figure 6H-36(CA).

Support:

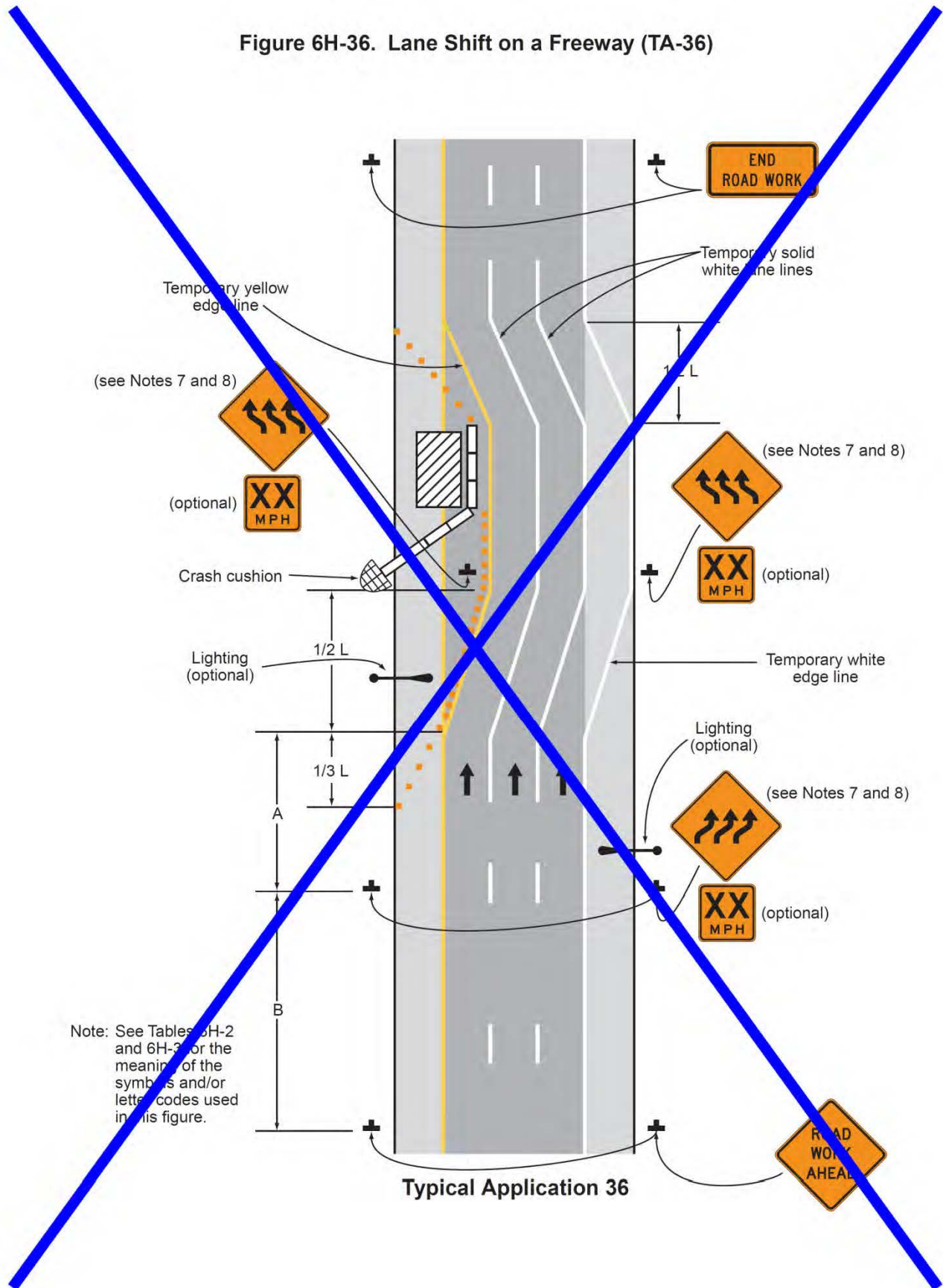
19. See Section 6F.106(CA) for use of the Slow For The Cone Zone (SC19(CA) and SC20(CA)) Signs.

Guidance:

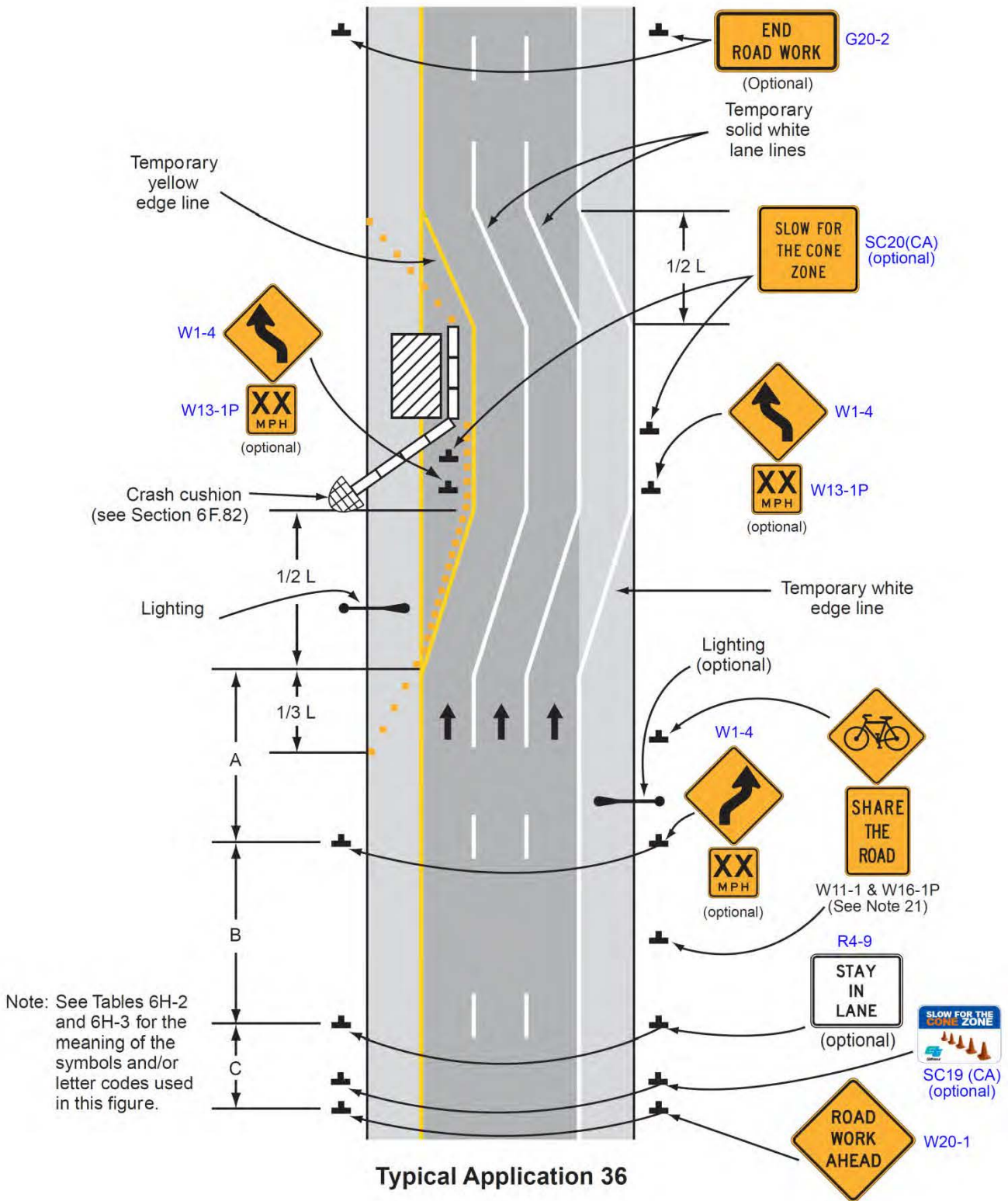
20. *All advance warning signs should be placed so that the path of travel for bicycles is not blocked, while maintaining visibility for road users.*
21. *When existing accommodations for bicycle travel are disrupted or closed in a long-term duration project (see Section 6G.02) and the roadway width is inadequate for allowing bicyclists and motor vehicles to travel side by side, the Bicycle Crossing (W11-1) sign and the SHARE THE ROAD (W16-1P) plaque should be used to advise motorists of the presence of bicyclists in the travel way lanes.*
22. *Except for short durations and mobile operations, when a highway shoulder is occupied and bicyclists would be sharing a lane with vehicular traffic, as a result of the TTC zone, speed reduction countermeasures should be used to reduce traffic speeds in the TTC zone. Refer to Sections 6C.01 and 6D.03.*
23. *Except for short durations and mobile operations, when a highway shoulder is occupied and bicyclists would be sharing a lane with vehicular traffic, as a result of the TTC zone, before narrowing the outside lane other measures such as widening the outside shoulder to allow bicyclists and motor vehicles to travel side by side through the TTC zone should be considered.*
24. *If traffic volumes make it feasible, the two left lanes should be merged into one lane to avoid using the shoulder as a traveled way lane and allowing continued use for emergency purposes and bicycle travel.*
25. *When existing accommodations for bicycle travel are disrupted or closed in a long-term duration project (see Section 6G.02) and the roadway width is inadequate for allowing bicyclists and motor vehicles to travel side by side, a separate path should be considered for bicyclists.*



Figure 6H-36. Lane Shift on a Freeway (TA-36)



**Figure 6H-36 (CA). Lane Shift on Freeway (TA-36)**



### Notes for Figure 6H-37—Typical Application 37 Double Lane Closure on a Freeway

**Standard:**

1. An arrow board shall be used when a freeway lane is closed. When more than one freeway lane is closed, a separate arrow board shall be used for each closed lane.

*Guidance:*

2. Ordinarily, the preferred position for the second arrow board is in the closed exterior lane at the upstream end of the second merging taper. However, the second arrow board should be placed in the closed interior lane at the downstream end of the second merging taper in the following situations:
  - a. When a shadow vehicle is used in the interior closed lane, and the second arrow board is mounted on the shadow vehicle;
  - b. If alignment or other conditions create any confusion as to which lane is closed by the second arrow board; and
  - c. When the first arrow board is placed in the closed exterior lane at the downstream end of the first merging taper (the alternative position when the shoulder is narrow).

**Standard:**

3. All advance warning signs mounted on portable supports shall be equipped with at least two flags or a flashing warning beacon. Each flag shall be at least 16 X16 inches in size and shall be orange or red in color. Flashing warning beacons (Section 6F.83) shall be used to call attention to the initial warning signs during hours of darkness. Flashing warning beacons is optional during daytime operations.

*Option:*

4. A truck-mounted attenuator may be used on the shadow vehicle.
5. If a paved shoulder having a minimum width of 10 feet and sufficient strength is available, the left and adjacent interior lanes may be closed and vehicular traffic carried around the work space on the right-hand lane and a right-hand shoulder.

*Guidance:*

6. When a shoulder lane is used that cannot adequately accommodate trucks, trucks should be directed to use the normal travel lanes.

**Standard:**

7. 3 cones or 2 Type II barricades shall be placed transversely across each closed lane at end of each merging taper and every 2000 feet throughout the lane closure.
8. On freeways, maximum spacing of channelizing devices shall be 50 feet in advance warning and transition areas, 100 feet in activity and termination areas (see figure 6C-1).
9. LANE CLOSED C30(CA) sign shall be placed every 2000 feet throughout the lane closure adjacent to the open lane within the closed lane.

*Support:*

10. For State highways, see the Caltrans' Standard Plan T10. See Section 1A.11 for information regarding this publication.



### **Notes for Figure 6H-38—Typical Application 38 Interior Lane Closure on a Freeway**

**Standard:**

- ~~1. An arrow board shall be used when a freeway lane is closed. When more than one freeway lane is closed, a separate arrow board shall be used for each closed lane.~~
- ~~2. If temporary traffic barriers are installed, they shall comply with the provisions and requirements in Section 6F.85.~~
- ~~3. The barrier shall not be placed along the shifting taper. The lane shall first be shifted using channelizing devices and pavement markings.~~
- ~~4. For long term stationary work, existing conflicting pavement markings shall be removed and temporary markings shall be installed before traffic patterns are changed.~~

*Guidance:*

- ~~5. For a long term closure, a barrier should be used to provide additional safety to the operation in the closed interior lane. A buffer space should be used at the upstream end of the closed interior lane.~~
- ~~6. The first arrow board displaying an arrow pointing to the right should be on the left hand shoulder at the beginning of the taper. The arrow board displaying a double arrow should be centered in the closed interior lane and placed at the downstream end of the shifting taper.~~
- ~~7. If the two arrow boards create confusion, the 2L distance between the end of the merging taper and beginning of the shift taper should be extended so that road users can focus on one arrow board at a time.~~
- ~~8. The placement of signs should not obstruct or obscure arrow boards.~~
- ~~9. For long term use, the dashed lane lines should be made solid white in the two lane section.~~

**Option:**

- ~~10. As an alternative to initially closing the left hand lane, as shown in the typical application, the right hand lane may be closed in advance of the interior lane closure with appropriate channelization and signs.~~
- ~~11. A short, single row of channelizing devices in advance of the vehicular traffic split to restrict vehicular traffic to their respective lanes may be added.~~
- ~~12. DO NOT PASS signs may be used.~~
- ~~13. If a paved shoulder having a minimum width of 10 feet and sufficient strength is available, the left hand and center lanes may be closed and motor vehicle traffic carried around the work space on the right hand lane and a right hand shoulder.~~

*Guidance:*

- ~~14. When a shoulder lane is used that cannot adequately accommodate trucks, trucks should be directed to use the normal travel lanes.~~

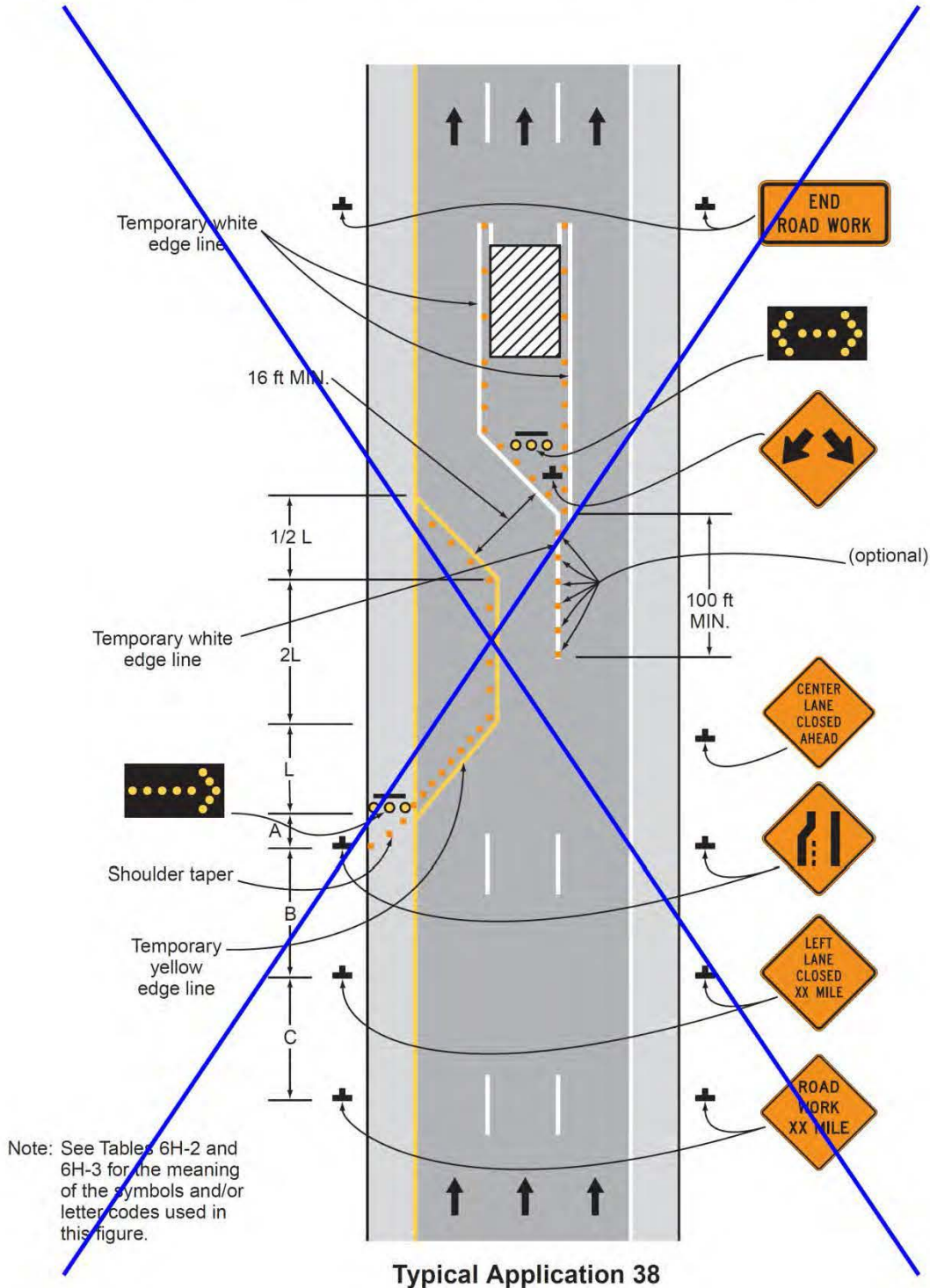
**Standard:**

**This typical application is deleted for application and shall not be used on freeways in California. Whenever an interior lane needs to be closed on freeways, all adjacent lane(s) to one side of this lane shall be closed as illustrated in Figure 6H-37.**

**Support:**

For State highways, see Caltrans' Standard Plan T10, T10A and T14. For interior lane closure on Freeways using mobile operation, see Caltrans' Standard Plan T16. See Section 1A.11 for information regarding this publication.

**Figure 6H-38. Interior Lane Closure on a Freeway (TA-38)**



### Notes for Figure 6H-39—Typical Application 39 Median Crossover on a Freeway

**Standard:**

- 1. Channelizing devices or temporary traffic barriers shall be used to separate opposing vehicular traffic.**
- 2. An arrow board shall be used when a freeway lane is closed. When more than one freeway lane is closed, a separate arrow board shall be used for each closed lane.**

*Guidance:*

- 3. For long-term work on high-speed, high-volume highways, consideration should be given to using a temporary traffic barrier to separate opposing vehicular traffic.*

*Option:*

4. When a temporary traffic barrier is used to separate opposing vehicular traffic, the Two-Way Traffic, Do Not Pass, KEEP RIGHT, and DO NOT ENTER signs may be eliminated.
5. The alignment of the crossover may be designed as a reverse curve.

*Guidance:*

- 6. When the crossover follows a curved alignment, the design criteria contained in the AASHTO "Policy on the Geometric Design of Highways and Streets" (see Section 1A.11) should be used.*
- 7. When channelizing devices have the potential of leading vehicular traffic out of the intended traffic space, the channelizing devices should be extended a distance in feet of 2.0 times the speed limit in mph beyond the downstream end of the transition area as depicted.*
- 8. Where channelizing devices are used, the Two-Way Traffic signs should be repeated every 1 mile.*

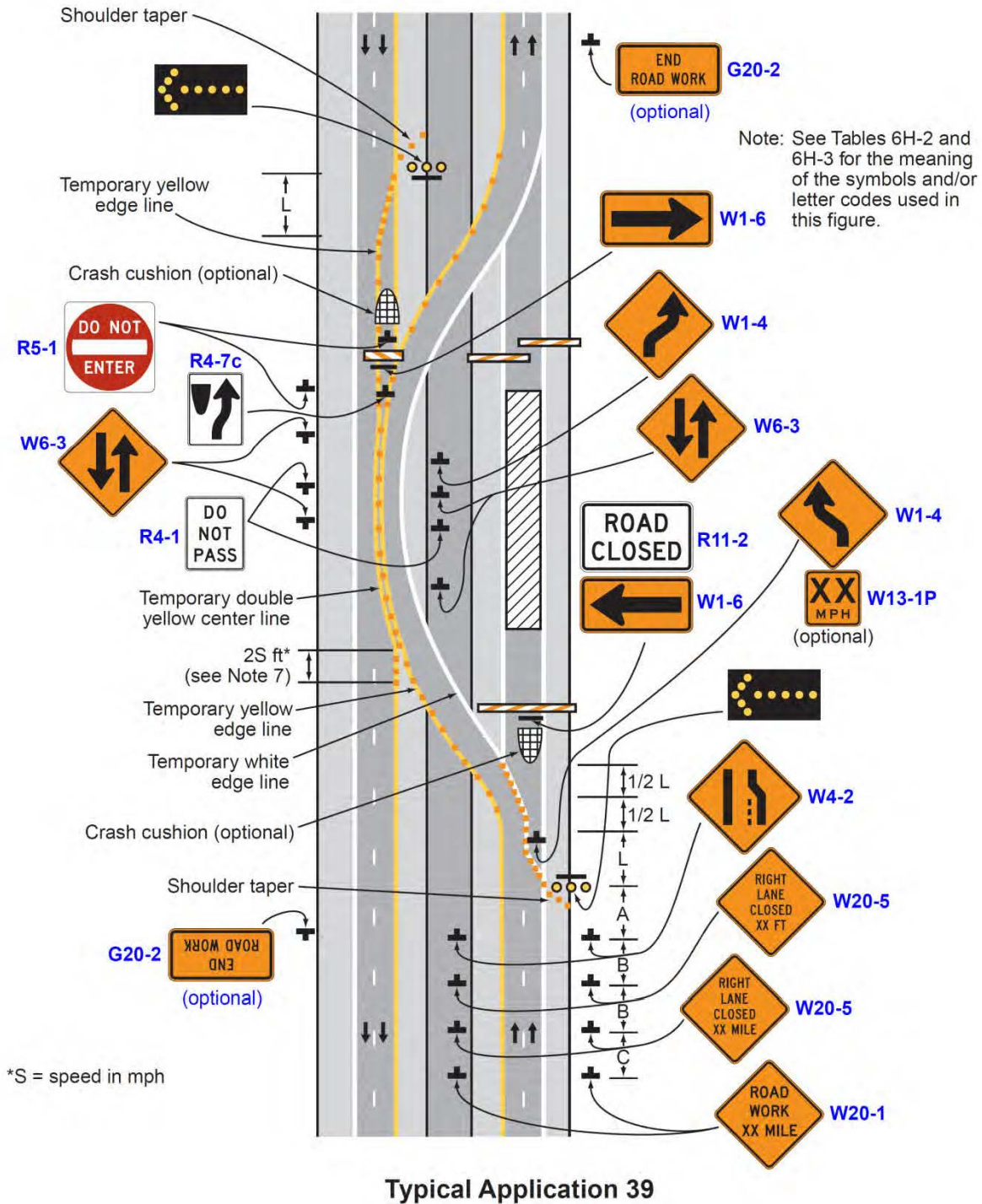
*Option:*

9. NEXT XX MILES Supplemental Distance plaques may be used with the Two-Way Traffic signs, where XX is the distance to the downstream end of the two-way section.

*Support:*

10. When the distance is sufficiently short that road users entering the section can see the downstream end of the section, they are less likely to forget that there is opposing vehicular traffic.
11. The sign legends for the four pairs of signs approaching the lane closure for the non-crossover direction of travel are not shown. They are similar to the series shown for the crossover direction, except that the left lane is closed.

**Figure 6H-39. Median Crossover on a Freeway (TA-39)**





### **Notes for Figure 6H-40—Typical Application 40 Median Crossover for an Entrance Ramp**

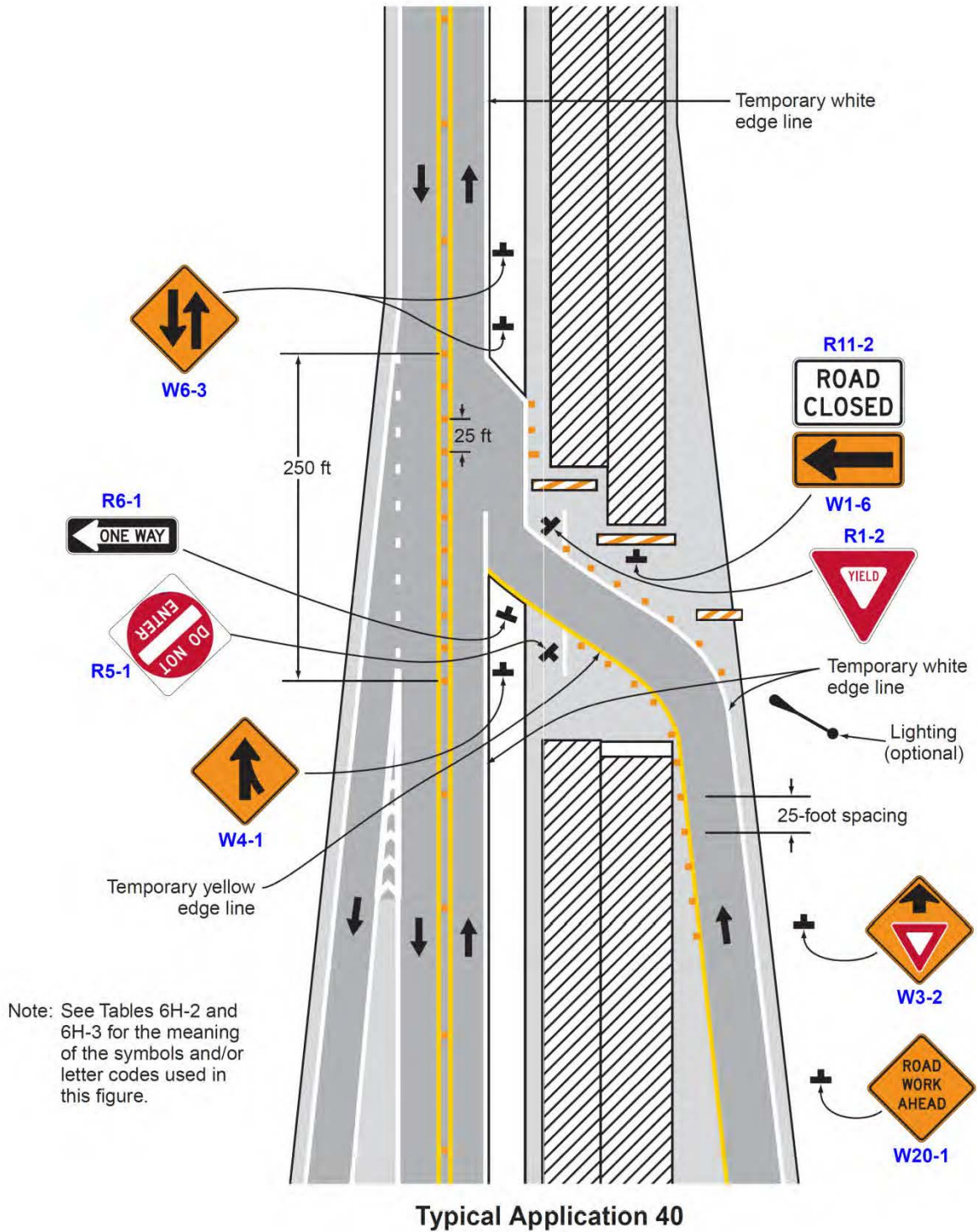
*Guidance:*

- 1. The typical application illustrated should be used for carrying an entrance ramp across a closed directional roadway of a divided highway.*
- 2. A temporary acceleration lane should be used to facilitate merging.*
- 3. When used, the YIELD or STOP sign should be located far enough forward to provide adequate sight distance of oncoming mainline vehicular traffic to select an acceptable gap, but should not be located so far forward that motorists will be encouraged to stop in the path of the mainline traffic. If needed, yield or stop lines should be installed across the ramp to indicate the point at which road users should yield or stop. Also, a longer acceleration lane should be provided beyond the sign to reduce the gap size needed.*

*Option:*

4. If vehicular traffic conditions allow, the ramp may be closed.
5. A broken edge line may be carried across the temporary entrance ramp to assist in defining the through vehicular traffic lane.
6. When a temporary traffic barrier is used to separate opposing vehicular traffic, the Two-Way Traffic signs and the DO NOT ENTER signs may be eliminated.

**Figure 6H-40. Median Crossover for an Entrance Ramp (TA-40)**



### **Notes for Figure 6H-41—Typical Application 41 Median Crossover for an Exit Ramp**

*Guidance:*

- 1. This typical application should be used for carrying an exit ramp across a closed directional roadway of a divided highway. The design criteria contained in the AASHTO "Policy on the Geometric Design of Highways and Streets" (see Section 1A.11) should be used for determining the curved alignment.*
- 2. The guide signs should indicate that the ramp is open, and where the temporary ramp is located. Conversely, if the ramp is closed, guide signs should indicate that the ramp is closed.*
- 3. When the exit is closed, a black on orange EXIT CLOSED sign panel should be placed diagonally across the interchange/intersection guide signs and channelizing devices should be placed to physically close the ramp.*
- 4. In the situation (not shown) where channelizing devices are placed along the mainline roadway, the devices' spacing should be reduced in the vicinity of the off ramp to emphasize the opening at the ramp itself. Channelizing devices and/or temporary pavement markings should be placed on both sides of the temporary ramp where it crosses the median and the closed roadway.*
- 5. Advance guide signs providing information related to the temporary exit should be relocated or duplicated adjacent to the temporary roadway.*

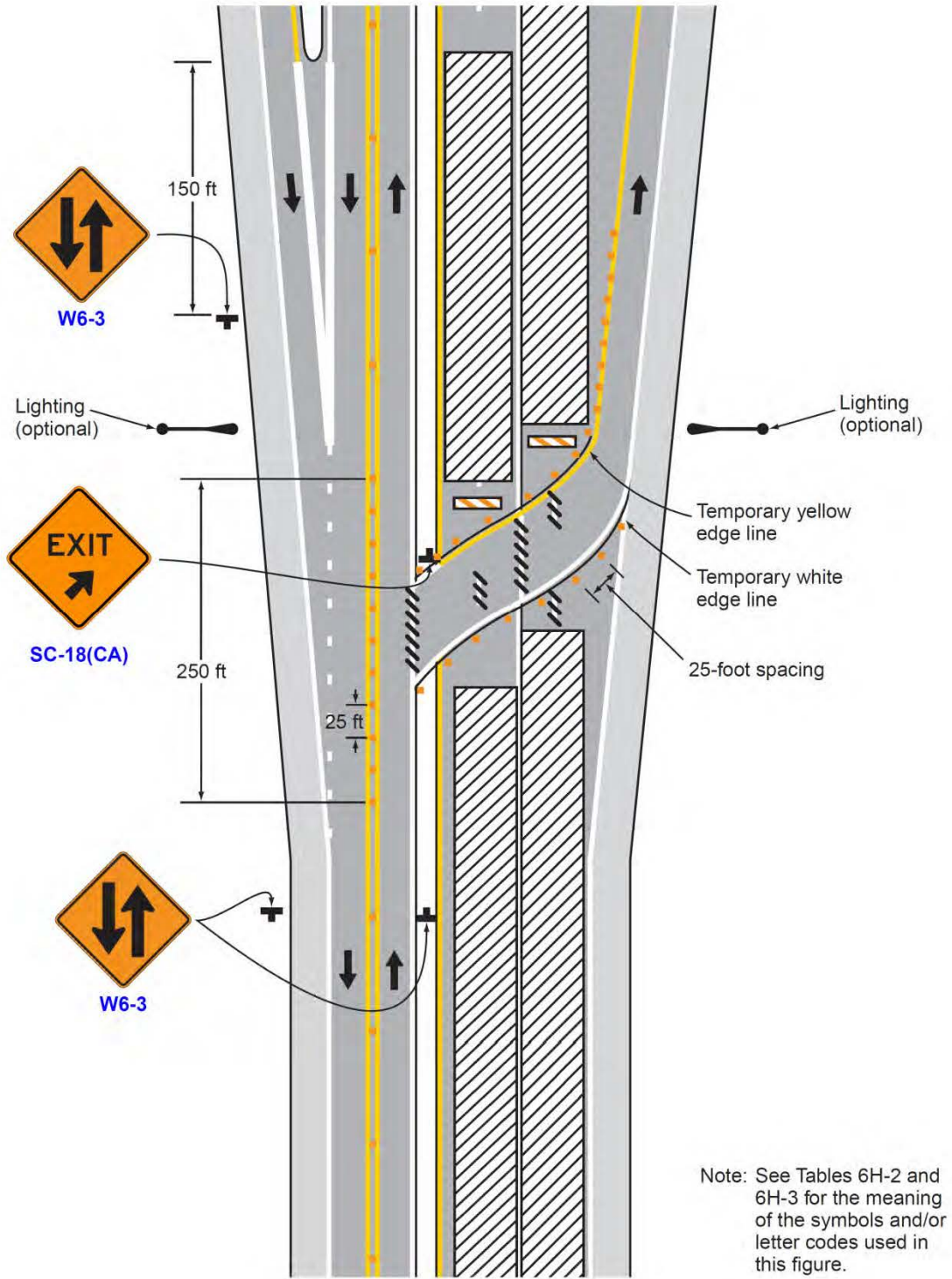
**Standard:**

- 6. A temporary EXIT sign shall be located in the temporary gore. For better visibility, it shall be mounted a minimum of 7 feet from the pavement surface to the bottom of the sign.**

*Option:*

- 7. Guide signs referring to the exit may need to be relocated to the median.*
- 8. The temporary EXIT sign placed in the temporary gore may be either black on orange or white on green.*
- 9. In some instances, a temporary deceleration lane may be useful in facilitating the exiting maneuver.*
- 10. When a temporary traffic barrier is used to separate opposing vehicular traffic, the Two-Way Traffic signs may be omitted.*

Figure 6H-41. Median Crossover for an Exit Ramp (TA-41)



Typical Application 41

### **Notes for Figure 6H-42—Typical Application 42 Work in the Vicinity of an Exit Ramp**

*Guidance:*

- 1. The guide signs should indicate that the ramp is open, and where the temporary ramp is located. However, if the ramp is closed, guide signs should indicate that the ramp is closed.*
- 2. When the exit ramp is closed, a black on orange EXIT CLOSED sign panel should be placed diagonally across the interchange/intersection guide signs.*
- 3. The design criteria contained in the AASHTO "Policy on the Geometric Design of Highways and Streets" (see Section 1A.11) should be used for determining the alignment.*

**Standard:**

- 4. A temporary EXIT sign shall be located in the temporary gore. For better visibility, it shall be mounted a minimum of 7 feet from the pavement surface to the bottom of the sign.**

*Option:*

- 5. The temporary EXIT sign placed in the temporary gore may be either black on orange or white on green.*
- 6. An alternative procedure that may be used is to channelize exiting vehicular traffic onto the right-hand shoulder and close the lane as necessary.*

**Standard:**

- 7. An arrow board shall be used when a freeway lane is closed. When more than one freeway lane is closed, a separate arrow board shall be used for each closed lane.**

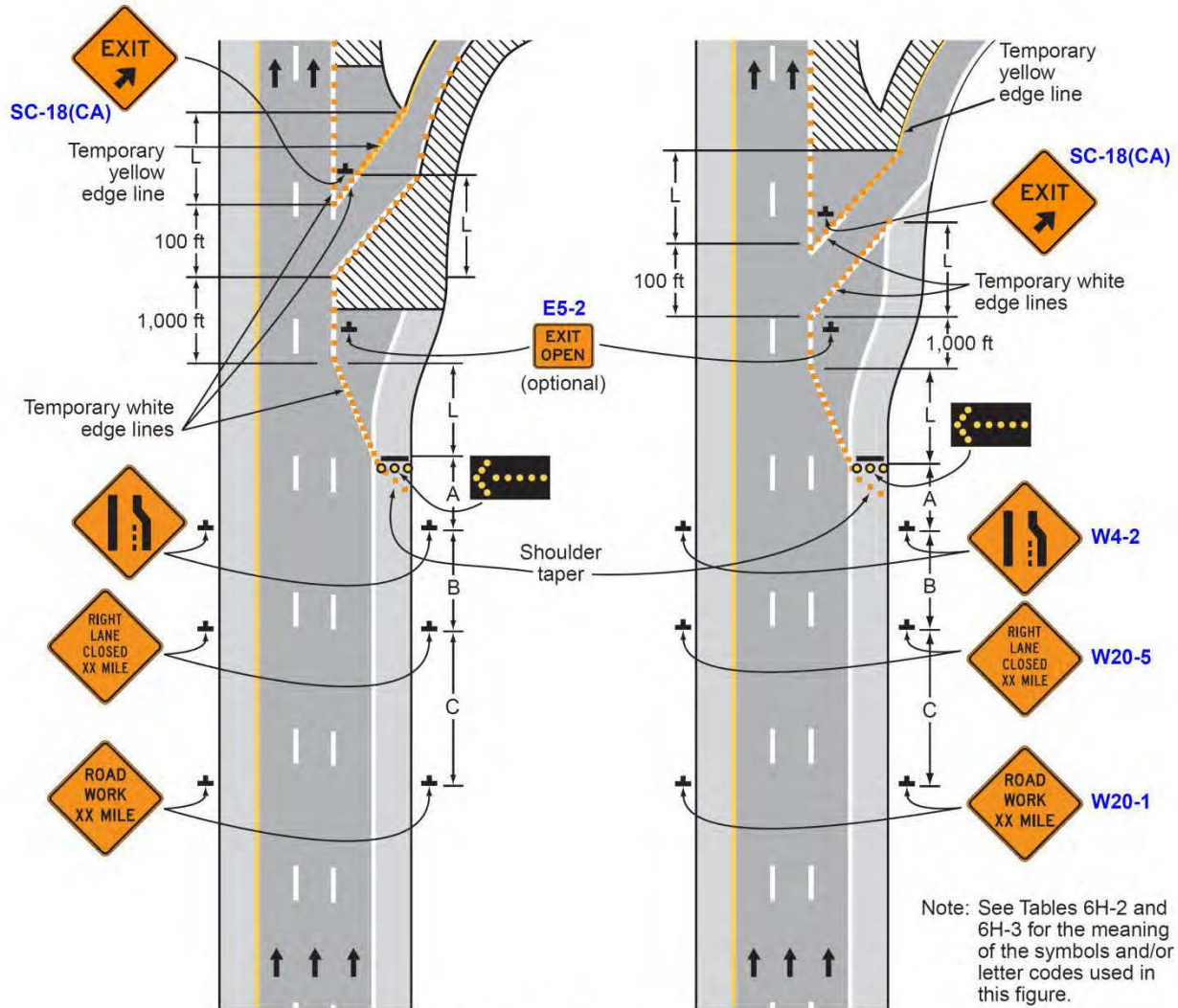
*Option:*

The Caltrans' Standard Plan T10, T10A and T14 may be used instead of this typical application.

*Support:*

See Section 1A.11 for information regarding this publication.

**Figure 6H-42. Work in the Vicinity of an Exit Ramp (TA-42)**



**Typical Application 42**

### **Notes for Figure 6H-43—Typical Application 43 Partial Exit Ramp Closure**

*Guidance:*

1. *Truck off-tracking should be considered when determining whether the minimum lane width of 10 feet is adequate (see Section 6G.08).*

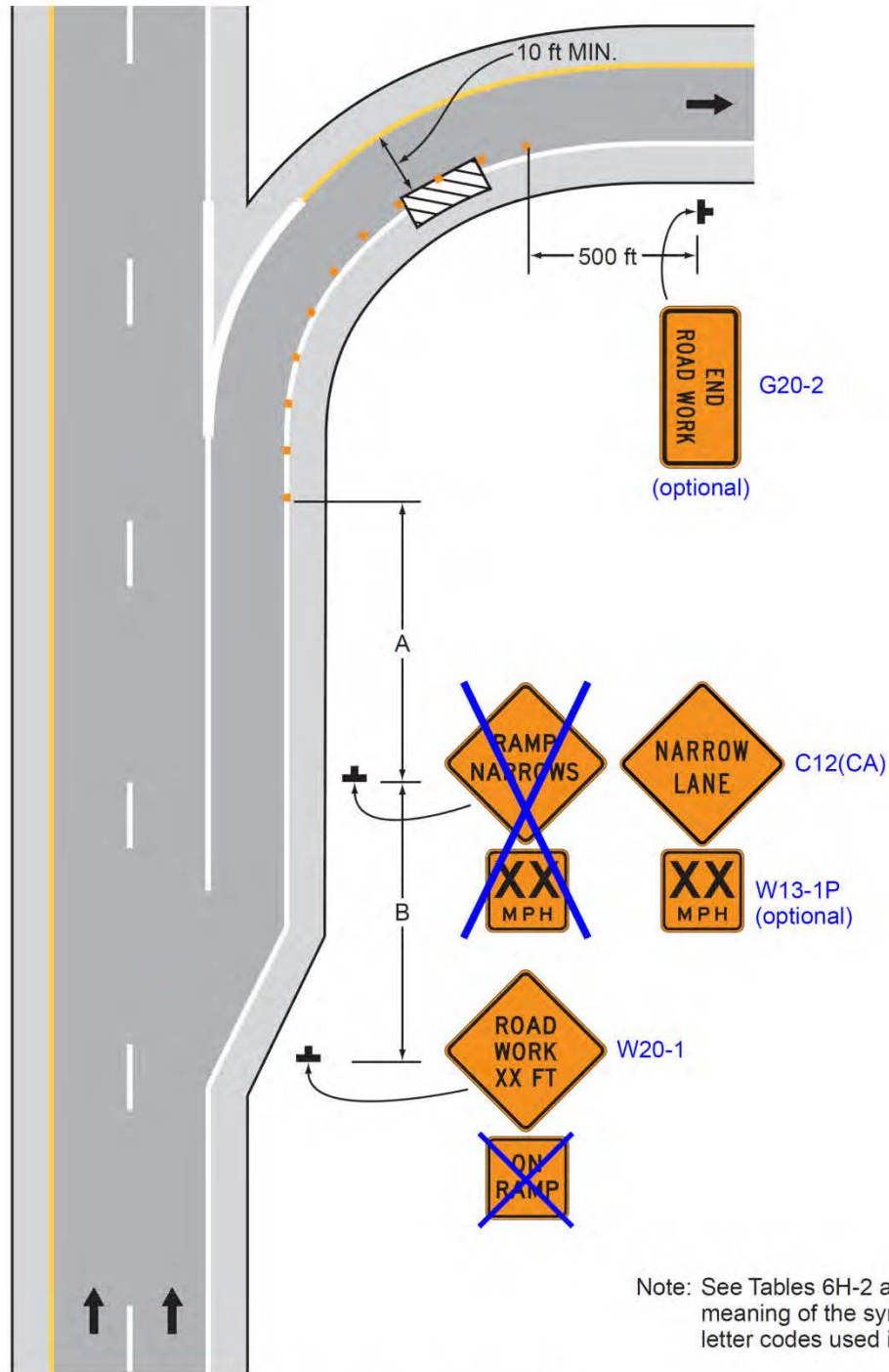
**Standard:**

2. **The RAMP NARROWS (W5-4) sign and ON RAMP (W13-4P) plaque shall not be used in California. The ROAD NARROWS (W5-1) sign or NARROW LANE(S) (C12(CA)) sign, as appropriate, shall be used instead. See Sections 2C.19 and 6F.102(CA).**

*Guidance:*

3. *For planned partial ramp closure, consideration should be given to closing the entire exit ramp. Refer to the Caltrans' Standard Plan T14. See Section 1A.11 for information regarding this publication.*

**Figure 6H-43. Partial Exit Ramp Closure (TA-43)**



**Typical Application 43**



### Notes for Figure 6H-44—Typical Application 44 Work in the Vicinity of an Entrance Ramp

*Guidance:*

1. An acceleration lane of sufficient length should be provided whenever possible as shown on the left diagram.

**Standard:**

2. For the information shown on the diagram on the right-hand side of the typical application, where inadequate acceleration distance exists for the temporary entrance, the YIELD sign shall be replaced with STOP signs (one on each side of the approach).

*Guidance:*

3. When used, the YIELD or STOP sign should be located so that ramp vehicular traffic has adequate sight distance of oncoming mainline vehicular traffic to select an acceptable gap in the mainline vehicular traffic flow, but should not be located so far forward that motorists will be encouraged to stop in the path of the mainline traffic. Also, a longer acceleration lane should be provided beyond the sign to reduce the gap size needed. If insufficient gaps are available, consideration should be given to closing the ramp.
4. Where STOP signs are used, a temporary stop line should be placed across the ramp at the desired stop location.
5. The mainline merging taper with the arrow board at its starting point should be located sufficiently in advance so that the arrow board is not confusing to drivers on the entrance ramp, and so that the mainline merging vehicular traffic from the lane closure has the opportunity to stabilize before encountering the vehicular traffic merging from the ramp.
6. If the ramp curves sharply to the right, warning signs with advisory speeds located in advance of the entrance terminal should be placed in pairs (one on each side of the ramp).

*Option:*

7. A Stop Beacon (see Section 4L.05) or a Type B high-intensity warning flasher with a red lens may be placed above the STOP sign.
8. Where the acceleration distance is significantly reduced, a supplemental plaque may be placed below the Yield Ahead sign reading NO MERGE AREA.

**Standard:**

9. An arrow board shall be used when a freeway lane is closed. When more than one freeway lane is closed, a separate arrow board shall be used for each closed lane.

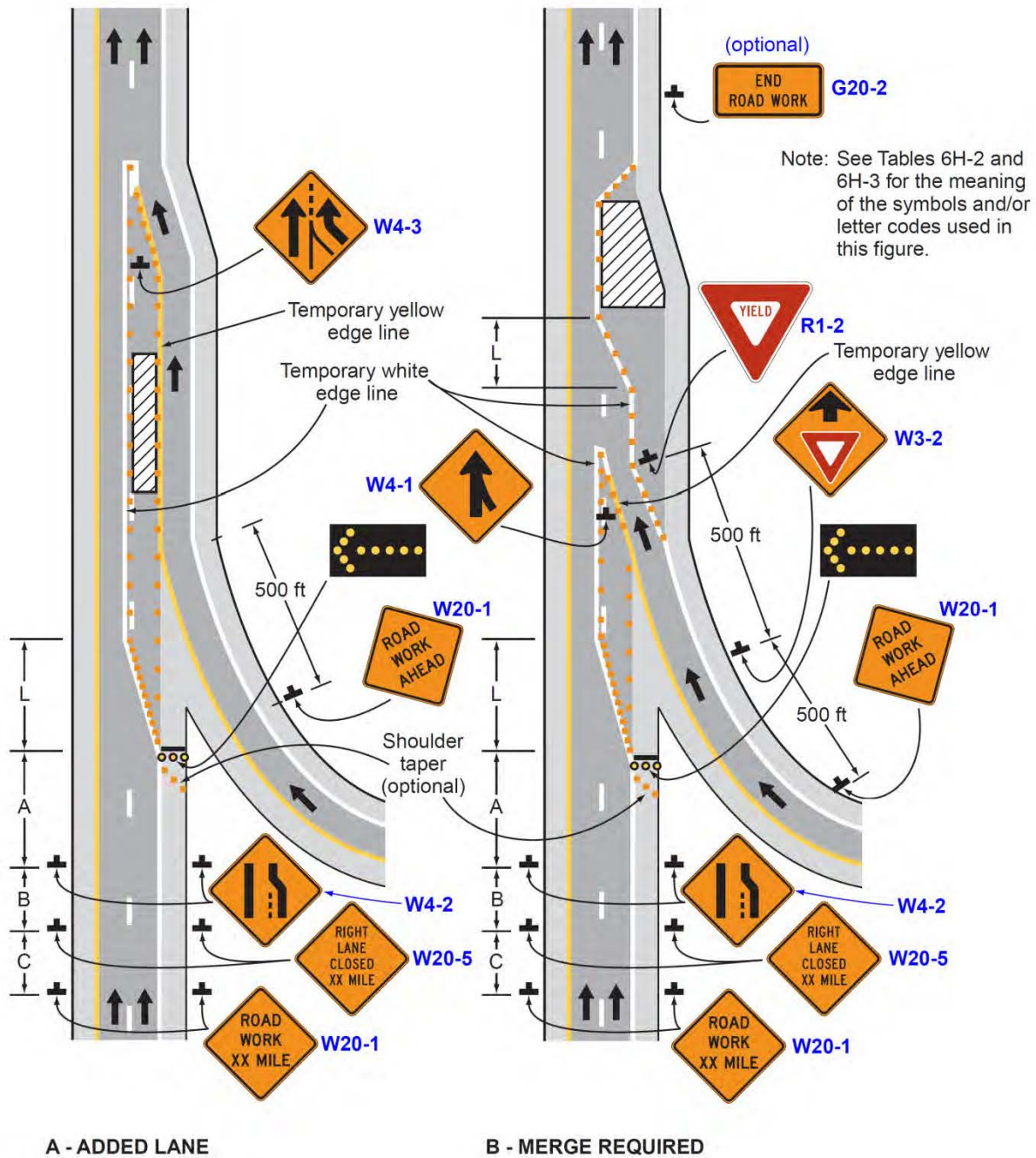
*Option:*

The Caltrans' Standard Plan T10, T10A and T14 may be used instead of this typical application.

*Support:*

See Section 1A.11 for information regarding this publication.

**Figure 6H-44. Work in the Vicinity of an Entrance Ramp (TA-44)**



## Notes for Figure 6H-45—Typical Application 45 Temporary Reversible Lane Using Movable Barriers

### Support:

1. This application addresses one of several uses for movable barriers (see Section 6F.85) in highway work zones. In this example, one side of a 6-lane divided highway is closed to perform the work operation, and vehicular traffic is carried in both directions on the remaining 3-lane roadway by means of a median crossover.

To accommodate unbalanced peak-period vehicular traffic volumes, the direction of travel in the center lane is switched to the direction having the greater volume, with the transfer typically being made twice daily.

Thus, there are four vehicular traffic phases described as follows:

- a. Phase A—two travel lanes northbound and one lane southbound;
- b. Transition A to B—one travel lane in each direction;
- c. Phase B—one travel lane northbound and two lanes southbound; and
- d. Transition B to A—one travel lane in each direction.

The typical application on the left illustrates the placement of devices during Phase A. The typical application on the right shows conditions during the transition (Transition A to B) from Phase A to Phase B.

### Guidance:

2. *For the reversible-lane situation depicted, the ends of the movable barrier should terminate in a protected area or a crash cushion should be provided. During Phase A, the transfer vehicle should be parked behind the downstream end of the movable barrier for southbound traffic as shown in the typical application on the left. During Phase B, the transfer vehicle should be parked behind between the downstream ends of the movable barriers at the north end of the TTC zone as shown in the typical application on the right.*

*The transition shift from Phase A to B should be as follows:*

- a. *Change the signs in the northbound advance warning area and transition area from a LEFT LANE CLOSED AHEAD to a 2 LEFT LANES CLOSED AHEAD. Change the mode of the second northbound arrow board from Caution to Right Arrow.*
  - b. *Place channelizing devices to close the northbound center lane.*
  - c. *Move the transfer vehicle from south to north to shift the movable barrier from the west side to the east side of the reversible lane.*
  - d. *Remove the channelizing devices closing the southbound center lane.*
  - e. *Change the signs in the southbound transition area and advance warning area from a 2 LEFT LANES CLOSED AHEAD to a LEFT LANE CLOSED AHEAD. Change the mode of the second southbound arrow board from Right Arrow to Caution.*
3. *Where the lane to be opened and closed is an exterior lane (adjacent to the edge of the traveled way or the work space), the lane closure should begin by closing the lane with channelizing devices placed along a merging taper using the same information employed for a stationary lane closure. The lane closure should then be extended with the movable-barrier transfer vehicle moving with vehicular traffic. When opening the lane, the transfer vehicle should travel against vehicular traffic. The merging taper should be removed in a method similar to a stationary lane closure.*

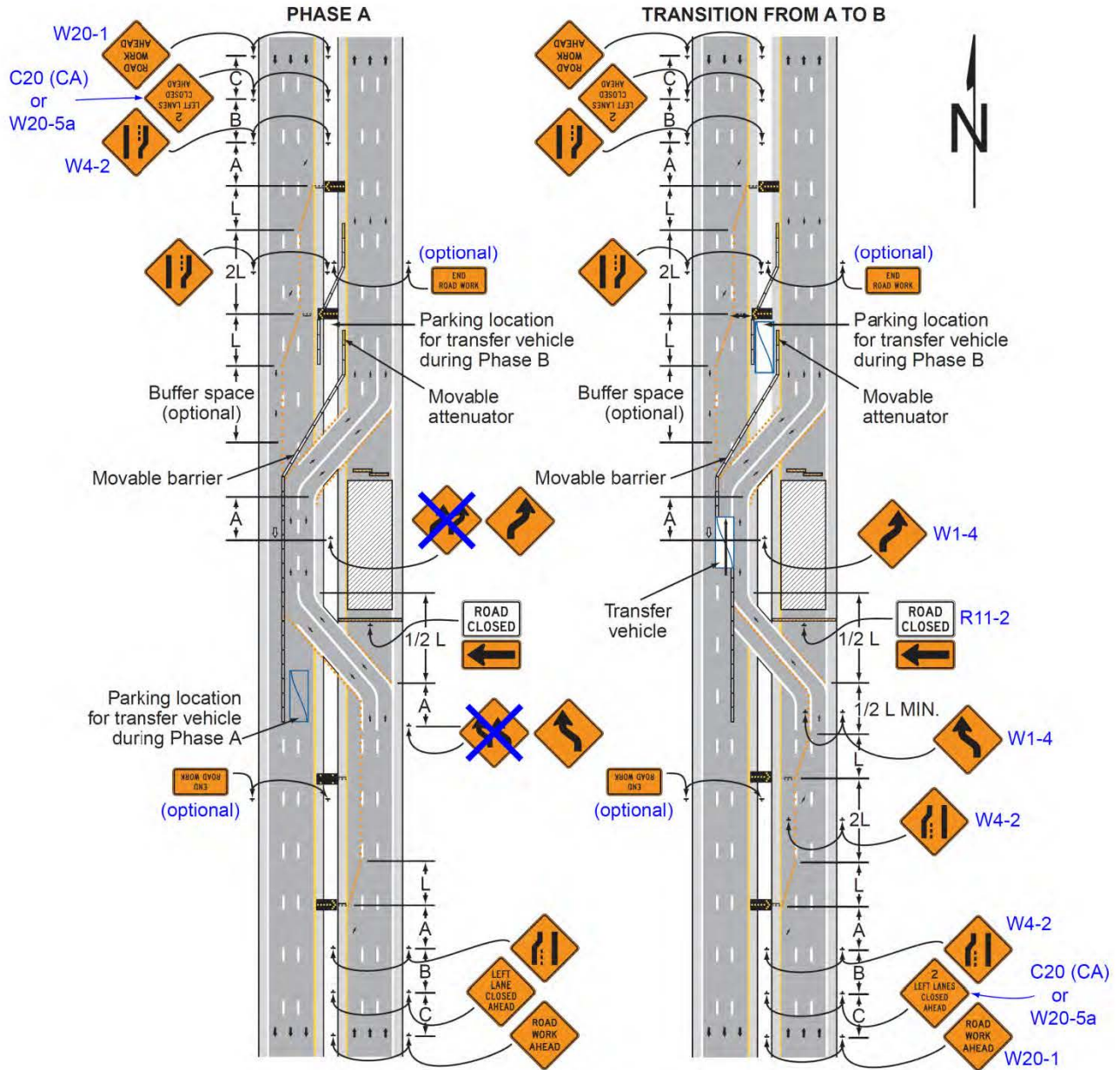
### Option:

4. The procedure may be used during a peak period of vehicular traffic and then changed to provide two lanes in the other direction for the other peak.
5. A longitudinal buffer space may be used in the activity area to separate opposing vehicular traffic.
6. A work vehicle or a shadow vehicle may be equipped with a truck-mounted attenuator.

### Standard:

7. **An arrow board shall be used when a freeway lane is closed. When more than one freeway lane is closed, a separate arrow board shall be used for each closed lane.**

**Figure 6H-45. Temporary Reversible Lane Using Movable Barriers (TA-45)**



**Typical Application 45**

Note: See Tables 6H-2 and 6H-3 for the meaning of the symbols and/or letter codes used in this figure. Although leader lines point to the signs on the right-hand side of the roadway, most of these signs should be installed on both sides of the roadway.

### Notes for Figure 6H-46—Typical Application 46 Work in the Vicinity of a Grade Crossing

*Guidance:*

1. *When grade crossings exist either within or in the vicinity of roadway work activities, extra care should be taken to minimize the probability of conditions being created, by lane restrictions, flagging, or other operations, where vehicles might be stopped within the grade crossing, considered as being 15 feet on either side of the closest and farthest rail. This should include roadway work activities on a street parallel to a highway-rail grade crossing where right-hand turns or left-hand turns could be impacted.*

**Standard:**

2. **If the queuing of vehicles across active rail tracks cannot be avoided, a uniformed law enforcement officer or flagger shall be provided at the grade crossing to prevent through or turning vehicles from stopping within the grade crossing (as described in Note 1), even if automatic warning devices are in place.**

*Guidance:*

3. *Early coordination with the railroad company or light rail transit agency should occur before work starts.*
4. *In the example depicted, the buffer space of the activity area should be extended upstream of the grade crossing (as shown) so that a queue created by the flagging operation will not extend across the grade crossing.*
5. *The DO NOT STOP ON TRACKS sign should be used on all approaches to a grade crossing within the limits of a TTC zone.*

*Option:*

6. *Flashing warning lights and/or flags may be used to call attention to the advance warning signs.*
7. *A BE PREPARED TO STOP sign may be added to the sign series.*

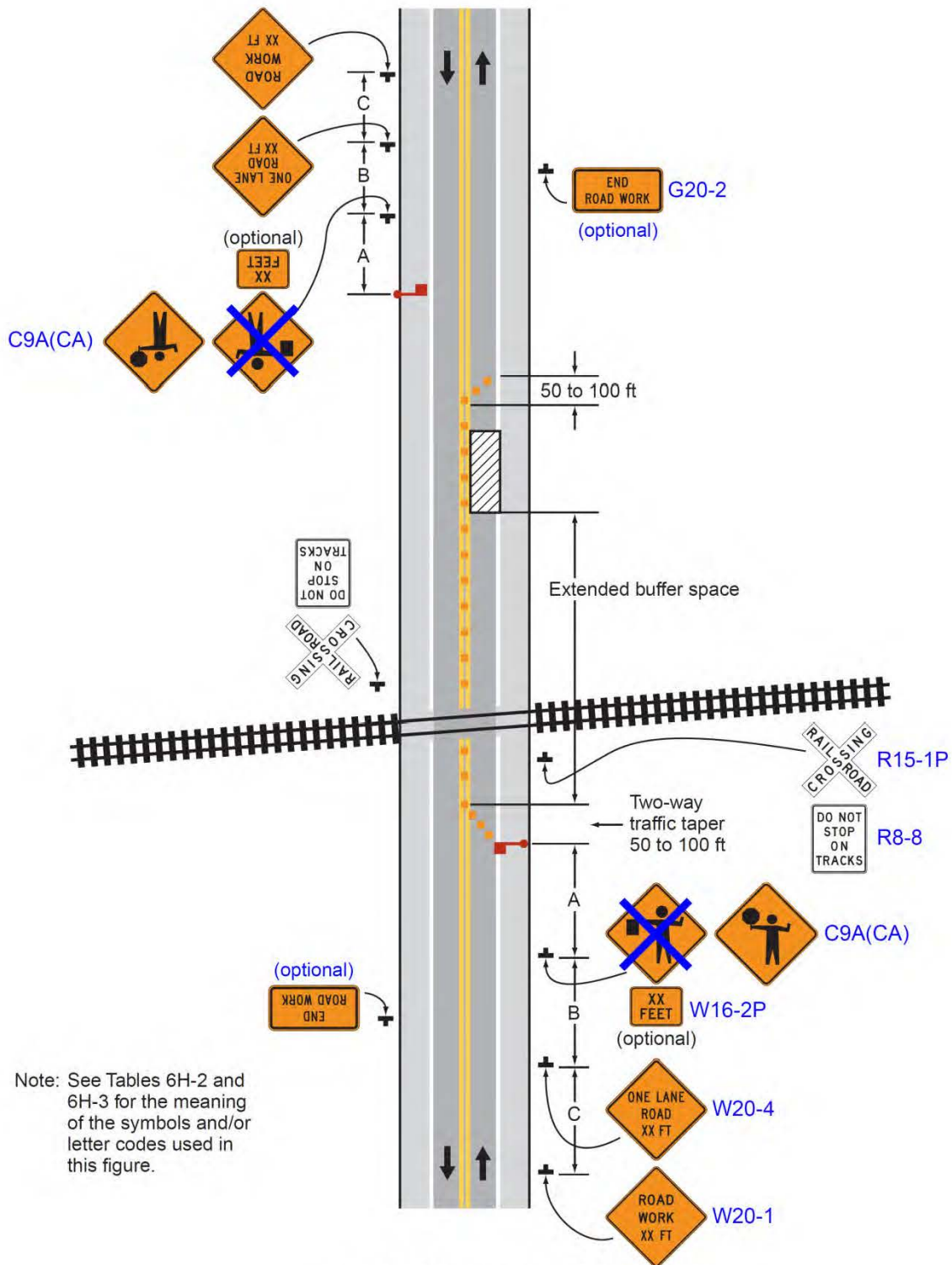
*Guidance:*

8. *When used, the BE PREPARED TO STOP sign should be located ~~before~~ after the Flagger symbol sign.*

**Standard:**

9. **At night, flagger stations shall be illuminated, except in emergencies.**

**Figure 6H-46. Work in the Vicinity of a Grade Crossing (TA-46)**



Note: See Tables 6H-2 and 6H-3 for the meaning of the symbols and/or letter codes used in this figure.

**Typical Application 46**

## **Notes for Figure 6H-101CA) – Typical Application 101(CA) Shoulder Closure on Urban (Low Speed) Locations to Accommodate Bicyclists**

**Guidance:**

1. *When existing accommodations for bicycle travel are disrupted or closed, information and devices contained in Figures 6H-101(CA) through 6H-104(CA), as appropriate per situation encountered, should be used to consider the needs and control of bicyclists through a TTC zone.*
2. *SHOULDER CLOSED signs should be used on limited-access roadways where there is no opportunity for disabled vehicles to pull off the roadway.*
3. *If road users cannot see a pull-off area beyond the closed shoulder, information regarding the length of the shoulder closure should be provided in feet or miles, as appropriate.*
4. *The use of a temporary traffic barrier should be based on engineering judgment.*

**Standard:**

5. **Temporary traffic barriers, including their end treatments, shall be crashworthy. In order to mitigate the effect of striking the upstream end of a temporary traffic barrier, the end shall be installed in accordance with AASHTO's "Roadside Design Guide" (see Section 1A.11) by flaring until the end is outside the acceptable clear zone or by providing crashworthy end treatments. See Section 6F.85 for more details.**

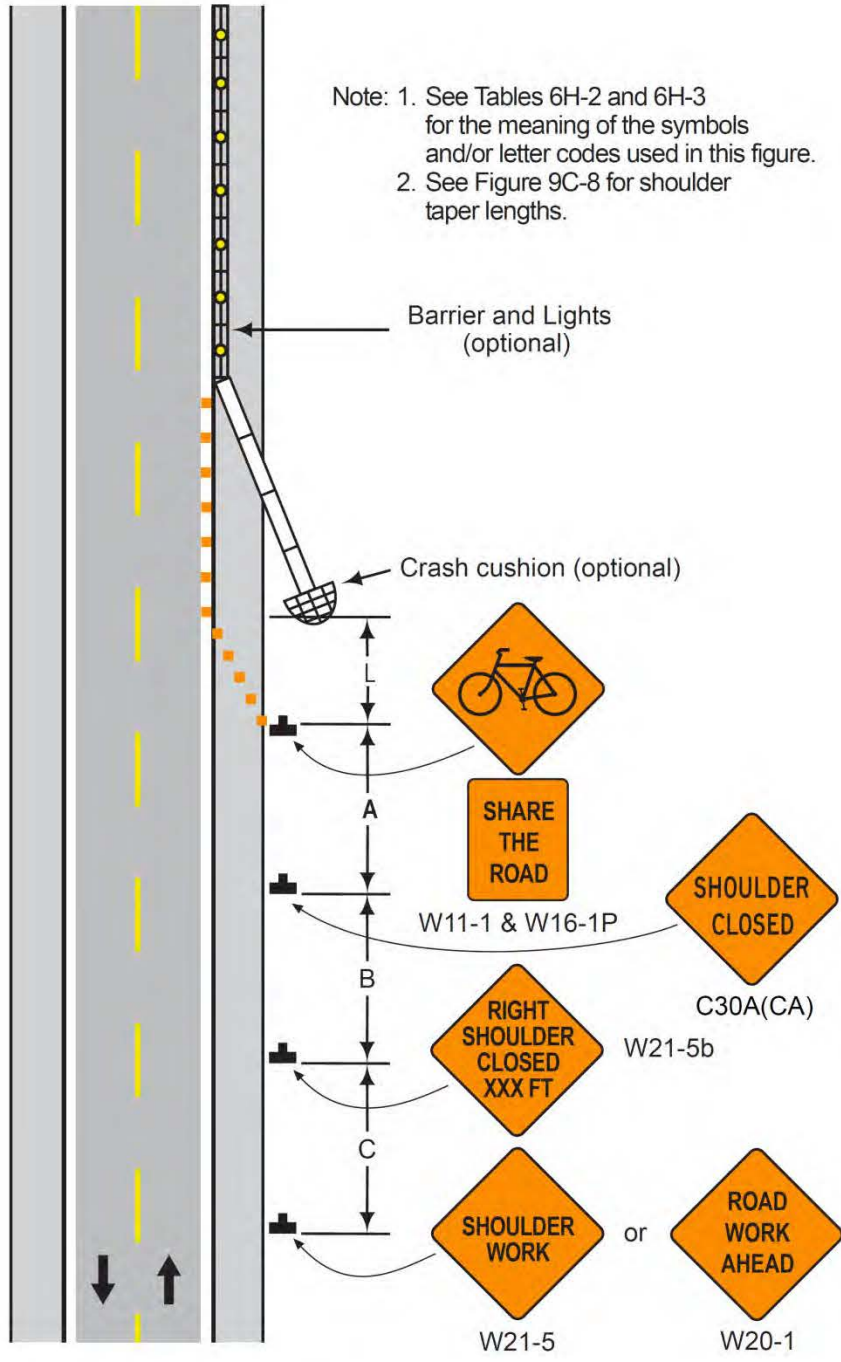
**Option:**

6. *The barrier shown in this typical application is an example of one method that may be used to close a shoulder of a long-term project.*
7. *The warning lights shown on the barrier may be used.*

**Guidance:**

9. *This typical application should only be used in urban areas where posted speed is 25 mph or less. For applications on roadway with a posted speed of 30 mph or more use typical application TA-102(CA).*
10. *All advance warning signs should be placed so that the path of travel for bicycles is not blocked, while maintaining visibility for road users.*
11. *Where feasible, an adequate lane width should be provided to allow bicyclists and motor vehicles to travel side by side throughout the TTC zone. If lane width conditions are not met, use the SHARE THE ROAD or Bicycles May Use Full Lane sign.*
12. *The speeds used for the shoulder taper calculations should be of bicyclists in the project vicinity or if a special event such as a bike race, the expected speed of bicyclists approaching the TTC zone.*

**Figure 6H-101 (CA). Shoulder Closure on Urban (Low Speed) locations to accommodate bicyclists (TA-101 (CA))**



**Typical Application 101 (CA)**



**Notes for Figure 6H-102(CA) – Typical Application 102(CA)  
Lane Closure on Freeway, Expressway, Rural and Urban (High Speed)  
Locations to Accommodate Bicyclists**

*Guidance:*

- 1. When existing accommodations for bicycle travel are disrupted or closed, information and devices contained in Figures 6H-101(CA) through 6H-104(CA), as appropriate per situation encountered, should be used to consider the needs and control of bicyclists through a TTC zone.*
- 2. SHOULDER CLOSED signs should be used on limited-access highways where there is no opportunity for disabled vehicles to pull off the roadway.*
- 3. If road users cannot see a pull-off area beyond the closed shoulder, information regarding the length of the shoulder closure should be provided in feet or miles, as appropriate.*
- 4. The use of a temporary traffic barrier should be based on engineering judgment.*

**Standard:**

- 5. Temporary traffic barriers, including their end treatments, shall be crashworthy. In order to mitigate the effect of striking the upstream end of a temporary traffic barrier, the end shall be installed in accordance with AASHTO's "Roadside Design Guide" (see Section 1A.11) by flaring until the end is outside the acceptable clear zone or by providing crashworthy end treatments. See Section 6F.85 for more details.**

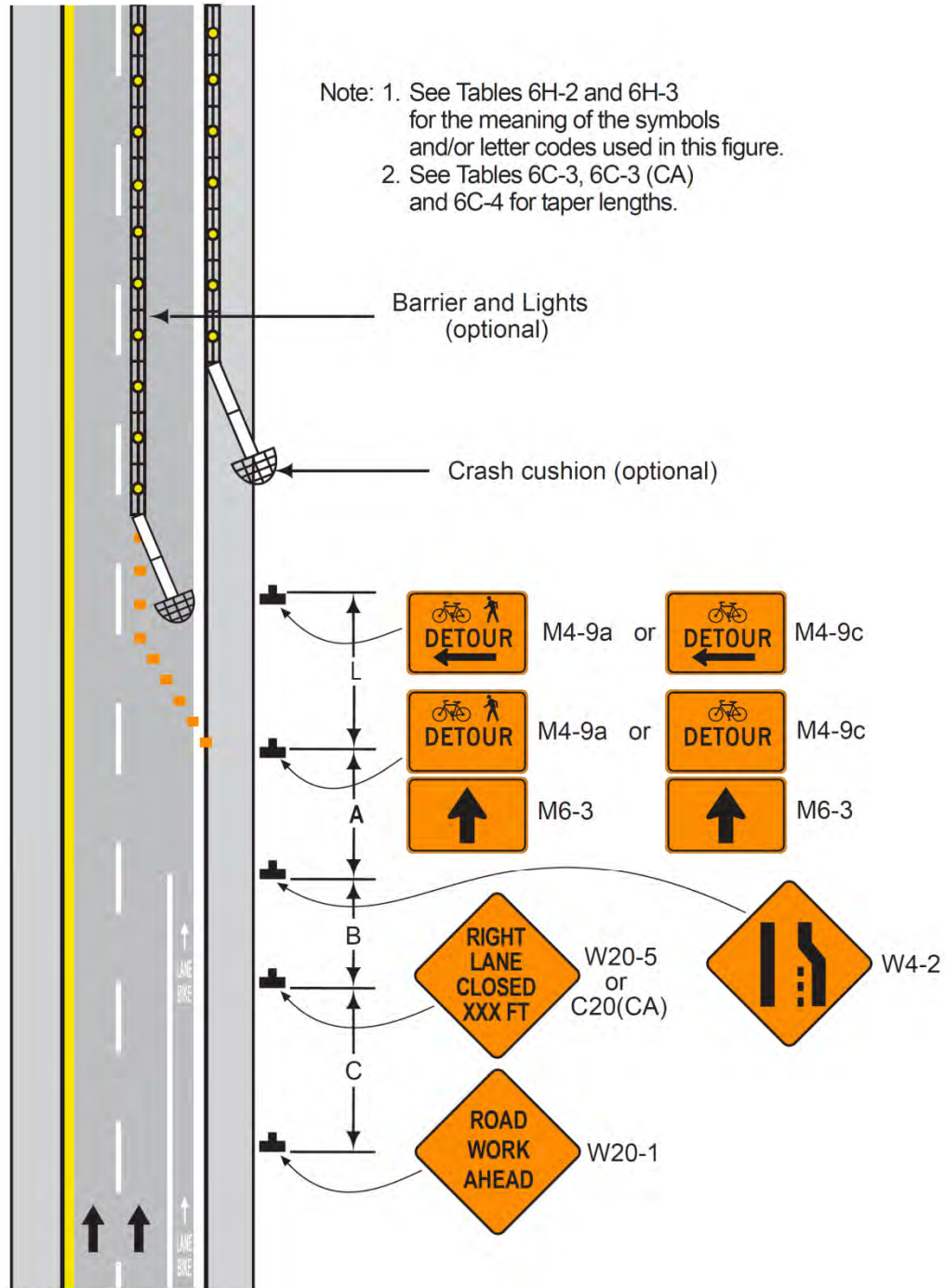
*Option:*

- 6. The barrier shown in this typical application is an example of one method that may be used to close a shoulder of a long-term project.*
- 7. The warning lights shown on the barrier may be used.*

*Guidance:*

- 9. All advance warning signs should be placed so that the path of travel for bicycles is not blocked, while maintaining visibility for road users.*
- 10. The width of the existing pedestrian facility should be provided for the temporary facility, if practical. When it is not possible to maintain a minimum width of 60 inch throughout the entire length of the pedestrian pathway, a 60 x 60 inch passing space should be provided at least every 200 feet to allow individuals in wheelchairs to pass.*

**Figure 6H-102 (CA). Lane Closure on Freeway, Expressway, Rural and Urban (High Speed) locations to accommodate bicyclists (TA-102 (CA))**



Typical Application 102 (CA)

## **Notes for Figure 6H-103(CA)—Typical Application 103(CA) Detour for Bike Lane on Roads with Closure of One Travel Direction**

**Guidance:**

1. *When existing accommodations for bicycle travel are disrupted or closed, information and devices contained in Figures 6H-101(CA) through 6H-104(CA), as appropriate per situation encountered, should be used to consider the needs and control of bicyclists through a TTC zone.*
2. *This plan should be used for streets without posted route numbers.*
3. *On multi-lane streets, Detour signs with an Advance Turn Arrow should be used in advance of a turn.*

**Option:**

4. The STREET CLOSED legend may be used in place of ROAD CLOSED.
5. Additional DO NOT ENTER signs may be used at intersections with intervening streets.
6. Warning lights may be used on Type III Barricades.
7. Detour signs may be located on the far side of intersections.
8. A Street Name sign may be mounted with the Detour sign. The Street Name sign may be either white on green or black on orange.

**Standard:**

- 9. When used, the Street Name sign shall be placed above the Detour sign.**

**Guidance:**

10. *The DETOUR (M4-8) sign should be placed on tangent sections at intervals not to exceed 1300 feet and at major intersections.*

**Option:**

11. In urban areas, the M4-8 signs may be placed at every intersection.

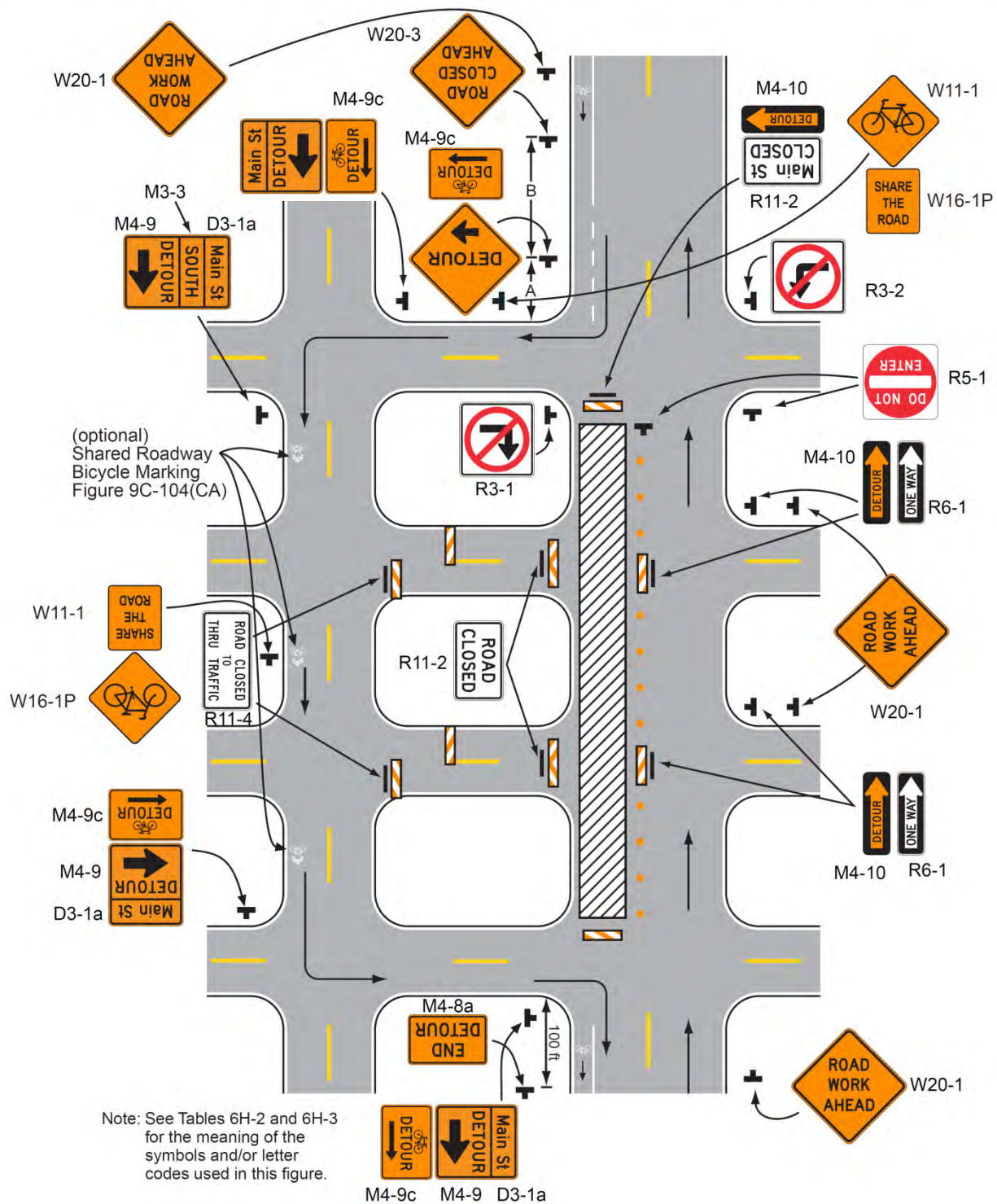
**Guidance:**

12. *When the detour is applicable to bicyclists and not pedestrians, the Bicycle Detour (M4-9c) sign should be used instead of the Pedestrian/Bicycle Detour (M4-9a) sign.*
13. *All advance warning signs should be placed so that the path of travel for bicycles is not blocked, while maintaining visibility for road users.*

**Option:**

14. For long-term duration projects (see Section 6G.02), the shared roadway bicycle marking may be used along detours with on-street parking and inadequate lane width.

**Figure 6H-103 (CA). Detour for Bike Lane on Roads with Closure of One Travel Direction (TA-103 (CA))**



**Typical Application 103 (CA)**

### **Notes for Figure 6H-104(CA)—Typical Application 104(CA) Right Lane and Bike Lane Closure on Far Side of Intersection**

**Guidance:**

1. *When existing accommodations for bicycle travel are disrupted or closed, information and devices contained in Figures 6H-101(CA) through 6H-104(CA), as appropriate per situation encountered, should be used to consider the needs and control of bicyclists through a TTC zone.*
2. *If the work space extends across a crosswalk, the crosswalk should be closed using the information and devices shown in Figure 6H-29.*

**Option:**

3. The normal procedure is to close on the near side of the intersection any lane that is not carried through the intersection. However, when this results in the closure of a right lane having significant right turning movements, then the right lane may be restricted to right turns only, as shown. This procedure increases the through capacity by eliminating right turns from the open through lane.
4. For intersection approaches reduced to a single lane, left-turning movements may be prohibited to maintain capacity for through vehicular traffic.
5. Flashing warning lights and/or flags may be used to call attention to the advance warning signs.
6. Where the turning radius is large, it may be possible to create a right-turn island using channelizing devices or pavement markings.

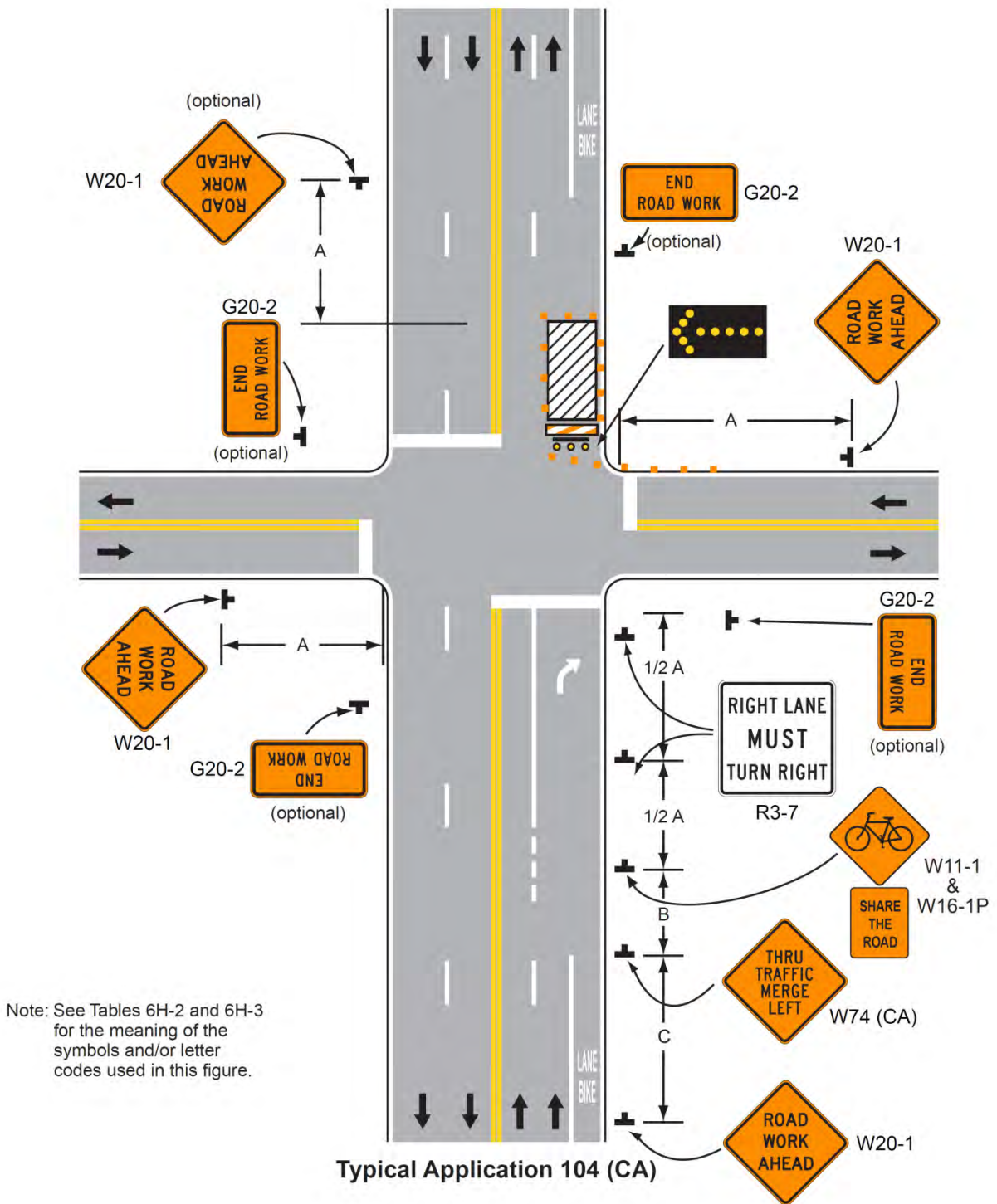
**Guidance:**

7. *All advance warning signs should be placed so that the path of travel for bicycles is not blocked, while maintaining visibility for road users.*
8. *For long-term duration projects (see Section 6G.02), consideration should be given to installing signs in an overhead location.*

**Option:**

9. A high-level warning device (flag tree) may supplement the advance warning signs. Refer to Section 6F.62.

**Figure 6H-104 (CA). Right Lane and Bike Lane Closure on Far Side of Intersection (TA-104 (CA))**



**Notes for Figure 6H-105(CA)—Typical Application 105(CA)**  
**Lane Shift on Road with Low Traffic Volumes**  
**(Refer to Part 5, Section 5A.01)**

*Guidance:*

1. *The lanes on either side of the center work space should have a minimum width of 10 feet as measured from the near edge of the channelizing devices to the edge of pavement or the outside edge of paved shoulder.*
2. *All advance warning signs should be placed so that the path of travel for bicycles is not blocked while maintaining visibility for road users.*

**Standard:**

3. **Workers in the roadway shall wear high-visibility safety apparel as described in Section 6D.03.**

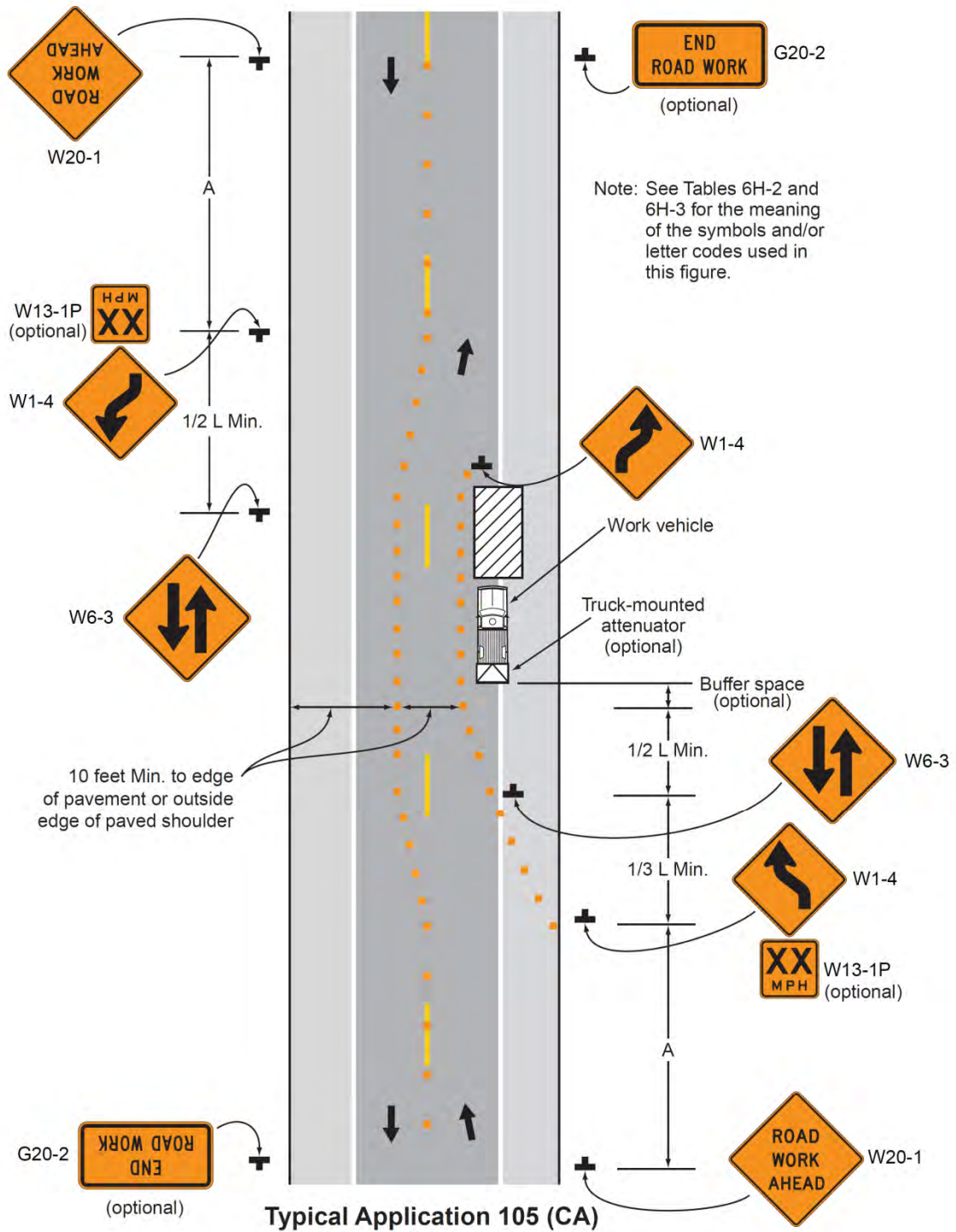
**Option:**

4. Flashing warning lights and/or flags may be used to call attention to the advance warning signs.
5. If the closure continues overnight, warning lights may be used on the channelizing devices.
6. A lane width of 9 feet may be used for short-term stationary work on low-volume, low-speed roadways when motor vehicle traffic does not include longer and wider heavy commercial vehicles.
7. A work vehicle displaying high-intensity rotating, flashing, oscillating, or strobe lights may be used instead of the channelizing devices forming the tapers or the high-level warning devices.
8. Vehicle hazard warning signals may be used to supplement high-intensity rotating, flashing, oscillating, or strobe lights.

**Standard:**

9. **Vehicle hazard warning signals shall not be used instead of the vehicle's high-intensity rotating, flashing, oscillating, or strobe lights.**

**Figure 6H-105 (CA). Lane Shift on Road With Low Traffic Volumes (TA-105 (CA))**





## CHAPTER 6I. CONTROL OF TRAFFIC THROUGH TRAFFIC INCIDENT MANAGEMENT AREAS

### Section 6I.01 General

#### Support:

01 The National Incident Management System (NIMS) requires the use of the Incident Command System (ICS) at traffic incident management scenes.

02 A traffic incident is an emergency road user occurrence, a natural disaster, or other unplanned event that affects or impedes the normal flow of traffic.

03 A traffic incident management area is an area of a highway where temporary traffic controls are installed, as authorized by a public authority or the official having jurisdiction of the roadway, in response to a road user incident, natural disaster, hazardous material spill, or other unplanned incident. It is a type of TTC zone and extends from the first warning device (such as a sign, light, or cone) to the last TTC device or to a point where vehicles return to the original lane alignment and are clear of the incident.

04 Traffic incidents can be divided into three general classes of duration, each of which has unique traffic control characteristics and needs. These classes are:

- A. Major—expected duration of more than 2 hours,
- B. Intermediate—expected duration of 30 minutes to 2 hours, and
- C. Minor—expected duration under 30 minutes.

05 The primary functions of TTC at a traffic incident management area are to inform road users of the incident and to provide guidance information on the path to follow through the incident area. Alerting road users and establishing a well defined path to guide road users through the incident area will serve to protect the incident responders and those involved in working at the incident scene and will aid in moving road users expeditiously past or around the traffic incident, will reduce the likelihood of secondary traffic crashes, and will preclude unnecessary use of the surrounding local road system. Examples include a stalled vehicle blocking a lane, a traffic crash blocking the traveled way, a hazardous material spill along a highway, and natural disasters such as floods and severe storm damage.

#### Guidance:

06 *In order to reduce response time for traffic incidents, highway agencies, appropriate public safety agencies (law enforcement, fire and rescue, emergency communications, emergency medical, and other emergency management), and private sector responders (towing and recovery and hazardous materials contractors) should mutually plan for occurrences of traffic incidents along the major and heavily traveled highway and street system.*

07 *On-scene responder organizations should train their personnel in TTC practices for accomplishing their tasks in and near traffic and in the requirements for traffic incident management contained in this Manual. On-scene responders should take measures to move the incident off the traveled roadway or to provide for appropriate warning. All on-scene responders and news media personnel should constantly be aware of their visibility to oncoming traffic and wear high-visibility apparel. See Section 6D.03 for details on high-visibility apparel requirements.*

08 *Emergency vehicles should be safe-positioned (see definition in Section 1A.13) such that traffic flow through the incident scene is optimized. All emergency vehicles that subsequently arrive should be positioned in a manner that does not interfere with the established temporary traffic flow.*

09 *Responders arriving at a traffic incident should estimate the magnitude of the traffic incident, the expected time duration of the traffic incident, and the expected vehicle queue length, and then should set up the appropriate temporary traffic controls for these estimates.*

#### Option:

10 Warning and guide signs used for TTC traffic incident management situations may have a black legend and border on a fluorescent pink background (see Figure 6I-1).

Support:

<sup>10a</sup> Signs used for regular TTC (black legend and border on orange or fluorescent orange background) are also acceptable. Truck or trailer mounted Portable Changeable Message (PCMS) signs are effective tools for traffic incident management.

<sup>11</sup> While some traffic incidents might be anticipated and planned for, emergencies and disasters might pose more severe and unpredictable problems. The ability to quickly install proper temporary traffic controls might greatly reduce the effects of an incident, such as secondary crashes or excessive traffic delays. An essential part of fire, rescue, spill clean-up, highway agency, and enforcement activities is the proper control of road users through the traffic incident management area in order to protect responders, victims, and other personnel at the site. These operations might need corroborating legislative authority for the implementation and enforcement of appropriate road user regulations, parking controls, and speed zoning. It is desirable for these statutes to provide sufficient flexibility in the authority for, and implementation of, TTC to respond to the needs of changing conditions found in traffic incident management areas.

Option:

<sup>12</sup> For traffic incidents, particularly those of an emergency nature, TTC devices on hand may be used for the initial response as long as they do not themselves create unnecessary additional hazards.

## **Section 6I.02 Major Traffic Incidents**

Support:

<sup>01</sup> Major traffic incidents are typically traffic incidents involving hazardous materials, fatal traffic crashes involving numerous vehicles, and other natural or man-made disasters. These traffic incidents typically involve closing all or part of a roadway facility for a period exceeding 2 hours.

Guidance:

<sup>02</sup> *If the traffic incident is anticipated to last more than 24 hours, applicable procedures and devices set forth in other Chapters of Part 6 should be used.*

Support:

<sup>03</sup> A road closure can be caused by a traffic incident such as a road user crash that blocks the traveled way. Road users are usually diverted through lane shifts or detoured around the traffic incident and back to the original roadway. A combination of traffic engineering and enforcement preparations is needed to determine the detour route, and to install, maintain or operate, and then to remove the necessary traffic control devices when the detour is terminated. Large trucks are a significant concern in such a detour, especially when detouring them from a controlled-access roadway onto local or arterial streets.

<sup>04</sup> During traffic incidents, large trucks might need to follow a route separate from that of automobiles because of bridge, weight, clearance, or geometric restrictions. Also, vehicles carrying hazardous material might need to follow a different route from other vehicles.

<sup>05</sup> Some traffic incidents such as hazardous material spills might require closure of an entire highway. Through road users must have adequate guidance around the traffic incident. Maintaining good public relations is desirable. The cooperation of the news media in publicizing the existence of, and reasons for, traffic incident management areas and their TTC can be of great assistance in keeping road users and the general public well informed.

<sup>06</sup> The establishment, maintenance, and prompt removal of lane diversions can be effectively managed by interagency planning that includes representatives of highway and public safety agencies.

Guidance:

<sup>07</sup> *All traffic control devices needed to set up the TTC at a traffic incident should be available so that they can be readily deployed for all major traffic incidents. The TTC should include the proper traffic diversions, tapered lane closures, and upstream warning devices to alert traffic approaching the queue and to encourage early diversion to an appropriate alternative route.*

<sup>08</sup> *Attention should be paid to the upstream end of the traffic queue such that warning is given to road users approaching the back of the queue.*

<sup>09</sup> *If manual traffic control is needed, it should be provided by qualified flaggers or uniformed law enforcement officers.*

**Option:**

<sup>10</sup> If flaggers are used to provide traffic control for an incident management situation, the flaggers may use appropriate traffic control devices that are readily available or that can be brought to the traffic incident scene on short notice.

**Guidance:**

<sup>11</sup> *When light sticks or flares are used to establish the initial traffic control at incident scenes, channelizing devices (see Section 6F.63) should be installed as soon thereafter as practical.*

**Option:**

<sup>12</sup> The light sticks or flares may remain in place if they are being used to supplement the channelizing devices.

**Guidance:**

<sup>13</sup> *The light sticks, flares, and channelizing devices should be removed after the incident is terminated.*

### **Section 6I.03 Intermediate Traffic Incidents**

**Support:**

<sup>01</sup> Intermediate traffic incidents typically affect travel lanes for a time period of 30 minutes to 2 hours, and usually require traffic control on the scene to divert road users past the blockage. Full roadway closures might be needed for short periods during traffic incident clearance to allow traffic incident responders to accomplish their tasks.

<sup>02</sup> The establishment, maintenance, and prompt removal of lane diversions can be effectively managed by interagency planning that includes representatives of highway and public safety agencies.

**Guidance:**

<sup>03</sup> *All traffic control devices needed to set up the TTC at a traffic incident should be available so that they can be readily deployed for intermediate traffic incidents. The TTC should include the proper traffic diversions, tapered lane closures, and upstream warning devices to alert traffic approaching the queue and to encourage early diversion to an appropriate alternative route.*

<sup>04</sup> *Attention should be paid to the upstream end of the traffic queue such that warning is given to road users approaching the back of the queue.*

<sup>05</sup> *If manual traffic control is needed, it should be provided by qualified flaggers or uniformed law enforcement officers.*

**Option:**

<sup>06</sup> If flaggers are used to provide traffic control for an incident management situation, the flaggers may use appropriate traffic control devices that are readily available or that can be brought to the traffic incident scene on short notice.

**Guidance:**

<sup>07</sup> *When light sticks or flares are used to establish the initial traffic control at incident scenes, channelizing devices (see Section 6F.63) should be installed as soon thereafter as practical.*

**Option:**

<sup>08</sup> The light sticks or flares may remain in place if they are being used to supplement the channelizing devices.

**Guidance:**

<sup>09</sup> *The light sticks, flares, and channelizing devices should be removed after the incident is terminated.*

### **Section 6I.04 Minor Traffic Incidents**

**Support:**

<sup>01</sup> Minor traffic incidents are typically disabled vehicles and minor crashes that result in lane closures of less than 30 minutes. On-scene responders are typically law enforcement and towing companies, and occasionally highway agency service patrol vehicles.

<sup>02</sup> Diversion of traffic into other lanes is often not needed or is needed only briefly. It is not generally possible or practical to set up a lane closure with traffic control devices for a minor traffic incident. Traffic control is the responsibility of on-scene responders.

**Guidance:**

<sup>03</sup> *When a minor traffic incident blocks a travel lane, it should be removed from that lane to the shoulder as quickly as possible.*

## **Section 6I.05 Use of Emergency-Vehicle Lighting**

### **Support:**

01 The use of emergency-vehicle lighting (such as high-intensity rotating, flashing, oscillating, or strobe lights) is essential, especially in the initial stages of a traffic incident, for the safety of emergency responders and persons involved in the traffic incident, as well as road users approaching the traffic incident. Emergency-vehicle lighting, however, provides warning only and provides no effective traffic control. The use of too many lights at an incident scene can be distracting and can create confusion for approaching road users, especially at night. Road users approaching the traffic incident from the opposite direction on a divided facility are often distracted by emergency-vehicle lighting and slow their vehicles to look at the traffic incident posing a hazard to themselves and others traveling in their direction.

02 The use of emergency-vehicle lighting can be reduced if good traffic control has been established at a traffic incident scene. This is especially true for major traffic incidents that might involve a number of emergency vehicles. If good traffic control is established through placement of advanced warning signs and traffic control devices to divert or detour traffic, then public safety agencies can perform their tasks on scene with minimal emergency-vehicle lighting.

### **Guidance:**

03 *Public safety agencies should examine their policies on the use of emergency-vehicle lighting, especially after a traffic incident scene is secured, with the intent of reducing the use of this lighting as much as possible while not endangering those at the scene. Special consideration should be given to reducing or extinguishing forward facing emergency-vehicle lighting, especially on divided roadways, to reduce distractions to oncoming road users.*

04 *Because the glare from floodlights or vehicle headlights can impair the nighttime vision of approaching road users, any floodlights or vehicle headlights that are not needed for illumination, or to provide notice to other road users of an incident response vehicle being in an unexpected location, should be turned off at night.*

## **Section 6I.101(CA) FLOODING AHEAD TURN AROUND DON'T DROWN W86(CA) Sign**

### **Support:**

01 The Federal Highway Administration has encouraged use of the phrase FLOODING AHEAD TURN AROUND DON'T DROWN as an official incident management sign.

### **Option:**

02 The FLOODING AHEAD TURN AROUND DON'T DROWN (W86(CA)) sign (see Figure 6I-1(CA)) may be deployed to warn during times when low-water crossings, bridges, or culverts cannot pass high flood flows.

### **Standard:**

03 **When used, W86(CA) sign shall be mounted on temporary sign holders, not on barricades.**

### **Guidance:**

04 *The W86(CA) sign should be deployed at locations where stream waters flooding across a road have made passage unsafe.*

## **Section 6I.102(CA) EMERGENCY SCENE AHEAD W90(CA) Sign**

### **Support:**

01 The Federal Highway Administration has encouraged use of the phrase EMERGENCY SCENE AHEAD as an official incident management sign.

### **Option:**

02 The EMERGENCY SCENE AHEAD (W90(CA)) sign (see Figure 6I-1(CA)) may be deployed to warn of an incident management scene ahead.

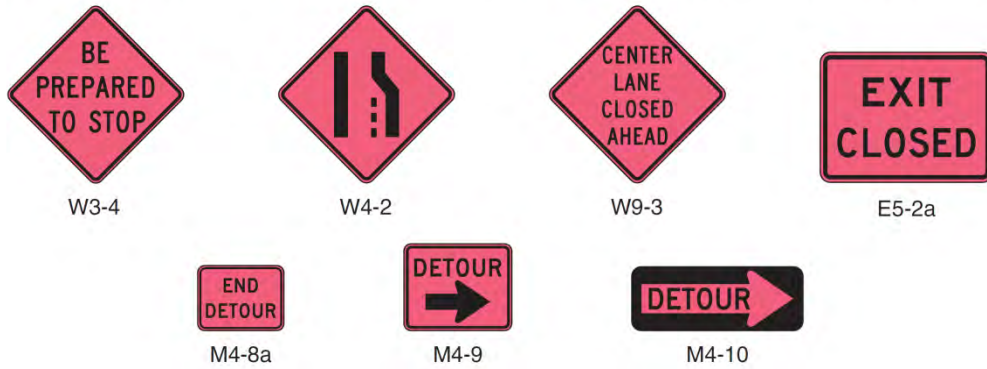
### **Standard:**

03 **If used, W90(CA) sign shall be mounted on temporary sign holders, not on barricades.**

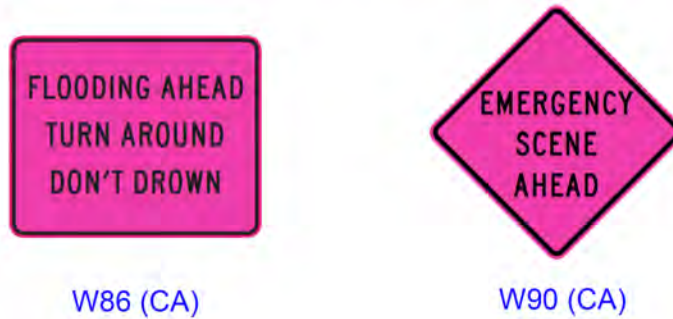
### **Guidance:**

04 *The W90(CA) sign should be deployed at locations upstream of the traffic queue that has formed due to incident management.*

**Figure 6I-1. Examples of Traffic Incident Management Area Signs**



**Figure 6I-1 (CA). Examples of Traffic Incident Management Area Signs**





# PART 7

## TRAFFIC CONTROL FOR SCHOOL AREAS

### CHAPTER 7A. GENERAL

#### **Section 7A.01 Need for Standards**

**Support:**

<sup>01</sup> Regardless of the school location, the best way to achieve effective traffic control is through the uniform application of realistic policies, practices, and standards developed through engineering judgment or studies.

<sup>02</sup> Pedestrian safety depends upon public understanding of accepted methods for efficient traffic control. This principle is especially important in the control of pedestrians, bicycles, and other vehicles in the vicinity of schools. Neither pedestrians on their way to or from school nor other road users can be expected to move safely in school areas unless they understand both the need for traffic controls and how these controls function for their benefit.

<sup>03</sup> Procedures and devices that are not uniform might cause confusion among pedestrians and other road users, prompt wrong decisions, and contribute to crashes. To achieve uniformity of traffic control in school areas, comparable traffic situations need to be treated in a consistent manner. Each traffic control device and control method described in Part 7 fulfills a specific function related to specific traffic conditions.

<sup>04</sup> A uniform approach to school area traffic controls assures the use of similar controls for similar situations, which promotes appropriate and uniform behavior on the part of motorists, pedestrians, and bicyclists.

<sup>05</sup> A school traffic control plan permits the orderly review of school area traffic control needs, and the coordination of school/pedestrian safety education and engineering measures. Engineering measures alone do not always result in the intended change in student and road user behavior.

**Guidance:**

<sup>06</sup> *A school route plan for each school serving elementary to high school students should be prepared in order to develop uniformity in the use of school area traffic controls and to serve as the basis for a school traffic control plan for each school.*

<sup>07</sup> *The school route plan, developed in a systematic manner by the school, law enforcement, and traffic officials responsible for school pedestrian safety, should consist of a map (see Figure 7A-1) showing streets, the school, existing traffic controls, established school walk routes, and established school crossings.*

<sup>08</sup> *The type(s) of school area traffic control devices used, either warning or regulatory, should be related to the volume and speed of vehicular traffic, street width, and the number and age of the students using the crossing.*

<sup>09</sup> *School area traffic control devices should be included in a school traffic control plan.*

**Support:**

<sup>10</sup> Reduced speed limit signs for school areas and crossings are included in this Manual solely for the purpose of standardizing signing for these zones and not as an endorsement of mandatory reduced speed zones.

<sup>11</sup> "School" and "school zone" are defined in Section 1A.13.

<sup>12</sup> Parents, school administrators, traffic officials, civic leaders, and vehicle drivers share the responsibility of educating school pedestrians on the use of traffic control devices. Programs in the home and school to train the child as a responsible pedestrian are an important factor in improving their understanding of traffic control devices.

<sup>13</sup> The words "School Pedestrians", "Children", and "Students" are used interchangeably and could include student bicyclists for the purpose of determining appropriate cross protection measures.

#### **Section 7A.02 School Routes and Established School Crossings**

**Support:**

<sup>01</sup> To establish a safer route to and from school for schoolchildren, the application of planning criterion for school walk routes might make it necessary for children to walk an indirect route to an established school

crossing located where there is existing traffic control and to avoid the use of a direct crossing where there is no existing traffic control.

*Guidance:*

*02 School walk routes should be planned to take advantage of existing traffic controls.*

*03 The following factors should be considered when determining the feasibility of requiring children to walk a longer distance to a crossing with existing traffic control:*

- A. The availability of adequate sidewalks or other pedestrian walkways to and from the location with existing control,*
- B. The number of students using the crossing,*
- C. The age levels of the students using the crossing, and*
- D. The total extra walking distance.*

*Support:*

*04 There is a need in each school district to establish an organization concerned with students enroute to and from school. Through such an organization, the school district can be responsibly involved in processing requests for traffic safety controls and for safety programs and can coordinate activities within and between the community and public agencies.*

*In order to provide a responsible administrative structure for the school area, each school district is encouraged to:*

- A. Assign student pedestrian responsibilities to a competent staff member and/or*
- B. Organize a school student pedestrian advisory committee to serve the needs of each public and private school.*

*Guidance:*

*05 When the advisory committee structure is used, the committee should include governmental and school district staff who has the responsibility and authority to initiate and provide programs and projects.*

*06 Representatives from the city and/or county superintendent of schools office should be the official members. Advisors should include representatives of the local area Safety Council, traffic engineers, police authorities, the Parent-Teachers Association, Automobile Clubs (AAA), local Bicycle or Pedestrian Advisory Committee, plus others as needed.*

**Staff and Committee Responsibility:**

*07 The duties of staff members and/or each committee should be to guide and coordinate all activities connected with the school traffic safety program, such as:*

- A. Establish traffic safety policies and procedures.*
- B. Recommend priorities for proposed improvement projects.*
- C. Notify the responsible agencies of school-pedestrian-traffic related issues.*
- D. Review and approve the various phases of the school student traffic safety program.*
- E. Review and process requests and complaints.*
- F. Promote good public relations.*

*08 The County Superintendent of School's office should coordinate all student pedestrian committees' actions in establishing and promoting uniform practices for school pedestrian safety throughout the county.*

**School Responsibility:**

*09 Traffic related issues about school pedestrians on the approaches to the school should be referred to the school district or local school principal for review and transmission to the appropriate staff person or to the school student pedestrian advisory committee.*

*Support:*

*10 Refer to CVC 21373 for school board request for traffic control devices.*

**Government Traffic Agency Responsibility:**

**Standard:**

**11 Upon request of the local school district, responsible traffic authorities shall investigate all locations along the school route and recommend appropriate traffic control measures. Refer to CVC 21373.**

*Support:*

*12 The following references from the California Vehicle Code relate to traffic controls for school areas:*

- A. Section 377 – Limit Line.*
- B. Section 627 – Engineering and Traffic Survey.*
- C. Section 21102 – Local Authority to Close Streets.*
- D. Section 21368 – Crosswalks Near Schools.*
- E. Section 21372 – Guidelines for Traffic Control Devices Near Schools.*



- F. Section 21373 – School Board Request for Traffic Control Devices.
- G. Section 21458 – Curb Markings.
- H. Section 21949 through 21971 – Pedestrians' Rights and Duties.
- I. Section 22350 – Basic Speed Law.
- J. Section 22352 – Prima Facie Speed Limits.
- K. Section 22358.4 – Decrease of Local Limits Near Schools or Senior Centers.
- L. Section 22504 – Unincorporated Area Parking; School Bus Stops.
- M. Section 40802 – Speed Traps.
- N. Section 42200 – Disposition by Cities and Other Local Entities.
- O. Section 42201 – Disposition by County.

### **Section 7A.03 School Crossing Control Criteria**

#### **Support:**

<sup>01</sup> The frequency of gaps in the traffic stream that are sufficient for student crossing is different at each crossing location. When the delay between the occurrences of adequate gaps becomes excessive, students might become impatient and endanger themselves by attempting to cross the street during an inadequate gap. In these instances, the creation of sufficient gaps needs to be considered to accommodate the crossing demand.

<sup>02</sup> A recommended method for determining the frequency and adequacy of gaps in the traffic stream is given in the "Traffic Control Devices Handbook" (see Section 1A.11).

<sup>03</sup> Engineering and traffic studies will determine the appropriate measures to be developed at school crossings. The devices and treatments described herein are for use in school zones and do not preclude use of other devices and treatments described elsewhere in this document. Types of school pedestrian measures that can be considered can include:

- A. Warning signs and markings.
- B. School speed limits.
- C. Intersection stop signs.
- D. Flashing yellow beacons.
- E. Traffic signals.
- F. Pedestrian Hybrid Beacons.
- G. Remove visibility obstructions.
- H. School Safety Patrol.
- I. Adult Crossing Guard.
- J. Pedestrian separation structures.
- K. Pedestrian walkways along the roadway.
- L. Pedestrian walkways separated from the roadway.
- M. Parking controls and curb-use zones.

### **Section 7A.04 Scope**

#### **Standard:**

<sup>01</sup> **Part 7 sets forth basic principles and prescribes standards that shall be followed in the design, application, installation, and maintenance of all traffic control devices (including signs, signals, and markings) and other controls (including adult crossing guards) required for the special pedestrian conditions in school areas.**

#### **Support:**

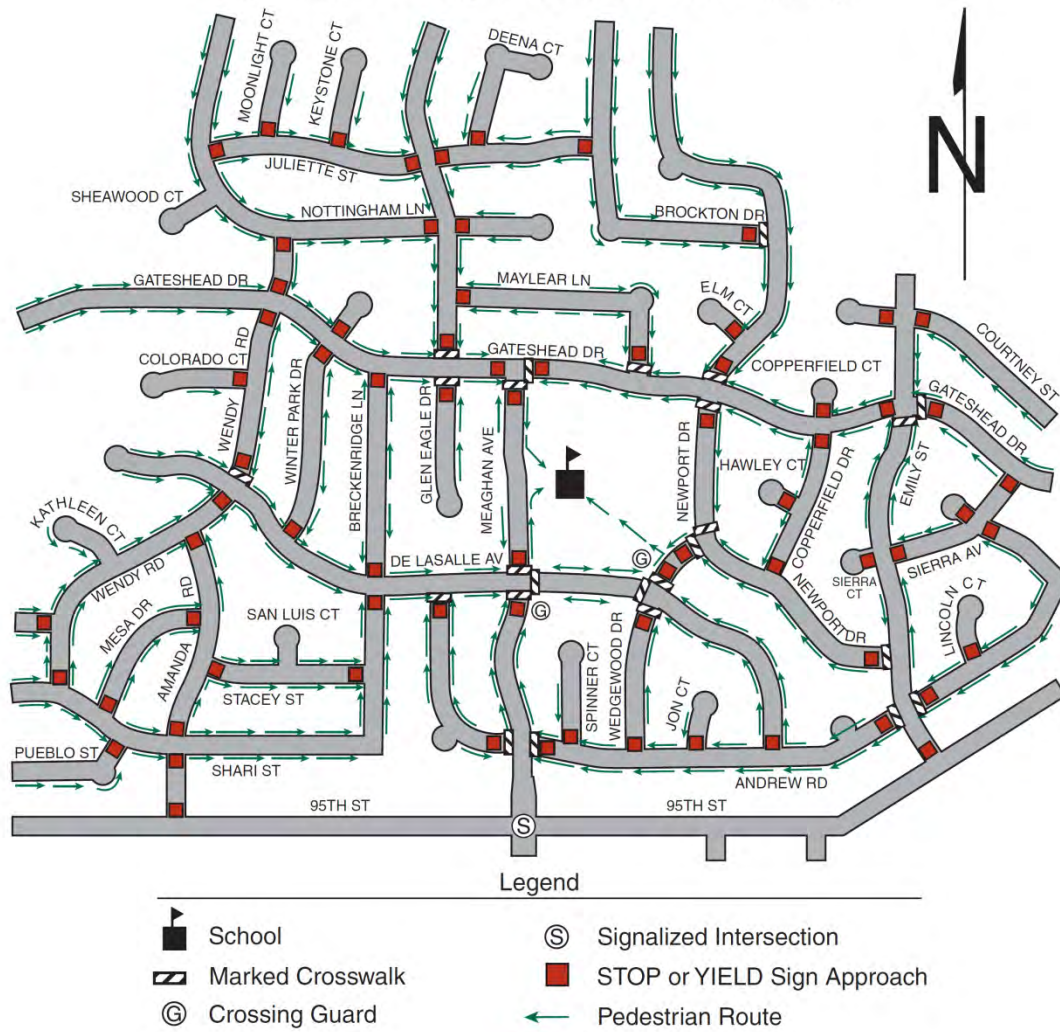
<sup>02</sup> Sections 1A.01 and 1A.08 contain information regarding unauthorized devices and messages. Sections 1A.02 and 1A.07 contain information regarding the application of standards. Section 1A.05 contains information regarding the maintenance of traffic control devices. Section 1A.08 contains information regarding placement authority for traffic control devices. Section 1A.09 contains information regarding engineering studies and the assistance that is available to jurisdictions that do not have engineers on their staffs who are trained and/or experienced in traffic control devices.

<sup>03</sup> Provisions contained in Chapter 2A and Section 2B.06 are applicable in school areas.

<sup>04</sup> Part 3 contains provisions regarding pavement markings that are applicable in school areas.

05 Part 4 contains provisions regarding highway traffic signals that are applicable in school areas. The School Crossing signal warrant is described in Section 4C.06.

Figure 7A-1. Example of School Route Plan Map



## CHAPTER 7B. SIGNS

### Section 7B.01 Size of School Signs

#### Standard:

- 01 Except as provided in Section 2A.11, the sizes of signs and plaques to be used on conventional roadways in school areas shall be as shown in Table 7B-1 and 7B-1(CA).
- 02 The sizes in the Conventional Road column shall be used unless engineering judgment determines that a minimum or oversized sign size would be more appropriate.
- 03 The sizes in the Minimum column shall be used only where traffic volumes are low and speeds are 3025 mph or lower, as determined by engineering judgment.
- 04 The sizes in the Oversized column shall be used on expressways.

#### Guidance:

05 The sizes in the Oversized column should be used on roadways that have four or more lanes with posted speed limits of 40 mph or higher.

#### Option:

06 The sizes in the Oversized column may also be used at other locations that require increased emphasis, improved recognition, or increased legibility.

07 Signs and plaques larger than those shown in Table 7B-1 may be used (see Section 2A.11).

#### Standard:

08 The standard sign dimensions prescribed in this California MUTCD, FHWA's "Standard Highway Signs and Markings" book and Caltrans' California Sign Specifications shall be used unless engineering judgment determines that other sizes are appropriate. Where engineering judgment determines that sizes smaller than the standard dimensions are appropriate for use, the sign dimensions shall not be less than the minimum dimensions specified in this California MUTCD, "Standard Highway Signs and Markings" book or Caltrans' California Sign Specifications. See Section 1A.11 for information regarding these publications.

### Section 7B.02 Illumination and Reflectorization

#### Standard:

- 01 The signs used for school area traffic control shall be retroreflectorized or illuminated.

### Section 7B.03 Position of Signs

#### Support:

01 Sections 2A.16 and 2A.17 contain provisions regarding the placements and locations of signs.

02 Section 2A.19 contains provisions regarding the lateral offsets of signs.

02a Examples of location of school area signs and California School Assemblies for typical installations are shown in Figures 7B-1(CA), 7B-4, 7B-5 and 7B-5(CA).

#### Option:

03 In-roadway signs for school traffic control areas may be used consistent with the requirements of Sections 2B.12, ~~7B-08~~, 7B.11 and 7B.12.

### Section 7B.04 Height of Signs

#### Support:

- 01 Section 2A.18 contains provisions regarding the mounting height of signs.

### Section 7B.05 Installation of Signs

#### Support:

01 Section 2A.16 contains provisions regarding the installation of signs.

02 Examples of school area signing, markings, flashing beacons and overhead school signs are shown in Figures 7B-1(CA), 7B-5(CA), 7B-4 through 7B-6 and Figures 7B-101(CA) through 7B-104(CA).

### **Section 7B.06 Lettering**

**Support:**

<sup>01</sup> The “Standard Highway Signs and Markings” book (see Section 1A.11) contains information regarding sign lettering.

### **Section 7B.07 Sign Color for School Warning Signs**

**Standard:**

<sup>01</sup> ~~School warning signs, including the “SCHOOL” portion of the School Speed Limit (S5-1) sign and including any supplemental plaques used in association with these warning signs, shall have a fluorescent yellow-green background with a black legend and border unless otherwise provided in this Manual for a specific sign.~~

### **Section 7B.08 School Advance Warning Assembly (S1-1 with Supplemental Plaque)**

**Support:**

<sup>01</sup> Many state and local jurisdictions find it beneficial to advise road users that they are approaching a school that is adjacent to a highway, where additional care is needed, even though no school crossing is involved and the speed limit remains unchanged. Additionally, some jurisdictions designate school zones that have a unique legal standing in that fines for speeding or other traffic violations within designated school zones are increased or special enforcement techniques such as photo radar systems are used. It is important and sometimes legally necessary to mark the beginning and end points of these designated school zones so that the road user is given proper notice.

<sup>02</sup> The School (S1-1) sign (see Figure 7B-1 or 7B-1(CA)) has the following four applications:

- A. School Area – the S1-1 sign can be used to warn road users that they are approaching a school area that might include school buildings or grounds, a school crossing, or school related activity adjacent to the highway.
- B. School Zone – the S1-1 sign can be used to identify the location of the beginning of a designated school zone (see Section 7B.09).
- C. School Advance Crossing – if combined with an AHEAD (W16-9P) plaque or an XX FEET (W16-2P or W16-2aP) plaque to comprise the School Advance Crossing assembly, the S1-1 sign can be used to warn road users that they are approaching a crossing where schoolchildren cross the roadway (see Section 7B.11).
- D. School Crossing – if combined with a diagonal downward pointing arrow (W16-7P) plaque to comprise the School Crossing assembly, the S1-1 sign can be used to warn approaching road users of the location of a crossing where schoolchildren cross the roadway (see Section 7B.12).

<sup>02a</sup> ~~The School Assemblies A(CA) through E(CA) are shown in Figure 7B-1(CA) and Table 7B-1(CA).~~

**Option:**

<sup>03</sup> If a school area is located on a cross street in close proximity to the intersection, a School (S1-1) sign with a supplemental arrow (W16-5P or W16-6P) plaque may be installed on each approach of the street or highway to warn road users making a turn onto the cross street that they will encounter a school area soon after making the turn.

### **Section 7B.09 School Zone Sign (S1-1) and Plaques (S4-3P, S4-7P) and END SCHOOL ZONE Sign (S5-2)**

**Standard:**

<sup>01</sup> ~~If a school zone has been designated under State or local statute, a School (S1-1) sign (see Figure 7B-1 or 7B-1(CA)) shall be installed to identify the beginning point(s) of the designated school zone (see Figure 7B-2).~~

**Option:**

<sup>02</sup> A School Zone (S1-1) sign may be supplemented with a SCHOOL (S4-3P) plaque (see Figure 7B-1 or 7B-1(CA)).

<sup>03</sup> ~~A School Zone (S1-1) sign may be supplemented with an ALL YEAR (S4-7P) plaque (see Figure 7B-1) if the school operates on a 12-month schedule.~~

~~04 The downstream end of a designated school zone may be identified with an END SCHOOL ZONE (S5-2) sign (see Figures 7B-1 and 7B-2).~~

05 If a school zone is located on a cross street in close proximity to the intersection, a School Zone (S1-1) sign with a supplemental arrow (W16-5P or W16-6P) plaque may be installed on each approach of the street or highway to warn road users making a turn onto the cross street that they will encounter a school zone soon after making the turn.

**Standard:**

**06 The School Warning Assembly A(CA) shall be used on streets with prima facie 25 mph speed limits that are contiguous to a school building or school grounds.**

**07 The SCHOOL (S4-3P) plaque shall not be used alone.**

**Guidance:**

08 If used, the School Warning Assembly A(CA) should be posted at the school boundary. Refer to CVC 22352.

**Option:**

09 If used, the School Warning Assembly A(CA) may be posted up to 500 feet in advance of the school boundary. Refer to CVC 22352.

**Support:**

10 The School Warning Assembly A(CA) does not need to be posted if there are no school pedestrians using the highway and the school grounds are separated from the highway by a fence, gate or other physical barrier. Refer to CVC 22352.

### **Section 7B.10 Higher Fines Zone Signs (R2-10, R2-11) and Plaques**

**Standard:**

~~01 Where increased fines are imposed for traffic violations within a designated school zone, a BEGIN HIGHER FINES ZONE (R2-10) sign (see Figure 7B-1) or a FINES HIGHER (R2-6P), FINES DOUBLE (R2-6aP), or \$XX FINE (R2-6bP) plaque (see Figure 2B-3) shall be installed as a supplement to the School Zone (S1-1) sign to identify the beginning point of the higher fines zone (see Figures 7B-2 and 7B-3).~~

**Option:**

~~02 Where appropriate, one of the following plaques may be mounted below the sign that identifies the beginning point of the higher fines zone:~~

- ~~A. An S4-1P plaque (see Figure 7B-1) specifying the times that the higher fines are in effect,~~
- ~~B. A WHEN CHILDREN ARE PRESENT (S4-2P) plaque (see Figure 7B-1), or~~
- ~~C. A WHEN FLASHING (S4-4P) plaque (see Figure 7B-1) if used in conjunction with a yellow flashing beacon.~~

**Standard:**

~~03 Where a BEGIN HIGHER FINES ZONE (R2-10) sign or a FINES HIGHER (R2-6P) plaque supplementing a School Zone (S1-1) sign is posted to notify road users of increased fines for traffic violations, an END HIGHER FINES ZONE (R2-11) sign (see Figure 7B-1) or an END SCHOOL ZONE (S5-2) sign shall be installed at the downstream end of the zone to notify road users of the termination of the increased fines zone (see Figures 7B-2 and 7B-3).~~

### **Section 7B.11 School Advance Crossing Assembly**

**Standard:**

01 The School Advance Crossing assembly (see Figure 7B-1 or 7B-1(CA)) shall consist of a **School Advance warning Assembly D(CA), or a School (S1-1) sign supplemented with an AHEAD (W16-9P) plaque or an XX FEET (W16-2P or W16-2aP) plaque.**

02 Except as provided in Paragraph 3, a School Advance Crossing assembly **or Assembly D(CA)** shall be used in advance (see Table 2C-4 for advance placement guidelines) of the first School Crossing assembly (see Section 7B.12) that is encountered in each direction as traffic approaches a school crosswalk (see Figure 7B-4).

**Option:**

03 The School Advance Crossing assembly **or Assembly D(CA)** may be omitted (see Figure 7B-5) where a School Zone (S1-1) sign (see Section 7B.09) is installed to identify the beginning of a school zone in advance of the School Crossing assembly.

<sup>04</sup> If a school crosswalk is located on a cross street in close proximity to an intersection, a School Advance Crossing assembly with a supplemental arrow (W16-5P or W16-6P) plaque may be installed on each approach of the street or highway to warn road users making a turn onto the cross street that they will encounter a school crosswalk soon after making the turn.

<sup>05</sup> A 12-inch reduced size in-street School (S1-1) sign (see Figure 7B-6), installed in compliance with the mounting height and special mounting support requirements for In-Street Pedestrian Crossing (R1-6 or ~~R1-6a~~) signs (see Section 2B.12), may be used in advance of a school crossing to supplement the post-mounted school warning signs. A 12 x 6-inch reduced size AHEAD (W16-9P) plaque may be mounted below the reduced size in-street School (S1-1) sign.

**Standard:**

<sup>06</sup> **The School Advance Warning Assembly D(CA) shall be used in advance of any School Crosswalk Warning Assembly B(CA), School Crosswalk Warning Assembly E(CA) or the School Speed Limit Assembly C(CA).**

### **Section 7B.12 School Crossing Assembly**

**Standard:**

<sup>01</sup> **If used, the School Crossing assembly ~~Assembly B(CA)~~ Assembly B(CA) (see Figure 7B-1 or 7B-1(CA)) shall be installed at the school crossing (see Figures 7B-4 and 7B-5), or as close to it as possible, and shall consist of a School (S1-1) sign supplemented with a diagonal downward pointing arrow (W16-7P) plaque to show the location of the crossing.**

<sup>02</sup> **The School Crossing assembly ~~Assembly B(CA) or E(CA)~~ Assembly B(CA) or E(CA) shall not be used at crossings other than those adjacent to schools and those on established school pedestrian routes.**

<sup>03</sup> **The School Crossing assembly ~~Assembly B(CA) or E(CA)~~ Assembly B(CA) or E(CA) shall not be installed on approaches controlled by a STOP (R1-1) sign, a ~~or~~ YIELD (R1-2) sign or a traffic signal.**

**Standard:**

<sup>03a</sup> **The School Crosswalk Warning Assembly B(CA) or E(CA) shall be posted at all yellow school crosswalks that are not controlled by a STOP (R1-1) sign, a YIELD (R1-2) sign or a traffic signal.**

*Guidance:*

<sup>03b</sup> *The School Crosswalk Warning Assembly B(CA) or E(CA) should be posted at all white school crosswalks that are not controlled by a STOP (R1-1) sign, a YIELD (R1-2) sign or a traffic signal.*

**Support:**

<sup>03c</sup> The School Crosswalk Warning Assemblies B(CA) and E(CA) are shown in Figure 7B-1(CA) and 7B-101(CA) through 7B-104(CA).

**Option:**

<sup>04</sup> The In-Street Pedestrian Crossing (R1-6 or ~~R1-6a~~) sign (see Section 2B.12 and Figure 7B-6) or the In-Street Schoolchildren Crossing (R1-6b or ~~R1-6e~~) sign (see Figure 7B-6) may be used at unsignalized school crossings. If used at a school crossing, a 12 x 4-inch SCHOOL (S4-3P) plaque (see Figure 7B-6) may be mounted above the sign. The STATE LAW legend on the R1-6 series signs may be omitted.

<sup>05</sup> The Overhead Pedestrian Crossing (R1-9 or ~~R1-9a~~) sign (see Section 2B.12 and Figure 2B-2) may be modified to replace the standard pedestrian symbol with the standard schoolchildren symbol and may be used at unsignalized school crossings. The STATE LAW legend on the R1-9 series signs may be omitted.

**Standard:**

<sup>05a</sup> **If used, the School Crosswalk Warning Assembly E(CA) (see Figures 7B-1(CA) and 7B-101(CA) through 7B-104(CA)) shall be installed in an overhead location at the marked crosswalk, or as close to it as possible, and shall consist of a modified R1-9 sign to show the location of the crossing.**

**Option:**

<sup>05b</sup> For uncontrolled locations with more than one lane in each direction of travel, advance yield lines (see Section 3B.16) may be used with the 'Yield Here to Pedestrians' signs (R1-5 or R1-5a).

<sup>06</sup> A 12-inch reduced size in-street School (S1-1) sign (see Figure 7B-6) may be used at an unsignalized school crossing instead of the In-Street Pedestrian Crossing (R1-6 or ~~R1-6a~~) or the In-Street Schoolchildren Crossing (R1-6b or ~~R1-6e~~) sign. A 12 x 6-inch reduced size diagonal downward pointing arrow (W16-7P) plaque may be mounted below the reduced size in-street School (S1-1) sign.

**Support:**

**06a** The In-Street Pedestrian Crossing and the In-Street Schoolchildren Crossing (R1-6a and R1-6c) signs are deleted as a stop is not required in California per CVC 21950.

**Standard:**

**07** If an In-Street Pedestrian Crossing sign, an In-Street Schoolchildren Crossing sign, or a reduced size in-street School (S1-1) sign is placed in the roadway, the sign support shall comply with the mounting height and special mounting support requirements for In-Street Pedestrian Crossing (R1-6 ~~or R1-6a~~) signs (see Section 2B.12).

**08** The In-Street Pedestrian Crossing sign, the In-Street Schoolchildren Crossing sign, the Overhead Pedestrian Crossing sign, and the reduced size in-street School (S1-1) sign shall not be used at ~~signalized locations~~ **controlled approaches**.

**Section 7B.13 School Bus Stop Ahead Sign (S3-1)**

**Guidance:**

**01** The School Bus Stop Ahead (S3-1) sign (see Figure 7B-1 or 7B-1(CA)) should be installed in advance of locations where a school bus, when stopped to pick up or discharge passengers, is not visible to road users for an adequate distance and where there is no opportunity to relocate the school bus stop to provide adequate sight distance.

**Standard:**

**02** The School Bus Stop Ahead (S3-1) sign shall be installed in advance of an approved school bus stop where there is not a clear view in advance of the stop from a distance of 200 feet. Refer to CVC 22504(c).

**Section 7B.14 SCHOOL BUS TURN AHEAD Sign (S3-2)**

**Option:**

**01** The SCHOOL BUS TURN AHEAD (S3-2) sign (see Figure 7B-1 or 7B-1(CA)) may be installed in advance of locations where a school bus turns around on a roadway at a location not visible to approaching road users for a distance as determined by the "0" column under Condition B of Table 2C-4, and where there is no opportunity to relocate the school bus turn around to provide the distance provided in Table 2C-4.

**Section 7B.15 School Speed Limit Assembly (S4-1P, S4-2P, S4-3P, S4-4P, S4-6P, S5-1) and END SCHOOL SPEED LIMIT Sign (S5-3)**

**Standard:**

**01** A School Speed Limit assembly **Assembly C(CA)** (see Figure ~~7B-1~~ **7B-1(CA)**) ~~or a School Speed Limit (S5-1) sign (see Figure 7B-1)~~ shall be used to indicate the speed limit where a reduced school speed limit zone has been established based upon an engineering study or where a reduced school speed limit is specified for such areas by statute. The School Speed Limit assembly **Assembly C(CA)** or School Speed Limit sign shall be placed at or as near as practical to the point where the reduced school speed limit zone begins (see Figures ~~7B-3 and 7B-5~~).

**02** If a reduced school speed limit zone has been established, a School (S1-1) sign shall be installed in advance (see Table 2C-4 for advance placement guidelines) of the first School Speed Limit sign assembly ~~or S5-1 sign~~ that is encountered in each direction as traffic approaches the reduced school speed limit zone (see Figures ~~7B-3 and 7B-5~~).

**03** ~~Where increased fines are imposed for traffic violations within a reduced school speed limit zone, a FINES HIGHER (R2-6P), FINES DOUBLE (R2-6aP), or \$XX FINE (R2-6bP) plaque (see Figure 2B-3) shall be installed as a supplement to the reduced school speed limit sign to notify road users.~~

**04** ~~Except as provided in Paragraph 5, the~~ The downstream end of an authorized and posted reduced school speed limit zone shall be identified with an END SCHOOL SPEED LIMIT (S5-3) and/or **Speed Limit (R2-1)** sign (see Figures 7B-1, **7B-1(CA)**, ~~and 7B-5 and 7B-5(CA)~~).

**Option:**

**05** If a reduced school speed limit zone ends at the same point as a higher fines zone, an END SCHOOL ZONE (S5-2) sign may be used instead of a combination of an END HIGHER FINES ZONE (R2-11) sign and an END SCHOOL SPEED LIMIT (S5-3) sign.

~~06 A standard Speed Limit sign showing the speed limit for the section of highway that is downstream from the authorized and posted reduced school speed limit zone may be mounted on the same post above the END SCHOOL SPEED LIMIT (S5-3) sign or the END SCHOOL ZONE (S5-2) sign or the Speed Limit (R2-1) sign may be posted by itself (see Figures 7B-5(CA) and 7B-102(CA)).~~

*Guidance:*

~~07 The beginning point of a reduced school speed limit zone should be at least 200 feet in advance of the school grounds, a school crossing, or other school related activities; however, this 200-foot distance should be increased if the reduced school speed limit is 30 mph or higher. Refer Figures 7B-1(CA), 7B-5, 7B-5(CA), and 7B-101(CA) through 7B-103(CA).~~

**Standard:**

~~08 The School Speed Limit assembly **Assembly C(CA)** shall be either a fixed-message sign assembly or a changeable message sign.~~

~~09 The fixed-message School Speed Limit assembly **Assembly C(CA)** shall consist of a top plaque (S4-3P) with the legend SCHOOL, a Speed Limit (R2-1) sign, and a bottom plaque **WHEN CHILDREN ARE PRESENT (S4-1P, S4-2P, S4-4P, or S4-6P)** indicating the specific periods of the day and/or days of the week that the special school speed limit is in effect (see Figure ~~7B-1~~ **7B-1(CA)**).~~

*Option:*

~~10 Changeable message signs (see Chapter 2L and Section 6F.60) may be used to inform drivers of the school speed limit. If the sign is internally illuminated, it may have a white legend on a black background. Changeable message signs with flashing beacons may be used for situations where greater emphasis of the special school speed limit is needed.~~

*Guidance:*

~~11 Even though it might not always be practical because of special features to make changeable message signs conform in all respects to the standards in this Manual for fixed-message signs, during the periods that the school speed limit is in effect, their basic shape, message, legend layout, and colors should comply with the standards for fixed-message signs.~~

~~12 A confirmation light or device to indicate that the speed limit message is in operation should be considered for inclusion on the back of the changeable message sign.~~

**Standard:**

~~13 **Fluorescent yellow-green pixels shall be used when the "SCHOOL" message is displayed on a changeable message sign for a school speed limit.**~~

*Option:*

~~14 Changeable message signs may use blank-out messages or other methods in order to display the school speed limit only during the periods it applies.~~

~~15 Changeable message signs that display the speed of approaching drivers (see Section 2B.13) may be used in a school speed limit zone.~~

~~16 A Speed Limit Sign Beacon (see Section 4L.04) also may be used, with a WHEN FLASHING legend, to identify the periods that the school speed limit is in effect.~~

**Standard:**

~~17 **The School Speed Limit Assembly C(CA) shall be used on streets with speed limits greater than 25 mph that are contiguous to a school building or school grounds.**~~

*Support:*

~~18 The School Speed Limit Assembly C(CA) is shown in Figure 7B-1(CA).~~

*Option:*

~~19 If used, the School Speed Limit Assembly C(CA) may be posted up to 500 feet in advance of the school boundary.~~

**Standard:**

~~20 **The "WHEN FLASHING" and specific time period messages shall not be used in school areas in California as they are not supported by CVC 22352. Hence, the Specific Time Period Plaque (S4-1P), WHEN FLASHING (S4-4P) and SCHOOL SPEED LIMIT 20 WHEN FLASHING (S5-1) signs shall not be used in California.**~~

*Support:*

~~21 The "WHEN FLASHING" message is misleading because it suggests that the speed limit is in force only when the flashing beacons are in operation. The prima facie speed limit of 25 mph is in effect based on the presence of children per CVC 22352, not on the operation of the flashing beacons.~~



22 Not using the "WHEN FLASHING" message also addresses the situation when children are present but the flashing beacons are inoperative for any reason.

23 Not using the "WHEN FLASHING" message does not alter the warrants or the use of a flashing yellow beacon or its effectiveness as an attention-getting device.

24 The specific time period message is misleading because it suggests that the speed limit is in force only during the time period specified. The prima facie speed limit of 25 mph is in effect based on the presence of children per CVC 22352, not on the time period specified.

### **EXTENDED 25 MPH AND/OR REDUCED SPEEDS IN SCHOOL ZONES**

Option:

25 A local authority may declare a 20 or 15 mph prima facie speed limit within 500 feet of a school building or school grounds and an extended 25 mph prima facie speed limit within 500 to 1000 feet from a school or school grounds.

Support:

26 The extended 25 mph school speed zone can provide a progressive speed reduction.

**Standard:**

27 **If the local authority declares by ordinance or resolution the above prima facie speed limits, all of the following criteria shall be met:**

- A. **Street (or highway) is in a residential district.**
- B. **Street (or highway) outside of a school zone has a posted speed limit no greater than 30 mph.**
- C. **Street (or highway) has no more than a total of two through traffic lanes (one in each direction or two in one direction).**
- D. **The reduced school zone speed limit of 20 or 15 mph is within 500 feet of school grounds.**
- E. **The extended school zone speed limit of 25 mph is within 500 to 1000 feet of school grounds.**

28 **When used, a local ordinance or resolution adopted to establish a 20 or 15 mph reduced school zone speed limit and/or an extended 25 mph school zone speed limit shall not be effective until School Speed Limit Assembly C (CA) giving notice of the speed limit(s) is erected upon the highway.**

29 **On a State highway, the ordinance or resolution shall not be effective until the ordinance or resolution has been approved by Caltrans and appropriate school zone speed signs are erected upon the State highway.**

30 **For purposes of a 20 or 15 mph reduced prima facie speed limit, School Speed Limit Assembly C (CA) indicating a speed limit of 20 or 15 mph shall be placed at a distance up to 500 feet away from school grounds. For purposes of an extended 25 mph prima facie speed limit, School Speed Limit Assembly C (CA) indicating a speed limit of 25 mph shall be placed at any distance between 500 to 1,000 feet away from school grounds. Refer to Figure 7B-103(CA).**

31 **The established school speed limits shall be effective when children are going to or leaving the school, either during school hours or during the noon recess hour. The school speed limits shall also apply when the school grounds are not separated from the highway by a fence, gate, or other physical barrier while the grounds are in use by children (this condition can apply at any time of day or any day of the week).**

32 **The determination to reduce a prima facie speed limit to 20 or 15 mph and/or extend a 25 mph school zone speed limit, as described above, shall be documented in writing, in an engineering study. The engineering study shall identify the provisions of Section 627 of the California Vehicle Code (CVC) that support the reduced and/or extended school zone speed limit(s).**

Guidance:

33 *When preparing an engineering study pursuant to the Standard above, the local authority should cite all elements of an Engineering and Traffic Survey, as discussed in CVC Section 627, that support the need for a reduced speed limit of 20 or 15 mph and/or an extended 25 mph school zone speed limit.*

Support:

34 The documentation of prevailing speeds found in CVC Section 627 can be used to establish an existing speed profile for the school zone, but the 85<sup>th</sup> percentile speed is not used to set the reduced or extended school speed limit.

**Standard:**

35 **The local authority shall reimburse Caltrans for all costs incurred by Caltrans under this section.**

### **Section 7B.16 Reduced School Speed Limit Ahead Sign (S4-5, S4-5a)**

*Guidance:*

*01 A Reduced School Speed Limit Ahead (S4-5, S4-5a) sign (see Figure 7B-1 or 7B-1(CA)) should be used to inform road users of a reduced speed zone where the speed limit is being reduced by more than 10 mph, or where engineering judgment indicates that advance notice would be appropriate for the School Advance Warning Assembly D(CA).*

**Standard:**

**02 If used, the Reduced School Speed Limit Ahead sign shall be followed by a School Speed Limit sign or a School Speed Limit assembly Assembly C(CA).**

**03 The speed limit displayed on the Reduced School Speed Limit Ahead sign shall be identical to the speed limit displayed on the subsequent School Speed Limit sign or School Speed Limit assembly Assembly C(CA).**

### **EXTENDED 25 MPH AND/OR REDUCED SPEEDS IN SCHOOL ZONES**

*Guidance:*

*04 For school area traffic control with a reduced school zone speed limit of 15 mph and/or an extended school zone speed limit of 25 mph in a residential district, the Reduced Speed School Zone Ahead (S4-5, S4-5a) sign should be used to give advance notice of a reduced 15 mph school zone speed limit and/or an extended school zone speed limit of 25 mph.*

*Option:*

*05 For school area traffic control with a reduced school zone speed limit of 20 mph and/or an extended school zone speed limit of 25 mph in a residential district, the Reduced Speed School Zone Ahead (S4-5, S4-5a) sign may be used to give advance notice of a reduced 15 mph school zone speed limit and/or an extended school zone speed limit of 25 mph.*

### **Section 7B.17 Parking and Stopping Signs (R7 and R8 Series)**

*Option:*

*01 Parking and stopping regulatory signs may be used to prevent parked or waiting vehicles from blocking pedestrians' views, and drivers' views of pedestrians, and to control vehicles as a part of the school traffic plan.*

*Support:*

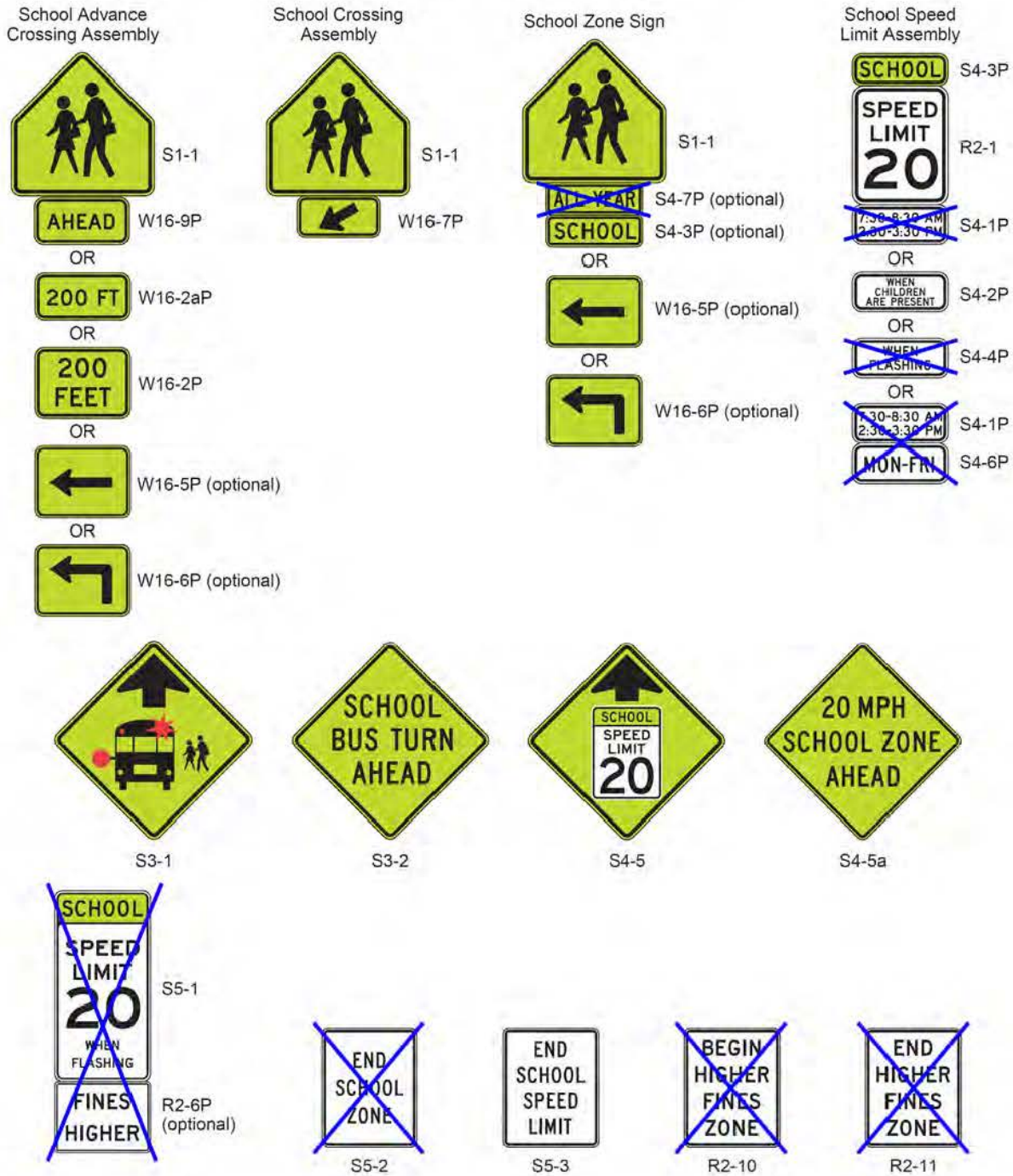
*02 Parking signs and other signs governing the stopping and standing of vehicles in school areas cover a wide variety of regulations. Typical examples of regulations are as follows:*

- A. No Parking X:XX AM to X:XX PM School Days Only,*
- B. No Stopping X:XX AM to X:XX PM School Days Only,*
- C. XX Min Loading X:XX AM to X:XX PM School Days Only, and*
- D. No Standing X:XX AM to X:XX PM School Days Only.*

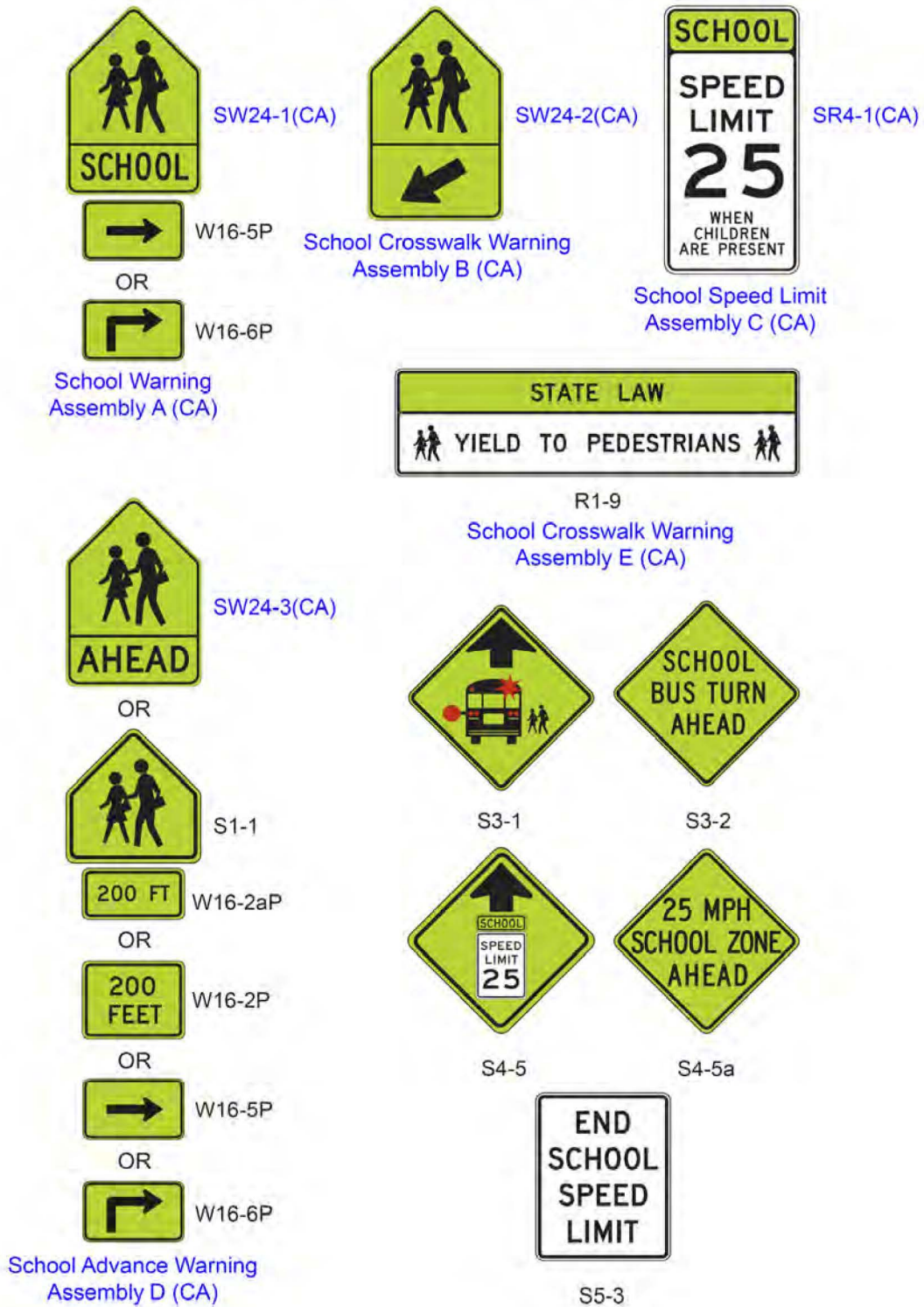
*03 Sections 2B.46, 2B.47, and 2B.48 contain information regarding the signing of parking regulations in school zone areas.*

*04 Street closures are authorized by local ordinance or resolution on streets crossing or dividing school grounds when necessary for the protection of persons attending the school. Refer to CVC 21102.*

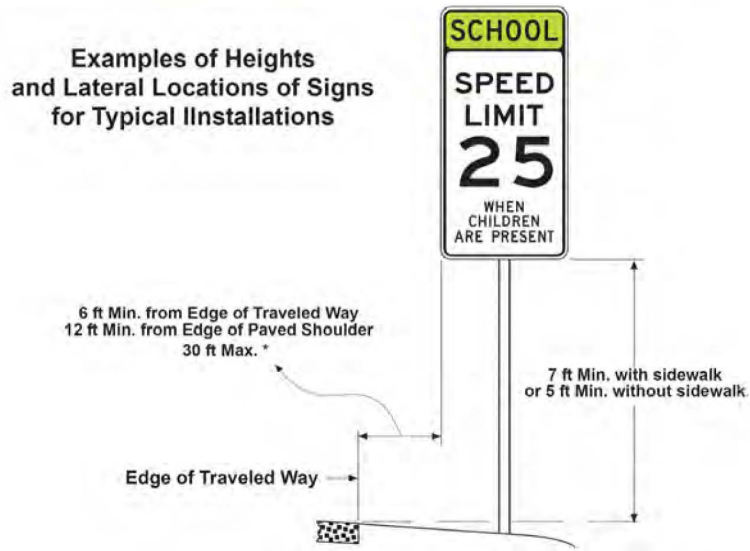
**Figure 7B-1. School Area Signs**



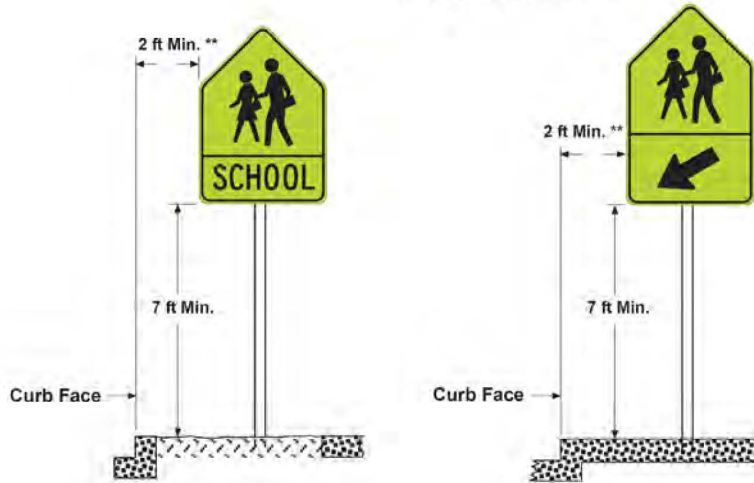
**Figure 7B-1(CA). School Area Signs (Sheet 1 of 2)**



**Figure 7B-1(CA). School Area Signs (Sheet 2 of 2)**



**Rural Locations**

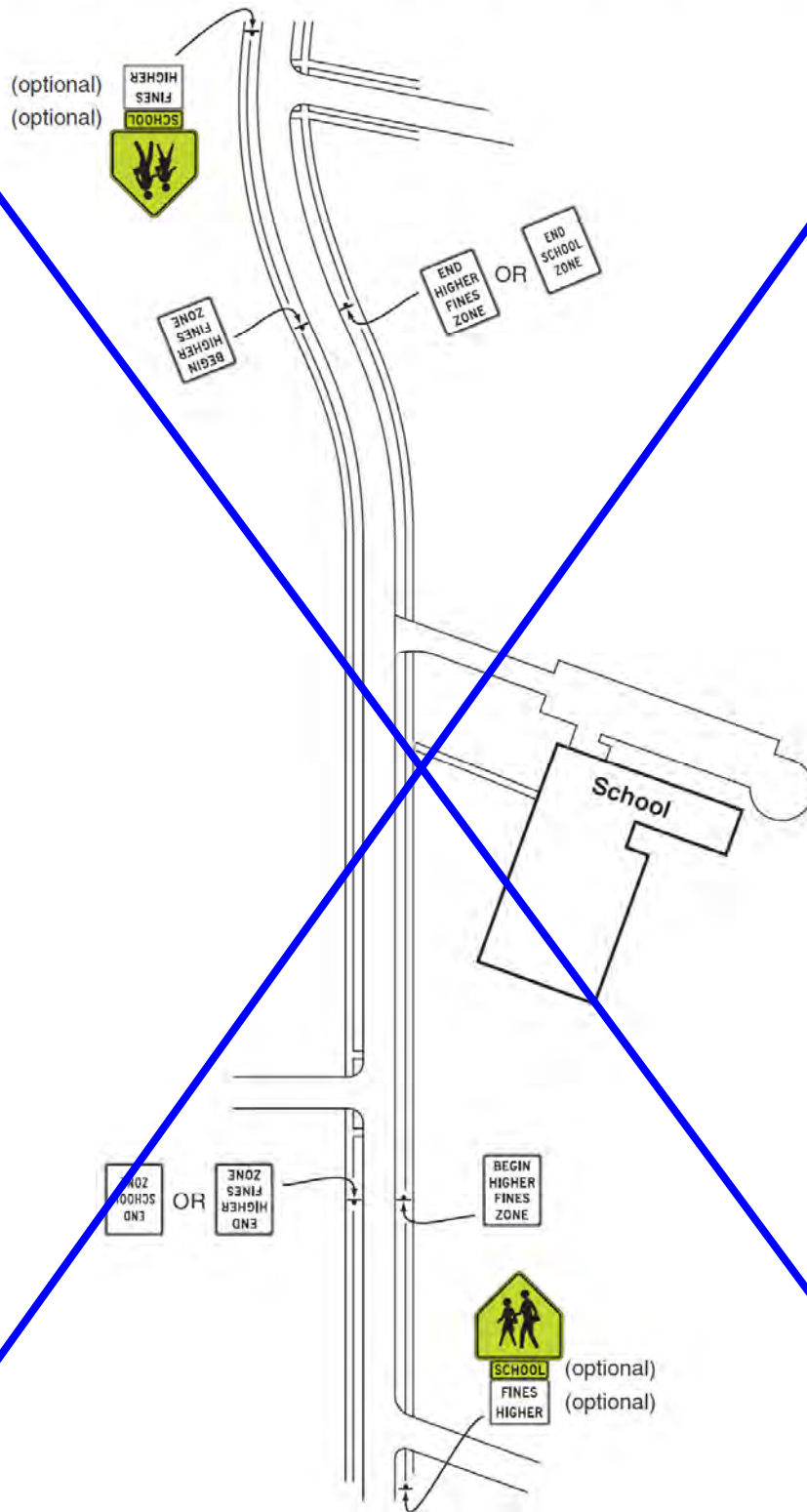


**Urban Locations and Rural Locations with Sidewalk**

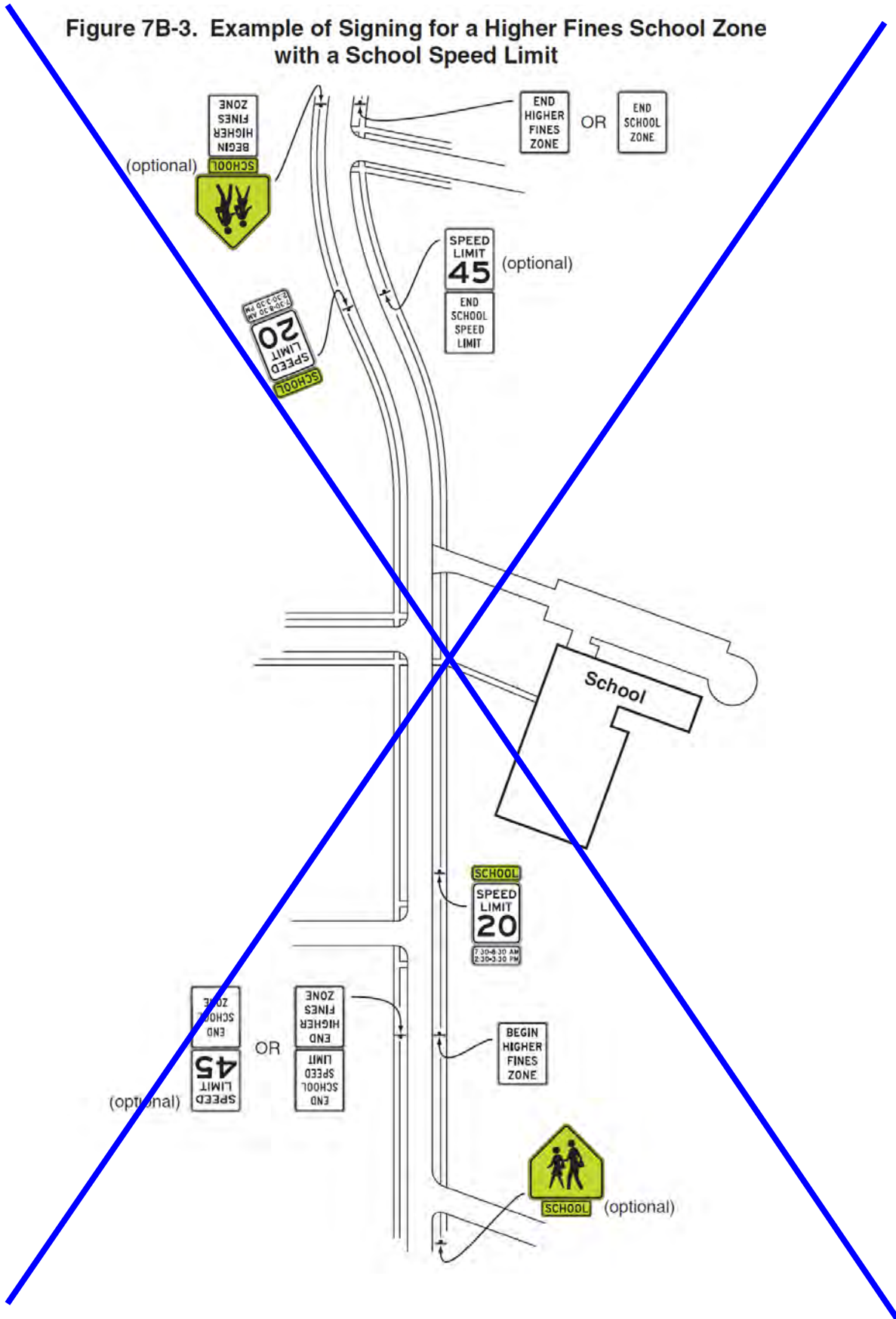
**NOTES:**

- (\*) When clear roadside recovery areas are provided, signs shall be placed as far from the edge of traveled way as possible, up to a maximum of 30 ft. When possible they shall be placed in locations less likely to be hit by a vehicle leaving the traveled way. Signs should not be closer than 6 ft from the edge of a paved shoulder, or if none, 12 ft from the edge of the traveled way.
- (\*\*) In urban areas, where sidewalk width is limited or existing poles are close to the curb, a clearance of 1 ft from the curb face is permissible.

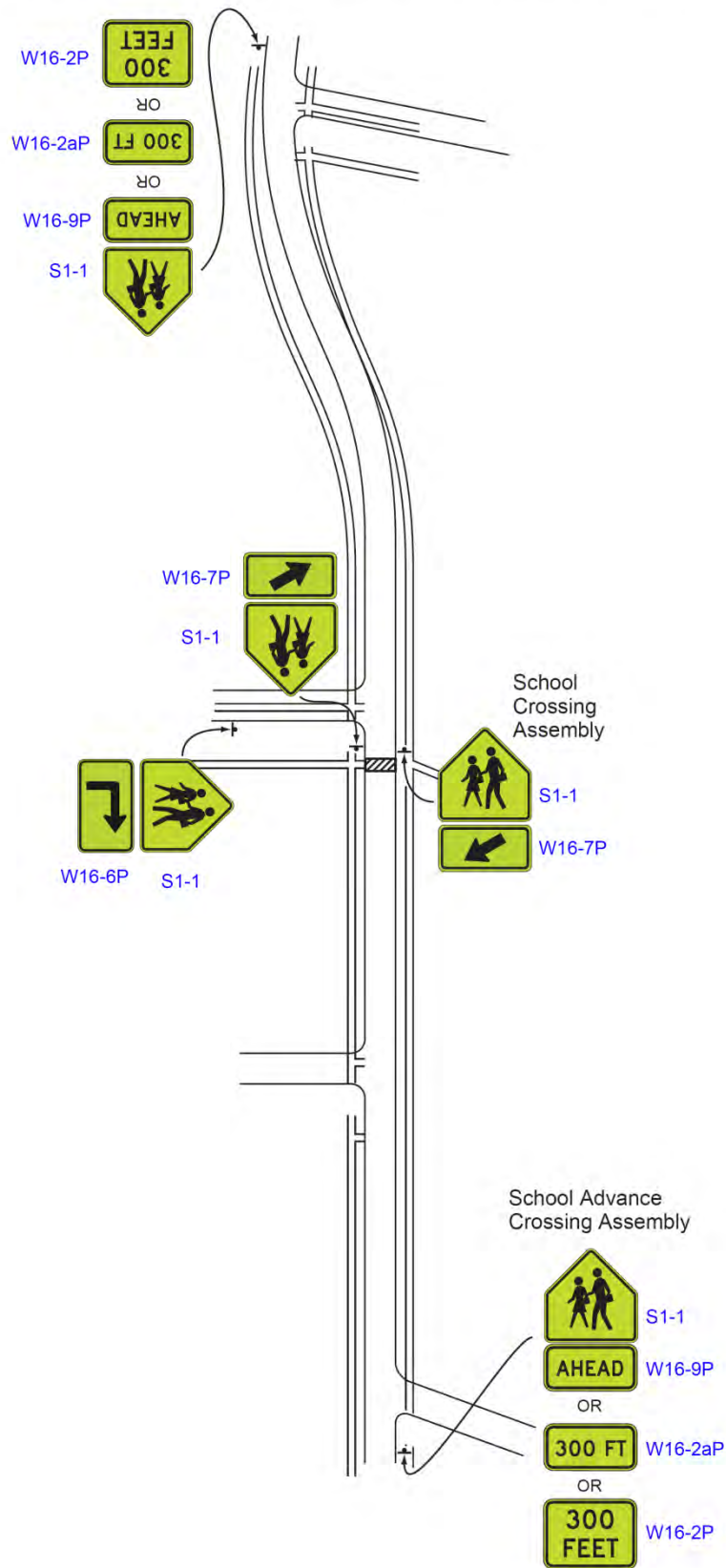
**Figure 7B-2. Example of Signing for a Higher Fines School Zone without a School Crossing**



**Figure 7B-3. Example of Signing for a Higher Fines School Zone with a School Speed Limit**

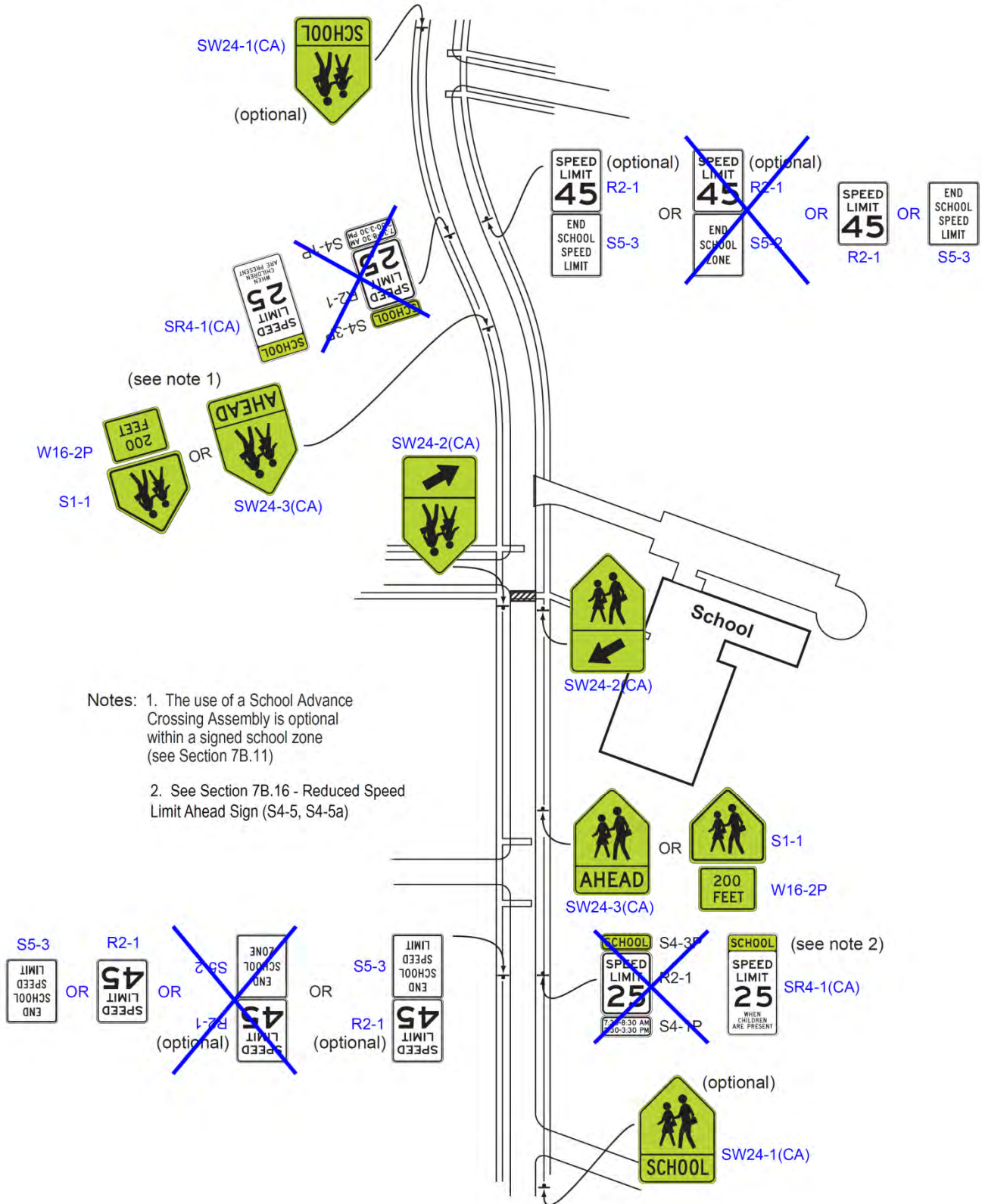


**Figure 7B-4. Example of Signing for a School Crossing Outside of a School Zone**

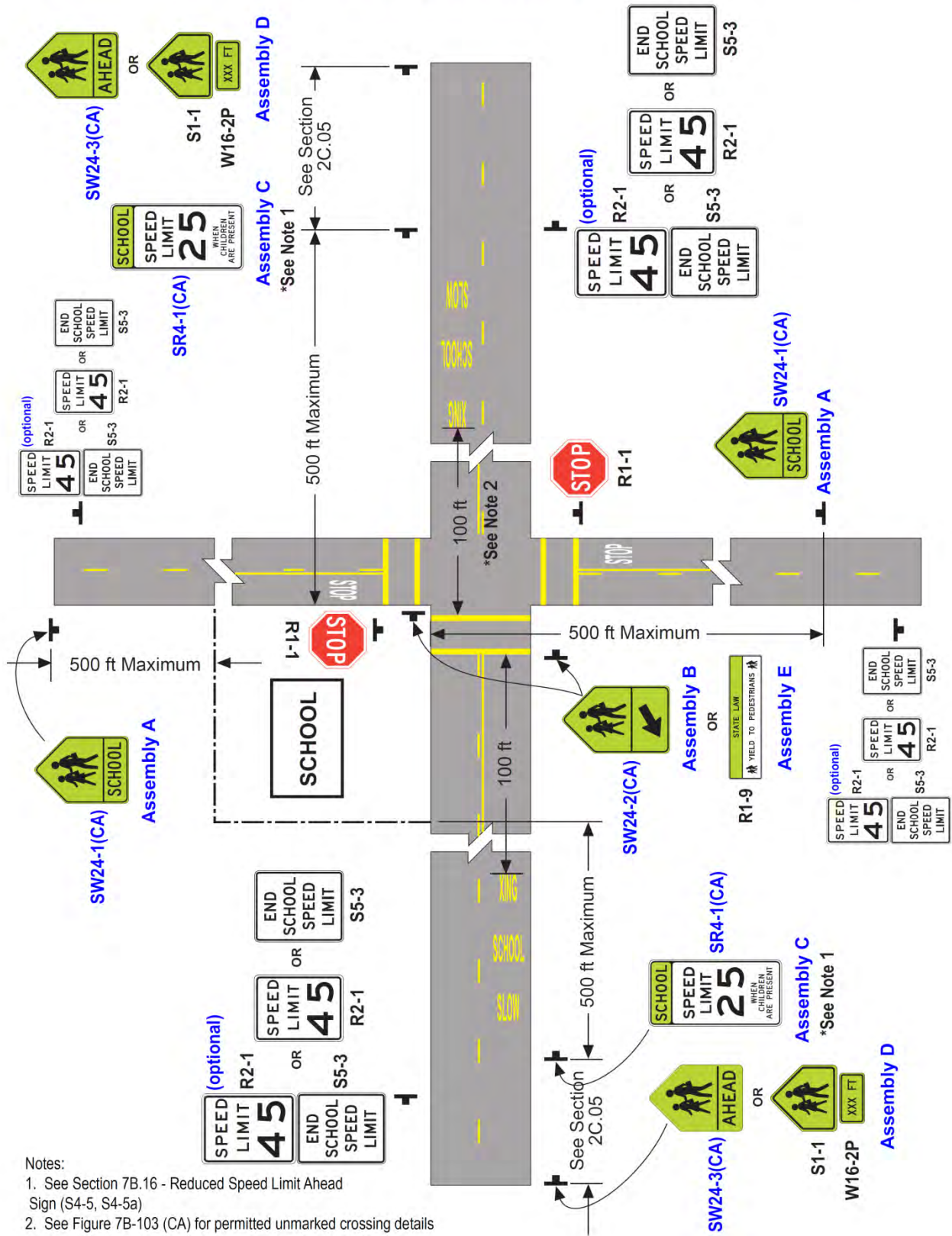




**Figure 7B-5. Example of Signing for a School Zone with a School Speed Limit and a School Crossing**



**Figure 7B-5(CA). Example of Signing for a School Zone with a School Speed Limit and a School Crossing**



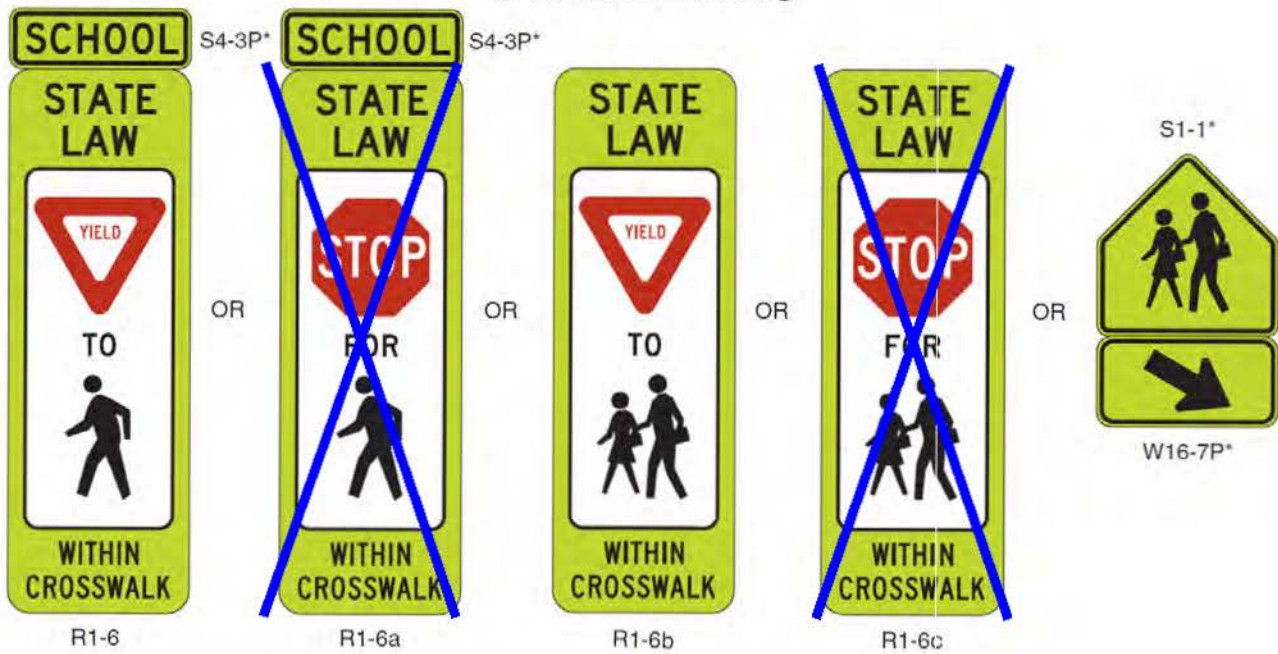
**Figure 7B-6. In-Street Signs in School Areas**

**A - In advance of the school crossing**



\* Reduced size signs:  
 S1-1 12 x 12 inches  
 S4-3P 12 x 4 inches  
 W16-7P 12 x 6 inches  
 W16-9P 12 x 6 inches

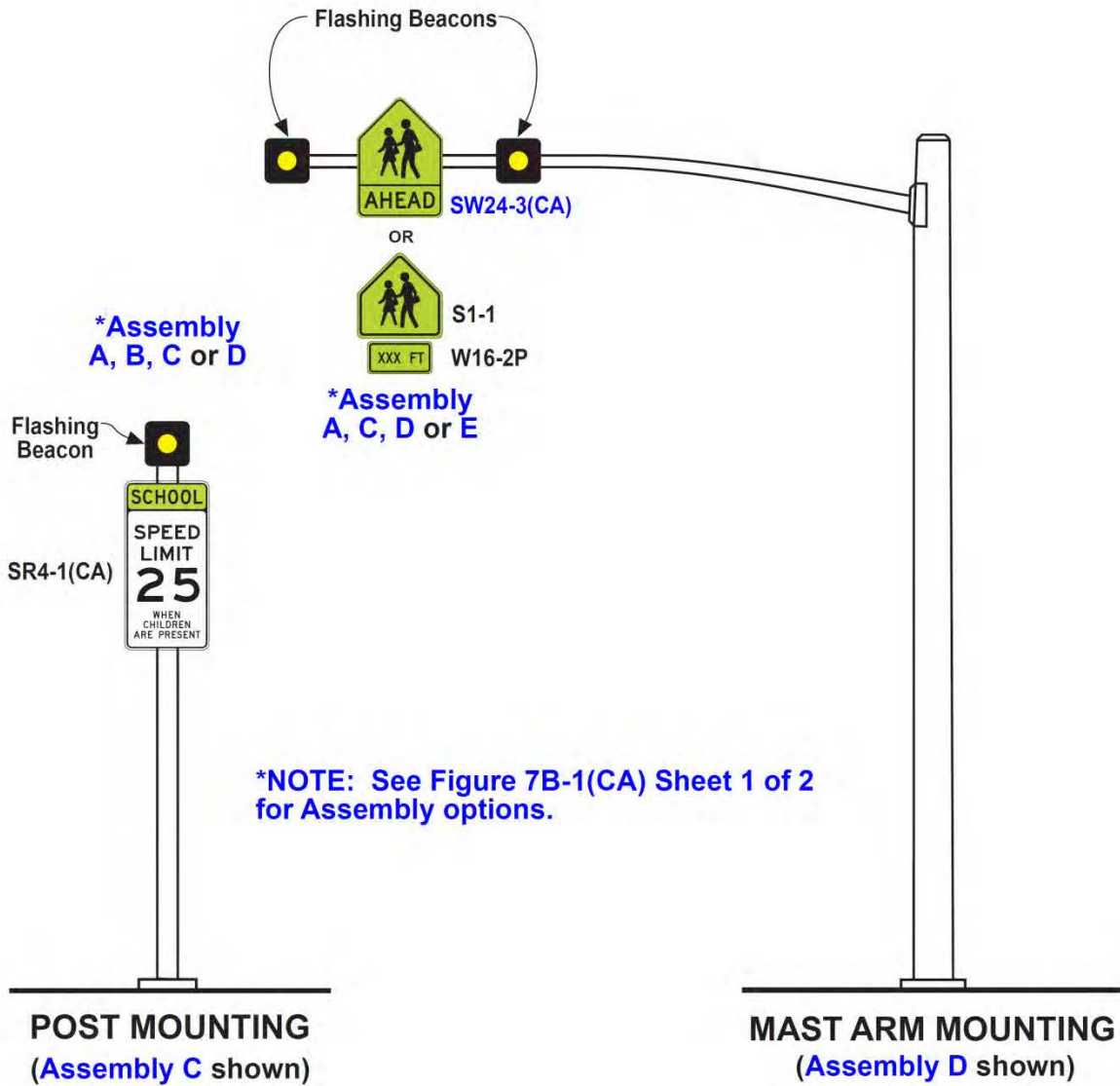
**B - At the school crossing**



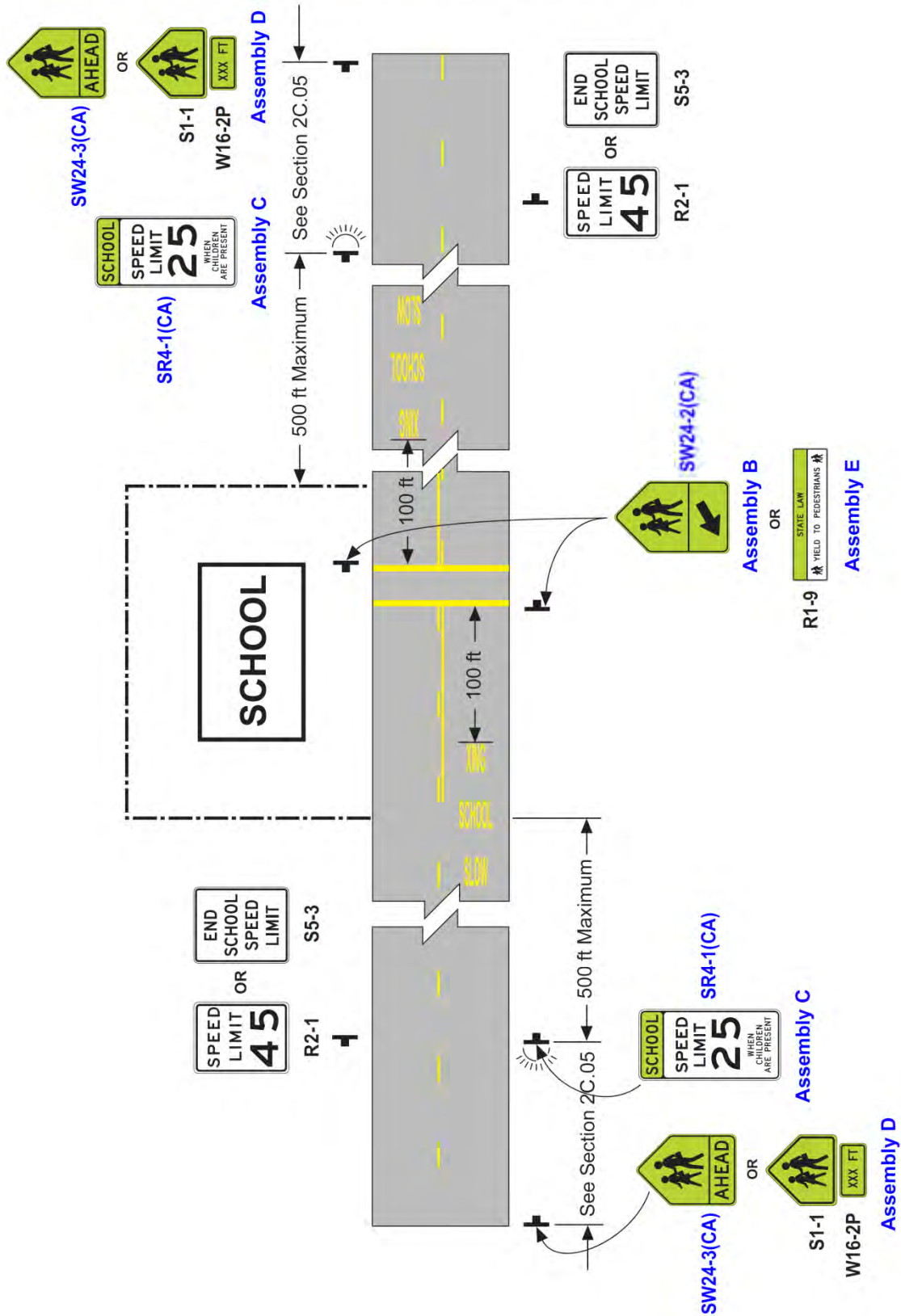
Notes:

1. The use of the STATE LAW legend is optional on the R1-6 series signs (see Section 7B.12).
2. The use of the SCHOOL plaque above the R1-6 and R1-6a signs is optional.

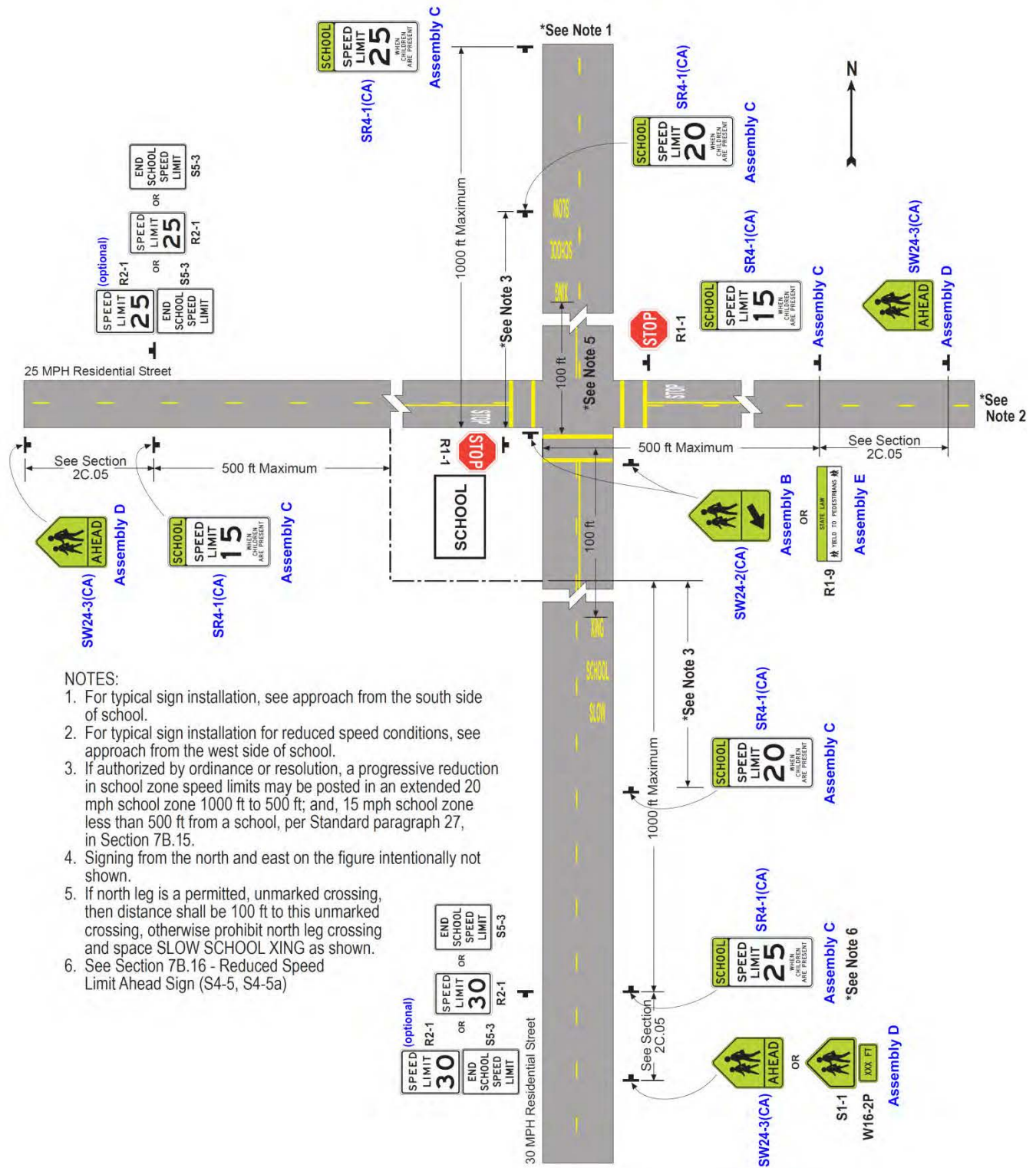
**Figure 7B-101 (CA). Example of School Area Signs with Flashing Yellow Beacons**



**Figure 7B-102 (CA). Example of Signing for Traffic Control in School Areas with Flashing Yellow Beacons**



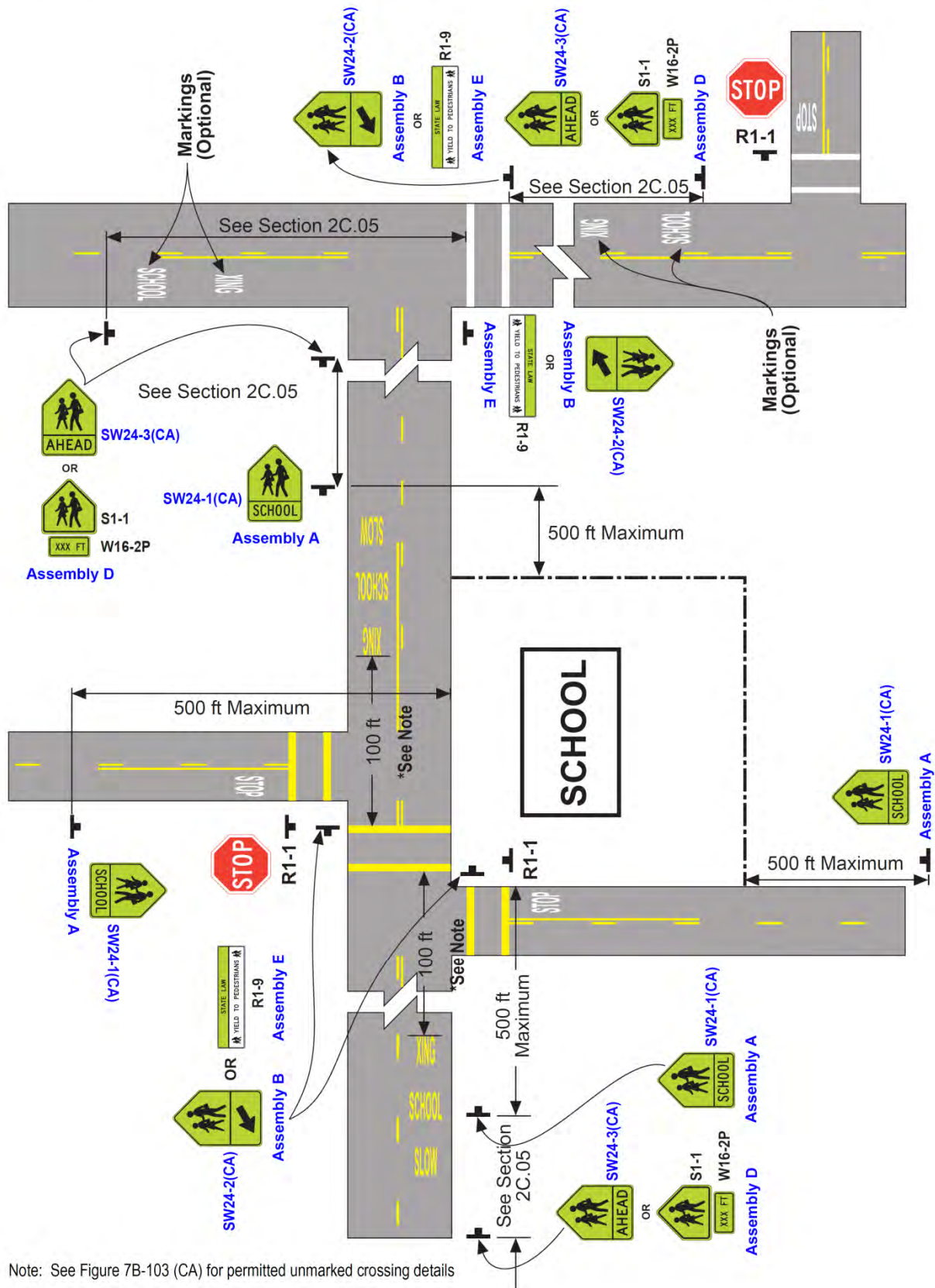
**Figure 7B-103(CA). Example of Signing for School Area Traffic Control with Extended and/or Reduced School Zone Speed Limits**



**NOTES:**

1. For typical sign installation, see approach from the south side of school.
2. For typical sign installation for reduced speed conditions, see approach from the west side of school.
3. If authorized by ordinance or resolution, a progressive reduction in school zone speed limits may be posted in an extended 20 mph school zone 1000 ft to 500 ft; and, 15 mph school zone less than 500 ft from a school, per Standard paragraph 27, in Section 7B.15.
4. Signing from the north and east on the figure intentionally not shown.
5. If north leg is a permitted, unmarked crossing, then distance shall be 100 ft to this unmarked crossing, otherwise prohibit north leg crossing and space SLOW SCHOOL XING as shown.
6. See Section 7B.16 - Reduced Speed Limit Ahead Sign (S4-5, S4-5a)

**Figure 7B-104(CA). Example of Signing for School Crosswalk Warning Assembly**



**Table 7B-1. School Area Sign and Plaque Sizes**

| Sign                                | Sign Designation          | Section      | Conventional Road | Minimum | Oversized |
|-------------------------------------|---------------------------|--------------|-------------------|---------|-----------|
| School                              | S1-1                      | 7B.08        | 36 x 36           | 30 x 30 | 48 x 48   |
| School Bus Stop Ahead               | S3-1                      | 7B.13        | 36 x 36           | 30 x 30 | 48 x 48   |
| School Bus Turn Ahead               | S3-2                      | 7B.14        | 36 x 36           | 30 x 30 | 48 x 48   |
| Reduced School Speed Limit Ahead    | S4-5, S4-5a               | 7B.16        | 36 x 36           | 30 x 30 | 48 x 48   |
| School Speed Limit XX When Flashing | S5-1                      | 7B.15        | 24 x 48           |         | 36 x 72   |
| End School Zone                     | S5-2                      | 7B.00        | 24 x 30           | 24 x 30 | 36 x 48   |
| End School Speed Limit              | S5-3                      | 7B.15        | 24 x 30           | 24 x 30 | 36 x 48   |
| In-Street Ped Crossing              | R1-6, R1-6a, R1-6b, R1-6c | 7B.11, 7B.12 | 12 x 36           | N/A     | N/A       |
| Speed Limit (School Use)            | R2-1                      | 7B.15        | 24 x 30           | 24 x 30 | 36 x 48   |
| Begin Higher Fines Zone             | R2-10                     | 7B.10        | 24 x 30           |         | 36 x 48   |
| End Higher Fines Zone               | R2-11                     | 7B.10        | 24 x 30           |         | 36 x 48   |

| Plaque                             | Sign Designation | Section             | Conventional Road | Minimum | Oversized |
|------------------------------------|------------------|---------------------|-------------------|---------|-----------|
| X:XX to X:XX AM<br>X:XX to X:XX PM | S4-1P            | 7B.15               | 24 x 10           |         | 36 x 18   |
| When Children Are Present          | S4-2P            | 7B.15               | 24 x 10           | 24 x 10 | 36 x 18   |
| School                             | S4-3P            | 7B.09, 7B.15        | 24 x 8            | 24 x 8  | 36 x 12   |
| When Flashing                      | S4-4P            | 7B.15               | 24 x 10           |         | 36 x 18   |
| Mon-Fri                            | S4-6P            | 7B.15               | 24 x 10           |         | 36 x 18   |
| All-Year                           | S4-7P            | 7B.00               | 24 x 12           |         | 36 x 18   |
| Fines Higher                       | R2-6P            | 7B.10               | 24 x 18           |         | 36 x 24   |
| XX Feet                            | W16-2P           | 7B.08               | 24 x 18           | 24 x 18 | 30 x 24   |
| XX Ft                              | W16-2aP          | 7B.08               | 24 x 12           | 24 x 12 | 30 x 18   |
| Turn Arrow                         | W16-5P           | 7B.08, 7B.09, 7B.11 | 24 x 12 24 x 18   | 24 x 18 | 36 x 18   |
| Advance Turn Arrow                 | W16-6P           | 7B.08, 7B.09, 7B.11 | 24 x 12 24 x 18   | 24 x 18 | 36 x 18   |
| Diagonal Arrow                     | W16-7P           | 7B.12               | 24 x 12           | 24 x 12 | 30 x 18   |
| Diagonal Arrow (optional size)     | W16-7P           | 7B.12               | 21 x 15           | N/A     | N/A       |
| Ahead                              | W16-9P           | 7B.11               | 24 x 12           | 24 x 12 | 30 x 18   |

Note: 1. Larger sizes may be used when appropriate  
 2. Dimensions are shown in inches and are shown as width x height  
 3. Minimum sign sizes for multi-lane conventional roads shall be as shown in the Conventional Road column  
 4. Larger plaque sizes can optionally be specified to match sign widths in school sign assemblies.

**Table 7B-1(CA). California School Area Sign Assembly Sizes**

| Assembly                                 | Sign Designation | Section      | Conventional Road | Minimum | Oversized |
|--|------------------|--------------|-------------------|---------|-----------|
| School Warning Assembly A (CA)           | SW24-1(CA)       | 7B.09        | 36 x 48           | 30 x 42 | 48 x 60   |
| School Crosswalk Warning Assembly B (CA) | SW24-2(CA)       | 7B.12        | 36 x 48           | 30 x 42 | 48 x 60   |
| School Speed Limit Assembly C (CA)       | SR4-1(CA)        | 7B.15        | 36 x 72           | 24 x 48 | 48 x 96   |
| School Advance Warning Assembly D (CA)   | SW24-3(CA)       | 7B.11        | 36 x 48           | 30 x 42 | 48 x 60   |
| School Crosswalk Warning Assembly E (CA) | R1-9             | 2B.12, 7B.12 | 90 x 24           | 90 x 24 | 90 x 24   |



## CHAPTER 7C. MARKINGS

### Section 7C.01 Functions and Limitations

**Support:**

01 Markings have definite and important functions in a proper scheme of school area traffic control. In some cases, they are used to supplement the regulations or warnings provided by other devices, such as traffic signs or signals. In other instances, they are used alone and produce results that cannot be obtained by the use of any other device. In such cases they serve as an effective means of conveying certain regulations, guidance, and warnings that could not otherwise be made clearly understandable.

02 Pavement markings have some potential limitations. They might be obscured by snow, might not be clearly visible when wet, and might not be durable when subjected to heavy traffic. In spite of these potential limitations, they have the advantage, under favorable conditions, of conveying warnings or information to the road user without diverting attention from the road.

### Section 7C.02 Crosswalk Markings

**Standard:**

00a **When transverse crosswalk lines are used, they shall be solid white or yellow, marking both edges of the crosswalk, except as noted in the Option. Refer to CVC 21368. They shall be not less than 12 inches nor greater than 24 inches in width.**

**Guidance:**

00b *If transverse crosswalk lines are used to mark a crosswalk, the gap between the lines should not be less than 6 feet. If diagonal or longitudinal lines are used without transverse lines to mark a crosswalk, the crosswalk width should not be less than 6 feet.*

00c *Crosswalk lines on both sides of the crosswalk should extend across the full width of pavement or to the edge of the intersecting crosswalk to discourage diagonal walking between crosswalks.*

01 *Crosswalks should be marked at all intersections on established routes to a school where there is substantial conflict between motorists, bicyclists, and student movements; where students are encouraged to cross between intersections; where students would not otherwise recognize the proper place to cross; or where motorists or bicyclists might not expect students to cross (see Figure 7A-1).*

02 *Crosswalk lines should not be used indiscriminately. An engineering study considering the factors described in Section 3B.18 should be performed before a marked crosswalk is installed at a location away from a traffic control signal or an approach controlled by a STOP or YIELD sign.*

03 *Because non-intersection school crossings are generally unexpected by the road user, warning signs (see Sections 7B.11 and 7B.12) should be installed for all marked school crosswalks at non-intersection locations. Adequate visibility of students by approaching motorists and of approaching motorists by students should be provided by parking prohibitions or other appropriate measures.*

**Support:**

04 Section 3B.18 contains provisions regarding the placement and design of crosswalks, and Section 3B.16 contains provisions regarding the placement and design of the stop lines and yield lines that are associated with them. Provisions regarding the curb markings that can be used to establish parking regulations on the approaches to crosswalks are contained in Section 3B.23.

**Support:**

05 *Examples of school area signing, markings, flashing beacons and overhead school signs are shown in Figures 7B-1(CA), 7B-5(CA), 7B-4 through 7B-6 and Figures 7B-101(CA) through 7B-104(CA).*

06 *Refer to CVC 21368 for crosswalks near schools.*

**Standard:**

07 **Whenever a marked pedestrian crosswalk has been established in a roadway contiguous to a school building or school grounds, it shall be yellow. If any one of the crosswalks is required to be yellow at an intersection, then all other marked pedestrian crosswalks at that intersection shall also be yellow. Refer to CVC 21368.**

Option:

<sup>08</sup> A marked pedestrian crosswalk may be yellow if the nearest point of the crosswalk is not more than 600 feet from a school building or school grounds. Refer to CVC 21368.

<sup>09</sup> A marked pedestrian crosswalk may be yellow if the nearest point of the crosswalk is not more than 2800 feet from a school building or school grounds and there are no intervening crosswalks other than those contiguous to the school grounds, and it appears that the facts and circumstances require special marking for the protection and safety of persons attending the school. Refer to CVC 21368.

Guidance:

<sup>10</sup> *Diagonal or longitudinal markings should be used when a crosswalk is marked at an uncontrolled crossing location. The diagonal or longitudinal lines should be 12 to 24 inches wide and spaced 12 to 60 inches apart. The spacing design should avoid the wheel paths.*

Option:

<sup>11</sup> For added visibility, the area of a crosswalk may be marked with white or yellow diagonal lines at a 45-degree angle to the line of the crosswalk or with white or yellow longitudinal lines parallel to traffic flow. Refer to CVC 21368. When diagonal or longitudinal lines are used to mark a crosswalk, the transverse crosswalk lines may be omitted.

### **Section 7C.03 Pavement Word, Symbol, and Arrow Markings**

Option:

<sup>01</sup> ~~If used, the SCHOOL word marking may extend to the width of two approach lanes (see Figure 7C-1).~~

Guidance:

<sup>02</sup> ~~If the two-lane SCHOOL word marking is used, the letters should be 10 feet or more in height.~~

Support:

<sup>03</sup> Section 3B.20 contains provisions regarding other word, symbol, and arrow pavement markings that can be used to guide, warn, or regulate traffic.

Standard:

<sup>04</sup> **If used, the SCHOOL pavement marking shown in Figure 7C-101(CA) shall be used and it shall be restricted to a single lane.**

Guidance:

<sup>05</sup> *On State highways, all letters, numerals, and symbols should be in accordance with Caltrans' Standard Plans publication. See Section 1A.11 for more information regarding this publication.*

Standard:

<sup>06</sup> **The SLOW SCHOOL XING marking shall be used in accordance with the provisions of CVC 21368 in advance of all yellow school crosswalks (see Figure 7C-101(CA)). They shall not be used where the crossing is controlled by stop signs, traffic signals, or yield signs. They shall be yellow, with the word XING at least 100 feet in advance of the school crosswalk.**

Option:

<sup>07</sup> The SCHOOL XING marking and crosswalks may be used at remote locations outside of the school zone.

Support:

<sup>08</sup> Remote crosswalk locations are locations near schools, which are not included in CVC 21368 criteria. Also refer to Section 7C.03.

Standard:

<sup>09</sup> **If the SCHOOL XING marking and crosswalks are used at remote locations outside of the school zone, they shall not be yellow (Refer to CVC 21368), but white.**

Guidance:

<sup>10</sup> *The SCHOOL XING marking should be used in advance of all white school crosswalks.*

Option:

<sup>11</sup> The SCHOOL marking may be used with the School Assemblies A(CA) or C(CA), except at locations where SLOW SCHOOL XING markings are required.

Standard:

<sup>12</sup> **If the SCHOOL marking is used with the School Assemblies A(CA) or C(CA) (See Section 7B.11), it shall be yellow.**

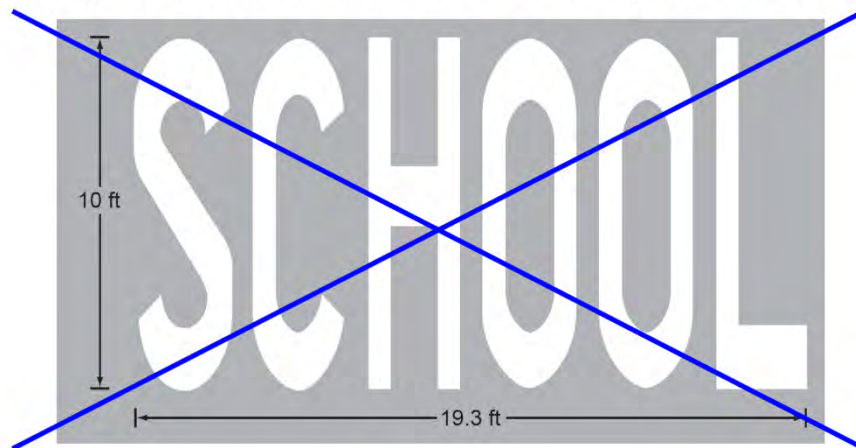
**Guidance:**

<sup>13</sup> *If used, the SCHOOL marking should be located adjacent to the School Assemblies A(CA) or C(CA) (See Section 7B.11).*

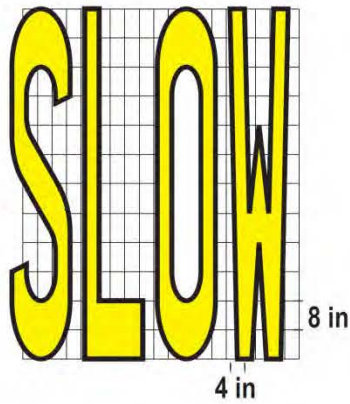
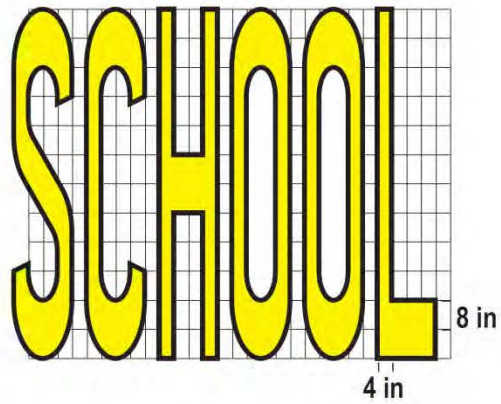
**Support:**

<sup>14</sup> Refer to Section 3B.20 for more details on SCHOOL marking.

**Figure 7C-1. Two-Lane Pavement Marking of "SCHOOL"**



**Figure 7C-101 (CA). Pavement Word Markings for School Areas**



NOT TO SCALE

## CHAPTER 7D. CROSSING SUPERVISION

### Section 7D.01 Types of Crossing Supervision

Support:

- 01 There are three types of school crossing supervision:
  - A. Adult control of pedestrians and vehicles by adult crossing guards,
  - B. Adult control of pedestrians and vehicles by uniformed law enforcement officers, and
  - C. Student and/or parent control of only pedestrians with student and/or parent patrols.
- 02 Information regarding the organization, administration, and operation of a school safety patrol program is contained in the "AAA School Safety Patrol Operations Manual" (see Section 1A.11).

### Section 7D.02 Adult Crossing Guards

Option:

01 Adult crossing guards may be used to provide gaps in traffic at school crossings where an engineering study has shown that adequate gaps need to be created (see Section 7A.03), and where authorized by law.

02 Adult Crossing Guards may be assigned at designated school crossings to assist school pedestrians at specified hours when going to or from school. The following suggested policy for their assignment applies only to crossings.

Guidance:

03 *An Adult Crossing Guard should be considered when:*

- A. *Special situations make it necessary to assist elementary school pedestrians in crossing the street.*
- B. *A change in the school crossing location is being made, but prevailing conditions require school crossing supervision until the change is constructed and it is not reasonable to install another form of traffic control or technique for this period.*

### Criteria for Adult Crossing Guards

Support:

04 Adult Crossing Guards normally are assigned where official supervision of school pedestrians is desirable while they cross a public highway, and at least 40 school pedestrians for each of any two hours (not necessarily consecutive) daily use the crossing while going to or from school.

Option:

05 Adult crossing guards may be used under the following conditions:

1. At uncontrolled crossings where there is no alternate controlled crossing within 600 feet; and
  - a. In urban areas where the vehicular traffic volume exceeds 350 during each of any two hours (not necessarily consecutive) in which 40 or more school pedestrians cross daily while going to or from school; or
  - b. In rural areas where the vehicular traffic volume exceeds 300 during each of any two hours (not necessarily consecutive) in which 30 or more school pedestrians cross daily while going to or from school.Whenever the critical (85th percentile) approach speed exceeds 40 mph, the guidelines for rural areas should be applied.
2. At stop sign-controlled crossing:

Where the vehicular traffic volumes on undivided highways of four or more lanes exceeds 500 per hour during any period when the school pedestrians are going to or from school.
3. At traffic signal-controlled crossings:
  - a. Where the number of vehicular turning movements through the school crosswalk exceeds 300 per hour while school pedestrians are going to or from school; or
  - b. Where justified through analysis of the operations of the intersection.

### Legal Authority and Program Funding for Adult Crossing Guards

Option:

06 Cities and counties may designate local law enforcement agencies, the governing board of any school district or a county superintendent of schools to recruit and assign adult crossing guards to intersections that meet approved guidelines for adult supervision.

Support:

<sup>07</sup> There are various methods for funding a school adult crossing guard program. One of these methods is through the use of fines and forfeitures received under the Penal Code. Disposition of these fines and forfeitures is defined in CVC Sections 42200 and 42201.

<sup>08</sup> An example of these dispositions by cities and counties is as follows:

- A. Disposition by cities (CVC 42200). Fines and forfeitures received by cities and deposited into a "Traffic Safety Fund" may be used to pay the compensation of school crossing guards who are not regular full-time members of the police department of the city.
- B. Disposition by county (CVC 42201). Fines and forfeitures received by a county and deposited in the road fund of the county may be used to pay the compensation of school crossing guards, and necessary equipment and administrative costs. The board of supervisors may adopt standards for crossing guards and has final authority over the total cost of the crossing guard program.

### **Section 7D.03 Qualifications of Adult Crossing Guards**

Support:

<sup>01</sup> High standards for selection of adult crossing guards are essential because they are responsible for the safety of and the efficient crossing of the street by schoolchildren within and in the immediate vicinity of school crosswalks.

Guidance:

<sup>02</sup> *Adult crossing guards should possess the following minimum qualifications:*

- A. *Average intelligence;*
- B. *Good physical condition, including sight, hearing, and ability to move and maneuver quickly in order to avoid danger from errant vehicles;*
- C. *Ability to control a STOP paddle effectively to provide approaching road users with a clear, fully direct view of the paddle's STOP message during the entire crossing movement;*
- D. *Ability to communicate specific instructions clearly, firmly, and courteously;*
- E. *Ability to recognize potentially dangerous traffic situations and warn and manage students in sufficient time to avoid injury.*
- F. *Mental alertness;*
- G. *Neat appearance;*
- H. *Good character;*
- I. *Dependability; and*
- J. *An overall sense of responsibility for the safety of students.*

### **Training Programs for Adult Crossing Guards**

Guidance:

<sup>03</sup> *Adequate training should be provided in adult crossing guard responsibilities and authority. This function can usually be performed effectively by a law enforcement agency responsible for traffic control.*

<sup>04</sup> *Training programs should be designed to acquaint newly employed crossing guards with their specific duties, local traffic regulations, and crossing techniques. Training workshops may be used as a method of advising experienced employees of recent changes in existing traffic laws and program procedures. For example, crossing guards should be familiar with the California law which provides that any person who disregards any traffic signal or direction given by a non-student school crossing guard authorized by a law enforcement agency, any board of supervisors of a county or school district shall be guilty of an infraction and subject to the penalties of Section 42001 of the CVC (Section 2815).*

### **Section 7D.04 Uniform of Adult Crossing Guards**

Standard:

<sup>01</sup> **Law enforcement officers performing school crossing supervision and adult crossing guards shall wear high-visibility retroreflective safety apparel labeled as ANSI 107-2004 standard performance for Class 2 as described in Section 6E.02.**

## **Section 7D.05 Operating Procedures for Adult Crossing Guards**

### **Standard:**

**01 Adult crossing guards shall not direct traffic in the usual law enforcement regulatory sense. In the control of traffic, they shall pick opportune times to create a sufficient gap in the traffic flow. At these times, they shall stand in the roadway to indicate that pedestrians are about to use or are using the crosswalk, and that all vehicular traffic must stop.**

**02 Adult crossing guards shall use a STOP paddle. The STOP paddle shall be the primary hand-signaling device.**

**03 The STOP (R1-1) paddle shall be an octagonal shape. The background of the STOP face shall be red with at least 6-inch series upper-case white letters and border. The paddle shall be at least 18 inches in size and have the word message STOP on both sides. The paddle shall be retroreflectorized or illuminated when used during hours of darkness.**

### **Option:**

**04 The STOP paddle may be modified to improve conspicuity by incorporating white or red flashing lights on both sides of the paddle. Among the types of flashing lights that may be used are individual LEDs or groups of LEDs.**

**05 The white or red flashing lights or LEDs may be arranged in any of the following patterns:**

- A. Two white or red lights centered vertically above and below the STOP legend,**
- B. Two white or red lights centered horizontally on each side of the STOP legend,**
- C. One white or red light centered below the STOP legend,**
- D. A series of eight or more small white or red lights having a diameter of 1/4 inch or less along the outer edge of the paddle, arranged in an octagonal pattern at the eight corners of the STOP paddle (more than eight lights may be used only if the arrangement of the lights is such that it clearly conveys the octagonal shape of the STOP paddle), or**
- E. A series of white lights forming the shapes of the letters in the legend.**

### **Standard:**

**06 If flashing lights are used on the STOP paddle, the flash rate shall be at least 50, but no more than 60, flash periods per minute.**

### **Option:**

**07 The 24 x 24 inch size of the STOP (C28A(CA) paddle may be used where greater emphasis is needed and speeds are 30 mph or more.**

### **Support:**

**08 See Section 6E.03 for details on STOP paddles and rigid staff.**

## **Section 7D.101(CA) School Safety Patrols**

### **Legal Authority**

#### **Standard:**

**01 For all purposes "School Safety Patrols" shall mean "Student Patrols" as referenced in this California MUTCD.**

**02 School Safety Patrols shall be authorized by the local school board. School authorities shall be responsible for organizing, instructing and supervising patrols with the assistance of the local police.**

#### **Support:**

**03 The California Education Code, Sections 49300 to 49307, and the California Code of Regulations, Sections 570 to 576 and 632, authorize the development of School Safety Patrols and outline rules for implementing these programs within the state.**

### **Uniforms:**

#### **Standard:**

**04 The use of the School Safety Patrol uniforms and insignia shall adhere to the following regulations (California Code of Regulations 576):**

- (a) A school safety patrol member (except a member of the R.O.T.C. or California Cadet Corps on traffic duty in his official uniform) shall wear, at all times while on duty, the basic standard uniform specified in this section, except that the rainy day uniform may be worn under appropriate weather conditions. Only the optional additions specified in this section may be added to the uniform.**

- (b) The basic standard uniform for patrol members is the white or fluorescent orange Sam Browne belt and either an overseas type federal yellow or fluorescent orange cap or a yellow or fluorescent orange helmet. Optional additions to the basic standard uniform are any or all of the following:
  - (1) Colored piping on the federal yellow cap.
  - (2) Colored striping on the yellow helmet.
  - (3) A red or fluorescent orange upper garment
  - (4) Insignia or a special badge identifying the organization, to be worn on the left breast, left arm, or cap.
- (c) The rainy-day uniform is a federal yellow raincoat and a federal yellow rain hat. The Sam Browne belt may be worn over the raincoat.
- (d) The insignia, or special badge and cap shall be worn only during official school safety patrol duty, except that the governing board may authorize members of the school safety patrol to wear the uniform and insignia for special school safety patrol functions.

### Operating Procedures

#### **Standard:**

<sup>05</sup> Student patrols shall be carefully selected. They shall be students from the fifth grade or higher and shall be at least 10 years of age. Refer to California Code of Regulations Section 571.

#### *Guidance:*

<sup>06</sup> Leadership and reliability should be determining qualities for patrol membership.

#### **Standard:**

<sup>07</sup> Parental approval shall be obtained in writing before a student is used as a member of a student patrol. Refer to California Education Code Section 49302.

#### *Support:*

<sup>08</sup> School Safety Patrols control children, not vehicles.

#### **Standard:**

<sup>09</sup> School Safety Patrols shall stop children back of the curb or edge of the roadway and allow them to cross only when there is an adequate gap in traffic (see California Code of Regulations Sections 570 to 576 and 632 for School Safety Patrols operating procedures and requirements).

#### **Criteria for Student Patrols:**

#### *Option:*

<sup>10</sup> A student patrol may be established at locations where an existing traffic control device, police officer or adult crossing guard is in operation. They may also be used where there are adequate crossing gaps in vehicular flow at an uncontrolled crossing and it is desirable to use student patrols to guide the school pedestrians.

#### *Support:*

<sup>11</sup> To determine the frequency and adequacy of gaps in the traffic stream, refer to Section 7A.03.



# PART 8

## TRAFFIC CONTROL FOR RAILROAD AND LIGHT RAIL TRANSIT GRADE CROSSINGS

### CHAPTER 8A. GENERAL

#### Section 8A.01 Introduction

##### Support:

<sup>01</sup> Whenever the acronym “LRT” is used in Part 8, it refers to “light rail transit.”

<sup>02</sup> Part 8 describes the traffic control devices that are used at highway-rail and highway-LRT grade crossings. Unless otherwise provided in the text or on a figure or table, the provisions of Part 8 are applicable to both highway-rail and highway-LRT grade crossings. When the phrase “grade crossing” is used by itself without the prefix “highway-rail” or “highway-LRT,” it refers to both highway-rail and highway-LRT grade crossings.

<sup>03</sup> Traffic control for grade crossings includes all signs, signals, markings, other warning devices, and their supports along highways approaching and at grade crossings. The function of this traffic control is to promote safety and provide effective operation of rail and/or LRT and highway traffic at grade crossings.

<sup>04</sup> For purposes of design, installation, operation, and maintenance of traffic control devices at grade crossings, it is recognized that the crossing of the highway and rail tracks is situated on a right-of-way available for the joint use of both highway traffic and railroad or LRT traffic.

~~<sup>05</sup> The highway agency or authority with jurisdiction and the regulatory agency with statutory authority, if applicable, jointly determine the need and selection of devices at a grade crossing.~~

<sup>05a</sup> A diagnostic team, consisting of knowledgeable representatives of parties of interest in a highway-rail or highway-LRT grade crossing, using crossing safety management principles, evaluates conditions at a grade crossing to make determinations or recommendations concerning safety needs at the grade crossing. The diagnostic team needs to, at a minimum, include representatives of the highway agency or authority with jurisdiction over the roadway, the railroad or LRT agency with responsibility for the track and signals, and the California Public Utilities Commission (CPUC), which is the state regulatory agency with statutory authority over grade crossings. The removal, reduction, addition, or change in the type of warning devices at each public grade crossing, or publicly-used private grade crossing (as determined by CPUC or a court competent jurisdiction), must be authorized by CPUC. This includes any changes that can affect interconnections with adjacent traffic signals, or any other modification that may impact the safety of the grade crossing. Refer to Public Utilities Code Sections 1201 through 1205, 7537, 99152 and CPUC General Orders 75 and 88, as amended.

<sup>06</sup> In Part 8, the combination of devices selected or installed at a specific grade crossing is referred to as a “traffic control system.”

##### Standard:

<sup>07</sup> **The traffic control devices, systems, and practices described in this Manual shall be used at all grade crossings open to public travel (see definition in Section 1A.13), consistent with Federal, State, and local laws and regulations.**

##### Support:

<sup>08</sup> Part 8 also describes the traffic control devices that are used in locations where light rail LRT vehicles are operating along streets and highways in mixed traffic with automotive vehicles.

<sup>09</sup> LRT is a mode of metropolitan transportation that employs LRT vehicles (commonly known as light rail vehicles, streetcars, or trolleys) that operate on rails in streets in mixed traffic, and LRT traffic that operates in semi-exclusive rights-of-way, or in exclusive rights-of-way. Grade crossings with LRT can occur at intersections or at midblock locations, including public and private driveways.

<sup>10</sup> An initial educational campaign along with an ongoing program to continue to educate new drivers is beneficial when introducing LRT operations to an area and, hence, new traffic control devices.

<sup>11</sup> LRT alignments can be grouped into one of the following three types:

A. Exclusive: An LRT right-of-way that is grade-separated or protected by a fence or traffic barrier. Motor vehicles, pedestrians, and bicycles are prohibited within the right-of-way. Subways and aerial structures are

included within this group. This type of alignment does not have grade crossings and is not further addressed in Part 8.

- B. Semi-exclusive: An LRT alignment that is in a separate right-of-way or along a street or railroad right-of-way where motor vehicles, pedestrians, and bicycles have limited access and cross at designated locations only.
- C. Mixed-use: An alignment where LRT operates in mixed traffic with all types of road users. This includes streets, transit malls, and pedestrian malls where the right-of-way is shared.

**Standard:**

**12 Where LRT and railroads use the same tracks or adjacent tracks, the traffic control devices, systems, and practices for highway-rail grade crossings shall be used.**

**Support:**

13 To promote an understanding of common terminology between highway and railroad and LRT signaling issues, definitions and acronyms pertaining to Part 8 are provided in Sections 1A.13 and 1A.14.

**Section 8A.02 Use of Standard Devices, Systems, and Practices at Highway-Rail Grade Crossings**

**Support:**

01 Because of the large number of significant variables to be considered, no single standard system of traffic control devices is universally applicable for all highway-rail grade crossings.

*Guidance:*

02 *The appropriate traffic control system to be used at a highway-rail grade crossing should be determined by an engineering study involving both the highway agency and the railroad company.*

*Option:*

03 The engineering study may include the Highway-Rail Intersection (HRI) components of the National Intelligent Transportation Systems (ITS) architecture, which is a USDOT accepted method for linking the highway, vehicles, and traffic management systems with rail operations and wayside equipment.

**Support:**

04 More detail on Highway-Rail Intersection components is available from the USDOT's Federal Railroad Administration, 1200 New Jersey Avenue, SE, Washington, DC 20590, or [www.fra.dot.gov](http://www.fra.dot.gov).

**Standard:**

**05 Traffic control devices, systems, and practices shall be consistent with the design and application of the Standards contained in this Manual.**

~~06 Before any new highway-rail grade crossing traffic control system is installed or before modifications are made to an existing system, approval shall be obtained from the highway agency with the jurisdictional and/or statutory authority, and from the railroad company.~~

**06a Before any new highway-rail grade crossing traffic control system is installed or before modifications are made to an existing system, approval shall be obtained from the California Public Utilities Commission. The highway agency with jurisdictional and/or statutory authority shall be consulted during the planning, design and installation of traffic control devices at grade crossings. Refer to CPUC General Orders 75 and 88, as amended, and Public Utilities Code Sections 1201 through 1205 and 7537.**

*Guidance:*

07 *To stimulate effective responses from road users, these devices, systems, and practices should use the five basic considerations employed generally for traffic control devices and described fully in Section 1A.02: design, placement, operation, maintenance, and uniformity.*

**Support:**

08 Many other details of highway-rail grade crossing traffic control systems that are not set forth in Part 8 are contained in the publications listed in Section 1A.11, including the "2000 AREMA Communications & Signals Manual" published by the American Railway Engineering & Maintenance-of-Way Association (AREMA) and the 2006 edition of "Preemption of Traffic Signals Near Railroad Crossings" published by the Institute of Transportation Engineers (ITE).

### **Section 8A.03 Use of Standard Devices, Systems, and Practices at Highway-LRT Grade Crossings**

#### **Support:**

01 The combination of devices selected or installed at a specific highway-LRT grade crossing is referred to as a Light Rail Transit Traffic Control System.

02 Because of the large number of significant variables to be considered, no single standard system of traffic control devices is universally applicable for all highway-LRT grade crossings.

03 For the safety and integrity of operations by highway and LRT users, the highway agency with jurisdiction, the regulatory agency with statutory authority, if applicable, and the LRT authority jointly determine the need and selection of traffic control devices and the assignment of priority to LRT at a highway-LRT grade crossing.

04 The normal rules of the road and traffic control priority identified in the "Uniform Vehicle Code" govern the order assigned to the movement of vehicles at an intersection unless the local agency determines that it is appropriate to assign a higher priority to LRT. Examples of different types of LRT priority control include separate traffic control signal phases for LRT movements, restriction of movement of roadway vehicles in favor of LRT operations, and preemption of highway traffic signal control to accommodate LRT movements.

#### *Guidance:*

05 *The appropriate traffic control system to be used at a highway-LRT grade crossing should be determined by an engineering study conducted by the LRT or highway agency in cooperation with other appropriate State and local organizations.*

#### **Standard:**

06 **Traffic control devices, systems, and practices shall be consistent with the design and application of the Standards contained in this Manual.**

07 **The traffic control devices, systems, and practices described in this Manual shall be used at all highway-LRT grade crossings.**

08 **Before any new highway-LRT grade crossing traffic control system is installed or before modifications are made to an existing system, approval shall be obtained from the highway agency with the jurisdictional and/or statutory authority, and from the LRT agency.**

#### *Guidance:*

09 *To stimulate effective responses from road users, these devices, systems, and practices should use the five basic considerations employed generally for traffic control devices and described fully in Section 1A.02: design, placement, operation, maintenance, and uniformity.*

#### **Support:**

10 Many other details of highway-LRT grade crossing traffic control systems that are not set forth in Part 8 are contained in the publications listed in Section 1A.11.

#### **Standard:**

11 **Highway-LRT grade crossings in semi-exclusive alignments shall be equipped with a combination of automatic gates and flashing-light signals, or flashing-light signals only, or traffic control signals, unless an engineering study indicates that the use of Crossbuck Assemblies, STOP signs, or YIELD signs alone would be adequate.**

#### **Option:**

12 Highway-LRT grade crossings in mixed-use alignments may be equipped with traffic control signals unless an engineering study indicates that the use of Crossbuck Assemblies, STOP signs, or YIELD signs alone would be adequate.

#### **Support:**

13 Sections 8B.03 and 8B.04 contain provisions regarding the use and placement of Crossbuck signs and Crossbuck Assemblies. Section 8B.05 describes the appropriate conditions for the use of STOP or YIELD signs alone at a highway-LRT grade crossing. Sections 8C.10 and 8C.11 contain provisions regarding the use of traffic control signals at highway-LRT grade crossings.

### **Section 8A.04 Uniform Provisions**

#### **Standard:**

**01 All signs used in grade crossing traffic control systems shall be retroreflectorized or illuminated as described in Section 2A.07 to show the same shape and similar color to an approaching road user during both day and night.**

**02 No sign or signal shall be located in the center of an undivided highway, unless it is crashworthy (breakaway, yielding, or shielded with a longitudinal barrier or crash cushion) or unless it is placed on a raised island.**

#### *Guidance:*

*03 Any signs or signals placed on a raised island in the center of an undivided highway should be installed with a clearance of at least 2 feet from the outer edge of the raised island to the nearest edge of the sign or signal, except as permitted in Section 2A.19.*

*04 Where the distance between tracks, measured along the highway between the inside rails, exceeds 100 feet, additional signs or other appropriate traffic control devices should be used to inform approaching road users of the long distance to cross the tracks.*

### **Section 8A.05 Grade Crossing Elimination**

#### *Guidance:*

*01 Because grade crossings are a potential source of crashes and congestion, agencies should conduct engineering studies to determine the cost and benefits of eliminating these crossings.*

#### **Standard:**

**02 When a grade crossing is eliminated, the traffic control devices for the crossing shall be removed.**

**03 If the existing traffic control devices at a multiple-track grade crossing become improperly placed or inaccurate because of the removal of some of the tracks, the existing devices shall be relocated and/or modified.**

#### *Guidance:*

*04 Any grade crossing that cannot be justified should be eliminated.*

*05 Where a roadway is removed from a grade crossing, the roadway approaches in the railroad or LRT right-of-way should also be removed and appropriate signs and object markers should be placed at the roadway end in accordance with Section 2C.66.*

*06 Where a railroad or LRT is eliminated at a grade crossing, the tracks should be removed or covered.*

#### **Option:**

**07 Based on engineering judgment, the TRACKS OUT OF SERVICE (R8-9) sign (see Figure 8B-1) may be temporarily installed until the tracks are removed or covered. The length of time before the tracks will be removed or covered may be considered in making the decision as to whether to install the sign.**

### **Section 8A.06 Illumination at Grade Crossings**

#### **Support:**

**01 Illumination is sometimes installed at or adjacent to a grade crossing in order to provide better nighttime visibility of trains or LRT equipment and the grade crossing (for example, where a substantial amount of railroad or LRT operations are conducted at night, where grade crossings are blocked for extended periods of time, or where crash history indicates that road users experience difficulty in seeing trains or LRT equipment or traffic control devices during hours of darkness).**

**02 Recommended types and locations of luminaires for illuminating grade crossings are contained in the American National Standards Institute's (ANSI) "Practice for Roadway Lighting RP-8," which is available from the Illuminating Engineering Society (see Section 1A.11).**

#### **Support:**

**03 Delineators can be placed on the right side of all approaches to non-illuminated rural grade crossings. If needed, place the delineators from the location of the Highway-Rail Grade Crossing Advance Warning (W10-1) sign to the Crossbuck (R15-1) sign and extend an equal distance downstream, spacing no more than 50 feet apart.**

**04 Other devices can be added to supplement the existing devices and device spacing can be adjusted to provide additional reaction time or delineation.**

### **Section 8A.07 Quiet Zone Treatments at Highway-Rail Grade Crossings**

**Support:**

01 49 CFR Part 222 (Use of Locomotive Horns at Highway-Rail Grade Crossings; Final Rule) prescribes Quiet Zone requirements and treatments.

**Standard:**

02 **Any traffic control device and its application where used as part of a Quiet Zone shall comply with all applicable provisions of the MUTCD.**

### **Section 8A.08 Temporary Traffic Control Zones**

**Support:**

01 Temporary traffic control planning provides for continuity of operations (such as movement of traffic, pedestrians and bicycles, transit operations, and access to property/utilities) when the normal function of a roadway at a grade crossing is suspended because of temporary traffic control operations.

**Standard:**

02 **Traffic controls for temporary traffic control zones that include grade crossings shall be as outlined in Part 6.**

03 **When a grade crossing exists either within or in the vicinity of a temporary traffic control zone, lane restrictions, flagging (see Chapter 6E), or other operations shall not be performed in a manner that would cause highway vehicles to stop on the railroad or LRT tracks, unless a flagger or uniformed law enforcement officer is provided at the grade crossing to minimize the possibility of highway vehicles stopping on the tracks, even if automatic warning devices are in place.**

*Guidance:*

04 *Public and private agencies, including emergency services, businesses, and railroad or LRT companies, should meet to plan appropriate traffic detours and the necessary signing, marking, and flagging requirements for operations during temporary traffic control zone activities. Consideration should be given to the length of time that the grade crossing is to be closed, the type of rail or LRT and highway traffic affected, the time of day, and the materials and techniques of repair.*

05 *The agencies responsible for the operation of the LRT and highway should be contacted when the initial planning begins for any temporary traffic control zone that might directly or indirectly influence the flow of traffic on mixed-use facilities where LRT and road users operate.*

06 *Temporary traffic control operations should minimize the inconvenience, delay, and crash potential to affected traffic. Prior notice should be given to affected public or private agencies, emergency services, businesses, railroad or LRT companies, and road users before the free movement of road users or rail traffic is infringed upon or blocked.*

07 *Temporary traffic control zone activities should not be permitted to extensively prolong the closing of the grade crossing.*

08 *The width, grade, alignment, and riding quality of the highway surface at a grade crossing should, at a minimum, be restored to correspond with the quality of the approaches to the grade crossing.*

**Support:**

09 Section 6G.18 contains additional information regarding temporary traffic control zones in the vicinity of grade crossings, and Figure 6H-46 shows an example of a typical situation that might be encountered.

### **Section 8A.101(CA) Relation to Other Documents**

**Support:**

01 The following rules and regulations govern traffic control devices at highway-rail grade crossings in the State and are available through the California Public Utilities Commission's (CPUC) web-site:

- A. General Order No. 75, as amended, REGULATIONS GOVERNING STANDARDS FOR WARNING DEVICES FOR AT-GRADE HIGHWAY-RAIL CROSSINGS IN THE STATE OF CALIFORNIA, Public Utilities Commission of the State of California.
- B. General Order No. 88, as amended, RULES FOR ALTERING PUBLIC HIGHWAY-RAIL CROSSINGS, Public Utilities Commission of the State of California.

- C. General Order No. 145, as amended, REGULATIONS GOVERNING RAILROAD GRADE CROSSINGS TO BE CLASSIFIED EXEMPT FROM THE MANDATORY STOP REQUIREMENTS OF SECTION 22452 OF THE VEHICLE CODE, Public Utilities Commission of the State of California.

## CHAPTER 8B. SIGNS AND MARKINGS

### Section 8B.01 Purpose

Support:

01 Passive traffic control systems, consisting of signs and pavement markings only, identify and direct attention to the location of a grade crossing and advise road users to slow down or stop at the grade crossing as necessary in order to yield to any rail traffic occupying, or approaching and in proximity to, the grade crossing.

02 Signs and markings regulate, warn, and guide the road users so that they, as well as LRT vehicle operators on mixed-use alignments, can take appropriate action when approaching a grade crossing.

**Standard:**

03 **The design and location of signs shall comply with the provisions of Part 2. The design and location of pavement markings shall comply with the provisions of Part 3.**

### Section 8B.02 Sizes of Grade Crossing Signs

**Standard:**

01 **The sizes of grade crossing signs shall be as shown in Table 8B-1.**

Option:

02 Signs larger than those shown in Table 8B-1 may be used (see Section 2A.11).

### Section 8B.03 Grade Crossing (Crossbuck) Sign (R15-1) and Number of Tracks Plaque (R15-2P) at Active and Passive Grade Crossings

**Standard:**

01 **The Grade Crossing (R15-1) sign (see Figure 8B-1), commonly identified as the Crossbuck sign, shall be retroreflectorized white with the words RAILROAD CROSSING in black lettering, mounted as shown in Figure 8B-2.**

Support:

02 In most States, the Crossbuck sign requires road users to yield the right-of-way to rail traffic at a grade crossing.

**Standard:**

03 **As a minimum, one Crossbuck sign shall be used on each highway approach to every highway-rail grade crossing, alone or in combination with other traffic control devices.**

Option:

04 A Crossbuck sign may be used on a highway approach to a highway-LRT grade crossing on a semi-exclusive or mixed-use alignment, alone or in combination with other traffic control devices.

**Standard:**

05 **If ~~automatic gates are not present~~ a Crossbuck (R15-1) sign is used and if there are two or more tracks at a grade crossing, the number of tracks shall be indicated on a supplemental Number of Tracks (R15-2P) plaque (see Figure 8B-1) of inverted T shape mounted below the Crossbuck sign in the manner shown in Figure 8B-2.**

06 **On each approach to a highway-rail grade crossing and, if used, on each approach to a highway-LRT grade crossing, the Crossbuck sign shall be installed on the right-hand side of the highway on each approach to the grade crossing. Where restricted sight distance or unfavorable highway geometry exists on an approach to a grade crossing, an additional Crossbuck sign shall be installed on the left-hand side of the highway, possibly placed back-to-back with the Crossbuck sign for the opposite approach, or otherwise located so that two Crossbuck signs are displayed for that approach.**

07 **A strip of retroreflective white material not less than 2 inches in width shall be used on the back of each blade of each Crossbuck sign for the length of each blade, at all grade crossings where Crossbuck signs have been installed, except those where Crossbuck signs have been installed back-to-back.**

*Guidance:*

<sup>08</sup> *Crossbuck signs should be located with respect to the highway pavement or shoulder in accordance with the criteria in Chapter 2A and Figures 2A-2, 2A-2(CA) and 2A-3, and should be located with respect to the nearest track in accordance with Figure 8C-2.*

<sup>09</sup> *The minimum lateral offset for the nearest edge of the Crossbuck sign should be 6 feet from the edge of the shoulder or 12 feet from the edge of the traveled way in rural areas (whichever is greater), and 2 feet from the face of the curb in urban areas.*

<sup>10</sup> *Where unusual conditions make variations in location and lateral offset appropriate, engineering judgment should be used to provide the best practical combination of view and safety clearances.*

## **Section 8B.04 Crossbuck Assemblies with YIELD or STOP Signs at Passive Grade Crossings**

**Support:**

<sup>00</sup> California Public Utilities Commission (CPUC) is the lead agency for coordinating the installation of STOP and YIELD signs at passive grade crossings.

**Standard:**

<sup>01</sup> **A grade crossing Crossbuck Assembly shall consist of a Crossbuck (R15-1) sign, and a Number of Tracks (R15-2P) plaque if two or more tracks are present, that complies with the provisions of Section 8B.03, and either a YIELD (R1-2) or STOP (R1-1) sign installed on the same support, except as provided in Paragraph 8. If used at a passive grade crossing, a YIELD or STOP sign shall be installed in compliance with the provisions of Part 2, Section 2B.10, and Figures 8B-2 and 8B-3.**

<sup>02</sup> **At all public highway-rail grade crossings that are not equipped with the active traffic control systems that are described in Chapter 8C, except crossings where road users are directed by an authorized person on the ground to not enter the crossing at all times that an approaching train is about to occupy the crossing, a Crossbuck Assembly shall be installed on the right-hand side of the highway on each approach to the highway-rail grade crossing.**

<sup>03</sup> **If a Crossbuck sign is used on a highway approach to a public highway-LRT grade crossing that is not equipped with the active traffic control systems that are described in Chapter 8C, a Crossbuck Assembly shall be installed on the right-hand side of the highway on each approach to the highway-LRT grade crossing.**

<sup>04</sup> **Where restricted sight distance or unfavorable highway geometry exists on an approach to a grade crossing that has a Crossbuck Assembly, or where there is a one-way multi-lane approach, an additional Crossbuck Assembly shall be installed on the left-hand side of the highway.**

<sup>05</sup> **A YIELD sign shall be the default traffic control device for Crossbuck Assemblies on all highway approaches to passive grade crossings unless an engineering study performed by the regulatory agency or highway authority having jurisdiction over the roadway approach determines that a STOP sign is appropriate.**

<sup>05a</sup> **STOP signs shall not be installed at any highway-rail grade crossing which is controlled by automatic traffic control devices except as provided in CVC 21355 and in the Options in this section of this Manual.**

*Guidance:*

<sup>06</sup> *The use of STOP signs at passive grade crossings should be limited to unusual conditions where requiring all highway vehicles to make a full stop is deemed essential by an engineering study. Among the factors that should be considered in the engineering study are the line of sight to approaching rail traffic (giving due consideration to seasonal crops or vegetation beyond both the highway and railroad or LRT rights-of-ways), the number of tracks, the speeds of trains or LRT equipment and highway vehicles, and the crash history at the grade crossing.*

**Support:**

<sup>07</sup> Sections 8A.02 and 8A.03 contain information regarding the responsibilities of the highway agency and the railroad company or LRT agency regarding the selection, design, and operation of traffic control devices placed at grade crossings.

**Option:**

<sup>08</sup> If a YIELD or STOP sign is installed for a Crossbuck Assembly at a grade crossing, it may be installed on the same support as the Crossbuck sign or it may be installed on a separate support at a point where the highway



vehicle is to stop, or as near to that point as practical, but in either case, the YIELD or STOP sign is considered to be a part of the Crossbuck Assembly.

**Standard:**

**09 If a YIELD or STOP sign is installed on an existing Crossbuck sign support, the minimum height, measured vertically from the bottom of the YIELD or STOP sign to the top of the curb, or in the absence of curb, measured vertically from the bottom of the YIELD or STOP sign to the elevation of the near edge of the traveled way, shall be 4 feet (see Figure 8B-2).**

**10 If a Crossbuck Assembly is installed on a new sign support (see Figure 8B-2) or if the YIELD or STOP sign is installed on a separate support (see Figure 8B-3), the minimum height, measured vertically from the bottom of the YIELD or STOP sign to the top of the curb, or in the absence of curb, measured vertically from the bottom of the YIELD or STOP sign to the elevation of the near edge of the traveled way, shall be 7 feet if the Crossbuck Assembly is installed in an area where parking or pedestrian movements are likely to occur.**

*Guidance:*

*11 If a YIELD or STOP sign is installed for a Crossbuck Assembly at a grade crossing on a separate support than the Crossbuck sign (see Figure 8B-3), the YIELD or STOP sign should be placed at a point where the highway vehicle is to stop, or as near to that point as practical, but no closer than 15 feet measured perpendicular from the nearest rail.*

**Support:**

12 The meaning of a Crossbuck Assembly that includes a YIELD sign is that a road user approaching the grade crossing needs to be prepared to decelerate, and when necessary, yield the right-of-way to any rail traffic that might be occupying the crossing or might be approaching and in such close proximity to the crossing that it would be unsafe for the road user to cross.

13 Certain commercial motor vehicles and school buses are required to stop at all grade crossings in accordance with 49 CFR 392.10 even if a YIELD sign (or just a Crossbuck sign) is posted.

14 The meaning of a Crossbuck Assembly that includes a STOP sign is that a road user approaching the grade crossing must come to a full and complete stop not less than 15 feet short of the nearest rail, and remain stopped while the road user determines if there is rail traffic either occupying the crossing or approaching and in such close proximity to the crossing that the road user must yield the right-of-way to rail traffic. The road user is permitted to proceed when it is safe to cross.

**Standard:**

**15 A vertical strip of retroreflective white material, not less than 2 inches in width, shall be used on each Crossbuck support at passive grade crossings for the full length of the back of the support from the Crossbuck sign or Number of Tracks plaque to within 2 feet above the ground, except as provided in Paragraph 16.**

**Option:**

16 The vertical strip of retroreflective material may be omitted from the back sides of Crossbuck sign supports installed on one-way streets.

17 If a YIELD or STOP sign is installed on the same support as the Crossbuck sign, a vertical strip of red (see Section 2A.21) or white retroreflective material that is at least 2 inches wide may be used on the front of the support from the YIELD or STOP sign to within 2 feet above the ground.

**Standard:**

**18 If a Crossbuck sign support at a passive grade crossing does not include a YIELD or STOP sign (either because the YIELD or STOP sign is placed on a separate support or because a YIELD or STOP sign is not present on the approach), a vertical strip of retroreflective white material, not less than 2 inches in width, shall be used for the full length of the front of the support from the Crossbuck sign or Number of Tracks plaque to within 2 feet above the ground.**

**19 At all grade crossings where YIELD or STOP signs are installed, Yield Ahead (W3-2) or Stop Ahead (W3-1) signs shall also be installed if the criteria for their installation in Section 2C.36 is met.**

**Support:**

20 Section 8B.28 contains provisions regarding the use of stop lines or yield lines at grade crossings.

## **Section 8B.05 Use of STOP (R1-1) or YIELD (R1-2) Signs without Crossbuck Signs at Highway-LRT Grade Crossings**

### **Support:**

<sup>00</sup> California Public Utilities Commission (CPUC) is the lead agency for coordinating the installation of STOP and YIELD signs at highway-LRT grade crossings.

### **Standard:**

<sup>01</sup> For all highway-LRT grade crossings where only STOP (R1-1) or YIELD (R1-2) signs are installed, the placement shall comply with the requirements of Section 2B.10. Stop Ahead (W3-1) or Yield Ahead (W3-2) Advance Warning signs (see Figure 2C-6) shall also be installed if the criteria for their installation given in Section 2C.36 is met.

### **Guidance:**

<sup>02</sup> The use of only STOP or YIELD signs for road users at highway-LRT grade crossings should be limited to those crossings where the need and feasibility is established by an engineering study. Such crossings should have all of the following characteristics:

- A. The crossing roadways should be secondary in character (such as a minor street with one lane in each direction, an alley, or a driveway) with low traffic volumes and low speed limits. The specific thresholds of traffic volumes and speed limits should be determined by the local agencies.
- B. LRT speeds do not exceed 25 mph.
- C. The line of sight for an approaching LRT operator is adequate from a sufficient distance such that the operator can sound an audible signal and bring the LRT equipment to a stop before arriving at the crossing.
- D. The road user has sufficient sight distance at the stop line to permit the vehicle to cross the tracks before the arrival of the LRT equipment.
- E. If at an intersection of two roadways, the intersection does not meet the warrants for a traffic control signal as provided in Chapter 4C.
- F. The LRT tracks are located such that highway vehicles are not likely to stop on the tracks while waiting to enter a cross street or highway.

## **Section 8B.06 Grade Crossing Advance Warning Signs (W10 Series)**

### **Standard:**

<sup>01</sup> ~~A Highway-Rail Grade Crossing Advance Warning (W10-1) sign~~ (see Figure 8B-4) shall be used on each highway in advance of every highway-rail grade crossing, and every highway-LRT grade crossing in semi-exclusive alignments, except in the following circumstances:

- A. On an approach to a grade crossing from a T-intersection with a parallel highway if the distance from the edge of the track to the edge of the parallel roadway is less than 100 feet and W10-3 signs are used on both approaches of the parallel highway;
- B. In advance of a highway-LRT grade crossing, on ~~On~~ low-volume, low-speed highways crossing minor spurs or other tracks that are infrequently used and road users are directed by an authorized person on the ground to not enter the crossing at all times that approaching rail traffic is about to occupy the crossing;
- C. In advance of a highway-LRT grade crossing, in ~~In~~ business or commercial areas where active grade crossing traffic control devices are in use; or
- D. In advance of a highway-LRT grade crossing, where ~~Where~~ physical conditions do not permit even a partially effective display of the sign.

### **Support:**

<sup>01a</sup> Refer to CVC 21362.

### **Standard:**

<sup>01b</sup> Placement of the Highway-Rail Grade Crossing Advance Warning (W10 Series) sign shall be in accordance with Figure 8B-6(CA).

<sup>02</sup> The placement of the Grade Crossing Advance Warning sign shall be in accordance with Section 2C.05 and Table 2C-4.

<sup>03</sup> A Yield Ahead (W3-2) or Stop Ahead (W3-1) Advance Warning sign (see Figure 2C-6) shall also be installed if the criteria for their installation given in Section 2C.36 is met. If a Yield Ahead or Stop Ahead

**sign is installed on the approach to the crossing, the W10-1 sign shall be installed upstream from the Yield Ahead or Stop Ahead sign. The Yield Ahead or Stop Ahead sign shall be located in accordance with Table 2C-4. The minimum distance between the signs shall be in accordance with Section 2C.05 and Table 2C-4.**  
Option:

04 On divided highways and one-way streets, an additional W10-1 sign may be installed on the left-hand side of the roadway.

**Standard:**

05 **If the distance between the tracks and a parallel highway, from the edge of the tracks to the edge of the parallel roadway, is less than 100 feet, W10-2, W10-3, or W10-4 signs (see Figure 8B-4) shall be installed on each approach of the parallel highway to warn road users making a turn that they will encounter a grade crossing soon after making a turn, and a W10-1 sign for the approach to the tracks shall not be required to be between the tracks and the parallel highway.**

06 **If the W10-2, W10-3, or W10-4 signs are used, sign placement in accordance with the guidelines for Intersection Warning signs in Table 2C-4 using the speed of through traffic shall be measured from the highway intersection.**

**Support:**

06a **Exceptions B, C and D stated in paragraph 01 for placement of the Highway-Rail Grade Crossing Advance Warning Sign along LRT alignments are typically understood to apply to W10-2, W10-3 and W10-4 signs along LRT alignments.**

**Guidance:**

07 *If the distance between the tracks and the parallel highway, from the edge of the tracks to the edge of the parallel roadway, is 100 feet or more, a W10-1 sign should be installed in advance of the grade crossing, and the W10-2, W10-3, or W10-4 signs should not be used on the parallel highway.*

**Standard:**

08 **The Number of Tracks (W48(CA)) sign shall be placed below the Highway-Rail Grade Crossing Advance Warning (W10-1) sign at grade crossings with two or more tracks.**

**Option:**

09 **The Number of Tracks (W48(CA)) sign may be placed below the Highway-Rail Grade Crossing Advance Warning (W10-2, W10-3, or W10-4) sign at grade crossings with two or more tracks.**

**Support:**

10 **The Number of Tracks (W48(CA)) sign is shown in Figure 8B-4(CA).**

**Section 8B.07 EXEMPT Highway-Rail Grade Crossing Plaques (R15-3P, W10-1aP)**

**Option:**

01 ~~When authorized by law or regulation, a supplemental EXEMPT (R15-3P) plaque (see Figure 8B-1) with a white background may be used below the Crossbuck sign or Number of Tracks plaque, if present, at the grade crossing, and a supplemental EXEMPT (W10-1aP) plaque (see Figure 8B-4) with a yellow background may be used below the Grade Crossing Advance Warning (W10-series) sign.~~

02 ~~Where neither the Crossbuck sign nor the advance warning signs exist for a particular highway-LRT grade crossing, an EXEMPT (R15-3P) plaque with a white background may be placed on its own post on the near right-hand side of the approach to the crossing.~~

**Support:**

03 ~~These supplemental plaques inform drivers of highway vehicles carrying passengers for hire, school buses carrying students, or highway vehicles carrying hazardous materials that a stop is not required at certain designated grade crossings, except when rail traffic is approaching or occupying the grade crossing, or the driver's view is blocked.~~

**Standard:**

04 **Highway-rail grade crossings shall be established as "exempt" from the stop requirements specified in CVC 22452 only with authorization of the California Public Utilities Commission (CPUC), pursuant to CVC 22452.5 and CPUC General Order 145, as amended.**

05 **The EXEMPT (W10-1aP) sign (see Figure 8B-4), having a yellow background with black legend, shall be placed and maintained by the roadway authority below Highway-Rail Grade Crossing Advance Warning (W10-1) signs on**

each approach to an exempt crossing that was established after January 1, 1978. This sign shall not be replaced with a W46A(CA) black background with yellow legend sign or R15-3 white background with black legend sign.

<sup>06</sup> The EXEMPT (W46A(CA)) sign (see Figure 8B-4(CA)), having a black background with yellow legend, shall be placed and maintained by the roadway authority below the Highway-Rail Grade Crossing Advance Warning (W10-1) signs on each approach to an exempt crossing that was established prior to January 1, 1978. The W46A(CA) sign displays the word EXEMPT above the crossing number assigned by the CPUC to the crossing which the sign governs. This sign shall have dimensions of 15 inch in width and 9 inch in height. This W46A (CA) sign shall not be replaced with a W10-1aP sign unless authorized by the CPUC.

<sup>07</sup> The EXEMPT (R15-3) sign (see Figure 8B-1), having a white background with black legend, shall not be used.  
Support:

<sup>08</sup> These EXEMPT signs (W10-1aP, W46A(CA)) inform drivers of certain vehicles that a stop may not be required at certain designated highway-rail grade crossings, per the CVC 22452.

<sup>09</sup> At crossings where the W10-1aP sign is installed, the CVC provides that any vehicle listed in CVC 22452(a), other than any school bus or any school pupil activity bus, is exempted from the highway-rail grade crossing stop requirements.

<sup>10</sup> At crossings where the W46A (CA) sign is installed and was approved prior to January 1, 1978, the CVC provides that any vehicle listed in CVC 22452(a) is exempted from the highway-rail grade crossing stop requirements.

### **Section 8B.08 Turn Restrictions During Preemption**

*Guidance:*

<sup>01</sup> *At a signalized intersection that is located within 200 feet of a highway-rail grade crossing, measured from the edge of the track to the edge of the roadway, where the intersection traffic control signals are preempted by the approach of a train, all existing turning movements toward the highway-rail grade crossing should be prohibited during the signal preemption sequences.*

*Option:*

<sup>02</sup> A blank-out or changeable message sign and/or appropriate highway traffic signal indication or other similar type sign may be used to prohibit turning movements toward the highway-rail grade crossing during preemption. ~~The R3-1a and R3-2a signs shown in Figure 8B-1 may be used for this purpose.~~ The symbolic No Right Turn (R3-1) and No Left Turn (R3-2) signs and the No Straight Through (R3-27) sign, as shown in Figure 8B-1(CA) may be used as blank-out signs for this purpose.

*Support:*

<sup>03</sup> LRT operations can include the use of activated blank-out sign technology for turn prohibition signs. The signs are typically used on roads paralleling a semi-exclusive or mixed-use LRT alignment where road users might turn across the LRT tracks. A blank-out sign displays its message only when activated. When not activated, the sign face is blank.

*Guidance:*

<sup>04</sup> *An LRT-activated blank-out turn prohibition (~~R3-1a or R3-2a~~ R3-1, R3-2 or R3-27) sign should be used where an intersection adjacent to a highway-LRT crossing is controlled by STOP signs, or is controlled by traffic control signals with permissive turn movements for road users crossing the tracks.*

*Option:*

<sup>05</sup> An LRT-activated blank-out turn prohibition (~~R3-1a or R3-2a~~ R3-1, R3-2 or R3-27) sign may be used for turning movements that cross the tracks.

<sup>06</sup> As an alternative to LRT-activated blank-out turn prohibition signs at intersections with traffic control signals, exclusive traffic control signal phases such that all movements that cross the tracks have a steady red indication may be used in combination with ~~No Turn on Red (R10-11, R10-11a, or R10-11b) signs~~ No Right Turn on Red (R13A(CA)) sign or No Left Turn on Red (R13B(CA)) sign (see Figure 2B-27(CA)) (see Section 2B.53).

**Standard:**

<sup>07</sup> **Turn prohibition signs that are associated with preemption shall be visible or activated only when the grade crossing restriction is in effect.**

*Support:*

<sup>08</sup> Left turns from a nearby signalized intersection toward a grade crossing can be prohibited during railroad or light rail transit preemption by use of a steady red left-arrow signal indication or a blank-out R3-2 sign. Likewise, right turns from a

nearby signalized intersection toward such a crossing can be prohibited by use of a steady red right-arrow signal indication or a blank-out R3-1 sign. Through movements from a nearby signalized intersection toward a grade crossing can be prohibited by a steady circular red signal indication or a blank-out R3-27 sign.

<sup>09</sup> Refer to Section 4D.27 for railroad preemption.

<sup>10</sup> Example of sign placement is shown in the ITE publication referenced in Section 1A.11.

### **Section 8B.09 DO NOT STOP ON TRACKS Sign (R8-8)**

*Guidance:*

<sup>01</sup> A **DO NOT STOP ON TRACKS (R8-8)** sign (see Figure 8B-1) should be installed whenever an engineering study determines that the potential for highway vehicles stopping on the tracks at a grade crossing is significant. Placement of the R8-8 sign should be determined as part of the engineering study. The sign, if used, should be located on the right-hand side of the highway on either the near or far side **or both sides** of the grade crossing, depending upon which position provides better visibility to approaching drivers **to provide sufficient visibility to motorists approaching the crossing or motorists stopped on the crossing.**

<sup>02</sup> If a **STOP** or **YIELD** sign is installed at a location, including at a circular intersection, that is downstream from the grade crossing such that highway vehicle queues are likely to extend beyond the tracks, a **DO NOT STOP ON TRACKS** sign (R8-8) should be used.

*Option:*

<sup>03</sup> ~~DO NOT STOP ON TRACKS signs may be placed on both sides of the track.~~

*Guidance:*

<sup>04</sup> **If used on ~~an~~ divided highways and one-way streets, a second DO NOT STOP ON TRACKS sign ~~may~~ should be placed on the ~~near or far~~ left-hand side of the highway at the grade crossing to further improve visibility of the sign.**

### **Section 8B.10 TRACKS OUT OF SERVICE Sign (R8-9)**

*Option:*

<sup>01</sup> The **TRACKS OUT OF SERVICE (R8-9)** sign (see Figure 8B-1) may be used at a grade crossing instead of a Crossbuck (R15-1) sign and a Number of Tracks (R15-2P) plaque or instead of a Crossbuck Assembly when railroad or LRT tracks have been temporarily or permanently abandoned, but only until such time that the tracks are removed or covered.

*Standard:*

<sup>02</sup> **When tracks are out of service, traffic control devices and gate arms shall be removed and the signal heads shall be removed or hooded or turned from view to clearly indicate that they are not in operation.**

<sup>03</sup> **The R8-9 sign shall be removed when the tracks have been removed or covered or when the grade crossing is returned to service.**

### **Section 8B.11 STOP HERE WHEN FLASHING Signs (R8-10, R8-10a)**

*Option:*

<sup>01</sup> The **STOP HERE WHEN FLASHING (R8-10, R8-10a)** sign (see Figure 8B-1) may be used at a grade crossing to inform drivers of the location of the stop line or the point at which to stop when the flashing-light signals (see Section 8C.02) are activated.

### **Section 8B.12 STOP HERE ON RED Signs (R10-6, R10-6a)**

*Support:*

<sup>01</sup> The **STOP HERE ON RED (R10-6, ~~R10-6a~~)** sign (see Figure 8B-1) defines and facilitates observance of stop lines at traffic control signals.

*Option:*

<sup>02</sup> A **STOP HERE ON RED** sign may be used at locations where highway vehicles frequently violate the stop line or where it is not obvious to road users where to stop.

*Guidance:*

<sup>03</sup> **If possible, stop lines should be placed at a point where the highway vehicle driver has adequate sight distance along the track.**

### **Section 8B.13 Light Rail Transit Only Lane Signs (R15-4 Series)**

**Support:**

01 The Light Rail Transit Only Lane (R15-4 series) signs (see Figure 8B-1) are used for multi-lane operations, where road users might need additional guidance on lane use and/or restrictions.

**Option:**

02 Light Rail Transit Only Lane signs may be used on a roadway lane limited to only LRT use to indicate the restricted use of a lane in semi-exclusive and mixed alignments.

**Guidance:**

03 *If used, the R15-4a, R15-4b, and R15-4c signs should be installed on posts adjacent to the roadway containing the LRT tracks or overhead above the LRT only lane.*

**Option:**

04 If the trackway is paved, preferential lane markings (see Chapter 3D) may be installed but only in combination with Light Rail Transit Only Lane signs.

**Support:**

05 The trackway is the continuous way designated for LRT, including the entire dynamic envelope. Section 8B.29 contains more information regarding the dynamic envelope.

### **Section 8B.14 Do Not Pass Light Rail Transit Signs (R15-5, R15-5a)**

**Support:**

01 A Do Not Pass Light Rail Transit (R15-5) sign (see Figure 8B-1) is used to indicate that motor vehicles are not allowed to pass LRT vehicles that are loading or unloading passengers where there is no raised platform or physical separation from the lanes upon which other motor vehicles are operating.

**Option:**

02 The R15-5 sign may be used in mixed-use alignments and may be mounted overhead where there are multiple lanes.

03 Instead of the R15-5 symbol sign, a regulatory sign with the word message DO NOT PASS STOPPED TRAIN (R15-5a) may be used (see Figure 8B-1).

**Guidance:**

04 *If used, the R15-5 sign should be located immediately before the LRT boarding area.*

### **Section 8B.15 No Motor Vehicles On Tracks Signs (R15-6, R15-6a)**

**Support:**

01 The No Motor Vehicles On Tracks (R15-6) sign (see Figure 8B-1) is used where there are adjacent traffic lanes separated from the LRT lane by a curb or pavement markings.

**Guidance:**

02 *The DO NOT ENTER (R5-1) sign should be used where a road user could wrongly enter an LRT only street.*

**Option:**

03 A No Motor Vehicles On Tracks sign may be used to deter motor vehicles from driving on the trackway. It may be installed on a 3-foot flexible post between double tracks, on a post alongside the tracks, or overhead.

04 Instead of the R15-6 symbol sign, a regulatory sign with the word message DO NOT DRIVE ON TRACKS (R15-6a) may be used (see Figure 8B-1).

05 A reduced size of 12 x 12 inches may be used if the R15-6 sign is installed between double tracks.

**Standard:**

06 **The smallest size for the R15-6 sign shall be 12 x 12 inches.**

### **Section 8B.16 Divided Highway with Light Rail Transit Crossing Signs (R15-7 Series)**

**Option:**

01 The Divided Highway with Light Rail Transit Crossing (R15-7) sign (see Figure 8B-1) may be used as a supplemental sign on the approach legs of a roadway that intersects with a divided highway where LRT equipment operates in the median. The sign may be placed beneath a STOP sign or mounted separately.

*Guidance*

<sup>02</sup> *The number of tracks displayed on the R15-7 sign should be the same as the actual number of tracks.*

**Standard:**

<sup>03</sup> **When the Divided Highway With Light Rail Transit Crossing sign is used at a four-legged intersection, the R15-7 sign shall be used. When used at a T-intersection, the R15-7a sign shall be used.**

**Section 8B.17 LOOK Sign (R15-8)**

**Option:**

<sup>01</sup> At grade crossings, the LOOK (R15-8) sign (see Figure 8B-1) may be mounted as a supplemental plaque on the Crossbuck support, or on a separate post in the immediate vicinity of the grade crossing on the railroad or LRT right-of-way.

*Guidance:*

<sup>02</sup> *A LOOK sign should not be mounted as a supplemental plaque on a Crossbuck Assembly that has a YIELD or STOP sign mounted on the same support as the Crossbuck.*

**Support:**

<sup>03</sup> The LOOK (R15-8) sign is used to provide additional warning for pedestrians and bicyclists.

<sup>04</sup> Section 8B.102(CA) discusses the Light Rail Transit (Trolley) Crossing / LOOK BOTH WAYS sign (W82-1(CA)).

**Section 8B.18 Emergency Notification Sign (I-13)**

*Guidance:*

<sup>01</sup> *Emergency Notification (I-13) signs (see Figure 8B-5) should be installed at all highway-rail grade crossings, and at all highway-LRT grade crossings on semi-exclusive alignments, to provide information to road users so that they can notify the railroad company or LRT agency about emergencies or malfunctioning traffic control devices.*

**Standard:**

<sup>01a</sup> **The emergency notification information including the USDOT or CPUC grade crossing inventory number and an emergency contact telephone number shall be installed and maintained by the railroad or LRT agency at each public grade crossing. Refer to CPUC General Order 75, as amended.**

**Option:**

<sup>01b</sup> The emergency notification information may be omitted at a highway-LRT grade crossing not equipped with automatic warning devices such as automatic flashing light signals and gates.

**Standard:**

<sup>02</sup> **When Emergency Notification signs are used at a highway-rail grade crossing, they shall, at a minimum, include the USDOT grade crossing inventory number and the emergency contact telephone number.**

<sup>03</sup> **When Emergency Notification signs are used at a highway-LRT grade crossing, they shall, at a minimum, include a unique crossing identifier either the CPUC or USDOT grade crossing inventory number and the emergency contact telephone number.**

<sup>04</sup> **Emergency Notification Signs shall have a white legend and border on a blue background.**

<sup>05</sup> **The Emergency Notification signs shall be positioned so as to not obstruct any traffic control devices or limit the view of rail traffic approaching the grade crossing.**

*Guidance:*

<sup>06</sup> *Emergency Notification signs should be retroreflective.*

<sup>07</sup> *Emergency Notification signs should be oriented so as to face highway vehicles stopped on or at the grade crossing or on the traveled way near the grade crossing.*

<sup>08</sup> *At station crossings, Emergency Notification signs or information should be posted in a conspicuous location.*

<sup>09</sup> *Emergency Notification signs mounted on Crossbuck Assemblies or signal masts should only be large enough to provide the necessary contact information. Use of larger signs that might obstruct the view of rail traffic or other highway vehicles should be avoided.*

### **Section 8B.19 Light Rail Transit Approaching-Activated Blank-Out Warning Sign (W10-7)**

**Support:**

01 The Light Rail Transit Approaching-Activated Blank-Out (W10-7) warning sign (see Figure 8B-4) supplements the traffic control devices to warn road users crossing the tracks of approaching LRT equipment.

**Option:**

02 A Light Rail Transit Approaching-Activated Blank-Out warning sign may be used at signalized intersections near highway-LRT grade crossings or at crossings controlled by STOP signs or automatic gates.

### **Section 8B.20 TRAINS MAY EXCEED 80 MPH Sign (W10-8)**

**Guidance:**

01 *Where trains are permitted to travel at speeds exceeding 80 mph, a TRAINS MAY EXCEED 80 MPH (W10-8) sign (see Figure 8B-4) should be installed facing road users approaching the highway-rail grade crossing.*

02 *If used, the TRAINS MAY EXCEED 80 MPH signs should be installed between the Grade Crossing Advance Warning (W10 series) sign (see Figure 8B-4) and the highway-rail grade crossing on all approaches to the highway-rail grade crossing. The locations should be determined based on specific site conditions.*

### **Section 8B.21 NO TRAIN HORN Sign or Plaque (W10-9, W10-9P)**

**Standard:**

01 **Either a NO TRAIN HORN (W10-9) sign (see Figure 8B-4) or a NO TRAIN HORN (W10-9P) plaque shall be installed in each direction at each highway-rail grade crossing where a quiet zone has been established in compliance with 49 CFR Part 222. If a W10-9P plaque is used, it shall supplement and be mounted directly below the Grade Crossing Advance Warning (W10 series) sign (see Figure 8B-4).**

**Option:**

02 *At grade crossings where Grade Crossing Advance Warning (W10 series) sign is used along with a Number of Tracks (W48(CA)) sign, the No Train Horn (W10-9P) plaque may be placed below the W48(CA) sign*

### **Section 8B.22 NO GATES OR LIGHTS Plaque (W10-13P)**

**Option:**

01 The NO GATES OR LIGHTS (W10-13P) sign plaque (see Figure 8B-4) may be mounted below the Grade Crossing Advance Warning (W10 series) sign at grade crossings that are not equipped with automated signals.

### **Section 8B.23 Low Ground Clearance Grade Crossing Sign (W10-5)**

**Guidance:**

01 *If the highway profile conditions are sufficiently abrupt to create a hang-up situation for long wheelbase vehicles or for trailers with low ground clearance, the Low Ground Clearance Grade Crossing (W10-5) sign (see Figure 8B-4) should be installed in advance of the grade crossing.*

**Standard:**

02 **Because this symbol might not be readily recognizable by the public, the Low Ground Clearance Grade Crossing (W10-5) warning sign shall be accompanied by an educational plaque, LOW GROUND CLEARANCE. The LOW GROUND CLEARANCE educational plaque shall remain in place for at least 3 years after the initial installation of the W10-5 sign (see Section 2A.12).**

**Guidance:**

03 *Auxiliary plaques such as AHEAD, NEXT CROSSING, or USE NEXT CROSSING (with appropriate arrows), or a supplemental distance plaque should be placed below the W10-5 sign at the nearest intersecting highway where a vehicle can detour or at a point on the highway wide enough to permit a U-turn.*

04 *If engineering judgment of roadway geometric and operating conditions confirms that highway vehicle speeds across the tracks should be below the posted speed limit, a W13-1P advisory speed plaque should be posted.*

**Option:**

05 If the grade crossing is rough, word message signs such as BUMP, DIP, or ROUGH CROSSING may be installed. A W13-1P advisory speed plaque may be installed below the word message sign in advance of rough crossings.



Support:

<sup>06</sup> Information on ground clearance requirements at grade crossings is available in the “American Railway Engineering and Maintenance-of-Way Association’s Engineering Manual,” or the American Association of State Highway and Transportation Officials’ “Policy on Geometric Design of Highways and Streets” (see Section 1A.11).

### **Section 8B.24 Storage Space Signs (W10-11, W10-11a, W10-11b)**

*Guidance:*

<sup>01</sup> A Storage Space (W10-11) sign supplemented by a word message storage distance (W10-11a) sign (see Figure 8B-4) should be used where there is a highway intersection in close proximity to the grade crossing and an engineering study determines that adequate space is not available to store a design vehicle(s) between the highway intersection and the train or LRT equipment dynamic envelope.

<sup>02</sup> The Storage Space (W10-11 and W10-11a) signs should be mounted in advance of the grade crossing at an appropriate location to advise drivers of the space available for highway vehicle storage between the highway intersection and the grade crossing.

*Option:*

<sup>03</sup> A Storage Space (W10-11b) sign (see Figure 8B-4) may be mounted beyond the grade crossing at the highway intersection under the STOP or YIELD sign or just prior to the signalized intersection to remind drivers of the storage space between the tracks and the highway intersection.

### **Section 8B.25 Skewed Crossing Sign (W10-12)**

~~Option:~~

*Guidance:*

<sup>01</sup> The Skewed Crossing (W10-12) sign (see Figure 8B-4) ~~may~~ **should** be used at a skewed grade crossing, **that is skewed 30 degrees or less from the roadway centerline**, to warn road users that the tracks are not perpendicular to the highway.

*Guidance:*

<sup>02</sup> If the Skewed Crossing sign is used, the symbol should show the direction of the crossing (near left to far right as shown in Figure 8B-4, or the mirror image if the track goes from far left to near right). If the Skewed Crossing sign is used ~~where the angle of the crossing is significantly different than 45 degrees~~, the symbol should show the approximate angle of the crossing.

<sup>02a</sup> If used, the W10-12 sign should be erected approximately midway between the crossing and the Highway-Rail Grade Crossing Advance Warning (W10-1) sign.

**Standard:**

<sup>03</sup> **The Skewed Crossing sign shall not be used as a replacement for the required Advance Warning (W10-1) sign. If used, the Skewed Crossing sign shall supplement the W10-1 sign and shall be mounted on a separate post.**

### **Section 8B.26 Light Rail Transit Station Sign (I-12)**

*Option:*

<sup>01</sup> The Light Rail Transit Station (I-12, **G96(CA)** and **G96A(CA)**) sign (see Figure 2H-1 and **8B-101(CA)**) may be used to direct road users to an LRT station or boarding location. It may be supplemented by the name of the transit system and by arrows as provided in Section 2D.08.

### **Section 8B.27 Pavement Markings**

**Standard:**

<sup>01</sup> **All grade crossing pavement markings shall be retroreflectorized white. All other markings shall be in accordance with Part 3.**

<sup>02</sup> **On paved roadways, pavement markings in advance of a grade crossing shall consist of an X, the letters RR, a no-passing zone marking (on two-lane, two-way highways with center line markings in compliance with Section 3B.01), and certain transverse lines as shown in Figures ~~8B-6~~ **8B-6(CA)** and ~~8B-7~~ **8B-7(CA)**.**

~~03 Identical markings shall be placed in each approach lane on all paved approaches to grade crossings where signals or automatic gates are located, and at all other grade crossings where the posted or statutory highway speed is 40 mph or greater.~~

~~04 Pavement markings shall not be required at grade crossings where the posted or statutory highway speed is less than 40 mph if an engineering study indicates that other installed devices provide suitable warning and control. Pavement markings shall not be required at grade crossings in urban areas if an engineering study indicates that other installed devices provide suitable warning and control.~~

**04a Identical (RXR) markings shall be placed in each approach lane on all paved approaches to grade crossings where Crossbuck (R15-1) signs, flashing light signals, or automatic gates are located.**

*Guidance:*

~~05 When pavement markings are used, a portion of the X symbol should be directly opposite the Grade Crossing Advance Warning sign. The X symbol and letters should be elongated to allow for the low angle at which they will be viewed.~~

~~05a Figures 8B-6(CA) and 8B-7(CA) should be used for X symbol and letters details.~~

*Option:*

06 When justified by engineering judgment, supplemental pavement marking symbol(s) may be placed between the Grade Crossing Advance Warning sign and the grade crossing.

07 Pavement (RXR) markings may be omitted where the distance between a cross street and the track is less than 50 feet.

## **Section 8B.28 Stop and Yield Lines**

**Standard:**

01 **On paved roadways at grade crossings that are equipped with active control devices such as flashing-light signals, gates, or traffic control signals, a stop line (see Section 3B.16) shall be installed to indicate the point behind which highway vehicles are or might be required to stop.**

*Guidance:*

02 *On paved roadway approaches to passive grade crossings where a STOP sign is installed in conjunction with the Crossbuck sign, a stop line should be installed to indicate the point behind which highway vehicles are required to stop or as near to that point as practical.*

03 *If a stop line is used, it should be a transverse line at a right angle to the traveled way and should be placed approximately 8 feet in advance of the gate (if present), but no closer than 15 feet in advance of the nearest rail.*

03a *Stop lines should be used as shown in Figures 8B-6(CA) and 8B-7(CA).*

**Standard:**

03b **Stop lines shall be 24 inch wide.**

*Option:*

04 On paved roadway approaches to passive grade crossings where a YIELD sign is installed in conjunction with the Crossbuck sign, a yield line (see Section 3B.16) ~~or a stop line~~ may be installed to indicate the point behind which highway vehicles are required to yield or stop or as near to that point as practical.

*Guidance:*

05 *If a yield line is used, it should be a transverse line (see Figure 3B-16) at a right angle to the traveled way and should be placed no closer than 15 feet in advance of the nearest rail (see Figure ~~8B-7~~ 8B-7(CA)).*

## **Section 8B.29 Dynamic Envelope Markings**

**Support:**

01 The dynamic envelope (see Figures ~~8B-8~~ 8B-6(CA) Sheet 1 of 3 and 8B-9) markings indicate the clearance required for the train or LRT equipment overhang resulting from any combination of loading, lateral motion, or suspension failure.

*Option:*

02 Dynamic envelope markings may be installed at all grade crossings, unless a Four-Quadrant Gate system (see Section 8C.06) is used.

**Standard:**

**03 If used, pavement markings for indicating the dynamic envelope shall comply with the provisions of Part 3 and shall be a 4-inch normal solid white line or contrasting pavement color and/or contrasting pavement texture.**

*Guidance:*

*04 If pavement markings are used to convey the dynamic envelope, they should be placed completely outside of the dynamic envelope. If used, dynamic envelope pavement markings should be placed on the highway 6 feet from and parallel to the nearest rail unless the operating railroad company or LRT agency advises otherwise. The pavement markings should extend across the roadway as shown in Figure ~~8B-8~~ **8B-6(CA)** Sheet 1 of 3. The dynamic envelope pavement markings should not be placed perpendicular to the roadway at skewed grade crossings.*

**Option:**

05 In semi-exclusive LRT alignments, the dynamic envelope markings may be along the LRT trackway between intersections where the trackway is immediately adjacent to travel lanes and no physical barrier is present.

06 In mixed-use LRT alignments, the dynamic envelope markings may be continuous between intersections (see Figure 8B-9).

07 In mixed-use LRT alignments, pavement markings for adjacent travel or parking lanes may be used instead of dynamic envelope markings if the lines are outside the dynamic envelope.

**Section 8B.101(CA) Train Station Signs (I-7, G95F(CA), G95G(CA) and G97A(CA))**

**Option:**

01 The Train Station (I-7) sign may be used to direct road users to a train station facility.

02 The Train Station NEXT RIGHT (G95F(CA)) or Specific Train Station NEXT RIGHT (G95G(CA)) sign may be used on freeways and conventional highways to direct road users to a transit authority facility. The G95G(CA) may be used in place of the G95F(CA) sign only when it is determined that the name of the station is needed to avoid confusion.

**Standard:**

**03 The AMTRAK (G97A(CA)) plaque shall be used for all new installations to identify Amtrak facilities.**

**Option:**

04 Alternatively, CALTRAIN, BART or other names of the transit system may be used, as appropriate.

**Support:**

05 The G95F(CA), G95G(CA) and G97A(CA) signs are shown in Figure 8B-101(CA).

**Section 8B.102(CA) Trolley Crossing Signs (W82(CA) and W82-1(CA))**

**Option:**

01 The Light Rail Transit (Trolley) Crossing sign (W82(CA)) may be used in advance of a highway-LRT grade crossing controlled by traffic signals or stop signs.

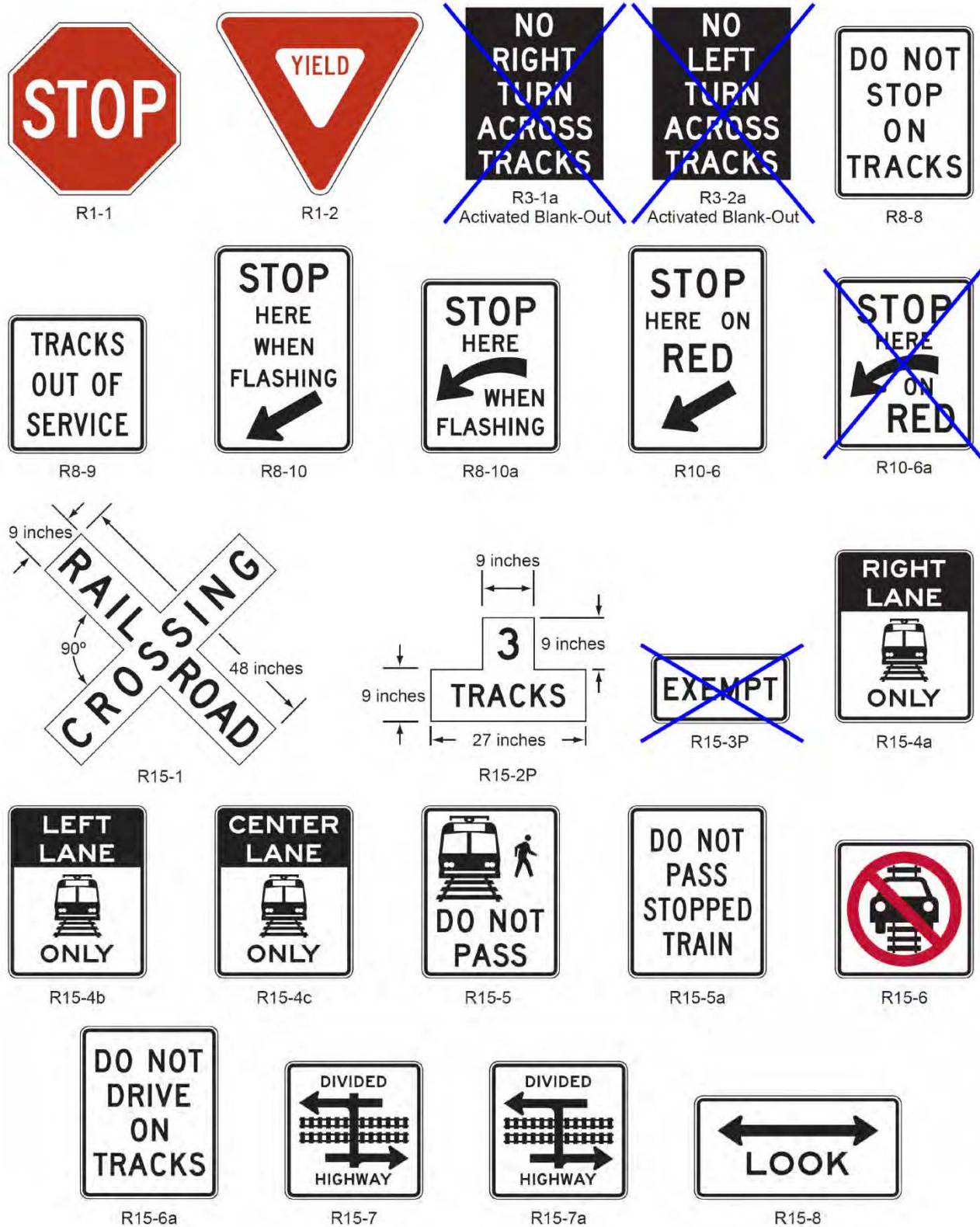
02 The Light Rail Transit (Trolley) Crossing / LOOK BOTH WAYS sign (W82-1(CA)) may be used at an LRT grade crossing to alert vehicle road users and pedestrians that the light rail transit vehicles approach from both directions.

**Support:**

03 The W82-1(CA) sign is typically used on driveways and alleys that cross a one-way street with two-way LRT side running operation, or at pathway grade crossings with LRT tracks.

04 The W82(CA) and W82-1(CA) signs are shown in Figure 8B-4(CA).

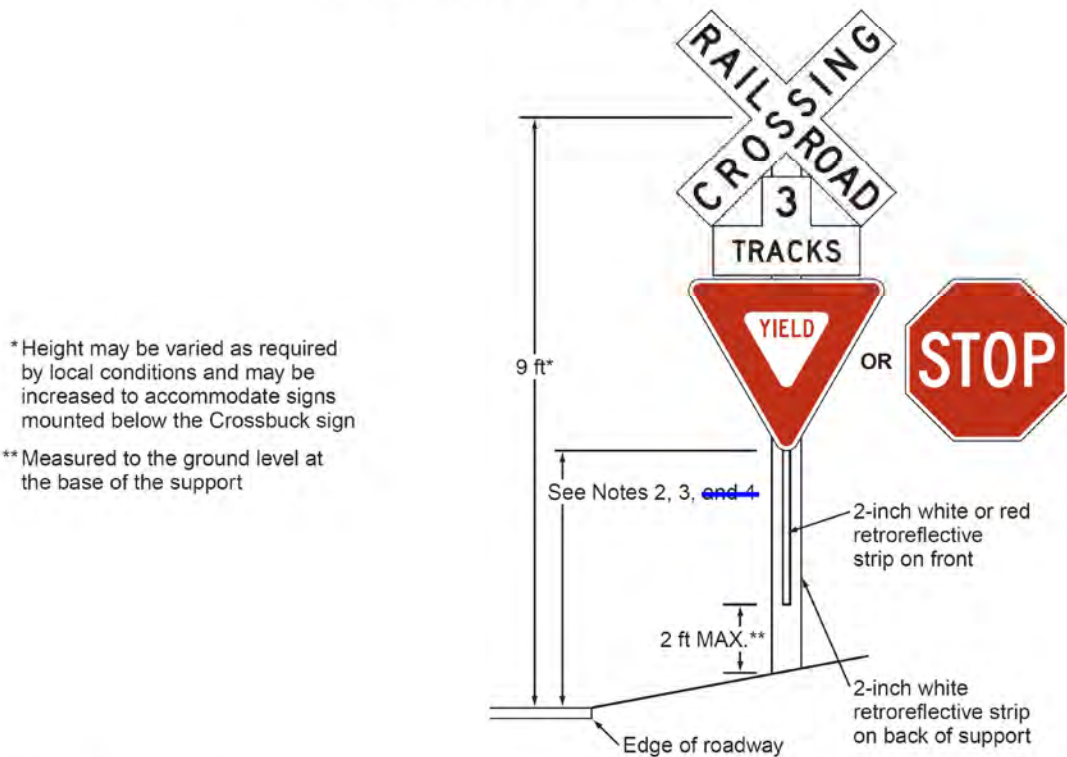
Figure 8B-1. Regulatory Signs and Plaques for Grade Crossings



**Figure 8B-1(CA) Regulatory Signs and Plaques for Grade Crossings**



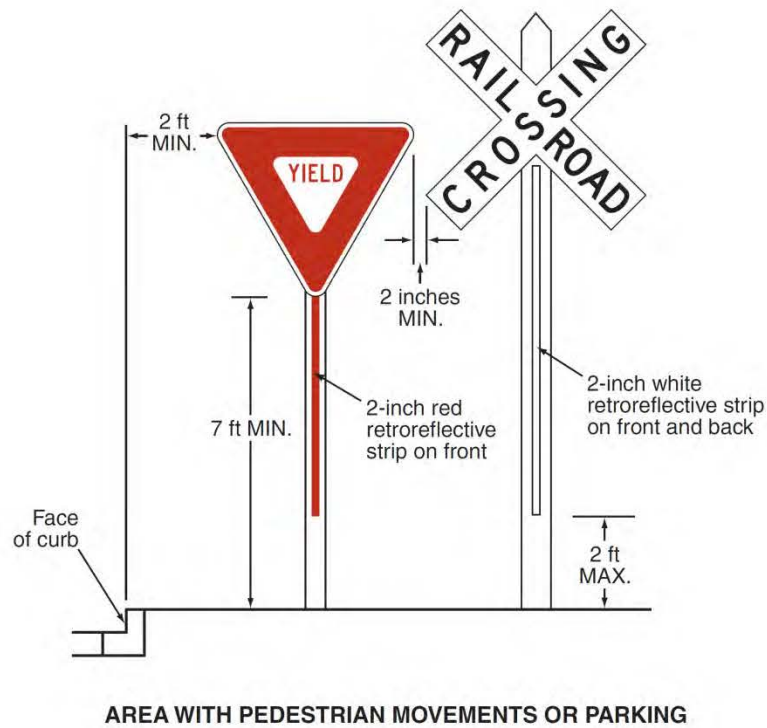
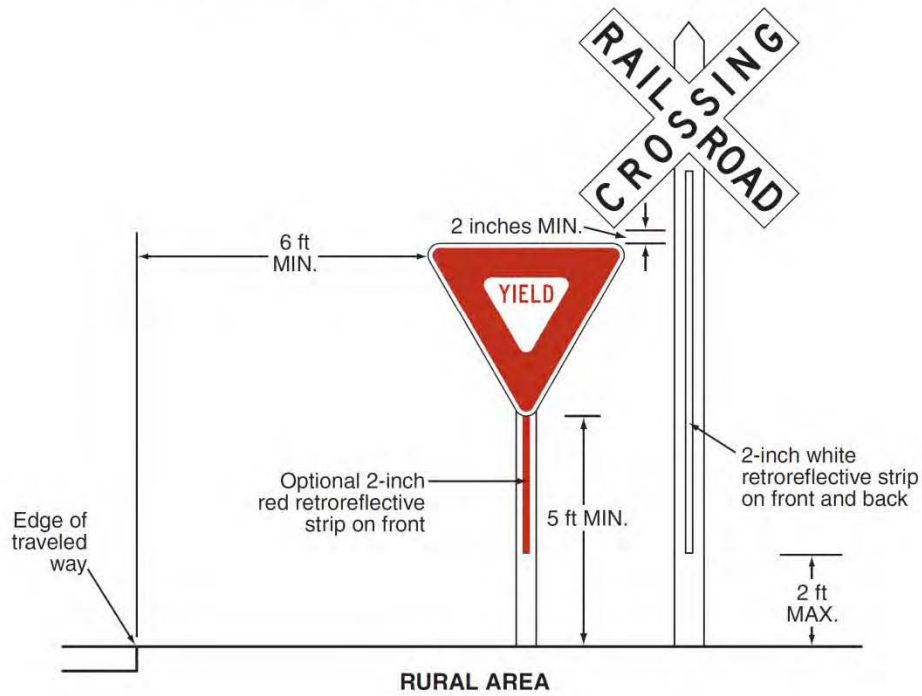
**Figure 8B-2. Crossbuck Assembly with a YIELD or STOP Sign on the Crossbuck Sign Support**



**Notes:**

1. YIELD or STOP signs are used only at passive crossings. A STOP sign is used only if an engineering study determines that it is appropriate for that particular approach.
2. Mounting height shall be at least 4 feet for installations of YIELD or STOP signs on existing Crossbuck sign supports.
3. Mounting height shall be at least 7 feet for new installations in areas with pedestrian movements or parking.

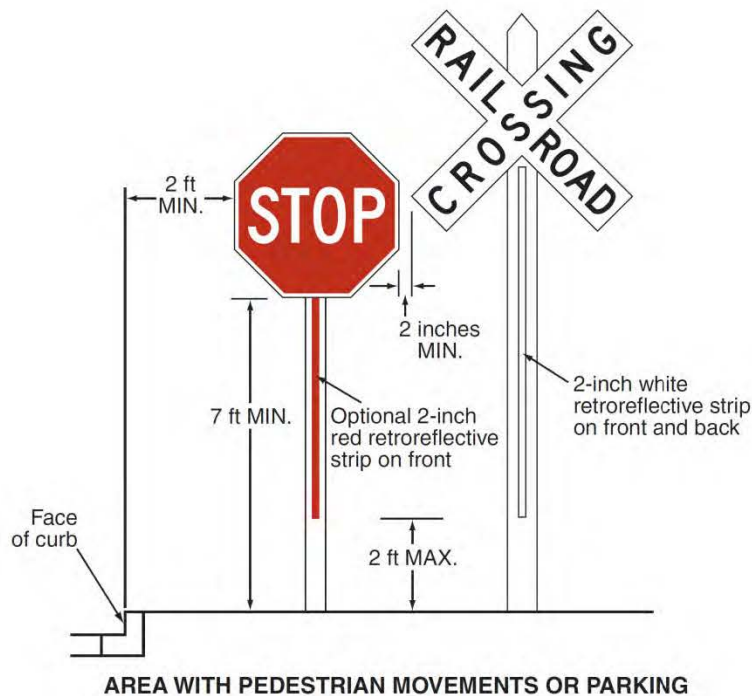
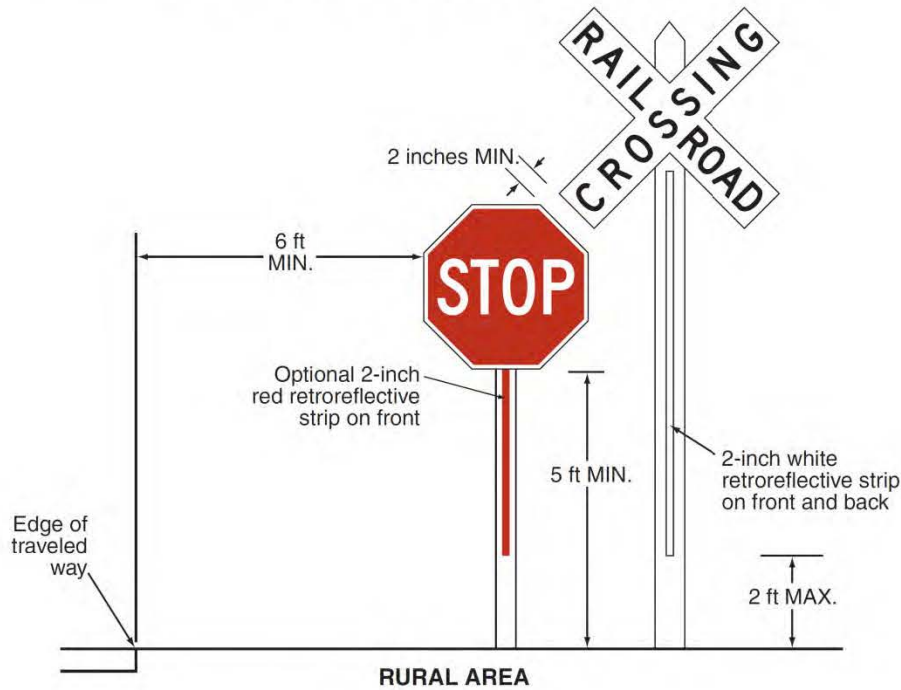
**Figure 8B-3. Crossbuck Assembly with a YIELD or STOP Sign on a Separate Sign Support (Sheet 1 of 2)**



**Notes:**

1. YIELD signs are used only at passive crossings.
2. Place the face of the signs in the same plane and place the YIELD sign closest to the traveled way. Provide a 2-inch minimum separation between the edge of the Crossbuck sign and the edge of the YIELD sign.

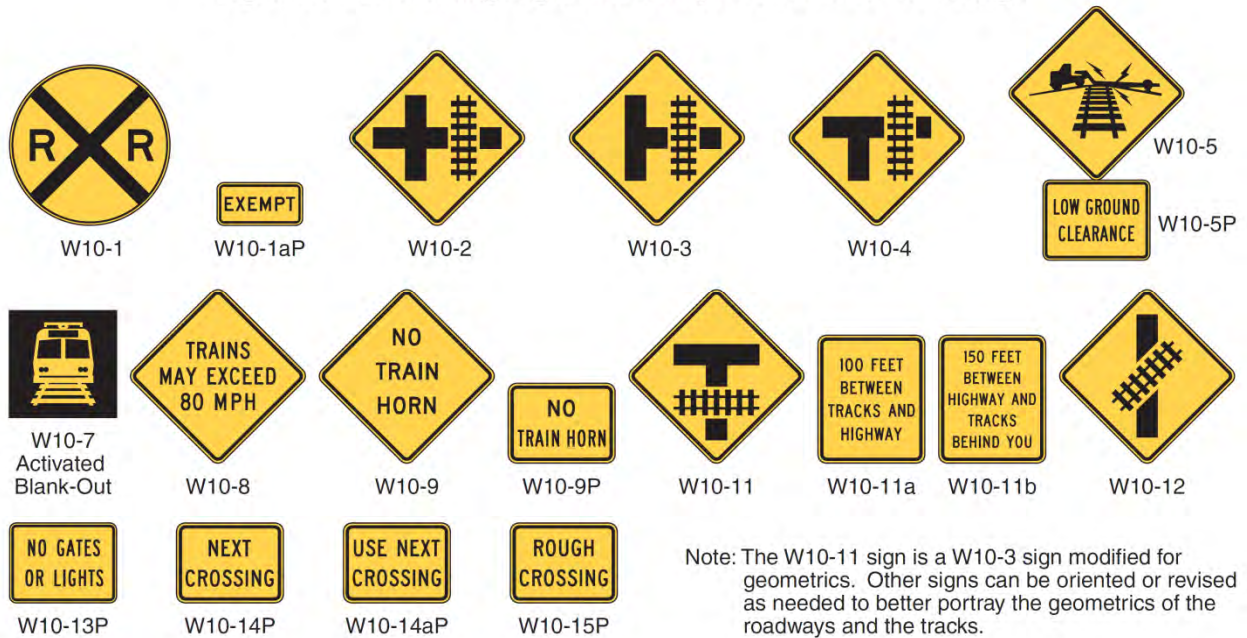
**Figure 8B-3. Crossbuck Assembly with a YIELD or STOP Sign on a Separate Sign Support (Sheet 2 of 2)**



**Notes:**

1. STOP signs are used only at passive crossings and only if an engineering study determines that it is appropriate for that particular approach.
2. Place the face of the signs in the same plane and place the STOP sign closest to the traveled way. Provide a 2-inch minimum separation between the edge of the Crossbuck sign and the edge of the STOP sign.

**Figure 8B-4. Warning Signs and Plaques for Grade Crossings**



**Figure 8B-4 (CA) Warning Signs and Plaques for Grade Crossings**



\* The number below the word "EXEMPT" is the identification number uniquely associated with the associated highway-rail crossing.

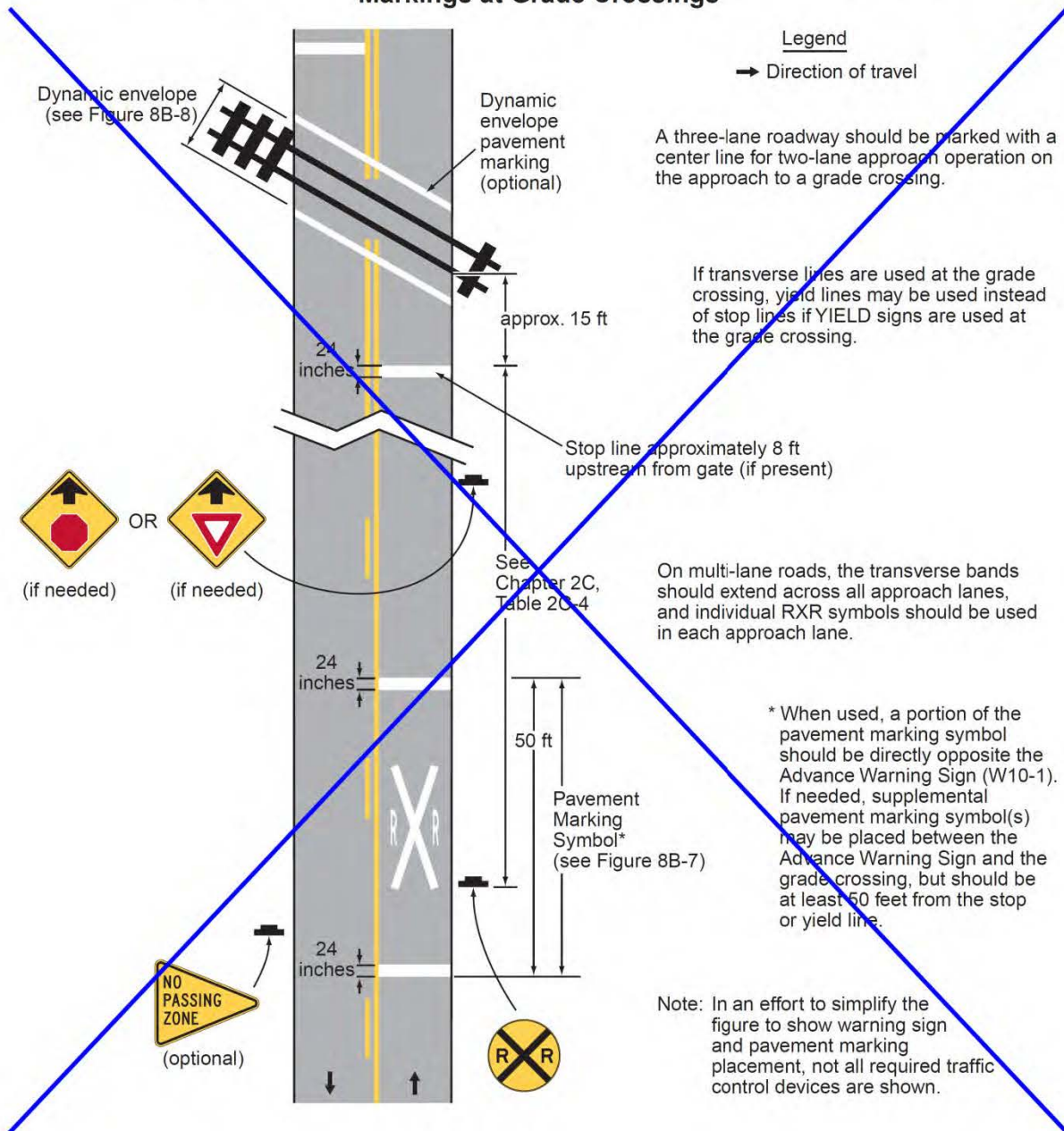
**Figure 8B-5. Example of an Emergency Notification Sign**



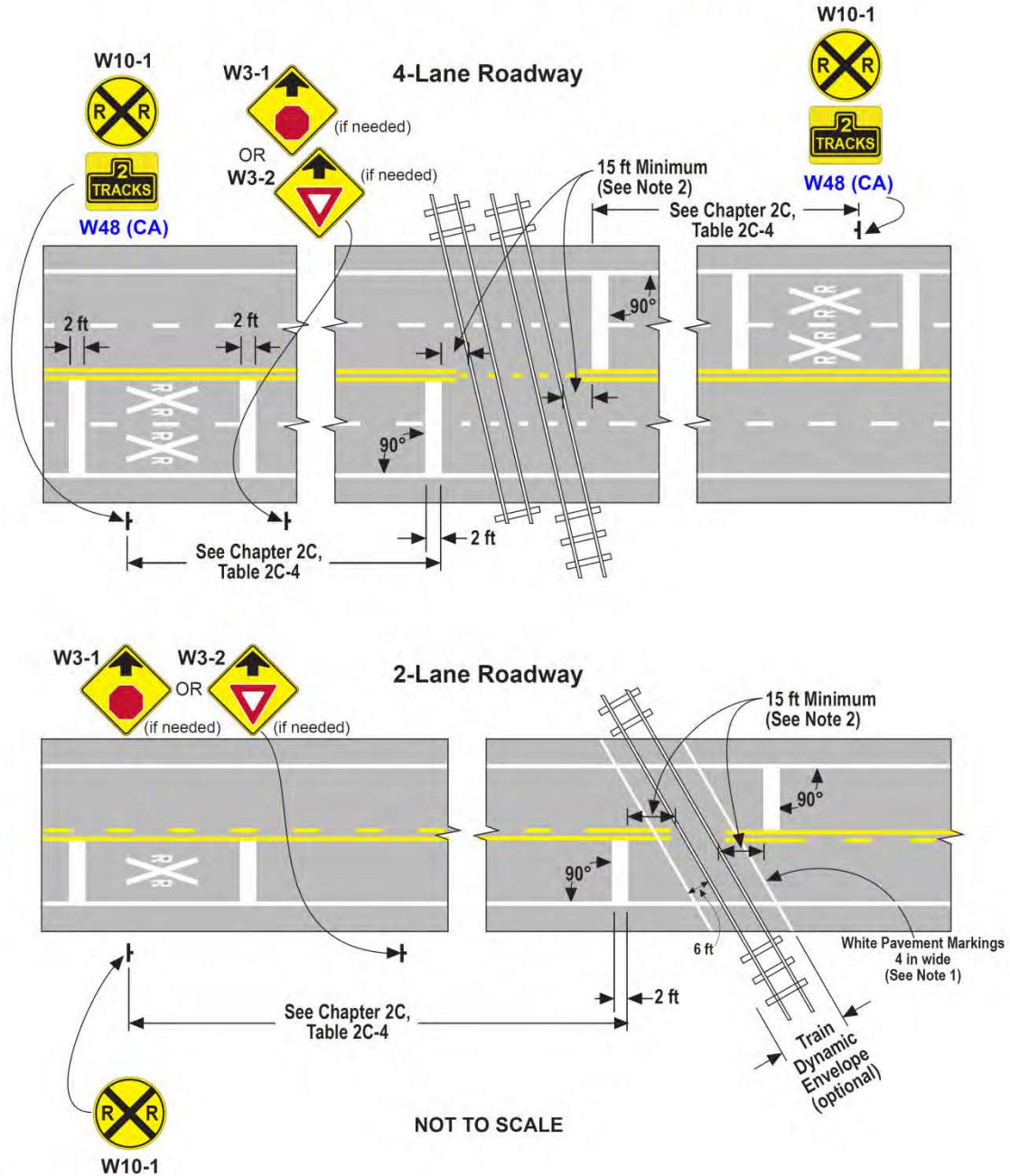
I-13



**Figure 8B-6. Example of Placement of Warning Signs and Pavement Markings at Grade Crossings**



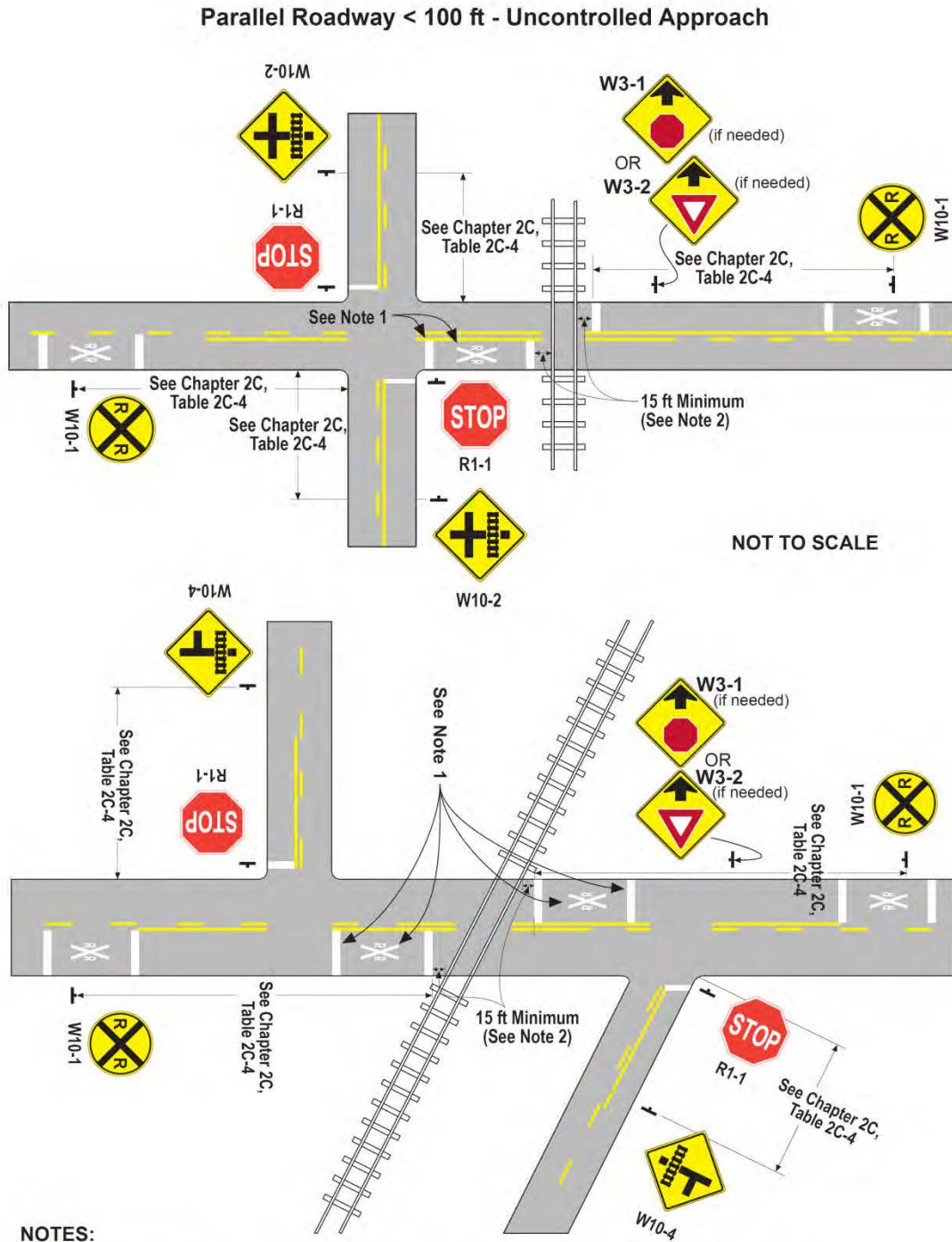
**Figure 8B-6 (CA). Example of Placement of Warning Signs and Pavement Markings at Grade Crossings (Sheet 1 of 3)**



**NOTES:**

1. The distance between rail and the optional dynamic envelope pavement marking should be equal to 6 ft unless otherwise advised by the operating railroad.
2. Minimum 8 ft from the gate (if present), but no closer than 15 ft from the nearest rail. See Section 8B.28.
3. Longitudinal markings can be extended across the tracks at offset, skewed, complex, multilegged, curved roadway or multiple track crossings. See Section 8B.27.

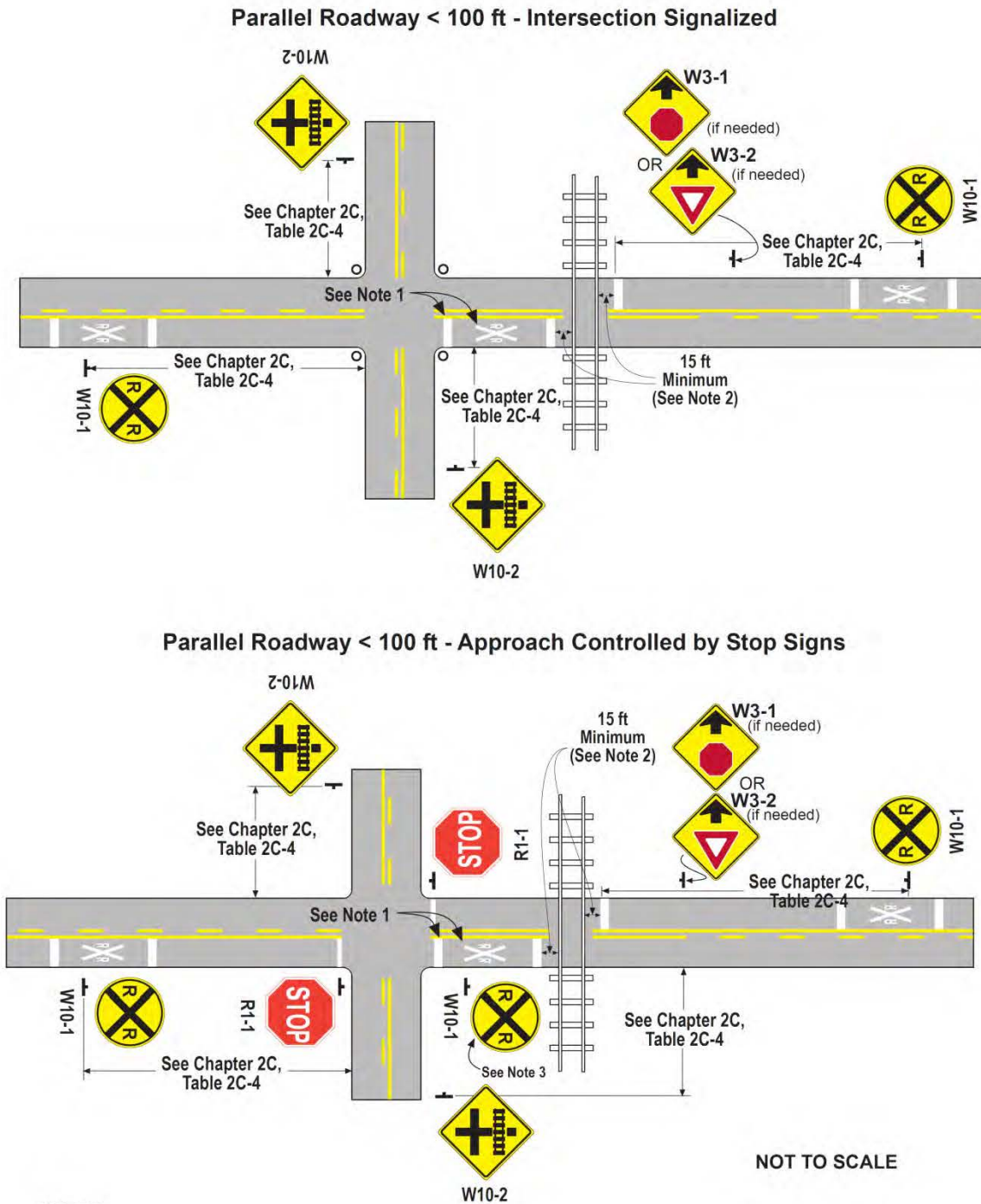
**Figure 8B-6 (CA). Example of Placement of Warning Signs and Pavement Markings at Grade Crossings (Sheet 2 of 3)**



**NOTES:**

1. These pavement markings can be omitted where the distance is less than 50 ft. See Section 8B.27.
2. Minimum 8 ft from the gate (if present), but no closer than 15 ft from the nearest rail. See Section 8B.28.
3. Longitudinal markings can be extended across the tracks at offset, skewed, complex, multilegged, curved roadway or multiple track crossings. See Section 8B.27.

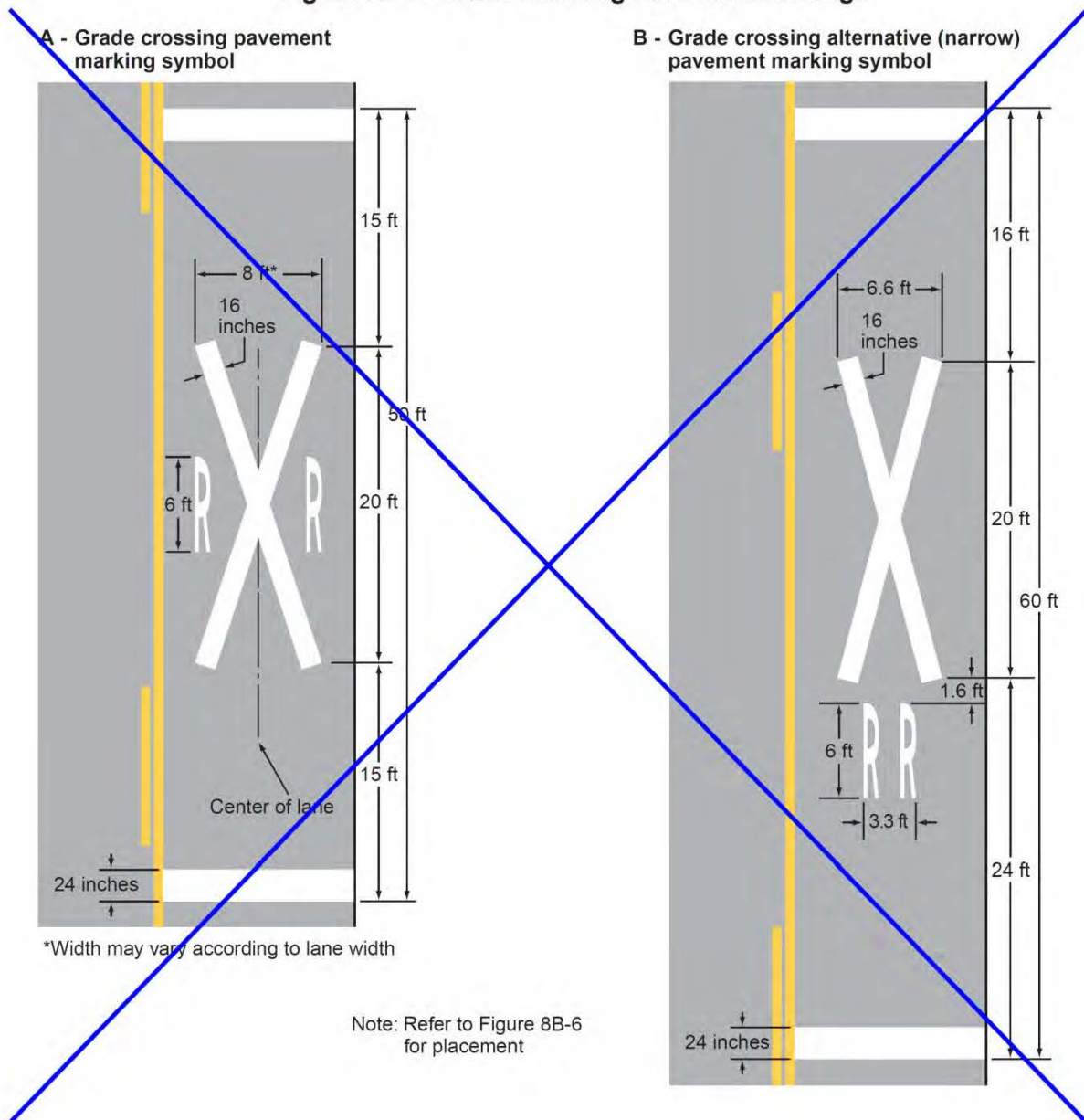
**Figure 8B-6 (CA). Example of Placement of Warning Signs and Pavement Markings at Grade Crossings (Sheet 3 of 3)**



**NOTES:**

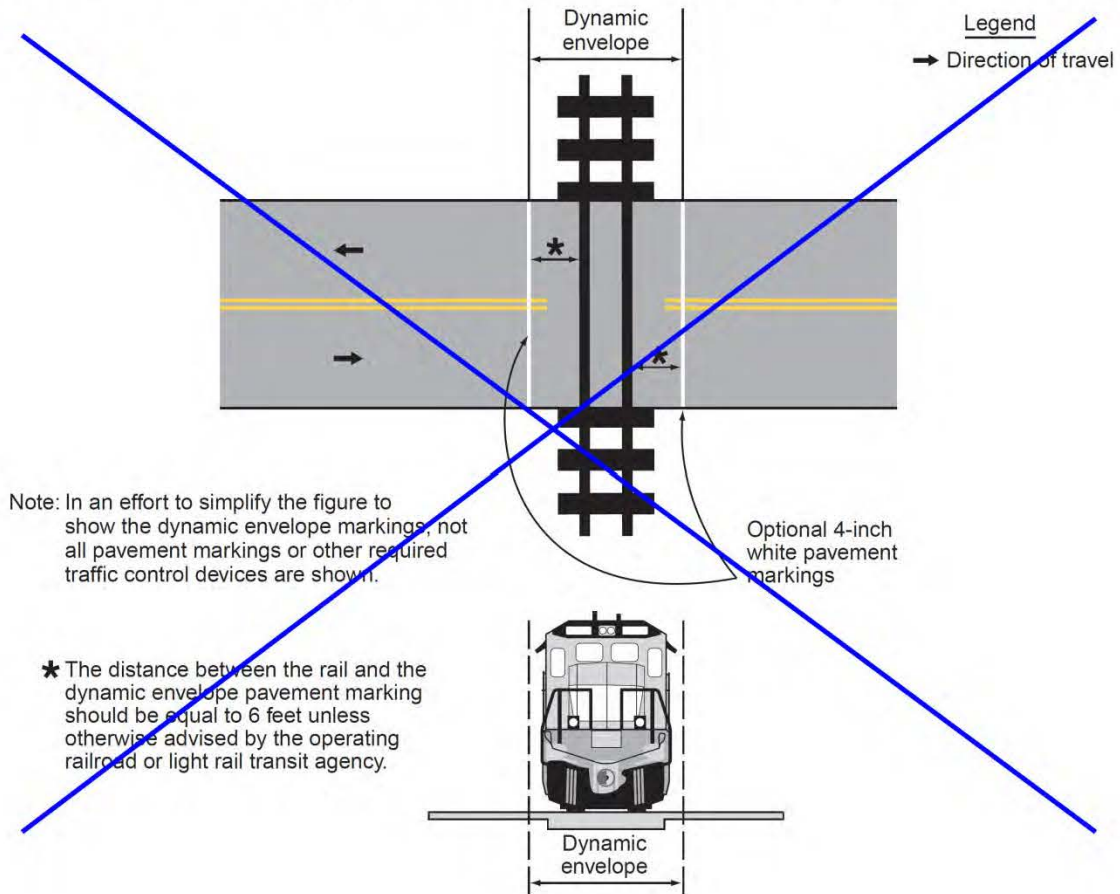
1. These pavement markings can be omitted where the distance is less than 50 ft. See Section 8B.27.
2. Minimum 8 ft from the gate (if present), but no closer than 15 ft from the nearest rail.
3. The W10-1 sign may be omitted between the intersection and the tracks where the distance is less than 100 feet and approaches to the intersection include appropriate advance warning signs. See Section 8B.06.

**Figure 8B-7. Grade Crossing Pavement Markings**

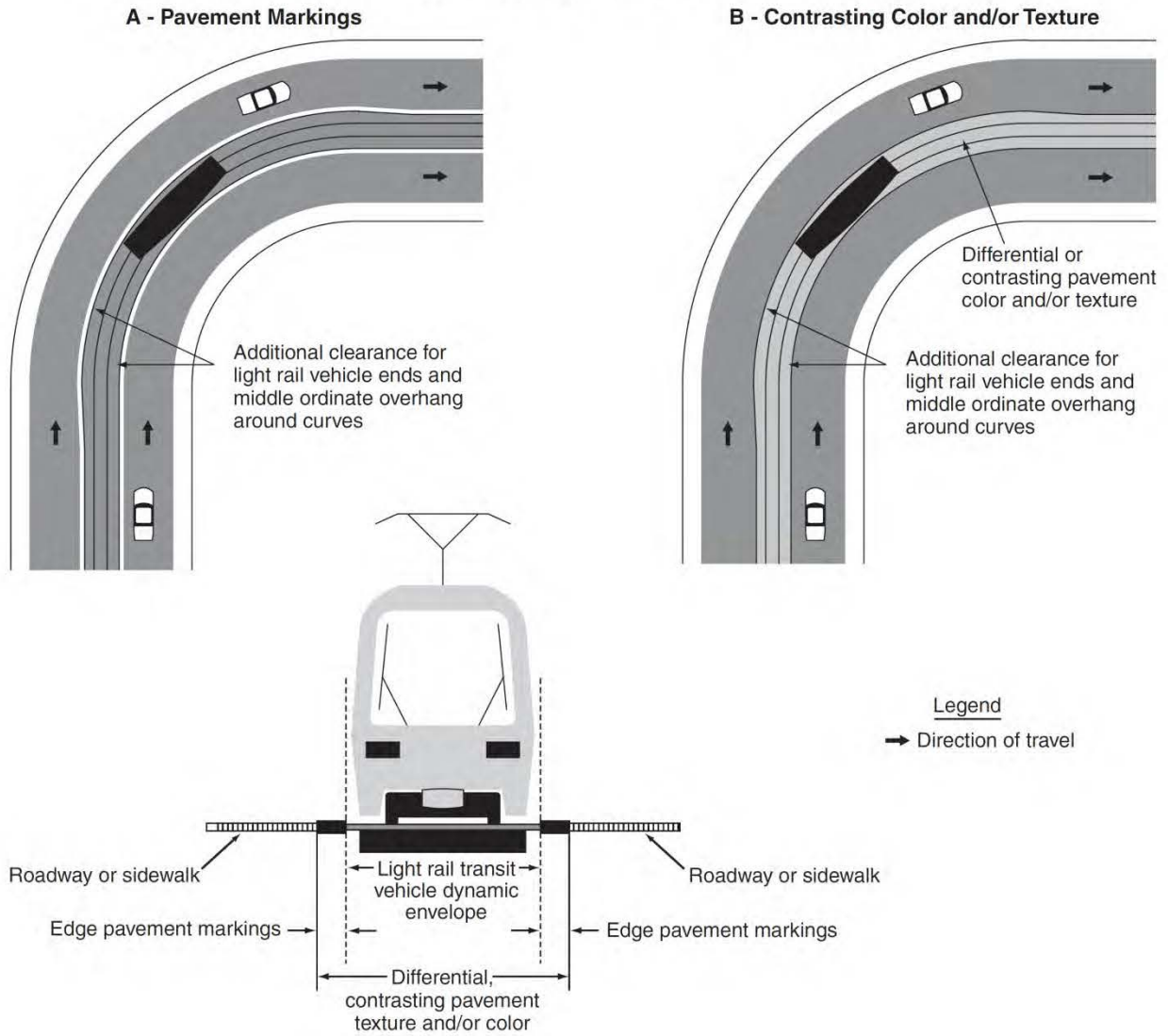




**Figure 8B-8. Example of Dynamic Envelope Pavement Markings at Grade Crossings**



**Figure 8B-9. Examples of Light Rail Transit Vehicle Dynamic Envelope Markings for Mixed-Use Alignments**





**Figure 8B-101(CA) Train Station Signs**



**Table 8B-1. Grade Crossing Sign and Plaque Minimum Sizes**

| Sign or Plaque  | Sign Designation  | Section          | Conventional Road  |   | Expressway   | Minimum      | Oversized          |
|---|-------------------|------------------|--------------------|---|--------------|--------------|--------------------|
|   |                   |                  | Single Lane        | Multi-Lane                              |              |              |                    |
| Stop  | R1-1              | 8B.04, 8B.05     | 30 x 30            | 36 x 36                                 | 36 x 36      | —            | 48 x 48            |
| Yield   | R1-2              | 8B.04, 8B.05     | 36 x 36 x 36       | <del>36 x 36 x 36</del><br>48 x 48 x 48 | 48 x 48 x 48 | 30 x 30 x 30 | —                  |
| <del>No Right Turn Across Tracks</del>                    | <del>R3-1a</del>  | <del>8B.08</del> | <del>24 x 30</del> | <del>30 x 36</del>                      |              |              |                    |
| <del>No Left Turn Across Tracks</del>                     | <del>R3-2a</del>  | <del>8B.08</del> | <del>24 x 30</del> | <del>30 x 36</del>                      |              |              |                    |
| Do Not Stop on Tracks                                     | R8-8              | 8B.09            | 24 x 30            | 24 x 30                                 | 36 x 48      | —            | 36 x 48            |
| Tracks Out of Service                                     | R8-9              | 8B.10            | 24 x 24            | 24 x 24                                 | 36 x 36      | —            | 36 x 36            |
| Stop Here When Flashing                                   | R8-10             | 8B.11            | 24 x 36            | 24 x 36                                 | —            | —            | 36 x 48            |
| Stop Here When Flashing                                   | R8-10a            | 8B.11            | 24 x 30            | 24 x 30                                 | —            | —            | 36 x 42            |
| Stop Here on Red  | R10-6             | 8B.12            | 24 x 36            | 24 x 36                                 | —            | —            | 36 x 48            |
| <del>Stop Here on Red</del>                               | <del>R10-6a</del> | <del>8B.12</del> | <del>24 x 30</del> | <del>24 x 30</del>                      |              |              | <del>36 x 42</del> |
| Grade Crossing (Crossbuck)                                | R15-1             | 8B.03            | 48 x 9             | 48 x 9                                  | —            | —            | —                  |
| Number of Tracks (plaque)                                 | R15-2P            | 8B.03            | 27 x 18            | 27 x 18                                 | —            | —            | —                  |
| <del>Exempt (plaque)</del>                                | <del>R15-2P</del> | <del>8B.03</del> | <del>24 x 12</del> | <del>24 x 12</del>                      |              |              |                    |
| Light Rail Only Right Lane                                | R15-4a            | 8B.13            | 24 x 30            | 24 x 30                                 | —            | —            | —                  |
| Light Rail Only Left Lane                                 | R15-4b            | 8B.13            | 24 x 30            | 24 x 30                                 | —            | —            | —                  |
| Light Rail Only Center Lane                               | R15-4c            | 8B.13            | 24 x 30            | 24 x 30                                 | —            | —            | —                  |
| Light Rail Do Not Pass                                    | R15-5             | 8B.14            | 24 x 30            | 24 x 30                                 | —            | —            | —                  |
| Do Not Pass Stopped Train                                 | R15-5a            | 8B.14            | 24 x 30            | 24 x 30                                 | —            | —            | —                  |
| No Motor Vehicles On Tracks Symbol                        | R15-6             | 8B.15            | 24 x 24            | 24 x 24                                 | —            | —            | —                  |
| Do Not Drive On Tracks                                    | R15-6a            | 8B.15            | 24 x 30            | 24 x 30                                 | —            | —            | —                  |
| Light Rail Divided Highway Symbol                         | R15-7             | 8B.16            | 24 x 24            | 24 x 24                                 | —            | —            | —                  |
| Light Rail Divided Highway Symbol (T-Intersection)        | R15-7a            | 8B.16            | 24 x 24            | 24 x 24                                 | —            | —            | —                  |
| Look  | R15-8             | 8B.17            | 36 x 18            | 36 x 18                                 | —            | —            | —                  |
| Grade Crossing Advance Warning                            | W10-1             | 8B.06            | 36 Dia.            | 36 Dia.                                 | 48 Dia.      | —            | 48 Dia.            |
| Exempt (plaque)   | W10-1aP           | 8B.07            | 24 x 12            | 24 x 12                                 | —            | —            | —                  |
| Grade Crossing and Intersection Advance Warning           | W10-2,3,4         | 8B.06            | 36 x 36            | 36 x 36                                 | 48 x 48      | —            | 48 x 48            |
| Low Ground Clearance                                      | W10-5             | 8B.23            | 36 x 36            | 36 x 36                                 | 48 x 48      | —            | 48 x 48            |
| Low Ground Clearance (plaque)                             | W10-5P            | 8B.23            | 30 x 24            | 30 x 24                                 | —            | —            | —                  |
| Light Rail Activated Blank-Out Symbol                     | W10-7             | 8B.19            | 24 x 24            | 24 x 24                                 | —            | —            | —                  |
| Trains May Exceed 80 MPH                                  | W10-8             | 8B.20            | 36 x 36            | 36 x 36                                 | 48 x 48      | —            | 48 x 48            |
| No Train Horn   | W10-9             | 8B.21            | 36 x 36            | 36 x 36                                 | 48 x 48      | —            | 48 x 48            |
| No Train Horn (plaque)                                    | W10-9P            | 8B.21            | 30 x 24            | 30 x 24                                 | —            | —            | —                  |
| Storage Space Symbol                                      | W10-11            | 8B.24            | 36 x 36            | 36 x 36                                 | 48 x 48      | —            | 48 x 48            |
| Storage Space XX Feet Between Tracks & Highway            | W10-11a           | 8B.24            | 30 x 36            | 30 x 36                                 | —            | —            | —                  |
| Storage Space XX Feet Between Highway & Tracks Behind You | W10-11b           | 8B.24            | 30 x 36            | 30 x 36                                 | —            | —            | —                  |
| Skewed Crossing   | W10-12            | 8B.25            | 36 x 36            | 36 x 36                                 | 48 x 48      | —            | 48 x 48            |
| No Gates or Lights (plaque)                               | W10-13P           | 8B.22            | 30 x 24            | 30 x 24                                 | —            | —            | —                  |
| Next Crossing (plaque)                                    | W10-14P           | 8B.23            | 30 x 24            | 30 x 24                                 | —            | —            | —                  |
| Use Next Crossing (plaque)                                | W10-14aP          | 8B.23            | 30 x 24            | 30 x 24                                 | —            | —            | —                  |
| Rough Crossing (plaque)                                   | W10-15P           | 8B.23            | 30 x 24            | 30 x 24                                 | —            | —            | 36 x 30            |

- Notes: 1. Larger signs may be used when appropriate  
 2. Dimensions in inches are shown as width x height  
 3. Table 9B-1 shows the minimum sizes that may be used for grade crossing signs and plaques that face shared-use paths and pedestrian facilities

**Table 8B-1(CA). California Grade Crossing Sign and Plaque Minimum Sizes**

| Sign or Plaque  | Sign Designation | Section    | Conventional Road |            | Expressway | Minimum  | Oversized |
|---|------------------|------------|-------------------|------------|------------|----------|-----------|
|   |                  |            | Single Lane       | Multi-Lane |            |          |           |
| Train Station NEXT RIGHT                                  | G95F(CA)         | 8B.101(CA) | VAR x 36          | VAR x 36   | VAR x 48   | VAR x 36 | VAR x 60  |
| Specific Train Station NEXT RIGHT                         | G95G(CA)         | 8B.101(CA) | VAR x 54          | VAR x 54   | VAR x 66   | VAR x 54 | VAR x 84  |
| Light Rail Station  | G96(CA)          | 8B.26      | 24 x 24           | 24 x 24    | 30 x 30    | 18 x 18  | ---       |
| TROLLEY Plaque  | G96A(CA)         | 8B.26      | 24 x 6            | 24 x 6     | 30 x 8     | 18 x 5   | ---       |
| AMTRAK  | G97A(CA)         | 8B.101(CA) | 24 x 6            | 24 x 6     | 30 x 8     | 18 x 5   | ---       |
| EXEMPT  | W46A(CA)         | 8B.07      | 15 x 9            | 15 x 9     | ---        | ---      | ---       |
| Number of Tracks  | W48(CA)          | 8B.06      | 30 x 24           | 30 x 24    | ---        | ---      | ---       |
| Light Rail Transit (Trolley) Crossing                     | W82(CA)          | 8B.102(CA) | 24 x 24           | 24 x 24    | 30 x 30    | 24 x 24  | ---       |
| Light Rail Transit (Trolley) Crossing /<br>LOOK BOTH WAYS | W82-1(CA)        | 8B.102(CA) | 24 x 24           | 24 x 24    | 30 x 30    | 24 x 24  | ---       |



## CHAPTER 8C. FLASHING-LIGHT SIGNALS, GATES, AND TRAFFIC CONTROL SIGNALS

### Section 8C.01 Introduction

#### Support:

01 Active traffic control systems inform road users of the approach or presence of rail traffic at grade crossings. These systems include four-quadrant gate systems, automatic gates, flashing-light signals, traffic control signals, actuated blank-out and variable message signs, and other active traffic control devices.

02 A composite drawing (see Figure 8C-1) shows a post-mounted flashing-light signal (two light units mounted in a horizontal line), a flashing-light signal mounted on an overhead structure, and an automatic gate assembly.

#### Option:

03 Post-mounted and overhead flashing-light signals may be used separately or in combination with each other as determined by an engineering study. Also, flashing-light signals may be used without automatic gate assemblies, as determined by an engineering study.

#### Standard:

04 **The meaning of flashing-light signals and gates shall be as stated in the “Uniform Vehicle Code” (see Sections 11-701 and 11-703 of the UVC), which is available from the National Committee on Uniform Traffic Laws and Ordinances (see Page i for the address).**

05 **Location and clearance dimensions for flashing-light signals and gates shall be as shown in Figure 8C-1.**

06 **When there is a curb, a horizontal offset of at least 2 feet shall be provided from the face of the vertical curb to the closest part of the signal or gate arm in its upright position. When a cantilevered-arm flashing-light signal is used, the vertical clearance shall be at least 17 feet above the crown of the highway to the lowest point of the signal unit.**

07 **Where there is a shoulder, but no curb, a horizontal offset of at least 2 feet from the edge of a paved or surfaced shoulder shall be provided, with an offset of at least 6 feet from the edge of the traveled way.**

08 **Where there is no curb or shoulder, the minimum horizontal offset shall be 6 feet from the edge of the traveled way.**

#### Guidance:

09 *Equipment housings (controller cabinets) should have a lateral offset of at least 30 feet from the edge of the highway, and where railroad or LRT property and conditions allow, at least 25 feet from the nearest rail.*

10 *If a pedestrian route is provided, sufficient clearance from supports, posts, and gate mechanisms should be maintained for pedestrian travel.*

11 *When determined by an engineering study, a lateral escape route to the right of the highway in advance of the grade crossing traffic control devices should be kept free of guardrail or other ground obstructions. Where guardrail is not deemed necessary or appropriate, barriers should not be used for protecting signal supports.*

12 *The same lateral offset and roadside safety features should apply to flashing-light signal and automatic gate locations on both the right-hand and left-hand sides of the roadway.*

#### Option:

13 In industrial or other areas involving only low-speed highway traffic or where signals are vulnerable to damage by turning truck traffic, guardrail may be installed to provide protection for the signal assembly.

#### Guidance:

14 *Where both traffic control signals and flashing-light signals (with or without automatic gates) are in operation at the same highway-LRT grade crossing, the operation of the devices should be coordinated to avoid any display of conflicting signal indications.*

#### Support:

15 LRT typically operates through grade crossings in semi-exclusive and mixed-use alignments at speeds between 10 and 65 mph. [California Public Utilities Commission General Order 143, “Safety Rules and Regulations Governing Light-Rail Transit”](#), as amended, governs the operation and allowable speeds of light rail transit systems.

16 When LRT speed is cited in this Part, it refers to the maximum speed at which LRT equipment is permitted to traverse a particular grade crossing.

## Section 8C.02 Flashing-Light Signals

### Support:

01 Section 8C.03 contains additional information regarding flashing-light signals at highway-LRT grade crossings in semi-exclusive and mixed-use alignments.

### Standard:

02 **If used, the flashing-light signal assembly (shown in Figure 8C-1) on the side of the highway shall include a standard Crossbuck (R15-1) sign, and where there is more than one track, a supplemental Number of Tracks (R15-2P) plaque, all of which indicate to motorists, bicyclists, and pedestrians the location of a grade crossing.**

### Option:

03 At highway-rail grade crossings, bells or other audible warning devices may be included in the assembly and may be operated in conjunction with the flashing lights to provide additional warning for pedestrians, bicyclists, and/or other non-motorized road users.

### Standard:

04 **When indicating the approach or presence of rail traffic, the flashing-light signal shall display toward approaching highway traffic two red lights mounted in a horizontal line flashing alternately.**

05 **If used, flashing-light signals shall be placed to the right of approaching highway traffic on all highway approaches to a grade crossing. They shall be located laterally with respect to the highway in compliance with Figure 8C-1 except where such location would adversely affect signal visibility.**

06 **If used at a grade crossing with highway traffic in both directions, back-to-back pairs of lights shall be placed on each side of the tracks. On multi-lane one-way streets and divided highways, flashing-light signals shall be placed on the approach side of the grade crossing on both sides of the roadway or shall be placed above the highway.**

07 **Each red signal unit in the flashing-light signal shall flash alternately. The number of flashes per minute for each lamp shall be 35 minimum and 65 maximum. Each lamp shall be illuminated approximately the same length of time. Total time of illumination of each pair of lamps shall be the entire operating time. Flashing-light units shall use ~~either 8-inch or~~ 12-inch nominal diameter lenses.**

### *Guidance:*

*08 In choosing between the 8-inch or 12-inch nominal diameter lenses for use in grade crossing flashing-light signals, consideration should be given to the principles stated in Section 4D.07.*

### Standard:

09 **Grade crossing flashing-light signals shall operate at a low voltage using storage batteries either as a primary or stand-by source of electrical energy. Provision shall be made to provide a source of energy for charging batteries.**

### Option:

10 Additional pairs of flashing-light units may be mounted on the same supporting post and directed toward vehicular traffic approaching the grade crossing from other than the principal highway route, such as where there are approaching routes on highways closely adjacent to and parallel to the track(s).

### Standard:

11 **References to lenses in this Section shall not be used to limit flashing-light signal optical units to incandescent lamps within optical assemblies that include lenses.**

### Support:

12 Research has resulted in flashing-light signal optical units that are not lenses, such as, but not limited to, light emitting diode (LED) flashing-light signal modules.

### Option:

13 Flashing-light signals may be installed on overhead structures or cantilevered supports as shown in Figure 8C-1 where needed for additional emphasis, or for better visibility to approaching traffic, particularly on multi-lane approaches or highways with profile restrictions.

14 If it is determined by an engineering study that one set of flashing lights on the cantilever arm is not sufficiently visible to road users, one or more additional sets of flashing lights may be mounted on the supporting post and/or on the cantilever arm.

**Standard:**

**15 Breakaway or frangible bases shall not be used for overhead structures or cantilevered supports.**

**16 Except as otherwise provided in Paragraphs 13 through 15, flashing-light signals mounted overhead shall comply with the applicable provisions of this Section.**

**Section 8C.03 Flashing-Light Signals at Highway-LRT Grade Crossings**

**Support:**

**01 Section 8C.02 contains additional provisions regarding the design and operation of flashing-light signals, including those installed at highway-LRT grade crossings.**

**Standard:**

**02 Highway-LRT grade crossings in semi-exclusive alignments shall be equipped with flashing-light signals where LRT speeds exceed 35 mph. Flashing-light signals shall be clearly visible to motorists, pedestrians, and bicyclists.**

**03 If flashing-light signals are in operation at a highway-LRT crossing that is used by pedestrians, bicyclists, and/or other non-motorized road users, an audible device such as a bell shall also be provided and shall be operated in conjunction with the flashing-light signals.**

**Guidance:**

**04 Where the crossing is at a location other than an intersection and LRT speeds exceed 25 mph, flashing-light signals should be installed.**

**Option:**

**05 Traffic control signals may be used instead of flashing-light signals at highway-LRT grade crossings within highway-highway intersections where LRT speeds do not exceed 35 mph. Traffic control signals or flashing-light signals may be used where the crossing is at a location other than an intersection, where LRT speeds do not exceed 25 mph, and when the roadway is a low-volume street where prevailing speeds do not exceed 25 mph.**

**Section 8C.04 Automatic Gates**

**Support:**

**01 An automatic gate is a traffic control device used in conjunction with flashing-light signals.**

**Standard:**

**02 The automatic gate (see Figure 8C-1) shall consist of a drive mechanism and a fully retroreflectorized red- and white-striped gate arm with lights. When in the down position, the gate arm shall extend across the approaching lanes of highway traffic.**

**03 In the normal sequence of operation, unless constant warning time detection or other advanced system requires otherwise, the flashing-light signals and the lights on the gate arm (in its normal upright position) shall be activated immediately upon detection of approaching rail traffic. The gate arm shall start its downward motion not less than 3 seconds after the flashing-light signals start to operate, shall reach its horizontal position at least 5 seconds before the arrival of the rail traffic, and shall remain in the down position as long as the rail traffic occupies the grade crossing.**

**04 When the rail traffic clears the grade crossing, and if no other rail traffic is detected, the gate arm shall ascend to its upright position, following which the flashing-light signals and the lights on the gate arm shall cease operation.**

**05 Gate arms shall be fully retroreflectorized on both sides and shall have vertical stripes alternately red and white at 16-inch intervals measured horizontally.**

**Support:**

**06 It is acceptable to replace a damaged gate with a gate having vertical stripes even if the other existing gates at the same grade crossing have diagonal stripes; however, it is also acceptable to replace a damaged gate with a gate having diagonal stripes if the other existing gates at the same grade crossing have diagonal stripes in order to maintain consistency per the provisions of Paragraph 24 of the Introduction.**

**Standard:**

**07 Gate arms shall have at least three red lights as provided in Figure 8C-1.**

**08 When activated, the gate arm light nearest the tip shall be illuminated continuously and the other lights shall flash alternately in unison with the flashing-light signals.**

**09 The entrance gate arm mechanism shall be designed to fail safe in the down position.**

*Guidance:*

10 *The gate arm should ascend to its upright position in 12 seconds or less.*

11 *In its normal upright position, when no rail traffic is approaching or occupying the grade crossing, the gate arm should be either vertical or nearly so (see Figure 8C-1).*

12 *In the design of individual installations, consideration should be given to timing the operation of the gate arm to accommodate large and/or slow-moving highway vehicles.*

13 *The gates should cover the approaching highway to block all highway vehicles from being driven around the gate without crossing the center line.*

*Option:*

14 The effectiveness of gates may be enhanced by the use of channelizing devices or raised median islands to discourage driving around lowered automatic gates.

15 Where gates are located in the median, additional median width may be required to provide the minimum clearance for the counterweight supports.

16 Automatic gates may be supplemented by cantilevered flashing-light signals (see Figure 8C-1) where there is a need for additional emphasis or better visibility.

**Section 8C.05 Use of Automatic Gates at LRT Grade Crossings**

*Guidance:*

01 *Highway-LRT grade crossings in semi-exclusive alignments should be equipped with automatic gates and flashing-light signals (see Sections 8C.02 and 8C.03) where LRT speeds exceed 35 mph.*

*Option:*

02 Where a highway-LRT grade crossing is at a location other than an intersection, where LRT speeds exceed 25 mph, automatic gates and flashing-light signals may be installed.

03 Traffic control signals may be used instead of automatic gates at highway-LRT grade crossings within highway-highway intersections where LRT speeds do not exceed 35 mph. Traffic control signals or flashing-light signals without automatic gates may be used where the crossing is at a location other than an intersection and where LRT speeds do not exceed 25 mph and the roadway is a low-volume street where prevailing speeds do not exceed 25 mph.

**Section 8C.06 Four-Quadrant Gate Systems**

*Option:*

01 Four-Quadrant Gate systems may be installed to improve safety at grade crossings based on an engineering study when less restrictive measures, such as automatic gates and median islands, are not effective.

**Standard:**

02 **A Four-Quadrant Gate system shall consist of entrance and exit gates that control and block road users on all lanes entering and exiting the grade crossing.**

03 **The Four-Quadrant Gate system shall use a series of drive mechanisms and fully retroreflectorized red- and white-striped gate arms with lights, and when in the down position the gate arms extend individually across the entrance and exit lanes of the roadway as shown in Figure 8C-2. Standards contained in Sections 8C.01 through 8C.03 for flashing-light signals shall be followed for signal specifications, location, and clearance distances.**

04 **In the normal sequence of operation, unless constant warning time detection or other advanced system requires otherwise, the flashing-light signals and the lights on the gate arms (in their normal upright positions) shall be activated immediately upon the detection of approaching rail traffic. The gate arms for the entrance lanes of traffic shall start their downward motion not less than 3 seconds after the flashing-light signals start to operate and shall reach their horizontal position at least 5 seconds before the arrival of the rail traffic. Exit gate arm activation and downward motion shall be based on detection or timing requirements established by an engineering study of the individual site. The gate arms shall remain in the down position as long as the rail traffic occupies the grade crossing.**



**05 When the rail traffic clears the grade crossing, and if no other rail traffic is detected, the gate arms shall ascend to their upright positions, following which the flashing-light signals and the lights on the gate arms shall cease operation.**

**06 Gate arm design, colors, and lighting requirements shall be in accordance with the Standards contained in Section 8C.04.**

~~07 Except as provided in Paragraph 19, the exit gate arm mechanism shall be designed to fail-safe in the up position.~~

**07a The exit gate arm mechanism shall be designed to fail-safe in the up position.**

**07b Timed Exit Gate Operating Mode shall not be used. Only Dynamic Exit Gate Operating Mode shall be used. A vehicle presence detection system shall be installed, whenever exit gates are used, to control exit gate operation based on vehicle presence within the minimum track clearance distance. Refer to CPUC General Order 75, as amended.**

**08 At locations where gate arms are offset a sufficient distance for highway vehicles to drive between the entrance and exit gate arms, median islands (see Figure 8C-2) shall be installed in accordance with the needs established by an engineering study.**

*Guidance:*

*09 The gate arm should ascend to its upright position in 12 seconds or less.*

*10 At highway-rail grade crossings, Four-Quadrant Gate systems should only be used in locations with constant warning time detection.*

~~11 The operating mode of the exit gates should be determined based upon an engineering study, with input from the affected railroad company or LRT agency.~~

~~12 If the Timed Exit Gate Operating Mode is used, the engineering study, with input from the affected railroad company or LRT agency, should also determine the Exit Gate Clearance Time (see definition in Section 1A.13).~~

~~13 If the Dynamic Exit Gate Operating Mode is used, highway vehicle intrusion detection devices that are part of a system that incorporates processing logic to detect the presence of highway vehicles within the minimum track clearance distance should be installed to control exit gate operation.~~

~~14 Regardless of which exit gate operating mode is used, the Exit Gate Clearance Time should be considered when determining additional time requirements for the Minimum Warning Time.~~

~~15 If a Four-Quadrant Gate system is used at a location that is adjacent to an intersection that could cause highway vehicles to queue within the minimum track clearance distance, the Dynamic Exit Gate Operating Mode should be used unless an engineering study indicates otherwise.~~

~~16 If a Four-Quadrant Gate system is interconnected with a highway traffic signal, backup or standby power should be considered for the highway traffic signal. Also, circuitry should be installed to prevent the highway traffic signal from leaving the track clearance green interval until all of the gates are lowered.~~

**Option:**

**16a Circuitry may be installed to prevent the highway traffic signal from leaving the track clearance green interval until vehicles are no longer detected in the track area by the vehicle presence detection system.**

~~17 At locations where sufficient space is available, exit gates should be positioned downstream from the track a distance that provides a safety zone long enough to accommodate at least one design vehicle between the exit gate and the nearest rail.~~

~~18 Four-Quadrant Gate systems should include remote health (status) monitoring capable of automatically notifying railroad or LRT signal maintenance personnel when anomalies have occurred within the system.~~

**Option:**

~~19 Exit gate arms may fail in the down position if the grade crossing is equipped with remote health (status) monitoring. Refer to CPUC General Order 75, as amended.~~

~~20 Four-Quadrant Gate installations may include median islands between opposing lanes on an approach to a grade crossing.~~

*Guidance:*

*21 Where sufficient space is available, median islands should be at least 60 feet in length.*

### **Section 8C.07 Wayside Horn Systems**

**Option:**

01 A wayside horn system (see definition in Section 1A.13) may be installed in compliance with 49 CFR Part 222 to provide audible warning directed toward the road users at a highway-rail or highway-LRT grade crossing or at a pathway grade crossing.

**Standard:**

02 **Wayside horn systems used at grade crossings where the locomotive horn is not sounded shall be equipped and shall operate in compliance with the requirements of Appendix E to 49 CFR Part 222.**

*Guidance:*

03 *The same lateral clearance and roadside safety features should apply to wayside horn systems as described in the Standards contained in Section 8C.01. Wayside horn systems, when mounted on a separate pole assembly, should be installed no closer than 15 feet from the center of the nearest track and should be positioned to not obstruct the motorists' line of sight of the flashing-light signals.*

### **Section 8C.08 Rail Traffic Detection**

**Standard:**

01 **The devices employed in active traffic control systems shall be actuated by some form of rail traffic detection.**

02 **Rail traffic detection circuits, insofar as practical, shall be designed on the fail-safe principle.**

03 **Flashing-light signals shall operate for at least 20 seconds before the arrival of any rail traffic, except as provided in Paragraph 4.**

**Option:**

04 On tracks where all rail traffic operates at less than 20 mph and where road users are directed by an authorized person on the ground to not enter the crossing at all times that approaching rail traffic is about to occupy the crossing, a shorter signal operating time for the flashing-light signals may be used.

05 Additional warning time may be provided when determined by an engineering study.

*Guidance:*

06 *Where the speeds of different rail traffic on a given track vary considerably under normal operation, special devices or circuits should be installed to provide reasonably uniform notice in advance of all rail traffic movements over the grade crossing. Special control features should be used to eliminate the effects of station stops and switching operations within approach control circuits to prevent excessive activation of the traffic control devices while rail traffic is stopped on or switching upon the approach track control circuits.*

### **Section 8C.09 Traffic Control Signals at or Near Highway-Rail Grade Crossings**

**Support:**

00 **Refer to Section 4D.27 for Railroad Preemption.**

**Option:**

01 Traffic control signals may be used instead of flashing-light signals to control road users at industrial highway-rail grade crossings and other places where train movements are very slow **speed does not exceed 10 mph**, such as in switching operations.

**Standard:**

02 **The appropriate provisions of Part 4 relating to traffic control signal design, installation, and operation shall be applicable where traffic control signals are used to control road users instead of flashing-light signals at highway-rail grade crossings.**

03 **Traffic control signals shall not be used instead of flashing-light signals to control road users at a mainline highway-rail grade crossing.**

*Guidance:*

04 *If a highway-rail grade crossing is equipped with a flashing-light signal system and is located within 200 feet of an intersection or midblock location controlled by a traffic control signal, the traffic control signal should be provided with preemption in accordance with Section 4D.27.*

05 *Coordination with the flashing-light signal system, queue detection, or other alternatives should be considered for traffic control signals located farther than 200 feet from the highway-rail grade crossing. Factors*

*to be considered should include traffic volumes, highway vehicle mix, highway vehicle and train approach speeds, frequency of trains, and queue lengths.*

*06 The highway agency or authority with jurisdiction and the regulatory agency with statutory authority, if applicable, should jointly determine the preemption operation and the timing of traffic control signals interconnected with highway-rail grade crossings adjacent to signalized highway intersections.*

Support:

*07 Section 4D.27 includes a recommendation that traffic control signals that are adjacent to highway-rail grade crossings and that are coordinated with the flashing-light signals or that include railroad preemption features be provided with a back-up power supply.*

**Standard:**

**08 Information regarding the type of preemption and any related timing parameters shall be provided to the railroad company so that they can design the appropriate train detection circuitry.**

**09 If preemption is provided, the normal sequence of traffic control signal indications shall be preempted upon the approach of trains to avoid entrapment of highway vehicles on the highway-rail grade crossing.**

**10 This preemption feature shall have an electrical circuit of the closed-circuit principle, or a supervised communication circuit between the control circuits of the highway-rail grade crossing warning system and the traffic control signal controller. The traffic control signal controller preemptor shall be activated via the supervised communication circuit or the electrical circuit that is normally energized by the control circuits of the highway-rail grade crossing warning system. The approach of a train to a highway-rail grade crossing shall de-energize the electrical circuit or activate the supervised communication circuit, which in turn shall activate the traffic control signal controller preemptor. This shall establish and maintain the preemption condition during the time the highway-rail grade crossing warning system is activated, except that when crossing gates exist, the preemption condition shall be maintained until the crossing gates are energized to start their upward movement. When multiple or successive preemptions occur, train activation shall receive first priority.**

*Guidance:*

*11 If a highway-rail grade crossing is located within 50 feet (or within 75 feet for a highway that is regularly used by multi-unit highway vehicles) of an intersection controlled by a traffic control signal, the use of pre-signals to control traffic approaching the grade crossing should be considered.*

**Standard:**

**12 If used, the pre-signals shall display a steady red signal indication during the track clearance portion of a signal preemption sequence to prohibit additional highway vehicles from crossing the railroad track.**

*Guidance:*

*13 Consideration should be given to using visibility-limited signal faces (see definition in Section 1A.13) at the intersection for the downstream signal faces that control the approach that is equipped with pre-signals.*

Option:

*14 The pre-signal phase sequencing may be timed with an offset from the downstream signalized intersection such that the railroad track area and the area between the railroad track and the downstream signalized intersection is generally kept clear of stopped highway vehicles.*

**Standard:**

**15 If a pre-signal is installed at an interconnected highway-rail grade crossing near a signalized intersection, a STOP HERE ON RED (R10-6) sign shall be installed near the pre-signal or at the stop line if used. If there is a nearby signalized intersection with insufficient clear storage distance for a design vehicle, or the highway-rail grade crossing does not have gates, a ~~No Turn on Red (R10-11, R10-11a, or R10-11b) sign~~ No Right Turn on Red (R13A(CA)) sign or No Left Turn on Red (R13B(CA)) sign (see Figure 2B-27(CA)) (see Section 2B.53) shall be installed for the approach that crosses the railroad track, if applicable.**

Option:

*16 At locations where a highway-rail grade crossing is located more than 50 feet (or more than 75 feet for a highway regularly used by multi-unit highway vehicles) from an intersection controlled by a traffic control signal, a pre-signal may be used if an engineering study determines a need.*

*17 If highway traffic signals must be located within close proximity to the flashing-light signal system, the highway traffic signals may be mounted on the same overhead structure as the flashing-light signals.*

Support:

<sup>18</sup> Section 4C.10 describes the Intersection Near a Grade Crossing signal warrant that is intended for use at a location where the proximity to the intersection of a grade crossing on an intersection approach controlled by a STOP or YIELD sign is the principal reason to consider installing a traffic control signal.

<sup>19</sup> Section 4D.27 describes additional considerations regarding preemption of traffic control signals at or near highway-rail grade crossings.

### **Section 8C.10 Traffic Control Signals at or Near Highway-LRT Grade Crossings**

Support:

<sup>01</sup> There are two types of traffic control signals for controlling vehicular and LRT movements at interfaces of the two modes. The first is the standard traffic control signal described in Part 4, which is the focus of this Section. The other type of signal is referred to as an LRT signal and is discussed in Section 8C.11.

**Standard:**

<sup>02</sup> **The provisions of Part 4 and Section 8C.09 relating to traffic control signal design, installation, and operation, including interconnection with nearby automatic gates or flashing-light signals, shall be applicable as appropriate where traffic control signals are used at highway-LRT grade crossings.**

<sup>03</sup> **If traffic control signals are in operation at a crossing that is used by pedestrians, bicyclists, and/or other non-motorized road users, an audible device such as a bell **an Accessible Pedestrian Signal** shall also be provided and shall be operated in conjunction with the traffic control signals.**

*Guidance:*

<sup>04</sup> *When a highway-LRT grade crossing equipped with a flashing-light signal system is located within 200 feet of an intersection or midblock location controlled by a traffic control signal, the traffic control signal should be provided with preemption in accordance with Section 4D.27.*

<sup>05</sup> *Coordination with the flashing-light signal system should be considered for traffic control signals located more than 200 feet from the crossing. Factors to be considered should include traffic volumes, highway vehicle mix, highway vehicle and LRT approach speeds, frequency of LRT traffic, and queue lengths.*

<sup>06</sup> *If the highway traffic signal has emergency-vehicle preemption capability, it should be coordinated with LRT operation.*

<sup>07</sup> *Where LRT operates in a wide median, highway vehicles crossing the tracks and being controlled by both near and far side traffic signal faces should receive a protected left-turn green phase from the far side signal face to clear highway vehicles from the crossing when LRT equipment is approaching the crossing.*

**Option:**

<sup>08</sup> Green indications may be provided during LRT phases for highway vehicle, pedestrian, and bicycle movements that do not conflict with LRT movements.

<sup>09</sup> Traffic control signals may be installed in addition to four-quadrant gate systems and automatic gates at a highway-LRT crossing if the crossing occurs within a highway-highway intersection and if the traffic control signals meet the warrants described in Chapter 4C.

<sup>10</sup> At a location other than an intersection, when LRT speeds are less than 25 mph, traffic control signals alone may be used to control road users at highway-LRT grade crossings only when justified by an engineering study.

<sup>11</sup> Typical circumstances may include:

- A. Geometric conditions preclude the installation of highway-LRT grade crossing warning devices.
- B. LRT vehicles share the same roadway with road users.
- C. Traffic control signals already exist.

Support:

<sup>12</sup> Section 4D.27 contains information regarding traffic control signals at or near highway-LRT grade crossings that are not equipped with highway-LRT grade crossing warning devices.

<sup>13</sup> Section 4C.10 describes the Intersection Near a Grade Crossing signal warrant that is intended for use at a location where the proximity to the intersection of a grade crossing on an intersection approach controlled by a STOP or YIELD sign is the principal reason to consider installing a traffic control signal.

*Guidance:*

<sup>14</sup> *When a highway-LRT grade crossing exists within a signalized intersection, consideration should be given to providing separate turn signal faces (see definition in Section 1A.13) for the movements crossing the tracks.*

**Standard:**

**15 Separate turn signal faces that are provided for turn movements toward the crossing shall display a steady red indication during the approach and/or passage of LRT traffic.**

*Guidance:*

*16 When a signalized intersection that is located within 200 feet of a highway-LRT grade crossing is preempted, all existing turning movements toward the highway-LRT grade crossing should be prohibited.*

**Support:**

17 Section 8B.08 contains information regarding the prohibition of turning movements toward the crossing during preemption.

18 Part 4 contains information regarding signal phasing and timing requirements.

**Section 8C.11 Use of Traffic Control Signals for Control of LRT Vehicles at Grade Crossings**

*Guidance:*

*01 LRT movements in semi-exclusive alignments at non-gated grade crossings that are equipped with traffic control signals should be controlled by special LRT signal indications.*

*02 LRT traffic control signals that are used to control LRT movements only should display the signal indications illustrated in Figure ~~8C-3~~ 8C-3(CA).*

**Support:**

03 Section 4D.27 contains information about the use of the signal indications shown in Figure ~~8C-3~~ 8C-3(CA) for the control of exclusive bus movements at “queue jumper lanes” and for the control of exclusive bus rapid transit movements on semi-exclusive or mixed-use alignments.

**Option:**

04 Standard traffic control signals may be used instead of LRT traffic control signals to control the movement of LRT vehicles (see Section 8C.10).

**Standard:**

**05 If a separate set of standard traffic control signal indications (red, yellow, and green circular and arrow indications) is used to control LRT movements, the indications shall be positioned so they are not visible to motorists, pedestrians, and bicyclists (see Section 4D.12).**

**06 If the LRT crossing control is separate from the intersection control, the two shall be interconnected. The LRT signal phase shall not be terminated until after the LRT vehicle has cleared the crossing.**

**Option:**

07 LRT signals may be used at grade crossings and at intersections in mixed-use alignments in conjunction with standard traffic control signals where special LRT signal phases are used to accommodate turning LRT vehicles or where additional LRT clearance time is desirable.

*Guidance:*

*08 LRT signal faces should be separated vertically or horizontally from the nearest highway traffic signal face for the same approach by at least 3 feet.*

**Section 8C.12 Grade Crossings Within or In Close Proximity to Circular Intersections**

**Support:**

01 At circular intersections, such as roundabouts and traffic circles, that include or are within close proximity to a grade crossing, a queue of vehicular traffic could cause highway vehicles to stop on the grade crossing.

**Standard:**

**02 Where circular intersections include or are within 200 feet of a grade crossing, an engineering study shall be made to determine if queuing could impact the grade crossing. If traffic queues impact the grade crossing, provisions shall be made to clear highway traffic from the grade crossing prior to the arrival of rail traffic.**

**Support:**

03 Among the actions that can be taken to keep the grade crossing clear of traffic or to clear traffic from the grade crossing prior to the arrival of rail traffic are the following:

- A. Elimination of the circular intersection,
- B. Geometric design revisions,

- C. Grade crossing regulatory and warning devices,
- D. Highway traffic signals,
- E. Traffic metering devices,
- F. Activated signs, or
- G. A combination of these or other actions.

### **Section 8C.13 Pedestrian and Bicycle Signals and Crossings at LRT Grade Crossings**

*Guidance:*

*01 Where LRT tracks are immediately adjacent to other tracks or a road, pedestrian signalization should be designed to avoid having pedestrians wait between sets of tracks or between the tracks and the road. If adequate space exists for a pedestrian refuge and is justified based on engineering judgment, additional pedestrian signal heads, signing, and detectors should be installed (see Section 4E.08).*

**Standard:**

**02 When used at LRT crossings, pedestrian signal heads shall comply with the provisions of Section 4E.04.**

*Guidance:*

*03 Flashing-light signals (see Figure 8C-4) with a Crossbuck (R15-1) sign and an audible device should be installed at pedestrian and bicycle crossings where an engineering study has determined that the sight distance is not sufficient for pedestrians and bicyclists to complete their crossing prior to the arrival of the LRT traffic at the crossing, or where LRT speeds exceed 35 mph.*

*04 If an engineering study shows that flashing-light signals with a Crossbuck sign and an audible device would not provide sufficient notice of an approaching LRT traffic, the LOOK (R15-8) sign (see Figure 8C-4) and/or pedestrian gates should be considered (see Figures 8C-5 through 8C-7).*

**Support:**

*05 A pedestrian gate is similar to an automatic gate except the gate arm is shorter.*

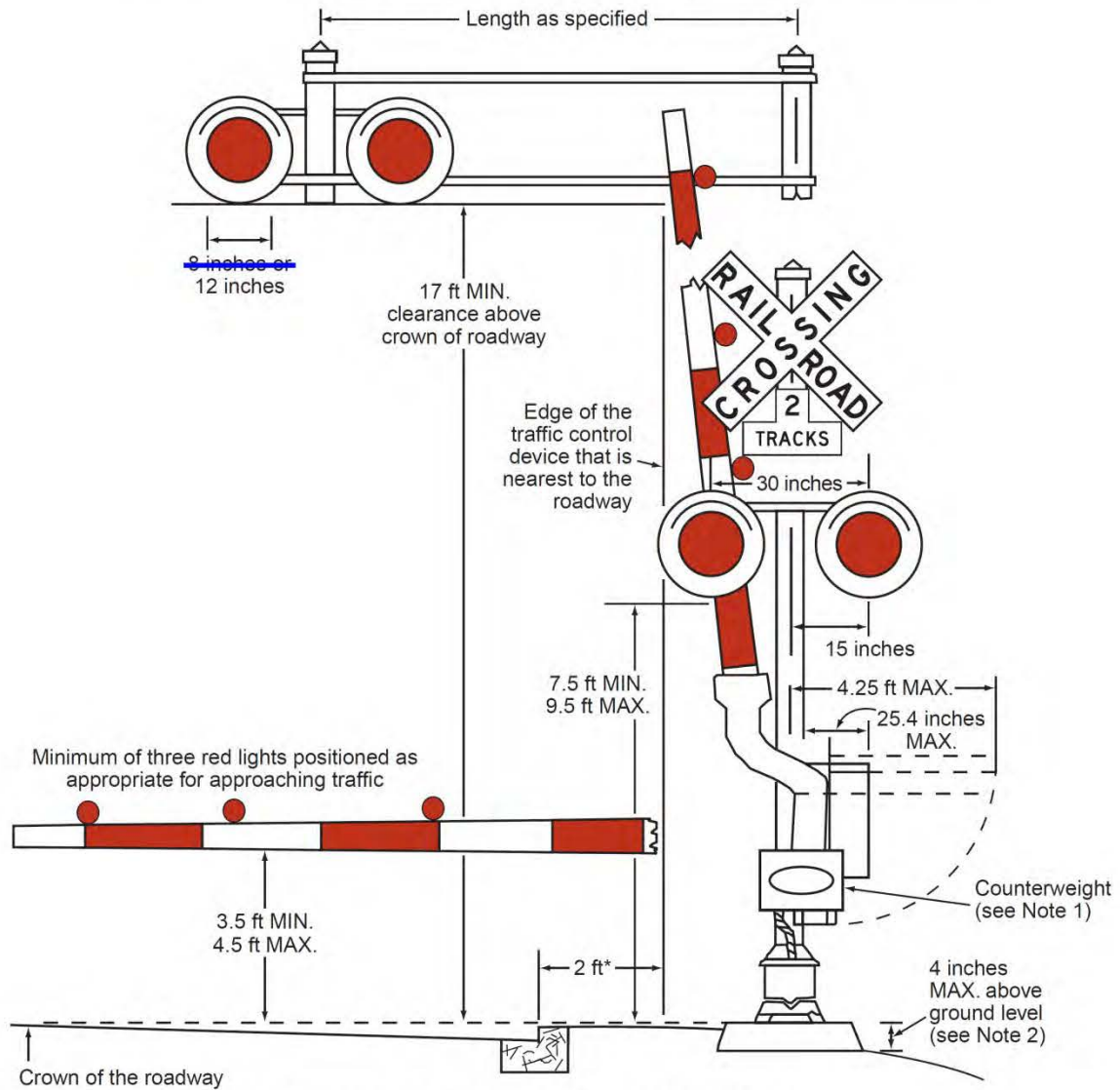
*06 The swing gate alerts pedestrians to the LRT tracks that are to be crossed. Swing gates are designed to open away from the tracks, requiring users to pull the gate open to cross, but permitting a quick exit from the trackway, and to automatically close.*

**Option:**

*07 Swing gates may be installed across pedestrian and bicycle walkways (see Figure 8C-8).*

*08 Pedestrian barriers at offset crossings may be used at pedestrian and bicycle crossings as passive devices that force users to face approaching LRT before entering the trackway (see Figures 8C-9 and 8C-10).*

**Figure 8C-1. Composite Drawing of Active Traffic Control Devices for Grade Crossings Showing Clearances**

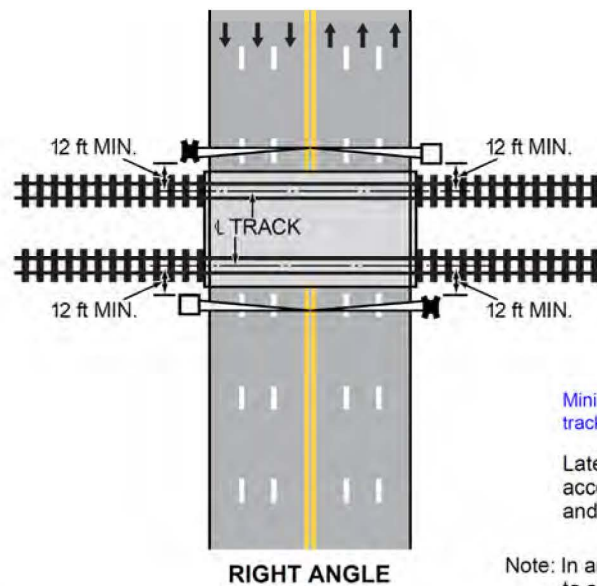
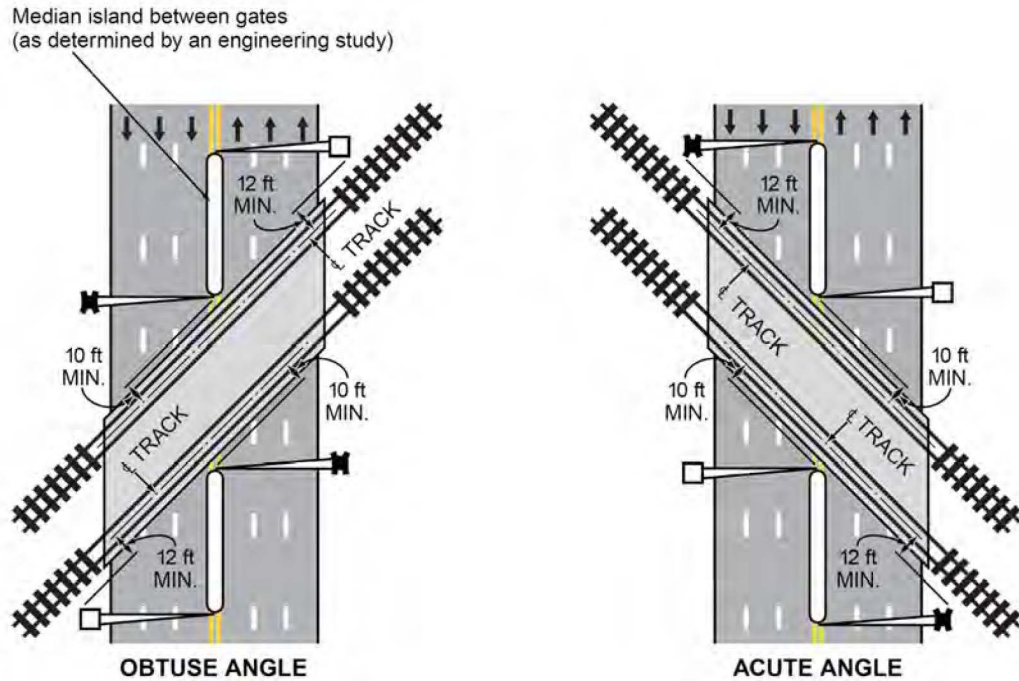


\*For locating this reference line on an approach that does not have a curb, see Section 8C.01.

Notes:

1. Where gates are located in the median, additional median width may be required to provide the minimum clearance for the counterweight supports.
2. The top of the signal foundation should be no more than 4 inches above the surface of the ground and should be at the same elevation as the crown of the roadway. Where site conditions would not allow this to be achieved, the shoulder side slope should be re-graded or the height of the signal post should be adjusted to meet the 17-foot vertical clearance requirement.

**Figure 8C-2. Example of Location Plan for Flashing-Light Signals and Four-Quadrant Gates**



- Legend**
- Direction of travel
  - ⊞ Entrance gate
  - Exit gate

































Minimum clearances from light rail tracks vary from those shown.

Lateral clearances shall be in accordance with Figure 8C-1 and Chapter 8C.

Note: In an effort to simplify the figure to show typical location plans for flashing-light signals and four-quadrant gates, not all traffic control devices are shown on this figure.






















**Figure 8C-3. Light Rail Transit Signals**

|   | Three-Lens Signal   | Two-Lens Signal   |
|---|---|---|
| <b>SINGLE<br/>LRT<br/>ROUTE</b><br>                | STOP <br>PREPARE TO STOP  Flashing<br>GO   | STOP <br>GO  <sup>(2)</sup>   |
| <b>TWO<br/>LRT<br/>ROUTE<br/>DIVERSION</b><br>     | <br> Flashing<br>  <sup>(1)</sup>   | <br>  <sup>(1),(2)</sup>   |
|    | <br> Flashing<br>  <sup>(1)</sup>  | <br>  <sup>(1),(2)</sup>   |
| <b>THREE<br/>LRT<br/>ROUTE<br/>DIVERSION</b><br> | <br> Flashing<br>   <sup>(1)</sup> | <br>   <sup>(1),(2)</sup> |

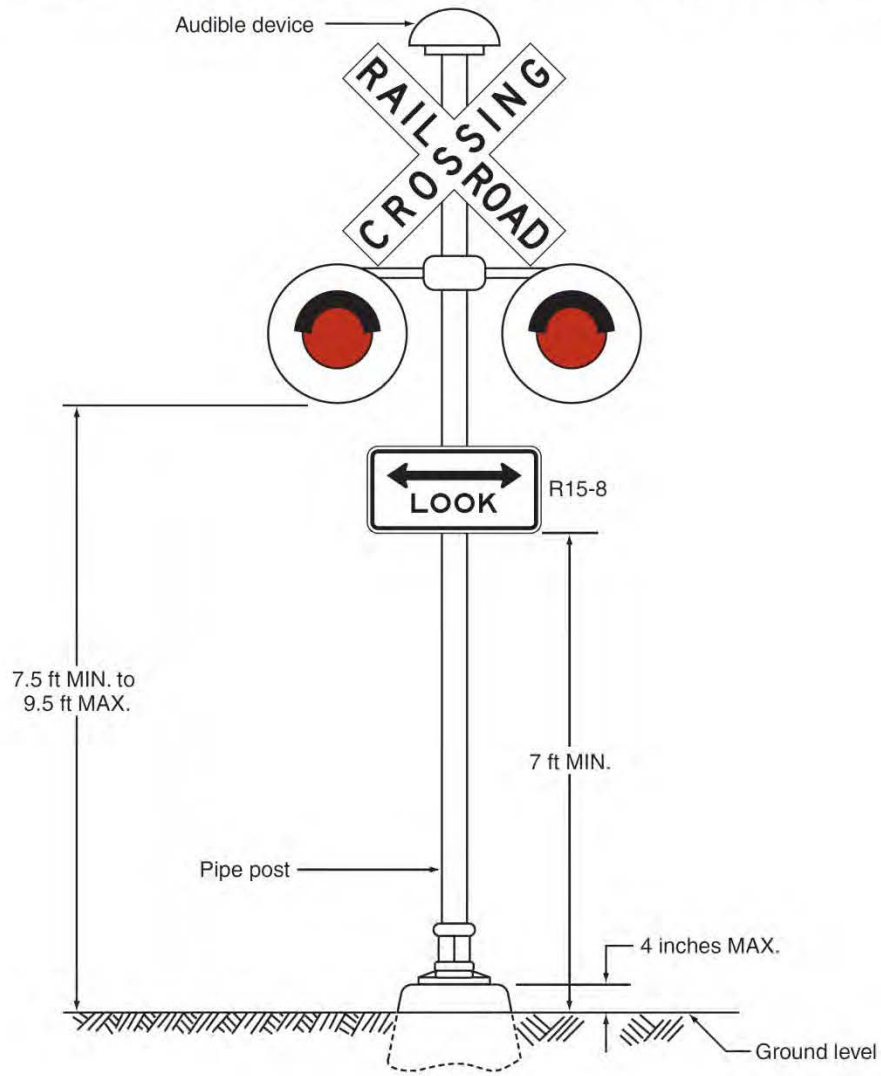
Notes:  
 All aspects (or signal indications) are white.  
 (1) Could be in single housing.  
 (2) "Go" lens may be used in flashing mode to indicate "prepare to stop".

**Figure 8C-3(CA) Light Rail Transit Signals**

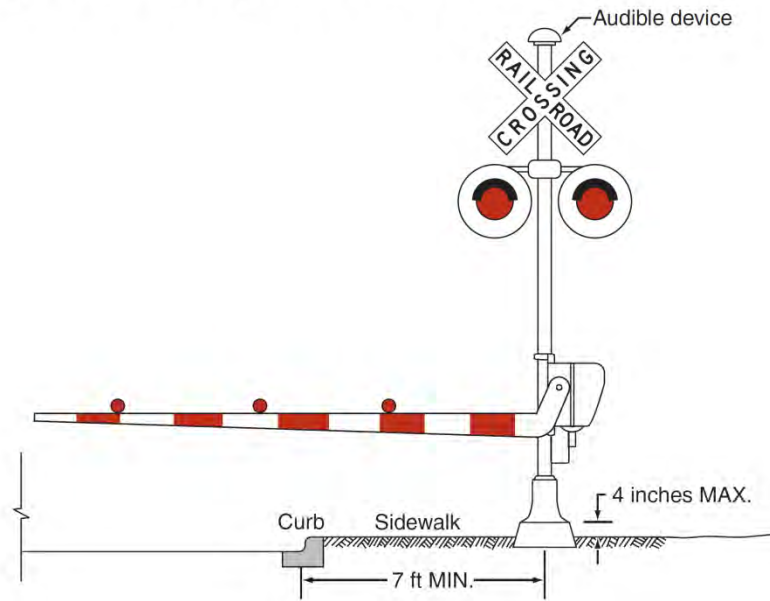
|   | Two-Lens Signal   | Three-Lens Signal   |
|---|---|---|
| <p><b>SINGLE<br/>LRT<br/>ROUTE</b></p>                 |  STOP<br> <sup>(2)</sup> GO   |   |
| <p><b>TWO<br/>LRT<br/>ROUTE<br/>DIVERSION</b></p>      | <br> <sup>(1),(2)</sup>    |   <br>STOP      PREPARE<br>TO STOP      GO<br><br>Diverging route signal aspects to be determined jointly by transit agency and highway agency.<br><br>The diagonal PREPARE TO STOP signal can be rotated 45 degrees either clockwise or counter-clockwise. |
|    | <br>  <sup>(1),(2)</sup>   |   |
| <p><b>THREE<br/>LRT<br/>ROUTE<br/>DIVERSION</b></p>  | <br> <sup>(1),(2)</sup>   |   |

**Notes:**  
 All aspects (or signal indications) are white.  
 (1) Could be in single housing.  
 (2) "Go" lens may be used in flashing mode to indicate "prepare to stop".

**Figure 8C-4. Example of Flashing-Light Signal Assembly for Pedestrian Crossings**

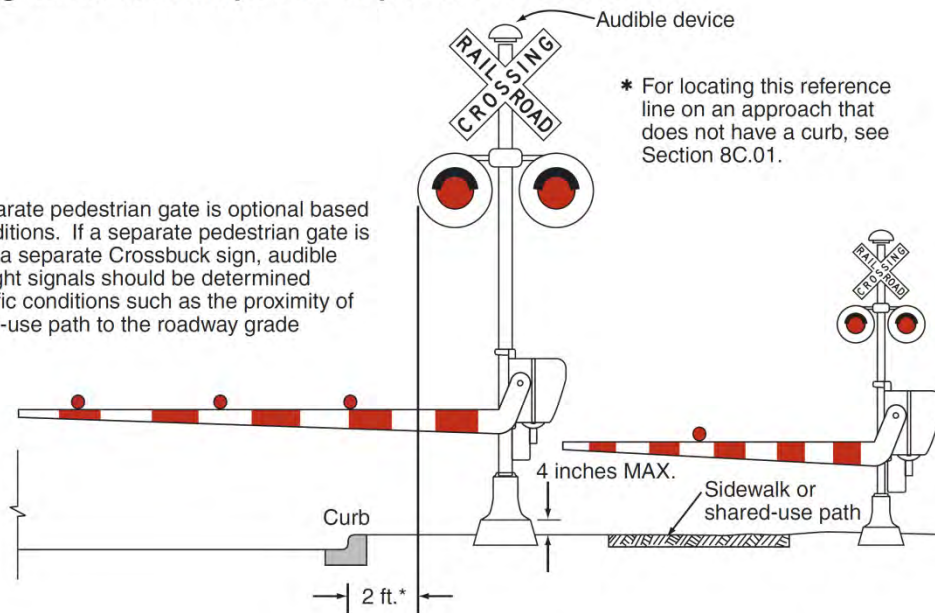


**Figure 8C-5. Example of a Shared Pedestrian/Roadway Gate**



**Figure 8C-6. Example of a Separate Pedestrian Gate**

Note: The provision of a separate pedestrian gate is optional based upon site-specific conditions. If a separate pedestrian gate is provided, the need for a separate Crossbuck sign, audible device, and flashing-light signals should be determined based upon site-specific conditions such as the proximity of the sidewalk or shared-use path to the roadway grade crossing devices.



**Figure 8C-7. Examples of Placement of Pedestrian Gates**

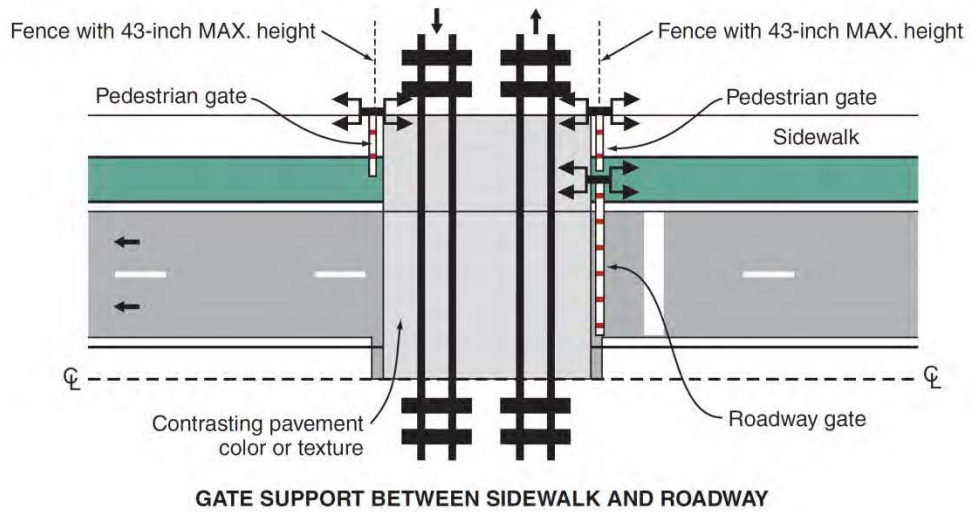
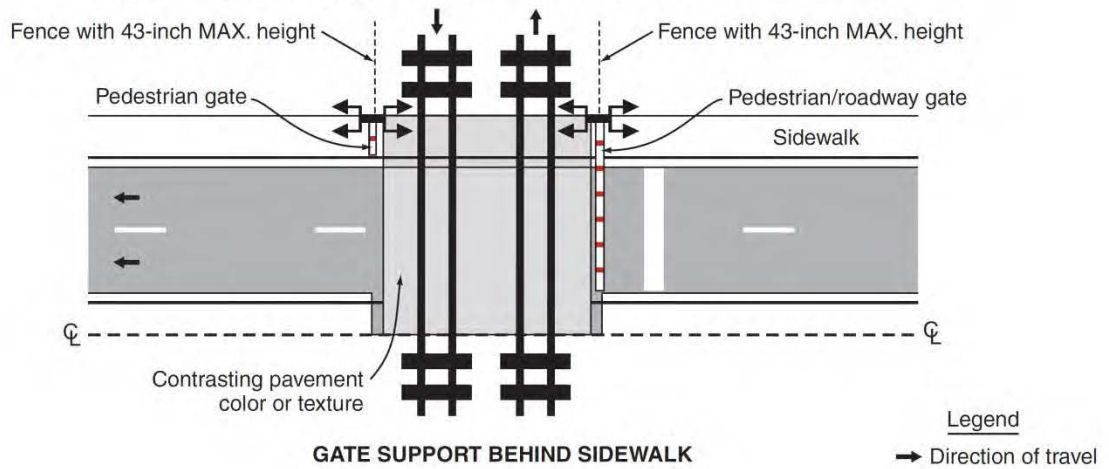


Figure 8C-8. Example of Swing Gates

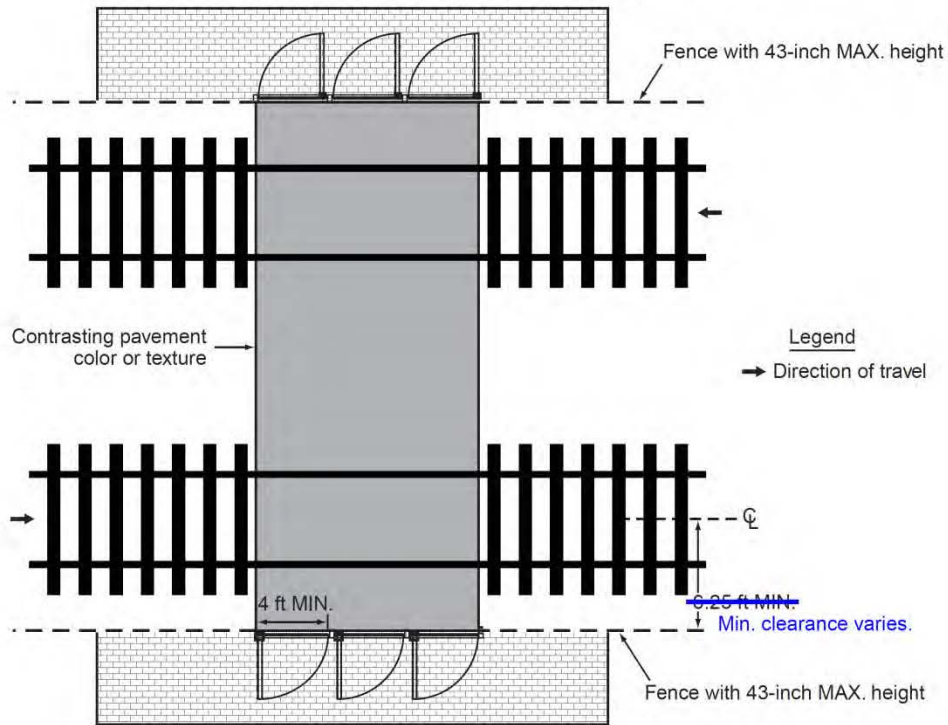
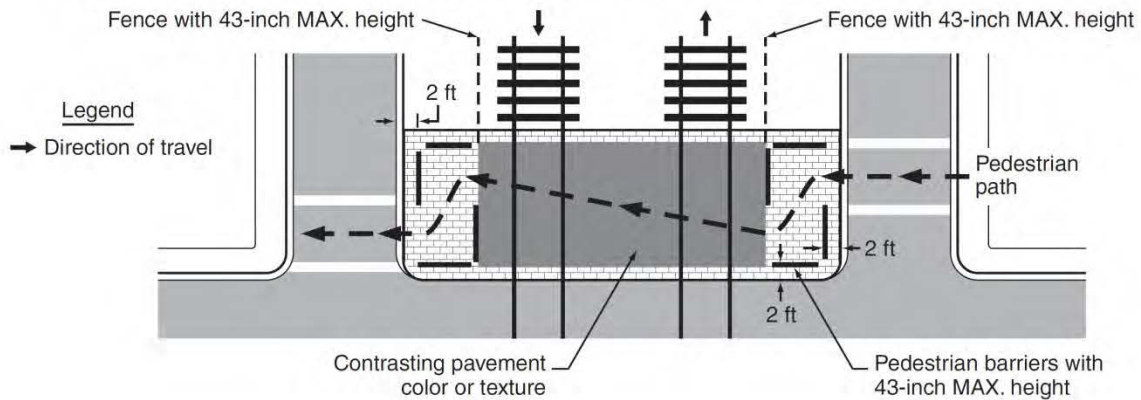
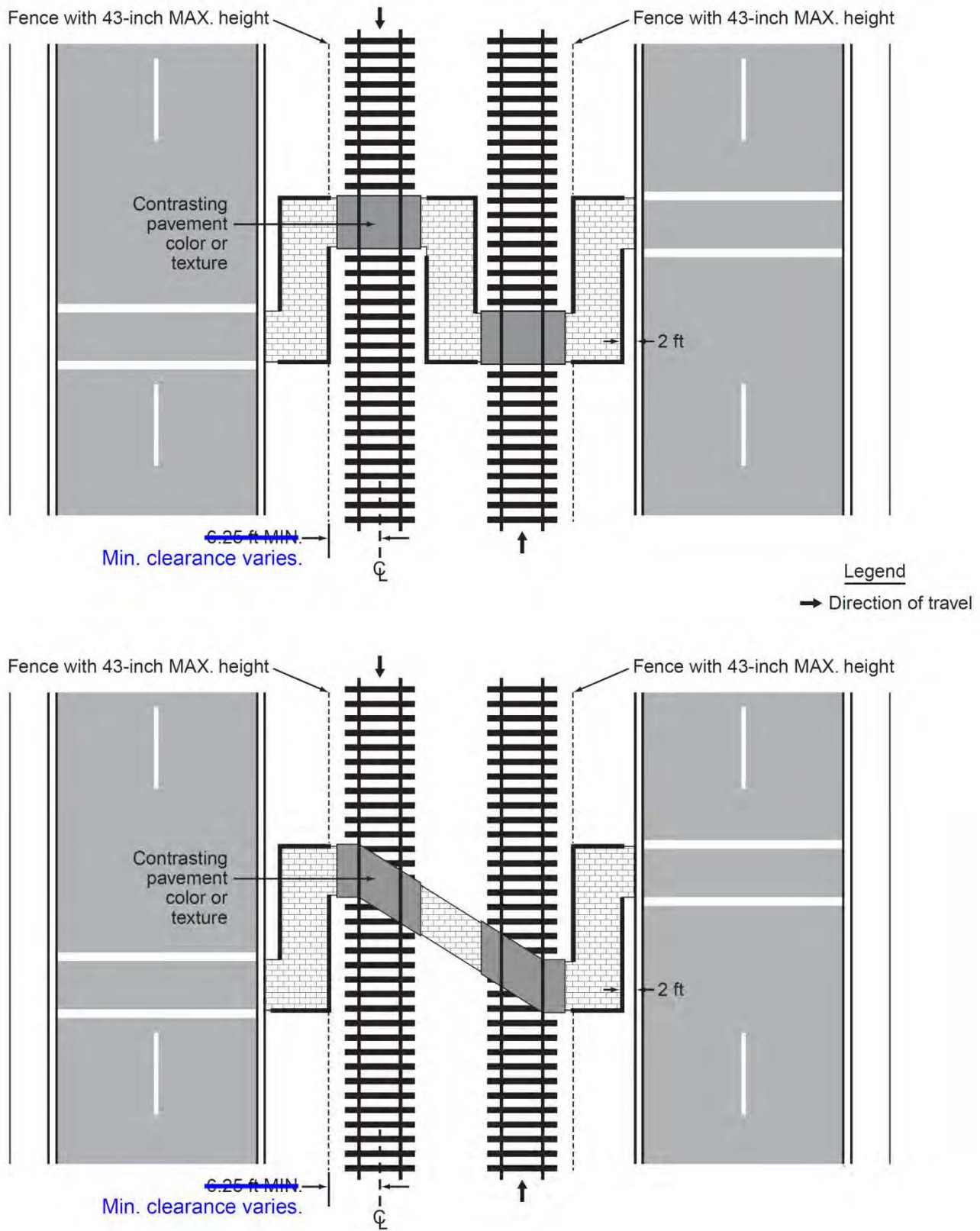


Figure 8C-9. Example of Pedestrian Barriers at an Offset Grade Crossing



**Figure 8C-10. Examples of Pedestrian Barrier Installation at an Offset Non-Intersection Grade Crossing**







## CHAPTER 8D. PATHWAY GRADE CROSSINGS

### Section 8D.01 Purpose

Support:

<sup>01</sup> Traffic control for pathway grade crossings includes all signs, signals, markings, other warning devices, and their supports at pathway grade crossings and along pathway approaches to grade crossings. The function of this traffic control is to promote safety and provide effective operation of both rail and pathway traffic at pathway grade crossings.

<sup>02</sup> Except as specifically provided in this Chapter, sidewalks are considered to be part of a highway-rail or highway-LRT grade crossing rather than a pathway grade crossing, and are covered by the provisions of Chapters 8B and 8C rather than by the provisions of this Chapter. However, many of the treatments outlined in this Chapter are applicable to sidewalks adjacent to highway-rail or highway-LRT grade crossings, including detectable warnings, swing gates, and automatic gates.

<sup>03</sup> Crosswalks at intersections where pedestrians cross LRT tracks in mixed-use alignments are covered by the provisions of Section 3B.18 rather than by the provisions of this Chapter.

### Section 8D.02 Use of Standard Devices, Systems, and Practices

Guidance:

<sup>01</sup> *The public agency with jurisdiction over the pathway and the regulatory agency with statutory authority, if applicable, should jointly determine the need and selection of devices at a pathway grade crossing, including the appropriate traffic control system to be used.*

### Section 8D.03 Pathway Grade Crossing Signs and Markings

Standard:

<sup>01</sup> **Pathway grade crossing signs shall be standard in shape, legend, and color.**

<sup>02</sup> **Traffic control devices mounted adjacent to pathways at a height of less than 8 feet measured vertically from the bottom edge of the device to the elevation of the near edge of the pathway surface shall have a minimum lateral offset of 2 feet from the near edge of the device to the near edge of the pathway (see Figure 9B-1).**

<sup>03</sup> **The minimum mounting height for post-mounted signs on pathways shall be 4 feet, measured vertically from the bottom edge of the sign to the elevation of the near edge of the pathway surface (see Figure 9B-1).**

<sup>04</sup> **Pathway grade crossing traffic control devices shall be located a minimum of 12 feet from the center of the nearest track.**

<sup>05</sup> **The minimum sizes of pathway grade crossing signs shall be as shown in the shared-use path column in Table 9B-1.**

<sup>06</sup> **When overhead traffic control devices are used on pathways, the clearance from the bottom edge of the device to the pathway surface directly under the sign or device shall be at least 8 feet.**

Guidance:

<sup>07</sup> *If pathway users include those who travel faster than pedestrians, such as bicyclists or skaters, the use of warning signs and pavement markings in advance of the pathway grade crossing (see Figure 8D-1) should be considered.*

### Section 8D.04 Stop Lines, Edge Lines, and Detectable Warnings

Guidance:

<sup>01</sup> *If used at pathway grade crossings, the pathway stop line should be a transverse line at the point where a pathway user is to stop. The pathway stop line should be placed at least 2 feet further from the nearest rail than the gate, counterweight, or flashing-light signals (if any of these are present) is placed, and at least 12 feet from the nearest rail.*

Option:

02 Edge lines (see Section 3B.06) may be used on approach to and across the tracks at a pathway grade crossing, a sidewalk at a highway-rail or highway-LRT grade crossing, or a station crossing to delineate the designated pathway user route.

Support:

03 Edge line delineation can be beneficial where the distance across the tracks is long, commonly because of a skewed grade crossing or because of multiple tracks, or where the pathway surface is immediately adjacent to a traveled way.

04 Detectable warning surfaces (see Section 3B.18) that contrast visually with adjacent walking surfaces, either light-on-dark or dark-on-light, can be used to warn pedestrians about the locations of the tracks at a grade crossing. The "Americans with Disabilities Act Accessibility Guidelines for Buildings and Facilities (ADAAG)" (see Section 1A.11) contains specifications for design and placement of detectable warning surfaces.

### **Section 8D.05 Passive Devices for Pathway Grade Crossings**

**Standard:**

01 **Except as provided in Paragraph 2, where active traffic control devices are not used, a Crossbuck Assembly shall be installed on each approach to a pathway grade crossing.**

Option:

02 The Crossbuck Assembly may be omitted at station crossings and on the approaches to a pathway grade crossing that is located within 25 feet of the traveled way at a highway-rail or highway-LRT grade crossing.

*Guidance:*

03 *The pathway user's ability to detect the presence of approaching rail traffic should be considered in determining the type and placement of traffic control devices or design features (such as fencing or swing gates).*

04 *Nighttime visibility should be considered if design features (such as fencing or swing gates) are used to channelize pathway users.*

05 *If automatic gates and swing gates are used, the pathway should be channelized to direct users to the entrance to and exit from the pathway grade crossing.*

**Standard:**

06 **If used, swing gates shall be designed to open away from the track(s) so that pathway users can quickly push the gate open when moving away from the track(s). If used, swing gates shall be designed to automatically return to the closed position after each use.**

Option:

07 When used in conjunction with automatic gates at pathway grade crossings, swing gates may be equipped with a latching device that permits the gate to be opened only from the track side of the gate.

Support:

08 The "Americans with Disabilities Act Accessibility Guidelines for Buildings and Facilities (ADAAG)" (see Section 1A.11) contains information regarding spring hinges and door and gate opening forces for swing gates.

### **Section 8D.06 Active Traffic Control Systems for Pathway Grade Crossings**

**Standard:**

01 **If used at a pathway grade crossing, an active traffic control system shall include flashing-light signals for each direction of the pathway. A bell or other audible warning device shall also be provided.**

Option:

02 Separate active traffic control devices may be omitted at a pathway grade crossing that is located within 25 feet of the traveled way of a highway-rail or highway-LRT grade crossing that is equipped with an active traffic control system.

**Standard:**

03 **If used at pathway grade crossings, alternately flashing red lights shall be aligned horizontally and the light units shall have a diameter of at least 4 inches. The minimum mounting height of the flashing red lights shall be 4 feet, measured vertically from the bottom edge of the lights to the elevation of the near edge of the pathway surface.**

Option:

<sup>04</sup> Traffic control devices may be installed between the tracks at multiple track crossings at stations.

**Standard:**

<sup>05</sup> **The mounting height for flashing lights that are installed between the tracks at multiple track crossings at stations shall be a minimum of 1 foot, measured vertically from the bottom edge of the lights to the elevation of the near edge of the pathway surface.**

Option:

<sup>06</sup> Automatic gates may be used at pathway grade crossings.

*Guidance:*

<sup>07</sup> *If used at a pathway grade crossing, the height of the automatic gate arm when in the down position should be a minimum of 2.5 feet and a maximum of 4 feet above the sidewalk.* <sup>08</sup> *If used, the gate configuration, which might include a combination of automatic gates and swing gates, should provide for full width coverage of the pathway on both approaches to the track.*

**Standard:**

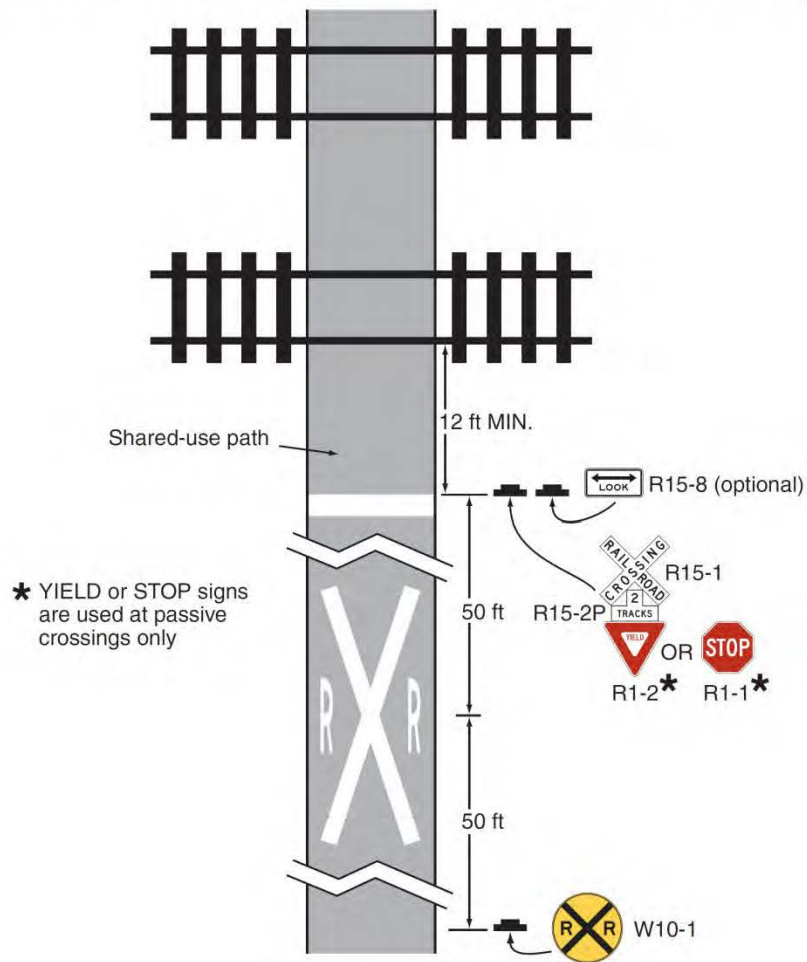
<sup>09</sup> **Where a sidewalk is located between the edge of a roadway and the support for a gate arm that extends across the sidewalk and into the roadway, the location, placement, and height prescribed for vehicular gates shall be used (see Section 8C.04).**

*Guidance:*

<sup>10</sup> *If a separate automatic gate is used for a sidewalk, the height of the gate arm when in the down position should be a minimum of 2.5 feet and a maximum of 4 feet above the sidewalk.*

<sup>11</sup> *If a separate automatic gate is used for a sidewalk at a highway-rail or highway-LRT grade crossing, instead of a supplemental or auxiliary gate arm installed as a part of the same mechanism as the vehicular gate, a separate mechanism should be provided for the sidewalk gate to prevent a pedestrian from raising the vehicular gate.*

**Figure 8D-1. Example of Signing and Markings for a Pathway Grade Crossing**



# PART 9

## TRAFFIC CONTROL FOR BICYCLE FACILITIES

### CHAPTER 9A. GENERAL

#### **Section 9A.01 Requirements for Bicyclist Traffic Control Devices**

Support:

01 General information and definitions concerning traffic control devices are found in Part 1.

#### **Section 9A.02 Scope**

Support:

01 Part 9 covers signs, pavement markings, and highway traffic signals specifically related to bicycle operation on ~~both~~ roadways, [separated bikeways](#) and shared-use paths.

Guidance:

02 *Parts 1, 2, 3, and 4 should be reviewed for general provisions, signs, pavement markings, and signals.*

Standard:

03 **The absence of a marked bicycle lane or any of the other traffic control devices discussed in this Chapter on a particular roadway shall not be construed to mean that bicyclists are not permitted to travel on that roadway.**

#### **Section 9A.03 Definitions Relating to Bicycles**

Support:

01 Definitions and acronyms pertaining to Part 9 are provided in Sections 1A.13 and 1A.14.

#### **Section 9A.04 Maintenance**

Guidance:

01 *All signs, signals, and markings, including those on bicycle facilities, should be properly maintained to command respect from both the motorist and the bicyclist. When installing signs and markings on bicycle facilities, an agency should be designated to maintain these devices.*

02 [Separated bikeways should be accessible to street maintenance equipment \(e.g., street sweeping, snow removal\).](#)

#### **Section 9A.05 Relation to Other Documents**

Support:

01 "The Uniform Vehicle Code and Model Traffic Ordinance" published by the National Committee on Uniform Traffic Laws and Ordinances [and the California Vehicle Code](#) (see Section 1A.11) ~~has~~ [have](#) provisions for bicycles and ~~is~~ [are](#) the basis for the traffic control devices included in this Manual.

01a [Refer to California Streets and Highway Code Section 890.4 for definition of "Bikeways".](#)

02 Informational documents used during the development of the signing and marking recommendations in Part 9 include the following:

- A. "Guide for Development of Bicycle Facilities," which is available from the American Association of State Highway and Transportation Officials (see Page i for the address); and
- B. State and local government design guides.
- C. ["Highway Design Manual" \(Caltrans\).](#)
- D. ["Complete Intersections: A Guide to Reconstructing Intersections and Interchanges for Bicyclists and Pedestrians" \(Caltrans\).](#)
- E. ["Separated Bike Lane Planning and Design Guide,"](#) which is available from the Federal Highway Administration (see Page ii for the address); and
- F. [NACTO Urban Bikeway Design Guide and Urban Street Design Guide](#) (see Page iii for the address).

<sup>03</sup> Other publications that relate to the application of traffic control devices in general are listed in Section 1A.11.

### **Section 9A.06 Placement Authority**

Support:

- <sup>01</sup> Section 1A.08 contains information regarding placement authority for traffic control devices.
- <sup>02</sup> The following references from the California Vehicle Code relate to bicycles:
  - A. Section 21100 – Rules and regulations for operation of bicycles on the public sidewalks.
  - B. Section 21113 – Driving or parking of bicycles or motorized bicycles on public grounds including University of California and the California State University campuses.
  - C. Section 21116 - Bicycle paths or routes on levees, canal banks, natural watercourse banks, or pipeline rights-of-way.
  - D. Sections 21200 through 21212 – Operation of bicycles on California roadways.
  - E. Section 21202 – Bicycle operation on roadway.
  - F. Section 21207 – Bicycle lanes.
  - G. Section 21208 – Permitted movements from bicycle lanes.
  - H. Section 21209 - Motor vehicles and motorized bicycles in bicycle lanes.
  - I. Section 21210 – Bicycle parking.
  - J. Section 21211 - Obstruction of bikeways or bicycle paths or trails.
  - K. Section 21229 – Operation of motorized scooters in bicycle lanes.
  - L. Section 21230 – Operation of motorized scooters on bicycle paths, trails or bikeways.
  - M. Section 21450 – Color-lighted bicycle symbols on official traffic control signals.
  - N. Section 21450.5 – Detection of motorcycles and bicycles at traffic-actuated signals.
  - O. Section 21456.2 – Bicycles and traffic signals.
  - P. Section 21456.3 – Bicycle signals.
  - Q. Section 21650.1 – Bicycle operated on roadway or highway shoulder.
  - R. Section 21717 – Turning across bicycle lane.
  - S. Section 21750 – Overtake and pass to left.
  - T. Section 21760 – Three Feet for Safety Act
  - U. Section 21960 – Bicycle and pedestrian restrictions on freeways and expressways.
  - V. Section 21966 – Pedestrians in bicycle lanes.
  - W. Section 23330 – Bicycles not permitted at vehicle crossings.
- <sup>03</sup> The following references from the California Streets and Highways Code relate to bicycles:
  - A. Section 885.2 –Statewide bicycle program.
  - B. Section 886 – State bicycle facilities coordinator.
  - C. Section 887 - Definition of non-motorized transportation facility.
  - D. Section 887.2 – Statewide bicycle map.
  - E. Section 887.6 – Agreements with local agencies to construct and maintain non-motorized transportation facilities.
  - F. Section 888 – Severance of existing major non-motorized route by freeway construction.
  - G. Section 888.2 – Incorporation of non-motorized transportation facilities in the design of freeways.
  - H. Section 889 – California Bicycle Routes of National, State, or Regional Significance Act.
  - I. Section 890.2 – Definition of bicycle.
  - J. Section 890.4 – Definitions of Class I, II, III and IV bikeways.
  - K. Section 890.6 – Caltrans, in cooperation with county and city governments, to establish minimum safety design criteria for the planning and construction of bikeways and roadways where bicycle travel is permitted.
  - L. Section 890.8 - Caltrans to establish uniform specifications and symbols for signs, markers, and traffic control devices for bikeways and roadways where bicycle travel is permitted.
  - M. Section 891 – Local agencies must comply with design criteria and uniform specifications and symbols for signs, markers, and traffic control devices established by Caltrans.
  - N. Section 891.2 & 891.4 – Local agencies bicycle transportation plan.
  - O. Section 891.8 – Local agency establishment of bikeways.
  - P. Section 892 – Use of abandoned right of way as a non-motorized transportation facility.

### **Section 9A.07 Meaning of Standard, Guidance, Option, and Support**

Support:

~~01 The introduction to this Manual~~ Paragraph 1 of Section 1A.13 and Section 1A.13 contains information regarding the meaning of the headings Standard, Guidance, Option, and Support, and the use of the words “shall,” “should,” and “may.”

### **Section 9A.08 Colors**

Support:

01 Section 1A.12 contains information regarding the color codes.

### **Section 9A.101(CA) Traffic Controls for Bicycle Facilities at Rail Crossings**

Standard:

01 Any bicycle facility traversing an at-grade railroad crossing shall conform to Part 8.





## CHAPTER 9B. SIGNS

### Section 9B.01 Application and Placement of Signs

#### Standard:

- 01 **Bicycle signs shall be standard in shape, legend, and color.**
- 02 **All signs shall be retroreflectorized for use on bikeways, including shared-use paths and bicycle lane facilities.**
- 03 **Where signs serve both bicyclists and other road users, vertical mounting height and lateral placement shall be as provided in Part 2.**
- 04 **Where used on a shared-use path, no portion of a sign or its support shall be placed less than 2 feet laterally from the near edge of the path, or less than 8 feet vertically over the entire width of the shared-use path (see Figure 9B-1).**
- 05 **Mounting height for post-mounted signs on shared-use paths shall be a minimum of 4 feet, measured vertically from the bottom of the sign to the elevation of the near edge of the path surface (see Figure 9B-1).**

#### Guidance:

- 06 *Signs for the exclusive use of bicyclists should be located so that other road users are not confused by them.*
- 07 *The clearance for overhead signs on shared-use paths should be adjusted when appropriate to accommodate path users requiring more clearance, such as equestrians, or typical maintenance or emergency vehicles.*

#### Support:

- 08 *California signs for bicycle facilities are shown in Figures 9B-2(CA) and 9B-4(CA).*

### Section 9B.02 Design of Bicycle Signs

#### Standard:

- 01 **If the sign or plaque applies to motorists and bicyclists, then the size shall be as shown for conventional roads in Tables 2B-1, 2C-2, or 2D-1.**
- 02 **The minimum sign and plaque sizes for shared-use paths shall be those shown in Table 9B-1, and shall be used only for signs and plaques installed specifically for bicycle traffic applications. The minimum sign and plaque sizes for bicycle facilities shall not be used for signs or plaques that are placed in a location that would have any application to other vehicles.**

#### Option:

- 03 *Larger size signs and plaques may be used on bicycle facilities when appropriate (see Section 2A.11).*

#### Guidance:

- 04 *Except for size, the design of signs and plaques for bicycle facilities should be identical to that provided in this Manual for signs and plaques for streets and highways.*

#### Support:

- 05 *Uniformity in design of bicycle signs and plaques includes shape, color, symbols, arrows, wording, lettering, and illumination or retroreflectorization.*

### Section 9B.03 STOP and YIELD Signs (R1-1, R1-2)

#### Standard:

- 01 **STOP (R1-1) signs (see Figure 9B-2) shall be installed on shared-use paths at points where bicyclists are required to stop.**
- 02 **YIELD (R1-2) signs (see Figure 9B-2) shall be installed on shared-use paths at points where bicyclists have an adequate view of conflicting traffic as they approach the sign, and where bicyclists are required to yield the right-of-way to that conflicting traffic.**

#### Option:

- 03 *A 30 x 30-inch STOP sign or a 36 x 36 x 36-inch YIELD sign may be used on shared-use paths for added emphasis.*

#### Guidance:

- 04 *Where conditions require path users, but not roadway users, to stop or yield, the STOP or YIELD sign should be placed or shielded so that it is not readily visible to road users.*

*05 When placement of STOP or YIELD signs is considered, priority at a shared-use path/roadway intersection should be assigned with consideration of the following:*

- A. Relative speeds of shared-use path and roadway users,*
- B. Relative volumes of shared-use path and roadway traffic, and*
- C. Relative importance of shared-use path and roadway.*

*06 Speed should not be the sole factor used to determine priority, as it is sometimes appropriate to give priority to a high-volume shared-use path crossing a low-volume street, or to a regional shared-use path crossing a minor collector street.*

*07 When priority is assigned, the least restrictive control that is appropriate should be placed on the lower priority approaches. STOP signs should not be used where YIELD signs would be acceptable.*

### **Section 9B.04 Bike Lane Signs and Plaques (R3-17, R3-17aP, R3-17bP)**

#### **Standard:**

**01 The Bike Lane (R3-17) sign and the R3-17aP and R3-17bP plaques (see Figure 9B-2) shall be used only in conjunction with marked bicycle lanes as described in Section 9C.04.**

#### **Guidance:**

*02 If used, Bike Lane signs and plaques should be used in advance of the upstream end of the bicycle lane, at the downstream end of the bicycle lane, and at periodic intervals along the bicycle lane as determined by engineering judgment based on prevailing speed of bicycle and other traffic, block length, distances from adjacent intersections, and other considerations.*

#### **Standard:**

**03 The Bike Lane (R81(CA)) sign shall be placed at the beginning of each designated Bike Lane and along each Bike Lane at all major changes in direction. The R81(CA) sign shall be used to regulate bicycle and motor vehicle traffic, in accordance with CVC Sections 21207, 21207.5, 21208, 21209 and 21717.**

#### **Guidance:**

*04 The Bike Lane (R81(CA)) sign should be placed at every arterial street and at 1/2 mile intervals of each designated Bike lane.*

#### **Option:**

*05 The BEGIN (R81A(CA)) and END (R81B(CA)) signs may be used below the R81(CA) sign to mark the beginning or end of a bike lane.*

#### **Support:**

*06 The R81(CA), R81A(CA) and R81B(CA) signs are shown in Figure 9B-2(CA).*

### **Section 9B.05 BEGIN RIGHT TURN LANE YIELD TO BIKES Sign (R4-4)**

#### **Option:**

*01 Where motor vehicles entering an exclusive right-turn lane must weave across bicycle traffic in bicycle lanes, the BEGIN RIGHT TURN LANE YIELD TO BIKES (R4-4) sign (see Figure 9B-2) may be used to inform both the motorist and the bicyclist of this weaving maneuver (see Figures 9C-1, 9C-4, and 9C-5).*

#### **Guidance:**

*02 The R4-4 sign should not be used when bicyclists need to move left because of a right-turn lane drop situation.*

### **Section 9B.06 Bicycles May Use Full Lane Sign (R4-11)**

#### **Option:**

*01 The Bicycles May Use Full Lane (R4-11) sign (see Figure 9B-2) may be used on roadways where no bicycle lanes or adjacent shoulders usable by bicyclists are present and where travel lanes are too narrow for bicyclists and motor vehicles to operate side by side.*

*02 The Bicycles May Use Full Lane sign may be used in locations where it is important to inform road users that bicyclists might occupy the travel lane.*

*03 Section 9C.07 describes a Shared Lane Marking that may be used in addition to or instead of the Bicycles May Use Full Lane sign to inform road users that bicyclists might occupy the travel lane.*

#### **Support:**

*04 The Uniform Vehicle Code (UVC) (Also refer to CVC 21202(a)(3)) defines a “substandard width lane” as a*

“lane that is too narrow for a bicycle and a vehicle to travel safely side by side within the same lane.”

### **Section 9B.07 Bicycle WRONG WAY Sign and RIDE WITH TRAFFIC Plaque (R5-1b, R9-3c)**

Option:

01 The Bicycle WRONG WAY (R5-1b) sign and RIDE WITH TRAFFIC (R9-3cP) plaque (see Figure 9B-2) may be placed facing wrong-way bicycle traffic, such as on the left side of a roadway.

02 This sign and plaque may be mounted back-to-back with other signs to minimize visibility to other traffic.

*Guidance:*

03 *The RIDE WITH TRAFFIC plaque should be used only in conjunction with the Bicycle WRONG WAY sign, and should be mounted directly below the Bicycle WRONG WAY sign.*

### **Section 9B.08 NO MOTOR VEHICLES Sign (R5-3)**

Option:

01 The NO MOTOR VEHICLES (R5-3) sign (see Figure 9B-2) may be installed at the entrance to a shared-use path.

02 The Bike Path Exclusion (R44A(CA)) sign may be used to identify a bike path and prohibit motor vehicles and motorized bicycles from entering the bike path. If motorized bicycles are permitted, the "Motorized Bicycles" portion may be replaced with "Motorized Bicycles Permitted".

Support:

03 The R44A(CA) sign is shown in Figure 9B-2(CA).

### **Section 9B.09 Selective Exclusion Signs**

Option:

01 Selective Exclusion signs (see Figure 9B-2) may be installed at the entrance to a roadway or facility to notify road or facility users that designated types of traffic are excluded from using the roadway or facility.

**Standard:**

02 **If used, Selective Exclusion signs shall clearly indicate the type of traffic that is excluded.**

Support:

03 Typical exclusion messages include:

- A. No Bicycles (R5-6),
- B. No Pedestrians (R9-3),
- C. No Skaters (R9-13), and
- D. No Equestrians (R9-14).

Option:

04 Where bicyclists, pedestrians, and motor-driven cycles are all prohibited, it may be more desirable to use the R5-10a word message sign that is described in Section 2B.39.

### **Section 9B.10 No Parking Bike Lane Signs (R7-9, R7-9a)**

**Standard:**

01 **If the installation of signs is necessary to restrict parking, standing, or stopping in a bicycle lane, appropriate signs as described in Sections 2B.46 through 2B.48, or the No Parking Bike Lane (R7-9 or R7-9a) signs (see Figure 9B-2) shall be installed.**

### **Section 9B.11 Bicycle Regulatory Signs (R9-5, R9-6, R10-4, R10-24, R10-25, and R10-26)**

Option:

01 The R9-5 sign (see Figure 9B-2) may be used where the crossing of a street by bicyclists is controlled by pedestrian signal indications.

02 Where it is not intended for bicyclists to be controlled by pedestrian signal indications, the R10-4, R10-24, or R10-26 sign (see Figure 9B-2 and Section 2B.52) may be used.

*Guidance:*

03 *If used, the R9-5, R10-4, R10-24, or R10-26 signs should be installed near the edge of the sidewalk in the vicinity of where bicyclists will be crossing the street.*

Option:

04 If bicyclists are crossing a roadway where In-Roadway Warning Lights (see Section 4N.02) or other warning lights or beacons have been provided, the R10-25 sign (see Figure 9B-2) may be used.

05 The R9-6 sign (see Figure 9B-2) may be used where a bicyclist is required to cross or share a facility used by pedestrians and is required to yield to the pedestrians.

### **Section 9B.12 Shared-Use Path Restriction Sign (R9-7)**

Option:

01 The Shared-Use Path Restriction (R9-7) sign (see Figure 9B-2) may be installed to supplement a solid white pavement marking line (see Section 9C.03) on facilities that are to be shared by pedestrians and bicyclists in order to provide a separate designated pavement area for each mode of travel. The symbols may be switched as appropriate.

01a The Shared-Use Path Restriction (R9-7) sign may be used for locations with sidewalk level separated bikeways to further communicate the appropriate use of each space. The symbols may be switched as appropriate.

Guidance:

02 *If two-way operation is permitted on the facility for pedestrians and/or bicyclists, the designated pavement area that is provided for each two-way mode of travel should be wide enough to accommodate both directions of travel for that mode.*

### **Section 9B.13 Bicycle Signal Actuation Sign (R10-22)**

Option:

01 The Bicycle Signal Actuation (R10-22) sign (see Figure 9B-2) may be installed at signalized intersections where markings are used to indicate the location where a bicyclist is to be positioned to actuate the signal (see Section 9C.05).

Guidance:

02 *If the Bicycle Signal Actuation sign is installed, it should be placed at the roadside adjacent to the marking to emphasize the connection between the marking and the sign.*

### **Section 9B.14 Other Regulatory Signs**

Option:

01 Other regulatory signs described in Chapter 2B may be installed on bicycle facilities as appropriate.

### **Section 9B.15 Turn or Curve Warning Signs (W1 Series)**

Guidance:

01 *To warn bicyclists of unexpected changes in shared-use path direction, appropriate turn or curve (W1-1 through W1-7) signs (see Figure 9B-3) should be used.*

02 *The W1-1 through W1-5 signs should be installed at least 50 feet in advance of the beginning of the change of alignment.*

### **Section 9B.16 Intersection Warning Signs (W2 Series)**

Option:

01 Intersection Warning (W2-1 through W2-5) signs (see Figure 9B-3) may be used on a roadway, street, or shared-use path in advance of an intersection to indicate the presence of an intersection and the possibility of turning or entering traffic.

Guidance:

02 *When engineering judgment determines that the visibility of the intersection is limited on the shared-use path approach, Intersection Warning signs should be used.*

03 *Intersection Warning signs should not be used where the shared-use path approach to the intersection is controlled by a STOP sign, a YIELD sign, or a traffic control signal.*

### **Section 9B.17 Bicycle Surface Condition Warning Sign (W8-10)**

Option:

01 The Bicycle Surface Condition Warning (W8-10) sign (see Figure 9B-3) may be installed where roadway or shared-use path conditions could cause a bicyclist to lose control of the bicycle.

02 Signs warning of other conditions that might be of concern to bicyclists, including BUMP (W8-1), DIP (W8-2), PAVEMENT ENDS (W8-3), and any other word message that describes conditions that are of concern to bicyclists, may also be used.

03 A supplemental plaque may be used to clarify the specific type of surface condition.

### **Section 9B.18 Bicycle Warning and Combined Bicycle/Pedestrian Signs (W11-1 and W11-15)**

Support:

01 The Bicycle Warning (W11-1) sign (see Figure 9B-3) alerts the road user to unexpected entries into the roadway by bicyclists, and other crossing activities that might cause conflicts. These conflicts might be relatively confined, or might occur randomly over a segment of roadway.

Option:

02 The combined Bicycle/Pedestrian (W11-15) sign (see Figure 9B-3) may be used where both bicyclists and pedestrians might be crossing the roadway, such as at an intersection with a shared-use path. A TRAIL X-ING (W11-15P) supplemental plaque (see Figure 9B-3) may be mounted below the W11-15 sign.

03 A supplemental plaque with the legend AHEAD or XX FEET may be used with the Bicycle Warning or combined Bicycle/Pedestrian sign.

Guidance:

04 *If used in advance of a specific crossing point, the Bicycle Warning or combined Bicycle/Pedestrian sign should be placed at a distance in advance of the crossing location that conforms with the guidance given in Table 2C-4.*

Standard:

05 **Bicycle Warning and combined Bicycle/Pedestrian signs, when used at the location of the crossing, shall be supplemented with a diagonal downward pointing arrow (W16-7P) plaque (see Figure 9B-3) to show the location of the crossing.**

Option:

06 A fluorescent yellow-green background color with a black legend and border may be used for Bicycle Warning and combined Bicycle/Pedestrian signs and supplemental plaques.

Guidance:

07 *When the fluorescent yellow-green background color is used, a systematic approach featuring one background color within a zone or area should be used. The mixing of standard yellow and fluorescent yellow-green backgrounds within a zone or area should be avoided.*

### **Section 9B.19 Other Bicycle Warning Signs**

Option:

01 Other bicycle warning signs (see Figure 9B-3) such as PATH NARROWS (W5-4a) and Hill (W7-5) may be installed on shared-use paths to warn bicyclists of conditions not readily apparent.

02 In situations where there is a need to warn motorists to watch for bicyclists traveling along the highway, the SHARE THE ROAD (W16-1P) plaque (see Figure 9B-3) may be used in conjunction with the W11-1 sign.

02a *In situations where there is a need to warn motorists to watch for bicyclists traveling along the freeway, the NEXT XX MILES (W7-3aP) plaque (see Figures 2C-4) may be used in conjunction with the W11-1 sign.*

Guidance:

03 *If used, other advance bicycle warning signs should be installed at least 50 feet in advance of the beginning of the condition.*

04 *Where temporary traffic control zones are present on bikeways, appropriate signs from Part 6 should be used.*

Option:

05 Other warning signs described in Chapter 2C may be installed on bicycle facilities as appropriate.

Support:

06 Refer to Section 8B.25 for Skewed Crossing (W10-12) Sign.

### **Section 9B.20 Bicycle Guide Signs (D1-1b, D1-1c, D1-2b, D1-2c, D1-3b, D1-3c, D11-1, D11-1c, D3-1, D3-1a and G7-1(CA))**

Option:

01 Bike Route Guide (D11-1) signs (see Figure 9B-4) may be provided along designated bicycle routes to inform bicyclists of bicycle route direction changes and to confirm route direction, distance, and destination.

02 If used, Bike Route Guide signs may be repeated at regular intervals so that bicyclists entering from side streets will have an opportunity to know that they are on a bicycle route. Similar guide signing may be used for shared roadways with intermediate signs placed for bicyclist guidance.

03 Alternative Bike Route Guide (D11-1c) signs may be used to provide information on route direction, destination, and/or route name in place of the "BIKE ROUTE" wording on the D11-1 sign (see Figures 9B-4 and 9B-6).

04 Destination (D1-1, D1-1a) signs, ~~Street Name (D3) signs~~, or Bicycle Destination (D1-1b, D1-1c, D1-2b, D1-2c, D1-3b, D1-3c) signs (see Figure 9B-4) may be installed to provide direction, destination, and distance information as needed for bicycle travel. If several destinations are to be shown at a single location, they may be placed on a single sign with an arrow (and the distance, if desired) for each name. If more than one destination lies in the same direction, a single arrow may be used for the destinations.

*Guidance:*

*04a Street Name (D3-1 or D3-1a or G7-1(CA)) signs should be installed at all street and Class I bikeway intersections and at all Class I bikeway intersections.*

*05 Adequate separation should be made between any destination or group of destinations in one direction and those in other directions by suitable design of the arrow, spacing of lines of legend, heavy lines entirely across the sign, or separate signs.*

**Standard:**

**06 An arrow pointing to the right, if used, shall be at the extreme right-hand side of the sign. An arrow pointing left or up, if used, shall be at the extreme left-hand side of the sign. The distance numerals, if used, shall be placed to the right of the destination names.**

**07 On Bicycle Destination signs, a bicycle symbol shall be placed next to each destination or group of destinations. If an arrow is at the extreme left, the bicycle symbol shall be placed to the right of the respective arrow.**

*Guidance:*

*08 Unless a sloping arrow will convey a clearer indication of the direction to be followed, the directional arrows should be horizontal or vertical.*

*09 The bicycle symbol should be to the left of the destination legend.*

*10 If several individual name signs are assembled into a group, all signs in the assembly should have the same horizontal width.*

*11 Because of their smaller size, Bicycle Destination signs should not be used as a substitute for vehicular destination signs when the message is also intended to be seen by motorists.*

**Support:**

12 Figure 9B-5 shows an example of the signing for the beginning and end of a designated bicycle route on a shared-use path. Figure 9B-6 shows an example of signing for an on-roadway bicycle route. Figure 9B-7 shows examples of signing and markings for a shared-use path crossing.

## **Section 9B.21 Bicycle Route Signs (M1-8, M1-8a, M1-9)**

**Option:**

01 To establish a unique identification (route designation) for a State or local bicycle route, the Bicycle Route (M1-8, M1-8a) sign (see Figure 9B-4) may be used.

**Standard:**

**02 The Bicycle Route (M1-8) sign shall contain a route designation and shall have a green background with a retroreflectorized white legend and border. The Bicycle Route (M1-8a) sign shall contain the same information as the M1-8 sign and in addition shall include a pictograph or words that are associated with the route or with the agency that has jurisdiction over the route.**

*Guidance:*

*03 Bicycle routes, which might be a combination of various types of bikeways, should establish a continuous routing.*

*04 Where a designated bicycle route extends through two or more States, a coordinated submittal by the affected States for an assignment of a U.S. Bicycle Route number designation should be sent to the American Association of State Highway and Transportation Officials (see Page i for the address).*

**Standard:**

**05 The U.S. Bicycle Route (M1-9) sign (see Figure 9B-4) shall contain the route designation as assigned by AASHTO and shall have a black legend and border with a retroreflectorized white background.**

*Guidance:*

*06 If used, the Bicycle Route or U.S. Bicycle Route signs should be placed at intervals frequent enough to keep bicyclists informed of changes in route direction and to remind motorists of the presence of bicyclists.*

*Option:*

*07 Bicycle Route or U.S. Bicycle Route signs may be installed on shared roadways or on shared-use paths to provide guidance for bicyclists.*

*08 The Bicycle Route Guide (D11-1) sign (see Figure 9B-4) may be installed where no unique designation of routes is desired.*

*Option:*

*09 The Bicycle Route Number Marker (SG45(CA)) sign may be used on public highways/bikeways where a numerical designation for bike routes is desired. The local agency that requests the SG45(CA) sign on State highways is responsible for furnishing, installing and maintaining the signs.*

*Guidance:*

*10 For numbered bike routes initiated by the State, the Bike Route (D11-1) sign should be used on State highways. The District Traffic Engineer is responsible for approving the use of SG45(CA) signs on State highways.*

*Option:*

*11 The Bicycle Route Name Marker (S17(CA)) sign may be installed above the Bike Route (D11-1) sign for those bicycle routes where a community or the responsible agency has given a designated name to selected routes.*

*Support:*

*12 The SG45(CA) and S17(CA) signs are shown in Figure 9B-4(CA).*

**Section 9B.22 Bicycle Route Sign Auxiliary Plaques**

*Option:*

*01 Auxiliary plaques may be used in conjunction with Bike Route Guide signs, Bicycle Route signs, or U.S. Bicycle Route signs as needed.*

*Guidance:*

*02 If used, Junction (M2-1), Cardinal Direction (M3 series), and Alternative Route (M4 series) auxiliary plaques (see Figure 9B-4) should be mounted above the appropriate Bike Route Guide signs, Bicycle Route signs, or U.S. Bicycle Route signs.*

*03 If used, Advance Turn Arrow (M5 series) and Directional Arrow (M6 series) auxiliary plaques (see Figure 9B-4) should be mounted below the appropriate Bike Route Guide sign, Bicycle Route sign, or U.S. Bicycle Route sign.*

*04 Except for the M4-8 plaque, all route sign auxiliary plaques should match the color combination of the route sign that they supplement.*

*05 Route sign auxiliary plaques carrying word legends that are used on bicycle routes should have a minimum size of 12 x 6 inches. Route sign auxiliary plaques carrying arrow symbols that are used on bicycle routes should have a minimum size of 12 x 9 inches.*

*Option:*

*06 With route signs of larger sizes, auxiliary plaques may be suitably enlarged, but not such that they exceed the width of the route sign.*

*07 A route sign and any auxiliary plaques used with it may be combined on a single sign.*

*08 Destination (D1-1b and D1-1c) signs (see Figure 9B-4) may be mounted below Bike Route Guide signs, Bicycle Route signs, or U.S. Bicycle Route signs to furnish additional information, such as directional changes in the route, or intermittent distance and destination information.*

**Section 9B.23 Bicycle Parking Area Sign (D4-3)**

*Option:*

*01 The Bicycle Parking Area (D4-3) sign (see Figure 9B-4) or Bicycle Parking (G93C(CA)) sign*

(see Figure 9B-4(CA)) may be installed where it is desirable to show the direction to a designated bicycle parking area. The arrow may be reversed as appropriate.

<sup>01a</sup> The Advance Turn Arrow or Directional Arrow auxiliary signs (see Section 2D.26 and 2D.28) may be used in combination with and below the G93C(CA) sign to show direction to a designated bicycle parking area.

**Standard:**

<sup>02</sup> The legend and border of the Bicycle Parking Area sign shall be green on a retroreflectorized white background.

**Section 9B.24 Reference Location Signs (D10-1 through D10-3) and Intermediate Reference Location Signs (D10-1a through D10-3a)**

**Support:**

<sup>01</sup> There are two types of reference location signs:

- A. Reference Location (D10-1, 2, and 3) signs show an integer distance point along a shared-use path; and
- B. Intermediate Reference Location (D10-1a, 2a, and 3a) signs also show a decimal between integer distance points along a shared-use path.

**Option:**

<sup>02</sup> Reference Location (D10-1 to D10-3) signs (see Figure 9B-4) may be installed along any section of a shared-use path to assist users in estimating their progress, to provide a means for identifying the location of emergency incidents and crashes, and to aid in maintenance and servicing.

<sup>03</sup> To augment the reference location sign system, Intermediate Reference Location (D10-1a to D10-3a) signs (see Figure 9B-4), which show the tenth of a mile with a decimal point, may be installed at one tenth of a mile intervals, or at some other regular spacing.

**Standard:**

<sup>04</sup> **If Intermediate Reference Location (D10-1a to D10-3a) signs are used to augment the reference location sign system, the reference location sign at the integer mile point shall display a decimal point and a zero numeral.**

<sup>05</sup> **If placed on shared-use paths, reference location signs shall contain 4.5-inch white numerals on a green background that is at least 6 inches wide with a white border. The signs shall contain the word MILE in 2.25-inch white letters.**

<sup>06</sup> **Reference location signs shall have a minimum mounting height of 2 feet, measured vertically from the bottom of the sign to the elevation of the near edge of the shared-use path, and shall not be governed by the mounting height requirements prescribed in Section 9B.01.**

**Option:**

<sup>07</sup> Reference location signs may be installed on one side of the shared-use path only and may be installed back-to-back.

<sup>08</sup> If a reference location sign cannot be installed in the correct location, it may be moved in either direction as much as 50 feet.

**Guidance:**

<sup>09</sup> *If a reference location sign cannot be placed within 50 feet of the correct location, it should be omitted.*

<sup>10</sup> *Zero distance should begin at the south and west terminus points of shared-use paths.*

**Support:**

<sup>11</sup> Section 2H.05 contains additional information regarding reference location signs.

**Section 9B.25 Mode-Specific Guide Signs for Shared-Use Paths (D11-1a, D11-2, D11-3, D11-4)**

**Option:**

<sup>01</sup> Where separate pathways are provided for different types of users, Mode-Specific Guide (D11-1a, D11-2, D11-3, D11-4) signs (see Figure 9B-4) may be used to guide different types of users to the traveled way that is intended for their respective modes.

<sup>02</sup> Mode-Specific Guide signs may be installed at the entrance to shared-use paths where the signed mode(s) are permitted or encouraged, and periodically along these facilities as needed.

<sup>03</sup> The Bicycles Permitted (D11-1a) sign, when combined with the BIKE ROUTE supplemental plaque (D11-1bP), may be substituted for the D11-1 Bicycle Route Guide sign on paths and shared roadways.



04 When some, but not all, non-motorized user types are encouraged or permitted on a shared-use path, Mode-Specific Guide signs may be placed in combination with each other, and in combination with signs (see Section 9B.09) that prohibit travel by particular modes.

Support:

05 Figure 9B-8 shows an example of signing where separate pathways are provided for different non-motorized user types.

### **Section 9B.26 Object Markers**

Option:

01 Fixed objects adjacent to shared-use paths may be marked with Type 1, Type 2, or Type 3 object markers (see Figure 9B-3) such as those described in Section 2C.63. If the object marker is not intended to also be seen by motorists, a smaller version of the Type 3 object marker may be used (see Table 9B-1).

**Standard:**

02 **Obstructions in the traveled way of a shared-use path shall be marked with retroreflectorized material or appropriate object markers.**

03 **All object markers shall be retroreflective.**

04 **On Type 3 object markers, the alternating black and retroreflective yellow stripes shall be sloped down at an angle of 45 degrees toward the side on which traffic is to pass the obstruction.**

### **Section 9B.101(CA) Freeway Bicycle Signs**

Support:

01 Refer Section 2B.39 and CVC 21960 for restrictions on use of freeways.

02 Refer Section 2B.39 for NO PEDESTRIANS BICYCLES MOTOR-DRIVEN CYCLES (R5-10a), NO PEDESTRIANS OR BICYCLES (R5-10b) and NO PEDESTRIANS (R5-10c) signs.

**Standard:**

03 **The BICYCLES MOTOR-DRIVEN CYCLES MUST EXIT (R44B(CA)) sign shall be used on freeways in advance of an exit ramp where bicycles and motor-driven cycles must exit.**

*Guidance:*

04 *The R5-10a, R5-10b or R5-10c sign, as appropriate, should be placed beyond the exit ramp gore as a follow-up message to the R44B(CA) sign.*

**Standard:**

05 **The BICYCLES MUST EXIT (R44C(CA)) sign shall be used on freeways where bicycles are required to exit.**

Support:

06 The R44B(CA) and R44C(CA) signs are shown in Figure 9B-2(CA).

### **Section 9B.102(CA) PASS Bicycle 3 FT MIN Sign (R117(CA))**

Option:

01 In situations where there is a need to remind motorists to pass bicyclists with sufficient lateral clearance in compliance with CVC 21760 (Three Feet for Safety Act) the PASS Bicycle 3 FT MIN sign (R117(CA)) may be used.

Support:

02 CVC 21202(a)(3) defines a "substandard width lane" as a lane that is too narrow for a bicycle and vehicle to travel safely side by side within the same lane.

03 Refer to Section 9B.06 for Bicycles May Use Full Lane (R4-11) sign

### **Section 9B.103(CA) EXCEPT Bicycle Plaque (R118(CA))**

*Guidance:*

01 *Where signs are provided to prohibit or regulate turns from streets or driveways that intersect with a roadway and those signs are not intended for bicycle traffic, the supplemental EXCEPT Bicycle plaque (R118(CA)) should be used.*

### **Section 9B.104 (CA) Signs on Overcrossing Structures**

Support:

01 Signage identifying overcrossing structures over a Class I bikeway can be useful in orienting bikeway users.

<sup>02</sup> Consider the skew of the structure (greater than 45 degrees), height of the overcrossing structure, and other pertinent factors while determining the feasibility of installing the sign.

Option:

<sup>03</sup> Street Name (D3-1 or D3-1a or G7-1(CA)) signs identifying the overcrossing structure over a Class I bikeway may be installed on the overcrossing structure. If sign installation on the overcrossing is not practical, roadside sign installation may be considered.

Guidance:

<sup>04</sup> Structural analysis should be considered prior to installation of signs on the overcrossing structure.

Standard:

<sup>05</sup> Encroachment permits shall be required for a local agency to install signs on overcrossing structures within State right-of-way.

**Figure 9B-1. Sign Placement on Shared-Use Paths**

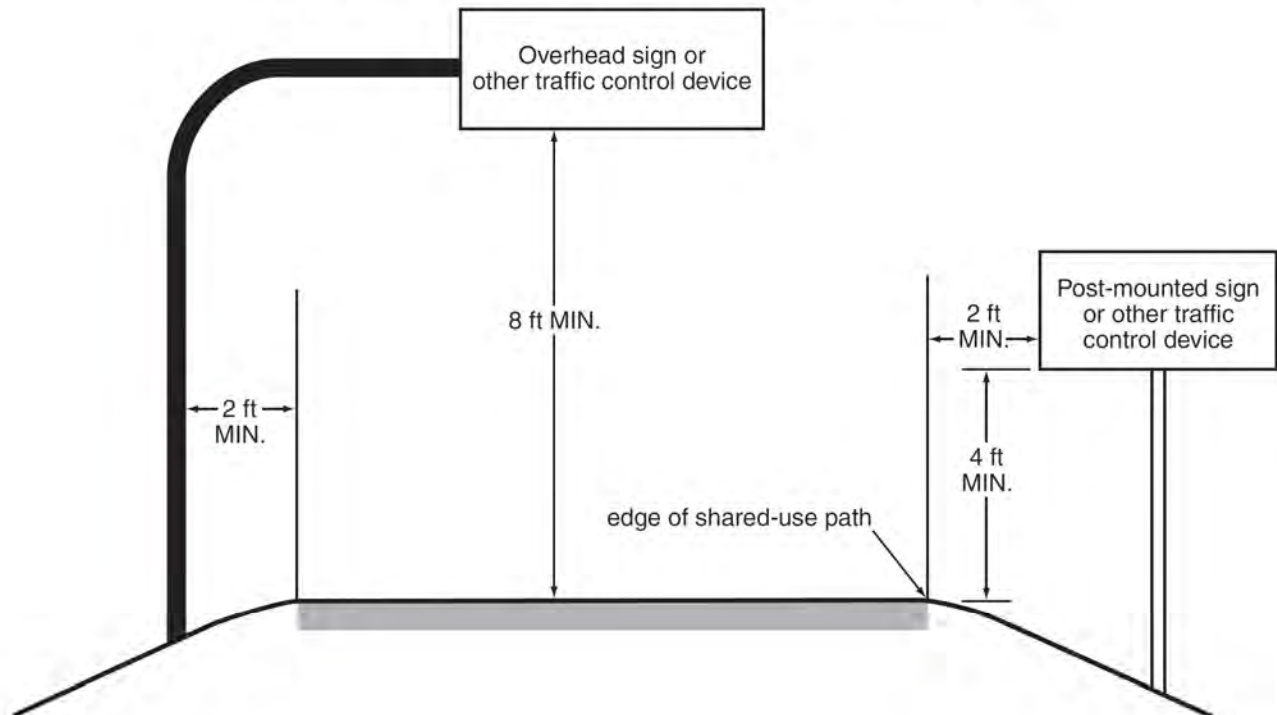
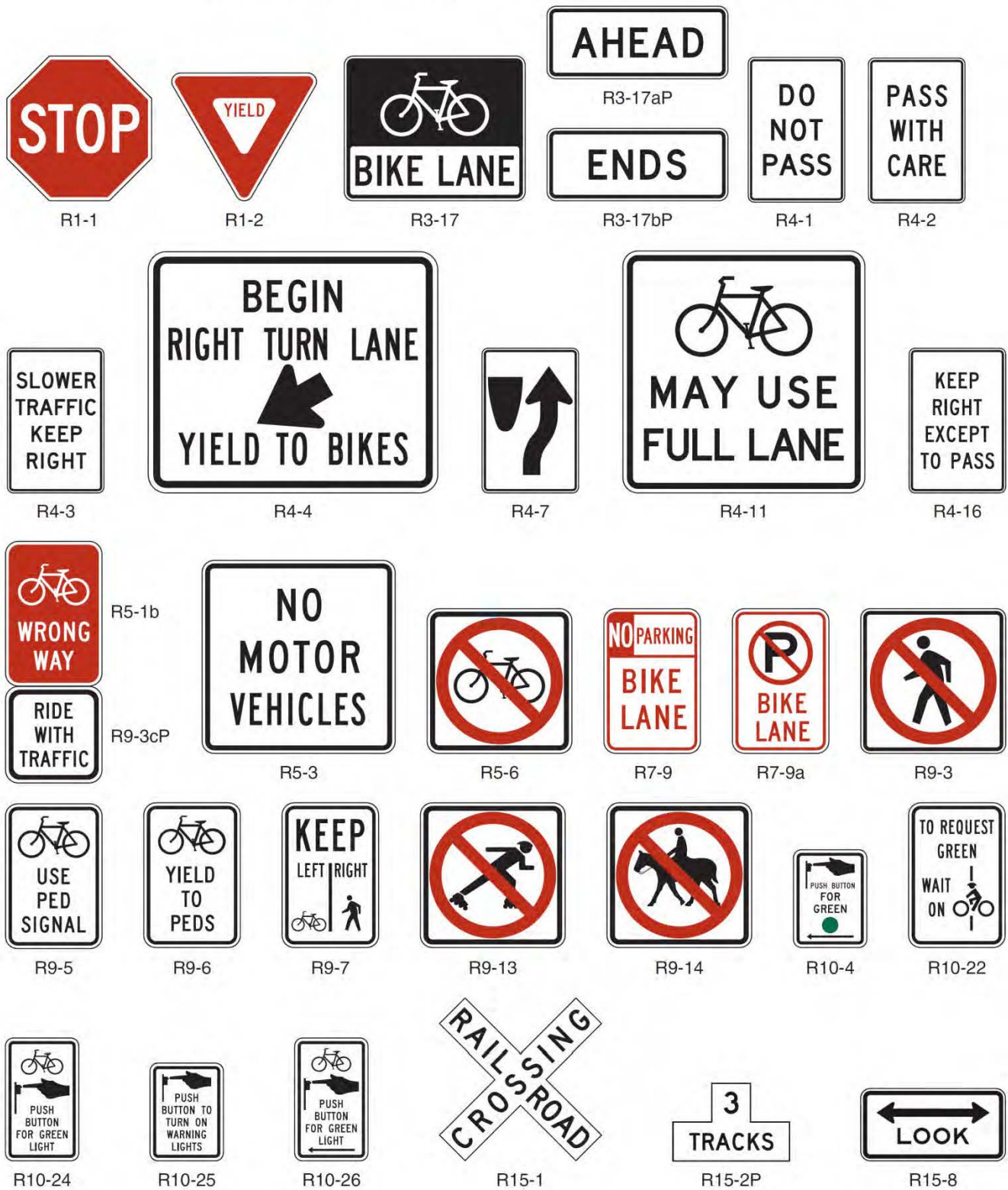


Figure 9B-2. Regulatory Signs and Plaques for Bicycle Facilities



**Figure 9B-2 (CA). California Regulatory Signs for Bicycle Facilities**



R44A (CA)



R44B (CA)



R44C (CA)



R81 (CA)



R81A (CA)



R81B (CA)

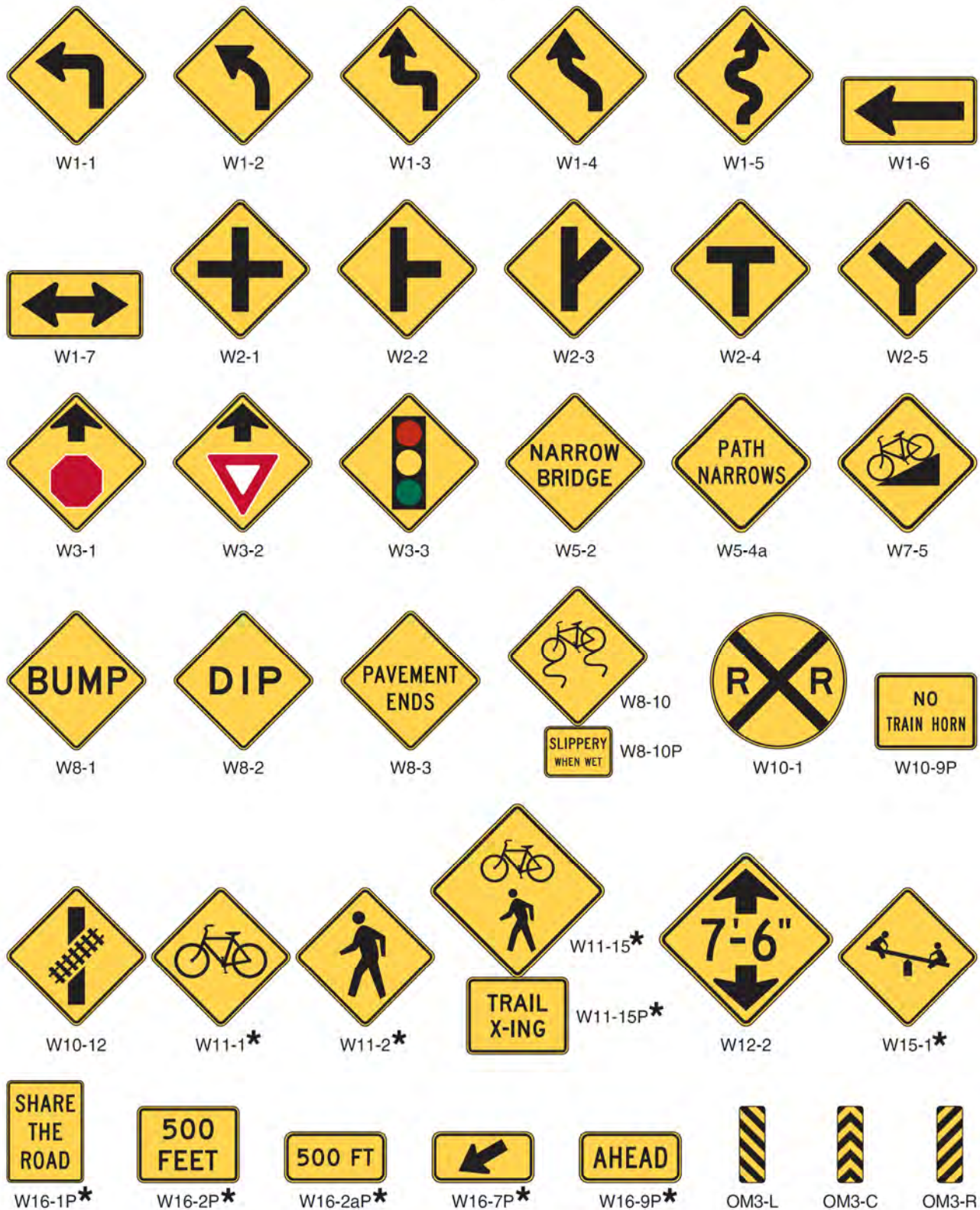


R117 (CA)



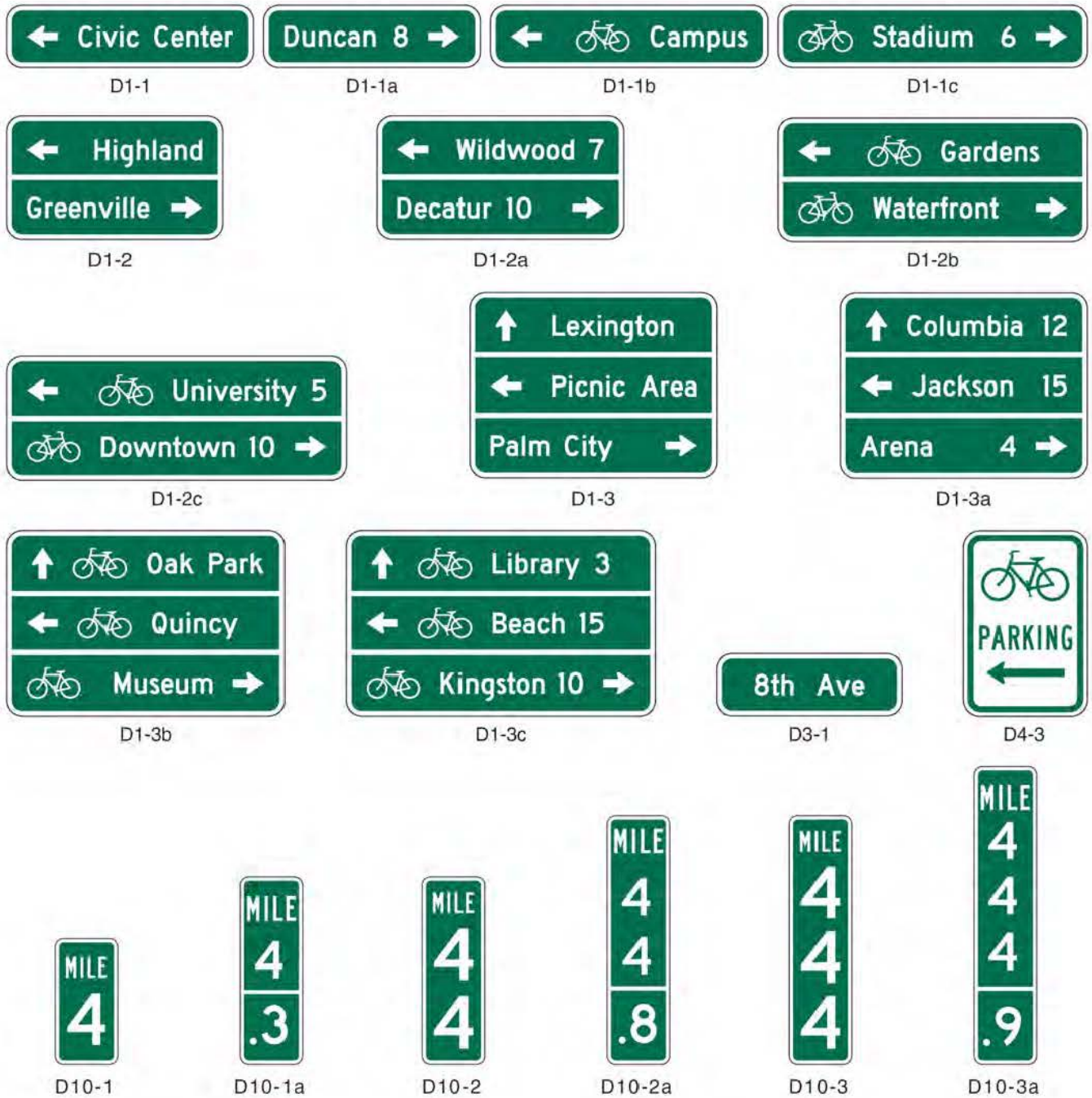
R118 (CA)

**Figure 9B-3. Warning Signs and Plaques and Object Markers for Bicycle Facilities**

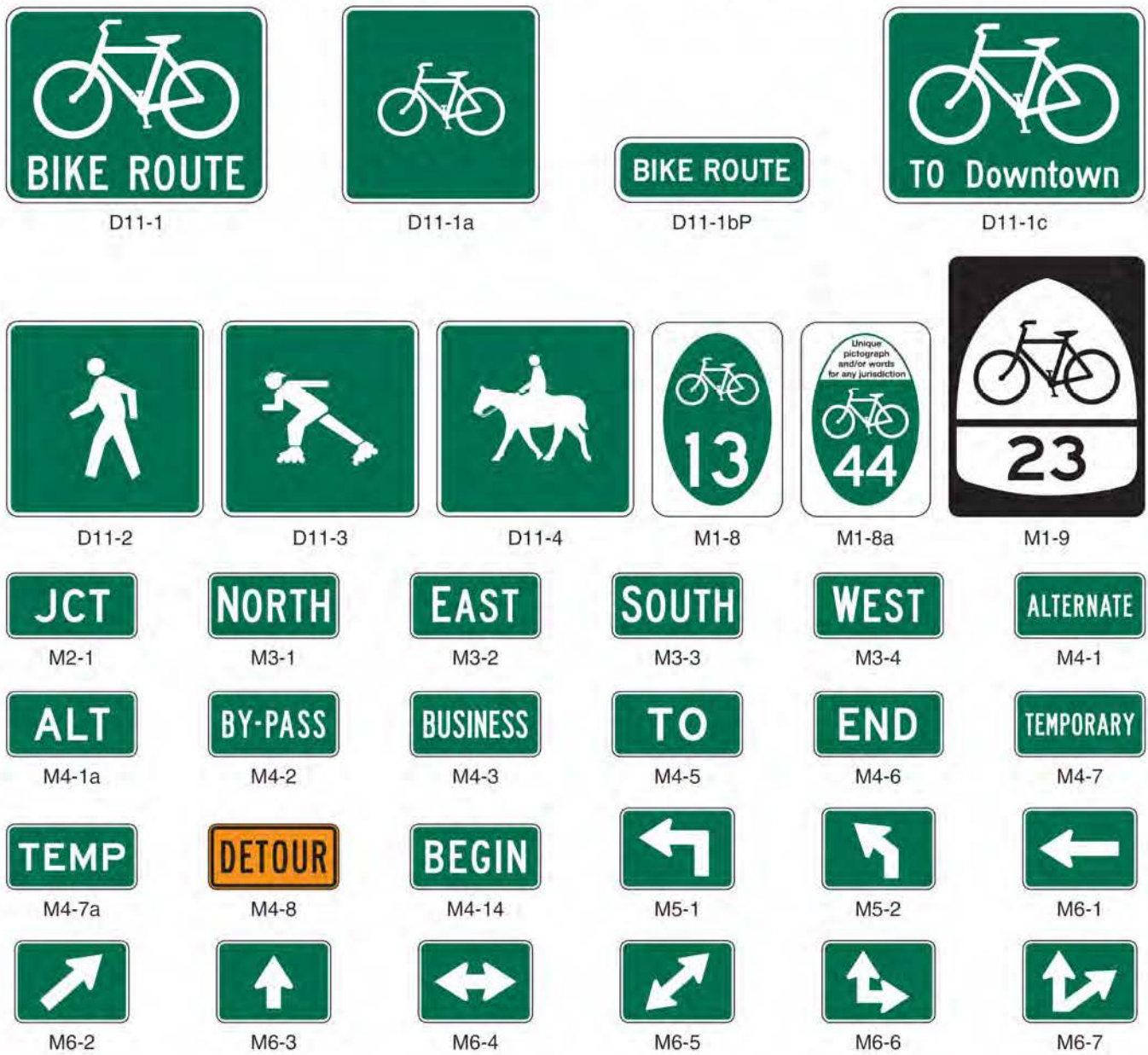


\* A fluorescent yellow-green background color may be used for this sign or plaque. The background color of the plaque should match the color of the warning sign that it supplements.

**Figure 9B-4. Guide Signs and Plaques for Bicycle Facilities (Sheet 1 of 2)**



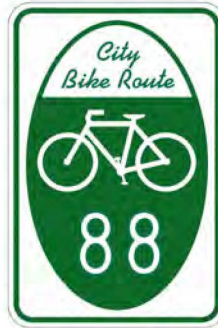
**Figure 9B-4. Guide Signs and Plaques for Bicycle Facilities (Sheet 2 of 2)**



**Figure 9B-4 (CA). California Guide Signs for Bicycle Facilities**



G93C (CA)



SG45 (CA)

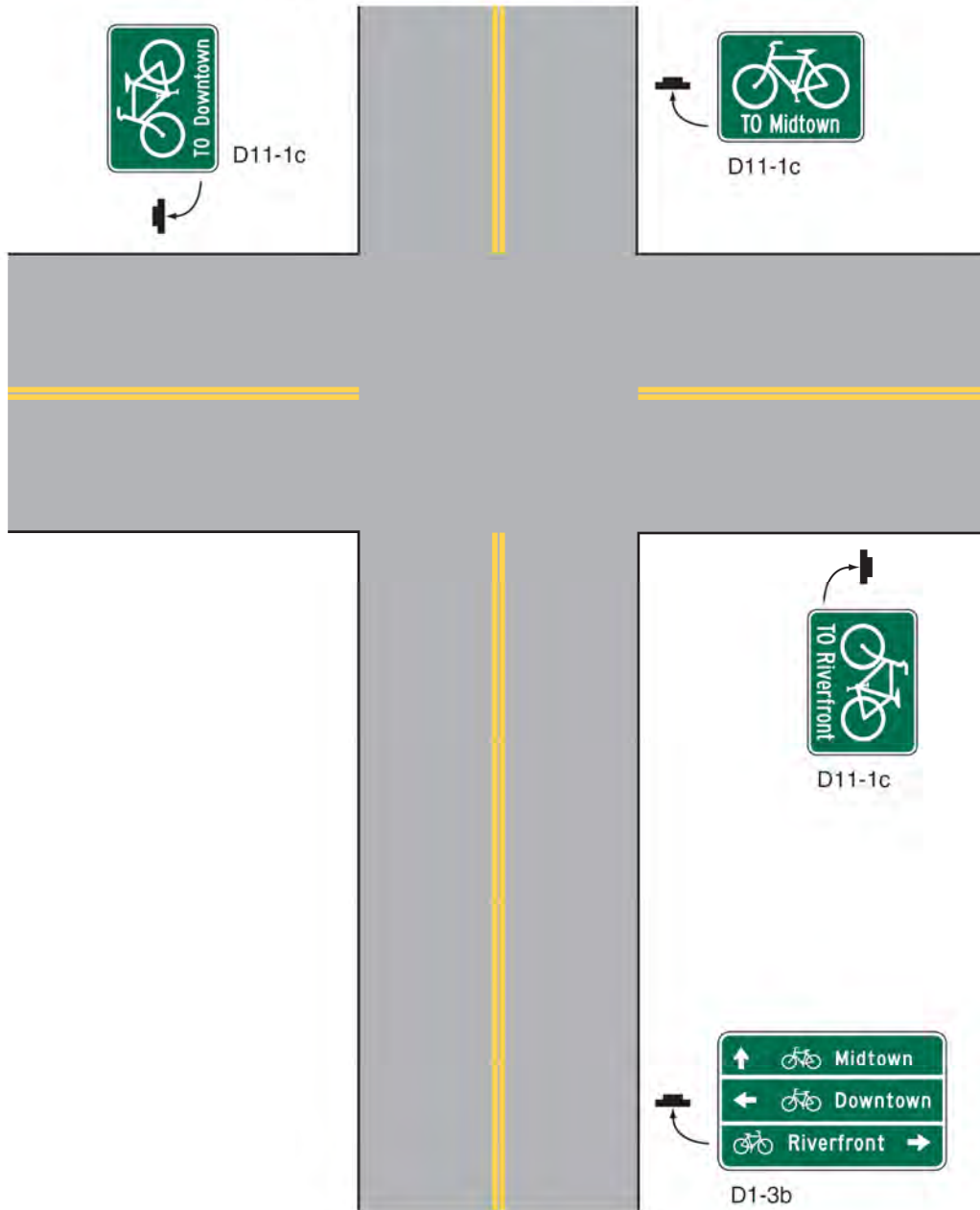


S17 (CA)

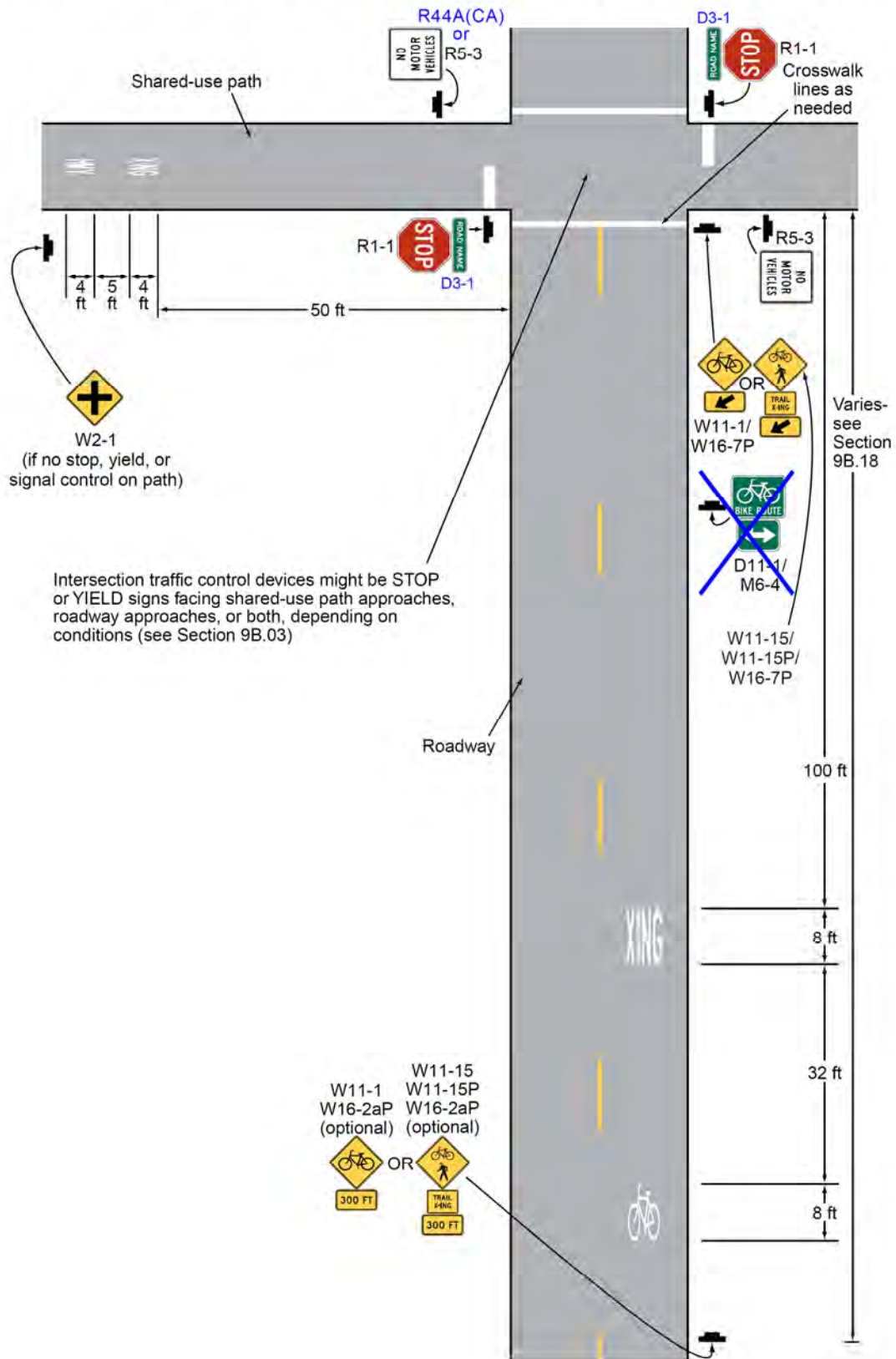




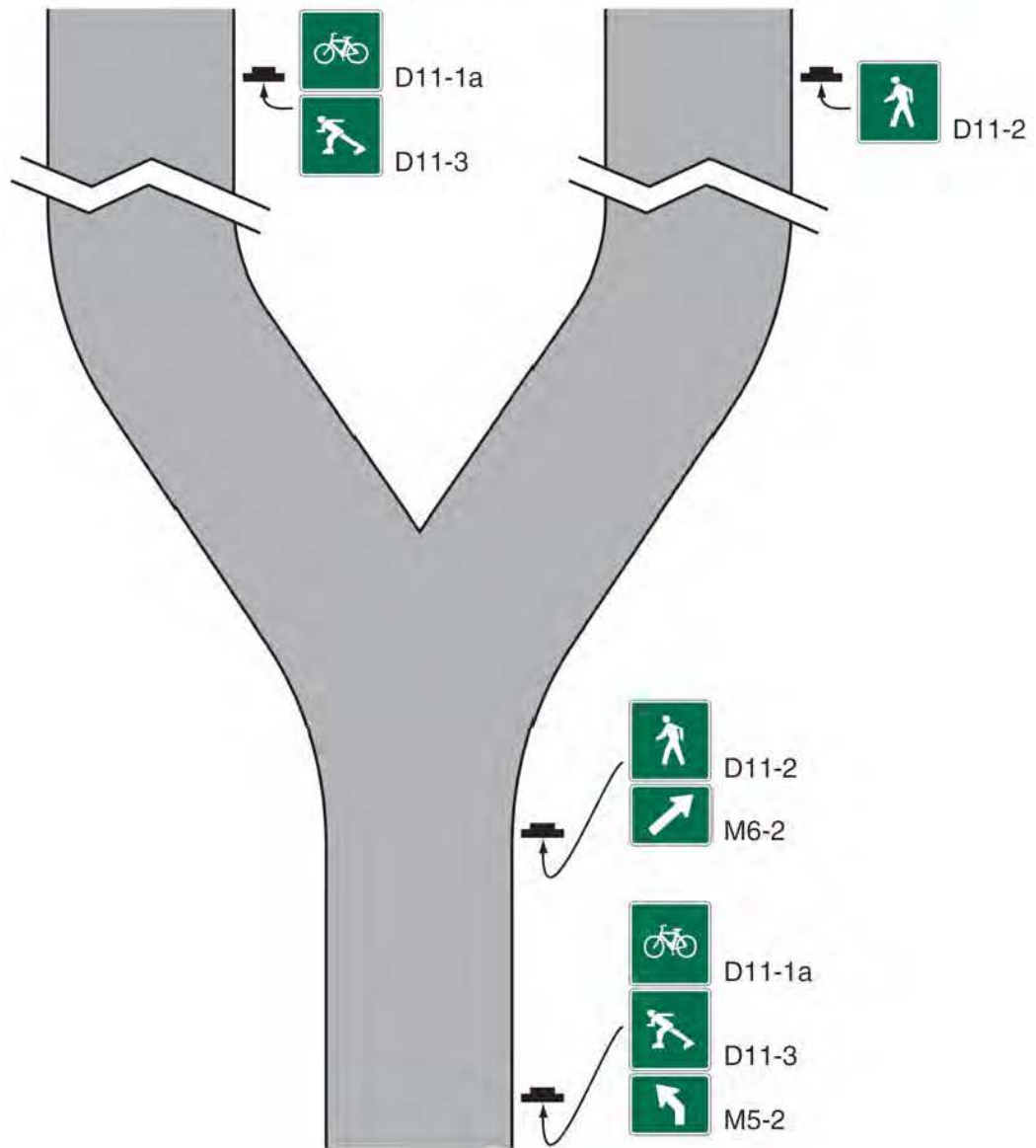
**Figure 9B-6. Example of Bicycle Guide Signing**



**Figure 9B-7. Examples of Signing and Markings for a Shared-Use Path Crossing**



**Figure 9B-8. Example of Mode-Specific Guide Signing on a Shared-Use Path**



**Table 9B-1. Bicycle Facility Sign and Plaque Minimum Sizes (Sheet 1 of 2)**

| Sign or Plaque                           | Sign Designation            | Section               | Shared-Use Path | Roadway            |
|--|-----------------------------|-----------------------|-----------------|--------------------|
| Stop                                     | R1-1                        | 2B.05, 9B.03          | 18 x 18         | 30 x 30            |
| Yield                                    | R1-2                        | 2B.08, 9B.03          | 18 x 18 x 18    | 30 x 30 x 30       |
| <del>Bike Lane</del>                     | <del>R9-17</del>            | <del>9B.04</del>      | <del>—</del>    | <del>24 x 18</del> |
| <del>Bike Lane (plaques)</del>           | <del>R9-17aP, R9-17bP</del> | <del>9B.04</del>      | <del>—</del>    | <del>24 x 0</del>  |
| Movement Restriction                     | R4-1,2,3,7,16               | 2B.28,29,30,32; 9B.14 | 12 x 18         | 18 x 24            |
| Begin Right Turn Lane Yield to Bikes     | R4-4                        | 9B.05                 | —               | 36 x 30            |
| Bicycles May Use Full Lane               | R4-11                       | 9B.06                 | —               | 30 x 30            |
| Bicycle Wrong Way                        | R5-1b                       | 9B.07                 | 12 x 18         | 12 x 18            |
| No Motor Vehicles                        | R5-3                        | 9B.08                 | 24 x 24         | 24 x 24            |
| No Bicycles                              | R5-6                        | 9B.09                 | 18 x 18         | 24 x 24            |
| No Parking Bike Lane                     | R7-9,9a                     | 9B.10                 | —               | 12 x 18            |
| No Pedestrians                           | R9-3                        | 9B.09                 | 18 x 18         | 18 x 18            |
| Ride With Traffic (plaque)               | R9-3cP                      | 9B.07                 | 12 x 12         | 12 x 12            |
| Bicycle Regulatory                       | R9-5,6                      | 9B.11                 | 12 x 18         | 12 x 18            |
| Shared-Use Path Restriction              | R9-7                        | 9B.12                 | 12 x 18         | —                  |
| No Skaters                               | R9-13                       | 9B.09                 | 18 x 18         | 18 x 18            |
| No Equestrians                           | R9-14                       | 9B.09                 | 18 x 18         | 18 x 18            |
| Push Button for Green Light              | R10-4                       | 9B.11                 | 9 x 12          | 9 x 12             |
| To Request Green Wait on Symbol          | R10-22                      | 9B.13                 | 12 x 18         | 12 x 18            |
| Bike Push Button for Green Light         | R10-24                      | 9B.11                 | 9 x 15          | 9 x 15             |
| Push Button to Turn On Warning Lights    | R10-25                      | 9B.11                 | 9 x 12          | 9 x 12             |
| Bike Push Button for Green Light (arrow) | R10-26                      | 9B.11                 | 9 x 15          | 9 x 15             |
| Grade Crossing (Crossbuck)               | R15-1                       | 8B.03, 9B.14          | 24 x 4.5        | 48 x 9             |
| Number of Tracks (plaque)                | R15-2P                      | 8B.03, 9B.14          | 13.5 x 9        | 27 x 18            |
| Look                                     | R15-8                       | 8B.17, 9B.14          | 18 x 9          | 36 x 18            |
| Turn and Curve Warning                   | W1-1,2,3,4,5                | 2C.04, 9B.15          | 18 x 18         | 24 x 24            |
| Arrow Warning                            | W1-6,7                      | 2C.12, 2C.47, 9B.15   | 24 x 12         | 36 x 18            |
| Intersection Warning                     | W2-1,2,3,4,5                | 2C.46, 9B.16          | 18 x 18         | 24 x 24            |
| Stop, Yield, Signal Ahead                | W3-1,2,3                    | 2C.36, 9B.19          | 18 x 18         | 30 x 30            |
| Narrow Bridge                            | W5-2                        | 2C.20, 9B.19          | 18 x 18         | 30 x 30            |
| Path Narrows                             | W5-4a                       | 9B.19                 | 18 x 18         | —                  |
| Next XX Miles (plaque)                   | W7-3aP                      | 2C.55, 9B.19          | 18 x 12         | 24 x 18            |
| Hill                                     | W7-5                        | 9B.19                 | 18 x 18         | 30 x 30            |
| Bump or Dip                              | W8-1,2                      | 2C.28, 9B.17          | 18 x 18         | 24 x 24            |
| Pavement Ends                            | W8-3                        | 2C.30, 9B.17          | 18 x 18         | 30 x 30            |
| Bicycle Surface Condition                | W8-10                       | 9B.17                 | 18 x 18         | 30 x 30            |
| Slippery When Wet (plaque)               | W8-10P                      | 9B.17                 | 12 x 9          | 12 x 9             |
| Grade Crossing Advance Warning           | W10-1                       | 8B.06, 9B.19          | 24 Dia.         | 36 Dia.            |
| No Train Horn (plaque)                   | W10-9P                      | 8B.21, 9B.19          | 18 x 12         | 30 x 24            |
| Skewed Crossing                          | W10-12                      | 8B.25, 9B.19          | 18 x 18         | 36 x 36            |
| Bicycle Warning                          | W11-1                       | 9B.18                 | 18 x 18         | 24 x 24            |
| Pedestrian Crossing                      | W11-2                       | 2C.50, 9B.19          | 18 x 18         | 24 x 24            |
| Combination Bike and Ped Crossing        | W11-15                      | 9B.18                 | 18 x 18         | 30 x 30            |
| Trail Crossing (plaque)                  | W11-15P                     | 9B.18                 | 18 x 12         | 24 x 18            |
| Low Clearance                            | W12-2                       | 2C.27, 9B.19          | 18 x 18         | 30 x 30            |
| Playground                               | W15-1                       | 2C.51, 9B.19          | 18 x 18         | 24 x 24            |
| Share the Road (plaque)                  | W16-1P                      | 2C.60, 9B.19          | —               | 18 x 24            |

**Table 9B-1. Bicycle Facility Sign and Plaque Minimum Sizes (Sheet 2 of 2)**

| Sign or Plaque                            | Sign Designation                               | Section      | Shared-Use Path | Roadway     |
|---|--|--------------|-----------------|-------------|
| XX Feet (plaque)                          | W16-2P   | 2C.55, 9B.18 | 18 x 12         | 24 x 18     |
| XX Ft (plaque)                            | W16-2aP  | 2C.55, 9B.18 | 18 x 9          | 24 x 12     |
| Diagonal Arrow (plaque)                   | W16-7P   | 9B.18        | —               | 24 x 12     |
| Ahead (plaque)                            | W16-9P   | 9B.18        | —               | 24 x 12     |
| Destination (1 line)                      | D1-1, D1-1a                                    | 2D.37, 9B.20 | varies x 6      | varies x 18 |
| Bicycle Destination (1 line)              | D1-1b, D1-1c                                   | 9B.20        | varies x 6      | varies x 6  |
| Destination (2 lines)                     | D1-2, D1-2a                                    | 2D.37, 9B.20 | varies x 12     | varies x 30 |
| Bicycle Destination (2 lines)             | D1-2b, D1-2c                                   | 9B.20        | varies x 12     | varies x 12 |
| Destination (3 lines)                     | D1-3, D1-3a                                    | 2D.37, 9B.20 | varies x 18     | varies x 42 |
| Bicycle Destination (3 lines)             | D1-3b, D1-3c                                   | 9B.20        | varies x 18     | varies x 18 |
| Street Name                               | D3-1   | 2D.43, 9B.20 | varies x 6      | varies x 8  |
| Bicycle Parking Area                      | D4-3   | 9B.23        | 12 x 18         | 12 x 18     |
| Reference Location (1-digit)              | D10-1  | 2H.02, 9B.24 | 6 x 12          | 10 x 18     |
| Intermediate Reference Location (1-digit) | D10-1a   | 2H.02, 9B.24 | 6 x 18          | 10 x 27     |
| Reference Location (2-digit)              | D10-2  | 2H.02, 9B.24 | 6 x 18          | 10 x 27     |
| Intermediate Reference Location (2-digit) | D10-2a   | 2H.02, 9B.24 | 6 x 24          | 10 x 36     |
| Reference Location (3-digit)              | D10-3  | 2H.02, 9B.24 | 6 x 24          | 10 x 36     |
| Intermediate Reference Location (3-digit) | D10-3a   | 2H.02, 9B.24 | 6 x 30          | 10 x 48     |
| Bike Route                                | D11-1, D11-1c                                  | 9B.20        | 24 x 18         | 24 x 18     |
| Bicycles Permitted                        | D11-1a   | 9B.25        | 18 x 18         | —           |
| Bike Route (plaque)                       | D11-1bP  | 9B.25        | 18 x 6          | —           |
| Pedestrians Permitted                     | D11-2  | 9B.25        | 18 x 18         | —           |
| Skaters Permitted                         | D11-3  | 9B.25        | 18 x 18         | —           |
| Equestrians Permitted                     | D11-4  | 9B.25        | 18 x 18         | —           |
| Bicycle Route                             | M1-8, M1-8a                                    | 9B.21        | 12 x 18         | 18 x 24     |
| U.S. Bicycle Route                        | M1-9   | 9B.21        | 12 x 18         | 18 x 24     |
| Bicycle Route Auxiliary Signs             | M2-1; M3-1,2,3,4;<br>M4-1,1a,2,3,5,6,7,7a,8,14 | 9B.22        | 12 x 6          | 12 x 6      |
| Bicycle Route Arrow Signs                 | M5-1,2; M6-1,2,3,4,5,6,7                       | 9B.22        | 12 x 9          | 12 x 9      |
| Type 3 Object Markers                     | OM3-L,C,R                                      | 2C.63, 9B.26 | 6 x 18          | 12 x 36     |

- Notes: 1. Larger signs may be used when appropriate  
 2. Dimensions are shown in inches and are shown as width x height

**Table 9B-1(CA). California Bicycle Facility Sign and Plaque Minimum Sizes**

| Sign or Plaque                         | Sign Designation | Section    | Shared-Use Path | Roadway   |
|--|------------------|------------|-----------------|-----------|
| Bicycle Parking                        | G93C(CA)         | 9B.23      | 24 x 18         | 24 x 18   |
| Bike Path Exclusion                    | R44A(CA)         | 9B.08      | 12 x 24         | ---       |
| BICYCLES MOTOR-DRIVEN CYCLES MUST EXIT | R44B(CA)         | 9B.101(CA) | ---             | 30 x 36   |
| BICYCLES MUST EXIT                     | R44C(CA)         | 9B.101(CA) | ---             | 30 x 30   |
| Bike Lane                              | R81(CA)          | 9B.04      | ---             | 12 x 8    |
| BEGIN                                  | R81A(CA)         | 9B.04      | ---             | 12 x 5    |
| END                                    | R81B(CA)         | 9B.04      | ---             | 8 x 5     |
| PASS Bicycle 3 FT MIN                  | R117(CA)         | 9B.102(CA) | ---             | 30 x 30 * |
| EXCEPT Bicycle                         | R118(CA)         | 9C.04      | ---             | 18 x 15 * |
| Bicycle Route Number Marker            | SG45(CA)         | 9B.21      | 12 x 18         | 12 x 18   |
| Bicycle Route Name Marker              | S17(CA)          | 9B.21      | 24 x 6          | 24 x 6    |

\* Other sign sizes are available, see specific California Sign Specification





## CHAPTER 9C. MARKINGS

### Section 9C.01 Functions of Markings

Support:

01 Markings indicate the separation of the lanes for road users, assist the bicyclist by indicating assigned travel paths, indicate correct position for traffic control signal actuation, and provide advance information for turning and crossing maneuvers.

### Section 9C.02 General Principles

Guidance:

01 *Bikeway design guides (see Section 9A.05) should be used when designing markings for bicycle facilities.*

**Standard:**

02 **Markings used on bikeways shall be retroreflectorized.**

02a **On State highways, markings material shall conform to Sections 84-2.02 and 84-3.02 of the Standard Specifications published by Caltrans.**

Guidance:

03 *Pavement marking word messages, symbols, and/or arrows should be used in bikeways where appropriate. Consideration should be given to selecting pavement marking materials that will minimize loss of traction for bicycles under wet conditions.*

**Standard:**

04 **The colors, width of lines, patterns of lines, symbols, and arrows used for marking bicycle facilities shall be as defined in Sections 3A.05, 3A.06, and 3B.20.**

Support:

05 Figures 9B-7 and 9C-1 through 9C-9 show examples of the application of lines, word messages, symbols, and arrows on designated bikeways.

Option:

06 A dotted line may be used to define a specific path for a bicyclist crossing an intersection (see Figure 9C-1) as described in Sections 3A.06 and 3B.08.

### Section 9C.03 Marking Patterns and Colors on Shared-Use Paths

Option:

01 Where shared-use paths are of sufficient width to designate two minimum width lanes, a solid yellow line may be used to separate the two directions of travel where passing is not permitted, and a broken yellow line may be used where passing is permitted (see Figure 9C-2).

Guidance:

02 *Broken lines used on shared-use paths should have the usual 1-to-3 segment-to-gap ratio. A nominal 3-foot segment with a 9-foot gap should be used.*

03 *If conditions make it desirable to separate two directions of travel on shared-use paths at particular locations, a solid yellow line should be used to indicate no passing and no traveling to the left of the line.*

04 *Markings as shown in Figure ~~9C-2~~ 9C-8 should be used at the location of obstructions in the center of the path, including vertical elements intended to physically prevent unauthorized motor vehicles from entering the path.*

Support:

05 A centerline marking is particularly beneficial in the following circumstances:

- A. Where there is heavy use;
- B. On curves with restricted sight distance; and,
- C. Where the path is unlighted and nighttime riding is expected.

Option:

05 A solid white line may be used on shared-use paths to separate different types of users. The R9-7 sign (see Section 9B.12) may be used to supplement the solid white line.

*05a* A solid white line may be used to delineate the traveled way of the bike path from the shoulder if the shoulder is paved with the same material as the bike path.

Support:

*05b* Refer to Caltrans' Highway Design Manual Index 1003.1.

*06* Smaller size letters and symbols may be used on shared-use paths. Where arrows are needed on shared-use paths, half-size layouts of the arrows may be used (see Section 3B.20).

## **Section 9C.04 Markings For Bicycle Lanes**

Support:

*01* Pavement markings designate that portion of the roadway for preferential use by bicyclists. Markings inform all road users of the restricted nature of the bicycle lane.

**Standard:**

*02* **Longitudinal pavement markings shall be used to define bicycle lanes.**

*Guidance:*

*03* If used, bicycle lane word, symbol, and/or arrow markings (see Figure 9C-3) should be placed at the beginning of a bicycle lane and at periodic intervals along the bicycle lane based on engineering judgment.

**Standard:**

*04* **If the bicycle lane symbol marking is used in conjunction with word or arrow messages, it shall precede them.**

Option:

*05* If the word, symbol, and/or arrow pavement markings shown in Figure 9C-3 are used, Bike Lane signs (see Section 9B.04) may also be used, but to avoid overuse of the signs not necessarily adjacent to every set of pavement markings.

### **Bicycle Lane Treatment at Intersections**

Option:

*05a* When a bike lane approaches an intersection with right- or left-turn only lanes, Figures 9C-1, 9C-4, 9C-4(CA) or 9C-5 may be used.

**Standard:**

*06* **A through bicycle lane shall not be positioned to the right of a right turn only lane or to the left of a left turn only lane.**

Support:

*07* A bicyclist continuing straight through an intersection from the right of a right-turn lane or from the left of a left-turn lane would be inconsistent with normal traffic behavior and would violate the expectations of right- or left-turning motorists.

*Guidance:*

*08* When the right through lane is dropped to become a right turn only lane, the bicycle lane markings should stop at least 100 feet before the beginning of the right-turn lane. Through bicycle lane markings should resume to the left of the right turn only lane.

*09* An optional through-right turn lane next to a right turn only lane should not be used where there is a through bicycle lane. If a capacity analysis indicates the need for an optional through-right turn lane, the bicycle lane should be discontinued at the intersection approach.

*09a* A dashed line across the right-turn-only lane should not be used on extremely long lanes, or where there are double right-turn-only lanes. For these types of intersections, all striping should be dropped to permit judgment by the bicyclists to prevail.

Option:

*09b* A Bicycle Crossing (W11-1) sign may be used to warn road users of the potential for bicyclists crossing their path. See Section 9B.18.

*09c* When a bike lane approaches ramp intersection that intersects the local facility at or close to 90° (typical of a compact or spread diamond configuration), then Figures 9C-4, 9C-4(CA) and 9C-5 may be used.

*Guidance:*

*09d* However, when a bike lane approaches one or more ramp intersections that intersect the local facility at various angles other than 90° (typically high-speed, skewed ramps), Figure 9C-103(CA) should be used.

Option:

<sup>09e</sup> At locations with right-turn-only lanes where bicycles are not prohibited but Class II bicycle facilities do not exist on the approach, a minimum 4-foot wide space for bicycle use may be provided between the right-turn and through lane, and where the posted speed is greater than 40 mph the minimum width should be 6 feet.

<sup>09f</sup> When the width between the right-turn and through lane is greater than 4-feet, a buffer area may be striped adjacent to the 4' minimum width for bicycle travel, regardless of the posted speed.

<sup>09g</sup> The buffer may be placed on the left or on the right of the 4' space for bicycle travel.

Support:

<sup>09h</sup> Refer to Caltrans' Highway Design Manual, Index 403.6.

**Standard:**

<sup>09i</sup> **If used, the space for bicycle use shall be delineated by Detail 39 on the right of the through lane and Detail 38A on the left of the right-turn-only lane.**

Support:

<sup>09j</sup> Refer to Figure 9C-4(CA) for details on striping and Figure 9C-104 (CA) for details on buffer area striping.

*Guidance:*

<sup>10</sup> Posts or raised pavement markers should not be used to separate bicycle lanes from adjacent travel lanes.

Support:

<sup>11</sup> Using raised devices creates a collision potential for bicyclists by placing fixed objects immediately adjacent to the travel path of the bicyclist. In addition, raised devices can prevent vehicles turning right from merging with the bicycle lane, which is the preferred method for making the right turn. Raised devices used to define a bicycle lane can also cause problems in cleaning and maintaining the bicycle lane.

Option:

<sup>11a</sup> A bicycle lane for travel in the same direction as the general purpose lanes may be placed on the left hand side of the general purpose lanes.

**Standard:**

<sup>12</sup> **Bicycle lanes shall not be provided on the circular roadway of a roundabout.**

*Guidance:*

<sup>13</sup> Bicycle lane markings should stop at least 100 feet before the crosswalk, or if no crosswalk is provided, at least 100 feet before the yield line, or if no yield line is provided, then at least 100 feet before the edge of the circulatory roadway.

Support:

<sup>14</sup> Examples of bicycle lane markings at right-turn lanes are shown in Figures 9C-1, 9C-4, and 9C-5. Examples of pavement markings for bicycle lanes on a two-way street are shown in Figure 9C-6. Pavement word message, symbol, and arrow markings for bicycle lanes are shown in Figure 9C-3.

<sup>15</sup> Class III Bikeways (Bike Route) are shared routes and do not require pavement markings. In some instances, a 4 inch white edge stripe separating the traffic lanes from the shoulder can be helpful in providing for safer shared use. This practice is particularly applicable on rural highways and on major arterials in urban areas where there is no vehicle parking.

Option:

<sup>16</sup> The Bike Lane Intersection (Detail 39A) line as shown in Figure 9C-101(CA) may be used to extend the bike lane to or through an intersection.

**Bicycle Lane Markings on Class II Bikeways (Bike Lane)**

*Guidance:*

<sup>17</sup> Bicycle lane markings on Class II Bikeways (Bike Lane) should be placed a constant distance from the marked lane line or centerline, as appropriate. Bike lanes with parking permitted should not be directed toward the curb at intersections or localized areas where parking is prohibited. Such a practice prevents bicyclists from following a straight course. Where transitions from one type of bike lane to another are necessary, smooth tapers should be provided.

Support:

<sup>18</sup> Class II Bikeways (Bike Lane) require standard signing and pavement markings as shown in Figure 9C-102(CA). This figure also depicts the proper method of striping bike lanes through intersections. Bike lane lines are not typically extended through intersections.

*Guidance:*

<sup>19</sup> Where right turns are not permitted, the solid bike lane stripe should extend to the edge of the intersection, and begin

*again on the far side. Where there is no right turn only lane and right turns are permitted, the solid stripe should terminate 50 feet to 200 feet prior to the intersection.*

Option:

<sup>20</sup> A dashed line, as shown in Figure 9C-102(CA), may be carried to, or near, the intersection. Where city blocks are short (less than 400 feet), the length of dashed stripe may be 50 feet.

Guidance:

<sup>21</sup> *Where blocks are longer or vehicle speeds are high (greater than 35 mph), the length of dashed stripe should be increased to 200 feet.*

**Standard:**

<sup>22</sup> **Raised barriers (e.g., raised traffic bars and asphalt concrete dikes) or raised pavement markers shall not be used to delineate bike lanes on Class II Bikeways (Bike Lane).**

Support:

<sup>23</sup> Raised barriers prevent motorists from merging into bike lanes before making right turns, as required by the CVC, and restrict the movement of bicyclists desiring to enter or exit bike lanes.

<sup>24</sup> They also impede routine maintenance. Raised pavement markers increase the difficulty for bicyclists when entering or exiting bike lanes, and discourage motorists from merging into bike lanes before making right turns.

Option:

<sup>25</sup> Physical barriers may be used to convert a Class II Bikeway (Bike Lane) to Class I Bikeway (Bike Path) or Class IV Bikeway (Separated Bikeway).

### **Bicycle Lane Treatment through Interchanges**

Support:

<sup>26</sup> Markings for a bike lane through a typical interchange are shown in Figure 9C-103(CA).

Option:

<sup>27</sup> Figure 9C-103(CA) may also be used where the preferred designation is a Class III Bikeway (Bike Route), with the Bike Lane (R81(CA)) signs being replaced with Bike Route (D11-1) signs and the bike lane delineation eliminated. A 4 inch stripe may be used to delineate the shoulder throughout the bike route designation.

**Standard:**

<sup>28</sup> **Signing and striping as shown in Figure 9C-103(CA) shall be repeated at additional onramps within the interchange.**

Guidance:

<sup>29</sup> *Where the onramps intersect at the local road at or near 90°, the striping should be per Figure 9C-4(CA).*

**Standard:**

<sup>30</sup> **The shoulder width shall not be reduced through the interchange area. The minimum shoulder width shall match the approach roadway shoulder width, but not less than 4 feet, or with not less than 3 feet of pavement if a gutter exists. If the shoulder width is not available, the designated bike lane shall end at the previous local road intersection.**

### **Bicycle Lane Treatment Where Vehicle Parking is Prohibited/Permitted**

Support:

<sup>31</sup> Markings for a bike lane where vehicle parking is prohibited or permitted are shown in Figure 9C-102(CA).

**Standard:**

<sup>32</sup> **Where motorist right turns are permitted, the solid bike lane shall either be dropped entirely, or dashed (Refer Bike Intersection lane, Detail 39A, shown in Figure 9C-101(CA)) beginning at a point between 50 feet and 200 feet in advance of the intersection.**

Option:

<sup>33</sup> In areas where parking stalls are not necessary (because parking is light), a 4 inch solid white stripe may be painted to fully delineate the bike lane. This may be advisable where there is concern that motorists may misconstrue the bike lane to be a traffic lane.

### **BIKE LANE Pavement Markings**

**Standard:**

<sup>34</sup> **The BIKE LANE pavement markings shall be placed on the far side of each intersection.**

Option:

<sup>35</sup> The BIKE LANE pavement markings may also be placed at other locations as desired.

Support:

<sup>36</sup> Examples of BIKE LANE pavement markings are shown in various figures in this chapter.

Option:

<sup>37</sup> Optional word, arrow and symbol markings with details as shown in Figure 9C-3 may be used.

### **Buffered Bicycle Lanes**

Support:

<sup>38</sup> A buffered bicycle lane is a bicycle lane that is separated from the adjacent general-purpose lane or parking lane by a pattern of standard longitudinal markings. The buffer area might include chevron or diagonal markings. The buffer area width includes the width of the parallel white lines.

<sup>39</sup> Markings for buffered bicycle lanes are shown in Figure 9C-104(CA).

<sup>40</sup> Pavement markings can designate a buffer area between a bicycle lane and adjacent general purpose lane and/or parking lane. A buffer area provides a greater separation between the bicycle lane and adjacent lanes than is provided by a single normal or wide lane line.

Option:

<sup>41</sup> A bicycle lane buffer area may be used to separate a bicycle lane from an adjacent general-purpose lane and/or parking lane.

**Standard:**

**<sup>42</sup> If used, a buffer area between a bicycle lane and general-purpose lane or parking lane shall be delineated by normal white longitudinal pavement markings.**

*Guidance:*

<sup>43</sup> *The use of chevron or diagonal markings should be considered in a bicycle lane buffer area and should be based on Section 3B.24 and engineering judgment.*

<sup>44</sup> *If used, interior chevron or diagonal markings should consist of 4 inch lines angled at 45 degrees and striped at intervals of 10 to 40 feet.*

Support:

<sup>45</sup> Increased interior chevron or diagonal marking frequency can increase motorist compliance.

Option:

<sup>46</sup> The chevron or diagonal markings may be omitted from bicycle lane buffer areas less than 4 feet wide.

*Guidance:*

<sup>47</sup> *If used and where there is parking on the right side of the buffered bicycle lane, the rightmost line should be broken. Where vehicles are expected to cross the buffer area at driveways, both lines should be broken. Where neither condition exists, both lines should be solid.*

<sup>48</sup> *End the buffer area on the approach to the intersection of side streets or major commercial driveways as shown in Figure 9C-104(CA).*

### **Contraflow Bicycle Lanes**

Support:

<sup>49</sup> A contraflow bicycle lane is an area of the roadway designated to allow for the lawful use by bicyclists to travel in the opposite direction from traffic on a roadway that allows traffic to travel in only one direction.

<sup>50</sup> Markings for contraflow bicycle lanes are shown in Figure 9C-105(CA).

**Standard:**

**<sup>51</sup> Where used, a contraflow bicycle lane shall be marked on the left side of travel lanes so that contraflow bicycle travel is on the left of opposing traffic.**

**<sup>52</sup> Where used, a contraflow bicycle lane shall be separated from opposite-direction travel by use of a solid double yellow center line marking, a painted median island, or raised median island.**

**<sup>53</sup> Where intersection traffic controls along the street exist, (e.g., stop signs, flashing light signals, or traffic signals), appropriate devices shall be oriented toward bicyclists in the contraflow lane.**

**<sup>54</sup> A contraflow bicycle lane shall not be installed on a two-way roadway.**

*Guidance:*

<sup>55</sup> *A buffer area per Section 3B.24 or an island should be used to separate the contraflow lane from adjacent travel lanes at posted speeds of 40 mph and above.*

*Guidance:*

<sup>56</sup> *Where signs are provided to regulate turns from streets or driveways that intersect with a roadway that has a contraflow bicycle lane, One Way (R6-1 or R6-2) signs should not be used. Turn Prohibition signs (R3-1 or R3-2) with supplemental*

*EXCEPT Bicycle plaques (R118(CA)) should be used. If DO NOT ENTER signs (R5-1) are used, an EXCEPT Bicycle plaque(R118(CA)) should be placed under the DO NOT ENTER sign. See Figure 9C-105(CA).*

Support:

<sup>57</sup> Contraflow bicycle travel can be unexpected by motorists crossing the contraflow bicycle lane when entering, exiting, or crossing the roadway. Consideration of additional signalization, signing and/or marking treatments is appropriate for intersections, alleys, grade crossings, and driveways.

Option:

<sup>58</sup> At locations where a contraflow bicycle lane is provided across an intersection or a driveway entrance, pavement markings that inform intersection or driveway traffic of the presence of the bicycle facility and the direction of permitted bicycle traffic may be placed within the contraflow bicycle lane across the intersection or driveway opening.

### **Bicycle Lane Line Extensions through Intersections**

Support:

<sup>59</sup> The extension of bicycle lanes through intersections advises motorists that bicyclists are likely to use the intended path.

Option:

<sup>60</sup> Bicycle lane markings may be extended through intersections consistent with the provisions of Section 3B.08.

<sup>61</sup> Bicycle lane markings as shown in Figure 9C-106(CA) may be used within the boundaries of bicycle lane extensions.

### **Section 9C.05 Bicycle Detector Symbol**

Option:

<sup>01</sup> A symbol (see Figure 9C-7) may be placed on the pavement indicating the optimum position for a bicyclist to actuate the signal.

<sup>02</sup> An R10-22 sign (see Section 9B.13 and Figure 9B-2) may be installed to supplement the pavement marking.

Support:

<sup>03</sup> Section 4D.105(CA) and Figure 4D-111(CA) contain information on bicycle detectors and their locations.

### **Section 9C.06 Pavement Markings for Obstructions**

Guidance:

<sup>01</sup> *In roadway situations where it is not practical to eliminate a drain grate or other roadway obstruction that is inappropriate for bicycle travel, white markings applied as shown in Figure 9C-8 should be used to guide bicyclists around the condition.*

### **Section 9C.07 Shared Lane Marking**

Option:

<sup>01</sup> The Shared Lane Marking shown in Figure 9C-9 may be used to:

- A. Assist bicyclists with lateral positioning in a shared lane with on-street parallel parking in order to reduce the chance of a bicyclist's impacting the open door of a parked vehicle,
- B. Assist bicyclists with lateral positioning in lanes that are too narrow for a motor vehicle and a bicycle to travel side by side within the same traffic lane,
- C. Alert road users of the lateral location bicyclists are likely to occupy within the traveled way,
- D. Encourage safe passing of bicyclists by motorists, and
- E. Reduce the incidence of wrong-way bicycling.
- F. Assist bicyclists with lateral positioning within a traffic circle or roundabout (See Figure 9C.107),
- G. Supplement a signed bicycle route that is identified as a Class III bicycle facility, and
- H. Encourage the lateral positioning of bicyclists away from on-street angled parking.

Guidance:

<sup>02</sup> *Except as provided in Paragraph 02a, the Shared Lane Marking should not be placed on roadways that have a speed limit above 35 mph.*

Option:

<sup>02a</sup> The Shared Lane Marking may be placed on roadways that have a speed limit above 35 mph, where there is bicycle travel and there is no marked bicycle lane and the right-hand traffic lane is too narrow to allow motor vehicles to safely pass bicyclists.

**Support:**

02b On roadways that have a speed limit above 35 mph, a Class II bikeway or Class IV bikeway is more appropriate to facilitate bicycle travel.

**Standard:**

03 **Shared Lane Markings shall not be used on shoulders, separated bikeways or in designated bicycle lanes.**

**Lateral Positioning**

**Support:**

03a The effective lane width as used in this section indicates the width of the pavement available after subtracting the width of the parked vehicle and door zone from the distance of the lane line/centerline to the face of the curb/edge of the pavement.

**Guidance:**

04 *If used in a shared lane with on-street parallel parking, if the effective lane width is 14 feet or greater, Shared Lane Markings should be placed so that the centers of the markings are at least ~~14~~ 13 feet from the face of the curb, or from the edge of the pavement where there is no curb. If the effective lane width is less than 14 feet, the marking should be centered within the effective lane width. See Figure 9C-108(CA).*

05 *If used on a street without on-street parking that has an outside travel lane that is less than 14 feet wide, the centers of the Shared Lane Markings should be centered in the travel lane. If used on a street without on-street parking that has an outside travel lane whose width is 14 feet or greater, the shared lane markings should be centered at least 4 feet from the face of the curb, or from the edge of the pavement where there is no curb.*

**Support:**

05a When a shared lane is sufficiently wide that motor vehicles can pass bicyclists within the lane, the purpose of the Shared Lane Marking is to indicate a bicyclist line of travel that facilitates passing while avoiding fixed obstructions (e.g. drainage inlet, gutter joint). When a shared lane is not wide enough to enable passing with adequate clearance, the purpose of the marking is to indicate a bicyclist line of travel that deters passing within the lane.

**Spacing**

06 *If used, the Shared Lane Marking should be placed immediately after an intersection and spaced at intervals not greater than 250 feet thereafter.*

**Option:**

06a Closer spacing between Shared Lane Markings may be considered approaching, traversing, and departing intersections, where there is higher potential for conflicts between motorists and bicyclists. See Figure 9C-109(CA).

06b Closer spacing between Shared Lane Markings may be considered where there are sight distance constraints, for example, approaching the crest of a vertical curve.

06c Closer spacing between Shared Lane Markings may be considered to guide bicyclists when deviating from a straight line of travel (e.g. merging, angled railroad crossing).

**Option:**

07 Section 9B.06 describes a Bicycles May Use Full Lane sign that may be used in addition to or instead of the Shared Lane Marking to inform road users that bicyclists might occupy the travel lane.

**Section 9C.101(CA) Barrier Posts on Class I Bikeways**

**Support:**

01 Before a decision is made to install barrier posts, consideration needs to be given to the implementation of other remedial measures, such as Bike Path Exclusion (R44A(CA)) signs (see Section 9B.08) and/or redesigning the path entry so that motorists do not confuse it with vehicle access.

02 It could be necessary to install barrier posts at entrances to bike paths to prevent motor vehicles from entering. When locating such installations, care needs to be taken to assure that barriers are well marked and visible to bicyclists, day or night (i.e., install reflectors or reflectorized tape).

*Guidance:*

*03 An envelope around the barriers should be striped as shown in Figure 9C-8. If sight distance is limited, special advance warning signs or painted pavement warnings should be provided. Where more than one post is necessary, 5 foot spacing should be used to permit passage of bicycle-towed trailers, adult tricycles, and to assure adequate room for safe bicycle passage without dismounting. Barrier post installations should be designed so they are removable to permit entrance by emergency and service vehicles.*

*Support:*

*04 Generally, barrier configurations that preclude entry by motorcycles present safety and convenience problems for bicyclists.*

*Guidance:*

*05 Such devices should be used only where extreme problems are encountered.*

**Section 9C.102 (CA) Class IV Bikeways**

**Support:**

**01 Refer to FHWA "Separated Bike Lane Planning and Design Guide" for detailed information on planning and design of separated bike lanes.**

**Option:**

**02 Separated bikeways may be delineated for one-way or two-way operation by using traffic control devices.**

**Standard:**

**03 Vertical elements shall be used to define separated bikeways.**

**Support:**

**04 Vertical elements in the buffer area are critical to separated bikeway design. Forms of vertical separation include, but are not limited to, grade separation, flexible delineator posts, inflexible physical barriers, or on-street parking. See Figure 9C-110(CA). See DIB 89 for more information.**

**Standard:**

**05 Where separated bikeways are designed for two-way travel, a solid yellow line shall be used to separate the two directions of travel where passing is not permitted. A broken yellow line shall be used where passing is permitted (Refer to Figure 9C-110(CA)). See Section 9C.03 for marking patterns.**

**Option**

**06 A through separated bikeway may be positioned to the right of a right turn only lane or to the left of a left turn only lane, if bicycle signals are used. See Section 4D.104 for optional use of Bicycle Signal Faces.**

**Standard:**

**07 The Bike Symbol pavement markings or Helmeted Bicyclist Symbol (Figure 9C-3 Option A or Option B) shall be placed on the far side of each intersection.**

**Option:**

**08 The DO NOT ENTER (R5-1) sign with the supplemental EXCEPT Bicycle plaque (R118 (CA)) may be used on separated bikeways to reduce the likelihood of accidental entrance by motor vehicles.**

**Buffer**

**Standard:**

**09 If used, the buffer area between the separated bikeway and general-purpose lane and parking lane (if present) shall be delineated.**

**10 The buffer area shall be delineated by longitudinal pavement markings. See Section 9C.04 for buffer striping details.**

**Support:**

**11 The buffer area width includes the width of the parallel lines.**

**12 See DIB 89 for buffer area width requirements.**

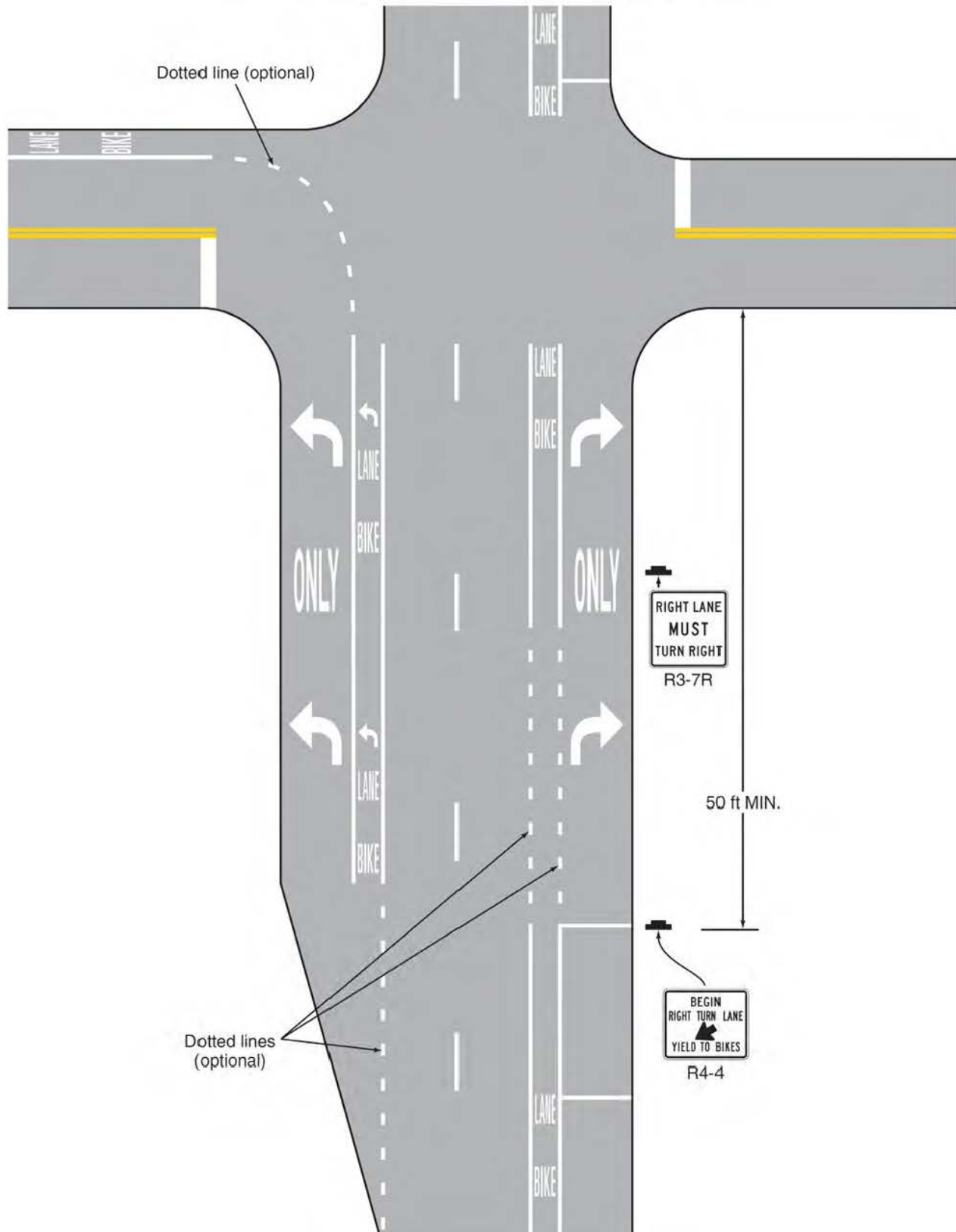
**Unobstructed passage**

**Standard**

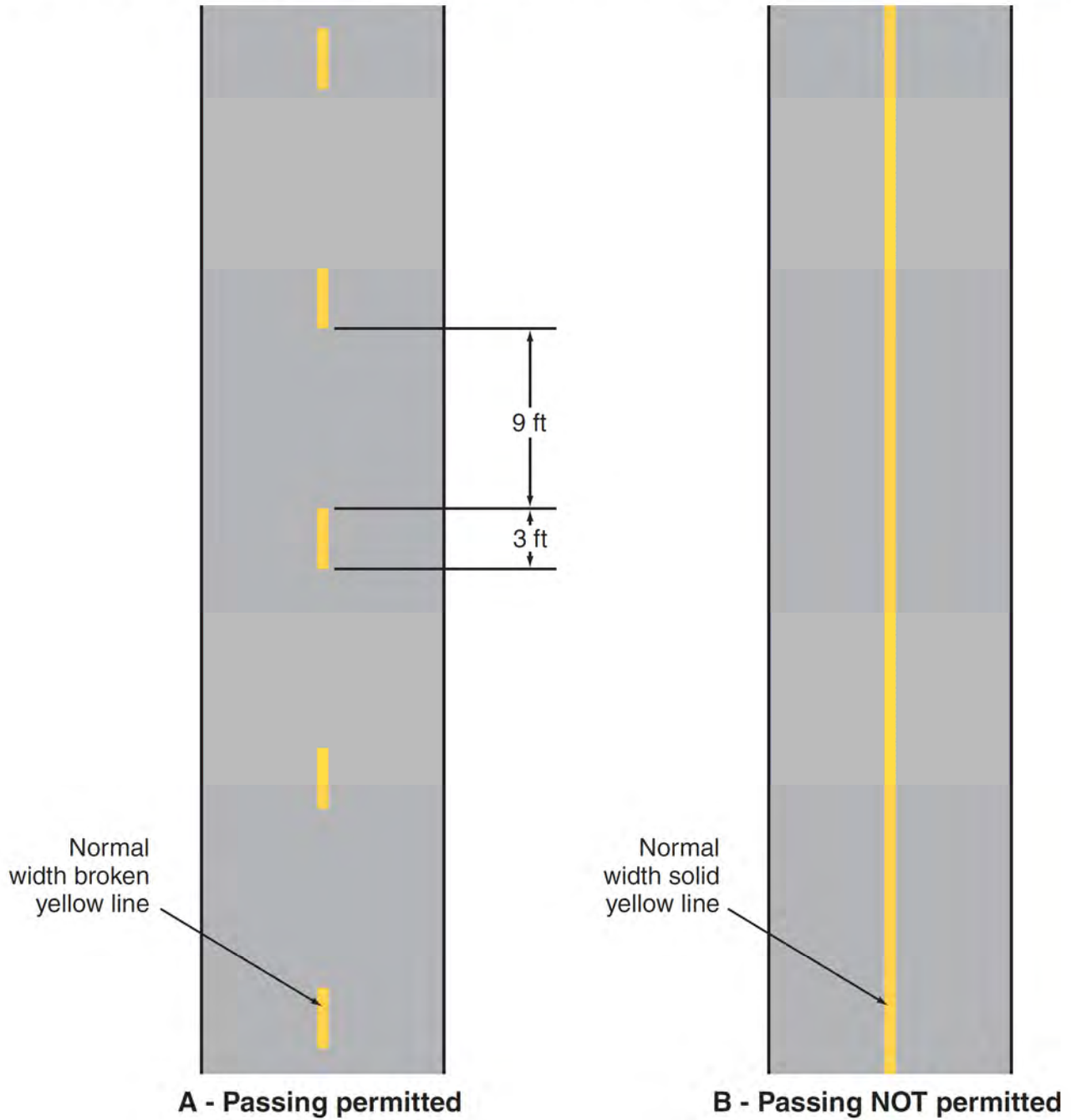
**13 If accessible parking or loading zones are provided on a roadway alongside a separated bikeway, then unobstructed access shall be maintained.**



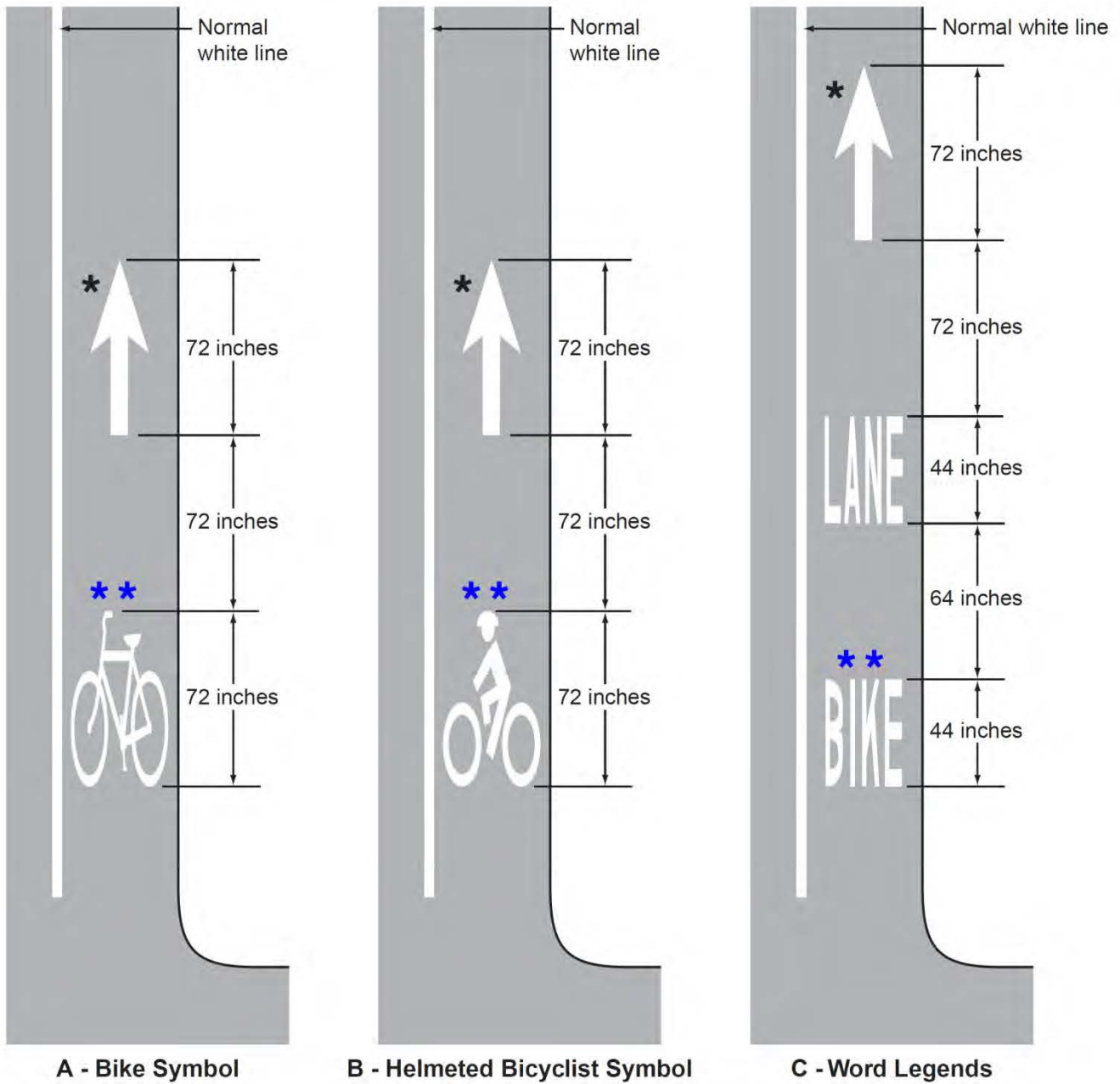
**Figure 9C-1. Example of Intersection Pavement Markings—Designated Bicycle Lane with Left-Turn Area, Heavy Turn Volumes, Parking, One-Way Traffic, or Divided Highway**



**Figure 9C-2. Examples of Center Line Markings for Shared-Use Paths**



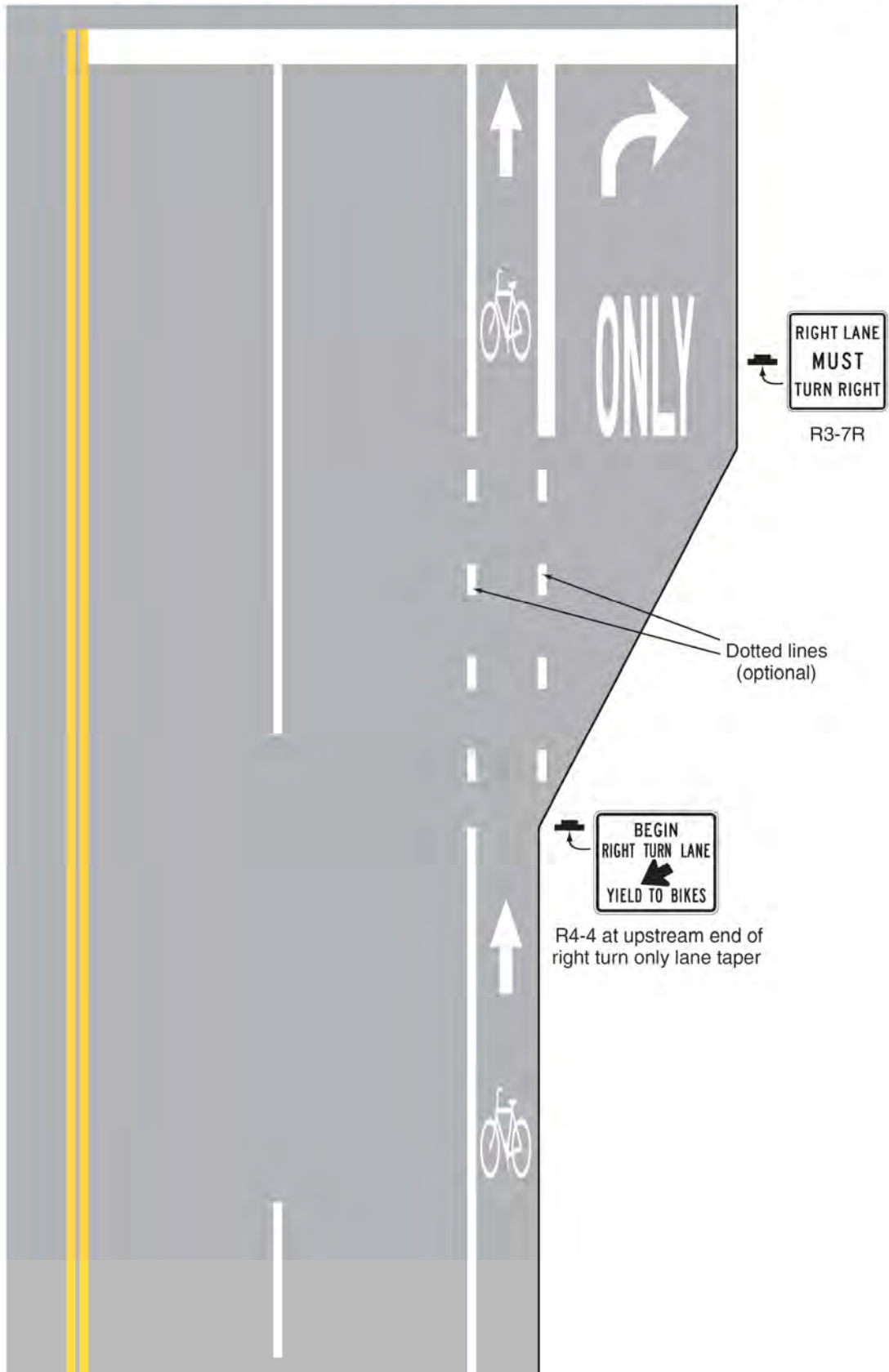
### Figure 9C-3. Word, Symbol, and Arrow Pavement Markings for Bicycle Lanes



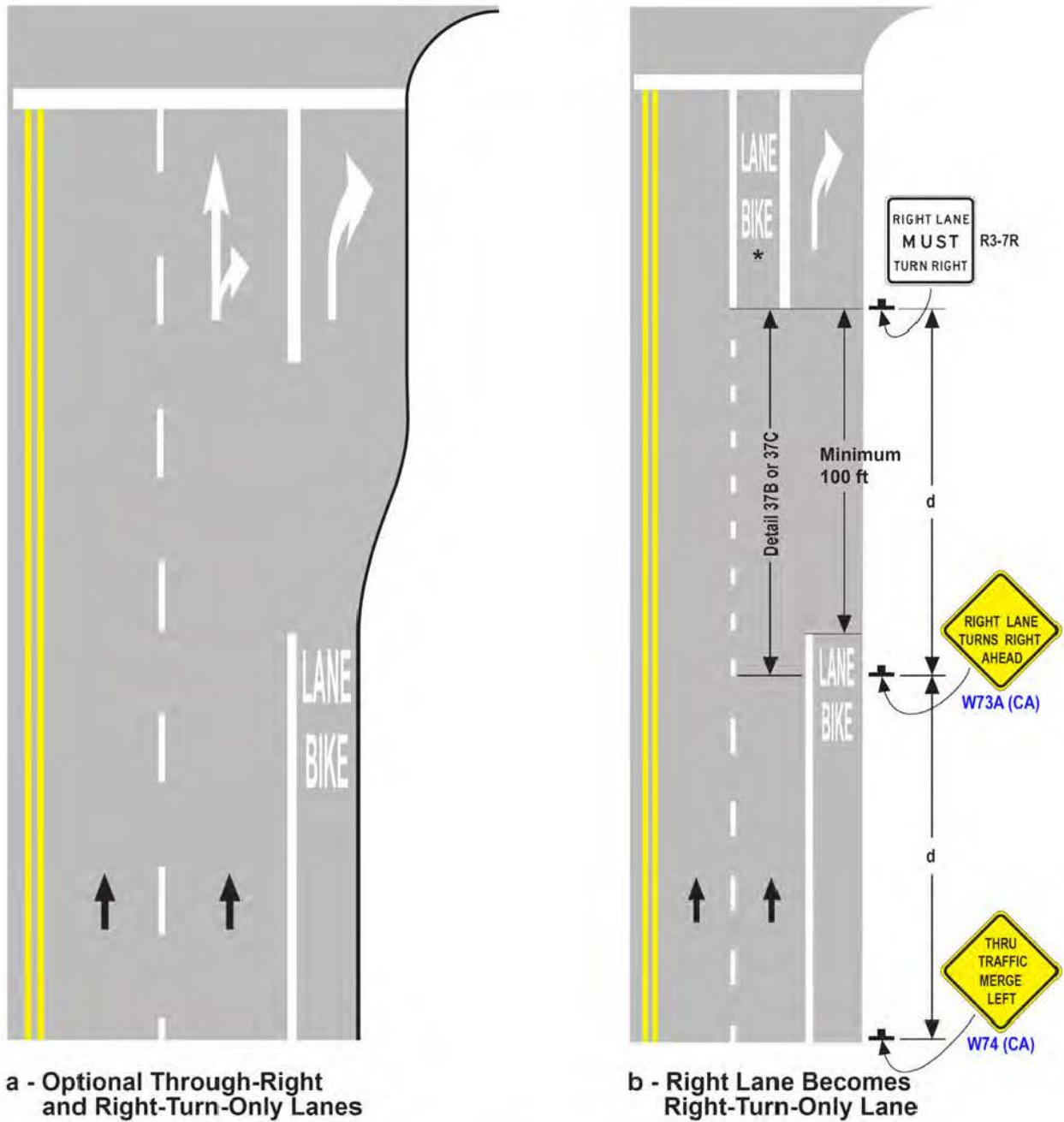
Legend

- \* Optional
- \*\* Required on far side of each intersection, optional at other locations

**Figure 9C-4. Example of Bicycle Lane Treatment at a Right Turn Only Lane**



**Figure 9C-4 (CA). Example of Bicycle Lane Treatment at a Right Turn Only Lane**  
 (Sheet 1 of 3)

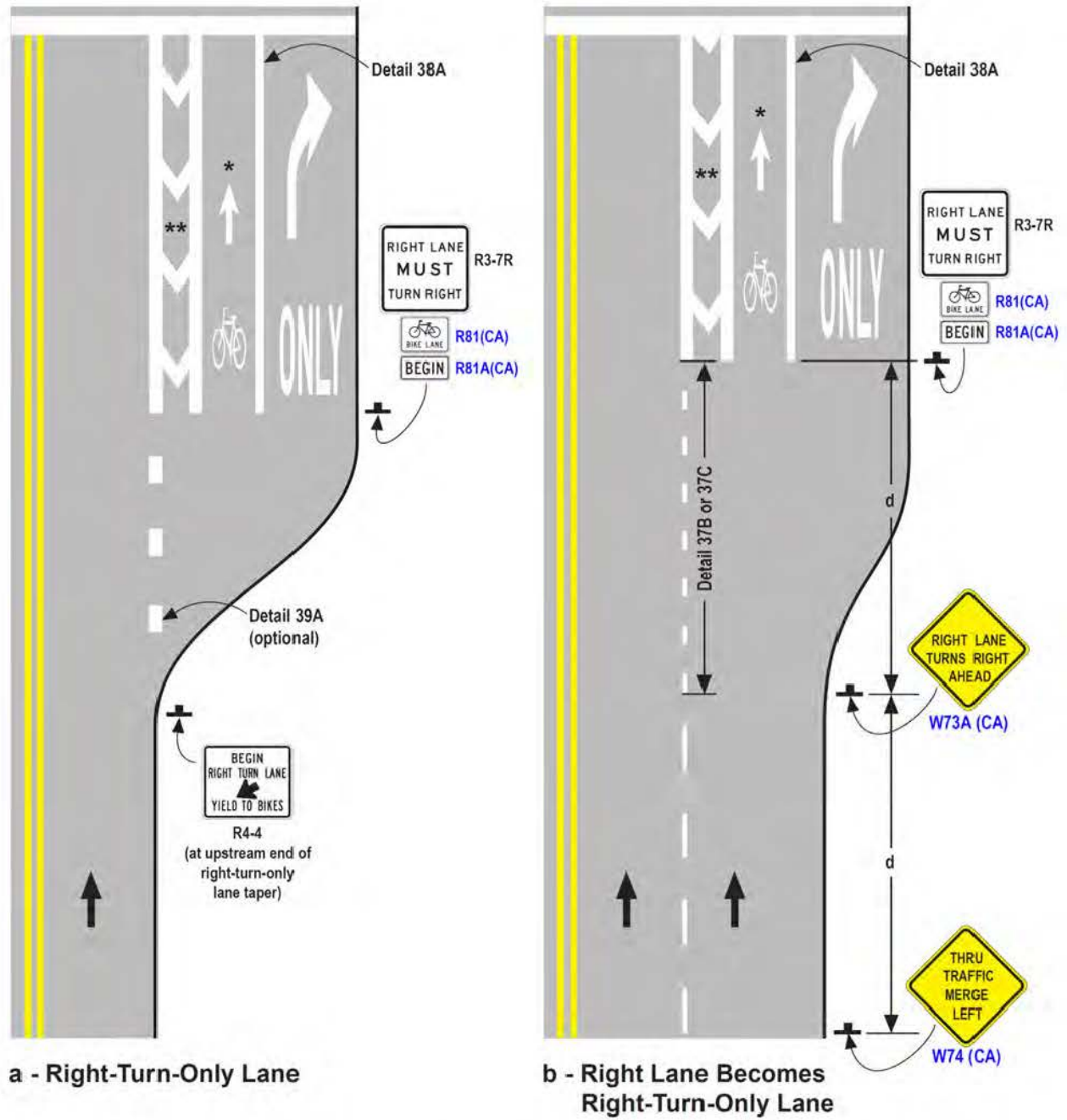


\* 4 ft minimum width,  
 6 ft minimum width for posted speed greater than 40 mph  
 d = Advance Placement Distance (See Section 2C.05)

**LEGEND**

➔ Direction of Travel      NOT TO SCALE

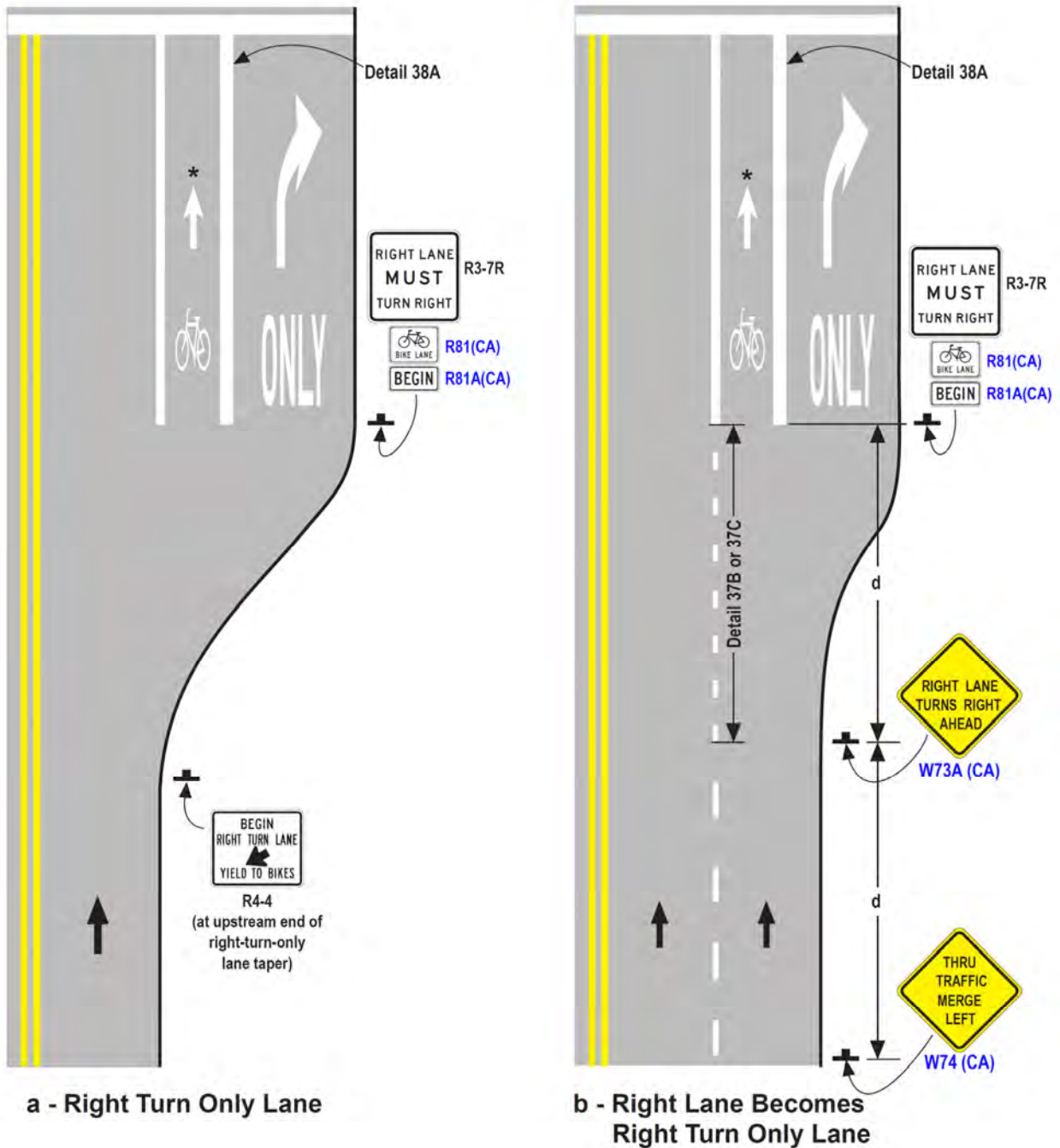
**Figure 9C-4 (CA). Example of Bicycle Lane Treatment at a Right Turn Only Lane, Posted Speed > 40 mph (Sheet 2 of 3)**



\* 4 ft minimum width  
 \*\* 2 ft (minimum 18 in) buffered area may be striped on the left or on the right within the space for bicycle use  
 d = Advance Placement Distance (See Section 2C.05)

**LEGEND**  
 → Direction of Travel      NOT TO SCALE

**Figure 9C-4 (CA). Example of Bicycle Lane Treatment at a Right Turn Only Lane, Posted Speed ≤ 40 mph (Sheet 3 of 3)**

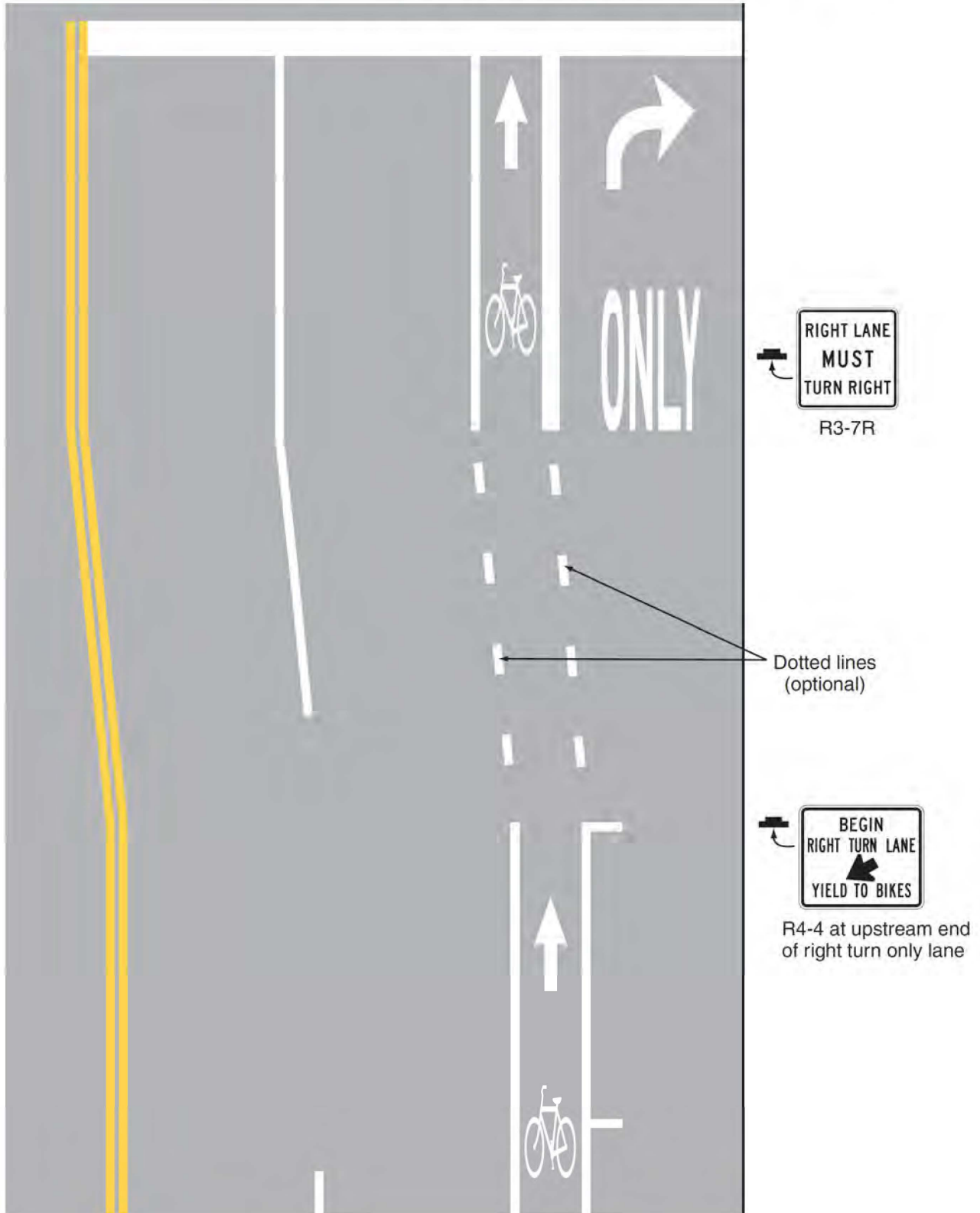


\* 4 ft minimum width  
 d = Advance Placement Distance (See Section 2C.05)

**LEGEND**

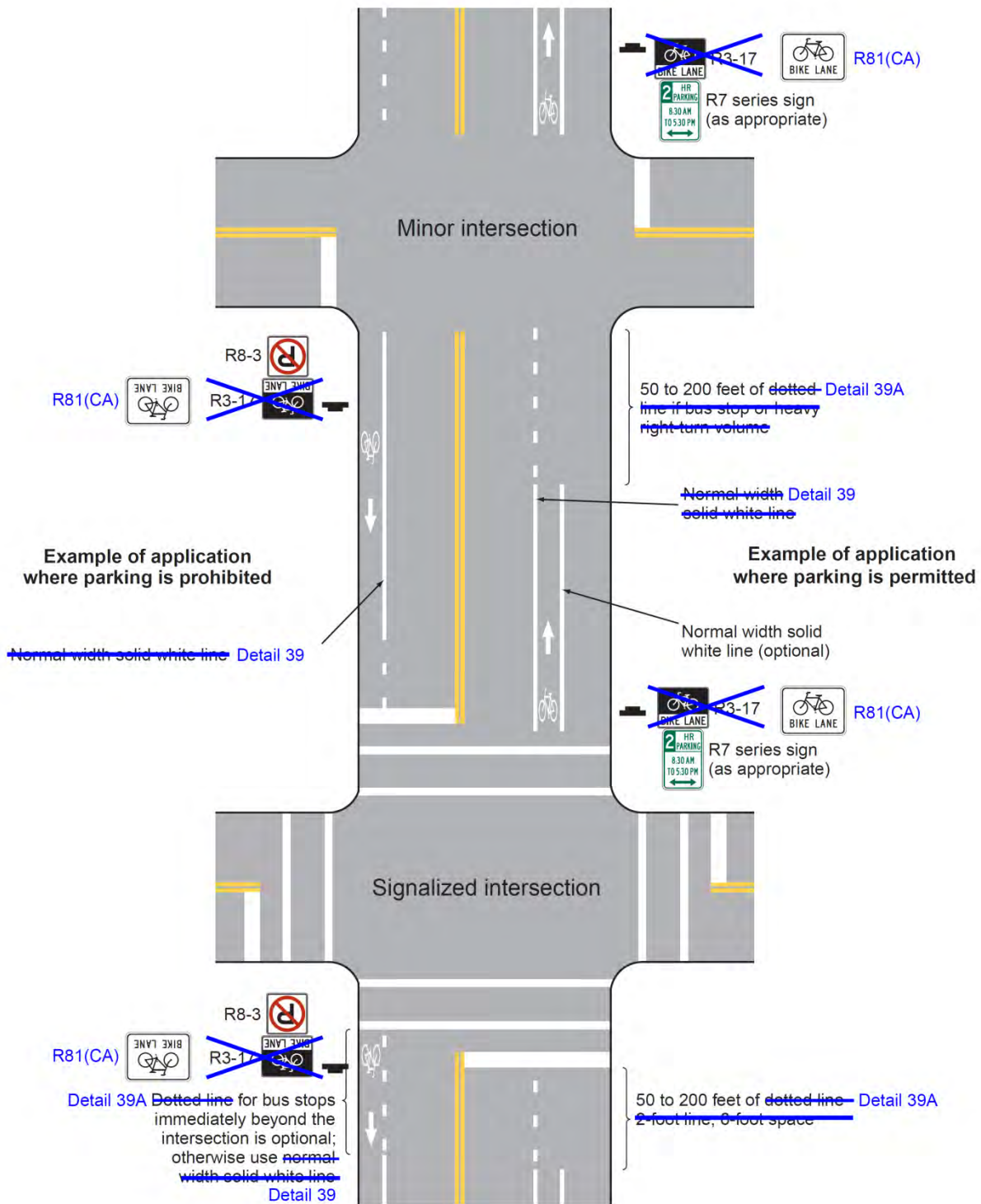
➔ Direction of Travel      NOT TO SCALE

**Figure 9C-5. Example of Bicycle Lane Treatment at Parking Lane into a Right Turn Only Lane**

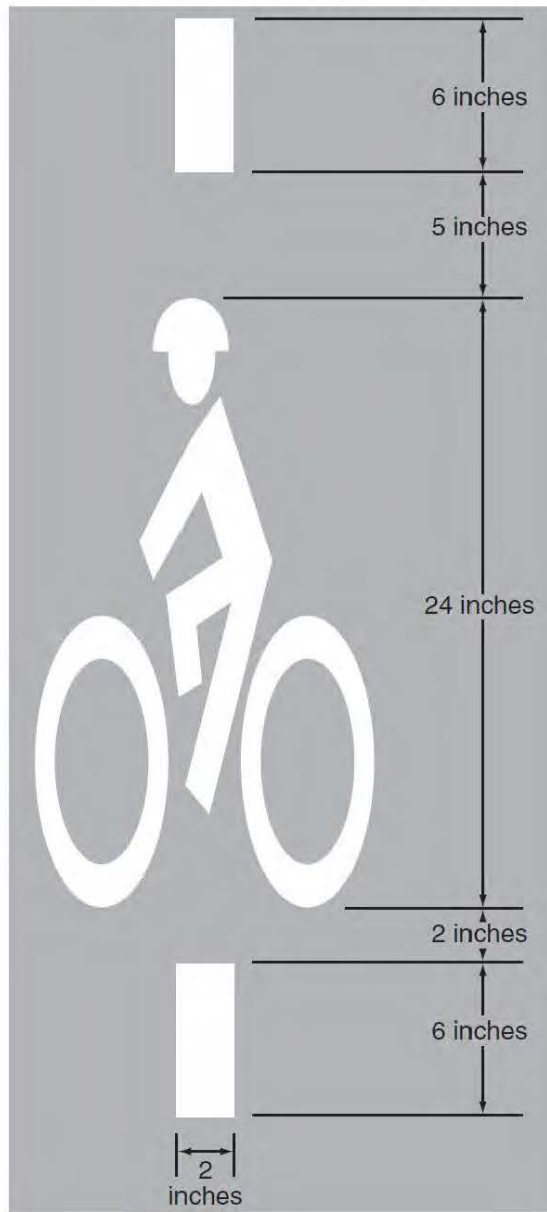




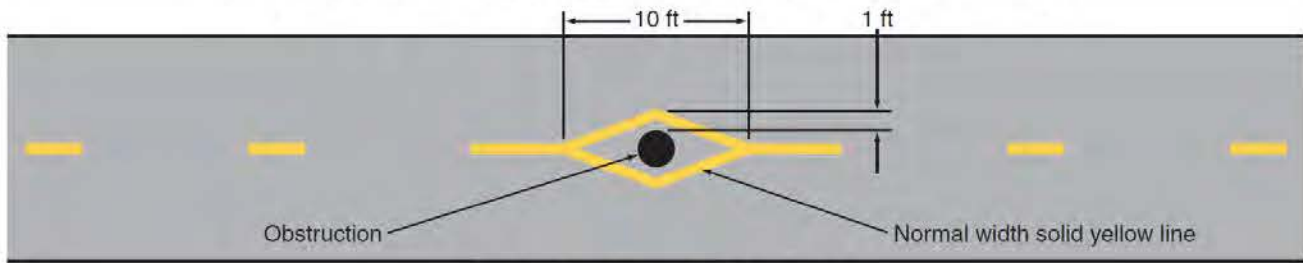
**Figure 9C-6. Example of Pavement Markings for Bicycle Lanes on a Two-Way Street**



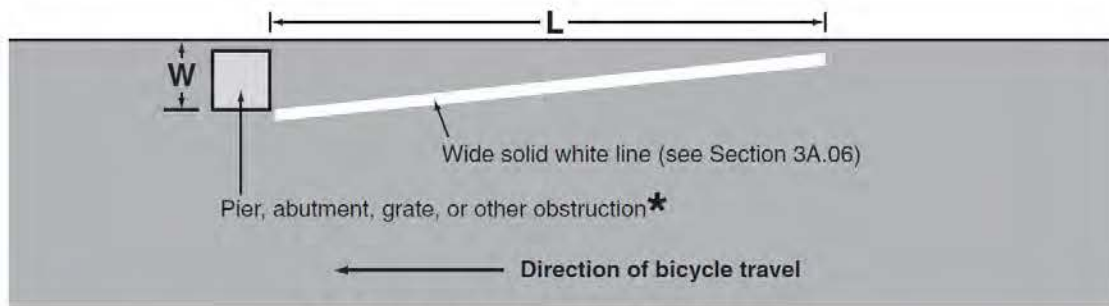
**Figure 9C-7. Bicycle Detector Pavement Marking**



**Figure 9C-8. Examples of Obstruction Pavement Markings**



**A - Obstruction within the path**

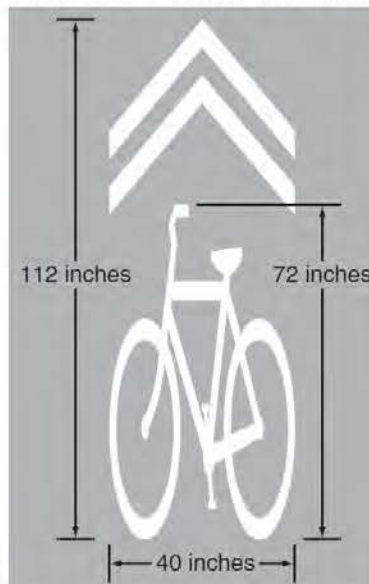


**B - Obstruction at edge of path or roadway**

$L = WS$ , where  $W$  is the offset in feet and  $S$  is bicycle approach speed in mph

\* Provide an additional foot of offset for a raised obstruction and use the formula  $L = (W+1) S$  for the taper length

**Figure 9C-9. Shared Lane Marking**

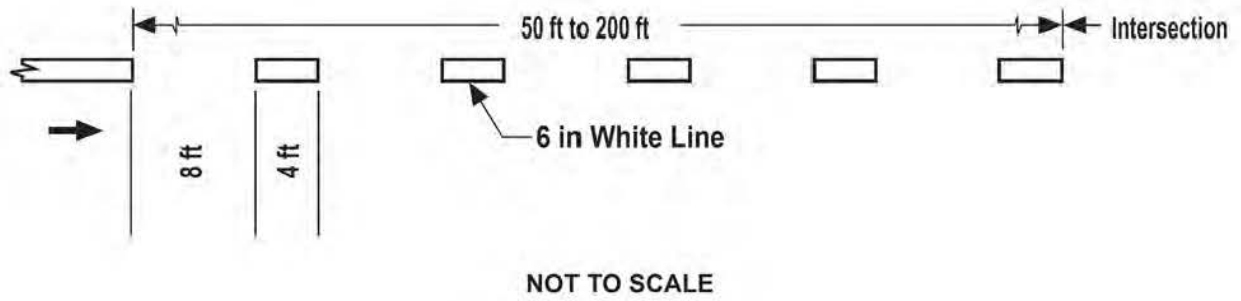


**Figure 9C-101 (CA). Marking Details for Bicycle Lanes**

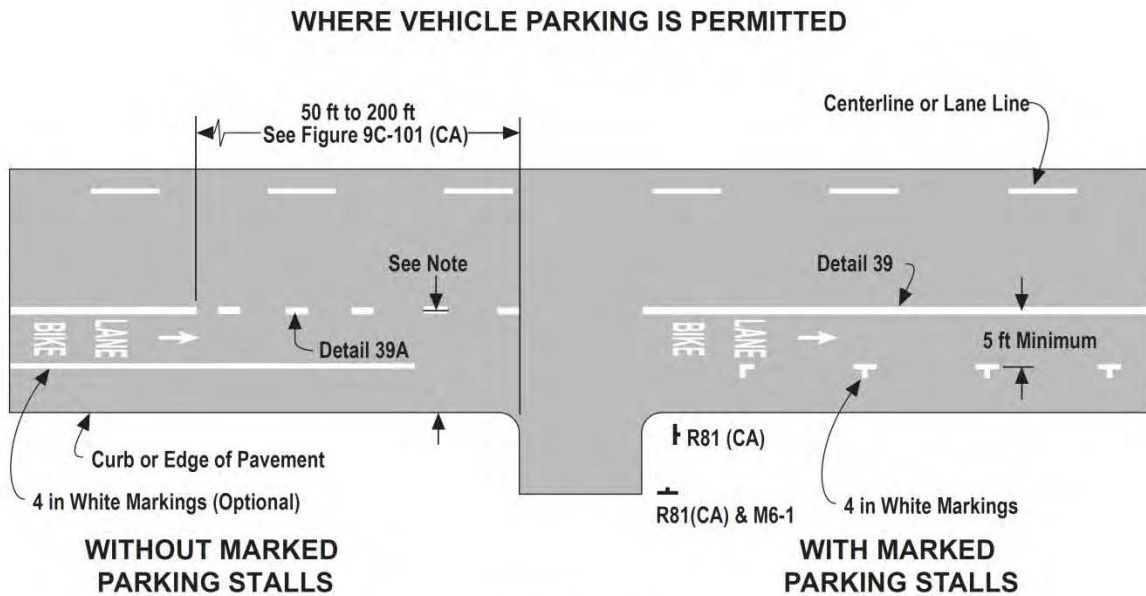
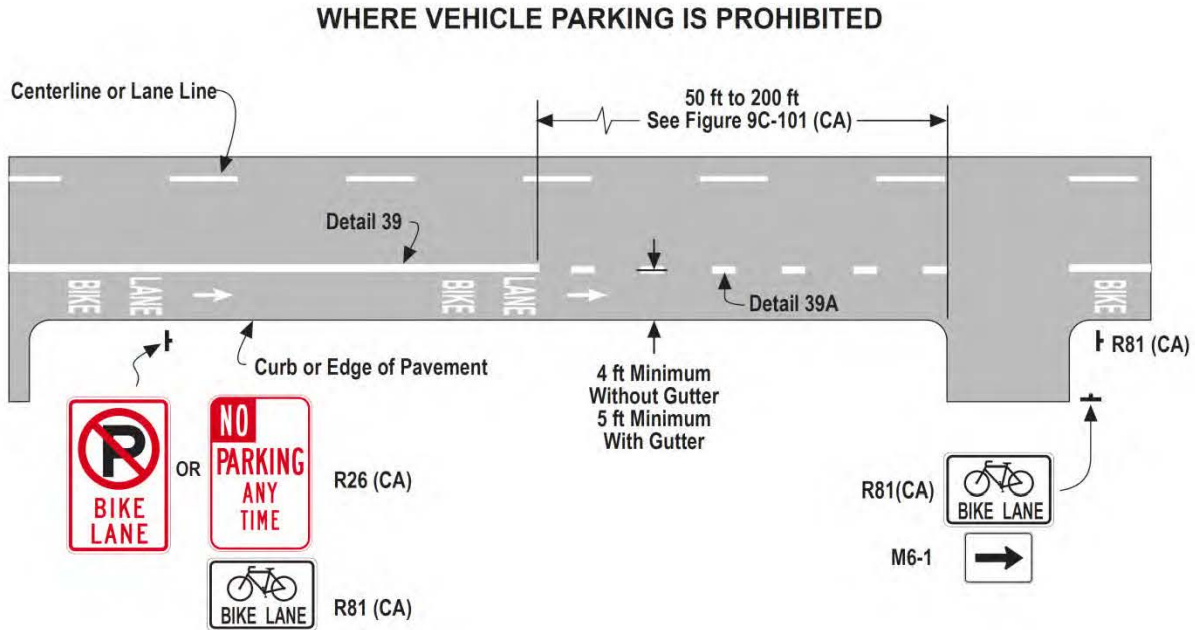
**DETAIL 39 - Bike Lane Line**



**DETAIL 39A - Bike Lane Intersection Line**



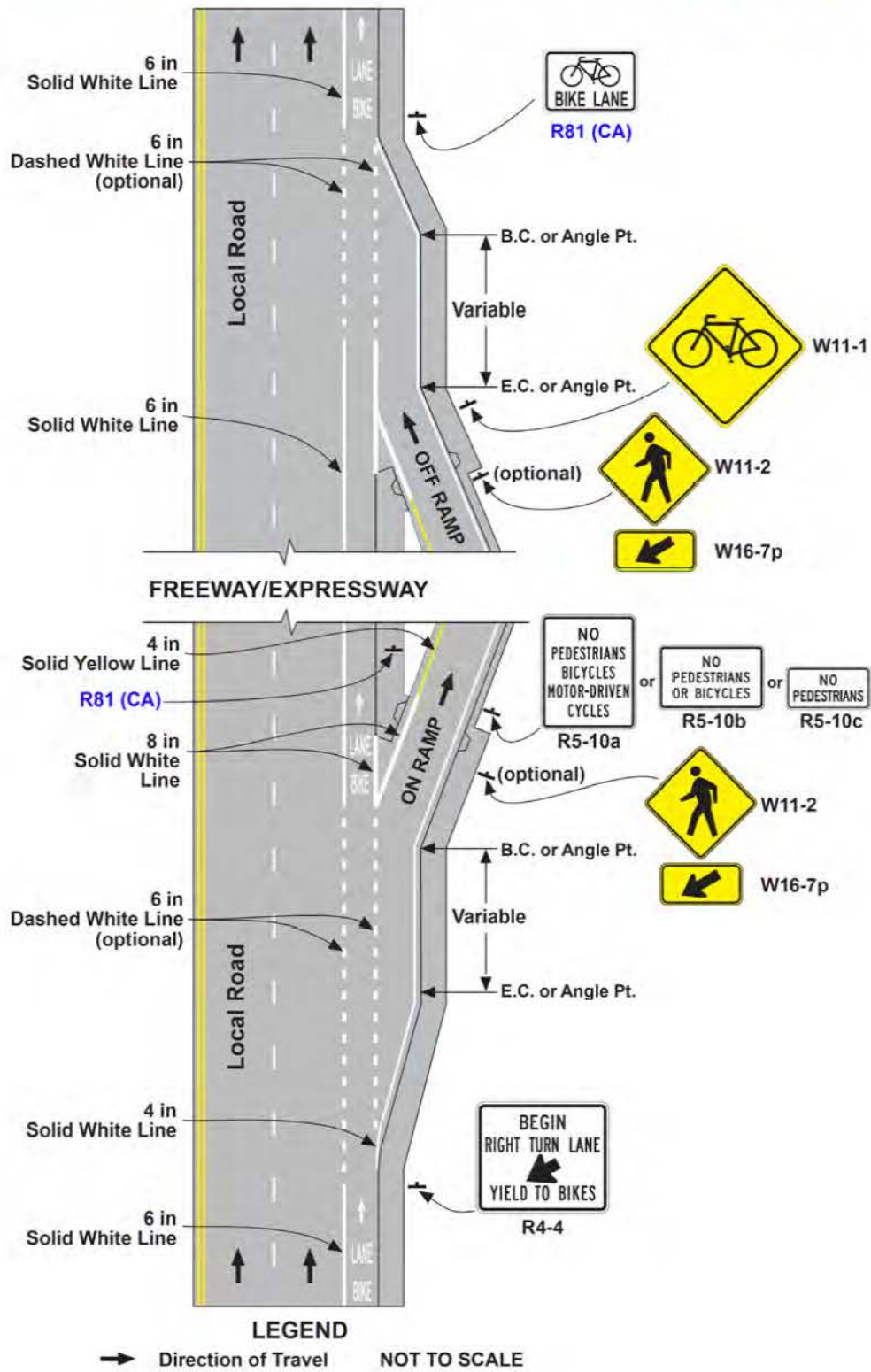
**Figure 9C-102 (CA). Examples of Bicycle Lane Treatment Where Vehicle Parking is Prohibited/Permitted**



NOT TO SCALE

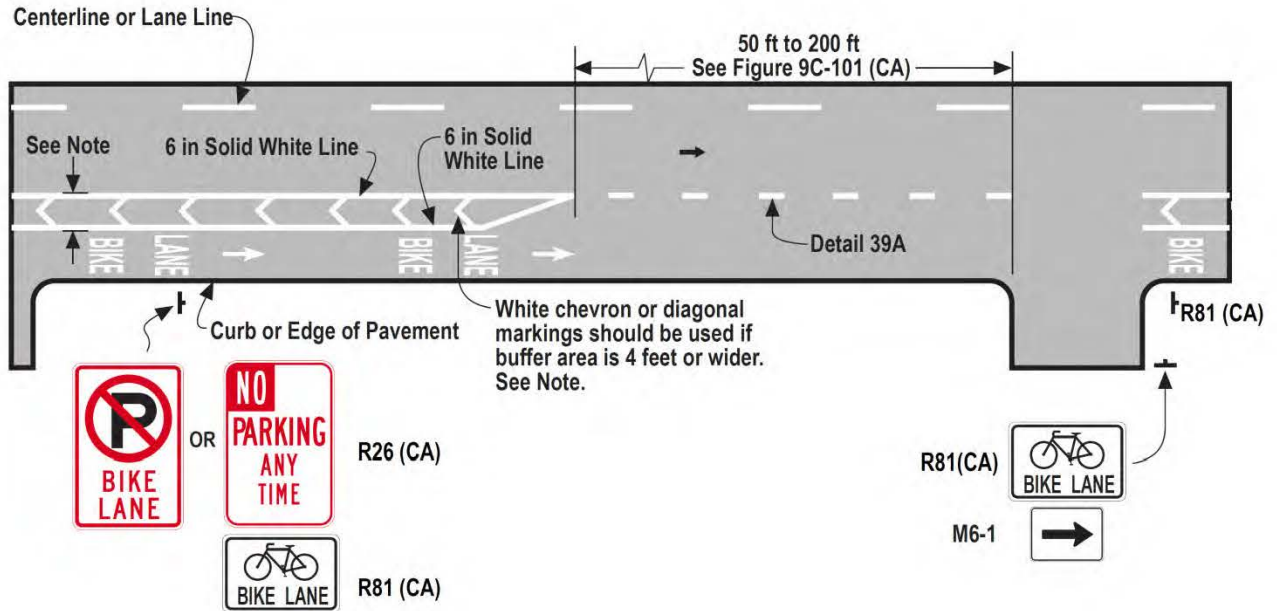
NOTE: 11 ft Minimum for Rolled Curb  
 12 ft Minimum for Vertical Curb

**Figure 9C-103 (CA). Example of Bicycle Lane Treatment Through an Interchange**

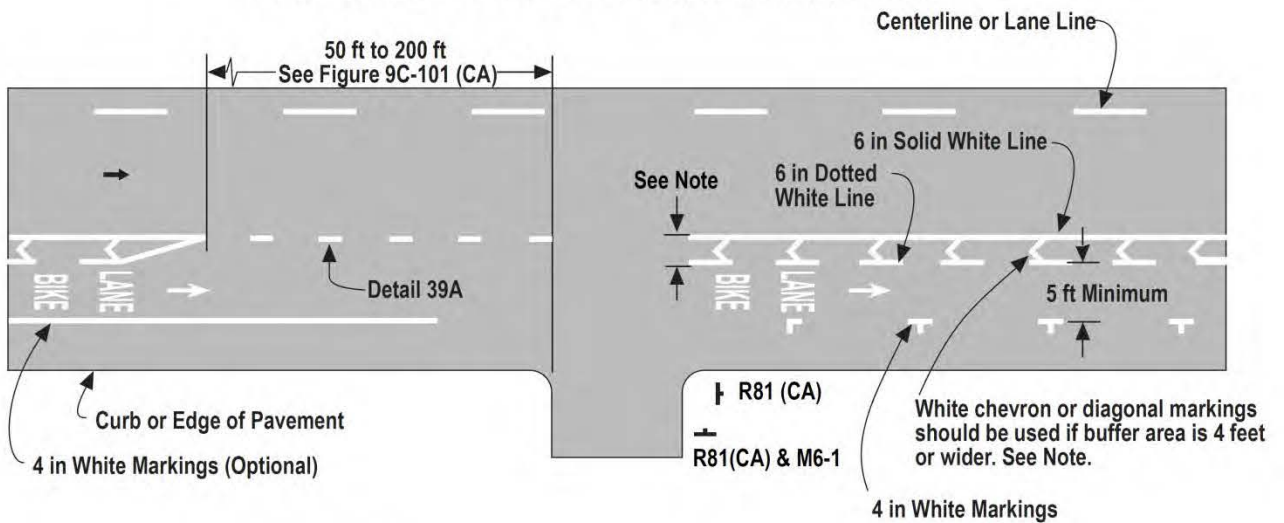


**Figure 9C-104(CA). Examples of Markings for Buffered Bicycle Lanes Where Vehicle Parking is Prohibited/Permitted (Sheet 1 of 2)**

**BUFFER BETWEEN BICYCLE LANE AND GENERAL PURPOSE LANE WHERE VEHICLE PARKING IS PROHIBITED**



**BUFFER BETWEEN BICYCLE LANE AND GENERAL PURPOSE LANE WHERE VEHICLE PARKING IS PERMITTED**



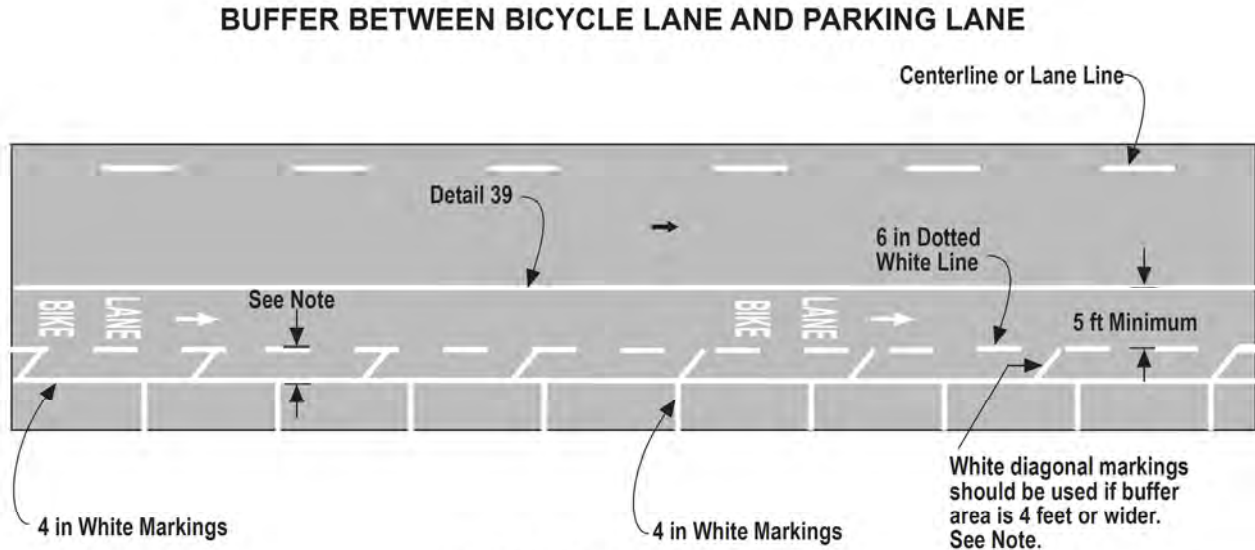
**WITHOUT MARKED PARKING STALLS**

**WITH MARKED PARKING STALLS**

NOT TO SCALE

Note: 18 in Minimum for Buffered Area Width. The Buffer Area Width includes the width of the parallel White Lines

**Figure 9C-104(CA). Examples of Markings for Buffered Bicycle Lanes Where Vehicle Parking is Prohibited/Permitted (Sheet 2 of 2)**

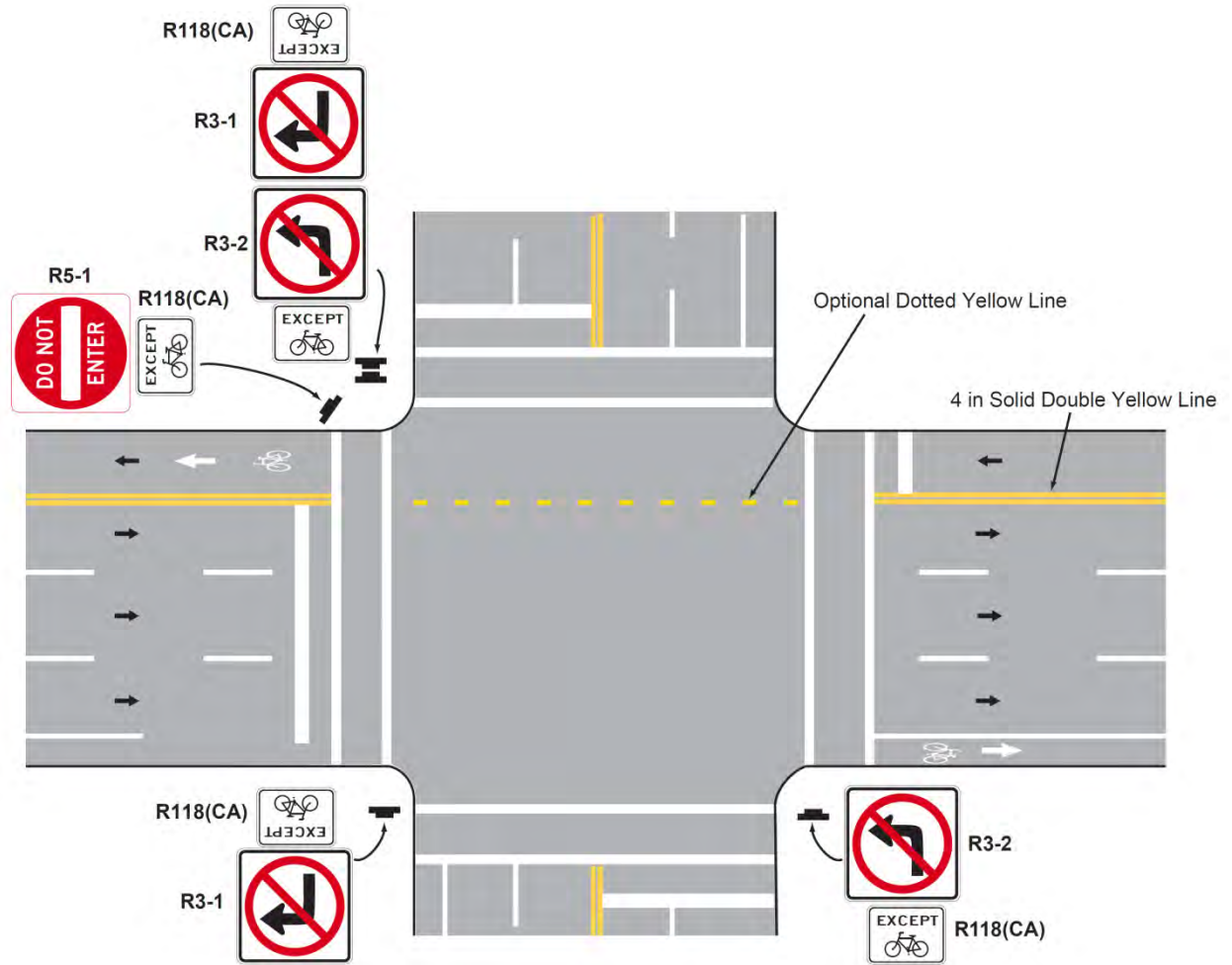


NOT TO SCALE

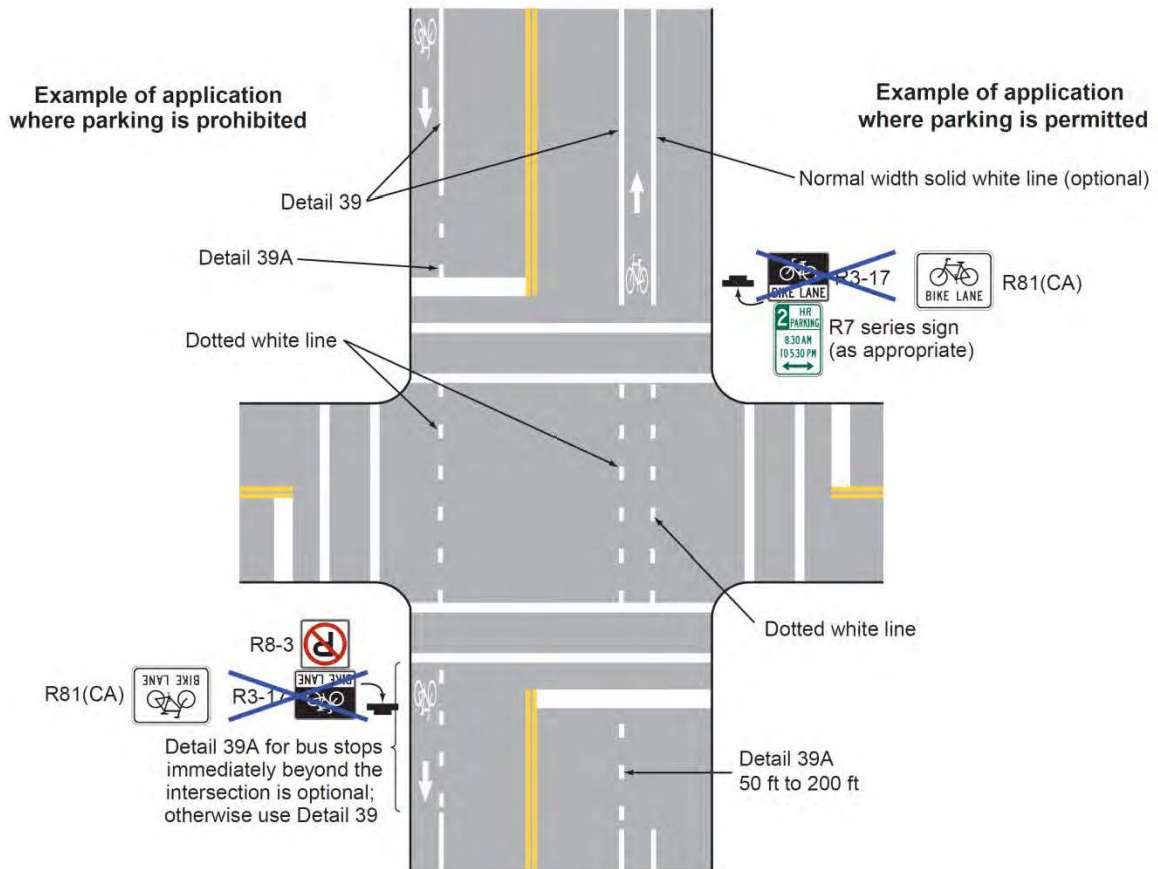
**Note: 18 in Minimum for Buffered Area Width. The Buffer Area Width includes the width of the parallel White Lines.**



**Figure 9C-105 (CA). Example of Contraflow Bicycle Lanes**

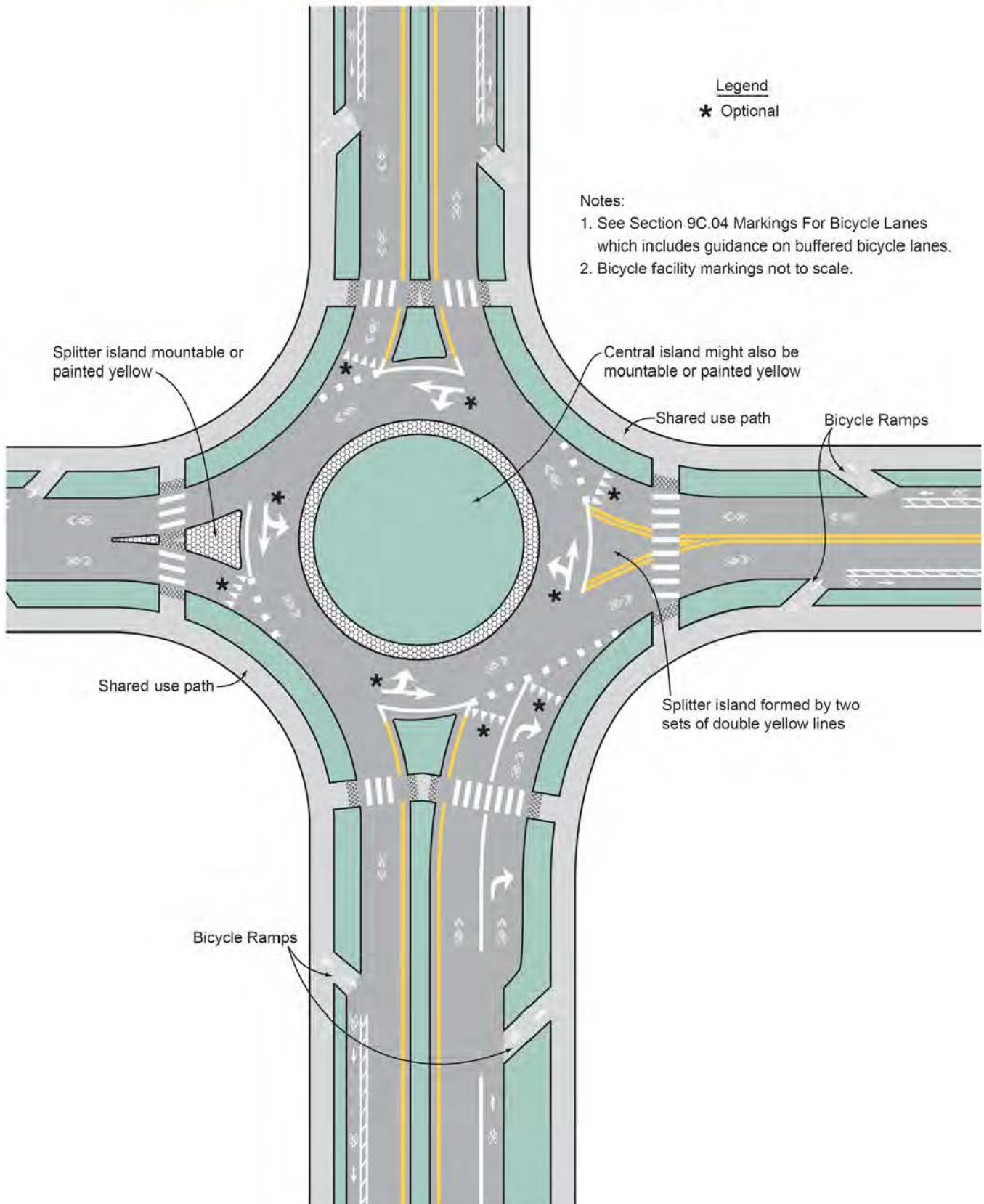


**Figure 9C-106(CA). Examples of Bicycle Lane Extensions Through an Intersection**

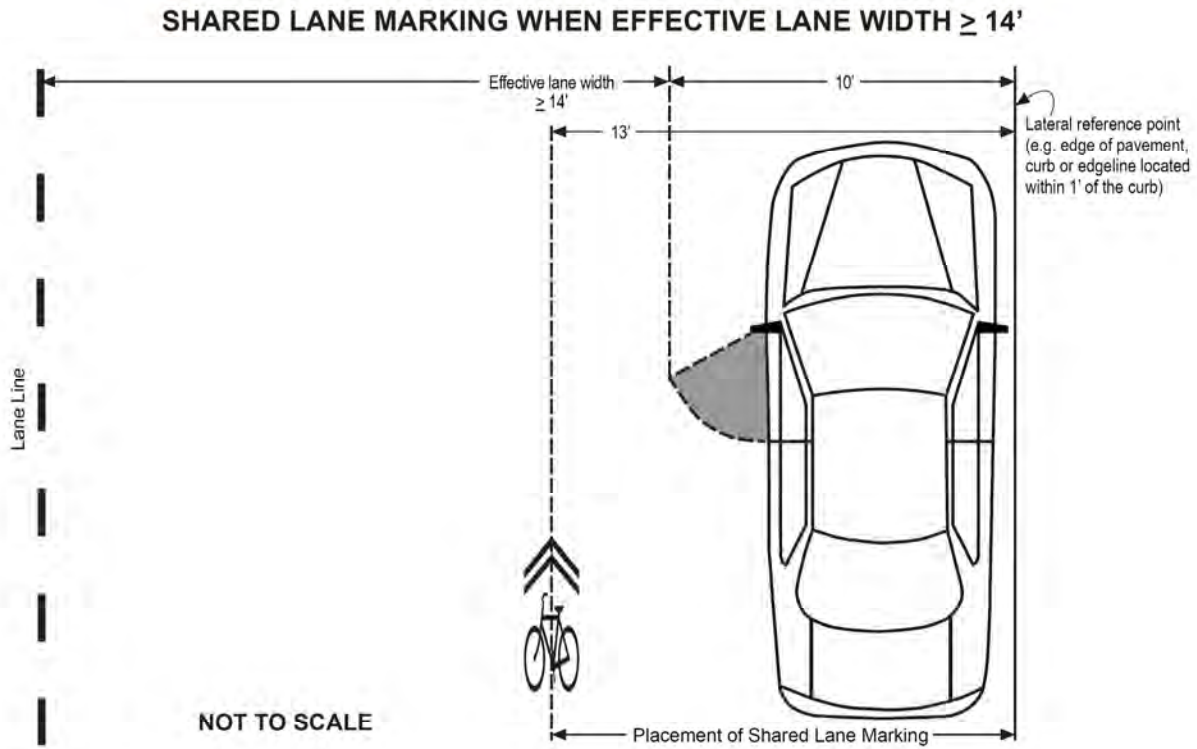


NOT TO SCALE

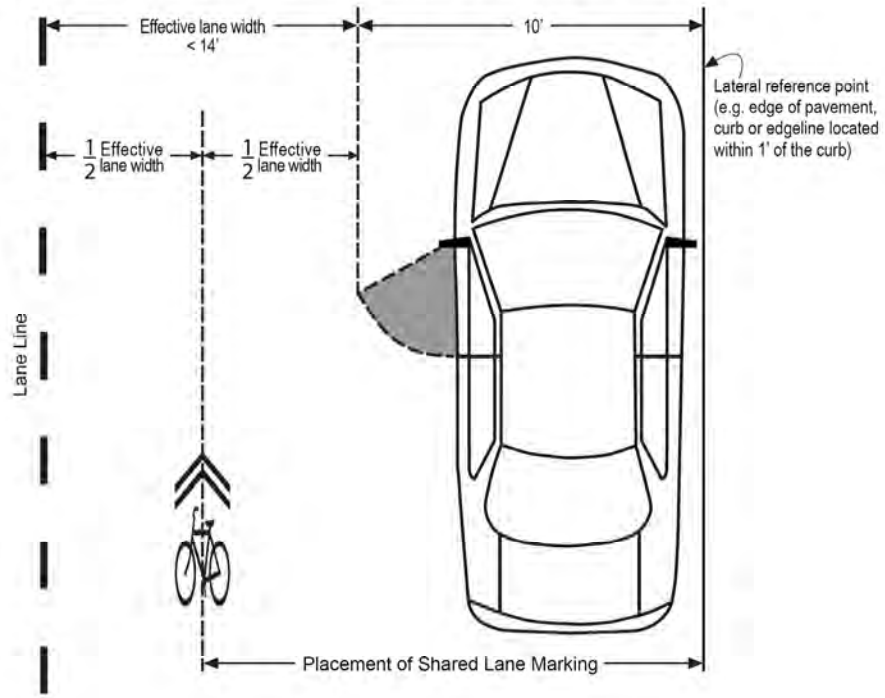
**Figure 9C-107 (CA). Example of Marking for a One-Lane Roundabout with Shared Lane Markings and Bicycle Lanes**



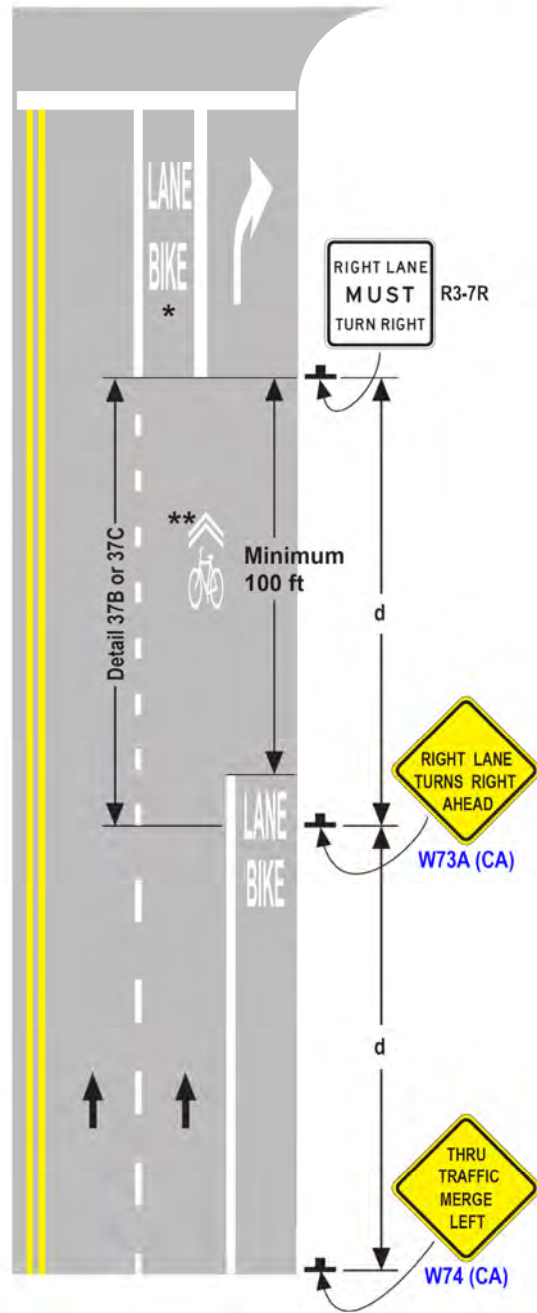
**Figure 9C-108 (CA). Example of Placement of Shared Lane Markings**



**SHARED LANE MARKING WHEN EFFECTIVE LANE WIDTH  $< 14'$**



**Figure 9C-109 (CA). Example of Shared Lane Marking While Approaching an Intersection**

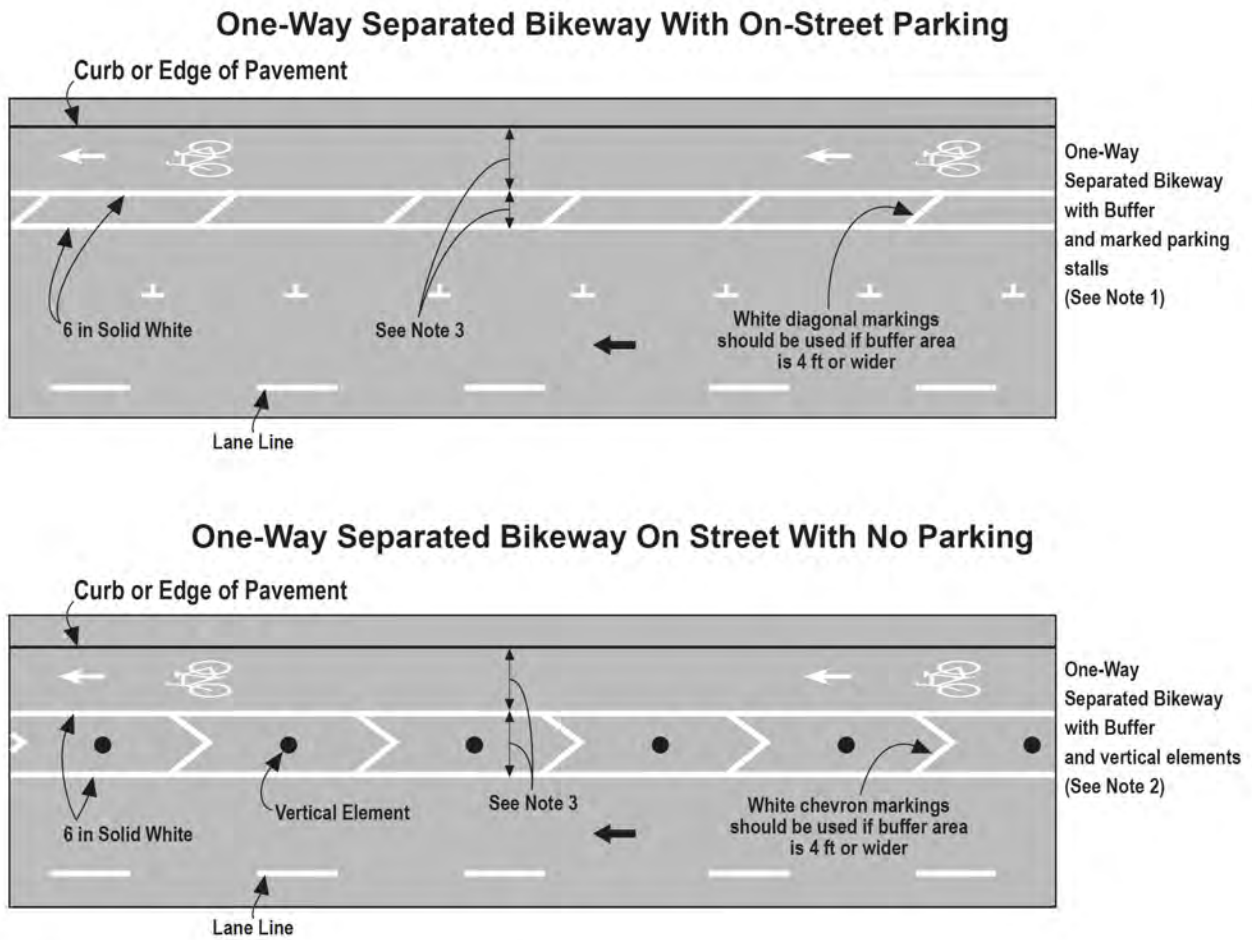


\* 4 ft minimum width, 6 ft minimum width for posted speed greater than 40 mph.  
 \*\* The shared lane markings are appropriate to assist bicyclists with positioning, with or without a bicycle lane at the intersection. More than one shared lane marking may be placed.  
 d = Advance Placement Distance (See Section 2C.05)

**LEGEND**

➔ Direction of Travel      NOT TO SCALE

**Figure 9C-110 (CA). Examples of Markings for Separated Bikeways (Sheet 1 of 2)**

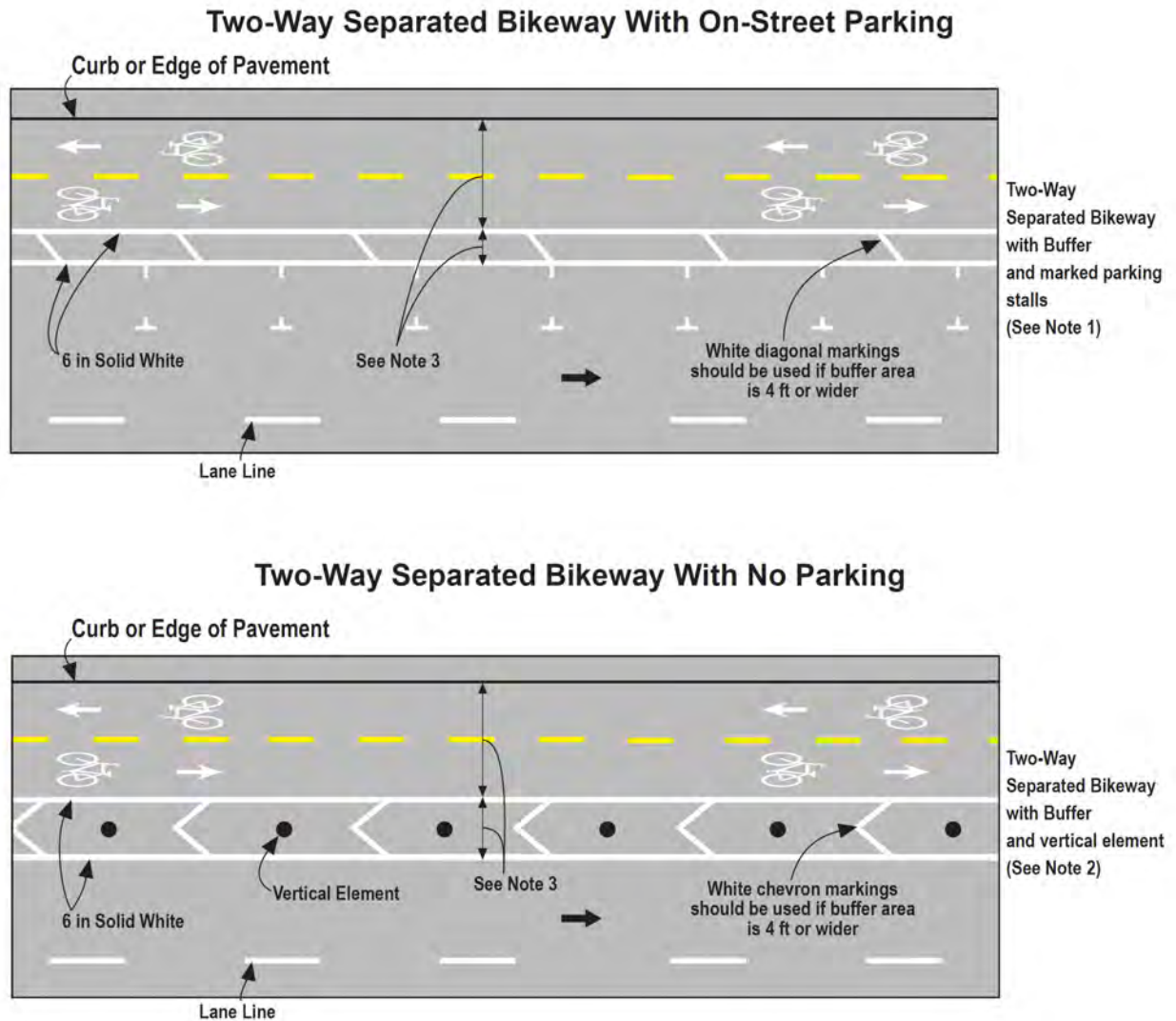


NOT TO SCALE

**NOTES:**

1. See Figure 3B-21(CA) for examples of parking space markings.
2. Vertical elements in the buffer are an important separation feature of the Separated Bikeway. These may include grade separation, flexible posts, inflexible physical barriers, or on-street parking. See DIB 89 for more information.
3. See DIB 89 for separated bikeway width and buffer width.

**Figure 9C-110 (CA). Examples of Markings for Separated Bikeways (Sheet 2 of 2)**



NOT TO SCALE

**NOTES:**

1. See Figure 3B-21(CA) for examples of parking space markings.
2. Vertical elements in the buffer are an important separation feature of the Separated Bikeway. These may include grade separation, flexible posts, inflexible physical barriers, or on-street parking. See DIB 89 for more information.
3. See DIB 89 for separated bikeway width and buffer width.





## CHAPTER 9D. SIGNALS

### Section 9D.01 Application

**Support:**

01 Part 4 contains information regarding signal warrants and other requirements relating to signal installations.

**Option:**

02 For purposes of signal warrant evaluation, bicyclists may be counted as either vehicles or pedestrians.

**Support:**

03 Also refer Part 4 of this Manual for highway traffic signals, in particular:

- A. Section 4D.104(CA) – Optional Use of Bicycle Signal Faces.
- B. Section 4D.105(CA) – Bicycle Detectors.

### Section 9D.02 Signal Operations for Bicycles

**Standard:**

01 **At installations where visibility-limited signal faces are used, signal faces shall be adjusted so bicyclists for whom the indications are intended can see the signal indications. If the visibility-limited signal faces cannot be aimed to serve the bicyclist, then separate signal faces shall be provided for the bicyclist.**

02 **On bikeways, signal timing and actuation shall be reviewed and adjusted to consider the needs of bicyclists.**



# Appendices



## APPENDIX A1 CONGRESSIONAL LEGISLATION

### **PUBLIC LAW 102-240-DEC. 18, 1991 (INTERMODAL SURFACE TRANSPORTATION EFFICIENCY ACT OF 1991)**

**Section 1077. REVISION OF MANUAL** — Not later than 90 days after the date of the enactment of this Act, the Secretary shall revise the Manual of Uniform Traffic Control Devices and such other regulations and agreements of the Federal Highway Administration as may be necessary to authorize States and local governments, at their discretion, to install stop or yield signs at any rail-highway grade crossing without automatic traffic control devices with 2 or more trains operating across the rail-highway grade crossing per day.

### **PUBLIC LAW 102-388-OCT. 6, 1992 (DEPARTMENT OF TRANSPORTATION AND RELATED AGENCIES APPROPRIATIONS ACT, 1993)**

**Section 406** — The Secretary of Transportation shall revise the Manual of Uniform Traffic Control Devices to include —

- (a) a standard for a minimum level of retroreflectivity that must be maintained for pavement markings and signs, which shall apply to all roads open to public travel; and
- (b) a standard to define the roads that must have a centerline or edge lines or both, provided that in setting such standard the Secretary shall consider the functional classification of roads, traffic volumes, and the number and width of lanes.

### **PUBLIC LAW 104-59-NOV. 28, 1995 (NATIONAL HIGHWAY SYSTEM DESIGNATION ACT OF 1995)**

**Section 205. RELIEF FROM MANDATES** —

(c) METRIC REQUIREMENTS —

- (1) PLACEMENT AND MODIFICATION OF SIGNS — The Secretary shall not require the States to expend any Federal or State funds to construct, erect, or otherwise place or to modify any sign relating to a speed limit, distance, or other measurement on a highway for the purpose of having such sign establish such speed limit, distance, or other measurement using the metric system.
- (2) OTHER ACTIONS — Before September 30, 2000, the Secretary shall not require that any State use or plan to use the metric system with respect to designing or advertising, or preparing plans, specifications, estimates, or other documents, for a Federal-aid highway project eligible for assistance under title 23, United States Code.
- (3) DEFINITIONS — In this subsection, the following definitions apply:
  - (A) HIGHWAY — The term ‘highway’ has the meaning such term has under section 101 of title 23, United States Code.
  - (B) METRIC SYSTEM — the term ‘metric system’ has the meaning the term ‘metric system of measurement’ has under section 4 of the Metric Conversion Act of 1975 (15 U.S.C. 205c).

**Section 306. MOTORIST CALL BOXES** — Section 111 of title 23, United States Code, is amended by adding at the end the following:

(c) MOTORIST CALL BOXES —

- (1) IN GENERAL — Notwithstanding subsection (a), a State may permit the placement of motorist call boxes on rights-of-way of the National Highway System. Such motorist call boxes may include the identification and sponsorship logos of such call boxes.
- (2) SPONSORSHIP LOGOS —
  - (A) APPROVAL BY STATE AND LOCAL AGENCIES — All call box installations displaying sponsorship logos under this subsection shall be approved by the highway agencies having jurisdiction of the highway on which they are located.
  - (B) SIZE ON BOX — A sponsorship logo may be placed on the call box in a dimension not to exceed the size of the call box or a total dimension in excess of 12 inches by 18 inches.
  - (C) SIZE ON IDENTIFICATION SIGN — Sponsorship logos in a dimension not to exceed 12 inches by 30 inches may be displayed on a call box identification sign affixed to the call box post.
  - (D) SPACING OF SIGNS — Sponsorship logos affixed to an identification sign on a call box post may be located on the rights-of-way at intervals not more frequently than 1 per every 5 miles.

- (E) DISTRIBUTION THROUGHOUT STATE — Within a State, at least 20 percent of the call boxes displaying sponsorship logos shall be located on highways outside of urbanized areas with a population greater than 50,000.
- (3) NONSAFETY HAZARDS — The call boxes and their location, posts, foundations, and mountings shall be consistent with requirements of the Manual on Uniform Traffic Control Devices or any requirements deemed necessary by the Secretary to assure that the call boxes shall not be a safety hazard to motorists.

**Section 353(a) SIGNS** — Traffic control signs referred to in the experimental project conducted in the State of Oregon in December 1991 shall be deemed to comply with the requirements of Section 2B-4 of the Manual on Uniform Traffic Control Devices of the Department of Transportation.

**Section 353(b) STRIPES** — Notwithstanding any other provision of law, a red, white, and blue center line in the Main Street of Bristol, Rhode Island, shall be deemed to comply with the requirements of Section 3B-1 of the Manual on Uniform Traffic Control Devices of the Department of Transportation.

## APPENDIX A2 METRIC CONVERSIONS

Throughout this Manual all dimensions and distances are provided in English units. Tables A2-1 through A2-4 show the equivalent Metric (International System of Units) value for each of the English unit numerical values that are used in this Manual.

**Table A2-1. Conversion of Inches to Millimeters**

| Inches | Millimeters | Inches | Millimeters | Inches | Millimeters | Inches | Millimeters |
|--------|-------------|--------|-------------|--------|-------------|--------|-------------|
| 0.25   | 6           | 3.5    | 87          | 12     | 300         | 36     | 900         |
| 0.4    | 10          | 4      | 100         | 15     | 375         | 42     | 1050        |
| 0.5    | 13          | 4.5    | 113         | 16     | 400         | 48     | 1200        |
| 0.75   | 19          | 5      | 125         | 18     | 450         | 54     | 1350        |
| 1      | 25          | 6      | 150         | 21     | 525         | 60     | 1500        |
| 1.25   | 31          | 8      | 200         | 24     | 600         | 72     | 1800        |
| 2      | 50          | 9      | 225         | 27     | 675         | 84     | 2100        |
| 2.25   | 56          | 10     | 250         | 28     | 700         | 120    | 3000        |
| 2.5    | 62          | 10.4   | 260         | 30     | 750         |        |             |
| 3      | 75          | 10.6   | 265         | 32     | 800         |        |             |

Note: 1 inch = 25.4 millimeters; 1 millimeter = 0.039 inches

**Table A2-2. Conversion of Feet to Meters**

| Feet | Meters | Feet  | Meters | Feet | Meters | Feet  | Meters |
|------|--------|-------|--------|------|--------|-------|--------|
| 1    | 0.3    | 11    | 3.4    | 40   | 12     | 200   | 60     |
| 2    | 0.6    | 12    | 3.7    | 50   | 15     | 250   | 75     |
| 2.5  | 0.75   | 12.75 | 3.9    | 53   | 16     | 300   | 90     |
| 3    | 0.9    | 14    | 4.3    | 60   | 18     | 330   | 100    |
| 3.25 | 1      | 15    | 4.6    | 70   | 21     | 400   | 120    |
| 3.5  | 1.1    | 16    | 4.9    | 72   | 22     | 500   | 150    |
| 4    | 1.2    | 17    | 5.2    | 75   | 23     | 530   | 160    |
| 4.5  | 1.4    | 18    | 5.5    | 80   | 24     | 600   | 180    |
| 4.75 | 1.45   | 19    | 5.8    | 90   | 27     | 650   | 200    |
| 5    | 1.5    | 20    | 6.1    | 95   | 29     | 700   | 210    |
| 5.67 | 1.7    | 22    | 6.7    | 100  | 30     | 750   | 230    |
| 6    | 1.8    | 23.5  | 7.2    | 110  | 34     | 800   | 245    |
| 7    | 2.1    | 25    | 7.6    | 120  | 37     | 1,000 | 300    |
| 8    | 2.4    | 25.6  | 7.8    | 125  | 38     | 1,500 | 450    |
| 9    | 2.7    | 30    | 9      | 130  | 675    | 2,000 | 600    |
| 9.25 | 2.8    | 32    | 9.8    | 140  | 700    | 2,300 | 700    |
| 9.5  | 2.9    | 33    | 10     | 150  | 750    | 3,000 | 900    |
| 10   | 3      | 36    | 11     | 180  | 800    |       |        |

Note: 1 foot = 0.3048 meters; 1 meter = 3.28 feet

**Table A2-3. Conversion of Miles to Kilometers**

| Miles | Kilometers | Miles | Kilometers | Miles | Kilometers | Miles | Kilometers |
|-------|------------|-------|------------|-------|------------|-------|------------|
| 0.25  | 0.4        | 1     | 1.6        | 5     | 8          | 70    | 110        |
| 0.5   | 0.8        | 2     | 3.2        | 10    | 16         |       |            |
| 0.6   | 1          | 3     | 4.8        | 15    | 25         |       |            |

Note: 1 mile = 1.609 kilometers; 1 kilometer = 0.621 miles

**Table A2-4. Conversion of Miles per Hour to Kilometers/Hour**

| mph | km/h | mph | km/h | mph | km/h | mph | km/h |
|-----|------|-----|------|-----|------|-----|------|
| 3   | 5    | 25  | 40   | 45  | 70   | 65  | 105  |
| 10  | 16   | 30  | 50   | 50  | 80   | 65  | 110  |
| 15  | 20   | 35  | 60   | 55  | 90   | 80  | 130  |
| 20  | 30   | 40  | 60   | 60  | 100  |     |      |

Note: 1 mile per hour = 1.609 kilometers/hour; 1 kilometer/hour = 0.621 miles per hour