



CALIFORNIA  
**Highways**  
and Public Works

JULY-AUGUST  
1962

OCCIDENTAL COLLEGE

SEP 24 1982

LIBRARY

# Policy on Scenic Values

A recent study on a proposed scenic highway system made by the Division of Highways to the State Legislature indicated that there is need for classification of the present policy of the division regarding the development of scenic values along the state highway system. Therefore, in addition to the aesthetic design features already contained in the Design Section of its Planning Manual of Instructions, the division has thought it advisable to restate the scenic criteria that should be considered in location and design studies so that potential scenic values will be developed and preserved.

## Basic Precepts

"In any highway, pleasing appearance is a consideration in the planning and design process. Scenic values must be considered along with safety, utility, economy and all the other factors considered in planning and design. This is particularly true of the many portions of the state highway system situated in areas of natural beauty. In such areas, the location of the highway, its alignment and profile, the cross-section design and other related features should be in harmony with the setting. Economy consistent with

traffic needs will always be of paramount importance, although a reasonable additional expenditure can be justified to enhance the beauty of the highway itself.

## Design Speed

"The design speed should be carefully chosen as it is the key element which directly fixes standards for the horizontal alignment and profile of the highway. These requirements in turn directly influence the manner in which the location of the highway blends onto the landscape. Scenic values, particularly in areas of natural scenic beauty, must play a part along with the factors set forth under Index No. 7-101.1 in selecting a design speed.

## Aesthetic Factors

"In a natural scenic environment, consideration should be given to the following factors to insure the most satisfactory results from an aesthetic standpoint.

(a) The location of the highway should be such that the new construction will preserve the natural environment and will lead to and unfold scenic positions.

(b) The general alignment and profile of the highway should fit the character of the area traversed so that unsightly scars of excavation and embankment will be reduced to a minimum. Curvilinear horizontal alignment and a gently rolling profile consistent with design requirements will help to accomplish this.

(c) As an agreeable and natural roadside appearance is essential, the destruction of valuable trees and growth should be avoided if suitable alternative locations are available at reasonable cost.

(d) Whenever feasible wide medians, curvilinear alignment and independent roadways should be provided on multilane facilities as these features add scenic interest and relieve the monotony of parallelism.

(e) Bridges, tunnels and walls merit consideration in lieu of prominent excavation and embankment slopes when costs of such alternatives are not excessive.

(f) Slopes should be flattened whenever practical and ground cover provided so that lines of construction are softened and beautified.

(g) Structures should be located and designed to give the most pleasing appearance.

(h) Scars from material sites should be avoided. Planting in harmony with the surroundings should be undertaken to screen such scars when they are unavoidable.

(i) Drainage appurtenances should be so located that erosion, sumps and debris collection areas are hidden from view or eliminated when the nature of site conditions permits.

(j) Interchange areas should be graded to provide an expanse of naturalistic easy flowing contours. The resulting pleasing appearance can be further enhanced by indigenous growth or by planting a vegetative cover appropriate to the locality."



PHOTO LEFT—US Highway 97 in Siskiyou County looking south with Mount Shasta in the background.

# California Highways and Public Works

Official Journal of the Division of Highways, Department of Public Works, State of California

Vol. 41

July-August 1962

Nos. 7-8

## CONTENTS

	Page
MacArthur Freeway .....	2
By J. B. Watson, Assistant District Engineer, and J. D. Collins, District Construction Engineer	
Hewes Award .....	8
Two-lane Expressways .....	11
Moonlight Ride .....	19
Traffic Engineering Award Presented to the Division .....	20
Traffic Census .....	21
By Thomas N. Tamburri, Assistant Traffic Engineer, and Carroll E. Dunham, Associate Highway Engineer	
Tolls Adopted for New State Bridges .....	28
Central Mix .....	29
By J. O. Kapono, Assistant Highway Engineer	
Final Route Link .....	33
Staff Promotions .....	35
State Launches Broad Motor Vehicle Study .....	36
C. G. Beer and C. T. Ledden Named to New Posts .....	36
Petaluma Bypass .....	37
By James H. Hampton, Right-of-Way Agent	
Illustrated Booklet Explains Road Work .....	44
Reduced Plans .....	45
By Harry Choi, Special Services Highway Engineering Associate	
Full Freeways Now Total 1,000 Miles .....	48
Evaporation Rate .....	49
By Rufus M. Hammond, Assistant Highway Engineer	
Safety Foundation Marks 25th Birthday .....	53
Twenty-five-year List .....	54
Division Exhibits Publications at State Library .....	55
Retirements	
Albert C. Briney .....	54
H. T. Forscher .....	54
Frank F. Green .....	54
Helen Halsted .....	18
A. A. Hilton .....	55
Richard H. Ramsey .....	55
Cass M. Rose .....	52
Department List .....	53
Obituaries	
In Memoriam .....	54

LESTER S. KORITZ, *Editor*

STEWART MITCHELL, *Associate Editor*      JOHN C. ROBINSON, *Associate Editor*

HELEN HALSTED, *Assistant Editor*

WILLIAM R. CHANEY, *Chief Photographer*

*Editors are invited to use information contained herein and to request prints of any black and white photographs.*

Address communications to: *EDITOR,*

**CALIFORNIA HIGHWAYS AND PUBLIC WORKS**

P. O. Box 1499

SACRAMENTO, CALIFORNIA



FRONT COVER—This two-lane section of Highway 29-128 south of Calistoga, in the charming Napa Valley, is a freeway, by legal definition. Access is controlled, and provision has been made for an eventual four lanes. See "Two-Lane Expressways," page 11. (Photo by John Meyerpeter.)

BACK COVER—The Golden State Freeway in Los Angeles looking south from the Griffith Park Road Overcrossing shows the kind of road the average person thinks of when the name "freeway" is mentioned. (Photo by Bob Dunn.)



# MacArthur Freeway

By J. B. WATSON, Assistant District Engineer and  
J. D. COLLINS, District Construction Engineer



DISTRICT  
IV

Since February, 1960 construction has been underway on MacArthur Freeway, a 15.3 mile section of US 50 (Interstate 5W) between the Bay Bridge Distribution Structure and

Route 228 at Castro Valley.

On May 15, 1962, Robert B. Bradford, State Director of Public Works and Chairman of the California Highway Commission and County Supervisor Francis Dunn, Chairman of the Alameda County Highway Advisory Committee, cut the ribbon to open the first 2.6 mile section of the MacArthur Freeway between the distribution

structure and Grand Avenue in Oakland.

In a previous issue of CH&PW (March-April 1960), the planning, design and right-of-way aspects of this freeway were discussed and it was revealed that borrow and excavation projects on several contracts in this metropolitan area were to be combined in order to effect an overall savings in the construction of freeway embankments. The extent to which this program has been carried out, to an even greater degree than contemplated, is discussed in the following paragraphs.

#### Three Contracts

This first section of the MacArthur Freeway opened to the public was the culmination of construction under

three contracts at a total cost of approximately \$11,596,000. Of the six remaining contracts in the entire freeway, two are now under construction, two are included in the current budget and two yet remain to be budgeted.

Contractors for the first three completed units were C. K. Moseman & Son, Guy F. Atkinson and Peter Kiewit Sons Co., respectively.

The first project, from the Bay Bridge Distribution Structure to Market Street, included revisions and additions to the distribution structure, construction of on- and off-ramps to the existing MacArthur Boulevard and construction of the freeway to San Pablo Avenue. Major structural work involved the construction of six retaining walls, averaging 15 feet in height and totaling 1,500 feet in length; 1,435 feet of widening and 490 feet of extension to the existing distribution structure; the MacArthur Boulevard Undercrossing and the Adeline Street Undercrossing, consisting of two parallel reinforced concrete box girder bridges approximately 1,100 feet long. A record pour of 740 yards of concrete in 13 hours was made while constructing this bridge.

Complicating the project, all four lanes of heavy traffic on US 50 had to be moved through the construction area, involving five intricate stages of traffic shifts and stage construction to accomplish this.

#### Demolition Required

One of these stages required the demolition and removal of over 400 feet of the existing distribution structure, and with timing an important factor, the crane and headache ball were at work knocking the bridge

---

*Looking westward over the recently completed portion of the MacArthur Freeway between Grand Avenue and the Distribution Structure. Overcrossing in the foreground is MacArthur Boulevard.*



# MAC ARTHUR FREEWAY

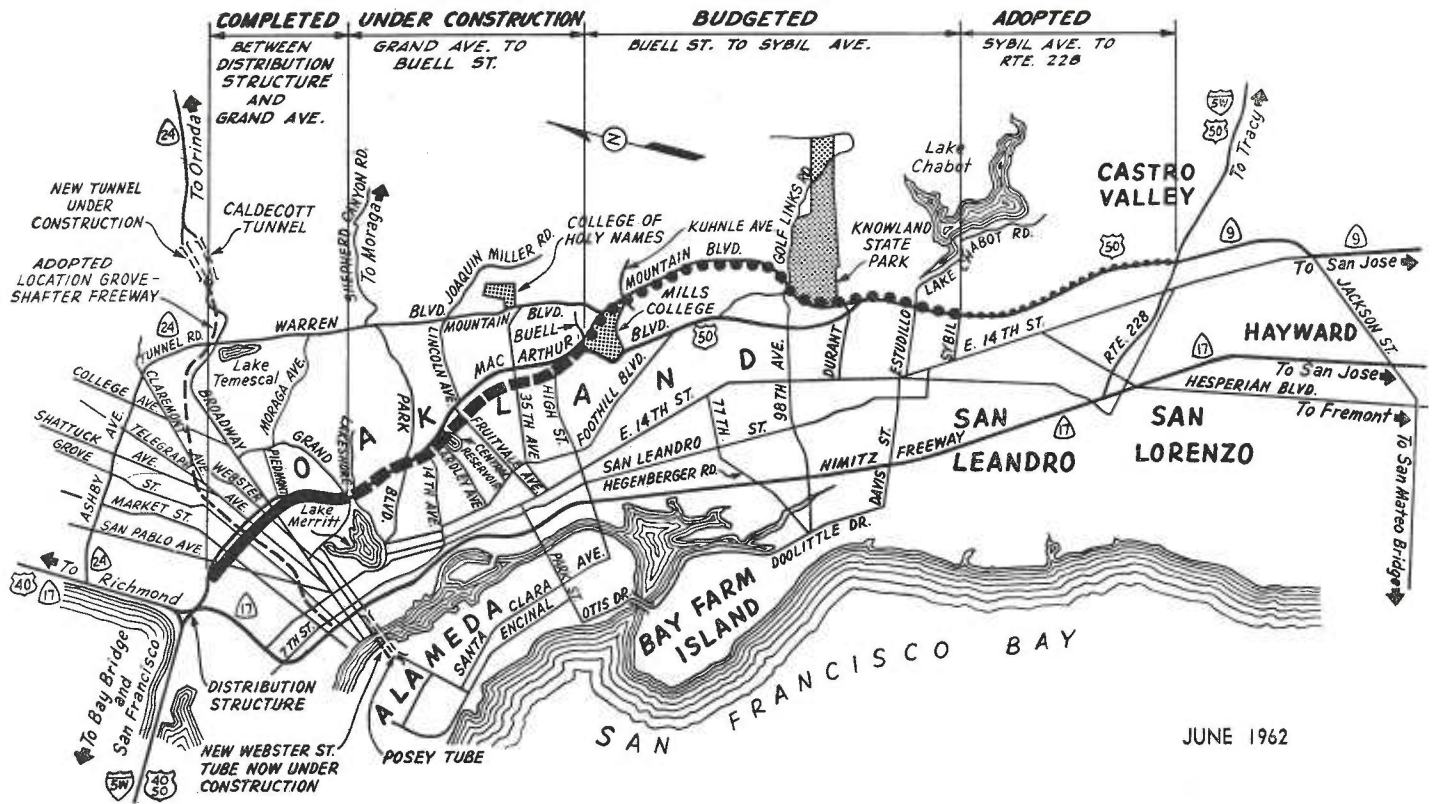

This map shows the current status of construction on the MacArthur Freeway.

down within five minutes after traffic was routed off the structure.

The MacArthur Boulevard Undercrossing is on a 65° skew from the usual freeway crossing, resulting in an unusual structure as indicated in the accompanying illustrations.

The 145,000 cubic yards of imported borrow required for this contract was to be obtained at the east portal site of the third bore of the Caldecott Tunnel east of Oakland on State Route 24. Due to the stage construction previously mentioned, all of this borrow was not needed during the first stage which was completed during May 1960. The remainder of the borrow was not required until later stages of work beginning in June 1961, and continuing, as it developed, until the end of January 1962.

In the meantime, however, the contract for the tunnel was awarded sooner than expected, and the tunnel contractor was to excavate and stockpile the borrow since it was necessary to have the portal area excavated before the material was needed on the



Westbound US 50 traffic is routed over the completed Lake Park overcrossing during construction.



Heavy traffic on MacArthur Boulevard in Oakland looking west from the Broadway intersection before completion of the freeway.



MacArthur Freeway in Oakland shortly after its completion. Broadway passes under the freeway by the building with the clock tower.

first MacArthur Freeway contract. Instead of resorting to this stockpiling, however, it was decided that the balance of the imported borrow could be more economically obtained from other sources, and as indicated later in this article, was finally obtained from a state-furnished stockpile on rented property immediately adjacent to the right-of-way.

The State was represented on this job by Resident Engineers William C. Sorlie and J. E. Somerville.

#### Second Contract Awarded

The second contract to be awarded was for the third unit of freeway from Webster Street to Grand Avenue. Construction started in April 1960 and included 19 retaining walls and six major structures, together with construction of one mile of freeway with ramps and city streets as frontage roads. It also provided for utilization of 350,000 cubic yards of surplus excavation for partial construction of embankments for the second unit between San Pablo Avenue and Webster Street. Most of the surplus was used for this purpose during the earlier stages of the job. The contract for the second unit was well underway by the time the last embankments of the third unit were to be built and the last surplus determined and ready to be moved. Reserving room for this last material would have delayed the second unit, so some other solution was desirable. This problem arose at the same time as the stockpile problem of the first contract, therefore the solution to both problems was found in placing the last quantities of surplus in a stockpile on rented property.

Roadway excavation on this contract was moved primarily using a shallow-pit beltloader to bottom-dump trucks. Greater hourly production was achieved through this relatively new loading method. In addition, material was loaded into the trucks gradually, almost eliminating the problem of compacted material which makes dumping difficult. Also, trucks could be fully loaded, yet have no spillage on the existing MacArthur Boulevard haul route, resulting in much less of a problem in keeping the city streets clean.

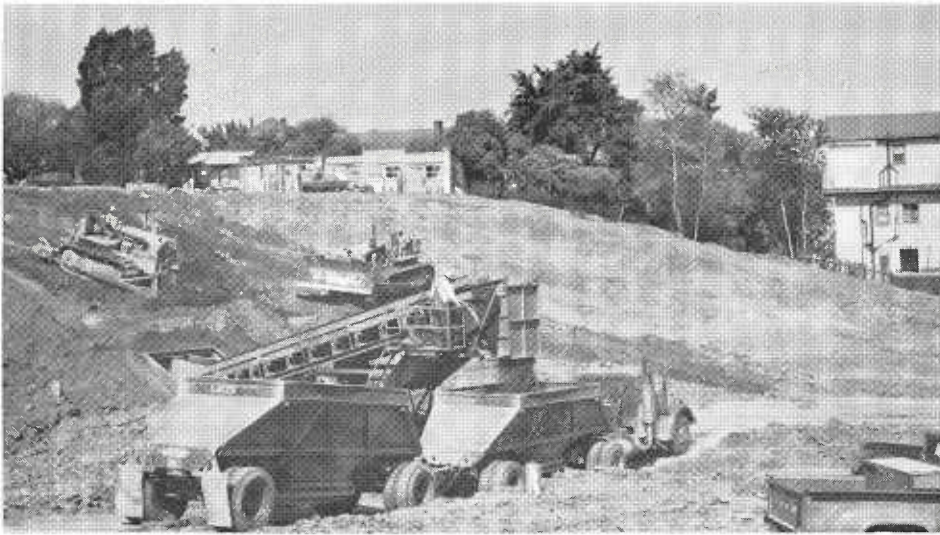

Grading operations during the early phases of construction on the freeway.

#### Six Structures

The six major structures included in this contract were: the Broadway-Richmond Boulevard Undercrossing—(two box girder bridges approximately 1,046 feet long); four structures in the Oakland-Harrison Street Interchange, and the Chetwood Street Overcrossing.

The Harrison Street Undercrossing (off ramp) was subjected to a series of tests by the State before it was used by traffic. These tests were conducted to measure the effect of:

1. Live load distribution to interior and exterior girders.
2. Effect of transverse diaphragms on live load distribution.
3. Dead load distribution to interior and exterior girders.

Field testing of this structure was completed in December 1960, and laboratory model testing concluded in December 1961. The final report is anticipated by late 1962. Resident Engineer James D. Collins represented the State on this job.

The second unit of the MacArthur Freeway—from Market Street to Webster Street—was the third contract to be awarded. Peter Kiewit Sons Co. started work on this 1.1-mile project on August 8, 1960. The contract called for the freeway with ramps and city streets as frontage roads and foundations for the ramp structures at the future Grove-Shafter Freeway Interchange. Only the foun-

ditions were placed at this time, in order to allow possible use of the median of the planned Grove-Shafter Freeway by the proposed Bay Area Rapid Transit System.

#### Goes Over City Streets

In this unit, the freeway goes over all city streets and included in the contract were 9 bridges and 11 retaining walls. The construction of retaining walls for the city streets was

an extensive project, as indicated by the accompanying photographs. With embankments partially constructed, as noted above, imported borrow from the site of future contracts was used to complete construction of the embankments.

One such area was the fourth unit, from Grand Avenue to Park Boulevard, where a cut on this section was designated as a surplus excavation area and a borrow site of 102,500 cubic yards for use on the second unit. This quantity represented most of the surplus excavation on this fourth unit that was available at this time. Additional borrow was required however, and 125,000 cubic yards were obtained from a cut near the Caldecott Tunnel portal site where borrow previously had been obtained for use on the first unit.

On this job, the State was represented by Resident Engineer William J. Zenoni.

Construction is now underway on the fourth unit of MacArthur Freeway from Grand Avenue to Park Boulevard. This, the fourth contract awarded, is a 1.2-mile project to cost approximately \$4,200,000 and to be completed in September 1962.

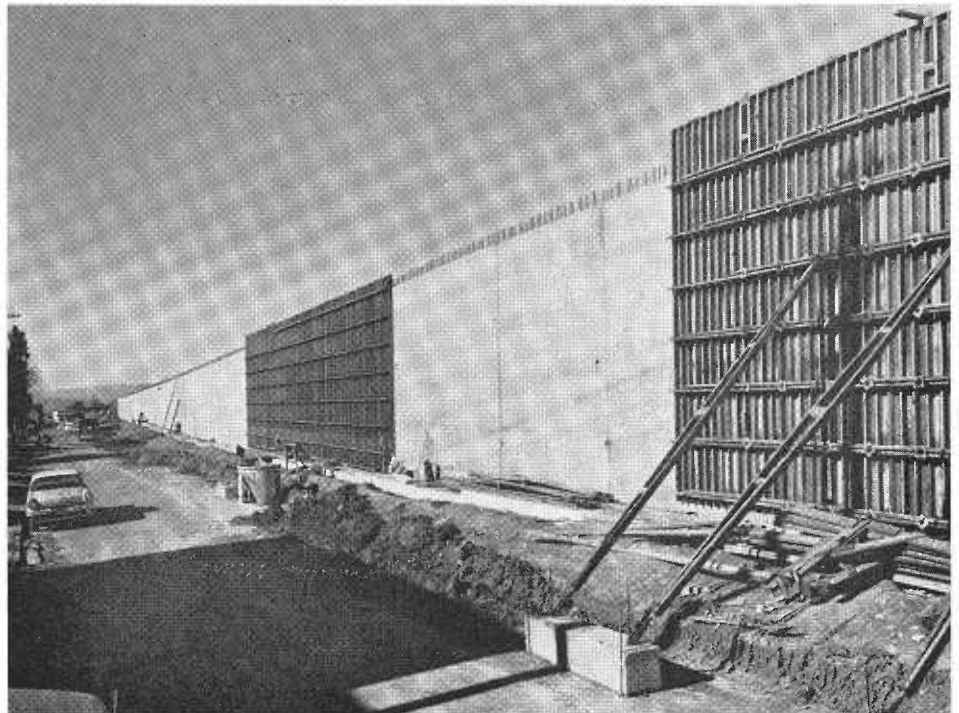

Retaining wall construction on the freeway in the Market Street area on 35th Street. The view is westward.



MacArthur Freeway construction at the Oakland-Harrison interchange.

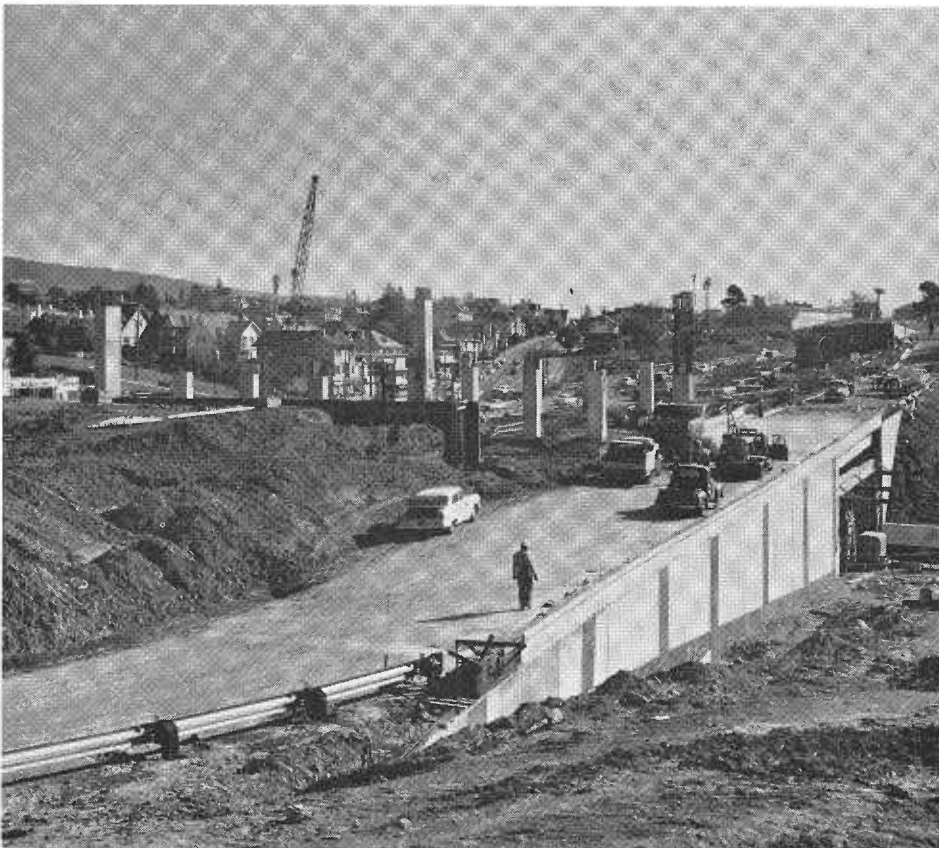

MacArthur Freeway construction at the Broadway-Richmond undercrossing.

#### Retaining Wall Needed

This contract will extend the freeway past Lake Merritt and the Grand Lakeshore area on structure and on sidehill cut and fill to Park Boulevard. This sidehill portion requires a median strip retaining wall 3900 feet long, an 800-foot-long retaining wall on the cut side, and 355 feet of retaining walls on the fill side. There are a total of 11 retaining walls and at one location there are retaining walls at the cut side, in the median and at the toe of the fill.

There are four major vehicular structures and two pedestrian overcrossings. The Lakeshore Park Undercrossing is a reinforced concrete bridge, 838 feet in length and carries the freeway across Grand and Lakeshore Avenues and the Lake Merritt area. The MacArthur Boulevard Overcrossing (Park Boulevard off ramp) is a reinforced concrete box-girder bridge approximately 172 feet long and carries eastbound on-ramp traffic from MacArthur Boulevard over the Park Boulevard off-ramp.

The Lake Park Avenue Overcrossing is a reinforced concrete box-girder bridge about 465 feet long to carry westbound MacArthur Boulevard traffic over the freeway. The Park Boulevard Undercrossing is a reinforced concrete bridge of two parallel spans, 176 feet long, which carries the freeway over Park Boulevard.

The two pedestrian overcrossings are reinforced concrete bridges; 566 feet long at Van Buren Avenue and 382 feet in length at Santa Clara Avenue. These overcrossings will provide for pedestrian traffic from existing MacArthur Boulevard to Santa Clara Avenue in the vicinity of Van Buren Avenue.

#### Four Stages

The job will be performed in four stages to facilitate handling of traffic through the construction area. This is necessitated by the new freeway alignment which crosses several heavily traveled city streets in the Lake Merritt-Lakeshore Avenue area and the reconstruction of sections of existing MacArthur Boulevard.

As indicated earlier, all of the known surplus material on this project was used on the second unit. It





The MacArthur Freeway through Oakland looking east from the Distribution Structure. The Cypress Street Viaduct on the Nimitz Freeway curves out of the photo to the right.

was later revealed that approximately 25,000 cubic yards was still surplus to this project. In anticipation of this, an area of the future Grove-Shafter Freeway was cleared and this excess material was placed in future fills for this pending freeway.

The State Resident Engineer on this job is W. G. Jue.

The fifth contract of the MacArthur Freeway from Park Boulevard to Buell Street was awarded in August 1961 and work was started on September 5, 1961. The \$7,650,000 project will include 16 vehicular structures, a pedestrian overcrossing and a pumping plant, 19 retaining walls and 2.9 miles of eight-lane freeway with appurtenant ramps and frontage roads. Completion date is scheduled for September 1963.

This project also has surplus excavation and this excess will be used in

the fills for the future Grove-Shafter Freeway. Since there is a shortage of embankment material for this pending project this disposition of excess provides an economical solution to a vital problem of materials.

On this project the freeway is depressed at several locations and a high ground water level is indicated in the soil borings, thus a major item is the extensive use of underdrains and pervious blankets.

Resident Engineer J. E. Somerville represents the State on this project.

#### Two More Projects

Two additional projects are budgeted on MacArthur Freeway. Between Buell Street and the east city limits near Durant Avenue, \$12,000,000 has been allotted for 4.5 miles of freeway. This project includes the connection to Warren Freeway near

Calaveras Avenue where a full directional interchange will be constructed. Modified diamond interchanges will be constructed at five other locations and a total of 12 overcrossings and undercrossings will be built.

South of this project, \$4,500,000 is budgeted for 1.9 miles of freeway between the city limits of Oakland and Sybil Avenue in San Leandro. On this unit, a directional type of interchange will be built at the intersection of the existing Foothill Boulevard at the northerly end of the project. Seven undercrossings will be built for city streets and ramps and there will be two bridges constructed over San Leandro Creek for the freeway and a frontage road. Access ramps will be provided at MacArthur Boulevard, Estudillo Street to Grand Avenue between Joaquin and Sybil Avenue and at Benedict Drive.

Funds are also budgeted for two landscaping projects on completed sections of MacArthur Freeway. These include a \$170,000 project of landscaping the 2.3-mile section between the distribution structure and Grand Avenue and a similar program between Grand Avenue and Park Boulevard at a cost of \$195,000.

With the completion of the various projects of the MacArthur Freeway, US 50 will be full freeway to east of Castro Valley. A major, immediate benefit to motorists will be decreased traffic on Nimitz Freeway as a result of this parallel route.

#### NEW SAFETY DIRECTOR

Federal Highway Administrator Rex M. Whitton has announced the appointment of James K. Williams, Jr., of Manchester, Connecticut, as Director of the Office of Highway Safety in the U. S. Bureau of Public Roads.

Williams will plan and direct the development of a broad highway safety program throughout the United States. The general objective of the office is to achieve effective use of resources in federal agencies on behalf of safer highway transportation.

# Hewes Award

Bridge Department's Roger Sunbury,  
Lab's Paul Jonas Are 1962 Winners

Roger D. Sunbury, Senior Bridge Engineer, and Paul G. Jonas, Senior Engineer Welding Technologist, are the winners of the 1962 Dr. L. I. Hewes Award, according to an announcement by the Western Association of State Highway Officials. Both men are career employees with the California Division of Highways.

The award, which was established in 1951, honors the memory of Dr. Hewes, the late Western Regional Chief of the U.S. Bureau of Public Roads. It is presented annually for outstanding contributions to western highway development and carries with it a cash prize of \$500. The 1962 award was announced on June 13 at the WASHO conference in Seattle.

The team of Sunbury and Jonas received a joint nomination for their contributions to the design and use of high-strength steel in large highway bridges and the development of the arc welding process to a position as an accepted and valuable tool in the structural engineer's field.

Sunbury's work was primarily in the field of the planning and design of structures utilizing high-strength steel members fabricated by welding. Jonas has done outstanding work in advancing and standardizing the technological aspects of welding to make the use of these high-strength steels practical and economical.

In his letter recommending Sunbury and Jonas for the award, State Highway Engineer J. C. Womack said that it was largely through their efforts that California has been able to establish precedents in the use of high-strength steel in major long-span highway structures, and has, at the same time, been able to confirm welding as the most satisfactory and economical method of fabricating steel members.

## Steels Are Combined

According to Womack, steels ranging from ordinary structural steel to the newest high-strength steels have been combined by Sunbury into structures with both marked economy and



Robert L. Byrne, editor of *Western Construction Magazine*, presents certificates and \$250 checks for Dr. L. I. Hewes awards to Paul G. Jonas (center) and Roger D. Sunbury, California Division of Highways Engineer.

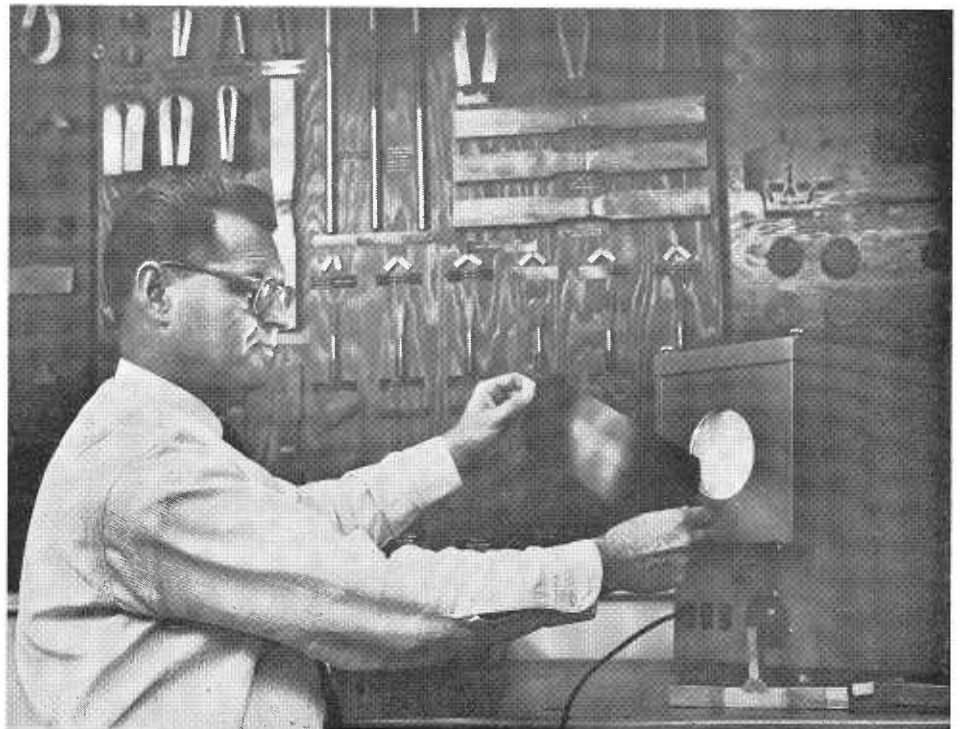

Paul Jonas, Senior Engineer Welding Technologist, examines a radiograph of one of the steel plates used in constructing the new span of the Carquinez Bridge. Jonas was responsible for perfecting many of the techniques used in welding together the various types of steel used in the structure.

improved appearance. These new adaptations of different steels are now being duplicated across the country.

The standards for welding procedure and inspection developed by Jonas have been widely adopted by many welding organizations and states, and the California Test Method 601 which he developed is recognized as the best and most comprehensive weld testing procedure available.

To qualify for the Dr. L. I. Hewes Award, a highway engineer must be recommended by the head of one of the 14 state highway departments in WASHO. Persons nominated must be highway engineers of the western states, must have made an outstanding contribution to highway development, and must not be chief engineers or members of the chief engineer's principal staff.

In addition, the engineer nominated must be engaged in planning, design, construction, maintenance, bridge, materials and research, or traffic engineering.

Final selection is made by the Executive Committee of WASHO.

Sunbury and Jonas are the third and fourth California Division of Highways employees to win this award. Previous winners were James T. McWilliam (co-winner-1952) and Arnold H. Carver (winner-1954).

#### **Sunbury Bridge Designer**

A native of Ohio, Sunbury graduated from Ohio State University in 1941 with a bachelor's degree in Civil Engineering. He went to work for the American Bridge Company in 1941 and served as an engineering draftsman and field engineer for the company on the Trans-Isthmian Highway in Panama, and on the Alcan Highway in Alaska and Canada. In 1944, he was commissioned as an ensign in the naval reserve and called to active duty in the Pacific.

Upon return to civilian life in 1946, Sunbury was employed as a construction engineer with the American Bridge Company until 1947, when he joined the California Division of Highways. His initial assignments were in construction and estimating, but since 1949, he has been active in the field of bridge design.



*An idea of the extensive riveting involved in creating the "lacework" on the older Carquinez Bridge is given in this photo taken during the construction of the new span (in background). The use of welded perforated box girders has virtually eliminated the use of riveting on such structures.*

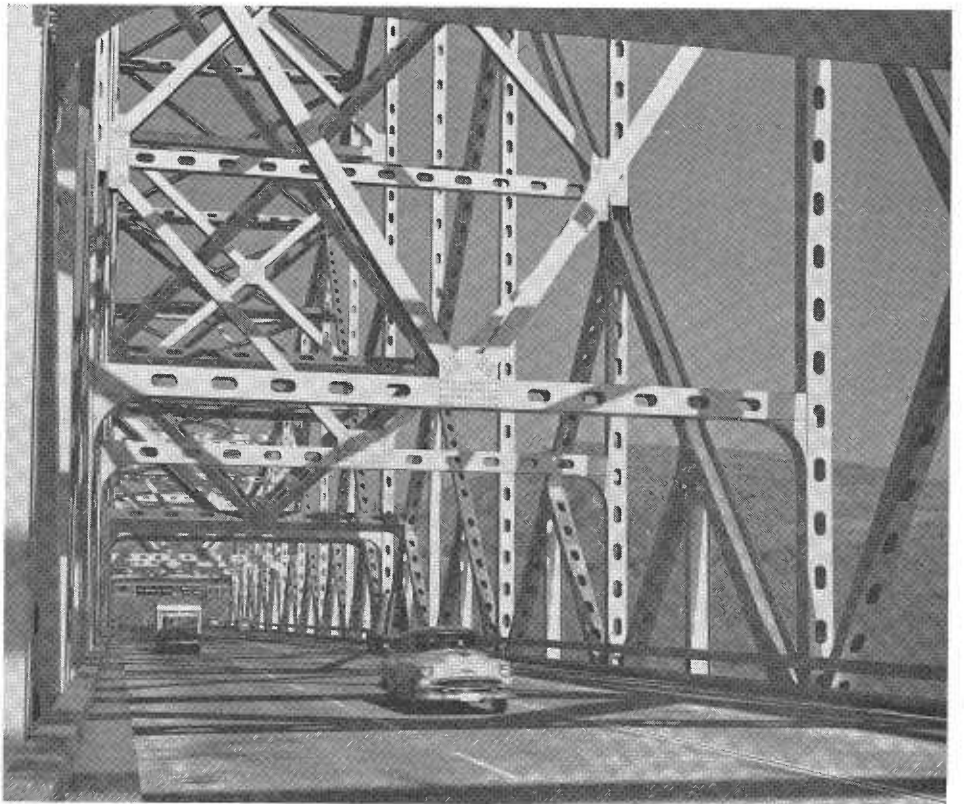

*The extensive use of perforated box girders in the new Carquinez Bridge presents a smoother, more eye-pleasing appearance while at the same time making maintenance and inspection faster, easier and more effective.*



*This view of the twin Carquinez Bridges shows the simple, more eye-pleasing structure made possible by the use of high-strength steels and modern welding techniques. The new structure, on the left, was built at a savings of \$800,000 by using these materials and techniques.*

Sunbury brought his broad background in engineering to bear on the subject of bridge design at a savings to California taxpayers of more than \$1,000,000 to date. Following up his earlier studies on the combining of high-strength steels, he was able to effect a saving of \$800,000 by combining three types of steel in a single structure—the Carquinez Bridge. A new high standard for clean, uncluttered truss design was established with the construction of this double cantilever bridge with its all-welded members and bolted joints. Use of high-strength steels allowed slimmer members and afforded great savings of weight in members previously required to be heavy in order to carry large secondary stresses.

Many refinements of design were worked out on the Carquinez Bridge, the Benicia-Martinez Bridge, and the Whiskey Creek Bridge. Different types of steel were successfully combined to save bridge weight and at the same time improve bridge appearance. Plates were butt welded so that higher strength compensated for bolt holes and no increase in section was neces-

sary. Box and H-sections were widely used to simplify the fabrication.

On the Whiskey Creek Bridge Sunbury carried plate girder design to a high degree of perfection by placing the higher strength steels in positions of higher stress, thereby maintaining uniform sections throughout the girder. All of these details are now being widely copied throughout the country.

#### **Jonas Welding Expert**

A native of Michigan, Jonas came to California with his family in 1923. He attended grade and high school in Antioch. He then completed a four-year night school vocational trade course in electric arc and oxyacetylene welding, layout, and machine shop practice.

Jonas has completed home study courses and night school courses in advanced welding, in metallurgy, and in teaching. He has had seven years teaching experience at Sacramento City College.

Prior to coming to work for the Division of Highways in 1946, Jonas worked in paper manufacturing, steel milling, ship building and repair, steel

fabricating, constructing road building equipment, and inspecting and doing research in welding. From 1944 until 1946 he served with the U. S. Navy in a ship repair unit.

With the California Division of Highways for more than 15 years, Jonas has spent five years with the Headquarters Shops and more than 10 years with the Materials and Research Department. He joined state service as a fusion welder and has served as Assistant Steel Inspector and Associate Steel Inspector. He is at present Senior Welding Technologist.

Starting at a time when structural welding was in its infancy, Jonas developed tests, test methods, and qualification procedures which established welding as a reliable method to be used in many types of structural work.

His California Test Method 601 and his development and interpretation of radiographic inspection results have been widely adopted and copied throughout the country. According to State Highway Engineer J. C. Womack, Jonas' work with the fabricators in developing procedures and inspection techniques and qualifying welders has done much to make welding a practical, dependable, usable shop tool.

Major projects on which he has worked or with which he has been affiliated include the all-welded Skyway in San Francisco, the Oakland Distribution Structure, the Carquinez Bridge, the Benicia-Martinez Bridge, the Whiskey Creek Bridge and the West Branch of the Feather River Bridge.

## **R.M. Monahan Named B.H.I.F. Executive**

Appointment of Robert M. Monahan as executive director of the Better Highways Information Foundation was announced in June by H. D. Anderson, chairman of the BHIF executive committee.

Monahan, who is a former special assistant to the Federal Highway Administrator, succeeds Ellis L. Armstrong, who had been executive head of the foundation since shortly after it was established in 1960.

Armstrong is a former U. S. Commissioner of Public Roads and Chief Highway Engineer of Utah.

# Two-Lane Expressways



*Good Alignment With Control of Access and Built-in Provision for the Future Serves Present Needs on Many Rural and Mountain Routes*

CALIFORNIA's spectacular progress in building multilane freeways and expressways often overshadows the impressive gains which are being made in providing modern two-lane highways to serve motorists in rural and mountain regions.

Obviously, two-lane highways are inadequate to cope with the extremely heavy traffic volumes which develop in metropolitan areas or on major through-routes; but these work-horse highways are still an essential component of California's 16,000-mile State Highway System.

Two-lane highways actually account for about 75% of the total operating state highway mileage. As

the state's population and traffic have continued to increase, many of these routes have become overcrowded and in urgent need of widening or upgrading to multilane freeway or expressway standards. These outmoded sections are steadily being eliminated under the state's extensive program of highway improvement.

However, there are many places in California where *modern two-lane*

*highways* will be adequate to handle traffic for a long time. In such areas, it is impractical to build four-lane highways initially; so high-standard two-lane facilities are constructed, with provisions for future widening when required.

An important distinction should be made.

Modern two-lane highways should not be confused with old-fashioned routes which meander through the countryside along ancient wagon roads or stock trails, or around farmsteads, taking motorists over narrow pavements, around hairpin curves, and up steep grades.

Today's two-laners are wider, straighter, and less steep. They present fewer driving hazards and points of traffic conflict. Their design is better oriented to the needs and habits of both local motorists and through travelers.



PHOTO TOP OF PAGE—Scenic two-lane expressway on State Sign Route 36 near Mineral in Tehama County. PHOTO LEFT—On this two-lane expressway section of Sign Route 120 near Oakdale, the old highway (foreground) now serves as a frontage road providing access to farms and homes.

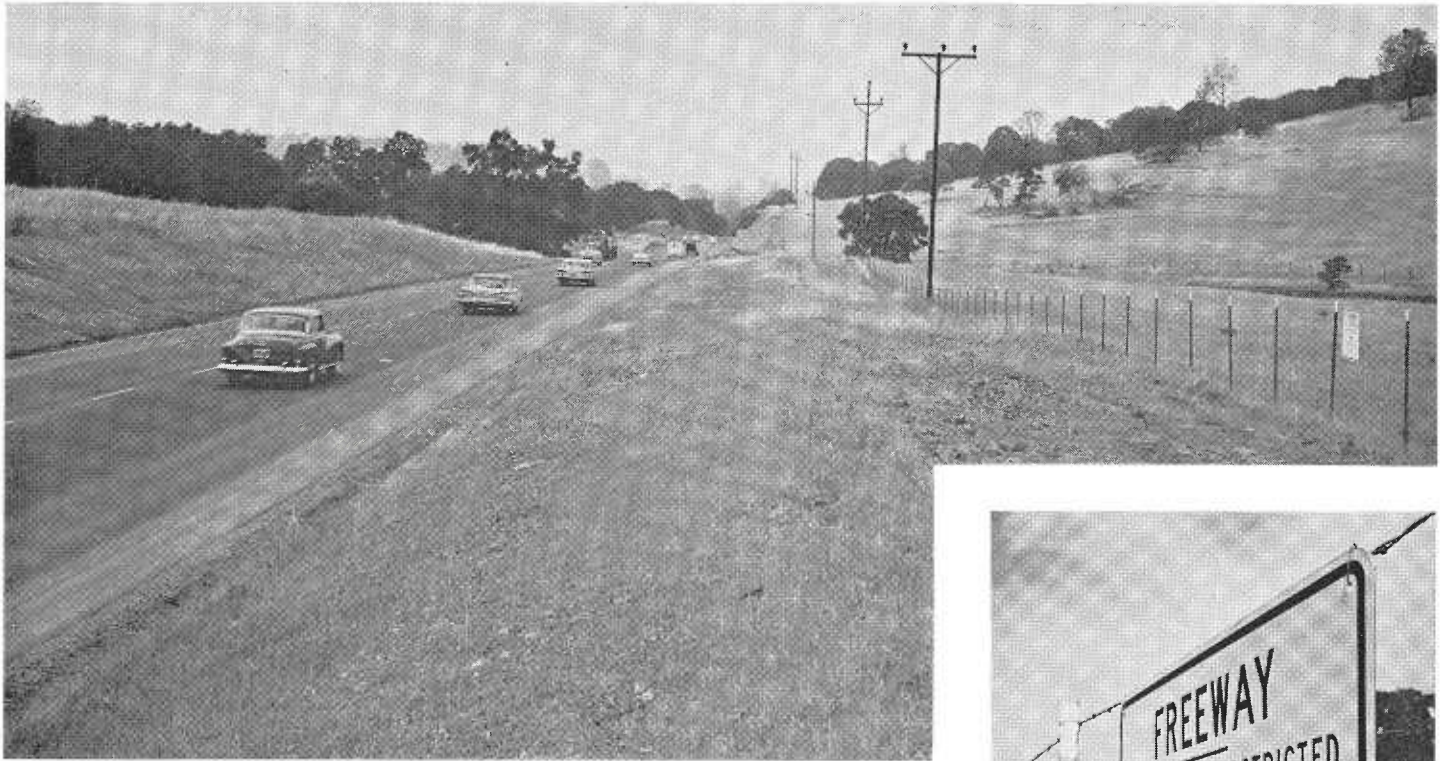

This section of US 50 east of Sacramento, commonly known as the Folsom Bypass, is identified as a two-lane expressway by the rectangular sign on the fence at the extreme right. Inset right is a blow-up of the sign.

There is another important, although not always recognized, difference. Most of the recently-built two-lane highways in California have provision for some measure of access control—that is, regulation or limitation of access to or from adjacent property.

Two-lane highways with access control are frequently referred to as “two-lane expressway,” or “two-lane freeways.” California now has more than 600 miles of limited access two-lane expressway in operation. Another 100 miles are under construction or budgeted.

#### Access Control

California adopted the access control principle in highway design in 1939 when the State Legislature enacted the state’s freeway law. This measure introduced the term “freeway” into the statutes. According to the law, a freeway is a highway “in respect to which the owners of abutting lands have no right or easement of access to or from their abutting lands or in respect to which such owners have only limited or restricted right or easement of access.”

*Thus, in a legal sense, any highway with controlled access is a freeway. This is true whether it has only two lanes or has eight lanes and a dividing strip.*

All freeway routes for limited access highways are established by the California Highway Commission, after careful planning by state and local agencies and subject to definite procedures for detailed public discussion, coordination with local master-planning and agreement with local government bodies regarding access provisions and local road adjustments. These procedures, which also apply to “two-lane expressways” as well as to urban multilane freeways, will be discussed later.

While any highway with access control is *legally* a freeway, the term has a more restricted meaning in common usage.

Most people think of a freeway (or a full freeway) as being a divided highway with from four to eight traffic lanes. Vehicles enter or leave this type of highway via interchange or access ramps. Cross traffic is carried over or under the main line. The right of way is fenced and roadside business dis-

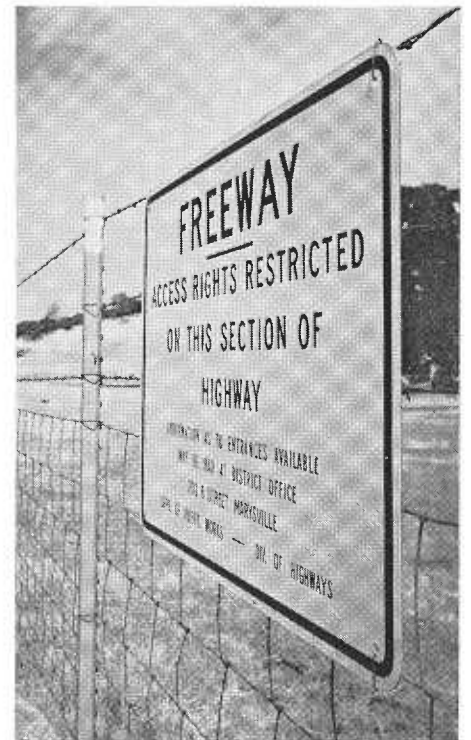

tricts or residential areas are served by frontage roads and special connectors.

Another type of controlled-access highway is the “expressway,” which is also a divided highway, usually four lanes. On these routes, some cross traffic and left turns, and sometimes private access, are permitted at certain intersections.

#### Purpose of Control

The access control concept, which California helped pioneer, is now accepted and endorsed by planners and highway designers throughout the world. Full freeways, or other types of limited access highways, are now planned, under construction or in op-



CALIFORNIA  
**Highways**  
and Public Works

JULY-AUGUST  
1962

OCCIDENTAL COLLEGE

SEP 24 1982

LIBRARY

# Policy on Scenic Values

A recent study on a proposed scenic highway system made by the Division of Highways to the State Legislature indicated that there is need for classification of the present policy of the division regarding the development of scenic values along the state highway system. Therefore, in addition to the aesthetic design features already contained in the Design Section of its Planning Manual of Instructions, the division has thought it advisable to restate the scenic criteria that should be considered in location and design studies so that potential scenic values will be developed and preserved.

## Basic Precepts

"In any highway, pleasing appearance is a consideration in the planning and design process. Scenic values must be considered along with safety, utility, economy and all the other factors considered in planning and design. This is particularly true of the many portions of the state highway system situated in areas of natural beauty. In such areas, the location of the highway, its alignment and profile, the cross-section design and other related features should be in harmony with the setting. Economy consistent with

traffic needs will always be of paramount importance, although a reasonable additional expenditure can be justified to enhance the beauty of the highway itself.

## Design Speed

"The design speed should be carefully chosen as it is the key element which directly fixes standards for the horizontal alignment and profile of the highway. These requirements in turn directly influence the manner in which the location of the highway blends onto the landscape. Scenic values, particularly in areas of natural scenic beauty, must play a part along with the factors set forth under Index No. 7-101.1 in selecting a design speed.

## Aesthetic Factors

"In a natural scenic environment, consideration should be given to the following factors to insure the most satisfactory results from an aesthetic standpoint.

(a) The location of the highway should be such that the new construction will preserve the natural environment and will lead to and unfold scenic positions.

(b) The general alignment and profile of the highway should fit the character of the area traversed so that unsightly scars of excavation and embankment will be reduced to a minimum. Curvilinear horizontal alignment and a gently rolling profile consistent with design requirements will help to accomplish this.

(c) As an agreeable and natural roadside appearance is essential, the destruction of valuable trees and growth should be avoided if suitable alternative locations are available at reasonable cost.

(d) Whenever feasible wide medians, curvilinear alignment and independent roadways should be provided on multilane facilities as these features add scenic interest and relieve the monotony of parallelism.

(e) Bridges, tunnels and walls merit consideration in lieu of prominent excavation and embankment slopes when costs of such alternatives are not excessive.

(f) Slopes should be flattened whenever practical and ground cover provided so that lines of construction are softened and beautified.

(g) Structures should be located and designed to give the most pleasing appearance.

(h) Scars from material sites should be avoided. Planting in harmony with the surroundings should be undertaken to screen such scars when they are unavoidable.

(i) Drainage appurtenances should be so located that erosion, sumps and debris collection areas are hidden from view or eliminated when the nature of site conditions permits.

(j) Interchange areas should be graded to provide an expanse of naturalistic easy flowing contours. The resulting pleasing appearance can be further enhanced by indigenous growth or by planting a vegetative cover appropriate to the locality."



PHOTO LEFT—US Highway 97 in Siskiyou County looking south with Mount Shasta in the background.



# California Highways and Public Works

Official Journal of the Division of Highways, Department of Public Works, State of California

Vol. 41

July-August 1962

Nos. 7-8

## CONTENTS

	Page
MacArthur Freeway .....	2
By J. B. Watson, Assistant District Engineer, and J. D. Collins, District Construction Engineer	
Hewes Award .....	8
Two-lane Expressways .....	11
Moonlight Ride .....	19
Traffic Engineering Award Presented to the Division .....	20
Traffic Census .....	21
By Thomas N. Tamburri, Assistant Traffic Engineer, and Carroll E. Dunham, Associate Highway Engineer	
Tolls Adopted for New State Bridges .....	28
Central Mix .....	29
By J. O. Kapono, Assistant Highway Engineer	
Final Route Link .....	33
Staff Promotions .....	35
State Launches Broad Motor Vehicle Study .....	36
C. G. Beer and C. T. Ledden Named to New Posts .....	36
Petaluma Bypass .....	37
By James H. Hampton, Right-of-Way Agent	
Illustrated Booklet Explains Road Work .....	44
Reduced Plans .....	45
By Harry Choi, Special Services Highway Engineering Associate	
Full Freeways Now Total 1,000 Miles .....	48
Evaporation Rate .....	49
By Rufus M. Hammond, Assistant Highway Engineer	
Safety Foundation Marks 25th Birthday .....	53
Twenty-five-year List .....	54
Division Exhibits Publications at State Library .....	55
Retirements	
Albert C. Briney .....	54
H. T. Forscher .....	54
Frank F. Green .....	54
Helen Halsted .....	18
A. A. Hilton .....	55
Richard H. Ramsey .....	55
Cass M. Rose .....	52
Department List .....	53
Obituaries	
In Memoriam .....	54

LESTER S. KORITZ, Editor

STEWART MITCHELL, Associate Editor      JOHN C. ROBINSON, Associate Editor

HELEN HALSTED, Assistant Editor

WILLIAM R. CHANEY, Chief Photographer

Editors are invited to use information contained herein and to request prints of any black and white photographs.

Address communications to: EDITOR,

CALIFORNIA HIGHWAYS AND PUBLIC WORKS

P. O. Box 1499

SACRAMENTO, CALIFORNIA



FRONT COVER—This two-lane section of Highway 29-128 south of Calistoga, in the charming Napa Valley, is a freeway, by legal definition. Access is controlled, and provision has been made for an eventual four lanes. See "Two-Lane Expressways," page 11. (Photo by John Meyerpeter.)

BACK COVER—The Golden State Freeway in Los Angeles looking south from the Griffith Park Road Overcrossing shows the kind of road the average person thinks of when the name "freeway" is mentioned. (Photo by Bob Dunn.)



# MacArthur Freeway

By J. B. WATSON, Assistant District Engineer and  
J. D. COLLINS, District Construction Engineer



DISTRICT  
IV

Since February, 1960 construction has been underway on MacArthur Freeway, a 15.3 mile section of US 50 (Interstate 5W) between the Bay Bridge Distribution Structure and

Route 228 at Castro Valley.

On May 15, 1962, Robert B. Bradford, State Director of Public Works and Chairman of the California Highway Commission and County Supervisor Francis Dunn, Chairman of the Alameda County Highway Advisory Committee, cut the ribbon to open the first 2.6 mile section of the MacArthur Freeway between the distribution

structure and Grand Avenue in Oakland.

In a previous issue of CH&PW (March-April 1960), the planning, design and right-of-way aspects of this freeway were discussed and it was revealed that borrow and excavation projects on several contracts in this metropolitan area were to be combined in order to effect an overall savings in the construction of freeway embankments. The extent to which this program has been carried out, to an even greater degree than contemplated, is discussed in the following paragraphs.

#### Three Contracts

This first section of the MacArthur Freeway opened to the public was the culmination of construction under

three contracts at a total cost of approximately \$11,596,000. Of the six remaining contracts in the entire freeway, two are now under construction, two are included in the current budget and two yet remain to be budgeted.

Contractors for the first three completed units were C. K. Moseman & Son, Guy F. Atkinson and Peter Kiewit Sons Co., respectively.

The first project, from the Bay Bridge Distribution Structure to Market Street, included revisions and additions to the distribution structure, construction of on- and off-ramps to the existing MacArthur Boulevard and construction of the freeway to San Pablo Avenue. Major structural work involved the construction of six retaining walls, averaging 15 feet in height and totaling 1,500 feet in length; 1,435 feet of widening and 490 feet of extension to the existing distribution structure; the MacArthur Boulevard Undercrossing and the Adeline Street Undercrossing, consisting of two parallel reinforced concrete box girder bridges approximately 1,100 feet long. A record pour of 740 yards of concrete in 13 hours was made while constructing this bridge.

Complicating the project, all four lanes of heavy traffic on US 50 had to be moved through the construction area, involving five intricate stages of traffic shifts and stage construction to accomplish this.

#### Demolition Required

One of these stages required the demolition and removal of over 400 feet of the existing distribution structure, and with timing an important factor, the crane and headache ball were at work knocking the bridge

---

Looking westward over the recently completed portion of the MacArthur Freeway between Grand Avenue and the Distribution Structure. Overcrossing in the foreground is MacArthur Boulevard.



# MAC ARTHUR FREEWAY

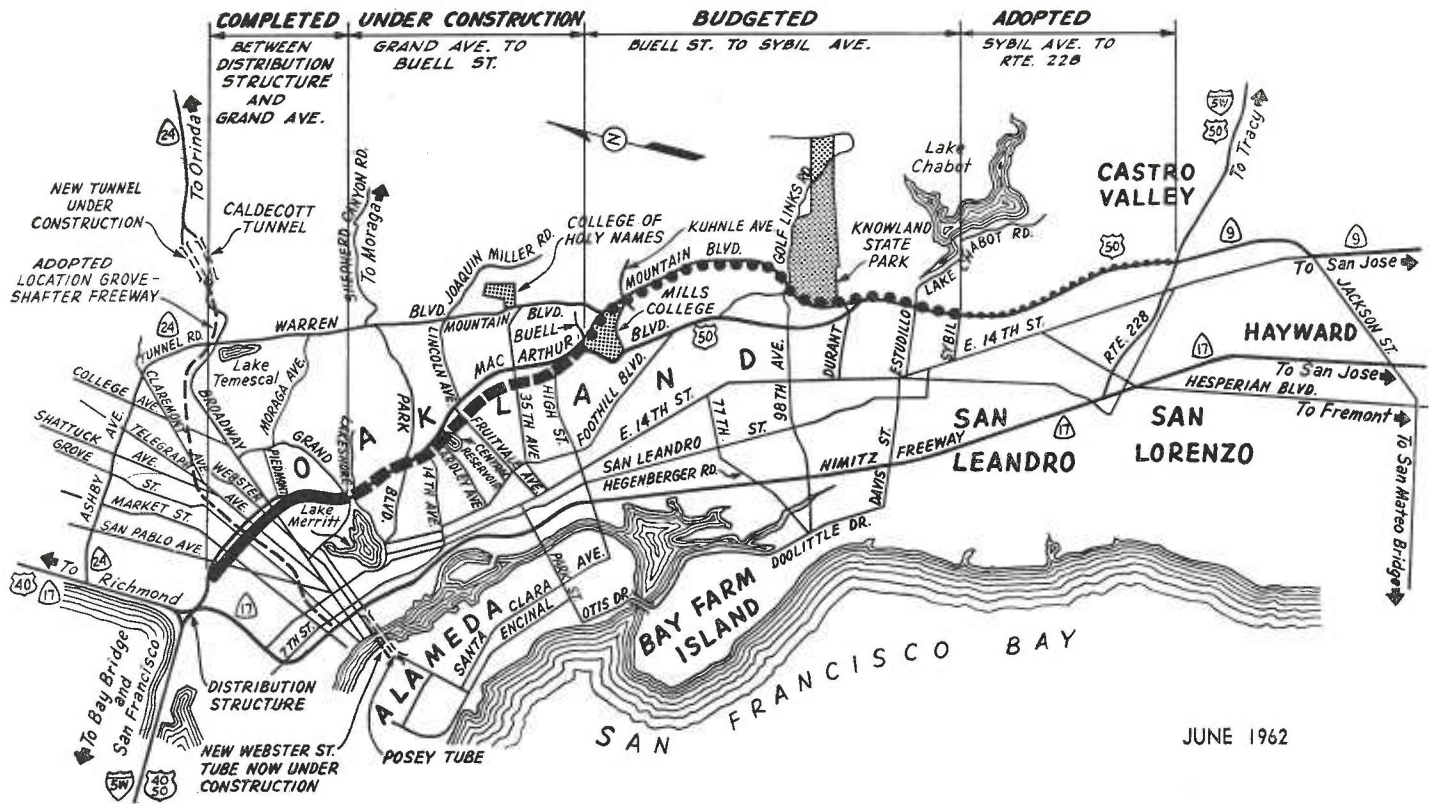

This map shows the current status of construction on the MacArthur Freeway.

down within five minutes after traffic was routed off the structure.

The MacArthur Boulevard Undercrossing is on a 65° skew from the usual freeway crossing, resulting in an unusual structure as indicated in the accompanying illustrations.

The 145,000 cubic yards of imported borrow required for this contract was to be obtained at the east portal site of the third bore of the Caldecott Tunnel east of Oakland on State Route 24. Due to the stage construction previously mentioned, all of this borrow was not needed during the first stage which was completed during May 1960. The remainder of the borrow was not required until later stages of work beginning in June 1961, and continuing, as it developed, until the end of January 1962.

In the meantime, however, the contract for the tunnel was awarded sooner than expected, and the tunnel contractor was to excavate and stockpile the borrow since it was necessary to have the portal area excavated before the material was needed on the



Westbound US 50 traffic is routed over the completed Lake Park overcrossing during construction.



Heavy traffic on MacArthur Boulevard in Oakland looking west from the Broadway intersection before completion of the freeway.



MacArthur Freeway in Oakland shortly after its completion. Broadway passes under the freeway by the building with the clock tower.

first MacArthur Freeway contract. Instead of resorting to this stockpiling, however, it was decided that the balance of the imported borrow could be more economically obtained from other sources, and as indicated later in this article, was finally obtained from a state-furnished stockpile on rented property immediately adjacent to the right-of-way.

The State was represented on this job by Resident Engineers William C. Sorlie and J. E. Somerville.

#### Second Contract Awarded

The second contract to be awarded was for the third unit of freeway from Webster Street to Grand Avenue. Construction started in April 1960 and included 19 retaining walls and six major structures, together with construction of one mile of freeway with ramps and city streets as frontage roads. It also provided for utilization of 350,000 cubic yards of surplus excavation for partial construction of embankments for the second unit between San Pablo Avenue and Webster Street. Most of the surplus was used for this purpose during the earlier stages of the job. The contract for the second unit was well underway by the time the last embankments of the third unit were to be built and the last surplus determined and ready to be moved. Reserving room for this last material would have delayed the second unit, so some other solution was desirable. This problem arose at the same time as the stockpile problem of the first contract, therefore the solution to both problems was found in placing the last quantities of surplus in a stockpile on rented property.

Roadway excavation on this contract was moved primarily using a shallow-pit beltloader to bottom-dump trucks. Greater hourly production was achieved through this relatively new loading method. In addition, material was loaded into the trucks gradually, almost eliminating the problem of compacted material which makes dumping difficult. Also, trucks could be fully loaded, yet have no spillage on the existing MacArthur Boulevard haul route, resulting in much less of a problem in keeping the city streets clean.

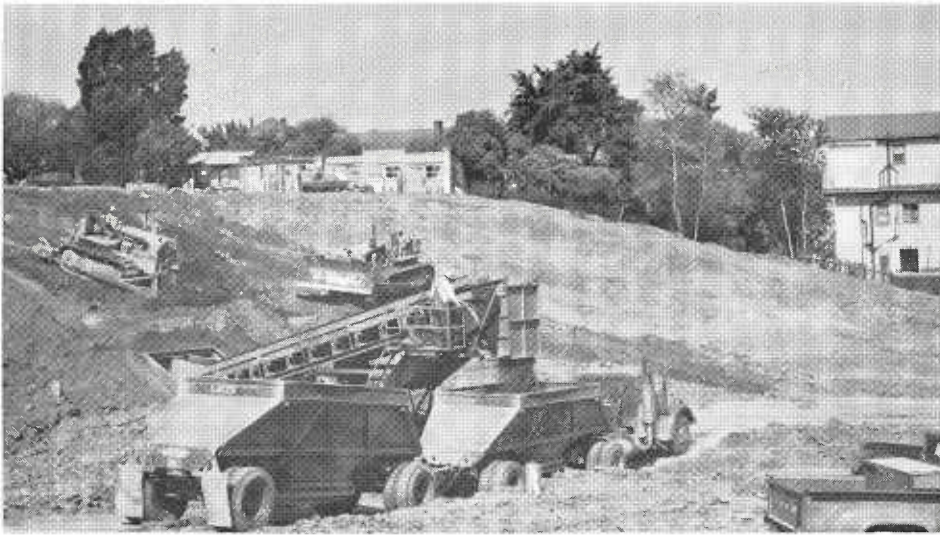

Grading operations during the early phases of construction on the freeway.

#### Six Structures

The six major structures included in this contract were: the Broadway-Richmond Boulevard Undercrossing—(two box girder bridges approximately 1,046 feet long); four structures in the Oakland-Harrison Street Interchange, and the Chetwood Street Overcrossing.

The Harrison Street Undercrossing (off ramp) was subjected to a series of tests by the State before it was used by traffic. These tests were conducted to measure the effect of:

1. Live load distribution to interior and exterior girders.
2. Effect of transverse diaphragms on live load distribution.
3. Dead load distribution to interior and exterior girders.

Field testing of this structure was completed in December 1960, and laboratory model testing concluded in December 1961. The final report is anticipated by late 1962. Resident Engineer James D. Collins represented the State on this job.

The second unit of the MacArthur Freeway—from Market Street to Webster Street—was the third contract to be awarded. Peter Kiewit Sons Co. started work on this 1.1-mile project on August 8, 1960. The contract called for the freeway with ramps and city streets as frontage roads and foundations for the ramp structures at the future Grove-Shafter Freeway Interchange. Only the four-

ditions were placed at this time, in order to allow possible use of the median of the planned Grove-Shafter Freeway by the proposed Bay Area Rapid Transit System.

#### Goes Over City Streets

In this unit, the freeway goes over all city streets and included in the contract were 9 bridges and 11 retaining walls. The construction of retaining walls for the city streets was

an extensive project, as indicated by the accompanying photographs. With embankments partially constructed, as noted above, imported borrow from the site of future contracts was used to complete construction of the embankments.

One such area was the fourth unit, from Grand Avenue to Park Boulevard, where a cut on this section was designated as a surplus excavation area and a borrow site of 102,500 cubic yards for use on the second unit. This quantity represented most of the surplus excavation on this fourth unit that was available at this time. Additional borrow was required however, and 125,000 cubic yards were obtained from a cut near the Caldecott Tunnel portal site where borrow previously had been obtained for use on the first unit.

On this job, the State was represented by Resident Engineer William J. Zenoni.

Construction is now underway on the fourth unit of MacArthur Freeway from Grand Avenue to Park Boulevard. This, the fourth contract awarded, is a 1.2-mile project to cost approximately \$4,200,000 and to be completed in September 1962.

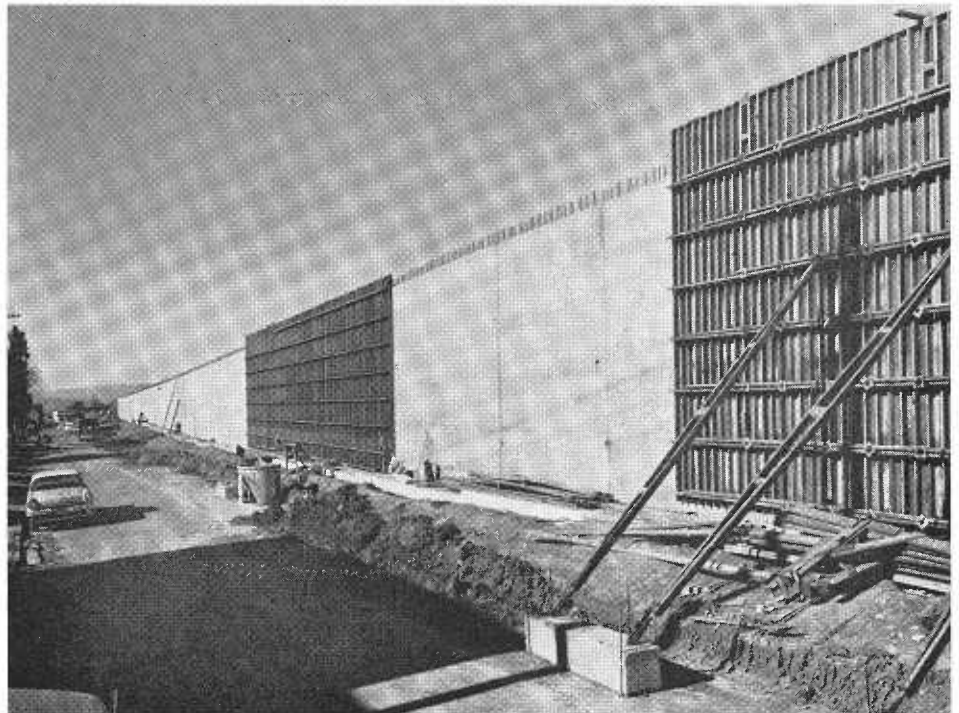

Retaining wall construction on the freeway in the Market Street area on 35th Street. The view is westward.



MacArthur Freeway construction at the Oakland-Harrison interchange.

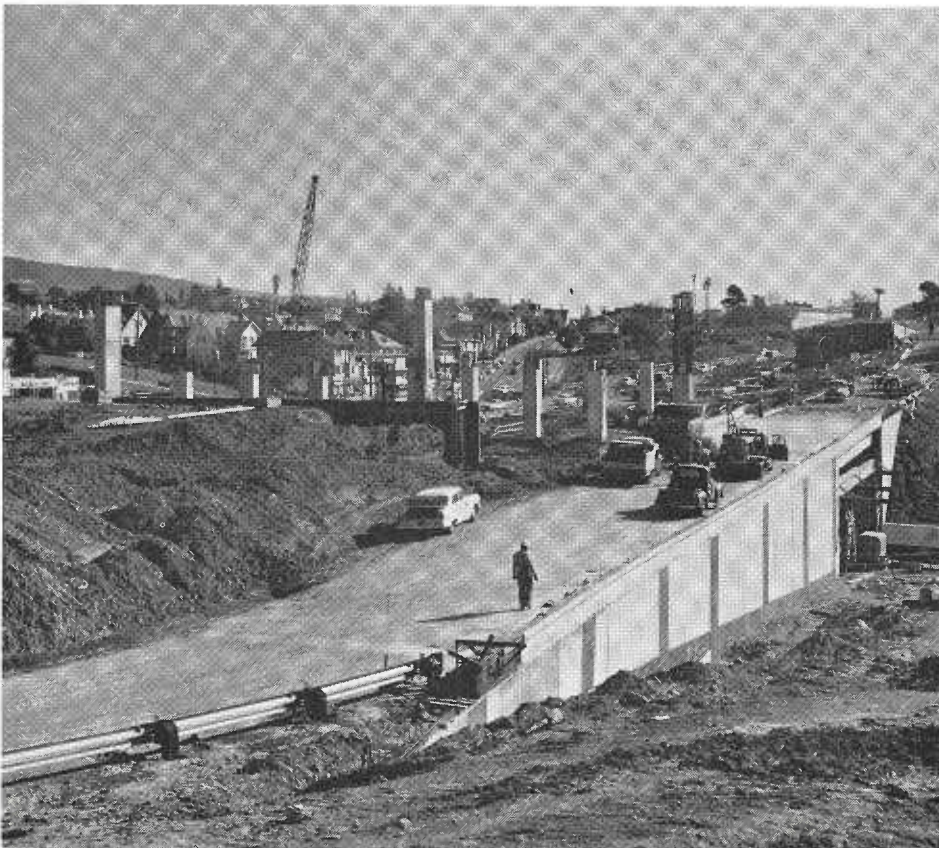

MacArthur Freeway construction at the Broadway-Richmond undercrossing.

#### Retaining Wall Needed

This contract will extend the freeway past Lake Merritt and the Grand Lakeshore area on structure and on sidehill cut and fill to Park Boulevard. This sidehill portion requires a median strip retaining wall 3900 feet long, an 800-foot-long retaining wall on the cut side, and 355 feet of retaining walls on the fill side. There are a total of 11 retaining walls and at one location there are retaining walls at the cut side, in the median and at the toe of the fill.

There are four major vehicular structures and two pedestrian overcrossings. The Lakeshore Park Undercrossing is a reinforced concrete bridge, 838 feet in length and carries the freeway across Grand and Lakeshore Avenues and the Lake Merritt area. The MacArthur Boulevard Overcrossing (Park Boulevard off ramp) is a reinforced concrete box-girder bridge approximately 172 feet long and carries eastbound on-ramp traffic from MacArthur Boulevard over the Park Boulevard off-ramp.

The Lake Park Avenue Overcrossing is a reinforced concrete box-girder bridge about 465 feet long to carry westbound MacArthur Boulevard traffic over the freeway. The Park Boulevard Undercrossing is a reinforced concrete bridge of two parallel spans, 176 feet long, which carries the freeway over Park Boulevard.

The two pedestrian overcrossings are reinforced concrete bridges; 566 feet long at Van Buren Avenue and 382 feet in length at Santa Clara Avenue. These overcrossings will provide for pedestrian traffic from existing MacArthur Boulevard to Santa Clara Avenue in the vicinity of Van Buren Avenue.

#### Four Stages

The job will be performed in four stages to facilitate handling of traffic through the construction area. This is necessitated by the new freeway alignment which crosses several heavily traveled city streets in the Lake Merritt-Lakeshore Avenue area and the reconstruction of sections of existing MacArthur Boulevard.

As indicated earlier, all of the known surplus material on this project was used on the second unit. It



The MacArthur Freeway through Oakland looking east from the Distribution Structure. The Cypress Street Viaduct on the Nimitz Freeway curves out of the photo to the right.

was later revealed that approximately 25,000 cubic yards was still surplus to this project. In anticipation of this, an area of the future Grove-Shafter Freeway was cleared and this excess material was placed in future fills for this pending freeway.

The State Resident Engineer on this job is W. G. Jue.

The fifth contract of the MacArthur Freeway from Park Boulevard to Buell Street was awarded in August 1961 and work was started on September 5, 1961. The \$7,650,000 project will include 16 vehicular structures, a pedestrian overcrossing and a pumping plant, 19 retaining walls and 2.9 miles of eight-lane freeway with appurtenant ramps and frontage roads. Completion date is scheduled for September 1963.

This project also has surplus excavation and this excess will be used in

the fills for the future Grove-Shafter Freeway. Since there is a shortage of embankment material for this pending project this disposition of excess provides an economical solution to a vital problem of materials.

On this project the freeway is depressed at several locations and a high ground water level is indicated in the soil borings, thus a major item is the extensive use of underdrains and pervious blankets.

Resident Engineer J. E. Somerville represents the State on this project.

#### Two More Projects

Two additional projects are budgeted on MacArthur Freeway. Between Buell Street and the east city limits near Durant Avenue, \$12,000,000 has been allotted for 4.5 miles of freeway. This project includes the connection to Warren Freeway near

Calaveras Avenue where a full directional interchange will be constructed. Modified diamond interchanges will be constructed at five other locations and a total of 12 overcrossings and undercrossings will be built.

South of this project, \$4,500,000 is budgeted for 1.9 miles of freeway between the city limits of Oakland and Sybil Avenue in San Leandro. On this unit, a directional type of interchange will be built at the intersection of the existing Foothill Boulevard at the northerly end of the project. Seven undercrossings will be built for city streets and ramps and there will be two bridges constructed over San Leandro Creek for the freeway and a frontage road. Access ramps will be provided at MacArthur Boulevard, Estudillo Street to Grand Avenue between Joaquin and Sybil Avenue and at Benedict Drive.

Funds are also budgeted for two landscaping projects on completed sections of MacArthur Freeway. These include a \$170,000 project of landscaping the 2.3-mile section between the distribution structure and Grand Avenue and a similar program between Grand Avenue and Park Boulevard at a cost of \$195,000.

With the completion of the various projects of the MacArthur Freeway, US 50 will be full freeway to east of Castro Valley. A major, immediate benefit to motorists will be decreased traffic on Nimitz Freeway as a result of this parallel route.

#### NEW SAFETY DIRECTOR

Federal Highway Administrator Rex M. Whitton has announced the appointment of James K. Williams, Jr., of Manchester, Connecticut, as Director of the Office of Highway Safety in the U. S. Bureau of Public Roads.

Williams will plan and direct the development of a broad highway safety program throughout the United States. The general objective of the office is to achieve effective use of resources in federal agencies on behalf of safer highway transportation.

# Hewes Award

Bridge Department's Roger Sunbury,  
Lab's Paul Jonas Are 1962 Winners

Roger D. Sunbury, Senior Bridge Engineer, and Paul G. Jonas, Senior Engineer Welding Technologist, are the winners of the 1962 Dr. L. I. Hewes Award, according to an announcement by the Western Association of State Highway Officials. Both men are career employees with the California Division of Highways.

The award, which was established in 1951, honors the memory of Dr. Hewes, the late Western Regional Chief of the U.S. Bureau of Public Roads. It is presented annually for outstanding contributions to western highway development and carries with it a cash prize of \$500. The 1962 award was announced on June 13 at the WASHO conference in Seattle.

The team of Sunbury and Jonas received a joint nomination for their contributions to the design and use of high-strength steel in large highway bridges and the development of the arc welding process to a position as an accepted and valuable tool in the structural engineer's field.

Sunbury's work was primarily in the field of the planning and design of structures utilizing high-strength steel members fabricated by welding. Jonas has done outstanding work in advancing and standardizing the technological aspects of welding to make the use of these high-strength steels practical and economical.

In his letter recommending Sunbury and Jonas for the award, State Highway Engineer J. C. Womack said that it was largely through their efforts that California has been able to establish precedents in the use of high-strength steel in major long-span highway structures, and has, at the same time, been able to confirm welding as the most satisfactory and economical method of fabricating steel members.

## Steels Are Combined

According to Womack, steels ranging from ordinary structural steel to the newest high-strength steels have been combined by Sunbury into structures with both marked economy and

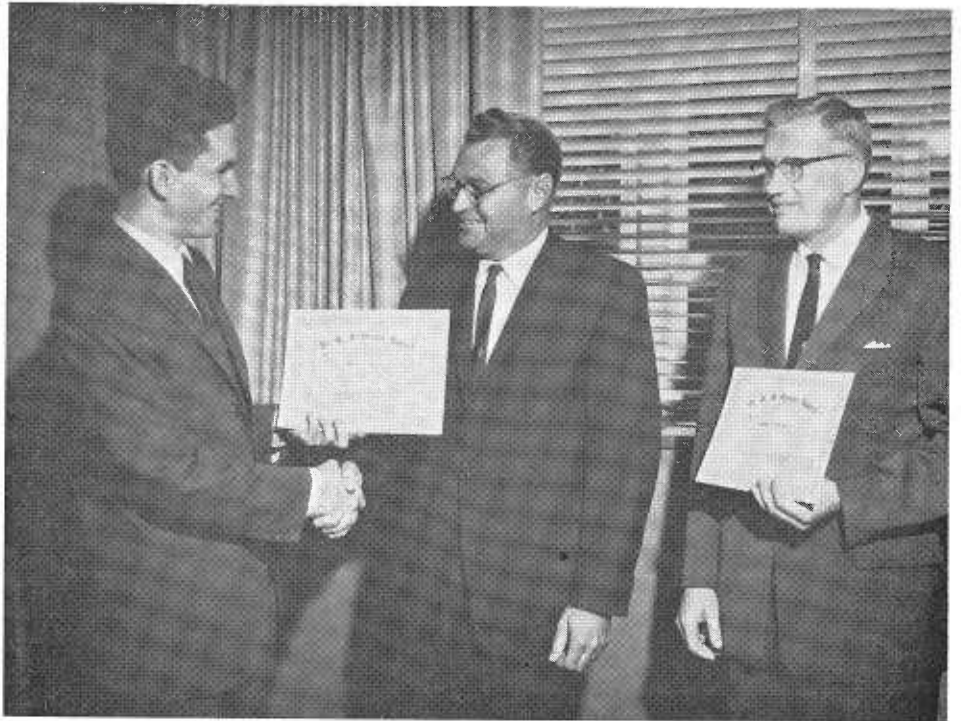

Robert L. Byrne, editor of *Western Construction Magazine*, presents certificates and \$250 checks for Dr. L. I. Hewes awards to Paul G. Jonas (center) and Roger D. Sunbury, California Division of Highways Engineer.

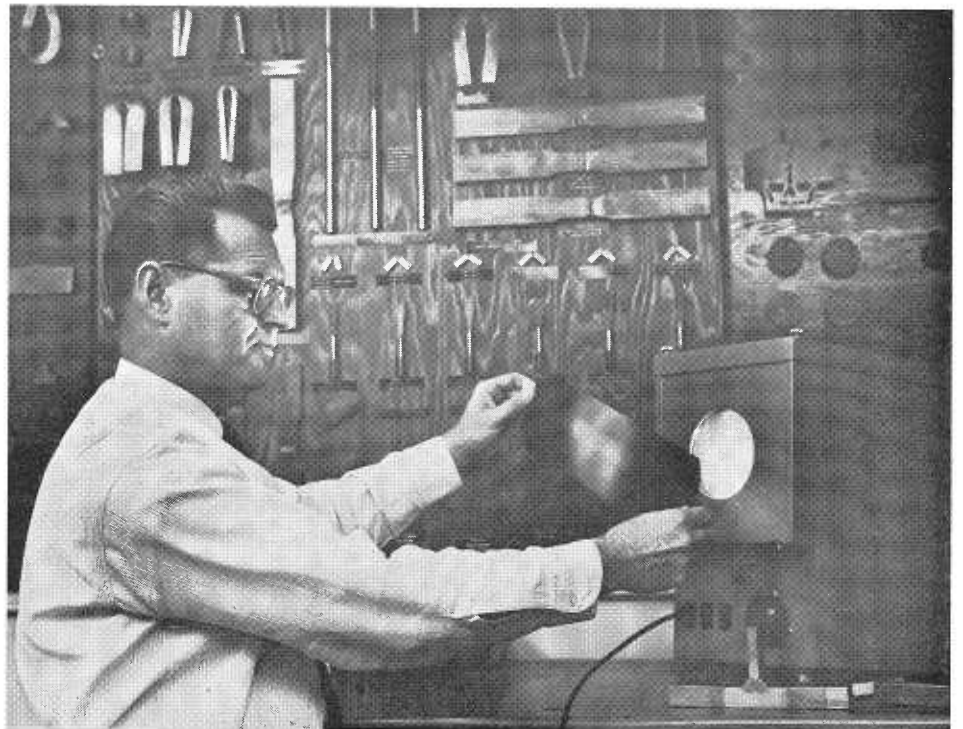

Paul Jonas, Senior Engineer Welding Technologist, examines a radiograph of one of the steel plates used in constructing the new span of the Carquinez Bridge. Jonas was responsible for perfecting many of the techniques used in welding together the various types of steel used in the structure.



improved appearance. These new adaptations of different steels are now being duplicated across the country.

The standards for welding procedure and inspection developed by Jonas have been widely adopted by many welding organizations and states, and the California Test Method 601 which he developed is recognized as the best and most comprehensive weld testing procedure available.

To qualify for the Dr. L. I. Hewes Award, a highway engineer must be recommended by the head of one of the 14 state highway departments in WASHO. Persons nominated must be highway engineers of the western states, must have made an outstanding contribution to highway development, and must not be chief engineers or members of the chief engineer's principal staff.

In addition, the engineer nominated must be engaged in planning, design, construction, maintenance, bridge, materials and research, or traffic engineering.

Final selection is made by the Executive Committee of WASHO.

Sunbury and Jonas are the third and fourth California Division of Highways employees to win this award. Previous winners were James T. McWilliam (co-winner-1952) and Arnold H. Carver (winner-1954).

#### **Sunbury Bridge Designer**

A native of Ohio, Sunbury graduated from Ohio State University in 1941 with a bachelor's degree in Civil Engineering. He went to work for the American Bridge Company in 1941 and served as an engineering draftsman and field engineer for the company on the Trans-Isthmian Highway in Panama, and on the Alcan Highway in Alaska and Canada. In 1944, he was commissioned as an ensign in the naval reserve and called to active duty in the Pacific.

Upon return to civilian life in 1946, Sunbury was employed as a construction engineer with the American Bridge Company until 1947, when he joined the California Division of Highways. His initial assignments were in construction and estimating, but since 1949, he has been active in the field of bridge design.



*An idea of the extensive riveting involved in creating the "lacework" on the older Carquinez Bridge is given in this photo taken during the construction of the new span (in background). The use of welded perforated box girders has virtually eliminated the use of riveting on such structures.*

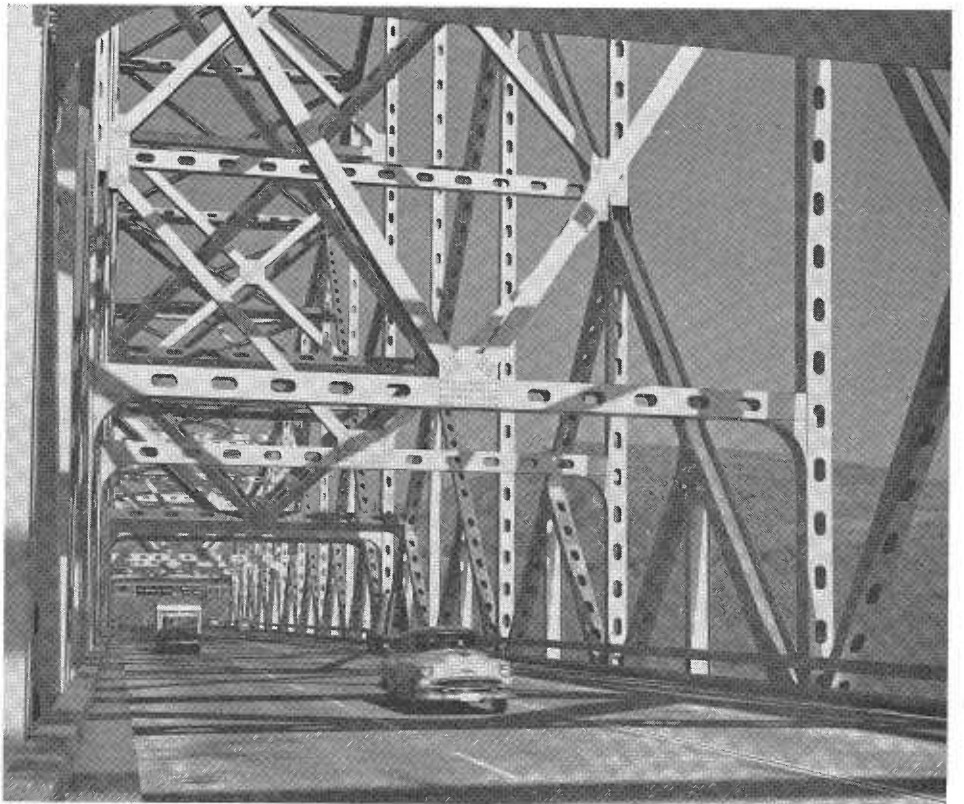

*The extensive use of perforated box girders in the new Carquinez Bridge presents a smoother, more eye-pleasing appearance while at the same time making maintenance and inspection faster, easier and more effective.*



*This view of the twin Carquinez Bridges shows the simple, more eye-pleasing structure made possible by the use of high-strength steels and modern welding techniques. The new structure, on the left, was built at a savings of \$800,000 by using these materials and techniques.*

Sunbury brought his broad background in engineering to bear on the subject of bridge design at a savings to California taxpayers of more than \$1,000,000 to date. Following up his earlier studies on the combining of high-strength steels, he was able to effect a saving of \$800,000 by combining three types of steel in a single structure—the Carquinez Bridge. A new high standard for clean, uncluttered truss design was established with the construction of this double cantilever bridge with its all-welded members and bolted joints. Use of high-strength steels allowed slimmer members and afforded great savings of weight in members previously required to be heavy in order to carry large secondary stresses.

Many refinements of design were worked out on the Carquinez Bridge, the Benicia-Martinez Bridge, and the Whiskey Creek Bridge. Different types of steel were successfully combined to save bridge weight and at the same time improve bridge appearance. Plates were butt welded so that higher strength compensated for bolt holes and no increase in section was neces-

sary. Box and H-sections were widely used to simplify the fabrication.

On the Whiskey Creek Bridge Sunbury carried plate girder design to a high degree of perfection by placing the higher strength steels in positions of higher stress, thereby maintaining uniform sections throughout the girder. All of these details are now being widely copied throughout the country.

#### **Jonas Welding Expert**

A native of Michigan, Jonas came to California with his family in 1923. He attended grade and high school in Antioch. He then completed a four-year night school vocational trade course in electric arc and oxyacetylene welding, layout, and machine shop practice.

Jonas has completed home study courses and night school courses in advanced welding, in metallurgy, and in teaching. He has had seven years teaching experience at Sacramento City College.

Prior to coming to work for the Division of Highways in 1946, Jonas worked in paper manufacturing, steel milling, ship building and repair, steel

fabricating, constructing road building equipment, and inspecting and doing research in welding. From 1944 until 1946 he served with the U. S. Navy in a ship repair unit.

With the California Division of Highways for more than 15 years, Jonas has spent five years with the Headquarters Shops and more than 10 years with the Materials and Research Department. He joined state service as a fusion welder and has served as Assistant Steel Inspector and Associate Steel Inspector. He is at present Senior Welding Technologist.

Starting at a time when structural welding was in its infancy, Jonas developed tests, test methods, and qualification procedures which established welding as a reliable method to be used in many types of structural work.

His California Test Method 601 and his development and interpretation of radiographic inspection results have been widely adopted and copied throughout the country. According to State Highway Engineer J. C. Womack, Jonas' work with the fabricators in developing procedures and inspection techniques and qualifying welders has done much to make welding a practical, dependable, usable shop tool.

Major projects on which he has worked or with which he has been affiliated include the all-welded Skyway in San Francisco, the Oakland Distribution Structure, the Carquinez Bridge, the Benicia-Martinez Bridge, the Whiskey Creek Bridge and the West Branch of the Feather River Bridge.

## **R.M. Monahan Named B.H.I.F. Executive**

Appointment of Robert M. Monahan as executive director of the Better Highways Information Foundation was announced in June by H. D. Anderson, chairman of the BHIF executive committee.

Monahan, who is a former special assistant to the Federal Highway Administrator, succeeds Ellis L. Armstrong, who had been executive head of the foundation since shortly after it was established in 1960.

Armstrong is a former U. S. Commissioner of Public Roads and Chief Highway Engineer of Utah.

# Two-Lane Expressways



*Good Alignment With Control of Access and Built-in Provision for the Future Serves Present Needs on Many Rural and Mountain Routes*

CALIFORNIA's spectacular progress in building multilane freeways and expressways often overshadows the impressive gains which are being made in providing modern two-lane highways to serve motorists in rural and mountain regions.

Obviously, two-lane highways are inadequate to cope with the extremely heavy traffic volumes which develop in metropolitan areas or on major through-routes; but these work-horse highways are still an essential component of California's 16,000-mile State Highway System.

Two-lane highways actually account for about 75% of the total operating state highway mileage. As

the state's population and traffic have continued to increase, many of these routes have become overcrowded and in urgent need of widening or upgrading to multilane freeway or expressway standards. These outmoded sections are steadily being eliminated under the state's extensive program of highway improvement.

However, there are many places in California where *modern two-lane*

*highways* will be adequate to handle traffic for a long time. In such areas, it is impractical to build four-lane highways initially; so high-standard two-lane facilities are constructed, with provisions for future widening when required.

An important distinction should be made.

Modern two-lane highways should not be confused with old-fashioned routes which meander through the countryside along ancient wagon roads or stock trails, or around farmsteads, taking motorists over narrow pavements, around hairpin curves, and up steep grades.

Today's two-laners are wider, straighter, and less steep. They present fewer driving hazards and points of traffic conflict. Their design is better oriented to the needs and habits of both local motorists and through travelers.



PHOTO TOP OF PAGE—Scenic two-lane expressway on State Sign Route 36 near Mineral in Tehama County. PHOTO LEFT—On this two-lane expressway section of Sign Route 120 near Oakdale, the old highway (foreground) now serves as a frontage road providing access to farms and homes.

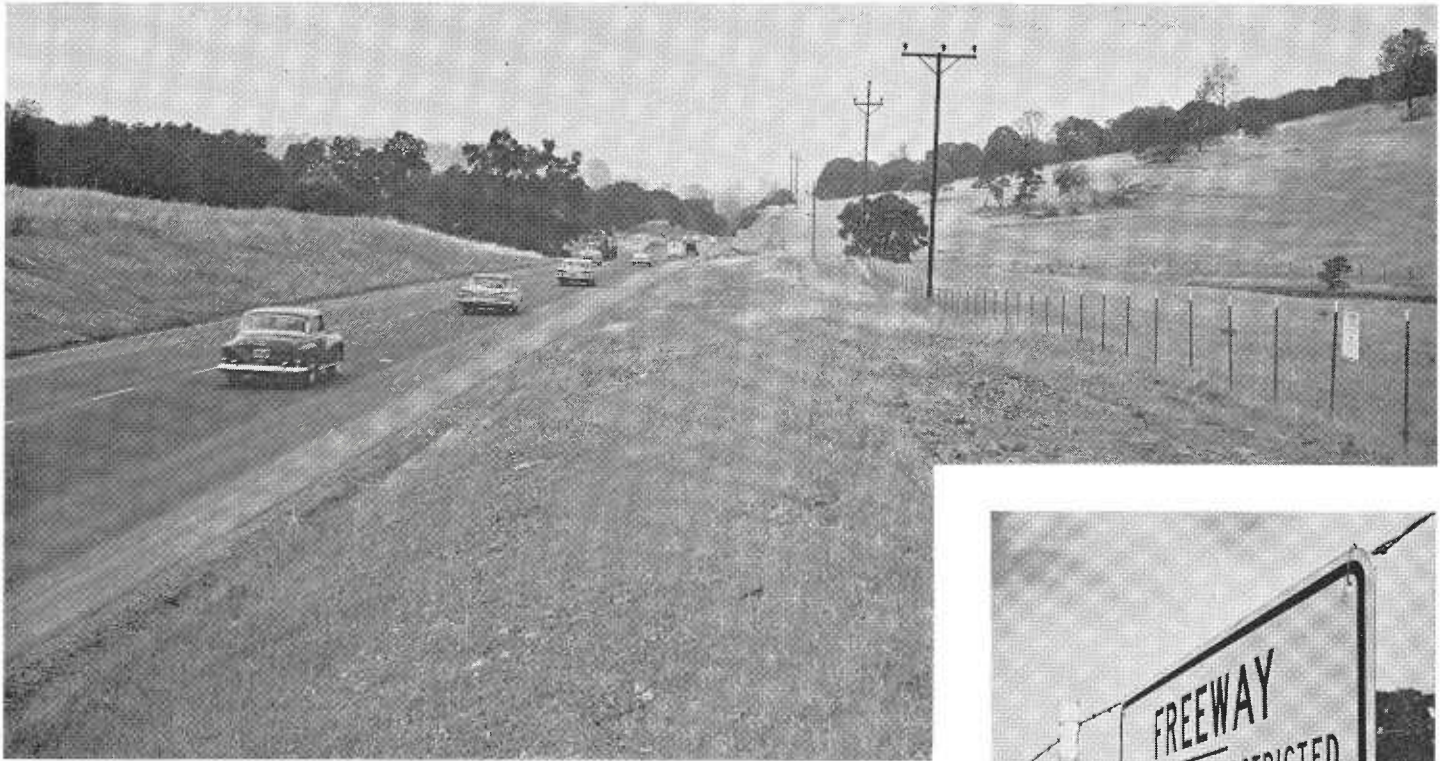

This section of US 50 east of Sacramento, commonly known as the Folsom Bypass, is identified as a two-lane expressway by the rectangular sign on the fence at the extreme right. Inset right is a blow-up of the sign.

There is another important, although not always recognized, difference. Most of the recently-built two-lane highways in California have provision for some measure of access control—that is, regulation or limitation of access to or from adjacent property.

Two-lane highways with access control are frequently referred to as “two-lane expressway,” or “two-lane freeways.” California now has more than 600 miles of limited access two-lane expressway in operation. Another 100 miles are under construction or budgeted.

#### Access Control

California adopted the access control principle in highway design in 1939 when the State Legislature enacted the state’s freeway law. This measure introduced the term “freeway” into the statutes. According to the law, a freeway is a highway “in respect to which the owners of abutting lands have no right or easement of access to or from their abutting lands or in respect to which such owners have only limited or restricted right or easement of access.”

*Thus, in a legal sense, any highway with controlled access is a freeway. This is true whether it has only two lanes or has eight lanes and a dividing strip.*

All freeway routes for limited access highways are established by the California Highway Commission, after careful planning by state and local agencies and subject to definite procedures for detailed public discussion, coordination with local master-planning and agreement with local government bodies regarding access provisions and local road adjustments. These procedures, which also apply to “two-lane expressways” as well as to urban multilane freeways, will be discussed later.

While any highway with access control is *legally* a freeway, the term has a more restricted meaning in common usage.

Most people think of a freeway (or a full freeway) as being a divided highway with from four to eight traffic lanes. Vehicles enter or leave this type of highway via interchange or access ramps. Cross traffic is carried over or under the main line. The right of way is fenced and roadside business dis-



tricts or residential areas are served by frontage roads and special connectors.

Another type of controlled-access highway is the “expressway,” which is also a divided highway, usually four lanes. On these routes, some cross traffic and left turns, and sometimes private access, are permitted at certain intersections.

#### Purpose of Control

The access control concept, which California helped pioneer, is now accepted and endorsed by planners and highway designers throughout the world. Full freeways, or other types of limited access highways, are now planned, under construction or in op-

eration in most countries where people depend on motor vehicles for daily transportation.

The access control design is a proven engineering answer to the problem of keeping heavy traffic on the move, expeditiously and safely.

The traffic benefits of access limitation are best demonstrated in the full freeway design which provides total control of access, thereby erasing many of the dangerous and annoying traffic conflicts so often encountered on conventional routes.

Stop lights and intersection pile-ups are eliminated. Pedestrians are usually prohibited, as are bicycles and scooters. On full freeways there are no vehicles crowding on to the main line at random from roadside businesses and private driveways. There are no sudden stops when the car ahead slows to make a left turn.

Access control also protects the highway investment. Where access is regulated, the safety and traffic capacity of the highway are permanently retained. By contrast, indiscriminate access means that the highway quickly becomes choked and inefficient.

Of course, traffic and economic benefits vary according to the extent of access control. Full control means maximum dividends in safety, convenience and long-term efficiency.

All access-controlled highways are marked with special freeway signs which are placed along the right of way (*see accompanying picture*). These signs will be found both on heavily traveled freeways and on two-lane expressways.

#### Two-lane Expressways

Although two-lane expressways closely resemble conventional two-lane highways in many respects, motorists can tell the difference by looking for these freeway signs and for certain characteristic design features.

At some locations, motorists on two-lane expressways will observe that specially constructed road connections and frontage roads are provided to serve adjacent business districts, recreational and camping areas, and other facilities.

At busy intersections, acceleration or deceleration lanes are often pro-

vided and left turn lanes are also included. Passing or truck lanes are added as necessary on upgrade sections in mountainous terrain.

Most two-lane expressways will have to be expanded at some future date to meet the demands of increasing population and resulting gains in motor vehicle travel.

When population and traffic estimates point to a probable future need for widening, the Division of Highways purchases enough right of way for this purpose at the time of the initial two-lane construction.

Consequently, there are many two-lane expressways now in operation on

established right of way wide enough for four or more lanes and a dividing strip.

This practice of satisfying future right of way needs at the time of initial construction results in substantial savings in right of way costs—especially in rapidly developing areas where land values are increasing and where considerable roadside business and residential construction is going on.

Although the Division of Highways acquires access rights for all two-lane expressways, occasionally these rights are held in reserve, with no special control measures taken at first. In

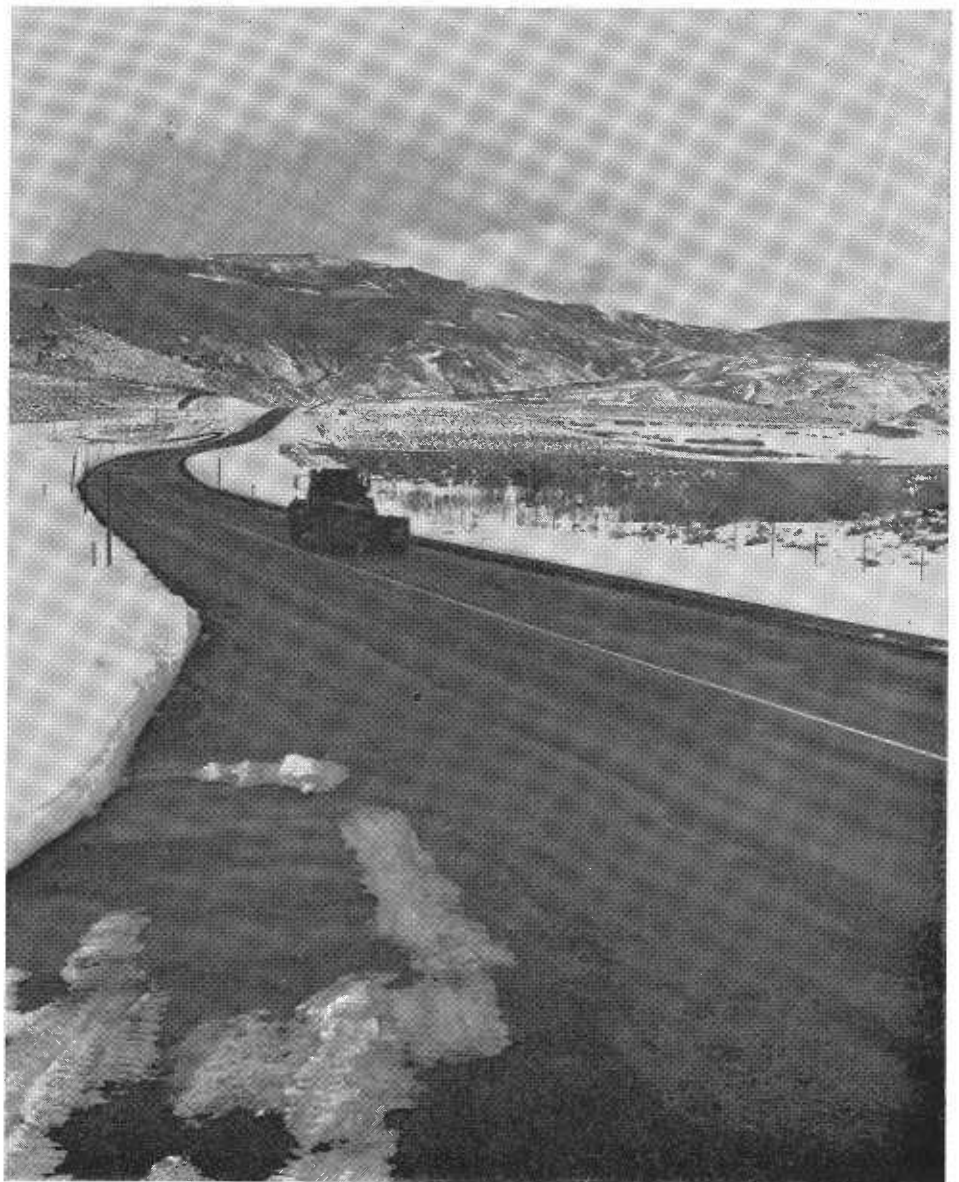

In winter, snow poles line this two-lane expressway section of US 395 just south of 8,138-foot Conway Summit (background) in Mono County.

sparsely populated sectors or in country where rough terrain restricts access, controls may not be necessary.

#### Freeway-Expressway System

In 1959, the Legislature adopted the California Freeway and Expressway System, a master plan which calls for the construction of a 12,500-mile network of limited access highways by 1980.

This system, adopted after many months of cooperative planning by state, city and county authorities, is expected to carry nearly 60 per cent of the state's total motor vehicle travel in 1980 and connect all cities of more than 5,000 population.

In rural and mountain areas where traffic is relatively light, many of these highways will be built first as two-lane expressways. They will be widened to four or more lanes when necessary, in some cases well beyond 1980. Some may not be four-laned for many decades.

Routes in the system have been designated by the Legislature in a general way. Usually only the termini are specified in the statutes.

Selection of the actual location for a route between these termini is the

PHOTO ABOVE LEFT—One of the more heavily traveled two-lane expressways is this section of US 395 north of San Diego. BELOW LEFT—Today's traffic is using this two-lane expressway bypass at San Juan Bautista. Right-of-way has already been prepared for widening to handle increased traffic of the future. BELOW RIGHT—An extra uphill lane, guard rail and lined drainage ditch are part of the two-lane expressway construction on Sign Route 1 north of Santa Cruz.

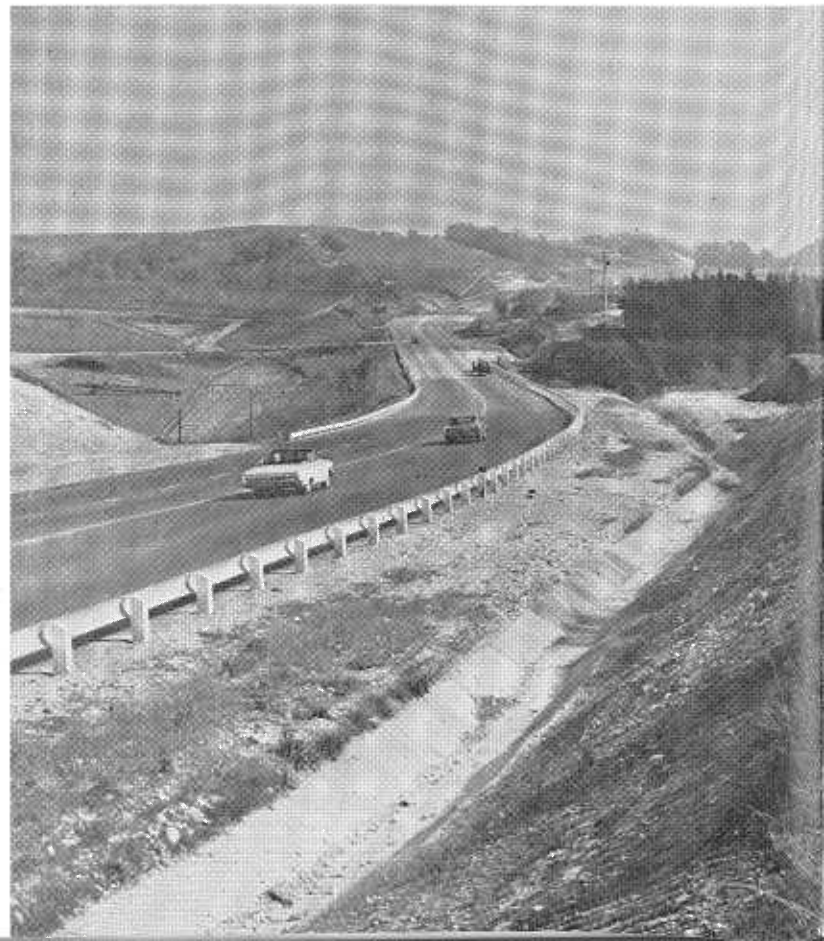

responsibility of the California Highway Commission, a seven-man body of business and professional men who represent the entire state rather than a particular city or region.

The six non-salaried commissioners are appointed by the Governor for four-year staggered terms. The seventh member of the Commission, and its ex-officio chairman, is the State Director of Public Works.

#### Freeway Route Selection

All freeway routes for limited access highways, including full freeways and two-lane expressways, are selected according to policies and procedures which have been followed for many years by the Highway Commission and the Division of Highways and which were incorporated into state law in 1961.

The object of these procedures is to insure painstaking study, careful consideration of all data, and complete public discussion of all possible routes. California insists that the people of a community must be informed and consulted early and often about freeway plans.

The procedure for selection of routes for limited access highways is outlined here in brief:

The general termini for a given route are set by the Legislature, often as a result of cooperative studies made by the state and local government.

Before possible routes between these termini are laid out, the Division of Highways consults city or county planners and traffic engineers to determine the area's needs, plans for development, and other factors. Local government agencies are notified that route studies are starting. Frequently, informal public meetings are held to explain problems and obtain preliminary ideas.

Working in close co-operation with local technical staffs, the division conducts extensive traffic, engineering and economic studies. Local master plans are reviewed.

On the basis of these studies, alternate routes are reviewed and evaluated. After careful examination, the division boils down the possibilities to those routes which are considered feasible.



On US Highway 99E through farming country near Chico, Butte County, the unused right-of-way (left of tall utility poles) is held in reserve until four lanes are required to accommodate increased traffic volume. Shown in foreground is part of a four-lane segment at the busy Oroville turn-off intersection.

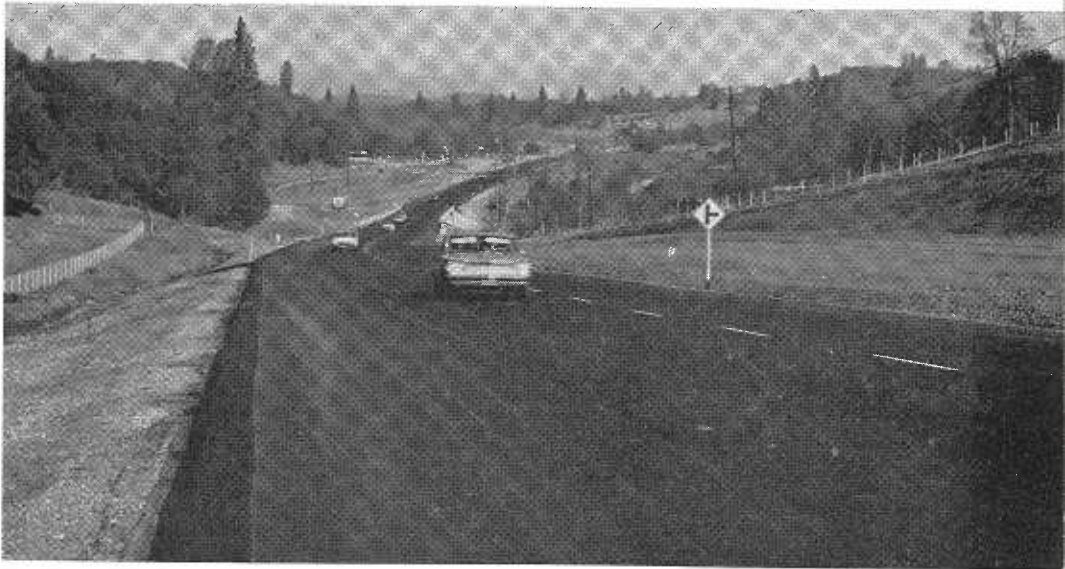
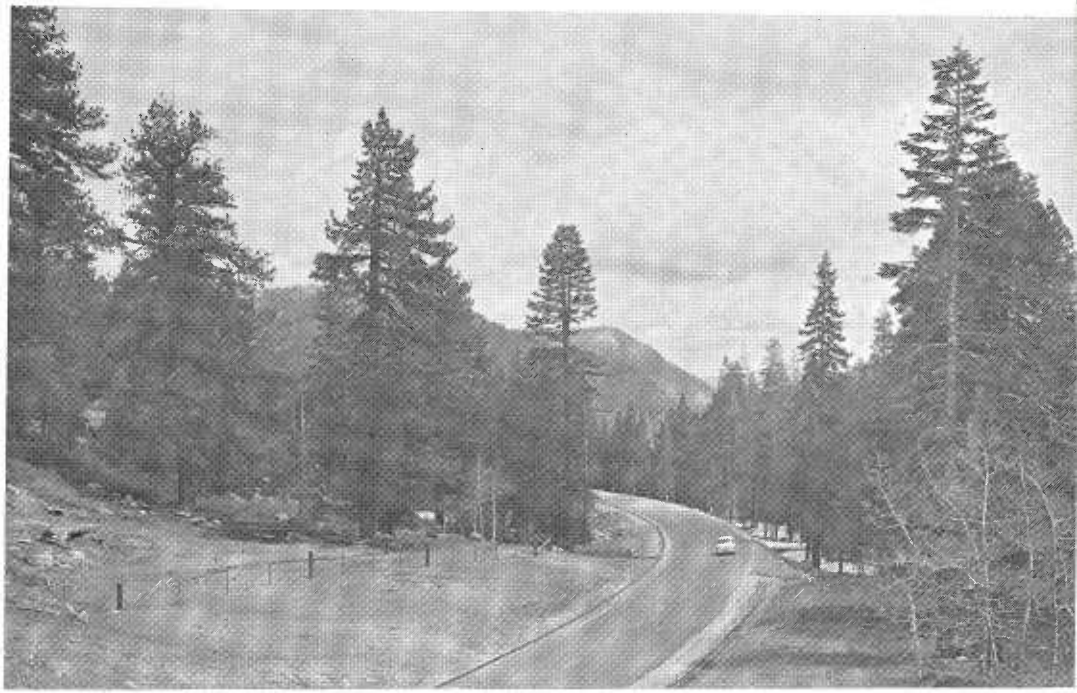

PHOTO ABOVE—Modern two-lane expressway on Sign Route 49 in the Mother Lode country between Auburn and Grass Valley. There is sufficient area between the right-of-way fences to permit future expansion of this highway when it becomes necessary. PHOTO BELOW—Two-lane expressway on the scenic Luther Pass (Sign Route 89) in Alpine and El Dorado Counties. Modern two-lane highways of this type are offering a more enjoyable ride to motorists in many of the state's scenic and recreational areas.



These alternate routes are then presented formally to the public at a series of map displays, group meetings and hearings. Further study frequently follows.

Upon completion of this additional study, the State Highway Engineer recommends to the Highway Commission the route which offers the best combination of advantages, considering engineering, economic and community values. Information on all other alternates is also presented to the commission.

The Highway Commission itself then takes the matter under consideration. Local governing agencies

are notified that if it is considered necessary or desirable, the Commission will hold a public hearing in the area concerned. Even when no hearing is requested, the Commission waits at least 30 days before making a decision. In some cases, when it appears advisable, the Commission will call a public hearing on its own.

After the Commission adopts a route, there is still another step. Under California law, there must be a "freeway agreement" with the local government concerning necessary street and road adjustments and closures.

Freeway agreements for initial two-lane expressways usually cover also

the ultimate designs standard—perhaps a four-lane expressway or even a full six or eight-lane freeway with crossing structures and total control of access.

#### **Occasional Misunderstanding**

During the course of all the study sessions, group meetings, map displays, and public hearings regarding the establishment of a freeway route for a two-lane expressway, misunderstandings sometimes develop, arising from the double-meaning of the word "freeway," which in a legal sense means any access-controlled highway, but which in common usage refers to a multilane divided highway with interchanges and crossing bridges.



*No special access-control measures have been required on this two-lane expressway section on Sign Route 20 in Mendocino County because natural terrain features—the stream and the steep wooded slope—already protect the right-of-way.*





*PHOTO ABOVE—Two-lane expressway on US Highway 395 south of Alturas, Modoc County. PHOTO BELOW—This section of US 395 in Lassen County resembles good two-lane highways which have been in operation for a long time. The right-of-way fence gives an indication to the observant motorist that he is traveling on a two-lane expressway where access is regulated.*





On two-lane expressways in the mountains, passing lanes are frequently provided on steep grades to alleviate tie-ups occasioned by slow-moving vehicles. Photo shows passing lane on US Highway 40 Alternate in Plumas County.

#### Superhighway Envisioned

When the term "freeway" is used during two-lane expressway planning sessions, a few individuals immediately envision a big superhighway such as might be required in a metropolitan area or on a heavily traveled through route.

With this picture firmly fixed in their minds, they offer alarmed pro-

tests, pointing out that traffic, population density, and the social and economic makeup of the area do not justify superhighway development:—"all we need is a good two-lane highway".

It sometimes takes a great deal of patient explanation and repeated assurances from highway planners to erase this confusion and to convince peo-

ple that "a good two-lane highway" is exactly what is being contemplated—a highway which will look much like the present two-lane route, except that access will be regulated, and the roadway will be wider with fewer steep grades and sharp curves, and there will be provision for eventual widening when warranted.

#### Summary

California's population will continue its upward spiral in the coming years.

As the population continues to increase, there will be even greater gains in travel on the state's roads, streets and highways. In 1980, there will be nearly twice as many people in California as there are today; and motor vehicle travel will have *tripled*.

The state is preparing for this future growth, following a Legislature-adopted master plan to construct the "California Freeway and Expressway System".

As work moves along on construction of this limited access highway network, full freeway construction in metropolitan areas and on major through routes will receive the greatest share of publicity and public recognition.

#### More Recognition Expected

This is to be expected because of the magnitude of such construction, the complex problems involved in centers of dense population and heavy traffic, and the enormous motoring and economic benefits which full freeways provide.

However, important rural highways with smaller traffic volumes will not be neglected.

In the years ahead, many of these highways in scenic mountain, forest, desert and seashore areas and through agricultural regions will be converted to modern two-lane expressway standards—with provision made for future expansion as required.

These new two-lane highways will permit safer, faster and more pleasurable travel for the residents of these areas, as well as for commercial traffic and for visitors on a summer vacation or a winter ski trip.

## Helen Halsted Retires From Information Section

Helen Halsted, Assistant Information Officer for the Division of Highways, will retire August 1, after more than 38 years of service with the division.

Mrs. Halsted came to work for the division in November of 1922, and has worked under all six State Highway Engineers. Her only break in service was one year in 1928-29.

Entering service as a stenographer, she progressed to senior clerk and senior stenographer-clerk before entering the information field in 1952.

She is an avid world traveler and frequently visits her son, Donald E. Halsted, who resides with his wife, Ann, and children, Jill and Mark, in Juneau, Alaska, where he is a bridge engineer for the state highway department.

# Moonlight Ride

San Diego 'Crosstown'  
Is Freeway With View

The following article by Hal D. Steward is reprinted from the *San Diego Union*.

If you haven't yet gone for a moonlight drive on the new Crosstown Freeway, you should.

It's really the "freeway with a view," the only one like it in California.

The first two links of the freeway, which were opened last Friday, take you from the vicinity of Lindbergh Field to Park Boulevard immediately in front of the U.S. Naval Hospital.

A reporter and a photographer took the "moonlight ride."

Should you take the same ride, you will enter the north end of the freeway from Palm Street off U.S. 101 east of Lindbergh Field. You'll travel two blocks down Palm and turn right on Kettner Boulevard. One block straight ahead is the freeway entry.

## Lights of City and Bay

As you come out of the ramp onto the freeway you will see the lights of San Diego to your right with San Diego Bay in the background.

The eight-lane, divided freeway takes you across the top of the city.

From here you see the lighted ships in the bay, the Lindbergh Field runway lights, the bright blue lights atop the Security First National Bank, the San Diego Gas and Electric Co., and tall civic center off to their right.

You will notice as you approach them that each overpass has markers telling you the configuration of the road ahead. This will help you from getting in the wrong lane and finding yourself on or off the freeway when you intended otherwise.

The first off-ramp you will come to as you take your drive south is marked Front Street and Second Avenue.

But before you reach the turnoff you will have noticed the glowing red neon lights atop El Cortez Hotel off to your left.

## Dips Under Overpasses

Once you're past the first off-ramp the freeway takes a dip under over-

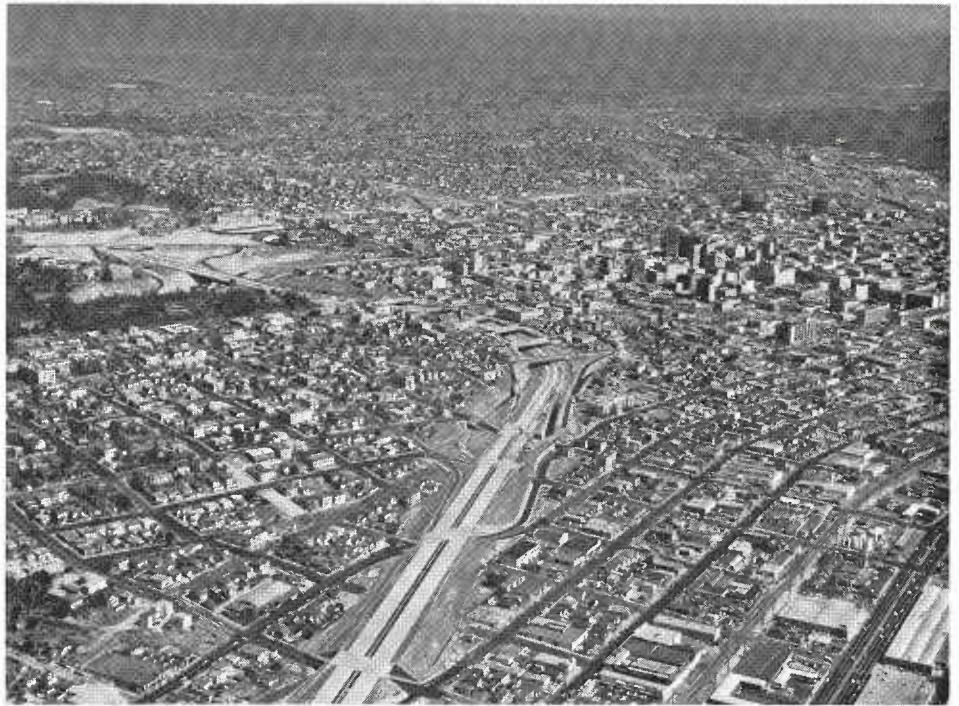

The San Diego "Crosstown Freeway" shortly before it was opened to traffic on June 6.

passes. As you come out you'll see an off-ramp marker for downtown. This brings you out at 10th Avenue and Ash Street.

As you approach the 10th and Ash turnoff, the freeway divides—left joins up with U.S. 395 to Escondido; right takes you to 10th Avenue.

When you have reached this point you've covered the new freeway links going south.

But you may have decided to take your drive of the new freeway coming in from the south. To do this you pick it up at 11th Avenue and A Street. Be sure you make your turn into the far right lane. A few hundred yards ahead you'll see an off-ramp to the right marked Los Angeles—this is your ramp. It carries you up, around to the left and over U.S. 395.

You also can enter the northbound on-ramp from Park Boulevard adjacent to the naval hospital.

The first off-ramp you'll come to going north is at Fourth Avenue. The other off-ramps are at Hawthorne and Palm Streets.

Your ride north will end at Olive Street.

## Part of Lengthy Route

The 1.7-mile Crosstown Freeway is a section of the San Diego Freeway, which eventually will run from the San Fernando Valley to the Mexican border.

A third unit now under construction will extend the freeway south, including a connection with the State 94 Freeway at 18th Street.

The first two links opened Friday and the third link under construction are the first units of a 12-mile \$60 million freeway which will knife through central San Diego and National City.

It will offer the traveler a scenic view all the way since much of it is being built above the city.

The links opened Friday are expected to relieve traffic in downtown San Diego during peak periods. San Diegans who live in the northern part of the city will want to use it to enter and leave the downtown district.

You can enter the freeway from downtown at either First or Fifth Avenues. The Fifth Avenue on-ramp south was not open Sunday, but it appears completed and should open to traffic shortly.

Motorists should experience no difficulty in traveling the Crosstown Freeway or in finding their way on and off it.

#### 'Vigor, Charm, Culture'

During Friday's freeway opening ceremonies, Roger Wooley, State Highway Commissioner from Rancho Santa Fe, said:

"The freeway is indicative of a San Diego which is combining the vigor of Los Angeles with the charm and culture of San Francisco."

The R. E. Hazard Contracting Co. and the W. F. Maxwell Co. built the freeway unit from Palm Street to Sixth Avenue at a cost of \$5.2 million. The link from Sixth Avenue to Park Boulevard was built by the Daley Corp. and R. M. Price Construction Co. for \$3.4 million.

Two central area streets have been made one way because of the new freeway. Front Street has become one way southbound and First Avenue northbound.

Today will be the first day San Diegans will give the new freeway full use.

So, if you haven't taken mama and the kids for a moonlight ride along the Crosstown Freeway, do it soon.

It will give you a new appreciation of the beauty and progress of your city.

## Contracts Awarded on Retirement Building

Four contracts totaling \$8,221,016 were awarded on June 25 for general, electrical and mechanical work and elevators for the State Retirement Fund Building, now under construction in Sacramento. Larger than any other state office building in California, the building will be the fourth largest office building west of Chicago. The bid opening date was extended from May 22 to June 19 because labor disputes prevented contractors from estimating labor costs.

## TRAFFIC ENGINEERING AWARD PRESENTED TO DIVISION



Presentation of the National Safety Council Certificate of Achievement in Traffic Engineering for 1961 to the State of California took place on June 25, 1962, in the Office of Governor Edmund G. Brown. Taking part in the ceremony before a group of local and regional safety council leaders from all parts of the State were, left to right: G. M. Webb, Traffic Engineer, State Division of Highways; J. C. Womack, State Highway Engineer; Governor Brown; and John G. Hall, Western District Director of the National Safety Council. California has consistently won the plaque for outstanding performance in traffic engineering in recent years, in competition with several other large states in that phase of the annual traffic inventory conducted by the NSC.

## National Cooperative Research Program Initiated

The beginning of the multimillion-dollar National Cooperative Highway Research Program (NCHRP) was announced in July by R. R. Bartelsmeyer, Chairman of the Highway Research Board, on behalf of the American Association of State Highway Officials, the Bureau of Public Roads, and the National Academy of Sciences-National Research Council. An agreement among the three organizations was signed June 19; less than a week later, on June 25, the board's NCHRP committee under the chairmanship of T. E. Shelburne held its first meeting in Washington.

The Highway Research Board, which will administer the program, operates within the Academy-Research Council's Division of Engineering and Industrial Research.

About \$2,500,000 will be spent on

the program during its first year of operation. Future expenditures will depend, in part, on the support received from sponsoring state highway officials.

The six research areas include studies of the extension of the AASHO road test findings; reliability of methods for determination of benefits from highway improvements; techniques for improvement of traffic capacity and safety; beneficiation of poor aggregates and development of new aggregates; freeway lighting, and highway structure protection; and snow and ice control. Other areas of research will be added to this list as the program progresses.

Program activities within the Highway Research Board have been placed under the supervision of M. E. Campbell, a member of the staff since 1945.

# Traffic Census

*Self-recording Equipment  
Replaces Manual Counting*

By THOMAS N. TAMBURRI, Assistant Traffic Engineer and  
CARROLL E. DUNHAM, Associate Highway Engineer

After nearly five decades, manual counting of traffic on the California State Highway System has given way to a new and expanded program of obtaining traffic census with automatic self-recording and mechanized equipment. The old method of counting 16-hour, two-days a year samples in July was replaced by a continuous year-round sampling and estimating procedure. The new method is designed to increase the efficiency of the statewide census count and to obtain a great deal more traffic information without increasing the cost.

The new program, adopted in January 1961, combined the rural and

urban count systems into a single composite program replacing the manual counting procedure with a completely mechanized system. It established small full-time census crews to replace the thousands of temporary employees formerly hired to conduct the annual July count. Through a firmer basis of control counting the new program permits 24-hour profile counting to be done throughout the year.

The new program further provides expansion factors (used to convert profile counts to Average Daily Traffic) to be applied by individual route assignment rather than by geographical subdistrict as in the past. The number of control and profile count stations was increased more than three times while the annual cost of the program was reduced to approximately one-half. The net result is that

considerably more traffic data (except for classifying trucks) of much greater accuracy is available at approximately one-half the former cost.

The annual Traffic Census Booklet also underwent major revision. The former raw count data (16-hour Sunday and Monday July counts) were replaced with Annual Average Daily Traffic estimates and Peak Seasonal Average Daily Traffic columns. The new booklet utilizes a county-route-postmile system for identifying count locations and an improved list of intersection and landmark names to make the information more meaningful to the public. The detailed average daily traffic profile can now be plotted directly from the booklet. (See page 23).

Control stations are counted for a minimum period of seven days each

---

*PHOTO BELOW—Ultrasonic traffic detectors (on steel girder, top of photo) are mounted over each traffic lane on high-volume, multilane freeways. This installation is on the Bayshore Freeway in Burlingame.*

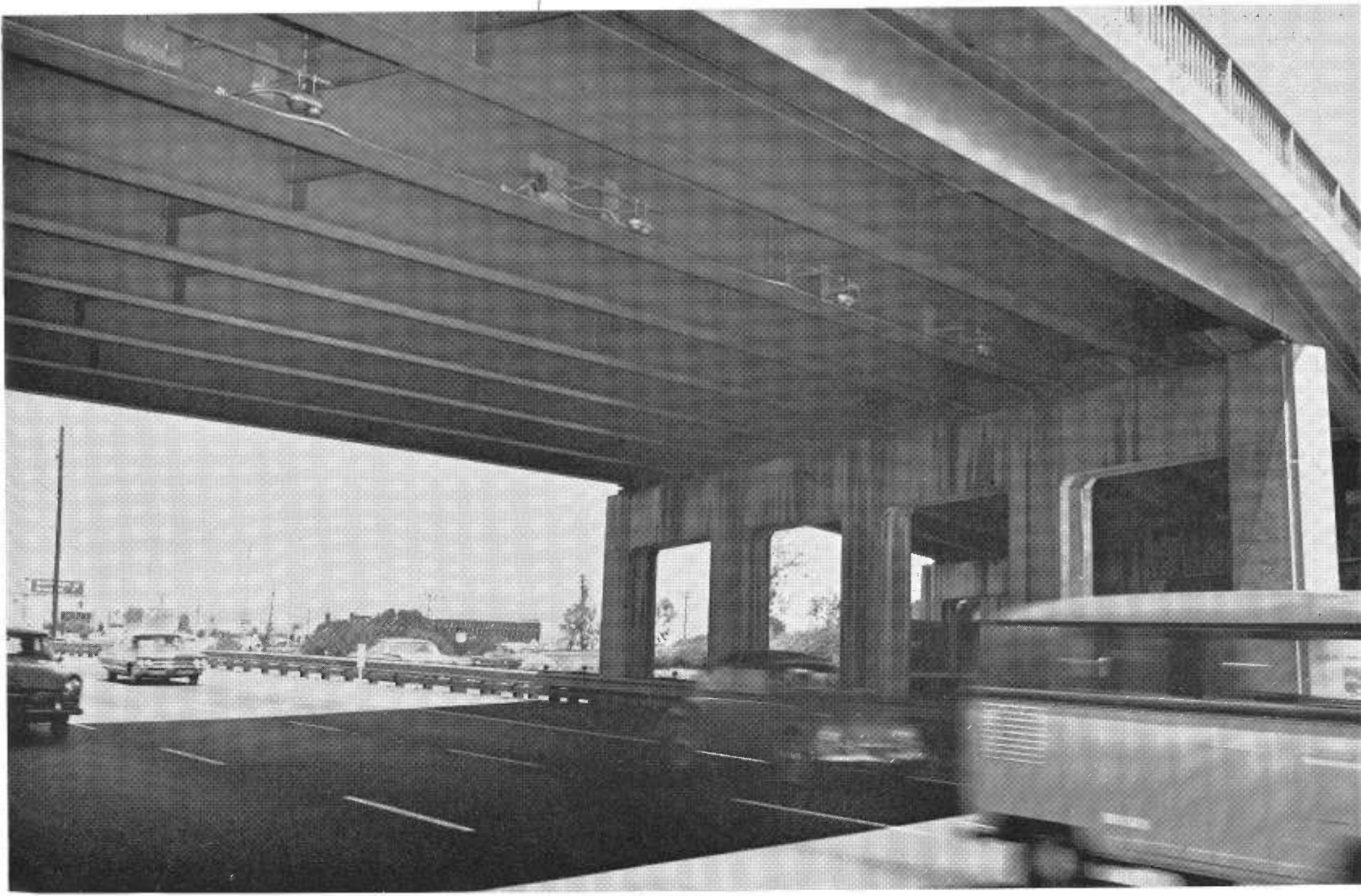

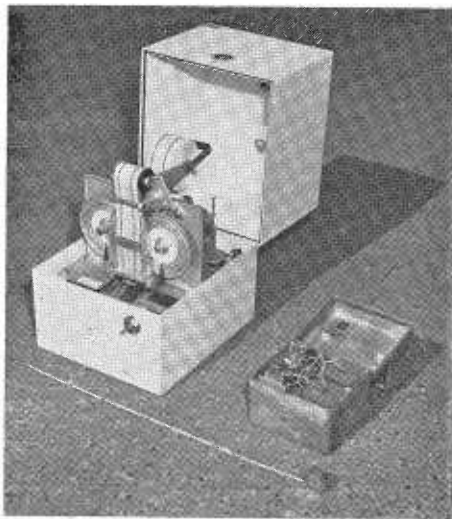

A punch-tape recorder counter (left) and a junior nonrecording traffic counter (right).

month. Profile stations are counted for approximately 24 hours once a year. To compile and publish the census booklet by the end of the calendar year, the count year is from October 1 to September 30.

#### History

California was among the leaders in initiating a regular system of counting and publishing traffic census data. The following census count table appeared in the "Fourth Biennial Report of the Department of Engineering." (Reproduce Table No. 48, Page 240, of Report.)

Although records of vehicle counts date from 1913, California obtained and published the first regular annual traffic census information in 1924. The first statewide traffic data came from 300 widely dispersed locations. Early day counts were recorded on a clipboard in the field. The counts were converted to average daily traffic by hand calculations in the office. All counts were classified by types of vehicles, including for many years, horse-drawn and foreign vehicles. This early day system was so successful (and checked so closely with the statewide estimate of vehicle miles driven derived independently from annual gasoline sales) that it was maintained with relatively little change through 1960.

Prior to 1936, the statewide vehicle count was made and published semi-annually, in mid-January and mid-July. From the midtwenties, the

counts were for 16 hours on two consecutive days (from 6 a.m. to 10 p.m. on the Sunday and Monday nearest the middle of the month). This type of sampling proved adequate in many respects. The Sunday-Monday relationship gave a clear indication of the weekend versus weekday traffic, hourly data were available for both days, and ample information was recorded on the various types of vehicles at each count point. From a very early date traffic was counted at highway junctions since a single observer could record traffic on all legs of a rural intersection simultaneously.

#### Minimum in January

During the period of the semiannual counts, approximate maximum and minimum daily counts were available for analysis. January has consistently remained the month of minimum daily traffic at the vast majority of points on the state highway system; while maximum daily counts are usually recorded in August, with July ranking a close second. (This pattern is usually reversed on the desert highways.) To verify the accuracy of the semiannual system of counting, a monthly count station was established and observed closely at San Lucas on U.S. 101 in Monterey County. Incidentally, this station is still being counted, providing an important link between the various

traffic counting systems utilized over the years.

In 1936, the January semiannual count was dropped. At the same time, 37 monthly control stations similar to that at San Lucas were established. Simultaneously, 33 geographic sub-districts were created with their boundaries encompassing areas of common climatic conditions and similar traffic patterns. Each subdistrict was represented by one or more monthly count stations which produced seasonal traffic factors capable of expanding all July counts within the subdistrict to average daily traffic. The monthly count stations provided 16-hour counts on the Monday nearest the middle of each month, except that 24-hour counts were made in July.

#### Seven-day Stations

A system of seven-day count stations was created in 1934 to verify that the ratio for weighting the July annual counts (one Sunday plus six Mondays divided by seven) was accurate. For many years, small adjustment factors were applied to correct this basic Sunday-Monday relationship where the true weeklong counts were not exactly equal to the sum of six Mondays plus one Sunday count. The seven-day count stations were originally established at the rate of one per district, but this number had grown to

TABLE No. 48.  
Traffic Census, State Roads.

Name of road	Year	Automobile number		Team number		Loose stock number	
		Through	Local	Through	Local	Through	Local
Emigrant Gap -----	1913	2,200		100		440,000	
	1914	4,500		1,100		440,000	
Myers-McKinneys -----	1913	10					
	1914	3,000		1,000			
Lake Tahoe -----	1913	2,919					
	1914	4,405					
Alpine:							
Carson Pass -----	1913	31	44	45	135		
	1914	139		228	200		
Ebbetts Pass -----	1913	20	70	158			
	1914	750	1,509	343			
Alpine Trunk -----	1913	192		146	7		
	1914	331					
Alpine, Mono section -----	1913	60	300	620	45		10,000
	1914	339	1,060	612			
Sonora-Mono -----	1913	200	50	100	75	90,000	120,000
	1914	500	360	170	612	98,000	123,000
Trinity-Humboldt -----	1913	200		50			
	1914	670		150			

Table of 1913-1914 traffic census reproduced from the "Fourth Biennial Report of the Department of Engineering." Note the types of vehicles and animals counted.



system proved very practical and efficient, but it was supplementary to the rural count system. It became increasingly difficult to integrate the two separate systems due to the non-classified machine counting and the scarcity of control counts in the urban system.

**New Program**

A major investigation and evaluation of the count programs was undertaken in 1959 by the headquarters traffic department in co-operation with the district traffic engineers, headquarters planning survey and the U.S. Bureau of Public Roads. It was decided to abandon the then existing rural and urban count programs for a new and integrated system which would equal or improve the accuracy of the old systems and which would substantially reduce cost.

The objectives of a traffic census program are:

1. To provide an estimate of annual average daily traffic at all points on the system. This estimate is used to estimate the total traffic that is carried on the state highway system, to keep track of changes in the amount of statewide travel and changes in travel patterns, and to compute accident rates.

2. To provide an indication of hourly and seasonal variations in flow.

The districts co-operated with the Headquarters Traffic Department in planning and designing the new census program. The program as adopted is hereafter described in its various component parts.

**Control Counting**

After studying the mass of seasonal data accumulated at the old monthly control stations in recent years and bearing in mind the approximate average daily traffic and vehicle miles driven on each rural section and on each city route, a system of 355 well-dispersed control stations was selected. Route segments having similar traffic patterns were assigned to a nearby control station having the same (or nearly the same) pattern. The limits of each control station's sphere of influence were pinpointed on as realistic a basis as possible, usually at major traffic profile breaks. Artificial

boundaries such as city limits and county lines were disregarded.

On a statewide average, each control station represents about 40 miles of highway. However, this varies considerably and according to the relative stability and similarity of individual traffic patterns. For example, in large metropolitan areas, seasonal, daily, and hourly patterns are relatively flat and are stabilized by a predominance of commuter traffic. Therefore, in a metropolitan area there is much less likelihood of making an inaccurate route assignment than in a remote rural area

where recreational traffic predominates.

A period of one week per month was chosen as the optimum count period at the control stations. This was done to record traffic in its minimum practical cycle, to allow maximum flexibility to counter crews, and to permit the use of portable equipment. (No attempt is made to count exactly seven days, however. The count period varies from seven to ten days and the individual 168 hours in the week are computed electronically from the available data by averaging

STATE OF CALIFORNIA  
DEPARTMENT OF ENGINEERING  
CALIFORNIA HIGHWAY COMMISSION

# TRAFFIC RECORD

## 191

OBSERVING STATION No. \_\_\_\_\_

DATE \_\_\_\_\_

LOCATION OF STATION \_\_\_\_\_

Div. \_\_\_\_\_ COUNTY \_\_\_\_\_, ROUTE \_\_\_\_\_, SEC. \_\_\_\_\_, STA. \_\_\_\_\_

\_\_\_\_\_  
SIGNATURE OF OBSERVER

KIND OF VEHICLE		7 A.M. TO 9 A.M.	9 A.M. TO 11 A.M.	11 A.M. TO 1 P.M.	1 P.M. TO 3 P.M.	3 P.M. TO 5 P.M.	5 P.M. TO 7 P.M.	7 P.M. TO 9 P.M.	TOTALS
SINGLE HORSE	LIGHT VEHICLE	<input type="checkbox"/>	<input type="checkbox"/>	<input type="checkbox"/>	<input type="checkbox"/>	<input type="checkbox"/>	<input type="checkbox"/>	<input type="checkbox"/>	
	HEAVY VEHICLE	<input type="checkbox"/>	<input type="checkbox"/>	<input type="checkbox"/>	<input type="checkbox"/>	<input type="checkbox"/>	<input type="checkbox"/>	<input type="checkbox"/>	
TWO OR MORE HORSES	LIGHT VEHICLE	<input type="checkbox"/>	<input type="checkbox"/>	<input type="checkbox"/>	<input type="checkbox"/>	<input type="checkbox"/>	<input type="checkbox"/>	<input type="checkbox"/>	
	HEAVY VEHICLE	<input type="checkbox"/>	<input type="checkbox"/>	<input type="checkbox"/>	<input type="checkbox"/>	<input type="checkbox"/>	<input type="checkbox"/>	<input type="checkbox"/>	
AUTOMOBILE	RUNABOUT	<input type="checkbox"/>	<input type="checkbox"/>	<input type="checkbox"/>	<input type="checkbox"/>	<input type="checkbox"/>	<input type="checkbox"/>	<input type="checkbox"/>	
	TOURING CAR	<input type="checkbox"/>	<input type="checkbox"/>	<input type="checkbox"/>	<input type="checkbox"/>	<input type="checkbox"/>	<input type="checkbox"/>	<input type="checkbox"/>	
	MOTOR TRUCKS	<input type="checkbox"/>	<input type="checkbox"/>	<input type="checkbox"/>	<input type="checkbox"/>	<input type="checkbox"/>	<input type="checkbox"/>	<input type="checkbox"/>	
	MOTOR-CYCLES	<input type="checkbox"/>	<input type="checkbox"/>	<input type="checkbox"/>	<input type="checkbox"/>	<input type="checkbox"/>	<input type="checkbox"/>	<input type="checkbox"/>	
TOTALS		<input type="checkbox"/>	<input type="checkbox"/>	<input type="checkbox"/>	<input type="checkbox"/>	<input type="checkbox"/>	<input type="checkbox"/>	<input type="checkbox"/>	
WEATHER CONDITIONS									

OBSERVER WILL NOT WRITE IN THIS SPACE

Count chart used by recorders for the 1913 traffic census. (See instructions, next page.)



duplicate hours.) The same week is counted each month at an individual control station, so certain stations would be counted the first week, another group of control stations the second week, etc. This method permits the reuse of each automatically recording count two or three times per month. No counts are scheduled in the last week of a month. This period is set aside for makeup counts in case of road tube failures or mechanical malfunctions.

#### Satellite Counting

Satellite (profile) counts were selected at all points of significant traffic breaks along the route. Distances

between satellite count points vary from every street intersection or freeway interchange in urban areas to 10 or more miles in remote rural areas. The distance depends entirely on the magnitude and percentage of traffic entering and leaving the highway. There are approximately 12,000 satellite count stations or an average of about one per mile of state highway.

All satellites fall within a predetermined sphere of influence of a control station and are assigned to that control station. It is, therefore, a basic assumption that the hourly, daily and seasonal traffic fluctuations are identical (or nearly so) at each satellite station and at its control station. The

patterns may differ only in magnitude (i.e., traffic volume).

Satellite counts are made annually for approximately 24-hour duration, during one of the times the related control station is in operation. The one-day count at the satellite bears the same relationship to the ADT at that point as the simultaneous count at the control station bears to its ADT, hence the name "satellite" or associated station. No attempt is made to count for a period of exactly 24 hours. Instead, the count at the satellite for any convenient period of approximately 24 hours is compared to the count at its associated control station for the identical period.

These counts may be made on any day during the year. Thus, the scheduling of the counts provides maximum efficiency in manpower with a minimum of equipment. As a practical matter, however, it is desirable to avoid counting on weekends and in the winter months when traffic patterns may be erratic. It is also desirable to count as many adjacent profile points along a route on the same day as possible.

On high volume urban freeways where mainline satellite counts cannot be obtained with conventional equipment, all entrance and exit ramps are counted instead and the mainline volumes are computed. However, frequent mainline counts are made and any discrepancies between computed volumes and counted volumes are corrected and balanced.

#### Future Truck Counts

The truck profile established during the year of 1960 is being used through the calendar years of 1961 and 1962 without benefit of additional classified counts. A study is now being made to determine the necessary interval and frequency of future truck counts. Since truck traffic, both total and by number of axles, is usually fairly stable and changes relatively slowly, classified truck counts can be obtained at considerably less frequent intervals of time and distance.

#### Equipment

A comprehensive examination of traffic counter equipment in use by other states and experimental work

## Instructions to Observers

1. Examine carefully the card marked "Sample," sent to you with the cards upon which you are to keep your records, and be sure that you understand the method of keeping the tally.

2. Your duties begin promptly at 7 o'clock in the morning and end at 9 o'clock in the evening for the seven days shown on the cards furnished to you.

3. In recording vehicles which pass your station, make a mark in the proper column and on the proper line for every vehicle of the kinds called for on the cards, but do not record bicycles or pedestrians. Make an entry for every vehicle, no matter in which direction it is going or whether it has passed you previously. Entries may be made with a lead pencil.

4. "Light Vehicle" means a buggy, democrat wagon, or any vehicle other than an automobile, which is used usually for pleasure or light business purposes.

"Heavy Vehicle" means a farm wagon, milk wagon, dump wagon, grocery or provision wagon or any vehicle except an automobile, which is used for carrying heavy loads.

"Runabout" means an automobile built to carry but two people.

5. After you have recorded all of the vehicles during the period from 7 a.m. to 9 p.m., add your tally marks, and place the totals at the right of the card and at the bottom of the card in the spaces provided.

6. When you are sure the totals are added correctly, enclose the card for the day, after you have signed it, in one of the stamped addressed envelopes furnished to you and mail it at once.

7. Be sure that you use the right card each day (look at the date at the top of the card), and do not fail to record every vehicle, called for by the card, which passes your station.

8. If there is anything which you do not understand about the cards or these instructions, write at once to the division engineer, to whom you are to send the cards.

*This instruction sheet accompanied the count chart (previous page). A glance of the text shows that problems of vehicle identification have changed somewhat in 50 years.*

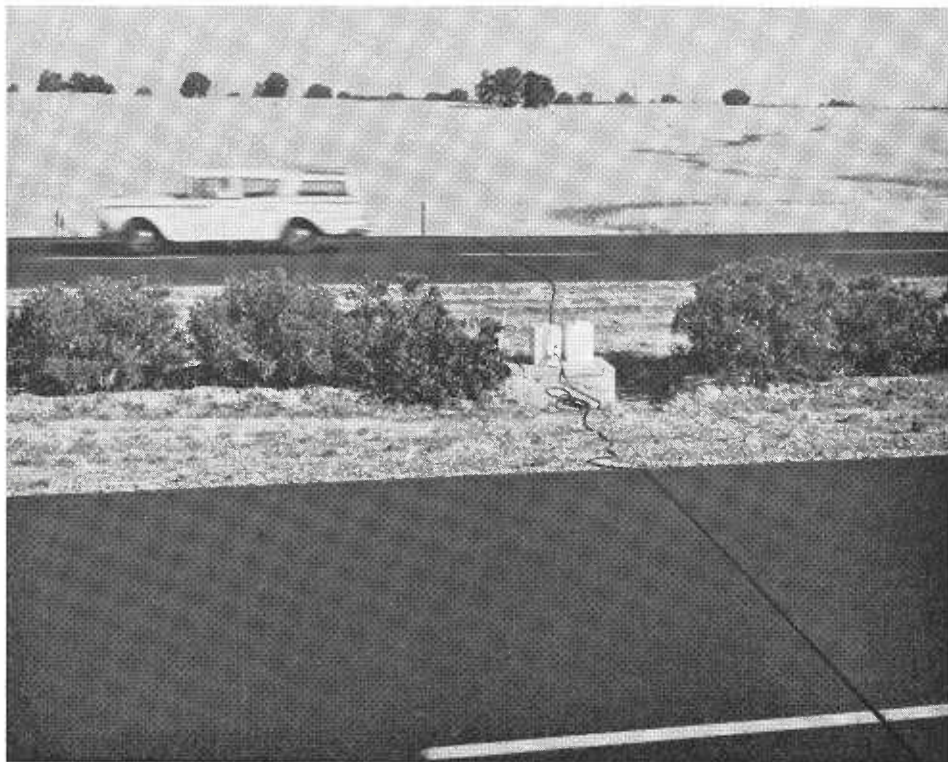

A typical control station set out on a four-lane divided highway.

done at the Materials and Research Laboratory resulted in a choice of the best equipment available consistent with the needs of the new program.

A new type of hourly recording counter was chosen to record traffic at the control stations. This counter is comparatively light (40 pounds), is powered by a long-life dry cell battery, and produces counts on a punched paper tape capable of being translated automatically and electronically to punched cards. The counter is capable of recording electric impulses from a variety of detectors under study as well as air impulses from a conventional road tube. A total of 264 of these portable counters were acquired to serve the majority of the control stations.

Special equipment was needed at eight control stations on very high volume multilane freeways where it was impractical to use road tubes. Thirty-two dual-lane ultrasonic detectors were installed on overhead mountings to count 60 lanes of traffic. Thirty-two AC powered recording and nonportable counts were added to record data.

A diaphragm operated nonrecording ("Junior") counter was chosen to

count at the satellite stations for three reasons: 1. It was already in widespread use by the districts. 2. As the result of an employee suggestion early last year, its performance was substantially improved by the addition of an inexpensive transistorized circuit. 3. The Junior is a lightweight counter powered with two 6-volt lantern batteries.

Transistorizing the Junior counter improved its accuracy, eliminated a tendency of contact points to corrode and stick, and simplified the adjustment for varied impulses. The State purchased an additional 320 Junior counters to handle all satellite counting in the new program.

Twelve trucks were provided by the Equipment Department for the exclusive use of the counter crews.

Seven of the trucks were of the step-in van type, designed to provide space for 20 or more recording counters and allied equipment. Space and tools are also available for field maintenance of the counters. Districts which chose this vehicle have their counter crews in the field for several days at a time.

Five of the trucks were the large station wagon type. These trucks are

more maneuverable, but carry only half as many counters and provide little work space. Districts which chose this vehicle have their crews work out of the District Office daily. In addition, five station wagons already in use as counter vehicles were carried over into the new program.

#### Maintenance Shops

In each district, adequate counter maintenance shops were set up or expanded if already in existence.

An automatic tape translator, complete with a dial-in time-date unit, was installed at Headquarters Office to decode traffic count tapes from the recorders. This translator converts the hourly data on the punched paper tapes directly to punched cards for tabulation and for various calculations.

Except for the few ultrasonic detectors mentioned above, all other counts are obtained from road tubes. The road tube method of detection is far from new and the majority of lost counts are due to hose failures. In the past all road tubes have been of the conventional round hose, but in recent months a new type semicircular hose with a flat bottom has come into widespread use. With some minor exceptions, the flat tube is performing more reliably.

The Materials and Research Laboratory has tested a large variety of traffic detecting devices during the past year, including infrared, ultrasonic, radar, ribbon switch tapes, electric, magnetic, and various air hoses. One or more of the devices now under consideration may eventually prove more efficient than road tubes. However, the road tube is versatile, easily handled and installed, and inexpensive to replace.

#### Cost of Program

The cost of the first full year of operation of the new census program was \$394,000, a 40 percent reduction from the \$658,000 cost of the 1960 statewide manual count. A major goal in the design of the new program was thus attained.

A substantial reduction in cost had been a primary objective as the four-year (1957-1960) average annual cost (\$642,000) was considered high, and expansion and improvement of the old system would have been prohibitive.



This two-unit automatic traffic tape translator is connected to the keypunch machine in the background. It transfers the hourly data to punched cards for machine listing and further processing.

Headquarters administrative and tabulating costs were not included in these comparisons. However, they are common to both past and present programs.

The cost of new equipment, including installation where required, was \$270,000. When amortized over a 10-or-more-year period this cost becomes nominal. Nonetheless, it was approximately paid for by the first year's savings in operational cost. The savings in cost brought about by the shift to the new program are largely the result of the more efficient operation made possible by the modern automatic equipment.

A total of 6,194 temporary employees were hired to conduct the 1960 annual July count. An additional number of temporary employees (average 389) were hired in every month except July to conduct the monthly counts. The number of full-time Traffic Department personnel needed to conduct the 1961 mechanized traffic census program was 40 (28 field, 12 office).

A comparison in manpower between the 1960 (manual) census and the 1961 census is shown in the following table.

	Man-hours	
	1960	1961
Permanent employees .....	71,131	80,337
Temporary employees.....	133,961	.....
Total .....	205,092	80,337

#### First Year Operation

Field crews, who began the year inexperienced and generally unfamiliar with the equipment, developed quickly into efficient countermen. These men did an excellent job of obtaining the counts accurately and on schedule. They developed a number of practices and count-saving devices which contributed materially to the success of the program.

The new recording counters were occasionally troublesome, but increasing familiarization by the counter

maintenance men and service under the company guarantee held these difficulties within an acceptable range. The statewide average for obtaining uninterrupted control counts (seven or more consecutive days) was 87 percent for 1961. Most of the 13 percent imperfect counts resulted in only a few hours lost data. The number of actual lost counts or unusable counts was under 5 percent. Of the troubles which did occur, hose failures accounted for 50 percent; counter malfunctions (usually related to the clock microswitch and reset mechanisms) accounted for 40 percent; and the remaining 10 percent were due to vandalism and other miscellaneous causes. For the first five months of 1962, imperfect counts amounted to 11 percent of the total.

#### Circuitry Altered

The ultrasonic detectors gave considerable difficulty through the first year. The manufacturer found it necessary to alter the interior circuitry and make several modifications before producing consistently accurate counts.

The transistorized nonrecorder counters were virtually trouble free and produce a high percentage of perfect satellite count data.

#### Districts Code Data

The district traffic departments shouldered a major but diminishing job of coding the data for machine

... Continued on page 28

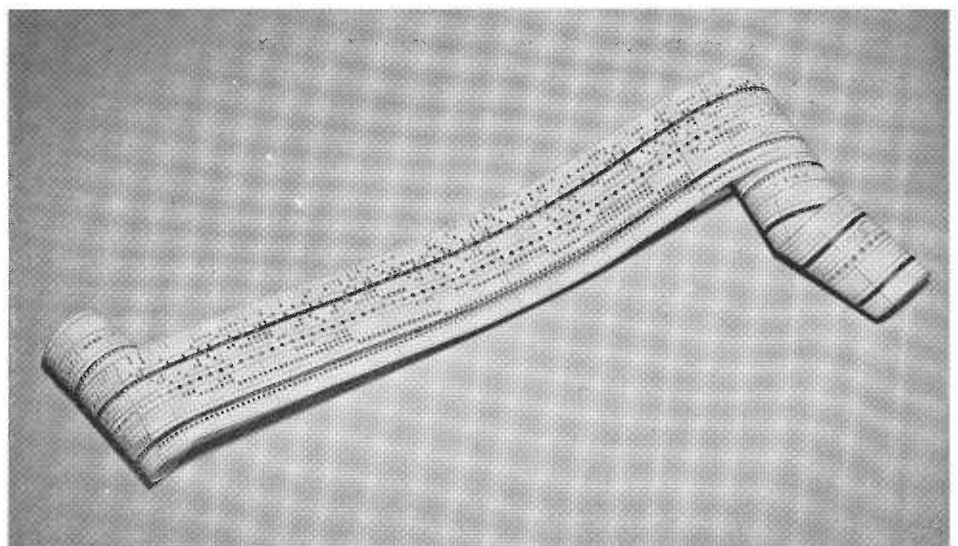

Your car may have helped make one of the punched patterns on this week-long traffic tape. A tape with hourly readings such as this can be decoded automatically in less than a minute.

## Tolls Adopted for New State Bridges

The California Toll Bridge Authority adopted toll schedules for the Benicia-Martinez and San Pedro-Terminal Island Bridges and authorized the Department of Public Works to continue its studies of a proposed crossing between San Diego and Coronado at its meeting in Sacramento on July 19.

The Benicia-Martinez Bridge will be opened to traffic on or about September 15. Its rates were set the same as those in effect on the Carquinez Bridge which runs roughly parallel to it, approximately 5.5 miles west. The single-trip toll for passenger cars will be 25 cents.

The Vincent Thomas (San Pedro-Terminal Island) Bridge will not open to traffic until the end of 1963. However, it was necessary to adopt toll rates at this time to incorporate them into the toll collection equipment now being manufactured.

The adopted toll schedule calls for slightly lesser charges to trucks and buses than on the Carquinez span, but with the same toll (25 cents) for automobiles. It is expected that the traffic induced by these rates will pay off revenue bonds sold for the bridge's construction in 20 years, one-half the time before the bonds become due.

The Division of Highways made preliminary location, traffic and revenue studies to determine the feasibility of a highway toll crossing between San Diego and Coronado under legislation enacted in 1961. Director of Public Works Robert B. Bradford conducted a public explanation and discussion meeting in Coronado on June 6. The report submitted to the Toll Bridge Authority on July 19 stated that four four-lane bridge and five two-lane tube routes were practical. It asked for continuing time to study the effects of the proposed crossings on community values, highway user benefits and city street traffic.

The authority granted this request and called for a final report by September 1962.

In addition to Governor Edmund G. Brown, ex officio chairman, the members of the Toll Bridge Author-



A counterman sets out a junior counter at a satellite station. One of the specially equipped step-in van counter trucks is parked beside him.

### Traffic Census

*Continued from page 27 . . .*

processing, identifying and transmitting punched tapes (totaling 500 per month), estimating hourly counts in tape gaps, and editing tabulations.

#### Programs Tested

The machine processing of the data was the responsibility of Headquarters Planning Survey. Twelve separate machine data processing programs had to be written, tested and "debugged." This proved to be a tremendous task. All data were tabulated by hour and by month. Average daily traffic was computed for each month and for the year, satellite raw counts had to be expanded from satellite-control ratios, and all raw counts adjusted for multi-

ple axle vehicle overcounting and for undercounting due to various factors. Unexpected difficulties in perfecting the machine programs delayed the publishing of the 1961 census. However, now that the programs are available, no delays are expected in the future.

---

ity are Lieutenant Governor Glenn M. Anderson, State Director of Finance Hale Champion, State Director of Public Works Robert B. Bradford, and James F. Thacher of San Francisco, public member.

Although many refinements still remain to be worked out, it is the consensus that the new mechanized traffic census program has proven itself in its first full year of operation.

### CONSERVATION CENTER

The Division of Architecture advertised in June for the construction of an 80-man branch conservation center near Bishop to be known as the Mono-Inyo Conservation Facility. The center will be operated by the Department of Corrections in conjunction with the Division of Forestry as part of the camp conservation program for the rehabilitation of prison inmates and the conservation of the State's natural resources.

# Central Mix

*Revised Method Speeds  
Road Paving Operations*

By J. O. KAPONO, Assistant Highway Engineer



The central mixed method of hauling concrete to the job site for paving operations is not new in the field of highway construction, but the practice had until recently fallen into

disuse in the west, partly because of segregation taking place in the bed of

the hauling unit and partly because of setting of the concrete owing to delays in the paving train. Hence standard paving operations up to this time have necessarily included on-site mixing, mixers, water trucks and batch trucks queued up on the grade.

The current revival of central mix and hauling by specially designed non-agitated trucks by the contracting firm of Peter Kiewit Sons on a District VII freeway construction project heralds new economy and efficiency of paving methods in freeway construction in this area.

First use of central mix was made on the San Diego Freeway project in

the Carson-Dominguez area of Los Angeles, between Carson and 190th Streets, a three-mile, \$8,120,000 project scheduled for opening to traffic in early August, 1962. (See *San Diego Freeway*, by James E. Martin, *California Highways and Public Works*, January-February 1962). Forty thousand cubic yards of concrete were placed by the same contractor in eight- and nine-inch pavements on this job and 55,000 cubic yards on a separate adjoining contract on the Harbor Freeway.

#### Concrete Plant

The central mixed concrete plant, erected by the contractor in conven-

PHOTO BELOW—The paving train in operation. In the foreground the hauling unit dumps into the spreader box. It is followed by the spreader and finishing equipment.





The San Diego Freeway with the Carson Street interchange in the foreground. The view is southward.

ient proximity to the construction site, was equipped with 100-cubic-yard capacity aggregate bins; a nine-cubic-yard aggregate weigh hopper; a tilt-drum type 8.25-cubic-yard mixer; a 750-barrel cement silo with 6,000-pound weigh hopper; and a 330-gallon metered water tank.

The control panel was located on a platform adjacent to the mixer and had two separate formulas of accumulated weight devices, whereby two different size batches could be placed on the panel and controlled by a two-position selector switch. The water, air entraining agent, cement, and mixing time were also controlled on this panel.

#### Coarse, Fine Aggregates

All of the coarse and fine aggregates were trucked in on bottom-dumps. The material was dumped into a hopper through a grizzly. Below the hopper a belt installed on a radial stacker conveyor delivered the ma-

terial into separate stockpiles, separated by bulkheads. From these stockpiles front-end loaders were used to charge hoppers that were installed for each size aggregate. Under the hoppers a fixed conveyor belt was used to deliver the material to the storage bins above the aggregate weigh hopper.

The cement was also trucked in bulk form. It was discharged into a hopper and transferred into the silo by means of a vertical screw conveyor, the capacity of which was 600 pounds per hour.

The aggregates were then weighed and dropped on a 54-inch conveyor belt approximately 57 feet in length. This belt was installed on an approximate grade of plus 18 degrees and had a capacity of 2,600 tons per hour. The aggregates were then chuted into the mixer.

The moment the aggregates entered the mixer, there was an approximate

delay of two to three seconds before the water, cement and air entraining agent entered. The discharge of the water, air entrainment and cement into the mixer was completed before all of the aggregates had entered the mixer. The plant was semiautomatic and fully interlocked.

#### Mixing

Actual mixing time started after all the ingredients had entered the mixer. As soon as all the scales read zero, and during the mixing, another batch was weighed. The time required to weigh out a complete batch and charge the mixer was approximately 35 to 40 seconds.

A push-button switch was used to tilt the mixer, causing it to discharge. To return the mixer to its mixing position, another push-button switch was used. On the return switch was a timing device that started the cycle of charging the mixer and weighing out the next batch. The total time consumed for a complete cycle was approximately 85 to 90 seconds.

#### Hauling and Paving

The dump truck body used in hauling the mixed material had all edges and corners rounded and was fitted with a watertight tail gate. It was designed to elevate to a sufficient height for self-cleaning and minimum segregation during dumping.

The mixed concrete was hauled to the grade and dumped into spreader boxes which sized the material into windrows. Then the material was internally vibrated, spread and struck off to the required width and depth by a paddle-type spreader without any segregation of the mix or excessive variation in the amount of concrete placed. A finishing machine screeded off the concrete to grade. Following this was a float for final finishing.

#### Tamping Bar Used

This float was equipped with a positive action tamping bar installed behind the oscillating screeds, and made as many passes as necessary—two, normally—to produce an even grade. Attached to the back end of the float was a plane or straight edge, on a 28-foot frame. The plane rested on the



*PHOTO ABOVE—The radial stacker conveyor stockpiles raw aggregates.*

*PHOTO BELOW—Central mixed concrete from the nonagitating hauling unit is spread into special contractor-built spreading boxes.*

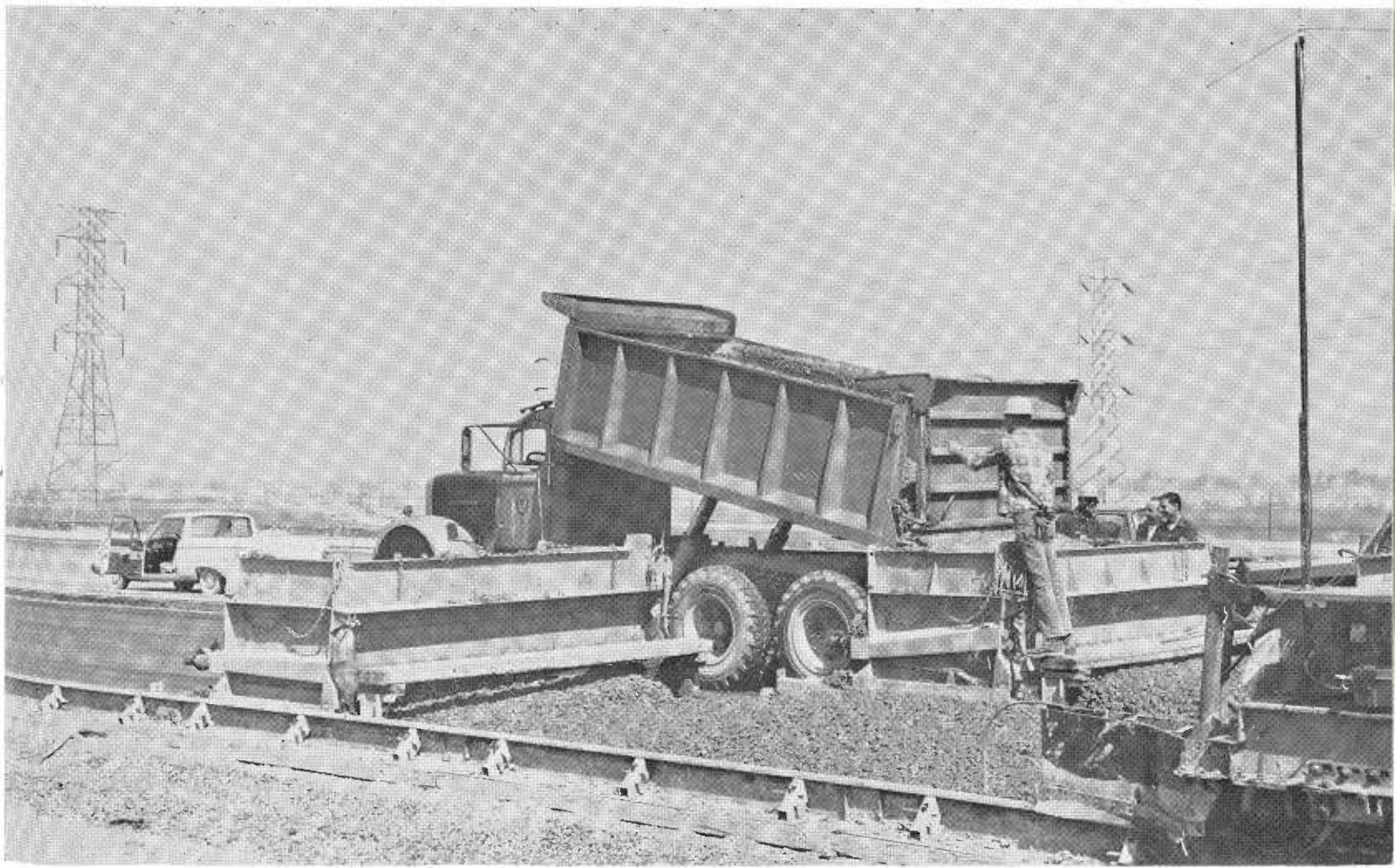

concrete by means of sleds installed on the front and back of the frame. Each sled, made of sheet metal, was approximately 30 inches long and 23 feet wide. In the middle of the plane two adjustable rigid screeds were attached to the frame. On the first pass the concrete was screeded again and the plane lowered so that it rested on the concrete.

The primary purpose of the plane was to cut off any bumps caused by the screeds or any variations in the grade caused by the side forms. The front rigid screed on the plane cut off the bump and the back screed sealed it off.

Concluding this operation, a burlap was dragged over the concrete for texture. The concrete was then edged along the side forms and the burlap was dragged again.

#### Summary

In summary, the central mix method simplifies paving operations by centralizing the concrete mixing at a single location near the job and by providing for the hauling of the ready-mixed material to the grade by means of nonagitated dump trucks for



*The chain belt at the central mix concrete plant is shown discharging into a nonagitated hauling unit.*

immediate spreading. A further improvement based on an experimental section on the San Diego Freeway was

put to use on the Harbor Freeway project between 208th Street and Pacific Coast Highway. As in slip-form paving, the cement treated base was placed in advance of header installation. On the Harbor Freeway project, this allowed the placement of one mile of 24-foot width pavement in a single day's operation, reducing the number of headers normally needed, and the labor force employed to right headers dislodged by cement treated equipment.

Central mix eliminates mixer and water trucks on the grade, combining batching and mixing into one off-the-job operation. It also lends itself to better dust control and greater safety.

## Carquinez Traffic Reaches New High

The summer buildup of traffic on the Carquinez Bridge began to be evident in June. A new record total was reached on June 17 when 64,325 vehicles crossed the parallel structures, the most for a single day since the toll project was opened in November, 1958. The previous day's high was 62,804 vehicles on September 2, 1961.



*A closeup of the chain belt showing the proportional aggregate conveyor (foreground) and the operator's platform and control panel with main mixing drum (left).*



# Final Route Link

316-Mile Westside  
Freeway Now Located

At its June meeting, the California Highway Commission completed route adoption procedure for the 316-mile Westside Freeway (Interstate 5 and 5 E) which will extend from Wheeler Ridge south of Bakersfield to Woodland. It is the longest stretch of Interstate Highway on new location planned in California.

The final link in the long route is in Sacramento, between 0.8 mile south of Freeport and 0.5 mile south of Broadway. Final route adoption was preceded by a commission public hearing in addition to that held by the Division of Highways.

Altogether in its May and June meetings the commission adopted routes for 147 miles of freeway in 14 separate actions, six of which were predicated on public hearings held by the commission itself.

In two instances the commission adopted routes differing in part from those recommended by State Highway Engineer J. C. Womack. These were on U.S. Highway 101 in and near King City and for the East-West (Foothill) Freeway in Pasadena.

In the King City adoption the commission by a four to three vote in effect reaffirmed an earlier route adoption preferred by the community, which opposed a recommended route farther from the business district. In Pasadena the commission brought the route closer into line with a route desired by the city. The commission had held public hearings on both these matters.

Commission public hearings also preceded adoption of routes for the relocation of 18 miles of Sign Route 120 in Tuolumne County; for six miles of Sign Route 29 in Lake County and for sections of Sign Routes 37 and 12 in Sonoma County. The commission followed the recommendation of the State Highway Engineer in regard to these.

## Other Freeway Route Adoptions

Los Angeles County—for a revision of an earlier adopted routing for nine-

## "ATMOSPHERE OF MUTUAL RESPECT"

(From "Editor's Diary" column by Lee Merriman,  
Pasadena Star-News, June 21, 1962)

If Pasadena came out well in final adoption of the East-West (Foothill) freeway route, and I'm certain it did, this was the result of forthright marshaling of fact, plus mutual respect.

At one time Pasadena and the State Division of Highways were in conflict over the "minor" sum of 7.5 million dollars. The state couldn't squander gasoline tax funds. The federal government, with 93 percent in the kitty, wouldn't go for it. And Pasadena, for the moment at least, would take nothing less.

Yet nobody reared up calling the other nasty names.

This complete lack of bitterness, this mutual integrity in exploring the deadlock, was largely a new experience for Division of Highways engineers, who are not unaccustomed to abuse; and for members of the State Highway Commission, whose Glendale, Sacramento, San Francisco and now Long Beach hearings have been marred by tirades.

In any such protracted discussion as marked location of our freeway, each side at the outset takes a negotiating position. You ask for much more than you expect to get. The other side offers much less than it thinks it will end up giving.

In the end, state engineers could have confronted the State Highway Commission with an adamant, economy recommendation. Instead the recommendation was softened by recognition that Pasadena's problems were unique, leaving the door ajar for commissioners to squeeze through onto Pasadena's side instead of having to repudiate their own staff in order to come our way.

State engineers, themselves, are content with the verdict.

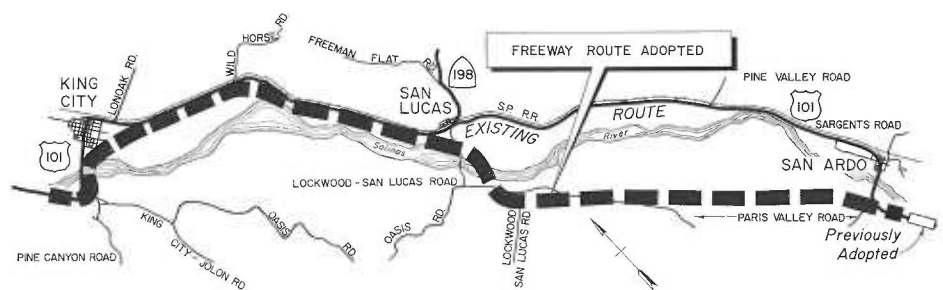

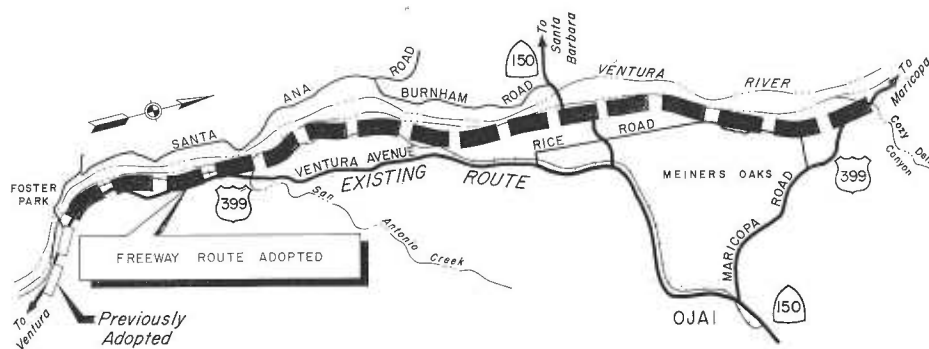
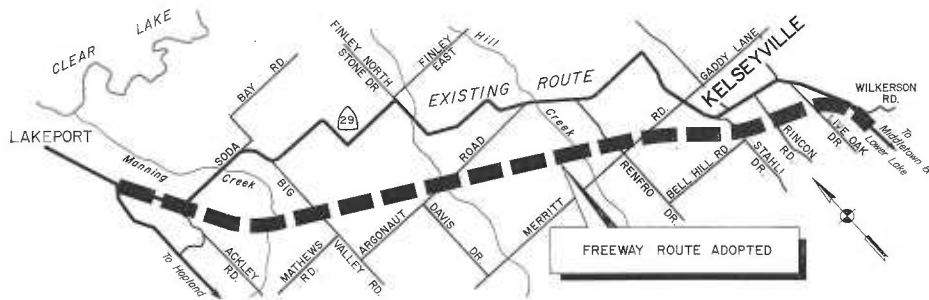
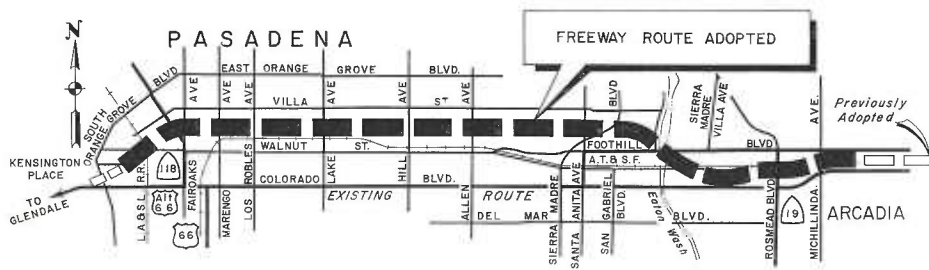

tenths of a mile of Sign Route 14 between Butler Avenue and Myrtle Avenue in the City of Long Beach.

Humboldt County—for the realignment of 5.5 miles of U.S. 101 between the north city limit of Trinidad and the easterly boundary of Patrick's Point State Park.

Mendocino County—for 5.1 miles of Sign Route 20 between 0.7 mile west of Potter Valley Road and 0.6 mile east of the North Fork of Cold Creek.

Riverside and San Bernardino Counties—for the Devore Cutoff (State Highway Route 193) between Norco and U.S. 66-91-395 near Devore.

San Diego County—for 18.2 miles of U.S. 101 between the north city limits of Oceanside and the Orange County line.

Siskiyou County—for the relocation of 16 miles of U.S. 99 between the Shasta River and Granada.

Tuolumne County—for Sign Route 120 between the Stanislaus County line, 12.5 miles east of Oakdale, and seven miles east of the county line.

Ventura County—for 8.4 miles of U.S. 399 between Foster Park and Cozy Dell Canyon northwest of Ojai.

One conventional highway route was adopted. It is for the relocation of a little over two miles of U.S. 101 in Mendocino County between one mile and 3.5 miles north of Laytonville.

## Construction Costs Show 15% Increase

An upturn in the California Highway Construction Cost Index took place during the second quarter of 1962. The index now stands at 271.1, an increase of 35.4 points or 15.0 percent over the first quarter of 1962.

The higher index reflects increases in materials and wages which have occurred in the construction industry, and is also affected by projects in California's mountainous areas, where difficult conditions tend to increase price averages.

The number of bidders per project during the second quarter dropped from 6.4 to 4.6.

# Staff Promotions

*Increased Levels of  
Responsibility Recognized*

Creation of a new position of Metropolitan District Engineer in Los Angeles and appointment of two new Assistant State Highway Engineers has been announced by State Highway Engineer J. C. Womack. Womack said the new positions would enable the Division of Highways to recognize increased levels of responsibility in several metropolitan areas of the State.

### Three Promoted

E. T. Telford was promoted from Assistant State Highway Engineer to Metropolitan District Engineer (a new class at the deputy state highway engineer level) in his present assignment as engineer in charge of District VII in Los Angeles.

Alan S. Hart was promoted from District Engineer to Assistant State Highway Engineer in his present assignment as engineer in charge of District III in Marysville.

Jacob Dekema was promoted from District Engineer to Assistant State



**E. T. TELFORD**

Highway Engineer in his present assignment as engineer in charge of District XI in San Diego.

### E. T. Telford

Telford was appointed Assistant State Highway Engineer in charge of the Los Angeles district in 1956. A native Californian, Telford attended schools in Buellton, Santa Ynez and Santa Barbara. His first engineering job was with the City of Santa Barbara. Later he worked on railroad location, mining and with the U.S. Bureau of Public Roads. He joined the Division of Highways in 1927 as a civil engineer in the District VI office in Fresno. In succeeding years, he served in district offices in Bishop, Eureka and at Sacramento headquarters. He is a veteran of World Wars I and II, and returned to civilian life in 1946 with the rank of colonel.

### Alan S. Hart

Hart was born in Santa Rosa and is a graduate of the University of California at Berkeley. His entire profes-

sional career has been spent with the Division of Highways, which he joined in 1928 between college semesters and to which he returned on a full-time basis upon graduation. He was District Engineer of District IX in Bishop before being transferred to a similar position in District I, Eureka, in 1953. He became District Engineer of District III in Marysville in 1957.

### Jacob Dekema

Dekema was born in the Dutch East Indies and came to California from Indonesia in 1919. He is a graduate of the Los Angeles High School and the University of Southern California with a degree in engineering. He began work with the Division of Highways in 1938 and rose steadily through the ranks to become District Engineer in San Diego in 1955. He has held positions in Bishop, San Bernardino and at headquarters in Sacramento where he was Assistant Construction Engineer. He served with the Navy in World War II.



**ALAN S. HART**



**JACOB DEKEMA**

## State Launches Broad Motor Vehicle Study

The interrelationship of the citizen, his motor vehicle and his state government is the subject of a broad-gauge, pioneering study now entering its second and third stages in California.

The first stage—the gathering of facts about how the State manages its highway “plant,” how it regulates drivers and their vehicles, and how it enforces traffic laws—was covered in 1960 in a report published by the Assembly Interim Committee on Transportation and Commerce.

The second stage—analysis and evaluation of the facts—is now in progress. Out of this evaluation will come the third stage—a future program keyed to the future needs of a state whose present 9,000,000 vehicles and 8,000,000 licensed drivers are expected to double in the next 20 years.

The task of completing the study has been undertaken by the State’s new Highway Transportation Agency, which encompasses the state departments most intimately concerned with the problems of the motorist: the California Highway Patrol, Department of Motor Vehicles and Department of Public Works, which includes the Division of Highways.

The agency is being assisted by the Automotive Safety Foundation, 25-year-old nationally prominent research organization, under the guidance of a steering committee of state and federal officials; and by a battery of technical consultants and specialized study groups composed of interested and knowledgeable citizens.

The study is being financed out of California’s share of federal-aid funds available to the Division of Highways for highway planning and research. Target date for its completion is September 1, 1963.

The A.S.F. staff directing the H.R. 381 study (referring to the Assembly resolution of 1959 under which it was undertaken) includes Louis R. Moroney and John H. Magill.

The steering committee includes the directors of the three state departments concerned, the State Highway Engineer, the Director of the University of California’s Institute of Trans-

## C. G. BEER AND C. T. LEDDEN NAMED TO NEW POSTS

Appointment of Charles G. Beer as Urban Planner and of Charles T. Ledden as City and County Projects Engineer for the California Division of Highways has been announced by State Highway Engineer J. C. Womack.

Both positions are new. The post of Urban Planner has been established,



C. G. BEER

Womack said, because of the increased importance of overall urban transportation planning in relation to state highways. The City and County Projects Engineer assignment is a combination of two previously distinct jobs.

Beer was recently appointed Engineer of Federal Secondary Roads upon the retirement of Harold B. LaForge.

His first assignment will be to supervise the preparation of a prospectus covering the scope and objectives of a comprehensive transportation study for nine counties in the San Francisco Bay area.

Ledden is being promoted from the post of assistant planning engineer, which he has held since 1950, to the new city and county projects position.

In his new position he will be responsible for state activities in connection with county road projects financed in part with federal and state funds and in connection with city



C. T. LEDDEN

transportation and Traffic Engineering, a representative of the U.S. Bureau of Public Roads and State Senator Randolph Collier, Chairman of the Senate Transportation Committee and the Senate Fact-finding Committee on Transportation and Public Utilities.

The headquarters of the study is in the offices of the Director of Motor Vehicles in Sacramento.

street projects financed with state gasoline tax funds.

“The combining of two previously separate jobs into one,” Womack explained, “reflects the pattern of California’s growth in population and traffic. City and county boundaries are becoming less and less significant in dealing with road and street problems, and it is being recognized at the federal as well as the state level that these problems must be solved on a comprehensive, areawide basis.”

As chief assistant planning engineer, a position he has held since 1950, Ledden has been in charge of staff work and project review covering many miles of freeway and conventional highway.

A native of St. Louis, Missouri, Ledden came to California in 1925 and finished secondary school in Santa Clara. He graduated from the University of Santa Clara with a degree cum laude in civil engineering.

He started his engineering career with the Division of Highways in 1931 in District IV which has headquarters in San Francisco. His assignments included construction in the Santa Cruz area, on the San Francisco-Oakland Bay Bridge, the Waldo Tunnel and in the District IV headquarters office. From 1943 to 1950 he was chief draftsman and design engineer in the district.

Beer moves to the new position of Urban Planner from a post as Engineer of Federal Secondary Roads to which he was appointed earlier this year. He was previously assistant district engineer in charge of administration for District VIII, with headquarters in San Bernardino.

Beer is a native of Los Angeles and received his bachelor’s degree in civil engineering at the University of California in Berkeley. He received a master’s degree in meteorology in 1945 at U.C.L.A., in the course of his World War II service as an Air Force meteorologist.

He has been on the Division of Highways staff for 26 years, serving in bridge engineering, traffic engineering, and other fields.

# Petaluma Bypass

Effect on Specific Businesses  
And the Community Is Analyzed

A REPORT OF THE LAND ECONOMIC STUDIES SECTION,  
RIGHT OF WAY DEPARTMENT

Summation by JAMES H. HAMPTON, Right of Way Agent



DISTRICT  
IV

THE CITY OF Petaluma (population 14,000) is located 38 miles north of San Francisco on U.S. Highway 101, the primary coastal highway leading north through the red-

woods to Oregon and Washington. The city services a large rural area which provides most of the business for the community. The nearest and most important competitive community is rapidly growing Santa Rosa, the county seat (population 31,000), located 16 miles to the north on Highway 101.

Prior to the opening of the bypass, on November 16, 1956, through highway traffic was carried by Petaluma Boulevard, the main street of town. Traffic counts taken in June 1956 indicated an average of 21,800 cars per

day used the street. Counts taken in May 1957 indicated 12,000 per day were using Petaluma Boulevard and that the remaining 45 percent of the total traffic had been diverted to the bypass.

There was considerable concern by local merchants and business people that the diversion of this traffic would have disastrous affects on business and property values along Petaluma Boulevard and even on the community as a whole. In fact, a number of service stations and a food market did close. And a major chain store also closed at the expiration of its lease in 1958. The latter especially was cited by many people as an example of damage to the community by the diversion of customers to the bypass. The closures plus the fact that the easterly (river) side of Petaluma Boulevard appears less active and contains a higher percentage of vacant buildings than Ken-

tucky Street which parallels Petaluma Boulevard one block west, gave an initial reaction that the bypass could have had a considerable affect.

### Other Changes

As this study progressed it became evident that the opening of the bypass was just one of a number of changes and shifts that the community has experienced in recent years. It was therefore necessary to determine what effect other changes of an economic nature may have had on the community.

Mr. Frank Toner, a leading banker of Petaluma, commented on some of these changes in a speech to the Fortuna Chamber of Commerce. Mr. Toner had been a banker in Fortuna and had been invited to present the experience of Petaluma to guide Fortuna in adapting to a bypass route which has just been completed. Toner said:

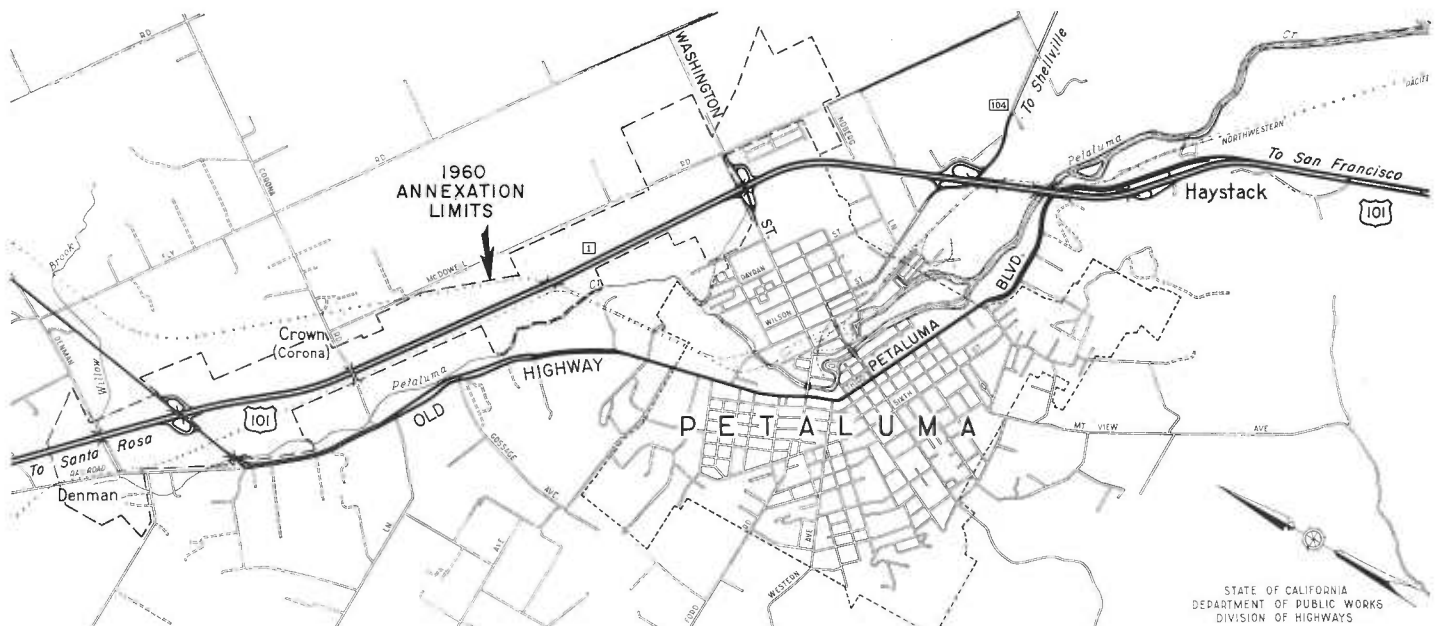

A map of the Petaluma area showing the location of the freeway and the old highway.

"A town's appearance as to cleanliness makes a remarkable change after bypass. In our town, most of the hay trucks, large cattle trucks, oil tankers, and in your case lumber trucks, previously routed right down our main street, now go around or are routed through a less congested area. The branch of our bank in which I work is located on a main intersection in downtown Petaluma and I can readily recall the difficulty experienced in trying to carry on a conversation with truck after truck rumbling by not more than 15 feet away. The fumes and dust, while not entirely eliminated, have certainly been minimized. Ask a truck driver how he feels about bypassing a heavily congested shopping area."

Mr. Toner concluded:

*"The highway bypassing your town is not a thing to fear or dread, but rather should be taken as a challenge. It will create opportunities impossible to imagine at the present time. Accept the loss of a lot of cars jamming your main street and go out after the shoppers' dollars in adjacent areas. Emphasize the benefits of shopping in your town; don't be negative and feel that you're doomed. Be patient, and above all be practical. You will not regret the highway by-passing your town in the years that follow."*

#### **History, Economic Background**

Petaluma is the oldest town in Sonoma County, having been incorporated in 1848. For many years in the early 1900's it was the primary shopping and business center in the entire area. Its importance stemmed from the existence here of the terminus of the navigable tidewater of the Petaluma River. Much agricultural produce, chickens and livestock were brought to Petaluma to be shipped by barge to San Francisco. There were many commission merchants, located mainly on the easterly (river) side of Petaluma Boulevard and the hotels in town did a thriving business. Petaluma Boulevard, being adjacent to the river, was the primary center of activity.

In recent years the primary shopping area has moved to Kentucky Street, located one block west of Petaluma Boulevard. The movement to Kentucky was occasioned by the

lessening of importance of barge transportation and the increasing space requirements of the automobile. The river, instead of being an advantage, became a disadvantage by causing confinement of adjacent buildings between it and Petaluma Boulevard. Reduced foot traffic along the easterly side of Petaluma Boulevard, perhaps to some extent caused by the crush of traffic on the street, further reduced the utility of these buildings in relation to those on Kentucky Street.

The major chain store originally leased its site on the easterly side of Petaluma Boulevard in 1929, when this was a prime location. In recent years, due to confinement by the river, parking became an increasing problem.

The chain's decision not to renew its lease in 1958 was a result of company policy to close smaller stores and concentrate on more modern stores in the larger communities. The chain now has branches in the two nearby cities of Santa Rosa and San Rafael.

A number of local merchants were questioned about the former chain store and adjacent buildings which have remained vacant. The general reaction was that the low amount of foot traffic, limited parking, and the fact that the buildings were old, resulted in their having limited utility. Only one merchant out of more than a dozen who were questioned on this subject, indicated he felt the reduced traffic on Petaluma Boulevard, as a result of the Bypass, was a cause factor in these buildings being vacant.

#### **Community Sources of Income**

Into the early 1950's agriculture provided most of Petaluma's income; divided mainly between poultry and dairying, with poultry being the most important. The poultry industry, starting about 1955 suffered some radical changes and now has dropped in importance to Petaluma businesses, but probably remains slightly more important than dairying.

In a discussion about the source of his business, a leading Petaluma home appliance retailer stated that only about 30 percent of his business is now from ranchers. The remaining 70 percent is from people in town, particularly those living in the new sub-

divisions. Many of the latter are commuters who work outside the community. It should be noted that appliances would be needed more by owners of new homes than the general population and hence would not be representative of the source of all business of the community.

Manufacturing is providing a small but increasing income to the community and is expected to accelerate as the City is able to provide utility services to a new industrial park area adjacent to the freeway.

#### **The Poultry Industry**

Petaluma's importance as a poultry center dates from 1902 when Lyman Byce, a local resident, invented and perfected the first mechanical incubator. *Westways* magazine in the March 1954 issue stated: "Nowhere else in the world are there so many hens, mostly white leghorns, within so small an area."

However, as the above quote was being written, major changes were shaping up. The price of eggs was dropping from the 50 cents per dozen range in the early 1950's to 40 cents in 1954 and downward to 36 cents in 1957. This resulted in a severe shake-out of the smaller operators during the same period that the freeway bypass was opened. The chicken business became concentrated in larger, more efficient operators, and small, older, chicken houses were abandoned.

While the number of eggs produced in the area is not much less than before, labor input per hen has dropped from 1.4 man hours in 1950 to .7 man hour per hen per year in 1960 (figures from Sonoma County Agricultural Extension Service). This has resulted in a lower percentage of total poultry income coming into the shopping area of Petaluma.

However, the picture was not as black as it might seem for the merchants of Petaluma. Most of the former chicken ranchers remained in the area, becoming employees of the large feed companies, or of large chicken ranches or found other jobs provided by a growing community. Some commuted to other communities such as Mare Island, (27 miles east), Santa Rosa (16 miles north), San Rafael (21

miles south) or San Francisco (38 miles south). In some cases they had more money to spend than before. It will be noted in the charts later in this report that retail sales in the city did not drop during this adjustment period.

**The Bypass Itself**

The first public meeting to discuss the proposed bypass was held in September 1948. Shortly thereafter the *California Farmer* reported the formation of the Petaluma-Cotati Freeway Association, composed of 140 chicken

ranchers and others. This group was organized to protest the proposed routing which was to go through many of their ranches. The members argued that 120 chicken ranches with a monthly gross income of \$125,000 would be destroyed. On July 21, 1959, 65 of these ranchers did their chores early and embarked in a caravan to a meeting of the State Highway Commission in Sacramento where they delivered their reasons for rerouting. Prior to that (on July 8, 1949) the local board of supervisors had, at the

ranchers' behest, reversed its original stand and recommended rerouting. The highway commission concurred with the route change recommendation and the present alignment which curves about 3/4 mile to the west of the originally proposed routing was adopted. Construction was started on July 1, 1953 and the bypass was opened for traffic on November 16, 1956.

**Entrance to Petaluma**

Petaluma now has three major entrances. The north entrance is located

**PETALUMA BUSINESSES**

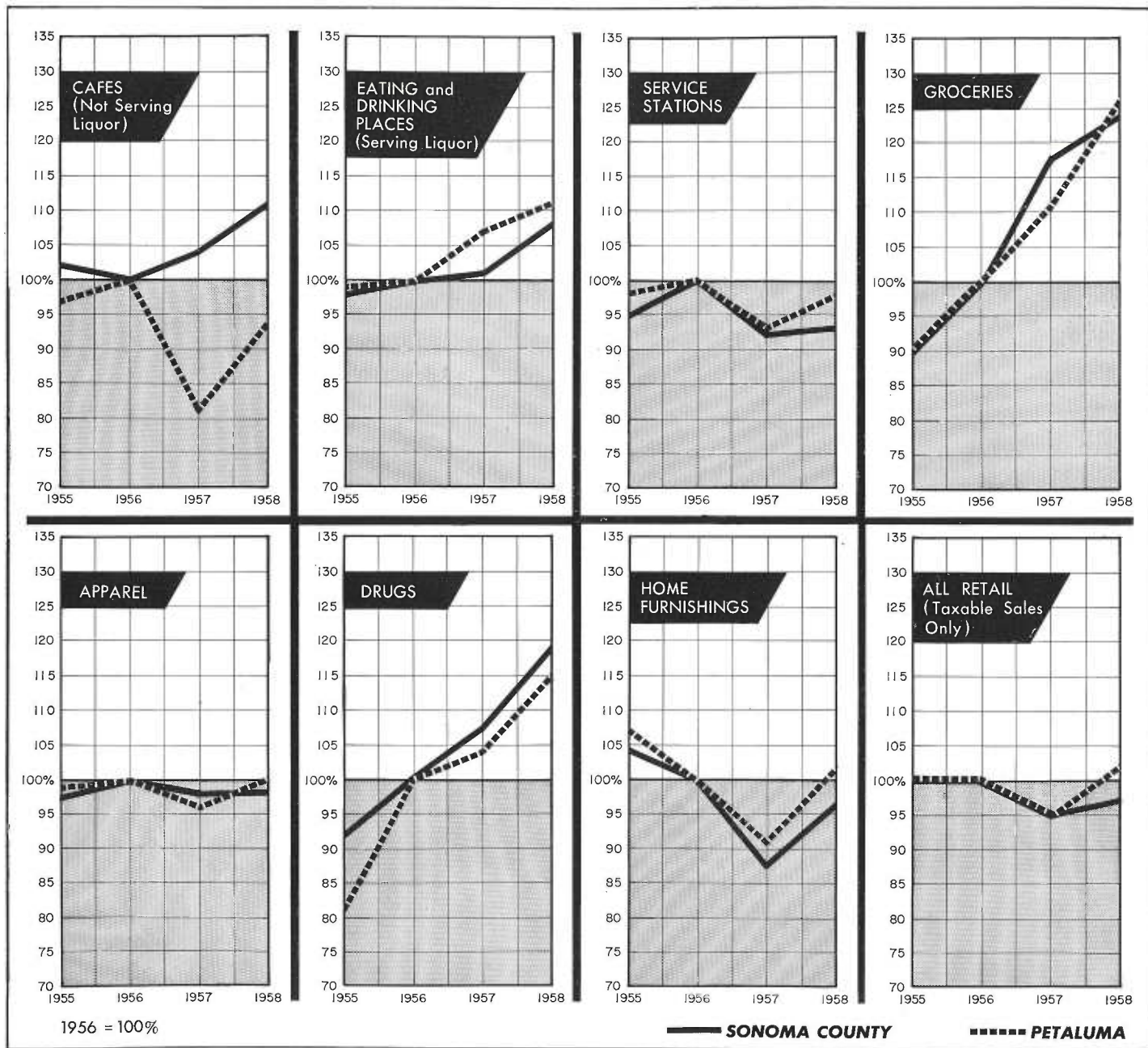

three miles from the business center where the old alignment crosses the new. The middle (East Washington Street) entrance is one mile east of the business center and the south entrance is located two and one-half miles from the business center.

The north entrance has been developed with two new service stations. A former lumber yard office building has been converted into a restaurant. There are additional large developments proposed for the area around this interchange as soon as the city can make utility services available. In preparation for this the city in 1960 annexed a large area (675 acres) adjacent to the freeway between the middle and north entrances. The area is planned as an industrial park.

The middle interchange has developed most rapidly. Subdivisions were being constructed in the area at the time the freeway was built and additional houses have since been completed adjacent to the freeway.

The middle interchange location is developing into a major shopping area. A major supermarket moved from downtown Petaluma to a new location here and additional stores are now being constructed. A 36-room motel with swimming pool and a new restaurant was built. The location is without question the most rapidly developing area in the community.

There has been no commercial development around the south entrance. The location is such that there is little advance notice of its proximity, since cars are coming up over a rise in the road just prior to arriving at the turn-off. In 1959 additional lighting and a larger sign were installed by the Division of Highways at this turnoff, after which the local paper printed an editorial of appreciation. Most tourists, however, continue to use the East Washington Interchange for entrance to Petaluma.

On and off ramps connect Shellville Road to the freeway at the foot of the Petaluma River Bridge. This connection is of minor importance and has attracted no development.

#### Individual Businesses

In order to measure the effect of the diversion of traffic, the business rec-

ords of 150 (nearly 90 percent of all) merchants in Petaluma were used to develop sales indices.

Since the opening of the bypass was an immediate action, i.e., not spread out in time, it was possible to make relatively accurate before and after measurements. Sonoma County sales tax summaries were used as checks to measure how Petaluma businesses deviated from areawide trends. The entire year 1956 was used as a base, or 100 percent, and changes were measured as percentage increases or decreases from this base. If a particular business was operating at a certain rate through 1956, then shifted to a new and steady rate starting in 1957, this step between 1956 and 1957 was considered a bypass effect. If a business had developed a trend of gain or loss prior to the end of 1956, and this same trend continued in 1957 and 1958, without an unusual shift in 1957, it was presumed that other factors were causing the change.

Interviews were conducted with most of the business people in town to determine any unusual factors which may have been present during the period under study. Certain businesses, particularly small restaurants, sometimes changed hands so frequently it was impossible to get meaningful information. These in general were low volume operations which had little competitive effect on the community.

#### Voice Friends' Views

It was interesting to note that, in a number of interviews, when a businessman complained about the bad effect of traffic diversion on business, it was not his *own* business that suffered; it was the fellow down the street. Occasionally someone would state the bypass had no effect on his business when actually his sales tax reports showed a considerable reduction. It appeared that when a merchant's analysis did not correspond with the facts, he was actually voicing the views of his friends or he was preserving a position he had previously taken among his friends, or he was using the bypass to explain a continuing loss of business due to other causes.

To gain perspective on the effect of the bypass on the community as a whole it is necessary to weigh each type of business according to its dollar importance in the community. The following table gives the approximate percentage of the total taxable and nontaxable retail sales in Petaluma that each type of business contributes. These percentages will vary of course from year to year and hence they are rounded to the nearest 5 percent.

	Percent
Motor Vehicle .....	20
General Merchandise .....	15
Grocery .....	15
Lumber and Hardware.....	10
Farm Implement .....	5
Apparel .....	5
Drug .....	5
Home Furnishings .....	5
Service Stations .....	5
Eating Places Serving Liquor.....	5
Cafes .....	5
Other Retail .....	5

It will be noted later that the cafes were the only group which was adversely affected by the opening of the bypass and they make up a relatively small percentage of the community retail trade. Service stations, cafes, bars and restaurants, which have been found to be the businesses most sensitive to traffic diversion, contribute 15 percent of all retail sales to the community's economy. This low percentage indicates that Petaluma was not particularly oriented to serving highway traffic.

#### Service Stations

The changing traffic patterns resulting from the bypass strongly affected many service stations, but by no means all of them. One of the purposes of this study was to determine what affect an individual service station operator may expect based on the experience of similarly situated Petaluma operators who have faced the problem.

As noted on the following chart, Sonoma County service stations experienced a business drop of 8 percent in 1957 and gained slightly to 7 percent below 1956 in 1958.

Petaluma stations, overall, dropped a similar amount in 1957 then recovered to within 2 percent of the 1956 sales in 1958. This considerably exceeded the countywide improvement.



# ON and OFF COMPARISON

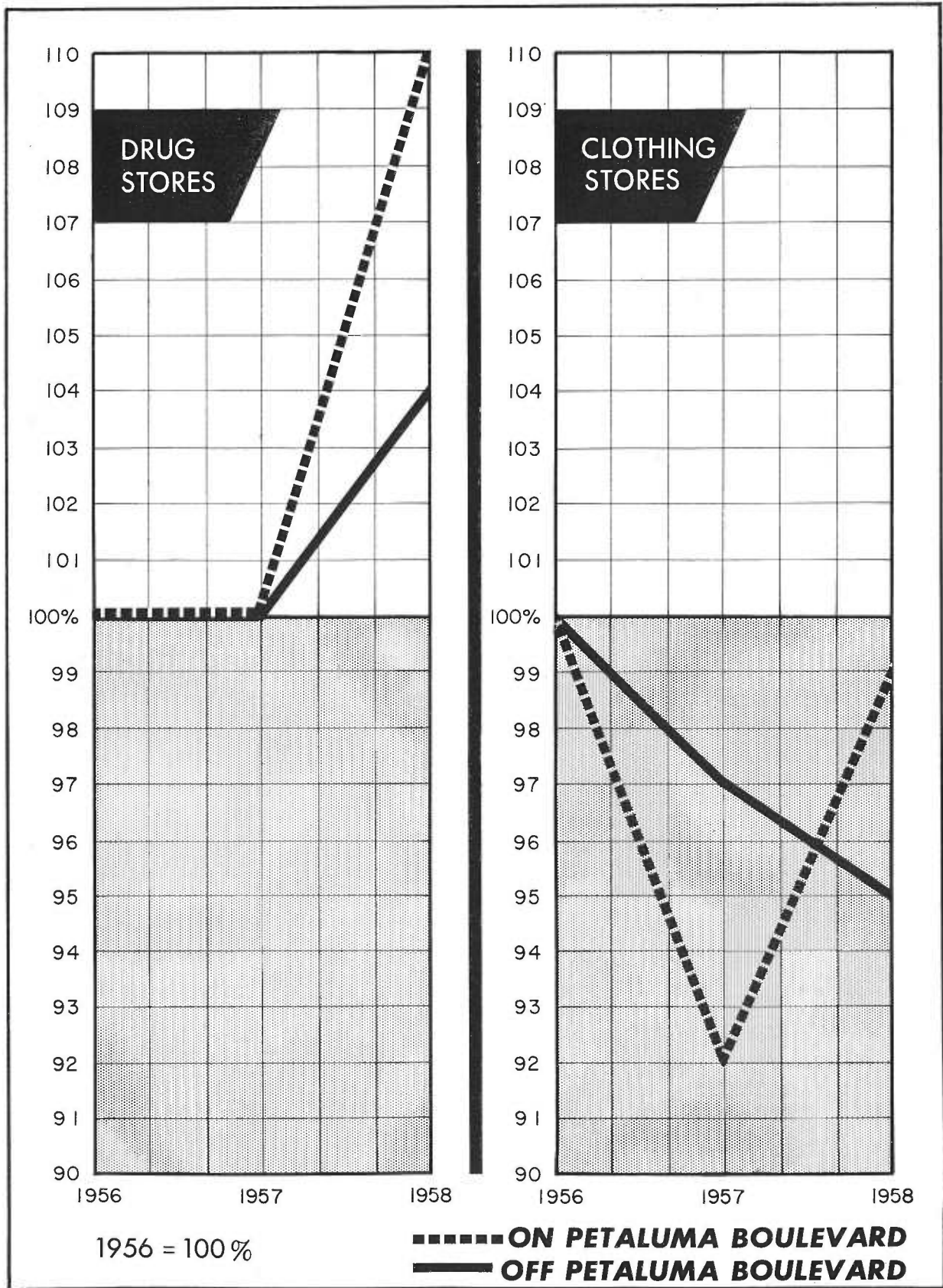

However, these bare statistics do not tell the whole story.

Those stations on the superseded highway lost an average of 20 percent of their business in 1957. Two stations lost more than 30 percent of their gross sales (which included nontaxable items.)

Most severely affected were those stations on the incoming lane of traffic. These lost an average of 21 percent of their gross sales. Stations on the outgoing lane of traffic lost an average of only 15 percent. However, most of this latter loss was caused by one station which continued to lose strongly in 1958 compared to 1957. This suggests that other factors besides the bypass were important. The other stations on the outgoing lane showed less loss than the county average after the bypass was opened.

One operator on Petaluma Boulevard lost 16 percent of his gross and 28 percent of his gallonage in 1957 compared to 1956. However, he stated that: "The gross business of the station was down but by trimming the help, which was mainly for gasoline customers, my net did not show a loss." He was probably more successful than average in meeting the challenge. He frankly stated that prior to the opening of the bypass, he strongly considered selling his station because of his concern about what would happen. Since 1957 his gasoline sales have been steadily increasing until today he is pumping at nearly the same rate as he did in 1956.

Citywide service station sales were boosted by a new high gallonage station opening in May, 1956 on East Washington, the middle entrance route, and a second new station opening in March, 1957 on this same street. Business at these two stations more than made up for the loss of business on Petaluma Boulevard and probably also affected the sales patterns of existing stations. Since then, three more stations have been constructed on this same street. Also, two new stations have been constructed on Petaluma Boulevard, the old highway route; two more stations have been built at the north freeway entrance and one at the middle entrance on East Washington.

To summarize the effect of the bypass on service stations, the following conclusions are evident:

1. Since the opening of the bypass five stations have closed. All were older, low gallonage stations. Ten new stations have opened, during the same period. The permanence of the new freeway and an expanding population have contributed to the new growth.
2. Stations on the outgoing lane of traffic apparently served mainly local customers and were affected little or none by the bypass opening.
3. New stations were opened which more than made up for loss of business of the other stations.
4. Existing stations adapted to new conditions by catering to local repeat customers, cutting down on hours and labor, and emphasizing service and repair work.

#### Motels

There were two motels serving highway traffic in town in 1956. One of these is near the downtown area on South Petaluma Boulevard. The other is on North Petaluma Boulevard about a mile north of the business center.

The "plight" of Petaluma was the subject of a widely quoted article in the *Wall Street Journal* in 1957. In the article the proprietress of one of the motels was quoted as follows: "We'll have 14 to 16 empty buildings in the next 30 to 60 days. Petaluma is a ghost town." This was written a few months after the bypass was opened and for many merchants on the old alignment who were used to the pressure of traffic, the "silence was deafening" at the time.

However, both motels remained in business and both in recent years have been refurbished. Recently, both motels reported a steadily increasing business—mainly from repeat customers—despite the addition of the new motel at East Washington Street.

The hotels in town have never benefited much from highway traffic and apparently were little affected by the bypass.

The cafe section of the accompanying series of charts on "Petaluma Busi-

nesses" illustrates the only major drop of a Petaluma business group compared to Sonoma County averages. Petaluma restaurant business dropped 19 percent in 1957, at a time when Sonoma County restaurants improved 4 percent. Restaurants along the northeast (river) side of Petaluma Boulevard lost an average of 31 percent of their gross while those on the westerly side lost only 17 percent, indicating again the low amount of foot traffic on the river side of Petaluma Boulevard. Restaurants in town off Petaluma Boulevard maintained a steady gross during the period.

Generally, the restaurants adapted to new conditions by catering to more local and repeat customers. One operator stated that he shifted from hamburgers to steaks. In all cases it was necessary to improve the food so that customers would return. This was apparently not necessary when there was continual "drop-in" traffic from the highway. Since 1957, adjustments by restaurant owners have resulted in a steadily increasing trade.

In contrast to the restaurants that did not serve liquor, the bars, taverns and restaurants which served liquor were not affected by the bypass, or if they were, they benefited. Some of the best restaurants in town are in this group and undoubtedly their clientele included more local people than transients.

#### Other Businesses

The remaining charts are for those businesses not generally sensitive to highway travelers. Various conclusions can be speculated in each case. However, in general, considering the entire group, it is evident that Petaluma fared somewhat better than did its parent county during 1957 and the disparity was accentuated in 1958. Some merchants in town feel that the business increase is due to the more pleasant shopping conditions in Petaluma since the removal of through traffic.

The disparity is further accentuated by a comparison of population growth rates. Petaluma gained population at an average rate of 3.3 percent per year between 1950 and 1960, while Sonoma County was growing at the rate of 3.7 percent per year.



*Petaluma's main business district is adjacent to the left branch of Petaluma Creek near the center of the photo. East Washington Street connects with the freeway at right center.*



*The subdivision at left was planned along the right-of-way line of the future freeway. The orchard in the center is now a junior high school site. East Washington Street interchange is under construction in this 1957 photo.*

#### **On and Off Comparisons**

There was sufficient information on drug stores and apparel stores both on and off Petaluma Boulevard to make an on-off comparison (see accompanying on and off charts). It is believed that drug stores are a better measure of the public's reaction to a shopping location than apparel stores because drug stores carry a more diversified line which would be less subject to individual management decisions. It can be seen that both types of businesses on the old highway were doing better in 1958 than their counterparts in other sections of town. However, this relative improvement did not commence until a year after the opening of the bypass. The delay could have been due to the uncertainty of merchants in launching promotional campaigns after the diversion of traffic and to the slowness of the general public to change established shopping habits.

The manager of a major nationwide clothing store located on the westerly side of Petaluma Boulevard was quoted in an advertisement in a national magazine in September 1959 as saying: "Our store is on Main Street. Before the new road, we couldn't carry on a conversation because of the noise of trucks. If we opened the door we got a noseful of fumes and dust. Our business has never been better than it is now."

#### **Petaluma Boulevard**

Property sales were secured throughout the commercial area of town, but it was impossible to develop sufficient good data within the scope of this report to draw any conclusions. Commercial property sales are generally very complex with trades, leases, tax factors, financing arrangements and large building-land ratios all combining to make each sale a maze of complications.

Therefore the leading realtors who owned commercial property on Petaluma Boulevard were consulted for their opinions. There was general agreement that commercial property values on Petaluma Boulevard had remained stable over the past 10 years and that the diversion of traffic to the bypass had had little effect. It was felt

that the only commercial area in town that had deviated from this static situation was East Washington Street, where values had increased three times or more; and areas near the freeway, particularly at the East Washington Street overpass, which were also increasing rapidly.

Also there was some indication of a rise on North Petaluma Boulevard near the city limits where a shopping district has been proposed. Residential property values throughout the city have continued to rise along with county trends in the past 10 years.

#### Safety Benefits

Aside from strictly economic effects, Petaluma became a safer place both for pedestrians and for autos after traffic diversion. The police chief reported that the citywide accident total dropped from 1,178 for the three years prior to the bypass to 895 for the three years after the bypass. Pedestrian accidents, involving crossing Petaluma Boulevard, dropped considerably. The latter subsequently became very important due to the construction of a new junior high school on the east side of town which drew students from across Petaluma Boulevard.

#### Summary

Eleven categories of business in Petaluma were compared to a norm of similar businesses throughout Sonoma County. Sales information was gathered from state tax records for most of the businesses in town. In addition, a majority of the business people were interviewed to get their personal reaction to the bypass and how it affected them.

The results indicated that—

1. Local conditions were more important than the bypass in the overall community business volume of Petaluma.
2. The only category of business in Petaluma that suffered a loss due to the bypass was cafes (not serving liquor). These represented 5 percent of the overall business of the community. The loss of business of the cafes due to the diversion of traffic averaged 19 percent. Most affected were those

cafes with little foot traffic to draw from to replace the traveling public. Cafes adapted to the new conditions by catering to local and repeat customers, by improved food, and by shifting from short orders and hamburgers to steaks and full course meals.

3. Bars, taverns, and restaurants serving liquor suffered no loss of business and in some instances may have been helped by the diversion of traffic.
4. Service stations, communitywide, did at least as well as the Sonoma County average. However, individual stations, particularly those on the incoming lane of traffic, lost an average of 21 percent of their gross sales (taxable and non-taxable). These stations adapted by reducing costs and catering to more local and repeat customers. Stations on the outgoing lane of traffic were not affected by the diversion of through traffic since apparently most of their customers were local. New stations were built which were generally high gallonage, and these more than made up for the losses described above and for the older, outdated stations which closed down.
5. The preferred area of new commercial growth is located adjacent to the new freeway and near the new subdivisions where the facilities can conveniently serve both local and traveling or commuting customers.
6. Property values along the old alignment (Petaluma Boulevard) were unaffected by the diversion of traffic.
7. Motels have adapted by refurbishing and attracting more repeat customers.
8. After about a year the shopping public began to move back to Petaluma Boulevard resulting in those businesses on the old alignment gaining more than their counterparts in other sections of town.
9. Accident rates throughout Petaluma were reduced 25 percent by the diversion of traffic.

## Illustrated Booklet Explains Road Work

"We're Going to Be Neighbors" is the title of an illustrated booklet distributed to residents of an area in and near San Jose where construction began recently on the first unit of the Junipero Serra Freeway.

Source of the booklet is the joint venture contractor on the project, Gibbons and Reed Company of Burlingame and Dan Caputo Company of San Jose.

Its purpose: to explain to the neighborhood the nature and purpose of the freeway construction work and to appeal, particularly to parents of youthful "sidewalk superintendents," for co-operation in the matter of safety.

Detour plans are also explained, coupled with a request for observance of posted traffic control and speed control signs.

The booklet is informal in tone, and covers not only basic information about the immediate project but also the individual's stake in highway improvement:

"You have a personal stake in better highways if you own a car, drive to work, drive to another town, or have children old enough to drive a car. You have a personal stake because of the higher standards of living highways promote; the increased business and tourist trade; and because of the higher cost to you, the taxpayer, of using *inadequate* highways. . . ."

The names, office addresses and telephone numbers of the people in charge of the project representing the Division of Highways and the contractors, are included.

Public reaction to the booklet has been excellent, according to District IV Construction Engineer Carl Hendrickson. Parents, in particular, have indicated an active interest in safety problems involved.

Distribution of the booklet was door-to-door, with the assistance of a local Boy Scout troop, as arranged by the contractors.

# Reduced Plans

Up-to-date Processes  
Realize Large Savings

By HARRY CHOI, Special Services Highway Engineering Associate

The large, unwieldy roll of blueprints, long characteristic of an engineer, is rapidly being replaced. Modern reproduction methods are furnishing today's engineer a more convenient means of job control.

## Program Initiated

In July 1954 the reduced size plan program was initiated by headquarters reproduction section using the offset process of printing layout sheets for construction contracts. This process, with subsequent modifications, has resulted in substantial savings to the Division of Highways as well as offering many other advantages. These savings are realized through the use of up-to-date processes which permit the use of plain sulphite paper rather than blueprint paper.

The cost per sheet of reduced plans is about one-third the cost of a full-size (23" x 36") blueprint sheet. The reduction of size to one-half scale reduces the shipping weight to approximately one-quarter of that required for full-size plans.

## Other Advantages

The reduced plans offer other advantages. Primarily, they are much handier and therefore lead to a greater use by field personnel which helps make everyone concerned more conversant with the construction details. Also, they may be marked with a regular pencil rather than requiring a special marking pencil. The earlier availability of the plans due to speedier processing provides more time for contractors to review projects. The lower cost also encourages more contractors to take out plans for projects.

## Original Process

The original process employed in preparing the reduced-size plans involved the following steps in handling the tracings or drawings:

1. Photography of the original on film at one-half scale.



Reproduction Machine Operator Donald Geiger demonstrates the transferring of a plan image to an offset paper master.

2. Special treatment of the developed film.
3. Preparation of a photosensitive offset paper master from the film.
4. Printing from the master by an offset duplicating machine.
5. Collating of the printed sheets into sets.

The first step, photography, was simply handled provided the original material was of satisfactory quality with adequate contrast whether inked

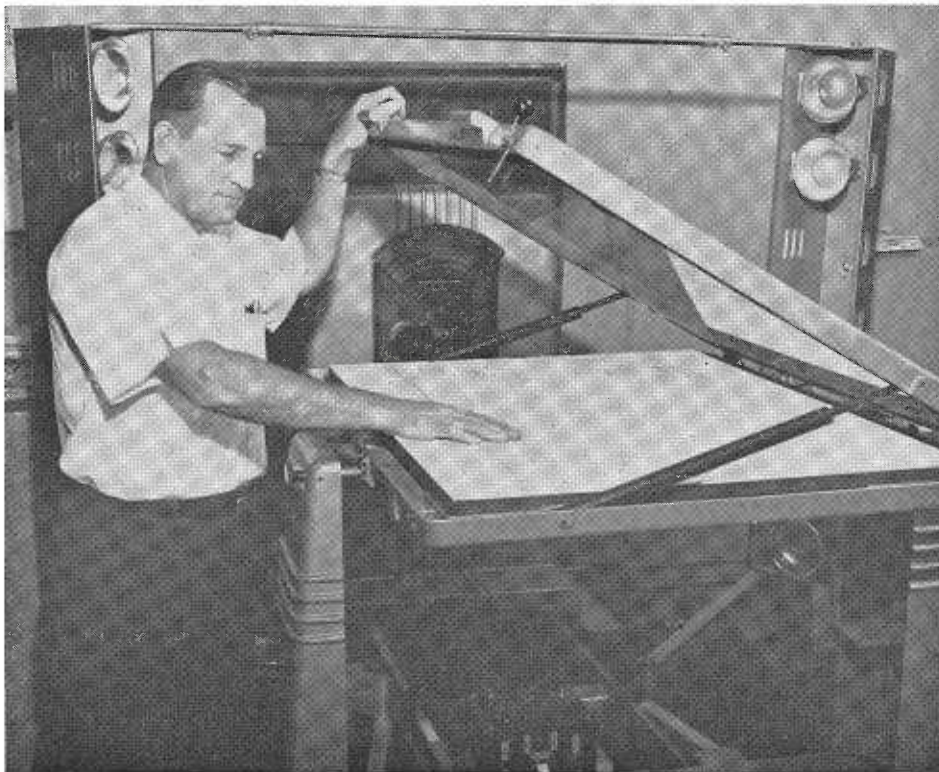

A plan is placed on the copyboard preparatory to making a photocopy of it by Senior Operator William J. Almond, Jr.

or pencilled. Difficulties were encountered in photographing diazo intermediates or any material which consisted of drawings with any part on both sides of the tracing.

#### Print Is Photographed

Diazo intermediates and tracings with both sides of the paper or cloth used required that a print be made in blueline or blackline. This print then had to be photographed as direct photography of such material is not possible. Diazo intermediates also invariably darken and deteriorate, which caused the background to be photographed with consequent loss of contrast and generally unastisfactory results.

#### Bottleneck Develops

During the early months of 1958 the increase in requirements reached the point where the division was experiencing difficulty in maintaining adequate production. The bottleneck that developed was due to the inability to process film negatives and offset masters on existing equipment with the speed required to meet the workload demands.

preparation of paper offset masters was put into effect in October 1958. This method eliminated the necessity of making a film negative. It was a simple matter to reduce the originals and transfer them to offset masters for the immediate reproduction of permanent highly detailed copies. A time study test proved that a master was prepared in one-third the amount of time. A cost study showed that there was a 30 percent reduction by use of the electrostatic process. The quality of work produced was adequate and better than that produced on the existing equipment. However, there was difficulty in obtaining the solid areas and light pencilled lines on the originals.

#### Work Multiplies Six-fold

From 1954 to February of 1962 the work load has multiplied over six times. In order to meet the ever increasing demand, the division changed over the present patented method, obtaining a direct photographic image on a reproducible master which increased the production about 10 percent and reduced the cost another 20 percent. This amounts to a savings of over 50 percent from the film negative

#### Dry Process

To break this bottleneck the dry electrostatic copying process for the

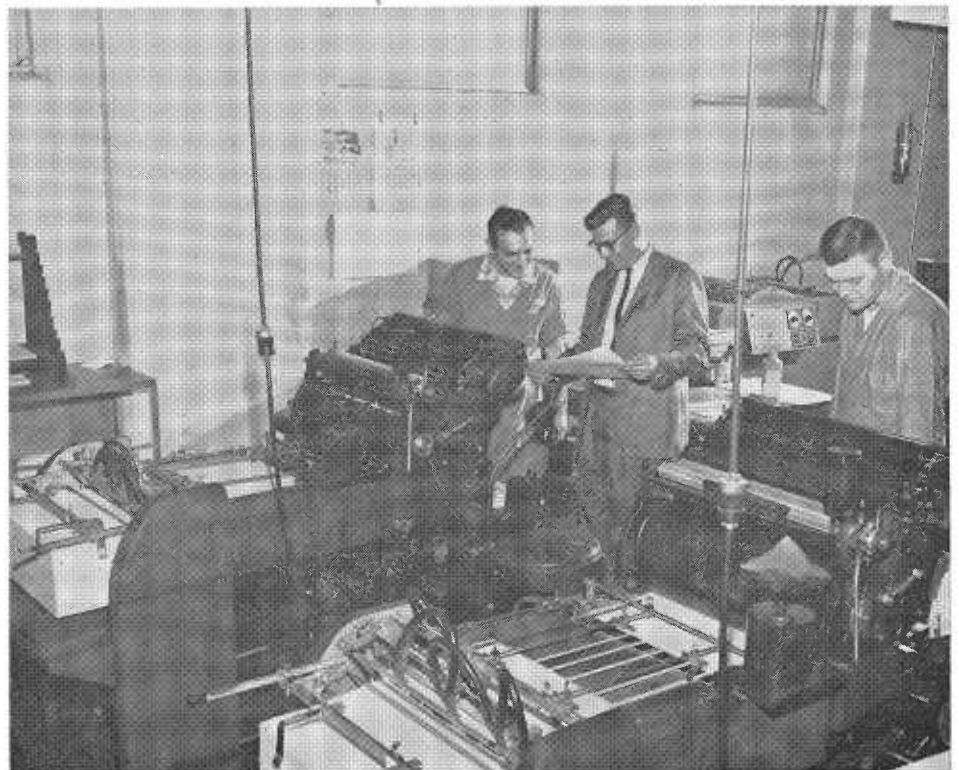

Supervisor Robert Freer (center) checks prints runoff on duplicating machines from processed offset paper masters with operators Charley Reynolds (left) and David Smith (right).

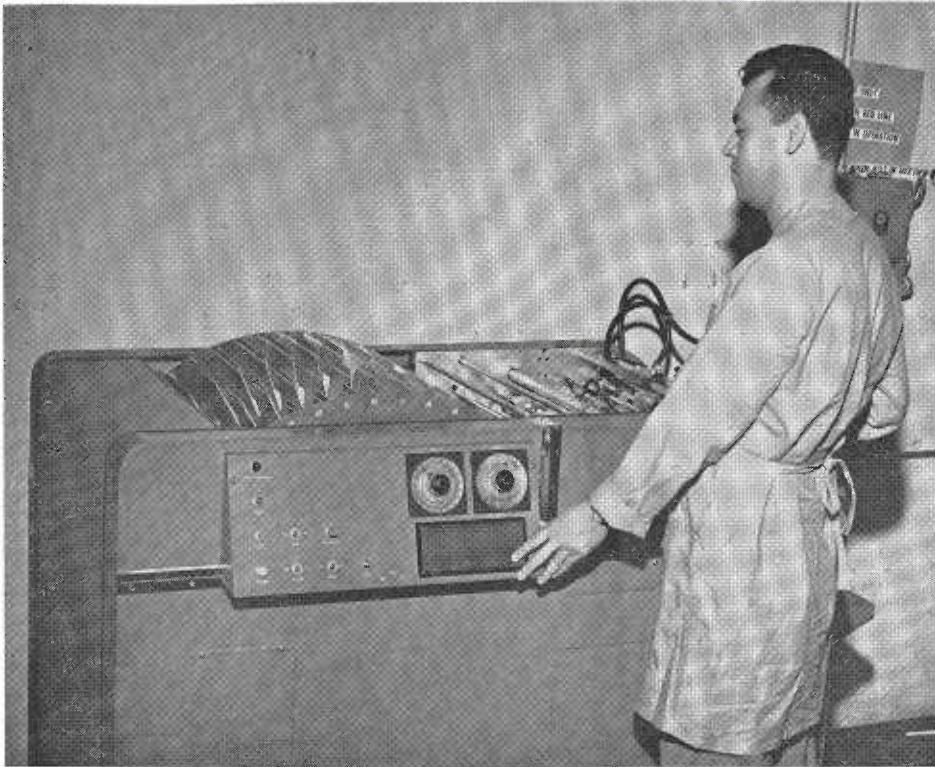

Operator Tom Sandoval collates copies of the plans.

method. Additionally, this method offers the following advantages:

1. Solids and bold-faced type headings are reproduced alongside fine detail without mottling.
2. A wide variety of halftone copy can be reproduced with acceptable fidelity.
3. Little or no clean-up time or fill-in work is required.
4. No shadow lines to remove when working with paste-ups.
5. Additions or deletions can readily be made prior to printing.

This method has produced offset masters capable of yielding clean and sharp copy that is most desirable.

#### Basic Standards

Careful consideration was given to the use of proper methods in producing drawings with high contrast so they were compatible with reproduction processes for reduced size plans. In order to secure completely legible reduced size plans certain basic standards were observed. The division set forth the following requirements:

1. Drawings shall be prepared on cloth, paper or polyester base

film using either pencil, ink or typing. All hand lettering should, if at all possible, be held to a minimum height of three-six-

teenths of an inch and under no circumstances should hand lettering smaller than one-eighth inch in height be used. For mechanical lettering, the minimum should be 0.140 inch with 0 or 00 pen.

2. The types of "duplicate" tracings that will be acceptable for contract plans are cloth, paper or polyester base film duplicates of the silver emulsion type, excluding diazo duplicates.
3. All "originals" sent to headquarters office as a part of contract plans shall have the material to be reproduced confined to one side of the sheet and it shall be direct reading.
4. No shading or coloring will be allowed on contract plan tracings. This will not reproduce photographically on reductions and blanks out dimensions on diazo reproductions.
5. Combination of ink and pencil work will not be tolerated on the same sheet due to difficulty in obtaining legible reproductions

... Continued on page 48



A completed set of plans is being punched on a multiple-head drilling machine by operator Charley Reynolds.

## Full Freeways Now Total 1,000 Miles

California has opened its 1,000th mile of multilane full freeway, Governor Edmund G. Brown has announced.

The state's highway system now includes a total of 2,425 miles of completed multilane divided highway of all types, including about 850 miles of expressway—access controlled, like the full freeways, but with some crossings still at grade.

The 1,000th mile of full freeway—with all crossings separated by structures and no left turn movements—was opened to traffic on July 14. It was a 2.8-mile section of U.S. 101 bypassing the City of Fortuna, in Humboldt County.

### Runners-up Listed

Runners-up for the "milestone" honor were two sections of freeway in the Los Angeles area—a 3½-mile section of the San Diego Freeway near Long Beach which opened on July 5 and a one-mile extension of the Hollywood Freeway in North Hollywood, which opened July 16.

"California is still the leading state in construction of modern tollfree multilane freeways and expressways," the Governor pointed out. "This achievement is directly due to a combination of farsighted legislation, sound long-range planning, and the finest brand of engineering skill on the part of the Division of Highways.

### More Under Construction

"I am proud of the fact that more than 300 miles of full freeway have been opened to our motor vehicle users in the past 3½ years, and that more than 400 miles are under construction right now. This means the saving of millions of dollars in operating costs to highway users, and, more important, hundreds of lives, because these freeways are the safest as well as the most efficient motor vehicle facility yet devised.

"I commend Director of Public Works Robert B. Bradford, the rest of the Highway Commission and the whole Division of Highways for the efficient and well-planned way in

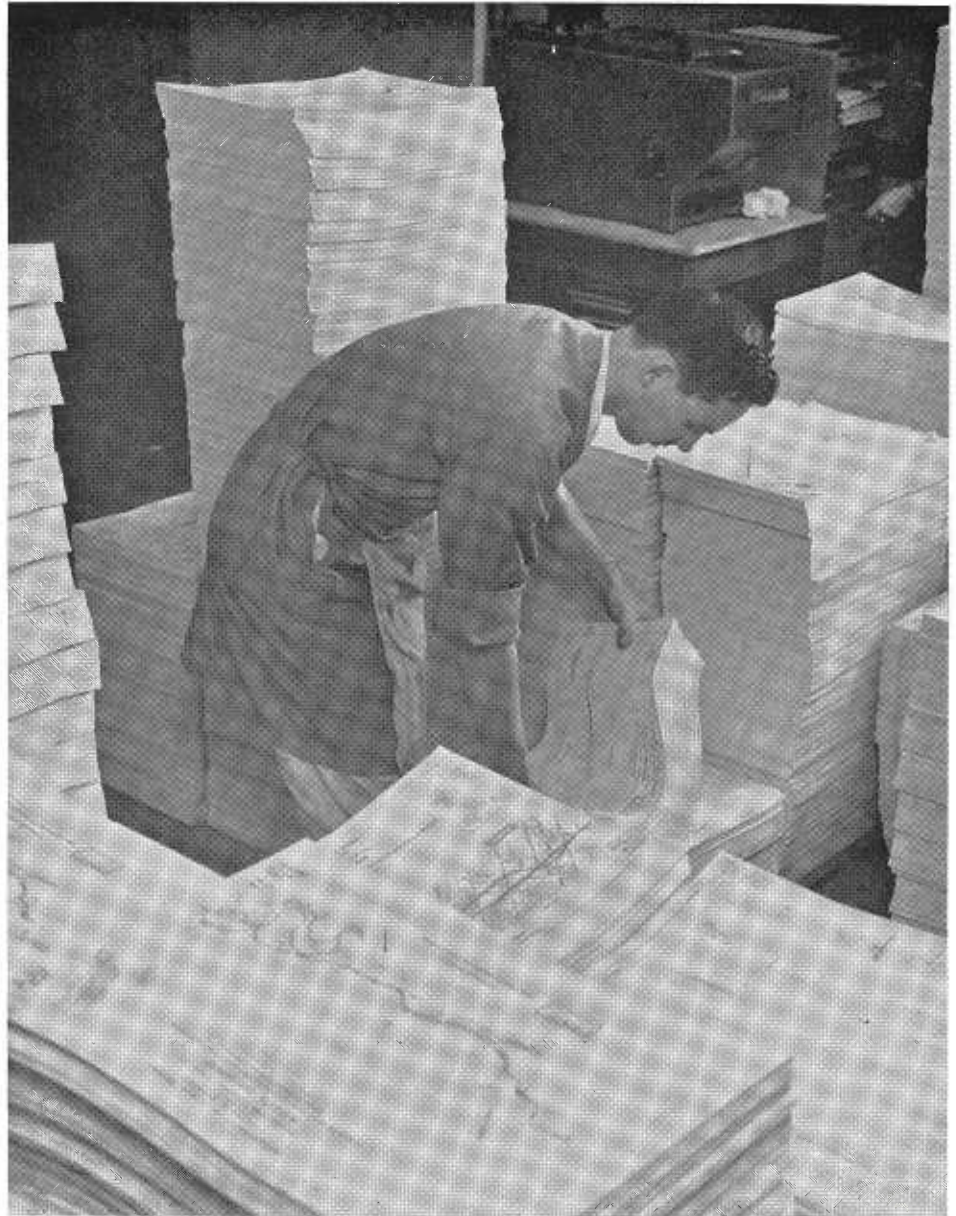

Duplicating Machine Operator Bob Humphrey stacks plans of various projects which will be shipped to the districts.

## Reduced Plans

Continued from page 47 . . .

- on account of unequal values of contrast.
- 6. Appliques of symbols and letters cannot be used on contract plans due to impermanency.

### Conclusion

This new combination provides the division with a most efficient means of reproducing reduced size contract plans rapidly at low cost.

which the freeway network is expanding all over the state."

The Governor also took note of a report from the Highway Commission that it has adopted route locations, after provision for public hearings, for a total of 6,200 miles of freeways. This represents half of the 12,400-

mile system of freeways and expressways established by the legislature in 1959, he pointed out. The freeway-expressway system is scheduled for completion by 1980, connecting all California communities of more than 5,000 people and carrying 60 percent of the total traffic.



# Evaporation Rate

Apparatus Measures Water Loss  
During Construction Operations

By RUFUS M. HAMMOND, Assistant Highway Engineer

As highways are essentially outdoor structures they must endure all the variations involved in climatic conditions. Undoubtedly no other element has such a profound effect on all aspects of highway engineering as does water. Virtually all soils would be completely stable and present few problems if they were dry. Water causes rusting of steel structures and deterioration of most materials. It has been called the universal solvent. Water is an essential in the manufacture of portland cement concrete and water loss must be prevented for proper curing. The question of how long water remains in place on the surface or in the pavement structure is often a matter of considerable importance and therefore an accurate knowledge of the potential evaporation rates can be important.

For example, the curing of portland cement concrete is relatively simple where there is no loss of water due to evaporation, and can represent a serious problem when evaporation losses are rapid and extensive. The successful construction of seal coats using emulsified asphalt, on the other hand, depends upon the ability to get rid of the water. Here rapid evaporation is desirable. The compaction of soils for embankments can only be carried out effectively when the moisture content is at exactly the right percentage for the given soil. This amount is usually referred to as the optimum moisture. When evaporation rates are very high, it can be very difficult, if not impossible, to maintain enough moisture in the soil to insure proper compaction, and if evaporation rates are very low and the soil is wet it may be even more difficult to get rid of the excess water in order that the soil will compact.

The removal of water during and following construction is mainly by evaporation, although some may be absorbed by the aggregates. The factors influencing evaporation may be

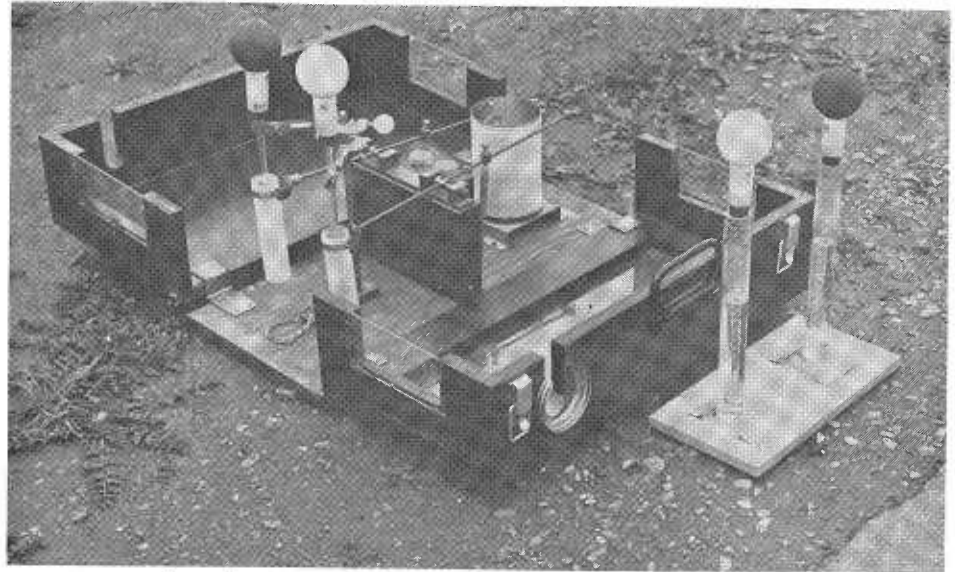

FIGURE 1—Recording unit equipped with porcelain atmometers (left); nonrecording unit (right). During use in the field the recording box unit is closed and only the atmometers exposed.

divided into two groups. The characteristics of the material in which the water is present affects its movement to the surface. These factors are briefly the color, surface area exposed and size of capillaries. The external factors are the humidity, air temperature, intensity of sunlight heating the evaporative surface and the movement or circulation of air over the surface.

## Measuring Evaporation

The most commonly known devices for making measurements in this field are usually limited to measuring atmospheric humidity alone. Such devices are the wet-dry bulb thermometers and the sling psychrometer. Many types of hygrometers have also been used. Some of the oldest used human hair which has a very marked tendency to stretch or contract with variations in humidity. None of these devices, however, indicate the total amount of evaporation which would occur as a result of the combined influences of temperature, wind speed and atmospheric humidity.

Any device that provides a measure of the evaporation rate of water is by

definition an atmometer. To others, than those engaged in highway construction, the evaporation rate of water is of great interest to physiological ecologists in studies of plant growth. They are responsible for the development of many types of atmometers which include open pans of water, surfaces of wet cloth or paper and porous porcelain pieces of various shapes. Naturally the size and shape of the instrument have an effect on the rate of evaporation and according to authorities the different types are not closely comparable. The most common type is a black or white porous porcelain sphere about 2 inches in diameter enclosed except for an opening of about  $\frac{3}{4}$  inch in diameter. This device is attributed to Dr. Livingston of Johns Hopkins and is generally known as the Livingston atmometer.

## Common Method

The most common method of operation is to connect the atmometer, previously filled with distilled water, to a reservoir by means of a glass tube and rubber stoppers. See apparatus on right Figure 1. The reservoir is nor-

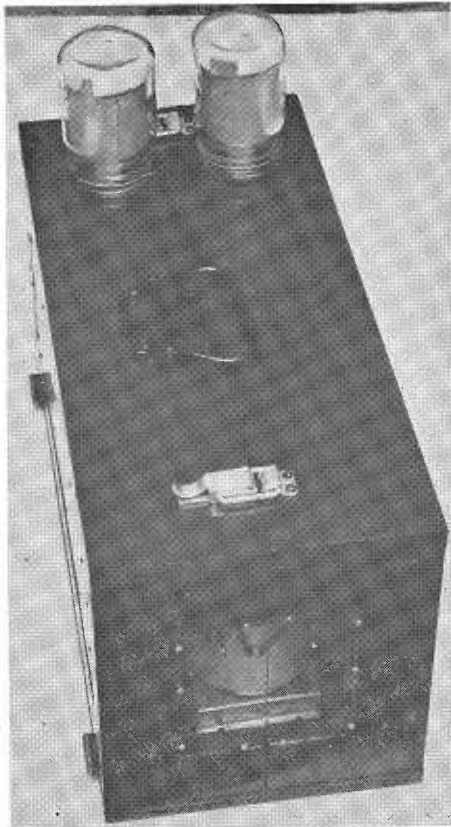

FIGURE 2—Recording unit equipped with porcelain atmometers ready for transportation.

mally a graduated cylinder of 100 ml. capacity. As water evaporates from the outer surfaces of the porous porcelain atmometer, it is replaced by suction from the container. Each unit, as supplied by the manufacturer, has a correction factor based on a previous calibration against a standard unit. This factor must always be used in determining the correct evaporation rate.

The atmometers both white and black were first used by this department about 1935, in connection with evaporation rates from emulsion treated bases. All of our studies from this time to 1957 were made with this spherical type which has the advantage that placement may be made without regard to wind direction. In normal operation the white and black bulbs are placed close together. The black type absorbs more heat and during the daylight hours the evaporation is higher than from the white bulb. On cloudy days or during the night both bulbs show the same evaporation rate. In use for highway work

one must decide, on the basis of the surface being constructed, which rate most nearly approximates the true condition.

The usual method of measuring the evaporation rate with the Livingston atmometer by means of a graduated cylinder has the disadvantage of requiring a time interval of about one-half hour between readings in order to permit sufficient volume change in the reservoir and furthermore someone must be present to obtain the readings. A further disadvantage is that variations in evaporation rate, during this interval of time, will not be detected. Our initial studies with this apparatus, as applied to seal coat work, convinced us that evaporation rates may vary quite markedly over relatively short periods of time. Therefore, it was decided to design and construct a simple recording device for providing a continuous record of evaporation rate with a minimum of necessary attendance by an observer on the job site.

#### Apparatus Is Mounted

Such an apparatus is shown in Figures 1, 2 and 3. Each atmometer bulb (A), Figure 3, (only one is shown) together with their supply tubes is mounted in a fixed position by means of support rod (B). The lower end of the supply tube is inserted into a test tube (C), which is supported on a beam (D). The beam is fastened to a support (E) by means of needle point bearings and moves freely in the same manner as a weighing device or balance. A pen (G) which makes a trace on the clock driven cylinder recorder (H) is mounted on the opposite end of the beam. The movement of the beam is partially restrained by a spring (F) which acts

as a damping element. The spring allows the operator to control the sensitivity of the apparatus, and from experience an adjustment is made so that the evaporation of 1 ml. of water registers as a spread of 0.10 inch on the recording chart. The instrument with the exception of the bulbs, is enclosed in a case, which prevents wind from interfering with the movements of the beam, Figure 1. It is necessary to soak the units in distilled water before setting them up, in order to force all the air out of the bulbs, also they should be operated for several hours before the start of readings. We have partly solved these problems by placing the entire apparatus in operation in the laboratory several hours before starting for the job site. Just prior to loading, a glass jar, Figure 2, is fitted over each atmometer bulb and screwed into the cap fastened on the case. This provides a dust free chamber for each bulb and also moisture equilibrium is soon established in the chamber so that water ceases to move through the bulbs. By this method the bulbs are saturated with water on arrival on the job site, and after removal of the jars, they rapidly reach equilibrium with their surroundings. This permits reliable readings to be obtained within about 15 minutes after start of operations.

#### Set Near Road Surface

At the job site the apparatus is set up on the ground as near the road surface as possible, the jars removed, the test tubes refilled with distilled water and the pens are placed on the chart. The hour of start is then recorded and the unit is in operation. Where high evaporation rates are encountered, the water supply must be replaced at least twice each day. This is the only atten-

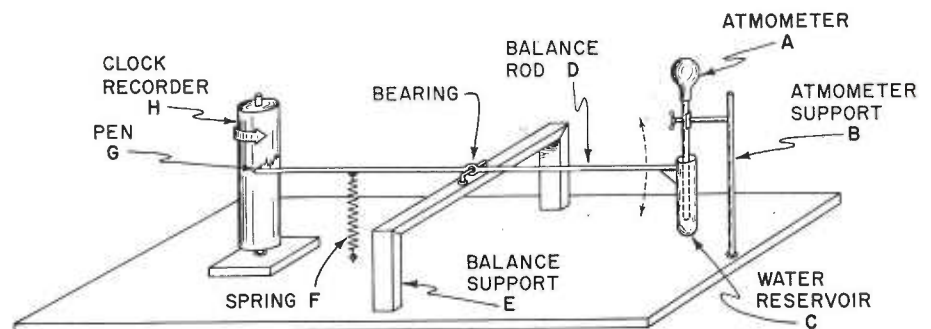

FIGURE 3—Schematic diagram of recording unit for measuring evaporation rate from atmometer bulbs.

#### Dust Is Problem

Another cause of serious error is the slow collection of dust on the outer surface of the bulb. In the laboratory all bulbs are carefully stored in desiccators, when not in active use. Dust is a problem in the field and the bulbs should be protected by bottles when transported or when the unit is not in operation. In any case, immediately after returning from a field trip, all bulbs must be removed and placed in distilled water, and carefully brushed. They are then dried and stored in the desiccator. Even with these precautions, it is necessary to recheck the calibration factor at various times.

The difficulties encountered with the proper care of atmometer bulbs under construction conditions prompted a study of other types of evaporation surfaces. After further study of literature on atmometers, we decided to perform experiments with a paper type. Although some tests had previously been made using paper as the evaporating surface, no satisfactory method of mounting the paper was developed. Using the basic principles described in the literature, the atmometer shown in Figure 4 was developed. This unit uses a heavy 6" circular

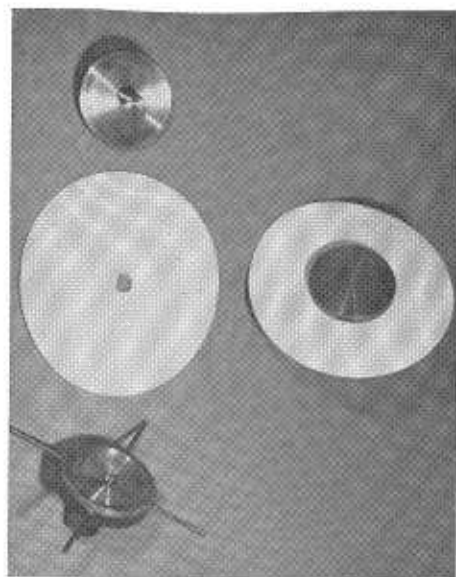

FIGURE 4—Filter paper type atmometer.

tion necessary in connection with the operation of the instrument.

The total cost of this instrument is somewhere around \$200 and the device appears to be sufficiently accurate for studies of evaporation rate under field conditions. Since the evaporation rate is markedly influenced by local conditions any chart readings must be applied to relatively short sections of the road in the vicinity of the instrument. Extreme accuracy is not necessary for such interpretations and errors caused by evaporation from the open test tube, acting as the supply vessel, are very small. A typical test run showed a loss of 0.045 ml/hr from the supply tube compared to an evaporation rate of 1.4 ml/hr from the atmometer bulb.

The apparatus can be used for most field studies with only normal care in transportation. However, the atmometers are rather fragile and must be handled carefully. Any foreign material which tends to clog the pores will radically change the calibration factor and large errors may result in the final calculated evaporation rate. Distilled water, not only for the supply vessel, but for all cleaning operations should be used. Salts in tap water will quickly collect in the atmometer pores, near the surface, and thus definitely change the calibration factor. Further, such salts are difficult to remove during cleaning operations.

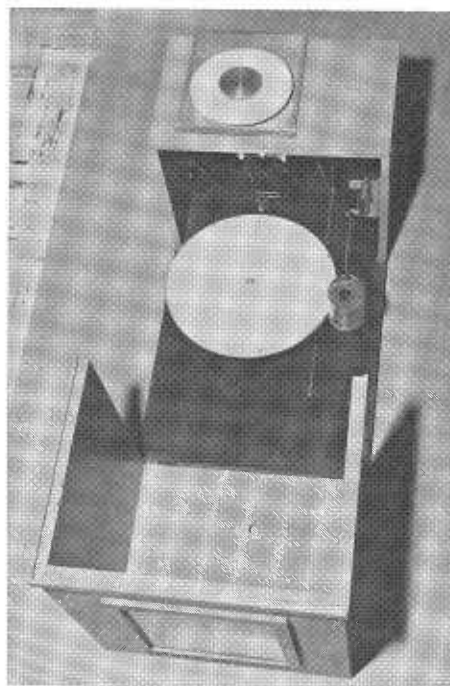

FIGURE 5—Recording unit equipped with paper atmometer.

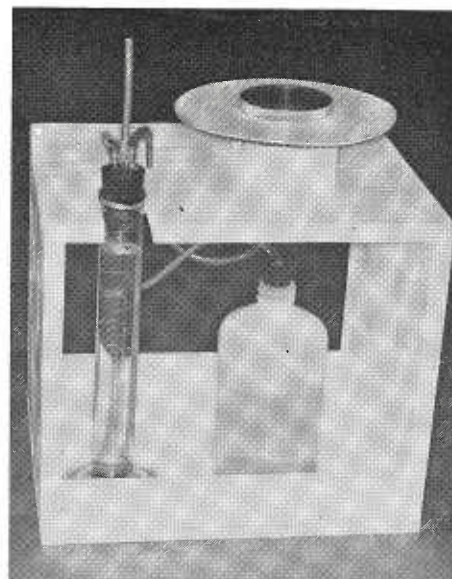

FIGURE 6—Paper atmometer, nonrecording type.

filter paper, Eaton-Dikeman grade 652 and the filter paper is clamped in a brass holder. The holder is hollow below the nob so that water may be fed to the paper. This atmometer will handle in excess of 20 ml/hr. in extreme drying conditions.

#### Clockwork Recorder Developed

In conjunction with the paper type atmometer, a clockwork drive recorder was developed. The complete apparatus is shown in Figure 5. Essentially it consists of a small water reservoir of about 125 ml with a  $\frac{1}{8}$ " diameter hose leading to the paper atmometer. The reservoir is attached to one end of an arm, the opposite end being attached to a horizontal shaft. One carries the recording pen and to the other is attached a spring which is balanced against the weight of the reservoir of water. A  $10\frac{1}{2}$ " circular Leeds and Northrup Chart No. 1001 is used. The clockwork drive is a Big Ben type alarm clock with the face and hand replaced by a  $10\frac{1}{2}$ " diameter circular aluminum disk to which the chart is attached.

The cost of this instrument is approximately the same as the previously described bulb unit. The advantage of the paper type is mainly that it is very cheap and can be discarded when a coating of dust collects. Also it eliminates the need of using distilled water as required in the porcelain type. This type of recording atmometer is very

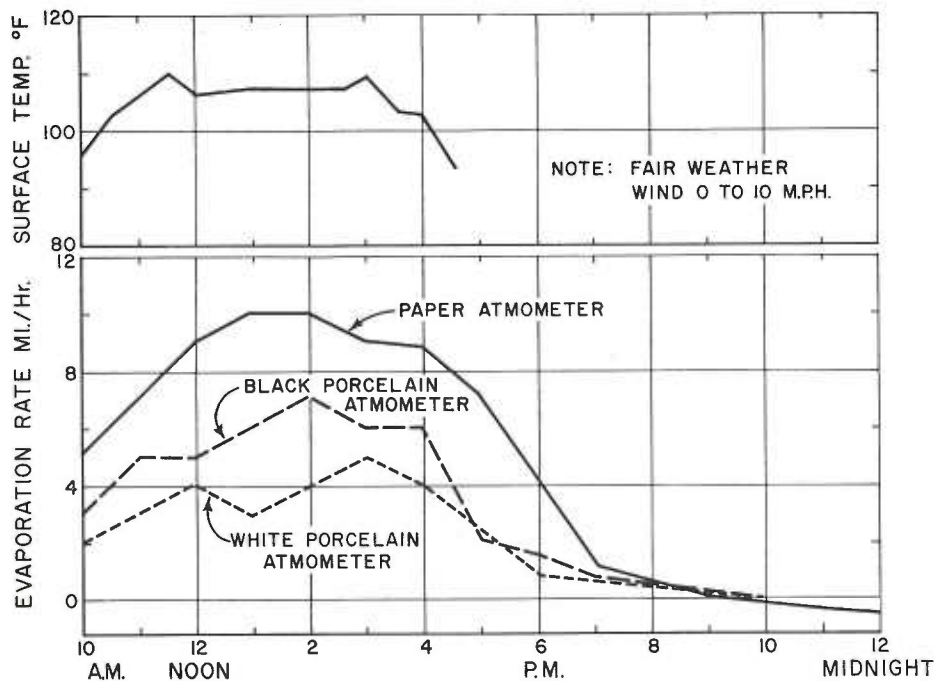

FIGURE 7—Evaporation rates for different types of atmometers.

useful when a continuous record is desired and an attendant is not present to make readings at short intervals.

#### Occasional Readings

There are many occasions where it might be more desirable to have a greater number of units along the job site and where only occasional readings by an observer are necessary. With this in mind another form of paper atmometer was developed which may be readily moved from place to place and in which the water supply may be easily replenished. The apparatus, shown in Figure 6 costs only about \$20, and is easily constructed. It consists of a paper atmometer (6" circular filter paper) which is connected to the 100 ml graduate by a 1/8" hose. The graduate is also connected to a one-pint plastic bottle for a water supply. The graduate is fitted with a rubber stopper having three outlets, the two already mentioned and an air vent.

#### No Moving Parts

In order to fill the graduate it is merely necessary to squeeze the plastic bottle, and to prime or start the atmometer, the air vent in the graduate is pinched off which forces air out through the paper atmometer, and

water into the system and filter paper. Having no moving parts, it can be picked up and moved at any time. Readings are taken at required intervals direct from the glass graduate.

Illustrations of atmometer records from the various types of previously described recorders are shown in Figure 7. It will be noted that the paper atmometer actually absorbed moisture from the air during the night hours. We have also observed this on other occasions when using the porcelain type.

#### Summary

The primary purpose of this paper is to bring to the attention of highway engineers the importance of evaporation during construction operations and that simple relatively sturdy equipment is available for measuring the evaporation rate.

We have not been able to collect sufficient data from various projects to justify recommendations regarding the possible use of evaporation rate results in connection with compaction, concrete paving and seal coat operations. However, the continued accumulation of such data may provide future useful information to the engineer with respect to one of the natural factors influencing construction operations.

## District VII Marks Cass Rose Retirement

Cass M. Rose, office engineer in District VII since 1955, and whose 46 years of engineering experience included 25 years of service with the Division of Highways, retired July 6.



CASS M. ROSE

Rose was transferred from headquarters in Sacramento to Los Angeles January 1, 1951, to organize the substructure section and map all underground utilities in the district. Later the group took over the processing of all minor contracts. He started with the Division of Highways in 1933 as an associate highway engineer in District I, but left the following year to become assistant city engineer in San Francisco. There he set up a program of WPA projects. In 1935 he returned to the State as an associate highway engineer in District IX, where he was on location and construction assignments, including four years as resident engineer in Mojave.

From 1941 to 1944 Rose was a civilian engineer with the U.S. Navy, acting as chief inspector at the Mare Island Navy Yard, Kearny Mesa Air Field and Litchfield Air Field. At the conclusion of this service he returned to the State and was assigned to District I. From 1947 until he transferred to District VII he was in Sacramento in the headquarters survey and plans department (now design).

Rose's engineering experience began in 1911 when he got a job with a survey party. During the next 21 years he worked for railroads in North Dakota, Montana, South Dakota, Minnesota and Illinois, and for the highway commissions in Minnesota, South Dakota and Iowa. During World War I, from 1917 to 1919, he served in the U.S. Army with the 13th Engineers in the American Expeditionary Force, and in the First Division in Germany with the Army of Occupation.

## Safety Foundation Marks 25th Birthday

The Automotive Safety Foundation, a nonprofit organization dedicated to safe and efficient highway transportation, observed its 25th anniversary June 2.

ASF was founded by the automotive industry in 1937 during the early years of mass highway travel, a period marked by drastic increases in traffic volumes and a corresponding rise in fatalities, injuries and property destruction.

Its program is financed through the voluntary contributions of more than 600 companies and industry associations which have invested a total \$25 million in ASF as a service to the motoring public and the United States' economy.

The results have revolutionized highway transportation. The traffic death rate of 15.1 per 100 million miles of travel in 1936 has been reduced to 5.2, making highway travel on a mile-age basis nearly three times safer than a quarter century ago.

ASF's highway engineers drafted the nationally accepted techniques for determining future highway needs and have conducted 35 highway studies in 27 states, including two in California, covering more than half of the nation's road mileage. These studies paved the way for innumerable highway improvement programs, including the 41,000-mile national system of interstate and defense highways, which alone is expected to save 5,000 lives when completed in about 10 years.

The highway engineering staff is now giving increased assistance to states in programing road projects according to urgency and in improving road management procedures. A study of this nature is underway in Washington.

With highway agencies expecting to spend more than \$125 billion in the next 10 years, ASF anticipates that the program will become an important contribution to efficient highway development.

Traffic engineers on the ASF staff have assisted 41 major cities in developing more effective methods for traf-

## DEPARTMENT ANNOUNCES RECENT RETIREMENTS

### District I

Cyril F. Collins, Highway Foreman, 35 years; Harry D. Hicker, Highway Bridge Maintenance Foreman, 28 years; Theodore W. Maxwell, Highway Maintenance Man II, 28 years; Joe O'Connell, Highway Maintenance Man I, 26 years.

### District II

Rolin M. Eslinger, Highway Maintenance Man III, 33 years.

### District III

Daniel D. Breuning, Highway Superintendent, 45 years; Paul W. Gruenhagen, Drawbridge Operator, 28 years; Marion Raugust, Assistant Highway Engineer, 9 years.

### District IV

Hugh F. MacKenzie, Assistant Highway Engineer, 29 years; Edward V. Metcalf, Junior Typist-Clerk, 10 years.

### District V

Stephen G. Jaeger, Highway Maintenance Man II, 23 years; William C. Mitchell, Highway Maintenance Man I, 15 years; Victor E. Pearson, Associate Highway Engineer, 34 years.

### District VI

Samuel H. Black, Highway Foreman, 36 years; \*Carlton V. Hadley, Highway Field Office Assistant, 6 years.

### District VII

Henry E. Cowan, Highway Maintenance Man II, 28 years; Drew J. Faulkner, Associate Highway Engineer, 29 years; Paul E. Holbrook, Highway Field Office Assistant, 6 years; Hugh H. Powell, Highway Maintenance Man II, 24 years; Loral Wiley, Highway Maintenance Man II, 28 years.

fic control and are now stepping up research for solutions to urban transportation problems.

ASF awards grants of funds to universities and public service groups for specific research and educational projects, provides technical services to government officials and agencies.

### District VIII

\*Rex E. McKinney, Highway Engineering Technician I, 7 years.

### District IX

Albert Radley, Highway Maintenance Man I, 29 years.

### District X

William D. Haigh, Highway Foreman, 36 years; Ben J. Harrigan, Drawbridge Operator, 29 years; Otis W. Holland, Drawbridge Operator, 13 years; Manuel G. Maciel, Drawbridge Operator, 29 years; Emery C. Nelson, Associate Right of Way Agent, 8 years.

### District XI

Landon W. Cope, Highway Foreman, 38 years; Austin C. Erwin, Highway Foreman, 28 years; Edward L. Reiner, Laborer, 14 years.

### Headquarters Office

Harold B. LaForge, Principal Highway Engineer, 45 years; Tom W. Reynolds, Senior Highway Engineer, 28 years.

### Bridge Department

Charles C. Darden, Highway Field Office Assistant, 7 years.

### State-owned Toll Bridges

Katie F. Carpenter, Telephone Operator, NMB, 17 years; Howard C. Wood, Principal Bridge Engineer, 33 years.

### Materials and Research Department

George C. Nickel, Skilled Laborer, 11 years; Arthur W. Root, Supervising Materials and Research Engineer, 9 years.

### Headquarters Shop

James J. Keleher, Associate Equipment Engineer, 31 years.

### Shop 5

Norman N. Weber, Automobile Mechanic, 34 years.

### Shop 7

John L. Jackson, Senior Machine Parts Storekeeper, 14 years.

\* Disability retirement.

## Equipment and Shops Lose Three Veterans

Three veteran employees of the State Division of Highways Equipment Department have retired from state service.

They are Frank F. Green, Senior Equipment Engineer, 30 years of service; Homer T. Forschler, General Superintendent of Shops, 40 years of service; and Albert C. Briney, Associate Equipment Engineer, 33 years of service.

Green joined the equipment department in 1931 as superintendent of the Bishop shop. In 1933 he transferred to Fresno. In 1943, he became superintendent of the Redding shop, and in 1947 was transferred to San Francisco. His career at equipment department headquarters began in 1950 when he became superintendent of the department's Sacramento shop. In 1952 he was promoted to senior equipment engineer in charge of operations at the equipment department.

Green and his wife, Hermione, have a daughter, Daphne, in Sacramento and a son, Maurice, in Fresno.

Forschler started his career with the Division of Highways in 1921 as a truck driver in Modoc County. In 1942 he was promoted to highway mechanic foreman in the Redding shop. In 1947 he became superintendent. His career brought him to Sacramento in 1954 as general superintendent of all highway shops which cover the entire State.

Forschler and his wife, Mabel, live in Sacramento.

Briney joined the California Division of Highways in 1928 as a draftsman in Redding. His career has taken him all through the northern and eastern part of the State as a resident engineer on various construction projects. In 1937 he was called to the



FRANK F. GREEN



HOMER T. FORSCHLER

## IN MEMORIAM

### District I

George L. Linton, Highway Maintenance Man II

### District IV

Ted L. Reeves, Tree Trimmer

### District VII

Jose T. Alvarez, Supervising Groundsman I

Giles H. Lamb, Jr., Senior Highway Engineer

Richard Q. Park, Highway Maintenance Man III

Jack E. Worley, Assistant Highway Engineer

### District VIII

David R. Henderson, Highway Maintenance Man III

Molly M. Price, Senior Stenographer

### Headquarters Office

Donald Alen Baugh, Senior Clerk  
Melbourne H. West, Principal Highway Engineer

### Bridge Department

Charles W. DuBois, Delineator

### Materials and Research Department

Anna L. Vairo, Intermediate Stenographer

Sacramento headquarters office where he worked in the highways specification section. In 1952 he transferred to the equipment department where he has been the office engineer and in charge of contracts for building and lands maintenance, and industrial safety promotion.



ALBERT C. BRINEY

Briney and his wife, Nina, have a son, Robert, an associate bridge engineer with the Division of Highways in Los Angeles, and three grandchildren.

## TWENTY-FIVE-YEAR LIST

The following employees received 25-year awards during May and June:

### District I

Luther Goodlin  
Glenn R. Wooldridge

### District II

William R. Borden

### District III

Francis W. Fox  
Lester J. Koster

### District IV

Burnell C. Kahn  
Leslie M. Petersen

### District V

Helen Rutherford

### District VI

Robert Lee Bradley  
Joseph H. Jensen  
Detmer F. Landreth

### District VII

Jack E. Eckhardt

### District VIII

Earl W. Ary

### District X

Bruno Dentino  
Walter H. Mariotti

### Headquarters Office

Paul E. Billings  
John L. Elia  
Howard H. Hoover  
Margaret Long  
Charles M. Zeitler

### Bridge Department

Winfield C. Names  
Bing Q. Wong

### State-owned Toll Bridges

Carl H. Waters

### Headquarters Shop

Roydon S. Lynn

### Shop 7

Edwin H. Hanks

## Richard H. Ramsey Retires in Eureka

Richard H. Ramsey, district right-of-way agent of District I, Division of Highways, was guest of honor at a retirement dinner on June 29 in Eureka, marking his retirement after more than 26 years of service with the State of California.

Ramsey's career of public service has included, in addition to his service with the State, a two-year term as auditor and controller for the State of Arizona. He served as district right-of-way agent of District I since April 1945.

His career with the State began in 1936 when he joined the District III office in Marysville. In August of 1938 he transferred to the office in Eureka, where he has guided the growth of his department from a section of two agents and one secretary to a present staff of 50 employees.

Ramsey is an active member of the Ingomar Club, the American Right of Way Association, and the Christ Episcopal Church of Eureka. He has been active in the California State Employees' Association for many years and served as its regional director in 1944.

Before entering state service, he held banking positions in Yuma, Arizona, and Imperial, California.

He was born on a farm near the town of Cleburne, Texas, and started work in 1914 in the Traders State Bank there. He moved to Arizona in 1915 and worked for the next 10 years in the banking business, interrupted in 1922 by election to a two-year term as state auditor and controller. He returned to the banking business until 1927, when he moved to San Diego and associated with a firm handling municipal bonds and other securities.

William A. Sloane has been transferred from the Stockton District Office of the Division of Highways and promoted to district right-of-way



R. H. RAMSEY

## DIVISION EXHIBITS PUBLICATIONS AT STATE LIBRARY



As part of a special program developed by the State Library in Sacramento to feature publications of various state agencies, during June and July. The Division of Highways placed an exhibit of its publications just outside the Government Publications Section on the third floor of the library building. Shown posing with the exhibit are, left to right, Mary E. Schell, Supervising Librarian, Government Publications Section; Ruth Elwonger, California State Publications Librarian; and Martin E. Thomas, Assistant Supervising Librarian, Government Publications Section.

## L. A. SUPERINTENDENT A. A. HILTON RETIRES

Albert A. Hilton, Highway Equipment Superintendent for the Division of Highways at its Shop 7 in North Hollywood, retired on July 1. He had been with the State 41 years.

Hilton began his service as a mechanic in District VII in the summer of 1921. He became a foreman in 1931 and was promoted to highway equipment superintendent I and transferred to Shop 8 (San Bernardino) in 1942. He was as-



ALBERT A. HILTON

agent to fill the vacated position, according to an announcement by Sam Helwer, District Engineer.

signed to Shop 4 (San Francisco) as superintendent II in 1954 and transferred back to Los Angeles two years later.

A native of Connecticut, Hilton came to California in 1921.

Hilton is a dog fancier. He owned and operated kennels in North Hollywood from 1930 to 1942. One of his late champion Great Danes, Ch. Sun-swept Alecto, holds a "best of breed" win over the largest entry of Great Danes on record.

Hilton and his wife, Marguerite, have three daughters: Mrs. William Foshee, now in Hahn, Germany; Mrs. Eunice Shepherd, North Hollywood; Mrs. Donald L. Campbell, Rialto.

The Hiltons will divide their time between their two homes, one in Westwood, Lassen County, and the other in the San Fernando Valley.

# STATE OF CALIFORNIA

EDMUND G. BROWN, Governor

## HIGHWAY TRANSPORTATION AGENCY

ROBERT B. BRADFORD . . . Administrator

### DEPARTMENT OF PUBLIC WORKS . . . ROBERT B. BRADFORD, Director

RUSSELL J. COONEY . . . Deputy Director (Management)  
HARRY D. FREEMAN . . . Deputy Director (Planning)  
FRANK A. CHAMBERS . . . Chief Deputy Director  
T. F. BAGSHAW . . . Assistant Director  
JOHN H. STANFORD . . . Assistant Director  
JUSTIN DuCRAY . . . Departmental Management Analyst  
S. ALAN WHITE . . . Departmental Personnel Officer

### DIVISION OF HIGHWAYS

J. C. WOMACK . . . State Highway Engineer, Chief of Division

CHAS. E. WAITE . . . Deputy State Highway Engineer  
J. P. MURPHY . . . Deputy State Highway Engineer  
J. A. LEGARRA . . . Deputy State Highway Engineer  
LYMAN R. GILLIS . . . Assistant State Highway Engineer  
J. E. McMAHON . . . Assistant State Highway Engineer  
GEO. LANGSNER . . . Assistant State Highway Engineer  
FRANK E. BAXTER . . . Assistant State Highway Engineer  
J. C. BURRILL . . . Comptroller  
C. G. BEER . . . Urban Planner  
L. L. FUNK . . . Planning Engineer  
MILTON HARRIS . . . Construction Engineer  
F. N. HVEEM . . . Materials and Research Engineer  
SCOTT H. LATHROP . . . Personnel and Public Information  
C. T. LEDDEN . . . City and County Projects Engineer  
H. C. McCARTY . . . Office Engineer  
A. M. NASH . . . Systems Research Engineer  
E. J. L. PETERSON . . . Program and Budget Engineer  
F. M. REYNOLDS . . . Planning Survey Engineer  
EARL E. SORENSON . . . Equipment Engineer  
E. L. TINNEY . . . Maintenance Engineer  
W. L. WARREN . . . Engineer of Design  
G. M. WEBB . . . Traffic Engineer  
A. L. ELLIOTT . . . Bridge Engineer—Planning  
L. C. HOLLISTER . . . Bridge Engineer—Special Projects  
I. O. JAHLSTROM . . . Bridge Engineer—Operations  
DALE DOWNING . . . Bridge Engineer—Southern Area

#### Right-of-Way

RUDOLF HESS . . . Chief Right-of-Way Agent  
DEXTER D. MacBRIDE . . . Assistant Chief  
RAY E. O'BIER . . . Assistant Chief  
R. S. J. PIANEZZI . . . Assistant Chief  
JACQUES T. ZEEMAN . . . Assistant Chief

#### District I, Eureka

SAM HELWER . . . District Engineer

#### District II, Redding

H. S. MILES . . . District Engineer

#### District III, Marysville

ALAN S. HART . . . Assistant State Highway Engineer

#### District IV, San Francisco

J. P. SINCLAIR . . . Assistant State Highway Engineer  
L. A. WEYMOUTH . . . District Engineer  
R. A. HAYLER . . . District Engineer  
HAIG AYANIAN . . . District Engineer

#### District V, San Luis Obispo

E. R. FOLEY . . . District Engineer

#### District VI, Fresno

W. L. WELCH . . . District Engineer

#### District VII, Los Angeles

E. T. TELFORD . . . Metropolitan District Engineer  
A. L. HIMELHOCH . . . District Engineer  
GEORGE A. HILL . . . District Engineer  
A. C. BIRNIE . . . District Engineer  
A. W. HOY . . . District Engineer

### CALIFORNIA HIGHWAY COMMISSION

ROBERT B. BRADFORD . . . Chairman and  
Director of Public Works  
ARTHUR T. LUDDY . . . Vice Chairman  
Sacramento  
JAMES A. GUTHRIE . . . San Bernardino  
ROGER S. WOOLLEY . . . San Diego  
JOHN ERRECA . . . Los Banos  
ABRAHAM KOFMAN . . . San Jose  
FRANKLIN S. PAYNE . . . Los Angeles  
JACK COOPER, Secretary . . . Sacramento

#### District VIII, San Bernardino

C. V. KANE . . . District Engineer

#### District IX, Bishop

C. A. SHERVINGTON . . . District Engineer

#### District X, Stockton

JOHN G. MEYER . . . District Engineer

#### District XI, San Diego

JACOB DEKEMA . . . Assistant State Highway Engineer

#### State-owned Toll Bridges

CHARLES L. SWEET . . . Bridge Engineer

### DIVISION OF CONTRACTS AND RIGHTS-OF-WAY (LEGAL)

ROBERT E. REED . . . Chief Counsel  
HOLLOWAY JONES . . . Assistant Chief  
GEORGE C. HADLEY . . . Assistant Chief  
HARRY S. FENTON . . . Assistant Chief

### DIVISION OF SAN FRANCISCO BAY TOLL CROSSINGS

NORMAN C. RAAB . . . Chief of Division  
BEN BALALA . . . Principal Bridge Engineer

### DIVISION OF ARCHITECTURE

EARL W. HAMPTON . . . Acting State Architect, Chief of Division  
EARL W. HAMPTON . . . Deputy Chief, Architecture and Engineering  
HUBERT S. HUNTER . . . Deputy Chief, Administrative  
CHARLES M. HERD . . . Chief Construction Engineer  
ARTHUR F. DUDMAN . . . Assistant State Architect (North)  
TOM MERET . . . Assistant State Architect (South)

### DIVISION OF AERONAUTICS

CLYDE P. BARNETT . . . Director, Chief of Division



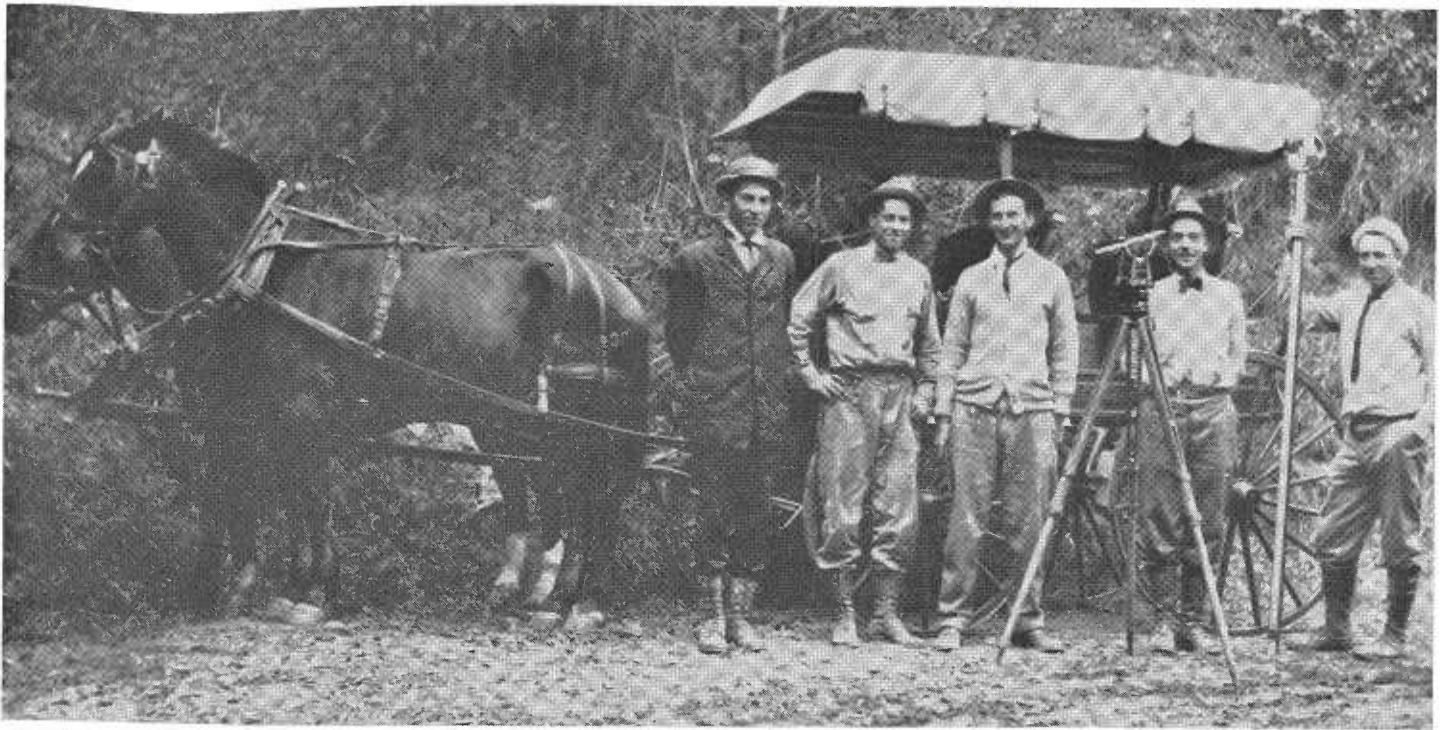

Last year's 50th anniversary feature showing the first permanent Highway Commission reminded Mr. Theodore R. Mini of Glendale of the above photo in his possession. Pictured is the Number One Survey Party working in 1911 on survey of El Camino Real in San Mateo County, one of the state routes authorized in the Highway Act of 1909. From left to right the men in the photograph are Willis G. Frost, chief of party, now a consulting engineer at Redwood City; William Sharp, chainman; Mr. Mini, instrumentman, now a consulting engineer; Robert A. Sinclair, chainman; and O. M. Moll, stakeman and driver.

Fifty years ago, in the summer of 1912, the first contract was let to build a California state highway system as required by the State Highways Act of 1909. Roads already existed, of course, but they were piecemeal efforts of the various counties in most cases. Often they petered out, or became rough wagon tracks when they crossed a county line.

The 1909 act provided for a bond issue of \$18,000,000 to provide a state highway system of about 2,600 miles, a system for which the growing number of automobile owners had been vociferously clamoring. Hence, when work started on Contract Number One of the system, in San Mateo County, it was not only big local news, but also big news statewide.

A fund of \$18,000,000 for paving and surfacing 2,600 miles seems ridiculously small today, but money went farther in 1912. Contract Number One, 5.4 miles in length, asphalt surface on portland cement concrete base, 24 feet wide, was bid at a cost of approximately \$17,000 a mile. This was a major route, and expensive.

The Good Road Builder First Surveys the Route; He Starts From Somewhere to Go Somewhere; He Shows How It Is Done; He Makes Traveling Easier for Others.—(From masthead of *California Highway Bulletin*, Volume 1, Number 1, October 15, 1912.)

Work on El Camino Real near Burlingame, 1912.



