

A Review of Advanced Power Technology Programs in the United States and Abroad Including Linked Transportation and Stationary Sector Developments

June 30, 2004

**Prepared for the California Air Resources Board (ARB) and the
California Stationary Fuel Cell Collaborative (CaSFCC)**

Final Report

Dr. Timothy E. Lipman*
Mr. Gregory Nemet
Prof. Daniel M. Kammen^

Energy and Resources Group
University of California - Berkeley

*Also affiliated with the Institutes of Transportation Studies at UC Berkeley and UC Davis

^Also affiliated with the Goldman School of Public Policy at UC Berkeley

Acknowledgements

This study was funded with support from the California Air Resource Board. We are appreciative of ARB's timely support for this research project, and we especially thank Ron Friesen of ARB and the California Stationary Fuel Cell Collaborative for his guidance and assistance throughout the project. We would like to thank Ryan Wiser of the Lawrence Berkeley National Lab for providing insights into U.S. and international renewable energy programs. We also thank all those who were interviewed to provide additional information on the various state and national programs. Finally, we would like to thank the Energy Foundation for their continued support of Prof. Kammen's ERG energy program research. Their funding has contributed to prior and ongoing energy technology and policy research at UC Berkeley that was helpful for this project.

Of course, the authors alone are responsible for the contents of this report.

Table of Contents

	<u>Page</u>
Acknowledgements.....	i
Executive Summary	iv
1.0 Introduction.....	1
1.1 Project Background	2
1.2 The California Stationary Fuel Cell Collaborative (CaSFCC)	3
1.3 Rationale for the Study	3
1.4 Scope of the Study.....	4
1.5 Report Organization	5
2.0 Review of U.S. Distributed Power Technology Programs.....	6
2.1 Connecticut	8
2.2 Massachusetts.....	9
2.3 Michigan	11
2.4 New Jersey	14
2.5 New York.....	15
2.6 Ohio	17
2.7 California	18
2.8 States with Less Active or Newer Advanced Power Technology Programs.....	22
2.9 Multi-State Programs.....	26
2.10 Lessons from Renewables.....	28
3.0 Review of International Distributed Power Technology Programs.....	31
3.1 Canada	35
3.2 Overview of DG Programs in Europe and the European Union.....	37
3.3 Germany.....	40
3.4 The United Kingdom (UK).....	43
3.5 Denmark.....	45
3.6 The Netherlands	46
3.7 General Summary of EU Renewables Programs	47
3.8 Overview of DG and Other Advanced Power Programs in Asia and Australia	48
3.9 Japan	48
3.10 Australia.....	52

3.11 China..... 53

3.12 Korea..... 54

3.13 Singapore 54

3.14 Thailand 54

4.0 Review of Combined Transportation / Stationary Power System Linkages and
 Concepts 56

4.1 DER Systems and Refueling for Advanced Technology Vehicles 56

4.2 Electric-Drive Vehicles as DER Sources or Components – “Vehicle-to-Grid” Power .. 62

4.3 Summary of Combined Transportation/Stationary Power System Concepts 68

5.0 Review of Combined Transportation / Stationary Power System Projects and
 Initiatives 69

5.1 Hydrogen Energy Station Projects 69

5.2 DG and EV Recharging 72

5.3 Vehicle-to-Grid (V2G) Power Demonstration Projects 73

6.0 Conclusions..... 75

6.1 Overall Findings from Power Program Review 75

6.3 Additional Critical Issues for the Incentive and Market Development Programs 80

6.4 The Broader Energy Technology Context – Potential for Lessons Learned 83

6.5 Linked Transportation and Stationary Power Systems 84

6.6 Specific Recommendations for the CaSFCC 84

6.7 Concluding Thoughts: The Importance of Market Development Programs for
 Emerging Technologies 88

References 89

Appendix A: Summary of Distributed Generation System Net Metering Rules By StateA-1

Executive Summary

A new generation of advanced power technologies is rapidly emerging based on the concept of distributed generation (DG) and, more broadly, distributed energy resources (DER). DER systems have the potential to dramatically increase the efficiency of end-user energy use, particularly when coupled with the utilization of waste heat for local heating and/or cooling needs. At the same time, DER systems can help to reduce the need for siting large power plants and transmission lines. Furthermore, DER systems can also offer environmental benefits through installation of clean technologies such as solar photovoltaic (PV), wind, and fuel cell systems, and by replacing or displacing the construction of relatively dirty ‘peaker’ power plants.

Global competition for renewable energy and other DG markets, particularly with regard to wind power and solar PV, has been intense in recent years. While as of about 1990 the U.S. played a dominant role in clean energy technology, it has lost ground since then with Japan and Europe now setting the pace with regard to total installed clean energy generating capacity, share of global markets, and ownership of manufacturing companies and facilities. In the opinion of many industry analysts including ourselves, this has been due to a lack of consistent and appropriate government support for these promising new technologies, particularly in relation to support and subsidies for traditional fossil fuel and nuclear-based power generation.

Examination of the current global status and historical success of clean energy technology market development efforts can provide insight into the potential opportunities for the U.S. and individual states to gain ground in this important race for “environmental technology.” These efforts include both “supply-side” measures to stimulate technology development and manufacturing, and “demand-side” measures to spur system purchase, installation, and operation.

This report examines various DG promotion and incentive programs within the U.S. (Section 2) and in other industrialized countries (Section 3), primarily including state and national government-sponsored DG programs, but also including some other noteworthy efforts (major academic/industry consortia, etc.). The report also examines potential linkages between DG systems and advanced transportation systems (Section 4), and reports on various demonstration projects that are exploring linked stationary power and transportation system concepts (Section 5). Finally, conclusions are drawn from the review, and specific recommendations for potential program activities are made for the CaSFCC (Section 6).

Review of U.S. State DG Programs

Many U.S. states are pursuing programs to advance the development and deployment of DG technologies. In addition to California, six states stand out in their efforts to promote advanced power technologies: Connecticut, Massachusetts, Michigan, New Jersey, New York, and Ohio. A second tier of states is also actively developing programs, but these states have initiated them more recently and with lower levels of funding. Multi-state collaborative efforts, such as the Public Fuel Cell Alliance, represent a third category of programs.

Some general findings from this review of U.S. state fuel cell and other DG incentive and R&D programs are as follows:

Program Focus

- States diverge on whether they focus on supporting development and manufacturing (*supply side*) vs. deployment and end use (*demand side*). Not many states do both of these things simultaneously.
- Whether funding comes from a *public benefits fund* (PBF) or an *economic development agency* seems to shape the type of program. PBF's are often associated with demand-side programs, while development-focused programs generally invest on the supply side.
- Some states, notably New York, felt that one of their roles is to create “understanding markets” by mandating that state agencies consider fuel cells in *new construction*. This idea is also popular in some of the less active states.
- A few states have indicated that they are designing programs to help develop a base of fuel cell *component suppliers*. This is an interesting extension that broadens the scope of those programs and enables some inter-state collaboration. This concept is also being explored in Europe, particularly in the United Kingdom.
- Several program managers indicate that they believe that fuel cell systems are still *too expensive* for commercialization. This reasoning was used to justify a focus of efforts on research and development, and lack of end-user incentives.
- Several states have indicated that one of their roles is to help companies attract *Federal funding*. This funding tends to be focused on R&D rather than commercialization.
- While many of these programs are broad in scope and in principle designed to support *advanced power technologies in general*, the vast majority of the effort is related to renewables and/or fuel cells.

Measuring Program Performance

- In describing their successes, states cited number of *jobs* created, number of *companies* in the state, and number of *fuel cells deployed* about evenly. However, only a few states provide specific figures. We expect job creation to be an important intra-state measure of program success, but as most of these programs are relatively new it is too early to determine how successful they may ultimately be in this regard.
- Numbers of *fuel cells deployed* also ranged on the lower end from 0 in several states to 5-10 for a few moderately active states. On the upper end, New York has played a role in at least 80 installations. Connecticut approved 23 projects in 2003 alone, and Oregon has provided public support for 16 fuel cell projects.
- Levels of state *funding* per project differ considerably. Of states that provide this type of assistance, we have found a range of from 25% of installation costs in Massachusetts to 70% in a former New Jersey program. The support level of 50% of installed system costs is pretty common.

Renewable Portfolio Standard Policies

- State *RPS* policies are often cited as a promising driver of future fuel cell demand –

but primarily for states in which non-renewable fuels are eligible. See Figure ES-1 for a summary of state RPS programs.

- In some states support for *renewables* seems to compete with support for fuel cells – especially for states where the RPS does not include natural gas powered fuel cell systems.
- Lessons learned from the experience of providing incentives for renewables, particularly solar PV, suggest that rewarding *performance* rather than rewarding purchase is effective especially if additional incentives to reduce capital costs are included.
- The development of market *niches* may work better for fuel cells than it has for renewables. Incentive programs can be developed which provide higher incentives for the most promising niches, such as markets for high-reliability power.
- Many fuel cell incentive programs are modeled after or combined with renewables incentive programs. The strategy of achieving scale by supporting niches may be more successful for fuel cells than it has been for solar PV and wind for two reasons: fuel cell technology is improving faster (it is less mature), and niche applications such as reliability could become significant markets.

Figure ES-1: State-Level Electricity Renewably Portfolio Standard Programs

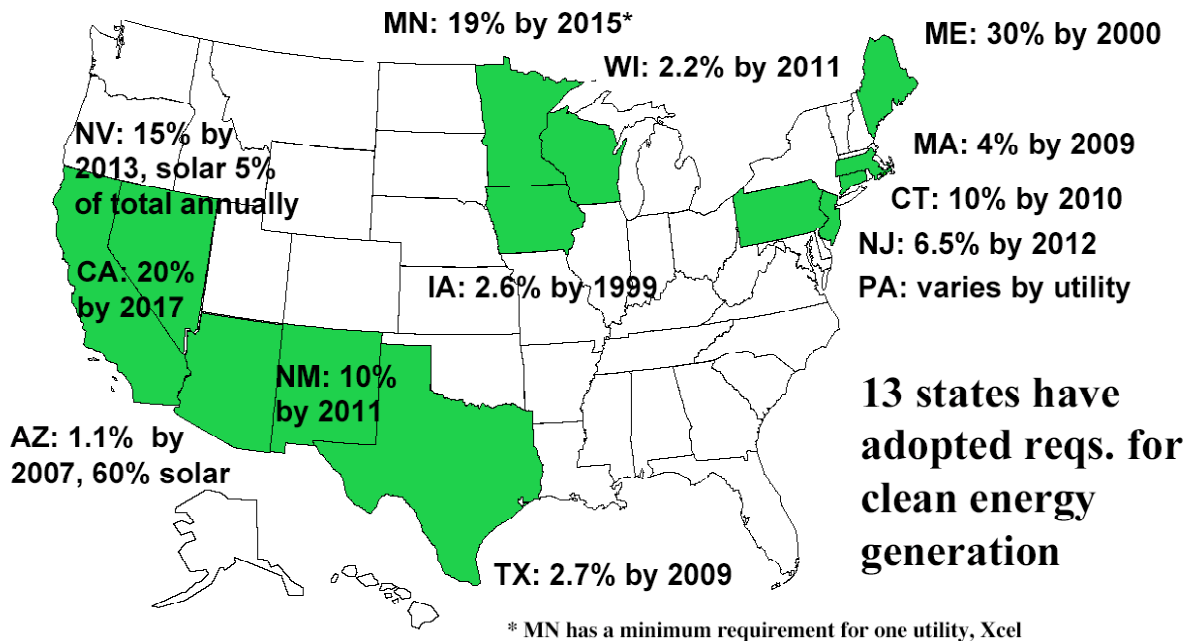

Note: In addition to the programs shown in the figure, the states of New York and Hawaii are currently in the process of adopting RPS measures.

Stationary Versus Automotive Fuel Cell Applications

- Most fuel cell programs are focused on *stationary* fuel cells. However, states near the

auto industry locus in Michigan/Ohio consistently mention supporting both mobile and stationary fuel cell development and deployment, and a few other states (e.g., California) do as well.

- The *automobile industry* almost certainly plays a big role in the Michigan and Ohio fuel cell programs – though the level of participation is thus far unclear and may be to some extent intentionally “behind the scenes.” See Figure ES-2 and Table ES-1 below for a summary of major U.S. state fuel cell programs.
- There are a few recent examples where *automotive* fuel cells are used in *stationary* contexts to gain operational experience, and we expect these efforts to expand over time (see Section 5 of this report). This both allows insight into the use of fuel cell systems in “real world” conditions as well as helping to bring down costs through production volume and experience.

Figure ES-2: State-Level Fuel Cell Commercialization Programs

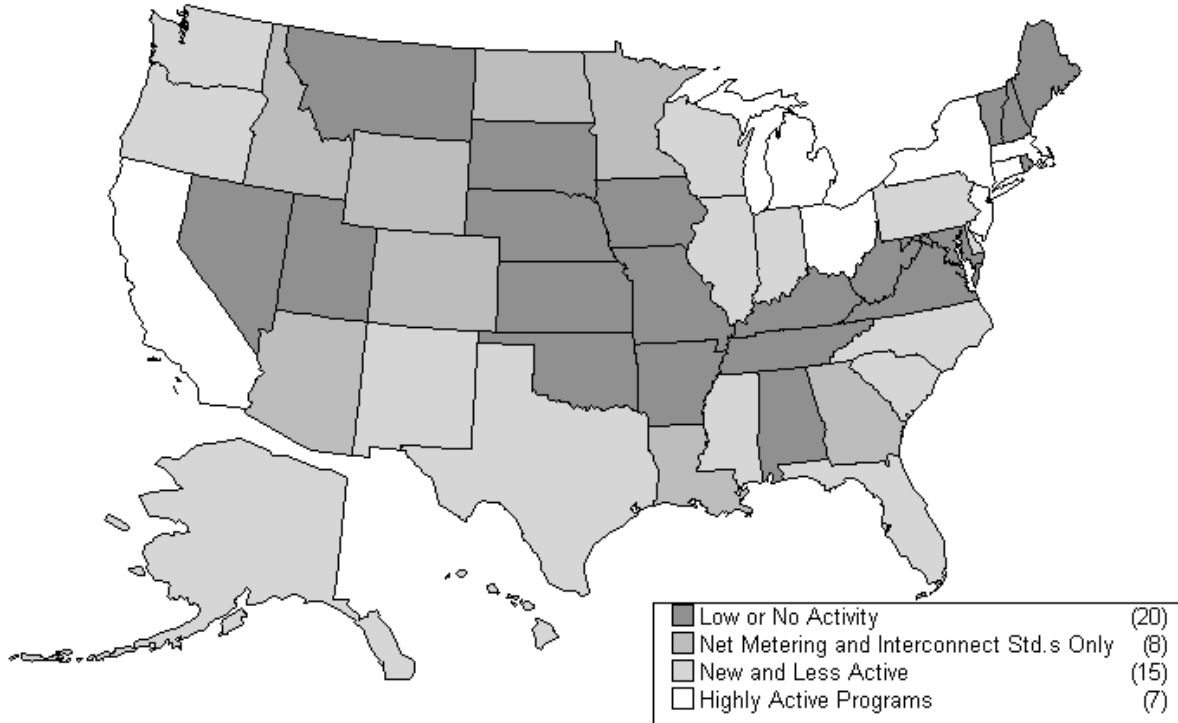

Table ES-1: Major State-Level Stationary Fuel Cell Commercialization Programs

	Mechanisms	Goals	Progress
California	<ul style="list-style-type: none"> • CPUC Self-Gen Program • CEC Buydown Program • CEC PIER R&D Grants • CA Stat. FC Collab. • CA Hydrogen Highways Initiative¹ 	<ul style="list-style-type: none"> • Fuel cell deployment • 50-250 MW by 2006 (CaSFCC) • Industry collaboration and support • Hydrogen infr. devt. by 2010 (H₂ Highways) 	<ul style="list-style-type: none"> • Grants and low-interest loans have been made • CPUC has funded 4 FC projects • Many solar PV, CHP, and wind systems added in recent years • H₂ Highways just initiated
Connecticut	<ul style="list-style-type: none"> • CT Clean Energy Fund Fuel Cell Initiative • CT RPS (allows natural-gas based FCs) 	<ul style="list-style-type: none"> • Creation of FC industry in CT 	<ul style="list-style-type: none"> • Funding increased from \$5M to \$9M per year • 23 projects funded through latest RFP • Strongest industry cluster
Massachusetts	<ul style="list-style-type: none"> • MA Renewable Energy Trust 	<ul style="list-style-type: none"> • Industry development • Fuel cell system deployment • Identify market niches 	<ul style="list-style-type: none"> • Has conducted 8 feasibility studies and funded one project
Michigan	<ul style="list-style-type: none"> • MI NextEnergy Program 	<ul style="list-style-type: none"> • Develop cluster of fuel cell companies around Next Energy center 	<ul style="list-style-type: none"> • NextEnergy center under construction • \$52 million budget over three years
New York	<ul style="list-style-type: none"> • NYSERDA DG/CHP Program 	<ul style="list-style-type: none"> • Industry development through deployment and field testing 	<ul style="list-style-type: none"> • \$10 million ann. budget • Plug Power is main success story • Most FCs deployed of any state
Ohio	<ul style="list-style-type: none"> • OH Fuel Cell Initiative 	<ul style="list-style-type: none"> • Expand manufacturing capacity and supply auto industry 	<ul style="list-style-type: none"> • \$103 million in funding so far, mostly for R&D

Notes:

¹May affect stationary fuel cell markets through development of “hydrogen energy stations” with co-production of electricity and hydrogen for vehicle refueling.

Review of European, Asian, and Canadian DG Programs

Compliance with the Kyoto Protocol for greenhouse gas (GHG) emission reductions is a major driver of renewable energy and DG/fuel cell commercialization throughout Europe. There is a widespread emphasis on renewables in the European Union (EU) that is leading the push to develop hydrogen for energy storage. There is significant activity at three levels in Europe. The European Commission provides research and development (R&D) funding, develops standards, and is increasingly involved in later-stage commercialization. The governments of individual countries have engaged in a diverse set of activities – although setting overall strategy to implement policy and “roadmapping” seem to be among their most important roles. Finally, states and in some cases individual cities are funding demonstration projects and are emphasizing the economic development benefits of fuel cells and hydrogen. The role of states

and cities is most pronounced in Germany. In addition to renewables, combined heat and power (CHP) systems have also been promoted heavily. This is particularly apparent in the Netherlands where DG accounts for about 40% of total electricity production.

The EU is playing an increasingly important role in supporting fuel cell development and commercialization. At present, its most significant role is in providing R&D funding and in developing standards and regulations. The EU to date has not played a large role in later stage commercialization and appears to be leaving that to the individual countries. In the transportation sector, the EU has set a goal of replacing 20% of vehicle fuels with “alternative fuels” by 2020.

Some general findings from this review of European, Asian, and Canadian DG incentive and R&D programs are as follows:

- An important driver for renewable energy, fuel cell, and hydrogen funding -- and of new power technologies in general -- is that almost all of these countries, having signed the Kyoto Protocol, have GHG emissions reduction commitments beginning in 2008. As a result, the vision of a transition to renewables and fuel cells powered by renewable hydrogen is seen as more of a near-term priority than in the U.S.
- Japan is an especially interesting case as it appears to be pursuing its fuel cell program similar to the way it developed its photovoltaic industry in the 1990s -- a very active initial government role, particularly in R&D, followed by swift termination of government subsidies.
- As in a few states in the U.S., several countries have indicated that they are trying to create a base of component suppliers for fuel cell manufacturing. In both the U.S. and abroad, it was the places with the most mature fuel cell programs that were looking toward building the component sector.
- Canada may provide the best example of a successful fuel cell industry that has received valuable government support, but not an especially large amount of funding.
- The CaSFCC may benefit from analyzing the various “roadmaps” that countries have put together. Japan, Canada, and the UK in particular have well-developed plans for commercialization including timing, roles for public and private sectors, and targets for number of fuel cells deployed and cost reduction levels.

Lessons From Renewable Energy R&D and Deployment Efforts

Incentive programs to promote renewables are relevant to advanced power technologies because many of the advanced power technology programs discussed above are closely related to efforts to promote renewables. The solar PV industry in particular, being largely composed of customer-sited installations is closer in nature to most other DG technologies than the wind

power industry, and has particularly relevant lessons to share with regard to prospects for DG more generally.

For solar PV and wind turbine technologies, historical market growth has been accompanied by cost declines that have allowed additional markets to open, through the so-called “virtuous circle” of increased production volume and product and manufacturing process innovation, and declines in technology manufacturing costs. Incentive measures of various types have been successful in stimulating both wind power and solar PV market development, with significant economic and environmental benefits accruing as a result. Some of the aspects of renewable energy technology buy-down programs that have proven important for solar PV could also be included in fuel cell and other DG programs. These include:

- Combining buy-down programs with performance incentives (e.g. based on system output and not only on placement/installation);
- Mandating that to be eligible for a buy-down program, manufacturers of advanced DG systems have to offer a 5-year warranty; and
- Including maintenance programs or service contracts with system purchases in order to be eligible for a rebate.

One significant difference between solar PV and fuel cell technologies is the role that niche markets can potentially play. In the history of incentive programs for solar PV, there was a strong and consistent emphasis on the need to identify and develop niche markets for PV applications. Unfortunately, with solar PV it has proven difficult to identify niches large enough to greatly enhance market demand and reduce manufacturing costs. PV system prices have declined slowly and steadily, due to a combination of greater production volumes and learning economies, but this has been due to broad industry growth and has not been led by any particularly successful niches having been found.

However, for two reasons niche markets could play a very different role for fuel cells and other emerging DG technologies. First, fuel cell technology is at a relatively early stage in technology development, so niche markets can play a potentially important role in accelerating the learning curve. Second, niche markets for fuel cells are potentially much larger than for PV. An example includes applications where fuel cells are used to ensure reliability in electricity supply. These are potentially large markets, and customers may be willing to pay a significant premium for the technology. As a result, including niche development in incentive and other market development programs -- for example, by providing targeted incentives for selected applications like reliability enhancement -- may be an effective way to accelerate commercialization.

Linkages Between Advanced Transportation and Stationary Power Systems

Sections 4 and 5 of this report review concepts for combining advanced transportation and stationary power systems, and actual projects that have been conducted or initiated that combine these two types of systems in some fashion. These include systems that combine electricity production with advanced vehicle refueling, systems that use advanced electric vehicles for power and/or grid ancillary services, and DG systems that are used to recharge or power electric-drive vehicles, heavy-duty vehicles (while parked at truck stops), and transit systems.

We find that there are many possible and some potentially very interesting concepts that would link transportation systems and DER systems, but relatively few actual demonstration projects conducted thus far. These include a few “hydrogen energy station” demonstration projects, the use of automotive fuel cell systems in a stationary power setting near a chemical plant that produces by-product hydrogen, a “vehicle-to-grid” power demonstration project, and a fuel cell system that is being used to recharge a fleet of shared-use electric vehicles.

Specific Recommendations for the CaSFCC

Based on the findings from this review, our understanding of the commercial status of stationary fuel cell technologies, and the overall “landscape” for DG in California, we have a number of recommendations that the Collaborative might consider. In general, we recommend an overall “push-pull” strategy, where market demand-pull measures are combined with support for technology R&D and manufacturing cost reductions. These combined programs have proven to be effective in the past, particularly with regard to solar PV development and deployment in Japan.

Specific recommendations include the following:

- As noted above, we are skeptical of the effectiveness of industrial “cluster” development programs given their relatively high costs and limited success demonstrated to date. We do not recommend that the Collaborative pursue this type of program, unless jobs creation becomes a critical goal.
- In addition to State agency buildings as potential locations for stationary fuel cell system placements, we recommend that the Collaborative also explore other public sector sites that are reinforced by policy directives for energy efficiency and clean generation. This includes the University of California system, where a new system-wide “Green Building Policy and Clean Energy Standard” has recently been enacted.
- At the appropriate juncture, we recommend that the Collaborative support continuation of the important CPUC Self-Generation Incentive Program. This program was recently extended until 2008, but we expect that continuation of the program beyond that point will continue to be important to reducing the first cost barrier for stationary fuel cells.
- We recommend that the Collaborative continue to pay close attention to market rules in California for DG interconnection, and consider taking a more active role in advocating “fair” market rules. The details of rules for interconnection procedures and fees, “exit” and “standby” fees, and net metering rules, can have important implications for fuel cell system and broader DG markets.
- State Treasurer Angelides has recently announced a “Green Wave” pension fund investment program for the clean technology sector. Investments of up to \$200 million are expected in the first phase of this program, and we recommend that the Collaborative explore the potential for investments under this program for fuel cell

companies to provide funding for R&D, especially focused on improved performance and manufacturing cost reduction.

- With the recent announcement by Gov. Schwarzenegger of the “Hydrogen Highways” initiative, we recommend that the Collaborative explore potential linkages between stationary fuel cells and hydrogen infrastructure for transportation. The potential role of “hydrogen energy stations” was specifically called out in the Hydrogen Highways Executive Order (S-7-04).
- Additional suggestions include the following:
 - Explore potential linkages between a new “clean technology incubator” -- to be established by PG&E under their recent bankruptcy settlement -- to fuel cell system R&D;
 - In addition to the State Hydrogen Highways initiative, examine prospects for integrating stationary fuel cell systems into projects to be conducted over the next five years under a U.S. DOE program for hydrogen “vehicle and infrastructure learning demonstrations.” Much of the activity under this program is expected to be in California;
 - Explore prospects for the California Alternative Energy and Advanced Transportation Financing Authority (CAEATFA) to provide financing for fuel cell installations at California facilities;
 - Explore the prospects for a proposed revised natural gas public purpose program with regard to its potential for contributing to fuel cell system R&D (CPUC proceeding R-0210001); and
 - Explore collaborations with automotive fuel cell manufacturers such as General Motors who wish to test and demonstrate fuel cell systems in stationary settings (see Section 5 for details on recent activities along these lines).

Conclusions

In conclusion, we would like to emphasize that market development programs such as those reviewed in this report are often critical to the introduction of new technologies. In the case of DER systems, the potential benefits of market development are more wide-ranging and socially important than for many other technologies, including economic development as well as potential benefits to human and environmental health. These reasons add to other arguments for publicly funded market development programs for clean energy technologies. These various arguments include:

- Potential economic benefits to commercial, industrial, and residential electricity ratepayers of using DG and other cost-saving DER technologies (such as demand response and other energy efficiency systems);
- Potential for reductions in GHG and criteria air pollutant emissions, and other waste streams (e.g., mercury, toxics, etc.);

- Potential economic benefits to utility grids, including substation upgrade deferrals, reduction in need for power lines in rural areas, local voltage and VAR support, spinning reserves potential, and load-leveling of the grid (through “peak shaving”);
- The potential energy security and energy diversity benefits that DER resources can offer; and
- The fact that public sector involvement in R&D is often required to prevent under-investment in innovation due to the difficulty that private firms have in fully appropriating the benefits of their own R&D and preventing “spillover” effects (see Duke and Kammen, 1999, for details on this latter point).

For these reasons, and particularly given the pressing environmental, social, and political problems that are caused by our present patterns of energy use, we believe that DER market and other clean technology development programs are especially worthy of consideration. We hope that this review and analysis proves useful to those who are considering developing or modifying such programs.

1.0 Introduction

A new generation of advanced power technologies is rapidly emerging based on the concept of distributed generation (DG) and, more broadly, distributed energy resources (DER). DER systems have the potential to dramatically increase the efficiency of end-user energy use, particularly when coupled with the utilization of waste heat for local heating and/or cooling needs. At the same time, DER can help to reduce the need for siting large power plants and transmission lines. Furthermore, DER systems can also offer environmental benefits through installation of clean technologies such as solar photovoltaic (PV), wind, and fuel cell systems, and by replacing or displacing the construction of relatively high emission ‘peaker’ power plants.

Global competition for renewable energy and other DG markets, particularly with regard to wind power and solar PV, has been intense in recent years. While as of about 1990 the U.S. played a dominant role in clean energy technology, it has lost ground since then with Japan and Europe now setting the pace with regard to total installed clean energy generating capacity, share of global markets, and ownership of manufacturing companies and facilities. In the opinion of many industry analysts including ourselves, this has been due to a lack of consistent and appropriate government support for these promising new technologies, particularly in relation to support and subsidies for traditional fossil fuel and nuclear-based power generation.

Examination of the current global status and historical success of clean energy technology market development efforts can provide insight into the potential opportunities for the U.S. and individual states to gain ground in this important race for “environmental technology.” These efforts include both “supply-side” measures to stimulate technology development and manufacturing, and “demand-side” measures to spur system purchase, installation, and operation.

Examples of such policy measures include:

- capital cost incentive/buy-down programs through direct support or tax credits;
- production cost or “feed-in” credits;
- tax incentives for siting manufacturing and R&D facilities;
- R&D effort and demonstration project support;
- renewable portfolio standard /renewable obligation credit measures;
- “net metering” rules that allow DG to “bank” power in utility grids; and
- strategic planning and “goal setting” activities such as developing clean energy technology roadmaps.

While the U.S. federal government has had an inconsistent record with regard to support for DG technologies (and in fact probably partly because of this), various U.S. states are now individually and in some cases collectively becoming increasingly active in attempting to attract clean energy industry developments in their states and regions. California is and has historically been one of the stronger states in the U.S. in this regard, but it is facing increasing pressure from other states that are developing aggressive DG technology development and market support

programs. This report is intended to inform California policy makers with regard to the nature and level of recent U.S. state and European/Asian nation activities in this area, and to discuss lessons learned from the activities that have been underway long enough to produce observable results.

1.1 Project Background

While DG is generally considered to include only power *generation* technologies – such as fuel cells, microturbines, reciprocating engine gen-sets, solar PV systems, etc. – DER systems also include energy storage and demand-side technologies and systems (e.g. smart metering and thermostats, used in conjunction with real-time electricity pricing). These definitions vary, particularly with regard to the upper-end definition of DG size above that where power generation is considered ‘central’ and not ‘distributed.’ This can be one megawatt (MW), ten MW, or even 100 MW. Regardless of the exact definitions, however, it is becoming clear that to meet growing energy needs while considering the environmental consequences of power generation, growth in the use of DER/DG may be important.

Among DG technologies that are customer-sited, combined heat and power (CHP) system implementation may be particularly important in the U.S. in the near term. The high overall efficiency of these systems can make them attractive economically while also offering significant environmental benefits. In 1998 the former United States (U.S.) Secretary of Energy developed a “CHP Challenge Goal” for the U.S. of doubling the contribution of CHP to the nation's power supply by 2010 (from 46 GW in 1998 to 92 GW) (U.S. CHPA, 2001). Regional efforts around the U.S., supported by DOE and industry groups, are now emerging to promote further CHP development and deployment activities.

Furthermore, as another strong potential stimulus for DG in California, the State Assembly in 2002 approved a renewable portfolio standard (RPS) that requires 20% of the electricity purchased by investor-owned utilities in California to be renewably generated by 2017. This compares with about 11% renewably generated electricity at present. This program has been recommended for acceleration -- to achieving the 20% target by 2010 -- by the California Energy Commission in its recent California Integrated Energy Policy Report (CEC, 2003).

Through programs like these, along with a variety of other incentive measures and policies, certain states in the U.S. and nations around the world are leading the way in the advancement of next generation stationary power technologies. These include states such as Connecticut, Massachusetts, Michigan, Ohio, New York, and California, among others, and various countries including Japan, Germany, the United Kingdom, and Denmark. These various efforts in some cases have similar features, but in other cases very different ones. In some regions the efforts are motivated primarily by environmental concerns, and in other cases local and regional economic development is the primary motivation.

There is competition among states and regions for economic growth and job creation, and that provides an important backdrop to these efforts. However, the development of a harmonized set

of programs in various geographical areas -- along with some tailoring of the specifics to local needs and with complementary linkages to other sectors such as transportation -- could help to reinforce these programs, provide a clearer ‘market signal’ to manufacturers, and help to further develop DER/CHP markets in all regions. Thus, with a variety of burgeoning efforts around the world to explore these potentially large DER markets, better information gathering and exchange with regard to diverse regional activity is of importance.

1.2 The California Stationary Fuel Cell Collaborative (CaSFCC)

The sponsor of this study is the California Stationary Fuel Cell Collaborative (CaSFCC), which in turn is sponsored primarily by the California Air Resources Board (ARB). In 2001, the CaSFCC was formed to promote stationary fuel cell commercialization. In 2002 and 2003, the Collaborative further organized its fuel cell market development efforts, conducted two market surveys, identified its mission, targets, and goals, and prepared a draft strategic plan. The primary challenges facing the Collaborative are how to help reduce fuel cell system costs, accelerate commercialization activities, and promote policies to assist the Collaborative’s efforts.

The Collaborative has a multi-pronged effort to implement its Strategic Plan. It recently completed its second annual review of major stationary fuel cell manufacturers (including several different fuel cell technologies) to determine the current and projected manufacturing capabilities and sales volumes for the installation of stationary fuel cell power plants in California over the past year and for the next three years. The Collaborative is also developing demonstration sites and procurement mechanisms that public agencies could use for purchasing fuel cells. Along with these efforts, the Collaborative is interested in other measures that California might undertake to help develop stationary fuel cell and other DER markets.

California also has other important efforts in the DG/DER area. The California Energy Commission (CEC) has two relevant program areas in its Public Interest Energy Research (PIER) program, including the Environmentally-Preferred Advanced Generation (EPAG) and Renewable Energy program areas. Under the EPAG program area, CEC has initiated a “California Advanced Combined Heat and Power Collaborative” that seeks to advance clean and efficient onsite generation technologies (CEC, 2004). The State also has several incentive programs relevant to DER technologies. These are discussed in the following chapter of this report along with other state programs around the U.S.

1.3 Rationale for the Study

To fulfill its mission, the CaSFCC formed a Core Group of agencies and organizations to provide leadership in the commercialization of fuel cells for power generation in California. The Collaborative has compiled information relative to the commercial availability of fuel cells for power generation over the next few years and identified the issues the State should address in order to create opportunities for the commercial application of fuel cells in California. The Collaborative’s Strategic Plan identifies several near term activities that are critical to accomplishing the mission of the Collaborative.

One such activity is an evaluation of approaches that are being taken throughout the U.S. and

abroad to remove barriers to implementation and commercialization. This information is important for the CaSFCC for the following reasons:

- It is not yet clear which types of incentives (monetary and non-monetary) are most appropriate and effective for the development of these new technologies;
- By reviewing the efforts of leading entities in the U.S. and other countries, California policymakers can determine the programs and policies of greatest use to California, and decide what programs should be developed and retained;
- Identification of institutions (public and private) that are developing incentive programs that would potentially be applicable to California may be useful to the Collaborative for various future projects and plans; and
- Information obtained by reviewing international activities may assist the Collaborative in refining and updating its expectations for development and implementation timelines for fuel cell and other DER technologies.

Furthermore, the Collaborative is also interested in an evaluation of potential linkages between the transportation sector and the stationary power-generation sector, particularly with regard to how the application of fuel cells may benefit from coordination for use in both of these sectors. In particular, the Collaborative would like to explore:

- Potential interconnections between technology development in the mobile sector and the stationary sector, that could provide opportunities that would benefit the fuel cell efforts in both sectors;
- Opportunities identified that are consistent with where progress in fuel cell technology development for both sectors is likely to be in the same timeframe, as this could be beneficial to the overall commercialization of fuel cells; and
- Pursuit of projects that link the stationary and mobile sectors, as this would potentially accelerate the timeline for the development of technologies of interest to the Collaborative.

Thus, this study is intended to help inform the Collaborative's efforts to identify barriers to implementation and commercialization of stationary fuel cells, and opportunities for advancing fuel cell commercialization. This evaluation seeks to enable the Collaborative to assess the relevance of the efforts that are being taken to develop advanced power technology throughout the U.S. and abroad, through the adoption of incentives and other initiatives, and including the role of the public sector and the potential benefits to society of these emerging technologies.

1.4 Scope of the Study

This study considers various U.S. and international programs to promote DG technology research, development, and deployment. The study focuses on DG technologies that are “customer sited,” and therefore does not explicitly consider, for example, utility-scale

technologies such as large wind farms that might in some cases be broadly considered DG. The technologies that are most typically included are fuel cell systems, a broader array of CHP systems (based on reciprocating engines, industrial turbine generators, microturbines and other combustion engines), and solar PV systems. The study examines noteworthy state programs in the U.S., as well as similar programs in Europe and Asia. Finally the study also examines concepts for linkages between stationary power generation and transportation systems, and identifies specific projects that are integrating these two sectors.

1.5 Report Organization

This report is organized as follows. First, Section 2 reviews stationary power generation programs around the U.S., including individual state programs and collective state programs. Section 3 provides a similar review for noteworthy programs in Europe and Asia. These programs are primarily at the national level, but in the case of Europe are also under the broad direction of the European Union. Section 4 provides an assessment of concepts that link stationary power generation with the transportation sector, and Section 5 examines specific projects that have been implemented that link stationary and transportation power and energy systems. Finally, Section 6 provides conclusions and recommendations.

2.0 Review of U.S. Distributed Power Technology Programs

Many U.S. states are pursuing programs to advance the development and deployment of DG technologies. This report section reviews recent program activity among states in the U.S., and provides information on key enabling legislation.

In addition to California, six states stand out in their efforts to promote advanced power system technologies. These states are Connecticut, Massachusetts, Michigan, New Jersey, New York, and Ohio. A second tier of states is also actively developing programs, but these states have initiated them more recently and with lower levels of funding. Multi-state collaborative efforts, such as the Public Fuel Cell Alliance, represent a third category of programs.

Some general findings from this review are as follows:

Program Focus

- States diverge on whether they focus on supporting development and manufacturing (*supply side*) vs. deployment and end use (*demand side*). Not many states do both of these things simultaneously.
- Whether funding comes from a *public benefits fund* (PBF) or an *economic development agency* seems to shape the type of program. PBF's are often associated with demand-side programs, while development-focused programs generally invest on the supply side.
- Some states, notably New York, have indicated that one of their roles is to create “understanding markets” by mandating that state agencies consider fuel cells in *new construction*. This idea is also popular in some of the less active states.
- A few states have indicated that they are designing programs to help develop a base of fuel cell *component suppliers*. This is an interesting extension that broadens the scope of those programs and enables some inter-state collaboration. This concept is also being explored in Europe, particularly in the United Kingdom.
- Several program managers indicate that they believe that fuel cell systems are still *too expensive* for commercialization. This reasoning was used to justify a focus of efforts on R&D, and lack of end-user incentives.
- Several states have indicated that one of their roles is to help companies attract *Federal funding*. This funding tends to be focused on R&D rather than commercialization.
- While many of these programs are broad in scope and in principle designed to support *advanced power technologies in general*, the vast majority of the effort is related to renewables and/or fuel cells.

Measuring Program Performance

- In describing their successes, states cited number of *jobs* created, number of *companies* in the state, and number of *fuel cells deployed* about evenly. However,

only a few states provide specific figures. We expect job creation to be an important intra-state measure of program success, but as most of these programs are relatively new it is too early to determine how successful they may ultimately be in this regard.

- Numbers of *fuel cells deployed* also ranged on the lower end from zero in several states to 5-10 for a few moderately active states. On the upper end, New York has played a role in at least 80 installations. Connecticut approved 23 fuel cell projects in 2003 alone, and Oregon has used public support for 16 projects.
- Levels of state *funding* per project differ considerably. Of states that provide this type of assistance, we have found a range of from 25% of installation costs in Massachusetts to 70% in a former New Jersey program. The support level of 50% of total installed system costs is relatively common.

Renewable Portfolio Standard Policies

- State *RPS* policies are often cited as a promising driver of future fuel cell demand – but only in states in which non-renewable fuels are eligible. Policies that initially allow hydrogen production from fossil fuels can be adjusted over time to favor low or zero carbon hydrogen sources, as these become more practical.
- In some states support for *renewables* seems to compete with support for fuel cells – especially for states where the RPS does not include natural gas powered fuel cells.
- Lessons learned from the experience of providing incentives for renewables, particularly solar PV, suggest that rewarding *performance* rather than rewarding purchase is effective especially if additional incentives to reduce capital costs are included.
- The development of market *niches* may work better for fuel cells than it has for renewables. Incentive programs can be developed which provide higher incentives for the most promising niches, such as markets for high-reliability power.
- Many fuel cell incentive programs are modeled after or combined with renewables incentive programs. The strategy of achieving scale by supporting niches may be more successful for fuel cells than it has been for solar PV and wind for two reasons: fuel cell technology is improving faster (it is less mature), and niche applications such as reliability enhancement could become relatively large markets.

Stationary Versus Automotive Fuel Cell Applications

- Most fuel cell programs are focused on *stationary* fuel cells. However, states near the auto industry locus in Michigan/Ohio consistently indicate support for both mobile and stationary fuel cell development and deployment, and a few other states (e.g., California) do as well.
- The *automobile industry* almost certainly plays a big role in the Michigan and Ohio programs – though the level of participation is thus far unclear and may be

to some extent intentionally “behind the scenes.”

- We are already seeing examples where *automotive* fuel cells are used in *stationary* contexts to gain operational experience, and we expect these efforts to expand over time (see Section 5 of this report). This both allows insight into the use of fuel cell systems in “real world” conditions as well as helping to bring down costs through production volume and experience.

This report section is organized as follows. First, the seven states including California that have, or have previously had, DG and or fuel cell programs that we consider to be “highly active” are described below in sections 2.1 through 2.7. Section 2.8 includes shorter summaries of several additional state programs. Finally, section 2.9 reviews collaborative state program activity. Also included is section 2.10 that provides a comparison of customer-sited renewables incentive programs and fuel cell programs. Please note that references for information in this section are provided along with each sub-section, as well as at the end of the report.

2.1 Connecticut

2.1.1 Background

Connecticut’s Clean Energy Fund (CCFEF) is probably the most active advanced-power program in promoting development of a fuel cell cluster. This program is large and active due to the strong presence of fuel cell developers and manufacturers in the state. Somewhat surprising given the early commercial status of fuel cell technology is that the Connecticut program is strongly focused on energy efficiency and generating near-term pay back to ratepayers. This may be because funding is coming from a “public benefits charge” rather than an “economic development fund” as in other states such as Michigan and Ohio.

The Connecticut Clean Energy Fund has a 5-year budget of \$100 million to support renewable energy and fuel cells. This includes \$22 million in 2002 and a somewhat scaled-back 2003 budget of \$16 million. Within this program, the Fuel Cell Initiative (CCFEF-FCI) provides loans, grants, and equity investment for the demonstration and commercialization of fuel cells. The CCFE-FCI disbursed \$9 million in funds in 2002, up from \$5 million in 2001, demonstrating the attention that fuel cell industry development is receiving under this program.

The Connecticut RPS, requiring 9% renewables by 2010, is especially favorable for fuel cells as it allows for natural gas powered fuel cell systems. Other states cited this is an important advantage for Connecticut with regard to attracting fuel cell market development.

2.1.2 Objectives

The intent of the CCFE program is to support the creation of the fuel cell industry in Connecticut. The focus is almost exclusively on stationary fuel cells. The program goals are stated in public benefit terms. For example, the CCFE mission includes the language that “in keeping with our Legislative Mandate, CCFE invests public funds only in projects, initiatives or enterprises that stand to benefit Connecticut ratepayers.”

In its most recent RFP, the CCFE-FCI was soliciting two types of projects:

- “Commercial Operation Projects” that include installation of commercially ready fuel cells in high value applications; and
- “Operational Demonstration Projects” that include installation of near-commercial fuel cell units to track performance and gather data to accelerate their commercialization.

2.1.3 Success Measures

The Connecticut program is notable for its size and level of activity. In their most recent announcement of candidate projects that have been approved for further review they included:

- 10 commercial projects; and
- 13 demonstration projects.

The list of commercial projects is especially interesting as it is both large (relative to other states) and diverse. It includes installations at hotels, municipal governments, military installations, pharmaceutical companies, telecommunications facilities, and healthcare companies.

The fund increased from \$5 million last year to almost \$9 million in 2003, and this is an indication that the program continues to be a priority. The local presence of firms such as FuelCell Energy, United Technologies Corporation (parent company of UTC Fuel Cells), and Proton Energy Systems helps to keep state support strong.

2.1.4 Relevant Legislation

SB 142 (2001): An Act Concerning Fuel Cell Technology Incentives

SB 1018 (2001): An Act Concerning A Fuel Cell Pilot Program In Public Schools

HB 5712 (2002): An Act Concerning Renewable Energy And Energy Conservation

HB 5346(2002): An Act Concerning Hydrogen Production Facilities And Hydrogen Conversion Technology And The Protection Of Long Island Sound

SB 733 (2003): An Act Concerning Revisions To The Electric Restructuring Legislation

2.1.5 Additional Sources

Connecticut Clean Energy Fund, Worldwide Web, <http://www.ctcleanenergy.com>.

2.2 Massachusetts

2.2.1 Background

The Massachusetts Renewable Energy Trust (MRET) administers the state’s advanced power programs. A public benefits charge of \$0.001/kWh on the state’s electricity sales provides funding for the trust. The MRET budget is for \$150 million over 5 years to support renewables, including renewably-fueled fuel cells.

Within MRET, the Fuel Cell Initiative provides 2 types of grants:

- Installation Grants – 75% of funding by end-user, 25% by MRET
- Feasibility Grants – 10% by end-user, 90% by MRET

The budget for both types of grants for FY 2003 is \$3 million. A typical feasibility grant is \$100,000. Installation grants are significantly higher and consist of a combination of cash awards, loans, and equity investments.

The Massachusetts Green Buildings Initiative also provides grants for design and construction of buildings incorporating fuel cells. However, funding levels and grant awards are smaller than in the MRET program.

2.2.2 Objectives

The overall purpose of the MRET Fuel Cell Initiative program is to remove barriers to fuel cell commercialization in Massachusetts. Emphasis seems equally balanced between fuel cell system deployment and industry development. The program stands out as being especially focused on identifying *niches* for fuel cells, especially for premium power applications. This emphasis reflects MRET's belief that security-related applications seem to have the highest potential at present. A second unique aspect of the program is its focus on developing a diverse portfolio of projects. Projects with a novel component are considered particularly attractive. The focus is clearly on commercialization and not on R&D.

2.2.3 Success Measures

To date the MRET program has funded eight feasibility studies. Of these projects, five were definitively not pursued, two were pursued to an extent but eventually aborted, and one has received preliminary authorization to proceed with installation. This project was only recently approved and details have yet to be released, but the project apparently involves a university site.

The 25% funding level is low relative to other states by design. The recently approved project is considered a particularly interesting success as it received go ahead from the end-user and manufacturer at only 25% funding from the state. Even though the 25% level is considered low and few projects are feasible at this level, MRET expects to stay at this funding level for the next few years and fund one or two installations per year.

MRET has played an important role in supporting the two largest fuel cell firms in Massachusetts -- Accumetrix and Nuvera. However, the fuel cell cluster is not very large in Massachusetts and attracting firms from outside the state is a secondary priority to supporting existing fuel cell firms. Connecticut is generally seen as a more attractive state for industry development, and Massachusetts does not seem particularly interested in competing for new firms.

The Massachusetts RPS only includes fuel cells powered by renewable-based fuels. As a result MRET expects the RPS to have minimal impact on fuel cell system commercialization in the next few years unless natural gas powered fuel cells eventually become eligible.

2.2.4 Relevant Legislation

HB 520 (2003): An Act Relative To An Initiative To Promote The Commercialization Of Fuel Cell Technology

HB 1213(2003): An Act To Establish A Green Building Income And Excise Tax Credit

2.2.5 Additional Sources

Christo, J. (2003), Personal Communication, Massachusetts Renewable Energy Trust (MRET) and Fuel Cell Initiative, July 31.

Massachusetts Technology Collaborative, Worldwide Web,
http://www.mtpc.org/RenewableEnergy/premium_power.htm.

Pratt, R. (2003), *The Massachusetts Renewable Energy Trust: Harnessing the Power Of Innovation*, Presentation, Massachusetts Technology Collaborative, Available at <http://www.mtpc.org>.

2.3 Michigan

2.3.1 Background

With the possible exception of Connecticut, Michigan has been the most aggressive state in trying to attract existing fuel cell and other clean energy companies from outside the state. The organization heading this effort is NextEnergy, a state-funded non-profit entity authorized to stimulate the development of advanced power systems, with a strong focus on fuel cells.

The passage of the Michigan Next Energy Authority Act in October 2002 created an independent non-profit organization whose key power is its authority to exempt firms from state taxes. Michigan has authorized \$52 million over three years to support NextEnergy.

One notable feature of NextEnergy is that it is highly *supplier* focused. Whereas other states provide demand-side incentives for fuel cell installations, the NextEnergy strategy is almost exclusively targeted toward manufacturers. As a result, tax incentives -- rather than grants and rebates -- are the prominent mechanism in its program. Tax incentives include the following measures:

- Exemption from employee payroll taxes;
- Exemption from property taxes until 2012;
- Exemption from state and local taxes plus a personal income tax credit for 20 years; and
- A small business tax incentive measure.

A second feature, which coincides with the supplier focus, is Michigan's effort to stimulate economic development by creating a physical cluster of new companies within a newly designated "Tech Zone". Only companies that locate in the zone will be eligible for the tax credits mentioned above. The centerpiece of the zone will be a building known as the

NextEnergy Center, adjacent to Wayne State University in Detroit, that will serve as an incubator for fuel cell companies.

The rationale for building the NextEnergy center is that officials believe that there is no real cluster of alternative energy technologies in the U.S. Michigan is attempting to create such a cluster by building an attractive place for companies to locate.

NextEnergy feels that three factors will play a role in attracting companies:

1. The *tax incentives* for companies locating within the NextEnergy Zone;
2. The *building* itself that provides conference facilities as well as access to suppliers and even marketing support in the form of publicly-funded demonstration projects; and
3. *Access to hydrogen* — the NextEnergy Center will feature a hydrogen fueling station early on, and they expect this feature will create a strong draw for the cluster.

2.3.2 Objectives

NextEnergy's stated mission is to "make Michigan a world center of excellence for alternative energy technology education, research, development, and manufacturing." Within this broad mandate, there are two main priorities at present:

- Construction of the NextEnergy Center; and
- Educational programs -- \$1 million has been set aside to disburse to several Michigan universities to create curricula in alternative energy technologies to help produce the "engineer of the future."

Industry recruitment is another priority and will likely rise in importance once the building nears completion. NextEnergy has a goal of creating five new advanced power technology companies within the state during 2003. They expect to work with existing companies both outside Michigan and outside the country in recruiting companies and partnerships.

Although the scope of NextEnergy includes all advanced power technologies, fuel cell commercialization and deployment will be its primary focus. The NextEnergy Program is intentionally broad -- this point was reiterated several times -- and it will include efforts for both stationary and transportation-related fuel cells. The Center itself will be powered by a stationary fuel cell system. However, with the automobile industry located nearby there is a strong long-term interest in fuel cells for transportation.

Collaboration with the automobile industry in Detroit seems to be a critical part of the programs, but it is unclear what the level of participation is currently. In Fall of 2003, NextEnergy indicated that the company expected "*some announcements later this Fall on how the industry will be involved*" but as of early 2004 these announcements had yet to be made.

The initial announcement of the NextEnergy program in May of 2002 occurred at the Henry Ford museum, with the governor of Michigan billing the program with statements such as the following: “*With alternative energy technologies, including fuel cells, we can leapfrog the debate and political logjam over old-fashioned regulations like CAFE.*” With its strong automobile industry orientation, linkages between stationary fuel cells and the transportation sector are expected to receive a strong emphasis under the Michigan program.

Jobs are another priority of NextEnergy. As the governor mentioned at the launching of the program:

“Ladies and gentlemen, the stakes are high. If we don’t act, we put at risk nearly 200,000 jobs. That translates to a \$10 billion hit on our state economy if we lose these critical jobs that are either directly or indirectly tied to the engineering and manufacturing of engines and transmissions.”

While mentioned in its literature, *deployment* of fuel cells in Michigan seems an exceptionally low priority relative to other states. Emphasis in Michigan is strongly on stimulating innovation and manufacturing capability.

2.3.3 Success Measures

It is difficult to find evidence of success at this stage as the NextEnergy Center has not yet been completed. The most significant progress so far has probably occurred in recruiting outside interest. An announcement that “*NextEnergy signed a cooperative agreement today with Germany’s Stuttgart Regional Economic Development Corporation, solidifying a partnership to help accelerate the development of alternative energy technologies,*” indicates that interest in NextEnergy has spread beyond the U.S. The partnership with the Stuttgart group is focused on creating networking and joint venture opportunities for Michigan and Stuttgart-based researchers via a web-based forum.

2.3.4 Relevant Legislation

2002 Public Act 593: Michigan Next Energy Authority Act

Tax Exemption and Credit Measures:

1893 Public Act 206 (Section 211.9i): Alternative Energy Personal Property Exemption From Tax

1975 Public Act 228, Single Business Tax Act (Section 208.39e): Tax Credit And Certification As Eligible Taxpayer Under Michigan NextEnergy Authority Act

2.3.5 Additional Sources

Kuntzsch, R. (2003), Personal Communication, Michigan NextEnergy, September, 8.

Michigan NextEnergy (2004), *Striking Connections in Alternative Energy Technologies*, Worldwide Web, <http://www.nextenergy.org>.

Michigan NextEnergy (2003), *NextEnergy: Promoting Alternative Energy Technology*, Presentation at the State Fuel Cell Managers Meeting, Washington, DC, February 12, Available at: <http://www.nextenergy.org>.

2.4 New Jersey

2.4.1 Background

While interest in renewable energy continues to be strong in New Jersey, the state has effectively abandoned its fuel cell commercialization program. The most important recent development in the New Jersey Clean Energy Fund was its decision in early 2003 to suspend its support of natural gas fuel cells.

The recently terminated program, administered by the New Jersey Board of Public Utilities Energy Division, was paying 30-70% of system costs for natural gas powered fuel cells. Funding was based on a production credit per kWh of electricity produced. The previous fund had \$10 million allocated annually in production credits for fuel cells, solar PV, wind, and biomass projects.

New Jersey's RPS includes fuel cells, but only those fueled by renewables. There is a proposal currently to strengthen this RPS significantly by doubling the level of the RPS and by requiring load-serving entities to provide 90 MW of solar power by 2008.

On October 1, 2003, New Jersey announced a new solicitation for renewable energy projects including renewable fuel cells. Over 3 years, up to \$50 million will be available through subsidized loans and grants. Approximately \$22 million is expected to be disbursed in 2003.

2.4.2 Objectives

The Clean Energy Fund has narrowed its goals to supporting renewables and meeting the state's RPS requirements. As a result fuel cell systems have become a considerably lower priority for the clean energy program.

Two additional potential sources of funding for fuel cells remain in New Jersey:

- The New Jersey Economic Development Program. This program is focused less on environmental benefits of fuel cells and more on developing the fuel cell industry in the state. The program issues grants to companies for late-stage fuel cell development, and was negotiating funding for at least a few projects in 2003.
- The Energy Efficiency Fund (EEF). The EEF does not presently fund fuel cell projects, but may do so in the future.

2.4.3 Success Measures

The recently suspended program funded twelve fuel cell installations. Starwood Hotels had at least one of these installations. These projects will be grandfathered under the new program and will continue to receive funding. However, given the high cost of renewable fuel powered fuel cells, the New Jersey Clean Energy Fund does not expect to fund any new fuel cell installations in the next couple of years.

As part of New Jersey’s recent push toward renewables, the state is being supportive of companies that are working on developing fuel cells and other technologies that can operate on fuels derived from renewable sources. These companies may eventually supply fuel cells that would qualify for the renewable fuel cell rebate program. However, New Jersey expects that this will take some time. H-Power was a strong player in this region until they were bought by PlugPower, and subsequently disbanded.

Overall, New Jersey sees the prospects for fuel cells in the state as relatively “bleak.” A reason for the recent development is that the fuel cell industry in New Jersey is disorganized, has little political influence, and may lack critical mass that industries in other states have.

2.4.4 Relevant Legislation

A2745 (2002): Establishes corporation business tax credit for purchase of certain fuel cell powered motor vehicles

A2697 (2002): Provides State purchasing preference to fuel cell-powered equipment

A2694 (2002): Requires certain minimum percentage of alternative fueled vehicles purchased by State to be fuel cell-powered vehicles

2.4.5 Additional Sources

Kling, C. (2003), Personal Communication, New Jersey Clean Energy Program, August 1.

2.5 New York

2.5.1 Background

New York’s program is similar to Michigan’s – and distinct from others – in its strong focus on supporting suppliers rather than end-users. Also, whereas other states intentionally avoid funding R&D, New York funds both early stage R&D and later-stage commercialization. The fact that New York’s fuel cell program sits within an R&D authority – the New York State Energy Research and Development Authority (NYSERDA) -- rather than an economic development authority helps to explain this earlier-stage focus.

NYSERDA provides \$10 million per year for fuel cell as well as other DG and CHP technology projects. These awards are made through its “Distributed Energy and Combined Heat and Power” program.

There are no incentives for DG end-users in New York, and NYSERDA does not expect any soon. However, the state’s recently passed RPS does include natural gas powered fuel cells. The state’s RPS includes aggressive targets for state agency energy procurement that could eventually stimulate additional DG and fuel cell systems demand.

2.5.2 Objectives

NYSERDA’s overall mandate is to:

- promote energy efficiency;
- stimulate economic development;

- expand the use of New York state’s energy resources; and
- mitigate environmental damage associated with energy production and use.

Within NYSERDA, the DG/CHP program evaluates project proposals based on similar set of goals that it informally refers to as the “3-E’s”: energy efficiency, environmental protection, and economic benefits.

It is important to the program that these various objectives be realized within the state of New York. In the past, the authority has funded companies outside of the state, but only in cases in which the projects delivered benefits within the state. At present, creating jobs in the state appears to be a high priority.

Component manufacturing is emerging as an increasingly important part of NYSERDA’s industry stimulation goals. One interesting exception to the in-state criterion above is that NYSERDA has funded outside companies that make or source a significant amount of their components from operations within New York. NYSERDA has even begun to play a role in introducing fuel cell manufacturers outside the state to component suppliers within the state. The large manufacturer Corning seems to be aiming to play a large role as a component supplier, especially for solid-oxide fuel cell systems. In trying to become a component supplier, New York may be trying to take advantage of its proximity to the fuel cell cluster in Connecticut.

2.5.3 Success Measures

Similar to Massachusetts, NYSERDA’s position is that it is still too early for demand-side incentive programs for fuel cells. The agency believes that the primary viable customers at present are large telecom companies, and there are few of those operating in New York. As a result, NYSERDA measures its success through the companies it has helped build.

NYSERDA points to the growth of PlugPower as its largest success. The authority provided initial funding to Mechanical Technology Inc. (MTI) to develop a fuel cell for vehicles, and this led to the development of PlugPower as a joint venture between MTI and Michigan’s largest electric utility, DTE Energy. PlugPower employs 350 people, and at its height employed about 500.

NYSERDA’s most ambitious and successful fuel cell project was providing funding for PlugPower to deploy 80 fuel cell systems, 50 of which were deployed in various state agency sites so that PlugPower could collect field data. After 3 months, PlugPower brought them back to the lab and “autopsied” them. NYSERDA provided \$3 million in funding for the project. PlugPower matched that with \$3 million up front and later spent an additional \$3 million in operations and maintenance. In addition, NYSERDA coordinated the various state agencies that were hosts for the installations and created what it calls “an understanding market for 50 fuel cells.” It feels it played an important role in this capacity.

2.5.4 Relevant Legislation

A4128 (2003) Tax Law: Exempts specified clean energy technologies from sales and use taxes

2.5.5 Additional Sources

Foster, J. (2003), Personal Communication, Distributed Generation and Combined Heat & Power Program, NYSERDA, July 24.

NYSERDA (2003), *NYSERDA CHP Case Studies/Success Stories*, <http://www.nyserda.org/industry/chpcasestudies.html>.

Patibandla, N. (2003), *Distributed Generation In New York's Deregulated Market*, Presentation, Available at: <http://www.nyserda.org>.

2.6 Ohio

2.6.1 Background

The Ohio Fuel Cell Initiative (FCI) is a \$103 million program that is part of Ohio's \$1.6 billion "Third Frontier Project" aimed at supporting high-tech sectors in Ohio. Launched on May 9, 2003, there are two main components to the FCI:

- Financing for company expansion (\$75 million budget over three years); and
- R&D support (\$25 million budget over three years)

There is also a fund of \$3 million dedicated to retraining workers.

The Ohio program stands out from other states in its ambitious plan to dedicate 75% of its resources to provide financing for fuel cell companies in order to expand their manufacturing operations. However, up until this point the R&D fund has been much more active.

2.6.2 Objectives

The FCI program's goal is economic development for the state of Ohio. A few years ago, a study by Battelle found that there was already a high tech core of companies, universities and government labs in Ohio. This study resulted in the decision to launch the Third Frontier program to grow high tech industry in Ohio.

In reviewing proposals, the FCI uses the following criteria:

- professional management;
- level of investment in Ohio;
- start-up or early-stage companies; and
- funding structure.

The Ohio FCI is promoting the advantages of locating manufacturing in Ohio. The program managers believe that a big advantage is their access to the automotive industry in Michigan since they see the automotive industry as a future customer for fuel cells. The FCI claims that there are as many suppliers to the auto industry in Ohio as in Michigan.

2.6.3 Success Measures

Activity in the financing program has been low thus far. As of 2003, only one company has applied for a loan through the financing program. Ohio FCI believes there are two main barriers to commercialization. First, the stagnant economy is making companies averse to expanding their operations or creating new ones. Second, fuel cells are still too expensive for companies to begin manufacturing them in large quantities. FCI expects that the R&D program will continue to be more active than the Financing program for at least the next 2-3 years.

The FCI has spent most of its funds to date on supporting R&D. A total of \$6.5 million has been distributed to five primary companies. However, they will be launching the first demonstration project this fall. Moving out of the lab is considered an important success.

There are no end-user incentives for DG in place in Ohio and the FCI believes that fuel cell systems are still too expensive to work on stimulating demand.

In terms of company recruitment successes, FCI has seen only a “trickle” of interest. However, in a positive development, program managers have been in talks with both a Massachusetts and a German company to discuss moving operations into the state. FCI considers these talks promising because they are discussing moving manufacturing, rather than just R&D, into Ohio.

2.6.4 Relevant Legislation

HB 675 (2002): Establishes the “Innovation Ohio Loan Program” in the Department of Development

SB 93 (2003): Renewable Energy Requirement

2.6.5 Additional Sources

McKay, M. (2003a), Personal Communication, Team Leader, Ohio Fuel Cell Initiative, July 30.

McKay, M. (2003b), *Ohio’s Fuel Cell Initiative*, Presentation, Available at: <http://www.thirdfrontier.com>.

Third Frontier Action Fund, *2004 Request for Proposals*, Available at: <http://www.thirdfrontier.com>.

2.7 California

2.7.1 Background

California has several programs that provide financial assistance and other support for DG and fuel cell system development. These include project financial assistance programs through the California Public Utilities Commission (CPUC) and California Energy Commission (CEC), research and development funding assistance, and efforts by the CaSFCC and the California Fuel Cell Partnership to promote fuel cell commercialization.

2.7.2 State Programs Related to Fuel Cells and DG

The following state programs provide various forms of assistance for DG and fuel cell systems:

CPUC Self-Generation Incentive Program and CEC Emerging Renewables Buydown Program
 The CPUC Self-Generation Incentive Program (SGIP) and the CEC Emerging Renewables Buydown Program are complementary programs that incentivize renewable and other clean energy technologies. The SGIP is the larger of the two programs, and is generally considered to be the most successful DG incentive program in the U.S. The two programs provide rebates for purchases of advanced power technologies, with limited in eligibility to system sizes of 1.5 MW for the CPUC SGIP program (but the incentives only apply to the first 1 MW of system output) and 30 kW for the CEC renewables program. The CEC program is thus focused on smaller system sizes, including residential systems. The levels of incentives provided through the CEC program have recently been reduced somewhat (see below).

The key details of these programs are as follows, as shown in Table 2-1.

Table 2-1: Distributed Power Generation Technology Incentive Programs in California

Incentive Program and Level		Eligible Technologies
<i>CPUC Self-Generation Incentive Program (extended through 2008 by AB 1685)</i>		
Level 1:	\$4.50/Watt up to 50% of project cost	PV, wind, renewable FCs, 30 kW to 1.5 MW
Level 2:	\$2.50/Watt up to 40% of project cost	Non-renewable FCs w/ CHP, up to 1.5 MW
Level 3-R:	\$1.50/Watt up 40% of project cost	Renewable microturbines, ICEs, and turbines, up to 1.5 MW
Level 3-N:	\$1.00/Watt up 30% of project cost	Non-renewable microturbines, ICEs, and turbines, w/CHP and reliability criteria, up to 1.5 MW
<i>CEC Emerging Renewables Program (new levels effective 1/1/04)</i>		
	\$3.60/Watt	Renewable fuel cells and solar thermal electric less than 30 kW
	\$3.20/Watt	Solar PV less than 30 kW
	\$2.10/Watt for first 7.5 kW + \$1.10/Watt thereafter	Wind less than 30 kW

For combustion-based technologies, the provision of these project support funds is contingent upon certain emissions criteria being met. These match the impending California ARB emissions regulation requirements for distributed generation of 0.014 lb/MWh NO_x in 2005 and 0.07 lb/MWh NO_x in 2007, with in 2007 the additional provision that combustion systems achieve at least 60% or better net efficiency (essentially requiring CHP applications for most technologies). Among his actions in his last days in office, former CA Gov. Gray Davis signed legislation (AB 1685 - Leno) on October 12, 2003 that extended this SGIP program through 2008 and made the above emissions regulation provisions.

As an additional type of incentive, the CPUC has also recently established a policy that exempts certain DG technologies from “cost responsibility surcharges” (also known as system “exit fees”). Eligible systems are those smaller than 1 MW that are net-metered and/or eligible for the above PUC/CEC incentives. An overall statewide cap eliminates further exit fee exemptions beyond the point at which total generation installed under the program reaches 3 GW.

CEC Public Interest Energy Research Program

The CEC Public Interest Energy Research (PIER) program, funded under a statewide “public goods charge” on electricity sales, provides up to \$62 million in annual funding for public interest energy research. The PIER program areas are:

- residential and non-residential buildings end-use energy;
- industrial/agricultural/water end-use energy efficiency;
- renewable energy technologies;
- environmentally-preferred advanced generation;
- energy-related environmental research;
- energy systems integration; and
- energy innovations small grants program (see below).

The PIER program provides \$3 million to \$6 million annually for research on stationary fuel cell systems through these programs.

Statewide Renewable Portfolio Standard

An RPS measure was enacted in California in 2002 that requires state investor-owned utilities (IOUs) to increase the level of renewably-generated electricity that they purchase and sell, from approximately 11% at present to 20% by 2017. This will likely help to primarily stimulate large-scale wind power, but may also stimulate development of other power plants running on biomass or other fuels that are on the upper end of the DG size spectrum and that supply power to utilities as “qualifying facilities.” Some municipal utilities have stated their goal to comply with this renewable electricity content requirement as well, though their compliance is not required by statute. Moreover, in its most recent “Integrated Energy Policy Report,” adopted in November of 2003, the CEC recommended that California attempt to achieve the 20% renewables goal by 2010.

CEC Energy Innovations Small Grant Program

The CEC Energy Innovations Small Grant (EISG) program (part of the PIER program) provides grants of up to \$75,000 for technology development and feasibility studies relating to advanced power technologies.

California Stationary Fuel Cell Collaborative

The CaSFCC’s stated objective is the “acceleration of stationary fuel cell commercialization in California and beyond.” The Collaborative has established a goal of installing 50 MW to 250 MW of fuel cell systems around the state by 2006.

California Power Authority Industrial Development Bond Financing Program

This program has been providing low-interest loans for power technology projects, ranging from \$500 thousand to \$10 million per project. The California Power Authority is apparently being

disbanded under the new administration of Gov. Schwarzenegger, and this program may or may not be continued in another form.

California Power Authority PULSE financing

This program provides low-interest loans specifically for energy efficiency and renewable energy projects. Loans of up to \$2 million or more are available per project.

The Green Wave Initiative

Green Wave is a new initiative launched by State Treasurer Angelides in 2004 that is intended to target private and public investments in clean energy and environmental technology industries, as well as calling on corporations to provide more detailed reporting on their environmental practices. The centerpiece of the program is a plan to invest up to \$500 million from State pension funds in environmental technology enterprises (the CalPERS and CalSTRS funds are the nation's first and third largest pension funds, with total assets of over \$270 billion).

California Fuel Cell Partnership

The California Fuel Cell Partnership focuses on demonstration and outreach activities related to fuel cells and hydrogen infrastructure for transportation. Since 1999, the program has demonstrated the operation of more than 50 fuel cell vehicles over a combined total of more than 145,000 miles.

2.7.3 Success Measures

As of December 2002, there were four fuel cell projects funded by the CPUC Self-Gen program. Most of the program's payouts have been for solar PV, microturbines, and ICE engines, and many such systems have been installed through the CPUC and CEC programs.

2.7.4 Key Legislation

AB 1685 (2003) -- Energy: Self-Generation Incentive Program - Peak Reduction

AB 1890 (1996) -- The Electric Utility Industry Restructuring Act

AB 970 (2000) – CPUC Self-Generation Incentive Program

SB 1038 and 1078 (2002) – California Renewable Portfolio Standard

2.7.5 Additional Sources

California Stationary Fuel Cell Collaborative (2004), Worldwide Web,

<http://www.stationaryfuelcells.org>.

California Public Utilities Commission (2004), *CPUC Self-Gen Program*, Worldwide Web,

<http://www.ora.ca.gov/distgen/selfgen/sgips/index.htm>.

California Energy Commission (2004a), *CEC Emerging Renewables Program*, Worldwide Web,

http://www.consumerenergycenter.org/erprebate/new_info.html.

California Energy Commission (2004b), *California Public Interest Energy Research (PIER)*

Program, Worldwide Web, <http://www.energy.ca.gov/pier/index.html>.

California Energy Commission (2003a), *Integrated Energy Policy Report*, Publication Number

100-03-019, Available at: <http://www.energy.ca.gov/energypolicy/index.html>, December.

California Energy Commission (2003b), Energy Innovations Small Grant Program, <http://www.energy.ca.gov/research/innovations/index.html>.

California Power Authority (2003), *Industrial Development Bond Financing Program*, Worldwide Web, <http://www.capowerauthority.ca.gov/News/IDB.htm>.

California Office of the Treasurer (2004), *The Green Wave Initiative*, Worldwide Web, <http://www.treasurer.ca.gov/news/greenwave.htm>.

California Fuel Cell Partnership (2004), *Progress Report 1999-2003*.

2.8 States with Less Active or Newer Advanced Power Technology Programs

Several states have launched programs with goals similar to those mentioned above but that so far are small and early-stage. Of these second-tier programs, Texas, Pennsylvania, and Oregon are making the most serious efforts and as a result will be the most interesting to monitor in the coming years.

2.8.1 Texas

In Texas, an initiative known as “Fuel Cells Texas” launched in 2001 as a result of the passing of House Bill 2845 which approved a fuel cell commercialization plan for Texas. There is currently a bill in the state senate to approve funding for research and demonstration programs, to come from funding for the Texas Council on Environmental Technology. Out of approximately \$12 million per year in funding for the Council, \$2 to 3 million per year is being sought for fuel cell demonstration programs. This effort is being backed by the Texas Consortium for Advanced Fuel Cell Research.

Also, in 2003, \$30 million was approved for construction of Texas Energy Center. Half of this was designated for hydrogen infrastructure and fuel cells.

Additional funding for fuel cell and other clean power generation projects is being pursued under the Texas Emissions Reduction Plan, similar to the “Carl Moyer” ARB program in California. This program is being funded at a level of \$130 million over four years, and stationary fuel cell deployment activities can qualify for funding under this program if they meet the cost-effectiveness threshold of \$13,000 per ton of oxides of nitrogen (NO_x) reduced. This program also includes \$12 million for R&D, for which fuel cells are also eligible.

Texas has also sought to promote wind power, with a total of \$1 billion reportedly invested. This has been in response to a statewide RPS program. As of 2003, 1 GW has been installed toward the RPS goal of 2 GW. The RPS does *not* include fuel cells.

Also, all new state agency construction must consider use of “alternative energy systems” including fuel cells.

Relevant Legislation:

HB 2845 (2001)

SB 1381 (2003)

2.8.2 Pennsylvania

Within Pennsylvania's Sustainable Development Fund (SDF), the Pennsylvania Fuel Cell Initiative supports development of the state's fuel cell industry. The program is largely undefined and seems to be at an early stage in defining mission and goals. The Pennsylvania SDF is divided into four regional state sustainable development funds. Each is funded by its own sustainable development fund. Annual budgets are as follows:

- First Energy SDF \$12 million
- West Penn Power SDF \$11 million
- PECO SDF \$32 million
- PP&L SDF \$20 million

Total funding for "sustainable energy" under these funds is about \$32 million, which includes fuel cells. All projects must produce a benefit to ratepayers – though these benefits can be broad and indirect.

Also, each of the four utility regions has an RPS standard, but only renewably-fueled fuel cell systems are eligible. Also, the state government has a mandate to purchase 5% of its energy from renewable sources.

Pennsylvania recently approved funding for three fuel cell demonstration projects, totaling \$300,000 in all.

Relevant Legislation:

HB 658 (2003): Establishing The Energy Partnership and Making an Appropriation

HB120, HB 121, HB 122, HB 125 (2003): Taxes on alternative transportation fuels

HB 123 (2003): Zero-Emission Vehicle Act

HB 993 (2003): Energy Efficient Building Tax Credit

2.8.3 Delaware

Delaware's Economic Development Office launched an initiative with the State Energy Office to provide rebates for alternative energy products including fuel cells. The state seems undecided about making a strong push into attracting fuel cell companies. However, in September 2003, Delaware received \$10 million in federal money for fuel cell system R&D.

2.8.4 Florida

The Florida Department of Environmental Protection launched its first stationary fuel cell demonstration project in 2003, with four more demonstrations to follow. The state does not provide economic development or incentive programs for fuel cells, but a number of groups within Florida are involved in the hydrogen and fuel cell industries.

2.8.5 Hawaii

The University of Hawaii is actively conducting fuel cell research and development projects and is working with industry partners through a unit known as the Hawaii Natural Energy Institute. The funding is coming from federal government grants as well as private sector funds. The state government has not been very active in DG/fuel cell system development to date, but the Hawaii Electric Company and Hawaii Gas Company have been involved and have shown particular interest in CHP systems. The State is starting to get more involved, and there is apparently growing momentum for renewable and other DG power system development in Hawaii. Only Honolulu has natural gas pipelines within the state, so this is one obstacle to natural-gas based DG, but propane is widely available and the state has abundant solar and wind power potential.

2.8.6 Illinois

During the summer of 2003, Illinois launched a fuel cell commercialization initiative known as Illinois 2H₂. The goals of this program are to:

- continue to attract major hydrogen-related research programs to Illinois institutions;
- promote technology transfer and commercialization from the state's major research institutions;
- create a culture conducive to the formation and growth of hydrogen economy businesses;
- provide access to appropriate sources of funding;
- develop public policy and infrastructure to create initial demand for hydrogen-based technologies; and
- establish Illinois as a national leader in support and standards for promoting distributed generation and hydrogen refueling.

The Illinois 2H₂ effort is at an early stage, and no significant funding has been approved or legislation passed yet. A recent effort to pass an RPS in Illinois failed in the latest legislative session.

The state also has a “Renewable Energy Resource Program Grants” fund. Fuel cells are eligible for this, but most of the \$5 million in annual program funding goes to renewables.

In addition, the Illinois Clean Energy Community Foundation is a non-profit funded by Commonwealth Edison. This foundation provides grants for renewable projects, including fuel cells that are renewably-powered.

2.8.7 New Mexico

In New Mexico, the Sustainable Energy Collaborative provides support for legislation and education on alternative energy technologies. Three to four fuel cell companies have reportedly located in the state in 2002-03. This progress is partly the result of spillovers from Los Alamos National Lab, which is very active in fuel cell research, and the attraction of significant federal fuel cell funding to the state.

2.8.8 Oregon

The Oregon Office of Energy offers a tax credit for the installation of fuel cell systems used in combined heat and power mode. Oregon also has a state property tax exemption for homeowners who install renewable technologies or fuel cells, and a “Renewable Energy Residential Tax Credit” of \$0.06 per kWh for electricity produced from fuel cells.

With regard to fuel cell system deployment, the Bonneville Power Administration is currently field-testing 16 PEM fuel cell systems and there is a 170 kW phosphoric acid fuel cell being fueled by anaerobic digesters at a waste water treatment facility.

2.8.8 South Carolina

The University of South Carolina received \$210,000 from the National Science Foundation to launch the National Center for Fuel Cell Research as an “industry/university cooperative research center.” The university expects an additional \$1.2 million in program funding to come from industrial partners.

2.8.9 Washington

Washington recently passed legislation (HB 2172) that requires that state buildings requiring uninterruptible power must consider purchasing fuel cells. Currently there is a 1 MW fuel cell in testing at a sewage treatment facility.

Washington also passed a bill (HB1703) in 2003 that creates tax exemptions for renewables, including fuel cells. It does not specify that fuel cells need to be powered by renewable fuels to be eligible.

Relevant Legislation:

HB 2172 (2002)

SB 1703 (2003)

2.8.10 Indiana

Indiana provides incentives for distributed generation in the form of grants of \$5,000 to \$30,000 per project. To be eligible, projects must have a thermal efficiency of 30% or greater and must provide at least 20 kW of baseload power to the facilities they serve.

2.8.11 Additional States with Small Programs

Finally, Alaska, Mississippi, North Carolina, and Wisconsin also have plans to develop advanced power technologies programs, though at present these efforts are at a low level. In addition, several states not mentioned above have developed *net metering* and *interconnection standards* to support the development of distributed power generation. These states include Arizona, Colorado, Georgia, Idaho, Louisiana, Minnesota, North Dakota, and Wyoming. See Appendix A for a comprehensive table of state net metering programs.

2.8.12 Additional Sources for States with Less Active Programs

Brown, E. and R.N. Elliott (2003), *State Opportunities for Action: Update of State’s Combined Heat and Power Activities*, American Council for an Energy Efficient Economy, Report Number

IE032, October.

Clark, R.E. (2003), *Pennsylvania Fuel Cell Initiative*, Presentation at the Fuel Cell Investment Summit, March 17-18.

Clean Energy Group (2003), *Recent Trends in State Fuel Cell Funding, Deployment and Commercialization Programs*, Presentation at the National Organizing Workshop For State Fuel Cell Program Managers, Washington, DC, February 12, <http://www.cleanegroup.org>.

Database of State Incentives for Renewable Energy (DSIRE) (2003), North Carolina State University, Available at: <http://www.dsireusa.org/>.

Delaware Energy Task Force (2002), Economic Development Work Group Meeting Minutes, August 22.

Delaware Economic Development Office (2003), Worldwide Web, <http://www.state.de.us/dedo>.

Gecils, I. and Schumacher, A. (2003), *Report on State Funding for Stationary Fuel Cells*, February, <http://www.cleanegroup.org>.

Gouchoe, S., V. Everette, and R. Haynes (2002), *Case Studies on the Effectiveness of State Financial Incentives for Renewable Energy*, National Renewable Energy Laboratory, September.

Haynes, R. (2003), *An Overview of U.S. State-Level Incentives and Policies Promoting Fuel Cell Technologies*, North Carolina State University.

King, R.J. et al (2003), *Fuel Cells and the States*, Fuel Cells Texas, <http://www.fuelcellstexas.org>, October.

State of Hawaii (2003), Department of Business, Economic Development and Tourism, Strategic Industries Division, Energy Branch, Worldwide Web, <http://www.state.hi.us/dbedt/ert/energy.html>.

University of South Carolina (2003), *Prospectus for the National Science Foundation Industry/University Cooperative Research Center for Fuel Cells*, <http://www.che.sc.edu/centers/PEMFC/index.html>, March.

2.9 Multi-State Programs

2.9.1 The Public Fuel Cell Alliance

The Public Fuel Cell Alliance (PFCFA) emerged out of the Clean Energy Group (CEG) in late 2002. CEG is a non-profit headed by Lew Milford whose primary activity is administering the Clean Energy States Alliance (CESA). CESA is funded by foundations and state PBFs, has a \$600,000 annual budget, and coordinates efforts by states to support clean energy, mostly including renewables. Much of the motivation and personnel driving PFCFA are connected to

CESA. The proposed annual budget is \$600,000 to \$1 million, with revenue coming from states, the federal government, foundations, and international organizations.

The first major meeting of PFCA was in February 2003, and was designed as an information-sharing seminar for administrators of state fuel cell programs. There is an underlying focus on *stationary* fuel cells, and appears to be a strong *Northeast U.S.* region focus.

In early 2003, the PFCA began building a database of state fuel cell programs. This database gives a good summary of state efforts. It is, however, more of a brief overview than provided in this document and is primarily focused on assessing the broad intentions of each state's program and the degree to which each state would find a fully functioning PFCA valuable.

2.9.2 Objectives

PFCA's objectives are general similar to those of CESA. Their stated operating principle is:

“To increase the use of various fuel cell technologies in the marketplace and accelerate the development of a North American hydrogen infrastructure in a way that meets the needs of public fuel cell program managers”

The detailed goals of PFCA are still being worked out. Some mechanisms include:

- sharing information relevant to deployment decisions;
- cooperating on joint activities that reduce program cost for individual agencies;
- improving effectiveness of public funding decisions; and
- developing partnerships with private industry, universities, and investors.

Based on the experience of CESA, some other benefits of the program might include:

- sharing of performance data for individual installations;
- joint solicitation of research;
- conferences and meetings; and
- bulk purchasing.

With regard to the latter “bulk purchasing” potential, this is potentially a high-impact area as it could provide lower purchase prices and allow manufacturers to sell product into assured markets. However, given that many of the state programs have the goal of attracting fuel cell manufacturing to their states, bulk-purchasing agreements may be challenging to arrange.

2.9.3 Success Measures

The PFCA is currently circulating its business plan and trying to raise initial funding, so there is no material progress to report to date. Given the descriptions of the member benefits in their business plan, some measures on which they could be assessed in the future include:

- in-state job creation;
- creation of objective information;
- communication of program successes to larger audiences; and
- development of partnerships with private industry.

2.9.4 Additional Sources

Clean Energy Funds Network (2000), *Renewable Energy Fund System Benefit Charge Summaries*, Worldwide Web, <http://www.cleanenergyfunds.org>.

Clean Energy Group (2003a), *Public Fuel Cell Alliance: Business Plan for Federal, State, and International Collaboration on Fuel Cell Deployment and Hydrogen Infrastructure*, Worldwide Web, <http://www.cleanegroup.org>.

Clean Energy Group (2003b), *Recent Trends in State Fuel Cell Funding, Deployment and Commercialization Programs*, Presentation at the National Organizing Workshop For State Fuel Cell Program Managers, Washington, DC, February 12, <http://www.cleanegroup.org>.

Wiser, R. (2003), Personal Communication, Energy Analysis Department, Lawrence Berkeley National Laboratory, October 16.

2.10 Lessons from Renewables

Incentive programs to promote renewables are relevant to advanced power technologies more generally because many of the advanced power technology programs discussed above are closely related to efforts to promote renewables. We describe these renewables programs, such as RPS and buy-down programs, in the summaries for each state. In addition, renewable programs are relevant because they have long enough histories such that conclusions can be drawn about which types of programs have been successful and what aspects of these programs might be transferable to other advanced power technologies such as fuel cells. Programs that promote solar PV are more directly relevant to fuel cells and other DG than wind programs, as these technologies can be customer-sited whereas wind projects are usually at the utility scale.

2.10.1 State Programs

There are four major solar PV “buy-down” programs in the U.S. These are in the states of California, New Jersey, New York, and Illinois.

State RPS measures are expected to provide incentives for the expansion of solar PV, though in most cases wind energy stands to benefit more due to its more favorable economics. More recently, the creation of state RPS measures with “solar set-asides” could provide a significant boost to the deployment of solar PV. Arizona’s RPS stipulates that at least 60% of its renewable energy must come from solar sources. Nevada also has a solar set-aside. Buy-down programs are likely to be the incentive program of choice in the U.S., but solar energy set-asides within RPS measures could have the most important near-term impact.

Some states have discussed moving from capital cost buy-down programs to performance-based systems (e.g., an incentive in terms of dollars/kWh produced). Performance-based systems have been difficult to implement because up-front capital cost is such a major aspect of decisions to install solar PV systems, and efforts have tended to focus primarily on addressing this “first cost” issue. Given this situation, there are two potential strategies where performance-based incentive measures could be complemented by buy-down measures. First, low-interest financing (such as that available in Germany) could help to make system installation more attractive even in the absence of a specific capital cost buy-down incentive. Second, buy-down programs can be combined with performance-based incentives, such as in Massachusetts and Pennsylvania.

Some of the aspects of buy-down programs that have proven important for solar PV could also be included in fuel cell programs. These aspects include:

- combining buy-down programs with performance incentives;
- mandating that to be eligible for a buy-down program, a fuel cell system manufacturer would have to offer a 5-year warranty; and
- maintenance/service programs could be required in the purchase to be eligible for a rebate.

2.10.2 Technological Maturity

An important difference between solar PV and fuel cell systems is that solar PV is a relatively “mature” technology where improvements are now basically incremental. Fuel cell systems on the other hand are changing more quickly and have still not settled on a dominant design. The expectation that fuel cells may see substantial declines in manufacturing costs and sales prices over the next ten years, and that the fuel cell industry may become a burgeoning one, has created interest in the economic development benefits of fuel cells.

This difference gets at the role that economic development agencies are playing in promoting fuel cell markets. They have played a much bigger role in this regard for fuel cells than they did for solar PV. There are three reasons for the difference:

- Solar PV is a relatively mature technology with a relatively established manufacturing/supplier base, whereas fuel cell industry development is at an earlier stage and is subject to being directed by targeted economic development measures;
- For fuel cells there remains the possibility of a “big winner” to emerge, and states believe there is a possibility that they could host the company that comes through with a major commercial breakthrough; and
- The excitement around fuel cells and the hydrogen economy – which some believe is hype but that has nevertheless garnered great attention — has promoted the expectation that the fuel cell industry will create jobs.

2.10.3 Niche markets

A second big potential difference between solar PV and fuel cell programs is the role that niche

markets can play. In the history of incentive programs for solar PV systems, there was a strong and consistent emphasis on the need to identify and develop niche markets for solar PV applications. Unfortunately, for solar energy it has proven difficult to achieve scale by the development of niches. At current prices and even with incentives, niche solar PV markets are simply not big enough to start generating large cost reductions in manufacturing.

However, for two reasons niche markets could play a very different role for fuel cells. First, the technology is at an earlier stage so niche markets can play a more important role in accelerating the learning curve. Second, the niche markets for fuel cells are potentially much larger than for solar PV. Applications where fuel cells are used to ensure reliability are potentially extensive, and customers may be willing to pay a significant premium for the technology. Furthermore, niches in the transportation sector hold the potential for large fuel cell markets, with the possibility of spillovers for stationary fuel cell systems (e.g., reductions in key materials and subcomponent costs).

As a result, including niche development in incentive programs, for example by providing higher incentives for selected applications such as those with “critical loads” that require high-reliability power, may be an effective way to accelerate fuel cell commercialization.

3.0 Review of International Distributed Power Technology Programs

This section of the report reviews noteworthy advanced power technology program activities in Europe, Asia, and Australia. Although many countries are using public funding to promote advanced power technologies, outside of the U.S. it is Japan, Germany, and Canada -- so far -- that have developed the most successful programs. These programs share similarities with many of the U.S. programs, but also have some interesting differences. There are additional limited efforts with regard to distributed power in South/Central America and Africa, but the most noteworthy of these are rather different in character than DG markets in North America, Europe, Asia, and Australia. For example, there is a considerable amount of CHP in Brazil, but most of it is associated with the sugarcane industry and not broader commercial / industrial sectors. In another example, solar PV has grown significantly in Kenya in recent years but almost entirely in the form of very small (e.g. 300-500 Watt) systems for off-grid applications.

In general, whereas economic development, air quality concerns, and energy security/diversity are the main drivers of programs in the U.S., in Europe concern about greenhouse gas emissions and climate change provides a primary driver. In Asia, the drivers appear to be similar to the U.S., with even more emphasis on economic development and energy security/diversity and perhaps somewhat less on environmental issues. Also, in Europe, the European Union (EU) provides the broad framework for power and energy program activities, and sets high-level policy and program goals, but actual implementation of EU policies is left to the individual nations. Hence, a focus on individual nations is the most appropriate scale to explore and analyze specific power program activities.

Some general findings from examining European and Asian advanced power system programs, particularly as they relate to potential fuel cell industry development, are as follows.

- An important driver for renewable energy, fuel cell, and hydrogen funding -- and of new power technologies in general -- is that almost all of these countries, having signed the Kyoto Protocol, have GHG emissions reduction commitments beginning in 2008. As a result, the vision of a transition to renewables and fuel cells powered by renewable hydrogen is seen as more of a near-term priority than in the U.S.
- Japan is an especially interesting case as it appears to be pursuing its fuel cell program similar to the way it developed its photovoltaic industry in the 1990s -- a very active initial government role, particularly in R&D, followed by swift termination of government subsidies.
- As in a few states in the U.S., several countries have indicated that they are trying to create a base of component suppliers for fuel cell manufacturing. In both the U.S. and abroad, it was the places with the most mature fuel cell programs that were looking toward building the component sector.
- Canada may provide the best example of a successful fuel cell industry that has

received valuable government support, but not an especially large amount of funding.

- The CaSFCC may benefit from analyzing the various “roadmaps” that countries have put together. Japan, Canada, and the UK in particular have well-developed plans for commercialization including timing, roles for public and private sectors, and targets for number of fuel cells deployed and cost reduction levels.

Please note that as with Section 2.0 of this report, references for the material presented in this section are shown within each subsection, as well as at the end of the report.

3.0.1 Comparing Program Activity Levels Across Countries

Comparing the activity levels and success of fuel cell programs across countries is an attractive way for California to learn from global experience. We present a few quantitative comparisons of R&D funding and infrastructure deployment efforts across countries, but note that few of these exist particularly that separate spending on distributed generation from other related technologies such as automotive fuel cells. We have found three direct comparisons of fuel cell, DG, and hydrogen commercialization activity across countries but no overall comparisons for the full range of renewable energy and DG/fuel cell advanced power program activity.

First, as a general measure of effort, FuelCells UK (2003) has compared public spending on fuel cell R&D and commercialization for 2002 (combined stationary and automotive). We have added a few other estimates for additional countries, and these estimates are as follows:

Government Spending on Fuel Cell R&D and Deployment:

United States.....	\$355 million/year
United Kingdom.....	\$200 million/year
Japan.....	\$200 million/year
Germany.....	\$60-90 million/year*
Canada.....	\$20 million/year*
China.....	\$15 million/year

*See paragraph below

FuelCells UK is not entirely clear with regard to how they handled issues such as proposed versus disbursed funding, double counting, and multi-year programs. However, it is one of the few direct comparisons available, and the estimates are generally in-line with other figures that we have seen for each country. Also, missing from the FuelCells UK comparison but shown above, Germany would rank fourth in our estimation with a funding level of about \$60-90 million per year in recent years.

An important caveat is that almost every country on this list has announced significant increases in public funding for fuel cells and hydrogen in 2003 (e.g., Canada with a near doubling of funding to over \$35 million per year) so many of these figures are on the rise. See the sections

below for more recent DG and fuel cell R&D and deployment spending estimates for various countries.

Second, another general measure of DG/fuel cell program activity in various countries is the extent to which DG has penetrated their marketplaces. This is more of a historical measure that reflects the level of the past several years of DG system deployment, and rather than funding or activity in any given year. The World Alliance for Distributed Energy (WADE) has analyzed DG deployment for 2002/2003 and found that as a global average about 7% of power capacity is in the form of DG, leaving 93% based on central plants. Denmark has the world’s highest installed capacity of DG, a full 50% as shown in Figure 3-1, with the U.S. very near the global average at about 8%.

Figure 3-1: Global Comparison of Total Power Generating Capacity in the Form of DG

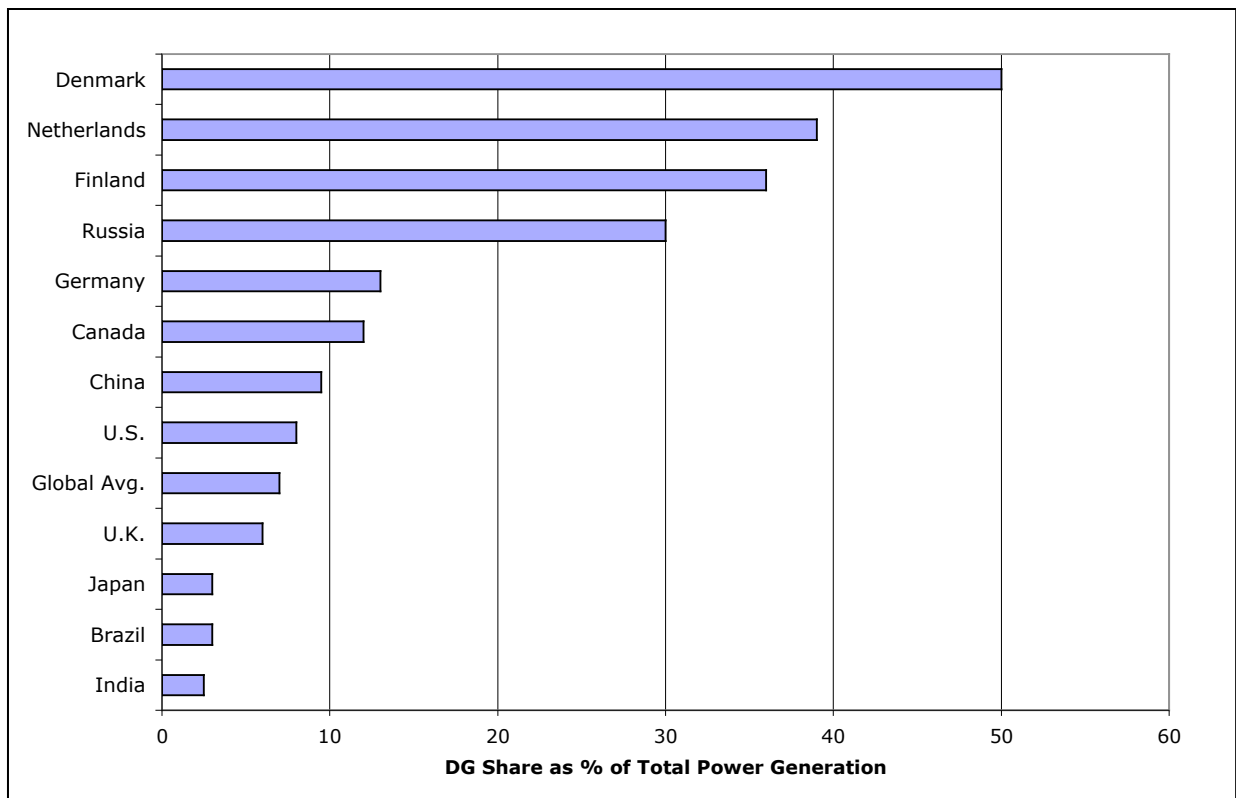

Source: WADE, 2003

Third, we present one globally comparative set of data for hydrogen infrastructure development for fuel cell vehicles. Hydrogen infrastructure development efforts for transportation systems are outside the general scope of this report, but do provide some indication of the level of emphasis on advanced power systems and fuel cell technology in general. Figure 3-1, below, shows the results of a comparison based on an up-to-date database of individual hydrogen fueling station projects. Germany and Japan stand out, along with the U.S. California has more projects than the rest of the U.S. combined. Canada’s efforts with regard to hydrogen infrastructure have been surprisingly low given the research effort and concentration of fuel cell companies, but appear to be on the rise.

Finally, one expert we interviewed in Germany suggested that while the graph looks accurate to him for 2003, it under-represents the “changes” that are now occurring. He commented that in particular, Japan and the U.S. are making large efforts that will make their infrastructure much more developed in the next few years, and that Japan would “surprise people” with regard to their heightened level of recent activity in this area.

Figure 3-1: International Projects to Demonstrate Hydrogen Vehicle Refueling

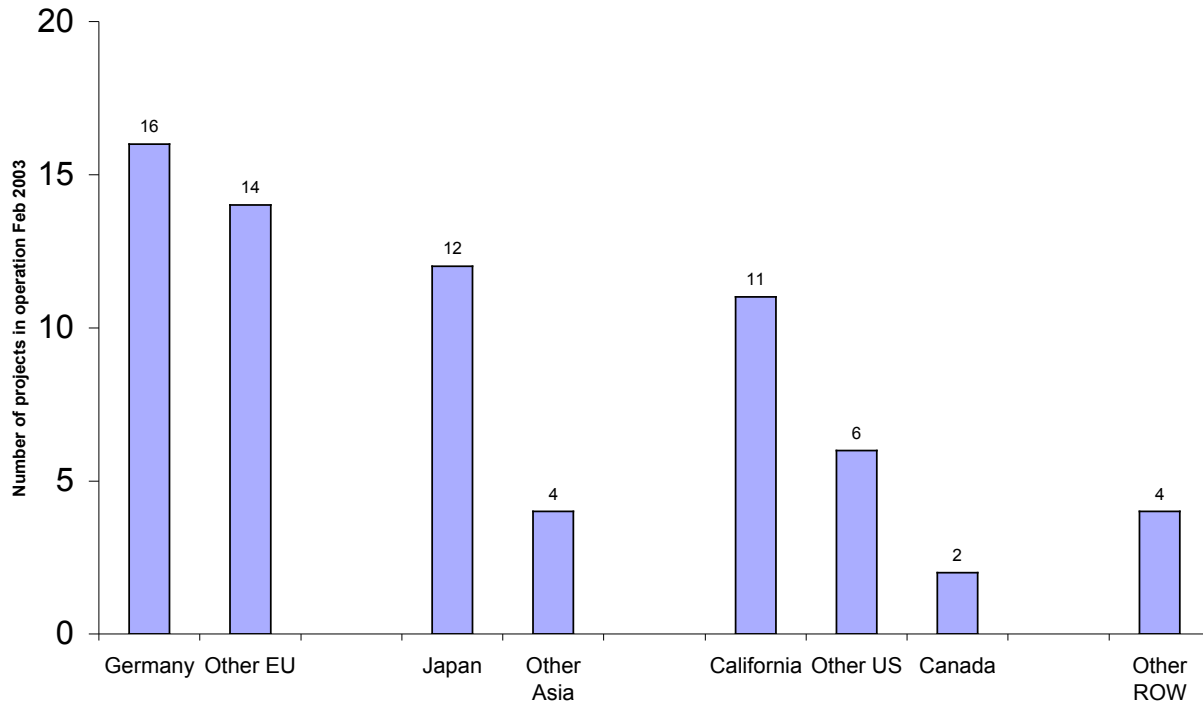

Source: L-B-Systemtechnik, 2003

3.0.2 Additional Sources of Information

Fuel Cells UK (2003), *A Fuel Cell Vision for the UK*, Synnogy Ltd.

L-B-Systemtechnik (2003), *Existing Hydrogen Refueling Station Projects*, Worldwide Web <http://www.h2cars.de/filling/index.html> (last updated February 2003).

World Alliance for Decentralized Energy (WADE) (2003), *World Survey of Decentralized Energy 2002/2003*, Worldwide Web, <http://www.localpower.org/pages/globaldedata.htm>.

3.1 Canada

Canada has a strong fuel cell industry. Government funding has not been especially large relative to the U.S., Japan, and Germany, but is considered to have been critical to the success of the Canadian fuel cell industry. Support for demonstration projects is among the most important roles the government has played. At present, funding appears to be growing considerably. The fuel cell industry in Canada is mature enough that the chain of suppliers is quite well developed. Finally, fuel cell development is highly clustered in five Canadian cities.

One of the most interesting DG/fuel cell organizations in Canada is Fuel Cells Canada, which is pursuing similar activities for Canada that the CaSFCC is for California. Of particular interest is their *Fuel-Cell Commercialization Roadmap*. Like the CaSFCC, Fuel Cells Canada is a collaborative effort between industry and government to promote Canada's fuel cell industry and coordinate demonstration projects.

3.1.1 Funding

The Canadian government has disbursed over \$C 200 million (\$146 million) in funding to support fuel cells and hydrogen over the last 20 years. However, the recent 2001-2003 funding levels of \$C 20-30 million per year have recently been increased with the announcement in October of 2003 of \$C 215 million (\$155 million) in government funding over the next 4-5 years, or about \$C 50 million (\$37 million) per year. New funding is being allocated to hydrogen, fuel cell, and other DG system development as part of Canada's Kyoto Protocol compliance fund.

Fuel Cells Canada describes the role of public support in the following way:

“Government support was critical to the early success of the Vancouver cluster. Recognizing the long-term benefits of fuel cell technology, both the federal and provincial governments provided early financial support to the industry. Critically, support was extended not just for research and technology development, but also for demonstration projects. These demonstration projects allowed significant progress to be made in data collection, knowledge of product performance, and in testing the robustness of products as they were prepared for commercial production.” – Fuel Cells Canada

3.1.2 Industry Characteristics

As of October 2001, 1,800 people were directly employed by the Canadian fuel cell industry with many more people employed in support sectors. Revenues reached \$96.9 million in 2001. Approximately 82% of these revenues were based on exports.

3.1.3 Industry Research and Development

In 2001, industry R&D expenditures were significantly higher than revenues, reaching \$179 million, and representing almost \$100,000 per employee. Also for 2001, and for purposes of comparison, R&D expenditures in the fuel cell and hydrogen sector were similar to those in the Canadian auto industry, despite the latter's ~\$92 billion in annual sales revenue.

3.1.4 Component Suppliers and Supply Chain

The maturity of fuel cell development in Canada has led to a rather well developed array of component suppliers. One study surveyed companies involved in fuel cell development and found the following major activities of respondent firms:

- Engineering services – 36 percent
- Hydrogen production equipment – 29 percent
- Testing equipment – 25 percent
- Fuel cell stacks – 25 percent
- Electrical components – 21 percent

Another way the various “layers” of fuel cell companies in Canada has been described is as follows:

- Companies whose primary focus or goal is fuel cell production and/or system integration, many of which have formed strategic international alliances or are pursuing such alliances;
- Major suppliers to the fuel cell producers, a number of which are selling to both foreign and Canadian companies;
- Companies that are focused on fueling infrastructure; and
- Providers of services to the fuel cell industry.

3.1.5 Industrial Clusters

Canada has embraced the idea of nourishing a few centers of fuel cell activity. The wide array of activities and firms involved in the fuel cell supply chain, as described above, is a strong justification for the cluster approach to encouraging commercialization. Clusters of fuel cell companies, suppliers, infrastructure developers and service providers exist in the Vancouver area, and are growing in the Calgary, Toronto, Kingston and Montreal areas. All have localized fuel cell and infrastructure. Western Canada is currently responsible for approximately 70 percent of fuel cell revenues.

3.1.6 Other Organizations

While Fuel Cells Canada is the organization most directly focused on fuel cell industry development, several other Canadian organizations play a role in supporting development. These include the following organizations.

The Canadian Transportation Fuel Cell Alliance

The Canadian Transportation Fuel Cell Alliance is a multi-year \$23 million federal government initiative that will demonstrate and evaluate fuelling options for fuel cell vehicles in Canada. Funding is part of the Canadian federal government’s program to address climate change. Different combinations of fuels and fueling systems will be demonstrated by 2005 for light, medium, and heavy-duty vehicles. The initiative will also develop standards and training and testing procedures as related to fuel cell and hydrogen technologies.

National Fuel Cell Research and Innovation Initiative

This initiative is funded with \$C 30 million over 5 years for hydrogen and fuel cell R&D.

Institute for Fuel Cell Innovation

Based in Vancouver, this institute has invested \$C 20 million over 5 years for research, testing, development, and demonstration. The funding has been provided from *National Research*

Council Canada.

Technology Partnerships Canada

This group has invested approximately \$C 60 million into Canadian firms doing fuel cell research.

Western Economic Partnership Agreement

A collaborative effort between federal government and the Province of British Columbia, this program has provided \$C 13 million in funding for demonstration projects.

3.1.7 Information Sources

Fuel Cells Canada (2003a), *The Canadian Fuel Cell Commercialization Roadmap*, Vancouver BC, Available at: <http://strategis.ic.gc.ca/electrical>

Fuel Cells Canada (2003b), *The Canadian Fuel Cell and Hydrogen Industry: A Capabilities Guide*, Vancouver, BC. Available at: <http://www.fuelcellscanada.ca>

The Globe and Mail (2003), Special Supplement on June 9, “Clean Energy for the Hydrogen Planet: The Global Acceleration of Hydrogen Fuel Cell Development.”

The Canadian Transportation Fuel Cell Alliance (2004), Worldwide Web, http://www.nrcan.gc.ca/es/etb/ctfca/index_e.html.

Natural Resources Canada (2004), Institute for Fuel Cell Innovation, Worldwide Web, <http://ifci-iipc.nrc-cnrc.gc.ca/about.html>.

3.2 Overview of DG Programs in Europe and the European Union

Compliance with the Kyoto Protocol for GHG emission reductions is a major driver of renewable energy and DG/fuel cell commercialization throughout Europe. There is a widespread emphasis on renewables in the EU that is leading the push to develop hydrogen for energy storage.

There is significant activity at three levels in Europe. The European Commission provides R&D funding, develops standards, and is increasingly involved in later-stage commercialization. The governments of individual countries have engaged in a diverse set of activities – although setting overall strategy to implement policy and “roadmapping” seem to be among their most important roles. Finally, states and in some cases individual cities are funding demonstration projects and are emphasizing the economic development benefits of advanced power generation industry growth. The role of states and cities is most pronounced in Germany. In addition to renewables, CHP has also been promoted heavily. This has been particularly apparent in the Netherlands where DG (much in the form of CHP) accounts for about 40% of electricity production.

The EU is playing an increasingly important role in supporting fuel cell development and commercialization. At present, its most significant role is in providing R&D funding and in developing standards and regulations. The EU to date has not played a large role in later stage

commercialization and appears to be leaving that to the individual countries and states within them. The EU has set a goal of replacing 20% of vehicle fuels with “alternative fuels” by 2020.

One potentially important development with Europe with regard to DG is the recent interest in “micro CHP.” Various systems are being developed based on Stirling engines, fuel cells, and other technologies to meet residential heating loads, with additional electricity production. Interest in micro-CHP is greatest in the UK, the Netherlands, and Germany (and less so in the Nordic countries because of the prevalence of district heating systems). Also, in Germany there is a significant amount of effort focusing on larger-scale CHP, but primarily with regard to renovating older CHP installations rather than with new installations or retrofits. Lowered electricity prices have reduced these other CHP market opportunities in Germany and other EU nations somewhat in recent years.

3.2.1 EU 6th Framework Program

This is the central organization for promoting hydrogen and fuel cells in Europe. The *European Economic Union’s 6th Framework Program (2002–2006)* includes the following research, technological development and demonstration activities:

- Provision of \$2.5 billion for fuel cell and hydrogen initiatives;
- Identifies a target of 5% of European Commission road transport to be hydrogen-powered by 2020;
- Identifies a target for fuel cell cost reductions in stationary power of capital costs of less than \$1,650/kW; and
- Includes a focus on identifying actions necessary for a vibrant fuel cell industry and sustainable hydrogen economy, with the ability to target additional expenditures of up to \$4.3 billion.

The funding described above is a significant increase from the 5th Framework, 1999–2002 period, when the average annual spending on fuel cell research, development and demonstration was \$140 million. The *European Fuel Cell and Hydrogen Projects 1999 – 2002* catalogues about 60 individual fuel cell and hydrogen projects.

3.2.2 The High Level Group on Hydrogen Fuel Cells

This committee, which is part of the European commission, produced a strategy document, “*Hydrogen Energy and Fuel Cells- a vision of our future.*” It is similar in intent to the “roadmaps” produced by Japan, Canada, and the UK. The document demonstrates a strong focus on renewables and on climate change. Priorities through 2010 include:

- Improving the efficiency of fossil based liquid fuels;
- Intensifying the use of renewables for producing hydrogen via electrolysis;
- Increasing the use of liquid fuels derived from natural gas and biomass;
- Introducing fuel cells in “premium niche markets” that use the existing hydrogen pipeline system; and
- Developing hydrogen-fueled internal combustion engines.

3.2.3 European Hydrogen and Fuel Cells Technology Partnership

This organization is new and, at the EU level, is the most similar organization to the CaSFCC. Launched in fall 2003, the collaboration of private and public stakeholders is tasked to devise a “Hydrogen Research Strategic Agenda.”

“The EU will also fund hydrogen development and deployment research projects and will foster joint public-private initiatives to promote commercialization and business development. It will ensure a consistent policy framework, identify a realistic deployment strategy, boost international co-operation in this field, and promote education, training, information and dissemination of results in the hydrogen R&D area.”

Key elements of the integrated European strategy on hydrogen include the following:

- A strategic research agenda;
- Proposals for demonstration and deployment projects;
- A policy framework that is coherent across transport, energy, and environment to reward technologies that meet policy objectives;
- A deployment strategy, including a European hydrogen roadmap and advice on policy measures; initiatives of public-private partnerships to promote commercialization and business development, bringing together different industrial and financing organizations;
- A framework to develop international co-operation;
- A Europe-wide education and training program, from schools to world-class research; and
- A communication and dissemination center for all these initiatives.

3.2.4 European Integrated Hydrogen Project

This is the main EU effort to provide standards and regulations for hydrogen fuel vehicles, both in the EU and globally. One activity they stress is the creation and harmonization of criteria for certifying hydrogen vehicles, both fuel cells and ICEs. They also are involved in developing standards and regulations for hydrogen filling stations and especially filling station-vehicle interfaces.

3.2.5 International Energy Agency (IEA) Hydrogen Program

While an international body, the IEA based in Paris is more active in promoting hydrogen and fuel cells in the EU than in other OECD countries. Like the EU governments, the IEA places a much stronger emphasis on hydrogen from renewables than does the U.S. They currently have at least 10 demonstration projects in operation and have plans for 10 more. Their future directions include increasing hydrogen production from non-energy uses (chemicals, ceramics industries), and continuing to increase the number of hydrogen demonstration projects.

3.2.6 SUSTELNET

SUSTELNET is a European Commission sponsored project for “Policy and Regulatory Roadmaps for the Integration of Distributed Generation and the Development of Sustainable Electricity Networks.” SUSTELNET includes various university-based and other energy

research group primarily in the UK, Germany, Denmark, and the Netherlands. SUSTELNET performs regulatory and policy analysis for DG in Europe, and is developing DG “regulatory roadmaps” for the Netherlands, UK, Germany, Italy, Denmark, Poland, the Czech republic, and Hungary.

3.2.6 Other European Programs

HYNET – promotes strategies to commercialize hydrogen at the pan-European level.

CUTE, ECTOS – demonstration project for 30 hydrogen-fueled “Evobus” fuel cell buses in nine European cities.

FC BUS (M.A.N.) -- introduction by Innotec of fuel cell buses in Berlin, Copenhagen, Lisbon in 2003.

3.2.7 Sources of Information

Elam, C. et al. (2003), “Realizing the Hydrogen Future: The International Energy Agency’s Efforts to Advance Hydrogen Energy Technologies,” *International Journal of Hydrogen Energy* **28**: 601-607.

European Commission (2003), *European Fuel Cell and Hydrogen Projects 1999-2002*, Brussels.

European Union, (2003), *Hydrogen Energy and Fuel Cells: A Vision of the Future*, High Level Group for Hydrogen and Fuel Cells, Summary Report, June.

Fraser, P. (2003), Personal Communication, International Energy Agency, November 13.

International Energy Agency (2003), *World Energy Outlook 2002*, Paris.

International Energy Agency (2002), *Distributed Generation in Liberalized Electricity Markets*, Paris.

SUSTELNET (2004), Worldwide Web, <http://www.sustelnet.net>.

3.3 Germany

Public support for fuel cells and other DG technologies in Germany comes from three sources: the federal government, the state government, and the EU. Estimates of current funding for fuel cells and hydrogen from those three sources range from \$60 to \$90 million per year. Perhaps even more so than in the U.S., the most intense efforts to commercialize fuel cells are happening at the state level. The most active federal program is a subsidy for CHP systems. Renewables have also received significant federal support, and this may ultimately stimulate demand for hydrogen fuel cells for energy storage.

3.3.1 Current and Future Priorities

The main emphasis currently is on fuel cells for transportation. Several cities are launching demonstration projects involving city buses and the building of hydrogen infrastructure. The

federal goal is to build 2000 hydrogen filling stations by 2010. A challenge that comes with this target is “internationalizing the infrastructure” -- that is, setting international standards and regulations for hydrogen infrastructure.

One person we spoke with said that the most important missing element for fuel cells in Germany is political leadership and “vision” at the federal level. A second important factor is progress in hydrogen storage. Finally, the feeling is that at this point a “roadmap” is more important than a new research program.

3.3.2 Renewables in Germany

Over the past decade, Germany has embarked on a significant, though expensive, effort to deploy renewable energy technologies. The German renewable incentive program provided a production incentive for photovoltaics of \$0.50/kWh. It also provided low-interest loans for rooftop PV on homes to address the issue of capital cost. While in some states and countries support for renewables is often in competition for support for fuel cells, this may not be the case in Germany. The scale of electricity production from renewables, especially wind, has grown so large, that storage is becoming an important issue. In the longer term, integrating hydrogen storage and fuel cell power with wind power developments may be the most attractive application for stationary fuel cells in Germany.

3.3.3 Federal Programs

Federal participation in fuel cell development in Germany has lagged behind that of the states. One interpretation for this is that the federal government invested heavily in fuel cells in the 1980s and 1990s, and then became frustrated because there was no market for the products of these R&D programs. Recently however the federal government has become more active.

Much of the new federal funding comes from the sale of telecommunications licenses in 2000. Since then federal fuel cell funding has been in the range of \$15-\$20 million per year. Germany’s “Investing into the Future Program” (known as ‘ZIP’) has committed \$99 million during the next three years to help fund 44 R&D projects involving fuel cells for stationary and mobile applications.

Another important program is the Kraft-Warme-Kopplungs Gesetz, a CHP law. This \$4.4 billion fund through 2010 provides a subsidy for CHP electricity, for systems of up to 2 MW. Fuel cell plants of up to 50 kW get €0.0511/kWh for 10 years for units installed by 2005.

3.3.4 State Programs

The states have been the most active governments in promoting fuel cell and hydrogen technology in Germany.

Bavaria – About \$50 million has been invested since 1997. BMW has been a major force in pushing for state support of hydrogen and fuel cell technology. The Bavarian Hydrogen Initiative is the state’s support program for hydrogen projects. These include a fuel cell CHP project in Nuremberg, hydrogen research studies in collaboration with Canada, and a hydrogen refueling station at the Munich airport. For more information on these programs see: <http://www.hydrogen.org/index-e.html>.

Baden-Württemberg - The Baden-Württemberg Fuel Cell Initiative is a research collaboration to support fuel cell industry in the area. There is a strong research base in the area, and state-level funding is \$5-6 million per year. Daimler-Chrysler, which is headquartered in Stuttgart, has a large network of component suppliers in the area that could play important roles in the fuel cell industry.

NorthRhein-Westfalia – About \$40 million has been invested since 1997. This state is home to Germany’s coal industry. Fuel cells are seen as a way to provide new jobs for those employed in the coal industry. The NorthRhein-Westfalia Fuel Cell Network aims to involve non-fuel cell companies in the fuel cell industry.

Hesse – home to automaker Opel, the “Hesse Hydrogen and Fuel Cell Initiative” coordinates demonstration projects.

Berlin – the Clean Energy Partnership Berlin (CEP) plays a role similar to the CaSFCC. It is currently launching a test of 30 fuel cell vehicles in Berlin. Berlin also hosts the German Hydrogen Association, a lobbying organization, and the Hydrogen Competence Center (Berlin), which provides training and education for the fuel cell industry.

The Sulzer Hexis Fuel Cell Demonstration – the Sulzer Hexis Company intends to test up to 400 solid oxide fuel cell systems throughout Germany. This may become the largest fuel cell demonstration project in the world.

3.3.5 Industry Structure

Germany has a well-developed industry of firms working on fuel cell and hydrogen technology. A 2003 survey found that there are 350 companies with 2,800 employees in the German fuel cell industry. About one third of the companies are involved in manufacturing, a third in research, and a third in finance, marketing, and system integration. Fifty-two percent of employees are in the manufacturing sector. Other figures for the German fuel cell industry are as follows:

- 76% of firms employ 5 people or less;
- 40% of these firms have existed for 10 years or more (in comparison, the UK has only 20% of its firms with >10 years experience);
- 49% of firms are focused on PEM fuel cells, and 14% on hydrogen infrastructure;
- There is a well-developed component supplier sector – many of these firms are chemical companies;
- 29% of fuel cell applications are for transport, 44% for stationary, and 10% for portable; and
- 65% of utilities have begun working on fuel cells, with an average budget of \$500,000 each.

One person we spoke with mentioned that large energy companies in Germany are major proponents of fuel cells. These firms see the eventual development of 1-5 kW residential fuel

cell systems as part of a strategic effort to sell more natural gas.

3.3.6 Information Sources

Geiger, S. (2003), “Fuel Cells in Germany – A Survey of Current Developments,” *Fuel Cell Today*, June 18.

Schmidtchen, U., (2003), Personal Communications, Executive Director, German Hydrogen Association, December 23.

Wiser, R. (2003), Personal Communication, Energy Analysis Department, Lawrence Berkeley National Laboratory, November 6.

3.4 The United Kingdom (UK)

The UK has several organizations involved in promoting the use of fuel cells and advanced energy technologies. Two of these are of particular relevance to the CaSFCC. Fuel Cells UK aims to promote the fuel cell industry for economic development. Meanwhile the Carbon Trust’s main concern is Kyoto compliance and it sees fuel cells as a promising route for carbon reduction. Other organizations play important roles as well, particularly those within the national government.

3.4.1 Fuel Cells UK

Fuel Cells UK is a program run by the government Department of Trade and Industry (DTI). Of particular note is their recently published “*A Fuel Cell Vision for the UK – The First Steps.*” This document discusses steps, timing, and government and industry roles for promoting fuel cells. The role for policy includes:

Near term (2003-07)

- Help develop a UK roadmap
- “New and modified fiscal instruments and purchasing commitments”
- Grid connectivity for small clusters and pilot projects

Medium term (2008-12)

- Clear policy setting
- Enable grid connectivity
- Target setting

Long term (2013 –2023)

- Develop a clear and consistent policy framework

Fuel Cells UK is a relatively new organization, being active only since February of 2003, and is considered to be about 18-24 months behind U.S. DOE and other leading efforts in the U.S.

3.4.2 The Carbon Trust

The UK Carbon Trust is playing an interesting role as a government sponsored non-profit, working closely with UK industry to examine and implement carbon emissions-reduction

programs. The Trust works with an implicit goal of a 60% reduction in CO₂ emissions being possible by 2050, believing that cuts of this magnitude are necessary for climate stabilization.

The organization assesses low-carbon technologies and chooses how to support them based on where they fall on two axes: carbon reduction, and scalability. CHP, fuel cells, and hydrogen all fit as “high” on both axes and are therefore among the six groups of technologies that the Carbon Trust will focus on in coming years.

The Trust has two major program thrusts – a “Today Program” emphasizing energy efficiency and carbon management, and a “Tomorrow Program” that focuses on “low carbon innovation.” The Today Program provides for energy audits for small and medium-sized enterprises, enhanced capital allowances (100% depreciation in year 1) for efficiency investments, and interest-free loans of up to £50,000 (\$90,000) per loan. The Tomorrow Program is focused on innovation with the longer-term 2050 goal in mind, and provides grants and equity with an emphasis on R&D projects. Programs include a “pump priming” program in conjunction with the UK Research Council that provides about £15 million (\$27 million) per year for R&D programs, mostly for university research, and a cost-sharing program that provides £5-7 million (\$9-12.5 million) per year to do technology assessments and examine the commercial potential for efficient power technologies, in conjunction with groups such as DTI and Fuel Cells UK.

3.4.3 The Renewable Power Association

The Renewable Power Association (RPA) does policy analysis and lobbies for renewable power development in the UK. Their efforts mainly involve working with legislators and the renewables industry on the UK’s renewables obligation program (formerly “non-fossil fuel” obligation or NFFO program). This market-based program slowly ratchets up the renewable energy requirement, requiring the acquisition of “renewable obligation credits” (or ‘ROCs’) for electricity production in the UK to 10.4% by 2010 (versus about 3% in 2003). A major issue with the program is that it does not extend beyond 2010, and this makes project financing for 15-30 year projects much more difficult. There is a movement being supported by the RPA to extend the ROC requirement to 20% of production by 2020, but this has not yet been committed to by the UK government.

3.4.4 Other Programs and Groups

Other UK programs include the following:

Advanced Fuel Cell Programme – This program has supported 156 projects with \$200 million in funding over the past 11 years.

Invest UK – this group has developed a new “Global Partnerships” initiative to attract foreign companies to open branches in the UK, eligible for R&D assistance. These now include fuel cell companies.

3.4.4 Information Sources:

Fuel Cells UK (2003a), *A Fuel Cell Vision for the UK*, Synnogy Ltd., Available At: <http://www.fuelcellsuk.org>.

Fuel Cells UK (2003b), *Review of UK Fuel Cell Commercial Potential*, Available at: <http://www.fuelcellsuk.org>.

Hartnell, G. (2003), Personal Communication, The UK Renewable Power Association, November 24.

UK Carbon Trust (2003), *Annual Review 2002-2003*.

Vincent, D. and G. Staunton (2003), Personal Communication, The UK Carbon Trust, November 24.

3.5 Denmark

Denmark is distinct from other countries in its strong focus on moving directly to renewable energy and renewably-fueled fuel cells rather than starting with natural gas-fueled fuel cells. As a result, the major driver for fuel cells in Denmark is for energy storage, especially to support the growth in wind power. Wind power accounts for 13% of energy production in Denmark today and is expected to reach 50% by 2030. The Danish Energy Agency has announced its “Hydrogen Plan,” which is focused on wide deployment of PEM fuel cells. Part of this plan includes a partnership with Fiat for vehicular applications.

A second notable feature of Denmark’s advanced energy technology programs is its success in developing its industry. In recent years the export of energy technology has increased rapidly and in 2000 comprised \$3 billion, or 5% of Denmark’s total exports.

3.5.1 Nordic Energy Research

Considering the interest in multi-state programs in the U.S., the Nordic Energy Research collaborative effort among the Scandinavian countries may represent an interesting model. In 2001 a new strategy for the 2003-2006 program was approved. The most important element in the new strategy was improved flexibility to solve current problems in the energy sector and to make Nordic companies more competitive internationally. In 2002-03, 15 new projects within five focus areas were initiated. These include climate change issues, Nordic electricity cooperation, and a stronger co-operation in the Baltic area.

In addition, Denmark supports several other advanced power technology programs. These include subsidies for CHP systems, support for R&D activities, and support for renewable energy development.

3.5.2 CHP Subsidies

Starting on July 1, 2002, the Danish government relaxed the tax burden on decentralized CHP plants. This subsidy corresponds to a tax reduction of \$200 to \$300 per year for a normal detached house in an open-field area. In addition, an extra \$15 million has been appropriated to improve the finances of the decentralized plants and other small plants that demonstrate financial difficulty.

Furthermore, electricity system operators ELTRA and ELKRAFTSYSTEM grant subsidies (\$18

million available in 2004) to research and development projects concerning environmentally-friendly production of power and heat.

3.5.3 Public R&D

The Danish Energy Authority subsidizes research and development in the energy field via the Energy Research Program (known as “Energiforskningsprogrammet” or EFP for short). The overall budget available in 2004 is expected to be approximately \$12 million.

Further, ELFOR, the main power utility, grants subsidies for research and development projects concerning the efficient use of electricity. Total funding of \$4 million is available in 2004.

Finally the Ministry of Science, Technology and Innovation offers grants for strategic renewable energy projects, DKK 45 million, or about \$7 million, is available in 2004.

3.5.4 Renewables

A four-year nationwide solar cell project, SOL 1000, is currently being implemented. In addition, ongoing development and demonstration projects under the Development Programme for Renewable Energy (Udviklingsprogrammet for Vedvarende Energi, UVE) and special programs for hydrogen, solar energy, geothermal and wave energy will be continued and are expected to be completed in 2004 at the latest. New projects are not being initiated at this time.

3.5.5 Information Sources

Danish Minister for Economic and Business Affairs (2003), *Energy Policy Statement 2003*, Pursuant to the Act on Energy Policy Measures, May.

Sorensen, B. (2002), *Trends in the Danish Hydrogen and Fuel Cell Programmes*, Roskilde University.

3.6 The Netherlands

The most striking feature of advanced technology programs in the Netherlands is the extent of distributed generation. The IEA reports that 40% of power production in the Netherlands consists of “decentralized power production.” Important drivers for this large base of DG are the government’s ongoing commitment to providing grid access, and efforts starting in 1997 to encourage the use of renewables.

Recently, the rise in natural gas prices has slowed the growth of DG and CHP. The government has compensated for the rise in fuel costs by subsidizing CHP power production in the following ways:

- Increased tax credit eligibility for new CHP;
- Consumption of energy from CHP excluded from regulatory energy tax; and
- A subsidy of €2.28/MWh for CHP output of up to 200 GWh/year, with a proposed increase in the subsidy to €5.57/MWh and for output of up to 1000 GWh/year.

3.6.1 Information Sources

International Energy Agency (2002), *Distributed Generation in Liberalized Electricity Markets*, OECD/IEA, Paris.

3.7 General Summary of EU Renewables Programs

The following chart provides an overall overview of the nature of European renewables programs:

Table S.1 Policy instruments per used in the EU Member States and Norway

Country/Policy instrument	Investment subsidies	Fiscal measures	Feed-in tariffs	Quota obligations/ Green certificates	Bidding systems
Austria	×	×	×	× (2002, hydro)	
Belgium	×	×	×	×	
Denmark	×	×	×		
Finland	×		×		
France	×		×		× (wind)
Germany	×		×		
Greece	×		×		
Ireland		×			×
Italy	×		×	×	
Luxembourg	×	×	×		
The Netherlands	×	×	×		
Norway	×	×			
Portugal	×	×	×		
Spain	×		×		
Sweden	×	×		×	
United Kingdom	×	×		×	

Source: H.J. de Vries, C.J. Roos, L.W.M. Beurskens, A.L. Kooijman - van Dijk, and M.A. Uytterlinde, 2003, *Renewable Electricity Policies in Europe*, Country Fact Sheets.

3.8 Overview of DG and Other Advanced Power Programs in Asia and Australia

Several Asian countries are making efforts to promote fuel cells and other advanced power technologies. Japan has, by far, the most ambitious program for both fuel cell vehicles and other hydrogen/fuel cell applications. Japan's fuel cell program shows similarities to its highly successful incentive program for solar PV. China has even more ambitious targets than Japan – though its goal of producing 700,000 FCVs by 2010 looks unrealistic relative to the progress of its current fuel cell program. Singapore is also becoming active, and has stated a goal of becoming a hub for clean energy technology research and manufacturing. Meanwhile, Australia has attractive renewable energy credit provisions that are boosting wind energy production, but has an electricity market structure that is unfavorable to DG in general.

3.9 Japan

The central government in Japan plays a more active role in promoting fuel cells than any other with the possible exception of recent activity in the U.S. The government provided over \$275 million in 2002 to support fuel cell research, development and commercialization. This spending was projected to exceed \$380 million per year in 2003. The Japanese government has said that it does not expect the private sector to play a leading role until after 2010.

3.9.1 Goals and Targets

A notable feature of the Japanese government's fuel cell program is its detailed targets for fuel cell deployment. As part of its announcement in 2002 that it would accelerate R&D spending, the government also emphasized applications and announced the following targets:

	<u>2010</u>	<u>2020</u>	<u>2030</u>
Fuel Cell Vehicles	50,000 vehicles	5M vehicles	15M vehicles
Stationary Fuel Cells	2,200 MW	4,000 H2 stations 10,000 MW	12,500 MW

These targets are widely promoted by the government and acknowledged by industry.

3.9.2 Subsidies

At present the primary form of subsidy in Japan comes in the form of government R&D spending. However, in addition there are programs that subsidize commercial development and end-use. The subsidies for "clean cars" and refueling stations are particularly large. These types of subsidies are expected to grow significantly larger in the next few years, especially considering the 40% increase in the government's fuel cell budget for 2003. Current subsidies include the following:

- CHP systems are eligible for a 15% government subsidy;
- The Bank of Japan provides low-interest loans for fuel cell technology projects; and
- Subsidies for clean cars:
 - clean cars, defined as vehicles running on compressed natural gas, propane, or electricity, are eligible for a 50% subsidy of incremental

- costs;
- refueling stations, which dispense any of the fuels mentioned above or methanol, are eligible for a 75% subsidy;
 - in 2002, the government budgeted \$70 million for the clean car subsidy and \$70 million for the refueling station subsidy.

The overall budget for vehicles and refueling stations will likely grow larger as the government aims for its target of 50,000 fuel cell vehicles in 2010, or alternately the level of the subsidy will have to come down. Subsidizing 50,000 FCVs at the 50% level would require a budget of at least a half a billion dollars. In addition, the government is leading investments in hydrogen infrastructure, and has indicated that “...hydrogen infrastructure should be established with government support according to expansion of uptake of FCVs.”

3.9.3 The Ministry of Economy, Trade and Industry (METI)

The powerful Ministry of Economy, Trade and Industry (METI) plays the central role in the government’s efforts to promote fuel cells and other DG. It devised the 2010 and 2020 fuel cell targets, and it plans to introduce a commercial PEM fuel cell into the market by 2005. METI launched 12 demonstration sites in 2002-03 and has planned 31 additional demonstration sites for 2003-04. METI requested a budget for fuel cells in FY2003 of \$256 million, which is up from \$183 million in 2002.

The following describes METI’s “New Hydrogen Project” announced in April 2003:

1. Objectives:

- To support market introduction of hydrogen fueled fuel cell vehicles from 2005;
- To establish hydrogen infrastructure for vehicles; and
- To contribute to global environment and to secure energy sources.

2. Project term: FY2003-FY2007 (5 years)

3. Total budget: ¥30 billion (about \$250 million)

4. R&D priorities:

- Validation and evaluation for safety of hydrogen to enact regulations, codes, and standards;
- Establishment of hydrogen infrastructure and development of related technologies (e.g., compressors and 70 MPa hydrogen cylinders); and
- Micro fuel cell systems for electronic devices.

Other government agencies involved in fuel cell development include the National Institute of Advanced Industrial Science and Technology and the Institute of Applied Energy (IEA).

3.9.4 Timeline

The METI division responsible for these fuel cell programs is the New Energy and Industrial Technology Development Organization (NEDO). In addition to the targets mentioned above, NEDO has also released its “Fuel Cell Commercialization and Popularization Scenario” which

describes the sequence of its general priorities:

Present to 2005 - Basic work and technology demonstration stage

- Drawing up fuel cell R&D strategy and its implementation;
- Infrastructure codes and standards (i.e., the “Millennium Project”);
- Demonstration project activities; and
- Establishment of fuel standards.

2005 to 2010 - Introduction stage

- Acceleration of the introduction and gradual establishment of fuel supply system; and
- Leadership of public sectors as well as fuel cell industries in promotion of fuel cell powered cars and buses.

Post 2010 - Diffusion stage

- Establishment of fuel supply system and self-sustained growth of the market; and
- Private sector promotion of fuel cell system introduction.

3.9.5 Industry Collaboration

The Japan Fuel Cell Commercialization Conference (FCCJ) was established in 2001 as a collaboration of Japanese fuel cell companies. Its primary role is in information sharing, and it plays a role similar to that of the CaSFCC in California. In conjunction with the Japanese Electric Vehicle Association, as well as industry partners, the FCCJ commissioned six hydrogen-fueling stations in Tokyo and Yokohama in 2002 and 2003.

3.9.6 Renewables in Japan

Japan’s renewables program has focused almost exclusively on deploying solar PV and nurturing its solar PV production and export industry. The emphasis on industry development appears to have been successful as close to 50% of global solar PV production is now located in Japan.

Significantly, the Japanese PV buy-down program has been terminated. It was ended for three reasons:

1. It was an expensive program, particularly as viewed in recent years with the downturn in the Asian economy that started in 1997 and persisted for three to four years thereafter.
2. The incentive level (% subsidy) had been intentionally declining over time and was intended to be phased out at some point.
3. The manufacturing base has been built, which was a major goal of the program.

Japan’s success in building the world’s leading solar PV industry may serve as a model for its fuel cell program. See Figure 3-2, showing that Japanese shipments of solar PV modules exceeded those of the U.S. in 1998, and accounted in 1999 for nearly half of the global total. Figure 3-3 shows a more recent “snapshot” of this trend (based on BP Solar estimates), and indicates that Japan and Germany have dominated solar PV markets in recent years. The figure

shows that almost 40% of solar PV installations in 2003 were in Japan, and 25% in Germany, compared with only 11% in the United States.

These trends and figures show how the U.S. is lagging behind Japan and Germany in this important area, having once had a leadership position as recently as the mid-1990s, and how the strong incentive programs in Japan and Germany have (apparently) had a major impact on developing these markets. We suspect that the combination of incentives on the demand side, along with support on the R&D side especially in Japan, have provided a combined “push-pull” effect on PV markets that has been highly effective. This has been effective in Japan to the point where incentives have to a large degree now been phased out. It will be interesting to see if the momentum for PV in Japan can be sustained moving forward.

The Japanese solar PV incentive program was distinct from large programs in other nations and U.S. states (e.g. Germany and California) in two ways. First, its initial levels were more generous and its targets more ambitious. Second, it ended subsidies much faster than programs in other places. It is possible that Japan’s fuel cell program is following a similar path. Japan’s rather swift termination of its solar PV subsidy may give it credibility in convincing the domestic fuel cell industry not to rely on subsidies for the longer term.

Figure 3-2: Global Solar Photovoltaic Module Shipments in Megawatts (1985-2003)

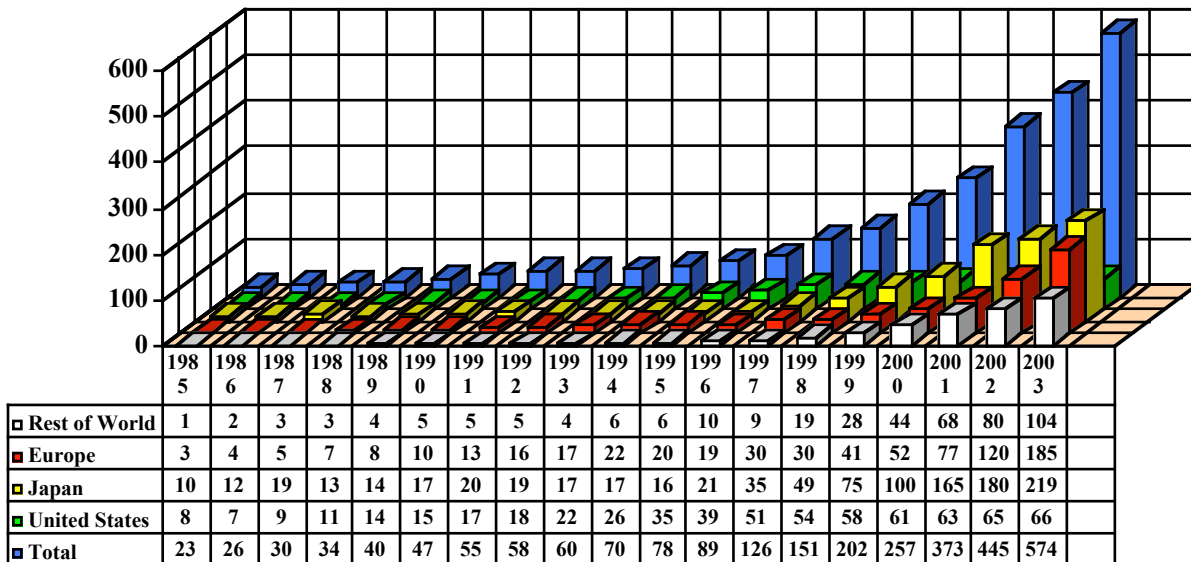

Source: Renewable and Appropriate Energy Laboratory, UC Berkeley, <http://www.socrates.berkeley.edu/~rael>.

Figure 3-3: Global Solar PV Installations in 2003 – Share by Country

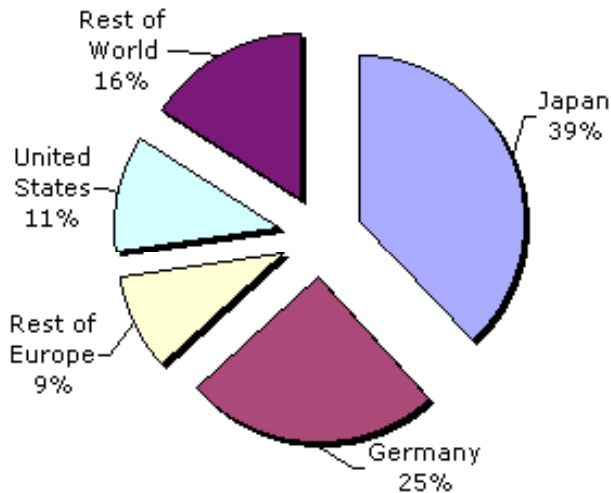

Source: BP Solar, 2003

3.9.7 Information Sources

Abe, T. (2003), “Japan’s Hydrogen Vision,” Hydrogen Energy Systems Technology Development Department, New Energy and Industrial Technology Development Organization (NEDO), Presentation at *IEA Renewable Energy Working Party Seminar*, March 3.

Fuel Cell Commercialization Conference of Japan (2004), Worldwide Web, <http://fccj.jp/index12.html>.

Kato, N. (2003), “Fuel Cell Status in Japan,” Toshiba International Fuel Cells Corporation, Presentation, March 18.

Ministry of Economy, Trade and Industry (2004), Worldwide Web, <http://www.meti.go.jp/english>.

Okano, K. (2003), “Hydrogen And Fuel Cell Activities In Japan,” *Energy Systems Society Of Japan*, Presentation, February 14.

3.10 Australia

Efforts to promote fuel cells and distributed generation in Australia are generally rather weak compared with other countries of its size and level of development. Some general findings include the following:

- There are very few incentives for distributed generation in Australia. Most efforts to promote new power technologies involve trying to establish “a level playing field” for DG. The recent electricity restructuring in Australia has proven unfriendly to DG.
- On the other hand, trading in Renewables Emissions Credits (REC) is having a

significant effect on the wind industry. RECs trade for about \$A 35/MWh (~\$22/MWh), and the average wholesale price for power is around \$A 35-40/MWh (~\$22-\$25/MWh), so RECs essentially double the revenue received for renewables. This subsidy is enough to make wind profitable but not (yet) enough for any other renewable technology.

Australia also lacks the need to comply with the Kyoto Protocol, which is a major factor in other countries' efforts to commercialize fuel cells.

3.10.1 Information Sources

Outhred, H. (2003), "The Evolving Australian National Electricity Market: An Assessment," Professor at University of New South Wales, Electricity Restructuring Group, Sydney, Presented at Lawrence Berkeley National Lab, December 11 (see <http://www.ergo.ee.unsw.edu.au>).

3.11 China

While China's activity in fuel cell and DG technology has so far been rather modest, there are indications that it is making efforts to become a large player, especially in the area of fuel cells for vehicles. The Ministry of Science and Technology of China recently launched an R&D program in this area. Also, in early 2002, China completed the construction of a 50 kW prototype fuel cell vehicle.

There are two major government programs to promote fuel cells in China:

- "The 863 Program" – Provides \$106 million from 2001 to 2005 to develop advanced hybrid and fuel cell vehicles. This commercialization program includes private sector partnerships, with the private sector expected to contribute \$200 to \$300 million to commercialization efforts over this five-year time period.
- "The 973 Program" – Provides \$4 million in annual funding by the Ministry of Science and Technology to support basic research on hydrogen storage materials, fuel cell membranes and catalysts.

The most striking aspect of China's advanced power technology programs is its ambitious goal for fuel cell vehicles. The government's plan is for widespread commercialization of fuel cell vehicles by 2010. Their goal is for fuel cell vehicles to comprise 2% of the market by 2010. The new car market in China is expected to be 34 million vehicles per year by 2010, so that plan means producing 700,000 FCVs in China by the end of the decade. To put this figure in perspective, this is 10 times the number of fuel cell vehicles that Japan expects to produce in 2010.

3.11.1 Information Sources:

Geiger, S. (2003), "Fuel Cells in China - A Survey of Current Developments", *Fuel Cells Today*, October 15.

3.12 Korea

There is extensive collaboration on advanced power technologies among companies in Korea. It appears that the Korean government is playing a large role in establishing and encouraging these collaborations. For example, Hyundai is working with United Technologies Corporation's fuel cell division, UTC Fuel Cells, to develop fuel cell vehicles. LG Chemicals, Inc. is working with Daimler Chrysler on fuel cell materials development. Samsung and Sanyo are working together on stationary PEM fuel cells.

3.12.1 Information Sources

UTC Fuel Cells (2003), Worldwide Web, <http://www.utcfuelcells.com/index.htm>.

Eye for Fuel Cells (2002), "Sanyo and Samsung Join Forces to Develop Emerging Technologies," <http://www.eyeforfuelcells.com/ReportDisplay.asp?ReportID=1053>, January 15.

3.13 Singapore

The Singapore government has established the Singapore Initiative in Energy Technology Program (SINERGY), which aims to make Singapore a leading player in the development of alternative energy technology. SINERGY is part of the government's effort to promote additional clean energy R&D and test-bedding activities for automotive and stationary power applications. BP and Daimler Chrysler are involved with SINERGY to help build DG infrastructure, including solar PV systems and hydrogen fueling stations.

The SINERGY effort is motivated by a few concerns on the part of the government, including the fact that the nation expects to be 60% reliant on natural gas for electricity generation by 2010. An additional motivation is the nation's relatively high electricity prices (about \$0.16/kWh residential and \$0.10-0.15/kWh commercial). SINERGY expects to spend about \$30 million on demonstration projects, including testing of seven DaimlerChrysler A-Class FCVs.

The SINERGY program will also test a 5-kW stationary PEM fuel cell (the first stationary fuel cell in Singapore), and also is working with Idatech and DRPL (a Singapore power utility) on stationary fuel cell demonstration/pilot project opportunities. Nanyang Technical University is also participating in these efforts, with a "Fuel Cell Strategic Research Program," and the National University of Singapore is also involved.

3.13.1 Information Sources

Ho, H-K. (2003), "Fuel Cell Research, Development and Demonstration Activities in Singapore," *Fuel Cell Seminar*, November 4-7, Miami, Florida.

3.14 Thailand

Thailand recently adopted an RPS of 8% by 2011 as part of its Renewable Energy Action Plan. Renewables account for only about 0.5% of Thai electricity today. The plan also includes a set of market-based incentive schemes for renewables. However, to date there has been no mention of fuel cells in the plan.

3.14.1 Information Sources

Thai Government Delegation (2003), Department of Alternative Energy Development and Efficiency, California Renewable Energy Study Tour, Berkeley, California, December 11.

4.0 Review of Combined Transportation / Stationary Power System Linkages and Concepts

An interesting aspect of both DER systems and advanced technology vehicles is the potential for linkages and synergies between developments in the stationary power and transportation sectors. This section of the report discusses various potential linkages between distributed power generation and transportation systems, and presents a summary of analysis conducted on the prospects for some of these systems. Following this discussion, Section 5 of the report presents the details of a few specific projects that have been conducted or are in progress that have linked stationary power generation and transportation.

Concepts for linking DER and transportation can be classified into two broad categories: 1) concepts that combine DER systems with refueling for advanced technology vehicles; and 2) actually using advanced technology vehicles as DER systems or as part of a larger DER system. With regard to the first category, concepts include “hydrogen energy stations” that would co-produce electricity for local building loads and/or utility grids along with hydrogen to refuel hydrogen-powered vehicles, and using DER resources to recharge electric vehicle types that require periodic battery recharging. In the second category, electric-drive vehicles themselves (or their powerplants, apart from the vehicles) would act as distributed power generators and/or as providers of utility grid ancillary services.

4.1 DER Systems and Refueling for Advanced Technology Vehicles

Promising advanced vehicle types for addressing energy and environmental concerns associated with transportation include battery electric vehicles (BEVs), hybrid electric vehicles (HEVs), hydrogen-powered internal combustion engine (ICE) vehicles, and hydrogen FCVs, among others. These vehicle types would in some cases require a different fuel than the gasoline or diesel fuel that has traditionally been used for vehicle refueling. BEVs and some types of HEVs would use electricity to refuel their batteries, and hydrogen-powered vehicles would need to refuel with hydrogen.

Combining refueling systems for these vehicles with DER systems could be attractive for several reasons. First, BEVs and “plug-in” HEVs would require grid power for battery recharging, and while recharging these vehicles off-peak would not require additional power generating capacity, any recharging that would occur during grid peak demand periods would require additional capacity to be installed. The additional capacity could be in the form of DG, with the advantages of reduced transmission and distribution losses and the possibility of using renewable DG for electricity production to maximize the environmental benefits of these vehicles. Second, hydrogen-powered vehicles require a hydrogen refueling infrastructure, but there is a “chicken or the egg” problem associated with creating this infrastructure. Consumers will not purchase hydrogen-powered vehicles without reasonable access to refueling locations, but the economic case for developing this infrastructure for what will initially be small numbers of vehicles is a difficult one.

One potential solution to this problem is to provide hydrogen refueling in conjunction with

distributed electricity production, with what have come to be known as “hydrogen energy stations” (or “H₂E-Stations”). These stations would primarily be designed to produce electricity using stationary fuel cells running on hydrogen, but would also include a hydrogen-vehicle refueling component. By in effect using the electricity cost savings from the DG part of the system to subsidize the hydrogen refueling part, these H₂E-Stations can have more attractive economics than dedicated hydrogen refueling stations, particularly for low numbers of vehicles supported (e.g., 5-50 vehicles refueled per day).

4.1.1 Hydrogen Energy Stations

With regard to the H₂E-Station concept, these stations would be either dedicated refueling facilities, or a key component of the energy production, use, and management portion of a commercial or industrial facility. The energy station component would consist of a natural gas reformer or other hydrogen generating appliance, a stationary fuel cell integrated into the building with the potential capability for combined heat and power (CHP) production, and a hydrogen compression, storage, and dispensing facility. In essence, H₂E-Stations would seek to capture synergies between producing hydrogen for a stationary fuel cell electricity generator that provides part or all of the power for the local building load (as well as the capability to supply excess electricity to the grid), and refueling hydrogen-powered vehicles with additional high-purity hydrogen that is produced through the same hydrogen-generation system.

Many different types of H₂E-Stations are possible. These stations could be primarily designed to produce hydrogen for vehicles, electricity for local building loads, electricity for export to the utility grid, or support for local electricity distribution grids. The most obvious near-term arrangement would be to combine a stationary fuel cell system that operates on hydrogen produced onsite (e.g. a proton-exchange membrane or phosphoric acid fuel cell system) from natural gas, with a hydrogen purification, compression, storage, and dispensing system for vehicle refueling. However, configurations using other fuel cell types and hydrogen generation systems are also possible. Table 4-1, below, presents four potential types of hydrogen energy stations and their basic characteristics.

Table 4-1: Four Potential Types of Hydrogen Energy Stations

	Vehicle Refueling Energy Station	DG Energy Station	Utility Support Energy Station	Residential Energy Station
Location	Service station	Commercial or industrial facility	Utility substation	Home or apartment building
Primary Purpose	Hydrogen refueling for vehicles	Electricity production	Local distribution grid support	Hydrogen refueling for vehicles
Vehicles Refueled	5-500 per day	5-50 per day	5-50 per day	1-10 per day
Approximate Fuel Cell Size	25-50 kW	100-1000 kW	100-500 kW	1-50 kW
Key Issues	<ul style="list-style-type: none"> • DG/fuel cell economics with low electrical loads 	<ul style="list-style-type: none"> • Utility tariffs and interconnection rules • Public access for refueling? 	<ul style="list-style-type: none"> • Public access for refueling? 	<ul style="list-style-type: none"> • Natural gas costs • Economics with low electrical loads

California’s recently announced “Hydrogen Highways” initiative specifically calls out the possibility for H2E-Stations to be used as part of the state’s future hydrogen refueling network in the preamble of the key executive order:

“Whereas, the economic feasibility of a hydrogen infrastructure is enhanced by building hydrogen energy stations that power vehicles as well as supply electricity for California’s power needs” (State of California Executive Order S-7-04)

4.1.2 Hydrogen Energy Station Economics

Recent analysis of the economics of several potential hydrogen energy designs shows that for the California setting examined, where prevailing commercial and residential electricity rates are high, these stations have the potential to be relatively attractive ways of supplying vehicles with hydrogen, particularly for small numbers of FCVs or other hydrogen-powered vehicles and in comparison with other options. In general, hydrogen energy stations tend to be more attractive economically than dedicated hydrogen refueling stations, especially for low numbers of vehicles supported per day, but the economics depend importantly on several variables including natural gas and electricity prices, capital equipment costs, the hydrogen sales price, and fuel cell maintenance and stack refurbishment costs.

Figure 4-1, below, shows that for a set of the “service station” cases examined the hydrogen energy station designs are more attractive economically than dedicated hydrogen refueling stations. None of the dedicated or hydrogen energy stations are economically profitable with so

few vehicles supported, but the energy stations offer a lower-cost pathway to ultimately supporting greater numbers of vehicles profitably.

Figure 4-1: Economics of Hydrogen Energy Station Designs at Service Station Location

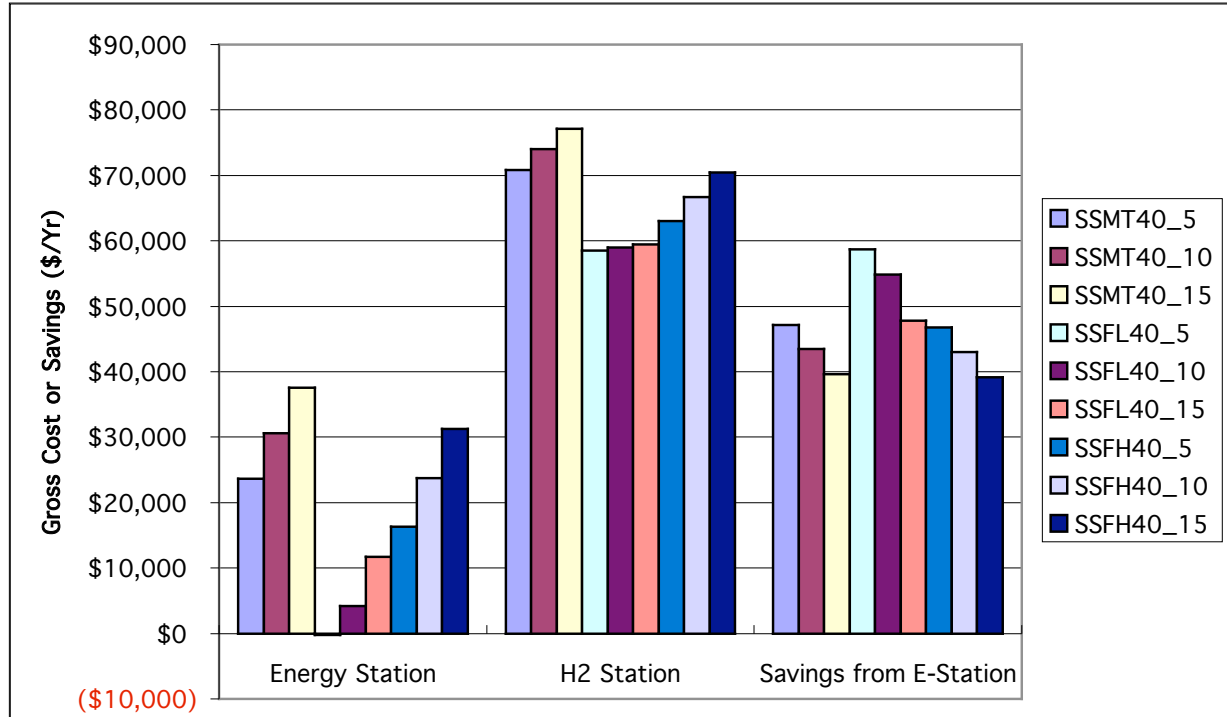

Notes: FH = future high case economic assumptions; FL = future low case economic assumptions; MT = medium term case economic assumptions; SS = service station; 40_Y = 40 kW fuel cell and 5-15 vehicles per day refueled. Source: Lipman et al., 2002a

Figure 4-2 shows how after a transitional period with low numbers of vehicles supported, H₂E-Stations at service station locations could begin to turn a profit with greater numbers of vehicles refueled per day and with hydrogen selling prices of around \$20 per GJ. This figure shows that a 10% simple return-on-investment (ROI) target can be met with the service station type of H₂E-Station, but only with relatively high hydrogen sales prices of about \$20 per GJ and only with about 50 or more vehicles per day refueled. At lower hydrogen sales prices of \$10-15/GJ, the economics of this type of station do not look attractive, even with significant numbers of vehicles refueled. However, with lower natural gas prices than the \$6/GJ assumed in this “future high cost” case, this picture would change somewhat, with hydrogen sales prices of \$15/GJ potentially becoming profitable for over about 40 or 50 vehicles per day supported (Lipman et al., 2002a).

Figure 4-2: Estimated Profit (or Loss) from H₂E-Service Station with a 40 kW Fuel Cell and 5 to 75 Hydrogen Vehicles Refueled per Day (w/approx. 10% ROI target)

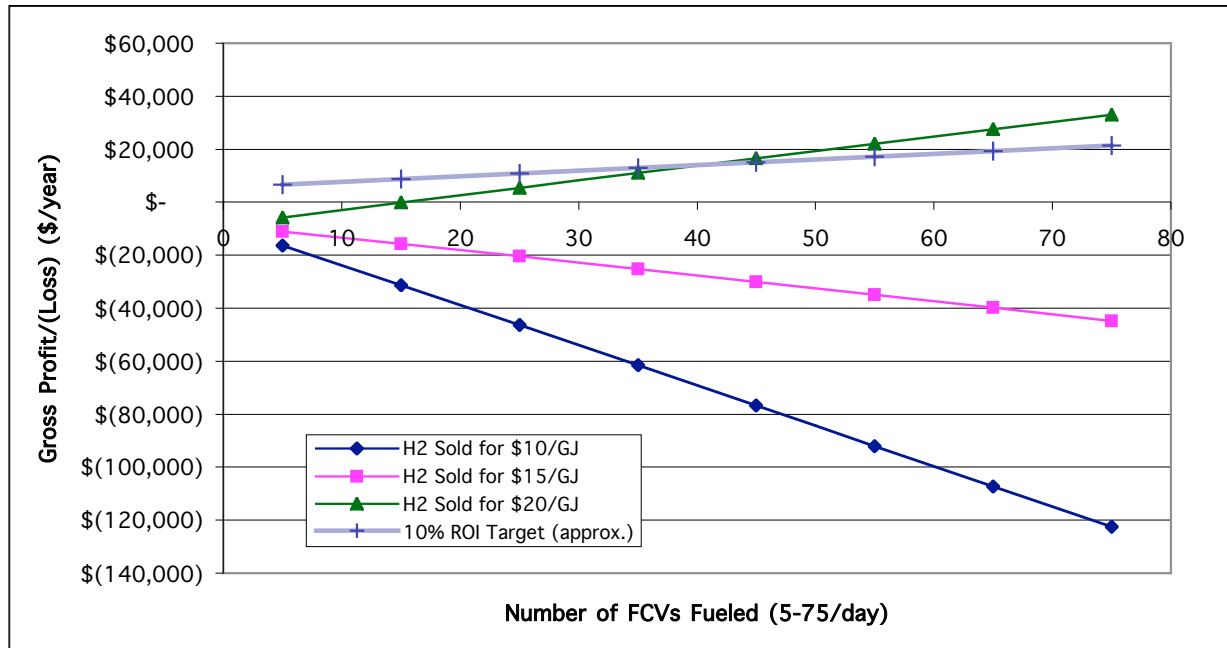

Notes: FCV = fuel cell vehicle (or other hydrogen powered vehicles); GJ = gigajoule.
 Source: Lipman et al., 2002a

More promising from an economic perspective than these “service station energy stations,” however, are energy stations that would be sited at office buildings or other commercial or industrial locations with larger electrical loads. Particularly when savings from peak-time electricity use and utility “demand charges” are included, the economics of these stations can look attractive because the potential savings from electricity self-generation are significant. Figure 4-3 shows the results of economic analysis of several H₂E-Station designs at an example California office building, showing that the designs that include fuel cell systems of 150 kW or larger can be profitable particularly when they are coupled with future projections of fuel cell system and hydrogen refueling system capital costs.

Figure 4-3: Estimated Profit/(Loss) from Office Building H₂E-Stations with 50 to 250-kW Fuel Cell and 10 Hydrogen Vehicles per Day Refueled

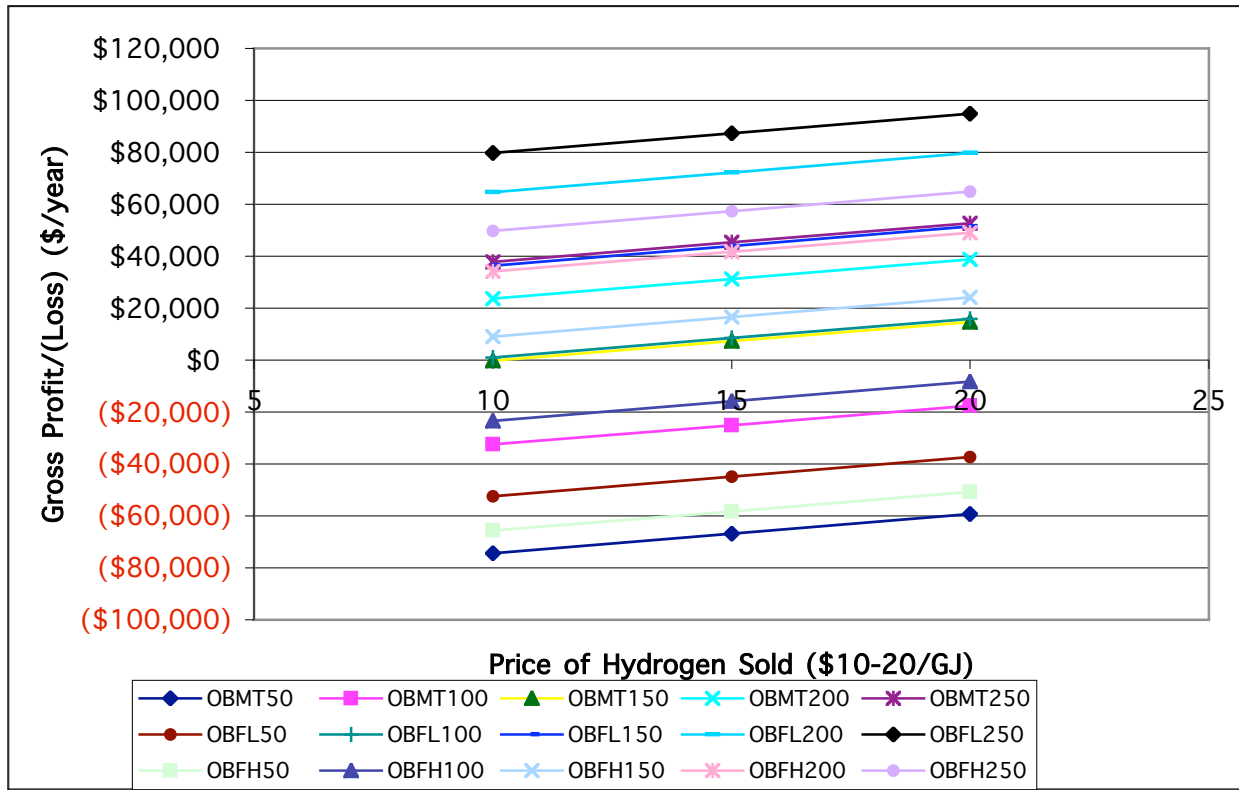

Notes: FH = future high cost case; FL = future low cost case; MT = medium term; OB = office building; 50-250 = fuel cell peak power in kW.
 Source: Lipman et al., 2002a

4.1.3 Distributed Power Generation for Recharging Battery EVs and Plug-in HEVs

EVs that require electrical power to refuel include battery EVs, plug-in HEVs (which would refuel with both electricity and gasoline or another combustible fuel), and FCVs or other hydrogen vehicles that operate on hydrogen produced from electrolysis. For all of these vehicle types, significant potential exists to take advantage of off-peak periods for electrical grids and to refuel the vehicles without significant power system capacity additions. However, to the extent that some on-peak electrical use will be required – potentially for hydrogen compression and/or liquefaction as well as actual vehicle refueling – the installation of DG systems in conjunction with vehicle refueling infrastructure could provide the necessary additional peak power without the need to construct additional centralized “peaker” power plants. Furthermore, some DG systems may actually have favorable economics compared with grid power, particularly in some utility service territories in California (and other “high cost” electricity states), and providing the power required to refuel vehicles from DG could then be economically advantageous.

4.1.4 Another Type of Energy Station – DG Linked to Electric Transit

Another type of “energy station” would involve linking DG resources with electric transit systems to produce power for the transit systems as well as potentially local loads and/or grid export. Large commuter rail and light-rail systems use considerable amounts of electricity,

typically supplied through a high-voltage DC “third rail.” Transit systems may find it attractive to install DG systems, particularly where waste heat from the systems could be used (e.g., in train station facilities or adjacent office buildings) for CHP and improved project economics. We note that fuel cell systems and other systems that fundamentally produce DC power could produce power directly for these DC-based transit networks without incurring the costs and efficiency losses of AC inverters.

4.2 Electric-Drive Vehicles as DER Sources or Components – “Vehicle-to-Grid” Power

A rather astounding fact is that the gross power generating capabilities of the motor vehicle fleets in California and the rest of the U.S. are enormous, and in fact dwarf the power generating capability of stationary powerplant generation. While at present this power is mainly in the form of mechanical rather than electrical power, a hypothetical electrified vehicle fleet in the U.S. would have approximately 14 times as much power generating capacity as all of the stationary power plants in the country!

As the market for various types of EVs continues to develop, the possibilities will emerge for using this power generating capacity in interesting ways. These include vehicle-to-grid power (V2G), where vehicles produce power and/or grid ancillary services for traditional building electrical loads and utility grids, as well as other potential arrangements where EVs interact with “microgrids” and remote renewable power systems.

Figure 4-4 shows one concept for EVs to produce the utility grid ancillary service of grid frequency regulation, using several novel technologies in combination. These include a vehicle with a battery system or other electrical device capable of producing and/or absorbing electrical energy, a radio frequency signal of local utility grid frequency, GPS-based vehicle location, a centralized grid operation center, and an internet-based service aggregation and administration system (Brooks, 2002).

Figure 4-4: One Concept of V2G Operation - EVs Acting As Grid Frequency Regulation Service Providers

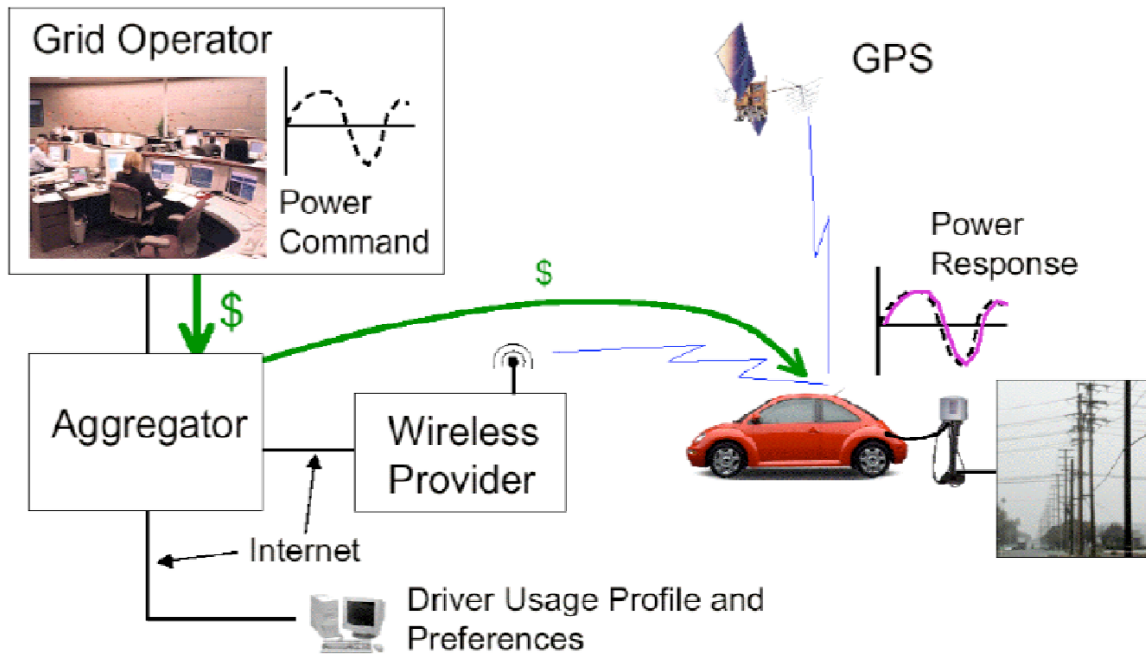

Source: AC Propulsion Inc., 2002

4.2.1 The Economics of Vehicle-to-Grid (V2G) Power

Vehicles with significant onboard electrical generating capability can generate power and other grid services efficiently and for various uses, many of which have economic value that could translate into reduced costs of ownership for these new vehicle types. The most comprehensive published analysis of the potential for EVs and FCVs to act as DG resources was conducted by Kempton et al. (2001). This report was prepared for the ARB by researchers at the University of Delaware, Green Mountain College, and the University of California. The analysis also involved collaboration with EV drivetrain manufacturer AC Propulsion, Inc., whose “Generation 2” electric motor controller unit allows for bi-directional grid interface that can support V2G connections. The Kempton et al. effort examined the economic potential of using various types of EVs to produce power for buildings and the grid, as well as to provide grid “ancillary services” such as spinning reserves, non-spinning reserves, and grid frequency regulation.

Table 4-2, below, presents some of the key findings of the Kempton et al. report, in terms of the range of annual values that might be expected for different EV types and for three different power generation or ancillary services. The results are highly variable among vehicle types, but show that annual returns to vehicle owners could amount to as much as a few thousands of dollars per year, depending on the vehicle type and ancillary service provided as well as how much of this potential income would be lost due to the transaction costs associated with bidding these services into electricity markets.

Table 4-2: Vehicle Owner's Potential Annual Net Profit from V2G

	Peak power	Spinning reserves	Regulation services
Battery EV (full function)	\$267 (510 – 243)	\$720 (775 – 55)	\$3,162 (4479 – 1317)
Battery EV (city car)	\$75 (230 – 155)	\$311 (349 – 38)	\$2,573 (4479 – 1906)
Fuel Cell EV (on-board H₂)	\$-50 (loss) to \$1,226 (2200 – 974 to 2250)	\$2,430 to \$2,685 (3342 – 657 to 912)	\$-2,984 (loss) to \$811 (2567 – 1756 to 5551)
Hybrid EV (gasoline)	\$322 (1500 – 1178)	\$1,581 (2279 – 698)	\$-759 (loss) (2567 – 3326)

Source: Kempton et al., 2001

Note: The figures represent \$net and (revenue – cost). These are representative mid-range figures extracted from full analysis in the report.

4.2.2 Fuel Cell Vehicles as DG Sources

The particular case of using FCVs to produce power has drawn particular attention due to the potential for FCVs to become commercialized as mass replacements for conventional vehicles, potentially beginning in the 2008-2012 timeframe. The significant fuel cell power generation capability of these vehicles ranges from perhaps 20 kW for hybrid FCVs (along with the potential for additional battery power) to 100 kW or more from larger FCVs with minimal battery or ultracapacitor assist systems.

In the study discussed above, Kempton et al. (2001) concluded that FCVs could compete in the peak power market, with generating costs on the order of \$0.18/kWh, but could not compete with “baseload” power. An earlier analysis of the potential for FCVs to provide power in stationary applications was conducted by Kissock (1998), who also considered the potential for waste heat recovery from the vehicles. This analysis assumed that FCVs equipped with 25 kW nominal (37.5 kW peak) PEM fuel cell systems would be used to produce electricity, or electricity and heating/cooling in a cogeneration mode, for New Jersey and Texas residences, for a New Jersey hospital, and for a Texas office building. The analysis concluded that annual savings of up to \$2,500 per FCV “docking station” could be realized with the residential setting (with some cases showing negligible benefits), that annual savings of \$1,200 to \$8,800 were possible for each docking station at the hospital, and that annual savings of \$2,300 to \$2,900 were possible for the office building cases (Kissock, 1998).

In a more recent and somewhat more detailed analysis, Lipman et al. (2002b) have shown that while the costs of producing power from stationary and motor vehicle systems are rather

different in terms of the costs involved – for stationary systems much of the cost is capital cost while for FCVs much of the cost is for periodically refurbishing the vehicle’s fuel cell stack – the economics of producing power from these systems can be comparable, and potentially competitive with grid power in the future, if the systems are operated with similar overall efficiencies. However, results are highly sensitive to the compounding effects of variations in several key input variables such as natural gas and electricity prices, fuel cell system costs, durability levels, and fuel cell stack “refurbishment” costs. Where FCVs are used to produce power to meet very low load levels, such as at individual residences (e.g. and operate at very high turndown ratios), their efficiencies suffer and they become much less economically attractive at producing power. This suggests that “net-metering” policies -- that would allow FCVs to be operated at higher power and efficiency levels and for excess power to be supplied to the grid for a credit -- may be critical to improving the economics of FCVs used to produce power in this way.

Figures 4-5 and 4-6, below, present results from the Lipman et al. (2002b) analysis, comparing the costs of producing power from FCVs and stationary PEM fuel cells at both California office building and residential locations, and with three different sets of economic assumptions (all assuming significant capital cost reductions from today’s levels – see report for details). These results show that the costs of power production at residences from FCVs can be highly variable, but that the economics of producing power from FCVs at commercial locations are better due to lower commercial natural gas prices, better fuel cell system efficiencies in meeting higher loads, excess FCV power availability during the day when it is highly valued, and other factors.

Figure 4-5: Electricity Costs for FCVs Used as DG Compared to Stationary PEM Fuel Cells (Medium-Sized California Office Building Setting)

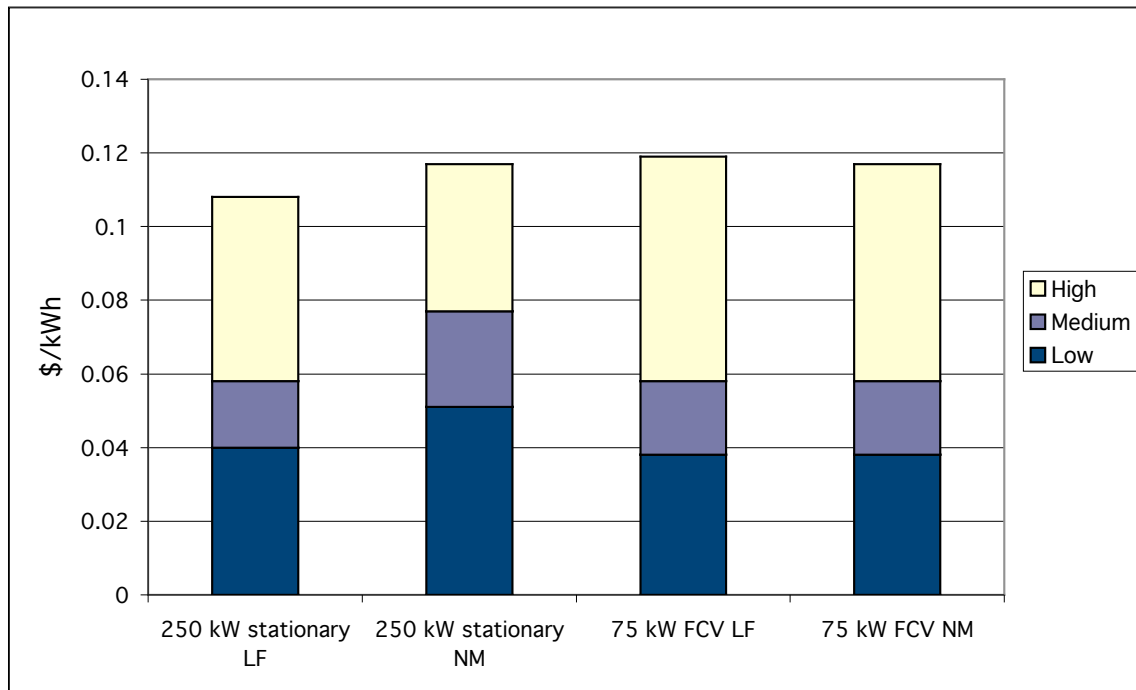

Note: LF = load following; NM = net metering.
 Source: Lipman et al., 2002b

Figure 4-6: Electricity Costs for FCVs Used as DG Compared to Stationary PEM Fuel Cells (California Residential Setting)

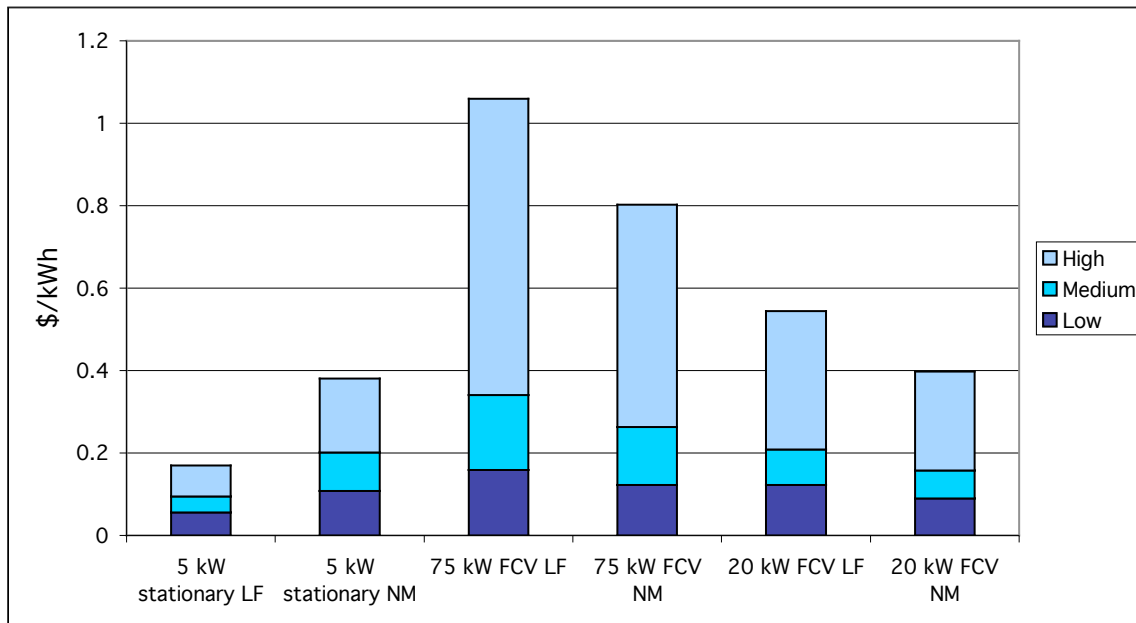

Note: LF = load following; NM = net metering.
 Source: Lipman et al., 2002b

4.2.3 Advanced Vehicles and “Microgrids”

Additional options for integrating advanced technology vehicles with DER systems include incorporating EVs into designs for “microgrids.” Microgrids are small clusters of DER technologies that act together to supply power and heating/cooling to one or more adjacent buildings, and that would connect with the main grid at one interface point. Microgrids could act as “model citizens” for the grid by supporting it in various ways, and they could also benefit themselves from supplying local generation with grid power at various times (depending on electricity rate schedules and other variables). EVs could play interesting roles in microgrids by supplying electrical storage and/or power generation capability, particularly with the availability of the EV resources coinciding with the arrival of people at various commercial and industrial microgrid locations and their associated energy needs.

4.2.4 Advanced Vehicles and Renewable Energy Systems

Similarly, EVs could help to provide additional power and “buffering” for small standalone renewable energy systems based on PV and wind power, along with a battery storage system. Small renewable systems that are “off-grid” because of their remote location are becoming increasingly common, but often are of relatively low power to keep costs low. Again, these systems could be bolstered by the use of EVs to provide additional power to operate high-power equipment for short periods of time, thereby allowing the size of the remote renewable system to be minimized.

4.2.5 Heavy-Duty Trucks and DER Systems

Finally, another interesting opportunity for combining motor vehicles and distributed energy systems involves efforts to reduce emissions from heavy-duty diesel trucks. Approximately 30% of the fuel use and emissions associated with long-haul diesel trucks is due to the idling that these trucks do when they are stopped, primarily in order to support electronic devices in the truck cabin (refrigerator, microwave, television, climate control, etc.) by operating a generator with the main diesel engine (Brodrick et al., 2002). This is highly inefficient and polluting, and efforts are underway to examine opportunities for reducing these emissions.

One such option would be to equip trucks with fuel cell auxiliary power units (APUs), running on pure hydrogen or possibly diesel fuel that is converted into a hydrogen-rich gas stream with an onboard fuel reformer. If operated on hydrogen, these heavy-duty truck APU systems could be refueled with hydrogen produced at truck stop hydrogen stations, possibly of a type of “H2E-Station” design as discussed above, where hydrogen is used both for truck APU and FCV refueling, as well as to produce electrical power and heat for the truck stop using a stationary fuel cell.

An alternative to using fuel cells as APUs onboard the trucks would simply be to have the trucks “plug in” to electrical outlets when near truck stops, and the electricity could be supplied either by the main utility grid or by a DG system at the truck stop. This would only reduce idling near truck stops, but would perhaps be easier to implement than the fuel cell option. Also note that both of these types of installations would be good candidate for integration of renewable PV or (if remote sites) wind power, in order to further reduce environmental impacts.

4.3 Summary of Combined Transportation/Stationary Power System Concepts

In summary, concepts for linking DER and transportation can be classified into two broad categories: 1) concepts that combine DER systems with refueling for advanced technology vehicles; and 2) actually using advanced technology vehicles as DER systems or as part of a larger DER system. With regard to the first category, concepts include “hydrogen energy stations” -- or ‘H₂E-Stations’ for short -- that would co-produce electricity for local building loads and/or utility grids along with hydrogen to refuel hydrogen-powered vehicles, and using DER resources to recharge electric vehicle types that require periodic battery recharging. In the second category, electric-drive vehicles themselves (or their powerplants, apart from the vehicles) would act as distributed power generators and/or as providers of utility grid ancillary services.

Within these categories, H₂E-Stations can be of various types and in different locations, making for a wide range of potential design possibilities that have only begun to be explored. Potential designs for H₂E-Stations include those based on different types of fuel cell systems, other hydrogen-to-electricity generating systems, hybridization with solar PV systems, different hydrogen purification and storage strategies, and different operational (and system control) strategies. Additional complexities are afforded by utility grid interaction, potential variations in natural gas or other fuel prices, and various utility tariff structures that may apply or be options for the facility that is the host site for the H₂E-Station.

The host site (e.g., service station, office building, apartment complex, etc.) also has specific electrical load profiles as well as thermal load profiles (important for waste-heat recovery potential that vary diurnally and seasonally, as well as regionally, and all of these various factors must be considered when analyzing and planning these systems. A few energy stations demonstration projects are being conducted at present in Las Vegas, Toronto, and Los Angeles (see Section 5 below). These projects include a diversity of system designs, and both reformer and electrolyzer-based systems.

With regard to the linked transportation/stationary power concepts that integrate advanced technology vehicles with DER systems, again a few demonstration projects have been or are being conducted, but significant analytical research has been conducted – though again with much more yet to learn due to the many potential arrangements for vehicles to provide power and/or grid services. For DER systems linked with transportation systems in order to provide power to the system (e.g. electric-drive vehicles or electric transit systems), conceptual designs with some analysis exist, but only a few real-world demonstrations have been conducted and these are at early stages.

In summary, this combination of stationary power oriented DER systems that are tied in with electric or hydrogen-powered transportation systems appears to be a fruitful area for continued research and development. The potential for synergies between system operations appears to be significant, particularly for large agencies and transit operators that both consume electrical power and have large vehicle fleets and/or transit networks.

5.0 Review of Combined Transportation / Stationary Power System Projects and Initiatives

Section 4.0 of this report discusses several potential concepts for integrating DER systems with transportation systems. This section reviews the status of various “real world” projects that are exploring these concepts. These experiences have been relatively limited to date, but are expected to expand rapidly with the growth of DG and further development of EV and other clean fuel vehicle markets.

California may be the first state to specifically note the potential for these types of projects to advance clean power for vehicles and buildings. The following language was included in the recent “Hydrogen Highways” Executive Order signed by Gov. Arnold Schwarzenegger on April 20, 2004:

“...Whereas, the economic feasibility of a hydrogen infrastructure is enhanced by building hydrogen energy stations that power vehicles as well as supply electricity for California’s power needs...” (Executive Order S-7-04, State of California)

This executive order may thus spur development of additional H₂E-Station projects in California, and perhaps other linked advanced vehicle and DG projects as well.

5.1 Hydrogen Energy Station Projects

A number of H₂E-Station concepts are being explored by various industrial groups, two actual stations have been constructed (plus one residential-scale demonstration), and a few others are in the planning stage. This section discusses the H₂E-Stations that have been built or proposed to date, and that have been publicly disclosed.

5.1.1 The Las Vegas Hydrogen Energy Station

The world’s first H₂E-Station was dedicated in Las Vegas, Nevada on November 15, 2002. The \$10.8 million, five-year demonstration project includes research, development of new technology, and the manufacturing and installation of equipment at the energy station. The project costs have been split equally under a cooperative agreement between Air Products and Chemicals Inc. and the U.S. DOE. The team also includes Plug Power, a New York-based fuel cell manufacturer, and the city of Las Vegas. These last two partners were responsible for the research, development, design, and construction of the station and are responsible for its operation. The station is capable of dispensing pure hydrogen for vehicle refueling and compressed natural gas (CNG) for CNG vehicles, as well as CNG/hydrogen blends (City of Las Vegas, 2002).

The station has reportedly experienced problems with its fuel cell system, and is at present using hydrogen that is being delivered from an industrial hydrogen production facility rather than produced onsite. Figure 5-1 presents a picture of the Las Vegas station.

Figure 5-1: The Las Vegas H₂E-Station

Source: Air Products and Chemicals, Inc.

5.1.2 The Toronto Hydrogen Energy Station

The world's second H₂E-Station was installed in Toronto, Canada and unveiled at the city's Exhibition Place during the annual 'Green Day' activities at the Canadian National Exhibition on August 27, 2003. The demonstration at the exhibition is the first phase of a three-year initiative undertaken by Hydrogenics, Inc., the City of Toronto and Exhibition Place. Electrical power generated by a Hydrogenics "HySTAT" fuel cell generator will be used to provide electrical demand "peak shaving" for the National Trade Center during periods of high electricity consumption when power is more expensive. In addition, a John Deere "Pro Gator" demonstrator FCV will be refueled with hydrogen produced by steam reformation of natural gas at the same site, and will demonstrate the use of fuel cell technology to enhance the productivity and reduce the emissions of work vehicles. In a "Phase 2" in 2004, the system will be capable of providing continuous power to the trade center as well as emergency backup power. And in a "Phase 3" of the project a renewable wind turbine/electrolyzer hydrogen generator will be added to the site, along with a 40-foot, fuel cell-powered passenger bus. The station also uses pressure-swing adsorption hydrogen purification technology from QuestAir Technologies, Inc. Funding support for installation of the fuel cell and vehicle fueling systems was provided by the Canadian Transportation Fuel Cell Alliance and Natural Resources Canada (QuestAir Technologies, Inc., 2003; City of Toronto, 2004). Figure 5-2 presents a picture of the "Phase 1" Toronto station.

Figure 5-2: The Toronto H₂E-Station



Source: City of Toronto, 2004

5.1.3 The Diamond Bar, California Hydrogen Energy Station

The South Coast Air Quality Management District (SCAQMD) has contracted with Stuart Energy Systems for construction of an electrolyzer-based H₂E-Station at SCAQMD's Diamond Bar, California headquarters location. This station will use an electrolyzer to produce hydrogen for hydrogen-powered vehicles as well as a 120-kW hydrogen internal combustion engine generator set. The power module will be used for peak-shaving and backup power, and the station is expected to open early in 2004. This will represent the first electrolyzer-based H₂E-Station to open in California (Stuart Energy Systems, 2003).

5.1.4 The Honda/Plug Power Home Energy Station

In late 2003, Honda Motor Company and Plug Power announced an integrated "home energy station" system that was co-developed by the two companies. The system incorporates a fuel reformer, a stationary PEM fuel cell, a refiner to purify the hydrogen, a hydrogen compressor, high-pressure tank storage, and a fuel dispenser. The system is designed to operate on natural gas, provide power for its own operation as well as local electrical loads and/or grid export, and produce enough additional hydrogen to refuel one vehicle per day. The system also includes the capability for "combined heat and power" and can provide space heating and/or hot water using

waste heat from the operation of the system (Plug Power, 2003).

Figure 5-3: Demonstration of the Honda/Plug Power H₂E-Station



Source: Plug Power, 2003

5.2 DG and EV Recharging

Another type of recent demonstration project combines DG with advanced technology vehicles by using the electricity produced from a DG unit to recharge battery-powered EVs. We are aware of one such project underway (discussed below) and a few others that are in the planning stage.

5.2.1 ZEV•NET

Zero-Emission Vehicle – Network Enabled Transport (ZEV•NET) is a concept developed by Toyota Motor Company and UC Irvine that combines distributed generation of electrical power and shared-use EVs. In the ZEV•NET scheme, EVs are recharged at a commuter train station using a combination of a stationary fuel cell system and solar PV panels. The EVs are used by commuters during the day, and also can be taken home by “home side” commuters in the evening where they also can be recharged using home charging stations (ZEV-NET, 2004).

ZEV•NET is currently operating under the “corporate model” where companies and other organizations can subscribe to a service where two or four vehicles are made available to employees of the company. The ZEV•NET program is being operated by UC Irvine’s National Fuel Cell Research Center and Institute of Transportation Studies (ZEV-NET, 2004).

5.3 Vehicle-to-Grid (V2G) Power Demonstration Projects

With regard to V2G power, little actual demonstration project activity has yet occurred. However, the concept of V2G power appears to be gaining momentum, particularly in the U.S., Germany, and Canada, and we expect more demonstration activity in the near future. The most noteworthy demonstration to date does not use EVs for power *per se*, but rather uses fuel cell powerplants that have been developed for vehicle applications in a stationary power setting. It is also worth noting that Hydrogenics Inc., a Toronto, Canada based fuel cell system and fuel cell test station developer, has recently acquired a fuel cell vehicle-to-grid power patent that was filed several years ago by a New Jersey company, and has shown considerable interest in pursuing the V2G concept commercially.

5.3.1 GM and Dow Chemical Vehicle/Stationary Fuel Cell Demonstration

In a noteworthy development with regard to the use of automotive fuel cell systems for distributed power generation, General Motors and Dow Chemical teamed up in 2003 to couple the use of GM's fuel cell systems, mounted into tractor trailer trucks, with one of the largest chemical plants in the world. This chemical plant, in Freeport, Texas, covers 30 square miles and produces significant quantities of by-product hydrogen. Under the GM/Dow agreement, Dow will provide hydrogen to the GM fuel cells and purchase the electricity that is produced for use in its onsite operations.

Both General Motors and Dow have provided lofty praise for the project (quotes from FCIR, 2004):

“...the pathway to getting an affordable FCV in your driveway sometime in the next decade runs right through Texas. What Dow is doing will directly impact the date when the hydrogen economy will become a reality” – Larry Burns of General Motors

“This is a real application, where a car maker is using fuel cell technology in distributed generation to produce electricity and heat. With the pull of this lever, we will decrease the dependency on fossil fuels, take a serious look at alternate energy, and create a milestone toward a sustainable future.” – Theo Walthie of Dow Chemical

The plan struck by the two companies calls for the initial 75 kW fuel cell system to be accompanied by 12 more in the summer of 2004, for a total generating capacity of 1 MW. The agreement calls for a potential full-scale level of up to 35 MW over seven years – equivalent to a fleet of 400 FCVs. Since that 35 MW would produce only 2% of the Dow facility's energy needs, the company expects to reach the 35 MW level ahead of the seven-year scale up plan. In a particularly interesting aspect of the project, the fuel cells will be operated on automotive cycles to mimic use in FCVs, with simulated acceleration and deceleration, rather than typical stationary fuel cell system patterns of operation (FCIR, 2004).

5.3.2 AC Propulsion V2G Demonstration

AC Propulsion Inc., a San Dimas, California manufacturer of electric drive systems for vehicles,

demonstrated its V2G system with the company’s “Gen-2” AC150 drivetrain at the Electric Transportation Industry conference in Sacramento in December of 2001. This drivetrain has been engineered to allow reverse power flow from EVs that incorporate its controller/inverter. AC Propulsion demonstrated a Beetle EV performing a grid ancillary service dispatched remotely via wireless internet (AC Propulsion, 2004). See Section 4.2 and Figure 4-4 for a description and picture of this concept, and Figure 5-4 below for a picture of the demonstration at the ETI conference.

Figure 5-4: AC Propulsion V2G Demonstration at 2001 Electric Transp. Industry Conf. in 2001 and (below) AC 150 Controller with Integrated Bi-directional Grid Interface

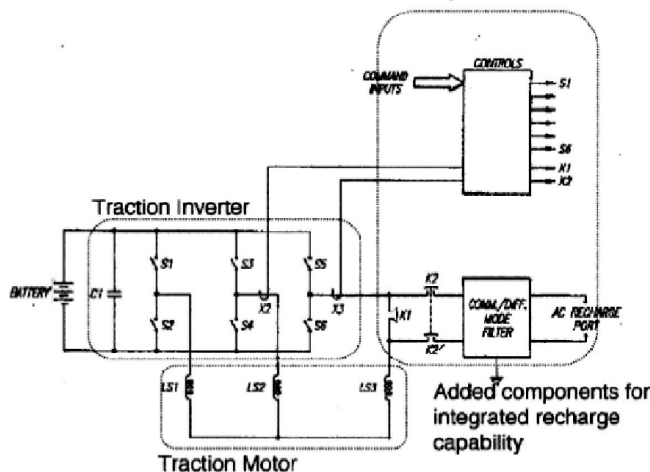

Source: AC Propulsion, 2004

6.0 Conclusions

This report has reviewed noteworthy advanced power technology programs around the U.S. and abroad. The focus of the report has been on programs that support research, development, and deployment of customer-sited DG technologies, particularly including fuel cell systems. Where utility-scale DG and advanced transportation technology programs are a major focus of activities, such as in Denmark, Japan, and China, we discuss these efforts briefly, but these types of additional technology programs are not the main focus of this report.

In sections 4 and 5 of the report, we also review concepts and specific projects that are linking stationary power technologies and transportation systems. These include concepts such as hydrogen energy stations that co-produce hydrogen for vehicles and electricity, the use of vehicle-based power (or “V2G”) to supply electrical power and/or grid ancillary services, and the use of DG systems to power electric vehicle fleets.

The overall goal of this report is to inform potential strategies and actions that the CaSFCC might undertake as it seeks to promote market development for stationary fuel cell systems in California. These efforts are important because of the economic *and* environmental benefits that stationary fuel cell systems can provide for the State as they become more developed and more widely deployed. Stationary fuel cells can reduce emissions of criteria pollutants and GHGs compared with central power plant generation, and with continued cost declines and the avoidance of transmission losses may be able to produce power at lower costs due to their high operational efficiencies (especially when used in CHP mode).

6.1 Overall Findings from Power Program Review

Based on our review of U.S. state and international power programs, we have found that the motivation for and nature, extent, and apparent effectiveness of these programs varies widely around the globe. In general, programs in the U.S. tend to be motivated by economic development and air quality concerns, with a desire for fuel diversity as an additional driver in some states. In Europe, greenhouse gas emission reductions are a much stronger driver than they are in the U.S., and generally the most important overall motivation behind efforts to introduce renewables, fuel cells, and CHP systems. In Asia, economic development is the primary driver, with environmental and fuel diversity concerns also playing a role in some countries.

Additional overall conclusions include the following:

- Demand-side purchase incentives have been highly effective in some nations/states in stimulating clean energy technology markets for customer-sited systems such as solar PV. The heavy Japanese (until recently) and German incentive programs for solar PV, and additional programs in various parts of the U.S., have been largely driving the 20-30% growth rates seen in PV manufacturing in recent years.
- Renewable obligation credit and RPS measures that are applied at the utility

procurement level are more likely to stimulate utility-scale wind farm and other large-scale renewable power system development than customer-sited DG. This is primarily due to the relatively attractive economics of these systems and for reasons related to the economics, logistics, and politics of customer-sited generation.

- Most U.S. state and many national programs emphasize either *supply-side* technology development efforts (R&D support and incentives for manufacturing) or *demand-side* market incentive measures, but not both simultaneously. Where this has been done, market development efforts appear to have been aided and both industrial development and domestic technology installations have resulted. Examples include Japan, Germany, and in parts of the U.S. where state-level market incentive measures have complemented federal and state R&D and industrial development support (e.g., New York, California, and Connecticut). The combination of these two types of mechanisms as a “push-pull” strategy seems to be particularly effective.
- A recent thrust of some efforts, particularly in Michigan, Ohio, and the UK, is to focus on establishing industrial “clusters” that form a geographically concentrated group of companies working on advanced power technologies, at the original equipment manufacturer and/or component supply levels. These programs hope to contribute to local economic development, as well as fostering industry learning due to the close proximity of companies working on similar technologies. Though much intellectual property in these high technology areas are proprietary, these industrial clusters provide enhanced possibilities for strategic alliances and other potential “spillovers.” These efforts are at too early a stage to reasonably begin to assess success or failure, but they appear to be gaining some momentum.
- With regard to fuel cell system development, states and nations with strong automobile industry presence are emphasizing automotive fuel cells (e.g., Japan, Germany, Michigan, and Ohio) while states and nations with or near a strong base of stationary-market focused fuel cell companies are emphasizing development of those markets (e.g., Connecticut, New York, Massachusetts, and to some extent Canada). However, some automotive fuel cell developers such as Ballard, Hydrogenics, and GM are increasingly exploring stationary markets, and this may lead to modifications in some state and nation advanced technology policy efforts as well.
- As noted above, efforts in Europe are more strongly focused on the issue of GHG emissions and climate change than those in the U.S. and Asia. For many U.S. states and Asian nations, economic development is a primary driver, with additional drivers including energy diversity/security and local air quality concerns. These different drivers have an effect on shaping the nature and design of incentive and other market development programs.

6.2 Lessons From Renewable Energy R&D and Deployment Efforts

Incentive programs to promote renewables are relevant to other advanced power technologies because many of the advanced power technology programs discussed above are closely related to efforts to promote renewables. The solar PV industry in particular, being largely composed of customer-sited installations, is closer in nature to most other DG technologies than the wind power industry. Experiences with solar PV market development programs have particularly relevant lessons to share with regard to the prospects for DG more generally.

In general, pincentive measures of various types have been successful in stimulating both wind power and solar PV market development, with significant economic and environmental benefits accruing as a result. Figures 6-1 and 6-2 show recent global growth in the wind and solar power industries.

Figure 6-1: Recent Global Growth in Wind Power Additions and Capacity

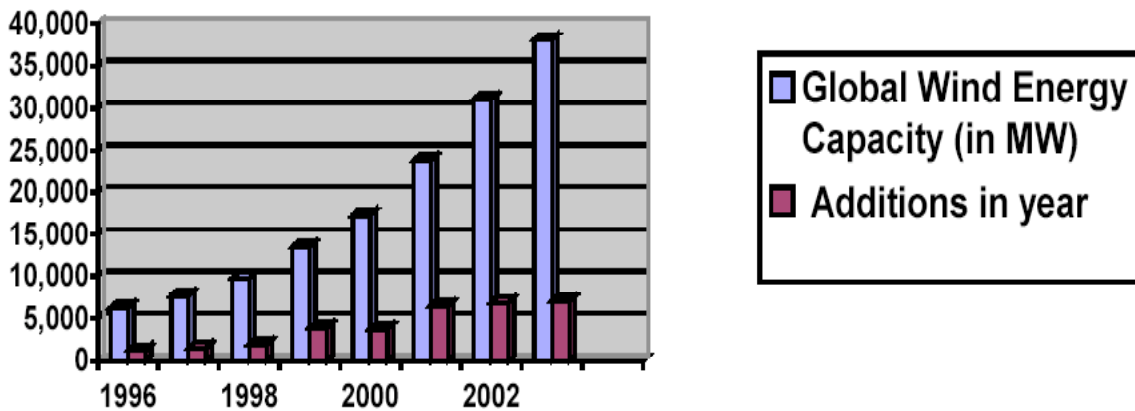

Source: AWEA, 2003

Figure 6-2: Historic Growth in the Global Solar PV Market (MW)

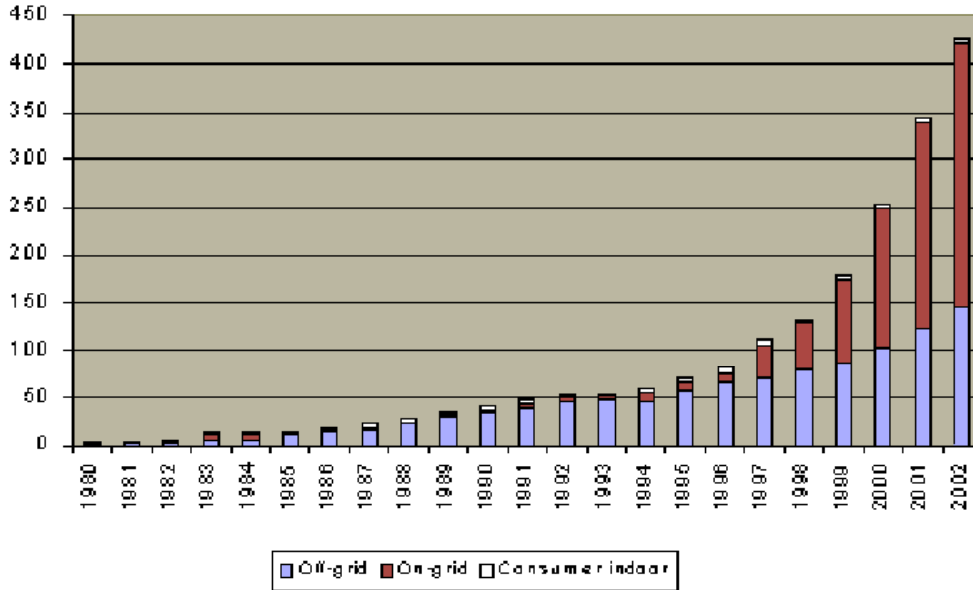

Source: Solarbuzz, 2004

This market growth was accompanied by cost declines that have allowed additional markets to open, through the so-called “virtuous circle” of increased production volume and product and manufacturing process innovation, and declines in technology manufacturing costs. Figure 6-3 below, presents a historical “learning curve” for solar PV and wind power technologies, along with older data for gas turbine systems. These curves show how all technologies have experienced cost reductions with the accumulation of manufacturing experience (expressed in terms of cumulative production over time), and how efforts to open markets for and otherwise deploy technologies can help to reduce their costs.

Figure 6-3: Experience Curves for Solar PV, Wind Generators, and Gas Turbines

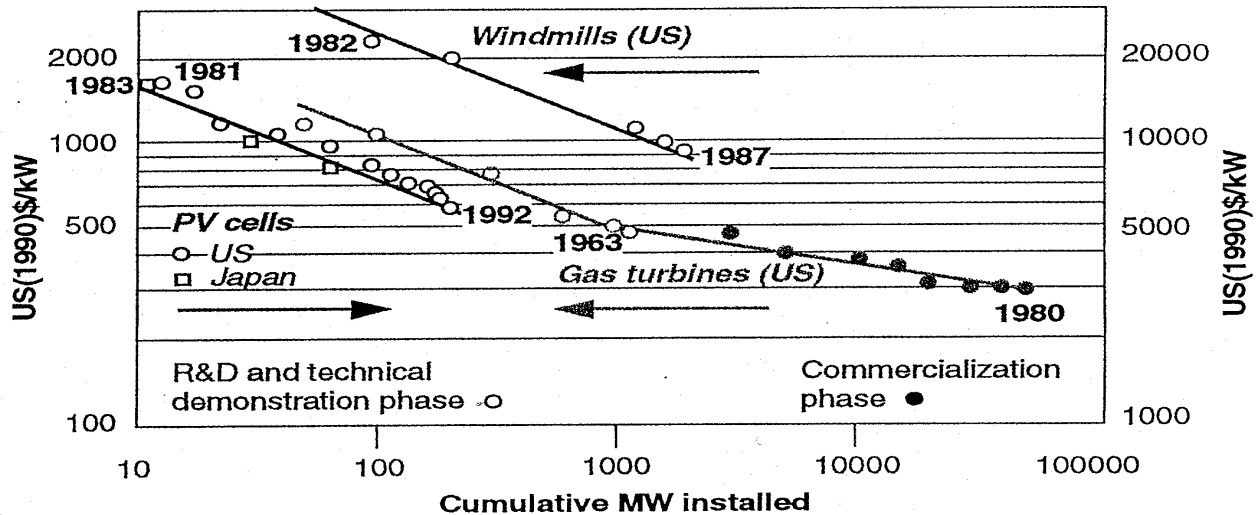

Note: All three technologies display initial progress ratios of approximately 0.8 (the “80% learning curve” often observed); however, after 1963 the gas turbine PR increased substantially, indicating attenuated experience effects. Source: IIASA/WEC (1995).

Some of the aspects of renewable energy technology buy-down programs that have proven important for solar PV could also be included in fuel cell and other DG programs. These include:

- Combining buy-down programs with performance incentives (e.g. based on system output and not only on placement/installation);
- Mandating that to be eligible for a buy-down program, manufacturers of advanced DG systems have to offer a 5-year warranty; and
- Maintenance programs or service contracts could be required to be included with the system purchase in order to be eligible for a rebate.

An important difference between solar PV and fuel cell systems is that solar PV is now a relatively mature technology where further improvements are likely to be incremental. Fuel cell systems, on the other hand, are changing more quickly and have still not settled on a dominant design. The expectation that fuel cells may see dramatic declines in price over the next ten to twenty years, with corresponding growth in fuel cell industry development, has created interest in the potential regional economic development benefits of the fuel cell industry.

A second significant difference between solar PV and fuel cell technology is the role that niche markets can potentially play. In the history of incentive programs for solar PV, there was a strong and consistent emphasis on the need to identify and develop niche markets for PV applications. Unfortunately, with solar PV it has proven difficult to identify niches large enough to greatly enhance market demand and reduce manufacturing costs. PV system prices have declined slowly and steadily, due to a combination of greater production volumes and learning

economies, but this has been due to broad industry growth and has not been led by any particularly successful niches having been found.

However, for two reasons niche markets could play a very different role for fuel cells and other emerging DG technologies. First, fuel cell technology is at a relatively early stage in technology development, so niche markets can play a potentially important role in accelerating the learning curve. Second, niche markets for fuel cells are potentially much larger than for solar PV. An example includes applications where fuel cells are used to ensure reliability. These are potentially large markets, and customers may be willing to pay a significant premium for the technology. As a result, including niche development in incentive programs, for example by providing higher incentives for selected applications, like reliability, may be an effective way to accelerate commercialization.

6.3 Additional Critical Issues for the Incentive and Market Development Programs

Based on our review of U.S. and international power programs, we find that the following additional issues have been and are important for historic programs, and should be considered in developing new programs and revising older ones.

6.3.1 Consistency and Certainty with Regard to Regulatory Signals

First, as the current situation in the UK with regard to the uncertain value of ROCs past 2010 highlights, it is critical in the promulgation of incentive and credit-obligation programs for industry to have certainty with regard to the future of the programs so that they can plan accordingly and so that project financing can be arranged. This does not mean that incentives necessarily have to stay in place, but if not then a clear phase-out or “sunset” plan should be developed. This need must be balanced against the potential advantages of having some degree of regulatory flexibility, to adjust targets and goals in light of innovation and technological progress (e.g., as with the CA zero-emission vehicle mandate). In general, however, uncertainty with regard to project benefits, arising from uncertain program incentive/credit levels, can be highly detrimental to markets for emerging energy technologies as they already tend to be hampered by some level of uncertainty with regard to system technical performance.

6.3.2 The Potential Benefits of “Road-mapping” and Program Targets

Many countries have developed technology development and deployment “roadmaps.” These seem to be helpful in allowing strategic thinking for program design and implementation, and helping to involve various stakeholders and “getting everyone on the same page.” Japan, Canada, and many European nations have developed roadmaps for DG and/or fuel cell deployment. Similar efforts have been undertaken within the U.S., but primarily at the federal (U.S. DOE) level and less so at the state or regional levels.

Also, setting targets is often part of the road-mapping process. These targets can serve a purpose that goes beyond the details of the roadmap if they are announced publicly and embraced seriously. In Japan, for example, reference to the national targets for fuel cell vehicles and stationary fuel cells in 2020 are included in presentations both by government officials and corporations. The simplicity of a few easy to convey targets can be an effective way to translate the details of road-mapping processes into long-term goals. The CaSFCC’s goal of 50MW by

2006 is one such target, but a series of longer-term goals might help to show a larger vision for a more expansive market.

6.3.3 The Importance of Strong Political Leadership

Highly visible support of advanced power programs from the highest elected officials has been an important criterion in the success of programs abroad. Perhaps most notably, Germany, which has invested heavily in fuel cell R&D as well as launching commercialization programs, has had only mild success to date. The German Hydrogen Association blames part of its limited success on a lack of political support from officials. Public displays of commitment to advanced power technology by elected officials can be an important element of program success, as they can convince investors and entrepreneurs that commercialization programs have government commitment behind them and are not ephemeral.

6.3.4 The Appropriate Timing for Demand-Side Incentives

Many of the program managers and agency staff that we interviewed for this report in other states and countries believe that fuel cells are still sufficiently expensive that subsidizing demand is likely to produce very little actual deployment. This is similar in many ways to efforts to introduce renewable energy in the 1970s, when costs were simply too high to be “bridged” with demand-side incentives, even as costs steadily declined. Market success was therefore limited.

As a result, many of these programs have been structured to place investments in R&D, support infrastructure, and public purchase of fuel cells, rather than demand-side incentives targeted at wider markets. This has been generally true in the U.S., but even more the case in Canada, Japan, and Germany. Some U.S. states (e.g. Massachusetts) have even reduced their end-user subsidies because of this rationale.

California and other states should thus carefully consider the potential effectiveness of demand-side incentives in making the economics of fuel cell installations attractive (such as with the CPUC SGIP), and consider programs such as state purchases of systems and other demonstration project efforts if instituting more general programs of demand-side incentives seems premature. With regard to stationary fuel cells, the most widespread deployment has occurred when government has directly purchased fuel cell systems, rather than subsidizing end-users. New York and German state and city government programs are examples where dozens of fuel cell systems have been installed in this way.

6.3.5 Interaction with other Primary Policy Drivers

Markets for DG and broader DER technologies are likely to interact with several other policy thrusts in complicated and potentially enforcing or prohibiting ways. In addition to the general nature of U.S. energy policy in being relatively encouraging or discouraging to DER (with regard to incentive and R&D funding through the U.S. DOE and other agencies), these include most notably state RPS policies (see below), state net-metering policies (see Appendix A), potentially cross-cutting energy infrastructure programs such as the recently-announced Hydrogen Highways program in California, and individual state public utility commission (PUC) proceedings with regard to implementation of electricity rate schedules, market access for DG, incentives and tax provisions of legislation, and so on. These programs have been discussed throughout this report, and the findings can be summarized as follows.

State RPS policies are likely to especially stimulate wind power especially due to the relatively competitive costs of wind electricity, as well as some additional solar PV and biomass energy developments. In some cases broader DG markets may be stimulated as well, but only a few states or nations allow fossil-based sources to be included so fuel cells as well as engines and turbines would need to run on renewable sources to be included.

There is no harmonized RPS standard at the federal level in the U.S., and though this has been discussed in the past as part of a more comprehensive national energy policy, it has stalled with regard to the political-economic considerations associated with the forecast shifts in state economies (e.g. transfers to the major wind states in the north-central part of the country and agricultural producers in the midwest). Figure 6-4 summarizes the major RPS standards programs in the U.S.

Figure 6-4: State-level Renewable Portfolio Standard Policies in the U.S.

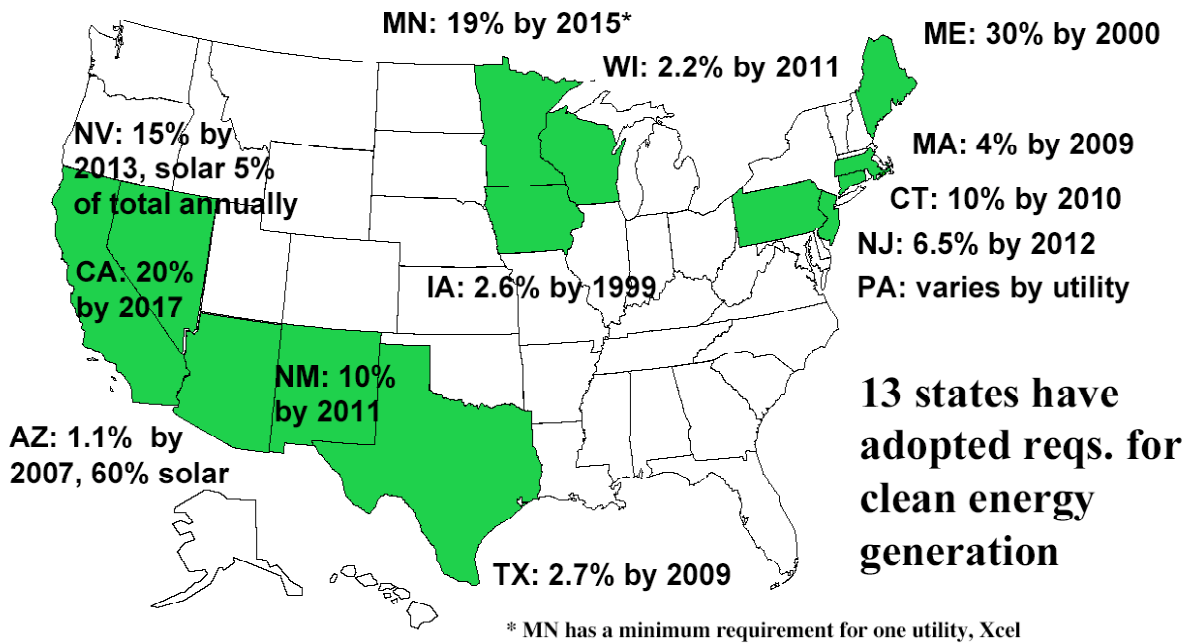

Note: In addition to the programs shown in the figure, the states of New York and Hawaii are currently in the process of adopting RPS measures.

State net-metering programs can be important to enabling DG market penetration, particularly for intermittent solar PV and wind systems. Fuel cell systems and other DG can potentially take advantage of net-metering as well if allowed, but this is typically less important than for intermittent renewables. This depends on how the generation is sized, the shape of the load profiles for the local application, and also depends on the market rules for crediting power generation that is added to the grid (i.e. credited at full retail prices, able to take advantage of time-of-use rate schedules, etc.). See Appendix A for a summary table of U.S. state DG net-metering programs.

Crosscutting policies, especially with transportation for the development of hydrogen infrastructure such as in California and Canada, may prove to be significant policy drivers for DG systems as well. This is due to schemes such as those discussed in Sections 4 and 5 for linking these two types of systems, especially “hydrogen energy stations” that would link electrical power production with hydrogen vehicle refueling.

Additionally, the prospects for DG and DER development are potentially strongly affected by individual state PUC decisions, and similar regulatory decisions internationally. These decisions affect local electricity rates and rate structures, market access rules and charges for DG, the application of grid interconnection procedures, and market access by generators and customers more generally. These decisions are highly variable between states and countries, particularly with regard to the overall context of market deregulation, and virtually all state PUC and other electricity commissions have ongoing proceedings that argue for various changes to the current situation with regard to DG.

6.3.6 Programs for Industrial “Cluster” Development

Efforts to lure fuel cell and other DG system manufacturers, such as with tax breaks, or in building technology parks as Michigan has done, have not yet proven to be particularly successful. These types of efforts have been relatively expensive for industry recruiting in other industries such as biotech, and this appears to be the case for DER industrial cluster development efforts as well. For example, Michigan’s five-year \$52 million budget for building its “NextEnergy” fuel cell center is of similar magnitude to the entire fuel cell budgets for the federal governments of Canada (\$80-100 million over 5 years) and China (about \$50-75 million over 5 years).

We are skeptical that these programs can produce as much value for the amount of funding spent than other programs that combine R&D support with other deployments efforts that are more direct. These include engaging in public-private partnerships to conduct demonstrations and place DER systems at public facilities (e.g., state office building, military facilities, universities and colleges, correctional facilities, transportation and transit maintenance and operations facilities, etc.). We note here that there are interesting synergies that can be exploited between various DER markets and some customer groups. These include those that produce “opportunity fuel” such as methane from landfills or water treatment plants, military facilities that require emergency backup power for critical loads as well as have a desire to be “good citizens” within their local communities by contributing to environmental protection, and electric transit operations that confront high power demands along with concerns about emergency power interruptions.

6.4 The Broader Energy Technology Context – Potential for Lessons Learned

This report has focused primarily on examining lessons learned from R&D programs for “customer-sited” DG systems, including stationary fuel cells, CHP systems, and other DG systems. To a much lesser extent we also have discussed programs that include for utility-scale wind power and advanced transportation technologies based on fuel cells and hydrogen. While these technologies are the most closely related to the stationary fuel cell market development

efforts of interest to the CaSFCC, we note that lessons learned from other energy technology market development efforts may be useful in informing potentially attractive options for stimulating stationary fuel cell markets.

These additional technologies include energy efficiency related technologies, such as more efficient end use devices (e.g. lighting systems, boilers, furnaces, chillers, other appliances, etc.), electricity demand response technologies (smart meters and thermostats and other electrical load curtailment systems), emission control systems for power plants, and advanced transportation technologies. While all of these technology groups are different in certain key respects from DG and stationary fuel cell systems, some of the lessons learned through efforts to develop markets and promote their deployment may be useful in helping to inform potential strategies for DG market development. Analysis of market development programs for these broader technology sets is beyond the scope of this report, but we hope that in the future we or others will be able to build on the work conducted here by including insights from past and ongoing experiences with these other technology markets.

6.5 Linked Transportation and Stationary Power Systems

Sections 4 and 5 of this report reviewed concepts for combining advanced transportation and stationary power systems, along with actual projects that have been conducted or initiated that combine these two types of systems in some fashion. These include systems that combine electricity production with advanced vehicle refueling, systems that use advanced electric vehicles for power and/or grid ancillary services, and DG systems that are used to recharge or power electric-drive vehicles, heavy-duty vehicles (while parked at truck stops), and transit systems.

We find that there are many possible and some potentially very interesting concepts that would link transportation systems and DER systems, but relatively few actual demonstration projects conducted to date. These include a few “hydrogen energy station” demonstration projects, the use of automotive fuel cell systems in a stationary power setting near a chemical plant that produces by-product hydrogen, a “vehicle-to-grid” power demonstration project, and a fuel cell system that is being used to recharge a fleet of shared-use electric vehicles. Hydrogen energy station developments may get a significant push from the recently announced California “Hydrogen Highways” initiative, that specifically calls out their use as part of the state’s future hydrogen refueling network.

6.6 Specific Recommendations for the CaSFCC

With regard to the stated mission of the CaSFCC, “to take specific actions to promote a wide variety of fuel cell technologies, sizes and applications for installation in California,” we have a number of recommendations that the Collaborative might consider. These recommendations reflect our understanding of the current technological status and trajectory of stationary fuel cell systems. In general, we recommend an overall “push-pull” strategy, where market demand-pull measures are combined with support for technology R&D and manufacturing cost reductions. These combined programs have proven to be effective in the past, particularly with regard to solar PV development and deployment in Japan.

First, we suggest that the CaSFCC *not* promote efforts similar to those in some other states to provide tax “holiday” and other measures to develop “industry clusters” within California for fuel cell system development and manufacturing. Our research suggests that these programs are relatively expensive and have provided limited success to date where they have been tried. We therefore do not recommend them *unless* jobs creation within California becomes a strong motivation for Collaborative activities. We feel that funds that the State might allocate toward this type of program could be more effectively spent for other programs that would be more likely to successfully develop fuel cell system markets in California.

Second, we suggest that the Collaborative continue with its activities to explore early markets and applications for fuel cell technologies, but we suggest re-orienting these programs to include additional markets as well as potential placements within State government facilities. While State buildings offer an interesting potential market opportunity, the current budget crisis in California makes the premium price of fuel cell based generation a difficult barrier. One public sector market opportunity that should be explored is the university and college campus sector, where recent initiatives have emphasized clean energy technologies and energy efficiency. One noteworthy development in this regard is the passage on July 17, 2003 of the University of California system-wide “Green Building Policy and Clean Energy Standard.” The main features of this policy require (University of California, 2003):

- The University to adopt principles of energy efficiency and sustainability in its capital projects to the fullest extent possible, consistent with budgetary constraints and regulatory and programmatic requirements;
- The University to minimize its impact on the environment and reduce non-renewable energy use by purchasing green power from the electrical grid, promoting energy efficiency, and creating local renewable power sources; and
- The development and implementation of this policy for all proposed and existing University facilities.

While budgetary constraints within the University of California system will also be a potential hindrance to consideration of fuel cell system installation under this policy, such installations would surely receive greater consideration than they previously would. Additional target markets for fuel cell system deployment that the CaSFCC might wish to explore include the “premium power” market where certain industries and commercial interests have critical loads that require reliable backup power and where fuel cell systems’ high reliability might be a competitive advantage, noise-sensitive applications such as at hospitals and other health care facilities, and opportunities to showcase the most technologically advanced DG technologies such as space and science museums and technology learning centers.

Third, we recommend that at the appropriate juncture the CaSFCC support continuation of the CPUC SGIP program beyond its current end date of 2008. This program provides critical capital cost buy-down support for fuel cell systems among other technologies, making installations attractive where they might otherwise be marginal or unattractive from an economic standpoint. Even with the SGIP program, fuel cell systems face a relative cost disadvantage compared with other more conventional DG types. The 2003 CaSFCC market survey indicates that fuel cell

system costs are expected to average above \$3,000 per kW through at least 2006 (CaSFCC, 2003), and capital cost buy-down programs for fuel cells are likely to be important through (in our view) at least 2010. Even with their relatively high costs, for some customers the incentives provided by the SGIP will bring costs down enough that the installation of fuel cells may be attractive given the additional benefits that fuel cell systems can offer. As one recent California fuel cell customer noted:

[T]he heat and power derived from these fuel cell power plants will reduce our energy costs compared with what we were paying from the grid. We could have saved even more by going with traditional, combustion-based natural gas generators, but we are willing to pay a premium for the environmental benefits delivered by the FuelCell Energy power plants. -- Ken Grossman, founder and owner of Sierra Nevada Brewing Co., quoted in a FuelCell Energy press release dated April 28, 2004

Given the “manufacturing experience curve” discussion above, fuel cell system production is important to generate manufacturing experience and production process improvement that can lead to cost reductions. The SGIP and other incentive programs that stimulate the demand side of fuel cell markets are thus important in this regard.

Fourth, we suggest that the Collaborative pay close attention to and become more active in the fuel cell system deployment policy arena, including the evolution of California market rules for DG. Such issues as rules for “standby fees,” “exit fees,” and net-metering/co-metering can have important implications for fuel cell system markets. Recent concessions in the area of standby fees for “ultra clean” DG of under 1 MW in size are encouraging in this regard, but we note that these programs exempt other technologies than fuel cell systems. More finely parsed programs that preferentially benefit the cleanest technologies could have a more beneficial effect for fuel cells, and we recommend that the Collaborative consider proposing such programs.

Fifth, we suggest that the Collaborative explore the recently announced “Green Wave” clean energy technology investment program developed by State Treasurer Angelides.² This program seeks solid returns on investments for the State’s pension funds (CalPERS and CalSTRS -- the first and third largest pension funds in the country) while also spurring clean energy technology development in California. The program may therefore tend to focus investments in companies that are either at or nearer to the point of profitability than most fuel cell companies. However, the funds available through this program for investment in industry are considerable, and this program should be investigated by the Collaborative for its potential to provide investments for fuel cell system R&D.

Sixth, we suggest that the collaborative issue policy recommendations for higher levels of federal R&D for stationary fuel cell development. Recent U.S. DOE efforts have emphasized fuel cells for transportation applications, but due to cost and onboard hydrogen storage challenges these markets are likely more distant than those for stationary fuel cells. The Collaborative should consider issuing policy recommendations to DOE that suggest increased stationary fuel cell R&D activities, and that highlight the potential for spillovers from stationary fuel cell R&D efforts to benefit automotive fuel cell development.

²See <http://www.treasurer.ca.gov/news/greenwave.htm>

Seventh, we suggest that the Collaborative examine the potential role of stationary fuel cells in the “Hydrogen Highways” program announced by Gov. Schwarzenegger on April 20, 2004. As noted above, the Executive Order specifically calls out the potential for hydrogen energy stations to play a role in the State’s hydrogen infrastructure development plans -- and as discussed in Section 4 of this report most hydrogen energy station concepts would have at their core some type of stationary fuel cell system. This Hydrogen Highways initiative may thus have significant implications for stationary fuel cell deployment, as the State pursues the development of hydrogen vehicle refueling infrastructure over the next several years.

Finally, in addition to those discussed above, additional project ideas and prospects that the Collaborative may wish to pursue include the following:

- Examine the potential for fuel cell system R&D and deployment experiments as part of a \$15 million “clean technology incubator” that PG&E will be establishing as part of the company’s Chapter 11 bankruptcy settlement announced on April 12, 2004. The details of this program have yet to be disclosed, but the settlement calls for PG&E to establish and fund a non-profit incubator that will be dedicated to supporting research and investment in clean energy technologies in the PG&E service territory, presumably including fuel cell systems.
- In addition to exploring the role of hydrogen fuel cell systems in the context of the California Hydrogen Highways initiative, also explore the potential for hydrogen energy stations in the context of the recent U.S. DOE award for hydrogen “vehicle and infrastructure learning demonstrations.” While the details of plans for activities under these awards are just beginning to be disclosed, at least two of these efforts are either considering or planning to integrate stationary fuel cell systems as part of hydrogen vehicle refueling projects. Particularly if strategic partnerships with stationary fuel cell manufacturers can be arranged, additional hydrogen energy stations could potentially be developed as part of the project activities to be funded under this five-year, \$190 million set of awards.
- Examine the potential for the California Alternative Energy and Advanced Transportation Financing Authority (CAEATFA) to provide financing for fuel cell system installations at California facilities. This authority finances the installation new energy sources and technologies, as well as the development of advanced transportation technologies. The program is able to issue tax exempt and taxable bonds to California facility managers, for programs that qualify.
- Monitor the progress in establishing a revised natural gas public purpose program, under the CPUC, with regard to its potential for contributing, to fuel cell system R&D. Through the end of 2004, this program will continue to be administered by the investor-owned utilities under PUC oversight. However, starting in 2005 this program is expected to become a centrally administered, non-utility program with potentially expanded funding for natural gas related demand-side management, R&D, and other public purpose programs. The CPUC recently issued a proposed decision for this program to be administered by the University of California, and for funding to

be increased from the present level of \$4-5 million per year to up to \$12 million in 2005 and up to \$24 million by 2009 (see CPUC proceeding R-0210001 for more details).

- Collaborate with automotive fuel cell manufacturers who wish to test and demonstrate automotive fuel cell systems in stationary power settings. General Motors has gone on record stating that they are more interested in this type of demonstration program at present than in FCV demonstration programs (see Section 5 for more discussion of recent GM fuel cell demonstration project activities). These demonstration projects can generate important lessons learned with regard to stationary fuel cell system siting, grid interconnection, and operation, as well as providing operational experience with the automotive fuel cell systems.

6.7 Concluding Thoughts: The Importance of Market Development Programs for Emerging Technologies

Finally, we conclude by emphasizing that market development programs such as those reviewed in this report are often critical to the introduction of new technologies. In the case of DER systems, the potential benefits of market development are more wide-ranging and socially important than for many other technologies, including economic development as well as potential benefits to human and environmental health. These reasons add to other arguments for publicly funded market development programs for clean energy technologies. These arguments include most notably:

- The potential economic benefits to commercial, industrial, and residential electricity ratepayers of using DG and other cost-saving DER technologies (such as demand response and other energy efficiency systems);
- The potential for reductions in GHG and criteria air pollutant emissions, and other waste streams (e.g., mercury, toxics, etc.);
- The potential economic benefit to utility grids, including substation upgrade deferrals, reduction in need for power lines in rural areas, local voltage and reactive power (VAR) support, spinning reserves potential, and load-leveling of the grid (through “peak shaving”);
- The potential energy security and energy diversity benefits that DER resources can offer; and
- The fact that public sector involvement in R&D is often more generally required to prevent under-investment in innovation due to the difficulty that private firms have in fully appropriating the benefits of their own R&D and preventing “spillover” effects (see Duke and Kammen, 1999, for details on this latter point).

For these reasons, and particularly given the pressing environmental, social, and political problems that are caused by our present patterns of energy use, we believe that DER market and other clean technology development programs are especially worthy of consideration. We hope that this review and analysis proves useful to those who are considering developing or modifying such programs.

References

- Abe, T. (2003), “Japan’s Hydrogen Vision,” Hydrogen Energy Systems Technology Development Department, New Energy and Industrial Technology Development Organization (NEDO), Presentation at *IEA Renewable Energy Working Party Seminar*, March 3.
- AC Propulsion, Inc. (2002), *Vehicle-to-Grid Demonstration Project: Grid Regulation Ancillary Service with a Battery Electric Vehicle*, Prepared for the California Air Resources Board by A. Brooks, Contract number 01-313, December 10.
- AC Propulsion Inc. (2004), “Electric Transportation Industry Conference, Sacramento,” Worldwide Web, <http://www.acpropulsion.com>.
- AWEA (2003), “Wind Energy Market Report: Wind Energy Industry Continued to Grow at Fast Pace in 2002,” *Global Wind Energy Market Report*.
- Brodrick, C-J., T.E. Lipman, M. Farschi, N. Lutsey, H.A. Dwyer, D. Sperling, S.W. Gouse, D.B. Harris, and F.G. King (2002), “Evaluation of Fuel Cell Auxiliary Power Units for Heavy-Duty Diesel Trucks,” *Transportation Research – D* 7(4): 303-315.
- Brown, E. and R.N. Elliott (2003), *State Opportunities for Action: Update of State’s Combined Heat and Power Activities*, American Council for an Energy Efficient Economy, Report Number IE032, October.
- California Stationary Fuel Cell Collaborative (2004), Worldwide Web, <http://www.stationaryfuelcells.org>.
- California Stationary Fuel Cell Collaborative (CaSFCC) (2003), *White Paper Summary of Interviews with Stationary Fuel Cell Manufacturers*, August.
- California Public Utilities Commission (2004), *CPUC Self-Gen Program*, Worldwide Web, <http://www.ora.ca.gov/distgen/selfgen/sgips/index.htm>.
- California Energy Commission (2004a), *CEC Emerging Renewables Program*, Worldwide Web, http://www.consumerenergycenter.org/erprebate/new_info.html.
- California Energy Commission (2004b), *California Public Interest Energy Research (PIER) Program*, Worldwide Web, <http://www.energy.ca.gov/pier/index.html>.
- California Energy Commission (2003a), *Integrated Energy Policy Report*, Publication Number 100-03-019, Available at: <http://www.energy.ca.gov/energypolicy/index.html>, December.
- California Energy Commission (2003b), *Energy Innovations Small Grant Program*, <http://www.energy.ca.gov/research/innovations/index.html>.

California Fuel Cell Partnership (2004), *Progress Report 1999-2003*.

California Power Authority (2003), *Industrial Development Bond Financing Program*, Worldwide Web, <http://www.capowerauthority.ca.gov/News/IDB.htm>.

California Office of the Treasurer (2004), *The Green Wave Initiative*, Worldwide Web, <http://www.treasurer.ca.gov/news/greenwave.htm>.

Christo, J. (2003), Personal Communication, Massachusetts Renewable Energy Trust (MRET) and Fuel Cell Initiative, July 31.

City of Las Vegas (2002), “City of Las Vegas Dedicates World’s First Energy Station Featuring Hydrogen and Electricity: Public-Private Partnership Demonstrates Hydrogen As A Non-Polluting Alternative,” Official Media Release, November 14.

City of Toronto (2004), “Fuel Cell Demonstration Project Description,” Worldwide Web, http://www.city.toronto.on.ca/wes/techservices/fuel_cells/project.htm.

Clark, R.E. (2003), *Pennsylvania Fuel Cell Initiative*, Presentation at the Fuel Cell Investment Summit, March 17-18.

Clean Energy Funds Network (2000), *Renewable Energy Fund System Benefit Charge Summaries*, Worldwide Web, <http://www.cleanenergyfunds.org>.

Clean Energy Group (2003a), *Public Fuel Cell Alliance: Business Plan for Federal, State, and International Collaboration on Fuel Cell Deployment and Hydrogen Infrastructure*, Worldwide Web, <http://www.cleanegroup.org>.

Clean Energy Group (2003b), *Recent Trends in State Fuel Cell Funding, Deployment and Commercialization Programs*, Presentation at the National Organizing Workshop For State Fuel Cell Program Managers, Washington, DC, February 12, <http://www.cleanegroup.org>.

Connecticut Clean Energy Fund (2004), Worldwide Web, <http://www.ctcleanenergy.com>.

Connecticut Clean Energy Fund (2001), *Strategic Framework, 2001 – 2005: The Power of Tomorrow*, Available at: <http://www.ctcleanenergy.com>.

Danish Minister for Economic and Business Affairs (2003), *Energy Policy Statement 2003*, Pursuant to the Act on Energy Policy Measures, May.

Database of State Incentives for Renewable Energy (DSIRE) (2003), North Carolina State University, Available at: <http://www.dsireusa.org/>.

Delaware Economic Development Office (2003), Worldwide Web, <http://www.state.de.us/dedo>.

Delaware Energy Task Force (2002), Economic Development Work Group Meeting Minutes, August 22.

Duke, R. and D. Kammen (1999), “The economics of energy market transformation initiatives,” *The Energy Journal*, **20** (4): 15–64.

Elam, C. et al. (2003), “Realizing the Hydrogen Future: The International Energy Agency’s Efforts to Advance Hydrogen Energy Technologies,” *International Journal of Hydrogen Energy* **28**: 601-607.

European Commission (2003), *European Fuel Cell and Hydrogen Projects 1999-2002*, Brussels.

European Union, (2003), *Hydrogen Energy and Fuel Cells: A Vision of the Future*, High Level Group for Hydrogen and Fuel Cells, Summary Report, June.

Eye for Fuel Cells (2002), “Sanyo and Samsung Join Forces to Develop Emerging Technologies,” <http://www.eyeforfuelcells.com/ReportDisplay.asp?ReportID=1053>, January 15.

Foster, J. (2003), Personal Communication, Distributed Generation and Combined Heat & Power Program, NYSERDA, July 24.

Fraser, P. (2003), Personal Communication, International Energy Agency, November 13.

Fuel Cell Commercialization Conference of Japan (2004), Worldwide Web, <http://fccj.jp/index12.html>.

Fuel Cells Canada (2003a), *The Canadian Fuel Cell Commercialization Roadmap*, Vancouver BC, Available at: <http://strategis.ic.gc.ca/electrical>

Fuel Cells Canada (2003b), *The Canadian Fuel Cell and Hydrogen Industry: A Capabilities Guide*, Vancouver, BC, Available at: <http://www.fuelcellscanada.ca>

Fuel Cells UK (2003a), *A Fuel Cell Vision for the UK*, Synnogy Ltd., Available At: <http://www.fuelcellsuk.org>.

Fuel Cells UK (2003b), *Review of UK Fuel Cell Commercial Potential*, Available at: <http://www.fuelcellsuk.org>.

Gecils, I. and Schumacher, A. (2003), *Report on State Funding for Stationary Fuel Cells*, February, <http://www.cleanegroup.org>.

Geiger, S. (2003a), “Fuel Cells in Germany – A Survey of Current Developments,” *Fuel Cell Today*, June 18.

Geiger, S. (2003b), “Fuel Cells in China - A Survey of Current Developments”, *Fuel Cells Today*, October 15.

Gouchoe, S., V. Everette, and R. Haynes (2002), *Case Studies on the Effectiveness of State Financial Incentives for Renewable Energy*, National Renewable Energy Laboratory, September.

Hartnell, G. (2003), Personal Communication, The UK Renewable Power Association, November 24.

Haynes, R. (2003), *An Overview of U.S. State-Level Incentives and Policies Promoting Fuel Cell Technologies*, North Carolina State University.

Ho, H-K. (2003), "Fuel Cell Research, Development and Demonstration Activities in Singapore," *Fuel Cell Seminar*, November 4-7, Miami, Florida.

International Energy Agency (2003), *World Energy Outlook 2002*, Paris.

International Energy Agency (2002), *Distributed Generation in Liberalized Electricity Markets*, OECD/IEA, Paris.

International Institute for Advanced Study (IIASA) and World Energy Council (WEC) (1995), *Global Energy Perspectives to 2050 and Beyond*, Laxenburg, Austria and London, UK.

Kato, N. (2003), "Fuel Cell Status in Japan," Toshiba International Fuel Cells Corporation, Presentation, March 18.

Kempton, W., J. Tomic, S. Letendre, A. Brooks, and T. Lipman (2001), *Vehicle-to-Grid Power: Battery, Hybrid, and Fuel Cell Vehicles as Resources for Distributed Electric Power in California*, Inst. of Transportation Studies, Davis, UCD-ITS-RR-01-03, Prepared for: California Air Resources Board (under contract #ARB00-612) and Los Angeles Department of Water and Power, June.

King, R.J. et al (2003), *Fuel Cells and the States*, Fuel Cells Texas, <http://www.fuelcellstexas.org>, October.

Kissock, J. K. (1998). "Combined Heat and Power for Buildings Using Fuel-Cell Cars," *ASME International Solar Energy Conference*, Albuquerque, NM.

Kling, C. (2003), Personal Communication, New Jersey Clean Energy Program, August 1.

Kuntzsch, R. (2003), Personal Communication, Michigan NextEnergy, September, 8.

L-B-Systemtechnik (2003), *Existing Hydrogen Refueling Station Projects*, Worldwide Web <http://www.h2cars.de/filling/index.html> (last updated February 2003).

Lipman, T. E., J. L. Edwards, and D. M. Kammen (2002a), “Economic Analysis of Hydrogen Energy Station Concepts: Are “H2E-Stations” a Key Link to a Hydrogen Fuel Cell Vehicle Infrastructure?” Energy Development and Technology Working Paper Series, EDT-003, University of California Energy Institute (UCEI), November.

Lipman, T. E., J. L. Edwards, and D. M. Kammen (2002b), “Economic Implications of Net Metering for Stationary and Motor Vehicle Fuel Cell Systems in California,” Program on Workable Energy Regulation (POWER) Paper Series, PWP-092, University of California Energy Institute (UCEI), February.

McKay, M. (2003a), Personal Communication, Team Leader, Ohio Fuel Cell Initiative, July 30.

McKay, M. (2003b), *Ohio’s Fuel Cell Initiative*, Presentation, Available at: <http://www.thirdfrontier.com>.

Michigan NextEnergy (2004), *Striking Connections in Alternative Energy Technologies*, Worldwide Web, <http://www.nextenergy.org>.

Michigan NextEnergy (2003), *NextEnergy: Promoting Alternative Energy Technology*, Presentation at the State Fuel Cell Managers Meeting, Washington, DC, February 12, Available at: <http://www.nextenergy.org>.

Ministry of Economy, Trade and Industry (2004), Worldwide Web, <http://www.meti.go.jp/english>.

Natural Resources Canada (2004), Institute for Fuel Cell Innovation, Worldwide Web, <http://ifci-iipc.nrc-cnrc.gc.ca/about.html>.

New Jersey Clean Energy Program (2004), Worldwide Web, <http://www.njcep.com>.

NYSERDA (2003), *NYSERDA CHP Case Studies/Success Stories*, <http://www.nyserda.org/industry/chpcasestudies.html>.

Okano, K. (2003), “Hydrogen And Fuel Cell Activities In Japan,” *Energy Systems Society Of Japan*, Presentation, February 14.

Outhred, H. (2003), “The Evolving Australian National Electricity Market: An Assessment,” Professor at University of New South Wales, Electricity Restructuring Group, Sydney, Presented at Lawrence Berkeley National Lab, December 11 (see <http://www.ergo.ee.unsw.edu.au>).

Patibandla, N. (2003), *Distributed Generation In New York’s Deregulated Market*, Presentation, Available at: <http://www.nyserda.org>.

Plug Power (2003), “Plug Power and Honda Demonstrate Home Energy Station,” Press Release in *Fuel Cell Today*, October 2.

Pratt, R. (2003), *The Massachusetts Renewable Energy Trust: Harnessing the Power Of Innovation*, Presentation, Massachusetts Technology Collaborative, Available at <http://www.mtpc.org>.

QuestAir Technologies Inc. (2003), “QuestAir Technologies Installs HyQuestor• Hydrogen Purifier at Toronto Hydrogen Power Demonstration,” Official Media Release, August 27.

Schmidtchen, U., (2003), Personal Communications, Executive Director, German Hydrogen Association, December 23.

Solarbuzz (2004), “Solar Energy Industry Statistics: Growth,” Worldwide Web, <http://search.solarbuzz.com/StatsGrowth.htm>.

Sorensen, B. (2002), *Trends in the Danish Hydrogen and Fuel Cell Programmes*, Roskilde University.

Stuart Energy Systems (2003), “Stuart Energy Receives Groundbreaking Order from South Coast Air Quality Management District for Hydrogen Energy Station in California,” Official Medial Release, November 17.

State of Hawaii (2003), Department of Business, Economic Development and Tourism, Strategic Industries Division, Energy Branch, Worldwide Web, <http://www.state.hi.us/dbedt/ert/energy.html>.

SUSTELNET (2004), Worldwide Web, <http://www.sustelnet.net>.

Thai Government Delegation (2003), Department of Alternative Energy Development and Efficiency, California Renewable Energy Study Tour, Berkeley, California, December 11.

The Canadian Transportation Fuel Cell Alliance (2004), Worldwide Web, http://www.nrcan.gc.ca/es/etb/ctfca/index_e.html.

The Globe and Mail (2003), Special Supplement on June 9, “Clean Energy for the Hydrogen Planet: The Global Acceleration of Hydrogen Fuel Cell Development.”

UK Carbon Trust (2003), *Annual Review 2002-2003*.

University of California (2003), “Green Building Policy and Clean Energy Standard,” Office of Strategic Communications, August.

University of South Carolina (2003), *Prospectus for the National Science Foundation Industry/University Cooperative Research Center for Fuel Cells*, <http://www.che.sc.edu/centers/PEMFC/index.html>, March.

U.S. Combined Heat and Power Association (U.S. CHPA) (2001), *National CHP Roadmap: Doubling Combined Heat and Power Capacity in the U.S. by 2010*, In Cooperation with U.S. Department of Energy and U.S. Environmental Protection Agency, Washington, D.C.

UTC Fuel Cells (2003), Worldwide Web, <http://www.utcfuelcells.com/index.htm>.

Vincent, D. and G. Staunton (2003), Personal Communication, The UK Carbon Trust, November 24.

Wiser, R. (2003a), Personal Communication, Energy Analysis Department, Lawrence Berkeley National Laboratory, October 16.

Wiser, R. (2003b), Personal Communication, Energy Analysis Department, Lawrence Berkeley National Laboratory, November 6.

World Alliance for Decentralized Energy (WADE) (2003), *World Survey of Decentralized Energy 2002/2003*, Worldwide Web, <http://www.localpower.org/pages/globaldedata.htm>.

ZEV-NET (2004), “Zero Emission Vehicle · Network Enabled Transport (ZEV·NET) provides commuters an alternative,” Worldwide Web, <http://www.zevnet.org>.

Appendix A: Summary of Distributed Generation System Net Metering Rules By State

Information in Table A-1 Collected from:

- DSIRE Database of State Incentives for Renewable Energy:
<http://www.dcs.ncsu.edu/solar/dsire/regulatory.html>
- Efficiency and Renewable Energy Network: <http://www.eren.doe.gov/greenpower/netmetering>
- Union of Concerned Scientists: <http://www.ucsusa.org/energy/statenet.pdf>

Abbreviations Used in Table A-1:

AF = alternative fuels; all customer classes = residential, industrial, and commercial; FC = fuel cell; kW = kilowatts; MW = megawatts; PV = solar photovoltaics; renewables = solar photovoltaics, wind, biomass, geothermal, and hydropower; NEG = net electricity generation.

Table A-1: Summary of Net Metering Rules by State

State	Allowable Technology	Allowable Customer	Allowable Capacity	Statewide Limit	Treatment of Net excess Generation	Enacted	Reference
Arizona 1)	All Renewables	All	10 kW	None	Purchased at avoided cost.	1994	Tariff EPR-4
2)	Qualifying Facilities (defined by PURPA)	All	100 kW	None	fixed rate may-oct: 4.4¢ Com., 4.84¢ ncom. Nov-apr: 3.5¢ com, 3.85¢ ncom	1996	Tariffs No. 101 & No. 102
Arkansas	All Renewables, Fuel Cells, Microturbines	All	25 kW res. 100 kW com.	Determined by PUC	Determined by PUC	2001	Legislative code HB 2325
California	Solar, Wind	All	1 MW	None	Granted to utility at year end	1/1/96 updated 1998, 2000, & 4/01	Senate Bill 656 CPUC 2827 AB29X in 4/01
Colorado	Renewables, AF, Cogen, Fuel Cells (DSIRE) PV, Wind (EREN)	All	10 kW	None	Excess carried over month-to-month	1994	C88-726, C88-1136, C96-901, PSCC advice letter 1265
Connecticut	Renewables (no Geothermal), Fuel Cells	Residential	None	None	Monthly NEG purchased at avoided cost	1990, updated 1998	CPUCA 159 ERPA 98-28
Delaware	Renewables	Residential, Small Commercial.	25 kW	None	Monthly NEG purchased at avoided cost	1999	Senate Amend. 1 HB10
District of Columbia	Fuel Cells, Solar, Wind, Biomass, Microturbine	All	100 kW	None	12 month carry forward	2000	
Georgia	PV, Wind, Fuel Cells	All	10 kW Res. 100 kW Com.	.2% system peak	Monthly NEG purchased at avoided cost. Higher rate if green priced.	2001	SB 93

Hawaii	PV, Wind, Biomass, Hydro	Residential, Commercial.	10 kW	.5% peak demand	Granted to utility	2001	Act 272 (HB 173)
Idaho	Renewables, Waste, Renewable Transportation Fuel (DSIRE) Cogen also (EREN)	Residential, Commercial.	100 kW	None	Monthly NEG purchased at avoided cost	1986	Idaho PUC order 16025. Tariff sheets 86-1 to 86-7
Illinois	PV, Wind, Biomass (DSIRE) Solar, Wind (EREN)	All	40 kW	.1% annual peak demand	Avoided cost	1999	ICC Title 83, Ch 1-c, Part 430
Indiana	Renewables, Waste, Cogen., Renewable transportation fuels	All	1000 kWh per month	None	Granted to utility. For >1000 kWh, generator can request purchase	1985	Indiana Administrative Code Title 170 §4-4.1-7
Iowa	Facility that derives 75% of its input from solar, wind, waste management, resource recovery, or biomass/ agricultural fuels. (fuel cells meeting above would count)	All	None	None	Avoided cost	1993 expiration pending	Iowa administrative code paragraph 15.11(5)
Kansas	Renewables	Residential, Commercial.	25 kW Res. 100 kW Com.	None	NEG credited to customer or paid at 150% avoided cost	2001	HB 2245
Maine	Renewables, municipal solid waste, Fuel Cells (non-renewable fuel ok)	All	100 kW	None	Avoided Cost	1997 (most recent)	PUC rules Ch. 313 PUC order 98-621 (12/19/98) Technology defn: Title 35-A, §3201
Maryland	Solar	Residential, Utilities	80 kW	34.7 MW or .2% of predicted load .2% of 1998 peak (UCS & EREN)	Granted to utility	1997	House Bill 869 (1997); Article 78 Public Service Commission Law, Section 54M

Massachusetts	Renewables & Cogen. Non-fossil fueled Fuel cells	All	60 kW	None	Monthly NEG purchased at avoided cost	1982	220 CMR §8.04(2)(C) Mass. General Legislature Ch. 164
Minnesota	Renewables (no Geothermal), Waste, Cogen.	all	40 kW	None	NEG purchased at average retail utility rate	1983	Minn. Stat §261B.164(3)
Montana	Solar, Wind, Hydro	all	50 kW	None	Annual NEG granted to utility	1999	SB 409
Nevada	Solar, Wind	all	10 kW	First 100 customers per utility	Granted to utility	1997	NRS 704.766-775
New Hampshire	PV, Wind, Hydro	all	25 kW	.05% peak	Granted to utility	1998	NHRS 362-A:1-a & 362-A:9
New Jersey	PV, Wind	Residential, Commercial	None	.1% of peak or \$2 million annual financial impact	Annual NEG purchased at avoided cost	1999	NJSA 48: 3-49 et.seq. "Electric Discount and Energy Competition Act"
New Mexico	Renewables, Waste, Renewable Transportation Fuel (DSIRE) Cogen. also (EREN)	All	10 kW	None	Avoided cost or month to month kWh credit	12-31-98	17 NMAC 10.571; 1998 NM PUC Order 2847
New York	PV	Residential	10 kW	.1% of 1996 demand per IOU	Annual NEG purchased at avoided cost	8/2/97	1997 Assembly Bill 8660, Senate Bill 5400
North Dakota	Renewables, waste, cogen, Renewable Transportation Fuel	All	100 kW	None	Monthly NEG purchased at avoided cost	1/1/91	ND Administrative Code @ 69-09-07-09
Ohio	Renewables, Landfill gas, Fuel Cells (non-ren. fuels ok), microturbines	All classes, Public, Nonprofit	None	1% of peak demand	Purchased at unbundled generation rate. Credit on bill	1999	Ohio Legislature, SB 3, sec-4928

Oklahoma	Renewables, cogen., waste, Renewable Transportation Fuel	All	100 kW annual output \leq 25,000 kWh	None	Monthly NEG granted to utility	1988	Oklahoma Corporate Commission Order 326195
Oregon	Solar, wind, hydro, fuel cells	All Customer classes, Public, Nonprofit	25 kW	.5% of peak load	Purchased at avoided cost or credited. Can be used for low income assistance	1999	HB 3219
Pennsylvania	PV (DSIRE) Renewables and fuel cells (UCS, EREN)	Residential	10 kW	None	Granted to utility	1998	52 Pennsylvania Code 57.34
Rhode Island	Wind, Solar, Biomass (sust.), Hydro (<100 MW), and Fuel Cells (no mention of renewable fuels)	All Classes	15 or 25 kW	1 MW for Naragansett Electric (nothing else specified)	Avoided cost	1998 (latest) 1/1/85 (original)	PUC Docket 2710 Supplementary Decision and Order, Docket No. 1549
Texas	Renewables inc. Tidal power, AF	All classes, Public, Utilities	50 kW	None	Monthly NEG purchased at avoided cost	9/23/85	Public Utility Commission Rule @23.66(f)(4)
Vermont	Solar, Wind, bio-gas, fuel cells with renewable fuel	All Customer Classes, including Agricultural	15 kW Solar, Wind, FC; 100 kW digesters	1% 1996 peak	Carried over, res. Credit granted to utility at year end	1998	Legislature H. 605 [30 V.S.A. Sec 219A]
Virginia	Solar, Wind, Hydro	Residential, Commercial	10 kW Res. 25 kW Com.	.1% annual peak	Annual NEG granted to utility	7/1/00	S.B. 1269
Washington	Solar, Wind, Hydro. Fuel Cells are included if fueled by the above.	All customer classes	25 kW	1% 1996 peak	Annual NEG granted to utility	1998 (FC's added in 2000)	RCW 80.60; WA Legislature HB 2773
Wisconsin	Renewables, waste, cogen, Renewable Transportation Fuel (DSIRE) All technologies (UCS & EREN)	All customer classes	20 kW	None	Purchased at retail rate for renewables, avoided cost for others	1/1/93	Rate Schedules; PSC of Wisconsin Order 6690-UR-107
Wyoming	PV, Wind, Hydro	Commercial., Residential	25 kW	None	Annual NEG purchased at avoided cost	2001	House Bill 195

Notes:

- 1) Does not include rules for small municipal utilities that may exist in addition to statewide rules.
- 2) When there are discrepancies between the different sources of information, the legislative code is referenced. If this code is unavailable or does not contain the correct information then all conflicting sources are listed.