

ALTERNATIVE 4 - LRT MEDIAN RUNNING/ UNDERGROUND

REV	DATE	BY	APP	REG. NO.	EXPIRES	SEAL HOLDER	DESCRIPTION

DESIGNED BY	
DRAWN BY	
CHECKED BY	
IN CHARGE	
DATE	

M Metro LOS ANGELES COUNTY METROPOLITAN TRANSPORTATION AUTHORITY

PROJECT MANAGER

EAST SAN FERNANDO VALLEY TRANSIT CORRIDOR
LIGHT RAIL TRANSIT ALTERNATIVE

PLAN & PROFILE
STA 110+00 TO STA 140+00

CONTRACT NO.	PS-4370-2622
DRAWING NO.	PP-04
SCALE	HORIZ: 1"=100' VERT: 1"=10'
SHEET NO.	

J:\2010\B01205 Metro Van Nuys Corridor Rapidway\Exhibit30\Concept Eng\Alternative Exhibits\Alt 4B PP-PP-04.dwg - LAST PLOTTED ON Thu 08/04/16 - 05:15PM BY vrodriquez

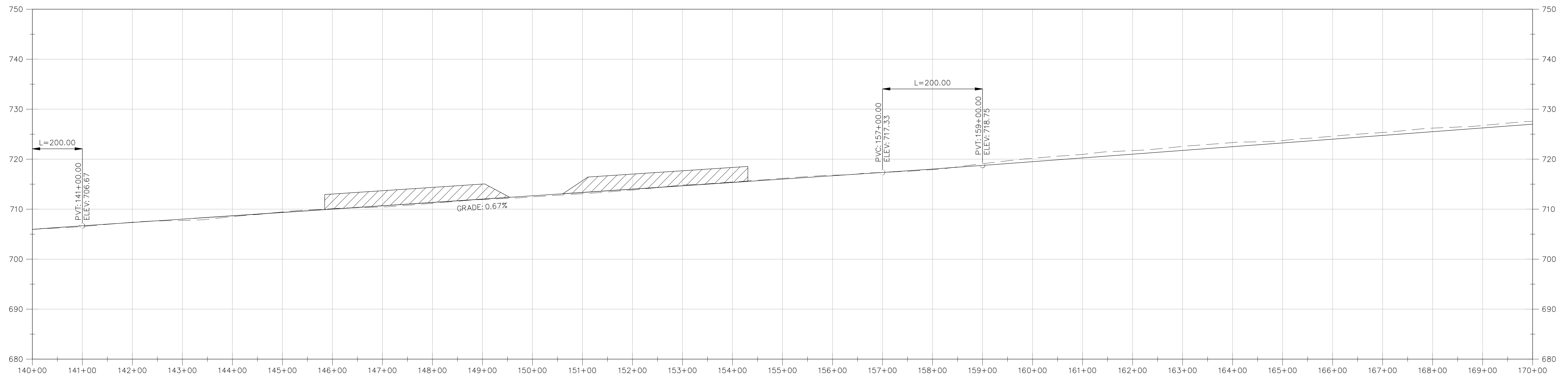
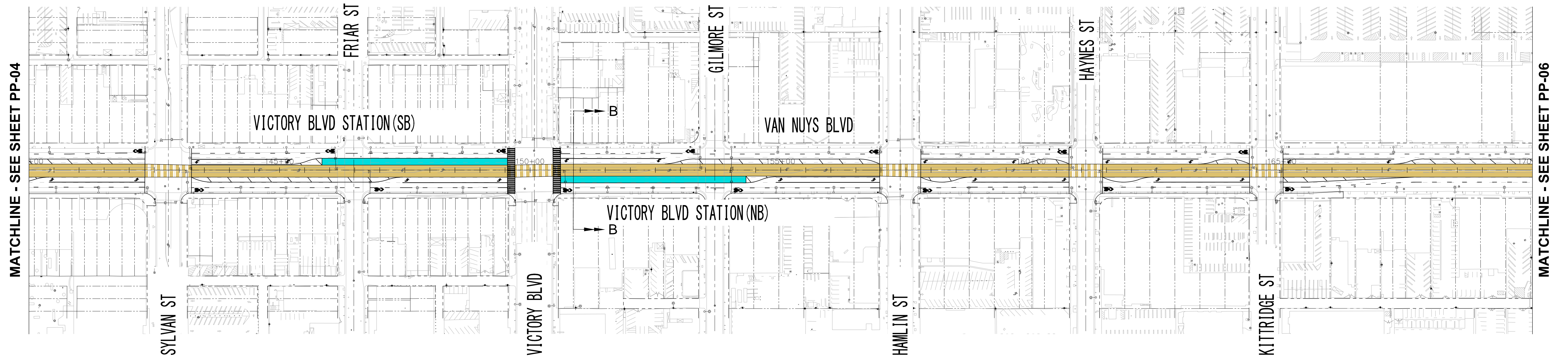
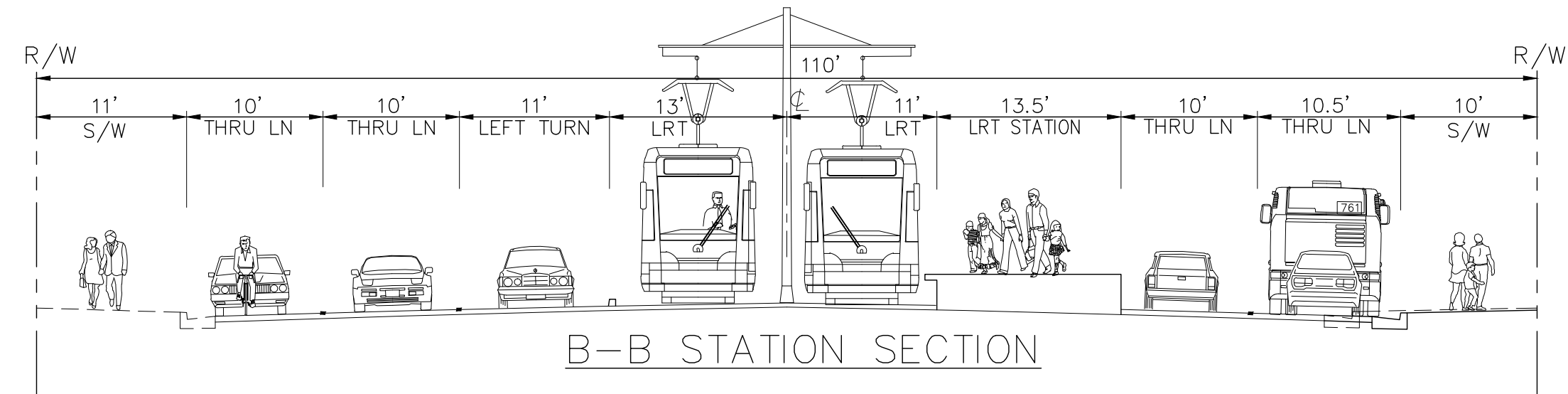
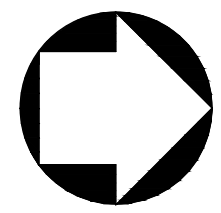

ALTERNATIVE 4 - LRT MEDIAN RUNNING/ UNDERGROUND

REV	DATE	BY	APP	REG. NO.	EXPIRES	SEAL HOLDER	DESCRIPTION

DESIGNED BY	
DRAWN BY	
CHECKED BY	
IN CHARGE	
DATE	



**LOS ANGELES COUNTY METROPOLITAN
TRANSPORTATION AUTHORITY**

EAST SAN FERNANDO VALLEY TRANSIT CORRIDOR
LIGHT RAIL TRANSIT ALTERNATIVE

PLAN & PROFILE
STA 140+00 TO STA 170+00

CONTRACT NO.	PS-4370-2622
DRAWING NO.	PP-05
SCALE	HORIZ: 1"=100' VERT: 1"=10'
SHEET NO.	

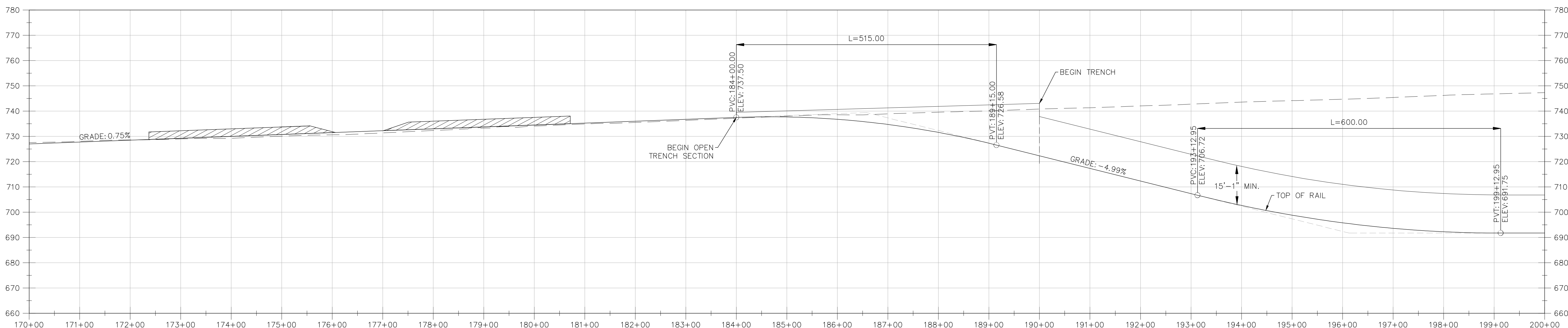
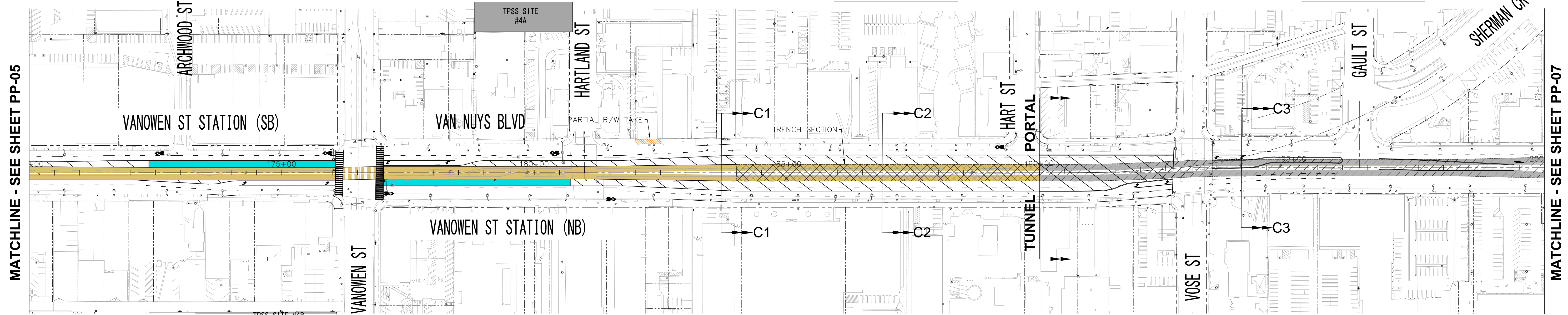
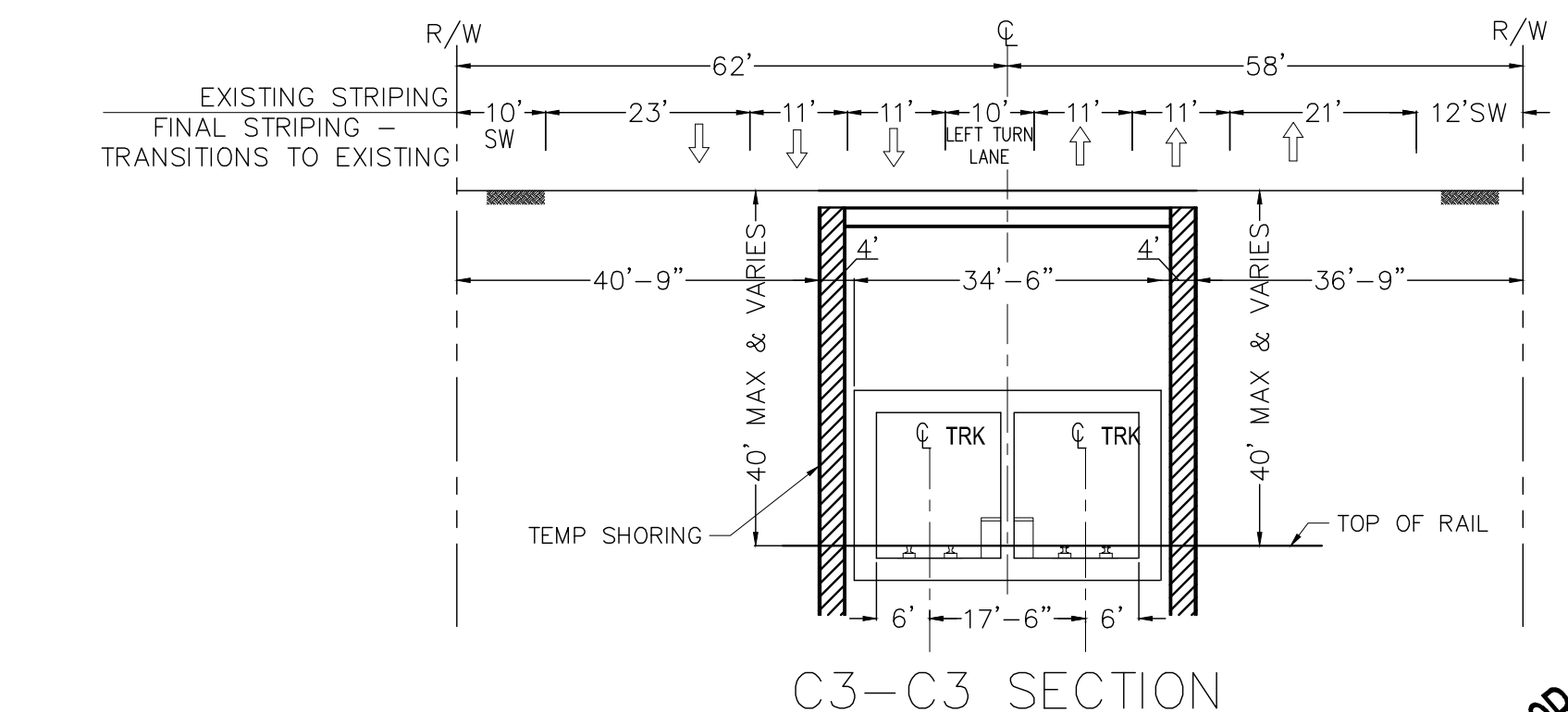
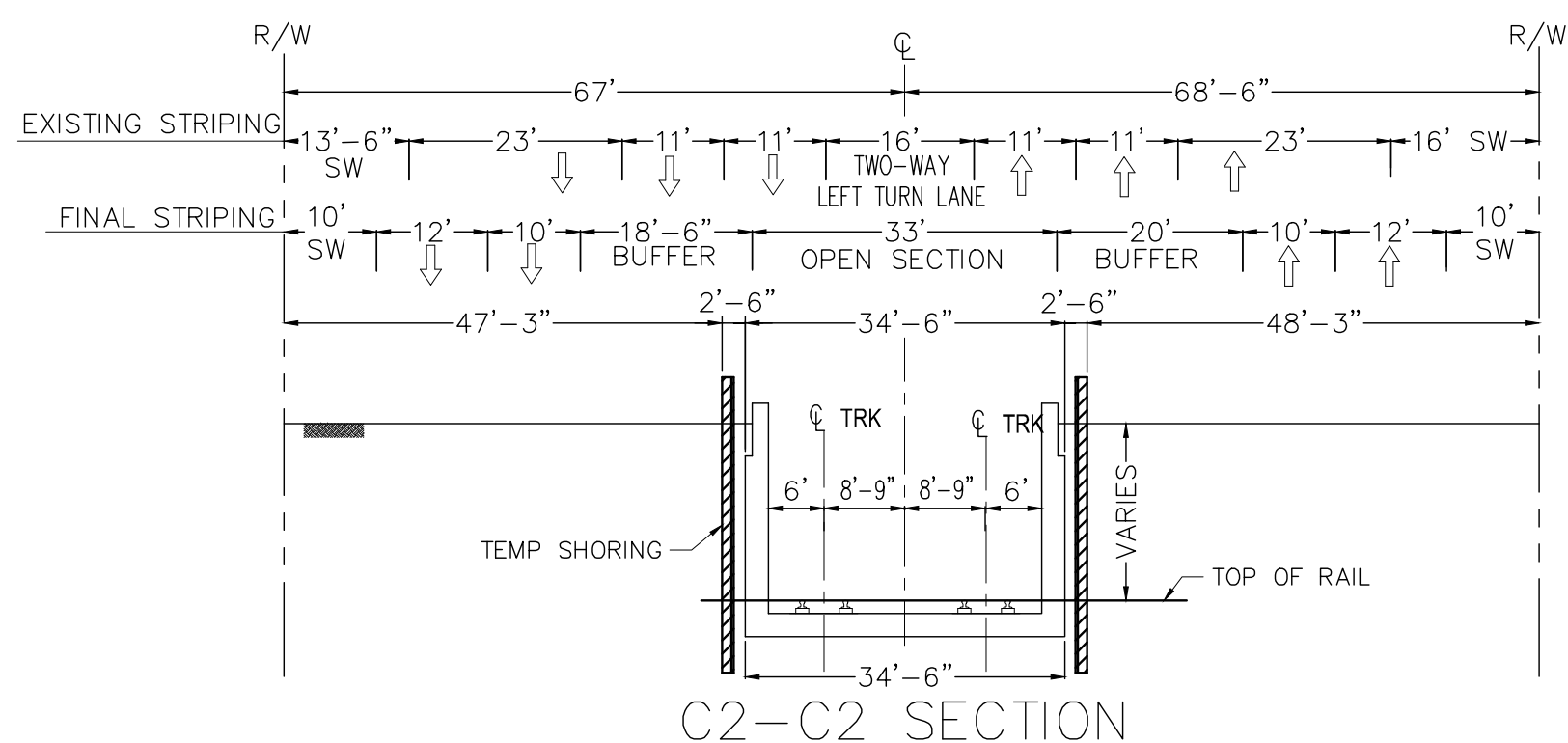
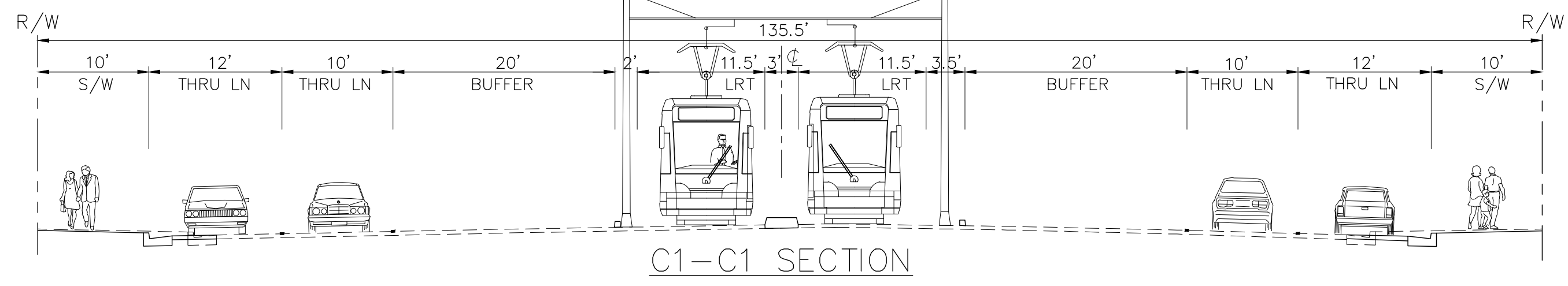
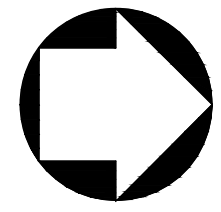

ALTERNATIVE 4 - LRT MEDIAN RUNNING/ UNDERGROUND

DESIGN SPEED = 50MPH

J:\2010\B01205 Metro Van Nuys Corridor Rapidway\Exhibit30% Concept\Eng\Alternative Exhibit\Alt 4B PP-06.dwg - LAST PLOTTED ON Thu 08/04/16 - 05:21 PM BY vrodriquez

REV	DATE	BY	APP	REG. NO.	EXPIRES	SEAL HOLDER	DESCRIPTION

DESIGNED BY	
DRAWN BY	
CHECKED BY	
IN CHARGE	
DATE	

M Metro LOS ANGELES COUNTY METROPOLITAN TRANSPORTATION AUTHORITY

PROJECT MANAGER

EAST SAN FERNANDO VALLEY TRANSIT CORRIDOR
 LIGHT RAIL TRANSIT ALTERNATIVE
 PLAN & PROFILE
 STA 170+00 TO STA 200+00
 OPTION A

CONTRACT NO.	PS-4370-2622
DRAWING NO.	PP-06A
SCALE	HORIZ: 1"=100' VERT: 1"=5'
SHEET NO.	

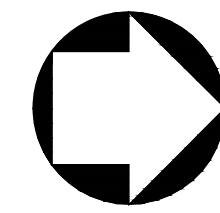

MATCHLINE - SEE SHEET PP-06

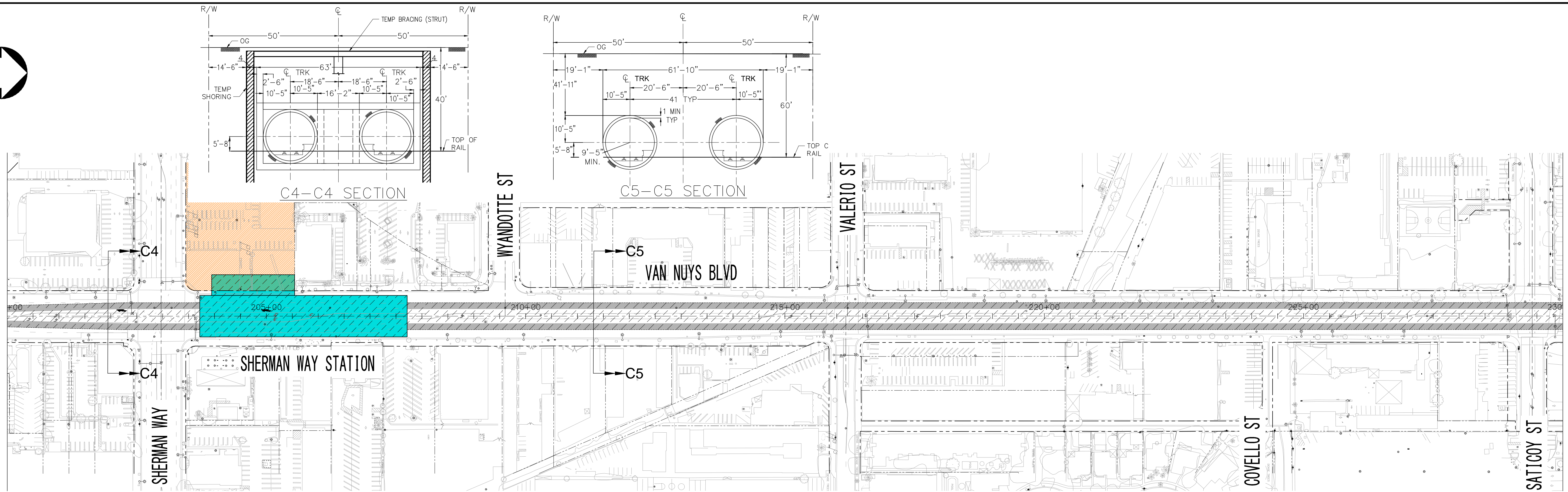

MATCHLINE - SEE SHEET PP-08

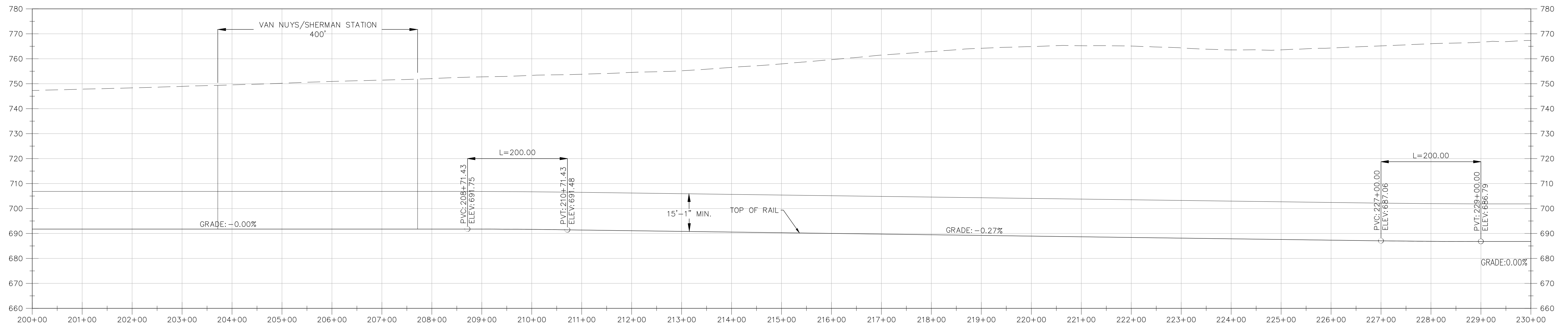

ALTERNATIVE 4 - LRT MEDIAN RUNNING/ UNDERGROUND

DESIGN SPEED = 50MPH

REV	DATE	BY	APP	REG. NO.	EXPIRES	SEAL HOLDER	DESCRIPTION

DESIGNED BY	
DRAWN BY	
CHECKED BY	
IN CHARGE	
DATE	

M Metro LOS ANGELES COUNTY METROPOLITAN TRANSPORTATION AUTHORITY

PROJECT MANAGER

EAST SAN FERNANDO VALLEY TRANSIT CORRIDOR
 LIGHT RAIL TRANSIT ALTERNATIVE
 PLAN & PROFILE
 STA 200+00 TO STA 230+00
 OPTION A

CONTRACT NO.	PS-4370-2622
DRAWING NO.	PP-07A
SCALE	HORIZ: 1"=100' VERT: 1"=5'
SHEET NO.	

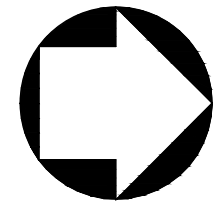

MATCHLINE - SEE SHEET PP-07

MATCHLINE - SEE SHEET PP-09

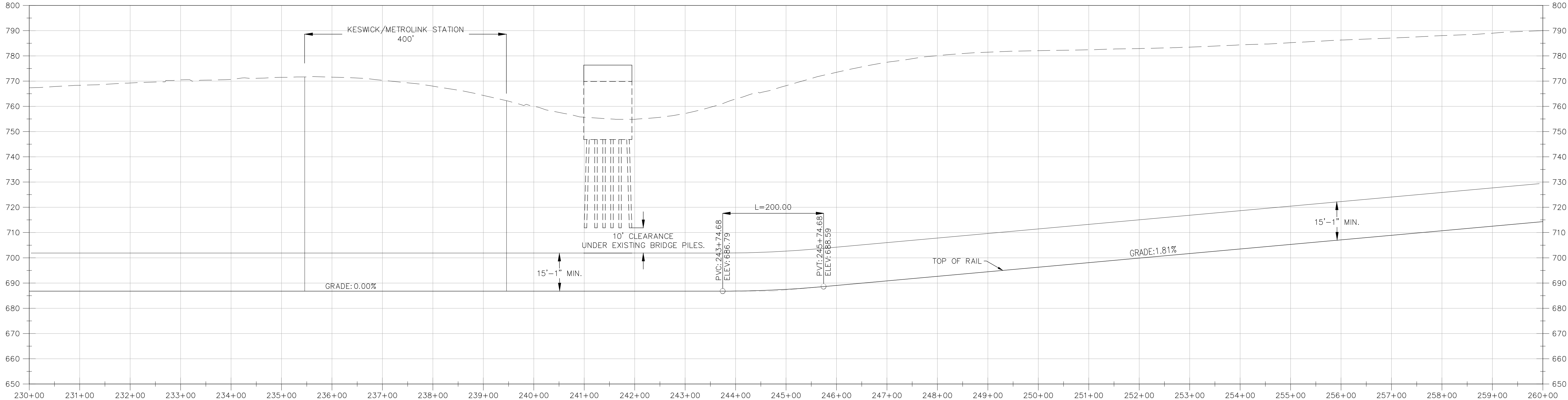
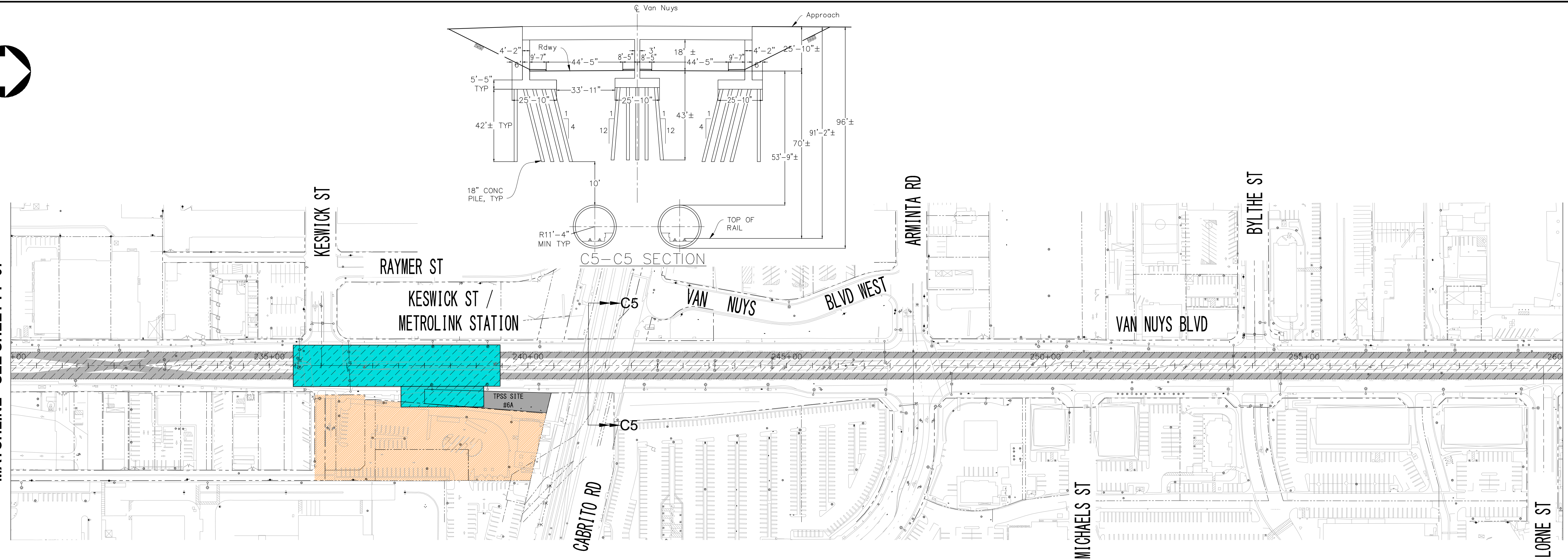

ALTERNATIVE 4 - LRT MEDIAN RUNNING/ UNDERGROUND

DESIGN SPEED = 50MPH

REV	DATE	BY	APP	REG. NO.	EXPIRES	SEAL HOLDER	DESCRIPTION

DESIGNED BY	
DRAWN BY	
CHECKED BY	
IN CHARGE	
DATE	

M Metro LOS ANGELES COUNTY METROPOLITAN TRANSPORTATION AUTHORITY

PROJECT MANAGER

EAST SAN FERNANDO VALLEY TRANSIT CORRIDOR
 LIGHT RAIL TRANSIT ALTERNATIVE
 PLAN & PROFILE
 STA 230+00 TO STA 260+00
 OPTION A

CONTRACT NO.	PS-4370-2622
DRAWING NO.	PP-08A
SCALE	HORIZ: 1"=100' VERT: 1"=5'
SHEET NO.	

J:\2010\B01205 Metro Van Nuys Corridor Rapidway\Exhibit30% Concept Eng\Alternative Exhibits\Alt 4B PP-08A.dwg - LAST PLOTTED ON Thu 08/04/16 - 05:33PM BY vrodriquez

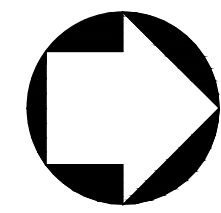

MATCHLINE - SEE SHEET PP-08

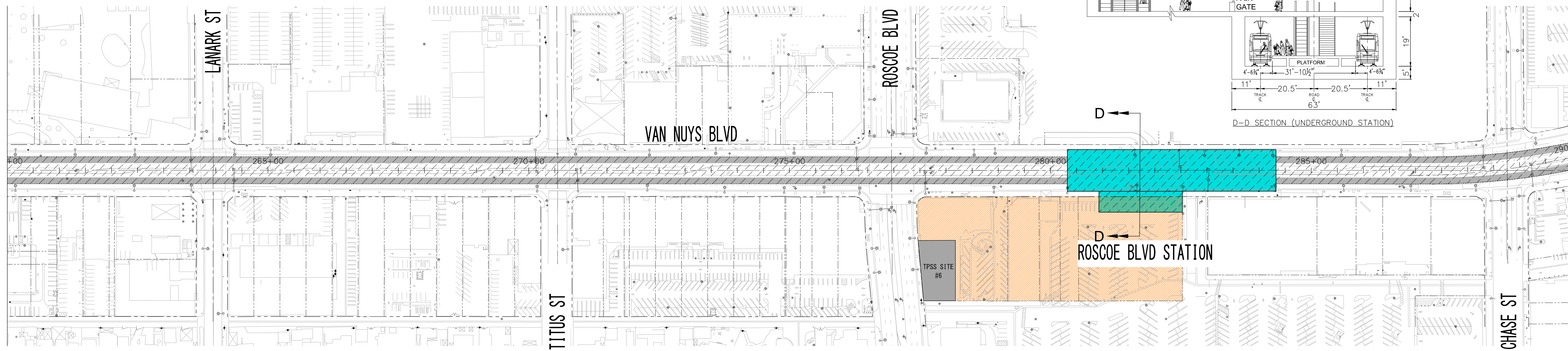

MATCHLINE - SEE SHEET PP-10

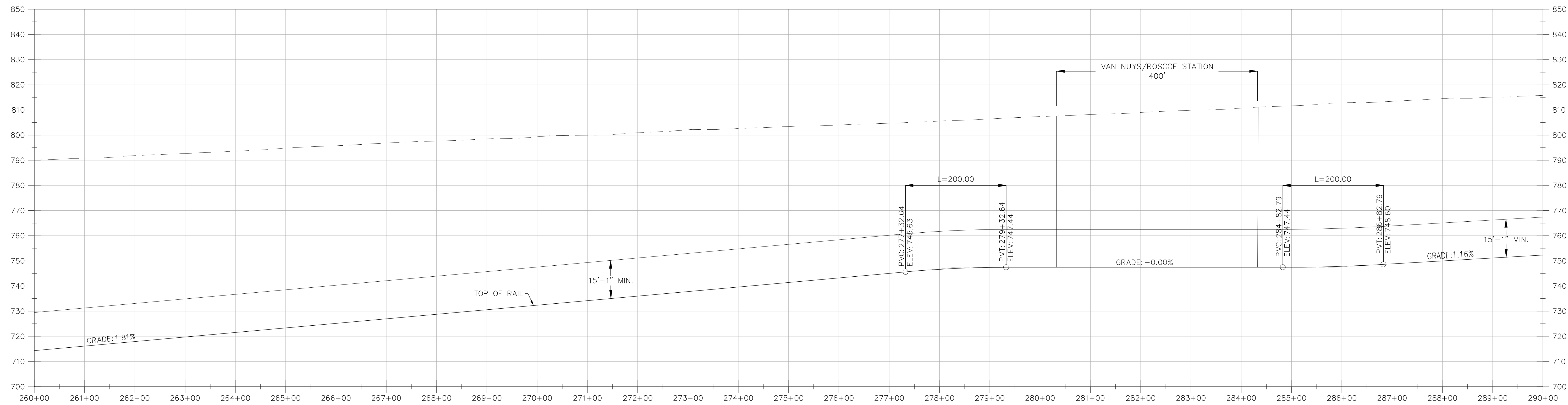

ALTERNATIVE 4 - LRT MEDIAN RUNNING/ UNDERGROUND

DESIGN SPEED = 50MPH

REV	DATE	BY	APP	REG. NO.	EXPIRES	SEAL HOLDER	DESCRIPTION

DESIGNED BY	
DRAWN BY	
CHECKED BY	
IN CHARGE	
DATE	

LOS ANGELES COUNTY METROPOLITAN TRANSPORTATION AUTHORITY
 PROJECT MANAGER

EAST SAN FERNANDO VALLEY TRANSIT CORRIDOR
 LIGHT RAIL TRANSIT ALTERNATIVE
 PLAN & PROFILE
 STA 260+00 TO STA 290+00
 OPTION A

CONTRACT NO.	PS-4370-2622
DRAWING NO.	PP-09A
SCALE	HORIZ: 1"=100' VERT: 1"=5'
SHEET NO.	

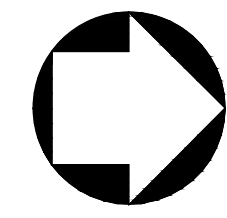

MATCHLINE - SEE SHEET PP-09

MATCHLINE - SEE SHEET PP-11

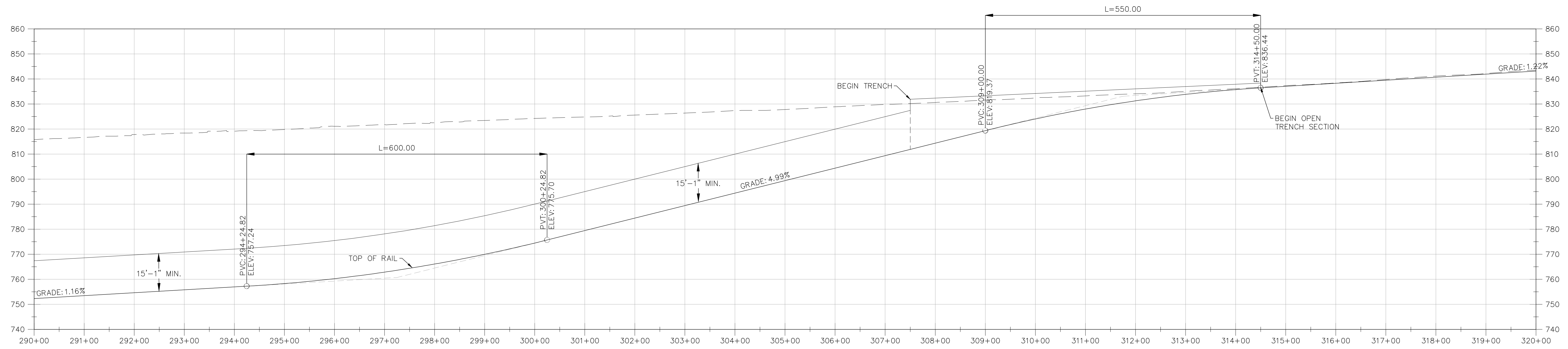
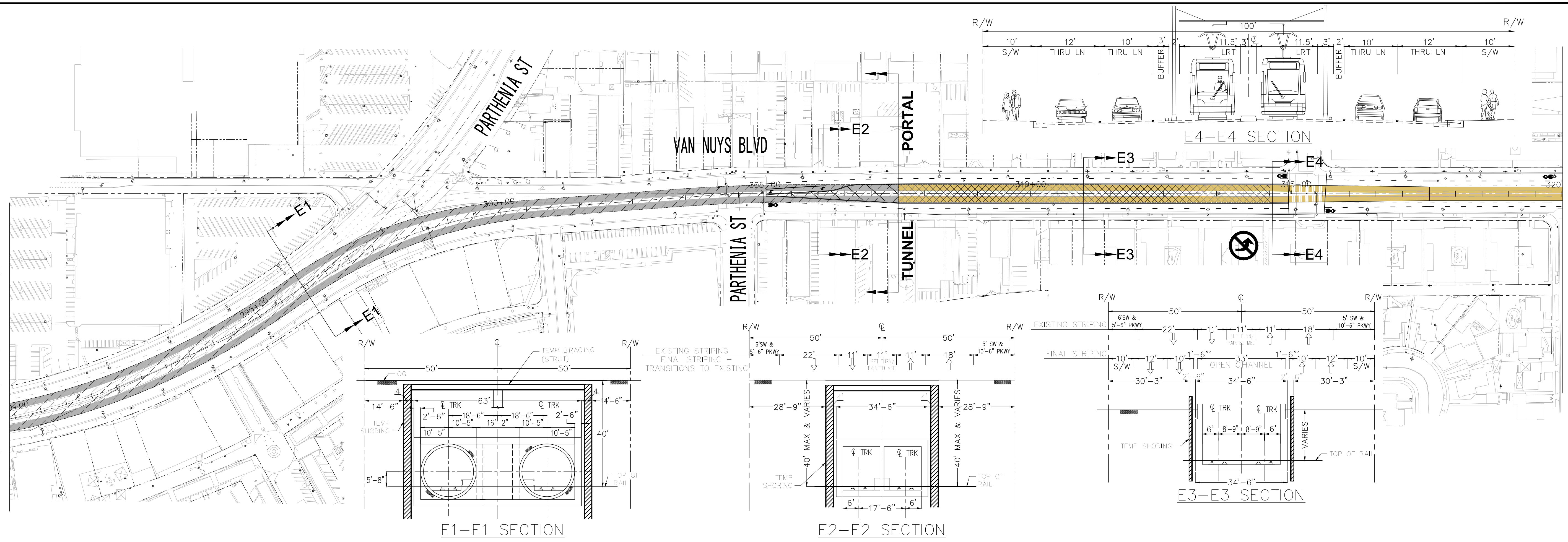

ALTERNATIVE 4 - LRT MEDIAN RUNNING/ UNDERGROUND

DESIGN SPEED = 50MPH

REV	DATE	BY	APP	REG. NO.	EXPIRES	SEAL HOLDER	DESCRIPTION

DESIGNED BY	
DRAWN BY	
CHECKED BY	
IN CHARGE	
DATE	

M Metro LOS ANGELES COUNTY METROPOLITAN TRANSPORTATION AUTHORITY

PROJECT MANAGER

EAST SAN FERNANDO VALLEY TRANSIT CORRIDOR
 LIGHT RAIL TRANSIT ALTERNATIVE
 PLAN & PROFILE
 STA 290+00 TO STA 320+00
 OPTION A

CONTRACT NO.	PS-4370-2622
DRAWING NO.	PP-10A
SCALE	HORIZ: 1"=100' VERT: 1"=5'
SHEET NO.	

J:\2010\B01205 Metro Van Nuys Corridor Rapidway\Exhibit30% Concept Eng\Alternative Exhibits\Alt 4B PP-10.dwg - LAST PLOTTED ON Thu 08/04/16 - 05:44PM BY vrodriquez

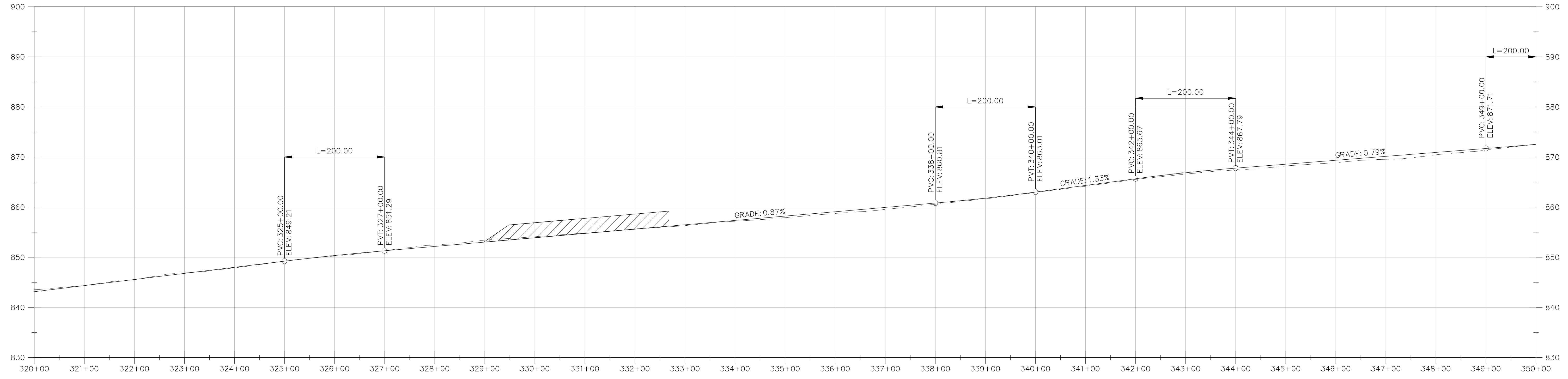
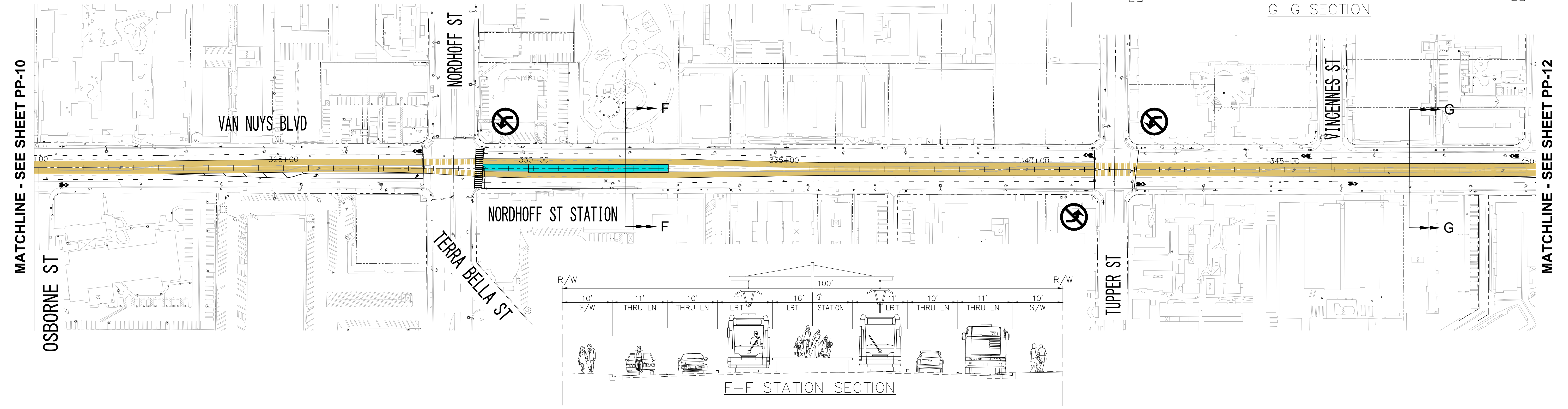
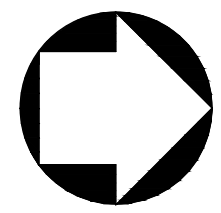

ALTERNATIVE 4 - LRT MEDIAN RUNNING/ UNDERGROUND

REV	DATE	BY	APP	REG. NO.	EXPIRES	SEAL HOLDER	DESCRIPTION

DESIGNED BY	
DRAWN BY	
CHECKED BY	
IN CHARGE	
DATE	

M Metro **LOS ANGELES COUNTY METROPOLITAN TRANSPORTATION AUTHORITY**

PROJECT MANAGER

EAST SAN FERNANDO VALLEY TRANSIT CORRIDOR
 LIGHT RAIL TRANSIT ALTERNATIVE
 PLAN & PROFILE
 STA 320+00 TO STA 350+00

CONTRACT NO.	PS-4370-2622
DRAWING NO.	PP-11
SCALE	HORIZ: 1"=100' VERT: 1"=10'
SHEET NO.	

J:\2010\B01205 Metro Van Nuys Corridor Rapidway\Exhibit30% Concept Eng\Alternative Exhibits\Alt 4B PP-11.dwg - LAST PLOTTED ON Thu 08/04/16 - 05:47PM BY yrodriguez

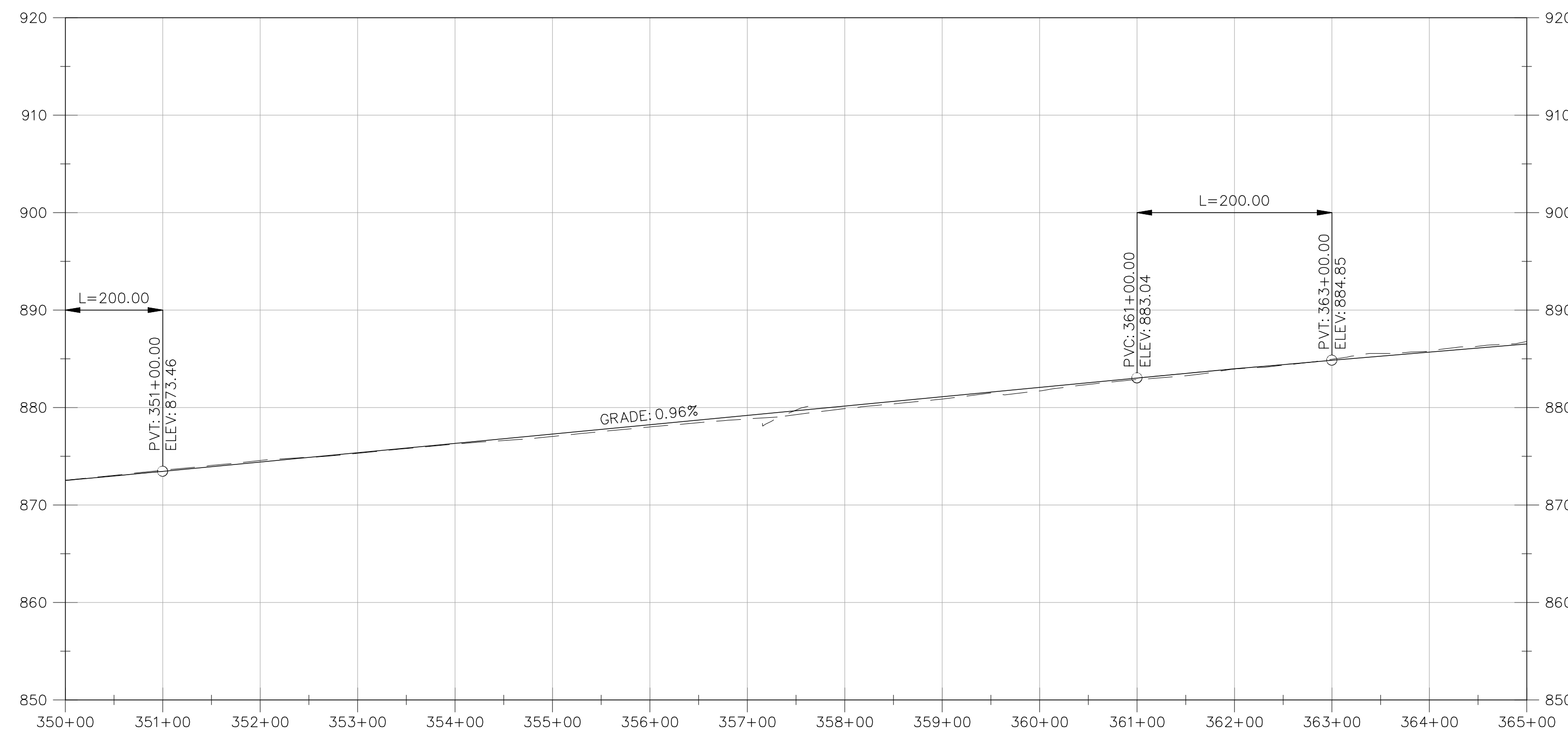
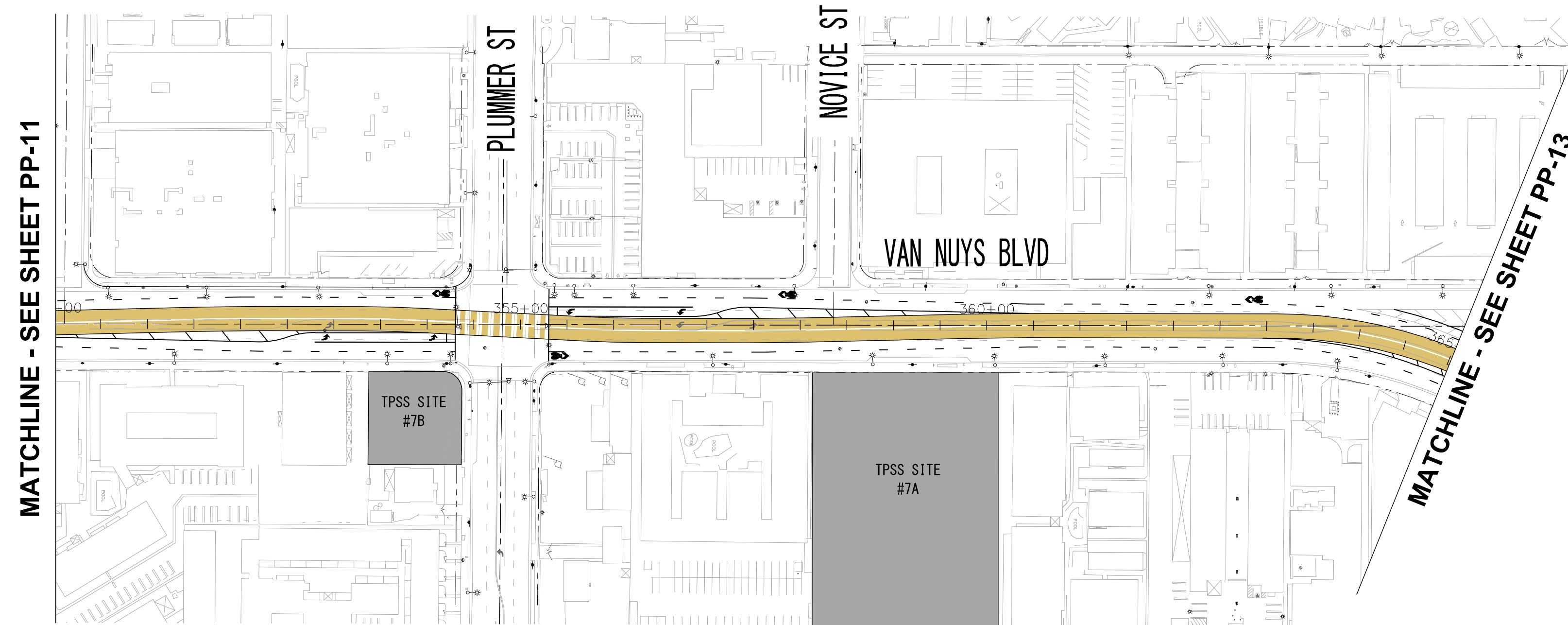
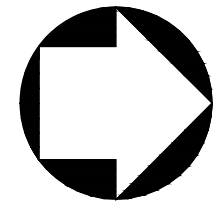

ALTERNATIVE 4 - LRT MEDIAN RUNNING/ UNDERGROUND

REV	DATE	BY	APP	REG. NO.	EXPIRES	SEAL HOLDER	DESCRIPTION

DESIGNED BY	
DRAWN BY	
CHECKED BY	
IN CHARGE	
DATE	

M Metro LOS ANGELES COUNTY METROPOLITAN TRANSPORTATION AUTHORITY

PROJECT MANAGER

EAST SAN FERNANDO VALLEY TRANSIT CORRIDOR
LIGHT RAIL TRANSIT ALTERNATIVE

PLAN & PROFILE
STA 350+00 TO STA 365+00

CONTRACT NO.	PS-4370-2622
DRAWING NO.	PP-12
SCALE	HORIZ: 1"=100' VERT: 1"=10'
SHEET NO.	

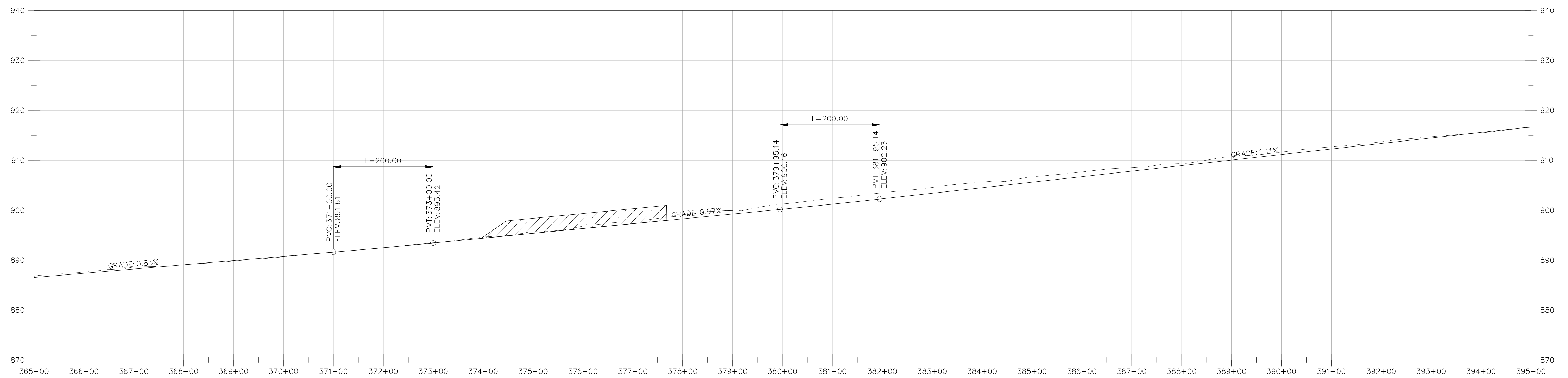
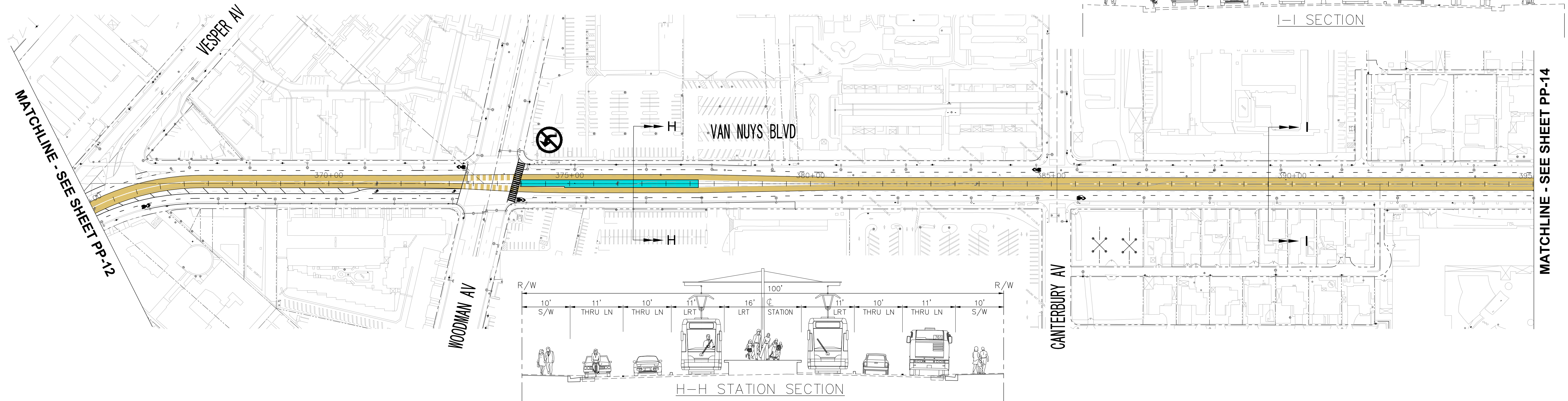
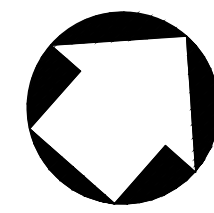

ALTERNATIVE 4 – LRT MEDIAN RUNNING/ UNDERGROUND

REV	DATE	BY	APP	REG. NO.	EXPIRES	SEAL HOLDER	DESCRIPTION

DESIGNED BY	—
DRAWN BY	—
CHECKED BY	—
IN CHARGE	—
DATE	—



**LOS ANGELES COUNTY METROPOLITAN
TRANSPORTATION AUTHORITY**

EAST SAN FERNANDO VALLEY TRANSIT CORRIDOR
LIGHT RAIL TRANSIT ALTERNATIVE

PLAN & PROFILE
STA 365+00 TO STA 395+00

CONTRACT NO.	PS-4370-2622
DRAWING NO.	PP-13
SCALE	HORIZ: 1"=100' VERT: 1"=10'
SHEET NO.	0

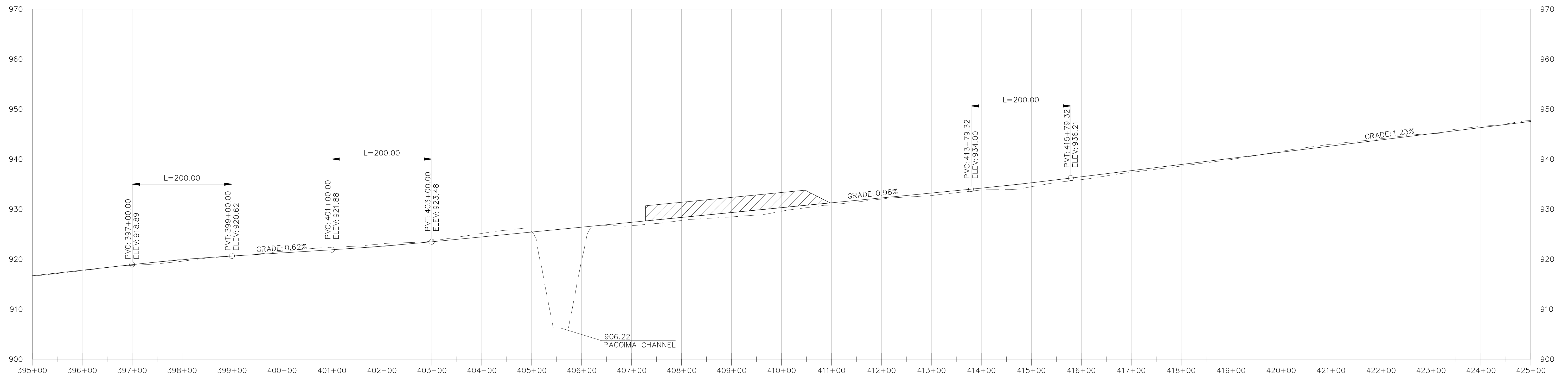
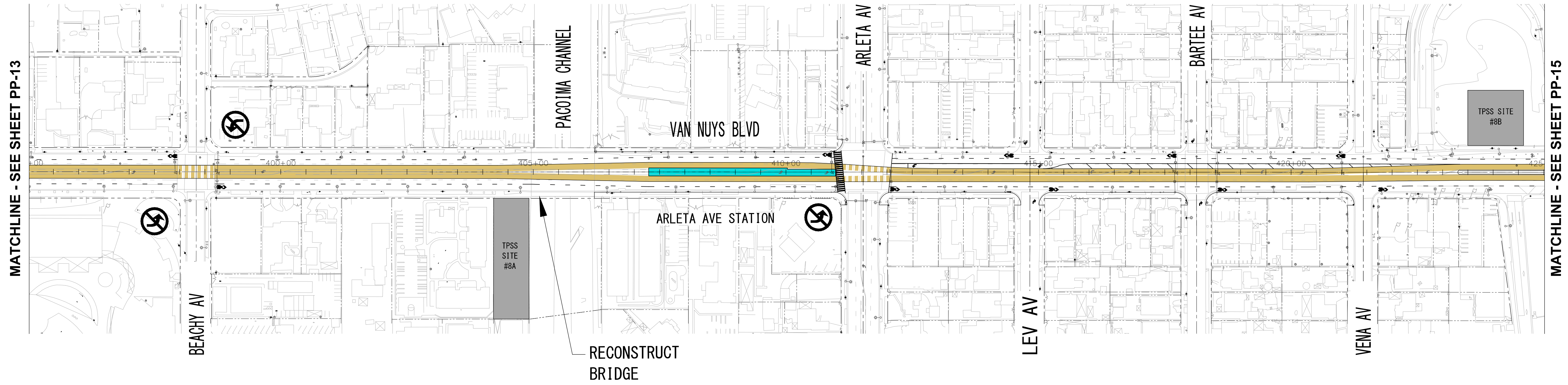
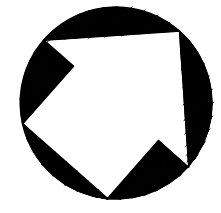

ALTERNATIVE 4 – LRT MEDIAN RUNNING/ UNDERGROUND

REV	DATE	BY	APP	REG. NO.	EXPIRES	SEAL HOLDER	DESCRIPTION

DESIGNED BY	—
DRAWN BY	—
CHECKED BY	—
IN CHARGE	—
DATE	—

LOS ANGELES COUNTY METROPOLITAN TRANSPORTATION AUTHORITY
 PROJECT MANAGER

EAST SAN FERNANDO VALLEY TRANSIT CORRIDOR
 LIGHT RAIL TRANSIT ALTERNATIVE
 PLAN & PROFILE
 STA 395+00 TO STA 425+00

CONTRACT NO.	PS-4370-2622
DRAWING NO.	PP-14
SCALE	HORIZ: 1"=100' VERT: 1"=10'
SHEET NO.	0

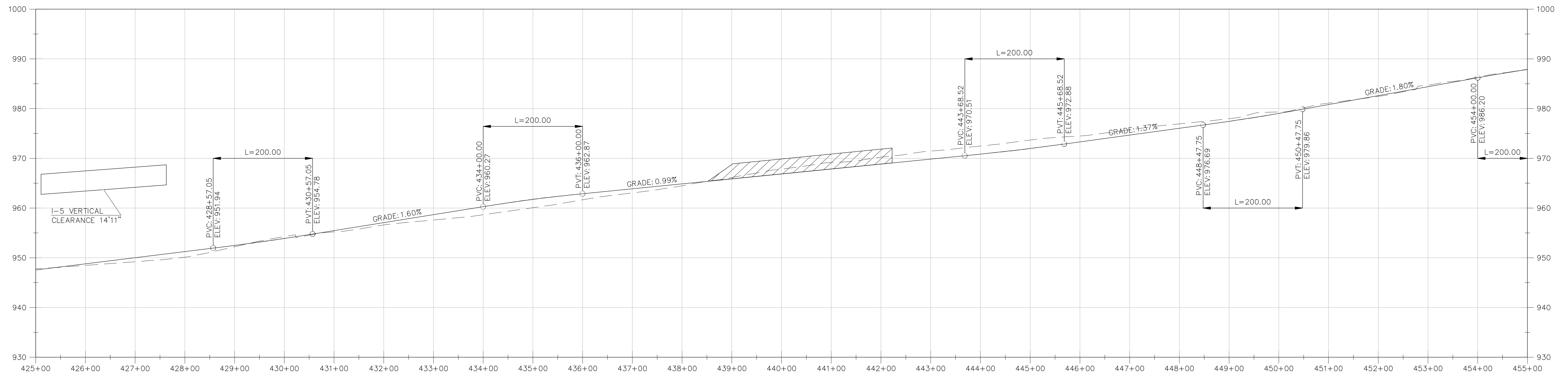
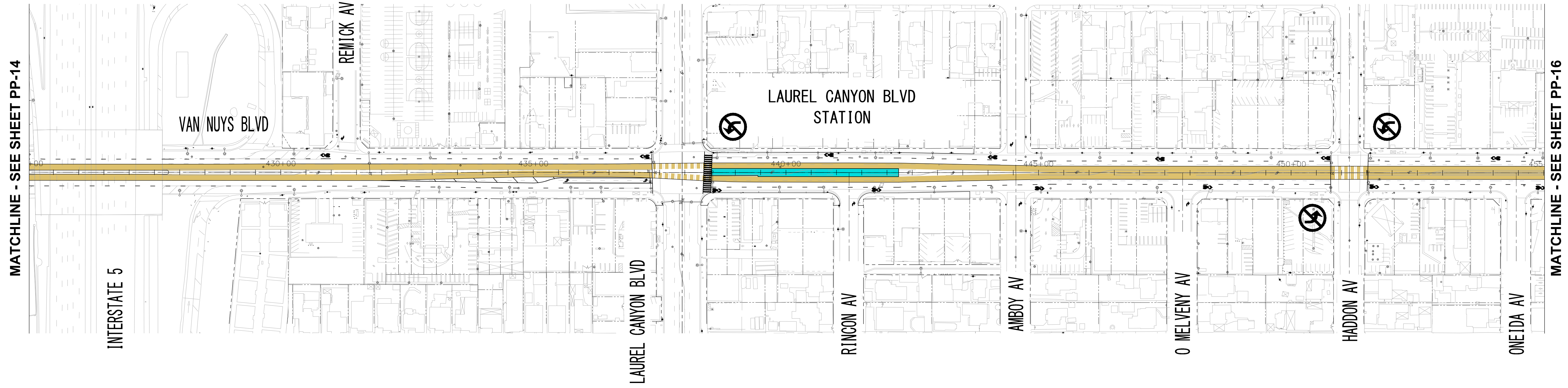
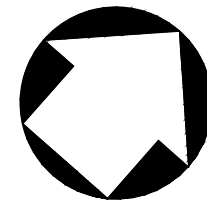

ALTERNATIVE 4 - LRT MEDIAN RUNNING/ UNDERGROUND

REV	DATE	BY	APP	REG. NO.	EXPIRES	SEAL HOLDER	DESCRIPTION

DESIGNED BY	
DRAWN BY	
CHECKED BY	
IN CHARGE	
DATE	

LOS ANGELES COUNTY METROPOLITAN TRANSPORTATION AUTHORITY
 PROJECT MANAGER

EAST SAN FERNANDO VALLEY TRANSIT CORRIDOR
 LIGHT RAIL TRANSIT ALTERNATIVE
 PLAN & PROFILE
 STA 425+00 TO STA 455+00

CONTRACT NO.	PS-4370-2622
DRAWING NO.	PP-15
SCALE	HORIZ: 1"=100' VERT: 1"=10'
SHEET NO.	

J:\2010\B01205 Metro Van Nuys Corridor Rapidway\Exhibit30\Concept Eng\Alternative Exhibit\Alt 4B PP-15.dwg - LAST PLOTTED ON Thu 08/04/16 - 06:01PM BY yrodriguez

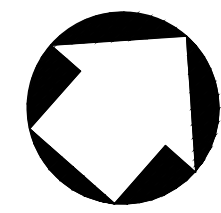

MATCHLINE - SEE SHEET PP-15

SEE SHEET PP-17

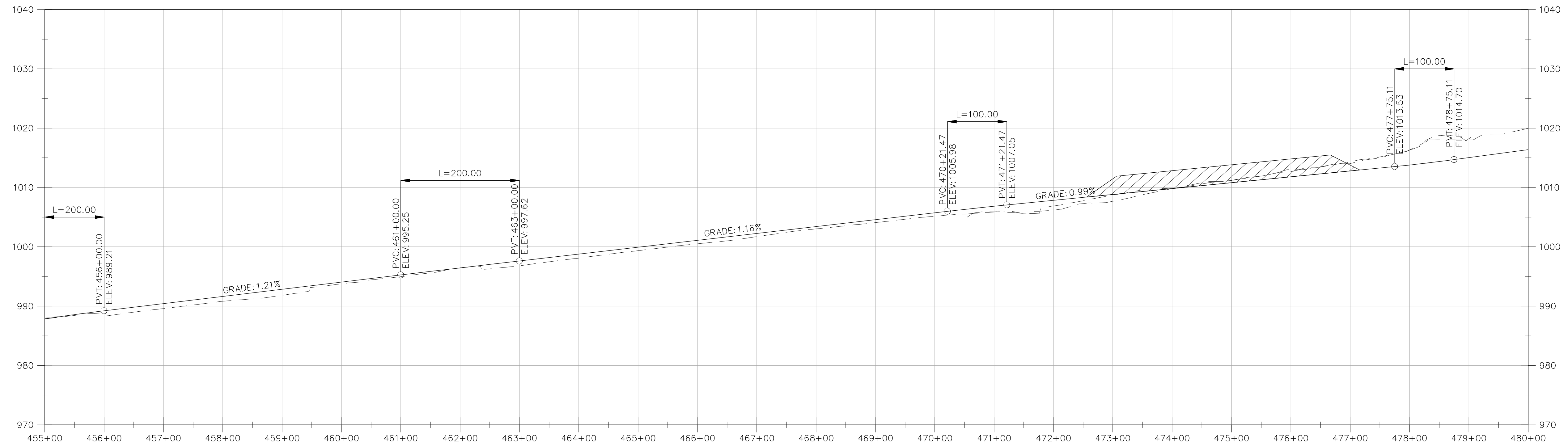
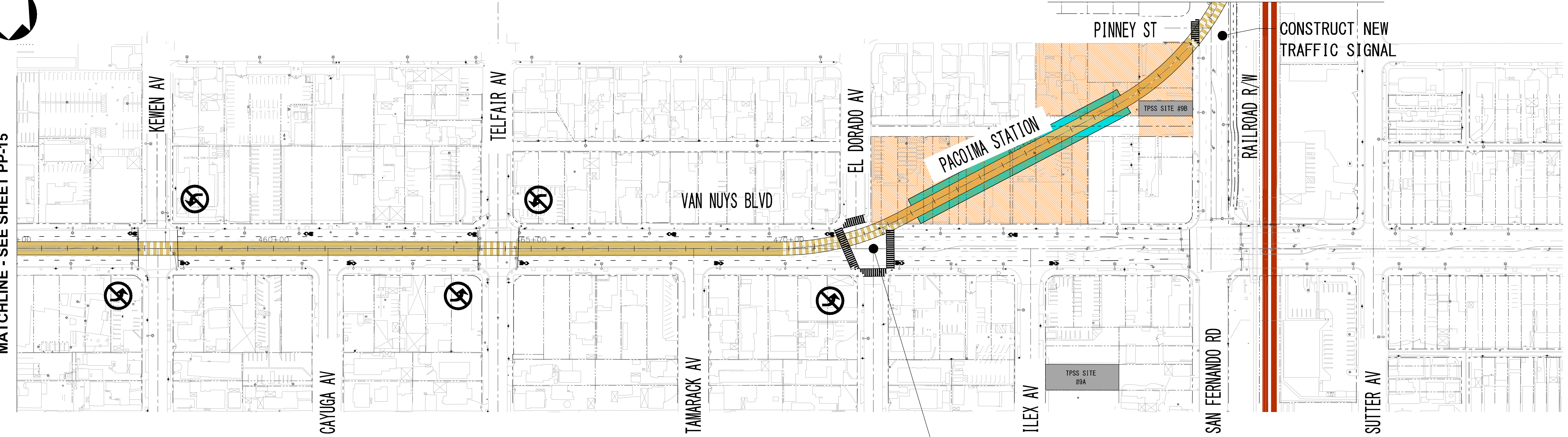

ALTERNATIVE 4 - LRT MEDIAN RUNNING/ UNDERGROUND

REV	DATE	BY	APP	REG. NO.	EXPIRES	SEAL HOLDER	DESCRIPTION

DESIGNED BY	
DRAWN BY	
CHECKED BY	
IN CHARGE	
DATE	



**LOS ANGELES COUNTY METROPOLITAN
TRANSPORTATION AUTHORITY**

EAST SAN FERNANDO VALLEY TRANSIT CORRIDOR
LIGHT RAIL TRANSIT ALTERNATIVE

PLAN & PROFILE
STA 455+00 TO STA 480+00

CONTRACT NO.	PS-4370-2622
DRAWING NO.	PP-16
SCALE	HORIZ: 1"=100' VERT: 1"=10'
SHEET NO.	

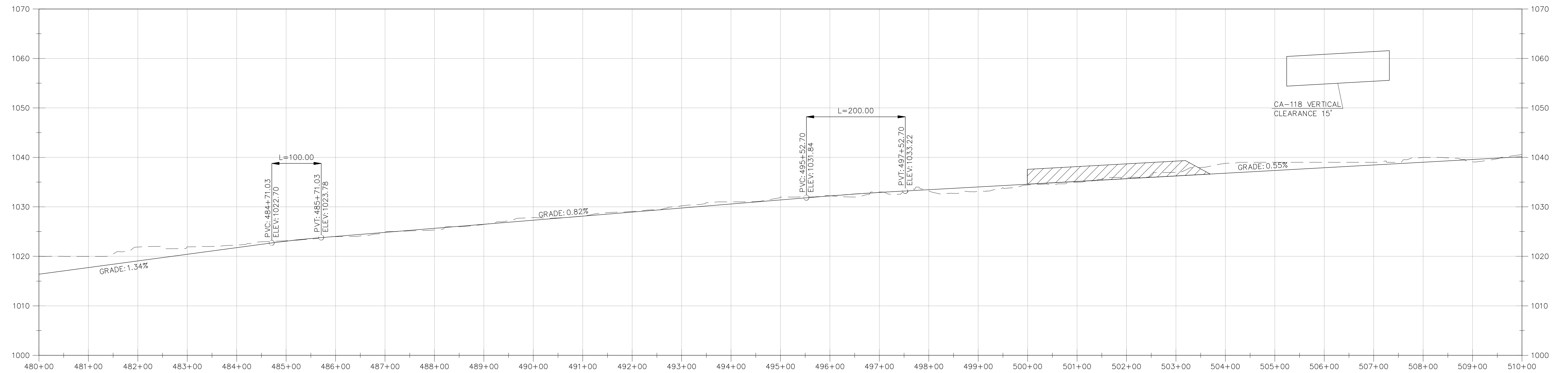
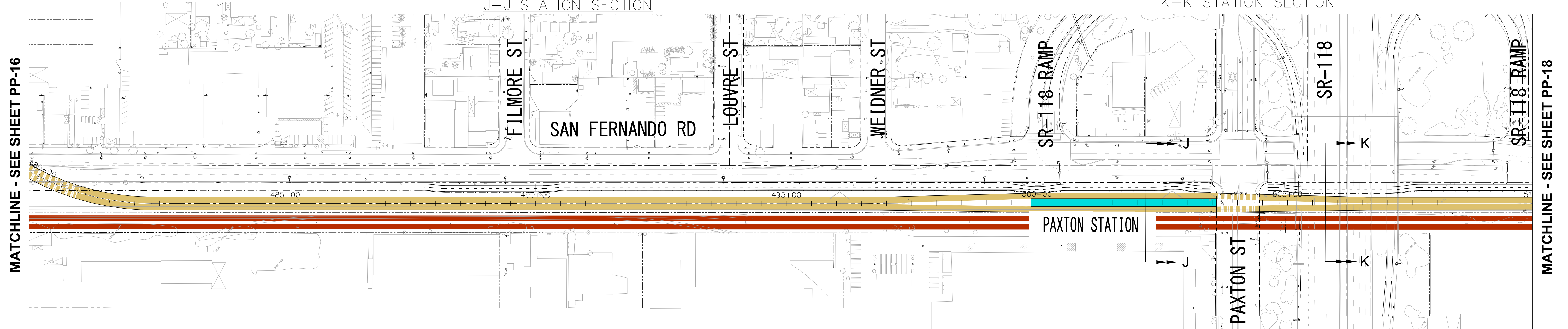
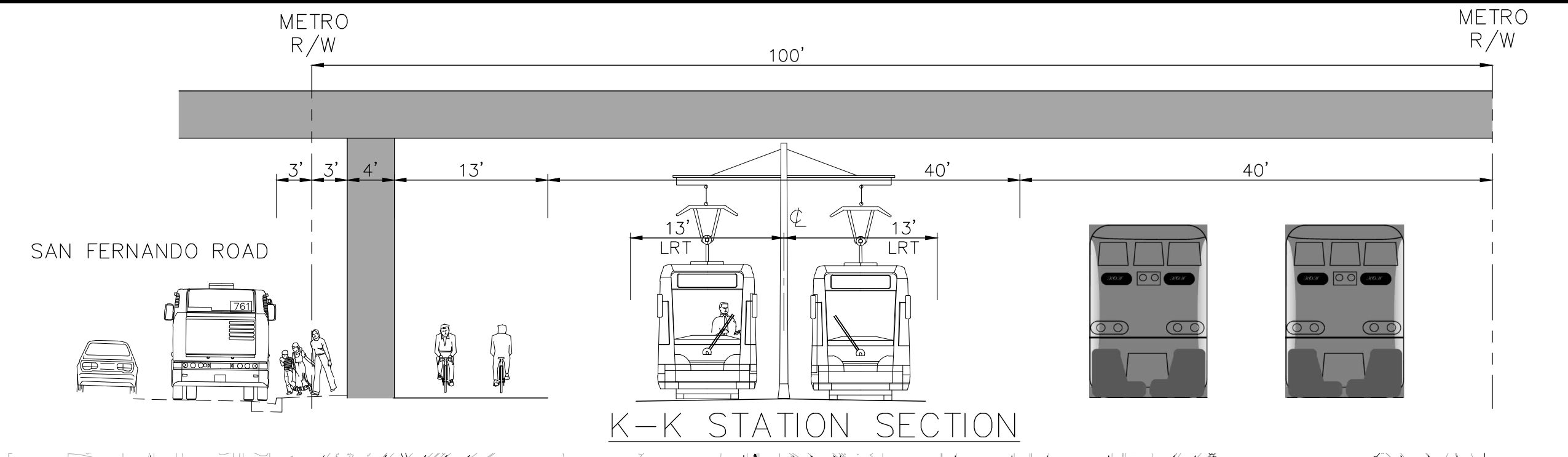
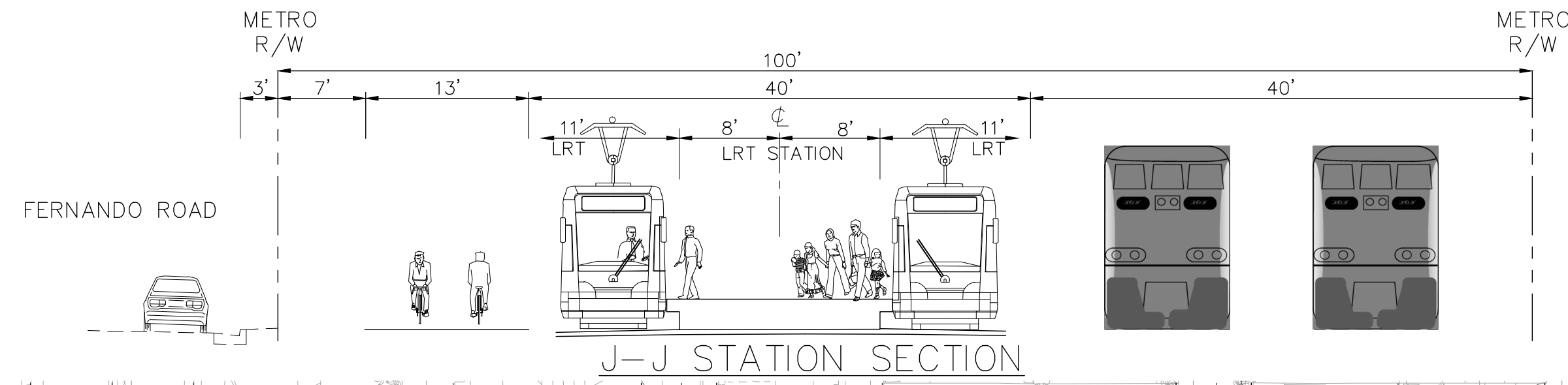
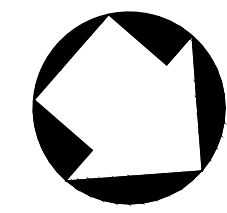

ALTERNATIVE 4 - LRT MEDIAN RUNNING/ UNDERGROUND

REV	DATE	BY	APP	REG. NO.	EXPIRES	SEAL HOLDER	DESCRIPTION

DESIGNED BY	
DRAWN BY	
CHECKED BY	
IN CHARGE	
DATE	



**LOS ANGELES COUNTY METROPOLITAN
TRANSPORTATION AUTHORITY**

EAST SAN FERNANDO VALLEY TRANSIT CORRIDOR
LIGHT RAIL TRANSIT ALTERNATIVE

PLAN & PROFILE
STA 480+00 TO STA 510+00

CONTRACT NO.	PS-4370-2622
DRAWING NO.	PP-17
SCALE	HORIZ: 1"=100' VERT: 1"=10'
SHEET NO.	0

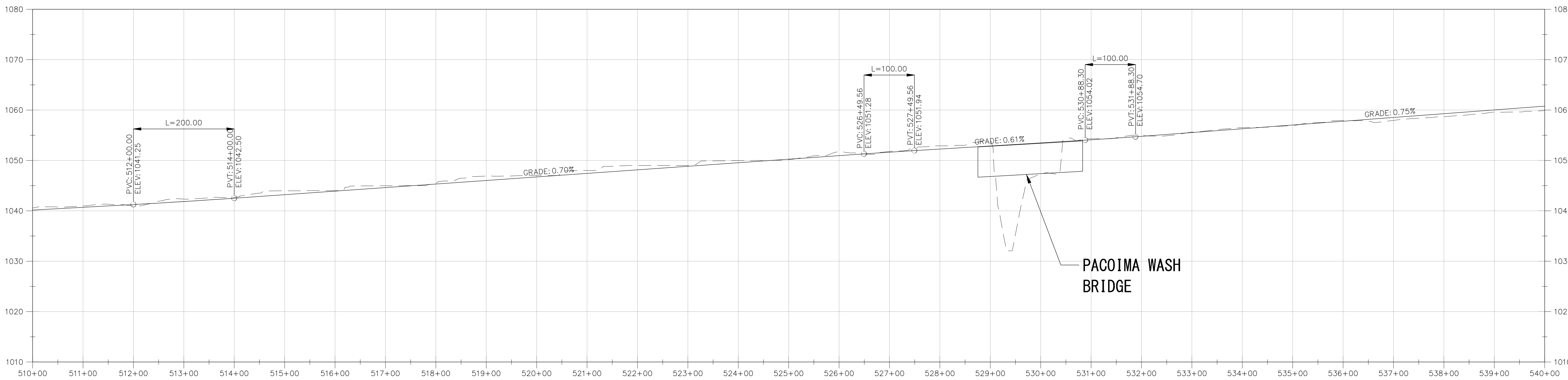
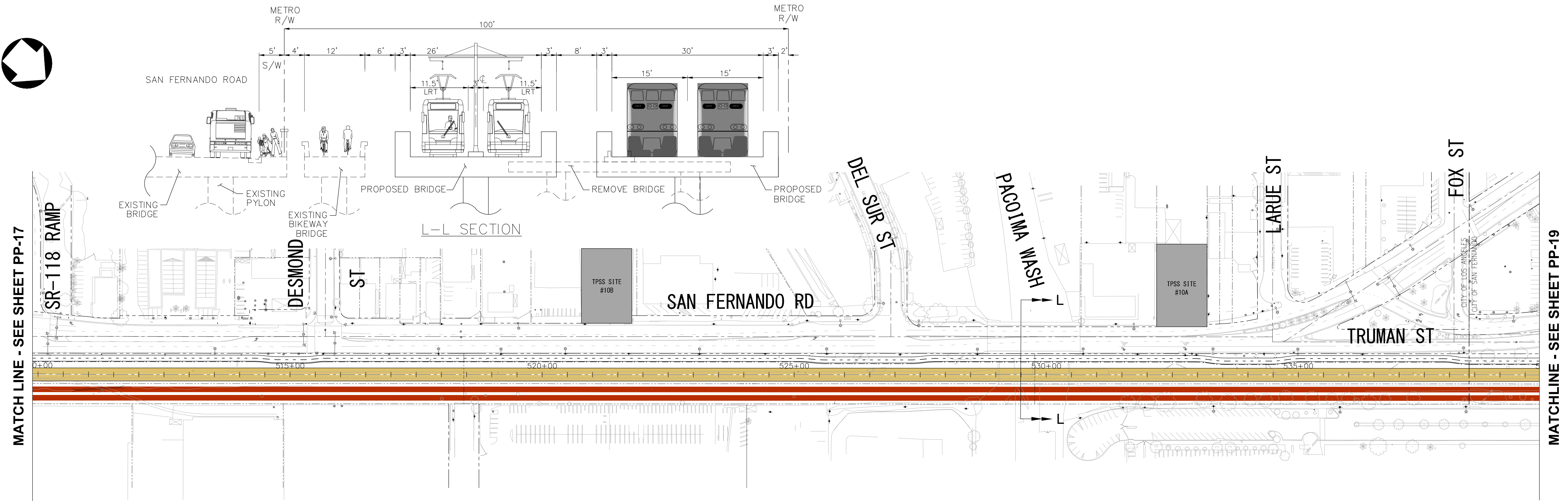
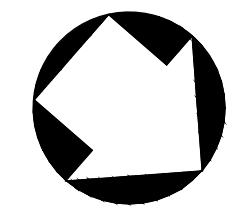

ALTERNATIVE 4 - LRT MEDIAN RUNNING/ UNDERGROUND

J:\2010\B01205 Metro Van Nuys Corridor Rapidway\Exhibit30\Concept Eng\Alternative Exhibits\Alt 4B PP-18.dwg - LAST PLOTTED ON Thu 08/04/16 - 06:09PM BY vrodriquez

REV	DATE	BY	APP	REG. NO.	EXPIRES	SEAL HOLDER	DESCRIPTION

DESIGNED BY	
DRAWN BY	
CHECKED BY	
IN CHARGE	
DATE	

LOS ANGELES COUNTY METROPOLITAN TRANSPORTATION AUTHORITY

PROJECT MANAGER

EAST SAN FERNANDO VALLEY TRANSIT CORRIDOR
 LIGHT RAIL TRANSIT ALTERNATIVE
 PLAN & PROFILE
 STA 510+00 TO STA 540+00

CONTRACT NO.	PS-4370-2622
DRAWING NO.	PP-18
SCALE	HORIZ: 1"=100' VERT: 1"=10'
SHEET NO.	

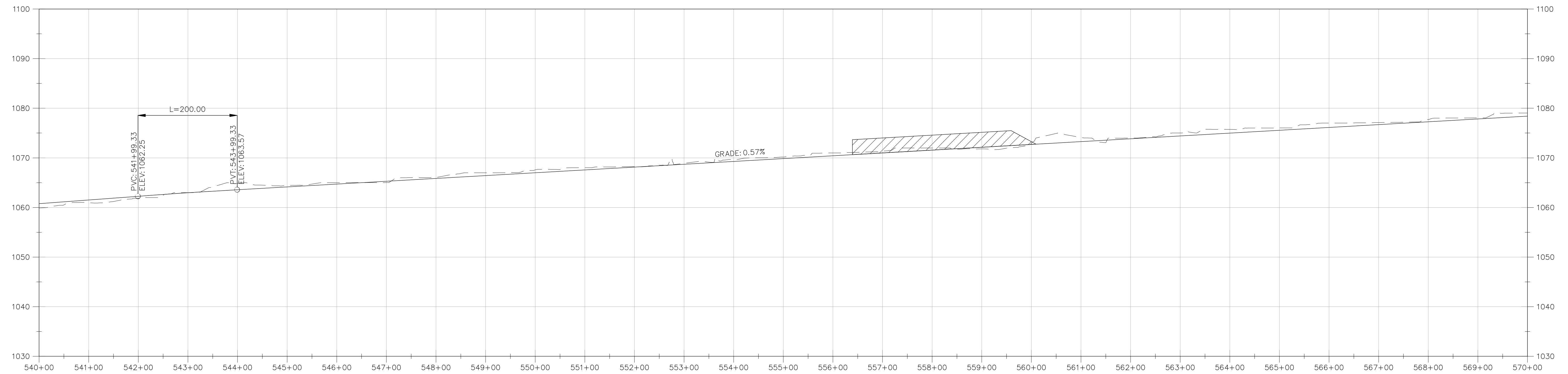
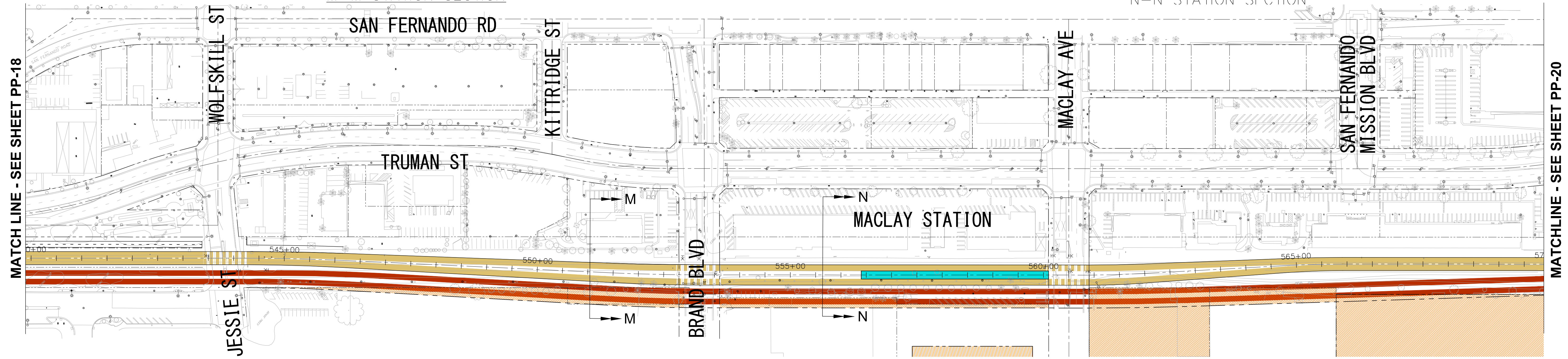
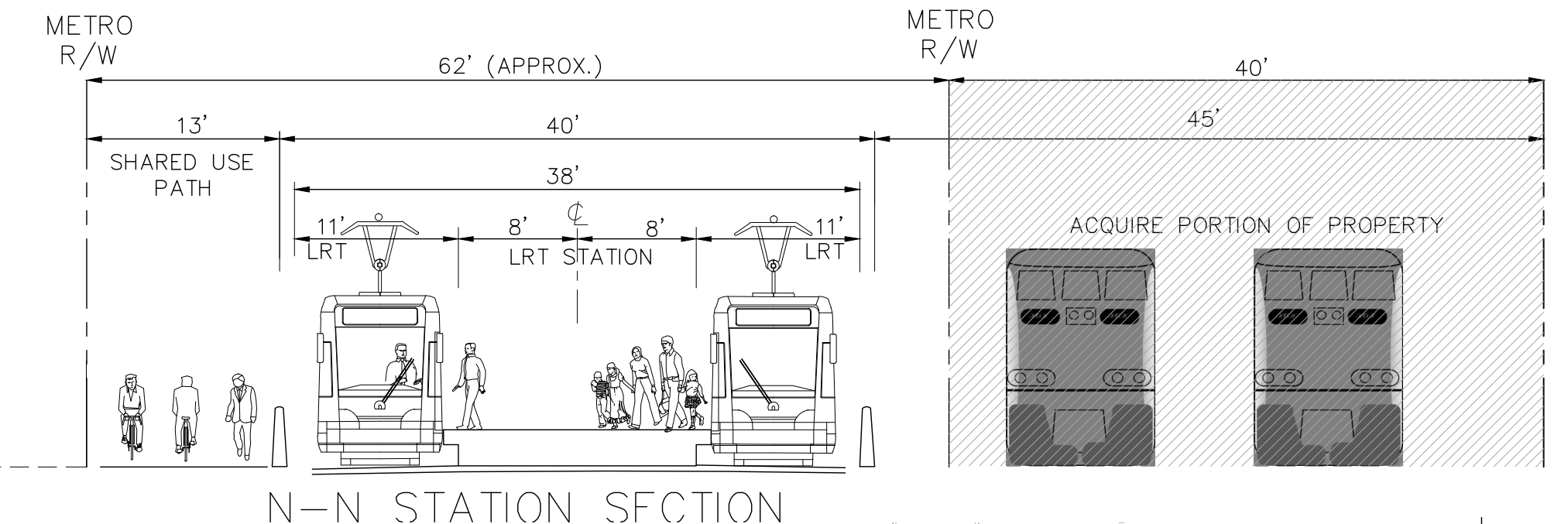
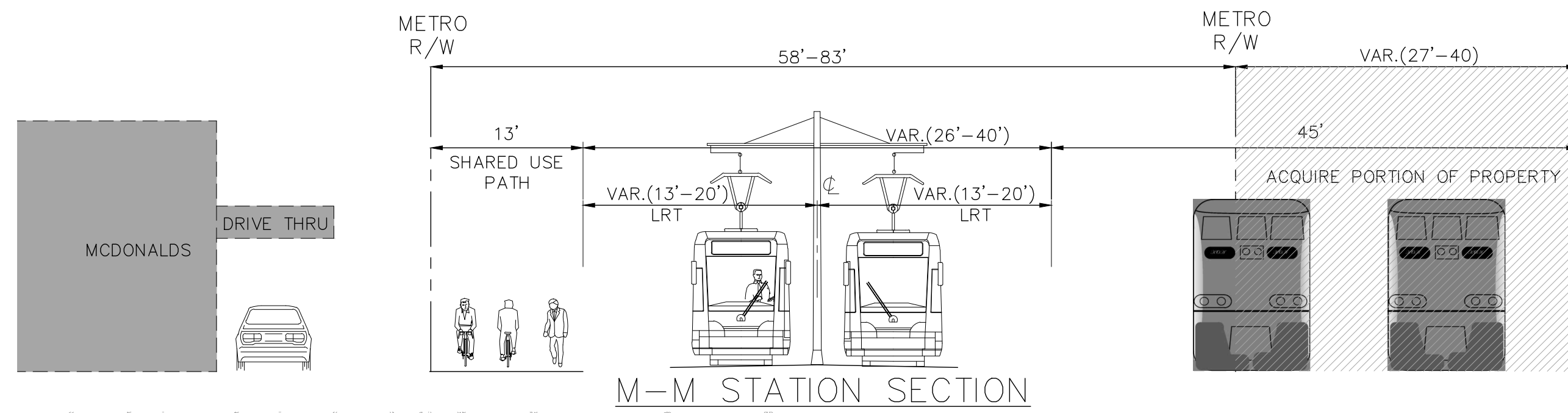
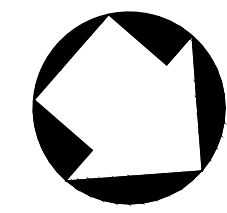

ALTERNATIVE 4 - LRT MEDIAN RUNNING/ UNDERGROUND

REV	DATE	BY	APP	REG. NO.	EXPIRES	SEAL HOLDER	DESCRIPTION

DESIGNED BY	
DRAWN BY	
CHECKED BY	
IN CHARGE	
DATE	

M Metro LOS ANGELES COUNTY METROPOLITAN TRANSPORTATION AUTHORITY

PROJECT MANAGER

EAST SAN FERNANDO VALLEY TRANSIT CORRIDOR
LIGHT RAIL TRANSIT ALTERNATIVE

PLAN & PROFILE
STA 540+00 TO STA 570+00

CONTRACT NO.	PS-4370-2622
DRAWING NO.	PP-19
SCALE	HORIZ: 1"=100' VERT: 1"=10'
SHEET NO.	0

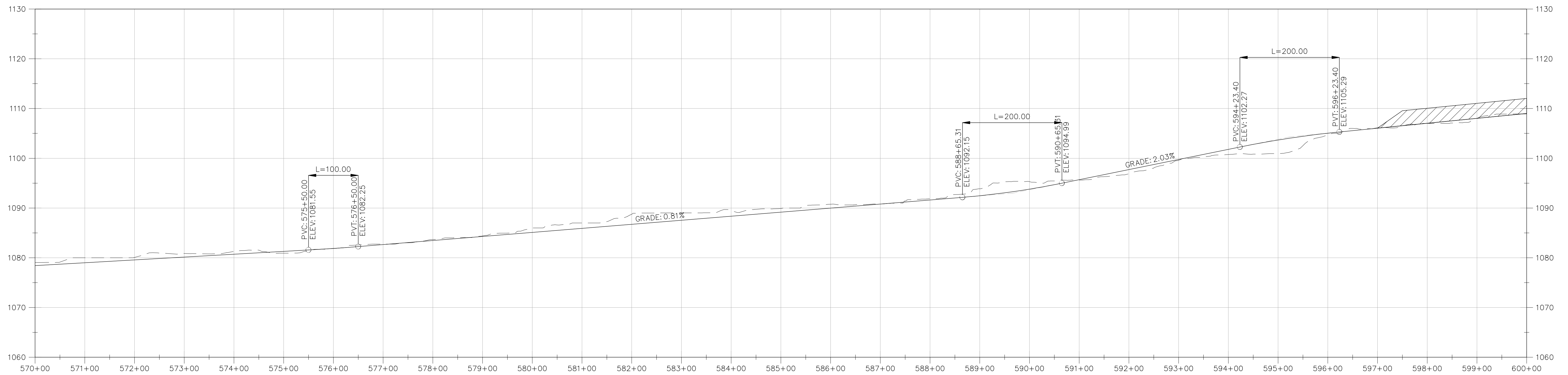
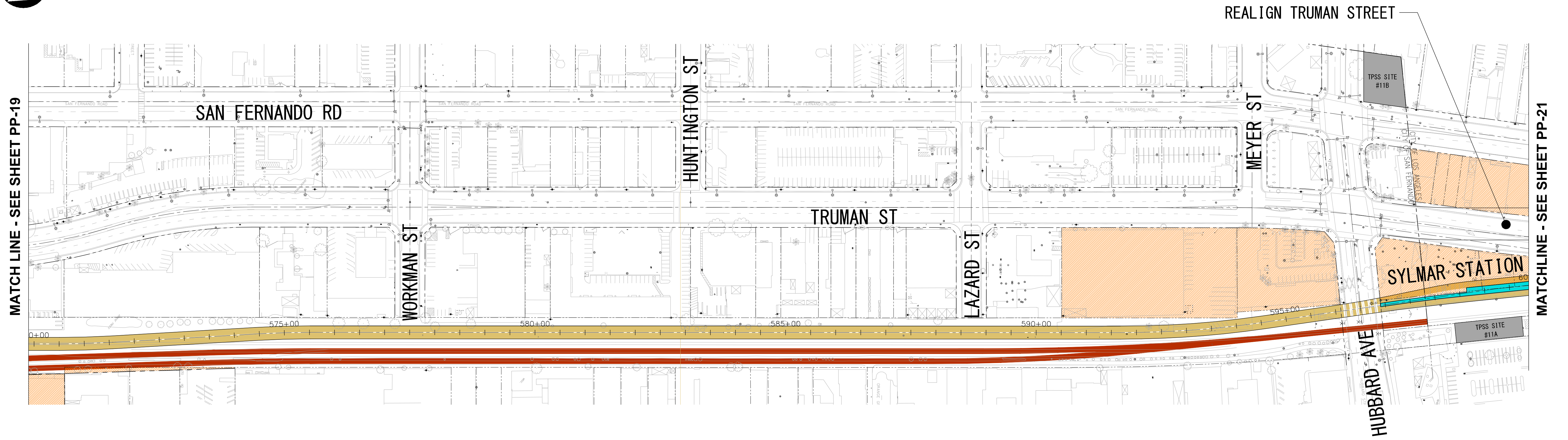
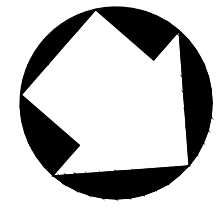

ALTERNATIVE 4 – LRT MEDIAN RUNNING/ UNDERGROUND

REV	DATE	BY	APP	REG. NO.	EXPIRES	SEAL HOLDER	DESCRIPTION

DESIGNED BY	—
DRAWN BY	—
CHECKED BY	—
IN CHARGE	—
DATE	—



**LOS ANGELES COUNTY METROPOLITAN
TRANSPORTATION AUTHORITY**

EAST SAN FERNANDO VALLEY TRANSIT CORRIDOR
LIGHT RAIL TRANSIT ALTERNATIVE

PLAN & PROFILE
STA 570+00 TO STA 600+00

CONTRACT NO.	PS-4370-2622
DRAWING NO.	PP-20
SCALE	HORIZ: 1"=100' VERT: 1"=10'
SHEET NO.	0

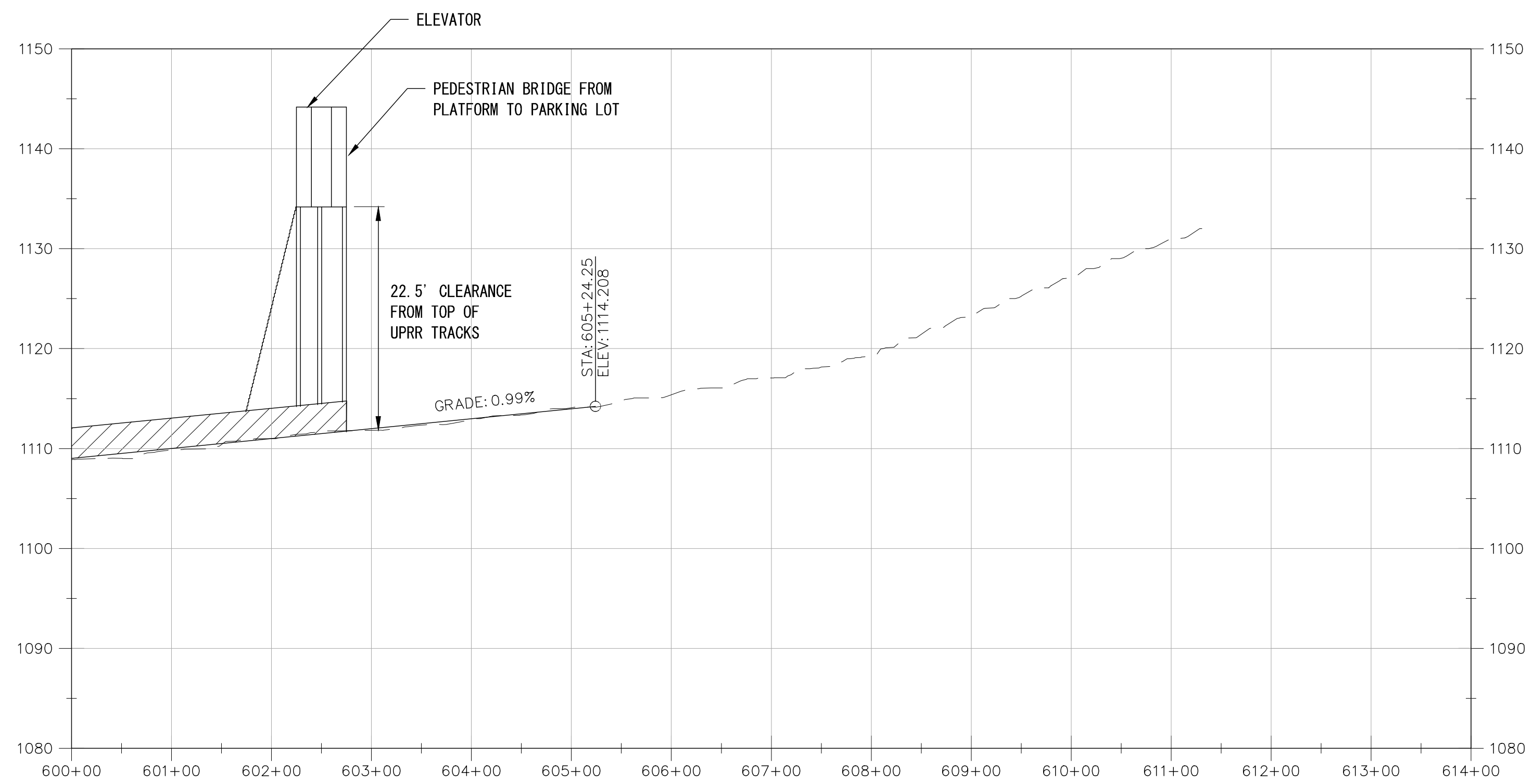
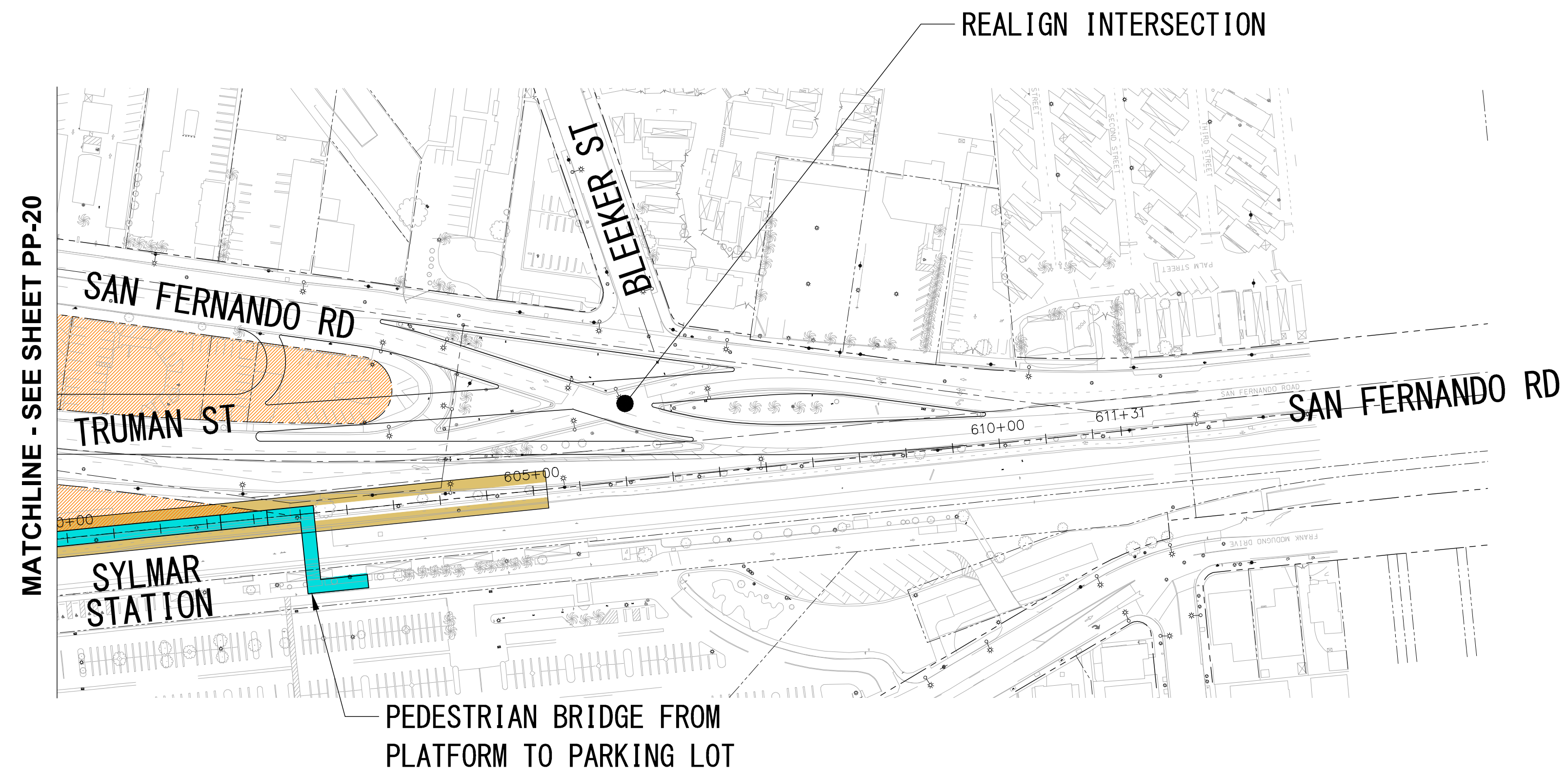
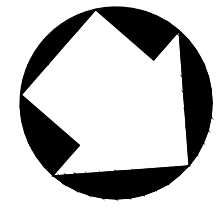

ALTERNATIVE 4 - LRT MEDIAN RUNNING/ UNDERGROUND

REV	DATE	BY	APP	REG. NO.	EXPIRES	SEAL HOLDER	DESCRIPTION

DESIGNED BY	
DRAWN BY	
CHECKED BY	
IN CHARGE	
DATE	



**LOS ANGELES COUNTY METROPOLITAN
TRANSPORTATION AUTHORITY**

EAST SAN FERNANDO VALLEY TRANSIT CORRIDOR
LIGHT RAIL TRANSIT ALTERNATIVE
PLAN & PROFILE
STA 600+00 TO STA 614+00

CONTRACT NO.	PS-4370-2622
DRAWING NO.	PP-21
SCALE	HORIZ: 1"=100' VERT: 1"=10'
SHEET NO.	