

ALTERNATIVE 4 - LRT MEDIAN RUNNING/ UNDERGROUND

DESIGN SPEED = 50MPH

J:\2010\B01205 Metro Van Nuys Corridor Rapidway\Exhibit30\Concept Eng\Alternative Exhibits\Alt 4B PP-06.dwg - LAST PLOTTED ON Thu 08/04/16 - 05:18PM BY vrodriquez

REV	DATE	BY	APP	REG. NO.	EXPIRES	SEAL HOLDER	DESCRIPTION

DESIGNED BY	
DRAWN BY	
CHECKED BY	
IN CHARGE	
DATE	

M Metro LOS ANGELES COUNTY METROPOLITAN TRANSPORTATION AUTHORITY

PROJECT MANAGER

EAST SAN FERNANDO VALLEY TRANSIT CORRIDOR
 LIGHT RAIL TRANSIT ALTERNATIVE
 PLAN & PROFILE
 STA 170+00 TO STA 200+00
 OPTION B

CONTRACT NO.	PS-4370-2622
DRAWING NO.	PP-06B
SCALE	HORIZ: 1"=100' VERT: 1"=10'
SHEET NO.	

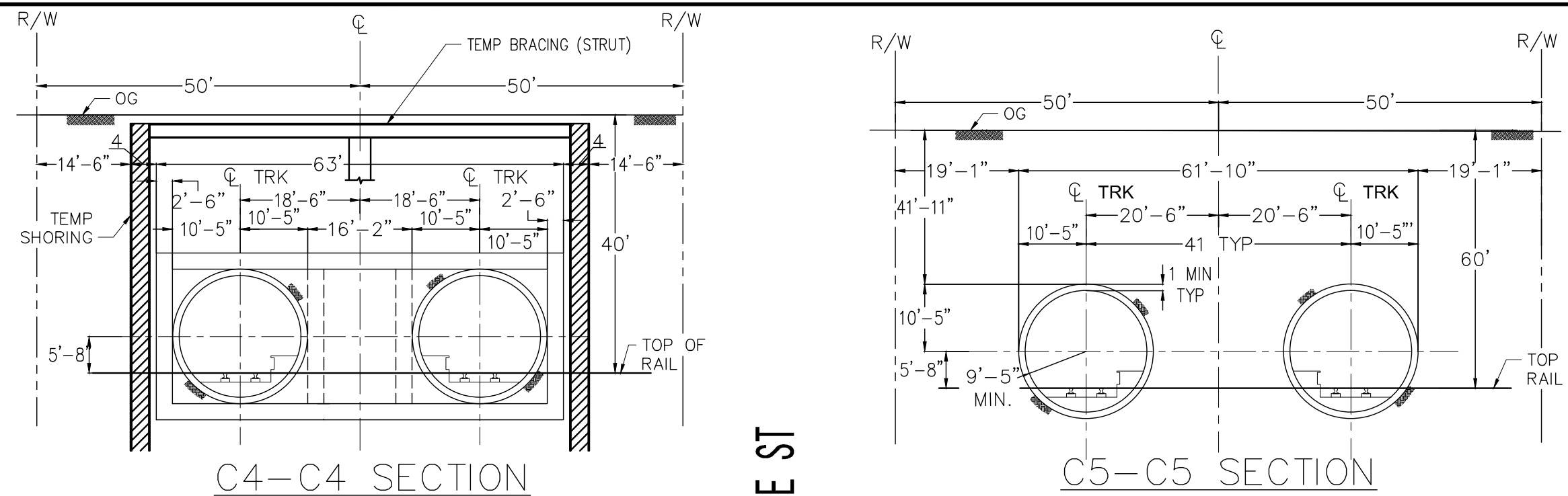
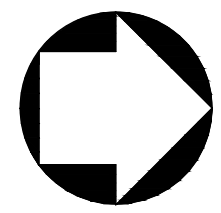

MATCHLINE - SEE SHEET PP-06

MATCHLINE - SEE SHEET PP-08

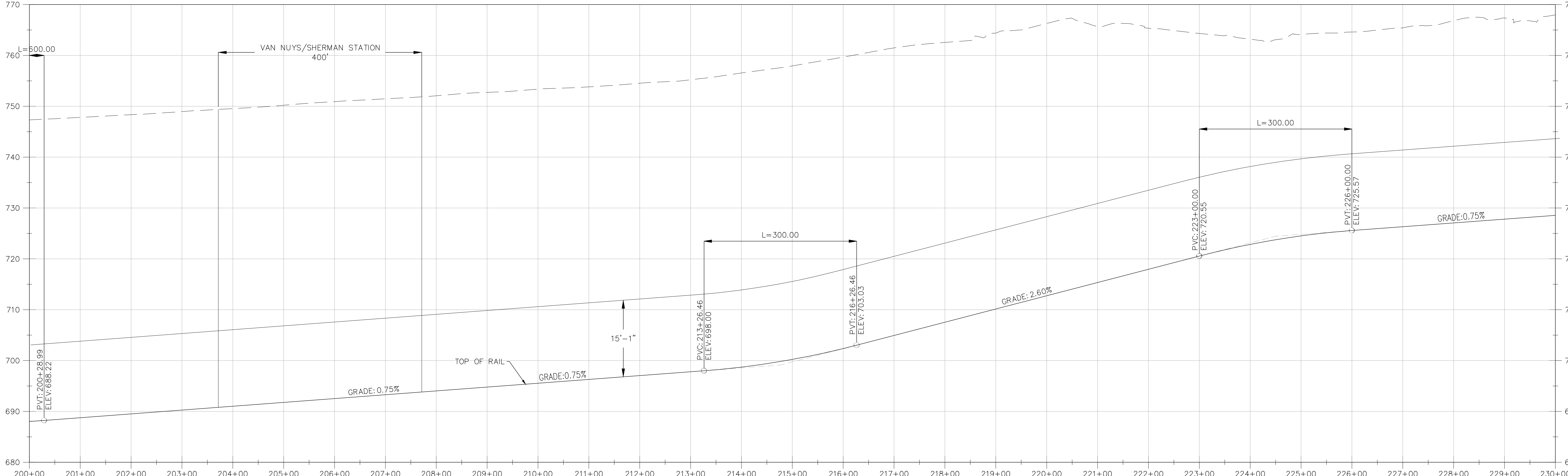
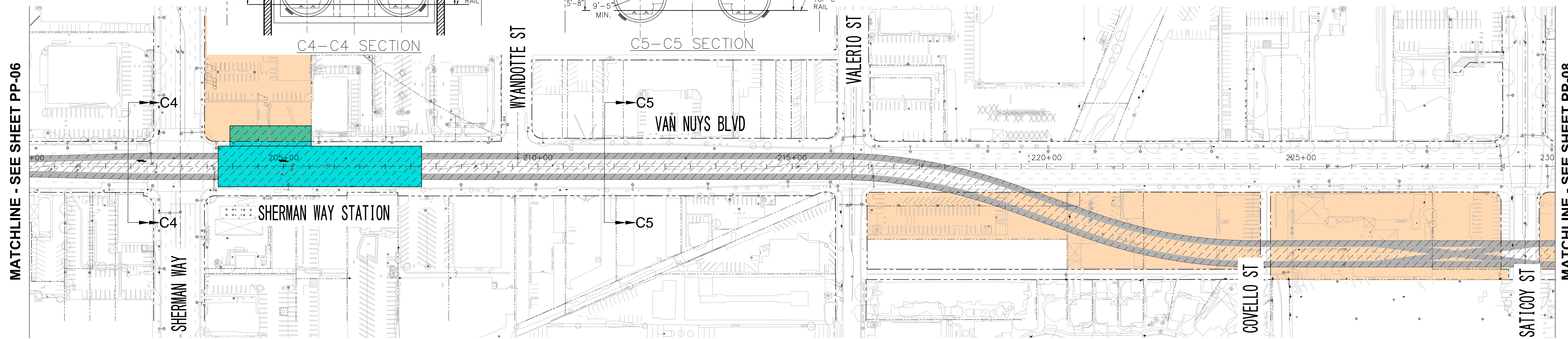

ALTERNATIVE 4 - LRT MEDIAN RUNNING/ UNDERGROUND

DESIGN SPEED = 50MPH

REV	DATE	BY	APP	REG. NO.	EXPIRES	SEAL HOLDER	DESCRIPTION

DESIGNED BY	
DRAWN BY	
CHECKED BY	
IN CHARGE	
DATE	

LOS ANGELES COUNTY METROPOLITAN TRANSPORTATION AUTHORITY
 PROJECT MANAGER

EAST SAN FERNANDO VALLEY TRANSIT CORRIDOR
 LIGHT RAIL TRANSIT ALTERNATIVE
 PLAN & PROFILE
 STA 200+00 TO STA 230+00
 OPTION B

CONTRACT NO.	PS-4370-2622
DRAWING NO.	PP-07B
SCALE	HORIZ: 1"=100' VERT: 1"=10'
SHEET NO.	

J:\2010\LB01205 Metro Van Nuys Corridor Rapidway\Exhibit30\Concept Eng\Alternative Exhibits\Alt 4B PP-07-07 - B.dwg - LAST PLOTTED ON Thu 08/04/16 - 05:24PM BY vrodriquez

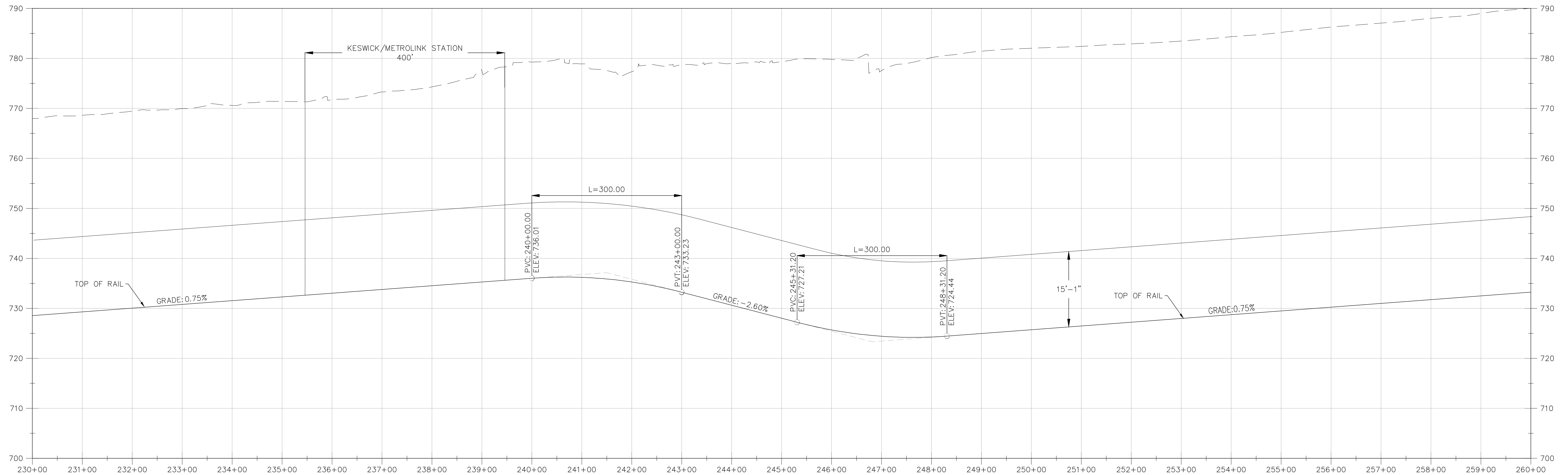
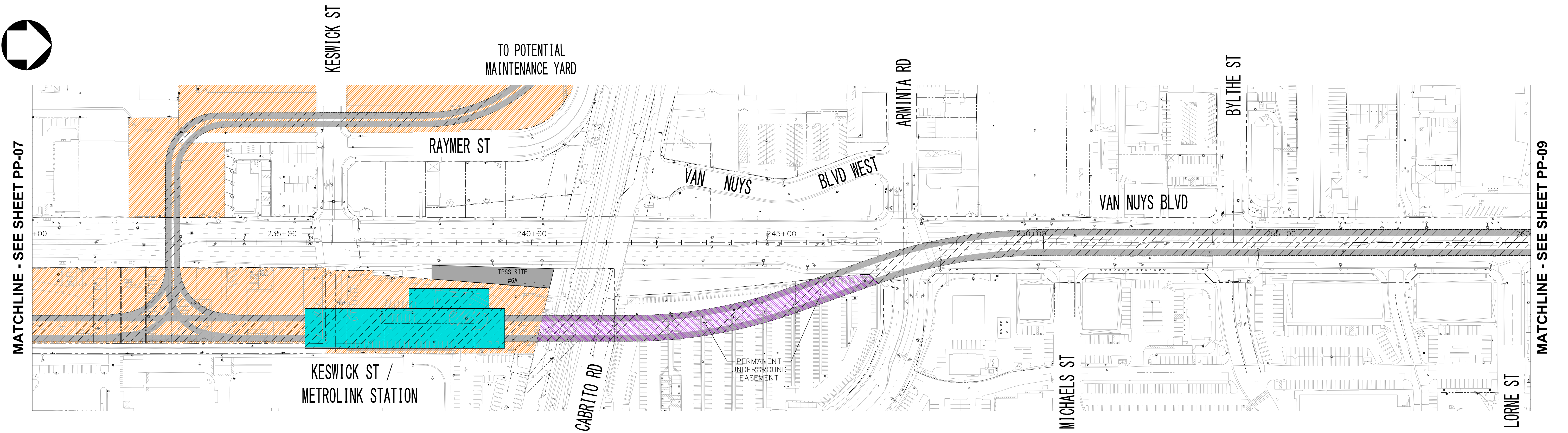
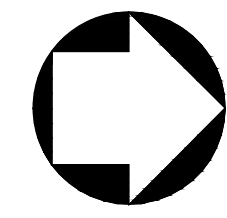

ALTERNATIVE 4 - LRT MEDIAN RUNNING/ UNDERGROUND

DESIGN SPEED = 50MPH

REV	DATE	BY	APP	REG. NO.	EXPIRES	SEAL HOLDER	DESCRIPTION

DESIGNED BY	
DRAWN BY	
CHECKED BY	
IN CHARGE	
DATE	

LOS ANGELES COUNTY METROPOLITAN TRANSPORTATION AUTHORITY
 PROJECT MANAGER

EAST SAN FERNANDO VALLEY TRANSIT CORRIDOR
 LIGHT RAIL TRANSIT ALTERNATIVE
 PLAN & PROFILE
 STA 230+00 TO STA 260+00
 OPTION B

CONTRACT NO.	PS-4370-2622
DRAWING NO.	PP-08B
SCALE	HORIZ: 1"=100' VERT: 1"=10'
SHEET NO.	

J:\2010\UB01205 Metro Van Nuys Corridor Rapidway\Exhibit30\Concept Eng\Alternative Exhibit\Alt 4B PP\PP-08 - B.dwg - LAST PLOTTED ON Thu 08/04/16 - 05:39PM BY vrodriquez

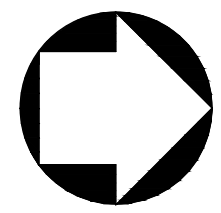

MATCHLINE - SEE SHEET PP-08

MATCHLINE - SEE SHEET PP-10

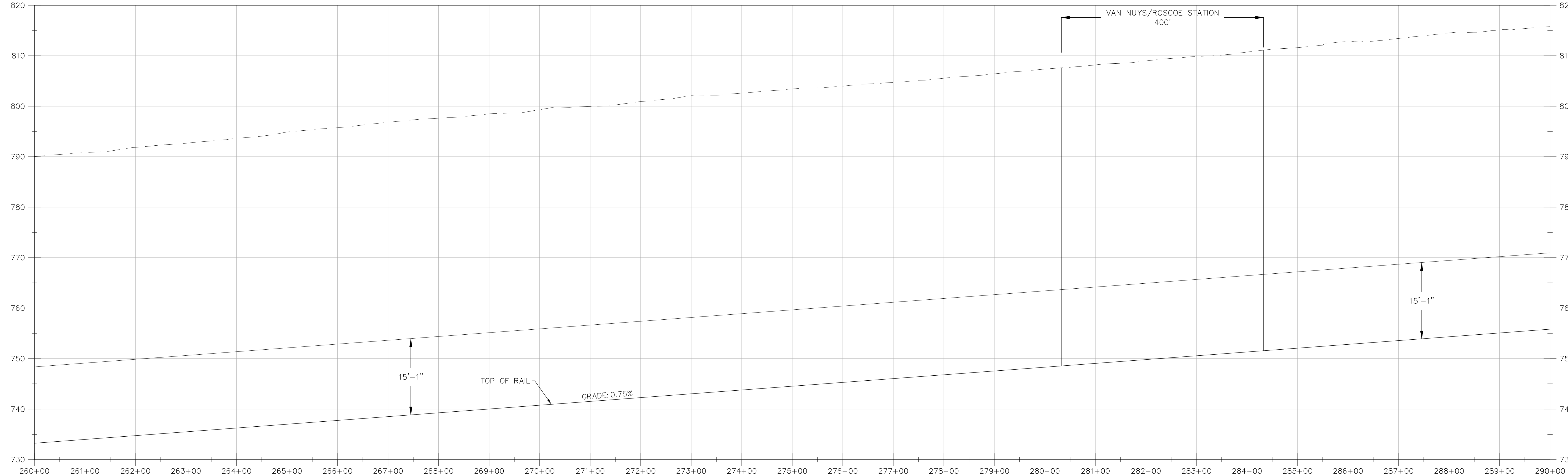
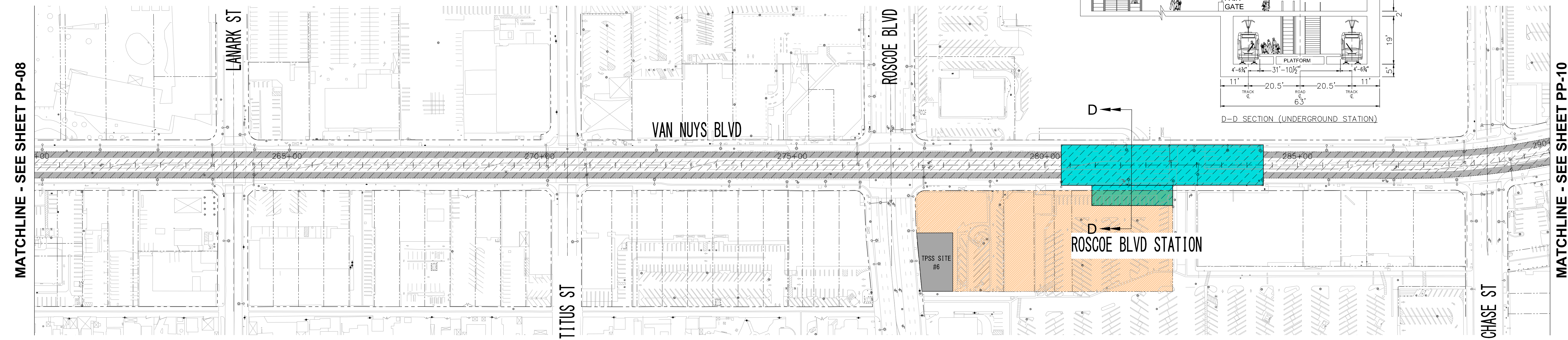

ALTERNATIVE 4 - LRT MEDIAN RUNNING/ UNDERGROUND

DESIGN SPEED = 50MPH

REV	DATE	BY	APP	REG. NO.	EXPIRES	SEAL HOLDER	DESCRIPTION

DESIGNED BY	
DRAWN BY	
CHECKED BY	
IN CHARGE	
DATE	

**LOS ANGELES COUNTY METROPOLITAN
TRANSPORTATION AUTHORITY**

PROJECT MANAGER

EAST SAN FERNANDO VALLEY TRANSIT CORRIDOR
LIGHT RAIL TRANSIT ALTERNATIVE
PLAN & PROFILE
STA 260+00 TO STA 290+00
OPTION B

CONTRACT NO.	PS-4370-2622
DRAWING NO.	PP-09B
SCALE	HORIZ: 1"=100' VERT: 1"=10'
SHEET NO.	

J:\2010\BIB1205 Metro Van Nuys Corridor Rapidway\Exhibit30\Concept Eng\Alternative Exhibits\Alt 4B PP-09B.dwg - LAST PLOTTED ON Thu 08/04/16 - 05:34PM BY vrodriquez

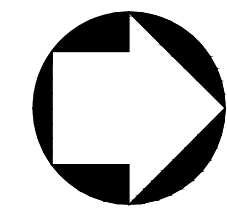

MATCHLINE - SEE SHEET PP-09

MATCHLINE - SEE SHEET PP-11

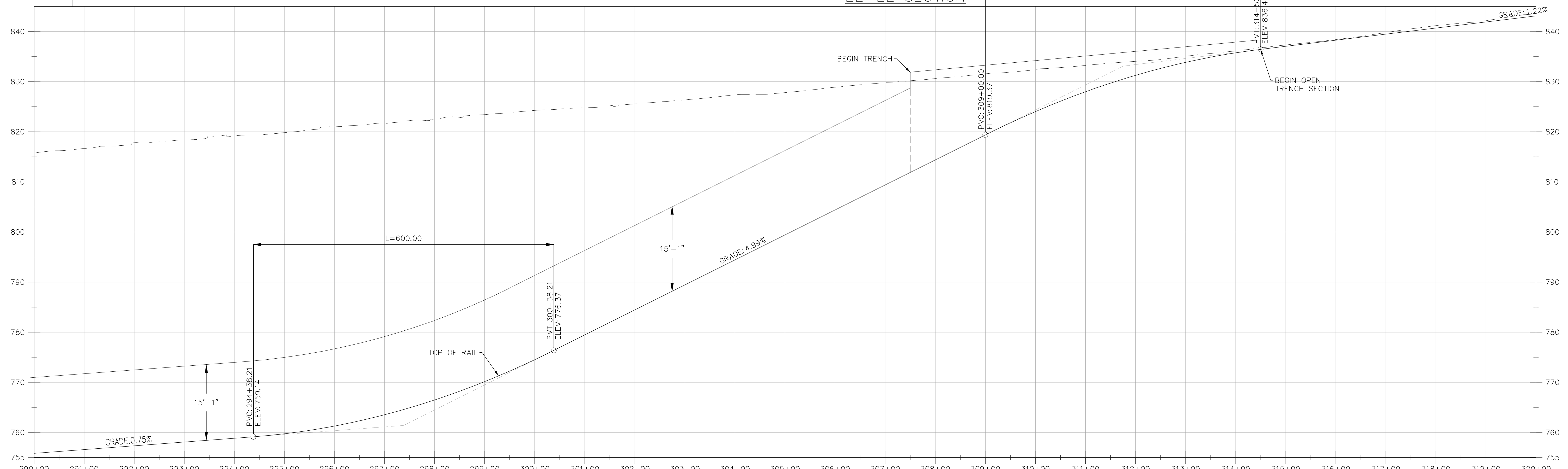
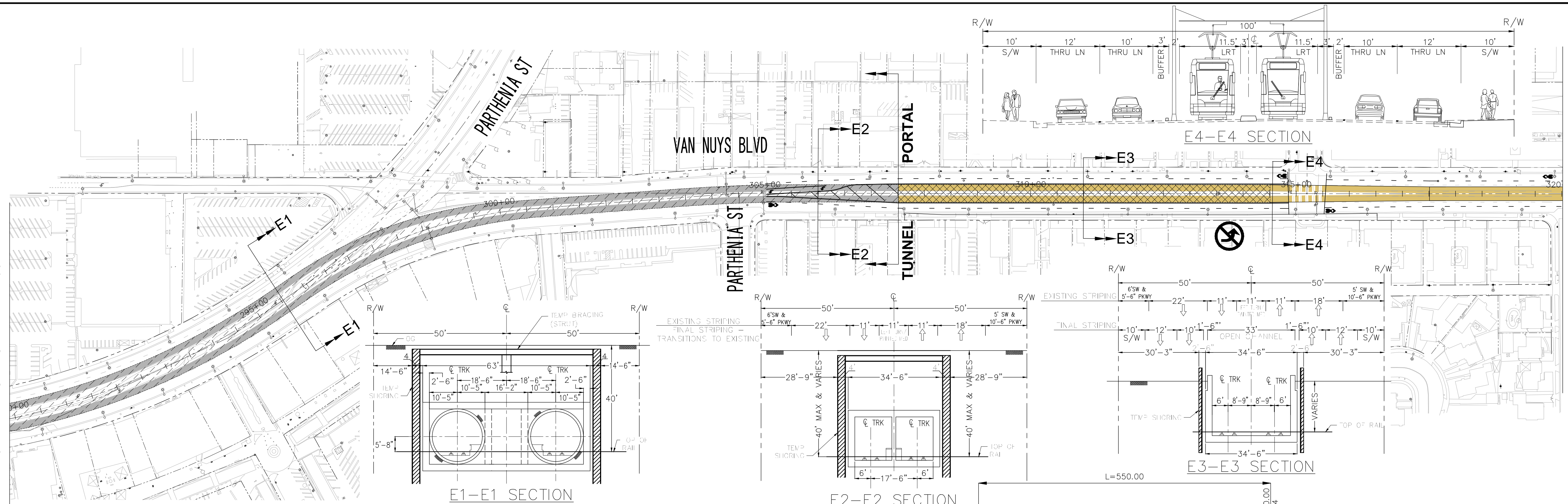

ALTERNATIVE 4 - LRT MEDIAN RUNNING/ UNDERGROUND

DESIGN SPEED = 50MPH

REV	DATE	BY	APP	REG. NO.	EXPIRES	SEAL HOLDER	DESCRIPTION

DESIGNED BY	
DRAWN BY	
CHECKED BY	
IN CHARGE	
DATE	



EAST SAN FERNANDO VALLEY TRANSIT CORRIDOR
 LIGHT RAIL TRANSIT ALTERNATIVE
 PLAN & PROFILE
 STA 290+00 TO STA 320+00
 OPTION B

CONTRACT NO.	PS-4370-2622
DRAWING NO.	PP-10B
SCALE	HORIZ: 1"=100' VERT: 1"=10'
SHEET NO.	

J:\2010\UB01205 Metro Van Nuys Corridor Rapidway\Exhibit30\Concept Eng\Alternative Exhibits\Alt 4B PP-10 - B.dwg - LAST PLOTTED ON Thu 08/04/16 - 05:39PM BY vrodriquez