

ALTERNATIVE 4 - LRT MEDIAN RUNNING/ UNDERGROUND

DESIGN SPEED = 50MPH

J:\2010\UB01205 Metro Van Nuys Corridor Rapidway\Exhibit30% Concept Eng\Alternative Exhibits\Alt 4B PP-06.dwg - LAST PLOTTED ON Thu 08/04/16 - 05:20PM BY vrodriquez

REV	DATE	BY	APP	REG. NO.	EXPIRES	SEAL HOLDER	DESCRIPTION

DESIGNED BY	
DRAWN BY	
CHECKED BY	
IN CHARGE	
DATE	

**M Metro** LOS ANGELES COUNTY METROPOLITAN TRANSPORTATION AUTHORITY

PROJECT MANAGER

EAST SAN FERNANDO VALLEY TRANSIT CORRIDOR  
 LIGHT RAIL TRANSIT ALTERNATIVE  
 PLAN & PROFILE  
 STA 170+00 TO STA 200+00  
 OPTION C

CONTRACT NO.	PS-4370-2622
DRAWING NO.	PP-06C
SCALE	HORIZ: 1"=100' VERT: 1"=10'
SHEET NO.	

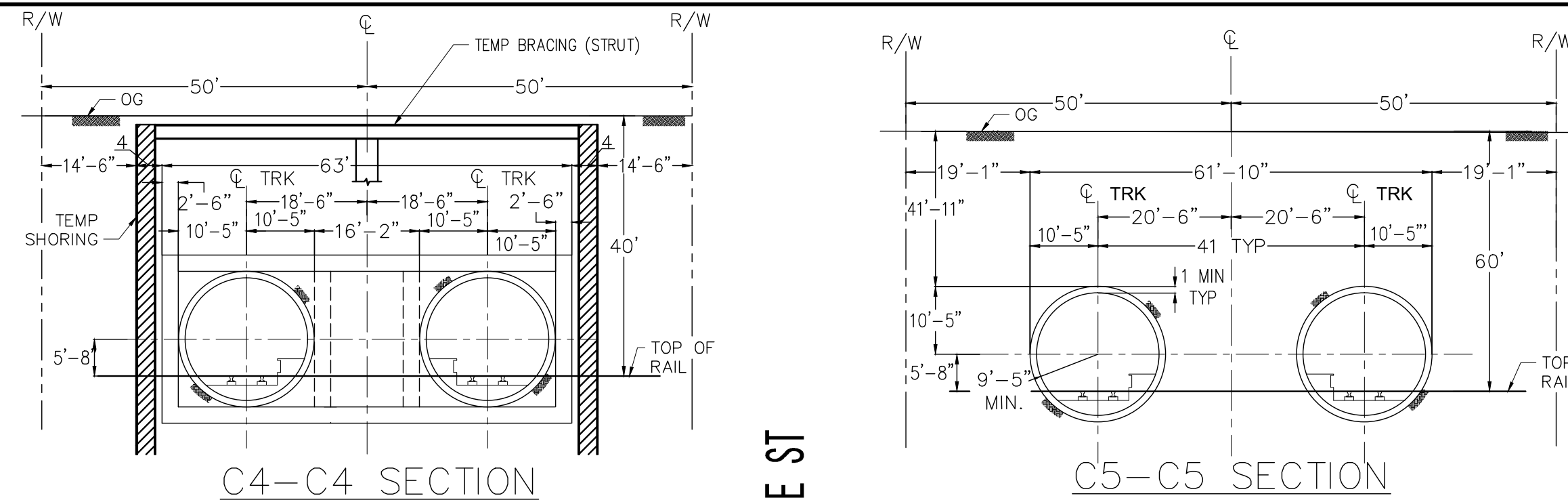
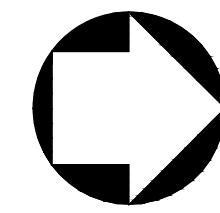

MATCHLINE - SEE SHEET PP-06

MATCHLINE - SEE SHEET PP-08

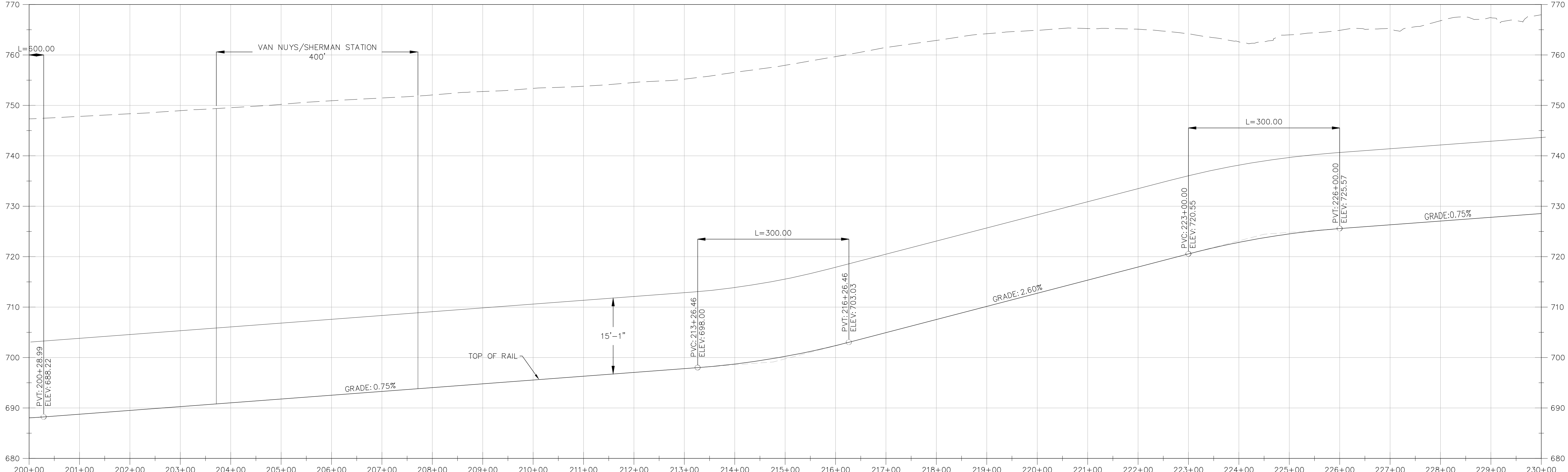
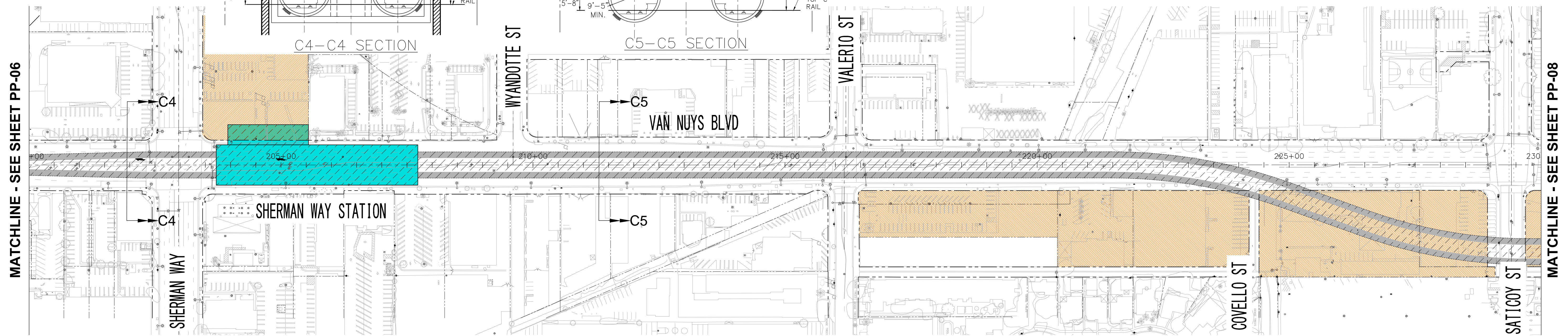

**ALTERNATIVE 4 - LRT MEDIAN RUNNING/ UNDERGROUND**

**DESIGN SPEED = 50MPH**

REV	DATE	BY	APP	REG. NO.	EXPIRES	SEAL HOLDER	DESCRIPTION

DESIGNED BY	
DRAWN BY	
CHECKED BY	
IN CHARGE	
DATE	

**LOS ANGELES COUNTY METROPOLITAN  
TRANSPORTATION AUTHORITY**

PROJECT MANAGER

EAST SAN FERNANDO VALLEY TRANSIT CORRIDOR  
LIGHT RAIL TRANSIT ALTERNATIVE  
PLAN & PROFILE  
STA 200+00 TO STA 230+00  
OPTION C

CONTRACT NO.	PS-4370-2622
DRAWING NO.	PP-07C
SCALE	HORIZ: 1"=100' VERT: 1"=10'
SHEET NO.	

J:\2010\B01205 Metro Van Nuys Corridor Rapidway\Exhibit30% Concept Eng\Alternative Exhibits\Alt 4B PP-07C.dwg - LAST PLOTTED ON Thu 08/04/16 - 05:25PM BY vrodriquez

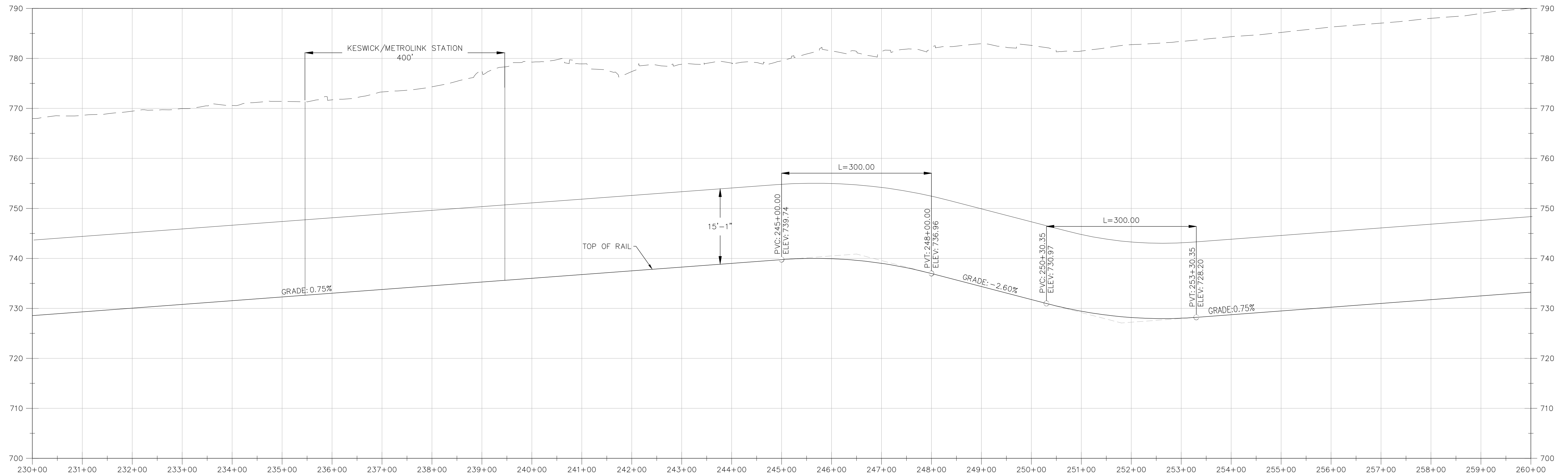
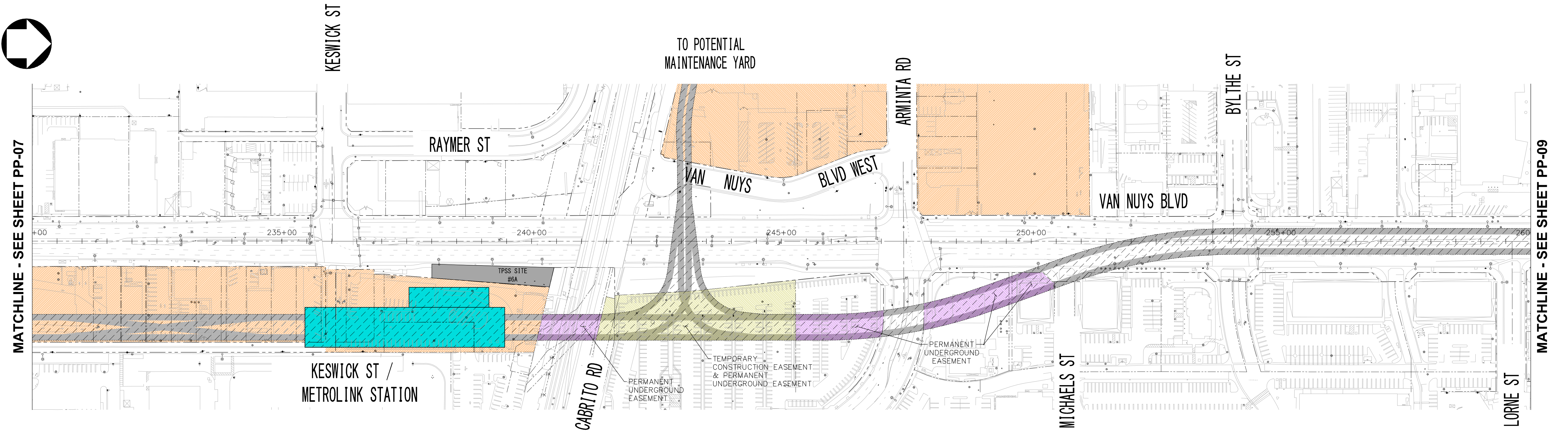
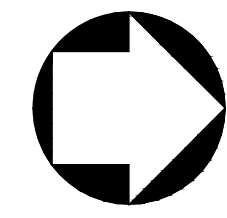

ALTERNATIVE 4 - LRT MEDIAN RUNNING/ UNDERGROUND

DESIGN SPEED = 50MPH

REV	DATE	BY	APP	REG. NO.	EXPIRES	SEAL HOLDER	DESCRIPTION

DESIGNED BY	
DRAWN BY	
CHECKED BY	
IN CHARGE	
DATE	

**M Metro** LOS ANGELES COUNTY METROPOLITAN TRANSPORTATION AUTHORITY

PROJECT MANAGER

EAST SAN FERNANDO VALLEY TRANSIT CORRIDOR  
 LIGHT RAIL TRANSIT ALTERNATIVE  
 PLAN & PROFILE  
 STA 230+00 TO STA 260+00  
 OPTION C

CONTRACT NO.	PS-4370-2622
DRAWING NO.	PP-08C
SCALE	HORIZ: 1"=100' VERT: 1"=10'
SHEET NO.	

J:\2010\B01205 Metro Van Nuys Corridor Rapidway\Exhibit30% Concept Eng\Alternative Exhibit\Alt 4B PP\PP-08 - C.dwg - LAST PLOTTED ON Thu 08/04/16 - 05:31PM BY vrodriquez

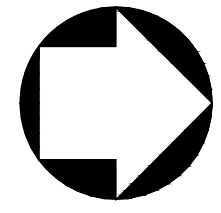

MATCHLINE - SEE SHEET PP-08

MATCHLINE - SEE SHEET PP-10

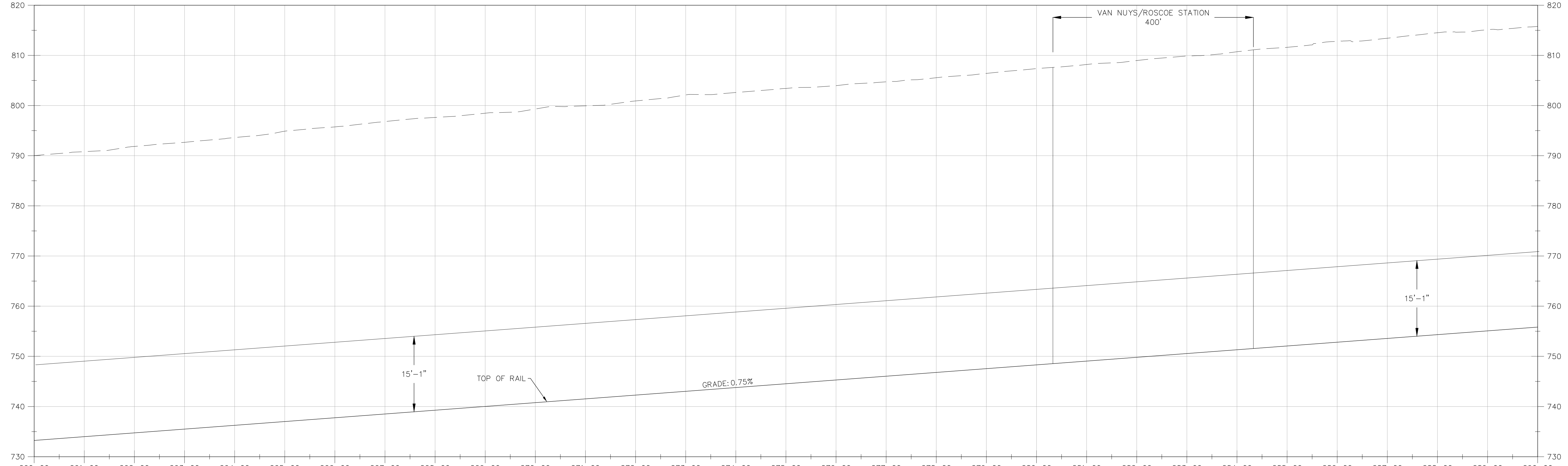
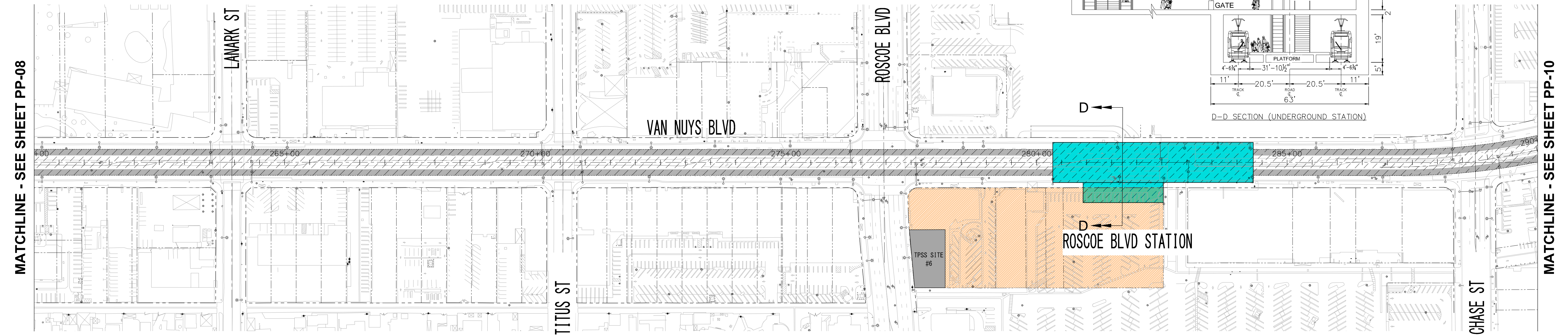

ALTERNATIVE 4 - LRT MEDIAN RUNNING/ UNDERGROUND

DESIGN SPEED = 50MPH

REV	DATE	BY	APP	REG. NO.	EXPIRES	SEAL HOLDER	DESCRIPTION

DESIGNED BY	
DRAWN BY	
CHECKED BY	
IN CHARGE	
DATE	



**LOS ANGELES COUNTY METROPOLITAN TRANSPORTATION AUTHORITY**

PROJECT MANAGER

EAST SAN FERNANDO VALLEY TRANSIT CORRIDOR  
 LIGHT RAIL TRANSIT ALTERNATIVE  
 PLAN & PROFILE  
 STA 260+00 TO STA 290+00  
 OPTION C

CONTRACT NO.	PS-4370-2622
DRAWING NO.	PP-09C
SCALE	HORIZ: 1"=100' VERT: 1"=10'
SHEET NO.	

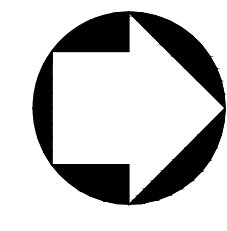
J:\2010\BIB1205 Metro Van Nuys Corridor Rapidway\Exhibit30\Concept Eng\Alternative Exhibits\Alt 4B PP-09C.dwg - LAST PLOTTED ON Thu 08/04/16 05:38PM BY vrodriquez



MATCHLINE - SEE SHEET PP-09

MATCHLINE - SEE SHEET PP-11

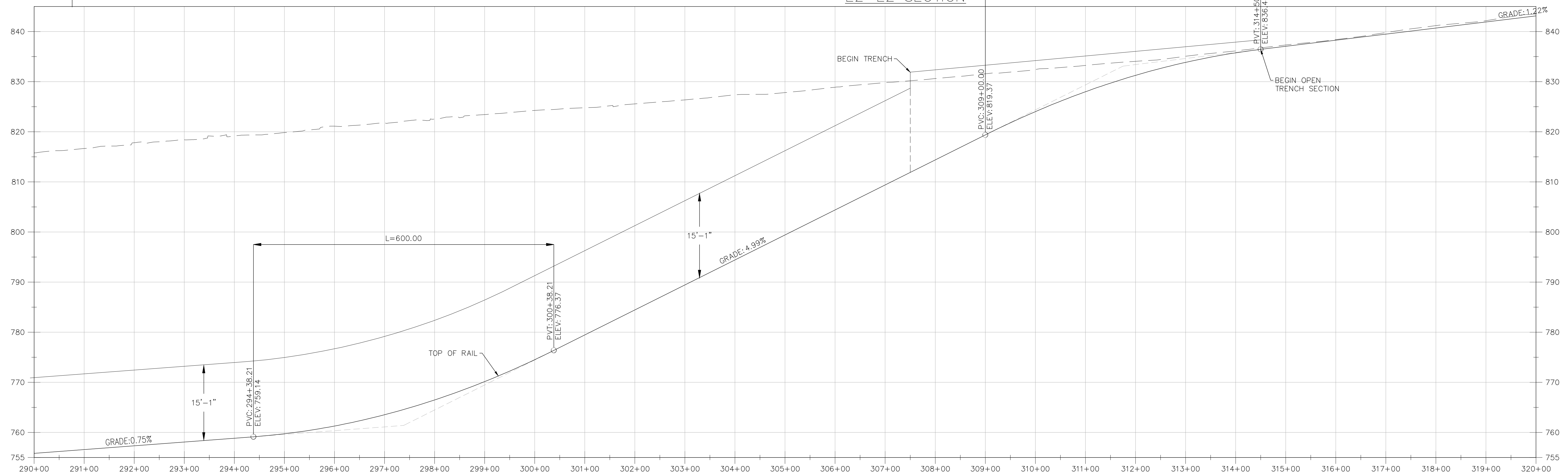
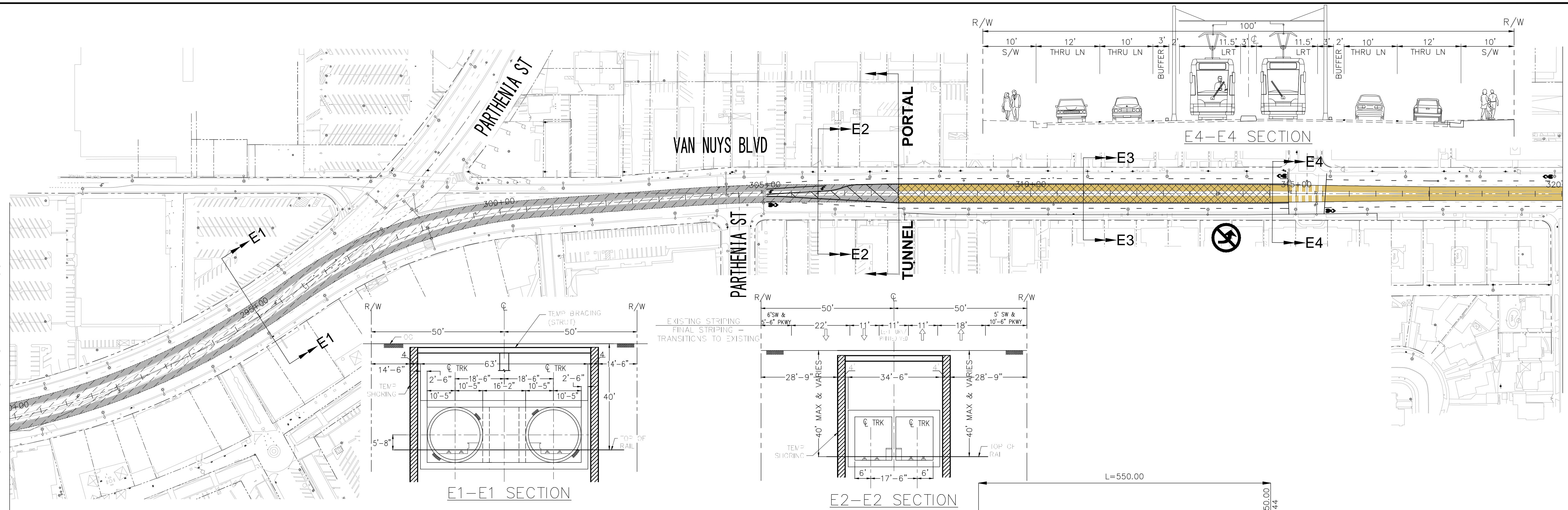

ALTERNATIVE 4 - LRT MEDIAN RUNNING/ UNDERGROUND

DESIGN SPEED = 50MPH

REV	DATE	BY	APP	REG. NO.	EXPIRES	SEAL HOLDER	DESCRIPTION

DESIGNED BY	
DRAWN BY	
CHECKED BY	
IN CHARGE	
DATE	

**M Metro** LOS ANGELES COUNTY METROPOLITAN TRANSPORTATION AUTHORITY

PROJECT MANAGER

EAST SAN FERNANDO VALLEY TRANSIT CORRIDOR  
 LIGHT RAIL TRANSIT ALTERNATIVE  
 PLAN & PROFILE  
 STA 290+00 TO STA 320+00  
 OPTION C

CONTRACT NO.	PS-4370-2622
DRAWING NO.	PP-10C
SCALE	HORIZ: 1"=100' VERT: 1"=10'
SHEET NO.	

J:\2010\LB1205 Metro Van Nuys Corridor Rapidway\Exhibit30\Concept Eng\Alternative Exhibits\Alt 4B PP-10 - C.dwg - LAST PLOTTED ON Thu 08/04/16 - 05:41 PM BY vrodriquez