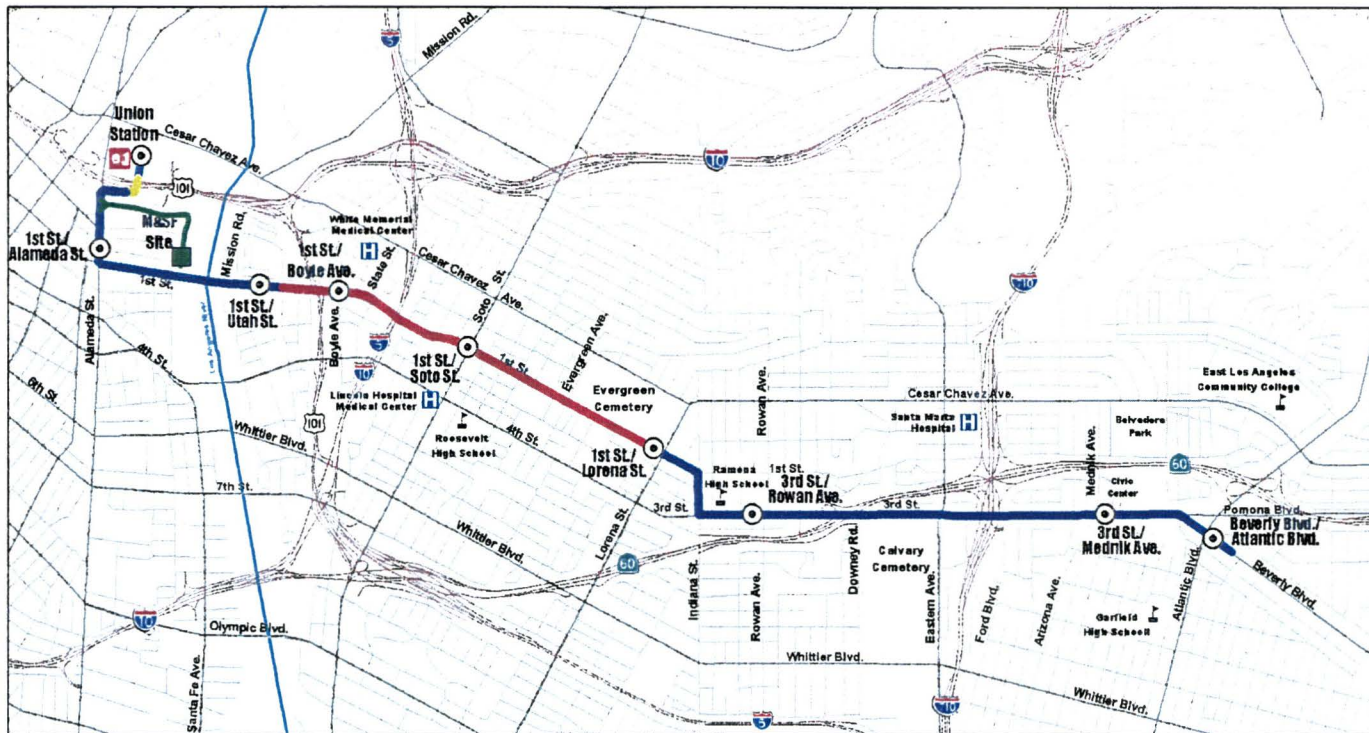


# Los Angeles Eastside Corridor



## Final Supplemental Environmental Impact Statement/ Final Subsequent Environmental Impact Report

### Volume I

Administrative Draft  
October 26, 2001

U.S. Department of Transportation  
Federal Transit Administration



Los Angeles County Metropolitan Transportation Authority



--- 34305

HE  
4491  
.L3  
L329  
F73ad  
v.1

MAR 15 2007



85839098

**FINAL SUPPLEMENTAL ENVIRONMENTAL IMPACT STATEMENT/  
SUBSEQUENT ENVIRONMENTAL IMPACT REPORT**

**For**

**THE LOS ANGELES EASTSIDE CORRIDOR PROJECT  
LOS ANGELES, CALIFORNIA**

**STATE CLEARINGHOUSE NUMBER NO. 1999081061**

Prepared in Accordance with the

National Environmental Policy Act of 1969, §102 (42 U.S.C. §4332); Federal Transit Laws (49 U.S.C. §5301(e), §5323(b) and §5324(b)); Title 49 U.S.C. §303 (formerly Department of Transportation Act of 1966, §4(f)); Executive Order 12898 (Environmental Justice); and California Environmental Quality Act, California Public Resources Code 2100, *et. seq.*

by the

**FEDERAL TRANSIT ADMINISTRATION  
U.S. DEPARTMENT OF TRANSPORTATION**

and

**LOS ANGELES COUNTY METROPOLITAN TRANSPORTATION  
AUTHORITY**

\_\_\_\_\_  
Date of Approval

\_\_\_\_\_  
Leslie Rogers  
Regional Administrator  
Federal Transit Administration

\_\_\_\_\_  
Date of Approval

\_\_\_\_\_  
Roger Snoble  
Chief Executive Officer  
Los Angeles County Metropolitan  
Transportation Authority



**FINAL SUPPLEMENTAL ENVIRONMENTAL IMPACT STATEMENT/SUBSEQUENT ENVIRONMENTAL IMPACT REPORT**

**RESPONSIBLE AGENCIES:**

Lead Agencies: Federal Transit Administration, U.S. Department of Transportation and  
Los Angeles County Metropolitan Transportation Authority

**TITLE OF PROPOSED ACTION:**

Los Angeles Eastside Corridor Transit Improvements, Los Angeles, California

**ABSTRACT:**

This report documents the environmental impacts of the Los Angeles Eastside Corridor Light Rail Transit (LRT) Build Alternative. The Los Angeles County Metropolitan Transportation Authority selected the LRT Build Alternative on May 24, 2001, based on extensive public involvement and environmental and technical analysis conducted as part of the Draft SEIS/SEIR. This 6-mile, nine station project will be an extension of the under construction Pasadena Blue Line. The project extends from Union Station to Atlantic Boulevard in East Los Angeles, via Alameda Street, 1<sup>st</sup> Street, Indiana Street, 3<sup>rd</sup> Street, and Beverly or Pomona Boulevards.

This project is a replacement project for the previously adopted and environmentally cleared Red Line East Side Corridor extension. The Red Line extension project was suspended in 1998 and alternatives to the suspended project were studied in the Re-Evaluation/Major Investment Study.

This report is a combined Final Supplemental Environmental Impact Statement/Subsequent Environmental Impact Report, satisfying the National Environmental Policy Act (NEPA) and the California Environmental Quality Act (CEQA). It focuses on the environmental impacts of the LRT Build Alternative with two options, Option A and Option B, and the selected Maintenance and Storage Facility (M&SF) utilizing the existing Red Line yard to house the 26 new light rail transit vehicles that will be required.

The Final SEIS/SEIR examines potential areas of impact including traffic, parking, land use and development, economic and fiscal, land acquisition/displacement and relocation, communities/neighborhoods, equity and environmental justice considerations, visual and aesthetics, air quality, noise and vibration, geologic and seismic, hazardous materials, water resources, natural resources and ecosystems, energy, safety and security, historic/archaeological/paleontological resources, community facilities, Section 4(f), utilities, and construction. Mitigation measures for the impacts are identified.

**FOR ADDITIONAL INFORMATION CONCERNING THIS DOCUMENT, PLEASE**

**CONTACT:**

Mr. Ray Sukys  
Office of Planning and  
Program Development  
Federal Transit Administration  
Region 9  
201 Mission Street, Suite 2210  
San Francisco, CA 94105  
Phone: (415) 744-3115

Mr. Erv Poka  
Metropolitan Office  
Federal Transit Administration/  
Federal Highway Administration,  
Region 9  
201 N. Figueroa St.,  
Suite 1460  
Los Angeles, CA 90012  
Phone: (213) 202-3952

Mr. Ray Sosa,  
Project Manager  
Los Angeles County  
Metropolitan Transportation  
Authority (LACMTA)  
One Gateway Plaza  
Los Angeles, CA 90012  
Phone (213) 922-3098



# TABLE OF CONTENTS

<u>SECTION</u>	<u>PAGE</u>
<b>Executive Summary .....</b>	<b>TBD</b>
<b>Chapter 1 - Purpose and Need .....</b>	<b>1-1</b>
1.1 Overview of Purpose and Need.....	1-1
1.1.1 Eastside Study Area .....	1-1
1.1.2 Regional Context.....	1-1
1.1.3 The Mobility Problem .....	1-3
1.1.4 Eastside Corridor Alternatives .....	1-3
1.2 Background and Planning Context.....	1-4
1.2.1 Regional Transportation Plan.....	1-6
1.2.2 General Plans .....	1-6
1.2.3 Systems Planning .....	1-6
1.2.4 Corridor Planning.....	1-8
1.3 Transportation Conditions and Needs .....	1-12
1.3.1 Roadway Conditions .....	1-13
1.3.2 Transit Services.....	1-16
1.3.3 Transportation System Performance .....	1-16
1.3.4 Community Factors.....	1-21
1.3.5 Goals and Objectives.....	1-24
1.3.6 Summary of Need .....	1-25
<b>Chapter 2 - Alternatives Considered .....</b>	<b>2-1</b>
2.1 Early Planning Studies .....	2-1
2.2 Previous EIS/EIR and Suspended Project (1990-1998) .....	2-2
2.3 Re-Evaluation/Major Investment Study (1999-2000).....	2-3
2.3.1 First-Round Screening of Alternatives.....	2-3
2.3.2 Second-Round Screening of Alternatives .....	2-5
2.3.3 Alternatives Considered for Evaluation in Re-Evaluation/MIS.....	2-6
2.3.4 MTA Board Action (February 24, 2000) .....	2-10
2.3.5 MTA Board Action (June 22, 2000) .....	2-10
2.4 Draft SEIS/SEIR Process, Selection of the LPA, and Response to Public Comments .....	2-10
2.4.1 Alternatives Considered in the Draft SEIS/SEIR.....	2-10
2.4.2 Selection of the Locally Preferred Alternative.....	2-14
2.4.3 Response to Public Comments and Modifications to the LPA (Option1).....	2-14
2.5 Alternatives Considered in this final SEIS/SEIR .....	2-19
2.5.1 No-Build Alternative.....	2-19
2.5.2 LRT Build Alternative .....	2-22
2.6 Other Alternatives Evaluated that May Reduce Impacts .....	2-34
2.7 Uses of this Final SEIS/SEIR Document – Selection of Locally Preferred Alternative for Implementation.....	2-34
<b>Chapter 3 – Transportation .....</b>	<b>3-1</b>
3.1 Transit .....	3-1
3.1.1 Affected Environment.....	3-1
3.1.2 Impacts .....	3-5
3.1.3 Mitigation.....	3-13
3.2 Traffic.....	3-14
3.2.1 Affected Environment.....	3-14

# TABLE OF CONTENTS

3.2.2	Existing Traffic Conditions.....	3-14
3.2.3	Future Traffic Impacts.....	3-21
3.2.4	Mitigation - Option A.....	3-38
3.2.5	Mitigation - Option B.....	3-42
3.3	Parking.....	3-44
3.3.1	Affected Environment.....	3-44
3.3.2	Impacts.....	3-44
3.3.3	Mitigation.....	3-51
3.4	Other Modes.....	3-53
3.4.1	Affected Environment.....	3-53
3.4.2	Impacts.....	3-53
3.4.3	Mitigation.....	3-60
3.5	Summary of Impacts.....	3-63
3.5.1	Unavoidable Significant Adverse Impacts.....	3-63
3.5.2	Impacts Found Not to be Significant.....	3-64
3.5.3	Cumulative Impacts.....	3-64
<b>Chapter 4 - Affected Environment and Environmental Consequences .....</b>		<b>4.0-1</b>
4.1	Land Use and Development.....	4.1-1
4.1.1	Affected Environment.....	4.1-1
4.1.2	Methodology for Impact Evaluation.....	4.1-13
4.1.3	Impacts.....	4.1-15
4.1.4	Mitigation.....	4.1-20
4.2	Economic and Fiscal Impacts.....	4.2-1
4.2.1	Affected Environment.....	4.2-1
4.2.2	Methodology for Impact Evaluation.....	4.2-2
4.2.3	Impacts.....	4.2-3
4.2.4	Mitigation.....	4.2-6
4.3	Land Acquisition/Displacement and Relocation.....	4.3-1
4.3.1	Affected Environment.....	4.3-1
4.3.2	Methodology for Impact Evaluation.....	4.3-1
4.3.3	Impacts.....	4.3-3
4.3.4	Mitigation.....	4.3-11
4.4	Communities/Neighborhoods.....	4.4-1
4.4.1	Affected Environment.....	4.4-1
4.4.2	Methodology for Impact Evaluation.....	4.4-10
4.4.3	Impacts.....	4.4-11
4.4.4	Mitigation.....	4.4-12
4.5	Equity and Environmental Justice Considerations.....	4.5-1
4.5.1	Affected Environment.....	4.5-1
4.5.2	Methodology for Impact Evaluation.....	4.5-4
4.5.3	Potential Beneficial Impacts.....	4.5-5
4.5.4	Adverse Impacts and Mitigation Measures.....	4.5-7
4.5.5	Conclusion.....	4.5-9
4.6	Visual and Aesthetics.....	4.6-1
4.6.1	Affected Environment.....	4.6-1
4.6.2	Methodology for Impact Evaluation.....	4.6-4
4.6.3	Impacts.....	4.6-5
4.6.4	Mitigation.....	4.6-15
4.7	Air Quality.....	4.7-1
4.7.1	South Coast Air Basin.....	4.7-1



# TABLE OF CONTENTS

4.7.2	Carbon Monoxide, Ozone, and Particulate Matter Levels .....	4.7-8
4.7.3	Impacts .....	4.7-9
4.7.4	Mitigation .....	4.7-11 ✓
4.7.5	Conformity Analysis .....	4.7-11
4.8	Noise and Vibration .....	4.8-1
4.8.1	Affected Environment .....	4.8-1
4.8.2	Methodology for Impact Evaluation .....	4.8-3
4.8.3	Impacts .....	4.8-8
4.8.4	Mitigation .....	4.8-20 ✓
4.9	Geologic and Seismic Conditions .....	4.9-1
4.9.1	Affected Environment .....	4.9-1
4.9.2	Methodology for Impact Evaluation .....	4.9-3
4.9.3	Impacts .....	4.9-6
4.9.4	Mitigation .....	4.9-9 ✓
4.10	Hazardous Materials .....	4.10-1
4.10.1	Affected Environment .....	4.10-1
4.10.2	Methodology for Impact Evaluation .....	4.10-3
4.10.3	Impacts .....	4.10-4
4.10.4	Mitigation .....	4.10-5 ✓
4.11	Water Resources .....	4.11-1
4.11.1	Affected Environment .....	4.11-1
4.11.2	Methodology for Impact Evaluation .....	4.11-5
4.11.3	Impacts .....	4.11-5
4.11.4	Mitigation .....	4.11-7 ✓
4.12	Natural Resources and Ecosystems .....	4.12-1
4.12.1	Affected Environment .....	4.12-1
4.12.2	Methodology for Impact Evaluation .....	4.12-3
4.12.3	Impacts .....	4.12-6
4.12.4	Mitigation .....	4.12-7 ✓
4.13	Energy .....	4.13-1
4.13.1	Affected Environment .....	4.13-1
4.13.2	Methodology for Impact Evaluation .....	4.13-1
4.13.3	Impacts .....	4.13-2
4.13.4	Mitigation .....	4.13-5 ✓
4.14	Safety and Security .....	4.14-1
4.14.1	Affected Environment .....	4.14-1
4.14.2	Methodology for Impact Evaluation .....	4.14-1
4.14.3	Impacts .....	4.14-2
4.14.4	Mitigation .....	4.14-3 ✓
4.15	Historic/Archaeological/Paleontological Resources .....	4.15-1
4.15.1	Affected Environment .....	4.15-1
4.15.2	Methodology for Impact Evaluation .....	4.15-11
4.15.3	Impacts .....	4.15-12
4.15.4	Mitigation .....	4.15-20 ✓
4.16	Community Facilities/Parklands .....	4.16-1
4.16.1	Affected Environment .....	4.16-1
4.16.2	Methodology for Impact Evaluation .....	4.16-7
4.16.3	Impacts .....	4.16-8
4.16.4	Mitigation .....	4.16-11 ✓
4.17	Section 4(f) Evaluation .....	4.17-1
4.17.1	Regulatory Setting .....	4.17-1

## TABLE OF CONTENTS

4.17.2	Section 4(f) Properties Affected by Option A of the LRT Build Alternative .....	4.17-1
4.17.3	Section 4(f) Properties Affected by Option B of the LRT Build Alternative .....	4.17-9
4.18	Utilities.....	4.18-1
4.18.1	Affected Environment.....	4.18-1
4.18.2	Methodology for Impact Evaluation .....	4.18-1
4.18.3	Impacts .....	4.18-2
4.18.4	Mitigation.....	4-18-3
4.19	Construction Impacts .....	4.19-1
4.19.1	Construction Methods .....	4.19-1
4.19.2	Construction Period Impacts and Mitigation.....	4.19-15
4.20	Maintenance and Storage Facilities .....	4.20-1
4.20.1	Introduction .....	4.20-1
4.20.2	Traffic.....	4.20-1
4.20.3	Parking .....	4.20-2
4.20.4	Land Use and Development .....	4.20-2
4.20.5	Economic and Fiscal .....	4.20-3
4.20.6	Land Acquisition/Displacements/Relocations .....	4.20-3
4.20.7	Communities/Neighborhoods.....	4.20-3
4.20.8	Visual and Aesthetics.....	4.20-3
4.20.9	Air Quality .....	4.20-4
4.20.10	Noise and Vibration .....	4.20-4
4.20.11	Geologic and Seismic Conditions .....	4.20-4
4.20.12	Hazardous Materials.....	4.20-5
4.20.13	Water Resources.....	4.20-5
4.20.14	Natural Resources and Ecosystems .....	4.20-5
4.20.15	Energy .....	4.20-5
4.20.16	Safety and Security .....	4.20-6
4.20.17	Historical/Archeological .....	4.20-6
4.20.18	Paleontological .....	4.20-6
4.20.19	Community Facilities/Parklands .....	4.20-6
4.20.20	Section 4(f).....	4.20-7
4.20.21	Utilities.....	4.20-7
4.21	Summary of Impacts.....	4.21-1
4.21.1	Unavoidable Significant Adverse Impacts.....	4.21-1
4.21.2	Impacts Found Not to be Significant .....	4.21-1
4.21.3	Cumulative Impacts .....	4.21-2
4.21.4	Growth Inducing Impacts.....	4.21-5
4.21.5	Irreversible and Irretrievable Commitment of Resources.....	4.21-6
4.21.6	Relationship Between Local Short-Term uses of the Environment and the Maintenance and Enhancement of Long-Term Productivity .....	4.21-6
4.21.7	Environmentally Superior Alternative .....	4.21-6
<b>Chapter 5 – Financial Analysis and Comparison of Alternatives.....</b>		<b>5-1</b>
5.1	Financial Analysis .....	5-1
5.1.1	Capital Cost Estimates .....	5-1
5.1.2	Operating and Maintenance Cost Estimates.....	5-2
5.1.3	The Project Finance Plan.....	5-3
5.1.4	Financial Capability to Build and Operate .....	5-4
5.2	Comparative Analysis of Alternatives .....	5-5
5.2.1	Effectiveness in Improving Mobility .....	5-5
5.2.2	Efficiency (Cost-Effectiveness) .....	5-7

# TABLE OF CONTENTS

5.2.3	Operating Efficiency .....	5-8
5.2.4	Equity Considerations .....	5-8
5.2.5	Trade-Offs Between Alternatives.....	5-10
<b>Chapter 6 – Coordination and Consultation .....</b>		<b>6-1</b>
6.1	Introduction.....	6-1
6.2	Scoping Meetings .....	6-1
6.3	Public Participation, Meetings, and Communication.....	6-2
6.4	Agency Coordination and Governmental Offices.....	6-7
6.5	Public Review of the Environmental Document.....	6-10
<b>Chapter 7 – Responses to Comments on the Draft SEIS/SEIR (See Volume II).....</b>		<b>7-1</b>
7.1	Introduction .....	7-1
7.2	Written Comments on the Draft SEIS/SEIR .....	7-8
7.3	Responses to Written Public Comments .....	7-9
7.4	Public Hearing Transcripts.....	7-10
7.5	Responses to Verbal Comments Submitted at Public Hearings.....	7-11
<b>Appendices</b>		
A.	Notice of Preparation/Notice of Intent	
B.	Distribution List	
C.	Bibliography	
D.	List of Preparers	
E.	Plan and Profile Drawings of the LRT Build Alternative, November 1, 2000	
F.	Proposed Property Acquisitions and Easements for the LRT Build Alternative, September 11, 2000	
G.	SHPO Letter of Concurrence and Draft Memorandum of Agreement	

## LIST OF TABLES

1-1	Los Angeles County Metro Rail Network in 2003 .....	1-1
1-2	Los Angeles General Plan Street Classifications.....	1-7
1-3	Lane Configurations of Arterial Streets .....	1-13
1-4	Selected Average Daily Traffic Volumes.....	1-15
1-5	CMP Monitoring Results.....	1-16
1-6	Bus Transit Routes in the Los Angeles Eastside Corridor.....	1-17
1-7	Frequency of Transit Service (in Minutes).....	1-19
1-8	Existing Conditions Screenline ADT Analysis .....	1-21
1-9	Year 2000 Intersection Levels of Service.....	1-22
1-10	A Comparison of Selected Population Characteristics Between the Los Angeles Eastside Corridor and Los Angeles County.....	1-24
2-1	Frequency of Weekday Bus Transit Service (in Minutes).....	2-21
2-2	Frequency of Weekday Rail Transit Service (in Minutes) .....	2-22
2-3	Bus Route Interface at LRT Stations – Option A .....	2-26
2-4	Operating Plan—LRT Build Alternative .....	2-28
2-5	Bus Route Interface at Selected LRT Station – Option B .....	2-32
3-1	Bus Transit Routes in the Eastside Corridor.....	3-2
3-2	Frequency of Transit Service (in minutes) .....	3-4
3-3	Bus Routes Overlapping the LRT Alignment At-Grade.....	3-7
3-4	Bus Route Interface at LRT Stations – Option A .....	3-10
3-5	Year 2020 Daily Boardings by Station – Option A .....	3-11
3-6	Bus Route Interface at Selected LRT Stations – Option B.....	3-12
3-7	Year 2020 Daily Boardings by Station – Option B .....	3-13
3-8	Existing Conditions Screenline ADT Analysis .....	3-18
3-9	Signalized Level of Service Definitions .....	3-19
3-10	Unsignalized Level of Service Definitions.....	3-19
3-11	Existing Intersection Level of Service Analysis.....	3-20
3-12	2020 No-Build Intersection Level of Service Analysis .....	3-22
3-13	Summary of Through Travel Lanes.....	3-28
3-14	Summary of 2020 Intersection Impacts – Option A .....	3-32
3-15	LADOT Intersection Criteria.....	3-34
3-16	Los Angeles County Intersection Criteria .....	3-34
3-17	Summary of 2020 Intersection Impacts – Option B .....	3-35
3-18	Left Hand Turn Prohibitions.....	3-38
3-19	2020 LRT with Mitigation Intersection LOS Analysis – Option A.....	3-41
3-20	LRT with Adjacent Mitigations Intersection LOS Analysis – Option A.....	3-41
3-21	2020 LRT with Mitigation Intersection LOS Analysis – Option B.....	3-43
3-22	LRT with Adjacent Mitigations Intersection LOS Analysis – Option B.....	3-43
3-23	Existing Roadway Characteristics .....	3-45
3-24	Parking Impacts on 1 <sup>st</sup> Street Near Stations and Tunnel Portals.....	3-47
3-25	Parking Impacts on Indiana Street – Option A .....	3-48
3-26	Indiana Street Parking Utilization Summary by Time of Day.....	3-48
3-27	Parking Utilization Analysis on Indiana Street.....	3-49
3-28	Summary of Total Parking Impacts .....	3-49
3-29	Parking Utilization Analysis on 1 <sup>st</sup> Street.....	3-52
4.1-1	Recent and Future Development Activity .....	4.1-14
4.2-1	Population/Employment Data.....	4.2-1

## LIST OF TABLES

4.2-2	Employment/Unemployment—September 1999.....	4.2-1
4.2-3	Estimated Long-Term Employment—LRT Build Alternative .....	4.2-4
4.3-1	Demographic Summary of Housing Characteristics for the Project Study Area and For a ½ Mile Radius Around Proposed Light Rail Stations .....	4.3-2
4.3-2	Residential and Non-Residential Acquisitions and Population Displacement By LRT Stations and Alignment for Option A.....	4.3-4
4.3-3	Residential and Non-Residential Acquisitions and Population Displacement By LRT Stations and Alignment for Option B .....	4.3-6
4.4-1	Demographic Summary for the Los Angeles Region and the Corridor Study Area.....	4.4-1
4.4-2	Demographic Summary for a ½ Mile Radius Around LRT Stations.....	4.4-3
4.4-3	Demographic Summary of Socio-Economic Characteristics for the Project Study Area and for a ½ Mile Radius Around LRT Stations .....	4.4-4
4.5-1	Regional Transit Travel Times (in Minutes) From Selected Origins in the Eastside Corridor .....	4.5-6
4.6-1	Visible Physical Changes – Option A.....	4.6-6
4.6-2	Consistency with Visual Policies.....	4.6-11
4.6-3	Visible Physical Changes – Option B.....	4.6-14
4.7-1	State and National Ambient Air Quality Standards.....	4.7-5
4.7-2	Air Quality Summary for Study Area Monitoring Stations, 1998-2000.....	4.7-6
4.7-3	SCAQMD Daily Emissions Thresholds .....	4.7-8
4.7-4	CFR 40 Part 51—Conformity Criteria.....	4.7-9
4.7-5	Criteria Pollutant Emissions Comparison.....	4.7-10
4.7-6	Worst-Case CO Concentrations—LRT Build Alternative .....	4.7-10
4.8-1	Noise Measurement Locations.....	4.8-1
4.8-2	FTA Noise Impact Criteria .....	4.8-5
4.8-3	FTA Ground-Borne Vibration and Noise Impact Criteria .....	4.8-6
4.8-4	Project Noise Levels at Buildings Along the At-Grade Segments .....	4.8-9
4.8-5	Summary of Noise-Impacted Structures (Without Mitigation).....	4.8-15
4.8-6	Ground-Borne Vibration Analysis: At-Grade Sections .....	4.8-17
4.8-7	Ground-Borne Noise and Vibration Analysis: Underground Section .....	4.8-19
4.8-8	Summary of Ground-Borne Vibration and Ground-Borne Noise Impacts (Without Mitigation).....	4.8-20
4.8-9	Operational Mitigation Measures .....	4.8-21
4.9-1	Major Named Faults Considered to be Active or Potentially Active in Southern California .....	4.9-4
4.12-1	Sensitive Plant Species Potentially Occurring Along the Los Angeles Eastside Corridor .....	4.12-4
4.12-2	Sensitive Wildlife Species Potentially Occurring Along the Los Angeles Eastside Corridor .....	4.12-5
4.12-3	Biological Impacts Factors Considered - LRT Build Alternative Options A and B.....	4.12-7
4.13-1	Energy Consumption Factors.....	4.13-2
4.13-2	Annual 2020 Operational Energy Consumption.....	4.13-3
4.13-3	Annual 2020 Energy Consumption (Kwh) for Specific Facilities.....	4.13-4
4.15-1	Summary of Site Types .....	4.15-6
4.15-2	Summary of Impacts on Archaeological Properties .....	4.15-13
4.15-3	Summary of Impacts on Architectural Properties.....	4.15-13
4.16-1	Parks and Recreation Facilities Within 0.5 Mile of LRT Alignment .....	4.16-1
4.16-2	Cemeteries Within 0.5 Mile of LRT Alignment.....	4.16-4
4.16-3	Schools Within 0.5 Mile of LRT Alignment .....	4.16-5
4.16-4	Hospitals/Clinics Within 0.5 Mile of LRT Alignment .....	4.16-5
4.16-5	Community Facilities Within 0.5 Mile of LRT Alignment .....	4.16-6

## LIST OF TABLES

4.18-1	Major Utility Providers.....	4.18-1
4.19-1	Typical Sequence of Construction Activities .....	4.19-3
4.19-2	Estimated Amounts of Excavated Materials for Station and Cut and Cover Construction.....	4.19-11
4.19-3	Estimated Amounts of Excavated Materials from Tunnel Construction .....	4.19-12
4.19-4	Daily Construction Emissions .....	4.19-21
4.19-5	Construction Phase Daily PM <sub>10</sub> Emissions.....	4.19-22
4.19-6	Mitigated PM10 Concentration Estimates Near the Schools.....	4.19-23
4.19-7	Damage Risk Vibration Criteria .....	4.19-24
4.19-8	Estimated Short-Term Employment - LRT Build Alternative .....	4.19-30
5-1	Capital Cost Estimates (1999 \$ and Year of Expenditure \$).....	5-2
5-2	Operating and Maintenance (O&M) Cost Model Variables.....	5-3
5-3	Funding Sources and Amount for Eastside LRT Project.....	5-4
5-4	Comparative Analysis of Alternatives.....	5-5
5-5	Transit Travel Times (in Minutes) from Selected Origins in the Eastside Corridor to Selected Destinations.....	5-6
5-6	Life Cycle Assumptions .....	5-7
5-7	Cost-Effectiveness Calculation: Incremental Values Over No-Build.....	5-7
5-8	Cost-Effectiveness of LRT Build Alternative: Annualized Cost Per New Daily Transit Trip.....	5-8
7-1	List of Commentors on the Draft SEIS/SEIR.....	7-2

## LIST OF FIGURES

1-1	Eastside Corridor Study Area .....	1-2
1-2	LRT Build Alternatives .....	1-5
1-3	Suspended Red Line Corridor Extensions .....	1-9
1-4	Eastside Corridor Street Network .....	1-14
1-5	Eastside Bus Routes.....	1-18
2-1	MIS Alternatives 1-4 .....	2-8
2-2	MIS Alternatives 5-8 .....	2-9
2-3	LRT Build Alternative.....	2-12
2-4	Alternatives Sites for Eastside Yard .....	2-13
2-5	LRT Build Alternative, Option A .....	2-16
2-6	LRT Build Alternative, Option B .....	2-18
2-7	Eastside Bus Routes.....	2-20
2-8	Modified Bus System with LRT .....	2-25
3-1	Current Bus Routes in the Eastside Corridor.....	3-3
3-2	Modified Bus Route System with LRT. ....	3-8
3-3	Eastside Corridor Street Network .....	3-15
3-4	Traffic Analysis Locations .....	3-16
3-5	Alameda Street Cross-Section .....	3-25
3-6	1st Street Cross-Section .....	3-25
3-7	1 <sup>st</sup> Street Bridge Cross-Section .....	3-26
3-8	Indiana Street Cross-Sections .....	3-27
3-9	3 <sup>rd</sup> Street Cross-Section .....	3-29
3-10	Beverly Boulevard Cross-Section.....	3-29
3-11	Traffic Lane Reductions .....	3-30
3-12	Pomona Boulevard Cross-Section .....	3-37
3-13	Summary of Parking Impacts .....	3-50
3-14	Existing and Proposed Bicycle Facilities.....	3-57
3-15	Proposed Regional Bikeway System .....	3-58
4.1-1	Jurisdictional Boundary General Plan Areas .....	4.1-3
4.1-2A	General Plan Land Use Designations, Central City and Central City North Communities.....	4.1-4
4.1-2B	General Plan Land Use Designations, Boyle Heights and East Los Angeles Communities.....	4.1-5
4.1-2C	General Plan Land Use Legend .....	4.1-6
4.1-3	Redevelopment Project Areas.....	4.1-11
4.1-4	Specialized Zones, Empowerment, Enterprise, & Revitalization Zones .....	4.1-12
4.4-1	Comparative 1990 And 2020 Population Density For The Corridor, Los Angeles County, and the SCAG Region .....	4.4-2
4.4-2	Minority Population.....	4.4-5
4.4-3	Low Income Population.....	4.4-6
4.4-4	Zero Car Households .....	4.4-8
4.6-1	Mariachi Plaza .....	4.6-3
4.7-1	South Coast Air Basin .....	4.7-2
4.7-2	Carbon Monoxide, Ozone, and Particulate Matter Levels.....	4.7-7
4.8-1	Noise Measurement Locations.....	4.8-2
4.8-2	Typical Ldns .....	4.8-4
4.8-3	Noise Impact Criteria for Transit Projects.....	4.8-4

## LIST OF FIGURES

4.8-4	Typical Levels of Ground-Borne Vibration.....	4.8-4
4.8-5	Noise and Vibration Receiver Locations .....	4.8-12
4.8-6	Noise and Vibration Receiver Locations .....	4.8-13
4.8-7	Noise and Vibration Receiver Locations.....	4.8-14
4.9-1	Regional Seismicity .....	4.9-5
4.10-1	Sites with Potential for Environmental Hazards, LRT Build Alternative.....	4.10-2
4.11-1	Water Resources and Floodplain .....	4.11-4
4.15-1	Area of Potential Effects.....	4.15-3
4.15-2	Area of Potential Effects.....	4.15-4
4.15-3	Area of Potential Effects.....	4.15-5
4.16-1	Community Facilities/Parklands, Central City, Central City North, Boyle Heights .....	4.16-2
4.16-2	Community Facilities/Parklands, East Los Angeles.....	4.16-3
4.19-1	Installation of Soldier Piles.....	4.19-8
4.19-2	Excavation and Bracing.....	4.19-9
4.19-3	Earth Pressure Balance Tunnel Boring Machine.....	4.19-13



## 1.0 PURPOSE AND NEED

### 1.1 OVERVIEW OF PURPOSE AND NEED

#### 1.1.1 Eastside Study Area

The Eastside Corridor study area is shown in Figure 1-1, extending from Alameda Street in Central Los Angeles east through the Boyle Heights community in the City of Los Angeles and the City Terrace, Belvedere and East Los Angeles communities of unincorporated Los Angeles County. The study area also includes a portion of the City of Monterey Park.

#### 1.1.2 Regional Context

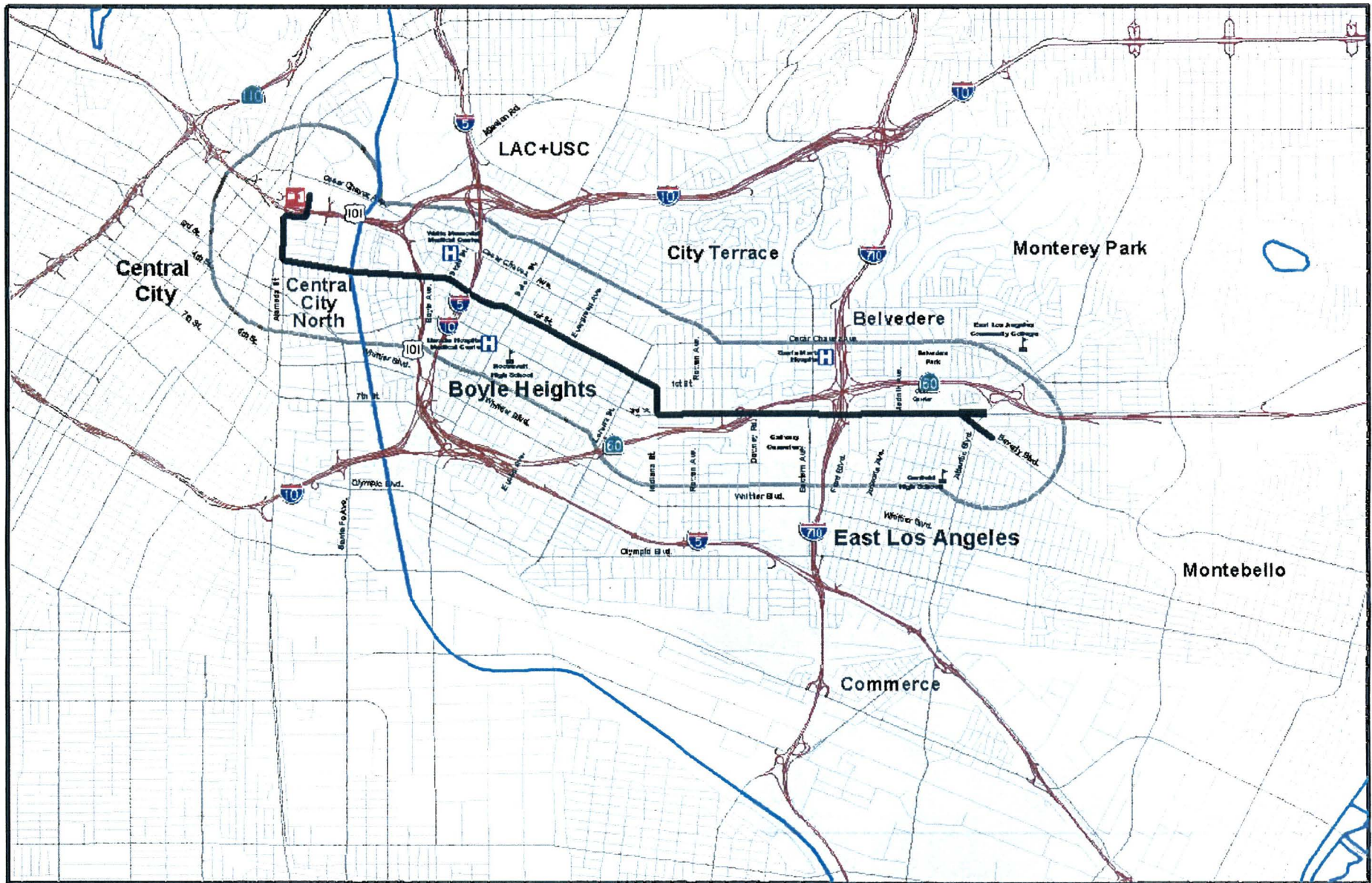
Los Angeles has a regional rail network that consists of heavy rail, light rail, and commuter rail components. The Los Angeles Rail Rapid Transit Project (Metro Red Line) is an 18-mile heavy rail rapid transit subway project extending from Union Station to North Hollywood. The final North Hollywood segment was completed and opened for revenue service on June 24, 2000. Opened for service in 1990, the 22-mile Metro Blue Line light rail system operates between Downtown Los Angeles and Long Beach. In 1994, the 19-mile Metro Green Line light rail system opened for service between Redondo Beach and Norwalk, primarily operating in the median of the Century Freeway (I-105). In 1992, commuter rail service was initiated with Metrolink, a regional rail network that connects Ventura, Los Angeles, Orange, San Bernardino, Riverside, and San Diego counties utilizing existing rail right-of-way. In 2003, the 13.8-mile Metro Blue Line to Pasadena will open for service and will connect Downtown Los Angeles with East Pasadena. All told, the region will have over 400 miles of commuter rail and over 70 miles of urban rail (Table 1-1) by the year 2003.

<b>Line</b>	<b>Length (Mi.)</b>	<b>Start</b>	<b>End</b>
Blue Line (Long Beach)	22	Downtown Los Angeles	Downtown Long Beach
Green Line	19	Redondo Beach	Norwalk
Red Line	18	North Hollywood/Wilshire Center	Union Station
Blue Line (Pasadena)	13.8	Union Station	Pasadena

Source: MTA, 2000.

In 1994, the Metro Red Line Eastern Extension was selected as the Locally Preferred Alternative, and final design was begun on this project. The project was to be an extension of the heavy-rail Red Line subway system from Union Station to Whittier and Atlantic Boulevards through Boyle Heights and East Los Angeles. The project was split into two phases, with a minimum operable segment initially to be constructed to 1<sup>st</sup> and Lorena Streets. This 3.7-mile first phase extension was to have stations located at Little Tokyo/Arts District near 3<sup>rd</sup> Street and Santa Fe Avenue, 1<sup>st</sup> Street and Boyle Avenue, Cesar Chavez Avenue and Soto Street, and 1<sup>st</sup> and Lorena Streets. Construction activities began on Phase 1 in 1997.





0 0.25 0.5 Miles

0 0.25 0.5 0.75 1 Kilometers

Legend

- Eastside Corridor
- SEIS Project Study Area
- LRT Alignment
- Highway
- Primary Road
- Secondary Road
- River



Los Angeles Eastside Corridor SEIS/SEIR

Eastside Corridor  
Transit Consultants

Note: Highways, primary, and secondary roads by Thomas Bros. Maps through conditional use from MTA 1997.

**Eastside Corridor Study Area**

Figure 1-1



Work on the planned Eastside extension of the Metro Red Line subway was suspended by MTA in January 1998 due to local financial difficulties. The MTA Restructuring Plan adopted in May 1998 called for the MTA to study "viable and effective options" for all parts of Los Angeles County, with an emphasis on the corridors in which rail projects had been suspended. Within the Eastside Corridor, this necessitated the examination of alternative fixed guideway options to the suspended heavy rail subway project.

Based on the results of the November 1998 draft Regional Transit Alternatives Analysis (RTAA Study), the MTA Board approved the concept of a rapid bus plan in March 1999, which included a rapid bus demonstration project on the Eastside. The Board also reaffirmed its commitment to fund fixed guideway transit improvements beyond rapid bus in the suspended rail corridors. The Board subsequently authorized the preparation of the Re-Evaluation/Major Investment Study (MIS) and Draft and Final Supplemental Environmental Impact Statement/Subsequent Environmental Impact Report (SEIS/SEIR) for the suspended Metro Red Line Eastside Transit Corridor Project. The Re-Evaluation/MIS was completed in February 2000 and analyzed several alternatives which are discussed in Section 1.2.3.7. This SEIS/SEIR identifies both beneficial and adverse environmental impacts associated with the LRT Build Alternative that was selected for further study following completion of the Re-Evaluation/MIS and compares them with those associated with the No-Build Alternative.

### **1.1.3 The Mobility Problem**

The East Los Angeles Transit Corridor Technical Report was prepared by the Southern California Association of Governments (SCAG) in July 1998 and provides an overview of community transit needs for the area. The Eastside Corridor communities of Boyle Heights and East Los Angeles are characterized by a large and growing population (over 212,000 according to the 1990 census, 275,000 expected by 2020) of predominantly Latino ethnic origin, a high percentage of low income households, and relatively high rates of transit use and transit dependence. In these communities, nearly 20 percent of workers use the bus system on their journey to work (as compared to 6.5 percent for Los Angeles County as a whole), and rates of carpooling and walking to work are also higher than the County average.

East Los Angeles and Boyle Heights are served by a significant number of bus routes, primarily operated by the Los Angeles County MTA, and generally organized in a grid pattern. There are approximately 40,000 weekday transit boardings in the area with several heavily used bus transit corridors that include Soto Street, Cesar Chavez Avenue, 1<sup>st</sup> Street, Whittier Boulevard, and Olympic Boulevard. New Metro Rapid bus service was initiated on Whittier Boulevard on June 24, 2000 and provides limited stop service and buses equipped with devices to extend the green phase of traffic signals to make for speedier trips. The heaviest bus routes carry passengers in an east-west direction. The average speed for all bus routes in the area is 12.9 MPH, and the typical passenger trip length for transit riders is between one and three miles.

The existing bus system has very high ridership on many routes during peak periods and moderate to low levels of ridership on other routes during peak as well as off-peak periods. Adequate transit services are not being provided to some locations of high transit demand. Most person trips to key activity centers within the study area require at least one transfer. This can result in longer travel times, less convenience, and an ultimate compromise in mobility for the traveler.

### **1.1.4 Eastside Corridor Alternatives**

The Re-Evaluation/MIS identified a range of fixed guideway transit service extensions, including heavy rail, light rail and bus rapid transit. The primary study objectives of this SEIS/SEIR are (1) to analyze the

environmental impacts of the LRT Build Alternative and to provide mitigation where feasible for adverse impacts, and (2) to determine if a fixed-guideway transit project is justified and if the LRT Build Alternative is to become the Locally Preferred Alternative (LPA) for the Los Angeles Eastside Corridor.

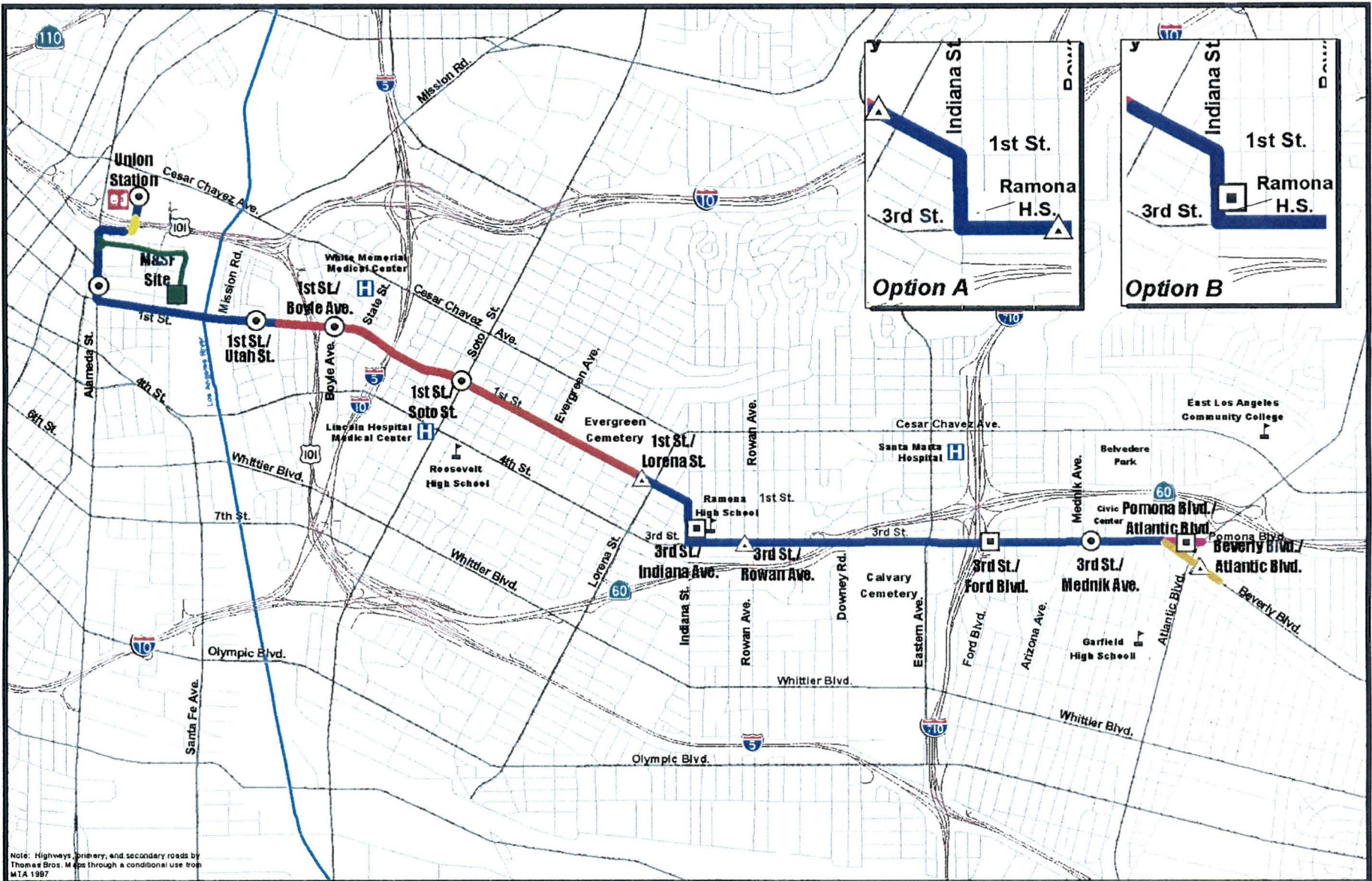
The Re-Evaluation/MIS yielded two alternatives for further consideration. They included one light rail transit (LRT) alternative and one bus rapid transit (BRT) alternative along the same alignment. On June 22, 2000, the MTA Board re-examined the BRT mode and determined that this mode should be dropped from further consideration in part because the new State Traffic Congestion Relief Program (TCRP) committed to funding only light rail.

As illustrated in Figure 1-2, the LRT alignment begins at the Union Station passenger terminal (trackways 1 and 2) and follows Alameda Street south to 1<sup>st</sup> Street. The alignment then follows 1<sup>st</sup> Street east to Indiana Street. The alignment is in a tunnel profile between the US-101 Freeway and Fresno Street along 1st Street. In both options, an at-grade station is located at 1st/Utah, and subway stations are located at 1<sup>st</sup>/Boyle and 1<sup>st</sup>/Soto. The alignment follows 1<sup>st</sup> Street east to Indiana Street and then follows Indiana Street south to 3<sup>rd</sup> Street. Option A removes on-street parking and a portion of the sidewalks on Indiana Street, while Option B provides for the purchase of right-of-way on the east side of Indiana Street to accommodate an off-street alignment, standard sidewalks and on-street parking. At-grade stations are located at 1st/Lorena and 3rd/Rowan in Option A, and at 3rd/Indiana and 3rd/Ford in Option B. The alignment continues east on 3<sup>rd</sup> Street and terminates at the intersection of Beverly and Atlantic Boulevards in Option A, and Beverly and Pomona Boulevards in Option B. Chapter 2 provides a complete description of the LRT alignment and station locations for each option. The LRT line will operate as an extension of the Pasadena Blue Line with continuing service through Union Station in both directions.

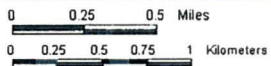
## 1.2 BACKGROUND AND PLANNING CONTEXT

The Metro Red Line Eastern Extension has been an integral element of local, regional and federal transportation planning since the early 1990's. Eastward from the Los Angeles Central Business District (LACBD) to just east of Atlantic Boulevard, the Eastern Extension had been the subject of in-depth technical studies and extensive community involvement during this period.

An Alternatives Analysis/Draft Environmental Impact Statement/Draft Environmental Impact Report (AA/DEIS/DEIR) was previously prepared in 1993, and a Final Environmental Impact Statement/Final Environmental Impact Report (FEIS/FEIR) was prepared in 1994. These documents are available for review at the offices of the Los Angeles County Metropolitan Transportation Authority (MTA). The documents are hereby incorporated by reference into this Final SEIS/SEIR. Following a systems planning study reviewed in Section 1.2.3, these two documents studied several subway alignments between Union Station in Central Los Angeles and the vicinity of Atlantic Boulevard in the unincorporated community of East Los Angeles. In 1994, after completion of the FEIS/FEIR and the Record of Decision (ROD) by the Federal Transit Administration (FTA), the Metropolitan Transportation Authority (MTA) Board adopted a Locally Preferred Alternative (LPA) for Metro Red Line Segment 3 in the corridor. The first phase of the Eastside extension was to operate between Union Station and 1st Street/Lorena Street. At the same time the MTA Board also adopted a LPA for the Metro Red Line for the Mid-City Corridor. Full Funding Grant Agreements were executed with the Federal Transit Administration (FTA), and the projects were transitioned into the construction phase.



Note: Highways, primary, and secondary roads by Thomas Bros. Maps through a conditional use from MTA 1997



**M** Eastside Corridor  
Transit Consultants

- LEGEND**
- ⊙ Stations - Both Options
  - △ Stations - Option A Only
  - Stations - Option B Only
  - Option A Only
  - Option B Only
  - At Grade
  - Tunnel
  - Elevated
  - M&SF Lead Line
  - Highway
  - Primary Road
  - Secondary Road



Los Angeles Eastside Corridor SEIS/SEIR

**LRT Build Alternative**

**Figure 1-2**





Subsequently, an evaluation of the current local funding available for the Eastside project and other rail projects in Los Angeles County led to a suspension of work in January 1998. Voters also approved a new County law in November 1998 that restricts the use of Proposition A and C sales tax revenues for "new subways". The MTA Restructuring Plan adopted in May 1998 called for the agency to study "viable and effective options" for all parts of Los Angeles County, with an emphasis on the corridors in which the rail lines had been suspended. Within the Los Angeles Eastside Corridor, this included the examination of alternative fixed guideway options to heavy rail subway. To evaluate feasible options, the MTA Board subsequently authorized preparation of a Re-Evaluation/MIS and Draft and Final SEIS/SEIRs for the suspended Metro Red Line Eastside Transit Corridor project.

### **1.2.1 Regional Transportation Plan**

The current Regional Transportation Plan (RTP) for the six-county Southern California region was prepared by the Southern California Association of Governments (SCAG) and adopted on April 16, 1998. The RTP incorporates the Los Angeles Eastside Transit Corridor Project, consistent with the MTA Locally Preferred Alternative for the Eastside Corridor. The RTP recommends the following actions:

- ◆ Construct exclusive transit corridors to minimize travel time and achieve certain ridership goals.
- ◆ Perform major investment studies on potential transit corridors.

A completion schedule of 2010 is shown in the RTP for the East Los Angeles Transit Corridor Project.

The MTA has also prepared a comprehensive long range planning document to guide the development of the countywide transportation system. The MTA's 30-Year Integrated Transportation Plan identified the Eastern Extension of the Metro Red Line as a high priority funded and committed rail project. An updated Long Range Plan (LRP) is presently being prepared by the MTA, reflecting the Eastside Corridor transit planning currently underway.

### **1.2.2 General Plans**

#### **1.2.2.1 County of Los Angeles Circulation Element**

The Circulation Element of the County of Los Angeles General Plan outlines a number of goals and policies that support the general aim of achieving a balanced transportation system. Specifically, the following policies relate to the Eastside LRT Project:

- ◆ Support the development of a mass transportation system that will provide a viable alternative to the automobile.
- ◆ Support development of rail transit or exclusive bus lanes in high demand corridors when sufficient patronage, cost-effectiveness, and support of land use policies are assured.
- ◆ Develop alternative transportation systems and procedures that will effectively reduce vehicle miles traveled (VMT) by automobiles.

#### **1.2.2.2 City of Los Angeles Transportation Element**

The Transportation Element of the City of Los Angeles General Plan addresses motorized and non-motorized transportation through the year 2010. It places emphasis on maximizing the efficiency of existing and proposed transportation infrastructure through advance transportation technology, reduction

of vehicle trips, and focusing growth in proximity to public transit. The general location of major thoroughfares, transportation routes, and Scenic Highways are shown on a number of maps within this element. Street designations and related standards as well as selection/performance criteria are included in this element. The street designations defined in Table 1-2 are also discussed in Section 3.2.2. Finally, the Transportation Element outlines implementation programs and a monitoring and evaluation program consistent with the General Plan Framework.

Classification	Selection Criteria	Performance Criteria
Major Highway - Class I	More than 50,000 ADT.	Four travel lanes in each direction during peak hours and left turn lanes at signalized intersections. 3,200 vehicles per hour (vph) in each direction during peak hours.
Major Highway - Class II	Typically located one mile apart in a grid system. 30,000 to 50,000 ADT.	Three travel lanes in each direction during peak hours and left turn lanes at signalized interstections. 2,400 vph in each direction during peak hours.
Secondary Highway	Supplement the through-traffic carrying characteristics of major highways. Typically located one mile apart midway between major highways in a grid system. 20,000 to 30,000 ADT.	Two travel lanes in each direction during peak hours and left turn lanes at signalized intersections. 1,400 vph in each direction during peak hours.
Collector Street	Assist local traffic flow to and from major and secondary highways. Up to 10,000 ADT.	One travel lane in each direction. 600 vph in each direction.

Source: Los Angeles General Plan Framework, Transportation Element

### 1.2.3 Systems Planning

The initial systems planning background and context for the 1999-2000 Re-Evaluation/MIS was developed in the *Metro Red Line Extension System Planning Study* prepared by SCAG in 1989, as well as in the *Los Angeles Metro Orange Line Extension: Transitional Analysis* prepared by the Los Angeles County Transportation Commission in 1990. The MTA is the successor agency to both the Transportation Commission and the Rapid Transit District. These reports document the historical framework for the definition of the Eastside/Santa Ana Transit Corridor and other corridors. They provide the background systems analysis that was used to justify the need for major capital expenditures in these corridors. The results of the two studies are summarized in the following sections.

### 1.2.3.1 SCAG System Planning Study

The August 1989 Metro Red Line Extension System Planning Study was prepared by SCAG for the Los Angeles County Transportation Commission (LACTC) to evaluate future extensions of the original 18-mile Metro Red Line subway line between Union Station and North Hollywood. The Extension Study evaluated travel corridor characteristics, reviewed existing transit operations and analyzed the proposed corridor for consistency with the adopted regional plan. Based on the analysis, the study identified proposed corridor extensions as shown in Figure 1-3 which met federal criteria for current ridership, projected transit demand and consistency with the adopted regional plan. Note that both of the proposed Red Line extension projects shown in the figure are the lines that have been suspended.

### 1.2.3.2 LACTC Transitional Analysis

Based on the 1989 System Planning Study, a Central East/West Corridor was identified as the highest priority for a Metro Red Line LPA heavy rail extension. The 1990 Transitional Analysis was undertaken to demonstrate that an extension to the east and west could meet federal cost-effectiveness thresholds and provide the basis for proceeding with an Alternatives Analysis/Draft Environmental Impact Statement. Based on conservative assumptions for the ridership projections, the total cost per new rider was determined to be under the federal threshold. This supported the decision to proceed with a full Alternatives Analysis/DEIS for the east-west corridor extensions.

## 1.2.4 Corridor Planning

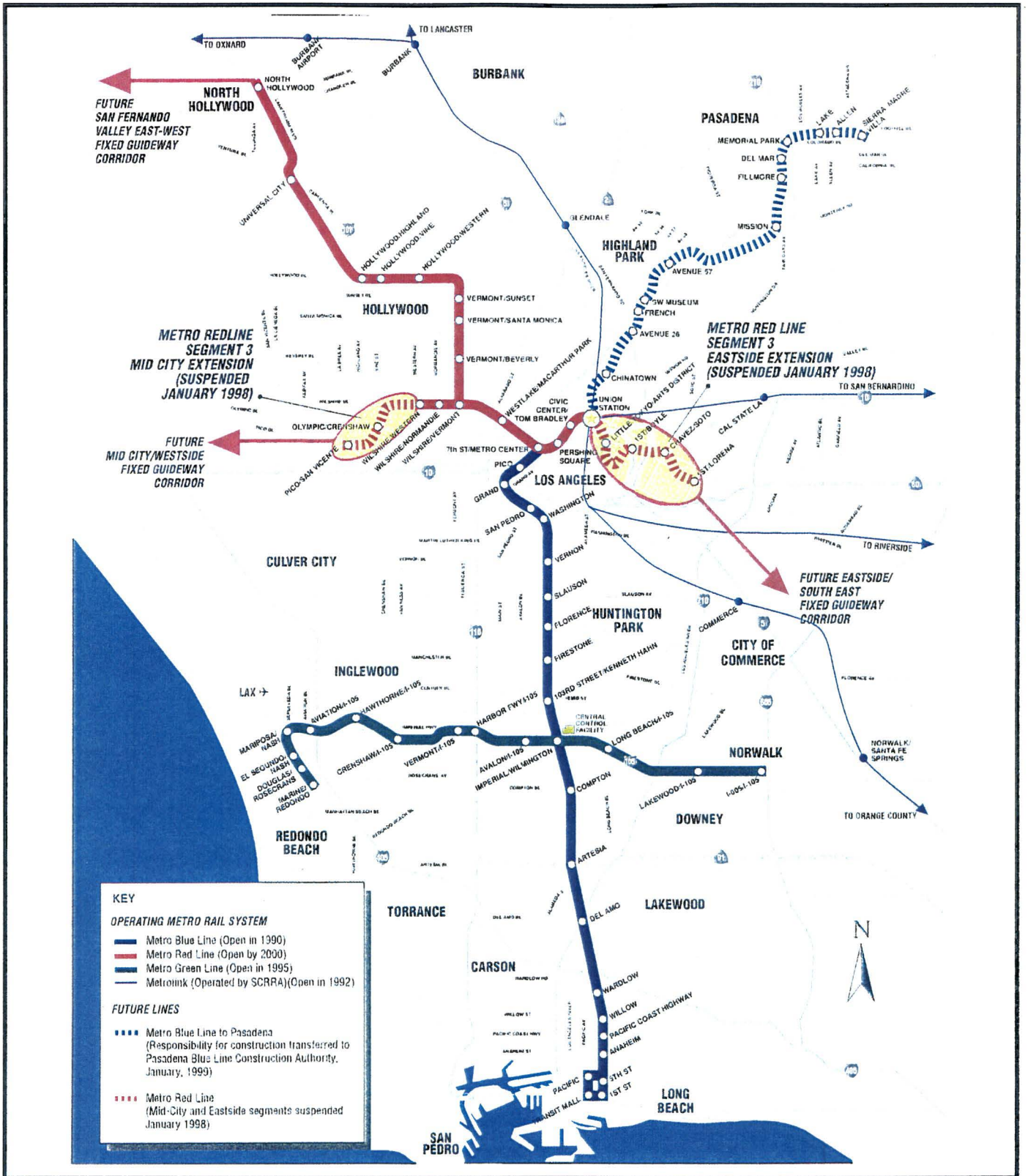
In January 1998, the MTA suspended work on extensions of the Metro Red Line heavy rail subway project, including the initial 3.7-mile segment of the Eastside LPA from Union Station to 1<sup>st</sup>/Lorena. Since the suspension, several planning initiatives have provided further guidance for the development of Eastside transit alternative improvements.

### 1.2.4.1 MTA Restructuring Plan

The MTA Restructuring Plan titled: *Analysis and Documentation of the MTA's Financial and Managerial Ability to Complete North Hollywood Rail Construction and Meet the Terms of the Bus Consent Decree*, was adopted by the MTA Board of Directors on May 13, 1998 and was subsequently approved by the FTA on July 2, 1998. The Restructuring Plan documented that the MTA did not have sufficient local matching funds to finance heavy rail subway projects in the Eastside Corridor as anticipated in the original Full Funding Grant Agreements for the project. At the same time, the Restructuring Plan called for the MTA to study "viable and effective options" for transit in all parts of Los Angeles County, with an emphasis on the corridors in which the rail lines had been suspended.

Within the Eastside corridor, this necessitated the examination of alternative fixed guideway options to heavy rail subway. It also committed the MTA to a reevaluation of the financial capacities of the agency to undertake new start, fixed guideway projects. To that end, the Board authorized the Regional Transit Alternatives Analysis (RTAA) Study that commenced in July 1998 and was completed in November 1998.





Los Angeles Eastside Corridor SEIS/SEIR

**Suspended Red Line Corridor Extensions**



### 1.3.1 Roadway Conditions

The Eastside Corridor study area is served by several freeways that connect to neighboring communities and other parts of the Southern California metropolitan region. The San Bernardino Freeway (I-10), with twelve general purpose traffic lanes and two high-occupancy vehicle (HOV) lanes, runs east-west along the northern edge of the study area west of the Long Beach Freeway (I-710). To the south, the Pomona Freeway (SR-60), with ten general purpose traffic lanes, also runs in an east-west orientation. Both freeways connect the study area with the Los Angeles Central Business District (LACBD) to the west and San Bernardino and Riverside Counties to the east.

The Santa Ana Freeway (I-5 and US-101), with six to ten general purpose traffic lanes, runs in a northwest-southeast orientation and connects the study area with the LACBD and Orange County. This major regional freeway connects with the Pomona (SR-60), Santa Monica (I-10), and Golden State (I-5) freeways at the East Los Angeles interchange, one of the busiest and most congested interchanges in the region. The Long Beach Freeway (I-710), with six general traffic lanes, runs north-south and connects the study area with Alhambra to the north and Long Beach to the south. It has interchanges with the San Bernardino (I-10), Pomona (SR-60) and Santa Ana (I-5) freeways.

The Los Angeles Eastside Corridor contains a developed network of arterial and neighborhood collector streets as shown in Figure 1-4. The east-west arterials include Cesar Chavez Avenue, 1<sup>st</sup> Street, 4<sup>th</sup>/3<sup>rd</sup> Streets, Pomona Boulevard, Beverly Boulevard, Whittier Boulevard, and Olympic Boulevard. North-south arterials include Soto Street, Eastern Avenue, and Atlantic Boulevard. The Boyle Heights portion of the corridor contains narrow roadways, as do many parts of the East Los Angeles portion. Both areas have very high levels of pedestrian activity. Lane configurations for major and minor arterial streets in the corridor are presented in Table 1-3. Table 1-4 shows the approximate average daily traffic volumes for selected major, secondary, collector, and local streets in the study area, based on LADOT Street Designations from the Los Angeles General Plan.

**TABLE 1-3  
LANE CONFIGURATIONS OF ARTERIAL STREETS**

Street	Street Orientation	Number of Lanes	On-Street Parking	Peak Hour Parking Restrictions
Cesar Chavez	E-W	5	Yes	Yes
1st Street	E-W	5	Yes	Yes
4th Street	E-W	5	Yes	Yes
3rd Street	E-W	7	Yes	Yes
Beverly Boulevard	E-W	5	Yes	No
Whittier Boulevard	E-W	5	Yes	Yes
Olympic Boulevard	E-W	7	Yes	No
Alameda Street	N-S	5	No	Yes
Soto Street	N-S	5	Yes	Yes
Lorena Street	N-S	4	Yes	No
Indiana Street	N-S	2	Yes	No
Arizona Street	N-S	5	Yes	No
Atlantic Boulevard	N-S	7	Yes	Yes

Refer to Figure 1-4 for locations of arterial streets.

Source: Field Survey and SCAG Land Use Data Base

Heights community in the City of Los Angeles and the City Terrace, Belvedere, and East Los Angeles communities of unincorporated Los Angeles County. South and east of the East Los Angeles area, the study area included major portions of the cities of Montebello, Pico Rivera, and Commerce and portions of Monterey Park, Santa Fe Springs, and Whittier. The eight build alternatives assessed in the Re-Evaluation/MIS included: three at-grade Bus Rapid Transit (BRT) alternatives; two at-grade Light Rail Transit (LRT) Alternatives; one LRT alternative consisting of an alignment combination of at-grade and subway segments; one hybrid alternative consisting of LRT at-grade alignment with heavy rail subway alignment; and one hybrid alternative consisting of BRT at-grade alignment with heavy rail subway alignment. All of the build alternatives would run along various alignments between Union Station and the intersection of Whittier Boulevard/Norwalk Boulevard in the City of Whittier. The reader is referred to the *Eastside Transit Corridor Study, Los Angeles, California, Re-Evaluation/MIS* draft report (February 24, 2000), incorporated herein by this reference, for additional information about the alternatives studied and the potential environmental impacts.

Subsequent to completion of the Re-Evaluation/MIS and an extensive public involvement program, the MTA Board directed further study of an alignment that was essentially a combination of a shortened segment of two of the LRT alternatives considered. The selected alignment runs between Union Station as its western terminus to the intersection of Beverly and Atlantic Boulevards in East Los Angeles. The board further directed that this alignment, consisting of an at-grade alignment as well as a subway segment through a portion of Boyle Heights, be studied comparing two alternative modes: LRT and BRT. The board decided to eliminate the segment of the alignment east of Atlantic Boulevard that was studied in the Re-Evaluation/MIS because of the need to further study the optimal path for a fixed-guideway alternative in this portion of the study area. On June 22, 2000, the board re-examined the BRT mode and determined that this mode should be dropped from further consideration in part because the new State Traffic Congestion Relief Plan had committed funding for the light rail mode only.

#### **1.2.4.8 Los Angeles Eastside Corridor SEIS/SEIR**

The FTA, as the Federal lead agency, and the MTA, as the local lead agency, are preparing this joint SEIS/SEIR in accordance with the National Environmental Policy Act of 1969 (NEPA) and the California Environmental Quality Act (CEQA). The SEIS/SEIR supplements the information in the 1994 Final EIS/EIR. The SEIS/SEIR assesses the impacts of the LRT Build Alternative (described in Section 1.1.4) that MTA directed for further study. In addition, the No-Build Alternative is assessed in accordance with NEPA and CEQA requirements.

There are a few differences between the regulations implementing NEPA and CEQA that affect reporting in this document. CEQA requires identification of, and mitigation for, significant adverse impacts in an EIR, while under NEPA, mitigation is considered for all of the adverse impacts of a project, regardless of significance. This combined NEPA/CEQA document identifies the impacts of the alternatives regardless of whether they would be considered "significant" under CEQA and proposes mitigation wherever practicable to reduce identified adverse effects. Specific discussion of impact significance and mitigation in accordance with CEQA is provided in Chapters 3 and 4. Chapter 4 also addresses growth-inducing and cumulative impacts analyses.

### **1.3 TRANSPORTATION CONDITIONS AND NEEDS**

The following sections provide an overview of the existing Eastside transportation system and transit services, including system performance, deficiencies and community factors related to corridor transportation needs.



#### **1.2.4.5 East Los Angeles Transit Corridor and Technology Study**

Additional information on corridor transit needs was developed in the *East Los Angeles Transit Corridor and Technology Study*. This study referenced a recent SCAG report which indicated that there are an estimated 212,000 people living in East Los Angeles based on the 1990 census and that the population is expected to grow to 275,000 by the year 2020. It was also estimated that almost 20 percent of the population uses the bus system on their journey to work. This rate of bus usage is three times higher than the county average of 6.8 percent. East Los Angeles and Boyle Heights are served by a substantial number of MTA bus routes. The study indicated that there are 40,000 daily transit boardings with several heavily used bus transit corridors operating on Soto Street, Cesar Chavez Avenue, Whittier Boulevard, and Olympic Boulevard.

Based on the above factors, the study found that the East Los Angeles population is heavily transit dependent and recommended that planning and implementation of proposed public transportation systems in East Los Angeles should support the basic community needs of the local population.

The study identified ways that the East Los Angeles transit dependent community can effectively access jobs, health services, and education. The study stated that substantial "quality of life" growth within this community can be initiated with a balanced and comprehensively planned transit system improvement implemented within available funding sources.

Once the transit infrastructure plan is in place, opportunities may develop for enhancing community amenities and stimulating economic development within the corridor. Community plans will identify areas where enhancements could be facilitated within the context of the community.

#### **1.2.4.6 Interstate 5 Corridor Improvement Project**

Additional data on Corridor transportation needs were developed in the 1998 I-5 Corridor Improvement Project. The study area for this corridor extends from SR 91 northwest along the I-5 corridor to Soto Street. The I-5 Corridor Study concluded that an effective multimodal transportation network within the I-5 study area is necessary to meet the mobility needs of residents and businesses in southeast Los Angeles County by providing vital intra- and inter-regional linkages and services.

The I-5 study area currently has severe mobility problems, and these problems are projected to worsen by the year 2015. These problems are manifest as extensive congestion on the freeway and on the local arterial network. The entire freeway segment is projected to be operating at level of service F3 (greater than three hours of congestion per day), and more than 28 percent of the major intersections will be operating below level of service E by the year 2015.

In addition, a significant proportion of the population in the study area does not have access to a private automobile and must rely on the public transportation system and/or other alternative transportation options to meet their basic travel needs.

#### **1.2.4.7 Eastside Transit Corridor Study Re-Evaluation/MIS**

The Re-Evaluation/MIS looked at eight build alternatives as well as a No-Build Alternative and a Transportation System Management (TSM) Alternative within a broadened study area from that evaluated in the original AA/DEIS/DEIR and FEIS/FEIR. The expanded study area for the Eastside Transit Corridor Study extended from Alameda Street in Central Los Angeles east through the Boyle

#### **1.2.4.2 Regional Transit Alternatives Analysis**

The RTAA Study accomplished several important objectives for the MTA. The study identified the amount of funding available for new projects between FY1999 and FY2004. It suggested possible funding allocations, identified immediate bus transit improvements in Los Angeles County, and established a framework for further fixed guideway project development in the Eastside, Westside, and San Fernando Valley corridors.

The study included a preliminary evaluation of fixed guideway alternatives in the three corridors. The study did not make recommendations with regard to preferred fixed guideway transit modes or configurations, but recommended that a Major Investment Study (MIS) level of analysis be conducted to provide more information regarding these choices.

Results of the RTAA Study were presented to the MTA Board on November 9, 1998. At that meeting, the Board approved the concept of a recommended rapid bus system serving the Eastside, Westside and San Fernando Valley. The Board also reaffirmed its commitment to fund fixed guideway transit improvements beyond rapid bus in the suspended rail corridors. A priority funding commitment of \$220 million through FY2004 was made to the Eastside and Mid-City areas from remaining uncommitted funds.

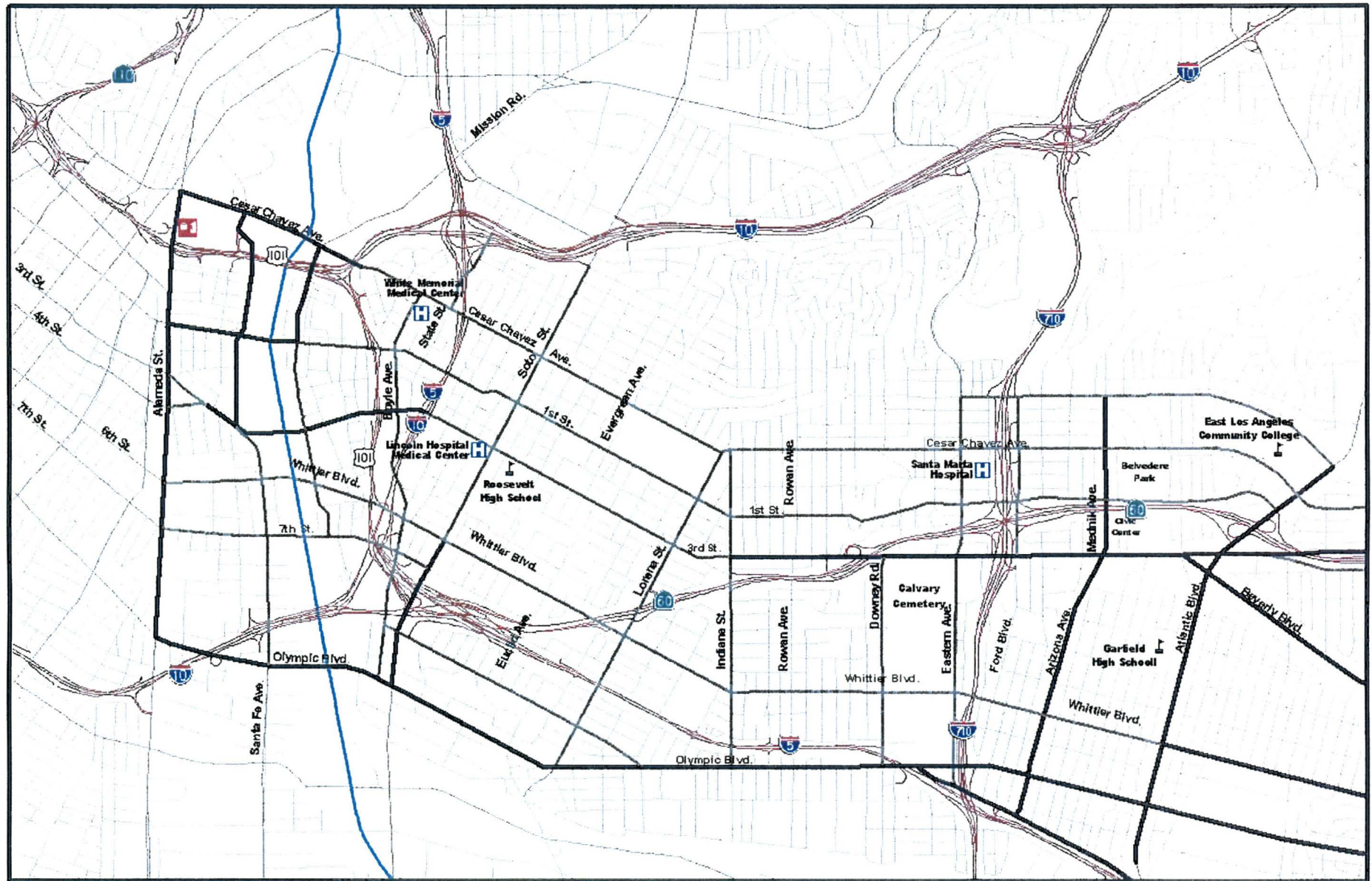
#### **1.2.4.3 TEA-21 Redefinition of Metro Red Line Segment 3**

To obtain greater flexibility in project definition for the project corridors, the MTA expanded the definition of Metro Red Line Segment 3. Segment 3 was defined in both the Intermodal Surface Transportation and Efficiency Act (ISTEA) and the Segment 3 Full Funding Grant Agreement as a "heavy rail subway" project. With the cooperation and assistance of the Los Angeles congressional delegation, the MTA obtained revised definitional language in the Transportation Equity Act for the Twenty-first Century (TEA-21), which was signed into law by the President on June 9, 1998. This action was taken with the intent to have the option available to utilize the Segment 3 funding balance in the future for any type of fixed guideway project in the Eastside corridor. The TEA-21 legislation expanded the definition of the Segment 3 project to include "any fixed guideway project" (not necessarily heavy rail subway) in the transportation corridors to be served by the three extensions of Segment 3. It also authorized the start of final design and construction for the Segment 3 project during the FY1998-2003 funding cycle under FTA section 5309 (new starts funding).

#### **1.2.4.4 Proposition A Ballot Initiative (Subway Funding Prohibition)**

A 1998 ballot initiative sponsored by County Supervisor Zev Yaroslavsky, referred to as the Metropolitan Transportation Authority Reform and Accountability Act, was approved (and became effective) on November 3, 1998. The most significant provision of the new law stipulates that no local Proposition A or C sales tax monies shall be used to fund the planning, design, construction, or operation of any New Subway. The term "New Subway" is defined to mean any subway project (a rail line which is in a tunnel below grade) other than the Metro Red Line Segments 1,2 or 3 (North Hollywood). As a result, the initiative prohibits the use of these sales tax revenues to build subway extensions in the Eastside corridor.

The initiative does not prohibit the use of sales tax revenues to design and construct light rail, at-grade rail, elevated rail systems, or busways in the Eastside, or in other areas of Los Angeles County. Nor does this initiative prevent the MTA from using State or Federal revenues or local revenues other than sales tax, to design and construct new subways in these areas.



0 0.25 0.5 Miles

0 0.25 0.5 0.75 1 Kilometers

**M** Eastside Corridor  
Transit Consultants

Source: Los Angeles Department of Transportation and Los Angeles County Department of Public Works Street Classification System.

Note: Base map courtesy of Thomas Bros. Maps through a conditional use from MTA 1997.

Legend

- Freeway
- Major Street
- Secondary Street
- Local Street
- River



Los Angeles Eastside Corridor SEIS/SEIR

**Eastside Corridor  
Street Network**

Figure 1-4



**TABLE 1-4  
SELECTED AVERAGE DAILY TRAFFIC VOLUMES**

Street	Designation <sup>1</sup>	Screenline	ADT Count
Alameda St	Major Highway Class II	South of 1 <sup>st</sup> Street	19,100
Alameda St	Major Highway Class II	South of Temple Street	26,580
Cesar Chavez	Major Highway Class II	East of Alameda	26,800
Cesar Chavez	Secondary Highway	West of I-5 Freeway	20,900
Cesar Chavez	Secondary Highway	West of Lorena	21,700
Cesar Chavez	Secondary Highway	West of Eastern	20,800
Cesar Chavez	Secondary Highway	West of Atlantic	13,600
1 <sup>st</sup> Street	Major Highway Class II	East of Alameda	17,370
1 <sup>st</sup> Street	Secondary Highway	West of I-5 Freeway	13,300
1 <sup>st</sup> Street	Secondary Highway	West of Lorena	15,300
1 <sup>st</sup> Street	Secondary Highway	West of Eastern	10,200
1 <sup>st</sup> Street	Secondary Highway	West of Atlantic	7,300
3 <sup>rd</sup> Street	Collector Street	East of Alameda	13,800
3 <sup>rd</sup> Street	Major Highway Class II	West of Eastern	19,100
4 <sup>th</sup> Street	Secondary Highway	West of Lorena	19,300
4 <sup>th</sup> Street	Major Highway Class II	East of Alameda	11,100
4 <sup>th</sup> Street	Major Highway Class II	West of I-5 Freeway	19,500
Mission Rd	Collector Street	South of 1 <sup>st</sup> Street	2,600
Boyle Ave	Secondary Highway	South of 1 <sup>st</sup> Street	12,100
Soto St	Secondary Highway	South of 1 <sup>st</sup> Street	17,500
Evergreen Ave	Collector Street	South of 1 <sup>st</sup> Street	5,700
Lorena St	Secondary Highway	South of 1 <sup>st</sup> Street	12,300
Indiana St	Secondary Highway	South of 1 <sup>st</sup> Street	10,500
Eastern Ave	Secondary Highway	South of 1 <sup>st</sup> Street	12,800
Mednik Ave	Major Highway Class II	South of 1 <sup>st</sup> Street	12,300
Atlantic Blvd	Major Highway Class II	South of 1 <sup>st</sup> Street	35,100
Pomona Blvd	Major Highway Class II	West of Atlantic	11,600
Beverly Blvd	Major Highway Class II	West of Atlantic	17,900

<sup>1</sup> LADOT Street Designations, City of Los Angeles General Plan, Transportation Element (Table 1-2)  
Source: The Traffic Solution, 2000; LADOT, 1997-2000; Los Angeles County, 1999

### 1.3.1.1 Congestion Management Plan

The Congestion Management Program (CMP) for Los Angeles County includes a program for monitoring major arterial, freeway and transit system conditions in the county. For freeways, the traditional Level of Service (LOS) scale of A to F is expanded to include LOS designations F0, F1, F2 and F3, which correspond to the length of time that a freeway segment experiences level of service F. The F3 designation represents the worst conditions, with level of service F conditions (severe congestion and speeds less than 20 MPH) experienced for three hours or more per day. Table 1-5 summarizes the results of CMP freeway monitoring in the study area.

Freeway	Location	Northbound/Eastbound		Southbound/Westbound	
		AM LOS	PM LOS	AM LOS	PM LOS
I-5	Ferris Ave	F1	C	D	F2
I-10	Indiana St	C	F0	D	C
SR-60	Indiana St	B	F1	F2	B
I-710	Whittier Blvd	D	E	E	F0

Source: 1999 Congestion Management Program for Los Angeles County

The monitoring results indicate that most freeways experience LOS F0 or worse during the AM or PM peak period in at least one direction, and in both directions at two of the four monitoring stations. The CMP data indicate that the PM peak period is the worse time period, with severe congestion on the freeways in the eastbound direction on I-10 and SR-60 (the outbound evening commute flow from Los Angeles). During the AM peak period, congested conditions exist on both I-10 and SR-60 in the westbound (inbound) direction.

### 1.3.2 Transit Services

The Eastside Corridor has one of the most extensive networks of bus routes in the County as shown in Figure 1-5. The corridor's transit routes generally follow a grid pattern and include many express and local routes and one limited service route. Four public agencies operate bus service in the Eastside Corridor. They include the Los Angeles County Metropolitan Transportation Authority, Montebello Transit, the City of Monterey Park, and the City of Commerce. Table 1-6 lists all the current bus transit routes operated in the corridor with the limits of their service.

Most of the heavily used routes are those that run in an east-west direction. These include bus routes that operate on Cesar Chavez Avenue, 1st Street, Whittier Boulevard, and Olympic Boulevard. Soto Street and Atlantic Boulevard are two north-south streets on which heavily used bus routes operate. Although north-south travel is constricted into two main through bus lines on Soto and Atlantic, the predominant flow of transit passengers in the corridor is in an east-west orientation. There is very high ridership on many of these routes during peak periods. A service allocation mismatch is evident in the fact that some bus lines have high ridership and others have low ridership during various periods of the day. Table 1-7 shows the service frequency (headways) for all the bus lines in the corridor. Some lines, such as the 30/31 on 1st Street and the 66 on Olympic, have very high levels of transit service.

### 1.3.3 Transportation System Performance

According to screenline analysis results (Table 1-8), one location had an Average Daily Traffic (ADT) level of service (LOS) D under existing conditions. This location was on Atlantic Boulevard south of 1<sup>st</sup> Street in the vicinity of the Pomona Freeway (SR-60) interchange. The remaining screenline locations exhibit levels of service A, B, and C operating conditions. Levels of service were also calculated across screenlines to provide corridor performance for more than one street at a given point in the corridor. These calculations reveal that each screenline operated at LOS A, which indicates good levels of service for all streets within the corridor taken together at one screenline location. Table 1-8 shows existing ADT capacities, volumes, volume-to-capacity (V/C) ratios, and corresponding levels of service (LOS) for

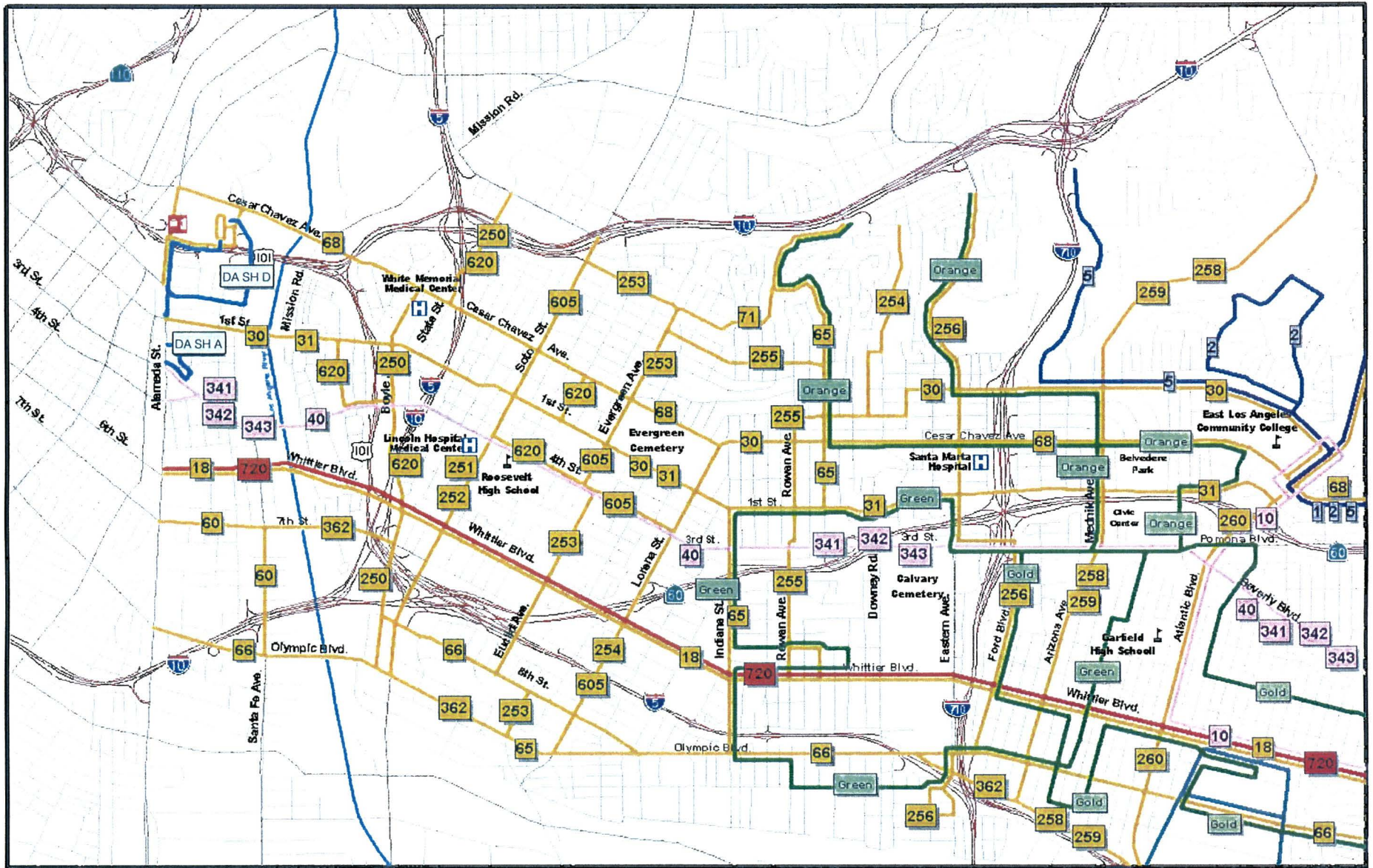
each screenline location analyzed in the Eastside Corridor. An in-depth explanation of V/C ratios can be found in Section 3.2.2.3 of this report.

<b>Operator</b>	<b>Line(s)</b>	<b>Destinations</b>
Commerce	Blue Green Orange Red Yellow	Community Circulator (Commerce) Community Circulator (Commerce) Community Circulator (Commerce) Community Circulator (Commerce) Community Circulator (Commerce)
Los Angeles County	Gold Green Orange	East Los Angeles East Los Angeles East Los Angeles - CSULA
Montebello	10 40 341,342,343	East LA College - Pico Rivera Downtown LA - Whittier Downtown LA - Montebello Express
Monterey Park	1 2 5	Community Circulator (Monterey Park) Community Circulator (Monterey Park) Community Circulator (Monterey Park)
MTA	18 30,31 65 66 68 71 250 251 252 253 254 255 256 258 259 260 362 605 620 720	Wilshire Center - Whittier Mid City - East LA College Downtown Los Angeles - CSULA Wilshire Center - Montebello West LA Transit Ctr - Montebello Towne Center Downtown Los Angeles - CSULA LAC+USC - Boyle Heights Cypress Park - Watts El Sereno - Lynwood LAC+USC - Boyle Heights LAC+USC - Willowbrook Montecito Heights - East Los Angeles Altadena - East Los Angeles Alhambra - South Gate El Sereno - South Gate Altadena - Compton Downtown Los Angeles - Hawaiian Gardens LAC+USC - Boyle Heights LAC+USC - Boyle Heights Santa Monica - Montebello
Source: 1999-2000 MTA, Montebello, Monterey Park, Los Angeles County, and Commerce bus timetables.		

The traffic intersection analysis results in Table 1-9 for the Eastside Corridor reveal that two signalized locations were operating at LOS E in the year 2000. These locations were Cesar Chavez at Mednik and Beverly at Atlantic. Five signalized locations were operating at LOS D, and the remaining signalized intersections were operating at LOS C or better. For the unsignalized intersections analyzed, two locations were operating at LOS F during the PM peak hour. These were 1<sup>st</sup> Street at Alma and 4<sup>th</sup> Street at the Southbound I-5 Ramps. One location was operating at LOS D, and the remaining unsignalized locations were operating at LOS C or better.







0 0.25 0.5 Miles

0 0.25 0.5 0.75 1 Kilometers

**M** Eastside Corridor  
Transit Consultants

Note: Highways, primary, and secondary roads by Thomas  
Bro. Maps through conditional use Tom MTA 1997.

Legend

- MTA Routes
- Metro Rapid Route
- DASHA
- LA County Routes
- Commeroe Routes (All Routes)
- Highway
- Primary Road
- Secondary Road
- River



Los Angeles Eastside Corridor SEIS/SEIR

## Eastside Bus Routes

Figure 1-5



**TABLE 1-7  
FREQUENCY OF TRANSIT SERVICE (IN MINUTES)**

Operator	Line	Days	AM Peak 6-9am	Midday 9am-3pm	PM Peak 3-7pm	Evening 7-11pm	Owl 11pm- 6am	Hours of Service
Commerce	Red	Weekday	60	60	60			6am-6pm
		Saturday	60	60	60			6am-6pm
	Blue	Weekday		60	60			9am-6pm
		Saturday		60	60			9am-6pm
	Green	Weekday	60	60	60			6am-9:30pm
		Saturday	60	60	60			6am-9:30pm
Orange	Weekday	60	60	60			5:30am-6pm	
	Yellow	Weekday	60	60	60			6am-9am
Los Angeles County	Gold	Weekday	60	60	60			6am-6pm
		Saturday		60	60			9am-5pm
	Green	Weekday	60	60	60			6am-6pm
		Saturday		60	60			9am-5pm
	Orange	Weekday	60	60	60			6am-6pm
		Saturday		60	60			9am-5pm
Montebello	10	Weekday	8	10	15			5am-11pm
		Saturday	20	10	20			5am-11pm
		Sunday	20	10	20			5am-11pm
	40	Weekday	10	12	30			5am-11pm
		Saturday	15	15	30			5am-12am
		Sunday	20	20	20			5am-11pm
	341	Weekday	30					7-9:30a, 3-6p
	342	Weekday	180					6-7am, 5-6pm
	343	Weekday	30					6-8am, 5-7pm
Monterey Park	1	Weekday	40	40	40			6:30am-6pm
		Saturday	40	40	40			6:30am-6pm
	2	Weekday	40	40	40			6:30am-6pm
		Saturday	40	40	40			6:30am-6pm
	5	Weekday	50	30	30			6:30am-6pm
MTA	18	Weekday	10	15	10	15	60	24 hours
		Saturday	15	12	15	20	60	24 hours
		Sunday	20	30	15	30	60	24 hours
	30 / 31	Weekday	4	7.5	5	15	60	24 hours
		Saturday	7	7	12	30	60	24 hours
		Sunday	12	7	8	30	60	24 hours
	65	Weekday	15	30	25	50		5:30am-10pm
		Saturday	60	60	60	60		6am-8pm
		Sunday		60	60	60		8am-8pm
	66	Weekday	3	8	7	30		4:30am-1:30am
		Saturday	4	10	15	30		5am-1:30am
		Sunday	15	12	12	30		5am-1am
	68	Weekday	8	12	12	40		4am-12:30am
		Saturday	15	10	15	40		4am-12:30am
		Sunday	40	15	20	40		4:30am-12:30am
	71	Weekday	12	22	20			4:30am-8:30pm
		Saturday	30	40	30			4:30am-8pm
		Sunday	40	30	30			5:30am-8pm
	250 251/252	Weekday	40	40	40			6am-7pm
		Weekday	5	12	10	30	60	24 hours
		Saturday	15	15	12	30	60	24 hours
		Sunday	30	20	20	30	60	24 hours

**TABLE 1-7  
FREQUENCY OF TRANSIT SERVICE (IN MINUTES)**

Operator	Line	Days	AM Peak 6-9am	Midday 9am-3pm	PM Peak 3-7pm	Evening 7-11pm	Owl 11pm- 6am	Hours of Service
MTA, cont.	253	Weekday	40	40	40			6am-8pm
		Saturday	40	40	40			6am-7:30pm
		Sunday	35	40	40			8am-6:30pm
	254	Weekday	60	55	30	60		4:30am-8:30pm
		Saturday	60	60	60			6:30am-7:30pm
		Sunday	45	60	60			7:30am-7:30pm
	255	Weekday	45	50	45			5am-8:30pm
		Saturday		45	45			5:30am-8:30pm
		Sunday		45	45			5:30am-8:30pm
	256	Weekday	35	50	35	50		6am-10:30pm
		Saturday	60	60	60	60		5:30am-9pm
		Sunday	60	60	60	60		5:30am-9pm
	258/259	Weekday	20	30	30			5am-8pm
	260	Weekday	12	15	15	60		4am-11:30pm
		Saturday	30	25	20	60		5am-12m
		Sunday	50	25	25	60		6am-12m
	362	Weekday	20	30	25	60		5am-11:30pm
		Saturday	50	60	60	60		5am-11:30pm
		Sunday	50	60	60	60		5am-11:30pm
	605	Weekday	15	30	15	30		6am-7:30pm
Saturday		30	30	30			6am-7:30pm	
Sunday		30	30	30			6am-7:30pm	
620	Weekday		12	12			9am-6:30pm	
720	Weekday	8	10	8	20		5am-1am	
	Saturday	12	12	12	20		5am-1am	
	Sunday	12	12	12	20		5am-1am	

Source: 1999-2000 LACMTA, Montebello, Commerce, Los Angeles County, and Monterey Park bus timetables.

As mentioned in the previous section, there are high levels of transit service provided on many of the bus routes in the Eastside Corridor during peak periods. The pattern of a grid-based system of transit service provision can provide for transit to be less convenient and inefficient for many of the transit-dependent residents of the corridor. A single trip to an activity may require at least one transfer to another bus line, and overcrowding makes the connection to other services unreliable. Transit speed reliability is another factor that hinders the mobility of the transit passenger. On MTA lines that run through the study area, average speeds range from 7.8 to 15.7 miles per hour. On the most heavily used lines, speeds average 12-14 mph. During congested peak periods on the major arterial streets, travel speeds decrease during the same time period where passenger loads are the highest. This creates a situation where the greatest number of people are being served at a lower level of service. The existing system of bus lines in the Eastside Corridor does not sufficiently serve the daily needs for mobility of those that are dependent on the system of public transit services.

**TABLE 1-8  
EXISTING CONDITIONS SCREENLINE ADT ANALYSIS**

Screenline Location	Street	V/C <sup>1</sup>	LOS <sup>2</sup>
1. East of Alameda	Cesar Chavez Ave	0.79	C
	1st Street	0.51	A
	3rd Street (WB street)	0.51	A
	4th Street (EB street)	0.41	A
2. West of I-5 Freeway	Cesar Chavez Ave	0.65	B
	1st Street	0.42	A
	4th Street	0.57	A
3. West of Lorena	Cesar Chavez Ave	0.68	B
	1st Street	0.48	A
	4th Street	0.54	A
4. West of Eastern	Cesar Chavez Ave	0.65	B
	1st Street	0.32	A
	3rd Street	0.56	A
5. West of Atlantic	Cesar Chavez Ave	0.40	A
	1st Street	0.22	A
	Pomona Blvd	0.34	A
	Beverly Blvd	0.53	A
6. South of Temple St	Alameda St	0.78	C
	Mission Rd	0.35	A
7. South of 1 <sup>st</sup> Street	Alameda St	0.56	A
	Mission Rd	0.17	A
	Boyle Ave	0.38	A
	Soto St	0.55	A
	Evergreen Ave	0.38	A
	Lorena St	0.38	A
	Indiana St	0.70	C
	Eastern Ave	0.40	A
	Mednik Ave	0.38	A
Atlantic Blvd	0.88	D	

<sup>1</sup>Volume/Capacity Ratio.

<sup>2</sup>Level of Service.

Source: City of Los Angeles DOT, County of Los Angeles Dept. of Public Works, The Traffic Solution, Parsons Brinckerhoff, 1997-2000.

### 1.3.4 Community Factors

The Eastside Corridor study area contains a low- to moderate-income population, which is expected to grow by 30 percent to 275,000 by 2020, according to Southern California Association of Governments (SCAG) forecast data. The Eastside Corridor contains a dense concentration of households.

Access to employment opportunities is one of the major mobility problems that affect Eastside Corridor residents. The 1990 Census analysis of the study area work force revealed a breakdown of home-based work trips generated from the Eastside Corridor area. Nine percent of work trips from the Eastside Corridor were destined for the Los Angeles CBD, 36 percent for areas north and west of the CBD, 13 percent for the South Bay region of the County, 24 percent for locations within the corridor, and 18 percent for areas in the remainder of the County.

**TABLE 1-9  
YEAR 2000 INTERSECTION LEVELS OF SERVICE**

No.	East-West Street	North-South Street	PM Peak Hour Level of Service
1	Cesar Chavez	Vignes St	B
2	Cesar Chavez	Mission Rd	B
3	Cesar Chavez	Boyle Ave	A
4	Cesar Chavez	State St	B
5 <sup>1</sup>	Cesar Chavez	I-5 SB Ramp	B
6	Cesar Chavez	I-5 NB Ramp	A
7	Cesar Chavez	Soto St	A
8	Cesar Chavez	Evergreen Ave	A
9	Cesar Chavez	Lorena St	A
10 <sup>1</sup>	Cesar Chavez	Indiana St	D
11	Cesar Chavez	Rowan Ave	A
12	Cesar Chavez	Eastern Ave	A
13	Cesar Chavez	Mednik Ave	E
14	Cesar Chavez	Atlantic Blvd	D
15	Commercial St	Alameda St	A
16 <sup>1</sup>	Commercial St	Vignes St	B
17	Temple St	Alameda St	B
18	1st Street	Alameda St	D
19	1st Street	Vignes St	A
20	1st Street	Mission Rd	C
21 <sup>1</sup>	1st Street	US-101 SB Ramp/Pecan St	C
22	1st Street	US-101 NB Ramp	A
23	1st Street	Boyle Ave	A
24	1st Street	Soto St	B
25	1st Street	Evergreen Ave	A
26	1st Street	Lorena St	A
27	1st Street	Indiana St	A
28 <sup>1</sup>	1st Street	Alma Ave	F
29	1st Street	Rowan Ave	A
30	1st Street	Eastern Ave	A
31	1st Street	Mednik Ave	A
32	1st Street	Atlantic Blvd	D
33	3 <sup>rd</sup> Street	Alameda St	A
34	4 <sup>th</sup> Street	Alameda St	B
35 <sup>1</sup>	4th Street	US-101 SB Ramps	B
36	4 <sup>th</sup> Street	US-101 NB Ramp	A
37	4 <sup>th</sup> Street	Boyle Ave	A
38 <sup>1</sup>	4 <sup>th</sup> Street	I-5 SB Ramps	F
39	4 <sup>th</sup> Street	I-5 NB Ramps	A
40	4 <sup>th</sup> Street	Soto St	A

**TABLE 1-9  
YEAR 2000 INTERSECTION LEVELS OF SERVICE**

No.	East-West Street	North-South Street	PM Peak Hour Level of Service
41	4 <sup>th</sup> Street	Evergreen Ave	A
42	4 <sup>th</sup> Street	Euclid Ave	A
43	3rd Street	Indiana St	D
44 <sup>1</sup>	3rd Street	Alma Ave	C
45	3rd Street	Rowan Ave	A
46	3rd Street	Eastern Ave	C
47	3rd Street	Ford Blvd	A
48	3rd Street	Mednik Ave	B
49	3rd Street	Woods Ave/Beverly Blvd	C
50	Pomona Blvd	Atlantic Blvd	D
51	Beverly Blvd	Atlantic Blvd	E
52	Beverly Blvd	Hillview Ave	A
53	SR-60 EB Off-Ramp	Atlantic Blvd	A
54	4 <sup>th</sup> Street	Atlantic Blvd	A

<sup>1</sup> Unsignalized intersection.

Source: Parsons Brinckerhoff and Kaku Associates, 2000.

SCAG forecast data for the year 2020 show an increase in the number of trips generated in the study area as the population grows. The forecast results indicate that there will be less reliance on the Los Angeles CBD and a greater number of trips being made to other sub-areas of the Los Angeles region. Work trips to the West Los Angeles area are projected to increase by 57% from the study area, and work trips to the southern part of the County are expected to increase by 42%. While work trips to the San Fernando Valley are expected to decrease by 46%, work trips to the San Gabriel Valley are expected to increase by 100%. Work trips destined for Orange County are expected to increase by 50%. As employment and activities in the region decentralize, greater reliance will be placed upon modes of travel that provide relatively convenient and timely service, especially in light of the increase in the amount of traffic congestion and resulting public transit delays that will be experienced in the coming 20 years.

The study area's mobility problems are exacerbated by socioeconomic factors. As reported in the 1990 Census, and shown in Table 1-10, the percentage of occupied dwelling units in the corridor whose residents did not have access to an automobile was approximately 30 percent, which is almost three times greater than the figure for the County of Los Angeles as a whole (11 percent). Many of the area's residents were young, with 21 percent between the ages of six and 18 years, and only eight percent being elderly (over 65 years). About 26 percent of the housing units were owner-occupied, and vacancy rates were generally low, averaging less than four percent. Most of the housing units were single-family houses with an average household size of 4.0 persons, which is about 35 percent higher than the City and County of Los Angeles averages of 2.9 and 3.0 persons per household, respectively. The minority composition of the study area in 1990 was 96.7 percent, most of whom were of Latino ethnic background. Given the growing population and the number of low-income households in the corridor (26 percent of total households), reliance on public transportation will not decrease, but will likely increase in the future.

Characteristic	Location	Percentage or Number
Percentage residents without access to an automobile	Eastside Corridor	30%
	Los Angeles County	11%
Percentage persons age 6-18 years	Eastside Corridor	21%
	Los Angeles County	18%
Percentage persons age over 65	Eastside Corridor	8%
	Los Angeles County	10%
Average household size	Eastside Corridor	4.0
	Los Angeles County	3.0
Percentage low-income households	Eastside Corridor	26%
	Los Angeles County	12%
Percentage minority households	Eastside Corridor	97%
	Los Angeles County	59%

Source: U.S. Census of Population and Housing, 1990.

### 1.3.5 Goals and Objectives

The goals and objectives of the SEIS/SEIR, Los Angeles Eastside Corridor have been developed from the extensive corridor and systems planning studies carried out over the past ten years, including the Eastside Alternatives Analysis/DEIS/DEIR process, public reviews leading to selection of the Locally Preferred Alternative, and the Re-Evaluation/MIS. Based on these planning and community involvement activities, the following goals and objectives listed were used. They are based on established transportation and land use goals and objectives of the major government jurisdictions within the study area, including the City of Los Angeles and the County of Los Angeles. These goals and objectives were utilized in the development and evaluation of the Eastside Corridor transit alternatives.

1. Improve access and mobility for residents, employees, and visitors to the Eastside Corridor.
  - ◆ Provide direct service to employment opportunities
  - ◆ Provide direct service to education, medical, shopping, and cultural opportunities
  - ◆ Minimize total travel times
  - ◆ Maximize transit ridership
  - ◆ Minimize transfers and changes of mode by integrating the system
  - ◆ Provide convenient access and improve connectivity to the regional transit system
  - ◆ Provide for the long term expansion of the future transit system
2. Support land use and development goals as stated in City of Los Angeles and County of Los Angeles plans for:
  - ◆ Community plan consistency
  - ◆ Regional plan consistency
  - ◆ Joint development opportunities
  - ◆ Increased land use intensity in transit station areas
  - ◆ Mixed-use commercial/residential development
  - ◆ Create a pedestrian-oriented environment
  - ◆ Enhance urban design features



3. Achieve local consensus by ensuring that the process is responsive to the community and policy-makers.
  - ◆ Define the desired transit system attributes from a community perspective
  - ◆ Maximize the opportunities for community and resident input
  - ◆ Enhance the public image of the proposed transit improvements
  - ◆ Build community and political support through effective communication and integration with local and regional plans
4. Provide a transportation project that is compatible with and enhances the physical environment wherever possible.
  - ◆ Implement an alternative that minimizes adverse impacts on the environment
  - ◆ Minimize air pollution
  - ◆ Minimize noise pollution
  - ◆ Minimize vibration impacts
  - ◆ Minimize the disturbance of public facilities
  - ◆ Minimize impacts on cultural resources, such as those that are historic, archaeological, or involve parkland
  - ◆ Conform to all local, state, and federal environmental regulations
5. Provide a transportation project that minimizes adverse impacts on the community.
  - ◆ Minimize business and residential dislocations, community disruptions, and damage to property
  - ◆ Avoid creating physical barriers, destroying neighborhood cohesion, or diminishing the quality of the human environment
  - ◆ Minimize traffic and parking impacts
  - ◆ Minimize impacts during periods of construction
6. Provide a transportation project that is reasonably within budget constraints for both capital and operating expenses.
  - ◆ Ensure adequate local funding commitments to secure federal and state contributions
  - ◆ Ensure adequate operating funds
  - ◆ Ensure fiscal consistency with the MTA's current financial plan
  - ◆ Minimize right-of-way costs by using land previously acquired by the MTA

### 1.3.6 Summary of Need

Travel demand forecasts prepared by SCAG and the MTA over the past decade have identified the need for transit improvements in the Southern California region, especially in Los Angeles County, to meet the mandates of the federal Clean Air Act and address the increasing mobility needs of the region. Current freeway and surface arterial street facilities cannot be expanded sufficiently to handle the forecasted demand for mobility. Regional forecasts for the year 2020 based on 1990 census data estimate that person trips will increase by over 40 percent in the region and by almost 30 percent in Los Angeles County. The MTA, in the development and adoption of its 1992 30-Year Integrated Transportation Plan, addressed the mobility deficiency issues identified in the regional plan developed by SCAG. Subsequent travel demand forecasting conducted for the update of the MTA Long Range Plan has confirmed the continuing need for improvements in mobility.

The existing population and employment density in the Eastside Corridor is high and very transit supportive. The corridor transit work trip mode split is 2.8 times higher than Los Angeles County as a whole. The corridor has a high concentration of low-income, minority, transit-dependent residents. Over 19 percent of workers use the bus system on their journey to work (as compared to 6.8 percent for Los Angeles County as a whole), and rates of carpooling and walking to work are higher than the County

average. Employment densities are six times higher within the Eastside Corridor than Los Angeles County as a whole. The corridor is growing (20 percent population and 30 percent employment growth between now and 2020), and a new transit investment would make the Corridor attractive for other types of urban investment in the future. This will make the corridor even more transit supportive over time, as new investments are attracted by transit and community centers and encouraged by potential development and tax incentives offered by other agencies responsible for these issues.

All major freeways serving the Eastside Corridor area are currently operating above their design capacities during peak periods, and for significant durations during off-peak periods. No major improvements to existing freeways in the study area are identified in the current SCAG Regional Transportation Plan except for the extension of the I-710 freeway north to Pasadena. During previous project scoping and community meetings, residents of the Eastside Corridor expressed their desire for improved transit service because many are transit-dependent and need improved access to the region's educational, employment and cultural opportunities. Current meetings with Eastside Corridor elected officials have confirmed the need for improved transit service and connections to the regional system, especially in light of community initiatives for revitalization, employment opportunities, and economic development on the Eastside. The project now under study in this SEIS/SEIR will further these goals and contribute to an improved overall transportation system for the Los Angeles region and for the Eastside Corridor specifically.

## 2.0 ALTERNATIVES CONSIDERED

This chapter describes the alternatives (options) that are evaluated in this Final SEIS/SEIR for the Los Angeles Eastside Corridor. Two basic alternatives are reviewed: (1) the No-Build Alternative, and (2) the Locally Preferred Alternative (LPA), the LRT Build Alternative that has two options, Option A and Option B.

Following public review in the Spring of 2001 of the No-Build Alternative and three LPA Options presented in the Draft SEIS/SEIR, the MTA Board adopted the LRT Build Alternative Option 1 (Indiana Street Remove Parking Option) along with the maintenance and storage facility (M&SF) site location at the existing Red Line Yard (also called Option 1). The Indiana Street Remove Parking Option and shared use of the Red Line Yard constituted the MTA Board's Locally Preferred Alternative (LPA) that was to be carried forward for evaluation in the Final SEIS/SEIR. Refer to Chapter 2.0 of the Draft SEIS/SEIR for a complete description of the LRT alignment and M&SF.

Since completion of the Draft SEIS/SEIR, MTA has decided to modify some portions of the LPA. In addition, MTA has added one route refinement option for consideration within portions of the LPA alignment. All of these changes have come about in response to community concerns that were revealed during circulation of the Draft SEIS/SEIR. Background assumptions and the physical and operating characteristics are provided in this chapter.

### 2.1 EARLY PLANNING STUDIES

The initial systems planning background and context for the Eastside Corridor was developed in the *Metro Red Line Extension System Planning Study* prepared by the Southern California Association of Governments (SCAG) in 1989, as well as in the *Los Angeles Metro Orange Line Extension: Transitional Analysis* prepared by the Los Angeles County Transportation Commission (LACTC) in 1990. These reports document the historical framework for the definition of the Eastside/Santa Ana Transit Corridor and other corridors. They provide the background systems analysis that was used to justify the need for major capital expenditures in these corridors. The results of the two studies are summarized below:

The August 1989 Metro Red Line Extension System Planning Study was prepared by SCAG for the Los Angeles County Transportation Commission (LACTC) to evaluate future extensions of the original 18-mile Metro Red Line subway line between Union Station and North Hollywood. The Extension Study evaluated travel corridor characteristics, reviewed existing transit operations and analyzed the proposed corridor for consistency with the adopted regional plan. Based on the analysis, the Systems Planning Study identified proposed corridor extensions, which meet federal criteria for current ridership, projected transit demand and consistency with the adopted regional plan.

Based on the 1989 System Planning Study, a Central East/West Corridor was identified as the highest priority for a Metro Red Line LPA heavy rail extension. The 1990 Transitional Analysis was undertaken by the LACTC to demonstrate that an extension to the east and west could meet federal cost-effectiveness thresholds and provide the basis for proceeding with an Alternatives Analysis/Draft Environmental Impact Statement. Based on conservative assumptions for the ridership projections, the total cost per new rider was determined to be under the federal threshold. This supported the decision to proceed with a full Alternatives Analysis/DEIS/DEIR for the east-west corridor extension.

## 2.2 PREVIOUS EIS/EIR AND SUSPENDED PROJECT (1990 –1998)

Eastside Corridor planning for the Red Line Extension was initiated in 1990 through the Alternative Analysis/DEIS/DEIR process. Following extensive public review of the ten alternatives presented in the April 1993 Alternative Analysis/DEIS/DEIR document, the MTA Board of Directors in June 1993 selected the Locally Preferred Alternative (LPA) for the Los Angeles Eastside Corridor. The LPA was subsequently incorporated into SCAG's Regional Mobility Element (RME) planning process and included as part of the regional Air Quality Management Plan. The East Side Extension Preferred Alternative was identified as a heavy rail subway line from Union Station to Whittier/Atlantic Boulevard, to be implemented in two phases.

The Final EIS/EIR for the Eastside Corridor was completed in June 1994. It evaluated the LPA to ensure that all significant environmental consequences and all reasonable and feasible mitigation measures were considered in its selection. The Record of Decision was signed on December 1994. Full Funding Grant Agreements were subsequently executed with the Federal Transit Administration and the projects were transitioned into the construction phase.

In January 1998, the MTA suspended work on extensions of the Metro Red Line heavy rail subway project, including the initial 3.7-mile segment of the Eastside LPA from Union Station to First/Lorena. Since the suspension, several planning initiatives have provided further guidance for the development of Eastside transit alternative improvements.

The MTA Restructuring Plan titled: *Analysis and Documentation of the MTA's Financial and Managerial Ability to Complete North Hollywood Rail Construction and Meet the Terms of the Bus Consent Decree*, was adopted by the MTA Board of Directors on May 13, 1998 and subsequently approved by the FTA on July 2, 1998. The Restructuring Plan documented that the MTA did not have sufficient local matching funds to finance heavy rail subway projects in the Eastside and Mid-City corridors as anticipated in the original Full Funding Grant Agreements for those projects. At the same time, the Restructuring Plan called for the MTA to study "viable and effective options" for transit in all parts of Los Angeles County, with an emphasis on the corridors in which the rail lines had been suspended.

Within the Eastside and Westside corridors, this necessitated the examination of alternative fixed guideway options to heavy rail subway. It also committed the MTA to a reevaluation of the financial capacities of the agency to undertake new start, fixed guideway projects. To that end, the Board authorized the Regional Transit Alternatives Analysis (RTAA) Study that commenced in July 1998 and was completed in November 1998.

The RTAA Study accomplished several important objectives for the MTA. The study identified the amount of funding available for new projects between FY1999 and FY2004. It suggested possible funding allocations, identified immediate bus transit improvements in Los Angeles County, and established a framework for further fixed guideway project development in the Eastside, Westside, and San Fernando Valley corridors.

The study included a preliminary evaluation of fixed guideway alternatives in the three corridors. The study did not make recommendations with regard to preferred fixed guideway transit modes or configurations, but recommended that a Major Investment Study (MIS) level of analysis be conducted to provide more information regarding these choices.

Results of the RTAA Study were presented to the MTA Board on November 9, 1998. At that meeting, the Board approved the concept of a recommended rapid bus system serving the Eastside, Westside and San Fernando Valley. The Board also reaffirmed its commitment to fund fixed guideway transit

document the alternatives that had been considered over the last ten years. Six major relevant studies (listed below) have been conducted in the Eastside Corridor.

1. Regional Transit Alternatives Analysis, November 1998, MTA.
2. East Los Angeles Study for 1<sup>st</sup> District, October 1998, ACG Environments.
3. 1998 RTP Transit Restructuring Evaluation, East Los Angeles, Transit Corridor Technical Report, July 1998, SCAG.
4. Los Angeles East Side Extension, FEIS/FEIR, September 1994, MTA.
5. Route 10/60 Corridor Preliminary Planning Study, June 1993, MTA.
6. Los Angeles Eastside Corridor, AA/DEIS/DEIR, April 1993, MTA.

From these six studies as well as input from the public and staff, 47 alternatives were identified. The goal was to reduce the identified alternatives to eight fixed guideway alternatives for analysis in the MIS in addition to the No Build and Transportation Systems Management (TSM) Alternatives. The eight alternatives had to consider the three possible modes of fixed guideway transit and service the full length of the Eastside Corridor.

As part of the Federal and local project development and environmental clearance process, a local and Federal process called "scoping" was initiated in addition to a very aggressive public involvement program. The scoping process was initiated with the cooperation of the Federal Transit Administration (FTA) and was properly noticed through a Federal Notice of Intent (August 13, 1999) and the State required Notice of Preparation (August 10, 1999) by MTA. The purpose of the intensive scoping process was to invite interested individuals, organizations, and Federal, State, and local agencies to participate in defining the alternatives to be evaluated in the Re-Evaluation Major Investment Study (MIS) and the subsequent environment impact statement and report and identifying any significant social, economic, or environmental issues related to the alternatives. The study area was defined in the scoping information booklets and the 47 alternatives were shown at the scoping meetings.

Three official community scoping meetings were noticed and conducted on August 24, 1999; August 26, 1999; and September 2, 1999 plus seven major follow-up community meetings were conducted over the course of the study and discussed in Chapter 6 of this document. Over 270 persons attended the three community scoping meetings and the comments are fully documented in the *Scoping Meeting Summary Report* dated September 24, 1999. In addition to the three community scoping meetings a separate governmental agency scoping meeting was conducted on August 25, 1999 at MTA Headquarters. Their comments are also documented in the *Scoping Meeting Summary Report*.

To further enhance the initial community outreach program for the MIS, meetings with the MTA Review Advisory Committee (RAC) for the Eastside were conducted on July 21, 1999; August 4, 1999; and August 18, 1999. These meetings brought the committee up to date on the efforts that had been initiated by MTA and presented the study process and schedule leading to a decision for an Eastside fixed guideway transit project by the MTA Board of Directors. The meeting agendas, distributed materials, and meeting minutes are also included in the *Scoping Meeting Summary Report*.

In addition to the above meetings with the community, meetings were held with the MTA Elected Officials Committee (representing the Eastside communities), and a number of community ad-hoc meetings were conducted during the scoping period. Throughout the whole MIS process, a very extensive and expensive public outreach program was conducted and is summarized in Chapter 6 of this Draft SEIS/SEIS document.

In order to reduce the number of identified alternatives, the first task was to identify a list of screening evaluation criteria that could be applied to the 47 alternatives. This was a very difficult and controversial

improvements beyond rapid bus in the suspended rail corridors. A priority funding commitment of \$220 million through FY2004 was made to the Eastside and Mid-City areas from remaining uncommitted funds.

In a step made to obtain greater flexibility in project definition for the project corridors, the MTA sought to expand the definition of Metro Red Line Segment 3. Segment 3 was defined in both the Intermodal Surface Transportation and Efficiency Act (ISTEA) and the Segment 3 Full Funding Grant Agreement as a "heavy rail subway" project. With the cooperation and assistance of the Los Angeles congressional delegation, the MTA obtained revised definitional language in the Transportation Equity Act for the Twenty-First Century (TEA-21), which was signed into law by the President on June 9, 1998. This action was taken with the intent to have the option available to utilize the Segment 3 funding balance in the future for any type of fixed guideway project in the Eastside and other corridors. The TEA-21 legislation expanded the definition of the Segment 3 project to include "any fixed guideway project" (not necessarily heavy rail subway) in the transportation corridors to be served by the three extensions of Segment 3. It also authorized the start of final design and construction for the Segment 3 project during the FY1998-2003 funding cycle under FTA section 5309 (new starts funding).

A 1998 ballot initiative sponsored by County Supervisor Zev Yaroslavsky, referred to as the Metropolitan Transportation Authority Reform and Accountability Act, was approved (and became effective) on November 3, 1998. The most significant provision of the new law stipulates that no local Proposition A or C sales tax monies will be used to fund the planning, design, construction, or operation of any New Subway. The term "New Subway" is defined to mean any subway project (a rail line which is in a tunnel below grade) other than the Metro Red Line Segments 1,2 or 3 (North Hollywood). As a result, the initiative prohibits the use of these sales tax revenues to build subway extensions in the Eastside or Mid-City/Westside corridors.

The initiative does not prohibit the use of sales tax revenues to design and construct light rail, at-grade rail, elevated rail systems, or busways in the Eastside, or other areas of Los Angeles County. Nor does this initiative prevent the MTA from using State or Federal revenues or local revenues other than sales tax, to design and construct a new subway in the Eastside or other areas.

## **2.3 RE-EVALUATION/MAJOR INVESTMENT STUDY (1999 –2000)**

In June 1999, the MTA initiated a Re-Evaluation/Major Investment Study (MIS) for the Eastside Transit Corridor. The MTA also authorized parallel Re-Evaluation/Major Investment Studies for the Mid-City/Westside and San Fernando Valley Corridors.

There were two major objectives for the Eastside Corridor Re-Evaluation/MIS study: (1) develop alternatives to the Suspended Project, and (2) identify the corridor long-term transportation needs to be addressed in the MTA Long Range Plan. The Re-Evaluation/MIS Report provided the public and MTA Board of Directors the technical information needed in order to make an informed decision related to selecting an alternative or alternatives that satisfy the needs of the Eastside Corridor. The selected alternatives will then be subject to the next phase of analysis, which is the preparation of this Draft Supplemental Environmental Impact Statement/Subsequent Environmental Impact Report (Draft SEIS/SEIR).

### **2.3.1 First-round Screening of Alternatives**

The MIS included not only alignments but also three different transit modes: Bus Guideway (also called Bus Rapid Transit or Busway and predominately at-grade or surface running); Light Rail Transit (mainly at-grade or surface running) and Heavy Rail Transit (mainly subway). The first task was to assemble and

Other assumptions included the provision that no traffic lanes would be replaced for the at-grade alignments, as much on-street parking would be retained as possible, and that the fixed guideway technologies would operate on exclusive rights-of-way. In addition, a key assumption was that the alternatives presented be implementable, even though they may have impacts and capable of being constructed in phases over time based on the resources available.

### 2.3.3 Alternatives Considered for Evaluation in Re-Evaluation/MIS

Based on the community, technical staff, and consultant team inputs, eight fixed guideway build alternatives, the No-Build Alternative, and the TSM Alternative were developed for environmental and technical analysis in the study. The alternatives are summarized below.

The No-Build Alternative includes all highway and transit projects and operations that the region and MTA expect to be in place in the year 2020 (the future analysis year for this SEIS/SEIR). These include improvements to the local bus system and the completion of the Red Line to North Hollywood and the Pasadena Blue Line to Sierra Madre Villa in Pasadena.

The Transportation System Management (TSM) Alternative is defined by the Federal Transit Administration (FTA) as the No-Build Alternative plus lower cost transit capital and operational improvements that are intended to enhance the performance of the transportation system within the study corridor. The TSM Alternative in comparison to the "build" alternatives should be a relatively low cost approach to addressing the transportation problems. The TSM should represent the best that can be done to improve transit mobility in the corridor without the construction of major new transit facilities. The TSM Alternative for the Eastside Corridor includes additions in bus service frequencies to the major east-west and north-south existing transit routes as well as the implementation of the Whittier/Wilshire Rapid Bus line from Whittier and Garfield (Montebello) to Colorado and Ocean (Santa Monica). This Rapid Bus Line was approved for implementation in June 2000 and provides a combined operating frequency of 1.75 minutes during the peak periods and five minutes during the off-peak periods. There are 24 stops along the route with six on the stops within the Eastside Corridor study area. This service would provide a strong linkage (no transfers) between a portion of the Eastside Corridor study area to Downtown, Mid-Wilshire, and the far westside of Los Angeles. The TSM Alternative also includes more frequent service for the Metro Red Line.

The eight fixed guideway build alternatives are listed below and shown in Figures 2-1 and 2-2.

1. Bus Rapid Transit (BRT) (Dedicated Busway), At-Grade. 1<sup>st</sup>/Alameda to Union Station (northside) to Whittier and Norwalk Boulevards via Cesar Chavez, Soto, 4<sup>th</sup>, 3<sup>rd</sup>, Beverly, and Whittier.
2. Bus Rapid Transit (Dedicated Busway), At-Grade. Union Station (southside) to Whittier and Norwalk Boulevards via Alameda, 1<sup>st</sup>, Soto, 4<sup>th</sup>, 3<sup>rd</sup>, and Whittier.
3. Light Rail Transit (LRT), At-Grade. Union Station (southside) to Whittier and Norwalk Boulevards via Alameda, 1<sup>st</sup>, Soto, 4<sup>th</sup>, 3<sup>rd</sup>, and Whittier.
4. Bus Rapid Transit (Dedicated Busway), At-Grade. Union Station (southside) to Whittier and Norwalk Boulevards via Alameda, 1<sup>st</sup>, Soto, 4<sup>th</sup>, 3<sup>rd</sup>, Beverly, and Whittier.
5. Light Rail Transit, At-Grade. Union Station (southside) to Whittier and Norwalk Boulevards via Alameda, 1<sup>st</sup>, Soto, 4<sup>th</sup>, 3<sup>rd</sup>, Beverly, and Whittier.

undertaking by the staff and consultant team. A number of staff and consultant team work sessions were undertaken after scoping to identify the eight fixed guideway alternatives to be analyzed. Some 32 measures or criteria, listed below, were used in the first round of screening.

1. Alternative considered in formal MTA study process.
2. Scoping meetings input – support.
3. Right-of-way acquired by the MTA is not used.
4. Alternative eliminated by previous studies.
5. Alternative does not penetrate the corridor.
6. Alternative does not serve major activity centers.
7. Section 4(f) or 106 properties (recreational or cultural resources) potentially affected.
8. Parking for businesses is removed.
9. Sensitive resources are affected by noise, vibration, etc.
10. Connections with existing transit facilities are non-existent.
11. Access is provided to high-density areas.
12. Major right of way impacts anticipated.
13. Major traffic impacts anticipated resulting in slow travel times.
14. Redevelopment/development potential low.
15. Major impacts on utilities.
16. Construction implementation difficult.
17. Major new structures or other high cost items are needed.
18. Major existing structures will be impacted.
19. Community supports the alternative.
20. Elected officials support for the alternative.
21. Equity is an issue.
22. Major visual impacts on surroundings.
23. Potential high contaminated lands affected (from previous studies).
24. Geotechnical/seismic issues.
25. Lane miles of traffic lanes removed.
26. Lane miles of parking lanes removed.
27. Provisions for north-south bus interface connections (major MTA, Montebello, and other community bus systems).
28. Cultural resources potentially impacted; schools, parks, churches, hospitals and cemeteries.
29. Street curb-to-curb width.
30. Street right of way width.
31. Serves the study goals and objectives.
32. Conceptual preliminary cost within reason.

From the 47 alternatives, some 15 alternatives were identified for further consideration.

### **2.3.2 Second-Round Screening of Alternatives**

A second round of evaluation was conducted in order to reduce the number of alternatives to eight. The eight alternatives were chosen based on a review of previous alternatives and studies, three fixed guideway technologies (Bus Rapid Transit, Light Rail Transit, and Heavy Rail Transit), a workshop by the consultant team to consider the initial screening criteria in reducing the number of alternatives, discussion with the MTA/consultant study team, identification of logical termini (Union Station and Whittier/Norwalk Boulevards) to serve the identified study area, and the basic objective to recommend eight build alternatives for analysis in the Re-Evaluation/MIS Report.

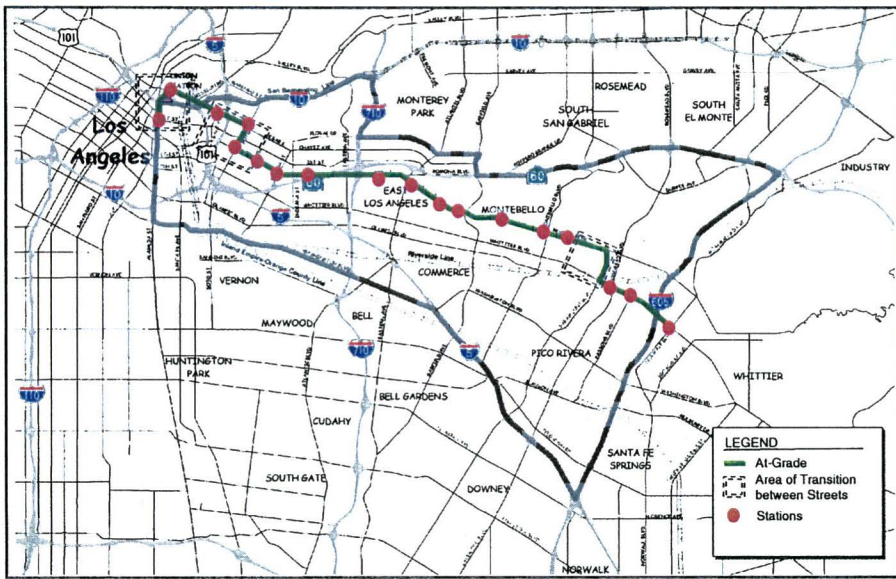




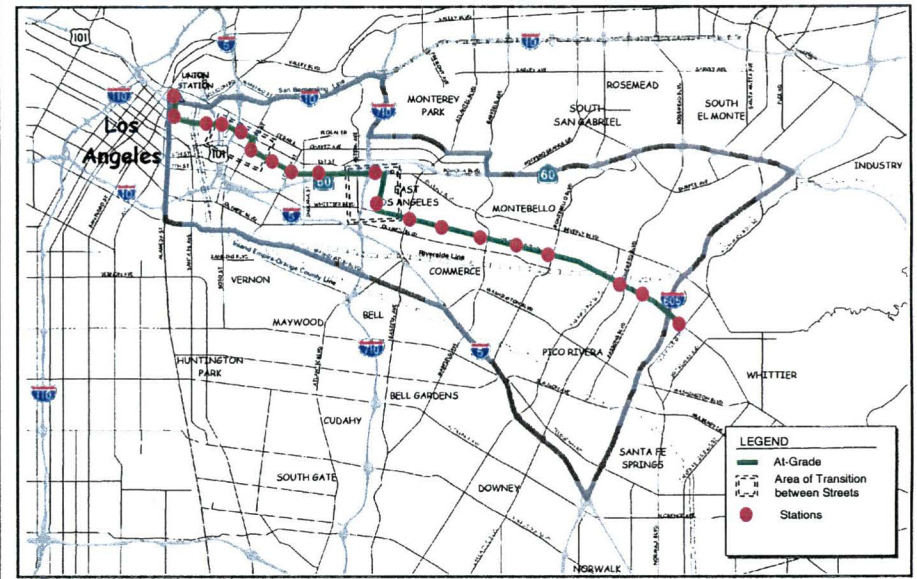
6. Light Rail Transit. At-grade Union Station (southside) to 1<sup>st</sup>/Boyle. LRT (subway) 1<sup>st</sup>/Boyle to 1<sup>st</sup>/Lorena. LRT (at-grade) from 1<sup>st</sup>/Lorena to Whittier and Norwalk Boulevards via Alameda, 1<sup>st</sup>, Indiana, 4<sup>th</sup>, 3<sup>rd</sup>, and Whittier.
7. Heavy Rail Transit and Light Rail Transit. Heavy Rail (subway) from Union Station to 1<sup>st</sup>/Lorena subway station with a subway station at 1<sup>st</sup>/Boyle and 1<sup>st</sup>/Lorena. Light Rail Transit (at-grade) from 1<sup>st</sup>/Lorena to Whittier and Norwalk Boulevards via Indiana, 4<sup>th</sup>, 3<sup>rd</sup>, Beverly, and Whittier.
8. Heavy Rail Transit and Bus Rapid Transit (Dedicated Busway). Heavy Rail (subway) from Union Station to Chavez/Soto subway station with a subway station at 1<sup>st</sup>/Boyle. Bus Rapid Transit (at-grade) from Chavez/Soto to Whittier and Norwalk Boulevards via Soto, 4<sup>th</sup>, 3<sup>rd</sup>, Beverly, and Whittier.

In the Re-Evaluation/MIS study each of the eight fixed guideway alternatives, the TSM Alternative, and the No-Build Alternative were analyzed with respect to each of the environmental conditions or potential impacts listed below. In addition preliminary mitigation measures were discussed for each of the potentially adverse impacts identified.

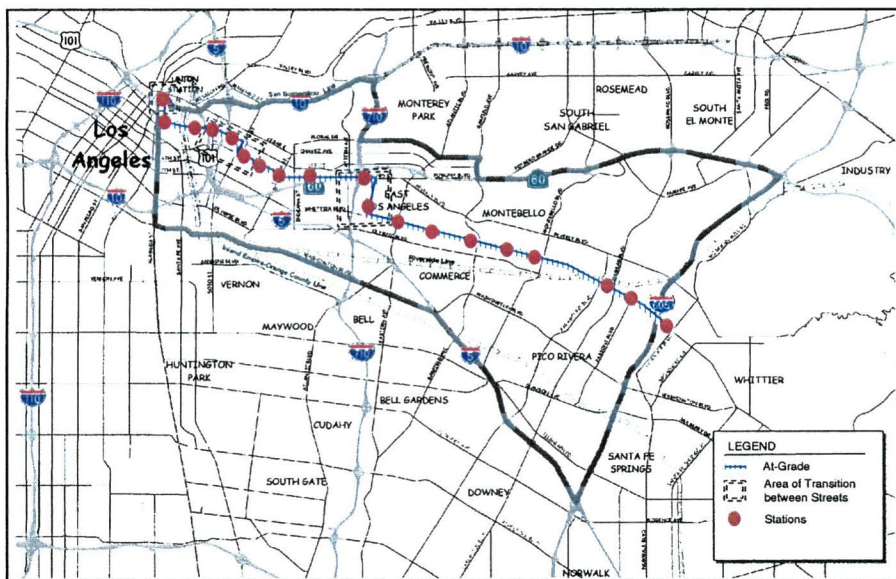
- |                                       |                        |                                    |
|---------------------------------------|------------------------|------------------------------------|
| ◆ Transit Service Levels              | ◆ Visual and Aesthetic | ◆ Energy                           |
| ◆ Transit Ridership                   | ◆ MTA Arts Program     | ◆ Cultural/Paleontologic Resources |
| ◆ Traffic                             | ◆ Air Quality          | ◆ Parks and Recreation Facilities  |
| ◆ Parking                             | ◆ Noise and Vibration  | ◆ Major Utilities                  |
| ◆ Land Use and Development            | ◆ Geotechnical         | ◆ Safety                           |
| ◆ Population and Employment           | ◆ Hazardous Substances | ◆ Capital Costs                    |
| ◆ Residences and Businesses Displaced | ◆ Water Resources      | ◆ Operating and Maintenance Costs  |
| ◆ Environmental Justice               | ◆ Wetlands             | ◆ Community Involvement Response   |



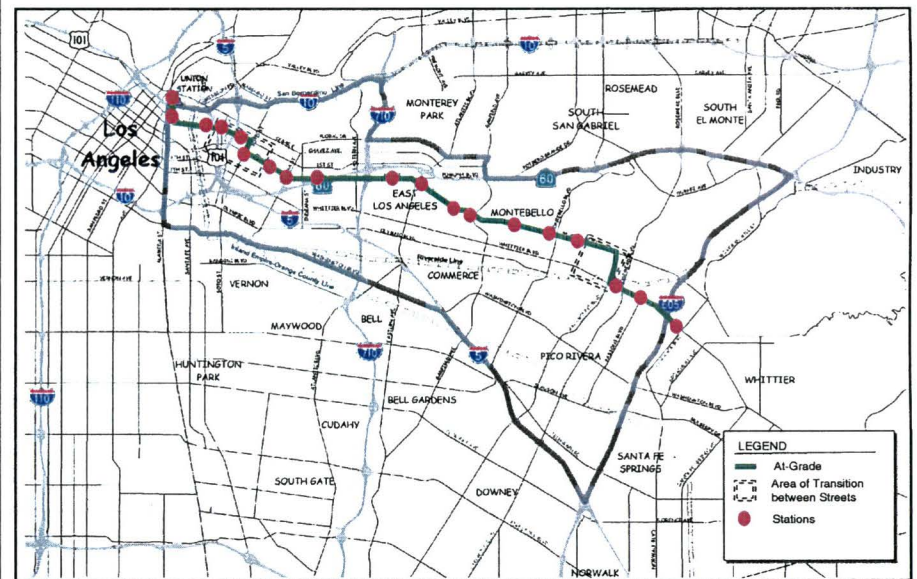
**Alternative 1**  
 Bus Rapid Transit (Dedicated Busway), At-Grade  
 Union Station to Whittier/Norwalk via Beverly



**Alternative 2**  
 Bus Rapid Transit (Dedicated Busway), At-Grade  
 Union Station to Whittier/Norwalk via Whittier



**Alternative 3**  
 Light Rail, At-Grade  
 Union Station to Whittier/Norwalk via Whittier

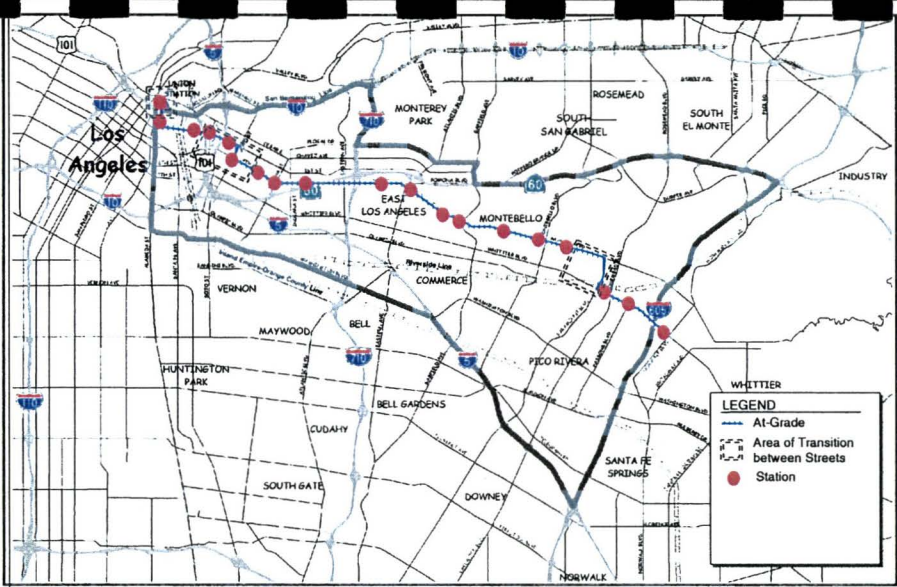


**Alternative 4**  
 Bus Rapid Transit (Dedicated Busway), At-Grade  
 Union Station to Whittier/Norwalk via Beverly

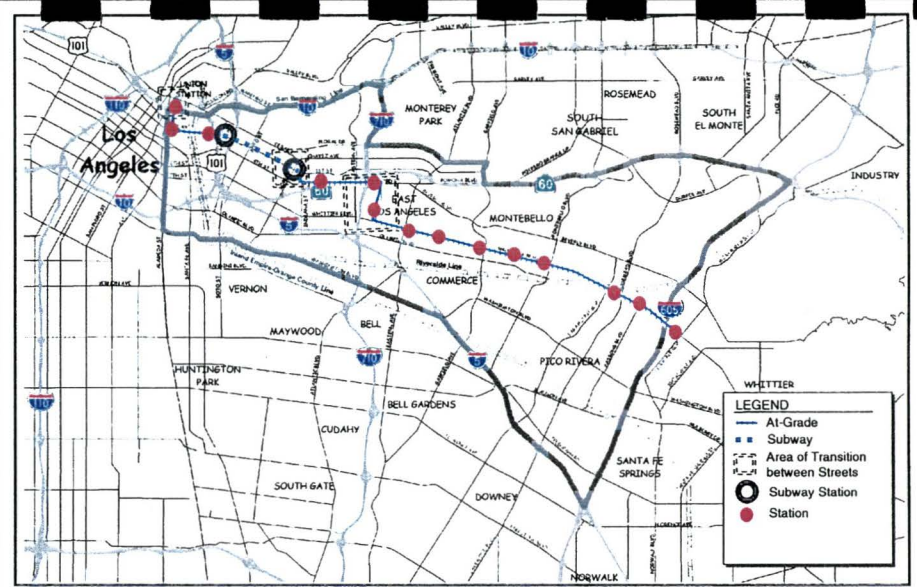
**Los Angeles Eastside Corridor SEIS/SEIR**



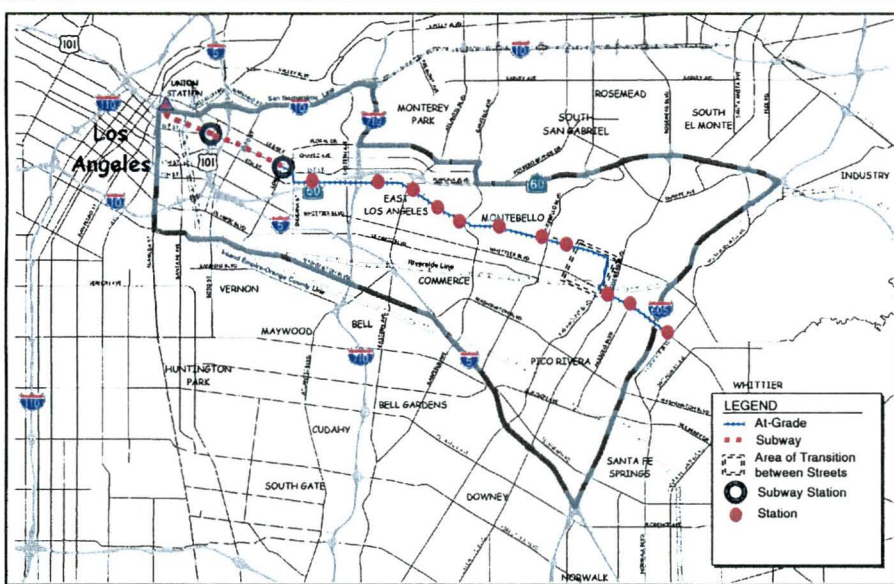




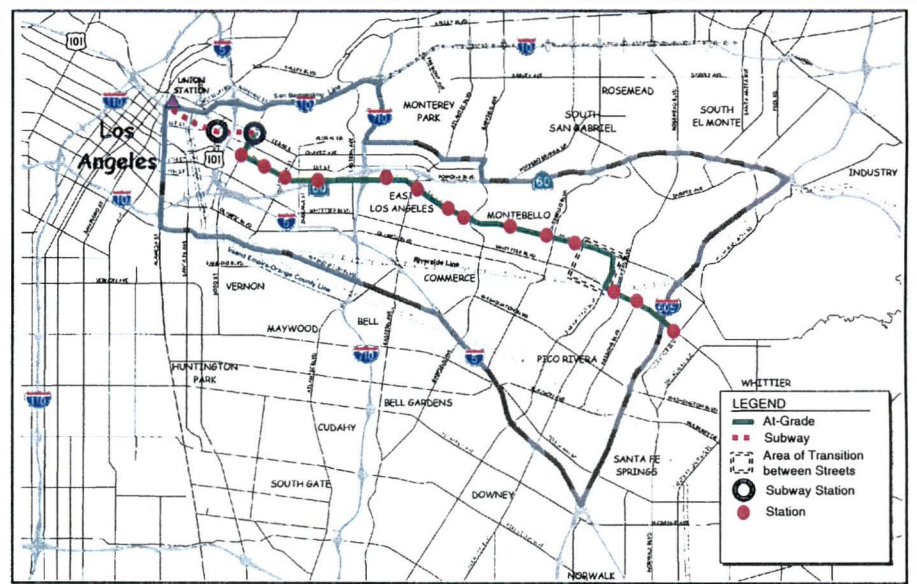
**Alternative 5**  
Light Rail, At-Grade  
Union Station to Whittier/Norwalk via Beverly



**Alternative 6**  
Light Rail, At-Grade-Union Station to 1st/Boyle  
Light Rail Subway-1st/Boyle to 1st/Lorena  
Light Rail At-Grade - 1st/Lorena to Whittier/Norwalk via Whittier



**Alternative 7**  
Heavy Rail and Light Rail  
Heavy Rail Subway-Union Station to 1st/Lorena  
Light Rail At-Grade - 1st/Lorena to Whittier/Norwalk via Beverly



**Alternative 8**  
Heavy Rail and Bus Rapid Transit (Dedicated Busway)  
Heavy Rail Subway-Union Station to Chavez/Soto  
Bus Rapid Transit At-Grade - Chavez/Soto to Whittier/Norwalk via Beverly

**Los Angeles Eastside Corridor SEIS/SEIR**





#### **2.3.4 MTA Board Action (February 24, 2000)**

In February 2000, the MIS study recommendations were presented to the Board of Directors of the MTA. The Board considered the environmental and technical information contained in the MIS study in making their decision. On February 24, 2000, the Board adopted a Light Rail Transit (LRT) Build Alternative that would extend from Union Station (as an extension of the Pasadena Blue Line) to Beverly and Atlantic Boulevards utilizing Alameda St., 1<sup>st</sup> St., 3<sup>rd</sup> St. and Beverly Boulevard, with a tunnel under Boyle Heights from approximately Utah St. to Lorena St. under 1<sup>st</sup> St. In selecting the LRT Build Alternative, the Board considered the reduced environmental impacts associated with tunneling through Boyle Heights as represented by the chosen alternative. The Board adopted alternative was a combination of alignments and station locations from the MIS Alternatives 5 and 6. The Board also directed that Bus Rapid Transit (BRT) be further studied in the EIS phase of project development, subject to financing availability for the LRT Build alternative.

#### **2.3.5 MTA Board Action (June 22, 2000)**

On June 22, 2000, the MTA Board of Directors officially dropped the Bus Rapid Transit technology from any further analysis and consideration in the project development phases and in this Draft SEIS/SEIR. The basis for the Bus Rapid Transit technology to be officially dropped from further consideration was based on the project funding being approved for the LRT Build Alternative in the State's Traffic Congestion Relief Program.

In addition, the Southern California Association of Governments (SCAG) found the MIS study process and technical work effort conducted for the Eastside Transit Corridor in full compliance with SCAG's adopted procedures. A Letter of Completion has been approved by SCAG. SCAG has also determined that the LRT Build Alternative, as the Locally Preferred Alternative for the Los Angeles Eastside Corridor, is part of the currently adopted Regional Transportation Plan and the Transportation Improvement Program.

### **2.4 DRAFT SEIS/SEIR PROCESS, SELECTION OF THE LPA, AND RESPONSE TO PUBLIC COMMENTS**

#### **2.4.1 Alternatives Considered in the Draft SEIS/SEIR**

The alternatives considered in the Draft SEIS/SEIR process included the No-Build Alternative and the LRT Build Alternative. These alternatives are described in detail in Chapter 2 of the Draft SEIS/SEIR. A brief summary is presented below.

##### **2.4.1.1 No-Build Alternative**

The No-Build Alternative, as defined by FTA, represents the baseline case consisting of existing and committed elements of the region's transportation plan, excluding the proposed fixed guideway transit (bus and light rail transit) investments for the study corridor. The No-Build Alternative includes all highway and transit projects and operations that the region and MTA expect to be in place by the year 2020. These include improvements to the local bus systems and operation of the existing Red, Blue, and Green Lines as well as completion of the Pasadena Blue Line from Union Station to Sierra Madre Villa in Pasadena.

### 2.4.1.2 LRT Build Alternative

The LRT Build Alternative introduces the light rail transit (LRT) mode to the Los Angeles Eastside Corridor. The LRT fixed guideway concept would operate in a dual track configuration in the center of selected streets and provide for high platform center station arrangements for the at-grade LRT segments (similar to that in use on the Long Beach Blue Line) and cut-and-cover station boxes for the subway segment (similar, but of shorter length, to that in use on the Metro Red Line subway). LRT is electrically powered and receives its electric power from overhead power lines (like the Long Beach Blue Line and Green Line) within the street rights-of-way or in the tunnel for the subway segment. The LRT operations would include a traffic signal priority system, to allow for faster travel times, similar to other MTA in-street running operations.

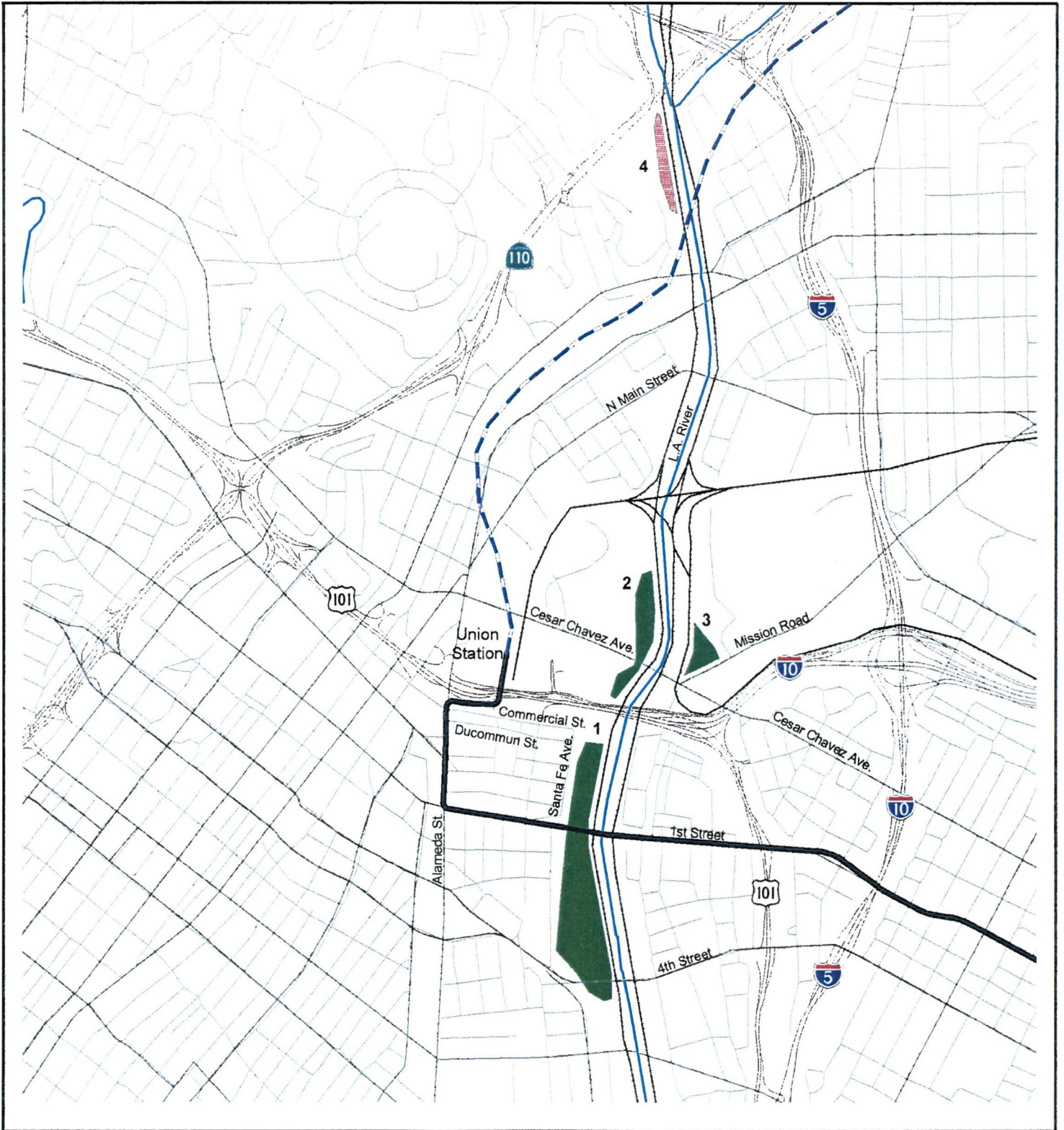
The LRT Build Alternative is approximately six miles long with eight new stations from a connection with, the under construction, Pasadena Blue Line at Union Station to Beverly and Atlantic Boulevards via Alameda Street, 1<sup>st</sup> Street, Indiana Street (with the exception of the options discussed below), 3<sup>rd</sup> Street, and Beverly Boulevard (Figure 2-3).

From about Lorena Street to about Hicks Avenue, three alignment options were studied as shown in Figure 2-3. They include: 1) Indiana Street Remove Parking Option; 2) Indiana Street Acquire Additional Right-of-Way Option; and 3) Extended Subway Option. The Indiana Street Remove Parking Option (Option 1) includes an at-grade segment traversing 1<sup>st</sup> Street east from Lorena Street to Indiana Street where it turns south and continues along Indiana Street to 3<sup>rd</sup> Street. At 3<sup>rd</sup> Street, the alignment turns eastward to Hicks Avenue. This option removes the existing parking lanes on both sides of Indiana Street and results in narrower sidewalks along that street. The Indiana Street Acquire Additional Right-of-Way Option (Option 2) is similar to Option 1 except that an additional 26-foot width of right-of-way on the west side of Indiana Street would be required to accommodate the two LRT tracks. However, the parking lanes and current sidewalk widths would be preserved with implementation of Option 2. Indiana Street has a narrower right-of-way than the other streets along the alignment, thus the LRT double-track facility requires additional area from the parking lanes or adjacent right-of-way to accommodate it. The Extended Subway Option (Option 3) involves continuation of the tunnel from Lorena Street in a southerly and easterly direction under several properties, including Ramona High School, to a point along 3<sup>rd</sup> Street just east of Hicks Avenue where the alignment again becomes at grade.

The LRT Build Alternative also included provisions for an eight to ten acre maintenance and storage facility (M&SF) to house the required new light rail vehicles using Ducommun and Commercial Streets as the possible connections to the three optional sites considered. Three alternative sites were considered for the maintenance and storage facility (M&SF) for the new light rail cars for the Los Angeles Eastside Corridor LRT extension. The locations considered are shown in Figure 2-4. Refer to Chapter 2 of the Draft SEIS/SEIR for a complete description of each location considered.

As a major component of implementing Light Rail Transit service in the Eastside Corridor, MTA designed a corresponding increase in feeder bus and increased service to existing routes that would serve the LRT stations. Increased service is proposed for MTA bus services in the Eastside Corridor as well as increased service for routes operated by Monterey Park and Los Angeles County. This increase in bus service will require an increase of over 40 peak period buses.





Los Angeles Eastside Corridor SEIS/SEIR

**Alternative Sites for Eastside Light Rail Maintenance and Storage Facility**



- LEGEND**
- Alternative Sites for Eastside Yard
    - 1 - Red Line Yard (MTA Owned Property)
    - 2 - West Bank Yard (MTA Owned Property and City of Los Angeles Owned Property)
    - 3 - East Bank Yard (Privately Owned - Bozek Family)
  - Part of the PBL Project
    - 4 - Midway Yard (MTA Owned Property)

- Pasadena Blue Line (PBL)
- Eastside Line (Extension of Pasadena Blue Line)
- Highway
- Primary Road
- Secondary Road
- Railroad





#### **2.4.2 Selection of the Locally Preferred Alternative (LPA)**

The public review of the Draft SEIS/SEIR began on March 2, 2001 through the Notice of Availability in the Federal Register and with a Notice of Completion filed with the California State Clearinghouse. Public notices also appeared in the local newspapers and through an extensive mailing to provide the public advance notice of the three community public hearings held on March 29, April 4, and April 5, 2001. The public hearings and other information community meetings were held to discuss the contents and comparisons presented in the Draft SEIS/SEIR. Considerable public input has been sought through additional community meetings, stations area meeting, etc., during the Final SEIS/SEIR development process regarding the modified options.

At the Board meeting of May 24, 2001, the MTA Board of Directors considered the comments received from the meetings and public hearings and public testimony. The MTA Board formally adopted the Locally Preferred Alternative (LPA) for the Eastside Corridor to be the Light Rail Transit project with Option 1 (transition from 1<sup>st</sup> Street and Lorena, via Indiana Street at-grade in the existing right of way, to 3<sup>rd</sup> Street) and the shared use of the existing Red Line Yard, Option 1, for the Eastside LRT Maintenance and Storage Facility (M&SF). The selection of the existing Red Line Yard, Option 1, for the Eastside M&SF facility was based on the requirement that additional property and/or construction of a bridge over the Los Angeles River would be needed for M&SF Options 2 or 3. The existing Red Line yard was considered to have sufficient capacity to handle the Eastside requirements. The Board also directed staff to prepare the Final SEIS/SEIR taking into account the comments received on the Draft SEIS/SEIR and directed the staff to "continue to work with the City of Los Angeles and the residents of Little Tokyo to mitigate their concerns about the alignment on Alameda and 1<sup>st</sup> Streets and to continue to further study the transition at Indiana Street and the impacts to parking at the end of the alignment on Beverly Boulevard."

#### **2.4.3 Response to Public Comments and Modifications to the LPA (Option 1)**

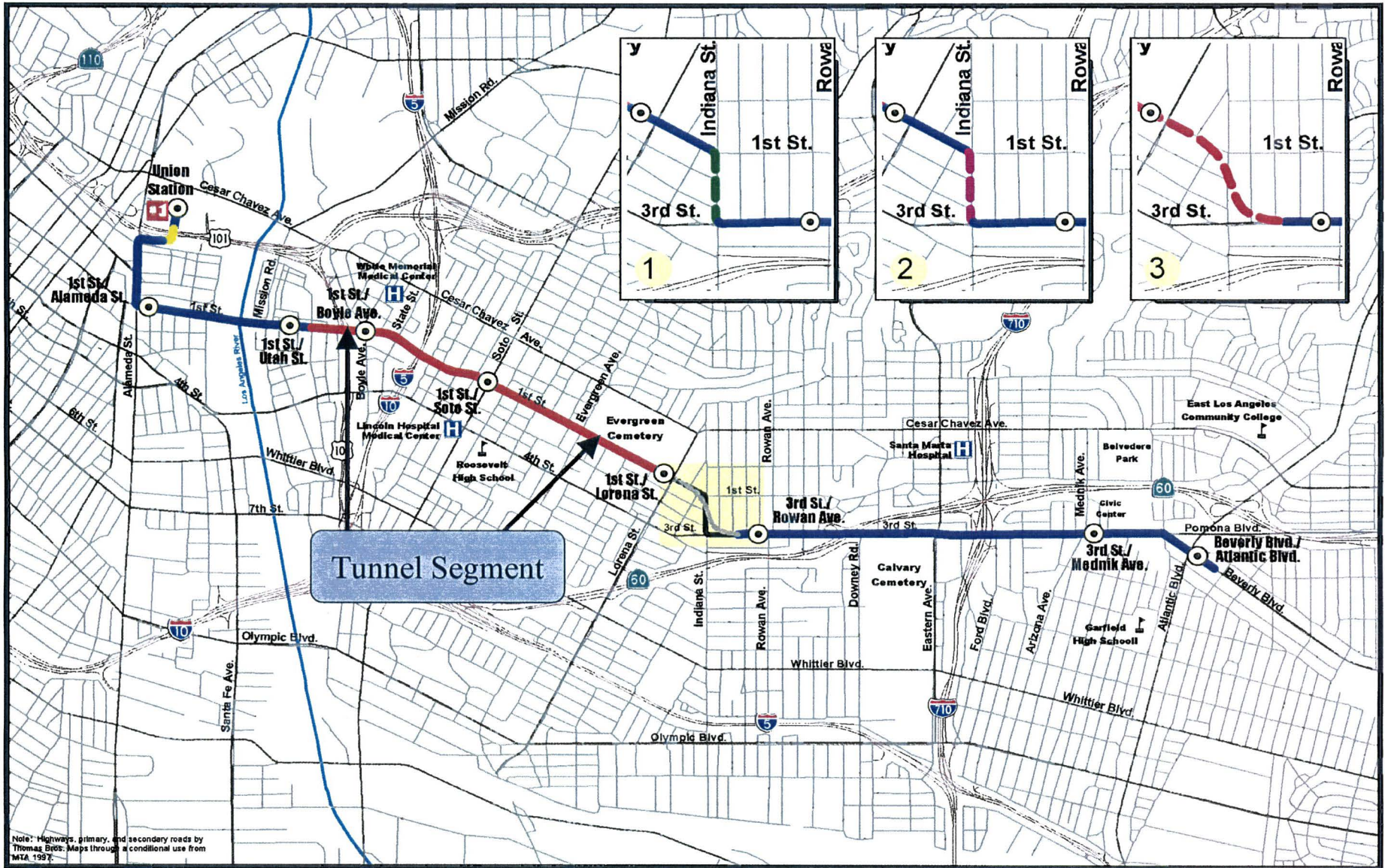
Since completion of the Draft SEIS/SEIR circulation period, MTA has decided to modify some portions of the LPA adopted by the MTA Board on May 24, 2001. In addition, MTA has added one route refinement option for consideration within portions of the LPA alignment. All of these changes have come about in response to community concerns that were revealed during circulation of the Draft SEIS/SEIR. Since that time, some portions of the MTA Board approved route of the LRT Build Alternative have been modified (Option A), and one refinement option (Option B) has been added to respond to public comments and to direction of the MTA Board when they approved the preferred alternative to be carried forward. Option A responds to the board's direction to "...continue to work with the City and the resident's of Little Tokyo to mitigate their concerns about the alignment on Alameda and 1<sup>st</sup> Streets." Option B responds to the board's direction to "...continue to further study the transition at Indiana Street and the impacts to parking at the end of the alignment on Beverly Boulevard."

The two options, A and B, are described below with the modifications made to the adopted LPA based on community concerns and comments received on the Draft SEIS/SEIR and by the MTA Board direction. The two options are described in more detail in Section 2.5 (Alternatives Considered in this Final SEIS/SEIR), and Chapters 6 and 7 discuss the public involvement program and the written response to all written and verbal comments received.

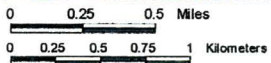
### 2.4.3.1 Changes to the Preferred Route (Option 1) Since Completion of the Draft SEIS/SEIR and MTA Board Approval – Option A

The changes below are included in Option A, Figure 2-5 (discussed in more detail in Section 2.5):

- ◆ Alameda Street—Alignment has been moved from the middle of the street to the east side necessitating some additional partial acquisitions and full acquisition of a gas station along the east side of that street from Commercial Street to 1<sup>st</sup> Street. This will provide higher traffic capacity on Alameda Street and address other LADOT concerns.
- ◆ 1<sup>st</sup>/Alameda Station—Station has been moved a short distance from 1<sup>st</sup> Street just east of Alameda to off-street right-of-way on the east side of Alameda just north of 1<sup>st</sup> Street. The movement of the station responds to Little Tokyo businesses' concerns to provide a more convenient location.
- ◆ 1<sup>st</sup> Street from Alameda to Vignes Street—Two lanes of traffic in each direction will be provided instead of one traffic lane in each direction to provide higher traffic capacity.
- ◆ 1<sup>st</sup> Street Bridge—LADOT intends to widen both ends of the bridge that they will environmentally clear as part of a separate project. The bridge itself will not be widened within the time frame of this project. The overhead catenary system for the LRT will use center poles over the bridge instead of span wire to address LA Bureau of Street Lighting concerns. (See Section 4.15 for additional information.)
- ◆ 1<sup>st</sup> Street Bridge— The 1<sup>st</sup> Street Bridge will require retrofitting to meet the current seismic codes and will be part of this project.
- ◆ 1<sup>st</sup>/Soto Station (Underground)—Station has moved 13 feet south of the previous planned location. The stairway configuration has been changed so that all of the station entrance will be under MTA property and not Soto Street. This reduces the need to excavate Soto Street for the station. A large storm drain on the north side of 1<sup>st</sup> Street will eliminate the need to acquire property on the northeast corner. Instead a property on the southeast corner will be acquired to accommodate the subway vent shafts and other facilities.
- ◆ 1<sup>st</sup>/Lorena Station—Station is in an open cut as before but has been moved to the north side of 1<sup>st</sup> Street. No property will be acquired from Evergreen Cemetery to accommodate the station. The station has been moved to respond to the LADOT concern that split lanes on both sides of the station box will not satisfy their fire/life safety criteria. This will require a traffic signal to be installed at Cheesbroughs Lane (east of Lorena) to accommodate traffic on 1<sup>st</sup> Street and the transition of the LRT alignment from the north side to the middle of 1<sup>st</sup> Street.
- ◆ Traction Power Substations (TPSS)—Four TPSSs were assessed in the Draft SEIS/SEIR. Engineering refinements have determined that a total of six TPSSs are required.
- ◆ Construction Staging—A new staging area has been added at Chavez/Soto on property currently owned by MTA. The other staging areas assessed in the Draft SEIS/SEIR remain the same.
- ◆ 3<sup>rd</sup> Street Overcrossing of the I-710 Freeway—The overcrossing will require substantial structural strengthening or alteration in order to support the LRT vehicles. The current approach intends to reduce the dead load of the bridge to compensate for the increased live load, thereby allowing the foundations to remain unchanged for both live load and seismic forces. However, some seismic retrofit is anticipated to be required.



Note: Highways, primary, and secondary roads by Thomas Bros. Maps through a conditional use from MTA 1997.



**LEGEND**

- Stations
- At Grade
- Tunnel
- Elevated
- Options Area
- ① Indiana Street Remove Parking Option
- ② Indiana Street Acquire Additional Right-of-Way Option
- ③ Extended Subway Option
- Highway
- Primary Road
- Secondary Road

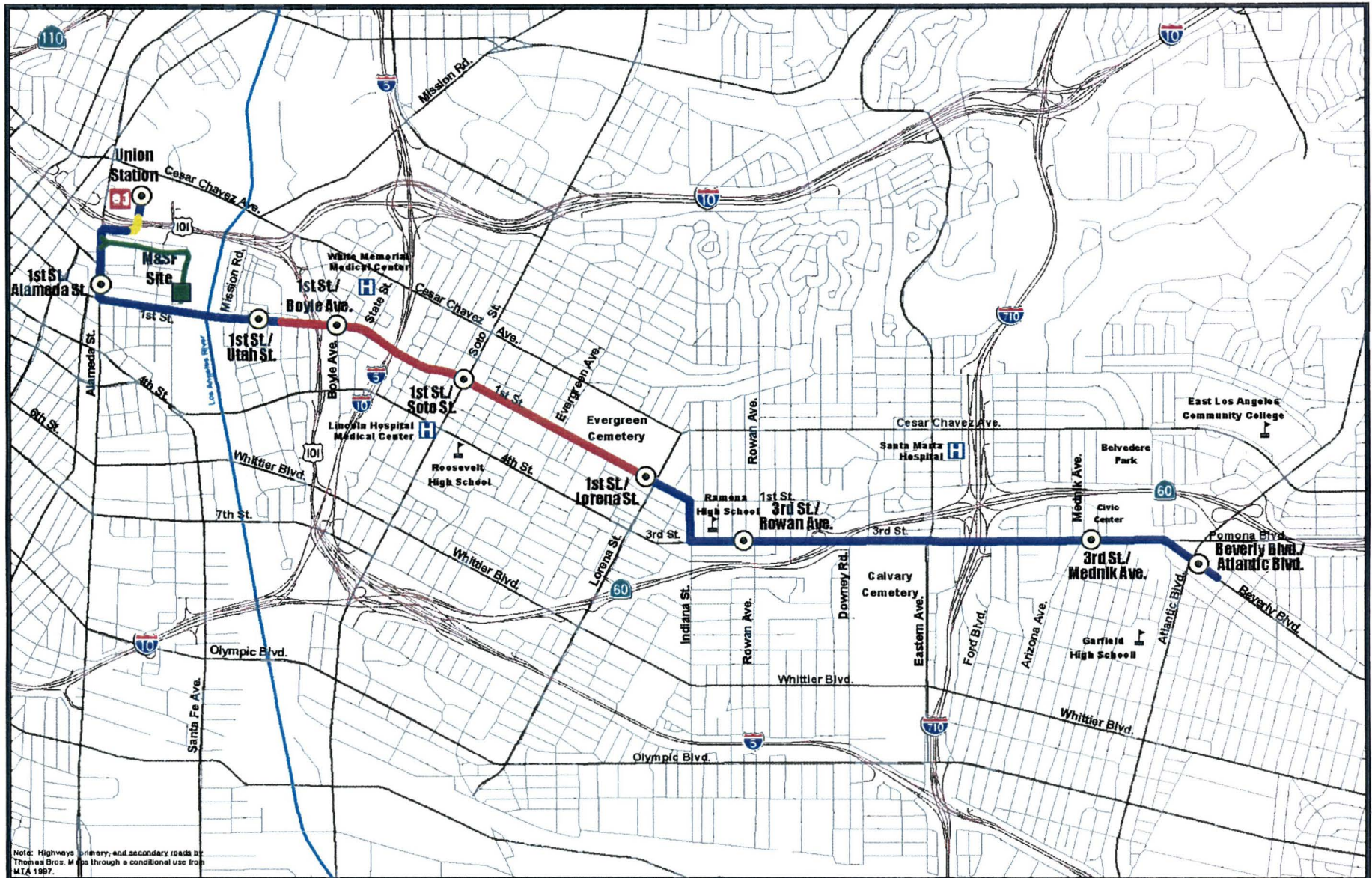


Los Angeles Eastside Corridor SEIS/SEIR

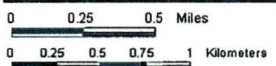
**LRT Build Alternative**

Figure 2-3





Note: Highways, primary, and secondary roads by Thomas Bros. Maps through a conditional use from MTA 1997.



**LEGEND**

- ⊙ Stations
- At Grade
- Tunnel
- Elevated
- M&SF Lead Line
- Highway
- Primary Road
- Secondary Road

**M** Eastside Corridor  
Transit Consultants

Los Angeles Eastside Corridor SEIS/SEIR

**LRT Build Alternative Option A**

Figure 2-5



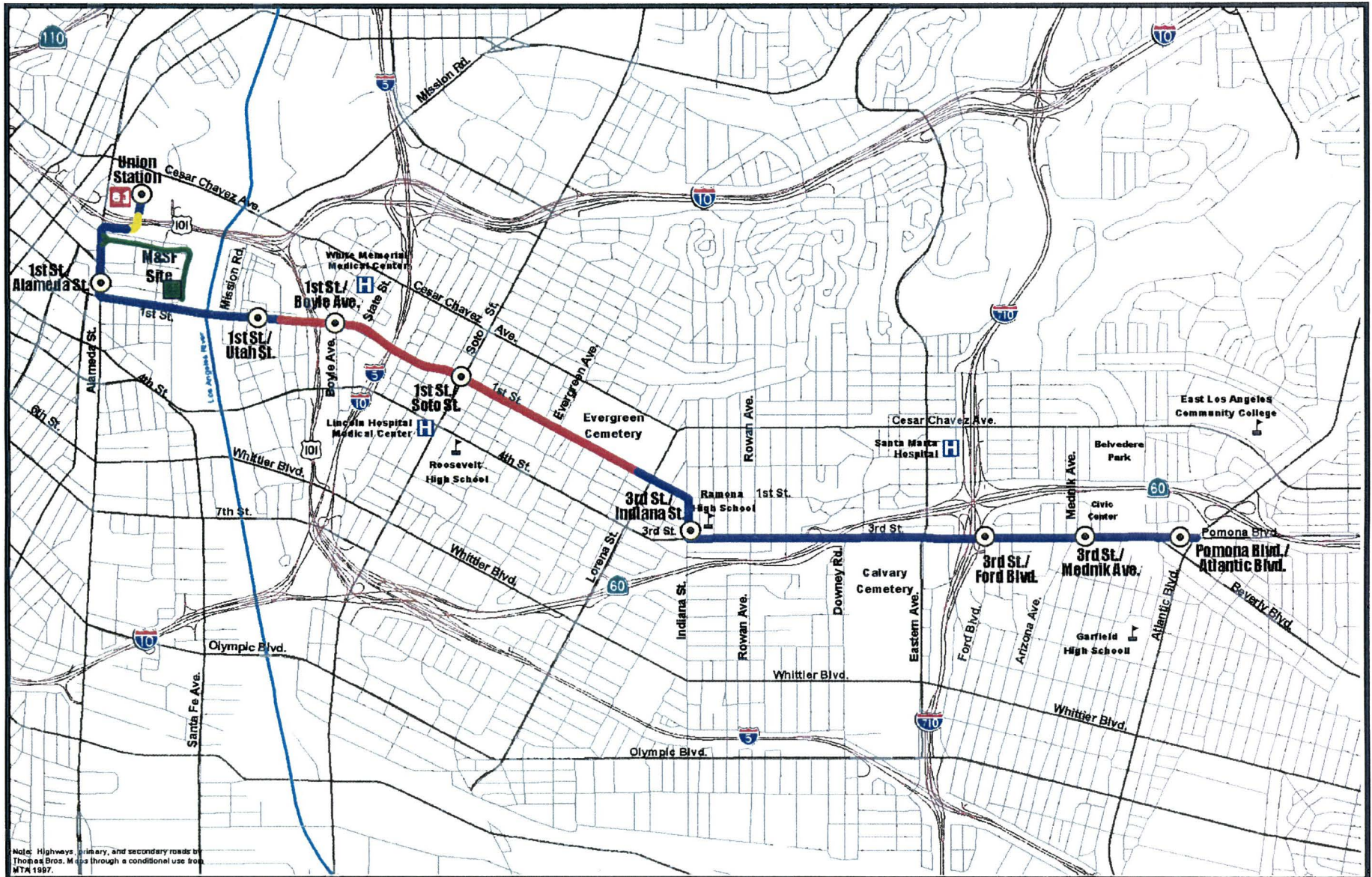


- ◆ **Parking Loss Mitigation**—MTA will provide replacement parking for areas with high utilization. The areas include: 1) 1<sup>st</sup> Street from Anderson to Utah Streets; 2) 1<sup>st</sup> Street east of Lorena Street; and 3) Indiana Street. For the first area, there is currently active redevelopment by the City of the Pico-Aliso complexes. The parking requirements of new developments, redevelopments, and new uses will be taken care of as part of the development approval process of the City. MTA will contribute an appropriate parking space replacement fee (to be negotiated) to the City for the 24 spaces of high utilization that will be removed between Anderson and Utah Streets. For 1<sup>st</sup> Street just east of Lorena Street, nine spaces currently have high utilization. These spaces will be replaced on property currently owned by MTA at that location. To accommodate the parking losses along Indiana Street under Option A only, three parcels located on the east side of that street just north of Ramona High School will be purchased to provide replacement parking.
- ◆ **Park and Ride**—Based on further evaluation, the park-and-ride site locations at Beverly and Atlantic have been modified to use the former Kaiser facility on the northwest corner of Pomona and Atlantic as a replacement site for the southwest corner location at Beverly and Atlantic. The joint use of the Pep Boys parking lot as recommended in Option 1 is still being considered.
- ◆ **Maintenance and Storage Facility (M&SF)** – In addition to the main yard and shop, a minor maintenance or storage facility is proposed for the Eastside LRT. The yard lead will consist of dual tracks branching off the LRT mainline at Alameda Street/Ducommun Street. The lead tracks will continue eastward on Ducommun Street to a point just east of Center Street where it will turn and traverse in a northeasterly direction for a short distance to the point where it enters the Red Line maintenance yard. At this point, the lead tracks turn south and continue into the yard. All curb parking will be eliminated on Ducommun Street to allow for the dual track lead to the M&SF. This will impact 97 mostly-metered curb parking spaces. A metered parking lot will be developed on the northeast corner of Ducommun and Garey Streets to replace these lost parking spaces.

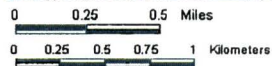
#### **2.4.3.2 Option B – Option A including Modifications to the Indiana Street Transition and Eastern Terminus**

Option B (Figure 2-6) basically follows the same alignment as Option A except that there is an off-street at-grade alignment between 1<sup>st</sup> and 3<sup>rd</sup> Streets (on the eastern side of Indiana Street outside the current street right-of-way), and Ramona High School (located at the northeast corner of 3<sup>rd</sup> Street/Indiana Street) will either be relocated to another site acceptable to the LAUSD and MTA or reconstructed on the existing site. The 1<sup>st</sup>/Lorena, 3<sup>rd</sup>/Rowan, and Beverly/Atlantic Stations would be moved to 3<sup>rd</sup>/Indiana (off-street location on the Ramona High School property), 3<sup>rd</sup>/Ford, and Pomona/Atlantic (west of Atlantic), respectively. Therefore, the following stations will be included in this alternative: Union Station, 1<sup>st</sup>/Alameda, 1<sup>st</sup>/Utah, 1<sup>st</sup>/Boyle, 1<sup>st</sup>/Soto, 3<sup>rd</sup>/Indiana, 3<sup>rd</sup>/Ford, 3<sup>rd</sup>/Mednik, and Pomona/Atlantic. Because the eastern terminal station has been moved from Beverly/Atlantic to Pomona/Atlantic, the alignment for Option B does not traverse the short distance from 3<sup>rd</sup> Street along Beverly Boulevard to just east of Atlantic. Instead, the alignment continues east on 3<sup>rd</sup> Street and a short distance on Pomona Boulevard to the optional eastern terminal station west of Atlantic Boulevard. However, the revised station is within walking distance of the former site. Two areas for park-and-ride facilities are also associated with this alternative. Like Option A, the first is the existing lot at Union Station. The second includes surface parking to be built on land adjacent to Kaiser Hospital, which is located near the eastern terminal station at Pomona/Atlantic. Unlike Option A, Option B would not require shared use of the existing Pep Boys lot.





Note: Highways, primary, and secondary roads by Thomas Bros. Maps through a conditional use from MTA 1997.



**LEGEND**

- Stations
- At Grade
- Tunnel
- Elevated
- M&SF Lead Line
- Highway
- Primary Road
- Secondary Road

Los Angeles Eastside Corridor SEIS/SEIR

**LRT Build Alternative Option B**



## 2.5 ALTERNATIVES CONSIDERED IN THIS FINAL SEIS/SEIR

### 2.5.1 No-Build Alternative

The No-Build Alternative, as defined by FTA, should represent the baseline case consisting of existing and committed elements of the region's transportation plan, excluding the proposed fixed guideway transit (bus and light rail transit) investments for the study corridor. The No-Build Alternative includes all highway and transit projects and operations that the region and MTA expect to be in place by the year 2020. These include improvements to the local bus systems and operation of the existing Red, Blue, and Green Lines as well as completion of the Pasadena Blue Line from Union Station to Sierra Madre Villa in Pasadena.

#### 2.5.1.1 Transit Service

Figure 2-7 shows the Eastside bus routes by MTA, Montebello, Monterey Park, Commerce, LADOT, and Los Angeles County in the Eastside service area. Section 1.3.2 of this document presents additional detail about the existing transit service. Table 2-1 shows the existing weekday service frequencies for the major bus routes in the Eastside Corridor as well as the frequencies planned for the No-Build Alternative. The development of the No-Build Alternative was based on a fiscally constrained local and regional plan. Additional service improvements are proposed for a number of the major east-west and north-south transit routes as well as more frequent service for the MTA operated rail lines as shown in Table 2-2.

#### 2.5.1.2 Highway/Roadway Improvements

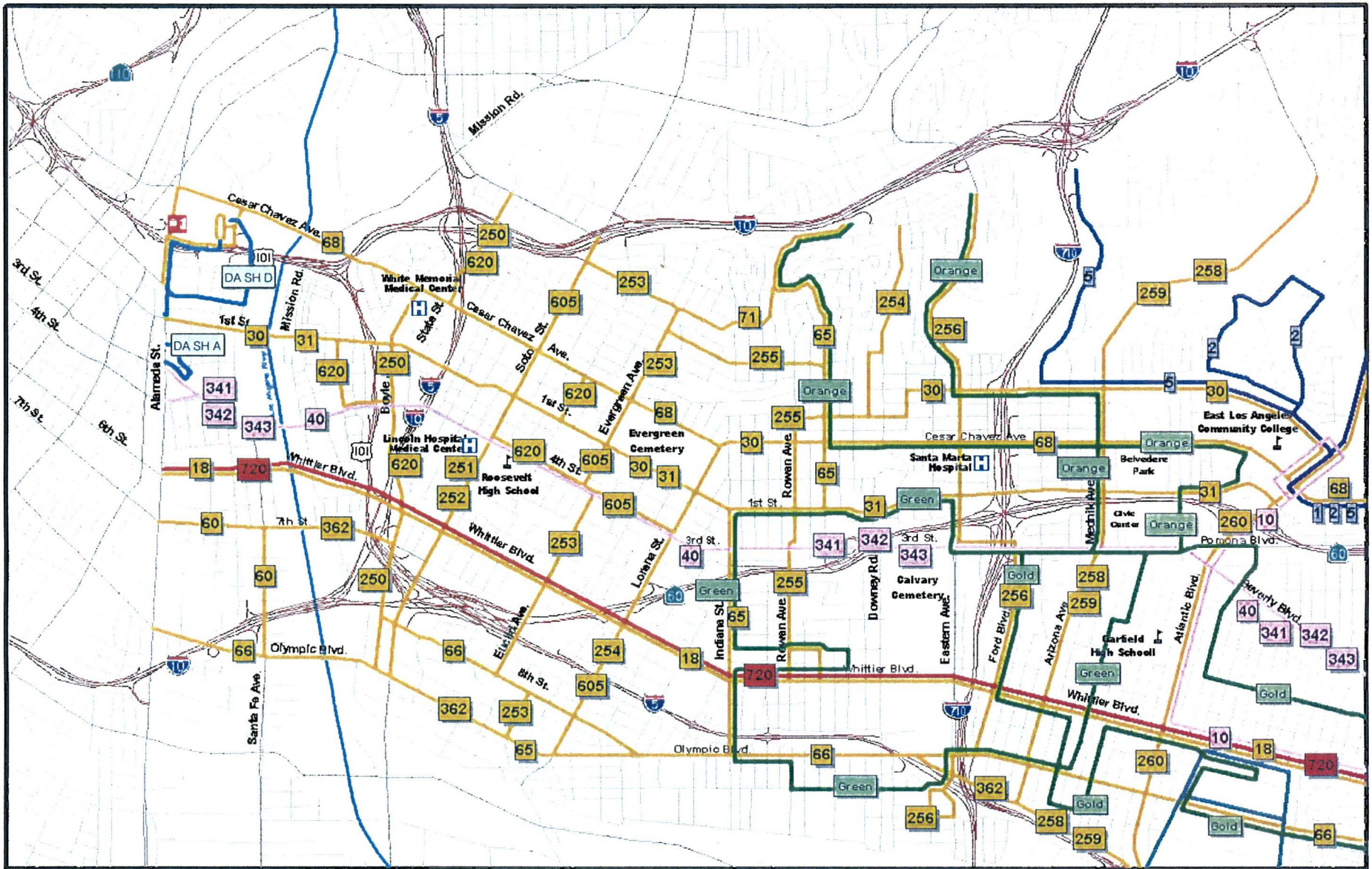
Within the Eastside Corridor, no major arterial street or freeway improvements are planned. Studies have identified the need for substantive improvements to the operations and capacity of the Santa Ana Freeway (I-5), the Pomona Freeway (SR 60), the Long Beach Freeway (I-710), and the San Bernardino Freeway (I-10), but agreement on the improvements to be made and the source of funding have not been agreed upon.

The only improvement planned is the widening of the U.S. 101 in the vicinity of Union Station, including relocation of the freeway entrances and exits at Vignes St. In this same area, the City of Los Angeles has proposed to widen Commercial Street from Alameda to Santa Fe Avenue, which is parallel to the U.S. 101 freeway in this area.

#### 2.5.1.3 Other Committed Improvements

The only other committed transportation improvement is the proposed extension of the Amtrak service tracks from Union Station, over U.S. 101 and parallel to the Eastside LRT Build Alternative, to the mainline Amtrak tracks in the vicinity of Jackson Street.





0 0.25 0.5 Miles











0 0.25 0.5 0.75 1 Kilometers



**Eastside Corridor  
Transit Consultants**

Note: Highways, primary, and secondary roads by Thomas Bro. Maps through conditional use from MTA 1997.

**Legend**

- |  |  |
|--|--|
|  MTA Routes           |  LA County Routes             |
|  Metro Rapid Route    |  Commerce Routes (All Routes) |
|  Montebello Routes    |  Highway                      |
|  Monterey Park Routes |  Primary Road                 |
|  LADOT Routes         |  Secondary Road               |
|  |  River                        |

Los Angeles Eastside Corridor SEIS/SEIR

**Existing Bus Routes**

Figure 2-7





**TABLE 2-1  
FREQUENCY OF WEEKDAY BUS TRANSIT SERVICE (IN MINUTES)**

Operator	Route	Destinations	Existing		No-Build		LRT Build		
			Peak	Off-Peak	Peak	Off-Peak	Peak	Off-Peak	
MTA	18	Wilshire Center - Whittier	10	15	6	10	6	10	
	30/31	Mid City - East Los Angeles	4-5	7.5	4	6.5	3.5	5	
	31A	East Los Angeles - 1 <sup>st</sup> /Lorena	-	-	-	-	10	15	
	65	Downtown Los Angeles - CSULA	15-25	30	13	45	10	15	
	66	Wilshire Center - Montebello	3-7	8	5.5	12	5.5	12	
	68	West LA Transit Ctr - Montebello Towne Center	8-12	12	8	10.5	8	10.5	
	250	LAC+USC - Boyle Heights	40	40	40	40	15	20	
	251	Cypress Park - Watts	12	24	15	24	10	20	
	252	El Sereno - Lynwood	12	24	12	24	10	20	
	253	LAC+USC - Boyle Heights	40	40	40	40	15	20	
	254	LAC+USC - Willowbrook	30-60	55	45	60	10	20	
	255	Montecito Heights - East Los Angeles	45	50	45	50	10	20	
	256	Altadena - East Los Angeles	35	50	30	50	30	50	
	258	Alhambra - South Gate	45	60	45	60	30	30	
	258A	Olympic - Floral	-	-	-	-	15	20	
	259	El Sereno - South Gate	45	60	45	60	30	30	
	260	Altadena - Compton	12-15	15	5.6	20	5.5	20	
	530	Panorama City - East Los Angeles	-	-	15	30	15	30	
	605	LAC+USC - Boyle Heights	15	30	22	30	10	12	
	620	LAC+USC - Boyle Heights	0-12	12	0-12	14	10	12	
	720	Santa Monica - Montebello	8	10	6	10	6	10	
	L.A. County	Gold	East Los Angeles	60	60	45	45	10	15
		Green	East Los Angeles	60	60	45	45	10	15
Orange		East Los Angeles - CSULA	60	60	45	45	10	15	
Monterey Park	1	Community Circulator	40	40	35	35	20	30	
	2	Community Circulator	40	40	35	35	20	30	
	5	Community Circulator	50	50	35	35	20	30	
Montebello	10	East LA College - Whittier	8-15	10	8	12	8	12	
	40	Whittier - Downtown LA	10-30	12	12	20	10	20	
	341(2) (3)	Downtown LA - Montebello Express Routes	30-60	-	30-60	-	30-60	-	
LADOT	Dash A	Little Tokyo - Convention Center	5	5	5	5	5	5	
	DashD	South Park	5	5	5	5	5	5	

Operator	Route	Destinations	Existing		No-Build		LRT Build	
			Peak	Off-Peak	Peak	Off-Peak	Peak	Off-Peak
MTA	Blue	7 <sup>th</sup> /Flower to Long Beach	6	12	5	12	5	12
	Blue	Union Station – Sierra Madre Villa	-	-	5	12	5	12
	Blue	Beverly/Atlantic – Union Station (Eastside) through to Pasadena (no transfer required at Union Station)	-	-	-	-	5	12
	Red	Union Station – North Hollywood	5	10	4	8	4	8
	Red	Union Station – Wilshire/Western	5	10	4	8	4	8
	Green	I-105/I-605 – El Segundo (Marine)	8	15	5	12	5	12

### 2.5.2 LRT Build Alternative

This section describes the two options (Option A and Option B) that are being considered in this Final SEIS/SEIR. The process leading to the decision to consider these options is described in Section 2.4.3 and shown in Figures 2-5 and 2-6.

#### 2.5.2.1 LRT Build Alternative – Option A

LRT Build Alternative Option A introduces the light rail transit (LRT) mode to the Los Angeles Eastside Corridor. The LRT fixed guideway concept would operate in a dual track configuration in the center of selected streets and provide for high platform center station arrangements for the at-grade LRT segments (similar to that in use on the Long Beach Blue Line) and cut-and-cover station boxes for the subway segment (similar, but of shorter length, to that in use on the Metro Red Line subway). LRT is electrically powered and receives its electric power from overhead power lines (like the Long Beach Blue Line and Green Line) within the street rights-of-way or in the tunnel for the subway segment. The LRT operations would include a traffic signal priority system, to allow for faster travel times, similar to other MTA in-street running operations. Fiber optics communications lines will be provided. The necessary communications connections between the LRT vehicle detectors and traffic signals will also be provided. Also additional space will be provided in the piping to allow for future expansion of fiber optic lines.

Option A is approximately six miles long with eight new stations from a connection with, the under construction, Pasadena Blue Line at Union Station to Beverly and Atlantic Boulevards via Alameda Street, 1<sup>st</sup> Street, Indiana Street, 3<sup>rd</sup> Street, and Beverly Boulevard (Figure 2-5). Appendix E, *Baseline Option A Design, October 22, 2001*, shows the plans and profiles and station site plans for Option A. Appendix E also shows the proposed property acquisitions and easements for Option A.

Option A also includes provisions for the shared use of the existing Red Line maintenance facility as the needed maintenance and storage facility (M&SF) to house the required 26 new light rail vehicles using Alameda Street and Ducommun Street as the connection to the Red Line yard. An emergency power generator will also be provided at the M&SF facility in order to provide emergency power for the tunnel segment and subway stations. There are six traction power substations along the six-mile route. They are located in the Red Line yard, near the 1<sup>st</sup>/Soto station (Appendix E, Sheet PI-005), near the 1<sup>st</sup>/Lorena

station on property owned by MTA (Appendix E, Sheet PI-007), at 3<sup>rd</sup>/Sunol (Appendix E, Sheet PI-008), at 3<sup>rd</sup>/Arizona (Appendix E, Sheet PI-011), and at Beverly/Atlantic (Appendix E, Sheet PI-012).

The subway or tunnel segment of Option A includes a number of ventilation and emergency exit areas for the subway segment in the vicinity of the subway stations. The locations for emergency exits and exhausts on MTA property and public rights-of-way (sidewalks or street) are shown in Appendix E. In Appendix E, Drawing No. A-3001 shows the locations for the area around the 1<sup>st</sup>/Boyle subway station; Appendix E, Drawing No. A-4001 shows the locations around the 1<sup>st</sup>/Soto subway station; and Appendix E, Drawing No. A-5002 shows the emergency exhaust location for the 1<sup>st</sup>/Lorena at-grade station area.

The three stations will house emergency ventilation fan shafts as well as separate emergency exit shafts at both ends of the stations. Ventilation fans are used for extracting smoke from the tunnels and stairs for evacuation in the event of an emergency – such as a fire in the underground areas. The two-level vent structure is generally a 45-foot-wide, approximately 70-foot-deep concrete box at two ends of the station, joining openings in the top of the tunnels to a vertical shaft penetrating the ground in a convenient location. Ventilation fans and their control equipment, as well as the emergency exit stairs, would be housed in this horizontal concrete box. The area of the shaft will be dependent on the height of the box. Where shafts vent at ground level the area is typically about 400 sq. ft. reducing to about half this area where towers are provided. Minimum tower height would be about ten feet. In some cases vent structures are incorporated with other structures and the height may be adjusted to match or compliment the structure. These fans are operated only for emergencies and for routine maintenance.

Each subway station at each end will have two exit hatches connected to emergency stairs. Each exit hatch is about 6 feet wide. Currently most of these hatches and gratings are shown at the station entrance plazas or right-of-way to be acquired for the construction staging areas. The construction staging areas are located on existing MTA property at the 1<sup>st</sup>/Boyle, Cesar Chavez/Soto, and 1<sup>st</sup>/Lorena sites as well as at additional properties at the 1<sup>st</sup>/Boyle and 1<sup>st</sup>/Soto sites. During the preliminary engineering design phase, further coordination with the City of Los Angeles will be required to determine if some or all of these hatches and gratings could be located within the public right-of-way. This may require variances from City codes.

### ***Bus Service***

As a major component of implementing Light Rail Transit service in the Eastside Corridor, MTA has designed a corresponding increase in feeder bus and increased service to existing routes that would serve the LRT stations. Table 2-1 shows the increase in service frequency as well as the addition of two routes (31A and 258A) expressly recommended to support the LRT Build Alternative. Increased service is proposed for MTA bus services in the Eastside Corridor as well as increased service for routes operated by Monterey Park and Los Angeles County. This increase in bus service will require an increase of over 40 peak period buses. The capital cost of these improvements as well as the increased bus operating costs are included in the costs for the LRT Build Alternative Option A as described in Chapter 5.

In order to maintain connectivity with other transit operators and bus services within the corridor, it is important that proposed stations interface with existing and proposed bus routes. The transit operating plan for Option A provides for a connection of existing bus lines at each station location. Figure 2-8 shows how the LRT system would fit into the Eastside Corridor's bus route network. At three station locations, bus lines would be rerouted in order to provide improved access to the light rail system. These rerouted lines include:

- ◆ MTA Line 65 to 3<sup>rd</sup>/Rowan Station via 3<sup>rd</sup> Street and Rowan Avenue
- ◆ MTA Line 530 to 1<sup>st</sup>/Soto Station via Soto and 1<sup>st</sup> Street

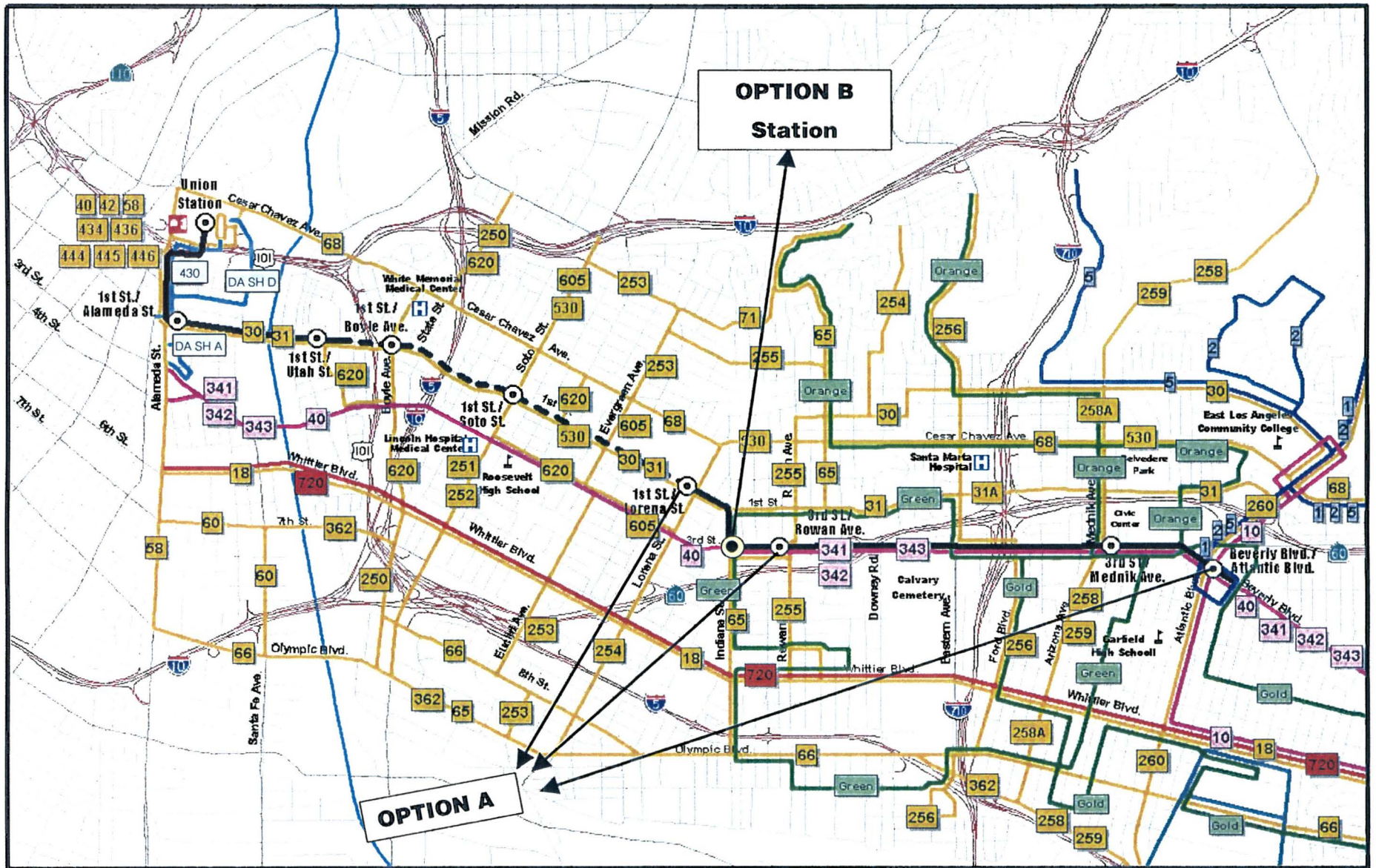
- ◆ MTA Line 620 to 1<sup>st</sup>/Utah Station via Utah Street
- ◆ Monterey Park Lines 1, 2 and 5 to Beverly/Atlantic Station via Atlantic Boulevard

MTA Line 65 is a local bus line that currently runs north on Indiana Street in the vicinity of the LRT Build Alternative alignment and turns east on 1<sup>st</sup> Street to Rowan Avenue. In order to provide access to the 3<sup>rd</sup>/Rowan Station, this line will be rerouted onto 3<sup>rd</sup> Street east to Rowan Avenue and then on Rowan to 1<sup>st</sup> Street. This minor reroute will not have a significant impact on transit ridership or transit access due to its proximity to the current routing one quarter of a mile to the west on Indiana Street. Access to the business district on 1<sup>st</sup> Street would still be provided at 1<sup>st</sup> and Rowan. Routing this bus line away from Indiana Street also will help to mitigate the impacts of Option A on Indiana Street for the transition between 1<sup>st</sup> and 3<sup>rd</sup> Streets if this option is chosen.

MTA Line 530 is a new service that will debut in 2001 as outlined in the MTA's 1998 Five-Year Plan. Line 530 is an express route that will connect East Los Angeles College and Boyle Heights with Panorama City via the County-USC Medical Center and the Burbank Media District. Line 530 currently is proposed to run south on Soto Street from the San Bernardino Freeway (I-10) to Cesar Chavez Avenue and then turn east to East Los Angeles College. In order to provide service to the 1<sup>st</sup>/Soto Station, this line will be rerouted south on Soto Street to 1<sup>st</sup> Street. It will then continue east on 1<sup>st</sup> Street to Lorena Street back to Cesar Chavez Avenue. Line 530 will also serve the 1<sup>st</sup>/Lorena Station on its amended route.

MTA Line 620 is a community shuttle service jointly operated by MTA and LADOT that currently runs on Clarence Street west of the 101 Freeway between 4<sup>th</sup> and 1<sup>st</sup> Streets. It is proposed that this line be rerouted from Clarence Street to 3<sup>rd</sup> Street and Utah Street where it will continue north to interface with the 1<sup>st</sup>/Utah Station at the corner of 1<sup>st</sup> and Utah streets. This minor reroute will not affect line patronage because of the close proximity of Utah Street to Clarence Street one block away.

Monterey Park's Spirit Transit system provides community transportation services on five routes within the City of Monterey Park. Three of its lines currently operate in the vicinity of Cesar Chavez Avenue and Atlantic Boulevard. These three routes (1, 2, and 5) will be extended southward along Atlantic to the Beverly/Atlantic Station. The extension of these three routes will provide convenient access to the LRT system from the City of Monterey Park. The three Monterey Park lines will also provide connecting service from the LRT system to the Atlantic Square shopping area as well as to East Los Angeles College.



0 0.25 0.5 Miles

0 0.25 0.5 0.75 1 Kilometers



**Eastside Corridor  
Transit Consultants**

Note: Highways, primary, and secondary roads by Thomas Bros. Maps through conditional use from MTA 1997.

**Legend**

- MTA Routes
- Metro Rapid Route
- Montebello Routes
- Monterey Park Routes
- LADOT Routes
- LA County Routes
- Commerce Routes (All Routes)
- LRT Alignment
- Highway
- Primary Road
- Secondary Road
- River

Los Angeles Eastside Corridor SEIS/SEIR

**Modified Bus System with LRT**

Figure 2-8



Table 2-3 shows the interface of bus lines at each station (except Union Station) along the alignment of the LRT Build Alternative Option A.

<b>TABLE 2-3</b>				
<b>BUS ROUTE INTERFACE AT LRT STATIONS – OPTION A</b>				
<b>Station</b>	<b>Operator</b>	<b>Line</b>	<b>Destinations</b>	
Union Station	Antelope Valley LADOT MTA	785	Gateway Transit Center – Antelope Valley	
		DASH D	Union Station – Grand Blue Line Station	
		33	Union Station – Venice Bl.	
		40	Union Station – South Bay Galleria	
		42	Union Station – LA Int'l Airport	
		55	Union Station – Rosa Parks Metro Rail Station	
		60	Union Station – Long Beach	
		333	Union Station – Venice Bl.	
		434	Union Station – Malibu	
		436	Union Station – Ocean Park	
		439	Union Station – Redondo Beach	
		442	Union Station – South Bay Galleria	
		444	Union Station – Rancho Palos Verdes	
		445	Union Station – San Pedro	
	446	Union Station – San Pedro		
	447	Union Station – San Pedro		
	OCTA Santa Clarita	466	Union Station – La Mirada	
701		Union Station – Huntington Beach		
794		Union Station – Santa Clarita		
1 <sup>st</sup> /Alameda	LADOT	DASH A	Little Tokyo – Los Angeles Convention Center	
		DASH D	Union Station – Grand Blue Line Station	
		MTA	30 / 31	Mid City – East LA College
			40	Union Station – South Bay Galleria
			42	Union Station – LA Int'l Airport
	MTA	58	Union Station – Washington Blue Line Station	
		434	Union Station – Malibu	
		436	Union Station – Ocean Park	
		442	Union Station – South Bay Galleria	
		445	Union Station – San Pedro	
1 <sup>st</sup> /Utah	MTA	30 / 31	Mid City – East LA College	
		620 (reroute)	LAC+USC – Boyle Heights	
1 <sup>st</sup> /Boyle	MTA	30 / 31	Mid City – East LA College	
		250	LAC+USC – Boyle/Olympic	
		620	LAC+USC – Boyle Heights	
1 <sup>st</sup> /Soto	MTA	30 / 31	Mid City – East LA College	
		250	Cypress Park – Watts	
		251	El Sereno – Lynwood	
		530 (reroute)	Panorama City – East LA College	
		605	LAC+USC – Boyle Heights	
1 <sup>st</sup> /Lorena	MTA	30 / 31	Mid City – East LA College	
		254	LAC+USC – Willowbrook	
		530 (reroute)	Panorama City – East LA College	
3 <sup>rd</sup> /Rowan	Montebello MTA	40	Downtown LA – Whittier	
		65 (reroute)	Downtown LA – CSULA	
		255	Montecito Heights – East Los Angeles	

Station	Operator	Line	Destinations
3 <sup>rd</sup> /Mednik	Los Angeles County	Gold	East Los Angeles
		Green	East Los Angeles
		Orange	East Los Angeles – City Terrace – CSULA
	Montebello MTA	40	Downtown LA – Whittier
		258	El Sereno – South Gate
259	Alhambra – South Gate		
Beverly/Atlantic	Montebello	10	East LA College – Pico Rivera
		40	Downtown LA – Whittier
	Monterey Park	341, 342, 343	Downtown LA – Montebello Express
		1 (reroute)	Monterey Park
		2 (reroute)	Monterey Park
	MTA	5 (reroute)	Monterey Park – CSULA
		260	Altadena – Compton
Source: 1999-2000 MTA, Montebello, Monterey Park, Los Angeles County, and Commerce bus timetables; Parsons Brinckerhoff.			

### ***LRT Alignment***

The alignment begins at Union Station and crosses over US 101 on an aerial structure (approximately 1,000 feet in length) and then gradually becomes an at-grade segment near where it intersects with Alameda Street. The alignment continues south along the east side of Alameda Street and then turns east to the center of 1<sup>st</sup> Street where it continues at grade to Clarence Street in Boyle Heights and then becomes a subway segment. The subway segment traverses underneath or adjacent to 1<sup>st</sup> Street for about 1.8 miles east to just west of Lorena Street in Boyle Heights.

For Option A, the alignment continues as an at-grade segment traversing 1<sup>st</sup> Street east from Lorena Street to Indiana Street where it turns south and continues along Indiana Street to 3<sup>rd</sup> Street. At 3<sup>rd</sup> Street, the alignment turns eastward to Hicks Avenue. This option removes the existing parking lanes on both sides of Indiana Street and results in narrower sidewalks along that street. From Hicks Avenue, the alignment travels east on 3<sup>rd</sup> Street at grade to Beverly Boulevard where it turns to the southeast and continues for a short distance on Beverly Boulevard to a point just east of Atlantic Boulevard.

For the at-grade sections, the LRT would operate mostly on existing arterial streets and would generally require removal of one general purpose travel lane in each direction. The center sections of all the designated arterial streets would require major reconstruction in order to implement the LRT system. This design configuration would allow for the retaining of a majority of the on-street parking on the arterial streets that are used. MTA will provide replacement parking for those areas where parking utilization is high (Refer to Chapter 3 for more details).

### ***LRT Service Characteristics***

The future operating plan for the LRT Build Alternative Option A is comprised of two components: 1) the LRT operating line (extension of the Pasadena Blue Line) between Sierra Madre Villa and Beverly/Atlantic Boulevards with five-minute peak service (7.5 minutes initial service) and 12-minute off-peak service; and 2) local connecting bus routes to all stations along the LRT line. Because the individual cars can be "trained" together, the train lengths can then vary from one to three cars depending on the demand and time of day. Local buses with local stops would continue to operate along the same arterial streets as the LRT but would be at lower service frequencies. This will also allow transit patrons to access areas that are not directly served by the LRT station stops. The LRT running time with making



stops at each station is estimated to be 17 minutes from Beverly/Atlantic Boulevards to Union Station. Based on the LRT operating plan, the number of trains per hour in the peak direction on the LRT track would be 12 (8 initially) during the peak times and five during the off-peak times.

The LRT operating speeds for the at-grade segments would be similar to existing street-running LRT operations in other parts of Los Angeles. Because of the placement of the LRT track and stations mainly within arterial streets, the maximum speed of operation would be limited by the streets' speed limit (varies from 25 mph to 35 mph) with a 35 mph maximum speed allowed under all circumstances by State PUC regulations. Based on experience with the Long Beach Blue Line operations, the lower speed at-grade operation has fewer fatalities than high speed (55 mph) operations even though the numbers of minor accidents are greater with the in-street operation proposed for most of the Los Angeles Eastside Corridor. The maximum LRT operating speed of the subway portion would be much faster (55 mph) than the at-grade segments because it would not operate along the existing street rights-of-way. The Eastside Corridor would not have high speed surface-running operations in a reserved right-of-way such as exists in the mid corridor of the existing Long Beach Metro Blue Line.

Table 2-4 shows the travel time between each proposed station and the total travel time from each station to Union Station.

Station (A)	Station (B)	Option A		Option B	
		Travel Time between Stations, minutes	Total Travel Time from Station (A) to Union Station, minutes	Travel Time between Stations, minutes	Total Travel Time from Station (A) to Union Station, Minutes
Beverly/Atlantic	3 <sup>rd</sup> /Mednik	1.6	17.2	-	-
Pomona/Atlantic	3 <sup>rd</sup> /Mednik	-	-	1.4	16.9
3 <sup>rd</sup> /Mednik	3 <sup>rd</sup> /Rowan	3.6	15.6	-	-
3 <sup>rd</sup> /Mednik	3 <sup>rd</sup> /Ford	-	-	1.2	15.5
3 <sup>rd</sup> /Ford	3 <sup>rd</sup> /Indiana	-	-	3.4	14.3
3 <sup>rd</sup> /Indiana	1 <sup>st</sup> /Soto	-	-	3.1	10.9
3 <sup>rd</sup> /Rowan	1 <sup>st</sup> /Lorena	2.4	12.0	-	-
1 <sup>st</sup> /Lorena	1 <sup>st</sup> /Soto	1.8	9.6	-	-
1 <sup>st</sup> /Soto	1 <sup>st</sup> /Boyle	1.6	7.8	1.6	7.8
1 <sup>st</sup> /Boyle	1 <sup>st</sup> /Utah	1.4	6.2	1.4	6.2
1 <sup>st</sup> /Utah	1 <sup>st</sup> /Alameda	1.8	4.8	1.8	4.8
1 <sup>st</sup> /Alameda	Union Station	3.0	3.0	3.0	3.0
	Total	17.2		16.9	

Automobiles and delivery vehicles would operate in a different fashion along the at-grade segments than they do now. In order to maximize the safety of the LRT operation and to minimize private vehicles conflict with the LRT trains, left turns and crossings of the LRT train track would be limited and mostly restricted to major intersecting streets where advanced traffic and train control systems can be implemented. Between major intersections, a six-inch curb next to the travel lane would protect the LRT track section and, therefore, driveways and minor or secondary streets would be limited to right-turns in and out. Private vehicles would not be able to make left turns across the LRT tracks or cross from one side to the other (no straight through movements) between intersections. Private vehicles left turns at designated intersections would be controlled and all safety measures (including the possibility of left-turn

gates) would be taken. The mountable curb for the track section would allow for emergency vehicles to park on or cross the track when necessary. MTA would arrange a permit system for non-peak hour large truck deliveries across the tracks to furniture stores and other businesses with occasional oversize deliveries. All of these changes will be similar to those encountered when a street has a raised center median of any type.

It is expected that the streets where the LRT tracks are located will become more "transit" oriented, and through traffic will be reduced and shifted to other streets within the corridor. On the narrower streets, left turns may need to be restricted at certain intersections during some portions of the day (probably peak periods) because of the lack of space for a dedicated left turn pocket. The reduction of one traffic lane in each direction in most locations would impact the level of service and possibly the ease of access by automobile to commercial buildings and other public activities. It is expected that, over time, traffic would re-orient itself because many of the streets in the corridor have some available capacity and might accept more traffic and still operate at acceptable levels of service. In addition, the LRT will provide an improved level of service of public transit service, which some may choose in preference to using an automobile.

If the LRT Build Alternative were implemented, an increase in the provision of transit service would occur in the Eastside Corridor. There would be the introduction of a premium service that would be regionally serving and provide improved service reliability and a decrease in travel times for transit patrons. Forecast data indicate that transit ridership would increase in the Corridor with the introduction of the improved service.

The introduction of a light rail system into the Eastside Corridor would provide passengers with greater access to regional transit opportunities and would provide for improved regional transit connectivity. Transfers could be made at Union Station to a variety of different transit alternatives. The Eastside Corridor Light Rail system will provide continuing service to Pasadena via the Pasadena Blue Line, which is expected to open for service in 2003. Transfers can be made to the Metro Red Line at Union Station with its subway service to Wilshire Center and North Hollywood. The Long Beach Blue Line can also be accessed via the Red Line at the 7<sup>th</sup>/Metro Center station in Downtown Los Angeles, and the Green Line to Norwalk and Redondo Beach is accessible via the Long Beach Blue Line. Dozens of local and express bus lines converge at Union Station including the Big Blue Bus's popular Line 10 express to Santa Monica. Several transit providers serve Union Station, including Santa Monica's Big Blue Bus, LADOT, Foothill Transit, Torrance Transit, Santa Clarita Transit, and the Antelope Valley Transportation Authority. Metrolink commuter rail service is also available for regional travel to Ventura, San Bernardino, Riverside, Orange, and San Diego counties as well as to northern Los Angeles County. Amtrak rail service can also be accessed at Union Station for long-distance travel to other cities in California and the nation. Impacts on regional transit access and connectivity as a result of the LRT Build Alternative are beneficial.

### ***Passenger Stations***

As discussed in the bus service section, the LRT Build Alternative Option A consists of eight new stations and one station modification: Union Station (station modification), 1<sup>st</sup>/Alameda, 1<sup>st</sup>/Utah, 1<sup>st</sup>/Boyle, 1<sup>st</sup>/Soto, 1<sup>st</sup>/Lorena, 3<sup>rd</sup>/Rowan, 3<sup>rd</sup>/Mednik, and Beverly/Atlantic. All stations are at grade with the exception of 1<sup>st</sup>/Boyle and 1<sup>st</sup>/Soto, which are within the subway segment and 1<sup>st</sup>/Lorena, which is located in an open cut. The LRT at grade station stops would entail constructing a 270-foot long platform (allows for a maximum of three-car trains) along with pedestrian walkways to allow for safe passage to crosswalks for arriving and departing passengers. The LRT underground stations will include 270-foot platforms. The subway stations are projected to have center platforms, a bridge-like mezzanine and single

entrances located in plazas adjacent to 1<sup>st</sup> Street. The at-grade stations will be similar to the Long Beach and Pasadena Blue Line stations.

#### ***Park-and-Ride Facilities (including bus interface at Beverly/Atlantic)***

Two areas for park-and-ride facilities are associated with this alternative. The first is the existing lot at Union Station, which is the western terminus of the Los Angeles Eastside Corridor LRT line. The project does not involve any expansion or improvements to that lot. The second is near the Beverly/Atlantic Station at the eastern terminus of the line. Park-and-ride surface parking for a total of about 200 vehicles would be provided near the station. One location is land adjacent to the former Kaiser facility on the northwest corner of Pomona/Atlantic, which is within walking distance of the Beverly/Atlantic station. The other location is the existing parking lot behind (to the east of) the Pep Boys auto parts store that is located on the east side of Atlantic Boulevard north of Beverly Boulevard (between Beverly and Pomona Boulevards). MTA intends to enter into negotiations with the owners of Pep Boys to develop a joint use agreement with them for the existing parking lot. Minor improvements to the Pep Boys lot are anticipated. It is expected that a long-term agreement will be entered into that will allow control of the parking spaces for the expected life of the improvement.

#### ***Vehicle Fleet***

The type of light rail transit (LRT) vehicles to be used for the Eastside Corridor will be the same as used on the Long Beach and Pasadena Blue Lines. They will be standard conventional articulated light rail transit vehicles. In order to provide the future service level of 5-minute frequencies between trains, as well as a maximum train length of 3 cars, a total of 26 new LRT vehicles will be required for the LRT Build Alternative Option A.

#### ***Maintenance and Storage Facility – Red Line Yard***

The existing Red Line maintenance yard will be used for the Maintenance and Storage Facility (M&SF) for the Eastside Corridor LRT. Excess capacity currently exists at the yard and is available to provide the needed facilities. The site was previously environmentally cleared for the Metro Red Line in the *Final Environmental Impact Statement, Los Angeles Rail Rapid Transit Project, Metro Rail*, USDOT, UMTA, and Southern California Rapid Transit District, December 1983. The yards and shops currently provide space for the following functions: storage of trains when not in mainline service; dispatch, receipt, and change in trains for mainline service; interior and exterior cleaning of trains; preventive and corrective maintenance of cars; and testing of cars before revenue service and after major repairs. The M&SF will include the addition of a blow down pit, car cleaner platform, and car wash for cleaning the light rail vehicles as well as two storage tracks. The yard lead will consist of dual tracks branching off the LRT mainline at Alameda Street/Ducommun Street (see Appendix E, Sheets C-101 to C-110). The lead tracks will continue eastward on Ducommun Street to a point just east of Center Street where it will turn and traverse in a northeasterly direction for a short distance to the point where it enters the Red Line maintenance yard. At this point, the lead tracks turn south and continue into the yard.

#### **2.5.2.2 LRT Build Alternative – Option B**

As discussed in Section 2.4.3.2 and shown in Figure 2-6, Option B basically follows the same alignment as Option A except that there is an off-street at-grade alignment between 1<sup>st</sup> and 3<sup>rd</sup> Streets (on the eastern side of Indiana Street outside the current street right-of-way), and Ramona High School (located at the northeast corner of 3<sup>rd</sup> Street/Indiana Street) will either be relocated to another site acceptable to the LAUSD and MTA or reconstructed on the existing site. The 1<sup>st</sup>/Lorena, 3<sup>rd</sup>/Rowan, and Beverly/Atlantic Stations would be moved to 3<sup>rd</sup>/Indiana (off-street location on the Ramona High School property), 3<sup>rd</sup>/Ford, and

Pomona/Atlantic (west of Atlantic), respectively. Therefore, the following stations will be included in this option: Union Station, 1<sup>st</sup>/Alameda, 1<sup>st</sup>/Utah, 1<sup>st</sup>/Boyle, 1<sup>st</sup>/Soto, 3<sup>rd</sup>/Indiana, 3<sup>rd</sup>/Ford, 3<sup>rd</sup>/Mednik, and Pomona/Atlantic. Because the eastern terminal station has been moved from Beverly/Atlantic to Pomona/Atlantic, the alignment for Option B does not traverse the short distance from 3<sup>rd</sup> Street along Beverly Boulevard to just east of Atlantic Boulevard. Instead, the alignment continues east on 3<sup>rd</sup> Street and a short distance on Pomona Boulevard to the optional eastern terminal station west of Atlantic Boulevard. However, the revised station is within walking distance of the former site.

Option B is approximately six miles long with eight new stations from a connection with, the under construction, Pasadena Blue Line at Union Station to Pomona and Atlantic Boulevards via Alameda Street, 1<sup>st</sup> Street, Indiana Street, 3<sup>rd</sup> Street, and Pomona Boulevard (Figure 2-6). Appendix F, *Option B Changes to the Option A Alternative, October 22, 2001*, shows the plans and profiles and station site plans for the changed areas between 1<sup>st</sup>/Lorena and Pomona/Atlantic. Appendix F shows the proposed property acquisitions and easements for Option B that are different from Option A.

Option B also includes provisions for the shared use of the existing Red Line maintenance facility as the needed maintenance and storage facility (M&SF) to house the required 26 new light rail vehicles using Alameda Street and Ducommun Street as the connection to the Red Line yard. An emergency power generator will also be provided at the M&SF facility in order to provide emergency power for the tunnel segment and subway stations. There are six traction power substations along the six-mile route. All are at the same locations as Option A, with the exception that the easternmost substation is at Pomona/Atlantic (see Appendix F, Sheet PI-012) instead of Beverly/Atlantic.

The subway or tunnel segment of Option B includes a number of ventilation and emergency exit areas for the subway segment in the vicinity of the subway stations and portal areas. The locations for emergency exits and exhausts on MTA property and public rights-of-way (sidewalks or street) are shown in Appendix E. These are the same as for Option A.

The stations will house emergency ventilation fan shafts as well as separate emergency exit shafts at both ends of the stations. Ventilation fans are used for extracting smoke from the tunnels and stairs for evacuation in the event of an emergency – such as a fire in the underground areas. The two-level vent structure is generally a 45-foot-wide, approximately 70-foot-deep concrete box at two ends of the station, joining openings in the top of the tunnels to a vertical shaft penetrating the ground in a convenient location. Ventilation fans and their control equipment, as well as the emergency exit stairs, would be housed in this horizontal concrete box. The area of the shaft will be dependent on the height of the box. Where shafts vent at ground level the area is typically about 400 sq. ft. reducing to about half this area where towers are provided. Minimum tower height would be about ten feet. In some cases vent structures are incorporated with other structures and the height may be adjusted to match or compliment the structure. These fans are operated only for emergencies and for routine maintenance.

Each subway station at each end will have two exit hatches connected to emergency stairs. Each exit hatch is about 6 feet wide. Currently most of these hatches and gratings are shown at the station entrance plazas or right-of-way to be acquired for the construction staging areas. The construction staging areas are the same locations as discussed for Option A. During the preliminary engineering design phase, further coordination with the City of Los Angeles will be required to determine if some or all of these hatches and gratings could be located within the public right-of-way. This may require variances from City codes.

### Bus Service

As a major component of implementing Light Rail Transit service in the Eastside Corridor, MTA has designed a corresponding increase in feeder bus and increased service to existing routes that would serve the LRT stations. Table 2-1 shows the increase in service frequency as well as the addition of two routes (31A and 258A) expressly recommended to support the LRT Build Alternative. Increased service is proposed for MTA bus services in the Eastside Corridor as well as increased service for routes operated by Monterey Park and Los Angeles County. This increase in bus service will require an increase of over 40 peak period buses. The capital cost of these improvements as well as the increased bus operating costs are included in the costs for the LRT Build Alternative Option B as described in Chapter 5.

In order to maintain connectivity with other transit operators and bus services within the corridor, it is important that proposed stations interface with existing and proposed bus routes. The proposed transit operating plan for the LRT Build Alternative Option B offers a connection of existing bus lines at each station location. At three station locations, it is proposed that certain bus lines be considered for rerouting in order to provide improved access to the light rail system. Rerouting considerations will follow the typical MTA bus route changes process, including some type of public review and comment process. The lines considered for rerouting include:

- ◆ MTA Line 530 to 1<sup>st</sup>/Soto Station via Soto and 1<sup>st</sup> Street
- ◆ MTA Line 620 to 1<sup>st</sup>/Utah Station via Utah Street
- ◆ Monterey Park Lines 1, 2 and 5 to Pomona/Atlantic Station via Atlantic Boulevard

The first two route changes (MTA Lines 530 and 620) remain as previously described in Option A. Monterey Park's Spirit Transit system provides community transportation services on five routes within the City of Monterey Park. Three of its lines currently operate in the vicinity of Cesar Chavez Avenue and Atlantic Boulevard. It is proposed to consider extending these three routes (1, 2, and 5) southward along Atlantic to the Pomona/Atlantic Station. The extension of these three routes will provide convenient access to the LRT system from the City of Monterey Park. The three Monterey Park lines will also provide connecting service from the LRT system to the Atlantic Square shopping area as well as to East Los Angeles College.

Table 2-5 shows the interface of bus lines at the revised stations along the alignment of the LRT Build Alternative Option B. Stations not included in the table remain the same as under Option A and as shown in Table 2-3.

Station	Operator	Line	Destinations
3 <sup>rd</sup> /Indiana	MTA	65	Downtown LA – CSULA
3 <sup>rd</sup> /Ford	N/A	N/A	N/A
Pomona/Atlantic	Montebello	10	East LA College – Pico Rivera
	Monterey Park	1 (reroute)	Monterey Park
		2 (reroute)	Monterey Park
		5 (reroute)	Monterey Park – CSULA
	MTA	260	Altadena – Compton

Source: 1999-2000 MTA, Montebello, Monterey Park, Los Angeles County, and Commerce bus timetables; Parsons Brinckerhoff.

### ***LRT Alignment***

The alignment begins at Union Station and crosses over US 101 on an aerial structure (approximately 1,000 feet in length) and then gradually becomes an at-grade segment near where it intersects with Alameda Street. The alignment continues south along the east side of Alameda Street and then turns east to the center of 1<sup>st</sup> Street where it continues at grade to Clarence Street in Boyle Heights and then becomes a subway segment. The subway segment traverses underneath or adjacent to 1<sup>st</sup> Street for about 1.8 miles east to just west of Lorena Street in Boyle Heights.

For Option B, the alignment continues as an at-grade segment traversing 1<sup>st</sup> Street east from Lorena Street to Indiana Street where it turns south and continues along the eastern side of Indiana Street in an off-street at-grade alignment to 3<sup>rd</sup> Street. At 3<sup>rd</sup> Street, the alignment turns eastward to Hicks Avenue. From Hicks Avenue, the alignment travels east on 3<sup>rd</sup> Street at grade to Pomona Boulevard and stops at a point just west of Atlantic Boulevard.

For the at-grade sections, the LRT would operate mostly on existing arterial streets and would generally require removal of one general purpose travel lane in each direction. The center sections of all the designated arterial streets would require major reconstruction in order to implement the LRT system. This design configuration would allow for the retaining of a majority of the on-street parking on the arterial streets that are used. MTA will provide replacement parking for those areas where parking utilization is high.

### ***LRT Service Characteristics***

The LRT operating plan and service characteristics for the LRT Build Alternative Option B is the same described for Option A above. Table 2-4 shows the travel time between each proposed station and the total travel time from each station to Union Station.

### ***Passenger Stations***

As discussed in the bus service section, the LRT Build Alternative Option B consists of eight new stations and one station modification: Union Station (station modification), 1<sup>st</sup>/Alameda, 1<sup>st</sup>/Utah, 1<sup>st</sup>/Boyle, 1<sup>st</sup>/Soto, 3<sup>rd</sup>/Indiana, 3<sup>rd</sup>/Ford, 3<sup>rd</sup>/Mednik, and Pomona/Atlantic. All stations are at grade with the exception of 1<sup>st</sup>/Boyle and 1<sup>st</sup>/Soto. The LRT at-grade station stops would entail constructing a 270-foot long platform (allows for a maximum of three-car trains) along with pedestrian walkways to allow for safe passage to crosswalks for arriving and departing passengers. The LRT underground stations will include 270-foot platforms. The subway stations are projected to have center platforms, a bridge-like mezzanine and single entrances located in plazas adjacent to 1<sup>st</sup> Street. The at-grade stations will be similar to the Long Beach and Pasadena Blue Line stations.

### ***Park-and-Ride Facilities (Including Bus Interface at Pomona/Atlantic)***

Two areas for park-and-ride facilities are associated with this alternative. The first is the existing lot at Union Station, which is the western terminus of the Los Angeles Eastside Corridor LRT line. The project does not involve any expansion or improvements to that lot. The second is near the Pomona/Atlantic Station at the eastern terminus of the line. Park-and-ride surface parking for a total of about 200 vehicles would be provided on land adjacent to the former Kaiser facility on the northwest corner of Pomona/Atlantic.

### **Vehicle Fleet**

The type of light rail transit (LRT) vehicles to be used for the Eastside Corridor will be the same as used on the Long Beach and Pasadena Blue Lines. They will be standard conventional articulated light rail transit vehicles. In order to provide the future service level of 5-minute frequencies between trains, as well as a maximum train length of 3 cars, a total of 26 new LRT vehicles will be required for the LRT Build Alternative Option B.

### **Maintenance and Storage Facility – Red Line Yard**

The existing Red Line maintenance yard will be used for the Maintenance and Storage Facility (M&SF) for the Eastside Corridor LRT. Excess capacity currently exists at the yard and is available to provide the needed facilities. The site was previously environmentally cleared for the Metro Red Line in the *Final Environmental Impact Statement, Los Angeles Rail Rapid Transit Project, Metro Rail, USDOT, UMTA, and Southern California Rapid Transit District, December 1983*. The yards and shops currently provide space for the following functions: storage of trains when not in mainline service; dispatch, receipt, and change in trains for mainline service; interior and exterior cleaning of trains; preventive and corrective maintenance of cars; and testing of cars before revenue service and after major repairs. The M&SF will include the addition of a blow down pit, car cleaner platform, and car wash for cleaning the light rail vehicles as well as two storage tracks. The yard lead will consist of dual tracks branching off the LRT mainline at Alameda Street/Ducommun Street (see Appendix E, Sheets C-101 to C-110). The lead tracks will continue eastward on Ducommun Street to a point just east of Center Street where it will turn and traverse in a northeasterly direction for a short distance to the point where it enters the Red Line maintenance yard. At this point, the lead tracks turn south and continue into the yard.

## **2.6 OTHER ALTERNATIVES EVALUATED THAT MAY REDUCE IMPACTS**

The *Re-Evaluation/Major Investment Study* along with the *Draft SEIS/SEIR* conducted a rigorous review, analysis, and screening of potential fixed guideway transit (Bus, Light Rail, and Heavy Rail) alternatives that could serve as a replacement to the suspended Red Line project and to provide an adequate level of service to the residents and businesses in the Eastside Corridor. This process included extensive public discussion of environmental impacts as well as the technical conditions. The Locally Preferred Alternative selected by the MTA Board of Directors considered all alternatives and especially the alternatives that reduced impacts in the sensitive Boyle Heights neighborhood, the transition between 1<sup>st</sup> and 3<sup>rd</sup> Streets along Indiana Street, and at the eastern terminus.

Options A and B presented in this Final SEIS/SEIR respond to and evaluate the concerns of the community based on the comments received on the Draft SEIS/SEIR and the direction of the MTA Board of Directors on May 24, 2001.

Only the No-Build Alternative being considered would not have any impacts but would be totally inconsistent with the Purpose and Need and the actions taken previously related to the Red Line suspended project.

## **2.7 USES OF THIS FINAL SEIS/SEIR DOCUMENT - SELECTION OF LOCALLY PREFERRED ALTERNATIVE FOR IMPLEMENTATION**

The preparation of this Final SEIS/SEIR, together with the required circulation, public hearings, and review of the Draft SEIS/SEIR, ensures that all significant transportation and environmental impacts have

been assessed, and that public participation and comments have been solicited to help guide the decision-making process.

The identification, examination, and assessment of all reasonable and feasible alternatives (*Re-Evaluation/MIS* and the *Draft SEIS/SEIR*) are necessary to meet the requirements of the National Environmental Policy Act (NEPA), as well as the California Environmental Quality Act (CEQA). CEQA requires similar environmental analysis in Environmental Impact Reports (EIRs) and public review for projects that will have significant effects on the environment. The State of California encourages joint preparation of EIRs and EISs and has produced guidelines to facilitate preparation of joint documents.

The purpose of this Final SEIS/SEIR is to evaluate the LRT Build Alternative along with its two options (Option A and Option B) and the No-Build Alternative and for the MTA Board of Directors to select the most appropriate project for the Eastside Corridor while ensuring that potentially significant environmental consequences are considered as part of this process. This Final SEIS/SEIR document will be circulated and made available as required by NEPA and CEQA to interested and concerned parties, including private citizens, community groups, the business community, elected officials, and public agencies.

This Final SEIS/SEIR will also be used by federal, state, regional, and local agencies to make discretionary decisions regarding this project.



### 3.0 TRANSPORTATION IMPACTS AND MITIGATION

The transportation chapter includes evaluation of the LRT system, traffic, parking, bicycling, and pedestrian modes within the Eastside Corridor. This section of the SEIS/SEIR covers the affected environment, existing conditions, anticipated impacts, and proposed mitigation for both the build and no-build LRT project alternatives. Detailed technical information may be found in the supporting Transportation Technical Report (December 2000) and Transportation Technical Report Addendum (November 2001) available at MTA's offices, One Gateway Plaza, Los Angeles, CA. These documents are hereby incorporated by reference to this Final SEIS/SEIR.

Anticipated impacts and the resulting proposed mitigations for the Eastside Corridor are based on ridership forecasts developed using the MTA's Travel Demand Model. The MTA Travel Demand Model uses the typical four-step modeling process: trip generation, trip distribution, mode choice and trip assignment. The regional demographics used in the modeling process are provided by the Southern California Association of Governments (SCAG), which is the metropolitan planning organization for the Southern California region.

The MTA mode choice model was developed and calibrated as a part of the Eastside Corridor Project to estimate the mode split between vehicular and transit usage. The mode split estimates the modal shares of the travel market given the time and cost characteristics of the various competing modes and the socio-economic and demographic characteristics of the urban residents. The MTA travel demand modeling process has been validated using observations of individual travel choices obtained through surveys in the region focusing on travel characteristics and behavior of travelers and their households. More detailed information concerning assumptions, land use and demographic forecasts, travel forecasting procedures and calibration results of the model is available through MTA.

#### 3.1 TRANSIT

##### 3.1.1 Affected Environment

The Eastside Corridor study area has one of the most extensive networks of bus routes in Los Angeles County. The study area's transit routes generally follow a grid pattern and include many express and local routes, one limited service route, and one new Metro Rapid bus route. Five public transit agencies operate bus service in the Eastside Corridor: Metropolitan Transportation Authority, Montebello Transit, the City of Monterey Park, the City of Commerce, and the County of Los Angeles. Table 3-1 lists all the current Eastside Corridor bus transit routes with the end destinations of their services, and Figure 3-1 illustrates these routes.

Most of the heavily used routes are those that run in an east-west direction. These include bus routes that operate on Cesar Chavez Avenue, 1<sup>st</sup> Street, Whittier Boulevard, and Olympic Boulevard. Soto Street and Atlantic Boulevard are two north-south streets on which heavily used bus routes also operate. Regional north-south travel is limited to these two main bus lines on Soto Street and Atlantic Boulevard. The predominant flow of transit passengers in the corridor is in an east-west orientation. Many of these routes experience very high ridership during peak periods. Table 3-2 shows the service frequency (headways) for all the bus lines in the corridor. This table illustrates the high demand for service on many of the lines, particularly on MTA lines 30/31 and 66 where headways during the morning peak period average three to four minutes.

A demonstration service, now officially operating, debuted on June 24, 2000 on Whittier Boulevard in the Eastside Corridor called Metro Rapid Bus. Operated by the MTA, this new streamlined limited-stop



**TABLE 3-2  
FREQUENCY OF TRANSIT SERVICE (IN MINUTES)**

Operator	Line	Days	AM Peak 6-9am	Midday 9am-3pm	PM Peak 3-7pm	Evening 7-11pm	Owl 11pm-6am	Hours of Service
Commerce	Red	Weekday	60	60	60			6am-6pm
		Saturday	60	60	60			6am-6pm
	Blue	Weekday		60	60			9am-6pm
		Saturday		60	60			9am-6pm
	Green	Weekday	60	60	60			6am-9:30pm
		Saturday	60	60	60			6am-9:30pm
Orange	Weekday	60	60	60			5:30am-6pm	
Yellow	Weekday	60	60	60			6am-9am	
Los Angeles County	Gold	Weekday	60	60	60			6am-6pm
		Saturday		60	60			9am-5pm
	Green	Weekday	60	60	60			6am-6pm
		Saturday		60	60			9am-5pm
	Orange	Weekday	60	60	60			6am-6pm
		Saturday		60	60			9am-5pm
Montebello	10	Weekday	8	10	15			5am-11pm
		Saturday	20	10	20			5am-11pm
		Sunday	20	10	20			5am-11pm
	40	Weekday	10	12	30			5am-11pm
		Saturday	15	15	30			5am-12am
		Sunday	20	20	20			5am-11pm
	341	Weekday	30					7-9:30am, 3-6pm
	342	Weekday	180					6-7am, 5-6pm
	343	Weekday	30					6-8am, 5-7pm
Monterey Park	1	Weekday	40	40	40			6:30am-6pm
		Saturday	40	40	40			6:30am-6pm
	2	Weekday	40	40	40			6:30am-6pm
		Saturday	40	40	40			6:30am-6pm
	5	Weekday	50	30	30			6:30am-6pm
								6:30am-6pm
MTA	18	Weekday	10	15	10	15	60	24 hours
		Saturday	15	12	15	20	60	24 hours
		Sunday	20	30	15	30	60	24 hours
	30 / 31	Weekday	4	7.5	5	15	60	24 hours
		Saturday	7	7	12	30	60	24 hours
		Sunday	12	7	8	30	60	24 hours
	65	Weekday	15	30	25	50		5:30am-10pm
		Saturday	60	60	60	60		6am-8pm
		Sunday		60	60	60		8am-8pm
	66	Weekday	3	8	7	30		4:30am-1:30am
		Saturday	4	10	15	30		5am-1:30am
		Sunday	15	12	12	30		5am-1am
	68	Weekday	8	12	12	40		4am-12:30am
		Saturday	15	10	15	40		4am-12:30am
		Sunday	40	15	20	40		4:30am-12:30am
	250	Weekday	40	40	40			6am-7pm
	251/252	Weekday	5	12	10	30	60	24 hours
		Saturday	15	15	12	30	60	24 hours
		Sunday	30	20	20	30	60	24 hours
	253	Weekday	40	40	40			6am-8pm
		Saturday	40	40	40			6am-7:30pm
Sunday		35	40	40			8am-6:30pm	

**TABLE 3-2  
FREQUENCY OF TRANSIT SERVICE (IN MINUTES)**

Operator	Line	Days	AM Peak 6-9am	Midday 9am-3pm	PM Peak 3-7pm	Evening 7-11pm	Owl 11pm-6am	Hours of Service
	254	Weekday	60	55	30	60		4:30am-8:30pm
		Saturday	60	60	60		6:30am-7:30pm	
		Sunday	45	60	60		7:30am-7:30pm	
	255	Weekday	45	50	45		5am-8:30pm	
		Saturday		45	45		5:30am-8:30pm	
		Sunday		45	45		5:30am-8:30pm	
	256	Weekday	35	50	35	50	6am-10:30pm	
		Saturday	60	60	60	60	5:30am-9pm	
		Sunday	60	60	60	60	5:30am-9pm	
	258/259	Weekday	20	30	30		5am-8pm	
	260	Weekday	12	15	15	60	4am-11:30pm	
		Saturday	30	25	20	60	5am-12m	
		Sunday	50	25	25	60	6am-12m	
	362	Weekday	20	30	25	60	5am-11:30pm	
		Saturday	50	60	60	60	5am-11:30pm	
		Sunday	50	60	60	60	5am-11:30pm	
	605	Weekday	15	30	15	30	6am-7:30pm	
		Saturday	30	30	30		6am-7:30pm	
		Sunday	30	30	30		6am-7:30pm	
	620	Weekday		12	12		9am-6:30pm	
	720	Weekday	8	10	8	20	5am-1am	
Saturday		12	12	12	20	5am-1am		
Sunday		12	12	12	20	5am-1am		

Source: 1999-2000 LACMTA, Montebello, Commerce, Los Angeles County, and Monterey Park bus timetables.

### 3.1.2 Impacts

#### 3.1.2.1 No-Build Alternative

The No-Build Alternative provides no significant improvement in transit services in the Eastside Corridor. As the population grows, the demand for increased transit service provision and service reliability increases. Without the introduction of premium transit service in the Eastside Corridor, such as a light rail system, transit service performance will likely decrease due to increased traffic congestion. This is likely to make travel via transit a less attractive option for Eastside patrons. For those transit patrons that have no other travel options, travel times will increase and transit usage will be less convenient. There will be a negative impact upon those that rely on the public transit system if no significant improvements in transit service are provided in the No-Build Alternative.

#### 3.1.2.2 LRT Build Alternative – Option A

##### *Regional Transit Access and Connectivity*

If the LRT Build Alternative is implemented, an increase in the provision of transit service will occur in the Eastside Corridor. There will be the introduction of a premium service that will be regionally serving and provide improved service reliability and a decrease in travel times for transit patrons. Forecast data indicate that transit ridership will increase in the Corridor with the introduction of the improved service.

The introduction of a light rail system into the Eastside Corridor will provide passengers with greater access to regional transit opportunities and will provide for improved regional transit connectivity. Transfers could be made at Union Station to a variety of different transit alternatives. The Eastside Corridor Light Rail system will provide continuing service to Pasadena via the Pasadena Blue Line, which is expected to open for service in 2003. Transfers can be made to the Metro Red Line at Union Station with its subway service to Wilshire Center and North Hollywood. The Long Beach Blue Line can also be accessed via the Red Line at the 7<sup>th</sup>/Metro Center station in Downtown Los Angeles, and the Green Line to Norwalk and Redondo Beach is accessible via the Long Beach Blue Line. Dozens of local and express bus lines converge at Union Station, and several transit providers service Union Station, including Santa Monica's Big Blue Bus, LADOT, Foothill Transit, Torrance Transit, Santa Clarita Transit, and the Antelope Valley Transportation Authority. Metrolink commuter rail service is also available for regional travel to Ventura, San Bernardino, Riverside, Orange, and San Diego counties as well as to northern Los Angeles County. Amtrak rail service can also be accessed at Union Station for long-distance travel to other cities in California and the nation. Impacts on regional transit access and connectivity as a result of the LRT Build Alternative are beneficial.

### ***Bus Route Interface***

There are several bus lines that will operate on the same streets as the LRT Build Alternative. These include MTA lines 30, 31, 65, Montebello lines 40, 341, 342, and 343, and Los Angeles County Gold, Green and Orange shuttles. The LRT Build Alternative will overlap MTA lines 30 and 31 on 1<sup>st</sup> Street, MTA line 65 (rerouted) and the Los Angeles County shuttles on 3<sup>rd</sup> Street, and Montebello lines 40, 341, 342, and 343 on 3<sup>rd</sup> Street and Beverly Boulevard. Bus transit service will continue to operate on streets where the LRT system will be running in order to maintain existing local service levels along these streets. Table 3-3 summarizes the bus lines that will overlap the alignment of the LRT Build Alternative.

In order to maintain connectivity with other transit operators and bus services within the corridor, it is important that proposed stations interface with existing and proposed bus routes. The proposed transit operating plan for the LRT Build Alternative offers a connection of existing bus lines at each station location. Figure 3-2 shows how the LRT system will fit into the Eastside Corridor's bus route network. At three station locations, it is proposed that certain bus lines be considered for rerouting in order to provide improved access to the light rail system. Rerouting considerations will follow the typical MTA bus route changes process, including some type of public review and comment process and input from members of the Bus Riders Union. The lines considered for rerouting include:

- ◆ MTA Line 65 to 3<sup>rd</sup>/Rowan Station via 3<sup>rd</sup> Street and Rowan Avenue
- ◆ MTA Line 530 to 1<sup>st</sup>/Soto Station via Soto and 1<sup>st</sup> Street
- ◆ MTA Line 620 to 1<sup>st</sup>/Utah Station via Utah Street
- ◆ Monterey Park Lines 1, 2 and 5 to Beverly/Atlantic Station via Atlantic Boulevard

MTA Line 65 is a local bus line that currently runs north on Indiana Street in the vicinity of the LRT Build Alternative alignment and turns east on 1<sup>st</sup> Street to Rowan Avenue. In order to provide access to the 3<sup>rd</sup>/Rowan Station, it is proposed to consider rerouting this line onto 3<sup>rd</sup> Street east to Rowan Avenue and then on Rowan to 1<sup>st</sup> Street. This minor reroute will not have a significant impact on transit ridership or transit access due to its proximity to the current routing one quarter of a mile to the west on Indiana. Access to the business district on 1<sup>st</sup> Street will still be provided at 1<sup>st</sup> and Rowan. Routing this bus line away from Indiana Street also will help to mitigate the impacts of Option A on Indiana for the transition between 1<sup>st</sup> and 3<sup>rd</sup> Streets if this option is chosen. All relevant agencies and organizations will be included in the discussion concerning any proposed bus routes considered for modification.

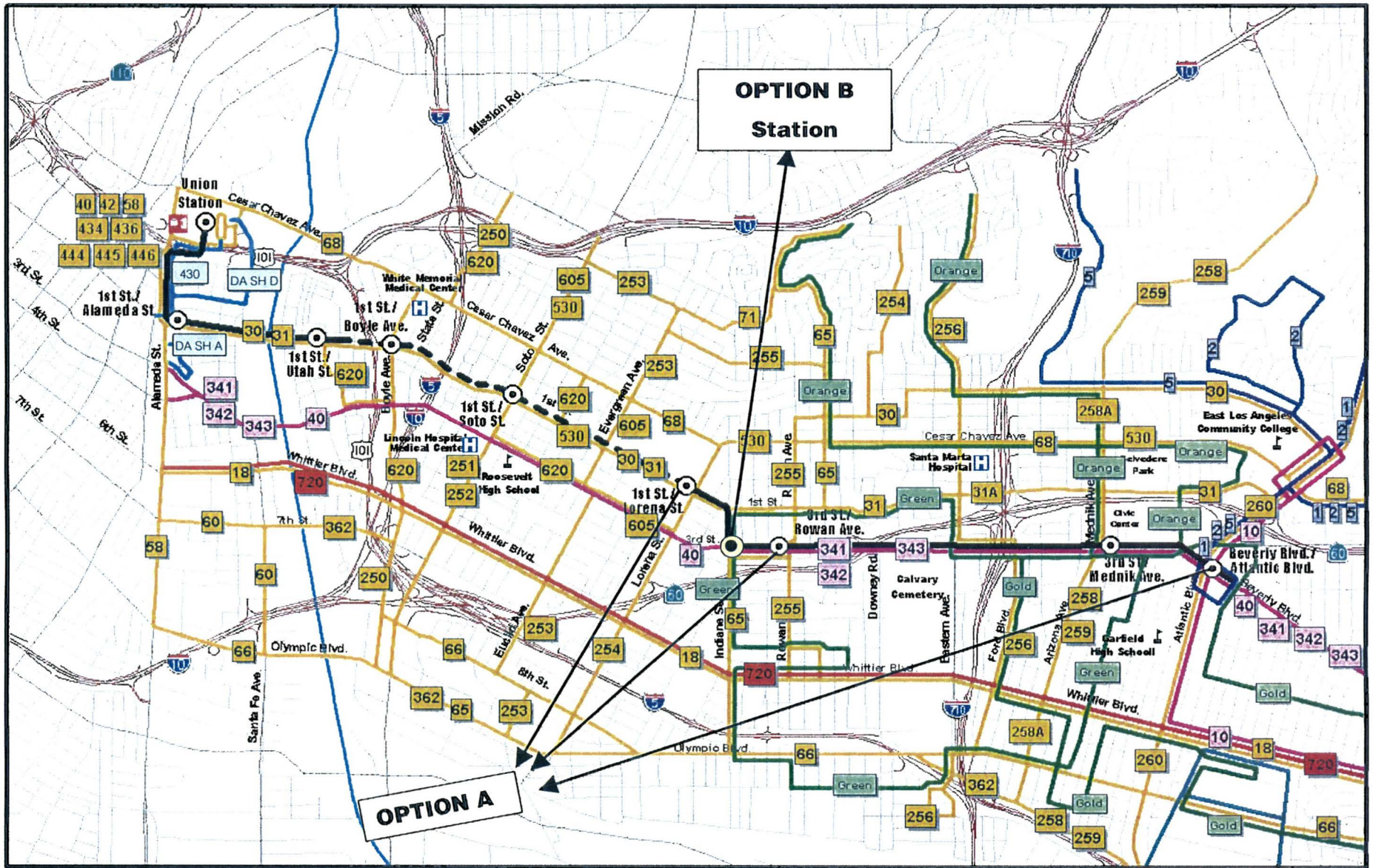
**TABLE 3-3  
BUS ROUTES OVERLAPPING THE LRT ALIGNMENT AT-GRADE**

Operator	Line	Street along Alignment	Limits of Overlapping Routes
Los Angeles County	Gold	3 <sup>rd</sup> Street	Ford Blvd – Beverly Blvd
	Green	Indiana Street	1 <sup>st</sup> Street – 3 <sup>rd</sup> Street
	Orange	3 <sup>rd</sup> Street 3 <sup>rd</sup> Street	Ford Blvd – La Verne Ave Mednik Ave – Beverly Blvd
LADOT	430	Alameda Street	Commercial St – Temple St
Montebello Transit	40	3 <sup>rd</sup> Street/Beverly Blvd	Indiana St – Atlantic Blvd
	341	3 <sup>rd</sup> Street/Beverly Blvd	Indiana St – Atlantic Blvd
	342	3 <sup>rd</sup> Street/Beverly Blvd	Indiana St – Atlantic Blvd
	343	3 <sup>rd</sup> Street/Beverly Blvd	Indiana St – Atlantic Blvd
MTA	30 / 31	1 <sup>st</sup> Street	Alameda St – 101 Freeway
	30 / 31	1 <sup>st</sup> Street	Fresno St – Indiana St
	40	Alameda Street	Commercial St – Temple St
	42	Alameda Street	Commercial St – Temple St
	65 (reroute)	3 <sup>rd</sup> Street	Indiana St – Rowan Ave
	434	Alameda Street	Commercial St – Temple St
	436	Alameda Street	Commercial St – Temple St
	444	Alameda Street	Commercial St – Temple St
	445	Alameda Street	Commercial St – Temple St
	466	Alameda Street	Commercial St – Temple St
530 (reroute)	1 <sup>st</sup> Street	Soto St – Lorena St	
620	1 <sup>st</sup> Street	Utah St – 101 Freeway	

Source: 1999-2000 MTA, Montebello, Monterey Park, Los Angeles County, and Commerce bus timetables; Parsons Brinckerhoff.

MTA Line 530 is a new service that will debut in 2001 as outlined in the MTA's 1998 Five-Year Plan. Line 530 is an express route that will connect East Los Angeles College and Boyle Heights with Panorama City via the County-USC Medical Center and the Burbank Media District. Line 530 currently is proposed to run south on Soto Street from the San Bernardino Freeway (I-10) to Cesar Chavez Avenue and then turn east to East Los Angeles College. In order to provide service to the 1<sup>st</sup>/Soto Station, it is proposed to consider rerouting this line south on Soto Street to 1<sup>st</sup> Street. It will then continue east on 1<sup>st</sup> Street to Lorena Street back to Cesar Chavez Avenue. Line 530 will also serve the 1<sup>st</sup>/Lorena Station on its amended route. All relevant agencies and organizations will be invited to provide input concerning any proposed route modifications.

MTA Line 620 is a community shuttle service jointly operated by MTA and LADOT that currently runs on Clarence Street west of the 101 Freeway between 4<sup>th</sup> and 1<sup>st</sup> Streets. It is proposed that this line be considered for rerouting from Clarence Street to 3<sup>rd</sup> Street and Utah Street where it will continue north to interface with the 1<sup>st</sup>/Utah Station at the corner of 1<sup>st</sup> and Utah Streets. This minor reroute will not affect line patronage because of the close proximity of Utah Street to Clarence Street one block away. However, since this line directly serves the 1<sup>st</sup>/Boyle station, the proposed rerouting may not be required.



**OPTION B  
Station**

**OPTION A**

0 0.25 0.5 Miles

0 0.25 0.5 0.75 1 Kilometers

**Eastside Corridor  
Transit Consultants**



Note: Highways, primary, and secondary roads by Thomas  
Brook Maps through conditional use from MTA 1987.

**Legend**

- MTA Routes
- Metro Rapid Route
- Montebello Routes
- Monterey Park Routes
- DASHA
- LADOT Routes
- LA County Routes
- Commerce Routes (All Routes)
- LRT Alignment
- Highway
- Primary Road
- Secondary Road
- River

Los Angeles Eastside Corridor SEIS/SEIR

**Modified Bus System with LRT**

**Figure 3-2**





Monterey Park's Spirit Transit system provides community transportation services on five routes within the City of Monterey Park. Three of its lines currently operate in the vicinity of Cesar Chavez Avenue and Atlantic Boulevard. It is proposed to consider extending these three routes (1, 2, and 5) southward along Atlantic to the Beverly/Atlantic Station. The extension of these three routes will provide convenient access to the LRT system from the city of Monterey Park. The three Monterey Park lines will also provide connecting service from the LRT system to the Atlantic Square shopping area as well as to East Los Angeles College. This is a beneficial impact under CEQA.

According to Federal Transit Administration regulations and guidelines for entities that receive federal transit funding, a public hearing must be offered for a change in fare structure or for service changes that affect more than 25 percent of the revenue or route-miles for a given transit line. CEQA requires that impacts be measured against criteria for significance and that all significant impacts be addressed and/or mitigated. The above bus route modifications constitute a less than significant impact and require no mitigation. Table 3-4 shows the interface of bus lines at each station (except Union Station) along the alignment of the LRT Build Alternative - Option A.

### ***Bus Operation Impacts***

Generally speaking, bus stop locations will remain in the current locations under the LRT Build Alternative scenario – Option A. Some stops may be relocated in order to better interface with the LRT station at station locations along 1<sup>st</sup> and 3<sup>rd</sup> Streets and Beverly Boulevard. Bus stops will be located close to the street corner where there is access to the station entrance at station locations.

Along 1<sup>st</sup> Street between LRT stations, buses will utilize curbside bus stops as provided in the No-Build condition. Because 1<sup>st</sup> Street will retain two lanes in each direction along most of the alignment, there should be few impacts to traffic operations. Between the 1<sup>st</sup> Street Bridge and the tunnel portal, as well as between Concord and Indiana Streets, the street will have one lane in each direction. In LRT station areas where parking is prohibited and only one traffic lane will exist, buses will utilize the traffic lane to accommodate the boarding and alighting of passengers. Along 3<sup>rd</sup> Street and Beverly Boulevard where there will be two lanes available, buses will utilize the curb lane to stop. As is the case in the No-Build condition, parking will be prohibited at bus stop locations.

Traffic lanes on major and secondary arterials on which bus lines will continue to operate, where the LRT has an at-grade profile, will be at least 11 feet wide to accommodate the operation of buses. On 1<sup>st</sup> Street, the traffic lanes will be between 11 and 13.5 feet wide, while 3<sup>rd</sup> Street and Beverly Boulevard will have traffic lanes between 12 and 15 feet wide. Indiana Street under Option A will have 11-foot traffic lanes, and this will provide for the operation of the County shuttle buses on this portion of Indiana Street. Alameda Street will have 11- to 12-foot traffic lanes, as will be the case in the No-Build Alternative. Overall, there may be significant impacts on local bus operations as a result of the LRT Build Alternative because of potential bus stop displacements and possible increases in bus operating times resulting from one lane operations along parts of 1<sup>st</sup> Street.

**TABLE 3-4  
BUS ROUTE INTERFACE AT LRT STATIONS – OPTION A**

Station	Operator	Line	Destinations
Union Station	Antelope Valley LADOT MTA	785	Gateway Transit Center – Antelope Valley
		DASH D	Union Station – Grand Blue Line Station
		33	Union Station – Venice Bl.
		40	Union Station – South Bay Galleria
		42	Union Station – LA Int'l Airport
		55	Union Station – Rosa Parks Metro Rail Station
		60	Union Station – Long Beach
		333	Union Station – Venice Bl.
		434	Union Station – Malibu
		436	Union Station – Ocean Park
		439	Union Station – Redondo Beach
		442	Union Station – South Bay Galleria
		444	Union Station – Rancho Palos Verdes
	445	Union Station – San Pedro	
	446	Union Station – San Pedro	
	447	Union Station – San Pedro	
	OCTA Santa Clarita	466	Union Station – La Mirada
701		Union Station – Huntington Beach	
794		Union Station – Santa Clarita	
1 <sup>st</sup> /Alameda	LADOT	DASH A	Little Tokyo – Los Angeles Convention Center
		DASH D	Union Station – Grand Blue Line Station
	MTA	30 / 31	Mid City – East LA College
		40	Union Station – South Bay Galleria
		42	Union Station – LA Int'l Airport
		58	Union Station – Washington Blue Line Station
		434	Union Station – Malibu
		436	Union Station – Ocean Park
		442	Union Station – South Bay Galleria
		445	Union Station – San Pedro
446	Union Station – San Pedro		
1 <sup>st</sup> /Utah	MTA	30 / 31 620 (reroute)	Mid City – East LA College LAC+USC – Boyle Heights
1 <sup>st</sup> /Boyle	MTA	30 / 31	Mid City – East LA College
		250	LAC+USC – Boyle/Olympic
		620	LAC+USC – Boyle Heights
1 <sup>st</sup> /Soto	MTA	30 / 31	Mid City – East LA College
		250	Cypress Park – Watts
		251	El Sereno – Lynwood
		530 (reroute)	Panorama City – East LA College
		605	LAC+USC – Boyle Heights
1 <sup>st</sup> /Lorena	MTA	30 / 31	Mid City – East LA College
		254	LAC+USC – Willowbrook
		530 (reroute)	Panorama City – East LA College
3 <sup>rd</sup> /Rowan	Montebello MTA	40	Downtown LA – Whittier
		65 (reroute)	Downtown LA – CSULA
3 <sup>rd</sup> /Mednik	Los Angeles County	255	Montecito Heights – East Los Angeles
		Gold	East Los Angeles
		Green	East Los Angeles
	Montebello MTA	Orange	East Los Angeles – City Terrace – CSULA
		40	Downtown LA – Whittier
		258	El Sereno – South Gate
		259	Alhambra – South Gate

Station	Operator	Line	Destinations
Beverly/Atlantic	Montebello	10	East LA College – Pico Rivera
		40	Downtown LA – Whittier
	Monterey Park	341, 342, 343	Downtown LA – Montebello Express
		1 (reroute)	Monterey Park
		2 (reroute)	Monterey Park
	MTA	5 (reroute)	Monterey Park – CSULA
260		Altadena – Compton	

Source: 1999-2000 MTA, Montebello, Monterey Park, Los Angeles County, and Commerce bus timetables; Parsons Brinckerhoff.

### *Eastside LRT Patronage Forecasts*

Table 3-5 shows the projected passenger boardings at each station based on transportation demand model results for the year 2020 LRT Build Alternative. The highest number of passengers boarding the system is at Union Station, with the next highest being at 1<sup>st</sup>/Alameda and the terminal station at Beverly/Atlantic. The stations with the highest patronage have the greatest number of connecting transit services. The highest concentration of boardings is in the peak periods as people utilize the system on their trips to and from their places of employment. Total boardings for the Eastside Corridor LRT system are projected to be 16,020 passengers per day by the year 2020. Combined boardings for the Pasadena Blue Line and the Eastside LRT are expected to be 44,700 passengers per day by the year 2020. These forecasts were determined using the MTA's Travel Demand Model, as discussed previously.

Station	Peak Boardings	Off-Peak Boardings	Total Daily Boardings
Union Station	2,577	1,222	3,799
1 <sup>st</sup> /Alameda	1,893	778	2,671
1 <sup>st</sup> /Utah	597	396	993
1 <sup>st</sup> /Boyle	618	385	1,003
1 <sup>st</sup> /Soto	925	521	1,446
1 <sup>st</sup> /Lorena	991	525	1,516
3 <sup>rd</sup> /Rowan	678	407	1,085
3 <sup>rd</sup> /Mednik	614	391	1,005
Beverly/Atlantic	1,660	844	2,504
Total Eastside LRT Daily Boardings			16,020
Combined Pasadena Blue Line and Eastside LRT Daily Boardings			44,700

Source: Parsons Brinckerhoff, 2000.

### **3.1.2.3 LRT Build Alternative – Option B**

For the most part, the transit impacts are the same as Option A, with a few exceptions. These are discussed below. The impacts on the stations at Beverly/Atlantic and Pomona/Atlantic are very similar.

#### *Regional Transit Access and Connectivity*

There are no changes from Option A.

### **Bus Route Interface**

Option B moves the eastern terminus to Pomona/Atlantic. Because there are no bus lines operating on Pomona Boulevard along the LRT alignment, the impacts on the bus route interface remain similar to those detailed in the previous section.

In order to maintain connectivity with other transit operators and bus services within the corridor, it is important that proposed stations interface with existing and proposed bus routes. The proposed transit operating plan for the LRT Build Alternative Option B offers a connection of existing bus lines at each station location. At three station locations, it is proposed that certain bus lines be considered for rerouting in order to provide improved access to the light rail system. Rerouting considerations will follow the typical MTA bus route changes process, including some type of public review and comment process. The lines considered for rerouting include:

- ◆ MTA Line 530 to 1<sup>st</sup>/Soto Station via Soto and 1<sup>st</sup> Street
- ◆ MTA Line 620 to 1<sup>st</sup>/Utah Station via Utah Street
- ◆ Monterey Park Lines 1, 2 and 5 to Pomona/Atlantic Station via Atlantic Boulevard

The first two route changes (MTA Lines 530 and 620) remain as previously described in Option A. Monterey Park's Spirit Transit system provides community transportation services on five routes within the city of Monterey Park. Three of its lines currently operate in the vicinity of Cesar Chavez Avenue and Atlantic Boulevard. It is proposed to consider extending these three routes (1, 2, and 5) southward along Atlantic to the Pomona/Atlantic Station. The extension of these three routes will provide convenient access to the LRT system from the city of Monterey Park. The three Monterey Park lines will also provide connecting service from the LRT system to the Atlantic Square shopping area as well as to East Los Angeles College. This is a beneficial impact under CEQA.

Table 3-6 shows the interface of bus lines at the revised stations along the alignment of the LRT Build Alternative Option B. Stations not included in the table remain the same as under Option A.

<b>Station</b>	<b>Operator</b>	<b>Line</b>	<b>Destinations</b>
3 <sup>rd</sup> /Indiana	MTA	65	Downtown LA – CSULA
3 <sup>rd</sup> /Ford	N/A	N/A	N/A
Pomona/Atlantic	Montebello	10	East LA College – Pico Rivera
	Monterey Park	1 (reroute) 2 (reroute) 5 (reroute)	Monterey Park Monterey Park Monterey Park – CSULA
	MTA	260	Altadena – Compton

Source: 1999-2000 MTA, Montebello, Monterey Park, Los Angeles County, and Commerce bus timetables; Parsons Brinckerhoff.

### **Bus Operation Impacts**

Generally speaking, bus stop locations will remain in the same locations under Option B. Some stops may be relocated in order to better interface with the LRT station at station locations along 1<sup>st</sup> and 3<sup>rd</sup> Streets and Pomona Boulevard. Bus stops will be located close to the street corner where there is access to the station entrance at station locations.

Bus operation impacts will remain the same as under Option A, with the exception of along Indiana Street between 1<sup>st</sup> and 3<sup>rd</sup> Streets. Indiana Street under Option B will have no change in traffic lane widths.

### ***Eastside LRT Patronage Forecasts***

Table 3-7 shows the projected passenger boardings at each station based on transportation demand model results for the year 2020 LRT Build Alternative. The highest number of passengers boarding the system is at Union Station, with the next highest being at 1<sup>st</sup>/Alameda and the terminal station at Pomona/Atlantic. The stations with the highest patronage have the greatest number of connecting transit services. The highest concentration of boardings is in the peak periods as people utilize the system on their trips to and from their places of employment. Total boardings for the Eastside Corridor LRT system are projected to be 16,330 passengers per day by the year 2020. Combined boardings for the Pasadena Blue Line and the Eastside LRT are expected to be 46,400 passengers per day by the year 2020.

Station	Peak Boardings	Off-Peak Boardings	Total Daily Boardings
Union Station	2,700	1,232	3,932
1 <sup>st</sup> /Alameda	1,825	661	2,486
1 <sup>st</sup> /Utah	615	416	1,031
1 <sup>st</sup> /Boyle	696	365	1,061
1 <sup>st</sup> /Soto	1,110	594	1,704
3 <sup>rd</sup> /Indiana	1,026	629	1,655
3 <sup>rd</sup> /Ford	603	375	978
3 <sup>rd</sup> /Mednik	683	360	1,043
Pomona/Atlantic	1,648	792	2,440
<b>Total Eastside LRT Daily Boardings</b>			<b>16,330</b>
<b>Combined Pasadena Blue Line and Eastside LRT Daily Boardings</b>			<b>46,400</b>

Source: Parsons Brinckerhoff, 2000.

### **3.1.3 Mitigation**

#### **3.1.3.1 Rerouted Bus Lines**

No mitigation is required for either option because no significant impacts have been identified. The re-routing of bus lines to connect with the LRT system at certain stations does not create any significant impacts.

#### **3.1.3.2 Bus Operations**

For both options, if any bus stops are displaced due to street design changes with the introduction of the LRT system, a replacement bus stop will be designated within one-eighth of a mile of the original stop. Bus stops will be relocated to the adjacent corner of the same intersection if possible in order to maintain service access for bus passengers. Local bus service schedules will be reviewed and adjusted if required to reflect the modified traffic conditions with LRT operations. These measures will reduce any potential impacts to a level that is less than significant for both options.

## 3.2 TRAFFIC

### 3.2.1 Affected Environment

The environment in which traffic will be examined includes the north-south major and secondary arterials between and including Alameda Street and Atlantic Boulevard and the east-west major and secondary arterials that are located one half mile to the north and south of the LRT alignment. The north-south streets include Alameda Street, Mission Road, Boyle Avenue, State Street, Soto Street, Evergreen Avenue, Lorena Street, Indiana Street, Rowan Avenue, Eastern Avenue, Ford Boulevard, Mednik Avenue, and Atlantic Boulevard. The east-west streets include Cesar Chavez Avenue, 1<sup>st</sup> Street, 3<sup>rd</sup> Street, 4<sup>th</sup> Street, Pomona Boulevard, and Beverly Boulevard. Figure 3-3 illustrates the street network in the Eastside Corridor.

### 3.2.2 Existing Traffic Conditions

#### 3.2.2.1 Traffic Analysis Locations

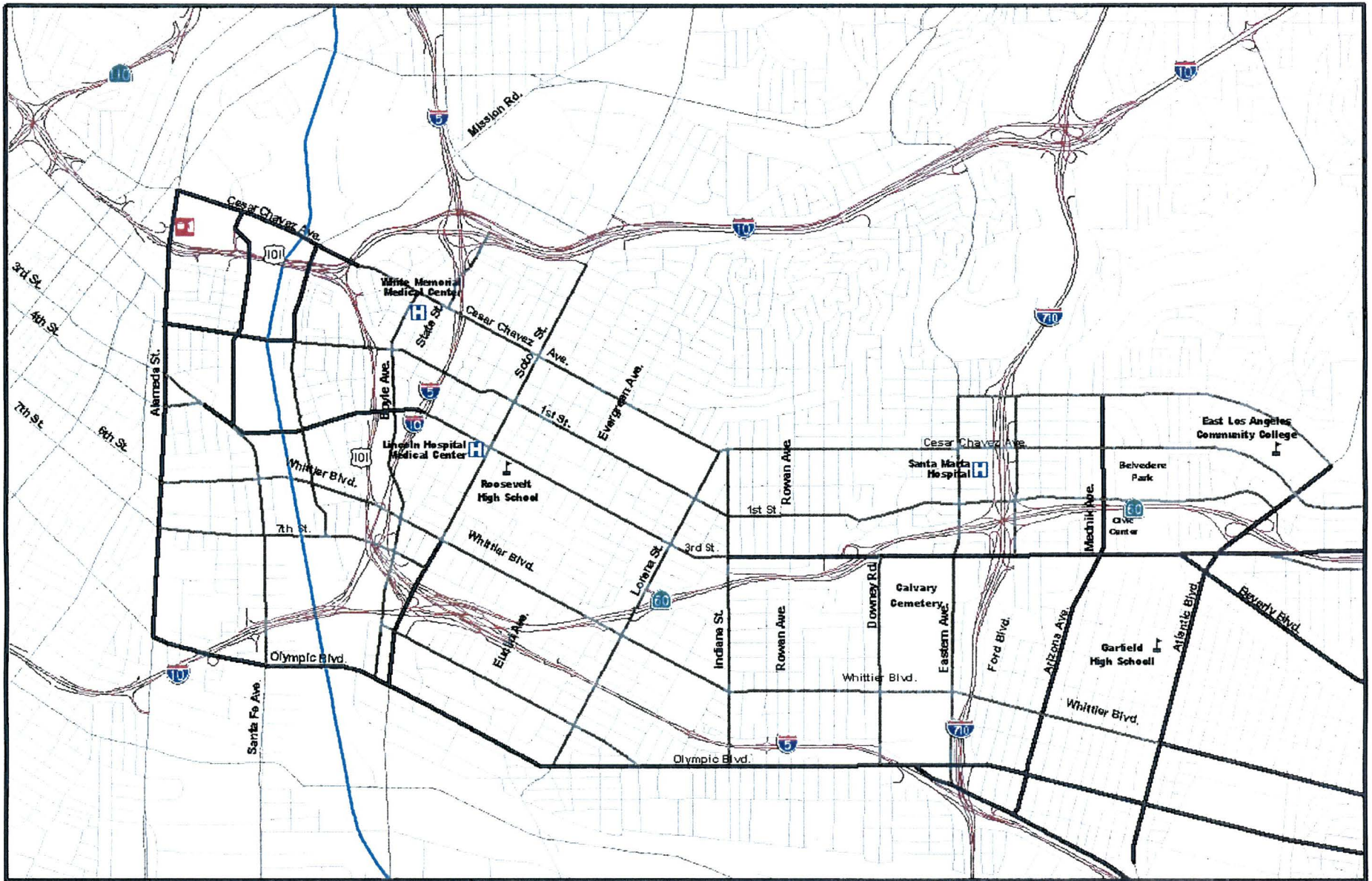
In order to determine the existing traffic operating conditions in the Eastside Corridor and perform traffic analysis for the future year 2020, seven screenline locations and 54 intersections were identified. The jurisdictions that are represented by the traffic analysis locations include the City of Los Angeles, County of Los Angeles, and City of Monterey Park. The screenline locations were used to identify traffic on different streets at a point in the corridor to compare volumes and aggregate corridor traffic flows. Screenline analysis was performed using average daily traffic (ADT) volumes, and intersections were analyzed using PM peak hour volumes. Figure 3-4 shows the screenline and intersection locations that were used in the traffic analysis for this Draft SEIS/SEIR.

#### 3.2.2.2 Screenline Traffic Analysis

Seven screenlines were used in the analysis to determine existing daily traffic operations. Five intercepted east-west streets and two summarized north-south street traffic volumes. There were 29 locations at which Average Daily Traffic (ADT) volumes were collected. Existing ADT count information was obtained from the City of Los Angeles, County of Los Angeles, and City of Monterey Park. New traffic counts were taken in June 2000, which account for 10 of the ADT counts and 49 of the peak hour counts. Figure 3-3 illustrates the existing street network and Figure 3-4 details the locations of the screenlines.

LADOT requested that information be added that explains how Level of Service (LOS) was determined. Volume/Capacity (V/C) was used as a method for determining LOS in the intersection analysis. V/C is obtained by dividing the measured volume (vehicles per day) by the capacity of that street. Capacity is based on the street classification as shown in the Transportation Element of the *Los Angeles General Plan* and presented in Section 1.3.1 of this Final SEIS/SEIR.

According to analysis results, one screenline crossing location experienced an existing level of service (LOS) F. This location was on Atlantic Boulevard south of 1<sup>st</sup> Street in the vicinity of the Pomona Freeway (SR-60) interchange. LOS D was found east of Alameda Street at Cesar Chavez Avenue and south of Temple Street at Alameda Street. The remaining screenline locations exhibit levels of service A, B, and C operating conditions.



0 0.25 0.5 Miles

0 0.25 0.5 0.75 1 Kilometers



**Legend**

- Freeway
- Major Street
- Secondary Street
- Local Street
- River

Source: Los Angeles Department of Transportation and Los Angeles County Department of Public Works Street Classification System.

Note: Base map courtesy by Thomas Bros. Maps through a condition of use from MTR, 1997.



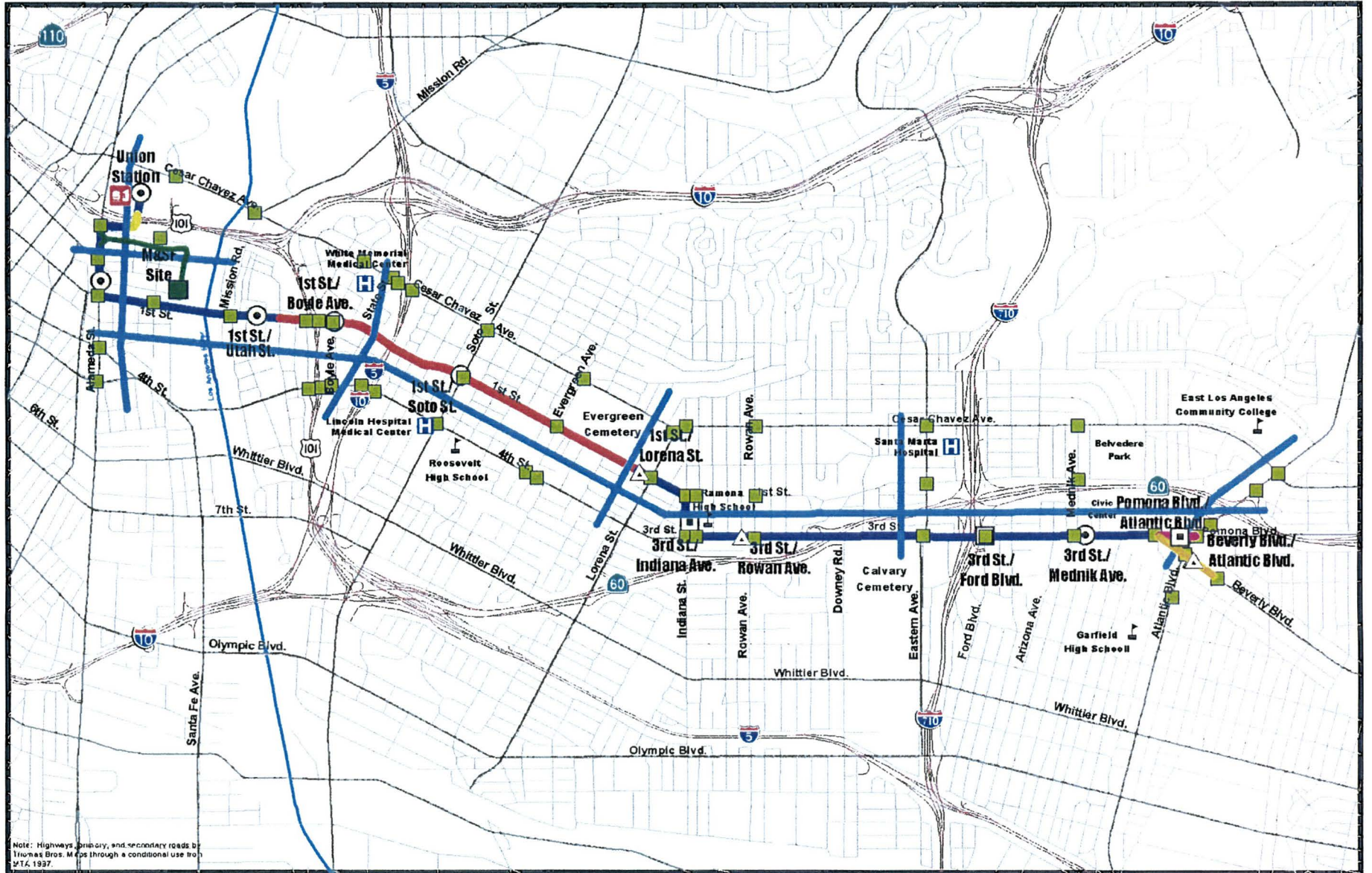
Los Angeles Eastside Corridor SEIS/SEIR

# Eastside Corridor Street Network

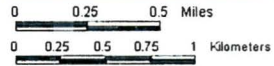
Figure 3-3







Note: Highways, primary, and secondary roads by Thomas Bros. Maps through a conditional use from 1974, 1997.



**LEGEND**

- Stations - Both Options
- ▲ Stations - Option A Only
- ◻ Stations - Option B Only
- Option A Only
- Option B Only
- Intersection Analysis Locations
- Screenline Locations
- At Grade
- Tunnel
- Elevated
- M&SF Lead Line
- Highway
- Primary Road
- Secondary Road

**M Eastside Corridor Transit Consultants**

Los Angeles Eastside Corridor SEIS/SEIR

**Traffic Analysis Locations**

Figure 3-4



Levels of service were also calculated across screenlines to assess overall corridor performance for more than one street at a given point in the corridor. These calculations reveal that each screenline operated at LOS A or B, which indicates good levels of service for all streets within the corridor taken together at one screenline location. Table 3-8 shows ADT capacities, volumes, volume-to-capacity ratios and corresponding levels of service (LOS) for each screenline location analyzed in the Eastside Corridor.

### 3.2.2.3 Peak Hour Traffic Analysis

The existing peak hour traffic conditions were assessed within the study area. This analysis concentrated on 54 study intersections located both along the proposed LRT alignment and along adjacent streets. The evening peak hour was identified as the critical time period for an assessment of existing conditions because, in general, it represents the worst-case conditions. Evening peak hour traffic counts were conducted at the majority of the study intersections in June of 2000. Peak hour traffic count data was also provided by LADOT for five locations.

The list of intersections analyzed in this report was assembled and approved in conjunction with MTA, LADOT, and Los Angeles County. Previously, the evening peak hour was identified as the critical time period for an assessment of existing conditions because, in general, it represents the worst-case conditions. However, AM counts have been requested by LADOT. They will not be completed in time to include in the Final SEIS/SEIR, but will be circulated under separate cover, per agreement with LADOT.

Signalized intersections within the study area and under the jurisdiction of the City of Los Angeles were recently connected to the City's Automated Traffic Surveillance and Control (ATSAC) signal system. The Boyle Heights ATSAC project provides an interconnected and coordinated signal system along major streets within the City limits from Indiana Street west to Downtown Los Angeles. The system includes signalized intersections along the LRT alignment from the intersection of Commercial Street and Alameda Street to 1<sup>st</sup> Street and Indiana Street. The remaining signalized intersections along the LRT alignment are located outside the City limits and are not included within the ATSAC system. However, the Los Angeles County Department of Public Works has recently begun administering numerous multi-jurisdictional Intelligent Transportation Systems projects. Currently the program is underway in the Gateway Cities I-5/Telegraph Road Corridor and in Pomona Valley.

Each study intersection was analyzed to determine peak hour operations and level of service. LOS) is a qualitative measure used to describe the condition of traffic flow, ranging from excellent conditions at LOS A to overload conditions at LOS F. LOS D is typically recognized as the minimum LOS that is acceptable in urban areas. This measure is obtained using V/C in the case of signalized intersections, and delay in the case of unsignalized intersections. V/C is obtained by dividing the measured volume (vehicles per day) by the capacity of that street. The definition of each LOS is included in Tables 3-9 and 3-10 for signalized and stop-controlled intersections, respectively. The CalcaDB program, developed by LADOT, was utilized to analyze the signalized intersections. This program is based upon the analysis methods outlined in *Circular 212*, by the Transportation Research Board in 1980. The stop-controlled intersection analysis techniques published in the *Highway Capacity Manual* by the Transportation Research Board in 1997 were used to analyze the unsignalized intersections.

**TABLE 3-8  
EXISTING CONDITIONS SCREENLINE ADT ANALYSIS**

Screenline Location	Street	Capacity	Volume	V/C <sup>1</sup>	LOS <sup>2</sup>
1. East of Alameda	Cesar Chavez Ave	32,000 <sup>3</sup>	26,839	0.84	D
	1 <sup>st</sup> Street	32,000	17,370	0.54	A
	3 <sup>rd</sup> Street (WB street)	18,000 <sup>4</sup>	13,784	0.77	C
	4 <sup>th</sup> Street (EB street)	24,000 <sup>5</sup>	11,135	0.46	A
	<b>Screenline Total</b>	<b>106,000</b>	<b>69,128</b>	<b>0.65</b>	<b>B</b>
2. West of I-5 Freeway	Cesar Chavez Ave	28,000 <sup>6</sup>	20,919	0.75	C
	1 <sup>st</sup> Street	28,000	13,333	0.48	A
	4 <sup>th</sup> Street	32,000	19,509	0.61	B
	<b>Screenline Total</b>	<b>88,000</b>	<b>53,761</b>	<b>0.61</b>	<b>B</b>
3. West of Lorena	Cesar Chavez Ave	28,000	21,731	0.78	C
	1 <sup>st</sup> Street	28,000	15,277	0.55	A
	4 <sup>th</sup> Street	28,000	17,337	0.62	B
	<b>Screenline Total</b>	<b>84,000</b>	<b>54,345</b>	<b>0.65</b>	<b>B</b>
4. West of Eastern	Cesar Chavez Ave	28,000	20,823	0.74	C
	1 <sup>st</sup> Street	28,000	10,242	0.37	A
	3 <sup>rd</sup> Street	32,000	19,126	0.60	B
	<b>Screenline Total</b>	<b>88,000</b>	<b>50,191</b>	<b>0.57</b>	<b>A</b>
5. West of Atlantic	Cesar Chavez Ave	28,000	13,637	0.49	A
	1 <sup>st</sup> Street	28,000	7,334	0.26	A
	Pomona Blvd	32,000	11,588	0.36	A
	Beverly Blvd	32,000	17,864	0.56	A
	<b>Screenline Total</b>	<b>120,000</b>	<b>50,423</b>	<b>0.42</b>	<b>A</b>
6. South of Temple St	Alameda St	32,000	26,577	0.83	D
	Mission Rd	24,000	11,769	0.49	A
	<b>Screenline Total</b>	<b>56,000</b>	<b>38,346</b>	<b>0.69</b>	<b>B</b>
7. South of 1 <sup>st</sup> Street	Alameda St	32,000	19,181	0.60	B
	Mission Rd	12,000 <sup>7</sup>	2,609	0.22	A
	Boyle Ave	28,000	12,099	0.43	A
	Soto St	28,000	17,492	0.62	B
	Evergreen Ave	12,000	5,746	0.48	A
	Lorena St	28,000	12,309	0.44	A
	Indiana St	14,000 <sup>8</sup>	10,532	0.75	C
	Eastern Ave	28,000	12,827	0.46	A
	Mednik Ave	32,000	12,291	0.38	A
	Atlantic Blvd	32,000	35,058	1.10	F
	<b>Screenline Total</b>	<b>246,000</b>	<b>140,144</b>	<b>0.57</b>	<b>A</b>

<sup>1</sup> Volume/Capacity Ratio.<sup>2</sup> Level of Service.<sup>3</sup> Capacity of 32,000 assumes 800 vehicles per lane per hour and 10% of daily demand in peak hour.<sup>4</sup> Capacity of 18,000 assumes 600 vehicles per lane per hour and 10% of daily demand in peak hour.<sup>5</sup> Capacity of 24,000 assumes 600 vehicles per lane per hour and 10% of daily demand in peak hour.<sup>6</sup> Capacity of 28,000 assumes 700 vehicles per lane per hour and 10% of daily demand in peak hour.<sup>7</sup> Capacity of 12,000 assumes 600 vehicles per lane per hour and 10% of daily demand in peak hour.<sup>8</sup> Capacity of 14,000 assumes 700 vehicles per lane per hour and 10% of daily demand in peak hour.

Sources: LADOT, County of Los Angeles Dept. of Public Works, The Traffic Solution, Parsons Brinckerhoff, 1997-2000.

Level of Service	Volume/Capacity Ratio	Definition
A	0.000 - 0.600	EXCELLENT. No vehicle waits longer than one red light and no approach phase is fully used.
B	0.601 - 0.700	VERY GOOD. An occasional approach phase is fully utilized; many drivers begin to feel somewhat restricted within groups of vehicles.
C	0.701 - 0.800	GOOD. Occasionally drivers may have to wait through more than one red light; backups may develop behind turning vehicles.
D	0.801 - 0.900	FAIR. Delays may be substantial during portions of the rush hours, but enough lower volume periods occur to permit clearing of developing lines, preventing excessive backups.
E	0.901 - 1.000	POOR. Represents the most vehicles intersection approaches can accommodate; may be long lines of waiting vehicles through several signal cycles.
F	>1.000	FAILURE. Backups from nearby locations or on cross streets may restrict or prevent movement of vehicles out of the intersection approaches. Tremendous delays with continuously increasing queue lengths.

Source: Transportation Research Board, *Transportation Research Circ. No. 212, Interim Materials on Highway Capacity*, 1980.

Level of Service	Average Vehicle Delay (seconds)
A	$\leq 10.0$
B	$> 10.0$ and $\leq 15.0$
C	$> 15.0$ and $\leq 25.0$
D	$> 25.0$ and $\leq 35.0$
E	$> 35.0$ and $\leq 50.0$
F	$> 50.0$

Source: Transportation Research Board, *Highway Capacity Manual, Special Report 209*, 1997.

Table 3-11 summarizes the existing peak hour operations and corresponding level of service at each of the study intersections. As shown in the table, the majority of the study intersections are currently operating at LOS D or better during the evening peak hour. The following four intersections are currently operating at LOS E or F during this period:

- ◆ Cesar Chavez Avenue and Mednik Avenue (signalized)
- ◆ 1<sup>st</sup> Street and Alma Avenue (stop sign)
- ◆ 4<sup>th</sup> Street and the I-5 SB Ramps (stop sign)
- ◆ Beverly Boulevard and Atlantic Boulevard (signalized)

TABLE 3-11				
EXISTING <sup>1</sup> INTERSECTION LEVEL OF SERVICE ANALYSIS				
E/W Street	N/S Street	Jurisdiction	Traffic Conditions	
			V/C or Delay	LOS <sup>2</sup>
Cesar Chavez Av	Vignes St	LADOT	0.686	B
Cesar Chavez Av	Mission Rd	LADOT	0.636	B
Cesar Chavez Av	Boyle Ave	LADOT	0.501	A
Cesar Chavez Av	State	LADOT	0.604	B
Cesar Chavez Av	I-5 SB Ramps	LADOT	10.9	B
Cesar Chavez Av	I-5 NB Ramps	LADOT	0.379	A
Cesar Chavez Av	Soto St	LADOT	0.583	A
Cesar Chavez Av	Evergreen Ave	LADOT	0.531	A
Cesar Chavez Av	Lorena St	LADOT	0.516	A
Cesar Chavez Av	Indiana St	LA County	27.6	D
Cesar Chavez Av	Rowan Ave	LA County	0.553	A
Cesar Chavez Av	Eastern Ave	LA County	0.561	A
<i>Cesar Chavez Av</i>	<i>Mednik Ave</i>	<i>LA County</i>	<i>0.951</i>	<i>E</i>
Cesar Chavez Av	Atlantic Blvd	Monterey Park	0.888	D
Commercial St	Alameda St	LADOT	0.482	A
Commercial St	Vignes St	LADOT	12.97	B
Temple St	Alameda St	LADOT	0.691	B
1st St	Alameda St	LADOT	0.895	D
1st St	Vignes St	LADOT	0.483	A
1st St	Mission Rd	LADOT	0.748	C
1st St	101 SB Ramps	LADOT	21.5	C
1st St	101 NB Ramps	LADOT	0.364	A
1st St	Boyle Ave	LADOT	0.493	A
1st St	Soto St	LADOT	0.622	B
1st St	Evergreen Ave	LADOT	0.448	A
1st St	Lorena St	LADOT	0.348	A
1st St	Indiana St	LADOT	0.560	A
<i>1st St</i>	<i>Alma Ave</i>	<i>LA County</i>	<i>128.1</i>	<i>F</i>
1st St	Rowan Ave	LA County	0.300	A
1st St	Eastern Ave	LA County	0.401	A
1st St	Mednik Ave	LA County	0.471	A
1st St	Atlantic Blvd	Monterey Park	0.850	D
3rd St	Alameda St	LADOT	0.521	A
4th St	Alameda St	LADOT	0.664	B
4th St	101 SB Ramps	LADOT	11.2	B
4th St	101 NB Ramps	LADOT	0.395	A
4th St	Boyle Ave	LADOT	0.416	A
<i>4th St</i>	<i>I-5 SB Ramps</i>	<i>LADOT</i>	<i>97.6</i>	<i>F</i>
4th St	I-5 NB Ramps	LADOT	0.536	A
4th St	Soto St	LADOT	0.542	A
4th St	Evergreen Ave	LADOT	0.373	A
4th St	Euclid Ave	LADOT	0.384	A
3rd St	Indiana St	LADOT	0.853	D

E/W Street	N/S Street	Jurisdiction	Traffic Conditions	
			V/C or Delay	LOS <sup>2</sup>
3rd St	Alma Ave	LA County	17.1	C
3rd St	Rowan Ave	LA County	0.550	A
3rd St	Eastern Ave	LA County	0.707	C
3rd St	Ford Blvd	LA County	0.473	A
3rd St	Mednik Ave	LA County	0.602	B
3rd St	Pomona / Beverly / Woods	LA County	0.727	C
Pomona Blvd	Atlantic Blvd	LA County	0.817	D
<b><i>Beverly Blvd</i></b>	<b><i>Atlantic Blvd</i></b>	<b><i>LA County</i></b>	<b><i>0.959</i></b>	<b><i>E</i></b>
Beverly Blvd	Hillview Ave	LA County	0.527	A
SR 60 EB Ramp	Atlantic Blvd	LA County	0.575	A
4th St	Atlantic Blvd	LA County	0.541	A

<sup>1</sup> Year 2000 PM peak hour.  
<sup>2</sup> Bolded, italicized text indicates intersections currently operating at LOS E or F.  
Source: LADOT Data, Kaku Associates, 2000.

### 3.2.3 Future Traffic Impacts

#### 3.2.3.1 No-Build Alternative

##### *Intersection Traffic Conditions*

In order to determine the potential changes in traffic operations within the study area with the proposed LRT system, the future conditions were first assessed without the LRT project.

The No-Build conditions for the next 20 years were discussed with representatives of the project team and LADOT. The study area was analyzed based upon: historical traffic data, potential growth within the study area and within areas directly adjacent to the study area, and the long-range traffic projections from the modeling efforts as part of this study. This assessment resulted in the determination that the No-Build future traffic projections would be developed by factoring the existing peak hour traffic data by 1.20. This factor represents an average annual growth rate of one percent.

The 1.20 growth factor was applied to each of the 54 study intersections. The future conditions (without the LRT) were analyzed and the resulting operating conditions and corresponding level of service are provided in Table 3-12. This analysis assumed no improvements to the existing roadway system. A review of the results indicates that under No-Build conditions, 42 intersections will continue to operate at level of service D or better. The 12 intersections that are projected to operate at level of service E or F are highlighted in the table.

#### 3.2.3.2 LRT Build Alternative – Option A

The LRT Build Alternative Option A includes 4.1 miles of at-grade light rail where trains will run in the center or to the side of existing streets, including Commercial Street, Alameda Street, 1<sup>st</sup> Street, Indiana Street, 3<sup>rd</sup> Street, and Beverly Boulevard. The typical width of the LRT envelope is 26 feet between stations and 37 feet at stations. Mountable raised curbs would be constructed along the edge of the LRT envelope to keep traffic out of the LRT right-of-way while allowing for emergency vehicle access.

TABLE 3-12 2020 NO-BUILD INTERSECTION LEVEL OF SERVICE ANALYSIS				
E/W Street	N/S Street	Jurisdiction	Traffic Conditions	
			V/C or Delay	LOS <sup>1</sup>
Cesar Chavez Av	Vignes St	LADOT	0.836	D
Cesar Chavez Av	Mission Rd	LADOT	0.764	C
Cesar Chavez Av	Boyle Av	LADOT	0.602	B
Cesar Chavez Av	State	LADOT	0.725	C
Cesar Chavez Av	I-5 SB Ramps	LADOT	12.5	B
Cesar Chavez Av	I-5 NB Ramps	LADOT	0.454	A
Cesar Chavez Av	Soto St	LADOT	0.680	B
Cesar Chavez Av	Evergreen Av	LADOT	0.637	B
Cesar Chavez Av	Lorena St	LADOT	0.618	B
<b>Cesar Chavez Av</b>	<b>Indiana St</b>	<b>LA County</b>	<b>76.5</b>	<b>F</b>
Cesar Chavez Av	Rowan Av	LA County	0.663	B
Cesar Chavez Av	Eastern Av	LA County	0.673	B
<b>Cesar Chavez Av</b>	<b>Mednik Av</b>	<b>LA County</b>	<b>1.141</b>	<b>F</b>
<b>Cesar Chavez Av</b>	<b>Atlantic Bl</b>	<b>Monterey Park</b>	<b>1.065</b>	<b>F</b>
Commercial St	Alameda St	LADOT	0.593	A
Commercial St	Vignes St	LADOT	18.04	C
Temple St	Alameda St	LADOT	0.843	D
<b>1st St</b>	<b>Alameda St</b>	<b>LADOT</b>	<b>1.087</b>	<b>F</b>
1st St	Vignes St	LADOT	0.595	A
1st St	Mission Rd	LADOT	0.898	D
<b>1st St</b>	<b>101 SB Ramps</b>	<b>LADOT</b>	<b>36.4</b>	<b>E</b>
1st St	101 NB Ramps	LADOT	0.437	A
1st St	Boyle Av	LADOT	0.613	B
1st St	Soto St	LADOT	0.835	D
1st St	Evergreen Av	LADOT	0.538	A
1st St	Lorena St	LADOT	0.451	A
1st St	Indiana St	LADOT	0.672	B
<b>1st St</b>	<b>Alma Av</b>	<b>LA County</b>	<b>229.3</b>	<b>F</b>
1st St	Rowan Av	LA County	0.361	A
1st St	Eastern Av	LA County	0.482	A
1st St	Mednik Av	LA County	0.565	A
<b>1st St</b>	<b>Atlantic Bl</b>	<b>Monterey Park</b>	<b>1.020</b>	<b>F</b>
3rd St	Alameda St	LADOT	0.625	B
4th St	Alameda St	LADOT	0.810	D
4th St	101 SB Ramps	LADOT	12.5	B
4th St	101 NB Ramps	LADOT	0.488	A
4th St	Boyle Av	LADOT	0.464	A
<b>4th St</b>	<b>I-5 SB Ramps</b>	<b>LADOT</b>	<b>*</b>	<b>F</b>
4th St	I-5 NB Ramps	LADOT	0.658	B
4th St	Soto St	LADOT	0.664	B
4th St	Evergreen Av	LADOT	0.461	A
4th St	Euclid Av	LADOT	0.475	A
<b>3rd St</b>	<b>Indiana St</b>	<b>LADOT</b>	<b>1.024</b>	<b>F</b>



E/W Street	N/S Street	Jurisdiction	Traffic Conditions	
			V/C or Delay	LOS <sup>1</sup>
3rd St	Alma Av	LA County	23.5	C
3rd St	Rowan Av	LA County	0.701	C
<b>3rd St</b>	<b>Eastern Av</b>	<b>LA County</b>	<b>0.939</b>	<b>E</b>
3rd St	Ford Bl	LA County	0.567	A
3rd St	Mednik Av	LA County	0.722	C
3rd St	Pomona Bl/Beverly Bl/Woods Av	LA County	0.873	D
<b>Pomona Bl</b>	<b>Atlantic Bl</b>	<b>LA County</b>	<b>0.981</b>	<b>E</b>
<b>Beverly Bl</b>	<b>Atlantic Bl</b>	<b>LA County</b>	<b>1.151</b>	<b>F</b>
Beverly Bl	Hillview Av	LA County	0.631	B
SR 60 EB Ramp	Atlantic Bl	LA County	0.691	B
4th St	Atlantic Bl	LA County	0.649	B

\* Denotes delay estimated to be greater than 999.9 sec/veh.  
<sup>1</sup> Bolded, italicized text indicates intersections projected to operate at LOS E or F.  
Source: Kaku Associates, 2000.

Traffic and pedestrians would be allowed to cross the LRT tracks only at signalized intersections along the alignment. All driveways and unsignalized intersections would have right-in and right-out access where vehicles, bicyclists, and pedestrians would be prohibited from crossing the tracks. Through and left turn movements across the tracks would be prohibited at these locations.

Some unsignalized intersections will be signalized to accommodate LRT crossings, such as the on-ramps to the SR-60 and I-710 Freeways. Where traffic signals will affect operation of the ramps, a Permitting, Engineering Evaluation Report will be developed as per Caltrans regulations, to be approved by the California Transportation Commission. In the County of Los Angeles, from Indiana Street, along 3<sup>rd</sup> Street, to the terminus on Beverly Boulevard, MTA will consult with the California Highway Patrol (CHP) on traffic matters including intersections and pedestrians.

In order to maintain the flow of traffic, left turns from the LRT alignment streets will be accommodated at signalized intersections only. At these locations, split-phase signal operation will be implemented to accommodate the left turn demand. In order to provide for safe LRT operations, these left turns across the tracks will be controlled via left turn arrows. Specific locations that would experience significant traffic impacts are identified in subsequent sections. At several locations, the mitigation consists of left turn prohibitions to reduce intersection traffic impacts.

### ***Traffic Lane Reductions***

In the at-grade segments of the alignment, the LRT tracks will, for the most part, utilize existing street right-of-way. For most at-grade sections, the LRT will run in or near the center of the street. The removal of some traffic lanes and elimination of some left turns is reflected in the analysis of intersection traffic impacts presented in the following pages.

### **Commercial Street**

The LRT system would utilize portions of Caltrans right-of-way and enter Commercial Street east of its intersection with Alameda Street. At this location, the LRT tracks would begin to curve through the

intersection and require that the westbound intersection stop line be moved back slightly in order to keep the LRT right-of-way clear and to avoid conflicts between cars and trains. There would be no traffic lanes removed on Commercial Street.

### Alameda Street

Alameda Street will be widened to the east by 14 feet to 24.5 feet to maintain the number of through traffic lanes provided in the No-Build Alternative and provide for adequate space on the east side of the street for the LRT system. No through traffic lanes will be eliminated on Alameda Street. However, the northbound right turn lane will be eliminated at the intersection of Temple Street. Turner and Banning Streets will be closed at Alameda Street due to the new station location on the east side of Alameda. Figure 3-5 illustrates the typical Alameda Street cross-section.

### 1<sup>st</sup> Street

Under the LRT Build Alternative Option A, 1<sup>st</sup> Street will maintain two traffic lanes in each direction, plus curb parking, in sections where the LRT system is at-grade between Alameda and Vignes Streets. Figure 3-6 illustrates the typical 1<sup>st</sup> Street cross-section, and Figure 3-7 shows the LA River Bridge cross-section. In at-grade station areas, the traffic lane will be 13.5 feet wide, curb parking will be prohibited, and sidewalks will be narrowed from 10 feet to 8 feet to maintain one traffic lane in each direction. The LRT alignment will run in the center of the street between Alameda and Vignes.

In the areas of 1<sup>st</sup> Street where the LRT has a tunnel profile, between the US-101 Freeway and Fresno Street, there will be no street modifications. However, some limited street modifications may occur at tunnel station locations, depending on specific designs. Upon exiting the eastern tunnel portal, the LRT will run on the north side of the street for one block to Lorena, where it will cross over to the center of the street before turning south on Indiana Street. The station at 1<sup>st</sup>/Lorena is located on the north side of the street, with one traffic lane in each direction and parking on the south side of the street.

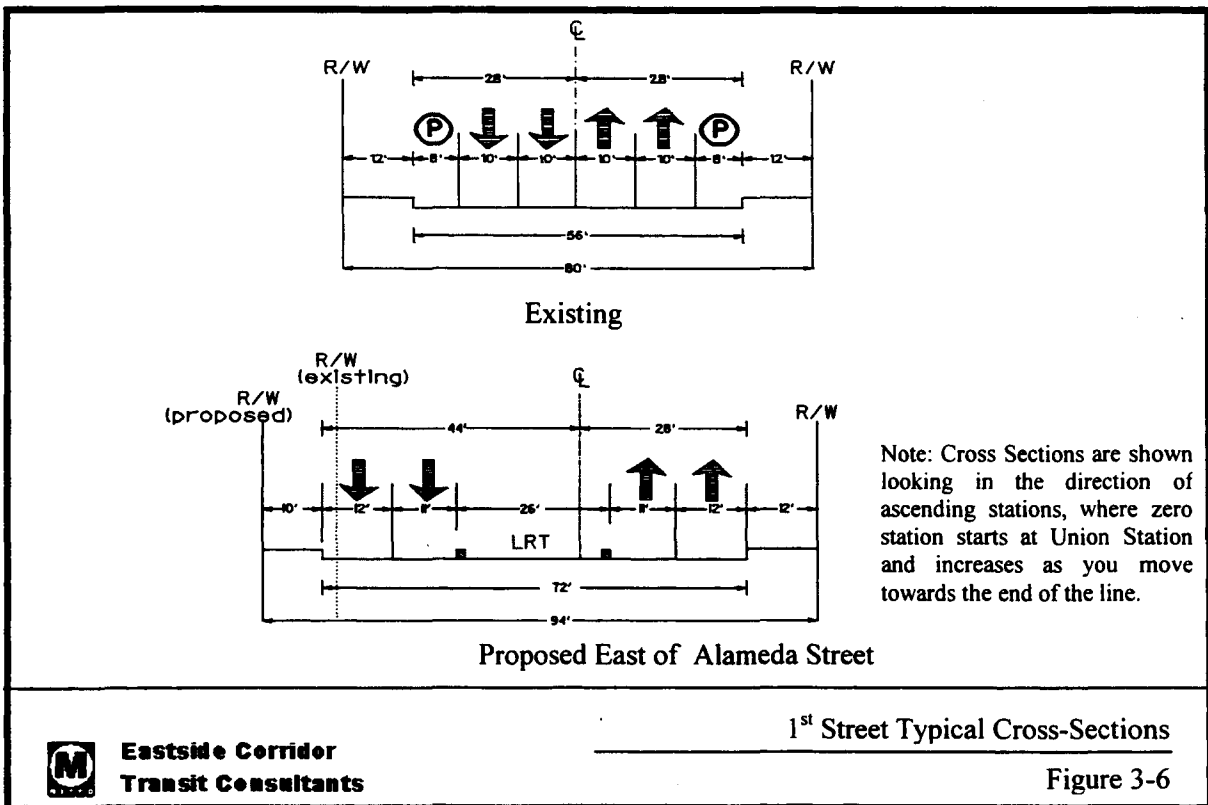
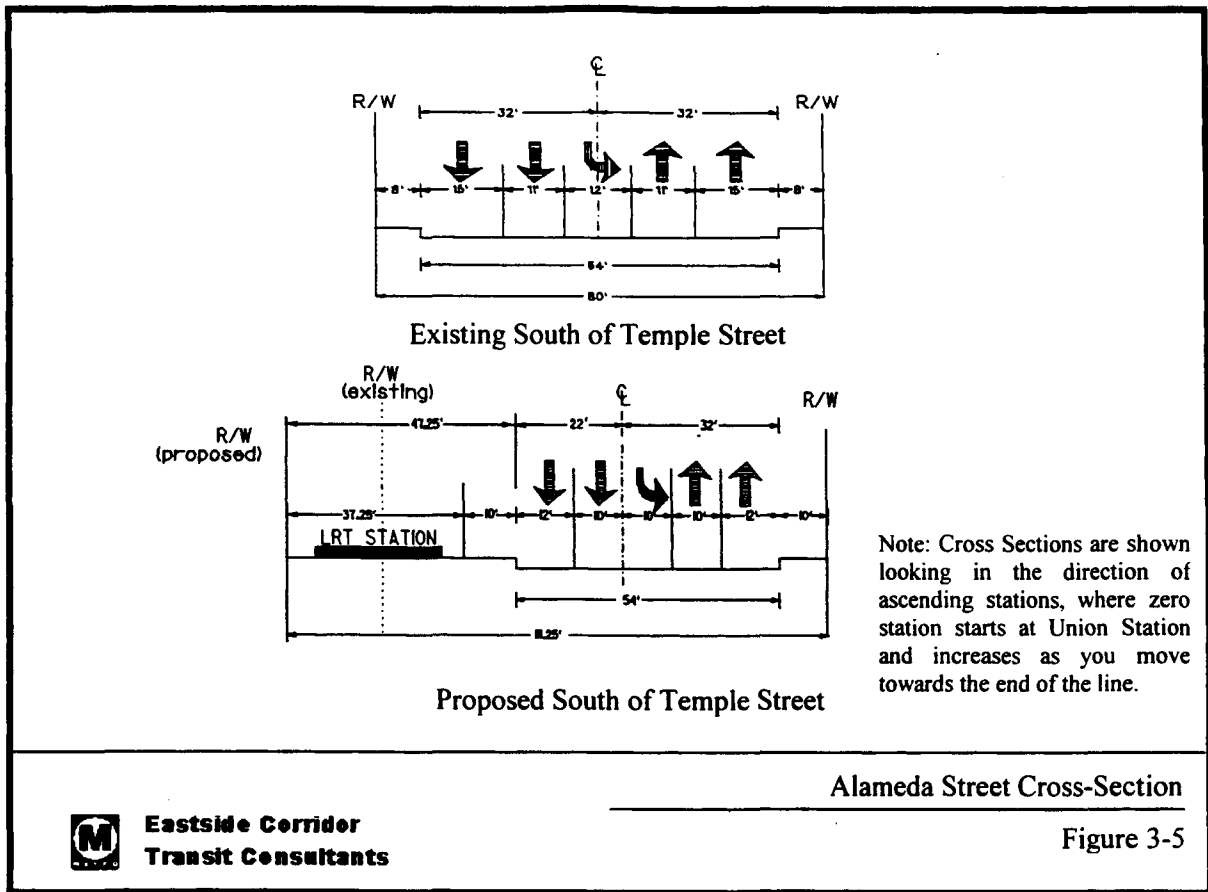
From Cheesbroughs Lane to Indiana Street, one lane in each direction (11-foot traffic lanes) and 8-foot curb parking lanes will be provided. Sidewalk narrowing from 12 feet to 8 feet will be necessary to accommodate the traffic lanes plus curb parking at these locations. Where curb parking is not required, 15-foot traffic lanes and existing 12-foot sidewalks with no curb parking will be provided within the existing 80-foot right-of-way.

The station at 1<sup>st</sup>/Lorena, directly east of the portal, will be located on the north side of 1<sup>st</sup> Street. To the east of the station, the LRT alignment would cross over to the center of 1<sup>st</sup> Street before turning south down Indiana Street.

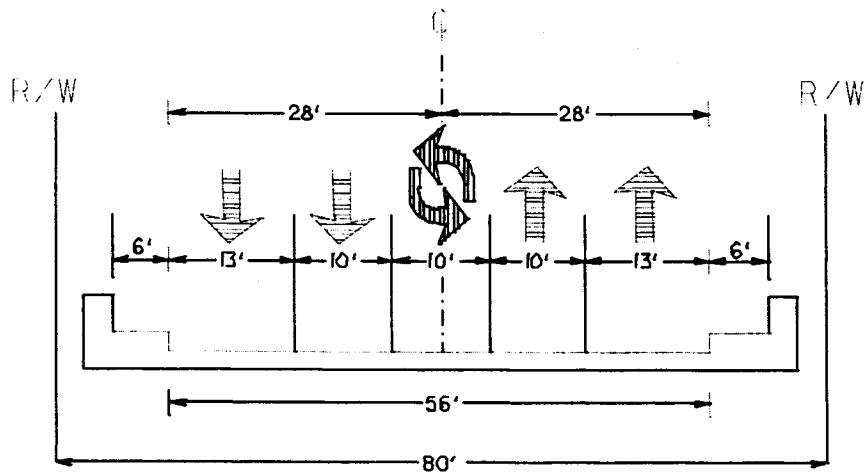
As part of the Mangrove Estates Development, a signal is proposed at 1<sup>st</sup> and Hewitt Streets to access the site. This signal will be environmentally cleared by others.

### Indiana Street

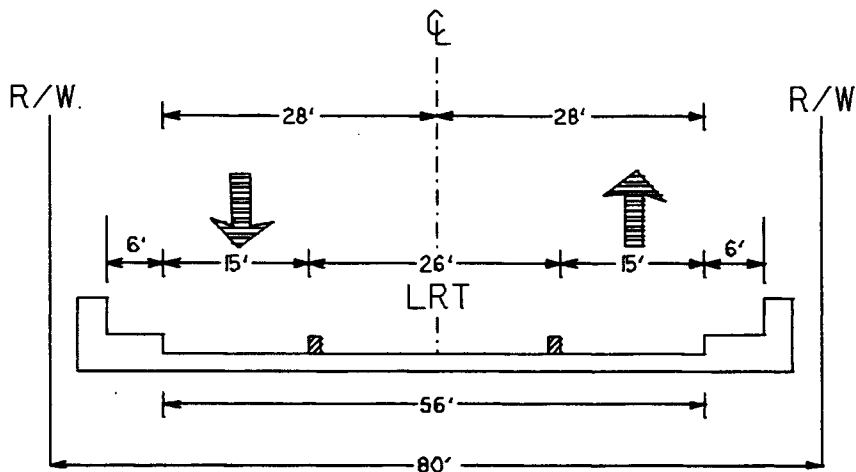
Under Option A of the LRT Build Alternative, a 26-foot LRT system will occupy the center of the street at-grade, and one 11-foot traffic lane will remain in each direction. Curb parking will be prohibited. At this location, the sidewalk will be narrowed to six feet on the west side to accommodate the LRT tracks within the existing 60-foot right-of-way. Figure 3-8 illustrates the typical Indiana Street cross-section.







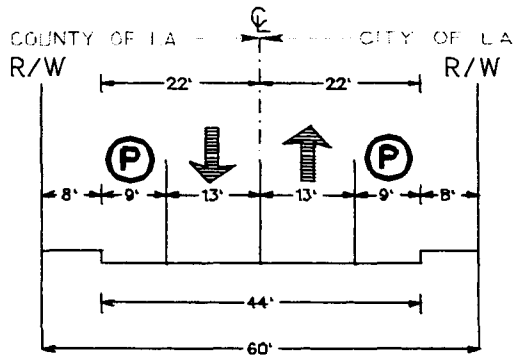
Existing on First Street Bridge



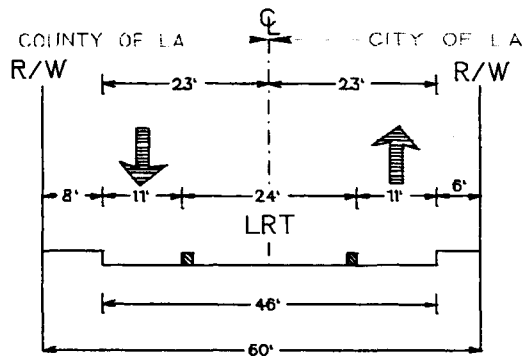
Proposed on First Street Bridge

Note: Cross Sections are shown looking in the direction of ascending stations, where zero station starts at Union Station and increases as you move towards the end of the line.



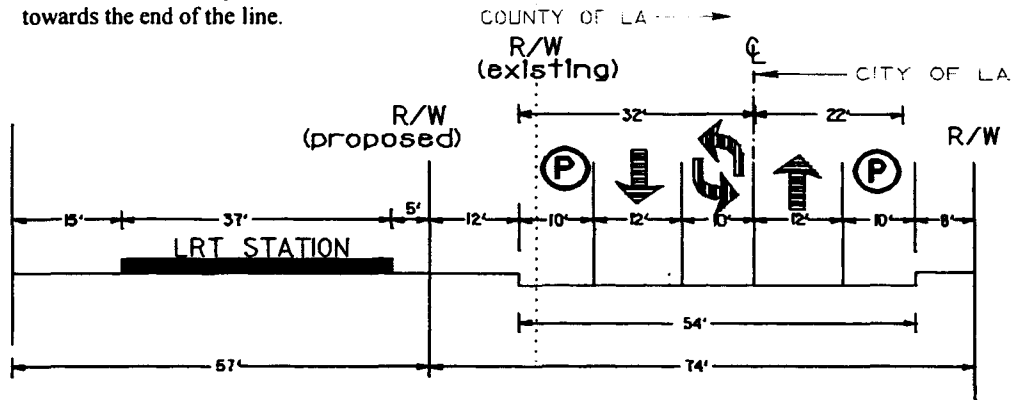


Existing



Proposed under Option A

Note: Cross Sections are shown looking in the direction of ascending stations, where zero station starts at Union Station and increases as you move towards the end of the line.



Proposed under Option B



**Eastside Corridor  
Transit Consultants**

**Indiana Street Cross-Sections  
North of 2<sup>nd</sup> Street**

Figure 3-8





3<sup>rd</sup> Street

3<sup>rd</sup> Street will have one traffic lane removed in each direction between Indiana Street and Beverly Boulevard. After the introduction of the LRT system on 3<sup>rd</sup> Street, one traffic lane plus curb parking will remain in each direction. The inside traffic lane will be 13 feet and 10.5 feet wide between stations and at station locations, respectively. The curb parking lane will be 15 feet and 12 feet wide between stations and at station locations, respectively. Similar to existing conditions and the No-Build Alternative, curb parking will be prohibited and the curb lane will be utilized as a traffic lane during the hours of 6:30-9 a.m. in the westbound direction and 4-6 p.m. in the eastbound direction. Lane continuity will be maintained for through traffic movements during both the peak and off-peak hours. At all other times, the curb lanes will continue to provide for parking. Sidewalks will not be modified along 3<sup>rd</sup> Street. Figure 3-9 illustrates the typical 3<sup>rd</sup> Street cross-section.

Beverly Boulevard

Under Option A, Beverly Boulevard will have one traffic lane removed in each direction because the LRT system will have an at-grade profile. Figure 3-10 shows the typical street cross-section of Beverly Boulevard at the Atlantic Boulevard station. The median will be removed on Beverly where the LRT will occupy the center of the street between 3<sup>rd</sup> Street/Woods Avenue and Hillview Avenue. One 10.5-foot traffic lane in each direction will be provided at the station. Curb parking will be maintained with existing regulations that stipulate that 2-hour parking is permitted between 7 a.m. and 6 p.m. Sidewalks will not be modified along Beverly Boulevard.

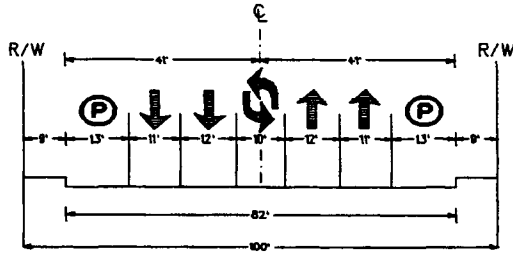
*Summary of Traffic Lane Reductions along the LRT Alignment*

A summary of lane reductions under both Options A and B is provided in Table 3-13. Refer to Section 3.2.3.3 for more information about Option B. Figure 3-11 illustrates the traffic lane reductions along the LRT alignment.

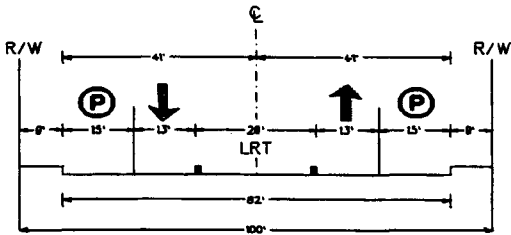
Street	From	To	Total Number of Traffic Lanes		
			No Build	Option A	Option B
Alameda St.	Commercial St	1 <sup>st</sup> Street	4	4	4
1 <sup>st</sup> Street	Alameda St	Vignes St	4	4	4
1 <sup>st</sup> Street <sup>1</sup>	Vignes St <sup>1</sup>	Gless St <sup>1</sup>	4	2	2
1 <sup>st</sup> Street <sup>2</sup>	Gless St <sup>2</sup>	Fresno St <sup>2</sup>	4	4	4
1 <sup>st</sup> Street	Fresno St	Indiana St	4	2	2
Indiana St	1 <sup>st</sup> Street	3 <sup>rd</sup> Street	2	2	2
3 <sup>rd</sup> Street	Indiana St	Beverly Blvd	5 / 4 <sup>3</sup>	3 / 2 <sup>4</sup>	3 / 2 <sup>4</sup>
Beverly Blvd	3 <sup>rd</sup> Street	Hillview Ave	4	2	4
Pomona Blvd	Beverly Blvd	Hillview Ave	4	4	2

<sup>1</sup> The alignment crosses over the LA River Bridge.  
<sup>2</sup> There is no at-grade LRT operation in this segment.  
<sup>3</sup> 5 lanes during peak periods/4 lanes during off-peak periods.  
<sup>4</sup> 3 lanes during peak periods/2 lanes during off-peak periods.  
Source: Parsons Brinckerhoff, 2000-2001

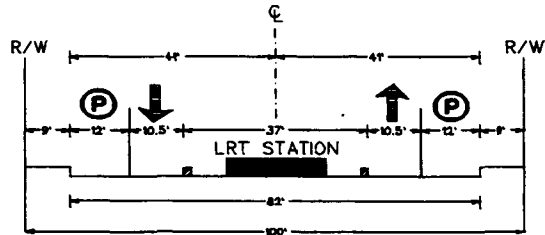




Existing with Peak Hour Parking Restrictions  
(AM Restrictions Westbound, PM Restrictions Eastbound)



Proposed Between Station Areas  
with Peak Hour Parking Restrictions  
(AM Restrictions Westbound, PM Restrictions Eastbound)



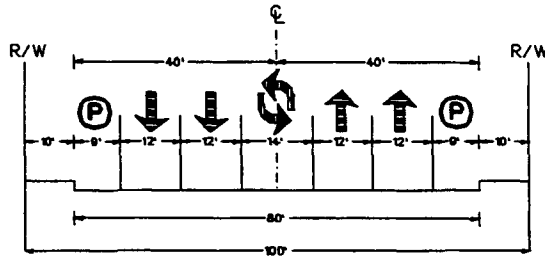
Proposed in Station Areas  
with Peak Hour Parking Restrictions  
(AM Restrictions Westbound, PM Restrictions Eastbound)



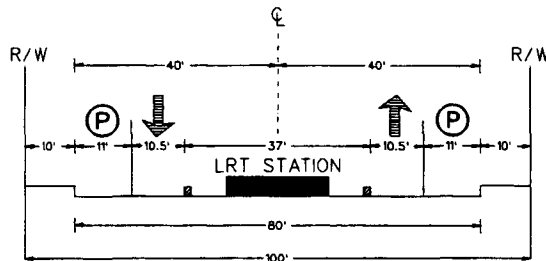
**Eastside Corridor  
Transit Consultants**

**3<sup>rd</sup> Street Typical Cross-Sections**

Figure 3-9



Existing (Same For Option B)



Proposed at Station Areas for Option A

Note: Cross Sections are shown looking in the direction of ascending stations, where zero station starts at Union Station and increases as you move towards the end of the line.

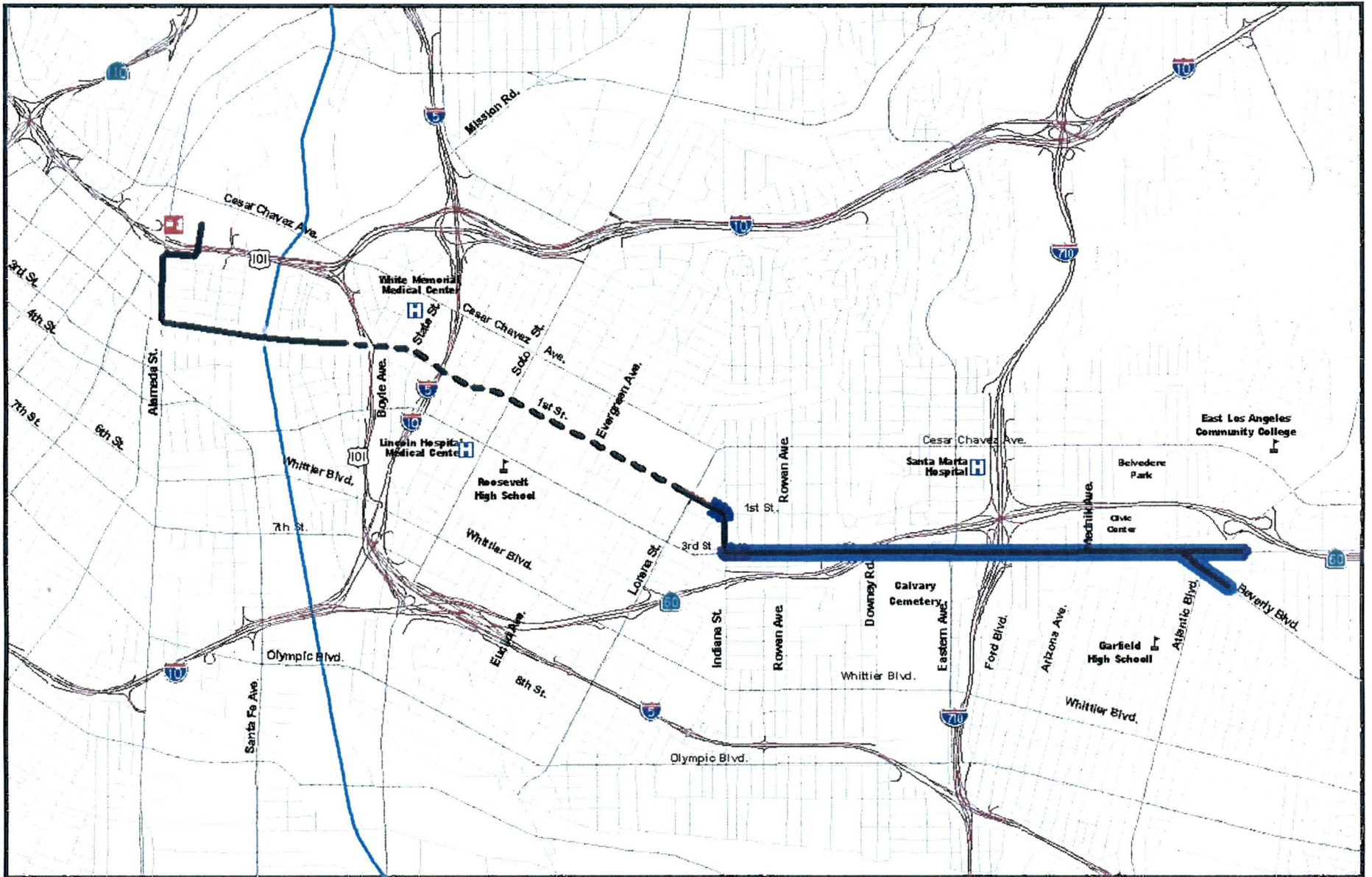


**Eastside Corridor  
Transit Consultants**

**Beverly Blvd Typical Cross-Section**

Figure 3-10





0 0.25 0.5 Miles

Source: Parsons Brinckerhoff, 2000.

0 0.25 0.5 0.75 1 Kilometers

Note: Highways, primary, and secondary roads by Thomas Bros. Maps through a conditional use from MTA 1997.

**M** Eastside Corridor  
Transit Consultants



One Traffic Lane  
Removed in Each Direction:  
**Option A+B**

Legend

- LRT Alignment not in Tunnel
- LRT Alignment in Tunnel
- Highway
- Primary Road
- Secondary Road
- River

Los Angeles Eastside Corridor SEIS/SEIR

## Traffic Lane Reductions

Figure 3-11



### ***Traffic Circulation and Neighborhood Accessibility***

Local neighborhood traffic patterns and pedestrian circulation across the LRT tracks would be modified with the LRT Build Alternative Option A. Traffic and pedestrian crossings at stop sign-controlled streets along the at-grade segments of the alignment will not be allowed to cross the tracks. This would also be the case for mid-block driveways. As stated earlier, these locations will be converted to right-in and right-out traffic operation. Delivery trucks will be able to access business via right hand turns. If there is not enough room to accommodate a right hand turn, the MTA will provide an alternative access point. Traffic and pedestrian movements that cross the tracks will be accommodated at signalized crossings with special traffic signal phasing to provide safe, separated intervals for train, traffic, and pedestrian crossings.

Due to the limited number of crossings of the tracks introduced by the LRT Build Alternative, traffic on streets that do cross the tracks may increase. Pedestrian paths may be modified if pedestrians are not able to cross the tracks at an unauthorized location. Pedestrians would be directed to cross the tracks at the nearest signalized intersection. Emergency vehicles would be the only vehicles allowed to mount the low curb and drive on the tracks.

### ***Shifts in Traffic Patterns along the LRT Alignment***

Adjustments to traffic flow patterns due to the proposed LRT project were determined by utilizing MTA model projections developed for this study, described previously in the introduction to Section 3.0. The future No-Build and LRT peak hour model data were compared to determine the effects of the proposed project on traffic flow. The PM peak hour link data from each model output were utilized in this analysis. The results of this analysis are summarized below, comparing the 2020 traffic forecasts with the LRT project versus the 2020 traffic forecasts without the LRT.

- ◆ On Cesar Chavez, the traffic volumes increased overall by an average of 2 to 3 percent.
- ◆ Along 1<sup>st</sup> Street, west of Indiana Street, the traffic volumes decreased within a range of 16 to 24 percent. East of Indiana Street, the traffic volumes on 1<sup>st</sup> Street increased by an average of 12 percent.
- ◆ On 3<sup>rd</sup> Street, the traffic volumes increased by 2 to 3 percent west of Interstate 5. Between I-5 and Indiana the volumes decreased by 3 to 4 percent. Along the alignment, east of Indiana Street, the traffic volumes on 3<sup>rd</sup> Street decreased by 40 to 45 percent. It is expected that much of the traffic would shift to adjacent parallel facilities in order to avoid traffic conditions due to the effects of the LRT alignment. Because of the reduction in number of travel lanes and/or the restriction of turn movements at key intersections, the 40 to 45 percent reduction could be expected.
- ◆ On the north/south roadways, the peak hour traffic volumes in general increased by 2 to 4 percent. The noted exceptions to this were along the alignment. On Alameda Street, the traffic decreased by 5 to 8 percent and along Indiana Street the traffic decreased by an average 24 percent.

The overall shifts in traffic identified above were applied to the Year 2020 No-Build peak hour turning movement volumes in order to develop the future LRT Build traffic volumes at each of the 54 study intersections.

### ***Intersection Traffic Service***

The future intersection geometrics for the No-Build conditions assumed no changes to the existing geometrics. As discussed previously, the proposed LRT project will result in changes to the geometrics at intersections along the alignment. The intersection traffic analysis accounted for these modifications.

The traffic signals on the proposed LRT alignment will require modification. An exclusive signal phase for the LRT is necessary at most locations. The intersection analysis assumed split phasing at intersections where no exclusive left-turn lane would be available due to the LRT project. The analysis incorporated a capacity reduction factor to reflect the time required by the LRT signal phase. The LRT capacity reduction factor was determined to be equivalent to a V/C of 0.22. This amount was added to the V/C ratio and equates to approximately 300 to 330 passenger cars added to the critical movement. This factor was based upon the following assumptions:

- ◆ Operation of 3-car trains at 5-minute headways per direction (train length is assumed to be approximately 270 feet).
- ◆ An average street running operating speed of 20 miles per hour.
- ◆ An average cross-street width of 80 feet.

The proposed Atlantic/Beverly Station was assessed to account for the patron related traffic utilizing the station. Parking areas are planned for the Pep Boys parking lot and at the intersection of Pomona and Atlantic Boulevards. A total of 200 parking spaces are planned. Future patron projections indicate that approximately 75 kiss-n-ride patrons would utilize the station during the evening peak hour. Traffic generated by the station was estimated and assigned to the local roadway system. Access to the parking and drop-off areas was assumed to be limited to right-turns entering and exiting only.

The future peak hour traffic volumes at the 54 study intersections were determined based upon the anticipated shifts in traffic and accounting for localized station related traffic. The future traffic operations were then analyzed utilizing the projected peak hour traffic volumes and accounting for modifications to the roadway geometrics and signal operations along the proposed alignment. The resulting intersection operations and LOS are provided in Table 3-14. As indicated in the table, 32 intersections are anticipated to operate at LOS D or better. Twenty-two intersections would operate at LOS E or F.

### **Summary of Impacts**

The future intersection operations under the No-Build and the LRT Build Alternative – Option A were compared. This comparison identified the study intersections where the LRT Build Alternative will result in significant traffic impacts under CEQA. The significant impact criteria utilized in this comparison were based upon the guidelines set forth by LADOT for the intersections within the City of Los Angeles, and by the County of Los Angeles for the intersections located in the County. The LADOT criteria are provided in Table 3-15, and the County criteria are provided in Table 3-16. As seen in Table 3-14, a total of 20 intersections are anticipated to be significantly impacted prior to mitigation. It should be noted that 11 intersections are expected to be positively impacted by the proposed LRT Build Alternative.

E/W Street	N/S Street	Jurisdiction	LRT		V/C or Delay Increase <sup>1</sup>	Significant Impact
			V/C	LOS		
Cesar Chavez Av	Vignes St	LADOT	0.851	D	0.015	NO
Cesar Chavez Av	Mission Rd	LADOT	0.769	C	0.005	NO
Cesar Chavez Av	Boyle Av	LADOT	0.608	B	0.006	NO
Cesar Chavez Av	State St	LADOT	0.733	C	0.008	NO
Cesar Chavez Av	I-5 SB Ramps	LADOT	13.2	B	0.7	NO
Cesar Chavez Av	I-5 NB Ramps	LADOT	0.467	A	0.013	NO
Cesar Chavez Av	Soto St	LADOT	0.697	B	0.017	NO



**TABLE 3-14**  
**SUMMARY OF 2020 INTERSECTION IMPACTS – OPTION A**

E/W Street	N/S Street	Jurisdiction	LRT		V/C or Delay Increase <sup>1</sup>	Significant Impact
			V/C	LOS		
Cesar Chavez Av	Evergreen Av	LADOT	0.657	B	0.020	NO
Cesar Chavez Av	Lorena St	LADOT	0.636	B	0.018	NO
Cesar Chavez Av	Indiana St	LA County	48.2	E	-28.3	NO
Cesar Chavez Av	Rowan Av	LA County	0.676	B	0.013	NO
Cesar Chavez Av	Eastern Av	LA County	0.693	B	0.020	NO
Cesar Chavez Av	Mednik Av	LA County	1.165	F	0.024	YES
Cesar Chavez Av	Atlantic Bl	Monterey Park	1.113	F	0.048	YES
Commercial St	Alameda St	LADOT	0.924	E	0.331	YES
Commercial St	Vignes St	LADOT	<sup>2</sup>	F	<sup>2</sup>	YES
Temple St	Alameda St	LADOT	0.790	C	-0.053	NO
1st St	Alameda St	LADOT	1.009	F	-0.078	NO
1st St	Vignes St	LADOT	1.055	F	0.460	YES
1st St	Mission Rd	LADOT	1.048	F	0.150	YES
1st St	101 SB Ramps	LADOT	58.8	F	22.4	YES
1st St	101 NB Ramps	LADOT	0.408	A	-0.029	NO
1st St	Boyle Av	LADOT	0.541	A	-0.072	NO
1st St	Soto St	LADOT	0.785	C	-0.050	NO
1st St	Evergreen Av	LADOT	0.485	A	-0.053	NO
1st St	Lorena St	LADOT	1.092	F	0.641	YES
1st St	Indiana St	LADOT	1.215	F	0.543	YES
1st St	Alma Av	LA County	<sup>2</sup>	F	<sup>2</sup>	YES
1st St	Rowan Av	LA County	0.399	A	0.038	NO
1st St	Eastern Av	LA County	0.515	A	0.033	NO
1st St	Mednik Av	LA County	0.608	B	0.043	NO
1st St	Atlantic Bl	Monterey Park	1.120	F	0.100	YES
3rd St	Alameda St	LADOT	0.595	A	-0.030	NO
4th St	Alameda St	LADOT	0.789	C	-0.021	NO
4th St	101 SB Ramps	LADOT	12.8	B	0.3	NO
4th St	101 NB Ramps	LADOT	0.493	A	0.005	NO
4th St	Boyle Av	LADOT	0.450	A	-0.014	NO
4th St	I-5 SB Ramps	LADOT	<sup>2</sup>	F	<sup>2</sup>	YES
4th St	I-5 NB Ramps	LADOT	0.672	B	0.014	NO
4th St	Soto St	LADOT	0.665	B	0.001	NO
4th St	Evergreen Av	LADOT	0.479	A	0.018	NO
4th St	Euclid Av	LADOT	0.478	A	0.003	NO
3rd St	Indiana St	LADOT	1.309	F	0.285	YES
3rd St	Alma Av	LA County	9.5	A	-14.0	NO
3rd St	Rowan Av	LA County	1.000	E	0.299	YES
3rd St	Eastern Av	LA County	1.345	F	0.406	YES
3rd St	Ford Bl	LA County	1.132	F	0.565	YES
3rd St	Mednik Av	LA County	1.244	F	0.522	YES
3rd St	Pomona					
3rd St	Bl/Beverly	LA County	1.016	F	0.143	YES
	Bl/Woods Av					
Pomona Bl	Atlantic Bl	LA County	0.977	E	-0.004	NO
Beverly Bl	Atlantic Bl	LA County	1.894	F	0.743	YES
Beverly Bl	Hillview Av	LA County	0.497	A	-0.134	NO
SR 60 EB Ramp	Atlantic Bl	LA County	0.779	C	0.088	YES
4th St	Atlantic Bl	LA County	0.686	B	0.037	NO

<sup>1</sup> over 2020 No Build results, Table 3-12<sup>2</sup> LRT intersection delay is estimated to exceed 999.9 sec/veh.

Source: Parsons Brinckerhoff, 2001.

**TABLE 3-15  
LADOT INTERSECTION CRITERIA**

<b>Intersection V/C Ratio with Project Traffic</b>	<b>Significant Increase in V/C ratio</b>
0.000 – 0.700	< 0.060
0.701 – 0.800	< 0.040
0.801 – 0.900	< 0.020
0.901 or greater	< 0.010

Source: City of Los Angeles, Department of Transportation, 2000.

**TABLE 3-16  
LOS ANGELES COUNTY INTERSECTION CRITERIA**

<b>Intersection V/C Ratio with Project Traffic</b>	<b>Significant Increase in V/C ratio</b>
0.701 – 0.800	< 0.040
0.801 – 0.900	< 0.020
0.901 or greater	< 0.010

Source: County of Los Angeles, Traffic Impact Analysis Guidelines, 1997.

### 3.2.3.3 LRT Build Alternative – Option B

The impacts of Option B are similar to Option A with the exceptions noted below.

#### *Traffic Lane Reductions*

Commercial, Alameda, and 3<sup>rd</sup> Streets maintain the same layout as previously described in Option A in Section 3.2.3.2. The differences for 1<sup>st</sup> and Indiana Streets and Pomona Boulevard are described below.

#### 1<sup>st</sup> Street

1<sup>st</sup> Street is very similar for both Options A and B. The only difference is at the 1<sup>st</sup>/Lorena Station, which is moved to 3<sup>rd</sup>/Indiana under Option B. The portal will come up in the middle of 1<sup>st</sup> Street just east of Concord Street and the alignment will remain in the center of the street. From the tunnel portal to Indiana Street, one lane in each direction (11-foot traffic lanes) and 8-foot curb parking lanes will be provided.

#### Indiana Street

Option B involves an off-street at-grade alignment between 1<sup>st</sup> and 3<sup>rd</sup> Streets. The alignment will be located on the eastern side of Indiana Street outside the current street right-of-way, and Ramona High School will be either relocated or rebuilt based on an agreement between LAUSD and MTA. The station at 1<sup>st</sup>/Lorena in Option A will be moved to 3<sup>rd</sup>/Indiana. This configuration will allow one traffic lane and one parking lane in each direction. Figure 3-8 illustrates the typical Indiana Street cross-section.

#### Pomona Boulevard

Because the eastern terminal station has been moved from Beverly/Atlantic to Pomona/Atlantic, the alignment for Option B does not travel along Beverly Boulevard from 3<sup>rd</sup> Street to just east of Atlantic. Instead, the alignment continues east on 3<sup>rd</sup> Street and a short distance on Pomona Boulevard to the

terminal station just west of Atlantic Boulevard. However, the revised station is within walking distance of the former site. Under Option B, Pomona Boulevard will have one traffic lane removed in each direction because the LRT system will be located in a trench slightly below street level. The median will be removed on Pomona where the LRT will occupy the center of the street between 3<sup>rd</sup> Street/Woods Avenue and Hillview Avenue. One 10.5-foot traffic lane in each direction will be provided at the station. Curb parking will be maintained with existing regulations that stipulate that 2-hour parking is permitted between 7 a.m. and 6 p.m. Sidewalks will not be modified along Pomona Boulevard. Figure 3-12 illustrates the typical Pomona Boulevard cross-section.

#### ***Summary of Traffic Lane Reductions along the LRT Alignment***

A summary of lane reductions for Option B is provided in Table 3-13 and Figure 3-11. Refer to Section 3.2.3.2 for more information.

#### ***Traffic Circulation and Neighborhood Accessibility***

Same as Option A.

#### ***Shifts in Traffic Patterns along the LRT Alignment***

Same as Option A.

#### ***Intersection Traffic Service***

As with Option A, the future peak hour traffic volumes at the study intersections were determined based upon the anticipated shifts in traffic and accounting for localized station related traffic. The future traffic operations were then analyzed utilizing the projected peak hour traffic volumes and accounting for modifications to the roadway geometrics and signal operations along the proposed alignment. The resulting intersection operations and LOS under Option B are provided in Table 3-17.

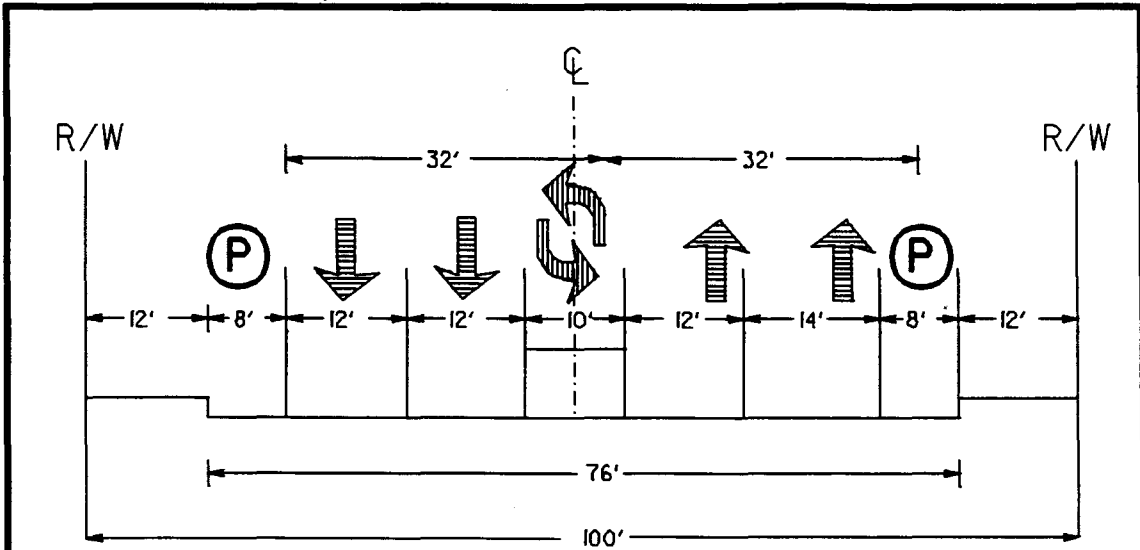
E/W Street	N/S Street	Jurisdiction	LRT		V/C or Delay Increase <sup>1</sup>	Significant Impact
			V/C	LOS		
Cesar Chavez Av	Vignes St	LADOT	0.851	D	0.015	NO
Cesar Chavez Av	Mission Rd	LADOT	0.769	C	0.005	NO
Cesar Chavez Av	Boyle Av	LADOT	0.608	B	0.006	NO
Cesar Chavez Av	State St	LADOT	0.733	C	0.008	NO
Cesar Chavez Av	I-5 SB Ramps	LADOT	13.2	B	0.7	NO
Cesar Chavez Av	I-5 NB Ramps	LADOT	0.467	A	0.013	NO
Cesar Chavez Av	Soto St	LADOT	0.697	B	0.017	NO
Cesar Chavez Av	Evergreen Av	LADOT	0.657	B	0.020	NO
Cesar Chavez Av	Lorena St	LADOT	0.636	B	0.018	NO
Cesar Chavez Av	Indiana St	LA County	48.2	E	-28.3	NO
Cesar Chavez Av	Rowan Av	LA County	0.676	B	0.013	NO
Cesar Chavez Av	Eastern Av	LA County	0.693	B	0.020	NO
Cesar Chavez Av	Mednik Av	LA County	1.165	F	0.024	YES
Cesar Chavez Av	Atlantic Bl	Monterey Park	1.113	F	0.048	YES
Commercial St	Alameda St	LADOT	0.924	E	0.331	YES
Commercial St	Vignes St	LADOT	<sup>2</sup>	F	<sup>2</sup>	YES
Temple St	Alameda St	LADOT	0.790	C	-0.053	NO

E/W Street	N/S Street	Jurisdiction	LRT		V/C or Delay Increase <sup>1</sup>	Significant Impact
			V/C	LOS		
1 <sup>st</sup> St	Alameda St	LADOT	1.009	F	-0.078	NO
1 <sup>st</sup> St	Vignes St	LADOT	1.055	F	0.460	YES
1 <sup>st</sup> St	Mission Rd	LADOT	1.048	F	0.150	YES
1 <sup>st</sup> St	101 SB Ramps	LADOT	58.8	F	22.4	YES
1 <sup>st</sup> St	101 NB Ramps	LADOT	0.408	A	-0.029	NO
1 <sup>st</sup> St	Boyle Av	LADOT	0.541	A	-0.072	NO
1 <sup>st</sup> St	Soto St	LADOT	0.785	C	-0.050	NO
1 <sup>st</sup> St	Evergreen Av	LADOT	0.485	A	-0.053	NO
1 <sup>st</sup> St	Lorena St	LADOT	1.131	F	0.680	YES
1 <sup>st</sup> St	Indiana St	LADOT	1.232	F	0.560	YES
1 <sup>st</sup> St	Alma Av	LA County	<sup>2</sup>	F	<sup>2</sup>	YES
1 <sup>st</sup> St	Rowan Av	LA County	0.399	A	0.038	NO
1 <sup>st</sup> St	Eastern Av	LA County	0.515	A	0.033	NO
1 <sup>st</sup> St	Mednik Av	LA County	0.608	B	0.043	NO
1 <sup>st</sup> St	Atlantic Bl	Monterey Park	1.120	F	0.100	YES
3 <sup>rd</sup> St	Alameda St	LADOT	0.595	A	-0.030	NO
4 <sup>th</sup> St	Alameda St	LADOT	0.789	C	-0.021	NO
4 <sup>th</sup> St	101 SB Ramps	LADOT	12.8	B	0.3	NO
4 <sup>th</sup> St	101 NB Ramps	LADOT	0.493	A	0.005	NO
4 <sup>th</sup> St	Boyle Av	LADOT	0.450	A	-0.014	NO
4 <sup>th</sup> St	I-5 SB Ramps	LADOT	<sup>2</sup>	F	<sup>2</sup>	YES
4 <sup>th</sup> St	I-5 NB Ramps	LADOT	0.672	B	0.014	NO
4 <sup>th</sup> St	Soto St	LADOT	0.665	B	0.001	NO
4 <sup>th</sup> St	Evergreen Av	LADOT	0.479	A	0.018	NO
4 <sup>th</sup> St	Euclid Av	LADOT	0.478	A	0.003	NO
3 <sup>rd</sup> St	Indiana St	LADOT	1.110	F	0.086	YES
3 <sup>rd</sup> St	Alma Av	LA County	9.5	A	-14.0	NO
3 <sup>rd</sup> St	Rowan Av	LA County	1.000	E	0.299	YES
3 <sup>rd</sup> St	Eastern Av	LA County	1.345	F	0.406	YES
3 <sup>rd</sup> St	Ford Bl	LA County	1.110	F	0.543	YES
3 <sup>rd</sup> St	Mednik Av	LA County	1.244	F	0.522	YES
3 <sup>rd</sup> St	Pomona Bl/Beverly Bl/Woods Av	LA County	0.895	D	0.022	YES
Pomona Bl	Atlantic Bl	LA County	1.247	F	0.266	YES
Beverly Bl	Atlantic Bl	LA County	1.082	F	-0.069	NO
Beverly Bl	Hillview Av	LA County	0.497	A	-0.134	NO
SR 60 EB Ramp	Atlantic Bl	LA County	0.779	C	0.088	YES
4 <sup>th</sup> St	Atlantic Bl	LA County	0.686	B	0.037	NO

<sup>1</sup> over 2020 No Build results, Table 3-12  
<sup>2</sup> LRT intersection delay is estimated to exceed 999.9 sec/veh.  
Source: Parsons Brinckerhoff, 2001.

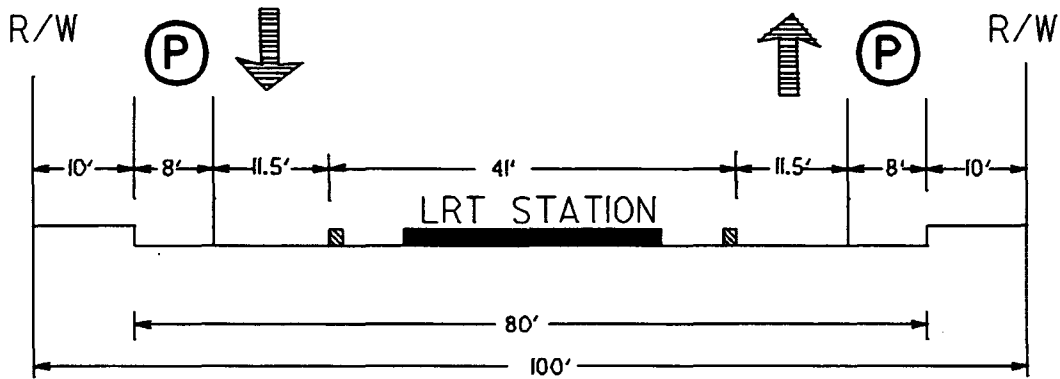
### Summary of Impacts

Table 3-17 indicates which locations are impacted per LADOT and County of Los Angeles guidelines by Option B. A total of 20 intersections are anticipated to be significantly impacted prior to mitigation. The major difference between the options is that the Pomona/Atlantic intersection is significantly impacted under Option B. However, the Beverly/Atlantic intersection is not significantly impacted.



**Existing (Same for Option A)**

Note: Cross Sections are shown looking in the direction of ascending stations, where zero station starts at Union Station and increases as you move towards the end of the line.



**Proposed at Station Areas for Option B**



**Eastside Corridor  
Transit Consultants**

**Pomona Blvd. Typical Cross-Section**

Figure 3-12



### 3.2.4 Mitigation – Option A

#### 3.2.4.1 Intersection Traffic Service

The intersections where significant traffic impacts are anticipated were evaluated to determine potential mitigation measures. The following modifications were considered:

- ◆ Modifications to intersection geometrics. This improvement was primarily limited to within the existing pavement width. If proposed traffic mitigation requires the narrowing of a sidewalk to provide additional roadway width, it will only be considered feasible if a minimum standard sidewalk width can be maintained.
- ◆ Changes to signal operations to improve efficiency.
- ◆ Signalization of selected intersections that are currently stop-controlled.
- ◆ The City of Los Angeles signal network system, referred to as the ATSAC system, coordinates signals for optimal operations. This is referred to as signal priority. The ATSAC system is currently in place in East Los Angeles, but will require the installation of additional software to coordinate with both car and train traffic.
- ◆ Prohibition of left turns at intersections along the alignment. This potential prohibition will allow for the LRT to operate concurrently with adjacent traffic and eliminate the need for split-phasing. Intersections with left turn prohibitions recommended as mitigation are listed in Table 3-18. This mitigation measure will also consider the potential impacts on adjacent locations where the left turn prohibitions will shift traffic volumes.

Street Name	Option A	Option B
1 <sup>st</sup> Street / Lorena Street	EB & WB	-
1 <sup>st</sup> Street / Indiana Street	EB	EB
3 <sup>rd</sup> Street / Indiana Street	WB	WB
3 <sup>rd</sup> Street / Pomona / Beverly / Woods	-	WB (Beverly to Woods)
Beverly Blvd. / Atlantic Blvd.	EB	-

Source: Parsons Brinckerhoff, 2001

It should be noted that along the alignment, several intersections were considered for left turn prohibitions as a mitigation. However, if the prohibition resulted in increased impacts to adjacent intersections that were already projected to operate at poor levels of service, this type of mitigation measure was not considered effective. For example, on Alameda Street, there are significant impacts at both Temple Street and 1<sup>st</sup> Street. The prohibition of left-turns at one of these locations will shift the impacts to the other location. Additionally, along 3<sup>rd</sup> Street, between Indiana Street and Beverly Boulevard, there are several locations where left-turns can be prohibited. However, the study intersections along 3<sup>rd</sup> Street are all projected to operate at level of service E or F. A shift of left-turns to an adjacent intersection will impact other locations that are already expected to operate with long delays. In addition, the potential shift of traffic onto adjacent residential streets was not considered a feasible mitigation measure.

The following list covers the planned improvements based on the mitigation measures considered to be feasible.

- ◆ Cesar Chavez Avenue and Mednik Avenue – Restripe the westbound and eastbound Cesar Chavez approaches to provide the following: one left-turn lane, one through lane, and one shared through/right-turn lane.

- ◆ Cesar Chavez Avenue and Atlantic Boulevard – Restripe the westbound and eastbound Cesar Chavez approaches to provide the following: one left-turn lane, two through lanes, and an exclusive right-turn lane.
- ◆ Commercial Street and Alameda Street – Augment existing ATSAC with additional software necessary for the efficient handling of both car and train traffic.
- ◆ 1<sup>st</sup> Street and Alameda Street – Augment existing ATSAC with additional software necessary for the efficient handling of both car and train traffic.
- ◆ 1<sup>st</sup> Street and Vignes Street – Augment existing ATSAC with additional software necessary for the efficient handling of both car and train traffic.
- ◆ 1<sup>st</sup> Street and Mission Road – Augment existing ATSAC with additional software necessary for the efficient handling of both car and train traffic.
- ◆ 1<sup>st</sup> Street and 101 SB Ramps – Signalization of this intersection is proposed.
- ◆ 1<sup>st</sup> Street and Lorena Street – Prohibit the eastbound and westbound left-turns. This will result in permissive east/west signal phasing and accommodate the LRT during the permissive phase.
- ◆ 1<sup>st</sup> Street and Indiana Street – Prohibit the eastbound left-turns. The signal phasing in the westbound direction will accommodate a protected only left-turn phase. The north/south phasing will be split and the LRT will be accommodated during the northbound signal phase.
- ◆ 1<sup>st</sup> Street and Alma Avenue – Signalization of this intersection is proposed.
- ◆ 1<sup>st</sup> Street and Atlantic Boulevard – Restripe the westbound approach from SR 60 WB Ramp to provide the following: one left-turn lane, one through lane, and an exclusive right-turn lane. Restripe the eastbound approach on 1<sup>st</sup> Street to provide the following: one left-turn lane and two exclusive right-turn lanes.
- ◆ 4<sup>th</sup> Street and I-5 SB Ramps – Signalization of this intersection is proposed.
- ◆ 3<sup>rd</sup> Street and Indiana Street – Prohibit the westbound left-turn. The eastbound phase will accommodate a protected only left-turn. The westbound direction will have permissive phasing. The northbound and southbound directions will be split phase. The LRT will operate during the southbound signal phase.
- ◆ 3<sup>rd</sup> Street and Rowan Avenue – Impose peak hour parking restrictions in the westbound direction. The westbound approach on 3<sup>rd</sup> Street will accommodate: one shared left-turn/through lane and one shared through/right-turn lane.
- ◆ 3<sup>rd</sup> Street and Eastern Avenue – Impose peak hour parking restrictions in the westbound direction. The westbound approach on 3<sup>rd</sup> Street will accommodate: one shared left-turn/through lane and one shared through/right-turn lane.
- ◆ 3<sup>rd</sup> Street and Ford Boulevard – Impose peak hour parking restrictions in the westbound direction. The westbound approach on 3<sup>rd</sup> Street will accommodate: one shared left-turn/through lane and one shared through/right-turn lane.
- ◆ 3<sup>rd</sup> Street and Mednik Avenue – Impose peak hour parking restrictions in the westbound direction. The westbound approach on 3<sup>rd</sup> Street will accommodate one shared left-turn/through lane and one shared through/right-turn lane.
- ◆ 3<sup>rd</sup> Street and Pomona Bl/Beverly Bl/Woods Av – Impose peak hour parking restrictions on Beverly Boulevard. The northbound approach on Beverly Boulevard will accommodate: one lane from Beverly to 3<sup>rd</sup> Street and one shared lane from Beverly to both 3<sup>rd</sup> Street and Woods Avenue.
- ◆ Beverly Boulevard and Atlantic Boulevard – Prohibit the eastbound left-turn on Beverly Boulevard. Impose peak hour parking restrictions on Beverly Boulevard. The westbound approach on Beverly will provide the following: one shared left-turn/through lane and one shared through/right-turn lane. The eastbound approach on Beverly will provide the following: one through lane and one shared through/right-turn lane.
- ◆ SR 60 EB Ramp and Atlantic Boulevard – No mitigation measures are considered feasible at this location.



### 3.2.4.2 Access to Businesses

Access to businesses along the Eastside Corridor right-of-way will be maintained. Delivery trucks will be able to access businesses via right-hand turns. If there is not enough room to accommodate a right-hand turn, the MTA will provide an alternative access point.

### 3.2.4.3 Impacts After Mitigation

The results of the intersection level of traffic service analysis with the mitigation measures are provided in Table 3-19. The table indicates those locations where residual significant impacts will occur. The following 12 intersections will continue to be impacted to significant levels with the planned mitigation measures:

- ◆ Commercial Street and Alameda Street
- ◆ 1<sup>st</sup> Street and Vignes Street
- ◆ 1<sup>st</sup> Street and Mission Road
- ◆ 1<sup>st</sup> Street and Indiana Street
- ◆ 3<sup>rd</sup> Street and Indiana Street
- ◆ 3<sup>rd</sup> Street and Rowan Avenue
- ◆ 3<sup>rd</sup> Street and Eastern Avenue
- ◆ 3<sup>rd</sup> Street and Ford Boulevard
- ◆ 3<sup>rd</sup> Street and Mednik Street
- ◆ 3<sup>rd</sup> Street and Pomona Bl/Beverly Bl/Woods Av
- ◆ Beverly Boulevard and Atlantic Boulevard
- ◆ SR 60 EB Ramp and Atlantic Boulevard

There are several locations where left-turn prohibitions are part of the mitigation measures. These prohibitions result in a re-routing of traffic within the study area. Five intersections, shown in Table 3-20, will be affected by this re-routed traffic. As indicated in the table, the re-routed traffic is not anticipated to significantly impact these five locations.

E/W Street	N/S Street	Jurisdiction	LRT w/ Mitigation		V/C Increase <sup>1</sup>	Residual Impact
			V/C	LOS		
Cesar Chavez Av	Mednik Av	LA County	1.027	F	-0.114	NO
Cesar Chavez Av	Atlantic Bl	Monterey Park	0.980	E	-0.085	NO
Commercial St	Alameda St	LADOT	0.897	D	0.304	YES
Commercial St	Vignes St	LADOT	0.796	C	N/A	NO
1 <sup>st</sup> St	Vignes St	LADOT	1.024	F	0.429	YES
1 <sup>st</sup> St	Mission Rd	LADOT	1.017	F	0.119	YES
1 <sup>st</sup> St	101 SB Ramps	LADOT	0.605	B	N/A	NO
1 <sup>st</sup> St	Lorena St	LADOT	0.551	A	0.100	NO
1 <sup>st</sup> St	Indiana St	LADOT	1.071	F	0.399	YES
1 <sup>st</sup> St	Alma Av	LA County	0.550	A	N/A	NO
1 <sup>st</sup> St	Atlantic Bl	Monterey Park	0.995	E	-0.025	NO
4 <sup>th</sup> St	I-5 SB Ramps	LADOT	0.679	B	N/A	NO
3 <sup>rd</sup> St	Indiana St	LADOT	1.104	F	0.08	YES
3 <sup>rd</sup> St	Rowan Av	LA County	0.901	E	0.200	YES
3 <sup>rd</sup> St	Eastern Av	LA County	1.289	F	0.350	YES
3 <sup>rd</sup> St	Ford Bl	LA County	0.988	E	0.421	YES
3 <sup>rd</sup> St	Mednik Av	LA County	1.153	F	0.431	YES
3 <sup>rd</sup> St	Pomona/Beverly/ Woods	LA County	0.929	E	0.056	YES
Beverly Bl	Atlantic Bl	LA County	1.397	F	0.246	YES
SR 60 EB Ramp	Atlantic Bl	LA County	0.779	C	0.088	YES

<sup>1</sup> over 2020 No Build results, Table 3-12  
Source: Parsons Brinckerhoff, 2001

E/W Street	N/S Street	Jurisdiction	LRT w/Adjacent Mitigation		V/C Increase <sup>1</sup>	Significant Impact
			V/C or Delay	LOS		
Cesar Chavez Av	Evergreen Av	LADOT	0.657	B	0.020	NO
Cesar Chavez Av	Lorena St	LADOT	0.667	B	0.049	NO
Cesar Chavez Av	Indiana St	LA County	45.4	E	-31.1	NO
1 <sup>st</sup> St	Evergreen Av	LADOT	0.577	A	0.039	NO
Pomona Bl	Atlantic Bl	LA County	0.983	E	0.002	NO

<sup>1</sup> over 2020 No Build results, Table 3-12  
Source: Parsons Brinckerhoff, 2001

### 3.2.5 Mitigation – Option B

#### 3.2.5.1 Intersection Traffic Service

The mitigations for all intersections except those listed here remain the same as in Option A. The intersections affected by mitigation involving the prohibition of left turns were listed previously in Table 3-18.

- ◆ 1<sup>st</sup> Street and Indiana Street – Prohibit the eastbound left-turns. The signal phasing in the westbound direction will accommodate a protected only left-turn phase. The north/south phasing will be permitted and the LRT will be accommodated during a separate signal phase.
- ◆ 3<sup>rd</sup> Street and Indiana Street – Prohibit the westbound left-turn. The eastbound phase will accommodate a protected only left-turn. The westbound direction will have permissive phasing. The northbound and southbound directions will be permitted phase. The LRT will operate during the north/south signal phase.
- ◆ 3<sup>rd</sup> Street and Rowan Avenue – Impose peak hour parking restrictions in the westbound direction. The westbound approach on 3rd Street will accommodate one shared left-turn/through lane and one shared through/right-turn lane.
- ◆ 3<sup>rd</sup> Street and Ford Boulevard – Impose peak hour parking restrictions in the westbound direction. The westbound approach on 3<sup>rd</sup> Street will accommodate one left, one through lane and one shared through/right-turn lane.
- ◆ 3<sup>rd</sup> Street and Pomona Bl/Beverly Bl/Woods Av – Prohibit the westbound left-turn from Beverly to Woods.
- ◆ Pomona Boulevard and Atlantic Boulevard – The eastbound phase will accommodate a protected only left-turn, and provide the following: one left-turn lane, one through lane, and one right-turn lane. The westbound direction will have permitted phasing.

#### 3.2.5.2 Impacts After Mitigation

The mitigation described for Option A will also be implemented for Option B

#### 3.2.5.3 Impacts After Mitigation

The results of the intersection level of traffic service analysis for Option B with the mitigation measures are provided in Table 3-21. The table indicates those locations where residual significant impacts will occur. The following ten intersections will continue to be impacted to significant levels with the proposed mitigation measures:

- ◆ Commercial Street and Alameda Street
- ◆ 1st Street and Vignes Street
- ◆ 1st Street and Mission Road
- ◆ 1st Street and Indiana Street
- ◆ 3rd Street and Rowan Avenue
- ◆ 3rd Street and Eastern Avenue
- ◆ 3rd Street and Ford Boulevard
- ◆ 3rd Street and Mednik Street
- ◆ Pomona Boulevard and Atlantic Boulevard
- ◆ SR 60 EB Ramp and Atlantic Boulevard

Unlike Option A, Option B has no residual impacts at 3<sup>rd</sup>/Indiana and 3<sup>rd</sup>/Pomona/Beverly/Woods.

E/W Street	N/S Street	Jurisdiction	LRT w/ Mitigation		V/C Increase <sup>1</sup>	Residual Impact
			V/C	LOS		
Cesar Chavez	Mednik Av	LA County	1.027	F	-0.114	NO
Cesar Chavez	Atlantic Bl	Monterey Park	0.980	E	-0.085	NO
Commercial St	Alameda St	LADOT	0.897	D	0.304	YES
Commercial St	Vignes St	LADOT	0.796	C	N/A	NO
1st St	Vignes St	LADOT	1.024	F	0.429	YES
1st St	Mission Rd	LADOT	1.017	F	0.119	YES
1st St	101 SB Ramps	LADOT	0.605	B	N/A	NO
1st St	Lorena St	LADOT	0.551	A	0.100	NO
1st St	Indiana St	LADOT	1.094	F	0.422	YES
1st St	Alma Av	LA County	0.550	A	N/A	NO
1st St	Atlantic Bl	Monterey Park	0.995	E	-0.025	NO
4th St	I-5 SB Ramps	LADOT	0.679	B	N/A	NO
3rd St	Indiana St	LADOT	0.843	D	-0.181	NO
3rd St	Rowan Av	LA County	0.901	E	0.200	YES
3rd St	Eastern Av	LA County	1.289	F	0.350	YES
3rd St	Ford Bl	LA County	0.943	E	0.376	YES
3rd St	Mednik Av	LA County	1.153	F	0.431	YES
3rd St	Pomona/Beverly/ Woods	LA County	0.860	D	-0.013	NO
Pomona Bl	Atlantic Bl	LA County	1.107	F	0.126	YES
SR 60EB Ramp	Atlantic Bl	LA County	0.779	C	0.088	YES

<sup>1</sup> over 2020 No Build results, Table 3-12  
Source: Parsons Brinckerhoff, 2001

As in Option A, there are several locations in Option B where left-turn prohibitions are mitigation measures. These prohibitions result in a re-routing of traffic within the study area. Option B resulted in a change to one intersection, shown in Table 3-22. As indicated in the table, the re-routed traffic is not anticipated to significantly impact this location.

E/W Street	N/S Street	Jurisdiction	LRT w/Adjacent Mitigation		V/C Increase <sup>1</sup>	Significant Impact
			V/C or Delay	LOS		
Cesar Chavez Av	Evergreen Av	LADOT	0.657	B	0.020	NO
Cesar Chavez Av	Lorena St	LADOT	0.667	B	0.049	NO
Cesar Chavez Av	Indiana St	LA County	45.4	E	-31.1	NO
1st St	Evergreen Av	LADOT	0.577	A	0.039	NO
Beverly Bl	Atlantic Bl	LA County	1.075	F	-0.076	NO

<sup>1</sup> over 2020 No Build results, Table 3-12  
Source: Parsons Brinckerhoff, 2001

### 3.3 PARKING

#### 3.3.1 Affected Environment

A comprehensive data collection effort was undertaken to develop a detailed description of the street characteristics along the LRT alignment, including the availability of on-street parking. The collected data provides the number of travel lanes by direction, type of median, speed limit, and the presence of on-street parking and associated parking restrictions, if any. Along most of the alignment, parking regulations permit on-street parking in one or both directions during peak hours and in both directions during off-peak hours. Table 3-23 provides a summary of this information.

#### 3.3.2 Impacts

##### 3.3.2.1 No-Build Alternative

The No-Build Alternative has no impact on the number of on-street parking spaces in the Eastside Corridor.

##### 3.3.2.2 LRT Build Alternative – Option A

Parking supply was based on 1999 and 2000 field surveys to inventory the number of parking spaces available. Every street segment was surveyed along the alignment where it has an at-grade profile. The survey also yielded parking restriction information on each of the street segments to determine whether parking is permitted in each block. For example, the presence of a 24-hour parking prohibition on a block where the LRT is running would yield no potential parking impact because there was no parking available in the No-Build condition.

The number of parking spaces removed was estimated based on the characteristics of each street segment and the proposed LRT street cross-sections. As the typical cross-sections illustrate in Figures 3-6 and 3-9, 1<sup>st</sup> Street has a curb-to-curb width of 56 feet and 3<sup>rd</sup> Street has a curb-to-curb width of 82 feet. Parking impacts are different on 1<sup>st</sup> Street under both options than on 3<sup>rd</sup> Street because of the differing curb-to-curb street widths. The anticipated impacts along each of the street segments that the alignment would traverse are discussed below.

##### *Commercial Street*

In the section of Commercial Street that will be affected by the LRT alignment aerial structure and at-grade section, curb parking is currently prohibited. There will be no parking impacts along Commercial Street.

##### *Alameda Street*

In the section of Alameda Street that will be affected by the LRT alignment between Commercial Street and 1<sup>st</sup> Street, curb parking is currently prohibited. There will be no parking impacts along Alameda Street.

**TABLE 3-23  
EXISTING ROADWAY CHARACTERISTICS**

Segment	From	To	No. Lanes		Median Type	Parking Restrictions		Speed Limit
			NB/EB	SB/WB		NB/EB	SB/WB	
Alameda St	Commercial St	Temple St	3	3	2LT	NSAT	NSAT	35
	Temple St	1 <sup>st</sup> St	2	2	2LT	NSAT	NSAT	35
1st St	Alameda St	Rose St	2	2	DY	NSAT	NSAT	30
	Rose St	Vignes St	2	2	DY	2HR (m)PA 8a-4p (NS 4-6p)	2HR (m)PA 9a-6p (NS 7a-9p)	30
	Vignes St	Mission Rd	2	2	DY	NSAT	NSAT	30
	Mission Rd	Anderson St	2	2	DY	NSAT	NSAT	30
	Anderson St	Clarence St	2	2	DY	1HR PA 8a-4p (NS 4-7p)	1HR PA 9a-6p (NS 7a-9p)	30
	Clarence St	Gless St	2	2	DY	1HR PA 8a-4p (NS 4-7p)	PA (NS 7-9a)	30
	Gless St	Boyle Av	2	2	DY	NSAT	NSAT	30
	Boyle Av	Mathews St	2	2	DY	1HR (m)PA 8a-6p	1HR (m)PA 8a-6p	30
	Mathews St	Fickett St	2	2	DY	1HR (m)PA 8a-6p	1HR (m)PA 8a-6p	30
	Fickett St	Mott St	2	2	DY	PA	1HR (m)PA 8a-6p	30
	Mott St	Saratoga St	2	2	2LT	NPAT 8a-6p	PA	30
	Saratoga St	Savannah St	2	2	DY	NPAT 7a-5p	PA	30
	Savannah St	Lorena St	2	2	DY	PA	PA	30
	Lorena St	Cheesbroughs Ln	2	2	DY	1HR PA 8a-6p	PA	30
Cheesbroughs Ln	Indiana St	2	2	DY	1HR PA 8a-6p	NSAT	30	
Indiana St	1st St	3 <sup>rd</sup> St	1	1	SDY	PA	PA	30
3 <sup>rd</sup> St	Indiana St	Gage St	2(3)	2(3)	2LT	PA (NS 4-6p)	PA (NS 6:30-9a)	35
	Gage St	Herbert Av	2(3)	2(3)	RM	PA (NS 4-6p)	PA (NS 6:30-9a)	35
	Herbert Av	Downey Rd	3	3	RM	NSAT	NSAT	35
	Downey Rd	Sunol Dr	3	3	RM	NSAT	NSAT	35
	Sunol Dr	Eastern Av	2(3)	2(3)	2LT	PA (NS 4-6p)	PA (NS 6:30-9a)	35
	Eastern Av	Humphreys Av	2(3)	2(3)	2LT	PA (NS 4-6p)	PA (NS 6:30-9a)	35
	Humphreys Av	Ford Bl	2(3)	2(3)	DY	PA (NS 4-6p)	PA (NS 6:30-9a)	35
	Ford Bl	Mednik Av	2(3)	2(3)	2LT	PA (NS 4-6p)	PA (NS 6:30-9a)	35
	Mednik Av	Fetterly Av	2(3)	2(3)	2LT	PA (NS 4-6p)	2HR PA 9a-6p (NS 6:30-9a)	35
	Fetterly Av	Beverly Bl	2(3)	2(3)	2LT	PA (NS 4-6p)	PA (NS 6:30-9a)	35
Beverly Bl	3rd St	Atlantic Bl	2	2	RM	PA	2HR PA 8a-5p	35
	Atlantic Bl	Margaret St	2	2	RM	2HR PA 7a-6p	2HR PA 7a-6p	35
Pomona Bl	3 <sup>rd</sup> St/Woods Av	Atlantic Bl	2	2	RM	PA	2HR PA 8a-5p	35
	Atlantic Bl	Hillview Ave.	2	2	RM	2HR PA 7a-6p	2HR PA 7a-6p	35

**Notes:****Lanes:** #( # ) = Number of Lanes (Lanes during Peak Hours)**Parking:** (m) = Metered Parking

PA = Parking Allowed with No Restrictions except for Street Sweeping

NSAT = No Stopping Anytime NPAT = No Parking Anytime

Source: Field Survey, Jenkins/Gales &amp; Martinez, 1999.

**Median Type:**

DY = Double Yellow Centerline

RM = Raised Median

2LT = Dual Left Turn Centerline

SDY = Single Dashed Yellow Centerline

**1<sup>st</sup> Street**

Figure 3-6 in Section 3.2 shows the typical cross-section dimensions and lane configurations for the existing conditions and the LRT Build Alternative scenario both at a station and between stations at-grade. There are no parking impacts at locations where the LRT is in a tunnel profile except near the

portals at each end of the tunnel. There will be parking spaces removed on 1<sup>st</sup> Street in the vicinity of at-grade LRT stations. The curb-to-curb street width on 1<sup>st</sup> Street (56 feet) is not sufficient to accommodate the light rail system in the center of the street and maintain two traffic lanes plus parking in each direction in the vicinity of at-grade stations or near tunnel portals located near Utah Street and Lorena Street. On other areas of 1<sup>st</sup> Street with at-grade rail, existing curb parking will be retained and sidewalks narrowed from 12 feet to 8 feet in order to provide sufficient space for traffic lanes and parking.

On-street parking on 1<sup>st</sup> Street is impacted in three areas: from Alameda Street to Vignes Street, from Anderson Street to the 101 Freeway, and from 200 feet west of Concord Street to Cheesbroughs Street. There will be no parking impacts on 1<sup>st</sup> Street in the areas where the LRT is in a tunnel profile, except in the vicinity of the portals near Utah Street and Lorena Street. There will also be no parking impacts between Cheesbroughs and Indiana Streets. In these blocks, sidewalks will be narrowed from 12 to 8 feet and parking will be retained. Parking is currently prohibited on the 1<sup>st</sup> Street Bridge over the Los Angeles River between Vignes Street and Mission Road.

During the AM Peak period, 100 on-street parking spaces will be removed under Option A. During the Midday period, 162 spaces will be removed, and 113 parking spaces will be removed during the PM Peak period. More parking spaces are removed during the midday period because there are fewer parking restrictions already in place at that time. In the morning and evening, peak hour parking restrictions limit the amount of available parking, so there is less parking affected by the LRT.

The spaces removed between Alameda Street and the Los Angeles River are metered, 1-hour only spaces. The remainder of the spaces removed are unmetered spaces. The impacted spaces located between the Los Angeles River and the 101 Freeway and between Lorena and Indiana Streets have a 1-hour time limit, but are not metered. Between Fresno and Lorena Streets, on-street parking is unrestricted. In the area where there are peak hour parking prohibitions (between Alameda Street and the 101 Freeway), spaces will be removed on the south side of the street (eastbound travel direction) in the AM Peak period (7-9 a.m.) and on the north side of the street (westbound travel direction) in the PM Peak period (4-6 p.m.). Parking on both sides of the street will be removed in the Midday period in this section. Refer to Table 3-24.

### *Indiana Street*

Table 3-25 shows the number of parking spaces that would be removed in each block along Indiana Street. Parking data on the table is disaggregated for each roadway segment along Indiana Street by side of the street, spaces available, and by time period (AM peak, off-peak, and PM peak). Because Indiana Street has no peak-hour parking prohibitions, parking impacts are the same for each time period during the day. Option A removes all parking on Indiana Street along the LRT alignment (between 1<sup>st</sup> and 3<sup>rd</sup> Streets). The number of on-street parking spaces removed under Option A is 48 for all time periods during the day. No on-street parking spaces have time restrictions or meters except for weekly street-sweeping operations.

### Parking Utilization Analysis

A parking utilization analysis study was conducted in order to assess the demand for parking on Indiana Street. The study was conducted in the Midday and PM Peak periods, and one parking count was performed at 10:00 p.m. in order to assess nightly parking utilization. Parking counts were performed on Thursday, June 15, 2000 between 12:00 p.m. and 6:00 p.m. The number of cars parked on the street was tallied at half-hour intervals with one count being performed at 10:00 p.m.

Block		Side of Street	Spaces Available	Spaces Removed AM Peak	Spaces Removed Off-Peak	Spaces Removed PM Peak
From	To					
Alameda	Rose	North	4	0	4	4
		South	0	0	0	0
Rose	Hewitt	North	6	0	6	6
		South	6	6	6	0
Hewitt	Garey	North	9	0	9	9
		South	5	5	5	0
Garey	Vignes	North	1	0	1	1
		South	1	1	1	0
Vignes	Mission	North	0	0	0	0
		South	0	0	0	0
Mission	Anderson	North	0	0	0	0
		South	0	0	0	0
Anderson	Utah	North	12	0	12	12
		South	12	12	12	0
Utah	Clarence	North	12	0	12	12
		South	10	10	10	0
Clarence	Gless	North	10	0	10	10
		South	9	9	9	0
Gless	Pecan	North	8	0	8	8
		South	6	6	6	0
Pecan	US-101 SB Ramp	North	0	0	0	0
		South	0	0	0	0
Fresno	Concord	North	20	8 <sup>1</sup>	8 <sup>1</sup>	8 <sup>1</sup>
		South	27	0	0	0
Concord	Lorena	North	14	14 <sup>1</sup>	14 <sup>1</sup>	14 <sup>1</sup>
		South	14	0	0	0
Lorena	Cheesbroughs	North	9	7 <sup>1</sup>	7 <sup>1</sup>	7 <sup>1</sup>
		South	7	0	0	0
Cheesbroughs	Velasco	North	8	0	0	0
		South	6	0	0	0
Velasco	Indiana	North	4	0	0	0
		South	1	0	0	0
<b>TOTALS</b>		Option A	221	78	140	91
		Option B	221	49	111	62

<sup>1</sup> Parking on the North side of these blocks is maintained in Option B.  
Source: Parsons Brinckerhoff, 2000-2001.



Block		Side of Street	Spaces Available	Spaces Removed AM Peak	Spaces Removed Off-Peak	Spaces Removed PM Peak
From	To					
1 <sup>st</sup> Street	Gleason	East	6	6	6	6
		West	8	8	8	8
Gleason	2 <sup>nd</sup> Street	East	14	14	14	14
		West	10	10	10	10
2 <sup>nd</sup> Street	3 <sup>rd</sup> Street	East	6	6	6	6
		West	4	4	4	4
<b>Total</b>			<b>48</b>	<b>48</b>	<b>48</b>	<b>48</b>

Source: Parsons Brinckerhoff, 2000.

The results of the utilization study are found in Tables 3-26 and 3-27. Overall parking utilization rates tend to be clustered in the 45%-60% range for both sides of Indiana Street between 1<sup>st</sup> and 3<sup>rd</sup> Streets. There are several hours where parking utilization is over 65% with one hour showing a utilization of 100% on the west side of the street between Gleason and 2<sup>nd</sup> Street. Although the northern block between 1<sup>st</sup> and Gleason Streets has some commercial uses, there is a substantial amount of residential uses on the west side of Indiana. The east side of the street contains Ramona High School. Table 3-27 shows a summary of parking utilization rates combining the three blocks between 1<sup>st</sup> and 3<sup>rd</sup> Streets on Indiana Street.

Time Period	Side of Street	Spaces Available	Utilization Rate
Midday	East	26	53%
	West	22	45%
PM Peak	East	26	45%
	West	22	61%
Night	East	26	46%
	West	22	32%

Source: Parsons Brinckerhoff, 2000.

### ***3rd Street and Beverly Boulevard***

In the sections of 3<sup>rd</sup> Street and Beverly Boulevard that will be affected by the LRT alignment, all existing parking regulations will be retained. There will be no parking impacts along 3rd Street or Beverly Boulevard.

### ***Summary of Parking Impacts***

The width of the streets along the LRT alignment largely determine whether curb parking spaces will be removed and during which time period during the day. Indiana Street will have parking removals during all periods of the day under Option A. There will be no parking impacts on Commercial Street, Alameda Street, 3<sup>rd</sup> Street, or Beverly Boulevard. Table 3-28 summarizes the total number of curb parking spaces removed by time period during the day by alignment option. Option A has the greatest number of spaces removed, which is due to the removal of parking on Indiana Street during all three time periods. In addition, parking losses and mitigation for losses due to the M&SF yard on Ducommon Street are

discussed in Section 4.20. Figure 3-13 illustrates the parking impacts for both options. Section 3.3.2.3 provides additional information about the impacts of Option B.

Block	Side	Capacity	Number of Occupied Spaces							
			Midday				PM Peak			Night
			12:00pm	1:00pm	2:00pm	3:00pm	4:00pm	5:00pm	6:00pm	10:00pm
1st to Gleason	East	6	1 17%	2 33%	3 50%	1 17%	3 50%	2 33%	3 50%	1 17%
	West	8	3 38%	5 63%	3 38%	3 38%	4 50%	3 38%	1 13%	0 0%
Gleason to 2nd	East	14	8 57%	7 50%	8 57%	8 57%	6 43%	9 64%	5 36%	10 71%
	West	10	5 50%	7 70%	5 50%	5 50%	9 90%	9 90%	10 100%	6 60%
2nd to 3rd	East	6	4 67%	4 67%	4 67%	5 83%	3 50%	3 50%	1 17%	1 17%
	West	4	2 50%	0 0%	0 0%	2 50%	2 50%	1 25%	1 25%	1 25%
Total by Hour	East	26	50%	50%	58%	54%	46%	54%	35%	46%
	West	22	45%	55%	36%	45%	68%	59%	55%	32%

Source: Parsons Brinckerhoff, 2000.

#### *Criteria for Determination of Impacts under CEQA*

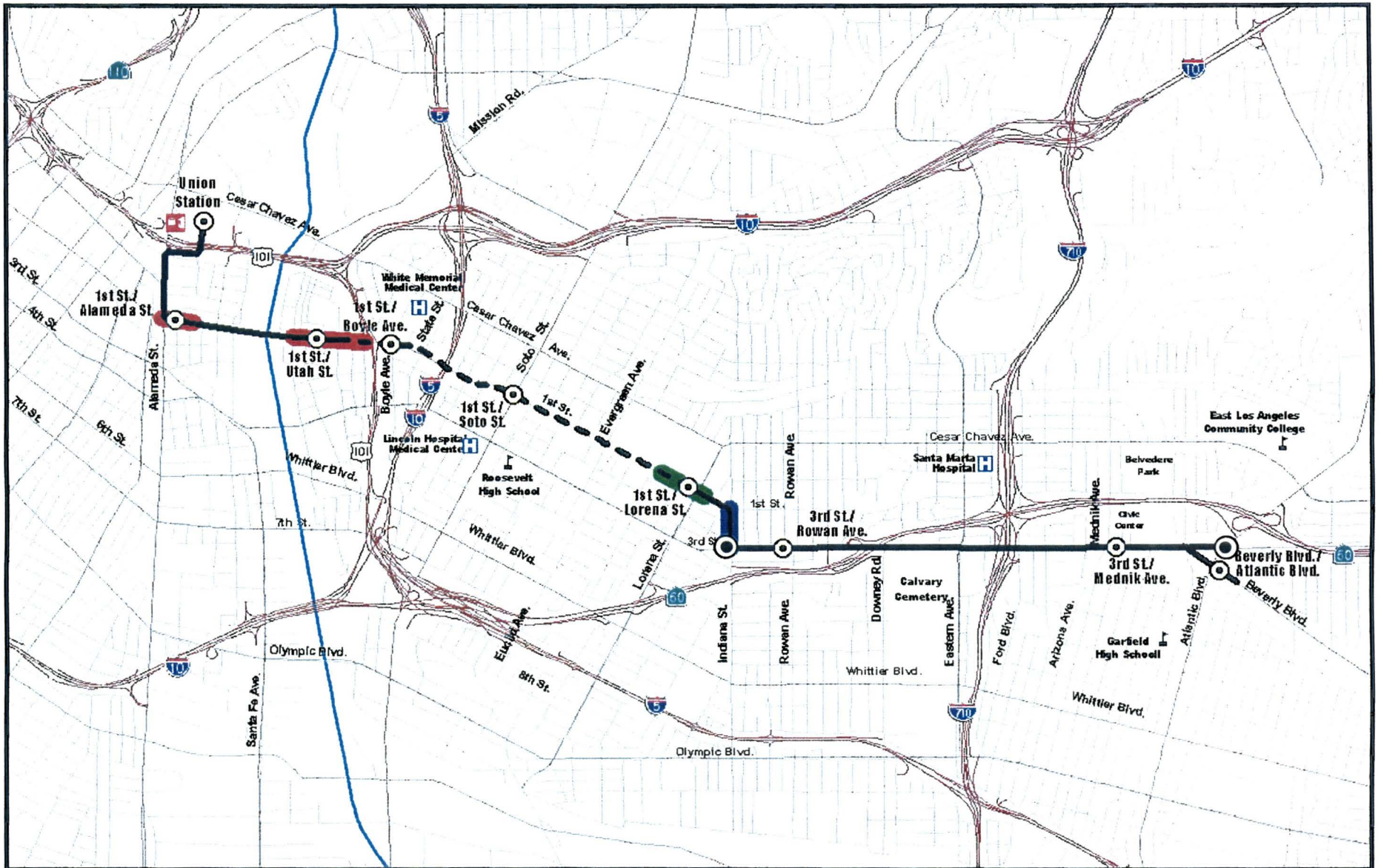
Based on the previous AA/DEIS/DEIR for which this is a supplement/subsequent document, the impact of the removal of parking spaces related to the project is potentially significant. The MTA is committed to implementing a parking replacement plan, as discussed in the mitigation section.

Option	Spaces Removed AM Peak	Spaces Removed Off-Peak	Spaces Removed PM Peak
Option A	126	188	139
Option B	49	111	62

Source: Parsons Brinckerhoff, 2001.

#### **3.3.2.3 LRT Build Alternative – Option B**

The parking impacts due to Option B are very similar to those of Option A. The number of parking spaces removed was estimated based on the characteristics of each street segment and the proposed LRT street cross-sections. The parking impacts on Commercial Street, Alameda Street, and 3<sup>rd</sup> Street remain the same as previously identified in Option A. 1<sup>st</sup> Street, Indiana Street, and Pomona Boulevard all have changes due to Option B.



0 0.25 0.5 Miles

Source: Parsons Brinckerhoff, 2000.

0 0.25 0.5 0.75 1 Kilometers

Note: Highways, primary, and secondary roads by Thomas Bird, Maps through a conditional use from MTA 1587.



**On-Street Parking Spaces Removed:**

- All Spaces in All Options
- North Side Spaces Only
- No Spaces Lost, Option B
- All Spaces, Option A

**Legend**

- LRT Alignment not in Tunnel
- LRT Alignment in Tunnel
- Highway
- Primary Road
- Secondary Road
- River

Los Angeles Eastside Corridor SEIS/SEIR

**Summary of Parking Impacts**

Figure 3-13



***1<sup>st</sup> Street***

Parking impacts on 1<sup>st</sup> Street are virtually the same for both Option A and B. The slight difference is due to the lack of a station at 1<sup>st</sup>/Lorena, which allows parking to be retained. Refer to the previous section for information on Option A. During the AM Peak period, 86 on-street parking spaces will be removed under Option B. During the Midday period, 148 spaces will be removed, and 99 parking spaces will be removed during the PM Peak period. Refer to Table 3-24 for a block-by-block breakdown of parking removals along 1<sup>st</sup> Street.

***Indiana Street***

Option B has no portion of the LRT alignment on Indiana Street, which results in no parking impacts to this street. No on-street parking spaces have time restrictions or meters except for weekly street-sweeping operations.

***Pomona Boulevard***

In the section of Pomona Boulevard that will be affected by the LRT alignment Option B, all existing parking regulations will be retained. There will be no parking impacts along Pomona Boulevard.

***Summary of Parking Impacts***

The width of the streets along the LRT alignment largely determine whether curb parking spaces will be removed and during which time period during the day. There will be no parking impacts on Commercial Street, Alameda Street, Indiana Street, 3<sup>rd</sup> Street, or Beverly Boulevard in Option B. Refer to Table 3-25 in the previous section for a summary of parking impacts. Figure 3-13 illustrates the parking impacts for both options.

**3.3.3 Mitigation****3.3.3.1 LRT Build Alternative – Option A**

There are three areas along the alignment where replacement parking will be required. These are (1) on 1<sup>st</sup> Street between Anderson and Utah Streets, (2) on 1<sup>st</sup> Street between Fresno and Indiana Streets, and (3) along Indiana Street between 1<sup>st</sup> and 3<sup>rd</sup> Streets.

Along 1<sup>st</sup> Street between Anderson and Utah Streets, there are a total of 24 peak-period restricted parking spaces. This section, when compared to other blocks on 1<sup>st</sup> Street between Mission Road to US-101, has comparatively high parking utilization. Coordination with the City Housing Authority will provide replacement parking north of 1<sup>st</sup> Street where there are plans to redevelop the Pico Aliso housing tract. A parking utilization study was conducted for this area, and the results indicate relatively low parking demand in this area. Table 3-29 illustrates the typical parking utilization for the different periods of the day. During the highest utilization period, the midday, there were 16 cars parked in this section between Mission Road and the 101 Freeway out of a total of 79 total spaces available. The highest utilization was in the block between Anderson and Utah Streets near the location of a convenience store. With the active redevelopment of the Pico-Aliso complexes by the City, the parking requirement of development, redevelopment, and new uses will be taken care of as part of the development approval process of the City. MTA will contribute an appropriate parking space replacement fee (to be negotiated) to the City for the 24 spaces removed between Anderson and Utah. The remaining 55 spaces are not utilized and removal by the City will have no impact on the area and the adjacent uses.

### ***1<sup>st</sup> Street***

Parking impacts on 1<sup>st</sup> Street are virtually the same for both Option A and B. The slight difference is due to the lack of a station at 1<sup>st</sup>/Lorena, which allows parking to be retained. Refer to the previous section for information on Option A. During the AM Peak period, 86 on-street parking spaces will be removed under Option B. During the Midday period, 148 spaces will be removed, and 99 parking spaces will be removed during the PM Peak period. Refer to Table 3-24 for a block-by-block breakdown of parking removals along 1<sup>st</sup> Street.

### ***Indiana Street***

Option B has no portion of the LRT alignment on Indiana Street, which results in no parking impacts to this street. No on-street parking spaces have time restrictions or meters except for weekly street-sweeping operations.

### ***Pomona Boulevard***

In the section of Pomona Boulevard that will be affected by the LRT alignment Option B, all existing parking regulations will be retained. There will be no parking impacts along Pomona Boulevard.

### ***Summary of Parking Impacts***

The width of the streets along the LRT alignment largely determine whether curb parking spaces will be removed and during which time period during the day. There will be no parking impacts on Commercial Street, Alameda Street, Indiana Street, 3<sup>rd</sup> Street, or Beverly Boulevard in Option B. Refer to Table 3-25 in the previous section for a summary of parking impacts. Figure 3-13 illustrates the parking impacts for both options.

## **3.3.3 Mitigation**

### **3.3.3.1 LRT Build Alternative – Option A**

There are three areas along the alignment where replacement parking will be required. These are (1) on 1<sup>st</sup> Street between Anderson and Utah Streets, (2) on 1<sup>st</sup> Street between Fresno and Indiana Streets, and (3) along Indiana Street between 1<sup>st</sup> and 3<sup>rd</sup> Streets.

Along 1<sup>st</sup> Street between Anderson and Utah Streets, there are a total of 24 peak-period restricted parking spaces. This section, when compared to other blocks on 1<sup>st</sup> Street between Mission Road to US-101, has comparatively high parking utilization. Coordination with the City Housing Authority will provide replacement parking north of 1<sup>st</sup> Street where there are plans to redevelop the Pico Aliso housing tract. A parking utilization study was conducted for this area, and the results indicate relatively low parking demand in this area. Table 3-29 illustrates the typical parking utilization for the different periods of the day. During the highest utilization period, the midday, there were 16 cars parked in this section between Mission Road and the 101 Freeway out of a total of 79 total spaces available. The highest utilization was in the block between Anderson and Utah Streets near the location of a convenience store. With the active redevelopment of the Pico-Aliso complexes by the City, the parking requirement of development, redevelopment, and new uses will be taken care of as part of the development approval process of the City. MTA will contribute an appropriate parking space replacement fee (to be negotiated) to the City for the 24 spaces removed between Anderson and Utah. The remaining 55 spaces are not utilized and removal by the City will have no impact on the area and the adjacent uses.

**TABLE 3-29  
PARKING UTILIZATION ANALYSIS ON 1<sup>ST</sup> STREET**

Block	Side	Capacity	Number of Occupied Spaces				
			AM Peak		Midday 12:30pm	PM Peak	
			7:30am	8:30am		4:30pm	5:30pm
Alameda to Rose	North	2	NS 7-9pm	NS 7-9pm	2 100%	0 0%	0 0%
	South	0	NPAT	NPAT	NPAT	NPAT	NPAT
Rose to Hewitt	North	6	NS 7-9pm	NS 7-9pm	3 50%	0 0%	0 0%
	South	6	0 0%	0 0%	2 33%	NS 4-6pm	NS 4-6pm
Hewitt to Garey	North	9	NS 7-9pm	NS 7-9pm	0 0%	0 0%	0 0%
	South	5	1 20%	1 20%	1 20%	NS 4-6pm	NS 4-6pm
Garey to Vignes	North	1	NS 7-9pm	NS 7-9pm	0 0%	0 0%	0 0%
	South	1	0 0%	0 0%	0 0%	NS 4-6pm	NS 4-6pm
Anderson to Utah	North	12	NS 7-9pm	NS 7-9pm	8 66%	6 50%	7 58%
	South	12	2 17%	2 17%	3 25%	NS 4-6pm	NS 4-6pm
Utah to Clarence	North	12	NS 7-9pm	NS 7-9pm	0 0%	0 0%	0 0%
	South	10	0 0%	0 0%	0 0%	NS 4-6pm	NS 4-6pm
Clarence to Gless	North	10	NS 7-9pm	NS 7-9pm	4 40%	3 30%	3 30%
	South	9	0 0%	1 11%	1 11%	NS 4-6pm	NS 4-6pm
Gless to Pecan	North	8	NS 7-9pm	NS 7-9pm	0 0%	0 0%	0 0%
	South	6	0 0%	0 0%	0 0%	NS 4-6pm	NS 4-6pm
Fresno to Concord	North	20	1 5%	0 0%	1 5%	0 0%	2 10%
	South	27	20 74%	21 78%	17 63%	20 74%	23 85%
Concord to Lorena	North	14	1 7%	2 14%	2 14%	2 14%	2 14%
	South	14	9 64%	11 79%	10 71%	9 64%	10 71%
Lorena to Cheesbroughs	North	9	3 33%	4 44%	8 89%	7 78%	5 56%
	South	7	0 0%	0 0%	4 57%	4 57%	3 43%
Cheesbroughs to Velasco	North	8	5 63%	5 63%	6 75%	2 25%	6 75%
	South	6	2	4	5	5	5

Block	Side	Capacity	Number of Occupied Spaces				
			AM Peak		Midday	PM Peak	
			7:30am	8:30am	12:30pm	4:30pm	5:30pm
			33%	66%	83%	83%	83%
Velasco to Indiana	North	4	3	3	4	0	0
			75%	75%	100%	0%	0%
	South	3	3	1	0	0	0
			100%	33%	0%	0%	0%

Source: Parsons Brinckerhoff, 2000. NS = No Stopping. NPAT = No Parking Any Time.

On-street parking will be removed on 1<sup>st</sup> Street between Fresno Street and Cheesbroughs Street. Nine spaces of replacement parking will be provided at 1<sup>st</sup>/Lorena on property currently owned by MTA.

On Indiana Street under Option A, development of an off-street parking lot will be utilized for replacement parking. The relatively high utilization of on-street parking spaces on Indiana Street precludes the possibility of demand being sufficiently transferred to side streets, such as 2<sup>nd</sup> or Gleason Streets. Three parcels on the eastern side of Indiana north of Ramona High School will be purchased to provide replacement parking for Option A.

#### ***Impacts Remaining after Mitigation***

The aforementioned parking replacement plan will reduce parking impacts to a less than significant level.

#### **3.3.3.2 LRT Build Alternative – Option B**

Parking mitigation for Option B is the same as for Option A, with the exception of Indiana Street. Mitigation is not required for Indiana Street as no parking will be lost.

#### ***Impacts Remaining after Mitigation***

The aforementioned parking replacement plan will reduce parking impacts to a less than significant level.

### **3.4 OTHER MODES**

#### **3.4.1 Affected Environment**

The areas that may have potential impacts on pedestrians and bicyclists include the streets and intersections where the LRT has an at-grade profile. This area includes Alameda Street between Commercial and 1<sup>st</sup> Streets, 1<sup>st</sup> Street between Alameda Street and the 101 Freeway and between Fresno and Indiana Streets, Indiana Street between 1<sup>st</sup> and 3<sup>rd</sup> Streets, 3<sup>rd</sup> Street between Indiana Street and Beverly Boulevard, and either Beverly Boulevard between 3<sup>rd</sup> Street and Hillview Avenue or Pomona Boulevard between Beverly Boulevard and Hillview Avenue.

#### **3.4.2 Impacts**

##### **3.4.2.1 No-Build Alternative**



There will be no impacts on bicycle or pedestrian facilities under the No-Build Alternative.

#### 3.4.2.2 LRT Build Alternative – Option A

##### *Pedestrians*

According to the 1990 census, approximately 6.7% of residents within the MTA Central Area (census designation), which includes communities along the LRT alignment, walk to work. This is significantly higher than the percent of Los Angeles County and the City of Los Angeles residents that walk to work (3.3% and 3.9% respectively). This indicates that walking is a significant commuting mode within the study area.

The 1994 AASHTO “Green Book” provides guidelines for the width of sidewalks for both urban and residential areas. Sidewalks with a planted strip separating the pedestrian from the curb are recommended to be between 8 and 14 feet wide. The planted strip should be no less than two feet in width to allow for maintenance access. Where planted strips are not an option, such as in urban settings, sidewalks are recommended to be 6 to 9.8 feet wide. This space closest to the curb allows for a buffer against moving traffic as well as space for street hardware, including light poles, meters, and street signs. The City of Los Angeles’ guidelines indicate secondary arterial sidewalk widths of between 9 and 10.7 feet.

##### Alameda Street

Between Commercial and 1<sup>st</sup> Streets on Alameda where the LRT system would operate at-grade, sidewalk widths would not change. The street would be widened to the east and landscaped in order to maintain the current number of traffic lanes and preserve existing sidewalk widths. Sidewalks are currently 10 feet wide north of Temple Street and 8 feet wide south of Temple. There would be no impact on sidewalks along Alameda Street under the LRT Build Alternative.

##### 1<sup>st</sup> Street

Two lanes of traffic in each direction will be provided between Alameda and Vignes Streets. The easements owned by LADOT between the Mangrove Estates property and Vignes Street will be used to maintain the existing number of lanes as well as existing 12-foot sidewalk width on the south side and provide for a 10-foot sidewalk width on the north side.

The station at 1<sup>st</sup>/Lorena in Option A will be located at the mouth of the tunnel on the north side of 1<sup>st</sup> Street. A traffic signal and pedestrian crosswalk will be installed at Cheesbroughs Lane (east of Lorena) to accommodate traffic on 1<sup>st</sup> Street and the transition of the LRT alignment from the north side to the middle of 1<sup>st</sup> Street. The northern sidewalk will be reduced to 4-feet in order to provide as much space as possible for traffic and the southern sidewalk. The sidewalk on the south side of 1<sup>st</sup> Street will be approximately 6 feet wide. Signage will be used to direct pedestrians to the southern sidewalk as an alternate route. No significant pedestrian impacts are anticipated under Option A due to these reduced sidewalk widths.

##### Indiana Street

The existing western sidewalk between 1<sup>st</sup> Street and 3<sup>rd</sup> Street, currently 8 feet wide, will be reduced to 6 feet and curb parking will be removed under Option A. No significant pedestrian impacts are anticipated under Option A due to a change in sidewalk widths.

### 3<sup>rd</sup> Street

Sidewalks will not be narrowed as part of the LRT street design on 3<sup>rd</sup> Street. They will remain at the current width of 9 feet.

### Crossing Issues

LRT stations would be located near major signalized intersections, where pedestrian crosswalks are currently in place. The station layouts are designed for pedestrians' convenience and safety. As is the design of the existing Metro Blue Line along Washington Boulevard, LRT passengers would enter and exit stations via a ramp that would lead to the crosswalk at signalized intersections. There would be a holding area at this location where pedestrians would wait for a walk signal in order to cross the street to the sidewalk areas.

All of the signalized intersections along the LRT alignment currently have pedestrian call buttons. All intersections that become signalized because of the introduction of the LRT system would be equipped with pedestrian call buttons. Although it may be legal for pedestrians to cross at unsignalized intersections in the existing condition, these movements would be prohibited across the LRT tracks in order to minimize potential conflicts. Signs would be placed at these unsignalized locations indicating that crossing is prohibited and that the nearest safe crossing is nearby at a signalized crosswalk.

The possibility of conflicts between trains and pedestrians may occur at the tunnel portal locations along the LRT alignment if pedestrians attempt to enter the tunnel during daytime operations or at night. The portals are located on 1<sup>st</sup> Street east of the 1<sup>st</sup>/Utah station and just west of the 1<sup>st</sup>/Lorena Station. Signing and surveillance will be utilized at the tunnel portals to reduce the possibility of unauthorized tunnel entry.

Unauthorized crossings occur specifically on 3<sup>rd</sup> Street at or near the intersection of Mariana Street. This occurs primarily on weekends as people attend the nearby Santuario Church. Potentially significant pedestrian safety issues associated with unauthorized pedestrian crossings of the tracks will be addressed during design and utilize MTA standards to minimize possible conflicts. Mitigation measures are discussed in Section 3.4.3.

The travel demand model indicates that the weekday peak period (seven hours) boardings (and same amount of alightings) at Union Station are 2,577 passengers under Option A and 2,700 passengers under Option B that are attributable to the Eastside LRT extension project. This represents approximately ten percent of the total weekday peak period boardings at Union Station for Metrolink (6,900), Metro Red Line (11,300), and the Pasadena-Eastside LRT Line (8,500) combined. There have been previous analyses done at Union Station for the subject transit services that would allow for accommodating this small increase (approximately ten percent) in activity due to the Eastside LRT project.

### *Bicyclists*

Bicycle use for the commute to work in the MTA Central Area (census designation) of Los Angeles is consistent with the City and County averages. The 1990 Census of Population and Housing counted 0.63% of the County of Los Angeles and 0.59% of the City of Los Angeles as bicycle commuters, compared to 0.57% of the MTA Central Area, which includes the Eastside Corridor.

### Bicycle Routes

The MTA Central Area Bicycle Master Plan, which incorporates the bicycle plans of the City of Los Angeles and the County, has designated 1<sup>st</sup> Street a future Commuter Bikeway. This is defined as a hybrid of a Class II and Class III bikeway. Class II bikeways are designated striped lanes on surface streets, and Class III bikeways are unstriped bike routes that are designated by green "bike route" signage. Commuter Bikeways are unstriped routes that utilize a wide curb lane where parking is prohibited during peak hours. On 1<sup>st</sup> Street, the Commuter Bikeway would utilize the curb lane during peak periods when parking is prohibited. During off-peak hours, bicyclists ride in the traffic stream to avoid the opening of car doors. Figure 3-14 shows the existing and proposed bicycle facilities in the Eastside Corridor.

If parking is prohibited during peak periods west of the 101 Freeway, as would be the case in the No-Build Alternative, then the proposed 1<sup>st</sup> Street Commuter Bikeway designation could be retained because there would be an 18-foot lane during peak periods that could be utilized by both cars and bicycles. Currently, 1<sup>st</sup> Street has two traffic lanes in each direction and carries a volume of more than 10,000 vehicles per day, and according to intersection traffic data presented in Section 3.2, curb lane volumes would be above the threshold for a commuter bikeway with implementation of the LRT Build Alternative. Under the criteria set forth, these volumes would be too high for the street to be considered a Commuter Bikeway along 1<sup>st</sup> Street between Alameda and Indiana Streets.

In the 1997 MTA Central Area Bicycle Master Plan, 1<sup>st</sup> Street between Glendale Boulevard and Eastern Avenue is included as part of the Proposed Regional Bikeway system. This is consistent with the 1996 City of Los Angeles General Plan Transportation Element Bicycle Plan Inventory. The MTA is currently re-evaluating the Central Area Bicycle Master Plan, which will take into consideration recent changes in the area, including the Eastside Corridor LRT project. Figure 3-15 shows the proposed regional bikeway system network in the Eastside Corridor according to the Central Area Bicycle Master Plan. Some routes in Figure 3-14 do not appear in Figure 3-15 because not all bicycle facilities are included in the regional bikeway system. A regional bikeway is a route that connects different regions of the county for longer distance, inter-regional travel.

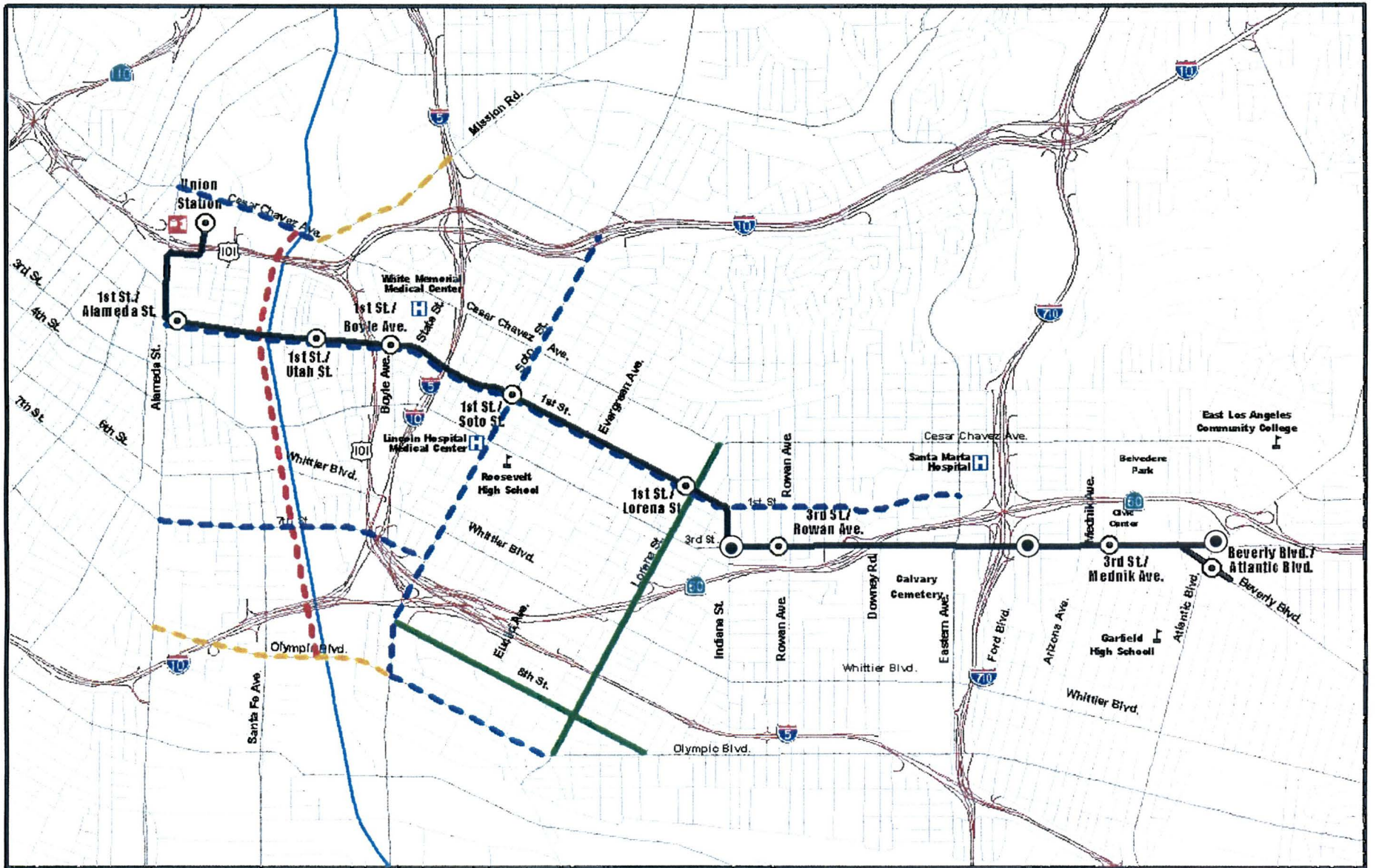
The Commuter Bikeway along Soto Street from the Los Angeles River to Huntington Drive is not affected by the LRT alignment because the LRT is in a tunnel where it crosses Soto Street. There are also no impacts on the Lorena Street Bike Route that crosses the LRT at-grade at 1<sup>st</sup> and Lorena Streets.

### Street Bikeway Design

The City of Los Angeles 1996 Transportation Element Bicycle Plan design standards recommend that the minimum curb lane width for streets designated as Commuter Bikeways should be 14 feet. This wider lane creates flexibility for all users of the facility, including automobile drivers, parked cars, buses, and bicyclists.

### 1<sup>st</sup> Street

Currently, 1<sup>st</sup> Street is a four-lane street that connects East Los Angeles and Boyle Heights with downtown Los Angeles. Under Option A, lane widths on 1<sup>st</sup> Street will vary between 11 and 15 feet. These are non-standard Commuter Bikeway designs, as the curb lanes will not meet the recommended minimum width of 14 feet in some areas. Option A calls for the station at 1<sup>st</sup>/Lorena to be located at the mouth of the tunnel on the north side of 1<sup>st</sup> Street. This station will be located in an open cut on the north side of the street. Cyclists must cross the tracks at an angle in order to continue on 1<sup>st</sup> Street, which creates a hazard. This is a less than ideal situation for cyclists, as traffic will utilize one lane in each direction at this location.



0 0.25 0.5 Miles

Source: Central Area Bicycle Master Plan, MITA, 1997

0 0.25 0.5 0.75 1 Kilometers



**Eastside Corridor**  
**Transit Consultants**

Note: Highways, primary, and secondary roads by Thomas  
 Bos. Maps through conditional use from MITA, 1997.

**Legend**

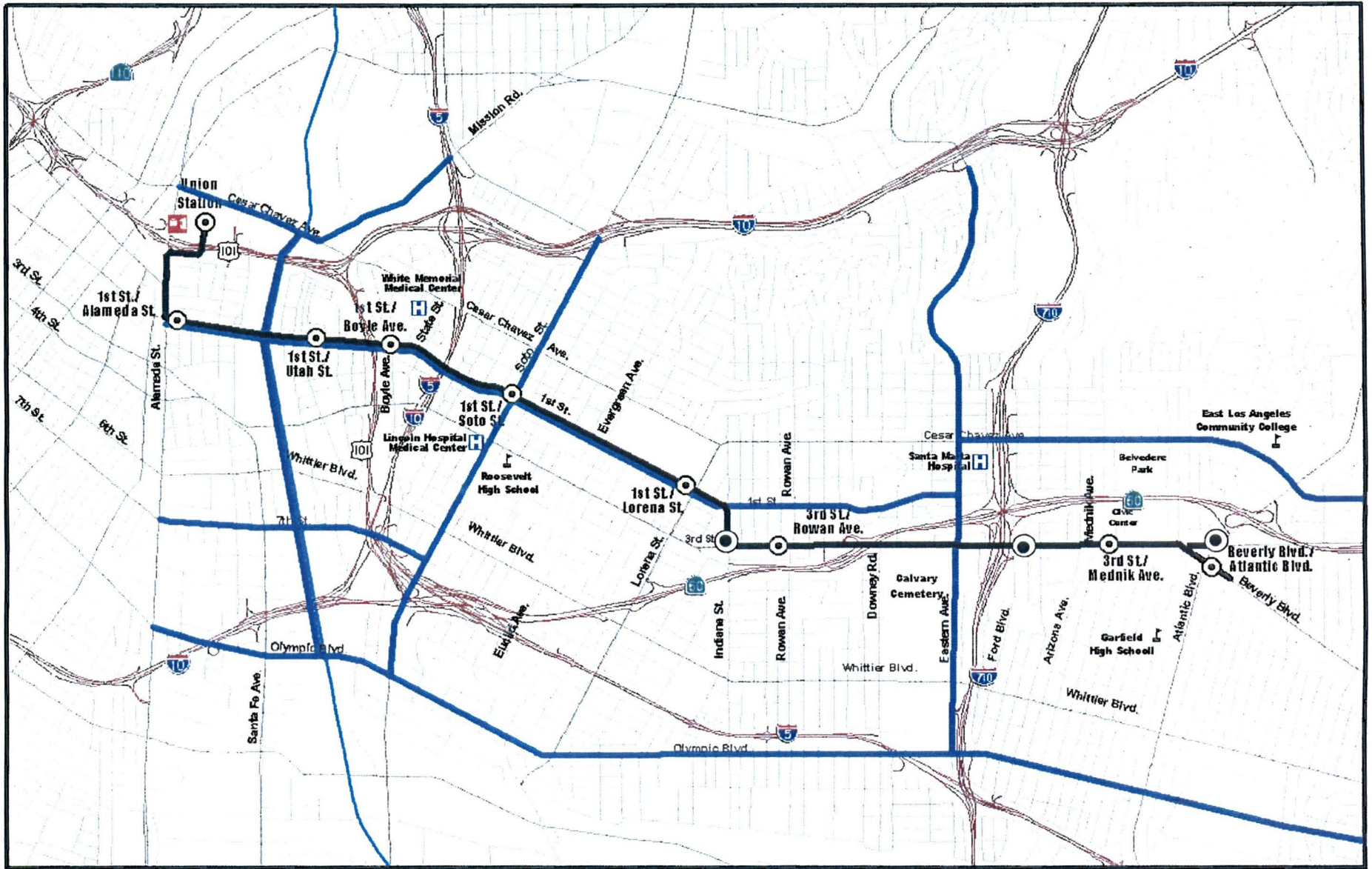
- Proposed Class I Bike Path
- Proposed Class II Bike Lane
- Existing Class III Bike Route
- Proposed Commuter Bikeway
- LRT Alignment
- Highway
- Primary Road
- Secondary Road
- River

Los Angeles Eastside Corridor SEIS/SEIR

**Existing and Proposed**  
**Bicycle Facilities**

Figure 3-14





0 0.25 0.5 Miles

Source: Central Area Bicycle Master Plan, MTA 1967

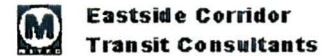
0 0.25 0.5 0.75 1 Kilometers



Legend

- Proposed Regional Bikeway
- LRT Alignment
- Highway
- Primary Road
- Secondary Road
- River

**Proposed Regional Bikeway System**



Note: Highways, primary, and secondary roads by Thomas & Os. Maps through conditional use from MTA 1967.

Los Angeles Eastside Corridor SEIS/SEIR

Figure 3-15



This situation will make 1<sup>st</sup> Street less attractive to bicyclists. As such, the commuter bikeway designation will be difficult to maintain with the introduction of the LRT system at-grade. It is unlikely that 1<sup>st</sup> Street will be designated a commuter bikeway, which will create a gap in the regional bikeway system. The resultant gap in the commuter bikeway and regional bikeway network will constitute a significant impact under CEQA.

#### Indiana Street

Indiana Street is not designated a bikeway. Option A removes the curb parking lane and narrows the traffic lanes to 11 feet. This is not enough space for a vehicle and bicyclist to share the same roadway space side by side. Bicyclists will typically either utilize the traffic lane, potentially slowing traffic, or utilize the sidewalks. This will be considered a less than significant impact under CEQA.

#### 3<sup>rd</sup> Street

There are no existing or proposed bikeways on 3<sup>rd</sup> Street. Although there are no designated bike routes on this street, the potential impacts on bicyclists that may use the street should be taken into account. The LRT alignment would operate in the center of 3<sup>rd</sup> Street at-grade and would require the removal of one traffic lane in each direction. The curb lane width would be 15 feet between stations and 12 feet near station locations. The curb lane would be utilized for traffic during peak periods and for parking during off-peak periods. During peak periods, bicyclists would travel near the curb in the 15-foot lane that meets the criterion for width for commuter bikeway width between stations. However, near stations the curb lane is not wide enough to comfortably accommodate traffic and bicyclists. It would be typical for bicyclists to utilize the 12-foot traffic lane for travel near stations. During off-peak hours when there would be parked cars occupying the curb lane, there would be enough space between parked cars and moving vehicles for the comfortable provision of bicycle traffic when the curb lane is 15 feet wide.

During peak periods between stations, the 15-foot wide curb lane would provide enough space to accommodate both moving vehicles and bicyclists. The impacts between stations are beneficial because there would be more space available for bicycle traffic, and at stations, there would be a less than significant impact.

### **3.4.2.3 LRT Build Alternative – Option B**

#### ***Pedestrians***

The issues previously described in Option A remain the same for Option B. Commercial Street, Alameda Street, Indiana Street, 3<sup>rd</sup> Street, and Pomona Boulevard do not have changes in sidewalk widths due to the Option B LRT alignment. The sidewalk widths for 1<sup>st</sup> Street are detailed below.

#### 1<sup>st</sup> Street

Two lanes of traffic in each direction will be provided between Alameda and Vignes Streets. The easements owned by LADOT between the Mangrove Estates property and Vignes Street will be used to maintain the existing number of lanes as well as existing 12-foot sidewalk width on the south side and provide for a 10-foot sidewalk width on the north side. Under Option B current sidewalk widths will be maintained because there will be no station at 1<sup>st</sup>/Lorena under this option. No significant pedestrian impacts are anticipated under Option B due to reduced sidewalk widths.



## Crossing Issues

The issues are the same as Option A.

### *Bicyclists*

The issues previously described in Option A remain the same for Option B. 1<sup>st</sup> Street and Indiana Street differ in layout and thus have different impacts on bicyclists.

#### 1<sup>st</sup> Street

Currently, 1<sup>st</sup> Street is a four-lane street that connects East Los Angeles and Boyle Heights with downtown Los Angeles. Under Option B, lane widths on 1<sup>st</sup> Street will vary between 11 and 15 feet. These are non-standard Commuter Bikeway designs, as the curb lanes will not meet the recommended minimum width of 14 feet in some areas. This situation will make 1<sup>st</sup> Street less attractive to bicyclists. As such, the commuter bikeway designation will be difficult to maintain with the introduction of the LRT system at-grade. It is unlikely that 1<sup>st</sup> Street will be designated a commuter bikeway, which will create a gap in the regional bikeway system. The resultant gap in the commuter bikeway and regional bikeway network will constitute a significant impact under CEQA.

#### Indiana Street

Indiana Street is not designated a bikeway. However, if cyclists use this street, Option B will maintain the existing street alignment by locating the LRT off-street. No significant bicycle impacts are anticipated under Option B, as there will be one traffic lane and one curb parking lane in each direction. No significant impacts are anticipated under Option B due to the LRT alignment.

### **3.4.3 Mitigation**

#### **3.4.3.1 LRT Build Alternative – Option A**

##### *Pedestrians*

The development of rail facilities in an already “built out” urban environment does require the modification of the existing roadway and sidewalk conditions in such a way as to preserve the character and structures already in place. The project will be designed or modified to insure the following in the areas directly adjacent to the rail stations:

- ◆ Sidewalk widths will be designed with the widest dimensions feasible in conformance with the LA City/MTA’s adopted “Land Use/Transportation Policy”, and with widths up to and exceeding 10 feet;
- ◆ Where existing building lines or landscape areas periodically preclude these preferred widths, minimum widths will not be less than those allowed by the State of California Title 24 access requirements, or the Americans with Disability Act (ADA) design recommendations;
- ◆ Where physical conditions present potential restrictions in pedestrian access, compliance with ADA or Title 24 minimum requirements accommodating pedestrian movements and flows will take priority over other transportation improvements including automobile access;
- ◆ At a minimum, MTA will implement physical improvements to insure that all stations are fully accessible as defined in the Americans with Disabilities Act; and
- ◆ Alternative routing for pedestrians that allow completion of access to the station and to destinations in the immediate vicinity of the station will be developed through the Community Linkages Study.

The Community Linkages Study will include the identification of preferred pedestrian access to each station, general pedestrian circulation within the immediate vicinity of the station, and potential sites for improvements in pedestrian queuing areas. The report will also include identification of preferred connections to bus services in the immediate vicinity of the rail station. The purpose of the report includes ensuring adequate circulation, access, and information important to potential users of the rail and bus systems.

In redevelopment areas along 1<sup>st</sup> Street, coordinated development planning is expected to mitigate the impact of narrowed sidewalks along 1<sup>st</sup> Street. In any event, the project will comply with the State of California Title 24 access requirements and ADA design recommendations. No significant pedestrian impacts are anticipated due to the reduction of the west sidewalk width from 8 feet to 6 feet wide along Indiana Street in Option A.

The alternative of removing or significantly altering existing building frontages facing the track or stations will create a more significant impact on the integrity and uniqueness of the surrounding community than periodic reductions in the adjacent sidewalk widths. In lieu of altering the building frontages or further reductions in the roadway width, alternative routing of pedestrian travel and improvements to the surrounding pedestrian network will be studied as part of the Community Linkages Study will provide a significant improvement to the pedestrian access to the station and to adjacent destinations beyond potential inconveniences resulting in periodic sidewalk narrowing.

Other mitigation measures to reduce the potential for unsafe LRT track crossings by pedestrians include the use of well-defined pedestrian paths, signage, and barriers, where appropriate. Distinctive crosswalk treatments such as textured paving and eye-catching designs can capture the attention of pedestrians and encourage the use of crosswalks. The use of pedestrian-oriented signal phasing will decrease crossing wait times and reduce the chances of impatient pedestrians crossing against the light. LRT train operations will be coordinated with traffic signal phasing to address safety issues and minimize delays. In addition, other techniques to increase pedestrian safety, including marketing and advertisement campaigns, crossing guards, and cohesive signage may be used. A signalized pedestrian crosswalk will be installed near the intersection of Mariana and 3<sup>rd</sup> Streets, where there are currently a high number of unauthorized crossings. Additionally, a crossing guard will be utilized on the weekends to create a safe crossing area for area residents.

Presentations and information will be made available at local schools, community groups, and social services locations to educate residents about safety related to the track crossing issue. Maps of the crossing opportunities will be made available to the community once the LRT project is in place to encourage the safe crossing of the tracks. Enforcement will also be provided to raise awareness of the crossing prohibitions and direct people to legally cross the tracks at designated locations. Additional safety measures are addressed in Section 4.14 of the Final SEIS/SEIR. The Long Beach Blue Line operation on Washington Boulevard and on Long Beach Boulevard will serve as examples of how to address pedestrian safety issues associated with the at-grade portions of the LRT system. The project will be required to meet MTA Rail Transit Design Criteria and Standards, Fire/Life Safety Criteria, Volume IX.

#### Impacts after Mitigation

Under Option A, no significant pedestrian impacts will remain after application of the mitigation measures discussed above.

### ***Bicycle Routes***

To address the issue of bicycle use on 1<sup>st</sup> Street, removal of the designation of 1<sup>st</sup> Street as a future commuter bicycle facility between Alameda and Indiana Streets is recommended. It is also recommended that the commuter bikeway designation be eliminated between the 101 Freeway and Fresno Street because this section will be discontinuous with other segments of the bikeway. In order to maintain network continuity for the regional bikeway plan, a parallel street will be designated as a bikeway, such as Cesar Chavez Avenue. Cesar Chavez Avenue is proposed to be part of the regional bikeway system east of Eastern Avenue. The extension of this designation should be considered between Alameda Street and Eastern Avenue as a way to maintain continuity with the bikeway network. Bicycle Commuter Route alternatives will be studied as part of the Community Linkages Study, funded by the MTA. LADOT and the Bureau of Street Services Bikeway Design Group will be included in the study of the bicycle commuter route alternatives.

No bicycle route mitigation is required on Alameda Street, 3<sup>rd</sup> Street, Indiana Street, or Beverly Boulevard because these streets are not designated bikeway facilities. Refer to Figure 3-14 for a map of existing and proposed bicycle facilities and Figure 3-15 for a view of the proposed regional bikeway system.

#### **Impacts after Mitigation**

After implementation of the aforementioned mitigation measures, no significant bicycle impacts will remain under CEQA.

### **3.4.3.2 LRT Build Alternative – Option B**

#### ***Pedestrians***

The mitigation measures applied to Option A will be used for Option B as well.

#### **Impacts after Mitigation**

No significant impacts will remain after application of the mitigation measures.

#### ***Bicycle Routes***

Mitigation measures described in the previous section also apply to Option B. No bicycle route mitigation is required on Alameda Street, 3<sup>rd</sup> Street, Indiana Street, or Pomona Boulevard because these streets are not designated bikeway facilities. Refer to Figure 3-14 for a map of existing and proposed bicycle facilities and Figure 3-15 for a view of the proposed regional bikeway system.

#### **Impacts after Mitigation**

After implementation of the aforementioned mitigation measures, no significant bicycle impacts will remain under CEQA.

### 3.5 SUMMARY OF IMPACTS

#### 3.5.1 Unavoidable Significant Adverse Impacts

##### 3.5.1.1 Impacts Found to be Significant After Mitigation

###### *Transit*

No unavoidable significant adverse impacts under CEQA have been identified after mitigation measures have been implemented.

###### *Traffic*

After the proposed mitigation measures have been implemented, 12 of the 20 impacted intersections will continue to be impacted to significant levels under Option A. After the proposed mitigation measures have been implemented, 10 of the 20 impacted intersections will continue to be impacted to significant levels under Option B.

###### *Parking*

No unavoidable significant adverse impacts under CEQA have been identified after mitigation measures have been implemented.

###### *Other Modes*

No unavoidable significant adverse impacts under CEQA have been identified after mitigation measures have been implemented.

##### 3.5.1.2 Impacts Found Not to be Significant after Mitigation

###### *Transit*

Any potential impacts resulting from the displacement of bus stops due to street design changes will be mitigated to a level that is less than significant under CEQA.

###### *Traffic*

In Option A, of the 20 impacted intersections, 8 were mitigated to a level less than significant under CEQA. In Option B, of the 20 impacted intersections, 10 were mitigated to a level less than significant under CEQA.

###### *Parking*

The MTA is committed to implementing a feasible parking replacement plan, which will reduce parking impacts to a less than significant level.

###### *Other Modes*

A parallel street such as Cesar Chavez Avenue will be designated as a bikeway facility to mitigate the removal of the Commuter Bikeway classification on 1<sup>st</sup> Street between Alameda Street and Indiana Street

due to the increased curb lane traffic volumes in both options. The alternate route will be developed during MTA-funded Community Linkages studies.

### **3.5.2 Impacts Found Not to be Significant**

#### ***Transit***

The re-routing of bus lines to connect with the LRT system at certain stations does not create any significant impacts.

#### ***Traffic***

Traffic impacts found not to be significant or beneficial were identified at 34 intersection locations for both Options A and B.

#### ***Parking***

No impacts found not to be significant have been identified under CEQA.

#### ***Other Modes***

A number of impacts were found to be less than or not significant under CEQA.

### **3.5.3 Cumulative Impacts**

#### ***Transit***

There are a number of small-to-medium scale development projects either under construction or planned in the Eastside Corridor that will benefit from increased transit service with a light rail system. The transit trips generated by these new development projects will contribute to the operational success of the LRT system. These impacts will be considered beneficial because they will benefit the transit system as a whole by increasing ridership.

#### ***Traffic***

Cumulative impacts due to overall growth in the Eastside Corridor are reflected in the No-Build and LRT Build traffic forecasts and level of service estimates.

#### ***Parking***

There are no cumulative parking impacts to be addressed.

#### ***Other Modes***

A number of developments are either under construction or planned along 1<sup>st</sup> Street between the Los Angeles River and the 101 Freeway, where existing sidewalks may be narrowed for the LRT Build Alternative. Through coordination with the City it is proposed that future full-width sidewalks be provided when these new developments are approved. This will constitute a beneficial cumulative impact under CEQA for pedestrians.

## 4.0 AFFECTED ENVIRONMENT AND ENVIRONMENTAL CONSEQUENCES

This chapter of the Final SEIS/SEIR analyzes the environmental consequences associated with the implementation of the LRT Build Alternative and its two Options A and B and compares it to that anticipated with the implementation of the No-Build Alternative. Detailed technical information may be found in the supporting environmental technical reports and addendums available at MTA's offices, One Gateway Plaza, Los Angeles, California. Those documents are hereby incorporated by reference into this Final SEIS/SEIR. In cases where those reports differ from this document, this document supercedes, as it was prepared subsequent to the technical reports and contains the most up-to-date information.

Analysis of each environmental topic consists of using a defined method for analyzing impacts, describing the impacts resulting from implementation of the LRT Build Alternative, and identifying mitigation measures that are needed to reduce or avoid adverse significant impacts. Discussion of each environmental category is generally organized as follows:

- ◆ **Affected Environment.** The regulatory framework and physical environment are described. The affected environment serves as the baseline against which project impacts are evaluated.
- ◆ **Methodology for Impact Evaluation.** A description of the amount or type of impact that constitutes a significant impact on the environment for California Environmental Quality Act (CEQA) purposes or an adverse impact under the National Environmental Policy Act (NEPA). Based on these criteria, project impacts can be classified as: no effect, adverse but not significant, potentially significant, significant, or beneficial.
- ◆ **Impacts.** A discussion of the impacts of the alternatives in qualitative and/or quantitative terms, and a conclusion of no effect, adverse but not significant impact, potentially significant impact, significant impact, or beneficial effect.
- ◆ **Mitigation.** Where impacts are identified as adverse or significant, mitigation to reduce or avoid the impacts is identified.

While CEQA requires that only effects that have a "significant impact" be identified in an Environmental Impact Report, the National Environmental Policy Act (NEPA) requires that all adverse impacts of a proposed project be analyzed. Accordingly, in this joint federal and state environmental document, reference to "significant impacts" is made to fulfill this requirement under CEQA, pursuant to standards of California law. However, regardless of level of significance, all potentially adverse environmental impacts have been analyzed and mitigation proposed where feasible to reduce identified adverse effects.

## 4.1 LAND USE AND DEVELOPMENT

### 4.1.1 Affected Environment

#### 4.1.1.1 Regional Setting

##### *Southern California Association of Governments (SCAG)*

The Southern California Association of Governments (SCAG) serves as the Metropolitan Planning Organization (MPO) for the region. The policies and goals of the SCAG Regional Comprehensive Plan and Guide (RCPG) focus on the need to coordinate land use and transportation decisions to manage travel demand within the region. They include:

- ◆ Promote Transportation Demand Management (TDM) programs along with transit and ridesharing facilities as a viable and desirable part of the overall mobility program while recognizing the particular needs of individual subregions;
- ◆ Support the coordination of land use and transportation decisions with land use and transportation capacity, taking into account the potential for demand management strategies to mitigate travel demand if provided for as a part of the entire package;
- ◆ Urban form, land use, and site-design policies should include requirements for safe and convenient non-motorized transportation, including the development of bicycle and pedestrian-friendly environments near transit;
- ◆ Encourage patterns of urban development and land use that reduce costs on infrastructure construction and make better use of existing facilities;
- ◆ Encourage local jurisdictions' plans that maximize the use of existing urbanized areas accessible to transit through infill and redevelopment;
- ◆ Support local plans to increase density of future development located at strategic points along the regional commuter rail, transit systems, and activity centers;
- ◆ Support local jurisdictions' strategies to establish mixed-use clusters and other transit oriented developments around transit stations and along transit corridors;
- ◆ Encourage developments in and around activity centers, transportation corridors underutilized systems, and areas needing recycling and redevelopment.
- ◆ Encourage water reclamation throughout the region where it is cost-effective, feasible, and appropriate to reduce reliance on imported water and wastewater discharges; and
- ◆ With respect to housing, SCAG supports the following objectives: Decent and affordable housing choices for all; Adequate supply and availability of housing; Housing stock maintenance and preservation; and Promoting a mix of housing opportunities regionwide.

##### *Los Angeles Community Development Department Consolidated Plan*

The City of Los Angeles Community Development Department prepared the 2000-2003 Consolidated Plan as required by the U.S. Department of Housing and Urban Development (HUD). The Plan is a comprehensive, integrated approach to planning and implementing the city's housing, community development, and economic development needs and priorities in the form of a strategic plan. Applicable priorities and strategies include:

- ◆ Basic infrastructure is important. Neighborhoods and businesses cannot flourish in an environment of decay. Clean and re-paved streets, closed nuisance alleys, and improved streetscapes and landscaping are all important to uplifting communities and their residents.

- ◆ The City must increase the availability of clean, safe, and decent affordable housing. The City must focus on preserving and revitalizing the city's existing housing stock, address problems of substandard housing, and support programs that promote home ownership. The City must utilize measures that are sensible and cost-effective.

#### 4.1.1.2 Study Area

##### *Existing Land Uses*

The study area encompasses the Central City, including the Little Tokyo and Arts District communities, Central City North and Boyle Heights communities within the City of Los Angeles, and the unincorporated East Los Angeles community of the County of Los Angeles, and a small southerly portion of the City of Monterey Park. Figure 4.1-1 indicates the communities in the study area and the respective Community Plan boundaries. Figures 4.1-2A and 4.1-2B present generalized land uses in the study area, and Figure 4.1-2C provides a legend for the graphic.

##### Central City and Central City North

The existing land uses of the Central City and Central City North area are primarily defined by the subdistricts that comprise these areas. West of Alameda Street and south of the Hollywood area is the eastern portion of the Los Angeles Civic Center, which contains governmental buildings. From 1st Street south to 3rd Street is the historic and contemporary Little Tokyo community. The land uses include a variety of retail uses, hotels, museums, residential complexes, and community oriented uses. South of 3<sup>rd</sup> Street, the area consists primarily of light industrial uses and the expanding retail toy industry, which has reused older structures and created some new infill industrial structures.

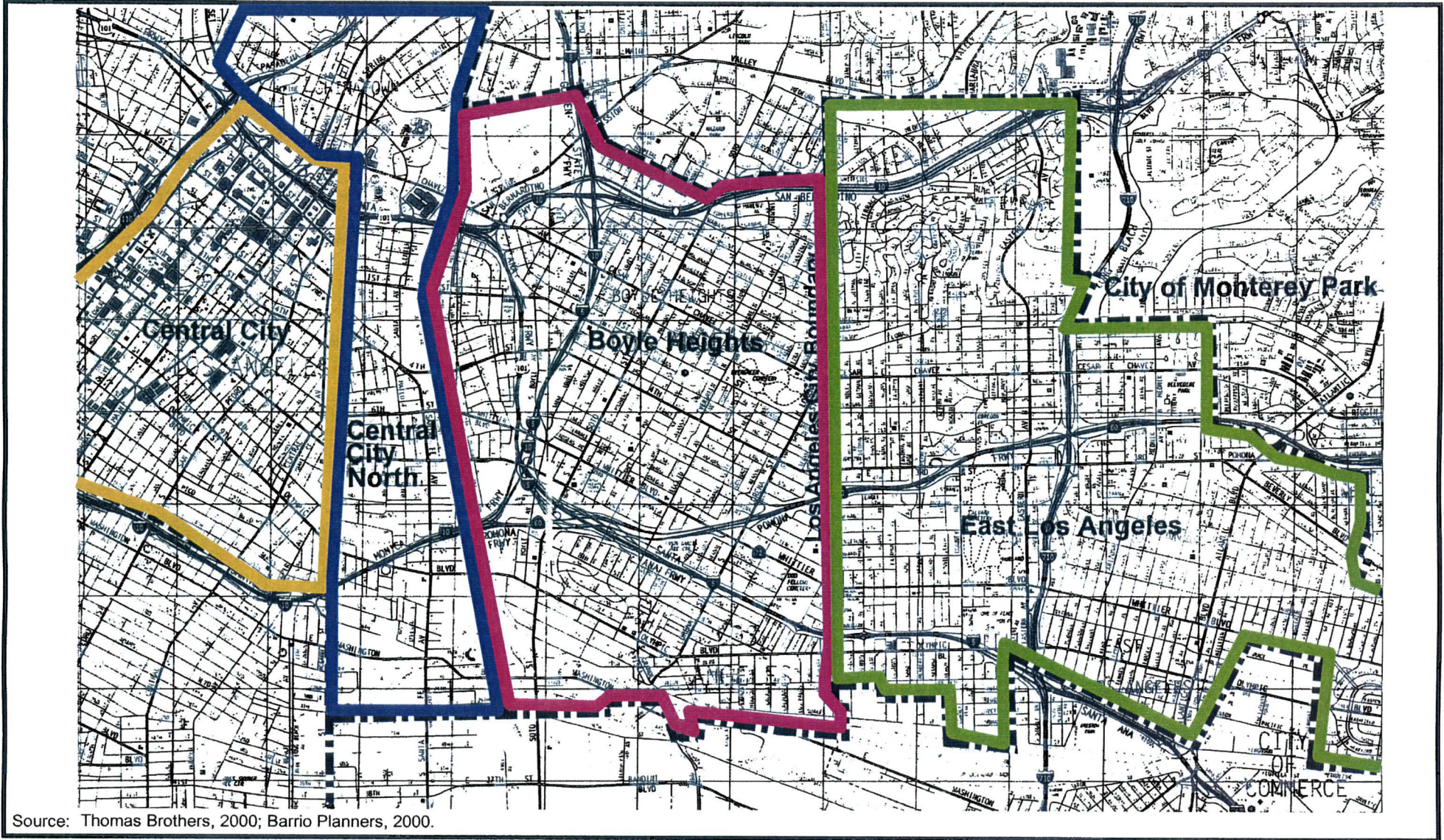
The area east of Alameda Street and north of the Hollywood Freeway is part of the Central City North area. The subdistrict north of Hollywood Freeway includes the El Pueblo State Historic Park, Union Station, and the Gateway Center. South of the Hollywood Freeway, the land uses are primarily light industrial uses, facilities for the Los Angeles Department of Water and Power, and several large vacant parcels. The area along 1<sup>st</sup> Street and south to 3<sup>rd</sup> Street also contains several Little Tokyo oriented retail uses. South of 1<sup>st</sup> Street are the expanding artist loft district and studios intermixed with light industrial uses and scattered vacant parcels. There are also 600 arts and residential units in the area. At Alameda and First Streets are the approved Mangrove Estates and First Street South Plaza projects, which will both replace currently vacant parcels with large, mixed-use projects (office, commercial, residential uses) once constructed.

##### Boyle Heights Community

Boyle Heights has a mixture of residential, commercial, and public uses. Between Boyle Avenue and Lorena Street, residential land uses include Aliso Village, Aliso-Pico, and Pico Gardens public housing projects and a variety of residential densities ranging from two to four units per lot to over five units per lot with small scattered areas of single-family units. Smaller parcels, coupled with the mix and variety of housing types and larger than county average household sizes all contribute to higher population densities in Boyle Heights. East from the proposed 1<sup>st</sup>/Lorena Station, the land uses are primarily single-family residential uses.







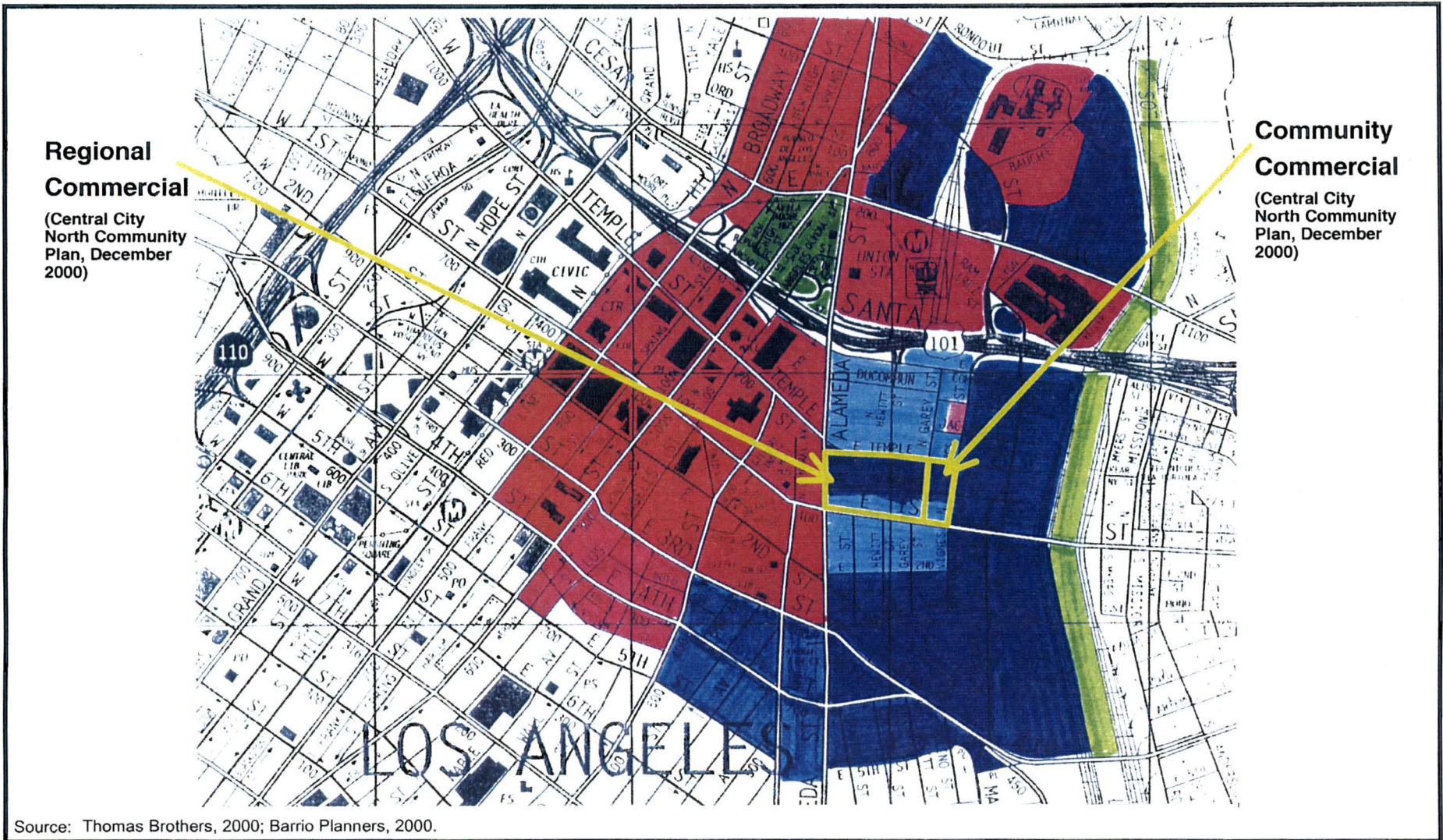
Source: Thomas Brothers, 2000; Barrio Planners, 2000.

*Los Angeles Eastside Corridor SEIS/SEIR*

**Jurisdictional Boundary  
General Plan Areas**

Figure 4.1-1

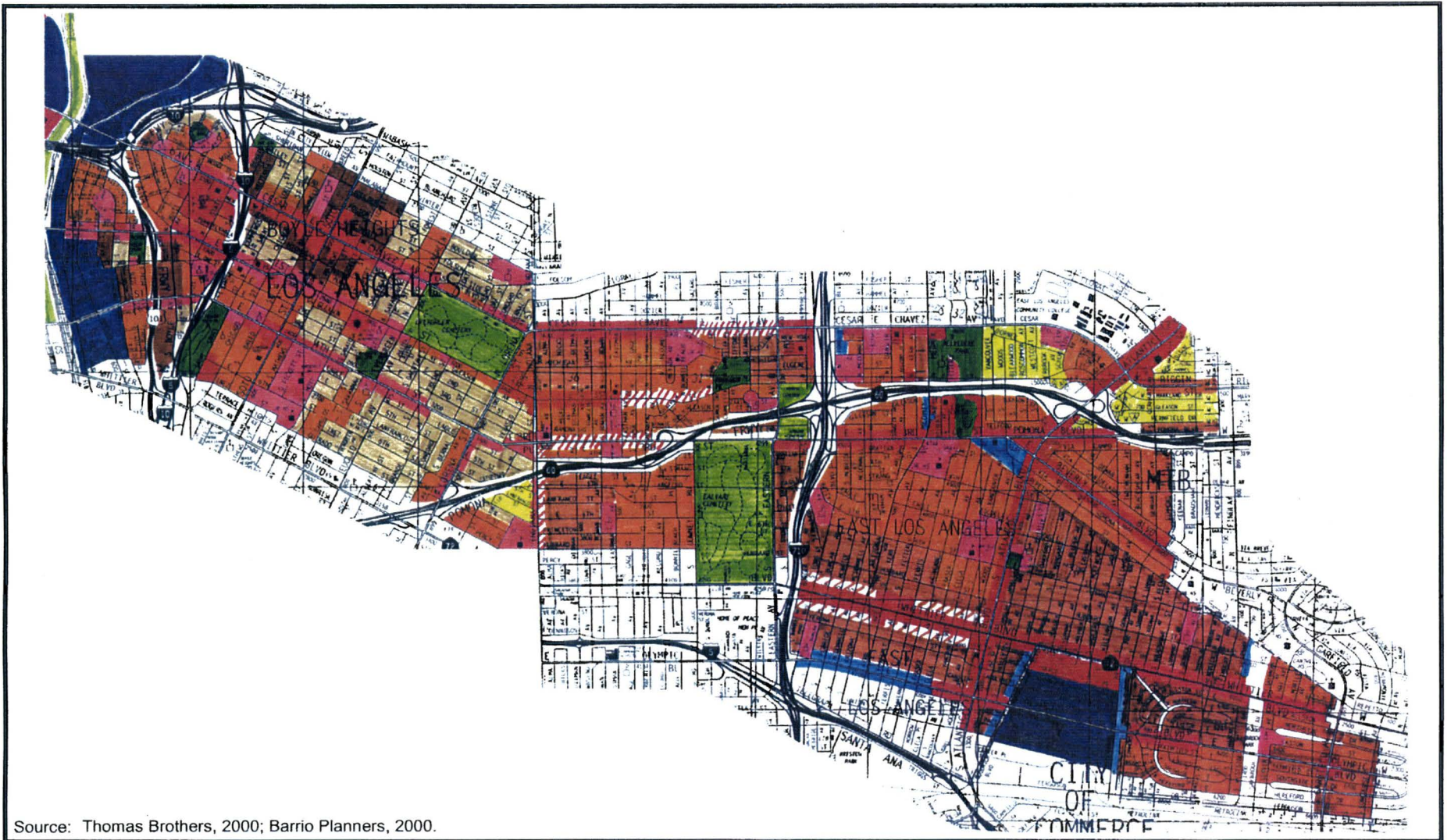




*Los Angeles Eastside Corridor SEIS/SEIR*

**General Plan  
Land Use Designations  
Central City & Central City North Communities**





Source: Thomas Brothers, 2000; Barrio Planners, 2000.

*Los Angeles Eastside Corridor SEIS/SEIR*

**General Plan  
Land Use Designations  
Boyle Heights & East Los Angeles Communities**





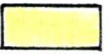








**GENERAL PLAN-LAND USE DESIGNATIONS**

City of Los Angeles

County of Los Angeles

City of Monterey Park

**Residential**

 Low Density 3-7 Units/Acre	 Low Density 0-8 Units/Acre	 Low Density 0-8 Units/Acre
 Low Medium 1 7-12 Units/Acre		
 Low Medium 2 12-24 Units/Acre	 Low Medium Density 9-17 Units/Acre	
 Medium 24-40 Units/Acre	 Medium Density 18-30 Units/Acre	 Medium Density 9-14 Units/Acre
	 Residential/Parking 18-30 Units/Acre	 High Density 15-22 Units/Acre









**Commercial**

 Highway Oriented	 Commercial/ Residential	
 Neighborhood	 Community	
 Community	 Major Commercial	 Commercial
 Regional		

**Industrial**

 Commercial Manufacturing	 Commercial Manufacturing
 Limited/Light	
 Heavy	 Industrial

**Public**

 Parks	 Parks
 Open Space	 Open Space
 Schools	 Schools
 Public/ Institutional	 Public/ Institutional

Source: Barrio Planners, 2000.

*Los Angeles Eastside Corridor SEIS/SEIR*

**General Plan  
Land Use Legend**

Figure 4.1-2C





Neighborhood oriented commercial uses exist along the frontage of 1<sup>st</sup> Street from Boyle Avenue on the west to Evergreen Avenue on the east. This commercial frontage is also intermixed with residential uses, public and community facilities. The small commercial hub, known as "El Mercado" is also located on 1<sup>st</sup> Street, just east of Lorena Street.

#### East Los Angeles Community

From Indiana Street to Mednik Avenue on the east, the neighborhoods are developed primarily with one and two-family residential dwellings per lot. A cluster of residential apartments is located along Mednik Avenue, south of Cesar Chavez Avenue. The Nueva Maravilla Housing Project, which was demolished and rebuilt in the early 1970's, is located north of Cesar Chavez Avenue.

Neighborhood serving commercial uses are located along Cesar Chavez Avenue with commercial nodes just east of Indiana Street and at Ford Boulevard and along 1<sup>st</sup> Street primarily concentrated east of Indiana Street. 3<sup>rd</sup> Street from Indiana Street to La Verne Avenue contains very scattered commercial uses intermixed with residential uses, public and community facilities. The frontages near the intersection of Beverly and Pomona Boulevards with Atlantic Boulevard contain a concentration of commercial related uses.

#### **General Plan Summaries**

##### Central City/City of Los Angeles

The *Central City Community Plan* was adopted by the Los Angeles City Council in 1974 and has been amended through 1998. The Central City planning area abuts the study area on the west, west of Alameda Street. Major land use and transportation policies of the plan are:

- ◆ Support additions to the housing stock in Little Tokyo;
- ◆ Retain the existing retail base in Central City;
- ◆ Make Downtown a tourist destination by combining its cultural and commercial offerings with those of the ethnic communities surrounding it;
- ◆ Encourage traditional and non-traditional sources of open space by capitalizing on linkages with transit, parking, historic resources, cultural facilities, and social services programs;
- ◆ Encourage rail connections and high occupancy vehicle lanes that will serve the Downtown traveler; and
- ◆ Reinforce the integration and accessibility of the neighborhoods surrounding Downtown with the Downtown core through enhanced levels of service.

##### Central City North/City of Los Angeles

The *Central City North Community Plan* was amended in December 2000, and includes the following applicable policies:

- ◆ To conserve and strengthen viable commercial development in the community and to provide additional opportunities for new commercial development and services (by requiring that projects be designed and developed to achieve a high level of quality, distinctive character and compatibility with existing uses and development);
- ◆ To attract uses which strengthen the economic base and expand market opportunities for existing and new businesses (by A. preserving existing pedestrian oriented areas; and B. adding and enhancing the existing pedestrian street activity);

- ◆ To retain industrial plan designations to maintain the industrial employment base for community residents and to increase it whenever possible (by protecting the numerous large rail yards and other industrially planned parcels located in predominantly industrial areas from development by other uses which do not support the industrial base of the city and the community);
- ◆ Develop a public transit system that improves mobility with convenient alternatives to automobile travel (by encouraging the expansion, wherever feasible, of programs aimed at enhancing the mobility of senior citizens, disabled persons, and the transit dependent population);
- ◆ To provide parking in appropriate locations in accord with citywide standards and community needs;
- ◆ Installing on-site lighting along all pedestrian walkways and vehicular access ways, as well as shielding and directing of on-site lighting onto driveways and walkways, directed away from adjacent residential uses; and
- ◆ New lighting systems will be designed to minimize glare and “light trespass,” (in compliance with currently adopted city standards, and approved by the Bureau of Street Lighting).

#### Boyle Heights/City of Los Angeles

The *Boyle Heights Community Plan* was amended in 1998 and includes the following updated policies:

- ◆ That the existing Low-Medium I and II density housing be preserved where such housing is in relatively good condition or can be made so with moderate improvements;
- ◆ That the pedestrian-oriented commercial centers of Avenida Cesar Chavez and Soto Street and the Mercado area on East First Street be preserved and continue to serve as focal points for shopping, social and entertainment activities;
- ◆ That the neighborhood commercial areas at Whittier Boulevard and Lorena Street, Evergreen and Wabash Avenues, Fourth and Soto Streets, and First and Bailey Streets continue to serve the everyday and weekly shopping needs of residents, providing supermarkets, drugstores, retail shops and other neighborhood-oriented services;
- ◆ That the unique character of community streets should be maintained and enhanced by improved design characteristics such as street trees, landscaped median strips, traffic islands and special paving;
- ◆ That Indiana Street remains designated as a Secondary Highway. Any widening and improvements shall be coordinated with the County of Los Angeles;
- ◆ That Medium density housing be located near commercial corridors where access to public transportation and shopping services is convenient and where a buffer from, or a transition between, low-density housing can be achieved to the extent feasible;
- ◆ That, in general, housing for the elderly has convenient access to public transportation, commercial services, recreation and health facilities;
- ◆ That the city continue to encourage and assist MTA in analyzing the community’s transit needs in order to increase bus service and improve its efficiency and comfort; and
- ◆ That public transportation, including rapid transit accessible to transit-dependent residents, be provided.

#### Framework Element of the City of Los Angeles General Plan

The Los Angeles General Plan Framework Element is a strategy for long-term growth that sets a citywide context to guide the subsequent amendments of the city’s community plans, zoning ordinances, and other pertinent programs. The Framework Element contains an objective and three land use policies that support housing in the city:

- ◆ Objective 4.2: Encourage the location of new multi-family housing development to occur in proximity to transit stations, along some transit corridors, and within some high activity areas with

adequate transitions and buffers between higher-density developments and surrounding lower-density residential neighborhoods;

- ◆ Policy 3.2.1: Provide a pattern of development consisting of distinct districts, centers, boulevards, and neighborhoods that are differentiated by their functional role, scale, and character. This shall be accomplished by considering factors such as the existing concentrations of use, community-oriented activity centers that currently or potentially service adjacent neighborhoods, and existing or potential public transit corridors and stations;
- ◆ Policy 3.2.4: Provide for the siting and design of new development that maintains the prevailing scale and character of the city's stable residential neighborhoods and enhances the character of commercial and industrial districts;
- ◆ Policy 3.4.1: Conserve existing stable residential neighborhoods and lower-intensity commercial districts and encourage the majority of new commercial and mixed-use (integrated commercial and residential) development to be located (a) in a network of neighborhood districts, community, regional and downtown centers, (b) in proximity to rail and bus transit stations and corridors, and (c) along the city's major boulevards, referred to as districts, centers, and mixed-use boulevards, in accordance with the Framework Long-Range Land Use Diagram; and
- ◆ Policy 3.4.3: Establish incentives for the attraction of growth and development in the districts, centers, and mixed-use boulevards targeted for growth that may include: (a) Densities greater than surrounding areas, (b) prioritization of capital investment strategies for infrastructure, services, and amenities to support development, (c) economic incentives (e.g., redevelopment, Enterprise Zones, Neighborhood Recovery, and other), (d) streamline development review processes, (e) "by-right" entitlements for development projects consistent with the community plans and zoning, (f) Modified parking requirements in areas in proximity to transit or other standards that reduce the cost of development, and (g) pro-active solicitation of development.

#### Rent Stabilization Ordinance/City of Los Angeles

The City of Los Angeles Municipal Code contains a Rent Stabilization Ordinance that stipulates what the owner or renting agency of a residential property can or cannot do in regards to charging their tenants, removing their tenants, and notifying their tenants of other information. This includes implementation of a rent-control policy that limits the owner or renting agency of frequent or dramatic changes in rent price over a certain period of time.

#### East Los Angeles/County of Los Angeles

The *East Los Angeles Community Plan* was adopted in 1988. The planning area is located in an unincorporated area of the County bounded by Indiana Street on the west, the San Bernardino Freeway, Floral Drive, Pomona Freeway, and Repetto Street on the north, Concourse Avenue on the east, and Telegraph Road and Union Pacific Avenue on the south. Major land use and transportation policies of the plan are:

- ◆ Maintain and enhance the quality of healthy and stable residential neighborhoods;
- ◆ Allow the intensification of land uses only if it does not adversely impact existing uses, neighborhoods, and the existing character and density of the East Los Angeles community;
- ◆ Encourage rehabilitation of existing commercial uses and development of new commercial in-fill along the major corridors (Whittier, Olympic, and Atlantic Boulevards) and where transportation and other municipal services can support development;
- ◆ Improve the local public transit to more closely serve the needs of the people; and
- ◆ Improve the image of the major corridors by use of landscaping, lighting, graphics, and/or other streetscape treatments.

### **Redevelopment Areas**

The corridor contains several redevelopment and specialized zone areas. They are delineated in Figures 4.1-3 and Figure 4.1-4.

#### **Central City and Central City North/City of Los Angeles**

The Central City planning area contains two redevelopment project areas.

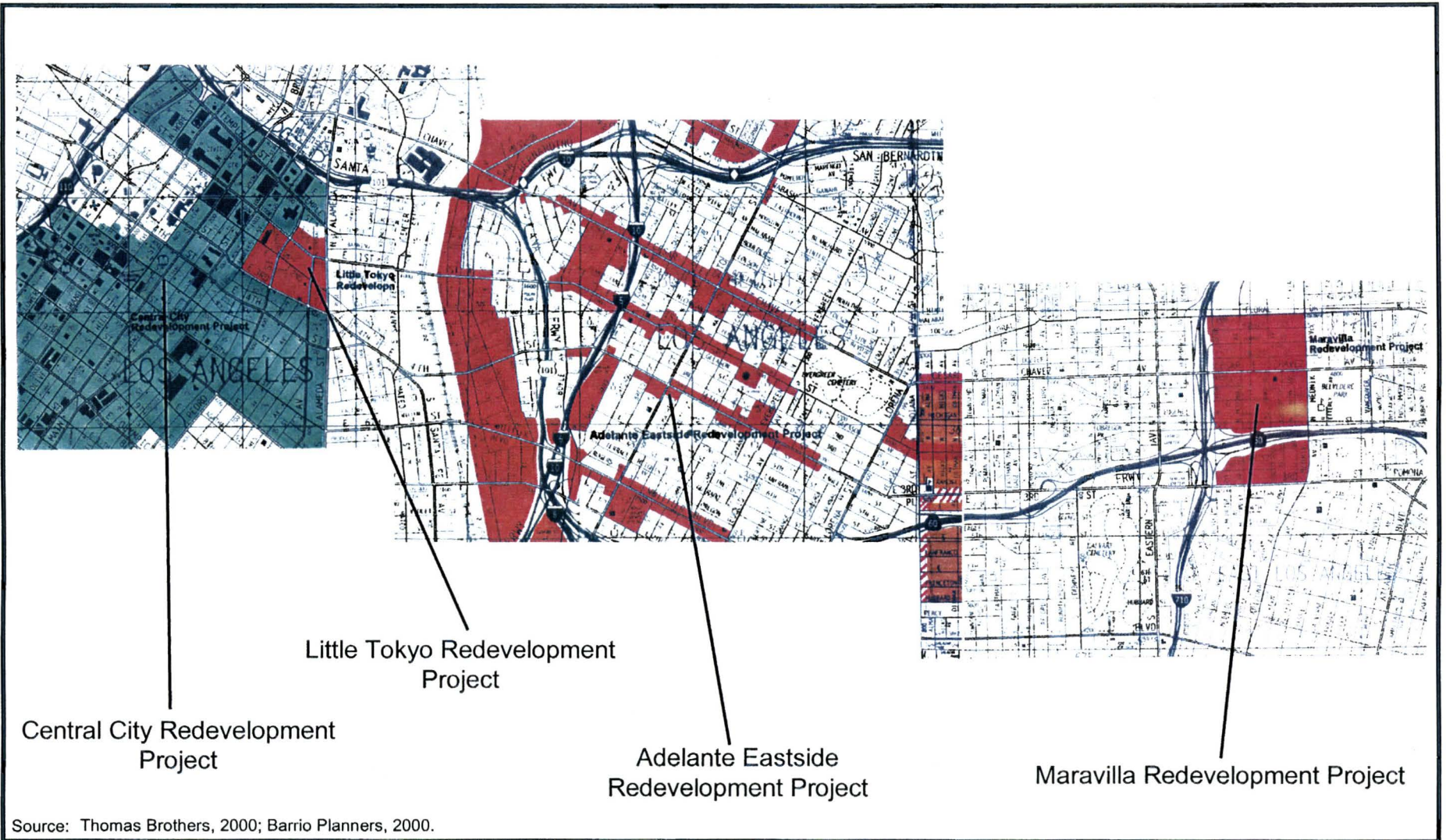
- ◆ The Little Tokyo Redevelopment Project is generally bounded by 1<sup>st</sup> Street on the north, Los Angeles Street on the west, 3<sup>rd</sup> Street on the south, and Alameda Street on the east. The Little Tokyo Redevelopment Project was adopted in 1970 and served as the catalyst for major changes in the community, including the restoration and reuse of historic structures, the Japanese American National Museum, and the Japanese American Cultural and Community Center. The community's revitalization has also included expansion of the residential base through housing developments for senior citizens and affordable housing unit complexes and commercial development to serve the residents. Some of these developments include Japanese Village Plaza and Yaohan Plaza. These projects have come about, in part, as a result of one of the plan's objectives to create new sites for residential development and the provision of housing units for families with low to moderate incomes and senior citizens.
- ◆ The Central City Redevelopment Project, which borders the Little Tokyo Redevelopment Project, and extends north to the Hollywood Freeway, east to Alameda Street, and west to the Harbor Freeway with the exception of the Bunker Hill area. The Central Business District Redevelopment Plan, for the Central City Redevelopment Project, provides two objectives that support housing in the redevelopment area: 1) to create a modern, efficient and balanced urban environment for people, including a full range of around-the-clock activities and uses, such as recreation and housing; and 2) to provide high- and medium-density housing close to employment and available to all ethnic and social groups, and to make an appropriate share of the city's low and moderate income housing available to residents of the area.

#### **Boyle Heights Community/City of Los Angeles**

The Boyle Heights Community has a primarily commercial and industrial redevelopment project known as the Adelante Eastside Redevelopment Project, which was adopted in 1999 and includes all of the commercial corridors and industrial sectors of the Boyle Heights community. The redevelopment project area includes the street frontages along Cesar E. Chavez Avenue, 1<sup>st</sup> Street, 4<sup>th</sup> Street, Whittier Boulevard as well as the industrial sector that lies immediately east of the Los Angeles River, south of Olympic Boulevard, and the greater LAC+USC Medical Center Complex, which is located north of I-10. The following objective of the plan supports housing: Promote the development of sound residential neighborhoods through mechanisms such as: land use, density and design standards; public improvements; property rehabilitation; sensitive mixed-use and in-fill housing rehabilitation and development; traffic and circulation programming; and development of open spaces and other services necessary to enable residents to live and work in or adjacent to the Redevelopment Area.

#### **East Los Angeles Community/County of Los Angeles**

The East Los Angeles Community includes the Maravilla Redevelopment Project, which was adopted in 1973. The redevelopment area is bounded by 3<sup>rd</sup> Street on the south, Mednik Avenue on the east, Floral Drive on the north, and Ford Boulevard on the west. Some new affordable housing and senior citizen housing has been developed within the Project area located north of 3<sup>rd</sup> Street and west of Mednik Avenue.

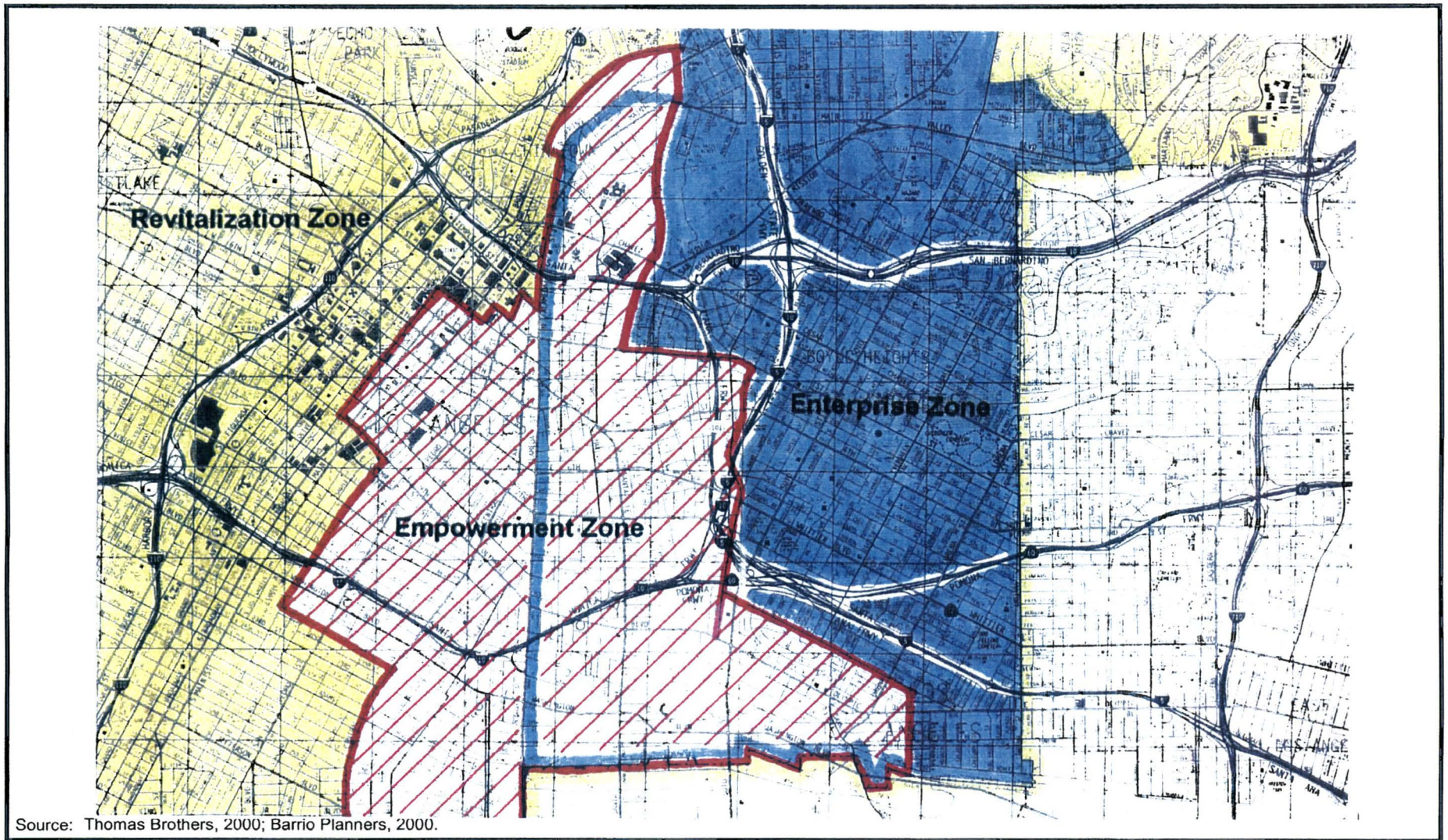


*Los Angeles Eastside Corridor SEIS/SEIR*

***Redevelopment Project Areas***

**Figure 4.1-3**





*Los Angeles Eastside Corridor SEIS/SEIR*

**Specialized Zones**  
**Empowerment, Enterprise, & Revitalization Zones**

Figure 4.1-4





## ***Specialized Zones/City of Los Angeles***

### **Eastside Enterprise Zone**

The Eastside Enterprise Zone was designated by the State of California in 1988. This zone area has been targeted for economic revitalization and investment. The zone area includes all of the Boyle Heights Community and almost all of the Central City North community plan area. The enterprise designation allows for State incentives such as: 1) hiring tax credit; 2) sales and tax credits; 3) business expense deduction; 4) net interest deduction for lenders; and 5) net operating loss carryover.

### **Los Angeles Revitalization Zone**

The Los Angeles Revitalization Zone was created by the City of Los Angeles in 1993 for areas affected by the 1992 civil unrest. In relation to the study area, the Revitalization Zone covers all of the Boyle Heights Community, Central City North, and Central City of the City of Los Angeles. The Revitalization Zone entitles the area to the following tax incentives: 1) employee hiring credit; 2) construction hiring credit; 3) sales and use tax credits; 4) business expense deduction; 5) net interest deduction for lenders; and 6) net operating loss carryover.

### **Empowerment Zone**

The Empowerment Zone is a federal program that seeks to create reinvestment and job creation within the nation's poorest urban communities. The Empowerment Zone includes most of the Central City North area, the western and southern portion of the Boyle Heights Community, and the eastern portion of the Central City area of the City of Los Angeles. Some of the opportunities provided in the Empowerment Zone include micro-loans, business loans, commercial real estate and venture capital financing, special tax-exempt bonds, "brownfields" deduction, and city business tax reduction.

### **Land Use/Transportation Policy – City of Los Angeles**

In 1993 and 1994, the Los Angeles City Council and the Los Angeles County Metropolitan Transportation Authority respectively adopted the *Land Use/Transportation Policy* to address land use, transportation, and air quality issues related to the regional transportation system. The Policy provides general objectives and principles to guide future development around transit station areas and addresses transit/land use coordination within the City of Los Angeles to promote transit-supportive land uses adjacent to the station areas.

### ***Recent and Future Development Activity***

A number of development projects are currently under construction, in the planning stages or proposed within the vicinity or adjacent to the LRT Build Alternative alignment. These projects, listed in Table 4.1-1, are considered in determining cumulative impacts that may arise if the LRT Build Alternative were implemented.

#### **4.1.2 Methodology for Impact Evaluation**

The evaluation of each of the alternatives' compatibility with local plans and policies as well as the types of redevelopment/revitalization areas that are serviced involved a pragmatic methodology. The community plans or general plans of each affected jurisdiction were reviewed to determine adopted land use designations and to identify appropriate land use and transportation /transit related policies. General plan land use designations were identified within an approximate 0.5-mile distance of the LRT alignment.

Information about existing redevelopment project areas and existing revitalization or special zones was reviewed from each affected jurisdiction.

TABLE 4.1-1 RECENT AND FUTURE DEVELOPMENT ACTIVITY				
Project	Location	Development	Land Use	Status
New Pico Gardens	Clarence Street/South of 4 <sup>th</sup> Street	280 units	Residential	Under Construction
Day Care Center/ Management Facility/ Youth Facility	4 <sup>th</sup> Street & Clarence Street	10,000 sq. ft.	Community Facility	Under Construction
Multipurpose Facility	4 <sup>th</sup> Street & Clarence Street	4,500 sq. ft.	Community Facility	Under Construction
Las Casitas	3 <sup>rd</sup> Street & Clarence Street	42 units	Residential	Completed
Las Casitas	3 <sup>rd</sup> Street & Clarence Street	39 units	Residential	Planned
Senior Housing	1 <sup>st</sup> Street & Clarence Street	75 units	Residential	Under Construction
Nuevo Aliso Village	Mission Road/North of 1 <sup>st</sup> Street	469 units	Residential	Proposed
Child Care Center	Utah Street/North of 1 <sup>st</sup> Street	-----	Community Facility	Proposed
Commercial Development	1 <sup>st</sup> Street & Mission Road	3 acres	Commercial	Proposed
Community Service/ Computer Learning Center	1 <sup>st</sup> Street & Clarence Street	3 acres	Community Facility	Proposed
White Memorial Medical Center	Avenida Cesar Chavez & Boyle Avenue	Seismic Upgrades & Replacement Facilities	Hospital Facility	Planned
Salesian Youth Center	4 <sup>th</sup> Street & Breed Street	17,000 sq. ft.	Community Facility	Completed
Commercial Development	3 <sup>rd</sup> Street & Mednik Avenue	34,000 sq. ft.	Commercial	Planned
ELA Civic Center	3 <sup>rd</sup> Street & Mednik Avenue	Site Enhancement	Public	Planned
Parking Structure Addition	Fetterly Avenue/North of 3 <sup>rd</sup> Street	180 additional parking spaces	Public	Planned
New Library	ELA Civic Center/North of 3 <sup>rd</sup> Street	26,000 sq. ft.	Public	Planned
Existing Library Building Reuse	3 <sup>rd</sup> Street & Fetterly Avenue	15,000 sq. ft.	Public	Planned
Child Care Center	ELA Civic Center	5,500 sq. ft.	Community Facility	Planned
Soledad Enrichment Action Facility	Fetterly & Gleason Avenues	6,000 sq. ft.	Community Facility	Planned
Kaiser Medical Clinic	Pomona Boulevard & Woods Avenue	50,000 sq. ft.	Medical Facility	Under Construction
Mangrove Estates Project	East of northeast corner of 1 <sup>st</sup> & Alameda Streets	2.7 million sq. ft.	Hotel, Multi-family, and Retail	Approved
SCI-ARC Architectural College and student apartments	Southwest of 3 <sup>rd</sup> Street and Santa Fe Avenue	---	College and Multi-family Residential	Under Construction
Los Angeles Children's Museum	Southwest corner of Alameda and Temple Streets	---	Community Facility	Proposed
First Street South Plaza	Southeast corner of Alameda and 1 <sup>st</sup> Streets	616,000 sq. ft.	Office, Retail, Health Club, and Multi-family Residential	Approved

Under CEQA, significant land use and planning impacts would occur if an alternative would:

- ◆ **Divide Community:** Physically divide an established community;
- ◆ **Conflict with Land Use Plans/Policies/Regulations:** Conflict with any applicable land use plan, policy, or regulation of an agency with jurisdiction over the project (including, but not limited to the

general plan, specific plan, local coastal program, or zoning ordinance) adopted for the purpose of avoiding or mitigating an environmental effect; and

- ◆ **Conflict with Conservation Plans:** Conflict with any applicable habitat conservation plan or natural community conservation plan.

### 4.1.3 Impacts

#### 4.1.3.1 No-Build Alternative

There would be no impacts on land use or development because this alternative only includes improvements to the transportation network that have already been approved and funded. Since no capital improvements are included under this alternative, no land use changes would occur in the study area. This alternative would maintain the status quo and, therefore, would not address the stated goals and objectives for the communities within the study area as well as the LRT Build Alternative.

#### 4.1.3.2 LRT Build Alternative

##### *Option A*

##### Compatibility with Local Plans and Policies

The general plan of both the County of Los Angeles and the City of Los Angeles contain transit-supportive concepts. The existence of these policies combine with the project area characteristics that form a strong transit orientation that would match well with the LRT Build Alternative Option A and strengthen efforts to improve the quality of life for area residents and businesses.

Option A would be compatible with policies in the Central City Plan. The proposed project would provide improved accessibility to the Central City area; support the redevelopment of Union Station as a transportation center; accommodate the expansion of the Little Tokyo Community east of Alameda Street; and continue the development of government facilities.

Option A of the LRT Build Alternative would generally be compatible with the policies of the Central City North Community Plan. It would attract uses that strengthen the economic base in the primarily industrial and commercial land uses with transit-oriented development. It would not result in displacing any industrial plan designations nor would it remove a significant amount of industrial uses that support the industrial base of the city and community. It would result in the development of a public transit system that would improve mobility with alternatives to automobile travel, especially for the transit-dependent population. Two multi-use developments are planned in the Central City near 1<sup>st</sup>/Alameda: Mangrove Estate and First Street South Plaza (FSSP). Option A would result in limiting planned access to the Mangrove Estate project by closing both Turner and Banning Streets and resulting in the prohibition of the northbound right-turn movement from Alameda Street onto eastbound Temple Street. Access to the property would be located at Hewitt Street, with installation of a new signal. An access point would be re-created as part of Option A, thus the reduction of planned access to the multi-use project is considered a less than significant land use impact, as it would not significantly detract from the proposed commercial development. It is anticipated that with mitigation in the form of coordination between MTA, the City of Los Angeles, and the Mangrove Estate developer, access issues would be offset further.

Option A would not significantly conflict on a land use/planning basis with the approved FSSP. Although there may be temporary land use impacts to the high-rise development buildings during construction, which may temporarily restrict access and/or parking for these land uses, Option A's transit

and station operation would not restrict access to nor displace or hinder land use-associated elements of the FSSP and, therefore, would have no operational impacts. Option A would not divide the FSSP's sense of community, nor would it conflict with land use policies associated with the FSSP. The transit facilities would be compatible with the adjacent "C2-2" zoning that was established for the FSSP. Although Option A would result in displacing street parking along the north and south sides of 1<sup>st</sup> Street between Alameda and Vignes Streets, it is not anticipated that this would be a significant land use impact because the nearby land uses are presently vacant. In the future, if the proposed multi-use projects were constructed, the developers would provide on-site parking. Implementation of Option A would add a mode of mass transit and provide additional access for residents and workers at the FSSP and Mangrove Estate for travel to the Union Station area and along the Eastside Transit Corridor, a beneficial impact. The Central City North Community Plan discourages "light trespass" on residential areas. Option A would not add major new light sources in areas that are currently dark. Generally, the areas through which this option would pass currently have street lights that are sufficient for visibility and safety. There would be new lighting in the vicinity of stations and station entrances, but these areas are not currently dark and the additional lighting would not change the overall lighting levels in the vicinity of the stations.

Option A under the LRT Build Alternative would be generally compatible with policies in the Boyle Heights Community Plan, which encourages alternative modes of travel, particularly to meet the needs of transit-dependent residents, preservation of commercial services in neighborhoods, and to conserve and strengthen viable commercial and pedestrian corridors. Aside from a few commercial relocations associated with the traction power substation facilities and new station locations, this option would be compatible with the Community Plan policies. Displacements on lands categorized as Medium-Density Residential would occur south of 1<sup>st</sup> Street and west of Boyle Avenue. Residential displacements on Neighborhood-Commercial designated land would also occur at the southwest corner of 1<sup>st</sup> and Soto Streets. In areas where Low-Medium I or II density housing would be displaced, such displacements are considered potentially significant impacts as they would disrupt existing housing land uses and thus conflict with the Boyle Heights Community Plan policy that states that: "...existing Low-Medium I or II density housing be preserved where such housing is in relatively good condition or can be made so with moderate improvements."

Option A would be compatible with the housing-related objective and policies of the Framework Element of the Los Angeles General Plan. It would create new transit in proximity to multi-family housing development; it would assist in providing a pattern of development consisting of distinct districts differentiated by their function role, scale, and character; it would maintain the prevailing scale and character of the City's stable residential neighborhoods; it would be located in proximity to stable residential neighborhoods and conserve these neighborhoods; and it would assist in attracting growth and development in the districts.

Option A would not adversely affect the Los Angeles rent-control policies or stipulations of the Rent Control Ordinance because, although the project has the potential to influence the increase in property values along the corridor, the Ordinance would still be in effect and govern the rate of increase at a moderate rate. Although real estate values along the corridor and areas it serves may increase, local sales taxes and commercial taxes are also anticipated to increase along with incomes, benefiting the community as a whole. In some cases, review by the City of Los Angeles Rent Adjustment Commission is required and would help to keep high increases in rent in check and affordable to the general community.

Option A would be consistent with the Los Angeles Community Development Department Consolidated Plan priorities and strategies, because it would improve the basic infrastructure for local neighborhoods and businesses by providing additional mass transit. Although it may result in increasing some property values along the corridor, there would still be an abundant supply of affordable housing stock in the area, and it would not result in degrading such affordable housing. Furthermore, MTA has established a fund

that will be used for housing replenishment by specifically assisting developers, community-based or otherwise, in the construction and rehabilitation of affordable housing in East Los Angeles.

Option A would be generally compatible with County of Los Angeles policies in the East Los Angeles Community. This option would maintain the quality of residential neighborhoods, assist in encouraging rehabilitation of existing commercial uses and promote in-fill where transportation can support development, improve public transit, and not significantly degrade the image of major corridors. Parking mitigation off of Indiana Street would result in displacing two multi-family buildings and two businesses. These are considered less than significant impacts, however, because the eastern side of Indiana Street is comprised of several types of land uses. Therefore, these displacements would not result in a significant land use impact. Although this option would result in commercial and industrial displacements associated with the other traction power substations and park-and-ride lot, no significant impacts related to compatibility with County of Los Angeles policies are anticipated.

Option A would be compatible with policies in SCAG's Regional Comprehensive Plan and Guide (RCPG) in several ways. The project would be influential in supporting transportation demand management in that it would decrease overall demand for vehicle ridership in the project corridor. By reducing vehicle demand and providing another mode of transportation, a more balanced demand for several modes of transportation would be supported. Land use patterns that are consistent with transportation and transit characteristics, such as transit-oriented development, would also be supported by Option A, as discussed in further detail in this section. The project would support safe and convenient means of non-motorized transportation, including bicycle and pedestrian-friendly environments near the project. Option A would also be located along an ideal corridor for its use, which would maximize the use of existing urbanized areas, support redevelopment, and increase density of land uses in many locations along the corridor. Although Option A may result in increasing property values, it would nevertheless support the housing objectives of the RCPG as it would not displace a significant amount of housing nor dramatically raise rental rates because of Los Angeles' rental control policies. As part of the MTA's project commitments, where water would be needed for irrigation of landscaping, bathroom facilities, and wherever else feasible, reclaimed water would be used to reduce reliance on imported water and wastewater discharges.

#### Compatibility with Redevelopment Areas/Specialized Zones

Option A under the LRT Build Alternative would support many of the policies of redevelopment areas and specialized zones in the project area, including housing policies. Although it may increase property values in redevelopment areas, which would be inconsistent with the Little Tokyo Redevelopment Plan objective to "provide housing units for families with low to moderate incomes and senior citizens," it is anticipated that many other places in these redevelopment areas would be available at affordable costs. It would not interfere with providing high- and medium-density housing close to employment in the Central Business District Redevelopment area, nor significantly hinder the promotion of sound residential development in the Adelante Eastside Redevelopment area. Furthermore, it would have an overall beneficial impact of supporting the activities of an efficient and balanced urban environment, as well as it would provide a new transportation mode to enable residents to live and work in or adjacent to the redevelopment areas.

#### Impacts of Stations and Ancillary Facilities

With the exception of the Alameda/1<sup>st</sup> and 1<sup>st</sup>/Soto Stations, stations would be accommodated within the existing right-of-way, and would include a raised platform with a canopied sign and lighting. The station at 1<sup>st</sup>/Alameda would require a partial taking of a strip of land along the planned Mangrove Estates multi-use project, resulting in less than significant impacts. The station/substation/construction staging at

1<sup>st</sup>/Soto would result in displacing several businesses and residences, which would be a less than significant land use impact. Parking removed for these stations would not result in significant impacts, because adequate replacement parking is part of the Option A design. The stations would be designed to blend with their surroundings and would not affect local neighborhoods at a land use level. As mentioned above, parking mitigation on Indiana Street would result in displacing two businesses and two multi-family buildings. Traction power substations throughout the corridor would result in displacing commercial uses. Individually and cumulatively, these would result in less than significant land use impacts, especially considering the potential transit-oriented development that would be spurred from the project.

At the eastern terminus, parcels containing several businesses would be acquired for development of a park-and-ride facility. Also, a Pep Boys parking lot will be utilized under a shared-use agreement for the park-and-ride facility. These land use displacements are not anticipated to be potentially significant as their absence would not disrupt the community nor be incompatible with land use policies for the area. (See Section 4.3 for further information about displacement impacts).

#### Potential for Transit Supportive Land Uses

FTA criteria for evaluating transit supportive land uses include: 1) promoting a variety of residential and commercial uses; 2) potential to assist in containment of sprawl; 3) encouraging greater population density, and 4) enhancing pedestrian facilities. Existing local and regional land use and transportation planning policies are compatible with these criteria and actively promote the implementation of transit supportive land uses and development. In addition, local plans and policies encourage high-traffic uses that are compatible with new transit facilities, such as schools, health care clinics, community centers, and libraries to be located along the proposed LRT alignment.

It is anticipated that transit oriented districts would be spurred by the project due to three major factors – the objectives of the *MTA Joint Development Policy*, the MTA's successful history of transit oriented districts, and the project area's long history of transit oriented development. MTA's objectives are established to encourage public-private joint partnerships in spurring transit oriented districts by: Encouraging transit compatible land use plans; providing comprehensive urban design, planning and development activities to ensure the most appropriate mix of land uses and densities; establishing procedures for the selection of private sector joint development participants through a competitive proposal process; and negotiating joint development transactions that create a long-term source of revenue to the MTA for the development, operation, and maintenance of the transit system. These objectives express MTA's commitment to nurturing and maintaining transit oriented development.

MTA projects have helped to spur and support transit oriented districts in several areas in the Los Angeles area. Districts adopted by the Los Angeles Planning Commission are located at the Broadway/Manchester (major MTA Bus lines), Avenue 57 (station on the future Pasadena Blue Line), and Vermont/Western (three stations on the red line). Fully implemented transit oriented districts include the Pine Street Project (in response to the MTA urban rail network) and the Holly Street Village (built partly on the space above the future Pasadena Blue Line). These examples show MTA's success in spurring transit-oriented districts.

The long history of the corridor's transit oriented development indicates that the dynamics for additional transit-oriented development may once again become present with the development of the LRT Build Alternative, Option A. Originally, the land uses were established in response to the streetcar system from the 1890s until 1963. The alignment passes through neighborhoods which have small lots and retail establishments under apartments, which are features sought by contemporary visions of transit oriented districts. These physical features of the corridor may act to spur new transit oriented development, and

the demographics of high transit dependency on the part of the residents of these largely Latino neighborhoods near the City Center may help to maintain such transit-oriented development. This would be a beneficial impact to the community.

### Significance of Impacts

With regard to dividing, disrupting, or isolating the community, Option A would have a less than significant impact. The LRT alignment will extend mainly along existing roadways or within tunnel sections and would therefore not require a new exclusive right-of-way that could divide the community. Pedestrian access will be maintained to maximum extent possible along the alignment through the use of existing or improved crosswalks. Although some sidewalks would be removed, it is anticipated that adequate access throughout the corridor will be maintained. Option A would not be compatible with all local land use plans and policies resulting in a potentially significant impact. Option A would not be compatible with the policy of the Boyle Heights Community Plan to conserve and improve existing sound housing, because housing displacements at 1st Street/Boyle Avenue and 1st Street/Soto Street would result in disruption of the intended land use. There would also be beneficial impacts because the City and County of Los Angeles have developed a number of transit-supportive land use plans and programs that Option A would further in the Los Angeles Eastside Corridor.

### *Option B*

#### Compatibility with Local Plans and Policies

The compatibility with Local Plans and Policies are the same as described for Option A with the exception of compatibility with the East Los Angeles Community Plans and Policies. Option B would displace all of the residential and commercial uses on the east side of Indiana Street, as well as Ramona High School. This is considered a potentially significant land use impact because it would disrupt a community. The displacement or reconstruction of Ramona High School on Indiana Street would contribute to this impact because the school serves as a community asset. This impact would be less if the school is reconstructed on the same site, but the removal of all other uses on the east side of Indiana Street would still be a significant impact. (Potential environmental impacts at the alternative site if the school would be relocated would be addressed in a separate document to be prepared by the Los Angeles Unified School District.)

#### Compatibility with Redevelopment Areas/Specialized Zones and Potential for Transit-Supportive Land Uses

Same as Option A.

#### Impacts of Stations and Ancillary Facilities

The impacts of stations and ancillary facilities are the same as described for Option A with the following exceptions. Under Option B, the station location at 3<sup>rd</sup> and Indiana Streets would result in either the relocation or reconstruction of Ramona High School, as discussed above. Land use impacts in this area relate to the removal of land uses, not the construction of the station. If the school is reconstructed, the location of the station on Indiana Street would provide an alternative means of access to the school, which would be a beneficial impact. For Option B, the 3<sup>rd</sup>/Ford and Pomona/Atlantic Stations would not result in right-of-way acquisitions, and thus no land use impacts would occur. The stations would be designed to blend with their surroundings and would not affect local neighborhoods at a land use level. The acquisitions associated with the eastern terminus of the Option B alignment would be the same as for Option A, however the Pep Boys parking lot would not be used.



## Significance of Impacts

With regard to dividing, disrupting, or isolating the community, Option B would have a potentially significant impact. Although much of the LRT alignment will extend mainly along existing roadways or within tunnel sections and would not require a new exclusive right-of-way, Option B would result in displacing all land uses along the eastern side of Indiana Street. If Option B results in displacing Ramona High School, potentially significant impacts associated disrupting and dividing the community would be greater. Pedestrian access will be maintained to the maximum extent possible along the alignment through the use of existing or improved crosswalks. Although some sidewalks would be removed, adequate access throughout the corridor will be maintained. Option B would have the same potentially significant impact as Option A with regard to compatibility with some of the local land use plans and policies and the same beneficial impact as Option A with regard to furthering transit-supportive land use plans and programs.

### **4.1.4 Mitigation**

#### **4.1.4.1 Option A**

The community generally supports transportation improvements as an important link to future revitalization. To assure compatibility with local land use objectives, to the extent possible, the provision of Option A will be closely coordinated with future local, state, and federal redevelopment and revitalization plans and programs. Coordination between MTA, the City of Los Angeles, and the developer of the Mangrove Estates project would further offset less than significant access impacts to the Mangrove Estates project. Option A would improve transit service in the Eastside Corridor in general agreement with future plans and policies. Option A would not be compatible with one policy of the Boyle Heights Community Plan, and this impact would be mitigated as described below.

#### ***Compatibility with Local Plans and Policies***

For residential displacements at the 1st/Boyle and 1st/Soto stations associated with Option A, the remaining space on residential parcels acquired by MTA for the alignment will be reconfigured and made available for neighborhood commercial to medium-density residential uses, as already designated by the Boyle Heights Community Plan. It is expected that the incorporation of this mitigation will reduce potentially significant impacts to land use policies to a less than significant level.

#### ***Significance of Impacts Remaining After Mitigation***

The mitigation measures would reduce impacts on land use policies to a less than significant level.

#### **4.1.4.2 Option B**

The community generally supports transportation improvements as an important link to future revitalization. To assure compatibility with local land use objectives, to the extent possible, the provision of Option B will be closely coordinated with future local, state, and federal redevelopment and revitalization plans and programs. Coordination between MTA, the City of Los Angeles, and the developer of the Mangrove Estates project would further offset less than significant access impacts to the Mangrove Estates project. Option B would improve transit service in the Eastside Corridor in general agreement with future plans and policies. Option B would not be compatible with one policy of the Boyle Heights Community Plan, as described below.

### ***Division of Community***

For residential displacements at the 1st/Boyle and 1st/Soto stations associated with Option B, the same mitigation as described for Option A will be implemented. For residential and commercial displacements along the eastern side of Indiana Street, MTA will acquire the remaining parcels and reconfigure and make them available for rezoning and re-use in accordance with Los Angeles County Regional Planning Department requirements. MTA will work closely with the City and County of Los Angeles Planning Departments to ensure that an adequate replacement land use (e.g., community facility, replacement housing, etc.) is chosen that works well along the county/city boundary and with MTA's proposed transit facilities.

If displacement of Ramona High School to another site is selected, MTA will provide the resources needed to acquire parcel(s) and construct a new facility. If reconstruction of Ramona High School is selected, MTA will design the alignment and station to allow access and safety for students and staff that attend Ramona High School. MTA will work closely with the school district, Los Angeles County Planning Department, and the City of Los Angeles Planning Department to ensure that adequate access and safety are implemented in their design. See Sections 4.14 and 4.16 for further information about safety issues and mitigation at Ramona High School.

### ***Compatibility with Local Plans and Policies***

The same mitigation measures will be implemented as for Option A.

### ***Significance of Impacts Remaining After Mitigation***

The mitigation measures would reduce impacts on land use policies to a less than significant level.

## 4.2 ECONOMIC AND FISCAL IMPACTS

### 4.2.1 Affected Environment

#### 4.2.1.1 Employment

As presented in Table 4.2-1, the 1994 employment within the Corridor was 170,328 and is projected to grow to 221,403 in 2020, about a 30 percent increase. This is at a lower rate than Los Angeles County, where employment is expected to increase by 40.7 percent. Employment in the entire Southern California Association of Governments (SCAG) region is expected to grow 60.1 percent during this same period, or twice the rate of the Corridor. The Los Angeles County labor force was approximately 4.7 million in September 1999. As indicated in Table 4.2-2, the unemployment rate for the Corridor was 9.2 percent, substantially greater than the City and County unemployment rates.

Jurisdiction	1994	2020	Growth (%)
<b>SCAG Region</b>			
Total Population	15,610,700	22,352,000	43.2%
Total Employment	6,604,000	10,574,000	60.1%
Total Area (square miles)	38,000		
<b>Los Angeles County</b>			
Total Population	9,231,600	12,249,100	32.7%
Total Employment	4,134,000	5,817,600	40.7%
Total Area (square miles)	4,083		
<b>Central Business District – Downtown LA</b>			
Total Population	45,464	69,686	53.3%
Total Employment	250,037	278,873	11.5%
Employment – Percent of SCAG Region	3.8%	2.6%	
Employment – Percent of LA County	6.1%	4.8%	
CBD Area (square miles)	6.31		
Employment Density (employees/square mile)	39,625	44,195	
<b>Eastside Corridor Study Area</b>			
Total Population	284,669	340,065	19.5%
Total Employment	170,328	221,403	30.0%
Population – Percent of SCAG Region	1.8%	1.5%	
Population – Percent of LA County	3.1%	2.8%	
Employment – Percent of SCAG Region	2.6%	2.1%	
Employment – Percent of LA County	4.1%	3.8%	
Corridor Area (square miles)	27.65		
Population Density (population/square mile)	10,295	12,299	
Employment Density (employees/square mile)	6,160	8,007	

Source: SCAG 1999 TAZ Data (Employment and Population Projections).

Area	Labor Force	Employment	Unemployment	Rate
East Los Angeles	52,840	47,960	4,880	9.2%
Los Angeles	1,897,590	1,771,650	125,940	6.6%
<b>Los Angeles County</b>	<b>4,734,900</b>	<b>4,458,400</b>	<b>276,500</b>	<b>5.8%</b>

Source: California Employment Development Department, 1999.

#### **4.2.1.2 Disadvantaged Business Enterprise Participation**

As part of its existing practices and procedures, MTA has established Disadvantaged Business Enterprise (DBE) Programs to encourage broad-based business participation in its mass transit procurement programs. A DBE is a firm that is owned by socially and economically disadvantaged individuals. The DBE Program was designed by MTA to comply with both state and federal laws to ensure that businesses are not discriminated against in procurement practices on the basis of gender, race, color, national origin, age, or disability. For its DBE Program, MTA reviews all businesses interested in participating in its DBE Program and evaluates each case to ensure that they meet the federal eligibility criteria set forth by U.S. Department of Transportation regulations.

#### **4.2.1.3 Fiscal Environment**

Total tax receipts for the City of Los Angeles in Fiscal Year 1999/2000 were \$2.85 billion, of which property taxes accounted for an estimated \$528 million; licenses, permits, fees, and fines accounted for an estimated \$420 million and business tax fees accounted for an estimated \$317 million. Sales tax revenue for the City of Los Angeles for Fiscal Year 1999/2000 was \$332 million. Los Angeles County receipts in Fiscal Year 1996/97 were \$36.5 billion, with property taxes accounting for \$1.2 billion and sales tax accounting for \$32 million.

The City of Los Angeles portion of the study area contains three specialized zones where economic revitalization and investment are targeted: Eastside Enterprise Zone, Los Angeles Revitalization Zone, and Empowerment Zone (refer to Section 4.1, Land Use).

### **4.2.2 Methodology for Impact Evaluation**

#### **4.2.2.1 Long-term Employment**

Operation of the LRT Build Alternative would generate jobs and increase customer patronage for local businesses especially those located near light rail stations. These jobs are considered permanent. The completion of a project can be expected to improve business conditions and employment opportunities. Employment is generated by new business activity that occurs as a result of project completion and transit operating expenditures.

The 2000 conceptual operating cost estimates (Fiscal Years 2007/20) developed for the LRT Build Alternative and the factors identified below were used to estimate the total number of long-term jobs created. Based on the Regional Industrial Modeling System (RIMS) developed by the U.S. Department of Commerce, Bureau of Economic Analysis (BEA), transit operating expenses create substantially more employment per \$100 million than do capital projects. Most of the direct impacts from operation are created in the transit industry, usually on-site. Others are created in other sectors, such as local businesses, that indirectly benefit from the new transit service. Based on the RIMS model and the indirect multiplier of 1.365, \$100 million spent on transit operations would support a total of 9,610 direct and indirect full-time equivalent (FTE) positions.

#### **4.2.2.2 Short-term Employment**

Construction of the LRT Build Alternative would generate employment opportunities at the local and regional level. Direct impacts account for construction workers, professional services, motor vehicle manufacturing, steel works, and others. Indirect impacts account for added employment in other sectors that is generated by LRT construction (the trickle down effect).

The 2000 conceptual construction cost estimates developed for the LRT Build Alternative and the direct and indirect factors identified above were used to estimate the total number of temporary jobs created. Based on the RIMS II model, transit capital investments have been shown to result in a direct regional employment benefit. Using the RIMS II model, the American Public Transit Association has determined that for each \$100 million<sup>1</sup> invested in new rail projects, it is estimated to directly increase employment by 3,380 FTE jobs. Of the total number of short-term jobs generated by new rail starts, over half are typically construction-related or business and professional services. Employment impacts of new start projects are attributable to the labor-intensity of new transit construction work and related professional services (APTA, 1983).

Indirect impacts are estimated through an employment multiplier of 1.365 drawn from a 1981 U.S. Department of Transportation study (USDOT, 1981). This estimate is based on Bureau of Labor Statistics studies, which have been used in a number of FTA projects. A new rail transit investment of \$100 million is estimated to indirectly increase short-term employment by 4,610 FTE jobs. The combination of direct and indirect short-term jobs would total 7,990 FTE positions.

#### **4.2.2.3 Fiscal**

Providing governmental services such as fire and police require additional funds supplied by the jurisdictions they are to serve. Information related to fire and police services in the study area was obtained from the Internet. Information regarding property and sales tax revenues was obtained from the City of Los Angeles for Fiscal Year 1999/2000 and from the County of Los Angeles for Fiscal Year 1996/97. Impacts were identified utilizing displacement data contained in Section 4.3, Land Acquisition/Displacement and Relocation.

### **4.2.3 Impacts**

#### **4.2.3.1 No-Build Alternative**

There would be no impacts on employment because the No-Build Alternative only includes improvements to the transportation network that have already been approved and funded. By maintaining the status quo, this alternative would not stimulate employment within the study area, generate fiscal impacts or create the need for additional government services, such as fire and police. In addition, the No-Build Alternative would not require property acquisitions that would diminish local tax revenues.

#### **4.2.3.2 LRT Build Alternative**

##### ***Option A***

##### **Long-term Employment Impacts**

Table 4.2-3 presents the conceptual operating costs for fiscal years beginning in 2006/07 and the potential long-term or permanent jobs created by the LRT Build Alternative over a 14-year period. The long-term employment estimate for direct and indirect jobs is based on operating costs. Within the first 14 years of operation, the LRT Build Alternative would support 1,078 long-term jobs, including indirect employment opportunities coming from potential business development and redevelopment along the alignment and near stations. Thus, operation of the LRT Build Alternative would result in indirectly fostering economic

---

<sup>1</sup> Does not include right-of-way.

and population growth that has been considered in the goals and policies of local plans, and the additional employment would ultimately be a beneficial impact.

**TABLE 4.2-3  
ESTIMATED LONG-TERM EMPLOYMENT – LRT BUILD ALTERNATIVE**

Fiscal Year	Conceptual Operating Costs (1999 \$ in millions) <sup>1</sup>	Estimated Direct Employment Generated <sup>2</sup>	Estimated Indirect Employment Generated <sup>2</sup>	Estimated New Employment-Per-Year Generated <sup>3</sup>	Estimated Total Employment Generated <sup>2</sup>
2006/2007	\$4.5	184	251	435	435
2008	\$6.8	275	376	216	651
2009	\$7.1	290	396	35	686
2010	\$7.5	305	417	36	722
2011	\$7.9	320	438	36	758
2012	\$8.3	335	458	35	793
2013	\$8.6	350	479	36	829
2014	\$9.0	365	499	35	864
2015	\$9.4	380	520	36	900
2016	\$9.7	395	540	35	935
2017	\$10.1	410	561	36	971
2018	\$10.5	425	582	36	1,007
2019	\$10.9	441	602	36	1,043
2020	\$11.2	456	623	35	1,078
<b>TOTAL</b>	<b>N/A</b>	<b>N/A</b>	<b>N/A</b>	<b>1,078</b>	<b>N/A</b>

Sources:  
<sup>1</sup> Conceptual operations costs (PBQD, 2000).  
<sup>2</sup> For each \$100 million operating expenses - 4,060 direct and 5,550 indirect jobs would be generated (APTA, 1983).  
<sup>3</sup> New employment-per-year generated is based on the difference between employment from immediate previous years only.

### Fire/Police Services

Local fire and police staff and services would be minimally affected by the direct and indirect employment created by operation of the LRT Build Alternative. No significant impacts to fire/police services are anticipated to occur because, according to discussions with the City and County police and fire departments' personnel, the existing fire and police would be sufficiently staffed to service the LRT facility. In addition, the LRT Build Alternative is not expected to significantly increase demand on police or fire prevention services operated by the City and County of Los Angeles. System security would be an important component of rail operations and would be the responsibility of MTA. Existing fire protection services in the local jurisdictions and the county, coupled with system-wide fire safety measures, are expected to serve the system adequately. The LRT Build Alternative, therefore, is not expected to have a significant effect on the cost of providing these services.

### Property Tax

Possible property acquisitions for the LRT Build Alternative have an estimated real estate value totaling approximately \$10.73 million. The estimated real estate value for partial acquisitions and easements total approximately \$6.07 million.<sup>2</sup> Properties that would be fully acquired for Option A of the LRT Build Alternative would reduce the tax bases of the City and County of Los Angeles. Property taxes are levied on the assessed value of all privately owned property and are collected by the County. Based on tax

<sup>2</sup> Accessed at [www.dataquick.com](http://www.dataquick.com) on November 16, 2000.

amounts per current property values, the property tax loss to all property acquisitions would total approximately \$141,870 annually.

The anticipated annual property tax loss to the City and the County would be minimal compared to their respective total property tax revenues. The resulting tax revenues would be sufficient to continue the current level of social spending and governmental services. The reduction of property tax revenue due to the LRT Build Alternative would, therefore, be less than significant. Indirect tax revenue benefits may be realized with infusion of development around stations and revitalization and development within the surrounding areas.

#### Sales Tax

If Option A of the LRT Build Alternative were implemented, the City of Los Angeles and East Los Angeles communities would lose 20 businesses. The business acquisitions would lower the level of sales tax revenues if the businesses could not relocate within the local jurisdiction. By relocating within their current jurisdictions, sales tax revenue losses would be temporary or offset in nature.

The loss of sales tax revenue would not be sufficient to adversely affect the tax base for the City or the County given the relatively small number of commercial/retail acquisitions compared to the total businesses operating within these jurisdictions. The existing tax revenue amounts would be sufficient to continue the current level of social spending and governmental services. No significant impact is expected.

#### Business License Fees

Business License Fees are generally assessed by individual jurisdictions based on the total number of employees or the annual gross sales receipts of a business. Acquisition of commercial properties would result in lost business license fee revenues. However, the loss is not expected to generate a significant impact, since these business license fees represent only a small portion of the City's or the County's revenues, and existing revenue amounts would be sufficient to continue the current level of governmental services.

#### Lighting Improvements and Proposition 218

In general, any street or pedestrian lighting improvements within the City of Los Angeles that create new assessments or increase existing assessments to property owners require the Proposition 218 process. This process not only requires community participation, but also public approval through a ballot process. Not all lighting improvements require the process. Lighting improvements associated with Option A will be reviewed for eligibility by the City of Los Angeles prior to installation. The lighting assessment is paid by property owners through the county property tax.

#### Significance of Impacts

There would be no impacts on staffing of fire or police services or reduction of tax revenues.

#### **Option B**

The economic and fiscal impacts and the significance of the impacts of Option B are the same as Option A.

#### 4.2.4 Mitigation

##### 4.2.4.1 No-Build Alternative

No operational impacts were identified for the No-Build Alternative; therefore no mitigation measures are required.

##### 4.2.4.2 LRT Build Alternative

From an employment and fiscal impact perspective, both Options A and B of the LRT Build Alternative are essentially the same. Therefore, the mitigation measures to reduce already less than significant impacts for each option are the same as described below.

Operation of the LRT Build Alternative would indirectly increase employment in the Los Angeles Eastside Corridor by improving mass transit along the corridor, and would not result in impacts requiring mitigation. In addition, MTA will be formulating a local employment policy for both construction-related and long-term job opportunities for the corridor that will be reviewed by the Eastside Corridor Review Advisory Committee. Such a program will include resources for job development and training.

The City and County of Los Angeles would have minimal short-term tax revenue losses, but it is anticipated that long-term development and revitalization would increase overall tax revenues. There is no mitigation for the loss of tax revenue. Operation of the LRT Build Alternative would not have a significant impact on the staffing of fire or police services, therefore, no mitigation measures are required.

MTA is currently conducting station area meetings that provide local residents, businesses, and organizations the opportunity to provide input into planning for specific station areas. The goal is to address specific station area concerns, such as impacts and mitigation measures during construction, as well as economic development opportunities, transit connections, and station plans. Implementation of these mitigation measures is anticipated to help offset less than significant economic impacts.



## **4.3 LAND ACQUISITION/DISPLACEMENT AND RELOCATION**

### **4.3.1 Affected Environment**

Properties within a half-mile strip on either side of the LRT alignment are shown on aerial photographs and plan and profile drawings for the light rail alignment and station areas (Appendix E). Properties required for construction and operation of the LRT Build Alternative are indicated on these drawings. The two alignment Options A and B, which have differing acquisition requirements, are displayed on separate drawings. During final design, the amount of property required at each acquisition site may increase or decrease. Property acquisition may be phased over time, depending on project funding and schedule.

The subway portion of the light rail alignment would be primarily under the public street rights-of-way. In those locations where the subway passed under individual parcels (either publicly or privately owned), MTA would need to obtain easements instead of acquiring or displacing the uses on those parcels. Table 4.3-1 provides a demographic summary of housing characteristics for the project study area and for one-half mile radius around the planned light rail stations. A description of land use characteristics along the alignment is presented in Section 4.1, Land Use and Development. Demographic characteristics are provided in Section 4.4, Communities/Neighborhoods.

### **4.3.2 Methodology for Impact Evaluation**

Engineering plans indicate the location of the alignment, tunnel portals, station locations, and park-and-ride facilities. The right-of-way required for these facilities was plotted on maps in July 2000. Aerial photographs of the study area, city and county land use and parcel maps, encoded real estate data for the County, as well as windshield surveys, were used to determine the characteristics of the properties needed for construction and operation of the LRT Build Alternative. Properties potentially affected were identified according to existing zoning and land use, square footage, and, in the case of residential properties, number of units and average household size. Affected properties were grouped by station location or, if they were located further than one-half mile from a proposed station site, by alignment segment.

The analysis assumed a worst-case scenario for property requirements. Full property acquisitions were assumed if the project physically intruded on existing buildings, removed a substantial portion of the available parking such that a business could not operate, or used the majority of vacant land leaving the remainder too small to develop. This assumption was also applied to properties that were needed for construction purposes only. However, in the case of parking lots, only the portion of the lot needed for the public right-of-way was included. Reference is made to properties originally acquired by MTA for the suspended Red Line Extension and needed for the construction or operation of the LRT Build Alternative. Since acquisition and displacement proceedings for these properties were finalized as part of the suspended project, they are not included in this analysis.

To determine the effect of the property acquisitions and displacements, an estimate of the number of displaced residents and employees was calculated. For residential properties, the number of persons affected was determined by multiplying the number of displaced units by 4.0, the average household size in the corridor. For non-residential displacements, the number of employees affected was determined by applying per-square-foot factors to the total building area of properties subject to full takes. The factors were taken from the Fiscal Impact Handbook (Burchell and Listokin, 1978) as follows:

- ◆ Office – 1 employee displaced for every 250 square feet of space
- ◆ Retail – 1 employee displaced for every 500 square feet of space

- ◆ Industrial – 1 employee displaced for every 525 square feet of space

If one property contained two different businesses, it was counted as two displacements, and the number of employees displaced was counted for each business. The calculations reflect full-time employees and may underestimate the number of part-time employees affected.

**TABLE 4.3-1  
DEMOGRAPHIC SUMMARY OF HOUSING CHARACTERISTICS FOR THE PROJECT  
STUDY AREA AND FOR A 1/2 MILE RADIUS AROUND PROPOSED LIGHT RAIL STATIONS**

Demographic Area/ Station	Housing Units		Average Size Households	Vacancy Rate	Percent Owner- Occupied	Median Value of Owner- Occupied Units	Median Rent
	1990 <sup>1</sup>	2020 <sup>2</sup> / % Increase	1990 <sup>1</sup>	1990 <sup>1</sup>	1990 <sup>1</sup>	1990 <sup>1</sup>	1990 <sup>1</sup>
Los Angeles County	2,989,552	4,239,050 (41.8%)	3.0	1.9	48.2	226,400	570
Project Study Area <sup>3,4</sup>	25,028	40,896 (63.3%)	4.0	3.6	26.1	123,756	404
Union Station	872	5,729 (557.0%)	2.8	3.7	1.0	59,615	376
1 <sup>st</sup> /Alameda	1,328	7,676 (78.0%)	2.6	9.2	8.8	57,673	349
1 <sup>st</sup> /Utah	3,069	3,133 (2.1%)	3.8	3.6	7.2	103,700	470
1 <sup>st</sup> /Boyle	4,273	4,545 (6.4%)	3.9	4.1	11.0	120,782	369
1 <sup>st</sup> /Soto	5,435	7,674 (41.2%)	4.1	3.8	16.4	140,383	398
1 <sup>st</sup> /Lorena (Option A only)	3,714	4,833 (30.1%)	4.2	3.7	34.1	137,419	416
3 <sup>rd</sup> /Indiana (Option B only)	3,696	4,513 (22.1%)	4.3	3.3	32.2	139,165	421
3 <sup>rd</sup> /Rowan (Option A only)	3,692	4,635 (25.5%)	4.3	2.7	32.2	141,661	427
3 <sup>rd</sup> /Ford (Option B only)	2,255	2,894 (28.3%)	4.1	3.4	35.3	127,056	379
3 <sup>rd</sup> /Mednik	2,544	3,134 (23.2%)	4.1	2.6	40.3	141,588	403
Beverly/Atlantic (Option A only)	2,374	3,228 (36.0%)	3.5	2.2	45.3	171,679	472
Pomona/Atlantic (Option B only)	2,154	3,013 (39.9%)	3.5	2.2	43.4	173,640	477

Notes:

1. U. S. Census of Population and Housing, 1990. Data based upon blocks, which are the smallest tabulated area measurement.
2. SCAG TAZ Population and Employment Projection Data, 2020. Data based upon U. S. Census full or partial tracts that are based upon aggregated blocks.
3. The Project Study Area extends east from Union Station to Beverly Blvd just east of Atlantic (Option A) and to Pomona Blvd just west of Atlantic Blvd (Option B) and is confined to the area one-half mile on either side of the alignment.
4. The Project Study Area and its associated nine stations excluded 1990 U. S. Census block groups 207400-1, 206000-2, and 207100-5 from demographic analysis due to the presence of jail facilities.

According to CEQA guidelines, acquisition and displacement impacts are considered “generally significant” if:

- ◆ Acquisition of privately-owned land is required, and would result in relocation of ten or more residences or businesses;
- ◆ Adequate replacement facilities for displaced households and businesses are not available;
- ◆ Housing sites and/or funds to construct replacement facilities are not available;
- ◆ Replacement facilities are available but are located in neighborhoods unfamiliar to the residents of the displaced households;
- ◆ Replacement facilities exceed the financial capability of displaced households;
- ◆ Relocation of businesses and/or industries would result in loss of jobs or decreased accessibility between residences and places of employment, resulting in loss of sales or incomes;
- ◆ Location of replacement facilities for businesses or industries decreases accessibility to established market areas; or
- ◆ A comparatively large or disproportionate number of minority, elderly, or low-income displacements would occur.

Acquisition and displacement impacts would be considered “potentially significant” if:

- ◆ Acquisition of privately owned land is required, and would result in relocation of one to ten residences and/or businesses: or
- ◆ Replacement facilities matching the needs of the displaced households and businesses are not available in the same or nearby neighborhoods.

The severity of acquisition and displacement impacts must be evaluated in terms of changes in land use, loss of housing stock, effects upon special needs populations, fiscal impact, and business loss and disruption. See Sections 4.1 and 4.2 for more information regarding land use and economic impacts.

### **4.3.3 Impacts**

#### **4.3.3.1 No-Build Alternative**

The No-Build Alternative would not require the acquisition or displacement of any property in the study area.

#### **4.3.3.2 LRT Build Alternative**

The LRT Build Alternative would require the acquisition and displacement of residential, commercial, and public utility property for the construction and operation of the light rail line. In the absence of mitigation, residential and non-residential displacements resulting from implementing the LRT Build Alternative are considered generally significant under CEQA. A summary of potential acquisitions and displacements is presented in Table 4.3-2 for Option A and Table 4.3-3 for Option B.

#### ***Option A***

##### **Residential Displacement**

As indicated in Table 4.3-1, residential displacements under Option A would require displacing a total of 18 residential units containing an estimated 72 persons. The displacements would occur at:

**TABLE 4.3-2  
RESIDENTIAL AND NON-RESIDENTIAL ACQUISITIONS AND POPULATION DISPLACEMENT BY LRT FACILITIES AND ALIGNMENT  
FOR OPTION A**

Residential Uses					Non-Residential Uses						
Station/ Alignment Location	Purpose of Property Acquisition	Multiple Family Units	Single Family Units	Estimated Persons Displaced <sup>1</sup>	Commercial Business	Public Facility	Vacant Lot	Parking Lot <sup>2</sup>	Estimated Parking Spaces	Estimated Building Sq. Ft. for Displaced Businesses <sup>3</sup>	Estimated Total Employ- ment <sup>3</sup>
Alameda between Commercial and 1 <sup>st</sup>	Right-of- Way/Train Control				2 businesses-gas station/repair shop and car wash	DWP Street Frontage		1 1 1	13 spaces 9 spaces 11spaces	Gas/mart – 2,250 Repair shop – 1,350	4 persons – gas/mart 3 persons – repair shop
1 <sup>st</sup> / Alameda	Right-of- Way/Station							1 1	None 19 spaces		
Alameda to 1 <sup>st</sup> /Boyle	Right-of-Way						1	1	7 private spaces		
1 <sup>st</sup> / Boyle	Construction Staging/ Station Entrance	4 units		16			1				
1 <sup>st</sup> / Soto	Construction Staging/ Station/ Substation		8 units	32	8 businesses-retail, medical office, and auto sales					18,300	42 persons
Indiana/Gleason	Offstreet Parking	6 units		24	2 businesses- plumbing supply and commercial					6,500	13 persons
3 <sup>rd</sup> /Sunol	Substation				1 vacant business, 2 outdoor signs					No active businesses	0 persons
3 <sup>rd</sup> /Arizona	Substation				1 business, auto sales					380	2 persons
Beverly/ Atlantic	Substation				1 business, auto repair					1,730	3 persons
Pomona/Atlantic	Park-and-Ride				5 businesses -	1 medical				9,810 for the 5	18 persons <sup>4</sup>

**TABLE 4.3-2  
RESIDENTIAL AND NON-RESIDENTIAL ACQUISITIONS AND POPULATION DISPLACEMENT BY LRT FACILITIES AND ALIGNMENT  
FOR OPTION A**

Residential Uses					Non-Residential Uses						
Station/ Alignment Location	Purpose of Property Acquisition	Multiple Family Units	Single Family Units	Estimated Persons Displaced <sup>1</sup>	Commercial Business	Public Facility	Vacant Lot	Parking Lot <sup>2</sup>	Estimated Parking Spaces	Estimated Building Sq. Ft. for Displaced Businesses <sup>3</sup>	Estimated Total Employ- ment <sup>3</sup>
Ducommun/Garey	Yard Lead				medical lab, used car lot, auto repair, furniture store and warehouse  2 businesses – storage and impound lot (part take/not displaced)	clinic (to be vacated by Kaiser Hospital <sup>4</sup> )				businesses  13,800 for storage business	26 persons
<b>Total Displacements for Option A</b>		<b>10 units</b>	<b>8 units</b>	<b>72 displaced persons</b>	<b>20 active businesses/1 vacant business/1 impound lot (part take)/2 outdoor signs</b>	<b>DWP frontage/1 hospital clinic<sup>4</sup></b>	<b>2 vacant lots</b>	<b>6 parking lots</b>	<b>59 spaces</b>	<b>54,120 square feet</b>	<b>111 persons</b>

<sup>1</sup>Estimated total population displacement is calculated by multiplying the number of displaced units by 4.0, the average number of persons per household.

<sup>2</sup>Only portions of the lots (See "Estimated Parking Spaces" column) would be acquired.

<sup>3</sup>Estimated employment displacement is calculated using square foot per use factors identified in the Fiscal Impact Handbook (Burchell and Listokin, 1978)

<sup>4</sup>Since the hospital clinic is being replaced by Kaiser Permanente prior to LRT project construction, the LRT project would not be responsible for displacing the clinic employees.

TABLE 4.3-3 RESIDENTIAL AND NON-RESIDENTIAL ACQUISITIONS AND POPULATION DISPLACEMENT BY LRT FACILITIES AND ALIGNMENT FOR OPTION B											
Residential Uses					Non-Residential Uses						
Station/ Alignment Location	Purpose of Property Acquisition	Multiple Family Units	Single Family Units	Estimated Persons Displaced <sup>1</sup>	Commercial Business	Public Facility	Vacant Lot	Parking Lot <sup>2</sup>	Estimated Parking Spaces	Estimated Building Sq. Ft. <sup>3</sup>	Estimated Total Employ- ment <sup>3</sup>
Alameda between Commercial and 1 <sup>st</sup>	Right-of- Way/Train Control				2 businesses-gas station/repair shop and car wash	DWP street frontage		1 1 1	13 spaces 9 spaces 11spaces	Gas/mart – 2,250 Repair shop – 1,350	4 persons – gas mart 3 persons- repair shop
1 <sup>st</sup> / Alameda	Right of Way/Station							1 1	None 19 spaces		
Alameda to 1 <sup>st</sup> /Boyle	Right-of-Way						1	1	7 private spaces		
1 <sup>st</sup> / Boyle	Construction Staging/ Station Entrance	4 units		16			1				
1 <sup>st</sup> / Soto	Construction Staging/ Station/ Substation		8 units	32	8 businesses-retail, medical office, and auto sales					18,300	42 persons
Indiana/1 <sup>st</sup> to 3rd	Alignment and Station	6 units		24	3 businesses- plumbing supply, medical office, and commercial	1 public high school (relocated or reconstructed)	5			10,500	29 persons
3 <sup>rd</sup> /Sunol	Substation				1 vacant business, 2 outdoor signs					No active businesses	0
3 <sup>rd</sup> /Arizona	Substation				1 business, auto sales					380	2 persons
Pomona/ Atlantic	Park-and-Ride Lot/Substation				5 businesses- auto repair, medical lab, used car lot, furniture store, warehouse	1 medical clinic (to be vacated by Kaiser Hospital <sup>4</sup> )				9,810 for the 5 businesses	18 persons <sup>4</sup>
Ducommun/Garey	Yard Lead				2 businesses-					13,800 for	26 persons

Residential Uses					Non-Residential Uses						
Station/ Alignment Location	Purpose of Property Acquisition	Multiple Family Units	Single Family Units	Estimated Persons Displaced <sup>1</sup>	Commercial Business	Public Facility	Vacant Lot	Parking Lot <sup>2</sup>	Estimated Parking Spaces	Estimated Building Sq. Ft. <sup>3</sup>	Estimated Total Employ- ment <sup>3</sup>
<b>Total Displacements for Option B</b>		<b>10 units</b>	<b>8 units</b>	<b>72 displaced persons</b>	storage and impound lot (part take/not displaced)  <b>20 active businesses/1 vacant business/ 1 impound lot (part take)/ 2 outdoor signs</b>	<b>DWP frontage/1 hospital clinic<sup>4</sup>/1 public high school</b>	<b>7 vacant lots</b>	<b>6 parking lots</b>	<b>59 spaces</b>	storage business  <b>56,390 square feet</b>	<b>124 persons</b>

<sup>1</sup>Estimated total population displacement is calculated by multiplying the number of displaced units by 4.0, the average number of persons per household.  
<sup>2</sup>Only portions of the lots (See "Estimated Parking Spaces" column) would be acquired.  
<sup>3</sup>Estimated employment displacement is calculated using square foot per use factors identified in the Fiscal Impact Handbook (Burchell and Listokin, 1978)  
<sup>4</sup>Since the hospital clinic is being replaced by Kaiser Permanente prior to LRT project construction, the LRT project would not be responsible for displacing the clinic employees.

- ◆ 1<sup>st</sup>/Boyle – A construction staging area on the south side of 1<sup>st</sup> Street just west of Boyle Avenue would require a four-unit apartment building. The residential units, which are affordable housing, house approximately 16 persons.
- ◆ 1<sup>st</sup>/Soto – Acquisition of one parcel on the southeast and six parcels on southwest corners at 1<sup>st</sup>/Soto, for construction of the 1<sup>st</sup>/Soto light rail station, a substation, and a construction staging area would require eight residences housing 32 persons. The units are affordable housing.
- ◆ Indiana Street between 1<sup>st</sup> and 3<sup>rd</sup> Streets – Acquisition of three parcels on the east side of Indiana Street opposite Gleason Street for replacement parking would require six units of housing, potentially displacing 24 residents. All of the units are affordable housing.

Under CEQA, the displacement of 18 dwelling units containing an estimated 72 residents would be a significant impact.

#### Impacts on Housing Stock

Option A would displace 18 low and moderate-income residences. This number represents one-tenth of one percent of the study area's housing stock and, with the projected increase in housing units in the study area, would not substantially diminish the total number of units. More detailed information is presented for the affected station areas below.

- ◆ 1<sup>st</sup>/Boyle – Of the 4,273 residential units located within a half-mile of this proposed station, four apartment units would be acquired (refer to Table 4.3-1). The loss of four affordable units would not substantially affect the quantity of homes or the low vacancy rate in the area, particularly since a six percent increase in housing units is anticipated in the 1<sup>st</sup>/Boyle area over the planning period. However, the rents for the newer units may not be comparable to those for the displaced units.
- ◆ 1<sup>st</sup>/Soto – Of the 5,435 residential units within one-half mile of the station, the acquisition of eight affordable units would not substantially affect the quantity of homes or the low vacancy rate in the area, particularly since construction of an additional 2,000 units is anticipated in the 1<sup>st</sup>/Soto area over the planning period. However, housing demand and the Corridor's low vacancy rate may limit the availability of comparable replacement homes in the study area.
- ◆ Indiana Street – The loss of six units along Indiana Street would not substantially reduce the number of housing units in the area between 1<sup>st</sup> and 3<sup>rd</sup> Streets, particularly since the number of housing units in the area is expected to increase by 23 percent over the planning period. However, housing demand and the Corridor's low vacancy rate may limit the availability of comparable (affordable) replacement homes in the study area.

#### Non-residential Displacement

Option A would displace six parking lots containing 59 spaces, Department of Water & Power (DWP) landscaped frontage, two vacant lots, one vacant commercial space, and two outdoor advertising signs. Option A would also displace 20 businesses, and one additional business would involve a partial take. As indicated in Table 4.3-2, non-residential displacements would occur at:

- ◆ Alameda between Commercial and 1<sup>st</sup> – Portions of three parking lots containing 33 spaces, DWP landscaped frontage, and a gas station, including a mini-mart, car wash, and a repair shop, would be acquired. The acquisitions include the perimeter of parcels bordering the sidewalks along Alameda and 1<sup>st</sup> Streets that are proposed to be part of the Mangrove Estates development, which has an approved preliminary development plan. The LRT track alignment is not expected to reduce the development potential for the site as the development plans are finalized and move forward through the City's approval process.



- ◆ 1<sup>st</sup>/Alameda – Portions of two parking lots containing 19 spaces would be acquired to accommodate the turning of the track from 1<sup>st</sup> Street onto Alameda and the installation of a station.
- ◆ Alameda to Boyle – Seven private parking spaces from the Los Angeles Hompa Hongwanji Buddhist Temple would be required.
- ◆ 1<sup>st</sup>/Boyle -- A vacant lot would be acquired east of the apartment building that will also be acquired as part of this project (see preceding residential displacement discussion). One business (a market) was previously purchased by MTA for the suspended Metro Red Line project (and is therefore not included in Table 4.3-2). The market continues to operate at this location and leases the property from the MTA. MTA has previously paid the market's costs to relocate the business whenever the lease is terminated. The property is needed to provide construction staging for the current project. The 1<sup>st</sup>/Boyle Station would be located underground beneath Mariachi Plaza, also owned by MTA. None of the station facilities would penetrate or use the surface of the Plaza.
- ◆ 1<sup>st</sup>/Soto – The proposed station, substation, and construction staging area would require the displacement of eight businesses employing approximately 42 people. The businesses, which serve neighborhood clientele, may be difficult to relocate in the neighborhood.
- ◆ 1<sup>st</sup>/Lorena -- No new acquisitions are required. However, property on the northeast corner was previously acquired by MTA for the suspended Metro Red Line project and is, therefore, not shown in Table 4.3-2. This vacant property will be used for construction staging and installation of a traction power substation.
- ◆ Indiana Street – Three parcels would be required for replacement parking on the east side of Indiana opposite Gleason Street. Two of the parcels contain businesses, a plumbing supply with a parking lot and a commercial space.
- ◆ 3<sup>rd</sup>/Sunol – Locating a traction power substation along 3rd Street immediately west of Sunol Drive and south of the Pomona Freeway would require acquisition of a parcel containing a vacant business and two outdoor advertising signs.
- ◆ 3<sup>rd</sup>/Arizona – Locating a substation on the southeast corner of 3<sup>rd</sup>/Arizona would require acquisition of a parcel containing an auto sales business.
- ◆ Beverly/Atlantic – A parcel of land would be acquired for a traction power substation on Beverly at Atlantic near the proposed eastern terminal of the light rail line under Option A. The site is currently occupied by an auto repair shop, which would be displaced. Station area parking would be co-located at the Pepboys parking lot (east side of Atlantic Boulevard north of Beverly Boulevard). MTA intends to negotiate a joint use agreement for use of the Pepboys lot.
- ◆ Pomona/Atlantic – A park-and-ride lot would be constructed on parcels along Atlantic Boulevard immediately north of Pomona Boulevard. The site is currently the location for a Kaiser Permanente hospital clinic and parking lot as well as five other businesses, including a medical laboratory, a used car lot, an auto repair shop, a furniture store, and a warehouse. Kaiser intends to dispose of their existing facility once the new clinic (now under construction) is completed, and MTA would purchase the facilities.

In addition, the lead track from the light rail line to the existing Red Line maintenance and storage facility would require two businesses (one full take and one part take) as follows:

- ◆ Ducommun/Garey – A warehouse would be acquired at Ducommun and Garey to accommodate the lead track from the LRT alignment to the maintenance and storage facility at the existing Red Line Yard. The building has been recently sold. Also, a partial take of an impound lot would require the owner to reconfigure the lot.

### Easements

MTA would obtain an easement from Caltrans to construct the aerial structure and at-grade tracks on their property south of Union Station. Also subsurface easements will be obtained for properties located above the tunnel segment between 1<sup>st</sup>/Gless and 1<sup>st</sup>/Lorena.

### Significance of Impacts

Since more than ten residences and businesses would be acquired under Option A, the displacements would be a significant impact without mitigation. Similarly, if replacement housing or business facilities are not available in the same or nearby neighborhoods, and the residences and businesses would need to relocate outside the study area, this impact would be potentially significant.

### **Option B**

#### Residential Displacements and Impacts on Housing Stock

As indicated in Table 4.3-3, residential displacements for Option B would be the same as Option A (18 single-family and multi-family household units containing an estimated 72 persons). Therefore, impacts on housing stock would also be the same as Option A.

#### Non-residential Displacements

Option B would require the same parking and other non-residential displacements as in Option A with the following exceptions:

- ◆ Indiana Street – Three parcels required for Option A for replacement parking on the east side of Indiana Street opposite Gleason Street would also be acquired to accommodate the light rail alignment and station along Indiana Street at Gleason Street in Option B. Two of the parcels contain businesses, a plumbing supply with parking lot and a commercial space. In addition, Option B would require a medical office building at 1<sup>st</sup>/Indiana with parking, a separate parking lot for the medical office building, and a lot providing access to the El Enganto furniture store from Indiana Street. Access to the furniture store will be provided at this or an alternate location. A portion or all of Ramona High School property will be acquired to accommodate the LRT track and 3<sup>rd</sup>/Indiana Station. The school will either be reconstructed at the existing site or relocated.
- ◆ Pomona/Atlantic – Instead of locating the eastern terminal station and substation at Beverly/Atlantic, under Option B the station, park-and-ride lot, and substation would be located along Atlantic Boulevard immediately north of Pomona Boulevard, using the site identified for a park-and-ride lot for Option A. The same non-residential displacements identified for this site under Option A would be required for Option B.
- ◆ Beverly/Atlantic – The property required for Option A for a traction power substation is not needed under Option B. Instead the substation will be provided at Pomona/Atlantic as discussed above.

### Easements

Same as Option A.

### Significance of Impacts

Same as Option A.

#### 4.3.4 Mitigation

##### 4.3.4.1 Option A

###### *Residential and Commercial Displacement*

The Uniform Relocation Assistance and Real Property Acquisition Policies Act of 1970 (Public Law 91-646, 84 Stat.1894), as amended by the Uniform Relocation Act Amendments of 1987, Title VI of the Surface Transportation and Uniform Relocation Assistance Act of 1987 (Public Law 100-17, 101 Stat. 246-256), and as incorporated by the 1991 Intermodal Surface Transportation Efficiency Act, mandates that certain relocation services and payments by MTA be made available to eligible residents, businesses and non-profit organizations displaced by construction and operation of MTA transit-related projects. The Act provides for uniform and equitable treatment of persons displaced from their homes, businesses, and farms by federal and federally assisted programs; and establishes uniform and equitable land acquisition policies.

The State of California's revised Government Code Section 7260, et seq. brings the California Relocation Act into conformity with the Federal Uniform Relocation Act. In the acquisition of real property by a public agency, both the federal and state acts seek to: (1) ensure consistent and fair treatment for owners of real property; (2) encourage and expedite acquisition by agreement in order to avoid litigation and relieve congestion in the courts; and (3) promote confidence in public land acquisition. Owners of private property have federal and state constitutional guarantees that their property will not be taken or damaged for public use unless they first receive just compensation. Just compensation is measured by the "fair market value" of the property taken, where "fair market value" is considered to be the:

"...highest price on the date of valuation that would be agreed to by a seller, being willing to sell, but under no particular or urgent necessity for so doing, nor obliged to sell; and a buyer, being ready, willing and able to buy but under no particular necessity for so doing, each dealing with the other with the full knowledge of all the uses and purposes for which the property is reasonably adaptable and available." (Code of Civil Procedure Section 1263.320a.)

Where acquisition and relocation are unavoidable, MTA will follow the provisions of the Uniform Act and the 1987 Amendments as implemented by the Uniform Relocation Assistance and Real Property Acquisition Regulations for Federal and Federally Assisted Programs adopted by the Department of Transportation, dated March 2, 1989. MTA will apply acquisition and relocation policies to assure compliance with the Uniform Act and Amendments. All real property acquired by MTA will be appraised to determine its fair market value. An offer of just compensation, which shall not be less than the approved appraisal, will be made to each property owner. Each homeowner, renter, business or nonprofit organization displaced as a result of the project will be given advanced written notice and would be informed of the eligibility requirements for relocation assistance and payments. Application by the MTA of the applicable acquisition and relocation programs, policies and procedures would result in relocation impacts deemed to be insignificant under CEQA after mitigation.

The Uniform Relocation Act requires that comparable, decent, safe and sanitary replacement housing which is within a person's financial means be made available before that person may be displaced. In the event that such replacement housing is not available to "re-house" persons displaced by the LRT Build Alternative within the statutory limits for replacement housing payments, the MTA may provide Last Resort Housing in a number of ways, including:

- ◆ Rehabilitating or constructing additions to existing replacement dwellings and making them available to the displaced person;

- ◆ Constructing new housing to be rented or sold to displaced persons for amounts within their financial means;
- ◆ Physically relocating comparable dwellings to replacement site;
- ◆ Purchasing existing housing to be rented or sold to displaced persons for amounts within their financial means;
- ◆ Removing barriers and/or rehabilitating structures to accommodate handicapped displaced persons when suitable replacement housing is not available;
- ◆ Making replacement-housing payments in excess of the statutory limits of \$22,500 for owner/occupants and \$5,250 for renters; or
- ◆ Offering a direct loan, or other financing techniques, to assist displaced persons in purchasing comparable replacement dwellings.

All eligible displaced persons have freedom of choice in the selection of comparable replacement housing, and MTA will not require any displaced person, without his/her written consent, to accept a replacement dwelling provided by MTA. If a displaced person decides not to accept the replacement housing offered by MTA, the displaced person may secure a comparable replacement dwelling of his/her choice, providing it meets decent, safe and sanitary housing standards. Although the residences and businesses located above the light rail tunnel will not be acquired in fee simple for the LRT Build Alternative, MTA will acquire subsurface easements from those properties.

MTA will be formulating a local employment policy for construction and operations-related job opportunities in the corridor. Such a program will include resources for job development and training and will be made available to persons unable to find a new job as a result of the business relocations.

Following application of these policies and regulations by the MTA, relocation/displacement impacts would not be significant under CEQA.

### ***Loss of Housing Stock***

As a mitigation measure for loss of housing stock resulting from the suspended Metro Red Line East Side Extension project, MTA established the revolving loan fund program, which included the following components<sup>3</sup>:

- ◆ MTA committed to making available sites for joint development projects, including housing;
- ◆ MTA established a \$5.2 million revolving loan fund (which was later reduced to \$2.6 million when the Red Line Extension was truncated at 1<sup>st</sup>/Lorena) targeted to replace units taken for the suspended project. The intent of the loan fund was to assist community based developers and property owners with financing of administrative, design, legal and other professional services required to obtain funding commitments for construction and permanent financing; and assist with affordable housing rehabilitation in Boyle Heights; and
- ◆ MTA committed to offer existing residential and other structures required for station construction to community-based housing and social service providers as well as other public agencies prior to their demolition.

Loan repayment was to be from construction and permanent loan proceeds. Criteria for eligibility, funding prerequisites, program administration, underwriting and repayment was to be formulated through

---

<sup>3</sup> Metro Red Line East Side Extension, Final Environmental Impact Statement, Los Angeles County Metropolitan Transportation Authority, Los Angeles, California, September 1994, pages 4-3.17 and 4-3.18.

the program, based on affordable housing guidelines set forth by the city, state, and federal governments. The program was designed to allow for flexibility in the type of projects MTA can fund.

To provide mitigation for the potential loss of housing stock if either Option A or Option B of the LRT Build Alternative were implemented, MTA would incorporate elements of the revolving loan fund program into a new Housing Replenishment Program. A new revolving loan fund will be set up that sets aside \$26,000 per acquired unit for affordable housing development and rehabilitation. Whereas, the suspended project's revolving loan fund only applied to residences within Boyle Heights, this fund would apply to all residences that are acquired as a result of the Eastside Corridor LRT Build Alternative. This fund would be used for housing replenishment as a result of the loss of housing stock. MTA will set aside the funding for the new revolving loan fund program, which will be implemented through a Memorandum of Understanding (MOU) with the City of Los Angeles Housing Department (LAHD), which will administer the program. MTA will work with LAHD, experts in the field of affordable housing finance and development, who will provide the expertise necessary to implement this program.

The loss of housing stock is a potentially significant impact if the displaced residents are unable to find replacement housing in the area. The revolving loan fund may not fully mitigate this impact but will provide funds to assist community-based developers in constructing and rehabilitating affordable housing in East Los Angeles.

#### ***Significance of Impacts Remaining After Mitigation***

Following application of these policies and regulations by the MTA, relocation/displacement impacts would not be significant under CEQA. However, impacts would be potentially significant if the displaced residences and businesses are unable to find replacement homes or businesses in the area.

#### **4.3.4.2 Option B**

Measures to mitigate acquisition and displacement impacts for Option B will be the same as for Option A, with the exception of mitigation for Ramona High School under Option B. MTA will commit to costs for relocating the school (if that is determined to be the course of action) to a site that is acceptable to LAUSD and MTA, and will also provide funds for construction of a new school off-site or reconstruction at the present location. LAUSD will conduct the necessary environmental studies once it is determined whether to relocate or reconstruct the school. The actions of LAUSD in replacing the school are beyond the scope of the analysis for the Eastside Corridor Project since LAUSD will be directing that program. However, MTA will work with LAUSD during their separate studies when LAUSD's plans for the school are better known.

#### ***Significance of Impacts Remaining After Mitigation***

Following application of these policies and regulations by the MTA, relocation/displacement impacts would not be significant under CEQA. However, impacts would be potentially significant if the displaced residences and businesses are unable to find replacement homes or businesses in the area.

## 4.4 COMMUNITIES/NEIGHBORHOODS

### 4.4.1 Affected Environment

#### 4.4.1.1 Regional Population and Demographics (1990 and 2020 Projections)

Los Angeles County, with a 1990 population of over 8.8 million, is the most populous county in California (Table 4.4-1). It contains 30 percent of the state's population, and the majority of residents in the six-county region included in the Southern California Association of Governments. By 2020, the County and the region are expected to grow by about 38 percent and 43 percent, respectively. During the same period, the number of housing units in the County will increase from approximately 3.0 million to 4.2 million, thereby augmenting population density.

Demographic Area	Total Population		Population Density		Populations 6 – 18 years		Populations 65 years +	
	1990 <sup>1</sup>	2020 <sup>2</sup> / % Increase	1990 <sup>1</sup>	2020 <sup>2</sup>	1990 <sup>1</sup>	2020 <sup>2</sup>	1990 <sup>1</sup>	2020 <sup>2</sup>
SCAG Region	14,531,529	20,768,041 (42.9%)	1,521	2,174	2,509,030	NA	1,584,540	NA
Los Angeles County	8,863,164	12,237,247 (38.1%)	2,240	3,093	1,586,022	NA	860,587	NA
Project Study Area <sup>3,4</sup>	103,289	128,585 (24.5%)	15,791	19,483	21,716	NA	8,499	NA

Notes:

1. U. S. Census of Population and Housing, 1990. Data based upon blocks, which are the smallest tabulated area measurement.
2. SCAG TAZ Population and Employment Projection Data, 2020. Data based upon U. S. Census full or partial tracts that are based upon aggregated blocks.
3. The Project Study Area for Option A extends east from Union Station to Beverly Blvd. just east of Atlantic and for Option B extends from Union Station to Pomona Blvd just west of Atlantic and is confined to the area one-half mile on either side of the alignment.
4. The Project Study Area and its associated nine stations excluded 1990 U. S. Census block groups 207400-1, 206000-2, and 207100-5 from demographic analysis due to the presence of jail facilities.

#### 4.4.1.2 Corridor Population and Demographics (1990 and 2020 Projections)

For this SEIS/SEIR, the Eastside Corridor extends from Union Station to the eastern terminal at Beverly/Atlantic under Option A or to Pomona/Atlantic under Option B and is confined to a half-mile strip on either side of the alignment. In 1990 the corridor (study area) had 103,289 residents living in an area with a population density over seven times that of the County. Twenty-one percent of corridor residents are between six and 18 years compared with 17.8 percent for the county as a whole. The senior population in the study area is similar to the County percentage of approximately nine percent. By 2020, the population of the study area is expected to increase to 128,585, a gain of 25 percent. This increase is less than the growth rate anticipated for Los Angeles County and is expected to occur with or without the implementation of the light rail line. Similarly, population densities in the corridor will increase from 15,791 to 19,483 residents per square mile (Figure 4.4-1).

**FIGURE 4.4-1  
COMPARATIVE 1990 AND 2020 POPULATION DENSITY  
FOR THE CORRIDOR, LOS ANGELES COUNTY, AND THE SCAG REGION**

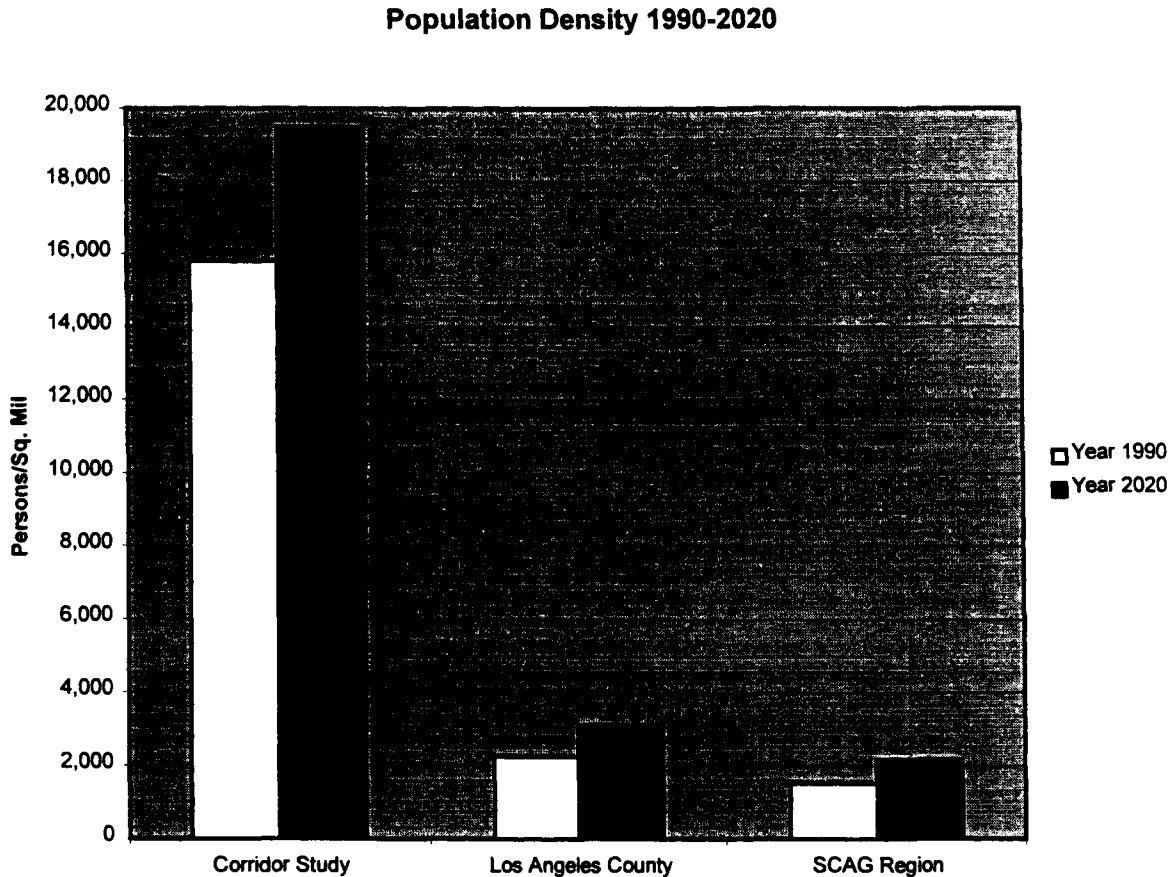


Table 4.4-2 presents 1990 and 2020 data for the area within a half-mile of each proposed light rail station location. The table indicates that the greatest concentration of area residents is located in the middle portion of the Corridor between 1<sup>st</sup>/Boyle and 3<sup>rd</sup>/Rowan under Option A. In this segment, over 15,000 people reside within one-half mile of each proposed station location. The population concentration drops off between the 3<sup>rd</sup>/Rowan and 3<sup>rd</sup>/Ford Stations as shown in Option B, where 9,653 people reside near the 3<sup>rd</sup>/Ford Station. The area surrounding the 1<sup>st</sup>/Soto Station has the largest and densest population of all station locations. By 2020, the number of residents in this area will have increased from 21,426 (1990 data) to 28,981, a 35 percent gain. This rate of increase appears to be typical for most station areas along the alignment except for Union Station and 1<sup>st</sup>/Alameda, which, due to redevelopment plans, are expected to grow by 41 percent and 230 percent, respectively, and 1<sup>st</sup>/Utah and 1<sup>st</sup>/Boyle, which will decrease in population.

#### 4.4.1.3 Corridor Socio-Economic Characteristics

As indicated in Table 4.4-3, the study area is nearly 97 percent minority, principally of Hispanic descent. The distribution of minority populations occurs fairly evenly throughout the corridor (Figure 4.4-2). Although the concentration of minority populations is not unusual in Los Angeles County, the percentage

of the total population that is minority is substantially higher in the corridor than in the county as a whole (97 percent compared with 59 percent).

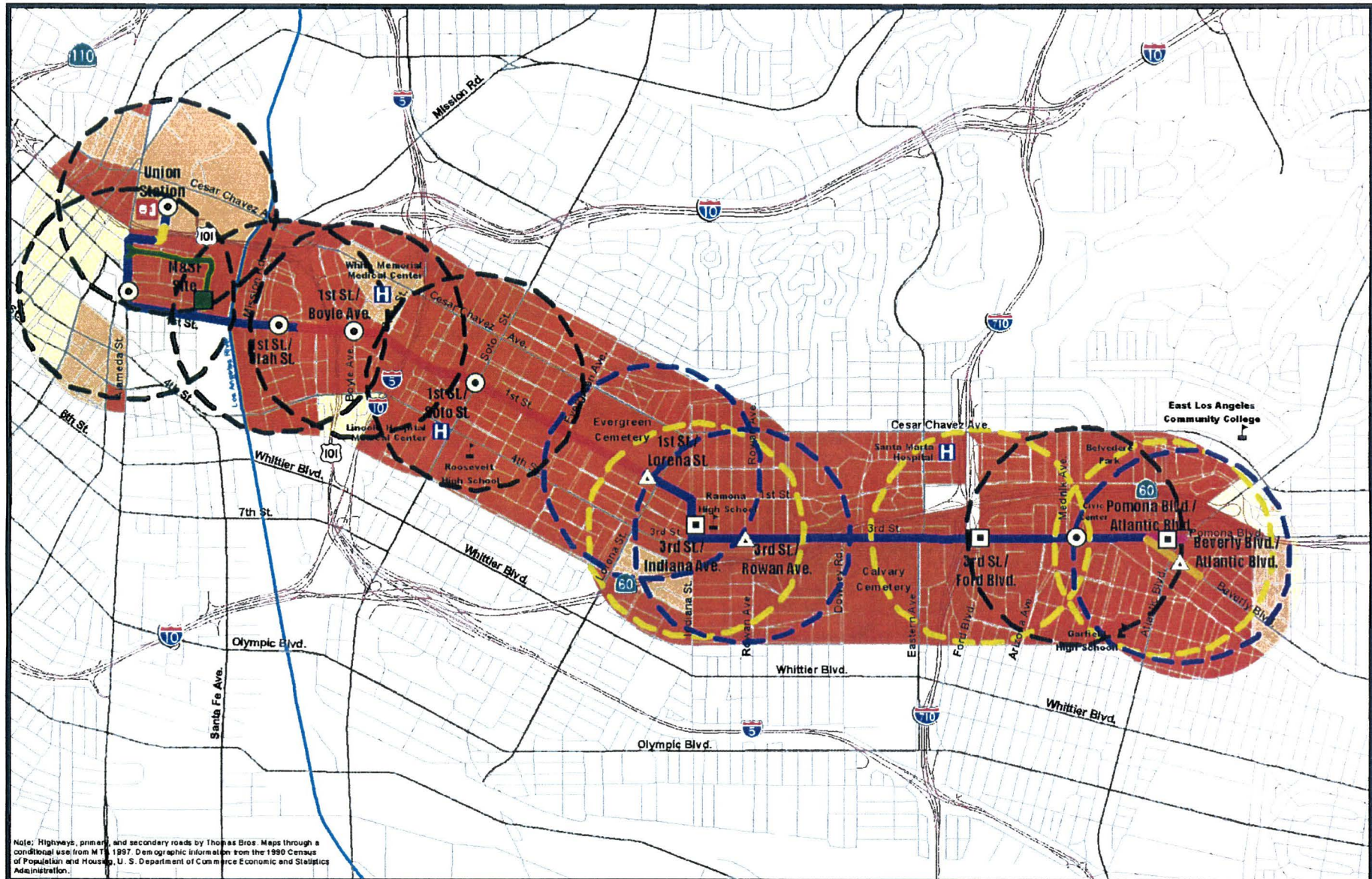
Proposed Station <sup>1,2</sup>	Total Population		Population Density		Populations 6 – 18 years		Populations 65 years +	
	1990 <sup>3</sup>	2020 <sup>4</sup> (% Increase)	1990 <sup>3</sup>	2020 <sup>4</sup>	1990 <sup>3</sup>	2020 <sup>4</sup>	1990	2020
<b>Option A</b>								
Union Station	8,147	11,467 (40.8%)	4,274	14,515	821	N/A	426	N/A
1 <sup>st</sup> /Alameda	3,154	10,395 (229.6%)	5,257	13,327	78	N/A	634	N/A
1 <sup>st</sup> /Utah	11,358	8,946 (-21.2%)	14,945	11,469	2,906	N/A	928	N/A
1 <sup>st</sup> /Boyle	16,214	15,598 (-3.9%)	21,057	19,744	3,903	N/A	1,295	N/A
1 <sup>st</sup> /Soto	21,426	28,981 (35.3%)	27,826	37,155	4,807	N/A	1,590	N/A
1 <sup>st</sup> /Lorena	15,098	20,256 (34.2%)	19,356	25,969	3,466	N/A	1,275	N/A
3 <sup>rd</sup> /Rowan	15,479	18,473 (19.3%)	19,594	23,384	3,724	N/A	1,199	N/A
3 <sup>rd</sup> /Mednik	10,129	11,416 (12.7%)	12,986	14,636	2,419	N/A	959	N/A
Beverly/Atlantic	8,133	10,556 (29.8%)	10,295	13,533	1,667	N/A	955	N/A
<b>Option B</b>								
Union Station	8,147	11,467 (40.8%)	4,274	14,515	821	N/A	426	N/A
1 <sup>st</sup> /Alameda	3,154	10,395 (229.6%)	5,257	13,327	78	N/A	634	N/A
1 <sup>st</sup> /Utah	11,358	8,946 (-21.2%)	14,945	11,469	2,906	N/A	928	N/A
1 <sup>st</sup> /Boyle	16,214	15,598 (-3.9%)	21,057	19,744	3,903	N/A	1,295	N/A
1 <sup>st</sup> /Soto	21,426	28,981 (35.3%)	27,826	37,155	4,807	N/A	1,590	N/A
3 <sup>rd</sup> /Indiana	15,242	18,535 (21.8%)	19,541	23,762	3,582	N/A	1,221	N/A
3 <sup>rd</sup> /Ford	9,653	11,679 (21.0%)	12,376	14,973	2,369	N/A	682	N/A
3 <sup>rd</sup> /Mednik	10,129	11,416 (12.7%)	12,986	14,636	2,419	N/A	959	N/A
Pomona/Atlantic	7,146	9,718 (36.0%)	9,161	12,459	1,440	N/A	915	N/A
Notes:								
1. The project study area and its associated nine stations excluded 1990 U. S. Census block groups 207400-1, 206000-2, and 207100-5 from demographic analysis due to the presence of jail facilities.								
2. Information for stations is confined to a one-half mile radius surrounding the proposed station locations.								
3. U. S. Census of Population and Housing, 1990. Data based upon blocks, which are the smallest tabulated area measurement.								
4. SCAG TAZ Population and Employment Projection Data, 2020. Data based upon U. S. Census full or partial tracts that are based upon aggregated blocks.								



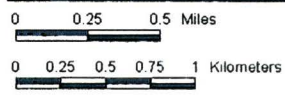
**TABLE 4.4-3  
DEMOGRAPHIC SUMMARY OF SOCIO-ECONOMIC CHARACTERISTICS FOR THE  
PROJECT STUDY AREA AND FOR A 1/2 MILE RADIUS AROUND  
LRT STATIONS**

Demographic Area	Minority Population <sup>1</sup>		Low-Income Households <sup>1</sup>		Workers 16 and Older Using Public Transportation <sup>1</sup>		Zero-Car Households <sup>1</sup>	
	No.	% of Total Pop.	No.	% of Total Households	No.	% of Workers 16 and Older	No.	% of Total Residential Units
Los Angeles County	5,228,442	59.0	355,295	11.9	267,210	6.5	333,562	11.2
Project Study Area <sup>2,3</sup>	99,971	96.7	6,350	25.8	6,890	19.9	7,365	30.1
<b>Option A</b>								
Union Station	7,356	86.5	309	37.1	270	32.2	570	60.5
1 <sup>st</sup> /Alameda	4,204	80.6	328	26.0	300	26.0	942	70.6
1 <sup>st</sup> /Utah	11,270	97.0	1,131	38.1	1,011	28.2	1,167	38.8
1 <sup>st</sup> /Boyle	16,921	97.6	1,343	32.9	1,672	27.6	1,591	36.3
1 <sup>st</sup> /Soto	21,100	98.7	1,410	27.1	2,208	27.0	1,818	34.8
1 <sup>st</sup> /Lorena	14,541	99.1	828	23.4	937	18.5	744	22.7
3 <sup>rd</sup> /Rowan	15,199	99.2	932	26.0	982	19.2	892	26.2
3 <sup>rd</sup> /Mednik	10,049	98.5	572	23.0	332	9.4	546	21.5
Beverly/Atlantic	7,723	95.8	397	17.1	254	8.2	376	16.4
<b>Option B</b>								
Union Station	7,356	86.5	309	37.1	270	32.2	570	60.5
1 <sup>st</sup> /Alameda	4,204	80.6	328	26.0	300	26.0	942	70.6
1 <sup>st</sup> /Utah	11,270	97.0	1,131	38.1	1,011	28.2	1,167	38.8
1 <sup>st</sup> /Boyle	16,921	97.6	1,343	32.9	1,672	27.6	1,591	36.3
1 <sup>st</sup> /Soto	21,100	98.7	1,410	27.1	2,208	27.0	1,818	34.8
3 <sup>rd</sup> /Indiana	15,013	98.8	884	24.6	1,081	19.7	849	23.6
3 <sup>rd</sup> /Ford	9,572	99.2	514	23.6	426	12.9	420	19.2
3 <sup>rd</sup> /Mednik	10,049	98.5	572	23.0	332	9.4	546	21.5
Pomona/Atlantic	6,903	95.4	370	17.1	230	8.2	363	17.1
Notes:								
1. U. S. Census of Population and Housing, 1990. Data based upon blocks, which are the smallest tabulated area measurement.								
2. The Project Study Area for Option A extends east from Union Station to Beverly Blvd just east of Atlantic and is confined to the area one-half mile on either side of the alignment. The Project Study Area for Option B is the same except that the eastern terminus extends to Pomona Blvd just west of Atlantic.								
3. The Project Study Area and its associated nine stations excluded 1990 U. S. Census block groups 207400-1, 206000-2, and 207100-5 from demographic analysis due to the presence of jail facilities.								

Similarly, the percentage of low-income households (refer to Section 4.4.2, Methodology for Impact Evaluation for definition of low income) in the corridor is over twice the percentage for the County (26.0 percent compared with 11.9 percent). The greatest concentration of low-income households is in the western portion of the corridor around Union Station, 1<sup>st</sup>/Utah, and 1<sup>st</sup>/Boyle. In these locations, low-income households comprise over 30 percent of total households, reaching 50 to 70 percent in certain census tracts. This percentage declines to 17 percent in the area surrounding Beverly/Atlantic and Pomona/Atlantic, the eastern terminals for the light rail alignment under Options A and B, respectively. (Figure 4.4-3).



Note: Highways, primary, and secondary roads by Thomas Bros. Maps through a conditional use from M.T. 1997. Demographic information from the 1990 Census of Population and Housing, U.S. Department of Commerce Economic and Statistics Administration.



**M** Eastside Corridor  
Transit Consultants

- Stations - Both Options
- △ Stations - Option A Only
- Stations - Option B Only
- Option A Only
- Option B Only
- ▭ Project Study Area
- - - 1/2 Mile Buffer - Option A & B
- - - 1/2 Mile Buffer - Option A
- 1/2 Mile Buffer - Option B
- At Grade
- Tunnel
- Elevated
- M&SF Lead Line
- Highway
- Primary Road
- Secondary Road

- Legend**
- Percent Minority
- 0-59 (59.0% Avg. La Co.)
  - 60-86 (86.6% Avg. MIS Study Area)
  - 87-92
  - 93-100 (96.7% Avg. Project Study Area)

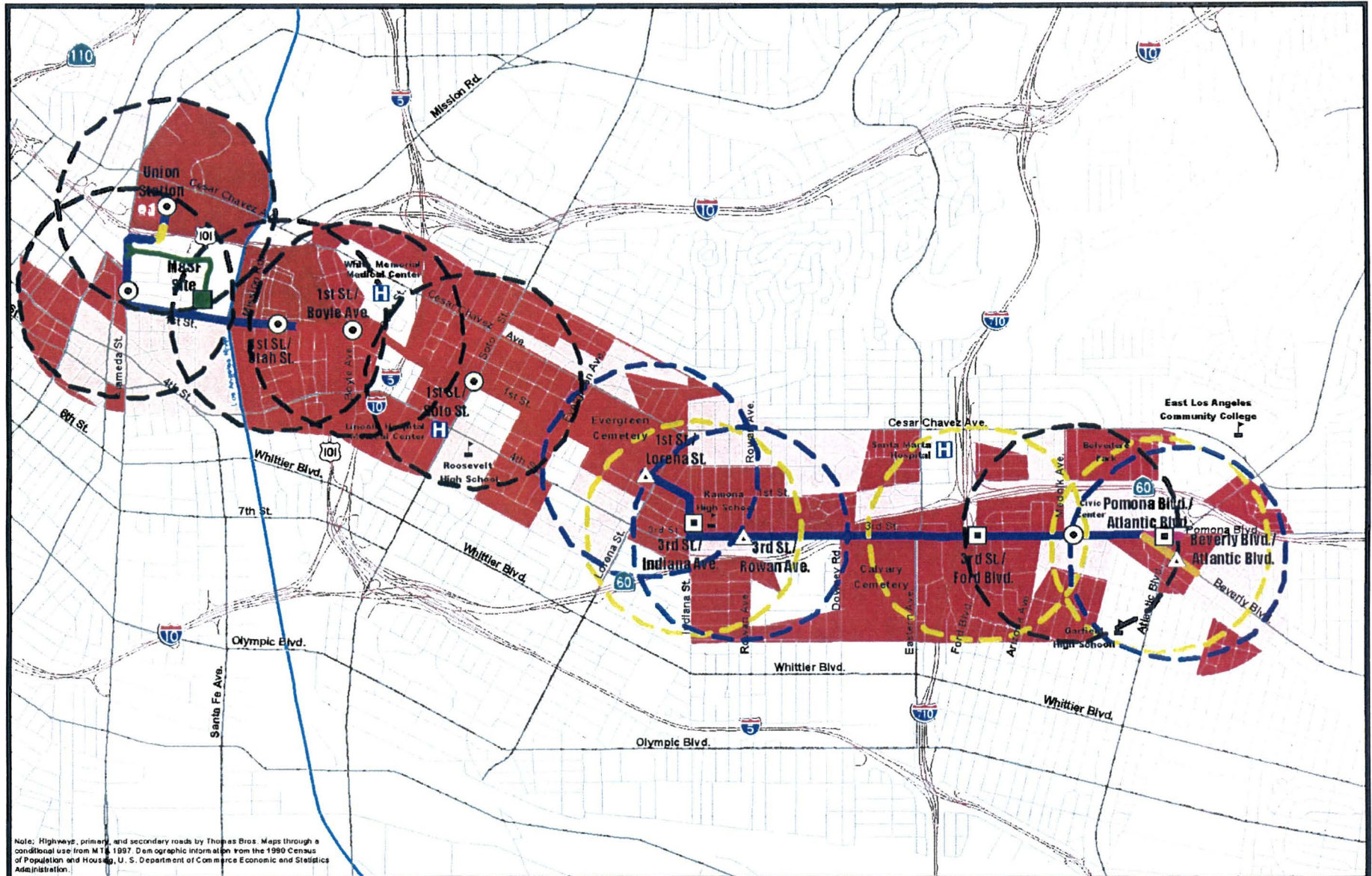


Los Angeles Eastside Corridor  
Draft SEIS/SEIR

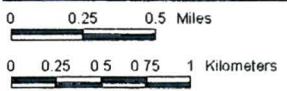
**Minority Population  
Census Blocks by % Population**

Figure 4.4-2





Note: Highways, primary, and secondary roads by Thomas Bros. Maps through a conditional use from MTL 1997. Demographic information from the 1990 Census of Population and Housing, U. S. Department of Commerce Economic and Statistics Administration.



**M** Eastside Corridor  
Transit Consultants

- Stations - Both Options
- △ Stations - Option A Only
- Stations - Option B Only
- Option A Only
- Option B Only
- Project Study Area
- 1/2 Mile Buffer - Option A & B
- 1/2 Mile Buffer - Option A
- 1/2 Mile Buffer - Option B
- At Grade
- Tunnel
- Elevated
- M&SF Lead Line
- Highway
- Primary Road
- Secondary Road

- Legend**
- Low-Income
- 0-11 (11.9% Avg. La Co.)
  - 12-20 (15.8% Avg. MIS Study Area)
  - 21-50 (26.0% Avg. Project Study Area)
  - 51-70



Los Angeles Eastside Corridor  
Draft SEIS/SEIR

**Low-Income Population  
Census Blocks by % Households**

Figure 4.4-3



Compared with the county's high percentage of car ownership (only 11 percent of households are without a car), 30 percent of corridor households do not own automobiles. The percentage of zero-auto households increases to over 70 percent surrounding the proposed 1<sup>st</sup>/Alameda Station (Figure 4.4-4). Further east, the percentage of zero-auto households drops dramatically. For example, in the area surrounding the proposed Beverly/Atlantic Station under Option A and Pomona/Atlantic under Option B, only 16 or 17 percent of total households are without cars. In spite of the relatively low rate of car ownership in the corridor, only 20 percent of the working population use public transportation to get to work, which may be an indication of unmet transit demand. The highest percentage of transit use is by residents who live in the western portion of the corridor, between Union Station and 1<sup>st</sup>/Soto.

The census data indicates that the corridor is characterized primarily as low income, minority, and transit dependent, containing one of the most densely populated sections of Los Angeles County. These demographic characteristics may be particularly favorable, in terms of ridership potential, to the success of proposed fixed guideway investments.

#### 4.4.1.4 Corridor Housing Characteristics

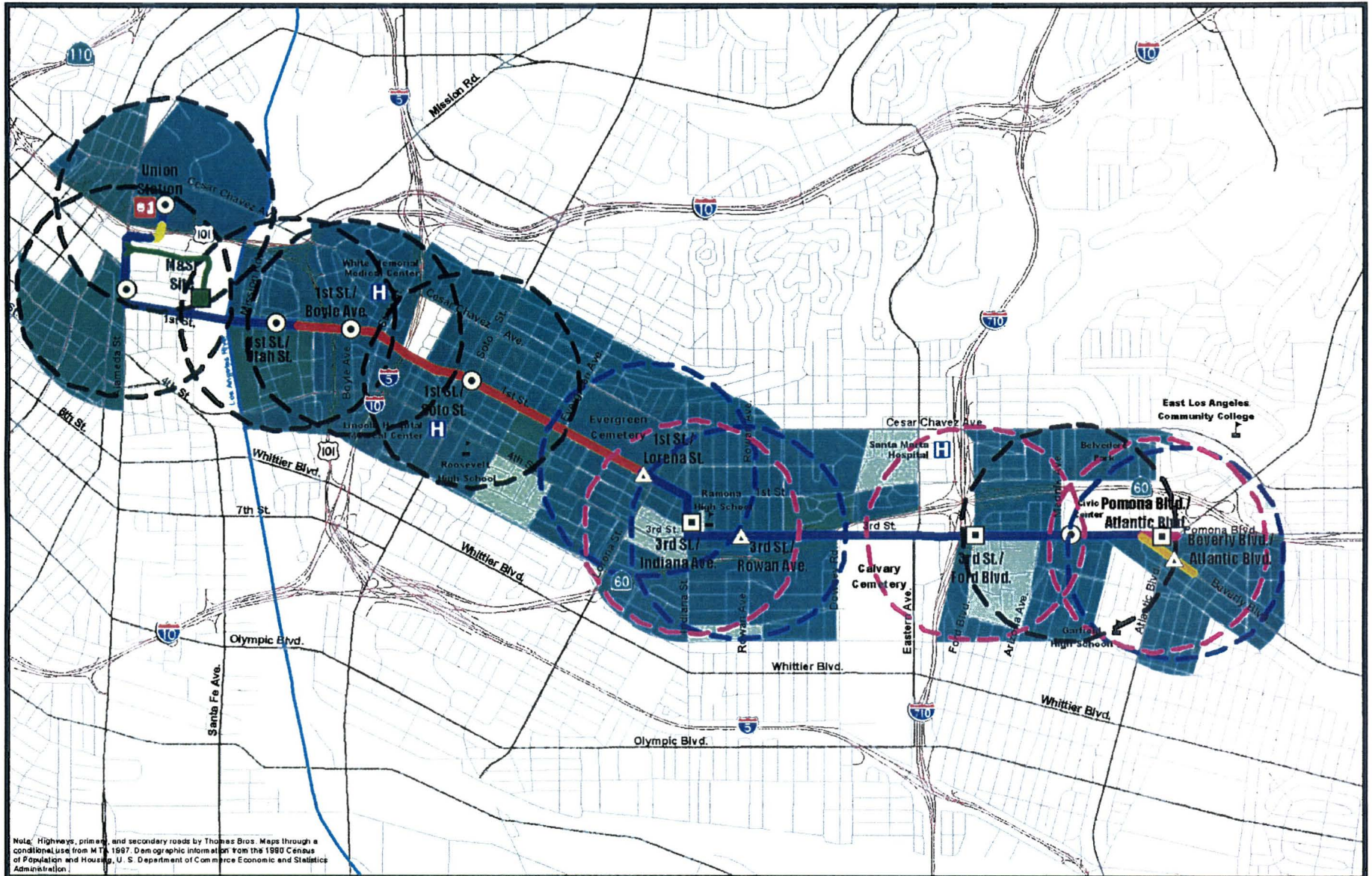
In 1990, over 25,000 households existed in the study area (refer to Table 4.3-1 in the Land Acquisition/Displacement section). This number is expected to increase to over 40,000 units in 2020, or a 63 percent rate of growth from 1990 to 2020. This rate of new housing construction is more than 20 percent greater than Los Angeles County as a whole. Yet the growth is not expected to occur uniformly throughout the corridor. Although the highest number of households are within a half-mile of proposed station locations at 1<sup>st</sup>/Boyle and 1<sup>st</sup>/Soto, the largest rates of housing development are expected to occur in less-populated areas close to the Central Business District, around Union Station and 1<sup>st</sup>/Alameda. By 2020, the area surrounding the 1<sup>st</sup>/Alameda Station is projected to surpass 1<sup>st</sup>/Soto as the area along the light rail alignment containing the greatest number of housing units.

Currently, the demand for housing in the study area exceeds the supply. Less than four percent of total units are vacant. As in many low-income communities, average household size is greater than the countywide average. Nearly 75 percent of housing units in the corridor are rentals, compared with 52 percent for the County as a whole. Home ownership is particularly rare in the segment between Union Station and 1<sup>st</sup>/Boyle. Less than 12 percent of households own their home. The median value of houses in the study area is approximately half the value of those countywide (refer to Table 4.3-1 in the Land Acquisition/Displacement section). Although housing values increase in the eastern portion of the corridor, they still do not approach the median value of housing in the County. Rental prices are also less expensive in the corridor than in the County and do not vary substantially throughout the corridor.

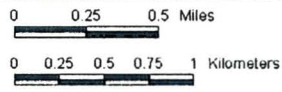
#### 4.4.1.5 Neighborhoods

The study area traverses or is adjacent to several districts or communities as defined by the City and County of Los Angeles in their adopted community plan areas. The identified communities included Central City and Central City North located west of the Los Angeles River; the Boyle Heights community located east of the Los Angeles River to the Los Angeles City and County boundary at Indiana Street; and the East Los Angeles community located east of Indiana Street to about one-quarter mile east of Beverly and Atlantic Boulevards under Option A or to just west of Pomona and Atlantic Boulevards under Option B (refer to Figure 4.1-1).





Note: Highways, primary, and secondary roads by Thomas Bros. Maps through a conditional use from MTA, 1997. Demographic information from the 1990 Census of Population and Housing, U. S. Department of Commerce Economic and Statistics Administration.



- Stations - Both Options
- △ Stations - Option A Only
- Stations - Option B Only
- Option A Only
- Option B Only
- ▭ Project Study Area
- 1/2 Mile Buffer - Option A & B
- 1/2 Mile Buffer - Option A
- 1/2 Mile Buffer - Option B
- At Grade
- Tunnel
- Elevated
- M&SF Lead Line
- Highway
- Primary Road
- Secondary Road

**Legend**

Percent Zero Car Households

Lightest Blue	0-11 (11.2% Avg. La Co.)
Light Blue	12-15 (15.5% Avg. MIS Study Area)
Medium Blue	16-49 (30.1% Avg. Project Study Area)
Darkest Blue	50-100

**M Eastside Corridor Transit Consultants**

Los Angeles Eastside Corridor  
Draft SEIS/SEIR

**Zero Car Households  
Census Blocks by % Households**

Figure 4.4-4





### ***Central City***

Central City is the generic term used to identify the greater downtown community planning area composed of several distinct sub-districts of which the Civic Center, Little Tokyo community, and Central City East sub-districts abut the proposed LRT alignment on the west side of Alameda Street. The Civic Center sub-district includes the El Pueblo State Historic Park, the birthplace of the City of Los Angeles, located just north of the Hollywood Freeway and west of Alameda Street and Union Station. Olvera Street, which was enhanced as a Mexican marketplace in 1932, contains 13 historic structures dating from 1818 to 1926. Over the past ten years, the El Pueblo area has undergone considerable improvements including seismic retrofit, building restoration, and public improvements. South of the Hollywood Freeway to First Street is the concentration of City, County, and Federal buildings that comprise the downtown Civic Center.

The Little Tokyo community, which lies west of Alameda Street between 1<sup>st</sup> and 3<sup>rd</sup> Streets, was the primary location for Japanese immigrants at the beginning of the 21<sup>st</sup> century. The population that resides in the Little Tokyo community is primarily minority (80%) with approximately one-half considered low income. Most residents (70%) do not own automobiles and are heavily dependent on public transportation. The Little Tokyo Redevelopment Project served as a catalyst for community revitalization (refer to Section 4.1, *Land Use and Development*).

### ***Central City North***

Central City North, which extends from Alameda Street east to the Los Angeles River, is one of the City's oldest industrial areas. This area has remained largely industrial with some large vacant parcels, public support facilities for the Department of Water and Power and the Los Angeles Unified School District, and some Little Tokyo related facilities such as temples, mortuary, and the Maryknoll School.

### ***Boyle Heights***

Boyle Heights, encompassing approximately six square miles between the Los Angeles River and Indiana Street, served as a primary port of entry for Molokan Russians, Jews, Armenians, Chinese, Japanese, and Mexican peoples around 1900. Today the ethnic composition of the community is primarily Hispanic. A range of 23% to 42% of existing families are considered low income; about 27% are transit dependent; and a range of 22% to 38% do not own an automobile.

The 1940's and 1950's saw the introduction and construction of four public housing projects in Boyle Heights. In total they represented 1,800 apartment units and over 11,000 residents. Over the past 20 years, a variety of revitalization programs have been implemented to address the physical deterioration of existing structures. Some of these are on-going such as the housing rehabilitation program administered through the Community Redevelopment Agency; the former Commercial Area Revitalization Program along Cesar Chavez Avenue; the Los Angeles Neighborhood Initiative Program along 1st Street; and the current Urban Revitalization Demonstration Program of the greater Pico-Aliso public housing project. More recently, in 1999, the City of Los Angeles adopted the Adelante Eastside Redevelopment Project (refer to Section 4.1, *Land Use and Development*).

### ***East Los Angeles***

The unincorporated East Los Angeles community is approximately eight square miles in size located between Indiana Street on the west and the incorporated cities of Monterey Park and Montebello on the east. Although East Los Angeles abuts the Boyle Heights community and presently shares similar social and demographic characteristics, its historical context is very different. The housing boom of the 1920's

generated the development of East Los Angeles, which was largely settled by persons of European background, particularly in the area between 3<sup>rd</sup> Street on the north and Whittier Boulevard on the south.

Current demographics indicate that approximately 95% of the population is minority and predominantly of Mexican descent in the East Los Angeles community. About one-quarter of the families are considered low income. Over the past 20 years, very few efforts have been attempted to address the need of rehabilitating the existing housing stock in East Los Angeles, although some new affordable housing and senior citizen housing has been developed, as have public improvements, including streetscape enhancements, including the famous Whittier Archway and Latino Walk of Fame along the commercial corridor of Whittier Boulevard. In the near future, a major revitalization effort is also scheduled for the East Los Angeles Civic Center complex at 3<sup>rd</sup> Street and Mednik Avenue.

#### **4.4.2 Methodology for Impact Evaluation**

The assessment of potential community/neighborhood impacts focuses on the following issues:

- ◆ The effect of the alternatives on the relationship of neighborhoods within the study area and the region;
- ◆ The effect of the alternatives within the neighborhoods; and
- ◆ The effect of the alternatives on the immediate vicinity of the station locations.

An impact would be considered significant under CEQA if an alternative induced substantial growth, if it would displace a large number of residents or businesses, or if it would substantially alter the location, distribution, density, or growth rate of population of an area in a manner inconsistent with public policy. Disruption of neighborhood access or isolation of a portion of a neighborhood from the remainder of the neighborhood would also constitute a significant impact. Impacts could be temporary (produced during construction) or long-term (produced by light rail operation).

The demographic information utilized in this analysis is based on the 1990 Census data since this is the most recent data available. A Geographic Information System (GIS) was used to collect and map data by census block for the entire study area as well as for areas within a half-mile of the stations. The analysis considers the number of persons served within a half-mile of each of the individual station areas. Where station areas are located less than one mile apart, the individual station data includes double counting where the half-mile radii of each station overlap. The total of persons served has been adjusted to account for the overlap and does not double-count.

In addition to total population and population density, data was collected for minority and low-income populations and on numbers of zero-car households. The latter criterion is reflective of the extent of transit-dependence within the corridor. The percentages for the County for these statistics were also used as a comparison to determine areas of high concentrations of such workers and zero-car households within the study area. Housing characteristics, such as average household size, vacancy rate, and percent owner-occupied, were also compared with countywide data.

Staff at the U.S. Census Bureau was consulted to determine the appropriate definition for poverty status. They indicated that the statistic, "Ratio of Income in 1989 to Poverty Level" should be used. This statistic was derived by the Census by testing the income of each household against the appropriate poverty threshold (48 thresholds were used based on household size and number of members under 18 years) to determine the poverty status of that household. Several ranges of ratios are reported. All households below a ratio of 1.0 are considered to be in poverty. Note that 1989 income was used since it was the last full year prior to the 1990 Census. Using this statistic, it was determined that low-income households

account for 11.9 percent of the households within the County. Therefore, any locations within the study area with higher percentages than the County's were considered low-income areas.

#### 4.4.3 Impacts

##### 4.4.3.1 No-Build Alternative

The No-Build Alternative would not induce growth nor would it displace or substantially alter the distribution of the population in the study area. Neighborhood cohesion and access also would not be affected. However, the No-Build Alternative would not offer study area residents enhanced mobility, regional connectivity, and accessibility provided by the LRT Build Alternative.

##### 4.4.3.2 LRT Build Alternative

###### *Option A*

###### Regional and Corridor Population and Demographics

Projected growth (2020) for the corridor is anticipated to increase at a somewhat slower pace (25 percent) than for Los Angeles County (38 percent). The growth is expected to occur with or without the implementation of the light rail line. By permitting infill development that is compatible with the surrounding communities (as established in local community plans), the number of new businesses and residences that could be accommodated at station locations would not be expected to substantially increase the population or alter its distribution in the study area. Therefore, no growth-inducing or adverse cumulative impacts are anticipated. The degree to which the projected population and housing growth would be accommodated at LRT stations is discussed in Section 4.1, Land Use and Development. The effect of project-related housing displacement on the corridor housing stock is described in Section 4.3, *Land Acquisition/Displacement*.

###### Corridor Socio-Economic Characteristics

The corridor is populated primarily by minority residents, most of whom live within walking distance of the proposed light rail stations (refer to Table 4.4-3). Over 6,000 low-income households, most without automobiles, are within one-half mile of the stations. The LRT Build Alternative would provide new transit connections and increased mobility for these transit-dependent residents. Light rail would produce beneficial impacts on the community without substantially altering the existing socio-economic characteristics of the corridor. No adverse impacts are expected.

###### Corridor Housing Characteristics

Construction of new housing is expected to occur in the corridor with or without the implementation of light rail. Since the corridor east of the Los Angeles River is essentially built-out, new development would occur on vacant parcels or in redevelopment areas. City and County of Los Angeles land use and economic development policies could promote transit-oriented development and encourage new housing to be constructed around light rail stations (refer to Section 4.1, *Land Use and Development*). The new development would not substantially alter the density or character of the neighborhood. Although the placement of stations may influence the market for surrounding commercial and residential property, the LRT Build Alternative by itself is not expected to sufficiently change market and other conditions necessary to cause significant changes in neighborhoods under CEQA.

## Neighborhoods

By fostering a closer linkage among East Los Angeles communities, the light rail line may serve to unify and enhance the cohesiveness of study area neighborhoods that were previously divided by construction of the freeway system. Study area businesses would benefit from improved access for their patrons and could market their goods and services to a larger area. Community facilities may also capture a larger service area because of the light rail line. Beneficial cumulative impacts may result from other transportation and transit projects planned for the region.

Adverse impacts on neighborhood traffic and pedestrian circulation and curb parking, described in Chapter 3, can be mitigated with the exception of several traffic intersections as discussed in that chapter. The noise and vibration analysis concludes that ground-borne noise and vibration impacts on many residences and businesses immediately adjacent to the alignment will be created by light rail operation. Under Option A, a total of 13 buildings will be severely impacted by noise, six structures will be affected by ground-borne noise, and 36 structures will be affected by ground-borne vibration impacts. Under Option A, 18 residential units, 20 active businesses, one vacant commercial building, and two outdoor advertising signs will be displaced. A partial take of one business is also planned. Option A will alter the historic setting for Mariachi Plaza by removal of buildings to accommodate the proposed 1<sup>st</sup>/Boyle subway station at this location.

### Significance of Impacts

Option A would produce beneficial mobility impacts for the community, especially for transit-dependent populations. However, neighborhoods would be subjected to traffic, parking, pedestrian circulation, noise, vibration, displacement, and historic resource impacts that are significant.

### ***Option B***

The impacts on regional and corridor population demographics and corridor socio-economic and housing characteristics are the same as Option A. With regard to impacts on neighborhoods, the impacts will be the same as those described for Option A, with the exception of noise and vibration and displacement impacts. Under Option B, the same numbers of buildings will be impacted by wayside and ground-borne noise as Option A. However, a total of 28 structures, instead of 36 structures as in Option A, will be affected by ground-borne vibration impacts. Nine fewer single and two-family residences would be affected than under Option A. However, one additional building (Kaiser Clinic) would be affected by vibration under Option B. With Option B, 18 residential units, 20 active businesses, one vacant commercial building, and two outdoor advertising signs will be displaced. A partial take of one business is also planned. The total numbers of acquisitions are the same as Option A. The exception is that Option B requires the acquisition of one more business along Indiana Street and one less business at Beverly/Atlantic than Option A. The significance of the impacts is also the same as Option A.

### **4.4.4 Mitigation**

The mitigation measures for both build Options A and B are essentially the same. Accordingly, measures for both options will be discussed jointly as the LRT Build Alternative. For a complete list of mitigation measures that relate to the aforementioned transportation, pedestrian circulation, noise/vibration, displacement, and cultural resource impacts that may affect study area neighborhoods, refer to the respective technical analyses in Chapters 3 and 4. Note also that alternative routing for pedestrians that allow completion of access to the station and to destinations in the immediate vicinity of the station will be developed through the Community Linkage Study/Program. That study will include the identification of preferred pedestrian access to each station, general pedestrian circulation within the immediate vicinity

of the station, and potential sites for improvements in pedestrian queuing areas. The study will also include identification of preferred connections to bus services in the immediate vicinity of the rail station. The purpose of the study includes ensuring adequate circulation, access, and information important to potential users of the rail and bus systems. Refer to Chapter 3 for more information.

#### **4.4.4.1 Significance of Impacts Remaining after Mitigation**

One impact on neighborhoods, worsening of conditions at several traffic intersections cannot be mitigated. All other potential impacts on neighborhoods resulting from the operation of the LRT Build Alternative can be mitigated to a level that is less than significant.

## 4.5 EQUITY AND ENVIRONMENTAL JUSTICE CONSIDERATIONS

### 4.5.1 Affected Environment

#### 4.5.1.1 Introduction

Executive Order 12898, *Federal Actions to Address Environmental Justice in Minority Populations and Low-Income Populations*, signed by President Clinton on February 11, 1994, requires that federal agencies consider and address disproportionately high adverse environmental effects of proposed federal projects on the health and environment of minority and low-income populations to the greatest extent practicable by law. The Executive Order requires that each federal agency shall:

- ◆ Make achieving environmental justice part of its mission by identifying and addressing, as appropriate, disproportionately high and adverse human health or environmental effects of its programs, policies, and activities on minority and low-income populations (Subsection 1-101);
- ◆ Conduct its programs, policies and activities that substantially affect human health or the environment, in a manner that ensures that such programs, policies, and activities do not have the effect of excluding persons (including populations) from participation in, denying person (including populations) the benefits of, or subjecting persons (including populations) to discrimination under such programs, policies and activities because of their race, color or national origin (Subsection 2-2); and
- ◆ Work to ensure that public documents, notices, and hearings relating to human health or the environment are concise, understandable, and readily accessible to the public [Subsection 5-5(c)].

The U.S. Department of Transportation has issued guidance on complying with Executive Order 12898 during the environmental review process. In addition to complying with the Executive Order, the Department of Transportation is committed to Title VI of the Civil Rights Act, which provides that no person in the United States shall, on the grounds of race, color or national origin, be excluded from participation in, be denied the benefits of, or be subject to discrimination under any program or activity receiving federal financial assistance.<sup>4</sup>

On April 21, 1997, President Clinton signed Executive Order 13045, *Protection of Children from Environmental Health Risks and Safety Risks*, which directs federal agencies to identify and assess environmental health risks and safety risks that may disproportionately affect children. Health and safety risks are defined as risks that are attributable to products or substances that a child is likely to come in contact with or ingest. Although no guidelines have been published to date, this environmental document has evaluated the anticipated impacts by comparing the presence of children in the study area to the presence in the county at large and by looking at impacts of the alternatives that may disproportionately affect concentrations of children in the study area.

Executive Orders 12898 and 13045 as well as guidance from the U.S. Department of Transportation encourages wherever possible the use of existing requirements and procedures to accomplish the goals of the Executive Orders. The Environmental Justice analysis presented in this document uses the aforementioned guidelines in accordance with the National Environmental Policy Act (NEPA) and the California Environmental Quality Act (CEQA) framework. The analysis identifies the beneficial and adverse impacts on minority and low-income populations in the Los Angeles Eastside Corridor if the LRT Build Alternative were implemented. In accordance with the provisions of Subsection 5-5 (c) of Executive Order 12898, a discussion and identification of the public involvement activities that have

<sup>4</sup> Federal Highway Administration, Federal Transit Administration, Interim Region 9 Guidance: *Addressing Environmental Justice in the Environmental Impact Statement*; May 9, 1997.

fostered and encouraged input from minority and low-income communities in the formulation and analysis of corridor alternatives is also included.

FTA will make the final determination whether adverse impacts fall disproportionately on minority and low-income populations. FTA will make this determination after having reviewed the Final SEIS/SEIR, the alternatives considered, public comments and testimony, and the public involvement process itself. If adverse impacts of the project fall disproportionately on minority and low-income populations, additional mitigation measures beyond those already identified may be required. If strategies cannot be taken to adequately minimize these impacts, then selection of an alternative with less adverse impacts may need to be considered.

The Environmental Justice analysis and the FTA determination for this project do not reduce or diminish previous commitments made by the Los Angeles County Metropolitan Transportation Authority (MTA) to redress grievances submitted by the Bus Riders Union to the U.S District Court for the Central District of California. The Consent Decree, ordered by the Court in October 1996, identified specific actions to be taken by MTA over a ten-year period to improve transit quality and maintain fare levels (with the exception of Consumer Price Index adjustments) for the transit dependent population in Los Angeles County. Specific actions, such as the purchase and placement of new buses on overcrowded routes, establishment of new routes, and the improvement of passenger amenities, will continue as authorized in the Consent Decree. The MTA has already added substantial new bus service in response to the Consent Decree. There currently is a dispute between the parties to the Consent Decree as to the exact amount of service required, and this dispute will be resolved by the courts. The MTA is prepared to implement such new service as is ultimately ordered by the courts regardless of whether the MTA moves forward with the construction of the Eastside Light Rail Project. Nothing in the Consent Decree limits the ability of the MTA to construct new rail lines. To the contrary, the Consent Decree specifically states "Capital improvement and programming for MTA shall include attention to all modes of transportation."

#### **4.5.1.2 Study Area Demographics**

Of the total study area population of 103,289, 96.7 percent of the population living in the corridor according to the 1990 U.S. Census data is considered minority (refer to Table 4.4-3 in Section 4.4, Communities/Neighborhoods). Minorities include all people of the following origins: Black; American Indian, Eskimo, or Aleut; Asian or Pacific Islander; other races; White Hispanic; Black Hispanic; American Indian, Eskimo, or Aleut Hispanic; Asian or Pacific Islander Hispanic; and other race Hispanic. People of Hispanic origin are the largest minority living within the study area. With the exception of areas west and south of the proposed 1<sup>st</sup>/Alameda Station and areas to the east and north of 3<sup>rd</sup>/Eastern, the high proportion of minorities occurs throughout the study area.

In the study area, 25.8 percent of total households were below the poverty level, compared with 11.9 percent for the county as a whole. With the exception of four scattered pockets in Boyle Heights (near 1<sup>st</sup>/State, 1<sup>st</sup>/Soto, 1<sup>st</sup>/Evergreen, and 3<sup>rd</sup>/Lorena), and three small areas in East Los Angeles (3<sup>rd</sup>/Downey, 1<sup>st</sup>/Eastern, and Atlantic south of Beverly), the distribution of low income households in the study area is consistently well above the countywide average.

An indicator often used to determine extent of transit dependence is the number of zero-car households, or occupied housing units with no available vehicles. Within the study area, 30.1 percent of households do not have access to a car, compared with 11.2 percent for the county as a whole (refer to Table 4.4-3 in Section 4.4). The lack of access to automobiles increases to 50 to 100 percent of all households in sections of the Central City and Boyle Heights neighborhoods and also one section in East Los Angeles.



#### **4.5.1.3 Major Issues of the Eastside Communities**

After World War II, the Boyle Heights and East Los Angeles communities were subjected to 30 years of freeway construction as a result of implementing the current regional freeway network. Five freeways traverse these communities, mostly through residential areas, resulting in impacts on neighborhood cohesiveness, pedestrian and traffic circulation impacts, visual, and noise impacts on nearby residences, schools, parks, and other public facilities. In addition, the area has been exposed to increases in automobile and truck traffic due to the location of freeway on- and off-ramps and the East Los Angeles freeway interchange.

It has been estimated that about 2,900 housing units were removed and 10,000 persons were displaced as a result of the freeway construction in the Boyle Heights community alone. Because the freeways were built prior to enactment of NEPA and CEQA, no environmental impact documentation was prepared for any of these freeway projects. Current provisions for relocation benefits to displaced persons were non-existent. These issues are of major concern to both current and former residents of the Boyle Heights and East Los Angeles communities, who bore the burden of the major transportation investments without receiving the benefits of improved mobility and enhanced regional connections.

#### **4.5.1.4 Public Involvement Program**

Opportunities for public participation in the Los Angeles Eastside Corridor Study have been provided by the MTA since the initiation of the study in July 1999. A series of community meetings have been held within the affected neighborhoods of Boyle Heights, East Los Angeles, Montebello, and Pico Rivera. These meetings occurred at locations most accessible to area residents, including the Resurrection Parish Hall, Saint Alphonsus School Auditorium, Centro Maravilla Community Service Center, and the Montebello Council Chambers. The meetings have had interpreters available, as needed, to translate the proceedings into Spanish.

Initially, three community scoping meetings were held in August and September 1999 at locations in Boyle Heights, East Los Angeles, and Montebello. About 70 people attended the meeting in East Los Angeles. Over 100 persons attended each of the other two meetings. The purpose of the scoping meetings was to solicit input regarding the range of alternatives and transit modes being considered, the study area, and major social, economic, or environmental issues related to the alternatives.

A second round of public meetings was held in October 1999 in Boyle Heights, East Los Angeles, and along Whittier Boulevard in the East Los Angeles commercial core district. Approximately 60 persons attended the meeting in Boyle Heights, 35 persons attended the meeting in East Los Angeles, and 50 persons attended the meeting on Whittier Boulevard. The purpose was to discuss the narrowed list of eight build alternatives and station locations being considered in the Re-Evaluation/MIS document and to solicit additional public input. Focus meetings were held in the City of Montebello and the City of Pico Rivera the third week of November 1999 to discuss the alternative routes and the impacts along their commercial corridors.

A third round of public meetings was convened in early January 2000. The meetings were held in Boyle Heights, Little Tokyo Arts District, East Los Angeles, and Montebello. The purpose was to present the findings of the comparison of the alternatives and to again solicit public input prior to the presentation of the findings to the MTA Board of Directors and their selection of a preferred alternative(s) to be carried forward for further evaluation. Since January 2000, additional community meetings have been held in various parts of the corridor. In early 2001, three public hearings were held during circulation of the Draft SEIS/SEIR as follows: 1) on March 29 at the Japanese American National Museum (100 attendees);

2) on April 4 at Roosevelt High School (150 attendees); and 3) on April 5 at Garfield High School (140 attendees).

One of the primary committees whose role is to inform MTA of the important issues and concerns of the Eastside communities related to the planning, design, construction, and operation of the transit project is the Review Advisory Committee (RAC). The RAC, which was originally formed during the initial planning phase of the suspended Red Line project, is comprised of local residents, business owners, elected official representatives, and community organizations. It has met on a monthly basis to discuss the progress of the study and to request input from its members.

In addition, focus meetings have also been held with individual community groups and organizations as well as with elected officials at various times since the inception of this study. Local churches, Chambers of Commerce, the Little Tokyo Service Center, and various community groups have helped to distribute over 67,000 flyers. In order to reach minority communities, flyers, project fact sheets, and meeting announcements have been published in Spanish. A complete list of community and agency meetings and the number of people attending is presented in Chapter 6.

#### **4.5.2 Methodology for Impact Evaluation**

For this evaluation, definitions of minority and low-income areas were established based on guidance provided by the Council on Environmental Quality (CEQ). CEQ's *Environmental Justice Guidance Under the National Environmental Policy Act*, December 10, 1997, states, "Minority populations should be identified where either (a) the minority population of the affected area exceeds 50 percent or (b) the population percentage of the affected area is meaningfully greater than the minority population percentage in the general population or other appropriate unit of geographic analysis." The CEQ further states that "The selection of the appropriate unit of geographic analysis may be a governing body's jurisdiction, a neighborhood, a census tract, or other similar unit that is chosen so as to not artificially dilute or inflate the affected minority population."

For this analysis, Los Angeles County was selected as the unit of geographic analysis for comparison. The U.S. Census Bureau provided the definition of minority populations to be used to identify locations within the study area with higher percentages of minority populations than the County's (refer to Section 4.5.1.2, *Study Area Demographics*). Staff at the Census Bureau advised use of the statistic, "Ratio of Income in 1989 to Poverty Level" to indicate low-income populations. This statistic was derived by testing the income of each household against the appropriate poverty threshold (48 thresholds were used based on household size and number of members under 18 years) to determine the poverty status of that household. All households below a ratio of 1.0 were considered to be in poverty. Using this statistic, it was determined that low-income households account for 11.9 percent of the households within the County. Locations within the study area with higher percentages of low-income households than the County's were considered low-income areas. Data was also collected on numbers of zero-car households, an indicator of the transit dependent population in the corridor.

In determining whether a project will have "disproportionately high adverse environmental effects," a number of factors were considered including its potential adverse impacts; mitigation and enhancement measures that will be incorporated into the project; and off-setting benefits. Adverse impacts were examined in these critical areas: 1) property acquisition and displacements; 2) transportation; 3) air quality; 4) noise and vibration; 5) community facilities/parklands; 6) hazardous materials; and 7) construction impacts. To estimate the extent of the benefits derived from the LRT Build Alternative, the following criteria were employed:

- ◆ Equity

- ◆ Daily transit trips/mobility
- ◆ Travel time savings
- ◆ Regional connectivity
- ◆ Economic revitalization
- ◆ Employment opportunities

Equity was examined by comparing regional transportation investments with the benefits of those investments relative to the study area. To assess transit mobility, regional connectivity, and accessibility, computer modeling was used to estimate the daily person trips, transit trips, and transit mode share within the corridor for 2020, the planning horizon year. The results for the LRT Build Alternative were compared with the No-Build Alternative. Although these measures apply to the entire corridor, they can also be used as an indicator of transit mobility and accessibility within minority and low-income areas since much of the corridor fits these definitions. Land use data as well as economic and fiscal projections were examined to determine the potential for economic revitalization and increased employment resulting from the LRT Build Alternative.

In accordance with Executive Order 13045, *Protection of Children from Environmental Health Risks and Safety Risks*, a determination of whether the potential for contact with hazardous products or substances used in the construction or operation of the LRT Build Alternative or whether other impacts would disproportionately affect children in the study area was made.

The evaluation summarizes the beneficial and adverse impacts for the LRT Build Alternative, including the efforts to date to solicit input from the public in considering the alternatives. A preliminary determination whether adverse impacts will fall disproportionately on minority and low-income populations is made at the end of the evaluation. After reviewing the Final SEIS/SEIR, FTA will decide if they concur with this determination.

#### **4.5.3 Potential Beneficial Impacts**

##### **4.5.3.1 No-Build Alternative**

The No-Build Alternative would not offer study area residents enhanced mobility, regional connectivity, and accessibility provided by the LRT Build Alternative.

##### **4.5.3.2 LRT Build Alternative**

###### ***Option A***

###### **Equity**

Indicators of transit dependence, such as low-income households and zero-auto households, are nearly three times higher than for Los Angeles County as a whole. The need for and reliance on transit has not been balanced by regional public transportation investments that would benefit this transit dependent community. For example, MTA rail services extend to Western Avenue and to North Hollywood, to Norwalk and El Segundo, to Long Beach and ultimately to Pasadena. Metrolink serves suburban destinations in all directions. Yet, no major investment in transit service, either bus or rail, has been made in the Eastside Corridor. A concerted effort to extend the Metro Red Line to the corridor was suspended in 1998. In addition, the corridor has borne the disproportionate effects of a regional freeway system that has cut through its neighborhoods to reach suburban destinations. Implementing LRT service in the

corridor would help restore the balance of regional capital transportation expenditures as well as compensate for the adverse impacts that previous transportation planning decisions have caused.

Mobility/Transit Travel Times/Regional Connectivity

Option A of the LRT Build Alternative is expected to increase the number of daily transit trips by 14,600 compared with the current bus service offered by the No-Build Alternative and reduce travel times. Travel times between the corridor and major travel destinations, such as Hollywood, Wilshire Boulevard, Downtown Los Angeles, and Pasadena, would decrease with Option A of the LRT Build Alternative. For two representative trip origins in the corridor, 1<sup>st</sup>/Soto and 3<sup>rd</sup>/Mednik, travel times for Option A could be reduced by as much as 16 percent over the No-Build Alternative (Table 4.5-1). This increase indicates the value of quality transit service in attracting riders. It also indicates that light rail service offers improved access for area residents to local destinations as well as to the regional rail and bus system and, therefore, to regional destinations. The LRT Build Alternative also would serve many educational and community centers in the corridor, enhancing mobility for young adults and school age children.

**TABLE 4.5-1  
REGIONAL TRANSIT TRAVEL TIMES (IN MINUTES) FROM SELECTED ORIGINS  
IN THE EASTSIDE CORRIDOR**

Trip Origin	Hollywood/Highland		Wilshire/ Fairfax		1 <sup>st</sup> /Hill		Fair Oaks/Colorado	
	No-Build	LRT Option A	No-Build	LRT Option A	No-Build	LRT Option A	No-Build	LRT Option A
1 <sup>st</sup> /Soto	62	53	70	60	26	25	67	55
3 <sup>rd</sup> /Mednik	67	60	75	67	39	32	47	45

Economic Revitalization

Option A includes eight new stations as well as the current Union Station. With proper incentives and with favorable market conditions, developers may consider the merits of constructing housing and commercial developments that are oriented to the light rail stations and that take advantage of the new light rail service. Station areas that have vacant land resulting from right-of-way acquisition for the suspended Metro Red Line project or for the construction of the LRT Build Alternative can be developed, in accordance with City and County of Los Angeles planning and redevelopment policies and Community Plans, to benefit the surrounding neighborhoods. In a corridor that has an extremely low vacancy rate and a great demand for affordable housing, such development could provide needed housing and space for retail and social service uses. The new development could offer larger units for families with children, helping to meet a dire need in the community. In addition, landscape treatments along the light rail line could enhance the urban design of the community, making opportunities for development more attractive.

Employment Opportunities

Option A is anticipated to generate approximately 47,000 new construction jobs and, within the first 14 years of operation, over 1,000 permanent jobs to operate and maintain the LRT line. In addition, MTA is formulating a local hiring policy for the construction and operational related job opportunities for the corridor. Such a program will include resources for job development and training. MTA currently offers a series of programs designed to encourage minority and women-owned businesses to participate in the construction and operation of new transportation projects. More information on employment benefits generated by Option A is provided in Section 4.2.

### ***Option B***

The impacts of Option B are the same as those described for Option A with the exception that Option B will generate 13,100 more daily transit trips compared to the bus service offered by the No-Build Alternative. However, this is approximately 1,500 fewer trips than Option A would provide.

#### **4.5.4 Adverse Impacts and Mitigation Measures**

##### **4.5.4.1 No-Build Alternative**

The No-Build Alternative would maintain the existing transportation system in the corridor and, as a result, would not address the transportation deficiencies experienced by area residents or correct the imbalance of transit expenditures that have benefited other portions of the region without providing similar improvements in the corridor. In addition, the No-Build Alternative could not compensate for the burdens imposed on the area by the construction of the regional freeway and railroad systems that traverse the corridor.

##### **4.5.4.2 LRT Build Alternative**

The LRT Build Alternative would produce construction and operation impacts throughout the corridor. Because the transportation improvements are being done in a largely minority and low-income area, the construction and operation impacts will fall almost exclusively on corridor residents. Construction and operation impacts on children would have the greatest likelihood to occur at schools during daytime hours. Key impacts of concern include residential displacements, traffic circulation and pedestrian safety, noise, vibration, parklands, hazardous materials, and air quality. The impacts and associated mitigation measures for these areas are described below for each option.

### ***Option A***

#### **Acquisitions and Displacements**

Construction of light rail facilities and acquisition of property for construction staging areas would displace 72 residents and 20 active businesses for Option A. The displacements, although not extensive, represent affordable housing units and businesses that are often neighborhood establishments serving the local population. The displacements would fall largely on low income and minority residents. Federal and state statutes require the agency responsible for the displacements to finance acceptable, equivalent replacement housing and business relocation. However, the low vacancy rate in the study area and the limited availability of affordable replacement housing has prompted MTA to provide additional assistance (See Section 4.3.4). The displacements for Option A would affect the historic setting of Mariachi Plaza. A possible mitigation measure is for MTA to replace the spatial and visual void created by the removal of Ranch Market with a facade that duplicates the mass and visual characteristics of an historic building while not recreating a building. The actual strategies to be implemented will be specified in a Memorandum of Agreement (MOA) pursuant to Section 106 between the MTA, FTA, and State Historic Preservation Office (SHPO). Section 4.15 provides additional information. MTA will be formulating a local employment policy for construction and operations-related job opportunities in the corridor. Such a program will include resources for job development and training and will be made available to persons unable to find a new job as a result of the business relocations.

### Traffic Circulation and Pedestrian Safety

Adverse impacts on neighborhood traffic and pedestrian circulation and curb parking, described in Chapter 3, can be mitigated with the exception of the worsening of traffic conditions at several traffic intersections. Refer to Chapter 3.0, *Transportation*, and Sections 4.14.4, *Safety and Security*, and 4.16.4, *Community Facilities/Parklands*, for mitigation measures that relate to traffic, parking, and pedestrian circulation impacts.

Construction activities would temporarily interfere with normal traffic flow, causing some lanes and streets to be closed to vehicles for various durations of time. However, these temporary lane closures are not expected to restrict access to schools located along or near 1<sup>st</sup> Street. There will be temporary curb parking restrictions along Indiana Street by Ramona High School. Although most temporary construction-related impacts can be mitigated, certain locations may experience traffic and parking impacts that cannot be fully mitigated (refer to Section 4.19.2, *Construction Period Impacts and Mitigation*).

### Noise and Vibration

At-grade and subway operations are not expected to generate noise and vibration impacts on schools or other community facilities except for moderate noise impacts are expected at Evergreen Cemetery and the Los Angeles Music and Art School, and vibration impacts are anticipated at the LA Music and Art School due to the location of special trackwork nearby. Since these facilities are regional, the impacts would not necessarily fall primarily on minority or low-income residents or children. Noise mitigation for moderate noise impacts due to LRT operation is not required under NEPA because a significant impact occurs only if a noise-sensitive receptor is severely impacted according to FTA criteria. For moderate noise impacts, mitigation is recommended when deemed cost-effective and feasible. Noise mitigation for moderately impacted buildings is normally in the form of sound-absorptive trackside noise barriers. However, trackside noise barriers are not feasible for this project since the LRT alignment runs in the street when it is at grade. Trackside noise barriers in the street would interfere with traffic and pedestrian movements. A variety of mitigation measures are available, as discussed in Section 4.8, that will fully mitigate the vibration impacts on the LA Music and Art School during operations. Construction activities may also produce temporary noise and vibration impacts on facilities located adjacent to the alignment. Section 4.19.2.7 presents mitigation measures that will be taken to minimize adverse impacts.

### Parklands

The historic setting of Mariachi Plaza would be affected by removing the Ranch Market located across the street from the Plaza. In addition, ornamental streetlights are present in the Mariachi Plaza area. Removal of these poles would result in a significant visual impact. Curb parking displaced at the portal location on 1<sup>st</sup> Street adjacent to Pecan Park would not affect access to the park since excess parking capacity exists along the streets surrounding the park. Similarly, access to parks would not be affected by the temporary traffic, bus, and pedestrian reroutings or the closure of Pleasant Avenue that borders the plaza on the north. Parklands bordering the proposed alignment, such as Pecan Park and Belvedere Park, may undergo temporary noise, vibration, visual, air quality, and circulation impacts due to construction activities. The use of Mariachi Plaza would be temporarily disrupted by excavation and finishing work on the eastern end of the plaza for the 1<sup>st</sup>/Boyle subway station. However, the gazebo and adjacent area on the western portion of this facility would remain intact throughout construction. The amount of differential settlement from the tunneling is not expected to cause structural or architectural damage to facilities at Pecan and Belvedere Parks or Mariachi Plaza. The parkland impacts would fall primarily on minority and low-income residents in the Boyle Heights community. Refer to Sections 4.15.4,

*Historic/Archaeological/Paleontological Resources*, and 4.16.4, *Community Facilities/Parklands*, for mitigation measures that relate to the aforementioned impacts.

#### Air Quality

Temporary air quality impacts may be generated by construction activities that would fall largely on area residents. Refer to Section 4.7.4, *Air Quality*, for appropriate mitigation measures.

#### Hazardous Materials

Hazardous materials may be present in construction areas, including tunnel segments and staging areas. Standard procedures for addressing the storage and removal of hazardous materials from construction areas would prevent local residents, particularly children, from being exposed to or ingesting hazardous materials. Standard procedures for safe storage and transportation of hazardous materials are presented in Section 4.10, *Hazardous Materials*.

#### **Option B**

The traffic circulation and pedestrian safety, air quality, and potential for hazardous materials contamination impacts as well as impacts on parklands are similar to that described under Option A. The differences for the other impact categories are presented below.

#### Acquisitions and Displacements

Under Option B, 72 residents and 20 active businesses, the same number as under Option A, would be displaced. In addition, Ramona High School would be displaced and need to be reconstructed or relocated. MTA will commit to costs for relocating the school (if that is determined to be the course of action) to a site that is acceptable to LAUSD and MTA, and will also provide funds for construction of a new school off-site or reconstruction at the present location. LAUSD will conduct the necessary environmental studies once it is determined whether to relocate or reconstruct the school. The actions of LAUSD in replacing the school are beyond the scope of the analysis for the Eastside Corridor LRT since LAUSD will be directing that program. However, MTA will work with LAUSD during their separate studies when LAUSD's plans for the school are better known.

#### Noise and Vibration

The long term and short term noise and vibration impacts associated with Option B are the same as Option A except for vibration impacts and moderate noise impacts expected at the Kaiser Medical Center on Pomona Boulevard. As stated for Option A, trackside noise barriers are not feasible for this project since the LRT alignment runs in the street when it is at grade. Trackside noise barriers in the street would interfere with traffic and pedestrian movements. As discussed under Option A, mitigation measures are available to fully mitigate the adverse vibration impacts.

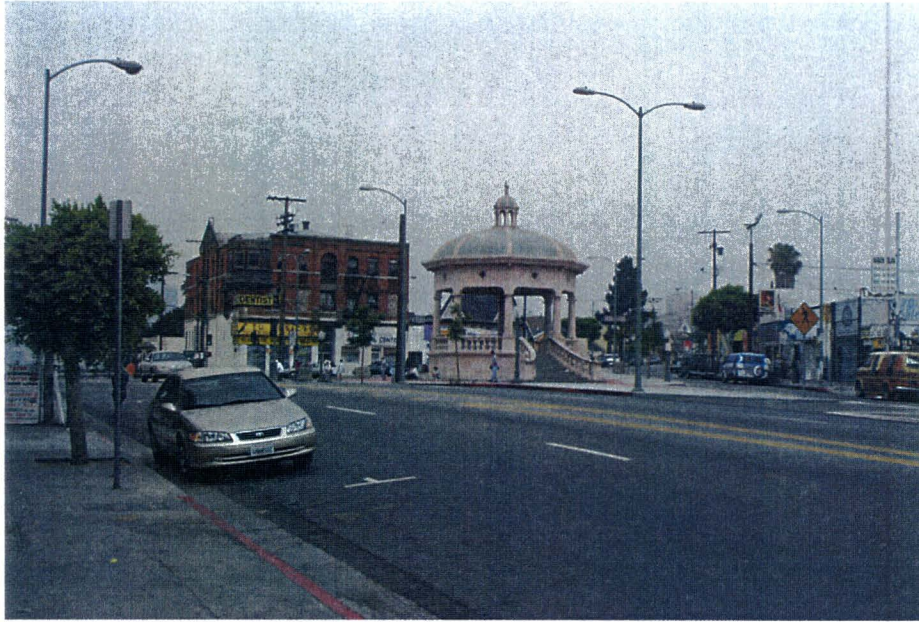
#### **4.5.5 Conclusion**

Adverse impacts from either Options A or B would fall primarily on low income and minority populations since they represent the primary population groups residing in the corridor. The potential long-term impacts for Options A and B could be mitigated with the exception of traffic impacts at 12 intersections for Option A and 10 for Option B. Although most temporary construction-related impacts can be mitigated, certain locations may experience traffic, parking, noise, and vibration impacts that cannot be fully mitigated.

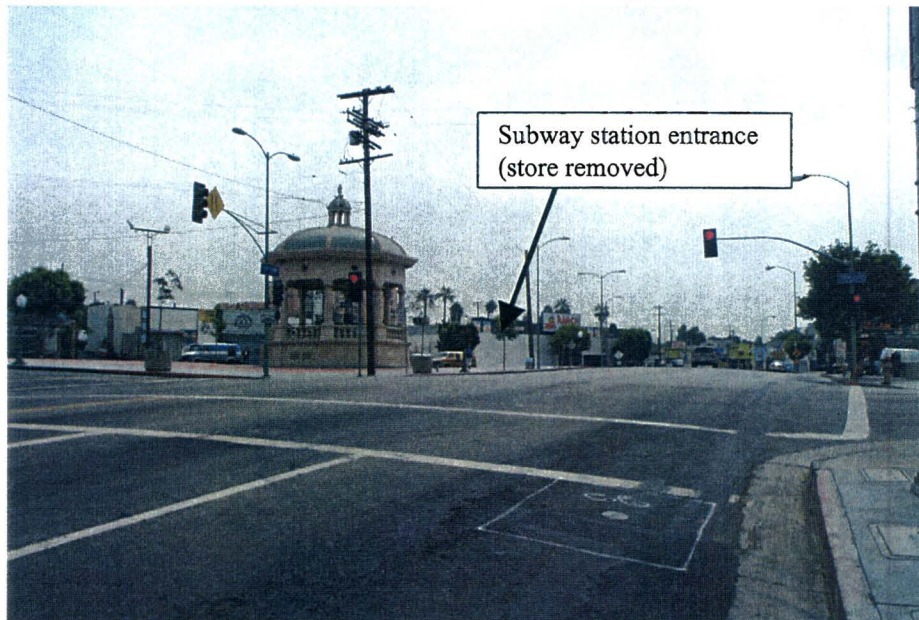
In view of the considerable project benefits and local support for implementing the LRT Build Alternative Options A or B, the impacts would not be disproportionate to the mobility, regional connectivity, equity, and economic gains either Option A or B could offer. In addition, the Eastside Corridor Project, with proper mitigation, would not increase the risk to children's health or safety that is attributable to products or substances that a child is likely to come in contact with or ingest. Public input related to project benefits and impacts has been solicited throughout the study, attracting over 1,000 community members at numerous public meetings held throughout the corridor.



**4.6 VISUAL AND AESTHETICS**



**Mariachi Plaza**, as viewed from 1<sup>st</sup> Street, looking west.



**Station entrances:** As viewed from 1<sup>st</sup> Street, looking east. The subway entrance would be where the grocery store is now.

*Los Angeles Eastside Corridor SEIS/SEIR*

**Mariachi Plaza**



### ***Murals***

Throughout the Eastside Corridor viewshed, there are numerous murals, painted on building facades and other structures. These murals are important visual resources commissioned by private businesses, public agencies, religious organizations, parents, and community groups, or self-sponsored by the artists themselves. Much of the wall art has been created since 1960. At least 250 murals are located in the neighborhoods of Boyle Heights, Lincoln Heights, City Terrace, and East Los Angeles.

### ***Skyline Views***

In the western portion of the Eastside Corridor viewshed, west of the Los Angeles River, there are views of the downtown skyline. East of the river, views of the skyline are limited to upper levels of buildings.

#### **4.6.2 Methodology for Impact Evaluation**

Visual analysis considers such existing conditions as the area that can view the LRT Build Alternative, the viewers within these areas, the quality of the existing visual environment, and policies from local jurisdictions applicable to the project site.

To analyze potential long-term (permanent) visual impacts, the physical changes that would be visible are considered. How these physical changes would affect the visual quality is also considered. The type of viewers and their sensitivity to these visual changes are then considered. Special attention is given to visual changes that would occur in the view of important visual resources, such as historic resources, cultural facilities, and important views. Compatibility with visual policies is also considered. For this analysis, the LRT Build Alternative is assumed to be compatible with policies that have been adopted or approved by MTA, unless project plans specifically demonstrate that the alternative is not compatible. Short-term (construction) impacts include those visual impacts that would only occur during the construction period, such as demolition, excavation, and construction staging.

For this analysis, significant visual impacts under CEQA would occur in the following circumstances:

- ◆ **Policy Impacts:** If the project would conflict with applicable policies related to vista protection, scenic resource protection, conflict with adopted design criteria, or conflict with other visual policies of local or regional agencies;
- ◆ **Important Visual Resources Impacts:** If the project would substantially alter or obstruct existing public views of important visual resources;
- ◆ **Impacts Affecting Use:** If the project would change the existing visual quality or character in such a way that use of adjacent land is adversely affected;
- ◆ **Light or Glare Impacts:** If the project would result in light or glare in the project vicinity in such a way that it causes a hazard or nuisance;
- ◆ **Shade or Shadow Impacts:** If the project would adversely affect uses of adjacent land by the introduction of shade or shadow patterns; or
- ◆ **Historical Resources Impacts:** If the project would result in indirect impacts on properties that are listed in the National Register of Historic Places or the state Office of Historic Preservation register.

### 4.6.3 Impacts

#### 4.6.3.1 No-Build Alternative

There would be no impacts on visual resources under the No-Build Alternative because this alternative only includes improvements to the transportation network that have already been approved and funded. Since no new capital improvements would occur, this alternative would produce no changes to the visual environment within the study area.

#### 4.6.3.2 LRT Build Alternative

##### *Option A*

Table 4.6-1 lists the physical changes that would be visible within the viewshed of Option A. Potential impacts are described below according to the type of change.

##### Aerial Structure

One aerial structure would be constructed to carry the LRT from the Union Station platform across US 101 towards Alameda Street. On the Union Station side, the visual impact would be minimal because the structure would be at a similar elevation to the existing platforms. To the motorists on US 101, viewing this structure would be similar to other nearby structures crossing the freeway. Viewed from industrial land, parking lots, and the jail to the south of the freeway, the structure would not be obtrusive. Therefore, the visual impact of the aerial structure would be less than significant.

##### Street Widening

Widening of Alameda Street would remove sidewalks, portions of parking lots, street trees and landscaping. A privacy wall protecting one parking lot/maintenance yard area would also be removed. It would also require removal of the service station in the southeast quadrant of the intersection of Alameda Street and Commercial Street. Sidewalks, privacy wall, and street trees/landscaping would be replaced. The visual impacts resulting from the removal and replacement would be minimal. In addition, removal of the service station would have a minimal visual impact in this commercial area.

Widening of 1<sup>st</sup> Street from Alameda to Vignes Streets would remove sidewalks, street trees and landscaping, and private property landscaping. Of particular note would be the removal of large mature street trees along the north side of the street. Sidewalks and street trees/landscaping would be replaced. Viewers in this area, including the future users in the planned First Street South Plaza adjacent to First Street, are mostly commercial users. The visual impacts resulting from the removal and replacement would be minimal.

##### Street-level Trackwork and Overhead Catenary System

Tracks for the LRT would be installed in the existing streets, mostly within the center of the street (several streets in the project area historically had rail service in the center of the street). This trackwork would not result in visual impacts. The catenary system would have significant visual impacts in some locations, such as on the 1<sup>st</sup> Street Bridge, which has been determined to be eligible for the National Register of Historic Places, and in narrow rights-of-way near residential areas. In these areas the visual clutter created by the wires and their supports would be significant.

**TABLE 4.6-1  
VISIBLE PHYSICAL CHANGES – OPTION A**

Type of Change	Description	Location(s)
Aerial structure	1,000-foot-long structure approximately 25 feet high at highest point, including foundations, support columns, girders, and deck slabs.	<ul style="list-style-type: none"> <li>Near Union Station, crossing US 101</li> </ul>
Street widening	Widening of street beyond current rights-of-way	<ul style="list-style-type: none"> <li>Alameda St. (would remove commercial building and landscaping on east side)</li> <li>1<sup>st</sup> St. between Alameda and Vignes Streets (would remove landscaping on north side)</li> </ul>
Street-level trackwork;  Overhead catenary system	<p>Within streets for aboveground portions; generally requires conversion of one general-purpose lane in each direction; includes track bed, track slab, rail, fasteners, and infill concrete.</p> <p>Wires, support poles, brackets, and other components</p>	<ul style="list-style-type: none"> <li>Alameda St., 1<sup>st</sup> St. west of Clarence St.</li> <li>1<sup>st</sup> St. east of Lorena St.</li> <li>Indiana St., between 1<sup>st</sup> St. and 3<sup>rd</sup> St.</li> <li>3<sup>rd</sup> St., between Indiana St. and Beverly Blvd.</li> <li>Beverly Blvd., between 3<sup>rd</sup> St. and Via Campo</li> </ul>
Bridge Seismic Retrofit	Additional reinforced concrete infilling of bents and concrete cast-in-drilled-hole piles.	<ul style="list-style-type: none"> <li>1<sup>st</sup> Street Viaduct</li> </ul>
Portals	Entrances to underground sections; include a U-shaped trench with protective railing at the transition points from street-level to underground sections.	<ul style="list-style-type: none"> <li>1<sup>st</sup> St., near Gless St.</li> <li>1<sup>st</sup> St., near Lorena St.</li> </ul>
Street-level stations	High-floor, 270-foot-long platforms and station amenities, including canopies, fare-vending equipment, station furniture, ramps, landscaping, signage, crosswalks, lighting, etc.	<ul style="list-style-type: none"> <li>Alameda St. near 1<sup>st</sup> St.</li> <li>1<sup>st</sup> St. near Utah St.</li> <li>3<sup>rd</sup> St. near Rowan Ave.</li> <li>3<sup>rd</sup> St. near Mednik Ave.</li> <li>Beverly Blvd. near Atlantic Blvd.</li> </ul>
Subway station entrances	Includes elevators, escalators, stairs, landscaping, railing, signage, lighting, etc.	<ul style="list-style-type: none"> <li>1<sup>st</sup> St. near Bailey St. (1<sup>st</sup>/Boyle Station), in northwest quadrant (would remove commercial building)</li> <li>1<sup>st</sup> St. at Soto St., in southwest quadrant (would remove residences and commercial buildings)</li> </ul>
U-section station	Station located in the portal; otherwise similar to street-level station.	<ul style="list-style-type: none"> <li>1<sup>st</sup> St. near Lorena St.</li> </ul>
Removal of parking	On-street parking would be removed and sidewalks made narrower.	<ul style="list-style-type: none"> <li>Indiana St.</li> </ul>
New parking facilities	Replacement parking in areas of high utilization	<ul style="list-style-type: none"> <li>Replacement parking on 1<sup>st</sup> St. near Lorena St.</li> <li>Replacement parking on Indiana St. (would remove commercial and residential structures)</li> <li>Park-and-ride facility at Pomona and Atlantic Boulevards near Kaiser Hospital (would remove commercial and medical-office structures, and utilize Pep Boys parking lot)</li> </ul>
Traction power substations	Electrical power substations, one-story enclosures on a concrete foundation, attached to electrical distribution lines (either aerially or underground), approximately 11 feet by 25 feet on a leveled site no smaller than 40 feet by 55 feet, with a perimeter fence at least 14 feet outside the enclosure.	<ul style="list-style-type: none"> <li>Within the MTA Maintenance Yard, north of First Street Viaduct</li> <li>Near the 1<sup>st</sup>/Soto Station (would remove commercial building)</li> <li>Near 1<sup>st</sup> St./Lorena St. intersection (on vacant property)</li> <li>Near the SR-60/3<sup>rd</sup> St. interchange at Sunol Ave. (would remove vacant commercial building)</li> <li>Near 3<sup>rd</sup> St./Arizona St. intersection (would remove auto sales business)</li> <li>At northeast corner of Beverly Blvd./Atlantic Blvd. (would remove commercial building/parking lot)</li> </ul>

Historically, the 1<sup>st</sup> Street Bridge carried an electrically powered rail system, which included overhead catenary wires. This system was removed approximately 35 years ago. Thus, to replace the catenary system on the bridge would not represent a significant impact to the historical nature of the bridge, but would add to the more recent urban clutter (including the existing overhead transmission lines), a significant impact. In addition, catenary wires in residential areas may add to the visual clutter of existing telephone, electrical, and cable television wires. This would be especially significant in narrow roadway areas with adjacent homes along Indiana Street and in some locations on 1<sup>st</sup> and 3<sup>rd</sup> Streets.

#### Bridge Seismic Retrofit

MTA has conducted additional seismic analysis of the 1<sup>st</sup> Street Bridge and found that the bridge does not meet Caltrans revised (1999) criteria for seismic design. The LRT project does not add significantly to the bridge loadings, and seismic retrofitting would otherwise be required by the City of Los Angeles Bureau of Engineering to bring it up to the current Caltrans criteria. In 1996, Caltrans and the City retrofitted the bridge to meet previous Caltrans standards. As a part of the retrofit, they added reinforced concrete infill to some of the openings in the bridge bents. To meet the new standards will require additional infill of the bents and construction of additional concrete cast-in-drilled-hole piles behind the original concrete abutments. The piles will not be visible following repair of the road surface. However, the additional infill will be visible to viewers underneath the bridge and in the nearby area. The infilling of the openings of the bents is a significant impact.

#### Portals

Portals are the locations where the LRT goes from above ground to underground. Because the portals take advantage of existing topographic changes, the extent of this U-section would be limited. Therefore, the portals would not result in significant visual impacts.

#### Street-level Stations

The street-level stations associated with Option A would generally result in minimal visual impacts. Most are located in commercial areas. Even for those with residential land uses nearby, the relatively open nature of the stations would prevent significant visual impacts. The 1<sup>st</sup>/Alameda Station would be located on the east side of Alameda Street, north of 1<sup>st</sup> Street. This location is directly across the street from the Japanese American National Museum and across Banning Street from the future Mangrove Estate 24-floor hotel. At this location, the overall open design of the street-level station would avoid significant visual impacts.

#### Subway Station Entrances

The 1<sup>st</sup>/Boyle Station would be accessed from an entrance at the current location of a grocery store. Removal of the structure would continue to open up this area and make it appear less densely developed. While the addition of open space represented by the ground-level portion of the transit station would be a benefit for the majority of the surrounding areas, unless it was carefully designed, the lack of an enclosing element would have a significant negative visual impact on Mariachi Plaza (refer to Section 4.15, *Historic/Archaeological/Paleontological Resources*).

The 1<sup>st</sup>/Soto Station would be entered from an entrance at the southwest quadrant of the 1<sup>st</sup>/Soto Streets intersection. Several buildings at this urban intersection would be removed, including residences and businesses. One business in the southeast quadrant of this intersection would also be removed for vent structures. (As discussed below, a traction power substation would also be placed immediately to the west of the station plaza, removing another business located in a converted single-family residence.) This

would represent a significant change in the dense urban character of this intersection, especially with the loss of sidewalk-side businesses, resulting in a significant visual impact.

#### U-section Station

The 1<sup>st</sup>/Lorena Station under Option A would be located within the eastern portal. At this location, the alignment would be along the north side of 1<sup>st</sup> Street. This would locate the station and the portal on the far side of the street from existing residential uses on the south side of 1<sup>st</sup> Street and against the retaining wall for Evergreen Cemetery on the north side of 1<sup>st</sup> Street. Visual impacts related to this station would be minimal due to this location.

#### Removal of Parking/Narrowing of Sidewalks

Under Option A, parking would be removed along Indiana Street and the sidewalk width would be reduced in order to accommodate the LRT. The removal of this parking alone would be a positive visual impact. Because alternative parking would be provided under Option A on the east side of Indiana Street, the adjacent land uses, especially the single-family residences, would remain usable and would not deteriorate. The reduction of sidewalk width in this area would be a visual impact because the area has a great deal of pedestrian traffic related to the residences, commercial and institutional land uses, and, especially, related to Ramona High School. (Refer to Chapter 3 for a discussion of impacts and mitigation for parking and pedestrian facilities.)

#### New Parking Facilities

On Indiana Street, replacement parking would be provided Under Option A by removing two commercial structures and two multi-family buildings on the east side of the street. This would potentially expose residences east of the new parking lot to view from Indiana Street and create new views from these residences of the street and parking lot. Currently these residential properties are separated from the adjacent commercial properties that would be displaced by boundary fencing or walls. These boundary fences/walls would be retained or replaced when the commercial properties are demolished and the parking lot is constructed. Therefore, visual impacts would be minimal. A park-and-ride facility at the eastern terminus near Kaiser Hospital would be provided and would displace four commercial and two medical-office buildings. Minimal visual impacts are anticipated at this area because the surrounding area is mainly commercial in nature. Elsewhere, proposed replacement parking would result in minimal physical changes and no significant visual impacts.

#### Traction Power Substation

Traction power substations would be used in the project to assist in electrical uses of the LRT. Substation equipment includes high-voltage switchgear, transformers, rectifiers, breakers, and other related equipment. All equipment would be covered in an approximate 11- by 25-foot building (or smaller) on a site no smaller than 40 feet by 55 feet, with a perimeter fence at least 14 feet outside the enclosure. Only the aboveground substations have the potential to result in visual impacts.

A substation would be located in the existing MTA maintenance yard near the 1st Street Bridge. Because the type of use – industrial-type service facility – would be similar to the surrounding uses on the property, and because it is generally not visible to sensitive viewers, this substation would not result in a significant visual impact. The substation near the 1<sup>st</sup>/Soto Station would require the removal of a commercial structure. This structure would be directly adjacent to the 1<sup>st</sup>/Soto Station, which would also remove several commercial structures. In combination with the removal of buildings for the station, this commercial neighborhood would undergo a significant visual transformation, from a dense, urban



environment with sidewalk side businesses to an open plaza area set well back from the street. This represents a significant visual impact.

The substation proposed at 1<sup>st</sup> and Lorena Streets would be located on vacant property owned by MTA. Surrounding uses are commercial, residential, and the Evergreen Cemetery. The site is not visible from most of the cemetery because of elevation changes and landscaping. The cemetery embankment and landscaping also screens the site from most of the surrounding residential areas. Because the substation would not be visible to most sensitive viewers, no significant visual impact would occur. Another aboveground substation would be located on the small, triangular parcel of land bordered by 3<sup>rd</sup> Street on the south, SR-60 on the northwest, and Sunol Drive on the east. This site would be visible from the extreme northwest corner of Calvary Cemetery. Construction of a new building in place of the existing structure, which is not well maintained, would be a positive visual impact.

The substation at the intersection of 3<sup>rd</sup> and Arizona Streets would require the removal of an auto sales business. Surrounding land uses vary, but are mostly commercial. The substation would be similar to the current use and would be compatible with the surrounding development. Therefore, no significant visual impact would occur. Finally, there would be a substation located at the northeast corner of Beverly and Atlantic Boulevards. It would require the removal of a commercial property and parking lot. This area is entirely commercial. Due to the surrounding commercial land uses and the lack of sensitive viewers, this substation location would not result in a significant visual impact.

#### Visual Impacts on Important Visual Resources

The physical changes to the visual and aesthetic environment of important visual resources in the study area are as follows:

- ◆ **Union Station** building and courtyards would be visually separated from the LRT platforms and would, therefore, not produce significant visual or aesthetic impacts on the historic station.
- ◆ **1<sup>st</sup> Street Bridge** (refer to *Street-level Trackwork and Overhead Catenary System* and *Bridge Seismic Retrofit* discussions).
- ◆ **Pecan Park** would be adjacent to the western portal for the subway portion of the LRT Build Alternative. The portal would not result in significant visual impacts.
- ◆ **Mariachi Plaza** (refer to *Subway Station Entrances* discussion). In addition, ornamental streetlights are present in the Mariachi Plaza area. Removal of these poles would result in a significant visual impact.
- ◆ **Evergreen Cemetery** has large trees along the 1<sup>st</sup> Street side of the cemetery, and the trees would screen most of the views of the LRT catenary system, resulting in minimal visual impacts.
- ◆ **Our Lady of Lourdes Catholic Church** is set back from 3<sup>rd</sup> Street and a lawn in front of it. Because of this relatively spacious streetscape, there would be less than significant visual impacts related to placing the station and the catenary system within view of the church under any LRT option.
- ◆ **Calvary Cemetery** would border the LRT alignment and a substation on 3<sup>rd</sup> Street. The visual impacts related to the catenary system, trackwork, and substation would be relatively minor due to the distance of most viewers.
- ◆ **Serbian Cemetery** is partially screened from view from 3<sup>rd</sup> Street so that the impacts of the catenary system and trackwork would be minor.
- ◆ **East Los Angeles Civic Center and Belvedere Park** would have the catenary system, trackwork, and the 3<sup>rd</sup>/Mednik Station located immediately in front of the main Civic Center building. Although these physical changes would be visible from the grounds, the street is relatively wide and there is considerable open space on either side of the street. As a result, visual impacts on either facility would be less than significant.

### Murals

None of the murals in the Eastside Corridor would be acquired for Option A, nor would they be blocked from view by project elements. Therefore, there would be no visual impacts on existing murals or public art.

### Skyline Views

In the western end of the project, generally west of the Los Angeles River, there are views of the Los Angeles skyline. Because none of the structures proposed by Option A would block views of the skyline, visual impacts on these views would be minimal.

### Consistency with Visual Resource Policies

Table 4.6-2 indicates whether Option A is consistent with the urban design policies of the appropriate local jurisdictions. As presented in the table, Option A would be consistent with applicable visual resource policies with appropriate mitigation.

### Light, Glare, Shade, and Shadow

Option A would not add new light sources in areas that are currently dark. Generally, the areas through which this option would pass currently have street lights that are sufficient for visibility and safety. There would be new lighting in the vicinity of stations and station entrances, but these areas are not currently dark and the additional lighting would not change the overall lighting levels in the vicinity of the stations. In most areas, Option A would not result in headlight glare into sensitive uses because the guideway would be in the middle of the streets. However, guideway vehicles traveling west on 3<sup>rd</sup> Street and turning north on Indiana Street would shine their headlamps into the adjacent residential land uses. This would be a significant impact. The only major change to shade and shadows would occur where the elevated structure crosses US 101, near Union Station. This would be a minor impact because the motorist that would view this shadow would only do so momentarily, while passing under it on the freeway.

### Graffiti

The project would introduce surfaces that could potentially be subjected to vandalism, specifically graffiti. The most susceptible surfaces would be those at the subway portals, the enclosures for the street-level stations, aboveground and underground surfaces associated with the subway stations, and the traction power substation enclosures. Graffiti on these surfaces can not only detract from the visual appearance of the transit facilities, but also contribute to a general decline of the surrounding properties.

### Significance of Impacts

Most visual impacts resulting from implementation of the Option A would be part of the urban landscape and would not significantly alter views or change the visual landscape. However, significant visual impacts would be expected on the 1<sup>st</sup> Street Bridge, Mariachi Plaza, 1<sup>st</sup>/Soto, and along Indiana Street (due to narrowing of sidewalk widths and light glare from the light rail vehicle at night for residences on Indiana Street near 3<sup>rd</sup> Street).

**TABLE 4.6-2  
CONSISTENCY WITH VISUAL POLICIES**

Agency	Policy	Consistent? Yes/No	Comments
City of Los Angeles (citywide)	Area around transit stations should be designed to support commercial/residential development to support that transit system ( <i>Citywide General Plan Framework</i> ).	Yes	The LRT Build Alternative would be designed to allow nearby development and to be visually compatible with surrounding development.
	Encourage incorporation of small-scaled public open spaces within transit-oriented development, both as plazas and small parks and as areas of public access in private joint development at transit stations ( <i>Citywide General Plan Framework</i> ).	Yes	The street-level stations would not utilize new right-of-way, so they would neither provide nor preclude use of adjacent areas for open space/recreational space. There is existing open space or vacant land available for use as open space/recreation at the Union Station, 1 <sup>st</sup> /Alameda Station, and 1 <sup>st</sup> /Lorena Station. The 1 <sup>st</sup> /Boyle Station would create new "open space" by removing an existing building and constructing a subway entrance plaza.
City of Los Angeles (citywide) and MTA	Create pedestrian-oriented environment in context of an enhanced urban environment ( <i>Land Use/Transportation Policy</i> ).	No (Yes, with mitigation proposed in Section 4.6.4) <sup>1</sup>	Pedestrian environment would be affected in several locations, including along Indiana Street and in the Soto Street area.
	Develop and apply urban design standards to ensure the development of a high-quality and safe and secure urban environment ( <i>Land Use/Transportation Policy</i> ).	Unknown (Yes, with mitigation proposed in Section 4.6.4) <sup>1</sup>	Mitigation proposed in Section 4.6.4 will make the project consistent.
	Provide open space and recreational space around transit station areas ( <i>Land Use/Transportation Policy</i> ).	Yes	See discussion of open space around transit stations above.
	Reflect the unique cultural and physical identity of each community ( <i>Land Use/Transportation Policy</i> ).	Unknown (Yes, with mitigation proposed in Section 4.6.4) <sup>1</sup>	Mitigation proposed in Section 4.6.4 will make the project consistent.
	Urban design guidelines for transit stations, including landscaping, public art, enhanced pedestrian environment, adequate walkway widths, set-asides for public open space, and conservation of historic character and structures ( <i>Land Use/Transportation Policy</i> ).	Unknown (Yes, with mitigation proposed in Section 4.6.4) <sup>1</sup>	Mitigation proposed in Section 4.6.4 will make the project consistent.
	Transit Station Area Prototypes are offered to guide development of Major Urban Center Transit Stations and Neighborhood Center Transit Stations ( <i>Land Use/Transportation Policy</i> ).	Unknown (Yes, with mitigation proposed in Section 4.6.4) <sup>1</sup>	Mitigation proposed in Section 4.6.4 will make the project consistent.
City of Los Angeles (Central City North)	Encourage the preservation and enhancement of varied and distinctive character of the community and its landmarks ( <i>Central City North Community Plan</i> ).	Yes	The LRT Build Alternative would not result in visual impacts within the Central City North community.

**TABLE 4.6-2 (continued)  
CONSISTENCY WITH VISUAL POLICIES**

Agency	Policy	Consistent? Yes/No	Comments
City of Los Angeles (Central City)	Improve Central City's competitiveness as location for offices, business, retail, industry by maintaining safe, clean, attractive, and lively environment ( <i>Central City Community Plan</i> ).	Yes	The LRT Build Alternative would not result in visual impacts within the Central City community.
	Numerous policies related to improving the pedestrian environment. ( <i>Central City Community Plan</i> ).	Yes	Pedestrian environment would not be significantly affected in the Central City area.
	Establish urban design guidelines and set up preservation priorities that strike a balance between historic preservation and new development ( <i>Central City Community Plan</i> ).	Yes	The LRT Build Alternative would not result in impacts on historic resources in the Center City community.
City of Los Angeles (Boyle Heights)	It is the city's policy that the unique character of community streets should be maintained and enhanced by improved design characteristics such as street trees, landscaped median strips, traffic islands, and special paving ( <i>Boyle Heights Community Plan</i> ).	No (Yes, with mitigation proposed in Section 4.6.4) <sup>1</sup>	The placement of the guideway in the center lanes of 1 <sup>st</sup> Street would preclude landscape medians and traffic islands.
County of Los Angeles (East LA)	Retain the single-family residential lifestyle of the community ( <i>East Los Angeles Community Plan</i> ).	Yes	The LRT Build Alternative would not affect adjacent land uses. For the most part, stations are located within existing commercial or institutional land use areas.
	Encourage high standards of development and improve aesthetics qualities of the community ( <i>East Los Angeles Community Plan</i> ).	Unknown (Yes, with mitigation proposed in Section 4.6.4) <sup>1</sup>	Mitigation proposed in Section 4.6.4 will make the project consistent.
	Maintain and enhance the quality of healthy and stable residential neighborhoods ( <i>East Los Angeles Community Plan</i> ).	Yes	The LRT Build Alternative would not affect adjacent land uses. For the most part, stations are located within existing commercial or institutional land use areas.
	Provide new development that is compatible with and complements existing uses ( <i>East Los Angeles Community Plan</i> ).	Unknown (Yes, with mitigation proposed in Section 4.6.4) <sup>1</sup>	Mitigation proposed in Section 4.6.4 will make the project consistent.
	Improve the image of the major corridors by use of landscaping, lighting, graphics, and/or other streetscape treatments ( <i>East Los Angeles Community Plan</i> ).	Unknown (Yes, with mitigation proposed in Section 4.6.4) <sup>1</sup>	Mitigation proposed in Section 4.6.4 will make the project consistent.
Los Angeles County MTA	Required allocation of 0.5 percent of construction cost for creation of original art works.	Yes	This required MTA program will be incorporated into the project.

<sup>1</sup>Per mitigation detailed in Section 4.6.4, MTA will create station-specific conceptual master plans that will include landscaping and artwork consistent with the surrounding neighborhood character. The development of the plans will be conducted with substantive community input. MTA's design guidelines for transit stations, including landscaping, public art, enhanced pedestrian environment, adequate walkway widths, set-asides for public open space, and conservation of historical character and structures will be implemented and will ensure a safe and secure urban environment. It is MTA's intent to ensure that the project would be designed with consideration of various local agencies' visual resource policies.

## **Option B**

Table 4.6-3 lists the physical changes that would be visible within the viewshed of Option B. The impacts of the aerial structure near Union Station, street level trackwork and overhead catenary system, 1<sup>st</sup> Street Bridge seismic retrofit, portals, subway station entrances, graffiti, and light, glare, shade, and shadow would be the same as described for Option A, with the exception that the potential glare of the light rail vehicle headlamps along Indiana Street under Option B would be reduced because the LRT would be further from the residences on the west side of the street. In addition, visual impacts on important visual resources, murals, and skyline views would be the same as Option A. Like Option A, Option B would be consistent with applicable visual resource policies with appropriate mitigation. The major differences between the options are discussed below.

### Street Widening

The impacts of widening Alameda and 1<sup>st</sup> Streets would be the same as described for Option A. However, the widening of Indiana Street to maintain one through travel lane in each direction and parking on each side of the street under Option B would result in the removal of all the businesses, residences, and the high school on the east side of the street. (Ramona High School would either be rebuilt on-site as a multi-story structure or moved to another location.) Removal of all of these structures would result in a significant change in the character of the street. Currently, it is a relatively narrow, busy area, with a combination of land uses. The Option B physical changes would create a very open streetscape, with the back of properties to the east set back at some distance from the edge of the street. These properties, which are currently screened from view from Indiana Street, would be open to view from the street, screened partially by the boundary fences and walls. In addition, the visual anchor of the street, Ramona High School, would either be moved out of the neighborhood or would be rebuilt as a taller structure. The combination of all of these physical changes could affect adjacent land uses and would result in a significant visual impact.

### Street-level Stations

The visual impacts related to the 1<sup>st</sup>/Alameda, 1<sup>st</sup>/Utah, and 3<sup>rd</sup>/Mednik Stations would be the same as those discussed for Option A. Under Option B, a station would be located along Indiana Street, on the property of Ramona High School, which would either be moved or rebuilt as a multi-story structure. The station by itself would not result in significant visual impacts, but in combination with the street widening and removal of commercial and residential structures, along with the relocation or rebuilding of the high school, significant visual impacts would occur. The 3<sup>rd</sup>/Ford Station associated with Option B would be located in the center of 3<sup>rd</sup> Street in an area with a popular restaurant on the south side and a large parking lot on the north side. Because this area is primarily commercial, and because the street cross section is relatively wide at this location, visual impacts would be less than significant. The Pomona/Atlantic Station under Option B is in a commercial area, and the street cross section is relatively wide. On either side of Pomona Boulevard, the commercial uses are generally set back from the street behind parking lots or do not face Pomona Boulevard. Therefore, the location of a station on Pomona Boulevard would result in minimal visual impacts.

### New Parking Facilities

The visual impacts of the planned parking facilities would be the same as those described under Option A, with the exception that no replacement facilities would be needed along Indiana Street under Option B since this option maintains the current on-street parking.

TABLE 4.6-3 VISIBLE PHYSICAL CHANGES – OPTION B		
Type of Change	Description	Location(s)
Aerial structure	1,000-foot-long structure approximately 25 feet high at highest point, including foundations, support columns, girders, and deck slabs.	<ul style="list-style-type: none"> <li>Near Union Station, crossing US 101</li> </ul>
Street widening	Widening of street beyond current rights-of-way	<ul style="list-style-type: none"> <li>Alameda St. (would require removal of existing service station and landscaping on east side)</li> <li>1<sup>st</sup> St. between Alameda and Vignes Streets (would require removal of landscaping on north side)</li> <li>Indiana Street (would require removal of businesses, residences, and high school; school would be relocated elsewhere or rebuilt on remainder property)</li> </ul>
Street-level trackwork;	Within streets for aboveground portions; generally requires conversion of one general-purpose lane in each direction; includes track bed, track slab, rail, fasteners, and infill concrete.	<ul style="list-style-type: none"> <li>Alameda St., 1<sup>st</sup> St. west of Clarence St.</li> <li>1<sup>st</sup> St. east of Lorena St.</li> <li>Indiana St., between 1<sup>st</sup> St. and 3<sup>rd</sup> St.</li> <li>3<sup>rd</sup> St., between Indiana St. and Beverly Blvd.</li> <li>Pomona Blvd., between 3<sup>rd</sup> St. and Atlantic Blvd.</li> </ul>
Overhead catenary system	Wires, support poles, brackets, and other components	
Bridge Seismic Retrofit	Additional reinforced concrete infilling of bents and concrete cast-in-drilled-hole piles.	<ul style="list-style-type: none"> <li>1<sup>st</sup> Street Viaduct</li> </ul>
Portals	Entrances to underground sections; include a U-shaped trench with protective railing at the transition points from street-level to underground sections.	<ul style="list-style-type: none"> <li>1<sup>st</sup> St., near Gless St.</li> <li>1<sup>st</sup> St., near Lorena St.</li> </ul>
Street-level stations	High-floor, 270-foot-long platforms and station amenities, including canopies, fare-vending equipment, station furniture, ramps, landscaping, signage, crosswalks, lighting, etc.	<ul style="list-style-type: none"> <li>Alameda St. near 1<sup>st</sup> St.</li> <li>1<sup>st</sup> St. near Utah St.</li> <li>Off Indiana St. near 3<sup>rd</sup> St., on Ramona High School property</li> <li>3<sup>rd</sup> St. near Ford Blvd.</li> <li>3<sup>rd</sup> St. near Mednik Ave.</li> <li>Pomona Blvd. near Atlantic Blvd.</li> </ul>
Subway station entrances	Includes elevators, escalators, stairs, landscaping, railing, signage, lighting, etc.	<ul style="list-style-type: none"> <li>1<sup>st</sup> St. near Bailey St. (1<sup>st</sup>/Boyle Station), in northwest quadrant (existing grocery store to be removed)</li> <li>1<sup>st</sup> St. at Soto St. (existing residences/businesses to be removed)</li> </ul>
New parking facilities	Park-and-ride surface lot to be build near eastern terminus and Pomona/Atlantic Station Replacement parking in areas of high utilization	<ul style="list-style-type: none"> <li>Replacement parking on 1<sup>st</sup> St. near Lorena St.</li> <li>Park-and-ride facility at Pomona and Atlantic Boulevards near Kaiser Hospital (would remove commercial and medical-office structures)</li> </ul>
Traction power substations	Electrical power substations, one-story enclosures on a concrete foundation, attached to electrical distribution lines (either aerially or underground), approximately 11 feet by 25 feet on a leveled site no smaller than 40 feet by 55 feet, with a perimeter fence at least 14 feet outside the enclosure.	<ul style="list-style-type: none"> <li>Within the MTA Maintenance Yard, north of First Street Viaduct</li> <li>Near the 1<sup>st</sup>/Soto Station (would remove commercial building)</li> <li>Near 1<sup>st</sup> St./Lorena St. intersection (on vacant property)</li> <li>Near the SR-60/3<sup>rd</sup> St. interchange at Sunol Ave. (would remove vacant commercial building)</li> <li>Near 3<sup>rd</sup> St./Arizona St. intersection (would remove auto sales business)</li> <li>Northwest corner of Pomona Blvd./Atlantic Blvd. (as part of park-and-ride facility)</li> </ul>

### Traction Power Substations

The impacts of these substations would be the same as that discussed under Option A, except that no substation would be provided at Beverly/Atlantic. Instead, the substation would be provided at the northwest corner of Pomona/Atlantic Boulevards at the site of the planned park-and-ride facility. Minimal visual impacts are anticipated because the area is mainly commercial.

### Significance of Impacts

Most visual impacts resulting from implementation of Option B would be part of the urban landscape and would not significantly alter views or change the visual landscape. However, significant visual impacts would be expected on the 1<sup>st</sup> Street Bridge, Mariachi Plaza, 1<sup>st</sup>/Soto, and along Indiana Street (due to removal of buildings on the east side of the street and potential light glare from the light rail vehicle at night for residences on Indiana Street near 3<sup>rd</sup> Street).

#### **4.6.4 Mitigation**

##### **4.6.4.1 Option A**

##### ***1st Street Bridge***

Significant visual impacts would result from the placement of the catenary system, including supports and catenary wires, on the historic 1st Street Bridge. Span wire cannot be used due to objections of the LA Bureau of Street Lighting and the potential impacts to the historical resource from replacement of the existing light standards with new standards incorporating the catenary supports that would require intense structural reconfiguration of the bridge. Therefore, mitigation previously proposed in the Draft SEIS/SEIR is not possible. Therefore, the impacts related to visual clutter on the First Street Viaduct, specifically the placement of poles to support the catenary system in the center of the bridge, cannot be mitigated. A significant visual impact would remain. To mitigate the infilling of the openings in some of the bents underneath the bridge required for the seismic retrofit, the infill concrete will be tinted to match the color of the existing infill that was previously done in the mid 1990s by the City. In addition to mitigate the historic features of the bridge, MTA, in consultation with the State Historic Preservation Office and the National Park Service, will record the bridge according to Historic American Engineering Record (HAER) standards and will provide opportunities for public interpretation as discussed in Section 4.15, *Historic/Archaeological/Paleontological Resources*.

##### ***Visual Clutter in Residential Areas***

The catenary systems proposed in the Eastside Corridor require overhead wiring. Thus, to reduce visual clutter in narrow residential areas with visual clutter from existing wires, the project planner will work with utility providers to consolidate wiring or to underground wiring where possible. Although some clutter would remain, there would not be a net increase in the amount of clutter, thereby reducing impacts to less than significant.

##### ***Mariachi Plaza***

The use of landscape materials, fencing, archways, or other “edge” treatments in the same location as the current grocery store will be incorporated into the transit plaza design to reduce visual impacts to less than significant (refer to Section 4.15, *Historic/Archaeological/Paleontological Resources*).

### ***1<sup>st</sup>/Soto Station Area (including the traction power substation)***

The pedestrian environment will be re-established at the 1<sup>st</sup>/Soto Station transit plaza so that the linear sidewalk element along 1<sup>st</sup> Street is re-created. This can be accomplished through the use of such edge elements as landscaping, street furniture, planters, etc., but the preferable method would be to re-establish a pedestrian-oriented commercial element into the plaza, either with permanent retail facilities or with portable commercial uses such as kiosks or carts. Incorporation of this mitigation into station plans will reduce visual impacts to less than significant.

### ***Quality of Urban Environment Around Transit Stations***

To ensure that a high-quality and safe and secure urban environment is provided in the transit station areas, MTA's urban design standards will be incorporated into the station-specific conceptual master plans, including landscaping and artwork consistent with the surrounding neighborhood character. MTA's design guidelines for transit stations, including landscaping, public art, enhanced pedestrian environment, adequate walkway widths, set-asides for public open space, and conservation of historical character and structures will be implemented. The Transit Station Area Prototypes will guide development of the transit stations. This mitigation will reduce visual impacts at transit stations to less than significant.

### ***Streetscapes***

The *Boyle Heights Community Plan* calls for maintenance and improvement of streetscapes with such design elements as street trees, landscape median strips, traffic islands, and special paving. In addition, the *East Los Angeles Community Plan* includes a policy calling for improvement of the image of major corridors by use of landscaping, lighting, graphics, and/or other streetscape treatments. Although some of these elements would be precluded by the project (such as median treatments), other street elements can be used. MTA will replace any streetscape features removed by the project in the same or similar locations and will work with the City and County of Los Angeles so as not to preclude streetscape features except for the median treatments and to incorporate streetscape features into project plans, where applicable. This would reduce potential visual impacts to the street environments to less than significant.

### ***Indiana Street Glare Impacts***

To shield properties against glare from headlamps on Indiana Street, landscaping or other screening material will be planted in the path of the headlamps. This would reduce impacts to less than significant.

### ***Lighting***

Designs for lighting systems for pedestrians and park-and-ride facilities will comply with the City of Los Angeles standards and the *Land Use/Transportation Policy* (City of Los Angeles/MTA). In general, any street or pedestrian lighting improvements within the city of Los Angeles that create new assessments or increase existing assessments to property owners require the Proposition 218 process. This process not only requires community participation, but also public approval through a ballot process. Not all lighting improvements require the process. Lighting improvements associated with Option A will be reviewed for eligibility by the City of Los Angeles prior to installation. The lighting assessment is paid by property owners through the county property tax.

Only full cut-off fixtures will be specified for all lighting improvements. Lighting levels will range from 2.0 to 2.5 foot-candles along the LRT alignment, with 3.0 to 4.0 foot-candles at intersections, and 1.0 to 2.0 foot-candles at sidewalks. Uniformity ratios will be in the range of 3:1 to 6:1. Lighting equipment



and design of lighting systems will be closely evaluated in terms of added value to public lighting, including light trespass, light pollution, glare, equipment maintenance, equipment energy efficiency and others. This evaluation will be coordinated with and approved by the City and County of Los Angeles.

Removal of the ornamental streetlights in the Mariachi Plaza area would result in a significant visual impact. These electroliers will be re-used or replaced with similar fixtures. If not re-used, the electroliers will be returned to the Los Angeles Bureau of Street Lighting. The lighting measures discussed above would prevent impacts related to lighting standards.

### ***Metro Art Program***

#### **Public Art**

As part of the process of designing the stations, artists will be hired to participate from the earliest stages of design. Reports that were prepared by Metro Art working with the Eastside Community Advisory Group will be presented to the design team. As needed, these will be updated and supplemented to reflect the new project area and impacted neighborhoods. These reports will assist the design team in adhering to FTA policy (Circular 9400.1A), which states:

. . . To create facilities that are integral components of communities, information about the character, makeup, and history of the neighborhood should be developed and local residents and businesses could be involved in generating ideas for the project. . . .

A budget will be established for public art, which will be based on a percentage of the hard costs (construction costs) for the project. Again, as directed by the FTA (Circular 9400.1A), "Funds spent on the art component of the project should be appropriate to the overall costs of the transit project and adequate to have an impact. MTA's policy is to spend one half of one percent of hard costs on public art. FTA also recommends that the agency "provide adequate administrative and technical support."

Artwork and artist ideas will be presented as part of the overall design. Fabrication of art elements and their future conservation will be the responsibility of Metro Art. Metro Art will ensure that the community continues to participate and is educated about the artwork and design before, during, and after the construction process.

#### **Design Excellence**

Following policies established by FTA for design and art in transit projects (Circular 9400.1A), MTA commits to the idea that:

. . . Good design and art can improve the appearance and safety of a facility, give vibrancy to its public spaces, and make patrons feel welcome. Good design and art will also contribute to the goal that transit facilities help to create livable communities. . . .

#### **Graphics and Wayfinding**

The quality of graphic signage and wayfinding within the system and within the adjacent neighborhood greatly affects the ease and comfort with which patrons will use the system. Station names, station identification, directional signage, logos, maps, and informational signage will adhere to the MTA Graphics Standards. The guiding principals for the standards are to simplify Metro signage systems in a way that makes sense for patrons, using uniformity in text styles, a rational hierarchy of sign sizes, clear

directional arrows, etc. Compliance with the Metro Art Program would result in a beneficial visual impact.

### ***Graffiti Prevention***

The following techniques will be used to prevent graffiti impacts within the project area:

- ◆ Project designers will take special consideration of graffiti prevention during project design, reducing as much as possible large, flat surfaces assessable and viewable to the public.
- ◆ Where large, flat surfaces accessible to the public cannot be eliminated, special graffiti-resistant surfaces, such as highly textured surfaces, will be incorporated into the project design.
- ◆ Use of mural and other art will be incorporated into areas where there is high graffiti potential to discourage vandalism. Use of locally known and respected artists is often effective in discouraging graffiti. Murals will be coated with a sealer to allow later clean-up, should the artwork be vandalized by graffiti.
- ◆ Where there is a high potential for graffiti, security systems, such as closed-circuit monitoring, will be utilized to discourage graffiti and to facilitate apprehension of the vandals.
- ◆ If the Eastside Corridor facilities are subjected to graffiti, the maintenance staff will clean up the vandalism as rapidly as possible to discourage repeat occurrences.

The graffiti-prevention program discussed above would reduce graffiti impacts to less than significant.

### ***Significance of Impacts Remaining After Mitigation***

By applying the aforementioned mitigations, all visual impacts of Option A would be reduced to an insignificant level, with the exception of the 1<sup>st</sup> Street Bridge. There would be impacts remaining due to visual clutter from the catenary system. Compliance with the Metro Art Program would result in a beneficial impact.

#### **4.6.4.2 Option B**

The mitigation measures discussed for Option B will be the same as that described for Option A. However, additional mitigation for Indiana Street will be implemented due to the removal of residences and businesses on the east side of that street. Indiana Street will be designed to provide a visual asset to the remaining neighborhood rather than an adverse impact. The excess property will be landscaped to provide a linear plaza/park-like setting with sidewalks and street furniture. Landscaping will include trees and vines along the eastern edge of the corridor to screen the backyards and rear facades of the adjacent residences from view from Indiana Street. Striped crosswalks between the residential area west of Indiana Street and the landscaped corridor will be provided. The visual compatibility of Ramona High School, if it is rebuilt on the site as a multi-story structure, cannot be determined at this time and will be assessed in the environmental document for the school that the Los Angeles Unified School District (LAUSD) would prepare. If requested by LAUSD, MTA will coordinate the design of the proposed station at this location with the design of the high school, with the station and the landscaping providing a transition between the multi-story high school and the mostly single-story surrounding development. By providing a visual asset to the remaining neighborhood, visual impacts along Indiana Street will be reduced to less than significant. The visual impacts of the high school, if reconstructed on the site, will be assessed in a separate environmental document, prepared by LAUSD.

***Significance of Impacts Remaining After Mitigation***

By applying the aforementioned mitigations, all visual impacts of Option B would be reduced to an insignificant level, with the exception of the 1<sup>st</sup> Street Bridge. There would be impacts remaining due to visual clutter from the catenary system. Compliance with the Metro Art Program would result in a beneficial impact.

## 4.7 AIR QUALITY

### 4.7.1 Affected Environment

#### 4.7.1.1 Regulatory Setting

Air quality in the United States is governed by the Federal Clean Air Act (CAA) and is administered by the United States Environmental Protection Agency (USEPA). In addition to being subject to the requirements of the CAA, air quality in California is also governed by the more stringent regulations under the California Clean Air Act (CCAA).

The CCAA, as amended in 1992, requires all air districts in the State to endeavor to achieve and maintain State Ambient Air Quality Standards. The CCAA is administered statewide by the California Air Resources Board (CARB). The State of California has also established ambient air quality standards, known as the California Ambient Air Quality Standard (CAAQS). These standards are generally more stringent than the corresponding federal standards and incorporate additional standards for sulfates, hydrogen sulfide, vinyl chloride and visibility reducing particles. California has established a statewide agency (CARB) to regulate mobile air pollution sources (such as motor vehicles). CARB also oversees the functions of local air pollution control districts and air quality management districts, which in turn administer air quality activities at the regional and county level. The CCAA is administered by CARB at the state level and by the Air Quality Management Districts at the regional level.

#### *U.S. Environmental Protection Agency*

The USEPA is responsible for establishing the national ambient air quality standards and enforcing the Clean Air Act. It also regulates emission sources under the exclusive authority of the federal government, such as aircraft, ships, and certain types of locomotives. The USEPA has jurisdiction over emission sources outside state waters (e.g., beyond the outer continental shelf) and establishes various emission standards, including those for vehicles sold in states other than California.

#### *California Air Resources Board*

CARB, which became part of the California Environmental Protection Agency (CalEPA) in 1991, is responsible for ensuring implementation of the California Clean Air Act, meeting state requirements of the federal Clean Air Act, and establishing state ambient air quality standards. It is also responsible for setting emission standards for vehicles sold in California and for other emission sources such as consumer products and certain off-road equipment.

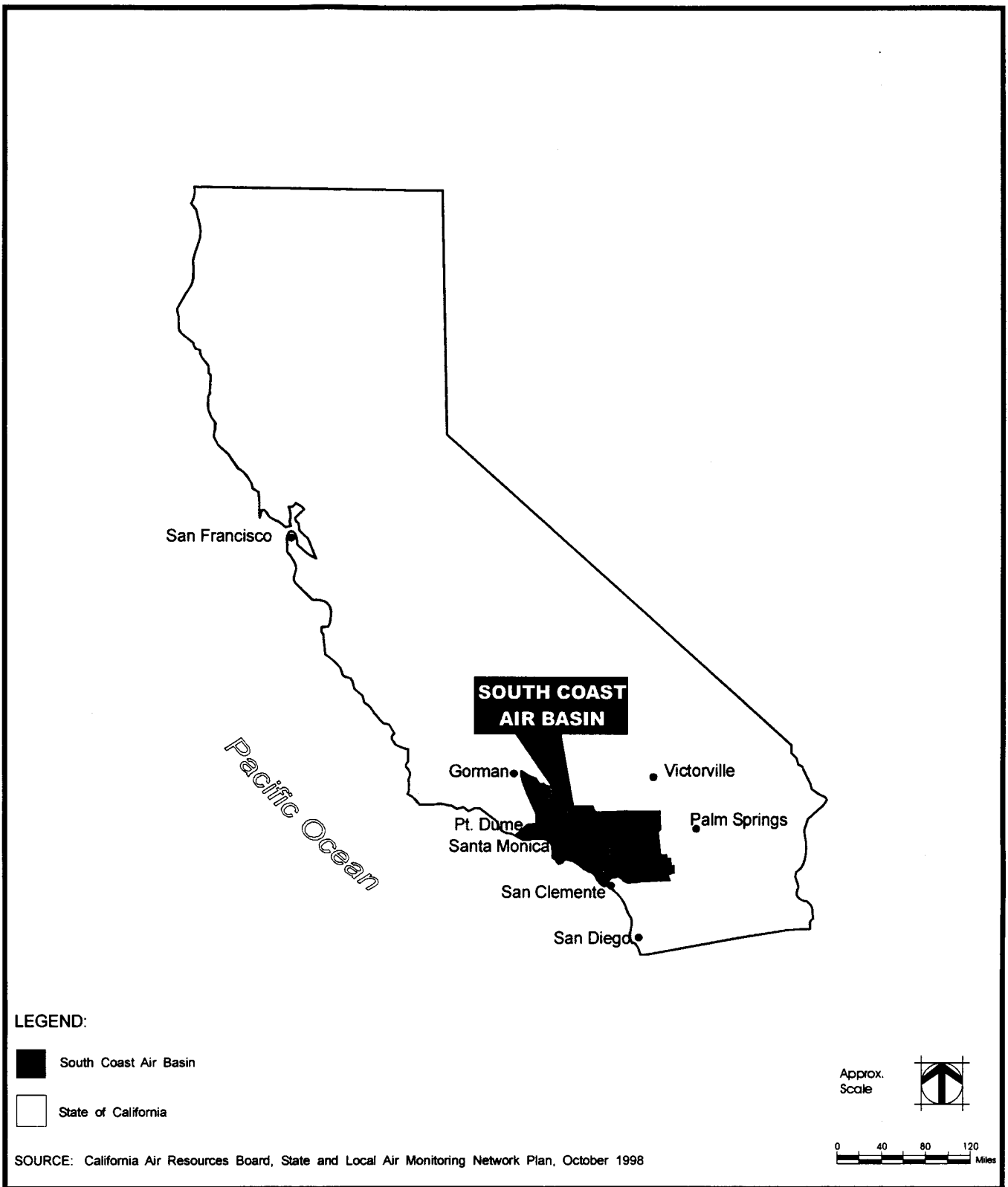
#### *Nonattainment and State Implementation Plans*

On the basis of regional monitoring data, the Los Angeles County portion of the South Coast Air Basin (Figure 4.7-1) has been designated as a non-attainment area for ozone, carbon monoxide, and suspended particulates (PM<sub>10</sub>), but is as an attainment area for nitrogen oxide and sulfur dioxide.<sup>5</sup>

CARB will designate an area as non-attainment for a pollutant if air quality data show that a State standard for a pollutant was violated at least once during the previous three calendar years. Exceedances that are affected by highly irregular or infrequent events are not considered violations of a State standard, and are not used as a basis for designating areas as non-attainment.

<sup>5</sup> California Air Resources Board: Proposed Amendments to the Designation Criteria and Amendments to the Area Designations for State Ambient Air Quality Standards and Proposed Maps of the Area Designations for the State and National Ambient Air Quality Standards, August 1998.





*Los Angeles Eastside Corridor SEIS/SEIR*

**South Coast Air Basin**



Federal clean air laws require areas with unhealthy levels of ozone, carbon monoxide, nitrogen dioxide, sulfur dioxide, and inhaleable particulate matter to develop plans, known as State Implementation Plans (SIPs), describing how they will attain national ambient air quality standards (NAAQS). The 1990 amendments to the federal Clean Air Act set new deadlines for attainment based on the severity of the pollution problem and launched a comprehensive planning process for attaining the NAAQS.

### ***South Coast Air Quality Management District***

The South Coast Air Quality Management District (SCAQMD) was created by the 1977 Lewis Air Quality Management Act, which merged four county air pollution control agencies into one regional district to better address the issue of improving air quality in Southern California. Under the act, the SCAQMD is the agency principally responsible for comprehensive air pollution control in the Basin, including monitoring air quality and planning, implementing, and enforcing programs designed to attain and maintain state and federal ambient air quality standards in the district.

The SCAQMD has jurisdiction over a 10,743 square mile area, commonly referred to as the South Coast Air Basin (SCAB). This area includes all of Orange County, Los Angeles County, except for the Antelope Valley, the non-desert portion of western San Bernardino County, and the western and Coachella Valley portions of Riverside County.

### ***Air Quality Management Plan***

Within the project area, the SCAQMD and the Southern California Association of Governments (SCAG) have responsibility for preparing the Air Quality Management Plan (AQMP), which address federal and state Clean Air Act requirements. The AQMP details goals, policies, and programs for improving air quality and establishes thresholds for daily operation emissions. Environmental review of individual projects within the region must demonstrate that daily construction and operational emissions thresholds as established by the SCAQMD would not be exceeded, nor would the number or severity of existing air quality violations.

In August of 1996 the SCAQMD submitted its AQMP to CARB for inclusion in the SIP. As mentioned earlier, the AQMP also meets CCAA requirements. The AQMP addressed CCAA requirements, which are intended to bring the SCAQMD into compliance with federal and state air quality standards. The AQMP focused on ozone and carbon monoxide emissions, which would be reduced through public education, vehicle and fuels management, transportation controls, indirect source controls, and stationary source controls programs.

The 1997 Draft Air Quality Management Plan, amended in 1999, has been prepared to reflect the requirements of the 1990 Clean Air Act Amendments and is consistent with the approaches taken in the 1994 AQMP. The Plan is expected to replace, in part or in whole, many of the proposed measures set forth in the SIP and anticipates the attainment of all criteria pollutants by 2010. The overall control strategy for the 1997 AQMP was designed to meet applicable state and federal requirements and to demonstrate attainment with ambient air quality standards. The 1997 AQMP is the first plan required by federal law to demonstrate attainment of the federal PM<sub>10</sub> ambient air quality standards and therefore, places a greater focus on PM<sub>10</sub>.

### ***National and State Ambient Air Quality Standards***

As required by the Clean Air Act, National Ambient Air Quality Standards (NAAQS) have been established for six major air pollutants: carbon monoxide, nitrogen oxides, ozone, particulate matter (PM<sub>10</sub> and PM<sub>2.5</sub>), sulfur oxides and lead. The State of California has also established ambient air quality



standards, known as the California Ambient Air Quality Standards (CAAQS). These standards are generally more stringent than the corresponding federal standards and incorporate additional standards for sulfates, hydrogen sulfide, vinyl chloride and visibility reducing particles. The state and national standards are presented in Table 4.7-1. Because the CAAQS are more stringent than the NAAQS, they are used as the comparative standard in the analysis contained in this report.

#### 4.7.1.2 Study Area Setting

##### *Regional Setting and Climate*

The SCAB is an area of high air pollution potential due to its climate and topography. The Basin experiences warm summers, mild winters, infrequent rainfalls, light winds, and moderate humidity. In addition, the mountains and hills within the area contribute to the variation of rainfall, temperature, and winds throughout the region. The region experiences frequent temperature inversions. Temperature inversions prevent air close to the ground from mixing with the air above it. As a result, air pollutants are trapped near the ground. During the summer, an upper layer of warm air mass forms over the cool marine layer, preventing air pollutants from dispersing upward. In addition, hydrocarbons and nitrogen dioxide react under strong sunlight, creating smog. Light, daytime winds, predominantly from the west, further aggravate the condition by driving the air pollutants inland, toward the mountains.

##### *Pollutants and Effects*

Air quality studies generally focus on five pollutants that are most commonly measured and regulated:

- ◆ **Carbon monoxide (CO)**, a colorless gas, interferes with the transfer of oxygen to the brain. It is emitted by motor vehicles, power plants, refineries, industrial boilers, ships, aircraft, and trains. Automobile exhausts release most of the CO in urban areas.
- ◆ **Ozone (O<sub>3</sub>)**, a colorless toxic gas, interferes with the transfer of oxygen to the brain. It forms in the atmosphere through a chemical reaction between reactive organic compounds and nitrogen oxides (NO<sub>x</sub>), which are emitted from industrial sources and from automobiles. Substantial O<sub>3</sub> formation generally requires a stable atmosphere with strong sunlight.
- ◆ **Nitrogen Dioxide (NO<sub>2</sub>)**, a brownish gas, can cause breathing difficulties at high concentrations. It is formed through a reaction between nitric oxide (NO) and atmospheric oxygen. NO and NO<sub>2</sub> are collectively referred to as nitrogen oxides (NO<sub>x</sub>) and are major contributors to ozone formation.
- ◆ **Suspended Particulate Matter (PM<sub>10</sub>)**, refers to particulate matter less than 10 microns in diameter, about one-seventh the thickness of a human hair. Particulate matter pollution consists of very small liquid and solid particles floating in the air, which can include smoke, soot, dust, salts, acids, and metals. Particulate matter also forms when industry and gases emitted from motor vehicles undergo chemical reactions in the atmosphere. When inhaled, these tiny particles can penetrate the human respiratory system's natural defenses and damage the respiratory tract.
- ◆ **Sulfur Oxides**, primarily sulfur dioxide (SO<sub>2</sub>), which is an irritant gas that attacks the throat and lungs, is a product of high-sulfur fuel combustion. The main sources of SO<sub>2</sub> are coal and oil used in power stations, industry and for domestic heating. Industrial chemical manufacturing is another source of SO<sub>2</sub>.

**TABLE 4.7-1  
STATE AND NATIONAL AMBIENT AIR QUALITY STANDARDS**

Pollutant	Averaging Period	California Standard	Federal Standards	
			Primary	Secondary
Ozone (O <sub>3</sub> )	1 hour	0.09 ppm (180 µg/m <sup>3</sup> )	0.12 ppm (235 µg/m <sup>3</sup> )	Same as Primary Standard
	8 hour	--	0.08 ppm (157 µg/m <sup>3</sup> )	
Respirable Particulate Matter (PM <sub>10</sub> )	Annual Geometric Mean	30 µg/m <sup>3</sup>	--	Same as Primary Standard
	24 hour	50 µg/m <sup>3</sup>	150 µg/m <sup>3</sup>	
	Annual Arithmetic Mean	--	50 µg/m <sup>3</sup>	--
Fine Particulate Matter (PM <sub>2.5</sub> )	24 hour	No Separate Standard	65 µg/m <sup>3</sup>	Same as Primary Standard
	Annual Arithmetic Mean		15 µg/m <sup>3</sup>	
Carbon Monoxide(CO)	8 hour	9.0 (10 mg/m <sup>3</sup> )	9.0 (10 mg/m <sup>3</sup> )	None
	1 hour	20 ppm (23 mg/m <sup>3</sup> )	35 ppm (40 mg/m <sup>3</sup> )	
Nitrogen Dioxide (NO <sub>2</sub> )	Annual Arithmetic Mean	--	0.053 ppm (100 µg/m <sup>3</sup> )	Same as Primary Standard
	1 hour	0.25 ppm (470 µg/m <sup>3</sup> )	--	
Sulfur dioxide (SO <sub>2</sub> )	Annual Arithmetic Mean	--	0.03 ppm (80 µg/m <sup>3</sup> )	--
	24 hour	0.04 ppm (105 µg/m <sup>3</sup> )	0.14 ppm (365 µg/m <sup>3</sup> )	--
	3 hour	--	--	0.5 ppm (1300 µg/m <sup>3</sup> )
	1 hour	0.25 ppm (655 µg/m <sup>3</sup> )	--	--
Lead	30 day average	1.5 µg/m <sup>3</sup>	--	--
	Calendar Quarter	--	1.5 µg/m <sup>3</sup>	Same as Primary Standard
Visibility Reducing Particulates	8 hour (10 am to 6 pm, PST)	In sufficient amount to produce an extinction coefficient of 0.23 per kilometer - visibility of ten miles or more (0.07-30 miles or more for Lake Tahoe) due to particles when the relative humidity is less than 70 percent.	No Federal Standards	
Sulfates	24 hour	25 µg/m <sup>3</sup>		
Hydrogen Sulfide	1 hour	0.03 ppm (42 µg/m <sup>3</sup> )		

Source: California Air Resources Board, Federal and State Air Quality Standards 1999 (1/25/99)

**Local Setting**

The SCAQMD monitors air quality conditions at 37 locations throughout the SCAB. For the purposes of this report, data from the Downtown Los Angeles and Pico Rivera monitoring stations were used to characterize existing conditions in the vicinity of the proposed project location, and to establish a baseline for estimating future conditions both with and without the proposed project. A summary of the data recorded at these stations is presented in Table 4.7-2 and graphically portrayed in Figure 4.7-2 for existing levels of carbon monoxide, ozone, and particulate matter.

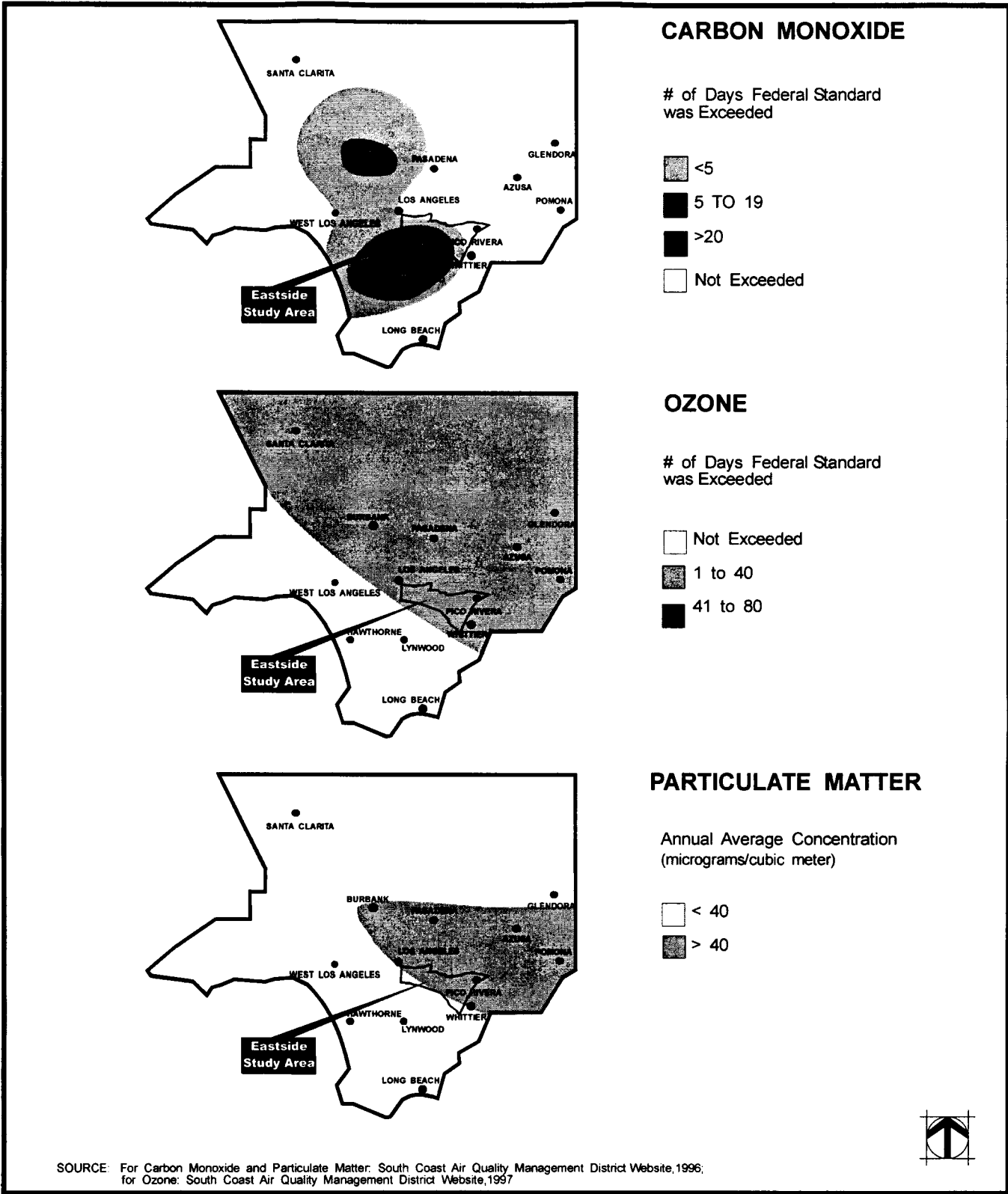
Pollutant	Federal and State Standard	Los Angeles-North Main Street			Pico Rivera		
		1998	1999	2000	1998	1999	2000
Carbon Monoxide (CO)	Maximum 8-hr concentration (ppm)	6.18	6.37	5.98	6.07	5.50	5.11
	Days > 9 ppm (federal 8-hr. standard)	0	0	0	0	0	0
	Days > 9 ppm (state 8-hr. standard)	0	0	0	0	0	0
Ozone (O <sup>3</sup> )	Maximum 1-hr Concentration (ppm)	0.148	0.128	0.136	0.183	0.119	0.139
	Maximum 8-hr. Concentration (ppm)	0.111	0.108	0.103	0.120	0.098	0.114
	Days > 0.12 ppm (federal 1-hr. standard)	5	1	1	10	0	2
	Days > 0.08 ppm (federal 8-hr. standard)	9	2	4	12	2	4
	Days 0.09 ppm (state 1-hr. standard)	17	13	8	31	6	11
Nitrogen Dioxide (NO <sup>2</sup> )	Maximum 1-hr Concentration (ppm)	0.170	0.212	0.152	0.140	0.155	0.150
	Days > 0.09 ppm (state 1-hr. standard)	0	0	0	0	0	0
Sulfur Dioxide (SO <sup>2</sup> )	Maximum 24-hr Concentration (ppm)	0.006	0.010	0.007			
	Days > 0.14 ppm (federal 24-hr standard)	0	0	0	n/a	n/a	n/a
	Days > 0.05 ppm (state 24-hr. standard)	0	0	0			
Suspended Particulates (PM <sup>10</sup> )	Maximum 24-hr. concentration (µg/m <sup>3</sup> )	80.0	88.0	80.0			
	Calculated > 150 µg/m <sup>3</sup> (federal 24-hr standard)	0	0	0	n/a	n/a	n/a
	Calculated > 50 µg/m <sup>3</sup> (state 24-hr standard)	66	114	90			

Note: n/a = pollutant not monitored

Source: California Air Quality Data Summaries 1998-2000, California Air Resources Board, [www.arb.ca.gov/adam](http://www.arb.ca.gov/adam)

**Sensitive Receptors**

The California Air Resources Board has identified children under 14, the elderly over 65, athletes, and people with cardiovascular and chronic respiratory diseases as the most likely to be affected by air pollution. These groups are classified as sensitive receptors. Locations that may contain a high concentration of these sensitive population groups include hospitals, daycare facilities, elder care facilities, elementary schools, and parks.



Los Angeles Eastside Corridor SEIS/SEIR

**Carbon Monoxide, Ozone, and Particulate Matter Levels**



## 4.7.2 Methodology for Impact Evaluation

### 4.7.2.1 Analysis Methodology

The following calculation methods and estimation models were utilized in ascertaining air quality impacts: SCAQMD construction emissions calculation formulas, the CARB Motor Vehicle Emission Inventory 7G (MVEI7G) emissions model, the Caltrans EMFAC emissions factor model, and the USEPA CAL3QHC dispersion model software. This air quality analysis is consistent with procedures described in the SCAQMD CEQA Handbook (1993 edition).

### 4.7.2.2 Impact Evaluation Criteria

A project would have a significant impact if its daily construction and/or operation emissions were to exceed significance thresholds for carbon monoxide (CO), reactive organic gas (ROG), nitrogen oxides (NO<sub>x</sub>), sulfur oxides (SO<sub>x</sub>) or particulates (PM<sub>10</sub>) as established by the SCAQMD. Significance thresholds appear in Table 4.7-3. In addition, a project would have a significant impact if it were to cause any criteria pollutant concentration to exceed the (CAAQS) at any sensitive receptor location.

Criteria Pollutant	Construction	Operations
Carbon Monoxide (CO)	550	550
Reactive Organic Gas (ROG)	75	55
Nitrogen Oxides (NO <sub>x</sub> )	100	55
Sulfur Oxides (SO <sub>x</sub> )	150	150
Particulates (PM <sub>10</sub> )	150	150

<sup>1</sup> Expressed in pounds per day. The LRT Build Alternative does not contain lead, hydrogen sulfide, or sulfate emissions sources; therefore, emissions and concentrations related to these pollutants were not analyzed in this report.  
Source: South Coast Air Quality Management District

A Federal air quality standard for PM<sub>2.5</sub> was adopted in 1997. Presently, no methodologies for determining impacts relating to PM<sub>2.5</sub> have been developed. In addition, no strategies or mitigation programs for this pollutant have been developed or adopted by federal, state, or regional agencies. Currently, this standard is not enforceable, but may be reinstated in the future. Thus, this air quality analysis does not analyze PM<sub>2.5</sub>.

### 4.7.2.3 Conformity Analysis

The Code of Federal Regulations (CFR) 40 Part 51 establishes conformity measures for the Federal or State Implementation Plan. Under CFR 40 Part 51, should criteria pollutants emitted by the proposed project exceed the amounts listed in Table 4.7-4 when compared to future no project conditions, a conformity analysis would be required.

Pollutant	Tons per Year (increase over no project conditions)
Ozone (O <sub>3</sub> )	10
Carbon Monoxide (CO)	100
Reactive Organic Gas (ROG)	10
Nitrogen Oxides (NO <sub>x</sub> )	10
Particulates (PM <sub>10</sub> )	70

Source: United States Environmental Protection Agency, CFR 40 Part 51

### 4.7.3 Impacts

#### 4.7.3.1 No-Build Alternative

##### *Burden Emissions*

There is a direct relationship between vehicle miles of travel (VMT) and air pollution. In urbanized regions, such as the Los Angeles Metropolitan area, mobile emissions are the primary source of air pollution. Transportation projects that significantly increase or decrease regional VMT will also significantly degrade or improve regional air quality. Criteria pollutant emissions were estimated for the No-Build Alternative using estimated VMT and emission factor data.<sup>6</sup> Results, which are used as a baseline to compare with the LRT Build Alternative, are presented below in Table 4.7-5.

##### *Carbon Monoxide Hot Spot Analysis*

Within the urban setting, vehicle exhaust is the main source of CO. Therefore, the highest concentrations of CO are found within close proximity to busy intersections. To provide a worst-case simulation of CO concentrations within the study area, the CO concentration at sidewalk locations adjacent to 15 study intersections that operate at LOS E and F and, therefore, have a higher concentration of air pollutants were modeled and compared to ambient air quality standards. The analysis found that no CO concentrations are anticipated to exceed the State 1-hour or 8-hour standard of 20 ppm or 9 ppm, respectively, under the No-Build Alternative (more detailed information regarding this analysis can be found in the *Air Quality Technical Report*, MTA, Los Angeles, Ca., December, 2000).

#### 4.7.3.2 LRT Build Alternative

##### *Option A*

##### Burden Emissions

Criteria pollutant emissions were estimated for Option A using estimated VMT and emission factor data.<sup>7</sup> Results are presented in Table 4.7-5. When compared to the No-Build Alternative, the annual regional VMT is anticipated to decrease by approximately 16 million under Option A, reducing CO and ROG by 57 tons and one ton per year, respectively. NO<sub>x</sub> and PM<sub>10</sub> emissions reductions would be negligible.

<sup>6</sup> Regional VMT for the No-Build and LRT Build Alternatives were estimated using the LACMTA transportation model.

<sup>7</sup> Regional VMT for the No-Build and LRT Build Alternatives were estimated using the LACMTA transportation model.

Project Alternative	Annual VMT (millions)			Criteria Pollutant Emissions (tons per year)			
	Passenger Vehicles	Urban Bus	Commuter Rail/Diesel	CO	NO <sub>x</sub>	ROG	PM <sub>10</sub>
No-Build	143,772	154.0	3.8	499,458	72,421	28,072	3,194
LRT (Options A and B)	143,755	155.3	3.8	499,401	72,421	26,071	3,194
Change	-17	+1.3	0	-57	0	-1	0

Source: Terry A. Hayes Associates

Emergency Burden Emissions

In the unlikely event of a subway fire (subway is designed for low flammability), emergency fans would emit toxic fumes in areas designed to be away from residents or other occupied spaces. Vent shafts are located in plazas and in one place (1<sup>st</sup>/Lorena) in a raised median in the center of 1<sup>st</sup> Street. During final design the ventilation shafts will be designed to ensure safe separation distances by use of landscaping, hardsurfaces, or signage.

Carbon Monoxide Hot Spot Analysis

Table 4.7-6 compares the 1- and 8-hour CO concentrations at the 15 study intersections for the LRT Build Alternative (both options) and the No-Build Alternative. As indicated in the table, Option A would not exceed the State 1-hour or 8-hour CO standard of 20 ppm or 9 ppm, respectively.

Intersection	1-Hour Concentration		8-Hour Concentration	
	No-Build	LRT Build (Options A or B)	No-Build	LRT Build (Options A or B)
Mednik/Cesar Chavez	6.7	6.7	4.7	4.7
Atlantic/Cesar Chavez	7.0	7.5	4.9	5.2
Alameda/Temple	6.8	6.6	4.8	4.6
Alameda/1 <sup>st</sup> Street	7.5	7.1	5.2	5.0
Vignes/1 <sup>st</sup> Street	6.0	5.8	4.2	4.1
Mission/1 <sup>st</sup> Street	6.1	6.2	4.3	4.3
Lorena/1 <sup>st</sup> Street	6.0	5.9	4.2	4.1
Indiana/1 <sup>st</sup> Street	5.9	5.7	4.1	4.0
Atlantic/1 <sup>st</sup> Street	6.7	7.3	4.7	5.1
Indiana/3 <sup>rd</sup> Street	6.2	6.1	4.3	4.3
Eastern/3 <sup>rd</sup> Street	6.6	6.4	4.6	4.5
Ford/3 <sup>rd</sup> Street	6.5	6.2	4.5	4.3
Mednik/3 <sup>rd</sup> Street	6.9	6.4	4.8	4.5
Atlantic/Pomona	7.0	7.1	4.9	5.0
Atlantic/Beverly	6.8	6.9	4.9	4.8
State Standard	20.0		9.0	

<sup>1</sup> Expressed in parts per million.  
Note: Includes the background concentration of 4.5 ppm and 3.2 ppm for the 1- and 8-hour averaging period, respectively.  
Source: Terry A. Hayes Associates



### Significance of Impacts

Beneficial air quality impacts are anticipated from Option A.

#### ***Option B***

Burden emissions are a function of VMT, and CO hotspots are a function of local intersection level of service (LOS). The alignment changes proposed under Option B would not materially change the regional VMT or local intersection LOS estimates predicted under Option A. Thus, there would be no material change in burden emissions under Option B.

### Significance of Impacts

Beneficial air quality impacts are anticipated from Option B.

#### **4.7.4 Mitigation**

The LRT Build Alternative (Options A and B) is anticipated to have a beneficial effect on regional air quality; no mitigation measures are required.

#### **4.7.5 Conformity Analysis**

The Regional Transportation Plan (RTP) is a 20-year transportation plan for six counties within the Southern California region (Ventura, Los Angeles, Orange, San Bernardino, Riverside, and Imperial counties). The RTP provides long-term solutions to the region's transportation needs under a framework that meets mobility, air quality regulations, and other regional goals. The RTP is a critical document for projects to qualify for future federal, state, and local funding sources. The Southern California Association of Governments (SCAG) revises the RTP every three years. The last updated plan was adopted by SCAG in April 1998, and reflects changes in regional demographics, environmental factors, land-use forecasts, technology, and sub-regional planning. The LRT Build Alternative is included in the RTP.

As detailed in Section 4.7.3, criteria pollutants emitted by the proposed project would not exceed the amounts previously listed in Table 4.7-4, when compared to future no project conditions. Thus, under CFR 40 Part 51, the proposed project does not require a conformity analysis.

## 4.8 NOISE AND VIBRATION

### 4.8.1 Affected Environment

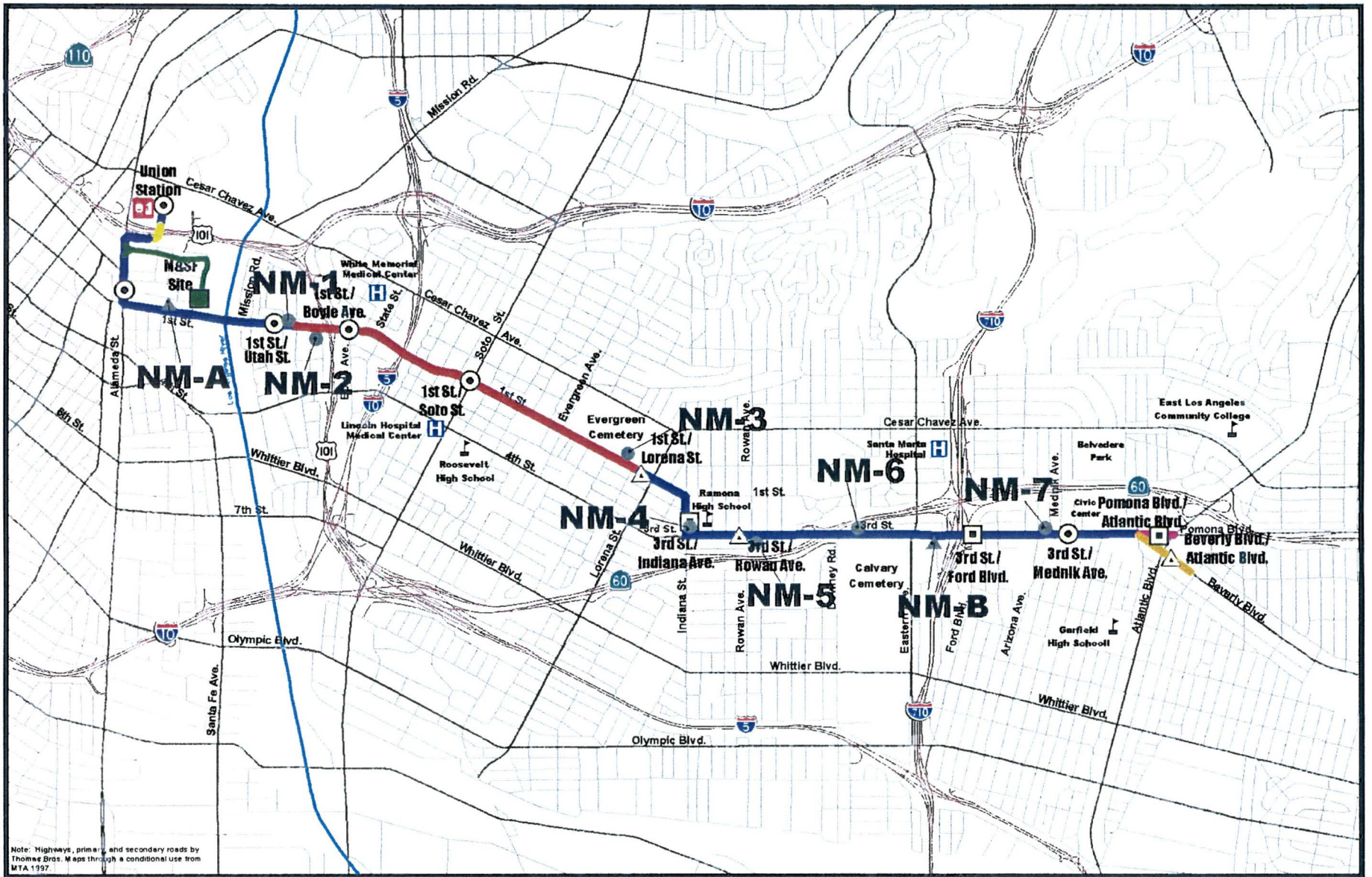
Prior to performing an analysis of the future noise and vibration levels associated with the LRT Build Alternative, it was necessary to establish the existing baseline noise levels along the corridor. This was accomplished by performing a series of measurements at representative locations along the corridor. FTA Vibration Impact Criteria (discussed in Section 4.8.2.2) were used to identify locations where potential impacts may occur based on existing land use activities.

Noise measurements were taken at nine noise-sensitive locations along the corridor (Table 4.8-1). These locations were deemed to be a good representation of all noise-sensitive land uses along the project corridor. Seven long-term (24-hour) noise readings and two short-term (15-minute) measurements readings were taken, and their locations are shown in Figure 4.8-1.

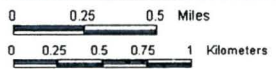
TABLE 4.8-1 NOISE MEASUREMENT LOCATIONS			
Site I.D.	Site Description	Measured Ldn (dBA)	Measured Peak-Hour Leq (dBA)
<b>Long-term (24-Hour) Noise Measurement Locations</b>			
NM-1	L.A. Housing Authority	72	73
NM-2	Pecan Park	75	75
NM-3	Evergreen Cemetery	68	67
NM-4	Ramona High School (Indiana Street)	70	68
NM-5	Our Lady of Lourdes School	71	69
NM-6	Guadalupe Church	72	71
NM-7	Casa Telacu Apartments	65	64
<b>Short-Term (15-Minute) Noise Measurement Locations</b>			
Site I.D.	Location Description	Measured Leq (dBA)	Adjusted Peak-Hour Leq (dBA) <sup>1</sup>
NM-A	L.A. Homba Hongwanji Buddhist Temple	66	68
NM-B	Single-Family Residences, 3 <sup>rd</sup> Street at I-710	70	73
<sup>1</sup> Each 15-minute sample is compared to the closest 24-hour sample at the same hour of the day. The 15-minute samples are then adjusted relative to the 24-hour samples in order to develop a peak Leq and Ldn for each of the 15-minute measurement locations.			

The highest levels were recorded at Pecan Park located along 1<sup>st</sup> Street near the US 101 Freeway, while the lowest levels were noted at Casa Telacu Apartments on 3<sup>rd</sup> Street at Dangler Avenue near the eastern end of the planned alignment. Section 4.8.2 provides further information regarding the noise descriptors used in the measurements.





Note: Highways, primary, and secondary roads by Thomas Bros. Maps through a conditional use from MTA 1997.



- LEGEND**
- ⊙ Stations - Both Options
  - △ Stations - Option A Only
  - Stations - Option B Only
  - Option A Only
  - Option B Only
  - At Grade
  - Tunnel
  - Elevated
  - M&SF Lead Line
  - Highway
  - Primary Road
  - Secondary Road
  - ▲ 15-Minute Noise Measurement Locations
  - 24-Hour Noise Measurement Locations

**Eastside Corridor**  
Transit Consultants

Los Angeles Eastside Corridor SEIS/SEIR

**Noise Measurement Locations**

Figure 4.8-1



## 4.8.2 Methodology for Impact Evaluation

This section presents the methods used to estimate noise and vibration levels and the criteria used to assess impacts.

### 4.8.2.1 Noise

#### *Noise Impact Criteria*

The FTA Noise Impact Criteria are divided into three groups, which place noise sensitive land uses into the following three categories:

- ◆ Category 1: Buildings or parks, where quiet is an essential element of their purpose.
- ◆ Category 2: Residences and buildings where people normally sleep. This includes residences, hospitals, and hotels where nighttime sensitivity is assumed to be of utmost importance.
- ◆ Category 3: Institutional land uses with primarily daytime and evening use. This category includes schools, libraries, churches, parks, certain historical sites, and recreational facilities.

The Day-Night Equivalent Sound Level (Ldn) is used to characterize noise exposure for residential areas (Category 2) and maximum 1-hour Leq is used for other noise sensitive land uses, such as school buildings (Categories 1 and 3) during the period that the facility is in use. The Leq (or equivalent noise level) is the level of a constant sound level in dBA, which in a given situation and time period, has the same sound energy as does the time-varying sound over the same period. One-hour equivalent noise levels measured every hour over a continuous 24-hour period are sometimes used to calculate a composite 24-hour noise exposure measure, or Ldn, which applies a 10-dBA penalty to nighttime sound levels between the hours of 10:00 PM and 7:00 AM to account for the increased noise-sensitivity of people during sleeping hours. Use of Leq and Ldn is appropriate for transportation noise analysis because these levels are sensitive to both the frequency of occurrence and duration of noise events, including rail and bus operations, which may be characterized by infrequent noise. Typical Ldn noise levels are presented in Figure 4.8-2.

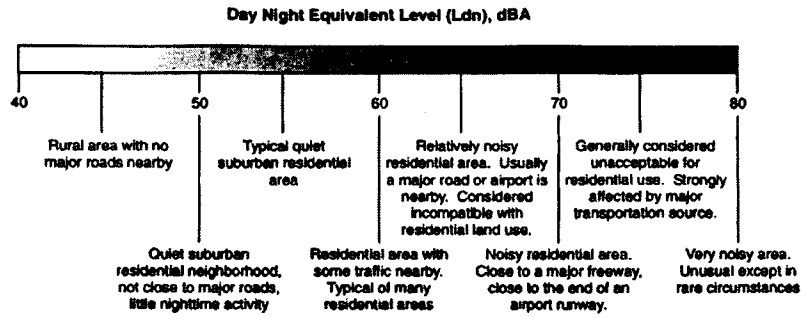
There are two levels of impact included in the FTA criteria, as shown in Figure 4.8-3. The interpretation of these two levels of impact are summarized below:

- ◆ Severe: Severe noise impacts are considered "significant" as this term is used in the National Environmental Policy Act (NEPA) and implementing regulations. Noise mitigation will normally be specified for severe impact areas unless there is no practical method of mitigating the noise.
- ◆ Impact (Moderate): In this range, other project-specific factors must be considered to determine the magnitude of the impact and the need for mitigation. These other factors can include the predicted increase over existing noise levels, the types and number of noise-sensitive land uses affected, existing outdoor-indoor sound insulation, and the cost effectiveness of mitigating noise to more acceptable levels. For purposes of clarification, this impact category will be referred to as moderate impact to better differentiate from severe impact.

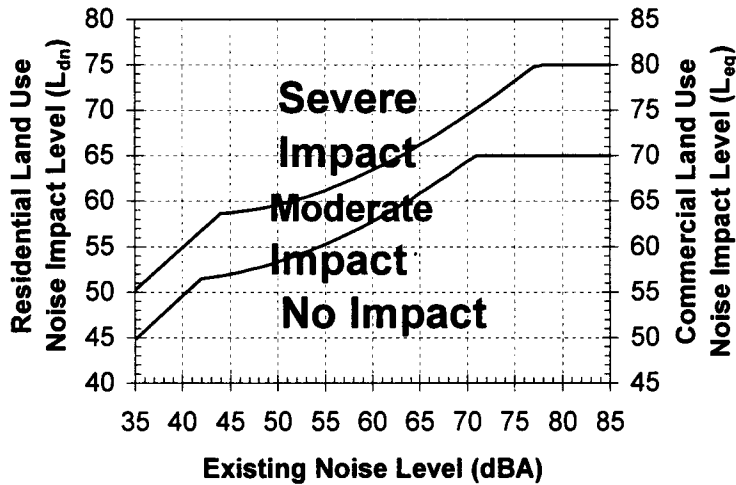
The noise impact criteria for transit operations are summarized in Table 4.8-2. The first column shows the existing noise exposure, and the remaining columns show how much additional noise exposure from the transit project is necessary to cause either a moderate or severe impact. The future noise exposure would be the combination of the existing noise exposure and the additional noise exposure caused by the LRT Build Alternative.



**FIGURE 4.8-2  
TYPICAL LdnS**

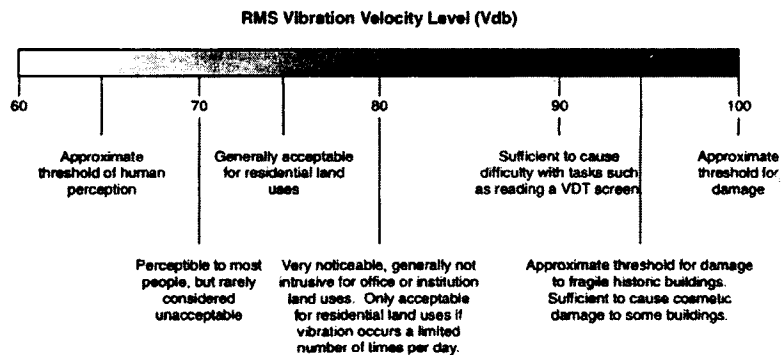


**FIGURE 4.8-3  
NOISE IMPACT CRITERIA FOR TRANSIT PROJECTS**



Source: *Transit Noise and Vibration Impact Assessment*, FTA, April 1995.

**FIGURE 4.8-4  
TYPICAL LEVELS OF GROUND-BORNE VIBRATION**







**TABLE 4.8-2  
FTA NOISE IMPACT CRITERIA**

Existing Noise Exposure Leq or Ldn <sup>1</sup>	Project Noise Exposure Impact Thresholds, Ldn. or Leq <sup>1</sup> (Noise levels in dBA)			
	Category 1 or 2 Sites		Category 3 Sites	
	Moderate Impact	Severe Impact	Moderate Impact	Severe Impact
<43	Amb.+10	Amb.+15	Amb.+15	Amb.+20
43-44	52	<58	57	<63
45	52	<58	57	<63
46-47	53	<59	58	<64
48	53	<59	58	<64
49-50	54	<59	59	<64
51	54	<60	59	<65
52-53	55	<60	60	<65
54	55	<61	60	<66
55	56	<61	61	<66
56	56	<62	61	<67
57-58	57	<62	62	<67
59-60	58	<63	63	<68
61-62	59	<64	64	<69
63	60	<65	65	<70
64	61	<65	66	<70
65	61	<66	66	<71
66	62	<67	67	<72
67	63	<67	68	<72
68	63	<68	68	<73
69	64	<69	69	<74
70	65	<69	70	<74
71	66	<70	71	<75
72-73	66	<71	71	<76
74	66	<72	71	<77
75	66	<73	71	<78
76-77	66	<74	71	<79
>77	66	<75	71	<80

<sup>1</sup> Ldn is used for land uses where nighttime sensitivity is a factor; Daytime Leq is used for land use involving only daytime activities.  
Source: *Transit Noise and Vibration Impact Assessment*, FTA, April 1995.

**Noise Assessment Methodology**

Noise impact from transit operations is a function of the transit vehicle, speed, and the number of vehicles in the daytime and nighttime hours, and the distance of the alignment from sensitive receptors. Type of track and number of cars per train are also important. Initial service would likely operate with 2-car consists, and the ultimate configuration would likely be 3-car consists. For the LRT vehicle, the interaction of the vehicle wheels with the guideway, propulsion system, and ancillary equipment (i.e. ventilation and air-conditioner fans) are the major sources of noise. The FTA Detailed Noise Analysis procedure was used to develop the projections of impact and the recommended mitigation measures for Eastside Corridor transit operations. The operating assumptions, speed, headways, and train schedule used to predict future LRT noise levels are presented in the separate *Noise and Vibration Technical Report* (December 2000) and *Addendum to the Noise and Vibration Technical Report* (October 2001), prepared for the Eastside Corridor, which is included herein by reference.

Regarding traffic noise, there is less than a one percent change in both projected vehicle miles traveled (VMT) and vehicle hours traveled (VHT) for the entire project corridor, between the 2020 No-Build and LRT Build Alternatives. Therefore, there will be very minimal, if any, changes in traffic noise between the two alternatives. No further traffic noise analysis was prepared.

#### 4.8.2.2 Ground-Borne Noise and Vibration

##### *Ground-Borne Noise and Vibration Impact Criteria*

The FTA has developed the impact criteria shown in Table 4.8-3 for acceptable levels of ground-borne noise and vibration. Some buildings, such as concert halls, TV and recording studios, and theaters, can be very sensitive to vibration, but they do not fit into any of the three land use categories shown in the table. Because of the sensitivity of these buildings, they usually warrant special attention during the environmental assessment of a transit project. Criteria for acceptable levels for various types of special buildings are also presented in Table 4.8-3.

<b>TABLE 4.8-3 FTA GROUND-BORNE VIBRATION and NOISE IMPACT CRITERIA</b>				
Land Use Category	Ground-Borne Vibration Impact Levels (VdB re 1 micro inch/sec)		Ground-Borne Noise Impact Levels (dB re 20 micro pascals)	
	Frequent Events <sup>1</sup>	Infrequent Events <sup>2</sup>	Frequent Events <sup>1</sup>	Infrequent Events <sup>2</sup>
Category 1: Buildings where low ambient vibration is essential for interior operations.	65 VdB <sup>3</sup>	65 VdB <sup>3</sup>	-- <sup>4</sup>	-- <sup>4</sup>
Category 2: Residences and buildings where people normally sleep.	72 VdB	80 VdB	35 dBA	43 dBA
Category 3: Institutional land uses with primarily daytime use.	75 VdB	83 VdB	40 dBA	48 dBA
<b>Special Buildings and Facilities<sup>3</sup></b>				
Concert Halls	65 VdB	65 VdB	25 dBA	25 dBA
TV Studios	65 VdB	65 VdB	25 dBA	25 dBA
Recording Studios	65 VdB	65 VdB	25 dBA	25 dBA
Auditoriums	72 VdB	80 VdB	30 dBA	38 dBA
Theaters	72 VdB	80 VdB	35 dBA	43 dBA
<sup>1</sup> "Frequent Events" is defined as more than 70 vibration events per day. <sup>2</sup> "Infrequent Events" is defined as fewer than 70 vibration events per day. This category includes most commuter rail systems. <sup>3</sup> This criterion is based on levels that are acceptable for most moderately sensitive equipment such as optical microscopes. Vibration sensitive manufacturing or research will require detailed evaluation to define the acceptable vibration levels. Ensuring lower vibration levels in a building often requires special design of the HVAC system and stiffened floors. <sup>4</sup> Vibration-sensitive equipment is not sensitive to ground-borne noise. <sup>5</sup> If the building will rarely be occupied when the trains are operating, there is no need to consider impact. Source: <i>Transit Noise and Vibration Impact Assessment</i> , FTA, April 1995.				

Ground-borne vibration consists of oscillatory waves that propagate from the source through the ground to adjacent buildings. On steel-wheel steel-rail train systems, ground-borne vibration is created by the interaction of the steel wheels rolling on the steel rails. Although the vibration is sometimes noticeable outdoors, it is almost exclusively an indoor problem. Ground-vibration is of such a low level that, for this project, there is almost no possibility of structural damage to buildings near the route. The low-frequency noise is caused by sound being radiated from vibrating room surfaces and is referred to as ground-borne noise. Ground-borne vibration and ground-borne noise are really the same phenomenon, yet they only

differ in the manner in which the building occupants perceive them. As noted, the vibration from trains is almost never of sufficient amplitude to cause even minor cosmetic damage to buildings. The primary concern is that the vibration and radiated noise can be intrusive and annoying to building occupants. Factors that influence the amplitudes of ground-borne vibration include vehicle suspension parameters, condition of the wheels and rails, type of track, track support system, type of building foundation, and the properties of the soil and rock layers that the vibration propagates through. Use of continuously welded rail eliminates wheel impacts at rail joints and results in significantly lower vibration levels than with jointed track.

Train vibration is virtually always characterized in terms of the root-mean-square (RMS) amplitude. RMS is a widely used but sometimes confusing method of characterizing vibration and other oscillating phenomena. It represents the average energy over a short time interval; typically, a one-second interval is used to evaluate human response to vibration. RMS vibration velocity is considered the best available measure of potential human annoyance from ground-borne vibration. Figure 4.8-4 gives a general idea of human and building response to different levels of vibration. Existing background building vibration is usually in the range of 40 to 50 VdB, which is well below the range of human perception. Although the perceptibility threshold is about 65 VdB, human response to vibration is usually not significant unless the RMS vibration velocity level exceeds 70 VdB, a typical vibration level 50 feet from a rapid transit or light rail system. Buses and trucks rarely create vibration that exceeds 70 VdB unless there are large bumps or potholes in the road.

#### ***Ground-borne Noise and Vibration Assessment Methodology***

Impacts were assessed based on the procedure outlined in the FTA manual, *Transit Noise and Vibration Impact Assessment*. The projections are based on characterizing the magnitude of the vibration forces generated by a transit train in terms of a force density and characterizing the propagation through the soil with a transfer mobility function. The force density is assumed to represent the combined effects of the vehicle suspension, the wheel and rail condition, and the track support system and is assumed to be independent of the local geologic conditions. Vibration measurements of the Nippon Sharyo vehicles operating on the Long Beach Blue Line and the Siemens vehicles operating in Portland were used to develop a force density level function. The measured data were modified above 40 Hz to represent the increased ground vibration levels of embedded and direct fixation trackwork. The transfer mobility functions used for the projections were based on the vibration propagation measurements conducted at three sites along the underground tunnel section (1<sup>st</sup>/Boyle, 1<sup>st</sup>/Soto, and 1<sup>st</sup>/Savannah) and four sites along the at-grade sections of the alignment (1<sup>st</sup>/Alameda, 3<sup>rd</sup>/Townsend, 3<sup>rd</sup>/Humphreys, and 3<sup>rd</sup>/Dangler). The combination of the force density and transfer mobility functions provides an estimate at the ground surface as a function of distance from the tracks, the horizontal distance for surface tracks and the diagonal (slant) distance for subways. All estimates of ground-borne vibration are projected to the foundation of each building and do not include any estimates of building coupling loss. In addition, a 5-decibel safety factor has been incorporated into all of the ground-borne vibration and ground-borne noise projections. The purpose of the safety factor is to account for the normal fluctuations in ground-borne vibration due to normal wheel and track wear, and unexpected differences in the local soil and geology that were not represented by the transfer mobility tests. For a complete description of the vibration analysis methods, see the *Addendum to the Noise and Vibration Technical Report*, which is included herein by reference.

#### **4.8.2.3 CEQA Significance Impact Criteria**

Under CEQA, a substantial noise increase may result in a significant adverse environmental effect and, if it does, it must be mitigated or identified as a noise impact for which it is likely that no, or only partial, abatement measures are available. Specific economic, social, environmental, legal, and technological

conditions may make additional noise mitigation measures infeasible. For the purposes of this study, a severe noise impact, as defined by FTA and shown in Table 4.8-2 and Figure 4.8-3, is used to determine the significance of the proposed project. The FTA vibration criteria presented in Table 4.8-3 will be used as the significance impact criteria for ground-borne noise and vibration.

#### 4.8.2.4 APTA Noise Guidelines

Although the Eastside Corridor LRT project uses FTA criteria for analysis of normal LRT operations, the American Public Transit Association (APTA) guidelines included in the MTA's Systemwide Design Criteria, Section 2, will be used for airborne noise from transit ancillary facilities such as traction power substations (TPSS), fan shafts, and emergency power generators. The criteria are based on maximum noise levels or L<sub>max</sub>. Wheel squeal on tight radius curves of less than 400 feet is also assessed using APTA criteria. APTA guidelines, as a single event passby noise level, are more appropriate to assessing the loudness and tonal content characteristics of wheel squeal. The L<sub>dn</sub>, used by FTA to evaluate normal transit operations, cannot account for the short term annoyance normally associated with wheel squeal. The criteria are discussed in Section 4.8.3.

### 4.8.3 Impacts

#### 4.8.3.1 No-Build Alternative

The principal transportation-related source of future noise levels under the No-Build Alternative would be traffic movements on the local arterials in the project area. In general, it would require a doubling of the traffic activity for the noise levels to increase by 3 dBA, which is the point at which most listeners detect the change. Traffic levels are not expected to experience such an increase between now and 2020. Therefore, no noise impacts are anticipated. Although all rubber tire transit vehicles and vehicular traffic can cause ground-borne vibration, the vibration is not usually perceptible because of the vibration isolation. Therefore, vibration impacts are also not anticipated.

#### 4.8.3.2 LRT Build Alternative

##### *Option A*

##### Noise

Table 4.8-4 displays anticipated project-related noise levels for both Options A and B at the sensitive receptor locations shown in Figures 4.8-5 through 4.8-7. The buildings listed in the table represent those structures that are adjoining the at-grade section of the alignment. Where the alignment is located in an underground subway section, airborne noise levels from train operations would not be audible. Potential noise impacts at each location have been identified as: no impact, moderate impact, or severe impact, in accordance with FTA Noise Impact Criteria. Note that the noise analysis for the Final SEIS/SEIR reflects the most recent design information for the LRT Build Alternative. As a result, the number of noise-impacted buildings is lower than presented in the Draft SEIS/SEIR because of changes in operating schedule, design speeds have been updated, and distances between the track and sensitive receivers have been modified. In addition, the location of special trackwork (crossovers and turnouts) has been identified, and the impacts of that trackwork are presented in this section.

Table 4.8-5 provides a summary of the noise impacts. Under Option A, severe impacts have been identified at 13 buildings due to the location of the special trackwork, which was not assessed during the Draft SEIS/SEIR phase since their locations were unknown at that time. Moderate impacts would occur at 23 buildings with two-car operation and at 48 buildings when three cars are operated.

**TABLE 4.8-4  
PROJECT NOISE LEVELS AT BUILDINGS ALONG THE AT-GRADE SEGMENTS**

Receiver	Street that Alignment Follows	Type of Building Structure	Number of Buildings	FTA Noise Sensitive Category (1,2,3)	Train Speed (mph)	Distance of Trackwork to Receiver (feet)	Existing Noise Level <sup>1</sup> (dBA)	2-Car LRT Train		3-Car LRT Train	
								Project Generated Noise <sup>1</sup> (dBA)	FTA Level of Noise Impact	Project Generated Noise <sup>1</sup> (dBA)	FTA Level of Noise Impact
1a	Alameda	Veterans Clinic	1	3	25	95 <sup>3</sup>	73	61 to 64 <sup>2</sup>	no impact	63 to 66 <sup>2</sup>	no impact
1	Alameda	Geffen Museum	1	3	25	90	73	55	no impact	56	no impact
2	Alameda	Japanese American National Museum	1	3	25	90	73	55	no impact	56	no impact
2a	Alameda	Mangrove Estates (Planned Hotel)	1	2	25	70	69	56	no impact	58	no impact
2b	1st Street	First Street South Plaza (Planned Office Building)	1	3	25	50	70	58	no impact	60	no impact
2c	1st Street	First Street South Plaza (Planned Condominium Building)	1	2	25	250	63	51	no impact	52	no impact
3	1st Street	Commercial	1	3	35	40	71	62	no impact	63	no impact
4	1st Street	Commercial	1	3	35	40	70	62	no impact	63	no impact
5 (NM-A)	1st Street	Hompa Hongwanji Buddhist Temple	1	3	35	80	68	58	no impact	60	no impact
6	1st Street	Commercial	1	3	35	35	70	63	no impact	64	no impact
7	1st Street	Commercial	1	3	35	30	70	63	no impact	64	no impact
8	1st Street	Multi-Family Residence	1	2	35	35	74	65	no impact	66	moderate
9 <sup>2</sup> (NM-1)	1st Street	Future Telacu Pico Aliso Housing	1	2	25	40 <sup>3</sup>	72	70 to 73 <sup>2</sup>	severe	72 to 75 <sup>2</sup>	severe
10 <sup>2</sup>	1st Street	Commercial	1	3	25	30 <sup>3</sup>	73	72 to 75 <sup>2</sup>	severe	73 to 76 <sup>2</sup>	severe
11 <sup>2</sup>	1st Street	Multi-Family Residence	1	2	25	30 to 70 <sup>3</sup>	73	66 to 69 <sup>2</sup>	moderate	67 to 71 <sup>2</sup>	moderate
12	1st Street	Single- and Two-Family Residences	3	2	25	35	76	64	no impact	65	no impact
12a	1st Street	Utah Elementary School	1	3	25	200	69	49	no impact	51	no impact
13 (NM-2)	1st Street	Pecan Park	None	3	25	40	75	60	no impact	62	no impact
18a	1st Street	Evergreen Cemetery	None	3	35	40	69	63	no impact	65	moderate

<sup>1</sup> Category 3 = Leq; Category 1&2 = Ldn

<sup>2</sup> These receivers are in close proximity to special trackwork.

<sup>3</sup> Distance of special trackwork switch frog to receiver.

<sup>4</sup> Distance of trackwork to receiver under Option B.

<sup>5</sup> Project generated noise levels and noise impacts under Option B.

**TABLE 4.8-4 (Cont'd)**  
**PROJECT NOISE LEVELS AT BUILDINGS ALONG THE AT-GRADE SEGMENTS**

Receiver	Street that Alignment Follows	Type of Building Structure	Number of Buildings	FTA Noise Sensitive Category (1,2,3)	Train Speed (mph)	Distance of Trackwork to Receiver (feet)	Existing Noise Level <sup>1</sup> (dBA)	2-Car LRT Train		3-Car LRT Train	
								Project Generated Noise <sup>1</sup> (dBA)	FTA Level of Noise Impact	Project Generated Noise <sup>1</sup> (dBA)	FTA Level of Noise Impact
19 (NM-3)	1st Street	Single-Family Residence	1	2	25	65	68	62	no impact	64	moderate
20	1st Street	Single- and Two-Family Residences	4	2	35	50	68	65	moderate	66	moderate
21	Indiana Street	Single- and Two-Family Residences	5	2	35	25/55 <sup>4</sup>	72	69/64 <sup>5</sup>	moderate/ no impact <sup>5</sup>	71/65 <sup>5</sup>	moderate/ no impact <sup>5</sup>
22	Indiana Street	Single- and Two-Family Residences	4	2	35	25/55 <sup>4</sup>	72	69/64 <sup>5</sup>	moderate/ no impact <sup>5</sup>	71/65 <sup>5</sup>	moderate/ no impact <sup>5</sup>
23 (NM-4)	Indiana Street	Ramona High School	1	3	15	40/20 <sup>4</sup>	68	58/59 <sup>5</sup>	no impact/ no impact <sup>5</sup>	60/61 <sup>5</sup>	no impact/ no impact <sup>5</sup>
26 <sup>2</sup>	3rd Street	LA Music and Art School	1	3	35	70 <sup>3</sup>	69	66 to 69	moderate	67 to 70	moderate
27 <sup>2</sup>	3rd Street	Single- and Two-Family Residences	3	2	35	40 to 60 <sup>3</sup>	72	70 to 73	severe	72 to 75	severe
28	3rd Street	Single- and Two-Family Residences	4	2	35	40 to 60	71	64 to 66	no impact to moderate	65 to 67	No impact to moderate
28 <sup>2</sup>	3rd Street	Single- and Two-Family Residences	8	2	35	60 to 70 <sup>3</sup>	71	69 to 73 <sup>2</sup>	severe	71 to 75 <sup>2</sup>	severe
29	3rd Street	Single- and Two-Family Residences	15	2	35	35 to 50	72	65 to 67	no impact to moderate	66 to 68	moderate
30	3rd Street	Paraiso Spanish Congregation	1	3	35	80	68	58	no impact	60	no impact
31	3rd Street	Single-Family Residence	1	2	35	65	72	63	no impact	64	no impact
32 (NM-5)	3rd Street	Our Lady of Lourdes Church/School	1	3	35	60	69	60	no impact	62	no impact
33	3rd Street	Commercial	1	3	35	45	73	65	no impact	67	no impact
34	3rd Street	Single-Family Residence	1	2	35	60	72	63	no impact	65	no impact
35	3rd Street	Single- and Two-Family Residences	7	2	35	50	75	64	no impact	66	moderate
36	3rd Street	Multi-Family Residences	2	2	35	65	72	63	no impact	64	no impact

<sup>1</sup> Category 3 = Leq; Category 1&2 = Ldn

<sup>2</sup> These receivers are in close proximity to special trackwork.

<sup>3</sup> Distance of special trackwork switch frog to receiver.

<sup>4</sup> Distance of trackwork to receiver under Option B.

<sup>5</sup> Project generated noise levels and noise impacts under Option B.

**TABLE 4.8-4 (Cont'd)**  
**PROJECT NOISE LEVELS AT BUILDINGS ALONG THE AT-GRADE SEGMENTS**

Receiver	Street that Alignment Follows	Type of Building Structure	Number of Buildings	FTA Noise Sensitive Category (1,2,3)	Train Speed (mph)	Distance of Trackwork to Receiver (feet)	Existing Noise Level <sup>1</sup> (dBA)	2-Car LRT Train		3-Car LRT Train	
								Project Generated Noise <sup>1</sup> (dBA)	FTA Level of Noise Impact	Project Generated Noise <sup>1</sup> (dBA)	FTA Level of Noise Impact
37 (NM-6)	3rd Street	Guadalupe Church	1	3	35	75	71	59	no impact	60	no impact
38	3rd Street	Single- and Two-Family Residences	4	2	35	50	74	64	no impact	66	moderate
39 (NM-B)	3rd Street	Single- and Two-Family Residences	6	2	35	50	74	64	no impact	66	moderate
40	3rd Street	Calvary Cemetery	None	3	35	50	73	61	no impact	63	no impact
41	3rd Street	Serbian Cemetery	None	3	35	50	73	61	no impact	63	no impact
42	3rd Street	Single- and Two-Family Residences	2	2	35	50	74	64	no impact	66	moderate
43	3rd Street	Single- and Two-Family Residences	2	2	35	65	73	63	no impact	64	no impact
44	3rd Street	Single-Family Residence	1	2	35	40	70	66	moderate	67	moderate
45	3rd Street	Single- and Two-Family Residences	2	2	35	50 to 105	66	58 to 64	no impact to moderate	60 to 66	no impact to moderate
46 (NM-7)	3rd Street	Casa Telacu Apartments	1	2	35	85	65	61	moderate	63	moderate
47	3rd Street	Single- and Two-Family Residences	2	2	35	45	69	65	moderate	67	moderate
48	3rd Street	Single- and Two-Family Residences	2	2	35	40 to 100	68	60 to 66	no impact to moderate	61 to 67	no impact to moderate
49	3rd Street	Sala Evangelica	1	3	35	48	65	61	no impact	63	no impact
50	3rd Street	Griffith Junior High School	1	3	35	280	60	50	no impact	52	no impact
51	3rd Street	Iglesia El Siloe	1	3	35	50	68	62	no impact	63	no impact
52	3rd Street	East L.A. Library, Belvedere Park, Sheriff's Station	3	3	35	55	66	61	no impact	62	no impact
52a	Pomona Boulevard	Kaiser Medical Center (Option B)	1	2	35	40	68	66	moderate	67	moderate

<sup>1</sup> Category 3 = Leq; Category 1&2 = Ldn

<sup>2</sup> These receivers are in close proximity to special trackwork.

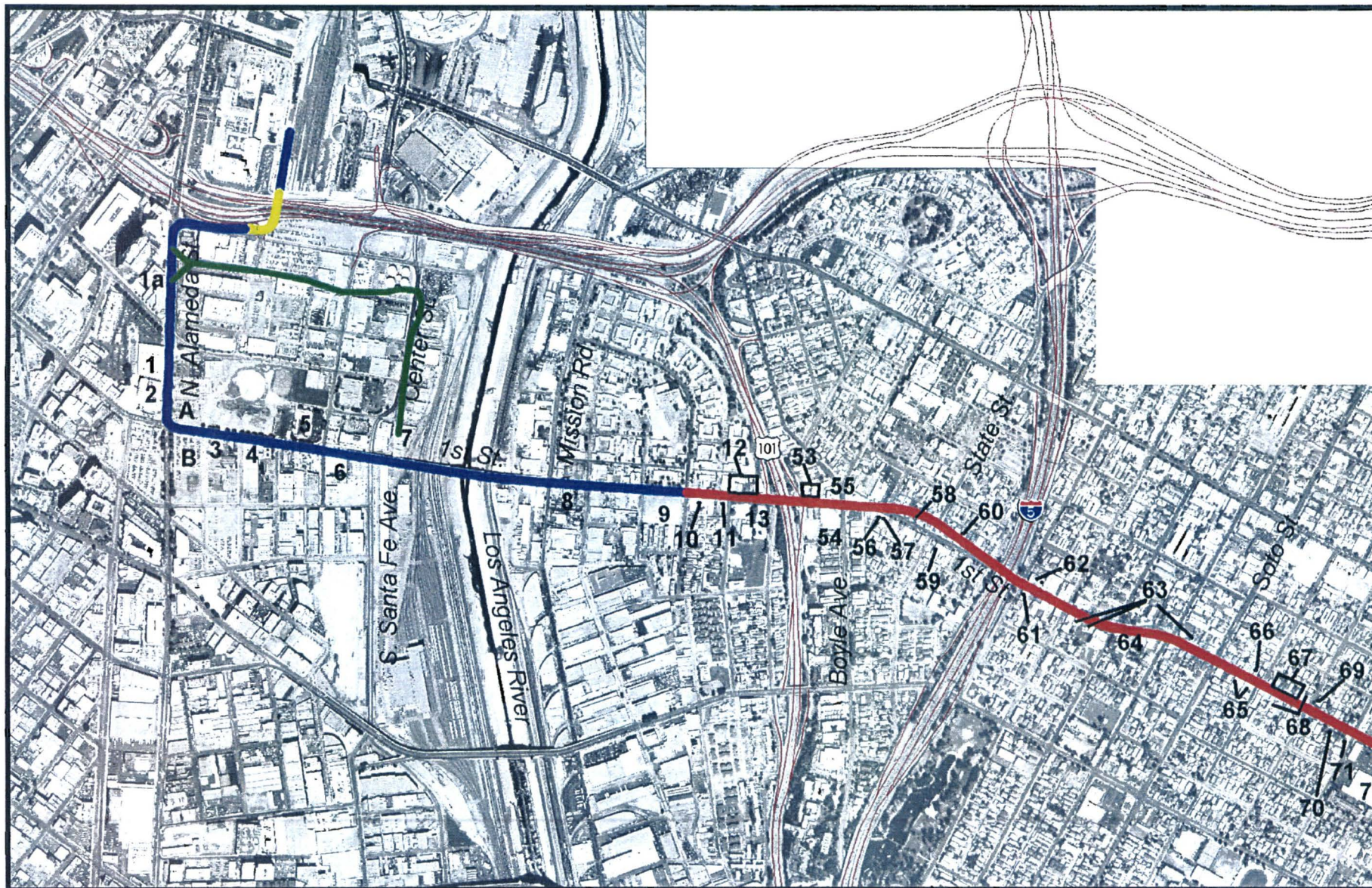
<sup>3</sup> Distance of special trackwork switch frog to receiver.

<sup>4</sup> Distance of trackwork to receiver under Option B.

<sup>5</sup> Project generated noise levels and noise impacts under Option B.







Legend

- At Grade
- Tunnel
- Elevated
- M&SF Lead Line
- Option A Only
- Option B Only

Los Angeles Eastside Corridor SEIS/SEIR

0 0.09 0.18 0.27 0.36 Miles

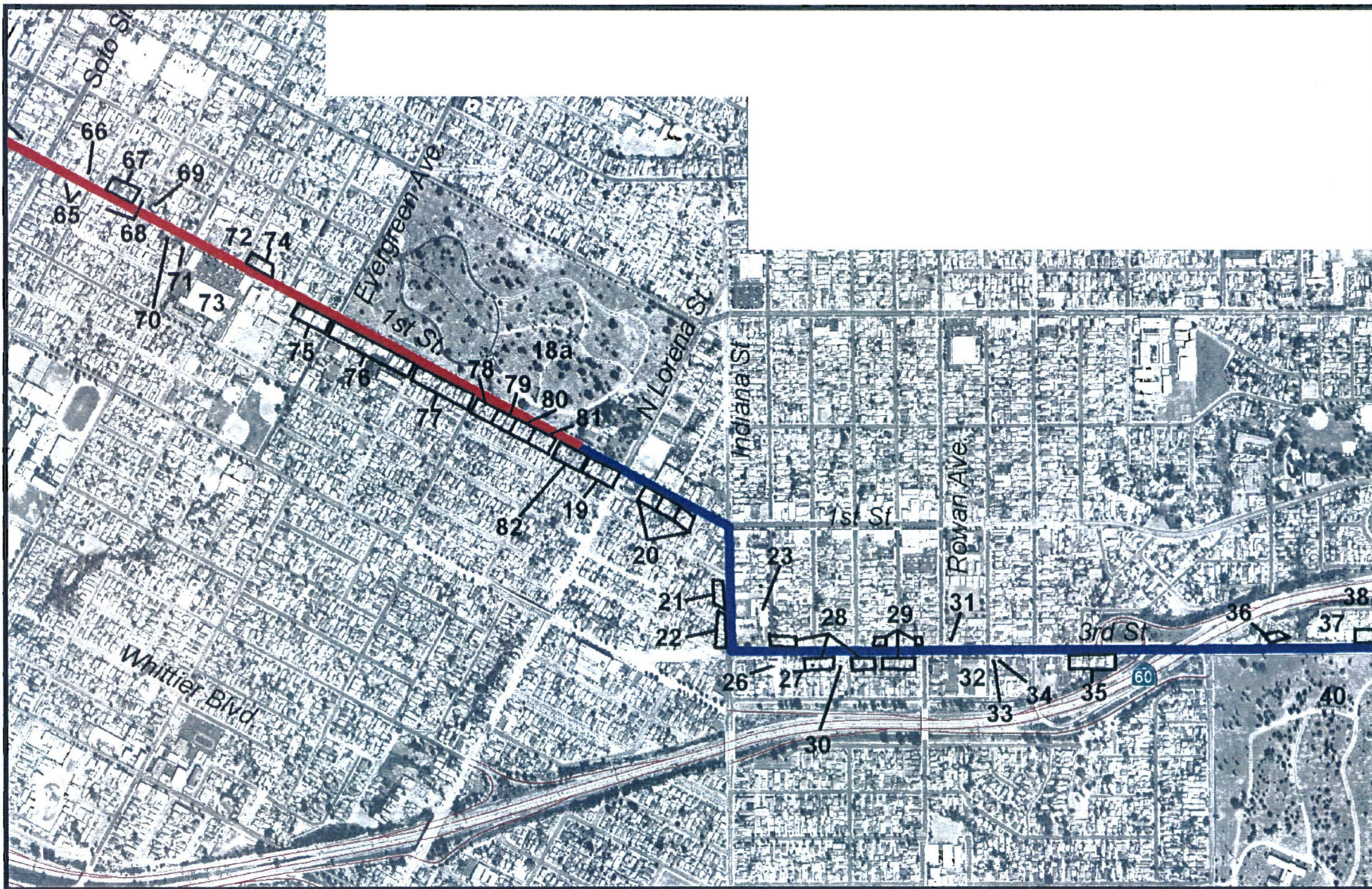


**M** Eastside Corridor  
Transit Consultants

Noise and Vibration Receiver Locations

Figure 4.8-5





0 0.09 0.18 0.27 0.36 Miles



**M** Eastside Corridor  
Transit Consultants

Legend

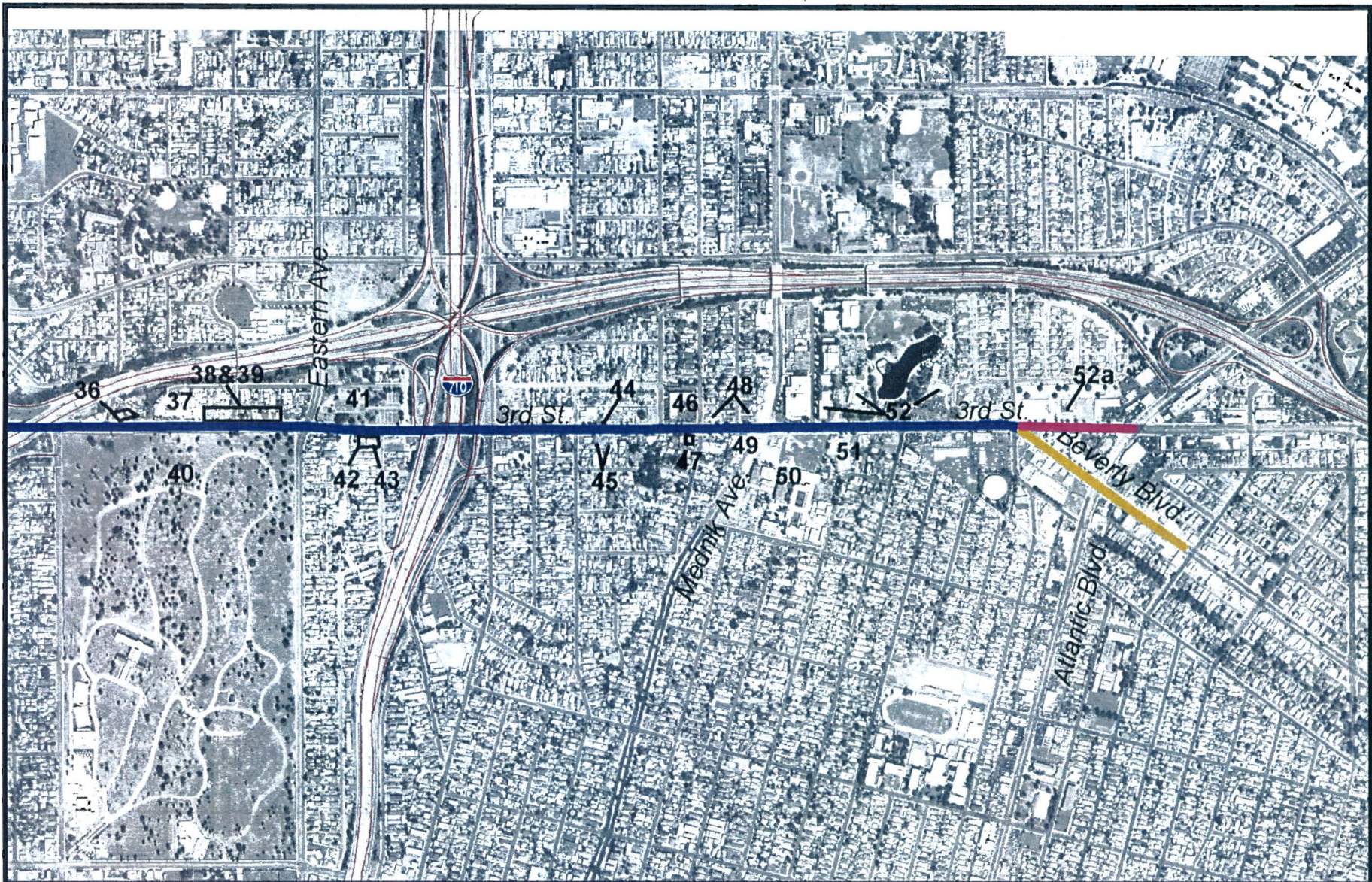
- At Grade
- Tunnel
- Elevated
- M&SF Lead Line
- Option A Only
- Option B Only

Los Angeles Eastside Corridor SEIS/SEIR

Noise and Vibration Receiver Locations

Figure 4.8-6





Legend

- At Grade
- Tunnel
- Elevated
- M&SF Lead Line
- Option A Only
- Option B Only

Los Angeles Eastside Corridor SEIS/SEIR

0 0.09 0.18 0.27 0.36 Miles



**M** Eastside Corridor  
Transit Consultants

Noise and Vibration Receiver Locations

Figure 4.8-7



Level of Impact	Type of Impacted Building	Option A		Option B	
		2-Car	3-Car	2-Car	3-Car
Moderate Impact	Single- and Two-Family Residences	20	44	11	35
	Multi-Family Residences	2	3	2	3
	Commercial	0	0	0	0
	Other	1	1	2	2
	<b>Total:</b>	<b>23</b>	<b>48</b>	<b>15</b>	<b>40</b>
Severe Impact	Single-Family Residences	11	11	11	11
	Multi-Family Residences	1	1	1	1
	Residential/Commercial Mix	1	1	1	1
	Other	0	0	0	0
	<b>Total:</b>	<b>13</b>	<b>13</b>	<b>13</b>	<b>13</b>

#### Special Trackwork

Special trackwork, which include switches, crossover diamonds, and turnouts, will generate higher passby noise levels than tangent track. An impact noise is generated on special trackwork as the wheel of the vehicle traverses a switch frog or crossover diamond gap. Wayside noise levels are estimated at 7 dBA to 10 dBA higher than normal tangent track operations at those buildings that are closest to the special trackwork. The receivers that are closest to the point of impact of the special trackwork are Sites 1a, 9, 10, 11, 26, 27 and seven of the twelve single-family residences at Site 28. The project generated noise at these sites is presented in Table 4.8-4 as a range of levels 7 dBA to 10 dBA higher than the predicted noise levels would be for tangent track locations.

#### Wheel Squeal

In general, sections of track with tight curves potentially can create a nuisance noise condition referred to as wheel squeal. The sliding or rubbing of the steel wheels of the LRT cars across the head of the steel rail causes wheel squeal. Wheel squeal impacts could occur along tight curves in the track with radii of less than 400 feet. In addition, there are other factors affecting the potential for wheel squeal, including: speed of the LRT train; rail vehicle truck geometry and rigidity; the conditions of the wheels and tracks; wheel damping technology; and contact-surface frictional characteristics. The maximum single-event noise level ( $L_{max}$ ) for wheel squeal associated with the passby of an LRT vehicle would be in the range of 80 dBA at 100 feet to 94 dBA at 25 feet. This data is based on recent measurements taken of the Tri-Met Eastside and Westside LRT lines. At distances of less than 100 feet from the centerline of track, the APTA maximum passby guideline of 80 dBA would be exceeded for multi-family residential land uses in the project area. The following five locations along the proposed LRT alignment, sections of track with a radius curve of less than 200 feet, are where there is the most potential for wheel squeal to occur:

- ◆ Hewitt Street at Commercial Street
- ◆ Commercial Street at Alameda Street
- ◆ Alameda Street at 1<sup>st</sup> Street
- ◆ 1<sup>st</sup> Street at Indiana Street



◆ Indiana Street at 3<sup>rd</sup> Street

The land uses at the first three track locations are industrial and commercial. At the last two locations (1<sup>st</sup> and Indiana Streets and 3<sup>rd</sup> and Indiana Streets) the land use is commercial and residential.

Vent Shafts

Both normal and emergency air ventilation would be supplied to the tunnel section and underground stations by fans located in the two underground stations, 1<sup>st</sup>/Boyle and 1<sup>st</sup>/Soto. The same fans used for emergency ventilation will also be used for normal ventilation at reduced speeds. Potential noise levels from the ventilation systems would be from the passby of trains transmitting through the vent shaft to the street, the operation of the ventilation fans under normal conditions, and the testing of the emergency ventilation fans. The vent shaft and the emergency ventilation fans will be designed to control noise levels from these sources to the noise guidelines required by the MTA Systemwide Design Criteria for a commercial area: 65 dBA for the train passby noise levels and 55 dBA for the fan noise, and for a residential area: 60 dBA for train passby noise levels and 50 dBA for the fan noise. Therefore, no adverse impacts are expected.

Ancillary Facilities

The proposed project includes six traction power substations (TPSS) and one emergency diesel generator. Their locations are presented in Chapter 2. Each TPSS will be designed to control operating noise levels to the noise guidelines required by the MTA Systemwide Design Criteria: 55 dBA for a commercial area and 50 dBA for a residential area. The operating noise levels of each TPSS will be substantially lower than either the existing traffic noise or LRT train noise. Therefore, no adverse impacts are expected. The proposed location of the emergency diesel power generator is the northeast corner of 1<sup>st</sup> Street and Lorena Avenue. This location is primarily commercial land uses with the nearest residences over 100 feet on the opposite side of 1<sup>st</sup> Street. The generator equipment will be tested during the time of day when existing ambient noise is at its maximum level. Equipment testing will be limited to a maximum period of ten minutes once a week or less. During times of periodic testing, the emergency power generator equipment will be limited to no more than 10 dBA sound level above the MTA Systemwide Design Criteria for continuous noise: 55 dBA for a commercial area and 50 dBA for a residential area, at a distance of 50 feet from the generator or at the nearest building or occupied area, whichever is closer. Therefore, no adverse impacts are expected.

Ground-Borne Noise and Vibration

Table 4.8-6 shows the projected ground-borne vibration levels for those building structures along the at-grade section of the alignment. Table 4.8-7 presents the projected ground-borne noise and vibration levels for those building structures along the underground subway section of the alignment. The levels are shown for both Options A and B. Option B impacts are discussed in a separate section below. Ground-borne noise impacts are limited to the underground subway segments. Vibration impacts will be limited to interior land use activities and will not be perceptible for outdoor land uses such as parks and recreation facilities. The building receivers that are listed in Tables 4.8-6 and 4.8-7 are shown on Figures 4.8-5 through 4.8-7. The projected number of impacts from ground-borne vibration are substantially lower than those presented in the Draft SEIS/SEIR for two reasons: 1) Design efforts subsequent to the Draft SEIS/SEIR have resulted in more detailed information on track location and subway depths; and 2) the effect of local geology was determined by borehole and surface vibration propagation tests. Another change, not known during the preparation of the Draft SEIS/SEIR, resulting in an increase in ground-borne vibration levels is the location of special trackwork, such as crossovers and turnouts, near vibration in close proximity to residential and commercial buildings.

**TABLE 4.8-6  
GROUND-BORNE VIBRATION ANALYSIS: AT-GRADE SECTIONS**

Site No.	Street Location	Type of Building	Number of Buildings	Distance to Track (feet)	Train Speed (mph)	FTA Vibration Criteria (VdB)	Predicted Vibration Levels (VdB)
1a	Alameda	Veterans Clinic	1	95	25	75	64/74 <sup>1</sup>
1	Alameda	Geffen Museum	1	90	25	75	64
2	Alameda	Japanese American National Museum	1	90	25	72	64
2a	Alameda	Mangrove Estates (Planned Hotel)	1	70	25	75	64
2b	1st Street	First Street South Plaza (Planned Office Building)	1	50	25	72	67
2c	1st Street	First Street South Plaza (Planned Condominium Building)	1	250	25	75	<58
3	1st Street	Commercial	1	40	35	75	71
4	1st Street	Commercial	1	40	35	75	71
5	1st Street	Hompa Hongwanji Buddhist Temple	1	80	35	75	64
6	1st Street	Commercial	1	35	35	75	72
7	1st Street	Commercial	1	30	35	75	64
8	1st Street	Multi-Family Residence	1	35	35	72	72
9	1st Street	Future Telacu Pico Aliso Housing	1	40	25	72	70/80 <sup>1</sup>
10	1st Street	Commercial	1	30	25	75	72/82 <sup>1</sup>
11	1st Street	Multi-Family Residence	1	30 to 70 <sup>4</sup>	25	72	72/75 <sup>1</sup>
12	1st Street	Single- and Two-Family Residences	3	35	25	72	71
12a	1st Street	Utah Elementary School	1	200	25	75	<58
13	1st Street	Pecan Park	None	40	25	N/A	N/A
18a	1st Street	Evergreen Cemetery	None	40	35	N/A	N/A
19	1st Street	Single-Family Residence	1	65	35	72	69
20	1st Street	Single- and Two-Family Residences	4	50	35	72	72
21	Indiana Street	Single- and Two-Family Residences	5	25/55 <sup>2</sup>	35	72	80/71 <sup>3</sup>
22	Indiana Street	Single- and Two-Family Residences	4	25/55 <sup>2</sup>	35	72	80/71 <sup>3</sup>
23	Indiana Street	Ramona High School	1	40/20 <sup>2</sup>	15	75	67/75 <sup>3</sup>
26	3rd Street	LA Music and Art School	1	55	35	75	71/81 <sup>1</sup>
27	3rd Street	Single- and Two-Family Residences	3	40 to 60 <sup>4</sup>	35	72	75/80 <sup>1</sup>
28	3rd Street	Single- and Two-Family Residences	13	40 to 60 <sup>4</sup>	35	72	72/80 <sup>1</sup>
29	3rd Street	Single- and Two-Family Residences	15	35 to 50	35	72	72 to 76
30	3rd Street	Paraiso Spanish Congregation	1	80	35	75	67
31	3rd Street	Single-Family Residence	1	65	35	72	69
32	3rd Street	Our Lady of Lourdes Church/School	1	60	35	75	70
33	3rd Street	Commercial	1	45	35	75	73
34	3rd Street	Single-Family Residence	1	60	35	72	70
35	3rd Street	Single- and Two-Family Residences	7	50	35	72	72
36	3rd Street	Multi-Family Residences	2	65	35	72	69
37	3rd Street	Guadalupe Church	1	75	35	75	68
38	3rd Street	Single- and Two-Family Residences	4	50	35	72	72
39	3rd Street	Single- and Two-Family Residences	6	50	35	72	72

<sup>1</sup> The predicted vibration levels for the special trackwork at sites 1a, 9, 10, 11, 26, 27 & 28 are indicated after the slash.  
<sup>2</sup> Distance of trackwork to receiver under Option B.  
<sup>3</sup> Project generated vibration levels under Option B.  
<sup>4</sup> Distance of special trackwork switch frog to receiver.  
 Note: Boldface numbers indicate impacts.

**TABLE 4.8-6 (Cont'd)**  
**GROUND-BORNE VIBRATION ANALYSIS: AT-GRADE SECTIONS**

Site No.	Street Location	Type of Building	Number of Buildings	Distance to Track (feet)	Train Speed (mph)	FTA Vibration Criteria (VdB)	Predicted Vibration Levels (VdB)
40	3 <sup>rd</sup> Street	Calvary Cemetery	None	50	35	N/A	N/A
41	3 <sup>rd</sup> Street	Serbian Cemetery	None	50	35	N/A	N/A
42	3 <sup>rd</sup> Street	Single- and Two-Family Residences	2	50	35	72	72
43	3 <sup>rd</sup> Street	Single- and Two-Family Residences	2	65	35	72	69
44	3 <sup>rd</sup> Street	Single-Family Residence	1	40	35	72	77
45	3 <sup>rd</sup> Street	Single- and Two-Family Residences	2	50 to 105	35	72	65 to 74
46	3 <sup>rd</sup> Street	Casa Telacu Apartments	1	85	35	72	68
47	3 <sup>rd</sup> Street	Single- and Two-Family Residences	2	45	35	72	76
48	3 <sup>rd</sup> Street	Single- and Two-Family Residences	2	40 to 100	35	72	65 to 77
49	3 <sup>rd</sup> Street	Sala Evangelica	1	48	35	75	75
50	3 <sup>rd</sup> Street	Griffith Junior High School	1	280	35	75	53
51	3 <sup>rd</sup> Street	Iglesia El Siloe	1	50	35	75	74
52	3 <sup>rd</sup> Street	East L.A. Library, Belvedere Park, Sheriff's Station	3	55	35	75	73
52a	Pomona Blvd	Kaiser Medical Center (Option B)	1	40	35	72	77

Note: Boldface numbers indicate impacts.

A summary of the buildings impacted under both Options A and B is presented in Table 4.8-8. Under Option A, 36 buildings will be impacted by vibration and six buildings will be impacted by ground-borne noise. Option B is discussed in a separate section below.

#### Significance of Impacts

With regard to noise, the 13 buildings that will be significantly impacted according to FTA criteria due to their proximity to the special trackwork would be considered significant impacts per CEQA. All exceedances of the FTA ground-borne noise and vibration criteria are considered significant impacts.

#### *Option B*

##### Noise

As shown in Tables 4.8-4 and 4.8-5, 13 buildings will be severely impacted (the same as Option A) due to the special trackwork. With two-car operations, 15 buildings will be moderately impacted, and with three-car operations, 40 buildings will be moderately impacted. Moderate noise impacts are the same as Option A regardless of two- or three-car operation, with the exception of the following buildings which are not impacted on Indiana Street: five single- and two-family residences at Site 21, and four single- and two-family residences at Site 22. The Kaiser Medical Center (currently under construction) on Pomona Boulevard between Woods Avenue and Atlantic Boulevard (Site 52a) will be affected under Option B under two- or three-car operation. A moderate noise impact is expected at this receiver location. The medical center is not adversely affected under Option A. The impacts of wheel squeal, vent shafts, and ancillary facilities are the same as that discussed for Option A.

**TABLE 4.8-7  
GROUND-BORNE NOISE AND VIBRATION ANALYSIS: UNDERGROUND SECTION**

Site No.	Cross Street Location	Type of Building	Number of Buildings	Depth to Top of Rail (feet)	Train Speed (mph)	FTA Ground-Borne Vibration Criteria (VdB)	Predicted Vibration Levels (VdB)	FTA Ground-Borne Noise Criteria (dBA)	Predicted Noise Levels (dBA)
53	US 101 Freeway	Single and Two-Famil Residences	3	40	25	72	65	35	30
54	US 101 Freeway	Multi-Family Residence	1	40	25	72	64	35	29
55	US 101 Freeway	Residential/Commercial	1	45	25	72	65	35	30
<b>1<sup>st</sup>/Boyle Station</b>									
56	Boyle Avenue	Residential/Commercial	1	45	55	72	70	35	35
57	Boyle Avenue	Mixed Use	1	45	55	72	66	35	31
58	Boyle Avenue	Single-Family Residence	1	45	55	72	74	35	39
59	Boyle Avenue	Multi-Family Residence	1	50	55	72	70	35	35
60	Boyle Street	Pentecostal Church	1	50	55	75	70	40	35
61	I-5 Freeway	Multi-Family Residence	1	60	55	72	66	35	31
62	I-5 Freeway	Mixed Use	1	60	55	72	63	35	28
63	I-5 Freeway	Mixed Use	3	65	55	72	64	35	29
64	I-5 Freeway	Ben Franklin Library	1	60	55	75	60	40	25
<b>1<sup>st</sup>/Soto Station</b>									
65	Soto Street	Mixed Use	2	50	55	72	69	35	34
66	Soto Street	Single-Family Residences	1	50	55	72	65	35	30
67	Mathews Street	Single- and Two-Famil Residences	6	50	55	72	68	35	33
68	Mathews Street	Mixed Use	2	55	55	72	66	35	31
69	Fickett Street	Multi-Family Residence	1	65	55	72	61	35	26
70	Fickett Street	Multi-Family Residence	1	65	55	72	62	35	27
71	Fickett Street	Single-Family Residence	1	70	55	72	62	35	27
72	Mott Street	Konko Church	1	75	55	75	60	40	25
73	Mott Street	1st Street School	1	75	55	75	61	40	26
74	Mott Street	Single- and Two-Famil Residences	3	75	55	72	61	35	26
75	Mott Street	Single- and Two-Famil Residences	3	70	55	72	62	35	27
76	Evergreen	Single- and Two-Famil Residences	5	50	55	72	64	35	29
77	Evergreen	Single- and Two-Famil Residences	10	50	55	72	64	35	29
78	Fresno Street	Single- and Two-Famil Residences	5	50	55	72	64	35	29
79	Fresno Street	Single- and Two-Famil Residences	3	45	55	72	64	35	29
80	Fresno Street	Single- and Two-Famil Residences	3	40	55	72	67	35	32
81	Fresno Street	Single- and Two-Famil Residences	5	25	55	72	71	35	36
82	Fresno Street	Single- and Two-Famil Residences	6	15	55	72	67	35	29
<b>1<sup>st</sup>/Lorena Station</b>									
Note: Boldface numbers indicate impacts.									

**TABLE 4.8-8  
SUMMARY OF GROUND-BORNE VIBRATION AND GROUND-BORNE  
NOISE IMPACTS (WITHOUT MITIGATION)**

Type of Impact	Type of Impacted Building	Option A	Option B
Ground-Borne Vibration	Single- and Two-Family Residences	33	24
	Multi-Family Residences	1	1
	Commercial	1	1
	Other	1	2
	<b>Total:</b>	<b>36</b>	<b>28</b>
Ground-Borne Noise	Single- and Two-Family Residences	6	6
	Multi-Family Residences	0	0
	Commercial	0	0
	Other	0	0
	<b>Total:</b>	<b>6</b>	<b>6</b>

### Ground-Borne Noise and Vibration

Under Option B, ground-borne noise impacts are the same as predicted for Option A (six buildings). Vibration impacts are the same as predicted for Option A with the exception of Site 21 (five single- and two-family residences) and Site 22 (four single- and two-family residences) where the impacts have been eliminated and the addition of one other impacted receiver, Site 52a, the Kaiser Medical Center that is currently under construction. Refer to Tables 4.8-6 through 4.8-8 for further information.

### Significance of Impacts

With regard to noise, like Option A, the 13 buildings that will be significantly impacted according to FTA criteria due to their proximity to the special trackwork would be considered significant impacts per CEQA. All exceedances of the FTA ground-borne noise and vibration criteria are considered significant impacts.

#### **4.8.4 Mitigation**

##### **4.8.4.1 Option A**

#### *Noise*

There are several operational measures that can be taken to assure that noise and vibration levels related to light rail operation remain at the levels projected in the analysis. Table 4.8-9 provides a list of measures that could be performed on a regular basis and the benefit that each of the measures will provide. Purchasing quiet light rail vehicles is another important step in minimizing noise impacts.

For severe noise impacts, mitigation is always recommended, whether it is sound-absorptive trackside noise barriers or sound insulation for the impacted buildings. For moderate noise impacts, noise mitigation is recommended when deemed cost-effective and feasible. Noise mitigation for moderately impacted structures is normally in the form of sound-absorptive trackside noise barriers. However, trackside noise barriers are not feasible for this project since the LRT alignment runs in the street when it is at grade. Trackside noise barriers in the street would interfere with traffic and pedestrian movements.

All the buildings that are severely impacted are in close proximity to special trackwork. The use of wayside noise barriers is not feasible as a noise mitigation measure for any of these buildings, which are

located along the at-grade sections of the alignment. Therefore, those buildings that are projected to be severely impacted will be sound insulated to reduce the interior noise levels from the train operations and mitigate noise impacts. The sound insulation will use the Housing and Urban Development (HUD) interior Ldn=45 dBA as the reference value for noise reduction. All occupied spaces within severely impacted buildings will be provided with sound insulation to achieve an interior noise level of Ldn=45 dBA or lower.

Operational Measure	System Benefit
Rail Grinding and Replacement	As rails wear, both noise levels from light rail by-passes and vibration levels can increase. By grinding down or replacing worn rail, noise and vibration levels will remain at the initial operating levels. Rail grinding or replacement is normally performed every three to five years.
Wheel Truing and Replacement	Wheel truing is a method of grinding down flat spots (commonly called "wheel flats") on the light rail's wheels. Flat spots occur primarily because of hard braking. When flat spots occur they can cause increases in both the noise and vibration levels produced by the light rail vehicles.
Vehicle Maintenance	Vehicle maintenance includes performing scheduled and general maintenance on items such as air conditioning units, bearings, wheel skirts, and other mechanical units on the light rail vehicles. Keeping the mechanical system on the light rail vehicles in top condition will also help to control noise and vibration levels.
Operator Training	Operators will be trained to maintain light rail travel speeds at those speeds given in the operation plan and to avoid "hard-braking" whenever possible. As stated, "hard-braking" can cause wheel flats and may also damage track. Furthermore, by training operators to identify potential wheel flats and other mechanical problems with the trains, proper maintenance can be performed in a more timely manner.

The potential for wheel squeal has been identified at those locations where the trackwork has a radius curve of less than 200 feet. Since it is only possible to anticipate, but not to predict the occurrence of wheel squeal, mitigation measures will be immediately available to treat a potential problem as soon as pre-revenue system operations begins. These measures for controlling wheel squeal include:

- ◆ Dry-stick friction modifiers. Apply friction modifiers on the wheel tread or directly on the running surface of the rail.
- ◆ Lubrication. Wayside lubrication applied to the rail gauge face and wheel flange.
- ◆ Optimize rail and wheel profiles. It is often possible to reduce levels of wheel squeal through modifications to the rail and wheel profiles.

Mitigation measures for the ventilation fan noise and the train passby noise transmitted from the vent shaft will consist of sound attenuators on the air inlet and outlet of the ventilation fans and sprayed-on sound absorptive treatment within the vent shafts. Noise levels will be mitigated to the MTA Systemwide Noise Criteria maximum noise levels.

Noise control measures used to meet the MTA Systemwide Noise Criteria for ancillary facilities will include locating these facilities in non-sensitive commercial or industrial areas, fully enclosing emergency power generating equipment and traction power substations in masonry buildings with sound rated doors or gates, high grade engine exhaust mufflers for diesel engine generators, and providing sound attenuation on all ventilation openings of any ancillary facility buildings.

### ***Ground-Borne Noise and Vibration***

Vibration impacts will be mitigated to the FTA criteria using one of the trackwork design measures described below, in addition to the operation mitigation measures presented in Table 4.8-9. The actual form of mitigation will be selected during final design.

- ◆ At-Grade Sections – An elastomeric trackwork isolation mat will be installed under the concrete supporting the embedded trackwork at those locations where ground-borne vibration impacts have been projected. The trackwork mat will be used for both tangent track and special trackwork.
- ◆ Tunnel Sections – A high resilience (soft) direct fixation fasteners will be used in the underground subway tunnel at those locations where ground-borne vibration and ground-borne noise have been projected.

### ***Significance of Impacts Remaining After Mitigation***

Residual impacts after mitigation are those that would remain either because no mitigation is proposed for a substantial impact or because the impacts will not be fully mitigated by proposed mitigation. All severe noise impacts will be mitigated by either sound insulating those noise-impacted buildings to an interior noise level of  $L_{dn}=45$  dBA or lower. Mitigation measures for moderate noise impacts will not be feasible because the alignment will be operating in a shared right-of-way with traffic vehicles. Noise impacts from ventilation fans, ancillary facilities, and wheel squeal will be mitigated to a level where they will meet the MTA Systemwide Noise Criteria for ventilation and ancillary facilities and the APTA guidelines for wheel squeal. It is expected, that during final engineering, when more information is known on the design of the project, that noise impacts related to these activities could be fully mitigated to a level of no significance. Vibration impacts, both ground-borne noise and vibration, will be fully mitigated to a level of no significance.

#### **4.8.4.2 Option B**

Mitigation measures will be the same as Option A with the exception of the proposed Kaiser Medical Center. The medical center may have vibration sensitive equipment or activities that will be affected by ground vibration. During preliminary and final engineering MTA will coordinate with the Kaiser Medical Center to further study this issue and to ensure that potential ground vibration impacts will not interfere with any sensitive medical equipment or surgical activities. The ground-borne vibrations at this location will be mitigated to a level that is below the FTA vibration criteria of 72 VdB for occupied spaces and for vibration sensitive equipment and medical instrumentation to a level that is below the manufacturer's recommended sensitivity threshold.

### ***Significance of Impacts Remaining After Mitigation***

Same as Option A.

## 4.9 GEOLOGIC AND SEISMIC CONDITIONS

### 4.9.1 Affected Environment

This section summarizes the geologic setting and the general topographic, geologic materials, groundwater features, and faults and seismic characteristics of the study area.

#### 4.9.1.1 Geologic Setting

The study area is located in the north-central portion of the Los Angeles Coastal Plain. The coastal plain is an alluviated lowland area that is bounded on the north by the Santa Monica Mountains and the Elysian, Repetto, and Puente Hills; and on the east and southeast by the Santa Ana Mountains and the San Joaquin Hills. A deep structural basin underlies the coastal plain. Parts of the basin have undergone deposition of sediments since late Cretaceous time and continuous marine deposition and subsidence of the basin have been ongoing since middle Miocene time. Numerous oil fields are located in the basin and within the study area.

The study area is located along the southern flank of the Elysian and Repetto Hills and generally traverses a dissected Pleistocene age terrace in an east-west direction. The Los Angeles River traverses the LRT Build Alternative. Younger Holocene age (within the last 11,000 years) alluvial deposits are present in the vicinity of the river.

Regionally, the study area is in the Peninsular Ranges geomorphic province, which is characterized by northwest-trending mountain ranges separated by sediment-floored valleys (Yerkes et al., 1965). The northwest trend is further indicated by the dominant geologic structural features of the province, which include northwest to west-northwest trending faults and fault zones such as the Newport-Inglewood fault zone and the Whittier fault zone.

The study area is underlain by the Elysian Park Thrust, which is generally accepted as the source of the 1987 Whittier Narrows earthquake. This thrust fault is a concealed, deep thrust fault that, in part, expresses itself at the surface as the Elysian Park Hills and the Repetto Hills and results in active folding along the trace of the Coyote Pass Escarpment. The escarpment is a gentle south-facing and east-west trending topographic feature northeast of downtown Los Angeles (Woodward-Clyde Consultants, Seih, 1997, 1998). The result of the fault investigations along the Coyote Pass Escarpment performed for the project indicate that this structure is active, resulting in monoclinial folding and deformation of the near-surface alluvial deposits and the underlying Fernando Formation and Puente Formation bedrock.

#### 4.9.1.2 Topography

The Los Angeles Coastal Plain slopes gently southward toward the ocean. The gently sloping topography is interrupted by the Palos Verdes Peninsula in the southwest, a northwest-trending series of low-lying hills (associated with the Newport-Inglewood fault zone) in the west, and the Coyote Hills in the northeastern portion of the coastal plain, respectively. Along the LRT Build Alternative, the topography generally slopes gently to the south or south-southwest. The exception is in the area between the Los Angeles River and Atlantic Boulevard where the topography consists of low-lying hills.

#### 4.9.1.3 Geologic Materials

The LRT Build Alternative traverses the physiographic features known as the Downey Plain (west of the Los Angeles River) and the Montebello Plain (east of that river) and numerous river and stream drainages. The Downey and Montebello Plains are mantled by Pleistocene age terrace and alluvial



deposits and form an alluvial fan originating from the Repetto and Merced Hills. These hills are comprised of sedimentary bedrock of the Pliocene age Fernando Formation. The bedrock that underlies the LRT Build Alternative consists of the Fernando Formation and the older Miocene age Puente Formation. The numerous river and stream drainages that are traversed by the alignment dissect the Downey Plain and the Montebello Plain and include the Los Angeles River. These drainages are in-filled with Holocene age alluvial deposits. Locally, artificial fills mantle the Pleistocene age terrace deposits and Holocene age alluvial deposits.

#### **4.9.1.4 Groundwater**

Groundwater levels vary beneath the project alignment. Groundwater levels east of Lorena Street have been historically greater than 50 feet beneath the existing ground surface. Groundwater levels west of Lorena Street have been previously documented in geotechnical reports by GeoTransit Consultants (1995, 1996a, 1996b, 1996c, 1996d). The measured groundwater levels along the tunnel sections and portals generally range from approximately 25 to 85 feet below ground surface (BGS). Assuming the groundwater levels during construction are the same as the most recently measured data, the portion of the tunnels approximately between State and Dacotah Streets will be partly or entirely below the groundwater levels. The groundwater levels measured at the 1<sup>st</sup>/Boyle Station area were 50 to 60 feet BGS, which is about two (2) feet above the planned bottom of the station. Groundwater level measurements in borings and monitoring wells at the 1<sup>st</sup>/Soto Station indicate that the current groundwater level at the station is at about 24 feet BGS; about 30 feet above the bottom of the proposed station structure. Based on review of groundwater levels at the 1<sup>st</sup>/Lorena Station location, groundwater levels are expected to range from 82 feet BGS at the west end of the station to 62½ feet BGS at the east end. Potentially perched groundwater conditions were observed in recent and previous investigations and may be locally present along portions of the alignment.

#### **4.9.1.5 Subsurface Gases**

Based on maps from the California Division of Oil and Gas, the LRT Build Alternative will traverse two existing oil fields. Also, based on available publications and subsurface information from previous geotechnical investigations in the vicinity of the proposed tunnel segment, there is documented subsurface methane and hydrogen sulfide gases, free oil and tar, and petroliferous bedrock in the area between Union Station and the Los Angeles River. Further discussion of subsurface gases is included in Section 4.10.

Recent investigations for the LRT Build Alternative have not found significant measurements of methane or hydrogen sulfide gases. At the time the Draft SEIS/SEIR was written, site-specific geotechnical investigations had not been initiated, and results of the investigation for the suspended project were used. Since May, 2001 borings and monitoring wells have been placed along 1<sup>st</sup> Street, and gas concentrations monitored. Data thus far shows that the highest methane level measured was 1,700 parts per million (ppm), in one location. The lower explosive limit for methane is 50,000 ppm. All other locations were below 100 ppm. No hydrogen sulfide gas has been measured in the borings for the 1<sup>st</sup> Street alignment to date.

#### **4.9.1.6 Corrosivity**

Based on results of chemical testing performed as part of the previous investigations for the suspended Metro Red Line project (GeoTransit Consultants, 1996a, 1996b, 1996c, 1996d), subsurface materials along the LRT Build Alternative are classified as corrosive to severely corrosive to metals and moderately deleterious to concrete.

#### 4.9.1.7 Faults and Seismicity

The numerous faults in Southern California include active, potentially active, and inactive faults. The criteria for these major groups are based on criteria developed by the California Division of Mines and Geology (CDMG) for the Alquist-Priolo Earthquake Fault Zoning Program (Hart, 1997). By definition, an active fault is one that has had surface displacement within Holocene time (about the last 11,000 years). A potentially active fault is a fault that has demonstrated surface displacement of Quaternary age deposits (last 1.6 million years). Inactive faults have not moved in the last 1.6 million years. A list of nearby active and potentially active faults and the distance in miles between the LRT Build Alternative and the nearest point on the fault, the maximum magnitude, and the slip rate for the fault is listed in Table 4.9-1.

Figure 4.9-1 shows the locations of major faults and earthquake epicenters in southern California. Several earthquakes of moderate<sup>8</sup> to major magnitude have occurred within the last 65 years that have produced significant ground shaking in the vicinity of the study area. The earliest of these was the March 10, 1933 magnitude 6.4 Long Beach earthquake. The epicenter of this earthquake was located about 26 miles south-southeast of the proposed alignment. The epicenter of the February 9, 1971, San Fernando earthquake, magnitude 6.6, was about 26 miles north-northwest of the LRT Build Alternative. Surface rupture occurred on various strands of the San Fernando fault zone as a result of this earthquake, including the Tujunga and Sylmar faults. The magnitude 5.9 Whittier Narrows earthquake occurred on October 1, 1987, on a previously unrecognized fault, now believed to be the Elysian Park Thrust. The earthquake epicenter was located about 2.4 miles north of the proposed alignment. The Sierra Madre earthquake occurred on June 28, 1991, along the Sierra Madre fault zone. The epicenter of the magnitude 5.8 earthquake was located in the San Gabriel Mountains about 17 miles north-northeast of the alignment.

On June 28, 1992, two major earthquakes occurred east of Los Angeles. A magnitude 7.5 earthquake occurred in the High Desert region and is known as the Landers earthquake. The epicenter was located about 91 miles east-northeast of the LRT Build Alternative. The second event occurred near Big Bear Lake and had a magnitude of 6.6; the epicenter was about 71 miles east-northeast of the LRT Build Alternative. On January 17, 1994, a magnitude 6.7 Northridge earthquake occurred on a previously unknown blind thrust fault that is now known as the Northridge Thrust. The Northridge Thrust is located beneath the majority of the San Fernando Valley and is considered to be the eastern extension of the active Oakridge fault. The epicenter of the Northridge earthquake was located about 20 miles northwest of the LRT Build Alternative. Most recently, the magnitude 7.1 Hector Mine earthquake occurred on October 16, 1999. The earthquake is believed to have occurred on the Lavic Lake fault, previously thought to have been inactive.

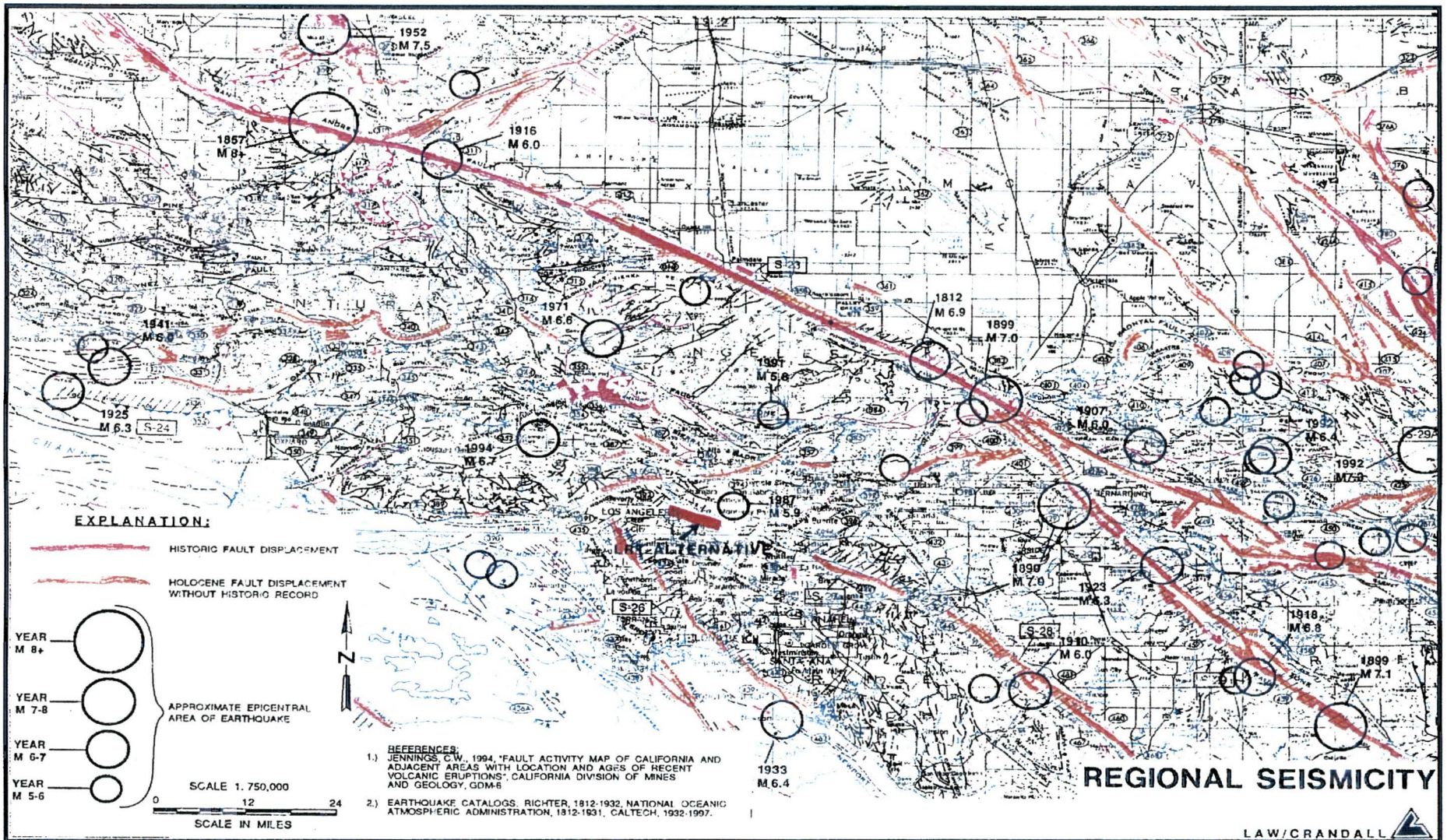
#### 4.9.2 Methodology for Impact Evaluation

Categories of potential geotechnical impacts are set forth by the California Environmental Quality Act (CEQA), the California Public Resources Code, and State CEQA Guidelines. Potential impacts associated with geotechnical considerations have been identified from a review of available published and unpublished geotechnical literature pertinent to the proposed project. These include, but are not limited to: the safety elements of the general plans for the City and County of Los Angeles, and the Cities of Commerce and Montebello aerial photographs; Official Alquist-Priolo Earthquake Fault Zone Maps; Official Seismic Hazard Zone Maps; geologic and topographic maps and other publications by the California Division of Mines and Geology, U.S. Geological Survey, and California Division of Oil and Gas; Wildcat Oil and Gas Maps; and available geotechnical reports pertinent to the project.

<sup>8</sup> Moderate earthquakes are those with magnitudes of 6.0 to 6.9; major earthquakes are those with magnitudes of 7.0 to 7.9; great earthquakes are those with magnitudes of 8.0 or greater (California Division of Mines and Geology, 1986).

**TABLE 4.9-1  
MAJOR NAMED FAULTS CONSIDERED TO BE ACTIVE<sup>1</sup>  
OR POTENTIALLY ACTIVE<sup>1</sup> IN SOUTHERN CALIFORNIA**

Fault (in alphabetical order)	Maximum Magnitude <sup>2</sup>	Fault Type <sup>6</sup>	Slip Rate (mm/r.)	Approximate Distance From LRT Build Alternative (Miles)	Direction From Alternative
<b>Considered Active:</b>					
Anacapa-Dume	7.3	RO	3.0	26	WSW
Compton-Los Alamitos Thrust	6.8	RO	1.5	4.4	SW
Cucamonga	7.0	RO	5.0	24	NE
Elsinore (Glen Ivy Segment)	6.8	SS	5.0	24	ESE
Elysian Park Thrust	6.7	RO	1.5	0.0	---
Hollywood	6.4	RO	1.0	4.5	NNW
Malibu Coast	6.7	RO	0.3	24	W
Newport-Inglewood Zone	6.9	SS	1.0	6.2	SW
Northridge Thrust	6.9	RO	1.5	15.5	NW
Oak Ridge	6.9	RO	4.0	38	NW
Palos Verdes	7.1	SS	3.0	17.5	SW
Raymond	6.5	RO	0.5	4.7	N
San Andreas (Southern Segment)	7.4	SS	24.0	33	NE
San Cayetano	6.8	RO	6.0	40	NW
San Fernando	6.7	RO	2.0	16	NW
San Gabriel	7.0	SS	1.0	17	N
San Jacinto (San Bernardino Segment)	6.7	SS	12.0	38	NE
Santa Monica	6.6	RO	1.0	9.2	W
Sierra Madre	7.0	RO	3.0	11.0	NE
Simi-Santa Rosa	6.7	RO	1.0	31	NW
Verdugo	6.7	RO	0.5	7.0	N
Whittier	6.8	SS	2.5	1.8	NNE
<b>Considered Potentially Active:</b>					
Fault (in alphabetical order)	Maximum Magnitude	Fault Type <sup>6</sup>	Slip Rate (mm/yr.)	Approximate Distance From LRT Build Alternative (Miles)	Direction From Alternative
Chamock	6.5 <sup>1</sup>	SS	0.1	11.0	SW
Chino-Central Avenue	6.7 <sup>2</sup>	NO	1.0	19.0	E
Clamshell-Sawpit	6.5 <sup>2</sup>	RO	0.5	12.5	NNE
Coyote Pass	6.7 <sup>3</sup>	RO	0.1	0.2	N
Duarte	6.7 <sup>1</sup>	RO	0.1	11.5	NE
Holser	6.5 <sup>2</sup>	RO	0.4	35	NW
Indian Hill	6.6 <sup>3</sup>	RO	0.1	14.0	NE
Los Alamitos	6.2 <sup>3</sup>	SS	0.1	11.0	SSW
MacArthur Park	5.7 <sup>4</sup>	RO	3.0	0.8	WSW
Northridge Hills	6.6 <sup>3</sup>	SS	1.2	17.5	NW
Norwalk	6.7 <sup>1</sup>	RO	0.1	5.2	SSW
Overland	6.0 <sup>1</sup>	SS	0.1	9.5	SW
San Jose	6.5 <sup>2</sup>	RO	0.5	14.5	NE
Santa Cruz Island	6.8 <sup>2</sup>	RO	1.0	57	W
Santa Susana	6.6 <sup>2</sup>	RO	5.0	24	NW
<sup>1</sup> Stemmons, 1979. <sup>6</sup> SS=Strike Slip      NO=Normal Oblique      RO=Reverse Oblique					
<sup>2</sup> CDMG, 1996.					
<sup>3</sup> Mark, 1977.					
<sup>4</sup> Hummon et al., 1994					
<sup>5</sup> Wesnousky, 1986.					



Los Angeles Eastside Corridor SEIS/SEIR

**Regional Seismicity**

Figure 4.9-1



The analysis of potential geologic and seismic impacts along the project alignment was determined specifically from: 1) the Los Angeles County Seismic Safety Element (1990); 2) the City of Los Angeles Safety Element (1996); 3) the Seismic Hazard Zone Maps published by the California Division of Mines and Geology (1999); 4) Alquist-Priolo Earthquake Fault Zone Maps; and 5) reports prepared for the MTA for the suspended Metro Red Line project and other Law/Crandall projects in the vicinity.

The determination of significance was based on guidelines established by CEQA. Per Section 15358 of the CEQA Guidelines, a significant geotechnical impact on the environment is defined as a substantial or potentially substantial adverse change in the physical environment due to the LRT Build Alternative. A significant impact on the project is defined as one having a substantial or potentially substantial adverse effect on the LRT Build Alternative.

### **4.9.3 Impacts**

#### **4.9.3.1 No-Build Alternative**

No impacts are anticipated as a result of the No-Build Alternative.

#### **4.9.3.2 LRT Build Alternative**

##### *Option A*

Potential operational impacts are discussed below, generally in order of significance.

##### Corrosivity

Subsurface materials along the underground segment of the project are classified as corrosive to severely corrosive to ferrous metals and non-deleterious to concrete. Subsurface materials along the at-grade portion of the project are classified as corrosive to severely corrosive to ferrous metals and moderately deleterious to concrete. The corrosivity of subsurface materials is anticipated to have a potentially significant impact under CEQA on Option A, depending on materials selected for construction of underground segments.

##### Groundwater

Shallow and perched groundwater may be encountered above design elevations for tunnels and underground stations, creating hydrostatic pressure on tunnel sections and station walls and floors below the groundwater table. Groundwater is anticipated to have a potentially significant impact under CEQA on Option A.

##### Ground Shaking

Significant ground shaking could occur along the proposed alignment as a result of earthquakes on any of the documented or undocumented nearby active or potentially active faults. The Seismic Shaking Hazard Map of California (CDMG, 1999) indicates the estimated peak ground acceleration with a 10 percent probability of being exceeded in 50 years in the study area ranges from 0.4g to 0.6g. The location of Option A in relation to known active or potentially active faults indicates that the alignment is not exposed to a greater seismic risk than other sites in Southern California.

MTA Design Criteria (Rail and Transit Design Criteria and Standards, 1996) requires that for important structures such as the LRT Build Alternative, special earthquake protection criteria be followed. "The

guiding philosophy of earthquake design for the Metro Rail projects is to provide a high level of assurance that the overall system will continue to operate during and after an Operating Design Earthquake (ODE).” Operating procedures assume safe shut down and inspection before returning to operation. “Further, the system design will provide a high level of assurance that public safety will be maintained during and after a Maximum Design Earthquake (MDE).” The ODE is defined as the earthquake event with a 40 percent probability of exceedance in 100 years, which corresponds to an average recurrence interval of 200 years. Such an event can reasonably be expected to occur during the 100-year facility design life. The MDE is defined as the earthquake event with a 5 percent probability of exceedance in 100 years, which corresponds to an average recurrence interval of 2000 years.

Investigations for the suspended Metro Red Line project provided site specific acceleration data, and design criteria were developed for the Little Tokyo, 1<sup>st</sup>/Boyle, 1<sup>st</sup>/Lorena, and Chavez/Soto Stations. For these stations, horizontal peak ground accelerations of 0.45g and 0.95g were the design values used for the ODE and MDE, respectively (Woodward-Clyde Consultants, 1997). Similar ground motions are anticipated for Option A, as it is nearly coincident with the suspended project. Thus, ground shaking is anticipated to have a potentially significant impact under CEQA on Option A.

#### Ground Deformation

The alignment parallels and is in close proximity of the Coyote Pass escarpment near the 1<sup>st</sup>/Soto underground station. The Coyote Pass escarpment is an area of surface deformation believed to be a result of movement along an underlying shallow thrust fault (Oskin et al., 2000). The buried thrust is considered active, and there is a potential for ground deformation (active folding) of the bedrock and the overlying alluvial sediments in the vicinity of the escarpment during the design life of the proposed project. An evaluation of the deformation potential for the Coyote Pass escarpment and its impact on the planned 1<sup>st</sup>/Soto Station was recently completed (Earth Consultants International, Inc., 2001). The results indicate that the station design should address the potential ground deformation induced by movement of the thrust fault. Therefore, ground deformation is anticipated to have a potentially significant impact under CEQA on Option A.

#### Liquefaction

Liquefaction is the transformation of submerged granular soils into a liquid-like mass due to excess pore pressure developed in response to earthquake ground shaking. Based on the investigations performed to date along the project alignment, the potential for liquefaction along both the underground and at-grade segments is considered negligible. Accordingly, liquefaction is not expected to be a significant impact under CEQA.

#### Seismically Induced Settlement

Seismically-induced settlement is often caused by loose to medium-dense granular soils densified during ground shaking. Based on the investigations performed to date, there is a potential for seismically-induced settlement along the at-grade portions of the LRT Build Alternative west of the underground segment. (The potential for seismically-induced settlement beneath the planned underground structures along the LRT Build Alternative alignment is negligible.) There is also a potential for seismically-induced settlement in localized areas of non-engineered fills. The total seismically-induced settlement of these vulnerable areas is estimated to be less than one inch, which the planned at-grade structures in these areas should be able to accommodate without damage. Accordingly, seismically-induced settlement is not anticipated to have an impact.

### Subsurface Gas

No evidence of subsurface gases was noted along the at-grade portions of the project (Group Delta Consultants, 2001). Field monitoring to date along the underground segment detected only low levels of methane gas and did not detect hydrogen sulfide gas. However, because the alignment crosses the Boyle Heights Oil Field, there exists the potential that subsurface gases such as methane and hydrogen sulfide may be encountered along the underground segment within and near the oil field. Accordingly, subsurface gas is anticipated to have a potentially significant impact under CEQA on Option A. Further discussion of subsurface gases appears in Section 4.10.

### Other

This discussion focuses on potential impacts on existing landforms, loss of mineral resources, potential for surface fault rupture, slope instability, subsidence, and inundation. Significant long-term impacts under CEQA are not anticipated in connection with any of these issues. With regard to existing landforms, tracks and stations will be located along existing streets. Tunnels and underground stations will not be visible from the surface, and the aerial structure crossing US 101 from Union Station to Alameda Street will be within an already highly developed industrial area.

Regarding loss of mineral resources, the LRT Build Alternative traverses two oil fields, the Union Station and Boyle Heights Fields. However, the access and recovery of the potential mineral resources associated with these fields will not be affected, and no loss of potential petroleum or gas resources will result from the proposed construction, especially since most of the route for the LRT alignment is located within existing street rights-of-way. All of the alignment traverses areas underlain by geologic materials such as sand and gravel that might be considered mineral resources, and which could be used as construction aggregate. However, these materials have not been previously mined in the area of the proposed alternative because of the low mineral value of these materials and their location within fully urbanized areas. Therefore, mining these materials is considered uneconomical. There is a potential for re-use of the excavated materials from the tunnels for fills.

Option A is not within, and does not traverse, a currently established Alquist-Priolo Earthquake Fault Zone for surface fault rupture hazards. The nearest Alquist-Priolo Earthquake Fault Zone, established for the East Montebello Hills fault, is located 1.8 miles to the north of Option A. Based on the available geologic data, active or potentially active faults with the potential for surface fault rupture are not known to be located within the study area. The potential for surface fault rupture due to fault plane displacement propagating to the surface across the planned LRT alignment during the design life of the project is considered low.

According to the Los Angeles County Seismic Safety Element (1990) and the City of Los Angeles Safety Element (1996), Option A is not within an area identified as having a potential for slope instability. Additionally, Option A is not located within an area identified as having a potential for seismic slope instability (California Division of Mines and Geology, 1999). There are no known landslides near the alignment, nor is it in the path of any known or potential landslides. The LRT alignment is also not within an area known to be susceptible to subsidence due to the withdrawal of fluids (petroleum or groundwater) or peat oxidation.

According to the City of Los Angeles Safety Element (1996) and the Los Angeles County Seismic Safety Element (1990), a portion of Option A in the western portion of the alignment is located within a potential inundation area (potential flood area) for an earthquake-induced dam failure from Hansen, Whittier Narrows, and Sepulveda Dams, and from Garvey Reservoir. The area is from Alameda and Banning Streets to 1<sup>st</sup> and Utah Streets. However, the referenced dams and reservoirs, as well as others in



California, are continually monitored by various governmental agencies (such as the State of California Division of Safety of Dams and the U.S. Army Corps of Engineers) to guard against the threat of dam failure. The possibility of a dam failure during an earthquake has been addressed by the California Division of Mines and Geology in the earthquake planning scenarios for a magnitude 8.3 earthquake on the San Andreas Fault zone (Davis et al., 1982) and a magnitude 7.0 earthquake on the Newport-Inglewood fault zone (Topozada et al., 1988). As stated in both reports, catastrophic failure of a major dam as a result of an earthquake is regarded as unlikely.

Current design and construction practices and ongoing programs of review, modification, or total reconstruction of existing dams are intended to ensure that all dams are capable of withstanding a maximum credible earthquake (MCE) on a nearby fault. The MCE is defined as an event with a ten percent probability of exceedance in 100 years, which corresponds to a 950-year average recurrence interval. Therefore, inundation is not anticipated to have a significant impact under CEQA on Option A. Furthermore, because the distance to the nearest retention structure is over  $\frac{3}{4}$  mile, Option A is not anticipated to impact these retaining structures nor influence their potential for causing inundation.

### Significance of Impacts

Corrosivity, groundwater, ground shaking, ground deformation, and subsurface gases are anticipated to have a potentially significant impact under CEQA on the LRT Build Alternative. Significant long-term impacts are not anticipated with regard to liquefaction, seismically-induced settlement, existing landforms, loss of mineral resources, potential for surface fault rupture, slope instability, subsidence, and inundation.

### **Option B**

The impacts and significance of the impacts are the same as described for Option A.

### **4.9.4 Mitigation**

From a geologic and seismic conditions perspective, both build Options A and B essentially are the same. Accordingly, mitigation for both options are discussed jointly as the LRT Build Alternative.

Measures to address corrosivity and groundwater will include:

- ◆ Concrete resistant to sulfate exposure and corrosion protection for metals will be used where required for underground structures in areas where corrosive groundwater or soil could potentially cause deterioration of tunnel liners and station walls.
- ◆ Tunnel liners and station walls and floors below groundwater will be designed for hydrostatic pressures and to minimize water leakage according to MTA Design Criteria and Standards.

The ground shaking hazard is common in Southern California, and structural elements will be designed to resist or accommodate appropriate site-specific ground motions and to conform to MTA Design Standards. In addition, portions of the LRT Build Alternative impacting bridge structures under the jurisdiction of the California Department of Transportation (Caltrans) will be designed to conform to Caltrans Design Standards.

Site-specific studies are currently being undertaken to determine the anticipated ground displacement (racking displacement) at underground station locations due to the MDE and ODE ground motions. The design of the underground station locations will incorporate mitigation measures for the anticipated site-specific ground displacement. Operational elements of the existing Red Line system are also designed to

detect and respond automatically during earthquakes. If sensors detect ground shaking over a prescribed acceleration, the Emergency Gas Operations System (EGOP) is activated. This activates an uninterruptible power supply (UPS) is in place such that, in the event of an earthquake and the local (DWP) supply is interrupted, the subway lighting and ventilation systems will operate for several hours. Back-up power generators can be activated if power is lost beyond this time. Train operators will be instructed by the Rail Operations Center to reduce speed and bring trains to the nearest station if possible.

To address potential impacts from ground deformation, the design will comply with standards set forth in the MTA Design Criteria and Standards, using the MDE criteria described in Section 4.9.3.2. The amount of ground deformation corresponding to the MDE design event was estimated based on the results of the project-specific evaluation of deformation potential for the Coyote Pass escarpment discussed in Section 4.9.3.2. The 1<sup>st</sup>/Soto Station will be designed to accommodate the estimated ground deformation corresponding to the MDE design event.

A barrier system similar to that designed for the suspended Metro Red Line project or the existing Red Line System will provide the primary protection from hazardous gases during operations. Further discussion of hazardous subsurface gases and liner design is contained in Section 4.10.

#### **4.9.4.1 Significance of Impacts Remaining After Mitigation**

The mitigation measures would reduce impacts to less than significant.

## 4.10 HAZARDOUS MATERIALS

### 4.10.1 Affected Environment

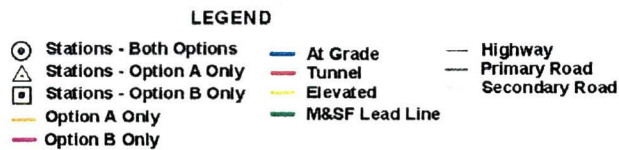
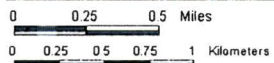
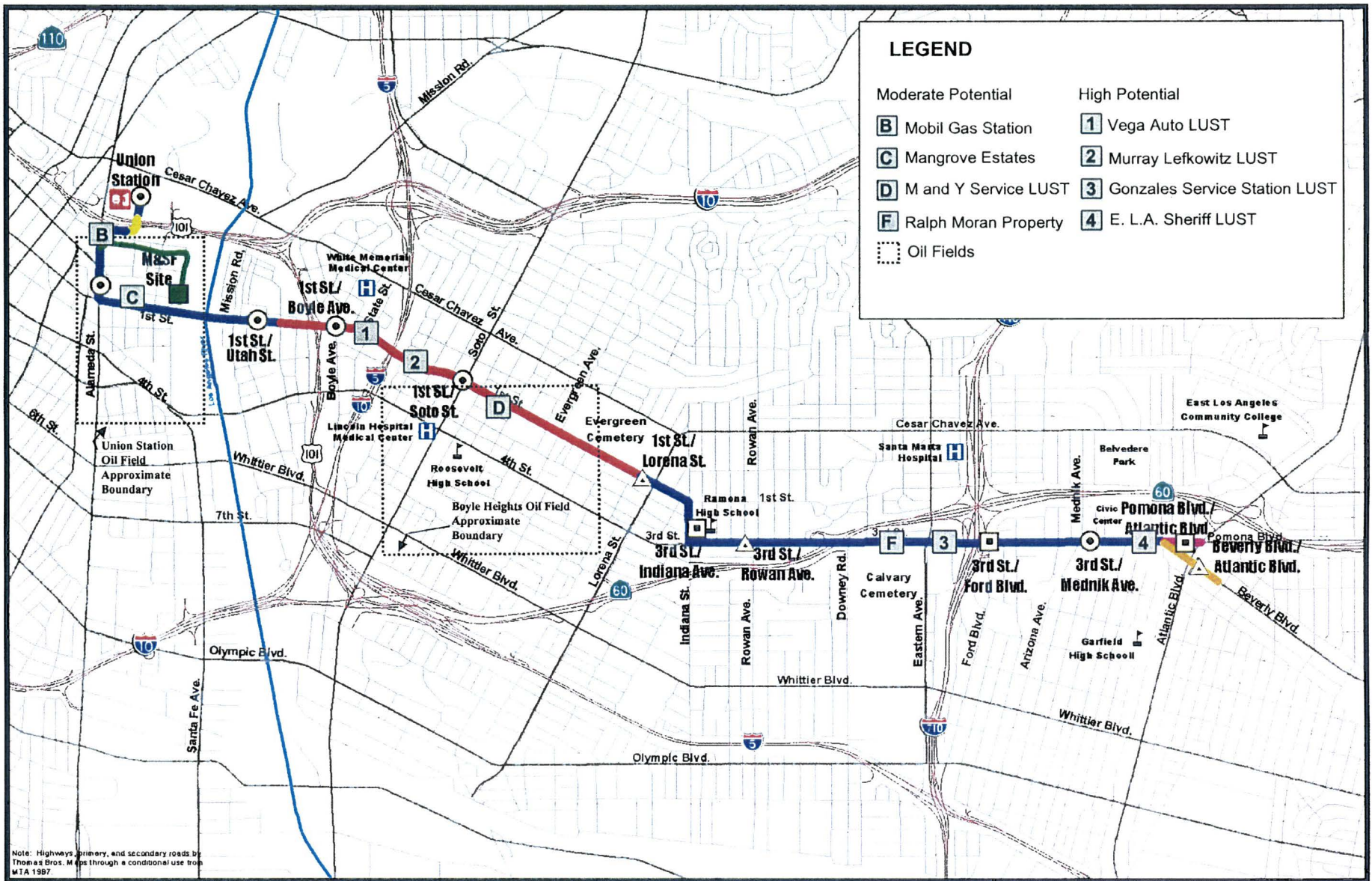
#### 4.10.1.1 Regulatory Setting

Hazardous substances are defined as substances, materials or waste, the exposure to which results, or may result, in adverse effects on health or safety. This generally includes substances defined as hazardous substances under the federal Comprehensive Environmental Response, Compensation and Liability Act of 1980 (CERCLA) and under Sections 25316 and 25317 of the California Health and Safety Code, which identifies substances, materials, or waste requiring hazardous substance removal, including petroleum and petroleum by-products, waste oil, crude oil, and natural gas. Other pertinent regulations include the Resource Conservation and Recovery Act, the Clean Water Act, and any Department of Transportation standards.

#### 4.10.1.2 Study Area Setting

The LRT Build Alternative traverses urbanized areas containing small commercial buildings, parking lots, gasoline stations, and interspersed residential developments. The potential for encountering pre-existing hazardous waste materials is present during any construction project, particularly within an urban area. Although no hazardous substances were reported in the recent explorations and monitoring along the underground segments of the LRT Build Alternative (Law/Crandall, 2001), it is possible that some hazardous substances, such as natural gases and petroleum contaminated soil and ground water, may be encountered between boring locations and below boring depths. Field monitoring of gas probes and laboratory test results to date indicate low levels of methane gas and hydrogen sulfide gas concentrations below detectable levels. The highest methane level measured was 1,700 parts per million (ppm), in one location. (The lower explosive limit for methane is 50,000 ppm). All other locations were below 100 ppm. No hydrogen sulfide gas has been measured in the explorations and monitoring to date for the underground segment. Explorations performed to date have not encountered evidence of abandoned oil well and pipe casings or mud pits. Nonetheless, because the underground segment of the alignment traverses the Boyle Heights oil field, there exists a potential for local soils and water inflows (between explorations and monitoring locations to date) to be contaminated with oil field related contaminants that, if encountered, will require treatment and disposal to approved facilities.

Recent explorations for the at-grade portions of the LRT Build Alternative (Group Delta Consultants, 2001) did not encounter groundwater or subsurface gases. Although soil contamination was encountered, the concentrations were low enough to be considered non-hazardous and would require remediation only for off-site disposal. Unidentified petroleum deposits may be encountered (between explorations and monitoring locations to date) during excavation of the tunnel and deep foundations for the aerial structure, which is planned to be adjacent to the Union Station oil field. The numerous potential sources of petroleum based contamination and migration of the contaminants via ground water flow could make it difficult to precisely determine the impacted areas. Further environmental testing for this section of the LRT Build Alignment is currently in progress. Figure 4.10-1 and the following discussion present the former oil fields and sources of potential hazardous substances by project segment that were identified through the regulatory search.



Los Angeles Eastside Corridor SEIS/SEIR

**Sites with Potential  
for Environmental Hazards**

Figure 4.10-1

- ◆ Resource Conservation and Recovery Information System (RCRIS) including transport, storage, and disposal (TSD) facilities;
- ◆ California Department of Health Bond Expenditure Plan (BEP) for Hazardous Substance Clean-up;
- ◆ California Environmental Protection Agency and the Department of Toxic Substances (CAL-SITES);
- ◆ California Regional Water Quality Control Board, Leaking Underground Storage Tank (LUST) Listings; and
- ◆ Underground Storage Tank (UST) Listings.

Potential impacts are defined as the potential exposure of human health and/or wildlife to hazardous waste or naturally occurring petroleum compounds by project activities or an increase in the likelihood of hazardous substance or petroleum compound migration. The operational and construction activities are most likely to encounter pre-existing hazardous substances where subsurface construction activity will be required near:

- ◆ Known formerly active oil fields, or
- ◆ Areas with known historic soil and groundwater contamination, gasoline stations, auto repair facilities, dry cleaners, and commercial manufacturing, or shipping facilities.

To assist in identifying the potential impacts, each contaminated or potentially contaminated site that was identified with respect to its proximity to the LRT Build Alternative was classified as high, moderate, or low based on its potential for detrimental environmental impacts. The classification of each site is based on type of operation, proximity to the alignment, anticipated hydrogeologic gradient, field observations, and historical and regulatory information. In general, the classification criteria is:

- ◆ High – sites with known or probable soil/groundwater contamination (e.g. LUSTs), and sites where remediation is incomplete or undocumented.
- ◆ Moderate – sites with identified or potential soil contamination (e.g. LUSTs), remediation is in progress, or groundwater contamination that does not appear to be migrating.
- ◆ Low – sites that have completed remediation or have historically utilized only small amounts of known contaminants (e.g., Resource Conservation and Recovery Act Information System [RCRIS] small quantity generators or underground storage tanks).

#### **4.10.3      Impacts**

##### **4.10.3.1    No-Build Alternative**

No impacts are anticipated as a result of the No-Build Alternative.

##### **4.10.3.2    LRT Build Alternative**

###### ***Option A***

Potential impacts along the LRT Build Alternative would include migration of subsurface gases into the

local soils and water inflows to be contaminated with oil field related contaminants (i.e., hydrocarbons, hydrogen sulfide, etc.) that, if encountered, will require treatment and disposal to approved facilities.

#### Significance of Impacts

Although unlikely, the migration of subsurface gases into the tunneled portions of the alignment and migration of future soil contamination could be potentially significant under CEQA.

#### **Option B**

The impacts of Option B are the same as Option A. Although Option B's at-grade alignment along Indiana Street is offset slightly to the east, the difference is not significant with respect to environmental contamination. Similarly, the eastern terminus for Option B is anticipated to encounter essentially the same geo-environmental conditions as the eastern terminus for Option A.

#### Significance of Impacts

Although unlikely, the migration of subsurface gases into the tunneled portions of the alignment and migration of future soil contamination could be potentially significant under CEQA.

#### **4.10.4 Mitigation**

The mitigation measures for Options A and B will be the same. Therefore, the measures are discussed collectively for both options as mitigation for the LRT Build Alternative. The operation of the tunneled elements will require addressing infiltration of hazardous gases and providing adequate ventilation procedures to maintain a safe environment. These issues are discussed below.

##### **4.10.4.1 Monitoring**

To detect and identify hazardous gases, the following measures will be implemented:

- ◆ Installation of automatic gas detection systems, including discrete sensors throughout the system, to allow early detection of infiltrating hazardous gases. Alert levels would be set well below dangerous concentrations.
- ◆ Emergency ventilation systems would automatically activate upon gas detection at alert levels.
- ◆ Installation of audible and visible alarm systems would alert employees when gases are detected.

##### **4.10.4.2 Ventilation**

Ventilation systems similar to those provided in the operating Metro Red Line System would:

- ◆ Provide an adequately sized ventilation system to prevent accumulation of hazardous gases.
- ◆ Provide an auxiliary ventilation system to rapidly evacuate hazardous gases.
- ◆ Prepare and implement a ventilation plan to provide adequate fresh airflow into the tunnels.

##### **4.10.4.3 Gas Barriers**

A barrier system, which includes use of bolted, gasketed, pre-cast tunnel liners, similar to that designed for the suspended Metro Red Line project or the existing Red Line System will provide the primary protection from hazardous gases during operations. This type of system has been found to be effective in

minimizing migration of hazardous gases. Refer to the separate *Hazardous Materials Technical Report* and *Addendum to the Hazardous Materials Technical Report* that were prepared for the Eastside Corridor for additional information about the effectiveness of this system. Additionally, natural ventilation, ventilation created by train movements, and ventilation fans will be provided in the stations and tunnels to mitigate migration of hazardous gases during operation.

#### **4.10.4.4 Safety and Security**

A comprehensive health and safety and emergency response plan will be developed to meet the City and County of Los Angeles standards, and will be coordinated with the City and County Fire Departments. MTA Fire Life Safety Committee, composed of members from the Los Angeles City and County Fire Departments, as well as MTA safety specialists, will approve the plan. At a minimum, the plan will address air monitoring, health risk assessment, refuge centers or tunnel cross passages, escape routes, communication, and training.

#### **4.10.4.5 Significance of Impacts Remaining After Mitigation**

The mitigation measures would reduce impacts to less than significant.

## 4.11 WATER RESOURCES

### 4.11.1 Affected Environment

#### 4.11.1.1 Regulatory Setting

There are several Federal and State laws and regulations that provide for the protection of water and water-related resources. The following is a listing of the applicable laws and the agencies responsible for protection of the water resources.

##### *Federal*

The United States Army Corps of Engineers (COE) under Section 404 of the Clean Water Act is responsible for a permit program for the discharges of dredged or fill material into waters of the U.S. The current plans for the Los Angeles Eastside Corridor does not call for discharge of any dredged or fill material into the Los Angeles River.

##### *State*

The State Water Resources Control Board, under Section 402 of the Clean Water Act, establishes a permitting system for the discharge of any pollutant (except for dredge or fill) into the waters of the United States. The permit is also called the National Pollution Discharge Elimination System (NPDES) permit. In California, the Regional Water Quality Control Board (RWQCB) oversees the permitting process. The jurisdiction of the RWQCB relative to the NPDES permits extends to "waters of the U.S." which is defined as: (1) navigable waters, (2) tributaries of navigable waters, and (3) wetlands. Potential project impacts on the Los Angeles River may include construction activities related to seismic strengthening of existing roadway bridges, and the discharge from dewatering activities related to structures or below ground rail construction.

The California Department of Fish and Game (CDFG) under Sections 1601 through 1603 of the California Fish and Game Code requires agencies to notify the CDFG of "...any project which will divert, obstruct or change the natural flow of bed, channel or bank of any river, stream, or lake designated by the department in which there is at any time an existing fish or wildlife resource or from which these resources derive benefit, or will use material from the streambed designated by the department..." Seismic retrofitting of the bridge may occur for the 1<sup>st</sup> Street Bridge over the Los Angeles River. Such activity may classify the project as being within the CDFG's jurisdiction regarding Section 1601. If required, MTA will work in cooperation with the CDFG to obtain project clearances.

##### *Local*

The Los Angeles River is designed and owned by the COE and maintained by the County of Los Angeles. No further flood control permitting activity is required with the City of Los Angeles regarding the river crossing, although any construction on the 1<sup>st</sup> Street Bridge would require a Public Works Permit from the City's Department of Public Works. MTA will work in cooperation with the regulating agencies and will obtain any required permits prior to construction. Because the Los Angeles River is maintained by the County, any activity in the waterway would require a permit from the County's Department of Public Works. The project would not require the placement of additional bridge piers into the waterway.



#### 4.11.1.2 Study Area Setting

##### *Surface Water*

##### General Watershed Conditions

The Los Angeles River, which runs from north to south along the western portion of the project area, is the only major surface water feature in the project area. The area adjacent to the river is densely populated with residential, commercial, and industrial development. Surface runoff has increased as a consequence of the impervious surfaces related to the development. Peak runoff rates for the coastal plain areas have also increased due to elimination of natural ponding areas and improved hydraulic efficiency of water carriers such as streets and storm drain systems.

The topography of the coastal plain is gradually sloped from the foothills of the San Gabriel Mountains to the Pacific Ocean with a few exceptions of rising hills and depressed areas. Ground elevations range from 10,000 feet in the San Gabriel Mountains, to 330 feet near the Arroyo Seco confluence, to mean sea level at the mouth of the Los Angeles River. The average annual rainfall ranges from 13.8 inches at the ocean to 28.2 inches in the San Gabriel Mountains. Two prominent hill formations are located in the lower reach of the Los Angeles River watershed, the Dominguez Hills on the west side of the river about four miles north of the coast (elevation 200 feet), and Signal Hill in the city of Long Beach (elevation 110 feet).

The soil is considered alluvial and varies from coarse sand and gravel to silty clay and gravel or clay. The land is generally well drained with relatively few perched water or artesian areas. Large deposits are present along the coast. Extensive pumping for oil has caused land subsidence in the lower reach. The Los Angeles River is a flood control facility emptying into the Pacific Ocean. It was not constructed to serve as conveyance for domestic water supplies. Percolation and water recharge basins are located along portions of the river, generally upstream of the Los Angeles Eastside Corridor study area.

##### Los Angeles River

The Los Angeles River originates at the western end of the San Fernando Valley in Southern California. The channel extends through the heart of Los Angeles County by flowing east to Glendale where it turns and flows south to the Pacific Ocean. The river is part of a network of dams, reservoirs, debris collection basins, and spreading grounds built (beginning in the late 1930s) by the Los Angeles County Flood Control Department (LACFCD) and the COE to minimize the flooding in the county. Through the project area, the channel has a concrete bottom and sides. The channel is trapezoidal with an additional smaller trapezoidal low flow channel. At the top of the banks the channel is approximately 250 feet wide and 25 to 30 feet deep. The low flow channel is 28 feet wide. The river flow is partially regulated by the Sepulveda, Pacoima, Big Tejuanga, Hansen, and Devil's Gate dams and by several spreading grounds, reservoirs, and debris basins located along the length of the river. The river is also subject to flow diversions from Big Tejuanga Creek, Arroyo Seco, and other domestic and irrigation diversions. The portion of the river that is located in the Los Angeles Eastside Corridor study area extends from Cesar Chavez Avenue on the north to Washington Boulevard on the south, just east of Union Station. The study area is considered in the middle reach of the Los Angeles River (the reach between U.S. Highway 101 and the confluence with the Rio Hondo River).

##### *Floodplains*

The floodplain of the Los Angeles River is extensively studied and mapped in the recent Federal Emergency Management Agency (FEMA) Flood Insurance Study for the City of Los Angeles, dated May

4, 1999. Figure 4.11-1 displays the existing defined 100-year floodplain for the Los Angeles River as presented in the current Flood Insurance Studies. The Los Angeles River basin has a long history of flooding which has caused extensive property damage and loss of lives. The major storms include January 1914, 1934, 1943, and 1956, February 1978 and 1980, and March 1938 and 1983. As previously mentioned, the portion of the river located in the study area is considered in the middle reach of the Los Angeles River. The channel capacity of the middle reach can safely convey the 100-year flow within the channel banks.

The upper reach of the Los Angeles River, the reach immediately upstream of the Los Angeles Eastside Corridor study reach, is not certified to adequately handle the 100-year flood. Overbank areas are susceptible to flooding caused by overtopping and failure of levee structures. Water escaping the channel in the left overbank of the upper reach may result from levee failure between the Santa Fe Railroad crossing and the Broadway Street Bridge immediately north of the study area. As identified on the current FEMA floodplain mapping, the 100-year flow in the Los Angeles River is fully contained in the channel at the 1<sup>st</sup> Street Bridge.

### **Groundwater**

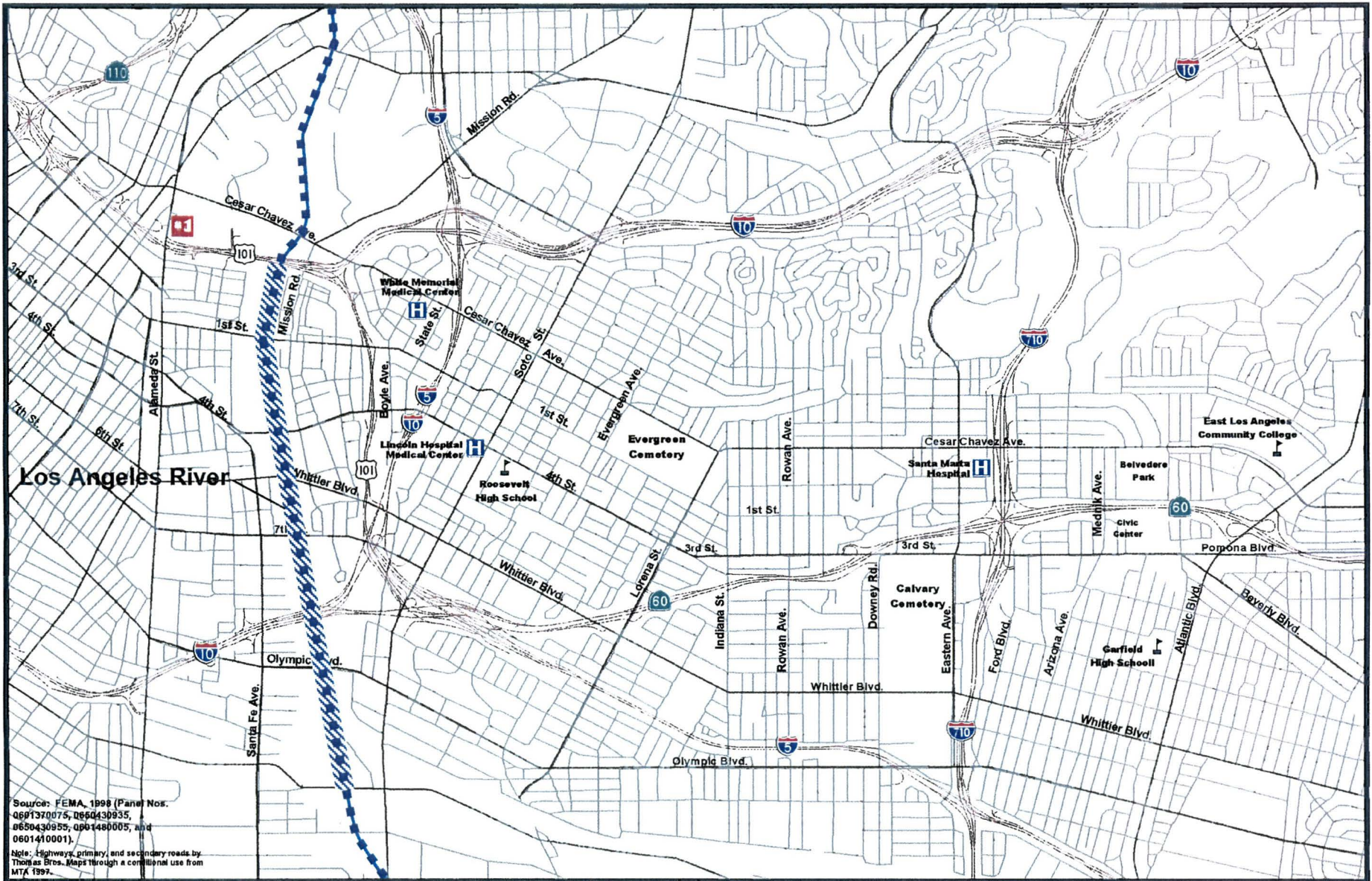
The LRT Build Alternative alignment is located in the Los Angeles Forebay groundwater area of the Central Basin along the Coastal Plain of Los Angeles County. The forebay area extends generally in a fan pattern around the Los Angeles River. The study area is underlain by the Lakewood and San Pedro (lowest) formations. The Lakewood formation is exposed on the surface of the La Brea and Montebello plains and extends underneath the recent alluvium on the Downey Plain. The aquifer in the formation, which consists of sand, sandy clay, clay, and gravel, ranges in thickness from 0 to 100 feet and extends to depths of 100 to 375 feet (up to 250 feet below sea level). This formation, which includes the Exposition, Gardena, and Gage aquifers, ranges from 0 to more than 220 feet thick in the southern part of the area. The Gage aquifer is the basal member of the Lakewood formation and rests on the underlying San Pedro formation.

The San Pedro formation is the lowest formation in the Los Angeles Forebay area. The aquifers of the San Pedro formation consist of various amounts of sand, sandy clay, clay, gravel and gravelly sand that range in thickness of 0 to 430 feet and extends to depths of 475 to 1600 feet (up to 1440 feet below sea level). This formation, which contains the Hollydale, Jefferson, Lynwood, Silverado, and Sunnyside aquifers, is about 1,050 feet thick in the Los Angeles Forebay area. The Silverado aquifer is found throughout most of the Los Angeles Forebay area and is the most significant aquifer for public water supply. This aquifer is protected from contamination from the surface by overlying low permeable strata.

The Coastal Plain of the Los Angeles County groundwater supply is consumed mainly by municipal users for drinking water and moderately by industrial and irrigation (limited use) purposes. The storage capacity of the Coastal Plain is estimated to be 31,730,000 acre-feet with a useable capacity of 2,363,000 acre-feet. Injection barriers, which consist of injection water wells along the Coastal Plain of Los Angeles County, are used by the local water agencies to control the seawater intrusion created by an overdrawn water table. This process of injecting surface water not only prevents seawater intrusion, but also contributes to the fresh water supply in the basin and thereby mitigates overdraft of water supplies.

Groundwater aquifers would be expected to be approximately 150 to 200 feet below the ground surface. Surface water sources can also contribute to the groundwater level as revealed by well data in the vicinity of the Los Angeles River. Additional information about groundwater levels can be found in Section 4.9.1.4.





Source: FEMA, 1998 (Panel Nos. 0601370075, 0650430935, 0650430955, 0601480005, and 0601410001).  
 Note: Highways, primary, and secondary roads by Thomas Bros. Maps through a conditional use from MTK, 1997.

0 0.25 0.5 Miles  
 0 0.25 0.5 0.75 1 Kilometers

**LEGEND**  
 100-year Floodplain  
 Water Resource

Los Angeles Eastside Corridor SEIS/SEIR

**Water Resources and Floodplain**

Figure 4.11-1



#### **4.11.2 Methodology for Impact Evaluation**

##### **4.11.2.1 Surface Water**

Construction and operational impacts on surface waters were assessed with regards to degradation of water quality and changes in surface water flow. Effects on future water quality, both with and without implementation of the LRT Build Alternative, have been estimated based on the potential for runoff surface water resources and the types of pollutants anticipated. Anticipated impacts have been compared to applicable water quality standards. The LRT Build Alternative would have a significant impact under CEQA on surface water resources if:

- ◆ Uncontrolled runoff from project facilities results in substantive erosion and subsequent sedimentation of downstream water bodies.
- ◆ Altered drainage patterns cause the reduction of existing vegetation.
- ◆ The project results in changes in water quality that could have human health and safety impacts.

##### **4.11.2.2 Floodplains**

An assessment of floodplains has been performed to determine the impacts of the LRT Build Alternative on identified floodplains by overlaying the project on floodplain maps and identifying areas of floodplain encroachment. An analysis has been performed on the anticipated changes in drainage patterns, potential for flooding, and structures that could be affected. The proposed alignments would have significant impacts under CEQA on floodplains if the project results in flood hazards on other properties.

The 1998 FEMA Flood Insurance Study for the Los Angeles River was reviewed to determine the boundaries of the 100-year floodplain relative to the location of the LRT Build Alternative alignment (both Options A and B). The conceptual plans for the LRT Build Alternative were also reviewed to determine if the planned design would have any effect on the floodplain. The plans were evaluated with respect to the floodplain issues defined in Federal Regulation 23 CFR 650A to determine if potential impacts are possible.

##### **4.11.2.3 Groundwater**

Under CEQA, the proposed alternatives would have significant impacts on groundwater resources if the project:

- ◆ Results in a net deficit in aquifer volume or reduction in the local groundwater table.
- ◆ Significantly reduces the area available for aquifer recharge.
- ◆ Results in changes in groundwater quality that could have human health and safety impacts.

#### **4.11.3 Impacts**

##### **4.11.3.1 No-Build Alternative**

The No-Build Alternative assumes that no improvements would be made to the Los Angeles Eastside Corridor study area beyond those already planned and approved. There would be no operation activities related to the Los Angeles Eastside Corridor project, and would therefore not affect or be affected by surface waters, floodplains, or groundwater.

#### 4.11.3.2 LRT Build Alternative

##### *Option A*

##### Surface Water

The introduction of new impervious surfaces resulting from stations and maintenance areas would increase runoff and associated contaminants, potentially resulting in some degradation of downstream water quality. Pollutants associated with transit projects include oil and grease. The highest concentration of these pollutants would be greatest following the first substantial rainfall of the season because long dry periods common to Southern California allow greater accumulation of compounds on paved surfaces than during periods of more frequent rainfall. Given that Option A would run primarily with the rights-of-way of existing streets, runoff would be collected by the storm sewer system already in place along these streets.

The Los Angeles River is the only major waterway within the LRT Build Alternative impact area. At the Los Angeles River, the LRT facility would utilize the 1<sup>st</sup> Street Bridge to cross the river. No new bridges are planned as part of Option A.

The effect on water quality would be minor because the watershed within the project corridor is urban. Since the area is urban, most of the alignment would be built on existing impervious surfaces and would not significantly alter surface water drainage patterns. The amount of impervious surfaces and additional runoff would be small compared to the region as a whole. However, surface water impacts could be potentially significant on water quality, human health, or safety unless measures are taken to control runoff.

##### Floodplains

FEMA has defined the 100-year floodplain for the Los Angeles River as illustrated in Figure 4.11-1. The floodplain issues, discussed below for Option A, are defined in Federal Regulation 23 CFR 650A as important for the consideration of impacts on floodplains.

Is the action a significant longitudinal encroachment? No. A significant encroachment is an encroachment and any direct support of likely base floodplain development that would involve construction or flood-related impacts. Option A would not be considered a longitudinal encroachment on the 100-year floodplain of the Los Angeles River. No fill will be placed in, or encroachment made to, an existing floodplain. No emergency vehicle access or evacuation routes would be affected, and no natural or beneficial floodplain values would be impacted. The transit improvements that are a part of this alternative would not significantly increase the existing depth or limits of flooding.

Are the risks associated with the action significant? No. Risk is defined as the consequences associated with the probability of flooding attributable to an encroachment. The transit improvements that are a part of this alternative would not significantly increase the existing depth or limits of flooding. The transit facility would utilize the existing 1<sup>st</sup> Street Bridge over the Los Angeles River.

Will the action support probable incompatible floodplain development? No. The project is consistent with local and regional land use and transportation planning. The defined floodplain for the Los Angeles River within the study area is predominantly within the defined, improved channel.

Is the action a significant floodplain encroachment? No. A significant encroachment is a highway encroachment and any direct support of likely base floodplain development. At the Los Angeles River

crossing, the transit facility would utilize an existing bridge over the waterway. No fill would be placed in, or encroachment made to, the existing floodplain, nor emergency vehicle access affected, nor impact natural or beneficial floodplain values. The transit facility would not significantly increase the existing depth or limits of flooding.

Are non-routine measures required to minimize floodplain impacts associated with the action? No. There are no identified significant impacts on the floodplain. No non-routine measures are required.

Are there significant impacts on natural and beneficial floodplain values? No. For Option A, no significant impacts are anticipated on natural and beneficial floodplain values. Such values include, but are not limited to: fish, wildlife, plants, open space, natural beauty, scientific study, outdoor recreation, agriculture, aquaculture, forestry, natural moderation of floods, water quality maintenance, and groundwater recharge.

Are non-routine measures required to restore and preserve the natural and beneficial floodplain values impacted by the action? No. No non-routine measures are required to restore or preserve the floodplain values.

#### Groundwater

The principal engineering problems encountered in tunneling and excavation are often related to groundwater. Groundwater entering an excavation can impede operations and reduce the strength of surrounding soils. Option A involves an underground section under 1<sup>st</sup> Street from the U.S. Highway 101 to Lorena Street. The subway section is not within the Los Angeles River 100-year floodplain.

No impacts would occur on groundwater levels or quality that is used for consumption by municipal, industrial, and irrigation purposes. During the operations phase, groundwater dewatering activities and subsequent discharge may occur. During operation, any water leaks into the tunnel would be pumped out by sump pumps as described in the mitigation measures discussion of Section 4.9.2.13. Therefore no residual impacts on groundwater are anticipated. Refer to Section 4.9 for additional information regarding impacts on groundwater during operation.

#### Significance of Impacts

Option A would have potentially significant impacts during operations on surface waters and groundwater and no impact on floodplain.

#### ***Option B***

The water resources impacts of Option B would be the same as those described for Option A.

#### Significance of Impacts

Option A would have potentially significant impacts during operations on surface waters and groundwater and no impact on floodplain.

#### **4.11.4 Mitigation**

The mitigation measures for Options A and B will be the same. Therefore, the measures are discussed collectively for both options as mitigation for the LRT Build Alternative.



During the operation of the system, water that may enter in tunnel structures and surface runoff from impervious areas will be treated before being discharged into the drainage system, and would therefore have no adverse impact on surface waters. Treatment methods will include the use of oil/water separators with siltation basins or similar equipment.

During preliminary engineering, construction, and operation of the Eastside LRT project, the MTA will strive to minimize storm water runoff within construction areas and within the parking lots and platforms of the finished project. The MTA will comply with storm water regulations of the State Water Resources Control Board (SWRCB) and the Los Angeles Regional Water Quality Control Board (LARWQCB) during construction and operation of the project. Storm water regulations applicable to the project include the General NPDES Storm Water permit program, and the use of structural best management practices (BMPs) as specified by the LARWQCB's newly adopted Standard Urban Storm Water Mitigation Plan (SUSMP). Construction, drainage, and landscaping techniques consistent with storm water runoff minimization will also be employed during construction and operation of the project. These measures are anticipated to reduce impacts on surface waters to less than significant.

No above ground or underground facilities will be located within the Los Angeles River 100-year floodplain. The LRT Build Alternative will utilize the existing 1<sup>st</sup> Street Bridge to cross the river. No mitigation related to floodplains is required.

In the event that discharge is expected, the proposed project will require preparation of a Report of Waste Discharge (ROWD), required by the State Water Resources Control Board (SWRCB) for any type of discharge affecting groundwater. This would ensure that any project-related discharges are regulated and therefore would not impact local groundwater.

Prior to excavation and construction, negotiations with the California Department of Water Resources (CDWR) and the Water Replenishment District of Southern California (WRD) will be initiated regarding water rights and pumping assessment. It is expected that coordination with CDWR and WRD will provide sufficient oversight to prevent environmental impacts due to over-withdrawing groundwater from the project area. These measures are anticipated to reduce impacts on groundwater to less than significant.

#### **4.11.4.1 Significance of Impacts Remaining After Mitigation**

The mitigation measures would reduce impacts on surface waters and groundwater to less than significant.

## 4.12 NATURAL RESOURCES AND ECOSYSTEMS

### 4.12.1 Affected Environment

#### 4.12.1.1 Regulatory Setting

Environmental laws governing biological resources relevant to the proposed project are summarized below.

##### *Federal*

**Federal Endangered Species Act (FESA).** Species listed as endangered and threatened by the U.S. Fish and Wildlife Service (USFWS) under this act are protected under this legislation. No species currently listed by FESA are expected to be affected directly or indirectly by the proposed project. Thus, although the project is a federal action under the National Environmental Policy Act (NEPA), no consultation with the USFWS under Section 7 of the FESA would be required.

**California Endangered Species Act (CESA).** This act was designed after FESA and is intended to provide additional protection to endangered and threatened species in California. No “take” of a species as defined per CESA would occur during construction or operation of the proposed project.

**Migratory Bird Treaty Act (MBTA).** The MBTA, first enacted in 1916, prohibits any person to: “pursue, hunt, take, capture, kill, attempt to take, capture, or kill, possess, offer for sale, sell, offer to barter, barter, offer to purchase, purchase . . .” any migratory bird. It is illegal under MBTA to directly kill, or destroy a nest of, nearly any bird species, not just endangered species. Activities that result in removal or destruction of an active nest (a nest with eggs or young being attended by one or more adults) would violate the MBTA. Removal of unoccupied nests, or bird mortality resulting indirectly, would not represent violations of the MBTA. However, if nesting birds are present during construction, such as under bridges, and construction activities were allowed to result in destruction of such nests, these activities may violate the MBTA.

**Section 404 of the U.S. Clean Water Act.** The objective of the Clean Water Act of 1977 is to restore and maintain the chemical, physical, and biological integrity of the nation’s waters. Section 404 of the Act regulates activities that result in discharge of dredged, fill, or excavated material into “waters of the United States.” This generally includes any waterway, intermittent stream, man-made wetland, or reservoir. Projects that include physical modification of a “water of the United States” must generally comply with Section 404 which is under the jurisdiction of the U.S. Army Corps of Engineers (Corps). Impacts on streambeds are calculated in terms of the area that would be modified between “mean high water” marks of the streambed.

##### *State*

**California Fish and Game Code Sections 1600 through 1607.** California Department of Fish and Game (CDFG) oversees streambeds and their associated habitats pursuant to Sections 1600 to 1607 of the code, which manages activities that would “substantially change” the “. . . bed, channel, or bank of any river, stream, or lake designated by the department in which there is at any time an existing fish or wildlife resource, or from which these resources derive benefit.” In addition to complying with Section 404 of the Clean Water Act, any modification of streambed habitat may require a Streambed Alteration Agreement from CDFG.

**California Fish and Game Code Sections 4150 through 4154.** CDFG's regulations address how nongame mammals may be taken. Nongame mammals include all mammals occurring naturally in California that are not game mammals, fully protected mammals, or fur-bearing mammals. These sections allow CDFG to enter into cooperative agreements with agencies of the state or the United States for the purpose of controlling nongame mammals.

**California Code of Regulations, Title 14, Natural Resources.** Under the provisions of Section 251.1, Harassment of Animals, no person is allowed to harass any game or nongame bird or mammal or fur-bearing mammal, except as otherwise authorized by regulations (such as under Section 4150 through 4154, above.) Harassment is defined as an intentional act that disrupts an animal's normal behavior patterns, which includes breeding, feeding, or sheltering. This regulation would require the project to avoid construction work on bridges if roosting bats or nesting birds are present or sign cooperative agreements with CDFG under the California Fish and Game Code Sections 4150 through 4154.

#### 4.12.1.2 Study Area Setting

##### *Vegetation*

The Eastside Corridor is located within a highly developed setting limiting vegetation to mainly ruderal and ornamental plant species. The majority of plant species found during the survey were non-native. Landscaped areas were dominated by exotic ornamental species such as date palm (*Phoenix* sp.), bamboo (*Bambusa* sp.), pine (*Pinus* sp.), ficus (*Ficus* sp.), eucalyptus (*Eucalyptus* sp.), fan palm (*Washingtonia* sp.), magnolia (*Magnolia grandiflora*), dracaena (*Dracaena* sp.), and oleander (*Nerium oleander*). Non-landscaped areas capable of supporting vegetation were dominated by invasive weedy species including black mustard (*Brassica nigra*), yellow star thistle (*Centaurea solstitialis*), and wild oats (*Avena fatua*). Sycamore (*Platanus racemosa*), a native species, was found within a landscaped site north of 1<sup>st</sup> Street.

##### *Sensitive Plants*

Prior to the survey, the most recent records of the California Natural Diversity Data Base (CNDDDB) (2000) and the California Native Plant Society's Electronic Inventory (CNPSEI) (1999) were reviewed regarding the potential presence of threatened, endangered, candidate, or other sensitive species within the study area. The results of the record searches and a characterization of suitable habitat are found on Table 4.12-1. As shown, eight sensitive plant species have the potential to occur in the vicinity of the Los Angeles Eastside Corridor. However, due to the highly developed nature along the corridor, suitable habitat for these species is not present.

##### *Wildlife*

No native mammals were observed during the site visit. The corridor runs through a highly developed area. Mammals that may utilize portions of the proposed corridor include the California ground squirrel (*Spermophilus beecheyi*), opossum (*Didelphis virginiana*), and raccoon (*Procyon lotor*). No amphibians or reptiles were observed during the survey. Reptiles that may utilize portions of the proposed corridor include the western fence lizard (*Sceloporus occidentalis*). Because of the highly disturbed nature of the Los Angeles Eastside Corridor, it is unlikely that any amphibians would occur along its length. Avian species comprised the majority of wildlife species observed onsite. Seven avian species were observed during the site visit including house finch (*Carpodacus mexicanus*), rock dove (*Columba livia*), mourning dove (*Zenaida macroura*), house sparrow (*Passer domesticus*), European starling (*Sturnus vulgaris*), American crow (*Corvus brachyrhynchos*), and Brewer's blackbird (*Euphagus cyanocephalus*).

### ***Sensitive Wildlife Species***

Prior to the survey, a record search was conducted using a current version of the CNDDDB for information on sensitive wildlife species known to occur in the vicinity of the project area. The USFWS, U.S. Forest Service (USFS), and CDFG sensitive wildlife lists were also referenced. Sensitive wildlife species include all federal and state endangered and threatened species, former federal candidate species, and California Species of Special Concern. The results of the record searches and a characterization of suitable habitat are found on Table 4.12-2. As noted, five sensitive wildlife species have the potential to occur in the vicinity of the Los Angeles Eastside Corridor. Suitable habitat for any of the above listed wildlife species does not occur in or adjacent to the project corridor. Therefore, potential for occurrence is low.

### ***Jurisdictional Waters***

One Corps/CDFG jurisdictional water body was encountered during the survey. The Los Angeles River crosses under the corridor along 1<sup>st</sup> Street in the western portion of the study area. This portion of the river has been highly modified to fit an urban setting. The stream bottom and banks consist of paved concrete, supporting no streamside vegetation. The Los Angeles River flows on a perennial basis and is fed substantially by urban runoff and treated waste water. No other features falling under the jurisdiction of the Corps or CDFG were detected during the survey. Storm drains are situated along the city streets on which the proposed project has been designed. These drains are not Corps/CDFG jurisdictional but do potentially flow into such jurisdictional waters.

The Los Angeles County Department of Public Works was contacted to determine if the Master Plan for the Los Angeles River, completed in 1996, identified wetland restoration projects. Additional information about wetland restoration was provided by the California Coastal Conservancy, which is currently working with several non-governmental agencies and community groups to implement wetland and open space projects along the Los Angeles River. North of I-10 along the Los Angeles River, several wetland restoration projects are being planned at the following locations: the mouth of Arroyo Seco, Chinatown Yard, and Taylor Yard (Kroll, 1999). Wetland restoration is also being planned north of I-10 along an abandoned rail spur that apparently used a former streambed to traverse Hazard Park west of Soto Street (Woods, 1999).

## **4.12.2 Methodology for Impact Evaluation**

### **4.12.2.1 Biological Resources**

Prior to conducting biological reconnaissance surveys, a literature review was performed to review previous studies of biological resources in the area and to determine whether there were existing records of sensitive species and habitats at or within the vicinity of the project site. The CNDDDB and the CNPSEI were reviewed for information in the project area. Physical characteristics of the project site were noted during the field surveys conducted on May 18, 2000. Attributes recorded included existing land use onsite and in adjacent areas, slope and aspect, topographical characteristics, and existing disturbances. A plant and wildlife species list was compiled and vegetation communities were described.

Prior to the survey, the most recent records of the following sources were reviewed to establish the potential presence of threatened, endangered, candidate, or other sensitive species in the study area:

- ◆ The California Natural Diversity Database (CNDDDB 2000, Hollywood, El Monte, Los Angeles); and
- ◆ The California Native Plant Society's Electronic Inventory of Rare and Endangered Vascular Plants of California (CNPSEI 1999, Hollywood, El Monte, Los Angeles).

**TABLE 4.12-1  
 SENSITIVE PLANT SPECIES POTENTIALLY OCCURRING  
 ALONG THE LOS ANGELES EASTSIDE CORRIDOR**

Common Name Scientific Name	Status	PFO	Habitat	Comments
Davidson's saltbush <i>Atriplex serenana</i> var. <i> davidsonii</i>	CNPS 1B	L	Typically occurs in coastal bluff scrub and coastal scrub communities with alkali soils.	Due to the highly developed nature along the proposed corridor, suitable habitat for this species is not present.
Santa Barbara morning-glory <i>Calystegia sepium</i> ssp. <i> binghamiae</i>	CNPS 1B	L	Typically occurs in coastal marshes and wetland areas.	Due to the highly developed nature along the proposed corridor, suitable habitat for this species is not present.
Parish's gooseberry <i>Ribes divarcatum</i> var. <i> parishii</i>	CNPS 1B FSOC	L	Typically occurs in riparian woodlands.	Due to the highly developed nature along the proposed corridor, suitable habitat for this species is not present.
Brand's phacelia <i>Phacelia stellaris</i>	CNPS 1B	L	Typically occurs in coastal scrub and coastal dunes habitats. This species prefers open areas within the above habitats.	Due to the highly developed nature along the proposed corridor, suitable habitat for this species is not present.
Southern skullcap <i>Scutellaria bolanderi</i> ssp. <i> austromontana</i>	CNPS 1B	L	Typically occurs in chaparral, cismontane woodlands, and lower montane coniferous forests. It is mainly found in gravelly soils located on stream banks.	Due to the highly developed nature along the proposed corridor, suitable habitat for this species is not present.
Plummer's mariposa lily <i>Calochortus plummerae</i>	CNPS 1B FSOC	L	Typically occurs in various habitats including coastal scrub, chaparral, valley and foothill grasslands, cismontane woodlands, and lower montane coniferous forests.	Due to the highly developed nature along the proposed corridor, suitable habitat for this species is not present.
Braunton's milk-vetch <i>Astragalus brauntonii</i>	CNPS 1B FE	L	Typically occurs in various habitats including coniferous forests, chaparral, coastal scrub, and valley and foothill grasslands.	Due to the highly developed nature along the proposed corridor, suitable habitat for this species is not present.
Los Angeles sunflower <i>Helianthus nuttallii</i> ssp. <i> parishii</i>	CNPS 1A FSOC	L	Typically occurs in coastal and freshwater marshes and wetlands.	Due to the highly developed nature along the proposed corridor, suitable habitat for this species is not present.

**Status Codes**

**Federal**

- FE = Federally listed; Endangered
- FT = Federally listed; Threatened
- FSOC = Federal Species of Concern

**State**

- ST = State listed; Threatened
- SE = State listed; Endangered
- CSC = California Species of Special Concern

- CNPS = California Native Plant Society Listed
  - List 1A = plants presumed extinct in California and elsewhere.
  - List 1B = plants that are considered rare, threatened or endangered in California and elsewhere.

**Potential for Occurrence (PFO)**

- L = Low potential for occurrence** - No recent or historical records exist of the species occurring in the project area or its immediate vicinity (within approximately 5 miles) and the diagnostic habitat requirements strongly associated with the species do not occur in the project area or its immediate vicinity.
- M = Moderate potential for occurrence** - Either a historical record exists of the species in the project area or its immediate vicinity or the diagnostic habitat requirements associated with the species do occur in the project area or its immediate vicinity.
- H = High potential for occurrence** - Both a historical record exists of the species in the project area or its immediate vicinity and the diagnostic habitat requirements strongly associated with the species do occur in the project area or its immediate vicinity.
- P = Species present** - The species was observed in the project area at the time of the survey.

Sources: California Natural Diversity Data Base, 2000; California Native Plant Society Electronic Inventory, 1999.

**TABLE 4.12-2  
 SENSITIVE WILDLIFE SPECIES POTENTIALLY OCCURRING  
 ALONG THE LOS ANGELES EASTSIDE CORRIDOR**

Common Name Scientific Name	Status	PFO	Habitat	Comments
<b>REPTILES — CLASS REPTILIA</b>				
<b>WATER TURTLES — EMYDIDAE</b>				
southwestern pond turtle <i>Clemmys marmorata pallida</i>	FSOC	L	Typically occurs in aquatic habitats that contain suitable basking sites. Found within woodlands, grasslands, and open forests.	Due to the highly developed nature along the proposed corridor, suitable habitat for this species is not present.
<b>IGUANID LIZARDS — IGUANIDAE</b>				
San Diego horned lizard <i>Phrynosoma coronatum blainvillei</i>	FSOC, CSC	L	Typically occurs in coastal sage scrub, open chaparral, riparian woodland, annual grassland habitats that support adequate invertebrate prey species.	Due to the highly developed nature along the proposed corridor, suitable habitat for this species is not present.
<b>BIRDS — CLASS AVES</b>				
<b>KINGLETS, GNATCATCHERS, BABBLERS — MUSCICAPIDAE</b>				
coastal California gnatcatcher <i>Poliptila californica californica</i>	FT, CSC	L	Typically occurs in coastal sage scrub vegetation on mesas, arid hillsides, and in washes. It nests almost exclusively in California sagebrush.	Due to the highly developed nature along the proposed corridor, suitable habitat for this species is not present.
<b>CUCKOOS, ANIS — CUCULIDAE</b>				
western yellow-billed cuckoo <i>Coccyzus americanus occidentalis</i>	SE	L	This species is a riparian forest nester. It is typically found along the broad, lower flood-bottoms of larger river systems. Also prefers thickets of willow mixed with cottonwood.	Due to the highly developed nature along the proposed corridor, suitable habitat for this species is not present.
<b>VIREOS — VIREONIDAE</b>				
least Bell's vireo <i>Vireo bellii pusillus</i>	FE, SE	L	Typically occurs in moist thickets and riparian areas dominated by willows and mulefat.	Due to the highly developed nature along the proposed corridor, suitable habitat for this species is not present.
<b>Status Codes</b>			<b>Potential for Occurrence (PFO)</b>	
Federal FE = Federally listed; Endangered FT = Federally listed; Threatened FSOC = Federal Species of Concern  State ST = State listed; Threatened SE = State listed; Endangered  CSC = California Species of Special Concern -- Taxa that are biologically rare, very restricted in distribution, declining throughout their range, or at a critical stage in their life cycle when residing in California. -- Population(s) in California that may be peripheral to the major portion of a taxon's range, but which are threatened with extirpation within California. -- Taxa closely associated with a habitat that is declining in California (e.g., wetlands, riparian, old growth forest).			L = Low potential for occurrence - No recent or historical records exist of the species occurring in the project area or its immediate vicinity (within approximately 5 miles) and the diagnostic habitat requirements strongly associated with the species do not occur in the project area or its immediate vicinity. M = Moderate potential for occurrence - Either a historical record exists of the species in the project area or its immediate vicinity or the diagnostic habitat requirements associated with the species do occur in the project area or its immediate vicinity. H = High potential for occurrence - Both a historical record exists of the species in the project area or its immediate vicinity and the diagnostic habitat requirements strongly associated with the species do occur in the project area or its immediate vicinity. P = Species present - The species was observed in the project area at the time of the survey.	
Source: California Natural Diversity Data Base, 2000				

Based on the database searches and the field surveys, a list of sensitive wildlife species potentially inhabiting the project area was developed. The potential for each species to inhabit the project area was assessed.

Impacts on biological resources were analyzed with respect to CEQA guidelines, which were recently revised to include a checklist (Appendix G of the guidelines) of environmental effects that may be considered significant. In order to determine the level of project impacts on biological resources under CEQA, the checklist includes several questions, presented in the impacts section, which are answered with respect to the LRT Build Alternative with one of the following possible checklist answers: significant impact, potentially significant unless mitigation included, less than significant impact, or no impact.

#### **4.12.2.2 Jurisdictional Waters**

The project site was examined on May 18, 2000 to determine the limits of (1) Corps jurisdiction pursuant to Section 404 of the Clean Water Act, and (2) CDFG jurisdiction pursuant to Division 2, Chapter 6, Section 1603 of the Fish and Game Code. Prior to beginning the field delineation USGS topographic maps were examined to determine the locations of potential areas of Corps/CDFG jurisdiction. Suspected jurisdictional areas were field checked for the presence of definable channels and/or wetland vegetation, soils and hydrology.

#### **4.12.3 IMPACTS**

##### **4.12.3.1 No-Build Alternative**

There would be no impacts on vegetation, wildlife, or jurisdictional waters because this alternative only includes improvements to the transportation network that have already been approved and funded. No capital improvements are included under this alternative and would therefore not result in any changes to biological resources within the Los Angeles Eastside Corridor study area.

##### **4.12.3.2 LRT Build Alternative**

###### *Option A*

Impacts were analyzed with respect to CEQA guidelines as discussed in the methodology section. The results of the evaluation are presented in Table 4.12-3.

###### Vegetation and Wildlife

No sensitive plant communities or suitable habitat for sensitive plants or wildlife occurs within the Los Angeles Eastside Corridor. Therefore, development of this alternative is not expected to adversely affect any sensitive plants and plant communities.

###### Jurisdictional Waters

The LRT Build Alternative traverses urban areas in Los Angeles County where urban development has often eliminated wetlands and associated natural vegetation and wildlife habitat. The study corridor is contained in existing public, particularly street, rights-of-way or in tunnel. Operation of the LRT Build Alternative is not expected to have an effect on any Corps or CDFG jurisdictional waters because the LRT would be built on an existing bridge over the Los Angeles River. As a result, jurisdictional waters would not be affected by project implementation. If, during the later stages of design, it is determined that bridge widening or additional piers may be required, then impacts on jurisdictional waters are likely

and possible conflict with the Migratory Bird Treaty Act unless suitable mitigation is adopted by MTA (MTA will undertake such mitigation if the design proves it necessary).

Significance of Impacts

Option A would have no impact with regard to all of the criteria listed in Table 4.12-3.

**Option B**

The impacts and the significance of the impacts of Option B would be similar to those described for Option A.

**4.12.4 Mitigation**

No mitigation is required for operational impacts of the LRT Build Alternative for either Options A or B on vegetation, wildlife, or jurisdictional waters.

<b>TABLE 4.12-3 BIOLOGICAL IMPACTS FACTORS CONSIDERED LRT BUILD ALTERNATIVE (OPTIONS A AND B)</b>	
Criterion	Significance of Impact
<b>Sensitive and Special Status Species.</b> Would the project have a significant adverse effect, either directly or through habitat modifications, on any species identified as a candidate, sensitive, or special status species in local or regional plans, policies, or regulations, or CDFG or USFWS?	No impact
<b>Riparian Habitat and Other Sensitive Natural Communities.</b> Would the project have a significant adverse effect on any riparian habitat or other sensitive natural community identified in local or regional plans, policies, and regulations or by the CDFG or USFWS?	No impact
<b>Wetlands.</b> Would the project have a significant adverse effect on federally protected wetlands as defined by Section 404 of the Clean Water Act (including, but not limited to, marsh, vernal pool, coastal, etc.) through direct removal, filling, hydrologic interruption, or other means?	No impact
<b>Waters of the United States.</b> Section 404 of the Clean Water Act addresses "waters of the United States," which is a broader category than wetlands. All wetlands are waters of the United States, but a water of the United States may or may not be a wetland. CEQA Guidelines do not specifically address waters of the United States. The one waterway in the study area is concrete-lined, and therefore does not contain sensitive biological resources.	No impact
<b>Movement of Species.</b> Would the project interfere substantially with the movement of any native resident or migratory fish or wildlife species or with established native resident or migratory wildlife corridors, or impede the use of native wildlife nursery sites?	No impact
<b>Conflict with Local Policies or Ordinances.</b> Would the project conflict with any local policies or ordinances protecting biological resources, such as a tree preservation policy or ordinance?	No impact
<b>Conflict with Conservation Plans.</b> Would the project conflict with the provisions of an adopted habitat conservation plan, natural community conservation plan, or other approved local, regional or state habitat conservation plan?	No impact
<b>Conflict with Migratory Bird Treaty Act.</b> CEQA guidelines do not specifically address the MBTA, which is discussed in Section 4.12.1.	No impact



## 4.13 ENERGY

### 4.13.1 Affected Environment

California's overall energy consumption continues to be dominated by transportation, which is growing faster than the population. Since 1973, the number of vehicles within the state has increased by 75 percent. Although the average fuel economy of these vehicles has improved, the fuel savings achieved are less noticeable due to an increase in the number of miles traveled (California Energy Commission, 2000). Currently, California's 17 million automobiles consume more than 13 billion gallons of gasoline, making California the third largest consumer of gasoline in the world (California Energy Commission, 2000).

The number of vehicle miles traveled (VMT) is directly related to energy use and is the main contributor to air quality pollutants in the SCAG (Southern California Association of Governments) region. Vehicle miles of travel are also important in determining the demand for infrastructure improvements. SCAG estimates the VMT for the agency's transportation plans. Their data shows a 19 percent increase in daily VMT between 1994 and 1997, from 283 million to 337 million miles (SCAG, 2000). This equates to a daily energy use of approximately 304,000 barrels of crude oil in 1994 to over 351,000 barrels of crude oil in 1997 (PBQD, 2000).

### 4.13.2 Methodology for Impact Evaluation

The analysis estimates the total amount of energy expected to be consumed in the region in 2020 by each of the alternatives. The direct (operational) energy impacts were assessed using the following methodology.

Direct energy consumption involves energy used by the operation of vehicles (automobile, truck, bus, or train) within the region. In assessing the direct energy impact, consideration was given to the following factors:

- ◆ Annual vehicle miles traveled (VMT) for automobiles, trucks, buses, LRT, and commuter rail vehicles
- ◆ Variation of fuel consumption rates by vehicle type.

The direct energy analysis for each alternative was based on projected year 2020 regional traffic volumes and total VMT. The 2020 daily traffic volumes for the region were provided by the MTA model and annualized using a factor of 315 days per year. The VMT fuel consumption method utilized for this project is outlined in the *Technical Guidance on Section 5309 New Starts Criteria* (FTA, 1999). Energy consumption factors for the various modes identified in Table 4.13-1 were developed by Oak Ridge Laboratory and published in the 1996 *Transportation Energy Book: Edition 16*.

Direct energy, measured in British thermal units, BTUs<sup>9</sup>, was converted to the equivalent barrels of crude oil for comparison of alternatives. The change in annual BTUs was also calculated for the LRT Build Alternative vs. the No-Build Alternative.

By comparing the alternatives' energy demands to current and anticipated energy supplies, it is possible to determine whether the alternatives would have a significant effect on energy supplies. Although no clear significance standards or thresholds are established, a one-percent demand increase in the relative supply would be significant.

<sup>9</sup> One BTU is the quantity of energy necessary to raise one pound of water one degree Fahrenheit.

Mode	Factor
Passenger Vehicles (auto, van, light truck)	6,233 BTU/Vehicle Mile
Heavy Truck	22,046 BTU/Vehicle Mile
Transit Bus (all vehicle types) <sup>1</sup>	41,655 BTU/Vehicle Mile
Rail (light or heavy)	77,739 BTU/Vehicle Mile
Commuter Rail (Metrolink)	100,000 BTU/Vehicle Mile

<sup>1</sup>FTA recommends utilizing a transit bus energy consumption factor of 41,655 BTUs/VMT for all bus types (including alternative fueled buses). Sufficient data has not been available to develop consumption factors for alternative fuels such as CNG (compressed natural gas), LNG (liquefied natural gas), and others.

Source: Oak Ridge Laboratory, 1996.

### 4.13.3 Impacts

Potential energy consumption of the LRT Build Alternative was compared to the No-Build Alternative in order to assess the impacts within the Los Angeles Eastside Corridor. The annual energy savings are expressed in British thermal units (BTUs).

The determination of California Environmental Quality Act (CEQA) importance for energy resources has until now been based on the criteria in Appendix G of CEQA: *Will the proposal use fuel, water, or energy in a wasteful manner?* On January 1, 1999, Appendix G was replaced by new guidelines implementing revisions to CEQA made by the legislature in 1992. While there are now no energy-specific criteria within the amended guidelines, one related to mineral resources would apply:

- ◆ Result in the loss of availability of a known mineral resource that would be of future value to the region and the residents of the state?

#### 4.13.3.1 No-Build Alternative

Under the No-Build Alternative, the annual 2020 VMT for automobiles within the region is forecast to be 138.02 billion miles, 5.75 billion miles for trucks, 235.8 million miles for buses, about 10 million miles for LRT, and 4.89 million miles for commuter rail. The annual VMT for automobiles and trucks would be slightly higher than for the LRT Build Alternative resulting in higher energy usage for these modes. The VMT for buses and rail, however, would be lower than for the LRT Build Alternative. Given the VMT and vehicle fuel consumption on an annual basis, vehicles operating within the region are anticipated to consume approximately 172.096 million barrels of oil or approximately 998,161 billion BTUs (Table 4.13-2). As shown in Table 4.13-2, the No-Build Alternative would have lower operational energy consumption compared to the LRT Build Alternative.

#### *Significance of Impacts*

While the No-Build Alternative would have lower overall operational energy consumption compared to the LRT Build Alternative, it would have a higher consumption of fossil fuels due to a higher VMT of automobiles and trucks. Fossil fuels will continue to be of future value to the region and the residents of the state. As discussed above, California obtains almost half of its crude oil supply from inside the state and the rest from Alaska.

**TABLE 4.13-2  
ANNUAL 2020 OPERATIONAL ENERGY CONSUMPTION**

	No-Build Alternative	LRT Build Alternative Options A and B
<b>Vehicle Miles Traveled (VMT)</b>		
Daily Auto and Truck VMT	425,828,072	425,778,055
<i>Annual Auto VMT (billions)</i>	<i>138.02</i>	<i>138.01</i>
<i>Annual Truck VMT (billions)</i>	<i>5.75</i>	<i>5.75</i>
Daily Bus VMT	696,380	712,132
<i>Annual Bus VMT</i>	<i>235,821,535</i>	<i>241,329,646</i>
Daily LRT VMT	29,955	31,742
<i>Annual LRT VMT</i>	<i>9,985,940</i>	<i>10,574,707</i>
Daily Commuter Rail VMT	14,639	14,639
<i>Annual Commuter Rail VMT</i>	<i>4,894,084</i>	<i>4,894,084</i>
<b>Energy Consumption (BTUs)<sup>1</sup> (billions)</b>		
Annual Auto BTUs <sup>1</sup>	860,288	860,187
Annual Truck BTUs <sup>1</sup>	126,784	126,769
Annual Bus BTUs <sup>1</sup>	9,823	10,052
Annual LRT BTUs <sup>1</sup>	776	822
Annual Commuter Rail BTUs <sup>1</sup>	489	489
<b>TOTAL ANNUAL DIRECT BTUs (billions<sup>2</sup>)</b>	<b>998,161</b>	<b>998,320</b>
<b>TOTAL ANNUAL BARRELS OF OIL<sup>3</sup></b>	<b>172,096,668</b>	<b>172,124,128</b>
<b>CHANGE IN BTUs vs. NO-BUILD (billions<sup>2</sup>)</b>	<b>N/A</b>	<b>159</b>
<b>CHANGE IN BARRELS vs. NO-BUILD</b>	<b>N/A</b>	<b>27,460</b>
<sup>1</sup> One British thermal unit (BTU) is the quantity of energy necessary to raise one pound of water one degree Fahrenheit. <sup>2</sup> Rounded. <sup>3</sup> One barrel of crude oil is equal to 5.8 million BTUs.		
Sources: Vehicle Miles Traveled (PBQD, 2000); Energy Consumption Factors (Oak Ridge National Laboratory, 1996)		

#### 4.13.3.2 LRT Build Alternative

##### *Option A*

Under Option A, the 2020 annual VMT for automobiles within the region is forecast to be 138.01 billion miles, 5.75 billion miles for trucks, 241.3 million miles for buses, 10.6 million miles for LRT, and 4.89 million miles for commuter rail. For Option A, the daily VMT for automobiles and trucks is about 50,000 miles less than the No-Build Alternative, while the VMT for buses and rail is considerably higher (15,000 miles for buses and 1,800 miles for LRT). Given the VMT and vehicle fuel consumption on an annual basis, vehicles operating within the region are anticipated to consume approximately 172.124 million barrels of oil or approximately 998,320 billion BTUs. Overall, Option A would have a slightly higher annual operational energy consumption (about 27,460 barrels of crude oil) compared to the No-Build Alternative.

Table 4.13-3 shows a breakdown of energy use in Kilowatt hours (Kwh) with and without the stations and maintenance and storage facility. Stations for Option A would use approximately 1.4 billion BTUs (112,378 Kwh or 241.4 barrels of oil) annually during the operation of the project (this is based on eight stations multiplied by 175,000,000 BTUs, using FTA's *Technical Guidance on Section 5309 New Starts Criteria*, July 1999). The maintenance and storage facility would use approximately 8.7 billion BTUs

(698,346 Kwh, 1,500 barrels of oil) annually during the operation of the project (Caltrans Division of Engineering Services, Office of Transportation Laboratory, *Energy and Transportation Systems*, Table G-3, July 1983).

Alternative	Energy Without Stations	LRT Stations	Maintenance and Storage Facility	Total
No-Build	62,313,130	N/A	N/A	62,313,130
LRT Build	65,987,088	112,378	698,346	66,797,812

MTA is hopeful that bus fuel economy will improve in the future with the introduction of composite fiber (lighter weight) buses, in which case, energy consumption would decrease for this mode across both alternatives. In addition, if Option A were constructed and ridership grew (as has been the case with the Blue Line), MTA anticipates that increased auto diversion to transit would result in an energy savings for this alternative. Given that automobile ownership in the Eastside Corridor is relatively low, as compared to other areas where the average income is higher, any future extensions of the LRT eastward through areas of higher automobile ownership may result in a higher diversion to transit and additional energy savings.

Note that Option A would mostly draw on electrical power from the Los Angeles Department of Water and Power (DWP) for its rail, station, and MS&F facilities. The DWP is on a transmission grid that is separate from the state grid maintained by the California Independent System Operator (ISO). The DWP has 24 major thermal generating units and 27 hydroelectric generating units, presently delivering power to its service area in Los Angeles without any rolling blackouts. The DWP anticipates consistent service for years to come even in ISO power deficits, by maintaining and expanding its electrical sources. The project would also draw on electrical power from Southern California Edison where county facilities would be located (stations, transit powered substations, etc.), but would be able to draw on DWP supplies if Edison supplies dramatically decrease or blackouts are experienced. Thus, no rolling blackouts, rate hikes, significant cumulative electrical deficiencies, or other burdens to electrical supplies are anticipated for Option A.

Option A would result in a net annual energy demand in the area of 3.78 million kilowatt hours (kwh), compared to the No-Build Alternative. When this number is compared to the DWP service area annual demand of 22,200 million kwh, it is clearly less than one percent of the current energy demand. Furthermore, the DWP anticipates a one- to two-percent increase in electricity demand over the next decade and has increased its abilities to serve the area for years to come by adding new facilities and increasing its energy supplies.

#### Significance of Impacts

While Option A would result in slightly greater energy consumption than the No-Build Alternative during operation, it would not result in a significant impact to the availability of fossil fuels or electricity within the region or the state given the current and projected available resources.

#### **Option B**

The impacts and significance of the impacts of Option B are the same as those described for Option A.

#### **4.13.4 Mitigation**

From an energy perspective, Options A and B are the same, and mitigation to further reduce already less than significant impacts is discussed collectively for the LRT Build Alternative.

As can be seen in Table 4.13-2, both the No-Build and LRT Build Alternatives are relatively equal in energy consumption. The LRT Build Alternative is only slightly higher in energy consumption. Under the LRT Build Alternative, schedule coordination and modal interface between LRT, commuter rail, and local buses will be optimized to conserve energy. Furthermore, every aspect of station design will be reviewed to minimize lighting, heating, ventilating and air conditioning loads. Passenger areas within stations will be designed so that lights can be turned off during off-service hours. Cold water, instead of warm water, will be used to wash the vehicles. The track layout will be designed to minimize non-revenue vehicle movements. All major facilities, except the car washing facility, will have electric meters to monitor energy consumption and conservation.

Regarding street lighting, the Los Angeles Bureau of Street Lighting requires that high-energy efficient fixtures only are to be specified in all public lighting improvements. This allows for the use of High-pressure Sodium, Metal Alloid, and Fluorescent lamps. This excludes the use of Mercury Vapor, Low-pressure Sodium, and incandescent lamps.

## **4.14 SAFETY AND SECURITY**

### **4.14.1 Affected Environment**

#### **4.14.1.1 Existing MTA Safety and Security Program**

MTA operates a bus, light rail, and heavy rail subway service for daily passenger boarding, and owns railroad right-of-way over which Metrolink trains are currently operating. Security services for MTA's customers, employees, and facilities are currently provided by the Los Angeles Police Department Transit Police Service Bureau and the Los Angeles County Sheriff's Department Transit Police Services Bureau. Both special officers and deputies are assigned to MTA to provide law enforcement services. Sheriff's special officers have limited peace officer powers. They provide field response to minor incidents involving MTA vehicles, as well as regular patrols of MTA property. The Sheriff's Department also provides special enforcement deputies, who work both in uniform and plain clothes, depending on the type of enforcement conducted.

Security and law enforcement for MTA facilities is provided on a 24 hour per day, seven-day per week basis or as needed to solve specifically targeted problem areas. Criminal reports or arrests, other than those accomplished by special enforcement deputies, remain the jurisdiction of the local law enforcement agency where the activity occurs.

#### **4.14.1.2 Existing Police Services in the Corridor**

The Los Angeles Police Department handles police duties and activities in the City of Los Angeles portion of the corridor. The Los Angeles Police Department Hollenbeck Police Station is located at the intersection of 1<sup>st</sup> Street and St. Louis Street that is two blocks west of the proposed 1<sup>st</sup>/Soto Station. In addition, Parker Center, the Los Angeles Police Department headquarters and central administration facility, is located at 1<sup>st</sup> Street and Los Angeles Street, approximately one quarter mile west of the proposed 1<sup>st</sup>/Alameda Station.

The Los Angeles Sheriffs Department handles police duties and activities in the County of Los Angeles portion of the corridor. The Sheriff Department's East Los Angeles Station is located at the intersection of 3<sup>rd</sup> Street and La Verne Avenue adjacent to the East Los Angeles Community Center, and approximately one half mile from the eastern terminus of the LRT route.

#### **4.14.1.3 Existing Fire and Emergency Services in the Corridor**

Fire suppression and emergency services in the City of Los Angeles portion of the corridor are handled by the City fire station located at the intersection of Cesar Chavez Avenue and Britannia Street. Fire suppression and emergency services in the County of Los Angeles portion of the corridor are handled by two County fire stations: 1) Station 3 located at 930 South Eastern Avenue; and 2) Station 22 located at 928 Gerhart Avenue. In the event of a fire occurring at the boundary of the City and the County, the two departments are working on a common communications frequency to facilitate joint operations.

### **4.14.2 Methodology For Impact Evaluation**

#### **4.14.2.1 Accidents and Safety Issues**

Input on safety and security issues has been obtained from MTA staff members who have developed considerable expertise in dealing with many of the safety and security impacts expected to result from construction and operation of light rail on the surface and in subway. In addition, input from the

community through the scoping process raised concerns about pedestrian and transit patron safety and the safety of LRT operation. The major concern was the presence of light rail trains operating on city streets, particularly the number of trains running during weekday peak hours.

In response to these concerns, an estimate of the possible number of light rail accidents that might be expected in the corridor was made using data from the MTA Operations Safety department report *Summary of Metro Blue Line Train/Vehicle and Train/Pedestrian Accidents (7/90-09/99)* dated October 29, 1999. Based on the data presented in the report, the average number of on-street accidents per year per mile for fiscal years 1993 to 1999 was approximately 4.0 per mile. For fiscal year 1999 only, the accident rate was approximately 5.1 per mile. The vast majority of the accidents were auto conflicts with LRT vehicles. Only five percent of the accidents involved pedestrians.

For safety impacts that have been identified for the LRT Build Alternative under both Options A and B, MTA project design features are analyzed to determine which safety enhancement measures could be included in the project design to mitigate any significant impacts under CEQA. MTA Rail Transit Design Criteria and Standards, Fire/Life Safety Criteria, Volume IX, would be used to develop these design features.

#### **4.14.2.2 Security and Crime Prevention Issues**

The analysis of security issues focuses on the potential for violent crimes, property theft, fare evasion, and vandalism. This analysis reviews project design features in the context of MTA procedures and prior experience of other rail systems to assess impacts. FTA and Los Angeles County crime data related to light rail operations are examined. Most crimes on existing MTA LRT lines appear to be thefts, especially auto thefts, near stations or parking areas. For the existing light rail system operating within the County of Los Angeles, 67 thefts, 69 auto thefts, ten burglaries, and two arsons were reported in 1999, a rate that is four percent lower than the previous year.

#### **4.14.2.3 Fire Services and Emergency Response**

Station and track design (access, layout, exits, alarms, evacuation) and operational procedures (interagency agreement, training, evacuation) are pertinent to the effectiveness and timeliness of emergency response.

### **4.14.3 Impacts**

#### **4.14.3.1 No-Build Alternative**

The No-Build Alternative would maintain the current MTA routes and service in the corridor, and, therefore, would not have an immediate impact on public safety or accidents.

#### **4.14.3.2 LRT Build Alternative**

##### *Option A*

##### Accidents and Safety Issues

Input on safety and security issues has been obtained from MTA staff members who have developed considerable expertise in dealing with many of the safety and security impacts expected to result from construction and operation of light rail on the surface and in subway. In addition, input from the community through the scoping process raised concerns about pedestrian and transit patron safety and the

safety of LRT operation. The major concern was the presence of light rail trains operating on city streets, particularly the number of trains running during weekday peak hours.

In response to these concerns, an estimate of the possible number of light rail accidents that might be expected in the corridor was made using data from the MTA Operations Safety department report *Summary of Metro Blue Line Train/Vehicle and Train/Pedestrian Accidents (7/90-09/99)* dated October 29, 1999. Based on the data presented in the report, the average number of on-street accidents per year per mile for fiscal years 1993 to 1999 was approximately 4.0 per mile. For fiscal year 1999 only, the accident rate was approximately 5.1 per mile. The vast majority of the accidents were auto conflicts with making left turns in front of the LRT vehicles. Only five percent of the accidents involved pedestrians; most did not result in fatalities.

For safety impacts that have been identified for Option A, MTA project design features are analyzed to determine which safety enhancement measures could be included in the project design to mitigate any significant impacts under CEQA. MTA Rail Transit Design Criteria and Standards, Fire/Life Safety Criteria, Volume IX, will be used to develop these design features.

#### Security and Crime Prevention Issues

Operation of Option A can be expected to concentrate people around stations and parking facilities as well as the LRT vehicles themselves. The potential for car thefts, robberies, vandalism, loitering and other crimes exists. If measures were not taken to create a safe, protected environment for LRT patrons and other citizens, the potential for criminal activity around station areas and in vehicles would be significant.

#### Fire Services and Emergency Response

LRT vehicles will contain a state-of-the-art communication system to enhance response time by fire, police, and emergency services. As a result, patrons of the system should not face a negative impact from delays in arrival of emergency assistance. However, the possibility of delaying an emergency vehicle responding to a call elsewhere must be considered a potentially significant impact.

#### Significance of Impacts

Safety features would be included in the design of LRT vehicles, station areas, and other facilities. Safety risk remains a consideration that could generate significant impacts. The possibility of delaying an emergency vehicle responding to a call elsewhere must be considered a potentially significant impact.

### ***Option B***

#### Accidents and Safety /Security and Crime Prevention Issues

The impacts of Option B will be the same as Option A, with the exception of potential impacts on Ramona High School if the school is relocated to another site removed from the LRT project. If that were to occur, then there would be no potential impacts from students and faculty crossing the tracks in the vicinity of the school and no potential security and crime prevention impacts at the school. The impacts will be similar to those discussed in Option A if Ramona High School is reconstructed except that the 3<sup>rd</sup>/Indiana Station will be closer to the high school than the 1<sup>st</sup>/Lorena Station planned with Option A. Also, the station area changes to 3<sup>rd</sup>/Indiana, 3<sup>rd</sup>/Ford, and Pomona/Atlantic under Option B will result in changes to locations (not severity of impacts) where pedestrian/LRT conflicts and crime activity could potentially occur around the stations.



## Fire Services and Emergency Response

The impacts will be the same as those described for Option A.

## Significance of Impacts

Safety features would be included in the design of LRT vehicles, station areas, and other facilities. Safety risk remains a consideration that could generate significant impacts. The possibility of delaying an emergency vehicle responding to a call elsewhere must be considered a potentially significant impact.

### **4.14.4 Mitigation**

#### **4.14.4.1 Option A**

#### ***Accidents and Safety Issues***

Mitigation measures will be developed to conform to MTA Rail Transit Design Criteria and Standards, Fire/Life Safety Criteria, Volume IX. To diminish the risk of collisions between light rail vehicles and automobiles on the street portion of the system, MTA will work with the City and County traffic control departments and comply with the Federal Highway Administration's Manual on Uniform Traffic Control Devices (MUTCD). Automobile movements across the LRT tracks will be minimized by allowing movements across the tracks, including left turns, only at major thoroughfares. This measure should also reduce the number of auto/auto accidents that would otherwise occur mid-block and at non-signalized intersections. Appropriate traffic controls will be installed as needed. At major intersections, left turns will be permitted and controlled, where appropriate, with green arrows. MTA will also implement methods the same or better than that done for the Blue Line along Washington Boulevard where next train coming automatic signs and intersection surveillance cameras have been installed, and ticketing of violators has been enforced.

Pedestrians will be discouraged from crossing at mid-block on major roads by concentrating crossings at major intersections and by installing physical pedestrian barriers. This could help minimize pedestrian accidents with autos as well as with trains. Designated/signalized pedestrian crosswalks will be provided at appropriate locations near schools or where warranted. Installation of pedestrian gates will be considered on a case by case basis. For example, pedestrian gates may not be appropriate for stations in the center of the street. In any event, MTA will comply with PUC safety standards for pedestrian crossings. Station platforms will be designed to reduce the risk of injury for persons waiting for trains. At Ramona High, Utah Elementary, Our Lady of Lourdes Elementary, and Griffith Middle Schools, MTA will provide a crossing guard during daily arrival and dismissal times if requested by the school administrators for as long as their presence is requested. All locations for crossing guards will be reviewed by the MTA Fire Life Safety Committee for adequacy during both construction and operation. This committee includes a fire chief each from the City and County of Los Angeles Fire Departments. The Fire Life Safety Committee will approve the crossing guard plan prior to the start of construction, and if either fire chief rejects the plan, it will not be approved nor construction commenced until the fire chiefs concerns are met.

MTA will also provide at no charge to the Los Angeles Unified School District, as well as neighborhood senior centers upon request, an instructional rail safety program with materials to all affected schools in the study area. The program will cover safety issues relative to both construction and operation of the LRT project. As part of this commitment, MTA will permanently fund school zone safety programs and law enforcement for the light rail project. The existing Red, Blue, and Green lines have law enforcement contracts, as will the Pasadena Blue Line project and the Eastside Corridor Light Rail Project. MTA will

consult with LAPD, LA County Sheriff, and the California Highway Patrol (CHP) during project development and operation to ensure that input from all agencies relative to safety concerns is received.

Appropriate lighting will be provided at locations where there is conflict between movement of pedestrians, vehicles, bicycles, and trains. In addition, lighting shall provide excellent visibility for train operators to be able to react to possible conflicts, especially to pedestrians crossing the track. In areas where the street is widened or sidewalks are modified, MTA will replace street lights as necessary and will reproduce conditions that are currently in place and conform to existing conditions.

In the areas directly adjacent to the rail stations: (1) sidewalk widths will be designed with the widest dimensions feasible in conformance with the LA City/MTA's adopted "Land Use/Transportation Policy", and with widths up to and exceeding ten feet; (2) minimum widths will not be less than those allowed by the State of California Title 24 access requirements, or the Americans with Disability Act (ADA) design recommendations where existing building lines or landscape areas periodically preclude these preferred widths; (3) accommodating pedestrian movements and flows will take priority over other transportation improvements including automobile access where physical conditions present potential restrictions in pedestrian access, compliance with ADA, or Title 24 minimum requirements; (4) physical improvements will ensure that all stations are fully accessible as defined in the Americans with Disabilities Act; and (5) alternative routing for pedestrians that allows completion of access to the station and to destinations in the immediate vicinity of the station will be developed through the Community Linkage Study/Program.

A fence will be put in place at the U-section trenched locations of the alignment near Utah Elementary School to prevent anyone from entering the tunnel. For both portals, MTA will evaluate during final design either an automatically closing gate, an alarm, or other advanced security measures against trespassing. The result will be reviewed by the MTA Fire Life Safety Committee including fire chiefs from the city and county fire departments. In addition, MTA will install distinctive signs and lights to warn pedestrians of trains emerging from the tunnel.

Other mitigation measures in accordance with MTA, Public Utility Commission (PUC), MUTCD, and State of California Highway Design Manual (HDM) criteria that will minimize potential operations safety and accident impacts are:

- ◆ Design of adequate storage pocket length for cars waiting to make a left turn;
- ◆ Design of programmed visibility train signals that are not visible to cars making left turns and are visible only to train operators;
- ◆ Design of photo enforcement camera equipment;
- ◆ Design of the train priority signal system;
- ◆ Design of crosswalks, stand behind the line markings, etc. Provide for an entire safe path from stations to sidewalks for pedestrians and patrons;
- ◆ Design of alignment, grade, horizontal and vertical curves to minimize or eliminate any visibility and/or operational problems;
- ◆ Design of active warning devices for pedestrians; and
- ◆ Installation of rumble strip/cobblestone distinctive design for pedestrian crossings.

The MTA has initiated a rail safety and pedestrian safety analysis/study near light rail facilities that includes the development of crossing control devices for automobiles and pedestrians. The MTA will direct that study to include specific application to locations along this rail corridor. Safety improvements specified by PUC and the HDM will be included in the construction of the rail system. In addition to improvements specified above, the project will include additional safety devices in priority areas identified in the rail safety and pedestrian study. Funding for pedestrian safety devices beyond those

specified by the PUC and HDM has been identified for demonstration of new technology safety devices on the Pasadena Blue Line and could be incorporated into the Eastside Corridor project.

In addition, to increase light rail vehicle safety, the light rail vehicles will be provided with front and rear safety fenders to minimize or prevent the potential for pedestrian contact with the vehicle coupler and/or the potential to fall under the vehicle.

For subway operation, the MTA Fire Life Safety Committee has developed the following safety-related design criteria for the proposed LRT subway stations:

- ◆ Fire alarm protection within the station area;
- ◆ Minimum of two fire emergency routes from each station;
- ◆ Emergency station ventilation and lighting;
- ◆ Communication systems between adjoining fire agencies; and
- ◆ A methane detection system for each station.

Building construction for underground stations shall not be less than Type I Construction as defined in the Uniform Building Code (UBC). Enclosure of patron use stairways, escalators, and protection of floor openings are not required within areas of the public occupancy. Stations having more than two levels below-grade or more than 80 feet to the lowest occupied level from grade will require protected level separation or other protection features to provide safe egress to the exits.

In public occupancy areas, fire separations will be provided and maintained. Station public occupancy will be separated from station ancillary occupancy by a minimum two-hour fire rated wall. The only exception is that a maximum of two station agents, supervisors, or information booths may be located within station public occupancy areas when constructed of approved noncombustible materials and limited in floor area to 100 square feet.

#### ***Security and Crime Prevention Issues***

Mitigation measures will be developed to conform to MTA Rail Transit Design Criteria and Standards, Fire/Life Safety Criteria, Volume IX. Increased policing, well-placed lighting, installation of cameras to monitor activities, and clear visibility of the station area from the street and sidewalk will substantially minimize criminal activity at LRT stations. Large concentrations of people and street level activity around stations may actually decrease crime rates. MTA will involve the LAPD and the County Sheriff in the planning and design of stations and parking facilities to improve station area security. The enforcement agencies are also obligated to provide a safe environment.

Consideration will be given to procuring one agency to provide on-board security for the LRT vehicles. While the LAPD or County Sheriff can cover the areas around stations and park-and-ride facilities, contracting for security with a single agency has proven to be an efficient method of patrolling LRT vehicles that cross jurisdictional boundaries. MTA will fund all law enforcement and security needs of the Project as it does for the existing Red, Blue, and Green Lines.

#### ***Fire Services and Emergency Response***

Mitigation measures will be developed to conform to MTA Rail Transit Design Criteria and Standards, Fire/Life Safety Criteria, Volume IX. During the project design phase, all public safety agencies will have input on street modifications or access limitations for emergency vehicles resulting from LRT operation. All limited access devices (gates, etc.) will conform to LA County and LA City Fire

Department standards. MTA will ensure that the Fire Departments are able to verify this to their satisfaction, in the drawings and after the project is constructed. MTA personnel will train with firefighters in preparing for project-related emergencies at MTA expense prior to project opening. Training will include simulated fires, simulated passenger with a heart attack etc., to the satisfaction of the MTA Fire Life Safety Committee.

In addition, MTA will ensure, through compliance with MTA Design Criteria (including MTA Fire Life Safety Criteria), that all emergency requirements are met specifically in regards to problems that may occur outside of the day-to-day construction and operational activities such as utility emergencies, natural disasters, and subsidence. The MTA Fire Life Safety Committee will review project drawings. No facilities will be built or operated which the fire chiefs deem unsafe. If initial designs contain flaws, MTA will meet with the fire chiefs until they certify that the design is correct. In addition, all designs will meet MTA Board adopted Fire Life Safety Criteria. A fire chief from each of the Los Angeles City and County Fire Departments will be on-hand to ensure the project meets all City and County Codes. A combination of proper facility design, operating equipment, hardware, procedures and software subsystems would reduce potential fire and emergency service response impacts to a less than significant level.

#### ***Significance of Impacts Remaining After Mitigation***

With mitigation, the aforementioned safety and security impacts would be reduced to an insignificant level.

#### **4.14.4.2 Option B**

##### ***Accident and Safety Issues***

Mitigation measures taken will be the same as those described under Option A. As noted, MTA will provide a crossing guard in the vicinity of Ramona High School during arrival and dismissal times if requested by LAUSD and the school administrator to ensure pedestrian safety around the high school, especially in light of the proximity of the 3<sup>rd</sup>/Indiana Station.

##### ***Security and Crime Prevention Issues***

Mitigation measures taken will be the same as those described under Option A with the exception that MTA, in concert with the LAPD and County Sheriff, will provide increased security in the vicinity of Ramona High School to minimize potential crime activity in the vicinity of the 3<sup>rd</sup>/Indiana Station.

##### ***Fire Services and Emergency Response***

The mitigation measures will be the same as those described for Option A.

#### ***Significance of Impacts Remaining After Mitigation***

With mitigation, the aforementioned safety and security impacts would be reduced to an insignificant level.

## 4.15 HISTORIC/ARCHAEOLOGICAL/PALEONTOLOGICAL RESOURCES

### 4.15.1 Affected Environment

#### 4.15.1.1 Historic/Archaeological Resources

##### *Regulatory Setting*

Regulations that address potential effects on historic, archaeological, and paleontological resources include Section 106 of the National Historic Preservation Act (NHPA), Section 4(f) of the Department of Transportation Act, and the California Environmental Quality Act (CEQA). Each of these acts as they pertain to cultural resources is briefly described below.

##### National Historic Preservation Act

Section 106 of the National Historic Preservation Act of 1966, as amended through 1992 (16 U.S.C. Section 470), and 36 CFR Part 800 requires that federal agencies take into account the effect of carrying out federally funded, assisted, or licensed projects on resources identified as included in, or determined eligible for, the National Register of Historic Places (NRHP), and, if a project adversely affects those characteristics qualifying a resource for inclusion on the NRHP Register, feasible alternatives are investigated.

The Section 106 review process follows these steps: 1) determine that the Section 106 provisions apply to the undertaking or proposed action; 2) determine whether the undertaking has the potential to create effects; 3) define the Area of Potential Effects (APE); 4) identify historic, archaeological and cultural resources, and evaluate their significance to determine eligibility for listing in the National Register; 5) Coordinate Section 106 with other reviews such as NEPA and Section 4(f); 6) apply the criteria of effect and adverse effect to determine impacts on identified resources; 7) consult with the State Historic Preservation Officer (SHPO) and other interested persons, agencies, and tribes to agree on appropriate mitigation measures; 8) execute a Memorandum of Agreement (MOA) with the SHPO that specifies the mitigations and identifies those responsible for carrying out the specific measures; and 9) obtain the comments and acceptance of the Advisory Council for Historic Preservation. The letter of concurrence from SHPO regarding determination of eligibility and finding of effect and the draft MOA is presented in Appendix G.

When evaluating a property against *National Register* criteria (Criteria of Effect), significance is defined as the importance of a property to the history, architecture, archaeology, engineering, or culture of a community, a State, or the nation. In order for a property to be considered eligible for inclusion on the *National Register*, it must meet at least one of four specific criteria (A through D) for evaluation identified in 36 CFR Part 60 of the NHPA, and certain other conditions. The *National Register* criteria for evaluation are defined below.

The quality of significance in American history, architecture, archaeology, and culture is present in districts, sites, buildings, structures, and objects that possess integrity of location, design setting, materials, workmanship, feeling and association, and that are: A) associated with events that have made significant contributions to the broad pattern of our history; or B) that are associated with lives of persons significant in our past; or C) that embody the distinctive characteristics of type, period or method of construction or that represent the work of a master, or that possess high artistic values, or that represent a significant and distinguishable entity whose components may lack individual distinction; or D) that have yielded or may be likely to yield information important in prehistory or history.

### California Environmental Quality Act

In September 1992, Section 21084 of CEQA was amended to categorize projects that may cause substantial adverse changes in the significance of historical resources as projects that may have significant effects on the environment and, therefore, are not exempt from CEQA. Historic resources were defined as any resource listed, or determined to be eligible for listing, in the California Register of Historical Resources (California Register). According to CEQA, Section 21084.1 of the Public Resources Code, historical resources listed in the California Register that are determined eligible for listing in the National Register or included in local registers of historical resources, are presumed to be historically or culturally significant.

### Section 4(f) of the Department of Transportation Act of 1966

Section 4(f) was established in order to limit the circumstances where protected lands and historic site areas can be used for transportation purposes. In this discussion, "historic site areas" refers to those areas where a historic structure is located and/or where a group of historic structures is located. This applies to those guidelines presented by the National Historic Preservation Act of 1966, and observes the guidance of the SHPO. Since the Eastside Project may affect historic structures either visually, partially or completely, a Section 4(f) evaluation is required. Specific Section 4(f) issues are discussed in detail within the SDEIS/SDEIR.

### ***Area of Potential Effects***

The APE (Figures 4.15-1 through 4.15-3) includes the immediate properties along each side of the roadway proposed to accommodate the system and those properties, which have an unobstructed view of the alignment. The APE includes properties directly affected by project construction or right-of-way acquisition, as well as properties that may be indirectly affected by visual or noise/vibration impacts. For the subway segment the APE includes properties, which lie directly over the alignment and properties adjacent to the properties over the alignment. The APE was defined to satisfy the requirements of Section 106 of the NHPA and CEQA.

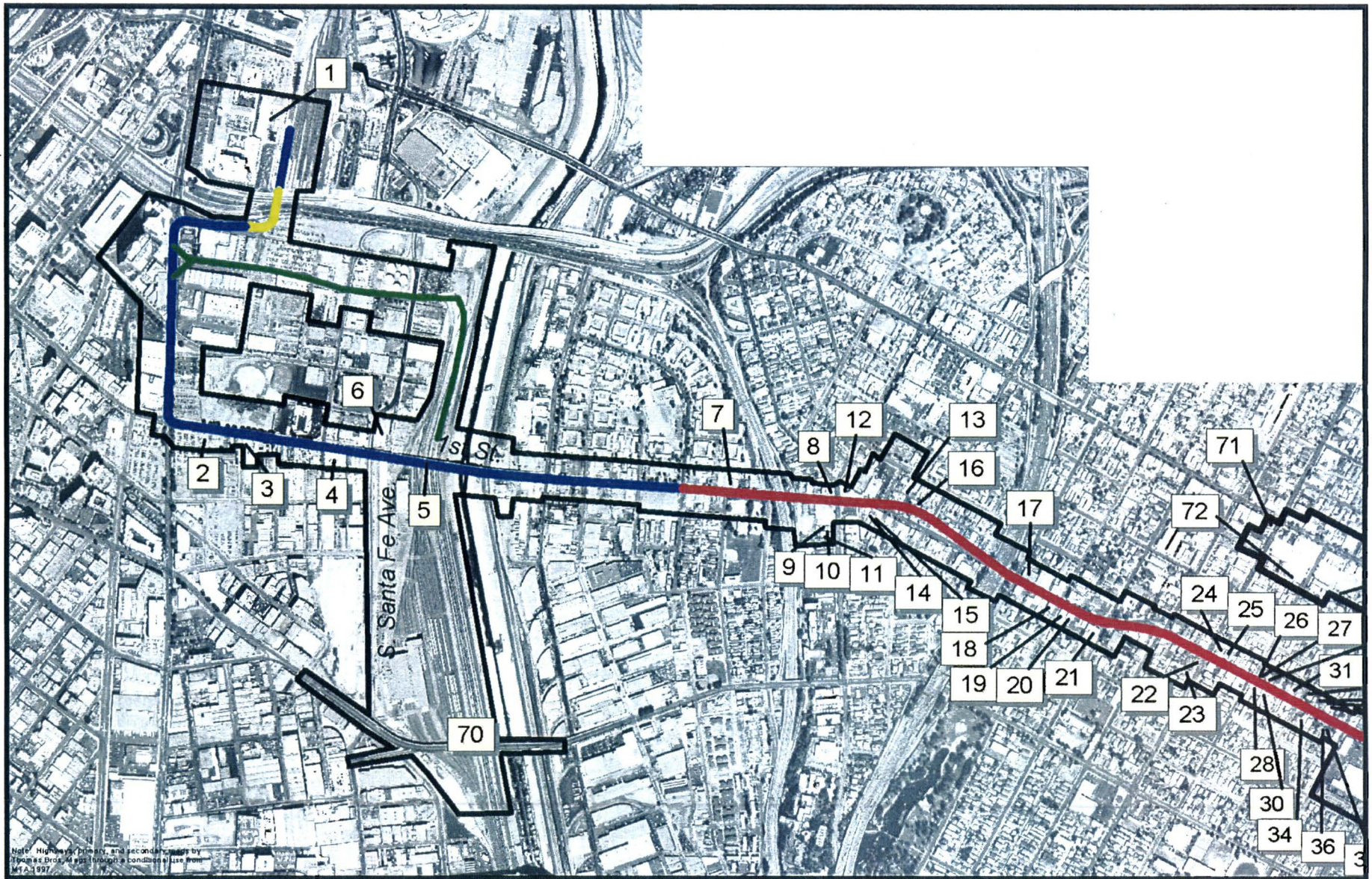
### ***Properties Identified within the APE***

A review of archival records, background literature, and field survey have identified two types of cultural resources (King 1998:221-222). These types include:

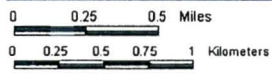
- ◆ Historic Properties – Places included in or eligible for the National Register of Historic Places by virtue of their historical, archaeological, architectural, engineering, or cultural significance; and
- ◆ Community cultural norms, values, and beliefs, and their expressions in the ways people work, play, relate to one another, organize to meet needs, and generally participate in society. This kind of resource, which may or may not involve historic properties or some other kind of resource, or use of the natural environment, is subject to NEPA.

The preliminary architectural/historical reconnaissance undertaken as part of the Draft SEIS/SEIR process identified over 150 properties within the APE for the various LRT Build Alternative options as significant, or potentially significant and warranting additional investigation. The intensive architectural survey, conducted in March to August 2001, evaluated 74 significant, or potentially significant individual buildings, structures, or objects. The State of California, Department of Parks and Recreation, Historic





Note: Highway, Primary, and Secondary Road by MTA 1997.

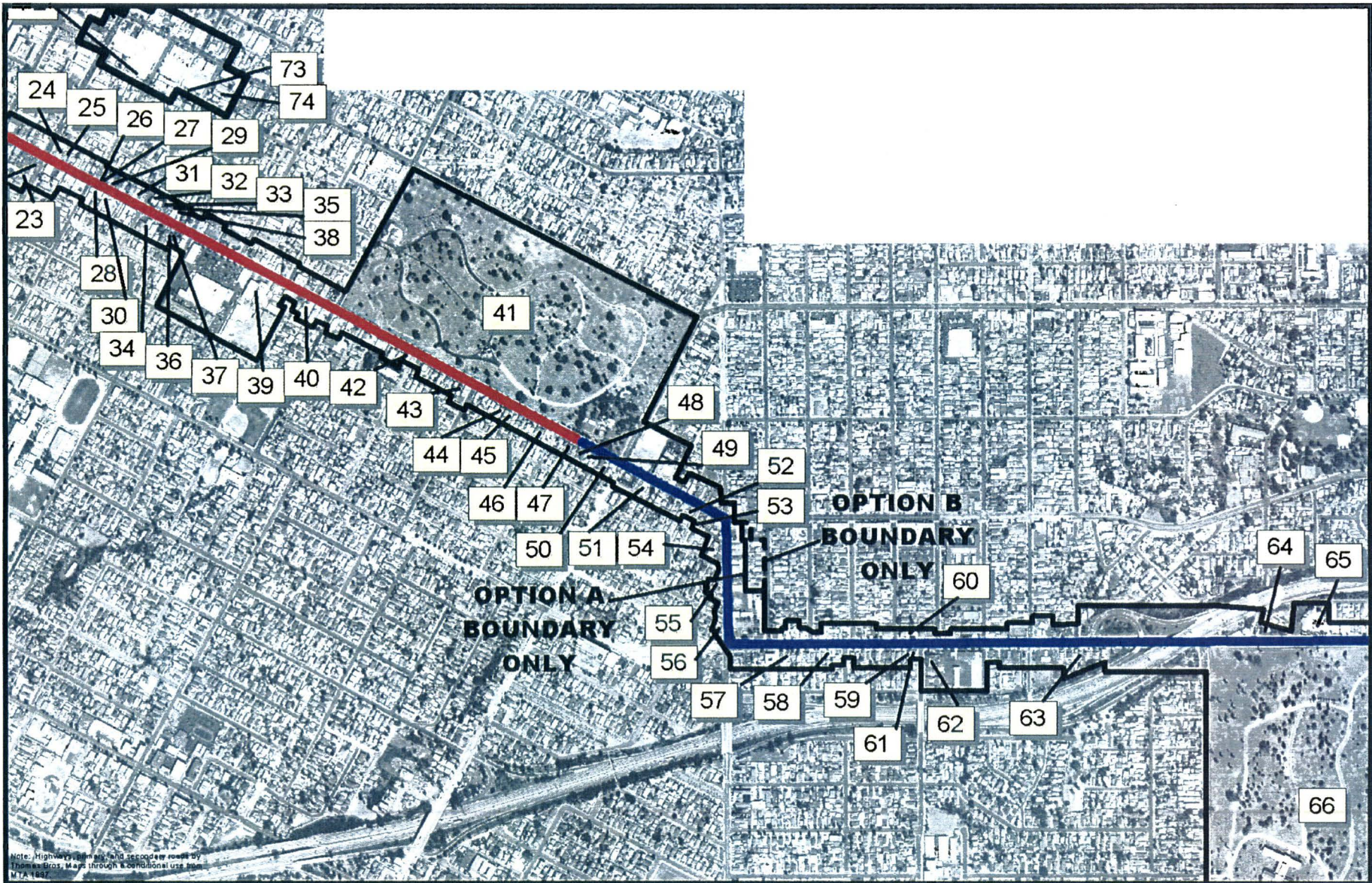


- LEGEND**
- 1 Area of Potential Effect - Option B Only
  - 1 Cultural Resource Buildings/Features
  - At Grade
  - Tunnel
  - Elevated
  - M&SF Lead Line
  - Highway
  - Primary Road
  - Secondary Road
  - Option A Only
  - Option B Only

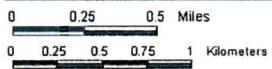
Los Angeles Eastside Corridor SEIS/SEIR







Note: Highways, bridges, and secondary roads by Thomas Bros. Maps through conditional use from MTA 1997.

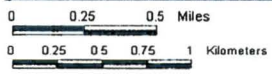
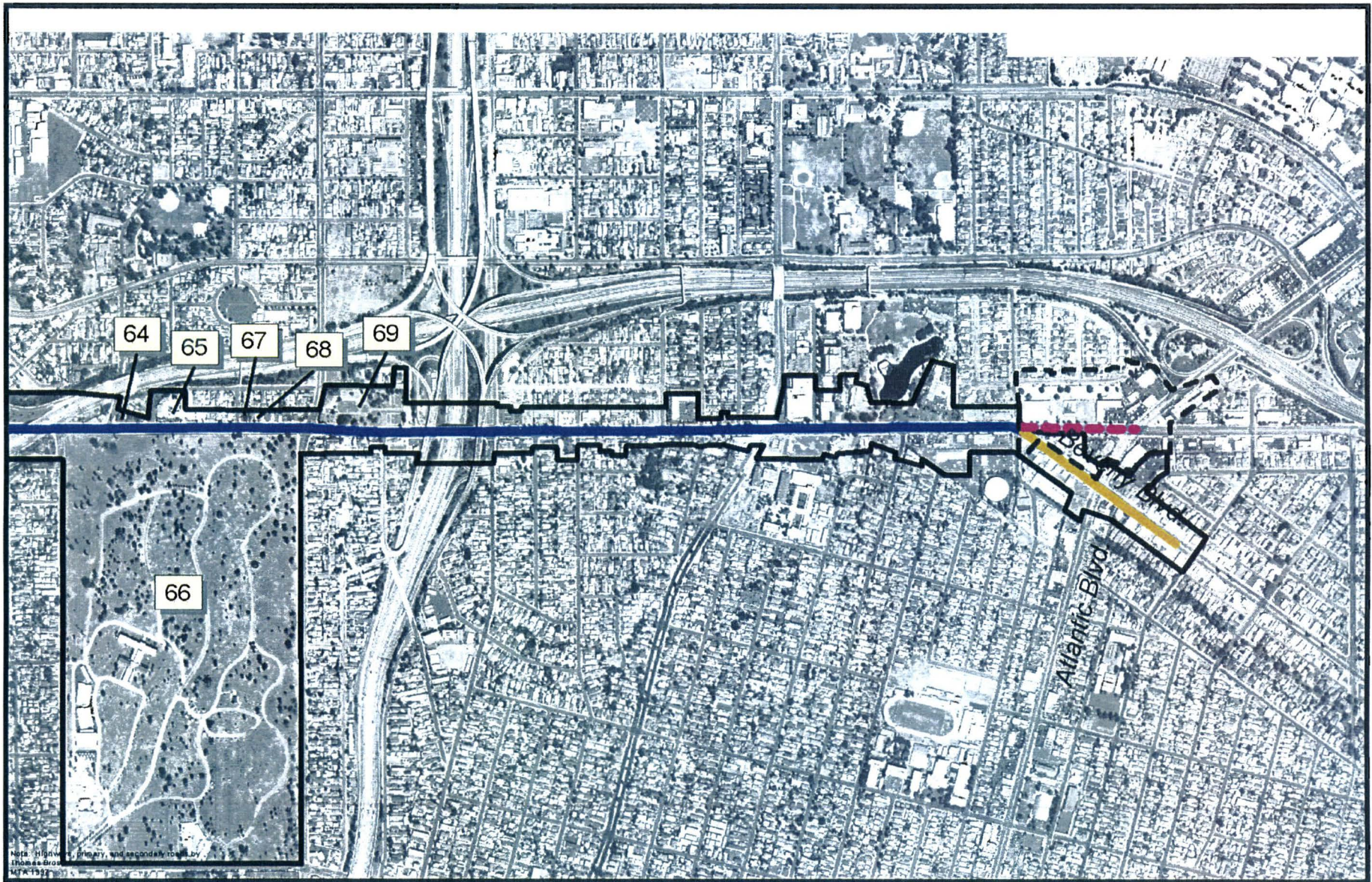


**LEGEND**

- Area of Potential Effect
- Area of Potential Effect - Option B Only
- Cultural Resource
- Buildings/Features
- At Grade
- Tunnel
- Elevated
- M&SF Lead Line
- Highway
- Primary Road
- Secondary Road
- Option A Only
- Option B Only

Los Angeles Eastside Corridor SEIS/SEIR





**LEGEND**

- |  |                |                |
|--|----------------|----------------|
| Area of Potential Effect                 | At Grade       | Highway        |
| Area of Potential Effect - Option B Only | Tunnel         | Primary Road   |
| Cultural Resource Buildings/Features     | Elevated       | Secondary Road |
| [1]                                      | M&SF Lead Line | Option A Only  |
|  |                | Option B Only  |

Los Angeles Eastside Corridor SEIS/SEIR

**Area of Potential Effect Map**

Figure 4.15-3



Resource Inventory form for each building is presented in the *Revised Cultural Resources Technical Report* that was prepared in support of the Final SEIS/SEIR. One building was identified as currently on the National Register of Historic Places. Two structures were previously determined eligible for the National Register as part of the Caltrans Historic Bridge Inventory. Eight properties had previously been determined eligible for National Register listing as a result of the FEIS/FEIR for the suspended Metro Red Line project. The present survey identified 14 properties that appear to meet the criteria for listing in the National Register, four buildings were found to be conditionally eligible for listing (currently ineligible), and 45 additional properties were found not to meet the National Register criteria, but appear significant at the state or local level. All other buildings, structures, and objects within the APE were found to have lost substantial integrity of design through alteration, or were less than 50 years of age and without significant overriding qualities of design and/or association. Final Determinations of Eligibility and Finding of Effect will be made through consultation with the State Historic Preservation Officer (SHPO).

Table 4.15-1 presents a summary of the 74 built resources, 12 murals and four archaeological sites that have been identified in the vicinity of the LRT Build Alternative for Options A and B. Those that are determined to be eligible, appear to be eligible, or are conditionally eligible to the National Register or are ineligible but may be eligible for state or local listing are identified below. The reference number that appears after each built resource corresponds to the resources identified in Figures 4.15-1 through Figures 4.15-3.

Site Type <sup>1</sup>	Number Present
Archaeological Site, Determined Eligible to the National Register	1
Archaeological Sites that Appear Eligible to the National Register	3
Murals, Not Eligible to the National Register	12
Properties Listed in the National Register	1
Properties Determined Eligible to the National Register	10
Properties that Appear Eligible to the National Register	14
Properties Conditionally Eligible to the National Register	4 <sup>2</sup>
Ineligible Properties (may be eligible for state or local listing)	45
<sup>1</sup> "Properties" may include buildings, structures, or objects.	
<sup>2</sup> = Currently ineligible	

Recorded Archaeological Sites Determined Eligible for the National Register of Historic Places

- ◆ CA-LAN-1575H; Historic Chinatown

Recorded Archaeological Sites

- ◆ CA-LAN-887H; La Placita: Zanja Madre foundations and historical deposits<sup>1</sup>
- ◆ CA-LAN-7H; Native American and Chinese historic deposits
- ◆ CA-LAN-2563H; Historical Deposits

Historic Property Previously Listed on the National Register of Historic Places

- ◆ Union Station, #1 (800 North Alameda)

Historic Properties Determined Eligible for Listing in the National Register

- ◆ 1<sup>st</sup> Street Viaduct, #5 (900 E. 1<sup>st</sup> Street)
- ◆ 4<sup>th</sup> Street Viaduct, #70 (100 E. 4<sup>th</sup> Street)
- ◆ Hotel Mount Pleasant, #8 (103-105 N. Boyle Avenue)
- ◆ Walter and Lillie Webb Residence, #9 (125 S. Boyle Avenue)
- ◆ Jewish Home for Wayfarers, #10 (127 S. Boyle Avenue)
- ◆ Simon Gless Farmhouse, #11 (131 S. Boyle Avenue)
- ◆ George and Emma Launder's Residence, #16 (1853 E. 1<sup>st</sup> Street)
- ◆ Alfred Guest Cottage, #72 (319 N. Mathews Street)
- ◆ Charles Fisher Residence, #74 (334 N. Pickett Street)
- ◆ Evergreen Cemetery and Ivy Chapel, #41 (204 N. Evergreen Avenue)

Historic Properties Found to Appear Eligible for Listing in the National Register (Require Consensus Determination from SHPO)

- ◆ J.R. Newberry Company Building, #4 (900 E. 1<sup>st</sup> Street)
- ◆ James Hill & Sons Pickle Works, #6 (1001-1007 E. 1<sup>st</sup> Street)
- ◆ Mariachi Plaza, #12 (1800 E. 1<sup>st</sup> Street)
- ◆ Hollenbeck Masonic Lodge #319/Chicago Plaza, #21 (2130 E. 1<sup>st</sup> Street)
- ◆ Peabody/Werden House, #25 (2415-2417 E. 1<sup>st</sup> Street)
- ◆ Lloyd Champion Residence, #27 (2631 E. 1<sup>st</sup> Street)
- ◆ Martha Sindell Residence, #28 (2508 E. 1<sup>st</sup> Street)
- ◆ James Scott Residence, #38 (2631 E. 1<sup>st</sup> Street)
- ◆ 3<sup>rd</sup> Street Market, #61 (3750 E. 3<sup>rd</sup> Street)
- ◆ Our Lady of Lourdes Church, #62 (3772 E. 3<sup>rd</sup> Street)
- ◆ William Goodhue Residence, #63 (3886 E. 3<sup>rd</sup> Street)
- ◆ Santuario de Nuestra Senora de Guadalupe Church, #65 (4101-4103 E. 2<sup>nd</sup> Street)
- ◆ St. Sava Serbian Eastern Orthodox Church and Cemetery, #66 (4355 3<sup>rd</sup> Street)
- ◆ New Calvary Cemetery, #69 (4201 E. Whittier Boulevard)

Historic Properties Found to be Conditionally Eligible for the National Register (As a Result of this Survey Pending Reversal of Alteration of the Historic Property)

- ◆ Joseph Kozinsky Block Building, #18 (2028-2036 E. 1<sup>st</sup> Street)
- ◆ Harvey Gregory Residence, #30 (2516 E. 1<sup>st</sup> Street)
- ◆ Apartment House, #32 (2601-2607 E. 1<sup>st</sup> Street)
- ◆ C.E. Bacon Residence and Max Glickman Barbershop, #35 (2625 E. 1<sup>st</sup> Street)

Properties Found not to Meet the Criteria for Listing in the National Register or the California Register but Should be Considered for Local Listing

- ◆ Granite Curbstones, #2 (500-800 Blocks, East 1<sup>st</sup> Street)
- ◆ Forthmann Est./Nippon Co. Building, #3 (702 E. 1<sup>st</sup> Street)
- ◆ Mrs. S. Uttly Residence, #7 (1613-1623 East 1<sup>st</sup> Street)
- ◆ Mrs. L. Murstein Residence, #13 (1806-1812 Pennsylvania Avenue)
- ◆ George B. Kellick Block Building, #14 (1832 East 1<sup>st</sup> Street )
- ◆ Joseph Joyeria, #15 (1832 East 1<sup>st</sup> Street)
- ◆ St. Louis Drug Co., #17 and #19 (2001 and 2100 East 1<sup>st</sup> Street )
- ◆ T. Wooden Block Building, #20 (2106 East 1<sup>st</sup> Street)
- ◆ Charles N. Poundstone Residence, #22 (113 South Soto Street)
- ◆ Brengartner Residence, #23 (121 South Soto Street)

- ◆ James M. Brayton Apartment House, #24 (2409 East 1<sup>st</sup> Street)
- ◆ Walter B. Thompson Residence, #26 (2505 East 1<sup>st</sup> Street)
- ◆ Samuel Wise Residence #29 (2511 East 1<sup>st</sup> Street)
- ◆ Maria E. Murdock Residence, #31 (2537 East 1<sup>st</sup> Street)
- ◆ Sophie Rochewald Residence, #33 (2611 East 1<sup>st</sup> Street)
- ◆ Dr. John W. Bacon Residence, #34 (2612 East 1<sup>st</sup> Street)
- ◆ Frederick W. Hamlin Residence, #36 (2626 East 1<sup>st</sup> Street)
- ◆ Harvey H. Vincent Residence, #37 (2630 East 1<sup>st</sup> Street)
- ◆ First Street School, #39 (2820 East 1<sup>st</sup> Street)
- ◆ Charles Engle Residence, #40 (2908 East 1<sup>st</sup> Street)
- ◆ Mt. Carmel Missionary Baptist Church Rectory, #42 (3068 East 1<sup>st</sup> Street )
- ◆ Albina Kerbee Residence, #43 (3138 East 1<sup>st</sup> Street)
- ◆ L.E. Parkam Residence, #44 (3222 East 1<sup>st</sup> Street)
- ◆ F.M. Davis Residence, #45 (3228 East 1<sup>st</sup> Street)
- ◆ William J. King Residence, #46 (3258 East 1<sup>st</sup> Street)
- ◆ George and J. Hollis Residence, #47 (3310 East 1<sup>st</sup> Street)
- ◆ Patrick Dooley Residence, #48 (3318 East 1<sup>st</sup> Street)
- ◆ John Harris Residence, #49 (3322 East 1<sup>st</sup> Street)
- ◆ Del Burridge Residence, #50 (3340 East 1<sup>st</sup> Street)
- ◆ George Potter Residence, #51 (3434 East 1<sup>st</sup> Street)
- ◆ W. A. Cunningham Service Station, #52 (3454 East 1<sup>st</sup> Street)
- ◆ G.E. Platt Dairy Residence, #53 (3464 East 1<sup>st</sup> Street)
- ◆ DWP Station No. 23, #54 (123 South Indiana Street)
- ◆ Maria Martone Residence, #55 (147 South Indiana Street)
- ◆ Wm. I. And M.A. Adams Residence, #56 (205 South Indiana Street)
- ◆ Residence, #57 (3644 East 3<sup>rd</sup> Street)
- ◆ Residence, #58 (3672 East 3<sup>rd</sup> Street)
- ◆ Residence, #59 (3744 East 3<sup>rd</sup> Street)
- ◆ Residence, #60 (3747 East 3<sup>rd</sup> Street)
- ◆ Residence, #64 (216 Sunol Drive)
- ◆ Residence, #67 (214 Marianna Avenue)
- ◆ Residence, #68 (4219 East 3<sup>rd</sup> Street)
- ◆ Rosen Block & Lodge, #71 (2334 East Cesar Chavez Avenue)
- ◆ Ferdinand Gottschalk Residence, #73 (329 No. Fickett Street)

### ***Historical Background***

Prehistoric settlement in the Los Angeles basin appears to have been patterned in relation to environmental attributes that favored subsistence practices and may represent either villages or temporary/seasonal camps of special functions. Native American inland sites were often distributed near springs or seeps, or in proximity to oak groves. Other sites, many undocumented, were located to take advantage of desirable faunal, mineral, wild plant and seed resources. With the arrival of the Spaniards and formation of the missions, the area was soon depopulated.

Los Angeles was established near the Los Angeles River in 1769. The settlement was close to a ford and a place to ascend the bluffs on the east side of the river, the direction of Mission San Gabriel. The core of the settlement was on the lower river terraces, with the lowest terraces and floodplain serving as fields. As time passed, settlement spread upslope and westward away from the periodic flooding.



The archaeological record of California history is extensive throughout the area along the river. Earlier excavation documented one section of *Zanja 3*, part of the first Los Angeles water delivery system (Cultural Resource Group 1987). The complexity of the archaeological record is seen in La Placita (CA-LAN-887H), a stratified site between Alameda Street and the Plaza area (Costello and Wilcoxon [1978]) and in adjacent historic Chinatown (Greenwood 1996). Borings made at the northwest corner of Temple and Alameda produced architectural remains of a mill, late nineteenth century domestic artifacts, and refuse bone (Padon 1986).

After the achievement of California statehood in 1850, the city continued to develop around the early core. The street grid was expanded as new tracts were surveyed and bridges were built across the river. The heart of the city continued to move upslope, both east and west, and former vineyards on the river terraces were subdivided for homes and businesses. Industries such as meat packing, gas generation, and brickyards were relegated to the lowlands along the river, which came to be known as "the Flats." The architectural (and potential archaeological) history of the study area reflects patterns of urban growth and maturation. The area of the Flats is the most intensively utilized, with documented multiple occupations. Remnants of several waves of construction are present at and below the surface.

By the 1880s, suburban development began on the bluffs above the river. New housing tracts were served by street railways, and business establishments followed along transportation corridors (refer to Section 4.4.1.5, *Communities/Neighborhoods* for more information about historic settlement patterns in the corridor). While evidence of early land use and cultural patterns has become part of the architectural and archaeological record, many land use and cultural patterns established by the 1880s have persisted. An example of such a pattern is commercial development along east-west arteries serving adjacent residential neighborhoods. Development of a transportation node on the flats and the two main waves of construction on the Boyle Heights bluffs, the 1880s through the 1890s and the 1920s, are visible in numerous structures.

The study area illustrates the strong American pattern of single-family detached dwellings prevalent through the middle of the twentieth century, nearly always of wood frame construction. These residences reflect trends in style, seen in the Queen Anne style of the 1890s, the Craftsman bungalows of the early twentieth century, the pre-World War II Mission Revival and other revival styles, and the Frank Lloyd Wright-influenced ranch style of the post-war period. Commercial architecture shows differences from dwellings; historic enterprises in the study area were frequently constructed of brick, often two stories in height. Unlike dwellings, which were set back from the street behind a fence demarcating the property, commercial structures were built to meet the property lines, with the entry on the main street. Commercial architecture can demonstrate the material correlates of marketing and consumer behavior.

Mural artwork, although used since the study area was settled by Spanish speakers, has in recent decades become an important element of the urban landscape. Some outstanding examples of mural artwork have already been lost, reinforcing the importance to the community and the special value of those murals that survived. Documented dates span more than 20 years, indicating that this is a tradition that speaks to the residents of the area and for which they have affinity and special concern.

Since the founding of the pueblo, the multicultural composition of the population, changing with patterns of migration and immigration, has left an impression on the city and its surroundings. The evidence is both visible, in the form of structures and wall art, and obscured, in the subsurface archaeological remains. The potential for discovery of subsurface historical remains is high from the area of Union Station to the foot of the Boyle Heights bluffs, is less along 1<sup>st</sup> Street from the Los Angeles River to the city boundary at Indiana Street, and decreases further along 3<sup>rd</sup> Street east to the end of the corridor.

#### 4.15.1.2 Paleontological Resources

##### *Regulatory Setting*

Paleontologic resources, including fossil remains, associated specimen data and corresponding geologic and geographic site data, fossil sites, and the fossil-bearing stratigraphic rock units, are a limited, nonrenewable, and very sensitive scientific and educational resource and, particularly with regard to fossil sites, are afforded protection under the following federal and state environmental legislation, as indicated below.

- ◆ National Environmental Policy Act of 1969 (NEPA) (P.L. 91-190; 31 Stat. 852, 42 U.S.C. 4321-4327). Requires that important natural aspects of our national heritage be considered in assessing the environmental consequences of a proposed project.
- ◆ Archaeological and Historic Data Preservation Act of 1974 (P.L. 86-253, as amended by P.L. 93-291; 88 Stat. 174, U.S.C. 469). Provides for the survey, recovery, and preservation of significant paleontologic data when such data might be destroyed or lost due to a federal, federally licensed, or federally funded project.
- ◆ California Environmental Quality Act of 1970 (CEQA) (13 Public Resources Code: 21000 *et seq.*). Requires that public agencies and private interests identify the environmental consequences of their proposed projects on any object or site of significance to the scientific annals of California (Division I, Public Resources Code: 5020.1 [b]).
- ◆ Guidelines for the Implementation of CEQA, as amended March 29, 1999 (Title 14, Chapter 3, California Code of Regulations: 15000 *et seq.*). Define procedures, types of activities, persons, and public agencies required to comply with CEQA, and include definitions of significant impacts on a fossil site (Section 15023, Appendix G [5.c]).
- ◆ Public Resources Code, Section 5097.5 (Stats. 1965, c. 1136, p. 2792). Defines any unauthorized disturbance or removal of a fossil site or remains on public land as a misdemeanor.
- ◆ Public Resources Code, Section 30244. Requires reasonable mitigation of adverse environmental impacts that result from development of public land and that affect paleontologic resources.

##### *Paleontological Setting*

Although no previously recorded fossil site has been documented in the study area, there exists a moderate to high potential to encounter fossil remains at previously unrecorded fossil sites by construction-related earth-moving activities where these activities will disturb previously undisturbed rock strata. At or near the surface, the younger alluvium probably is too young to contain remains old enough to be considered fossilized and, therefore, there probably is only a low potential for any fossil remains or previously unrecorded fossil site being encountered by shallow earth-moving activities in areas underlain by this rock unit.

East of Highway 101, the study area is underlain by older alluvium, except along some of the passes and in the eastern end of the study area (refer to Section 4.9, *Geologic and Seismic Conditions* for more information about soils in the study area). In other sections of Los Angeles outside the study area, the older alluvium has yielded fossilized bones and teeth representing a diversity of continental vertebrate species, including extinct late Pleistocene (Ice Age) land mammals species, at a number of previously

recorded fossil sites (including La Brea tar pits) west of downtown Los Angeles and in the Hollywood area (Hay, 1927; Jefferson, 1991a, -b; Lander, 1994, in press; Miller, 1971). Some of these fossil remains were recovered at newly discovered fossil sites encountered by tunneling under Hollywood and Wilshire Boulevards during construction of the Metro Red Line tunnels. One of these fossil sites, which yielded extinct bison remains, was encountered by tunneling immediately west of Union Station during construction of the Metro Red Line tunnel between Union Station and the Tom Bradley/Civic Center Station (Lander, in press).

#### 4.15.2 Methodology for Impact Evaluation

##### *Archaeological/Historic Resources*

The approach used to conduct this analysis began with the identification of known historic resources within the APE. A field survey was conducted to provide a preliminary evaluation of resources that have not been previously recorded, and to map the identified resources relative to the proposed alignments. All historic buildings and structures that, from the windshield survey appear to possess characteristics that may warrant evaluation, have been recorded for this work effort. Properties that meet the age criteria, but do not possess visual characteristics that appear important/significant have been considered and are included in this analysis. Final Determinations of Eligibility and Finding of Effect will be made through consultation with the State Historic Preservation Officer (SHPO).

Following background research and development of the project area's historical context, an intensive architectural/historical survey of the APE was conducted, and the results recorded according to the following methods:

- ◆ Review of previous surveys conducted in the vicinity of the APE and inventories of significant historical resources;
- ◆ Field investigation consisting of a visual on-site examination of each building, structure, and object within the APE boundaries;
- ◆ Photography and recordation of architectural attributes, condition, and level of alteration of all buildings and properties previously documented as significant, or dating to before 1951 and displaying integrity of design, and/or appearing to have historic/cultural significance;
- ◆ Background historical research for each building identified by the field survey, including building permits maintained by the City and County of Los Angeles Departments of Building and Safety, Los Angeles County Assessor's Records, local construction journals, historic Sanborn Map Company insurance maps, Los Angeles City Directories, and other sources; and
- ◆ Preparation of California Historic Resource Inventory forms (DPR 523) for all structures potentially eligible for listing on the National Register of Historic Places or the California Register of Historical Resources.

An adverse effect is found when an undertaking may alter, directly or indirectly, those characteristics of a historic property that qualify the property for inclusion in the National Register in a manner that would diminish the integrity of the property's location, design, setting, materials, workmanship, feeling, or association. Consideration shall be given to all qualifying characteristics of a historic property, including those that may have been identified subsequent to the original evaluation of the property's eligibility for the National Register. Adverse effects may include reasonably foreseeable effects caused by the undertaking that may occur later in time, be farther removed in distance, or be cumulative.

For the analysis of historic properties, an adverse effect occurs if there is:

- ◆ Physical destruction of or damage to all or part of the property;
- ◆ Alteration of a property, including restoration, rehabilitation, repair, maintenance, stabilization, hazardous material remediation and provision of handicapped access, that is not consistent with the Secretary's Standards for the Treatment of Historic Properties (36 CFR part 68) and applicable guidelines;
- ◆ Removal of the property from its historic location;
- ◆ Change of the character of the property's use or of physical features within the property's setting that contribute to its historic significance;
- ◆ Introduction of visual, atmospheric or audible elements that diminish the integrity of the property's significant historic features;
- ◆ Neglect of a property which causes its deterioration; and
- ◆ Transfer, lease, or sale of property out of federal ownership or control without adequate and legally enforceable restrictions or conditions to ensure long-term preservation of the property's historic significance.

The agency official may propose a finding of no adverse effect if the undertaking is modified or conditions are imposed to avoid adverse effects (36 CFR 800.5 (b)). If avoidance is not possible, then the agency official shall consult further to resolve the adverse effect pursuant to 36 CFR 800.6.

### ***Paleontological Resources***

Geologic maps, cross sections, and reports covering the Los Angeles Eastside Corridor study area were reviewed to determine the stratigraphic rock units underlying the study area. Surficial geological mapping of the study area is provided by Dibblee (1989). An archival search was conducted at the Natural History Museum of Los Angeles County (LACM) Vertebrate Paleontology Section (VP) to determine the locations of previously recorded fossil sites in each rock unit in and near the study area, as well as the taxa represented by the fossil remains recovered at these sites.

The potential for fossil remains being uncovered at previously unrecorded fossil sites that might be encountered by construction-related earth-moving activities, if any, for each alternative in previously undisturbed strata was assessed. This assessment is based on the type of transportation mode (subway, aerial, at-grade) and construction method to be implemented for Options A and B of the LRT Build Alternative, the depths at which earth-moving activities will occur, and the paleontologic productivity of the stratigraphic rock unit in which these activities will occur.

### **4.15.3 Impacts**

#### **4.15.3.1 No-Build Alternative**

There would be no construction related impacts on cultural resources because this alternative only includes improvements to the transportation network that have already been approved and have environmental clearance. No capital improvements are included under this alternative, and it would therefore not result in any changes to historic properties within the study area.

#### **4.15.3.2 LRT Build Alternative – Option A**

Tables 4.15-2 and 4.15-3 summarize impacts on cultural resources. Table 4.15-2 displays the archaeological site or area of sensitivity, the type of impact anticipated and the effect of the impact. Table 4.15-3 identifies architectural properties, the type of potential impact, either caused by the construction or operation of the LRT Build Alternative or the visual impact to the historic setting, and whether the impact

creates an adverse effect or not pursuant to Section 106 of the NHPA. The determination of effect shown in the table assumes that mitigation (as discussed in Section 4.15.4) is implemented.

<b>TABLE 4.15-2 SUMMARY OF IMPACTS ON ARCHAEOLOGICAL PROPERTIES</b>			
<b>Location/Activity</b>	<b>Resource</b>	<b>Type of Impact</b>	<b>Type of Effect</b>
<b>Known Archaeological Sites</b>			
Aerial Structure	Archaeological Site, CA-LAN-1575H (Determined Eligible)	Ground Disturbance	Unknown
Alameda/101 Fwy	Archaeological Site, CA-LAN-7H	Ground Disturbance	Unknown
Alameda/101 Fwy	Archaeological Site, CA-LAN-887H	Ground Disturbance	Unknown
Maintenance and Storage Facility	Archaeological Site, CA-LAN-2563H	Ground Disturbance	Unknown
<b>Areas of High Archaeological Sensitivity</b>			
1 <sup>st</sup> /Alameda	Possible Historical Remains (stone curbing, structural remains, and historic rail track).	Ground Disturbance	Unknown
1 <sup>st</sup> Street at Alameda to Rowan	Historic Transportation	Ground Disturbance	Unknown
All stations on 1 <sup>st</sup> and Indiana Streets	Historic Transportation	Ground Disturbance	Unknown
Cut and cover between Gless and Pecan Streets	Historic Transportation	Ground Disturbance	Unknown
1 <sup>st</sup> /Boyle, MTA property, southwest corner	Historical Resources	Ground Disturbance	Unknown
1 <sup>st</sup> /Boyle, MTA property, northeast corner	Historical Resources	Ground Disturbance	Unknown
1 <sup>st</sup> /Bailey Street, MTA property on northwest corner	Historical Resources	Ground Disturbance	Unknown
Bailey/Pennsylvania, MTA property on southeast corner	Historical Resources	Ground Disturbance	Unknown
1 <sup>st</sup> /Soto, property acquisition on southwest corner	Historical Resources	Ground Disturbance	Unknown
1 <sup>st</sup> /Soto, property acquisition on southeast corner	Historical Resources	Ground Disturbance	Unknown

<b>TABLE 4.15-3 SUMMARY OF IMPACTS ON ARCHITECTURAL PROPERTIES<sup>1</sup></b>				
<b>Property/Impact</b>	<b>Construction</b>	<b>Operation<sup>2</sup></b>	<b>Visual</b>	<b>Effect<sup>3</sup></b>
Union Passenger Terminal, 800 N. Alameda Street (Map Reference #1)	X	X	X	No Adverse Effect
1 <sup>st</sup> Street Viaduct, 900-1100 Blocks of E. 1 <sup>st</sup> Street (Map Reference #5).	X	X	X	No Adverse Effect
Fourth Street Viaduct, 100-1700 Blocks of E. 4 <sup>th</sup> Street (Map Reference #74)		X	X	No Adverse Effect
Hotel Mount Pleasant, 103-105 N. Boyle Avenue (Map Reference #8).			X	No Adverse Effect
Walter and Lillie Webb Residence, 125 S. Boyle Avenue (Map Reference #9)	X			No Adverse Effect

**TABLE 4.15-3  
SUMMARY OF IMPACTS ON ARCHITECTURAL PROPERTIES<sup>1</sup>**

Property/Impact	Construction	Operation <sup>2</sup>	Visual	Effect <sup>3</sup>
Jewish Home for Wayfarers, 127 S. Boyle Avenue (Map Reference #10).	X			No Adverse Effect
Simon Gless Farmhouse, 131 S. Boyle Avenue (Map Reference #11).	X			No Adverse Effect
Mariachi Plaza, 1800 Block, E. 1 <sup>st</sup> Street (Map Reference #12).	X	X	X	No Adverse Effect
George E. and Emma Lauanders Residence, 1853 E. 1 <sup>st</sup> Street (Map Reference #16)				No Effect
Alfred Guest Cottage, 319 N. Mathews Street (Map Reference #72).	X			No Adverse Effect
Charles W. Fisher Residence. 334 N. Fickett Street (Map Reference #74).	X			No Adverse Effect
Evergreen Cemetery/Ivy Chapel, 204 N. Evergreen Avenue (Map Reference #41).		X	X	No Adverse Effect
J.R. Newberry Company Building, 900 E. 1 <sup>st</sup> Street (Map Reference #4).		X		No Adverse Effect
James K. Hill & Sons Pickle Works, 1001-1007 E. 1 <sup>st</sup> Street (Map Reference #6).		X		No Adverse Effect
Hollenbeck Masonic Lodge#319/ Chicago Plaza, 2130 E. 1 <sup>st</sup> Street (Map Reference #21).				No Effect
Peabody/Werden House, 2415-2417 E. 1 <sup>st</sup> Street (Map Reference #25).		X		No Adverse Effect
Loyd Champion Residence, 2507 E. 1 <sup>st</sup> Street (Map Reference #27).				No Effect
Martha Sindell Residence, 2508 E. 1 <sup>st</sup> Street (Map Reference #28).				No Effect
James J. Scott Residence, 2631 E. 1 <sup>st</sup> Street (Map Reference #38).				No Effect
3 <sup>rd</sup> Street Market, 3750 E. 3 <sup>rd</sup> Street (Map Reference # 61).		X		No Adverse Effect
Our Lady of Lourdes Church, 3772 E. 3 <sup>rd</sup> Street (Map Reference #62)		X	X	No Adverse Effect
William C. Goodhue Residence, 3886 E. 3 <sup>rd</sup> Street (Map Reference #63).		X		No Adverse Effect
Santuario de Nuestra Señora de Guadalupe, 4101-4103 E. 2 <sup>nd</sup> Street (Map Reference #65).		X	X	No Adverse Effect
New Calvary Cemetery, 4201E. Whittier Boulevard (Map Reference #66).		X	X	No Adverse Effect
St. Sava Serbian Orthodox Church and Cemetery, 4355 E. 3 <sup>rd</sup> Street (Map Reference #69)		X	X	No Adverse Effect

<sup>1</sup> Settlement and Noise/Vibration Impacts have been assessed as less than significant for all properties and, therefore, are not included in this Table.

<sup>2</sup>Operation includes track and catenary elements, traction power substations, and passenger stations.

<sup>3</sup> Effect as determined pursuant to Section 106 of the NHPA. The determination of effect assumes that mitigation (as discussed in Section 4.15.4) is implemented.

### ***Archaeological Resources***

Any disturbance of the ground surface has the potential to impact archaeological resources, whether this results from permanent change such as excavation for a station or tunnel entrance, or only temporary use for parking, storage or lay-down yards. Potential archaeological impacts could occur during construction of Option A of the LRT Build Alternative at the following locations:

- ◆ At the intersection of Alameda and 1<sup>st</sup> Streets, earthmoving could potentially remove or destroy archaeological remains below the roadbed and parking lot at the northeast corner of 1<sup>st</sup>/Alameda.
- ◆ The industrial area of the Flats, from Union Station to the foot of the Boyle Heights bluffs near the Los Angeles River has the highest likelihood of subsurface resource disturbance.
- ◆ The beginning of the LRT alignment and the station platform at Union Station are on historic Chinatown, archaeological site CA-LAN-1575H.
- ◆ Earth moving activities may affect archaeological site CA-LAN-7H, which may extend from west of Union Station into the APE, and along Alameda Street east of the 101 Freeway.
- ◆ The alignment along Alameda Street will abut archaeological site CA-LAN-887H, historical site La Placita. Although the site is recorded only on the west side of Alameda, other remains have since been discovered on the east side of the street.
- ◆ Earth moving along 1<sup>st</sup> Street as far as the 1<sup>st</sup> Street Viaduct may encounter unrecorded archaeological remains.
- ◆ Within the maintenance and storage facility site south of the 1<sup>st</sup> Street Viaduct and west of the Los Angeles River lies historic site CA-LAN-2563H, which was the location of the Santa Fe Railroad's La Grande Station and related features.
- ◆ Cut and cover activities between Clarence and Pecan Streets as well as construction of the 1<sup>st</sup>/Utah Station could remove or destroy buried rails and other cultural remains.
- ◆ Construction of a station at 1<sup>st</sup>/Boyle and staging area at Bailey and Pennsylvania could encounter buried remains relating to the mixed commercial and residential uses during the 19<sup>th</sup> and early 20<sup>th</sup> centuries, as well as affect the use of the historic open space, now named Mariachi Plaza, at this location.
- ◆ Construction near 1<sup>st</sup>/Soto Station could potentially reveal buried remains since this area has historically been a densely built-up residential area prior to evolving into a major neighborhood shopping location during the first decades of the last century.
- ◆ Features from operating street railways and trolleys along 1<sup>st</sup> Street to Rowan Street and along Indiana Street may be encountered along these streets during LRT construction.

The tunnel itself will be at a sufficient depth that it will not directly impact cultural resources. However, any excavation near the surface and settlement has the potential to affect buried remains and/or standing structures. Further connections of the tunnel to the surface, such as air shafts or emergency exits, and new or relocated utilities will require close attention.

### **Significance of Impacts**

These impacts on archaeological resources are potentially significant.

### ***Architectural/Historic Resources***

The potential architectural/historical resource impacts resulting from the implementation of Option A are described below.

### Property Acquisition Impacts on Architectural Resources

A standing commercial structure on 1<sup>st</sup> Street near Bailey Street, the Ranch Market, which was previously acquired by MTA for the suspended Red Line Extension project and environmentally cleared in the Final EIS/EIR for that project (1994), would be demolished to construct the portal entrance and construction staging area for the 1<sup>st</sup>/Boyle Station. Since the market has lost architectural integrity and is not historically or architecturally significant, its removal will not constitute an effect on cultural resources.

### Alteration of the Historic 1<sup>st</sup> Street Bridge

One of 15 significant bridges/viaducts over the Los Angeles River, the 1<sup>st</sup> Street Viaduct was opened to traffic on January 1, 1929. It was influenced by the principals of the City Beautiful movement, the bridges were built in Period Revival styles and included the Macy Street Bridge (1926), which was designed in the Spanish Colonial style, the 1<sup>st</sup> Street Viaduct (1929), designed in Neo-Classical style, and the 4<sup>th</sup> Street Bridge (1931), rendered in the Gothic Revival style. Other character defining features of the 1<sup>st</sup> Street Viaduct include large Roman triumphal arches that rise from the arch and girder abutments, within which are projecting balconies with benches. Spandrel columns constructed within the main spans above the Los Angeles River terminate in arches and are highly decorative. Openings in 13 of the 23 bridge piers are also arched, in keeping with the structure's Neo-Classical style, as are openings of the central pier and abutments. The Neo-Classical detail extends to the entablature pattern on the fascia girders and to the bracketing for the sidewalk. The handrails along the outer edges of the walkways are arcaded and interspersed with roundels. Lampposts are integrated with the handrails and have fluted shafts that rise well above the height of lighting fixtures and originally carried streetcar catenary lines.

The 1<sup>st</sup> Street Viaduct is eligible for the National Register of Historic Places under Criterion A as an important element in the development of the Los Angeles transportation system. Designed in the Neo-Classical style, it is also eligible under Criterion C, Design/Construction, as one of a subset of Period Revival structures.

Following the January 1994 Northridge earthquake, the City of Los Angeles conducted a seismic evaluation and retrofit of the structure of the 1<sup>st</sup> Street Viaduct. With the exception of minor patching and repair, work was limited to the substructure of the viaduct. The seismic retrofit of the 1<sup>st</sup> Street Viaduct was assessed as constituting an adverse effect on the resource (Lee 1995). Mitigation measures implemented as a result of the finding of effect included completion of Historic American Engineering Record documentation for the structure. Additional measures designed to preserve or highlight, as much as possible, the character defining features of the structure specified that infill of the bent openings should be completed with black pigmented concrete (later amended to dark gray) to suggest the missing openings. Further, the shear walls were recessed three inches from the face of the columns on either side to create a reveal that would accentuate the outline of the opening.

As part of the Los Angeles Eastside Corridor project, MTA would conduct supplemental seismic retrofit work for the 1<sup>st</sup> Street Viaduct to meet the upgraded Caltrans Bridge Design Specifications (1999) as follows:

- ◆ Bents 1-5 and 17-21: Reinforced concrete infill shear walls will be constructed between columns. Central bent openings (one of three) have previously been infilled. Proposed work would completely infill the remaining two openings of each bent.
- ◆ Bents 6-16, 22, and 23: Reinforced concrete infill shear walls will be constructed between columns. The two central bent openings (of six) have previously been infilled. Proposed work would completely infill two additional intermediate cells of each bent, leaving only the outermost cells open.



- ◆ Arch Span Central Pier, East and West Arch Abutments: Reinforced concrete infill shear walls will be constructed between columns. The two central bent openings (of four) have previously been infilled. Proposed work would completely infill the remaining two openings of each bent.
- ◆ East and West Girder Abutments: Additional concrete cast-in-drilled-hole piles will be constructed behind the original concrete abutments. This upgrade will not be visible following repair of the road surface.

The proposed seismic retrofit of the 1<sup>st</sup> Street Viaduct, consisting of additional infill of viaduct pier openings with reinforced concrete shear walls at Bents 1-23, infill of center pier and arch abutment openings, and construction of additional cast-in-drilled-hole piles at viaduct end abutments, will result in an adverse effect on the viaduct's integrity of design with respect to the qualities of significance under Criterion C. An essential character-defining quality of the design is the visual effect of the columns supporting the span. Construction of the concrete infill walls will close off the open spaces between the columns, leaving the columns substantially less distinct.

#### Settlement Impacts

Settlement impacts could occur from tunnel excavation due to loss of ground. Such impacts could be cracking of buildings or subsidence over areas of tunnel construction, affecting standing structures directly over or immediately adjacent to the tunneled area between 1<sup>st</sup>/Gless and 1<sup>st</sup> Lorena.

#### Visual Impacts

Visual resources include important views, places where visual quality is important to the use of the property, and recognized historical resources. The following resources have special circumstances that require a more detailed explanation.

#### Union Station

Because the platform area of Union Station is visually separated from the historic station building itself and from the courtyards around, and because rail tracks and train operation is a historic and continuing present activity at Union Station, there would be no visual impacts on Union Station resulting from Option A of the LRT Build Alternative.

#### 1<sup>st</sup> Street Viaduct

To address the concerns of the LA Bureau of Street Lighting and other concerned parties, a catenary system utilizing poles along the roadbed centerline will be utilized. The reuse of the original poles to suspend catenary lines from the street lamp supports along the outer edge of the bridge was not possible for modern light rail since it would have resulted in the replacement of the original poles and required structural augmentation potentially impacting the historic fabric of the bridge. The catenary supports will be designed in a manner compatible with the historic character of the viaduct. Because the Viaduct was once used for an earlier street rail system, placement of the catenary system on the historic 1<sup>st</sup> Street Viaduct will not result in a visual impact on the resource or surrounding resources.

#### 4<sup>th</sup> Street Viaduct

The light rail maintenance and storage facility for the LRT line will extend under the 4<sup>th</sup> Street Viaduct in the form of track extensions and utility pits. There are no anticipated direct impacts to the Viaduct. The visual setting of the Viaduct has already been affected by construction of the Metro Red Line Maintenance Yard.

### Mariachi Plaza

Mariachi Plaza is a triangular plaza, bordered on the south by 1<sup>st</sup> Street, on the west by Boyle Avenue, and on the northeast by Pleasant Avenue. The plaza, which is an historical resource potentially eligible to the National Register, includes a gazebo structure where mariachi bands perform regularly. A subway entrance, located in a parcel adjacent to the plaza, would require removal of a grocery store and parking lot. The removal of the grocery store and the open space created by the entrance plaza would alter the setting by creating a spatial and visual void in the line of the buildings which frame Mariachi Plaza on the northeast.

### Evergreen Cemetery

The LRT corridor along the Evergreen Cemetery's 1<sup>st</sup> Street side transitions from an underground to above grade alignment at the eastern end of the cemetery property. Physical changes visible from Evergreen Cemetery would be the rail trench, trackwork, catenary system and, under Option A only, the 1<sup>st</sup>/Lorena Station, which would be located within a U-section trench near the eastern end of the cemetery. Although the trench, tracks, and catenary system would be partially visible from the southeast corner of the cemetery property, large trees along the 1<sup>st</sup> Street side of the cemetery would screen most of the views, resulting in minimal visual impacts. In addition, screening and the distance from viewers would minimize visual impacts of the station. Option A would restore the historic setting along 1<sup>st</sup> Street since this area was served by street cars that used an overhead catenary system.

### Our Lady of Lourdes Catholic Church

Our Lady of Lourdes is an historic church located on E. 3<sup>rd</sup> Street, east of Rowan Avenue. Physical changes visible from the church grounds include the catenary system and trackwork along 3<sup>rd</sup> Street. A station at 3<sup>rd</sup>/Rowan would be associated with Option A only. The street-level, center-lane station would be located about a block away from the church. Since 3<sup>rd</sup> Street is relatively wide at this location and since the church is set back from the street with a lawn in front, no visual impacts would occur by placing the station and the catenary system within view of the church.

### Santuario de Nuestra Señora de Guadalupe

The Santuario de Nuestra Señora de Guadalupe is a historic church located on the north side of E. 3<sup>rd</sup> Street, between Sunol Drive and Eastern Avenue. Physical changes visible from the property include the rail trench, trackwork, and catenary system along 3<sup>rd</sup> Street. Because the church is set back from the street and elevated considerably above street level, and because trees and other landscaping on the intervening slope largely screen it from view from E. 3<sup>rd</sup> Street, the impacts of the catenary system, trench, and light rail tracks would be minor. The mural associated with the church is also elevated and would not be blocked from view by the LRT facilities.

### New Calvary Cemetery

Along New Calvary Cemetery's 3<sup>rd</sup> Street frontage the light rail track bed is depressed. Physical changes visible from the cemetery grounds would include the rail trench, tracks, and catenary system. While the trench and catenary system would be partially visible from the cemetery, an existing perimeter wall topped by fencing, along with trees and other landscaping, would screen most of the views. The existing 3<sup>rd</sup> Street is relatively wide at this location, and this relatively spacious streetscape, combined with perimeter barriers and landscaping, would minimize visual impacts related to Option A.

### St. Sava Serbian Orthodox Church and Cemetery

St. Sava Serbian Orthodox Cemetery borders E. 3<sup>rd</sup> Street, between Eastern Avenue and I-710. An associated church on the north side of E. 2<sup>nd</sup> Street is well-removed from the proposed LRT alignment. Physical changes visible from the Serbian Cemetery would be the catenary system and trackwork in E. 3<sup>rd</sup> Street. Because this property is partially screened from view from E. 3<sup>rd</sup> Street, the impacts of the catenary system and trackwork would be minor.

### Murals

None of the murals in the Eastside Corridor would be acquired for the project, nor would any of them be blocked from view by project elements. Therefore, there would be no visual impacts on existing murals or public art.

### Noise and Vibration Impacts on Cultural Resources

The results of the vibration and noise study, that was conducted for the operation of the LRT Build Alternative, does not indicate any adverse effects on cultural resources that would diminish the integrity of the property's significant historic features. The noise analysis found that some historic properties that appear eligible for listing on the National Register of Historic Places would be moderately impacted as defined by FTA criteria. None would be severely impacted. With regard to NEPA and CEQA significance impact criteria, a significant impact occurs only if a noise-sensitive receptor is severely impacted according to FTA criteria. In addition, all construction activities within 200 feet of a historic building or cultural resource structure will have to meet the vibration limits and monitoring requirements presented in Section 4.8, *Noise and Vibration*.

### Significance of Impacts

Without mitigation, the visual impacts on Mariachi Plaza are potentially significant under CEQA. Impacts as a result of the seismic retrofit required for the 1<sup>st</sup> Street Bridge are significant without mitigation. Other visual, property acquisition, settlement, and noise and vibration impacts on historic structures would be less than significant.

### ***Paleontological Resources***

Impacts will result from the construction of Option A in those parts of the study area where earth-moving activities will be conducted in previously undisturbed strata. These activities will occur primarily in the tunnel segment between Clarence Street (just east of 1<sup>st</sup>/Utah Station) and Lorena Street (just east of 1<sup>st</sup>/Lorena Station). The activities also will occur in the aerial segment in the area of the Santa Ana (101) Freeway adjacent to Union Station, and also could occur in the at-grade segment. In the tunnel segment, these activities will include (but not necessarily be limited to) open cut excavation for the tunnel portals, 1<sup>st</sup>/Lorena Station box, and line vent structures; cut-and-cover excavation for the 1<sup>st</sup>/Boyle and 1<sup>st</sup>/Soto Station boxes and those portions of the tunnels adjacent to one or both of the portals; possible mining (instead of cut-and-cover excavation) of that portion of the tunnel segment between the western portal and the 1<sup>st</sup>/Boyle Station without using a tunnel boring machine (TBM); and tunneling of the remaining portions of the tunnel segment using a TBM. In the aerial segment, these activities will include drilling or driving piles for aerial guideway column foundations. In the at-grade segments and at other at-grade facility sites in the tunnel segment, these activities might include grading and trenching or other shallow excavation in some track segments (such as 60 Freeway undercrossing), at least some of the at-grade station and traction power substation sites, etc.

The potential impact on the paleontologic resources of the older alluvium and, at depths greater than five feet below grade, the younger alluvium as a result of the construction of Option A probably will be of moderate to high significance because there probably will be a moderate to high potential for the loss of paleontologic resources as a result of earth-moving activities in previously undisturbed strata. On the other hand, the potential impact on the paleontologic resources of the younger alluvium at depths less than five feet below grade probably will be only of low significance because there probably will be no more than a low potential for the loss of paleontologic resources as a result of shallow earth-moving activities in previously undisturbed strata.

#### Significance of Impacts

Without mitigation, the visual impacts on Mariachi Plaza are potentially significant under CEQA. Impacts as a result of the seismic retrofit required for the 1<sup>st</sup> Street Bridge are significant without mitigation. Other visual, property acquisition, settlement, and noise and vibration impacts on historic structures would be less than significant. Many of the construction-related impacts on paleontological resources are potentially significant.

#### **4.15.3.3 LRT Build Alternative – Option B**

Impacts on significant cultural resources are the same as Option A. Because Option B will require an off-street at-grade alignment on the east side of Indiana Street between 1<sup>st</sup> and 3<sup>rd</sup> Streets, Ramona High School, located at the northeast corner of Indiana and 3<sup>rd</sup> Streets, will either be relocated to another site or reconstructed on the existing site. One additional structure, a medical office, currently standing along Indiana Street would also be removed. Neither Ramona High School nor the other structure appears eligible for national, state, or local historic listing. Their demolition will not be considered an adverse effect on cultural resources.

Regarding paleontological impacts, construction of Option B will affect the paleontologic resources of the study area similarly to those of Option A. However, under Option B, fewer fossil-bearing strata will be encountered by cut-and-cover excavation because the 1<sup>st</sup>/Lorena Station box will be replaced by the at-grade 3<sup>rd</sup>/Indiana Station platform.

#### Significance of Impacts

Many of the construction-related impacts on paleontological resources are potentially significant.

#### **4.15.4 Mitigation**

Since the impacts on cultural and paleontological impacts are the same for Options A and B, mitigation measures discussed in this section apply to both options. The MTA is in the Section 106 process that will lead to an Memorandum of Agreement (MOA) between MTA, FTA, and SHPO for any adverse effects that are determined. The MOA specifies mitigation measures and otherwise resolves impacts. The draft MOA is presented in Appendix G. The final MOA will be completed before the Record of Decision (ROD) is issued for the Final SEIS/SEIR.

#### **4.15.4.1 Archaeological**

In the event that archaeological and buried historic sites are encountered, evaluation of the site is often accomplished through test level excavation designed to determine the horizontal and vertical extent of the site, and to characterize the content of the site. If the site is determined to be potentially eligible for listing on the National Register, and project plans cannot be altered to avoid impacting the site, then an

adverse effect would result pursuant to 36 CFR 800.5 (d) (2). To resolve an adverse effect it will be necessary to implement a MOA per 36 CFR 800.6 (c) to resolve the adverse effect (refer to Appendix G). Under CEQA, significant archaeological sites can be mitigated to a level of less than significant impact through the preparation and implementation of a data recovery plan. When any potentially significant archaeological evidence is observed, work will be halted in the immediate vicinity and the procedures set forth in the MOA will be followed.

### ***Significance of Impacts Remaining after Mitigation***

With proper mitigation, impacts on archaeological resources would be less than significant.

#### **4.15.4.2 Architectural/Historic**

##### ***Ground Surface Settlement Resulting from Tunneling***

To limit surface settlement to acceptable levels, pressure-face Tunnel Boring Machines (TBMs), and pre-cast, bolted, gasketed lining systems were proposed for the suspended Metro Red Line project. The pressure-face TBM technology maintains positive fluid or soil pressure on the tunnel face, which decreases the potential for soil movement and surface settlement. Where conditions warrant, for example, shallow tunnels directly below sensitive structures or utilities, additional methods to reduce settlement would be specified. Such methods could include permeation grouting to improve the ground prior to tunneling; compaction grouting as the tunnel is excavated; compensation grouting involving the carefully controlled injection of grout between underground excavations and structures requiring protection from settlement; or underpinning the structure's foundation. More detailed information regarding mitigation of potential settlement impacts is presented in Section 4.19.2, *Potential Construction Period Impacts and Mitigation*.

During construction, instrumentation, e.g., ground surface, and building monitoring programs, will be in place to measure movements and provide information to the contractor on tunneling performance as well as to document that the settlement specifications are met. If measurements indicate settlement limits will be exceeded, the contractor will be required to change or add methods and/or procedures to comply with those limits. Application of these measures will result in a less than significant effect under CEQA.

##### ***Visual***

The placement of the catenary system on the historic 1<sup>st</sup> Street Viaduct (bridge over the Los Angeles River) would not result in a visual impact because the catenary supports will be designed to be compatible with the historic street lamp standards and other stylistic features of the bridge. Second, because the 1<sup>st</sup> Street Viaduct was once used for an earlier street rail system, references to this predecessor of the LRT Build Alternative can be made in the style of the catenary supports. Either of these methods will reduce the visual impacts on the bridge, and to a less than significant degree. The track/pole installation may result in direct impacts on the bridge through removal of original fabric, and installation of support hardware. While Historic American Engineering Record (HAER) documentation has been accomplished for the structure, the Secretary of the Interior's Standards for Rehabilitation will be used in designing the system.

##### ***Noise and Vibration***

The Contractor will be responsible for the protection of vibration sensitive historic buildings or cultural resource structures that are within 200 feet of any construction activity. The maximum peak particle vibration (PPV) velocity level, in any direction, at any of these structures should not exceed 0.12

inches/second for any length of time as recommended by FTA guidance for extremely fragile historic buildings. The Contractor will be required to perform periodic vibration monitoring at the closest structure to any construction activities using approved seismographs. If at any time the vibration levels are exceeded, the contractor will be required to immediately halt activity until an alternative construction method can be implemented that will reduce vibrations to acceptable levels. For any fragile historic properties within 200 feet of the Eastside LRT tunnels, MTA will evaluate the vibration results from the excavating materials train as it passes under historic properties. If the vibration levels emanating from the train exceed 0.1 inches/second PPV, the contractor will take action to reduce the vibration levels to 0.1 inches/second or less. Such action could include reducing the muck train speed, additional rail and tie isolation, and more frequent rail and wheel maintenance. This measure will not apply to the tunnel boring machine, but only to operations resulting from the train hauling excavated materials under fragile historic properties. Which historic properties are to be deemed fragile will be determined through a pre-construction survey. Application of these measures will result in a less than significant effect under CEQA.

### ***Architectural Documentation for Changes in Historic Setting***

#### **1<sup>st</sup> Street Bridge**

Seismic retrofit work will incorporate the following design and construction features:

- ◆ Bents 1-5 and 17-21: Concrete infill shear walls between columns closing the remaining two cells constitutes an adverse effect. All concrete infill walls must be recessed three inches from the face of existing columns on either side, matching the reveals of the central cells created by the earlier City of Los Angeles seismic retrofit. Concrete used for the infill walls will be tinted to match the color of the existing infill walls.
- ◆ Bents 6-16, 22, and 23: Concrete infill shear walls between columns closing two additional cells constitutes an adverse effect. All concrete infill walls must be recessed three inches from the face of existing columns on either side, matching the reveals of the central cells created by the earlier City of Los Angeles seismic retrofit. Concrete used for the infill walls will be tinted to match the color of the existing infill walls.
- ◆ Arch Span Central Pier, East and West Arch Abutments: Concrete infill shear walls between columns closing two additional cells constitutes an adverse effect. All concrete infill walls must be recessed three inches from the face of existing columns on either side. Concrete used for the infill walls will be tinted to match the color of the existing infill walls.
- ◆ New work, which will of necessity become a permanent part of the bridge, should be done so that if it is removed in the future, essential form and integrity of the bridge will be unimpaired.

The MTA, in consultation with the State Office of Historic Preservation (SHPO) and the National Park Service (NPS), will record the 1<sup>st</sup> Street Viaduct according to Historic American Engineering Record (HAER) standards. HAER documents utilize the Secretary of the Interior's *Standards for Architectural and Engineering Documentation*, which are linked to the Secretary's *Guidelines for Architectural and Engineering Documentation* and the HABS/HAER Procedures Manual for more specific guidance and technical information. Recording of the viaduct will be consistent with Documentation Level 1, as defined by the *Secretary's Standard*, including:

- ◆ A full set of measured drawings depicting existing and historic conditions;
- ◆ Photographs with large format negatives of exterior and interior views, photocopies with large format negatives of select existing drawings or historic views where available; and
- ◆ Written data, history and description.

HAER recordation for the 1<sup>st</sup> Street Viaduct will update and augment previously completed documentation of the structure, with particular attention paid to areas of proposed seismic retrofitting. Documentation will be completed within 120 days of release of FTA funding for the Los Angeles Eastside Corridor project. The product will be submitted to the NPS for review and addition to the HABS/HAER collection maintained by the Library of Congress. Copies of the document will also be provided to local institutions or agencies (Los Angeles Public Library, Los Angeles Conservancy) and made available for public review.

The MTA, in consultation with the City of Los Angeles and SHPO, will create a permanent display within an Eastside Corridor station area, or other MTA facility readily accessible to the public, and a traveling interpretive exhibit for display at various public venues within Los Angeles County, such as public libraries, museums, or schools. The exhibits will interpret the history and construction of the 1<sup>st</sup> Street Viaduct and its historical context as one of 15 significant Los Angeles River bridges constructed between 1910 and 1934. The interpretive displays will consist of durable panels and will include items such as: reproductions of historical photographs of the bridges, original construction drawings, drawings and photographs that are part of HAER documentation previously completed for the various bridges and as part of the current mitigation measures, and explanatory text. Items such as reproductions or casts of bridge architectural elements, discarded hardware, lighting fixtures, or other items used in the original bridge construction may also be included. The interpretive displays will be completed and in place prior to initiation of service on the Eastside Corridor LRT line.

#### Mariachi Plaza

Alteration of the setting at Mariachi Plaza is an adverse effect without mitigation. Recordation will be undertaken for this resource similar to that described for the 1<sup>st</sup> Street Bridge. The extent and methods of recordation by a HABS or compatible document are determined in consultation with the National Park Service, which establishes the required level of effort for each recordation. The sequence of actions will be to undertake the HABS recordation as promptly as possible, but prior to any disturbance of the building or its setting, followed by the other recommendations depending upon the option selected. In addition to the recordation, MTA will initiate work to create a facade that is comparable to the facade of the existing building in its scale, visual characteristics, and relationship to the street, while not recreating that building. This will restore the overall sense of space and enclosure that characterize the plaza and gives it its focus. These measures will reduce impacts to a level that is less than significant and under Section 106 to a no adverse effect.

#### *Significance of Impacts Remaining after Mitigation*

With proper mitigation, all potential impacts to historic properties would be reduced to an insignificant level.

#### **4.15.4.3 Paleontological Resources**

Mitigation measures discussed below are the same for Option B as for Option A, except that, under Option B, a paleontologic construction monitor will not be required to monitor open cut excavation for the 1<sup>st</sup>/Lorena Station box since this station will be replaced by the at-grade 3<sup>rd</sup>/Indiana.

The following mitigation measures will reduce the potentially significant (including cumulative) construction impacts on the paleontologic resources to an insignificant level by allowing for the recovery of fossil remains and associated data that might be uncovered by earth-moving activities in the tunnel and aerial segments. These measures will ensure project compliance with mitigation measures stipulated in

the MTA Specifications Section 01170 and with Society of Vertebrate Paleontology (SVP, 1995, 1996) standard measures for mitigating construction-related impacts on paleontologic resources and for the museum repository acceptance of a mitigation program fossil collection.

- ◆ Prior to any earth-moving activity in the study area, the MTA will retain the services of a vertebrate paleontologist approved by the Natural History Museum of Los Angeles County Vertebrate Paleontology Section (LACMVP) to manage a paleontologic resource impact mitigation program in support of earth-moving activities associated with construction of the Eastside Corridor.
- ◆ The paleontologist will develop a storage agreement with the LACMVP regarding permanent storage and maintenance of any vertebrate fossil remains recovered as a result of the mitigation program.
- ◆ The paleontologist or his/her designated representative will present an environmental awareness training session to construction workers regarding the appropriate procedures to be implemented if fossil remains are uncovered by earth-moving activities, particularly tunneling and/or when mitigation program personnel are not on site.
- ◆ A paleontologic construction monitor will monitor earth-moving activities in areas underlain by older alluvium and those extending beyond five feet in younger alluvium. Monitoring will include the inspection of strata freshly exposed by these activities and will allow for the recovery of larger fossil remains uncovered by the activities. Although tunneling will not be monitored because of the confined working space and safety concerns, tunneling debris will be inspected for larger fossil remains if an earth pressure balance TBM is used. In areas underlain by younger alluvium, monitoring will not begin until earth-moving activities have reached a depth five feet below grade.
- ◆ The monitor will recover fossil remains uncovered by earth-moving activities.
- ◆ The monitor or a paleontologic technician will recover and process rock samples to allow for the recovery of smaller fossil remains. The total weight of all samples recovered from each rock unit and subsequently processed will not exceed 6,000 pounds (12,000 pounds combined total for older and younger alluvium).
- ◆ The monitor will have the authority to temporarily divert any earth-moving activity around a newly discovered fossil site or a sampling site until the fossil remains or a rock sample have been recovered and the earth-moving activity has been allowed to proceed through the site by the monitor.
- ◆ The monitor will record associated specimen/sample data (taxon, element) and corresponding geologic (stratigraphic rock unit, stratigraphic level, lithology) and geographic site data (location, depth), and will plot site locations on maps of the study area.
- ◆ All identifiable fossil remains will be fully treated. Treatment will include preparation of the remains by a paleontologic technician to the point of identification; identification to the lowest taxonomic level possible by knowledgeable paleontologists; curating and cataloguing the remains, plotting fossil site locations on maps of the study area, and entry of associated specimen data and corresponding geologic and geographic site data into appropriate computerized data bases by the technician; and placement of the remains in the appropriate museum repository fossil collection for permanent storage and maintenance. Any vertebrate and invertebrate fossil remains will be placed in the LACMVP and LACM Invertebrate Paleontology Section (IP), respectively. Fossil plant remains will be placed in the University of California Museum of Paleontology (UCMP). Associated data will be archived at the appropriate museum repository, where the data, along with the fossil remains, will be made available for future study by qualified scientific investigators.
- ◆ The paleontologist will prepare a comprehensive final report of results and findings that describes study area geology/stratigraphy, summarizes field and laboratory methods used, includes a faunal list and an inventory of curated/catalogued fossil remains, evaluates the scientific importance of the remains, and discusses the relationship of any newly recorded fossil site in the study area to relevant fossil sites previously recorded from other areas.



***Significance of Impacts Remaining After Mitigation***

With these mitigation measures, earth-moving activities associated with construction of Options A or B of the LRT Build Alternative could result in beneficial effects, including the recovery of scientifically highly important fossil remains that would not even have been exposed without the project and, therefore, would not have been available for future study. However, significant impacts on the paleontologic resources of the study area could remain after mitigation. If implemented, drilling using the slurry displacement method for cast-in-place caissons or the impact driving of piles for the aerial guideway column foundations in the aerial segment, and the use of a slurry TBM in the tunnel segment will destroy any fossil remains and associated data.

## 4.16 COMMUNITY FACILITIES/PARKLANDS

### 4.16.1 Affected Environment

A variety of parks and community type facilities exist in or near the proposed LRT alignment in the study area. Community facilities and parklands within one-half mile distance north and south of the LRT alignment are identified in this section. The types of facilities noted include neighborhood and community parks, cemeteries, schools, hospitals, public facilities, such as libraries, fire and police stations, and other community facilities such as churches, youth centers, and museums. The facilities and their locations are identified in Tables 4.16-1 through 4.16-5 and displayed in Figures 4.16-1 and 4.16-2.

#### 4.16.1.1 Parks and Recreation Facilities

A total of eleven parks and recreation facilities are in the study area; one is designated as a State Historic Park. The El Pueblo de Los Angeles State Historic Park is located in the City of Los Angeles along Alameda Street, just north of the Hollywood Freeway.

With the exception of Mariachi Plaza and LANI Park, all parks and recreation facilities located in the City of Los Angeles are under the jurisdiction of the City's Department of Recreation and Parks. Mariachi Plaza is owned by MTA; however, the City's Department of Recreation and Parks, assisted by the Boyle Heights Chamber of Commerce, maintains the facility. LANI Park, a traffic island that has been beautified and converted into open space as part of the Los Angeles Neighborhood Initiative (LANI), is under the jurisdiction of the Department of Public Works. Parks located in the unincorporated communities of East Los Angeles are under the jurisdiction of the County of Los Angeles Department of Parks and Recreation.

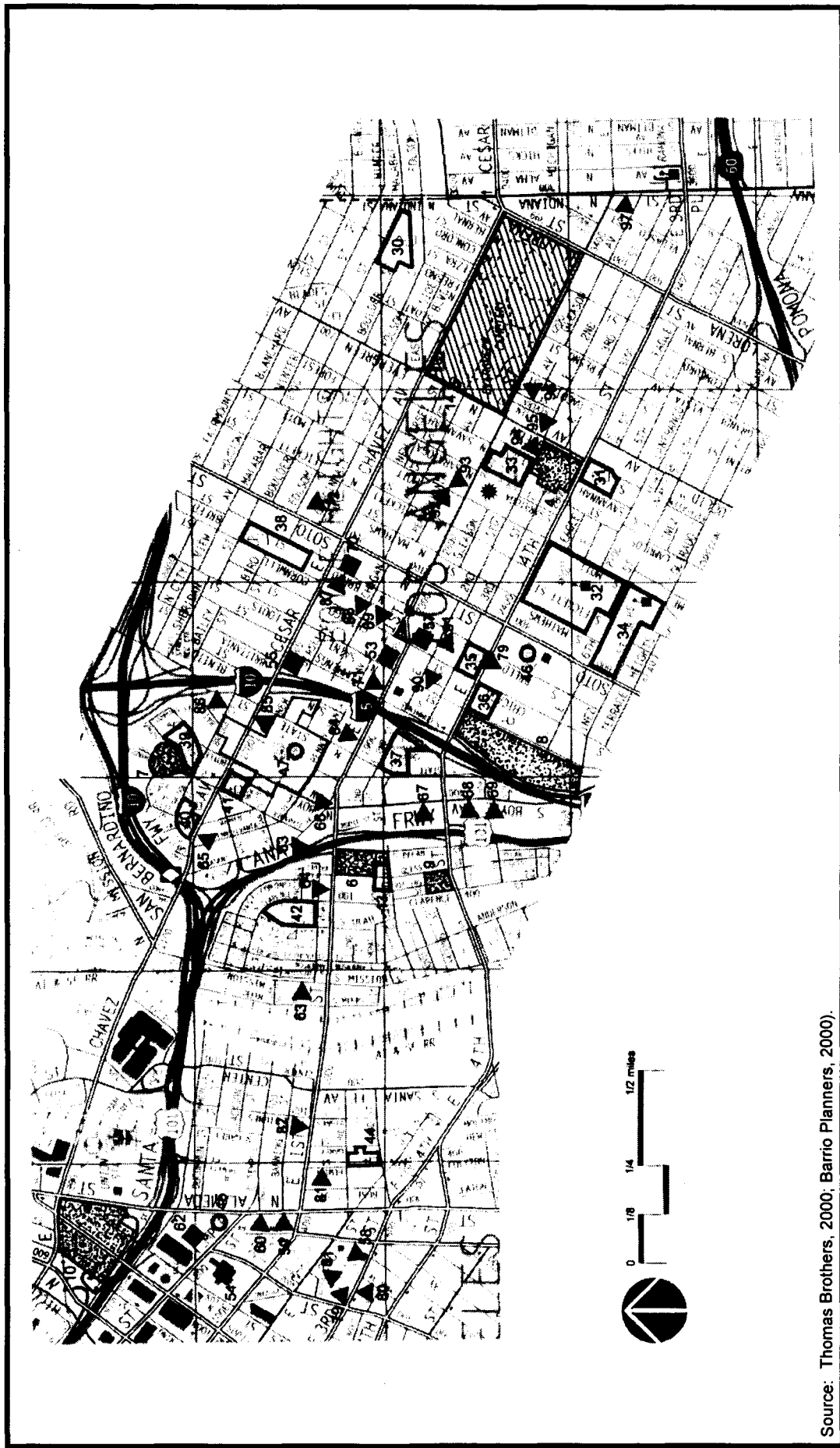
Three of the eight parks and recreation facilities in the study area are located within the City of Los Angeles immediately adjacent to the LRT alignment along 1<sup>st</sup> Street. These include Pecan Park, Mariachi Plaza, and LANI Park. One of the three parks in the community of East Los Angeles, Belvedere Park, is located adjacent to the alignment along 3<sup>rd</sup> Street. This park, which extends to the north side of the Pomona Freeway, is part of the East Los Angeles Civic Center.

**TABLE 4.16-1  
PARKS AND RECREATION FACILITIES  
WITHIN 0.5 MILE OF LRT ALIGNMENT**

No. <sup>1</sup>	Facility	Location	City/Community
1	Belvedere Park	3 <sup>rd</sup> Street & La Verne Avenue	East Los Angeles
2	Atlantic Park	Atlantic Boulevard & 6 <sup>th</sup> Street	East Los Angeles
3	Obregon Park	1 <sup>st</sup> Street & Sunol Avenue	East Los Angeles
4	Evergreen Park	4 <sup>th</sup> Street & Evergreen Avenue	Boyle Heights
5	LANI Park	1 <sup>st</sup> Street & Chicago Street	Boyle Heights
6	Pecan Park	1 <sup>st</sup> Street & Pecan Street	Boyle Heights
7	Prospect Park	Bridge Street & Enchandia Street	Boyle Heights
8	Hollenbeck Park	4th Street & Saint Louis Street	Boyle Heights
9	Aliso Pico Rec. Center	4 <sup>th</sup> Street & Clarence Street	Boyle Heights
10	El Pueblo De Los Angeles State Historic Park	Alameda Street & Cesar Chavez Avenue	Central City
66	Mariachi Plaza	1 <sup>st</sup> Street & Boyle Avenue	Boyle Heights

<sup>1</sup>No. corresponds to numbers shown in Figures 4.16-1 and 4.16-2.





Source: Thomas Brothers, 2000; Barrio Planners, 2000).

Los Angeles Eastside Corridor SEIS/SEIR

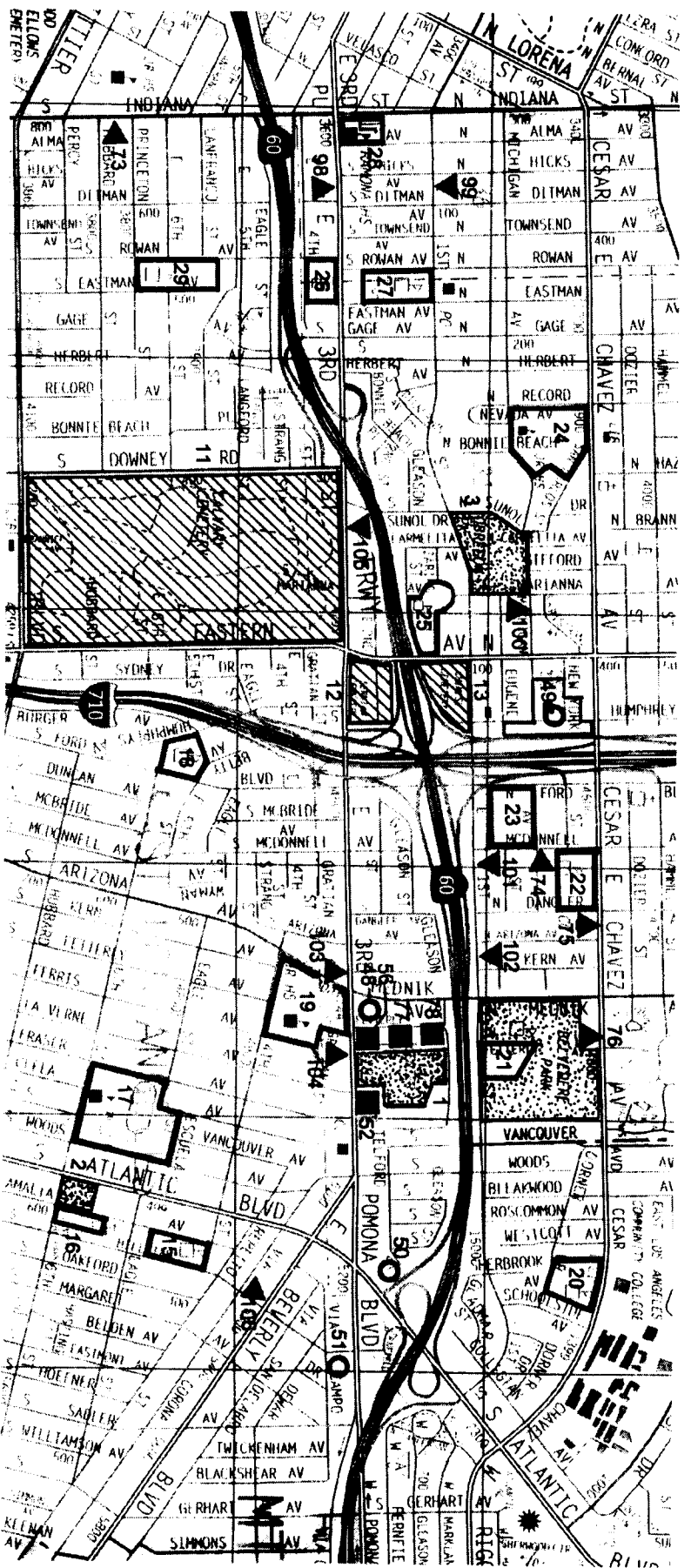
**Community Facilities/Parklands  
Central City, Central City North, Boyle Heights**

Figure 4.16-1





Source: Thomas Brothers, 2000; Barrio Planners, 2000.



Los Angeles Eastside Corridor SEIS/SEIR

Community Facilities/Parklands  
East Los Angeles



#### 4.16.1.2 Cemeteries

There are four cemeteries (Table 4.16-2) in the study area. Calvary Cemetery and Serbian Cemetery in the East Los Angeles Community and Evergreen Cemetery in Boyle Heights are located immediately adjacent to the proposed alignment.

No. <sup>1</sup>	Facility	Location	City/Community
11	Calvary Cemetery	3 <sup>rd</sup> Street & Eastern Avenue	East Los Angeles
12	Serbian Cemetery	3 <sup>rd</sup> Street & Eastern Avenue	East Los Angeles
13	Chinese Cemetery	1 <sup>st</sup> Street & Eastern Avenue	East Los Angeles
14	Evergreen Cemetery	1 <sup>st</sup> Street & Evergreen Avenue	Boyle Heights

<sup>1</sup>No. corresponds to numbers shown in Figures 4.16-1 and 4.16-2.

#### 4.16.1.3 Schools

A total of thirty schools (Table 4.16-3) including public elementary, intermediate, and high schools, and several parochial schools are located in the study area. The Los Angeles Unified School District has jurisdiction over public schools located in communities within the City of Los Angeles and the unincorporated community of East Los Angeles. In the East Los Angeles community, Griffith Intermediate School, Ramona High School, Belvedere School, and Our Lady of Lourdes Church and School are all located adjacent to or near the LRT alignment. In Boyle Heights, Utah School is in close proximity of the alignment, and First Street School is adjacent to the subway segment of the project.

#### 4.16.1.4 Hospitals/Clinics

There are three hospitals and four clinics (Table 4.16-4) located within a 0.5-mile distance of the proposed LRT alignment. White Memorial Medical Center, with approximately 310 beds, is located within 400 feet of the proposed 1<sup>st</sup> Street alignment and the 1<sup>st</sup>/Boyle Station in the Boyle Heights community. The Roybal Comprehensive Health Center is located adjacent to the 3<sup>rd</sup> Street alignment and proposed 3<sup>rd</sup> Street/Mednik Station in the East Los Angeles community. The Veterans Clinic is located in the Central City at Temple and Alameda Streets, next to the Alameda Street alignment.

#### 4.16.1.5 Law Enforcement

The Los Angeles Police Department provides law enforcement services in the City of Los Angeles. Two facilities (Table 4.16-5) are in the study area, including Parker Center Headquarters in the Central City and the Hollenbeck Police Station, which is located on 1<sup>st</sup> Street in Boyle Heights. The Los Angeles County Sheriff's Department, which provides law enforcement services in the East Los Angeles community; is located along the 3<sup>rd</sup> Street portion of the alignment.

#### 4.16.1.6 Fire Protection

There is only one fire station located in the study area. Fire Station 2, in Boyle Heights, is located at Cesar Chavez Avenue and Britannia Street. In the East Los Angeles community, all existing fire stations are located beyond the half-mile distance.



**TABLE 4.16-3  
SCHOOLS  
WITHIN 0.5 MILE OF LRT ALIGNMENT**

No. <sup>1</sup>	Facility	Location	City/Community
15	Fourth Street School	4 <sup>th</sup> Street & Amalia Avenue	East Los Angeles
16	Saint Alphonsus School	6 <sup>th</sup> Street & Amalia Avenue	East Los Angeles
17	Garfield High School	6 <sup>th</sup> Street & Woods Avenue	East Los Angeles
18	Humphreys Avenue School	6 <sup>th</sup> Street & Humphreys Avenue	East Los Angeles
19	Griffith Junior High School	3 <sup>rd</sup> Street & Arizona Avenue	East Los Angeles
20	Lane School	Cesar E. Chavez Avenue & Westcott Avenue	Monterey Park
21	Morris Hamasaki School	1 <sup>st</sup> Street & Mednik Aenue	East Los Angeles
22	Brooklyn Avenue School	Cesar E. Chavez Avenue & McDonnel Avenue	East Los Angeles
23	A. Perez Special Ed. Center	1 <sup>st</sup> Street & Ford Blvd.	East Los Angeles
24	Belvedere Intermediate School	Cesar E. Chavez Avenue & Record Avenue	East Los Angeles
25	Marianna Avenue School	Gleason Avenue & Marianna Avenue	East Los Angeles
26	Our Lady of Lourdes School	3 <sup>rd</sup> Street & Rowan Avenue	East Los Angeles
27	Belvedere School	1 <sup>st</sup> Street & Rowan Avenue	East Los Angeles
28	Ramona High School	3 <sup>rd</sup> & Indiana Streets	East Los Angeles
29	Rowan Avenue School	6 <sup>th</sup> Street & Rowan Avenue	East Los Angeles
30	Malabar Street School	Malabar Street & Fresno Street	Boyle Heights
31	Our Lady of Talpa School	4 <sup>th</sup> Street & Evergreen Avenue	Boyle Heights
32	Roosevelt High School	4 <sup>th</sup> & Mott Streets	Boyle Heights
33	First Street School	1 <sup>st</sup> & Savannah Streets	Boyle Heights
34	Hollenbeck Intermediate School	6 <sup>th</sup> & Soto Streets	Boyle Heights
35	Breed Street School	4 <sup>th</sup> & Breed Streets	Boyle Heights
36	St. Mary's School	4 <sup>th</sup> & Chicago Streets	Boyle Heights
37	Second Street School	2 <sup>nd</sup> & State Streets	Boyle Heights
38	Sheridan Street School	Sheridan & Breed Streets	Boyle Heights
39	Bridge Street School	Bridge & Enchandia Streets	Boyle Heights
40	San Antonio De Padua School	Cesar E. Chavez Avenue & Bridge Street	Boyle Heights
41	Seventh Day Adventist School	Cesar E. Chavez Avenue & Enchandia Street	Boyle Heights
42	Utah Street School	Clarence Street & Via Las Vegas	Boyle Heights
43	Dolores Mission School	3 <sup>rd</sup> Street & Gless Street	Boyle Heights
44	Maryknoll School	Hewitt & 2 <sup>nd</sup> Streets	Central City North

<sup>1</sup>No. corresponds to numbers shown in Figures 4.16-1 and 4.16-2.

**TABLE 4.16-4  
HOSPITALS/CLINICS  
WITHIN 0.5 MILE OF LRT ALIGNMENT**

No. <sup>1</sup>	Facility	Location	City/Community
45	Veterans Clinic	Alameda & Temple Streets	Central City
46	Lincoln Hospital	Soto Street (South of 4 <sup>th</sup> Street)	Boyle Heights
47	White Memorial Medical Center	Cesar E. Chavez & Boyle Avenues	Boyle Heights
48	Roybal Health Center	3 <sup>rd</sup> Street & Fetterly Avenue	East Los Angeles
49	Santa Marta Hospital	New York Street & Humphreys Avenue	East Los Angeles
50	Kaiser Clinic	5220 E. Teleford Street	East Los Angeles
51	Alta Med Health Services	5425 E. Pomona Avenue	East Los Angeles

<sup>1</sup>No. corresponds to numbers shown in Figures 4.16-1 and 4.16-2.

**TABLE 4.16-5  
COMMUNITY FACILITIES  
WITHIN 0.5 MILE OF LRT ALIGNMENT**

No. <sup>1</sup>	Facility	Location	City/Community
<b>Law Enforcement</b>			
52	ELA Sheriffs Station	3 <sup>rd</sup> Street & La Verene Avenue	East Los Angeles
53	Hollenbeck Police Station	1 <sup>st</sup> Street & St. Louis Street	Boyle Heights
54	Parker Center	1 <sup>st</sup> Street & Los Angeles Street	Central City
<b>Fire Protection</b>			
55	Fire Station #2	Cesar Chavez Avenue & Britania Street	Boyle Heights
<b>Libraries</b>			
56	ELA Library	3 <sup>rd</sup> Street & Fetterly Avenue	East Los Angeles
57	Benjamin Franklin Library	1 <sup>st</sup> Street & Chicago Street	Boyle Heights
58	Little Tokyo Library	1 <sup>st</sup> Street & Crocker Avenue	Little Tokyo
<b>Places of Worship</b>			
79	Union Church	4 <sup>th</sup> & San Pedro Streets	Little Tokyo
80	Jodoshin Temple	Boyd Street & Omar Street	Little Tokyo
81	Zenshuji Soto Mission	Hewitt Street (South of 1 <sup>st</sup> Street)	Central City-North
82	Hompa Hongwanji Buddhist Temple	1 <sup>st</sup> & Vignes Streets	Central City North
83	Our Lady of Queen of Martyrs	1339 Pleasant Avenue	Boyle Heights
84	Pentecostal Church	1917 E. 1 <sup>st</sup> Street	Boyle Heights
85	Seventh Day Adventist	Cesar Chavez Avenue & State Street	Boyle Heights
86	Spanish Seventh Day Adventist	1815 Bridge Street	Boyle Heights
87	Talmud Torah Temple	247 N. Breed Street	Boyle Heights
88	Tenrikyo So. Pacific Church	219 N. Chicago Street	Boyle Heights
89	Iglesia Bautista Unida	2923 E. 2 <sup>nd</sup> Street	Boyle Heights
90	Calvary Baptist Church	206 S. St. Louis Street	Boyle Heights
91	Church of the Nazarene	213 S. Breed Street	Boyle Heights
92	Rissho Kosei-Kai Buddhist Church	118 N. Mott Street	Boyle Heights
93	Konko Church	2924 E. 1 <sup>st</sup> Street	Boyle Heights
94	Evergreen Baptist Church	2923 E. 2 <sup>nd</sup> Street	Boyle Heights
95	Free Methodist Church	3012 E. 2 <sup>nd</sup> Street	Boyle Heights
96	Mt. Carmel Baptist Church	3064 E. 1 <sup>st</sup> Street	Boyle Heights
97	Iglesia Evangelica	3501 Gleason Avenue	Boyle Heights
98	Paraiso Spanish Congregation	3684 E. 3 <sup>rd</sup> Street	East Los Angeles
99	La Trinidad Methodist Church	3565 E. 1 <sup>st</sup> Street	East Los Angeles
26	Our Lady of Lourdes Church/School (See Table 4.16-3)	3 <sup>rd</sup> Street & Rowan Avenue	East Los Angeles
100	Baptist Church	Michigan & Marianna Avenues	East Los Angeles
101	Pius X Church	1 <sup>st</sup> Street & McDonnell Avenue	East Los Angeles
102	La Luz Del Mundo	1 <sup>st</sup> Street & Arizona Avenue	East Los Angeles
103	Sala Evangelica	3 <sup>rd</sup> Street & Arizona Avenue	East Los Angeles
104	Iglesia El Siloe	3 <sup>rd</sup> Street & Arizona Avenue	East Los Angeles
105	Sanctuario de Guadalupe Church	3 <sup>rd</sup> Street (near Marianna Avenue)	East Los Angeles
106	Iglesia Cristiana Ejercito de Salvacion	Beverly Blvd. & Hillview Avenue	East Los Angeles
<b>Other Community Facilities</b>			
59	Japanese American National Museum	1 <sup>st</sup> & Alameda Street	Little Tokyo
60	Geffen Contemporary Museum	Alameda Street (North of 1 <sup>st</sup> Street)	Little Tokyo
61	Japanese American Cultural Center	San Pedro & Azuza Streets	Little Tokyo
62	Roybal Center & Federal Building	Temple & Los Angeles Streets	Central City
63	St. Elizabeth Day Nursery	Mission Road (North of 1 <sup>st</sup> Street)	Boyle Heights
64	Aliso Pico Multipurpose Center	1 <sup>st</sup> & Clarence Streets	Boyle Heights

**TABLE 4.16-5 (Continued)  
COMMUNITY FACILITIES  
WITHIN 0.5 MILE OF LRT ALIGNMENT**

No. <sup>1</sup>	Facility	Location	City/Community
65	CYO Brown Stone House Teen Club	Cesar Chavez & Pennsylvania Avenues	Boyle Heights
66	(refer to Table 4.16-1)		
67	Japanese Retirement Home	325 S. Boyle Avenue	Boyle Heights
68	International Institute	435 S. Boyle Avenue	Boyle Heights
69	PUENTE Learning Center	South Boyle Avenue	Boyle Heights
70	Social Security Office	240 N. Breed Street	Boyle Heights
71	Hollenbeck Youth Center	1 <sup>st</sup> Street (West of St. Louis Street)	Boyle Heights
72	Variety Boys & Girls Club	Cincinnati Street (East of Soto Street)	Boyle Heights
73	Plaza Community Center	648 S. Indiana Street	East Los Angeles
74	Eastside Boys & Girls	N. McDonnell & Michigan Avenues	East Los Angeles
75	Maravilla Service Center	Cesar Chavez & N. Dangler Avenues	East Los Angeles
76	Centrode Ninos	Cesar Chavez Avenue (East of Mednik Avenue)	East Los Angeles
77	ELA Municipal Courts	Fetterly Avenue (North of 3 <sup>rd</sup> Street)	East Los Angeles
78	Probation Department	Fetterly Avenue (North of 3 <sup>rd</sup> Street)	East Los Angeles
79	Salesian Youth and Family Center	4 <sup>th</sup> and Breed Streets	Boyle Heights

<sup>1</sup>No. corresponds to numbers shown in Figures 4.16-1 and 4.16-2.

#### 4.16.1.7 Libraries

Of the three libraries located within one-half mile of the alignment, two are adjacent to the alignment. The East Los Angeles Library is on 3<sup>rd</sup> Street and Fetterly Avenue, and the Benjamin Franklin Library in Boyle Heights is located on 1<sup>st</sup> Street at Chicago.

#### 4.16.1.8 Places of Worship

Of the twenty-eight places of worship identified in the study area, those that are located adjacent to the proposed alignment include the Hompa Hongwanji Buddhist Temple in Central City North; Pentacostal Church, Konko Church, and Mt. Carmel Baptist Church on 1<sup>st</sup> Street in Boyle Heights; and Pariaso Spanish Congregation, Sala Evangelica, Iglesia Cristina Ejercito de Salvacion, Iglesia El Siloe, and Guadalupe Church on 3<sup>rd</sup> Street in East Los Angeles.

#### 4.16.1.9 Other Community Facilities

Also within one-half mile of the alignment are twenty other types of community facilities. These facilities range from child care centers to museums. Four of these facilities are located immediately adjacent to the proposed alignment including the Japanese American National Museum and Geffen Contemporary Museum both located near 1<sup>st</sup> and Alameda Streets, and the Aliso Pico Multipurpose Center and Hollenbeck Youth Center located on 1<sup>st</sup> Street in Boyle Heights.

#### 4.16.2 Methodology For Impact Evaluation

Significant impacts on community services and facilities would result if construction or operation of the LRT Build Alternative (Option A or B) displaced or altered a community facility, restricted access to that facility, or hindered the operation or services offered at the facility. Similarly, parks and recreational facilities would be significantly affected if they were altered or displaced or if their use or function were diminished. Parklands as well as cultural and recreational facilities are subject to guidelines established by Section 4(f) of the U.S. Department of Transportation Act (USC 1653 (f)). Use of parkland or

recreational property for the implementation of the LRT Build Alternative would be a significant impact, requiring consultation with the U.S. Department of Transportation, U.S. Department of the Interior, State Department of Parks and Recreation, and the Los Angeles City and County departments that have jurisdiction over parks and recreational facilities in the corridor. An assessment of the project pursuant to Section 4(f) appears in Section 4.17, *Section 4(f) Evaluation*.

In addition, community facilities, parklands, and recreational facilities may be significantly affected by the noise and vibration from construction activities or from operation of light rail vehicles. Community, parklands, and recreational facilities within one-half mile of the proposed LRT facilities, including the tunnel alignment, or construction staging areas were considered to determine whether light rail operation would produce significant noise and vibration impacts on these facilities. Construction activities could also produce temporary, but significant, air quality and traffic and transportation impacts at these facilities. The potential for significant construction impacts on these facilities increases as the distance between that facility and the light rail facility decreases. In addition to distance, a number of factors could affect the level of impact, including construction requirements for the tunnel and stations, structural characteristics of the community or recreational facility, and the schedule and level of activity at the facility. Recognizing the highly variable potential for significant impacts under CEQA, a conservative estimate of 350 feet from a light rail construction site or staging area was used to identify facilities that may be subject to some level of impacts.

#### **4.16.3 Impacts**

##### **4.16.3.1 No-Build Alternative**

The No-Build Alternative would not alter or displace community and recreational facilities or parklands in the corridor or hinder or disrupt activities at these facilities. However, the No-Build Alternative would not provide any beneficial effects, in terms of improved access to community and recreational facilities and services, to corridor residents.

##### **4.16.3.2 LRT Build Alternative**

###### *Option A*

###### Parks and Recreation Facilities

Increased access to park and recreational facilities would be a beneficial impact of Option A. However, adverse impacts may also occur. At Mariachi Plaza, potential noise and vibration impacts from a vent shaft and emergency ventilation fans, located across the street from the Plaza, would be attenuated through design of these facilities. Noise and vibration due to LRT operation in the subway is not expected to affect the use of either Mariachi Plaza or LANI Park.

Option A would eliminate curb parking at the portal location on 1<sup>st</sup> Street adjacent to Pecan Park. Since excess parking capacity exists along the streets surrounding the park, this would not be a significant impact (refer to Chapter 3). No long-term noise, vibration, or visual impacts are expected at Pecan or Belvedere Parks, but the historic setting of Mariachi Plaza would be affected by removing the Ranch Market located across the street from the Plaza, a significant impact without mitigation (refer to Section 4.15.4 for mitigation measures that would reduce this impact to an insignificant level).

### Cemeteries

A subway portal would be located at 1<sup>st</sup>/Lorena bordering Evergreen Cemetery. Although curb parking would be eliminated adjacent to the portal location, it is not expected to affect access to the cemetery. None of the cemeteries would be adversely affected by the LRT Build Alternative.

### Schools

Increased access to educational facilities would be a benefit of Option A. Most schools are not located adjacent to the alignment and, therefore, would not be affected by LRT operation. The noise and vibration analysis conducted for Option A indicated that there would be no noise impacts on any of the schools situated along the alignment (refer to Section 4.8, *Noise and Vibration*). However, due to the location of the special trackwork along 3<sup>rd</sup> Street, the Los Angeles Music and Art School would be subjected to vibration impacts. The visual setting and the historic integrity of First Street School, Ramona High, and Our Lady of Lourdes School would not be affected by light rail.

Traffic and pedestrian circulation at school sites would be maintained except in the vicinity of Ramona High School where curb parking would be displaced along Indiana Street, a significant impact without mitigation since the parking utilization is high at this location.

For schools that are located near the alignment, the safety and security of the students crossing is a concern of the Los Angeles Unified School District. The safety and security issues could represent potentially significant impacts. Mitigation measures that would reduce potential safety and security impacts at light rail stations and pedestrian crossings near area schools are described in Section 4.16.4 and also in Section 4.14.4.

### Hospitals/Clinics

Increased access to corridor medical facilities would be a beneficial impact of Option A. No other impacts from LRT operation are anticipated.

### Libraries

Option A would provide improved access to community libraries, a beneficial impact. The noise, vibration, and visual analysis have determined that light rail operation would not affect Ben Franklin Library, located along the subway alignment, and the East Los Angeles Library and the Little Tokyo Library, located near at-grade segments of the alignment (refer to Sections 4.6, *Visual and Aesthetics* and 4.8, *Noise and Vibration*).

### Places of Worship

Option A would provide improved access to places of worship, a beneficial impact. Of the 28 places of worship located within one-half mile of the LRT alignment, only LA Hompa Hongwanji Buddhist Temple, Mount Carmel Missionary Baptist Church, Konko Church, Our Lady of Lourdes Church, Santurio de Guadalupe Church, and Sala Evangelica Church would be situated along the alignment. The visual setting and the historic nature of these structures would not be affected by LRT operation.

Due to the center alignment of the LRT in the vicinity of Our Lady of Lourdes Church, the center turn lane will be removed, and traffic will be prohibited from making left- or U-turns mid-block. Access from 3<sup>rd</sup> Street in front of the church will still be possible by making a right turn from the eastbound lanes. Left- and U-turns will still be possible at nearby signalized intersections. On-street parking will not be

removed during the operation of the line. Current peak period parking restrictions will remain in effect. A split-phase signal operation will be used to accommodate the left-turn demand at Vignes Street near Hompa Hongwanji Buddhist Temple. Therefore, access will not be adversely affected. However, to accommodate four through lanes on 1<sup>st</sup> Street plus the LRT track, Option A will require a strip of land to be taken from the parking lot of the temple resulting in the loss of about seven parking spaces. Sufficient underutilized parking is available in the vicinity of the temple; therefore, the loss of parking is not a significant impact. See Chapter 3 of the Final SEIS/SEIR for more information regarding parking utilization. Parking will not be affected near any other places of worship.

#### Other Community Facilities

Option A would provide improved access to many other community facilities, a beneficial impact. None of the youth and child care centers, judicial facilities, senior centers, and other community facilities located within one-half mile of the LRT alignment would be adversely affected by light rail operation. Although curb parking would be removed in front of the Aliso Pico Multipurpose Center near the portal location on 1<sup>st</sup>/Gless, excess parking capacity exists on the surrounding streets (refer to Chapter 3). Therefore, the removal of curb parking at this location would not be a significant impact.

#### Significance of Impacts

Option A would produce beneficial impacts for the community by improving access to parklands and other community facilities. However, other impacts on parklands and schools, such as vibration, curb parking, and historic resource impacts, are potentially significant.

#### ***Option B***

The impacts of Option B will be the same as those described for Option A with regard to parks and recreation facilities, cemeteries (with the exception that parking spaces will no longer be removed in the vicinity of Evergreen Cemetery), libraries, places of worship, and other community facilities.

The impacts on schools will also be the same except for Ramona High School. Option B will involve either relocation of the school or reconstruction on the existing site. MTA will commit to the mitigation measures described in Section 4.16.4 below. LAUSD will conduct the necessary studies that may be required by the local jurisdiction (County or City) for the appropriate environmental clearances or building permits once it is determined whether to relocate or reconstruct the school. The actions of LAUSD in replacing the school are beyond the scope of the impact analysis for the Eastside Corridor LRT since LAUSD will be directing that program. However, MTA will work with LAUSD, as needed, during their separate studies when LAUSD's plans for the school are better known. Regardless of whether the school is relocated or reconstructed on site, curb parking would not be displaced along Indiana Street under Option B since the track will be placed off-street along the eastern side of Indiana Street. If the school is relocated to an alternate site, the issue of students crossing the LRT tracks is no longer a concern. However, if the school remains but is reconstructed, the safety and security of students crossing the tracks could represent potentially significant impacts. As discussed under Option A, the mitigation measures that would reduce potential safety and security impacts at light rail stations and pedestrian crossings near area schools are described in Sections 4.16.4 below and 4.14.4.

The Pomona/Atlantic Station will be located in the middle of the street adjacent to Kaiser Clinic. The clinic is anticipated to experience vibration impacts due to LRT operations.

## Significance of Impacts

The significance of the impacts of Option B is the same as those described for Option A with the exception of impacts on hospitals/clinics. The vibration impact on Kaiser Clinic is potentially significant without mitigation.

### **4.16.4 Mitigation**

#### **4.16.4.1 Option A**

To mitigate the impacts related to schools, MTA will:

- ◆ Inform the Los Angeles Unified School District and private institutions along the light rail alignment of changes to MTA bus routes, school bus routes, and pedestrian crossings prior to construction;
- ◆ Work with LADOT, LAPD, LA Bureau of Street Lighting, and the County Sheriff to implement mutually agreed upon measures, such as posting of clearly marked signs, pavement markings, lighting as well as implementing rail safety instructional programs, to enhance the safety of pedestrians, particularly in the vicinity of schools, crossing the LRT alignment. MTA will provide funds for these measures. The measures will be developed to conform with MTA Rail Transit Design Criteria and Standards, Fire/Life Safety Criteria, Volume IX;
- ◆ Provide a crossing guard during arrival and dismissal times at Ramona High School, Griffith Middle School, Utah Elementary School, and Our Lady of Lourdes School if requested by the LAUSD or Our Lady of Lourdes School for as long as their presence is requested (MTA will permanently fund school zone safety programs);
- ◆ Provide funds for City LADOT/LAUSD review of the “Safest Routes to School” (STEPS) maps for necessary revisions and development of mitigation at crossings;
- ◆ Purchase three parcels of land north of Ramona High School to utilize as surface off-street parking and to relieve the high utilization of on-street parking demand on Indiana Street;
- ◆ MTA will provide at no charge to LAUSD an instructional rail safety program with materials to all affected elementary and middle schools;
- ◆ LAUSD Transportation will be contacted regarding potential impact of the LRT operations, if any, upon existing school bus routes.

MTA will provide an on-going informational program to nearby senior centers, if requested by the centers to enhance safety. The program will be similar to that described for the schools except the information and materials provided will be geared toward senior citizens.

In addition, though not an impact of the LRT project, MTA will address an existing pedestrian safety issue at the Santuario de Nuestra Señora de Guadalupe Church located along 3<sup>rd</sup> Street near Marianna Avenue (across from the Calvary Cemetery). During worship services, people park their vehicles across 3<sup>rd</sup> Street and illegally cross the street to go to church. To avoid the illegal crossings, MTA will install a pedestrian signal at Marianna Avenue and provide a crossing guard on weekends during services.

Other mitigation measures that pertain to vibration, cultural resource, and safety and security impacts are presented in Sections 4.8, *Noise and Vibration*, 4.14, *Safety and Security*, and 4.15, *Historic/Archaeological/Paleontological Resources*.

***Significance of Impacts Remaining After Mitigation***

Mitigation measures would reduce impacts on parklands and community facilities to an insignificant level.

**4.16.4.2 Option B**

The mitigation measures described under Option A would be the same for parks and recreation facilities, cemeteries, libraries, places of worship, and other community facilities. With regard to schools, some differences in mitigation for Ramona High School are associated with Option B. MTA will commit to costs for relocating the school (if that is determined to be the course of action) to a site that is acceptable to LAUSD and MTA, and will also provide funds for construction of a new school off-site or reconstruction at the present location. LAUSD will conduct the necessary environmental studies once it is determined whether to relocate or reconstruct the school. The actions of LAUSD in replacing the school are beyond the scope of the analysis for the Eastside Corridor LRT since LAUSD will be directing that program. However, MTA will work with LAUSD during their separate studies when LAUSD's plans for the school are better known. No parking replacement is necessary near Ramona High School along Indiana Street between 1<sup>st</sup> and 3<sup>rd</sup> Streets under Option B since no curb parking will be displaced.

Mitigation measures, described in Section 4.8, *Noise and Vibration*, will be implemented to reduce ground-borne vibration on the Kaiser Clinic to a less-than-significant level.

***Significance of Impacts Remaining After Mitigation***

Mitigation measures would reduce impacts on parklands and community facilities to an insignificant level.



## 4.17 SECTION 4(f) EVALUATION

### 4.17.1 Regulatory Setting

Federal funds will be used to help finance this transit project. Section 4(f) of the Department of Transportation Act of 1966, as amended (49 U.S.C. 303), states that federal funds cannot be used for any "program or project which requires the use of any publicly owned land from a public park, recreation area, or wildlife and waterfowl refuge of national, State, or local significance as determined by the Federal, State, or local officials having jurisdiction thereof, or any land from an historic site of national, State, or local significance as determined by such officials unless (1) there is no feasible and prudent alternative to the use of such lands, and (2) such program includes all possible planning to minimize harm to such park, recreational area, wildlife and waterfowl refuge, or historic site resulting from such use." The word "use" refers to either a direct or a constructive use of the property. A direct use occurs when land is permanently incorporated into a transportation facility or a partial or full acquisition or easement of the property is required. Constructive use occurs when the project's proximity impacts are so severe that the activities, features, or attributes that qualify a resource for protection under 4(f) are substantially impaired. Typically, a constructive use of a resource would involve permanent and severe noise, vibration, visual, or access impacts. As outlined in Subsection 23 CFR 771.135 (p)(4), a constructive use of a protected resource occurs under any of the following situations:

- ◆ Predicted noise level increase, attributable to the proposed project, substantially interferes with the use and enjoyment of a noise-sensitive facility of a resource.
- ◆ Proximity of the proposed project substantially impairs the aesthetic features or attributes of a resource, where such features or attributes are considered important contributing elements to the value of the resource.
- ◆ Restricted access, which substantially diminishes the utility of a publicly owned park, recreation area, or historic site.
- ◆ Vibration associated with the proposed project impairs the use of a resource.
- ◆ Ecological intrusion of the proposed project diminishes the value of wildlife habitat in a wildlife or waterfowl refuge adjacent to the project.
- ◆ Substantial interference with the access to a wildlife or waterfowl refuge when such access is necessary for established wildlife migration or critical life cycle processes.

The following sections evaluate park, archaeological and historic resources as they relate to Section 4(f). After reviewing the 4(f) evaluation, FTA may determine that: 1) there is no prudent or feasible alternative to using 4(f) properties in this section; and 2) the project includes all possible planning to minimize harm to parks, recreation areas, wildlife and waterfowl refuges and historic sites resulting from the use. With this determination, Section 4(f) permits the Secretary of Transportation to approve a project for federal funding participation or other federal undertaking that requires the use of publicly owned land from a park; recreation area; wildlife and waterfowl refuge of national, State, or local significance; or any land from a historic site of national, State, or local significance. FTA is consulting with U.S. Department of Interior and the State Historic Preservation Officer (SHPO) regarding Section 4(f) properties.

### 4.17.2 Section 4(f) Properties Affected by Option A of the LRT Build Alternative

This section describes the Section 4(f) properties that would be affected by Option A of the LRT Build Alternative. No such properties would be affected by the No-Build Alternative. Parklands and recreational facilities, archaeological sites, and historic properties that would be affected by Option A are identified below. For these properties, a description and the significance of the affected property and the

application of Section 4(f) criteria for use are presented. Alternatives that would avoid use, measures to minimize harm, and coordination with the appropriate agencies are also described.

#### 4.17.2.1 Parks and Recreation Property

Eleven parks and recreational facilities are located in the study area (refer to Section 4.16, Community Facilities/Parklands). Of these, four (Pecan, LANI, and Belvedere Parks and Mariachi Plaza) are adjacent to the proposed LRT alignment. Option A of the LRT Build Alternative would include an easement for a subway section under LANI Park. Given the depth of the subway, the absence of any noise, vibration or visual impacts at the surface and that no alteration of the surface would occur, this is not considered a "use" within the intent of Section 4(f). Similarly, no long-term impacts would occur at Pecan and Belvedere Parks. However, construction of a subway station at Mariachi Plaza would require permanent modification to the park setting, which would be considered a "use" as described below.

##### *Mariachi Plaza*

##### Description and Significance of Affected Property

Mariachi Plaza is a 15,000 square-foot triangular plaza, bordered on the south by 1<sup>st</sup> Street, on the west by Boyle Avenue, and on the northeast by Pleasant Avenue. The Plaza, which contains a gazebo where mariachi bands perform regularly, is owned by MTA. However, the City's Department of Recreation and Parks, assisted by the Boyle Heights Chamber of Commerce, maintains the facility.

Mariachi Plaza is a relatively modern, mid-1990's, monument important to the community, and the area where it stands is the center of an early crossroads at the top of the bluffs that might hold cultural remains. A review of Sanborn maps revealed that this area was used as open space during the late 19<sup>th</sup> and early 20<sup>th</sup> centuries. Low-level buildings were constructed along the bordering streets, visually enclosing the Plaza. During the 20<sup>th</sup> century, the open space was encroached upon by private businesses, which were acquired and removed by MTA as part of the suspended Metro Red Line Extension project in the 1990's. The improvements to Mariachi Plaza, including the gazebo structure and kiosks were installed by MTA in 1998 using MTA funds.

##### Application of Section 4(f) Criteria for Use

Mariachi Plaza has been determined to be potentially eligible for listing in the National Register of Historic Places (NRHP). In addition, because it is a publicly owned property that is open for public use, and its major use is recreation, it is also a resource that is protected under Section 4(f). Construction of the proposed subway station at 1<sup>st</sup>/Boyle may temporarily disrupt use of the open space by musicians and local residents. In addition, access may be temporarily restricted on 1<sup>st</sup> Street during deck installation and removal. The section of Pleasant Street between Boyle Avenue and 1<sup>st</sup> Street would be closed.

The station, located under 1<sup>st</sup> Street along side Mariachi Plaza, would not require space from or permanently use the Plaza. However, the entrance to the subway station and station vent shaft would be sited on property already owned by MTA across the street from Mariachi Plaza. The property contains the Ranch Market, which would be demolished to provide space for the station entrance. Over time, the Ranch Market has been altered substantially so that the building's historic integrity has been compromised, and the building is not eligible for listing in the NRHP. Nevertheless, its removal would create a spatial and visual void in the line of buildings which frame Mariachi Plaza on the northeast, thereby altering the historic setting for Mariachi Plaza.

### Alternatives that Would Avoid Use

Initially, MTA examined the opportunity to place the station entrance plaza and vent shaft for the 1<sup>st</sup>/Boyle subway station in Mariachi Plaza. By locating the subway entrance in the Plaza, no buildings surrounding the Plaza would be demolished. However, the small Plaza would be substantially altered by this use. To avoid this impact on Mariachi Plaza, MTA moved the station entrance outside the Plaza allowing it to remain sufficiently close to provide direct access to the subway station under 1<sup>st</sup> Street at Boyle Avenue.

### Measures to Minimize Harm

During construction, MTA will maintain access to Mariachi Plaza. If the need arises to close access to 1<sup>st</sup> Street and Boyle Avenue to install and remove decking, it will be done during non-peak hours. MTA will publicize that local businesses and the mariachi performers will continue during construction. If a majority of mariachis thinks that the conditions at Mariachi Plaza are not suitable for performing during construction, MTA will provide an alternative location and publicize the temporary location with signs at Mariachi Plaza. An alternative location that has been identified as a possible site for relocation is the nearby LANI Park at 1<sup>st</sup> and Chicago Streets.

After construction is completed, MTA will restore and expand Mariachi Plaza and provide a façade, mural, or building that can re-create the feeling of intimacy and fill the spatial and visual void created by the demolition of the Ranch Market. During final design, MTA will develop a community linkages study/program for this station (as well as others) that will include extensive public involvement in the design for the improvements to the station area that includes Mariachi Plaza. A similar program was carried out for the 1<sup>st</sup>/Boyle Station proposed under the suspended Metro Red Line project. An architect and artist worked together and developed a design for the station that took into consideration the needs of the community and the characteristics of the surrounding environment. MTA's design guidelines for transit stations, including landscaping, public art, enhanced pedestrian environment, adequate walkway widths, set-asides for public open space, and construction of historical character and structures will be implemented.

### Coordination with Other Agencies

MTA is in the Section 106 process that will lead to a Memorandum of Agreement (MOA) between MTA, FTA, SHPO and the Advisory Council on Historic Preservation. The MOA will specify mitigation measures to resolve adverse impacts on Mariachi Plaza. The draft MOA is included in Appendix G. The final MOA will be completed before the Record of Decision (ROD) is issued for the Final SEIS/SEIR.

#### **4.17.2.2 Archaeological Resources**

In accordance with Section 4(f), Sections 106 and 110 of the National Historic Preservation Act, Executive Order 11593 and the guidelines promulgated by the Advisory Council on Historic Preservation (ACHP), MTA has undertaken an extensive search for cultural resources that could be affected by Option A of the LRT Build Alternative. MTA has determined that four known archaeological sites and 10 areas of high archaeological sensitivity exist in the Area of Potential Effects (See Section 4.15, *Historic/Archaeological/Paleontological Resources*). Of these, one, Historic Chinatown (CA-LAN-1575H), has been determined eligible for the NRHP. All of the identified sites and areas of high archaeological sensitivity may have "use" under Section 4(f) guidelines.

### ***Description and Significance of Affected Properties***

In the vicinity of the intersection of Alameda and 1<sup>st</sup> Streets is an area where cut stone curbs, rather than poured concrete, suggest that undisturbed remains, e.g., historic track, are present below the surface. The highest likelihood of subsurface resource disturbance is in the industrial area of the Flats, from Union Station to the foot of the Boyle Heights bluffs near the Los Angeles River. At Union Station lies archaeological site CA-LAN-1575H. CA-LAN-7H, which includes Native American, historical, and Chinese components, is documented immediately west of Union Station, but could potentially extend into the APE; earthmoving activities along Alameda Street east of the 101 Freeway may encounter archaeological deposits. Nearby along the 101 Freeway may be subsurface remains, although none has been recorded to date because this area was intensively developed in the nineteenth century obscuring the surface. Along Alameda Street south of the 101 Freeway is archaeological site CA-LAN-887H, historical site La Placita. Although the site is recorded only on the west side of Alameda, other remains have since been discovered on the east side of the street. To the south of the 1<sup>st</sup> Street Viaduct and west of the Los Angeles River, within the maintenance and storage facility site, lies historical CA-LAN-2563H. The site was the location of the Santa Fe Railroad's Le Grande Station and related features may be encountered during construction.

Breaking the surface for the tunnel at the 1<sup>st</sup>/Boyle Station could also encounter buried remains. The proposed station entrance/plaza area at the northwest corner of E. 1<sup>st</sup> and Bailey presents a potential for buried remains relating to the mixed commercial and residential use of this area during the nineteenth and early twentieth centuries. The staging area at the corner of Bailey and Pennsylvania Streets also has the potential for buried domestic remains because this was a residential neighborhood. Buried remains may lie beneath 1<sup>st</sup>/Soto since this area has historically been a major neighborhood shopping location.

Rail lines were a part of the historic streetscape along 1<sup>st</sup> Street as far east as Rowan Street. Streetcars ran on Indiana Street as well. Removal of the surviving rails and related elements would destroy the integrity of these historical resources.

### ***Application of Section 4(f) Use Criteria***

One of the archaeological sites, Historic Chinatown (CA-LAN-1575H), has been determined eligible for listing on the NRHP. The other three aforementioned archaeological sites appear eligible. LRT construction activities such as earthmoving eastward along 1<sup>st</sup> Street as far as the river and along Alameda Street would likely encounter unrecorded archaeological remains, as would any earthmoving along Alameda Street. Rail lines were a part of the historic streetscape along 1<sup>st</sup> Street as far east as Rowan Street. Streetcars ran on Indiana Street as well. Removal of the surviving rails and related elements would destroy the integrity of these historical resources. As commuter suburbs, Boyle Heights and East Los Angeles were among the first to be served by street railways and trolleys. There is the potential that tracks and other related light rail features may be encountered along these streets.

### ***Alternatives that Would Avoid Use***

Alternative LRT alignments that would shift construction activities from the streets where archaeological sites have been recorded or where buried remains may be found would traverse private property. Alternatives to this might include constructing the alignment on another major east-west street. However, the other major streets in the study area also previously contained rail routes of the Los Angeles Railway. The B Line was on Brooklyn Avenue (now Chavez Avenue); the F Line was on 4<sup>th</sup> St.; and the R Line was on 7<sup>th</sup> St. and also on Whittier Boulevard in the eastern portion of the study area. Therefore, historic transit features would also likely be found on any of the other streets. Features of the historic rail found during construction could be donated to a museum as has been done on previous MTA projects. If the rail

alignment were to be placed outside of the street rights-of-way to avoid the historic rail routes, this would require acquisition of many private properties. Demolishing many historic properties to accommodate Option A as well as the neighborhood disruption it would cause would be an adverse impact. In addition, by avoiding the Union Station area, interface with the regional system could not occur, obviating a primary project goal.

### ***Measures that Would Minimize Harm***

In the event that archaeological and buried historic sites are encountered, evaluation of the site is often accomplished through test level excavation designed to determine the horizontal and vertical extent of the site, and to characterize the content of the site. For the suspended Metro Red Line East Side Extension FEIS/FEIR (1994), MTA adopted the *Identification Study and Treatment Plan* and a MOA authorized by the Department of the Interior (September 12, 1994) in consultation with the ACHP and SHPO. The MOA is the preferred mechanism for implementing Section 106 where alternatives under consideration consist of corridors, or where access to properties is restricted.

When identification efforts, in accordance with 36 CFR 800.4, indicate that historic properties are likely to be discovered during implementation of an undertaking, the MOA shall include a process to resolve any adverse effects upon resources discovered during the project construction (36 CFR 800.13 (a)). The MOA shall include a provision for monitoring and a mechanism for reporting its implementation (36 CFR 800.6 (c) (4)). Since it is not feasible to conduct an archaeological evaluation of the known and possible archaeological sites prior to construction, MTA will consider any sites encountered are eligible for the NRHP until an evaluation of the site can be made. MTA will manage archaeological resources encountered during construction of the Light Rail Build Alternative in accordance with the Cultural Resource Monitoring and Mitigation Plan established in concurrence with SHPO. Specific elements and measures in the Plan are indicated in the draft MOA presented in Appendix G.

### ***Coordination with Other Agencies***

MTA is in the Section 106 process that will lead to a MOA between MTA, FTA, and SHPO. The MOA specifies mitigation measures to resolve adverse impacts on archaeological resources. The draft MOA is presented in Appendix G. The final MOA will be completed before the Record of Decision (ROD) is issued for the Final SEIS/SEIR.

#### **4.17.2.3 Historic Properties**

MTA has identified 25 buildings that are listed, potentially eligible, or appear to be eligible for inclusion in the NRHP (See Section 4.15, *Historic/Archaeological/Paleontological Resources*). When a determination is made under Section 106 of the National Historic Preservation Act that an adverse effect to a historic property occurs, this would be considered a use under Section 4(f). The historic properties discussed below would be used, or with further study, may need to be used by Option A of the LRT Build Alternative. The sections that follow describe the property, the proposed use for Option A, the feasibility and prudence of alternatives that avoid Section 4(f) involvement, and the measures to mitigate project-related impacts on these historic properties.

#### ***1<sup>st</sup> and Soto Streets Altered Historic Setting***

This intersection of 1<sup>st</sup> and Soto Streets, like 1<sup>st</sup> and Boyle, has historically been a major neighborhood shopping precinct. As a result of the intensive architectural/historical research, the number of potential historical resources at 1<sup>st</sup> and Soto has been reduced to one property from those identified by the Draft SEIS/SEIR. The character and integrity of the historical streetscape opposite this structure, 2415-2417 E. 1<sup>st</sup>

Street, has been compromised through modern in-fill construction and alteration of the historical fabric. Therefore, there will be no adverse effect on the setting of this resource.

### *Alteration of the Historic 1<sup>st</sup> Street Viaduct*

#### Description and Significance of Affected Property

The 1<sup>st</sup> Street Viaduct, which opened to traffic on January 1, 1929, is a 71 foot wide, 1300 feet long, symmetrical structure with a double arch mainspan over the Los Angeles River, and 26 lesser spans extending over rail yards and city streets to the east and west. The mainspans are reinforced concrete, open spandrel, fixed, elliptical, 125 foot, four-ribbed arches, and the approach spans are I girders. The viaduct presently carries four traffic lanes and cantilevered walkways.

The Viaduct is one of the historic bridges over the Los Angeles River built by the Bureau of Engineering of the City of Los Angeles. The structure replaced a steel truss and trestle span bridge built in 1888 that had become inadequate for the amount of traffic being generated by the rapid growth of the downtown area. It is eligible for the National Register of Historic Places under Criterion A as an important element in the development of the Los Angeles transportation system. Because the Viaduct is designed in the Neo-Classical style, it is also eligible under Criterion C, Design/Construction, as one of a subset of Period Revival structures. The designers' choice of Neo-Classical elements reflects the desire to exhibit monumental grandeur and formal planning in architecture, particularly in municipal buildings, emphasized by the advocates of the City Beautiful Movement, a philosophy highly influential on the Los Angeles Municipal Art Commission who approved the design and plans and budgets for city projects [Lee 1995].

#### Application of Section 4(f) Criteria for Use

Following the January 1994 Northridge earthquake, the City of Los Angeles conducted a seismic evaluation of the 1<sup>st</sup> Street Viaduct and plans for a seismic retrofit of the structure were completed in July of that year. With the exception of minor patching and repair, work was limited to the substructure of the viaduct. The retrofit was completed in 1996. Visible modifications included construction of concrete infill shear walls within each of the 23 bents.

Because the Viaduct is an historic structure eligible for the National Register of Historic Places, the seismic retrofit conducted by the City of Los Angeles was assessed as constituting an adverse effect on the resource (Lee 1995). Mitigation measures implemented as a result of the finding of effect included completion of Historic American Engineering Record documentation for the structure. Additional measures were designed to preserve or highlight, as much as possible, the character defining features of the structure.

Since the completion of the initial seismic retrofit work, Caltrans has promulgated more substantive seismic standards for bridges in California (1999). As a result, the use of the 1<sup>st</sup> Street Viaduct for the LRT project would require supplemental seismic retrofit work to meet these new standards. The work would involve:

- ◆ Bents 1-5 and 17-21: Reinforced concrete infill shear walls will be constructed between columns. Central bent openings (one of three) have previously been infilled. Proposed work would completely infill the remaining two openings of each bent.
- ◆ Bents 6-16, 22, and 23: Reinforced concrete infill shear walls will be constructed between columns. The two central bent openings (of six) have previously been infilled. Proposed work would completely infill two additional intermediate cells of each bent, leaving only the outermost cells open.

- ◆ Arch Span Central Pier, East and West Arch Abutments: Reinforced concrete infill shear walls will be constructed between columns. The two central bent openings (of four) have previously been infilled. Proposed work would completely infill the remaining two openings of each bent.
- ◆ East and West Girder Abutments: Additional concrete cast-in-drilled-hole piles will be constructed behind the original concrete abutments. This upgrade will not be visible following repair of the road surface.

The proposed seismic retrofit of the 1<sup>st</sup> Street Viaduct, which as an historic structure is also protected under Section 4(f), will result in an adverse effect on the viaduct's integrity of design with respect to the qualities of significance under Criterion C. An essential character-defining quality of the design is the visual effect of the columns supporting the span. Construction of the concrete infill walls will close off the open spaces between the columns, leaving the columns substantially less distinct.

#### Alternatives that Would Avoid Use

Alternatives to the seismic retrofit work detailed above and the reasons they are not deemed prudent or feasible alternatives are indicated below:

- ◆ Use of rigid cross bracing in place of the concrete infill. This was assessed as resulting in more of a visual impact on the resource than the infill solution.
- ◆ Obtain a City of Los Angeles Bureau of Engineering exception to using the upgraded Caltrans Bridge Design Specification. Currently the bridge does not meet the Caltrans (1999) seismic criteria. This solution would result in increased liability for MTA.
- ◆ Thicken the existing infill walls (this would cause the infills to be thicker than the existing columns and cover the existing visible column reveals).
- ◆ Column strengthening. While potentially less detrimental to the historic appearance of the viaduct, this approach may not be technically feasible and would not result in the level of seismic upgrade necessary to meet the Caltrans criteria.
- ◆ Use of an alternative bridge across the Los Angeles River. Use of the Chavez Avenue Bridge (parallel and to the north of 1<sup>st</sup> Street) would require the LRT to be placed on Chavez Avenue rather than 1<sup>st</sup> Street. This alignment does not connect well with the Pasadena Blue Line, does not serve Little Tokyo and Mariachi Plaza, and would require cross-country subway to travel to 1<sup>st</sup>/Lorena. One of the objectives of the Eastside LRT project is to provide a more cost-effective alternative to the suspended project. This would not meet that objective. Use of the 4<sup>th</sup> Street Bridge (parallel and to the south of 1<sup>st</sup> Street) would require the LRT to operate on 4<sup>th</sup> Street instead of 1<sup>st</sup> Street. Fourth Street is considered a major roadway access to downtown from the eastside with a reversible middle lane across the bridge up to the freeway. It would be difficult to place fixed guideway transit on the 4<sup>th</sup> Street Bridge and maintain it as a major thoroughfare without widening or replacing this historic bridge. In addition, 4<sup>th</sup> Street would not easily provide the connection needed to the heart of Boyle Heights (1<sup>st</sup> Street).

#### Measures to Minimize Harm

Seismic retrofit work will incorporate the following design and construction features:

- ◆ Bents 1-5 and 17-21: Concrete infill shear walls between columns closing the remaining two cells constitutes an adverse effect. All concrete infill walls must be recessed three inches from the face of existing columns on either side, matching the reveals of the central cells created by the earlier City of Los Angeles seismic retrofit. Concrete used for the infill walls will be tinted to match the color of the existing infill walls.

- ◆ Bents 6-16, 22, and 23: Concrete infill shear walls between columns closing two additional cells constitutes an adverse effect. All concrete infill walls must be recessed three inches from the face of existing columns on either side, matching the reveals of the central cells created by the earlier City of Los Angeles seismic retrofit. Concrete used for the infill walls will be tinted to match the color of the existing infill walls.
- ◆ Arch Span Central Pier, East and West Arch Abutments: Concrete infill shear walls between columns closing two additional cells constitutes an adverse effect. All concrete infill walls must be recessed three inches from the face of existing columns on either side. Concrete used for the infill walls will be tinted to match the color of the existing infill walls.
- ◆ New work, which will of necessity become a permanent part of the bridge, should be done so that if it is removed in the future, essential form and integrity of the bridge will be unimpaired.

In addition, MTA, in consultation with SHPO and the National Park Service, will record the 1<sup>st</sup> Street Viaduct according to Historic American Engineering Record (HAER) standards. The documentation shall be performed prior to the commencement of any alteration, grading, and/or change in setting for properties determined eligible for listing in the NRHP. The documentation shall be consistent with Historic American Buildings Survey (HABS) standards, which are generally applied to specific buildings, but may also apply to streetscapes. MTA, in consultation with the City of Los Angeles and SHPO, will also create a permanent display within an Eastside Corridor station area, or other MTA facility readily accessible to the public, and set up a traveling interpretive exhibit for display at various public venues within Los Angeles County, such as public libraries, museums, or schools. The measures to minimize harm are presented in more detail in the draft MOA, which is included as Appendix G.

#### Coordination with Other Agencies

MTA is in the Section 106 process that will lead to a MOA between MTA, FTA, and SHPO (refer to Appendix G). The MOA specifies mitigation measures to resolve adverse impacts on the 1<sup>st</sup> Street Viaduct. The final MOA will be completed before the Record of Decision (ROD) is issued for the Final SEIS/SEIR.

#### *Potential Visual Impacts*

Visual resources include important views, places where visual quality is important to the use of the property, and recognized historical resources. The LRT line would pass the following major historic resources:

- ◆ Union Station
- ◆ 1<sup>st</sup> Street Viaduct
- ◆ 4<sup>th</sup> Street Viaduct
- ◆ Mariachi Plaza
- ◆ Evergreen Cemetery
- ◆ Our Lady of Lourdes Church
- ◆ Santuario de Nuestra Señora de Guadalupe Church
- ◆ New Calvary Cemetery
- ◆ St. Sava Serbian Orthodox Church and Cemetery
- ◆ Murals

With the exception of Mariachi Plaza and 1<sup>st</sup> Street Viaduct described above, none of these resources is expected to have their visual setting compromised as a result of implementing Option A of the LRT Build



Alternative because of the screening, building set back, or width of the streetscape at these sites (refer to Section 4.15.3.2 for more information about the potential visual impacts on historic properties).

### ***Potential Construction and Operation Noise and Vibration***

The results of the vibration and noise study, that was conducted for the operation of Option A does not indicate any adverse effects on cultural resources that would diminish the integrity of the property's significant historic features. The noise analysis found that some historic properties that appear eligible for listing on the National Register of Historic Places would be moderately impacted as defined by FTA criteria. None would be severely impacted. With regard to NEPA and CEQA significance impact criteria, a significant impact occurs only if a noise-sensitive receptor is severely impacted according to FTA criteria. In addition, ground-borne vibration for any type of train operation would not cause building damage, and would rarely result in even minor cosmetic damage.

The Contractor will be responsible for the protection of vibration sensitive historic buildings or cultural resource structures that are within 200 feet of any construction activity. The maximum peak particle vibration (PPV) velocity level, in any direction, at any of these structures should not exceed 0.12 inches/second for any length of time as recommended by FTA guidance for extremely fragile historic buildings. The Contractor will be required to perform periodic vibration monitoring at the closest structure to any construction activities using approved seismographs. If at any time the vibration levels are exceeded, the contractor will be required to immediately halt activity until an alternative construction method can be implemented that will reduce vibrations to acceptable levels. For any fragile historic properties within 200 feet of the Eastside LRT tunnels, MTA will evaluate the vibration results from the excavating materials train as it passes under historic properties. If the vibration levels emanating from the train exceed 0.1 inches/second PPV, the contractor will take action to reduce the vibration levels to 0.1 inches/second or less. Such action could include reducing the muck train speed, additional rail and tie isolation, and more frequent rail and wheel maintenance. This measure will not apply to the tunnel boring machine, but only to operations resulting from the train hauling excavated materials under fragile historic properties. Which historic properties are to be deemed fragile will be determined through a pre-construction survey. Application of these measures will result in a less than significant effect under CEQA.

### ***Settlement Impacts***

Settlement impacts could occur from tunnel excavation due to loss of ground. Such impacts could be cracking of buildings or subsidence over areas of the tunnel during and after construction. These impacts would most affect standing structures directly over, or immediately adjacent to the project corridor in the tunneled area between 1<sup>st</sup>/Gless and 1<sup>st</sup> Lorena. A variety of measures are available and will be implemented to ensure that the applicable settlement limit specifications are met. Thus, no adverse impacts are anticipated.

### **4.17.3 Section 4(f) Properties Affected by Option B of the LRT Build Alternative**

This section describes the Section 4(f) properties that would be affected by Option B of the LRT Build Alternative. Parklands and recreational facilities, archaeological sites, and historic properties that would be affected by Option B are the same as those identified for Option A above. For the parkland, archaeological, and historic properties that would be affected by implementing Option B, refer to the description and the significance of the affected property, the application of Section 4(f) criteria for use, alternatives that would avoid use, measures to minimize harm, and coordination with the appropriate agencies described in Sections 4.17.2.1 through 4.17.2.6.

## 4.18 UTILITIES

### 4.18.1 Affected Environment

Utility lines are located underneath or immediately adjacent, parallel to and across the roadways in the study area. Utility providers include municipal agencies, special utility districts, and private companies providing electricity, water, wastewater and stormwater collection, natural gas, steam, telecommunications, and cable television services. A summary of some of the utility providers by municipality is presented in Table 4.18-1.

Electric power is provided by the Los Angeles Department of Water and Power (LADWP) within the City of Los Angeles and by Southern California Edison (SCE) for the remainder of the study area. The deregulation of the industry in the California market increased competition in the marketplace, which would benefit the utility users like MTA in the negotiation of favorable utility rates for new rail starts.

Telephone lines in urban areas are typically located within street rights-of-way, above ground on utility poles, and underground in newer areas. Other smaller utilities often share these underground trenches or duct banks. Several private companies maintain fiber optic cables and/or provide long distance/cable television and other telecommunications services in Los Angeles County.

Municipality	Providers
City of Los Angeles	Los Angeles Department of Water and Power Pacific Bell Southern California Gas Company Los Angeles City Public Works Department, Sanitation Bureau Los Angeles City Public Works Department, Bureau of Street Lighting Los Angeles County Flood Control District
Los Angeles County	Pacific Bell Southern California Edison Southern California Gas Company California Water Service Los Angeles County Sanitation District Los Angeles County Flood Control District

### 4.18.2 Methodology for Impact Evaluation

Impacts on public services were evaluated for the operational and construction phase of the LRT Build Alternative (Options A and B). Operational impacts include: 1) public utility facilities to be relocated, or 2) facilities impaired as a result of the other impacts such as vibration, safety, or access. Construction impacts occur if the delivery of services provided by public utility facilities would be interrupted or substantially diminished for a prolonged period of time.

Impacts on utilities from LRT operation would result if an additional demand upon utilities were to exceed existing or planned capacity and, therefore, require substantial infrastructure improvements. Substantial interface with the existing utility infrastructure systems or a prolonged disruption of utility services resulting from construction would constitute an adverse impact.

To catalog public services and utilities along the alignment extensive field surveys will be performed as part of the preliminary and final engineering design. The data accumulated will be mapped and tabulated and potential impacts will be identified, using the criteria and considerations identified in MTA's System Design Criteria and Standards, Volumes 1 through 4.

### 4.18.3 Impacts

#### 4.18.3.1 **No-Build Alternative**

The No-Build Alternative would maintain the current utility service in the corridor, and therefore would not have an immediate impact on public infrastructure.

#### 4.18.3.2 **LRT Build Alternative**

##### *Option A*

No significant impacts on natural gas, telephone and telecommunications, cable television, water supply, wastewater, streambeds, or solid waste collection and disposal services are expected during LRT operations. Significant service disruptions to utility customers during LRT repair and maintenance operations are not expected as a result of the sufficient capacity and strategies to provide additional service as the LRT line becomes operational.

The following measures will minimize any potential utility service interruptions and conserve resources:

- ◆ MTA and their contractors will comply with applicable utility policies and strategies as specified in the adopted operational comprehensive plans of the City of Los Angeles and the County of Los Angeles, including those provisions related to levels of service, conservation strategies, and coordination of service provisions;
- ◆ MTA will incorporate City of Los Angeles, County of Los Angeles, and California State energy code, building code, fire code, MTA's Design Criteria and Standards (Volumes I through IV), and other applicable requirements into all design aspects of the system, stations, maintenance facility, and parking areas;
- ◆ MTA and their contractors will use standard practices, including cathodic protection, to reduce the effect of stray currents from power lines that cross 1<sup>st</sup> Street near the Los Angeles River and at other locations where the potential for stray currents exists. Where necessary and possible, MTA and their contractors will install devices to reduce the impact of stray current between the traction power system and the utilities facilities, or replace particularly metallic utility infrastructure with nonmetallic materials; and
- ◆ MTA and their contractors will coordinate with affected water utilities and local fire departments to ensure that water use, especially at the maintenance facility and subway section, does not compromise flow required for fire protection.

In addition, the LRT line will be located so that access to utilities for maintenance and repair will be maintained. If necessary, manholes, pipes, vaults, and other access points may have to be relocated.

#### Significance of Impacts

The strategies to accommodate the LRT line and to avoid interference with normal utility operations ensure that no significant impacts will occur.

***Option B***

The impacts and significance of the impacts are the same as those described for Option A.

**4.18.4 Mitigation**

No mitigations are required under Options A or B since significant impacts to utilities are not expected as a result of LRT operation.

## 4.19 CONSTRUCTION IMPACTS

### 4.19.1 Construction Methods

The construction of the Los Angeles Eastside Corridor LRT project (Options A and B) will employ conventional construction techniques and equipment used in the Southern California region. Major project elements include construction of guideway and trackwork, at-grade station platforms, underground stations and tunnels, a new bridge across U.S. 101 to Union Station, and installation of specialty system work such as traction power, communications and signaling. All work will conform to industry specifications and standards. The equipment used in construction would include graders, dozers, cranes, concrete trucks, pumping equipment, flat bed trucks, dump trucks to haul dirt, tunnel boring machines, and rail mounted cars to transport spoil material within the tunnel. Spoil materials would be hauled away from the work sites by trucks to approved disposal sites. Traffic detours and truck routes would be required during construction. Section 4.19.2.2 discusses mitigation measures to be taken to minimize adverse traffic impacts.

The various work activities to be performed over an estimated four-to five-year construction period will include the following facility and system items:

- ◆ Construction of a bridge and elevated approach sections near Union Station (including foundations, support columns, girders, and deck slabs). This construction will be either “cast-in-place,” partially precast, steel or a combination of these depending on the final design and the preferred approach of the construction contractor.
- ◆ Modifications of existing bridge structures at the 1<sup>st</sup> Street Viaduct, US 60, and the 710 Freeway
- ◆ Demolition of existing structures at underground station sites and potentially at substation locations
- ◆ Construction of retaining walls for approaches to the bridge, portal structures and shallow trenches.
- ◆ Construction of about 1.4 miles of tunnels by Tunnel Boring Machine (TBM)
- ◆ Construction of portal structures, cut and cover tunnel sections, and underground stations.
- ◆ Relocation, modification or protection in place of utilities in conflict or impacted by excavations for street level trackwork, tunnels, bridge and station construction.
- ◆ Construction of Eastside Corridor LRT high floor station platforms on street level locations using typical “cast-in-place” or pre-cast construction methods.
- ◆ Construction of underground duct banks for electrical power feeds and for signaling/communications systems.
- ◆ Construction of surface drainage systems and subdrainage.
- ◆ Construction of traction power substations with electrical power feeds.
- ◆ Construction of overhead catenary pole foundations or alternative power distribution support systems, and street lighting where required.
- ◆ Construction of a parking facility near Beverly/Pomona to accommodate vehicles parking at the LRT’s eastern terminus. Under Option A, minor improvements to an existing lot would also be made near Beverly/Atlantic.
- ◆ Installation of traffic signal and train control improvements.
- ◆ Installation of overhead catenary wires, support brackets, feeder cables, and other components or alternative power distribution systems.
- ◆ Installation of trackwork complete with preparation of track bed, track slab, rail, fasteners, and infill concrete in street level areas, and with direct fixation fasteners on the aerial guideway and 1<sup>st</sup> Street bridge.
- ◆ Construction of station finishes, such as canopies, fare vending equipment, station furniture, ramps, elevators, escalators, landscaping, and all other amenities necessary for a functional station.
- ◆ Conducting subsystem and system testing.

- ◆ Conducting simulated revenue operation test runs and final commissioning of the system.

More detailed information related to the LRT at-grade and subway construction activities and schedule are provided below.

#### **4.19.1.1 Required Construction Areas and Easements**

Construction of the underground stations and portal access to tunnels will require the use of existing MTA property at the 1<sup>st</sup>/Boyle, Cesar Chavez/Soto and 1<sup>st</sup>/Lorena sites, and additional properties at the 1<sup>st</sup>/Soto and 1<sup>st</sup>/Boyle sites. Temporary easements, typically a portion of the sidewalk, will be required at the portals to allow a single lane of traffic in each direction during construction. Access to residences and businesses (during business hours) will be maintained during construction.

For street level LRT sections, the street area alongside the station and track areas, supplemented by adjacent off-street areas, would be used for construction staging and for equipment and material storage.

#### **4.19.1.2 General Construction Scenario**

The LRT Build Alternative would be constructed during an approximate five-year period. Surface streets would be impacted for approximately 24 to 36 months. LRT construction would begin simultaneously at several locations along the selected route to accommodate areas requiring lengthy construction times, such as the tunnels, underground stations, and aerial segments, and to bring the various segments to completion at approximately the same time.

Many contractors specializing in various methods of construction would be working on the project for the overall length of the construction period. The physical construction would involve the method that is most suitable for each segment of the project. A representative sequence of construction is shown in Table 4.19-1. Many of the project elements would be constructed in parallel for an overall duration of five years.

Construction of the project would follow all applicable local, state and federal laws for building and safety. Working hours would be varied to meet special circumstances. Standard construction methods would be used for traffic, noise, vibration and dust control, consistent with all applicable laws, and as described in the following paragraphs.

#### **4.19.1.3 Surface Construction**

##### ***Utility Relocation and Street Closures***

Prior to beginning construction it would be necessary to relocate, modify or protect in place all utilities and underground structures, which would conflict with excavations for street level trackwork, subways, bridge and station structures. Shallow utilities, such as maintenance holes or pull boxes, which would interfere with guideway excavation work, will require relocation. The utilities would be modified and moved away from the proposed facilities. Temporary interruptions in services (several hours) could be experienced during re-location or re-routing of utilities. Depending on the extent of utility relocation work, estimated construction durations are four to six months for a one-mile segment of work.

An exception to the general utility relocation scenario given above would be at Indiana Street if Option A were selected. For this option, major utilities in Indiana Street would require relocation into a large underground utility box structure. Construction of the box would require a deep excavation to be constructed similar to the cut and cover station boxes described in subsequent sections. Work will require

that Indiana Street be open to only two lanes of traffic (one in each direction) and parking removed while decking is being installed and for the contractor's access to the underground section. Flaggers will be required to guide contractor's equipment in and out of the work area. Total construction duration would be approximately nine months. Complete closure of Indiana Street would be required for limited durations (several eight to 12 hour weekend periods) to move heavy equipment. Work will include removal of existing pavement, excavation and support of (install piles, lagging and bracing) the open cut excavation, installation of new utilities, place forms and concrete for the box structure, back fill the section and re-pave the street. Equipment used would include backhoes, dump trucks, cranes and pile installation equipment, concrete trucks and paving equipment. Option B would not require this work as the station would be located off-street.

**TABLE 4.19-1  
TYPICAL SEQUENCE OF CONSTRUCTION ACTIVITIES**

Activity	Tasks	Average Time Required (months) <sup>1</sup>
Survey	Locate utilities, establish ROW and project control points and centerlines, and relocate survey monuments.	4 – 6
Site Preparation	Relocate utilities and clear and grub ROW (demolition), widen streets, establish detours and haul routes, erect safety devices and mobilize special construction equipment, prepare construction equipment yards and stockpile materials.	12 – 18
Heavy Construction	Construction of tunnels, aerial structures (includes bridge to Union Station), street guideways including trackbed, subway stations and portals, trenches, piles, piers and columns and disposal of excess material. Refinish roadways and sidewalks.	24 – 36
Medium Construction	Lay track, construct surface stations, drainage, backfill and pave streets.	12 – 24
Light Construction	Finish work, install all system elements (electrical, signals, and communication), street lighting where applicable, landscaping, signing and striping, close detours, clean-up and test system.	6 – 12
Pre-revenue Service	Testing of communications, signaling, and ventilation systems, training of operators and maintenance personnel	3 – 6
Open-Project		
Notes:		
<sup>1</sup> Some of these activities will be conducted in parallel.		

### **Street Widening**

Along portions of the alignment, such as along Alameda Street and portions of 1<sup>st</sup> Street, street work will be required to widen the existing roadway widths to maintain the required number of through lanes and turning lanes. All work would be initially done at the curb line to construct new curb and gutter, sidewalks and outside traffic lanes. An estimated construction duration is five months to a year depending on the extent of widening and utility relocation for a one-mile segment. During this stage of work, property owners and businesses located immediately adjacent to the work areas would also be affected. Mitigation measures for adverse impacts are discussed in Sections 4.19.2.2 and 4.19.2.9.

### ***Surface Trackwork***

For most of the alignment, the LRT tracks will be centered in the street right-of-way. The reader is referred to Chapter 2.0 for illustrations of representative LRT right-of-way cross-sections. Mountable curbs will be constructed to discourage vehicular traffic from driving on the tracks. At-grade sections are to be located primarily along Alameda, 1<sup>st</sup>, Indiana, 3<sup>rd</sup>, and Beverly (Option A) or Pomona (Option B). After any required utility relocation, rough grading would be completed within the streets, followed by trackbed excavation, and track slab placement for support of the rails. Duct banks would be installed during this time to carry communication and signaling conduits.

Trackwork construction involves work to demolish the roadway section being displaced by the LRT trackway, preparation of the track bed, construction of the supporting track slab, and laying of rails. Foundations for overhead wires poles may be installed with the track installation. At this point in construction, center lanes will be closed, which will effectively eliminate all mid block turns and street parking. One-mile segments are likely to be recommended to achieve economies of scale and minimize the schedule. Segments could be under construction both east and west of the underground section. Within each mile segment, rails would be stockpiled, welded into rail strings and moved into place as work progresses. Work durations are estimated to be four months to complete trackwork in each mile segment. Periodic lane closures, predominately on one side or the other of the work zone, would be required for delivery of materials and during concrete pours. Construction of station platform slabs would likely be included in line segment contracts and would be coordinated with trackwork installation within each mile segment.

Minor cross streets and alleyways may also be temporarily closed but access to adjacent properties will be maintained. Major cross streets would require partial closure, half of the street at a time, while relocating utilities if required for surface stations and constructing the light rail trackbed. Depending on allowable working hours, full blocks may require closures during excavation, preparation of subgrade, and track foundations placement. Closures would be in a staggered sequence to facilitate traffic control. Where streets are not fully closed, two-way traffic would be allowed on half of the street. After the trackbed is constructed across a local street and the roadway is restored to its permanent condition, vehicles can resume original traffic patterns.

Rails would be brought to the sites by truck, and local rail storage areas will be necessary for short-term storage and to facilitate placement of rails.. Equipment used for construction of the surface tracks (and surface stations) would be similar to what is required for relocation of the utilities with the addition of track-laying equipment, paving machines, concrete mixers, and concrete finishers.

### ***Trench, Retaining Wall and Fill Construction***

Some trenching and filling would be constructed under and between the I-710 and SR-60 freeways to minimize the rail grade. Relatively small retaining walls (estimated to be less than five feet) will be necessary to retain these sections. The excess material would be excavated using bulldozers, earthmovers, front-end loaders, and tractor-trailer rigs. Excess material would be transported to approved disposal sites.

### ***At-Grade Stations***

All stations could be constructed simultaneously with the various segments of the system. However, the contractor may elect to construct them sequentially. At-grade stations on the LRT would be constructed approximately one mile apart from each other. These stations would be constructed from standard building materials, such as brick, concrete, steel, aluminum, and heavy plastic, which are durable and



resistant to vandalism. The stations would be similar to the existing Long Beach Blue Line stations and proposed Pasadena Blue Line stations. The reader is referred to Chapter 2.0 for illustrations of typical station cross-sections.

### ***Operating Systems Installation***

The operating systems include traction power, an overhead catenary system, communications, and train control. Catenary systems consist of poles connected to drilled shaft foundations with overhead wires to supply power to the trains. Traction power includes six substations to provide Direct Current power for the trains. These include grounding systems and pre-fabricated units which are placed on foundation slabs by crane and connected to the system. Where existing structures must be demolished to accommodate the substation, demolition work will be completed prior to construction of the substation. Construction equipment will include highrail vehicles for installation of the wires from the guideway area. While wires are strung at cross streets, temporary street closures of a few hours during nighttime are anticipated.

Systems installation contracts are generally bid as system wide contracts and follow the completion of line segment construction. Finishing contracts for stations and landscaping would be planned to overlap with systems work and be completed prior to final testing and pre-revenue operations. The systems installation work is considered to be significantly less disruptive to communities as compared to the line segment construction work, and is estimated to be about five months for a one-mile segment

### ***Parking Facilities***

Parking facilities would be provided near the eastern terminus station providing a total of about 200 spaces. Construction of the parking lot would involve subgrade preparation of the parking area, paving, and striping. Concrete curbs, lighting, driveways, and sidewalks would be re-constructed as necessary, as well as planting the appropriate landscaping. Equipment used for construction of the parking facility would include diamond saws, pavement breakers, jackhammers, compressors, concrete pumping equipment, paving machines, dump trucks, front-end loaders, etc.

### ***Bridge Construction***

Aerial structures (bridge and elevated approach section) required for the LRT project would be constructed as the initial portion of the project from Union Station to beyond the US-101 freeway. Lower elevation portions of the bridge approach structures could be constructed on retained fills. The overall length of the elevated portion is expected to be about 1,000 feet. A 1,000-foot bridge could require as much as 18 months to complete. Typical construction methods for the bridge would involve several phases of work: foundation construction, installation of columns, and setting in place of concrete or steel girders or steel trusses.

Construction of the column foundations could begin at the same time that the utilities are relocated, providing the utilities do not directly impact the foundation locations. Once the foundations are in place, the columns would be constructed. It may be possible to conduct most of the column construction and girder placement during late night hours to minimize disruptions on the freeway and local streets. Traffic will not be allowed to pass under the structure during form and concrete placement, and temporary lane closures would be necessary during these periods.

Construction of the bridge approach structure south of the US 101 will include an aerial structure from the bridge which transitions to at-grade just before Alameda Street. Approximately one-half of Commercial Street will need to be closed during construction of this approach structure for access to the work. The

US 101 off ramp to Alameda will also be closed. Closure of the ramps will be coordinated with Caltrans who will be re-aligning the section of the 101 freeway in this area and re-locating the ramps to the east. Traffic along Commercial can be accommodated by providing one lane of traffic in each direction or by providing a temporary couplet of traffic movement along Ducommun and Commercial Streets.

Equipment used for construction of the aerial guideway would include drill rigs/augers, cranes, pile drivers, jackhammers, compressors, concrete trucks and pumping equipment, dump trucks, front-end loaders, paving machines, and large tractor-trailer rigs to carry girders and miscellaneous tools.

### ***Existing Bridge Retrofitting***

#### **1<sup>st</sup> Street Viaduct**

The City of Los Angeles' 1<sup>st</sup> Street Viaduct over the LA River is now carrying five lanes of HS20 (semi-trailer) rubber tired vehicular loading. Upon completion of the MTA's Eastside LRT system, the viaduct will be required to carry 2 lanes of HS20 vehicular loading and 2 LRT system trackways. The total live load for these differing conditions is approximately the same. Rubber grade crossing panels will be installed creating embedded trackways that allow emergency traffic to travel in the LRT guideway width.

The bridge was retrofitted by the City of Los Angeles using 1996 Caltrans criteria for increased seismic strength. Since 1996, Caltrans' seismic criteria have increased somewhat. Analysis is currently underway, but the probability of avoiding major additional seismic retrofit currently appears favorable. However, modifications to the bridge abutments/bents appear likely. These would include similar elements to those provided during the 1996 retrofit: additional foundation elements (piles under existing abutments) and infill at bents. Note that the LRT project does not add significantly to the bridge loadings, and seismic retrofitting would otherwise be required by the City of Los Angeles Bureau of Engineering to bring it up to the current Caltrans criteria. The project assumes the catenary poles are to be placed in the center of the bridge.

#### **3<sup>rd</sup> Street Underpass of the 60 Freeway and Freeway Ramps**

Because of the LRT's overhead catenary system and MTA's criteria inclusion of the American Railway Engineering and Maintenance of Way Association (AREMA) code requiring barriers to protect existing bridge piers, Caltrans' 3<sup>rd</sup> Street 60 Freeway Ramp and Bridge Underpasses require Caltrans review and approval prior to construction. In addition, Caltrans 60 Freeway On- and Off-Ramps connect directly with 3<sup>rd</sup> Street, and therefore a traffic control management plan for construction of the LRT guideway on 3<sup>rd</sup> Street will be required and will require Caltrans approval prior to awarding a construction contract. A traffic signal is currently planned at the point where these ramps intersect 3<sup>rd</sup> Street.

#### **3<sup>rd</sup> Street Overcrossing of the 710 Freeway**

The 3<sup>rd</sup> Street Overcrossing of the 710 Freeway requires substantial structural strengthening or alteration in order to support the LRT vehicles. Caltrans' will require a combined Project Report/Project Study Report (PR/PSR) for this bridge overcrossing. The current approach is to reduce the dead load of the bridge to compensate for the increased live load, thereby allowing the foundations to remain unchanged for both live load and seismic forces. Nevertheless, some seismic retrofit is anticipated to be required for this bridge.

Because of the LRT's overhead catenary system, both the Caltrans' 3<sup>rd</sup> Street 710 Freeway South West Overhead Connector Ramp, and the 3<sup>rd</sup> Street 710 Freeway N.W. Overhead Connector Ramp must be included in the above report.

One of Caltrans On-Ramps to the 710 Freeway leads directly off of 3<sup>rd</sup> Street and two of Caltrans' I-710 Freeway On-Ramps connect with South Ford Boulevard, which is only 200 feet from its intersection with 3<sup>rd</sup> Street. A traffic control management plan for construction of the LRT guideway on 3<sup>rd</sup> Street (and station at 3<sup>rd</sup>/Ford in Option B) will require Caltrans approval prior to awarding a construction contract.

#### **4.19.1.4 Underground Construction**

Pre-construction activities would include building assessments (pre-construction evaluation of existing structures along the alignment) and preparation of worksite traffic control plans. During preliminary and final design of the project, subsurface (geotechnical) investigations would be undertaken to evaluate soil, groundwater, seismic, and environmental conditions along the alignment. The geologic conditions will influence design and construction methods specified for stations and tunnels as well as foundations. The studies are discussed in more detail in Section 4.19.2.13.

The stations as well as the portals would be constructed by cut-and-cover and open cut methods. The depths of the stations would be as required to allow for utilities, access to the station's center station platform, structure thickness, and for cover over the tunnels extending from the stations. Conceptual design depths range from about 50 to 60 feet. Station widths are about 60 feet to include the trackways and the center platforms. Portals are designed for accommodation of the twin tracks, station widths, traffic flow around the portals, and existing topography.

Prior to underground construction, work sites will require clearing and building demolition in some areas. Demolition equipment typically includes bulldozers and loaders. Prior to demolition, contractors may salvage items such as fixtures, mechanical equipment, and lumber, unless the contract states otherwise. Where economical, materials such as concrete and steel may be recycled.

Construction of the project would follow all applicable local, state and federal laws for building and safety. MTA Fire Life Safety Committee would approve all construction methods. The Fire Life Safety Committee is composed of members from the Los Angeles City and County Fire Departments, as well as MTA safety specialists. For several months before passenger service begins, pre-revenue operations will be conducted to familiarize train operators with the new alignment and emergency operating procedures.

#### ***Underground Utilities***

Subject to other constraints, the underground stations have been located to avoid to the extent possible conflicts with the space occupied by utilities. In certain instances, the positioning of the station or the location of station entrances and vent shafts would require that conflicting utilities be relocated to clear the way for the station structures. Utilities, such as high-pressure water mains and gas lines, which could represent a potential hazard during cut-and-cover and open-cut station construction and that are not to be permanently relocated away from the work site, would be re-routed temporarily to prevent accidental damage to the utilities, to construction personnel and to the adjoining community. Buried utilities are often protected in place and supported by hanging from deck beams at cut and cover sections.

#### ***Station Excavation - Initial Support***

If the building assessments indicate the necessity to protect nearby structures, the first step in construction of an underground station is to support the foundations of buildings adjacent to the station excavation. This is done by underpinning (additional foundations placed under the building), or by other means such as soil grouting. In lieu of underpinning or grouting, or in combination with grouting, the support of

adjacent structures is commonly accomplished by use of excavation support systems, which in conjunction with proper excavation and bracing procedures, serve as building protection.

The excavation's initial support systems could include reinforced concrete drilled-in-place piles, braced soldier piles and lagging, tangent pile walls, diaphragm walls, and tied-back excavations. Initial support allows support of the ground while soil is removed from the excavation and for the temporary duration of tunneling and other work in the shaft. Final support includes the concrete slabs, walls, and walkways for the stations and portals. Some lateral movement of the excavation walls will occur during removal of soil. The amount of movement will depend on the contractor's excavation methods, wall design, and the height of the wall. Project specifications will call for monitoring of walls and adjacent ground for lateral movements and surface settlement. Acceptable movements, such that adjacent buildings will be protected, will be determined during final design. Specifications will call for the contractor to take appropriate action if limiting movements are approached.

Prior to installation of the ground support system, dewatering is likely to be required at the underground station sites to temporarily lower the groundwater level below the station excavation depth or to an impermeable soil layer. This facilitates installation of the piles, improves soil stability, and allows excavation in dry conditions. Groundwater is pumped from wells installed around the perimeter of the excavation. If contaminated water is encountered, it is treated at the site or hauled to a treatment facility. At the completion of the stations, pumping is discontinued and groundwater levels return to their natural level.

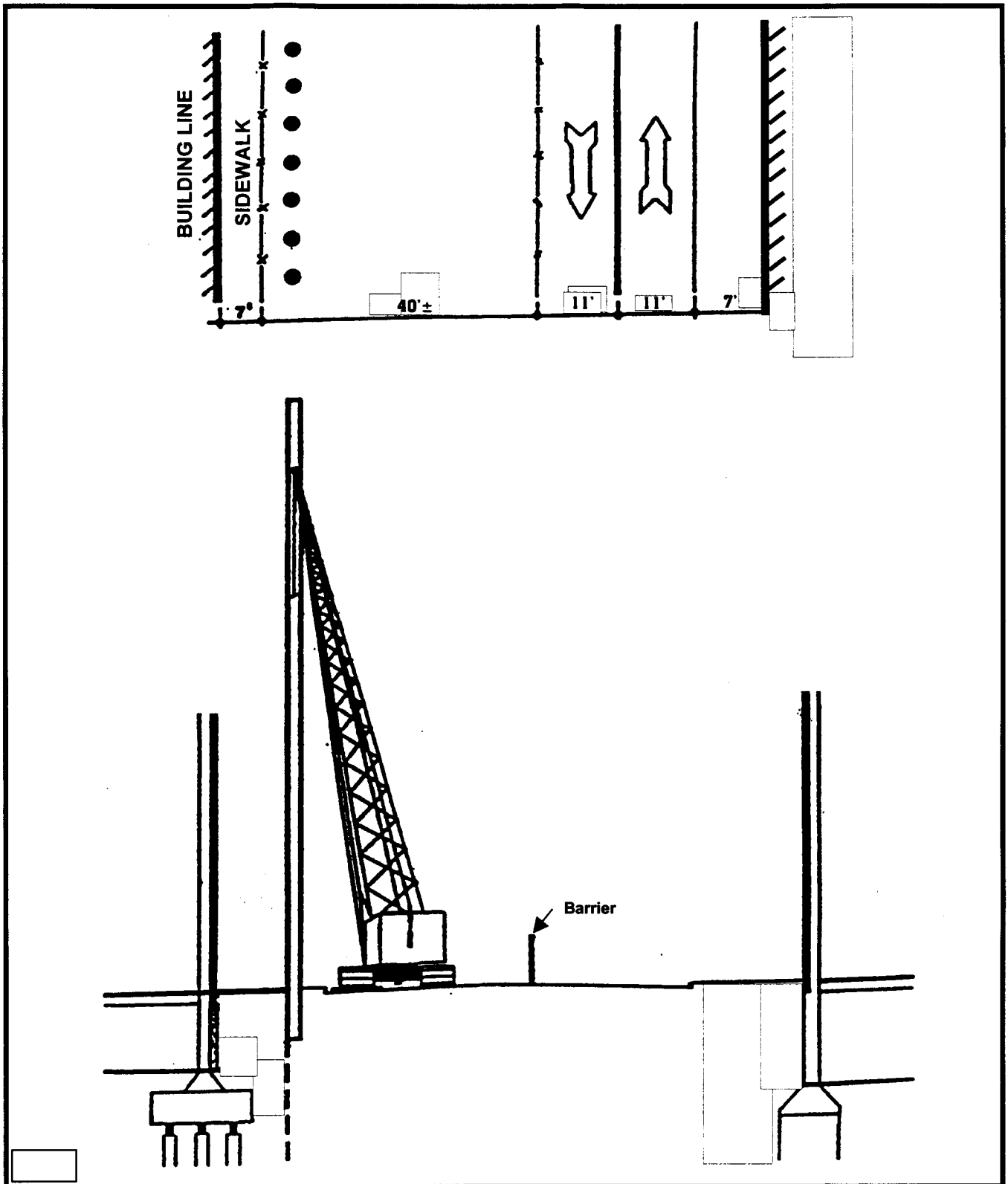
To install the soldier piles and lagging for the support of the excavation, it is necessary to auger out the holes for the placement of the piles. This process is shown in Figure 4.19-1. The pre-drilling of holes is necessary to eliminate pile driving and reduce project noise levels that would otherwise occur with pile driving. The contractor would occupy one side of the street to install one line of soldier piles while the other side would remain open for traffic circulation. The equipment required for installation of the soldier piles includes drill rigs, concrete trucks, cranes, and dump trucks.

After installation of soldier piles on both sides of the street for the underground stations, the contractor would proceed with installation of deck beams, installation of the deck and excavation and bracing as shown in Figure 4.19-2. Pre-cast concrete panels (decking) allows continued traffic and pedestrian circulation since they will be installed flush with the existing street or sidewalk levels. However, deck installation would require lane and night street closures at the stations. The concrete decking would be installed in progressive stages. Portal construction would follow similar construction methods as for the station excavations and retaining walls. The portal would remain permanently open, and thus no decking will be used during construction.

#### ***Excavation, Bracing, and Hauling of Soil***

With the decking installed and the utilities supported, the major excavation work can proceed. The method of removing the material for hauling away from the job site is a choice made by the contractor. A typical operation would be for bulldozers and/or overhead loaders to move the material to a central pickup point or several such points, where a clam shell bucket from a crane or a vertical or diagonal conveyor belt can hoist the material and place it into waiting trucks or a loading hopper. Spoils from the station site will be moved sideways out from under the deck onto an off street work site and loaded from there into hauling trucks. Spoils will not be loaded in the street, except during the initial drilling of soldier piles and deck installation.

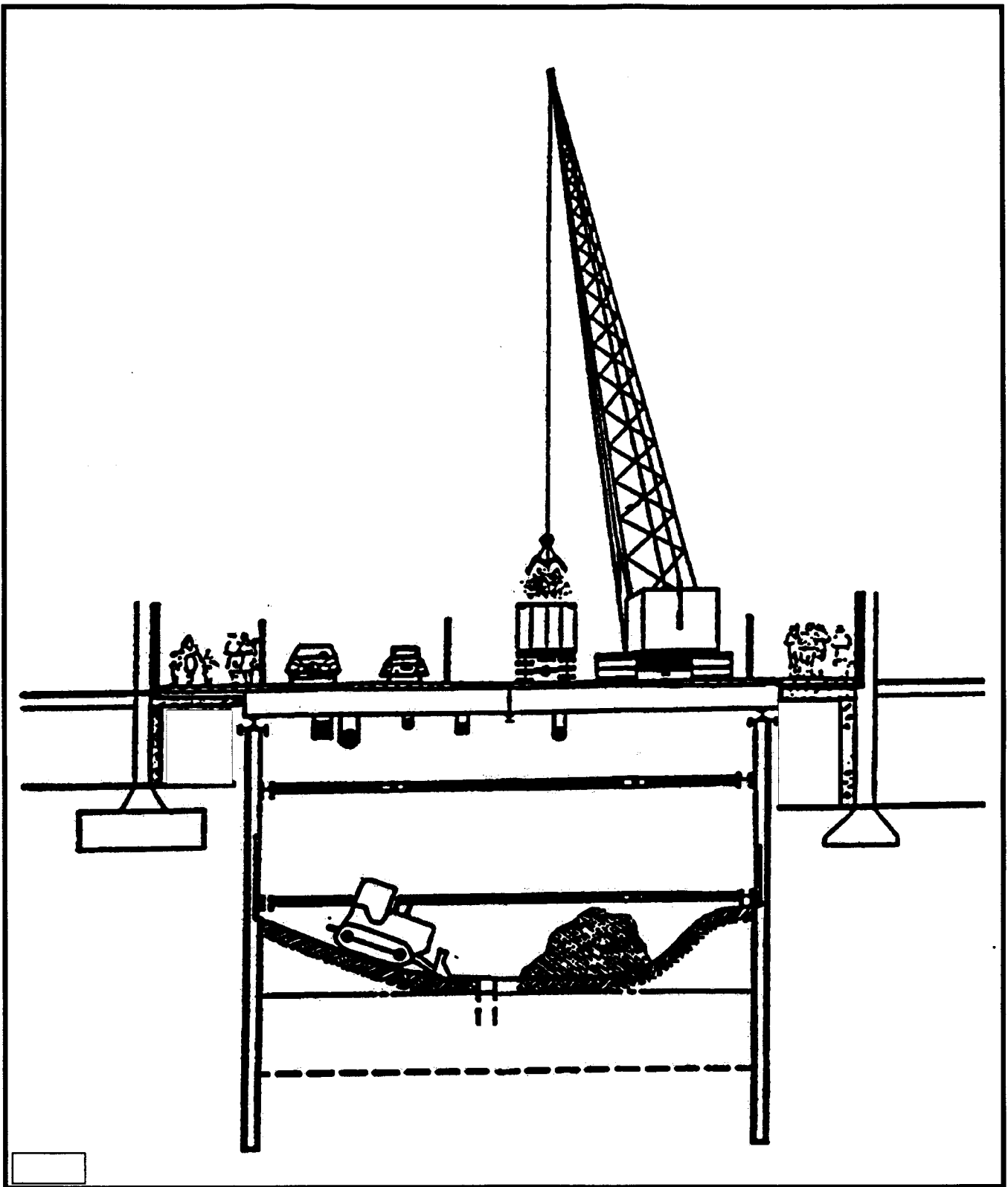




Los Angeles Eastside Corridor SEIS/SEIR

*Installation of Soldier Piles*





Los Angeles Eastside Corridor SEIS/SEIR

*Excavation and Bracing*

Figure 4.19-2





The majority of the soil will be removed through the 1<sup>st</sup> and Boyle Street location. The soil excavated from the 1<sup>st</sup>/Boyle Station area and the 1.4-mile tunnel will most likely be removed by the nearby US 101 freeway. The soil excavated from the 1<sup>st</sup>/Soto and 1<sup>st</sup>/Lorena Stations will have to be removed using surface streets, then freeways. Haul routes to disposal sites would be predetermined by agreement with local authorities before construction. They would follow streets and highways forming the safest or shortest route with the least adverse effect on traffic, residences and businesses.

Table 4.19-2 identifies the estimated number of cubic yards of material to be removed during excavation for each station, as well as the estimated number of truck trips required to haul that material. It has been assumed that each truck would haul 20 cubic yards of material. Excavation at the station area and portal areas is estimated to take six to eight months per station. Trucks could potentially operate from 8 to 24 hours a day. LADOT and Los Angeles County permitting procedures may limit the hours of on-street truck operations and LADOT must approve haul routes

Station	Estimated Cubic Yards <sup>1</sup>	Estimated Maximum Number of Daily Truck Trips <sup>2</sup>	Estimated Number of Total Truck Loads <sup>3</sup>
1 <sup>st</sup> /Boyle <sup>2</sup>	141,000	45	7,100
1 <sup>st</sup> /Soto	60,000	20	3,000
East Portal	17,000	20	850

Notes:  
<sup>1</sup>This column includes an estimated 1.3 expansion factor for the soil due to excavation and handling.  
<sup>2</sup>It has been assumed that each truck could haul up to 20 cubic yards.  
<sup>3</sup>Includes adjacent cut and cover station and west portal.

***Construction of Station and Portal Final Structures***

The construction sequence for the final station structure would include installation of the station floor, also known as the base slab, followed by the installation of exterior walls and any interior column elements. Slabs are poured as the columns and intermediate floor and roof wall pours progress. Portal structures will use similar construction methods involving placement of concrete inverts, walls, and walkways. Station entrance locations are generally used as access points to the underground station during the construction process. Exterior entrances would be constructed after the station structure has been completed.

***Street Restoration/Site Restoration***

After the subway station structure has been completed and the roof slab allowed to cure for a specified period, the backfilling operation can begin. During the backfilling operations, the utilities would be restored to their permanent locations. Where sidewalks have been demolished because of the cut-and-cover construction, they would be restored. After backfilling, the permanent street would be installed and the sidewalks and pavement restored to City standards.

***Tunnel Construction***

The 1<sup>st</sup> Street tunnels would be constructed from the portal west of the US 101 Freeway and ending at the 1<sup>st</sup>/Lorena Street cut-and-cover section, a tunneling distance of about 1.4 miles for each tunnel, which excludes the 1<sup>st</sup>/Soto Station and cut and cover section lengths. Tunnel boring machine(s) (TBM) would

be lowered into the shaft by a crane and would mine from the shaft along the alignment from the 1<sup>st</sup>/Boyle Street excavation to 1<sup>st</sup>/Lorena (Figure 4.19-3). It is anticipated that the 1<sup>st</sup>/Soto Station would be excavated prior to the arrival of the TBMs, allowing the machines to be transported through the excavation and resume mining east of the extended excavation. An alternative second sequencing option could be to drive the tunnels the entire distance from 1<sup>st</sup>/Boyle to 1<sup>st</sup>/Lorena, and follow with the station excavation.

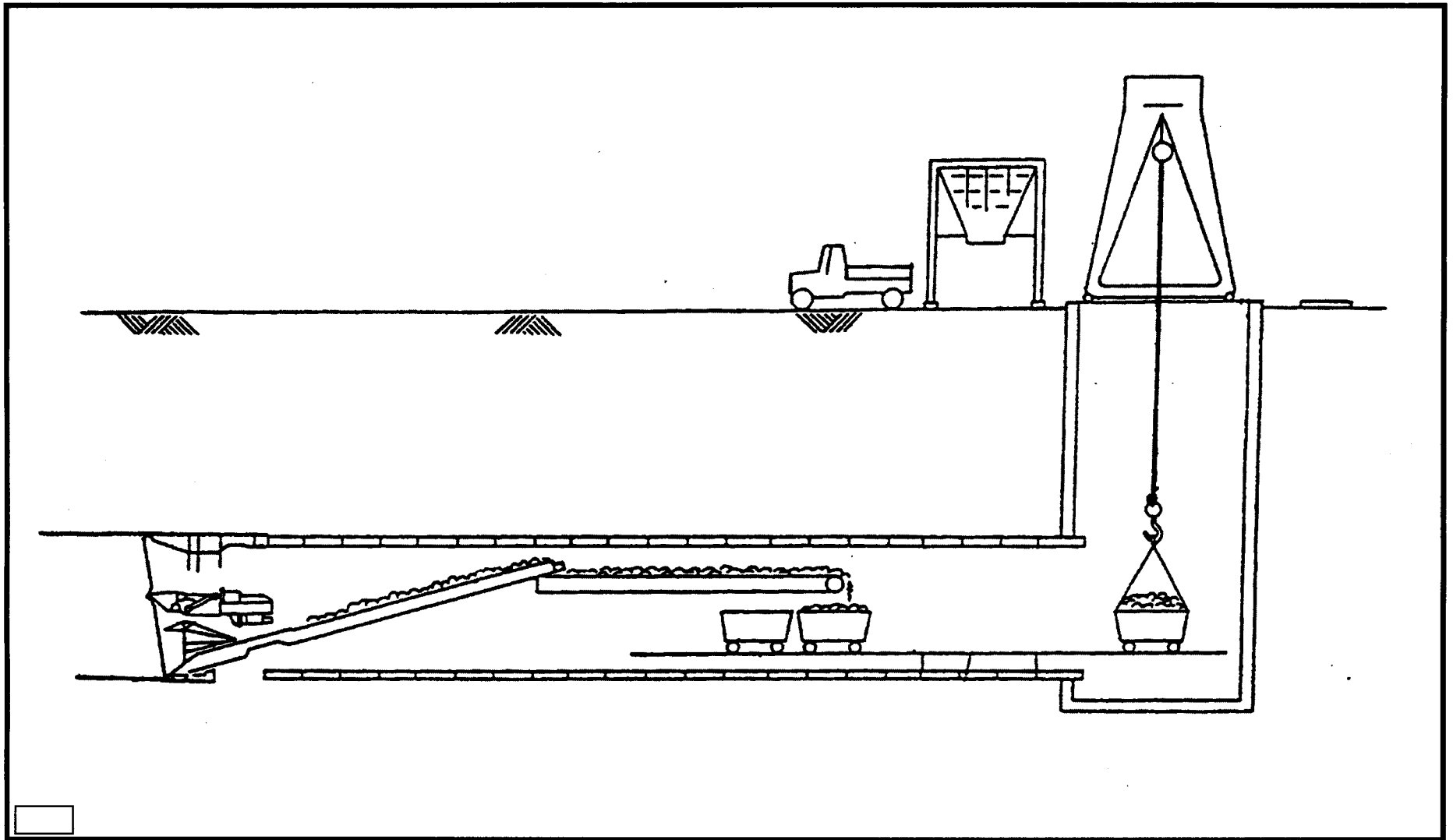
Tunnel driving operations consist of a series of activities. The TBM is advanced a small distance (typically 4 to 6 feet) by means of hydraulic jacks, which react against the previously installed tunnel lining ring. Tunnel lining rings are typically pre-cast concrete segments bolted together in place. Elastomeric gaskets are placed at segment joints to prevent groundwater inflows during and after construction. The machine is advanced and the process is repeated until the entire length of tunnel has been excavated. The pre-cast concrete liners are fabricated off-site and delivered by truck to the site. Segment loads are estimated to be 400 to 500 total truck loads. Several days' production of segments may be stored at the worksites to allow continuous tunneling.

Excavated material (muck) is taken to the rear of the TBM and deposited on a conveyor belt. The conveyor belt drops the muck into mine cars, which are then taken back to the shaft by a locomotive operating on temporary rail tracks laid or fastened to the bottom of the tunnel. At the shaft, the mine cars are lifted out by a crane or hoist and the material is put into trucks for off-site disposal or temporarily stockpiled for later disposal. Alternatively, belt conveyor systems could be used to transport muck through the tunnel and/or from the shaft to the surface. Table 4.19-3 presents the estimated amount of excavated materials and number of daily truck trips required for the tunnel construction.

Tunnel Section	Estimated Total Cubic Yards <sup>1</sup>	Estimated Maximum Number of Daily Truck Trips <sup>2</sup>
1 <sup>st</sup> /Boyle to 1 <sup>st</sup> /Soto	105,000	40-80
1 <sup>st</sup> /Soto to East Portal	150,000	40-80

Notes:  
<sup>1</sup>This column includes an estimated 1.3 expansion factor for the soil due to handling.  
<sup>2</sup>It has been assumed that each truck could haul up to 20 cubic yards, range of number of daily trips doubles depending if one or two tunnels are mined simultaneously.

The pressure face tunnel boring machines to be used on the project may require that soil is "conditioned" in the pressure chamber of the machine. These conditioners (which include surfactants, polymers, bentonite, and the like) help provide a more fluid material which aids in adjusting the earth or fluid pressure on the tunnel face. In addition, the lubrication reduces wear of the equipment. When the conditioned excavated soil reaches the ground surface, it is still wet, and transport to dump sites could require that dump trucks be lined to prevent water leaking onto the roadway.



Los Angeles Eastside Corridor SEIS/SEIR

***Earth Pressure Balance Tunnel Boring Machine***



If a slurry face tunneling machine is selected by the contractor for the project, excavated material would be treated at the site in a slurry separation system. This tunneling system requires that enough bentonite (clay) slurry is added to the face to provide hydrostatic pressure to stabilize the tunnel face. Depending on the ground encountered, conditioners may also be added to the bentonite slurry. Excavated material mixes with the fluid and is pumped out through the tunnel. The soil is then separated from the slurry fluid at a separation plant constructed at the work site. After separation, the soil can be transported in trucks to a disposal site. These trucks may also require lining.

### ***Ground Surface Settlement Resulting from Tunneling***

Geologic conditions for most of the alignment are sands, clays and gravels, which in tunneling terms are described as “soft ground,” as opposed to solid rock, known as “hard ground.” During tunneling, some ground loss will occur, producing surface settlement. The amount of settlement measured at the surface will be a function of the tunnel depth, size, tunneling techniques, and geology.

To reduce surface settlement and the potential for ground loss and soil instability (sloughing, caving) at the tunnel face, pressure-face TBMs and pre-cast, bolted, gasketed lining systems would be employed. In combination with the face pressure, grout is installed immediately behind the TBM between the installed precast concrete liners (tunnel rings) and the ground. The pressure-face TBM can tunnel below the groundwater table without requiring dewatering or lowering of the groundwater table. Where conditions warrant, for example, shallow tunnels directly below sensitive structures or utilities, additional methods to reduce settlement would be specified and are discussed in Section 4.19.2.13.

### ***Mined (non-TBM) Excavated Tunnels***

Because of the long TBM set-up times, the relatively short tunnel section west of the 1<sup>st</sup>/Boyle Station extending to the cut and cover and portal section could be constructed by non-TBM mining methods such as the sequential excavation and support method. Cut and cover techniques are also an option, but would be more disruptive to surface traffic. Sequential excavation and support methods call for the ground to be excavated in small areas and supported with shotcrete and steel supports. After the crown (roof) area is excavated and supported, the larger area of the tunnel is completed. Whereas TBMs can only excavate a fixed (circular) shape, the sequential method permits a tunnel of horseshoe or rounded shape. This construction technique is useful in areas where the tunnel shape or size needs to change, such as where the single bore tunnel from the portal separates into two tunnels to allow the center platform station.

### ***Ventilation Shafts and Emergency Exits***

The subway or tunnel segment of the LRT Build Alternative includes a number of ventilation and emergency exit areas for the subway segment in the vicinity of the subway stations. The locations for emergency exits and exhausts on MTA property and public rights-of-way (sidewalks or street) are shown in Appendix E. In Appendix E, Drawing No. A-3001 shows the locations for the area around the 1<sup>st</sup>/Boyle subway station; Drawing No. A-4001 shows the locations around the 1<sup>st</sup>/Soto subway station; Drawing No. A-5001 shows the emergency exhaust location for the 1<sup>st</sup>/Lorena at-grade station area; and Drawing No. A-5002 shows the locations around the 1<sup>st</sup>/Lorena subway station for the extended subway option.

The stations will house emergency ventilation fan shafts as well as separate emergency exit shafts at both ends of the stations. Ventilation fans are used for extracting smoke from the tunnels and stairs for evacuation in the event of an emergency – such as a fire in the underground areas. The exact location of these facilities would be determined during the final design. These shafts are constructed as extensions of the station excavation, using cut and cover construction methods.

The two-level vent structure is generally a 45-foot-wide, approximately 70-foot-deep concrete box at two ends of the station, joining openings in the top of the tunnels to a vertical shaft penetrating the ground in a convenient location. Ventilation fans and their control equipment, as well as the emergency exit stairs, would be housed in this horizontal concrete box. The area of the shaft will be dependent on the height of the box. Where shafts vent at ground level the area is typically about 400 sq. ft. reducing to about half this area where towers are provided. Minimum tower height would be about ten feet. In some cases vent structures are incorporated with other structures and the height may be adjusted to match or compliment the structure. Since these fans are operated only for emergencies and for maintenance, noise is not considered a significant impact.

It is assumed that each subway station at each end will have two exit hatches connected to emergency stairs. Each exit hatch is about 6 feet wide. Currently most of these hatches and gratings are shown at the station entrance plazas or right-of-way to be acquired for the construction staging areas. During the preliminary engineering design phase, further coordination with the City of Los Angeles will be required to determine if some or all of these hatches and gratings could be located within the public right-of-way. This may require variances from City codes.

#### **4.19.2 Construction Period Impacts and Mitigation**

This section discusses the potential impacts during construction and includes mitigation measures that would minimize adverse effects that cannot be avoided. The evaluation focuses on the LRT Build Alternative and its Options A and B. There would be no construction-related activities associated with the No-Build Alternative because this alternative only includes improvements to the transportation network that have already been approved and funded. No capital improvements are included under this alternative and would therefore not result in any construction-related impacts within the Los Angeles Eastside Corridor study area. However, it should be noted that the No-Build Alternative would not provide short-term benefits, such as construction and residual employment, associated with the LRT Build Alternative. Note that Options A and B of the LRT Build Alternative are similar with regard to most category of impacts during construction. Therefore, the analysis focuses on impacts and mitigation for the LRT Build Alternative. For those areas where the two options vary, the differences are stated.

##### **4.19.2.1 Transit**

###### ***Impacts***

During construction of the LRT system, it may be necessary for traffic lanes to be temporarily closed. Night closures of several blocks on certain streets may also be required. Pre-construction activities that include the relocation of utilities and the construction of the trackway and stations would require the temporary closure of lanes on Commercial Street, Alameda Street, 1<sup>st</sup> Street, Indiana Street, 3<sup>rd</sup> Street, and Beverly Boulevard (Option A) or Pomona Boulevard (Option B). When traffic lanes are closed during the day, transit bus service would be maintained where feasible. Travel times may be increased due to the potential for increased traffic congestion due to construction activities and lane closures. During night closures of entire street blocks, transit bus service may be affected, and buses would be re-routed. Bus stops may also need to be temporarily relocated due to construction in some areas.

###### **Significance of Impacts**

Although these impacts may be temporary, they would be significant under CEQA.

###### ***Mitigation***

MTA is working closely with the City, the County, and the affected transit operators in developing mitigation plans. Bus lines that will be affected by lane closures due to construction activities will continue to operate where feasible in the remaining traffic lanes. Bus stops that will be affected by sidewalk construction will be temporarily relocated, and construction activities will be phased to consider the maintenance of bus service and minimize disruption. During periods at night when entire blocks may be closed to traffic, bus lines will be re-routed to adjacent streets in a manner that minimizes the inconvenience to bus passengers. If a block is closed that includes a bus stop, the bus stop will be temporarily relocated to the portion of the street segment that is still open to bus service. Before any significant re-routing changes are made to East Los Angeles buses as a result of the construction of the Eastside Corridor project, fliers will be provided on buses at least two weeks in advance notifying riders of route modifications. In addition, hoods will be placed over the bus-stop signs, also notifying riders of what modifications have been made to the bus route.

###### **Significance of Impacts Remaining After Mitigation**

After the implementation of the aforementioned mitigation measures, there would continue to be potentially significant impacts during construction due to the possibility of increased transit travel times.



#### 4.19.2.2 Traffic

##### *Impacts*

Construction of the LRT would temporarily interfere with the normal traffic flow, causing some lanes and streets to be closed to vehicles for various durations. At least one street, Pleasant Avenue between Boyle Avenue and 1<sup>st</sup> Street, would be closed for the duration of station and tunnel construction (estimated 3 to 4 years). It is possible that in some instances, block-long sections of streets would be closed temporarily for utility relocation, guideway and station construction, and laying rail. Additional information on street restrictions, access issues, and impacts of bridge/overpass/underpass construction can be found in Section 4.19.1.3 in the discussions of utility relocation and street closures, street widening, surface trackwork, bridge construction, and existing bridge retrofitting.

For street level LRT sections, the street area within and alongside the station areas, supplemented by adjacent off-street areas, will be used for construction staging and for equipment and material storage. In general, some areas under the LRT elevated section near Union Station may be used as a construction staging area and equipment and materials storage area. The minimum construction area or "footprint" required will be the width of the structure plus a temporary 20-foot construction easement on at least one side of the guideway. Haul and delivery truck routes will affect residents and commuters along the alignment. Tunnel spoil hauling, rail and catenary deliveries, and general construction traffic will affect traffic patterns as well. In addition to affecting traffic patterns, there may be slight physical damage to the roads from hauling trucks.

##### Significance of Impacts

The impacts during construction would be considered significant under CEQA.

##### *Mitigation*

Site and street specific Worksite Traffic Control Plans that meet LADOT and County DPW requirements will be developed during final design in cooperation with those agencies and the City of Monterey Park to accommodate required pedestrian and traffic movements. In the event that freeway access ramps are affected by construction, Traffic Control Plans will be developed in coordination with Caltrans as well. Because Caltrans' Route 60 Freeway on- and off-ramps connect directly with 3<sup>rd</sup> Street, a traffic control management plan for construction of the LRT guideway on 3<sup>rd</sup> Street will require Caltrans approval prior to awarding a construction contract. To the extent practical, traffic lanes will be maintained in both directions, particularly during peak traffic hours. Access to homes and businesses will be maintained throughout the construction period.

In some cases, specific construction techniques will be utilized that minimize the construction envelopes such as the use of segmental construction, which minimizes the need for extensive falsework on the ground. At least one traffic lane in each direction in addition to pedestrian access will be maintained during construction. A quick response tow truck service, funded by MTA, will target Indiana Street, 1<sup>st</sup> Street Bridge, and where warranted, to minimize any impacts during construction or operation.

Designated haul routes for trucks and hours of operation will be established by LADOT, County DPW, and Caltrans and identified during final design. These routes will be situated to minimize noise, vibration, and other possible impacts. Oversize and overweight vehicles will obtain Transportation Permits from Caltrans if their routes require the use of any State Highways. Following completion of the Eastside LRT, if slight physical damage to the haul route roads is found, the road will be treated as necessary.

### Significance of Impacts Remaining After Mitigation

After the implementation of the aforementioned mitigation measures, there would continue to be potentially significant traffic impacts, although they would be temporary.

#### **4.19.2.3 Parking**

##### *Impacts*

It may be necessary to prohibit curb parking when traffic lanes are closed due to construction activities. During sidewalk construction along 1<sup>st</sup> Street, parking will be prohibited. Along other streets that are wider, such as 3<sup>rd</sup> Street and Beverly Boulevard (Option A) or Pomona Boulevard (Option B), it may not be necessary to temporarily prohibit parking. Indiana Street will have temporary parking prohibitions during construction between 1<sup>st</sup> and 3<sup>rd</sup> Streets. Contractors will be required to have all employees park off-street at MTA approved locations to minimize the loss of crucial commercial parking.

The width of the streets along the LRT alignment largely determine whether curb parking spaces will be removed and during which time period during the day. Indiana Street will have parking removals during all periods of the day under Option A. There will be no parking impacts on Commercial Street, Alameda Street, 3<sup>rd</sup> Street, Beverly Boulevard, or Pomona Boulevard in both options. Option A has the greatest number of spaces removed, which is due to the removal of parking on Indiana Street during all three time periods.

##### Significance of Impacts

The impacts during construction would be considered significant under CEQA.

##### *Mitigation*

A parking mitigation plan will be developed to the standards of, and reviewed by, LADOT and County DPW prior to construction to minimize impacts on curb parking. It may be possible to sequence construction activities so that multiple blocks of on-street parking are not temporarily removed at one time. This will make various on-street parking spaces available in an area under construction for a period of time. Some of the parking mitigation measures outlined in Chapter 3 will be developed early so that they may be utilized during the period of construction. For example, the MTA-owned parcel near 1<sup>st</sup> and Lorena Streets will be utilized for replacement parking during construction. The park-and-ride facility proposed for development at the eastern project terminus will be developed in time to provide for replacement parking for on-street spaces that may be removed during construction. The MTA will lease parking lots for construction employees if necessary, in order to minimize the loss of crucial commercial parking.

##### Significance of Impacts Remaining After Mitigation

After the implementation of the aforementioned mitigation measures, there would continue to be potentially significant parking impacts, although they would be temporary.

#### 4.19.2.4 Other Modes

##### *Impacts*

Pedestrian access to adjoining properties will be maintained during construction, although in some instances, at subway station locations, portions of the sidewalks may be closed temporarily for decking construction. Temporary night sidewalk closures may be necessary in some locations. Some existing crosswalks may be temporarily closed. Lane and street closures may inhibit the flow of bicycle traffic during construction.

##### Significance of Impacts

Although temporary, the impacts during construction on pedestrian and bicycle movement would be considered significant under CEQA.

##### *Mitigation*

Special facilities, such as handrails, fences, and walkways will be provided for the safety of pedestrians in areas where construction activities will impact sidewalk areas. If crosswalks are temporarily closed, pedestrians will be directed to use one that is in close proximity to the one being temporarily closed. Several adjacent crosswalks will not be closed at the same time to allow for pedestrian movement across the streets. Bicyclists will be encouraged through signage in the area to ride with caution in the streets, ride with caution on sidewalks, or choose other routes during construction activities. Site and street specific Worksite Traffic Control Plans that meet LADOT and County DPW requirements will be developed during final design in cooperation with those agencies and the City of Monterey Park to accommodate required pedestrian and bicycle movements.

##### Significance of Impacts Remaining After Mitigation

After implementation of the aforementioned mitigation measures, there would continue to be potentially significant impacts on pedestrian circulation and bicycle movement, although they would be temporary.

#### 4.19.2.5 Land Use and Development

##### *Impacts*

##### Compatibility with Local Plans and Policies

Short-term impacts associated with construction would include community disruptions from noise, dust, and traffic congestion caused by construction equipment and activities. Access to local facilities, services, and residences could be obstructed during the short-term. Although these impacts would not be permanent, they would not generally support goals and policies for improving the study area. Similarly, congestion around construction staging areas could interfere with plans and policies intended to attract new businesses and residents to the area. These impacts would conclude when construction of the LRT Build Alternative is complete. While there would be short-term impacts, the long-term benefits would further goals and policies within the study area.

##### Compatibility with Redevelopment Areas/Specialized Zones

Construction activities also would not generally be compatible with objectives for redevelopment zones and specialized zones, especially where work efforts are concentrated such as around construction staging

areas. Community disruptions during construction may delay potential revitalization efforts until activities are near completion. When completed, the LRT project would likely support, and perhaps reinforce, goals for redevelopment as indicated in the discussion of operational impacts in Section 4.1.

#### Impacts of Stations and Ancillary Facilities

Station construction for the LRT Build Alternative may result in concentrations of activity in these areas and would potentially result in similar disruptive impacts as identified above.

#### Significance of Impacts

Construction has the potential to divide the community for limited durations. This would result from some street closures and traffic detours, especially in areas of tunnel construction. Land uses around the construction staging areas would also be temporarily impacted because of potential traffic, noise, air quality, and visual effects. Overall, however, these are anticipated to be less than significant impacts because they would end at the completion of project construction. Although the LRT construction would not generally be compatible with local plans, policies, or redevelopment objectives or could delay potential revitalization efforts until construction activities are near completion, these land use impacts would be less than significant due to their temporary duration.

#### ***Mitigation***

The LRT Build Alternative will be built in stages thereby diminishing the overall impact of construction activity on land use. MTA will coordinate with local businesses and residents to provide advanced notification of traffic detours and delays, and potential utility disruptions associated with construction. Measures to reduce noise and dust are identified in Sections 4.19.2.6, *Air Quality* and 4.19.2.7, *Noise and Vibration*. Measures to reduce visual and aesthetics and traffic impacts are discussed in Sections 4.19.2.8 and 4.19.2.1, respectively. Mitigation measures would reduce short-term land use impacts to less than significant.

#### Significance of Impacts Remaining After Mitigation

After the implementation of the aforementioned mitigation measures, temporary land use impacts would be reduced to an insignificant level.

#### **4.19.2.6 Air Quality**

##### ***Impacts***

The project would generate pollutant emissions from the following construction activities: 1) the demolition of existing structures, 2) excavation related to cut-and-cover and tunneling operations, 3) welding related to continuously welded rail (CWR) operations, 4) mobile emissions related to construction worker travel to and from project sites, 5) mobile emissions related to the delivery and hauling of construction supplies and debris to and from project sites, and 6) stationary emissions related to fuel consumption by on-site construction equipment.

Table 4.19-4 presents the estimated worst-case daily emissions associated with each construction phase. As indicated in the table, NO<sub>x</sub> and PM<sub>10</sub> emissions are anticipated to exceed SCAQMD significance thresholds during most of the construction period. Short-term dust nuisance impacts would also occur as a result of construction activity.

**TABLE 4.19-4  
DAILY CONSTRUCTION EMISSIONS<sup>1</sup>**

Construction Phase	Duration <sup>2</sup>	CO	ROG	NO <sub>x</sub>	SO <sub>x</sub>	PM <sub>10</sub>
<b>SCAQMD Threshold</b>		<b>550</b>	<b>75</b>	<b>100</b>	<b>150</b>	<b>150</b>
Demolition	1	17	4	38	3	26
Cut-and-Cover (Underground Excavation)	14	37	8	67	4	186
Tunnel Boring (Dual Operation)	12	100	23	172	10	109
Finish Stations and Tunnels	15	54	11	99	8	54
Continuously Welded Rail Operations	26	42	14	100	11	12
At-Grade Platforms and Rail Installation	26	74	16	141	10	461
Simultaneous Excavation and Tunnel Boring	6	137	31	239	14	295
Simultaneous Excavation, Tunnel Boring & Demolition	1	154	35	277	17	321
Simultaneous CWR and Rail Installation	26	116	29	241	21	473
<b>Potential Threshold Violation?</b>		<b>No</b>	<b>No</b>	<b>Yes</b>	<b>No</b>	<b>Yes</b>

<sup>1</sup> Expressed in pounds per day  
<sup>2</sup> Expressed in months.

Source: Terry A. Hayes Associates.

Although the construction period will last about four to five years, air quality impacts would still be localized and short-term. This is because construction equipment, and, therefore, air quality impacts, would move throughout the six-mile project alignment area. Thus, impacts on individual receptor locations within the area that may be affected by the proposed project would be short-term. Furthermore, because of the nature of construction activity and the phased construction schedule, some days will experience a higher level of construction activity (which in turn generates a higher level of emissions), while others will not.

### Significance of Impacts

Air quality impacts during construction are potentially significant.

### *Mitigation*

The contract will require specific stipulations that the contractor must follow to meet criteria included in MTA's Systems Design Criteria and Standards, Volumes I through IV, to minimize adverse affects during construction. The following measures will be taken to minimize construction-related air quality impacts:

- ◆ **Diesel Equipment Usage.** The LACMTA will require contractors as part of their contract to minimize use of on-site diesel construction equipment, particularly unnecessary idling.
- ◆ **Electric Powered Equipment.** The LACMTA will require contractors to replace diesel-powered machinery with electrically powered machinery, where feasible.
- ◆ **Equipment Emissions.** Construction equipment will be shut off to reduce idling when not in direct use. Diesel engines, motors, or equipment will be located as far away as possible from existing residential areas. Low sulfur fuel will be used for construction equipment.
- ◆ **Location of Staging Areas.** If required, haul truck staging areas will be approved by the Los Angeles Department of Transportation. When feasible, haul trucks will be staged in non-residential areas away from school buildings and playgrounds.
- ◆ **Fugitive Dust Control.** Maintain a fugitive dust control program consistent with the provisions of SCAQMD Rules 403 and 1186 for any grading or earthwork activity that may be required.

- ◆ **Site Watering.** Site wetting shall occur often enough to maintain a twelve percent (12%) surface soil moisture content throughout any site grading or excavation activity. All unpaved parking or staging areas shall be watered at least four times daily, and all on-site stockpiles of debris, dirt, or dusty material shall be covered or watered in accordance with SCAQMD Rule 403.
- ◆ **Truck Covering.** Require all trucks hauling dirt, sand, soil, or other loose substances and building materials to be covered.
- ◆ **Street Sweeping.** Utilize efficient street sweeping equipment at site access points and all adjacent streets used by haul trucks or vehicles that have been on site in compliance with SCAQMD Rule 403.
- ◆ **Phasing.** To the extent feasible, phase construction activities to minimize concurrent dust generating activities within a twenty-five hundred foot (2,500) radius of shaft site locations.
- ◆ **Wheel Washing Equipment.** MTA will require contractors as part of their contract to install wheel/undercarriage-washing equipment at tunnel excavation site exits to ensure that haul trucks have clean wheels and undercarriage before entering public roadways.
- ◆ **Suspend Operations.** Suspend grading operations during first and second stage smog alerts, and during high winds, i.e., greater than 25 miles per hour.
- ◆ **Sidewalk and Window Cleaning.** MTA will implement a sidewalk and window cleaning program, if needed, to reduce construction-related dust impacts to local businesses and residences.
- ◆ **MTA Section 01566 Pollution Controls Mandates.** All contractors as part of their contract must meet MTA Section 01566 pollution controls mandates, which requires that all equipment engines be properly tuned at all times.
- ◆ **Coordinate Construction Activities.** MTA will coordinate construction activities with school, daycare, and convalescent centers within the area that may be affected by the proposed project to minimize air quality impacts to these sensitive receptor locations.
- ◆ **Signage Requirement.** Signs will be posted throughout the proposed alignment area that will include anticipated dates of construction activity, and the telephone number of a construction information desk that can log complaints, or offer additional information regarding the construction process.
- ◆ **VMT Reduction Strategy.** With regard to project construction, MTA will require (through the construction contract administration process) that all contractors implement car/van pool programs throughout the construction process to minimize worker travel related VMT.

Implementations of the above-mentioned mitigation measures are anticipated to result in a significant reduction in airborne particulate (PM<sub>10</sub>) emissions; however, reductions in CO, ROG, NO<sub>x</sub>, and SO<sub>x</sub> emissions would be negligible. The estimated PM<sub>10</sub> emissions reduction for each major construction phase is presented in Table 4.19-5.

Construction Phase	Without Mitigation	With Mitigation	Net Reduction
Demolition	26	22	-4
Cut-and-Cover (Underground Excavation)	186	32	-154
Tunnel Boring (Dual Operation)	109	109	0
Finish Stations and Tunnels	54	54	0
Continuously Welded Rail (CWR) Operations	12	12	0
At-Grade Platforms and Rail Installation	461	197	-264
Simultaneous Excavation and Tunnel Boring	295	141	-154
Simultaneous Excavation, Tunnel Boring & Demolition	321	163	-158
Simultaneous CWR and Rail Installation	473	209	-264

<sup>1</sup>Expressed in pounds per day  
Source: Terry A. Hayes Associates, see Appendix A

As indicated above, even with application of best available control measures, PM<sub>10</sub> emissions are anticipated to exceed the SCAQMD significance threshold of 150 ppd during periods of at-grade platforms and rail installation, simultaneous excavation, tunnel boring and demolition, and simultaneous continuously welded rail and rail installation activity. Similarly, NO<sub>x</sub> emissions are anticipated to exceed the SCAQMD significance threshold of 100 ppd during periods of tunnel boring, at-grade platform/rail installation. These short-term air quality impacts would be significant and unavoidable. Dust nuisance impacts are also anticipated to remain after application of best available control measures, although to a lesser extent.

Air Quality at Local Schools

A 1994 letter agreement between MTA and the Los Angeles Unified School District (LAUSD) on the suspended Metro Red Line project indicated that MTA would go beyond preparation of the usual analysis presented in an EIS/EIR level of study required by NEPA and CEQA and conduct additional air quality analysis for schools within 700 feet of the alignment. Although the LRT project is modified from the suspended project, MTA has conducted the additional analysis for the four schools within that distance: Utah Street, Ramona High, Our Lady of Lourdes Elementary, and Griffith Middle.

Since PM<sub>10</sub> concentrations are a function of PM<sub>10</sub> emissions, the emissions reduction shown in Table 4.19-5 with mitigation would lead to lower PM<sub>10</sub> concentrations throughout the area that may be affected by the proposed project. Concentration estimates at the four schools nearest the alignment after application of best available control measures are presented in Table 4.19-6.

<b>TABLE 4.19-6</b>			
<b>MITIGATED PM<sub>10</sub> CONCENTRATION ESTIMATES NEAR THE SCHOOLS</b>			
Distance from Construction Activity	Concentration (micrograms per cubic meter)		
	1 <sup>st</sup> High	4 <sup>th</sup> High	Average
50 feet	178.3	145.3	77.2
100 feet	108.7	83.6	50.8
200 feet	66.6	54.8	42.0
300 feet	54.2	47.7	40.5
400 feet	48.6	44.5	39.9
500 feet	45.7	42.8	39.7
California Ambient Air Quality Standard (24-hour average)	50.0		
Ambient Concentration <sup>1</sup>	39.2		
<sup>1</sup> Included in all concentrations. Note: All concentrations are 24-hour average concentrations. Source: Terry A. Hayes Associates.			

As shown above, PM<sub>10</sub> concentrations could potentially exceed the state standard of 50 micrograms per cubic meter (µg/m<sup>3</sup>) at receptor locations within a distance of approximately 350 feet from the LRT alignment right-of-way, which would include all four of the abovementioned school site locations. This would result in a short-term impact that is significant and unavoidable. It is anticipated that the at-grade portion of the LRT alignment will be constructed in one-mile segments, and that each segment will be under construction for six to eight months. Therefore, impacts on schools within the 350-foot boundary could potentially occur over a six to eight month period. To address this issue, MTA will provide a liaison to the schools to discuss specific air quality concerns as they may arise. As previously prescribed in the mitigation measures, the MTA will coordinate construction activities to minimize the effect of air quality impacts at school site locations to the greatest extent feasible.

Significance of Impacts Remaining After Mitigation

Although mitigation would be provided to the greatest extent feasible, short-term PM<sub>10</sub> and NO<sub>x</sub> emissions and dust nuisance impacts generated by construction activities would remain significant after mitigation.

**4.19.2.7 Noise and Vibration**

*Impacts*

Construction Noise and Vibration Criteria

The criteria for assessing noise and vibration impacts for construction are based on the City of Los Angeles, Draft L.A. CEQA Thresholds Guide and the MTA Baseline Specifications Section 01565, Construction Noise and Vibration Control. The noise and vibration limits specified by Section 01565 are based on eliminating or minimizing noise and vibration generated by construction activities. The criteria can be found in the separate *Noise and Vibration Technical Report* that was prepared for the Los Angeles Eastside Corridor.

Vibration, as it is related to risk of building damage, is generally assessed in terms of peak particle velocity (PPV). PPV is the appropriate metric for evaluating the potential of building damage and is often used in monitoring blasting and construction vibration since it relates to the stresses that are experienced by buildings. PPV is typically a factor of 1.7 to 6 times greater than root mean square (rms) vibration velocity. As discussed in Section 4.8, rms vibration velocity is used to assess potential human annoyance from vibration. A factor of four has been used to relate the building damage criteria used to approximate rms vibration velocity levels, which are used by FTA to define the vibration generated by LRT operations. The criteria levels, presented in Table 4.19-7 would be used to judge the potential risk of damage to historic buildings or cultural resource structures during construction of the project. The criteria are based on research to date on structural building, architectural building, and historic buildings and cultural resource structures damage. These levels are significantly greater than the FTA vibration criteria of 72 to 75 VdB for LRT operations and are also greater than the maximum vibration levels projected from the LRT operations at any structure along the alignment.

<b>TABLE 4.19-7 DAMAGE RISK VIBRATION CRITERIA</b>		
	<b>Peak Particle Velocity (in./sec)</b>	<b>RMS Velocity – VdB (re: 1 micro inch/sec)</b>
Structural Building Damage	2.0	120
Architectural Building Damage	0.5	108
Damage Risk to Historic Buildings and Cultural Resource Structures	0.12 to 0.20	95 to 100
Note: Peak particle velocity (PPV) is assumed to be four times greater than root mean square (rms) vibration velocity.		

Construction Noise Levels

Noise impacts from construction will differ for the at-grade and the underground section of the project. At-grade construction noise will be generated by heavy equipment (such as bulldozers, backhoes, haul trucks, scrapers, loaders, cranes, and paving machines) used during major construction periods as close as 25 feet to existing structures along the alignment. Most of the underground tunnel activities will not be



audible at street level. Support equipment for the excavation and tunneling would be located at street level and could include ventilation fans, compressors, electric generator sets, and a concrete batch plant. Construction of a tunnel vent shaft would include equipment at street level such as a crane, excavator, loader, and haul trucks. Construction activities at each of the tunnel portals could potentially affect nearby noise sensitive receivers. Tunnel excavation material will be removed and stock-piled at one of the portals. Haul trucks, used to remove the excavated material, would be a potential source of noise along city streets. LADOT and Los Angeles County are responsible for selecting the haul routes; however, MTA will work with the agencies to develop a plan to avoid impacting residential areas, schools, and playgrounds as much as possible.

### Construction Vibration Levels

Common vibration producing equipment used during at-grade construction activities include, pile drivers, jackhammers, pavement breakers, hoe rams, auger drills, bulldozers and backhoes. There is not expected to be pile driving during construction of this project. Pavement breaking and soil compaction will probably be the activities that produce the highest level of vibration. The other potential vibration source would be the demolition of existing buildings or structures that will be required under the LRT Build Alternative and its two options.

Equipment used for underground construction, such as a tunnel boring machine and mine trains would generate vibration levels that could result in audible ground-borne noise levels in residential buildings at the surface. The operation of the mine trains would be the major source of underground construction vibration since it will operate continuously during the excavation, mining, and finishing of the tunnel. Since underground construction is expected to occur continuously over a 24-hour day, there is the potential for these operations, particularly the mine trains, to be audible during the nighttime sleep hours when background noise levels inside the residential buildings are very low.

The most recent transit tunneling project in Los Angeles, the Metro Red Line Project, used a driven-shield TBM for the mining work. A ground vibration study of the mining operations was conducted to estimate construction vibration both from actual excavation of the tunnel and from the trains used to haul mine spoils out of the tunnel. Similar effects from the mining operations for the LRT Build Alternative would be expected. The primary conclusions of the study are:

- ◆ Vibration from the tunnel excavation will rarely be a significant problem in adjacent communities, although the vibration can be sufficient to cause several hours of intrusive low level ground-borne vibration at residential buildings above the tunnel.
- ◆ Although well below any damage thresholds, vibration from mine trains has the potential of causing intrusive ground-borne noise inside buildings above the tunnel.

### Significance of Impacts

The noise and vibration impacts during construction would be significant.

### ***Mitigation***

Noise and vibration impacts from construction of the LRT project will require mitigation to meet the Los Angeles CEQA Noise Thresholds and the MTA specified limits. The final determination of construction noise and vibration impacts will depend on the equipment and activities used by the contractor to construct this project. Since this information on means and methods of construction is not available now, noise mitigation is presented as typical noise control measures which have been used on other similar construction projects.

The Draft CEQA Thresholds Guide and MTA construction specifications define several possible mitigation measures for construction noise. They include the following:

- ◆ Use noise control devices, such as equipment mufflers, enclosures, and barriers. Natural and artificial barriers such as ground elevation changes and existing buildings can shield construction noise. Stage construction operations as far from noise sensitive uses as possible;
- ◆ Avoid residential areas when planning haul truck routes;
- ◆ Maintain all sound-reducing devices and restrictions throughout the construction period;
- ◆ Replace noisy equipment with quieter equipment (for example, a vibratory pile driver instead of a conventional pile driver and rubber-tired equipment rather than track equipment); and
- ◆ Change the timing and/or sequence of the noisiest construction operations to avoid sensitive times of the day.

MTA Baseline Specifications Section 01565, *Construction Noise and Vibration Control* requires that the contractor shall, among other provisions:

- ◆ Hire or retain the services of an Acoustical Engineer to be responsible for preparing and overseeing the implementation of the Noise Control and Monitoring Plans;
- ◆ Prepare a Noise Control Plan that includes an inventory of construction equipment used during daytime and nighttime hours, estimate of projected construction noise levels, and locations and types of noise abatement measures that may be required to meet the specified noise limits;
- ◆ In the case of nighttime construction, the contractor will comply with the provisions of the nighttime noise variance issued by the Los Angeles Police Department;
- ◆ Conduct periodic noise measurement in accordance with an approved Noise Monitoring Plan, specifying monitoring locations, equipment, procedures, and schedule of measurements and reporting methods to be used;
- ◆ During nighttime hours, use equipment at the surface of the construction site that, operating under full load, is certified to meet the specified lower noise level limits than standard equipment; and
- ◆ Erect MTA designed noise barrier walls at each construction site prior to the start of any construction activities.

If vibration levels at residences located above the subway segment exceed the vibration limits indicated below, MTA will require contractors to install a system of resilient isolation between the construction and the tunnel invert. The isolation system must ensure that the ground borne noise and vibration from trains carrying excavated material does not exceed project criteria.

The contractor will be responsible for the protection of vibration-sensitive historic buildings or cultural resource structures that are within 200 feet of any construction activity. These structures have been identified in Section 4.15. In order to ensure proper protection, the contractor will be required to perform periodic vibration monitoring at the closest structure to any construction activities using approved seismographs. Specifically, for any fragile historic properties located within that 200-foot range, the contractor will evaluate the vibration levels resulting from the excavated-materials train, as it passes under historic properties. If the vibration levels emanating from the train exceed 0.1 inches/second maximum peak particle vibration (PPV) velocity level, the contractor will take action to reduce the vibration levels to 0.1 inches/second or less, as soon as possible. If vibration levels exceed 0.12 inches/second PPV, the contractor will cease excavation operations until (s)he takes action to reduce vibration levels below 0.1 inches/second. Such action could include reducing the speed of trains carrying excavated material, additional rail and tie isolation, and more frequent rail and wheel maintenance. Which historic properties are to be deemed fragile will be determined through a pre-construction survey.

This measure will not apply to the tunnel boring machine, but only to operations resulting from the train hauling excavated materials under fragile historic properties.

The MTA's Public Affairs Officers will be administering a construction impact program for the benefit of the community. While keeping the community informed of all construction activities, especially for those that affect the public, the program also includes a hotline number for a direct connection to MTA staff familiar with the community and the project. The same Public Affairs staff will provide individual consultation for residents, facilities, and businesses for remedies appropriate to the impacts. These remedies may include strategic placement of sound- or vibration-absorbing materials.

The Los Angeles Unified School District (LAUSD) has expressed concern about potential noise and vibration impacts on schools in the vicinity of the construction. The MTA will adhere to the Letter Agreement dated June 21, 1994 and amended July 21, 1997. Specifically in regards to noise impacts, "if noise from construction activities creates disruption at schools, MTA will take action to resolve the issue through reducing or blocking noise from reaching the school, or shift construction activity to less sensitive time periods." During construction the Contractor will be required to implement mandatory mitigation measures to reduce potential noise and vibration impacts on nearby schools including: Utah Elementary, First Street, Our Lady of Lourdes, Ramona High, and Griffith Middle Schools. These measures will be based on maintaining acceptable interior noise levels within the school classrooms and occupied spaces. MTA will develop these criteria in coordination with LAUSD and individual school administrators. MTA will require the Contractor to prepare noise and vibration control plans to meet these criteria and will also require the Contractor to adhere to a plan to monitor the construction noise and vibration levels to ensure compliance.

#### Significance of Impacts Remaining After Mitigation

Although mitigation would be implemented to minimize the impacts, it is possible that the noise and/or vibration levels during construction at some locations still may not be reduced to the applicable criteria. Therefore, impacts remaining could be potentially significant.

#### **4.19.2.8 Visual and Aesthetics**

##### ***Impacts***

##### Construction Staging Areas

Construction staging areas are located in areas that are primarily commercial. Mariachi Plaza is directly across the street from the 1<sup>st</sup>/Boyle Station, however, and it is possible that visual and other impacts (noise, traffic disruption, etc.) would lead to this plaza being temporarily unusable for its primary use as a bandstand for mariachi performances. This would be a significant impact, though not necessarily related to the visual impacts alone. Across from the 1<sup>st</sup>/Lorena construction staging area is Evergreen Cemetery. Residences are located diagonally across the intersection. There would be visual impacts from the construction staging, although they would not prevent use of either of these areas. Another staging area will be located on existing MTA property on the south side of Chavez Avenue between Soto and Fickett Streets. In this location there are a mixture of land uses, including commercial, residence hotels, and single-family and multi-family residences. Views into the proposed construction staging area would be possible from residential land uses on some of the adjacent parcels, either directly through fencing, through entrance gates, or over fencing from second-story windows. If not screened from view, construction staging activities could affect the use of the adjacent residential uses, at least temporarily, resulting in a significant visual impact. Lighting of the construction staging area at night could also result in significant visual impacts during the construction period for adjacent residential land uses.

### Demolition

Short-term visual impacts due to demolition of the service station at Alameda and Commercial Streets in this commercial/industrial/institutional area would be less than significant. Demolition of the single remaining structure on the south side of 1<sup>st</sup> Street, between the northbound US 101 off-ramp and Boyle Avenue, would not result in significant short-term visual impacts. The structure is already bordered by vacant land and the site is not near any sensitive viewers.

Mariachi Plaza is directly across the street from where the existing grocery store would be demolished to make way for the 1<sup>st</sup>/Boyle Station. It is possible that visual and other impacts (noise, traffic disruption, etc.) would lead to this plaza being unusable for its primary use as a bandstand for mariachi performances during demolition. This would be a significant temporary impact, though not necessarily related to the visual impacts alone. Demolition at the 1<sup>st</sup>/Soto Station entrance would result in less-than-significant short-term visual impacts on the adjacent uses. Several structures would be removed, some within view of sensitive viewers (residents), but the visual impacts from this demolition would not prevent the use of adjacent properties. Demolition of the one commercial, one residence/commercial, and one residential structure on the east side of Indiana Street (Option A only) would not result in significant visual impacts.

Demolition of the vacant commercial building at 3<sup>rd</sup> Street and Sunol Drive, the auto sales facility at 3<sup>rd</sup> Street and Arizona Avenue, the auto repair facility at Beverly/Atlantic (Option A only), and multiple commercial buildings and the former Kaiser Clinic at Beverly and Pomona Boulevards would result in minimal visual impacts.

In addition, minor demolition would occur throughout the corridor, including removal of street trees, bus shelters, pavement demolition, reconstruction of Union Station, etc. None of these would result in significant visual impacts in the short term.

Option B would involve the same demolition impacts with the exception that all of the buildings, including Ramona High School on the east side of Indiana Street between 1<sup>st</sup> and 3<sup>rd</sup> Streets would be demolished (note that the high school may be rebuilt on the site as a multi-story structure or rebuilt elsewhere). Visual impacts during demolition would be significant because of the scale of the activities and, in the case of the high school, because of the significance of the structure being removed.

### Excavation

Visual impacts at the 1<sup>st</sup>/Gless excavation site may combine with other impacts (such as noise) to prevent use of at least a portion of the adjacent Pecan Park. Because children are present at this location, the construction site would also be considered an attractive nuisance, with potential safety impacts related to the visibility of the site. These would be significant visual impacts. At the 1<sup>st</sup>/Boyle excavation site, the impacts related to construction, including visual, may prevent use of Mariachi Plaza, in a similar manner as discussed for the nearby construction staging area. This would also be a significant impact. At all other locations, visual impacts would be less than significant because they would not affect use of adjacent properties.

### Significance of Impacts

The LRT project would result in significant construction-related visual impacts at Pecan Park and Mariachi Plaza because it would temporarily prevent full use of these properties. Impacts at the Chavez/Soto construction staging area would be significant where viewable from adjacent residential land uses, especially those with second-story windows. On Indiana Street (Option B only), the scale and

significance of the demolition activities would result in significant visual impacts during the construction period.

### ***Mitigation***

#### **Pecan Park**

Short-term impacts on Pecan Playground would include deterioration of views and attractive nuisance impacts. To prevent both of these, solid, tamper-proof screening materials will be installed along the perimeter of the park. This screening will be made as attractive as possible and could offer the opportunity for decoration by the children (playground side only, for safety purposes). (Note: The outside surfaces would also provide an opportunity for decoration, mural art, etc., unrelated to the visual impact discussed here.) Screening would allow full use of the park and would thus reduce temporary visual impacts to less than significant.

#### **Mariachi Plaza**

To mitigate the short-term visual impacts at Mariachi Plaza related to the demolition of the adjacent grocery store, construction of the 1<sup>st</sup>/Boyle Station, and the use of the nearby construction staging area, the demolition and construction staging area will be screened and construction accelerated as much as possible. In addition, if required, a suitable and nearby alternative site for mariachi performances will be provided (refer to Section 4.17, *Section 4(f) Evaluation*).

#### **Construction Staging Area at Chavez/Soto**

Lighting for nighttime operations will be the minimum necessary for security and safety. Hooded lamps will be used to direct the light downward and to prevent "spillover" into adjacent residential areas. The construction entrances will be regularly cleaned to prevent an unkempt and dirty appearance. Views into the construction site will be screened from view. Where the construction staging is adjacent to multi-story residential land uses with windows overlooking the construction site, screening materials will need to be high enough to prevent these views. If this is not feasible due to the height of the residential structures and construction storage or staging must be placed directly below residential windows, resulting in the impairment of use of these residences, a significant short-term visual impact would remain.

#### **Indiana Street (Option B only)**

Visual impacts related to the scale and significance of the demolition on the east side of Indiana Street under Option B will be reduced to less than significant through a public education campaign and through screening of demolition. Information materials will be present and in plain view on the site showing how the site will look after construction is complete. This information may be on boards or at an information kiosk, and will show plans and elevations of the completed site. Screening of demolition, especially screening of views of the demolition of the high school from adjacent areas, will be used. The demolition site will be kept as clean as possible. Landscaping of the site after demolition will take place as soon as possible.

#### **Significance of Impacts Remaining After Mitigation**

With the incorporation of the aforementioned mitigation measures, short-term visual impacts, with the possible exception of the impacts of the Chavez/Soto construction staging area, would be reduced to less than significant. If screening materials cannot be provided to screen views from the taller multi-story

residential buildings with windows overlooking the construction site or if construction storage or staging must be in place directly below residential windows resulting in impairment of use of these residences, a significant short-term visual impact would remain.

**4.19.2.9 Economic Activity**

***Impacts***

Construction Employment

Table 4.19-8 presents the conceptual construction cost estimates and short-term jobs created for the LRT Build Alternative (Options A and B). Given that short-term employment is directly related to the construction cost of the alternative, the higher the construction cost, the higher the potential employment opportunities would be. Although it is likely that the majority of construction labor would come from Southern California and within Los Angeles County, recruiting short-term construction workers from within the corridor is a priority for MTA. The number of short-term employment opportunities throughout construction would be dependent on phasing. The data in Table 4.19-7 is for a project constructed at one time. Employment generated by construction of the LRT Build Alternative would be a beneficial impact. In light of other development projects planned for the corridor, this alternative would produce a cumulative benefit that would help offset employee displacements resulting from business acquisitions related to this project.

<b>TABLE 4.19-8 ESTIMATED SHORT-TERM EMPLOYMENT-LRT BUILD ALTERNATIVE</b>			
<b>Conceptual Construction Costs (1999 \$millions)<sup>1</sup></b>	<b>Estimated Direct Employment Generated<sup>2</sup></b>	<b>Estimated Indirect Employment Generated<sup>2</sup></b>	<b>Estimated Total Employment Generated<sup>2</sup></b>
<b>\$586.5</b>	<b>19,824</b>	<b>27,038</b>	<b>46,862</b>

Sources:  
<sup>1</sup> Conceptual construction costs do not include right-of-way costs (PBQD, 2000).  
<sup>2</sup> For each \$100 million investment - 3,380 direct and 4,610 indirect jobs would be generated for new rail starts (APTA, 1983).

Fire/Police Services Employment

Although construction of the project would require temporary closures and/or road blocking, and thus require fire and police units to possibly travel alternate routes for emergency response, no additional staff would be required for such temporary impacts. Furthermore, local fire and police staff and services would be affected minimally by the direct and indirect employment created by construction of the LRT Build Alternative. Standard coordination between MTA and City/County fire and police departments for construction times and locations will allow these services to anticipate changes in emergency response routes, and thus prevent the need for any new personnel and, thus, additional spending on these services. As no facilities would be affected, and only a minimal amount of fire and police employees would need to be hired in the study area, no significant impacts on fire/police services and costs are anticipated.

Fiscal Impacts

Construction of the LRT Build Alternative would not result in reduction of property tax revenue relative to the construction of the project. Business impacts could include reduced visibility of commercial signs and businesses. These construction impacts could in turn produce economic impacts to the commercial

establishments. Businesses most likely to be affected would include those that depend on on-street parking or street access, which would be limited during construction. Access, however, will be provided by MTA during construction at all times in some form or proximal location to all businesses. Businesses that are sensitive to noise/vibration/dust may also be affected by construction activities. These are potentially significant temporary impacts. Sales tax revenues may actually increase within the local communities and the county due to higher employment activity and spending. This beneficial impact is anticipated to reduce potentially significant impacts to less than significant. In addition, no reduction of business license fees is expected. Employees and contractors requiring parking during construction would use only MTA-owned parcels for parking, thus not interfering with parking for customers of businesses.

### Significance of Impacts

Impacts due to the additional jobs created during construction would be beneficial. There will be no impact on fire/police staffing. Fiscal impacts would be less than significant.

### *Mitigation*

MTA will provide resources to train people in the community, as needed, to employ as many local residents as possible in the construction-related employment generated by the Eastside Corridor project. MTA will coordinate with local businesses and residents to provide advanced notification of traffic detours and delays, and potential utility disruptions associated with construction. A pre-construction survey will be performed which will include the following measures: Public affairs and construction staff will contact and interview individual businesses, allowing for knowledge and understanding of how these businesses carry out their work. This survey will identify business usage, delivery, and shipping patterns and critical times of the day or year for business activities. This survey will aid MTA in developing Worksite Traffic Control plans and identifying alternative access routes to maintain access to all businesses and ensure that critical business activities are not disrupted.

Additional measures to notify the community of temporary fiscal impacts during construction will include:

- ◆ Use MTA's Public Affairs Department to identify community/businesses needs prior to and during the construction period;
- ◆ Provide the community and businesses with the name and telephone numbers of public affairs staff who will know important information pertaining to construction;
- ◆ Participate in local events in an effort to promote public awareness of the project;
- ◆ Notify property owners, residences, and businesses of major construction activities (e.g., utility relocation/disruption and milestones, re-routing of delivery trucks);
- ◆ Provide literature to the public;
- ◆ Provide presentations on the project;
- ◆ Respond to phone inquiries;
- ◆ Coordinate business outreach programs;
- ◆ Schedule promotional displays; and
- ◆ Participate in community committees.

In addition, MTA will provide support to those businesses most affected by the construction impacts by implementing promotions for their businesses. MTA will develop bilingual (English/Spanish and other languages as needed) advertisements for local print and radio for affected businesses. Appropriate signage will be developed and displayed by MTA to direct both pedestrian and vehicular traffic to businesses via

alternate routes. Access to businesses will be provided by MTA during construction at all times in some form or proximal location to all businesses.

MTA is currently conducting station area meetings that provide local residents, businesses, and organizations the opportunity to provide input into planning for specific station areas. The goal is to address specific station area concerns, such as impacts and mitigation measures during construction, as well as economic development opportunities, transit connections, and station plans. Employees and contractors associated with construction of the LRT Build Alternative will be required to park only in MTA-owned parcels. This measure will be monitored by MTA's construction affairs program.

One or more Metro Field Offices will be staffed by MTA to address community issues and concerns that arise during construction. More information about the office(s) can be found in Section 4.19.2.10, *Neighborhoods*. Mitigation measures for pedestrian safety and access during construction are presented in Section 4.19.2.4, *Other Modes* and 4.19.2.19, *Safety and Security*. Specific measures to reduce temporary impacts from noise and dust are identified in Sections 4.19.2.6, *Air Quality* and 4.19.2.7, *Noise and Vibration*.

#### Significance of Impacts Remaining After Mitigation

After the implementation of the aforementioned mitigation measures, temporary economic and fiscal impacts would be reduced to an insignificant level.

#### **4.19.2.10 Neighborhoods**

##### ***Impacts***

Light rail construction activities may also generate temporary visual, air quality, and circulation impacts. For example, motorists and pedestrians may on occasion be inconvenienced by traffic delays during the construction period. In addition, temporary removal of on-street parking and rerouting of buses, as well as traffic lane and sidewalk closures, may be necessary for movement of construction equipment. Operation of construction equipment and the use of mining cars to haul excavation from the tunnel may cause noise and vibration perceptible to adjacent residences and businesses. Operation of the tunnel boring machine is generally short-term in nature, lasting only a few days for the areas affected. Fugitive dust may result from operation of construction machines, excavation, and building demolition. These impacts are potentially significant. The impacts of Option B are as described previously with the following exceptions. Station area changes from 1<sup>st</sup>/Lorena, 3<sup>rd</sup>/Rowan, and Beverly/Atlantic under Option A to 3<sup>rd</sup>/Indiana, 3<sup>rd</sup>/Ford, and Pomona/Atlantic under Option B would result in changes to locations (not severity of impacts) where construction activity would occur in the vicinity of stations. If Ramona High School is relocated, there will be no construction impacts on the school. If the school is reconstructed on the existing site, then construction of the LRT tracks and station at 3<sup>rd</sup>/Indiana would have impacts on the students and faculty similar to those described for Option A, except that the construction activity would occur on school property that will be purchased for the LRT project instead of on the Indiana Street right-of-way.

#### Significance of Impacts

Certain construction-related neighborhood impacts, although temporary, are significant under CEQA.



## **Mitigation**

Mitigation measures to reduce these impacts are presented in Sections 4.19.2.2, *Traffic*, 4.19.2.4 *Other Modes*, 4.19.2.6, *Air Quality*, 4.19.2.7 *Noise and Vibration*, and 4.19.2.8 *Visual and Aesthetics*. In addition, MTA will provide the resources needed to open and maintain during construction one or more Metro Field Offices with staff who will be available to address community issues and concerns that arise. The field office(s) and MTA staff will serve multiple purposes that include:

- ◆ Provide the community and businesses with one or more field offices where information pertaining to construction can be exchanged;
- ◆ Enable MTA to better understand community/business needs during the construction period;
- ◆ Allow MTA to participate in local events in an effort to promote public awareness of the project;
- ◆ Manage construction-related matters pertaining to the public;
- ◆ Notify property owners, residences, and businesses of major construction activities (e.g., utility relocation/disruption and milestones, re-routing of delivery trucks);
- ◆ Provide literature to the public and press;
- ◆ Promote and provide presentations on the project via MTA's Speaker Bureau;
- ◆ Respond to phone inquiries;
- ◆ Coordinate business outreach programs;
- ◆ Schedule promotional displays; and
- ◆ Participate in community committees.

The Metro information offices will be open various days of the work week for the duration of the construction period. A schedule will be developed prior to construction. In addition, site-specific mitigation programs will be developed, as needed, to handle unanticipated impacts that may occur in the stations or construction staging areas that have not been addressed elsewhere in this document. MTA will provide the resources necessary to employ a public affairs staff to develop such programs for residences and businesses that may be adversely impacted by the construction.

### Significance of Impacts Remaining After Mitigation

After the implementation of mitigation measures, temporary neighborhood impacts (with the exception of air quality, noise, transit, traffic, parking, and pedestrian and bicycle movements) would be reduced to an insignificant level. Impacts on the excepted categories would still be potentially significant after mitigation is applied. Refer to the specific sections of the Final SEIS/SEIR for more information on each impact category.

#### **4.19.2.11 Community Facilities/Parklands**

### ***Impacts***

#### Parklands

Parklands bordering the proposed alignment and construction staging areas, such as Pecan Park and Belvedere Park, may undergo temporary noise, vibration, visual, air quality, and circulation impacts due to construction activities. In addition, cumulative construction impacts may result at Pecan Park because of construction of an outdoor pool and gymnasium, which, if operational at the time of light rail construction, could have dust impacts that affect use of the pool. The use of Mariachi Plaza would be temporarily disrupted by excavation and finishing work on the eastern end of the plaza for the 1<sup>st</sup>/Boyle subway station. The gazebo and adjacent area on the western portion of this facility would remain intact

throughout construction. In addition, the street bordering the plaza on the north, Pleasant Avenue between Boyle Avenue and 1<sup>st</sup> Street, would be closed to traffic. Curb parking may be temporarily restricted during construction on 1<sup>st</sup> Street, which could reduce access to Pecan Park, LANI Park, and Mariachi Plaza although MTA is committed to maintaining access to these parks throughout the construction period. The impacts are potentially significant. The amount of differential settlement from the tunneling is not expected to cause structural or architectural damage to facilities at Pecan and Belvedere Parks or Mariachi Plaza. During construction, ground settlement will be monitored, and steps will be taken to ensure no structural damage occurs at these sites.

### Cemeteries

Access to Evergreen Cemetery at 1<sup>st</sup>/Fresno would not be affected by temporary lane closures and night street closures along 1<sup>st</sup> Street between Lorena and Fresno Streets since MTA is committed to maintaining access to cemeteries during construction. No significant impacts would occur.

### Schools

Temporary noise, vibration, air quality, circulation, and safety impacts are possible at schools located adjacent to the LRT alignment, station locations, or construction staging areas. Construction activities would temporarily interfere with the normal traffic flow, causing some lanes and streets to be closed to vehicles for various durations of time. However, these temporary lane closures are not expected to restrict access to schools located along or near 1<sup>st</sup> Street. There would be temporary curb parking restrictions along Indiana Street by Ramona High School (with the exception if the school is relocated under Option B, there would be no such impacts because the school would be relocated prior to construction in the area). If the school is reconstructed on the existing site under Option B, impacts would be similar to those described for Option A except that the construction will occur on school property that will be acquired by MTA instead of on Indiana Street right-of-way.

Ground-borne noise and vibration generated by mine cars carrying excavated material tunneling machinery may affect school activities at First Street School for a several-day period. Ground settlement from tunneling is not expected to cause structural or architectural damage to the school facilities that lie adjacent to or above the subway. However, as a precautionary measure, structural surveys will be undertaken during final design to determine building condition. Construction-related noise and vibration impacts on schools may occur along the at-grade portion of the alignment and may affect Griffith Middle School, particularly with construction of the 3<sup>rd</sup>/Mednik Station.

A 1994 letter agreement between MTA and the Los Angeles Unified School District (LAUSD) on the suspended Metro Red Line project indicated that MTA would go beyond preparation of the usual analysis presented in an EIS/EIR level of study required by NEPA and CEQA and conduct additional air quality analysis for schools within 700 feet of the alignment. Although the LRT project is modified from the suspended project, MTA has conducted the additional analysis of construction activities for the four schools within that distance: Utah Street, Ramona High, Our Lady of Lourdes Elementary, and Griffith Middle. The results of that analysis, discussed in Section 4.19.2.6, *Air Quality*, indicate that the State standards for PM<sub>10</sub> concentrations could potentially be exceeded at all four of the schools. It is anticipated that the at-grade portion of the alignment will be constructed in one-mile segments. Each segment will be under construction for approximately six to eight months. Therefore, impacts near the schools are expected to last about that length of time and not throughout the entire construction period of the project.

### Hospitals/Clinics

Temporary noise, vibration, and air quality impacts may occur at the Veterans Clinic on Alameda Street and at the Roybal Health Center, which are along the LRT alignment due to construction activities. These impacts are potentially significant. Temporary lane closures are not expected to affect access to these health centers.

### Libraries

The Ben Franklin Library, which is located adjacent to the tunnel alignment on 1<sup>st</sup> Street, may experience noise and vibration impacts during tunnel construction, a period of several days. The East Los Angeles Library would face the LRT alignment along 3<sup>rd</sup> Street, close to the proposed 3<sup>rd</sup>/Mednik Station. Temporary noise, vibration, and air quality impacts may result from at-grade construction activities. These impacts are potentially significant. Temporary lane closures are not expected to affect access to the libraries. No construction activities would occur at the Little Tokyo Library, which is further from the alignment.

### Places of Worship

Construction of traction power substations on 3<sup>rd</sup> Street at Arizona Avenue near Sala Evangelica Church and across Sunol Drive from Santuaria de Guadalupe Church may create temporary noise and vibration impacts. At-grade construction would occur on streets fronting Homba Hongwanji Buddhist Temple, Paraiso Spanish Congregation, Our Lady of Lourdes Church, Santuaria de Guadalupe Church, Sala Evangelica, Iglesia El Siloe, and Iglesia Cristiana Ejercito de Salvacion producing temporary noise, vibration, and air quality impacts. Vibration impacts could result from tunnel construction under the Pentecostal Church. These impacts are potentially significant. Tunneling is not expected to cause structural or architectural damage to the Pentecostal Church due to differential settlement. Temporary lane closures are not expected to affect access to places of worship. Construction equipment and activity near Homba Hongwanji Buddhist Temple grounds would temporarily impair its appearance. Activities and festivities are currently being planned for the 2005 Temple Centennial. Restricted access resulting from LRT construction could affect these events.

### Other Community Facilities

Construction of the track and station in the vicinity of 1<sup>st</sup>/Alameda may create temporary noise, vibration, and air quality impacts for the Japanese American National Museum and the Geffen Contemporary Museum. St. Elizabeth Day Nursery is located north of 1<sup>st</sup> Street along Mission Road, removed from the effects of construction activities. Traffic delays due to construction of the subway portal at 1<sup>st</sup>/Gless Streets is not expected to disrupt access to the Aliso Pico Multipurpose Center. Short-term noise, vibration, and air quality impacts may affect use of the center. Noise and vibration impacts and possible settlement impacts from tunneling may also affect the Hollenbeck Youth Center, located on 1<sup>st</sup> Street west of St. Louis Street.

### Significance of Impacts

Many of the construction-related impacts to parklands and community facilities are potentially significant impacts.

### **Mitigation**

Mitigation measures to reduce these potentially significant temporary impacts to parklands and community facilities are presented in Sections 4.19.2.2, *Traffic*, 4.19.2.3, *Parking*, 4.19.2.4, *Other Modes*, 4.19.2.6, *Air Quality*, 4.19.2.7, *Noise and Vibration*, 4.19.2.8, *Visual and Aesthetics*, and 4.19.2.13, *Geologic and Seismic Conditions*. In addition, MTA will work with the City of Los Angeles to avoid construction conflicts between the LRT project and gymnasium and pool construction at Pecan Park. MTA encourages the City to move forward with these much needed projects as soon as possible and will coordinate project construction as necessary to avoid delays to either project.

With regard to mitigation measures for the schools, construction contractors will be required to inform their drivers that they must drive cautiously in areas with concentrations of school children and must stop when they encounter school buses using red flashing lights. Refer to Section 4.19.2.19 for additional safety-related mitigation measures that will be taken to minimize impacts on the schools. Regarding potential air quality impacts at the four schools closest to the alignment, MTA will provide a liaison to the schools to discuss specific air quality issues as they may arise and to coordinate construction activities with the schools to minimize air quality impacts of the construction to the extent possible. Regarding potential noise impacts during construction, MTA will take action to resolve the issue through reducing or blocking noise from reaching the school or shifting construction activity to less sensitive time periods. During construction, the Contractor will be required to implement mandatory mitigation measures to reduce potential noise and vibration impacts on nearby schools including: Utah Elementary, First Street, Our Lady of Lourdes, Ramona High, and Griffith Middle Schools. These measures will be based on maintaining acceptable interior noise levels within the school classrooms and occupied spaces. MTA will develop these criteria in coordination with LAUSD and individual school administrators. MTA will require the Contractor to prepare noise and vibration control plans to meet these criteria and will also require the Contractor to adhere to a plan to monitor the construction noise and vibration levels to ensure compliance. Other mitigation measures to be taken to minimize impacts on the schools include:

- ◆ MTA will maintain ongoing communication with administrators at impacted school sites providing sufficient notices to forewarn children and parents when currently existing school pedestrian routes will be impacted. MTA will furnish school pedestrian routes maps upon request;
- ◆ If noise from construction activities creates disruption at schools, MTA will take action to resolve the issue through reducing or blocking noise from reaching the school or shifting construction activities to less sensitive time periods;
- ◆ MTA will provide crossing guards near construction sites as warranted. This item is further defined in the Section 4.19.2.19, *Safety and Security*;
- ◆ MTA will provide at no charge to LAUSD an instructional rail safety program with materials to all affected elementary and middle schools; and
- ◆ Barriers and fencing will be installed at construction sites as needed to minimize trespassing, vandalism, and short-cut attractions. Security patrols will also be provided at construction sites.

MTA will meet with affected organizations, including Hompa Homgwanji Buddhist Temple, as well as the businesses in Little Tokyo to discuss their concerns regarding construction and will make every attempt to avoid or minimize adverse impacts. Depending on the timing of the 2005 Temple Centennial activities, it may be possible to schedule the contractor to avoid construction activities in the area during that time. Construction will likely temporarily impair the appearance of the temple. However, it will not result in any long-term impacts to its appearance and will ultimately provide worshippers with much improved transit access.

The above measures also apply to Option B. In addition, MTA will commit to costs for relocating Ramona High School (if that is determined to be the course of action) to a site that is acceptable to

LAUSD and MTA and will also provide funds for construction of a new school off-site or reconstruction at the present location. LAUSD will conduct the necessary environmental studies once it is determined whether to relocate or reconstruct the school. The actions of LAUSD in replacing the school are beyond the scope of the analysis for the Eastside Corridor LRT since LAUSD will be directing that program. However, MTA will work with LAUSD during their separate studies when LAUSD's plans for the school are better known. Because LRT track and station construction will occur on Ramona High School property, the following mitigation measures will be taken if the school is reconstructed at the existing site:

- ◆ The construction contractor will either provide: 1) fencing or other suitable barriers around the Eastside Corridor LRT off-street construction site between 1<sup>st</sup> and 3<sup>rd</sup> Streets; or 2) a security patrol in the area that will provide security services during normal school hours; and
- ◆ MTA will make available a MTA staff person or construction contractor representative who will keep the school administrator informed about ongoing and planned construction activities in the vicinity and will act as liaison between the high school and the construction contractor regarding safety issues, as well as other issues, that may arise.

#### Significance of Impacts Remaining After Mitigation

Although most construction-related visual, transportation, noise, and vibration impacts on parklands and community facilities can be reduced to an insignificant level after mitigation, some impacts, though temporary, will remain significant (refer to the respective sections for more information).

#### **4.19.2.12 Historic/Archaeological/Paleontological Resources**

Refer to Section 4.15, *Historic/Archaeological/Paleontological Resources*, for a complete discussion of impacts during construction.

#### **4.19.2.13 Geologic and Seismic**

##### ***Impacts***

##### Tunneling-Induced Ground Surface Settlement

Geologic conditions for much of the tunnel alignment are sands, clays, and gravels, which in tunneling terms are described as "soft ground." Based on the previous geotechnical investigations for the suspended Metro Red Line project, and available publications, the proposed LRT Build Alternative tunnel sections have a potential for running ground conditions during construction. These conditions occur where poorly graded, poorly cemented sand and gravel exist in the presence of water. There is also a potential along the tunnel for slow raveling conditions in areas where silty sands and clayey sands are encountered during construction. Additionally, mixed face conditions (soil/bedrock interface) could be encountered in areas where bedrock might be shallow.

During tunneling, some "ground loss" will occur, resulting in surface settlement. The amount of ground loss and subsequent settlement measured at the surface will be a function of the tunnel depth, size, tunneling techniques, and geology. For previous Metro Red Line projects in similar geology as the LRT Build Alternative, surface settlement measured directly above the tunnel crown was typically less than one inch (Eisenstein et. al, 1995).

Building (or utility) damage from tunneling may result when there is differential settlement of the foundation, that is, a change in elevation of one foundation element relative to another. The degree of damage is dependent on the amount of such differential settlement, the buildings construction materials,

quality of construction, and age. The amount of differential settlement expected for the LRT Build Alternative is not expected to cause structural damage, although minor and repairable hairline cracks may occur on occasion. During final design, structural surveys and analyses will be completed, along with further geotechnical investigation, to determine the condition of existing buildings which are in proximity to the stations and tunnels, and to estimate the need for additional building protection. Therefore, ground surface settlement is anticipated to have a potentially significant impact under CEQA on the construction of the proposed LRT Build Alternative.

#### Cut-and-Cover Excavation for Station Sites and Tunnels Adjacent to Portals

Based on the previous geotechnical investigations for the suspended Metro Red Line project, and available publications, poorly graded, poorly cemented sand and gravel may be encountered. Excessive sloughing and localized caving may occur in these soils when dry or when saturated, which may have a potentially significant impact under CEQA on the construction of the LRT Build Alternative.

#### Groundwater

Shallow and perched groundwater may be encountered above design tunnel and station elevations creating difficult working conditions and instability in mined tunnel sections and excavation walls and bottoms. Groundwater may have a potentially significant impact under CEQA on the construction of the LRT Build Alternative. Methods for handling groundwater during construction are addressed in the Sections 4.19.1, *Construction Methods* and 4.19.2.15, *Water Resources*. Methods for disposal of groundwater, should it be contaminated, are discussed in Section 4.19.2.14, *Hazardous Materials*.

#### Significance of Impacts

Ground surface settlement, excessive sloughing and localized caving in poorly graded, poorly cemented sand and gravel, and groundwater may have a potentially significant impact under CEQA on the construction of the LRT Build Alternative.

#### Mitigation

##### Tunneling-Induced Ground Surface Settlement

To further limit surface settlement to acceptable levels, pressure-face TBMs, described in Section 4.19.2.1, *Construction Methods*, and pre-cast, bolted, gasketed lining systems were proposed for the suspended Metro Red Line project. The pressure-face TBM technology maintains positive fluid or soil pressure on the tunnel face, which decreases the potential for ground loss and soil instability (sloughing, caving) at the tunnel face, which in turn reduces soil movement and surface settlement. In combination with the face pressure, grout is installed immediately behind the TBM to fill the annular space between the installed precast concrete tunnel liners (tunnel rings) and the ground. This technology provides an additional measure to reduce surface settlement. An additional benefit of the pressure-face TBM is the ability to tunnel below the groundwater table without requiring dewatering or lowering of the groundwater table. Where soil conditions are more favorable for tunneling, such as within the bedrock formations, pressure on the face may not be required.

Where conditions warrant, for example, shallow tunnels directly below sensitive structures or utilities, additional methods to reduce settlement will be specified. During preliminary design, a differential settlement criteria limiting angular distortion to 1/600 (vertical deflection over horizontal distance) was established as a threshold for implementation of mitigation measures (Jacobs Associates, 2001). These mitigation measures could include:

- ◆ **Permeation grouting** to improve the ground prior to tunneling: Chemical (sodium silicate) or cement grouts are injected into the ground to fill voids between soil particles – typically sandy soils - and provide greater strength and stand-up time for the soil. This grout can be placed through pipes from the surface before the tunnel reaches the grouted area, from pits or shafts adjacent to the grouted area, or in some instances from the tunnel face. In this latter case, the tunneling machine must be stopped for a period of time to drill grout placement pipes, install grout, and allow the grout to set. The permeation grouting method has been used successfully for the Metro Red Line in instances where the tunnel passed under potentially sensitive or important structures such as the US 101 freeway (downtown, Hollywood and at Universal City).
- ◆ **Compaction grouting** as the tunnel is excavated: This method involves injection of a stiff “grout,” typically sand with small amounts of cement, above the tunnel crown as the tunnel advances. The grout densifies soil above the tunnel crown and replaces some of the lost ground, and thereby preventing settlement from propagating to the surface. This method was used in several instances for the Metro Red Line project in the Downtown Los Angeles area and along portions of Hollywood Boulevard.
- ◆ **Compensation Grouting**: Compensation grouting involves carefully controlled injection of grout between underground excavations and structures requiring protection to from settlements. For tunnel applications, the pipes for grouting are installed above the intended tunnel position, in advance of tunneling. A key component in controlling compensation grouting is careful monitoring of both structure and ground movements to allow the timing and quantities of grout injected to be optimized. Grout injection can take place before, during, and after tunneling activity by reusing the grout pipes.
- ◆ **Underpinning**: Underpinning involves re-supporting the structure’s foundation on ground that will not be influenced by the tunneling. This may not be feasible where the structure is directly over the tunnel.

For compaction, permeation, and compensation grouting, surface preparation is likely to be required (removal of landscaping etc.) to allow space for drilling equipment, installation of grout pipes, and injection of grout. In cases where large structures are directly over the tunnel, access into the building or basement, where basements exist, could be required for grouting operations, and use of the area could be limited during the grouting operations. After grouting is completed, the area is restored to its existing condition. Detailed geotechnical investigations, settlement analyses, and evaluation of the structures with respect to their condition and position relative to the LRT Build Alternative will be required during final design before the TBM type is recommended and additional protection measures, if any, are designed and specified.

In addition to the building condition evaluations and analyses described above, pre-construction surveys will be performed to document the existing conditions of buildings along the alignment before the tunneling begins. During construction, instrumentation, e.g., ground surface and building monitoring programs, will be in place to measure movements and provide information to the contractor on tunneling performance as well as to document that the settlement specifications are met. If measurements indicate settlement limits will be exceeded, the contractor will be required to change or add methods and/or procedures to comply with those limits. Construction work will be reassessed when settlements exceed action (warning) levels. Contractors will be required to modify construction methods if settlements exceed specified maximum levels.

Both action (warning) level and maximum allowable ground surface settlements are typically given in the project construction specifications. They may be specified as a maximum settlement at the ground surface over the centerline of the tunnel, or as measured near the tunnel crown by pre-installed ground

instrumentation. For some structures and utilities, specific settlement limits are set based on the type of structure and any special procedures (such as grouting or underpinning) used. For the suspended Metro Red Line project, the action level for settlement five feet above the tunnel crown was 1.5 inches and 2 inches was the maximum allowable. Settlement limits similar to those used for the suspended project are anticipated for the LRT Build Alternative tunnel.

#### Cut-and-Cover Excavation for Station Sites and Tunnels Adjacent to Portals

If necessary, tunnel sections and excavation walls and bottoms will be stabilized during construction with specialized shoring and/or chemical grouting and dewatering.

#### Groundwater

Dewatering systems will likely be implemented for station construction extending below groundwater. Alternatively, the initial excavation support systems could be designed to prevent groundwater inflows if slurry walls, or other relatively impervious wall systems are used. Further discussion of the initial support systems is included in Section 4.19.1, *Construction Methods*. In any event, the methods will be in accordance with accepted engineering practice and developed under the direction and signature of a licensed engineer specializing in dewatering systems.

If dewatering methods are used and depending on the site soil conditions and groundwater level at the time of construction, some surface settlement may be experienced. For the LRT Build Alternative, settlements at the 1<sup>st</sup>/Boyle excavation are estimated to be about ¼ inch, and about ½ inch at the 1<sup>st</sup>/Soto site. These predictions corresponded to lowering the groundwater elevation about 35 feet at 1<sup>st</sup>/Boyle and about 20 feet at 1<sup>st</sup>/Soto. Dewatering will not be required for 1<sup>st</sup>/Lorena.

During construction, the MTA will monitor adjacent streets, sidewalks, and buildings for settlement and other movement. If movement is detected, the contractor will be required to take action to control it. Action levels to trigger additional measures to control settlement near station excavations are typically on the order of ½ inch to one inch, depending on the construction methods used and structures to be protected.

If contaminated water is encountered during dewatering, it will be treated at the site or hauled to a treatment facility in accordance with applicable federal, state, and local regulations. Any potential impact of dewatering on vegetation will be limited to the construction area and its immediate vicinity. Vegetation within the construction area will likely be sacrificed to facilitate construction. Mature vegetation in the immediate vicinity of the station construction area with root systems drawing moisture from the capillary fringe above the groundwater table may be affected by dewatering. If necessary, irrigation programs designed to mitigate this issue will be provided to the appropriate parties for implementation during dewatering.

At the completion of the stations, pumping is discontinued and groundwater levels return to their natural level. No permanent change in the groundwater level is anticipated as a result of dewatering during construction. Groundwater levels along the tunnels should not be affected as the recommended TBM and tunnel liner block entry of water into the tunnels.

#### Encountering Subsurface Gases

It is not anticipated that specialized methods to mitigate exposure to hazardous gases during tunnel construction and deep excavations will be required for the LRT Build Alternative since field monitoring to date along the underground segment detected only low levels of methane gas and did not detect



hydrogen sulfide gas. It is anticipated that tunnels will be constructed with a pressure-face Tunnel Boring Machine and precast, bolted, gasketed tunnel liners, which will essentially exclude water and gases from the assembled tunnel liner both during construction and operation. During construction, gas detection systems, alarms and emergency ventilation systems, in accordance with Cal-OSHA requirements will be in place to monitor and to protect workers if gas concentrations exceed acceptable levels in working areas. In addition, contractors will be required to use non-sparking, or intrinsically safe equipment underground. Further discussion of hazardous conditions is discussed in Section 4.19.2.14, *Hazardous Materials*.

#### Significance of Impacts Remaining After Mitigation

Implementation of the mitigation measures would reduce geologic and seismic impacts to a less than significant level.

#### **4.19.2.14 Hazardous Materials**

##### *Impacts*

The construction activities (i.e., tunneling, foundation excavations) are most likely to encounter pre-existing hazardous substances where subsurface construction work will be required near the following locations:

- ◆ Within known oil fields,
- ◆ In areas with known historic soil and groundwater contamination, gasoline stations, auto repair facilities, dry cleaners and commercial manufacturing or shipping facilities, or
- ◆ In locations where buildings will be demolished and asbestos and/or lead may be present.

Some pre-existing hazardous substances such as natural gases and contaminated soil and groundwater may be encountered during construction through the locations discussed below. Impacts without mitigation could be potentially significant.

#### Union Station Oil Field (see Figure 4.10-1 in Section 4.10)

Although no hazardous substances were reported in the recent explorations along the at-grade segments of the LRT Build Alternative (Group Delta Consultants, 2001), it is possible that some hazardous substances such as natural gases and petroleum contaminated soil and ground water may be encountered between boring locations and below boring depths during construction of pile foundations for the aerial guideway across US 101. During a prior investigation (GeoTransit Consultants, 1996d), hydrogen sulfide and methane gases were detected in the industrial area between 1<sup>st</sup> Street and US 101 and west of the Los Angeles River, to the north of the LRT Build Alternative. Prior investigations (*Environmental Summary Report*, June 1998, completed for a deep tunnel) indicated that hydrogen sulfide gas was found as a dissolved compound in ground water in the industrial area north of 1<sup>st</sup> Street and west of the Los Angeles River. In two instances, when gas was allowed to accumulate in closed gas sampling wells, studies determined that hydrogen sulfide gas could evolve (off-gas) from groundwater to hazardous levels when exposed to air. Maximum concentrations of dissolved hydrogen sulfide in groundwater were found to be 200 mg/l. Methane gas was detected in a number of sampling wells at quantities above the LEL.

Petroleum-related hazardous substances in soils could be encountered during excavations for surface guideway construction along existing streets. Based on findings of previous investigations, surface construction of the LRT, and the planned limited subsurface construction in this segment, it appears that the Union Station oil field may present a low to moderate potential concern to the LRT Build Alternative.

Boyle Heights Oil Field (see Figure 4.10-1 in Section 4.10)

The Boyle Heights oil field is located east of the Los Angeles River. The 1998 *Environmental Summary Report* for the suspended Metro Red Line project indicated that significant concentrations of dissolved hydrogen sulfide are not expected in areas east of the Los Angeles River. The results of the most recent additional explorations also indicate that the underground segment of the LRT Build Alternative has no significant soil or groundwater contamination requiring remedial action. Nonetheless, there exists a potential for local soils and water inflows to be contaminated with such contaminants as hydrocarbons, hydrogen sulfide, etc. between boring locations that would require treatment and disposal to approved facilities.

Properties with Known or Potential Environmental Contamination

Based on the methodology for impact evaluation found in Section 4.10, a total of four properties were identified to be of high concern, six properties to be of moderate concern, and 24 properties to be of low concern. Each of the high and moderate concern properties are briefly discussed below by the segment in which they were noted, and their locations are displayed in Figure 4.10-1 in Section 4.10. The Environmental Data Resources (EDR) database listing is also indicated along with the name and address of the property of concern.

- a. Properties with High Level of Concern—all properties are listed on the LUST database.

Segment 1: Union Station to Boyle Avenue—None.

Segment 2: Boyle Avenue to Indiana Boulevard

1. Vega Auto Service at 1869 East 1<sup>st</sup> Street—The facility is noted to have impacted area groundwater and the remediation program is in the design phase.
2. Murray Lefkowitz at 2239 East 1<sup>st</sup> Street—The facility is noted to have impacted soil only with no action taken.

Segment 3: Indiana Boulevard to Atlantic Boulevard

3. Gonzales Service Station at 4302 East 3rd Street—The facility is noted to have impacted soil only with no action taken.
4. East Los Angeles Sheriff Department at 5019 3rd Street—The facility is noted to have impacted soil only with no action taken.

- b. Properties with Moderate Level of Concern

Segment 1: Union Station to Boyle Avenue

1. Union Station Oil Field/ Former Gassification Plant—This facility is listed as the Southern California (So-Cal) Gas Company-Aliso A Manufactured Gas Plant (MGP) bounded by Keller, Vignes, and US 101 in the CAL-SITE listings. A second portion of this facility (Aliso C) is noted as a CAL-SITE and COAL-GAS facility bound by Center, Commercial, Ducommun and Jackson Street. Union Station was noted on the CERCLIS list in relation to historic coal gassification in a prior report. H<sub>2</sub>S gas and methane gas have been reported in the subsurface at this facility at levels beyond the Immediate Danger to Life and Health (IDLH) and LEL. The LRT segment in this area requires limited subsurface excavation and construction typically associated with a surface guideway.
2. Mobil Gas Station at 520 Alameda Street (at Commercial Street)—LUST (groundwater reported to be impacted. Regulatory closure of the site was granted with no further action required.)

3. Mangrove Estate at 617 East 1<sup>st</sup> Street—LUST (groundwater reported to be impacted. Regulatory closure of the site was granted with no further action required.)

Segment 2: Boyle Avenue to Indiana Boulevard

4. M and Y Service Center at 2701 East 1<sup>st</sup> Street—LUST. The facility is noted to have impacted area groundwater. Remedial action is complete or unnecessary.
5. Boyle Heights Oil Field: This area is noted in the CDOG maps as having been historically developed with oil and gas wells.

Segment 3: Indiana Boulevard to Atlantic Boulevard

6. Ralph Moran Property at 4247 East 3rd Street—LUST.

c. Properties with Low Level of Concern

The regulatory search identified 24 properties of low potential concern. A listing of these properties can be found in the separate *Hazardous Materials Technical Report* prepared for the Los Angeles Eastside Corridor. These properties are mostly auto service centers, dry cleaning facilities, and warehouses located along the LRT Build Alternative. These sites have completed remediation, have historically utilized only small amounts of known contaminants, are considered small quantity generators or own underground storage tanks. If construction were to be performed on these sites, further investigation would be needed at these properties to assess the environmental conditions.

Significance of Impacts

The impacts of pre-existing hazardous substances that may be encountered during construction would be potentially significant.

***Mitigation***

Emergency response procedures will be developed in conformance with federal, state, and local regulations in the unlikely event of a major hazardous materials release close to or within the vicinity of the proposed improvements. Construction and operations personnel will report to the appropriate regulatory agency any suspicious dumping or releases observed along the alignment. The MTA will coordinate with the California Department of Toxic Substance Control, State Water Resources Board, South Coast Air Quality Management District, and other agencies as appropriate to keep abreast of current RCRA notifications, hazardous materials spill reports, LUST reports, and results of any sampling conducted within the project vicinity.

Hazardous Subsurface Gases

During final design of the suspended Metro Red Line East Side Extension, the MTA identified several methods to mitigate exposure to hazardous gases during tunnel construction and deep excavations. These included both specialized excavation methods and gas or groundwater treatment methods.

Specialized tunnel excavation methods include the use of pressure-face Tunnel Boring Machines (TBMs) and bolted, gasketed tunnel liners. The pressure-face (slurry shield) TBM provides a contained excavation system such that worker exposure to the excavated face and spoil is reduced or eliminated. This method was specified for use on the west side of the Los Angeles River where high gas concentration was anticipated. The pressure face machine is used in combination with a gasketed, pre-cast or pre-fabricated lining system, to minimize gas intrusion during tunneling and operations. For further protection during tunnel construction and in deep excavations, continuous and automated gas monitoring

will be maintained and additional ventilation provided if gas concentrations exceed action/alert levels. Similar gas monitoring and ventilation systems have been used during the construction of the operating Metro Red Line system, which was constructed through former oil fields containing natural gases.

At station sites where gases are potentially present, previous designs for the suspended Metro Red Line East Side Extension used gas impermeable liners to reduce the probability of infiltration. These special High Density Polyethylene (HDPE) Liners are currently in place in Metro Red Line Segments 1, 2, and 3. An alternate system will be used for the LRT Build Alternative stations where the potential for gas seepage exists. A precast, gasketed, bolted liner will provide a continuous barrier that reduces the impact from gas inflows to less than significant levels.

#### Contaminated Water

Groundwater contamination encountered during subsurface construction activities may be treated on-site to acceptable local and state criteria and then discharged into the sanitary sewer or storm water system. If on-site treatment is not feasible due to the type and severity of the contamination identified, the contaminated ground water may need to be disposed of by recycling in a permitted facility. During construction, the roles and responsibilities of the MTA and Contractor relative to water pollution controls, including operations involving the segregation, treatment and disposal of contaminated groundwater derived from dewatering, tunneling operations and any liquid derived from muck separation will be addressed by the project specifications. For the suspended Metro Red Line project, the Contractor was to be responsible for providing, operating and maintaining a water treatment unit (or units) to treat wastewater discharges to achieve the following effluent limitations:

- ◆ pH: between 5.5 to 11
- ◆ Dispersed oil and grease: <600 mg/L
- ◆ Floatable oil and grease: No visible sheen.

Solid residues from the Contractor's water treatment operations will also be addressed in the specifications. The MTA will be responsible for any additional water treatment required to meet National Pollutant Discharge Elimination Standards (NPDES), including organic and inorganic constituents, and will provide, operate, and maintain a water treatment system (or systems) for this purpose.

#### Soil

Soils containing hazardous material could be disturbed by construction activities. Mitigation of the material would be required to conform to the applicable local, state, and federal requirements. Depending upon the amount of affected material encountered, the concentrations of hazardous constituents, and the type of hazardous constituents encountered during construction activities, the following options may be considered for mitigation:

- ◆ Removal and disposal – One mitigation option will be to identify, remove, and haul and dispose of the material in a licensed Class I, II or III disposal facility.
- ◆ Recycling – Impacted material may be treated and recycled at regulated recycling facilities.
- ◆ Combination – An off-site remediation facility could be used to remediate the waste material to a Class III standard and then dispose of it as clean fill at a Class III landfill.

Operations involving the segregation, handling, transportation and disposal of contaminated soil, hazardous substances, solid waste, USTs, oil and gas wells, and other environmentally related issues encountered during earthwork operations will be addressed in the project specifications. "Contaminated

soil” is determined using a risk based assessment and is site specific. It depends on the distance the contamination is located from groundwater as well as other factors, but can be loosely defined as soil that exhibits any of the following characteristics:

- ◆ Greater than (>) 100 mg/kg Total Recoverable Petroleum Hydrocarbons (TRPH) per EPA Method 418.1; *or*
- ◆ >5 mg/kg Total Petroleum Hydrocarbons as gasoline (TPHg) per EPA Method 8015; *or*
- ◆ >50 mg/kg direct reading from a hand held Photoionization Detector (PID) calibrated to 100 ppm isobutylene per South Coast Air Quality Management District Rule 1166; *or*
- ◆ Any characteristic of Toxicity per Title 22 CCR §66699 (TTLIC and STLC); *or*
- ◆ >10 micro gram/kg Polynuclear Aromatic Hydrocarbons per EPA Method 8270.

MTA, or its designated representative, will sample and analyze excavated soil, including tunnel muck, for the purpose of classifying material and determining disposal requirements. If excavated soil is suspected or known to be contaminated, MTA will direct the contractor to perform the following operations:

- ◆ Segregate and stockpile the material in a way that will facilitate measurement of the stockpile volume
- ◆ Spray the stockpile with water or an SCAQMD-approved vapor suppressant and cover the stockpile with a heavy-duty plastic (e.g., Visqueen) to prevent exposure of the soil.

If required by federal, state, or local regulations, MTA will direct the contractor to load, transport, and unload contaminated soil and construction debris at an MTA-designated facility (i.e., a Class III landfill, a recycling facility or an unclassified waste management unit located within 30 miles of the project worksite). The contractor will provide qualified and trained personnel and personal protective equipment (PPE) to perform operations that require the disturbance of hazardous substances including, but not limited to, excavation, slurry/muck processing, segregation, stockpiling, loading and hauling.

In addition to the above, the MTA will include information regarding Resource Conservation and Recovery Act (RCRA) compliance and other State hazardous waste disposal requirements that apply to this project in the final construction documents. No on-site treatment of hazardous soils will be conducted during the project. All contaminated soils and hazardous soils will be transported off-site to the MTA's temporary storage facility regulated by the Department of Toxic Substances Control (DTSC); the MTA will follow the provisions CCR Title 22, Division 4 and CCR Title 23 Chapter 15 as it relates to the classification and disposal of hazardous wastes. All soil believed to be contaminated will be sampled in accordance with SW-846 sampling protocols, and profiled into a legally acceptable and properly permitted disposal facility.

The MTA is currently regulated as a hazardous waste generator and all manifesting of potentially hazardous materials will be conducted with the MTA as sole generator. Other government agencies and/or the contractor will not be regulated as hazardous waste generators as it relates to this project. The MTA has an EPA Generator Number. As chemical properties and disposal classifications of contaminated soils excavated will be variable, haul routes and anticipated disposal facilities are unknown at this time. However, haul routes and waste disposal facilities will be included in the final contract documents.

#### Oil and Gas Wells

At this time, no known wells have been located directly in the area of tunneling or underground station construction. The nearest well was identified approximately 70 feet southwest of the 1<sup>st</sup>/Lorena intersection. Provisions will be included in the project specifications (similar to those for the suspended

project and previous Red Line segments, to instruct the contractor as to procedures to be followed if a well is encountered.) Plugged and abandoned oil wells (ARCO Evergreen and Taylor Royalties) located within close proximity to the project limits will be shown on the project contract drawings. In addition, the final geotechnical report for the underground segment will include a discussion of the oil fields and any known wells.

#### Building Demolition

In locations where buildings will be demolished, asbestos and/or lead may be present and will be handled by specialty contractors licensed in asbestos and lead abatement.

#### Significance of Impacts Remaining After Mitigation

The mitigation measures would reduce impacts to less than significant.

#### **4.19.2.15 Water Resources**

##### *Impacts*

##### Surface Water

Potential surface water impacts resulting from construction would primarily be associated with sediment loadings on the storm water and/or surface water (Los Angeles River) systems. Sediment sources would include unstabilized, exposed soil at excavations, drainage from stockpiles of excavated materials, and dewatering activities.

Tunneling operations and cut-and-cover construction of stations would involve dewatering (removal of water from area soils) before and during construction. If warranted, when dewatering activities occur during construction, they would be limited to the immediate excavation area by using such methods as compressed air, cement or approved chemical grouting, freezing, slurry shields or earth pressure balance shields where local geologic or other constraints dictate, thus avoiding potential ground subsidence or differential settlement of adjacent structures. Moreover, by confining groundwater control activities to the immediate area of excavation, the proposed project would avoid potential adverse impacts on flora caused by a lowered water table. Water from dewatering would be discharged into the storm drain system, which, in turn, drains into the Los Angeles River.

The application of impervious surfaces resulting from facility paving and construction would increase runoff and associated contaminants (oil, grease) discharged to area storm water systems and surface waters. However, the additional amounts of the types of pollutants that would enter runoff would be negligible and would not constitute a significant environmental impact under CEQA.

With regard to erosion and sedimentation, subsurface tunneling activities would not cause any surface erosion. Minor surface erosion is possible at the station excavation sites where soil is exposed. The project is not expected to result in significant impacts related to erosion. Sedimentation of the Los Angeles River resulting from dewatering activities is not expected to occur, since treatment would remove solids and suspended solids from the groundwater.

Seismic retrofitting of the 1<sup>st</sup> Street Bridge would be performed to strengthen its columns. This construction would require equipment and vehicles to work directly in the Los Angeles River bed during construction. This construction would be located within the Los Angeles River ordinary high-water mark. Such an impact would require coordination with the U.S. Army Corps of Engineers (COE) under Section

404 of the Clean Water Act, with the Regional Water Quality Control Board (RWQCB) under Section 401 of the Clean Water Act, and the California Department of Fish and Game (CDFG) under Section 1600 of the California Fish and Game Code. The short-term nature of the impact would probably require only notification of the COE through a Pre-construction Notice, or possibly authorization under an existing Nationwide Permit. Coordination with the RWQCB would determine the process for complying with Section 401 of the Clean Water Act. Coordination with the CDFG would determine what permitting, if any, is necessary, considering that there is no existing habitat in the vicinity of the 1<sup>st</sup> Street Bridge.

### Floodplains

Most of the construction in the Los Angeles River floodplain area is completely at-grade, and the existing 1<sup>st</sup> Street Bridge over the river would be used by the LRT alignment for crossing the river. Construction of the 1<sup>st</sup> Street Bridge seismic retrofit would not result in any floodplains impacts to the Los Angeles River 100-year floodplain.

### Groundwater

There is a potential for contamination of groundwater that is used for consumption by municipal, industrial and irrigation purposes. This issue is further addressed in Section 4.9.2.14, *Hazardous Materials*. The principal engineering problems encountered in tunneling and excavation are often related to groundwater. Relatively shallow groundwater could be encountered during construction in younger and older alluvial sediments. Sediments in the vicinity of the 1<sup>st</sup>/Boyle Station are of this type and may require dewatering prior to and during the excavation of the station. Groundwater flows entering tunnels and surface excavations can be large, especially in areas of shallow groundwater where construction takes place below the water table. Inflows could be controlled by gravity flow to sump and pump systems, by direct pumping to lower the water table, or by other approved methods. Refer to Section 4.19.2.13, *Geologic and Seismic*, for additional information.

### Significance of Impacts

There would be no impact on floodplains. The impacts to surface waters associated with the 1<sup>st</sup> Street retrofitting may be potentially significant. The impacts due to contamination of groundwater may be potentially significant.

### *Mitigation*

#### Surface Water

A Notice of Intent (NOI), along with a National Pollutant Discharge Elimination System (NPDES) permit application and detail plans, will be submitted to the RWQCB by MTA or a designated contractor during the final design period and prior to construction activity. The NOI will discuss how soil disturbances associated with construction may affect storm water runoff. This permit will require the completion of a Storm Water Pollution Prevention Plan (SWPPP), and a Monitoring Program designed to check whether the measures identified in the SWPPP are adequate and properly implemented. The SWPPP for this permit will contain or identify pollutant sources, source controls, material inventory, preventative maintenance program, spill prevention and response program, employee training, facility inspections, record keeping, and elimination of non-storm water discharges. The plans will include provisions for construction process water to be treated and discharged to the Publicly Owned Treatment Works (POTW). Contaminated runoff from large paved areas such as parking lots and construction sites will be minimized through the installation of oil/water separators or siltation basins and trash filters. New standards, such as the standard urban

stormwater mitigation plan, will be implemented into the project. The SWPPPs will be developed in coordination with the RWQCB. Mitigation measures are anticipated to reduce impacts on surface water quality to less than significant.

Prior to discharging into the City storm drain system, MTA will: 1) Obtain water samples from the locations and depths where the dewatering is planned; 2) perform water quality sampling tests to determine the different constituents and levels of contamination; 3) present these findings to the RWQCB to obtain an NPDES permit that will determine the allowed levels of contaminants and volume of discharges into the storm drain system; and 4) provide the City of Los Angeles with a copy of the NPDES permit.

In the event that discharge is expected, the proposed project would require preparation of a Report of Waste Discharge (ROWD), required by the State Water Resources Control Board (SWRCB) for any type of discharge affecting surface water. This would ensure that any project-related discharges are regulated and therefore would not impact local surface water. Section 4.19.2.13, *Geologic and Seismic Conditions*, addresses mitigation relating to potential subsidence from tunnel and station construction.

Spoil from tunneling activities will be stored in the tunnel staging area and trucked to appropriate sites in order to minimize sedimentation. Spoil material will not be stored near water drainage facilities to prevent increased sedimentation in the drainage system. In addition, measures will be adopted to prevent accumulation of large amounts of spoil material, and spoil piles will be kept low and/or graded to minimize erosion. Mitigation measures are anticipated to reduce sedimentation impacts to surface water quality to less than significant.

Construction of the 1<sup>st</sup> Street Bridge structural retrofitting will require close coordination with the COE, CDFG, and the Los Angeles Flood Control District. The COE may require mitigation in order to comply with Section 404 of the Clean Water Act. The RWQCB may require mitigation for clearance under Section 401 of the Clean Water Act. The CDFG may also require mitigation to comply with Section 1600 of the California Fish and Game Code. Compliance with the requirements of these regulations would result in avoidance of significant impacts.

#### Floodplains

Mitigation of potential impacts on the Los Angeles River are not required because the alignment, which would cross the river on the existing 1<sup>st</sup> Street Bridge, poses little if any impact on the river. However, crossing the Los Angeles River will require consultation with the County and the COE.

#### Groundwater

Mitigation measures for dewatering and groundwater contamination are discussed in this section and in more detail in Sections 4.19.2.13 and 4.19.2.14. Field pump tests will be performed in the areas that require pre-construction dewatering for tunnel and underground station construction to determine groundwater quality and to help design suitable dewatering systems and treatment systems, if required. Through the use of a pressure-face TBM, there is the ability to tunnel below the groundwater table without requiring dewatering or lowering the groundwater table.

Potential remedial options for contaminated groundwater, if encountered, include the use of hydrogen peroxide to treat hydrogen sulfide, filtration of colloidal sulfur or suspended solids, siltation basins, oil water separators and active carbon for removal of volatile organic compounds (VOCs). Perched groundwater will also be treated appropriately. Treated water will then be discharged into a nearby storm drain. Remedial options will be developed in conformance with all applicable federal, state, and local



regulations. Mitigation measures in the event that contaminated groundwater may be encountered are anticipated to reduce impacts to less than significant.

Prior to excavation and construction, negotiations with the California Department of Water Resources (CDWR) and the Water Replenishment District of Southern California (WRD) will be initiated regarding water rights and pumping assessment. It is expected that coordination with CDWR and WRD will provide sufficient oversight to prevent environmental impacts due to over-withdrawing groundwater from the project area.

In the event that discharge is expected, the proposed project will require preparation of a Report of Waste Discharge (ROWD), required by the State Water Resources Control Board (SWRCB) for any type of discharge affecting groundwater. This will ensure that any project-related discharges are regulated and therefore would not impact local groundwater.

#### Significance of Impacts Remaining After Mitigation

The mitigation measures would reduce impacts on water resources to less than significant.

#### **4.19.2.16 Natural Resources and Ecosystems**

##### ***Impacts***

No sensitive plant communities or suitable habitat for sensitive plants or wildlife species occurs within the Los Angeles Eastside Corridor. Therefore, construction of the LRT Build Alternative, and its two options, are not expected to adversely affect any sensitive plants and plant communities. Construction activities along the Los Angeles Eastside Corridor are not expected to modify or affect any Corps or CDFG jurisdictional waters. An effort should be made to limit construction-related debris and sediment from entering nearby storm drains or the Los Angeles River.

Seismic retrofit work will be performed on the 1st Street Bridge within the Los Angeles River channel as part of the project. This construction may result in temporary impacts on the Los Angeles River. Although no habitats or species are identified as occurring in the Los Angeles River at this location, impacts on surface water quality may result in potentially significant biological impacts downriver.

##### Significance of Impacts

There may be potentially significant impacts on biological resources associated with seismic retrofitting construction activities in the Los Angeles River channel.

##### ***Mitigation***

1st Street Bridge retrofit work will be limited to the dry season in accordance with the COE and CDFG permitting procedures. Construction will also require close coordination with the COE, CDFG, and the Los Angeles Flood Control District. The COE may require mitigation in order to comply with Section 404 of the Clean Water Act. The RWQCB may require mitigation for clearance under Section 401 of the Clean Water Act. The CDFG may also require mitigation to comply with Section 1600 of the California Fish and Game Code. Construction in the dry season and compliance with the requirements of these regulations would result in avoidance of significant impacts.

### Significance of Impacts Remaining After Mitigation

The mitigation measures would reduce impacts to less than significant.

#### 4.19.2.17 Utilities

##### *Impacts*

Construction of the trackway, stations, subway and other facilities will require relocating, abandoning or otherwise avoiding utilities. Some of the impacts may potentially be significant due to added costs, disruption of service or temporary loss of access. These include relocation of utility poles supporting overhead lines and street lights; relocation of underground utilities from the track zone, station areas, subway tunneling and maintenance facility site; and inspection, repairs and encasement of underground utilities at track crossings. In cases where utilities that occupy the right-of-way pose a safety hazard or conflict with construction activities, lines may be relocated before construction.

The approximate locations of subsurface and overhead utility lines are being identified as part of preliminary engineering in accordance with MTA's System Design Criteria and Standards Volumes I through IV. Utilities include facilities belonging to government agencies, public utility corporations, and privately owned companies for the provision of sewer, water, storm drain, gas, electrical, telephone, telegraph, cable television, street lighting, pipelines, alarm systems and parking meters.

Construction of the LRT project will involve extensive renovation and construction in the streets along which the route travels. At the subway portion of the alignment, tunneling will occur. Underground utilities may be affected by these construction activities. Every effort will be made to cross utilities at 90 degrees and to position utilities that run longitudinally to the track a minimum of ten feet from the centerline of the track to the edge of the pipe. Additionally, tone wires will be attached to all non-metallic centerline utilities pipes or casings and will be terminated within the right-of-way to help in field locating buried pipes. All abandoned pipes beneath the trackbed will be filled with sand or slurry concrete and plugged. Similar type requirements will be developed for the relocation of any affected overhead utilities. Those overhead utilities in conflict with train operations will be raised to provide the required separation to the overhead contact system.

##### Significance of Impacts

Many of the construction-related impacts on utilities are potentially significant impacts.

##### *Mitigation*

MTA or their contractors will minimize impacts due to temporary utility service interruptions during construction by carefully scheduling the occasional interruptions and notifying affected properties prior to service interruptions. One or more of the following mitigation measures will be used to minimize the potential effects of disruption of utility service during project construction. All measures taken will follow MTA Design Criteria and Standards (Volumes I through IV), and applicable utility standards and criteria or best industry practices.

- ◆ Maintain and protect existing utilities in place during construction;
- ◆ Provide temporary connection for services that must be disconnected for extended periods of time;
- ◆ Maintain existing service as long as reasonably possible;

- ◆ Notify users well in advance of any anticipated service disruption and coordinate with the utility owner's convenient times for necessary service outages;
- ◆ Monitor the project's contractors as part of construction management/oversight and include terms in construction contracts that encourage contractors to actively seek to avoid accidental disruption of service;
- ◆ Coordinate the schedules of multiple utility rearrangements in order to minimize negative impacts on users;
- ◆ Develop a contingency plan in cooperation with the utility providers for emergency repairs of any utilities unexpectedly found or that disintegrated because of age during excavations;
- ◆ Adjust portions of the alignment of station locations, where feasible, to prevent a major utility relocation;
- ◆ Comply with the City of Los Angeles and the County of Los Angeles on procedures for utility construction, inspection, and operation; and
- ◆ Use pipe and conduit support systems, trench sheeting and shoring, and other precautionary measures during construction to minimize the potential for damage to exposed utilities.

#### Significance of Impacts Remaining After Mitigation

After the mitigation measures are adopted, the construction-related utility impacts would be reduced to a level that is less than significant.

#### **4.19.2.18 Energy**

##### *Impacts*

The LRT Build Alternative would result in the one-time, non-recoverable energy costs associated with subway tunneling, construction of trackwork, systems/equipment, transportation-related facilities (stations, maintenance facilities), and vehicles. Facility-related energy would account for energy consumed during the production of construction materials used in new construction and maintenance and construction of the LRT Build Alternative including structures. Short-term use of oil, gas, and electricity for construction would reduce the overall amount of fossil fuels used within the area, region, and state. Construction of the LRT Build Alternative would not result in a significant impact under CEQA to the availability of fossil fuels or electricity within the region or the state given the current and projected available resources.

##### Significance of Impacts

Impacts would not be significant.

##### *Mitigation*

No mitigation is required. However, through implementation of standard construction practices and techniques, fossil fuels and electricity would not be used in a wasteful or inefficient manner. MTA will work with the local solid waste vendors to investigate methods of minimizing construction and demolition waste, including recycling options. MTA will comply with all federal, state, and local requirements for separation of differing standards of waste materials. During design and construction of the LRT Build Alternative, the MTA procurement department will comply with the requirements of Resource Conservation and Recovery Act (RCRA) Section 6002 (EPA's Buy-Recycled program) where technically feasible and appropriate. The MTA will strive to incorporate the latest Comprehensive Procurement Guide (CPG) listings of recycled or re-used materials applicable to construction,

landscaping, and transportation products used on the LRT Build Alternative. Procurement decisions regarding RCRA Section 6002 compliance will consider the price of designated items made with recovered materials versus typical products, the competition base of recovered goods suppliers, unusual and unreasonable delays for procurement of products, and the compliance of recovered and/or recycled goods with MTA design criteria for the LRT Build Alternative.

#### 4.19.2.19 Safety and Security

##### *Impacts*

##### Accidents and Safety

Construction of the LRT at-grade alignment and subway will require a number of activities that could impact public safety. These include:

- ◆ Intensive construction activity in the center of streets along the LRT route at the location of the stations where the alignment is at the level of the street;
- ◆ Shallow excavation and construction activity along the centerline of streets along the LRT route between stations to install track and power facilities;
- ◆ Activities at the location of staging and storage of construction equipment and materials;
- ◆ Movement of construction equipment and materials between staging and storage areas and the areas of construction;
- ◆ Heavy excavation activities at the portals and along the portion of the LRT route which is below the level of the street; and
- ◆ Transport of debris from tunnel excavation along the haul route to the point that trucks enter the freeway and depart the community.

The impacts of Options A and B are similar, with the exception that the three at-grade station area changes associated with each option would result in changes to locations (not severity of impacts) where construction activity would occur in the vicinity of the stations. If Ramona High School is relocated (if this is the course of action to be taken), under Option B then construction of the LRT would have no impact on students and faculty because the relocation will be completed prior to LRT construction. However, if the school is reconstructed at the current site, then impacts will be significant unless mitigation measures are taken. The impact of construction of the LRT system on public safety is significant.

##### Security and Crime Prevention

The potential adverse impacts on emergency response (medical, police, and fire) during construction relates to detours, street closures, increased traffic near emergency facilities and staging plans. Unless special provisions are in place prior to construction, these impacts could be potentially significant. Construction equipment will be stored at construction sites and staging areas close to the LRT alignment. If such areas were not adequately secured, or became attractive nuisances, they could attract individuals who might steal equipment or create other difficulties. Such a result could be considered significant.

In order to prevent people from gaining access to construction sites and thus subjecting themselves to potential injury, a chain link fence will typically enclose the sites. Where this is not possible, holes, trenches or other potentially dangerous features will be barricaded. Where the construction activity would be adjacent to a sidewalk which cannot be closed, shields will be constructed to prevent falling objects from hitting pedestrians. Security lighting will be provided for emergency response around

construction zones. The City of LA will require standard lighting levels for detour roadways through and around construction zones. One result of almost any kind of construction operation is that people have a tendency to stop and observe. Cars passing the site would slow possibly resulting in a traffic hazard if no mitigation measures are taken.

The impacts of Options A and B are similar, with the exception that the three at-grade station area changes associated with each option would result in changes to locations (not severity of impacts) where construction activity would occur in the vicinity of the stations. If Ramona High School is relocated (if this is the course of action to be taken), then construction of the LRT would have no impact on students and faculty because the relocation will be completed prior to LRT construction. However, if the school is reconstructed at the current site, then impacts will be potentially significant unless mitigation measures are taken.

#### Fire Service and Emergency Response

Potential adverse impacts on emergency response (medical, police and fire) during construction may be caused by detours, street closures, increased traffic congestion and construction staging activities. Unless special provisions are in place prior to construction, these impacts could be considered significant.

#### Significance of Impacts

With regard to accidents and safety issues and fire service and emergency response, impacts would be significant without mitigation. Construction-related impacts with regard to security and crime prevention are potentially significant impacts.

#### ***Mitigation***

##### Accidents and Safety

Construction sites, especially those located in residential areas or near schools, will receive particular attention to ensure that the sites are not attractive to children. Local agencies that specialize in safety and security will review final designs to ensure the inclusion of appropriate safety features. The project will be required to meet MTA Rail Transit Design Criteria and Standards, Fire/Life Safety Criteria, Volume IX.

- ◆ MTA will develop Worksite Traffic Control Plans in cooperation with the Los Angeles Department of Transportation (LADOT) and Los Angeles County Department of Public Works (DPW) to accommodate required pedestrian and traffic movements. The plans will be subject to those agencies' approvals based on their established criteria. LAUSD will be invited to participate as part of MTA's Third Party Coordination Group to develop the plans prior to approval by LADOT and DPW;
- ◆ LAUSD, as well as LADOT and the County DPW, will be invited to participate as part of MTA's Third Party Coordination Group to ensure safe and convenient pedestrian routes to schools are maintained, including the publication and distribution of school pedestrian route maps;
- ◆ MTA will provide sufficient notices to forewarn children and parents when school pedestrian routes are affected;
- ◆ MTA or their designated contractor will coordinate with and notify the LAUSD, to the fullest extent possible, the scheduling planned for LRT construction. With regard to hauling scheduling, LADOT and DPW are responsible for determining haul routes and times. However, most of the excavated rock and soil materials from the tunneling operation will be removed at the construction staging area near the intersection of 1<sup>st</sup> Street/Boyle Avenue. The haul trucks will be routed along the on- and off-

ramps of the nearby US 101 freeway, and impacts on sensitive uses in the project area will, therefore, be minimized;

- ◆ As part of the stipulations of the construction contract, the contractor will not allow construction vehicles to stage or park along streets bordering school sites unless they contain vehicle-mounted machinery actively in use as part of construction while the vehicle is parked. Vehicles used to transport construction workers will be required to park elsewhere. The adequacy of these provisions will be reviewed with the LAUSD School Traffic and Safety Department.
- ◆ The construction contractor will be required to maintain access to community facilities affected by construction activities;
- ◆ MTA will install appropriate traffic controls (signs and signals) as needed in conformance with LADOT, County DPW, HDM, MUTCD, and PUC standards to ensure pedestrian and vehicular safety during construction
- ◆ MTA will provide at no charge to the Los Angeles Unified School District, as well as neighborhood senior centers upon request, an instructional safety program that will cover safety issues relative to construction of the LRT project.
- ◆ MTA will notify the LAUSD of impending impacts on existing school bus routes;
- ◆ MTA will inform the public, including LAUSD, of bus stops that are to be abandoned or changed during or after construction of the LRT line;
- ◆ Construction will generally occur between the hours of 7:00 AM and 10:00 PM. Construction will not cease during school arrival and departure times. However, the contractor will be required to inform their workers of the need to be especially cognizant of school children and others in the vicinity of the schools while they are performing their work;
- ◆ MTA will provide the funding for crossing guards in the vicinity of all construction sites and haul routes as warranted in accordance with criterion contained in the *California DOT Traffic Manual, Chapter 10-07.3, Warrants for Adult Crossing Guards*. Where the manual criterion does not warrant placement of crossing guards, MTA may provide crossing guards during school hours on a site-specific basis considering the conditions and criterion stated in the manual. MTA will provide crossing guards during school hours during construction, where related lane closures will divert traffic to residential streets utilized by elementary and middle school students;
- ◆ The construction contractor will be responsible for providing flag persons at construction sites, as needed, where construction activities compromise the safety of pedestrians and/or motorists while traveling to and from school;
- ◆ The contractors will be required, in conformance with provisions in the California Vehicle Code, to inform their drivers that they must drive cautiously in areas with concentrations of school children and must stop when they encounter school buses using red flashing lights; and
- ◆ The contractor will be responsible for providing security at construction sites at a level that MTA determines to be appropriate in accordance with MTA Rail Transit Design Criteria and Standards, Fire/Life Safety Criteria, Volume IX. In addition to the strategies previously discussed, other measures could include: use of security patrols; installation of temporary fencing around material laydown, subway excavation, and station sites; installation of screening to block construction site views from motorists' to avoid distraction; and installation of appropriate signing and lighting as required by LADOT and DPW.

Temporary fencing that may need to be installed will be of good quality, capable of supporting the accidental application of the weight of an adult without collapse or major deformation. Where major streets must be fenced, business owners will be offered the opportunity to request covered walkways in lieu of chain link type fencing. Where covered walkways or other solid surface fencing is installed, a program will be implemented to allow for artwork (e.g., by local students) on the surfaces. Where feasible and approved by local neighbors and businesses, chain link fences will be planted with vines to

minimize visual impact during the construction period. Covered walkways will be installed at locations where fencing is up and must contain work.

MTA security will normally be located at construction site access points. Temporary fencing or screens will be modified at construction site access driveways to provide visibility between pedestrians and vehicles, and flag persons will be provided as required by LADOT. MTA will follow a strict construction methods manual developed as part of the Final SEIS/SEIR, which includes the use of flaggers, cones, and flashing lights, among other items, to enhance safety within the areas of construction.

The above mitigation measures apply to both Options A and B. In addition, under Option B, LRT track and station construction will occur on Ramona High School property. Particular attention to safety issues will be taken if the school is reconstructed on the existing site. Measures to be taken under these circumstances will include:

- ◆ The construction contractor will either provide: 1) fencing or other suitable barriers around the Eastside Corridor LRT off-street construction site between 1<sup>st</sup> and 3<sup>rd</sup> Streets; or 2) a security patrol in the area that will provide security services during normal school hours; and
- ◆ MTA will make available a MTA staff person or construction contractor representative who will keep the school administrator informed about ongoing and planned construction activities in the vicinity and will act as a liaison between the high school and the construction contractor regarding safety issues, as well as other issues, that may arise.

#### Security and Crime Prevention

The following mitigation measures will minimize criminal activities and maintain security:

- ◆ The contractor will be responsible for providing barriers at subway excavation and material laydown sites, as needed, to minimize trespassing, vandalism, and short-cut attractions. The LRT surface-running sections will involve mostly shallow excavation in the street rights-of-way. For these areas, as well as at all construction sites as applicable, such measures as the following will be taken by the contractor to increase safety during construction: secure tools and small parts during non-work hours; cover small, but deep excavations with heavy metal plates during non-work hours; and maintain tidy work sites at all times. Measures will be taken to conform to MTA Rail Transit Design Criteria and Standards, Fire/Life Safety Criteria, Volume IX.
- ◆ The contractor will be responsible for providing security at construction sites at a level that MTA determines to be appropriate in accordance with MTA Rail Transit Design Criteria and Standards, Fire/Life Safety Criteria, Volume IX. In addition to the strategies previously discussed, other measures could include: use of security patrols; installation of temporary fencing around material laydown, subway excavation, and station sites; installation of screening to block construction site views from motorists' to avoid distraction; and installation of appropriate signing and lighting as required, including providing temporary street and pedestrian lighting at all times during the construction phase.
- ◆ The contractor will be required to use equipment and facilities that are vandal and graffiti resistant to the extent possible. Graffiti will be removed within 24 hours at construction sites, facilities under construction, and from equipment.
- ◆ Citations with fines will be issued for trespassing on construction sites.
- ◆ Newsletters will be prepared and distributed to keep the public informed about safety issues during construction. In addition, information booths will be provided at local community events.
- ◆ Visibility of surrounding areas will be maintained to the extent possible to minimize the potential for crime.

The above mitigation measures apply to both Options A and B. In addition, under Option B, LRT track and station construction will occur on Ramona High School property. Particular attention to security and crime prevention issues will be taken if the school is reconstructed on the existing site. Measures to be taken under these circumstances will include the same described in the mitigation for accidents and safety issues.

#### Fire Service and Emergency Response

The impact of construction of the LRT system on emergency services will be mitigated by use of best practices of the construction industry. Construction staging/detour plans for the LRT Build Alternative will be reviewed with the appropriate emergency service providers and medical facilities prior to construction. The plans will be developed to satisfy their criteria/standards. MTA will provide sufficient advance notice to the emergency service providers of road and lane closures to ensure a minimum of service disruption. Requirements to maintain uninterrupted emergency vehicle access will be included in construction contract specifications. At the location of construction, proper control will be required from the contractor. All sites will have flag persons to control traffic speed and to warn of dangers. In addition:

- ◆ To satisfy LA Fire Department criteria, a minimum residual water pressure of 20 pounds per square inch is to remain in the water system, with the required gallons per minute flowing. The required fire-flow for this project has been set at 4,000 GPM from four fire hydrants flowing simultaneously.
- ◆ During any demolition activities, the Fire Department access will remain clear and unobstructed.
- ◆ Adequate public and private fire hydrants shall be required in accordance with City of Los Angeles and Los Angeles County standards.
- ◆ When the subway tunnel is under construction or major repair, all portions of the California Administration Code Industrial Relations Title 8, Sub 20, Tunnel Safety Orders shall be adhered to.
- ◆ In order to mitigate impact of street closures to an acceptable level, the LA Fire Department must know about access to street, fire hydrants, or structures. The construction contractor will be required to notify the LA Fire Department's Operations Control Dispatch Section regarding changes.
- ◆ The proposed project will comply with all applicable State and local codes and ordinances, and the guidelines found in the Fire Protection and Fire Prevention Plan, as well as the Safety Plan, both of which are elements of the General Plan of the City of LA CPC 19708.

A fire chief from each of the Los Angeles City and County Fire Departments will be on-hand to ensure the project meets all City and County Codes.

#### Significance of Impacts Remaining After Mitigation

With mitigation, safety and security impacts would be reduced to less than significant.



## 4.20 MAINTENANCE AND STORAGE FACILITIES YARD LEAD

### 4.20.1 Introduction

The existing Red Line maintenance yard will be used for the Maintenance and Storage Facility (M&SF) for the Eastside Corridor LRT. Excess capacity currently exists at the yard and is available to provide the needed facilities. The site was previously environmentally cleared for the Metro Red Line in the *Final Environmental Impact Statement, Los Angeles Rail Rapid Transit Project, Metro Rail, USDOT, UMTA, and Southern California Rapid Transit District, December 1983. Chapter 2, Alternatives Considered*, provides additional information regarding use of the Red Line M&SF for the Eastside Corridor LRT project. This section evaluates the impacts of the dual lead tracks that branch off of the LRT mainline at Alameda/Ducommun since this alignment was not a part of the existing Red Line maintenance yard project. Mitigation is also specified as appropriate. The lead tracks travel eastward on Ducommun Street from Alameda Street to a point just east of Center Street where it will turn and traverse in a northeasterly direction for a short distance to the point where it enters the Red Line maintenance yard. At this point, the lead tracks turn south and continue into the yard. Figure 2-5 in Chapter 2 and Appendix E, Sheets C-101 through C-110, show the yard lead alignment.

The following categories of impacts were considered in the evaluation: (1) traffic; (2) parking; (3) land use and development; (4) economic and fiscal; (5) land acquisition/displacements/relocations; (6) communities/neighborhoods; (7) visual and aesthetics; (8) air quality; (9) noise and vibration; (10) geologic and seismic conditions; (11) hazardous materials; (12) water resources; (13) natural resources and ecosystems; (14) energy; (15) safety and security; (16) historic/archaeological; (17) paleontological; (18) community facilities/parklands; (19) Section 4(f); and (20) utilities.

### 4.20.2 Traffic

All curb parking along Ducommun Street will be eliminated, and right turn access (especially trucks) to and from driveways and intersecting streets will be constricted when turning to or from the 11.5-foot curb lane. LRT operations along Ducommun Street will be much less frequent than along the LRT mainline since the track on Ducommun Street will be used only for light rail vehicles to access the M&SF. The trains will run with mixed flow; therefore, left turns will be acceptable.

Access to businesses along the Eastside Corridor right-of-way will be maintained. Delivery trucks will be able to access businesses via right-hand turns. Deliveries to local businesses will not be significantly impacted by the operation of the LRT on Ducommun Street due to the infrequency of LRT operations on this street. If there is not enough room to accommodate a right-hand turn, the MTA will provide an alternative access point. However, this is not expected to be a problem due to the design of the lead tracks, and the entire width of the street will be available for truck turning movements.

A three-way track junction at Alameda Street and 90° turns at Center Street will require special traffic control including additional Alameda Street and Center Street signals and stop bar setbacks to prevent traffic from blocking the LRT turning movement path. Lead track crossings of Vignes Street and Center Street must be signalized to accommodate important street traffic movements, since these streets feed traffic to and under the 101 Freeway, respectively.

After the implementation of the aforementioned mitigation measures, the impacts on traffic during operations are considered less than significant under CEQA.

Construction of the LRT lead tracks will temporarily interfere with the normal flow of traffic. In order to minimize construction impacts, some streets will be subject to partial lane and total nighttime closures.

If needed, full closures will be scheduled during overnight hours and coordinated with the appropriate agencies. Site and street specific Worksite Traffic Control Plans will be developed in cooperation with the City of Los Angeles Department of Transportation (LADOT) and Los Angeles County to accommodate required pedestrian and traffic movements. These plans will be prepared using LADOT and MTA criteria. To the extent practical, traffic lanes will be maintained in both directions, particularly during peak traffic hours. Access to businesses will be maintained throughout the construction period. During utility relocation, it may be necessary to occupy additional traffic lanes at one time. It is possible that in some instances, block-long sections of streets will be closed temporarily for utility relocation and guideway construction. Pedestrian access (sidewalks) will remain open, although in some instances, portions of the sidewalks may be closed temporarily for decking construction. Temporary night sidewalk closures may be necessary in some locations for the delivery of oversized materials. Special facilities, such as handrails, fences, and walkways will be provided for the safety of pedestrians.

Minor cross streets and alleyways may also be temporarily closed but access to adjacent properties will be maintained. Major cross streets will require partial closure, half of the street at a time, while relocating utilities and constructing the light rail trackbed. Depending on allowable working hours, full blocks may require closures during excavation, preparation of subgrade, and track foundations placement. Where streets are not fully closed, one-way traffic will be allowed on half of the street. After the trackbed is constructed across a local street and the roadway is restored to its permanent condition, vehicles can resume original traffic patterns.

#### **4.20.3 Parking**

All 97 curb parking spaces will be eliminated on Ducommun Street. A windshield survey taken on a representative weekday identified approximately 70% usage of the spaces. Parking will remain available on adjacent streets. To mitigate for the parking losses, MTA will develop a metered parking lot on the northeast corner of Ducommun and Garey Streets in the parcel that will be acquired for the lead track alignment. This lot will be administered by LADOT in a manner similar to that of the metered curb parking currently in place. After these mitigations are implemented, no significant parking impacts will remain on Ducommun Street.

Regarding construction phase impacts, the width of the streets along the LRT alignment largely determine whether curb parking spaces will be removed and during which time period during the day. All curb parking will be eliminated on Ducommun Street to allow for the construction of the dual track LRT alignment. The impacts during construction are considered significant under CEQA. To minimize parking impacts, contractors will be required to have all employees park off-street at MTA approved locations to minimize the loss of crucial commercial parking. MTA will lease parking lots for construction employees if necessary. A parking mitigation plan will be developed to the standards of, and reviewed by, LADOT prior to construction to minimize impacts on curb parking. It may be possible to sequence construction activities so that multiple blocks of on-street parking are not temporarily removed at one time. This will make various on-street parking spaces available in an area under construction for a period of time. Some of the parking mitigation measures outlined in the parking discussion in Chapter 3 will be developed early so that they may be utilized during the period of construction. The lot proposed at Ducommun/Garey will be developed prior to beginning construction on Ducommun Street in order to mitigate lost parking. After the implementation of the planned mitigation measures, construction period parking impacts are considered potentially significant under CEQA.

#### **4.20.4 Land Use and Development**

Construction and operation of the M&SF lead track would be compatible with plans or policies of the Central City North Community Plan, because it would be implemented among other industrial,

commercial, and rail-related land uses. While construction would result in delaying traffic at times, less than significant impacts are anticipated due to their temporary duration. The lead track would result in one business displacement (commercial manufacturing use, designated "Commercial"). The commercial manufacturing displacement would be a less than significant land use impact, as there are other similar land uses in the vicinity. The lead track would not be located within a redevelopment area. No impacts are anticipated in the Empowerment specialized zone, as the lead track would not interfere with financing, "brownfields" deductions, or other city-aided business promotion programs supported in the Empowerment Zone. Because there are no significant impacts on land use and development, no mitigation measures are required.

#### **4.20.5 Economic and Fiscal**

The M&SF yard lead would result in displacing one business: a warehouse in an industrial area at the corner of Garey and Ducommun Streets. Although this business would result in employment reductions, long-term employment would increase due to the operation of the LRT Build Alternative associated with transit oriented development, LRT operations and maintenance, and other project-spurred employment growth. Thus, there would be less than significant long-term employment impacts. There would be no impacts on fire and police services associated with the yard lead.

#### **4.20.6 Land Acquisition/Displacements/Relocations**

One warehouse would be displaced, and there would be a partial take of an impound lot. Reconfiguration of the impact lot will result in less than significant impacts on that business. The Uniform Relocation Assistance and Real Property Acquisition Policies Act of 1970, as amended, mandates that certain relocation services and payments by MTA be made available to businesses displaced by construction and operation of MTA transit-related projects. Section 4.3.4 provides additional information about the Act. Implementation of the provisions of the Act will result in less than significant impacts on the displaced business.

#### **4.20.7 Communities/Neighborhoods**

The criteria considered to determine impacts includes: (1) substantial growth inducement; (2) displacement of a large number of businesses or residents; (3) substantial alteration of location, distribution, density, or growth rate of population in a manner inconsistent with public policy; and (4) disruption of neighborhood access or isolation of a portion of a neighborhood. The lead track to the M&SF, which will be located in an industrial area, will not result in adverse impacts on neighborhoods with regard to the criteria evaluated. There will be no residential displacements, one business displacement, and a partial take of one business. The lead track will not disrupt neighborhood access, nor will it isolate any portion of existing neighborhoods. The impacts on neighborhoods are not significant, and no mitigation is required.

#### **4.20.8 Visual and Aesthetics**

The M&SF lead track would result in demolition of an industrial building. Other physical changes would include trackwork and the overhead catenary system along the yard lead alignment. The removal of the industrial structure would not result in a significant visual impact because the surrounding parcels are also industrial. The street-level trackwork and the overhead catenary system would not result in significant visual impacts to the surrounding viewers because the streets are relatively wide and most of the surrounding land uses are industrial. There are no important visual resources in proximity to the yard lead. Therefore, there would be no visual impact related to important visual resources. No visual resource policies (see Section 4.6) apply to the yard lead. Therefore, there would be no visual impact

related to visual resource policies. The yard lead would not introduce new light, shade, or shadow elements. Glare from headlamps would be a factor where the yard lead would turn at Center Street, but the surrounding uses are industrial, so no visual impacts would occur. The yard lead would not introduce new opportunities for graffiti, so no visual impacts would occur. Because there are no significant impacts, no mitigation measures are required.

#### **4.20.9 Air Quality**

No adverse impacts on air quality are expected during LRT operations. Similar to the LRT mainline, emissions would be generated from the following construction activities: 1) demolition of one building; 2) welding related to continuously welded rail (CWR) operations; 3) mobile emissions related to construction worker travel to and from project sites; 4) mobile emissions related to the delivery and hauling of construction supplies and debris to and from project sites; and 5) stationary emissions related to fuel consumption by on-site construction equipment. Construction emissions related to these activities were considered in the air quality analysis presented in Section 4.19.2.6. The mitigation measures discussed in that section also apply to the yard lead portion of the project.

#### **4.20.10 Noise and Vibration**

The existing buildings along the yard lead alignment are all industrial uses with no noise-sensitive receivers with the exception of one company, Heet Sound Products, a light manufacturing and recording business. This company conducts audio recordings during times when the existing daytime noise levels are at their lowest, after 4 p.m. and on the weekends. The movement of LRT vehicles along the yard lead could potentially impact their operations depending on the number of trains and time of day this would occur. The potential vibration impact on the recording studio will be based on meeting the MTA Systemwide Criteria for maximum ground-borne vibration in studios of 65 VdB. However, since there is no information at this time as to the location of the studio within the building or the construction of the room containing the studio, no assessment of vibration impact can be made. Further study will be conducted in coordination with the owners of Heet Sound Products to complete the vibration analysis. If it is determined that train operations will impact the recording studio, then vibration control measures will be provided to mitigate the ground vibration to a level where they will meet the MTA Systemwide Criteria for maximum ground-borne vibration in studios of 65 VdB. These measures will consist of either an elastomeric trackwork isolation mat installed under the embedded trackwork along Ducommun Street, or vibration isolation of the recording studio using a floating room design with floor, walls and ceiling supported on vibration isolators. Therefore, vibration levels will be fully mitigated to a level of no significance.

#### **4.20.11 Geologic and Seismic Conditions**

Near-surface soils are moderately corrosive to metals and moderately deleterious to concrete. Accordingly, the corrosivity of subsurface materials is anticipated to have a potentially significant impact under CEQA. Concrete resistant to moderate sulfate exposure and corrosion protection for metals will be used for new planned structures reducing impacts to a level that is less than significant. Groundwater is expected to be approximately 30 to 45 feet below existing grade and is not expected to have an impact under CEQA. Like the other portions of the LRT project, the lead track alignment could be subject to significant ground shaking as a result of earthquakes on any of the documented or undocumented nearby active or potentially active faults. The alignment in relation to known active or potentially active faults indicates that the site is not exposed to a greater seismic risk than other sites in Southern California. The elements of the project will be designed in accordance with MTA's System Design Criteria and Standards, Volumes I through IV, and current building codes and standard engineering practices. This will reduce potential ground shaking impacts to a level of insignificance. The potential for liquefaction,

seismically-induced settlement, and subsidence are not anticipated to be major issues. It is unlikely that construction activity will encounter subsurface gases because the lead tracks will be at grade. The project will not result in the loss of potential mineral resources. The potential for surface fault rupture due to fault plane displacement propagating to the surface across the lead track alignment is considered low. The yard lead is not located within an area identified as having a potential for seismic slope instability, and there have been no known landslides in the vicinity. Therefore, slope instability is not anticipated to have a significant impact under CEQA.

#### **4.20.12 Hazardous Materials**

No evidence of subsurface gases was noted along the at-grade portions of the LRT Build Alignment (Group Delta Consultants, 2001). Although the yard lead is located within the Union Station Oil Field; based on the explorations and monitoring to date, it is unlikely that construction activities will encounter contamination. The potential for encountering contamination between exploration locations during construction is possible but is highly contingent upon the depth of excavation required. No excavations deep enough to impact groundwater are planned. Construction of new at-grade tracks will require only shallow excavation; therefore, the likelihood of encountering contamination is considered low. Nonetheless, considering that the yard lead is located in an area with a long industrial history and is within the Union Station oil field, encountering soil contamination is a potentially significant impact under CEQA. Remediation activities, if necessary, will be similar to those described in Section 4.19.2.14. With the implementation of mitigation efforts, no significant impacts will remain that would affect the proposed construction activities for the lead track.

#### **4.20.13 Water Resources**

Operation of the M&SF lead track would not result in creating new impervious surfaces, nor significantly increase water runoff or associated contaminants. Although daily operations of the track and trains may result in some petroleum-based contaminants leaking on the track surface, this is relatively negligible and will be mitigated by implementation of the project's Storm Water Pollution Prevention Plan (SWPPP). Construction of the lead track is not anticipated to result in increased sediment sources on the storm water and/or surface water systems, nor would it increase impervious surfaces associated with construction staging. Operation and construction of the lead track would not result in impacts to the Los Angeles River 100-year floodplain or any other floodplains, as it would not be located within these areas. Operation and construction of the lead track would result in no groundwater contamination or supply impacts to the regional groundwater aquifers, as it would not increase impervious surfaces, result in contaminated runoff eventually leading to groundwater, or involve excavation that would directly threaten groundwater quality. Although less than significant impacts on water resources are anticipated with the construction and operation of the lead track, mitigation for the entire project, as discussed in Sections 4.11.4 and 4.19.2.15, will be implemented.

#### **4.20.14 Natural Resources and Ecosystems**

No impacts are anticipated on vegetation, wildlife or on jurisdictional waters as a result of construction and operation of the yard lead. Therefore, no mitigation measures are required.

#### **4.20.15 Energy**

Operation of the lead track would not result in significantly increasing the regional energy consumption resulting from implementation of the entire LRT Build Alternative (see Section 4.13 for more information). Overall, the LRT Build Alternative would have a slightly higher annual operational energy consumption (about 27,460 barrels of crude oil) compared to the No-Build Alternative. This is

considered a less than significant energy consumption impact. Construction of the lead track would result in the one-time, non-recoverable energy costs associated with construction of trackwork, systems/equipment, vehicles, and other lead track-related functions. Facility-related energy would account for energy consumed during the production of construction materials used in new construction and maintenance and construction of the LRT Build Alternative including structures. Short-term use of oil, gas, and electricity for construction would unsubstancially reduce the overall amount of fossil fuels used within the area, region, and state. As with the entire LRT project, schedule coordination and modal interface between LRT, commuter rail, and local buses will be optimized to conserve energy. Furthermore, every aspect of station design will be reviewed to minimize lighting, heating, ventilating and air conditioning loads. Passenger areas within stations will be designed so that lights can be turned off during off-service hours. Cold water, instead of warm water, will be used to wash the vehicles. The track layout will be designed to minimize non-revenue vehicle movements. All major facilities, except the car washing facility, will have electric meters to monitor energy consumption and conservation. Through implementation of standard construction practices and techniques, fossil fuels and electricity will not be used in a wasteful or inefficient manner.

#### **4.20.16 Safety and Security**

The accident and safety, security and crime prevention, and fire services and emergency response impacts during both operation and construction will be similar to those cited in Sections 4.14.3 and 4.19.2.19, respectively. However, the magnitude of potential impacts will be less due to the shorter track length and because the LRT will operate much less frequently along the lead track than along the revenue mainline track. In addition, the lead track runs through a commercial/industrial area where there are few pedestrians and little through traffic. The main concern regards potential conflicts of the light rail vehicles during operations and activities during construction with delivery trucks operating in the area. The impacts are potentially significant. The mitigation measures presented in Sections 4.14.4 and 4.19.2.19 will also apply to the lead track portion of the project. However, because no schools are in the vicinity of the lead track, LAUSD will not need to be involved in this part of the project. Also, the mitigation stipulated for the subway segment will not apply to this at-grade portion of the project. With mitigation, these impacts would not be significant.

#### **4.20.17 Historic/Archaeological**

No impacts on historic or archaeological resources are anticipated as a result of construction or operation of the yard lead. Refer to Section 4.15 regarding potential impacts on the M&SF site itself.

#### **4.20.18 Paleontological**

The M&SF lead track segment is underlain by younger alluvium. There will be no potentially significant impact on paleontologic resources as a result of operation of the M&SF lead track segment because there will be no earth-moving activity in previously undisturbed strata. Therefore, no mitigation measures will be necessary. There will be potentially significant impacts as a result of construction of the M&SF lead track segment if and where earth-moving activities occur at least five feet below grade in previously undisturbed strata because of the moderate to high potential for encountering remains old enough to be considered fossilized. Mitigation measures, if necessary, will be the same as those presented in Section 4.15.4.

#### **4.20.19 Community Facilities/Parklands**

There are no parklands or other community facilities in close proximity to the lead track for the M&SF. Therefore, no adverse impacts would occur, and no mitigation is required.

**4.20.20 Section 4(f)**

There are no Section 4(f) resources in close proximity to the lead track for the M&SF. Therefore, no adverse impacts would occur, and no mitigation is required.

**4.20.21 Utilities**

The impacts of the lead track during operations and construction will be similar to those cited in Sections 4.18 and 4.19.2.17, respectively. However, the magnitude of potential impacts will be less due to the shorter length of the lead track compared to the LRT mainline track. The strategies to accommodate the LRT lead track to the M&SF and to avoid interference with normal utility operations ensure that no significant impacts will occur during LRT operations. No mitigation measures are required. During construction, many of the construction-related impacts on utilities are potentially significant. The mitigation measures cited in Section 4.19.2.17 will also apply to the lead track construction. After the mitigation measures are adopted, the impacts would be reduced to a level that is less than significant.

## 4.21 SUMMARY OF IMPACTS

### 4.21.1 Unavoidable Significant Adverse Impacts

No significant unavoidable adverse impacts under CEQA are expected to occur for the No-Build Alternative. The following environmental impacts may remain significant after mitigation is implemented for Options A and B of the LRT Build Alternative:

- ◆ The project will require property acquisition and relocation of residents and businesses. The high housing demand and low vacancy rate in the area may limit the availability of comparable replacement housing resulting in the need for some residents to relocate outside of the corridor. Likewise, it is possible that some displaced businesses may need to relocate outside the corridor.
- ◆ There will be significant impacts on 12 traffic intersections in the study area under Option A and on ten intersections under Option B. This issue is discussed in Chapter 3.0, *Transportation*.
- ◆ The placement of the catenary system on the 1<sup>st</sup> Street Bridge would add to the visual clutter of overhead lines already in the area possibly affecting sensitive uses around the bridge which cannot be mitigated; however, no adverse effect on the historic features of the bridge is anticipated since the bridge was once used for an earlier street rail system, and the catenary supports will be designed in a manner compatible with the historic character of the viaduct.
- ◆ Tunneling during construction of the subway segment may result in destruction of fossils.
- ◆ Temporary impacts during construction are possible with regard to parking losses, traffic lane closures, potential bus stop relocations, partial daytime sidewalk closures, total nighttime sidewalk closures, and traffic patterns due to movement of general construction traffic.
- ◆ Temporary air quality and noise and vibration impacts are also possible during construction. Visual and aesthetics impacts are possible in the vicinity of the Chavez/Soto construction staging area if screening materials cannot be placed high enough to prevent impacts on surrounding multi-story residential land uses with windows overlooking the construction site or if staging must take place directly below nearby residential windows.

### 4.21.2 Impacts Found Not to be Significant

The following impact areas were found not to be significant or are beneficial under CEQA and require no mitigation:

- ◆ Economic and fiscal
- ◆ Air quality during operations
- ◆ Energy
- ◆ Floodplains
- ◆ Utilities during operations

The following impact areas were found not to be significant after mitigation is implemented:

- ◆ Land use and development
- ◆ Property acquisition and displacement of businesses and residents, with the possible exception if residents and businesses cannot find adequate replacement facilities within the corridor.
- ◆ Visual and aesthetics with the possible exception of impacts on the 1<sup>st</sup> Street Bridge and on the neighborhood surrounding the Chavez/Soto construction staging area
- ◆ Noise and vibration during operations
- ◆ Geologic/seismic issues
- ◆ Hazardous materials



- ◆ Water resources
- ◆ Natural resources and ecosystems
- ◆ Safety and security
- ◆ Historic and archaeological resources
- ◆ Utilities

#### **4.21.3 Cumulative Impacts**

Cumulative impacts are the combined effects of independent projects and the Los Angeles Eastside Corridor project on the environment. A listing of recent and future development activity in the study area is provided in Section 4.1, *Land Use and Development*. Cumulative impacts refer to those effects that "...result from the incremental impact of a proposed action when added to other past, present, and reasonably foreseeable future actions. Cumulative impacts can result from individually minor but collectively significant actions taking place over a period of time." (40 CFR 1508.7). The anticipated cumulative impacts of Options A and B are the same, so the discussion of cumulative impacts presented below refers to both Options A and B collectively as the LRT Build Alternative.

##### **4.21.3.1 Land Use and Development**

Over the years, numerous freeways have been developed that cross the corridor, thus dividing the area and altering development patterns. The LRT Build Alternative would tend to integrate communities in the corridor and encourage transit-oriented development. The LRT Build Alternative would be compatible with local land use plans and policies and, as a result, would further local plan goals and policies within the study area. Construction activities would contribute to community disruptions resulting from other development projects in the area. This may result in a longer duration of noise and dust from construction, and greater traffic delays and traffic obstructions. The combined impact may heighten the perception of disruption experienced by the local community. These impacts may be concentrated in some locations at different times during construction but would diminish as the project concludes, and upon completion would no longer affect the community.

##### **4.21.3.2 Economic and Fiscal Impacts**

Over the years, the LRT Build Alternative would have long-term benefits for the communities it traverses and would further goals and policies for revitalization and investment within the study area. The fiscal benefits of operation would have a long-term impact for the communities. The loss of tax revenue would be offset by increased development near stations and along the LRT alignment. The LRT Build Alternative would not result in a cumulative adverse impact during operation and would be economically beneficial to its surrounding communities. Construction activities would contribute to community disruptions resulting from other development projects in the area. This may result in short-term economic impacts on local businesses, but would be temporary. Construction may result in overall beneficial impacts on tax revenues with increases in employment and spending that help offset any short-term economic impacts. Given that construction of the LRT Build Alternative would happen over a period of years and in different phases, impacts on fire and police services from this project and in conjunction with other development projects in the area may result in short-term cumulative impacts that would be less than significant due to advanced notices on traffic detours and closures.

##### **4.21.3.3 Land Acquisition/Displacement and Relocation**

Other properties in the corridor may be acquired and structures demolished as result of unrelated development projects. For example, between 1990 and 1993, 35 residential units and 11 businesses were

demolished in Boyle Heights<sup>10</sup>. In the context of overall demolition activity in the corridor, including the limited number of residential and commercial displacements resulting from construction of the LRT Build Alternative, these displacements do not represent significant cumulative or growth-inducing impacts.

#### **4.21.3.4 Communities/Neighborhoods**

A number of residential, commercial, and community facility projects are being planned for 1<sup>st</sup> and 3<sup>rd</sup> Streets along the LRT alignment. If these projects occur simultaneously with light rail construction, without appropriate mitigation, potentially significant cumulative impacts could occur on the surrounding neighborhoods. MTA will coordinate with other jurisdictions and agencies regarding the timing of construction activities for projects affected by or that may affect light rail construction. LADOT and the County DPW will require traffic plans to be developed and implemented to meet their requirements that will take into account construction of not only the LRT project, but other projects in the vicinity that may be simultaneously undergoing construction so that traffic impacts will be minimized to the extent possible.

#### **4.21.3.5 Visual and Aesthetics**

The addition of overhead wires related to the catenary system would contribute to existing and cumulative visual clutter in the vicinity of the Eastside Corridor. Otherwise, the project would not contribute to cumulative impacts.

#### **4.21.3.6 Air Quality**

The LRT Build Alternative would contribute to an increase in transit ridership, which would in fact reduce criteria pollutant emissions from transportation sources. While the cumulative effect of related projects may result in an overall increase in regional emissions and negative air quality impacts, the LRT Build Alternative would reduce the daily regional emissions of criteria pollutants. The LRT Build Alternative would have a beneficial cumulative effect on regional air quality.

#### **4.21.3.7 Noise and Vibration**

Noise levels in the corridor would be increased by the presence of the LRT Build Alternative since it would involve operating transit vehicles. Some of the other planned projects in the study area would also increase noise because they would result in increased travel. However, the LRT Build Alternative was not found to produce significant adverse impacts after mitigation. There are no known project locations where related projects would also produce noise increases. The project's level of increased noise after mitigation would not be significant because it would not involve violations of FTA's noise guidelines for severe impacts or ground-borne noise and vibration guidelines for impacts. However, the LRT Build Alternative would add to the ambient noise environment in a cumulative sense, although if projected transit patrons were traveling by private automobile, the likely increase in ambient noise would be greater.

#### **4.21.3.8 Geologic and Seismic Conditions**

Seismic hazards may be considered to be cumulative per CEQA. For example, liquefaction is the cumulative impact of shallow groundwater and ground shaking, and seismic settlement is the cumulative impact of loose soils and ground shaking. The geologic and seismic impacts will not be compounded by the LRT Build Alternative and future projects. The primary source of the hazards, the earthquake faults

---

<sup>10</sup> City of Los Angeles Building and Safety Department, 1994

affecting the site, are not and will not be affected by past, current, or future projects. Even geologic impacts that could potentially be affected by projects are also unlikely to be adversely affected because the project area is already developed and densely populated. Future projects that could potentially have an effect on geologic impacts would have to be large-scale projects, such as the LRT Build Alternative, and as such would be required to demonstrate that existing impacts will not be compounded. Accordingly, no cumulative impacts due to multiple projects are anticipated.

#### **4.21.3.9 Hazardous Materials**

Although the LRT Build Alternative has the potential to affect or be affected by potentially hazardous waste sites during operation, hazardous contamination was not encountered in explorations and monitoring performed to date in the vicinity of the alignment. Even if some hazardous contamination is encountered between exploration and monitoring locations during construction, proper mitigation will be implemented prior to operation. The operation of the electrically powered LRT vehicles is not expected to introduce hazardous materials to the project area. The proposed operation activities are not likely to present a significant cumulative impact under CEQA. The cumulative impacts which relate to the proposed construction activities are comprised of those impacts from other projects which add to existing hazardous waste (installation of hazardous materials pipelines; facilities of hazardous waste generators; transfer, storage or disposal facilities, etc.); or impacts of the proposed construction activities which add to the amount of existing hazardous waste. The proposed construction activities are not likely to present a significant cumulative impact under CEQA if conducted in accordance with applicable hazardous waste laws, statutes and regulation in conjunction with use of sound hazardous material detection and management practices. Hazardous materials encountered during construction will be removed or treated in place, thus reducing the potential for cumulative impacts.

#### **4.21.3.10 Water Resources**

Planned and approved projects in conjunction with the LRT Build Alternative have the possibility of short-term construction-related impacts to surface waters and groundwater. These conditions may exist until the project is completed and/or permanent protective measures are established. All facilities will be constructed pursuant to guidance published in Sections 401, 402, and 404 of the Clean Water Act and will follow the most current guidance within the NPDES program. Best Management Practices (BMPs) will be incorporated, as appropriate.

#### **4.21.3.11 Natural Resources and Ecosystems**

The entire study area is entirely within developed portions of Los Angeles County. Because no unmitigated adverse impacts on the natural environment have been identified in this study, construction and operation of the project would not contribute to the cumulative loss of native trees, shrubs, and groundcover, or to the loss of wildlife habitat supported by such vegetation.

#### **4.21.3.12 Energy**

The energy conservation measures for the Los Angeles Eastside Corridor, as discussed in Section 4.13, also apply to the other rail transit, bus fleet, and fixed facilities that would serve the entire Los Angeles region. These area-wide conservation measures would conserve large quantities of energy throughout the regional transit network. In addition, the LRT Build Alternative, in coordination with other regional public transportation improvements, would help to reduce dependency on single-occupant vehicles (SOVs). This would in turn reduce fossil fuel energy consumption and improve roadway congestion. Construction of the LRT Build Alternative in combination with other construction projects occurring within the same period and within the region may result in a short-term increase in energy consumption.

This would be a temporary effect and given the available energy resources available within the region and state, no significant impact is anticipated. Some of the materials needed to construct the project may not be manufactured within the region or state and would therefore not result in the use of local or statewide energy resources.

#### **4.21.3.13 Safety and Security**

The number of vehicular accidents may increase in the corridor due to the increased number of vehicles traveling to station locations and background growth. The potential cumulative effect of increased vehicle trips in the corridor may be counterbalanced by a slight mode shift away from autos toward public transportation. This latter effect could be argued to reduce cumulative accident potential, rather than add to it. The addition of new LRT stations may add to the number of locations in the corridor where crimes could occur. However, the additional activity concentrated around the stations may actually reduce crime. In any case, with proper surveillance, the possible number of increased crimes occurring at such locations is expected to be small. Even with planned development in the corridor, the magnitude of additional criminal activities is not expected to be significant on a cumulative basis. The LRT Build Alternative could cause a slight increase in demand for additional fire or police personnel. This increase, if it occurs, would be characterized as a cumulative impact, although the magnitude is not considered significant.

#### **4.21.3.14 Historic/Archaeological/Paleontological Resources**

All proposed and projected impacts to cultural resources from other projects within all jurisdictions crossed by the LRT alignment have been or will be mitigated through application of CEQA, NEPA, and Section 106 of the National Historic Preservation Act regulations. Therefore, the LRT Build Alternative will not cause a cumulative impact on cultural resources. Construction of this alternative, in combination with other projects in the study area, could contribute to a cumulative loss of fossil remains from the older and younger alluvium that potentially would have been available for future study, a potentially significant impact. However, the mitigation measures discussed in Section 4.15.4 would reduce impacts to an insignificant level.

#### **4.21.3.15 Utilities**

A number of other development projects are currently under construction, in the planning stages, or proposed within the vicinity or adjacent to the LRT Build Alternative. To minimize potential cumulative impacts associated with these projects, coordination of all projects with the utility service providers is critical to avoid any temporary or prolonged utility service outage. The utility companies and utility customers should consider planning any service upgrades now at the beginning of these urban renewal projects rather than trying to maintain a patch work utility infrastructure until all the proposed projects are completed. If acceptable to the utility providers, MTA will create a third party arbitrator to facilitate resolution of any disagreements between MTA, major utility companies, and city agencies regarding any utility issues. The third party arbitrator would rule on utility issues that would affect the LRT Build Alternative project or other development project within the vicinity or adjacent to the LRT Build Alternative. With proper planning and scheduling, potential cumulative impacts would be reduced to a level that is less than significant.

#### **4.21.4 Growth-Inducing Impacts**

The LRT Build Alternative, combined with other projects in the area, would improve transportation service and could promote opportunities for new development. Station locations would be the most likely areas where future growth could occur. The proposed project alignment already has several transit-

oriented characteristics and uses that provide a strong base for future LRT service, and existing local policies promote transit improvements in the area. Provision of the proposed project would be consistent with goals and policies for transit service and redevelopment and revitalization locally. However, much of the adjacent project area is currently developed which may limit opportunities for additional infill. To the extent that measures to promote revitalization efforts are successful, new growth resulting from the proposed project is likely to be directed to areas most suitable for more intense land uses and is likely to occur in the form of high density, multi-unit development. This is a beneficial impact as it helps the community realize their revitalization goals. With regard to the Central Business District and Union Station, the Los Angeles Community Redevelopment Agency (CRA)<sup>11</sup> has indicated that the Central Business District and Union Station would be minimally affected with respect to inducing further development because there are already several modes of transportation in the area, and a new one would have little additional effects. The Little Tokyo District, however, would benefit from moderate induced growth, as the LRT Build Alternative would help to centralize and organize development along the project corridor.

#### **4.21.5 Irreversible and Irretrievable Commitment of Resources**

Construction of the LRT Build Alternative would involve irreversible and irretrievable commitments of resources. Fossil fuels would be used to power construction vehicles and equipment and in the manufacturing process for project components. Construction materials such as asphalt, cement, steel, lumber, and fabricated materials would be irreversibly committed to the rail line. Operation of the LRT Build Alternative would require the use of electricity for power but would also reduce vehicular energy consumption.

#### **4.21.6 Relationship Between Local Short-Term Uses of the Environment and the Maintenance and Enhancement of Long-Term Productivity**

The No-Build Alternative would not involve a short-term use of the environment but would allow long-term conditions to worsen, such as poor transit access, particularly for transit dependent portions of the population, and increased traffic congestion and associated air quality problems. The LRT Build Alternative would involve short-term uses of the environment during the project's construction period, such as the use of fuel and construction materials (as described in Section 4.21.5). However, these short-term adverse environmental effects and uses of resources would be outweighed by the project's long-term benefits, which include the following:

- ◆ Improved transit access to employment, commercial, and recreational centers served by the project;
- ◆ Better achievement of certain development objectives in most station areas;
- ◆ Decreased traffic congestion; and
- ◆ Improved air quality during operations.

#### **4.21.7 Environmentally Superior Alternative**

An environmentally superior alternative needs to be identified under CEQA. Although the No-Build and TSM Alternatives would involve fewer environmental impacts, they would not provide the desired levels of mobility and accessibility for this lower-income, transit-dependent and principally Hispanic community. The LRT Build Alternative would, on the other hand, provide access to a broader range of employment, shopping, educational, and cultural opportunities, consistent with the goals and objectives for the Eastside Corridor. It is likely that transit-oriented development districts would also be spurred by the project, and additional short-term (construction) and long-term employment would be generated.

<sup>11</sup> Telephone conversation with Donald Spivack, Deputy Administrator, CRA, December 14, 2000.

The impacts of the other alternatives that were evaluated in the Re-Evaluation/Major Investment Study (refer to Chapter 2.0, *Alternatives Considered*, for more information) and the suspended Metro Red Line project vary by subject area for each alternative. Overall, none of these alternatives can be identified as necessarily superior in terms of environmental considerations. Even the suspended Metro Red Line project, which only extended 3.7 miles, instead of the approximate six-mile alignment of the LRT Build Alternative, involved more property acquisition and displacements.



## 5.0 FINANCIAL ANALYSIS AND COMPARISON OF ALTERNATIVES

### 5.1 FINANCIAL ANALYSIS

The cost of a transportation investment falls into two categories: capital costs, and operating and maintenance (O&M) costs. Capital costs are the start-up costs for the project, including the costs of guideway construction, vehicles, and any system facilities necessary before the project can begin operation. Operating and maintenance costs are the costs associated with the regular running of a new transportation facility. Costs such as labor, vehicle maintenance, and overall facility maintenance all fall into this category.

This section discusses both types of costs, presents the proposed capital financing plan, and then analyzes the Los Angeles County Metropolitan Transportation Authority (MTA's) ability to afford the alternatives under consideration.

#### 5.1.1 Capital Cost Estimates for the LRT Build Alternatives

This section summarizes the capital cost estimates for the Light Rail Transit (LRT) Build Alternatives, Option A and Option B. The No-Build Alternative does not have any associated capital costs for comparative purposes as they are considered in the overall financial capability of the MTA with the LRT Build Alternatives.

The capital cost estimating approach is based on the Preliminary Engineering level cost estimates done by MTA for Options A and B. The capital cost estimates were prepared with all costs expressed in 2001 dollars. Cost estimates are developed by identifying quantities on preliminary engineering drawings and applying standardized rates. For guideways and/or alignment lengths, typical cross sections and engineering studies provided a basis for identifying costs on a linear foot basis. The alignment plans and station concepts are included in Appendices E and F for Options A and B. In addition, capital costs for additional buses (for the expanded bus services) and the LRT vehicles as well as the costs for improving the existing Red Line Yard as the maintenance and storage facility (M&SF) for the Eastside LRT Build Alternatives have been included.

The total capital cost includes allowances for Owner Controlled Insurance Program (OCIP), professional services (final design, design services during construction, agency costs, construction management, specialty subconsultants), yard leads, bridge retrofits, right-of-way, testing and pre-revenue operations, environmental mitigation, urban design, and artwork. Additionally, a project contingency has been included.

In addition, an implementation schedule was needed in order to conduct the financial analyses as required by the Federal Transit Administration (FTA). Revenue service is expected in March 2008. The capital costs are also presented in year-of expenditure dollars. Year of expenditure dollars are important because they take into account inflation over the time of project development. The year of expenditure estimate is an estimate of the actual cost of the project options.



Table 5-1 presents the total capital costs (in millions of dollars) for Option A and Option B in both 2001 dollars and in year of expenditure dollars. The year of expenditure capital costs vary between \$822 million (LRT Option A) and \$826 million (LRT Option B). The difference in capital costs between the two options relates to the treatment of the Indiana Street transition as described in Chapter 2. These are additions to the right-of-way costs but reductions in the cost of the special conditions identified in Indiana Street and the movement of the 1<sup>st</sup>/Lorena station to 3<sup>rd</sup>/Indiana balance out the difference between the options. Both Option A and Option B are consistent with the current financial plan of MTA and have funding available for either option.

	2001 Dollars in Millions		Year of Expenditure Dollars in Millions	
	LRT Option A	LRT Option B	LRT Option A	LRT Option B
<b>Construction and Procurement</b>				
Guideways	\$195.2	\$190.2	\$216.2	\$210.9
Yards and Shops	\$5.5	\$5.5	\$6.3	\$6.3
Systems	\$65.8	\$64.4	\$75.7	\$74.1
Stations	\$85.5	\$85.6	\$97.1	\$97.2
LRT vehicles and buses	\$100.6	\$100.6	\$113.3	\$113.3
Special Conditions	\$68.5	\$60.8	\$76.5	\$68.0
Right-of-Way	\$19.0	\$35.2	\$20.2	\$37.9
Subtotal	\$540.1	\$542.4	\$605.3	\$607.7
<b>Professional Services</b>	\$144.2	\$144.2	\$156.3	\$156.3
<b>Project Contingency</b>	\$54.5	\$56.1	\$60.7	\$62.3
<b>Total Cost</b>	<b>\$738.8</b>	<b>\$742.8</b>	<b>\$822.3</b>	<b>\$826.3</b>

### 5.1.2 Operating and Maintenance Cost Estimates

This section summarizes the Operating and Maintenance (O&M) cost estimate for the LRT Build Alternatives, Option A and Option B. The O&M costs were determined using the MTA's O&M cost model. This cost model was developed to estimate O&M costs for MTA's bus, Blue Line, Green Line, and Red Line operating modes, as well as support department costs related to operations.

The MTA O&M cost model estimates staffing requirements, labor costs, and non-labor expenses by transit mode (i.e., Motor Bus, Blue Line, Green Line, Red Line) and department within each mode. The model is calibrated to MTA's latest fiscal year (FY) 2000-2001 Adopted Budget. Overhead costs are allocated to the transit modes based on the allocations made for MTA's Adopted Budget. The model uses operating characteristics (e.g., peak vehicles, number of stations, passengers) to determine future costs. As future operating plans change (e.g., new rail lines are constructed), costs change accordingly.

The model meets Federal Transit Administration (FTA) guidelines for estimating operating costs. These guidelines specify that:

- ◆ Costs are computed by estimating labor and materials needed to provide a given level of service, and then unit costs are applied to the estimated future labor and material cost items;

- ◆ Costs are calculated based on operating characteristics for each mode (e.g., Red Line train hours), rather than for all modes combined (e.g., systemwide passengers);
- ◆ Each reported labor and non-labor expense is calculated separately, which ensures that equations are mutually exclusive and cover all operating costs; and
- ◆ Most cost items are variable, meaning that cost estimates will change with projected changes in service.

The model calculates costs separately for each labor and non-labor item in MTA's FY 2001 budget. The driving variables used in the O&M cost model are presented in Table 5-2 below.

Input Statistic	MTA Bus	Rail Modes
Annual Boardings (Unlinked Passengers)	X	X
Peak Vehicles	X	X
Active Fleet Vehicles	X	X
Operating Divisions	X	X
Annual Revenue Bus/Car Miles	X	X
Annual Revenue Bus/Train Hours	X	X
Contract Service Hours	X	
Route Miles		X
Elevated Stations	X	X
At-Grade Stations	X	X
Subway Stations	X	X
Total Stations		X
Automated Operation (Green Line)		X

For the No-Build and Eastside LRT Build Alternatives, O&M costs were calculated for the entire MTA system of bus, Red Line, Green Line and Blue Line service.

The costs were first estimated for the MTA's No-Build Alternative. The costs for the LRT Build Alternative were then estimated for the year 2020 in 2001 dollars. The LRT Build Alternative includes not only the operation and maintenance cost of the LRT service, but includes the cost of the enhanced bus system as described in Chapter 2.

The increase in annual operating and maintenance cost for the LRT Alternatives Options A and B over the No-Build Alternative is approximately \$23.5 million in the year 2020 in 2001-dollar equivalents. Of the \$23.5 million additional cost required for the Eastside Corridor project approximately \$11.5 million would be spent on the LRT service and \$12 million would be spent on supporting the increased bus services.

### **5.1.3 The Project Finance Plan**

The Eastside LRT project became a reality in July 2000 when the Governor and the California State Legislature approved the Traffic Congestion Relief Program (TCRP). This program provided \$236 million in State funds for the Eastside LRT project. At the same time the MTA developed a comprehensive financial program that would demonstrate that MTA could construct and operate the Eastside Corridor project as well as fixed guideway projects in the San Fernando Valley and Mid-City/Wilshire corridors. The financial program is described in more detail in the following section. The Eastside LRT project has a capital budget of between \$822 and \$826 million as described above in year

of expenditure dollars. Table 5-3 lists the anticipated source of capital funds and the expected amount. Less than 60% Section 5309 New Starts federal funding is proposed in accordance with current FTA policies and the balance coming from other formula or State and Local funded programs.

Source	Option A		Option B	
	Amount (\$ millions)	Amount (\$ millions)	Amount (\$ millions)	Amount (\$ millions)
<b>Federal</b>		<b>\$532.7</b>		<b>\$532.7</b>
FTA Section 5309 New Starts	\$490.7		\$490.7	
FTA Section 5309 Fixed Guideway Modernization	\$38.9		\$38.9	
Congestion Relief and Air Quality (CMAQ)	\$3.1		\$3.1	
<b>State/Local</b>		<b>289.6</b>		<b>293.6</b>
State Traffic Congestion Relief Program	\$236.0		\$236.0	
State Regional Improvement Funds (AB 1012)	\$5.2		\$5.2	
Proposition A 35%	\$48.4		\$52.4	
<b>TOTAL</b>	<b>\$822.3</b>	<b>\$822.3</b>	<b>\$826.3</b>	<b>\$826.3</b>

#### **5.1.4 Financial Capability to Build and Operate**

MTA has used its financial forecasting model for Los Angeles County to assess the financial feasibility of the Eastside Corridor alternative. This financial model is the tool used to project all capital and operating costs and revenues for all transportation modes in Los Angeles County from FY 2000 through FY 2025.

In a document submitted to the FTA (Section 5309 submittal, August 2001), the MTA provided detailed analysis from the financial forecasting model to establish the ability to fund projects in the Mid-City/Westside, San Fernando Valley, and Eastside corridors of Los Angeles County. The No-Build scenario was modeled to provide a baseline for the build alternatives.

The model includes revenues from the State Traffic Congestion Relief Plan (AB 2928) and FTA 5309 New Starts funds, which are expected to provide 75% of the capital funding, needed for the capital costs of the corridors. The balance of the capital funding plan for these projects will come from committed flexible federal funds (Congestion Relief and Air Quality - CMAQ and Regional Surface Transportation Program - RSTP) and local half-cent sales tax funds. The funding plan for the projects is stable and reliable given the commitments of funding recently realized. The financial analysis indicates that funding is available to complete the Eastside LRT Alternative Option A or Option B so that operations can begin as soon as March 2008.

The twenty-year cash flows indicate that MTA has the financial capacity to build and operate the Eastside LRT project, Option A or Option B, including the supporting bus operations while continuing the operation and maintenance of the entire regional transit system. Selection of an Eastside LRT Alternative, which requires funding beyond the financial analysis outlined in the Section 5309 submittal, would need to be integrated into the MTA's Long Range Plan, since it would commit funds that could otherwise be considered for other projects.

## 5.2 COMPARATIVE ANALYSIS OF ALTERNATIVES

This section provides a variety of measures to evaluate and compare the LRT Build Alternatives, Option A and Option B to the No-Build Alternative. These measures are consistent with the FTA guidelines for assessing major investments. Enactment of the Transportation Equity Act for the 21st Century (TEA-21) in 1998 requires that FTA evaluate and rate candidate New Starts projects as the basis for approving projects for federal funding. Table 5-4 summarizes the indices included in this section.

Analysis Category	Measures
Effectiveness in Improving Mobility	Corridor Goals and Objectives
	Ridership
	Travel Time Comparison
	Travel Time Savings
Cost-Effectiveness	Annualized Cost per New Daily Transit Trip
Operating Efficiencies	Operating Cost per Passenger Mile
Equity	Discussion of Demographic Factors

Other analyses and discussion for FTA measures related to air quality and transit supportive land use can be found in Chapter 4. This chapter ends with a discussion of the trade-offs between the No-Build Alternative and the LRT Build Alternative Option A and the LRT Build Alternative Option B.

### 5.2.1 Effectiveness in Improving Mobility

Various elements serve as indicators of improved mobility including responsiveness to goals and objectives. Ridership describes the amount of people using the proposed project, as estimated through a transportation demand model. A travel time comparison provides an understanding of how the proposed project performs during an average transit trip between two points. Travel time savings assess the annual hours of time saved for both transit and automobile users as a result of the proposed project.

#### 5.2.1.1 Corridor Goals and Objectives

In addition to the evaluation factors discussed below, the LRT Build Alternatives, Option A and Option B, relate directly to the goals and objectives presented in Section 1.3.5. Throughout the planning development process these goals have been at the forefront of the alternatives development, analysis, and selection. The six goals are listed below:

- ◆ Improve access and mobility for residents, employees, and visitors to the Eastside Corridor.
- ◆ Support land use and development goals as stated in the City of Los Angeles and County of Los Angeles community plans and regional plans.
- ◆ Achieve local consensus by ensuring that the process is responsive to the community and policy-makers.
- ◆ Provide a transportation project that is compatible with and enhances the physical environment wherever possible.
- ◆ Provide a transportation project that minimizes adverse impacts to the community.
- ◆ Provide a transportation project that is reasonably within budget constraints for both capital and operating expenses.

The LRT Build Alternatives, Option A and Option B, have been developed to respond to the above goals of the Eastside Corridor community and policy-makers.

### 5.2.1.2 Ridership

For all proposed projects, ridership is a function of travel time and cost. All else being equal, the faster technologies attract more riders. The speed is usually a function of both the technology and the physical conditions in which it has to operate. Longer segments have higher ridership because they service a larger area, incorporate more stations, and potentially reduce transfers.

Ridership has been estimated for the proposed project LRT Build Alternatives through the MTA's travel simulation model, based on the forecast year 2020. Model runs were performed for the No-Build Alternative, LRT Build Alternative Option A, and the LRT Build Alternative Option B.

The implementation of the LRT Build Alternative Option A, which includes the additional bus system improvements, would increase transit trips in the region by about 25,000 per day compared to the No-Build Alternative. Option B would increase transit trips by about 28,000 per day compared to the No-Build Alternative. The estimated daily ridership in the forecast year 2020 on the Eastside segment of the light rail line from Union Station to Atlantic Boulevard, for both options, is over 16,000 per day. With the combination of the Eastside segment and the Pasadena Blue Line, the estimated daily ridership in the forecast year of 2020 is over 45,000 for the 20-mile line.

### 5.2.1.3 Travel Time Comparisons

In order to compare the LRT Build Alternatives, Options A and B, to the No-Build Alternative related to showing mobility improvements related to reducing travel times, two points along the proposed LRT line were compared to four different destination points in the Los Angeles area. The four destination points included downtown Hollywood (Hollywood/Highland); Wilshire and Fairfax; Downtown Los Angeles (1st/Hill); and Pasadena Downtown (Fair Oaks/Colorado). 1st/Soto and 3rd/Mednik were used as the beginning points for the transit trip comparisons. Based on the station areas selected, Options A and B would have the same travel times. Table 5-5 presents these comparisons.

Trip Origin	Hollywood/Highland			Wilshire/ Fairfax			1st/Hill			Fair Oaks/Colorado		
	No- Build	Option A	Option B	No- Build	Option A	Option B	No- Build	Option A	Option B	No- Build	Option A	Option B
1st/Soto	62	53	53	70	60	60	26	25	25	67	55	55
3rd/Mednik	67	60	60	75	67	67	39	32	32	47	45	45

All of the comparisons show improvement over the No-Build Alternative.

### 5.2.1.4 Travel Time Savings

This measure is defined as the total travel time savings that are expected to result from the LRT Build Alternatives, Options A and B, in the forecast year (2020), compared to the No-Build Alternative. This aggregate value includes travel time savings for people making trips on transit (both new and existing

transit riders) as well as savings that accrue to people using competitive modes (automobile users). This measure is calculated using reported values from the MTA's transportation simulation model. It is expected that the LRT Build Alternative, Option A or Option B, will save users over 400,000 hours in travel time in the forecast year (2020) over the No-Build Alternative.

### 5.2.2 Efficiency (Cost-Effectiveness)

Cost-effectiveness is a measure used to evaluate how the costs of a transit project (for both construction and operation) compare to the expected benefits (increased transit ridership).

The FTA's cost effectiveness criterion is measured by the incremental cost per incremental passenger in the forecast year. This measure is based on the annualized total capital investment and annual operating and maintenance (O&M) costs, divided by the change in annual transit system ridership, expressed as the following equation:

$$\text{Cost Effectiveness Index} = \frac{\Delta \text{Capital Cost} + \Delta \text{O\&M Cost}}{\Delta \text{Linked Transit Trips}}$$

The smaller the index, the more cost-effective the project alternative. To calculate the change in capital cost, project costs discussed in Section 5.1.1 were aggregated according to their assumed useful life and annualized accordingly, using FTA annualization factors shown in Table 5-6:

Project Element	Useful Life	Annualization Factor
Right-of-way	100 years	0.070
Structures, trackwork, signals, electrification	30 years	0.081
Rail vehicles	25 years	0.086
Buses	12 years	0.126

Source: Technical Guidance on Section 5309 New Starts Criteria, FTA, July 2000.

Annual operating and maintenance costs were calculated using the approach described in Section 5.1.2. The change in transit trips for the forecast year 2020 was determined using the MTA travel forecasting model.

Table 5-7 summarizes the data used in the calculation of the cost-effectiveness index for Options A and B of the LRT Build Alternative, and the resulting incremental cost per incremental passenger is shown in Table 5-8.

LRT Build Alternative/Options	Annualized Capital Cost (millions)	Annual O&M Cost (millions)	Annual Linked Trips (millions)
LRT Build Alternative – Option A	\$61.06	\$23.5	7.864
LRT Build Alternative – Option B	\$61.39	\$23.5	8.844

LRT Build Alternative/Options	Over No-Build Alternative
LRT Build Alternative – Option A	\$10.76
LRT Build Alternative – Option B	\$9.60

Based on cost-effectiveness, LRT Build Alternative Option B is slightly most cost-effective, but not significantly when compared to the No-Build Alternative.

The ridership projections are based on the 1998 adopted demographic projections by the regional metropolitan planning organization, the Southern California Association of Governments (SCAG). As such they are the official future demographic projections. However, they are believed to understate project ridership. Since the 1998 adopted demographic projections assume most of the future growth in Los Angeles County will occur on the outer edges of the county.

### **5.2.3 Operating Efficiency**

The FTA uses a single measure for the Operating Efficiencies criterion, which is the change in operating cost per passenger mile for the entire regional transit system. The basic calculation involves dividing the system annual operating cost for transit service by the system annual passenger-miles projected for the year 2020. Calculation of the total transit operating costs is discussed under Section 5.1.2, (Operating and Maintenance Cost Estimates). System annual passenger-miles are produced from the MTA transportation model. The No-Build Alternative has an operating cost per passenger mile of \$0.36. The LRT Build Alternative, Options A and B, with the increases in service and usage produced the same overall system operating cost per passenger mile of \$0.36. Therefore the LRT Build Alternatives compared to the No-Build Alternative for this FTA measure shows no change.

### **5.2.4 Equity Considerations**

Equity considerations generally fall into three interrelated classes: (1) the extent to which the transportation investments improve transportation service to various population segments (i.e., the extent to which transit improvements benefit the transit dependent); (2) the distribution of project costs across the population through the funding mechanisms used for the local contribution for construction and operation; and (3) the incidence of significant environmental impacts. In addition, Executive Order 12898, *Federal Actions to Address Environmental Justice in Minority Populations and Low-Income Populations*, requires that federal agencies consider and address disproportionately high adverse environmental effects of proposed federal projects on the health and environment of minority and low-income populations to the greatest extent practicable by law. Section 4.5 of this document discusses in detail the equity and environmental justice considerations for the Eastside Corridor and for the LRT Build Alternatives, Options A and B. It discusses the study area demographics, the historic major issues of the Eastside Communities related to major infrastructure projects, and the extent of the public involvement program conducted as part of this planning process.

The No-Build Alternative would not offer the study area residents and businesses the enhanced mobility, regional connectivity, and accessibility provided by the LRT Build Alternative as stated in Goals and Objectives for the Eastside Corridor.

The LRT Build Alternative provides many benefits related to equity, mobility improvements, economic revitalization, employment opportunities, federal and state funds for construction, and additional local funds for the operating and maintenance costs of the LRT and expanded bus services, as discussed below. There are some potential impacts as identified in Section 4.5.4., but the benefits by far outweigh the impacts.

#### **5.2.4.1 Equity**

Indicators of transit dependence, such as low-income households and zero-auto households, are nearly three times higher than for Los Angeles County as a whole. The need for and reliance on transit has not been balanced by regional public transportation investments that would benefit this transit dependent community. For example, MTA rail services extend to Western Avenue and to North Hollywood, to Norwalk and El Segundo, to Long Beach and ultimately to Pasadena. Metrolink serves suburban destinations in all directions. Yet, no major investment in transit service, either bus or rail, has been made in the Eastside Corridor. A concerted effort to extend the Metro Red Line to the corridor was suspended in 1998 as discussed in Chapter 1. In addition, the corridor has borne the disproportionate effects of a regional freeway system that has cut through its neighborhoods to reach suburban destinations. Implementing LRT service in the corridor would help restore the balance of regional capital transportation expenditures as well as compensate for the adverse impacts that previous transportation planning decisions have caused.

#### **5.2.4.2 Mobility/Transit Travel Times/Regional Connectivity**

The LRT Build Alternative is expected to increase the number of daily transit trips compared with the current bus service offered by the No-Build Alternative and reduce travel times. Travel times between the corridor and major travel destinations, such as Hollywood, Wilshire Boulevard, Downtown Los Angeles, and Pasadena, would decrease with the LRT Build Alternative. (As discussed in Section 5.2.1 above). This increase indicates the value of quality transit service in attracting riders. It also indicates that light rail service offers improved access for area residents to local destinations as well as to the regional rail and bus system and, therefore, to regional destinations. The LRT Build Alternative also would serve many educational and community centers in the corridor, enhancing mobility for young adults and school age children.

#### **5.2.4.3 Economic Revitalization**

The LRT Build Alternative includes eight new stations as well as a station at Union Station. With proper incentives and with favorable market conditions, developers may consider the merits of constructing housing and commercial developments that are oriented to the light rail stations and that take advantage of the new light rail service. Station areas that have vacant land resulting from right-of-way acquisition for the suspended Metro Red Line project or for the construction of the LRT Build Alternative can be developed, in accordance with City and County of Los Angeles planning and redevelopment policies and Community Plans, to benefit the surrounding neighborhoods. In a corridor that has an extremely low vacancy rate and a great demand for affordable housing, such development could provide needed housing and space for retail and social service uses. The new development could offer larger units for families with children, helping to meet a dire need in the community. In addition, landscape treatments along the light rail line could enhance the urban design of the community, making opportunities for development more attractive.



#### **5.2.4.4 Employment Opportunities**

The LRT Build Alternatives are anticipated to generate approximately 47,000 (Options A and B) new construction jobs and, within the first 14 years of operation, over 1,000 permanent jobs to operate and maintain the LRT line and additional bus service. In addition, MTA will be formulating a local hiring policy that will be reviewed by the Eastside Corridor Review Advisory Committee. Such a program will include resources for job development and training. MTA also currently offers a series of programs designed to encourage minority and women-owned businesses to participate in the construction and operation of new transportation projects.

#### **5.2.4.5 Project Funding**

As discussed in Section 5.1.3, almost \$830 million in Federal and State/Local funding has been anticipated for the LRT Build Alternatives. The estimated \$23.5 million in additional annual operating and maintenance funds will be provided from local MTA sales tax dedicated to transit uses.

#### **5.2.5 Trade-Offs Between Alternatives**

The following observations highlight key financial differences and the tradeoffs between the No-Build Alternative and the LRT Build Alternatives, Options A and B, relative to cost, performance, mobility, and impacts.

The tradeoff between the No-Build Alternative and the LRT Build Alternative is that the No-Build Alternative would involve fewer environmental impacts, but would not provide an enhanced level of mobility and accessibility to this lower-income, transit-dependent and principally Hispanic community. The LRT Build Alternative would, on the other hand, provide improved access to a broader range of employment, shopping, educational, and cultural opportunities, consistent with the goals and objectives outlined in Chapter 1 (Section 1.3.5) for the Eastside Corridor and discussed above in Section 5.2.1.1. The LRT Build Alternative and its two options will also provide improvements in air quality. The LRT Build Alternatives will have some impacts and disruptions during construction but that is a consideration in the tradeoff between the No-Build Alternative and the LRT Build Alternative and its two options.

The tradeoffs between the LRT Build Alternative, Options A and B, involve funding availability to build each option, the relative cost-effectiveness, and the possible impacts.

From a mobility standpoint, as discussed in Section 5.2.1, LRT Build Alternative, Options A and B provide a comparable level of improved mobility to the Eastside Corridor. The capital costs, operating costs, and cost-effectiveness are similar. Both Options A and B are within the funding capability of MTA with the assistance of FTA and State funds.

Related to equity, as discussed in Section 5.2.4, Options A and B both provide additional investment and job opportunities to the Eastside Corridor while providing increased mobility and economic revitalization potential.

The transportation and environmental consequences are discussed in detail in Chapters 3 and 4. Relative to traffic and parking, both options impact traffic operations at a number of intersections but Option B has less impacted intersections especially related to the reduction of traffic impacts on Indiana Street. Related to parking, Option A has the most number of on-street parking spaces removed compared to LRT Build Alternative Option B.

One of the most significant tradeoffs between the LRT Build Alternative options is relative to the amount of land acquisition/displacement and relocations required. As discussed in Section 4.3, LRT Build Alternative Option A would acquire 10 multi-family and 8 single-family units (displacing about 72 persons) and 20 businesses (displacing approximately 111 employees). LRT Build Alternative Option B, because of the proposed acquisitions along the east side of Indiana Street, would require the acquisition of 10 multi-family and 8 single-family units (displacing about 72 persons), 20 businesses (displacing approximately 124 employees), and the relocation or reconstruction of Ramona High School. The MTA established a \$2.6 million Affordable Housing Revolving Loan Fund Program to replenish the housing units MTA acquired for the previous Metro Red Line Eastside Extension project. The MTA will incorporate elements of the revolving loan fund program into a new Housing Replenishment Program that will apply to all residents that are acquired as a result of the Eastside Corridor LRT Build Alternative. The fund will set aside \$26,000 per acquired unit for affordable housing development and rehabilitation. Section 4.3.4 provides additional information about the program. This a critical tradeoff category because of the area's high housing demand and its low vacancy rate that may limit the availability of comparable replacement homes in the immediate area.



## 6.0 COORDINATION AND CONSULTATION

### 6.1 INTRODUCTION

A comprehensive two-year outreach program was conducted to coordinate with and obtain input from public agencies, private interests, community organizations and the public at large during the Eastside Corridor Study Re-Evaluation/MIS and Draft and Final SEIS/SEIR process. Community outreach efforts were held throughout the development of the initial study phase for the project. This chapter summarizes the coordination and consultation activities and approaches, organized as follows: (1) scoping meetings, (2) public participation, meetings and communication, (3) public notification of meetings, (4) Governmental, City and County participation, and (5) public review of the environmental document.

The objectives of the Re-Evaluation/MIS and SEIS/SEIR Coordination and Consultation Program for the Los Angeles Eastside Corridor are to:

- ◆ Obtain full and continuous public participation and involvement throughout the project.
- ◆ Assure that the process is open and fair.
- ◆ Assure that community concerns are incorporated into the project planning.
- ◆ Obtain full and continuous public involvement throughout the entire project process.
- ◆ Respond to local desires and comply with FTA requirements for public participation.
- ◆ Develop and continue a program for public participation and community involvement in the continuing phases of the project.
- ◆ Achieve consensus, to the maximum extent possible, on ongoing project development.

### 6.2 SCOPING MEETINGS

The scoping process began with the filing of the Notice of Intent (NOI) to prepare a Supplemental Environmental Impact Statement on August 13, 1999. A Notice of Preparation (NOP) for the SEIS/SEIR was prepared and distributed on August 11, 1999. Notices were also mailed to State, County, City, Federal and local agencies notifying them of the filing of the NOP/NOI. The scoping meeting process began with the first Elected Officials Meeting on July 20, 1999 and the first Community Ad-Hoc Meetings on July 21, 1999. MTA held three meetings with the Elected Officials Staff and met with eight elected officials. Throughout the scoping process MTA continued to meet with the MTA Review Advisory Committee to obtain their input on the study.

The Public Community Scoping Meetings began on August 24, 1999 at Resurrection Parish with almost 100 persons attending. The second was held on August 26, 1999 at Saint Alphonsus School Auditorium in East Los Angeles and was attended by 64 persons. The last was on September 2, 1999 at Montebello City Council Chambers and also was well attended with 99 community residents, business owners and legislative offices. Public comments were made and were submitted as part of the Re-Evaluation MIS report. An agency scoping meeting was also held on August 25, 1999 at the MTA offices. A total of 66 agency representatives were invited, and nine attended the meeting.

Overall, the scoping process had a high response from the community, its elected officials, and the business owners. The persons who attended the meeting were very interested in continuing with the process to see the outcome of the alternatives and the selection by the Board of the preferred alternative for the Eastside communities.

### 6.3 PUBLIC PARTICIPATION, MEETINGS, AND COMMUNICATION

Opportunities for public participation in the Los Angeles Eastside Corridor Study have been provided by the MTA since the initiation of the study in July 1999. Serious efforts have been made to conduct meetings within the affected neighborhoods of Boyle Heights, East Los Angeles, Montebello, Pico Rivera, and Whittier. These meetings were held at Resurrection Parish Hall, Saint Alphonsus School Auditorium, Centro Maravilla Community Service Center, and the Montebello Council Chambers. These locations were selected in order to make these meetings more accessible to the residents who would be most affected by the project. The distribution of 20,000 flyers was done by the local Churches bulletin, the Boyle Heights, East Los Angeles, Montebello, and Pico Rivera Chamber of Commerces, and the various community groups. Project fact sheets and meeting announcements have been published in both English and Spanish. The meetings have had interpreters available, as needed, to translate the proceedings into Spanish for those who do not speak fluent English. As previously mentioned, three community scoping meetings were held in August and September 1999 at locations in Boyle Heights, East Los Angeles, and Montebello. The purpose of the scoping meetings was to solicit input regarding the range of alternatives and transit modes being considered, the study area, and major social, economic, or environmental issues related to the alternatives.

A second round of public meetings was held in October 1999 in Boyle Heights, East Los Angeles and along Whittier Blvd. in the East Los Angeles commercial core district. Approximately 60 persons attended the meeting in Boyle Heights, 34 persons attended the meeting in East Los Angeles, and 50 persons attended the meeting on Whittier Boulevard. The purpose was to discuss the narrowed list of eight build alternatives and station locations being considered in the Re-Evaluation/MIS document and to solicit additional public input. Focus meetings were held in the City of Montebello and the City of Pico Rivera during the third week of November 1999 to discuss the alternative routes and the impacts along their commercial corridors. A third round of public meetings was convened in early January 2000. The meetings were held in Boyle Heights, Little Tokyo Arts District, East Los Angeles, and Montebello. The purpose was to present the findings of the comparison of the alternatives and to again solicit public input prior to the presentation of the findings to the MTA Board of Directors and their selection of a preferred alternative(s) to be carried forward for further evaluation in the Draft SEIS/SEIR. A fourth round of community meetings was held in the latter part of September 2000. The purpose of the meetings was to inform the community of the up and coming release of the Draft SEIS/SEIR document. A series of two meetings were held as well as a Review Advisory Committee meeting in October and November, and an open invitation to the community was extended at these meetings.

Three public hearings were held in March and April of 2001 to obtain public comment on the Draft SEIS/SEIR document. The hearings were held in Little Tokyo/Arts District at the Japanese American National Museum, in Boyle Heights at Roosevelt High School and in East Los Angeles at Garfield High School. Public comment was given verbally and submitted in writing at these hearings. Translation services as well as a sign language interpreter was provided at the hearings.

A Review Advisory Committee (RAC), comprised of local residents, business owners, elected official representatives, and community organizations meet on a monthly basis to discuss the progress of the study and to request input from its members. Focus meetings have also been held with individual community groups and organizations as well as with elected officials at various times since the inception of this study. The following is a list of all meetings conducted on the Re-Evaluation/MIS and SEIS/SEIR process with community organization, governmental agencies and public at large, as well as flyer distribution, newspaper notifications and mailing distribution amounts:

**Community Scoping Meetings:**

August 24, 1999	Boyle Heights Scoping Meeting (97 persons)
August 26, 1999	East Los Angeles Scoping Meeting (64 persons)
September 2, 1999	Montebello/Pico Rivera Scoping Meeting (99 persons)
<b>Total</b>	<b>260 persons attended scoping meetings</b>

**Agency Scoping Meeting:**

August 25, 1999	Agency Scoping Meeting at MTA (9 persons)
<b>Total</b>	<b>9 persons attended agency scoping meeting</b>

**Public Hearings Draft SEIS/SEIR**

March 29, 2001	Little Tokyo / Arts District
April 4, 2001	Roosevelt High School
April 5, 2001	Garfield High School

**Community Meetings:**

October 20, 1999	Boyle Heights Community Meeting (60 persons)
October 21, 1999	Centro Maravilla Community Meeting (24 persons)
October 25, 1999	ELA Wells Fargo Bank Community Meeting (34 persons)
November 15, 1999	Montebello Focus Meeting (12 persons)
November 18, 1999	Pico Rivera Focus Meeting (8 persons)
December 1, 1999	Community Meeting at MTA (41 persons)
January 6, 2000	Boyle Heights Community Meeting (50 persons)
January 10, 2000	ELA Community Meeting (33 persons)
January 11, 2000	Little Tokyo Community Meeting (33 persons)
January 13, 2000	Montebello/Pico Rivera Community Meeting (30 persons)
Sept 28, 2000	Ramona High School (108 persons)
September 30, 2000	Chicago Plaza Councilman Pacheco's Field Office (54 persons)
October 18, 2000	Review Advisory Committee Mtg/Community Mtg (58 persons)
November 15, 2000	Review Advisory Committee Mtg/Community Mtg (80 persons)
January 17, 2001	Review Advisory Committee Mtg/Community Mtg (160 persons)
February 13, 2001	1st/Alameda Station Area Meeting (17 persons)
February 14, 2001	1st/Soto Station Area Meeting (6 persons)
February 15, 2001	Atlantic/Beverly Station Area Meeting (25 persons)
February 21, 2001	Review Advisory Committee Mtg/Community Mtg (57 persons)
March 12, 2001	3 <sup>rd</sup> / Rowan Station Area Meeting Our Lady of Lourdes (5 persons)
March 13, 2001	1 <sup>st</sup> / Boyle Station Area Meeting Santa Cecilia Restaurant (44 persons)
March 14, 2001	3 <sup>rd</sup> / Mednik Station Area ELA Library (2 persons)
March 15, 2001	1 <sup>st</sup> / Lorena Station Area Meeting Ramona High School (8 persons)
April 11, 2001	Review Advisory Committee Meeting (30 persons)
May 9, 2001	Review Advisory Committee Meeting (24 persons)
June 13, 2001	Review Advisory Committee Meeting (29 persons)
July 11, 2001	Review Advisory Committee Meeting (48 persons)
August 8, 2001	Review Advisory Committee Meeting (51 persons)
August 21, 2001	Station Area Meeting Little Tokyo/Arts District (22 persons)
August 29, 2001	Station Area Meeting 1 <sup>st</sup> & Boyle Station (35 persons)
August 30, 2001	Focus Draft SEIS/SEIR Station Area Mtg 1 <sup>st</sup> & Lorena (21 persons)
September 6, 2001	Focus Draft SEIS/SEIR Station Area Mtg 3 <sup>rd</sup> & Rowan (58 persons)
September 13, 2001	Review Advisory Committee Meeting (29 persons)
September 17, 2001	Focus Draft SEIS/SEIR Station Area Mtg Beverly/Pomona (8 persons)
September 20, 2001	Focus Draft SEIS/SEIR Proposed Station 3 <sup>rd</sup> & Ford (12 persons)
September 25, 2001	Station Area Meeting 3 <sup>rd</sup> & Mednik (15 persons)
October 11, 2001	Review Advisory Committee Meeting (47 persons)
<b>Total</b>	<b>1378 persons attended community meetings</b>

**Legislative Meetings:**

July 20, 1999	Elected Officials Meeting (9 offices)
July 27, 1999	Jamie De La Vega – City of LA Mayor’s Office
July 28, 1999	Assemblymember Gloria Romero & John Longoria Dist Deputy
August 10, 1999	Enrique Gasca, Councilmember Calderon’s Office
August 17, 1999	Elected Officials Meeting (9 offices)
August 19, 1999	Congresswoman Lucille Roybal-Allard & Kim Tachiki
August 19, 1999	Congresswoman Napolitano’s Office & 6 various Cities(6 offices)
August 20, 1999	Senator Martha Escutia & William Sanchez
August 25, 1999	Congressman Xavier Becerra & Martha Saucedo
August 30, 1999	MTA Board Member Jose Legaspi
August 31, 1999	Elected Officials Meeting (8 offices)
September 14, 1999	Elected Officials Meeting (8 offices)
September 15, 1999	Paul Hernandez Meeting
September 22, 1999	Speaker Antonio Villaraigosa meeting
October 4, 1999	Assemblymember Marco Firebaugh
October 5, 1999	Elected Officials Meeting (5 offices)
October 7, 1999	Supervisor Gloria Molina Briefing
October 7, 1999	Commissioner Esteban Torres Briefing
October 19, 1999	Elected Officials Meeting (6 offices)
November 16, 1999	Elected Officials Meeting (8 offices)
November 5, 1999	Councilman Nick Pacheco
November 5, 1999	Congresswoman Napolitano Chief Deputy Ray Cordova
December 13, 1999	Commissioner Jose Legaspi
December 14, 1999	Elected Officials Meeting (11 offices)
December 14, 1999	City of Whittier City Council Meeting
December 21, 1999	Carmen Martinez & Marco Cuevas City of Pico Rivera
January 5, 2000	Elected Officials Meeting (10 offices)
January 25, 2000	Elected Officials Meeting (8 offices)
January 3, 2000	Supervisor Gloria Molina
January 19, 2000	Supervisor Gloria Molina staff
January 21, 2000	Commissioner Esteban Torres
January 26, 2000	Supervisor Gloria Molina staff
January 19, 2000	So. El Monte, Rosemead & Montebello Councilmembers (3 cities)
February 2, 2000	Elected Officials Meeting (10 offices)
March 28, 2000	Elected Officials Meeting (8 offices)
April 11, 2000	Elected Officials Meeting (7 offices)
May 30, 2000	Elected officials Meeting (7 offices)
June 16, 2000	Briefing for Senator Solis Office
June 27, 2000	Elected officials Meeting (8 offices)
September 12, 2000	Elected officials Meeting (6 offices)
October 24, 2000	Elected officials Meeting (4 offices)
January 17, 2000	Elected officials Meeting (4 offices)
February 16, 2001	Briefing Assemblymember Cedillo
February 16, 2001	Briefing Assemblymember Firebaugh
March 2, 2001	Briefing for Speaker / State Assemblymember Robert Hertzbert
March 6, 2001	Briefing for Supervisor Molina’s Office
March 7, 2001	Elected Officials Meeting (4 Offices)
March 22, 2001	Elected Officials Meeting (5 Offices)
April 12, 2001	Elected Officials Meeting (4 Offices)
June 12, 2001	Elected Officials Meeting (9 Offices)
July 17, 2001	Elected Officials Meeting (8 offices)
August 28, 2001	Elected Officials Meeting (8 offices)
September 17, 2001	Briefing with Councilmember Perry’s office

September 24, 2001	Briefing with Senator Gloria Romero's office
September 25, 2001	Elected Officials Meeting (8 offices)
<b>Total</b>	<b>55 meetings</b> <b>219 persons who were briefed that are Elected officials or staff members</b>

**MTA Board Meetings**

February 4, 2000	MTA Board Workshop to consider information related to the eight alternatives studied in the Re-Evaluation/MIS
February 24, 2000	MTA Board approval of Locally Preferred Alternative Route (Both LRT & BRT modes to be further considered)
June 22, 2000	MTA Board action to drop the BRT mode, the Locally Preferred Alternative to be studied is the LRT
May 24, 2001	MTA Board approved the Draft SEIS/SEIR and to continue with the preparation of the Final SEIS/SEIR document

**Technical Advisory Committee Meetings:**

October 6, 1999	TAC Meeting (17 persons)
January 10, 2000	TAC Meeting (12 persons)
April 26, 2000	TAC Meeting (15 persons)
July 12, 2000	TAC Meeting (14 persons)
September 13, 2000	TAC Meeting (24 persons)
December 13, 2000	TAC Meeting (16 persons)
<b>Total</b>	<b>6 meetings with a total of 98 agencies attended meetings</b>

**Third Party Meetings with City, County & Utility Companies regarding Preliminary Engineering Phase:**

May 10 2001  
June 14, 2001  
July 19, 2001  
August 16, 2001  
September 13, 2001  
October 11, 2001

**Coordination Meetings with Union Station / CalTrans / Amtrak**

January 15, 2001  
February 19, 2001  
March 19, 2001  
April 16, 2001  
May 21, 2001  
June 18, 2001  
July 16, 2001  
August 20, 2001  
September 17, 2001  
October 15, 2001

**Community Ad-Hoc Meetings:**

July 21, 1999	Review Advisory Committee Mtg at BH Senior Center(16 persons)
August 4, 1999	Review Advisory Committee Meeting at WMMC (15 persons)
August 10, 1999	Boyle Heights Chamber of Commerce (15 persons)
August 11, 1999	ELA Chamber of Commerce (15 persons)
August 11, 1999	Eastside Intercambios ELA Doctors Hospital (50 persons)
August 18, 1999	Whittier Blvd Merchants Association Ray Abboud (20 persons)
August 18, 1999	Plaza Community Center (7 persons)
August 18, 1999	Review Advisory Committee Meeting at WMMC (16 persons)
August 23, 1999	MTA Community Tour of modes of transportation (45 people)
September 1, 1999	Maravilla Community Advisory Committee Meeting (12 persons)



September 13, 1999	Deanery (16 priests)
September 22, 1999	Review Advisory Committee meeting @ WMMC (15 persons)
September 27, 1999	Little Tokyo Service Center meeting (40 persons)
September 29, 1999	ELA Chamber of Commerce meeting (50 persons)
September 30, 1999	Mothers of East Los Angeles (30 persons)
October 13, 1999	Review Advisory Committee meeting (22 persons)
October 16, 1999	Soledad Enrichment Group Church Notifications
October 20, 1999	Pico Rivera Chamber of Commerce (25 persons)
October 28, 1999	Little Tokyo Japanese American Cultural Com. Center (25 persons)
November 9, 1999	Boyle Heights Chamber of Commerce (18 persons)
November 9, 1999	Reverend Ochoa The Lords Vinyard Christian Church (1 person)
November 10, 1999	Whittier Boulevard Merchants Association (12 persons)
November 10, 1999	Hope Olmos – Rio Hondo College (1 person)
November 11, 1999	Montebello Chamber of Commerce (12 persons)
November 15, 1999	Advance – Steve Torres (7 persons)
November 24, 1999	Resurrection Parish (20 persons)
December 7, 1999	Resurrection Parish Meeting (20 persons)
December 2, 1999	City of Whittier Transportation Commission (8 persons)
December 8, 1999	AQMD Hispanic Council (20 persons)
December 13, 1999	Review Advisory Committee (22 persons)
January 5, 2000	City of LA Community Redevelopment Agency (2 persons)
January 6, 2000	Montebello Transportation Department (2 persons)
January 12, 2000	Review Advisory Committee Meeting (22 persons)
January 14, 2000	City of LA Department of Transportation (5 persons)
February 9, 2000	Review Advisory Committee Meeting (25 persons)
February 30, 2000	Eastside Intercambios (35 persons)
May 8, 2000	Los Angeles Unified School District
May 31, 2000	East Los Angeles Chamber of Commerce (55 persons)
June 5, 2000	Los Angeles Unified School District
July 12, 2000	Review Advisory Committee Meeting (25 persons)
July 25, 2000	Bus Tour of LRT Route and Blue Line (40 persons)
August 9, 2000	Los Angeles County Community Development Commission
August 23, 2000	Review Advisory Committee Meeting (24 persons)
September 20, 2000	Review Advisory Committee Meeting (38 persons)
September 25, 2000	Little Tokyo Advisory Committee
October 25, 2000	Community Redevelopment Agency Project Area Committee
November 6, 2000	Deanery Meeting 18 priests
March 13, 2001	LARABA Meeting in Little Tokyo (20 persons)
March 14, 2001	ELA Chamber of Commerce (12 persons)
March 21, 2001	Maravilla CAC Meeting (25 persons)
April 10, 2001	White Memorial Medical Center (6 persons)
May 1, 2001	Evergreen Cemetery (5 persons)
May 1, 2001	Japanese Buddhist Temple
May 1, 2001	Los Angeles County Dept of Public Works Civic Center
May 9, 2001	Attorney Manuel & Miguel Hidalgo
May 15, 2001	Little Tokyo / Arts District Focus meeting
May 15, 2001	Attorney Manuel Hidalgo
May 18, 2001	White Memorial Medical Center Briefing
June 5, 2001	Los Angeles County Department of Public Works Civic Center
July 12, 2001	Coordination meeting w/ Housing Authority of the City of LA
July 18, 2001	Presentation to the Union Pacific Redevelopment Committee
August 22, 2001	Boyle Heights Chamber of Commerce Mixer
September 10, 2001	Los Angeles County Department of Public Works Civic Center
September 17, 2001	Father Leslie Delgado Santuario de Guadalupe
October 2, 2001	Father Leslie Delgado Santuario de Guadalupe
<b>Total</b>	<b>65 Community Ad-Hoc committee meetings</b>

**Flyers Distributions:**

First Round Mtgs.	20,000 flyers (August/September 1999)
Second Round Mtgs	15,000 flyers (October 1999)
Mont/PR Mtg	7,500 flyers (November 1999)
Third Round Mtgs	25,000 flyers (January 2000)
Fourth Round Mtgs	9,500 flyers (September 2000)
Public Hearings	12,000 flyers (March/April 2001)
RAC Mtgs	1,200 flyers (June and August 2001)
<b>Total</b>	<b>90,200 flyers distributed throughout the study area</b>

**Mailing Distributions:**

First Round Mtg:	570 notices (August/September 1999)
Second Round Mtgs.	600 notices (October 1999)
Third Round Mtgs.	650 notices (November 1999)
RAC Notices	471 notices were mailed (119 persons attended meetings)
Supervisory Molina Letter	61,000 notices on project
January 2001 RAC Mtg	1,870 notices
February 2001 RAC Mtg	1,200 notices
Public Hearings	3,500 notices (March/April 2001)
Supervisor Molina Newsletter	65,000 notices
April 2001 RAC Mtg	750 notices
May 2001 RAC Mtg	750 notices
June 2001 RAC Mtg	900 notices
July 2001 RAC Mtg	900 notices
Aug 2001 RAC Mtg	900 notices
Sept 2001 RAC Mtg	900 notices
Oct 2001 RAC Mtg	980 notices
<b>Total</b>	<b>138,650 notices were mailed for community meetings</b>

**Newspaper Notifications:**

- ◆ 17 ads were placed in the following newspapers: LA Times, LA Opinion, Eastside Sun, Rafu Shimpo
- ◆ Fourth Round and October/November RAC Meetings: 12 ads were placed in the following newspapers: LA Times, LA Opinion, Eastside Sun, Rafu Shimpo, Downtown News
- ◆ December/January RAC Meetings: 12 ads were placed in the following newspapers: LA Times, LA Opinion, Eastside Sun, Rafu Shimpo, Downtown News
- ◆ Public Hearings: 10 ads placed in the following newspapers LA Times, LA Opinion, Eastside Sun, Rafu Shimpo, Downtown News

**6.4 AGENCY COORDINATION AND GOVERNMENTAL OFFICES**

The following is a list of the various Municipal Government Offices, Education Facilities, Political Offices, Community Organizations, and Local Business Owners who were informed of the Re-Evaluation/MIS and SEIS/SEIR process of the project:

**Community Organizations**

Resident Advisory Council  
 Boyle Heights Chamber of Commerce – Joe Coria  
 Montebello Chamber of Commerce  
 City of Commerce Chamber of Commerce  
 Pico Rivera Chamber of Commerce  
 East Los Angeles Chamber of Commerce  
 Proyecto Pastoral  
 Mothers of East Los Angeles – Mary Lou Trevis  
 East Los Angeles Community Corporation – Maria Cabildo

Boyle Heights Senior Center  
Montebello Senior Center  
Pico Rivera Senior Center  
Centro Maravilla  
East Los Angeles Community College  
Aliso Village Resident Advisory Council  
Pico Gardens Resident Advisory Council  
Estrada Courts Resident Advisory Council  
Plaza Community Center  
Whittier Boulevard Merchants Association – Ray Abboud  
San Gabriel District Deanery  
More Advocates for Safe Housing (MASH) ELA organization – Martha Cooper  
Neighborhood Watch Captains – Mary Lou Trevis, Chair  
International Institute of Los Angeles  
Soledad Enrichment Corporation  
Latino Business Association – Hector Bareto  
Impacto Pico Aliso Community Team Outreach  
Instituto de Educacion Popular Del Sur de California  
Boyle Heights Resident Homeowner Association  
Community Rehabilitation Services, Inc.  
Little Tokyo Service Center  
Maravilla Community Advisory Committee  
Advance – Steve Torres  
ELA Skills Center  
Los Angeles Conservancy  
Abuelitos de Boyle Heights Community Organization  
Minority Business Development Center – ELA Office  
Jovenes Youth Organization  
Salesian Youth Center  
Sierra Club  
Union y Fuerza  
Community Redevelopment Agency Project Area Committee  
Puente Learning Center  
Dolores Mission  
Las Palomas  
Latino Urban Forum  
M.A.P.A

**Municipal Government Offices**

City of Los Angeles Redevelopment Agency – Boyle Heights Field Office - Al Santillanes  
City of Commerce Community Development Department  
County of Los Angeles Community Development Commission – Carlos Jackson  
City of Montebello Community Development Department  
City of Pico Rivera Community Development Department  
City of Commerce Transportation  
City of Whittier Transportation Commission  
City of Whittier Department of Transportation  
City of Montebello Municipal Bus Transportation  
City of Los Angeles Department of Transportation  
City of Los Angeles Police Department – Bernard Parks – Hollenbeck Division  
City of South El Monte Councilmembers  
City of Rosemead Councilmembers

City of Monterey Park Councilmembers  
Los Angeles County Sheriffs – Lee Baca – ELA Station – Capt. Tom Angel – Pico Rivera Station  
Capt. Juan Rodriguez  
California Highway Patrol – ELA Station - Pete Ramos  
City of Los Angeles Eastside Enterprise Zone – Margaret Gonzales  
Southern California Air Quality Management Advisory Board

**Educational Facilities**

Montebello Unified School District  
Pico Rivera Unified School District  
Los Angeles Unified School District  
Principal Roosevelt High School  
Principal Garfield High School  
Principal Montebello High School  
Principal Schurr High School  
Principal Ramona High School  
Los Angeles County Librarian

**Local Business Owners**

White Memorial Medical Center  
Mariachi Plaza Owners / Tenants  
El Mercado Owners / Tenants  
Cesar Chavez Commercial Strip owners  
Montebello Business Owners –Commercial Strip  
Whittier Boulevard Commercial Business owners  
Maravilla Business Persons Association - Richard Alonzo  
Los Angeles Neighborhood Initiatives – First Street

**Political Officials**

Congressman Xavier Becerra  
Congressmember Lucille Roybal-Allard  
Congressmember Grace Napolitano  
Congresswoman Hilda Solis  
U.S. Senator Dianne Feinstein  
Senator Martha Escutia  
Senator Richard Polanco  
Senator Gloria Romero  
Former Assemblymember Antonio Villaraigosa  
Assemblymember Jackie Goldberg  
Assemblymember Gil Cedillo  
Assemblymember Marco Firebaugh  
Assemblymember Judy Chu  
Assemblymember Tom Calderon  
Supervisor Gloria Molina  
City of Los Angeles Councilmember Jan Perry  
City of Los Angeles Councilmember Nick Pacheco  
City of Montebello Councilwoman Kathy Salazar  
City of Montebello Councilwoman Mary Ann Saucedo  
City of Pico Rivera Councilman Carlos Garcia

**Review Advisory Committee**

Richard Alonzo	Maravilla Citizen Advisory Committee
Joel Bloom	Bloom's General Store / Los Angeles River Artisit & Business Association
Sherry Petrie Breskin	1 <sup>st</sup> & Lorena Station Area / Ramona High School Principal
Anita Castellanos	1st & Boyle Station Area Property Owner
Renee Chavez	1st & Soto Station Area Resident
Joseph Coria	White Memorial Medical Center / Boyle Heights Chamber of Commerce
Nadine Diaz	1st & Lorena Station Area Resident / CRA Adelante Project Area Committee
Victor Duran	3 <sup>rd</sup> & Mednik Station Area Business Owner
Rosa Marina Gabaldon	Boyle Heights Homeowners Association
Jose L. Gomez	Brown Berets / Beverly Atlantic Station Area Resident
Dorothy (DJ) Hartshorn	Neighborhood Music School
Francis K. Hashimoto	Little Tokyo Business Association
Art Herrera	1 <sup>st</sup> & Lorena Station Area Resident
Louis Martinez	Comite de Padres / Pro-Defensa del Estudiante / Comunidad e Igualdad de Derrechos
Carlos Montante	Boyle Heights Homeowner Association
Ron Mukai	3 <sup>rd</sup> & Mednik Station Area Business & Property Owner
Laura Pizana	1 <sup>st</sup> & Boyle Station Area Resident
Rita Govea Rodriguez	1 <sup>st</sup> & Lorena Station Area Business Owner
Olga Salas	1 <sup>st</sup> & Boyle Station Area Resident
Jose Salomon	Beverly & Atlantic Station Business Owner
Rachael Santos	1 <sup>st</sup> & Lorena Station Area Resident
Albert H. Taira	1 <sup>st</sup> & Alameda Station Area Property Owner
Diana Tarango	1 <sup>st</sup> & Lorena Station Area Resident
Luigi Torres	King Taco Restaurant
Ross Valencia	Boyle Heights Homeowner Association
Silvia Viramontes	1 <sup>st</sup> & Boyle Station Area Resident
Armando Ybarra	3 <sup>rd</sup> & Rowan Station Area Representative

**6.5 PUBLIC REVIEW OF THE ENVIRONMENTAL DOCUMENT**

As required by law, copies of the Draft SEIS/SEIR were made available to the public for comment. Chapter 7 (Volume II) contains all comments received during the Draft SEIS/SEIR public comment period along with written responses to those comments. In accordance with requirements for preparing a Final SEIS/SEIR, MTA has responded to all comments received and the responses are contained in Chapter 7.

**APPENDIX A**

**NOTICE OF PREPARATION AND NOTICE OF INTENT**



**NOTICE OF PREPARATION  
FOR  
EASTSIDE TRANSIT CORRIDOR**

**RE-EVALUATION MAJOR INVESTMENT STUDY AND  
SUPPLEMENTAL ENVIRONMENTAL IMPACT REPORT/  
SUPPLEMENTAL ENVIRONMENTAL IMPACT STATEMENT**

**DATE:** August 10, 1999

**TO:** All Interested Agencies, Organizations, and Individuals

**FROM:** Los Angeles County Metropolitan Transportation Authority  
Steven Brye, Project Manager (telephone number 213-922-3078)  
One Gateway Plaza, Los Angeles, CA 90012

The Los Angeles County Metropolitan Transportation Authority (MTA) will be the lead agency in the preparation of a Supplemental Environmental Impact Report (SEIR) in accordance with the California Environmental Quality Act (CEQA). Its purpose is to address the social, economic, or environmental issues associated with proposed transit improvements to the Eastside communities within the Los Angeles metropolitan area. In accordance with the National Environmental Policy Act (NEPA), a separate Re-Evaluation Major Investment Study (MIS) will be prepared and a Supplemental Environmental Impact Statement (SEIS) will be prepared as a joint document with the SEIR. The Federal Transit Administration (FTA) is the lead agency for the SEIS.

The purpose of this Notice of Preparation (NOP) is to notify agencies, organizations, and individuals that the MTA plans to prepare a Re-Evaluation MIS and an SEIR/SEIS and to request input on the environmental analysis to be performed. From public agencies, we are requesting comments on the scope and content of the environmental information which is germane to each agency's statutory responsibilities in connection with the proposed project. We are also requesting interested individuals' or organizations' view on the scope of the environmental document.

A description of the proposed alternatives to be analyzed in the Re-Evaluation MIS and the SEIR/SEIS, location, and the probable environmental effects is contained within this NOP.

Comments should be submitted to:

Mr. Steven Brye, Project Manager, Los Angeles County Metropolitan Transportation Authority,  
One Gateway Plaza, Los Angeles, California 90012, or by fax to (213) 922-3005.

Comments are due no later than Friday, September 10, 1999.



## **BACKGROUND**

The MTA has considered extension of the Los Angeles Rail Rapid Transit Project (Metro Red Line) to the Eastside communities for many years. The 1994 Los Angeles Eastside Extension Final EIS/EIR led to the adoption of a Locally Preferred Alternative to extend the Metro Red Line as a subway for 6.8 miles into the Eastside communities. The initial phase (3.7 miles) of the Eastside heavy rail subway project continued into Final Design and right-of-way acquisition activities assuming the funding was available to construct the project, and MTA entered into a Full Funding Grant Agreement for the initial phase with FTA in December 1994. Subsequently, an evaluation of the current local funding available for the Eastside project and other rail projects in Los Angeles County led to a suspension of work in May 1998. Voters also approved a new County law in November 1998 that restricts the use of Proposition A and C sales tax revenues for "new subways". The MTA was directed to study viable and effective options for all parts of Los Angeles County, with an emphasis on the corridors in which rail lines project development efforts had been suspended. As a result, MTA has decided to undertake this current study that will involve an in-depth review of fixed guideway and other modal alternatives (rail and bus) that could lead to a project that is affordable, meets corridor mobility and related needs and goals, and is acceptable to the community. The Eastside community is one of the most transit-dependent and transit-oriented communities in Los Angeles County. Many of the highest MTA and Montebello Transit ridership bus routes are there. The commercial and shopping areas on Cesar Chavez Avenue, 1<sup>st</sup> Street and Whittier Boulevard are not only important to the community but serve the needs of a much larger area. The two colleges (California State University at Los Angeles and the East Los Angeles Community College) in the study area are important to the cultural and educational needs of the Eastside and require quality public transit accessibility.

A Re-Evaluation Major Investment Study (MIS) will initially be prepared to evaluate several rail and/or bus mode and alignment options. The MIS/Draft SEIS/SEIR and the conceptual engineering for the project will be prepared simultaneously. Following FTA approval, Preliminary Engineering would be conducted during preparation of the Final SEIS/SEIR. The impacts of these initial alternatives will be evaluated on a corridor-level basis. The most feasible alternatives coming out of the initial evaluation will then be assessed in the Draft SEIS/SEIR. The Draft SEIS/SEIR/conceptual engineering process will assess the social, economic, and environmental impacts of the proposed alternatives at a project-level while refining their design to minimize and mitigate any adverse impacts. After its publication, the Draft SEIS/SEIR will be available for public and agency review and comment, and a public hearing will be held. On the basis of the Draft SEIS/SEIR and comments received, MTA will select a preferred alternative to carry forward into the Final SEIS/SEIR. The Final SEIS/SEIR will be based on information resulting from Preliminary Engineering.

## **PROJECT STUDY AREA and ALTERNATIVES**

The Eastside Transit Corridor study area is a major travel corridor in the Los Angeles region as identified in the previous environmental documents referenced in the Background above. For this Re-Evaluation MIS, a study area has been defined that includes that portion of East Los Angeles bounded by the Los Angeles Central Business District on the west (Alameda Avenue, Union Station), Interstate 10 (San Bernardino Freeway, to the I-710) and State Route 60 (Pomona Freeway, I-710 to I-605) on the north, I-605 (San Gabriel River Freeway) on the

east, and Interstate 5 (Santa Ana Freeway) on the south. LACMTA and FTA are interested in comments as to the possible need to extend the boundaries of this corridor study area to consider longer range transportation needs. The western part of the Los Angeles Central Business District (to the I-110 Harbor Freeway) may be considered a part of the study area depending on the extent of the alternatives considered west of Union Station and Alameda Avenue.

The alternatives proposed for initial evaluation in the Re-Evaluation MIS include:

- 1) Exclusive busway alternatives between Union Station and Whittier/Atlantic via 1<sup>st</sup> St., Lorena, Whittier or other alternative arterials that would be at-grade or elevated.
- 2) Light rail alternatives between Union Station and Whittier/Atlantic via 1<sup>st</sup> St., Lorena, Whittier or other alternative arterials that would be at-grade or elevated.
- 3) A Heavy Rail alternative from Union Station to Chavez/Soto without a Little Toyko station.
- 4) The Heavy Rail LPA initial operating segment (IOS- 2, 3.7 miles) from Union Station to 1<sup>st</sup>/Lorena as identified in the Final *Los Angeles Eastside Corridor EIS/EIR*, May 1994 and the FTA Record of Decision, December 1994 and is the currently suspended Locally Preferred Alternative project.
- 5) The Heavy Rail Locally Preferred Alternative (LPA) from Union Station to Whittier/Atlantic. This 6.8-mile alternative consists of a heavy rail subway that would follow the alignment identified in the Final *Los Angeles Eastside Corridor EIS/EIR*, May 1994 and the FTA Record of Decision, December 1994.
- 6) A Transportation Demand Management (TDM)/Transportation System Management (TSM) Alternative.
- 7) A No Build Alternative, which involves no change to transportation services or facilities in the corridor beyond already committed projects.

Other alignment alternatives involving rail or bus will also be developed in the early stages of the study based on public/agency comments. The attached map graphically portrays the study area.

#### **PROBABLE EFFECTS OF THE PROJECT**

FTA and MTA will evaluate all significant environmental, social, and economic impacts of the alternatives to be analyzed in the SEIR/SEIS. Among the primary transit issues to be evaluated are the expected increase in transit ridership, the expected increase in mobility for the corridor's transit dependent, the support of the region's air quality goals, the capital outlays needed to construct the project, the cost of operating and maintaining the facilities created by the project, and the financial impacts on the funding agencies. Potentially affected environmental and social resources proposed for analysis include land use and neighborhood impacts, residential and business displacements and relocations, traffic and parking impacts near stations, traffic circulation, visual impacts, impacts on cultural and archaeological resources, and noise and vibration impacts. Impacts on air and water quality, groundwater,

hazardous waste sites, and water resources will also be covered. The impacts will be evaluated both for the construction period and for the long-term period of operation. Measures to mitigate significant adverse impacts will be considered.

**Published in the Federal Register on Friday, August 13, 1999**

**DEPARTMENT OF TRANSPORTATION**

**Federal Transit Administration**

Supplemental Environmental Impact Statement on the Los Angeles Eastside Transit Corridor

**AGENCY:** Federal Transit Administration, DOT

**ACTION:** Notice of intent to prepare a Supplemental Environmental Impact Statement

**SUMMARY:** The Federal Transit Administration (FTA), as Federal lead agency, and the Los Angeles County Metropolitan Transportation Authority (MTA) intend to prepare a Re-Evaluation Major Investment Study (MIS) and a Supplemental Environmental Impact Statement (SEIS) in accordance with the National Environmental Policy Act of 1969 (NEPA) on a proposal by MTA to provide additional transit service to the Eastside communities within the Los Angeles metropolitan area. In addition to NEPA, the proposed project is subject to compliance with the California Environmental Quality Act (CEQA); therefore, a joint SEIS/Supplemental Environmental Impact Report (SEIR) will be prepared.

The Re-Evaluation MIS and the SEIS/SEIR will consider the following alternatives: 1) Exclusive busway alternatives between Union Station and Whittier/Atlantic via 1<sup>st</sup> St., Lorena, Whittier or other alternative arterial roadways that would be at-grade or elevated. 2) Light rail alternatives between Union Station and Whittier/Atlantic via 1<sup>st</sup> St., Lorena, Whittier or other alternative arterial roadways that would be at-grade or elevated. 3) A Heavy Rail alternative from Union Station to Chavez/Soto without a Little Tokyo station. 4) The Heavy Rail LPA initial operating segment (IOS-2, 3.7 miles) from Union Station to 1<sup>st</sup>/Lorena as identified in the *Los Angeles Eastside Corridor Final Environmental Impact Statement/Final Environmental Impact Report (FEIS/FEIR)*, May 1994 and the FTA Record of Decision, December 1994 and is the currently suspended Locally Preferred Alternative project. 5) The Heavy Rail Locally Preferred Alternative (LPA) from Union Station to Whittier/Atlantic. This 6.8-mile alternative consists of a heavy rail subway that would follow the alignment identified in the 1994 *FEIS/FEIR* and the FTA Record of Decision, December 1994. 6) A Transportation Demand Management (TDM)/Transportation System Management (TSM) Alternative. 7) A No Build Alternative, which involves no change to transportation services or facilities in the corridor beyond already committed projects. Potential new feasible alternatives generated through the scoping process will also be considered.

The results of the Re-Evaluation MIS process is intended to narrow the alternatives to be evaluated in detail in the SEIS/SEIR. Scoping will be accomplished through correspondence with interested persons, organizations, and Federal, State, and local agencies; three public scoping meetings; and one inter-agency scoping meeting.

**DATES:** Comment Due Date: Written comments on the scope of alternatives and impacts to be considered should be submitted by September 10, 1999. Written comments should be sent to Mr. Steven Brye, Los Angeles County Metropolitan Transportation Authority, One Gateway Plaza, Los Angeles, California 90012. Written comments may also be made at the public scoping meetings scheduled below.

Scoping meeting: The public scoping meetings will take place on the following days and locations at the time indicated:

1. Tuesday, August 24, 1999, 4:30 p.m. to 8 p.m. - Resurrection Parish Hall, 3324 E. Opal Street, Los Angeles, CA 90023
2. Thursday, August 26, 1999, 4:30 p.m. to 8 p.m. - St. Alphonsus School Auditorium, 552 S. Amalia, Los Angeles, CA 90022
3. Wednesday, September 2, 1999, 4:30 p.m. to 8 p.m. - Montebello City Hall, City Council Chamber, 1600 West Beverly Blvd., Montebello, CA 90640

A scoping meeting for governmental agencies will be held on Wednesday, August 25, 1999, 9 a.m. to 11 a.m. - Los Angeles County MTA, 1 Gateway Plaza, 3<sup>rd</sup> Floor Board Room, Los Angeles, CA 90012.

People with special needs should contact Steven Brye at MTA at the address below or by calling (213) 922-3078. The selected locations are accessible to people with disabilities.

The scoping meetings will be held in an "open-house" format, and representatives will be available to discuss the project throughout the time periods given. Informational displays and written material will also be available throughout the time periods given.

**ADDRESSES:** Written comments should be sent to Mr. Steven Brye, Los Angeles County Metropolitan Transportation Authority, One Gateway Plaza, Los Angeles, California 90012. Written comments may also be made at the scoping meetings. See DATES above for meeting locations.

**FOR FURTHER INFORMATION CONTACT:** Mr. Robert Hom, Director, Program Development, FTA Region IX, 201 Mission St, Suite 2210, San Francisco, CA 94105-1831. Phone: (415) 744-3133.

#### **SUPPLEMENTARY INFORMATION:**

##### I. Scoping

FTA and MTA invite interested individuals, organizations, and Federal, State, and local agencies to participate in defining the alternatives to be evaluated in the Re-Evaluation Major Investment Study (MIS) and the SEIS/SEIR and identifying any significant social, economic, or environmental issues related to the alternatives. An information packet describing the purpose of the project, the location, the proposed alternatives, and the

impact areas to be evaluated is being mailed to affected Federal, State, and local agencies. Others may request the scoping materials by contacting Mr. Steven Bbye, Los Angeles County Metropolitan Transportation Authority, One Gateway Plaza, Los Angeles, California 90012, (213) 922-3078. Scoping comments may be made in writing at the public scoping meeting. See the DATES section above for the location and time. During scoping, comments should focus on identifying specific social, economic, or environmental impacts to be evaluated and suggesting alternatives that are less costly or less environmentally damaging while meeting the identified mobility needs. Scoping is not the appropriate time to indicate a preference for a particular alternative. Comments on preferences should be communicated after the Re-Evaluation MIS and the Supplemental Draft EIS/EIR has been completed. If you wish to be placed on the mailing list to receive further information as the project develops, contact: Mr. Steven Bbye, Los Angeles County Metropolitan Transportation Authority, One Gateway Plaza, Los Angeles, California 90012, (213) 922-3078.

## II. Description of the Study Area and Project Need

The Eastside Transit Corridor study area is a major travel corridor in the Los Angeles region as identified in the previous environmental documents referenced in the Summary above. For this Re-Evaluation MIS, the study area has been defined that includes that portion of East Los Angeles bounded by the Los Angeles Central Business District on the west (Alameda Avenue, Union Station), Interstate 10 (San Bernardino Freeway, to the I-710) and State Route 60 (Pomona Freeway, I-710 to I-605) on the north, I-605 (San Gabriel River Freeway) on the east, and Interstate 5 (Santa Ana Freeway) on the south. MTA and FTA are interested in comments as to the possible need to extend the boundaries of this corridor study area to consider longer range transportation needs. The western part of the Los Angeles Central Business District (to the I-110 Harbor Freeway) may be considered a part of the study area depending on the extent of the alternatives considered west of Union Station and Alameda Avenue.

The MTA has considered extension of the Los Angeles Rail Rapid Transit Project (Metro Red Line) to the Eastside communities for many years. The most recent study led to the adoption of a Locally Preferred Alternative to extend the Metro Red Line as a subway for 6.8 miles into the Eastside communities. The initial phase (3.7 miles) of the Eastside heavy rail subway project continued into Final Design and right-of-way acquisition activities assuming the funding was available to construct the project, and MTA entered into a Full Funding Grant Agreement for the initial phase with FTA in December 1994. Subsequently, an evaluation of the current local funding available for the Eastside project and other rail projects in Los Angeles County led to a suspension of work in May 1998. Voters also approved a new County law in November 1998 that restricts the use of Proposition A and C sales tax revenues for "new subways". The MTA was directed to study viable and effective options for all parts of Los Angeles County, with an emphasis on the corridors in which rail project development efforts had been suspended. As a result, MTA has decided to undertake this current study that will

involve an in-depth review of fixed guideway and other modal alternatives (rail and bus) that could lead to a project that is affordable, meets corridor mobility and related needs and goals, and is acceptable to the community. The Eastside community is one of the most transit-dependent and transit-oriented communities in Los Angeles County. Many of the highest MTA and Montebello Transit ridership bus routes are there. The commercial and shopping areas on Cesar Chavez Avenue, 1<sup>st</sup> Street and Whittier Boulevard are not only important to the community but serve the needs of a much larger area. The two colleges (California State University at Los Angeles and the East Los Angeles Community College) in the study area are important to the cultural and educational needs of the Eastside and require quality public transit accessibility.

### III. Alternatives

The alternatives proposed for initial consideration in the Re-Evaluation Major Investment Study (see FTA Procedures below) include: 1) Exclusive busway alternatives between Union Station and Whittier/Atlantic via 1<sup>st</sup> St., Lorena, Whittier or other alternative arterial roadways that would be at-grade or elevated. 2) Light rail alternatives between Union Station and Whittier/Atlantic via 1<sup>st</sup> St., Lorena, Whittier or other alternative arterial roadways that would be at-grade or elevated. 3) A Heavy Rail alternative from Union Station to Chavez/Soto without a Little Tokyo station. 4) The Heavy Rail LPA initial operating segment (IOS-2, 3.7 miles) from Union Station to 1<sup>st</sup>/Lorena as identified in the 1994 FEIS/FEIR and the FTA Record of Decision, December 1994 and is the currently suspended Locally Preferred Alternative project. 5) The Heavy Rail Locally Preferred Alternative (LPA) from Union Station to Whittier/Atlantic. This 6.8-mile alternative consists of a heavy rail subway that would follow the alignment identified in the 1994 FEIS/FEIR and the FTA Record of Decision, December 1994. 6) A Transportation Demand Management (TDM)/Transportation System Management (TSM) Alternative. 7) A No Build Alternative, which involves no change to transportation services or facilities in the corridor beyond already committed projects.

Other alignment alternatives involving rail or bus may be developed in the scoping process in the early stages of the study.

### IV. Probable Effects

FTA and MTA will evaluate significant environmental, social, and economic impacts of the alternatives to be analyzed in the SEIS/SEIR. Among the primary transit issues to be evaluated are the expected increase in transit ridership, the expected increase in mobility for the corridor's transit dependent, the support of the region's air quality goals, the capital outlays needed to construct the project, the cost of operating and maintaining the facilities created by the project, and the financial impacts on the funding agencies. Potentially affected environmental and social resources proposed for analysis include land use and neighborhood impacts, residential and business displacements and relocations, traffic and parking impacts near stations, traffic circulation, visual

impacts, impacts on cultural and archaeological resources, and noise and vibration impacts. Impacts on air and water quality, groundwater, hazardous waste sites, and water resources will also be covered. The impacts will be evaluated both for the construction period and for the long-term period of operation. Measures to mitigate adverse impacts will be considered.

#### V. FTA Procedures

A Re-Evaluation Major Investment Study (MIS) will initially be prepared to evaluate several rail and bus mode and alignment options. The MIS/Draft SEIS/SEIR and the conceptual engineering for the project will be prepared simultaneously. Following FTA approval, Preliminary Engineering would be conducted during preparation of the Final SEIS/SEIR. The impacts of these initial alternatives will be evaluated on a corridor-level basis during the Re-Evaluation/MIS and SEIS/SEIR scoping phase. The alternatives coming out of this initial evaluation will then be assessed in the Draft SEIS/SEIR. The Draft SEIS/SEIR/conceptual engineering process will assess the social, economic, and environmental impacts of the proposed alternatives at a project-level while refining their design to minimize and mitigate any adverse impacts. After its publication, the Draft SEIS/SEIR will be available for public and agency review and comment, and a public hearing will be held. On the basis of the Draft SEIS/SEIR and comments received, MTA will select a preferred alternative to carry forward into the Final SEIS/SEIR. The Final SEIS/SEIR will be based on information resulting from Preliminary Engineering.

Issued: August 9, 1999

Leslie Rogers,

Regional Administrator, Federal Transit Administration, Region IX.





**APPENDIX B**  
**DISTRIBUTION LIST**



**Mailing Distribution List Final SEIS/SEIR Eastside Transit Project  
October 26, 2001**

**FEDERAL AGENCIES**

Advisory Council on Historic Preservation, Executive Director (Washington, D.C.)  
Office of Management and Budget (Washington, D.C.)  
U.S. Army Corps of Engineers, Colonel Robert Davis (Washington, D.C.)  
U.S. Army Corps of Engineer, District Engineer (Los Angeles)  
US Department of Agriculture Office of Secretary (Washington, D.C.)  
U.S. Department of Commerce  
    National Oceanic and Atmospheric Administration  
    Office of the Secretary (Newport Beach)  
U.S. Department of Energy, Office of Environment Compliance, Director  
U.S. Department of Environmental Affairs  
U.S. Department of Health and Human Services (Washington, D.C.)  
U.S. Department of Housing & Urban Development, Environmental Clearance Officer (Washington, D.C.)  
U.S. Department of Housing & Urban Development, Environmental Clearance Officer (San Francisco)  
U.S. Department of Interior  
    Office of the Secretary (Washington, D.C.)  
    Director of Environment Project Review  
    U.S. Fish & Wildlife Services, Jaime Rappaport, Director (Carlsbad, CA)  
    U.S. Fish & Wildlife Services, Ken Berg, Field Supervisor (Carlsbad, CA)  
    National Parks Service  
U.S. Department of Transportation  
    Office of the Secretary (Washington, D.C.)  
    AWP 600 FAA Western Pacific Region, Manager Airports Division  
    Federal Aviation Administration  
    Federal Highway Administration, Region 9  
    Federal Railroad Administration Office of Policy & Plans  
    Federal Transit Administration Region 9, Leslie Rogers  
    Federal Transit Administration Region 9, Robert Horn  
    Federal Transit Administration, Ray Tellis  
    Federal Transportation Agency / Federal Highway Administration Metro Office, Sandra Balmir  
    Federal Transit Administration / Federal Highway Administration Metro Office, Ervin Poka  
    U.S. Coast Guard (Long Beach)  
U.S. Environmental Protection Agency, Deanna Wieman (San Francisco)  
U.S. Environmental Protection Agency, Lisa Hanf (San Francisco)  
U.S. Environmental Protection Agency (Washington, D.C.)  
U.S. Federal Emergency Management Agency # 9, Regional Director

**STATE AGENCIES**

Air Resources Board California Environmental Protection Agency, Dr. Alan Lloyd, Chairman (Sacramento)  
California Air Resources Board, Michael Denny, Executive Director  
California Coastal Commission, Elizabeth Fachs  
California Department of Fish & Game Environment Service Division, William Tippetts  
California Department of Fish & Game, Director  
California Department of Heath Services, Diana M. Bonta, RN.DR.PH.P  
California Department of Fish & Game Environment Service Division, Robert C. Hight, Director  
California Department of General Services, Mike Cortney, Assistant Deputy Director

California Department of Park & Recreation, Carl Drake, Director  
California Energy Commission, Keneth Smith, Acting Director  
California Highway Patrol, Chief Helmik  
California Highway Patrol, Pete Ramos  
California Native Plant Society, Allen Barns, Executive Director  
California Regional Quality Control Board Los Angeles Region, Scott Dawson  
California State Building Southern California Public Utilities Commission, Maxine Harrison-  
Acting Commission Representative  
California Transportation Commission , Robert Chung, Deputy Director Mass Transportation  
California Transportation Commission, Robert I. Remen, Executive Director  
California Wildlife Conservation, Jon Schmiht, Executive Director  
California Department of Food & Agriculture, William Lyons Jr. Secretary  
California Department of Transportation District 7, Dan Lasiewicz  
California Department of Transportation Transit Rail, Lisa Cooke  
California Department of Transportation Transit Rail, Maria Aranguiz  
California Department of Transportation, Division of Aeronautics, Gary Cappy  
California Department of Transportation, Division of Aeronautics Marlin Beckwith  
California Department of Transportation, Environmental Planning Branch, Ron Kesinski, Office Chief  
Department of Conservation, Steve Arthur, Chief Dept Dir.  
Department of Parks Superintendent  
Integrated Waste Management Board, Ralph Chandler, Executive Director  
Museum of Vertebrate Zoology, Dr. Wake, Director  
Native American Heritage Commission, Larry Myers, Executive Secretary  
Office of Historic Preservation, Hans Kretzberg  
Public Utilities Commission, Wesley Franklin, Executive Director  
State Clearinghouse Office of Planning & Research, Terry Roberts, Senior Planner  
State Dept of Housing & Community Development, Judy Nevis, Acting Director  
State Lands Commission, Betty Silva  
State Resource Agency, Nadell Gayon  
State Resources Agency, Dr. Knox Mellon  
State Resources Agency, Kenneth Trott  
State Water Resources Control Board, Walt Pettit, Executive Director

## **COUNTY AGENCIES**

### **Administrative Offices**

Agricultural Commissioner

Community Development Commission, Eduardo Hernandez

Community Development Commission, Carlos Jackson

Community Development Commission, Elvia Delgadillo, Senior Project Manager

County Clerk

County Sheriffs Department, Sheriff Lee Baca

Department of Public Works & Floor Control, Harry W. Stone, Director

Department of Public Works, Ann Meiners, Programs Development Division

Department of Public Works, Jennifer Tiffin

Department of Public Works, John Huang, P.E.

Department of Public Works, Jose Pou

Department of Public Works, James Noyes

Department of Regional Planning, Dave Cowardin

Department of Regional Planning, Esther Ibarra

## **Appendix B**

### **Distribution List**

Department of Regional Planning, Leonard Erlanger  
East Los Angeles Sheriffs Department, Captain Tom Angel  
Fire Department, Fire Chief P. Michael Freeman  
Health Services Department  
Pico Rivera Sheriffs Department, Captain Rodriguez

## **LOCAL AGENCIES**

### **CITY OF LOS ANGELES**

#### Administrative Offices

Bureau of Engineering, Vitaly B. Troyan, Director  
Bureau of Street Lighting, Jonathan L. Levy, Director  
Bureau of Street Services, Delphia Jones  
Bureau of Street Services, Victor Osugi  
Bureau of Street Trees, Gregory L. Scott, Director

City Attorney

City Clerk

Community Development Department

Community Redevelopment Agency, Al Santillanes, Project Manager

Community Redevelopment Agency, Jeff Carpenter

Community Redevelopment Agency, Parker Anderson, Director

Community Redevelopment Agency, Rodolfo Bocanegra

Community Redevelopment Agency, Jerry Scharlin

Cultural Affairs Department

Department of Building & Safety, Andrew Adelman, General Manager

Department of Recreation & Parks, Jackie M. Tatum, General Manager

Department of Transportation, David Rzepinski

Department of Transportation, Farhad Zaltash

Department of Transportation, Frances T. Banerjee, General Manager

Department of Transportation, James Okasaki

Department of Transportation, Jeannie Shen

Department of Transportation, Mortesa Delpasana

Department of Transportation, Phil Aker

Department of Transportation, Sean Skehan

Department of Transportation, Susan Bok

Department of Water & Power

Department of Public Works, Robert La France

Eastside Enterprise Zone, David Eder

Eastside Enterprise Zone, Margaret Gonzales

Environmental Affairs Department

Environmental Affairs Department

Fire Department, William Baratre

General Services Department

Hollenbeck Police Station, Captain Moselle

Housing Authority, James Bochon

Housing Department

Planning Department, Con Howe, Director

Planning Department, Daniel Scott

Planning Department, Kevin Keller

Planning Department, Loretta Rosas

## **Appendix B**

### **Distribution List**

Planning Department, Michael Davies  
Planning Department, Patricia A. Diefenderfer  
Planning Department, Phil Bacerra  
Police Department, Chief Bernard Parks

**CITY OF COMMERCE**

City Administrator, Raul Romero  
City Clerk, Linda Kay Olivieri  
Public Services Department, Robert Sepulveda, Director  
Transportation Department, Dan Gomez, Director

**CITY OF ALHAMBRA**

City Clerk, Frances A. Moore  
City Manager, Julio J. Fuentes

**CITY OF MONTEBELLO**

City Administrator, Richard Torres  
Economic Community Development, Linda Puyan, Asst. City Admin.  
Economic Development Analyst, John Bazua  
Economic Development, Didacus Ramos  
Park & Recreation Department, Louie Lozano, Manager  
Planning Department, Tonya Pace  
Public Works Department, Steve Blancart, Asst City Admin  
Transportation Department, Jack Gabig, Director  
Transportation Department, Katheryn Engel, Manager

**CITY OF MONTEREY PARK**

City Administrator, Chris Jeffers  
City Clerk, David Barron  
Community Development Department, Adolfo Reata, Director  
Economic Development, Kelvin Tainatongo  
Public Works Department, Ron Merry, Director  
Transportation Department, Amy Ho, Manager

**CITY OF PICO RIVERA**

City Clerk, Christine Schaefer  
City Manager, Dennis Courtemarche  
Community Development, David Hertzling, Director  
Park & Recs Department, Cindy Lu Gans, Director  
Public Works Department, Enrique Acevedo, Director  
City Administration Asst., Carmen Martinez  
Redevelopment Agency, Ann Negendank, Director  
Sheriffs Department, Captain Juan Rodriguez

**CITY OF SANTA FE SPRINGS**

City Manager, Fred Lapham, Manager

**CITY OF WHITTIER**

Public Works Department, David Mochizuki, Director

Transportation Department, Joe Dyer, Asst Director

City Manager, Tom Mauk

Assistant City Manager, Douglas Chotkevys

Community Development, Ann Ybarra, Manager

Parks & Recreation Department, Hideo Hamano, Director

**CITY OF NORWALK**

Transportation Department, Jim Parker

**AGENCIES**

Foothill Transit, Julie Austin, Executive Director

Hill International, Inc., Terry W. Esteb, Project Director

Interstate 5 Consortium Cities Joint Power Authority, Ralph Webb

Los Angeles County Office of Education East Los Angeles

Metrolink-David Solow

Metropolitan Water Dist, Water Resources & Env., Robbie Saltz, Director

San Gabriel Valley Council of Governments, Brent Cardwell

San Gabriel Valley Council of Governments, Nicolas Conway, Executive Director

Southern California Association of Governments, Jim Gosnell

Southern California Association of Governments, Michelle Glickert, Associate Planner

Southern California Association of Governments, Planning & Technical Advancement, Katheryn Higgins

Southern California Association of Governments, Von Loveland

Southern California Regional Rail Authority Metrolink, David Solow, Executive Director

The Nature Conservancy, Steve McCormick, Director

**LOS ANGELES UNIFIED SCHOOL DISTRICT**

Belmont High School

Belvedere Elementary School, Robert G. Quihuis, Principal

Breed Street Elementary School

Brooklyn Elementary School

Castelar Elementary School

Environmental Section, Joan Friedman

Environmental Section, Ray Dippel

First Street Elementary School, Judith Wisotsky Leff, Principal

Fourth Street Elementary School

Garfield High School

Griffith Middle School, Mark Nagayama, Teacher

Griffith Middle School, Raul Perez Salcido, Principal

Hamasaki Elementary School

Humphreys Elementary School

Los Angeles Unified School Board Superintendant, Roy Romer

Los Angeles Unified School District, Estela R. Herman

Los Angeles Unified School District, Lupe Pramo

Marianna Avenue Elementary School, Lee White, Principal

Nightingale Middle School

**Appendix B**

**Distribution List**



Ramona High School, Sherry Petrie Breskin, Principal  
Roosevelt High School, Henry Ronquillo, Principal  
Rowan Elementary School  
School Board Member Takosfsky's Office, Enrique Juarez  
School Safety, Ann Altieri  
Second Street Elementary School  
Stevenson Middle School  
Superintendent District F, Richard Alonzo  
Superintendent District H, Bonnie Rubio  
Superintendent District H, Peggy Selma  
Traffic Safety, Joe Nardulli  
Utah Street Children's Center, Bettie Holmes, Principal  
Utah Street Elementary School, Elsa M. Lonon, Principal

#### **EDUCATIONAL FACILITIES**

Dolores Mission School  
East Los Angeles Community College  
East Los Angeles Occupational Center  
East Los Angeles Skill Center  
LA County office of Education East Los Angeles  
Montebello High School  
Montebello Unified School District  
Our Lady Of Lourdes Catholic School  
Pico Rivera Unified School District  
Puente Learning Center  
Rio Hondo Community College  
Shurr High School

#### **GOVERNOR, U.S., SENATORS AND U.S. CONGRESSMEN**

Governor Gray Davis  
Lieutenant General Cruz Bustamante  
U.S. Senator Barbara Boxer  
    Sam Chapman, Chief of Staff  
    Malena Avila  
U.S. Senator Dianne Feinstein  
    Jim Lazarus, State Director  
    Guillermo Gonzales  
U.S. Congresswoman Hilda Solis (District #31)  
    Adolfo Chaidez  
U.S. Congresswoman Napolitano (District #34)  
    Scott Lines  
U.S. Congresswoman Lucille Roybal-Allard (District #33)  
    Kim Tachiki  
U.S. Congressman Xavier Becerra (District #30)  
    Gayle Greenberg

#### **STATE LEGISLATORS**

State Senator Martha Escutia (District #30)  
    William Sanchez

State Senator Richard Polanco (District #22)  
Barbara Romero  
State Assemblymember Jackie Goldberg (District #45)  
George Magallanes  
State Assemblymember Gilbert Cedillo (District #46)  
Dan Farkas  
Iris Miranda  
Assemblymember Marco Firebaugh (District #50)  
Jose Sigala  
Assemblymember Judy Chu (District #49)  
Roland Aranjó  
Assemblymember Tom Calderon (District #58)  
Gary Mann

**COUNTY BOARD OF SUPERVISORS**

Supervisor Gloria Molina (District #1)  
Nicole Englund  
Supervisor Yvonne Brathwaite Burke (District #2)  
Supervisor Don Knabe (District #3)  
Fred Guido  
Supervisor Zev Yaroslavsky (District #4)  
Supervisor Michael Antonovich (District #5)

**LOCAL OFFICIALS-City of Los Angeles**

Mayor James Hahn  
City of Los Angeles Council Member District 1 Ed Reyes  
City of Los Angeles Council Member District 2 Joel Wachs  
City of Los Angeles Council Member District 3 Dennis P. Zine  
City of Los Angeles Council Member District 4  
City of Los Angeles Council Member District 5 Jack Weiss  
City of Los Angeles Council Member District 6 Ruth Galanter  
City of Los Angeles Council Member District 7 Alex Padilla  
City of Los Angeles Council Member District 8 Mark Ridley-Thomas  
City of Los Angeles Council Member District 9 Jan Perry  
City of Los Angeles Council Member District 10 Nate Holden  
City of Los Angeles Council Member District 11 Cindy Miscikowski  
City of Los Angeles Council Member District 12 Hal Bernson  
City of Los Angeles Council Member District 13 Eric Garcetti  
City of Los Angeles Council Member District 14 Nick Pacheco  
Maryam Torben  
Brissa Sotelo  
City of Los Angeles Council Member District 15 Janice Hahn

**CITY OF ALHAMBRA**  
Mayor, Daniel R. Arguello

**CITY OF COMMERCE**  
Mayor, Raquel Arriaga

**CITY OF MONTEBELLO**

Mayor Mary Anne Saucedo

**CITY OF MONTEREY PARK**

Mayor Benjamin "Frank" Venti

**CITY OF PICO RIVERA**

Mayor Garth Gardner

**CITY OF SANTA FE SPRINGS**

Mayor Luis Gonzalez

**CITY OF WHITTIER**

Mayor Allan Zolnekoff

**PUBLIC LIBRARIES**

Anthony Quinn Library  
Atlantic Library  
Benjamin Franklin Library  
California State University, Los Angeles Library  
City Terrace Public Library  
Commerce Public Library  
East Los Angeles College Library  
East Los Angeles Public Library  
El Camino Library  
Garfield High School Library  
Grenwood Branch Library  
Griffith Middle School Library  
Hinomoto Library  
Lincoln Heights Branch Library  
Little Tokyo Library  
Little Tokyo Service Center  
Los Angeles Central Library  
Los Angeles Library-Wabash St.  
Los Angeles Library-Spence St.  
Malabar Library  
Montebello Public Library  
Monterey Park Public Library  
MTA Library  
Romona High School Library  
Roosevelt High School Library

**LOCAL MEDIA**

Downtown News  
Eastern Group Publications, Inc.  
La Opinion Editorial  
Los Angeles Times  
Rafu Shimpō

## **INTERESTED ORGANIZATIONS .**

AAA-Stephen Finnegan  
Abuelitos de Boyle Heights  
Adelante Eastside Redevelopment Project-George Magallanes  
ADVANCE  
Archdiocese of Los Angeles  
Boyle Heights Chamber of Commerce  
Boyle Heights Homeowners Association  
Boyle Heights Majoramiento-Margarita Sanchez  
Boyle Heights Senior Center  
Bus Riders Union, Eric Orosz  
Bus Riders Union, Edgar Sanchez  
Bus Riders Union, John Walsh  
Campaign for Better Transit-Thomas Stanley  
Centro Maravilla Service Center  
CHAROCD  
Children's Museum of Los Angeles - Candace Barrell  
City Terrace Coordinating Council  
Committee Against the Adelante Redevelopment Project-Ernestina Montellano  
Community and Human Resource Agency  
Community Redevelopment Agency Advisory Council  
Community Service Organization Alcohol Service Program  
Community Rehabilitation Service  
East Los Angeles Chamber of Commerce  
East Los Angeles Rehabilitation Center  
East Los Angeles YMCA  
East Los Angeles One Stop Center  
Eastmont Community Center  
ELA Minority Business Development Center  
Environmental Defense  
Family Center Santa Fe Springs  
Friends for Expo Transit-Darrell Clarke  
Hollenbeck Youth Center  
Humphrey's MASH Organization  
IDEPSCA  
Instituto de Educacion Popular California  
Inter-Community Child Guidance Center – Whittier  
International Institute of Los Angeles  
Japanese American National Museum - Nancy Araki  
LA Center for Law and Justice  
LA Family Housing Corp Homeless Service Center  
LAFLA  
LARABA  
Latin Business Association  
Latino Urban Forum, Dr. Ramon Garcia  
League of Women Voters  
Legal Aid Foundation-Barbara Schultz  
Lincoln Heights Chamber of Commerce  
Little Tokyo Community Council-Irene Hirano

Little Tokyo Lions  
Little Tokyo Service Center  
Los Angeles County Chicano Employees Assistance  
Los Angeles Family Housing Corporation  
Los Angeles Family Housing Corporation  
Los Angeles Neighborhood Initiative  
Madres del Este de Los Angeles  
Maravilla Business Persons Association  
Maravilla Community Advisory Committee-Richard Alonzo  
Mexican American Grocers Association  
Mexican American Opportunity Foundation  
Montebello Chamber of Commerce  
Montebello Senior Center  
Mothers of East Los Angeles-Mary Lou Trevis  
NAACP-E. Richard Larson  
Neighborhood Watch Captain, Mary Lou Trevis  
PACE Development  
Pico Aliso Resident Advisory Council  
Pico Rivera Chamber of Commerce  
Pico Rivera Senior Citizen  
Plaza Community Center  
Plaza Family Preservation  
Proyecto Pastoral  
Salesian Boys and Girls Club  
San Gabriel Valley Hispanic Chamber of Commerce  
Santa Fe Springs Neighborhood Center  
Santa Marta Hospital  
Self Help Graphics  
Society of Hispanic Professional Engineers  
Soledad Enrichment Action Program  
Southern California Transit  
Southern California Transit Authority  
Southwest Voter Registration  
TELACU  
Union y Fuerza-Silvia Viramontes  
USC Center for Religion and Civic Culture  
USC University Hospital  
White Memorial Medical Center-Albert Deininger  
Whittier Area Family Violence Prevention Council  
Whittier Boulevard Merchants Association

**MTA REVIEW ADVISORY COMMITTEE**

Richard Alonzo  
Joel Bloom  
Sherry Petrie Breskin  
Anita Castellanos  
Renee Chavez  
Joseph Coria  
Nadine Diaz

Victor Duran  
Rosa Marina Gabaldon  
Jose L. Gomez  
Dorothy Hartshorn  
Frances K. Hashimoto  
Art Herrera  
Louis Martinez  
Carlos Montante  
Ron Mukai  
Laura Pizana  
Rita Govea Rodriguez  
Olga Salas  
Jose Salomon  
Rachael Santos  
Albert H. Taira  
Diana Tarango  
Luigi Torres  
Ross Valencia  
Silvia Viramontes  
Armando Ybarra

#### **RELIGIOUS INSTITUTIONS**

All Saints Church  
Apostolic Church  
Assumption Church  
Bethesda Tabernacle Church  
Brotherhood Tenrikyo Church  
Boyle Heights Latin Amer Church  
Capilla la Luz  
Christian Council of Hispanic  
Church of God of Prophecy  
Church of Jesus Christ of LDS  
Community Baptist Church  
Dolores Mission Church  
East Los Angeles S D A Church  
Ebenezer Asambleas de Dios  
El Camino Church  
First Baptist Church-Commerce  
Iglesia Bautista -Resurreccion  
Iglesia Bautista Unida  
Iglesia Christiana de LA  
Iglesia de Dios  
La Puerta Abierta Church  
Los Angeles Central Korean Church  
Los Angeles Homba Hongwanji Buddhist Temple-Rev. George Matsibayashi  
Mexican Evangelical Memorial  
Ministerio Sol de Justicia  
Mission MI Fuente de Salvacion  
Our Lady of Guadalupe (Hammel)

#### **Appendix B Distribution List**

Our Lady of Guadalupe (Rose Hills)  
Our Lady of Guadalupe (Sanctuary)  
Our Lady of Solitude  
Our Lady of Talpa  
Our Lady of Victory Church  
Our Lady Queen of Martyrs  
Praise Chapel  
Primera Iglesia Bautista-Ferris Ave.  
Primera Iglesia Bautista-Kinsie St.  
Resurrection Parish  
Rissho Kosei-Kai of la Church  
Rosa de Saron  
Sacred Heart Church  
San Antonio de Padua Church & School  
San Francisco Church  
Santa Isabel Church  
Santa Teresita  
Seventh-Day Adventist  
Spanish American SDA Community  
Spanish American Seventh Day  
St. Alphonsus Church  
St. Lucy's Church  
St. Marcellinus Church  
St. Mary's Church  
Tenrikyo Mission Headquarters  
Tenrikyo Southern Pac Church  
United Mexican Baptist Church  
Universal Church of God  
Victory Outreach  
White Memorial Seventh-Day Adventist

**Individuals**

Anne Abraham  
Tim Adams  
Charles Adelman  
Sean Armstrong  
John Arroyo  
Bruce Beckett  
Robert Bellinger  
Gladys Bryant  
Jorge Cabrera  
Consuelo Cardona  
Santiago Cardona  
Juaquin Castellanos  
Fernando Castro  
Catellus Development Corporation-Dean Pertou  
Tony Chavez  
Roger Christensen  
Gilbert Cortez

**Appendix B  
Distribution List**

Raymond Covarrubias  
Victor Delgado  
Lillian de Loza  
George del Rio  
Michael Diaz  
Silvia Diharce  
Artemio Dominguez  
Byron Edwards  
Gary Einstein  
Alfonso Falcon  
Bertha Faustinos  
Erica Friedman  
James Fujita  
Dana Gabbard  
Antonio Gardea  
Gabrele Garib  
Frances Galvan  
Lester Garcia  
Allen Gee  
Feliciano Gomez  
Estella Gonzalez  
Ron Granados  
Armando Herman  
Anita Hernandez  
Lois Hernandez  
Rolando Hidalgo  
Karen Hirai-Olen  
Charles Hockett  
Ester Ibarra  
Joe Itow  
Keri Itow  
Jose Jimenez  
John Langoria  
Jose Leon  
J. Lesko  
Guadalupe Lopez  
Lupe Lopez  
Robert Lopez  
Jackie MacCauley  
Antonio Maldonado  
Armida Marquez  
Doug Matsumoto  
Adela Mendoza  
Ricardo Mireles  
Ricardo Mojarro  
Ramon Montanez  
Rovert Montanez  
Carlos Montes  
Ricky Monugium

**Appendix B**  
**Distribution List**



Juan Morales  
William Morrison  
Thun Motto  
Alexis Navarro  
Philip Nurenberg  
Servando Omelas  
Angelo Orosco  
Arturo Osoro  
Paul Perez  
Tomas Perez  
Adelina Portillo  
Mario Prietto  
Annette Ramirez  
Ramon Ramirez  
Mary Reeves  
Alberto Rodriguez  
Rita Rodriguez  
Jose Ruiz  
Linda Sabori  
Mich Sakata  
Gerardo Salas  
John Sanchez  
Juan Patri Sanchez  
Patricio Sanchez  
Silvia Sanchez  
Sandra Sandoval  
Shoji S. Shimizu A.I.A.  
John Smart  
Clara Solis  
Jesus Somono  
Luis Soto  
Darren Stroud  
John Sullivan  
Albert Taira  
Tunde Thomas  
Mirna Troncoso  
Conceptcion Vasquez  
Raul Vazquez  
Michael Vega  
Robert Volk  
Diniel Walker  
Robert Wang  
Michael Weintraub  
Jarome Weymouth  
Diane Zaeptel

**APPENDIX C**

**BIBLIOGRAPHY**



## APPENDIX C

### BIBLIOGRAPHY

- AASHTO. "Green Book," *A Policy on Geometric Design of Highways and Streets*. 1994.
- ACG Environments. *East Los Angeles Transit Corridor and Technology Study*, prepared for Supervisor Gloria Molina, County of Los Angeles, First Supervisorial District. October 1998.
- Albert, Peter. Station Area Planning, Bay Area Rapid Transit. Telephone interview by Mark Weisman, S.R. Beard & Associates. 1999.
- American Public Transit Association (APTA). *Employment Impacts of Capital Investment and Operating Expenditures*. April 1983.
- Arrington, G.B. Parsons Brinckerhoff (Portland), former Planning Manager with Tri-Met (Portland). Telephone interview by Mark Weisman, S.R. Beard & Associates. 1999.
- Asher, Greg. Transit-Oriented Development Manager, Santa Clara VTA. Telephone interview by Mark Weisman, S.R. Beard & Associates. 1999.
- Barrio Planners Inc. *East Los Angeles Visual Survey and Analysis*. April 1974.
- *Eastside Redevelopment Feasibility Study*. 1993.
- *Urban Design Analysis/Planning and Urban Design, Metro Red Line Eastside Extension, Final FEIS/FEIR and Project Planning*. July 1994.
- *Station Area Concept Plans Final Report, Metro Red Line Eastside Extension, Project Planning And Community Linkages for Whittier/Rowan, Whittier/Arizona, and Whittier/Atlantic*. April 1995.
- *Station Area Concept Plan Final Report, Metro Red Line Eastside Extension, Project Planning and Community Linkages for Mariachi Plaza, Chavez/Soto and First/Lorena*. April 1995.
- *Field Surveys*. October through December 1999.
- *East Los Angeles Civic Center – Urban Planning Study*. December 1999.
- Barrows, A.G. A Review of the Geology and Earthquake History of the Newport–Inglewood Structural Zone, Southern California. California Division of Mines and Geology Special Report 114. 1974
- Battalion Chief Littleton, Los Angeles City Fire Department, Los Angeles, California. Meeting with Scott Forbes, Jenkins/Gales & Martinez, (JGM). August 3, 2000.

- Bolton, Herbert Eugene. "The Mission as a Frontier Institution in the Spanish American Colonies." *New Spain's Far Northern Frontier; Essays on Spain in the American West, 1540-1821*. Ed. David J. Weber, pp.49-65. Albuquerque: University of New Mexico Press, 1979.
- Brigado, Nancy. Senior Planner, Metropolitan Transit Development Board (San Diego). Telephone interview by Mark Weisman, S.R. Beard & Associates, 1999.
- Brown, Joan. *Archaeological Literature and Records Review, and Impact Analysis for the Eastside Corridor Alternatives, Los Angeles, California*. RMW Paleo Associates, Mission Viejo, California. Submitted to Parsons Brinckerhoff, Quade and Douglas, Los Angeles. 1992.
- Bullard, T. R. and Lettis, W. R. "Quaternary Fold Deformation Associated with Blind Thrust Faulting, Los Angeles Basin, California," *Journal of Geophysical Research* 98.B5 (1993): 8349-8369.
- Burchell and Listokin. *Fiscal Impact Handbook*. 1978.
- Burns, John A. *Recording Historic Structures*. Washington, DC: American Institute of Architects Press, 1989.
- California Department of Fish and Game (CDFG). *Special Plants List*. Natural Heritage Division, Natural Diversity Data Base, Sacramento, California. April 2000.
- California Department of Water Resources, *Planned Utilization of Groundwater Basins of the Coastal Plain of Los Angeles County*, Bulletin 104, Appendix A. 1961.
- *Planned Utilization of Groundwater Basin, San Gabriel Valley*, Bulletin 104-2, Appendix A. 1966.
- *Hydrologic Data on Microfiche*. 1988.
- California Division of Mines and Geology. *Seismic Shaking Hazard Maps of California*. Map Sheet 48. 1999.
- *State of California Seismic Hazard Zones, Los Angeles Quadrangle, Official Map*. 1999.
- *State of California Seismic Hazard Zones, El Monte Quadrangle, Official Map*. 1999.
- *State of California Seismic Hazard Zones, Whittier Quadrangle, Official Map*. 1999.
- *State of California Seismic Hazard Zones, Los Angeles Quadrangle, Official Map*. 1999.
- *State of California Seismic Hazard Zones, South Gate Quadrangle, Official Map*. 1999.
- *Seismic Hazard Evaluation of the Burbank 7.5 Minute Quadrangle, Los Angeles County, California*. Open File Report 98-07. 1998.
- *Seismic Hazard Evaluation of the Hollywood 7.5 Minute Quadrangle, Los Angeles County, California*. Open File Report 98-17. 1998.

- *Guidelines for Evaluating and Mitigating Seismic Hazards in California*. Special Publication 117. 1997.
- *Probabilistic Seismic Hazard Assessment for the State of California*. Open File Report 96-08. 1996.
- *Faults and Earthquakes in California*. DMG Note 31. 1986.
- *Guidelines for Geologic/Seismic Considerations in Environmental Impact Reports*. Note 46. 1982.
- California Division of Oil and Gas, "Regional Wildcat Map Showing Wells Not On Division of Oil and Gas Field Maps, Los Angeles and Kern Counties," Wildcat Map WI-1. 1986.
- California Energy Commission. *California Energy Facts*. Accessed at [www.energy.ca.gov/html/calif\\_energy\\_facts.html](http://www.energy.ca.gov/html/calif_energy_facts.html) by David Freytag, Parsons Brinckerhoff. June 23, 2000.
- California Native Plant Society Electronic Inventory (CNPSEI). *Data Base Record Search*. California Native Plant Society. Sacramento, California. 1999.
- California Natural Diversity Data Base (CNDDDB). *Data Base Record Search*. California Department of Fish and Game, State of California Resources Agency. Sacramento, California. 2000.
- California Regional Water Quality Control Board, LA Region, *Los Angeles Region Water Quality Control Plan*, Adopted June 1994.
- California, State Department of Finance, Economic Research. *California County Profiles* (Los Angeles County - February 2000), Accessed at [http://www.dof.ca.gov/HTML/FS\\_DATA/profiles/losangeles.xls](http://www.dof.ca.gov/HTML/FS_DATA/profiles/losangeles.xls) by David Freytag, Parsons Brinckerhoff on August 15, 2000.
- Cannon, Bruce E. *Arch Bridge Rating Sheet: Bridge # 53C-1166*. U.S. Department of Transportation, Federal Highway Administration, Sacramento. 1986.
- Commerce, City of. *Bus timetables*. 1999.
- Converse Consultants, Earth Science Associates, Geo-Resource Consultants. *Geotechnical Investigation Report*, Volume I; and Volume II, Appendices 1 and 2, for Southern California Rapid Transit Metro Rail Project. 1981.
- Converse Davis and Associates, *Groundwater Investigation, Vicinity of Forest Lawn, Glendale-Los Angeles, California*. Drawings 1 and 2, CDA Project 70-044-EH. 1972.
- Corridor Community Facilities Existing Setting Technical Memorandum, Raul Escobedo, Barrio Planners, Inc., Los Angeles, California, May 2000.
- Corridor Neighborhood Existing Setting Technical Memorandum, Raul Escobedo, Barrio Planners, Inc., Los Angeles, California, May 2000.

- Costello, Julia G., and Larry R. Wilcoxon. *An Archaeological Assessment of Cultural Resources in Urban Los Angeles; El Pueblo de Los Angeles, la Placita de Dolores*. Prepared for Bureau of Engineering, City of Los Angeles. Cultural Resource Group (CRG). 1978.
- Cramer, C.H. and Petersen, M.D. "Predominant Seismic Source Distance and Magnitude Maps for Los Angeles, Orange, and Ventura Counties, California," *Bulletin of Seismological Society of America* 86.5 (1996): 1645-1649.
- Crook, R., Jr., and Proctor, R.J. "The Santa Monica and Hollywood Faults and the Southern Boundary of the Transverse Ranges Province," *Engineering Geology Practice in Southern California* (1992).
- Crook, R., Jr., Allen, C.R., Kamb, B., Payne, C.M., and Proctor, R.J. "Quaternary Geology and Seismic Hazard of the Sierra Madre and Associated Faults Western San Gabriel Mountains," *U.S. Geological Survey Professional Paper 1339*, Ch. 2, pp. 27-63. 1987.
- Crook, R., Jr., Proctor, R.J., and Lindvall, E.E. "Seismicity of the Santa Monica and Hollywood Faults Determined by Trenching," *Technical Report to the U.S. Geological Survey*, Contract No. 14-08-001-20523, p. 26. 1983.
- Dakin Publishing Company. *Los Angeles, California*. Vol. 2. San Francisco. 1888.
- Davis, J.F., Bennett, J.H., Borchardt, G.A., Kahle, J.E., Rice, S.J., Silva, M.A. "Earthquake Planning Scenario for a Magnitude 8.3 Earthquake on the San Andreas Fault in Southern California," *California Division of Mines and Geology Special Publication 60*. 1982.
- Deetz, James. *In Small Things Forgotten: The Archaeology of Early American Life*. New York: Anchor/Doubleday. 1977.
- Dibblee, T. W., Jr. *Geologic Map of the Los Angeles Quadrangle*. Dibblee Geological Foundation Map DF-22. 1989.
- Davis, J.F., Bennett, J.H., Borchardt, G.A., Kahle, J.E., Rice, S.J., Silva, M.A., "Earthquake Planning Scenario for a Magnitude 8.3 Earthquake on the San Andreas Fault in Southern California," *California Division of Mines and Geology Special Publication 60*. 1982.
- Dolan, J.F. and Sieh K. *Tectonic Geomorphology of the Northern Los Angeles Basin: Seismic Hazards and Kinematics of Young Fault Movement*. 1993.
- "Paleoseismology and Geomorphology of the Northern Los Angeles Basin: Evidence for Holocene Activity on the Santa Monica Fault and Identification of New Strike-Slip Faults through Downtown Los Angeles," *EOS, Transactions of the American Geophysical Union*. 73 (1992): 589.
- Dumke, Glenn S. *The Boom of the Eighties in Southern California*. Huntington Library, San Marino, California. 1944.
- Eastside Corridor Transit Consultants. *Re-Evaluation/Major Investment Study Report, Los Angeles County Metropolitan Transportation Authority, Los Angeles, California*. February 2000.

- Re-Evaluation/Major Investment Study, Los Angeles Eastside Corridor, *Scoping Meetings Summary Report*. September 1999.
  - Re-Evaluation/Major Investment Study, Los Angeles Eastside Corridor, *Second Round of Community Meetings Summary Report*. October 1999.
  - Re-Evaluation/Major Investment Study, Los Angeles Eastside Corridor, *Third Round of Community Meetings Summary Report*. February 2000.
  - Re-Evaluation/Major Investment Study, Los Angeles Eastside Corridor, *Final Purpose and Need Statement*. September 1999.
  - Re-Evaluation/Major Investment Study, Los Angeles Eastside Corridor, *Preliminary Systems Planning for Modal Extensions*. December 28, 1999.
  - Re-Evaluation/Major Investment Study, Los Angeles Eastside Corridor, *Baseline Set of Alternatives Working Paper*. September 1999.
  - Re-Evaluation/Major Investment Study, Los Angeles Eastside Corridor, *Conceptual Engineering and Design Drawings*. December 1999.
  - Re-Evaluation/Major Investment Study, Los Angeles Eastside Corridor, *Report of Geologic-Seismic Hazards Evaluation*. December 1999.
  - Re-Evaluation/Major Investment Study, Los Angeles Eastside Corridor, *Proposed Urban Design Guidelines*. December 1999.
  - Re-Evaluation/Major Investment Study, Los Angeles Eastside Corridor, *Urban Design Concept Report*. December 1999.
  - Re-Evaluation/Major Investment Study, Los Angeles Eastside Corridor, *Capital Cost Estimates*. December 1999.
  - Re-Evaluation/Major Investment Study, Los Angeles Eastside Corridor, *Environmental Setting Chapter*. January 2000.
  - Re-Evaluation/Major Investment Study, Los Angeles Eastside Corridor, *Environmental Issues Chapter*. February 2000.
  - Re-Evaluation/Major Investment Study, Los Angeles Eastside Corridor, *Operating Plans*. November 1999.
  - Re-Evaluation/Major Investment Study, Los Angeles Eastside Corridor, *Screening Methodology Working Paper and Criteria*. September 1999.
- Eastside Corridor Transit Consultants and Greenwood & Associates. *Cultural Resources Technical Report, Draft Supplemental Environmental Impact Statement/Draft Subsequent Environmental Impact Report*, Los Angeles Eastside Corridor. December 2000.



----. *Revised Cultural Resources Technical Report*, Final Supplemental Environmental Impact Statement/Final Subsequent Environmental Impact Report, Los Angeles Eastside Corridor. November 2001.

Eastside Corridor Transit Consultants and Jenkins/Gales & Martinez. *Safety and Security Technical Report*, Draft Supplemental Environmental Impact Statement/Draft Subsequent Environmental Impact Report, Los Angeles Eastside Corridor. December 2000.

----. *Safety and Security Technical Report Addendum*, Final Supplemental Environmental Impact Statement/Final Subsequent Environmental Impact Report, Los Angeles Eastside Corridor. November 2001.

----. *Utility Technical Report*, Draft Supplemental Environmental Impact Statement/Draft Subsequent Environmental Impact Report, Los Angeles Eastside Corridor. December 2000.

----. *Utility Technical Report Addendum*, Final Supplemental Environmental Impact Statement/Final Subsequent Environmental Impact Report, Los Angeles Eastside Corridor. November 2001.

Eastside Corridor Transit Consultants and Law/Crandall. *Geologic and Seismic Conditions Technical Report*, Draft Supplemental Environmental Impact Statement/Draft Subsequent Environmental Impact Report, Los Angeles Eastside Corridor. December 2000.

----. *Geologic and Seismic Conditions Technical Report Addendum*, Final Supplemental Environmental Impact Statement/ Final Subsequent Environmental Impact Report, Los Angeles Eastside Corridor. November 2001.

----. *Hazardous Materials Technical Report*, Draft Supplemental Environmental Impact Statement/Draft Subsequent Environmental Impact Report, Los Angeles Eastside Corridor. December 2000.

----. *Hazardous Materials Technical Report Addendum*, Final Supplemental Environmental Impact Statement/Final Subsequent Environmental Impact Report, Los Angeles Eastside Corridor. November 2001.

Eastside Corridor Transit Consultants and Paleo Environmental Associates, Inc. *Paleontological Technical Report*, Draft Supplemental Environmental Impact Statement/Draft Subsequent Environmental Impact Report, Los Angeles Eastside Corridor. December 2000.

----. *Paleontological Technical Report Addendum*, Final Supplemental Environmental Impact Statement/ Final Subsequent Environmental Impact Report, Los Angeles Eastside Corridor. November 2001.

Eastside Corridor Transit Consultants and Parsons Brinckerhoff Quade & Douglas. *Biology Technical Report*, Draft Supplemental Environmental Impact Statement/Draft Subsequent Environmental Impact Report, Los Angeles Eastside Corridor. December 2000.

----. *Biology Technical Report Addendum*, Final Supplemental Environmental Impact Statement/ Final Subsequent Environmental Impact Report, Los Angeles Eastside Corridor. November 2001.

- . *Construction Methods Technical Report*, Draft Supplemental Environmental Impact Statement/ Draft Subsequent Environmental Impact Report, Los Angeles Eastside Corridor. December 2000.
- . *Economic and Fiscal Technical Report*, Draft Supplemental Environmental Impact Statement/ Draft Subsequent Environmental Impact Report, Los Angeles Eastside Corridor. December 2000.
- . *Economic and Fiscal Technical Report Addendum*, Final Supplemental Environmental Impact Statement/ Final Subsequent Environmental Impact Report, Los Angeles Eastside Corridor. November 2001.
- . *Energy Technical Report*, Draft Supplemental Environmental Impact Statement/Draft Subsequent Environmental Impact Report, Los Angeles Eastside Corridor. December 2000.
- . *Energy Technical Report Addendum*, Final Supplemental Environmental Impact Statement/ Final Subsequent Environmental Impact Report, Los Angeles Eastside Corridor. November 2001.
- . *Land Use and Development Technical Report*, Draft Supplemental Environmental Impact Statement/Draft Subsequent Environmental Impact Report, Los Angeles Eastside Corridor. December 2000.
- . *Land Use and Development Technical Report Addendum*, Final Supplemental Environmental Impact Statement/ Final Subsequent Environmental Impact Report, Los Angeles Eastside Corridor. November 2001.
- . *Noise and Vibration Technical Report*, Draft Supplemental Environmental Impact Statement/ Draft Subsequent Environmental Impact Report, Los Angeles Eastside Corridor. December 2000.
- . *Noise and Vibration Technical Report Addendum*, Final Supplemental Environmental Impact Statement/ Final Subsequent Environmental Impact Report, Los Angeles Eastside Corridor. November 2001.
- . *Transportation Technical Report*, Draft Supplemental Environmental Impact Statement/Draft Subsequent Environmental Impact Report, Los Angeles Eastside Corridor. December 2000.
- . *Transportation Technical Report Addendum*, Final Supplemental Environmental Impact Statement/Final Subsequent Environmental Impact Report, Los Angeles Eastside Corridor. November 2001.
- . *Visual and Aesthetics Technical Report*, Draft Supplemental Environmental Impact Statement/ Draft Subsequent Environmental Impact Report, Los Angeles Eastside Corridor. December 2000.
- . *Visual and Aesthetics Technical Report Addendum*, Final Supplemental Environmental Impact Statement/ Final Subsequent Environmental Impact Report, Los Angeles Eastside Corridor. November 2001.

- . *Water Resources Technical Report*, Draft Supplemental Environmental Impact Statement/  
Draft Subsequent Environmental Impact Report, Los Angeles Eastside Corridor. December  
2000.
  - . *Water Resources Technical Report Addendum*, Final Supplemental Environmental Impact  
Statement/ Final Subsequent Environmental Impact Report, Los Angeles Eastside Corridor.  
November 2001.
- Eastside Corridor Transit Consultants and S. R. Beard & Associates. *Community Facilities/  
Parklands Technical Report*, Draft Supplemental Environmental Impact Statement/Draft  
Subsequent Environmental Impact Report, Los Angeles Eastside Corridor. December 2000.
- . *Community Facilities/Parklands Technical Report Addendum*, Final Supplemental  
Environmental Impact Statement/ Final Subsequent Environmental Impact Report, Los  
Angeles Eastside Corridor. November 2001.
  - . *Communities/Neighborhoods Technical Report*, Draft Supplemental Environmental Impact  
Statement/Draft Subsequent Environmental Impact Report, Los Angeles Eastside Corridor.  
December 2000.
  - . *Communities/Neighborhoods Technical Report Addendum*, Final Supplemental Environmental  
Impact Statement/ Final Subsequent Environmental Impact Report, Los Angeles Eastside  
Corridor. November 2001.
  - . *Environmental Justice Technical Report*, Draft Supplemental Environmental Impact  
Statement/Draft Subsequent Environmental Impact Report, Los Angeles Eastside Corridor.  
December 2000.
  - . *Environmental Justice Technical Report Addendum*, Final Supplemental Environmental  
Impact Statement/ Final Subsequent Environmental Impact Report, Los Angeles Eastside  
Corridor. November 2001.
  - . *Land Acquisition/ Displacement and Relocation Technical Report*, Draft Supplemental  
Environmental Impact Statement/Draft Subsequent Environmental Impact Report, Los  
Angeles Eastside Corridor. December 2000.
  - . *Land Acquisition/ Displacement and Relocation Technical Report Addendum*, Final  
Supplemental Environmental Impact Statement/ Final Subsequent Environmental Impact  
Report, Los Angeles Eastside Corridor. November 2001.
  - . *Section 4(f) Technical Report*, Draft Supplemental Environmental Impact Statement/Draft  
Subsequent Environmental Impact Report, Los Angeles Eastside Corridor. December 2000.
  - . *Section 4(f) Technical Report Addendum*, Final Supplemental Environmental Impact  
Statement/ Final Subsequent Environmental Impact Report, Los Angeles Eastside Corridor.  
November 2001.
- Eastside Corridor Transit Consultants and Terry A. Hayes & Associates. *Air Quality Technical  
Report*, Draft Supplemental Environmental Impact Statement/Draft Subsequent  
Environmental Impact Report, Los Angeles Eastside Corridor. December 2000.

- . *Air Quality Technical Report Addendum, Final Supplemental Environmental Impact Statement/ Final Subsequent Environmental Impact Report, Los Angeles Eastside Corridor.* November 2001.
- Eisenstein et. al. *Los Angeles County Metro Rail Project, Report on Tunneling Feasibility and Performance.* LACMTA. November 1995.
- Eng, Thomas. Metropolitan Transportation Authority, (MTA), Los Angeles, California. Meeting with Scott Forbes, Jenkins/Gales & Martinez, (JGM). August 2000.
- Engineering Management Consultant. *Los Angeles County Metropolitan Transit Authority, Metro Rail Project, Geotechnical Design Summary Report, Tunnels and Little Tokyo/Arts District Station, Contract C0502/C0541.* 1998.
- Envicom Corporation et al. "The Citywide General Plan Framework." *City of Los Angeles General Plan.* Approved December 11, 1996. Accessed at [www.lacity.org](http://www.lacity.org) on June 19, 2000.
- Federal Insurance Administration. *Flood Hazard Area Maps.* Compiled by Flood Data Systems, Inc. 1988.
- Federal Transit Administration and Metropolitan Transportation Authority. *Alternatives Analysis/Draft Environmental Impact Statement/Draft Environmental Impact Report (AA/DEIS/DEIR) for the Eastside Corridor.* Los Angeles. 1993.
- . *Final Environmental Impact Statement/Final Environmental Impact Report, Los Angeles Eastside Corridor.* Los Angeles. 1994.
- Federal Transit Administration, Office of Planning (FTA). *Technical Guidance on Section 5309 New Starts Criteria.* July 1999.
- Foster, John M. *Archaeological Site Record: CA-LAN-1575H.* 1989.
- Foster, John M., and Robin D. Turner. *Primary Record: 19-002563.* Greenwood and Associates, Pacific Palisades, California. 1997.
- Gates, Worthington (compiler). *Los Angeles.* Western Litho Company, [Los Angeles]. On file, Library of Congress, Washington, D.C. 1909.
- Gebhard, David, and Robert Winter. *Los Angeles, An Architectural Guide.* Salt Lake City:Gibbs-Smith. 1994.
- GELA (Greater East Los Angeles) Cultural Heritage Survey Team. *Community Mural Resources Inventory: "The Birth of Our Art."* TELACU/CRG, Los Angeles. 1979.
- . *Community Mural Resources Inventory: "First World War."* TELACU/CRG, Los Angeles. 1979.
- . *Community Mural Resources Inventory: "The Four Elements as Plato Saw Them."* TELACU/CRG, Los Angeles. 1979.

- *Community Mural Resources Inventory: "A History of Our Struggle ."* TELACU/CRG, Los Angeles. 1979.
- *Community Mural Resources Inventory: "Home Boy and Home Girl."* TELACU/CRG, Los Angeles. 1979.
- *Community Mural Resources Inventory: "Mexican American Culture and Heritage."* TELACU/CRG, Los Angeles. 1979.
- *Community Mural Resources Inventory: "A Search for Identity."* TELACU/CRG, Los Angeles. 1979.
- *Community Mural Resources Inventory: "Mexican American Culture and Heritage."* TELACU/CRG, Los Angeles. 1979.
- *Community Mural Resources Inventory: "A Search for Identity."* TELACU/CRG, Los Angeles. 1979.
- *Community Mural Resources Inventory: Untitled.* TELACU/CRG, Los Angeles. 1979.
- *Community Mural Resources Inventory: "Viva Mi Raza."* TELACU/CRG, Los Angeles. 1979.
- *Historic Resources Inventory: Conchita's Restaurant.* TELACU/CRG, Los Angeles. 1979.
- *Historic Resources Inventory: Evergreen Cemetery, Ivy Chapel and Cemetery Gates.* TELACU/CRG, Los Angeles. 1979.
- *Historic Resources Inventory: New Calvary Cemetery.* TELACU/CRG, Los Angeles. 1979.
- *Historic Resources Inventory: Russian Molokan Spiritual Cemetery.* TELACU/CRG, Los Angeles. 1979.
- *Historic Resources Inventory: St. Sava Serbian Eastern Orthodox Church and Cemetery.* TELACU/CRG, Los Angeles. 1979.
- *Historic Resources Inventory: Unique Theatre.* TELACU/CRG, Los Angeles. 1979.
- *Historic Resources Inventory: 3886 East Third Street.* TELACU/CRG, Los Angeles. 1979.
- *Historic Resources Inventory: 4219 East Third Street.* TELACU/CRG, Los Angeles. 1979.
- GeoTransit Consultants. *Final Geotechnical Investigation for: First/Lorena Station & Tail Track Tunnels, East Side Extension, Metro Red Line Project, Project No. 95-8347-15.* 1996.
- *Final Geotechnical Investigation for: First/Boyle Station with Crossover and Little Tokyo-First/Boyle Tunnels, East Side Extension, Metro Red Line Project, Project No. 95-8347-24.* 1996.
- *Final Geotechnical Investigation for: Chavez/Soto Station and Adjacent Tunnels, East Side Extension, Metro Red Line Project, Project No. 95-8347-24.* 1996.

- *Final Geotechnical Investigation for: Union-Little Tokyo Tunnels & Little Tokyo Station, East Side Extension, Metro Red Line Project, Volume II of II, (Appendix A through Appendix D), Project No. 95-8347-04. 1996.*
- *Final Draft Geotechnical Investigation for: Union-Little Tokyo Tunnels & Little Tokyo Station, East Side Extension, Metro Red Line Project, Volume I of II, Project No. 95-8347-04. 1995.*
- Glover, E. S. *Bird's Eye View of Los Angeles, California.* On file, Library of Congress, Washington, D.C. 1877.
- Gould, Joe. Los Angeles City Fire Department, Los Angeles, California. Meeting with Scott Forbes, Jenkins/Gales & Martinez, (JGM). August 3, 2000
- Greenwood, Roberta S. *Down By the Station, Los Angeles Chinatown, 1880-1933.* Monumenta Archaeologica 18. Institute of Archaeology, UCLA, Los Angeles. 1996.
- Greenwood, Roberta S., and John M. Foster. *Archaeological Investigations at Maintenance of Way Facility, South Santa Fe Avenue (CA-LAN-2563H).* Greenwood and Associates, Pacific Palisades. Prepared for Metropolitan Transportation Authority, Los Angeles. 1998.
- Greenwood, Roberta S., John M. Foster, and Judith A. Rasson. *Historical and Archaeological Assessment of the Southern California Rapid Transit District (SCRTD) Union Station Headquarters Project.* Greenwood and Associates, Pacific Palisades, California. Prepared for Converse Environmental West, Pasadena, California. 1992.
- Greenwood, Roberta S., and Portia Lee. *Transportation-Related Resources on South Santa Fe Avenue, Los Angeles.* Greenwood and Associates, Pacific Palisades. Prepared for Metropolitan Transportation Authority, Los Angeles. 1998.
- Hancock, Henry. *Plat of the City Lands of Los Angeles Finally Confirmed to the Mayor and Common Council of the City of Los Angeles.* 1858.
- Hansen, George *Map of the 35-Acre Lots of the Los Angeles City Lands, Hancock's Survey, Situated East of Los Angeles River.* 1868.
- Harlow, Neal. *Maps and Surveys of the Pueblo Lands of Los Angeles.* Dawson's Book Shop, Los Angeles. 1976.
- Hart, E.W., "Fault-Rupture Hazard Zones in California," *California Division of Mines and Geology Special Publication 42.* 1973, revised 1997.
- Hauksson, E. "Seismotectonics of the Newport-Inglewood Fault Zone in the Los Angeles Basin, Southern California," *Bulletin of the Seismological Society of America* 77 (1987): 539-561.
- Hauksson, E. "Earthquakes, Faulting, and Stress in the Los Angeles Basin," *Journal of Geophysical Research* 95.B10 (1990): 15,365-15,394.
- Hay, O.P. *The Pleistocene of the Western Region of North America and its Vertebrated Animals,* Carnegie Institution of Washington, Publication 322B:1-3476. 1927.

- Housing Replenishment Program, *Section 5309 Report*, Los Angeles Metropolitan Transportation Authority, Los Angeles, CA. August 2000.
- Hubaud, Louis. Metropolitan Transportation Authority, (MTA), Los Angeles, California. Meeting with Scott Forbes, Jenkins/Gales & Martinez, (JGM). July 12, 2000.
- Huey, G. and J. Romani. *Archeological Site Survey Record: CA-LAN-7H*. 1980.
- Hummon, C., Schnieder, C.L., Yeats, R.S., Dolan, J.F., Sieh, K.E., and Huftile, G.J. "Wilshire Fault: Earthquakes in Hollywood?," *Geology* 22 (1994): 291-294.
- Jackson, D.D., et al. "Seismic Hazards in Southern California: Probable Earthquakes, 1994 to 2024," *Seismological Society of America Bulletin* 85.2 (1995).
- Jefferson, G.T. "A Catalogue of Late Quaternary Vertebrates from California, Part One, Nonmarine Lower Vertebrate and Avian Taxa", *Natural History Museum of Los Angeles County Technical Reports* 5:1-60. 1991.
- "A Catalogue of Late Quaternary Vertebrates from California, Part Two, Mammals", *Natural History Museum of Los Angeles County Technical Reports* 7:1-129. 1991.
- Jennings, C.W. "Fault Activity Map of California and Adjacent Areas with Locations and Ages of Recent Volcanic Eruptions," California Division of Mines and Geology Map No. 6. 1994.
- Katz, Okitsu and Associates and Los Angeles County Metropolitan Transportation Authority. *Central Area Bicycle Master Plan*. 1997.
- Khawani, Vijay. Metropolitan Transportation Authority, (MTA), Los Angeles, California. Meeting with Scott Forbes, Jenkins/Gales & Martinez, (JGM). July 26, 2000
- Kirker, Harold. *California's Architectural Frontier; Style and Tradition in the Nineteenth Century*. Santa Barbara: Peregrine Smith. 1973.
- Kramer, S. L. *Geotechnical Earthquake Engineering*. New York: Prentice Hall. 1996.
- Kroll, Chris. California Coastal Conservancy Oakland, CA. Telephone conversation with Mark Weisman, S.R. Beard & Associates. October 12, 1999.
- Lamar, D.L. "Geology of the Elysian Park–Repetto Hills Area, Los Angeles County, California," *California Division of Mines and Geology Special Report 101*. 1970.
- Land Acquisition Memoranda and Graphics (June 23, 2000 and July 10, 2000), Raul Escobedo, Barrio Planners, Los Angeles, CA.
- Lander, E.B. *Paleontologic Resources*. U.S. Department of Transportation Federal Transit Administration and Los Angeles County Metropolitan Transportation Authority, Final Environmental Impact Statement, Los Angeles East Side Extension. 1994.
- , in review. *Los Angeles Metro Red Line Project Final Paleontologic Resource Impact Mitigation Program Final Technical Report of Findings*. Paleo Environmental Associates,

Inc., Project 94-6A/B. Prepared for Los Angeles County Metropolitan Transportation Authority.

- Law/Crandall. *Report of Environmental Assessment—Metro Red Line Eastside Transit Corridor Study Area*. Prepared for Eastside Corridor Transit Consultants, Project 70131-9-0387. 1999.
- . *Geotechnical Data Report for Seismic Hazard Investigation, Eastern Extension, Metro Red Line, Los Angeles, California*. Prepared for Engineering Management Consultants, Project 70131-8-0077.0001. 1998.
- . *Report of Geotechnical Investigation, Proposed Modernization, Home Economics Building, Belvedere Middle School 312 North Record Avenue, Los Angeles, California*. Prepared for Los Angeles Unified School District, Project 70131-7-0112.0001. 1997.
- . *Geotechnical Investigation Report—Large Diameter Borings, East Side Extension, Metro Red Line, Los Angeles, California*. Prepared for Engineering Management Consultants, Project 70131-6-0552.1000. 1997.
- . *Geotechnical Investigation Data Report Pressuremeter Testing and Soil Velocity Measurements, East Side Extension, Metro Red Line, Los Angeles, California*. Prepared for Engineering Management Consultants, Project 70131-9-60552.5000. 1996.
- . *Report of Potential Fault Displacements, Wastewater Treatment Plant Number 2, Huntington Beach, California*. Prepared for County Sanitation Districts of Orange County, Project 2661.30140.0001. 1993.
- LeRoy Crandall & Associates. *Report of Supplementary Studies, Proposed Office Buildings and Parking Structure, Brooklyn Avenue between Boyle Avenue and Biley Street, Los Angeles, California*. Prepared for White Memorial Medical Center, Project LCA L89344.AO. 1989.
- . *Report of Foundation Investigation, Proposed Building Development, Santa Fe Avenue and Third Street, Los Angeles, California*. Prepared for the Santa Fe Land Improvement Company, Project A-88008. 1988.
- . *Report of Geotechnical Investigation, Proposed New Dormitory Building, 325 South Boyle Avenue, Los Angeles, California*. Prepared for the Japanese Retirement Home Project AE-87136. 1988.
- . *Report of Foundation Investigation, Proposed Classroom Building, Breed Street Elementary School, 2226 East Third Street, Los Angeles, California*. Prepared for the Los Angeles Unified School District, Project A-87104. 1987.
- . *Report of Foundation Investigation, Proposed Zody's—East Los Angeles, First and Mott Streets, Boyle Heights District, Los Angeles, California*. Prepared for the Herbert M. Piken Company, Project A-79206. 1982.
- . *Report of Foundation Investigation, Proposed Addition To Store No. 110, Brooklyn Avenue and Rowan Street, East Los Angeles Area, Los Angeles County, California*. Prepared for Safeway Stores Incorporated, Project A-80326. 1982.



- *Supplemental Geologic Information on Raymond Fault, San Marino High School.* Prepared for the San Marino Unified School District, Project E-77186. 1978.
  - *Geologic and Seismic Evaluation, Ramona High School, 231 South Alma Avenue, Boyle Heights District, Los Angeles, California.* Prepared for the Los Angeles City Unified School District, Project E-75038. 1975.
  - *Report of Foundation Investigation, Proposed East Los Angeles Neighborhood Center, Capital Project No. 9080.02, North Sunol Drive and East First Street, Los Angeles County, California.* Prepared for the County of Los Angeles, Project A-71073. 1972.
  - *Report of Foundation Investigation, Proposed Community Social Center, Capital Project No. 8776, 4800 Brooklyn Avenue, Los Angeles County, California.* Prepared for the Department of Recreation and Parks of the County of Los Angeles, Project A-69309. 1970.
  - *Report of Preliminary Soil Investigation, Proposed Land Purchase, Indiana and First Streets, Los Angeles, California.* Prepared for the Glendale Federal Savings and Loan Association, Project A-69233. 1969.
  - *Report of Soils Investigation, Center-North 220 KV Transmission Line, Los Angeles County, California.* Prepared for the Southern California Edison Company, Project 61105. 1961.
  - *Report of Foundation Investigation, Proposed Additions, Belvedere Elementary School, First Street and Eastman Avenue, Los Angeles County, California.* Prepared for the Los Angeles City Board of Education, Project 61494. 1961.
  - *Report of Foundation Investigation, Proposed Safeway Store No. 108, Beverly and Atlantic Boulevards, Los Angeles County, California.* Prepared for Safeway Stores, Incorporated, Project 58413. 1959.
- Los Angeles, City of, Department of City Planning. *Boyle Heights Plans: A Part of the General Plan of the City of Los Angeles.* Adopted August 14, 1979, updates through December 9, 1987.
- *Bike Plan, Transportation Element of the Los Angeles City General Plan.* Accessed at <http://www.lacity.org/PLN/Trans-Element/bike-plan> by Tesse Roberts, Parsons Brinckerhoff, August 2000.
  - *Central City Community Plan Text.* November 1998.
  - *Central City North Community Plan: A Part of the General Plan of the City of Los Angeles.* Adopted February 9, 1979. Amended through January 5, 1988.
  - *Land Use/Transportation Policy.* 1993.
  - *Safety Element of the Los Angeles City General Plan.* 1996.
- Los Angeles, City of, Cultural Heritage Commission. *Historic-Cultural Monuments 1-588.* Cultural Affairs Department, Los Angeles. 1994.

- Los Angeles, City of, Community Development Department. *Economic Development Incentives*. 1998.
- Los Angeles, City of, Community Redevelopment Agency. *Little Tokyo Redevelopment Project Web Site*. Accessed at <http://www.cityofla.org/CRA/lthome.htm> by Donna McCormick, Parsons Brinckerhoff, August 11, 2000.
- *Little Tokyo Redevelopment Project*. 1970.
- *Central City Redevelopment Project*. 1975.
- *Adelante Eastside Redevelopment Project*. 1999.
- Los Angeles, City of, Office of Controller. *Controller's Preliminary Financial Report for the Fiscal Year Ended June 30, 2000*. August 2000.
- Los Angeles, County of. *Technical Appendix to the Safety Element of the Los Angeles County General Plan*. Draft Report by Leighton and Associates with Sedway Cooke Associates. 1990.
- Los Angeles, County of, Community Development Agency. *Maravilla Redevelopment Project*. 1973.
- Los Angeles, County of, Department of Public Works. *Hydrologic Report 1994-1996*. 1996.
- Los Angeles, County of, Metropolitan Transportation Authority. *Bus timetables for selected routes operated by the agency*. 1999-2000.
- Los Angeles, County of, Metropolitan Transportation Authority, U.S. Department of Transportation, and U.S. Department of Transportation Federal Transit Administration. *Los Angeles Eastside Corridor, Final Environmental Impact Statement/Final Environmental Impact Report, Volumes 1-2*. May 1994.
- *Los Angeles Eastside Corridor, Alternatives Analysis/Draft Environmental Impact Statement/Draft Environmental Impact Report*. April 1993.
- Los Angeles, County of, Transportation Commission. *Eastside Corridor Alternatives Analysis/Draft Environmental Impact Statement/Draft Environmental Impact Report; Social, Economic, and Environmental Impact Assessment Methodology Report*. January 1993.
- Los Angeles Mural Conservancy. Web site. [www.usc.edu/isd/archives/la](http://www.usc.edu/isd/archives/la). 2000.
- Louis Berger and Associates. *Zanja No. 3: Brick Culvert Historic American Engineering Record Documentation at the Proposed Federal Center Complex, Los Angeles, California*. Prepared for U. S. Department of Justice, Federal Bureau of Prisons, Washington, D. C. 1987.
- MacAdam, Lewis. "Los Angeles River Bridges," *Conservation* (Getty Conservation Institute) 13.3 (1998): 1-2.

- Mark, R.K., "Application of Linear Statistical Models of Earthquake Magnitude Versus Fault Length in Estimating Maximum Expectable Earthquakes," *Geology* 5 (1977): 464-466.
- McNeil, Alvin. Manager of Property Planning and Development, Washington Metropolitan Area Transit Authority. Telephone interview by Mark Weisman, S.R. Beard & Associates. 1999.
- Meighan, C. *Archaeological Site Survey Record: Lan-7/H*. On file, South Central Coastal Information Center, California State University, Fullerton. 1951.
- Michael Brandman Associates (MBA) and Cordoba Corporation. *East Los Angeles Community Plan*. March 1988 (adopted June 23, 1988).
- Miller, W.E. "Pleistocene Vertebrates of the Los Angeles Basin and Vicinity (exclusive of Rancho La Brea)," Bulletin of the Los Angeles County Museum of Natural History, *Science* 10 (1971): 1-124.
- Montebello, City of, Municipal Bus Lines. Bus timetables for routes operated by the agency. 1999-2000.
- Monterey Park, City of. Bus timetables for routes operated by the agency. 1999-2000.
- Monterey Park, City of, Planning Department. *Monterey Park General Plan*. 1990.
- Myra L. Frank and Associates, and Greenwood and Associates. *Section 106 Documentation for the Metro Rail Red Line East Extension in the City and County of Los Angeles, California*. Prepared for Federal Transit Administration, Washington, D.C. 1994.
- National Geographic Society. *Field Guide to the Birds of North America*, Third edition. National Geographic Society, Washington, DC. 1999.
- Newmark, H. *Sixty Years in Southern California, 1853-1913; Containing the Reminiscences of Harris Newmark*. Third Edition [1930]. Houghton Mifflin Company, Boston. 1916
- Oak Ridge Laboratory. *Transportation Energy Book: Edition 16*. 1998.
- Olive, Sue. Project Manager, San Francisco MUNI. Telephone interview by Mark Weisman, S.R. Beard & Associates. 1999.
- Orange County Transportation Authority. *Orange County CenterLine, Draft Environmental Impact Statement/Environmental Impact Report, Environmental Justice/Protection of Children*. Orange County, California. 1999.
- Ord, Lt. E. O. C., and William R. Hutton. *Plan de la Ciudad de Los Angeles*. 1849.
- Parsons Brinckerhoff Quade & Douglas, Inc. (PBQD). Conceptual Construction and Operating Costs. June/July 2000.
- *Vehicle Miles Traveled*. June 2000.
- *I-5 Corridor Improvement Project, Final Evaluation Report*. 1998.

- Padon, B. *Los Angeles Outpatient Clinic*. Prepared for U. S. Veterans Administration, Washington, D.C. Newport Beach: LSA. 1986.
- Petersen, M. and S. Wesnousky. "Fault Slip Rate and Earthquake Histories for Active Faults in Southern California," *Bulletin of the Seismological Society of America* 84 (1994): 1608-1649.
- Petersen, M., W. Bryant, and C. Cramer. "Table of Fault Parameters Used by the California Division of Mines and Geology to Compile the Probabilistic Seismic Hazard Maps of California," *California Division of Mines and Geology Open File Report 96-08*, Appendix A. 1996.
- Poland, J., Garrett, A., and Sinnott, A. "Geology, Hydrology, and Chemical Character of Groundwaters in the Torrance-Santa Monica Area, California," *U.S. Geological Survey Water Supply Paper 1461*. 1959.
- Post, R. *Street Railways and the Growth of Los Angeles, Horse-Cable-Electric Lines*. San Marino: Golden West Books. 1989.
- Rasson, J. *Metro Rail Red Line Eastern Extension: Historical and Archaeological Evaluation of Seven Stations*. Greenwood and Associates, Pacific Palisades, California. Prepared for Cordoba Corporation, Los Angeles. 1994.
- Right-of-way Maps, Los Angeles Eastside Corridor Draft SEIS/SEIR, Los Angeles Metropolitan Transportation Authority, Los Angeles, CA, July 21, 2000.
- RJD Enterprises. *Los Angeles Murals*. Accessed at <http://www.muralart.com> by Donna McCormick, Parsons Brinckerhoff, August 10, 2000.
- Sanborn Perris Map Company. *1890 Los Angeles, California Map*. Chicago: Sanborn. 1999.
- *1894 Los Angeles, California*. Chicago: Sanborn. 1999.
- *1900 Los Angeles, California*. Chicago: Sanborn. 1999.
- *1906 Los Angeles, California*. Chicago: Sanborn. 1999.
- *1921 Los Angeles, California*. Chicago: Sanborn. 1999.
- Schneider, C., C. Hummon, R. Yeats, and G. Huftile. "Structural Evolution of the Northern Los Angeles Basin, California, Based on Growth Strata," *Tectonics* 15.2 (1996): 341-355.
- Sergeant Vanalli, John. Los Angeles City Police Department, Los Angeles, California. Telephone conversation with Scott Forbes, Jenkins/Gales & Martinez, (JGM). July 27, 2000
- Shaw, J. "Active Blind-Thrust Faulting and Strike-Slip Folding in California," Diss., Princeton University, 1993.
- Shaw, J.H. and J. Suppe. "Earthquake Hazards of Active Blind Thrust Faults Under the Central Los Angeles Basin, California," *Journal of Geophysical Research* 101.B4 (1996): 8623-8642.

- Sieh, K.E. "Lateral Offsets and Revised Dates of Large Pre-historic Earthquakes at Pallett Creek, California," *Journal of Geophysical Research* 9 (1984): 7461-7670.
- . *Report of Investigation of the Coyote Pass Structure at Cummings and St. Louis Streets*. Prepared for Engineering Management Consultants. April 1998.
- Sitton, T. *Historic Resources Inventory: Our Lady of Lourdes Church*. Natural History Museum, Los Angeles. 1976.
- Slemmons, D. "Evaluation of Geomorphic Features of Active Faults for Engineering Design and Siting Studies." Association of Engineering Geologists Short Course. 1979.
- Society of Vertebrate Paleontology. "Assessment and Mitigation of Adverse Impacts to Nonrenewable Paleontologic Resources; Standard Guidelines," *Society of Vertebrate Paleontology News Bulletin* 163 (1995): 22-27.
- . "Conditions of Receivership for Paleontologic Salvage Collections," *Society of Vertebrate Paleontology News Bulletin*, 166 (1996): 31-32.
- Southern California Association of Governments (SCAG). *The State of the Region 2000 - The Region at the Dawn of the 21<sup>st</sup> Century*. May 2000.
- . *1998 Regional Transportation Plan*, Adopted forecasts. April 1998.
- . *TAZ Population and Employment Projection Data 1995*, based upon U. S. Census full or partial tracts that are based upon aggregated blocks.
- . *TAZ Population and Employment Projection Data 2020*, based upon U. S. Census full or partial tracts that are based upon aggregated blocks.
- Starzak, Richard. *Primary Record: Evergreen Cemetery*. Myra L. Frank and Associates, Los Angeles. 1994.
- . *Primary Record: First Street Viaduct*. Myra L. Frank and Associates, Los Angeles. 1994.
- . *Primary Record: Hotel Mt. Pleasant*. Myra L. Frank and Associates, Los Angeles. 1994.
- . *Primary Record: 1832 East 1st Street*. Myra L. Frank and Associates, Los Angeles. 1994.
- . *Primary Record: 3464 East 1st Street*. Myra L. Frank and Associates, Los Angeles. 1994.
- . *Primary Record: 1832 East 1st Street*. Myra L. Frank and Associates, Los Angeles. 1994.
- State Water Resources Control Board (SWRCB)*. <http://www.swrcb.ca.gov/sbforms/index.html>. Accessed June 29, 2000, by Edward Tadross, Parsons Brinckerhoff.
- Stebbins, R. *A Field Guide to Western Reptiles and Amphibians*. Boston: Houghton Mifflin. 1985.

- Tanaka/Tetra Design Architects. *Station Area Concept Final Report, Metro Red Line Eastside Extension, Project Planning and Community Linkages for Little Tokyo Arts District Station*. 1995.
- San Francisco Municipal Railway. *Third Street Light Rail Project, Final Environmental Impact Statement/Environmental Impact Report*. San Francisco, California. November 1998.
- Thompson, A. and T. West. *History of Los Angeles County*. Oakland, CA. 1880. Berkeley: Howell-North. Reprinted 1959.
- Topozada, T.R., J.H. Bennett, G.A. Borchardt, R. Saul, and J.F. Davis. "Planning Scenario for a Major Earthquake on the Newport–Inglewood Fault Zone," *California Division of Mines and Geology Special Publication 99*. 1988.
- University of Southern California (USC), Information Services Division. *Los Angeles: Past, Present, and Future*. Accessed at <http://www.usc.edu/isd/archives/la/> by Donna McCormick, Parsons Brinckerhoff. August 2000.
- U. S. Census of Population and Housing, 1990. Data based upon blocks, which are the smallest tabulated area measurement.
- U.S. Department of Transportation (USDOT). *National Level Employment Impacts of the Department of Transportation's Grant Programs*, Volume II: Main Report. October 1991.
- U.S. Fish and Wildlife Service (USFWS). *Endangered and Threatened Wildlife and Plants*. Federal Register 50, CFR 17.11 and 17.12. U.S. Department of the Interior, Washington, D.C. .2000.
- Vergara, Camilo. Photographs by Camilo José Vergara. In *El Nuevo Mundo; the Landscape of Latino Los Angeles*, edited by Gustavo Leclerc, Michael J. Dear, and J. Dallas Dishman, pp.20-48. Southern California Studies Center, University of Southern California, Los Angeles. 2000.
- Wallace, R.E. "Notes of Stream Channel Offset by San Andreas Fault, Southern Coast Ranges, California," Dickinson, U.R., and Grantz, A., eds., *Proceedings of Conference of Geologic Problems on San Andreas Fault System*, Stanford University Publications, Geological Sciences, Vol. IX, p. 6–21. 1968.
- Water Replenishment District of Southern California (WRD)*. <http://www.wrd.org>. Accessed June 29, 2000 by Edward Tadross, Parsons Brinckerhoff.
- Wesnousky, S.G. "Earthquakes, Quaternary Faults and Seismic Hazard in California," *Journal of Geophysical Research* 91.B12 (1986): 12,587–12,631.
- Wissler, S.G. "Stratigraphic Formations of the Producing Zone of the Los Angeles Basin Oil Fields," *California Division of Mines Bulletin* 118.2 (1943): 210–234.
- Wohlwill, David. Busway Planning, Port Authority Transit (Pittsburgh, PA). Telephone interview by Mark Weisman, S.R. Beard & Associates. 1999.

- Woods, Sean. California Coastal Conservancy, Oakland, CA. Telephone conversation with Mark Weisman, S.R. Beard & Associates. October 14, 1999.
- Woodward-Clyde Consultants. *East Side Extension Stations, Seismic Hazard Evaluation, Los Angeles Metro Rail System, Los Angeles, California*. Prepared for Engineering Management Consultants. 1997.
- Working Group on California Earthquake Probabilities. "Seismic Hazards in Southern California: Probable Earthquakes, 1994 to 2024," *Bulletin of the Seismological Society of America* 85.2, April 1995.
- Wright, T.L. "Structural Geology and Tectonic Evolution of the Los Angeles Basin, California," *American Association Petroleum Geologists*, Memoir 52 (1991): 35-134.
- Yerkes, R. F., J.C. Tinsley, and K.M. Williams. *Geologic Aspects of Tunneling in the Los Angeles Area, California*. Miscellaneous Field Studies Map MF-866. 1977.
- Yerkes, R.F., T.H. McCulloch, J.E. Schoellhamer, and J.G. Vedder. "Geology of the Los Angeles Basin—An Introduction," *U.S. Geological Survey Professional Paper* 420-A. 1965.
- Ziony, J.I., and L.M. Jones. "Map Showing Late Quaternary Faults and 1978–1984 Seismicity of the Los Angeles Region, California," *U.S. Geological Survey Miscellaneous Field Studies Map* MF-1964. 1989.

**APPENDIX D**

**LIST OF PREPARERS**





## APPENDIX D

### LIST OF PREPARERS

#### Federal Transit Administration

Ray Sukys, Region 9, San Francisco  
Ervin Poka, Metropolitan Office, Los Angeles  
A. Joseph Ossi, Headquarters, Washington, D.C.

#### Los Angeles County Metropolitan Transportation Authority

##### Transportation Development and Implementation

Diego Cardoso, Project Director  
Steven Brye, Lead Project Manager  
Ray Sosa, Project Manager  
Henry Gonzalez, Public Affairs  
Robin Blair, Urban Design & Transit Linkages  
Rufina Juarez, PE/Environmental Coordination  
Dolores Roybal, Land Use  
Joanna Cucchi, Project Planner  
Adrian Alvarez, Technical Review

##### Transportation Demand Modelling

Dr. Chausie Chu, Director Systems Analysis and Research  
Rena Lum, Transportation Planning Manager  
Stewart Chesler, Transportation Planning Manager  
Maryam Ershagi, System Analysts  
Armineh Saint, Transportation Planning Manager  
John Stesney, Transportation Planning Manager

##### Service Planning/ Operations

Martha Butler, Transportation Planning Manager  
Scott Holmes, Transportation Planning Manager

##### Construction

Dennis Mori, Deputy Executive Officer  
Girish Roy, Engineering Project Manager  
Rick Wilson, Project Control Manager  
John Higgins, 3<sup>rd</sup> Party Administration  
Lee Agee, Rail Activation Manager  
David Hewitt, Transportation Project Manager

Environmental Compliance

James Sowell, Environmental Compliance Manager  
Andre Villaseñor, Environmental Specialist

MTA Tunnel Advisory Panel

Dr. Dan Eisenstein  
Dr. Geoff Martin

Safety

Tom Eng, Safety Certification Manager  
John Tripp, Battalion Chief - Metro Rail Coordinator  
Michael Littleton, Battalion Chief - Los Angeles Fire Department  
Vijay Khawani, Operations & Maintenance Systems/Safety Manager

Real Estate

Velma Marshall, Director of Real Estate  
Lynn Bell, Real Estate Officer

**Parsons Brinckerhoff Quade and Douglas, Inc.**

Thomas Jenkins	Project Manager/Engineer
Lorenzo Sanchez	Engineer
Armando Solis	Engineer
Clint Herrera	Engineer
Myrna Valdez	Alternatives development
Amanda Elioff	Geotechnical analysis
David Freytag	Energy, land use, water resources, biological resources, and employment
George Vail	Demographic analysis, GIS analysis, and graphics
Donna McCormick	Visual analysis
Bill Feulner	Graphics
Bill Boynton	GIS analysis and graphics
Derek Ross	Energy, population, employment, and graphics
Steven Wolf	Noise and vibration analysis
Ed Tadross	Noise and vibration analysis, water resources, energy
Tesse Roberts	Parking, traffic, transit and other modes analysis, purpose and need
Mark Brown	Parking, traffic, transit and other modes analysis, purpose and need
Fred Pearson	Parking, traffic, and other modes analysis, purpose and need
Farid Naguib	Parking, traffic, and other modes analysis
Bill Davidson	Travel demand forecasting
Dawn McKinstry	Travel demand forecasting
Tracey Quinton	Travel demand forecasting
Herb Higginbotham	Travel demand forecasting

Nicole Boulanger                      Travel demand forecasting

**Jenkins/Gales & Martinez**

Earl Gales, Jr.                      Project Director  
Terry Marcellus                      Project Planner  
Bob Hulse                              Project Engineer  
Vali Nitu                                CADD Operator  
Eric Mangacat                        CADD Operator  
Edgar Zelaya                        Public Involvement  
Scott Forbes                         Engineer

**Barrio Planners, Inc.**

Raul Escobedo                      Planning, urban design, land use and development,  
residential and business displacement analysis, parklands and  
community facilities identification, neighborhoods and  
communities identification, public involvement  
  
Frank Villalobos                      Planning, urban design, public involvement  
Luzmaria Chavez                      Public involvement  
William Villalobos                      Urban design  
Chris Baffo                              Urban design  
Jennifer Villalobos                      Urban design  
Adriana T. Saltikov                      Urban design

**S. R. Beard & Associates, L.L.C.**

Steven Beard                        Environmental Project Manager  
Jerri Horst                              Environmental Coordinator  
Mark Weisman                        Environmental justice, community facilities and parklands,  
residential and business displacements, Section 4(f), and  
communities/neighborhoods analyses

**Kaku Associates**

Dick Kaku                              Traffic analysis  
Bryan Mayeda                        Traffic analysis

**Law Crandall**

Carl Kim                                Geotechnical analysis  
Susan Kirkgard                        Geotechnical analysis  
Perry Maljian                        Geotechnical analysis  
Bill O'Braitas                        Hazardous substances analysis  
Razmik Gozalians                      Hazardous substances analysis  
Matt Fraychineaud                      Hazardous substances analysis

**Terry Hayes Associates**

Keith Cooper                        Air quality analysis

**Roberta S. Greenwood and Associates**

Judith Rasson Cultural resource analysis  
Dana Slawson Cultural resource analysis  
John Foster Cultural resource analysis

**Paleo Environmental Associates**

Bruce Lander, Ph.D. Paleontologic resource analysis

**Kal Krishnan Consulting Services**

Ron Anderson Capital cost estimates

**Associated Engineers**

Jim Imborski Engineering mapping

**Gilchrist & Rutter Professional Corporation**

Amy Freilich Legal analysis

**The Chambers Group**

Don Mitchell Biological resources  
Chris Blandford Biological resources

**APPENDIX E**

**BASELINE OPTION A DESIGN,  
OCTOBER 22, 2001**

- ◆ **Plans and Profiles**
- ◆ **Site Plans for Stations**
- ◆ **Maintenance and Storage Facility Yard Lead and Improvements**
- ◆ **Property Identification Plan**
- ◆ **Underground Structures, Plans and Profiles**

**(Separate attachment)**



**APPENDIX F**

**OPTION B CHANGES TO OPTION A, OPTION B DESIGNS,  
OCTOBER 22, 2001**

- ◆ **Plans and Profiles (1<sup>st</sup>/Lorena to Pomona/Atlantic)**
  - ◆ **Site Plans for New Stations**
- ◆ **Property Identification Plan (Indiana and Pomona/Atlantic areas)**
  - ◆  
**(Separate attachment)**





**APPENDIX G**

**SHPO LETTER OF CONCURRENCE AND  
DRAFT MEMORANDUM OF AGREEMENT**



**SHPO LETTER OF CONCURRENCE**

**Will be included in the Final SEIS/SEIR**



**MEMORANDUM OF AGREEMENT  
AMONG THE FEDERAL TRANSIT ADMINISTRATION,  
LOS ANGELES COUNTY METROPOLITAN  
TRANSPORTATION AUTHORITY, AND THE CALIFORNIA  
STATE HISTORIC PRESERVATION OFFICER REGARDING  
CONSTRUCTION OF THE EASTSIDE TRANSIT CORRIDOR  
PROJECT**

*Whereas* the Los Angeles County Metropolitan Transportation Authority (MTA) proposes to construct a Light Rail Transit (LRT) Project to provide improved transportation in the East Los Angeles area; and

*Whereas* Federal Transit Administration (FTA) has agreed to assume the lead Agency role with MTA participating as the Lead Administrative Agency in review of the proposed Eastside Transit Corridor Project under Section 106 of the National Historic Preservation Act (NHPA) on behalf of itself; and

*Whereas* MTA is giving consideration to the preferred route of the LRT Build Alternative, two options (Option A [Option 1 including modifications to Alameda and 1<sup>st</sup> Streets], and Option B [Option A including modifications to the Indiana Street transition and eastern terminus]), and a No-Build Alternative; and

*Whereas* MTA has established the project's area of potential effects, as defined at 36 CFR . 800.16(d); and

*Whereas* FTA has determined that the corridor may have effects on sites, structures, and/or objects eligible for inclusion in the National Register of Historic Places (historic properties) if the LRT alternative is pursued; and

*Whereas* MTA has conducted background studies, preliminary field investigations, and consultations with interested parties, on the basis of which it predicted the location and character of known and possible historic properties subject to effect by the proposed project (Greenwood and Associates 2001); and

*Whereas* it is possible that there are historic properties in the Area of Potential Effects (APE), that may exist in the area of Union Station to the foot of the Boyle Heights bluffs, along 1<sup>st</sup> Street from the bluffs to the city boundary at Indiana Street, and farther along 3<sup>rd</sup> Street east to the end of the corridor; and

*Whereas* modifications to the 1<sup>st</sup> Bridge will necessitate seismic retrofit which will have an adverse effect on the property; and

*Whereas* there is a potential for permanent effects to occur to cultural resources as a result of project activities such as grading, cutting and filling, excavation, trenching, augering, or other construction process which disturbs, alters, removes, or destroys an historic property; and

*Whereas* FTA has consulted with the California State Historic Preservation Officer (SHPO) in accordance with Section 106 of the National Historic Preservation Act and its implementing regulations (36 CFR Part 800) to resolve the potential adverse effects of the Eastside Transit Corridor Project on historic properties; and

*Whereas* FTA intends to use the provisions of this Memorandum of Agreement (MOA) to address applicable requirements of NHPA and to ensure the undertaking is carried out in accordance with the MOA;

*NOW, THEREFORE*, FTA and the California State Historic Preservation Officer agree that should MTA elect to proceed with the corridor improvements, FTA shall ensure that the following stipulations are implemented, in order to take into account the effect of the improvements on historic properties.

### Stipulations

#### Archaeological Stipulations

1. Prior to the start of the project earth disturbing activities, the project archaeologist shall prepare and the MTA shall submit to the SHPO a draft Cultural Resource Monitoring and Mitigation Plan (CRMMP) for a 30 day comment, review, and approval. The CRMMP will identify general and specific measures to avoid, minimize, or mitigate potential impacts to significant cultural resources within the project area.
2. The Cultural Resource Monitoring and Mitigation Plan shall include, but not be limited to, the following elements and measures:
  - A) A proposed research design for both prehistoric and historical archaeology that includes a discussion of questions that may be answered by the mapping, data and artifact recovery conducted during monitoring and mitigation activities, and by the analysis of recovered data and materials. It shall provide details of the data needed to address the research issues and the methods proposed to obtain such data;
  - B) A discussion of the implementation sequence and the estimated time frames needed to accomplish all project-related tasks during pre-construction, construction, and post-construction phases of the project;
  - C) Identification of the person(s) expected to perform each of the tasks, a description of each team member's qualifications and responsibilities, the structure

of the mitigation team, and the reporting relationships. The cultural resource team shall include one member professionally qualified in historical archaeology;

D) A discussion of the inclusion of Native American observers or monitors, the procedures to be used to select them, the areas where they will be needed, and their role and responsibilities;

E) A discussion of where monitoring or project activities is deemed necessary by the designated Project Archaeologist (PA). The PA will determine the size or extent of the areas where monitoring is to occur and will estimate the percentage of the time that the monitor(s) will be present;

F) Provision that cultural material recovered from survey and data recovery projects will be curated in accordance with 36 CFR Part 79;

G) A contract agreement with the public institution that has agreed to receive any data and cultural resources recovered during project-related monitoring and mitigation work. Discussion of the requirements, specifications, or funding needed for the materials to be delivered for curation and how they will be met;

H) The PA or the PA's delegated monitor(s) shall have the authority to halt or redirect earth disturbing activities or construction if previously unknown cultural resource sites or materials are encountered during project-related land clearing, grading, trenching, or other earth disturbing activities. Cultural resource monitors shall be members of the approved cultural resource team with a background and experience appropriate to the project area being monitored;

I) If such resources are found and the PA determines that they are not significant, the PA will document the observations and assessments and may allow construction to resume;

J) If such resources are found and the PA believes that they are or may be significant, the halting or redirection of earth disturbing activities or construction shall remain in effect until:

the PA has notified the MTA of the find and the work stoppage;

the PA, FTA, and MTA have conferred and determined what, if any, testing, data recovery or other mitigation is needed; and

any necessary testing, data recovery, and/or other mitigation has been completed.



K) If data recovery or other mitigation measures are required, the PA shall monitor earth disturbing and construction activities and implement data recovery and mitigation measures as needed;

L) Following completion of data recovery and all mitigation work, the MTA shall ensure that the designated PA prepares a proposed scope of work for the Cultural Resources Report. The MTA shall submit the proposed scope of work to SHPO for review and approval;

M) The MTA shall ensure that the PA prepares a Cultural Resources Report. The MTA shall submit the report to SHPO for review and approval, and complete any suggested revisions.

3. Since it is not feasible to conduct an archaeological evaluation of the known and possible archaeological sites prior to construction, MTA has agreed to stipulate that any sites encountered are eligible to the NRHP until an evaluation can be made and that if encountered, MTA shall manage any such unanticipated resources in accordance with the CRMMP.

#### Architectural Stipulations for the 1<sup>st</sup> Street Bridge

##### 1. Structural

- a. Bents 1-5 and 17-21: Concrete infill shear walls between columns closing the remaining two cells constitutes an adverse effect. All concrete infill walls must be recessed 3 inches from the face of existing columns on either side, matching the reveals of the central cells created by the earlier City of Los Angeles seismic retrofit. Concrete used for the infill walls should be tinted to match the color of the existing infill walls.
- b. Bents 6-16, 22, and 23: Concrete infill shear walls between columns closing two additional cells constitutes an adverse effect. All concrete infill walls must be recessed 3 inches from the face of existing columns on either side, matching the reveals of the central cells created by the earlier City of Los Angeles seismic retrofit. Concrete used for the infill walls should be tinted to match the color of the existing infill walls.
- c. Arch Span Central Pier, East and West Arch Abutments: Concrete infill shear walls between columns closing two additional cells constitutes an adverse effect. All concrete infill walls must be recessed 3 inches from the face of existing columns on either side. Also, concrete used for the infill walls should be tinted to match the color of the existing infill walls.

- d. New work, which will of necessity become a permanent part of the bridge, should be done so that if it is removed in the future, essential form and integrity of the bridge will be unimpaired.

## 2. Historic American Engineering Record (HAER)

The MTA, in consultation with the State Office of Historic Preservation (OHP) and the National Park Service (NPS), will record the 1<sup>st</sup> Street Viaduct according to Historic American Engineering Record (HAER) standards. HAER documents utilize the Secretary of the Interior's *Standards for Architectural and Engineering Documentation*, which are linked to the Secretary's *Guidelines for Architectural and Engineering Documentation* and the HABS/HAER Procedures Manual which provide more specific guidance and technical information. Recording of the viaduct should be consistent with Documentation Level 1, as defined by the *Secretary's Standards*. Level 1 documentation includes:

- a. Drawings: a full set of measured drawings depicting existing and historic conditions.
- b. Photographs: photographs with large format negatives of exterior and interior views, photocopies with large format negatives of select existing drawings or historic views where available.
- c. Written data: history and description. HAER recordation for the 1<sup>st</sup> Street Viaduct should update and augment previously completed documentation of the structure, with particular attention paid to areas of proposed seismic retrofitting. Documentation should be completed within 180 days of when the FTA releases funds for the Eastside Corridor project. The product should be submitted to the NPS for review and addition to the HABS/HAER collection maintained by the Library of Congress. Copies of the document should also be provided to local institutions or agencies (Los Angeles Public Library, Los Angeles Conservancy) and made available for public review.

## 3. Public Interpretation

- a. The MTA, in consultation with the City of Los Angeles and in consultation with the SHPO, will create a permanent display within an Eastside Corridor station area, or other MTA facility readily accessible to the public, that will interpret the history and construction of the 1<sup>st</sup> Street Viaduct and its historical context as one of 15 significant Los Angeles River bridges constructed between 1910 and 1934. The interpretive display may consist of durable panels and should include items such as: reproductions of historical photographs of the bridges, original construction drawings, or other drawings, drawings and photographs that are part of HAER documentation previously completed for the various bridges and as part of the current mitigation measures, and explanatory text. Items such as reproductions or casts of

bridge architectural elements, discarded hardware, or other items used in the original bridge construction may also be included. The interpretive display should be completed and in place prior to initiation of service on the Eastside Corridor LRT line.

- b. The MTA, in consultation with the City of Los Angeles and SHPO, will create a traveling interpretive exhibit for display at various public venues within the City of Los Angeles/Los Angeles County, such as public libraries, museums, or schools, that will present the history and construction of the 1<sup>st</sup> Street Viaduct and its historical context as one of 15 significant Los Angeles River bridges constructed between 1910 and 1934. The interpretive display may consist of panels that include items such as reproductions of historical photographs of the bridges, original construction drawings, or other drawings and original artwork, drawings and photographs that are part of HAER documentation previously completed for the various bridges, and as part of the current mitigation measures, and explanatory text. The traveling interpretive exhibit should be completed and ready for installation prior to commencement of seismic retrofit work on the 1<sup>st</sup> Street Viaduct. Documentation should be completed within 180 days of when the FTA releases funds for the Eastside Corridor project.

## **Administration**

A. Review of submittals. Whenever any party to this MOA is given the opportunity to review documents prepared pursuant to the terms of this MOA, that party shall have thirty (30) calendar days to conduct such review. Failure of a reviewing party to provide comments in accordance with this stipulation may be taken to indicate approval of the pertinent document by the reviewing party.

B. Alterations to Project Documents. MTA shall not alter any plan, scope of services, or other document that has been reviewed and commented on pursuant to this MOA, except to finalize documents commented on in draft, without first affording the other parties to this MOA the opportunity to review the proposed change and determine whether it shall require that this MOA be amended. If one or more of the parties determines that an amendment is needed, the parties to this MOA shall consult to consider such an amendment.

### **C. Annual Report and Review**

- 1. On or before December 5 of each year until MTA, FTA, and the SHPO agree in writing that the terms of this MOA have been fulfilled, MTA shall prepare and provide an annual report to the parties to this MOA, detailing how the applicable terms of this MOA are being implemented.

2. The SHPO and FTA shall review the annual report and provide comments to MTA. Other parties to this MOA may review and comment on the annual report at their discretion.

3. At the request of any party to this MOA, a meeting or meetings shall be held to facilitate review and comment, to resolve questions, or to resolve adverse comments.

4. Based on this review, SHPO, FTA, and the MTA shall determine whether this MOA shall continue in force, be amended, or be terminated.

#### D. Resolving Objections

1. Should any party to this MOA object to any action carried out or proposed with respect to development of the Program or implementation of this MOA, MTA shall consult with the objecting party to resolve the objection. If after initiating such consultation MTA determines that the objection cannot be resolved through consultation, MTA shall forward all documentation relevant to the objection to the Advisory Council on Historic Preservation, including MTA's proposed response to the objection. Within thirty days after receipt of all pertinent documentation, the Council will provide an opinion.

2. At any time during implementation of the measures stipulated in this MOA, should an objection pertaining to this MOA be raised by a member of the public, FTA shall notify the parties to this MOA and take the objection into account, consulting with the objector and should the objector so request, with any of the parties to this MOA to resolve the objection.

3. Amendments. Any party to this MOA may propose to FTA that the MOA be amended, whereupon FTA shall consult with the other parties to this MOA to consider such an amendment.

#### E. Termination

1. If FTA determines that it cannot ensure implementation of the terms of this MOA, or if the SHPO determines that the MOA is not being properly implemented, FTA or the SHPO may propose to the other parties to this MOA that it be terminated.

2. The party proposing to terminate this MOA shall so notify all parties to this MOA, explaining the reasons for termination and affording them at least 30 days to consult and seek alternatives to termination.

3. If the terms of this agreement have not been implemented by January 20, 2005, this agreement shall be considered null and void. In such event the

agency shall so notify the parties to this agreement, and if it chooses to continue with the undertaking, shall reinitiate review of the undertaking in accordance with 36 CFR Part 800.

Execution of this MOA and implementation of its terms evidence that FTA has afforded the SHPO an opportunity to comment on development of the Program, and that FTA has taken into account the effects of the Program on historic properties.

Federal Transit Administration

By: \_\_\_\_\_ Date:

California State Historic Preservation Officer

By: \_\_\_\_\_ Date:

Los Angeles County Metropolitan Transportation Authority

By: \_\_\_\_\_ Date:

