

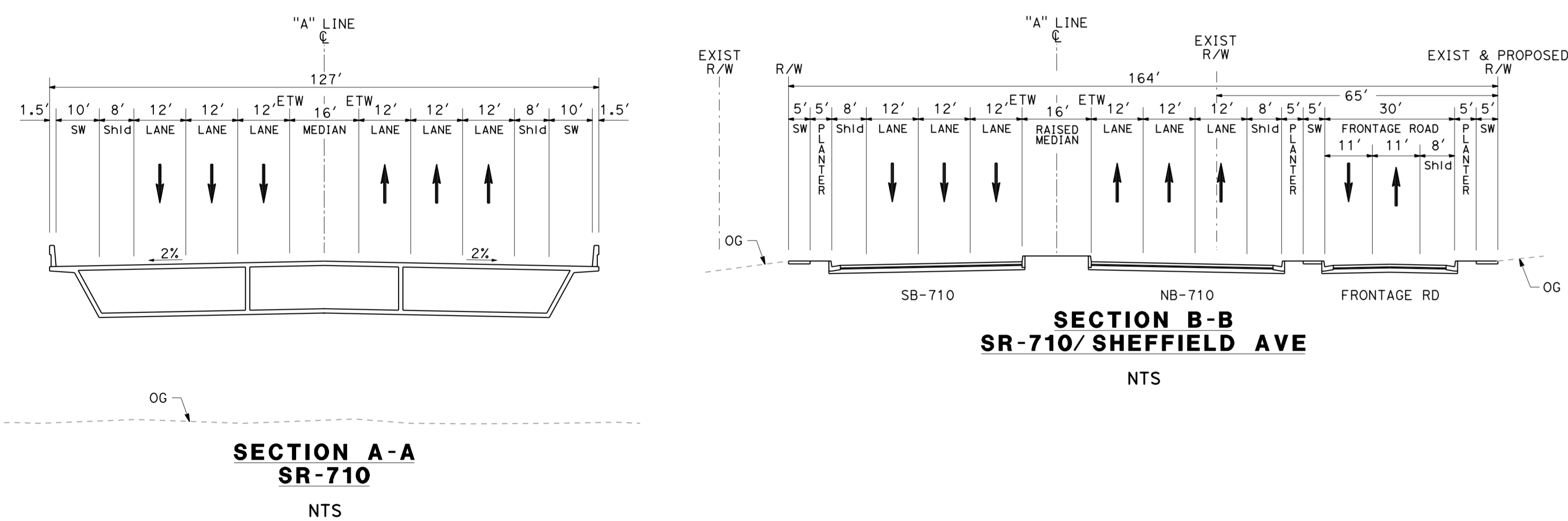

MATCHLINE STA "A" 124+50.00 - SEE SHEET 2

PLAN
SCALE 1"=200'



CURVE DATA

No.	R	D	T	L
1	2000.00	27°33'54"	490.60	962.20
2	20000.00	3°47'45"	662.73	1324.97
3	2000.00	5°38'48"	98.63	197.11
4	150.00	84°51'38"	137.11	222.16
5	300.00	32°35'27"	87.70	168.35
6	150.00	103°56'32"	166.22	235.84
7	250.00	83°28'16"	223.02	364.21

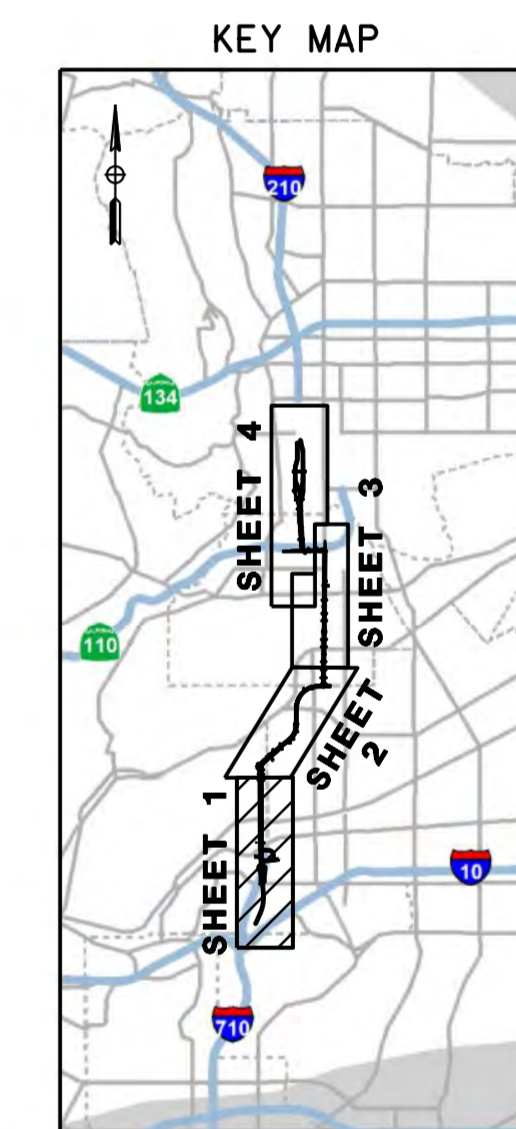

- LEGEND:**
- BRIDGE
 - PAVEMENT
 - LANDSCAPING
 - SIDEWALK
 - HISTORIC PROPERTY
 - DISTURBANCE LIMIT LINE (DLL)

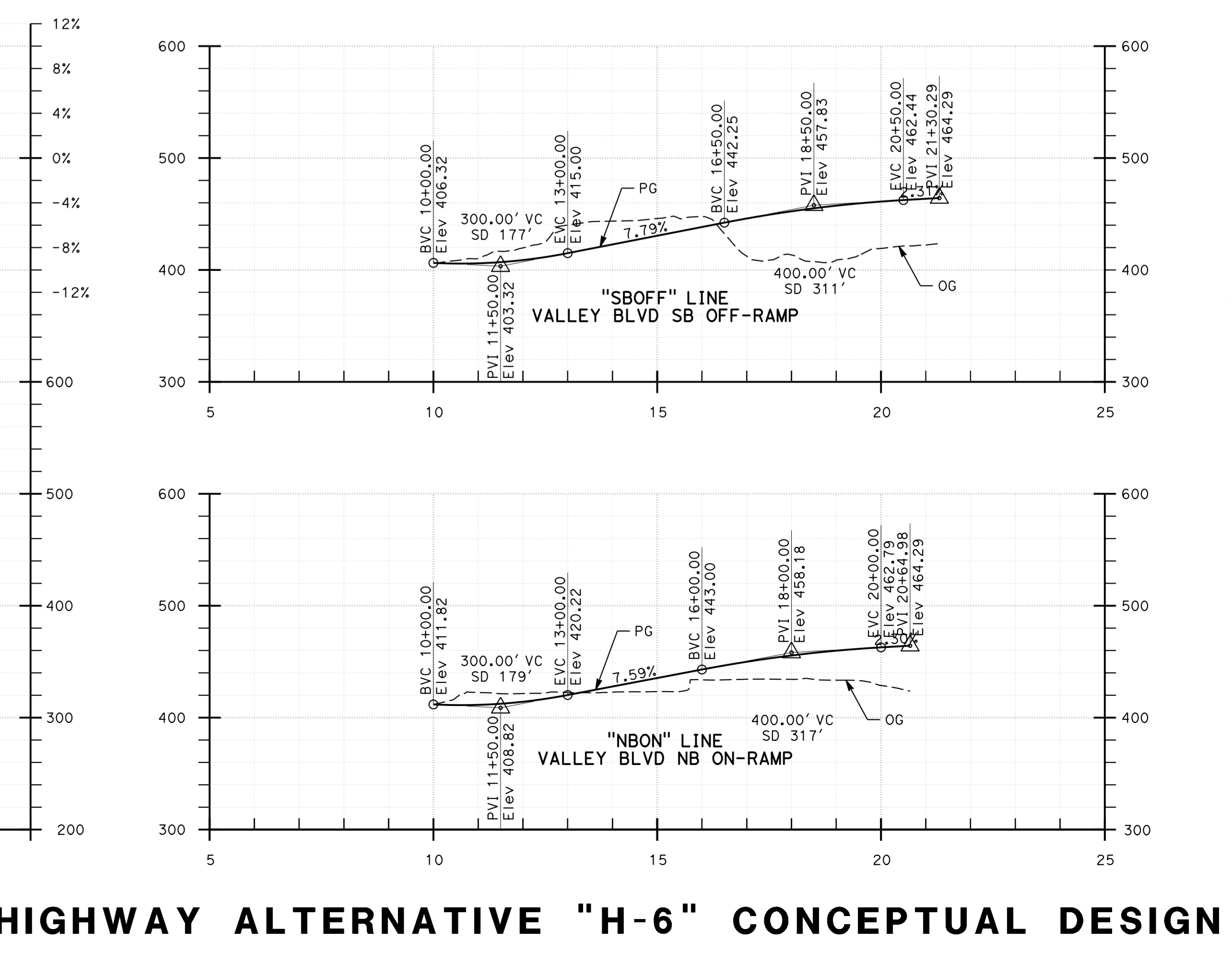
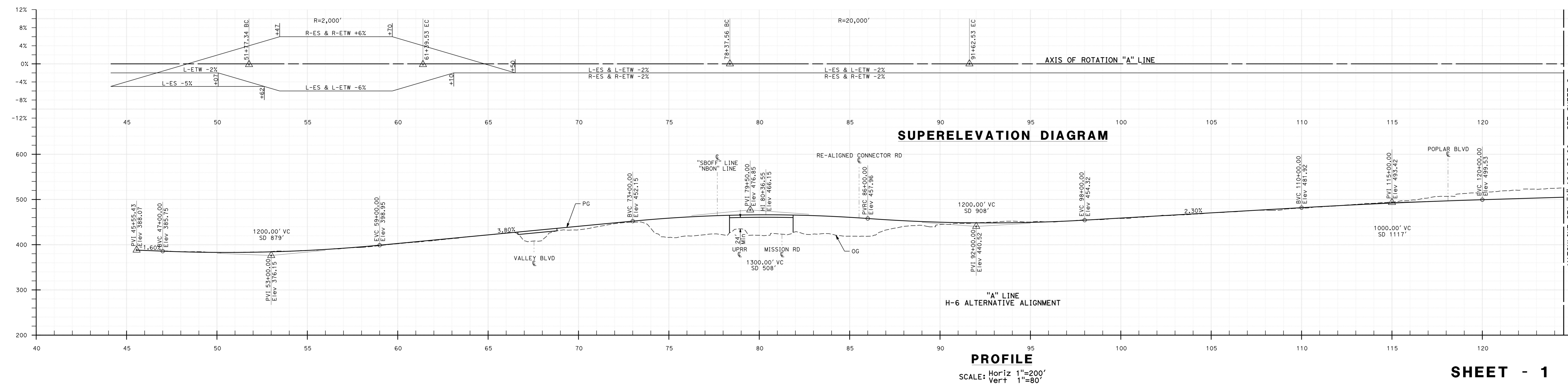

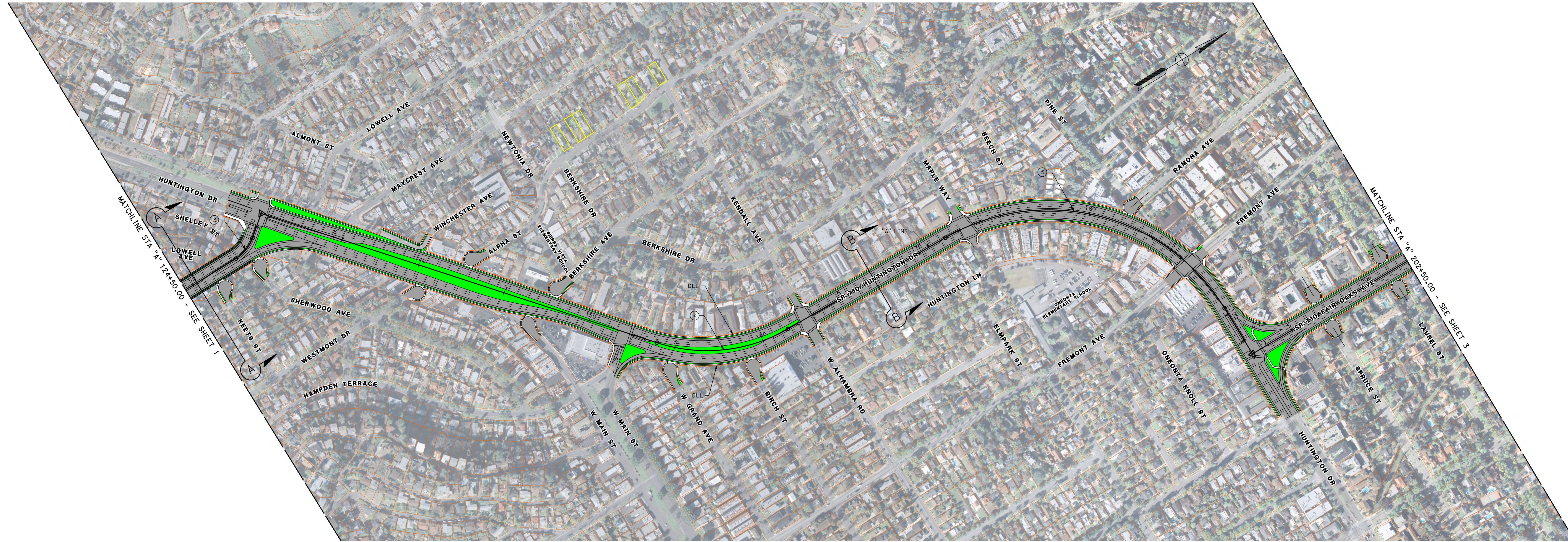

PLAN
SCALE 1"=200'

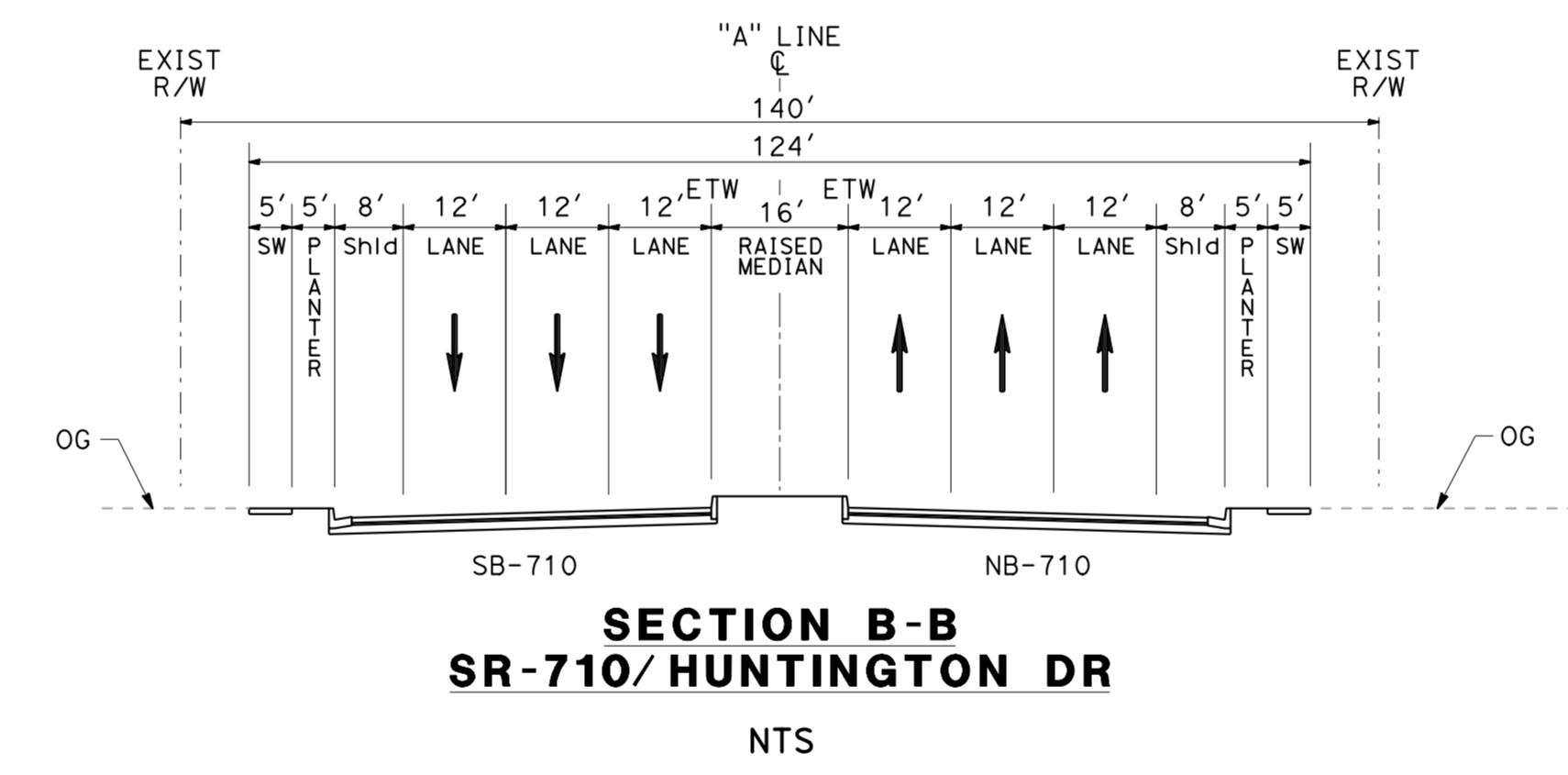
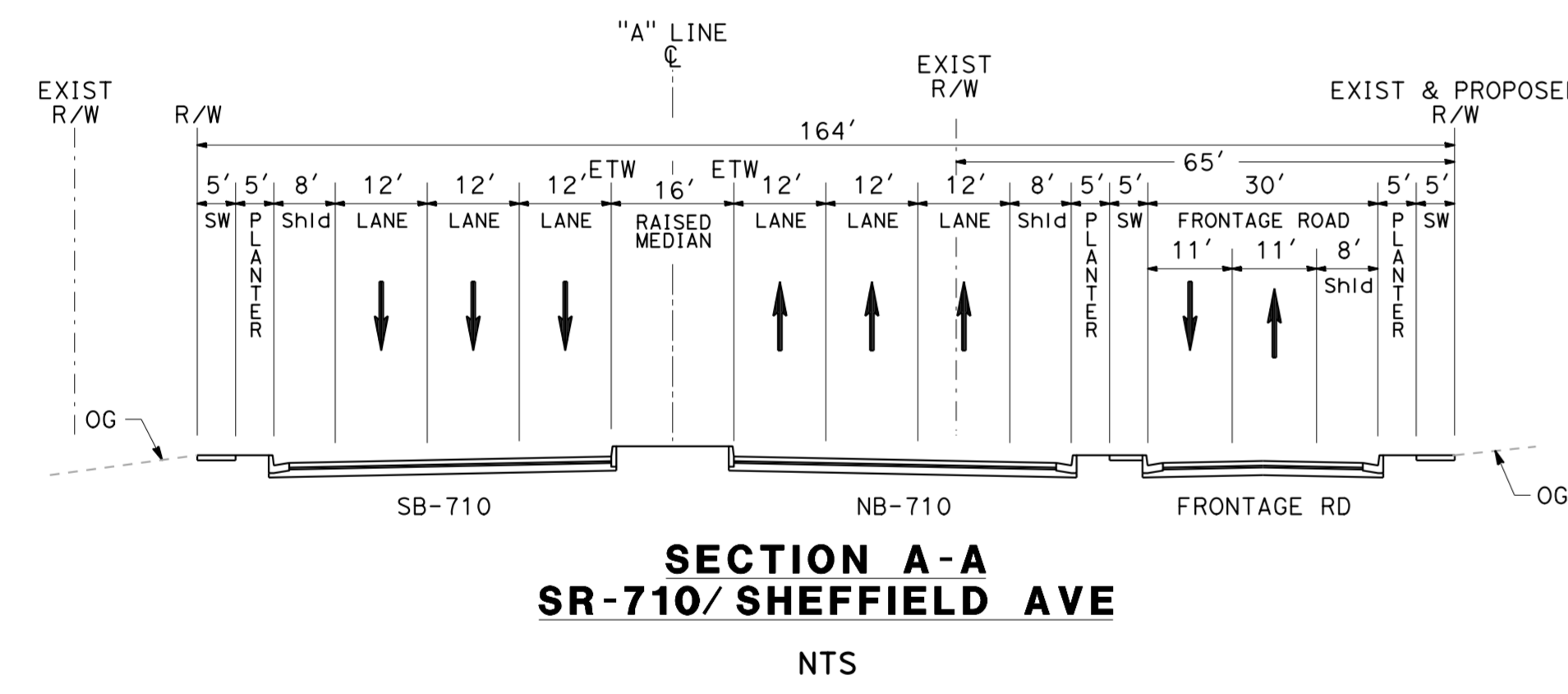

CURVE DATA

No.	R	D	T	L
①	220.00	38°47'29"	77.46	148.95
②	900.00	48°10'55"	402.42	756.84
③	1150.00	88°32'42"	1121.16	1777.21

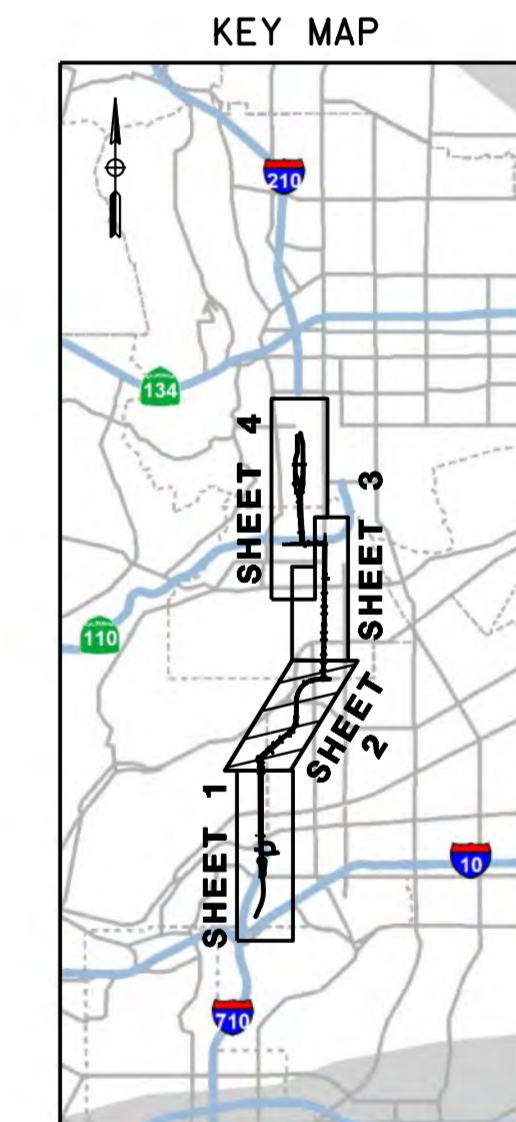

- LEGEND:**
- BRIDGE
 - PAVEMENT
 - LANDSCAPING
 - SIDEWALK
 - HISTORIC PROPERTY
 - DISTURBANCE LIMIT LINE (DLL)





PLAN
SCALE 1"=200'

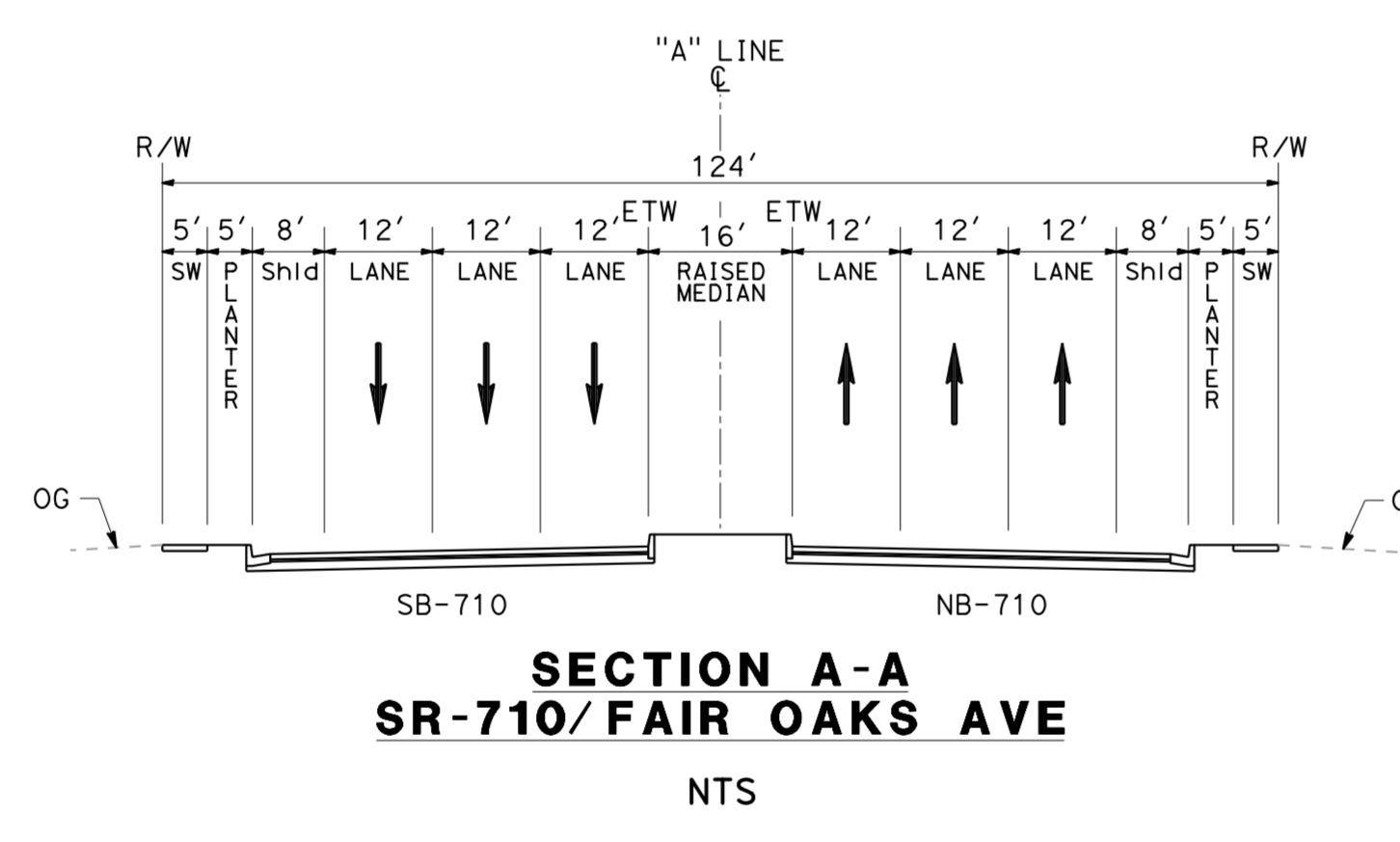

CURVE DATA

NO.	R	D	T	L
(6)	20000.00	1°09'51"	203.18	406.34
(7)	20000.00	1°09'51"	203.18	406.34

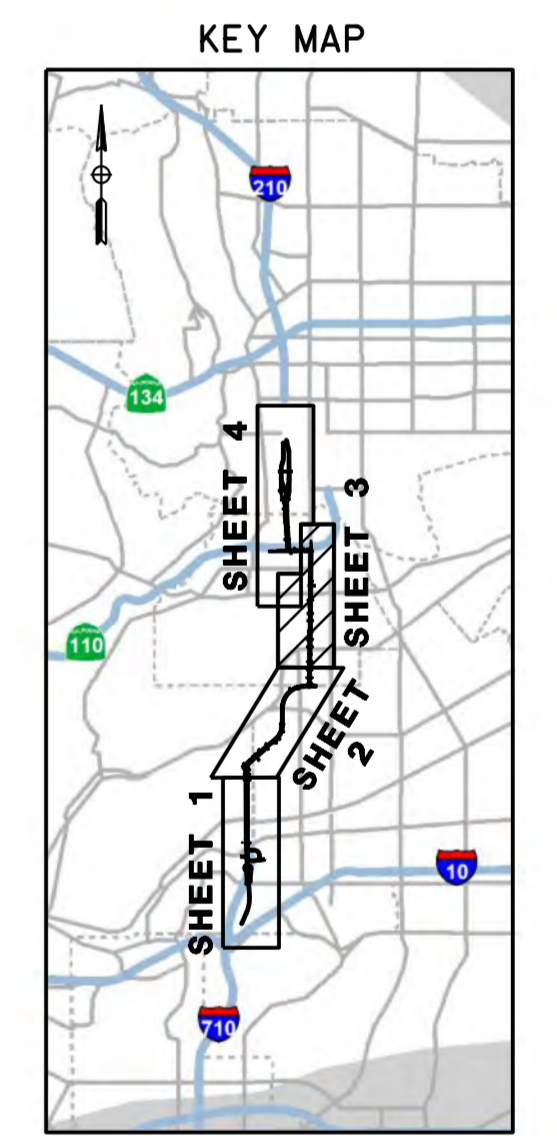

- LEGEND:**
- BRIDGE
 - PAVEMENT
 - LANDSCAPING
 - SIDEWALK
 - HISTORIC PROPERTY
 - DISTURBANCE LIMIT LINE (DLL)





MATCHLINE STA "A" 270+50.00 - SEE SHEET 3

PLAN

SCALE 1"=200'

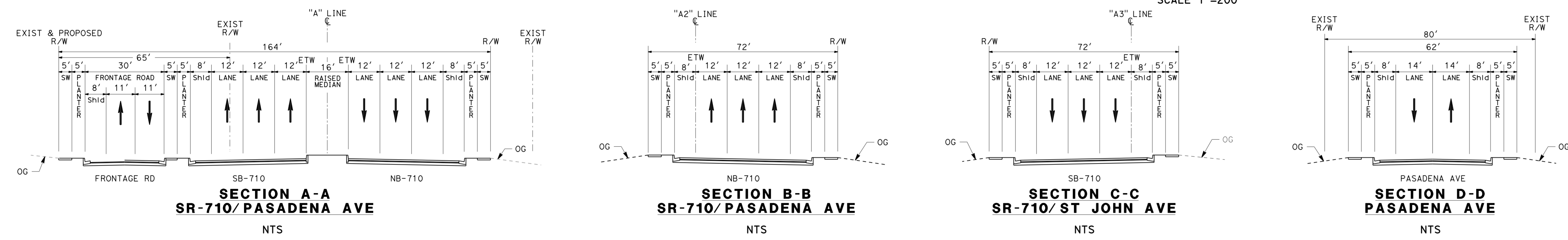

CURVE DATA

NO.	R	D	T	L
(1)	1500.00	10°04'10"	132.15	263.62
(2)	1500.00	10°02'58"	131.89	263.10
(3)	400.00	17°20'23"	60.99	121.05
(4)	842.00	8°01'59"	59.12	118.05
(5)	700.00	21°40'47"	134.04	264.87
(6)	700.00	21°38'05"	133.75	264.33
(7)	858.00	16°49'05"	126.84	251.85
(8)	842.00	17°28'33"	129.41	256.82

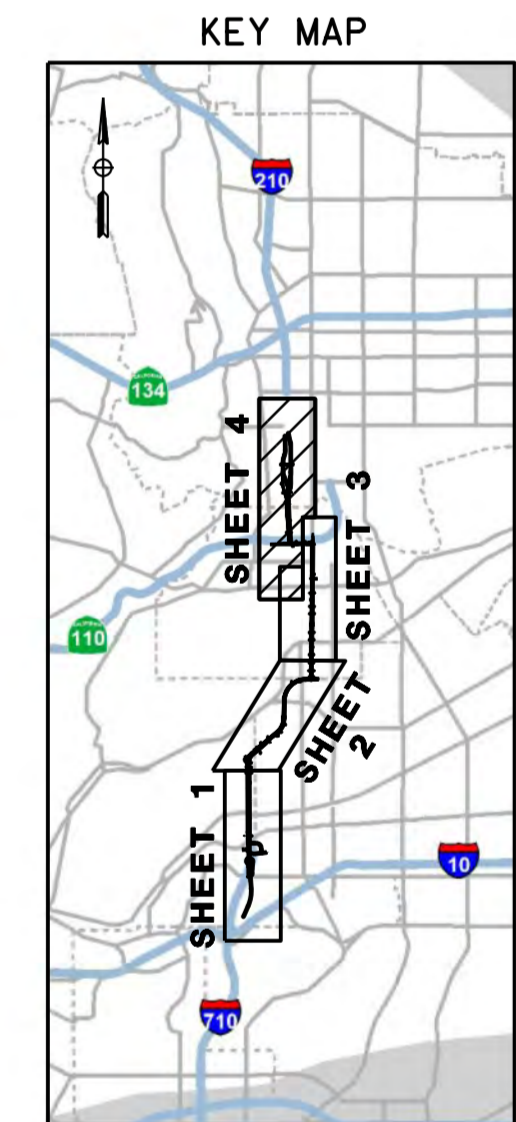

- LEGEND:**
- BRIDGE
 - PAVEMENT
 - LANDSCAPING
 - SIDEWALK
 - HISTORIC PROPERTY
 - DISTURBANCE LIMIT LINE (DLL)

