

**DOT/FAA/AR-00/45**

Office of Aviation Research  
Washington, D.C. 20591

# **Air Carrier Operations System Model**

March 2001

Final Report

This document is available to the U.S. public  
through the National Technical Information  
Service (NTIS), Springfield, Virginia 22161.



U.S. Department of Transportation  
**Federal Aviation Administration**

## **NOTICE**

This document is disseminated under the sponsorship of the U.S. Department of Transportation in the interest of information exchange. The United States Government assumes no liability for the contents or use thereof. The United States Government does not endorse products or manufacturers. Trade or manufacturer's names appear herein solely because they are considered essential to the objective of this report. This document does not constitute FAA certification policy. Consult your local FAA aircraft certification office as to its use.

This report is available at the Federal Aviation Administration William J. Hughes Technical Center's Full-Text Technical Reports page: [actlibrary.tc.faa.gov](http://actlibrary.tc.faa.gov) in Adobe Acrobat portable document format (PDF).

1. Report No. DOT/FAA/AR-00/45		2. Government Accession No.		3. Recipient's Catalog No.	
4. Title and Subtitle AIR CARRIER OPERATIONS SYSTEM MODEL				5. Report Date March 2001	
				6. Performing Organization Code	
7. Author(s) Don Arendt*, Darrell Bandy**, Jean-Pierre Dagon***, Kathleen Fazen†, Robert Gray††, Larry Jones†††, Frederick Leonelli✓, Huasheng Li✓, Timothy I. Liddle✓, James W. Scandlin†††, and Robert Zitney††				8. Performing Organization Report No.	
9. Performing Organization Name and Address  *Federal Aviation Administration Flight Standards Cert. and Surveillance Prog. Off. Gateway Building, Suite 131 45005 Aviation Drive Dulles, VA 20166-7537  ***Northwest Airlines, Inc. 5101 Northwes Drive St. Paul, MN 55110-3034  ††Airborne Express 145 Hunter Drive Wilmington, OH 45177  ✓Hi-Tec Systems 500 Scarborough Drive English Creek Corporate Center Egg Harbor Twp, NJ 08234		**Delta Airlines Quality Systems Management Group Dept. 218 P.O. Box 20706 Atlanta, GA 30320-6001  †Federal Aviation Administration Airport and Aircraft Safety R&D Division Wm. J. Hughes Technical Center Atlantic City International Airport, NJ 08405  †††American Trans Air 7661 North Perimeter Road Indianapolis, IN 46251  ✓Federal Aviation Administration DFW Flight Standards District Office Southwest Airlines Certification Mgmt. Team DFW Business Center, Suite 400 DFW Airport, TX 75261-9020		10. Work Unit No. (TRAIS)	
				11. Contract or Grant No.	
				13. Type of Report and Period Covered Final Report	
				14. Sponsoring Agency Code AFS-900	
12. Sponsoring Agency Name and Address U.S. Department of Transportation Federal Aviation Administration Office of Aviation Research Washington, DC 20591					
15. Supplementary Notes					
16. Abstract Representatives from the Federal Aviation Administration (FAA) and several 14 Code of Federal Regulations (CFR) Part 121 air carriers met several times during 1999-2000 to develop a system engineering model of the generic functions of air carrier operations. From these meetings, the team developed the Air Carrier Operations System Model (ACOSM), Version 1.0. ACOSM serves as the foundation for FAA research, engineering and development (R,E&D) efforts to support a system safety approach to aviation safety oversight. It is currently being used in the development of safety performance measures and risk indicators; work processes to support the collection of data to be used in analysis; and analytical methods, including information presentation. The model also provides an important communications bridge between the FAA and the aviation industry during this evolution of a system safety approach. For example, each carrier has its own internal models of their processes. By developing an external model in which industry and FAA participants identify and agree upon the functions and definitions of the model, a standard model is put forward that provides a common point of reference. Thus, everyone is looking at the same model, using the same definitions, and talking about the same thing. The model structure uses the Integrated Definition Function Model (IDEF0) format, as defined in Federal Information Processing Standards (FIPS) Publication 183, and as captured in BPwin, a commercial product from Platinum Technologies. With this structured language and tool, the analysis of critical system interactions and potential system vulnerabilities will be enhanced and clarified. The descriptions of complex operations will be explicit and open. ACOSM concentrates on the following key air carrier operation processes: Operational Management, Air Transportation, Aircraft Maintenance, Personnel Training, and Operational Resources Provision.					
17. Key Words Functional model, System engineering, IDEF0, Aviation industry			18. Distribution Statement This document is available to the public through the National Technical Information Service (NTIS) Springfield, Virginia 22161.		
19. Security Classif. (of this report) Unclassified		20. Security Classif. (of this page) Unclassified		21. No. of Pages 179	
22. Price					

## ACKNOWLEDGEMENTS

Representatives from the following organization also contributed to this report:

Alaska Airlines

FJLeonelli Group Inc.

Flight Standards Continuous Air Transportation Oversight System (ATOS) Development (CAD) Team

Sandia National Laboratories - Aviation Safety Risk Analysis Technical Support (ASRATS) and Certification and Surveillance System Safety Support (CS4) Teams

United Airlines

## TABLE OF CONTENTS

	Page
EXECUTIVE SUMMARY	xi
1. INTRODUCTION	1
1.1 Air Carrier Operations System Model (ACOSM)	1
1.2 Objectives	2
1.3 Development Phases	2
1.4 R,E&D Efforts	2
2. IDEF0 NOTATION	3
3. ACOSM DESCRIPTION	5
3.1 Model Definition	5
3.1.1 Purpose	5
3.1.2 Scope	5
3.1.3 Viewpoint	5
3.1.4 Audience	5
3.2 ACOSM Activity (Function) Decomposition	6
3.3 ACOSM Activity Hierarchy	7
4. MODEL DIAGRAMS	8
4.1 A-0—Perform Air Carrier Operations	13
4.2 A0—Perform Air Carrier Operations	17
4.2.1 A1—Manage Air Carrier Operations	17
4.2.2 A2—Perform Air Transportation	17
4.2.3 A3—Perform Aircraft Maintenance	17
4.2.4 A4—Perform Personnel Training	17
4.2.5 A5—Provide Air Carrier Operation Resources	18
4.3 A1—Manage Air Carrier Operations	21
4.3.1 A1.1—Manage Air Carrier Operations Coordination	21
4.3.2 A1.2—Plan Operations	21
4.3.3 A1.3—Perform Operational Control	21
4.3.4 A1.4—Project Utilization	22
4.3.5 A1.5—Develop Maintenance Policies & Procedures	22
4.3.6 A1.6—Develop Operations Policies & Procedures	22
4.3.7 A1.7—Provide Air Carrier Operations Management Resources	22

4.4	A1.3—Perform Operational Control	25
4.4.1	A1.3.1—Manage Operational Control	25
4.4.2	A1.3.2—Evaluate Weather	25
4.4.3	A1.3.3—Plan Flight Routes	25
4.4.4	A1.3.4—Perform Load/Fuel Planning	25
4.4.5	A1.3.5—Assign Crewmembers	26
4.4.6	A1.3.6—Dispatch Aircraft	26
4.4.7	A1.3.7—Perform Maintenance Control	26
4.4.8	A1.3.8—Provide Operational Control Resources	26
4.5	A1.3.6—Dispatch Aircraft	29
4.5.1	A1.3.6.1—Manage Aircraft Dispatch	29
4.5.2	A1.3.6.2—Create & Deliver Preflight Package	29
4.5.3	A1.3.6.3—Sign Dispatch Release	29
4.5.4	A1.3.6.4—Monitor Flight	30
4.5.5	A1.3.6.5—Provide Aircraft Dispatch Resources	30
4.6	A1.5—Develop Maintenance Policies & Procedures	33
4.6.1	A1.5.1—Manage Maintenance Policy & Procedure Development	33
4.6.2	A1.5.2—Collect & Process Operational Data	33
4.6.3	A1.5.3—Perform Technical Evaluations	33
4.6.4	A1.5.4—Modify Maintenance Program	33
4.6.5	A1.5.5—Provide Maintenance Policy & Procedure Development Resources	33
4.7	A1.6—Develop Operations Policies & Procedures	35
4.7.1	A1.6.1—Manage Operations Policy & Procedure Development	35
4.7.2	A1.6.2—Identify & Effect Operations Policies	35
4.7.3	A1.6.3—Develop & Evaluate Operations Policies & Procedures	35
4.7.4	A1.6.4—Provide Operations Policy & Procedure Development Resources	35
4.8	A2—Perform Air Transportation	37
4.8.1	A2.1—Manage Air Transportation	37
4.8.2	A2.2—Perform Passenger Services	37

4.8.3	A2.3—Perform Ground Operations	37
4.8.4	A2.4—Perform Aircraft Operations	38
4.8.5	A2.5—Provide Air Transportation Resources	38
<b>4.9</b>	<b>A2.2—Perform Passenger Services</b>	<b>41</b>
4.9.1	A2.2.1—Manage Passenger Services	41
4.9.2	A2.2.2—Perform Boarding Services	41
4.9.3	A2.2.3—Perform In-Flight Services	41
4.9.4	A2.2.4—Perform Deplaning Services	42
4.9.5	A2.2.5—Provide Passenger Service Resources	42
<b>4.10</b>	<b>A2.2.2—Perform Boarding Services</b>	<b>45</b>
4.10.1	A2.2.2.1—Manage Boarding Services	45
4.10.2	A2.2.2.2—Provide Check-In Services	45
4.10.3	A2.2.2.3—Provide Security Services	45
4.10.4	A2.2.2.4—Provide Seating Services	45
4.10.5	A2.2.2.5—Provide Boarding Service Resources	45
<b>4.11</b>	<b>A2.3—Perform Ground Operations</b>	<b>47</b>
4.11.1	A2.3.1—Manage Ground Operations	47
4.11.2	A2.3.2—Perform Ground Handling	47
4.11.3	A2.3.3—Perform Cargo Handling	47
4.11.4	A2.3.4—Replenish Consumables	47
4.11.5	A2.3.5—Perform Line Services	48
4.11.6	A2.3.6—Perform Deicing/Anti-Icing Program	48
4.11.7	A2.3.7—Provide Ground Operation Resources	48
<b>4.12</b>	<b>A2.3.3—Perform Cargo Handling</b>	<b>51</b>
4.12.1	A2.3.3.1—Manage Cargo Handling	51
4.12.2	A2.3.3.2—Check/Weigh/Screen Cargo	51
4.12.3	A2.3.3.3—Secure Cargo	51
4.12.4	A2.3.3.4—Load/Unload Cargo	51
4.12.5	A2.3.3.5—Provide Cargo-Handling Resources	51
<b>4.13</b>	<b>A2.4—Perform Aircraft Operations</b>	<b>53</b>
4.13.1	A2.4.1—Manage Aircraft Operations	53
4.13.2	A2.4.2—Perform Predeparture Ground Operations	53
4.13.3	A2.4.3—Perform Takeoff Operations	54
4.13.4	A2.4.4—Perform Climb Operations	54
4.13.5	A2.4.5—Perform Cruise Operations	54
4.13.6	A2.4.6—Perform Descent Operations	54

4.13.7	A2.4.7—Perform Approach Operations	55
4.13.8	A2.4.8—Perform Landing Operations	55
4.13.9	A2.4.9—Perform Postarrival Ground Operations	55
4.13.10	A2.4.10—Provide Aircraft Operation Resources	55
<b>4.14</b>	<b>A2.4.3—Perform Takeoff Operations</b>	<b>57</b>
4.14.1	A2.4.3.1—Manage Takeoff Operations	57
4.14.2	A2.4.3.2—Perform Takeoff Prior to V1	57
4.14.3	A2.4.3.3—Perform Takeoff At/After V1	57
4.14.4	A2.4.3.4—Provide Takeoff Operation Resources	57
<b>4.15</b>	<b>A2.4.4—Perform Climb Operations</b>	<b>59</b>
4.15.1	A2.4.4.1—Manage Climb Operations	59
4.15.2	A2.4.4.2—Perform Initial Climb Operations	59
4.15.3	A2.4.4.3—Perform Normal Climb Operations	59
4.15.4	A2.4.4.4—Provide Climb Operation Resources	59
<b>4.16</b>	<b>A2.4.6—Perform Descent Operations</b>	<b>61</b>
4.16.1	A2.4.6.1—Manage Descent Operations	61
4.16.2	A2.4.6.2—Perform Initial Descent Operations	61
4.16.3	A2.4.6.3—Perform Approach Descent Operations	61
4.16.4	A2.4.6.4—Provide Descent Operation Resources	61
<b>4.17</b>	<b>A3—Perform Aircraft Maintenance</b>	<b>63</b>
4.17.1	A3.1—Manage Aircraft Maintenance	63
4.17.2	A3.2—Evaluate Aircraft	63
4.17.3	A3.3—Perform Scheduled/Nonscheduled Maintenance	63
4.17.4	A3.4—Provide Aircraft Maintenance Resources	63
<b>4.18</b>	<b>A3.2—Evaluate Aircraft</b>	<b>65</b>
4.18.1	A3.2.1—Manage Aircraft Evaluation	65
4.18.2	A3.2.2—Detect Aircraft Discrepancies	65
4.18.3	A3.2.3—Diagnose Aircraft Discrepancies	65
4.18.4	A3.2.4—Evaluate Aircraft Discrepancies	65
4.18.5	A3.2.5—Provide Aircraft Evaluation Resources	65
<b>4.19</b>	<b>A3.3—Perform Scheduled/Nonscheduled Maintenance</b>	<b>67</b>
4.19.1	A3.3.1—Manage Scheduled/Nonscheduled Aircraft Maintenance	67
4.19.2	A3.3.2—Perform Line Maintenance	67



4.19.3	A3.3.3—Perform Heavy/Depot Maintenance	67
4.19.4	A3.3.4—Perform Component Maintenance	67
4.19.5	A3.3.5—Provide Scheduled/Nonscheduled Aircraft Maintenance Resources	67
<b>4.20</b>	<b>A3.3.3—Perform Heavy/Depot Maintenance</b>	<b>69</b>
4.20.1	A3.3.3.1—Manage Heavy/Depot Maintenance	69
4.20.2	A3.3.3.2—Perform Aircraft Repair	69
4.20.3	A3.3.3.3—Perform Aircraft Test and Evaluation	69
4.20.4	A3.3.3.4—Provide Heavy/Depot Maintenance Resources	69
<b>4.21</b>	<b>A3.3.4—Perform Component Maintenance</b>	<b>71</b>
4.21.1	A3.3.4.1—Manage Component Maintenance	71
4.21.2	A3.3.4.2—Perform Configuration Control	71
4.21.3	A3.3.4.3—Assess Aircraft Components	72
4.21.4	A3.3.4.4—Perform Part Usage Analysis	72
4.21.5	A3.3.4.5—Provide Component Maintenance Resources	73
<b>4.22</b>	<b>A4—Perform Personnel Training</b>	<b>75</b>
4.22.1	A4.1—Manage Personnel Training	75
4.22.2	A4.2—Identify & Analyze Training Requirements	75
4.22.3	A4.3—Design & Develop Training	75
4.22.4	A4.4—Implement Training	75
4.22.5	A4.5—Evaluate Training	76
4.22.6	A4.6—Provide Personnel Training Resources	76
<b>4.23</b>	<b>A4.3—Design &amp; Develop Training</b>	<b>79</b>
4.23.1	A4.3.1—Manage Training Design & Development	79
4.23.2	A4.3.2—Develop Training Objectives	79
4.23.3	A4.3.3—Set Performance Standards	79
4.23.4	A4.3.4—Select Training Provider	79
4.23.5	A4.3.5—Develop Training Curriculum	79
4.23.6	A4.3.6—Provide Training Design & Development Resources	80
<b>4.24</b>	<b>A4.4—Implement Training</b>	<b>83</b>
4.24.1	A4.4.1—Manage Training Implementation	83
4.24.2	A4.4.2—Conduct Class Training	83
4.24.3	A4.4.3—Conduct Computer-Based Training	83
4.24.4	A4.4.4—Conduct Device/Simulator Training	83
4.24.5	A4.4.5—Conduct Aircraft Training	83

4.24.6	A4.4.6—Provide Training Implementation Resources	84
4.25	A4.5—Evaluate Training	87
4.25.1	A4.5.1—Manage Training Evaluation	87
4.25.2	A4.5.2—Conduct System Evaluation	87
4.25.3	A4.5.3—Conduct Device Evaluation	87
4.25.4	A4.5.4—Conduct Aircraft Evaluation	87
4.25.5	A4.5.5—Provide Training Evaluation Resources	87
4.26	A5—Provide Air Carrier Operation Resources	89
4.26.1	A5.1—Manage Air Carrier Operation Resource Provision	89
4.26.2	A5.2—Supply Available Aircraft	89
4.26.3	A5.3—Supply Available Expendable Supplies	89
4.26.4	A5.4—Supply Available Materials/Equipment/Facilities	89
4.26.5	A5.5—Supply Available Personnel	89
4.26.6	A5.6—Provide Air Carrier Operation Resource Provision Support	90
5.	GLOSSARY	91
6.	GENERAL DEFINITIONS AND ACRONYMS	156
6.1	General Definitions	156
6.2	Acronyms	163

## APPENDIX A—IDENTIFIED ITEMS FOR FURTHER DEVELOPMENT

### LIST OF FIGURES

Figure		Page
1	IDEF0 Model View	3
2	A Typical IDEF0 Diagram Hierarchy	4
3	Typical Diagram Template	6

## EXECUTIVE SUMMARY

Rigorous, defensible analyses, based on a validated system model and standardized, objective data, are a necessary integral component of the system safety approach to identifying, measuring, and predicting safety-related problems. The foundation for an effective systems safety approach is a requirements analysis to determine the capabilities that an air carrier oversight system must have and a functional analysis to describe the structure of an air carrier. Important aspects of the functional analysis are a description of the elements of the air carrier's functions and an analysis of the relationship between these elements. These analyses form the foundation or basic architecture upon which other task areas—hazard analysis, performance measure, and risk indicator design—are based. The output of a functional analysis is a system-engineering model that presents, in graphical format, the major processes of the system, identifying inputs, outputs, mechanisms, and controls.

Representatives from the Federal Aviation Administration (FAA) and several 14 Code of Federal Regulations (CFR) Part 121 air carriers met several times during 1999-2000 to develop a system engineering model of the generic functions of air carrier operations. From these meetings, the team developed the Air Carrier Operations System Model (ACOSM), Version 1.0.

ACOSM, Version 1.0, serves as the foundation for FAA research, engineering and development (R,E&D) efforts to support a system safety approach to aviation safety oversight. It is currently being used in the development of safety performance measures and risk indicators; work processes to support the collection of data to be used in analysis; and analytical methods, including information presentation.

The model also provides an important communications bridge between the FAA and the aviation industry during this evolution of a system safety approach. For example, each carrier has its own internal models of their processes. By developing an external model, in which industry and FAA participants identify and agree upon the functions and definitions of the model, then a standard model is put forward that provides a common point of reference. Thus, everyone is looking at the same model, using the same definitions, and talking about the same thing.

The model structure uses the Integrated Definition Function Model (IDEF0) format, as defined in Federal Information Processing Standards (FIPS) Publication 183, and as captured in BPwin, a commercial product from Platinum Technologies. With this structured language and tool, the analysis of critical system interactions and potential system vulnerabilities will be enhanced and clarified. The descriptions of complex operations will be explicit and open.

Because ACOSM, Version 1.0, was open for discussion and revision as it was being developed by a small group of subject matter experts within a limited timeframe, some important areas were not addressed in this first iteration. Appendix A provides a list of areas that the team identified as requiring further evaluation and definition in the next version.

The development of the ACOSM is scheduled to occur in two phases:

- Version 1.0
- Version 2.0 will modify Version 1.0 based upon the following methods for improvement:
  - The topics identified in appendix A.
  - Areas that an FAA and aviation industry team identify as needing to be added/modified/deleted.
  - Areas that the FAA R,E&D efforts identify as requiring further definition or decomposition.

Any developments beyond Version 2.0 will be determined jointly by the FAA and a team of representatives from the aviation industry.

ACOSM concentrates on the following key air carrier operation processes:

- Operational management
- Air transportation
- Aircraft maintenance
- Personnel training
- Operational resources provision

## 1. INTRODUCTION.

Rigorous, defensible analyses, based on a validated system model and standardized, objective data, are a necessary integral component of the system safety approach to identifying, measuring, and predicting safety-related problems. The foundation for an effective systems safety approach is a requirements analysis to determine the capabilities that an air carrier oversight system must have and a functional analysis to describe the structure of an air carrier. Important aspects of the functional analysis are a description of the elements of the air carrier's functions and an analysis of the relationship between these elements. These analyses form the foundation or basic architecture upon which other task areas—hazard analysis, performance measure, and risk indicator design—are based. The output of a functional analysis is a system-engineering model that presents, in graphical format, the major processes of the system, identifying inputs, outputs, mechanisms, and controls.

### 1.1 AIR CARRIER OPERATIONS SYSTEM MODEL (ACOSM).

Representatives from the Federal Aviation Administration (FAA) and several 14 Code of Federal Regulations (CFR) Part 121 air carriers met several times during 1999-2000 to develop a system engineering model of the generic functions of air carrier operations. From these meetings, the team developed the Air Carrier Operations System Model (ACOSM), Version 1.0.

ACOSM, Version 1.0, serves as the foundation for FAA research, engineering and development (R,E&D) efforts to support a system safety approach to aviation safety oversight. It is currently being used in the development of safety performance measures and risk indicators; work processes to support the collection of data to be used in analysis; and analytical methods, including information presentation.

The model also provides an important communications bridge between the FAA and the aviation industry during this evolution of a system safety approach. For example, each carrier has its own internal models of their processes. By developing an external model, in which industry and FAA participants identify and agree upon the functions and definitions of the model, then a standard model is put forward that provides a common point of reference. Thus, everyone is looking at the same model, using the same definitions, and talking about the same thing.

The model structure uses the Integrated Definition Function Model (IDEF0) format, as defined in Federal Information Processing Standards (FIPS) Publication 183, and as captured in BPwin, a commercial product from Platinum Technologies. With this structured language and tool, the analysis of critical system interactions and potential system vulnerabilities will be enhanced and clarified. The descriptions of complex operations will be explicit and open.

Because ACOSM, Version 1.0, was open for discussion and revision as it was being developed by a small group of subject matter experts within a limited timeframe, some important areas were not addressed in this first iteration. Appendix A provides a list of areas that the team identified as requiring further evaluation and definition in the next version.

This document provides a brief overview of the reason for developing ACOSM and a description of the IDEF0 method used to develop the model, followed by a presentation of the ACOSM, Version 1.0.

## 1.2 OBJECTIVES.

The goals of the ACOSM effort are to

- a. develop a system engineering model, using the IDEF0 standard, which demonstrates the processes and inter-relationships of the air carrier functions to be used in the development of performance measures and risk indicators, and
- b. provide a common definition of air carrier processes and terminology to promote understanding of air carrier operational activities and functions.

The ACOSM is critical for understanding the impact of change related to air carrier and FAA activities, and the interactions among the elements of the air carriers and other programs. It is hoped that an accurate descriptive functional model will enable air carriers and the FAA to interact more effectively on safety management matters.

## 1.3 DEVELOPMENT PHASES.

The development of the ACOSM is scheduled to occur in two phases:

- Version 1.0, contained herein
- Version 2.0 will modify Version 1.0 based upon the following methods for improvement:
  - The topics identified in appendix A.
  - Areas that an FAA and aviation industry team identify as needing to be added/modified/deleted.
  - Areas that the FAA R,E&D efforts identify as requiring further definition or decomposition.

Any developments beyond Version 2.0 will be determined jointly by the FAA and a team of representatives from the aviation industry.

## 1.4 R,E&D EFFORTS.

The following R,E&D efforts also support the model:

- The development of additional models to be used to give more consideration to the understanding of safety critical relationships between air carriers and their supporting maintenance and training contractors.
- A Failure, Mode, Effects, and Criticality Analysis (FMECA) of the ACOSM.

- Identification of the 14 CFRs associated with each Input, Control, Output, Mechanism (ICOM) and process.
- Identification of the 14 CFRs associated with the interfaces across diagrams.
- Identification of the hazards associated with 14 CFR Part 121.

## 2. IDEF0 NOTATION.

IDEF0 (pronounced eye-deaf-zero) is a modeling technique used to create a description of a business or organizational process and is used where process or functional models are beneficial in analyzing how the organization or system currently conducts its business.

IDEF0 is a graphical approach using boxes and arrows to describe a process. The boxes represent activities conducted within the organization or system and arrows represent objects or information involved in the activities. The arrows are subdivided into four categories:

- Inputs: Items consumed by the activity, e.g., materials, information
- Controls: Documentation that guides, regulates, or influences the activity, e.g., rules, regulations, policies, procedures
- Outputs: Items produced by the activity, e.g., material, information
- Mechanisms: Entities used to realize the activity, e.g., people, organizations, systems, facilities, equipment

In IDEF0 terminology, these are called ICOMs, an acronym for **I**nput, **C**ontrol, **O**utput, and **M**echanism. ICOMs connect to an activity box from different sides of the box: Controls connect at the top, Inputs connect at the left, Outputs connect at the right, and Mechanisms connect at the bottom as shown in figure 1.

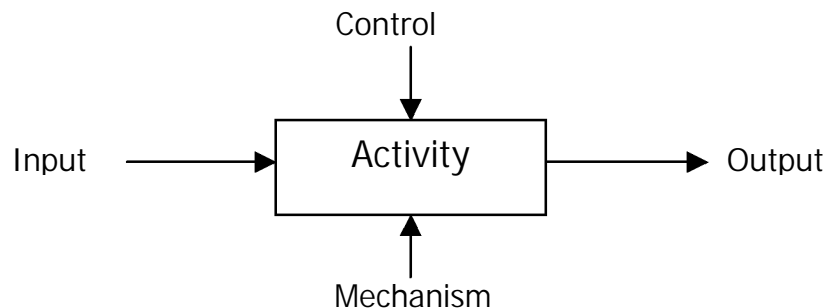

FIGURE 1. IDEF0 MODEL VIEW

An IDEF0 model starts by representing the whole system as a simple activity in a single diagram called the context activity. A diagram is the detailed description of a certain activity (or function) whose name (TITLE) and activity number (NODE) in the activity hierarchy are shown at the bottom of each diagram. A diagram consists of boxes representing the activities (functions) and arrows representing the information or objects interacting with the related activities.

The context diagram, the A-0 diagram, called the “A minus 0 diagram,” defines the context and boundary of the system the model addresses. Only one box called the context activity appears on this diagram representing the function of the system and arrows entering or exiting this box indicate interactions between the system and the external environment. When the context activity is decomposed into detailed levels, those arrows will automatically link to corresponding subactivities and appear on the subdiagrams. Each of these subactivities will be further decomposed into its own subactivities, using subdiagrams, to describe the process in more detail. This decomposition process continues until each activity has enough detail to evaluate all the relevant processes. These hierarchical diagrams comprise the core of the IDEF0 model.

Figure 2 shows a typical decomposition diagram hierarchy.

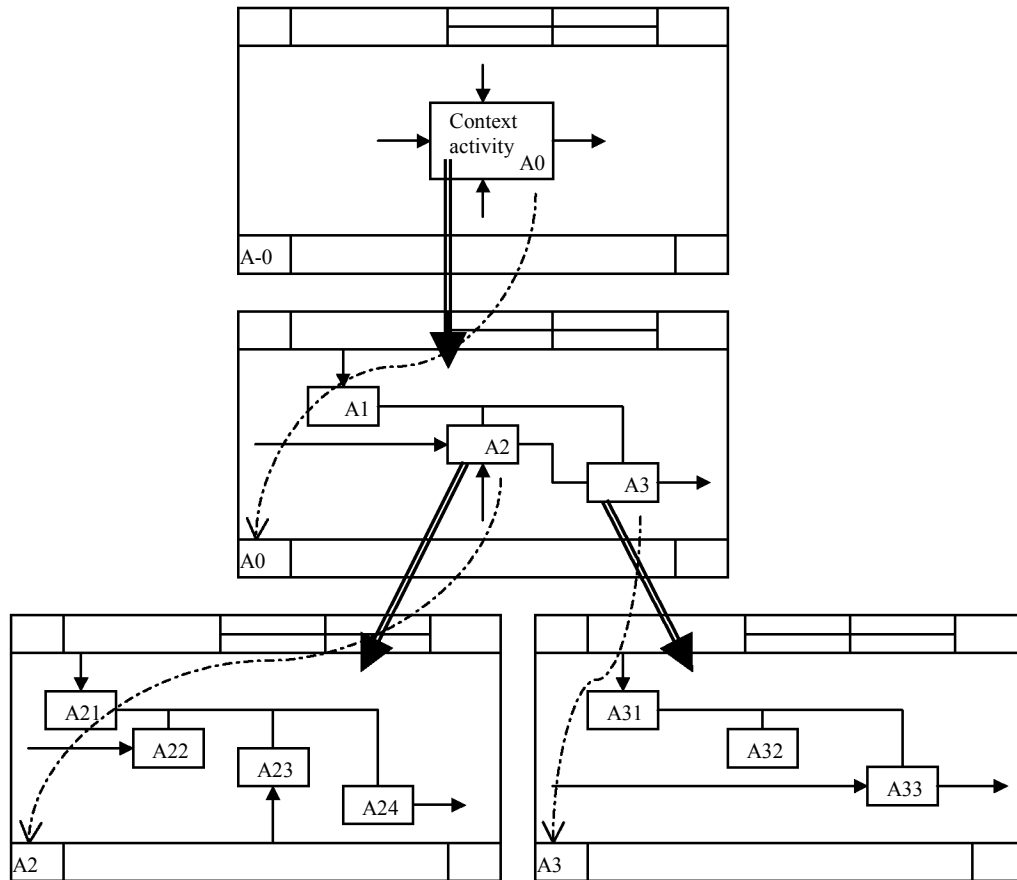

FIGURE 2. A TYPICAL IDEF0 DIAGRAM HIERARCHY



### 3. ACOSM DESCRIPTION.

#### 3.1 MODEL DEFINITION.

Model Name: Air Carrier Operations System Model (ACOSM)  
Author Name: ACOSM team  
Status: Version 1.0  
Last Revision Date: July 25, 2000

##### 3.1.1 Purpose.

The purpose of the ACOSM is to develop a system engineering model of the generic functions of 14 CFR Part 121 air carrier operation activities and interactions among functions used to accomplish those activities.

##### 3.1.2 Scope.

ACOSM concentrates on following key air carrier operation processes:

- Operational management
- Air transportation
- Aircraft maintenance
- Personnel training
- Operational resources provision

The following are beyond the scope of the ACOSM model:

- Sales and marketing initiatives such as pricing, scheduling, advertising, ticket and cargo sales, reservations, and customer services.
- Processes with supporting staff such as accounting, finances and property acquisition, information services, human resources, medical, legal, and public relations.
- Processes done by some subcontractors, e.g., screening and food services.

The model can be defined at different levels of detail to meet various kinds of requirements. As the first version of the project, ACOSM details air carrier operation processes down several layers until further detail becomes less beneficial in the generic model.

##### 3.1.3 Viewpoint.

The model is developed from the air carrier owners or air carrier business managers viewpoint.

##### 3.1.4 Audience.

The model is intended for those who have a basic understanding or background in the air transportation industry.

### 3.2 ACOSM ACTIVITY (FUNCTION) DECOMPOSITION.

The context activity, which is used to describe the system itself, of ACOSM is defined as “Perform air carrier operations.” Here, Perform air carrier operations is understood as a set of activities directly related to the movement of aircraft with passengers and/or cargo from the departing airport to the destination airport, conducted by air carriers operated under 14 CFR Part 121. The context activity, Perform air carrier operations, is decomposed into five subactivities that comprise a child diagram relative to the parent diagram:

- Manage air carrier operations
- Perform air transportation
- Perform aircraft maintenance
- Perform personnel training
- Provide air carrier operation resources

Each subactivity on this child diagram is further decomposed into a more detailed level on its own subordinate diagrams, based on the diagram template defined in figure 3.

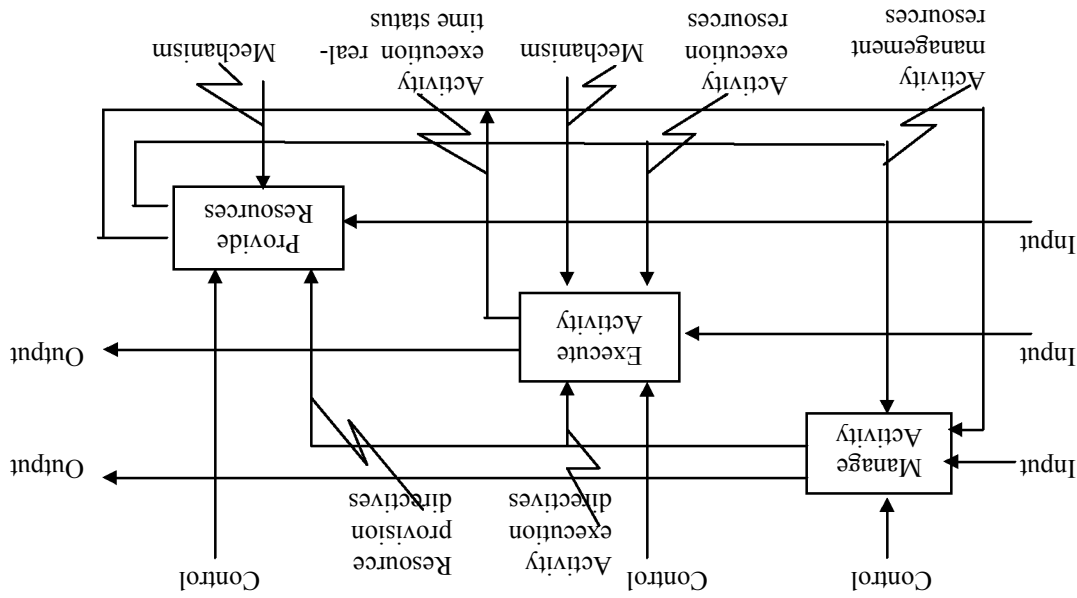

FIGURE 3. TYPICAL DIAGRAM TEMPLATE

The *Manage Activity* on the diagram template provides activity management functions including the scheduling, directing, and coordination of the execution of other activities on the same diagram and also identifies resource requirements to conduct those activities.

The *Execute Activity* on the diagram template performs the function of converting the input into the output under the directives from the *Manage Activity* and with the resources from the *Provide Resources activity*.

The *Provide Resources Activity* on the diagram template activity selects, allocates, and supplies any necessary resources to support the above two activities. Here “resources” means the components necessary for the successful accomplishment of certain functions. The components are defined as properly trained and certified personnel, adequate facilities, required information, and material support. Since the major function of this activity is to allocate the resources, and not produce resources, its outputs are basically the same as its inputs except for their locations. As those resources are mechanisms in the IDEF0 model, it is a straight way to represent the resources to be allocated as its mechanisms instead of its inputs. Therefore, this activity can be understood as to provide sorted and appropriate resources (shown as its outputs in the IDEF0 model) by allocating and selecting from a resource pool or warehouse (shown as its mechanism).

### 3.3 ACOSM ACTIVITY HIERARCHY.

The activity number in the front of each activity shows its location in the activity hierarchy. Examples include:

- A-0 is the context activity defining the system, and it is located at the top of the activity hierarchy.
- A1, A2, A3, A4, and A5 are subactivities decomposed from A0 and are located on the first level of the decomposition hierarchy.
- A3.1, A3.2, A3.3, and A3.4 are subactivities decomposed from A3 and are located on the second level of the decomposition hierarchy.
- A3.3.1, A3.3.2, A3.3.3, A3.3.4, and A3.3.5 are subactivities decomposed from A3.3 and are located on the third level of the decomposition hierarchy.

In the IDEF0 model, a set of subactivities directly decomposed from a parent activity comprise a diagram that shows the interaction between those activities. As the activity is decomposed, following the template shown in figure 3, the functions *Manage* and *Provide Resources* will appear on each child diagram. Those two functions on a child diagram manage and provide resources to the execution of activities on the same diagram, based on the directives and resources from the same functions located on the parent diagram.

For example, on the *A1.3 Perform operation control* diagram, *A1.3.1 Manage operation control* and *A1.3.8 Provide operation control resources* manage and provide resources to support the activities on the same diagram such as *A1.3.2 Evaluate weather*, *A1.3.3 Plan flight routes*, *A1.3.4 Perform load/fuel planning*, *A1.3.5 Assign crewmembers*, *A1.3.6 Dispatch aircraft*, and *A1.3.7 Perform maintenance control*. To perform management and resource provision, these two functions are controlled and supported by *A1.1 Manage air carrier operations coordination* and *A1.7 Provide air carrier operation management resources* located on the parent diagram through *operational control directives* and *operational control resources*, which are a control to A1.3.1 and a mechanism to A1.3.8, respectively. Therefore, the functions: *Manage* and *Provide resources* on the child diagram concentrate on more detailed and more specific issues compared

with the same functions on the parent diagram and are also controlled and supported by the parent activities.

#### 4. MODEL DIAGRAMS.

The IDEF0 diagrams of the ACOSM, showing the interactions among activities and generated by the BPwin tool, are presented in this section. Each diagram is followed by the definitions of activities appearing on the diagram. Section 5, Glossary, provides the definitions of information/objects as arrows on the diagrams followed by the arrow connections to show the information/object flows in the model. The definitions for general terms and acronyms used in the model are given in section 6 to provide a mutual understanding of the model.

The activity hierarchy of the ACOSM is presented below.

#### A0 Perform air carrier operations

##### A1 Manage air carrier operations

##### A1.1 Manage air carrier operations coordination

##### A1.2 Plan operations

##### A1.3 Perform operational control

##### A1.3.1 Manage operational control

##### A1.3.2 Evaluate weather

##### A1.3.3 Plan flight routes

##### A1.3.4 Perform load/fuel planning

##### A1.3.5 Assign crewmembers

##### A1.3.6 Dispatch aircraft

##### A1.3.6.1 Manage aircraft dispatch

##### A1.3.6.2 Create & Deliver preflight package

##### A1.3.6.3 Sign dispatch release

##### A1.3.6.4 Monitor flight

##### A1.3.6.5 Provide aircraft dispatch resources

##### A1.3.7 Perform maintenance control

##### A1.3.8 Provide operational control resources

##### A1.4 Project utilization

##### A1.5 Develop maintenance policies & procedures

##### A1.5.1 Manage maintenance policy & procedure development

##### A1.5.2 Collect & process operational data

##### A1.5.3 Perform technical evaluation

##### A1.5.4 Modify maintenance program

##### A1.5.5 Provide maintenance policy & procedure development resources

##### A1.6 Develop operations policies & procedures

##### A1.6.1 Manage operations policy & procedure development

##### A1.6.2 Identify & effect operations policies

##### A1.6.3 Develop & evaluate operations policies and procedures

##### A1.6.4 Provide operations policy and procedure development resources

##### A1.7 Provide air carrier operation management resources

- A2 Perform air transportation
  - A2.1 Manage air transportation
  - A2.2 Perform passenger services
    - A2.2.1 Manage passenger services
    - A2.2.2 Perform boarding services
      - A2.2.2.1 Manage boarding services
      - A2.2.2.2 Provide check-in services
      - A2.2.2.3 Provide security services
      - A2.2.2.4 Provide seating services
      - A2.2.2.5 Provide boarding service resources
    - A2.2.3 Perform in-flight services
    - A2.2.4 Perform deplaning services
    - A2.2.5 Provide passenger service resources
  - A2.3 Perform ground operations
    - A2.3.1 Manage ground operations
    - A2.3.2 Perform ground handling
    - A2.3.3 Perform cargo handling
      - A2.3.3.1 Manage cargo handling
      - A2.3.3.2 Check/weigh/screen cargo
      - A2.3.3.3 Secure cargo
      - A2.3.3.4 Load/unload cargo
      - A2.3.3.5 Provide cargo handling resources
    - A2.3.4 Replenish consumables
    - A2.3.5 Perform line services
    - A2.3.6 Perform deicing/anti-icing program
    - A2.3.7 Provide ground operation resources
  - A2.4 Perform aircraft operations
    - A2.4.1 Manage aircraft operations
    - A2.4.2 Perform predeparture ground operations
    - A2.4.3 Perform takeoff operations
      - A2.4.3.1 Manage takeoff operations
      - A2.4.3.2 Perform takeoff prior to V1
      - A2.4.3.3 Perform takeoff at/after V1
      - A2.4.3.4 Provide takeoff operation resources
    - A2.4.4 Perform climb operations
      - A2.4.4.1 Manage climb operations
      - A2.4.4.2 Perform initial climb
      - A2.4.4.3 Perform normal climb
      - A2.4.4.4 Provide climb operation resources
    - A2.4.5 Perform cruise operations
    - A2.4.6 Perform descent operations
      - A2.4.6.1 Manage descent operations
      - A2.4.6.2 Perform initial descent operations
      - A2.4.6.3 Perform approach descent operations
      - A2.4.6.4 Provide descent operation resources
    - A2.4.7 Perform approach operations

- A2.4.8 Perform landing operations
  - A2.4.9 Perform postarrival ground operations
  - A2.4.10 Provide aircraft operation resources
- A2.5 Provide air transportation resources
- A3 Perform aircraft maintenance
  - A3.1 Manage aircraft maintenance
  - A3.2 Evaluate aircraft
    - A3.2.1 Manage aircraft evaluation
    - A3.2.2 Detect aircraft discrepancies
    - A3.2.3 Diagnose aircraft discrepancies
    - A3.2.4 Evaluate aircraft discrepancies
    - A3.2.5 Provide aircraft evaluation resources
  - A3.3 Perform scheduled/nonscheduled maintenance
    - A3.3.1 Manage scheduled/nonscheduled maintenance
    - A3.3.2 Perform line maintenance
    - A3.3.3 Perform heavy/depot maintenance
      - A3.3.3.1 Manage heavy/depot maintenance
      - A3.3.3.2 Perform aircraft repair
      - A3.3.3.3 Perform aircraft test & evaluation
      - A3.3.3.4 Provide heavy/depot maintenance resources
    - A3.3.4 Perform component maintenance
      - A3.3.4.1 Manage component maintenance
      - A3.3.4.2 Perform configuration control
      - A3.3.4.3 Assess aircraft components
      - A3.3.4.4 Perform part usage analysis
      - A3.3.4.5 Provide component maintenance resources
    - A3.3.5 Provide scheduled/nonscheduled maintenance resources
  - A3.4 Provide aircraft maintenance resources
- A4 Perform personnel training
  - A4.1 Manage personnel training
  - A4.2 Identify & Analyze training requirements
  - A4.3 Design & Develop training
    - A4.3.1 Manage training design & development
    - A4.3.2 Develop training objectives
    - A4.3.3 Set performance standards
    - A4.3.4 Select training provider
    - A4.3.5 Develop training curriculum
    - A4.3.6 Provide training design & development resources
  - A4.4 Implement training
    - A4.4.1 Manage training implementation
    - A4.4.2 Conduct class training
    - A4.4.3 Conduct computer-based training
    - A4.4.4 Conduct device/simulator training
    - A4.4.5 Conduct aircraft training
    - A4.4.6 Provide training implementation resources
  - A4.5 Evaluate training

- A4.5.1 Manage training evaluation
- A4.5.2 Conduct system evaluation
- A4.5.3 Conduct device evaluation
- A4.5.4 Conduct aircraft evaluation
- A4.5.5 Provide training evaluation resources
- A4.6 Provide personnel training resources
- A5 Provide air carrier operation resources
  - A5.1 Manage air carrier operation resource provision
  - A5.2 Supply available aircraft
  - A5.3 Supply available expendable supplies
  - A5.4 Supply available materials/equipment/facilities
  - A5.5 Supply available personnel
  - A5.6 Provide air carrier operation resource provision support

USED AT:	AUTHOR: ACOSM team	DATE: 5/27/99	WORKING	READER	DATE	CONTEXT: <b>TOP</b>
	PROJECT: Air Carrier Operations System Model	REV: 5/1/00	DRAFT			
			RECOMMENDED			
	NOTES: 1 2 3 4 5 6 7 8 9 10		PUBLICATION			

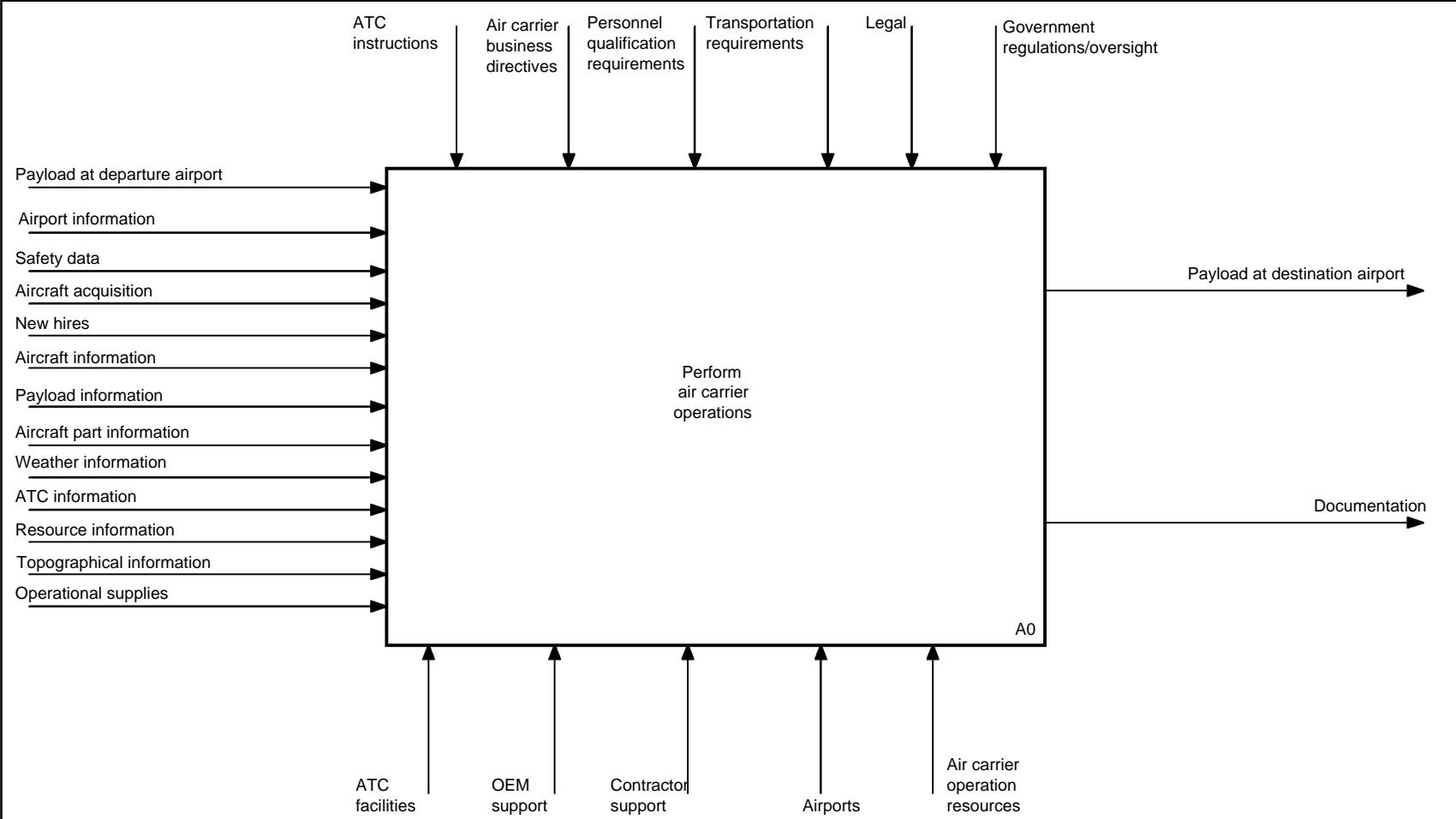

12

NODE: <b>A-0</b>	TITLE: <b>Perform air carrier operations</b>	NUMBER:	P. 1
---------------------	---	---------	------



#### 4.1 A-0—PERFORM AIR CARRIER OPERATIONS.

This function captures the process conducted by the air carrier to provide air transportation services to transport payload (passengers and/or cargo) by aircraft from one airport to another airport. This function consists of the following five major components:

- Operation management
- Air transportation
- Aircraft maintenance
- Personnel training
- Operation resource provision

This is the context activity of ACOSM, which defines the system and system boundaries. The information/objects linking to this activity represent the interaction between the air carrier operations system and the external environment.

The outputs of this activity, shown as arrows exiting from the right side of the activity box, are:

- Payload at destination airport
- Documentation

The inputs used to generate these outputs, shown as arrows entering the left side of activity box, are:

- Payload at departure airport
- Airport information
- Safety data
- Aircraft acquisition
- New hires
- Aircraft information
- Payload information
- Aircraft part information
- Weather information
- ATC information
- Resource information

- Topographical information
- Operational supplies

The execution of this activity is governed by a set of regulations or constraints related to the government, air carrier and its environment, etc. They are represented as controls entering the top of the activity box and include:

- ATC instructions
- Air carrier business directives
- Personnel qualification requirements
- Transportation requirements
- Legal
- Government regulations/oversight

A set of resources are needed to support the execution of the activity that are considered as mechanisms entering the bottom side of the activity box in the diagram:

- ATC facilities
- OEM support
- Contractor support
- Airports
- Air carrier operation resources

The ICOMs appearing on this A-0 diagram will automatically appear on its child diagrams throughout the activity decomposition but will be connected to more specific activities since the decomposition is on a more detailed level.

[THIS PAGE IS INTENTIONALLY LEFT BLANK]

USED AT:	AUTHOR: ACOSM team	DATE: 5/27/99	WORKING	READER	DATE	CONTEXT:  A-0
	PROJECT: Air Carrier Operations System Model	REV: 8/22/00	DRAFT			
			RECOMMENDED			
	NOTES: 1 2 3 4 5 6 7 8 9 10		PUBLICATION			

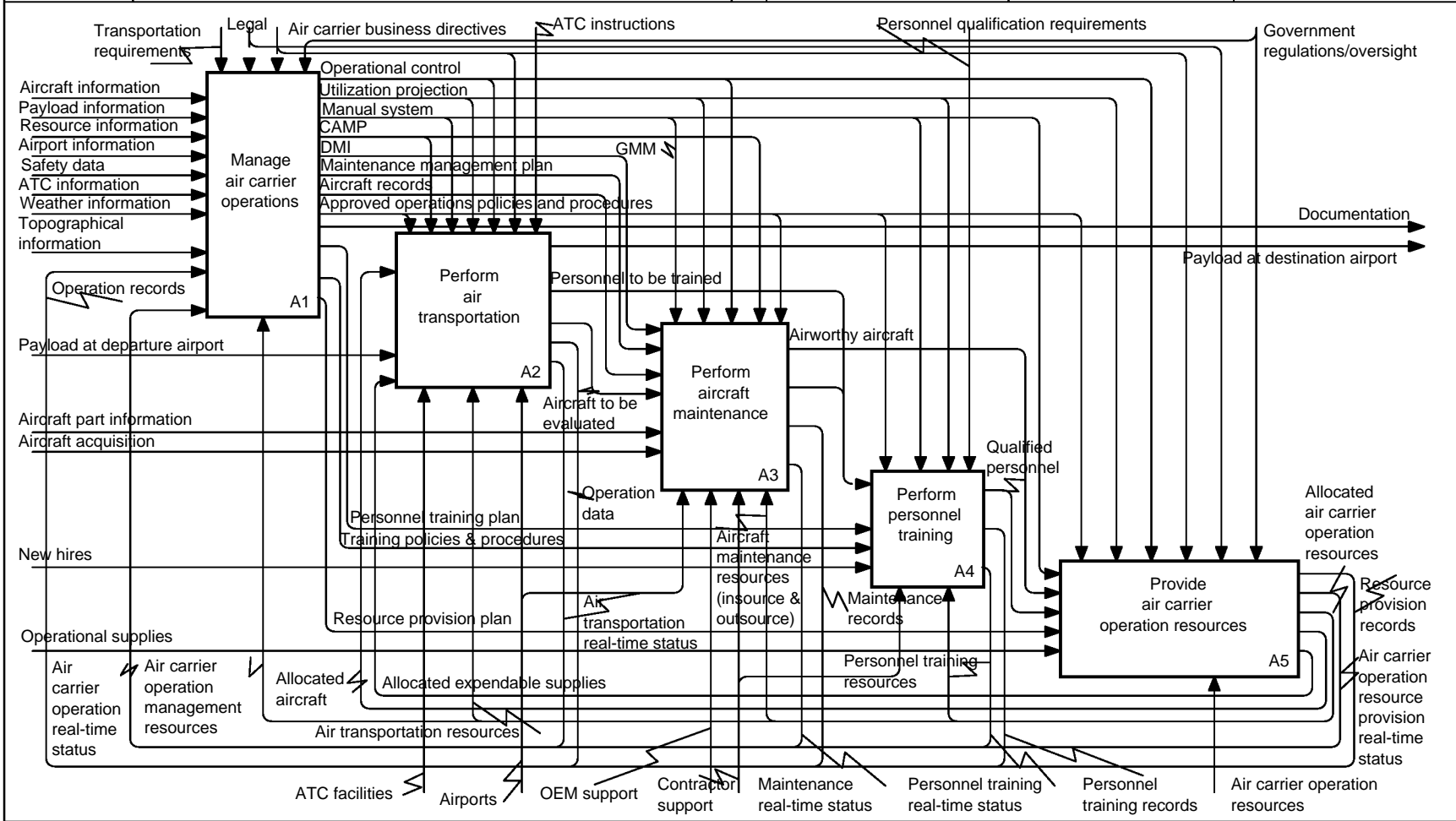

NODE: <b>A0</b>	TITLE: <b>Perform air carrier operations</b>	NUMBER:  
--------------------	---	-----------------

## 4.2 A0—PERFORM AIR CARRIER OPERATIONS.

### 4.2.1 A1—Manage Air Carrier Operations.

This function directs, schedules, and coordinates the following component activities of air carrier operations:

- Perform air transportation
- Perform aircraft maintenance
- Perform personnel training
- Provide air carrier operation resource provision

It provides directives, defines requirements and controls, establishes performance standards for the execution of those activities, and also checks that the execution is done in accordance with company policies and procedures and any required regulations for these activities. This activity also provides controls (on-line/off-line directives) to other process modules.

### 4.2.2 A2—Perform Air Transportation.

17

Air transportation means interstate, overseas, or foreign air transportation or the transportation of mail by aircraft (CFR Part 1). This function carries out the task of transporting payload (passengers/cargo) from one place to another. This function includes customer services/passenger services, ground operations, and aircraft operations.

### 4.2.3 A3—Perform Aircraft Maintenance.

Maintenance means inspection, overhaul, repair, preservation, and the replacement of parts (CFR Part 1). This function inspects and maintains aircraft to prevent deterioration of the inherent safety and reliability levels of the equipment to ensure the aircraft is in safe and efficient condition for flight services. This process includes aircraft evaluation and scheduled/nonscheduled maintenance. The aircraft after maintenance will be utilized for flight services.

### 4.2.4 A4—Perform Personnel Training.

This function plans, designs, implements, and evaluates an array of procedures, methods, and practices to improve work force capabilities to meet mission/workload requirements and increase/maintain individual employee knowledge, skills, and abilities.

#### 4.2.5 A5—Provide Air Carrier Operation Resources.

This function allocates and supplies available aircraft, personnel, parts, materials, facilities, equipment, automation, information infrastructure, tools, budget, publications, and any other required resources to support the execution of air carrier operations.

[THIS PAGE IS INTENTIONALLY LEFT BLANK]

USED AT:	AUTHOR: ACOSM team	DATE: 5/27/99	WORKING	READER	DATE	CONTEXT: A0
	PROJECT: Air Carrier Operations System Model	REV: 8/22/00	DRAFT			
			RECOMMENDED			
	NOTES: 1 2 3 4 5 6 7 8 9 10		PUBLICATION			

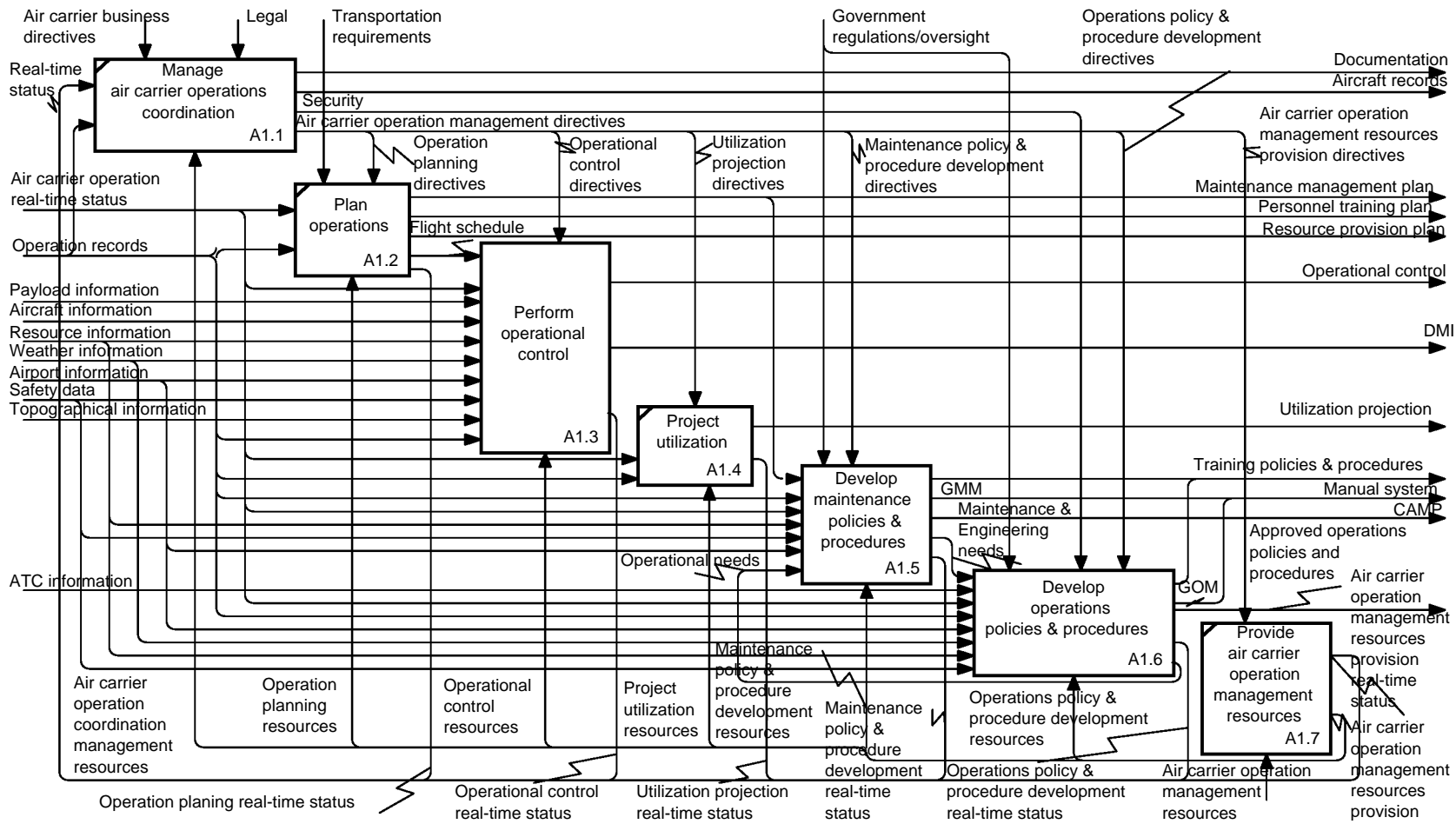

20

NODE: <b>A1</b>	TITLE: <b>Manage air carrier operations</b>	NUMBER:
--------------------	--	---------



### 4.3 A1—MANAGE AIR CARRIER OPERATIONS.

#### 4.3.1 A1.1—Manage Air Carrier Operations Coordination.

This function directs, schedules, and coordinates the following component activities of air carrier operations management:

- Plan operations
- Perform operational control
- Project utilization
- Develop maintenance policies & procedures
- Develop operations policies & procedures
- Provide air carrier operation management resources

It provides directives, defines requirements and controls for the execution of those activities, ensures manual dissemination, and also checks that the execution is done in accordance with company policies and procedures and any required regulations for these activities. This activity also provides controls (on-line/off-line directives) to other process modules.

#### 4.3.2 A1.2—Plan Operations.

This function produces plans for the execution of air carrier operations such as the following:

- Flight schedule
- Maintenance management plan
- Resource provision plan
- Personnel training plan

#### 4.3.3 A1.3—Perform Operational Control.

Operational control, with respect to a flight, means the exercise of authority over initiating, conducting, or terminating a flight (CFR Part 1). This function makes those decisions and performs those actions on a daily basis that are necessary to operate flights safely and in compliance with the regulations. Operational control functions include, but are not limited to, the following:

- Crewmembers and aircraft scheduling

- Accepting charter flights
- Reviewing weather and Notices To Airmen (NOTAMs)
- Flight planning

Information that needs to be collected and disseminated to plan and conduct a flight safely includes, but are not limited to, the following:

- En route and terminal weather conditions
- Fuel requirements
- Navigation
- Airport facilities

This function supplies a real-time control over release of resources and direction of activities required for flight operations both prior to dispatch and during the flight.

#### 4.3.4 A1.4—Project Utilization.

This function provides estimates or requirements for the utilization of assets and develops the utilization plan.

#### 4.3.5 A1.5—Develop Maintenance Policies & Procedures.

This function provides maintenance management controls by providing standardized policies and procedures and by disseminating these directives to company organizations and contractors. This includes Continuing Analysis Surveillance Systems (CASS), reliability programs, etc.

#### 4.3.6 A1.6—Develop Operations Policies & Procedures.

This function provides operations management controls by providing standardized policies and procedures and by disseminating these directives to company organizations and contractors.

#### 4.3.7 A1.7—Provide Air Carrier Operations Management Resources.

This function allocates and supplies available personnel, materials, equipment, tools, and any other required resources to support the execution of air carrier operation management.

[THIS PAGE IS INTENTIONALLY LEFT BLANK]

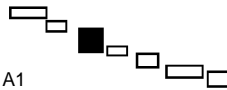
USED AT:	AUTHOR: ACOSM team	DATE: 8/5/99	WORKING	READER	DATE	CONTEXT: 
	PROJECT: Air Carrier Operations System Model	REV: 8/22/00	DRAFT			
			RECOMMENDED			
	NOTES: 1 2 3 4 5 6 7 8 9 10		PUBLICATION			

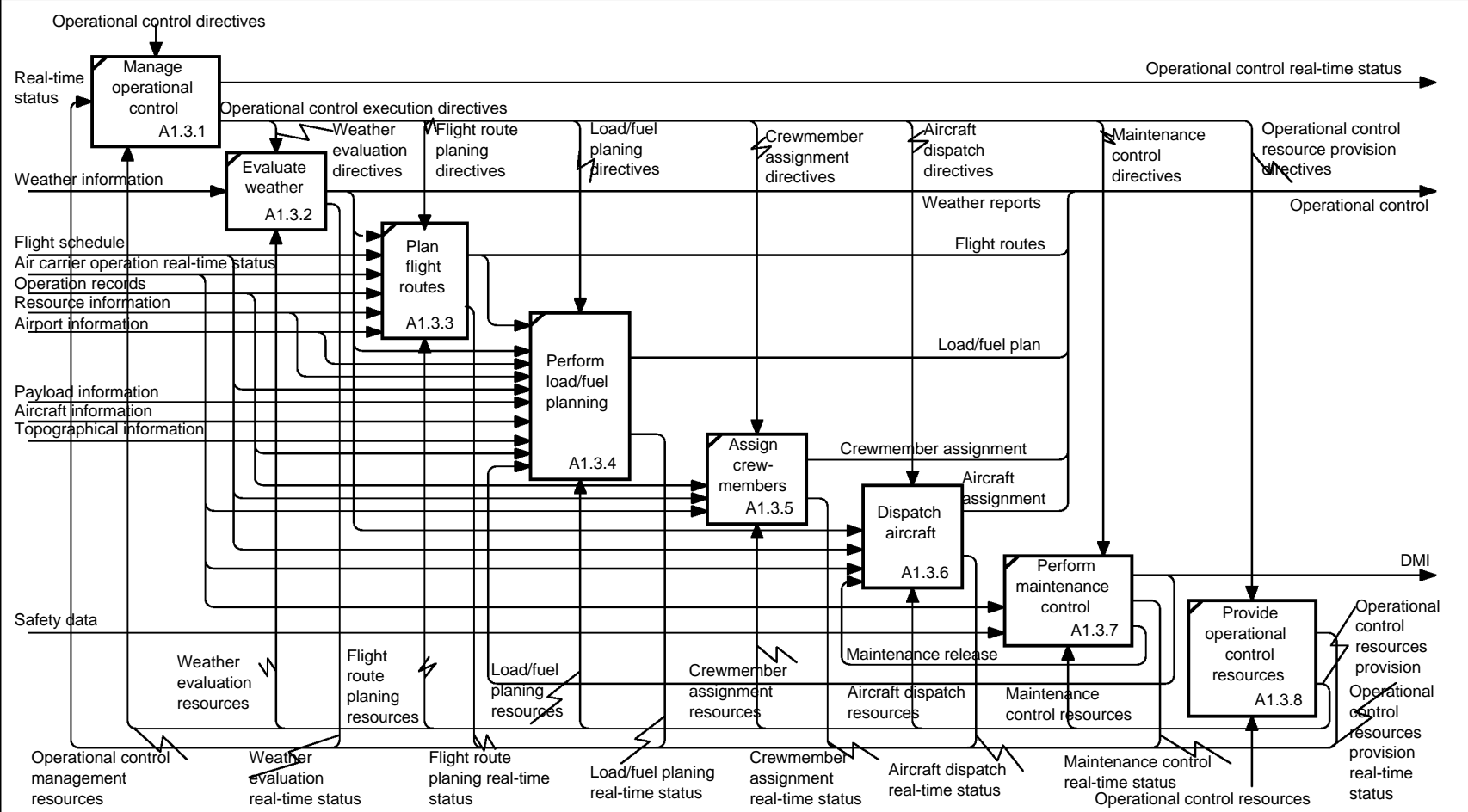

NODE: <b>A1.3</b>	TITLE: <b>Perform operational control</b>	NUMBER: <b>P. 4</b>
----------------------	--	------------------------

#### 4.4 A1.3—PERFORM OPERATIONAL CONTROL.

##### 4.4.1 A1.3.1—Manage Operational Control.

This function directs, schedules, and coordinates the following component activities of operational control:

- Evaluate weather
- Plan flight routes
- Perform load/fuel planning
- Assign crewmembers
- Dispatch aircraft
- Perform maintenance control
- Provide operational control resources

It provides directives, defines requirements and controls for the execution of those activities, and also checks that the execution is done in accordance with company policies and procedures and any required regulations for these activities. This activity also provides controls (on-line/off-line directives) to other process modules.

##### 4.4.2 A1.3.2—Evaluate Weather.

This function collects, interprets, and disseminates weather information.

##### 4.4.3 A1.3.3—Plan Flight Routes.

This function considers all factors such as wind, temperature, and aircraft performance data, etc., to plan the route of flight for specific aircraft.

##### 4.4.4 A1.3.4—Perform Load/Fuel Planning.

This function plans the payload and fuel before the flight based on the operational requirements.

#### 4.4.5 A1.3.5—Assign Crewmembers.

Crewmember means a person assigned to perform duty in an aircraft during flight time (CFR Part 1). This function schedules and assigns crewmembers to perform specific flight tasks. The following is also taken into consideration in this function:

- Flight and duty time
- Crewmember qualifications
- Specific conditions operations such as CAT II, CAT III, etc.
- Special requirements such as crew pairing, etc.

#### 4.4.6 A1.3.6—Dispatch Aircraft.

This function schedules, assigns, and releases aircraft to perform specific flight tasks. This function is conducted by certified aircraft dispatchers in conjunction with Pilot in Command (PIC) to directly control flight operations.

#### 4.4.7 A1.3.7—Perform Maintenance Control.

This function provides controls on the airworthiness of aircraft and issues the maintenance release to permit aircraft to be dispatched. The Maintenance Control Center (MCC) also coordinates the provisions of maintenance resources, such as tools, equipment, parts, and supplies. Decisions about whether to continue or divert flights and repair or defer discrepancies are also provided by this functional element. The MCC also coordinates maintenance information between the air carrier and contract maintenance organizations.

#### 4.4.8 A1.3.8—Provide Operational Control Resources.

This function allocates and supplies available personnel, materials, equipment, tools, and any other required resources to support the execution of operational control.

[THIS PAGE IS INTENTIONALLY LEFT BLANK]

USED AT:	AUTHOR: ACOSM team	DATE: 8/18/99	WORKING	READER	DATE	CONTEXT: 
	PROJECT: Air Carrier Operations System Model	REV: 7/20/00	DRAFT			
	NOTES: 1 2 3 4 5 6 7 8 9 10		RECOMMENDED			
			PUBLICATION			

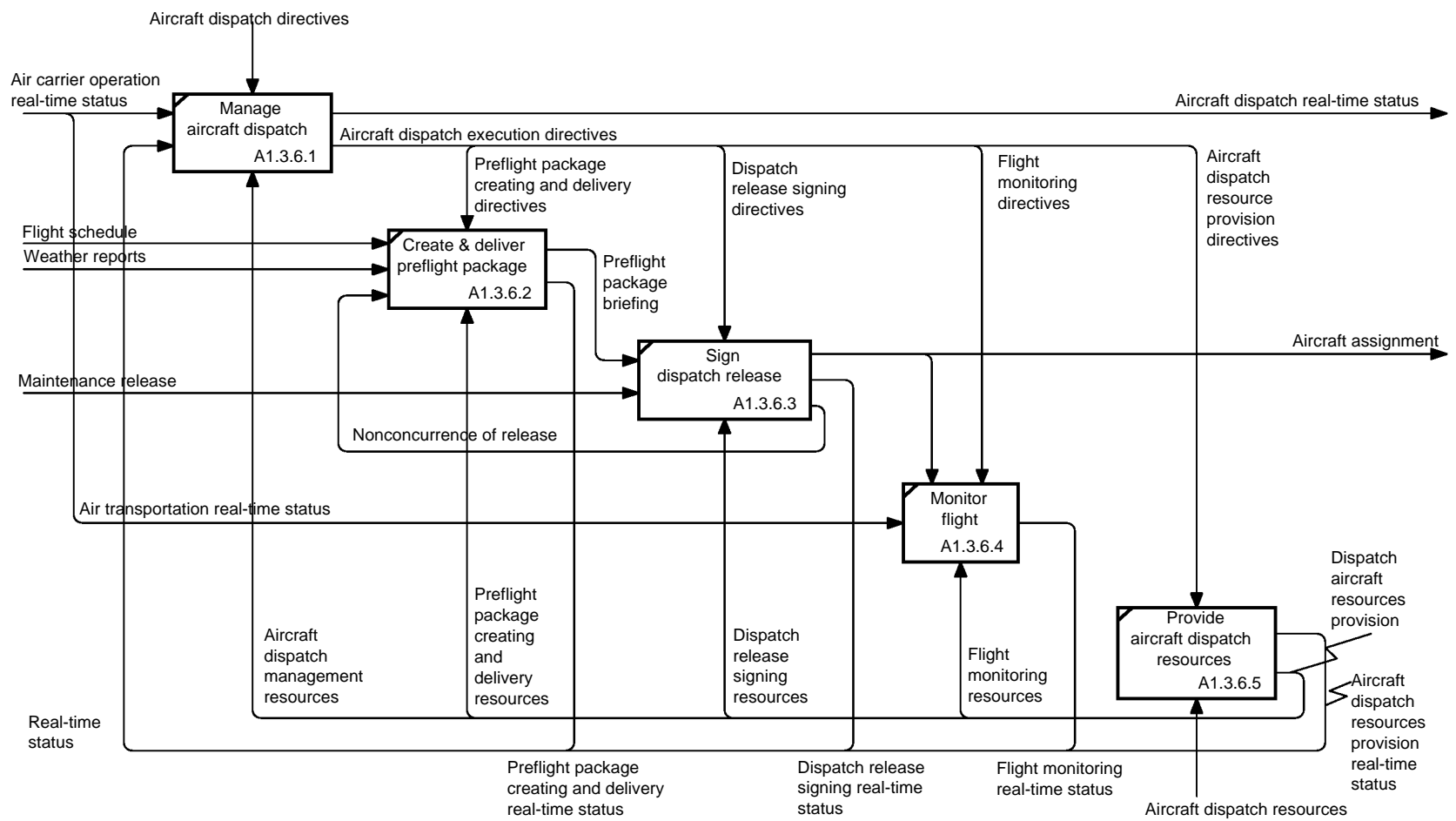

28

NODE: <b>A1.3.6</b>	TITLE: <b>Dispatch aircraft</b>	NUMBER:	P. 5
------------------------	------------------------------------	---------	------



## 4.5 A1.3.6—DISPATCH AIRCRAFT.

### 4.5.1 A1.3.6.1—Manage Aircraft Dispatch.

This function directs, schedules, and coordinates the following component activities of aircraft dispatch:

- Create & deliver preflight package
- Sign dispatch release
- Monitor flight
- Provide aircraft dispatch resources

It provides directives, defines requirements and controls for the execution of those activities, and also checks that the execution is done in accordance with company policies and procedures and any required regulations for these activities. This activity also provides controls (on-line/off-line directives) to other process modules.

### 4.5.2 A1.3.6.2—Create & Deliver Preflight Package.

This function conducts preflight planning to ensure that flights are conducted:

- to the standards of navigational accuracy required in the airspace traversed,
- to meet regulatory fuel requirements,
- to satisfy air traffic control (ATC) compliance and reporting requirements,
- to ensure arrangements for international flights, i.e., overflight clearance, and
- to ensure that flights are operated safely.

As a result of the preflight planning, a paper document or an electronic data file is created called the “flight plan” that consists of selecting an appropriate aircraft cruise schedule and applying forecast wind, temperature, and aircraft performance data to a planned route to predict estimated time en route (ETE) and estimated fuel consumption.

### 4.5.3 A1.3.6.3—Sign Dispatch Release.

This function refers to the CFR requirements that both the aircraft dispatcher and the PIC (pilot-in-command) sign the dispatch release before flight. The dispatcher’s and PIC’s signatures certify that, in the judgment of each, the flight can be made safely as planned.

#### 4.5.4 A1.3.6.4—Monitor Flight.

This function refers to a need for monitoring the progress of each flight under that dispatcher's control from its point of origin:

- until the flight has landed at the destination, including its arrival and departure from intermediate stops, or
- until the flight has passed beyond the dispatcher's area of control, or
- until the dispatcher is properly relieved by another aircraft dispatcher.

This activity includes the monitoring of each flight's fuel state, flight time remaining, destination and alternate airport weather trends, en route winds and weather (including pilot reports), and the status of airports and navigational facilities.

#### 4.5.5 A1.3.6.5—Provide Aircraft Dispatch Resources.

This function allocates and supplies available personnel, materials, equipment, tools, and any other required resources to support the execution of aircraft dispatch.

[THIS PAGE IS INTENTIONALLY LEFT BLANK]

USED AT:	AUTHOR: ACOSM team	DATE: 9/21/99	WORKING	READER	DATE	CONTEXT: 
	PROJECT: Air Carrier Operations System Model	REV: 8/22/00	DRAFT			
			RECOMMENDED			
	NOTES: 1 2 3 4 5 6 7 8 9 10		PUBLICATION			

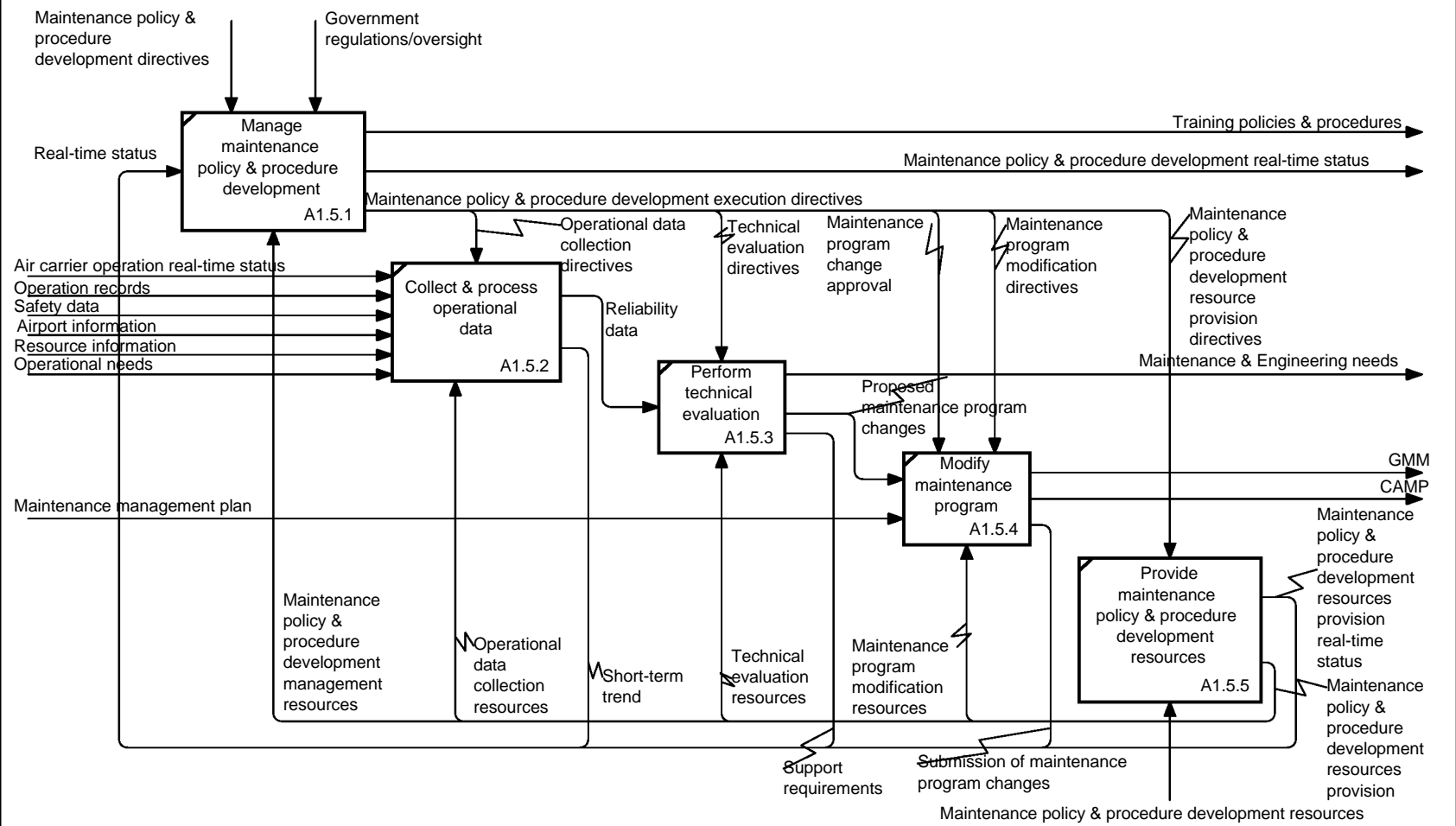

32

NODE: <b>A1.5</b>	TITLE: <b>Develop maintenance policies &amp; procedures</b>	NUMBER: <b>P. 6</b>
----------------------	--	------------------------

## 4.6 A1.5—DEVELOP MAINTENANCE POLICY & PROCEDURES.

### 4.6.1 A1.5.1—Manage Maintenance Policy & Procedure Development.

This function directs, schedules, and coordinates the following component activities of maintenance policy and procedure development:

- Collect and process operational data
- Perform technical evaluation
- Modify maintenance program
- Provide maintenance policy & procedure development resources

It provides directives, defines requirements and controls for the execution of those activities, and also checks that the execution is done in accordance with company policies and procedures and any required regulations for these activities. This activity also provides controls (on-line/off-line directives) to other process modules.

### 4.6.2 A1.5.2—Collect & Process Operational Data.

This function obtains operational data, including Mechanical Interruption Summary (MIS) reports, pilot reports, Minimum Equipment List (MEL), Service Difficulty Reports (SDR), etc., and organizes the data for action as required, such as adjustments to maintenance programs and reliability programs and generating emergency orders.

### 4.6.3 A1.5.3—Perform Technical Evaluations.

This function evaluates information from the reliability data and other data to propose maintenance program actions.

### 4.6.4 A1.5.4—Modify Maintenance Program.

This function adjusts, modifies, and revises the impact of proposed maintenance program changes on the operations of air carriers and implements, including publishing and disseminating, the proposed changes after regulatory review.

### 4.6.5 A1.5.5—Provide Maintenance Policy & Procedure Development Resources.

This function provides the necessary resources to accomplish the execution of maintenance policy and procedure development.

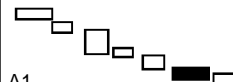
USED AT:	AUTHOR: ACOSM team	DATE: 12/8/99	WORKING	READER	DATE	CONTEXT:  A1
	PROJECT: Air Carrier Operations System Model	REV: 8/22/00	DRAFT			
			RECOMMENDED			
	NOTES: 1 2 3 4 5 6 7 8 9 10		PUBLICATION			

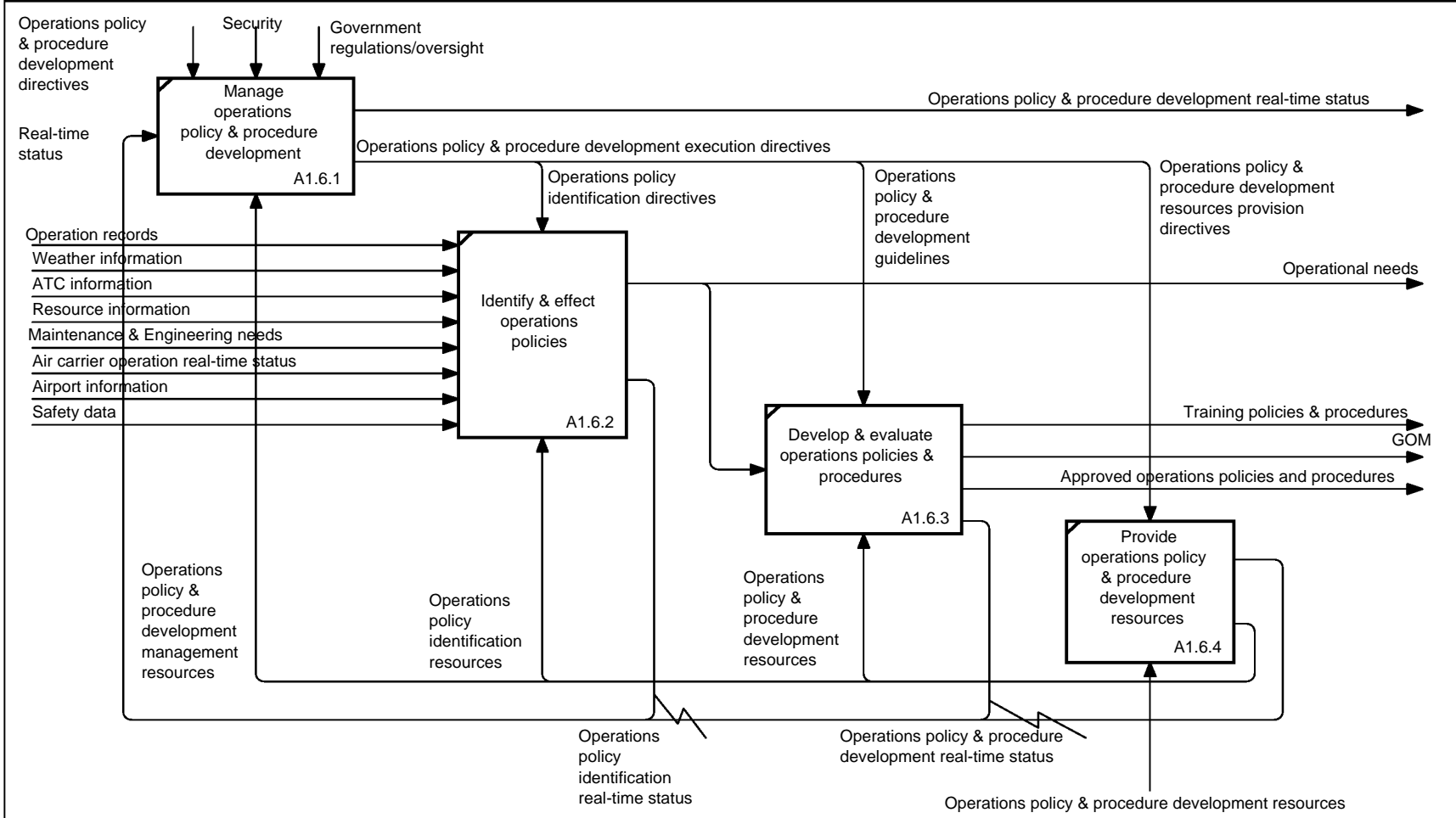

NODE: <b>A1.6</b>	TITLE: <b>Develop operations policies &amp; procedures</b>	NUMBER: <b>P. 7</b>
----------------------	---	------------------------

## 4.7 A1.6—DEVELOP OPERATIONS POLICIES & PROCEDURES.

### 4.7.1 A1.6.1—Manage Operations Policy & Procedure Development.

This function directs, schedules, and coordinates the following component activities of operational policy and procedure development:

- Identify and effect operations policies and procedures
- Develop and evaluate operations policies and procedures
- Provide operations policy and procedure development resources

It provides directives, defines requirements and controls for the execution of those activities, and also checks that the execution is done in accordance with company policies and procedures and any relevant regulations for these activities. This activity also provides controls (on-line/off-line directives) to other process modules.

### 4.7.2 A1.6.2—Identify & Effect Operations Policies.

This function analyzes the management control of the air carrier operations and generates the necessary operational needs to address the operations policy issues to include aircraft and personnel.

### 4.7.3 A1.6.3—Develop & Evaluate Operations Policies & Procedures.

This function assesses operational needs of air carrier operations and implements, including publishing and disseminating, the policies and procedures including human resource issues.

### 4.7.4 A1.6.4—Provide Operation Policy & Procedure Development Resources.

This function provides the necessary resources to accomplish the execution of operational policy and procedure development.

USED AT:	AUTHOR: ACOSM team	DATE: 5/27/99	WORKING	READER	DATE	CONTEXT: A0
	PROJECT: Air Carrier Operations System Model	REV: 7/20/00	DRAFT			
			RECOMMENDED			
	NOTES: 1 2 3 4 5 6 7 8 9 10		PUBLICATION			

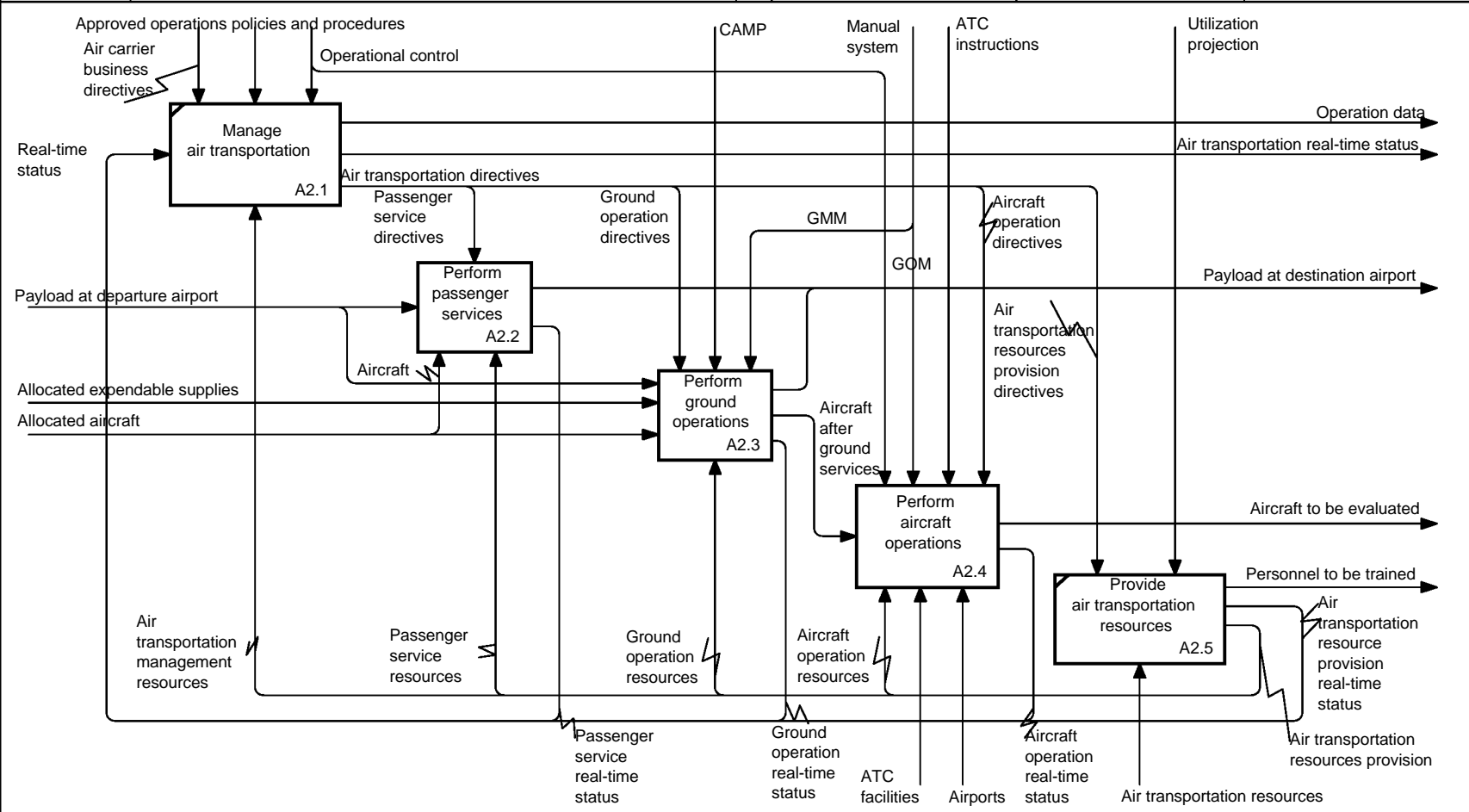

NODE: <b>A2</b>	TITLE: <b>Perform air transportation</b>	NUMBER:
--------------------	---	---------

36



## 4.8 A2—PERFORM AIR TRANSPORTATION.

### 4.8.1 A2.1—Manage Air Transportation.

This function directs, schedules, and coordinates the following component activities of air transportation:

- Perform passenger services
- Perform ground operations
- Perform aircraft operations
- Provide air transportation resources

It provides directives, defines requirements and controls for the execution of those activities, and also checks that the execution is done in accordance with company policies and procedures and any required regulations for these activities. This activity also provides controls (on-line/off-line directives) to other process modules.

### 4.8.2 A2.2—Perform Passenger Services.

This function provides services for passengers such as:

- Controlling the gate agent
- Screening for carry-on baggage
- Checking for passenger regulatory compliance, i.e., smoking, seat belt, and exit-row-seating rules
- Briefing passengers
- Ensuring the safety of passengers during boarding, flight, and deplaning
- Performing flight attendant activities and responding to passengers

### 4.8.3 A2.3—Perform Ground Operations.

This function provides ground services to flight operations, including:

- Ground handling
- Cargo handling
- Consumables replenishment

- Line services
- Deicing/anti-icing services

#### 4.8.4 A2.4—Perform Aircraft Operations.

This function operates and moves aircraft from the gate or blocks-off at the departure airport to the arrival at destination, until the aircraft comes to a complete stop at the gate or on the ramp. This function begins with maintenance release with aircraft available for passenger boarding/cargo loading and crewmember check-in, ready for preflight activity. The life cycle of this activity includes:

- Predeparture ground operations
- Takeoff
- Climb
- Cruise
- Descent
- Approach
- Landing
- Postarrival ground operations

#### 4.8.5 A2.5—Provide Air Transportation Resources.

This function allocates and supplies available personnel, materials, equipment, tools, and any other required resources to support the execution of flight operations.

[THIS PAGE IS INTENTIONALLY LEFT BLANK]

USED AT:	AUTHOR: ACOSM team	DATE: 8/5/99	WORKING	READER	DATE	CONTEXT:  A2
	PROJECT: Air Carrier Operations System Model	REV: 8/22/00	DRAFT			
			RECOMMENDED			
	NOTES: 1 2 3 4 5 6 7 8 9 10		PUBLICATION			

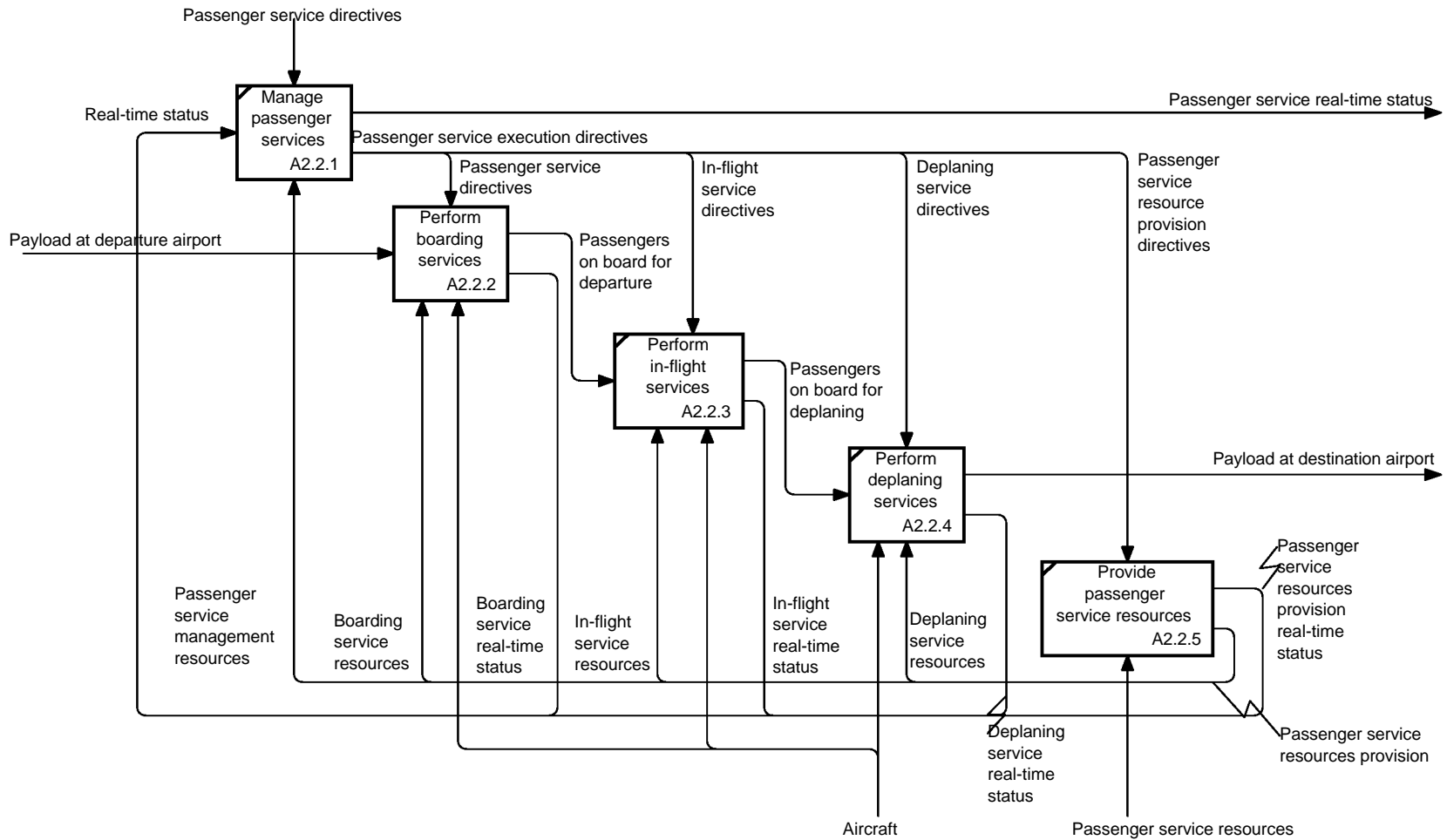

NODE: <b>A2.2</b>	TITLE: <b>Perform passenger services</b>	NUMBER:
----------------------	---	---------

## 4.9 A2.2—PERFORM PASSENGER SERVICES.

### 4.9.1 A2.2.1—Manage Passenger Services.

This function directs, schedules, and coordinates the following component activities of passenger services:

- Perform boarding services
- Perform in-flight services
- Perform deplaning services
- Provide passenger service resources

It provides directives, defines requirements and controls for the execution of those activities, and also checks that the execution is done in accordance with company policies and procedures and any required regulations for these activities. This activity also provides controls (on-line/off-line directives) to other process modules.

### 4.9.2 A2.2.2—Perform Boarding Services.

41

This function boards passengers and includes, but is not limited to, the following activities:

- Check-in
- Security screening
- Screening for carry-on baggage
- Checking for intoxicated passengers, exit-row-seating compliance, and so forth
- Seating services before aircraft leaves the gate for takeoff

### 4.9.3 A2.2.3—Perform In-Flight Services.

This function serves passengers during the aircraft flight, such as:

- Briefing passengers
- Controlling passengers during flight
- Storing of carry-on baggage
- Ensuring passenger regulatory compliance, i.e., Portable Electronic Device's (PED), smoking, and seat belt rules

This process starts at the departure airport after all the doors of the aircraft are secured for departure and ends at the destination airport before the doors of the aircraft are opened for passenger/cargo deplaning.

4.9.4 A2.2.4—Perform Deplaning Services.

This function serves passengers by checking passenger compliance with signs, passenger safety on jetways/stairs, and abnormal or emergency evacuation requirements.

4.9.5 A2.2.5—Provide Passenger Service Resources.

This function allocates and supplies available personnel, materials, equipment, tools, and any other required resources to support the execution of passenger services.

[THIS PAGE IS INTENTIONALLY LEFT BLANK]

USED AT:	AUTHOR: ACOSM team	DATE: 7/2/99	WORKING	READER	DATE	CONTEXT: A2.2
	PROJECT: Air Carrier Operations System Model	REV: 7/21/00	DRAFT			
			RECOMMENDED			
	NOTES: 1 2 3 4 5 6 7 8 9 10		PUBLICATION			

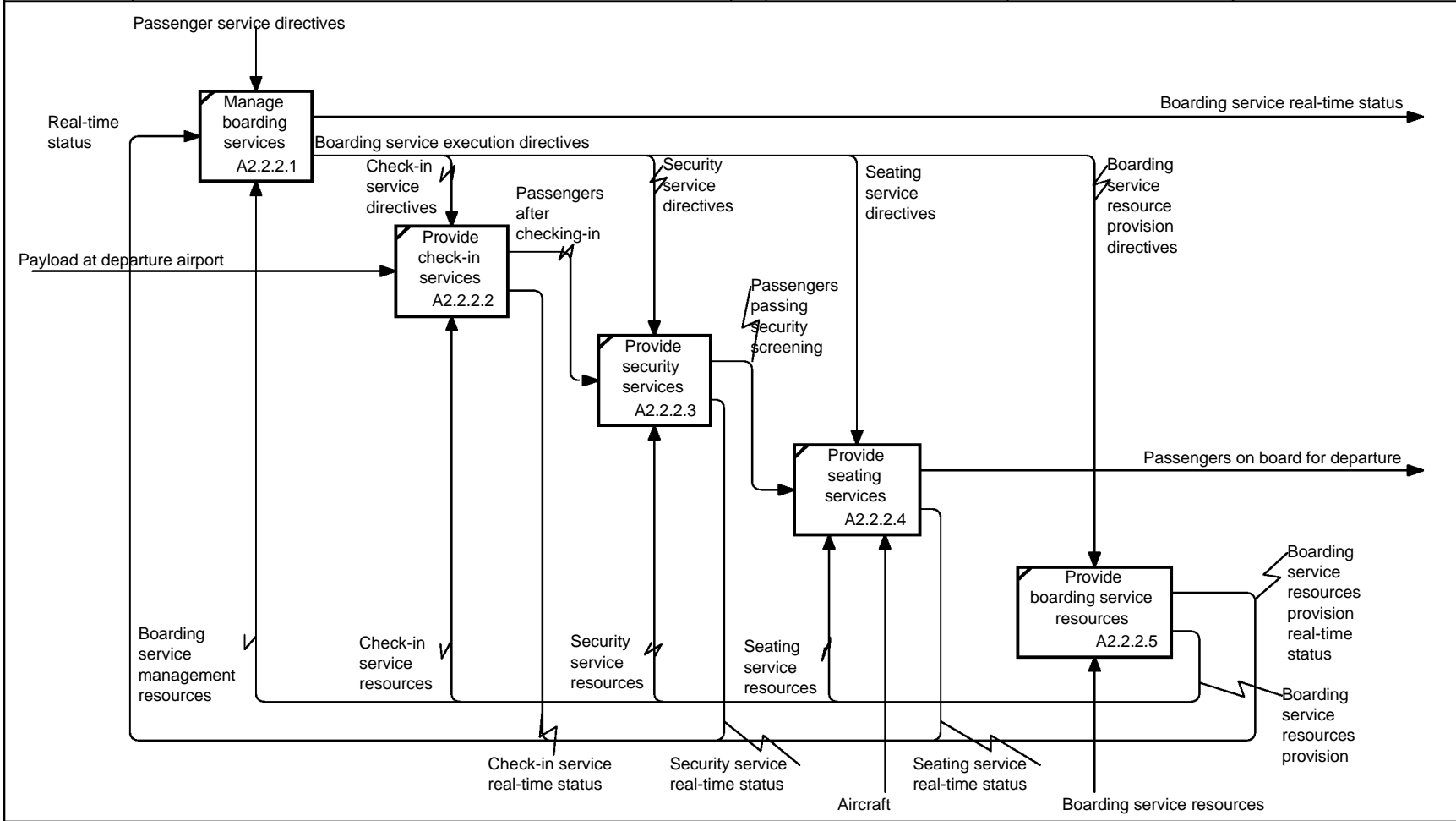

NODE: <b>A2.2.2</b>	TITLE: <b>Perform boarding services</b>	NUMBER:
------------------------	--	---------



## 4.10 A2.2.2—PERFORM BOARDING SERVICES.

### 4.10.1 A2.2.2.1—Manage Boarding Services.

This function directs, schedules, and coordinates the following component activities of passenger boarding services:

- Provide check-in services
- Provide security screening
- Provide seating services
- Provide boarding service resources

It provides directives, defines requirements and controls for the execution of those activities, and also checks that the execution is done in accordance with company policies and procedures and any required regulations for these activities. This activity also provides controls (on-line/off-line directives) to other process modules.

### 4.10.2 A2.2.2.2—Provide Check-In Services.

45

This function captures the process of checking and registering the passenger's ticket and luggage and providing the passenger with a boarding pass indicating flight number, boarding gate, time, seat number, etc. International flights require emergency notification of next of kin forms to be completed.

### 4.10.3 A2.2.2.3—Provide Security Services.

This function carries out the security screening of passengers and carry-on baggage to ensure no weapons or other dangerous goods and materials are being brought onto the aircraft.

### 4.10.4 A2.2.2.4—Provide Seating Services.

This function serves the passenger's needs for safe seating and luggage placement.

### 4.10.5 A2.2.2.5—Provide Boarding Service Resources.

This function allocates and supplies available personnel, materials, equipment, tools, and any other required resources to support the execution of boarding services.

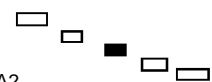
USED AT:	AUTHOR: ACOSM team	DATE: 8/6/99	WORKING	READER	DATE	CONTEXT: 
	PROJECT: Air Carrier Operations System Model	REV: 7/20/00	DRAFT			
	NOTES: 1 2 3 4 5 6 7 8 9 10		RECOMMENDED			
			PUBLICATION			

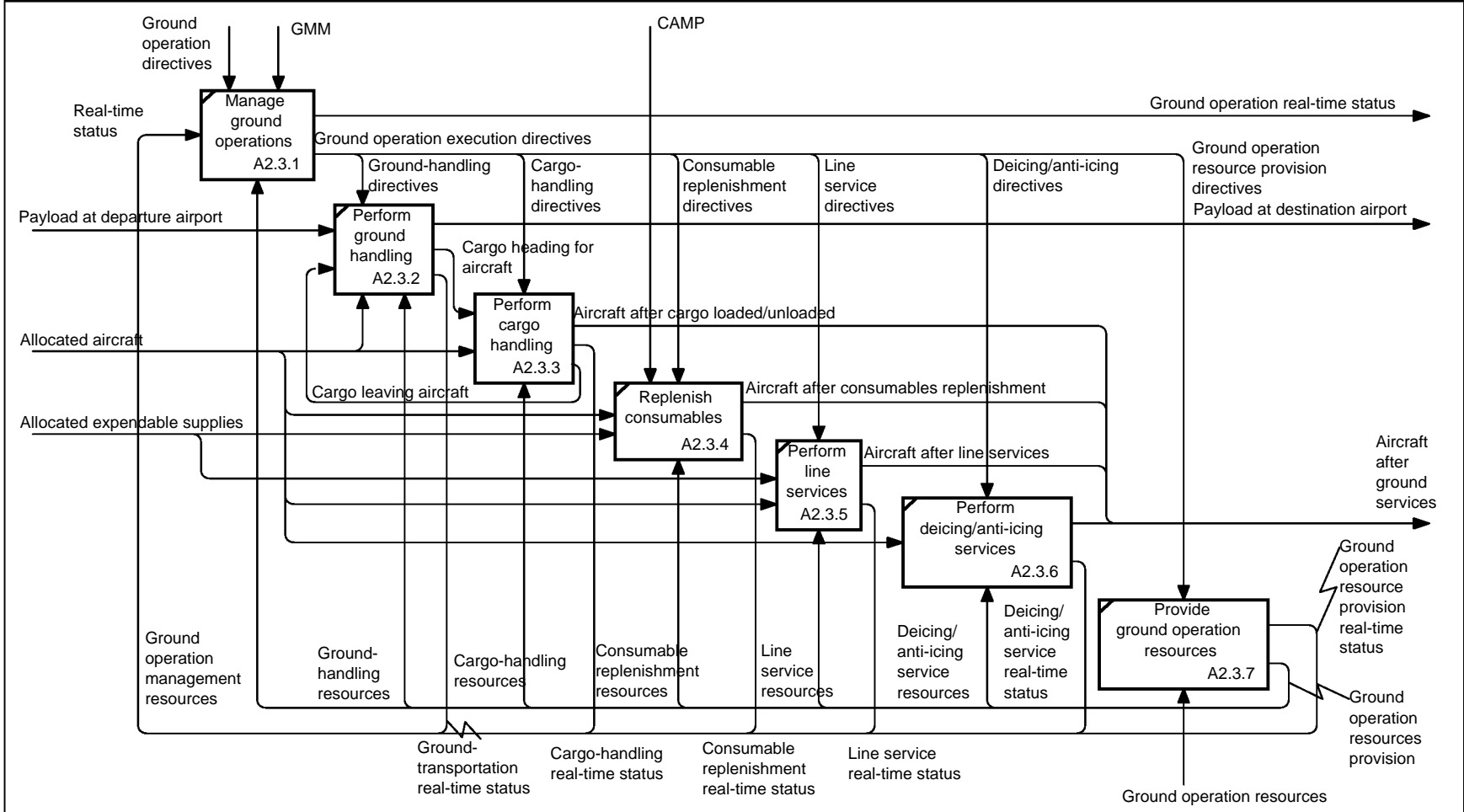

NODE: <b>A2.3</b>	TITLE: <b>Perform ground operations</b>	NUMBER: <b>P. 11</b>
----------------------	--	-------------------------

## 4.11 A2.3—PERFORM GROUND OPERATIONS.

### 4.11.1 A2.3.1—Manage Ground Operations.

This function directs, schedules, and coordinates the following component activities of ground transportation:

- Perform ground handling
- Perform cargo handling
- Replenish consumables
- Perform line services
- Perform deicing/anti-icing program
- Provide ground operation resources

It provides directives, defines requirements and controls for the execution of those activities, and also checks that the execution is done in accordance with company policies and procedures and any required regulations for these activities. This activity also provides controls (on-line/off-line directives) to other process modules.

### 4.11.2 A2.3.2—Perform Ground Handling.

This function uses airport ground traffic tools such as trucks, trailers, or transfer belts to move luggage/cargo from customers to the aircraft for loading or from aircraft to customers for pick up.

### 4.11.3 A2.3.3—Perform Cargo Handling.

This function moves cargo, including the handling of hazardous materials (HAZMAT) and company-owned materials (COMAT), onto the aircraft for departure or down from the aircraft after aircraft landing at the destination airport.

### 4.11.4 A2.3.4—Replenish Consumables.

This function fuels the aircraft and replenishes gases (i.e., nitrogen for tires and oxygen for passengers and crewmembers) and liquids (i.e., water and lubricants) before flight to meet the flight requirements.

4.11.5 A2.3.5—Perform Line Services.

This function provides cabin services for providing a clean, safe, and comfortable environment for passengers. This includes providing passenger-briefing cards, potable water, cabin cleaning, food and drink supplies, etc.

4.11.6 A2.3.6—Perform Deicing/Anti-Icing Program.

This function removes the ice/snow or provides anti-icing services at the airport to ensure the safe operation of the aircraft.

4.11.7 A2.3.7—Provide Ground Operation Resources.

This function allocates and supplies available personnel, materials, equipment, tools, and any other required resources to support the execution of ground operations.

[THIS PAGE IS INTENTIONALLY LEFT BLANK]

USED AT:	AUTHOR: ACOSM team	DATE: 11/1/99	WORKING	READER	DATE	CONTEXT:  A2.3
	PROJECT: Air Carrier Operations System Model	REV: 8/22/00	DRAFT			
	NOTES: 1 2 3 4 5 6 7 8 9 10		RECOMMENDED			
			PUBLICATION			

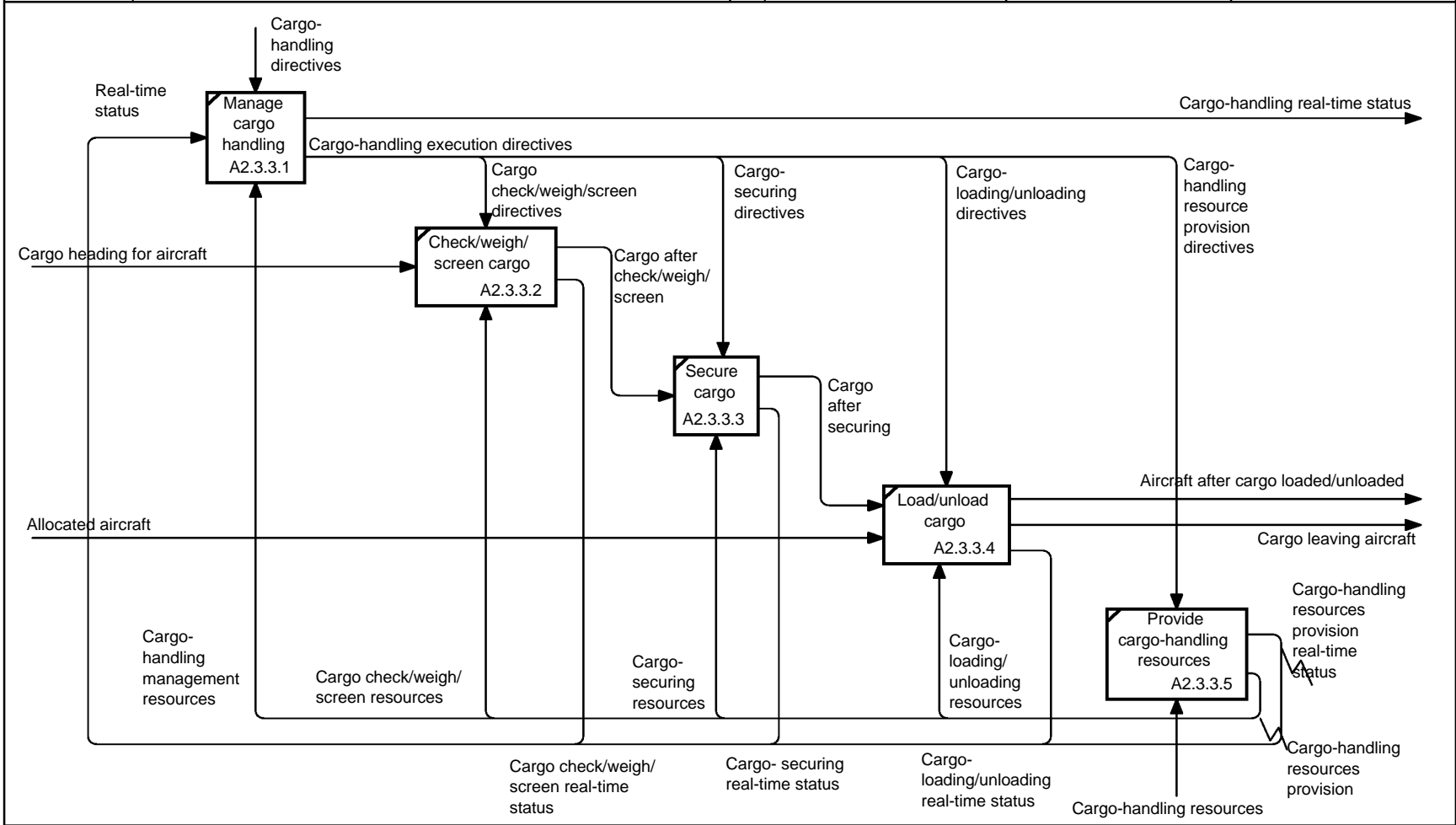

50

NODE: <b>A2.3.3</b>	TITLE: <b>Perform cargo handling</b>	NUMBER:
------------------------	---	---------

## 4.12 A2.3.3—PERFORM CARGO HANDLING.

### 4.12.1 A2.3.3.1—Manage Cargo Handling.

This function directs, schedules, and coordinates the following component activities of cargo handling:

- Check/weigh/screen cargo
- Secure cargo
- Load/unload cargo
- Provide cargo-handling resources

It provides directives, defines requirements and controls for the execution of those activities, including screening for HAZMAT and COMAT handling, and also checks that the execution is done in accordance with company policies and procedures and any required regulations for these activities. This activity also provides controls (on-line/off-line directives) to other process modules.

### 4.12.2 A2.3.3.2—Check/Weigh/Screen Cargo.

This function examines and screens for HAZMAT, COMAT, weight, and packaging.

### 4.12.3 A2.3.3.3—Secure Cargo.

This function ties down cargo in the cargo area and secures pallets/nets/Unit Load Devices (ULD).

### 4.12.4 A2.3.3.4—Load/Unload Cargo.

This function places cargo in the aircraft cargo areas before aircraft doors are secured for flight or removes cargo from the aircraft after the aircraft lands at the destination airport.

### 4.12.5 A2.3.3.5—Provide Cargo-Handling Resources.

This function allocates and supplies available personnel, materials, equipment, tools, and any other required resources to support the execution of cargo handling.

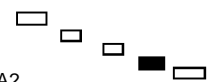
USED AT:	AUTHOR: ACOSM team	DATE: 6/11/99	WORKING	READER	DATE	CONTEXT:  A2
	PROJECT: Air Carrier Operations System Model	REV: 8/22/00	DRAFT			
	NOTES: 1 2 3 4 5 6 7 8 9 10		RECOMMENDED			
			PUBLICATION			

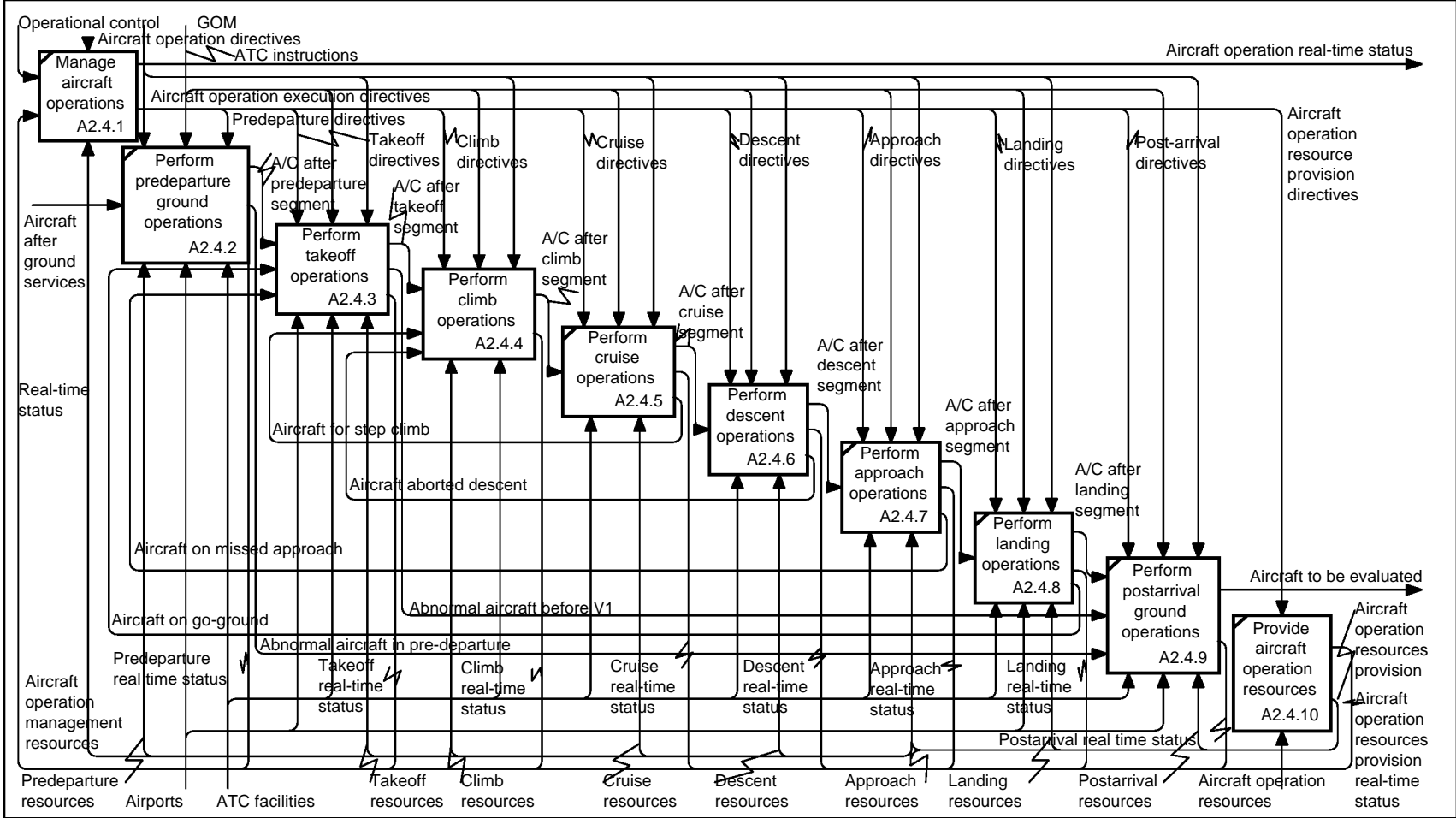

NODE: <b>A2.4</b>	TITLE: <b>Perform aircraft operations</b>	NUMBER:
----------------------	--	---------

52



## 4.13 A2.4—PERFORM AIRCRAFT OPERATIONS.

### 4.13.1 A2.4.1—Manage Aircraft Operations.

This function directs, schedules, and coordinates the following component activities of aircraft operations:

- Perform predeparture ground operations
- Perform takeoff operations
- Perform climb operations
- Perform cruise operations
- Perform descent operations
- Perform approach operations
- Perform landing operations
- Perform postarrival ground operations
- Provide aircraft operation resources

It provides directives, defines requirements and controls for the execution of those activities, and also verifies that the execution is done in accordance with company policies and procedures and any required regulations for these activities. This activity also provides controls (on-line/off-line directives) to other process modules.

### 4.13.2 A2.4.2—Perform Predeparture Ground Operations.

This function captures the pilots' operations for the movement of the aircraft from push-back to engine start, to taxi up to the hold-short line, and before the takeoff check list. The push-back and engine start activity will depend on whether the aircraft starts at the gate for power-back operations, or uses remote parking. All ground equipment necessary for this activity may include a tug, powered air carts, ground power units, and ancillary connections at the gate. Once the engines are started, the aircraft moves under its own power and proceeds onto the taxiways. The pilots need to perform the following tasks during this process:

- Preflight preparation
- Interior/exterior preflight/flight deck preparation before the start procedures
- Perform power-back/push-back/engine start procedures
- Perform pretaxi checks, taxi, and before takeoff procedures

Any abnormal situation would preclude the aircraft from continuing, thus a return at the gate is warranted, the aircraft may go directly to the postarrival ground operation stage.

#### 4.13.3 A2.4.3—Perform Takeoff Operations.

This function captures the pilots' operations from the moment the aircraft is authorized to taxi into position, moving on the active runway for takeoff, and through the takeoff phase of flight. The pilots need to comply with company, FAA, and other applicable takeoff guidance and regulations regarding takeoff operations.

#### 4.13.4 A2.4.4—Perform Climb Operations.

This function captures the pilots' operations for the climb movement of the aircraft from the climb power being set or flaps retracted which ever occurs last until it reaches the cruise altitude. The pilots need to perform the following tasks during this process:

- Comply with company, FAA, and other applicable guidance and regulations and performance requirements regarding climb operations
- Perform climb to cruise altitude

#### 4.13.5 A2.4.5—Perform Cruise Operations.

This function captures pilots' operations for keeping the aircraft at certain cruise altitudes and ends when the aircraft descent is initiated below cruise altitude. The pilots need to perform the following tasks during this process:

- Comply with company, FAA, and other applicable guidance and regulations and performance limitations regarding cruise operations
- Perform cruise checklist

#### 4.13.6 A2.4.6—Perform Descent Operations.

This function captures the pilots' operations for the descent movement of the aircraft from its cruise altitudes until the aircraft begins its initial approach. The pilots may need to perform the following tasks during this process:

- Comply with company, FAA, and other applicable guidance and regulations regarding descent/holding operations
- Perform initial descent from cruise altitude to the initial approach fix
- Perform approach holding procedures if required
- Perform descent check and approach briefing

#### 4.13.7 A2.4.7—Perform Approach Operations.

This function captures the pilots' operations for aircraft descent from the Initial Approach Fix (IAF) or initiation of radar vectors to the Final Approach Fix (FAF) to the Missed Approach Point (MAP). The pilots should perform the following tasks during this process:

- Comply with company, FAA, and other applicable guidance and regulations regarding approach operations
- Perform a precision or nonprecision or a visual approach

#### 4.13.8 A2.4.8—Perform Landing Operations.

This function captures the pilots' operations from MAP, Decision Height (DH), or Visual Descent Point (VDP) to making aircraft touchdown and movement on the runway, and until the aircraft leaves the active runway. The pilots may need to conduct the following tasks during this process:

- Comply with company, FAA, and other applicable guidance and regulations regarding landing operations
- Perform normal landing

#### 4.13.9 A2.4.9—Perform Postarrival Ground Operations.

This function captures the pilots' operations to make the aircraft move onto the taxiway after clearing the runway to assigned parking. The pilots may need to conduct the following tasks during this process:

- Comply with company, FAA, and other applicable guidance and regulations regarding postarrival ground operations
- Perform taxi operations
- Perform shutdown and associated checklists

#### 4.13.10 A2.4.10—Provide Aircraft Operation Resources.

This function allocates and supplies available personnel, materials, equipment, tools, and any other required resources to support the execution of aircraft operations.

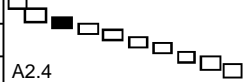
USED AT:	AUTHOR: ACOSM team	DATE: 3/30/00	WORKING	READER	DATE	CONTEXT:  A2.4
	PROJECT: Air Carrier Operations System Model	REV: 7/20/00	DRAFT			
			RECOMMENDED			
	NOTES: 1 2 3 4 5 6 7 8 9 10		PUBLICATION			

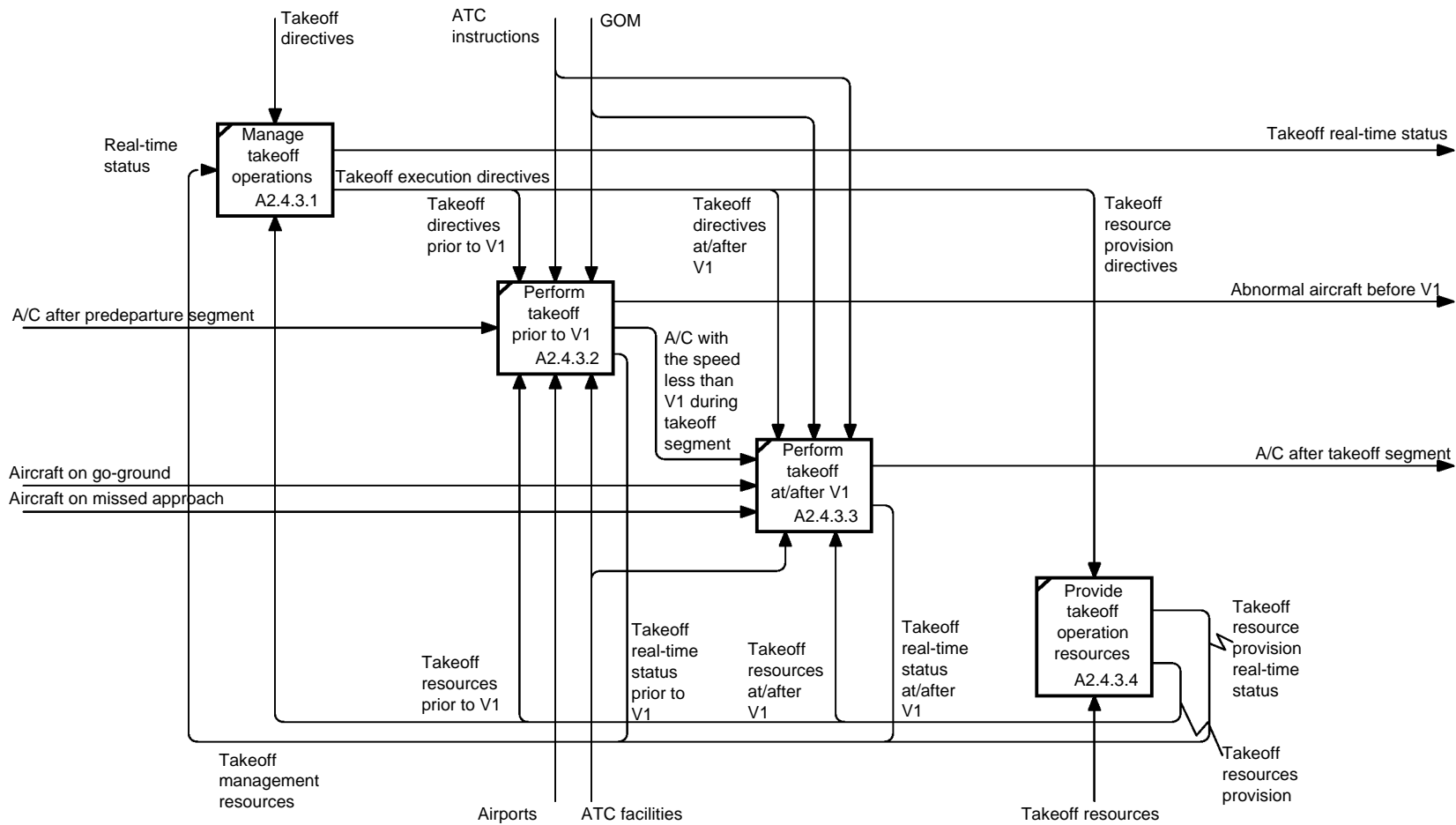

56

NODE: <b>A2.4.3</b>	TITLE: <b>Perform takeoff operations</b>	NUMBER:
		P.14

#### 4.14 A2.4.3—PERFORM TAKEOFF OPERATIONS.

##### 4.14.1 A2.4.3.1—Manage Takeoff Operations.

This function directs, schedules, and coordinates the following component activities of takeoff operations:

- Perform takeoff operation prior to V1
- Perform takeoff at/after V1
- Provide takeoff operation resources

It provides directives, defines requirements and controls for the execution of those activities, and also checks that the execution is done in accordance with company policies and procedures and any required regulations for these activities. This activity also provides controls (on-line/off-line directives) to other process modules.

##### 4.14.2 A2.4.3.2—Perform Takeoff Prior to V1.

This function captures the pilots' operations to move the aircraft into position and perform normal takeoff procedures until the aircraft reaches V1. Considerations need to be taken with regard to:

- Crew coordination
- Aircraft performances

##### 4.14.3 A2.4.3.3—Perform Takeoff At/After V1.

This function captures the pilots' operations after the airspeed V1 and continues until the aircraft enters the climb phase of flight.

##### 4.14.4 A2.4.3.4—Provide Takeoff Operation Resources.

This function allocates and supplies available personnel, materials, and any other required resources to support the execution of takeoff operations.

USED AT:	AUTHOR: ACOSM team	DATE: 3/30/00	WORKING	READER	DATE	CONTEXT: A2.4
	PROJECT: Air Carrier Operations System Model	REV: 7/21/00	DRAFT			
	NOTES: 1 2 3 4 5 6 7 8 9 10		RECOMMENDED			
			PUBLICATION			

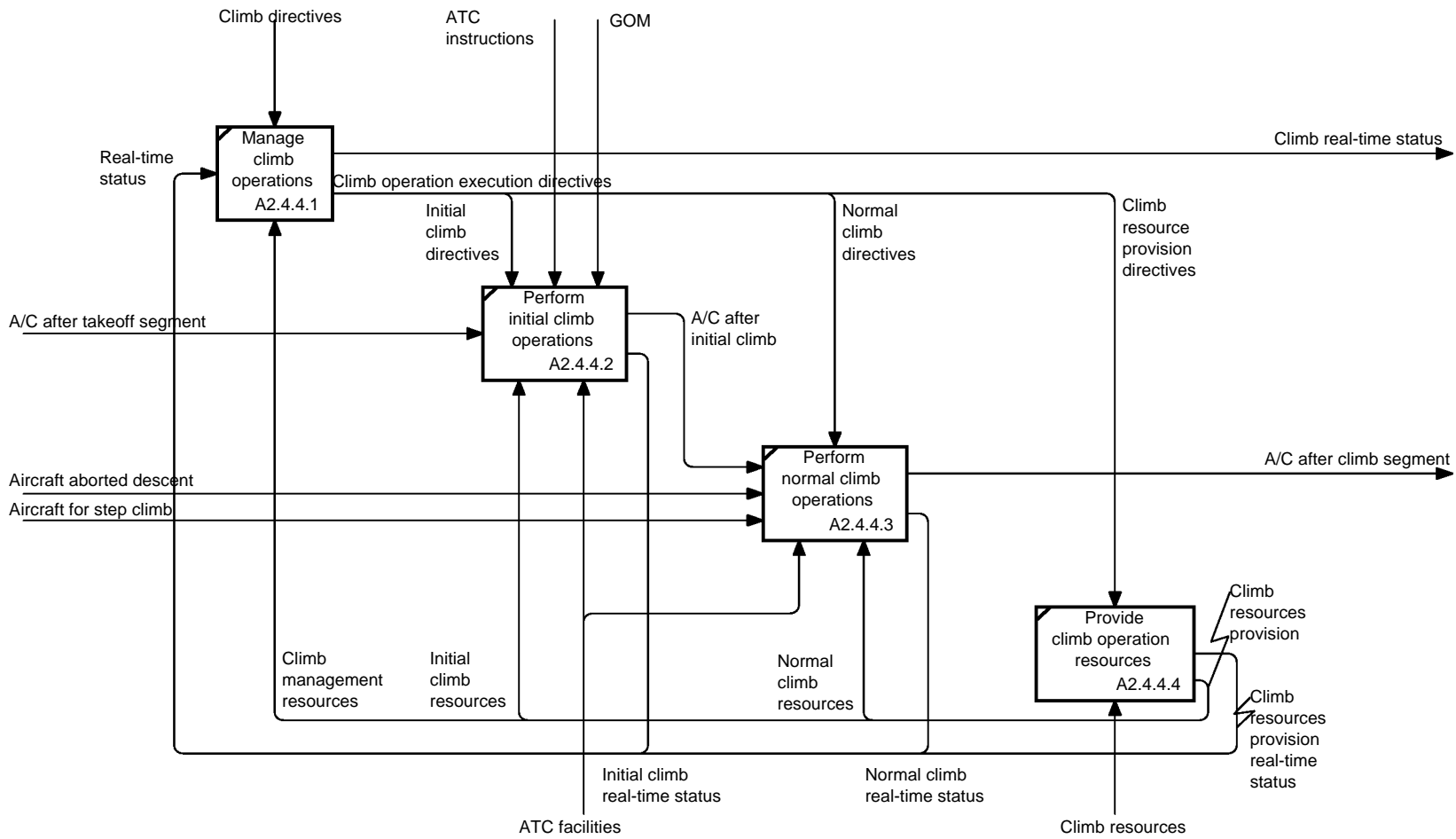

58

NODE: <b>A2.4.4</b>	TITLE: <b>Perform climb operations</b>	NUMBER:
		P.15

#### 4.15 A2.4.4—PERFORM CLIMB OPERATIONS.

##### 4.15.1 A2.4.4.1—Manage Climb Operations.

This function directs, schedules, and coordinates the following component activities of climb operations:

- Perform initial climb operations
- Perform normal climb operations
- Provide climb operation resources

It provides directives, defines requirements and controls for the execution of those activities, and also checks that the execution is done in accordance with company policies and procedures and any required regulations for these activities. This activity also provides controls (on-line/off-line directives) to other process modules.

##### 4.15.2 A2.4.4.2—Perform Initial Climb Operations.

This function captures the pilots' operations of an aircraft from the climb power being set or flaps retracted to acceleration altitude. This segment coincides with the second segment in aircraft performance.

##### 4.15.3 A2.4.4.3—Perform Normal Climb Operations.

This function captures the pilots' operations to make the aircraft climb from acceleration altitude. During this process, the pilots may need to perform the following tasks:

- Adjust climb power as appropriate
- Ensure aircraft accelerates to appropriate climb speed to cruise altitude

##### 4.15.4 A2.4.4.4—Provide Climb Operation Resources.

This function allocates and supplies available personnel, materials, and any other required resources to support the execution of the climb operations.

USED AT:	AUTHOR: ACOSM team	DATE: 3/30/00	WORKING	READER	DATE	CONTEXT: A2.4
	PROJECT: Air Carrier Operations System Model	REV: 7/20/00	DRAFT			
	NOTES: 1 2 3 4 5 6 7 8 9 10		RECOMMENDED			
			PUBLICATION			

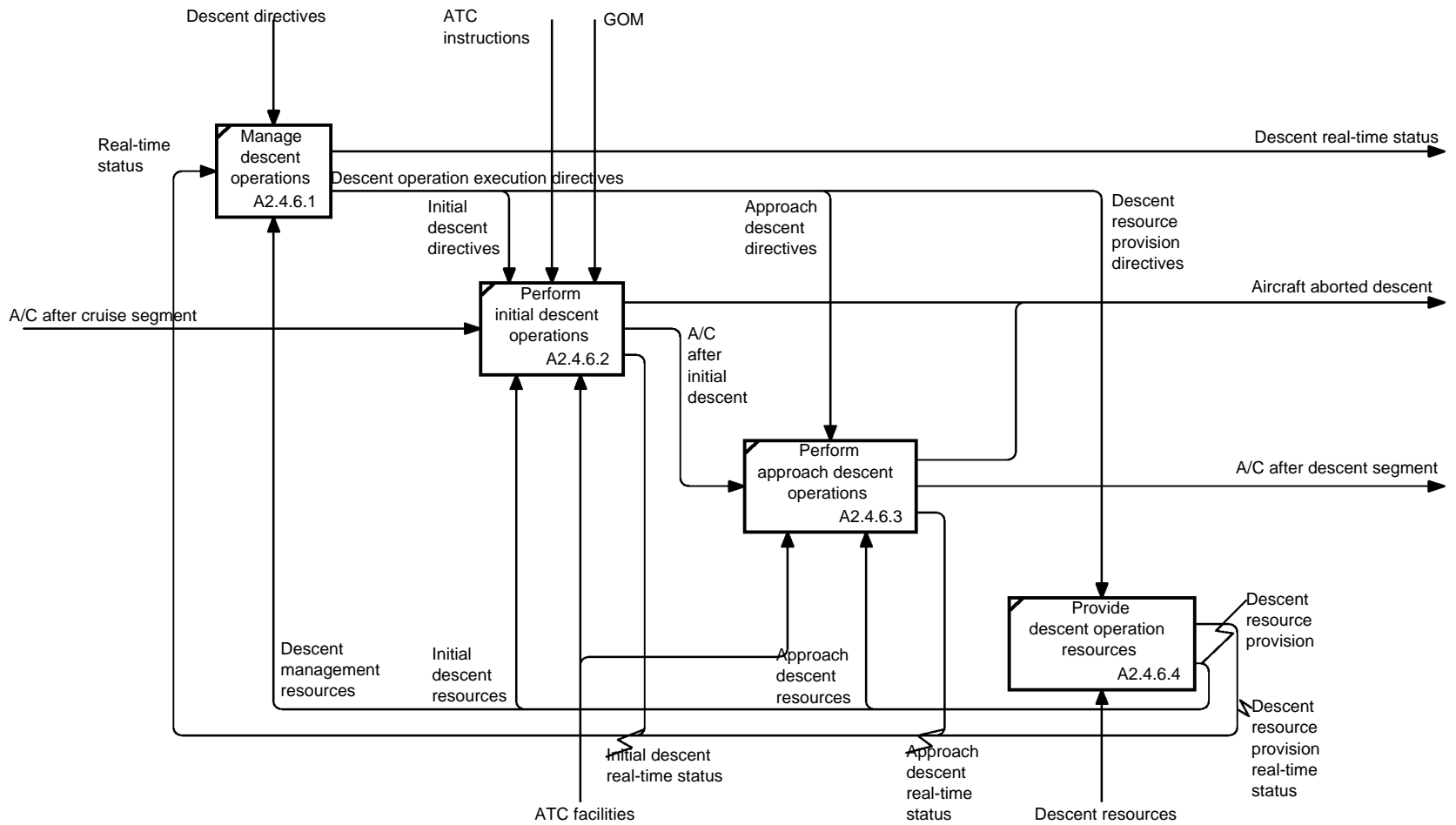

60

NODE: <b>A2.4.6</b>	TITLE: <b>Perform descent operations</b>	NUMBER:
------------------------	---	---------



## 4.16 A2.4.6—PERFORM DESCENT OPERATIONS.

### 4.16.1 A 2.4.6.1—Manage Descent Operations.

This function directs, schedules, and coordinates the following component activities of descent operations:

- Perform initial descent operations
- Perform approach descent operations
- Provide descent operation resources

It provides directives, defines requirements and controls for the execution of those activities, and also checks that the execution is done in accordance with company policies and procedures and any required regulations for these activities. This activity also provides controls (on-line/off-line directives) to other process modules.

### 4.16.2 A2.4.6.2—Perform Initial Descent Operations.

This function captures the pilots' operations to make the aircraft descend from cruise altitude to initial approach altitude. During this process, the pilots may need to perform airspeed and altitude control.

### 4.16.3 A2.4.6.3—Perform Approach Descent Operations.

This function captures the pilots' operations to make the aircraft descend from the IAF altitude to the FAF or final approach on a visual approach. During this process, the pilots may need to perform airspeed and altitude control.

### 4.16.4 A2.4.6.4—Provide Descent Operation Resources.

This function allocates and supplies available personnel, materials, and any other required resources to support the execution of aircraft descent operations.

USED AT:	AUTHOR: ACOSM team	DATE: 5/28/99	WORKING	READER	DATE	CONTEXT: A0
	PROJECT: Air Carrier Operations System Model	REV: 8/22/00	DRAFT			
	NOTES: 1 2 3 4 5 6 7 8 9 10		RECOMMENDED			
			PUBLICATION			

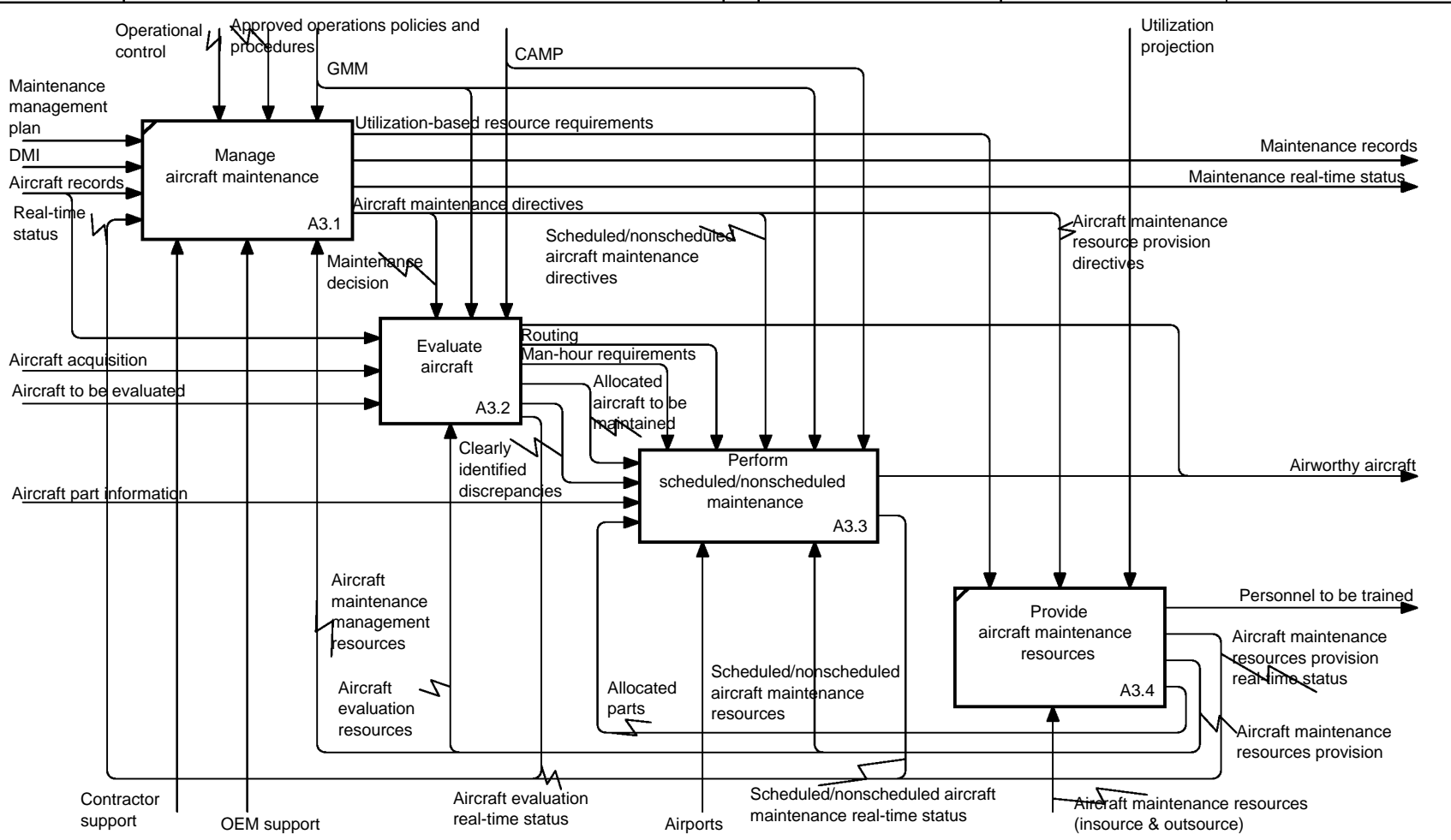

62

NODE: <b>A3</b>	TITLE: <b>Perform aircraft maintenance</b>	NUMBER:
--------------------	---	---------

## 4.17 A3—PERFORM AIRCRAFT MAINTENANCE.

### 4.17.1 A3.1—Manage Aircraft Maintenance.

This function directs, schedules, and coordinates the following component activities of the aircraft maintenance:

- Evaluate aircraft
- Perform scheduled/nonscheduled maintenance
- Provide aircraft maintenance resources

It provides directives, defines requirements and controls for the execution of those activities, and also checks that the execution is done in accordance with company policies and procedures and any required regulations for these activities. This activity also provides controls (on-line/off-line directives) to other process modules.

### 4.17.2 A3.2—Evaluate Aircraft.

This function controls aircraft inspection, test, and evaluation. A determination of whether the aircraft is in an airworthy condition, if deficiencies can be deferred, and where (line or hangar) corrective action can be accomplished. An assessment is made of resources required and their availability.

### 4.17.3 A3.3—Perform Scheduled/Nonscheduled Maintenance.

This function conducts aircraft maintenance to correct discrepancies based on the information obtained from the aircraft evaluation, including deferrals. Here, scheduled (routine) maintenance is referred to as the performance of maintenance tasks at prescribed intervals, and nonscheduled (nonroutine) maintenance is referred to as the performance of maintenance tasks when mechanical irregularities occur. These irregularities are categorized as to whether or not they occur during flight time.

### 4.17.4 A3.4—Provide Aircraft Maintenance Resources.

This function allocates and supplies available personnel, parts, materials, equipment, tools, and any other required resources to support the execution of aircraft maintenance.

USED AT:	AUTHOR: ACOSM team	DATE: 9/27/99	WORKING	READER	DATE	CONTEXT: 
	PROJECT: Air Carrier Operations System Model	REV: 7/21/00	DRAFT			
	NOTES: 1 2 3 4 5 6 7 8 9 10		RECOMMENDED			
			PUBLICATION			

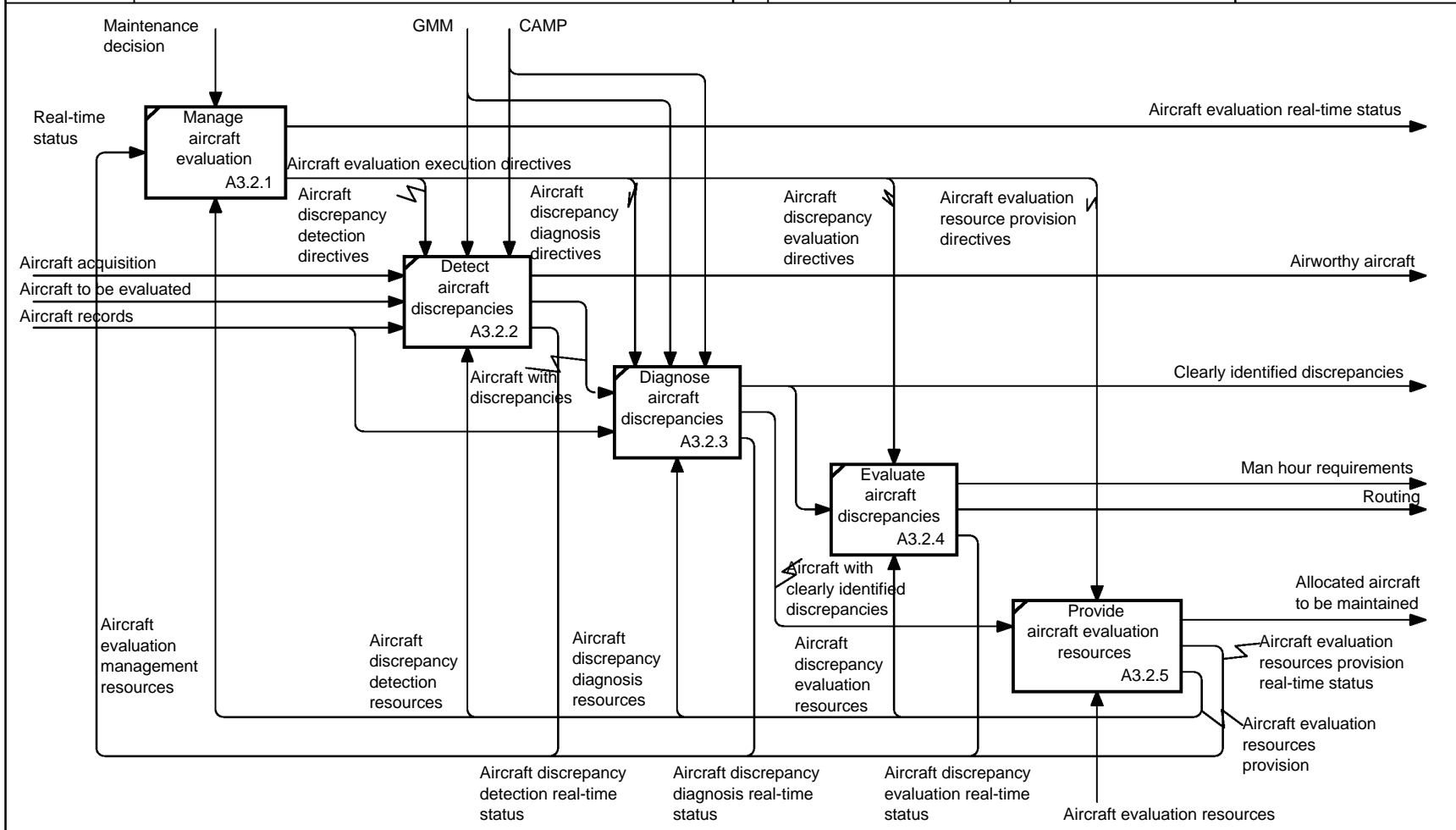

NODE: <b>A3.2</b>	TITLE: <b>Evaluate aircraft</b>	NUMBER:
----------------------	------------------------------------	---------

64

## 4.18 A3.2—EVALUATE AIRCRAFT.

### 4.18.1 A3.2.1—Manage Aircraft Evaluation.

This function directs, schedules, and coordinates the following component activities of aircraft evaluation:

- Detect aircraft discrepancies
- Diagnose aircraft discrepancies
- Evaluate aircraft discrepancies
- Provide aircraft evaluation resources

It provides directives, defines requirements and controls for the execution of those activities, and also checks that the execution is done in accordance with company policies and procedures and any required regulations for these activities. This activity also provides controls (on-line/off-line directives) to other process modules.

### 4.18.2 A3.2.2—Detect Aircraft Discrepancies.

☞

This function checks and finds evidence that some discrepancies exist with the aircraft.

### 4.18.3 A3.2.3—Diagnose Aircraft Discrepancies.

This function includes troubleshooting the root cause(s) of aircraft discrepancies based on the information from aircraft discrepancies and records.

### 4.18.4 A3.2.4—Evaluate Aircraft Discrepancies.

This function assesses aircraft discrepancies and estimates the workload and parts required to fix the discrepancies and also determines the routing plan for the aircraft maintenance.

### 4.18.5 A3.2.5—Provide Aircraft Evaluation Resources.

This function allocates and supplies available personnel, parts, materials, equipment, tools, and any other required resources to support the execution of aircraft evaluation.

USED AT:	AUTHOR: ACOSM team	DATE: 6/11/99	WORKING	READER	DATE	CONTEXT: A3
	PROJECT: Air Carrier Operations System Model	REV: 8/22/00	DRAFT			
	NOTES: 1 2 3 4 5 6 7 8 9 10		RECOMMENDED			
			PUBLICATION			

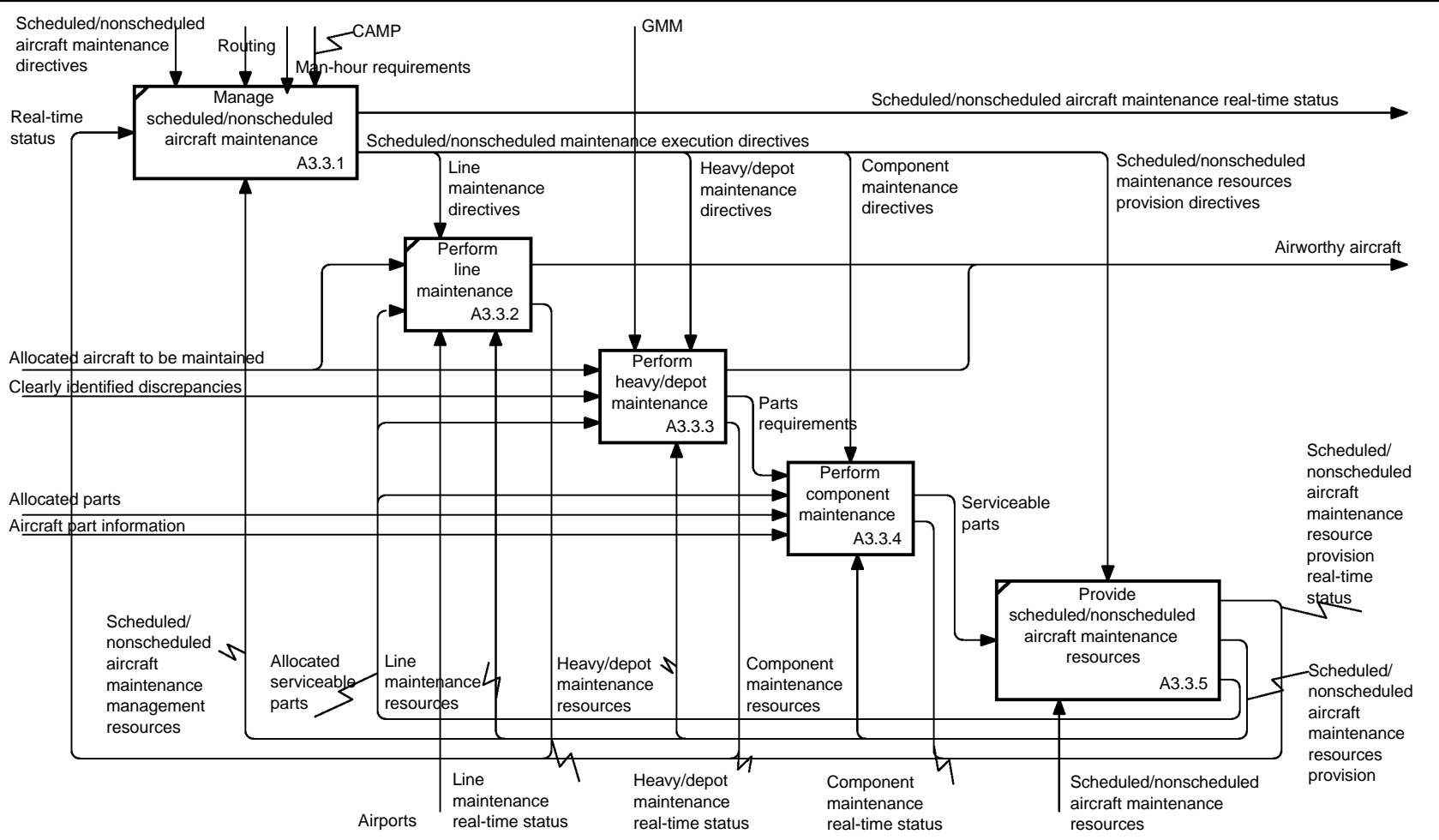

69

NODE: <b>A3.3</b>	TITLE: <b>Perform scheduled/nonscheduled maintenance</b>	NUMBER:
		P. 19

## 4.19 A3.3—PERFORM SCHEDULED/NONSCHEDULED MAINTENANCE.

### 4.19.1 A3.3.1—Manage Scheduled/Nonscheduled Aircraft Maintenance.

This function directs, schedules, and coordinates the following component activities of scheduled/nonscheduled maintenance:

- Perform line maintenance
- Perform heavy/depot maintenance
- Perform component maintenance
- Provide scheduled/nonscheduled aircraft maintenance resources

It provides directives, defines requirements and controls for the execution of those activities, and also checks that the execution is done in accordance with company policies and procedures and any required regulations for these activities. This activity also provides controls (on-line/off-line directives) to other process modules.

### 4.19.2 A3.3.2—Perform Line Maintenance.

This function provides aircraft maintenance, testing, inspection, and servicing that can be performed on-line to fix the discrepancies. This activity is usually conducted in the airport within a limited time period without necessarily sending the aircraft to a maintenance station.

### 4.19.3 A3.3.3—Perform Heavy/Depot Maintenance.

This function provides maintenance that must be performed off-line, including heavy maintenance checks, repairs, alterations, and modifications based on the results from aircraft evaluation. This activity is usually conducted in maintenance stations under a controlled environment.

### 4.19.4 A3.3.4—Perform Component Maintenance.

This function maintains the aircraft component to ensure the serviceability of parts. Here, a component can be an appliance, instrument, radio, or an accessory.

### 4.19.5 A3.3.5—Provide Scheduled/Nonscheduled Aircraft Maintenance Resources.

This function allocates and supplies available personnel, parts, materials, equipment, tools, and any other required resources to support the execution of scheduled aircraft maintenance.

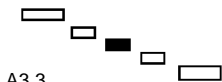
USED AT:	AUTHOR: ACOSM team	DATE: 9/28/99	WORKING	READER	DATE	CONTEXT:  A3.3
	PROJECT: Air Carrier Operations System Model	REV: 7/21/00	DRAFT			
	NOTES: 1 2 3 4 5 6 7 8 9 10		RECOMMENDED			
			PUBLICATION			

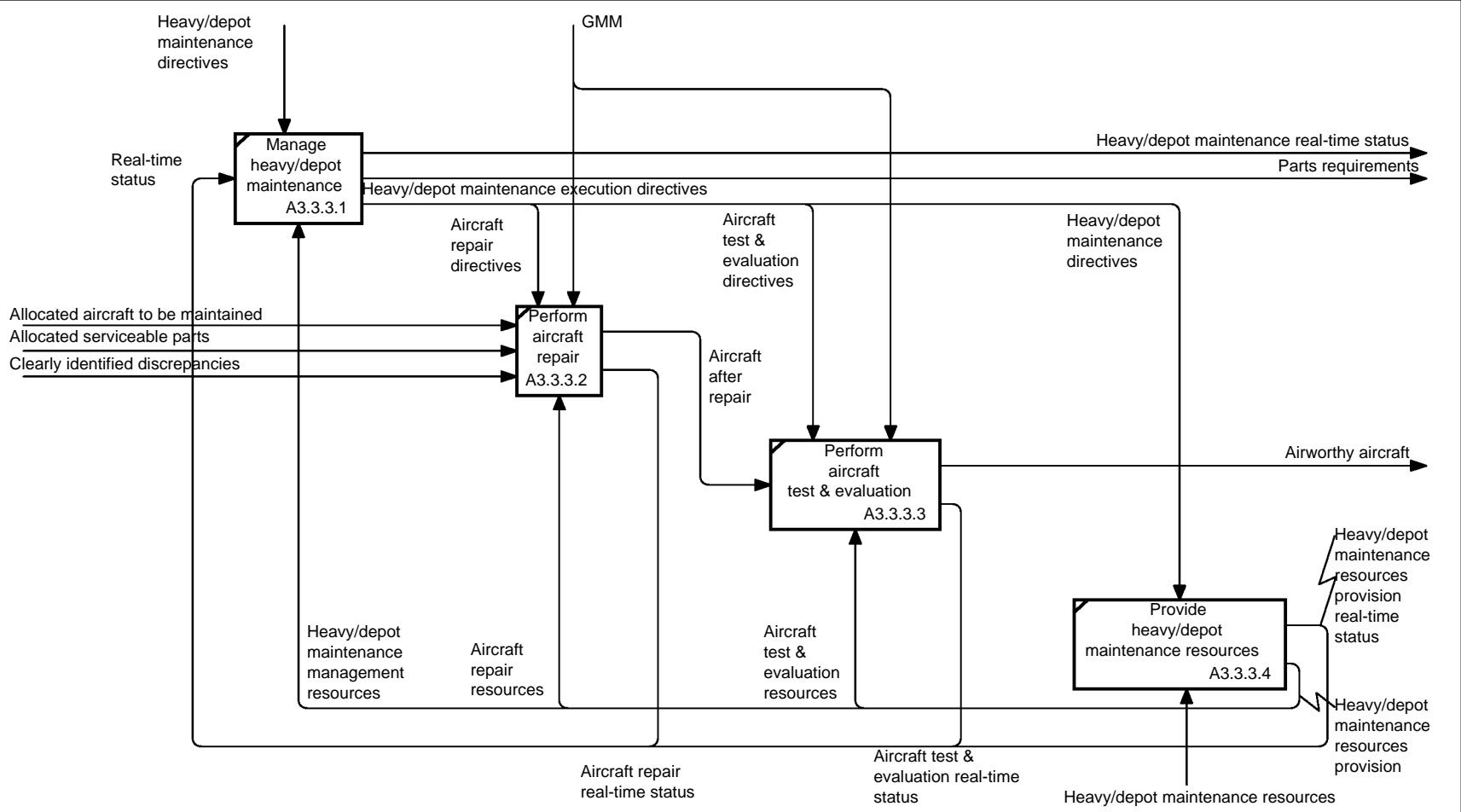

88

NODE: <b>A3.3.3</b>	TITLE: <b>Perform heavy/depot maintenance</b>	NUMBER: <b>P. 20</b>
------------------------	--	-------------------------



#### 4.20 A3.3.3—PERFORM HEAVY/DEPOT MAINTENANCE.

##### 4.20.1 A3.3.3.1—Manage Heavy/Depot Maintenance.

This function directs, schedules, and coordinates the following component activities of heavy/depot maintenance:

- Perform aircraft repair
- Perform aircraft test and evaluation
- Provide heavy/depot maintenance resources

It provides directives, defines requirements and controls for the execution of those activities, and also checks that the execution is done in accordance with company policies and procedures and any required regulations for these activities. This activity also provides controls (on-line/off-line directives) to other process modules.

##### 4.20.2 A3.3.3.2—Perform Aircraft Repair.

This function captures the process of correcting the discrepancies.

##### 4.20.3 A3.3.3.3—Perform Aircraft Test and Evaluation.

This function tests and evaluates the performance of the aircraft after maintenance is completed.

##### 4.20.4 A3.3.3.4—Provide Heavy/Depot Maintenance Resources.

This function allocates and supplies available personnel, parts, materials, equipment, tools, and any other required resources to support the execution of heavy/depot maintenance.

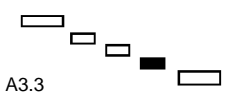
USED AT:	AUTHOR: ACOSM team	DATE: 3/6/00	WORKING	READER	DATE	CONTEXT:  A3.3
	PROJECT: Air Carrier Operations System Model	REV: 7/21/00	DRAFT			
	NOTES: 1 2 3 4 5 6 7 8 9 10		RECOMMENDED			
			PUBLICATION			

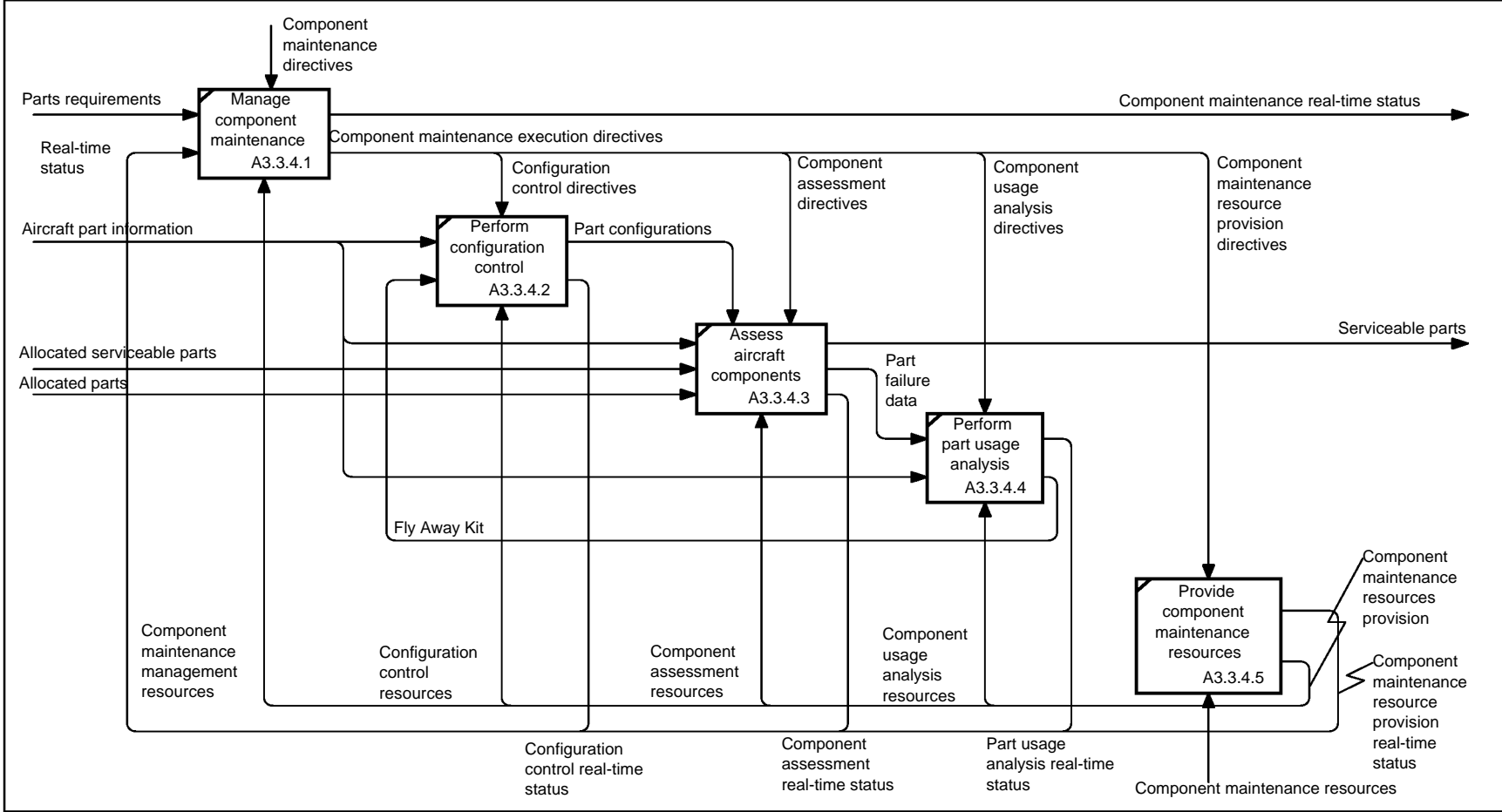

NODE: <b>A3.3.4</b>	TITLE: <b>Perform component maintenance</b>	NUMBER:
------------------------	--	---------

#### 4.21 A3.3.4—PERFORM COMPONENT MAINTENANCE.

##### 4.21.1 A3.3.4.1—Manage Component Maintenance.

This function directs, schedules, and coordinates the following component activities of parts maintenance:

- Perform configuration control
- Assess aircraft components
- Perform part usage analysis
- Provide component maintenance resources

It provides directives, defines requirements and controls for the execution of those activities, and also checks that the execution is done in accordance with company policies and procedures and any required regulations for these activities. This activity also provides controls (on-line/off-line directives) to other process modules.

##### 4.21.2 A3.3.4.2—Perform Configuration Control.

This function analyzes the part requirements and part specifications and configures the strategies used to provide serviceable parts for aircraft maintenance. The following factors should be considered to perform this function:

- Regulations
- CATII, CATIII, and ETOPs
- Lower landing minimums
- Reduced Vertical Separation Minimum airspace (RVSM) requirements
- Manufacturer part number
- Part record keeping
- Part effectiveness
- Mod status
- Life limits
- Cannibalization
- Interchangeability between manufacturers
- Internal and alternate part number
- Other

#### 4.21.3 A3.3.4.3—Assess Aircraft Components.

This function evaluates and maintains the parts to provide serviceable parts for aircraft maintenance and also to provide failure data for future part tracking and analysis purposes. The following factors should be considered to perform this function:

- Part types such as consumable or rotatable
- Part status such as quarantined or in storage
- Compatibility of consumables
- Alternate process material substitution
- Technical Standard Order (TSO)
- Electrostatic Discharge (ESD)
- Part removal tracking records
- Precision Measurement Equipment Tooling (PMET) - calibrated tooling
- Environmental control and facilities
- Other

#### 4.21.4 A3.3.4.4—Perform Part Usage Analysis.

This function tracks and analyzes the part usage information and monitors and controls their usage conditions. Examples of parts usage information include:

- Vendor lead time (a.k.a. turn time)
- Air Transportation Association (ATA) chapter and code
- Borrow/part pools
- Shelf life
- Component usage analysis
- Specification 2000
- Receiving inspection
- Technical control of reliability critical parts
- Serialization to reveal rogue parts
- Condition monitoring (i.e., oil consumption, engine vibration monitoring, FADEC/EEC data analysis)
- Nontechnical miscellaneous restraints (i.e., small business, minority owned, HUB zone)

4.21.5 A3.3.4.5—Provide Component Maintenance Resources.

This function allocates and supplies available personnel, parts, materials, equipment, tools, and any other required resources to support the execution of component maintenance.

USED AT:	AUTHOR: ACOSM team	DATE: 8/11/99	WORKING	READER	DATE	CONTEXT:  A0
	PROJECT: Air Carrier Operations System Model	REV: 8/22/00	DRAFT			
			RECOMMENDED			
	NOTES: 1 2 3 4 5 6 7 8 9 10		PUBLICATION			

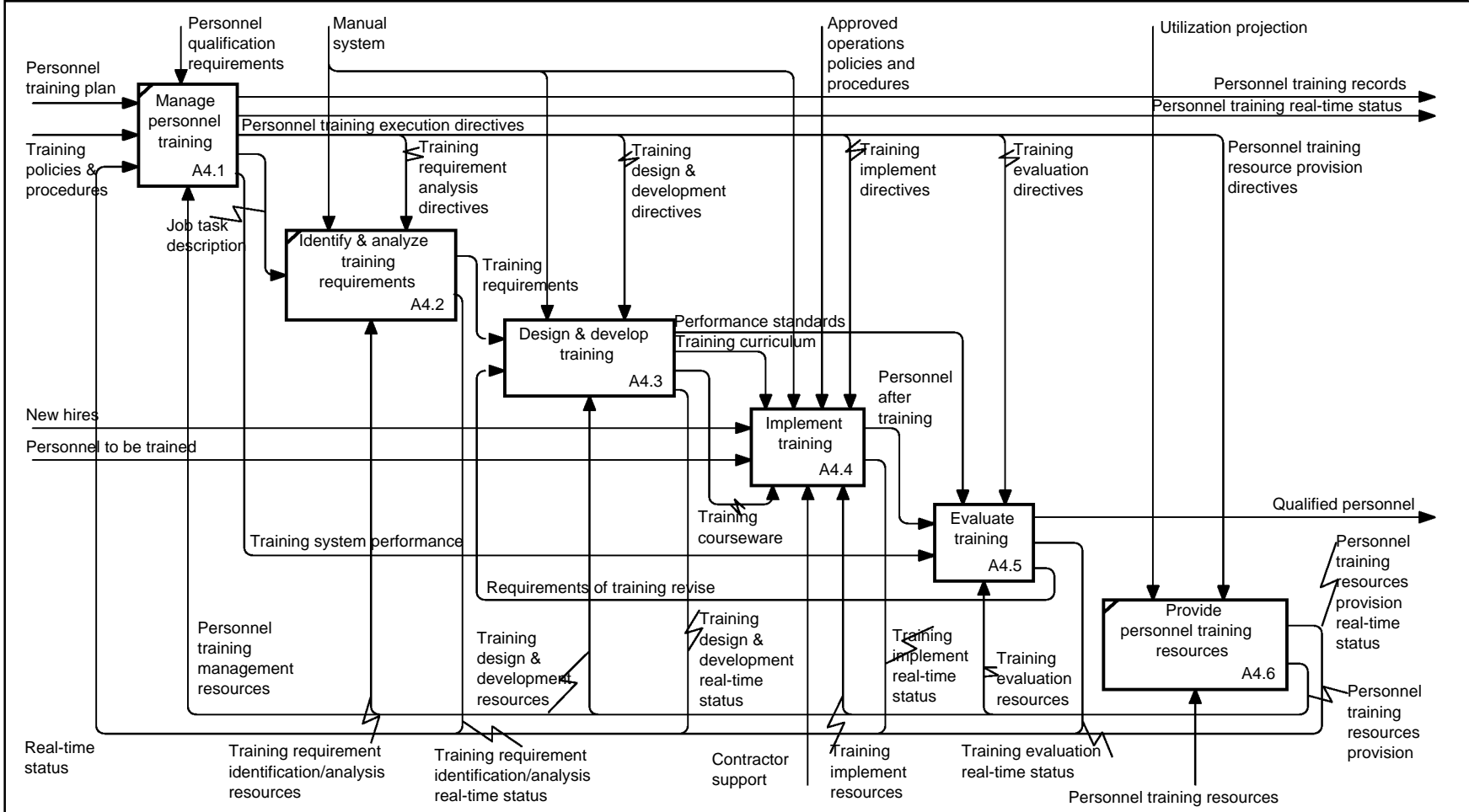

NODE: <b>A4</b>	TITLE: <b>Perform personnel training</b>	NUMBER:
--------------------	---	---------

## 4.22 A4—PERFORM PERSONNEL TRAINING.

### 4.22.1 A4.1—Manage Personnel Training.

This function directs, schedules, and coordinates the following component activities of personnel training:

- Identify & analyze training requirements
- Design & develop training
- Implement training
- Evaluate training
- Provide personnel training resources

It provides directives, defines requirements and controls for the execution of those activities, and also checks that the execution is done in accordance with company policies and procedures and any required regulations for these activities. This activity also provides controls (on-line/off-line directives) to other process modules.

### 4.22.2 A4.2—Identify & Analyze Training Requirements.

This function performs job task analysis to identify and analyze the skills and knowledge which require training based on job task requirements and personnel performance and qualification.

### 4.22.3 A4.3—Design & Develop Training.

This function designs, develops, and sequences learning objectives and qualification standards, and also creates training materials (e.g., curriculum, instructor manuals, student instructional materials, assessment instruments) to conduct training. This function also identifies and determines the most appropriate and cost-effective method for developing or obtaining the training such as the use of internal staff and facilities and/or outsource training providers.

### 4.22.4 A4.4—Implement Training.

This function delivers the knowledge, methods, procedures, skills, etc. to personnel who requires training by utilizing various means such as classroom sessions, computer, simulator, training devices, or even real aircraft.

#### 4.22.5 A4.5—Evaluate Training.

This function collects, analyzes, and interprets systematic training information, such as:

- Course content
- Course objectives
- Learning outcomes
- Student demonstration of a required level of knowledge in a subject
- Student feedback on the application of the knowledge and skills learned in the training programs to practical situations

This training information can be used to:

- Improve training effectiveness
- Determine whether training objectives/goals are met
- Assess the return on investment (ROI) of training
- Improve processes for acquiring, developing, and delivering future training

#### 4.22.6 A4.6—Provide Personnel Training Resources.

This function allocates and supplies available personnel, materials, equipment, tools, and any other required resources to support the execution of personnel training.

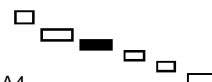

[THIS PAGE IS INTENTIONALLY LEFT BLANK]

USED AT:	AUTHOR: ACOSM team	DATE: 2/23/00	WORKING	READER	DATE	CONTEXT:  A4
	PROJECT: Air Carrier Operations System Model	REV: 8/22/00	DRAFT			
	NOTES: 1 2 3 4 5 6 7 8 9 10		RECOMMENDED			
			PUBLICATION			

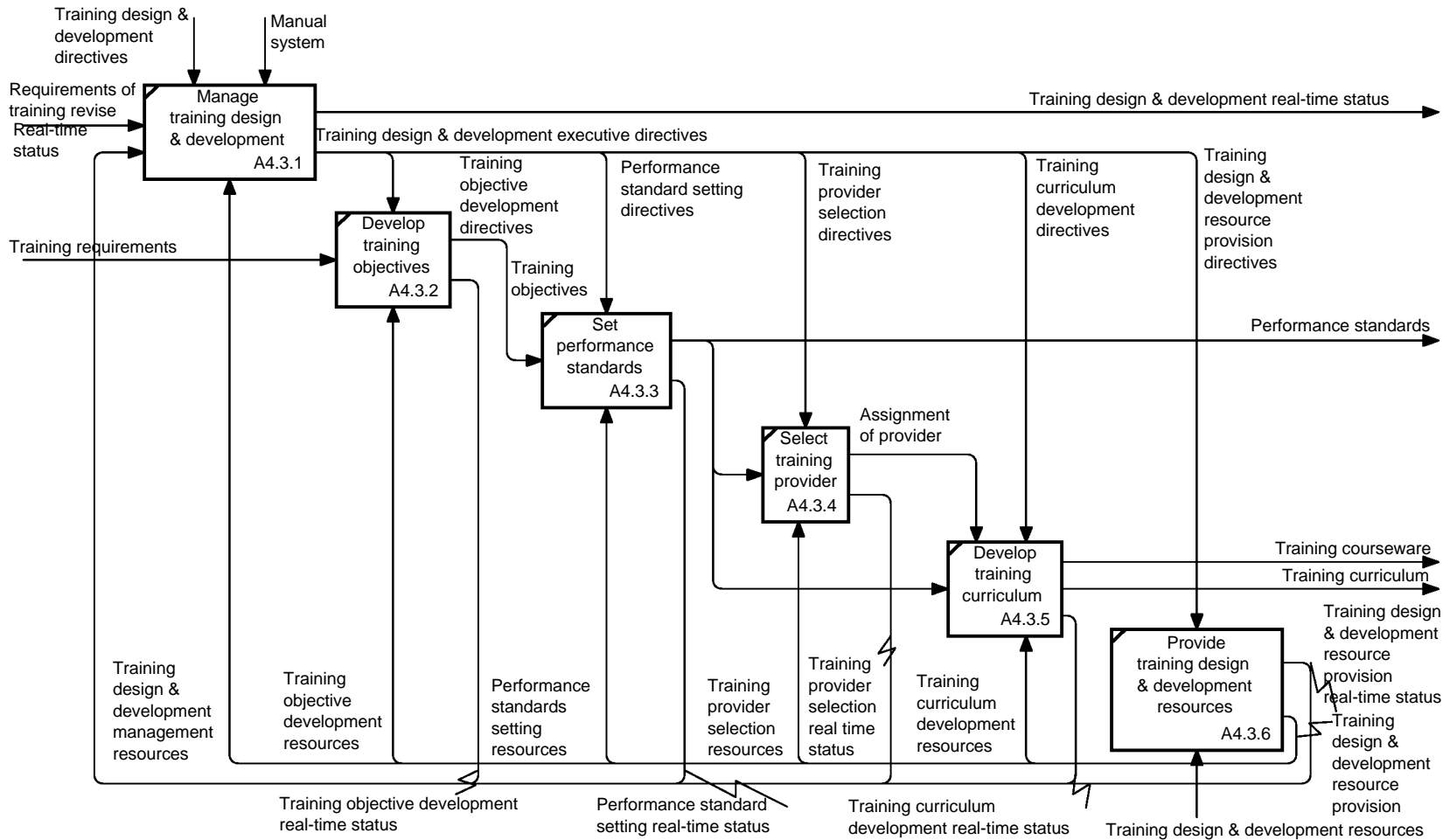

78

NODE: <b>A4.3</b>	TITLE: <b>Design &amp; develop training</b>	NUMBER:	P. 23
----------------------	--	---------	-------

## 4.23 A4.3—DESIGN & DEVELOP TRAINING.

### 4.23.1 A4.3.1—Manage Training Design & Development.

This function directs, schedules, and coordinates the following component activities of training design and development:

- Develop training objectives
- Set performance standards
- Select training provider
- Develop training curriculum
- Provide training design & development resources

It provides directives, defines requirements and controls for the execution of those activities, and also checks that the execution is done in accordance with company policies and procedures and any required regulations for these activities. This activity also provides controls (on-line/off-line directives) to other process modules.

### 4.23.2 A4.3.2—Develop Training Objectives.

This function clarifies the target of the training and the skill or performance level personnel should have after the training. The objectives for duty position training are categorized as initial new hire training, initial equipment training, transition training, upgrade training, recurrent training, and requalification training.

### 4.23.3 A4.3.3—Set Performance Standards.

This function establishes the requirements for the performance personnel should achieve after the training.

### 4.23.4 A4.3.4—Select Training Provider.

This function selects the most appropriate and cost-effective training provider based on the training requirements.

### 4.23.5 A4.3.5—Develop Training Curriculum.

This function creates a complete training agenda specific to an aircraft type, a position (i.e., a crewmember, mechanic, or dispatcher), or a category of training (i.e., new hire indoctrination). Each curriculum consists of several curriculum segments.

4.23.6 A4.3.6—Provide Training Design & Development Resources.

This function allocates and supplies available personnel, materials, equipment, tools, and any other required resources to support the execution of training design and development.

[THIS PAGE IS INTENTIONALLY LEFT BLANK]

USED AT:	AUTHOR: ACOSM team	DATE: 2/23/00	WORKING	READER	DATE	CONTEXT: A4
	PROJECT: Air Carrier Operations System Model	REV: 8/22/00	DRAFT			
	NOTES: 1 2 3 4 5 6 7 8 9 10		RECOMMENDED			
			PUBLICATION			

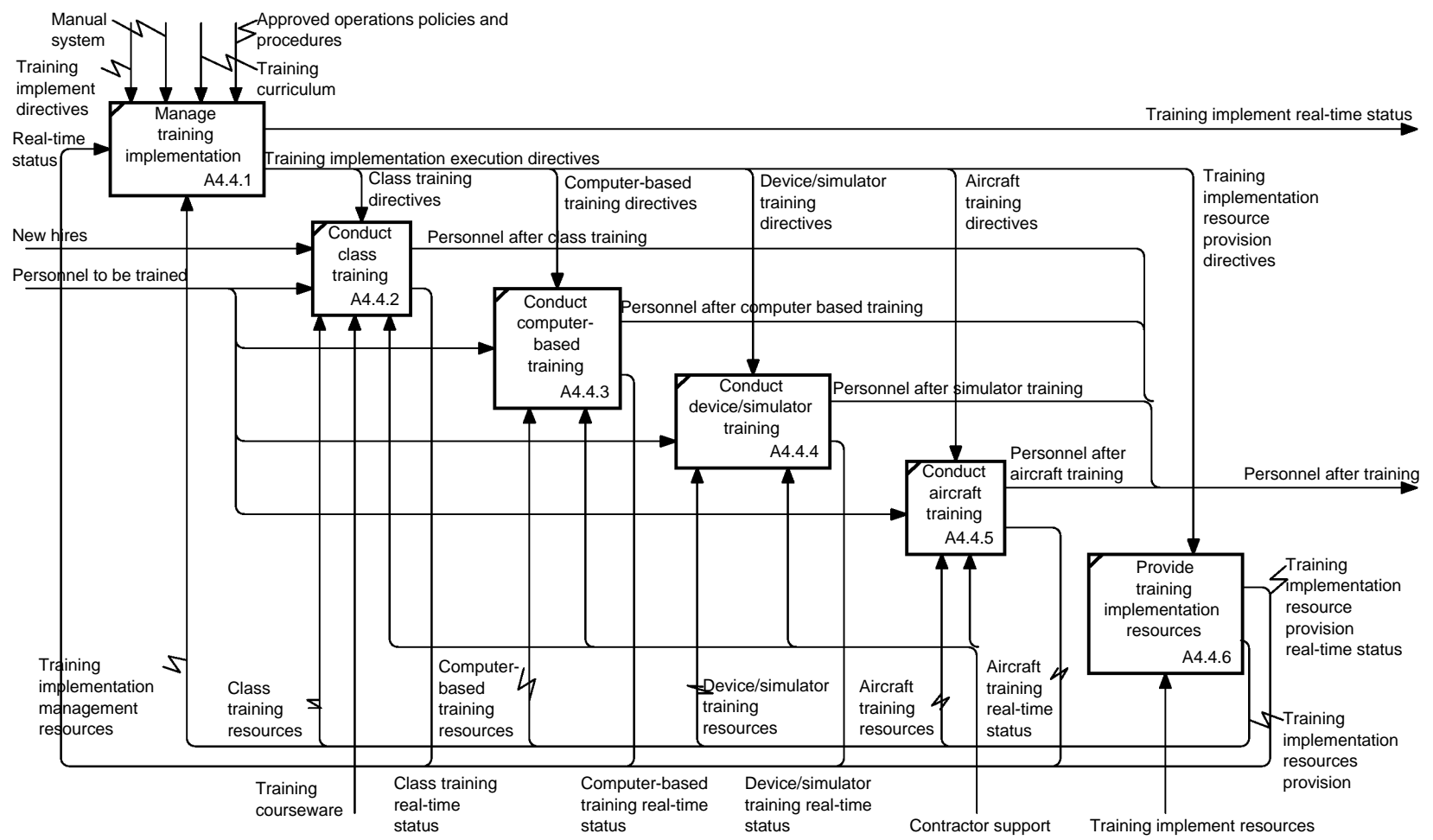

82

NODE: <b>A4.4</b>	TITLE: <b>Implement training</b>	NUMBER:
----------------------	-------------------------------------	---------

## 4.24 A4.4—IMPLEMENT TRAINING.

### 4.24.1 A4.4.1—Manage Training Implementation.

This function directs, schedules, and coordinates the following component activities of training implementation:

- Conduct class training
- Conduct computer-based training
- Conduct device/simulator training
- Conduct aircraft training
- Provide training implementation resources

It provides directives, defines requirements and controls for the execution of those activities, and also checks that the execution is done in accordance with company policies and procedures and any required regulations for these activities. This activity also provides controls (on-line/off-line directives) to other process modules.

### 4.24.2 A4.4.2—Conduct Class Training.

This function delivers training to personnel through instructor-led classroom sessions or multimedia presentation/facilitation. Instructors utilize effective presentation, facilitation, and communication skills to exhibit knowledge of subject matter content to accomplish lesson objectives.

### 4.24.3 A4.4.3—Conduct Computer-Based Training.

This function delivers training to personnel through various kinds of computer software.

### 4.24.4 A4.4.4—Conduct Device/Simulator Training.

This function delivers training to personnel through various kinds of devices/simulators.

### 4.24.5 A4.4.5—Conduct Aircraft Training.

This function delivers training to personnel through aircraft instruction.

4.24.6 A4.4.6—Provide Training Implementation Resources.

This function allocates and supplies available personnel, materials, equipment, tools, and any other required resources to support the execution of training implementation and evaluation.

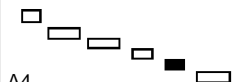

[THIS PAGE IS INTENTIONALLY LEFT BLANK]

USED AT:	AUTHOR: ACOSM team	DATE: 4/5/00	WORKING	READER	DATE	CONTEXT: 
	PROJECT: Air Carrier Operations System Model	REV: 8/22/00	DRAFT			
			RECOMMENDED			
	NOTES: 1 2 3 4 5 6 7 8 9 10		PUBLICATION			

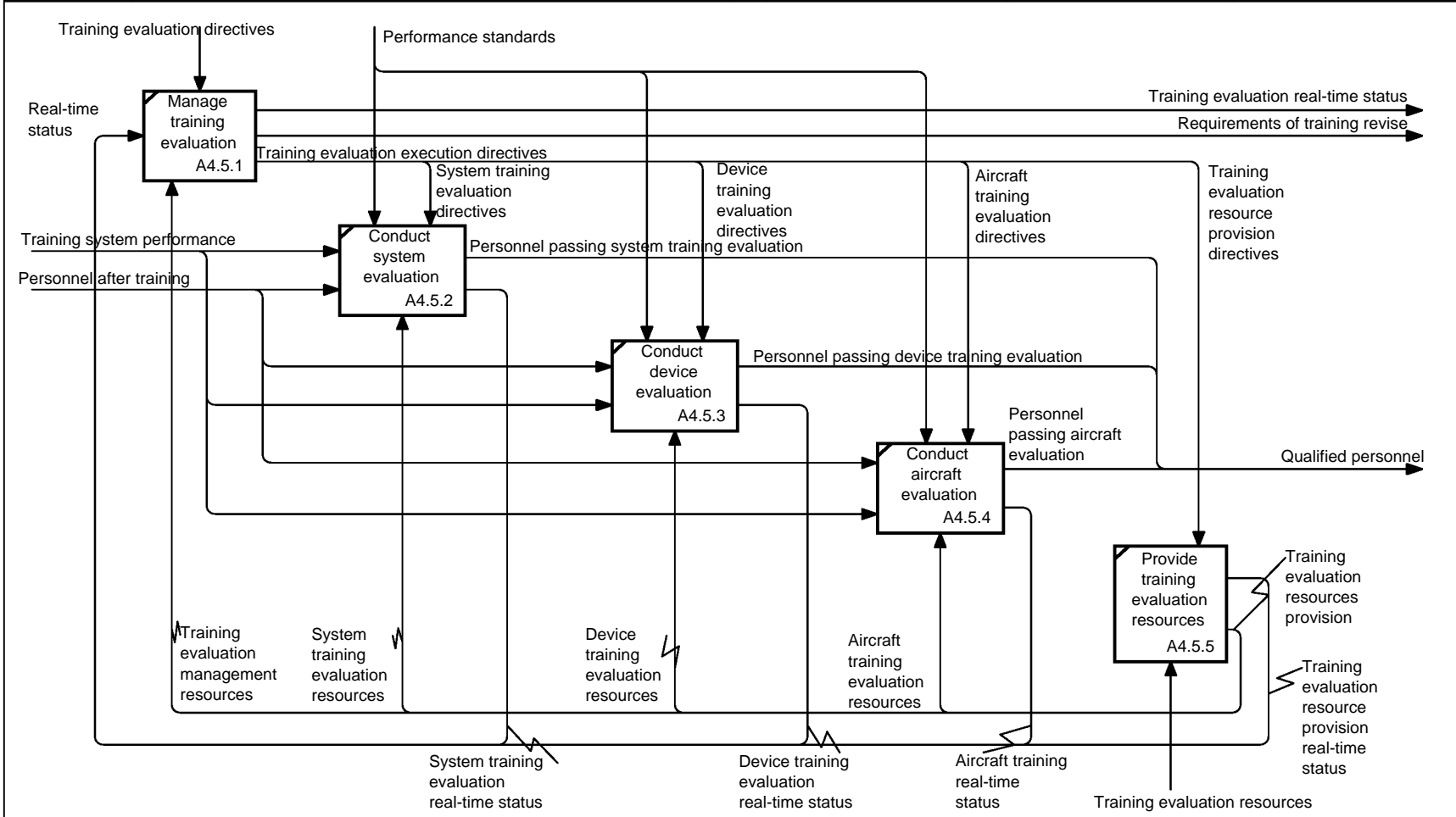

NODE: <b>A4.5</b>	TITLE: <b>Evaluate training</b>	NUMBER:
----------------------	------------------------------------	---------

## 4.25 A4.5—EVALUATE TRAINING.

### 4.25.1 A4.5.1—Manage Training Evaluation.

This function directs, schedules, and coordinates the following component activities of training evaluation:

- Conduct system evaluation
- Conduct device training evaluation
- Conduct aircraft evaluation
- Provide training evaluation resources

It provides directives, defines requirements and controls for the execution of those activities, and also checks that the execution is done in accordance with company policies and procedures and any required regulations for these activities. This activity also provides controls (on-line/off-line directives) to other process modules.

### 4.25.2 A4.5.2—Conduct System Evaluation.

This function evaluates, by using systems evaluation guidelines, personnel's knowledge of aircraft equipment, aircraft systems, system operations, system performance, and limitations.

### 4.25.3 A4.5.3—Conduct Device Training Evaluation.

This function evaluates, by using devices, personnel's competency in operating, working with, and dealing with those devices.

### 4.25.4 A4.5.4—Conduct Aircraft Evaluation.

This function evaluates, by using aircraft, personnel's competency in operating, working with, and dealing with the aircraft.

### 4.25.5 A4.5.5—Provide Training Evaluation Resources.

This function allocates and supplies available personnel, materials, equipment, tools, and any other required resources to support the execution of training evaluation.

USED AT:	AUTHOR: ACOSM team	DATE: 5/28/99	WORKING	READER	DATE	CONTEXT: A0
	PROJECT: Air Carrier Operations System Model	REV: 9/5/00	DRAFT			
	NOTES: 1 2 3 4 5 6 7 8 9 10		RECOMMENDED			
			PUBLICATION			

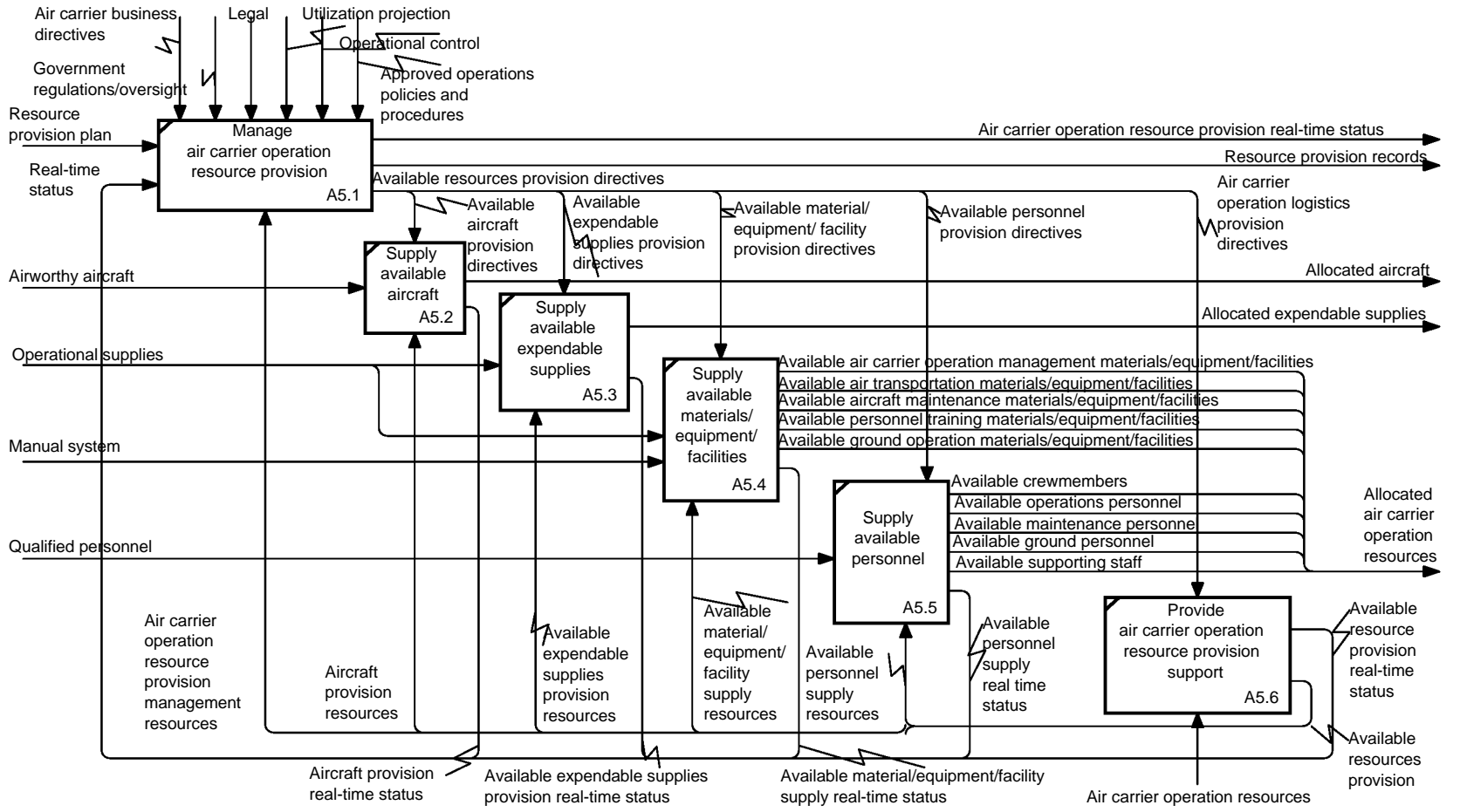

88

NODE: <b>A5</b>	TITLE: <b>Provide air carrier operation resources</b>	NUMBER:
--------------------	--	---------

#### 4.26 A5—PROVIDE AIR CARRIER OPERATION RESOURCES.

##### 4.26.1 A5.1—Manage Air Carrier Operation Resource Provision.

This function directs, schedules, and coordinates the following component activities of air carrier operation resource provision:

- Supply available aircraft
- Supply available expendable supplies
- Supply available materials/equipment/facilities
- Supply available personnel
- Provide air carrier operation resource provision support

It provides directives, defines requirements and controls for the execution of those activities, and also checks that the execution is done in accordance with company policies and procedures and any required regulations for these activities. This activity also provides controls (on-line/off-line directives) to other process modules.

##### 4.26.2 A5.2—Supply Available Aircraft.

This function allocates and supplies available airworthy aircraft for air transportation.

##### 4.26.3 A5.3—Supply Available Expendable Supplies.

This function allocates and supplies available expendable supplies such as food, fuel, water, gas, and paper.

##### 4.26.4 A5.4—Supply Available Materials/Equipment/Facilities.

This function selects, allocates, and hands over available parts, materials, tools, facilities, and equipment to support the execution of air transportation such as flight, maintenance, personnel training, etc.

##### 4.26.5 A5.5—Supply Available Personnel.

This function supplies and allocates available human resources to support the execution of air carrier operations.

4.26.6 A5.6—Provide Air Carrier Operation Resource Provision Support.

This function allocates and supplies available personnel, materials, equipment, tools, and any other required resources to support the execution of air carrier operation resource provision.

## 5. GLOSSARY.

**Abnormal aircraft in predeparture segment:** Aircraft in the unexpected situation after predeparture segment and before takeoff segment.

- Arrow Source (O): A2.4.2—Perform predeparture ground operations
- Arrow Destination (I): A2.4.9—Perform postarrival ground operations

**Abnormal aircraft before V1:** Aircraft under the unexpected situation during the takeoff segment before its speed reaches V1.

- Arrow Source (O): A2.4.3—Perform takeoff operations
- Arrow Destination (I): A2.4.9—Perform postarrival ground operations

**A/C after approach segment:** Aircraft just completing approach flight maneuver.

- Arrow Source (O): A2.4.7—Perform approach operations
- Arrow Destination (I): A2.4.8—Perform landing operations

**A/C after climb segment:** Aircraft just completing climb flight maneuver.

- Arrow Source (O): A2.4.4.3—Perform normal climb operations
- Arrow Destination (I): A2.4.5—Perform cruise operations

**A/C after cruise segment:** Aircraft just completing en route cruise flight maneuver.

- Arrow Source (O): A2.4.5—Perform cruise operations
- Arrow Destination (I): A2.4.6.2—Perform initial descent operations

**A/C after descent segment:** Aircraft just completing descent flight maneuver.

- Arrow Source (O): A2.4.6.3—Perform approach descent operations
- Arrow Destination (I): A2.4.7—Perform approach operations

**A/C after initial climb segment:** Aircraft just completing initial climb flight maneuver.

- Arrow Source (O): A2.4.4.2—Perform initial climb operations
- Arrow Destination (I): A2.4.4.3—Perform normal climb operations

**A/C after initial descent segment:** Aircraft just completing initial descent flight maneuver.

- Arrow Source (O): A2.4.6.2—Perform initial descent operations
- Arrow Destination (I): A2.4.6.3—Perform approach descent operations

**A/C after landing segment:** Aircraft just completing landing flight maneuver.

- Arrow Source (O): A2.4.8—Perform landing operations
- Arrow Destination (I): A2.4.9—Perform postarrival ground operations

**A/C after predeparture segment:** Aircraft just completing predeparture maneuver at departure airport.

- Arrow Source (O): A2.4.2—Perform predeparture ground operations
- Arrow Destination (I): A2.4.3.2—Perform takeoff prior to V1

**A/C after takeoff segment:** Aircraft just completing takeoff flight maneuver.

- Arrow Source (O): A2.4.3.3—Perform takeoff at/after V1
- Arrow Destination (I): A2.4.4.2—Perform initial climb operations

**A/C with the speed less than V1 during takeoff segment:** Aircraft moving on the runway for takeoff while its airspeed has not reach V1 yet.

- Arrow Source (O): A2.4.3.2—Perform takeoff prior to V1
- Arrow Destination (I): A2.4.3.3—Perform takeoff at/after V1

**Air carrier business directives:** Policies/procedures/instructions that air carriers use for business. The directives are originated from various factors of consideration such as:

- Adding new business segments
- Airline specifications
- Cost of living adjustments
- Customer services
- Delays
- Demographics
- Economics
- Environmental impacts
- Geographical issues
- Interchange/code share agreements
- Labor relations
- Marketing/financial information
- Mergers
- Modification commission
- Operational efficiency
- Purchasing
- Regulatory authority differences
- Reliability information
- Salary markets
- Security—domestic and international



- Tax base subsidies
- Wet leasing/dry leasing
- Arrow Source (C): { Border }
- Arrow Destination (C): A1.1—Manage air carrier operations coordination + A2.1—Manage air transportation + A5.1—Manage air carrier operation resource provision

**Air carrier operation logistics provision directives:** A set of policies/procedures/instructions that directs the logistics provision of air carrier operations.

- Arrow Destination (C): A5.6—Provide air carrier operation resource provision support

**Air carrier operation management directives:** A set of policies/procedures/instructions that directs the management of air carrier operations.

- Arrow Source (O): A1.1—Manage air carrier operations coordination

**Air carrier operation management resources:** The components necessary for the successful accomplishment of air carrier operation management. The components are defined as properly trained and certified personnel, adequate facilities, required information, material support, and any other required resources to accomplish the activity.

- Arrow Destination (M): A1.1—Manage air carrier operations coordination + A1.7—Provide air carrier operation management resources

**Air carrier operation management resources provision:** Allocation and supply of air carrier operation management resources

- Arrow Source (O): A1.7—Provide air carrier operation management resources

**Air carrier operation management resources provision directives:** A set of policies/procedures/instructions that directs the provision of air carrier operation management resources.

- Arrow Destination (C): A1.7—Provide air carrier operation management resources

**Air carrier operation management resources provision real-time status:** Real-time performance report during the execution of air carrier operation management resource provision.

- Arrow Source (O): A1.7—Provide air carrier operation management resources

**Air carrier operation real-time status:** Real-time performance report during the execution of air carrier operations.

- Arrow Destination (I): A1.2—Plan operations + A1.4—Project utilization + A1.3.3—Plan flight routes + A1.3.5—Assign crewmembers + A1.3.7—Perform maintenance control + A1.5.2—Collect & Process operational data + A1.6.2—Identify & effect operations policies + A1.3.6.1—Manage aircraft dispatch

**Air carrier operation resource provision management resources:** The components necessary for the successful accomplishment of air carrier operation resource provision management. The components are defined as properly trained and certified personnel, adequate facilities, required information, material support, and any other required resources to accomplish the activity.

- Arrow Destination (M): A5.1—Manage air carrier operation resource provision

**Air carrier operation resource provision real-time status:** Real-time performance report during the execution of air carrier operation resource provision.

- Arrow Source (O): A5.1—Manage air carrier operation resource provision

**Air carrier operation resources:** The components necessary for the successful accomplishment of air carrier operations. The components are defined as properly trained and certified personnel, adequate facilities, required information, materials, equipment, tools, and any other required resources to accomplish the activity.

- Arrow Source (M): { Border }
- Arrow Destination (M): A5—Provide air carrier operation resources

**Air transportation directives:** A set of policies/procedures/instructions to direct the air transportation.

- Arrow Source (O): A2.1—Manage air transportation

**Air transportation management resources:** The components necessary for the successful accomplishment of air transportation management. The components are defined as properly trained and certified personnel, adequate facilities, required information, material support, and any other required resources to accomplish the activity.

- Arrow Destination (M): A2.1—Manage air transportation

**Air transportation real-time status:** Real-time performance report during the execution of air transportation.

- Arrow Source (O): A2.1—Manage air transportation

**Air transportation resource provision real-time status:** Real-time performance report during the execution of air transportation resource provision.

- Arrow Source (O): A2.5—Provide air transportation resources

**Air transportation resources:** The components necessary for the successful accomplishment of air transportation. The components are defined as properly trained and certified personnel, adequate facilities, required information, materials, equipment, tools, and any other required resources to accomplish the activity.

- Arrow Destination (M): A2.5—Provide air transportation resources

**Air transportation resources provision:** Allocation and supply of air transportation resources.

- Arrow Source (O): A2.5—Provide air transportation resources

**Air transportation resources provision directives:** A set of policies/procedures/instructions that directs the provision of air transportation resource.

- Arrow Destination (C): A2.5—Provide air transportation resources

**Aircraft:** A device that is used or intended to be used for flight in the air (FAA CFR Part 1).

- Arrow Destination (M): A2.2.3—Perform in-flight services + A2.2.4—Perform deplaning services + A2.2.2.4—Provide seating services

**Aircraft aborted descent:** The preplanned descent maneuver of an aircraft which is terminated.

- Arrow Source (O): A2.4.6—Perform descent operations
- Arrow Destination (I): A2.4.4—Perform climb operations

**Aircraft acquisition:** Aircraft newly joining the fleet.

- Arrow Source (I): { Border }
- Arrow Destination (I): A3.2.2—Detect aircraft discrepancies

**Aircraft after cargo loaded/unloaded:** Aircraft after cargo is placed onboard or unloaded after the aircraft parks.

- Arrow Source (O): A2.3.3.4—Load/unload cargo

**Aircraft after consumables replenishment:** Aircraft after some consumables are replenished, for example, fuel for aircraft, oxygen for crewmember and passengers, nitrogen for aircraft tires, and so forth.

- Arrow Source (O): A2.3.4—Replenish consumables

**Aircraft after ground services:** Aircraft after being loaded/unloaded, deiced, or cleaned.

- Arrow Source (O): A2.3.6—Perform deicing/anti-icing program
- Arrow Destination (I): A2.4.2—Perform predeparture ground operations

**Aircraft after line services:** Aircraft after its supplies are replenished and its cabin is cleaned.

- Arrow Source (O): A2.3.5—Perform line services

**Aircraft after repair:** Aircraft after its discrepancies are corrected.

- Arrow Source (O): A3.3.3.2—Perform aircraft repair
- Arrow Destination (I): A3.3.3.3—Perform aircraft test & evaluation

**Aircraft assignment:** Assignment to aircraft by “N” number and gate number for carrying out certain flight task.

- Arrow Source (O): A1.3.6.3—Sign dispatch release
- Arrow Destination (C): A1.3.6.4—Monitor flight

**Aircraft discrepancy detection directives:** A set of policies/procedures/instructions that directs the detection of aircraft discrepancies.

- Arrow Destination (C): A3.2.2—Detect aircraft discrepancies

**Aircraft discrepancy detection real-time status:** Real-time performance report during the execution of aircraft discrepancy detection.

- Arrow Source (O): A3.2.2—Detect aircraft discrepancies

**Aircraft discrepancy detection resources:** The components necessary for the successful accomplishment of aircraft discrepancy detection. The components are defined as properly trained and certified personnel, adequate facilities, required information, materials, equipment, tools, and any other required resources to accomplish the activity.

- Arrow Destination (M): A3.2.2—Detect aircraft discrepancies

**Aircraft discrepancy diagnosis directives:** A set of policies/procedures/instructions directs the diagnosis of aircraft discrepancy.

- Arrow Destination (C): A3.2.3—Diagnose aircraft discrepancies

**Aircraft discrepancy diagnosis real-time status:** Real-time performance report during the execution of aircraft discrepancy diagnosis.

- Arrow Source (O): A3.2.3—Diagnose aircraft discrepancies

**Aircraft discrepancy diagnosis resources:** The components necessary for the successful accomplishment of aircraft discrepancy diagnosis. The components are defined as properly trained and certified personnel, adequate facilities, required information, materials, equipment, tools, and any other required resources to accomplish the activity.

- Arrow Destination (M): A3.2.3—Diagnose aircraft discrepancies

**Aircraft discrepancy evaluation directives:** A set of policies/procedures/instructions that directs the evaluation of aircraft discrepancy.

- Arrow Destination (C): A3.2.4—Evaluate aircraft discrepancies

**Aircraft discrepancy evaluation real-time status:** Real-time performance report during the execution of aircraft discrepancy evaluation.

- Arrow Source (O): A3.2.4—Evaluate aircraft discrepancies

**Aircraft discrepancy evaluation resources:** The components necessary for the successful accomplishment of aircraft discrepancy evaluation. The components are defined as properly trained and certified personnel, adequate facilities, required information, materials, equipment, tools, and any other required resources to accomplish the activity.

- Arrow Destination (M): A3.2.4—Evaluate aircraft discrepancies

**Aircraft dispatch directives:** A set of policies/procedures/instructions that directs aircraft dispatch.

- Arrow Destination (C): A1.3.6.1—Manage aircraft dispatch

**Aircraft dispatch execution directives:** A set of policies/procedures/instructions to direct the execution of aircraft dispatch.

- Arrow Source (O): A1.3.6.1—Manage aircraft dispatch

**Aircraft dispatch management resources:** The components necessary for the successful accomplishment of aircraft dispatch management. The components are defined as properly trained and certified personnel, adequate facilities, required information, material support, and any other required resources to accomplish the activity.

- Arrow Destination (M): A1.3.6.1—Manage aircraft dispatch

**Aircraft dispatch real-time status:** Real-time performance report during the execution of aircraft dispatch.

- Arrow Source (O): A1.3.6.1—Manage aircraft dispatch

**Aircraft dispatch resource provision directives:** A set of policies/procedures/instructions that directs the provision of aircraft dispatch resources.

- Arrow Destination (C): A1.3.6.5—Provide aircraft dispatch resources

**Aircraft dispatch resources:** The components necessary for the successful accomplishment of aircraft dispatch. The components are defined as properly trained and certified personnel, adequate facilities, required information, materials, equipment, tools, and any other required resources to accomplish the activity.

- Arrow Destination (M): A1.3.6.5—Provide aircraft dispatch resources

**Aircraft dispatch resources provision real-time status:** Real-time performance report during the execution of aircraft dispatch resources provision.

- Arrow Source (O): A1.3.6.5—Provide aircraft dispatch resources

**Aircraft evaluation execution directives:** A set of policies/procedures/instructions to direct the execution of aircraft evaluation.

- Arrow Source (O): A3.2.1—Manage aircraft evaluation

**Aircraft evaluation management resources:** The components necessary for the successful accomplishment of aircraft evaluation management. The components are defined as properly trained and certified personnel, adequate facilities, required information, material support, and any other required resources to accomplish the activity.

- Arrow Destination (M): A3.2.1—Manage aircraft evaluation

**Aircraft evaluation real-time status:** Real-time performance report during the execution of aircraft evaluation.

- Arrow Source (O): A3.2.1—Manage aircraft evaluation

**Aircraft evaluation resource provision directives:** A set of policies/procedures/instructions that directs the provision of aircraft evaluation resources.

- Arrow Destination (C): A3.2.5—Provide aircraft evaluation resources

**Aircraft evaluation resources:** The components necessary for the successful accomplishment of aircraft evaluation. The components are defined as properly trained and certified personnel, adequate facilities, required information, materials, equipment, tools, and any other required resources to accomplish the activity.

- Arrow Destination (M): A3.2.5—Provide aircraft evaluation resources

**Aircraft evaluation resources provision:** Allocation and supply of aircraft evaluation resources.

- Arrow Source (O): A3.2.5—Provide aircraft evaluation resources

**Aircraft evaluation resources provision real-time status:** Real-time performance report during the execution of aircraft evaluation resources provision.

- Arrow Source (O): A3.2.5—Provide aircraft evaluation resources

**Aircraft for step climb:** Aircraft from cruise maneuver to climb maneuver.

- Arrow Source (O): A2.4.5—Perform cruise operations
- Arrow Destination (I): A2.4.4-Perform climb operations

**Aircraft information:** Data related to aircraft, such as:

- Approved Flight Manual (AFM) performances
- Approved Flight Manual (including airworthiness directives)
- Center of gravity
- Engine deterioration/derivative performance
- Fuel dumping capacity
- Maximum structural limits
- Specific fuel consumption
- Type and configuration
- Weights
- Arrow Source (I): { Border }
- Arrow Destination (I): A1.3.4—Perform load/fuel planning

**Aircraft maintenance directives:** A set of policies/procedures/instructions to direct the aircraft maintenance.

- Arrow Source (O): A3.1—Manage aircraft maintenance

**Aircraft maintenance management resources:** The components necessary for the successful accomplishment of aircraft maintenance management. The components are defined as properly trained and certified personnel, adequate facilities, required information, material support, and any required resources to accomplish the activity.

- Arrow Destination (M): A3.1—Manage aircraft maintenance

**Aircraft maintenance resource provision directives:** A set of policies/procedures/instructions that directs the provision of aircraft maintenance resources.

- Arrow Destination (C): A3.4—Provide aircraft maintenance resources

**Aircraft maintenance resources (insource & outsource):** The components necessary for the successful accomplishment of aircraft maintenance. The components are defined as properly

trained and certified personnel, adequate facilities, required information, materials, equipment, tools, and any other required resources to accomplish the activity.

- Arrow Destination (M): A3.4—Provide aircraft maintenance resources

**Aircraft maintenance resources provision:** Allocation and supply of aircraft maintenance resources.

- Arrow Source (O): A3.4—Provide aircraft maintenance resources

**Aircraft maintenance resources provision real-time status:** Real-time performance report during the execution of aircraft maintenance resources provision.

- Arrow Source (O): A3.4—Provide aircraft maintenance resources

**Aircraft on go-ground:** Aircraft under the instruction of a pilot to abandon his approach to landing. Additional instructions may follow. Unless otherwise advised by ATC, a Visual Flight Rules (VFR) aircraft or an aircraft conducting visual approach should overfly the runway while climbing to traffic pattern altitude and enter the traffic pattern via the crosswind leg. A pilot on an Instrument Flight Rules (IFR) flight plan making an instrument approach should execute the published missed approach procedure or proceed as instructed by ATC; e.g., “Go around” (additional instructions if required).

- Arrow Source (O): A2.4.8—Perform landing operations
- Arrow Destination (I): A2.4.3—Perform takeoff operations

**Aircraft on missed approach:** Aircraft under the maneuver conducted by a pilot when an instrument approach cannot be completed to a landing. The route of flight and altitude are shown on instrument approach procedure charts. A pilot executing a missed approach prior to the Missed Approach Point (MAP) must continue along the final approach to the MAP. The pilot may climb immediately to the altitude specified in the missed approach procedure.

- Arrow Source (O): A2.4.7—Perform approach operations
- Arrow Destination (I): A2.4.3—Perform takeoff operations

**Aircraft operation directives:** A set of policies/procedures/instructions that directs operating flight.

- Arrow Destination (C): A2.4.1—Manage aircraft operations

**Aircraft operation execution directives:** A set of policies/procedures/instructions to direct the execution of aircraft operations.

- Arrow Source (O): A2.4.1—Manage aircraft operations



**Aircraft operation management resources:** The components necessary for the successful accomplishment of aircraft operation management. The components are defined as properly trained and certified personnel, adequate facilities, required information, material support, and any other required resources to accomplish the activity.

- Arrow Destination (M): A2.4.1—Manage aircraft operations

**Aircraft operation real-time status:** Real-time performance report during the execution of flight operations.

- Arrow Source (O): A2.4.1—Manage aircraft operations

**Aircraft operation resources:** The components necessary for the successful accomplishment of flight operations. The components are defined as properly trained and certified personnel, adequate facilities, required information, materials, equipment, tools, and any other required resources to accomplish the activity.

- Arrow Destination (M): A2.4.10—Provide aircraft operation resources

**Aircraft operation resource provision directives:** A set of policies/procedures/instructions to direct the aircraft operation resource provision.

- Arrow Destination (C): A2.4.10—Provide aircraft operation resources

**Aircraft operation resources provision:** Allocation and supply of aircraft operation resources.

- Arrow Source (O): A2.4.10—Provide aircraft operation resources

**Aircraft operation resources provision real-time status:** Real-time performance report during the execution of aircraft operation resources provision.

- Arrow Source (O): A2.4.10—Provide aircraft operation resources

**Aircraft part information:** Data related to aircraft parts such as identification, manufacturer, price, specifications, appropriate records, and so forth.

- Arrow Source (I): { Border }
- Arrow Destination (I): A3.3.4.2—Perform configuration control + A3.3.4.3—Assess aircraft components + A3.3.4.4—Perform part usage analysis

**Aircraft provision real-time status:** Real-time performance report during the execution of aircraft provision.

- Arrow Source (O): A5.2—Supply available aircraft

**Aircraft provision resources:** The components necessary for the successful accomplishment of aircraft provision. The components are defined as properly trained and certified personnel, adequate facilities, required information, materials, equipment, tools, and any other required resources to accomplish the activity.

- Arrow Destination (M): A5.2—Supply available aircraft

**Aircraft records:** The document recording an aircraft's history for maintenance reference.

- Arrow Source (O): A1.1—Manage air carrier operations coordination
- Arrow Destination (I): A3.1—Manage aircraft maintenance + A3.2.2—Detect aircraft discrepancies + A3.2.3—Diagnose aircraft discrepancies

**Aircraft repair directives:** A set of policies/procedures/instructions that directs aircraft repair.

- Arrow Destination (C): A3.3.3.2—Perform aircraft repair

**Aircraft repair real-time status:** Real-time performance report during the execution of aircraft repair.

- Arrow Source (O): A3.3.3.2—Perform aircraft repair

**Aircraft repair resources:** The components necessary for the successful accomplishment of aircraft repair. The components are defined as properly trained and certified personnel, adequate facilities, required information, materials, equipment, tools, and any other required resources to accomplish the activity.

- Arrow Destination (M): A3.3.3.2—Perform aircraft repair

**Aircraft test and evaluation directives:** A set of policies/procedures/instructions that directs aircraft testing.

- Arrow Destination (C): A3.3.3.3—Perform aircraft test & evaluation

**Aircraft test and evaluation real-time status:** Real-time performance report during the execution of aircraft testing.

- Arrow Source (O): A3.3.3.3—Perform aircraft test & evaluation

**Aircraft test and evaluation resources:** The components necessary for the successful accomplishment of aircraft testing. The components are defined as properly trained and certified personnel, adequate facilities, required information, materials, equipment, tools, and any other required resources to accomplish the activity.

- Arrow Destination (M): A3.3.3.3—Perform aircraft test & evaluation

**Aircraft to be evaluated:** Aircraft to be checked after flight to determine if it is necessary to be maintained.

- Arrow Source (O): A2.4.9—Perform postarrival ground operations
- Arrow Destination (I): A3.2.2—Detect aircraft discrepancies

**Aircraft training directives:** A set of policies/procedures/instructions that directs aircraft training.

- Arrow Destination (C): A4.4.5—Conduct aircraft training

**Aircraft training evaluation directives:** A set of policies/procedures/instructions that directs aircraft training evaluation.

- Arrow Destination (C): A4.5.4—Conduct aircraft evaluation

**Aircraft training evaluation resources:** The components necessary for the successful accomplishment of aircraft training evaluation. The components are defined as properly trained and certified personnel, adequate facilities, required information, materials, equipment, tools, and any other required resources to accomplish the activity.

- Arrow Destination (M): A4.5.4—Conduct aircraft evaluation

**Aircraft training real-time status:** Real-time performance report during the execution of aircraft training.

- Arrow Source (O): A4.5.4—Conduct aircraft evaluation

**Aircraft training resources:** The components necessary for the successful accomplishment of aircraft training. The components are defined as properly trained and certified personnel, adequate facilities, required information, materials, equipment, tools, and any other required resources to accomplish the activity.

- Arrow Destination (M): A4.4.5—Conduct aircraft training

**Aircraft with clearly identified discrepancies:** Aircraft with discrepancies that have been clearly identified.

- Arrow Source (O): A3.2.3—Diagnose aircraft discrepancies
- Arrow Destination (I): A3.2.5—Provide aircraft evaluation resources

**Aircraft with discrepancies:** Aircraft with unacceptable performance.

- Arrow Source (O): A3.2.2—Detect aircraft discrepancies
- Arrow Destination (I): A3.2.3—Diagnose aircraft discrepancies

**Airport information:** Information about the airport, such as:

- Aerodrome obstacle charts
- Arrival/departure slots
- Crash fire rescue capability
- Gate availability
- Load bearing capacity
- Runway length
- Security status
- Special procedures
  
- Arrow Source (I): { Border }
  
- Arrow Destination (I): A1.3.3—Plan flight routes + A1.3.4—Perform load/fuel planning + A1.5.2—Collect & Process operational data + A1.6.2—Identify & effect operational policies

**Airports:** An area of land or water that is used or intended to be used for the landing and takeoff of aircraft and includes its buildings and facilities, if any (FAA CFR Part 1).

- Arrow Source (M): { Border }
  
- Arrow Destination (M): A2.4.2—Perform predeparture ground operations + A2.4.8—Perform landing operations + A2.4.9—Perform postarrival ground operations + A2.4.3.2—Perform takeoff prior to V1 + A3.3.2—Perform line maintenance

**Airworthy aircraft:** Aircraft in airworthy condition in which the aircraft, airframe, engine, propeller, accessories, and appliances meet their design and are in a condition for safe operations.

- Arrow Source (O): A3.2.2—Detect aircraft discrepancies + A3.3.2—Perform line maintenance + A3.3.3.3—Perform aircraft test & evaluation
  
- Arrow Destination (I): A5.2—Supply available aircraft

**Allocated air carrier operation resources:** The components available for the successful accomplishment of air carrier operations. The components are defined as properly trained and certified personnel, adequate facilities, required information, materials, equipment, tools, and any other required resources to accomplish the activity.

- Arrow Source (M): { Border }
- Arrow Destination (M): A5.6—Provide air carrier operation resource provision support

**Allocated aircraft:** Aircraft available for operations.

- Arrow Source (O): A5.2—Supply available aircraft
- Arrow Destination (I, I, M, I): A2.3.4—Replenish consumables + A2.3.5—Perform line services + A2.3.6—Perform deicing/anti-icing program + A2.3.2—Perform ground handling + A2.3.3.4—Load/unload cargo

**Allocated aircraft to be maintained:** Aircraft parked at maintenance site for either line maintenance or heavy/depot maintenance.

- Arrow Source (O): A3.2.5—Provide aircraft evaluation resources
- Arrow Destination (I): A3.3.2—Perform line maintenance + A3.3.3.2—Perform aircraft repair

**Allocated expendable supplies:** Expendable supplies such as fuel, oxygen, and nitrogen.

- Arrow Source (O): A5.3—Supply available expendable supplies
- Arrow Destination (I): A2.3.4—Replenish consumables + A2.3.5—Perform line services

**Allocated parts:** Aircraft components, which are new or repaired, arriving from vendors for receiving inspection. This inspection includes checking the physical condition of the parts and reviewing associated documents to ensure that they are properly maintained and approved.

- Arrow Source (O): A3.4—Provide aircraft maintenance resources
- Arrow Destination (I): A3.3.4.3—Assess aircraft components

**Allocated serviceable parts:** Serviceable aircraft components handed over and ready to be used for aircraft or component maintenance.

- Arrow Source (O): A3.3.5—Provide scheduled/nonscheduled aircraft maintenance resources
- Arrow Destination (I): A3.3.2—Perform line maintenance + A3.3.3.2—Perform aircraft repair + A3.3.4.3—Assess aircraft components

**Approach descent directives:** A set of policies/procedures/instructions that directs approach descent flight operations of aircraft.

- Arrow Destination (C): A2.4.6.3—Perform approach descent operations

**Approach descent real-time status:** Real-time performance report during the execution of approach descent operations of aircraft.

- Arrow Source (O): A2.4.6.3—Perform approach descent operations

**Approach descent resources:** The components necessary for the successful accomplishment of aircraft approach descent flight operations. The components are defined as properly trained and certified personnel, required information, and material support.

- Arrow Destination (M): A2.4.6.3—Perform approach descent operations

**Approach directives:** A set of policies/procedures/instructions that directs approach flight operations of aircraft.

- Arrow Destination (C): A2.4.7—Perform approach operations

**Approach real-time status:** Real-time performance report during the execution of approach operations.

- Arrow Source (O): A2.4.7—Perform approach operations

**Approach resources:** The components necessary for the successful accomplishment of aircraft approach flight operations. The components are defined as properly trained and certified personnel, required information, and material support

- Arrow Destination (M): A2.4.7—Perform approach operations

**Approved operations policies and procedures:** The policies and procedures that assure compliance with the Code of Federal Regulations and/or other regulatory authority requirements approved by FAA and/or air carrier's internal board.

- Arrow Source (O): A1.6.3—Develop & evaluate operation policies & procedures
- Arrow Destination (C): A2.1—Manage air transportation + A3.1—Manage aircraft maintenance + A5.1—Manage air carrier operation resource provision + A4.4.1—Manage training implementation

**Assignment of provider:** Appointment to training provider to provide training for the personnel.

- Arrow Source (O): A4.3.4—Select training provider
- Arrow Destination (C): A4.3.5—Develop training curriculum

**ATC facilities:** Facilities that provide air traffic control services. These services are services to promote the safe, orderly, and expeditious flow of air traffic within a national airspace system.

- Arrow Source (M): { Border }
- Arrow Destination (M): A2.4.2—Perform predeparture ground operations + A2.4.5—Perform cruise operations + A2.4.7—Perform approach operations + A2.4.8—Perform landing operations + A2.4.9—Perform postarrival ground operations + A2.4.3.2—

Perform takeoff prior to V1 + A2.4.3.3—Perform takeoff after V1 + A2.4.6.3—Perform initial climb operations + A2.4.4.3—Perform normal climb operations + A2.4.6.2—Perform initial descent operations + A2.4.6.3—Perform approach descent operations

**ATC information:** Information about ATC used for operational policy and procedure development.

- Arrow Source (I): { Border }
- Arrow Destination (I): A1.6.2—Identify & effect operation policies + A1.3.6.4—Monitor flight

**ATC instructions:** Directives issued by air traffic control for the purpose of requiring a pilot to take specific actions; e.g., “turn left heading two five zero,” “go-around,” “clear the runway.”

- Arrow Source (C): { Border }
- Arrow Destination (C): A2.4.2—Perform predeparture ground operations + A2.4.5—Perform cruise operations + A2.4.7—Perform approach operations + A2.4.8—Perform landing operations + A2.4.9—Perform postarrival ground operations + A2.4.3.2—Perform takeoff prior to V1 + A2.4.3.3—Perform takeoff after V1 + A2.4.6.3—Perform initial climb operations + A2.4.6.2—Perform initial descent operations

**Available air carrier operation management materials/equipment/facilities:** Available materials, equipment, and facility used as resources for supporting the management of air carrier operations.

- Arrow Source (O): A5.4—Supply available materials/equipment/facilities

**Available air transportation materials/equipment/facilities:** Available materials, equipment, and facility used as resources for supporting air transportation.

- Arrow Source (O): A5.4—Supply available materials/equipment/facilities

**Available aircraft maintenance materials/equipment/facilities:** Available materials, equipment, and facility used as resources for supporting aircraft maintenance.

- Arrow Source (O): A5.4—Supply available materials/equipment/facilities

**Available aircraft provision directives:** A set of policies/procedures/instructions that directs the provision of available aircraft.

- Arrow Destination (C): A5.2—Supply available aircraft

**Available crewmembers:** Flight personnel available for conducting flight tasks.

- Arrow Source (O): A5.5—Supply available personnel

**Available expendable supplies provision directives:** A set of policies/procedures/instructions that directs expendable supplies provision.

- Arrow Destination (C): A5.3—Supply available expendable supplies

**Available expendable supplies provision real-time status:** Real-time performance report during the execution of expendable supplies provision.

- Arrow Source (O): A5.3—Supply available expendable supplies

**Available expendable supplies provision resources:** The components necessary for the successful accomplishment of available expendable supplies provision. The components are defined as properly trained and certified personnel, adequate facilities, required information, materials, equipment, tools, and any other required resources to accomplish the activity.

- Arrow Destination (M): A5.3—Supply available expendable supplies

**Available ground operation materials/equipment/facilities:** Available materials, equipment, and facility used as resources for supporting ground operations.

- Arrow Source (O): A5.4—Supply available materials/equipment/facilities

**Available ground personnel:** Personnel ready for conducting ground services.

- Arrow Source (O): A5.5—Supply available personnel

**Available maintenance personnel:** Personnel ready for conducting aircraft maintenance tasks.

- Arrow Source (O): A5.5—Supply available personnel

**Available material/equipment/facility provision directives:** A set of policies/procedures/instructions that directs the provision of available material, equipment, and facility resources.

- Arrow Destination (C): A5.4—Supply available materials/equipment/facilities

**Available material/equipment/facility supply real-time status:** Real-time performance report during the execution of available material, equipment, and facility resource supply.

- Arrow Source (O): A5.4—Supply available materials/equipment/facilities

**Available material/equipment/facility supply resources:** The components necessary for the successful accomplishment of available material/equipment/facility supply. The components are



defined as properly trained and certified personnel, adequate facilities, required information, materials, equipment, tools, and any other required resources to accomplish the activity.

- Arrow Destination (M): A5.4—Supply available materials/equipment/facilities

**Available operations personnel:** Personnel ready for conducting flight operations.

- Arrow Source (O): A5.5—Supply available personnel

**Available personnel provision directives:** A set of policies/procedures/instructions that directs available personnel provision. The directives are originated from various factors of considerations such as:

- Company ATC coordination
- Drug and Alcohol FAA Approved Program
- E.A.P.—Employee Assistance Program
- Environment, health, and safety
- Exempt/Nonexempt salary
- Family Assistance Act—victim assistance
- HAZMAT
- Job description and responsibility
- Management infrastructure
- P.R.I.A.—Pilots Records Improvement Act
- Security background check
- Substance Abuse Programs

- Arrow Destination (C): A5.5—Supply available personnel marketing and contracting

**Available personnel supply real-time status:** Real-time performance report during the execution of supplying available personnel.

- Arrow Source (O): A5.5—Supply available personnel

**Available personnel supply resources:** The components necessary for the successful accomplishment of available personnel supply. The components are defined as properly trained and certified personnel, required information, materials, equipment, tools, and any other required resources to accomplish the activity.

- Arrow Destination (M): A5.5—Supply available personnel

**Available personnel training materials/equipment/facilities:** Materials, equipment, and facilities used as resources for supporting personnel training.

- Arrow Source (O): A5.4—Supply available materials/equipment/facilities

**Available resource provision real-time status:** Real-time performance report during the execution of available resource provision.

- Arrow Source (O): A5.6—Provide air carrier operation resource provision support

**Available resources provision:** Allocation and supply of available resources.

- Arrow Source (O): A5.6—Provide air carrier operation resource provision support

**Available resources provision directives:** A set of instructions to direct the provision of available resources.

- Arrow Source (O): A5.1—Manage air carrier operation resource provision

**Available supporting staff:** Personnel, such as H.R., company medical advisor, interpreters, instructors, ready for conducting some support tasks.

- Arrow Source (O): A5.5—Supply available personnel

**Boarding service execution directives:** A set of policies/procedures/instructions to direct the execution of boarding services.

- Arrow Source (O): A2.2.2.1—Manage boarding services

**Boarding service management resources:** The components necessary for the successful accomplishment of boarding service management. The components are defined as properly trained and certified personnel, adequate facilities, required information, material support, and any other required resources to accomplish the activity.

- Arrow Destination (M): A2.2.2.1—Manage boarding services

**Boarding service real-time status:** Real-time performance report during the execution of passenger boarding.

- Arrow Source (O): A2.2.2.1—Manage boarding services

**Boarding service resource provision directives:** A set of policies/procedures/instructions that directs the provision of passenger boarding resource.

- Arrow Destination (C): A2.2.2.5—Provide boarding service resources

**Boarding service resources:** The components necessary for the successful accomplishment of boarding services. The components are defined as properly trained and certified personnel, adequate facilities, required information, materials, equipment, tools, and any other required resources to accomplish the activity.

- Arrow Destination (M): A2.2.2.5—Provide boarding service resources

**Boarding service resources provision:** Allocation and supply of boarding service resources.

- Arrow Source (O): A2.2.2.5—Provide boarding service resources

**Boarding service resources provision real-time status:** Real-time performance report during the execution of boarding service resources provision.

- Arrow Source (O): A2.2.2.5—Provide boarding service resources

**Continuous Airworthiness Maintenance Program (CAMP):** The Continuous Airworthiness Maintenance Program is a compilation of the individual maintenance and inspection functions utilized by an operator to fulfill its total maintenance needs. Authorization to use CAMP is documented by Operations Specifications—Aircraft Maintenance and is approved by the FAA. The basic elements of CAMP include aircraft inspection; scheduled maintenance; unscheduled maintenance; engine, propeller, and appliance repair and overhaul; structural inspection program/airframe overhaul; required inspection items (RII); and maintenance manuals.

- Arrow Source (O): A1.5.4—Modify maintenance program
- Arrow Destination (C): A2.3.4—Replenish consumables + A3.2.2—Detect aircraft discrepancies + A3.2.3—Diagnose aircraft discrepancies + A3.3.1—Manage scheduled/nonscheduled aircraft maintenance

**Cargo after check/weigh/screen:** Cargo meeting the safety requirement and ready for tie down.

- Arrow Source (O): A2.3.3.2—Check/weigh/screen cargo
- Arrow Destination (I): A2.3.3.3—Secure cargo

**Cargo after securing:** Cargo after being tied down.

- Arrow Source (O): A2.3.3.3—Secure cargo
- Arrow Destination (I): A2.3.3.4—Load/unload cargo

**Cargo check/weigh/screen directives:** A set of policies/procedures/instructions that directs cargo checking, weighing, and screening.

- Arrow Destination (C): A2.3.3.2—Check/weigh/screen cargo

**Cargo check/weigh/screen real-time status:** Real-time performance report during the execution of cargo checking, weighing, and screening.

- Arrow Source (O): A2.3.3.2—Check/weigh/screen cargo

**Cargo check/weigh/screen resources:** The components necessary for the successful accomplishment of cargo check/weigh/screen. The components are defined as properly trained

and certified personnel, adequate facilities, required information, materials, equipment, tools, and any other required resources to accomplish the activity.

- Arrow Destination (M): A2.3.3.2—Check/weigh/screen cargo

**Cargo-handling directives:** A set of policies/procedures/instructions that directs cargo handling.

- Arrow Destination (C): A2.3.3.1—Manage cargo handling

**Cargo-handling execution directives:** A set of policies/procedures/instructions that directs the execution of cargo handling.

- Arrow Source (O): A2.3.3.1—Manage cargo handling

**Cargo-handling management resources:** The components necessary for the successful accomplishment of cargo-handling management. The components are defined as properly trained and certified personnel, adequate facilities, required information, material support, and any other required resources to accomplish the activity.

- Arrow Destination (M): A2.3.3.1—Manage cargo handling

**Cargo-handling real-time status:** Real-time performance report during the execution of cargo handling.

- Arrow Source (O): A2.3.3.1—Manage cargo handling

**Cargo-handling resource provision directives:** A set of policies/procedures/instructions that directs the provision of cargo-handling resources.

- Arrow Destination (C): A2.3.3.5—Provide cargo-handling resources

**Cargo-handling resources:** The components necessary for the successful accomplishment of cargo handling. The components are defined as properly trained and certified personnel, adequate facilities, required information, materials, equipment, tools, and any other required resources to accomplish the activity.

- Arrow Destination (M): A2.3.3.5—Provide cargo-handling resources

**Cargo-handling resources provision:** Allocation and supply of cargo-handling resources.

- Arrow Source (O): A2.3.3.5—Provide cargo-handling resources

**Cargo-handling resources provision real-time status:** Real-time performance report during the execution of cargo-handling resource provision.

- Arrow Source (O): A2.3.3.5—Provide cargo-handling resources

**Cargo heading for aircraft:** Cargo to be loaded onto aircraft.

- Arrow Source (O): A2.3.2—Perform ground handling
- Arrow Destination (I): A2.3.3.2—Check/weigh/screen cargo

**Cargo leaving aircraft:** Cargo unloaded from aircraft.

- Arrow Source (O): A2.3.3.4—Load/unload cargo
- Arrow Destination (I): A2.3.2—Perform ground handling

**Cargo-loading/unloading resources:** The components necessary for the successful accomplishment of cargo loading/unloading. The components are defined as properly trained and certified personnel, adequate facilities, required information, materials, equipment, tools, and any other required resources to accomplish the activity.

- Arrow Destination (M): A2.3.3.4—Load/unload cargo

**Cargo-loading/unloading directives:** A set of policies/procedures/instructions that directs cargo loading and unloading.

- Arrow Destination (C): A2.3.3.4—Load/unload cargo

**Cargo-loading/unloading real-time status:** Real-time performance report during the execution of cargo loading and unloading.

- Arrow Source (O): A2.3.3.4—Load/unload cargo

**Cargo-securing directives:** A set of policies/procedures/instructions that directs cargo securing.

- Arrow Destination (C): A2.3.3.3—Secure cargo

**Cargo-securing real-time status:** Real-time performance report during the execution of cargo securing.

- Arrow Source (O): A2.3.3.3—Secure cargo

**Cargo-securing resources:** The components necessary for the successful accomplishment of cargo securing. The components are defined as properly trained and certified personnel, adequate facilities, required information, materials, equipment, tools, and any other required resources to accomplish the activity.

- Arrow Destination (M): A2.3.3.3—Secure cargo

**Check-in service directives:** A set of policies/procedures/instructions that directs passenger check-in services.

- Arrow Destination (C): A2.2.2.2—Provide check-in services

**Check-in service real-time status:** Real-time performance report during the execution of check-in services.

- Arrow Source (O): A2.2.2.2—Provide check-in services

**Check-in service resources:** The components necessary for the successful accomplishment of check-in services. The components are defined as properly trained and certified personnel, adequate facilities, required information, materials, equipment, tools, and any other required resources to accomplish the activity.

- Arrow Destination (M): A2.2.2.2—Provide check-in services

**Class training directives:** A set of policies/procedures/instructions that directs class training.

- Arrow Destination (C): A4.4.2—Conduct class training

**Class training real-time status:** Real-time performance report during the execution of class training.

- Arrow Source (O): A4.4.2—Conduct class training

**Class training resources:** The components necessary for the successful accomplishment of class training. The components are defined as properly trained and certified personnel, adequate facilities, required information, materials, equipment, tools, and any other required resources to accomplish the activity.

- Arrow Destination (M): A4.4.2—Conduct class training

**Clearly identified discrepancies:** Failures that have been clearly identified through various analysis techniques.

- Arrow Source (O): A3.2.3—Diagnose aircraft discrepancies
- Arrow Destination (I): A3.2.4—Evaluate aircraft discrepancies + A3.3.3.2—Perform aircraft repair

**Climb directives:** A set of policies/procedures/instructions that directs aircraft climb operations.

- Arrow Destination (C): A2.4.4.1—Manage climb operations

**Climb execution directives:** A set of policies/procedures/instructions to direct the execution of aircraft climb operations.

- Arrow Source (O): A2.4.4.1—Manage climb operations

**Climb management resources:** The components necessary for the successful accomplishment of aircraft climb flight management. The components are defined as properly trained and certified personnel, required information, material support, and any other required resources.

- Arrow Destination (M): A2.4.4.1—Manage climb operations

**Climb real-time status:** Real-time performance report during the execution of aircraft climb flight operations.

- Arrow Source (O): A2.4.4.1—Manage climb operations

**Climb resource provision directives:** A set of policies/procedures/instructions that directs climb flight resource provision.

- Arrow Destination (C): A2.4.4.4—Provide climb operation resources

**Climb resources:** The components necessary for the successful accomplishment of climb flight operations. The components are defined as properly trained and certified personnel, required information, and material support.

- Arrow Destination (M): A2.4.4.4—Provide climb operation resources

**Climb resources provision:** Allocation and supply of aircraft climb flight resources.

- Arrow Source (O): A2.4.4.4—Provide climb operation resources

**Climb resources provision real-time status:** Real-time performance report during the execution of aircraft climb flight resource provision.

- Arrow Source (O): A2.4.4.4—Provide climb operation resources

**Component assessment directives:** A set of policies/procedures/instructions that directs component assessment.

- Arrow Destination (C): A3.3.4.3—Assess aircraft components

**Component assessment real-time status:** Real-time performance report during the execution of component assessment.

- Arrow Source (O): A3.3.4.3—Assess aircraft components

**Component assessment resources:** The components necessary for the successful accomplishment of component assessment. The components are defined as properly trained and certified personnel, adequate facilities, required information, materials, equipment, tools, and any other required resources to accomplish the activity.

- Arrow Destination (M): A3.3.4.3—Assess aircraft components

**Component maintenance directives:** A set of policies/procedures/instructions that directs aircraft component maintenance.

- Arrow Destination (C): A3.3.4.1—Manage component maintenance

**Component maintenance execution directives:** A set of policies/procedures/instructions that directs the execution of component maintenance.

- Arrow Source (O): A3.3.4.1—Manage component maintenance

**Component maintenance management resources:** The components necessary for the successful accomplishment of aircraft component maintenance. The components are defined as properly trained and certified personnel, adequate facilities, required information, material support, and any other required resources to accomplish the activity.

- Arrow Destination (M): A3.3.4.1—Manage component maintenance

**Component maintenance real-time status:** Real-time performance report during the execution of aircraft component maintenance.

- Arrow Source (O): A3.3.4.1—Manage component maintenance

**Component maintenance resource provision directives:** A set of policies/procedures/instructions that directs aircraft component maintenance resource provision.

- Arrow Destination (C): A3.3.4.5—Provide component maintenance resources

**Component maintenance resource provision real-time status:** Real-time performance report during the execution of aircraft component maintenance resource provision.

- Arrow Source (O): A3.3.4.5—Provide component maintenance resources

**Component maintenance resources:** The components necessary for the successful accomplishment of aircraft component maintenance. The components are defined as properly trained and certified personnel, adequate facilities, required information, materials, equipment, tools, and any other required resources to accomplish the activity.

- Arrow Destination (M): A3.3.4.5—Provide component maintenance resources

**Component maintenance resources provision:** Allocation and supply of aircraft component maintenance resources.

- Arrow Source (O): A3.3.4.5—Provide component maintenance resources

**Component usage analysis directives:** A set of policies/procedures/instructions that directs aircraft component usage analysis.

- Arrow Destination (C): A3.3.4.4—Perform part usage analysis



**Component usage analysis resources:** The components necessary for the successful accomplishment of component usage analysis. The components are defined as properly trained and certified personnel, adequate facilities, required information, materials, equipment, tools, and any other required resources to accomplish the activity.

- Arrow Destination (M): A3.3.4.4—Perform part usage analysis

**Computer-based training real-time status:** Real-time performance report during the execution of computer-based training.

- Arrow Source (O): A4.4.3—Conduct computer-based training

**Computer-based training resources:** The components necessary for the successful accomplishment of computer-based training. The components are defined as properly trained and certified personnel, adequate facilities, required information, materials, equipment, tools, and any other required resources to accomplish the activity.

- Arrow Destination (M): A4.4.3—Conduct computer-based training

**Computer-based training directives:** A set of policies/procedures/instructions that directs computer-based training.

- Arrow Destination (C): A4.4.3—Conduct computer-based training

**Configuration control directives:** A set of policies/procedures/instructions that directs configuration control.

- Arrow Destination (C): A3.3.4.2—Perform configuration control

**Configuration control real-time status:** Real-time performance report during the execution of configuration control.

- Arrow Source (O): A3.3.4.2—Perform configuration control
- Arrow Destination (I): A3.3.4.1—Manage component maintenance

**Configuration control resources:** The components necessary for the successful accomplishment of configuration control. The components are defined as properly trained and certified personnel, adequate facilities, required information, materials, equipment, tools, and any other required resources to accomplish the activity.

- Arrow Destination (M): A3.3.4.2—Perform configuration control

**Consumable replenishment directives:** A set of policies/procedures/instructions that directs the replenishment of consumables such as fuel, gases, and liquids.

- Arrow Destination (C): A2.3.4—Replenish consumables

**Consumable replenishment real-time status:** Real-time performance report during the execution of consumable replenishment.

- Arrow Source (O): A2.3.4—Replenish consumables

**Consumable replenishment resources:** The components necessary for the successful accomplishment of consumable replenishment. The components are defined as properly trained and certified personnel, adequate facilities, required information, materials, equipment, tools, and any other required resources to accomplish the activity.

- Arrow Destination (M): A2.3.4—Replenish consumables

**Contractor support:** Efforts from contractors to support some activities with air carrier operations, for example, some contractor-based aircraft cleaning or maintenance efforts.

- Arrow Source (M): { Border }
- Arrow Destination (M): A3.1—Manage aircraft maintenance

**Crewmember assignment:** Selection of personnel to conduct certain tasks with consideration given to the crew's position, qualifications, crew pairing, flight, and duty time.

- Arrow Source (O): A1.3.5—Assign crewmembers

**Crewmember assignment directives:** A set of policies/procedures/instructions that directs crewmember assignment.

- Arrow Destination (C): A1.3.5—Assign crewmembers

**Crewmember assignment real-time status:** Real-time performance report during the execution of crewmember assignment.

- Arrow Source (O): A1.3.5—Assign crewmembers

**Crewmember assignment resources:** The components necessary for the successful accomplishment of crewmembers assignment. The components are defined as properly trained and certified personnel, adequate facilities, required information, materials, equipment, tools, and any other required resources to accomplish the activity.

- Arrow Destination (M): A1.3.5—Assign crewmembers

**Cruise directives:** A set of policies/procedures/instructions that directs aircraft cruise flight operations.

- Arrow Destination (C): A2.4.5—Perform cruise operations

**Cruise real-time status:** Real-time performance report during the execution of aircraft cruise flight operations.

- Arrow Source (O): A2.4.5—Perform cruise operations

**Cruise resources:** The components necessary for the successful accomplishment of aircraft cruise flight operations. The components are defined as properly trained and certified personnel, required information, and material support.

- Arrow Destination (M): A2.4.5—Perform cruise operations

**Deicing/anti-icing service real-time status:** Real-time performance report during the execution of performing deicing/anti-icing services.

- Arrow Source (O): A2.3.6—Perform deicing/anti-icing program

**Deicing/anti-icing service resources:** The components necessary for the successful accomplishment of deicing/anti-icing services. The components are defined as properly trained and certified personnel, adequate facilities, required information, materials, equipment, tools, and any other required resources to accomplish the activity.

- Arrow Destination (M): A2.3.6—Perform deicing/anti-icing program

**Deicing/anti-icing directives:** A set of policies/procedures/instructions that directs aircraft deicing/anti-icing.

- Arrow Destination (C): A2.3.6—Perform deicing/anti-icing program

**Deplaning service directives:** A set of policies/procedures/instructions that directs passenger deplaning services.

- Arrow Destination (C): A2.2.4—Perform deplaning services

**Deplaning service real-time status:** Real-time performance report during the execution of passenger deplaning services

- Arrow Source (O): A2.2.4—Perform deplaning services

**Deplaning service resources:** The components necessary for the successful accomplishment of deplaning services. The components are defined as properly trained and certified personnel, adequate facilities, required information, materials, equipment, tools, and any other required resources to accomplish the activity.

- Arrow Destination (M): A2.2.4—Perform deplaning services

**Descent directives:** A set of policies/procedures/instructions that directs aircraft descent flight operations.

- Arrow Destination (C): A2.4.6.1—Manage descent operations

**Descent management resources:** The components necessary for the successful accomplishment of aircraft descent flight management. The components are defined as properly trained and certified personnel, required information, material support, and any other required resources.

- Arrow Destination (M): A2.4.6.1—Manage descent operations

**Descent operation execution directives:** A set of policies/procedures/instructions that directs the execution of aircraft descent flight operations.

- Arrow Source (O): A2.4.6.1—Manage descent operations

**Descent real-time status:** Real-time performance report during the execution of aircraft descent flight operations.

- Arrow Source (O): A2.4.6.1—Manage descent operations

**Descent resource provision:** Allocation and supply of aircraft descent flight operation resources.

- Arrow Source (O): A2.4.6.4—Provide descent operation resources

**Descent resource provision directives:** A set of policies/procedures/instructions that directs aircraft descent flight operation resource provision.

- Arrow Destination (C): A2.4.6.4—Provide descent operation resources

**Descent resource provision real-time status:** Real-time performance report during the execution of aircraft descent flight operation resource provision.

- Arrow Source (O): A2.4.6.4—Provide descent operation resources

**Descent resources:** The components necessary for the successful accomplishment of aircraft descent flight operations. The components are defined as properly trained and certified personnel, adequate facilities, required information, and material support.

- Arrow Destination (M): A2.4.6.4—Provide descent operation resources

**Device-training evaluation directives:** A set of policies/procedures/instructions that directs device-training evaluation.

- Arrow Destination (C): A4.5.3—Conduct device evaluation

**Device-training evaluation real-time status:** Real-time performance report during the execution of device-training evaluation.

- Arrow Source (O): A4.5.3— Conduct device evaluation

**Device-training evaluation resources:** The components necessary for the successful accomplishment of device-training evaluation. The components are defined as properly trained and certified personnel, adequate facilities, required information, materials, equipment, tools, and any other required resources to accomplish the activity.

- Arrow Destination (M): A4.5.3— Conduct device evaluation

**Device/simulator training directives:** A set of policies/procedures/instructions that directs device/simulator training.

- Arrow Destination (C): A4.4.4—Conduct device/simulator training

**Device/simulator training real-time status:** Real-time performance report during the execution of device/simulator training.

- Arrow Source (O): A4.4.4—Conduct device/simulator training

**Device/simulator training resources:** The components necessary for the successful accomplishment of device/simulator training. The components are defined as properly trained and certified personnel, adequate facilities, required information, materials, equipment, tools, and any other required resources to accomplish the activity.

- Arrow Destination (M): A4.4.4—Conduct device/simulator training

**Dispatch aircraft resources provision:** Allocation and supply of dispatch aircraft resources.

- Arrow Source (O): A1.3.6.5—Provide aircraft dispatch resources

**Dispatch release signing directives:** A set of policies/procedures/instructions that directs signing of dispatch release.

- Arrow Destination (C): A1.3.6.3—Sign dispatch release

**Dispatch release signing real-time status:** Real-time performance report during the execution of signing dispatch release.

- Arrow Source (O): A1.3.6.3—Sign dispatch release

**Dispatch release signing resources:** The components necessary for the successful accomplishment of dispatch release signing. The components are defined as properly trained and certified personnel, adequate facilities, required information, and material support.

- Arrow Destination (M): A1.3.6.3—Sign dispatch release

**DMI:** Deferred Maintenance Items, are the inoperative equipment that allow an aircraft to continue a flight or series of flights based on an air carrier's approved Minimum Equipment List/Configuration Deviation List (MEL/CDL).

- Arrow Source (O): A1.3.7—Perform maintenance control
- Arrow Destination (I): A3.1—Manage aircraft maintenance + A1.3.4—Perform load/fuel planning

**Documentation:** Documents generated during the operations of an air carrier used for communicating with external organizations such as the FAA, Original Equipment Manufacturers (OEM), contractors, etc.

- Arrow Source (O): A1.1—Manage air carrier operations coordination
- Arrow Destination (O): { Border }

**Flight monitoring directives:** A set of policies/procedures/instructions that directs monitoring of flight.

- Arrow Destination (C): A1.3.6.4—Monitor flight

**Flight monitoring real-time status:** Real-time performance report during the execution of aircraft flight monitoring.

- Arrow Source (O): A1.3.6.4—Monitor flight

**Flight monitoring resources:** The components necessary for the successful accomplishment of flight monitoring. The components are defined as properly trained and certified personnel, adequate facilities, required information, materials, equipment, tools, and any other required resources to accomplish the activity.

- Arrow Destination (M): A1.3.6.4—Monitor flight

**Flight route planning directives:** A set of policies/procedures/instructions that directs planning of flight route.

- Arrow Destination (C): A1.3.3—Plan flight routes

**Flight route planning real-time status:** Real-time performance report during the execution of planning flight route.

- Arrow Source (O): A1.3.3—Plan flight routes

**Flight route planning resources:** The components necessary for the successful accomplishment of flight route planning. The components are defined as properly trained and

certified personnel, adequate facilities, required information, materials, equipment, tools, and any other required resources to accomplish the activity.

- Arrow Destination (M): A1.3.3—Plan flight routes

**Flight routes:** Route information, such as en route, altitude, and alternative route, for aircraft to follow during the flight.

- Arrow Source (O): A1.3.3—Plan flight routes
- Arrow Destination (I): A1.3.4—Perform load/fuel planning

**Flight schedule:** Operationalized marketing plan that integrates marketing data and requests to serve markets (why, where, when) with real world tactics, as in performance engineering, such as what plane, what fuel, and how long of a flight, used for operational control.

- Arrow Source (O): A1.2—Plan operations
- Arrow Destination (I): A1.3.3—Plan flight routes + A1.3.4—Perform load/fuel planning + A1.3.5—Assign crewmembers + A1.3.6.2—Create & deliver preflight package

**Flyaway kit:** Records tracking parts usage and failure data used to identify items contained in the flyaway kit.

- Arrow Source (O): A3.3.4.4—Perform part usage analysis
- Arrow Destination (I): A3.3.4.2—Perform configuration control

**GMM:** General Maintenance Manual, or equivalent, that contains the policies and procedures of the air carrier dealing with organizational matters, the policies of the maintenance section, and procedures for the administration of the continuous airworthiness program, test flight requirements, and any other subjects that are peculiar to each individual operator.

- Arrow Source (O): A1.5.3—Perform technical evaluation
- Arrow Destination (C): A3.1—Manage aircraft maintenance + A2.3.1—Manage ground operations + A3.2.2—Detect aircraft discrepancies + A3.2.3—Diagnose aircraft discrepancies + A3.3.3.2—Perform aircraft repair + A3.3.3.3—Perform aircraft test & evaluation

**GOM:** General Operation Manual, or equivalent, that contains the policies and operational segment of the air carrier's manual dealing with organizational matters, the policies of the operational section, the administration of the flight, dispatch, ground operations, training, personnel scheduling, flight safety, and any other subjects that are peculiar to each individual operator such as personnel selection criteria, operation specification changes, and organization changes, etc.

- Arrow Source (O): A1.6.3—Develop & evaluate operation policies & procedures

- Arrow Destination (C): A2.4.2—Perform predeparture ground operations + A2.4.5—Perform cruise operations + A2.4.7—Perform approach operations + A2.4.8—Perform landing operations + A2.4.9—Perform postarrival ground operations + A2.4.3.2—Perform takeoff prior to V1 + A2.4.3.3—Perform takeoff after V1 + A2.4.6.3—Perform initial climb operations + A2.4.6.2—Perform initial descent operations

**Government regulations/oversight:** A set of documents from applicable governments to regulate air carrier operations, including the activities by the applicable governments to assure compliance with the requirements of those documents and the operator’s manual. The operator’s program should be adjusted as required.

- Arrow Source (C): { Border }
- Arrow Destination (C): A5.1—Manage air carrier operation resource provision + A1.5.1—Manage maintenance policy & procedure development + A1.6.1—Manage operations policy & procedure development

**Ground-handling directives:** A set of policies/procedures/instructions that directs ground handling.

- Arrow Destination (C): A2.3.2—Perform ground handling

**Ground-handling real-time status:** Real-time performance report during the execution of ground transportation.

- Arrow Source (O): A2.3.2—Perform ground handling

**Ground-handling resources:** The components necessary for the successful accomplishment of ground handling. The components are defined as properly trained and certified personnel, adequate facilities, required information, materials, equipment, tools, and any other required resources to accomplish the activity.

- Arrow Destination (M): A2.3.2—Perform ground handling

**Ground operation directives:** A set of policies/procedures/instructions that directs ground operations. This includes marshalling.

- Arrow Destination (C): A2.3.1—Manage ground operations

**Ground operation execution directives:** A set of policies/procedures/instructions that directs the execution of ground operations.

- Arrow Source (O): A2.3.1-Manage ground operations

**Ground operation management resources:** The components necessary for the successful accomplishment of ground operation management. The components are defined as properly



trained and certified personnel, adequate facilities, required information, material support, and any other required resources to accomplish the activity.

- Arrow Destination (M): A2.3.1—Manage ground operations

**Ground operation real-time status:** Real-time performance report during the execution of ground operations.

- Arrow Source (O): A2.3.1—Manage ground operations

**Ground operation resource provision directives:** A set of policies/procedures/instructions that directs the provision of ground operation resources.

- Arrow Destination (C): A2.3.7—Provide ground operation resources

**Ground operation resource provision real-time status:** Real-time performance report during the execution of ground operation resource provision.

- Arrow Source (O): A2.3.7—Provide ground operation resources

**Ground operation resources:** The components necessary for the successful accomplishment of ground operations. The components are defined as properly trained and certified personnel, adequate facilities, required information, materials, equipment, tools, and any other required resources to accomplish the activity.

- Arrow Destination (M): A2.3.7—Provide ground operation resources

**Ground operation resources provision:** Allocation and supply of ground operation resources.

- Arrow Source (O): A2.3.7—Provide ground operation resources

**Heavy/depot maintenance directives:** A set of policies/procedures/instructions that directs heavy/depot maintenance.

- Arrow Destination (C): A3.3.3.1—Manage heavy/depot maintenance + A3.3.3.4—Provide heavy/depot maintenance resources

**Heavy/depot maintenance execution directives:** A set of policies/procedures/instructions that directs the execution of heavy/depot maintenance.

- Arrow Source (O): A3.3.3.1—Manage heavy/depot maintenance

**Heavy/depot maintenance management resources:** The components necessary for the successful accomplishment of heavy/depot maintenance management. The components are defined as properly trained and certified personnel, adequate facilities, required information, material support, and any other required resources to accomplish the activity.

- Arrow Destination (M): A3.3.3.1—Manage heavy/depot maintenance

**Heavy/depot maintenance real-time status:** Real-time performance report during the execution of heavy/depot maintenance.

- Arrow Source (O): A3.3.3.1—Manage heavy/depot maintenance

**Heavy/depot maintenance resources:** The components necessary for the successful accomplishment of heavy/depot maintenance. The components are defined as properly trained and certified personnel, adequate facilities, required information, materials, equipment, tools, and any other required resources to accomplish the activity.

- Arrow Destination (M): A3.3.3.4—Provide heavy/depot maintenance resources

**Heavy/depot maintenance resources provision:** Allocation and supply of heavy/depot maintenance resources.

- Arrow Source (O): A3.3.3.4—Provide heavy/depot maintenance resources

**Heavy/depot maintenance resources provision real-time status:** Real-time performance report during the execution of heavy/depot maintenance resources provision.

- Arrow Source (O): A3.3.3.4—Provide heavy/depot maintenance resources

**In-flight service directives:** A set of policies/procedures/instructions that directs in-flight services.

- Arrow Destination (C): A2.2.3—Perform in-flight services

**In-flight service real-time status:** Real-time performance report during the execution of in-flight services.

- Arrow Source (O): A2.2.3—Perform in-flight services

**In-flight service resources:** The components necessary for the successful accomplishment of in-flight services. The components are defined as properly trained and certified personnel, adequate facilities, required information, materials, equipment, tools, and any other required resources to accomplish the activity.

- Arrow Destination (M): A2.2.3—Perform in-flight services

**Initial climb directives:** A set of policies/procedures/instructions that directs aircraft initial climb flight operations.

- Arrow Destination (C): A2.4.4.2—Perform initial climb operations

**Initial climb real-time status:** Real-time performance report during the execution of aircraft initial climb flight operations.

- Arrow Source (O): A2.4.4.2—Perform initial climb operations

**Initial climb resources:** The components necessary for the successful accomplishment of aircraft climb flight operations. The components are defined as properly trained and certified personnel, required information, and material support.

- Arrow Destination (M): A2.4.4.2—Perform initial climb operations

**Initial descent directives:** A set of policies/procedures/instructions that directs aircraft initial descent flight operations.

- Arrow Destination (C): A2.4.6.2—Perform initial descent operations

**Initial descent real-time status:** Real-time performance report during the execution of aircraft initial descent flight operations.

- Arrow Source (O): A2.4.6.2—Perform initial descent operations

**Initial descent resources:** The components necessary for the successful accomplishment of aircraft initial descent flight. The components are defined as properly trained and certified personnel, required information, and material support.

- Arrow Destination (M): A2.4.6.2—Perform initial descent operations

**Job task description:** A description of the job task, including its contents, requirements, and goals.

- Arrow Source (O): A4.1—Manage personnel training
- Arrow Destination (I): A4.2—Identify & analyze training requirements

**Landing directives:** A set of policies/procedures/instructions that directs aircraft landing operations.

- Arrow Destination (C): A2.4.8—Perform landing operations

**Landing real-time status:** Real-time performance report during the execution of aircraft landing operations.

- Arrow Source (O): A2.4.8—Perform landing operations

**Landing resources:** The components necessary for the successful accomplishment of aircraft landing. The components are defined as properly trained and certified personnel, required information, and material support.

- Arrow Destination (M): A2.4.8—Perform landing operations

**Legal:** A framework to regulate the organization's activities to ensure their compliance with the law.

- Arrow Source (C): { Border }

- Arrow Destination (C): A1.1—Manage air carrier operations coordination + A5.1—Manage air carrier operation resource provision

**Line maintenance directives:** A set of policies/procedures/instructions that directs line maintenance.

- Arrow Destination (C): A3.3.2—Perform line maintenance

**Line maintenance real-time status:** Real-time performance report during the execution of line maintenance.

- Arrow Source (O): A3.3.2—Perform line maintenance

**Line maintenance resources:** The components necessary for the successful accomplishment of line maintenance. The components are defined as properly trained and certified personnel, adequate facilities, required information, materials, equipment, tools, and any other required resources to accomplish the activity.

- Arrow Destination (M): A3.3.2—Perform line maintenance

**Line service directives:** A set of policies/procedures/instructions that directs line services.

- Arrow Destination (C): A2.3.5—Perform line services

**Line service real-time status:** Real-time performance report during the execution of line services.

- Arrow Source (O): A2.3.5—Perform line services

**Line service resources:** The components necessary for the successful accomplishment of line services. The components are defined as properly trained and certified personnel, adequate facilities, required information, materials, equipment, tools, and any other required resources to accomplish the activity.

- Arrow Destination (M): A2.3.5—Perform line services

**Load/fuel plan:** Predetermined information on how to load and fuel an aircraft.

- Arrow Source (O): A1.3.4—Perform load/fuel planning

**Load/fuel planning directives:** A set of policies/procedures/instructions that directs load/fuel planning. Those instructions were originated from various factors of consideration such as available flight level, overflight restrictions, AFM performances (includes airworthiness directives), maintenance fuel savings practices, special FMS/FMC procedures, and charter versus regular flights.

- Arrow Destination (C): A1.3.4—Perform load/fuel planning

**Load/fuel planning real-time status:** Real-time performance report during the execution of load/fuel planning.

- Arrow Source (O): A1.3.4—Perform load/fuel planning

**Load/fuel planning resources:** The components necessary for the successful accomplishment of load/fuel planning. The components are defined as properly trained and certified personnel, adequate facilities, required information, materials, equipment, tools, and any other required resources to accomplish the activity.

- Arrow Destination (M): A1.3.4—Perform load/fuel planning

**Maintenance and engineering needs:** The requirements to keep air carrier's equipment in condition to provide safe and salable air transportation. "Safe," in this sense, implies full compliance with the carrier's own operating specifications and also with all applicable directives and regulations of the FAA. "Salable" means fast and dependable service in modern equipment with comfortable furnishings and decor, without which the company would be unable to compete successfully.

- Arrow Source (O): A1.5.3—Perform technical evaluation
- Arrow Destination (I): A1.6.2—Identify & effect operations policies

**Maintenance control directives:** A set of policies/procedures/instructions that directs maintenance control.

- Arrow Destination (C): A1.3.7—Perform maintenance control

**Maintenance control real-time status:** Real-time performance report during the execution of maintenance control.

- Arrow Source (O): A1.3.7—Perform maintenance control

**Maintenance control resources:** The components necessary for the successful accomplishment of maintenance control. The components are defined as properly trained and certified personnel, adequate facilities, required information, materials, equipment, tools, and any other required resources to accomplish the activity.

- Arrow Destination (M): A1.3.7—Perform maintenance control

**Maintenance decision:** Decision on when, where, and how to maintain and repair certain aircraft.

- Arrow Destination (C): A3.2.1—Manage aircraft evaluation

**Maintenance management plan:** Predetermined information on how to manage aircraft maintenance.

- Arrow Source (O): A1.2—Plan operations
- Arrow Destination (I): A3.1—Manage aircraft maintenance + A1.5.4—Modify maintenance program

**Maintenance policy and procedure development directives:** A set of policies/procedures/instructions that directs the development of maintenance policy & procedures.

- Arrow Destination (C): A1.5.1—Manage maintenance policy & procedure development

**Maintenance policy and procedure development execution directives:** A set of policies/procedures/instructions that directs the execution of policy and procedure development.

- Arrow Source (O): A1.5.1—Manage maintenance policy & procedure development

**Maintenance policy and procedure development management resources:** The components necessary for the successful accomplishment of maintenance policy and procedure development management. The components are defined as properly trained and certified personnel, adequate facilities, required information, material support, and any other required resources.

- Arrow Destination (M): A1.5.1—Manage maintenance policy & procedure development

**Maintenance policy and procedure development real-time status:** Real-time performance report during the execution of maintenance policy and procedure development.

- Arrow Source (O): A1.5.1—Manage maintenance policy & procedure development

**Maintenance policy and procedure development resource provision directives:** Allocation and supply of maintenance policy and procedure development resources.

- Arrow Destination (C): A1.5.5—Provide maintenance policy & procedure development resources

**Maintenance policy and procedure development resources:** The components necessary for the successful accomplishment of maintenance policy & procedure development. The components are defined as properly trained and certified personnel, adequate facilities, required information, and material support.

- Arrow Destination (M): A1.5.5—Provide maintenance policy & procedure development resources

**Maintenance policy and procedure development resources provision:** Allocation and supply of maintenance policy and procedure development resources.

- Arrow Source (O): A1.5.5—Provide maintenance policy & procedure development resources

**Maintenance policy and procedure development resources provision real-time status:** Real-time performance report during the execution of providing maintenance policy and procedure development resources.

- Arrow Source (O): A1.5.5—Provide maintenance policy & procedure development resources

**Maintenance program change approval:** The authorization of maintenance program changes.

- Arrow Destination (C): A1.5.4—Modify maintenance program

**Maintenance program modification directives:** A policy that controls the development of a maintenance program.

- Arrow Destination (C): A1.5.4—Modify maintenance program

**Maintenance program modification resources:** The components necessary for the successful accomplishment of a maintenance program development. The components are defined as properly trained and certified personnel, adequate facilities, required information, material support, and any required resources.

- Arrow Destination (M): A1.5.4—Modify maintenance program

**Maintenance real-time status:** Real-time performance report during the execution of aircraft maintenance.

- Arrow Source (O): A3.1—Manage aircraft maintenance

**Maintenance records:** Information, recorded from instrument or written by persons, describing the status, results, costs, profits, conformance to requirements, and so forth, of aircraft maintenance.

- Arrow Source (O): A3.1—Manage aircraft maintenance

**Maintenance release:** A document certifying the airworthiness of an aircraft.

- Arrow Source (O): A1.3.7—Perform maintenance control
- Arrow Destination (I): A1.3.6.3—Sign dispatch release

**Man-hour requirements:** Amount of time needed for conducting certain task(s).

- Arrow Source (O): A3.2.4—Evaluate aircraft discrepancies
- Arrow Destination (C): A3.3—Perform scheduled/nonscheduled maintenance

**Manual system:** A document system that provides instructions and information necessary to allow the personnel concerned to perform their duties and responsibilities with a high degree of safety (CFR Part 121.135). A document system includes items such as the GOM and GMM.

- Arrow Destination (C,I,C,C): A4.2—Identify & analyze training requirements + A5.4—Supply available materials/equipment/facilities + A4.3.1—Manage training design & development + A4.4.1—Manage training implementation

**New hires:** Personnel newly joining the air carrier.

- Arrow Source (I): { Border }
- Arrow Destination (I): A4.4.2—Conduct class training

**Nonconcurrency of release:** A requirement for amending the original dispatch plan.

- Arrow Source (O): A1.3.6.3—Sign dispatch release
- Arrow Destination (I): A1.3.6.2—Create & deliver preflight package

**Normal climb directive:** A set of policies/procedures/instructions that directs the aircraft's normal climb flight operations.

- Arrow Destination (C): A2.4.4.3—Perform normal climb operations

**Normal climb real-time status:** Real-time performance report during the execution of an aircraft's normal climb flight operations.

- Arrow Source (O): A2.4.4.3—Perform normal climb operations

**Normal climb resources:** The components necessary for the successful accomplishment of normal climb flight operations. The components are defined as properly trained and certified personnel, required information, and material support.

- Arrow Destination (M): A2.4.4.3—Perform normal climb operations

**OEM support:** Efforts, documents, or data from original equipment manufacturer to be used to analyze the performance of equipment and/or maintenance of equipment.

- Arrow Source (M): { Border }
- Arrow Destination (M): A3.1—Manage aircraft maintenance

**Operation data:** The information recording the performance of operations.

- Arrow Source (O): A2.1—Manage air transportation

**Operation planning real-time status:** Real-time performance report during the execution of planning operations.

- Arrow Source (O): A1.2—Plan operations



**Operation planning directives:** A set of policies/procedures/instructions that directs operation planning.

- Arrow Destination (C): A1.2—Plan operations

**Operation planning resources:** The components necessary for the successful accomplishment of operation planning. The components are defined as properly trained and certified personnel, adequate facilities, required information, materials, equipment, tools, and any other required resources to accomplish the activity.

- Arrow Destination (M): A1.2—Plan operations

**Operation policy and procedure development guidelines:** The directives used for developing operational policy and procedures.

- Arrow Destination (C): A1.6.3—Develop & evaluate operations policies & procedures

**Operation policy and procedure development resources:** The components necessary for the successful accomplishment of operation policy and procedure development. The components are defined as properly trained and certified personnel, adequate facilities, required information, material support, and any required resources.

- Arrow Destination (M): A1.6.3—Develop & evaluate operations policies & procedures

**Operation records:** Documents that record the historical performance of air carrier operations.

- Arrow Destination (I): A1.1—Manage air carrier operations coordination + A1.2—Plan operations + Project utilization + A1.3.3—Plan flight routes + A1.3.4—Perform load/fuel planning + A1.3.5—Assign crewmembers + A1.5.2—Collect & process operational data + A1.6.2—Identify & effect operations policies

**Operational control:** With respect to a flight, means the exercise of authority over initiating, conducting, or terminating a flight ( FAR Part 1).

- Arrow Destination (C,C,C,I): A2.1—Manage air transportation + A3.1—Manage aircraft maintenance + A5.1—Manage air carrier operation resource provision + A2.4.1—Manage aircraft operations

**Operational control directives:** A set of policies/procedures/instructions that directs operational control.

- Arrow Destination (C): A1.3.1—Manage operational control

**Operational control execution directives:** A set of policies/procedures/instructions that directs the execution of operational control.

- Arrow Source (O): A1.3.1—Manage operational control

**Operational control management resources:** The components necessary for the successful accomplishment of operational control management. The components are defined as properly trained and certified personnel, adequate facilities, required information, material support, and any other required resources.

- Arrow Destination (M): A1.3.1—Manage operational control

**Operational control real-time status:** Real-time performance report during the execution of operational control.

- Arrow Source (O): A1.3.1—Manage operational control

**Operational control resource provision directives:** A set of policies/procedures/instructions that directs the provision of operational control resources.

- Arrow Destination (C): A1.3.8—Provide operational control resources

**Operational control resources:** The components necessary for the successful accomplishment of operational control resources. The components are defined as properly trained and certified personnel, adequate facilities, required information, materials, equipment, tools, and any other required resources to accomplish the activity.

- Arrow Destination (M): A1.3.8—Provide operational control resources

**Operational control resources provision:** Allocation and supply of operational control resources.

- Arrow Source (O): A1.3.8—Provide operational control resources

**Operational control resources provision real-time status:** Real-time performance report during the execution of operational control resources provision.

- Arrow Source (O): A1.3.8—Provide operational control resources

**Operational data collection directives:** A policy that dictates the applicable data to collect.

- Arrow Destination (C): A1.5.2—Collect & process operational data

**Operational data collection resources:** The components necessary for the successful accomplishment of operational data collection. The components are defined as properly trained and certified personnel, adequate facilities, required information, material support, and any required resources.

- Arrow Destination (M): A1.5.2—Collect & process operational data

**Operational needs:** Requirements for improving operations including personnel training, maintenance and operational program changes, maintenance and operational requirements, and so forth.

- Arrow Source (O): A1.6.2—Identify & effect operations policies
- Arrow Destination (I): A1.5.2—Collect & process operational data + A1.6.3—Develop & evaluate operations policies & procedures

**Operational supplies:** Equipment, facilities, fuel, administrative, commercial supplies, consumables, and so forth, imported to the air carrier to be used in the air carrier operations.

- Arrow Source (I): { Border }
- Arrow Destination (I): A5.3—Supply available expendable supplies + A5.4—Supply available materials/equipment/ facilities

**Operations policy and procedure development directives:** A set of policies/procedures/instructions that directs the development of operational policy and procedures.

- Arrow Destination (C): A1.6.1—Manage operations policy & procedure development

**Operations policy and procedure development execution directives:** A set of policies/procedures/instructions that directs the execution of operation policy and procedure development.

- Arrow Source (O): A1.6.1—Manage operations policy & procedure development

**Operations policy and procedure development management resources:** The components necessary for the successful accomplishment of operational policy and procedure development management. The components are defined as properly trained and certified personnel, adequate facilities, required information, material support, and any other required resources to accomplish the activity.

- Arrow Source (O): A1.6.4—Provide operations policy & procedure development resources
- Arrow Destination (M): A1.6.1—Manage operations policy & procedure development

**Operations policy and procedure development real-time status:** Real-time performance report during the execution of operation policy and procedure development.

- Arrow Source (O): A1.6.1—Manage operations policy & procedure development + A1.6.3—Develop & evaluate operations policies & procedures

**Operations policy and procedure development resources:** The components necessary for the successful accomplishment of operational policy and procedure development. The components

are defined as properly trained and certified personnel, adequate facilities, required information, material support, and any other required resources to accomplish the activity.

- Arrow Destination (M): A1.6.4—Provide operations policy & procedure development resources

**Operations policy and procedure development resources provision directives:** A set of guidelines that directs the provision of operation policy and procedure development resources including fleet requirements, dispatch, operating requirements, and so forth.

- Arrow Destination (C): A1.6.4—Provide operations policy & procedure development resources

**Operations policy identification directives:** A set of policies/procedures/instructions that directs the operation policy identification.

- Arrow Destination (C): A1.6.2—Identify & effect operations policies

**Operations policy identification real-time status:** Real-time performance report during the execution of operation policy identification.

- Arrow Source (O): A1.6.2—Identify & effect operations policies

**Operations policy identification resources:** The components necessary for the successful accomplishment of operational policy identification. The components are defined as properly trained and certified personnel, adequate facilities, required information, materials, equipment, tools, and any other required resources to accomplish the activity.

- Arrow Destination (M): A1.6.2—Identify & effect operations policies

**Part configurations:** Specifications and strategies for selecting and handling components to be installed on the aircraft.

- Arrow Source (O): A3.3.4.2—Perform configuration control
- Arrow Destination (C): A3.3.4.3—Assess aircraft components

**Part failure data:** Data related to malfunctioned parts such as removal data, no fault found (NFF), confirmed failure, and failure model.

- Arrow Source (O): A3.3.4.3—Assess aircraft components
- Arrow Destination (I): A3.3.4.4—Perform part usage analysis

**Part usage analysis real-time status:** Real-time performance report during the execution of part usage analysis.

- Arrow Source (O): A3.3.4.4—Perform part usage analysis

**Parts requirements:** Requests for aircraft parts during aircraft maintenance.

- Arrow Source (O): A3.3.3.1—Manage heavy/depot maintenance
- Arrow Destination (I): A3.3.4.1—Manage component maintenance

**Passenger service directives:** A set of policies/procedures/instructions that directs passenger services.

- Arrow Destination (C): A2.2.1—Manage passenger services + A2.2.2.1—Manage boarding services

**Passenger service execution directives:** A set of policies/procedures/instructions that directs the execution of passenger services.

- Arrow Source (O): A2.2.1—Manage passenger services

**Passenger service management resources:** The components necessary for the successful accomplishment of passenger service management. The components are defined as properly trained and certified personnel, adequate facilities, required information, material support, and any other required resources to accomplish the activity.

- Arrow Destination (M): A2.2.1—Manage passenger services

**Passenger service real-time status:** Real-time performance report during the execution of passenger services.

- Arrow Source (O): A2.2.1—Manage passenger services

**Passenger service resource provision directives:** A set of policies/procedures/instructions that directs the provision of passenger service resources.

- Arrow Destination (C): A2.2.5—Provide passenger service resources

**Passenger service resources:** The components necessary for the successful accomplishment of passenger services. The components are defined as properly trained and certified personnel, adequate facilities, required information, materials, equipment, tools, and any other required resources to accomplish the activity.

- Arrow Destination (M): A2.2.5—Provide passenger service resources

**Passenger service resources provision:** Allocation and supply of passenger service resources.

- Arrow Source (O): A2.2.5—Provide passenger service resources

**Passenger service resources provision real-time status:** Real-time performance report during the execution of passenger service resources provision.

- Arrow Source (O): A2.2.5—Provide passenger service resources

**Passengers after checking-in:** Passengers after check-in and ready for security check.

- Arrow Source (O): A2.2.2.2—Provide check-in services
- Arrow Destination (I): A2.2.2.3—Provide security services

**Passengers onboard for departure:** Passengers sitting in their seats ready for departure.

- Arrow Source (O): A2.2.2.4—Provide seating services
- Arrow Destination (I): A2.2.3—Perform in-flight services

**Passengers onboard for deplaning:** Passengers standing up from their seats and preparing to leave the aircraft after the aircraft arrives at the destination airport.

- Arrow Source (O): A2.2.3—Perform in-flight services
- Arrow Destination (I): A2.2.4—Perform deplaning services

**Passengers passing security screening:** Passengers who passed the safety screen at the airport and are permitted to board the aircraft.

- Arrow Source (O): A2.2.2.3—Provide security services
- Arrow Destination (I): A2.2.2.4—Provide seating services

**Payload at departure airport:** Passengers/cargo at an airport to be transferred to another airport.

- Arrow Source (I): { Border }
- Arrow Destination (I): A2.3.2—Perform ground handling + A2.2.2.2—Provide check-in services

**Payload at destination airport:** Passengers/cargo at the destination airport after the flight.

- Arrow Source (O): A2.2.4—Perform deplaning services + A2.3.2—Perform ground handling
- Arrow Destination (O): { Border }

**Payload information:** Data related to payload such as category (passengers, cargo, mail), types (i.e., medical, dangerous goods and materials), and considerations (i.e., average passenger weight).

- Arrow Source (I): { Border }
- Arrow Destination (I): A1.3.4—Perform load/fuel planning

**Performance standard setting directives:** A set of policies/procedures/instructions that directs setting the performance standards.

- Arrow Destination (C): A4.3.3—Set performance standards

**Performance standard setting real-time status:** Real-time performance report during the execution of performance standard setting.

- Arrow Source (O): A4.3.3—Set performance standards

**Performance standards:** The specifications of the performance personnel should achieve after being trained.

- Arrow Source (O): A4.3.3—Set performance standards
- Arrow Destination (I, I, C,C,C,C): A4.3.4—Select training provider + A4.3.5—Develop training curriculum + A4.5.2—Conduct system evaluation + A4.5.3—Conduct device evaluation + A4.5.4—Conduct aircraft evaluation

**Performance standards setting resources:** The components necessary for the successful accomplishment of performance standard setting. The components are defined as properly trained and certified personnel, adequate facilities, required information, materials, equipment, tools, and any other required resources to accomplish the activity.

- Arrow Destination (M): A4.3.3—Set performance standards

**Personnel after class training:** Personnel after completing class training.

- Arrow Source (O): A4.4.2—Conduct class training

**Personnel after computer-based training:** Personnel after completing computer-based training.

- Arrow Source (O): A4.4.3—Conduct computer-based training

**Personnel after device/simulator training:** Personnel after completing device/simulator training.

- Arrow Source (O): A4.4.4—Conduct device/simulator training

**Personnel after aircraft training:** Personnel after completing aircraft training.

- Arrow Source (O): A4.4.5—Conduct aircraft training

**Personnel after training:** Personnel after completing training.

- Arrow Source (O): A4.4—Implement training
- Arrow Destination (I): A4.5.2—Conduct system evaluation

**Personnel passing aircraft training evaluation:** Personnel succeeded in aircraft training evaluation. Those who fail in the aircraft training evaluation may need to be retrained.

- Arrow Source (O): A4.5.4—Conduct aircraft evaluation

**Personnel passing device-training evaluation:** Personnel succeeded in device-training evaluation. Those who fail in the device training evaluation may need to be retrained.

- Arrow Source (O): A4.5.3—Conduct device training evaluation

**Personnel passing system training evaluation:** Personnel who passed the system training evaluation. Those who fail in the system training evaluation may need to be retrained.

- Arrow Source (O): A4.5.2—Conduct system evaluation

**Personnel qualification requirements:** Requirements for personnel to conduct certain professional jobs.

- Arrow Source (C): { Border }
- Arrow Destination (C): A4.1—Manage personnel training

**Personnel to be trained:** Personnel required to be trained to improve their skills and knowledge in order to be qualified to conduct certain tasks.

- Arrow Source (O): A2.5—Provide air transportation resources + A3.4—Provide aircraft maintenance resources
- Arrow Destination (I): A4.4.2—Conduct class training + A4.4.3—Conduct computer-based training + A4.4.4—Conduct device/simulator training + A4.4.5—Conduct aircraft training

**Personnel training execution directives:** A set of policies/procedures/instructions that directs the execution of personnel training.

- Arrow Source (O): A4.1—Manage personnel training

**Personnel training management resources:** The components necessary for the successful accomplishment of personnel training management. The components are defined as properly trained and certified personnel, adequate facilities, required information, material support, and any other required resources to accomplish the activity.

- Arrow Destination (M): A4.1—Manage personnel training



**Personnel training plan:** Schedules, contents, and other predetermined matters used for training personnel.

- Arrow Source (O): A1.2—Plan operations
- Arrow Destination (I): A4.1—Manage personnel training

**Personnel training real-time status:** Real-time performance report during the execution of personnel training.

- Arrow Source (O): A4.1—Manage personnel training

**Personnel training records:** A document recording historical performance of personnel training.

- Arrow Source (O): A4.1—Manage personnel training

**Personnel training resource provision directives:** A set of policies/procedures/instructions that directs the provision of personnel training resources.

- Arrow Destination (C): A4.6—Provide personnel training resources

**Personnel training resources:** The components necessary for the successful accomplishment of personnel training. The components are defined as properly trained and certified personnel, adequate facilities, required information, materials, equipment, tools, and any other required resources to accomplish the activity.

- Arrow Destination (M): A4.6—Provide personnel training resources

**Personnel training resources provision:** Allocation and supply of personnel training resources.

- Arrow Source (O): A4.6—Provide personnel training resources

**Personnel training resources provision real-time status:** Real-time performance report during the execution of personnel training resources provision.

- Arrow Source (O): A4.6—Provide personnel training resources

**Postarrival directives:** A set of policies/procedures/instructions that directs aircraft postarrival operations.

- Arrow Destination (C): A2.4.9—Perform postarrival ground operations

**Postarrival real-time status:** Real-time performance report during the execution of aircraft postarrival operations.

- Arrow Source (O): A2.4.9—Perform postarrival ground operations

**Postarrival resources:** The components necessary for the successful accomplishment of aircraft postarrival operations. The components are defined as properly trained and certified personnel, adequate facilities, required information, material support, and any other required resources to accomplish the activity.

- Arrow Destination (M): A2.4.9—Perform postarrival ground operations

**Predeparture directives:** A set of policies/procedures/instructions that directs aircraft predeparture operations.

- Arrow Destination (C): A2.4.2—Perform predeparture ground operations

**Predeparture real-time status:** Real-time performance report during the execution of aircraft predeparture operations.

- Arrow Source (O): A2.4.2—Perform predeparture ground operations

**Predeparture resources:** The components necessary for the successful accomplishment of aircraft predeparture operations. The components are defined as properly trained and certified personnel, adequate facilities, required information, material support, and any other required resources to accomplish the activity.

- Arrow Destination (M): A2.4.2—Perform predeparture ground operations

**Preflight package briefing:** Dissemination of flight information package to the pilot in command.

- Arrow Source (O): A1.3.6.2—Create & deliver preflight package
- Arrow Destination (I): A1.3.6.3—Sign dispatch release

**Preflight package creating and delivery directives:** A set of policies/procedures/instructions that directs the preflight package creation and delivery.

- Arrow Destination (C): A1.3.6.2—Create & deliver preflight package

**Preflight package creating and delivery real-time status:** Real-time performance report during the execution of preflight package creating and delivery.

- Arrow Source (O): A1.3.6.2—Create & deliver preflight package

**Preflight package creating and delivery resources:** The components necessary for the successful accomplishment of preflight package creation and delivery. The components are defined as properly trained and certified personnel, adequate facilities, required information, material support, and any other required resources to accomplish the activity.

- Arrow Destination (M): A1.3.6.2—Create & deliver preflight package

**Project utilization resources:** The components necessary for the successful accomplishment of project utilization. The components are defined as properly trained and certified personnel, adequate facilities, required information, materials, equipment, tools, and any other required resources to accomplish the activity.

- Arrow Destination (M): A1.4—Project utilization

**Proposed maintenance program changes:** Presentation of proposed maintenance program changes.

- Arrow Source (O): A1.5.3—Perform technical evaluation
- Arrow Destination (I): A1.5.4—Modify maintenance program

**Qualified personnel:** Persons qualified for conducting certain tasks.

- Arrow Destination (I): A5.5—Supply available personnel

**Real-time status:** Real-time performance report during the execution of activities.

**Reliability data:** Information developed and gathered by air carriers as required by their maintenance program to identify characteristics indicating a need for program adjustment, revision to maintenance practices, hardware improvement (modification), and so forth. Examples of these sources of data include:

- Bench checks
  - Confirm failures
  - Engine shutdowns
  - Functional checks
  - In-flight engine performance data
  - Inspection write-ups
  - Mechanical interruptions/delays
  - Pilot reports
  - Sampling inspections
  - Service difficulty reports
  - Shop findings
  - Unscheduled removals
- Arrow Source (O): A1.5.2—Collect & process operational data
  - Arrow Destination (I): A1.5.3—Perform technical evaluation

**Requirements of training revise:** Requests for revising training process after evaluating the performance of training.

- Arrow Source (O): A4.5.1—Manage training evaluation
- Arrow Destination (I): A4.3.1—Manage training design & development

**Resource information:** Information regarding resources such as fuel (grade, quality, availability, audits, cost), staffing, human resources requirements, ground facility/supply equipment, and automation.

- Arrow Source (I): { Border }
- Arrow Destination (I): A1.3.3—Plan flight routes + A1.3.4—Perform load/fuel planning + A1.5.2—Collect & process operational data + A1.6.2—Identify & effect operations policies

**Resource provision plan:** Definition of resources necessary to support planned operations.

- Arrow Source (O): A1.2—Plan operations
- Arrow Destination (I): A5.1—Manage air carrier operation resource provision

**Resource provision records:** Information, recorded from instrument or written by persons, describing the status, results, costs, profits, conformance to requirements, and so forth, of resource provisions.

- Arrow Source (O): A5.1—Manage air carrier operation resource provision

**Routing:** A decision on where to maintain the aircraft.

- Arrow Source (O): A3.2.4—Evaluate aircraft discrepancies
- Arrow Destination (C): A3.3.1—Manage scheduled/nonscheduled aircraft maintenance

**Safety data:** Data sources related to safety such as Flight Operation Quality Assurance (FOQA), internal evaluation, contractor oversight, and so forth.

- Arrow Source (I): { Border }
- Arrow Destination (I): A1.3.7—Perform maintenance control + A1.5.2—Collect & process operational data + A1.6.2—Identify & effect operations policies

**Scheduled/nonscheduled aircraft maintenance resource provision real-time status:** Real-time performance report during the execution of scheduled/nonscheduled aircraft maintenance resource provision.

- Arrow Source (O): A3.3.5—Provide scheduled/nonscheduled aircraft maintenance resources

**Scheduled/nonscheduled aircraft maintenance resources provision:** Allocation and supply of scheduled/nonscheduled aircraft maintenance resources.

- Arrow Source (O): A3.3.5—Provide scheduled/nonscheduled aircraft maintenance resources

**Scheduled/nonscheduled aircraft maintenance directives:** A set of policies/procedures/instructions that directs scheduled/nonscheduled aircraft maintenance.

- Arrow Destination (C): A3.3.1—Manage scheduled/nonscheduled aircraft maintenance

**Scheduled/nonscheduled aircraft maintenance management resources:** The components necessary for the successful accomplishment of scheduled/nonscheduled aircraft maintenance management. The components are defined as properly trained and certified personnel, adequate facilities, required information, material support, and any other required resources to accomplish the activity.

- Arrow Destination (M): A3.3.1—Manage scheduled/nonscheduled aircraft maintenance

**Scheduled/nonscheduled aircraft maintenance real-time status:** Real-time performance report during the execution of scheduled/nonscheduled aircraft maintenance.

- Arrow Source (O): A3.3.1—Manage scheduled/nonscheduled aircraft maintenance

**Scheduled/nonscheduled aircraft maintenance resources:** The components necessary for the successful accomplishment of scheduled/nonscheduled aircraft maintenance. The components are defined as properly trained and certified personnel, adequate facilities, required information, materials, equipment, tools, and any other required resources to accomplish the activity.

- Arrow Destination (M): A3.3.5—Provide scheduled/nonscheduled aircraft maintenance resources

**Scheduled/nonscheduled maintenance execution directives:** A set of policies/procedures/instructions that directs the execution of scheduled/nonscheduled aircraft maintenance.

- Arrow Source (O): A3.3.1—Manage scheduled/nonscheduled aircraft maintenance

**Scheduled/nonscheduled maintenance resources provision directives:** A set of policies/procedures/instructions that directs the provision of scheduled/nonscheduled maintenance resources.

- Arrow Destination (C): A3.3.1—Provide scheduled/nonscheduled aircraft maintenance resources

**Seating service directives:** A set of policies/procedures/instructions that directs seating services.

- Arrow Destination (C): A2.2.2.4—Provide seating services

**Seating service real-time status:** Real-time performance report during the execution of seating services.

- Arrow Source (O): A2.2.2.4—Provide seating services

**Seating service resources:** The components necessary for the successful accomplishment of seating services. The components are defined as properly trained and certified personnel, adequate facilities, required information, materials, equipment, tools, and any other required resources to accomplish the activity.

- Arrow Destination (M): A2.2.2.4—Provide seating services

**Security:** Freedom from danger.

- Arrow Source (O): A1.1—Manage air carrier operations coordination
- Arrow Destination (C): A1.6.1—Manage operations policy & procedure development

**Security service directives:** A set of policies/procedures/instructions that directs security services.

- Arrow Destination (C): A2.2.2.3—Provide security services

**Security service real-time status:** Real-time performance report during the execution of security services.

- Arrow Source (O): A2.2.2.3—Provide security services

**Security service resources:** The components necessary for the successful accomplishment of security services. The components are defined as properly trained and certified personnel, adequate facilities, required information, materials, equipment, tools, and any other required resources to accomplish the activity.

- Arrow Destination (M): A2.2.2.3—Provide security services

**Serviceable parts:** New or used aircraft parts installed on aircraft.

- Arrow Source (O): A3.3.4.3—Assess aircraft components
- Arrow Destination (I): A3.3.1—Provide scheduled/nonscheduled aircraft maintenance resources

**Short-term trend:** Data on recent repeat maintenance problems.

- Arrow Source (O): A1.5.2—Collect & process operational data

**Submission of maintenance program changes:** Delivery of proposed maintenance program changes.

- Arrow Source (O): A1.5.4—Modify maintenance program

**Support requirements:** Requirements for supporting a certain activity.

- Arrow Source (O): A1.5.3—Perform technical evaluation

**System training evaluation directives:** A set of policies/procedures/instructions that directs system training evaluation.

- Arrow Destination (C): A4.5.2—Conduct system evaluation

**System training evaluation real-time status:** Real-time performance report during the execution of system training evaluation.

- Arrow Source (O): A4.5.2— Conduct system evaluation

**System training evaluation resources:** The components necessary for the successful accomplishment of system training. The components are defined as properly trained and certified personnel, adequate facilities, required information, materials, equipment, tools, and any other required resources to accomplish the activity.

- Arrow Destination (M): A4.5.2— Conduct system evaluation

**Takeoff directives:** A set of policies/procedures/instructions that directs aircraft takeoff.

- Arrow Destination (C): A2.4.3.1—Manage takeoff operations

**Takeoff directives at/after V1:** A set of policies/procedures/instructions that directs aircraft takeoff after its airspeed surpasses V1.

- Arrow Destination (C): A2.4.3.3—Perform takeoff after V1

**Takeoff directives prior to V1:** A set of policies/procedures/instructions that directs aircraft takeoff before its airspeed reaches V1.

- Arrow Destination (C): A2.4.3.2—Perform takeoff prior to V1

**Takeoff execution directives:** A set of policies/procedures/instructions that directs the execution of aircraft takeoff operations.

- Arrow Source (O): A2.4.3.1—Manage takeoff operations

**Takeoff management resources:** The components necessary for the successful accomplishment of aircraft takeoff management. The components are defined as properly trained and certified personnel, adequate facilities, required information, material support, and any other required resources to accomplish the activity.

- Arrow Destination (M): A2.4.3.1—Manage takeoff operations

**Takeoff real-time status:** Real-time performance report during the execution of aircraft takeoff.

- Arrow Source (O): A2.4.3.1—Manage takeoff operations

**Takeoff real-time status at/after V1:** Real-time performance report during the execution of aircraft takeoff after its airspeed surpasses V1.

- Arrow Source (O): A2.4.3.3—Perform takeoff after V1

**Takeoff real-time status prior to V1:** Real-time performance report during the execution of aircraft takeoff before its airspeed reaches V1.

- Arrow Source (O): A2.4.3.2—Perform takeoff prior to V1

**Takeoff resource provision directives:** A set of policies/procedures/instructions that directs aircraft takeoff resource provision.

- Arrow Destination (C): A2.4.3.4—Provide takeoff operation resources

**Takeoff resource provision real-time status:** Real-time performance report during the execution of aircraft takeoff resource provision.

- Arrow Source (O): A2.4.3.4—Provide takeoff operation resources

**Takeoff resources:** The components necessary for the successful accomplishment of aircraft takeoff. The components are defined as properly trained and certified personnel, required information, and material support.

- Arrow Destination (M): A2.4.3.4—Provide takeoff operation resources

**Takeoff resources at/after V1:** The components necessary for the successful accomplishment of aircraft takeoff after its airspeed surpasses V1. The components are defined as properly trained and certified personnel, required information, and material support.

- Arrow Destination (M): A2.4.3.3—Perform takeoff after V1

**Takeoff resources prior to V1:** The components necessary for the successful accomplishment of aircraft takeoff before its airspeed reaches V1. The components are defined as properly trained and certified personnel, required information, and material support.

- Arrow Destination (M): A2.4.3.2—Perform takeoff prior to V1

**Takeoff resources provision:** The components necessary for the successful accomplishment of aircraft takeoff resource provision. The components are defined as properly trained and certified personnel, adequate facilities, required information, materials, equipment, tools, and any other required resources to accomplish the activity.

- Arrow Source (O): A2.4.3.4—Provide takeoff operation resources



**Technical evaluation directives:** A policy that defines the appropriate analytical processes.

- Arrow Destination (C): A1.5.3—Perform technical evaluation

**Technical evaluation resources:** The components necessary for the successful accomplishment of technical evaluation. The components are defined as properly trained and certified personnel, adequate facilities, required information, materials, equipment, tools, and any other required resources to accomplish the activity.

- Arrow Destination (M): A1.5.3—Perform technical evaluation

**Topographical information:** Data related to obstacles in terminal and en route areas, i.e., ICAO takeoff data, one engine inoperative flight path, and so forth.

- Arrow Source (I): { Border }
- Arrow Destination (I): A1.3.4—Perform load/fuel planning

**Training courseware:** Instructional material developed for each curriculum. This is information in lesson plans, instructor guides, computer software programs, audiovisual programs, workbooks, aircraft operating manuals, and handouts. Courseware must accurately reflect curriculum requirements, be effectively organized, and properly integrate with instructional delivery methods.

- Arrow Source (O): A4.3.5—Develop training curriculum
- Arrow Destination (M): A4.4.2—Conduct class training

**Training curriculum:** A complete training agenda specific to an aircraft type, a crewmember or dispatcher duty position, and a category of training. An example is an “initial new-hire, Boeing 727 flight engineer curriculum.” Each curriculum consists of several curriculum segments.

- Arrow Source (O): A4.3.5—Develop training curriculum
- Arrow Destination (C): A4.4.1—Manage training implementation

**Training curriculum development directives:** A set of policies/procedures/instructions that directs training curriculum development.

- Arrow Destination (C): A4.3.5—Develop training curriculum

**Training curriculum development real-time status:** Real-time performance report during the execution of training curriculum development.

- Arrow Source: A4.3.5—Develop training curriculum + A4.3.6—Provide training design & development resources

**Training curriculum development resources:** The components necessary for the successful accomplishment of training curriculum development. The components are defined as properly

trained and certified personnel, adequate facilities, required information, material support, and any other required resources to accomplish the activity.

- Arrow Source (O): A4.3.6—Provide training design & development resources
- Arrow Destination (M): A4.3.5—Develop training curriculum

**Training design and development executive directives:** A set of policies/procedures/instructions that directs the execution of training design and development.

- Arrow Source (O): A4.3.1—Manage training design & development

**Training design and development management resources:** The components necessary for the successful accomplishment of training design and development management. The components are defined as properly trained and certified personnel, adequate facilities, required information, material support, and any other required resources to accomplish the activity.

- Arrow Destination (M): A4.3.1—Manage training design & development

**Training design and development resource provision directives:** A set of policies/procedures/instructions that directs the provision of training design and development.

- Arrow Destination (C): A4.3.6—Provide training design & development resources

**Training design and development resource provision:** Allocate and supply the training design and development resources.

- Arrow Source (O): A4.3.6—Provide training design & development resources

**Training design and development resource provision real-time status:** Real-time performance report during the execution of training design and development resource provision.

- Arrow Source (O): A4.3.6—Provide training design & development resources

**Training design and development real-time status:** Real-time performance report during the execution of training design and development.

- Arrow Source (O): A4.3.1—Manage training design & development

**Training design and development resources:** The components necessary for the successful accomplishment of training design and development. The components are defined as properly trained and certified personnel, adequate facilities, required information, material support, and any other required resources to accomplish the activity.

- Arrow Destination (M): A4.3.6—Provide training design & development resources

**Training design and development directives:** A set of policies/procedures/instructions that directs training development.

- Arrow Destination (C): A4.3.1—Manage training design & development

**Training evaluation directives:** A set of policies/procedures/instructions that directs training evaluation.

- Arrow Destination (C): A4.5.1—Manage training evaluation

**Training evaluation execution directives:** A set of policies/procedures/instructions that directs the execution of training evaluation.

- Arrow Source (O): A4.5.1—Manage training evaluation

**Training evaluation management resources:** The components necessary for the successful accomplishment of training evaluation management. The components are defined as properly trained and certified personnel, adequate facilities, required information, material support, and any other required resources to accomplish the activity.

- Arrow Destination (M): A4.5.1—Manage training evaluation

**Training evaluation real-time status:** Real-time performance report during the execution of training evaluation.

- Arrow Source (O): A4.5.1—Manage training evaluation

**Training evaluation resource provision directives:** A set of policies/procedures/instructions that directs the training evaluation resource provision.

- Arrow Destination (C): A4.5.5—Provide training evaluation resources

**Training evaluation resource provision real-time status:** Real-time performance report during the execution of training evaluation resource provision.

- Arrow Source (O): A4.5.5—Provide training evaluation resources

**Training evaluation resources:** The components necessary for the successful accomplishment of training evaluation. The components are defined as properly trained and certified personnel, adequate facilities, required information, materials, equipment, tools, and any other required resources to accomplish the activity.

- Arrow Destination (M): A4.5.5—Provide training evaluation resources

**Training evaluation resources provision:** Allocate and supply the training evaluation resources.

- Arrow Source (O): A4.5.5—Provide training evaluation resources

**Training implement directives:** A set of policies/procedures/instructions that directs training implementation.

- Arrow Destination (C): A4.4.1—Manage training implementation

**Training implement real-time status:** Real-time performance report during the execution of training implementation.

- Arrow Source (O): A4.4.1—Manage training implementation

**Training implement resources:** The components necessary for the successful accomplishment of training implementation. The components are defined as properly trained and certified personnel, adequate facilities, required information, material, equipment, tools, and any required resources to accomplish the activity.

- Arrow Destination (M): A4.4.6—Provide training implementation resources

**Training implementation execution directives:** A set of policies/procedures/instructions that directs the execution of training implementation.

- Arrow Source (O): A4.4.1—Manage training implementation

**Training implementation management:** The components necessary for the successful accomplishment of training implementation management. The components are defined as properly trained and certified personnel, adequate facilities, required information, material support, and any other required resources to accomplish the activity.

- Arrow Destination (M): A4.4.1—Manage training implementation

**Training implementation resource provision directives:** A set of policies/procedures/instructions that directs training implementation resource provision.

- Arrow Destination (C): A4.4.6—Provide training implementation resources

**Training implementation resource provision real-time status:** Real-time performance report during the execution of training implementation resource provision.

- Arrow Source (O): A4.4.6—Provide training implementation resources

**Training implementation resources provision:** Allocate and supply the training implementation resources.

- Arrow Source (O): A4.4.6—Provide training implementation resources

**Training objective development directives:** A set of policies/procedures/instructions that directs training objective development.

- Arrow Destination (C): A4.3.2—Develop training objectives

**Training objective development real-time status:** Real-time performance report during the execution of training objective development.

- Arrow Source (O): A4.3.2—Develop training objectives

**Training objective development resources:** The components necessary for the successful accomplishment of training objective development. The components are defined as properly trained and certified personnel, adequate facilities, required information, material support, and any other required resources to accomplish the activity.

- Arrow Destination (M): A4.3.2—Develop training objectives

**Training objectives:** The goals towards which the training is conducted.

- Arrow Source (O): A4.3.2—Develop training objectives
- Arrow Destination (I): A4.3.3—Set performance standards

**Training policy and procedures:** The policy and procedures for directing personnel training.

- Arrow Source (O): A1.5.1—Manage maintenance policy & procedure development + A1.6.3—Develop & evaluate operations policies & procedures
- Arrow Destination (I): A4.1—Manage personnel training

**Training provider selection directives:** A set of policies/procedures/instructions that directs training provider selection.

- Arrow Destination (C): A4.3.4—Select training provider

**Training provider selection real-time status:** Real-time performance report during the execution of training provider selection.

- Arrow Source (O): A4.3.4—Select training provider

**Training provider selection resources:** The components necessary for the successful accomplishment of training provider selection. The components are defined as properly trained

and certified personnel, adequate facilities, required information, material support, and any other required resources to accomplish the activity.

- Arrow Destination (M): A4.3.4—Select training provider

**Training requirement analysis directives:** A set of policies/procedures/instructions that directs training requirement analysis.

- Arrow Destination (C): A4.2—Identify & analyze training requirements

**Training requirement identification/analysis real-time status:** Real-time performance report during the execution of training requirement identification and analysis.

- Arrow Source (O): A4.2—Identify & analyze training requirements

**Training requirement identification/analysis resources:** The components necessary for the successful accomplishment of training requirement identification and analysis resources. The components are defined as properly trained and certified personnel, adequate facilities, required information, material support, and any other required resources to accomplish the activity.

- Arrow Destination (M): A4.2—Identify & analyze training requirements

**Training requirements:** Specifications on what kind of training is needed based on the analysis of job task requirement and personnel qualification requirement.

- Arrow Source (O): A4.2—Identify & analyze training requirements
- Arrow Destination (I): A4.3.2—Develop training objectives

**Training system performance:** Characteristics of training system generated from the real-time status reports from each training activity.

- Arrow Source (O): A4.1—Manage personnel training
- Arrow Destination (I): A4.5.2—Conduct system evaluation + A4.5.3—Conduct device evaluation + A4.5.4—Conduct aircraft evaluation

**Transportation requirements:** Specifications of transportation tasks.

- Arrow Source (C): { Border }
- Arrow Destination (C): A1.2—Plan operations

**Utilization-based resource requirements:** Requirements on resources in terms of utilization.

- Arrow Source (O): A3.1—Manage aircraft maintenance
- Arrow Destination (C): A3.4—Provide aircraft maintenance resources

**Utilization projection:** Estimation and specialization of utilization assets.

- Arrow Source (O): A1.4—Project utilization
- Arrow Destination (C): A2.5—Provide air transportation resources + A3.4—Provide aircraft maintenance resources + A4.6—Provide personnel training resources + A5.1—Manage air carrier operation resource provision

**Utilization projection directives:** A set of policies/procedures/instructions that directs utilization projection.

- Arrow Destination (C): A1.4—Project utilization

**Utilization projection real-time status:** Real-time performance report during the execution of projecting utilization.

- Arrow Source (O): A1.4—Project utilization

**Weather evaluation directives:** A set of policies/procedures/instructions that directs weather evaluation.

- Arrow Destination (C): A1.3.2—Evaluate weather

**Weather evaluation real-time status:** Real-time performance report during the execution of weather evaluation.

- Arrow Source (O): A1.3.2—Evaluate weather

**Weather evaluation resources:** The components necessary for the successful accomplishment of weather evaluation. The components are defined as properly trained and certified personnel, adequate facilities, required information, materials, equipment, tools, and any other required resources to accomplish the activity.

- Arrow Destination (M): A1.3.2—Evaluate weather

**Weather information:** A collection of data related to weather affecting aircraft flight operations. This weather data comes from outside operation control center such as:

- Contractor Weather Services
- Field conditions
- International Weather Services
- National Weather Service
- Other government weather services
- Pilot reports
- RADAR
- SWARS

- Arrow Source (I): { Border }
- Arrow Destination (I): A1.3.2—Evaluate weather + A1.6.2—Identify & effect operations policies

**Weather reports:** A briefing created by in-house or outsourced meteorological service based on the analysis and evaluation of weather information to provide weather service to air carrier operations.

- Arrow Source (O): A1.3.2—Evaluate weather
- Arrow Destination (I): A1.3.3—Plan flight routes + A1.3.4—Perform load/fuel planning + A1.3.6.2—Create & deliver preflight package

## 6. GENERAL DEFINITIONS AND ACRONYMS.

### 6.1 GENERAL DEFINITIONS.

**Abnormal:** When abnormal is used to describe a procedure or process, it refers to a nonroutine operation in which certain procedures or actions must be taken to maintain an acceptable level of system integrity or airworthiness.

**Activity:** A named process, function, or task that occurs over time and has recognizable results. Activities use assigned resources to produce products and services.

**Activity model:** Model of the processes that make up the functional activity showing inputs, outputs, controls, and mechanisms through which the process of the functional activity are (or will be) conducted.

**Airworthiness:** A condition in which the aircraft, airframe, engine, propeller, accessories, and appliances meet their type design and are in a condition for safe operations.

**Air carrier:** A person who undertakes directly by lease, or other arrangement, to engage in air transportation.

**Air traffic control:** A service operated by appropriate authority to promote the safe, orderly, and expeditious flow of air traffic.

**Air transportation:** An interstate, overseas, or foreign air transportation or the transportation of mail by aircraft.

**Alternate airport:** An airport at which an aircraft may land if a landing at the intended airport becomes inadvisable.

**Appliance:** Any instrument, mechanism, equipment, part, apparatus, appurtenance, or accessory, including communications equipment, that is used or intended to be used in operating



or controlling an aircraft in flight, is installed in or attached to the aircraft, and is not part of an airframe, engine, or propeller.

**Approved:** When approved is used to describe a document, manual, or checklist, it means that a regulation requires FAA approval and that the FAA has evaluated and specifically approved the document, manual, or checklist.

**Automation:** A system consisting of software and hardware to perform certain tasks.

**Aviation weather service:** A service provided by the National Weather Service (NWS) and the FAA which collects and disseminates pertinent weather information for pilots, aircraft operators, and ATC. Available aviation weather reports and forecasts are displayed at each NWS office and FAA Flight Service Station (FSS).

**Cargo:** Goods carried for revenue purposes, including dangerous goods and materials (HAZMAT, COMAT), as outlined in HMR 175.

**Category II operation:** With respect to the operation of aircraft, it means a straight-in Instrument Landing System (ILS) approach to the runway of an airport under a Category II ILS instrument approach procedure issued by the Administrator or other appropriate authority.

**Category III operations:** With respect to the operation of aircraft, it means an ILS approach to, and landing on, the runway of an airport using a Category III ILS instrument approach procedures issued by the Administrator or other appropriate authority.

**CFR Part 121 Air Carrier:** Established Part 121 air carriers, new entrant carriers, and new entrant transition carriers who hold or are required to hold an Air Carrier Certificate or Operating Certificate approved under CFR Part 121 for the purpose of conducting operations, including maintenance, preventative maintenance, and alteration of aircraft.

**Consumables:** Materials to be consumed during air carrier operations.

**Crewmember:** A person assigned to perform a duty in an aircraft during flight time.

**Cruising altitude:** An altitude or flight level maintained during en route level flight. This is a constant altitude and should not be confused with a cruise clearance.

**Departure:** The process when an aircraft begins to move under its own power (forward or backward) for purposes of flight.

**Directives:** Policies/procedures/instructions to direct how to conduct certain tasks.

**Dispatcher:** An airline employee who is responsible for authorizing the departure of an aircraft. The dispatcher must ensure, among other things, that the aircraft's crew have all the proper information necessary for their flight and that the aircraft is in proper mechanical condition.

**Document:** A written description of a system, a method, or a procedure; a written statement of authorization, conditions, or limitations; or a file of information.

**Dry lease:** Any agreement in which a lessor, which could be an air carrier, bank, or leasing company, leases an aircraft without flight crewmembers to an air carrier (the lessee) and in which the lessee maintains operational control.

**Duty position:** The functional or operating position of a crewmember or aircraft dispatcher. For CFR Parts 121 and 135 operations, duty positions are pilot-in-command (PIC), second-in-command (SIC), flight engineer (FE), flight attendant (FA), flight navigator (NAV), and aircraft dispatcher (AD).

**Emergency:** When emergency is used to describe a procedure or process, it refers to a nonroutine operation in which certain procedures or actions must be taken to protect the crew, the passengers, or the aircraft from a serious hazard or potential hazard.

**Equipment:** An artifact needed for an undertaking or to perform a service in the air carrier operations.

**Execution directives:** Compared with directives, execution directives are more detailed and specific as to how to conduct certain tasks.

**Facility:** Support system providing the mechanisms for supporting the execution of certain tasks.

**Federal Aviation Administration:** The government agency responsible for air safety and operation of the air traffic control system.

**Flaps:** Control surfaces installed on the trailing edge of a wing and used to increase the amount of lift generated by the wing at slower speeds. Flaps also have the effect of slowing an aircraft during its landing approach.

**Fix:** A geographical position determined by visual reference to the surface, by reference to one or more radio Navigational Aids (NAVAID), by celestial plotting, or by another navigational device.

**Flightcrew member:** A pilot, flight engineer, or flight navigator assigned to duty in an aircraft during flight time.

**Flight manual:** Any manual approved by the FAA and required to be carried aboard each aircraft for the guidance of crewmembers when conducting flight operations. A flight manual may be an approved Airplane Flight Manual (AFM), an approved Rotorcraft Flight Manual (RFM), or an approved Company Flight Manual (CFM).

**Flight Operations:** The system which pertains to aircraft movement.

**Flight plan:** Specified information relating to the intended flight of an aircraft that is filed orally or in writing with air traffic control.

**Flight time:** The time from the moment the aircraft first moves under its own power for the purpose of flight until the moment it comes to rest at the next point of landing.

**Function:** Appropriate or assigned duties, responsibilities, missions, tasks, powers, or duties of an individual, office, or organization.

**General manual:** A manual providing guidance for all categories of flight and ground personnel conducting air transportation operations. The general manual must include the duties and responsibilities of each category of employee, adequate policy, direction, and guidance for the safe and efficient performance of the duties assigned to each category of employee. General Operations Manual (GOM) and General Maintenance Manual (GMM) are two major segments of an air carrier's general manual.

**Go-around:** Instructions for a pilot to abandon his approach to landing.

**Holding procedure:** A predetermined maneuver which keeps aircraft within a specified airspace while awaiting further clearance from air traffic control. This maneuver is also used during ground operations to keep aircraft within a specified area or at a specified point while awaiting further clearance from air traffic control.

**Inspection:** The routine performance of inspection tasks at prescribed intervals. The inspection must ensure the airworthiness of an aircraft up to and including its overhaul or life-limits.

**Lease:** Any agreement by a person (the lessor) to furnish an aircraft to another person (lessee) to be used for compensation or hire purposes.

**Liability:** The accountability for failure to comply with the air carrier's policies and procedures.

**Mail:** This includes airmail, company mail (i.e., parts), or documents to ensure operational integrity or dangerous goods or materials.

**Maintenance:** Inspection, overhaul, repair, preservation, and the replacement of parts, but excludes preventive maintenance.

**Manual:** A collection of the information, policies, procedures, and guidance prepared by an air carrier to instruct company employees in the performance of their assigned duties.

**Material:** Substance to be consumed or processed during the air carrier operations.

**Minimum equipment list:** A list of aircraft equipment that must be in good working order before an aircraft may legally takeoff with passengers. Repairs to some items not essential to an aircraft's airworthiness may be deferred for limited periods of time approved by the FAA.

**Missed approach:** The segment between the missed-approach point, or point of arrival at decision height, and the missed-approach fix at the prescribed altitude.

**Model:** An abstraction of a subject that allows us to answer questions about the subject. A representation of a complex, real-world phenomenon within some acceptable and predictable tolerance.

**Normal:** When normal is used to describe a procedure or process, it refers to a routine operation (without malfunctions).

**Operations:** The movement of aircraft operated under CFRs 121, 119, and 135 regulations, and the air carrier's resources and organizational structure that supports or has impact on that activity.

**Oversight:** An activity that assures compliance with CFRs and the operator's manual. Included in this process are adjustments to the operators program as required.

**Parts:** Any engine, propeller, component, accessory, material, or hardware used on an air carrier aircraft.

**Passenger:** Revenue and nonrevenue passengers.

**Payload:** Passengers, cargo, and mail transferred by aircraft.

**Performance analysis:** The process that defines the differences between what is expected in a task and what is actually being done.

**Performance measurement:** A description of the desired outcome of an air carrier element process, used to determine if the desired results of the process were achieved.

**Pilot weather report:** A report of meteorological phenomena encountered by aircraft in flight.

**Policy:** A written requirement established by an air carrier's management that is expected to be complied with by appropriate employee personnel. A policy may be within a procedure or stated separately. A written requirement such as "No flight may depart on a cross-country flight without a spare case of oil" is an example of a policy.

**Preflight package:** Documents delivered to pilots before the flight that contains detail flight information of route, weather, fuel, airport, and so forth.

**Procedures:** A logical progression of actions and/or decisions in a fixed sequence that is prescribed by an air carrier to achieve a specified objective. In short, a procedure is a step-by-step guidance on how to do something.

**Process:** Linked activities designed to produce a desired result or end product for an air carrier.

**Real-time information:** Information related to the activities that is gathered during the time the activity is being conducted. Compilation of this same information is the historical basis for adjustments to policies and procedures.

**Quality assurance:** An oversight function that assures compliance with Code of Federal Regulations and the air carrier's policies and procedures.

**Ramp:** The aircraft parking area at an airport, usually adjacent to a terminal.

**Records:** Information gathered from the operations of an air carrier.

**Records and reporting systems:** The subsystem by which an air carrier manages the records used to show the aircraft are airworthy; that reflect the air carrier's use of its procedures; and that ensure the issuance of required reports.

**Resources:** Assets and services used to support the execution of certain tasks. The resource/services include, but not limited to, personnel, equipment, financial, information infrastructure and technologies, legal services, telecommunications, and the actual operational facilities.

**Resource provision:** Plan for, acquire, allocate, and supply the resources to support the execution of certain tasks.

**Responsibility:** The air carrier organization, or person within, who owns the process and is answerable for the quality of the process.

**Risk:** An expression of the probability and impact of an undesired event in terms of event severity and event likelihood.

**Risk indicator:** A grouping of safety and/or performance-related data that reflects an area of potential risk which is expected to have sufficient data or justification to calculate a representative value for a particular air carrier system, subsystem, or element.

**Risk management:** An iterative management activity dedicated to assuring that risk is identified, documented, eliminated, or controlled within defined program risk parameters.

**Route segment:** A portion of a route to be flown, as defined by two consecutive significant points specified in a flight plan.

**Safety:** An inherent attribute of an air carrier's properly designed systems, subsystems, and elements.

**Safety assessment:** A systematic process of collecting, analyzing, and evaluating performance data to determine an air carrier's exposure to risk.

**Safety Risk:** An expression of the probability and impact of an undesired event in terms of hazard severity and hazard likelihood.

**Scheduled maintenance:** The performance of maintenance tasks at prescribed intervals.

**Nonscheduled maintenance:** The performance of maintenance tasks when mechanical irregularities occur. These irregularities are categorized as to whether or not they occur during flight time.

**Simulator:** A ground-based device used to train pilots that simulates flight scenarios, including emergency situations.

**Stopway:** An area beyond the takeoff runway, no less wider than the runway and centered upon the extended centerline of the runway, able to support the airplane during an aborted takeoff without causing structural damage to the airplane, and designated by the airport authorities for use in decelerating the airplane during an aborted takeoff.

**System:** A group of interrelated processes which are a composite of people, procedures, materials, tools, equipment, facilities, and software operating in a specific environment to perform a specific task or achieve a specific purpose, support, or mission requirement for an air carrier.

**System safety:** The application of special technical and managerial skills to identify, analyze, assess and control hazards and risks associated with a complete system. System safety is applied throughout a system's entire life cycle to achieve an acceptable level of risk within the constraints of operational effectiveness, time, and cost.

**Systems approach:** The structured, safety-driven means by which the FAA will certificate and survey elements that are designed to interact predictably within the air carrier's systems and subsystems.

**Systems safety analysis:** An activity designed to quantify air carrier systems through modeling and analysis of their subsystems and assessment of their processes and procedures to explore and understand the interactions of the safety elements.

**Tool:** An instrument used in air carrier operations to provide functional services such as a hammer, test apparatus, and so forth.

**Training program:** A system of instruction including curriculums, facilities, instructors, check airmen, courseware, instructional delivery methods, testing, and checking procedures by which an air carrier ensures personnel are trained to perform assigned duties in accordance with the air carrier's approved programs.

**Training delivery methods:** Methodology for conveying information to a student. For example, this may include lectures, demonstrations, audiovisual presentations, programmed and directed self-study workshops, drills, training devices, simulators, aircraft, computer workstations, and so forth.

**Wet lease:** Any agreement in which a lessor (U.S. air carrier only) leases an aircraft, with at least one pilot and one flight crewmember, to either a U.S. air carrier, foreign air carrier, or a foreign person (the lessee).

**Work force:** Human resources including air carrier employees and contractors to accomplish assigned operational missions.

## 6.2 ACRONYMS.

ACOSM	Air Carrier Operations System Model
AFM	Approved Flight Manual
AQP	Advanced Qualification Program
ATC	Air Traffic Control
ATOS	Air Transportation Oversight System
CAMP	Continuous Airworthiness Maintenance Program
CASS	Continuing Analysis Surveillance Systems
CAT II	Category II
CAT III	Category III
CBT	Computer-Based Training
CDL	Configuration Deviation List
CFR	Code of Federal Regulations
CMF	Company Flight Manual
CMT	Certificate Management Team
COMAT	Company Owned Material
CRM	Crew Resource Management
DH	Decision Height
DMI	Deferred Maintenance Item
ESD	Electrostatic Discharge
ETE	Estimated Time En Route
ETOP	Extended-Range Operation With Two-Engine Airplanes
FAA	Federal Aviation Administration
FAF	Final Approach Fix
FAR	Federal Aviation Regulation
FOQA	Flight Operation Quality Assurance
FSS	Flight Service Station
GMM	General Maintenance Manual
GOM	General Operations Manual
HAZMAT	Hazard Material
IAF	Initial Approach Fix
ICOM	Input, Control, Output, Mechanism
IDEF0	Integrated DEFinition Language
IFR	Instrument Flight Rules
MAP	Missed Approach Point
MCC	Maintenance Control Center
MEL	Minimum Equipment List

MIS	Mechanical Interruption Summary
NFF	No Fault Found
NOTAM	Notice to Airmen
NWS	National Weather Service
OEM	Original Equipment Manufacturer
PED	Portable Electronic Device
PIC	Pilot in Command
PMET	Precision Measurement Equipment Tooling
POI	Principal Operations Inspectors
RFM	Rotorcraft Flight Manual
RII	Required Inspection Items
RVSM	Reduced Vertical Separation Minimum Airspace
ROI	Return on Investment
SIC	Second in Command
TSO	Technical Standard Order
ULD	Unit Load Device
VDP	Visual Descent Point



## APPENDIX A—IDENTIFIED ITEMS FOR FURTHER DEVELOPMENT

### Specific Areas Within the Model

#### A1—Management

- Review and update human resources function
- Ensure correct interface with A4 on the subject of personnel selection

#### A3—Maintenance

- Address the Continuing Analysis and Surveillance Program (CASP)
- Address Quality Assurance
- Review and update engineering activities including:
  - Additional authorizations including Designated Alteration Stations, SFAR 36
  - Interfaces between maintenance departments and repair stations
  - Engineering approvals of repairs, IMODs, and maintenance procedures
- Maintenance Control and specifically how operations (dispatch/scheduling) and maintenance departments interface during daily operations. Need to specifically address deferred maintenance, special flight authorizations, and so forth.

#### A4—Training

- Split the second level into Operations, Maintenance, Other
- Tailor ISD process to each to make contest-sensitive functions, subfunctions for each type of training.
- Examine where “weather” fits into training
- Look at management interface with contract training

#### A5—Resources

- Review model to ensure that controls from management blocks are present and correct
- Review entire model to ensure that inputs to resourcing blocks are correctly modeled (inputs rather than resources)

## **Modelwide Issues**

- Modelwide simplification of management and resource functions
  - Analyze management subfunctions and retitle/redefine as necessary
  - Eliminate unnecessary resource functions
- Rewrite definitions, including, but not limited to, the following
  - Flyaway kit
  - Contractor support
  - Check/weigh/screen
  - New hires
  - Security
  - Outsource
  - Passenger service
  - Procedures
  - Utilization means different definitions at different levels, e.g., to marketing, maintenance, etc.

## **Areas to be Addressed Within the Model**

- Airworthiness Directives—Explain or illustrate how they fit into the model for operations and maintenance
- Building specifications
- Cabin safety
- Cargo bulletins
- Crew economics as applied to crew assignment
- Dangerous goods and materials
- Emergency needs
- Emergency response
- Failure modes

- Maintenance program changes
- Marshalling
- Modifications
- Operation specifications
- Required inspection items
- Safety programs

### **Other Areas to be Re-examined**

- Parts identified within A334 that are not serviceable or repairable
- Demonstrate the following processes:
  - When a part fails a test
  - How new people/equipment/parts are inspected
- The influence of DoD on controls, inputs, outputs, and so forth
- Should “perform deicing/anti-icing program” be renamed “perform deicing/anti-icing services?”
- Is the phrase “perform operational control” correct?
- Should Operations and Maintenance Policies and Procedures be combined?
- Have the following been addressed:
  - Approved inspection programs
  - Internal oversight processes
  - New airlines and growth issues
- Should the model address the interface between the carrier and the airport? security? For example, snow removal, lighting, icing, etc.
- Where are field specifications, parts manuals developed?