

INSTITUTE OF TRANSPORTATION STUDIES
UNIVERSITY OF CALIFORNIA, BERKELEY

**Dual Influences on Vehicle Speeds in Special-Use Lanes and
Policy Implications**

Kitae Jang and Michael J. Cassidy

UCB-ITS-VWP-2011-4



September 2011

Abstract

We verify that slow speeds in a special-use lane, such as a carpool or bus lane, can be due to both high demand for that lane and slow speeds in the adjacent regular-use lane. These dual influences are confirmed from months of data collected from all freeway carpool facilities in the San Francisco Bay Area. Additional data indicate that both influences hold not only for other types of special-use lanes, including bus lanes, but also for other parts of the world.

The findings do not bode well for a new US regulation stipulating that most classes of Low-Emitting Vehicles, or LEVs, are to vacate slow-moving carpool lanes. These LEVs invariably constitute small percentages of traffic; e.g. they are only about 1% of the freeway traffic demand in the San Francisco Bay Area. Yet, we show that relegating some or all of these vehicles to regular-use lanes can significantly add to regular-lane congestion, and that this, in turn, can also be damaging to vehicles that continue to use the carpool lanes. Counterproductive outcomes of this kind are predicted first by applying kinematic wave analysis to a real Bay Area freeway. The site stands to suffer less from the regulation than will others in the region. Yet, we predict that the site's people-hours and vehicle-hours traveled during the rush will each increase by more than 10%, and that carpool-lane traffic will share in the damages. Real data from the site support these predictions. Further parametric analysis of a hypothetical, but more generic freeway system indicates that these kinds of negative outcomes will be widespread. Constructive ways to amend the new regulation are discussed, as are promising strategies to increase the vehicle speeds in carpool lanes by improving the travel conditions in regular lanes.

Keywords

Highway Traffic Speeds, Carpool Lanes, Low-Emitting Vehicles

1. Introduction

The present study is concerned with special-use highway lanes that are reserved for select vehicle classes, such as carpools or buses. Previous studies suggest that the vehicle speeds in a lane of this kind may be negatively influenced by both growing use of that lane and diminishing vehicle speeds in the adjacent regular-use lane (Chen et al., 2005; Guin et al., 2008; Menedez and Daganzo, 2007). These dual influences have implications when formulating policy because they act in opposite directions, as explained below.

Suppose that an attempt were made to increase the speeds in a special lane by reducing the number of vehicles that use it; e.g. by further limiting the vehicle classes that are allowed access. Some or all of the newly-excluded vehicles would now be added to the regular lanes, and this could make regular traffic more congested. The net outcome could be lower speeds in all lanes, including the special one. We will explain why this counterproductive outcome can occur even when the newly-excluded vehicles constitute a small percentage of the traffic. And we will demonstrate that damage can persist even if large portions of the newly-excluded commuters respond by altering their travel behavior in highly favorable ways. The analyses will be performed for freeways with carpool lanes that are reserved primarily for vehicles that carry more than a predetermined number of occupants (Caltrans, 1991; Fuhs, 1990).

US policy had previously stipulated that access to carpool lanes should also go to a variety of vehicle classes that satisfy low emission standards, even when these so-called Low-Emitting Vehicles (LEVs) carry small numbers of people. However, recent federal regulation has partially reversed this policy: many LEV classes are now to be expelled from a carpool lane when any portion of that lane (of unspecified physical length) exhibits vehicle speeds below 45 mph (72.4 km/hr) for more than 10% of its operating period.¹ The regulation is aimed at increasing the carpool-lane speeds in so-called “degraded” facilities of this kind, and the reader can refer to SAFETEA-LU section 1121 (2005) for details on it. The regulation took effect in August 2005. States throughout the US are currently evaluating their freeway carpool facilities to determine which are degraded as per the regulation’s criteria. We will demonstrate in the ways described below why the regulation can be counterproductive.

Six-months of data were collected from all loop detectors in the network of freeway carpool facilities throughout the San Francisco Bay Area. On each of these facilities, the median lane is reserved for carpools (and formerly for various LEV classes as well) during weekday rush periods, and these carpool lanes are not physically separated from the regular ones. The data confirm that the dual influences on speed cited above are invariably felt by the carpool lanes (see sect 2). Based upon the

¹ Naturally, LEVs in these classes would still be allowed carpool-lane access when these vehicles carry the prescribed number of occupants.

observed magnitudes of these two influences, the Bay Area site that would seem to be most favorably affected by the SAFETEA-LU regulation was analyzed using kinematic wave theory. Even for this site, we predict that *all* of its rush-period traffic, in or out of the carpool lane, will be damaged by the regulation, and real data support this prediction (sect 3). Further analysis of a hypothetical, but more generic freeway system indicates that this wholesale damage can be expected in many instances (sect 4).

The above findings constitute a cautionary tale that holds for more than just so-called non-separated carpool lanes in the San Francisco area. Other data, including data from a bus lane in Seoul, Korea, show that the dual influences on speed occur for other types of special-use lanes. Alternative policies to improve travel in all lanes, including in the special ones, are explored (sect 5).

2. Observed Influences

We first examine data from the site shown in Fig 1. According to the criteria of the SAFETEA-LU regulation, the site is the most “degraded” facility in the San Francisco Bay Area: carpool-lane speeds fall below 45 mph for more than 40% of the lane’s operating times, and do so for extended distances. The data for the illustration to follow were measured by the two inductive loop detectors circled in the figure. Note that these reside in the site’s median lane, which operates as the carpool lane during rush periods, and in the adjacent regular-use one. The data were collected during the carpool lane’s morning and evening operating times over a 6-month period extending from May through October 2009.

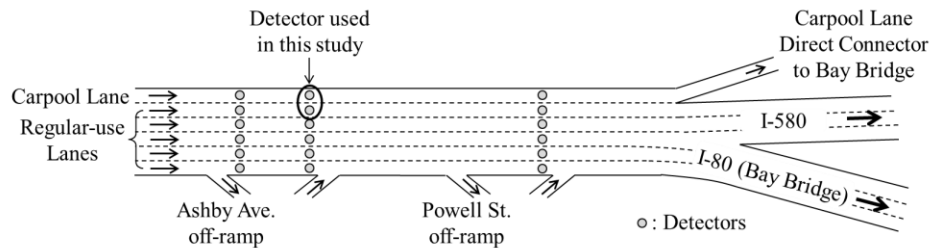

Fig. 1 Example site: I-80 West, Berkeley, California

Fig 2 presents average vehicle speeds in the carpool lane, V_c , for different values of average speed in the adjacent regular-use lane, V_r , and detector occupancy (a dimensionless measure of density) in the carpool lane, ρ_c . The shading in this figure corresponds to the magnitude of the carpool-lane speed; the darker the shade, the lower the V_c . The data were measured over 5-min intervals. To construct the figure, the 5-min measurements of V_r and ρ_c were partitioned into cells at increments of 2 mph and 1%, respectively. The average V_c was then computed for each cell.

Visual inspection of Fig 2 reveals a negative correlation between the carpool lane’s speed and its occupancy: note how the shades grow darker as the eye moves upward along a vertical line of some fixed regular-lane speed, V_r ; i.e., V_c diminishes as ρ_c increases. Interestingly, we find from these data that low values of V_c do not necessarily coincide with values of ρ_c that are especially high: less than 2% of the data from this site coincide with ρ_c that were greater than 20%. Scatterplots of ρ_c vs carpool-lane flow indicate that ρ_c below about 20% correspond to uncongested (albeit often slow-moving) carpool-lane traffic.² This state of affairs reveals that low V_c is not a reliable indicator that the carpool lane is over-used. It turns out that low V_c are largely due instead to low speeds in the adjacent regular-use lane.

To see this latter influence, note first the positive correlation between V_c and V_r visible in Fig 2: note how V_c increases (shades grow lighter) when moving the eye rightward along some horizontal line of fixed ρ_c . To confirm the direction of causality in this relation, note as an example the time-series curves of V_c and V_r in Fig 3. These were measured by our two detectors during a 15-min period spanning the onset of a morning rush (on May 21, 2009). Notice both, the precipitous decline in V_r that began at around 6:10:30 hr, and the comparable reduction in V_c that began 1.5-min later at 6:12 hr.

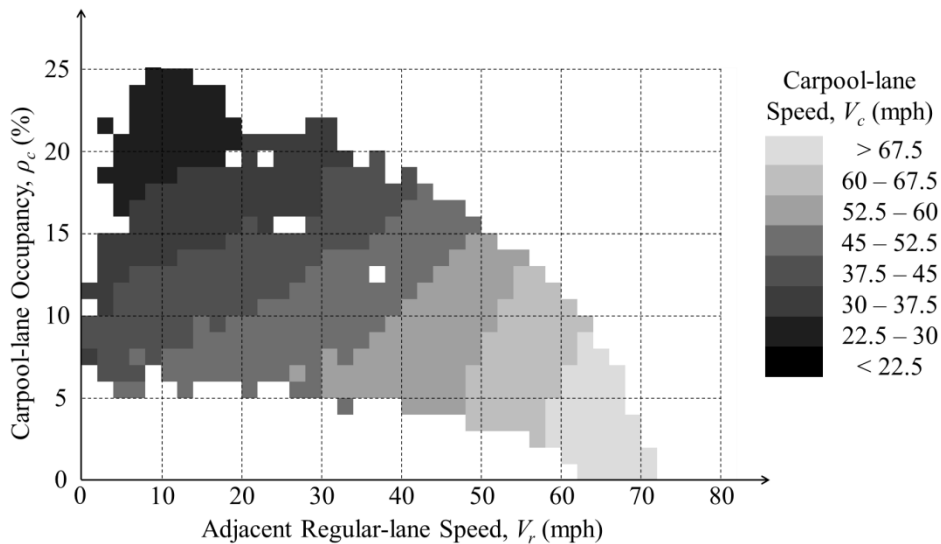

Fig. 2 Average carpool-lane speeds at example site

Constructing similar time-series curves at the site for all other days in our 6-month period, and then repeating this exercise for all other Bay Area sites, showed that: reductions in V_r always preceded reductions in V_c . There were no exceptions. This temporal sequence of events establishes that reductions

² These scatterplots revealed the well-known concave relations between occupancy and flow (e.g., Edie and Foote, 1958; Greenberg, 1954; Greenshields, 1934; Lighthill and Whitham, 1955), in this case between ρ_c and V_c . These relations began bending downward at occupancies, ρ_c , above about 20%. This indicates that $\rho_c \approx 20\%$ is the approximate boundary between congested and uncongested carpool-lane traffic.

in regular-lane speeds, V_r , trigger reductions in carpool-lane speeds, V_c . To argue the reverse (i.e., that precipitous reductions in V_c trigger similar reductions in V_r) would be to claim that an effect can precede its cause.

This influence of V_r on V_c points to the inherent risks of the SAFETEA-LU regulation. The regulation may reduce vehicle density in the carpool lane, but the migration of LEVs can add to congestion in the regular lanes and this, in turn, can further reduce speeds in the carpool lanes. These unintended consequences are explored next.

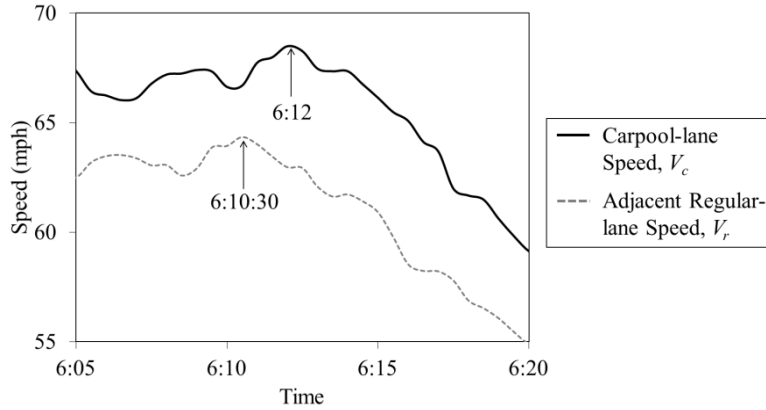

Fig. 3 Time-series speeds in carpool lane and adjacent lane

3. Case Study 1: Real Site with a Single Bottleneck

The 4-mile freeway stretch in Fig 4 will serve as our first case study. Earlier studies have found that, during each rush, a bottleneck arises at the downstream end of this site, as annotated in the figure (Cassidy et al., 2010). According to the SAFETEA-LU criteria, the site is degraded: speeds in the carpool lane fall below 45-mph for more than 35% of its operating times. This site was selected because, of all carpool facilities in the San Francisco area, it is the one that stands the greatest chance of benefiting from the SAFETEA-LU regulation. The first analysis to follow is based on measurements taken from the detectors circled in the figure. These data were collected over the 6-month observation period from May through October 2009.

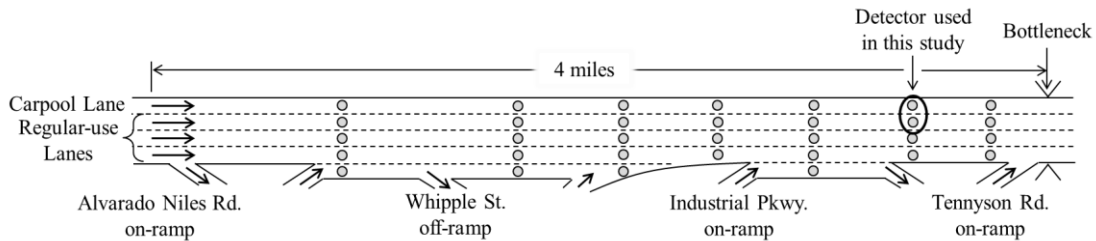

Fig. 4 Case-study site: I-880 North, Hayward, California

Fig 5a presents V_c , the average carpool-lane speed (shown again with shading) as functions of V_r and ρ_c . Once again, we see how V_c is affected positively by diminishing ρ_c and negatively by diminishing V_r .

To explore these influences in more quantitative fashion, imagine that Fig 5a is a surface in which the V_c are displayed on a third axis. Further imagine taking vertical slices through this surface at select V_r (say at 10-mph increments from 20- to 60-mph). The relations between V_c and ρ_c can then be viewed for fixed V_r .

Cross-sectional views of this kind are presented in Fig 5b. Each data point in that figure shows the V_c vs ρ_c in a cell. A best-fit line is shown for each data set corresponding to a select V_r . Each best-fit line reveals a well-defined relation between V_c and ρ_c : note that the R^2 -values annotated in the figure are all quite high. Note too that distinct best-fit lines were estimated for those data with $\rho_c > 16\%$, since these were found to fall into the congested traffic regime, as per the reasoning described in footnote 2. (Only 5% of the data from this site fell into this congested regime.) Finally, note from Fig 5b that, for uncongested carpool-lane conditions, the slopes of the best-fit lines range from -1.33 to -2.52 . These were the steepest of any slopes observed across all carpool facilities in the San Francisco area. Stated simply, carpool-lane speeds on our case-study site are more sensitive to ρ_c than are the carpool-lane speeds on any other site in the region. From this relative perspective, expelling LEVs from our site's carpool lane would favorably impact V_c to the greatest degree.

Analogous cross-sectional views are featured in Fig 5c: it presents relations between V_r and V_c at specified values of ρ_c . Best-fit lines again reveal that relations are well-defined. The slopes of these lines, which range from 0.29 to 0.37 (see the figure), are the lowest of those observed across all Bay Area carpool facilities; i.e., the carpool-lane speeds in our case-study site are the least sensitive to speeds in the adjacent regular-use lane. This means that if congestion in regular lanes is worsened due to the migration of LEVs into those lanes, the resulting reductions in V_c would be modest, relatively speaking.

Given that its V_c is relatively sensitive to ρ_c and relatively insensitive to V_r , it seems that the SAFETEA-LU regulation stands greater chance of producing favorable outcomes for our case-study site than for any other site in the region. Yet, we find that the regulation is detrimental to *all* commuters at our site. The evidence follows.

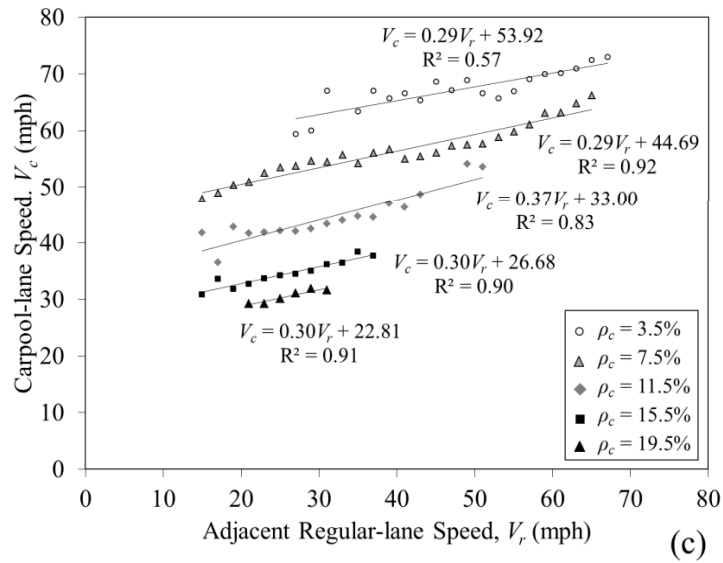
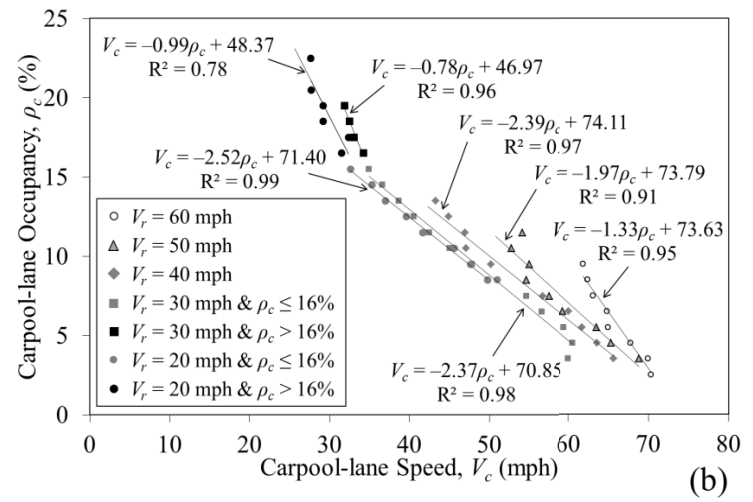
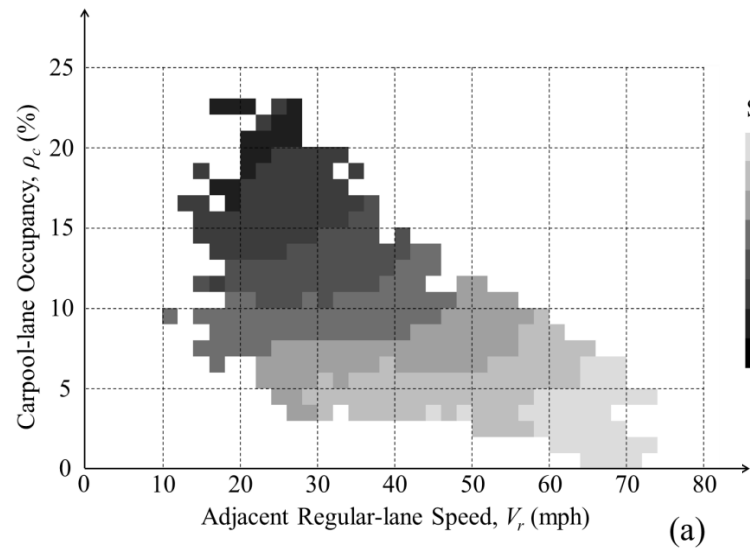

Fig. 5 (a) Average carpool-lane speeds at case-study site; (b) carpool-lane speed, V_c vs carpool-lane occupancy, ρ_c ; and (c) regular-lane speed, V_r vs carpool-lane speed, V_c

3.1 Preliminaries

Though LEVs are relatively few in number (they constitute only about 1.2% of our site's commute-time traffic demand), their migration from the carpool lane can severely damage travel conditions in the regular lanes. To fix ideas, consider the idealized queueing diagram in Fig 6. It provides a reasonable description of commute traffic in the regular lanes in that most of their traffic travels through the single bottleneck at the downstream end of the site. Without loss of generality, assume that this bottleneck has a fixed capacity; i.e., the slope of the dashed curve of cumulative vehicle departures from the bottleneck vs time has a constant slope. Further assume that there is a fixed demand that exceeds bottleneck capacity during a portion of the rush, and a lower fixed rate thereafter: note the piecewise linear patterns of the solidly-drawn demand curves. Suppose that the lighter-drawn solid curve is regular-lane demand absent LEV migration, and that its darker counterpart is demand when LEVs are added to the regular lanes.

The differences in demand rates with and without LEVs in the mix may be modest, but the vertical displacements between the solid curves can obviously grow large if the congested period is long. This vertical divergence in demand curves reflects congestion's added physical expansion due to the LEV migration.³ This expansion means that the infusion of LEVs into the regular lanes will cause the vehicles in these lanes to travel greater distances in congestion.

Congestion subsides at the time when a (solid) demand curve re-converges with the (dashed) departure curve (Newell, 1982). Note from the figure how congestion persists for a greater duration due to LEV migration. This added duration means that more vehicles will encounter slowed, congested states.

For our first case-study site, we predict that LEV migration can add to congestion's spatial extent by as much as 40%, and to its temporal extent by 15%. The methods used to predict these sizable expansions are described next.

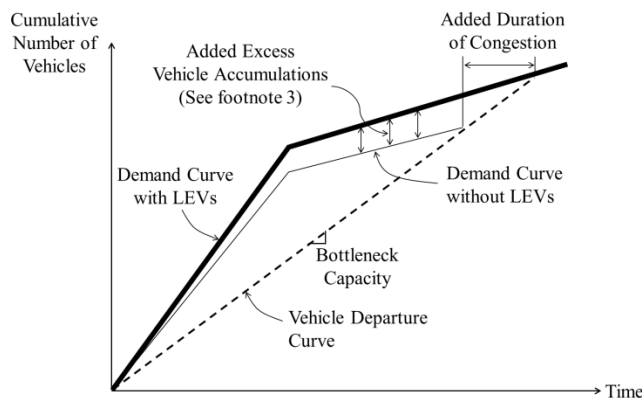

Fig. 6 Hypothetical queueing diagram for regular lanes

³ The vertical displacements between the demand curves in Fig 6 are the added excess numbers of vehicles that are stored upstream of the bottleneck (see Newell, 1982). The excess number of stored vehicles is smaller than the number of vehicles enveloped in congestion (see Lawson et al., 1997), though this detail is an aside to the present discussion.

3.2 Kinematic Wave Analysis

Predictions for the first case-study site were performed using the Cell Transmission Model (CTM). As described in Daganzo (1995), the CTM approximates kinematic wave analysis by modeling traffic in discrete space and time; i.e., analysis is performed for short, interconnected roadway segments, termed cells, in short time steps. Cell lengths of approximately 150-m and time steps of 5-sec duration were used in the present case.

Modest additions were introduced to the CTM logic so as to model two adjacent traffic streams (carpools and regular traffic) with distinct flows and speeds; see Appendix A of this report for details on these modifications. For simplicity, it was assumed that a carpool-lane user travels from her on-ramp to the carpool lane (and from that lane to her off-ramp) without encountering delays in the regular-use lanes. This simplification could cause us to under-predict slightly the SAFETEA-LU regulation's negative impacts.

Inputs to the analyses were estimated from data collected at the site from all the afternoon rush periods in August 2009. Averages were used for this purpose. Values of ρ_c and V_r were predicted for each cell and time step, and were used as inputs to Fig 5a to predict time-varying V_c in each cell. The CTM simulations were performed for 5-hour periods that bracketed the afternoon rush.

3.3 Aggregate Predictions

We first present predictions for regular and carpool-lane traffic combined. The boldly-drawn curve in Fig 7 displays the total People Hours Traveled, the PHT, predicted for the afternoon rush. These are given as functions of the additional traffic quantities admitted into the carpool lane, over and above what is allowed access under the SAFETEA-LU regulation. These added quantities are expressed as percentages of the site's total demand.

Note that the predicted PHT is nearly 3800 person-hrs when only vehicles that are approved under the regulation use the carpool lane (i.e. when the added quantity on the x-axis of Fig 7 is zero). Further note that PHT drops to 3390 person-hrs when an additional 1.2% of the demand use the carpool lane. Recall that 1.2% is the proportion of rush-period demand that are LEVs, and that these vehicles were previously allowed carpool-lane access. Thus, we predict that the SAFETEA-LU regulation can increase a rush period's PHT at the site by more than 400 person-hours, a 12% increase. In similar fashion, the thin curve in Fig 7 indicates that the regulation can increase the total rush-period Vehicle Hours Traveled, the VHT, by roughly 11%.

Interestingly, both curves in Fig 7 monotonically decrease over the range of added quantities shown. This means that the site's commute conditions would improve, on the whole, not by tightening

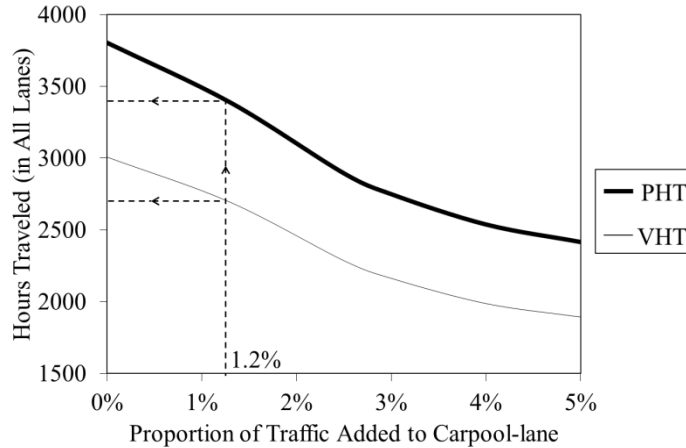

Fig. 7 Predicted total PHT and VHT as functions of the added traffic proportions that are given access to the carpool-lane

the carpool lane’s restrictions, but by easing them somewhat so that more vehicle classes would enjoy access to that lane.

3.4 Carpool-Lane Predictions

The curves in Fig 8 present time series of travel speeds predicted for the carpool lane only. The 4-hr period shown in the figure spans the carpool lane’s active period. Each curve depicts what can occur when a distinct quantity of additional traffic (e.g. LEVs) enjoy carpool-lane access. These added quantities are again expressed as percentages of the site’s total demand.

The speeds in Fig 8 are averages for the carpool lane taken over the site’s entire 4-mile length. Note how the average speeds gradually fall and then recover as congestion in the regular lanes gradually grows and then recedes on our 4-mile site. On most days, regular-lane congestion does not engulf this entire length. Rather, the site’s upstream end typically remains uncongested. Thanks to this uncongested portion upstream, the average carpool-lane speeds predicted over the 4-mile length tend to exceed 45 mph. Our predicted carpool-lane speeds at the downstream portion of the site, where congestion persists in the regular lanes, are significantly lower. (Slow downstream speeds are the reason that the facility was designated as a “degraded” one.)

Our predictions indicate that the SAFETEA-LU regulation can be damaging to carpool-lane speeds. To see this, note first the dashed curve that presents the speeds when only vehicles approved under the SAFETEA-LU criteria are admitted into the carpool lane. Further note the solid, bold curve that presents speeds when an additional 1.2% of the demand is admitted to that lane. The solid, bold curve lies mostly above its dashed counterpart and the implication of this is clear: we predict that speeds in the site’s carpool lane would be higher in the absence of the SAFETEA-LU regulation.

The solid, thin curve in Fig 8 describes speeds in the carpool lane when a greater portion of demand (3%) enjoys access to that lane. Note how the carpool lane’s speeds are predicted to increase when we admit greater (not lesser) quantities into it. It seems that reducing the spatial and temporal extents of congestion favorably impacts speeds in the carpool lane, even when the utilization of that lane is increased.

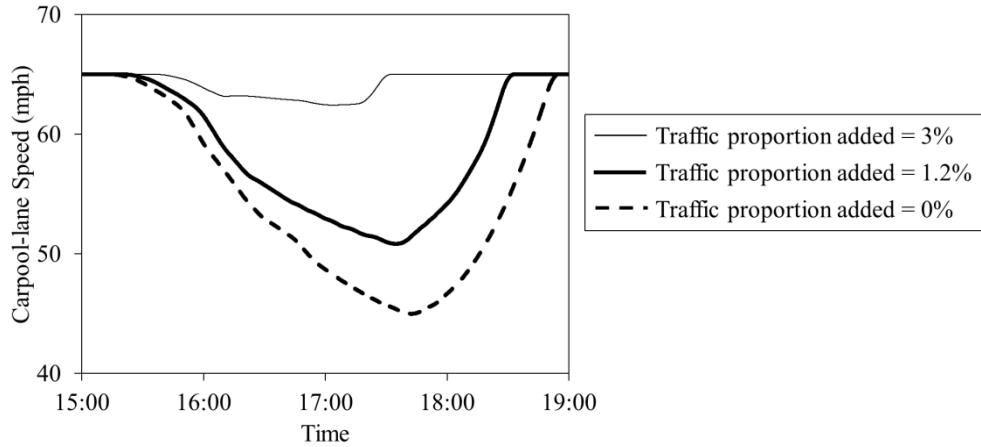

Fig. 8 Predicted average carpool-lane travel speeds over the entire 4-mile length

3.5 Changes in Travel Behavior?

Our predictions until now have assumed that the LEVs expelled from the carpool lane will *all* migrate to the congested regular-use lanes. In reality, some of the newly-expelled commuters may choose not to travel in the site’s regular lanes during the rush. These kinds of behavioral changes are notoriously tricky to predict. Moreover, the changes can bring on costs that are equally tricky to assess. For example, an LEV-driver who diverts from the freeway to surface streets would typically suffer added costs of her own (as compared against the good-old-days prior to the SAFETEA-LU regulation), and could also impart added costs to others by adding to congestion on her new surface-street travel route.

To keep things simple (while still illustrating a key point), let us optimistically assume that fully one-half of newly-expelled LEV-users do not join congested traffic in the site’s regular lanes. In the same spirit of unbridled optimism, we will further suppose that these behavioral changes do not add any costs to the system. (Perhaps the erstwhile commuters now stay home every day, and are somehow indifferent to their lifestyle change.) Despite these assumptions that are favorable enough to strain credulity, we predict that the SAFETEA-LU regulation would still be damaging to all commuters who remain on the site.

For illustration, the solid, bold curve in Fig 9 presents – for a second time – the time series of predicted average travel speeds in the carpool lane, when LEVs totaling 1.2% of the site’s demand are allowed access to that lane. The dashed curve shows the carpool lane’s speeds when LEVs are expelled

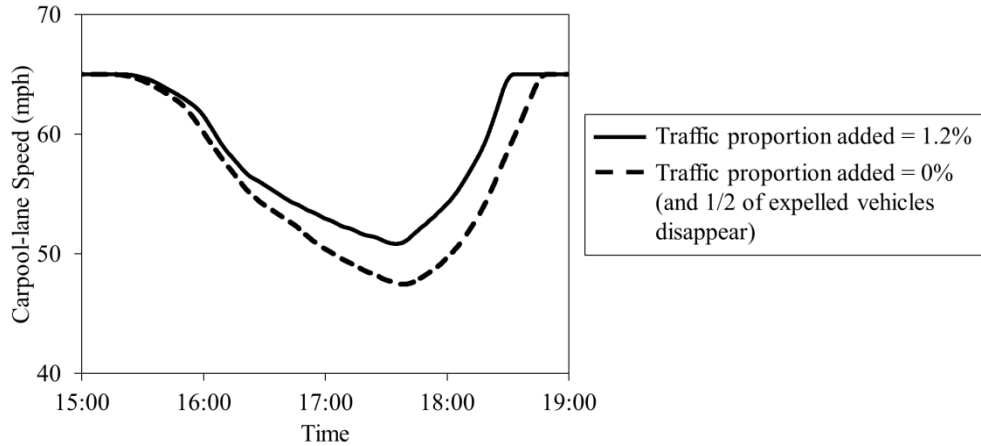

Fig. 9 Predicted average carpool-lane travel speeds over the site’s 4-mile length, with optimistic assumptions regarding the changes in travel behavior

from it and one-half of these expelled vehicles disappear from the scene. The dashed line still mostly falls below its solidly-drawn counterpart. The damage to the carpool lane is lessened (as compared against what we saw in Fig 8), but damage persists, nonetheless.

3.6 Empirical Verification

It so happens that California has opted not to renew the exemption that had formerly granted carpool-lane access to select classes of LEVs. The resulting prohibition, which took effect on July 1, 2011, has affected 85,000 LEVs statewide; See SB 535 (2010) for further details on this California policy. Consequently, the LEVs totaling 1.2% of our site’s traffic demand are now banned from its carpool lane. This new state of affairs affords us opportunity to test our predictions against real data. The data are limited: as of this writing, California’s new policy has been in effect for little more than 2 months. The preliminary assessment to follow is instructive nonetheless.

The curves in Fig 10a display time-series average speeds in our site’s carpool lane measured over the lane’s entire 4-mile length. The speeds were measured by the loop detectors in that lane (see again Fig 4) during the carpool lane’s afternoon operating periods in June 2011, the month prior to LEV expulsion (solid curve), and in July 2011, immediately following this expulsion (dashed curve). Averages over each month were used, though data from periods that included major incidents were excluded. These incidents were identified from the site’s incident log (PeMS, 2011).

By comparing the measured curves in Fig 10a against the predicted ones in Figs 8 and 9, we see that our simulations over-predicted carpool-lane speeds. More to the point, we further see that our predictions regarding the damaging effects of LEV expulsion are in qualitative agreement with the real data. Note from Fig 10a how the dashed curve lies beneath its solid counterpart for most of the carpool-

lane operating period. Thus, we see that the measured average speeds in the carpool lane did in fact diminish following LEV expulsion.

Travel conditions in the regular lanes erode as well, as migrating LEVs cause the regular-lane queue to expand spatially and temporally. This is evident in Fig 10b. It presents time-series curves of the measured speeds averaged across all regular lanes. Averages over the month just before and just after the LEV expulsion are shown.

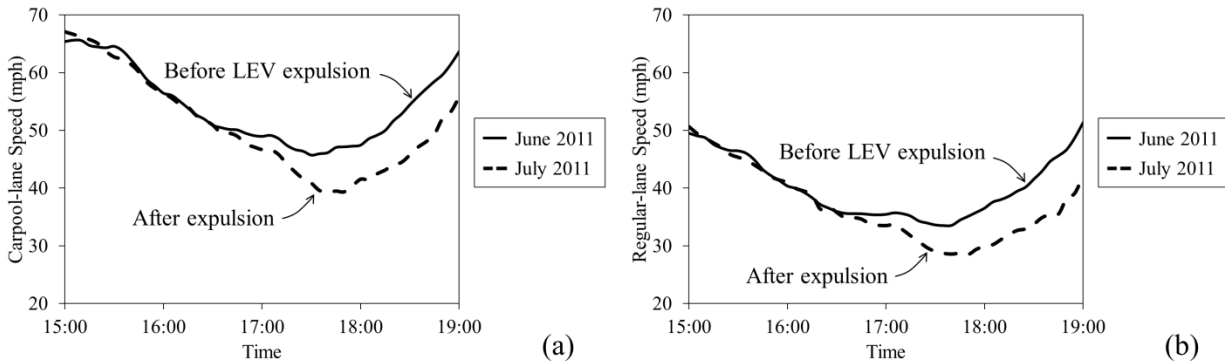

Fig. 10 Measured average travel speeds over the site's 4-mile length before and after LEV expulsion: (a) carpool lane; and (b) averages across all regular lanes

3.7 Closing Thought on this Case Study

Since our first case-study site was, relatively speaking, favorably disposed to the SAFETEA-LU regulation, the damage it does may be different (possibly even worse) at other sites in the region and elsewhere. This concern underscores the need for parametric assessments that are more general in nature. These come next.

4. Case Study 2: Hypothetical Congested Beltway

Consider a rotationally symmetric and fully-congested closed-loop beltway, with L lanes to serve traffic in a single direction, and where one of those lanes is reserved for carpools during part of the day. Our select facility is an idealization of a generic freeway network: the beltway's uniform (rotationally-symmetric) congestion pattern approximates what can arise on a freeway system with multiple bottlenecks throughout; and like an urban freeway, the beltway can have any number of access and egress points; see Daganzo and Cassidy (2008) for further discussion on the generic attributes of a beltway system.

Parametric analysis will now be used to predict how LEV-expulsion from the carpool lane can make congestion worse (denser) in the beltway's regular lanes (sect 4.1). These predictions will be used

jointly with the observed relations previously displayed in Fig 5a to estimate impacts on the carpool lane (sect 4.2).⁴

We will assume that inflows to the congested beltway are controlled in such way that its total density across all lanes is held constant, whether or not the carpool lane is active. This is a sound strategy: it would ensure that congestion outside the beltway (e.g. on access roads) is kept constant as well; see again Daganzo and Cassidy (2008) for further discussion on this matter.

We will further assume that the controlled (e.g. metered) on-ramps do not have bypass lanes for carpool-lane vehicles. This assumption will lessen the damage done by the SAFETEA-LU regulation. In the absence of on-ramp bypass lanes, severe congestion on the beltway's regular lanes will limit the inflows of carpool-lane vehicles, and thus the utilization of the carpool lane itself. As a result, the damaging effects of slow regular-lane speeds on the carpool lane will be offset somewhat by low densities in that lane.

4.1 Regular-Lane Predictions

We borrow ideas from Cassidy, et al. (2009) for assessing impacts of bus lanes on regular (i.e., car) traffic in a beltway and examine now the case of a carpool lane. It is assumed that traffic in each regular lane is described by a triangular-shaped fundamental diagram. Prior to the carpool lane's activation, $q = Q(k)$, where q is the flow in a lane and k is its density. Both k and triangular relation Q are inputs to the analysis.

When the carpool lane eventually activates, carpools use that lane as do LEVs in the absence of any expulsion policy. Since the beltway's total density is unchanged by this activation, the density in each of the $L - 1$ regular lanes becomes $k_r = L/(L - 1) \cdot k \cdot (1 - p_c - p_l)$, where p_c and p_l are the fixed proportions of beltway demand that are carpools and LEVs, respectively. Total flow in those lanes becomes $q^R = Q(k_r) \cdot (L - 1)$, where the superscript is used to denote a total flow across all the regular lanes.

If LEVs are expelled from the carpool lane and migrate to the regular ones, we similarly define $k_{er} = L/(L - 1) \cdot k \cdot (1 - p_c)$ as the resulting density in a regular lane, and $q_e^R = Q(k_{er}) \cdot (L - 1)$ as the total flow across those lanes. We can now explore impacts of LEV expulsion by comparing q^R with q_e^R .

For illustration, Fig 11 presents comparisons for a freeway beltway with $L = 4$ lanes, including the carpool lane.⁵ The figure displays $\Delta q_r = (q_e^R - q^R)/q^R$, the percent change in regular-lane flow due to LEV expulsion, vs $\rho_r = q/q_{max}$, a regular lane's flow normalized by its capacity, q_{max} . Note that ρ_r is a

⁴ Had we chosen instead to use the relations from a different Bay Area facility (e.g. those in Fig. 2), our predictions would have reflected even less favorably on the SAFTEA-LU regulation.

⁵ The fundamental diagram used for the analysis is suitable for a freeway lane: capacity, $q_{max} = 2000$ vehs/hr/lane; free-flow vehicle speed = 60 mph; and backward wave speed = 15 mph.

measure of regular-lane congestion: it ranges from capacity flow ($\rho_r = 100\%$), and diminishes as the flow becomes progressively more constrained by denser congestion. The curves in Fig 11 correspond to distinct inputs, as explained below.

The two dotted curves in the figure (both the bold and lightly-drawn one) correspond to cases when $p_c = 10\%$. The dashed and solid curves correspond to p_c of 15% and 20%, respectively. The extremes (10% and 20%) roughly bound the range of carpool-lane demand that we observed on so-called degraded facilities in the San Francisco Bay Area. The curves drawn bold correspond to cases with $p_l = 1\%$, which is comparable to the LEV levels on Bay Area freeways. The family of light curves correspond to $p_l = 3\%$, which could be viewed as a target that might be achieved through thoughtful policies to promote LEVs. Moreover, by including the case of $p_l = 3\%$, we can analyze what could occur should the SAFETEA-LU regulation ever become even more restrictive.

The curves confirm that, for all cases, LEV expulsion reduces regular-lane flow; i.e., denser congestion brought by LEV migration to these lanes further constrains their flow. This reduction is undesirable. It means that regular vehicles exit the beltway at diminished rates, and therefore reach their destinations later in time, with more delay. The curves further show how the negative impacts grow worse at lower ρ_r , meaning that the LEV migration is especially damaging to regular lanes when those lanes are already congested. Congested regular-use lanes is, of course, the norm on freeway carpool facilities: congestion is typically a reason for installing a carpool lane in the first place. As expected, we see that the damage is also more extreme: when the carpool lane serves a small demand (the dotted curve of either hue lies below its dashed and solid counterparts); and when greater proportions of traffic are expelled from that lane (the lightly-drawn curves lie below the bold ones).

As in our first case study, the damage done in the regular lanes will likely damage the carpool lane as well. This matter is explored next.

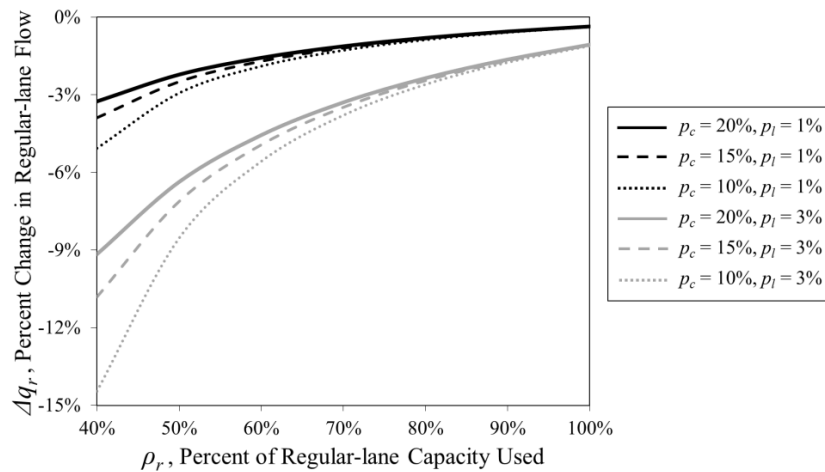

Fig. 11 Curves of ρ_r vs Δq_r for a congested beltway with a carpool lane

4.2 Carpool-Lane Predictions

While the carpool lane is active, and absent any policy to expel LEVs, the average speed in a regular lane is $V_r = (q^R / (L - 1)) / k_r$; and the density in the carpool lane is $k_c = L \cdot k \cdot (p_c + p_l)$. With the expulsion of LEVs, the regular-lane speed is $V_{er} = (q_e^R / (L - 1)) / k_{er}$, and carpool-lane density is $k_{ec} = L \cdot k \cdot p_c$. The densities k_c and k_{ec} are converted to occupancies in the customary way (e.g. see Cassidy and Coifman, 1997). Speeds and occupancies are then used as inputs to the surface in Fig 5a to estimate the carpool-lane average speed without LEV expulsion, V_c , and with this expulsion V_{ec} .

Fig 12 presents $\Delta V_c = (V_{ec} - V_c) / V_c$ vs ρ_r for our 4-lane freeway beltway. The curves reveal that carpool-lane speeds invariably diminish under LEV expulsion. The reductions are always modest (e.g. less than 0.5% for $p_l = 1\%$), and this is no doubt due in part to our assumptions that are favorable to the SAFETEA-LU regulation. Yet reductions occur. In light of our favorable assumptions, the findings suggest that the regulation stands little chance of improving carpool-lane speeds in any circumstance. Moreover, the predicted speed reductions in the carpool lane come part and parcel with the worsened conditions predicted for the regular lanes. Everyone seems to suffer under the regulation. Possible remedies are discussed next.

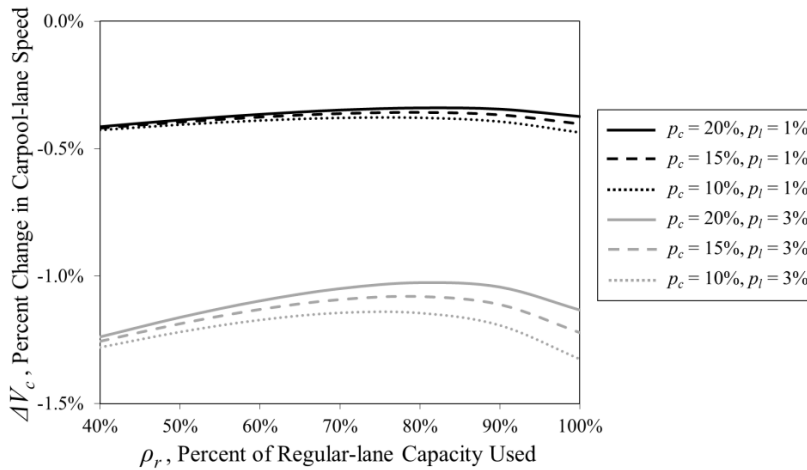

Fig. 12 Curves of ρ_r vs ΔV_c for a congested beltway with a carpool lane

5. Conclusions

Empirical evidence from across the San Francisco Bay Area indicates that slow carpool-lane speeds do not necessarily indicate that the lane is over-used. Typically, the slowness is due in part to congestion in the adjacent regular-use lanes. Carpool-lane drivers may be reluctant to travel fast when adjacent traffic is moving at slow, congested speeds. And when regular lanes are congested, lane-changing maneuvers made into and out of a carpool lane may become disruptive and diminish its speeds. This means that

current US policy to restrict LEVs from slow-moving carpool lanes can be counterproductive because some or all of the LEVs will now add to congestion and slowing in the regular lanes.

Analysis of a real freeway stretch illustrates just how damaging the policy can be. Negative impacts were predicted for *all* commuters at that site, even if LEV-users were to adjust their travel behavior in highly-favorable ways. The predictions were in line with limited observations collected from the site. More generalized analysis of a hypothetical beltway suggests that these problems will be common to a wide range of freeways with so-called non-separated carpool lanes, despite our favorable assumptions.

The above concerns notwithstanding, there is something positive about the present findings. They indicate that carpool-lane travel can be improved by improving travel conditions in the regular lanes. This means that strategies to regulate regular-traffic inflows to facilities (e.g. Cassidy and Rudjanakanoknad, 2005; Daganzo, 1996; Daganzo et al., 2002; Haj-salem and Papageorgiou, 1995; Papageorgiou and Kotsialos, 2002; Persaud et al., 2001) can be Pareto improving and can promote the use of more environmentally-friendly LEVs. This knowledge can be used to further justify the deployment of these strategies. There remain possible downsides to strategies of this kind, however; e.g. sometimes they transfer congestion to access facilities that have insufficient queue storage space (e.g. Cassidy, 2003). One might therefore look for other options.

5.1 Alternatives

In some cases, it may be beneficial to transfer some of the regular traffic into a so-called “degraded” special lane. This might be achieved by admitting a wider spectrum of vehicle (e.g. LEV) classes into that lane. Or, one might deploy so-called High Occupancy Toll lanes, or HOT lanes into which access is given to those drivers of regular vehicles who pay a fee (Fielding and Klein, 1993). A more equitable policy might entail turn-taking over days, such that all commuters enjoy a turn in the special lane (see Daganzo and Garcia, 2000).

To explore impacts of policies of this kind, we briefly return to our rotationally symmetric, congested beltway. We define as V_{ca} the carpool lane’s speed when it serves carpools, LEVs and an added proportion of beltway traffic demand, p_a . Fig 13a presents $\Delta = (V_{ca} - V_c)/V_c$, the percent change in the carpool lane’s speed when $p_a=1\%$. Note that these speed changes are shown for different values of carpool-lane demand and occupancy. From the figure, we see how mitigating regular-lane congestion by relaxing slightly the restrictions to the carpool lane can improve speeds in that lane. However, the improvements are modest; i.e., always less than 1%, consistent with what we saw earlier in Fig 12.

Given that the above improvements are small, one might also look for opportunities to improve carpool-lane travel by increasing regular-lane capacities. As an example of how this might be done, we

note that findings from both theoretical work (Menendez and Daganzo, 2007) and natural experiments (Cassidy et al., 2010) indicate that the capacities of freeway bottlenecks can be significantly increased by discouraging, but not necessarily prohibiting, vehicle lane-changing maneuvers in bottleneck vicinities.

To explore impacts of something like this, we define as V_{cr} the carpool-lane speed when the capacity of a regular-use beltway lane, q_{max} , is increased by a percentage p_r . Fig 13b presents the percent change in the carpool lane’s speed, $\Delta_r = (V_{cr} - V_c)/V_c$, when only high-occupancy vehicles are admitted to that lane and q_{max} is increased by $p_r = 5\%$. Our select value of p_r in this instance is small relative to the gains in bottleneck capacities reported in the above-cited references (and we found that larger values of p_r produce larger predicted values of Δ_r). Yet the predicted improvements shown in Fig 13b may themselves justify whatever experiments might be needed to refine strategies that increase bottleneck capacities.

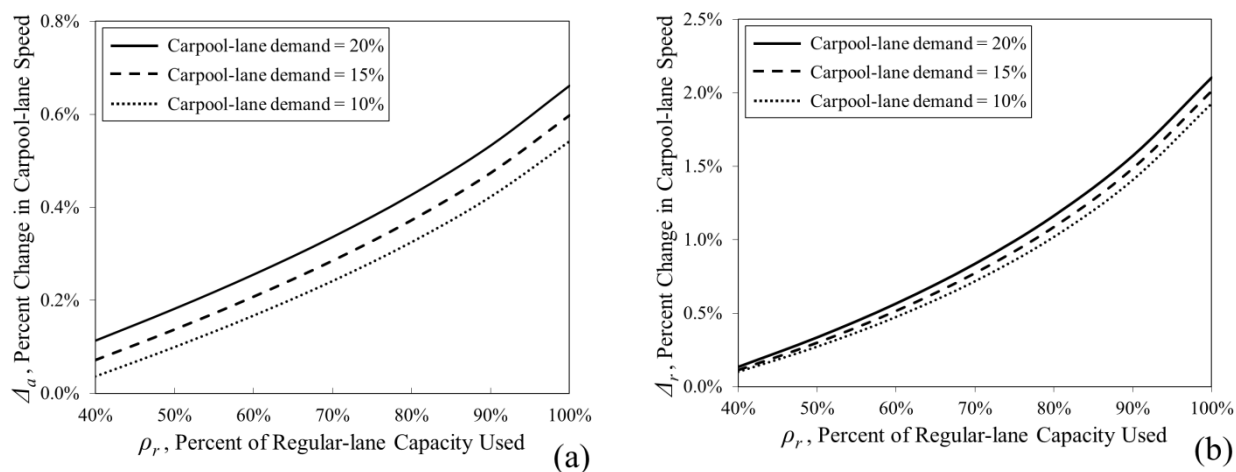

Fig. 13 (a) Curves of ρ_r vs Δ_a when $p_a = 1\%$; and (b) Curves of ρ_r vs Δ_r when $p_r = 5\%$

5.2 Amending the Regulation

Even if we can set aside the damages that will apparently result from the SAFETEA-LU regulation, we would remain puzzled by its logic. The regulation’s objective – to maintain a carpool lane’s speeds at or above 45 mph for 90% of its operating hours – seems off-target. After all, the literature indicates that a carpool lane’s attractiveness to commuters is based less on the magnitude of its speed than on the quality of travel that it provides relative to that of the adjacent regular-use lanes (Dahlgren, 1998; Jang and Chung, 2010; Li et al. 2007). From what we have seen, even slow-moving carpool lanes tend to perform well by this relative standard (e.g. see Wu et al. 2011). Moreover, carpool lanes are probably most attractive when regular-lane speeds are especially slow, even though the carpool-lane speeds would therefore be slow as well.

We are further puzzled by the regulation’s use of speed as its metric of choice. It seems that a facility can be classified as a “degraded” one based even on the speeds that occur over short segments of a

carpool lane. The literature indicates that travelers are more concerned about the trip times over their entire journeys than they are about their shorter-run speeds (Ben-Akiva and Lerman, 1985; Brownstone, et al., 2003; Hensher, 2008; Hess et al., 2005).

In light of the above, it makes sense to change the regulation’s criteria to capture relative trip times over extended lengths of a carpool facility. The ratio of the average time to travel an extended distance in the carpool lane to that in the regular lanes might do for this purpose. Mitigation measures could be prescribed for those facilities with trip time ratios that are persistently close to 1. However, expelling LEVs from the carpool lanes would seem not to be the best course of action in these cases.

5.3 Generalizations

The present findings seem to hold for more than just the non-separated freeway carpool lanes in the San Francisco area. As an example, Fig 14a presents data from a freeway carpool lane in southern California. In this case, the lane is separated from regular traffic by a solid painted stripe to prohibit maneuvers in or out of the lane. Note how the speeds display the now-familiar patterns.⁶ Of further interest, the present findings evidently hold for other types of special-use lanes, and for other parts of the world. Fig 14b presents data from a bus-only lane on an expressway in Seoul, South Korea. Again we see the familiar patterns in speed.

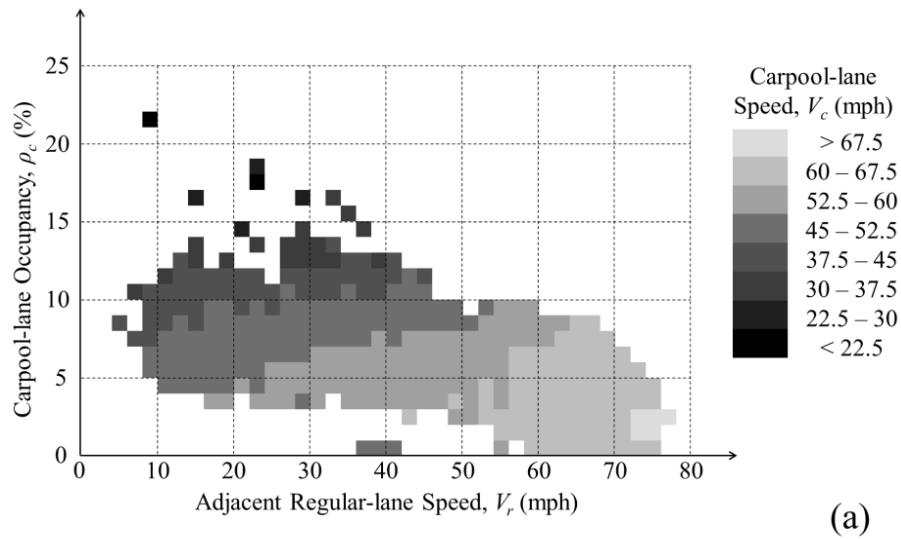

Fig. 14 (a) Average speeds in separated carpool lane (data collected from Northbound, Interstate 605 in Orange, California)

⁶ We suspect that the findings would hold even when a special lane is separated by a wall or some other physical barrier. A special lane’s access points (e.g. the occasional openings in the barrier) often become bottlenecks (Xu et al., 1999). Added congestion in the regular lanes (e.g. due to the migration of LEVs) can worsen these bottlenecks, quite possibly to the detriment of all commuters.

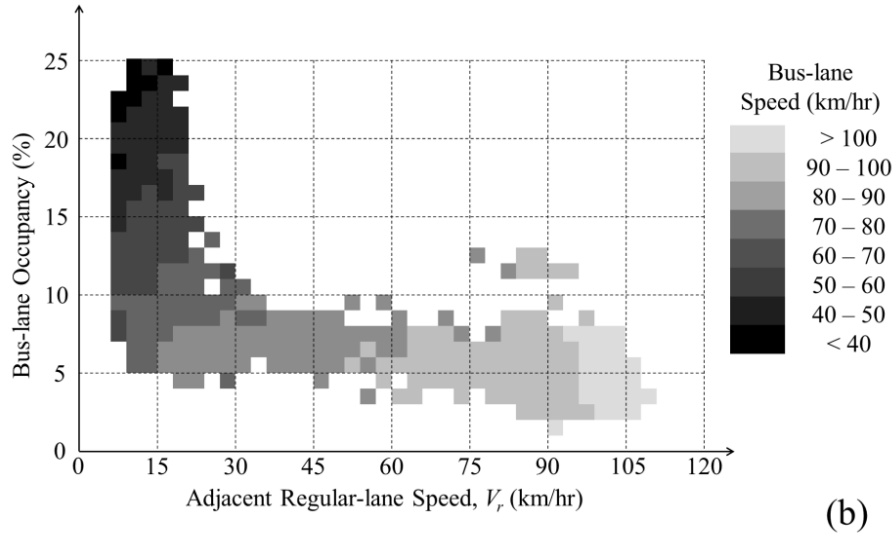

Fig. 14 (cont'd) (b) Average speeds in bus lane (data collected from Seoul-bound direction, Gyeongbu Expressway in Seoul, South Korea)

5.4 Closing Thought

It seems that improved travel in a special lane will often not be realized by further restricting access to it. Policies that do this could in many instances prove to be recipes for disaster, whereby all commuters are made worse off. Efforts might better be directed at improving traffic conditions in adjacent regular lanes. Thoughtful policies of this kind could benefit all commuters. The resulting reductions in congestion would benefit the environment as well.

Acknowledgement

The work described in this paper was supported by the UC Berkeley Center of Excellence for Future Urban Transport.

References

- Ben-Akiva, M. and Lerman, S.R. (1985) *Discrete Choice Analysis: Theory and Application to travel demand*, Cambridge: MIT Press.
- Brownstone, D., Ghosh, A., Golob, T.F., Kazimi, C. and Amelsfort, D.V. (2003) Drivers' willingness-to-pay to reduce travel time: evidence from the San Diego I-15 congestion pricing project, *Transportation Research Part A* 37(4), pp. 373–387.

- Cassidy, M.J. (2003) Freeway on-ramp metering, delay savings, and diverge bottleneck, , *Transportation Research Record: Journal of the Transportation Research Board* Vol. 1856, Transportation Research Board of the National Academies, Washington, D.C., pp. 1–5.
- Cassidy, M.J. and Coifman, B. (1997) Relation among average speed, flow, and density and analogous relation between density and occupancy, *Transportation Research Record: Journal of the Transportation Research Board* Vol. 1591, Transportation Research Board of the National Academies, Washington, D.C., pp. 1–6.
- Cassidy, M.J., Jang, K. and Daganzo, C.F. (2010) The smoothing effect of carpool lanes on freeway bottlenecks, *Transportation Research Part A* 44(2), pp. 65–75.
- Cassidy, M.J., Daganzo, C.F., Jang, K. and Chung, K. (2009) Spatiotemporal effects of segregating different vehicle classes on separate lanes, in: Lam, W.H.K., Wong, S.C. and Hong, K.L. (Eds.), *Proceedings of the 18th International Symposium on Transportation and Traffic Theory*, pp. 57–74.
- Cassidy, M.J. and Rudjanakanoknad, J. (2005) Increasing capacity of an isolated merge by metering its on-ramp, *Transportation Research Part B* 39(10), pp. 896–913.
- California Department of Transportation (Caltrans) (1991) *Guidelines for Planning, Design, and Operations*, Division of Traffic Operations.
- California Senate Bill No. 535 (SB 535) (2010)
- Chen, C., Varaiya, P. and Kohn, J. (2005) An empirical assessment of traffic operations, in: Mahmassani, H. (Ed.), *Proceedings of the 16th International Symposium on Transportation and Traffic Theory*, pp. 105–124.
- Daganzo, C.F. (1995) The cell transmission model, part II: Network traffic, *Transportation Research Part B* 29(2), pp. 79–93.
- Daganzo, C.F. (1996) The nature of freeway gridlock and how to prevent it, in: Lesort, J.B.. (Eds.), *Proceedings of the 13th International Symposium on Transportation and Traffic Theory*, pp. 629–646.
- Daganzo, C.F. (2007) Urban gridlock: Macroscopic modeling and mitigation approaches, *Transportation Research Part B* 41(1), pp. 49–62.
- Daganzo, C.F. and Cassidy, M.J. (2008) Effects of high occupancy vehicle lanes on freeway congestion, *Transportation Research Part B* 42(10), pp. 861–872.
- Daganzo, C.F. and Garcia, R.C. (2000) A Pareto improving strategy for the time-dependent morning commute problem, *Transportation Science* 34(3), pp. 303–311.
- Daganzo, C.F., Laval, J.A. and Muñoz, J.C. (2002) Ten strategies for freeway congestion mitigation with advanced technologies, *Traffic Engineering and Control* 43, pp. 397–403.
- Dahlgren, J. (1998) High occupancy vehicle lanes: Not always more effective than general purpose lanes, *Transportation Research Part A* 32(2), pp. 99–114.
- Hensher, D.A. (2008) Influence of vehicle occupancy on the valuation of car driver’s travel time savings: Identifying important behavioural segments, *Transportation Research Part A* 42(1), pp. 67–76.
- Hess, S., Bierlaire, M. and Polak, J.W. (2005) Estimation of value of travel-time savings using mixed logit models, *Transportation Research Part A* 39(2-3), pp. 221–236.
- Edie, L.C. and Foote, R.S. (1958) Traffic flow in tunnels, *Proceedings of Highway Research Board* 37, pp. 334–344.

- Fielding, G.J. and Klein, D.B. (1993) High Occupancy/Toll Lanes: Phasing in Congestion Pricing a Lane at a Time, University of California Transportation Center, Paper No. 179, Berkeley, California.
- Freeway Performance Measurement System (PeMS) (2011), pems.dot.ca.gov
- Fuhs, C.A. (1990) High-Occupancy Vehicle Facilities: A Planning, Design, and Operation Manual, Parsons-Brinckerhoff, New York.
- Guin, A., Hunter, M. and Guensler, R. (2008) Analysis of Reduction in Effective Capacities of High-Occupancy Vehicle Lanes Related to Traffic Behavior, Transportation Research Record: Journal of the Transportation Research Board Vol. 2065, Transportation Research Board of the National Academies, Washington, D.C., pp. 47–53.
- Greenberg, H. (1959) An analysis of traffic flow, Operations Research 7, pp. 79–85.
- Greenshields, B.D. (1934) A study of traffic capacity, Proceedings of Highway Research Board 14, pp. 448–477.
- Haj-Salem, H. and Papageorgiou, M. (1995) Ramp metering impact on urban corridor traffic: field results, Transportation Research Part A 29(4), pp. 303–319.
- Jang, K. and Cassidy, M.J. (2011) Dual influences on vehicle speed in special-use lanes and critique of US regulation, Institute of Transportation Studies, UCB-ITS-VWP-2011-4, University of California, Berkeley, CA.
- Jang, K. and Chung, K. (2010) A dynamic congestion pricing strategy for high-occupancy toll lanes, in: Proceedings of the Transportation Research Board 89th Annual meeting, Washington, D.C.
- Lawson, T.W., Lovell, D.J. and Daganzo, C.F. (1997) Using input-output diagram to determine spatial and temporal extents of a queue upstream of a bottleneck, Transportation Research Record: Journal of the Transportation Research Board Vol. 1572, Transportation Research Board of the National Academies, Washington, D.C., pp. 140–147.
- Li, J., Embry, P., Mattingly, S.P., Sadabadi, K.F., Rasmidatta, I. and Burris, M.W. (2007) Who Chooses to Carpool and Why?: Examination of Texas Carpoolers, Transportation Research Record: Journal of the Transportation Research Board Vol. 2021, Transportation Research Board of the National Academies, Washington, D.C., pp. 110–117.
- Lighthill, M.J. and Whitham, J.B. (1955) On kinematic waves. II. A Theory of traffic flow on long crowded roads. In: Proceedings of Royal Society A229, pp. 281–345.
- Menendez, M. and Daganzo, C.F. (2007) Effects of HOV lanes on freeway bottleneck, Transportation Research Part B 41(8), pp. 809–822.
- Newell, G.F. (1982) Applications of queueing theory (2nd ed.), Chapman and Hall, London.
- Papageorgiou, M. and Kotsialos, A. (2002) Freeway ramp metering: an overview, IEEE Transactions on Intelligent Transportation Systems 3(4).
- Persaud, B., Yagar, S., Tsui, D. and Look, H. (2001), Breakdown-related capacity for freeway with ramp metering, Transportation Research Record: Journal of the Transportation Research Board Vol. 1748, Transportation Research Board of the National Academies, Washington, D.C., pp. 110–115.
- Safe, Accountable, Flexible, Efficient Transportation Equity Act: A Legacy for Users (SAFETEA-LU), (2005) Public Law 109-59.

Wu, G., Du, Y., Jang, K., Chan, C. and Boriboonsomsin, K. (2011) Preliminary evaluation of operational performance between different types of HOV facilities in California: Continuous-access vs. limited access, in: Proceedings of the Transportation Research Board 90th Annual meeting, Washington, D.C.

Xu, G., Huang, X. P. and Pant, P. (1999) Method for Estimating Capacity Reduction in High-Occupancy-Vehicle Lane Ingress and Egress Sections, Transportation Research Record: Journal of the Transportation Research Board Vol. 1678, Transportation Research Board of the National Academies, Washington, D.C., pp. 107–115.

Appendix A. Modifications to CTM for Case Study 1

This appendix describes refinements made to the Cell Transmission Model (CTM) to perform analysis on two adjacent traffic streams – carpools and regular vehicles – with distinct flows and speeds. Only the alterations to the CTM framework are described. Readers interested in full details on the CTM can refer to Daganzo (1995).

The CTM was modified to accept additional demand inputs, namely; the proportions of total demand that are comprised of carpools and LEVs, p_c and p_l , respectively. To model the distinct (carpool and regular) traffic streams, parallel sets of cells were used. Each cell in its set was connected by links as per the CTM's original logic.

Each cell that happened to represent either an on- or off-ramp was linked to both sets of cells. It was assumed that on-ramp (i.e. merging) vehicles bound for the carpool lane entered that lane within the length of its merge cell. Similarly, these vehicles exited the carpool lane and reached its off-ramp within the length of its diverge cell. Thus, the merge and diverge maneuvers for carpool-lane vehicles occurred without delay and without disrupting regular traffic.

At each on-ramp, traffic advanced into two intermediate cells: the fraction $p_c + p_l$ entered the intermediate cell designated for carpool-lane traffic, and the fraction $1 - p_c - p_l$ entered the other intermediate cell designated for regular traffic. The traffic in each intermediate cell then merged into its (carpool or regular) cell at predetermined ratios, α , as shown in Fig A1(a). Exiting traffic was handled in analogous fashion: diverging traffic in each lane set merged into intermediate cells at ratio β , as shown in Fig A1(a).

When performing the simulations during the period when the carpool lane was active, each cell of the carpool lane adopted a fundamental diagram estimated from real data taken from the case-study site. Recall that carpool-lane speed, V_c , were determined for each carpool cell and

time step via Fig 5a given the values of ρ_c and V_r that were generated from the CTM simulations.

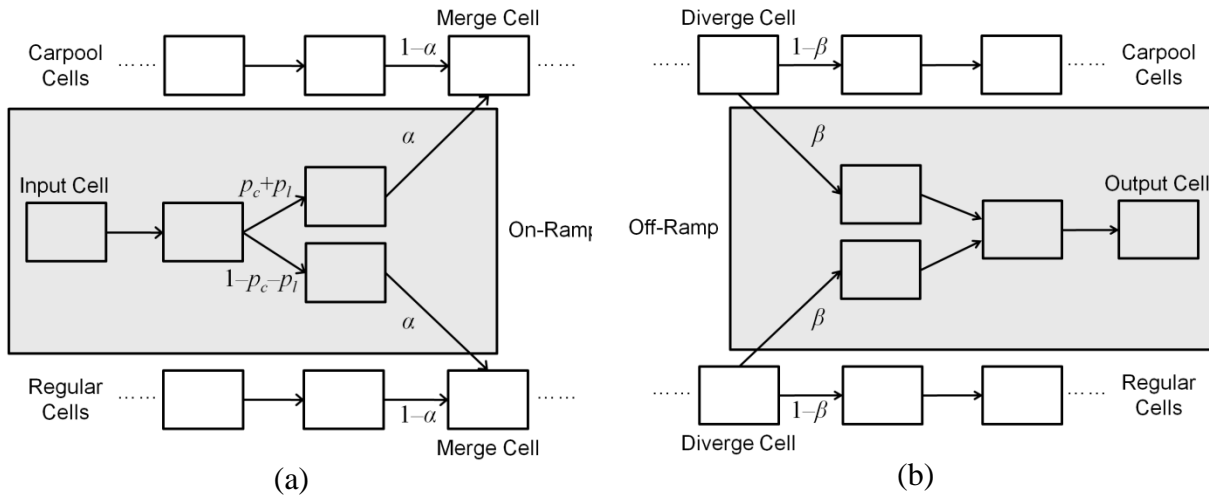

Fig. A1 Representation of (a) on-ramp; and (b) off-ramp in the modified CTM