

# FTA RESEARCH

FEDERAL TRANSIT ADMINISTRATION

## Safe Transit in Shared Use

JULY 2011

FTA Report No. 0008  
Federal Transit Administration

**PREPARED BY**

Alfred E. Fazio, PE  
A. R. Troup  
Bridget Hodgeson  
Jack Kanarek

SYSTRA Consulting, Inc.  
Philadelphia, PA



U.S. Department of Transportation  
Federal Transit Administration

## COVER PHOTO

*Courtesy of Alfred E. Fazio of BRT Services*

## DISCLAIMER

*This document is intended as a technical assistance product. It is disseminated under the sponsorship of the U.S. Department of Transportation in the interest of information exchange. The United States Government assumes no liability for its contents or use thereof. The United States Government does not endorse products of manufacturers. Trade or manufacturers' names appear herein solely because they are considered essential to the objective of this report.*

*SYSTRA Consulting, Inc. is an EEO/AA/Title VII/Title IX/Section 504/ADA/ADEA employer and actively seeks to diversify its work force.*

# Safe Transit in Shared Use

**JULY 2011**

FTA Report No. 0008

**PREPARED BY**

SYSTRA Consulting, Inc.  
1600 Market St., Ste 1310  
Philadelphia, PA 19103  
in Association with BRT Services, LLC  
<http://www.fta.dot.gov/research>

**SPONSORED BY**

Federal Transit Administration  
Office of Research, Demonstration and Innovation  
U.S. Department of Transportation  
1200 New Jersey Avenue, SE  
Washington, DC 20590

**AVAILABLE ONLINE**

<http://www.fta.dot.gov/research>

## Metric Conversion Table

SYMBOL	WHEN YOU KNOW	MULTIPLY BY	TO FIND	SYMBOL
<b>LENGTH</b>				
<b>in</b>	inches	25.4	millimeters	mm
<b>ft</b>	feet	0.305	meters	m
<b>yd</b>	yards	0.914	meters	m
<b>mi</b>	miles	1.61	kilometers	km
<b>VOLUME</b>				
<b>fl oz</b>	fluid ounces	29.57	milliliters	mL
<b>gal</b>	gallons	3.785	liters	L
<b>ft<sup>3</sup></b>	cubic feet	0.028	cubic meters	m <sup>3</sup>
<b>yd<sup>3</sup></b>	cubic yards	0.765	cubic meters	m <sup>3</sup>
NOTE: volumes greater than 1000 L shall be shown in m <sup>3</sup>				
<b>MASS</b>				
<b>oz</b>	ounces	28.35	grams	g
<b>lb</b>	pounds	0.454	kilograms	kg
<b>T</b>	short tons (2000 lb)	0.907	megagrams (or "metric ton")	Mg (or "t")
<b>TEMPERATURE (exact degrees)</b>				
<b>°F</b>	Fahrenheit	$\frac{5}{9}(F-32)$ or $(F-32)/1.8$	Celsius	°C



REPORT DOCUMENTATION PAGE		Form Approved OMB No. 0704-0188	
Public reporting burden for this collection of information is estimated to average 1 hour per response, including the time for reviewing instructions, searching existing data sources, gathering and maintaining the data needed, and completing and reviewing the collection of information. Send comments regarding this burden estimate or any other aspect of this collection of information, including suggestions for reducing this burden, to Washington Headquarters Services, Directorate for Information Operations and Reports, 1215 Jefferson Davis Highway, Suite 1204, Arlington, VA 22202-4302, and to the Office of Management and Budget, Paperwork Reduction Project (0704-0188), Washington, DC 20503.			
1. AGENCY USE ONLY	2. REPORT DATE July 2011	3. REPORT TYPE AND DATES COVERED Final Report, July 2011	
4. TITLE AND SUBTITLE Safe Transit in Shared Use		5. FUNDING NUMBERS NJ-026-7025	
6. AUTHOR(S) Alfred E. Fazio, PE; A. R. Troup; Bridget Hodgeson; Jack Kanarek			
7. PERFORMING ORGANIZATION NAME(S) AND ADDRESS(ES) SYSTRA Consulting Inc. 1600 Market St., Suite 1310 Philadelphia, PA 19103		8. PERFORMING ORGANIZATION REPORT NUMBER FTA Report No. 0008	
SPONSORING/MONITORING AGENCY NAME(S) AND ADDRESS(ES) U.S. Department of Transportation Federal Transit Administration 1200 New Jersey Avenue, SE Washington, DC 20590		10. SPONSORING/MONITORING AGENCY REPORT NUMBER FTA Report No. 0008	
11. SUPPLEMENTARY NOTES [http://www.fta.dot.gov/research]			
12A. DISTRIBUTION/AVAILABILITY STATEMENT Available From: National Technical Information Service (NTIS), Springfield, VA 22161 Phone 703.605.6000, Fax 703.605.6900, Email [orders@ntis.gov]		12B. DISTRIBUTION CODE TRI-20	
13. ABSTRACT During the last 30 years, due to the flexibility of light rail transit (LRT), new systems have been implemented, some of which include line segments that share tracks with freight operations regulated by the Federal Railroad Administration (FRA). To operate on the general railroad system, these LRT systems have obtained waivers from FRA safety regulations by operating with temporal separation. The aim of this research study was to further develop concepts for temporal separation to enable shared use operations in additional locations with more frequent and more flexible operations of FRA-compliant and non-compliant services. Based on the operating concepts and technology that facilitate temporal separation on the NJ TRANSIT River LINE, this project prepared a design for expanding freight and passenger operations while maintaining separation of modes in a configuration that is very similar to designs that have already been accepted by FRA.			
14. SUBJECT TERMS Shared use, rail transit, light rail, freight railroad, operations, engineering systems		15. NUMBER OF PAGES 140	
16. PRICE CODE			
17. SECURITY CLASSIFICATION OF REPORT Unclassified	18. SECURITY CLASSIFICATION OF THIS PAGE Unclassified	19. SECURITY CLASSIFICATION OF ABSTRACT Unclassified	20. LIMITATION OF ABSTRACT

## TABLE OF CONTENTS

1	Executive Summary
11	Section 1: Introduction
11	Background
12	Recent Research on Shared Use Operations
15	Project Objectives
17	Section 2: Evolution of Shared Use of Railroad Rights of Way
17	Rail Modes
18	General Railroad System
19	Light Rail Transit
20	FTA Oversight of Captive Systems (Rail Transit)
21	FRA and FTA Policy Statements Regarding Shared Use
22	Light Rail and Interurban Transit
25	Section 3: Development of Operating Practices and Technologies for Shared Use Operations
25	Technology and the Duration of the Temporal Separation Window
26	Recent Implementation of Shared Use Operations
31	Temporal Separation on the River LINE and Newark Light Rail
37	Section 4: Proposed Advanced Temporal Separation for River LINE North (Burlington Subdivision)
38	Business Case
39	Concept of Operations
43	Engineering Systems
45	Safety Case
47	Section 5: Key Elements of Shared Use with Advanced Temporal Separation
47	FRA Review of Shared Use Operations Utilizing Advanced Temporal Separation
48	Technology Integration and Human Interface
49	Section 6: Potential Applications of the Operating Doctrine
49	NJ TRANSIT Atlantic City Line
52	Capital Metro Red Line, Austin, Texas
53	Conrail's Vineland Secondary (Proposed Glassboro–Camden Light Rail Line)
56	Metro-North Railroad, Waterbury Branch
58	Section 7: Summary and Conclusions
61	Appendix A: Glossary of Terms
66	Appendix B: River LINE, Existing Operation
70	Appendix C: Overview of Train Separation and Train Routing
76	Appendix D: Script of Video on Proposed ETS/SITS for River LINE North
80	Appendix E: Draft FRA Waiver Narrative for ETS/SITS for River LINE North
113	Appendix F: Shared Use Railway Operating Hazards Analysis
129	References

## LIST OF FIGURES

1	Figure 1: Example of Freight Train Operating on the General Railroad System
3	Figure 2: Example of Light Rail Vehicle: NJ TRANSIT River LINE
5	Figure 3: NJ TRANSIT River LINE Map
6	Figure 4: Diagrams of Tracks and Interlockings with Shared Track Operations
17	Figure 5: Rail Modes
22	Figure 6: Newark Light Rail Shared Track Schematic
24	Figure 7: NJ TRANSIT River LINE: Near-Compliant Rail Car Running Alongside through Freight Train
30	Figure 8: 32-Mile Segment (Thick Blue Line) of River LINE that is Part of the General Railroad System of the United States
30	Figure 9: 24-Mile Segment (Thick Blue Line) of River LINE Currently Utilized by Freight Trains
31	Figure 10: At-Grade Crossing of Rail Lines
32	Figure 11: River LINE CP 17, CP 45 and CP Hatch
33	Figure 12: Freight Train Crossing Passenger Track at River LINE CP 45, a Location Where SITS Is in Place to Ensure Absolute Temporal Separation
35	Figure 13: Two-Mile Segment (Thick Blue Line) of Camden Subdivision of River LINE with ETS and SITS
35	Figure 14: Track Schematic of Segment of River LINE Camden Subdivision with ETS
37	Figure 15: Six-Mile Segment (Thick Red Line) of Burlington North Subdivision of River LINE Proposed for Implementation of ETS and SITS
39	Figure 16: River LINE Burlington Subdivision: Existing Track Configuration and Proposed Concept with ETS
40	Figure 17: Schematic Diagrams of Segment of River LINE Burlington Subdivision Illustrating Proposed Track Sharing using ETS and SITS
44	Figure 18: Split Rail Derail Utilized to Provide Positive Stop for Freight Trains to Separate Them from Passenger Trains to Provide Absolute Temporal Separation of Shared Track
44	Figure 19: Trip Stop Utilized to Provide Positive Stop for Passenger Trains to Separate Them from Freight Trains to Provide Absolute Temporal Separation of Shared Track
49	Figure 20: NJ TRANSIT Atlantic City Line
51	Figure 21: Existing Atlantic City Line Track Configuration in Atlantic City
52	Figure 22: Capital Metro Diesel Light Rail Vehicle
55	Figure 23: Proposed Camden–Glassboro LRT: Potential Configuration of Track to Facilitate Track Sharing North of Woodbury
67	Figure 24: Track Schematic of River LINE (not to scale)
100	Figure 25: Existing Signal Plans and Proposed Signal and Train Operations Design Plans for the River LINE, Burlington Division, Drawing No. 1
101	Figure 26: Existing Signal Plans and Proposed Signal and Train Operations Design Plans for the River LINE, Burlington Division, Drawing No. 2

102	Figure 27: Existing Signal Plans and Proposed Signal and Train Operations Design Plans for the River LINE, Burlington Division, Drawing No. 3
103	Figure 28: Existing Signal Plans and Proposed Signal and Train Operations Design Plans for the River LINE, Burlington Division, Drawing No. 4
104	Figure 29: Existing Signal Plans and Proposed Signal and Train Operations Design Plans for the River LINE, Burlington Division, Drawing No. 5
105	Figure 30: Existing Signal Plans and Proposed Signal and Train Operations Design Plans for the River LINE, Burlington Division, Drawing No. 6
106	Figure 31: Existing Signal Plans and Proposed Signal and Train Operations Design Plans for the River LINE, Burlington Division, Drawing No. 7
107	Figure 32: Existing Signal Plans and Proposed Signal and Train Operations Design Plans for the River LINE, Burlington Division, Drawing No. 8
108	Figure 33: Existing Signal Plans and Proposed Signal and Train Operations Design Plans for the River LINE, Burlington Division, Drawing No. 9
109	Figure 34: Existing Signal Plans and Proposed Signal and Train Operations Design Plans for the River LINE, Burlington Division, Drawing No. 10
110	Figure 35: Existing Signal Plans and Proposed Signal and Train Operations Design Plans for the River LINE, Burlington Division, Drawing No. 11
111	Figure 36: Existing Signal Plans and Proposed Signal and Train Operations Design Plans for the River LINE, Burlington Division, Drawing No. 12
112	Figure 37: Existing Signal Plans and Proposed Signal and Train Operations Design Plans for the River LINE, Burlington Division, Drawing No. 13

## LIST OF TABLES

36	Table 1: Camden Subdivision Shared Track Operations Scenarios
43	Table 2: Proposed Operating Modes for Burlington Subdivision Shared Track
56	Table 3: Potential Shared Use Operating Configurations
73	Table 4: Hazards Associated with Train Separation and Train Routing
89	Table 5: Mode Operations 1 and 3
89	Table 6: Extended Temporal Separation Operation: Mode 2 – CP 211 to CP 269
89	Table 7: Extended Temporal Separation Operation: Exclusive Use CP45 to CP 70
90	Table 8: Non-Critical Risks and Mitigations
92	Table 9: Additional Office Controls – CP 211 and CP Del
92	Table 10: Additional Office Indications – CP 211 and CP Del
92	Table 11: Additional Office Controls – CP 242
92	Table 12: Additional Office Indications – CP 242
92	Table 13: Additional Office Controls – CP 269
92	Table 14: Additional Office Indications – CP 242
93	Table 15: River LINE, Existing Operation

94	Table 16: Special Locking Table While in Mode 1
94	Table 17: LRV Route: CP 211 to CP 269 Mode 2
95	Table 18: Freight Route Special Locking Mode 2
95	Table 19: Special Locking Table While in Mode 2
95	Table 20: Stop Signals with Active Trip Stops
115	Table 21: Hazard Severity Categories
115	Table 22: Hazard Probability Levels
116	Table 23: OHA Worksheets

## FOREWORD

The research completed under Federal Transit Administration Cooperative Agreement NJ-026-7025-00 has resulted in the development of a template for use by rail transit systems for planning and development of shared use operations by light rail passenger operations with Federal Railroad Administration-compliant railroad operations. This research developed a complete design for expanding shared use operations by light rail operations with Conrail freight services on the NJ TRANSIT River LINE in New Jersey.

## ACKNOWLEDGMENTS

Our gratitude is first expressed to the members of the formal Technical Advisory and Review Panel (TARP), comprising the following individuals: Steve Fiel, Joe North, Tom Hickey, William Sheffield, Roger Wood, Thomas E. Frawley, Raj Wagley, Paul Stangas, Larry Light, and N. Shashidhara. In addition to the continuing review by the TARP, the research team benefited greatly from informal reviews held with a number of individuals, including Dan Censullo; Richard Haselman; Grady Cothen; Jeff Marinoff; River LINE staff, including Nick Corce and George Major; and the FRA technical staff of Region I, specifically Larry Kuhn. We would also like to thank Tom Nemeth of Rail Pace Company for his assistance in providing document images.

We appreciate the involvement, access, and guidance from NJ TRANSIT staff, particularly Richard Sarles, Executive Director (retired), and Steve Santoro, Assistant Executive Director, Capital Planning and Programs. Their commitment to shared use and practical application of principles has been an invaluable contribution to this research and especially to the evolution of shared use in North America.

Finally, the research team thanks the technical and safety staff and the Federal Transit Administration for their support and contributions, in particular Mike Flannigan of the Office of Safety; Terrell Williams, Sr. Engineer; and Patrick Centolanzi, P.E., Project Manager; and Raj Wagley, Project Manager. Their insight, assistance, commentary, and commitment to advancing rail transit systems were especially helpful in the production of this research and corresponding documentation.

## EXECUTIVE SUMMARY

### Introduction

Since its invention in the early 19th century, railroad transportation systems have evolved into several modes that are used to transport people and freight. The most widespread form of railroad transportation has come to be known as the general railroad system of the United States. This interstate system of railroads is used to transport freight and passengers and, with respect to safety requirements, is regulated by the Federal Railroad Administration (FRA).

Most of the general railroad system was built by private railroad corporations, which currently focus their business operations on freight transportation (Figure 1). Passenger transportation is also operated on segments of the railroad system to provide intercity services (generally operated by Amtrak) or commuter (also known as regional) passenger rail services in several metropolitan areas.

Other modes of railroad transportation have been developed separately from the general railroad system to serve passenger transportation needs, particularly in cities and the adjacent areas. These railroad modes are known as heavy rail rapid transit and light rail transit. Heavy rail rapid transit generally provides high capacity and frequent services in dense urban areas on alignments that are separate from other modes. Light rail transit (LRT) encompasses a range of rail transit vehicle types, including streetcar, trolley, and interurban lines that were developed in the early 20th century, and the modern light rail and streetcar operations that have been deployed in the last 30 years.

**Figure 1**  
*Example of Freight Train Operating on the General Railroad System*





When the railroad system was built to transport both people and freight, the private railroads used a range of vehicle types for each type of transportation. Up until the 1950s, there were railroad lines on which relatively light passenger vehicles operated concurrently with heavier freight trains carrying all types of commodities. As FRA has developed its safety oversight role, it has issued regulations that have been developed to be applied uniformly across an industry whose technology and operating practices are relatively standardized. As a result, the concurrent or simultaneous operation of different vehicle types on the same tracks has been constrained with consideration for the safety of operations. Currently, the general railroad system tracks are limited to freight trains and passenger trains that meet the numerous FRA requirements. As a result, the other modes of railroad transportation, including LRT, are designated as non-compliant for operation on the general railroad system, unless FRA grants waivers to its rules.

### Shared Use Involving Light Rail Transit

With the resurgence of public transit systems, interest has emerged in the use of corridors that are part of the general railroad system. Many of these corridors are located in areas where LRT is the preferred transit mode, due, in part, to the adaptability of LRT and the fact that it is physically capable of operating on the general railroad system in most respects. The most prominent exception is non-compliance with FRA vehicle safety requirements. The FRA regulation receiving most of the attention regarding shared use operations is the required buff strength of 800 kips. Light rail vehicles in use in the United States do not meet this standard, although vehicles recently put in service have structural characteristics that are near compliant (Figure 2). Other FRA vehicle requirements, including window glazing, horn, bells, and headlight patterns, must also be addressed for shared use operations.

Where freight operations can be limited to times when LRT would not operate, such as late night, FRA has granted waivers to their rules. Temporal separation reflects the original method of management of train movements based on timetable authority. In temporal separation of FRA-compliant and non-compliant modes, trains are kept absolutely separate by assignment of specific blocks of time to each mode. The duration of the blocks, or the time scale for compliant and non-compliant temporal separation, has traditionally been in 8- to 12-hour blocks, with one non-compliant (traditionally LRT) block and one compliant (i.e., freight) block per 24-hour cycle. This type of temporal separation of LRT and freight operations has been applied by several rail systems, beginning with the introduction of LRT in San Diego in 1981. In some locations, this type of shared use of track by compliant and non-compliant trains is not satisfactory for the concerned service providers, as the frequency and flexibility of operations is constrained, curtailing the quality and service for each mode. This has prompted significant research and discussion regarding techniques for shared use of track.



**Figure 2**  
 Example of Light Rail  
 Vehicle: NJ TRANSIT  
 River LINE



## Research and Federal Policy Development Regarding Shared Use

Extensive research and federal policy development preceded this study and provide useful background for the concepts developed in this project. The following are among the documents pertaining to shared use:

- Transit Cooperative Research Program (TCRP) Report 52, “Joint Operation of Light Rail Transit or Diesel Multiple Unit Vehicles with Railroads” (1999)
- *Federal Register*, Vol. 65, No. 132, Monday, July 10, 2000, pp. 42,526–42,528, FRA/FTA Joint Policy: “Joint Statement of Agency Policy Concerning Shared Use of the Tracks of the General Railroad System by Conventional Railroads and Light Rail Transit Systems”
- *Federal Register*, Vol. 65, No. 132, Monday, July 10, 2000, pp. 42,529–42,553, FRA 49, CFR Parts 209 and 211 and “Statement of Agency Policy Concerning Jurisdiction Over Safety of Railroad Passenger Operations and Waivers Related to Shared Use of Tracks of the General Railroad System by Light Rail and Conventional Equipment.”
- *TCRP Research Results Digest* Number 43, Supplementing and Updating TCRP Report 52, “Joint Operation of Light Rail Transit or Diesel Multiple Unit Vehicles with Railroads” (September 2001)
- *TCRP Research Results Digest* Number 47, International Transit Studies Program Report of the Spring 2000 Mission, “Germany’s Track-Sharing Experience: Mixed Use of Rail Corridors” (March 2002)
- TCRP Report 130, “Shared Use of Railroad Infrastructure with Noncompliant Public Transit Vehicles: A Practitioner’s Guide” (2009)

These documents provide in-depth background and analysis of track sharing. The most recent document, TCRP Report 130, encouraged the work performed in this research study on the application of technology to facilitate increased shared use of track while maintaining temporal separation acceptable to the FRA.

### Technology and the Duration of the Temporal Separation Window

The duration of the temporal blocks is related to the technology utilized to assure the absolute nature of the modal separation. Advanced technology, in conjunction with sound operating practices, is capable of considerably shortening the time scale of separation. With the appropriate design, rules, and training, the minimum duration of the temporal separation window may be expressed in periods of an hour or less.

### Development of Shared Use Operations and Design of Extended Temporal Separation and Short Interval Temporal Separation

The success of two significant temporal separation shared operations, the San Diego Trolley and the NJ TRANSIT River LINE light rail systems, has demonstrated the benefits of shared track operations to both passenger and freight operations. They have operated with outstanding safety records and have resulted in transportation and economic benefits for the public.

Of particular relevance to the research in this study are the last two stages of shared track operations on the River LINE. The River LINE, a 34-mile long LRT service between Trenton and Camden, New Jersey, commenced operation in March 2004 (Figure 3). The line includes both in-street operation and operation over exclusive right-of-way, most of which is shared with Conrail freight operations under a shared use waiver from FRA that specified the typical day/night separation of modes. Thirty-two miles of the line are currently part of the general railroad system. Four to five freight trains currently operate on the line during weekdays. The implementation of the River LINE not only expanded mobility for transit passengers, but it upgraded the infrastructure for freight service. On the River LINE right-of-way freight was previously operated at 10 to 15 mph over Class 1 and Class 2 track, using manual blocking (dark territory). With the development of the passenger infrastructure, freight operates at 30 mph, on signal indication, and all track comprises continuous welded rail that meets Class 5 requirements. Along the shared use southern section of the River LINE, known as the Camden Subdivision, three to four freight trains operate daily, with an annual volume approaching one million gross tons.

Under the initial waiver approved by FRA for LRT operations on the River LINE, LRT and freight operations were temporally separated by allowing LRT operations on weekdays from early morning to early evening and freight operations during the overnight hours. However, at one location, even during the passenger

hours of operation, the use of vital signal design known as Short Interval Temporal Separation (SITS) allowed freight trains to cross over passenger tracks. SITS permits short interval shifts between modes while maintaining absolute mode separation in a single interlocking.

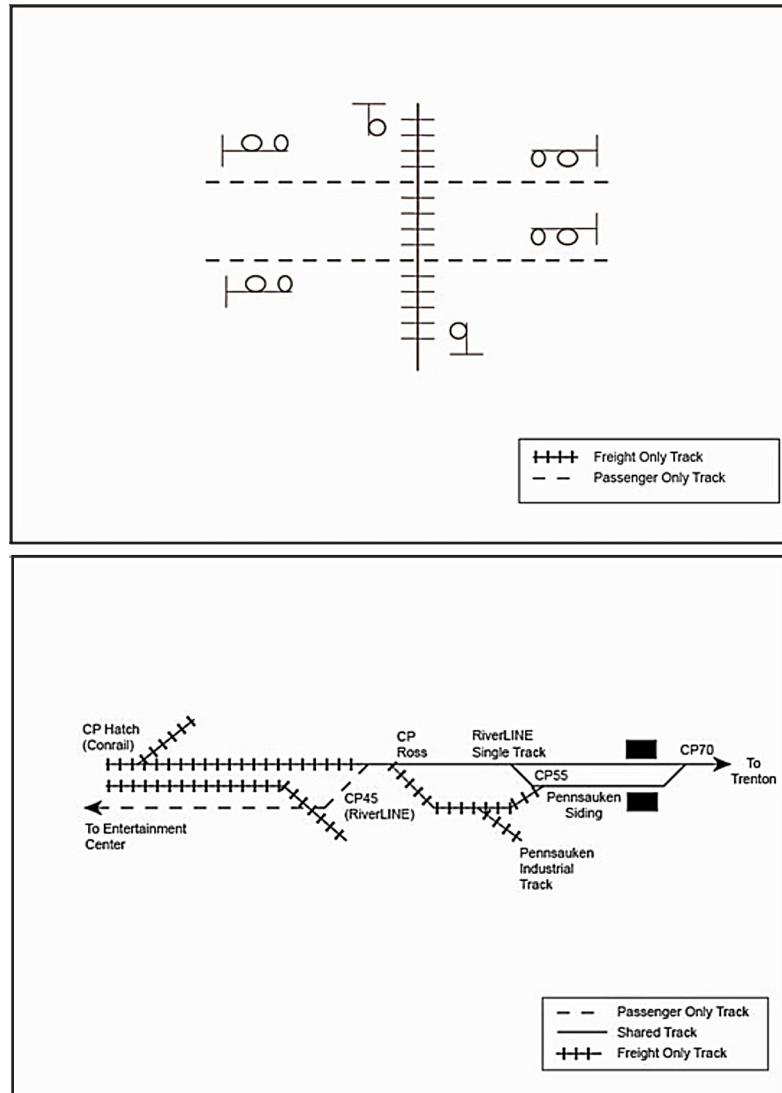
**Figure 3**  
NJ TRANSIT  
*River LINE Map*



A major adjustment to the River LINE waiver was obtained from FRA based on vital signal design, known as Extended Temporal Separation (ETS). ETS was applied to two miles of the River LINE, enabling passenger and freight trains to share track, making more efficient use of the railroad. ETS involves a method of employing vital signal logic to integrate actions of two or more consecutive railroad interlockings covering an extended section of railroad, so that separate passenger and freight routes may be called and locked. ETS provides temporal separation over a segment of a line, rather than uniformly over the entire length of any given railway system. SITS raises the possibility of ETS as it permits the shortening of the time interval while still retaining absolute and positive modal separation. The diagrams in Figure 4 illustrate the River LINE track configuration where SITS and ETS have been implemented.

**Figure 4**

*Diagrams of Tracks and Interlockings with Shared Track Operations*



The upper diagram shows a freight track crossing of passenger tracks. The application of signal technology that implements SITS enables freight trains to cross the passenger tracks between passenger trains. The lower diagram show the two-mile section of the River LINE, which contains multiple interlockings, between CP 45 and CP 70, where SITS and ETS have facilitated freight and passenger shared track operations.

The implementation of SITS and ETS on the River LINE indicates that FRA will permit temporal separation on a fast clock under carefully-controlled conditions. TCRP Report 130 observed that ETS provides improved service flexibility while holding to high levels of safety. That report also recognized that the roots of the River LINE’s success in receiving FRA approval for ETS, and the ensuing safe and successful operations, may be attributable to the River LINE’s railroad-style operating practices. The River LINE’s “operating doctrine,” which is a combination of operating practices and technology, incorporates many characteristics of railroad

operating doctrine. The line's vehicles are compliant with FRA requirements, with the exception of buff strength, and the signal system on the shared track segment of the line is designed to railroad standards. The SITS and ETS signal components consist of conventional off-the-shelf railroad equipment. Track inspection and maintenance practices are consistent with railroad procedures. Regarding operating practices, the River LINE operations control center dispatches and controls both freight and LRT operations utilizing standard railroad practices.

The River LINE's operating doctrine demonstrates that a light rail operation can be designed to be near-compliant with FRA standards, such that FRA has granted waivers for temporal separation that provides shared use of track by LRT and railroad freight.

### Advanced Temporal Separation for River LINE North

To further expand the hours of passenger service while concurrently allowing freight service to operate, this research study developed a specific signal design and the related operating practices for shared use operations utilizing ETS and SITS for more than six miles of the northern River LINE. These proposed improvements would provide for increased utilization of the existing infrastructure by expansion of the passenger operating period and enhancing daytime freight operation (by allowing Conrail selected use of two industrial sidings and a freight branch line) while assuring separation of freight.

The ETS design for River LINE north utilizes signal components known as object controllers to exchange information of switch position and track circuit occupancy among the interlockings in the ETS territory. The object controllers ensure the proper sequencing of switches under the three operating modes designed for River LINE north. The first mode allows for passenger-only operation, the second is for shared use, and the third is for freight only. The links between interlockings are specifically defined for each of these modes. The operating modes are selected by the (non-vital) Supervisory System. However, all safety logic, including the ETS links, between interlockings would reside in vital wayside equipment.

The second mode, the shared use time period, is proposed for only the non-rush periods between 5:30 AM and midnight, when the light rail vehicles operate on 30-minute headways. During the shared use period, when the River LINE operations controller requests mode 2, four interlockings would effectively be joined into one by use of the object controllers. Using a pre-defined sequence of operations, a freight train can be allowed to operate into the ETS territory. However, once it is in the proper position, using derails, it is locked into a segment of track for freight-only use, and the passenger route is locked as well to ensure complete separation of modes. The freight train can remain and work in the gated freight territory with derails preventing any intrusion into passenger-only territory, and the light rail vehicles are kept separate by trip stops.

The proposed design for River LINE north represents an advancement in the application of SITS and ETS in that it is for a longer shared use territory than in previous applications and it is designed to provide more than one route for each mode while continuing to maintain absolute temporal separation.

### Potential Applications of the Operating Doctrine

The operating practices, technology, and design principles for ETS and SITS employed on the River LINE combine to form a template for shared use operations that has nationwide applications. This template represents the evolution of railroad and transit modes into a mode similar to the interurban lines developed in the early 20th century. The interurban mode provides light rail service for local area travel with the potential to share tracks of the general railroad system under the safety regulation of FRA.

To illustrate the potential for shared use operations utilizing the interurban template, four different hypothetical examples were identified. They represent a variety of operational types, including shared use by interurban with commuter rail, intercity rail, and freight. The variety of examples is provided to illustrate the diversity of potential applications of shared use. Importantly, each of these applications could provide transportation benefits. However, none of the transportation organizations involved in these operations have endorsed these hypothetical concepts. More detailed planning and design work would be required to advance these concepts.

### NJ TRANSIT's Atlantic City Railroad Line

A suburban passenger operation utilizing light weight rail cars could potentially be superimposed on the commuter railroad (Atlantic City, New Jersey, to Philadelphia) in the Atlantic City area. This illustrates the potential for shared use of mainline trackage by compliant and near-compliant passenger trains, as well as shared use of a branch line by freight and near-compliant passenger trains.

### Capital Metro, Austin, Texas

This is a regional rail line operating over a portion of a former Southern Pacific line. Passenger equipment is high performance, near-compliant Diesel MUs. While local freight operates over most of the line, the western segment supports unit stone trains. This provides an example of the application of SITS that could provide a business benefit to the freight operations.

### Conrail Vineland Secondary

This line is a former electrified (600v.d.c. until 1931) mainline of the Pennsylvania–Reading Seashore Lines, which extended south from Camden, New Jersey, to Woodbury, Glassboro, and beyond. It is presently designated as the Conrail Vineland Secondary. Currently, planning and environmental analysis are in progress for the development of an LRT (interurban railway), similar to the River LINE, on the



Conrail right-of-way using separate tracks. The use of ETS between Camden and Woodbury and the use of SITS between Woodbury and Glassboro would likely provide a benefit to both freight and future passenger operations.

### **Metro-North New Haven line, Waterbury Branch**

Commuter rail rolling stock is now utilized to serve this branch line. In this hypothetical proposal, the branch line would be served by lightweight near-compliant rail cars, which would operate onto the New Haven Line to the Stratford Station for passenger transfer to main line trains. This illustrates the potential for shared use of mainline trackage by compliant and near-compliant passenger trains.

### **Summary and Conclusions**

A template for an advanced concept of temporal separation for LRT and FRA-compliant railroad services was developed by this research study, funded by FTA. The template will safely permit more flexible shared use operations than is possible with time-of-day-based temporal separation. This template incorporates the application of “railroad-based” rather than “transit-based” operating doctrine. The resulting mode is similar to “interurban” rail services that shared track with freight operations in the past. The NJ TRANSIT River LINE is an example of the interurban mode. However, as demonstrated on NJ TRANSIT’s Newark Light Rail (which is designed and operated utilizing a transit-based operating doctrine), features of this template can also be applied to transit-based LRT to implement shared use operations.

The template employs advanced but nevertheless “conventional off-the-shelf” engineering technology, the primary element of which is “vital” signal design practice and equipment. It provides for short interval temporal separation (SITS) based on reducing, yet still maintaining, separation of modes based on time. It also provides for extended temporal separation (ETS), wherein vital separation of modes is accomplished over a territory (segment of railway) that spans multiple interlockings.

SITS and ETS may be used together to achieve the highest flexibility of shared operations, or SITS may be used separately. A case of the former described in this document is the ETS/SITS on River LINE’s Camden Subdivision. A case of the use of SITS used alone is “GROVE” interlocking on the Newark Light Rail system. This report includes a full design for a major increment in the SITS/ETS application, which is for more than six miles of River LINE’s Burlington Subdivision, which operates as a modern-day “interurban.” A package similar to that which would be required in an FRA waiver is included in this report. The essential elements include:

- business case
- concept of operations providing a description of anticipated train movements, associated operating rules or rule changes

- engineering design and operational analysis
- safety case

A number of conclusions may be drawn from this research, many of which hold significant implications for the future implementation of LRT lines sharing track of the general railroad system:

- The use of the template described herein is likely to provide a more expeditious review by regulatory and oversight agencies, the potential for more favorable waiver conditions, and the approval of more flexible “shared use” operations. The template provides a framework for a shared use operation, and not a uniform standard. This is due to the great variation in design standards and operating practice between transit properties as well as the site-specific nature of the desired shared use operations.
- The proposed template is based on the premise that FRA regulates any transit system that engages in shared use of general railroad system track; this includes rail transit properties whose shared use is very limited in extent.
- Shared use railways may operate as transit systems, where the compliant service is limited in extent of territory, traffic volume, or duration (time). This template is of value to such systems, even in cases where they retain the core of their transit-based operational practices. In such cases, the entire railway may not be considered as part of the general railroad system.
- Railways proposing extensive segments of shared use and/or where advanced concepts of Temporal Separation are desired will benefit from basing their operating practices more fully in railroad operating doctrine. For such railways, the waiver process is likely to be more expeditious and the granted shared-use operations more flexible than for railways using transit-based operational philosophies. Such systems may be labeled as interurbans. For such railways, a near-compliant passenger service shared with a compliant passenger service is also possible.
- Available technology is fully capable of providing for positive, absolute, and reliable separation of modes. Critical systems include track, signals, and supervisory control. In addition, an interurban rail car should achieve near compliance with FRA requirements.
- A comprehensive, accurate, and objective safety case is an essential element in the development of a shared use operation. The core of such an analysis is an identification of hazards, their likelihood of occurrence, and the consequence of occurrence. It forms the basis for development of equivalent safety for waived items. In accordance with standard system safety practice, equivalent measures should first be based in design (track, signals, railcars), and, second, be based in operating practices, rules, and training. Equivalent safety measures for waived safety regulations are subject to continued surveillance by a State Safety Oversight Agency; this is a necessary condition of a waiver.

This report contains a video that summarizes the results of this research and illustrates the design of the shared use template. The script of the video and a link to the video can be found in Appendix D.



# Introduction

## Background

Since its invention in the early 19th century, railroad transportation systems have evolved into several modes that are used to transport people and freight. The most widespread form of railroad transportation has come to be known as the general railroad system of the United States. This interstate system of railroads is used to transport freight and passengers and, with respect to safety requirements, is regulated by the Federal Railroad Administration (FRA).

Most of the general railroad system was built by private railroad corporations, which currently focus their business operations on freight transportation. Passenger transportation is also operated on segments of the railroad system to provide intercity services (generally operated by Amtrak) or commuter (also known as regional) passenger rail services in several metropolitan areas.

Other modes of railroad transportation have been developed separately from the general railroad system to serve passenger transportation needs, particularly in cities and adjacent areas. These railroad modes are known as heavy rail rapid transit and light rail transit (LRT). Heavy rail rapid transit generally provides high capacity and frequent services in dense urban areas on alignments that are separate from other modes. LRT encompasses a range of rail transit vehicle types, including streetcar, trolley, and interurban lines, that were developed in the early 20th century, and the modern light rail and streetcar vehicles that have been deployed in the last 30 years.

When the railroad system was built to transport both people and freight, the private railroads used a range of vehicle types for each type of transportation. Up until the 1950s, there were railroad lines on which relatively light passenger vehicles operated concurrently with heavier freight trains carrying all types of commodities. As FRA has developed regulations for railroad vehicles and train operations, the concurrent or commingled operation of different vehicle types on the same tracks has been constrained with consideration for the safety of operations. Currently, the general railroad system tracks are limited to freight trains and passenger trains that meet the numerous FRA requirements, which include regulations pertaining to the structural strength, often referred to as buff strength, of the vehicles. To date, all light rail vehicles in service in the United States are not compliant with the FRA buff strength requirements for commingled operations with compliant passenger and freight trains.

With the resurgence of public transit systems, interest has emerged in the use of corridors that are part of the general railroad system. Many of these corridors are located in areas where light rail is the preferred transit mode. Where freight

operations can be limited to times when light rail would not operate, such as late night, temporal separation of freight and passenger operations has been achieved using the same tracks. This type of temporal separation has been applied by several rail systems, beginning with the introduction of light rail in San Diego in 1981. These operations have been reviewed by FRA and have been granted waivers to their safety rules by FRA.

In some locations, this type of shared use of track by compliant and non-compliant trains is not satisfactory for the concerned service providers. This has prompted significant research and discussion regarding techniques for sharing of track with concurrent operation of services. This study builds on the work to date. It reviews the context for shared use of railroad corridors and tracks and provides a template for incrementally expanding shared use by the application of off-the-shelf railroad technology.

## Recent Research on Shared Use Operations

Since the late 1990s, extensive analysis and documentation of shared use operations has been provided by studies sponsored by the Transit Cooperative Research Program (TCRP):

- TCRP Report 52: “Joint Operation of Light Rail Transit or Diesel Multiple Unit Vehicles with Railroads” (1999)
- *TCRP Research Results Digest* Number 43, “Supplementing and Updating TCRP Report 52: Joint Operation of Light Rail Transit or Diesel Multiple Unit Vehicles with Railroads” (September 2001)
- *TCRP Research Results Digest* Number 47, “International Transit Studies Program Report of the Spring 2000 Mission—Germany’s Track-Sharing Experience: Mixed Use of Rail Corridors” (March 2002)
- TCRP Report 130, “Shared Use of Railroad Infrastructure with Noncompliant Public Transit Vehicles: A Practitioner’s Guide” (2009)

The initial research in TCRP Report 52 was undertaken as strong interest developed in shared use as the transit community in the United States observed the development and expansion of shared track rail operations in Europe and, in particular, in Karlsruhe, Germany. The report, published in 1999, provided a comprehensive analysis of regulations, institutions, historical context, operations, infrastructure, rolling stock, and risk assessment aspects. Report 52 also included an extensive review of overseas experience with commingled, or simultaneous, train operation on shared track by railroad trains (freight, passenger, or both) and light rail trains.

At the time of the research conducted for TCRP Report 52, the San Diego Trolley and the Baltimore Light Rail use of temporal separation represented the state of the art. In those operations, specific time periods of the day were allocated for

freight and passenger train operations, providing a clear separation of operations over significant segments of the rail line.

TCRP Report 52 included a number of potential concepts for shared use operations. One of the concepts, referred to as Limited Track Sharing/Absolute Block Passing Tracks, may be viewed as an early version of Extended Temporal Separation (ETS, explained below in this report), which applies absolute blocking between modes over extended segments of track (but not entire lines) utilizing conventional off-the-shelf signal technology with railroad operating practices.

Concurrent with the publication of Report 52 in 1999, FRA and FTA jointly introduced a draft policy statement on shared track. With consideration for public comments, in 2000, FRA and FTA distributed the final policy statement on shared use of track and at the same time FRA published “Statement of Agency Policy Concerning Jurisdiction Over Safety of Railroad Passenger Operations and Waivers Related to Shared Use of Tracks of the General Railroad System by Light Rail and Conventional Equipment.” In this document, FRA explained its policies for regulating shared track proposals and provided guidance for requesting waivers from FRA rules for implementation of such operations. The FRA policy statement specifically reviewed the overseas examples of joint use. The following is an excerpt from the policy statement:

**European Experience with Simultaneous Joint Use of the Same Trackage**

*As discussed above, many of the commenters urge FRA to study the success of mixed operations in parts of Europe, where passenger and freight vehicles of different strengths operate on the same track at the same time. The commenters stress that joint use of tracks by transit and standard railroad vehicles has proved to be an important innovation in Europe that should be permitted here.*

*In response, FRA observes that the agency is very familiar with the European systems. FRA has studied European high speed passenger systems in detail for many years, and more recently has directly observed the mixed use operations in places such as Karlsruhe, Germany. If some of those systems were replicated in the United States in every detail, FRA would very likely approve them by rule or waiver. However, FRA is not aware of any current or proposed light rail system in the United States that is fully comparable to the European systems the commenters offer as a model.*

*The successful European experience with mixed light rail and freight traffic is best exemplified by the system in Karlsruhe, Germany. FRA and FTA officials (including FRA safety experts) have personally observed that operation twice in the last several months, most recently as part of a joint visit in April 2000. In Karlsruhe, the light rail system shares some trackage with freight and intercity passenger trains, and the different operations are not segregated by time of day. However, unlike many candidate lines for new light rail starts in the United States, the predominant*

*traffic in Karlsruhe is scheduled passenger trains, rather than a mix of local and through freight trains. More important, the Karlsruhe system involves certain features critical to its safety: all trains that operate in the shared use portions must be equipped with automatic train control; the light rail vehicles have very high braking capacities (as compared to light rail vehicles used in the United States); all trains use a common communications system that permits radio communication with the control center and all types of other trains; all trains operate under the same operating rules; train crews are part of an integrated work force that is trained to operate all types of vehicles in use on the line and in fact operates different vehicles during the average work week; all dispatching is done centrally for all trains; all train crews are limited to less than 40 hours of work per week; the different types of rail equipment that operate in the shared use area differ less in mass and structural strength than do conventional and light rail vehicles in the United States; and grade crossings, which are not as common as in the United States, are protected by four-quadrant gates.*

*The combination of all of these features has produced what appears to be a very safe, integrated system in Karlsruhe. The commenters who advocate that system as a model for shared, simultaneous use of track in this country imply that FRA is unwilling to permit such innovation here. That is not correct. Instead, FRA is unwilling to permit simultaneous use of track that does not entail the full complement of Karlsruhe's most important safety features or comparable protections. Automatic train control, for example, entails a significant investment in infrastructure, both in the right-of-way and on board each train. While many light rail systems may have comparable train control technology, FRA has not seen a proposal to equip all trains (freight, passenger, and light rail) with this technology in the shared use area. Yet there is no reason to believe that the Karlsruhe system would exist without it. Nor is FRA aware of any proposal that involves an integrated workforce operating all the trains, with all crews working less than 40 hours per week. The idea of a freight railroad and a light rail operation using exactly the same operating rules has not commonly been a feature of proposed shared use operations in this country.*

*FRA admires the integrated rail system in Karlsruhe, which has begun to be replicated elsewhere in Europe. However, we ask that anyone who invokes that system as a model be fully cognizant of its traffic mix and basic safety features and what it would take to replicate them on America's freight lines. Corporate structures, labor agreements, and differing railroad and transit cultures make some of these features extremely hard to replicate in this country. We think that the future of simultaneous joint use in this country will likely depend on safety innovations specifically crafted for the rail network we have, such as positive train control systems that are being tested in various locations, and the development of light rail vehicles that are compliant with FRA's passenger equipment standards. However, we are open to consideration of any reasonable proposal.*

In this section of its policy statement, FRA clearly explained the hurdles that need to be addressed if mixed, or commingled, operations are to be implemented, as illustrated by the Karlsruhe example. However, as they identified the hurdles, they noted that they are open to “any reasonable proposal.”

Subsequently, *TCRP Research Results Digest* Number 43 was published in September 2001 providing a supplement and update of Report 52, incorporating the FRA and FTA policy statements. Digest Number 43 also included additional information on overseas track sharing, which was further supplemented by material included in *TCRP Research Results Digest* Number 47.

These documents brought awareness of the potential for shared use operations to the transit industry, the various safety regulatory and oversight organizations, and the research and professional community. As stated in the summary of TCRP Report 52:

*The research team was urged by those interested in the study to produce “the last word” on joint use. It has instead uttered “the first word” by reintroducing the concept of genuine joint use in North America.” The summary concludes by saying, “To the extent that this report makes joint use of tracks a subject of productive debate and encourages and directs subsequent research into the topic, it might be considered useful.”*

Following TCRP Report 52, research and development of the shared track concept has continued, and implementation experience has been gained from the development of NJ TRANSIT’s Newark Light Rail and River LINE, San Diego’s Sprinter, and Austin’s Capital Metro Red Line. These projects were advanced with consideration for FRA’s July 10, 2000, policy statement and, as a result, they illustrate that the application of temporal separation techniques can result in successful petitions for waivers from the FRA rules.

The follow-up TCRP research sponsored by FRA, as presented in TCRP Report 130, provides a comprehensive users guide for alternatives analysis and planning for shared use operations. A portion of the report reviewed the temporal separation concepts that have been utilized on the NJ TRANSIT River LINE, which are the basis of the engineering analysis in this research project.

## Project Objectives

Recently, the growth in demand for rail transit, along with the diminishing number of abandoned (or easily-abandoned) railroad rights-of-way, has prompted interest in shared use operation in many communities. The objective of this research as stated in the request for proposals was to:

- I. Define an approach that could assist light rail project planners seeking an FRA waiver for shared use operation with conventional railroad operations.

2. Apply the approach to a demonstration project and prove that the approach for shared track operations would provide an acceptable level of safety in comparison to the time-of day-approach to temporal separation previously utilized.
3. Identify the technology, equipment, and procedures that will allow transit vehicles to share tracks with railroad equipment without relying on buff strength or temporal separation to mitigate collision risk.

This research project specifically focused on NJ TRANSIT's River LINE, a 34-mile long light rail line that operates part of its route on track shared with Conrail freight trains. As the research progressed for the River LINE, where freight and light rail trains operate with temporal separation under a waiver from FRA, it became evident that in the near term, temporal separation will be necessary considering FRA's policies and regulations. However, the research and design work in this study defined methods to meet FRA's temporal separation requirements in the operation of light rail and freight trains in closer proximity than in the past, while maintaining appropriate separation of modes.

This research project describes the proposed design concept, or template, in a manner where its basic premises, design features, and operating concepts can be applied to a number of other existing and potential shared use operations. Since most shared use proposals involve differing conditions, the template is not written as a standard. Each waiver application submitted to FRA is expected to be evaluated on an individual basis and to extend beyond safety elements. As stated in the FRA–FTA Joint Policy Statement, FRA will consider the business case and the general public good. TCRP Reports 52 and 130 provide guidance regarding analysis of these factors, while this project analyzed the means and methods whereby equivalent safety may be shown. Thus, the template designed in this research is focused on the signal system design and safety-critical operating practices that FRA is expected to consider as part of a waiver application.

SECTION  
2

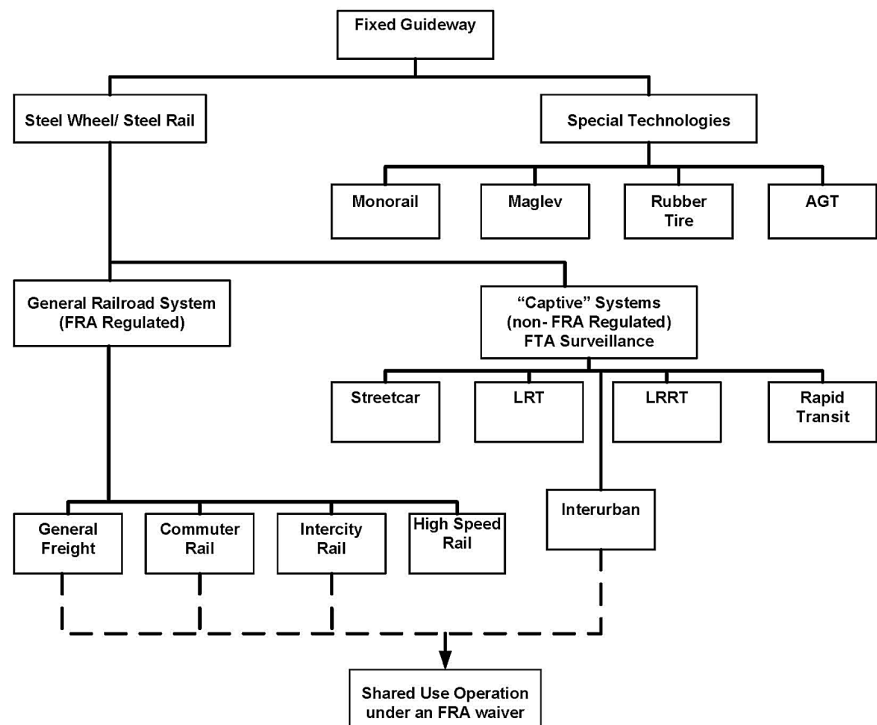
# Evolution of Shared Use of Railroad Rights-of-Way

This section provides an overview of rail modes, including light rail, to provide the reader with a background and understanding of the railroad and transit systems in the United States that are involved in the discussion of shared use operations. Included in this background is a description of railroad and transit operating doctrine and a review of federal policy and regulations. Based on this background, an explanation is provided of the development of the temporal separation concepts that have been further developed in this research project.

## Rail Modes

FTA categorizes passenger railroads as fixed guideway transport systems. Figure 5 illustrates the family tree of fixed guideway modes. The modes whose basis is in specialized technology, such as monorails, are shown for purposes of completeness; they are not relevant to this research. They rely on specialized technology, which is, in many cases, proprietary and, as a result, does not have the potential for interoperation with railroads.

**Figure 5**  
*Rail Modes*





The left side of the diagram in Figure 5 shows the modes that rely on conventional steel wheel on conventional steel rails for load bearing and guidance. In this report, these are referred to as railroads. For railroads, the first and most significant differentiation is between properties that are subject to FRA regulation and those that are not. The simplest test for FRA jurisdiction is whether or not the railroad comprises part of the general railroad system of the United States. This is based on actual interoperation, but FRA also regulates operations where interoperation is likely or possible, even if none occurs at the time at which jurisdiction is asserted. Captive rail systems that typically have no interoperation with the general railroad system, such as light rail and rapid transit lines, are not regulated by FRA and are subject, for purposes of safety, to FTA's State Safety Oversight (SSO) Program, which is described later in this section.

One of the prime benefits of conventional railroad technology (and perhaps one of the factors that has contributed to its longevity) is that it can be adapted and applied to a variety of situations to meet a wide range of service needs. As a result, railroad technology has evolved and produced a continuum of sub-modes. The boundaries between transit sub-modes are often blurred. For example, the Los Angeles Green Line, which is a fully grade-separated, high-platform, automatically-operated system, has the configuration of a rapid transit system, but it utilizes a light rail vehicle. Likewise, Chicago's Skokie Swift and the SEPTA Norristown High Speed Line are currently classified as light rail or light rapid transit. However, both of these lines are remnants of "interurban" services.

*Interurbans were often extensions of existing streetcar lines running between urban areas or from urban to rural areas. The lines were mainly electrified in an era when steam railroads had not yet adopted electricity to any large degree. By 1910, there was a very large network of small interurban lines in the U.S.... Many did not survive the 1920s following the country's growing adoption of the automobile and the onset of the Great Depression in 1930.... Interurban routes that have survived to the present day evolved into commuter railroads, freight short lines [or light rail lines]. (Wikipedia)*

The exceptions to the continuum of rail modes are the hard and fast boundaries that exist between the special technologies listed in Figure 5 and railroads, and the boundaries that exist between the FRA-regulated and non-regulated rail systems that are addressed in this report.

## General Railroad System

Currently, the general railroad system is primarily oriented towards freight services, which operates in a variety of scenarios, ranging from high speed (up to 70 mph) unit container trains to local switching operations. The freight operation in North America is primarily operated by private railroads on their owned rights of way and track. The system's greatest strength is its standardization, which has led to great reliability in fixed plant and rolling stock, as well as nearly universal



interoperability. An example of this key feature of the railroad system is the NJ TRANSIT River LINE, which was previously designated as the Bordentown Secondary when it was owned by Conrail. On this line, it is common to see locomotives belonging to other railroads operating into Conrail's Pavonia yard, where this equipment can be serviced and, if necessary, repaired by Conrail crews prior to its return west.

FRA governs the movement of goods, services, and passengers over the general railroad system. Loosely defined, this network exempts any systems that are not connected and are captive transit systems. The governance of FRA is focused mainly on ensuring, through the Code of Federal Regulation (CFR), the public safety in the performance of the railroads' business activities. All passenger services on the general system are operated with equipment that is fully compliant with FRA regulations, unless waivers have been granted.

## Light Rail Transit

LRT is among the modes within the "rail transit" family. The strength of LRT is that it suits a wide range of applications and possesses site-specific adaptability. LRT can be effective in a wide variety of environments, utilize a range of engineering technology, and employ an array of operating practices. LRT lines can operate in a range of conditions, including on-street in mixed traffic at low speeds with closely spaced stations, or in dedicated right-of-way at high speeds (up to 65 mph) with relatively long station spacing (2 miles or more). Using this range of attributes, LRT can provide local downtown transit service or provide transit service for outlying areas.

Since LRT is such an adaptable mode, it is also physically capable of operating on the general railroad system in most respects, with the exception of FRA vehicle safety requirements. The FRA regulation receiving most of the attention in the discussion of shared use operations is the required buff strength of 800 kips. However, other FRA vehicle requirements, including window glazing, horn, bells, and head light patterns, must also be addressed for shared use operations. Differences between LRT and the general system also extend to operating practices. While able to adapt to a wide range of applications, LRT is a mode whose operating doctrine, which is a combination of operating practices and technology, generally remains based in rail transit and not in "railroad operating doctrine," which is regulated by FRA safety rules.

For shared use operations to be implemented on FRA-regulated rail lines, waivers from FRA's rules must be requested. The adaptability and flexibility that enables LRT to be considered for operation on segments of the general railroad system also presents issues as operators request waivers from FRA. The diversity of design, technology (e.g., signalization and rolling stock), maintenance standards, and operating practices for light rail systems are not typically consistent with railroad practices. FRA utilizes prescriptive standards in its safety oversight role,

which have been developed to be applied uniformly across an industry whose design and operating practices are relatively standardized. This is in contrast to the fact that nearly all modern North American LRT systems trace the roots of their operating practices, including employee training and qualification, to the bus or rail transit community, not to railroads or to the older, freight-carrying interurbans.

## FTA Oversight of Captive Systems (Rail Transit)

In contrast to FRA's regulatory process, the "captive systems," more commonly referred to as "rail transit systems," have been subject to a different approach for safety oversight. FTA, at present, does not promulgate and enforce an industry-wide set of standards pertaining to operating, employee, and passenger safety. There are two reasons for this:

- FTA does not have federal authority to establish such standards and enforce them as a matter of regulatory law (management of the use of controlled substances drugs and alcohol is the singular exception).
- Significant variations exist in systems design between different transit systems; this occurs because interoperability is not necessary. These variances make setting engineering standards somewhat problematic. As a result, values of fundamental safety critical parameters that are defined in FRA regulations vary among rail transit systems. It should be noted, however, that such variation in engineering standards does not completely inhibit the setting of prescriptive, quantitative engineering standards for systems, nor does it prevent the establishment of nationwide standards for safety critical operational practices, such as limitations on hours of service. Currently, FTA is evaluating the practicality of issuing minimum safety standards for the transit industry. The context, form, and method of enforcement of such standards are under consideration.

Within the transit environment, the American Public Transportation Association (APTA) has had a continuing effort, funded, in part, by FTA, to develop a set of operating safety standards, such as for limiting hours of service for operating employees. To date, this program has had limited focus on setting standards but has developed a number of useful Recommended Practices for the transit industry.

FTA applies the requirement for an effective system safety process by requiring agencies to maintain a System Safety Program Plan (SSPP) as a condition for receiving federal transit funds. FTA has delegated the oversight or surveillance of SSPPs to the states. Each state is required to designate a State Safety Oversight (SSO) agency or office that is independent of the transit agency.

## FRA and FTA Policy Statements Regarding Shared Use

Over the last 30 years, several factors have prompted interest in light rail and rail freight shared use operations, including:

- lack of readily-available abandoned railroad rights-of-way, due, in part, to retention of light density rail freight lines through the use of short line railroads
- the increased demand for new short haul passenger transit, partly due to specific transportation needs and partly due to transit's role in stimulating economic growth and redevelopment
- the modal shift in deployment of new transit systems from full rapid transit or Metro to light rail transit; while this is largely due to cost, in many locations, the attributes of light rail are more appropriate for community development and compatibility than rapid transit
- improvements in signaling and vehicular technology and in how these technologies are applied to light rail

The great interest in shared use encouraged FRA and FTA to collaborate on the articulation of a common policy. After careful deliberation, the joint FRA/FTA policy statement on shared use operations was issued in July 2000. Concurrent with the issuance of the Joint Policy Statement, the FRA issued the “Statement of Agency Policy Concerning Jurisdiction over the Safety of Railroad Passenger Operations and Waivers Related to Shared Use of the Tracks of the General Railroad System by Light Rail and Conventional Equipment.” This FRA statement, “Concerning Jurisdiction,” along with existing FRA regulations, is of fundamental importance in undertaking the development of shared use operations and in the formulation of designs and operational practices. The results of this project and the recommendations made in this report are based on these statements.

The Joint Policy Statement recognizes the importance of shared use due to the present difficulties encountered in obtaining rights-of-way for expansion of rail transit. The statement observed that shared use “take[s] advantage of underutilized urban freight rail corridor(s) to provide service that, in the absence of existing right-of-way, would be prohibitively expensive.”

The Joint Statement also recognizes that “... expansion of rail passenger transportation promises significant benefits to America’s communities in terms of reducing highway congestion, reduced pollution, lower commuting times, and increased economic opportunities.” (*Federal Register*, Vol. 65, No. 132, 2000, pp. 42525-42528).

The FRA’s companion “Statement Concerning Jurisdiction” specifically addresses the operational aspects of shared use, and clarifies FRA’s jurisdiction. The operational aspects are discussed in both statements; the Joint Policy Statement recognizes that “... where complete temporal separation between light rail and

conventional operations is achieved, the risk of collision between the two types of equipment can be minimized or eliminated.”

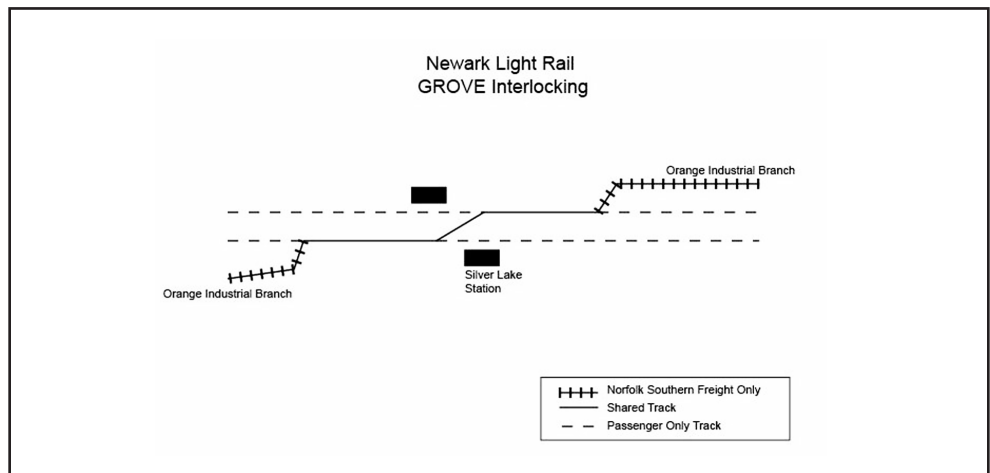
Conversely, FRA’s “Statement Concerning Jurisdiction” states that for proposed operations where compliant and light rail equipment will share track at the same time (so called co-mingled operation), “petitioners will face a steep burden of demonstrating that extraordinary safety measures will be taken to adequately reduce the likelihood of a collision between conventional and light rail equipment to the point where safety risks associated with joint use will be acceptable.” The operative words in this statement are “steep burden of proof.”

Taken together, the two preceding statements have resulted in this project taking a direction that retains temporal separation. The temporal separation concepts further developed in this research are highly optimized forms of temporal separation. An added benefit of the designs employed in this work is that the separation is based on principles of vital signal design; this extends to train routing, the blocking and locking of boundaries, enforcement of positive stop by vital appurtenances, and train detection based on track circuits.

## Light Rail and Interurban Transit

Much of the shared use operation that occurs on light rail transit properties is typically restricted to a small segment of the transit line. As such, the transit system is able to accommodate the shared use while retaining its transit-based operating practices over most of the system. This is the case on NJ TRANSIT’s Newark Light Rail, which, until recently, had approximately 2,000 feet of (infrequently) shared operation with Norfolk Southern local freight trains (see Figure 6). This limited shared use, which utilizes the concept of Short Interval Temporal Separation (SITS) (explained in Chapter III), does not necessarily require that the entire rail transit system assume railroad-based operating practices or fall under FRA jurisdiction. However, the sharing of tracks of the general railroad system has resulted in the need to request a waiver from FRA.

**Figure 6**  
Newark Light Rail  
Shared Track  
Schematic



Other LRT operations, such as San Diego Trolley, see shared use over a significant portion of their core system. For these LRT systems, the percentage of the core system that, by virtue of the shared use, is considered to be part of the general railroad system becomes significant. Such short-haul passenger systems are somewhat similar to the interurban lines from the past. Additional existing examples are NJ TRANSIT's River LINE (Camden to Trenton), North San Diego County's Sprinter (Oceanside to Escondido in California), and the Capital Metro Red Line in Austin, Texas. In effect, a railway of this nature can be viewed as part of the general railroad system, with a few miles or branches excluded, rather than as a transit system that has a few miles included into the general railroad system. These railways are not full-fledged "commuter railroad" systems, nor should they be so judged because of the nature of the passenger trips. This is an important distinction since classification by FRA as "commuter railroads" may carry commercial and business implications that are unrelated to the safety case. This is because the "commuter railroad" label typically applies to passenger railroad operations on the general railroad system that is subject to FRA safety regulation.

Recognition of interurban transit as a rail mode may simplify the development of a template that is suitable for industry-wide use in planning for shared use operations over existing light density freight lines. The interurban mode, by drawing on railroad operating practices and technologies, utilizes a railroad-oriented operating doctrine that, to a significant extent, complies with FRA regulations, except for the vehicle buff strength requirement. The result is that the interurban mode is "near compliant" with FRA requirements. As demonstrated by the NJ TRANSIT River LINE, the interurban operating doctrine provides the framework for applying conventional off-the-shelf technologies and operating practices to further develop the techniques for shared use operations, providing a template for other locations. It is anticipated that this approach may ease the process relating to development and submission of waiver applications to FRA for shared use of track of the general railroad system.

Figure 7 shows a near-compliant NJ TRANSIT River LINE rail car running alongside a through freight train, illustrating the concept for interurban transit.

**Figure 7**  
NJ TRANSIT River  
LINE: Near-Compliant  
Rail Car Running  
Alongside Through-  
Freight Train





SECTION  
3

# Development of Operating Practices and Technologies for Shared Use Operations

## Technology and the Duration of the Temporal Separation Window

Temporal separation reflects the original method of management of train movements based on timetable authority. In temporal separation, modes are kept absolutely separate by assignment of specific blocks of time to each mode. The duration of the blocks, or the time scale, has traditionally been in 8- to 12-hour blocks, with one non-compliant (traditionally light rail transit) and one compliant (i.e., freight) per 24-hour cycle.

The duration of the temporal blocks is related to the technology utilized to assure the absolute nature of the modal separation. Advanced technology, in conjunction with sound operating practices, is capable of considerably shortening the time scale of separation. With the appropriate design, rules, and training, the minimum duration of the temporal separation window may be expressed in periods of one hour or less. Recent experience indicates that FRA will permit temporal separation on a fast clock under carefully-controlled conditions. This ability to absolutely separate modes in periods on the order of minutes, or of some relatively small number of slots, is referred to as Short Interval Temporal Separation (SITS). SITS is the use of vital technology to permit short interval shifts between modes while maintaining absolute mode separation in a single interlocking.

SITS raises the possibility of Extended Temporal Separation (ETS), which is the application of temporal separation over a segment of a line, which includes two or more consecutive interlockings, rather than uniformly over the entire length of any given railway system. SITS is a prerequisite to achieving the benefits of ETS, since SITS permits the shortening of the time interval, while still retaining absolute and positive modal separation. ETS involves the use of vital design to assure absolute and failsafe separation of modes over the design segment of trackage. ETS involves the use of conventional off-the-shelf hardware to link otherwise independent interlockings to operate as a single extended interlocking with respect to modes.

## Recent Implementation of Shared Use Operations

The success of two significant temporal separation shared operations (freight and light rail transit), San Diego Trolley and the NJ TRANSIT River LINE, have demonstrated the benefits to both passenger and freight operations. They have operated with outstanding safety records and have resulted in transportation and economic benefits for the public.

The modern history of shared use began with the introduction of San Diego Trolley light rail transit service on the Tijuana Line of the San Diego and Arizona Eastern Railroad in 1981. The evolution of operating concepts continued with the opening of the initial segment of the St. Louis LRT System (MetroLink) on what was a former Wabash Railroad line (and where a freight branch line's diamond crossing required an FRA waiver) and Baltimore Central Light Rail Line where localized freight remained on the branch to the north (the former Pennsylvania Railroad Northern Central of downtown Baltimore) and the line to Glen Burnie (the former Baltimore and Annapolis Railroad). Within the past 10 years, the number of shared use applications has grown.

The list below identifies transit properties in the United States that have or are using temporal separation for shared use operations according to TCRP Report 130:

- Baltimore Central Light Rail (Maryland)
- Capital Metro Red Line (Austin, Texas)
- Newark Light Rail (NJ TRANSIT): Shared use in active operation until January 2009, when customer discontinued freight service; Norfolk Southern has not formally discontinued this service
- River LINE (NJ TRANSIT)
- San Diego Trolley (California)
- Sprinter (North San Diego County, California)
- TRAX (Salt Lake City, Utah)

Most of the rail systems listed may be considered as having transit roots and have achieved shared use using conventional methods of temporal separation. The advancement of shared use operations has been accomplished using an evolutionary process, one in which the iterative development of technology, the application of that technology (i.e., its use in design), and refinement of operating practices has been an ongoing process. Because of the safety and liability implications of shared operations, the development of step-wise applications has proceeded using conventional off-the-shelf technology and iterative development of operating doctrine, with significant time to evaluate and review each advancement.



The incrementally-greater application of proven technology has resulted in FRA granting waivers that are progressively more flexible (importantly, without loss of rigor in maintaining separation) in terms of how separation of modes are operated, provided other conditions are met. Successful shared use operations are not derived from technology alone; the other prerequisites may be generalized, as are all of those involved in proving a sustainable equivalent safety case. Safety equivalency requires the implementation of adequate operating practices in parallel with technology, which, in combination, define the operating doctrine.

Listed below are the specific shared use operations where the development of the operating doctrine (technology and operating practices) led in a logical and stepwise manner to the successful implementation of SITS and ETS on the River LINE. These, in turn, led to the principles of “advanced shared use operations,” which form the basis of the shared use template defined by this research study. The operations are listed in order of the progression of the incremental development of the operating doctrine:

- San Diego Trolley’s shared use with freight
- River LINE, CPI7 and CP 45
- Newark Light Rail Grove Interlocking
- River LINE South/Camden Subdivision
- River LINE North/Burlington Subdivision design, which is the focal point of this research; it is a logical (stepwise) extension of previous work.

The following is a description of these projects from TCRP Report 130:

### *San Diego Trolley*

**1981–1989: Commingled operation.** San Diego Trolley’s track-sharing practice is both the earliest and the most advanced example of a shared-track rail corridor operating in North America. On both the Orange and Blue lines in San Diego, freight trains operate almost every weeknight under FRA waivers. The San Diego Trolley, Inc. (SDTI) track-sharing operation commenced in 1981, when trolley operations began on the Blue Line to the international border on half-hourly headways. Initially, the operation was fully commingled, with freight trains operating in the slots between light rail trains. This historic practice was extended to the Orange Line when trolley service began on that line in 1989. Neither of these commingled operations resulted in mishaps or injuries. The shared-track segment consists of 13.5 miles on the Blue Line, and 17.0 miles on the Orange Line.

**1990s: Commingling terminated, reversion to temporal separation.** As transit service demand in the corridor increased during the mid-1990s, and headways were reduced from 30 minutes to 15 minutes, freight operations were moved to the early morning hours. Commingled operations continued on the fringes of the transit service day, when light rail trains ran less frequently. Sometime after the opening of the Orange Line, FRA disallowed the freight operations while light rail vehicles were on-line, resulting in effective temporal separation. The commingled operations on the fringes of the service day were outlawed.

**2001: Restricted parallel single track operation.** FRA later relented somewhat and allowed movements on separate tracks under highly restricted conditions. In 2001, FRA granted a waiver to SDTI to permit its continued operations under a petition for “grandfathering” the previous practices. However, several aspects were restricted. This operating scenario was termed “limited night-time joint operation.” It was not permitted for westbound movements on the Blue Line due to a potential single-track conflict.

**2004: Scripted Temporal Separation.** In 2004, a further waiver was granted to allow limited night-time joint operations for westbound movements on the Blue Line. Under the federally approved Standard Operating Procedure (SOP), one freight train is allowed to operate on one track while one trolley is allowed to operate on the other during the fringe period. The westbound freight train must come to a complete stop at a predefined meeting place on the double-track mainline before the SDTI dispatcher can release an eastbound trolley from the yard with signal indication. The trolley must pass the standing freight train at no more than 20 mph. SOP reflects considerable caution regarding the possibility of overlapping authorities being granted by the train dispatcher, the possibility of trains exceeding movement authorities, and the possibility that freight train lading will intrude into the path of the passenger train. Under SOP, the two tracks are treated like two, almost independent, single track railways. During this carefully scripted mode of operation, the light and conventional rail vehicles remain spatially and temporally separated.

### *NJ TRANSIT Newark Light Rail*

**2001: Temporal separation.** One Diamond Crossing with a freight carrier; 19-hour passenger window; 5-hour freight window 5 nights per week; impacts late-night passenger movements.

**2004: Short interval temporal separation (one mode at a time separation).** Added vital signal protection with automatic train stop and interlocking at diamond, and central control of movement.

#### *NJ TRANSIT River LINE*

**1999 (date of FRA waiver; service initiated March 2004): Temporal separation.** Two Diamond Crossings with 24-hour access, then approximately 30 miles of mainline track; 16-hour passenger window; 8-hour freight window; transit vehicle equipped with automatic train stops (ATS), freight movement controlled by derail.

**2007: Extended temporal separation.** Added another 2.5 miles of shared track by using entrance/exit control (NX signal logic) over 3 interlockings. Applied ATS and derails to permit use by one mode at a time.

Of particular relevance to the research in this study are the last two stages involving the River LINE. River LINE service commenced in March 2004 under a shared use waiver from FRA that specified the typical day/night separation of modes. On the River LINE, freight was previously operated at 10 to 15 mph over Class 1 and Class 2 track using manual blocking (dark territory). Currently, freight operates at 30 mph on signal indication, and all track comprises continuous welded rail that meets Class 5 requirements. On the southern section of the River LINE in shared use, known as the Camden Subdivision, three to four freights operate daily, with an annual volume approaching one million gross tons. Thirty-two miles of the line are currently part of the general railroad system (Figure 8). Four to five freight trains, based out of the Camden Pavonia Yard or the Burlington Yard, currently operate on the line during weekdays (Figure 9).

**Figure 8**  
 32-Mile Segment  
 (Thick Blue Line) of  
 River LINE that is  
 Part of the  
 General Railroad  
 System of the  
 United States



**Figure 9**  
 24-Mile Segment  
 (Thick Blue Line) of  
 River LINE Currently  
 Utilized by Freight  
 Trains. Freight trains  
 are based in Camden  
 Pavonia Yard (photo on left)  
 and Burlington  
 Yard (photo on right).



A major adjustment to the River LINE waiver was obtained from FRA based on vital signal design, known as Extended Temporal Separation (ETS). ETS involves a method of employing vital signal logic to integrate actions of multiple railroad interlockings covering an extended section of railroad so that separate passenger and freight routes may be called and locked. TCRP Report 130 observed that ETS provides improved service flexibility while holding to high levels of safety. That report also recognized that the roots of the River LINE’s success in receiving FRA approval for ETS and the ensuing safe and successful operations may be attributable to the River LINE’s railroad-style operating practices (described in Appendix B, River LINE, Existing Operations).

## Temporal Separation on the River LINE and Newark Light Rail

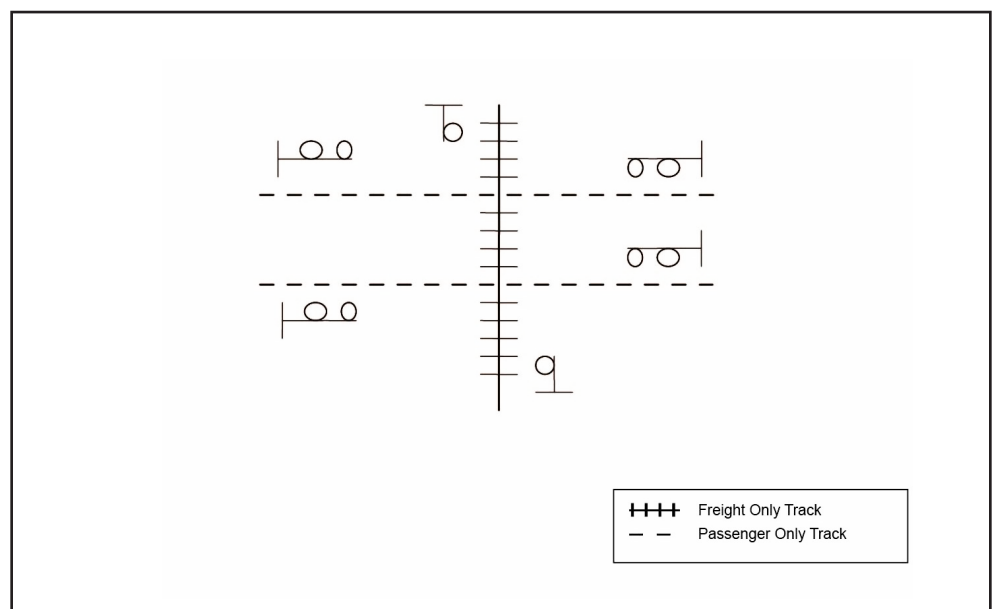
The development of the operating doctrine of these technologies has been an evolution, i.e., a step-wise progression to greater flexibility of operations. This development occurred progressively over five years. This section describes the development of the engineering design for achieving the positive separation of modes using conventional off-the-shelf signaling and track equipment:

### River LINE CP 17

The most historic form of separation of modes occurred at grade crossings where streetcars (or early interurbans) crossed mainline railroads. While these once were common occurrences, very few exist today. Those that do remain are protected by vital grade-crossing equipment, although positive stop is not employed. Appendix C provides background on train separation and train routing concepts.

The level crossing at CP 17 on the River LINE is somewhat representative of these early crossings in that the track configuration physically prevents routing trains of one mode onto tracks of the other. The signal system provides so-called flanking protection in an absolute manner since the crossing (see schematic in Figure 10) is constructed as an interlocking with positive stop provided for each mode. The passenger line dispatcher has control of the interlocking; the passenger tracks approach is ABS/26I territory (this operating rule is for a section of track that has signaling for operation in either direction) on either side of the CP, and the freight track is yard track outside of the CP. The arrangement at CP 17 is not uncommon and, in fact, could be said to define an actual standard.

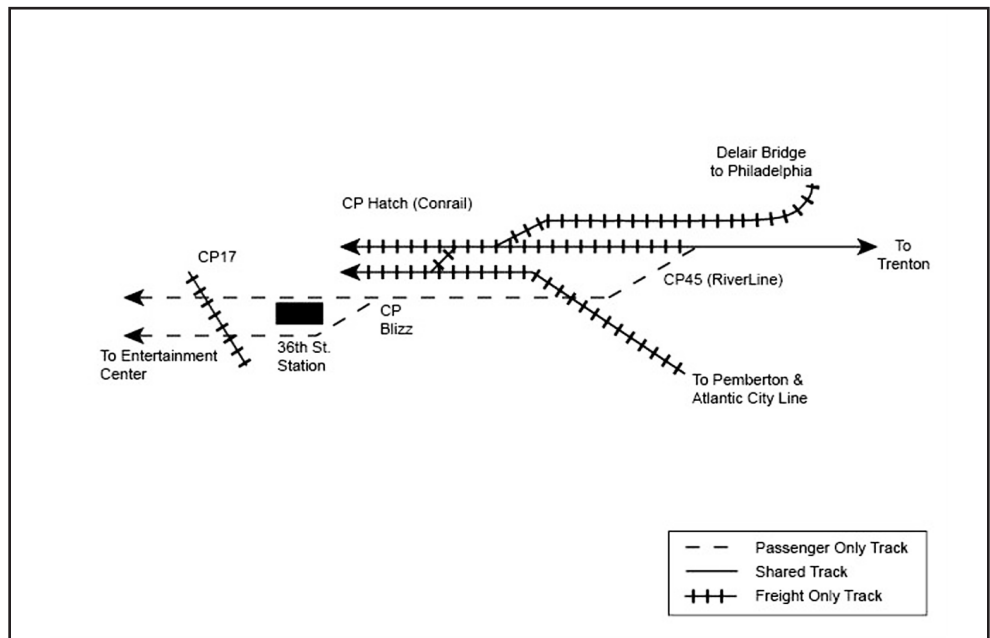
**Figure 10**  
*At-Grade Crossing of  
Rail Lines*



### River LINE CP 45

Approximately 2 miles from CP 17, the River LINE has a slightly more complex variation of a level crossing at CP 45. Figure 11 illustrates the railway configuration at CP Hatch and CP 45, which are adjoining interlockings. The former is Conrail's and is under the control of the Conrail dispatcher. It passes more than 20 freight trains a day, including unit coal trains, mixed through-freights destined for Harrisburg (Enola) and Allentown, and locals. One route in Hatch leads to the River LINE's single main through Pennsauken, and another crosses the River LINE's single main and connects to NJ TRANSIT's Atlantic City Line. CP 45 is a River LINE interlocking, which is under the control of the River LINE dispatcher (train controller). The route from CP Hatch to the River LINE single main is inhibited by temporal separation. The route across the River LINE's main line track is an application of SITS. While River LINE trains are operated, freight trains can be operated through CP 45 (Figure 12) when it is pulled up by the dispatcher.

**Figure 11**  
River LINE CP 17, CP 45, and CP Hatch





**Figure 12**

*Freight Train Crossing  
Passenger Track at  
River LINE CP 45,  
a Location Where  
SITS is in Place to  
Ensure Absolute Tem-  
poral Separation*



The logic across the River LINE replicates that at CP 17, however, it is more complex in that a handshake exists between the River LINE and Conrail dispatchers for River LINE's CP 45 and Conrail's CP Hatch. If CP 45 is not first pulled up for the freight crossing, the route through CP Hatch to CP 45 is inhibited. This configuration illustrates the application of SITS on a more complex level than that used at CP 17. Although this location involves two interlockings, it is not considered an application of ETS since the two CPs are back-to-back and do not have any signal blocks separating them. This case is important to ETS, however, since it provided an incremental increase of complexity that formed the basic concept for linking disparate CPs.

### **Newark Light Rail, Grove Interlocking**

In August 2002, a one-mile extension of the Newark Light Rail system (historically known as the Newark City Subway) opened. This extension was constructed along the alignment of Norfolk Southern's (former Erie Railroad) Orange Branch to Bloomfield and included one new intermediate station as well as a new terminal station. Concurrent with the opening of the extension, the entire line was upgraded (construction had been in progress for two years prior along the original portion of the subway) to light rail standards, and a new ATC-equipped light rail vehicle (LRV) replaced the President's Conference Car (PCC) streetcars that had been operated on the line since the 1950s. A new yard and (rail) Vehicle Base Facility (VBF) was constructed at the outer end of the line to support the new LRV fleet and to accommodate and support work equipment.

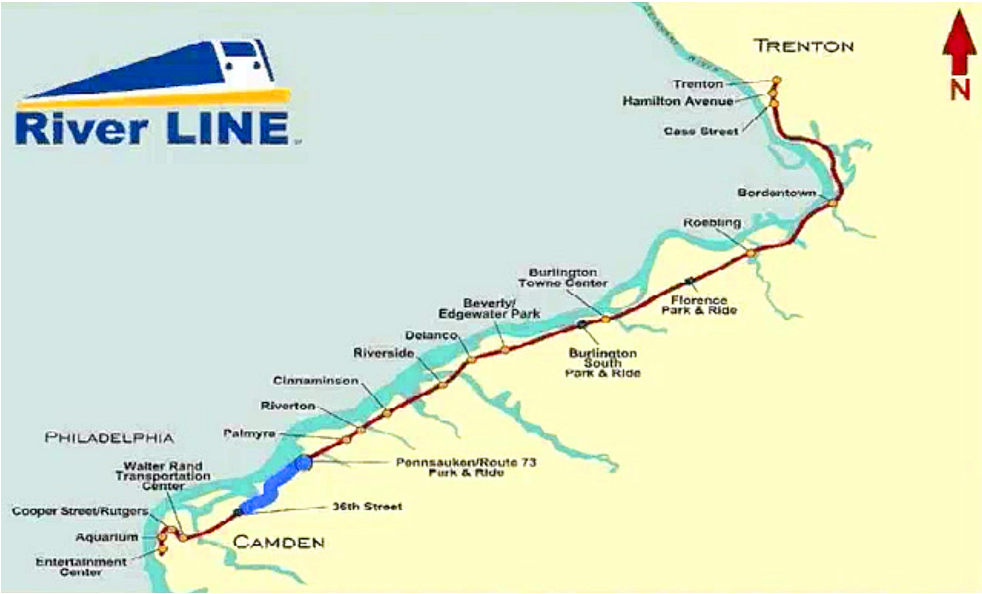


Since some local freight remained on the Orange Branch, the Grove interlocking was constructed to permit Norfolk Southern locals to cross the new LRV line at grade. This interlocking was configured in a way that required freight to operate on LRV trackage for approximately 1,000 feet. FRA approved a traditional temporal separation waiver on the shared territory; passenger service was not permitted to operate onto the extension north of Branch Brook Park Station between 10:00 PM and 6:00 AM. The impact of this was more severe than restricting service hours at two stations, since the VBF was the only maintenance facility suitable for the new LRVs and was planned as the originating location for LRV assignments (e.g., for early rush-hour service) and the facility for LRV maintenance. Based on the operation at CP 45 on the River LINE, an application of SITS using one extended interlocking was developed, and a waiver modification was filed for SITS within interlocking limits. This configuration is illustrated in Figure 6.

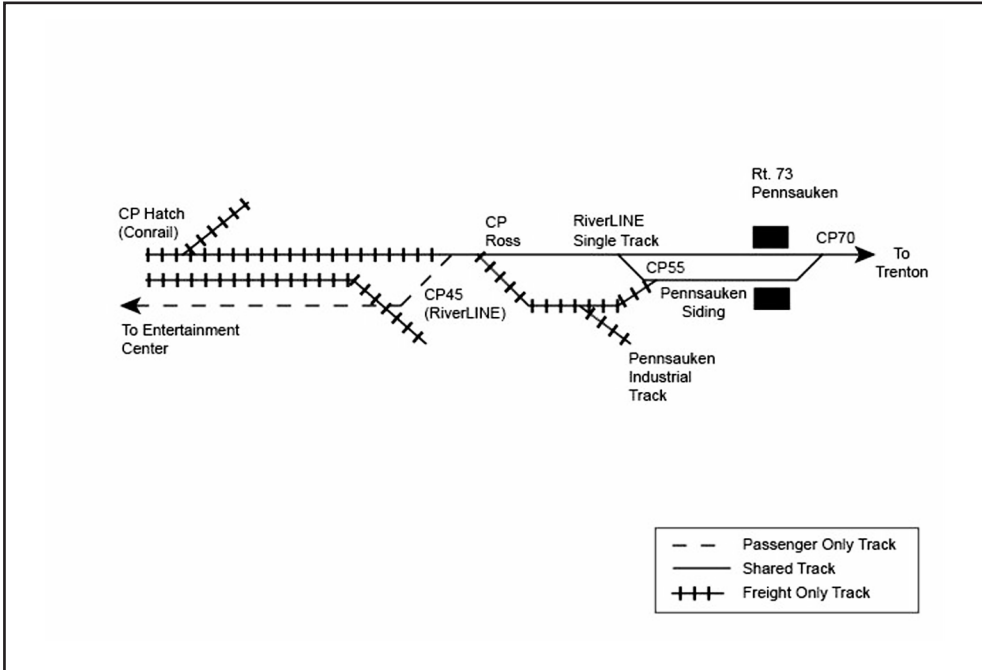
FRA agreed to modify the waiver. Passenger service (including deadhead moves) may operate over the entire line to and from the VBF, and freight may operate through Grove, subject to the Operating Doctrine of SITS. Since the LRVs are equipped with ATC with a zero-code-equals-zero-speed design, the need for inductive trip stop is eliminated. Although the configuration of a single, artificially-extended interlocking, which includes a station stop, reduces passenger train capacity, this has not been an operating constraint, since the peak hour service plan schedules alternate trains as short turns at the Branch Brook Park Station. Although the use of SITS provided a benefit at this location, ETS would provide additional operating flexibility. In the future, to increase the frequency of peak-hour passenger trains, the application of ETS could be considered since it would support closer headways in the passenger-only mode.

### **River LINE; ETS/SITS on Camden Subdivision**

The next step in the incremental development of the new shared use operating doctrine was the installation of ETS on the Camden Subdivision (referred to as ETS South). The two-mile segment of the line is identified in Figure 13. This operation, which permits passenger operation into freight territory as far as the Pennsauken Route 73 Station until 1:00 AM and freight locals to operate as far north as Pennsauken Industrial Track at all times, was approved by FRA in 2007. Figure 14 illustrates the track configuration, which permits a new third shared mode during passenger service hours.



**Figure 13**  
Two-Mile Segment (Thick Blue Line) of Camden Subdivision of River LINE with ETS and SITS



**Figure 14**  
Track Schematic of Segment of River LINE Camden Subdivision with ETS

Referred to as the ETS scenario, this configuration vitally inhibits prohibited train movements and erects positive stop modal boundaries. It also incorporates SITS. Table I summarizes the operations.

**Table 1**  
Camden Subdivision  
Shared Track  
Operations Scenarios

Scenario	Operations Summary
Freight Scenario (1:00 AM until 5:30 AM)	All passenger movements are inhibited in this territory; it is freight only.
Passenger Scenario (6:00 AM until 10:00 PM)	Freight may operate across CP 45 to Pemberton Branch/ Atlantic City Mainline. Under the conditions of the revised FRA waiver using ETS/SITS, freight may also operate on the River LINE main track to/from Pennsauken Industrial Track (only) at any time of the day.
ETS Scenario (10:00 PM until 1:00 AM and 5:30 AM until 6:00 AM)	Passenger Mode: Passenger trains may operate to the Pennsauken Route 73 Station routed over the passenger single track main only, and the passenger route north of the station is vitally inhibited at CP 70. Freight may operate north of CP 70. Freight Mode: Passenger route from 36th Street Station to the Pennsauken Passenger Siding is inhibited. Freight may operate from CP 45 to Pennsauken Siding or to Pennsauken Industrial track. Freight may operate north of CP 70.

### Northern River LINE (Burlington Subdivision) Operation

The next advancement of shared use operations on the River LINE was undertaken to connect with early morning Northeast Corridor Line express trains from Trenton to New York. Earlier service was needed from Burlington South Station (M.P.17) than permitted by the original waiver. Following the approval of the ETS South Waiver and the successful and safe implementation of the extended service to Pennsauken Route 73 Station, FRA was requested to modify the River LINE's waiver to permit the 5:45 AM start of passenger service (instead of 6:00 AM), with trains originating in Burlington City Yard, on the Burlington Subdivision (RiverLINE track schematic in Figure 24). In approving this operation in 2006, FRA concurred in the design concepts employed in ETS. This involved setting a subdivision boundary at CP 150 (M.P. 15), having all signals set at stop, and the turnout aligned to the passenger siding (away from the main track between 5:45 AM and 6:00 AM). This operating arrangement enables a freight train to operate south of CP 150 (M.P. 15) while a passenger train is loading at Burlington South Station (M.P. 17 at 5:50 AM).

To some extent, this replicates the practice followed on San Diego Trolley during the shoulders of the temporal separation window. However, San Diego uses the equivalent of a temporary block station to split the mainline into two segments. River LINE defines formal subdivisions, with dispatcher, track department, and signal maintainer territories mapped onto the subdivisions and vital positive stop protection at the subdivision boundaries. This service improvement, while small from an engineering technology perspective, illustrates the type of operating practices for shared use operations that FRA considers in evaluating waiver requests.

SECTION

4

# Proposed Advanced Temporal Separation for River LINE North (Burlington Subdivision)

To further expand the hours of passenger service while concurrently allowing freight service to operate, this research study developed a design and the related operating practices for more advanced temporal separation utilizing ETS and SITS on the northern River LINE. The proposed improvements were developed to the point that if funding can be identified, it would be possible to submit the project to FRA for a modification of the waiver that is in place for shared use operation on the River LINE. Appendix E provides a draft waiver submission to FRA for this potential project, which represents a template for other projects. The following sections are a summary description of the proposed operations and signal design for the application of advanced temporal separation to six miles of the River LINE North (map of segment in Figure 15).

**Figure 15**  
*Six-Mile Segment (Thick Red Line) of Burlington North Subdivision of River LINE Proposed for Implementation of ETS and SITS*



## Business Case

The northern segment of the River LINE serves a market in Mercer and northern Burlington counties, which is highly oriented to the Northern New Jersey/ Metropolitan New York Region in both its business commuting, recreational and shopping trips. As such, River LINE service is a logical feeder to NJ TRANSIT's peak period Northeast Corridor service at Trenton. However, the restrictions imposed upon passenger service hours by virtue of River LINE's temporal separation waiver severely limit the connections between the trains of the two lines in Trenton, resulting in limiting service to and from Newark and New York. Expanding the operating window in the morning and evening would provide passengers with greater flexibility and convenience.

When the River LINE opened for service in March 2004, the earliest departure from Burlington to Trenton was 6:20 AM. This Burlington departure was the first northbound train that was permitted to enter the shared use territory at CP 45 at 6:00 AM (under the original FRA waiver). Likewise, the last evening departure to Burlington from Trenton was at 9:00 PM; this was the latest that a train could depart Trenton and be scheduled to clear CP 45 by the time designated as the start of the freight window, which was 10:00 PM.

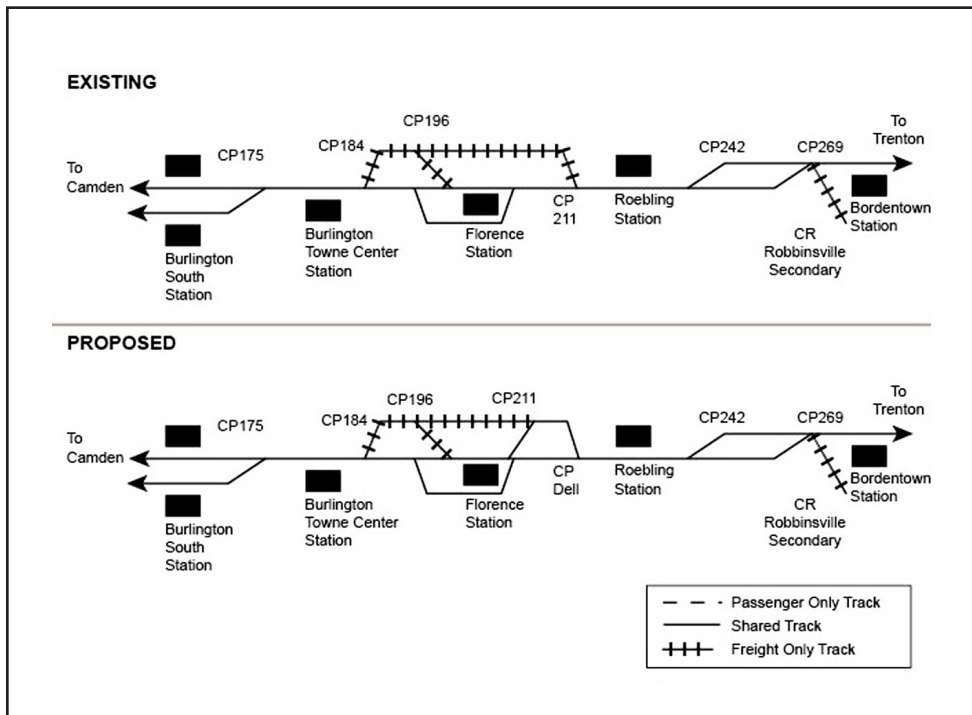
The construction of a small yard at Burlington, coupled with speed enhancements over the line and FRA's agreement to allow the start of the passenger window on Burlington Subdivision 15 minutes earlier, have allowed an expansion of the service hours between Burlington and Trenton. The northward early train (#202) now departs Burlington at 6:00 AM, and the last train to Burlington now departs Trenton at 9:30 PM. The 9:30 PM train from Trenton does not operate all the way to Camden; it terminates at Burlington City Yard. While this change makes one full additional hour of connecting Northeast Corridor service available in Burlington, it remains inadequate. The corresponding arrivals and departures available in Pennsylvania Station, New York, remain limited to approximately 8:00 AM to 8:00 PM, only a 12-hour span of service. Because of this restriction in New York connecting service, many Burlington County passengers drive directly for relatively long distances over congested highways to the Northeast Corridor Line's Hamilton or Princeton Junction stations. Expanded hours of service to at least Florence, New Jersey, where a large park-and-ride lot is located and which is directly accessible to both the Pennsylvania and New Jersey Turnpikes, would likely attract greater ridership, providing improved mobility and the related social and environmental benefits.

Freight service on the Burlington Subdivision is light north of the Burlington Freight Yard; the south lead to this yard is CP 184, and the north lead is at CP 196 (milepost 20) (Figure 16). North of CP 196 are three consignees on the River LINE proper. There are an additional three to four consignees on the Robbinsville Secondary, which leaves the River LINE at CP 269 (milepost 27). Conrail is presently restricted to serving these few consignees at night, causing two road locomotives

to tie up for the entire day at Burlington Freight Yard where they sit idle. The ETS/SITS plans developed under this research would permit all but one of these consignees to be served at any time of the day or night other than peak hours.

The expanded hours of service for transit and freight and the related benefits for operators and customers indicates that the business case for ETS/SITS on River LINE's Burlington Sub is positive.

**Figure 16**  
 River LINE Burlington Subdivision: Existing Track Configuration and Proposed Concept with ETS



## Concept of Operations

The operating concept is to permit passenger service between the Florence Park-and-Ride Station and Trenton Station to continue until midnight, thereby permitting an 11:40 PM departure from Trenton to Florence. There would be no alteration in the present 9:30 PM departure from Trenton to Burlington, since the territory between Florence and Burlington (approximately 3 miles) would not be included in this zone of ETS. However, this territory could be added in the future if required, with some additional track and signaling changes. River LINE trains departing Trenton between 9:30 PM and 11:40 PM would be scheduled in coordination with NJ TRANSIT and Amtrak trains from Newark and New York, permitting a departure as late as 10:30 PM from New York to reliably connect with River LINE service.

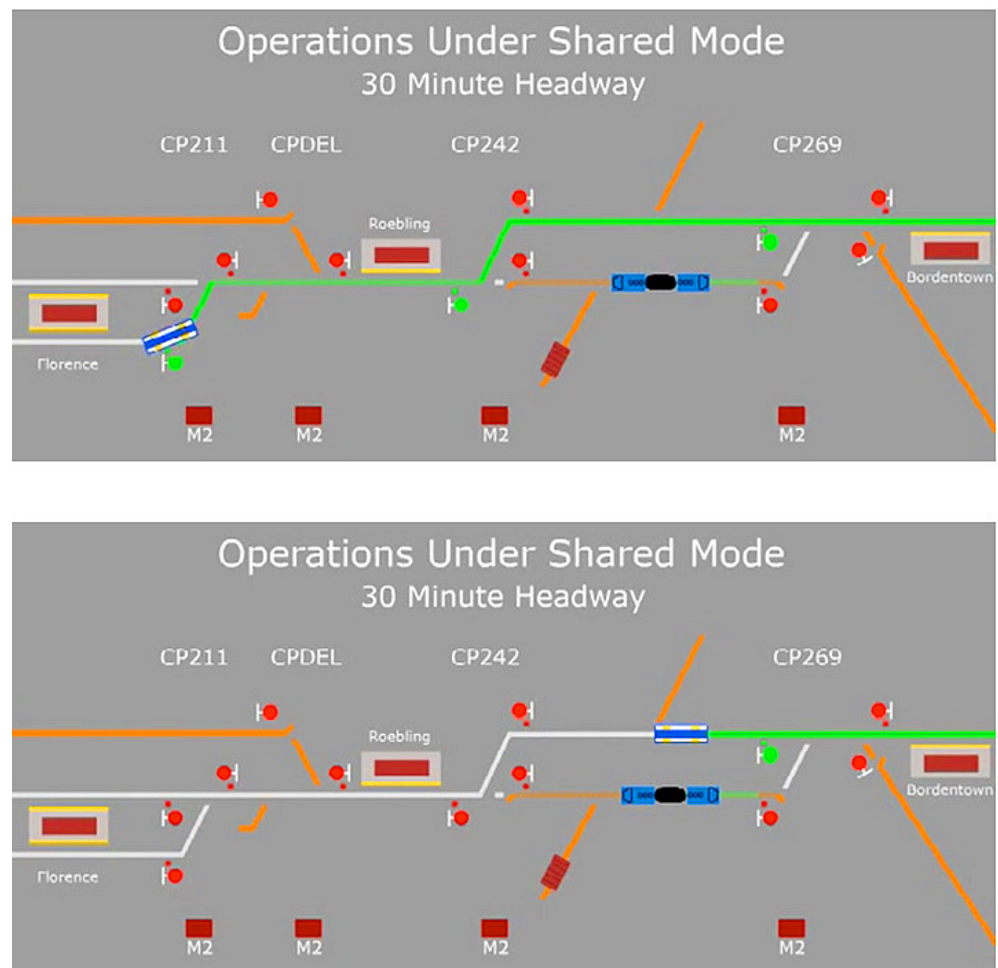


To permit this increment in passenger service, additional operating flexibility must be afforded to the freight service. The application of ETS and SITS in this design would permit freight to operate between a new interlocking to be referred to as CP DEL and CP 242 on the single main track during off-peak passenger hours using the principles of SITS (Figure 17). A freight train would operate on either the single main or the Roebling Siding, depending exclusively on the direction from which it entered this double-track section. Northward freights will be recognized as such when they enter the ETS zone on the Florence Running track at CP 211. The only allowable route at CP 242 for such a train will be Roebling Siding. All other exit routes at CP 242 are inhibited for a train entering the ETS zone from the Florence Running track. Likewise, at CP 269 the only allowable route will be to the Robbinsville Branch for a train entering from the Florence Running track. All freights will be required to clear the limits of CP 269 on the Robbinsville Branch prior to reversing direction. A southward freight, identified as such by its entering CP 269 from Robbinsville, will be routed to the single main only; the route to the Roebling Siding will be inhibited. Likewise, the only allowable route at CP Del and CP 211 will be on the Florence Running track to Burlington Yard.

**Figure 17**

*River LINE Burlington Subdivision: Existing Track Configuration and Proposed Concept with ETS*

*The top diagram shows a passenger train leaving Florence Station while a freight train is on a main line track working a freight siding between Roebling and Bordertown stations. The lower diagram shows a passenger train passing a freight train as it travels toward the Bordertown Station.*





The presence and method of entry of a freight train into the ETS would be recognized by the modal sub-system (which is configured with vital object controllers and described in more detail in the section below on design). This sub-system will allow a passenger train into this zone, provided that the freight is within the double-track territory between CP 242 and CP 269 and is absolutely blocked into the limits with appropriate modal barriers applied. If the conditions are satisfied, the passenger train will be routed to the available track, which is the Main or the Roebling Siding, regardless of its direction.

In implementing this operating concept, the following three modes are proposed to be superimposed on the existing waiver condition on the Burlington Subdivision:

**Mode 1—Peak Hours (approximately 5:30 to 8:30 AM and 4:00 to 6:30 PM):** Provide improved 15-minute service by mitigating delays at the Florence meet. This mode would permit the initiation of tripper service between Florence and Trenton, which will allow selected peak-hour through-trains to express between Burlington and Trenton. During these hours, the present Florence Industrial track would become a passenger track north of Florence Station (expanded CP 211). Freight movements during these hours would continue to be permitted on the Industrial track but would be restricted to south of John Galt Way, i.e., to the limits of expanded CP 211.

**Mode 2 —Shared Use Operations in Off-Peak Utilizing SITS /ETS to Ensure Temporal Separation:** The Florence Industrial reverts to freight-only operation in its entirety as far north as CP DEL. SITS would be employed between CP 211/CP DEL and CP 269. Northward freight may enter at CP 211, but routing will be inhibited through the use of vital logic. Any train entering CP DEL from the Industrial track will be routed only to the siding at CP 242 and only to the Robbinsville Industrial track. Passenger trains entering at CP 211 will be routed only to the non-freight track at CP 242. In a similar manner, trains entering the zone of ETS/SITS from the North will be routed as follows:

- From Robbinsville at CP 269 to Florence Industrial at CP DEL via the Roebling Main track only (there are freight trains).
- From River LINE at CP 269 to River LINE at CP DEL via the non-freight track only. This configuration will allow the passing of freight and passenger trains on their separate tracks between CP 242 and CP 269, as well as between CP DEL and CP 211, and will permit switching of Stefan Chemical and Church Brick sidings when freight is on the appropriate track. Church Brick will be serviced by northward freight trains, and Stefan Chemical by southward trains. Under this configuration, off-peak passenger train meets cannot be scheduled for this zone if a freight train movement has been called.

**Mode 3—Night Operations: Passenger Trains Do Not Operate South of CP 269:** Freight has unlimited use of trackage in the Burlington Subdivision. Freight trains may operate over Neck Road Crossover and on any route between CP DEL and CP 269 and may serve Land O Lakes siding. Night operations are considered as

12:00 midnight and 5:30 AM. The vital design will permit passenger operation between Bordentown and Trenton (independent of policy or service planning issues); hence, the design will include positive mode separation at CP 269 for this mode.

## Design Logic for Mode 2

The operating concept provides the basis for the design logic, which is summarized as follows:

- The presence and direction of a freight train defines the routing logic.
- A northward freight train will be routed from the Conrail Florence Runner at CP211 to CP DEL and there to the Conrail Robbinsville Branch via the Roebling Siding.
- A southward freight will be routed from the Robbinsville Branch at CP296 to CP DEL and to CP211 on the Florence Running Track only, and only via the main track.
- Passenger trains will be routed to the available track between CP242 and CP269. The system is designed for operation under NORAC rule 261.
- All movements must be completed; that is, when in the ETS scenario, the configuration design will not permit a train to reverse direction. Consequently, any train entering the zone (CP211 to CP269) must complete its trip through the zone. The conventional vital signal logic for railroad traffic that might, for example, permit a local freight with cars destined only for Church Brick to reverse between CP242 and CP269 and receive a permissive signal south at CP242 will be inhibited by the modal separation subsystem. In this example, the local freight must clear CP269 onto the Robbinsville Branch in order to reverse.

The single track between CP DEL and CP242 will replicate the logic utilized on ETS South (Camden Subdivision) with regard to Modal Separation. While following trains of the same mode will be permitted, mixed modes will not commingle in this section. Also similar to ETS South is the replication of entrance/exit control (NX signal logic) over an extended territory comprising multiple interlockings and the intervening non-interlocked (Rule 261) territory. When the ETS scenario is in place, the modal separation subsystem will cause the territory from CP 211 to CP 296 inclusive (approximately 7 miles) to operate as a virtual NX interlocking with regard to trains of different modes, but will permit full flexibility of conventional operation for trains of the same mode.

Under this proposed operating concept, the ETS mode (Mode 2) would be in place between 9:00 AM and 3:00 PM and between 7:00 PM and 12:00 midnight. These are the hours when passenger trains operate, but with a headway that is greater than 15 minutes. The normal passenger-train-only mode would be in place during peak service hours (6:00 AM to 9:00 AM and 3:00 PM to 7:00 PM). This is the period during which passenger trains currently operate on a 15-minute headway, precluding freight operations. The freight-only mode would be in place at other times. Table 2 summarizes the operating modes.

**Table 2**  
*Proposed Operating  
 Modes for Burlington  
 Subdivision  
 Shared Track*

Mode	Type	Hours of Service
1	Passenger Only	5:45 AM to 9:00 AM and 3:00 PM to 7:00 PM
2	Extended Temporal Separation	9:00 AM to 3:00 PM 7:00 PM to 11:59 PM
3	Freight Only	12:00 AM to 5:45 AM

## Engineering Systems

Four engineering systems were of importance in the development of the River LINE design. While these are state-of-the-art systems, they utilize conventional off-the-shelf technologies.

### Object Controllers

Object controllers are microprocessors that are added to each interlocking to provide a vital link to allow the sharing of information between independent interlockings (control points). They are the critical element in extending logic over multiple interlockings, as required to support the concept of ETS. In the ETS design for River LINE north, they vitally inhibit the available routing at CP 242 and CP 269. For example, based on a train's entry point at CP 211 during the SITS mode, it is possible for a passenger train to enter CP 211 only from either the main track or the Florence siding and for a freight train to enter CP 211 only from the Florence Running track. This entry point serves as a vital surrogate for train (mode) identification and is carried throughout the ETS zone using the object controllers.

The use of the object controllers fits the desired requirements of design where any train control system can be adapted to fit the logic parameters required by the template for the waiver application to FRA. They are commercially available and permit application and integration of multiple types of vital signal programmable logic controller or all-relay applications.

### Automatic Train Control /Automatic Train Protection (ATC /ATP)

On the River LINE, ATC is in place intermittently at modal barriers (derails [Figure 18] and trip stops [Figure 19]), but no speed control is in place. A future improvement would be the provision of continuous ATC to enhance the safety measures on the line. Paradoxically, this enhancement of the safety systems on the line would require a waiver from FRA. The waiver is required because all trains would be required to be equipped with cab signal capability. On this line, not all freight locomotives are equipped. However, this is not to suggest that FRA would not be amenable to such a waiver request provided that there were significant benefits presented and that the freight safety could be mitigated through other means, i.e., temporal separation derails.

**Figure 18**

*Split Rail Derail Utilized to Provide Positive Stop for Freight Trains to Separate Them from Passenger Trains to Provide Absolute Temporal Separation of Shared Track*



**Figure 19**

*Trip Stop Utilized to Provide Positive Stop for Passenger Trains to Separate Them from Freight Trains to Provide Absolute Temporal Separation of Shared Track*





## Supervisory Control Systems

Supervisory control systems are normally considered non-vital; however, they involve safety-critical functions:

- They are used to set the mode; however, the mode setting is still a request that is made to the vital system. When a train is on the track, the mode cannot be changed.
- They provide a level of situational awareness to the train dispatcher or train controller.
- Where freight and passenger dispatching is done separately, an approach to transfer of dispatching responsibility must be clearly defined and rigorously implemented to ensure clear lines of responsibility.

## Loss of Shunt Mitigation

This is a systems integration item relating to four systems: track (and sub-grade), signals, vehicle, and supervisory control (for loss of shunt alarms). The positive train detection by track circuits is the fundamental principle of the ETS/SITS designs and has been the essential element of North American signal practice since the invention of the original DC track circuit. Proper shunting is essential to the mitigation of risk elements. The River LINE has demonstrated, through practical methods and data verification, that their loss of signal mitigation efforts is successful. Use of the Aqua Train, Exciters, and wheel scrubbers have allowed FRA to have a level of confidence that any loss of signal conditions is being resolved quickly and efficiently.

## Safety Case

The technology design for the River LINE north is to prevent incursion of one mode into the other mode, ensuring the physical separation of the modes. Derails vitally prevent incursion of freights into the passenger zone, and light rail vehicles are prevented through the use of vital wayside electronic trippers from entering the freight zone. The objective is not to have train (modal) separation based on safe braking (as in traditional signaling) but to have physical separation of modes where collision is vitally prevented by restraining barriers (trippers, derails). The concern that a runaway boxcar could be a danger is addressed by the deployment of derails as part of the design.

The ETS/SITS design utilizing proven and familiar “conventional off-the-shelf” technology meets FRA’s requirement that operations would be safe, verifiable, reliable, and repeatable. The design utilizes existing technology that can be applied over a wide range of signal and control systems and performs the functions with standard application of signal logic. Furthermore, system safety is assured through integrated operational, maintenance, and design efforts.

System design relied on three integrated levels of protection to ensure safe physical separation of the LRVs and freight trains: Vital Logic Controllers,

Operations Control Center (non-vital control and indication), and Operational Rules and Training. These items are not implemented independently but are co-dependent and act together in a fail-safe configuration.

The primary level of protection was designed in the vital signal logic through the programmable microprocessor units, Vital Harmon Logic Controller (VHLC), manufactured by GE Transportation Systems. Since the ETS-affected territory includes multiple adjacent interlockings, with each mode it is necessary to link these through vital methods. CP 211 and CP 269 work in various configuration(s) with remote VHLC links and Object Controllers for exchange of information between interlockings. This allows for integration of logic and switch controls through the vital level. As an example, if ETS is in Mode 2, the derail at CP DEL on the track for freight cannot be moved out of the derailing position until all switches allowing LRV routes are lined to inhibit display of signals, thereby protecting entrance of LRVs through the wayside trip stops. For transfer of information between interlockings, a small microprocessor, Union Switch and Signal (US&S) MicroLok Object Controller, was utilized to link the units serially over communication cable and provide discrete inputs and outputs to/from the VHLC. This provides information for switch positioning, track circuit information, and directional inhibiting of switches to be vitally shared between the affected interlockings. This vital exchange of information is important, particularly with the use of local control.

A simulation of operations is an element of the safety case to be submitted to FRA. The ability of the design to support the operating concept in a fail-safe manner must be proven, typically by manual stringline or computer simulation and the development of a signal blocking diagram. The concept of operations must be proven to be practical, not just theoretically feasible.

For the River LINE North application, an operations analysis was performed to demonstrate that the ETS/SITS operations concept is feasible and practical for revenue service during the off-peak periods when headways are 30 minutes. Interestingly the operations analysis of the ETS/SITS operation indicates that although it would be theoretically feasible during the peak-period 15-minute headway periods, it would not be practical and reliable for daily operation.

An additional element of the safety case developed for River LINE shared use operations was the preparation of an Operating Hazards Analysis (OHA), which identifies and systematically assesses conditions that could potentially affect the safety of both freight and passenger rail operations. A draft OHA is provided in Appendix F.

## Key Elements of Shared Use with Advanced Temporal Separation

All of the principles included in the proposed application of SITS and ETS to the northern River LINE were directly derived from those that have been in place on the River LINE's Camden Subdivision since May 2007. However, the proposed changes to the Burlington Subdivision involves three incremental advances beyond SITS and ETS, as practiced on the Camden Subdivision (both operating and design) that have been approved by the FRA:

- Selection of route, which is based on freight status—Under ETS South, there was a single entry and single exit only. ETS North provides multiple exit points for the LRVs based on freight occupancy. This allows for operational flexibility of both the freight and LRV, as access to track is not restricted.
- Sectional releasing of absolute blocking—Giving trains permission for movement through multiple ETS sections through logic that closes switches behind train movements allows for operations of freight during short windows (15 minutes). Greater flexibility for release of trains is also provided should trains become late and schedule recovery is required.
- Switching alongside a parallel track where track centers are less than 17 feet—Through operational rules or with an intrusion detection system, the movement of various modes would be allowed under ETS North.

### FRA Review of Shared Use Operations Utilizing Advanced Temporal Separation

In assessing the safety of proposed shared operations utilizing temporal separation, FRA will typically expect the following analyses in a waiver request:

- The Safety Case should include a comprehensive Failure Modes, Effects, and Criticality Analysis. This analysis should be comprehensive and fully objective and must define how hazards are to be mitigated and how surveillance is to be provided over the methods of mitigation.
- The design and use of technology and its place within the railway's operating doctrine should be clearly defined. The analysis should demonstrate the



selected technology's ability to fail safe and include the response of personnel to incremental, partial, or total failure of the safety critical equipment.

The analyses submitted to FRA should include the following elements, which can be implemented by a mix of conventional off-the-shelf technology and operating practices:

1. Absolute and clearly-delineated use of a segment of track by only one mode for a specified-time-only duration.
2. The limits of the shared use segment and the modal boundaries must be clearly defined and provide for positive stop to prevent a train from unauthorized crossing of a demarcation point.
3. The positive stop nature of the boundary must be an engineering barrier, i.e., a rule will not suffice with regard to separation of modes.
4. Locking of modal boundaries once a train has entered the segment with a positive method of assuring that the train has cleared the segment prior to releasing the locking.
5. Control of the segment by a single movement authority that governs all trains over the segment and is capable of efficient coordination with any movement authorities that may govern adjoining segments. This includes common communication protocols.
6. Consideration of violation of the integrity of the absolute segment at unanticipated locations, e.g., due to roll-out or derailment. FRA does not, a priori, define the allowable (spatial) segment length nor does it define the minimum time period used to assign use of the segment to one or another of the modes.

## Technology Integration and Human Interface

The human interface with technology is an important factor in the engineering and design of integrated systems. The involvement in operations of train engineers, LRV operators, dispatch controllers, and other operating personnel must be considered. It is essential that in shared use applications that the concept of rules are kept as consistently as possible in regards to procedural elements and practices. All involved in operations must be qualified and abide by the rules so that the overall safety case and risk mitigation efforts can be successfully implemented and maintained. By applying and integrating railroad operating practices and technologies, the resulting operating doctrine can provide the framework for implementing shared use operations for light rail and FRA-compliant rail operations.

SECTION  
**6**

# Potential Applications of the Operating Doctrine

## NJ TRANSIT Atlantic City Line

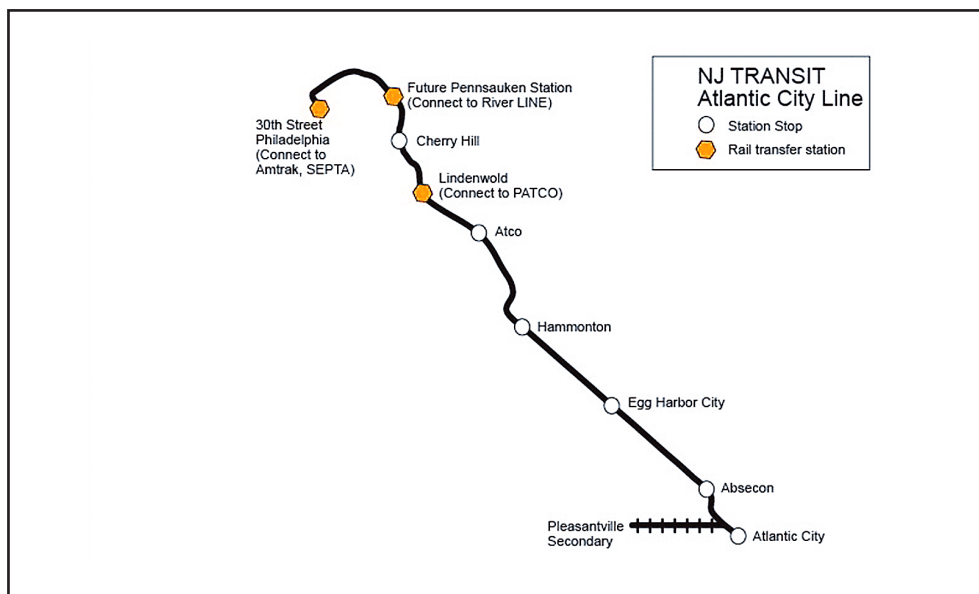
### Proposal

A suburban passenger operation utilizing light weight rail cars could potentially be superimposed on the NJ TRANSIT Atlantic City commuter railroad line in the Atlantic City area. This extension of passenger rail service would operate between the Pleasantville area and Atlantic City using the existing freight-only Pleasantville Secondary and the existing Atlantic City Rail Line. The concept for a service extension was identified by the Southern Jersey Regional Rail Study (December 2002), sponsored by the South Jersey Transportation Planning Organization.

The application of interurban service as defined in this research illustrates the potential for shared use of mainline trackage by freight and compliant and near-compliant passenger trains, as well as shared use of a branch line by freight and near compliant passenger trains.

### Location and Description

The Atlantic City Line operates between 30th Street Station in Philadelphia, Pennsylvania and Atlantic City, New Jersey (Figure 20). Commuter rail trains operate at variable headways that are sometimes as long as two hours using conventional diesel power and commuter rail equipment. In addition, casino-sponsored express trains operate between New York City, Newark, and Atlantic City intermittently, typically on weekends.



**Figure 20**  
NJ TRANSIT  
Atlantic City Line

A service could be developed from Atlantic City onto the Pleasantville Secondary utilizing the principles of the shared use template developed in this research study. SITS would be used to gain access into Atlantic City over the existing railroad moveable bridge (Beach Thorofare), and ETS would be applied to operate on the existing freight line.

### **Business Case**

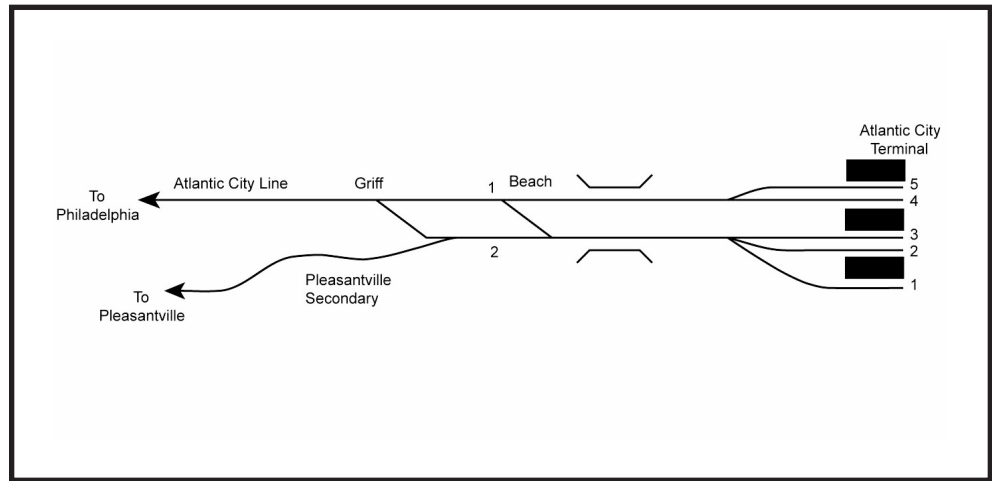
The Atlantic City Rail Line, serving 3,200 trips per day (4th quarter of fiscal year 2010) on 24 trains per day, and the Pleasantville Secondary (4 to 5 local freights weekly) have the potential to accommodate additional trains and passengers. Furthermore, the terminal station in Atlantic City, with five tracks, has the capacity to accommodate additional trains.

New passenger train service on the Pleasantville Secondary could be utilized by employees of the casinos and hospitality businesses in Atlantic City. This could stimulate redevelopment in Pleasantville, a State of New Jersey-designated transit village, which is now served by a network of local bus lines serving the Atlantic City area. The potential interurban service could complement the extensive bus service.

### **Operational Concept and Configuration**

The potential service between Pleasantville and Atlantic City could operate frequently using near-compliant vehicles. It would be superimposed on the portion of the Atlantic City Line between the Atlantic City Station and Griff, where the Pleasantville secondary diverges from the Atlantic City Line tracks (Figure 21). This segment, which includes the double track swing bridge, could be converted to shared use using SITS. In this segment, track 2 can be blocked absolutely to permit the near-compliant train to operate between the Atlantic City Station and Griff, at which point the near-compliant train will divert to the Pleasantville Secondary. The movement of the near-compliant train will require an estimated five minutes, counting blocking and unblocking time. This would result in a temporal separation window of approximately 10 minutes, during which time compliant passenger trains will be blocked from this track but could operate in either direction on the north track (on signal indication) to/from the compliant tracks in the Atlantic City Terminal.

**Figure 21**  
Existing Atlantic  
City Line Track  
Configuration in  
Atlantic City



### ETS and/or SITS Scenarios

Shifts for casino and other employees involve 24-hour commutation. To address this, ETS could be utilized to permit freight operation to the consignees during hours of reduced passenger demand.

SITS on the Atlantic City Line proper would be employed on a 24-hour basis to move non-compliant trains between Atlantic City Station and their home tracks on the Pleasantville Secondary. Freight traffic for Pleasantville comes from Winslow Jct. When a freight move is required, ETS design would be utilized to provide positive stop at mode boundaries and to inhibit prohibited train movements.

### Other Elements

A possible expansion of the near-compliant service between Pleasantville and Atlantic City could be the development of the line east of the existing Atlantic City Terminal. The use of articulated near-compliant light rail vehicles would permit the future rail service to enter street territory in Atlantic City and operate directly to areas near the boardwalk or other destinations.

The NJ TRANSIT Atlantic City Line dispatcher would control all movements on the Atlantic City Line. A Pleasantville Line dispatcher would control the near compliant service. A handshake would be required in order to route a freight train between Atlantic City Line and the Pleasantville Line.

## Capital Metro Red Line, Austin, Texas

### Proposal

This is a regional rail line operating over a portion of a former Southern Pacific line. Passenger equipment is high-performance, near-compliant diesel light rail vehicles (Figure 22). While local freight operates over most of the line, the western segment supports unit stone trains. This provides an example of the application of SITS that could provide a business benefit to the freight operations.

**Figure 22**  
*Capital Metro Diesel  
Light Rail Vehicle*



### Location and Description

The Capital Metro Red Line is a 32-mile, mostly single-track line (with short passing sidings) that runs in a northwesterly direction from downtown Austin. The Red Line operates on right-of-way owned by the transit agency. While some local freight operates over the entire line using conventional temporal separation, it is the extreme northwest segment that provides an excellent opportunity to develop an advanced shared use operation based on the results of this research. Unit aggregate trains operate from the Union Pacific interchange, through the passenger territory, to quarries located beyond the western limits of passenger service. Since these are high-value unit trains, use of conventional temporal separation to protect their movement is somewhat problematic.

## Business Case

The commodity carried by most of these unit trains is crushed rock used for construction. To maximize equipment utilization, these trains operate on an extremely tight schedule between the supply quarry and consignee. In this example, nearly the entire business benefit of the use of advanced methods of temporal separation apply to the freight carrier and quarry owners, as under the current operating plan unit train movements are constrained by the passenger window.

## Operational Concept and Configuration

ETS can be combined with SITS to permit unit train movement through the passenger territory to/from the Union Pacific interchange track during the time assigned to passenger service under the current conventional temporal separation arrangement. Since the scheduled interval between passenger trains is 20 to 30 minutes, at a minimum, it is possible to apply full blocking at modal boundaries, operate a unit train, and unblock, provided that all of the blocking is organized and applied using ETS.

## Operational Scenarios

Conventional temporal separation would remain in effect over the entire length of the passenger line. However, during the passenger period, SITS would be employed to permit the virtually on-demand movement of unit trains over the ETS territory. The blocking would provide for derrails on the quarry tracks with a route aligned to the existing freight tracks.

## Other Elements

- Train dispatch for all trains on the Capital Metro Line, including unit trains, would be performed by the Capital Metro dispatcher.
- Modal barrier at entry points would require special design. Entry from the Northwest segment of the Capital Metro Line is from dark territory; hence, advance (distant) signalization is required prior to the home signal at the derail. Exchange of unit trains at the UP boundary requires design of a handshake with the UP dispatcher.
- This is a conceptual application of this Operating Doctrine that does not include a full analysis of business case factors, including labor issues (such as crew consist agreements) and freight operations considerations.

# Conrail's Vineland Secondary (Proposed Glassboro–Camden Light Rail Line)

## Proposal

This line is a former electrified (600 volts d.c. until 1931) mainline of the Pennsylvania–Reading Seashore Lines, which extended south from Camden, New Jersey,

to Woodbury, Glassboro, and beyond. It is presently designated as the Conrail Vineland Secondary. At Woodbury, two other Conrail lines branch from the Vineland Secondary. Currently, planning and environmental analysis are in progress for the development of an LRT (interurban railway) similar to the River LINE on the Conrail right-of-way using separate tracks. The use of ETS between Camden and Woodbury and the use of SITS between Woodbury and Glassboro would likely provide a benefit to both freight and future passenger operations.

### Location and Description

The Delaware River Port Authority has initiated the preparation of an environmental impact statement for the implementation of light rail service between Camden and Glassboro. The proposed line would serve the existing Broadway Station/Walter Rand Transportation Center Station in Camden that is served by the PATCO Lindenwold Line and the NJ TRANSIT River LINE. From that station, the line is proposed to be routed southward onto the Conrail Vineland Secondary and would serve several municipalities, including Woodbury, the Gloucester County county seat, and Glassboro, the home of Rowan University.

The Conrail Vineland Secondary extends from Pavonia Yard in Camden southward through CP Brown interlocking (where junctions exist to the Beesly's Point Secondary and the Camden Belt Railway) and Woodbury. For the roughly eight miles between CP Brown and Woodbury, there are no passing sidings. This is despite the fact that this segment once consisted of three electrified tracks. The original right-of-way is intact. At Woodbury, two lines leave the Vineland Secondary, the Salem Branch and the Pennsgrove Secondary. The latter line is used by unit coal trains bound for power plants, large tank trains going to refineries, and some mixed freight. In addition, a new deep-water port is presently under development along the Pennsgrove Secondary.

The Vineland Secondary continues south, with a single track to Glassboro and Vineland. South of Woodbury, the original line consisted of two main tracks. There are no active consignees between Woodbury and Glassboro; however, in Vineland active interchange occurs with a shortline railroad, the Winchester and Western.

### Business Case

Demand for passenger service on the proposed Camden–Woodbury–Glassboro passenger line is such that a conventional temporal separation with a 10 PM to 6 AM freight window would be problematic. Late-night and early-morning service will be necessary to support travel to at least two major hospitals located on the line as well as to Rowan University (with its main campus in Glassboro and satellite campus in Camden). Conversely, expanded deep-water port shipping will require enhanced, not reduced, rail freight capability. Importantly, provisions can be made for a one-mile-long passing siding that could accommodate 70-car freight



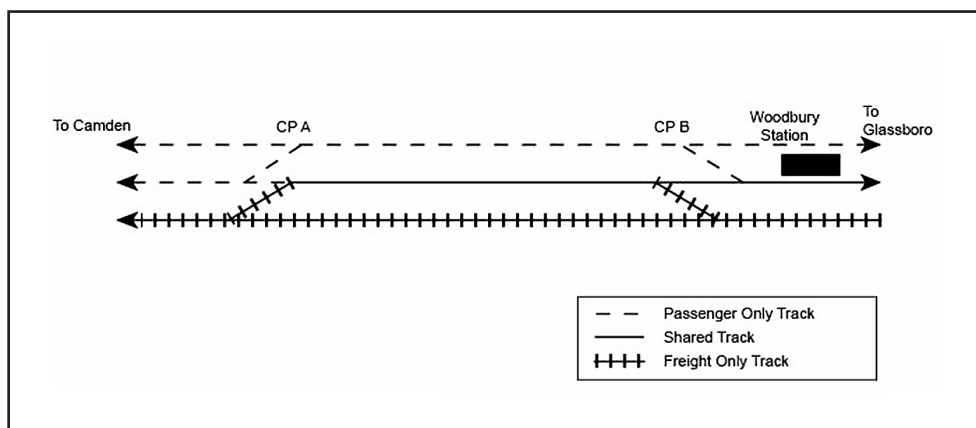
trains on the segment between Woodbury and Camden as part of the construction of the new passenger line. As illustrated in Figure 23, the proposed configuration includes parallel high speed (#20) crossovers at either end of a one-mile segment of middle track. These interlockings are indicated as CP A and CP B. The design of these interlockings would include positive-stop modal barriers. This would allow use of this section of middle track by near-compliant passenger equipment during peak service hours and by freight trains during all off-peak hours. This application of ETS, wherein CP A and CP B are linked, would be part of the improvements that would be proposed for the implementation of shared use. Among the other improvements that would likely be needed would be an intrusion detection system.

For the approximately 10-mile segment between Woodbury and Glassboro, where freight and passenger service are anticipated to be less dense, ETS can be used to implement shared use operations at night on this two-track line segment. Using ETS, one track would be for exclusive freight operations and one would be for exclusive passenger service. Such an arrangement will support a service headway as short as 30 minutes over this segment, which would be adequate to meet anticipated late-night demand for passenger service. Currently, although one round-trip freight local traverses this route, the freight window must be of sufficient duration to permit the round trip, including interchange, to occur in one tour of duty.

### Operational Concepts and Configurations

Figure 23 illustrates the proposed Camden-to-Woodbury segment that would utilize both ETS and SITS; the former is used to tie CP A and CP B and their associated modal barrier appurtenances into one extended railway configuration. This would permit SITS to occur in 3- to 4-hour blocks. For example, the middle track is assigned exclusively to passenger trains between 6:00 AM and 9:30 AM and from 4:00 PM to 7:00 PM and is assigned exclusively to freight at other times. This freight configuration would still permit an off-peak passenger headway on the order of 15 minutes over the Woodbury-to-Camden segment.

**Figure 23**  
Proposed Camden  
Glassboro LRT:  
Potential Configuration  
of Track to Facilitate  
Track Sharing North  
of Woodbury



**Table 3**  
Potential Shared  
Use Operating  
Configurations

	Time	Camden-to-Woodbury Segment	Woodbury-to-Glassboro Segment
1	6:00 AM to 9:00 AM	Passenger (two tracks passenger, one freight) by ETS and SITS	Passenger Only
2	9:00 AM to 4:00 PM	Freight Passing (middle track is split)	Passenger Only
3	4:00 PM to 7:00 PM	Passenger (two tracks passenger, one freight) by ETS and SITS	Passenger Only
4	7:00 PM to 9:00 PM	Freight Passing (middle track is split)	Passenger Only
5	9:00 PM to 6:00 AM	Freight Passing (middle track is split)	ETS—one freight track

### Other Elements

A number of additional items were evaluated for this proposed new railway, each of which can be addressed by the design and then evaluated under the System Safety process prior to formulating a waiver request to FRA. These include:

- **Track Centers**—Current design practice calls for minimum track centers of 17 feet for concurrent operation of freight and near-compliant passenger. Under the proposed operating and track configuration scenario, this will require each of the three tracks to be at a minimum of 17-ft centers between CP A and CP B. This requirement may impact the design or placement of stations in this segment.
- **Stations**— Stations, and particularly station access, must be planned within the context of the anticipated freight operating plan. Grade separations may be needed at stations, and if grade crossings are utilized, pedestrian access and protection signage and devices will require customized design based on a location-specific operational hazard analysis.
- **Grade Crossings**— Since the middle track may be used to hold long freight trains in the clear for extended periods, there should be no highway or pedestrian grade crossing in this zone. At present, there are none in the location anticipated for the freight passing siding.
- **Dispatching**— Separate but well-coordinated movement offices/control centers will be needed. The control of the center track can be configured to swing over to the appropriate dispatcher (freight or passenger) in accordance with the use. A method for this changeover can be developed as the ETS elements of the project are designed.

## Metro-North Railroad, Waterbury Branch

The Waterbury Branch is a 28-mile-long single track branch line that serves south central Connecticut. It joins the four-track, electrified Metro-North–New Haven

Line at Devon, Connecticut. The first station west (towards New York City) of the junction is Stratford Station. Currently, commuter rail equipment is used to operate trains on this branch line to and from the Bridgeport Station or Stamford Station where passengers transfer between trains for trips to and from destinations along the New Haven Line, including Grand Central Terminal in New York City. The service on this branch is provided by 15 trains per day and, in the off-peak periods, trains are typically two to three hours apart.

In this hypothetical proposal, more frequent service would be operated in the off-peak periods on the branch line by near-compliant interurban vehicles. The interurban service would operate onto the New Haven Line to the Stratford Station for passenger transfer to main line trains. This concept presumes that it would be cost-effective to reconfigure the Waterbury Branch to accommodate the more frequent interurban service instead of utilizing diesel-locomotive-propelled commuter rail trains. The modifications would continue to accommodate the existing commuter rail operations in the peak periods. The more frequent off-peak service would serve travel between stations on the branch line and provide more service connecting with trains to New York City and New Haven.

In this hypothetical proposal, there would be shared use of the approximately one mile of the New Haven Line mainline track between the Waterbury Branch and the Stratford Station, where it may be desirable to place a new terminal track and platform for the interurban trains. ETS and SITS would be utilized to implement temporal separation of the branch line and the portion of the New Haven Line where the lightweight passenger cars would operate. Mode blocking devices would be placed to ensure that temporal separation is maintained.

This proposal would involve numerous challenges, in that the New Haven Line is not only utilized by Metro-North operations, but it accommodates freight operations and Amtrak Acela Express and Regional trains. A thorough feasibility analysis addressing engineering, operations, safety, and economic factors would be required for a project of this type to advance.

## SECTION 7

# Summary and Conclusions

The research and design work in this study, which focused on the northern segment of the River LINE, illustrates the evolution of shared use operations involving near-compliant LRT and FRA-compliant railroad services. This design would allow the operation of LRVs and freight trains in closer proximity than are already in place on the line while maintaining temporal separation. The proposed technology and operating practices provide a template for more flexible shared use operations involving LRT and FRA-compliant railroad services than exist using day/night time-of-day temporal separation. This template includes an option for a “railroad-based” rather than “transit-based” operational philosophy. The resulting mode is similar to “interurban” rail services that shared track with freight operations in the past. The NJ TRANSIT River LINE is an example of the interurban mode. The operating doctrine—technology and operating practices—for the River LINE are railroad-based. However, as demonstrated on NJ TRANSIT’s Newark Light Rail (a rail system that was part of the streetcar and bus operation of NJ TRANSIT’s predecessor organization), features of this template can also be applied to transit-based LRT operations.

The template employs advanced but nevertheless “conventional off-the-shelf” engineering technology, the primary element of which is “vital” signal design practice and equipment. It provides for short-interval temporal separation (SITS) based on reducing, yet still maintaining, separation of modes based on time. It also provides for Extended Temporal Separation (ETS), wherein vital separation of modes is accomplished over a territory (segment of railway) that spans multiple interlockings in a manner similar to the logic employed in “NX” (entry/exit) interlockings.

SITS and ETS may be used together to achieve the highest flexibility of shared operations, or SITS may be used separately. A case of the former described in this document is the ETS/SITS on River LINE’s Camden Subdivision. A case of the use of SITS used alone is “GROVE” interlocking on the Newark Light Rail system. This report includes a full design for a major increment in the SITS/ETS application, which is for approximately seven miles of River LINE’s Burlington Subdivision, which operates as a modern-day “interurban.” A package similar to that which would be required in an FRA waiver is included in Section IV and Appendix E of this report, the essential elements of which are:

- business case
- concept of operations providing a description of anticipated train movements, associated operating rules or rule changes

- engineering design and operational analysis
- safety case

A number of conclusions may be drawn from this research, many of which hold significant implications for the future growth of light to medium density passenger service.

- The template developed in this research can be used as a user guide for safe shared use operations by non-compliant and compliant rail services. The template is based on a comprehensive operating doctrine and addresses engineering systems and their application and design.
- The use of the template described herein is likely to provide a more expeditious review by regulatory and oversight agencies, the potential for more favorable waiver conditions, and the approval of more flexible “shared use” operations. The template provides a framework for a shared use operation and not a uniform standard. This is due to the great variation in design standards and operating practice between transit properties as well as the site-specific nature of the desired shared use operations.
- The proposed template is based on the premise that FRA regulates any transit system that engages in shared use of general railroad system track; this includes rail transit properties whose shared use is very limited in extent.
- Shared use railways may operate as transit systems, where the compliant service is limited in extent of territory, traffic volume, or duration (time). This template is of value to such systems, even in cases where they retain the core of their transit-based operational practices. In such cases, the entire railway may not be considered as part of the general railroad system.
- Railways proposing extensive segments of shared use and/or where advanced concepts of temporal separation are desired will benefit from basing their operating practices more fully in railroad operating doctrine. For such railways, the waiver process is likely to be more expeditious and the granted shared-use operations more flexible than for railways using transit-based operational philosophies. Such systems may be labeled as “interurbans.” For such railways, a near-compliant passenger service shared with a compliant passenger service is also possible.
- Available technology is fully capable of providing for positive, absolute, and reliable separation of modes. Critical systems include track, signals, and supervisory control. In addition, an interurban rail car should achieve near-compliance with FRA requirements.
- A comprehensive, accurate, and objective safety case is an essential element in the development of a shared use operation. The core of such an analysis is an identification of hazards, their likelihood of occurrence, and the consequence of occurrence. It forms the basis for development of equivalent safety for waived items. In accordance with standard system safety practice, equivalent measures should first be based in design (track, signals, railcars) and, second, be based in operating practices, rules, and training. Equivalent Safety Measures for waived safety regulations are subject to continued

surveillance by a State Safety Oversight Agency; this is a necessary condition of a waiver.

This report contains a video that summarizes the results of this research and illustrates the design of the shared use template. The script of the video and a link to the video can be found in Appendix D.



## Glossary of Terms

While a large number of terms receive common usage and interpretation in both the railroad and transit industries as well as in the vernacular, a number of terms require clarification and precise definition with regard to their usage in this report. In part, these definitions will standardize terms whose usage may vary between the transit and railroad industries and will address terms that may apply to new technology. While industry usage continues to evolve, this glossary delineates the use of these terms in this research. An additional source of terms related to shared use can be found in Appendix 2 of TCRP Report 130.

### Automatic Block Signal System (ABS)

Provides for movement of trains along a track in a single, pre-determined direction based on signal indication. While providing indication of train separation requirements to a train operator, ABS does not of itself positively enforce train separation or train routing requirement; appropriate action to conform with signal indications is required.

### Automatic Train Control (ATC)

A sub-system that provides some level of automated governance of a train's compliance with signal indications. The ATC systems level of governance may vary from minimal control, e.g., with intermittent trip stops, to full continuous automatic control with enforced stop capabilities.

### Automatic Train Control (ATO)

Any form of train operation that is completely automated, including train separation and train routing functions and that includes an Automatic Train Protection sub-system. Based on ATO capability, Advanced Technology systems may be operated as UTO (Unattended Train Operation); these are not presently relevant to shared use operations.

### Extended Temporal Separation (ETS)

The application of the principles of Temporal Separation over segments of a given line, that is, on a line segment basis (for example, over a section of railway that includes two or three consecutive interlockings), rather than uniformly over the entire length of any given railway system; involves the use of vital train control technology to assure absolute and fail safe separation of modes over the design segment of trackage.

### Interlocking

A series of railway devices and appurtenances connected in a manner to permit only certain configurations and/or to permit configurations to be operated only in a pre-determined sequence. The primary application of interlockings as used here applies to signals, turnouts, and train stops or derails.

### Lightweight Equipment

Refers to passenger equipment that does not satisfy FRA's minimum requirements for passenger buff strength. This is an absolute definition, independent of the vehicles' other characteristics and attributes. Such equipment may be characterized as near-compliant or non-compliant. Such equipment is also referred to as light rail vehicles (LRV).

### Mode

As used in this report, there are two modes. The first consists of rail systems that are required to comply with the regulatory (safety) standards promulgated by FRA; these are referred to as a railroad mode. The other refers to rail that may be constructed to similar designs as railroads, but that are considered as captive systems and are not required to comply with FRA Safety Standards. Each mode has a number of sub-modes. Transit sub-modes include LRT, LRRT, and streetcars. Railroad sub-modes include commuter rail, high speed rail, and freight. In addition, this research postulates the emergence of a new mode, the interurban. Also, note that in common industry usage, mode may refer to passenger, freight, or ETS mode.

### Near-Compliant Equipment

Lightweight passenger equipment with a buff strength less than 800,000 lbs, which is supplemented by crash energy management to provide a level of crash worthiness in excess of the typical LRV or streetcar; equipped with FRA-mandated safety appliances such as a horn, a bell, and a triangular headlight pattern.

### Non-Compliant Equipment

Lightweight passenger equipment that is widely deficient with regard to FRA's buff strength standard or that lacks typical railroad safety appliances (headlight pattern, horn, bells, pilots). This equipment includes streetcars or traditional LRVs and is typically intended for use only on captive transit systems.

### Northeast Operating Rules Advisory Committee (NORAC)

A voluntary association of railroads that maintains a common set of operating rules for the northeastern United States. The main members include Amtrak, Conrail, NJ TRANSIT, Southeastern Pennsylvania Transportation Authority (SEPTA), Providence & Worcester, New York Susquehanna & Western, and a number of other railroads. CSX Transportation and Norfolk Southern incorporate elements of NORAC rules within their own rulebooks.

### Positive Separation of Modes

The use of vital design and equipment (or proven equivalents) to enforce the absolute, safe separation of modes during shared use operations.

### Positive Train Control (PTC)

The employment of technology and operating rules to provide for the protection of train movements. PTC has become commonly associated with the federally-mandated

Rail Safety Act, which requires the implementation of PTC to automatically provide enforcement of train separation, civil speed restrictions, temporary speed restrictions, prevention of work zone incursion, and restriction of movement over a switch improperly aligned.

### Railroad

A system of lines that form part of the general railroad system of North America and that is required, by law, to conform to the safety regulations of FRA.

### Railroad Traffic Control

The function of a railroad signal system that controls the direction of allowed entry and movement on a single piece of traffic; sometimes simply referred to as railroad traffic.

### Rail Transit

A mode that generally employs steel-wheel-on-steel rail technology, but that may not conform to the safety regulations of FRA. Although an isolated connection may exist to the general railroad system, e.g., for special deliveries, rail transit systems are considered as captive systems.

### Railway

In this report, railway is used to refer to either rail transit or a railroad.

### Railway Signalization/Railway Signal System

A system designed according to vital design principles whose primary purposes are to assure, through the combined use of equipment, automatic devices, and the train's operator, the following functions:

- the safe separation of trains that are traveling in the same direction on the same track
- safe train routing, i.e., prevention of trains of opposite direction from entering the same section of track (without proper authorization)
- secondary purposes include reporting of train location based on track occupancy and the provision of broken rail protection

### Safety Case

The formal evaluation of a product, design, or operation according to the principles and practices of System Safety.

### Safety-Critical System

Engineering systems that have a global impact on the daily risk profile of a railway. While a deficiency or a failure in any engineered system potentially may cause an isolated injury, failure in the daily performance of certain systems may cause multiple injuries or system shutdown. Because of this, safety-critical systems on railroads are subject to FRA safety standards; no such equivalent practice or distinction exists at

this time for transit properties. These safety-critical systems, which are designed to fail-safe where feasible, include rolling stock, train control (signaling), track, and bridges; under certain circumstances, other systems, which are generally not safety-critical, may have a safety-critical role. This is becoming the case with supervisory (non-vital) control systems that may be required to provide loss of shunt alarms or control tunnel ventilation.

### Shared Use Operations

The common use of a section of track or of adjacent sections of track with less than 17-ft track centers, or of different tracks within a single interlocking by both modes, according to a pre-defined and approved method of providing positive, fail safe, and repeatable separation of the two modes.

### Short Interval Temporal Separation (SITS)

Temporal separation in which the interval of modal separation is expressed in periods of one hour or less. This technique positively restricts train movements as operating windows are shifted between freight and passenger while providing absolute separation of modes.

### Supervisory Control System

A non-vital control and reporting system designed along the lines of a supervisory control and data acquisition (SCADA) system, customized to interface (request and report status) with a railroad signal system, and in this respect differs from a traditional SCADA system. Because railroad supervisory systems may request only a repeat action, they are generally considered to be non-vital.

### System Safety

Use of object evaluations and quantitative methods to identify hazards, assign risks to hazards, and develop hazard mitigation methods that primarily focus on designing out unacceptable risks. This is a quantitative approach to safety strongly based in engineering practice and employing mathematical gaming theory. SSTD 882 defines the methods of hazard identification analysis and the risk management processes utilized in System Safety.

### Temporal Separation

A method of providing for separation of modes in shared use operations that relies on assigning each mode a specific allowed period (time) of operation over common trackage.

### Traffic Control Sub-System

The sub-system of the train control system that controls the direction in which trains may operate on a single section of track according to single indication. In the direction of traffic, train separation is accomplished by the signal system. Train movement in a direction opposite that of railroad traffic cannot be accomplished by signal indication; such movement is inhibited by interlocking or controlled signals at the entry point of that section of track.

### Train Control

A generic term referring to some means of delineating and enforcing authority for train movements. This could be accomplished through a traditional railroad signal system, through Dispatcher Control and train orders, or potentially through an advanced technology system.

### Vital Design Principles

The fail safe design practices and standards employed in railroad signaling, as expressed in the Standards of the Association of American Railroads (AAR) as well as in the regulations of FRA. This design practice also extends to product requirements, e.g., the certification of relays for suitability of use in vital circuits.

## APPENDIX B

# River LINE, Existing Operation

The River LINE, officially known as the Southern New Jersey Light Rail Transit System, a modern incarnation of an “interurban railway,” operates between the Camden waterfront and the Trenton Transit Center (the western terminal of NJ TRANSIT Northeast Corridor Line passenger service and an Amtrak Northeast Corridor station stop). The line is owned by New Jersey Transit Corporation and was deployed under a design, build, operate and maintain (DBOM) contract. Under the terms of the contract, all operations and maintenance activities (with the exception of policy and fare collection) are performed by the private operator: Railgroup. Importantly, FRA views Railgroup as the operator of record.

The line, which is 34 miles in length (Figure 24), is operated as two subdivisions; the Camden Subdivision extends from milepost -0.5 north to milepost 15 (at CP 150). This subdivision includes approximately one mile of street running between the Camden waterfront and the multi-modal station at Walter Rand Transportation Center (WRTC), which is directly connected to the Broadway Station on the PATCO Lindenwold High Speed Line.

From WRTC to approximate M.P. (north) 3.5, the River LINE is on its own double track alignment but is in shared right-of-way with Conrail trackage, including the busy Vineland Secondary. An Intrusion Detection System (IDS) is in place where freight-to-passenger track centers are less than 17 feet. Shared track territory begins at CP 45 (M.P. 4.5) and extends north. The Camden Subdivision supports 3 to 4 freight trains daily, one of which operates 6 nights/week as far north as Burlington (freight) yard, which is located on the Burlington Subdivision. The maximum freight tonnage operated is approximately one million gross tons per year.

The Burlington Subdivision begins at the northern limit of CP 150 and extends to end of track in Trenton, at M.P. 33.5. Freight operates as far north as Bordentown, CP 269 (M.P. 27). In addition, Conrail retains rights to operate to CP 329 (M.P. 33), where a connection exists to the former Pennsylvania RR Bel Del, which connects to the Amtrak-owned Northeast Corridor Line at Port Running.

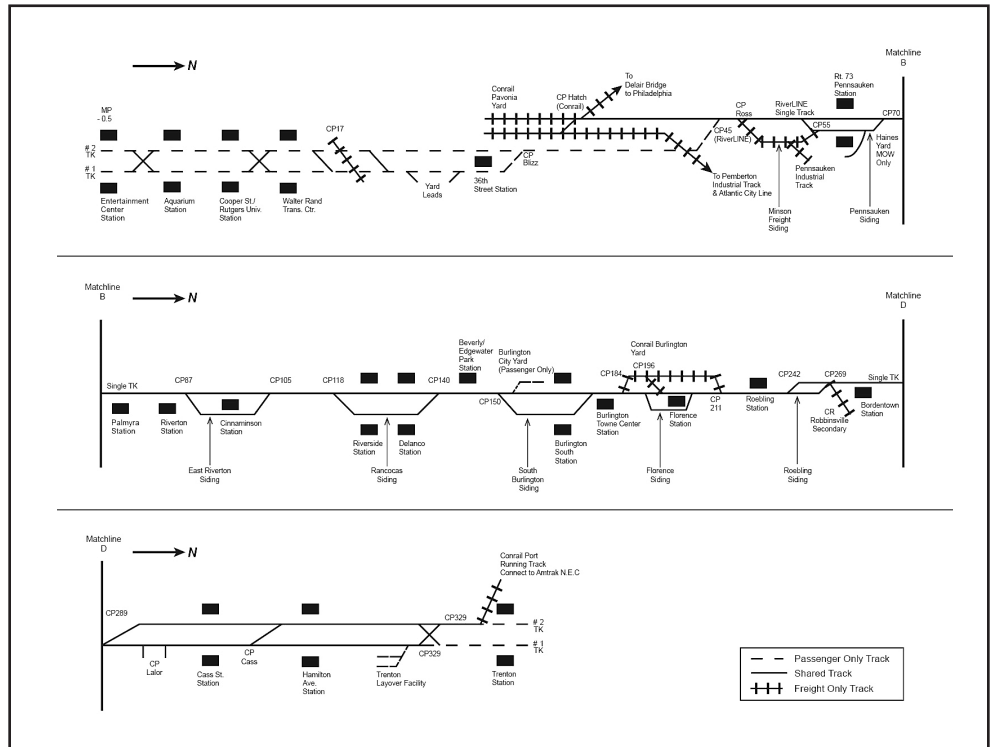
The River LINE is an integrated part of the general railroad system as evidenced by:

- Existence of a connection to the NEC
- A connection to the Conrail Delair Branch and the NJ TRANSIT Atlantic City Line at CP 45
- Active freight operation over 25 miles of the River LINE’s 34-mile length, with freight rights (currently not used) over an additional 5 miles and alongside running over an additional 2 miles



- A fully-interlocked diamond crossing at M.P. 1.7 (CP 17), which allows an individual siding to cross the River LINE at grade.

**Figure 24**  
Track Schematic of  
River LINE (not to  
scale)



The River LINE has operated under a series of increasingly progressive and more-flexible FRA waivers, each of which has been based on retaining absolute temporal separation of modes, enforced through vital signal design and appliances.

Under the initial waiver, which permitted opening of the River LINE for revenue service in March 2004, freight trains could cross at CP 17 and CP 45 at any time of day using Short Interval Temporal Separation (SITS). For the balance of the line, freight was restricted to the hours of 10:00 PM until 6:00 AM. In 2006, a highly-advanced waiver was granted for use of Extended Temporal Separation/Short Interval Temporal Separation (ETS/SITS) over the portion of the Camden Subdivision between Rt. 73 Station (M.P. 6) and CP 45. Under this waiver, freight trains are permitted to operate to the Pennsauken Industrial Track, which departs River LINE at CP ROSS (M.P. 5.3) at any time, and passenger trains may operate as far north as Rt. 73 station until 1:00 AM (three hours into the freight window). Passenger trains are vitally blocked from operating north of the allowed territory and are also inhibited by signal design from operation onto the Pennsauken Siding, as this is reserved for freight, which, in turn, is inhibited from accessing the Rt. 73 Station tracks while passenger trains operate (Figure 14).

Special rules apply to operation on the double track segment through Pennsauken since track centers are less than 15 feet. Under a subsequent waiver, FRA recognized the different operational characteristics of the River LINE's two subdivisions.

For sound business and operational reasons, and in compliance with the temporal separation mandate, the start of the passenger window (and completion of the freight window) on Burlington Subdivision was changed to 5:45 AM. This allows early operation of the early-morning special (train no. 202), which departs Burlington South at 5:56 AM to connect in Trenton with a NJ TRANSIT Northeast Corridor express to New York City. The start of the passenger window remains at 6:00 AM on the Camden Subdivision.

Railgroup operates its own fleet of railroad work trains. These include ballast trains, an Aqua Train for cleaning the top of the rail to prevent loss of shunt mitigation, and right-of-way cleanup. This railroad equipment includes two SW 1500 locomotives, seven 70-ton ballast cars, a flat car, a caboose, and the special Aqua train, which consists of a tank car for water supply and a flat equipped with high-pressure spray equipment. These trains are crewed by engineers (with licenses meeting FRA standards) and qualified conductors. While passenger train operators receive training and qualification that generally complies with railroad practices (including full qualification on physical characteristics), they may not operate work trains without also holding a locomotive engineer's license. In calendar year 2009, Railgroup operated 42 work trains.

River LINE operates approximately 110 passenger trains each weekday with a peak period headway of 15 minutes; there are a few shorter intervals of service due to short trains and express trains. The railway carries 9,000 to 10,000 trips each weekday (as of fiscal year 2010) with a balanced mix of commute and local ridership. Passenger operation on River LINE is supplied by a fleet of 20 double-articulated diesel multiple-unit cars (DMUs) (Figure 2). These rail cars have a buff strength of 1,386 kN (310,826 lbf) and a triangular headlight pattern and are equipped with rear markers. The 100-ft-long, 10-ft-wide railcars are capable of a maximum speed of 70 mph; maximum authorized speed is 65 mph. The railway has engaged in an active program of trip time reduction. Track is maintained to FRA class 5, maximum super elevation (each) is 6 inches, and maximum cant deficiency is 4 inches.

The railway's premier express operates in the morning peak period over the 33 miles between WRTC and Trenton in a mere 45 minutes (a schedule speed of 44 mph). Other express and locals achieve a schedule speed of approximately 40 mph for this territory. The River LINE maintains an active internal system safety program that is coordinated with that of NJ TRANSIT. All regulatory requirements waived by FRA are subject to the surveillance of the New Jersey State Oversight Program.

Close liaison is maintained in all departments and at all organizational levels with Conrail. An integrated aspect of the system safety program is a formal monthly general managers' inspection trip; Conrail, state safety oversight, and NJ TRANSIT officials routinely participate. While freight trains are operated by Conrail crews, they are dispatched by River LINE and are protected by River LINE track and signal forces as required.

# Overview of Train Separation and Train Routing

This appendix is a summary of the theory and methods in use for separation and protection of trains.

## Train Separation

The original forms of scientific train separation are attributed to Charles Minot, a Superintendent on the New York and Erie Railroad, who is credited with issuing the first train order in 1851. Until that event, trains had run on defined schedules with predefined meets. Because the scheduled meets were viewed as invariable, a delay of one train would result in delays to all trains. When a train on which Minot was riding was delayed at a meet by a late opposing train, he used the then-new technology of the telegraph to hold the opposing train at a more distant meet point, thus allowing the train he was riding to proceed. The concept of train blocking was thereby established by Minot's directive: "To Agent and Operator at Goshen; hold the train for further orders." This effectively established a block between Minot's location (Harrison, New York) and Goshen; such blocks (a block is defined as a section of track with specifically-delineated limits, the entrance to which can be controlled; a block is the basis for spatial separation) are the basis for spatial separation of trains (i.e., separation by space interval rather than time interval).

Blocking may be accomplished by the manual action of an operator (manual block); in such case, the condition of the block is strictly ascertained by operators and their block sheets, allowing relatively great margin for human error. Blocking may also be accomplished by controlled manual block (where block status is determined using technology [track circuits], but movement is authorized by an operator-actuated manual block signal). Blocking may also be accomplished automatically, such as by an automatic block signal (ABS) system. Signalization led to a combination of space and time interval separation; while following trains may operate to a defined schedule, separation of trains is based on safe braking distance (and, hence, is space-interval-based); authority for train movement is given by the signal system.

Prior to the existence of FRA, the Interstate Commerce Commission (ICC) evaluated a series of serious railroad accidents. In 1952, the ICC issued an order—essentially carried forward by FRA, that the Maximum Authorized Speed in dark territory (a railroad line without signaling) is not to exceed 60 mph, and not to exceed 79 mph in the absence of a system of Automatic Train Control.

## Conflicting and Opposing Trains/Train Routing Protection

In most cases, the direction of a train's movement over a section of track is not up to the discretion of the train's operator; it is predefined by signal indication, rule, train order, or a combination of all of these.

Opposing train movements on space interval separation systems (i.e., manual block or controlled manual block) are managed by train order, wherein entrance to the block is denied to opposing trains. In signalized territory, signals may provide authority for train movement in one direction only (NORAC Rule 251) or in both directions (NORAC Rule 261). In the case of the former (opposing move in 251 territory), entrance to a block is governed by home signals (entrance to an interlocking or block), which are limited in what they are able to display, and a train order is necessary to enter the block against the direction of signal indications. In the case of the latter, the direction of the signal operation is controlled by railroad traffic circuits, which inhibit entry in the opposing direction until the block is completely clear and the signal at the opposing entry (interlocking, block station, or control point) is at stop and has not been requested. At such time, railroad traffic over the block can be reversed, and train movements may occur in the opposing direction. These movements will be governed by the spacing provided by the signal system as defined in signal control lines. Signal control lines provide for space interval separation of following trains based on safe braking distance; they used incremental lengths of track based on track circuits. Depending on the density of trains and the technology employed, these increments (or quanta) may be as short as 1,000 feet or as long as 8,000 feet.

More advanced (but not fully-proven in mainline railroad applications) train separation technologies rely on moving blocks and/or continuous control. A major potential advantage of continuous control is that the track is no longer divided into quanta (i.e., incremental lengths) rather it is treated as a true continuum. Train speed and train braking (theoretically) can be based on the actual dynamics necessary to affect a stop just prior to the rear of a train ahead. Even these systems currently utilize a brick wall stop paradigm and, hence, lose much of their potential for capacity enhancements.

It is important to realize the premise upon which signal control is based—that is, it is based upon always maintaining a safe braking interval for following moves. The worst case condition is assumed to be a so-called brick wall stop by the leading (i.e., immediate stop, independent of the laws of inertia) train. Should the leading train reverse direction within the block, the space interval will be inadequate to provide safe braking distance. Reversal of trains in a block is generally not permitted by rule, except where a specific "Train Order" is written, e.g., for train rescue. NORAC and the River LINE do not specifically use Train Orders. Instead, NORAC uses Movement Form D, and the River LINE uses Track Permits.

### Train Flanking Protection

Flanking (fouling) and crossing moves create a limited two dimensional control problem. At controlled junctions of rail lines, protection against crossing movements (two tracks crossing) or flanking movements (two tracks merging) is provided by interlocking design. This is also a form of train routing protection, as a route must be clear of conflicting and flanking (as well as opposing) trains before it can be cleared. Design of such protection is based on well-established (and FRA regulated) principles, and such protection is required to be vital.

### Intrusion into Guideway

To some extent, intrusion violates the basic premise of a secure one dimensional guideway. Design of intrusion protection is related to the potential source of intrusion. In railroads, such incursions exist by virtue of the openness of the guideway and must therefore be addressed in system design.

- Authorized Crossings (Grade Crossing)—Modern protection is provided by vital gates and flashers; trains are required to sound a designated (FRA delineated) warning on the approach. Certain installations provide additional control of vehicle traffic, e.g., four quadrant gates and highway channelization.
- Roll-in—Rail equipment that is stored on sidings may roll onto main track. This could be the result of human error, equipment failure, or vandalism. Protection may be provided with appliances, reverse grading, or both.
- Adjacent Track—Railroads generally do not employ signalization directly for adjacent track protection; indirectly, this is provided by dragging equipment and hot box detectors, and oversize/shifted load detectors.
- Other Intrusions—These may include protection against slides and wash-outs.

### List of Hazards Associated with Train Separation and Protection

Based on the preceding summary of methods of train separation and train routing, the following hazards may be identified with respect to train movements. Rail signal design practice (as prescribed by FRA regulations and AAR Standards) address each of these hazards in a vital manner; that is, the basis of railroad signalization is to design-out these hazards. Such is not always the case in LRT signalization design. The mitigations listed in Table 4 are for passenger train movement within the exclusive passenger space/time. A similar but more extensive table is included in Appendix F (Table 23) that indicates the hazards and their mitigation for the ETS-North operation.



**Table 4**  
*Hazards Associated  
 with Train Separation  
 and Train Routing*

Type of Hazard	Description of Hazard	Mitigation
Train Separation	Following train overtaking and collides with train ahead	Primary mitigation is by design of a block signal system. However, ATC/ATP for separation of passenger trains is not presently deployed; thus, reliance on operator conformance with operating rules.
Train Separation	Train parts within block and rollback occurs	Maximum length of passenger train is two cars; operator will be aware of an uncouple. Passenger couplers are of tight-lock design, minimizing possibility of uncoupling.
Train Routing	Unauthorized opposing movement into block caused collision	Rule 261 operation exists based on vital design of railroad traffic circuits using standard practice for a railroad TCS system, and trip stops at block entry are designed to stop a passenger train that violates a stop signal.
Train Routing	Train reverses within block without authorization	Mitigation is by operating rule and operator training. A supplementary mitigation is achieved through the surveillance provided through the Supervisory Control Systems train tracking and display capability.
Train Routing	A flanking collision occurs due to violation of fouling point at interlocking or Control Point	Stop signals, with vital inductive trip stop devices, will protect conflicts between passenger trains with the proviso that the signal violation does not occur at speeds exceeding 38 mph commanded by the distant signal to the home signal.
Intrusion	Rollout of engine or loose car occurs at siding	Locked derails are integrated in the signal system are provided at all sidings
Intrusion	Grade crossing accident due to equipment failure or unauthorized movement	Vital grade crossing protection is provided at all public grade crossings. Lunar light indications advise operators of gate status; these warnings provide some ability to stop short of an unauthorized intrusion due to the passenger trains high rate of braking. Supplemental warnings are provided, including signage and use of train horn.

**Table 4  
(cont.)**

*Hazards Associated  
with Train Separation  
and Train Routing*

Type of Hazard	Description of Hazard	Mitigation
Intrusion	Train on adjacent track derails or otherwise intrudes into or obstructs clearance envelope of track	This hazard has not been designed-out for passenger-to-passenger intrusions; protection relies on conformance with operating rules. Design-out for freight intrusions from adjacent track includes track centers of 17 ft or more where adjacent running is permitted, or an intrusion detection system where adjacent running is allowed at track centers less than 17 ft. All adjacent freight tracks are inspected by River LINE track forces, and close communications are maintained with Conrail's Movement Office, and many are maintained by River LINE.
Intrusion	Miscellaneous other intrusions, e.g., rockslides, wash-outs, automotive vehicles	This hazard is not designed-out using the signal system. Retaining walls, drainage, and tree reduction are complemented by a rigorous program of track and right-of-way patrols, including special foul weather inspections.
Intrusion	Violation of modal boundaries at junctions or crossings.	Vital stop enforcement exists at modal boundaries at locations where light rail operation may intrude on freight operations inductive trip stops. Since freight locomotives are not equipped for use of these devices, at locations where freight trains may intrude on light rail operations, vital split point derails are installed.

### Separation of Modes

It is useful to view the methods utilized for separation of modes in shared use railways within the context of the theory and methods described for train separation:

#### *Temporal Separation*

Despite the name, this is effectively space-based separation of rail cars of different modes. An entire line or major segment of line is awarded to one mode or the other exclusively, based on a pre-written Train Order (i.e., as specified in a waiver) that delineates hours assigned to each mode.

#### *Extended Temporal Separation (ETS)*

ETS introduces the concept of absolute blocking of a line, wherein a defined segment may be assigned to one mode, say lightweight passenger, while another may be assigned to the compliant mode. The blocking is based on

technology, at present, on conventional off-the-shelf technology signal equipment and vital signal design practice. The term “extended” was applied to indicate the vital design for separation applied over an extended length of track that includes multiple interlockings. It is still primarily a space-based means of separation on the River LINE; for example, a passenger train could be at Route 73 at 5:45 AM, another lightweight passenger train could be at Burlington South Station, and a freight could be working a siding between CP 70 and CP 150. The modal block point at this time of day is CP 70 and CP 150, and the blocking is absolute.

#### *Short Interval Temporal Separation (SITS)*

The term SITS is used to define the concepts and protection afforded by temporal separation, but the application is based on an as-needed basis. Essentially, modal separation is protected through the use of technology and applied in specific circumstances over defined sections of track. Normally, these defined sections are where movement of either mode is necessary in a short interval and in critical operating sections for both modes, i.e., Freight–Sidings, LRVs–Stations.

This is a time- and space-based means of separation. It mimics the space interval separation utilized in automatic block signal systems; however, the space is defined by the limits of an absolute block, not by safe braking distance between modes. It is time-based in that the blocking can be adjusted over a relatively short time interval.

# Script of Video on Proposed ETS/SITS for River LINE North

*(Clarifications of video narration are noted in italic type)*

## Introduction

Under a research grant funded by FTA, a team of systems engineers and safety and operating specialists have developed a template, or user's guide, for use by the rail industry in the design, planning, and operation of shared use railways.

FTA Research Project Number NJ-26-7025 also resulted in a full design for use of these advanced concepts, referred to as Extended Temporal Separation, or ETS, and Short Interval Temporal Separation, or SITS, on the River LINE.

## Description of River LINE Operations

The River LINE is a modern high speed interurban railway which connects Trenton with the Camden waterfront (Figure 3: River LINE Map) (Figure 24: River LINE Track Schematic). Owned by NJ TRANSIT, deployed by Southern New Jersey Rail Group as a DBOM (*design/build/operate/maintain*), the line is currently operated and maintained by Bombardier Transportation as a full turn-key operation.

MAS (maximum authorized speed) for passenger trains is 65 miles per hour, and 30 miles per hour for freight and work trains. Thirty-two miles of the River LINE's 34-mile system are considered to be an integral part of the general railroad system of the United States. Freight currently operates over 24 miles. Four to five freight trains operate from either Pavonia Yard, located in Camden, or Burlington Yard, each weeknight. Freight trains are crewed by Conrail but are dispatched by River LINE train controllers. Routes and trackage are maintained by River LINE MOW (*maintenance of way*) forces strictly in conformance with FRA (*Federal Railroad Administration*) standards. All work trains are crewed by River LINE.

For passenger service, the River LINE operates a near-compliant railcar (Figure 2) under a temporal separation waiver from the FRA. Unlike some other cases of temporal separation, the River LINE's mode separations are enforced by vital signal equipment with positive stop devices—trip stops for passenger vehicles and split rail derails for freight.

The terms of this waiver have been successfully modified to incorporate progressively more flexible freight and passenger operations, while rigorously maintaining the absolute separation of modes. At CP 45, for example, freights may cross the River LINE main (*using a diamond track crossing*) during passenger hours subject to the control of the River LINE's movement office. The temporal separation at CP 45 is referred to as

Short Interval Temporal Separation (or SITS), since the modal window can be as little as 3 or 4 minutes, yet mode separation remains absolute.

In order to expand late-night passenger service from Camden to a major park-and-ride station in Pennsauken, the FRA permitted the concept of Extended Temporal Separation, or ETS, to be introduced over a two-mile segment (Figures 13 and Figure 14) of the River LINE's Camden subdivision in April 2007. Under ETS, multiple interlockings, which normally operate individually and are linked by *centralized traffic control (CTC)* territory, are vitally linked by object code controllers to act as one with respect to mode separation. ETS and SITS were combined to provide for a safe and highly flexible form of temporal separation. Estimates for the cost of expanding the service by double-tracking the territory ranged from \$6 to 12 million. The cost for ETS was \$1.3 million, yet provides the same operating capabilities.

### Shared Use Research for River LINE

In 2009, the concepts of SITS and ETS were selected by the Federal Transit Administration for further development under an FTA R&D (research and development) project. The River LINE was to serve as the benchmark rail property for this research, with additional application to other select rail properties. The objective of this research was to develop a template or user's guide for industry-wide use.

This project also developed a design for ETS and SITS on a section of the River LINE. Particular attention was paid to the operating doctrine of ETS and SITS. Standard railroad practices are followed, and standard railroad hardware is employed. With this design, passenger and freight is never commingled. The concept of temporal separation is rigorously maintained. Through proper *interlocking logic* and sequencing and *by using* positive stop devices, mode separation is absolute.

The territory selected for development was the section of the River LINE between Florence Park-and-Ride Station (*which has two large parking lots with excess capacity*) and Bordentown, a distance of over six miles. Implementation of ETS and SITS in this territory will greatly expand River LINE service and allow River LINE trains to operate as a convenient connecting service to New Jersey Transit's highly-popular Northeast Corridor commuter rail service. Additionally, this project significantly reduces Conrail's operating costs and improves service to freight shippers.

The area of interest begins at Burlington Freight Yard, Mile Post 20, and at Florence Station, Mile Post 21. At CP Del (*Mile Post 22*), the freight track and two passenger tracks merge to single track. This is 65 mph territory for passenger trains and 30 mph for freight. Passing Roebling Station, the line returns to two tracks at CP 242, as far as CP 269 (*Mile Post 27*), where the freight only Robbinsville Secondary separates from the River LINE.

There are two freight consignees between CP 242 and CP 269: Church Brick, served from the east track shoving south, and Stepan Chemical, served from the west track shoving north. Several more consignees are served along the Robbinsville Secondary.

And now, a detailed description of how SITS and ETS apply to this segment.

### Video Animation

The River LINE is operated at its shortest design headway of 15 minutes during rush hour, so there is little opportunity to increase utilization of the tracks during these times. There are meets at every passing siding. However, during non-peak operations, with 30-minute headways for passenger trains (*north bound and south bound passenger trains meet at Florence Station every 30 minutes*), there is an opportunity to better utilize the infrastructure to benefit both passenger and freight operations. This is established by stringline analysis of passenger and freight movements.

Using ETS and SITS operating doctrine, a freight route can be selected maintaining strict temporal separation between modes. The four interlockings are effectively joined into one (Figure 17) by use of off-the-shelf vital object controllers.

The sequence of operations is as follows:

- 1) The controller requests mode 2 (shared use operation).
- 2) All tracks must be clear and appropriate signals at stop.
- 3) The controller requests an entrance for the freight.
- 4) Specified exits are inhibited.
- 5) To release the derail at CP Del, first opposing traffic is established on inhibited tracks.
- 6) All derails are verified to be in the normal, derailing position.
- 7) Only now can the route be lined.
- 8) The derail at CP Del is aligned reverse and the signal is now displayed for the freight to enter what is now freight-only territory.
- 9) Once into the freight-only territory, the freight train is locked in.
- 10) The derail on the east track behind the freight aligns normal.
- 11) The derail is verified to be lined normal.
- 12) The derail at CP Del is aligned normal.
- 13) The derail on the west track aligns reverse.
- 14) Switches are aligned normal and the passenger route, into what is now passenger-only territory, is set.
- 15) The freight train can remain and work in the gated freight territory with derails preventing any intrusion into passenger-only territory.
- 16) Once it is ready to leave, the freight train may only head north and must clear to the Robbinsville Secondary.
- 17) Traffic is set opposing.
- 18) Appropriate switches are lined reverse.
- 19) The derail north of the freight is aligned reverse and the route is set.



- 20) Only after the freight is clear and the derail on the Robbinsville secondary is set normal can the passenger route be set. Freight continues serving customers on the Robbinsville.
- 21) Once ready, the freight train is given a route southbound using similar operating principles as the northbound move. But now the west track becomes freight only for the south bound freight move. Freight occupancy determines the available passenger-only territory and, thus, the available route for passenger trains.
- 22) Once the freight train has been locked into what is now freight-only territory, it is free to serve Stepan Chemical.
- 23) After serving Stepan, the freight train can be given a route back to Burlington Yard using similar operating principles; each time using positive vital gates, split derails and trip stops to ensure absolute separation between the passenger and freight trains.

In Mode 2, a southbound freight train must clear to Burlington Yard. Once the freight train is cleared and locked in by the derail, the controller can revert to Mode 1, passenger-only service, or change to Mode 3, freight-only service, as needed.

### Closing

The combination of the following provides an Operating Doctrine that will benefit both the transit and railroad industries across the country:

- SITS, using vital signal system technology to permit short interval shifts between modes, while maintaining absolute mode separation;
- ETS, using off-the-shelf hardware to link otherwise independent interlockings to operate as a single extended interlocking with respect to modes;
- Appropriate Operating Practices, including crew qualification, dispatching methods and MOW practices; and
- A Robust Safety Case, in which risks are identified and mitigated.



*Click here to  
link to the video*



## APPENDIX

## E

## Draft FRA Waiver Narrative for ETS/SITS for River LINE North

With the continuing growth of River LINE passenger service and the economic importance of Conrail operations, it is necessary to provide opportunities for improvement of services to maintain viable passenger and freight operations in southern New Jersey. The purpose of this report is to identify specific signal improvements and proposed changes to the temporally-separated River LINE and Conrail freight operations on the shared track. These proposed adjustments provide for superior utilization of the existing infrastructure by enhancing daytime freight operation while assuring separation of freight from light rail by methods that are proven, safe, reliable, and verifiable. Modifications include 1) expansion of the passenger period and 2) allowing Conrail selected use of two (2) industrial sidings (Church Brick and Stepan Chemical) and access to the Robbinsville Secondary during Passenger Operations.

These modifications will preserve temporally-separated operations on the shared track, expand River LINE passenger operations, and allow Conrail increased operating flexibility. Through use of existing signal technology and operational improvements, the River LINE can safely mitigate risks to allow for shared, mode-exclusive use within the territory from CP 211 to CP 269. These improvements and risk mitigation methods are explained within the context of this document.

### Existing Operations

River LINE passenger operations and Conrail operations are temporally-separated, with light rail having exclusive use of the shared track during the “passenger period” and Conrail maintaining exclusive rights during the “freight period.” There is also an Extended Temporal Separation (ETS) territory in place from CP 45 to CP 70 that provides for freight movements during passenger operations as well as extended passenger services through the freight window. This existing ETS is employed vitally through the use of respective modes and is established and set by the River LINE controller through the use of the Operations Control Center (OCC). When aligned for exclusive use by passenger service, the shared track is protected from encroachment of freight trains through wayside signals and derails located at both entrances. When aligned for use by Conrail freight operations, the subject territory is protected against encroachment from light rail vehicles by wayside signals, track circuits, traffic blocking, and positive stop wayside transponders. In all cases, the control of these signals and devices is through the vital signal logic located in the local signal control houses.

## Objectives

The objectives of the ETS North Project are to improve service and ridership on the Burlington Sub-division. The specific objectives are for:

1. Freight: To provide increased flexibility in service times, namely to allow freight service during the 30-minute passenger period.
2. Passenger: To lengthen hours of service to Florence and to therefore enable Florence-to-Trenton River LINE service to operate as an extension of NJ TRANSIT's Northeast Corridor Line service. Secondary objectives include to improve the scheduled zero-tolerance meet at Florence to provide for delay recovery and to provide optimum capability for express service.

## Requirements

The requirements to accomplish these objectives involve the use of ETS/SITS design and operating concepts to improve the flexibility and service levels for freight and passenger between Florence and Bordentown/ Trenton (see Figure 15, 16, and 25 through 37).

*Base Requirements:* During peak hours, the Florence Industrial from CP 211 to new "CP Del" is used as a passenger track, thereby providing significant betterments to operational capability. This track will be upgraded to meet FRA Class 5 track standards and signals will be installed. This requires three "modes of operations" as follows:

- Mode 1—During the 15-minute headway, no freight will operate. Passenger trains operate between CP 211 and CP DEL on both the present Florence Industrial track and on the present single Main.
- Mode 2—Freight and passenger operations during the 30-minute headway under an application of SITS, CP 211 to CP269.
- Mode 3—Freight only from CP 269 to Burlington (passenger service is restricted to north of CP269).

Currently, the River LINE "ETS South" operations, which control movements between CP 45 and CP 70, are distinguished by three modes of operation and, as indicated above, it is our intent to maintain the same criteria of mode operation within the proposed ETS North limits of the Burlington Subdivision in order to maintain conformity of operations within the OCC.

## Baseline Concept of Operations (CONOPS)

The following summarizes the configurations and the three distinct operating modes. The modes are based on passenger service levels as follows:

- I. Mode 1—Peak Hours: Approximately 5:30 AM to 8:30 AM and 4:00 PM to 6:30 PM. Provide improved 15-minute service by mitigating delays at the Florence meet. This mode would permit the initiation of "tripper" service between Florence and Trenton; "tripper" service will allow selected peak-

- hour through-trains to express between Burlington and Trenton. During these hours, the present Florence Industrial Track would become a passenger track north of Florence Station (CP 211 to CP Del). Freight movements during these hours would continue to be permitted on the Industrial Track but would be restricted to south of John Galt Way, i.e., to the limits of expanded CP 211.
2. Mode 2—Off-Peak: The Florence Industrial reverts to freight-only operation in its entirety, i.e., as far north as CP DEL. Short Interval Temporal Separation (SITS) is employed between CP 211/CP DEL and CP 269, with routes as indicated in Figure 16. Northward freight may enter at CP 211 but routing will be inhibited through the use of vital logic. Any train entering CP DEL from the Industrial Track will be routed only to the siding at CP 242 and only to the Robbinsville Industrial track. Passenger trains entering at CP 211 will be routed only to the non-freight track at CP 242. In a similar manner, trains entering the zone of ETS/SITS from the North will be routed as follows (Figure 15 and Figure 16):
    - a. From Robbinsville at CP 269 to Florence Industrial at CP DEL via the Roebling Main track only (there are freight trains).
    - b. From River LINE @ CP 269 to River LINE at CP DEL via the non-freight track only. This configuration will allow the passing of freight and passenger trains on their separate tracks between CP 242 and CP 269, as well as between CP DEL and CP 211, and will permit switching of Stepan Chemical and Church Brick sidings when freight is on the appropriate track. Church Brick will be serviced by Northward freight trains and Stepan Chemical by Southward trains. Note that under the configuration “off-peak,” passenger train meets cannot be scheduled for this zone if a freight train movement has been called.
  3. Mode 3—Night Operations: Passenger trains do not operate south of CP 269. Freight has unlimited use of trackage on the Burlington Subdivision. Freight trains may operate over Neck Road Crossover and on any route between CP DEL and CP 269 and may serve Land O Lakes siding. Night operations are considered as 12:00 midnight to 5:30 AM. The vital design will permit passenger operation between Bordentown and Trenton (independent of policy or service planning issues); hence, the design will include positive mode separation at CP 269 for this mode.

### System Service Benefits

Implementation of ETS North will permit longer hours of service to both Roebling and Florence Station; the Baseline Concept will also provide for more frequent peak-hour service to Florence (and Bordentown, if this station is designated as an express stop) and will permit implementation of a zone express service between Florence and Trenton. Improved service to Florence is anticipated to raise ridership due to the excellent highway access to both South Jersey and Bucks County, Pennsylvania, at that location.

## Configuration Changes

Configuration changes are required to accommodate the request for waiver and are shown at the end of this Appendix in Proposed and Existing Drawing No. 001. The configuration changes consist of:

1. Installation of Crossover 3 at CP 211, installation of signals 10N and 10S at CP 211. Installation of derail #5 at CP 211.
2. Establishing a new CP Del at the present CP 211A location and upgrading the existing mainline turnout switch to a #15 and addition of a northbound controlled signal at CP Del stationing 1230+26 (braking point to turnout fouling for LRV).
3. Upgrading existing freight track between CP 211 and new CP Del to Class III standards.
4. Installation of mainline controlled split point derails at CP 242.
5. Installation of mainline controlled split point derails at CP 269.

## Functional Operational Criteria

The following narratives represent the alignment and operations of the various appurtenances required for movement through the ETS North territory. Certain

devices (signals, switches, derails) are conditioned and inhibited until other devices are lined and locked properly. Note that derails in “normal” position are set to derail, and derails in reverse position are set for permissive moves.

To establish an exclusive freight move through the Main Track at CP 211 (Figure 31 (Drawing No. 007)) northbound Signal 10N to Exit Signal 2S-I (CP 242), the following conditions must be met:

1. OCC set function Mode 2—ETS Operations, under which 3 switch at CP 211 is set and inhibited normal. Also, 8N (CP Del) to exit 2S-I (CP 242) route inhibited.
2. Under Mode 2, OCC may display signal 10N (CP 211) and Conrail may approach Signal 8N which is set at “Stop.” Note: Only under Mode 2 can 5DR (CP 211) be lined reverse and signal 10N displayed.
3. Conrail requests movement from the OCC through the shared use track in accordance with Operating Rules.
4. OCC requests signal 8N (CP Del), provided the freight train shows “occupied approach,” signal is displayed provided the following conditions hold true
  - a. All signals at CP 45 are set at “Stop” with no signals in “time.”

- b. No track occupancy in the interlocking.
- c. Track block between CP 211 and CP 242 unoccupied.
- d. Traffic set southbound in rear of signal 8N-2 (CP Del).
- e. Track block between CP 242 and CP 269 unoccupied.
- f. Derail set normal CP 242.
- g. Derail set normal CP 269.
- h. Signal 2N (CP 242) displayed over 1 SW normal to track 1 exit 2S-1 (CP Del).
- i. Once above conditions are met, 5DR (CP Del) and 7 SW (CP Del) permitted to be lined reverse.
- j. Signal 8N “cleared” to exit 2S-1 (CP Del).
- k. Route is maintained and “stored” in CP 242 vital logic.
- l. All conditions as stated above remain in effect for the entire train movement through the interlocking and release only after train has exited the interlocking and 5DR and 7 SW (CP Del) and 5DR (CPI) derails are set normal.
- m. Freight train not permitted to make reverse (southbound drill) move back through CP 242.
- n. 5DR and 7SW (CP Del) not permitted to be set normal until 5DR (CP 242) and 7DR (CP 269) are lined normal.

To complete an exclusive freight move through the Main Track at CP 269 (Figure 31 (Drawing No. 007)) northbound Signal 2N- to Exit Signal 2S-2 (CP 269), the following conditions must be met:

- 1. Mode 2 function remains enabled.
- 2. Conrail requests movement from the OCC through the shared use track in accordance with Operating Rules.
- 3. OCC requests signal 2N-1 (CP 269) provided the freight train shows “occupied approach,” signal is displayed provided the following conditions hold true:
  - a. Previous move was from northbound 8N (CP Del) exit 2S-1 (CP 242).
  - b. 9 DR (CP 269) lined normal.
  - c. Above true, 3 SW lined reverse.
  - d. Above true, 7 DR lined reverse.
  - e. Signal 2N-1 “cleared” to exit 2S-2 (CP 269).
  - f. All conditions as stated above remain in effect for the entire train movement through the interlocking and release only after train has exited. Once released 9DR, 7DR, and 3 SW are inhibited until 5DR is set normal.

To establish an exclusive freight move through the Main Track at CP 269 (Figure 3I (Drawing No. 007)) southbound Signal 2S-2 to Exit Signal 2N-2, the following conditions must be met:

1. OCC set function Mode 2—ETS Operations, under which 3 switch at CP 211 is set and inhibited normal. Also, exit to 2N-1 route from 2S-2 is inhibited.
2. Conrail requests movement from the OCC through the shared use track in accordance with Operating Rules.
3. OCC requests signal 2S-2 (CP 269) provided the freight train shows “occupied approach,” signal is displayed provided the following conditions hold true:
  - a. All signals at CP 269 are set at “Stop” with no signals in “time.”
  - b. No track occupancy in the interlocking.
  - c. Track block between CP 269 and CP 242 unoccupied.
  - d. Traffic set northbound in rear of signal 2S-1 (CP 269).
  - e. Track block between CP 242 and CP 269 unoccupied.
  - f. Derail 3DR and 5DR set normal CP 242.
  - g. Derail 7DR set normal at CP 269.
  - h. I SW normal at CP 269.
  - i. With above true, 3 switch can be set reverse.
  - j. Signal 2N (CP 242) displayed over I SW normal to track I exit 2S-1 (CP Del).
  - k. Signal 2S-2 “cleared” to exit 2N-2 (CP 269).
  - l. Route is maintained and “stored” in CP 242 vital logic.
  - m. All conditions as stated above remain in effect for the entire train movement through the interlocking and release only after train has exited the interlocking.
  - n. Freight train not permitted to make reverse (northbound drill) move back through CP 269.
  - o. 3SW (CP 269) not permitted to be set normal until 5DR (CP 269), 9DR (CP 269), and 3DR (CP 242) are lined normal.

To complete an exclusive freight move through the Main Track at CP 242 (Figure 3I (Drawing No. 007)) southbound Signal 2S-2 to Exit Signal 8N (CP Del), the following conditions must be met:

1. Mode 2 function remains enabled.
2. Conrail requests movement from the OCC through the shared use track in accordance with Operating Rules.
3. OCC requests signal 2S-2 (CP 242) provided the freight train shows “occupied approach,” signal is displayed provided the following conditions hold true:



- a. Previous move was from southbound CP 269 2S-2.
  - b. 5 DR (CP 242) lined normal.
  - c. 7 SW (CP Del) lined reverse.
  - d. 7DR (CP Del) lined reverse.
  - e. Above true 3 DR lined reverse.
  - f. Signal 8S (CP Del) cleared to exit 8N (CP Del).
  - g. Signal 2S-2 “cleared” to exit 8N (CP Del).
4. All conditions as stated above remain in effect for the entire train movement through the interlocking and release only after train has exited. Once 7DR (CP Del) is lined normal, operations can release other switches.

To establish an exclusive LRV move through the Main Track at CP 211 (Figure 30 (Drawing No. 006)) northbound Signal 6N to Exit Signal 2S-1 (CP 269), the following conditions must be met:

1. OCC set function Mode 2—ETS Operations, under which 3 switch at CP 211 is set and inhibited normal.
2. River LINE operator requests movement from the OCC through the shared use track in accordance with Operating Rules.
3. OCC requests signal 6N or 4N (CP 211), signal is displayed provided the following conditions hold true:
  - a. Derails 5DR (CP 211), 7DR (CP Del), and 5DR (CP 269) are lined normal.
    - i. With freight occupying track 1 derails, 5DR (CP 242) and 7DR (CP269) must be lined normal.
    - ii. With freight occupying track 2 derails, 3DR (CP 242) and 9DR (CP 269) must be lined normal
  - b. Switches 7 SW (CP Del) and 3 SW (CP 269) must be lined normal.
  - c. CP 242 selects route based on freight occupancy and calls for signal northbound at CP 269.
  - d. Once respective signal at CP 269 clears route, Signal 2N clears at CP 242.
  - e. With above true, route through CP Del is enabled and cleared.
  - f. With above true, respective route through CP 211 is enabled and cleared.
  - g. All conditions as stated above remain in effect for the entire train movement through the ETS territory.

To establish an exclusive LRV move through the Main Track at CP 269 (Figure 30 (Drawing No. 006)) southbound Signal 2S-1 (CP 269) to Exit Signal 8N-2 (CP Del), the following conditions must be met:

1. OCC set function Mode 2—ETS Operations, under which 3 switch at CP 211 is set and inhibited normal.
2. River LINE operator requests movement from the OCC through the shared use track in accordance with Operating Rules.
3. OCC requests signal 2S-I (CP 269), signal is displayed provided the following conditions hold true:
  - a. Derails 5DR (CP 211), 7DR (CP Del), and 5DR (CP 269) are lined normal.
    - i. With freight occupying track 1 derails, 5DR (CP 242) and 7DR (CP 269) must be lined normal.
    - ii. With freight occupying track 2 derails, 3DR (CP 242) and 9DR (CP 269) must be lined normal.
  - b. Switches 7 SW (CP Del) and 3 SW (CP 269) must be lined normal.
  - c. CP 269 selects route based on freight occupancy and calls for Signal 8S (CP Del). 8S (CP Del) enables southbound move at CP 242 (predicated by freight occupancy). Respective southbound signal at CP 242 clears.
  - d. Once respective signal at CP 242 clears route, Signal 2S-I clears at CP 269.
  - e. All conditions as stated above remain in effect for the entire train movement through the ETS territory.

Movement authority and respective operational and wayside conditions for the various proposed operating scenarios are provided in accordance with the Operational Plates.

### **Risk Analysis and Mitigation for Proposed Modifications during Passenger and Extended Temporal Separation Operations**

Primary risk mitigation is to provide exclusive track usage through the vital signal logic and operational plans. Exclusivity for freight is determined through the use of wayside signals, magnetic trip stops, and traffic to inhibit LRVs from encroaching on the subject territory. Exclusivity for LRVs is determined through the use of wayside signals and derails to inhibit freight trains from encroaching on the subject territory. Insurance of Temporal Separation will be a function of the vital signal logic.

Secondary risk mitigation is through the use of operating parameters and rules that are required to be followed by the controllers and train operators (both LRV and freight). These operating parameters and rules will be further set through application of a defined design document that will require certain functionality of the signal system. This functionality includes a specific sequence of operations to insure protection is applied before a route can be established.

### **Significant Differences in the ETS Operations CP 45 to CP 70 and the Proposed Operations of CP 211 to CP 269**

While, fundamentally, the concept of operations of mode establishment and protection of LRV and freight encroachment is similar, there are three distinct differences in the application and execution of ETS CP 211 to CP 269. The following outlines these design differences and the mitigation techniques to reduce the risk:

1. Two trains (i.e., passenger and freight) must be allowed to operate in the ETS zone simultaneously.
  - a. System will vitally “store” information concerning freight movement into track section. This will inhibit ability to align derails for permissive routes while LRV is occupying ETS territory.
  - b. Tracks are established as “mode exclusive”; only one mode may occupy a specific track during the prescribed time.
  - c. Freight running is “direction dependent”; northbound freight may enter only into Track 1 and exit to Robbinsville secondary, southbound freight may enter only into Track 2 and exit to Conrail Florence Yard. All routes are protected by the vital inhibiting of switch selection and position prior to releasing exit derails.
  - d. System will vitally hold derails in derailed position while train is occupying track section CP 242 to CP 269. Switches will be aligned away from occupied track and vitally inhibited.
2. Routes for LRVs are not predefined; rather, track assignments depend on the location where the freight entered, i.e., CP 269 or CP Del.
  - a. System will store trains both vitally and non-vitally. OCC will identify trains from entrance point and hold trains as freight or LRV accordingly.
  - b. Vital logic will be developed that identifies entrance route and disallows certain exits based on entrance points. As an example, a train entering from Robbinsville will only be allowed to proceed south on the main; all other routing will be inhibited in the route-check network under the respective mode (Mode 2). Entrance to the main is then inhibited until train exits into Florence Yard. LRV routes are inhibited in this manner and can be allowed only if full derail protection is provided on the main (protecting against freight encroachment).
3. Defined view of sectional release of routes.
  - a. Vital logic defines route exits based on entrance points. Once freight enters siding from the yard, the route system recognizes the entrance and, through “look back,” identifies that the only exit is to Robbinsville.
  - b. Freight trains must make “two-button” operation through shared trackage. This is where a train entering the double track is required to have derails thrown behind prior to exiting. LRVs cannot make a move until the respective derails are placed in the derailing position.
  - c. Train latches occupancy behind itself based on entrance point. Vital network can “store” train type (LRV or freight) within the system to inhibit encroachment or “mode conflict” routing.

### **Risk Mitigation Tables**

System safety has reviewed the proposed operations and defined the various risks and associated mitigation factors that are to be incorporated into the system. Note that the architecture is a comprehensive approach that utilizes technology and procedures for risk mitigation. Table 5–8 are risk and mitigation tables utilized for the analysis of the operating plan revisions.

**Table 5**

Mode Operations  
1 and 3

Risk	Mitigation
Freight encroachment under Mode 1	<ol style="list-style-type: none"> <li>1. Vital Local Signal Logic:               <ol style="list-style-type: none"> <li>a. Derails and switches set normal and inhibited:                   <ol style="list-style-type: none"> <li>i. 5DR (CP 211)</li> <li>ii. 5DR (CP 269)</li> <li>iii. 3SW (CP 269)</li> </ol> </li> <li>b. Signals inhibited:                   <ol style="list-style-type: none"> <li>i. 10N (CP 211)</li> <li>ii. 2S-2 (CP 269)</li> </ol> </li> </ol> </li> <li>2. OCC Logic applies blocks on 10N (CP 211) or 2S-2 (CP 269).</li> </ol>
LRV encroachment under Mode 3	<ol style="list-style-type: none"> <li>1. 3 SW (CP 269) lined reverse and inhibited.</li> <li>2. Signal 2S-1 (CP 269) inhibited.</li> <li>3. OCC logic applies blocks on Signal 2S-1 (269) and 3 SW (CP 269) reverse.</li> </ol>

**Table 6**

Extended Temporal  
Separation Operation:  
Mode 2—CP 211  
to CP 269

Risk	Mitigation
LRV encroachment to track with freight occupied CP 211 to CP 269	<ol style="list-style-type: none"> <li>1. Vital Local Signal Logic:               <ol style="list-style-type: none"> <li>a. 3 SW (CP 211) lined normal and inhibited.</li> <li>b. Signal 2N-2 and Signal 2N-1 (CP 211) inhibited and Signal 8N-2 (CP Del) inhibited and trip stops active.</li> <li>c. Signal 2S-1 (CP 269) inhibited and trip stops active.</li> <li>d. Route Locking for duration of movement.</li> </ol> </li> <li>2. OCC conflicting route exits restricted.</li> </ol>
LRV encroachment to track with freight occupied CP 269 to Robbinsville Secondary	<ol style="list-style-type: none"> <li>1. Vital Local Signal Logic:               <ol style="list-style-type: none"> <li>a. 3 SW (CP 211) lined normal and inhibited.</li> <li>b. Signal 2N (CP 242) inhibited and trip stop active.</li> <li>c. Route integrity intact to move LRV.</li> <li>d. Signal 2S-1 (CP 269) inhibited and trip stops active.</li> <li>e. Route Locking for duration of movement</li> </ol> </li> <li>2. OCC conflicting route exits restricted.</li> </ol>
Freight encroachment to track with LRV occupied CP 211 to CP 269.	<ol style="list-style-type: none"> <li>1. Vital Local Signal Logic:               <ol style="list-style-type: none"> <li>a. 3 SW (CP 211) lined normal and inhibited.</li> <li>b. 7DR (CP Del) lined normal and inhibited.</li> <li>c. Occupied freight track CP 242 to CP 269 derails set normal and inhibited, respectively.</li> <li>d. Route integrity required to be intact to move LRV.</li> <li>e. 5DR (CP 269) lined normal and inhibited</li> <li>f. Route Locking for duration of movement.</li> </ol> </li> <li>2. OCC conflicting route exits restricted.</li> </ol>

**Table 7**

Extended Temporal  
Separation Operation:  
Exclusive Use CP 45  
to CP 70

Risk	Mitigation
Parallel routes CP 242 to CP 269 Track(s) 1 and 2 load shift	Operational rules restricts freight and LRV movement in same block, LRV must pass at restricted speed.
Pedestrian strike at Roebing Station due to extended freight operation	<ol style="list-style-type: none"> <li>1. Existing message panel mounted on pole adjacent to platform advising pedestrians to “watch for train.”</li> <li>2. Adjacent parking lot does not require pedestrians to cross track.</li> <li>3. Flashers, gates, and bells at Hornberger Crossing located 206 ft. south of end of platform.</li> </ol>
Derailment of freight	Operational rules restricts freight and LRV movement in same block, LRV must pass at restricted speed.

**Table 8**  
*Non-Critical Risks  
 and Mitigations*

Risk	Mitigation
RTC fails to enable proper mode for movement	Based upon proposed operating mode time delineations, 10 minutes prior to transfer of mode, pop-up window appears to remind controller to change Temporal Separation mode. Controller must acknowledge window (press "OK"). Window does not enable any requests for mode change; it merely serves as a reminder.
RTC does not know what mode they are operating in	Software designates the mode in red on the lower right-hand side of the screen display (similar to current freight mode designation).

During Extended Temporal Separation North Operations, the River LINE will be running trains on a 30-minute headway, providing Conrail with sufficient time for operations (see Figure 33 (Drawing 009)).

### Freight Operation

From 1:00 AM to 5:00 AM, the railroad will be set in Freight Mode. This mode effectively releases all designated freight tracks to the management of the controller. Normal exclusive running LRV tracks are blocked for entrance through selection of blocking devices and movement of switches. This operation is currently in effect, and no LRVs are permitted on the right-of-way during this time period.

### Safety Assessment

With regard to the aforementioned hazards and their respective mitigations associated with the proposed operating system modifications, there are very few potential hazards and modes of failure, all of which have been reviewed by system safety. It is the finding of system safety that the potential hazards have been controlled via their respective mitigations vastly reducing the potential for an incident to occur or eliminated through design. Through the vital logic and operational rules and practices appropriate and acceptable prevention and detection of hazards has been achieved.

### FRA Waiver Functional Design

#### Project Description

The proposed plan for the increase of operational hours for both River LINE passenger service and Conrail would be involve signal improvements and modification of the existing temporal separation operating plan. In order to provide for safe, efficient temporal separation, specific signal modifications would be made from CP 211 to CP 269 involving both configuration changes and logic modifications. A drawing detailing these configuration changes is provided in Figure 25 (Drawing 001).

#### CP 211 and CP Del Functional Description

Configuration change for CP 211 will be the addition of a controlled crossover from track 2 to the existing Conrail siding and a derail south of the new switch installation on the siding track. Signals 10N and 10S will be added for protection of the new crossover and derail as well as track circuits and track upgrades on the siding

track from CP 211 to CP Del. CP Del will be located at existing CP 211A, and the current turnout will be upgraded from a #10 to a #15. CP Del will retain its master control from CP 211 but will be an autonomous interlocking in regards to logic and operations. Direct buried cables shall be provided to all track circuits, signals, switches, switch heaters, GCP's, and derails. Electrocode track circuits shall be installed on the Conrail siding. Office control and associated program controls must be provided to accommodate the proposed changes. All work shall be performed in accordance with standards established for the River LINE.

#### CP 242 Functional Description

Configuration changes for CP 242 shall include the installation of two (2) derails on the main and siding tracks, respectively, located between the existing signals 2S-2 and 2S-1 and the existing turnout. The signals will not be required to be relocated as a result of the switch install. Direct buried cables shall be provided to all switches, switch heaters, and derails. All control equipment for the new devices shall be provided within the existing CIH. Programming changes shall be made to the existing VHLC. Office control and associated program controls shall be provided to accommodate the proposed changes. All work shall be performed in accordance with standards established for the River LINE.

#### CP 269 Functional Description

Configuration changes for CP 269 shall include the installation of two (2) derails on the main and siding tracks, respectively, located between the existing signals 2N-2 and 2N-1 and the No. 1 existing turnout. The signals will not be required to be relocated as a result of the switch install. Direct buried cables shall be provided to all switches, switch heaters, and derails. All control equipment for the new devices shall be provided within the existing CIH. Programming changes shall be made to the existing VHLC. Office control and associated program controls shall be provided to accommodate the proposed changes. All work shall be performed in accordance with standards established for the River LINE.

#### Communication Functional Description

Fiber optic cable and associated modems and communication devices will be installed between CP 211 and CP 269. This cable is required for the Union Switch and Signal MicroLok Object Controllers, which will be installed in the respective CIHs and provide vital logic exchanges for the implementation of the proposed ETS North. OCC revisions will include the additional controls and indications as necessitated by the new appurtenances and mode controls.

#### Functional Logic Description

This document represents the logic revisions and additions that will be necessary to accommodate the proposed Extended Temporally Separated track usage between CP 211 and CP 269. Program revisions are required to the vital and non-vital logic of the field VHLC and also to the office control center. Office-to-field communications backbone will remain as is currently designed and implemented.

## Revised Controls and Indications/OCC

Table 9–Table 14 list new control and indication functions for the OCC required to implement ETS North.

**Table 9**

*Additional Office Controls—CP 211 and CP Del*

Mode 1 Passenger	Mode 2 ETS	Mode 3 Freight	
I0N Request	I0 Stop	3 SW Normal	7DR Normal
I0S Request	8N-2 Request	3 SW Reverse	7DR Reverse
I0S Trk Block On	I0S Trk Block Off	I0T Trk Block On	I0T Trk Block Off
I0N Trk Block On	I0N Trk Block Off	8N2 Trk Block On	8N2 Trk Block Off
5DR Normal			
5DR Reverse			

**Table 10**

*Additional Office Indications—CP 211 and CP Del*

Mode 1 Request	Mode 2 Request	Mode 3 Request	
I0N GK	I0N RK	3 SW NWK	7DR NWK
I0S GK	I0S RK	3 SW RWK	7DR RWK
I0N Trk Block	6N TBK	3 SW LK	7DR LK
Mode 1	I0T TBK	5DR NWK	I0T TK
Mode 2	I0S Trk Block	5DR RWK	2142 TK
Mode 3		5DR LK	

**Table 11**

*Additional Office Controls—CP 242*

Mode 1 Passenger	Mode 2 ETS	Mode 3 Freight
3DR Normal	5DR Normal	
3DR Reverse	3DR Reverse	

**Table 12**

*Additional Office Indications—CP 242*

Mode 1 Request	Mode 1	Mode 2	Mode 3
Mode 2 Request	3DR LK	3DR NWK	5DR NWK
Mode 3 Request	5DR LK	3DR RWK	5DR RWK

**Table 13**

*Additional Office Controls—CP 269*

Mode 1 -Passenger	Mode 2 ETS	Mode 3 Freight
7DR Normal	9DR Normal	
7DR Reverse	9DR Reverse	

**Table 14**

*Additional Office Indications—CP 242*

Mode 1 Request	Mode 1	Mode 2	Mode 3
Mode 2 Request	7DR LK	7DR NWK	9DR NWK
Mode 3 Request	9DR LK	7DR RWK	9DR RWK



The following conditions will be set and secured under the respective mode:

- CP 211—Mode 1 ETS will set 5DR normal and inhibit switch request and control.
- CP 211—Mode 1 ETS will lock signal I0N from display.
- CP 211—Mode 2 ETS will set 3SW in the normal position and inhibit switch request and control.
- To function into Mode 1, set all appurtenances “normal,” all track circuits clear, no signals in time.
- To function into Mode 2, set all appurtenances “normal,” all track circuits clear, no signals in time.
- To function into Mode 3, set all appurtenances “normal,” except 3 Switch at CP 269 must be set reverse, all track circuits clear, no signals in time.
- Mode functions will not change if conditions are not met.

Additional appurtenance control and conditional inhibiting are specific to functional matrices and are indicated in the following paragraph.

#### Conditional Functional Inhibiting based on Modes

Typical applications already designed for the River LINE, such as signal lighting, switch control, and track circuits, will be utilized for the signal network. Logic sequences shall be derived from those currently in place. However, there are various functions that will require “non-standard” application in order to force execution of the ETS logic. Table 15–Table 20 list the design parameters that shall be followed.

**Table 15**

*LRV Route: CP 211  
to CP 269 Mode 1*

Device	Status	Special Condition
5DR (CP 211)	Normal	Inhibited when in Mode 1.
I0N Signal (CP211)	Stop	Inhibited when in Mode 1.
5DR (CP 269)	Normal	Inhibited in Mode 1.
3SW (CP 269)	Normal	Inhibited in Mode 1
2S-2 (CP 269)	Stop	Inhibited in Mode 1
Signal is requested and route is locked under normal signal operating parameters. Exit to 2S-2 (CP 269) and 8N (CP Del) and I0N (CP 211) is disallowed under Mode 1 bit in route check.		

**Table 16**

*Special Locking  
Table While  
in Mode 1*

Device	Special Condition
5DR (CP 211)	Lined normal and movement and control inhibited.
5DR (CP 269)	Lined normal and movement and control inhibited.
3SW (CP 269)	Lined normal and movement and control inhibited.
10N Signal (CP 211)	Control request inhibited.
2S-2 Signal (CP 269)	Control request inhibited.
Route exit 2S-2 (CP 269)	Route check exit disabled.
Route exit 10N (CP 211)	Route check exit disabled.
5DR (CP 211) to go reverse	3SW (CP 211) must be normal.
3SW (CP 211) to go reverse	5DR must be normal.

**Table 17**

*LRV Route: CP 211  
to CP 269 Mode 2*

Device	Status	Special Condition
3SW (CP 211)	Normal	Inhibited when in Mode 2.
Route	Aligned	Whole route must be intact before entering signal will display.
7DR (CP Del)	Normal	Will not go reverse until 7SW (CP Del) is reverse.
ISW (CP 242)	Position	Switch position dependent on freight occupancy between CP 242 and CP 269.
5DR (CP 242)	Position	Set normal and inhibited when freight is in respective track section.
3DR (CP 242)	Position	Set normal and inhibited when freight is in respective track section.
7DR (CP 269)	Position	Set normal and inhibited when freight is in respective track section.
9DR (CP 269)	Position	Set normal and inhibited when freight is in respective track section.
5DR (CP 269)	Normal	Will not go reverse until 3SW (CP 269) is reverse
ISW (CP 269)	Position	Switch position dependent on freight occupancy between CP 242 and CP 269.
Signal is requested and route is locked through entire movement of train to exiting signal. Route requires display of last exiting control signal prior to allowing permissive aspect on entering signal. Exit to 2S-2 (CP 269) and 8N (CP Del) is disabled through Mode 2 bit and route check circuit. 10S (CP 211) is disallowed as 3SW is lined and inhibited normal.		

**Table 18**

*Freight Route Special Locking Mode 2*

Device	Special Condition
2S-2 (CP 269) Signal display: Freight southbound	Route exit 2N-1 (CP 269) disabled, 7SW (CP Del) 8S (CP Del) must be displayed.
8N (CP Del) Signal display: Freight northbound	Route exit 2S-2 (CP 242) disabled, ISW (CP 242) must be normal, tracks 1 & 2 unoccupied, 7DR (CP 269) must be normal. All switches locked during route. 2N Signal (CP 242) must be displayed.
2N-1 (CP 269) Signal display: Freight northbound	Route exit disabled to 2S-1 when entering from 8N, 3SW must be reverse before 7DR is normal
2S – 2 (CP 242) Signal display: Freight Southbound	Route identified as freight route and exit at 8N-2 disabled. 7SW (CP Del) must be reverse prior to ISW (CP242) reverse. Signal 8S must be cleared.

**Table 19**

*Special Locking Table While in Mode 2*

Device	Special Condition
3SW (CP 211)	Switch lined normal and movement and control inhibited.
ISW (CP 211)	No special restriction.
5DR (CP 211) to go reverse	3SW (CP 211) normal.
7SW (CP Del) to go reverse	7DR & 9DR (CP 269) must be normal.
7DR (CP Del) to go reverse	7SW (CP Del) must be reverse, 7DR & 9DR(CP 269) must be normal.
ISW (CP242) to go reverse	5DR (CP 242) must be normal; if freight route then 7SW (CP Del) must be reverse; if passenger route, 7SW (CP Del must be normal).
5DR (CP242) to go reverse	ISW (CP 242) must be normal; freight route disabled 7SW (CP Del) normal.
3DR (CP 242) to go reverse	7SW (CP Del) must be reverse if freight route; 7SW (CP Del) must be normal if passenger route.
5DR (CP 269) to go reverse	3SW (CP 269) must be reverse, 5DR & 3DR (CP 242) must be normal, 2 track must be unoccupied.
3SW (CP 269) to go normal	7DR & 9DR (CP269) must be reverse.

**Table 20**

*Stop Signals with Active Trip Stops*

CP 211	CP Del	CP 242	CP 242
6N and 4N	8S	2S-2	2N-2
2N-2 and 2N-1	8N-2	2S-1	2N-1
2S	2N	2N	2S-1
10S			

**Functional Cable Description**

All cable installed as part of this project shall be similar in type and construction to that previously installed on the River LINE. Exceptions to this shall be the switch control and indication cable, which shall be installed as a 15c composite. Cable make-ups required for the project shall be as follows:

- 2-IC #6TW UG – Track Wire
- 1-2C #6 UG – Switch Heater/Train Stop
- 5C #6 UG – Signal Light/Switch Control
- 7C #14 UG – Switch Indication
- 3C #4 UG – Switch Heater Power to Control Case
- 3C #2 UG – Main AC Feed - House Power/Switch Heater
- 25PR #19 – Communication Cable

All terminations shall be installed per accepted industry standards and in conformance with standards previously established on the River LINE. All cable shall be direct buried, installed a minimum of 30 in. below grade outside of track and installed in schedule 40 PVC 30 in. below bottom of tie in track.

#### Track and Switch Installation

Switch and Lock movement shall be installed in accordance with River LINE standards. Switch movement control and indication circuits shall be similar in design to that already employed on the River LINE. Switch layouts for both turnout points and derails shall be identical to those provided under the construction contract.

Insulated joints shall be full contact, epoxy glued type, preassembled by the manufacturer, such as manufactured by Allegheny Drop Forge, Inc. Two (2) RAILTECH Boutet CJ thermite weld kits shall be provided for each insulated joint. Each weld kit shall contain the following items:

- Two half molds
- A bottom base briquette and a diverter plug
- A welding charge packaged in a sealed plastic bag
- A CJ crucible equipped with a self tapping thimble

The following standard shall be referenced in the execution of the trackwork:

- American Railway Engineering Association (AREA)
- Manual for Railway Engineering
- Portfolio of Trackwork Plans
- American Society for Testing and Materials (ASTM)
- The American Association of Railroads (AREMA)

#### Functional Testing

Full functional testing shall be provided prior to placing in service any system or sub-system. The River LINE is an operating railroad and adequate pre-cut-over testing shall be completed to insure the system is functioning as intended prior to in-service commissioning. This pre-testing is to ensure minimal disruption to service and passengers.

A Wiring Verification Test shall be made in accordance with the approved circuit plans. The wiring verification test shall include a count of wires at each termination, the assurance of continuity of each wire between terminations and the installation of the proper tags with correct circuit information. Both ends of each wire shall be checked during these tests to be certain that their terminations are solidly applied and that they are properly held in their correct place. These tests shall also include the verification of correct current where resistors are used to reduce current.

A Circuit Breakdown Test shall be made in accordance with the approved circuit plans. Each circuit in each instrument housing and case shall be tested from origination to termination. The continuity of each circuit shall be metered while each contact in the circuit under test is opened to verify its position in the circuit under test. Where parallel paths exist, the tests shall validate each path, and circuits shall be disconnected to ensure the proper test. Where parallel paths exist in a relay circuit, the circuit shall be checked to prove that all paths are energized from the same fuse.

All functions external to the instrument housings and cases shall be simulated to assure proper interface to internal circuits, the proper function of external apparatus and the proper indication response from the external apparatus. Simulated conditions of both normal operations and anticipated failures shall be imposed on the system to insure that the system complies with all fail-safe requirements. The following field test shall be performed prior to cut-over:

1. Power Verification.
2. Insulation resistance test values shall be recorded on approved insulation resistance record cards and forwarded to the Engineer after completion of the tests.
3. Relay Tests:
  - a. Test all vital DC relays for pick-up, working and drop-away values. These values shall be in accordance with the field requirement values stated in Table I of the AREMA Signal Manual Part 6.4.1 Recommended Instructions for DC Relays, and the Manufacturer's instructions.
4. Track Switches:
  - a. Check continuity of wiring to switch movements to verify proper wiring.
  - b. Apply power and call for switch machine Normal and then Reverse. Observe in field that switch machine operation corresponds to position requested, and also observe in the instrument housing that the proper switch correspondence relay is energized.
  - c. Breakdown each contact in the switch circuit controller and observe that the proper switch correspondence relay is de-energized. Repeat this procedure for both positions of the switch.

5. Insulated Joints—Test all new insulated joints after installation in accordance with the requirements of the AREMA Signal Manual Part 8.6.35 Recommended Instructions for Insulated Joints, and Part 8.1.10 Recommended Direct-Current Test Record.
6. Track Circuit Adjustments:
  - a. After the track has been removed from service, the Contractor shall temporarily disconnect the existing track circuit(s), install required temporary bonding, and energize the new track circuit(s).
  - b. Terminate, adjust, test and record results for all track circuits. Adjust track circuits, including fouling portions, in accordance with Manufacturer's instructions. Test sensitivity with a 0.06 ohm shunt.
  - c. Track Circuits shall be tested in accordance with the AREMA Signal Manual Part 8.1.1 Recommended Functional/Operating Guidelines for Track Circuits, and Part 8.6.1 Recommended Instructions for Vital Track Circuits, where the instructions are applicable and do not conflict with these Specifications.
  - d. Observe and test for proper track circuit polarity connections to the rails.
  - e. The track relay and vital processor shall be de-energized when any one of the insulated joints defining the track circuit is shunted.
  - f. Test each track circuit to ensure that the energy level at the relay end is in conformance with the operating voltage levels of the track relay and vital processors and provides maximum broken rail protection.
  - g. Remove all temporary wiring and bonding and restore original track circuit. Apply a 0.06 ohm shunt to both the relay end of the circuit and the supply end and verify track relay is de-energized each time before returning original track circuit to service.
7. Signal Lighting Adjustments.
8. Time Release.
9. Switch Fouling Circuits:
  - a. Visually check that fouling wires (at least independent two parallel conductors) are installed properly and provide a good electrical connection between the main rails of a track circuit and the turnout rails.
10. Supervisory Control Equipment.
11. All cut-over testing shall provide for full functional and operational testing of the system. All applicable operational tests, as described herein, in the AREMA Signal Manual Part 2.4.1 Recommended Inspection and Test of Signal Installations Before Placing in Service, and in the RS&I of the FRA shall be successfully completed.
12. Time Locking.
13. Route Locking.
14. Traffic Locking.

#### 15. Track Circuits:

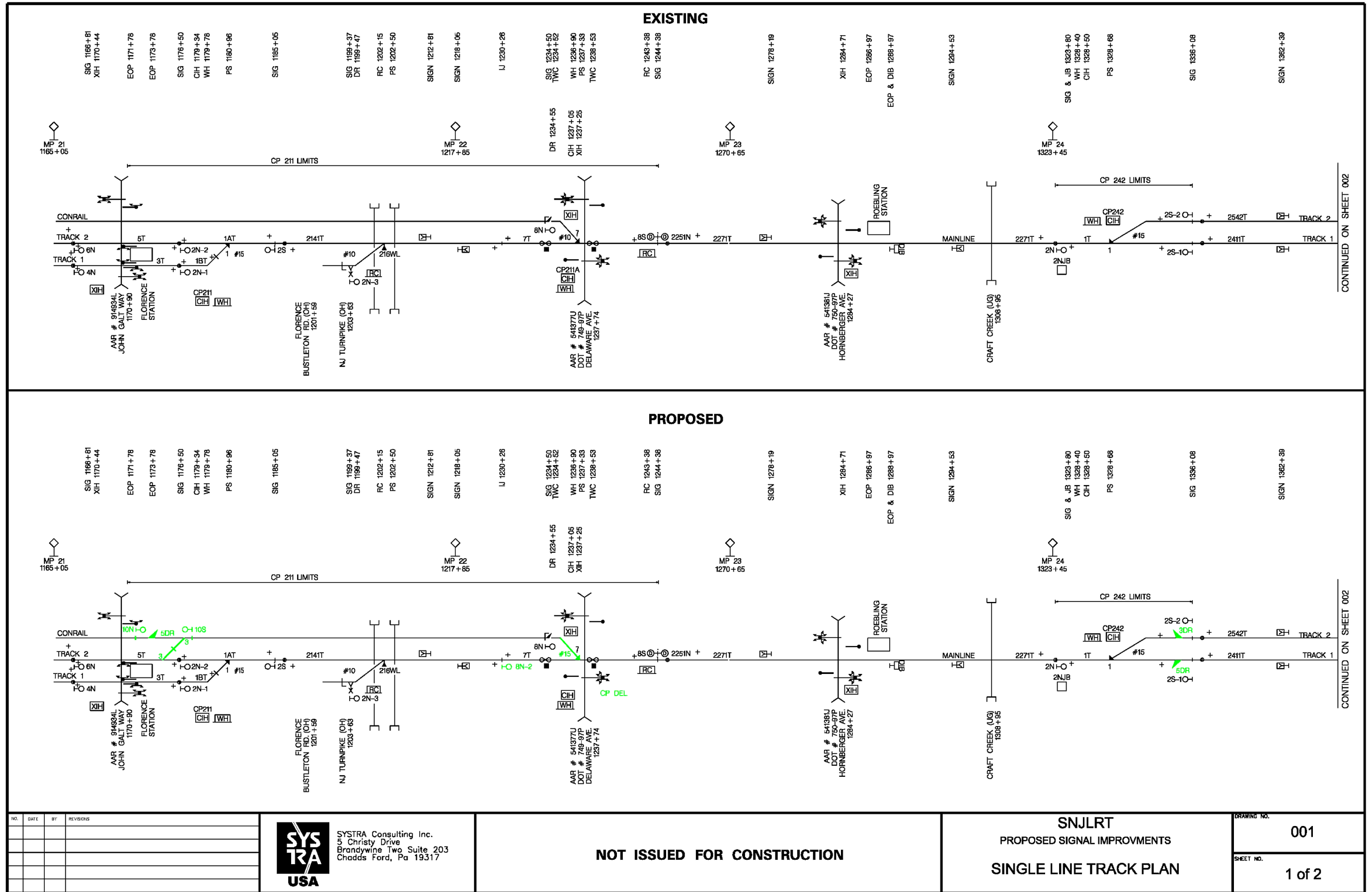
- a. Test to ensure that track relays and vital processors are not over energized in accordance with the Manufacturer's instructions. Record track circuit voltage at relay terminals, and arrange for prompt correction where voltage is high.
- b. Test to ensure that track circuits are adjusted to shunt at the maximum value of shunt resistance. Test shall be made at both the relay and feed ends of the circuit. Test shall be made with a 0.06 ohm shunt. Reversible track circuits shall be tested in both directions.
- c. Test to ensure that track circuits are adjusted properly for cab signals. Adjustments shall be made in accordance with the Manufacturer's specifications and instructions.
- d. Test to ensure that the polarities of adjoining track circuits are in accordance with the approved plans.
- e. Test to ensure that a loss of shunt of 5 seconds or less shall not release route locking circuit of each power operated switch. Open the track relay control circuit.

#### 16. Signal Aspects:

- a. Upon satisfaction of completion of pre-testing, in-service commissioning may be scheduled and shall include all tests performed in the pre-test with all adjustments and relocations made permanent prior to final test.
- b. Software management plan shall be followed for document and revision control. All plans shall be as-in-serviced after final cut-over.



**Figure 25**  
Existing Signal Plans and Proposed Signal and Train Operations Design Plans for the River LINE, Burlington Division, Drawing No. 1



NO.	DATE	BY	REVISIONS

**SYSTR**  
USA

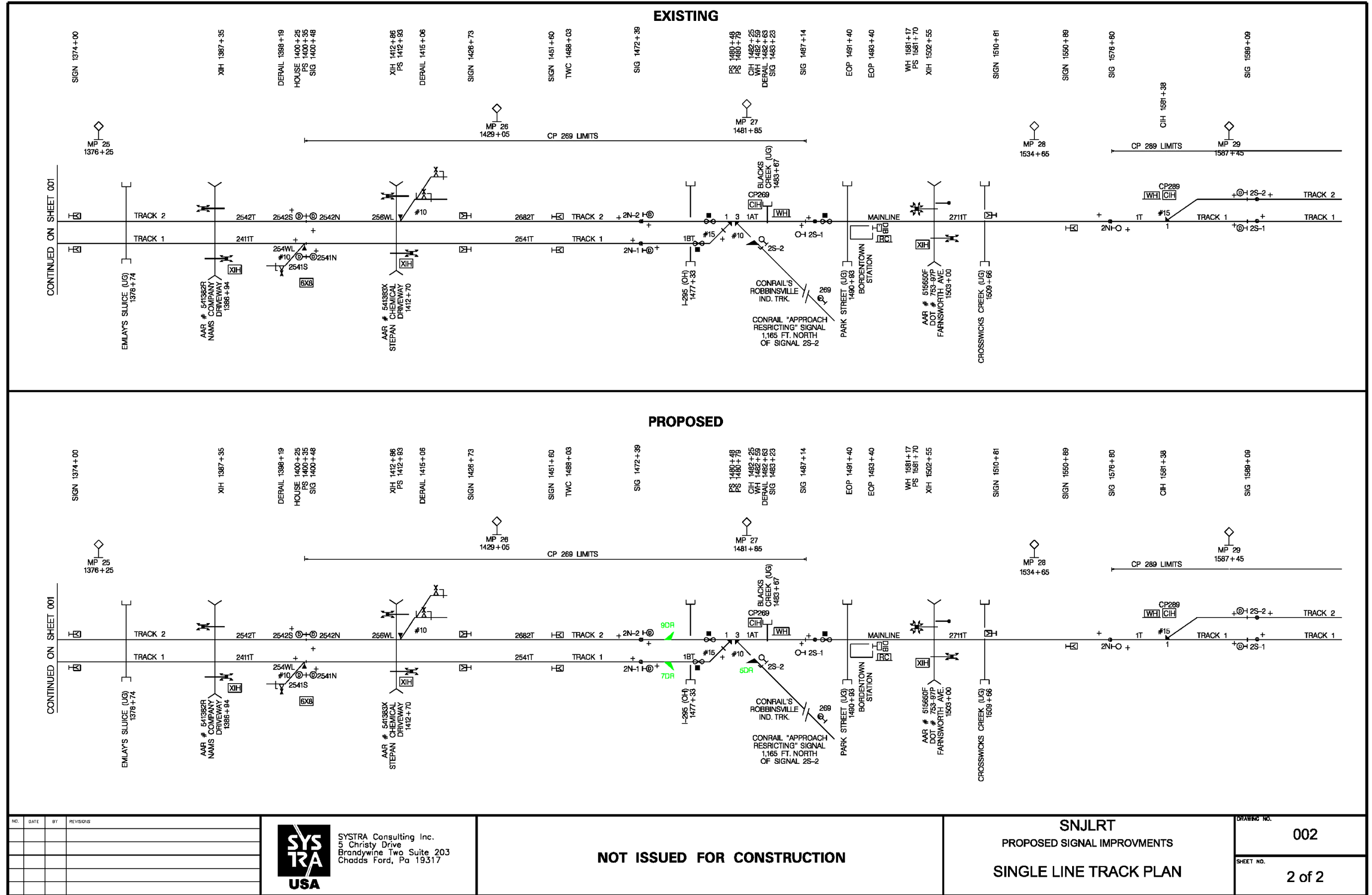
SYSTR Consulting Inc.  
5 Christy Drive  
Brandywine Two Suite 203  
Chadds Ford, Pa 19317

**NOT ISSUED FOR CONSTRUCTION**

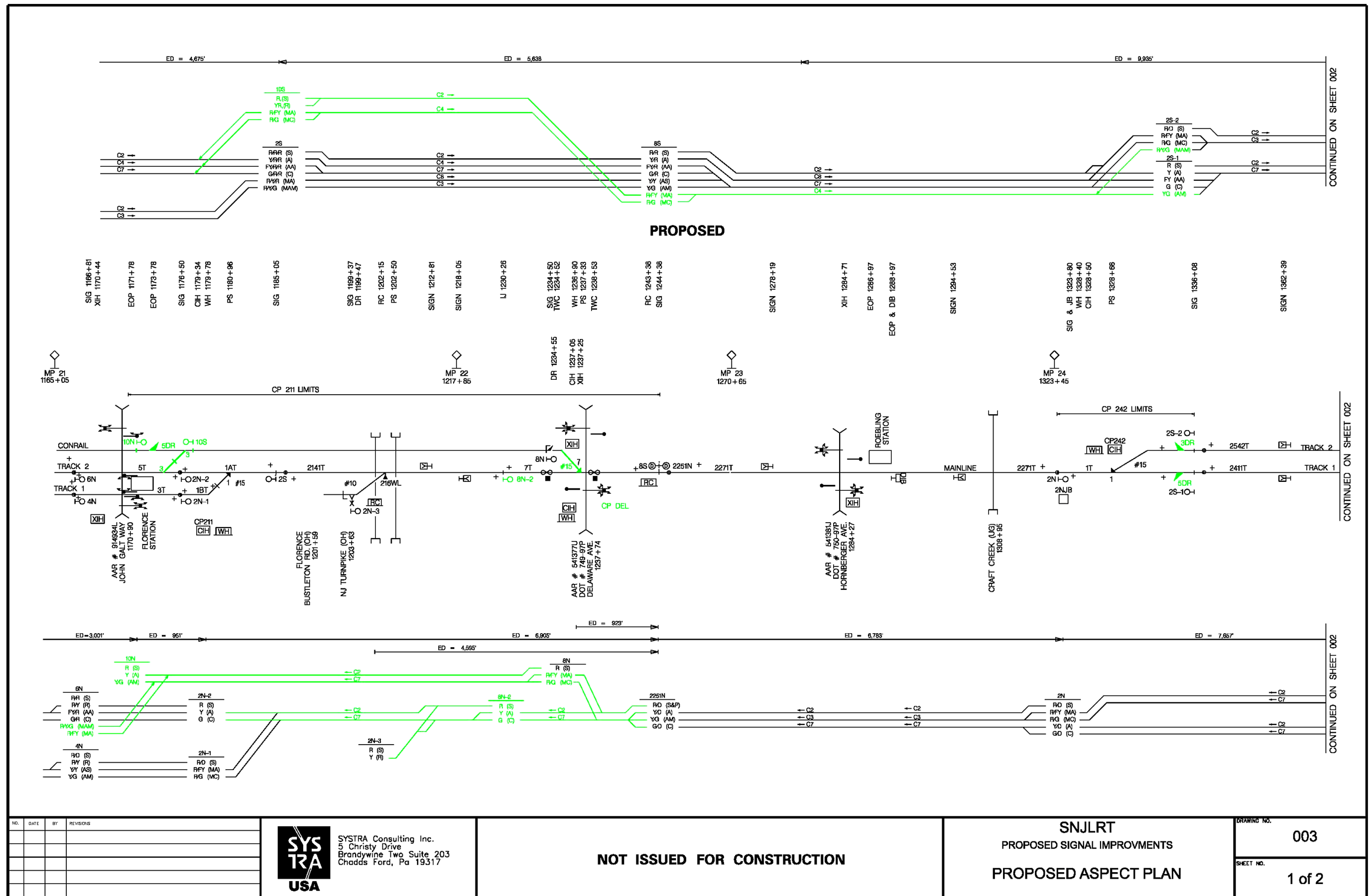
**SNJLRT**  
PROPOSED SIGNAL IMPROVMENTS  
SINGLE LINE TRACK PLAN

DRAWING NO.	001
SHEET NO.	1 of 2

**Figure 26**  
Existing Signal Plans and Proposed Signal and Train Operations Design Plans for the River LINE, Burlington Division, Drawing No. 2



**Figure 27**  
Existing Signal Plans and Proposed Signal and Train Operations Design Plans for the River LINE, Burlington Division, Drawing No. 3



NO.	DATE	BY	REVISIONS

**SYSTR**  
USA

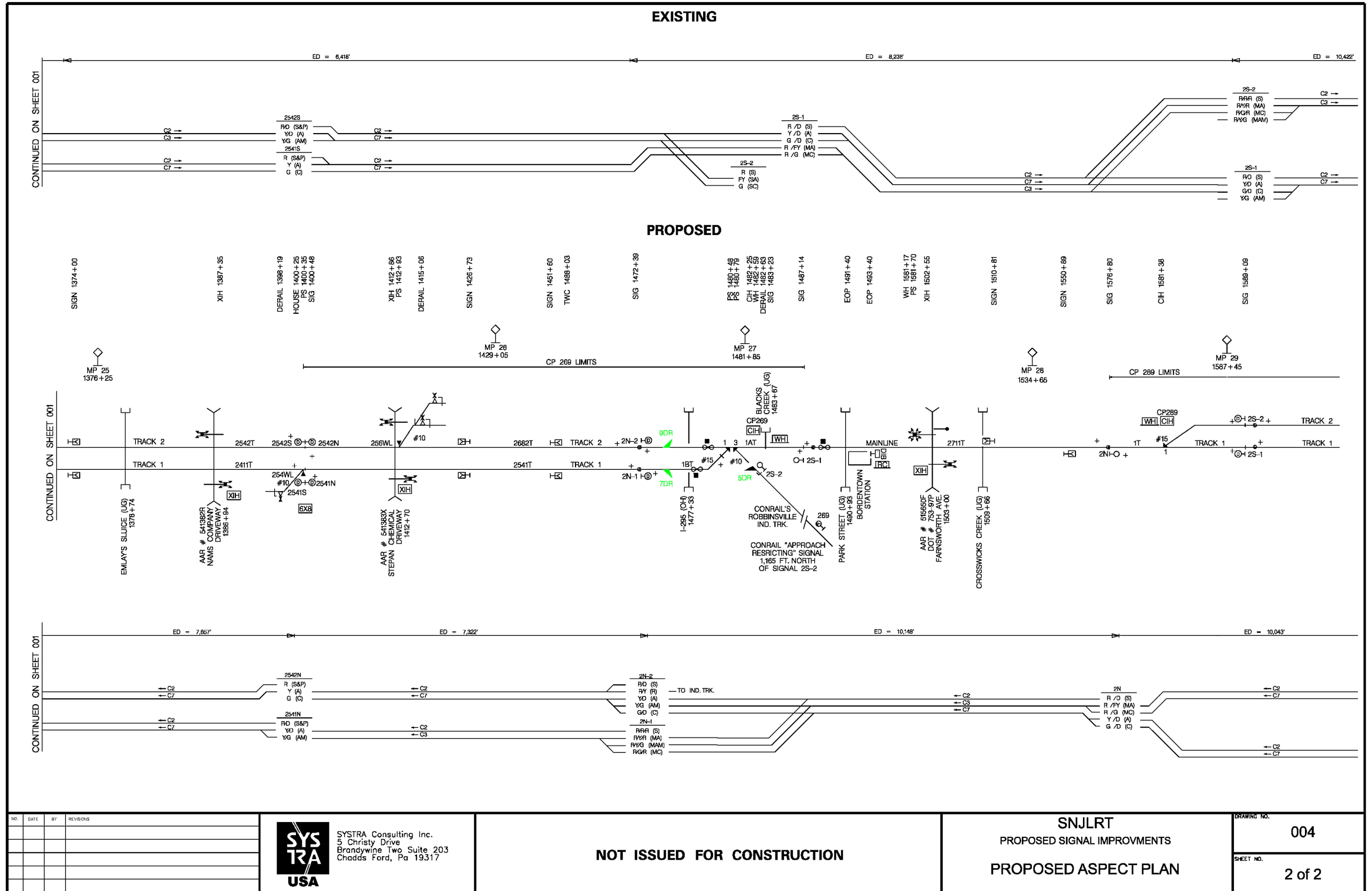
SYSTR Consulting Inc.  
5 Christy Drive  
Brandywine Two Suite 203  
Chadds Ford, Pa 19317

**NOT ISSUED FOR CONSTRUCTION**

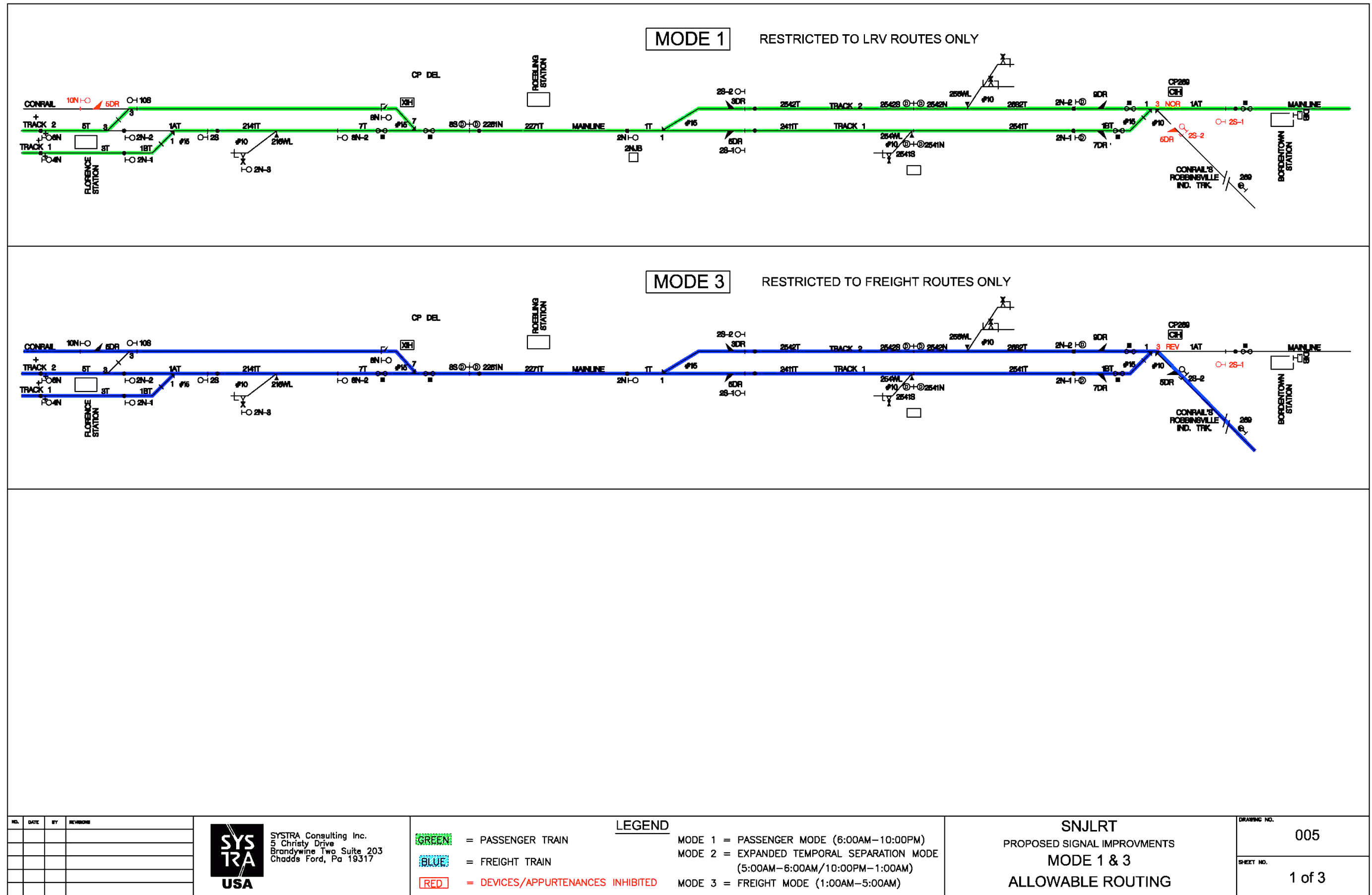
**SNJLRT**  
PROPOSED SIGNAL IMPROVEMENTS  
PROPOSED ASPECT PLAN

DRAWING NO.	003
SHEET NO.	1 of 2

**Figure 28**  
Existing Signal Plans and Proposed Signal and Train Operations Design Plans for the River LINE, Burlington Division, Drawing No. 4

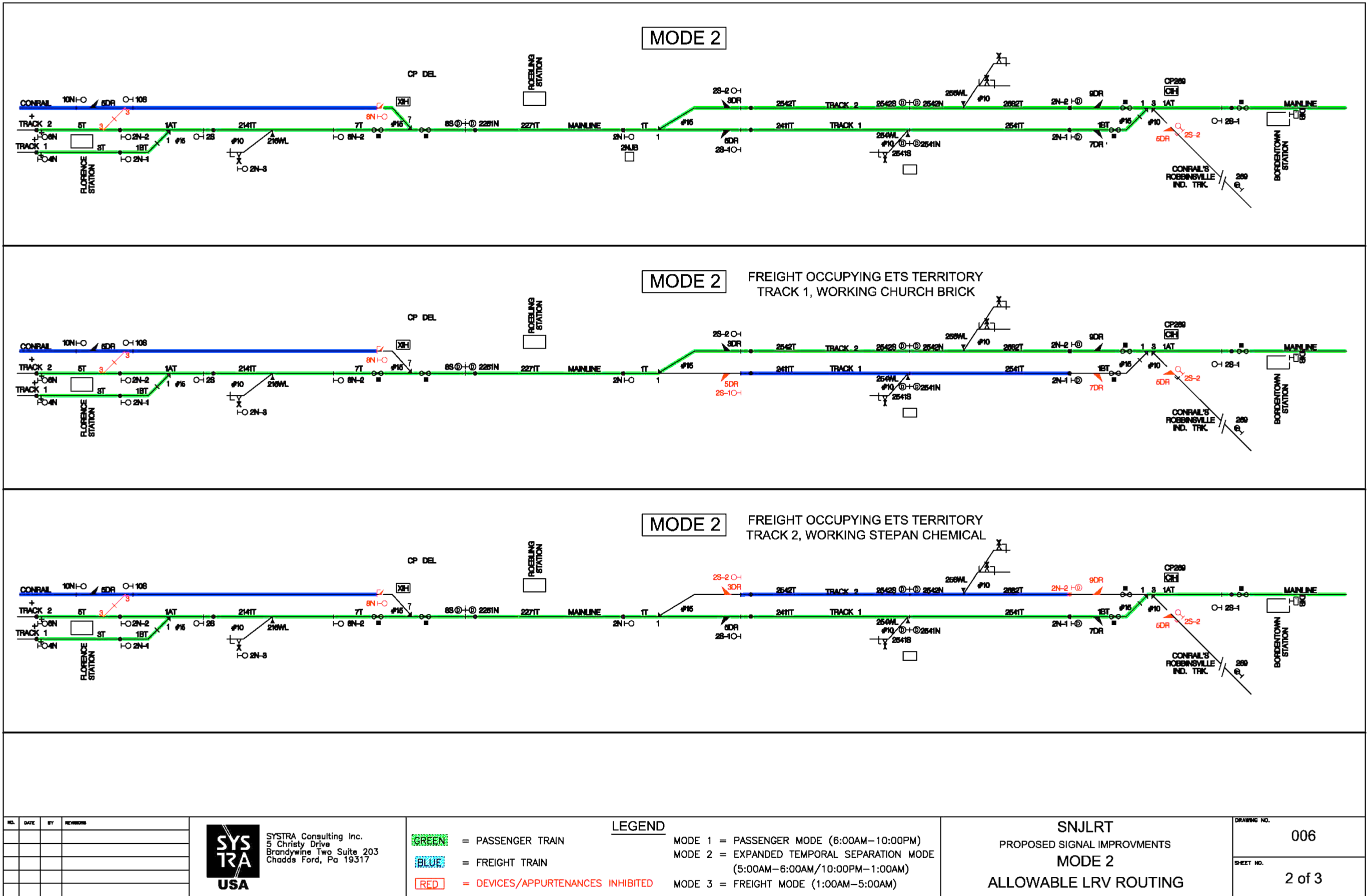


**Figure 29**  
Existing Signal Plans and Proposed Signal and Train Operations Design Plans for the River LINE, Burlington Division, Drawing No. 5



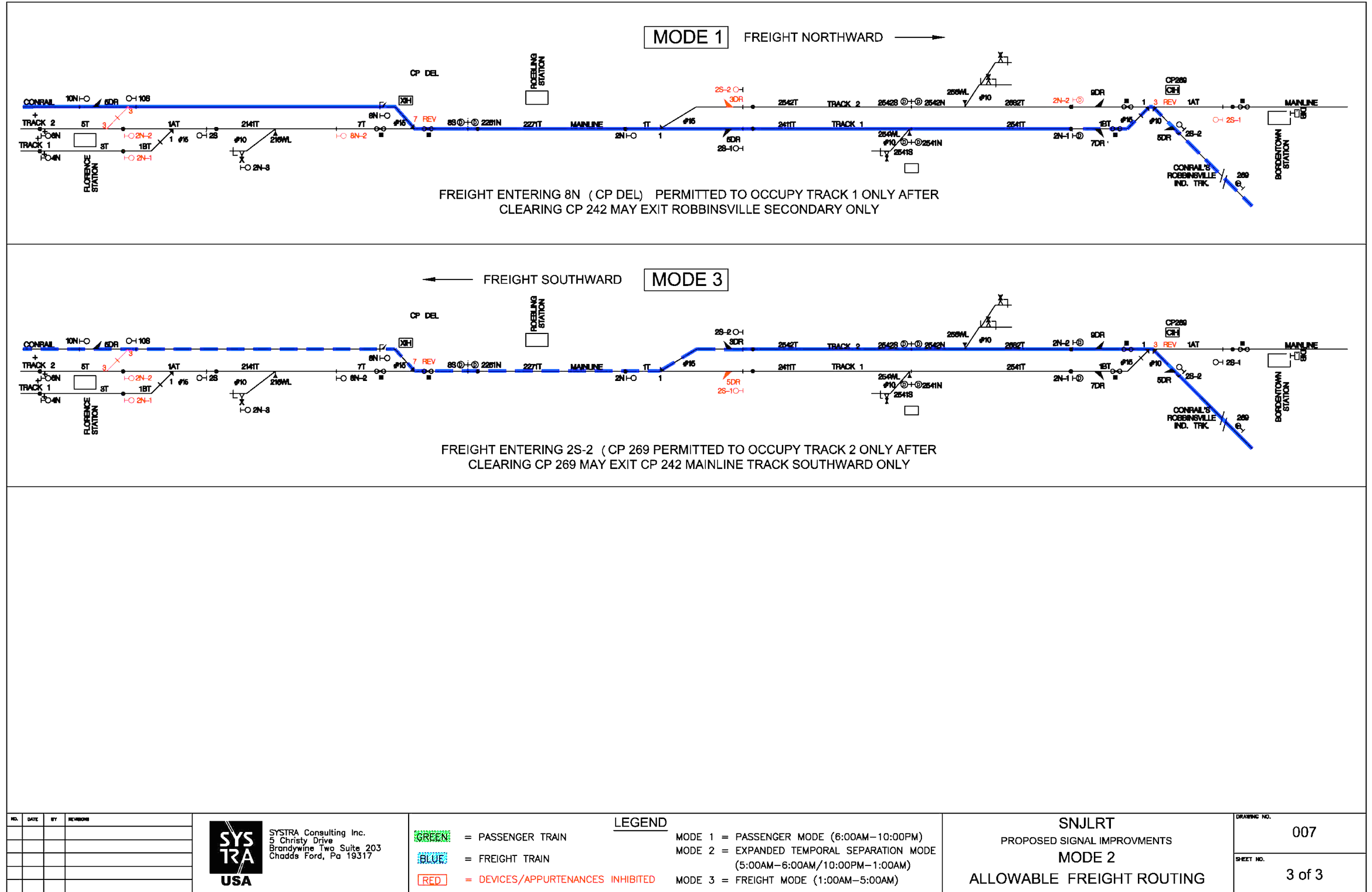


**Figure 30**  
Existing Signal Plans and Proposed Signal and Train Operations Design Plans for the River LINE, Burlington Division, Drawing No. 6



**Figure 31**

Existing Signal Plans and Proposed Signal and Train Operations Design Plans for the River LINE, Burlington Division, Drawing No. 7



NO.	DATE	BY	REVISION

**SYSTR**  
USA

SYSTRA Consulting Inc.  
5 Christy Drive  
Brandywine Two Suite 203  
Chadds Ford, Pa 19317

**LEGEND**

GREEN = PASSENGER TRAIN

BLUE = FREIGHT TRAIN

RED = DEVICES/APURTENANCES INHIBITED

MODE 1 = PASSENGER MODE (6:00AM-10:00PM)

MODE 2 = EXPANDED TEMPORAL SEPARATION MODE (5:00AM-6:00AM/10:00PM-1:00AM)

MODE 3 = FREIGHT MODE (1:00AM-5:00AM)

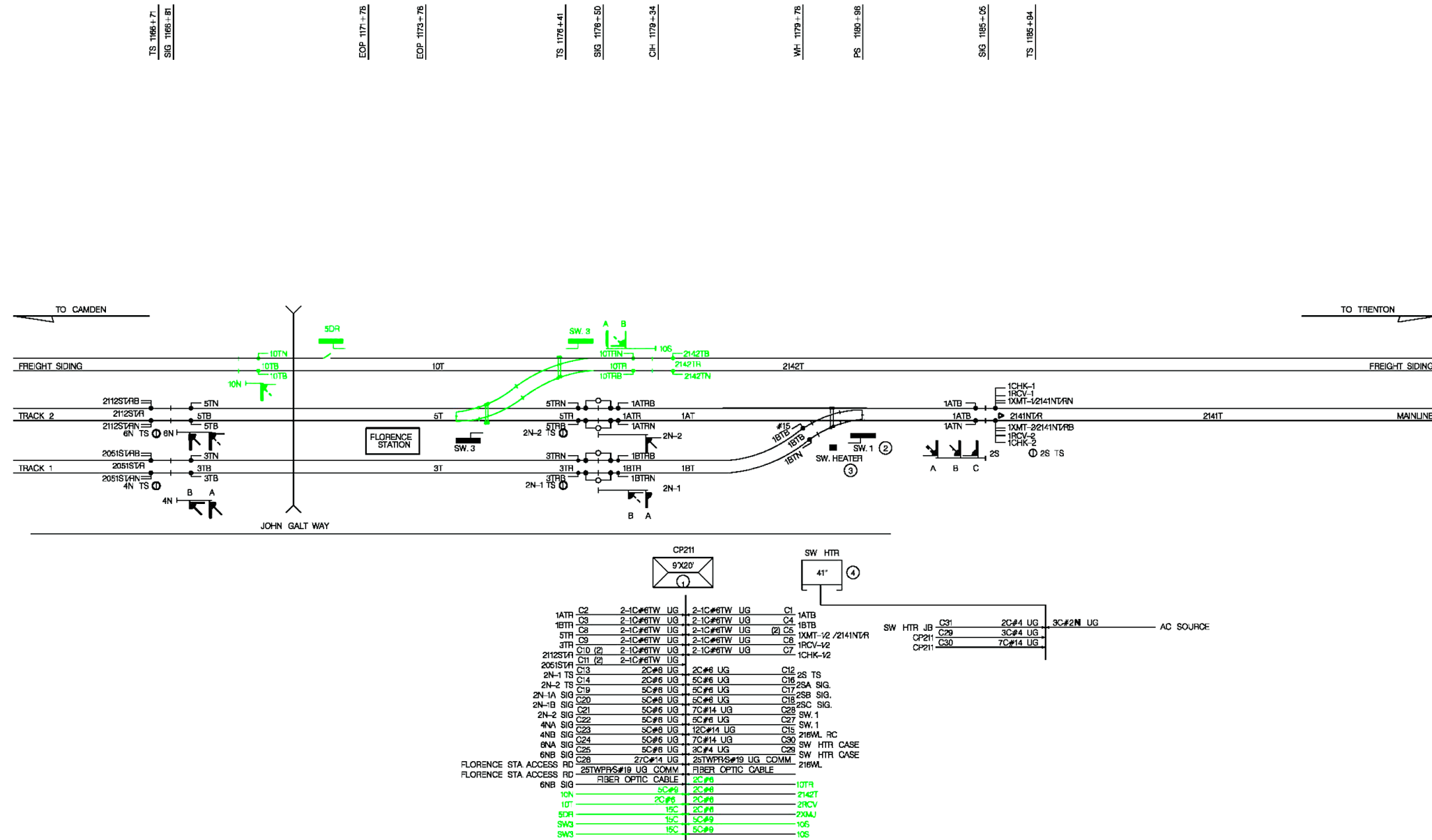
**SNJLRT**  
PROPOSED SIGNAL IMPROVMENTS  
**MODE 2**  
ALLOWABLE FREIGHT ROUTING

DRAWING NO. 007

SHEET NO. 3 of 3



**Figure 32**  
Existing Signal Plans and Proposed Signal and Train Operations Design Plans for the River LINE, Burlington Division, Drawing No. 8



- ① - INSTRUMENT HOUSE
- ② - ELECTRIC SWITCH MACHINE
- ③ - SWITCH HEATER
- ④ - SWITCH HEATER CASE

NO.	DATE	BY	REVISIONS

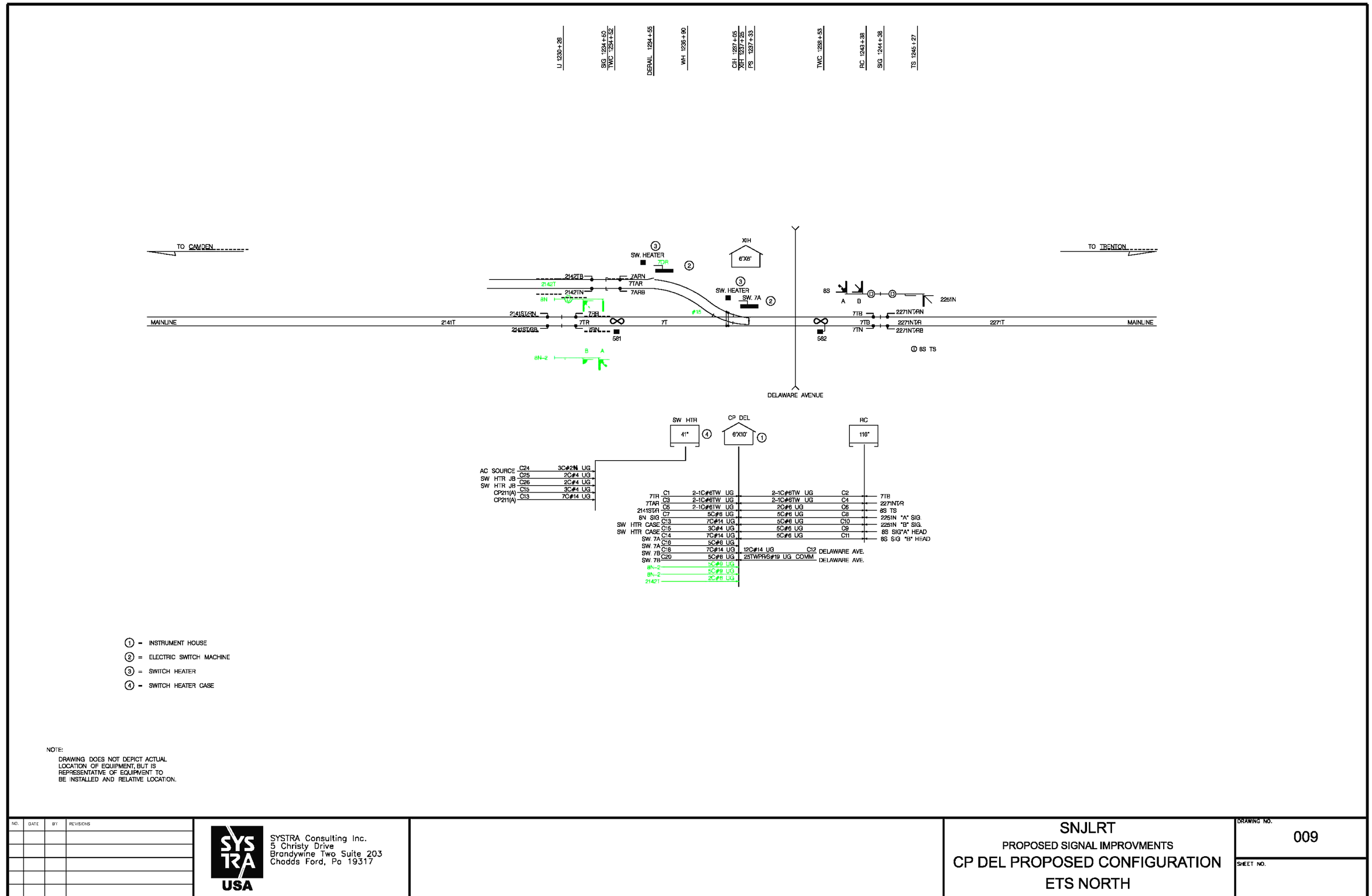
**SYSTR**  
USA

SYSTR Consulting Inc.  
5 Christy Drive  
Brandywine Two Suite 203  
Chodds Ford, Pa 19317

**SNJLRT**  
PROPOSED SIGNAL IMPROVMENTS  
**CP211 PROPOSED CONFIGURATION**  
ETS NORTH

DRAWING NO. **008**  
SHEET NO.

**Figure 33**  
Existing Signal Plans and Proposed Signal and Train Operations Design Plans for the River LINE, Burlington Division, Drawing No. 9



NOTE:  
DRAWING DOES NOT DEPICT ACTUAL LOCATION OF EQUIPMENT, BUT IS REPRESENTATIVE OF EQUIPMENT TO BE INSTALLED AND RELATIVE LOCATION.

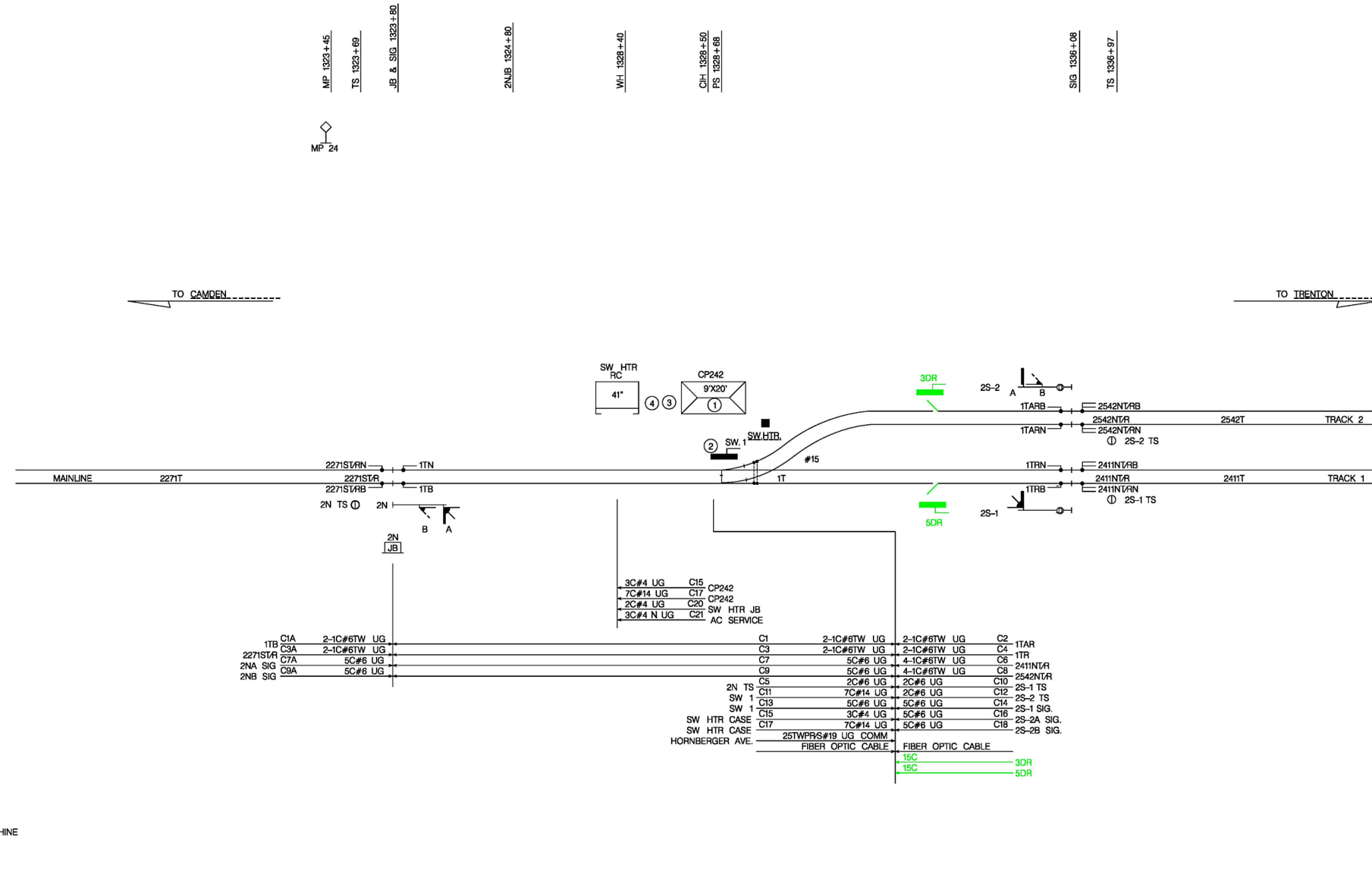
NO.	DATE	BY	REVISIONS

**SYS TRA USA**  
SYSTRA Consulting Inc.  
5 Christy Drive  
Brandywine Two Suite 203  
Chadds Ford, Pa 19317

**SNJLRT**  
PROPOSED SIGNAL IMPROVMENTS  
CP DEL PROPOSED CONFIGURATION  
ETS NORTH

DRAWING NO. **009**  
SHEET NO.

**Figure 34**  
 Figure 34:  
 Existing Signal Plans and  
 Proposed Signal and Train  
 Operations  
 Design Plans for  
 the River LINE,  
 Burlington  
 Division,  
 Drawing No. 10



NO.	DATE	BY	REVISIONS

**SYSTR**  
**USA**

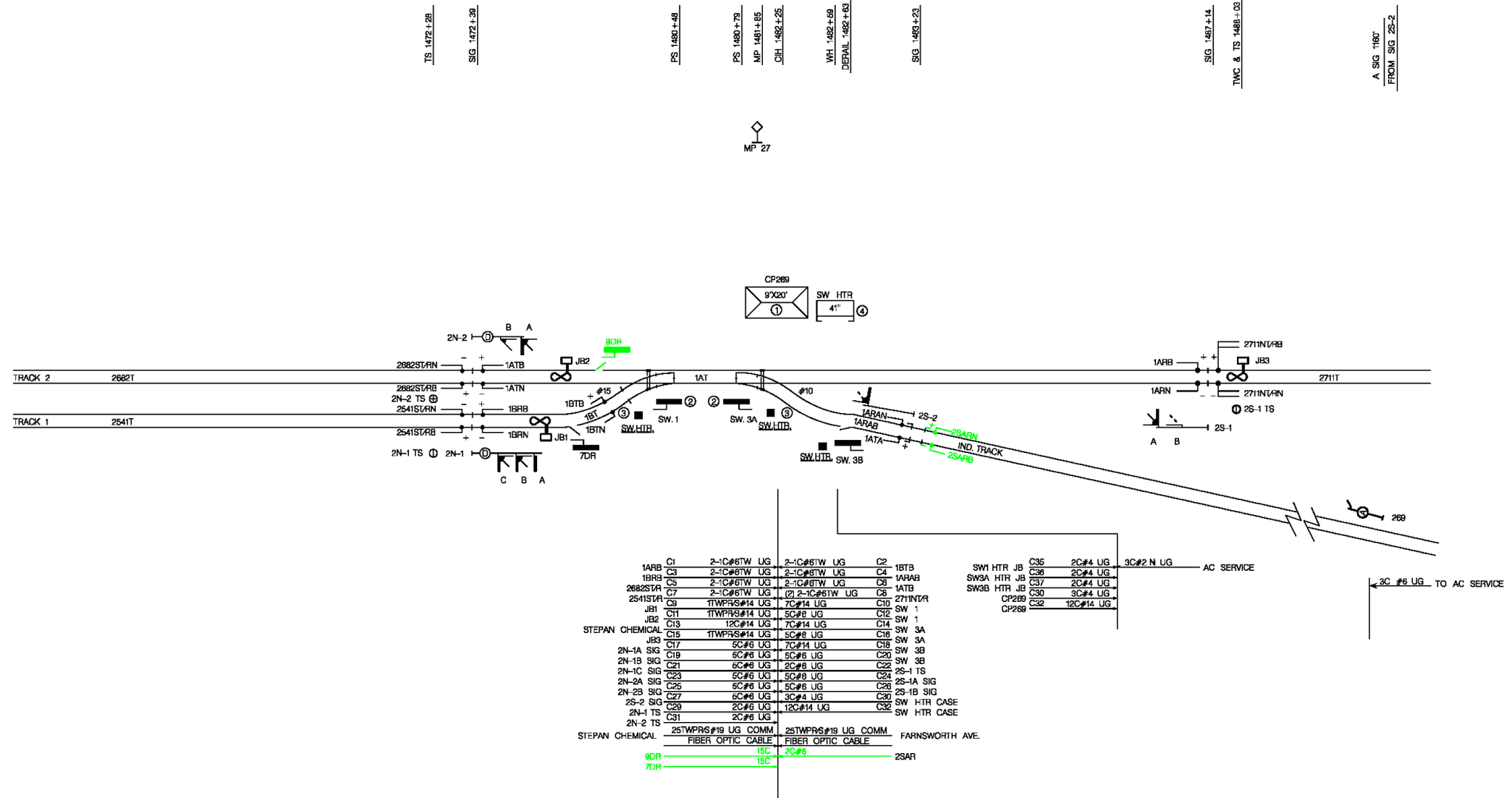
SYSTRA Consulting Inc.  
 5 Christy Drive  
 Brandywine Two Suite 203  
 Chadds Ford, Pa 19317

**SNJLRT**  
 PROPOSED SIGNAL IMPROVMENTS  
**CP242 PROPOSED CONFIGURATION**  
 ETS NORTH

DRAWING NO.	<b>010</b>
SHEET NO.	

**Figure 35**

Existing Signal Plans and Proposed Signal and Train Operations Design Plans for the River LINE, Burlington Division, Drawing No. 11



- ① - INSTRUMENT HOUSE
- ② - ELECTRIC SWITCH MACHINE
- ③ - SWITCH HEATER
- ④ - SWITCH HEATER CASE

NO.	DATE	BY	REVISIONS

**SYSTR**  
USA

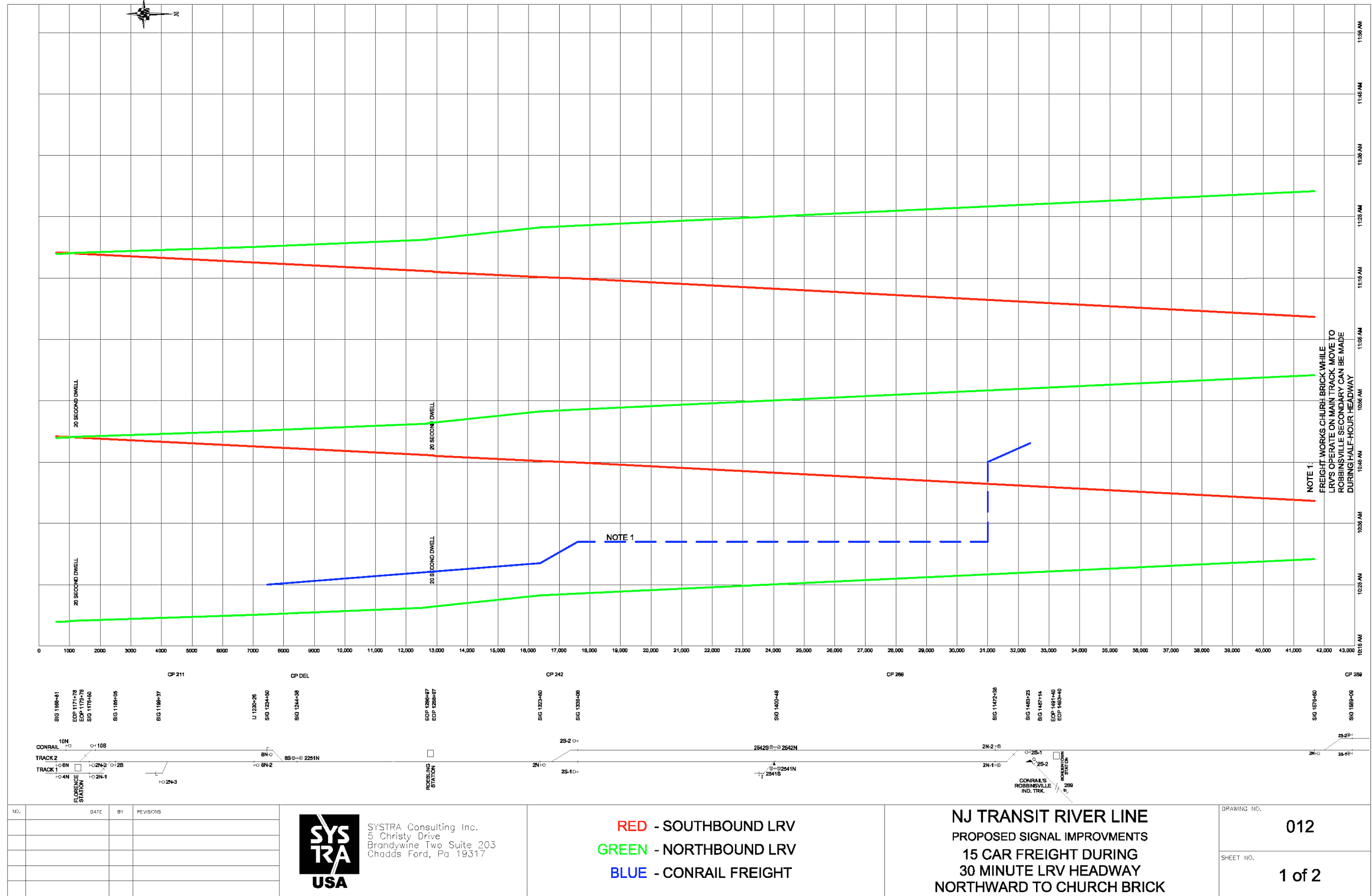
SYSTRA Consulting Inc.  
5 Christy Drive  
Brandywine Two Suite 203  
Chodds Ford, Po 19317

**SNJLRT**  
PROPOSED SIGNAL IMPROVMENTS  
**CP269 PROPOSED CONFIGURATION**  
ETS NORTH

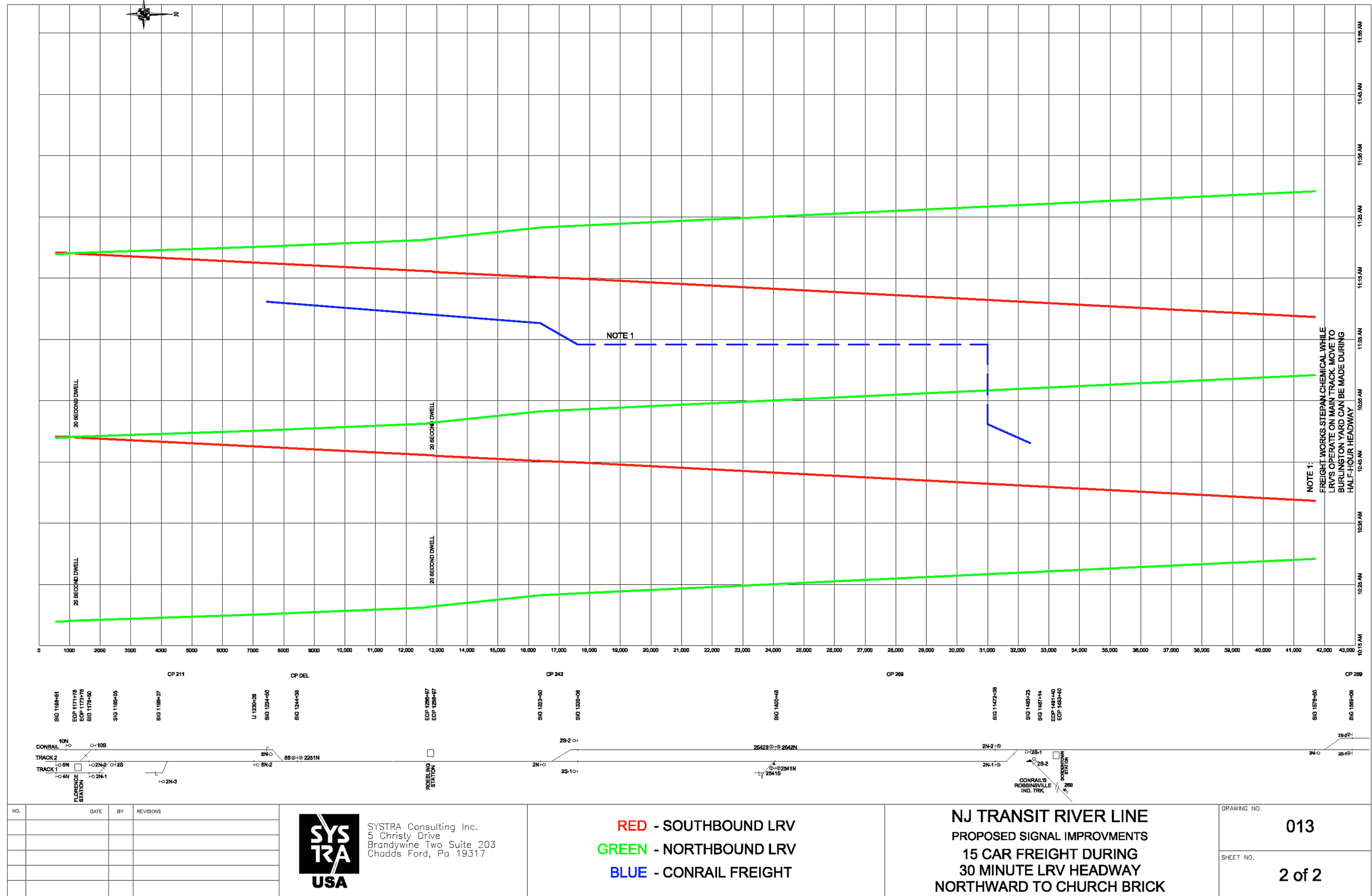
DRAWING NO.  
**011**

SHEET NO.

**Figure 36**  
Existing Signal Plans and Proposed Signal and Train Operations Design Plans for the River LINE, Burlington Division, Drawing No. 12



**Figure 37**  
Existing Signal Plans and Proposed Signal and Train Operations Design Plans for the River LINE, Burlington Division, Drawing No. 13



## APPENDIX

## F

# Shared Use Railway Operating Hazards Analysis

## Purpose

The purpose of this Operating Hazard Analysis (OHA) for shared use railways is to identify and systematically assess conditions that could potentially affect the safety of both freight and passenger rail operations.

The OHA includes the following elements:

- Identify hazards and hazardous conditions that could potentially exist; evaluate the effects of the hazards to passengers, personnel, and equipment; and define designs and criteria to eliminate, or control the identified hazards.
- Document the safety concepts incorporated during system development and provide the basis for developing plans and procedures.
- Provide a checklist against which the system design can be evaluated during preliminary and final stages of development.
- Provide a basis to assess whether more detailed safety and/or security analyses for specific project elements and subsystems are needed.

## Scope

The OHA can be performed for the following extended temporal separation elements:

- Alignment (single track, double track, sidings)
- Stations and freight sidings
- Signaling
- Communications
- EMI/EMC/RFI
- Traffic Control Systems
- Track inspection and maintenance
- System-wide

The OHA is an iterative analysis that is revised as necessary when hazards are identified, controlled, or eliminated. The OHA evaluates the system throughout its operational life. It can be used as a checklist during system reviews to ensure that relevant safety and security issues, hazards, and operational and maintenance risks are part of the review activity. Further, it can be used as a mechanism to ensure that identified hazards are tracked to closure.



The OHA is a formal safety analysis conducted in the safety program and it can be used to determine if more detailed analyses are required to mitigate the identified hazards or risk conditions.

### Methodology

The OHA consists of the following three components:

- Hazard identification
- Hazard assessment
- Hazard resolution

The methods used for identifying hazards and operational risks contained in this OHA include reviewing the design specifications and drawings and examining historical information and safety and security data from other existing systems. Where references are made to operating procedures, rules, maintenance procedures, etc., they are based on current practices, which will need to be revised or newly created to address an Extended Temporal Separation Report.

The OHA serves to establish priorities for corrective action of identified hazards; the analysis is based primarily on the potential severity of the hazard, and its probability of occurrence. These measures should be periodically re-evaluated as more information becomes available.

The methodology to resolve hazards identified in this OHA employs the following order of precedence:

1. Eliminate the existing hazard if possible.
2. Design for minimum hazard.
3. Utilize safety devices.
4. Utilize warning devices.
5. Implement procedures and training.

### Format

The format of the OHA worksheets is as follows:

- **System Element:** A major functional element of the light rail transit system.
- **Hazard Number:** A unique hazard scenario identifier used for tracking purposes.
- **Hazard Scenario Description:** A potential hazardous condition that exists, including potential causes.
- **Effect on Personnel/Transit System:** The safety effects, both minor and major, resulting from the hazard.
- **Hazard Severity:** Qualitative measure of the worst potential consequence resulting from the hazard (refer to Table 21).

- **Hazard Probability:** Qualitative measure of the hazard occurring during the planned life of the system (refer to Table 22).
- **Possible Controlling Measures and Remarks:** Actions that can be taken or procedural changes that can be made to prevent the anticipated hazardous event from occurring.
- **Resolution (Next Action):** Measures taken to demonstrate an adequate level of safety can be achieved (i.e., functional verification tests, procedure validation).

Reference: MIL-STD-882C, System Safety Program Requirements

**Table 21**

*Hazard Severity  
Categories*

Description	Category	Definition
Catastrophic	I	Death, system loss, or severe environmental damage.
Critical	II	Severe injury, severe occupational illness, or minor system damage.
Marginal	III	Minor injury, minor occupational illness, or less than minor system damage.
Negligible	IV	Less than minor injury, occupational illness, or less than minor system damage.

**Table 22**

*Hazard Probability  
Levels*

Description	Level	Specific Individual Item	Fleet or Inventory
Frequent	A	Likely to occur frequently.	Continuously experienced.
Probable	B	Will occur several times in the life of an item.	Will occur frequently.
Occasional	C	Likely to occur sometime in the life of an item.	Will occur several times.
Remote	D	Unlikely, but possible to occur in the life of an item.	Unlikely, but can reasonably be expected to occur.
Improbable	E	So unlikely, it can be assumed occurrence may not be experienced.	Unlikely to occur, but possible.

**Table 23**

OHA Worksheets

Operating Hazards Analysis			Page: <u>1</u> of _____		
System Element: <u>Alignment (Right-Of-Way)</u>			Prepared by: _____ Date: _____		
			Reviewed by: _____ Date: _____		
			Approved by: _____ Date: _____		
			Hazard Severity: I Catastrophic II Critical III Marginal IV Negligible		
Hazard Number	Hazard Scenario Description	Effect on Personnel/ Transit System	Hazard Severity/ Probability	Possible Controlling Measures and Remarks	Resolution
ALGN 1	Fire/Smoke on the alignment caused by fire/smoke adjacent to the right-of way (ROW).	Potential for fire/ smoke entry into train interior causing distress to passengers. Emergency evacuation may be required. Potential for ignition of rail car under-car equipment and subsequent interior fire. Service interruption.	III/D	Assess current train operations for responding to such incidents, including proceed/do not proceed criteria. Continue ROW maintenance procedures to minimize debris and brush build-up along alignment.	Emergency Operations Procedures (Train Operator and Control Center). Determine egress routes for passengers evacuating Train onto ROW.
ALGN 2	Fire/smoke on the alignment between 22nd Street Station due to rail vehicle fire.	Potential for fire/ smoke entry into rail vehicle interior causing distress to passengers. Emergency evacuation may be required. Service interruption.	III/D	LRV designed to preclude spread of under car equipment fire into passenger compartment. Assess current train operations for responding to such incidents.	Emergency Operations Procedures (Train Operator and Control Center). Determine egress routes for passengers evacuating LRV onto ROW.
ALGN 3	Intrusion of toxic or flammable gases and/or liquids into alignment area due to HAZMAT gas accident/spill occurring in adjacent freight yard or on freight industrial mainline.	Potential for serious injury/ death to passengers/ employees as a result of contaminated air and possible fire. Emergency evacuation is required. Service interruption.	I/D	Assess current train operation procedures for appropriate train operations during these conditions. Assess procedures for Control Center coordination. Establish plan for local emergency response.	Emergency Operations Procedures (Train Operator and Control Center). Establish coordination meetings, drill exercises and regular correspondence with local emergency response agencies and Freight Railroad.

## OHA Worksheets

Operating Hazards Analysis			Page: <u>2</u> of _____		
System Element: <u>Alignment (Right-Of-Way)</u>			Prepared by: _____ Date: _____		
			Reviewed by: _____ Date: _____		
			Approved by: _____ Date: _____		
			Hazard Severity: I Catastrophic II Critical III Marginal IV Negligible		
Hazard Number	Hazard Scenario Description	Effect on Personnel/ Transit System	Hazard Severity/ Probability	Possible Controlling Measures and Remarks	Resolution
ALGN 4	Intrusion of unauthorized person(s) onto the alignment due to absence of proper barriers, signage, etc., or disregard thereof.	Potential for severe injury/death to person/s if struck by train service interruption.	III/C	Assess whether areas of the alignment should be considered for fencing. Assess the use of track separation fences where freight/passenger tracks are 17 feet or less apart. Implement public outreach programs to enhance awareness of new extension.	Public Outreach Program safety bulletins, flyers, etc. Assess if school safety and Operation Lifesaver Programs are necessary.
ALGN 5	Collapse of track, pier structures or embankments due to inappropriate inspection/ maintenance resulting in structural deficiencies, adjacent excavation, excessive static or dynamic loads.	Potential for severe injury/multiple deaths. Possible train derailment. Track and alignment damage. System-wide service cessation.	I/E	Implement/verify correct specifications used for track, ballast and bridge structures are consistent with expected Passenger/Freight Train Operation (pier loading rating analysis and condition report performed). Perform periodic inspection and maintenance. Establish corrosion control plan and procedure for raised surfaces.	Verify controlling measures in design documents. Revise track and facilities inspection and maintenance procedures.

OHA Worksheets

<h1 style="margin: 0;">Operating Hazards Analysis</h1>			Page: <u>3</u> of _____ Prepared by: _____ Date: _____ Reviewed by: _____ Date: _____ Approved by: _____ Date: _____										
System Element: <u>Alignment (Right-Of-Way)</u>			Hazard Severity: <table style="margin-left: 20px; border-collapse: collapse;"> <tr><td style="padding-right: 10px;">I</td><td>Catastrophic</td></tr> <tr><td>II</td><td>Critical</td></tr> <tr><td>III</td><td>Marginal</td></tr> <tr><td>IV</td><td>Negligible</td></tr> </table>			I	Catastrophic	II	Critical	III	Marginal	IV	Negligible
I	Catastrophic												
II	Critical												
III	Marginal												
IV	Negligible												
Hazard Number	Hazard Scenario Description	Effect on Personnel/ Transit System	Hazard Severity/ Probability	Possible Controlling Measures and Remarks	Resolution								
ALGN 6	Collapse or washout of alignment due to flooding, gradual soil erosion, or embankment collapse.	Potential for severe injury/multiple deaths. Possible train derailment. Track and alignment damage. System-wide service cessation.	I/E	Perform periodic inspection and maintenance of culverts, etc. Survey and map alignment. Identify areas susceptible to soil erosion or collapse, and provide measures to protect the alignment in these locations.	Verify controlling measures in design documents. Revise track and facilities inspection and maintenance procedures.								
ALGN 7	Encroachment of freight railroad equipment due to improper operation, shifted loads, or derailment on adjacent tracks.	Potential for severe injury/multiple deaths Possible Passenger Train derailment. Track and alignment damage. Service interruption.	I/D	Relocation of adjacent railroad (passenger/freight) minimizes the possibility of freight equipment encroachment. Installation of Intrusion Detection System (IDS) – physical fence along the alignment where track spacing is 17 feet or less enables detection of shifted loads or physical encroachment of freight equipment.	Establish operational procedures to address IDS notification. Establish notification protocols between passenger and freight railroad to address issues of encroachment. Establish inspection and maintenance regimen for IDS.								

OHA Worksheets

Operating Hazards Analysis			Page: <u>4</u> of _____										
System Element: <u>                    Signaling                    </u>			Prepared by: _____ Date: _____ Reviewed by: _____ Date: _____ Approved by: _____ Date: _____										
			Hazard Severity: <table style="margin-left: 20px; border: none;"> <tr><td>I</td><td>Catastrophic</td></tr> <tr><td>II</td><td>Critical</td></tr> <tr><td>III</td><td>Marginal</td></tr> <tr><td>IV</td><td>Negligible</td></tr> </table>			I	Catastrophic	II	Critical	III	Marginal	IV	Negligible
			I	Catastrophic									
II	Critical												
III	Marginal												
IV	Negligible												
Hazard Number	Hazard Scenario Description	Effect on Personnel/ Transit System	Hazard Severity/ Probability	Possible Controlling Measures and Remarks	Resolution								
SIG 1	Loss of or incorrect wayside signal aspects due to failure of signaling component or equipment failure.	Potential for train collision and/or derailment. Potential for serious injury/death to passengers and employees. Track/property damage. Service interruption. cessation.	I/D	Loss of wayside signaling is minimized by the use of redundant vital components, which if failed would be in the most restrictive state. Wayside signals are placed at safe braking distances from the fouling points of switches. In the immediate loss of wayside signals, the signal system enables a safe state to be met via existing train detection, movement authority and route security parameters.	Verify during signal design review, final installation and cutover with existing signal systems. Assess whether a Failure Mode Effects Analysis (FMEA) for signaling hardware/software is required, or that existing safety analysis is sufficient to qualify by similarity.								
SIG 2	Loss of or incorrect wayside signal aspects due to vandalism of signaling equipment.	Potential for train collision and/or derailment. Potential for serious injury/death to passengers and employees. Track/property damage.	I/D	Signaling equipment housings, cases, and junction boxes fabricated of steel and/or aluminum construction with locking panels to prevent inadvertent entry.	Verify signal design, final installation and cutover into existing system.								

OHA Worksheets

<h1 style="text-align: center; background-color: #1a3d4d; color: white; padding: 10px;">Operating Hazards Analysis</h1>			Page: <u>5</u> of _____		
			Prepared by: _____ Date: _____ Reviewed by: _____ Date: _____ Approved by: _____ Date: _____		
System Element: <u>                    Signaling                    </u>			<b>Hazard Severity:</b> I     Catastrophic II    Critical III   Marginal IV    Negligible		
Hazard Number	Hazard Scenario Description	Effect on Personnel/ Transit System	Hazard Severity/ Probability	Possible Controlling Measures and Remarks	Resolution
SIG 3	Loss of block detection capability due to component or equipment failure.	Loss of block detection capability due to component or equipment failure.	I/D	Loss of block detection capability will be minimized by use of track circuits with redundant vital functions. The Control Center will automatically be updated with local block information corresponding to train location and can make available to the operator if required. Fail-safe design will be implemented to ensure that train presence in a section will be maintained if a train is actually in the section, and that the route stays locked.	Operations/Maintenance inspection/test procedures.



OHA Worksheets

<h1 style="margin: 0;">Operating Hazards Analysis</h1>			Page: <u>6</u> of _____ Prepared by: _____ Date: _____ Reviewed by: _____ Date: _____ Approved by: _____ Date: _____										
System Element: <u>                    Signaling                    </u>			Hazard Severity: <table style="margin-left: 20px; border-collapse: collapse;"> <tr><td style="padding-right: 10px;">I</td><td>Catastrophic</td></tr> <tr><td>II</td><td>Critical</td></tr> <tr><td>III</td><td>Marginal</td></tr> <tr><td>IV</td><td>Negligible</td></tr> </table>			I	Catastrophic	II	Critical	III	Marginal	IV	Negligible
I	Catastrophic												
II	Critical												
III	Marginal												
IV	Negligible												
Hazard Number	Hazard Scenario Description	Effect on Personnel/ Transit System	Hazard Severity/ Probability	Possible Controlling Measures and Remarks	Resolution								
SIG 4	Signal violation by Train Operator due to lack of visibility, misinterpreted aspect, fatigue, etc.	Injuries/death to passengers and employees resulting from derailment or collision. Track and/or property damage. Service interruption.	IIC	Wayside signals provided to enable a clear distinction of their aspects at both close and long ranges. Trains have windshield wipers/washer and defrost mechanisms. Aspects to be used are standard signal convention and rail operating rules to minimize confusion to a train operator. Operator schedules are required to reflect adequate layover time.	Utilize and enforce operational rules and regulations. Continue to update Operating Plan as required.								
SIG 5	Disregard of or inability to slow or stop train within signalized section as required.	Potential for serious injuries/death to passengers and employees resulting from derailment or collision. Track and/or property damage. Service interruption.	II/D	Utilize positive stop enforcement. Trains passing a restrictive (RED) signal will be automatically tripped stopped or derailed before the danger point is reached, consistent with the allowed speed for that section.	Verify during signal design, installation and cutover with existing system.								

OHA Worksheets

<h1 style="text-align: center; background-color: #1a3d4d; color: white; padding: 10px;">Operating Hazards Analysis</h1>			Page: <u>7</u> of _____		
			Prepared by: _____ Date: _____ Reviewed by: _____ Date: _____ Approved by: _____ Date: _____		
System Element: <u>Communications</u>			<b>Hazard Severity:</b> I Catastrophic II Critical III Marginal IV Negligible		
Hazard Number	Hazard Scenario Description	Effect on Personnel/ Transit System	Hazard Severity/ Probability	Possible Controlling Measures and Remarks	Resolution
COM 1	Loss of, or degraded radio communications between train (passenger or freight) and Control Center due to power interruption, component failure, RFI, etc.	Control Center unable to assess abnormal or emergency conditions. Train operator unable to advise Control Center of service delay, system emergency.  Service interruption. cessation.	IIC	Current Control Center facilities have UPS and backup capability. Train radios equipped with multiple communications channels to minimize loss of voice communications should a single channel fail.	Require an RF coverage analysis along the right-of-way. Perform radio test along entire alignment.
COM 2	Loss of monitoring capability and supervisory control at the Control Center due to external events (fire, intrusion), or accidental damage during maintenance actions.	Failure to detect and advise system operations of unsafe conditions in a timely manner. Potential for serious injury/death and equipment damage.	II/C	Provide supervised system with provisions for routine checks. Control Center is designed in accordance with and the equipment will be installed in compliance with applicable codes to address electrical hazards associated with structures used in this manner.	Provide a back-up control facility or dispatch maintenance personnel to field locations for local control of operations.

OHA Worksheets

<h1 style="text-align: center; background-color: #1a3d4d; color: white; padding: 10px;">Operating Hazards Analysis</h1>			Page: <u>8</u> of _____		
			Prepared by: _____ Date: _____ Reviewed by: _____ Date: _____ Approved by: _____ Date: _____		
System Element: <u>Communications</u>			<b>Hazard Severity:</b> I Catastrophic II Critical III Marginal IV Negligible		
Hazard Number	Hazard Scenario Description	Effect on Personnel/ Transit System	Hazard Severity/ Probability	Possible Controlling Measures and Remarks	Resolution
COM 3	Ineffective and/or incorrect information provided in the event of a rail transit or rail freight emergency by TFC and CONRAIL dispatchers.	Potential to inadvertently dispatch trains into incident area. Potential for injury to passengers dependent on the type of rail freight emergency (e.g., chemical spill). Potential for compromising egress time for passengers from train if required. Service disruption.	IIC	Establish operations procedure between Freight and Passenger Systems (to be used in the event of emergencies affecting both transportation modes along adjacent right-of-way). Continue emergency incident notification protocols between.	Review emergency procedures. Consider incident scenarios to be included in emergency drills or exercises.
COM 4	Lack of, or delayed response to rail transit or rail freight emergency incidents (because of common communications frequency/channels), with emergency responders resulting in passenger, employee, or public injuries.	Potential for injury/ death to passengers in the event poor/ loss of communications results in delayed emergency response when required.	II/D	Law enforcement and emergency services personnel along railway corridor utilize specified radio channels to communicate in the event of an emergency, and follow predefined protocols.	Review Freight and Passenger emergency response protocols for system to ensure a state of readiness in emergencies.

OHA Worksheets

<h1 style="margin: 0;">Operating Hazards Analysis</h1>			Page: <u>9</u> of _____ Prepared by: _____ Date: _____ Reviewed by: _____ Date: _____ Approved by: _____ Date: _____										
System Element: <u>Track Inspection and Maintenance</u>			Hazard Severity: <table style="margin-left: 20px; border-collapse: collapse;"> <tr><td>I</td><td>Catastrophic</td></tr> <tr><td>II</td><td>Critical</td></tr> <tr><td>III</td><td>Marginal</td></tr> <tr><td>IV</td><td>Negligible</td></tr> </table>			I	Catastrophic	II	Critical	III	Marginal	IV	Negligible
I	Catastrophic												
II	Critical												
III	Marginal												
IV	Negligible												
Hazard Number	Hazard Scenario Description	Effect on Personnel/ Transit System	Hazard Severity/ Probability	Possible Controlling Measures and Remarks	Resolution								
INSP 1	Broken rail resulting in a derailment .	Serious injury or death to passengers/ employees. Major equipment and infrastructure damage. Service outage.	I/C	Ensure rail and fastening systems are in accordance with FRA and Industry Standards for and track equipment wheel loads. Perform welding, heat stressing and broken rail detection inspections using certified procedures. Ensure rail and welds meet specifications via QA/QC procedures.	Monitor and review rail inspection and maintenance procedures. Perform inspection of all welds by qualified personnel.								
INSP 2	Unstable track due to improper track bed design, poor installation and maintenance, water seepage, resulting in derailment of LRV/ LRVs.	Serious injury or death to passengers/ employees. Major equipment and infrastructure damage. Service outage.	I/D	Design and test in accordance with FRA, AREMA and ASTM criteria. Inspection and maintenance procedures to include assurance of track system stability. Employ track geometry car periodically and perform service inspections. Rulebook and SOP require Train Operator to report any perceived changes in ride quality. Walking inspections of alignment.	Continuous review rail inspection and maintenance procedures. Verification via design reviews and testing. Continuous review of SOPs and Train Operation Rule-books.								

OHA Worksheets

Operating Hazards Analysis			Page: <u>10</u> of _____		
System Element: <u>Track Inspection and Maintenance</u>			Prepared by: _____ Date: _____		
			Reviewed by: _____ Date: _____		
System Element: <u>Track Inspection and Maintenance</u>			Approved by: _____ Date: _____		
			Hazard Severity: I Catastrophic II Critical III Marginal IV Negligible		
Hazard Number	Hazard Scenario Description	Effect on Personnel/ Transit System	Hazard Severity/ Probability	Possible Controlling Measures and Remarks	Resolution
INSP 3	Overgauge (spread rail) conditions due to improperly installed rail fasteners. Poor inspection and maintenance. Rail stress due to excessive speed, or train and track equipment weight. Rail expansion (kinks) due to prolonged periods of high temperature.	Derailment of freight or passenger train; serious injury/death to passengers and employees. Service disruption.	I/C	Test and certify completed rail fastening system to assure compliance to FRA and Industry Standards. Perform rail destressing in accordance with specifications for rail type, weather conditions, welding processes, etc. Inspection and maintenance procedures and QA/QC control system to verify.	Perform installation, inspection and testing. Monitor and review Rulebook and Inspection and Maintenance Procedures.
INSP 4	Worn rail due to rail hardness being less than required, poor inspection and maintenance procedures, inadequate design (e.g., superelevation), poor rail/wheel interface.	Derailment of train, serious injury/death to passengers and employees. Service disruption.	I/C	Assure that specified rail hardness, wheel rail interface, and rail geometry profiles are achieved. Monitor inspection and testing to assure proper construction and rail profiles. Inspection and maintenance procedures to include assurance of minimum acceptable rail profiles.	Verification during final installation, inspection and test. Monitor and review rulebook, and inspection and maintenance procedures.

OHA Worksheets

<h1 style="margin: 0;">Operating Hazards Analysis</h1>	Page: <u>11</u> of _____
	Prepared by: _____ Date: _____
	Reviewed by: _____ Date: _____
	Approved by: _____ Date: _____

<b>System Element:</b> <u>Track Inspection and Maintenance</u>	<b>Hazard Severity:</b> <ul style="list-style-type: none"> <li>I Catastrophic</li> <li>II Critical</li> <li>III Marginal</li> <li>IV Negligible</li> </ul>
--	--

Hazard Number	Hazard Scenario Description	Effect on Personnel/ Transit System	Hazard Severity/ Probability	Possible Controlling Measures and Remarks	Resolution
INSP 5	Inadequate wheel/rail adhesion due to wet leaves or oil/grease on rail compromising train braking performance.	Vehicle design and operational braking distance cannot be achieved, resulting in possible collision, derailment, injury/death, equipment damage, and service disruption	I/C	Verify braking performance along the alignment. Minimize tree and shrub growth adjacent to tracks. Conduct periodic maintenance of way-side foliage. Require Train Operator to contaminants on the rail, leaves etc., and to operate at a lower speed under these conditions.	Review safe braking test reports. Performance tests over alignment. Monitor and review SOPs, Rulebook, and inspection and maintenance procedures.
INSP 6	Improper or unobserved track switch operation due to poor visibility, or improper remote switch actuation.	Derailment, injury/death, equipment damage, and service disruption.	I/C	Ensure that design of train control/signaling system positively locks track switch upon correct route on approach of train. Position line of sight signals, if required, to ensure they are clearly visible to the Train Operator of an approaching train. Maintain signals to ensure aspects are in working order.	Assure that signal layout is correct along all alignment sections. Monitor and review SOPs, Rulebook, and inspection and maintenance procedures.

OHA Worksheets

<h1 style="margin: 0;">Operating Hazards Analysis</h1>			Page: <u>12</u> of _____ Prepared by: _____ Date: _____ Reviewed by: _____ Date: _____ Approved by: _____ Date: _____										
System Element: <u>System-Wide</u>			Hazard Severity: <table style="margin-left: 20px; border-collapse: collapse;"> <tr><td>I</td><td>Catastrophic</td></tr> <tr><td>II</td><td>Critical</td></tr> <tr><td>III</td><td>Marginal</td></tr> <tr><td>IV</td><td>Negligible</td></tr> </table>			I	Catastrophic	II	Critical	III	Marginal	IV	Negligible
I	Catastrophic												
II	Critical												
III	Marginal												
IV	Negligible												
Hazard Number	Hazard Scenario Description	Effect on Personnel/ Transit System	Hazard Severity/ Probability	Possible Controlling Measures and Remarks	Resolution								
SYS 1	Trespassers along the alignment.	Potential for serious injury/death to trespassers if struck by trains or track inspection/maintenance equipment.	II/C	New alignment segment will be evaluated for fencing requirements. No Trespassing signs will be posted in track alignment and adjacent areas to warn of presence of trains.	Perform inspection of alignment to verify placement of posted signs.								
SYS 2	Personnel or equipment on track, or in close proximity of track during operating hours due to repair/maintenance activities in progress.	Potential for serious injury/death to worker/s if struck by Train or track inspection /maintenance equipment.	II/C	All work on the right-of-way to be performed in accordance with the safety rules of the operating railroad company (i.e., Rail Employee On-Track Safety Procedures).	Monitor and review procedures for work on the ROW. Conduct Job Safety Briefings prior to all work in the vicinity of the ROW.								
SYS 3	Threats (e.g., bomb) via telephone or letter (these may be real or hoax).	Service interruption. Passenger and employee fear. Potential for decreased.	II/D	Threat calls made to the Control Center are managed in accordance with established procedures. The System Security Plan for Operations identifies contingencies to be taken, and coordination of law enforcement agencies.	Train worker staff and supervisors in procedures to be followed, and immediate reporting to law enforcement officials.								



OHA Worksheets

Operating Hazards Analysis			Page: <u>13</u> of _____ Prepared by: _____ Date: _____ Reviewed by: _____ Date: _____ Approved by: _____ Date: _____		
System Element: <u>System-Wide</u>			Hazard Severity: <ul style="list-style-type: none"> <li>I Catastrophic</li> <li>II Critical</li> <li>III Marginal</li> <li>IV Negligible</li> </ul>		
Hazard Number	Hazard Scenario Description	Effect on Personnel/ Transit System	Hazard Severity/ Probability	Possible Controlling Measures and Remarks	Resolution
SYS 4	Sabotage by disgruntled employees.	Potential for serious injury/death to passengers/employees/public. Property damage.	I/D	Minimize potential by requiring prompt management attention to grievances raised. Promote alertness on the part of supervisory and worker staff. Limit access to critical areas to authorized personnel.	Minimize potential by requiring prompt management attention to grievances raised Promote alertness on the part of supervisory and worker staff Limit access to critical areas to authorized personnel.
SYS 5	Revenue service disruption due to adverse weather conditions, (i.e., flooding, blizzard, high winds, hurricane, etc.).	Potential for system delays, stranded trains. Potential for situation requiring evacuation of passengers.	III/C	Develop criteria defining adverse weather operations including identifying when operations should be suspended. Some passenger vehicles are equipped with sanding systems to assist wheel traction in these conditions. Most passenger vehicles have a low cg, thus having a high degree of stability/resistance to overturning moments caused by high winds. Elevated track sections are evaluated to assess vehicle operational limits when exposed to high wind conditions.	Continuous monitoring and review of SOPs, EOPs. Review coordination protocols between railway agencies and local emergency response agencies.

## References

- Booz | Allen | Hamilton, Jacobs Edwards & Kelcey, ICF Consulting, New Jersey Institute of Technology. TCRP Report 130, “Shared Use of Railroad Infrastructure with Noncompliant Public Transit Rail Vehicles: A Practitioner’s Guide,” TRB, National Research Council, Washington, D.C., 2009.
- Fazio, A. E., and A. R. Troup. “A New View of Shared Use.” *Railway Age*, October 2007.
- Fazio, A. E., A. R. Troup, and B. Hodgeson. “Signalization for Advanced Concepts of Temporal Separation.” *Railway Age 2011 C&S Buyer’s Guide*, 2011.
- Federal Railroad Administration and Federal Transit Administration. “Statement of Agency Policy Concerning Jurisdiction Over the Safety of Railroad Passenger Operations and Waivers Related to Shared use of the Tracks of the General Railroad System by Light Rail and Conventional Equipment.” *Federal Register*, Vol. 65, No. 132, 2000, pp. 42525–42528.
- Federal Railroad Administration. “Shared Use of the Tracks of the General Railroad System by Conventional Railroads and Light Rail Transit Systems—Notice and Final Rule.” *Federal Register*, Vol. 65, No. 132, 2000, pp. 42529–42553.
- “Interurban.” (2011, March 24). In *Wikipedia, The Free Encyclopedia*. Retrieved April 18, 2011, from <http://en.wikipedia.org/wiki/Interurban>.
- Phraner, D., R. Roberts, P. Stangas, K. Korach, J. Shortreed, and G. Thompson. TCRP Report 52, “Joint Operation of Light Rail Transit or Diesel Multiple Unit Vehicles with Railroads.” TRB, National Research Council, Washington, D.C., 1999.
- Phraner, D. “Supplementing and Updating TCRP Report 52: Joint Operation of Light Rail Transit or Diesel Multiple Unit Vehicles with Railroads Issue,” *TCRP Research Results Digest 43*, TRB, National Research Council, Washington, D.C., 2001.
- Phraner, D. “Germany’s Track Sharing Experience: Mixed Use of Rail Corridor.” *TCRP Research Results Digest 47*, TRB, National Research Council, Washington, D.C., 2002.



U.S. Department of Transportation  
**Federal Transit Administration**

---

U.S. Department of Transportation  
Federal Transit Administration  
East Building  
1200 New Jersey Avenue, SE  
Washington, DC 20590  
<http://www.fta.dot.gov/research>