

**NASA
Reference
Publication
1075**

April 1982

Magnetic Tape Recording for the Eighties

CASE FILE
COPY

NASA



**NASA
Reference
Publication
1075**

April 1982

Magnetic Tape Recording for the Eighties

Ford Kalil, *Editor*
Goddard Space Flight Center
Greenbelt, Md.

Sponsored by
Tape Head Interface Committee

NASA

National Aeronautics
and Space Administration

**Scientific and Technical
Information Branch**

List of Contributors

Hal Book, *formerly of Bell & Howell*
Al Buschman, *Naval Intelligence Support Center*
Tom Carothers, *National Security Agency*
Vincent Colavitti, *Lockheed-California Co.*
R. Davis, *EMI Technology, Inc.*
Larry Girard, *Honeywell, Inc.*
Frank Heard, *formerly with National Security Agency, now retired*
Finn Jorgensen, *DANVIK*
Ford Kalil, *NASA Goddard Space Flight Center*
Jim Keeler, *National Security Agency*
James Kelly, *Ampex Corp.*
Avner Levy, *Advanced Recording Technology*
Dennis Maddy, *Goddard Space Flight Center*
M. A. Perry, *Ashley Associates Ltd.*
Sanford Platter, *Platter Analysis and Design*
Joe Pomian, *CPI*
William Sawhill, *Ampex Corp.*
Herbert M. Schwartz, *RCA*
Garry Snyder, *Ampex Corp.*
Ken Townsend, *National Security Agency*
J. B. Waites, *General Electric Co.*
Dale C. Whysong, *BOW Industries, Inc.*
Don Wright, *IIT Research Institute*

Library of Congress Cataloging in Publication Data

Main entry under title:

Magnetic tape recording for the eighties.

(NASA reference publication ; 1075)

Includes bibliographical references and index.

1. Magnetic recorders and recording. I. Kalil, Ford, 1925- . II. Series.

TK7881.6.M26 621.389'324 82-6431
AACR2

Preface

This book deals with both the practical and theoretical aspects of state-of-the-art magnetic tape recording technology. Topics covered include the following:

- (1) Tape and head wear
- (2) Wear testing
- (3) Magnetic tape certification
- (4) Care, handling, and management of magnetic tape
- (5) Cleaning, packing, and winding of magnetic tape
- (6) Tape reels, bands, and packaging
- (7) Coding techniques for high-density digital recording
- (8) Tradeoffs of coding techniques

The chapters in this book are devoted to detailed discussions and/or analyses of these topics, especially as they might affect the serious business, technical, or scientific user of magnetic tape. The contributors are the foremost experts in this country.

Users and would-be users of magnetic tape recording will find this book helpful, and, in many cases, essential. This includes individuals as well as organizations—students, technicians, engineers, scientists, educators, libraries, colleges and universities, laboratories, Government, military, and industry.

This book was prepared as an activity of the Tape Head Interface Committee (THIC), a professional “society” that cohosts its meetings with the American National Standards Institute (ANSI) and the Inter-Range Instrumentation Group (IRIG).

Ford Kalil
NASA Goddard Space Flight Center

Acknowledgments

As editor, I wish to acknowledge the assistance of the entire Tape Head Interface Committee and the Steering Committee for their many helpful comments and suggestions. In particular, I wish to thank A. Buschman who served as assistant editor and chapter chairman of chapter 4; each of the chapter chairmen, who authored their chapters in large part from papers presented at THIC meetings; Don Wright who has been President of THIC for the past three terms and who has provided much useful information and assistance; Linda Fredericks, Don Wright's secretary, who has done so very much in the way of typing and mailings; Greg Purdom, past Secretary of THIC for two terms, who helped me gather and catalog the materials and papers presented at THIC meetings; William Poland of NASA, President of ANSI, for his generous assistance; Donald Tinari of the Goddard Space Flight Center Data Evaluation Laboratory, J. L. Perry of NASA, and Taylor Pilkin and J. T. Smith of Bendix, who all assisted in obtaining photographs for some of the figures; and various people behind the scenes at the contributing organizations without whose help this book could not have been published.

Ford Kalil
NASA Goddard Space Flight Center

Contents

<i>Chapter</i>		<i>Page</i>
1	INTRODUCTION <i>Ford Kalil</i>	1
2	TAPE AND HEAD WEAR..... <i>James J. Kelly</i>	7
3	WEAR TESTING <i>Avner Levy</i>	23
4	MAGNETIC TAPE CERTIFICATION <i>Al Buschman</i>	35
5	CARE, HANDLING, AND MANAGEMENT OF MAGNETIC TAPE..... <i>J. B. Waites</i>	45
6	CLEANING, PACKING AND WINDING OF MAGNETIC TAPE..... <i>R. Davis</i>	61
7	TAPE REELS, BANDS, AND PACKAGING <i>Ken Townsend</i>	77
8	HIGH-DENSITY RECORDING..... <i>Finn Jorgensen</i>	85
9	TRADEOFFS OF RECORDING TECHNIQUES <i>M. A. Perry</i>	99
10	INTRODUCTION TO HIGH-DENSITY DIGITAL RECORD- ING SYSTEMS..... <i>M. A. Perry</i>	107
	Appendix A—THE EVOLUTION OF HIGH-DENSITY DIG- ITAL TAPE..... <i>Garry Snyder</i>	123
	Appendix B—A CARE AND HANDLING MANUAL FOR MAGNETIC TAPE RECORDING <i>Care and Handling Committee of THIC (Chairman: Frank Heard)</i>	127
	Appendix C—GLOSSARY <i>Herbert M. Schwartz, Joe Pomian, and Sanford Platter</i>	149
	INDEX	163

CHAPTER 1

Introduction

Ford Kalil
NASA Goddard Space Flight Center

Much has been written that touches on the history and development of magnetic tape recording (refs. 1-1 to 1-15). Hence, very little will be said about that here. Only some of the more salient points of magnetic tape recording technology will be discussed here, in particular as they may relate to subsequent chapters in this book, to provide the reader with a proper perspective.

Magnetic recording is a blend of many disciplines, including but not limited to the sciences of mechanics, sound, video, telemetry, plastics, lubricants, ceramics, magnetics, and electronics. The state of the art in these disciplines as pertains to magnetic recording has been continually advancing to keep pace with increasing requirements and applications. It is expected that this will continue to be the case.

The magnetic tape recorder/player (reproducer) is a complex electromechanical system. It involves, basically, a magnetic tape on reels or cassettes; tape drives; magnetic heads for erasing, recording, and reproducing; and associated electronics. These subsystems must be precise, durable, and maintainable. The tape drive must be precise to maintain the proper tension in the magnetic tape to minimize tape flutter and other mechanical distortions of the tape, which distort the recording and/or damage the tape. The magnetic recording and playback heads must be precise and accurately aligned to permit recording on one machine and undistorted playback on another.

Magnetic tape recording technology has evolved over the years from the recording of relatively low fidelity audio to the recording of high fidelity audio, video, analog signals (at relatively low frequencies at first and then to frequencies in the range of a few megahertz), and digital data on multitrack machines at bit rates approaching 1 Gb/s.

The technology has advanced from recording digital signals at low bit rate (serial bit streams of a few kilobits per second) on one track to multitrack recording of bit streams at 1 Gb/s. To accomplish this, a serial bit stream is electronically converted to a parallel bit stream in the recording process and then converted back to the original serial bit stream during playback, with each of the bits in

its proper place in the bit sequence. Thus, even though the original bit stream may have been coded, formatted, and fitted with overhead bits to identify the source of data, time at which the data were acquired, and/or destination of the data, the recorder must also code the data in its serial-to-parallel bit conversion process. Furthermore, because of the high data rates, the frequency response of the recording/playback system dictates that direct recording with unique code(s) to minimize the dc content be used in lieu of frequency modulation (FM) recording to take advantage of the entire passband/bandwidth of the system. In FM recording, the data are first frequency modulated onto a carrier the frequency of which is at the center of the recording system bandpass. Thus, only half of the bandpass is used. FM recording was originally developed and used to overcome the poor system response to the lower frequencies (0 to about 400 Hz), which was experienced during direct recording. Hence, to return to direct recording of digital data to take advantage of the full passband, techniques had to be developed to overcome the poor response at the lower frequencies. The poor response is eliminated by coding the bit stream to decrease the amount of energy at the lower frequencies; i.e., to minimize the occurrence of bit sequences of only "1" or only "0" values. Such sequences correspond to a dc signal for the duration of the sequence, which increases the energy at the lower frequency end of the power spectrum. The objective is to minimize such long sequences by essentially randomizing the occurrences of "1" and "0" values by a coding technique during the recording process and still retain the capability to efficiently derandomize the data in the playback mode. These randomizing codes, which are inserted by the recording system, should not be confused with other codes that may be inherent in the incoming bit stream.

In the art of high-density digital recording, several codes may be involved. First, in the process of digitizing the analog signal at the data source, the analog signal is sampled at regular and frequent intervals. Typically, in the analog to digital (A/D) conversion process, the analog signal is sampled at a sampling rate slightly higher than

twice the maximum frequency present in the signal. Then each sample is coded with a binary code of "1" and "0" values called bits. This code, usually called a word, tells the amplitude of the sample. The general technique of coding is called pulse code modulation (PCM).

There are other code words inserted into the data stream of bits (called a bit stream) to block out a frame of words analogous to a page of words in a book. These code words, called frame synchronization (or just frame sync) words, tell the page number, so to speak, and enable one to detect the beginning of the sequence of coded bits and to decipher the code in a subsequent digital to analog (D/A) conversion process. That is, the frame sync words are needed in the deciphering process to tell which bit is the beginning of a word and which word is the beginning of a frame or page.

In addition, there may be other code words inserted at the beginning of each frame to identify the source and destination of the data. Still other codes may be used to assist a decipherer in correcting bit errors caused by (or due to) the transmission process. Consider the case of a satellite carrying a number of experiments, and transmitting via radio waves the experimental data to one of a number of ground stations in a worldwide network of ground stations. The ground station in turn transmits the received data via ground communications, such as telephone lines and/or microwave links, to a central network operations control center. The control center may be receiving data from several ground stations simultaneously. The telecommunications center then routes the data to the proper satellite control center. Eventually, the data must be sorted out and identified according to experiment, time, and the spacecraft location and orientation at the time the data were taken. Hence, one can see that several codes or code words may be added to the data. Words or codes that are added to the data are sometimes referred to as overhead. In this example, code words may be inserted by the spacecraft to identify the spacecraft, the experiment, and perhaps spacecraft orientation and/or the time when the measurement (experimental data) was taken. The ground station(s) could also insert code words to identify the station and the time at which the data were received and the destination of the data.

In addition, magnetic tape recorders are generally used at several points and/or interfaces of the telecommunication process, such as in the spacecraft to record data for subsequent transmission to a ground station, at the ground station, at the network control center, at the spacecraft operations control center, at the data processing center, by the experimenter(s), and by the archiving center.

In the spacecraft, data may be recorded for subsequent transmission to a ground station because the spacecraft may not be in view of a ground station at the time the data are obtained. In this case, the data may be recorded at a slow speed and played back to the ground station at a

higher speed, because of the relatively short contact time with the ground station. The ground station may record the data at predetection and postdetection points to insure that data are not lost.

In some cases where the data are received in analog form, the ground station may digitize and code the data, as in the case of the SEASAT mission.

In other cases, as in the Apollo mission, several measurements were received in digital and coded form. The different types of data, such as astronaut heartbeat, blood pressure, cabin temperature, and pressure, were separately recorded on different Inter-Range Instrumentation Group (IRIG) subcarriers and then onto different tracks of a multitrack recorder. The ground station was required to extract essential data, such as astronaut heartbeat and blood pressure, for immediate real-time transmission to the control center because at that time the ground transmission links did not have enough bandwidth to accommodate all the data. Subsequently, all the data could be played back at a rate lower than the recording rate to match the ground transmission link capacity and transmitted to the control center.

More than one IRIG subcarrier modulated with data may be recorded onto one track of a multitrack recorder, provided one stays within the recorder bandwidth. There are 16 standard IRIG subcarriers, so a total of $16R$ different types of data could be recorded on one magnetic tape recorder, where R is the number of tracks. During the days of the Apollo manned space program, 7- and 14-track recorders were common, so that as many as 16×14 or 224 different data streams could be recorded simultaneously on one recorder. In fact, recently all the recorder tracks and IRIG subcarriers were used to record a large variety of data during test firings to measure the effects of the Space Shuttle solid rocket booster plume on the Space Shuttle telecommunications links (refs. 1-16 and 1-17).

At the data processing center, data are received from a number of recorders, at different spacecraft ground stations, and a variety of space experiments. The data for each space experiment are then extracted according to magnetic tape time sequence and merged and recorded along with the time, the spacecraft altitude, and location that correspond to the measured data. Generally, the recorded data are archived and copies are sent to the scientist/experimenter for analysis, evaluation, and reporting. In this process, the scientist may play back the data many times, at slower and/or faster speeds. The magnetic tape recorder permits the experimenter to do this without damaging the recorded data.

Furthermore, the reels of the magnetic tape that have served their purpose in this complex structure of data retrieval may then be demagnetized, rehabilitated, and/or recertified for repeated use.

In any event, it is clear that the magnetic tape recorder is

a complex, very accurate, yet a versatile and veritable workhorse. J. Pelant (ref. 1–18) has referred to the magnetic tape recorder as an unsung hero.

The complex hierarchy of coding and decoding can challenge the ingenuity of the most skilled professionals. The repeated use of the magnetic tape and also the recording/reproducing magnetic head with the resulting wear and tear require a durability that taxes the manufacturing state of the art.

The close packing of bits, the ability to crossplay between recorders (record on one and reproduce/play-back on another), the required record/reproduce head alignment, and the required tape-to-head alignment impose stringent mechanical tolerances that test the mettle of even the most skilled machinists.

The record and reproduce heads are milled to an accuracy on the order of millionths of an inch, and are designed to maintain these tolerances over a range of environments from laboratory use to instrumental aircraft and spacecraft. Yet the magnetic tape recorders are the most cost-effective general data storage and retrieval medium available today.

Furthermore, the high data rates approaching 1 Gb/s, the information explosion (data retrieval, storage, and archiving), and the required bit packing densities (33 kb/in. and perhaps 66 kb/in. per track) will require, in most instances, nearly perfect magnetic tape. Otherwise the microscopic holes and bumps in the magnetic material of the tape could cause intolerable dropouts of signal and an accompanying loss of bits of information.

At first glance it would appear that a magnetic tape is somewhat shrouded in mystery. For instance, oxide particles, the magnetic material that stores data on the tape, are by nature an abrasive substance. To efficiently transfer data from and to recorder/reproducer heads, the tape must make physical contact. Abrasive contact with any material, including dirt and dust as well as the magnetic oxide particles on the tape, tends to destroy the effectiveness of the head. Even with normal use, the tape heads must be replaced periodically. The technical ingenuity of the tape manufacturers with their secret formulas of elasticizers, lubricants, polishing agents, and manufacturing techniques has constantly extended useful life, from hundreds of hours in the 1950's to thousands of hours in nonspacecraft use (i.e., open environment) and many thousands of hours in spacecraft use (closed environment). One well-known tape manufacturer advertises that a phase of its tape construction requires the use of special pebbles found only on the beaches of Normandy (ref. 1–18). Another manufacturer used a brush containing jaguar bristles mounted on the transport to clean the tape surface during use (ref. 1–18).

Although this discussion has emphasized the use of instrumentation magnetic recording, it is important to keep in proper perspective the extensive role of magnetic

tape recording in the fields of audio and video/television, and the applications of digital recording in these fields as well as in instrumentation data recording. For instance, for the audio perfectionists there is now the exciting prospect of digital recording. Digital recording removes all mechanical flutter and brings the background noise level as close to zero as desired. Perfect copies can be made generation after generation, and the original recording is so robust that aging, magnetic loss, or print-through have no deleterious effect.

To record digitally, the analog input signal (audio or otherwise) is sampled at a rate exceeding twice its highest frequency and the samples are translated into binary code numbers representing amplitudes at the instant of sampling. Numbers of 11 to 16 digits may be used, giving accuracies (or signal-to-noise ratios) of about 2^{11} (66 dB) to 2^{16} (96 dB). The code numbers are recorded in sequence on tape. When played back, the code numbers become amplitudes; irregularities in timing (tape flutters) are corrected by a buffer memory; and the sample rate is reproduced in perfect crystal-clock sequence, thus reconstituting a signal the perfection of which is limited only by the binary code. The cost of perfection is the bandwidth needed for a high digital data rate and the sophisticated A/D converters required for encoding and decoding the recorded signal.

Digital audio recording is comparable to video recording in both complexity and expense. Nevertheless, where expense is no object, the recording process is no longer a factor that limits quality. The British Broadcasting Corp. is already using digital recordings within its network, and digital master tapes will be common in the future.

Although a large part of the advances in the art of tape recording are mechanical and electronic, a good portion of the progress has resulted from better quality tape. Improved oxide formulations and backing materials have resulted from concentrated industrial research.

Early experiments in magnetic recording used steel ribbon with its excessive expense and handling difficulties. Later, wire recorders solved some of the handling problems but offered only minimal improvements in signal quality. It was not until the early forties that all the right ingredients came together.

Short-wave radio listeners (ref. 1–12) eavesdropping on German broadcasts during World War II were among the first to realize that audio recording technology had entered a new era. Somehow “live” orchestra performances were emanating from occupied Europe on a time schedule unrelated to the musicians’ logistics problems or sleeping habits. When hostilities ended, the secret was revealed—a new electronic marvel called the Magnetophon that recorded almost flawlessly on reels of iron-oxide-impregnated tape. Gone were the hiss, crackle, and miserable frequency response long associated with disk, sound on film, and wire recording techniques.

Recording studios, broadcasters, and consumer elec-

tronics manufacturers worldwide soon adopted the Magnetophon principle in several specialized tape formats. Users are presently offered cassette, eight-track cartridges, and open-reel products, while studio, computer, and instrumentation engineers have stayed strictly with reel-to-reel machines. Improved magnetic oxides and special noise-reduction circuits have made narrow-width, low-speed cassette formats acceptable for casual music listening while simultaneously transforming professional studio and scientific operations with wide multitrack recording tapes.

When magnetic properties of a tape are specified (ref. 1-12), it is customary to give its intrinsic coercivity, H_{ci} (normally 225 to 400 Oe) and its retentivity after saturation, B_{rs} (usually 800 to 1500 G). High coercivity is desirable for good high-frequency response (short recording wavelength), but a coercivity of 400 Oe or more should only involve extra-thin tape coatings and supersmooth recording surfaces. Otherwise, the high-frequency advantages are not realized, and the tape will be difficult to bias and erase.

High retentivity is associated with high signal output. However, it is not really a direct measure because the output is also proportional to the magnetic-oxide thickness and the width of the recorded track. A better index of tape output is the remanance ϕ_R , which is the magnetic flux retained by a specified width of tape. A typical value of ϕ_R for general-purpose tapes is about 0.65 Mx per $\frac{1}{4}$ in. of tape width. High-output and studio master tapes may range from 0.90 to 1.25 Mx per $\frac{1}{4}$ in. of tape width. These represent maximum saturated values; practical recording allows 15 dB of headroom so that "0 dB" on the recording volume-level meter represents a magnetized flux level of about 0.12 Mx on general-purpose $\frac{1}{4}$ -in. tape (0.12 Mx per $\frac{1}{4}$ in. equals 185 nWb/m). Playback head voltage E is directly proportional to remanance in nanowebers per meter and may be calculated from the equation

$$E = \frac{N d\phi}{dt}$$

Standard iron-oxide tape has evolved over the last three decades to a high state of perfection. It is smooth, uniform, and stable (magnetically and chemically) and features high output, low noise, and minimum head wear. The active material is a gamma magnetic oxide, Fe_2O_3 , in the form of acicular (needlelike) crystals about $0.5 \mu\text{m}$ long and about $0.05 \mu\text{m}$ in diameter. These crystals are suspended in a liquid binder and are coated on one surface of a plastic backing material such as cellulose acetate or polyester film. While still liquid, the coating is run through a magnetic field that orients the oxide particles so that they point in the proper direction for recording. The dried magnetic coating is about 5 to $12 \mu\text{m}$ thick. Typical magnetic properties include a coercivity of 300 to 350 Oe

and a retentivity of 1000 to 1400 G. To improve smoothness, the tape surface may be polished, burnished, or calendered. Lubricants such as silicones are incorporated to reduce friction and improve head life.

Most tape research has been devoted to developing a coating that gives more output, less noise, and better high-frequency response. Many "super" tapes now on the market still use the tried-and-true acicular gamma iron oxide, but with smaller particles to reduce noise. Greater particle density within the binder gives more output, and a mirrorlike oxide surface gives increased high-frequency response.

Some new tapes are made with a gamma iron oxide that has been modified by substituting a small percentage of cobalt atoms in the spinel crystal lattice. The process has been called "cobalt doping"; however, the amount of cobalt required for an appreciable effect is many orders of magnitude higher than the doping levels associated with semiconductors. Oxide-coating coercivity can be adjusted anywhere between 250 and 1000 Oe (or even higher) by increasing the cobalt content. The high-frequency response of tape improves in proportion to its coercive force, but to use such capability the recorder may have to supply more biasing, erasing, and signal voltage. An undesirable side effect of cobalt doping is thermal instability (the magnetic properties of tape decrease as temperature is raised, with some deterioration occurring even at high room temperatures).

To cope with these problems, two grades of cobalt-doped tapes are marketed. For professional use, where machines can be adjusted, the doping is high enough to give a marked increase in magnetic properties. For consumer recorders, which are not adjustable, less cobalt is used, and cobalt-doped tapes remain interchangeable with ordinary kinds. Tape performance (and associated side effects) is between that of the standard iron-oxide grade and the highly doped professional grade.

An improved material—chromium dioxide—is now available in cassette tapes. The active ingredient is an acicular oxide of chromium (CrO_2), which is surprising because chromium and its compounds are generally nonmagnetic. An electron micrograph of the oxide shows it to be more elongated and somewhat smaller than gamma iron oxide. Magnetic properties can be controlled during manufacture to give a product with any desired coercivity (up to 1000 Oe or more). A coercivity of 450 to 550 Oe has been chosen for commercial tapes—high enough to require adjustment of the recorder for optimum bias and recording level.

Another unusual property of chromium dioxide is its relatively low Curie temperature of 140°C , above which it becomes nonmagnetic. (Iron oxide has a Curie temperature of 620°C .) Fortunately, the magnetic properties of chromium dioxide are quite stable even at the highest temperatures ordinarily encountered. The unique com-

bination of low Curie point and high coercivity make chromium dioxide useful for magnetic contact printing, in both master and copy tapes.

Early U.S. tapes (1946 to 1955) were coated on a cellulose-acetate, or even paper, base. A base thickness of 1.5 mils (38.1 μm) was needed for adequate strength. When polyester films such as Mylar became available, the thin gages were stronger than 1.5-mil acetate and were far more stable with respect to temperature, humidity, and aging. Cellulose acetate does have one appealing characteristic—it breaks clean with negligible stretch for easy mending. Polyester usually elongates before it breaks, so any recording on a permanently stretched section would be lost. However, breakage is so rare that this is a minor consideration. The choice then is polyester for best performance or cellulose acetate for economy. In Germany, vinyl chloride has been a popular base material because it is more flexible than cellulose acetate and less expensive than polyester.

For any recording tape the plastic backing determines breaking strength, surface smoothness, head conformity, and dimensional stability. Its thickness determines the length of tape in a given package. A standard of comparison is the common 7-in.-diameter plastic reel filled with 0.25-in. tape. Depending on tape thickness, a 7-in. reel may contain 1200 ft (standard play), 1800 ft (extended play), 2400 ft (double play), 3600 ft (triple play), or even 4800 ft (quadruple play). The best compromise is the 1800-ft reel in which the tape is 1 mil thick. Thinner tape may stretch or snarl in some recorders, and is more prone to print through between adjacent layers; thicker 1.5-mil tape is stronger than necessary and does not conform to record/reproduce heads as well as the thinner tapes.

REFERENCES

1-1. Mee, C. D.: *The Physics of Magnetic Recording*. Interscience Pub., Inc., 1964.

- 1-2. Snel, D. A.: *Magnetic Sound Recording*. Philips Technical Library, N. V. Philips Gloeilampenfabrieken, Eindhoven, The Netherlands, 1963.
- 1-3. Westcott, C. G.; and Dubbe, R. F.: *Tape Recorders—How They Work*. Second ed., TRW-2, Howard Sams Photofact Publication, Bobbs-Merrill Co., Inc., New York, 1964.
- 1-4. Bernstein, J. L.: *Video Tape Recording*. John F. Rider Publisher, Inc., New York, 1960.
- 1-5. McWilliams, A. A.: *Tape Recording and Reproduction*. Focal Press, New York, 1964.
- 1-6. Spratt, H. G. M.: *Magnetic Tape Recording*. (D. Van Nostrand Co., Inc., 1964.
- 1-7. Stewart, W. E.: *Magnetic Recording Techniques*. McGraw-Hill Book Co., Inc., 1958.
- 1-8. Tall, J.; and Kellogg, P. P.: *Techniques of Magnetic Recording*. Macmillan Co., 1958.
- 1-9. "Video Cartridge Cassette and Disc Player Systems." *Proc. Symp., Soc. Motion Pict. Telev. Eng.* (Montreal, Canada), Oct. 7 and 8, 1971.
- 1-10. Sharps, W. S.: *Tape Recorder Manual*. Fountain Press, London, 1960.
- 1-11. "Video and Data Recording." *Proc., Inst. Electron. Radio Eng. Conf. No. 26* (University of Birmingham), July 10-12, 1973.
- 1-12. Camras, M.: "State of the Audiotape Art." *IEEE Spect.* 14(10): 28-35, Oct. 1977.
- 1-13. Athey, S. W.: *Magnetic Tape Recording*. NASA-SP-5038 (prepared under contract NASW-945), Jan., 1966.
- 1-14. Lowman, C. E.: *Magnetic Recording*. McGraw-Hill Book Co., Inc., 1972.
- 1-15. *Modern Instrumentation Tape Recording*. EMI Technology, Inc. (Library of Congress Catalog Card No. 78-60084), 1978.
- 1-16. Kalil, F.: *Attenuation and Degradation of Radio Frequency Signals by Rocket Exhausts*. NASA X-863-77-65, Jan., 1977.
- 1-17. Kalil, F.: *Shuttle Solid Rocket Booster (SRB) Plume Attenuation Test Results, DM-1*. NASA X-862-77-280, Oct. 1977.
- 1-18. Pelant, J.: "For the Unsung Heroes—A Boost." *Certif. Eng. Technician J.*: p. 4, Nov. 1977.

Tape and Head Wear

James Kelly
Ampex Corp.

Signal-to-noise ratio (and, therefore, dynamic range) in the tape recording process is a function of head-to-tape separation as defined in the equation

$$\text{loss} = \frac{54.6d}{\lambda} \text{ dB}$$

where

d = length of separation, in.

λ = wavelength of signal on tape, in.

This equation indicates that when reproducing short wavelength signals, extremely intimate head-to-tape contact must be maintained. Consequently, there will be friction and erosion of both the head and the tape. The situation is compounded by the need to incorporate very shallow gap depths in the reproduce head. This is dictated by the need to maximize flux concentration in the gap. Consequently, heads on wideband recorders will wear out and fail in typically 2000 to 3000 h of use. The replacement of these heads, which are relatively costly, is a significant operating expense in magnetic recording applications. It follows, also, that abrasion and wear of the coating on the magnetic tape will also take place. However, an application in which the same piece of tape will be used repeatedly to the point where wearing of the tape becomes noticeable is rare. Consequently, the emphasis is on head wear.

Magnetic heads available in the late 1970's fail from head wear in typically 2000 to 3000 h. Replacement cost of these heads is many thousands of dollars. With the trend toward the use of 28-channel heads, this replacement cost is almost doubled. As a consequence, a wideband tape recorder will require between \$2 and \$10 per hour of operation for consumables. The consumable product being the wearing of the heads. Obviously then, all parties in the tape recorder community must address themselves to minimizing this operating expense. The manufacturer of heads must look to head design and material that is least vulnerable to abrasion. The manufacturer of tape must look to minimizing the abrasiveness of

the tape surface, and the user of the equipment must strive for an optimum operating environment. This chapter presents a detailed discussion of these various considerations.

ABRASIVITY

Abrasiveness is the characteristic of the tape that erodes material from the surface of the heads. All tape is not alike in its abrasive quality. Therefore, users must consider this quality of the tape they use. Abrasiveness is controlled by the manufacturer of the recording tape and is a major consideration in head wear. However, as is the case in many technical problems, there are conflicting demands that require compromise. A highly polished tape surface that offers minimal abrasivity will have a tendency to stick to the head surface and create brown stain (discussed later in this chapter) with its associated loss in band edge response. This is especially true if the tape is kept under tension in the head area for long periods of time when the tape drive is in a stop mode or shut down. Another conflicting demand is that soft binder and oxide systems, which quickly polish to a smooth surface with minimum abrasivity, may show a tendency to shed. Severe shedding will necessitate frequent service and cleaning of the tape drive.

Federal Specification WT-001553 specifies the abrasivity of instrumentation recording tapes procured by the Federal Supply Service for use by the U.S. Government. Samples of all tape procured by the Federal Supply Service are tested to this specification. Chapter 3 outlines in detail the various techniques that may be employed to measure abrasivity of tape.

The brass shim test is one of many techniques used by the industry to measure the relative abrasivity of tape. Bell & Howell, in its 1975 comparison, used actual head stacks and measured the wear on the head face with a profilometer at 25-h intervals. In 1976 the National Security Agency published a working paper on magnetic tape abrasivity using a radicon test (ref. 2-1). This was followed by a report from Spin Physics that described still

another technique. It measured dimensional changes of an indentation on a test core. Still later, the Fulmer Research Laboratories in the United Kingdom developed a technique in which change in resistance of a vacuum-deposited alloy on a test mandrel was measured. This later technique is probably the fastest, with cost nearly as low as that for the brass shim test, the least expensive. (See ch. 3 for additional information on these tests.)

CONTAMINATION WITH DEBRIS

Airborne abrasive particles that impinge on the tape obviously will aggravate the problem of tape abrasivity. Any effort that will reduce the dirt in the atmosphere where recording equipment is used will result in a cost saving due to decreased head wear. In a similar manner, the design of heads must take into consideration head material, which may tend to shed particles that by their very nature may be very hard. These particles riding on the tape will aggravate the abrasive head wear of downstream heads.

HUMIDITY

Empirical results have shown that head wear is a function of the relative humidity (RH) of the environment

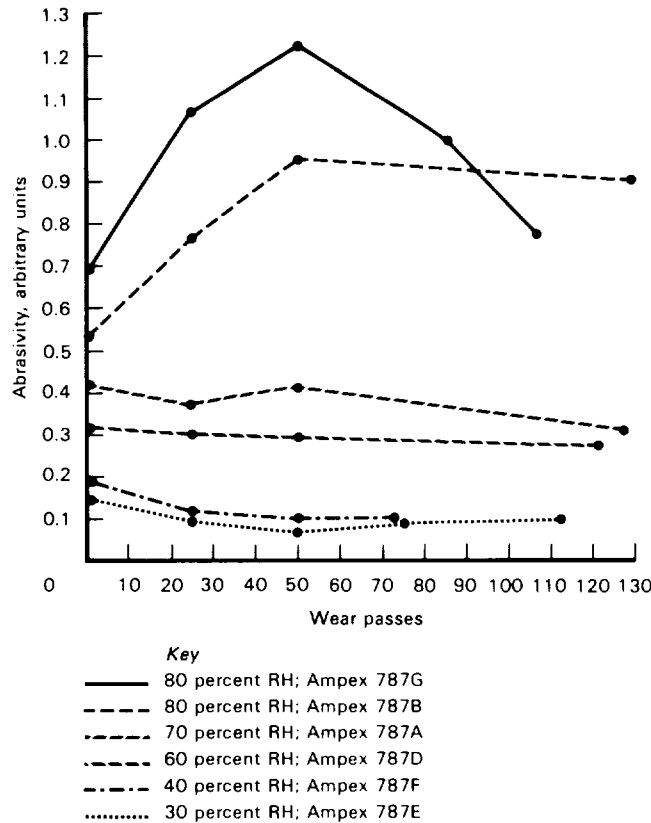

Figure 2-1.—Head wear of Ampex 787 recording tape measured at the National Security Agency using the Radicon technique.

in which the head operates. When RH is greater than 40 percent, head wear dramatically increases. It is unresolved as to whether increasing RH causes the abrasiveness of the tape to increase, or increases in RH accelerate breakdown in the molecular structure of the head and tape surface. Nevertheless, it is obvious that the user of tape recording equipment should endeavor to optimize the environment in which the tape recorder operates.

To illustrate this phenomenon, the results of three different test procedures are shown in figures 2-1 to 2-3. Figure 2-1 illustrates the results of testing done by an end user of tape recording equipment, the National Security Agency. These results were obtained in a test in which the cover door of the tape recorder was modified so that there was effectively a hood over the tape drive system that was connected by hoses to an environmental chamber. In this manner the humidity of the environment of the tape-to-head interface was controllable. Head wear was measured using the Radicon technique.

Figure 2-2 displays the test results obtained by a manufacturer of tape heads, Spin Physics, Inc. These results were obtained on a special transport specifically designed for head wear measurements. Wear rate was determined using a Vickers hardness indentation technique on a sample core surface.

Figure 2-3 displays the results obtained by a manufacturer of recording tape, Ampex Corp. These data were obtained by using a profilometer to physically measure the contour of an actual recording head that had been subjected to head wear under various controlled conditions.

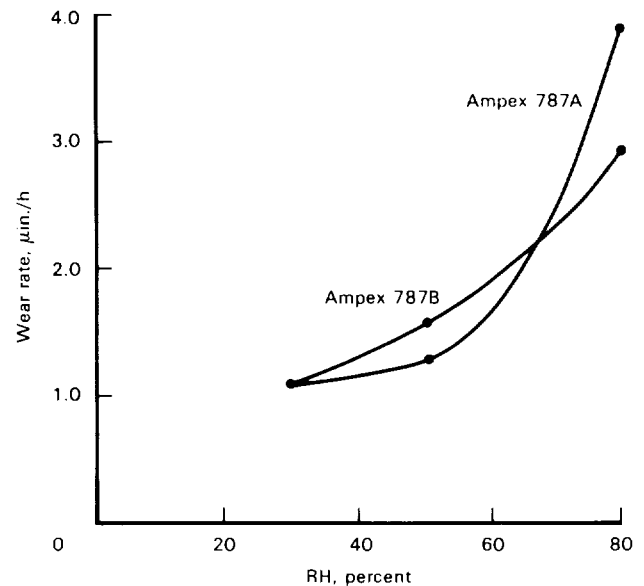

Figure 2-2.—Head wear measured using a Vickers hardness indentation technique at Spin Physics, Inc. (Tape speed = 60 in./s; number of passes = 10; tape tension = 3.5 oz; core pressure = 6.1 lb/in.²; core material = Spinalloy (Spin Physics Corp.).

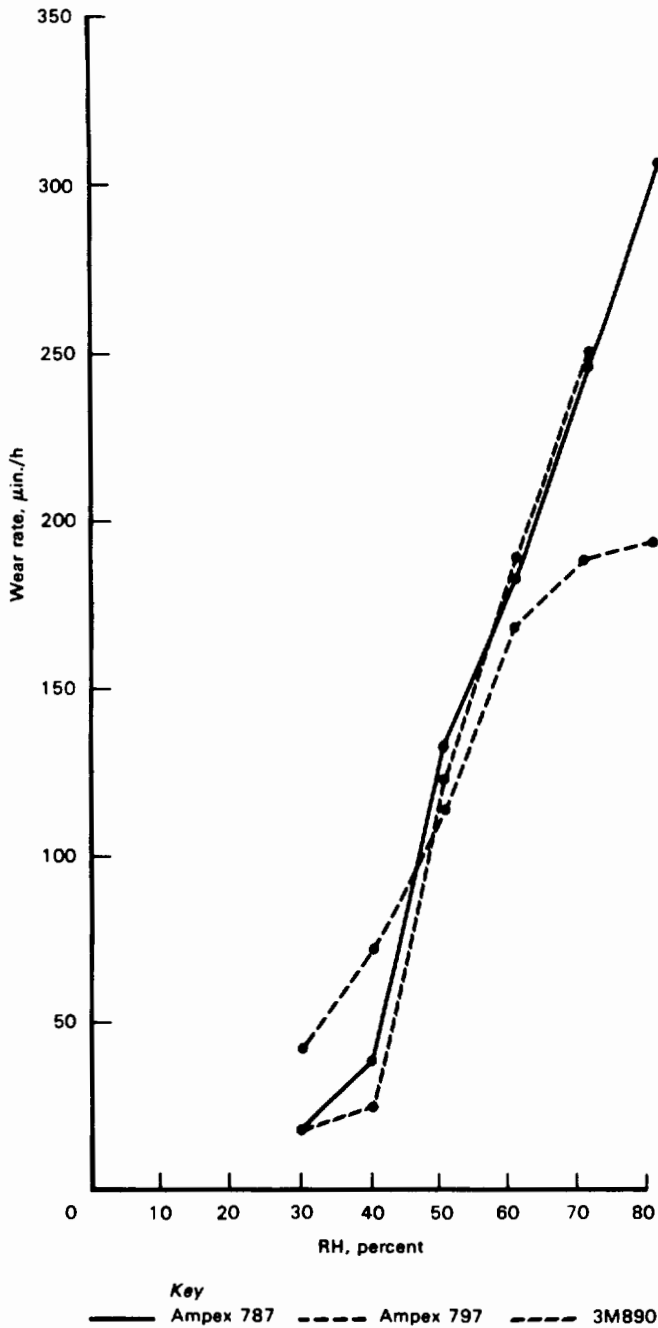

Figure 2-3.—Measurement of head wear by profilometer at Ampex Corp.

Fulmer Laboratories also performed tests showing the effect of humidity on abrasivity. They measured the change in abrasivity caused by a person's breath.

It has been reported that the abrasive wear of recording heads by tape increases with RH, which is gradual or almost negligible up to about 40 to 45 percent RH, and that above this level, abrasive wear becomes significant, increasing in some cases by many orders of magnitude with further increases in RH. A generalized representation of this behavior is plotted in figure 2-4. Typically, the

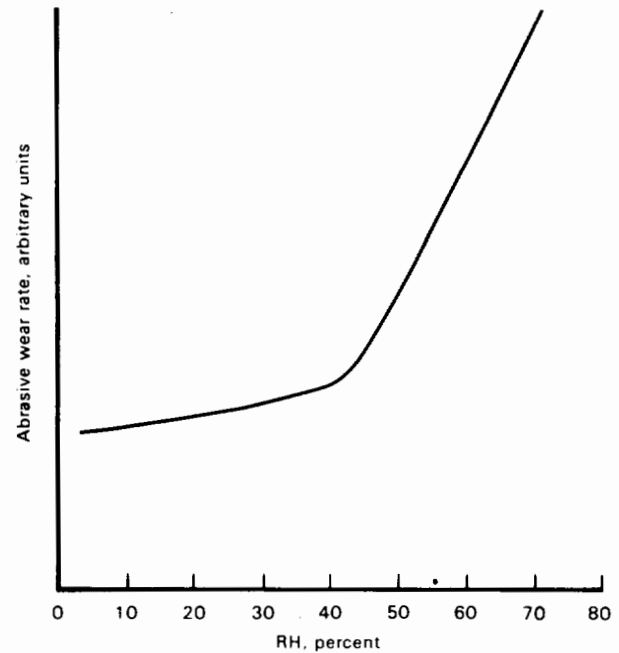

Figure 2-4.—Head wear as a function of RH.

cause of this behavior has been assigned to the tape, suggesting that the tape has low abrasivity below 40 to 45 percent RH, and very high abrasivity above 40 to 45 percent RH.

One objective of this study was to detect some basic change in the hygroscopic property of the magnetic coating at around 40 to 45 percent RH that could be correlated with the reported abrasive wear pattern; however, no dramatic events occurred at around that RH level, but rather the dependence of the water content of the magnetic coating on RH proceeded smoothly and linearly through 40 to 45 percent RH. This is not to imply that the hygroscopic property is or is not involved in the abrasive process, but only to observe that no change occurred in the property in parallel with the usually reported abrasive wear pattern.

It is possible that there is some as yet unrecognized characteristic of tape that varies with RH to yield the pattern of figure 2-4, but it is the intent of this section to suggest that this pattern may not be tape related and to advance an alternative hypothesis. Simply stated, it is suggested that this wear pattern with RH is a property associated with the materials used in recording heads, that their tendency to wear by abrasion is humidity dependent, and that they undergo significant increase in susceptibility to abrasive wear at about 40 to 45 percent RH. The pattern is a property of the recording head materials, not the tape, although the tape would be involved in dictating the magnitude of abrasive wear.

This alternative hypothesis is suggested from a comparison of the experimental results reported in two articles dealing with the RH dependence of abrasive wear.

Carroll and Gotham (ref. 2-2) measured the RH dependence of head wear by tape under experimental conditions in which they could independently regulate the localized RH at the head/tape interface and the humidity conditioning of the tape and its surface. They observed that the pattern of figure 2-4 was generated only as a function of the localized RH and was independent of the humidity conditioning of the tape and its surface. That is, neither the tape nor its surface underwent the humidity-dependent changes in abrasiveness in parallel with the pattern of figure 2-4. They did observe, however, under conditions of constant RH that there were differences in the abrasiveness of various brands of tapes that affected the magnitude of head wear.

Larsen-Basse (ref. 2-3) made a general study of the RH dependence of abrasive wear using silicon carbide and aluminum oxide as abrasives, and a backing wheel to provide rotary motion for the abrasion process. He found that a wide variety of materials such as aluminum, copper, glass, ceramics, nickel, and low-carbon steels undergo a rapid increase in abrasive wear at RH values above 40 to 45 percent. Thus his studies reveal that the humidity dependence is a more general property of the abrasion process and is *not* exclusive to head wear by tape.

Larsen-Basse advanced an explanation for his results, namely, "moisture-assisted-fracturing" of the abrasive grains to yield finer particles. These finer particles were credited with increasing the abrasive wear. He published data that indeed demonstrated that there were reductions in the particle sizes of the abrasive grains, but the resultant distributions of the particle sizes were essentially identical for any humidity above or below 40 to 45 percent RH.

An explanation relegating the humidity effect of figure 2-4 to the abrasives is contrary to the reported observations of Carroll and Gotham who used tape as the abrasive medium. It is suggested that the breakdown of the abrasive grains resulted from purely mechanical action. Thus it is being speculated from the common experimental results of Larsen-Basse and Carroll and Gotham that the humidity effect is a general property of materials undergoing abrasive wear. Perhaps, in addition, "moisture-assisted-fracturing" of material surfaces occurs at higher RH values.

However, even if it is true that materials undergoing abrasion are susceptible to the humidity effect, there may be some properties of the abrasive materials that reduce their abrasiveness to a level that the humidity effect is minimized, or does not occur. For one wheel backing material with lower hardness and surface friction than his other test materials, Larsen-Basse found that the humidity effect was not observed—abrasive wear decreased smoothly and gradually with increases in RH. His studies, however, are still in progress; the individual significance of hardness and friction have not been assessed. Nevertheless, his findings demonstrate that there are material

parameters associated with abrasives that can dramatically alter the process of abrasive wear.

In a sense, the RH dependence of head wear by tape, or alternately, the deposition of tape binder materials onto heads, appears capable of some compact description. Tapes formulated to have magnetic coatings that are either hard or high in surface friction probably tend to wear recording heads, and the dependency with RH would be that of figure 2-4. On the other hand, magnetic coatings formulated to be softer, or with reduced surface friction, are probably less abrasive, and therefore head wear and the humidity effect would tend to be minimized or nonoccurring. In turn, it is possible that heads would now wear the surfaces of these latter classes of tapes, and the wear products from tape could either be powdery or gummy, depending on RH and the hygroscopic property of the magnetic coating. Increasing the water content would increase the tendency for tape wear products to be gummy. Thus the hygroscopic properties of magnetic coatings formulated to be either softer, or reduced in surface friction, may be an important parameter dictating whether tape wear products will be powdery and nonadhering or gummy and promote tape sticktion to recording heads.

In conclusion, some remarks should be made about the popular technique to measure tape abrasivity using radioactive Kovar. In this test, tape is passed over the Kovar, and as abrasive wear progresses, traces of the Kovar material are transferred to the tape, where a subsequent radioactive count of the tape determines its relative abrasiveness based on an established correlation curve. If the hypotheses of this discussion are valid, then perhaps Kovar also is dependent on RH for its susceptibility to abrasive wear. If true, then past data rating tape by that technique may be suspect, especially if no effort was made to control humidity. In fact, discrepancies in data reported for Kovar measurements taken at different installations may be related to variations in humidity. In the future, the humidity at the time of test and the prior humidity conditioning of the tape pack should be controlled.

BROWN STAIN

The converse of the humidity consideration—that is, the lower the humidity, the more optimum the operating environment—does not hold true either. In conditions of very low humidity, the phenomenon known as brown stain occurs. (With some head material the stain appears to be more of a blue color, but the problem remains the same.) Operating a wide-band tape recorder under conditions of very low humidity for a period of time results in a discoloration of the head surface that is associated with a loss of upper-band-edge signal performance. This staining results in the appearance of material on the head surface that causes head-to-tape separation and, therefore, loss of

upper-band-edge signals in accordance with the formula shown at the beginning of this chapter.

Brown stain on wide-band heads is a phenomenon that has been observed for 20 years. It should not be confused with ordinary debris that is easily removed with a cotton-tipped applicator and head cleaning solvent. Brown stain can only be removed by mechanical means, the most common being green tape, chromium dioxide tape, or, for light staining, a mid-range tape. In the past it has generally been assumed that a small quantity of brown stain is desirable because head wear is reduced in its presence: There is an inverse relationship between brown stain and head wear.

Stain varies in appearance, the most commonly observed being a salt-and-pepper motif in which small spots on the order of 10 to 200 $\mu\text{in.}$ appear to have been randomly sprinkled over the entire area of contact. Frequently, solid area agglomerations are formed that confine themselves to strips running parallel to the head lamination.

Under a microscope it is difficult to see whether a spot is actually a bump or a dimple although it had been assumed that coloration was in fact a deposit and that reduction in head performance was caused by spacing loss. (See fig. 2-5) A styrene replica of the head working surface was prepared, chromium flashed, set in epoxy, and sectioned.

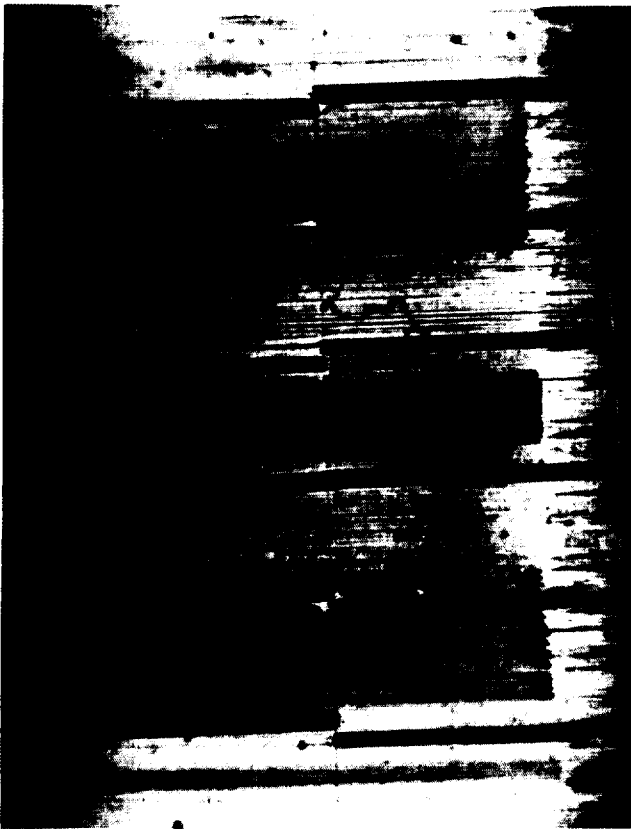

Figure 2-5.—Mu-metal heads with brown stain (magnified 400 \times).

Using a magnification of 16 000 \times with an electron beam microscope, more or less spherical small blobs could be seen, mostly about 30 to 40 $\mu\text{in.}$ in diameter, but ranging from about 10 to 80 $\mu\text{in.}$

Over the years, many tests have been run with different brands of tape, formulations, tape tensions, head configurations, speeds, and environmental conditions. In addition, uncoated base film and coatings with TiO_2 substituted for Fe_2O_3 have been used. All of the different tapes have produced brown stain.

As stated earlier, there is an inverse relationship between brown stain and head wear. Low humidity gives low head wear and results in high brown stain. It may well be that brown stain occurs under all environmental conditions and that the high head wear encountered at high humidity serves to keep the head clean.

Data indicate that brown staining increases below 35 percent RH. Above 45 percent RH head wear increases more rapidly; consequently, 35 to 45 percent RH seems to be ideal.

LUBRICATION

Various lubricating materials can be employed in the tape coating. However, we are limited to the use of materials that do not accumulate on the surface of the tape and result in head-to-tape separation. Lubricants that tend to adhere dirt and debris on the tape surface must also be rejected.

Recording tape manufactured for instrumentation recorders contains lubricants as constituent parts of the binder material. In addition, although not in common use, lubricants have been developed that are to be applied to the tape surface after manufacture.

IIT Research Institute has developed a technique that greatly increases the operating life of the magnetic tape media as well as that of the head. This is accomplished by the application of a very thin coating of an inert lubricant to the surface of the media. Tests have been performed with a variety of commercially available tapes and various head materials. Greater than 5 million passes of 3M900 on a loop tester were achieved with no apparent effect on the tape. Without lubrication, the same tests achieved only 30 000 passes. Head wear was decreased by as much as a factor of 10 when lubricated tape was used.

The minimization of friction between the magnetic media (i.e., tape, cards, drums, etc.) and the magnetic transducer (heads, etc.) is an important requirement in recording systems. Frictional forces and associated thermal effects may lead to the rapid deterioration of the tape, deposition of debris on the record and reproduce heads, and excessive head wear or loss of signal, resulting in the functional failure of the system. Accordingly, some form of lubrication is used in magnetic tapes to reduce the

coefficient of friction between the tape and the head. Manufacturers of quality magnetic media products incorporate lubricating compounds as additives in the tape coatings. The coating formulation into which lubricating compounds are introduced consists essentially of a dispersion of magnetic oxide particles (e.g., gamma ferric oxide, chromium dioxide, or nickel-cobalt-doped Fe_2O_3) in an organic resin that constitutes the binding matrix for the magnetic material. This binder system is applied to the tape substrate, such as polyethylene terephthalate or aluminum by coating processes common to the trade. The lubricating agents used in magnetic coatings include petroleum-based natural products, synthetic liquids such as esters of dicarboxylic acids and branched chain alcohols (e.g., 2-ethylhexyl sebacate), polysiloxane fluids (silicone fluids) as well as solid lubricants (such as talcum, molybdenum sulfide, and fluorinated polymers).

The main function of these lubricants is to reduce the amount of close contact between the solid surface (metal, ferrite, plastic, etc.) of the record and reproduce heads and the surface of the magnetic media by interposing an easily shearable or interaction-lessening layer of lubricating agent at the interfacial boundary of those elements that remain in sliding contact when the media is in use.

Incorporation of lubricating compounds within the bulk of the magnetic coating has an advantage in that it affords a means of replenishing the friction-reducing agent at the tape surface, exposing new layers of lubricant as the coating wears. A major disadvantage is that internal lubricants, having a chemical incompatibility with most binders, have undesirable effects on the structural integrity of the magnetic pigment/binder system because they impair interfacial bond conditions and interfere with the proper polymerization of the resin.

The incorporation of lubricants has been identified as a major limit of tape life in extensive studies. Layer concentrations, while reducing the dynamic coefficient of friction, actually reduce tape life. It is postulated that because the lubricants migrate to the surface of the tape, they also migrate to the substrate, inhibiting proper binding of the oxide to the substrate. Consequently, only small quantities of lubricants can be added before severe degradation is noticed, and when the quantities of lubricants added are small, the effects on lubricity or coefficient of friction are similarly reduced.

The addition of a separate lubricant layer, in an attempt to eliminate the problems discussed, has been postulated previously. This work relates to the addition of finite-sized solid lubricant particles to the surface of the magnetic media—polytetra fluoroethylene (0.05 to 0.5 μm), DuPont Vydax (initial size of around 5 μm and a subsequent reduction to 0.5 to 1 μm), or molybdenum bisulfide and graphite particles of colloidal size (between 0.01 and 1 μm).

The incorporation of finite-sized solid lubricant parti-

cles also causes separation of the magnetic media from the magnetic transducer by at least a distance equal to the size of the particles. This causes a loss in recorded signal on the tape and subsequent reproduce losses as defined by the function $e^{-d/\lambda}$ where λ is the recorded wavelength and d is the distance from the surface of the magnetic oxide to the gap of the reproduce transducer. Thus, at the extremely short wavelengths (1.27 μm or 0.05 mil) frequently used in demanding instrumentation applications, it is obvious that reproduce signal output will be severely reduced by incorporating surface-coated finite-sized solid lubricant particles. No successful method incorporating these principles has been marketed.

Other attempts to eliminate the weakening effects of lubricants in magnetic coating systems have been made in the direct application of friction-reducing treatments, such as solid fluorinated polymer films, to read/record heads of magnetic recording equipment. The effectiveness of this approach is inevitably lessened by the inherently abrasive nature of conventionally lubricated magnetic tape, which taxes the film on the heads and leads to the deposition of abraded film fragments on the tape surface or in the gaps of the heads, thereby interfering with recording or reproducing processes.

The work performed at IIT Research Institute eliminated the previously encountered disadvantages of friction-reducing treatments by depositing an inert liquid film on a fully manufactured (cured) magnetic media. The film contains no particles, is a compound that is characterized by good lubricating and thermal properties, is inert with respect to the normal formulation constituents, and has low surface tension and vapor pressure characteristics. The deposited film need only be molecularly thin to impart adequate lubricating properties to the tape.

Characteristics of the Surface Lubricant

A coating of an inert liquid lubricant with a low surface tension, high molecular weight, and excellent lubrication and wetting properties is either dispersed in a suitable solvent and applied to the magnetic medium or is applied undiluted to the surface of the medium to form a very thin layer of lubrication between the medium and the transducer.

The selection of a liquid lubricant free of particles such as those previously described is essential. Low surface tension (preferably lower than the critical surface tension of the resin binder) is desirable because a lubricant spontaneously spreads on the tape surface, wetting the microscopic asperities and depressions that are characteristics of typical tape topography. Good wettability is required to ensure lubrication of those elements of magnetic tape that are likely to come into contact with the transducer surface and to facilitate entry of the liquid lubricant into microscopic tape depressions, which then

serve as miniature reservoirs from which the lubricant is transferred to the medium and to transducer surfaces over extended periods of tape usage.

Because the sustained action of the friction-reducing compounds depends also on resistance to volatilization, a relatively low vapor pressure, preferably less than 10^{-2} mm Hg at 25° C, is desired for the lubricating agent.

Other desired properties of the selected surface coating include the following:

(1) High degree of chemical inertness—so as not to react with the wide variety of binder systems presently in use in the manufacture of magnetic media

(2) High thermal and oxidative stability—to permit usage in a wide variety of media applications where thermal extremes would preclude usage of a conventional lubricant

(3) Nonflammability—to allow usage in magnetic media required to be self-extinguishing when exposed to fire

(4) Inertness with metals, glasses, and plastics at temperatures below 100° C—to ensure no damage to such parts as magnetic transducers or guides, vacuum columns, and capstans

(5) Wide range of viscosities as a function of temperature—to facilitate application in commercial processes

(6) Non-deposit-forming nature—to prevent buildup on such parts as magnetic transducers, guides, vacuum columns, and capstans

The fluorocarbon compounds and their derivatives are particularly attractive in tape lubricating applications because of their low friction, low surface tension, and good thermal properties. Their chemical inertness minimizes the danger of modifying (weakening) the mechanical properties of the magnetic coating.

A preferred compound for the treatment of magnetic media that satisfies all the aforementioned conditions is a perfluoroalkyl polyether having the general formula $FCF(CF_3)CF_2O_nC_2F_5$, such as the Krytox[®] family of oils (Krytox[®] types 143AZ, 143AA, 143AY, 143AB, 143AX, 143AC, and 143AD) manufactured by the E. I. du Pont de Nemours & Co., Inc., Petroleum Chemicals Division. These oils are characterized by a molecular weight from about 2000 to 7000, a viscosity of 18 to 495 cSt at 100° F, a surface tension of 16 to 19 dynes/cm, and a vapor pressure of less than 10^{-2} mm Hg at 25° C. The Krytox[®] oils are also characterized by a high degree of chemical inertness, high thermal and oxidative stability, nonflammability, and are nondeposit forming.

The advantages derived from the use of perfluorinated alkyl polyether treatments for magnetic tape in regard to reduced head/tape friction and corresponding increased head wear and tape life have their bases in the low surface energy and high lubricity that characterize perfluorinated compounds. This low surface energy, which is associated

with the close packing of fluorosubstituted CF_3 groups along the carbon-carbon backbone, reduces the interaction between two surfaces that are brought into mutual contact when a thin coating of perfluorinated compound is deposited on one of these surfaces. The low surface energy condition of solids treated with such a compound is reflected in the large contact angles that these surfaces exhibit in comparison with uncoated tapes.

Method of Application

The surface lubricant may be used without dilution or dispersed in a suitable solvent such as trichlorotrifluoroethane (Freon TF). The application of this and other liquid lubricants may be accomplished by conventional methods of knife, spray roller coating, or by deposition. It is extremely critical, however, that the amount applied be carefully controlled to insure that a layer as near to molecular thickness as possible is applied.

A typical application method consists of transporting the media either as a web or as a ribbon over the top roll of a reverse roll coater to achieve contact over approximately 30°. The lubricant is picked out of a fountain located at the base of the lower roller by the driven lower roller. The lubricant may be heated or cooled to achieve the viscosity necessary for proper application by cooling or heating coils mounted within the base of the fountain. The surface finish of the lower roller may be very smooth or may be treated by sandblasting or chemical etching to achieve the desired quantity of lubricant to be removed from the fountain. An instrumented variable loading doctor blade may be lowered to the surface of the lower roll to remove excess lubricant picked up by the lower roller from the fountain.

The lubricant is then passed by the lower roller to the upper roller at a line contact between these rollers. The line contact loading may be adjusted by two variable loading helix springs. The upper roller is heated to a temperature of 125° to 150° F to modify the viscosity of the selected lubricant. The upper roller surface should have an extremely smooth surface finish to insure thin layer transfer to the tape.

Tape from a supply reel may be guided to the top surface of the reverse roll and wrapped between 30° and 90° over the top roller. Precision supply and takeup tension servo systems are used to insure that web tension is correct as it passes over the top roller. The preferred direction of the top roller is in the direction opposite that of tape motion. The speed of the tape passing over the top roller may be from several inches per second to hundreds of feet per minute.

After application of the surface lubricant, the surface is buffed using industrial clean grade natural filament buffing material. This buffing treatment promotes dispersion of the applied lubricant to cover the surface asperities

frequently found in magnetic media. The direction of rotation of the buffers is preferably in the direction opposite to the web motion. The speed and quantity of the surface stations is a function of the surface conditions of the buffing media. It has been found in some instances that this is not a necessary process for those media having an extremely smooth surface prior to the application of lubricant.

Surface-Coated Magnetic Media Test Results

Various forms of magnetic media were prepared using the lubricating techniques developed by IIT Research Institute. The test results have indicated a significant improvement in tape life (as measured by such factors as dropout activity and oxide shed), head wear (measured using both "soft" and "hard" heads), static and dynamic coefficients of friction, together with negligible effects on other media characteristics.

HERMETICALLY SEALED TAPE

RH has been recognized as an important environmental factor in many head-to-tape interface phenomena such as head wear, friction, staining, and tape shed. Accordingly, RH is usually specified in many applications of tape use, especially when tape recorders are enclosed in hermetically sealed cases. In the past RH was believed to be regulated by humidification of the fill gas to the specification RH. However, this study demonstrates that internal RH in a sealed case is completely controlled by the time dependence of the hygroscopic properties of the pack of magnetic recording tape. Procedures for humidity conditioning of sealed cases must be established on the basis of the hygroscopic properties of the tape, not on humidification of the fill gas. If the tape is not considered, final, stabilized, RH may be significantly different from the specification. In addition, this same study finds differences in the hygroscopic properties of the same brand of tape that apparently result from aging. These differences may have significance in the occurrence of head-to-tape interface phenomena during long-term use of the tape.

Hygroscopicity is a property of materials relating to the absorption of atmospheric moisture. The quantity of absorbed water is a function of material type, temperature, and RH. Hygroscopicity is a reversible property, and thus hygroscopic materials will also readily desorb water as RH is lowered. For any given hygroscopic material at constant temperature, there will also exist an equilibrium relationship between RH and the quantity of absorbed water.

Magnetic recording tape is hygroscopic, readily absorbing and desorbing atmospheric moisture as a function of RH. Because this is an equilibrium property, tape will absorb or desorb water as necessary to achieve a constant water content that will be in equilibrium with the RH of its

environment. Magnetic recording tape is constructed with a magnetic coating on a plastic substrate, usually polyethylene glycol terephthalate film (polyester). Some tapes, including the tape used in this study, are constructed with an additional back-coating, intended as a conductive path to drain off static electricity. Both the magnetic coating and the back-coating, as well as the polyester substrate, are individually hygroscopic; therefore, the total water content of the tape at any RH equilibrium is the sum of the separate equilibrium water content values of the tape components.

RH has been recognized as an important environmental factor in many head-to-tape interface phenomena, such as head wear, friction, stick-slip, stain formation, and deposition of tape debris. The water content of the magnetic coatings as controlled by RH may be one of the important basic parameters involved in the occurrence of these head-to-tape phenomena.

Many applications of tape recorders require that they be hermetically sealed in cases, as is common practice for space and satellite tape recorders. In an open area such as a room, the water content of tapes will come into equilibrium with the RH of the atmosphere. On the other hand, in a small, closed case, the RH of the gas space will be regulated by the water content of the tape, according to the equilibrium relationship between the water content of the tape and the RH. Because the water content of a tape pack is typically 10 or more times the water content of the gas space in a sealed recorder at any RH value, a procedure for humidification must not merely change the gas RH, but must change the water content of the tape pack so that it is at equilibrium with the required RH. It takes several days to change the absorbed water content of a wound tape pack, as contrasted to the few minutes required to change gas RH. The hygroscopic properties of the tape and the time for the tape to adjust its water content must be taken into account when establishing a procedure to achieve a specification humidity in a sealed case.

A study was performed to measure the hygroscopic properties of a tape and its components, using a commercial half-inch back-coated wide-band instrumentation tape. Both new and 3-year-old supply tapes were investigated to determine whether any variations in hygroscopic properties result from aging. The time dependence for the tape to change its water content resulting from changes in RH of the environment was determined for both wound and unwound tape.

In addition, the tape studied was used on a spacecraft tape recorder and was hermetically sealed inside a small case in which the inert gas environment was to be humidified at 30 ± 5 percent RH. This study investigated the influence of a wound tape pack on RH in the sealed case, including the conditions required to achieve a final, stabilized specification humidity, and the changes in RH that occurred inside the sealed case as a result of heating and cooling through specification temperature limits.

Basic Hygroscopic Properties

The hygroscopic properties of the new and the 3-year-old tapes were determined by measuring their weight changes when exposed to changing levels of RH. The test consisted of first measuring the weight changes for the whole tape as a function of RH. Then the magnetic coating was removed and the determination repeated. Finally, the back-coat was removed mechanically, and the hygroscopic property of the remaining polyester substrate was measured. Through this approach not only were the hygroscopic properties of the whole tape determined but also the individual hygroscopic properties of each tape component.

Experimental Procedure

A Cahn microbalance enclosed in a glass environmental chamber was employed for this study. The Cahn balance is an all electric device that is servo operated from an external control panel and is connected electrically by means of a vacuum tight bulkhead electrical connector in the wall of the chamber. The weight output from the Cahn is fed directly to a strip-chart recorder. This allows both direct readings of weight as well as monitoring of time dependence of weight changes. The Cahn balance is sensitive to weight changes as low as 1 μg .

RH was regulated in the chamber by the following method. A glass reservoir containing distilled water was attached to the chamber via a stopcock connection. This reservoir was additionally immersed in a temperature bath. When the stopcock was opened, water vapor filled the evacuated chamber at a pressure directly dictated by the temperature of the water reservoir. RH is the ratio of the vapor pressure of water at the reservoir temperature divided by the vapor pressure of water at the temperature of the chamber. Therefore, if the test chamber is at 25° C, and the water reservoir is at 0° C, RH in the chamber is the vapor pressure of water at 0° C (4.579 mm) divided by the vapor pressure of water at 25° C (23.69 mm), or

$$\frac{4.579}{23.69} \times 100 = 19.3 \quad \text{percent}$$

RH in the chamber was controlled by regulating the temperature of the water reservoir.

For values of RH below 19.3 percent, the water reservoir was cooled below 0° C to freeze the water, and the vapor pressure above ice at any given reservoir temperature regulated the lower RH levels in the Cahn chamber.

The magnetic coating was mechanically removed by gently scraping with a razor blade. By placing the tape over a light, it was visually possible to tell when the oxide was completely removed. The back-coat was also removed by the razor blade technique.

Experimentally, the tape specimens were first vacuum dried to achieve constant weight, which usually occurred within about 10 to 15 min. Then the stopcock was opened and water vapor was allowed to fill the chamber at some RH value determined by the temperature of the water/ice reservoir. The weight change of the specimen was recorded on the strip chart, and the RH level was maintained until constant weight for the specimen was achieved.

RH was then incrementally changed and the weight monitoring procedure repeated. This technique was continued for incremental changes in RH between zero and near saturation to achieve the equilibrium curves of water content versus RH.

Results

A primary observation was the ready reversibility of the water content of the tapes and components with changes in RH. All rapidly absorbed or desorbed water, depending on the direction of change of RH. At constant RH, the water contents were repeatable, and the equilibrium curves were reproducible. No evidence was found that the tapes or their components permanently retained water, which could not be removed either by decreases in RH or exposure to vacuum. In addition, there was no evidence that under vacuum the tapes permanently or temporarily lost any other volatile components. In general, and independent of the direction of change in RH, unwound tapes required approximately 0.6 min to change water content for each percent change in RH. Therefore, for a 30-percent change in RH, the unwound tapes required nearly 18 min. to achieve a water content in equilibrium with the new RH level.

The equilibrium curves at 25° C for both the new and the 3-year-old tapes are plotted in figure 2-6. The surprising observation was that the new tape was more hygroscopic than the 3-year-old tape, indicating either that some basic manufacturing difference had occurred in tape chemistry over the 3 years or, if chemistry is identical, an aging effect had occurred.

Figure 2-7 plots the equilibrium curves for the tapes with their magnetic coatings removed and for their polyester substrates stripped of both coatings. No differences in the two tapes were observed for these equilibrium curves; thus the differences observed in figure 2-6 are caused by differences in the hygroscopic properties of the magnetic coatings.

From the data of figures 2-6 and 2-7 and the weight distribution of the components of the tapes, the individual equilibrium curves for the back-coats and the magnetic coatings can be calculated. These curves are plotted in figures 2-8 and 2-9 as water content of the coatings in weight percent versus RH in percent at 25° C.

The equilibrium curves (fig. 2-8) of the back-coats from both tapes are essentially identical, and the back-coat as a material was found to be the most hygroscopic of the three

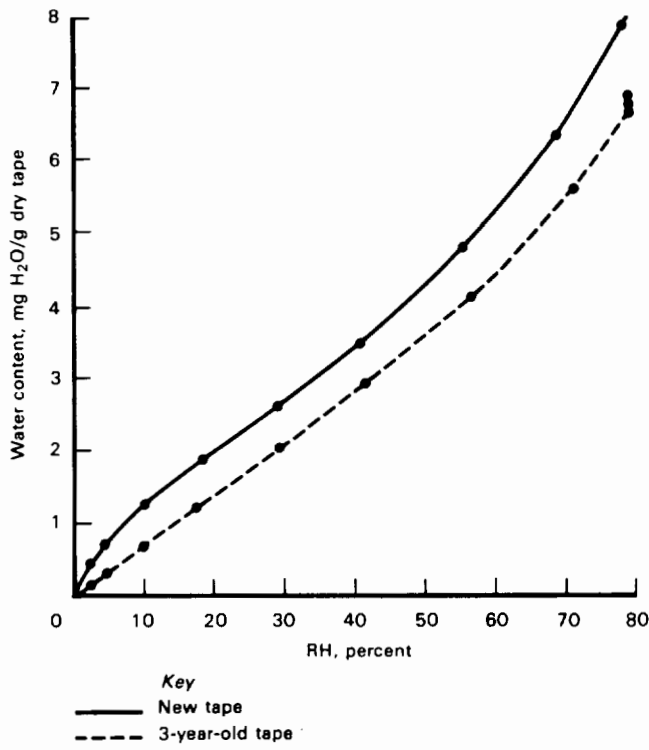

Figure 2-6.—Equilibrium curves of tape water content versus RH at 25° C.

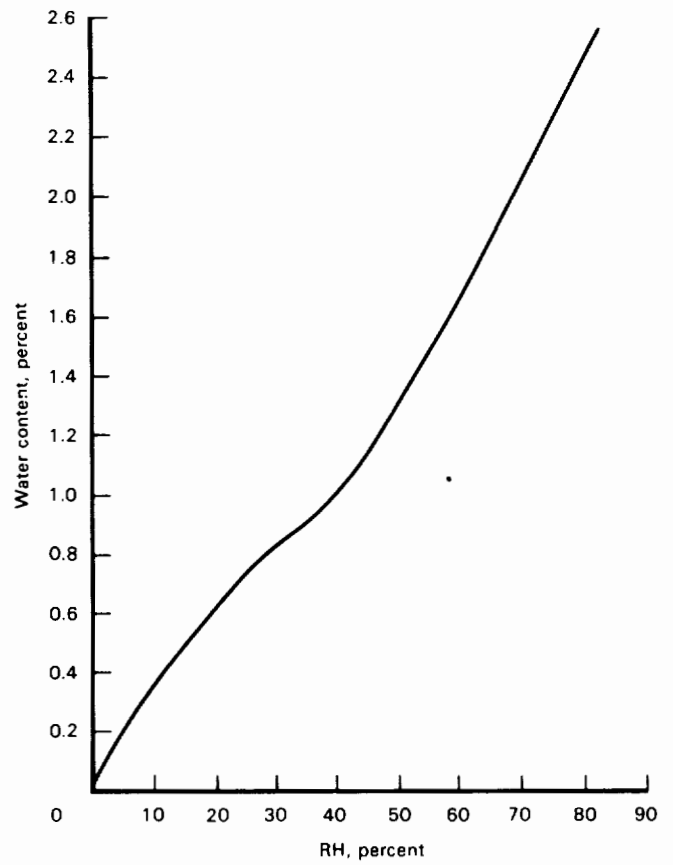

Figure 2-8.—Equilibrium water content of back-coated material at 25° C.

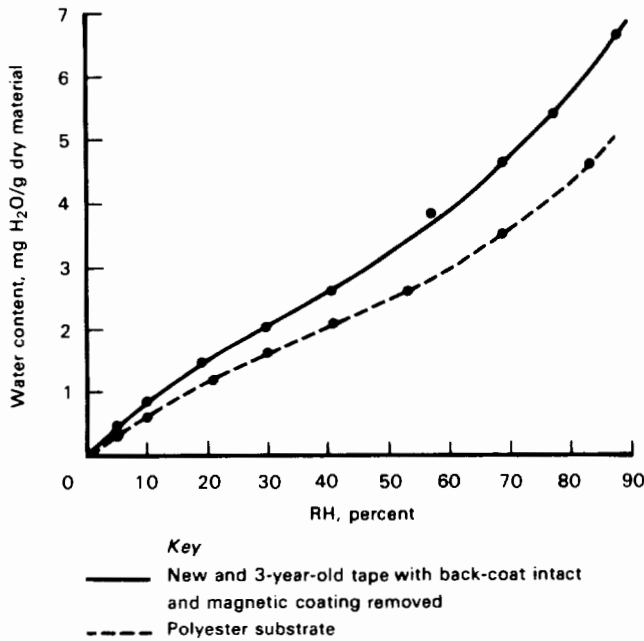

Figure 2-7.—Equilibrium curve of water content versus RH at 25° C for polyester and for polyester plus back-coated material.

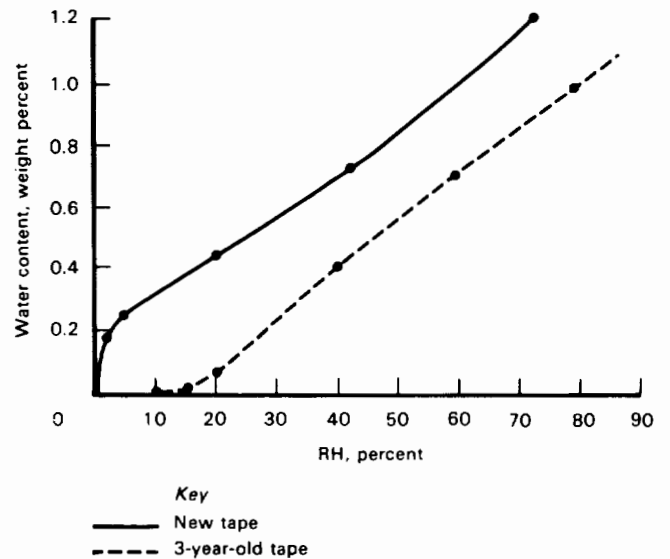

Figure 2-9.—Equilibrium water content of magnetic oxides at 25° C.

tape components. Because the function of the back-coat is to be a conductive path for static electricity, and because absorbed water plays a role in eliminating static electricity, the back-coat is perhaps intentionally fabricated to be

highly hygroscopic. No aging effects were detected for these back-coats.

The equilibrium curves for the magnetic coatings (fig. 2-9) show dramatic differences. The water content of the

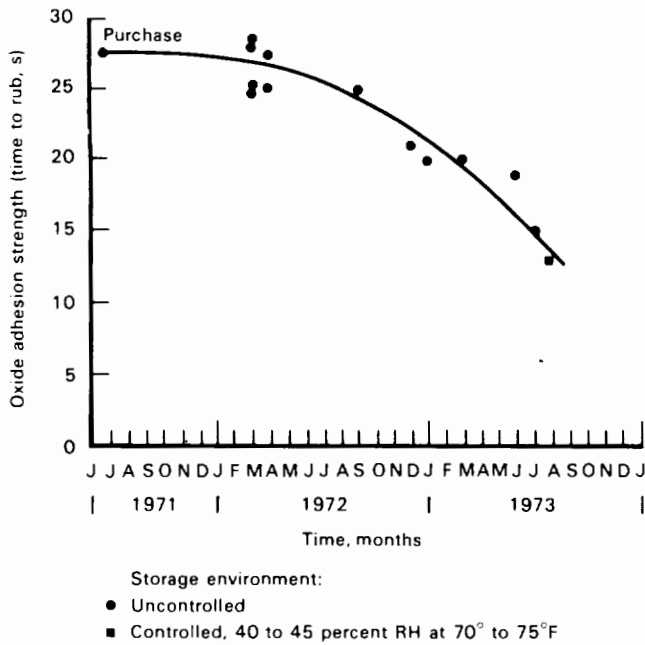

Figure 2-10.—Decrease in oxide adhesion strength with time (aging).

magnetic coating of the 3-year-old tape at any RH value is less than that of the new tape, and as RH decreases to less than 20 percent, the 3-year-old magnetic coating dries out and contains negligible, if any, absorbed water below 10 percent RH. Such differences have been previously observed. Magnetic coatings are a dispersion of a magnetic oxide in a polymeric binder, and the mechanical and physical properties of polymeric binder materials are affected by their absorbed water content. Usually these materials become softer with increasing water content, and this can affect their friction properties. The role of absorbed water in reducing or increasing the sliding friction of many polymers has been observed and reported. This observation of hygroscopic differences in tapes of the same brand raises questions of variations for other brands of tapes, both old and new, and what role absorbed water content of magnetic coatings plays in such head-to-tape phenomena as head wear, head staining, oxide shed, stick-slip, static electricity problems at low humidities, and friction and frictional heating.

Assuming the difference in the hygroscopic properties to be an aging effect, it is interesting that this same brand of tape exhibited another aging property. It was found that the strength of adhesion of the magnetic coating to the polyester substrate decreased with time. Adhesion strength was roughly monitored by measuring the time to rub off a fixed area of the magnetic coating with a cotton-tipped swab saturated with a strong chemical solvent. In this case, tetrahydrofuran was used in rubbing away a 1½-by-½-in. area. The rubbing times monitored over a 2-year period for samples of this tape kept in an uncontrolled laboratory area and in a controlled environment are

plotted in figure 2-10. Recognizing the inherent pitfalls in using rubbing times for exacting analysis, the magnetic coating nevertheless became easier to remove with time. Whether this aging effect is related to the changes in hygroscopic properties can only be conjectured, but both have been demonstrated as detectable aging processes occurring in tape that may have significance in use over a long time period.

RH Behavior

Many applications of tape recorders require that they be enclosed in hermetically sealed cases, and usually under some specified value of RH. A common specification is for RH to be 5 percent or less; that is, a dry gas environment. Sealed cases are typically fabricated having either one or two valves, depending on which of two common techniques is to be employed for humidity conditioning.

Using two valves, dry gas, or gas prehumidified at specification levels, is made to flow through the case for a specified length of time, or until a humidity probe at the exit indicates the desired humidity has been attained. For a sealed case with one valve, the case is first partially evacuated and then repressurized, with this cycle repeated a specified number of times. Considering this latter technique, if the case is sealed with a room RH between 40 and 50 percent, followed by six cycles of evacuation to one-half atmosphere and repressurization with a dry gas, then the final gas RH is assumed to be less than 1 percent. Each cycle reduces RH by one-half; for six cycles the total RH reduction is one sixty-fourth of the starting RH.

To achieve a desired RH in the sealed case, however, it is also necessary for the tape pack to have an absorbed water content corresponding to the desired RH in accordance with its equilibrium hygroscopic properties. In a small volume case, the tape pack at equilibrium will contain 10 or more times the water content of the same pack in the gas environment; therefore, the tape pack will completely dominate and dictate the RH behavior in the sealed case. It is necessary, therefore, for humidity conditioning not merely to adjust the gas RH but to effect a change in the water content of a wound tape pack to achieve a specification RH.

Experimental Procedure

An aluminum case, approximately 8 in. high by 12 in. wide by 16 in. long, which could be hermetically sealed, was constructed and fitted with two valves. A temperature and RH probe (universal, direct-reading probe with a range from 40° to 120° F and 8 to 100 percent RH manufactured by Hydrodynamics, Division of American Instrument Co., Silver Spring, Md.) was mounted in the interior of the case and positioned to avoid any contact with the walls. Electrical connections were made with the probe to its external direct temperature and RH meters

through vacuum- and pressure-tight electrical bulkhead fittings mounted on one wall of the case.

The tape employed in this study was the 3-year-old, ½-in., back-coated wide-band instrumentation tape. A length of 1275 ft of this tape was wound into a tight smooth pack under a tension of 5 to 8 oz. The tape pack weighed 204 g.

To monitor the water content of the tape pack, a Mettler p-1200 direct reading analytical balance, constructed with nonhygroscopic materials, was positioned inside the aluminum case, and the wound pack of tape placed on the balance pan. A small window was built into one wall of the aluminum case to allow viewing of the direct reading weight scale of the balance.

The aluminum case was in turn placed inside an air-circulating combination oven and cooling chamber offering temperature control between 55° and -5° C. The aluminum case was so positioned inside the chamber that a window in the chamber door allowed a view of the balance scale inside the aluminum case.

Appropriate plumbing was connected to the two valves of the aluminum case to provide for vacuum, pressure, and gas flow. The inert gas selected for this study was nitrogen, supplied dry in standard gas cylinders. Nitrogen gas flow from the cylinders was divided externally into two lines: one dry as delivered from the cylinders and the other bubbled through a 5-gal reservoir of water. The two lines were then combined before entering the aluminum case. By regulating the flow rates in the two lines, any RH between 0 and 100 percent could be achieved. Adjustable flow rotometers with capacities up to 2 ft³/h were installed in each line, yielding a total monitorable flow capacity of 4 ft³/h. Total combined flow rates into the aluminum case were held typically to between 1 and 2 ft³/h.

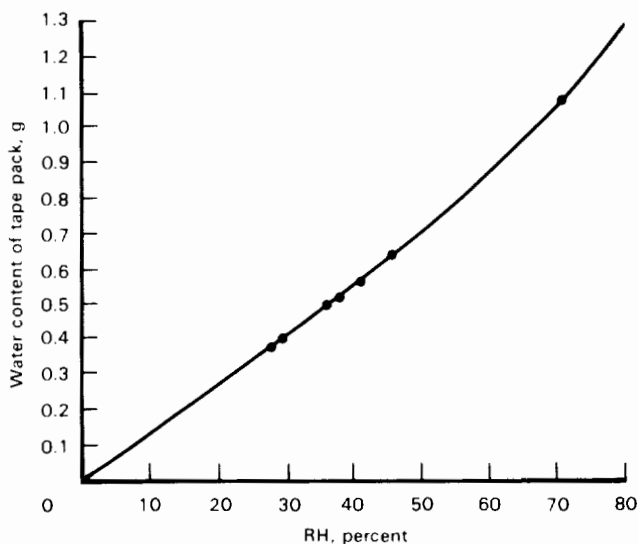

Figure 2-11.—Equilibrium water content of 204-g wound tape pack at 25° C.

The humidity entering the case was monitored by a model 880 Dew Point Hygrometer manufactured by the Environmental Equipment Division of EG&G International, Inc. This device is designed to measure the humidities of flowing gases, and by a combination of valving, this same device was also used to monitor the humidities of the gases discharging from the aluminum case.

Additionally, a saturated solution of calcium chloride (CaCl₂) in water was used to generate a fixed RH humidity of 30 ± 3 percent to the nitrogen gas. This salt solution will automatically impart a fixed 30 ± 3 percent RH to any gas being bubbled through, and, therefore, provided a simple gas humidification technique without the need for extensive valving to mix wet and dry gases. (Other salts in saturated solutions can be used to achieve different RH values. A tabulation of salt and their RH values in saturated solutions may be found in a *Handbook of Chemistry and Physics*.)

Results

Equilibrium Curve

Figure 2-11 is a plot of the equilibrium water content in grams as a function of RH at room temperature for the 204-g tape pack. The curve was calculated from the equilibrium data given in figure 2-6 for the 3-year-old tape.

The solid circles on this calculated curve are actual equilibrium conditions observed in the sealed chamber throughout the study. This demonstrated that equilibrium data for a large pack can be generated from data measured on a small piece of the loose, unwound tape.

Initial Experiment and Vacuum Dehydration

The tape pack was sealed inside the aluminum case with the ambient atmosphere at a humidity that varied from 35 to 40 percent RH. A vacuum was then applied to dry out the tape pack and to exhaust the case of the ambient atmosphere. About 3 to 4 days were required to achieve a constant weight condition for the tape pack. No effort was made to bring the balance to zero at installation. Thus this constant weight reading became the base line weight for the dry tape pack. The case was then pressurized to one atmosphere with dry nitrogen to measure the buoyancy correction of the tape pack. Following this, nitrogen gas humidified to 30 ± 3 percent RH by bubbling through the saturated CaCl₂ solution was directed at approximately 1 to 2 ft³/h through the aluminum case, until a constant weight condition was achieved for the tape pack. An equilibrium condition of 28 percent RH was reached in 3 to 4 days, essentially identical to the initial dry out time from 35 to 40 percent RH.

The tape pack, now equilibrated at 28 percent RH in a nitrogen gas atmosphere, was again exposed to vacuum,

and the time dependence for the weight loss of water from the tape pack is plotted in figure 2-12. Again about 3 days were required to dry out the tape pack. A trial and error procedure determined that the optimum plotting format for these data was on semilog paper, with weight of the water in the tape pack on the linear scale and time on the log scale. The curves display a symmetry that has not been theoretically explored.

The tape pack was also equilibrated to 72 percent RH, followed by vacuum exposure. This time dependence is also plotted in figure 2-12. About 5 to 6 days were required to dry out the tape pack from this higher humidity level.

For both the 28- and 72-percent RH equilibrations, humidified nitrogen at these levels was directed through the case at 1 to 2 ft³/h, starting for both with a dry tape pack. The time dependences for the weight gain of water were essentially the mirror images of the weight loss curves plotted in figure 2-12. Thus winding a tape into a pack does not change the absorption or desorption characteristics compared to the tape when unwound, but only changes the time dependence. To dry out the loose tape from 28 percent RH required only about 17 min, but to dry out the wound tape required almost 3 days. That is, it takes about 250 times longer for a pack of 1/2-in. tape wound under 5 to 8 oz of tension to adjust its water content as compared to the tape when loose.

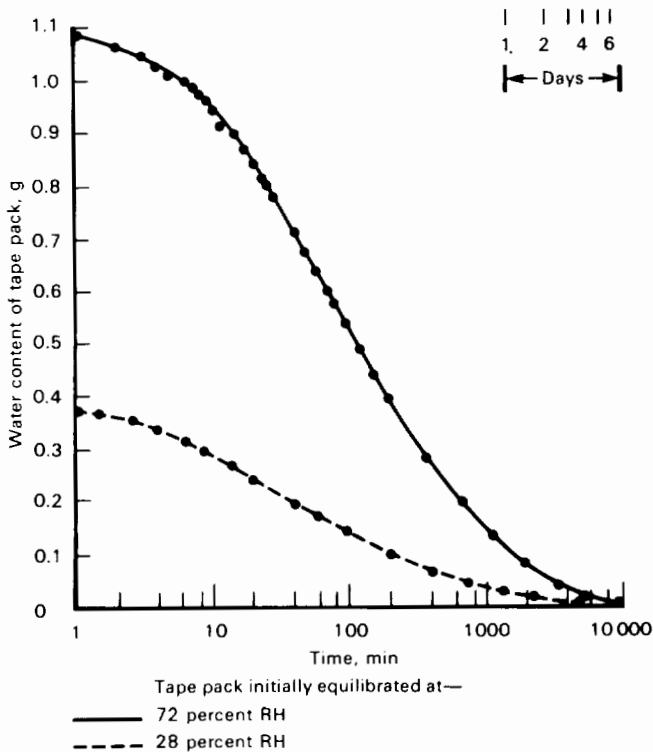

Figure 2-12.—Time dependence for vacuum-drying wound tape pack at 25° C.

Tape Pack Control of Case RH

To achieve a known and stabilized RH in a sealed case, it is necessary that the water content of the tape pack be at equilibrium with the desired RH. Otherwise, a different RH can result. This is demonstrated in the data of figure 2-13. The water content of the tape pack and case RH were first stabilized at 36 percent RH, followed by flowing nitrogen gas humidified to 62 percent RH through the case at approximately 2 ft³/h. The humidity of the discharging gas was monitored and found to increase from 36 to 62 percent RH in about 10 min. An additional 10 min of flow was allowed for a total flow time of 20 min. The weight of the tape pack increased insignificantly during this time.

The flow was stopped and the valves closed to seal the case. The time dependence of the decrease in case RH from 62 percent to a final 38 percent is also plotted in figure 2-13, which shows that the decrease in RH was completed in about 1 to 2 days. The 2-percent gain in RH was caused by the gain in water content of the tape pack from the humid gas environment, the water gain requiring a slightly higher RH at equilibrium.

A calculation for this system indicated that at equilibrium the tape pack will have approximately 13 times more water content than the humidified gas in the case. Thus a 13-percent change in gas RH, without a corresponding change in the water content of the tape, will result in only about a 1-percent final change. This was observed when the gas RH was increased from 36 to 62 percent, a change of 26 percent, which ultimately resulted in a final RH change of only about 2 percent. Sealed systems having even smaller gas volume compared with the tape pack will experience correspondingly smaller changes in RH when the water content of the tape pack is not allowed to adjust.

Humidity Conditioning

Humidity conditioning of a sealed recorder case is directly related to the tape pack and to the time dependence for the tape pack to adjust its water content. For

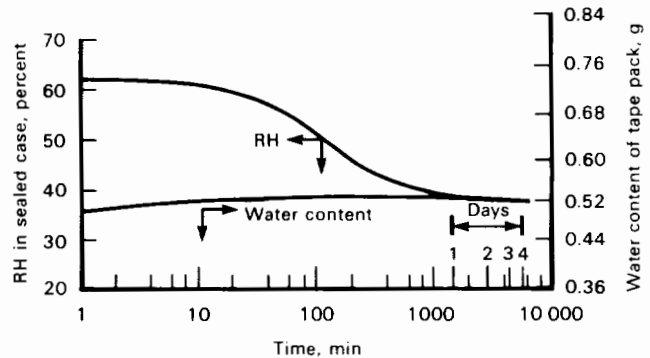

Figure 2-13.—Control of wound tape packs of RH in sealed case at 25° C.

assured conditioning to a dry gas environment, an optimum procedure would be to evacuate the case and maintain the vacuum for approximately 3 days, followed by repressurization with the desired dry gas. If the case cannot be designed to withstand a full vacuum, an alternate approach would be to allow dry gas to flow through the case for about 3 days.

Figure 2-13 details the humidity events occurring in a sealed case when the intent is to achieve a dry gas environment ($RH < 1$ percent) by a purge/fill technique. The case RH and tape pack water content were stabilized at 46 percent RH, a common room humidity existing at the time of installation and sealing of tape recorder cases. The procedure here was to first evacuate to 22 in. Hg (full vacuum = 29.92 in. Hg), hold for 3 min, then pressurize with dry nitrogen to 7 psig, hold 3 min, and repeat this cycle six times. Based exclusively on gas calculations, this procedure should have reduced the case RH to much less than 1 percent.

The linear scale on the left of figure 2-14 details the changes occurring in case RH during the six purge/fill cycles. The case RH decreased from 46 to 9 percent, the RH level being kept up because of water desorption from the tape pack as it responded to the lowering gas humidity. Following the final pressurization, the valve was closed to seal the case, and the internal RH gradually increased to a final level in about 2 to 3 days near 30 percent. The net effect of this purge/fill technique was only a 15-percent decrease in case RH, and certainly did not achieve the desired dry gas environment. The total time of approximately 36 min involved in the purge/fill cycles was

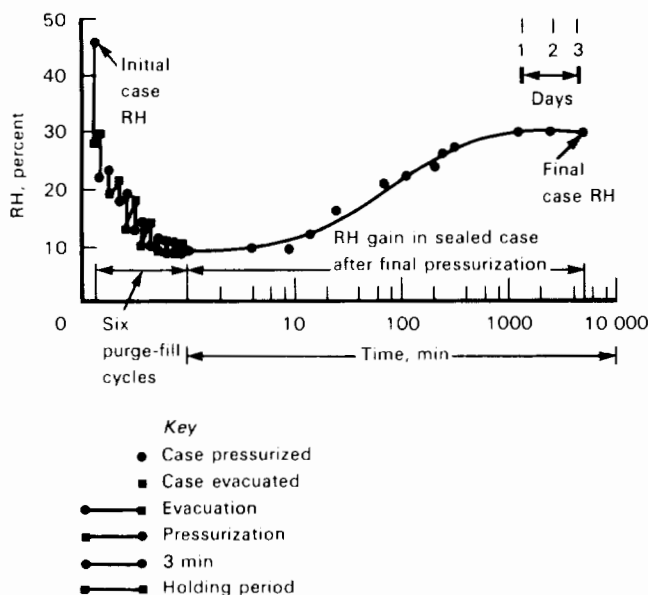

Figure 2-14.—RH behavior in sealed case containing wound tape packs employing humidity conditioning by purge-fill technique.

inadequate to dry out the tape pack. For sealed cases presumably adjusted to a dry gas environment by this technique, there is the interesting question of whether there is a need to reevaluate tape recorder performance, which was interpreted on the basis of a dry gas environment.

For humidity levels other than dry, consider placing the open case with the installed tape recorder in a laboratory chamber maintained at the desired specification RH for 3 days. The tape pack will come into equilibrium with that humidity. Then seal the case, and if required, direct a flow of specification fill gas (dry or humidified) through the case to exchange the atmosphere. The brief time involved in gas exchange will have little effect on the water content of the tape, which will then regulate the internal RH to be at the specification level.

Humidity conditioning can also be accomplished by a constant flow of humidified gas through the case. Figure 2-15 details the changes in tape pack water content in case RH for this technique. Both the tape pack and case RH were initially stabilized at 41 percent RH, followed by flowing 29 percent RH nitrogen gas through the case at 1.5 ft³/h. About 2 to 3 days were required to change the water content of the tape pack from equilibrium at 41 percent RH to equilibrium at 29 percent RH. Note that the case RH became essentially 20 to 30 percent RH in about 2 h. If flow had then been stopped, the final RH in the case would have risen to correspond to the water content of the tape pack, about 36 to 38 percent RH.

These various experiments indicate that about 1 to 3 days are required for a wound pack of 0.5-in. tape to adjust its water content to changing RH conditions, and therefore this is the time period required to affect humidity conditioning in a sealed case to accomplish a specification RH.

Heating and Cooling of a Sealed Case

The tape pack and case RH were initially stabilized to 29 percent RH and 20° C, and the case was sealed. Following this, the system was heated to 55° C at a rate of 15° C/h. The change with time in case RH, temperature, and water content of the tape pack are plotted in figure 2-16. The tape pack temperature was not monitored, but based on heat transfer theory, tape packs should accommodate rapidly to changing temperatures. Initially, as the temperature increased, the case RH began to drop as theoretically expected. But the tape pack began to desorb water, and eventually the case RH minimized and then began to increase to a final RH near 24 percent within 1 day. The tape pack acted to maintain a near constant RH in the case by desorbing water. The system was returned to 20° C, and the tape pack water content and case RH returned to their initial conditions.

The system was then cooled from 20° C to -5° C at a rate of 15° C/h. The time-dependent changes are plotted

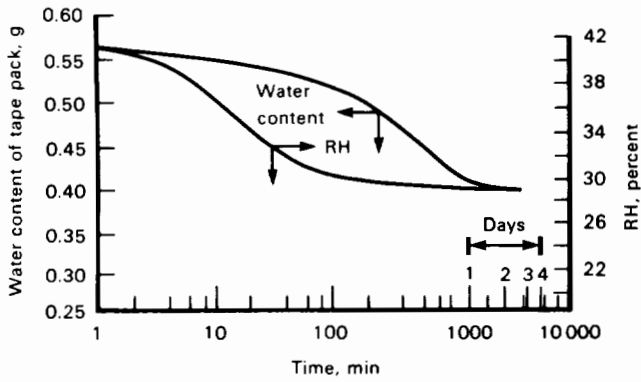

Figure 2-15.—Time dependence at 25° C for humidity conditioning by constant flow through case of gas humidified at 29 percent RH (initial equilibrium: 41 percent RH).

in figure 2-17. Initially the case RH began to increase as theoretically expected, but then the tape pack began to absorb water, and the case RH maximized and decreased to a final value within 1 day near 31 percent. Again the tape pack acted as an RH buffer and acted to maintain a near constant RH. This experiment also demonstrated that the cooling of a case sealed with tape and a humidified gas need not result in internal condensation of moisture. The tape behaves as a sponge to soak up the moisture. For this experiment, gas having an RH value of 29 percent at 20° C has a dew point of 5° C; therefore, theoretically, cooling the sealed case to -5° C should have resulted in internal condensation of moisture. It did not happen.

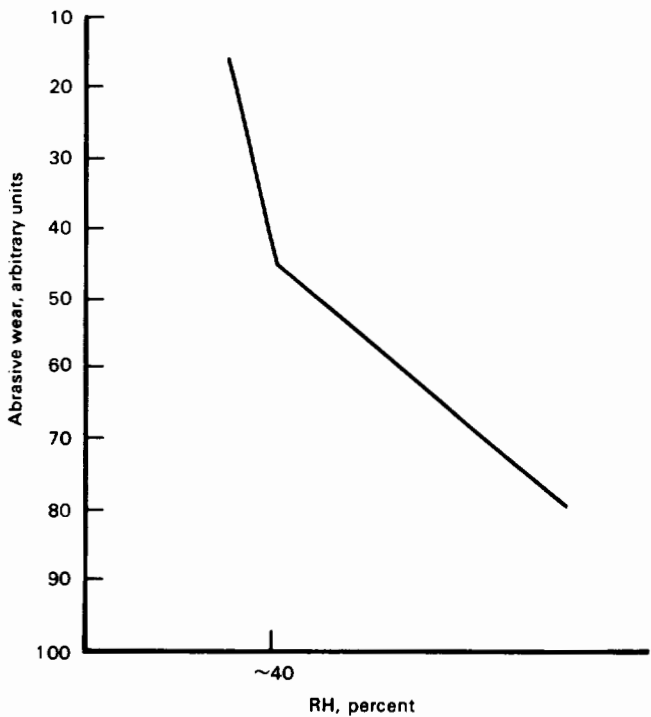
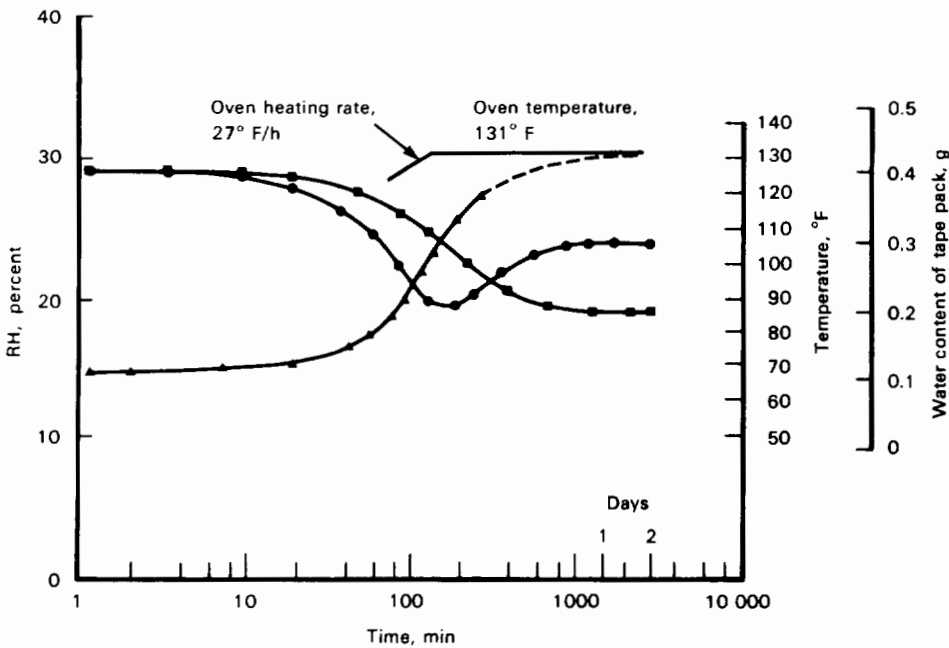

Figure 2-17.—Generalized representation of abrasive wear rate as function of RH.

Other Tapes

This humidity-regulating behavior would be general to all tapes having a polyester substrate, back-coated or not, and not just exclusively to the particular tape of this study.



- Key**
- Interior temperature in sealed case
 - RH in sealed case
 - ▲ Water content of tape pack

Figure 2-16.—Heating of sealed case containing wound tape pack.

This is because polyester is hygroscopic, which gives rise to the humidity-regulating behavior, and the polyester content of tapes generally ranges between 70 and 90 percent by weight. In fact, a fair approximation of the hygroscopic equilibrium curve for any tape can be generated, from the equilibrium curve for polyester given in figure 2-7 by simply considering the entire tape to be polyester.

REFERENCES

- 2-1. Heard, Frank: *Abrasivity Vs Relative Humidity as Measured on the Radicon*. National Security Agency.
- 2-2. Carroll, J. F., Jr.; and Gotham, R. C.: "The Measurement of Abrasiveness of Magnetic Tape." *IEEE Trans. Magn. Mag-2*(1): Mar. 1966.
- 2-3. Larsen-Basse, J.: "Influence of Atmospheric Humidity on Abrasive Wear. I. 3-Body Abrasion." *Wear* **31**: 373, 1975.

BIBLIOGRAPHY

- Benn, G. S. L.: "Characterization of 3M MTA-20250 Magnetic Tape for Use in Unattended Spacecraft Application." Final Rept., IIT Res. Inst. Proj. No. E6229 (JPL Contract No. 953318), Jan. 1973.
- Bowers, R. C.; and Murphy, C. M.: *Status of Research on Lubricants, Friction, and Wear*. NRL Rept. 6466, Naval Research Laboratories, Washington, D.C., Jan. 1967.
- Buchanan, J. D.; and Tuttle, J. D.: "A Sensitive Radiotracer Technique for Measuring Abrasivity of Magnetic Recording Tapes." *Int. J. Appl. Radiat. Isotop.* **19**: 101, 1968.
- Cuddihy, E. F.: *Chemical and Physical Investigation of Magnetic Head Assemblies from the Skylab EREP Tape Recorders*. JPL Pub. 900-668, 1974.
- Cuddihy, Edward F.: "Hygroscopic Properties of Magnetic Recording Tape." *IEEE Trans. Magn.* **12**: 126-135, Mar. 1976.
- Cuddihy, E. F.; and Van Keuren, W.: "Mathematical Description of Heat Transfer in Packs of Magnetic Recording Tapes." *IFT J.* **1**: 5, 1974.
- Deffeyes, R., ed.: *Headwear Measurements*. Graham Magnetics, Inc., Apr. 5, 1970.
- Golding, B.: *Polymers and Resins*. D. Van Nostrand Co., Inc., 1959.
- Granum, Freeman: *Abrasivity as a Function of Relative Humidity*. Ampex Corp.
- Griffith, N.: *Tape Abrasivity Vs Relative Humidity; Preliminary Report*. Spin Physics, Inc.
- Hogan, J. M., et al.: "Humidity Characteristics of HR and Hot Urethane Foams." *J. Cell. Plast.* **9**: 219, 1973.
- Kalfayan, S. H.; Silver, R. H.; and Hoffman, J. K.: *A Study of the Frictional and Stick-Slip Behavior of Magnetic Recording Tapes*. JPL TR 32-1548, 1972.
- Pourny, J. L.; and Reichenbach, G. S.: "The Importance of Humidity in Friction Measurement." *J. Amer. Soc. Lubric. Eng.* **20**: 409, Nov. 1964.
- RCA Newsletter, Febr. 28, 1973.
- Saunders, J. H.; and Frisch, K. C.: "Polyurethanes: Chemistry and Technology." Vol. XVI, *High Polymers*, Interscience Pub., Inc., 1964.
- Sawhill, Bill: "Brown Stain Discussion." Ampex Corp.
- Wright, C. D.; and Tobin, H. G.: "Surface Lubrication of Magnetic Tape." *Int. Telemetering Conf., Proc.*, Instrum. Soc. Amer., Pittsburgh, pp. 336-344.

CHAPTER 3 *Wear Testing*

Avner Levy
Advanced Recording Technology

The problem of head life in tape recorders is as old as magnetic recording. That problem became more demanding, however, as the relative head-to-tape speed increased both in video and instrumentation recording.

Several test techniques have been developed over the years to establish relative abrasivity of various tapes and the life expectancy or resistance to wear of various head materials. The tests could be divided into two categories: the short simulated sampling test and the long, detailed test. Among the most widely used are the following:

- (1) Brass shim
- (2) Radicon
- (3) Thin film technique (Fulmer Research Institute)
- (4) Ampex
- (5) Honeywell
- (6) Bell & Howell

THE BRASS SHIM TEST

The brass shim method mostly used by the General Services Administration is described in detail in Federal Specification No. WT-001553. (See app. 3-A.) The following is the highlight of that test procedure.

A sample of 0.6-mil brass shim with a specified hardness is placed on the reproduce heads only. A tape, prerecorded with 50 kHz at 60 in./s, is played back until a minimum of 50 000 ft of tape has passed over the shim head in the normal play mode with tape tension of 8 ± 0.5 oz/in. The output level of the center and edge tracks is measured at the start of the test with the shim in place. After passing 50 000 ft of tape over the shim, the output of the same tracks is again measured. The increase in reproduce level is used to determine shim wear by using the spacing formula transposed as follows:

$$\text{shim wear (mils)} = \frac{1.2 \times \text{increased output level (dB)}}{54.6}$$

since the recorded wavelength is 1.2 mils. The abrasivity of the magnetic tape tested shall cause an increase in sig-

nal level output no greater than a specified number. For high resolution and standard instrumentation tape that number is 2.5 dB (equivalent to wear of approximately 55 μ in.).

THE RADICON TEST

Tom Carothers
National Security Agency

This test relies heavily on radio trace technique for measuring tape abrasivity. A tape sample is passed over an irradiated Kovar head. A small, weighted piece of irradiated Kovar is used as a known standard against which the tape sample, having been run over the Kovar head, is evaluated on a scintillation counting system. The abrasivity of the sample is calculated and expressed in micrograms of Kovar per pass.

The radicon technique is a result of a study by John D. Buchanan and John D. Tuttle (ref. 3-1).

The term "radicon" comes from the Radicon Co., consultants on the design of the tape transport and radioactive heads. This method is used in current National Security Agency (NSA) specifications.

The purpose of this test was to determine the abrasivity of Ampex type 787 instrumentation tape under various humidity and wear conditions. Magnetic tape procured against NSA specifications is normally tested for abrasivity under controlled laboratory conditions (50 ± 10 percent relative humidity; $75^\circ \pm 5^\circ$ F). The testing performed under this study evaluated abrasivity under various conditions, such as high and low humidity, new tape, and tape with a number of passes over heads. Ampex 797, 3M888, and 3M8390 were a part of this test for reference purposes.

The Radicon abrasivity test unit was modified so that the glass door panels were replaced with clear Plexiglas. A 3½-in.-diameter supply and return hose was connected through the upper and lower Plexiglas panels. The hoses were connected to an environmental chamber, and the air from the chamber was circulated through the door of the

recorder/reproducer and returned to the chamber. In this manner the environment that the tape and heads were subjected to was controlled by the environmental chamber.

The tests were performed using the same equipment and operator throughout to reduce the chance of error.

The following procedures were followed and repeated for each tape type and humidity:

(1) A 4600-ft tape sample wound on a 10½-in. reel was selected.

(2) Recorder and environmental chamber were adjusted for humidity condition under test.

(3) Humidity condition tape samples were taken for a minimum of 64 h.

(4) A 200-ft tape sample was removed from the 4600-ft reel and stored in the environmental chamber (to become the zero-wear pass sample).

(5) The remainder of the tape sample was subjected to 25 wear passes on the radicon. A 200-ft sample was removed (the 25 pass wear sample) and stored in the environmental chamber.

(6) The remainder of the tape sample was subjected to an additional 25 wear passes. A 200-ft sample was removed (the 50 pass wear sample) and stored in the environmental chamber.

(7) The remainder of the tape sample was subjected to an additional 25 wear passes. A 200-ft sample was removed (the 75 pass wear sample) and stored in the environmental chamber.

(8) The remainder of the tape sample was subjected to an additional 25 wear passes. A 200-ft sample was removed (the 100 pass wear sample) and stored in the environmental chamber.

(9) The abrasivity of each sample was calculated.

The term "abrasivity" refers to the abraded material, as measured using the following procedure. The tape samples, 200 ± 1 ft, were wound onto hubs. The samples were then passed over a Kovar head (app. 3-B) at a tension of 8 ± 0.5 oz and a speed of 30 in./s. This procedure was repeated until four passes over the Kovar head were completed. The Kovar head and all guides were cleaned, and the cleaning material was placed with the tape sample for the scintillation count.

The tape samples were evaluated for abrasivity using the following procedure, which appears in NSA Specification L14-3-75. The scintillation counting system was allowed to warm up according to the specifications of the manufacturer. The counting period was adjusted for 5 min. A background count was made, and the count recorded. The standard (app. 3-B) will then be placed on the crystal and a 5 ± 0.1 min count taken and recorded. The first sample will then be placed on the crystal and a 5 ± 0.1 min count taken and recorded. This shall be repeated for all samples to be evaluated. The two background counts will be averaged and the average noted.

The two standard counts will be averaged and the background count subtracted from this. The sample counts will then be evaluated according to the following formula:

$$\frac{KC_{Sa}/N}{C_{St}} = \text{Kovar per sample per pass } (\mu\text{g})$$

where

K = Kovar in standard (μg)

C_{Sa} = total counts of sample, background subtracted (μg)

N = total number of passes over Kovar head

C_{St} = total counts of standard, background subtracted

Figures 3-1 to 3-4 show the variations of abrasivity as a function of wear passes and relative humidity for Ampex 787, Ampex 797, 3M888 and 3M8390 recording tapes, respectively. Samples 787A, 787B, 787D, 787E, and 787F in figure 3-1 are from reels that were adjacent during manufacture; therefore, changes in abrasivity would be primarily a function of humidity and wear passes. Sample 787G was run to verify the 80-percent curve using a tape sample from another manufacture lot.

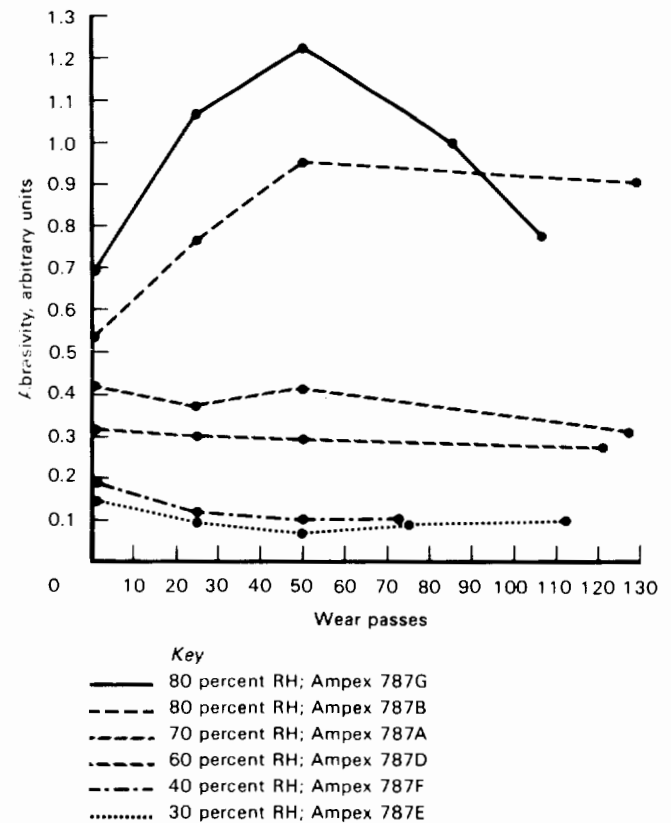

Figure 3-1.—Head wear of Ampex 787 recording tape measured at the National Security Agency using the Radicon technique. (RH = relative humidity.)

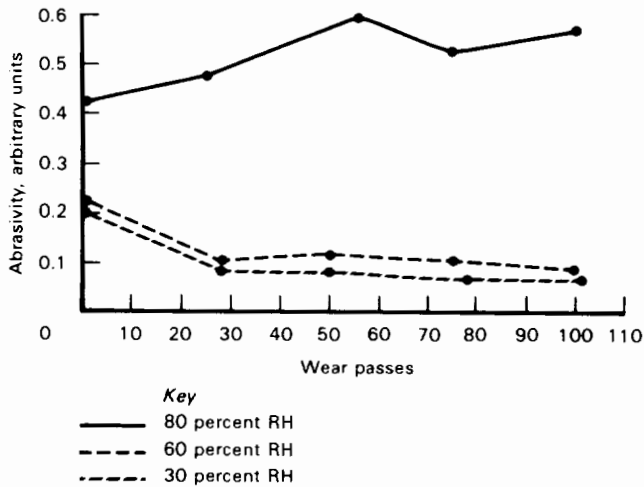

Figure 3-2.—Head wear of Ampex 797A recording tape measured using the radicon technique.

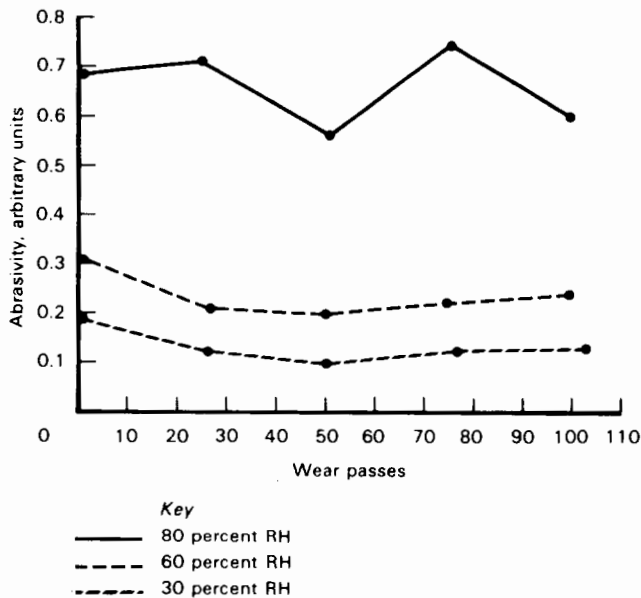

Figure 3-3.—Head wear of 3M888A recording tape measured using the radicon technique.

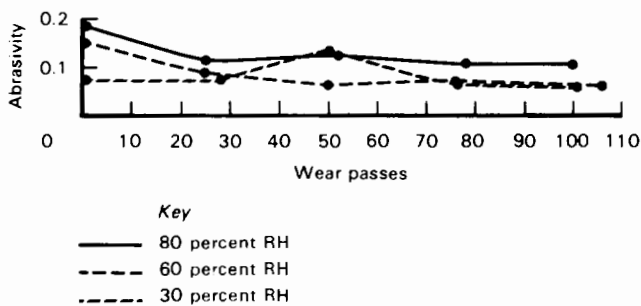

Figure 3-4.—Head wear of 3M8390A recording tape measured using the radicon technique.

It is interesting to note the margin of error between essentially the same tape in figure 3-1 (787B and 787G) with increased number of passes or in figure 3-3 between the wear of the same 888A tape and in figure 3-4 between the wear of the same 8390A tape.

With the exception of testing performed at a relative humidity of 80 percent, all samples met or exceeded present NSA specifications.

THIN FILM METHOD

M. A. Perry
Ashley Associates Ltd.

The need to have a quick comparison of tapes with a direct readout of abrasivity led to the adoption of a method, still relatively new, whereby the tape is run in contact with a thin film material of approximately the same average hardness as the head. As the film wears, the resistance of the film is monitored on a chart recorder continuously as an out of balance voltage of a bridge, one arm of which is the thin film.

The rate of change of this voltage with time or with the number of feet of tape as it passes over the "head" is a measure of the ability of the tape to remove material from the head. The correlation between this type of test and the actual wear of a real head is the important factor in determining the usefulness of this method toward making a comparison of abrasivity of tapes.

The method has been described previously (ref. 3-2). Briefly, the dummy head is constructed as in figure 3-5, the resistive element contained in a ceramic tube where the radius conforms to that of the simulated head.

Each element is capable of making at least 20 measurements before it is worn out and, because there are 8 elements around the tube, the dummy head is suitable for approximately 160 measurements before changing. The elements are vacuum-deposited alloys of hardness 175 HD; the deposition takes place in a carousel that rotates the elements during the deposition process.

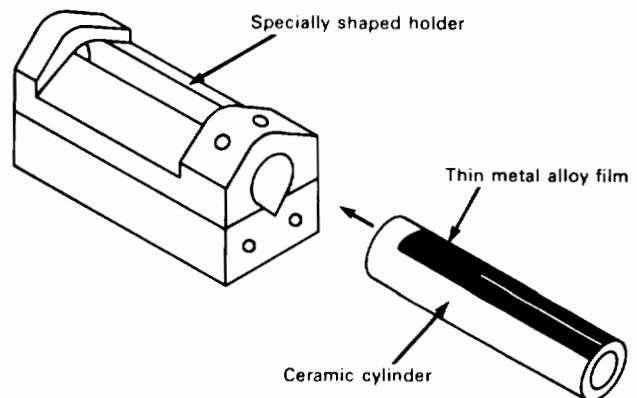

Figure 3-5.—Dummy head configuration.

A typical readout is shown in figure 3-6. The sensitivity of the method is demonstrated by the change in slope that occurred when the local humidity was increased by breathing on the tape.

The method is repeatable and cheap, and it is easy to realize an abrasivity ranking on a small sample of only 100 ft of tape. Ranking is in arbitrary units against a "standard" tape. The success of the method is perhaps indicated by the increasing use made by tape manufacturers of the confidential service provided by the Fulmer Research Institute.

The method is not a panacea for determination of head wear, and it could be argued that the results cannot be extrapolated to real situations on other types of heads fabricated with alfsil or ferrite. However, this criticism could be leveled at any other simulated tests currently

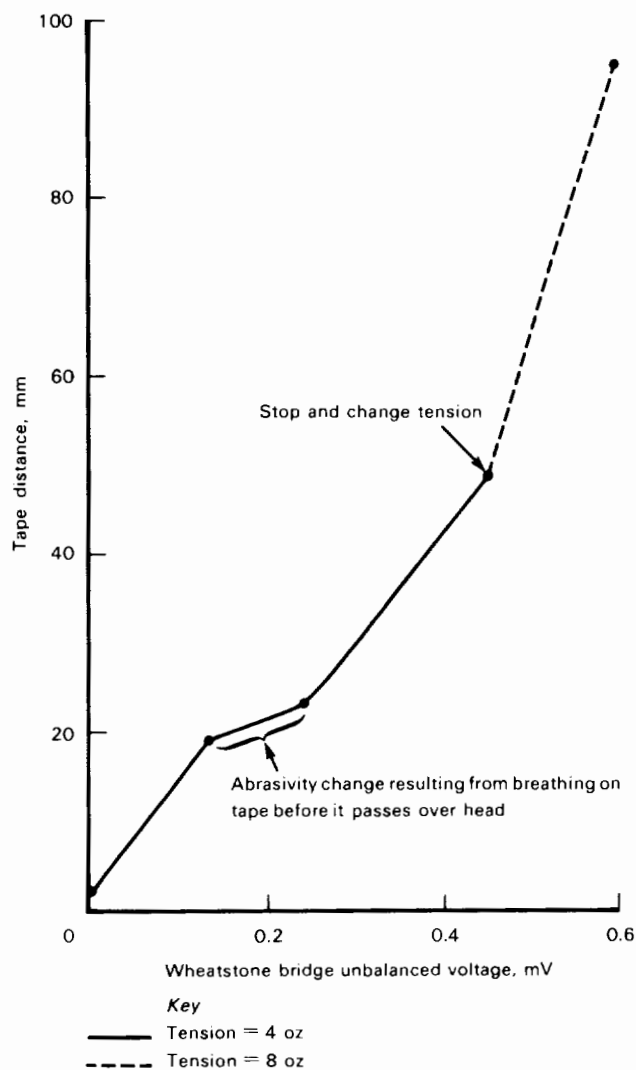

Figure 3-6.—Typical readout showing effect of humidity change with thin film method of measuring head wear. (Tape width = $\frac{1}{2}$ in.; tape speed = $7\frac{1}{2}$ in./s; Temperature (ambient room) = 21° C; relative humidity (ambient) = 63 percent; chart speed: 30 mm/min.)

used for head wear evaluation. Nevertheless, there is good correlation on permalloy heads and no reason to suppose that limited extrapolation of results is inappropriate for heads of the alfsil or ferrite type in contact with these particular tapes.

Examination of figure 3-7 taken from the paper by Cash and Pagel (ref. 3-2) shows that in an actual installation where three types of tapes were used and the heads were completely worn out, correlation was extremely good with the abrasivity ranking made by the thin film method. The installation and experience proved that by selecting the correct tape and by optimizing the head profile, extended operating life could be achieved. Because the method is very sensitive and has instantaneous electrical readout, it could be used to examine a wide range of parameters that affect head wear, such as differential tension over the head, relative humidity, and tape speed. The wear material does not contaminate the tape to any great extent and, therefore, can be used in a quality assurance mode. An example of abrasivity change with tape speed is given in figure 3-8.

Related Work

The Fulmer Institute is examining the surface of tapes by a variety of techniques, including electron spectrometry, with the goal of making tape formulations less abrasive.

Electron spectrometry is a technique that measures

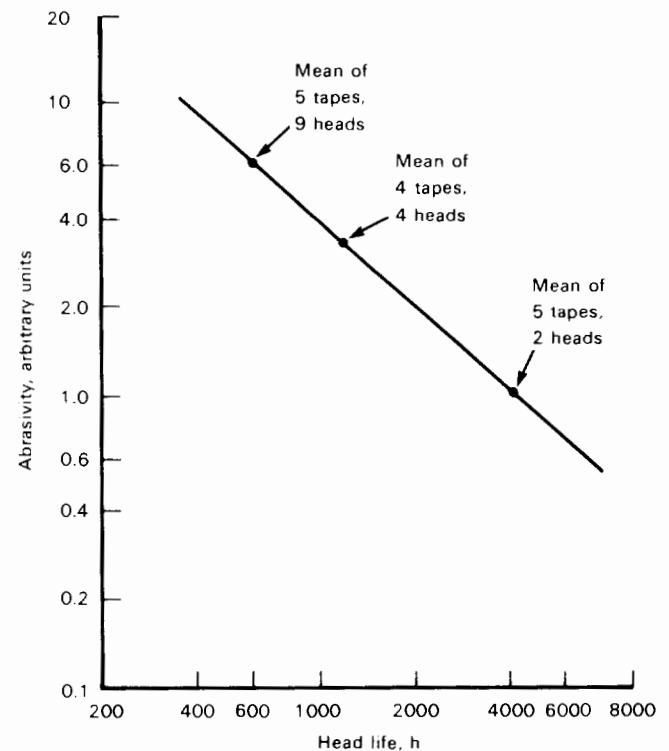

Figure 3-7.—Actual wear tests correlated against abrasivity measurement (ref. 3-2.).

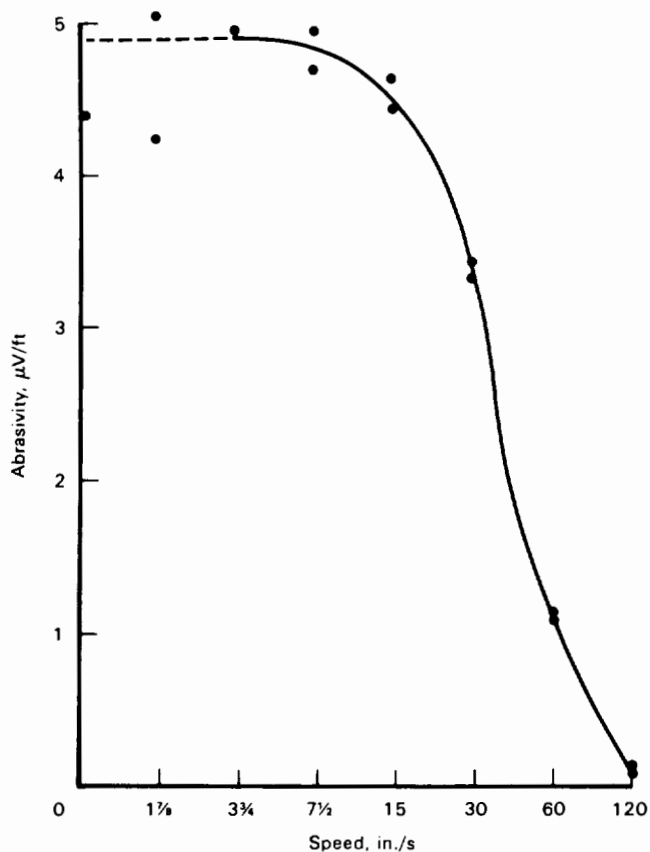

Figure 3-8.—Abrasive change with tape speed.

with extremely high resolution the energies of the electrons emitted from surface atoms or molecules on irradiation with X-rays. The energies of the electrons vary according to the atoms from which they originate. An electron spectrometry spectrum is thus characterized by peaks corresponding to electrons of different energy levels.

The ability to measure small binding energies in the surface of materials to a depth of 30 Å enables the valence state of atoms to be detected and allows the experimenter to perform qualitative elemental analysis.

Figure 3-9 shows the results of electron spectrometry examination of two tapes that have been run over magnetic recording heads. Tape A shows considerable amounts of nickel that have migrated to the tape from the head materials. In tape B, the nickel peak is absent, but a silicon peak appears. By its position (102.8 eV), it is identified as the silicon that was deliberately added to the tape formulation and which has successfully reduced head wear.

Conclusions

The thin film method of ranking the abrasivity of tapes, together with electron spectrometry, allows the user to have a better understanding of the tape-to-head interface

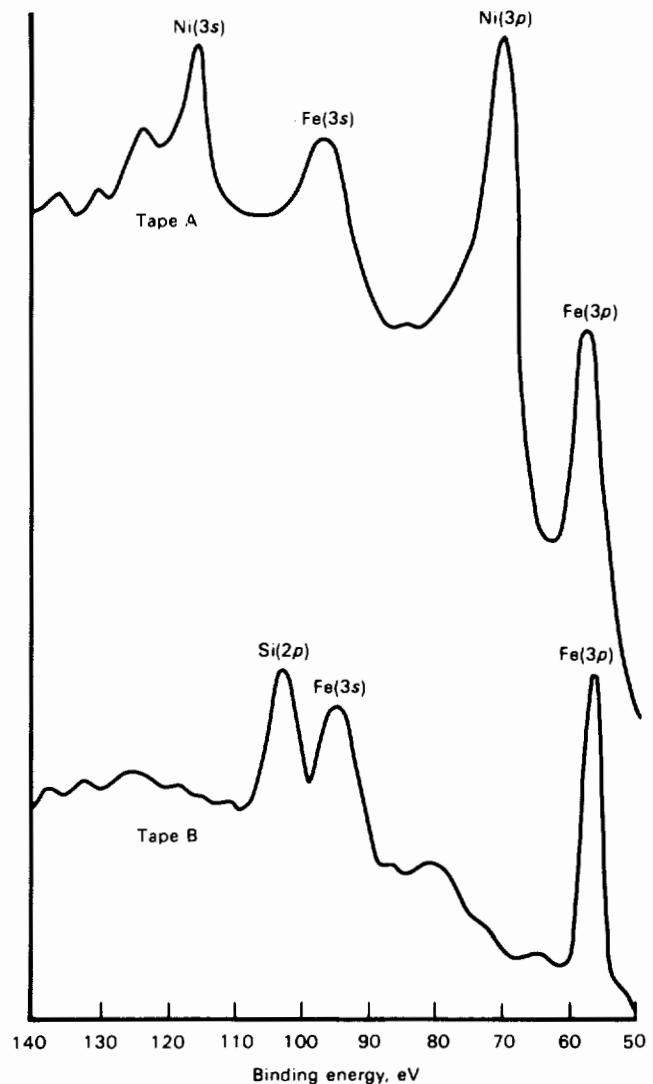

Figure 3-9.—Electron spectrometry examination of surface of tapes in contact with permalloy heads.

problem in relation to head wear. Although there are competing methods, the simplicity and the immediate results that can be obtained from a short length of tape make this method a useful tool for identifying potentially abrasive tapes.

THE AMPEX TEST

The main difference between the Ampex test and any of the previously described tests is the use of an actual head recontoured to assume the initial contour at the start of every test. The use of one stack, however, does not allow these tests to reflect the "upstream/downstream effect"; i.e., the influence of an upstream head on the wear of a downstream head.

Using an FR-1400 tape transport with only one set of heads (record or reproduce), only the head stack closest to the pinch roller is monitored. A sample of 1800 ft of virgin

tape is run at 120 in./s for 3 h (reverse is run in a shuttle mode with head engaged but with pinch rollers not engaged). The head used is a mu-metal (soft face) type head recontoured to its initial contour. Temperature and relative humidity are maintained around $70 \pm 2^\circ \text{F}$ and 50 ± 2 percent, respectively. The wear is measured by comparing profilometer traces made before and after the wear. Using the unworn area of the head as a reference, measuring and adding the wear of each individual track and dividing by the number of tracks and the number of hours yields the average wear per hour per track.

Equipment Required

Proficorder—Amplicorder Type RAC, Model 8 with Linear Piloter (Micrometrical Manufacturing Co.)
 Small machinist vise
 Ampex head cleaner (Part No. 087-007)
 FR-1400 tape transport (set up for 1/2-in. tape) and control bay
 FR-1400, 3- or 4-track, newly contoured, mechanically good reproduce head
 FR-1400 mechanically good (dummy) complementary reproduce head (The dummy stack configuration should be such that the overall head assembly conforms to a 7-channel interlace system. The dummy stack shall be undercut if the test stack is undercut and smooth if the test head is smooth; special head stack No. 120411-039, 3-channel playback; special head stack No. 120412-039, 4-channel playback.)
 Polishing tape, 1/2-in. width (Reeve's No. 5-5831-12-1 or equivalent)
 Operator's manual for Proficorder
 FR-1400 instruction manual

General Operating Precautions and Instructions

Proficorder

(1) Avoid prolonged handling of Piloter and Tracer adjustments on the Proficorder because they may be affected enough by body heat to cause errors or other difficulty.

(2) Allow at least 15 min warmup time for the Proficorder.

(3) Thoroughly clean the head surface to be profiled. Wipe off all oxide, chips, and dust, using Ampex head cleaner to avoid false readings or needless wear to the Proficorder Tracer point.

FR-1400

(1) Thoroughly clean the tape path, removing all oxide from transport, tape guides, capstan, turnaround idler, and

pinchrollers, using alcohol, Kimwipes, and cotton-tipped applicators.

(2) Install reel flanges on test tape hub.

Operating Procedure

This procedure assumes the operator is familiar with the normal FR-1400 and Proficorder operations. In any case, a careful review of the instruction manuals is recommended.

(1) Mount the newly contoured reproduce head assembly on the FR-1400 reproduce head carriage.

(2) Remove the record head assembly from the machine.

(3) Thread the polishing tape on the machine and run approximately 50 ft across the heads in "Play" mode at 120 in./s. This results in roughly $50 \mu\text{in.}$ of head wear and brings the "peak" of the head surface down to a more linear wear region.

(4) Remove the contoured head from the head assembly and mount with the head gaps facing up in the machinist's vise.

(5) Using the Proficorder, locate the highest point along the gap apex and use this area as a reference. Two such reference areas usually exist in the shield material at either end of the head or in the aluminum section. See figure 3-10.

(6) Having located the reference points, measure along the entire apex of the head. The chart recording obtained will look like figure 3-11. (Measurements not made along the apex of the head will give misleading results.)

(7) Referring to figure 3-11, measure the distance from the reference line to each head (y , in microinches) and record directly on the chart. Record the average of these readings as "Initial reading" on the data sheet.

(8) Remount the head on the head assembly and mount on the FR-1400.

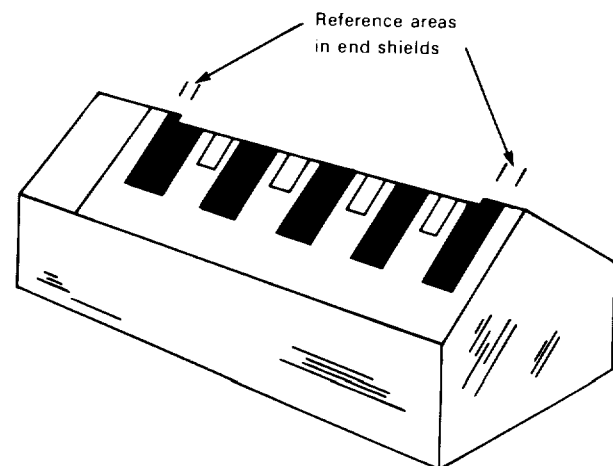

Figure 3-10.—Head.

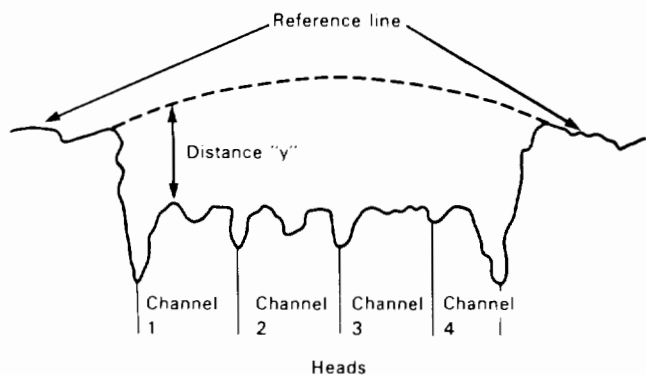

Figure 3-11.—Chart recording of head apex.

(9) Thread the virgin tape under test on the system. (Note: 1800 ft of tape are required for the actual measurement; therefore, the minimum length of tape used should be roughly 2400 ft to prevent the tape from running off the reel.)

(10) Place the FR-1400 in "Rewind Search" or "Fast Forward Search" mode at 120 in./s to locate the point at which the test cycle is to start; then set the left-hand set of digits on the reel rotation counter to 0000.

(11) Place the FR-1400 in "Drive" mode and run the tape for 3 min. This is the point at which one-half the cycle will end and represents approximately 1800 ft of tape.

(12) Place the right-hand set of digits on the reel rotation counter to 0000.

(13) Turn the "Automatic Cycling" switch to "Reproduce." Set the "Rewind-Forward Speed" switch to "Search."

(14) Push the "Rewind" button. (Note: The FR-1400 will operate in "Rewind Search" mode with heads in contact with tape until the beginning of the cycle is reached. The system will come to a momentary stop and will then operate in the "Reproduce" mode for the forward half cycle until the end of the cycle is reached. After a momentary stop, the system will repeat the above operation until manually switched to another mode.)

(15) After 30 complete "Rewind/Reproduce" cycles (3 h), stop the machine.

(16) Remeasure the head as described in steps (4) to (7).

(17) Record the average increase in distance y on the data sheet as "Total wear."

(18) Fasten the chart recordings to the data sheet.

HONEYWELL WEAR TEST OF FERRITE HEADS

Larry Girard
Honeywell, Inc.

Wear tests of hot-pressed ferrite heads were conducted by Honeywell Inc., Denver, Colo. The test was run using

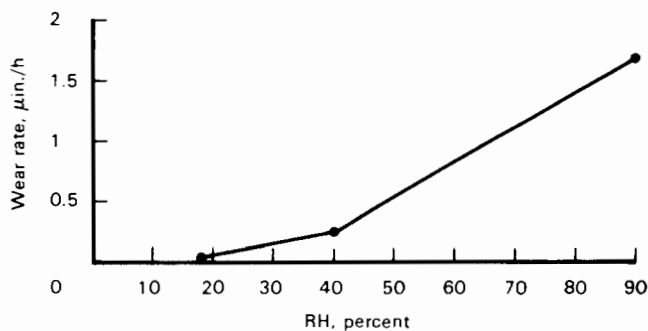

Figure 3-12.—Average ferrite head wear rate on Honeywell Model 96 transport with Ampex 786 and 787 tapes in forward and reverse at 60 in./s.

Ampex 787 and 786 as well as 3M971 tapes under varying environmental conditions.

Tape speed was set at 60 in./s except where specified, and the tape transport, Honeywell model 96, was set for 8 oz of tape tension, slightly lower than the Bell & Howell tension setup of 10 oz. Virgin tapes were used for all tests. The Ampex tapes were changed every 48 to 50 h and the 3M971 tapes were changed every 27 h.

In the first test, Ampex 787 tape was used at 90 percent relative humidity (80° F). After 116 h of running time, 196 μin. of average wear was measured, for an average wear rate of 1.7 μin./h.

In the second test, Ampex 786 tape was used at 18 percent relative humidity (92° F). After 114 h of running time, 2 μin. of average wear was measured, for an average wear rate of 0.018 μin./h.

In the third test, 3M971 tape was used. This time, however, virgin tape was changed every 27 h, and the tape was run at 60 in./s in the forward mode and at 280 in./s in the rewind mode. Relative humidity was held at 35 percent (80° F). After 83 h of forward running time (the rewind time discounted, average wear was 15 μin., for an average wear rate of 0.18 μin./h.

Figure 3-12 shows the effect of relative humidity on the wear rate of the combined results for Ampex 787 and 786 tapes. The trend of dramatically increased wear with relative humidity correlates well with Bell & Howell's findings on the same subject (fig. 3-19) as presented in the next section.

The profile readings (fig. 3-13) of the worn heads presented by Honeywell clearly show the phenomenon generally referred to as "scalloping"; i.e., the uneven wear of the various materials constituting the magnetic heads. The magnetic head designer ideally would select poletips, intertrack shields, and the head bracket such that the poletips would wear less than the shields and the bracket, thereby providing intimate contact between the tape and the poletips of the individual tracks throughout the life of the head. In some cases, however, this delicate balance between materials is upset by the "upstream" effect,

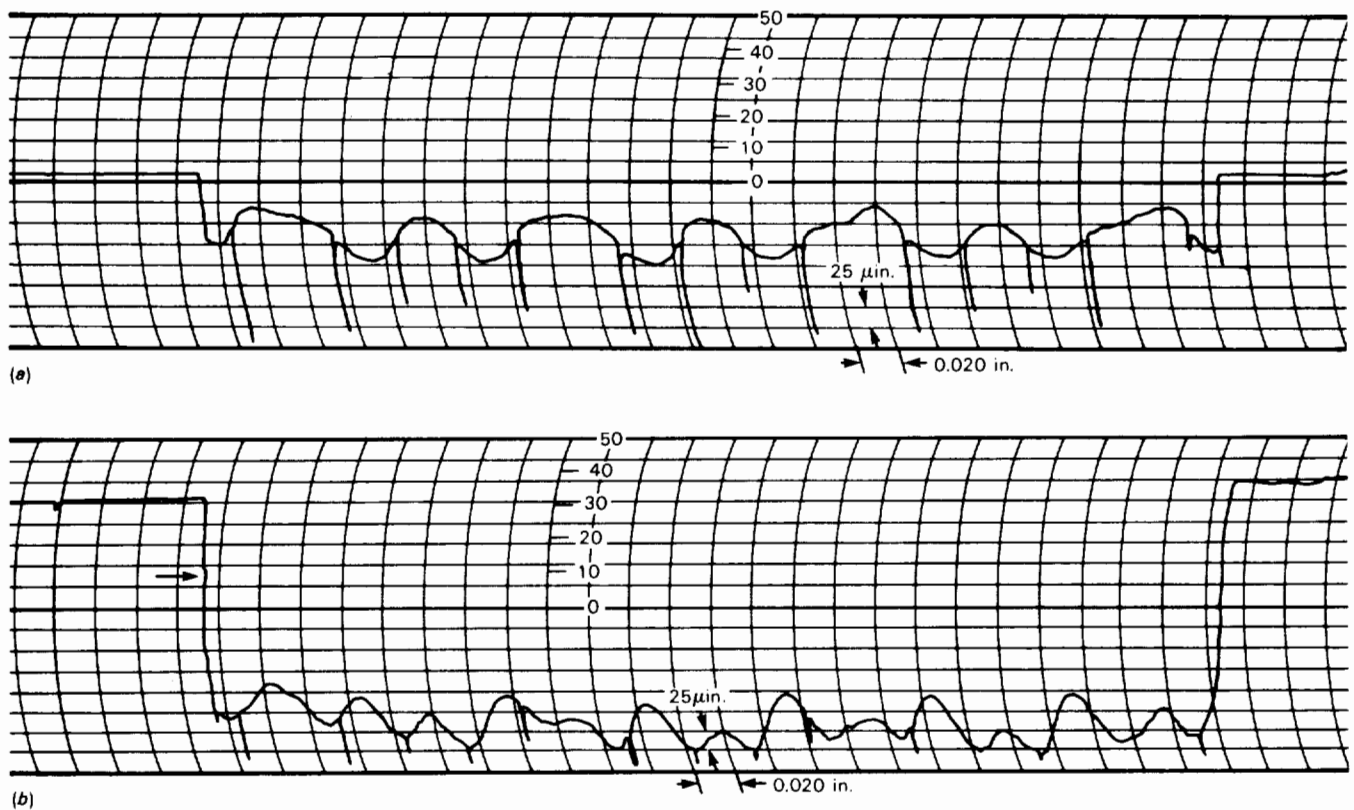

Figure 3-13.—Profilmeter tracings showing the head profile. Ampex 787 tape was used on a Model 96 recorder with 90 percent relative humidity and a temperature of 80° F. (a) Start of tracing. (b) After 116 h of operation.

causing the poletips to wear faster than the shields and the bracket. The result is separation between the poletips and tape resulting in a loss of signal output.

BELL & HOWELL WEAR TESTS

The purpose of these wear tests was to evaluate the difference in the abrasivity and wear rate between several instrumentation magnetic recording tapes both under normal laboratory conditions as well as under changing environmental conditions. The tests were run in four groups: 3M888 and Ampex 787, 3M890 and Ampex 797, 3M971, and 3M890 and Ampex 787 under changing temperatures and relative humidity conditions. The tests were designed to simulate as closely as practical actual operating conditions. This was so chosen to eliminate or reduce to a minimum the many variations and narrow the margin of error so apparent in many other wear tests.

The selection of a full complement of heads for every test, in spite of the cost, was done to include the important but not always recognized "upstream and downstream" wear effect: Under normal operation conditions, the wear of a head stationed downstream is always affected by the wear of the heads stationed upstream because the tape,

loaded with material picked up from the first head, wears the next head or heads downstream to a greater extent.

The selection of 300 h of wear as well as the procedure of an ever-increasing cycle of changing tapes was done to get over the initial condition of both heads and tapes and arrive at the steady state of the wear process. (This is usually reached after 25 to 50 h of wear).

The initial wear of the head is usually high because of the small radius of curvature of the new head, which results in high unit pressure. The initial wear is also high when using virgin tape. By carrying the test well into the steady state these errors can be reduced dramatically.

Finally, the selection of a sample of five reels of tape all from the same product to be tested reduces and normalizes the errors resulting from abrasivity change from reel to reel and lot to lot. A better, more accurate representation of the product tested is thereby achieved.

Test Procedure

To neutralize the effect of temperature and relative humidity, some of the comparative tests (3M888 and Ampex 787 and Ampex 797 and 3M890) were conducted on two tape transports running simultaneously side by side in the same room while the test of Ampex 787 and

3M890 was run in an environmental chamber. Each transport had a full complement of new record and reproduce heads and was adjusted for the same tape tension recommended by the manufacturer (10 oz for 1-in. tape). Tape speed was selected at 120 in./s.

New sets of heads were used for each test, and zero wear reference was established by running profilometer traces on all four stacks before the beginning of each test and comparing them with profilometer traces taken at each and every milestone. To reduce the affect of abrasivity of virgin tape, the tapes were changed at an ever-increasing cycle. At the first cycle, each reel was run for about 2 h, then the cycle was repeated using 5 h per reel, finally increasing to 10 and 25 h per reel.

Data

Figure 3-14 shows the temperature and humidity as recorded throughout the experiments of Ampex 787 and

3M888, Ampex 797 and 3M890, and 3M971, respectively.

Figure 3-15 shows wear versus time. Two variables were of interest: The average wear calculated as the average of all 14 tracks and the area of maximum wear on any of the 14 record or reproduce tracks. The importance of the latter becomes apparent if one keeps in mind that a head assembly loses its usefulness when one track out of the 14 is worn through. Hence, the maximum wear signifies the maximum achievable life for a head assembly.

Figure 3-16 shows the wear rate of hard-tipped heads operating with Ampex 787 and 3M888 tape. As pointed out before, the initial wear rate of any new head and new tape is very high. The resolution or the ability to discriminate between high and low abrasivity tape at this point is very poor. Hence, a large margin of error should be expected. As wear continues, the ability to discriminate between tapes of different abrasivity improves considerably.

Figure 3-17 shows the result of the separate compar-

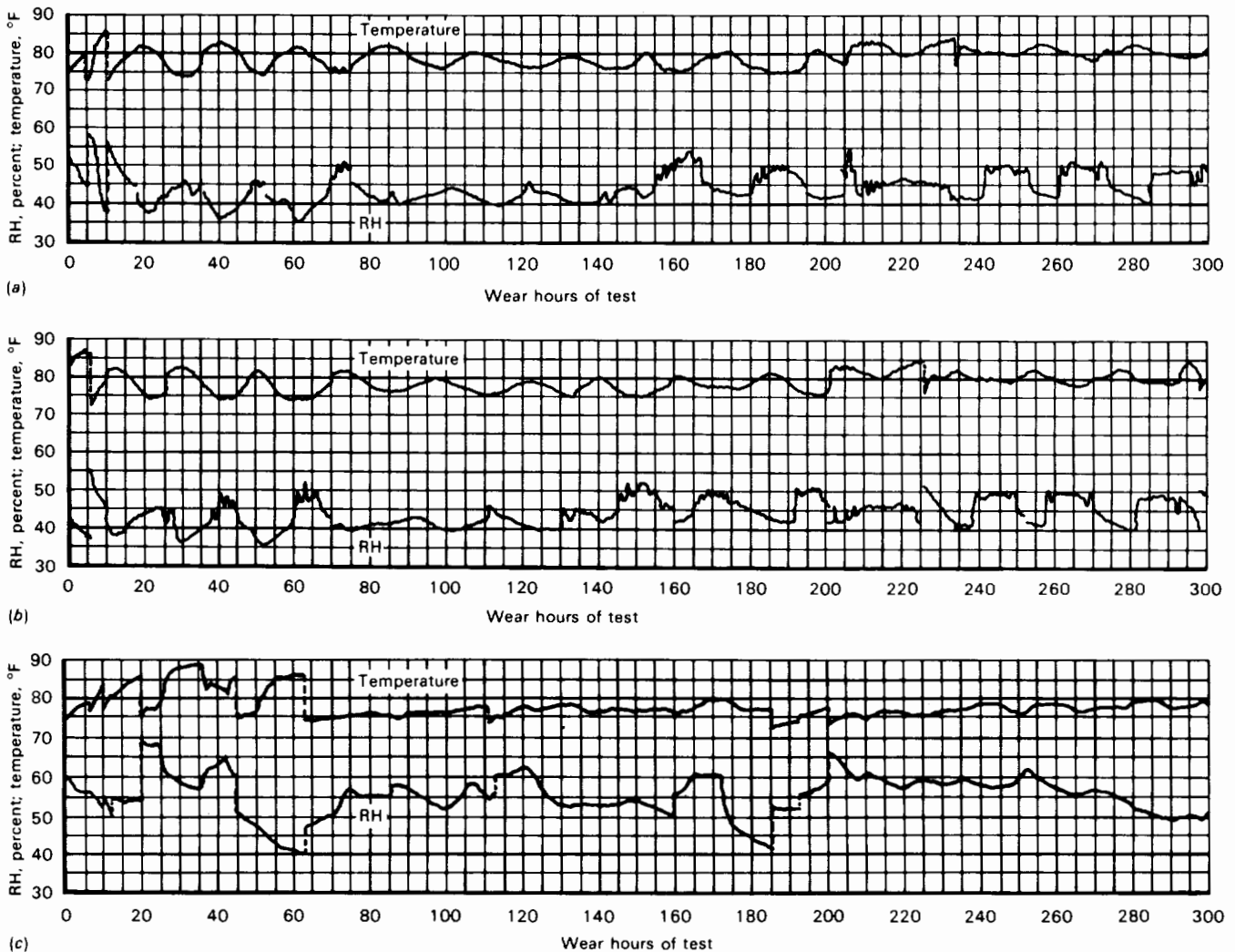

Figure 3-14.—Temperature and relative humidity. (a) 3M888. (b) Ampex 787. (c) 3M890.

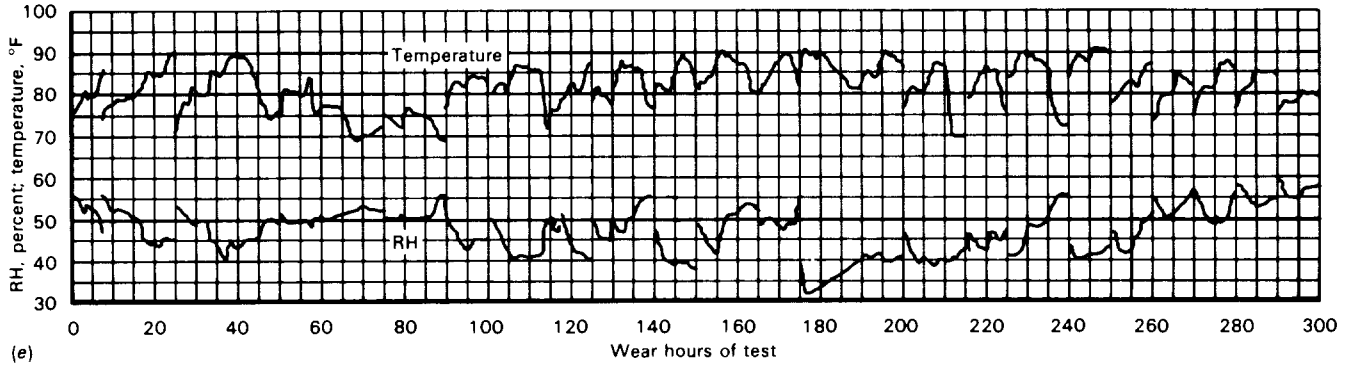
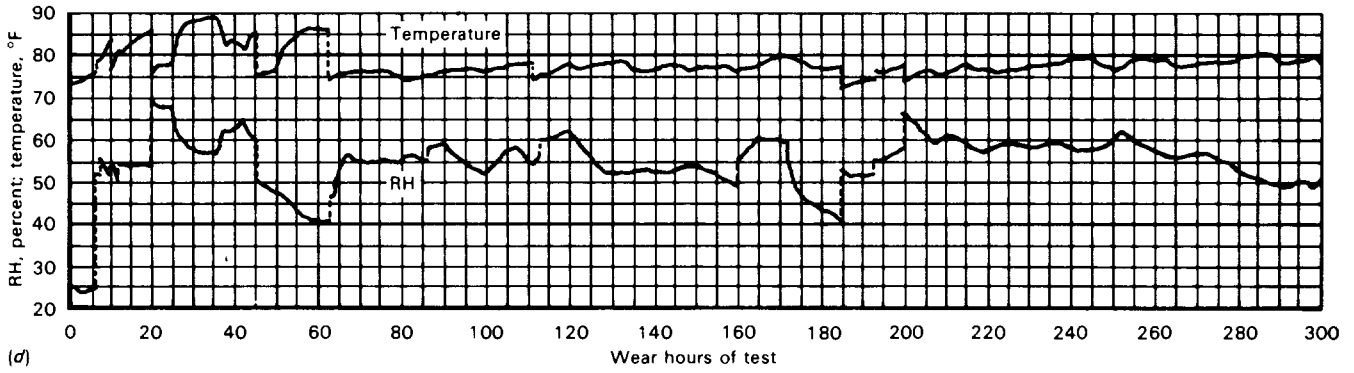

Figure 3-14 (concluded).—Temperature and relative humidity. (d) Ampex 797. (e) 3M971.

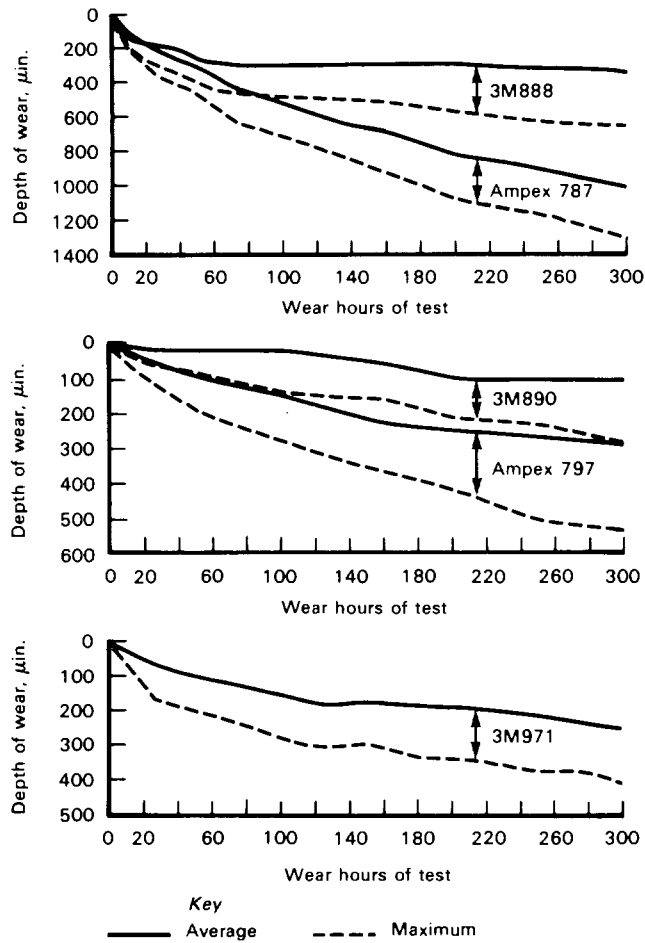

Figure 3-15.—Wear versus time.

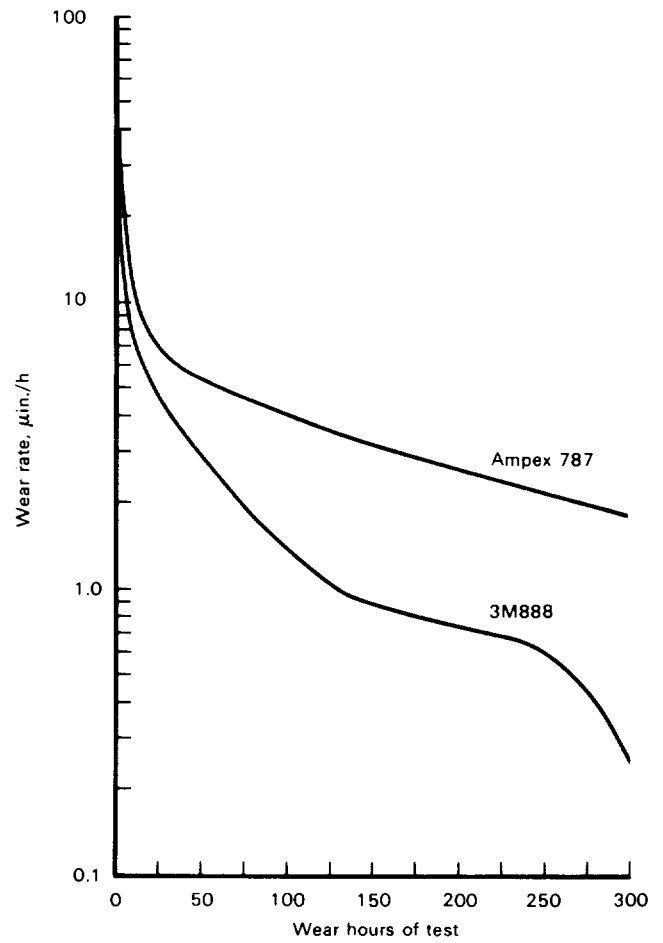

Figure 3-16.—Wear rate of hard-tipped heads.

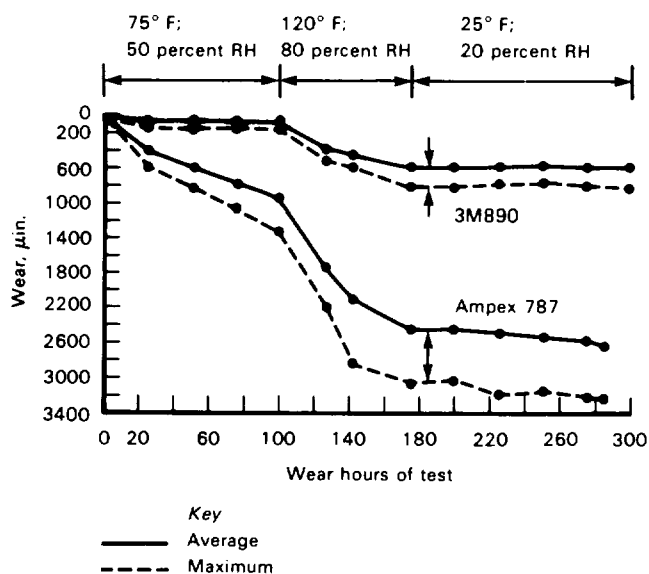

Figure 3-17.—Wear tests under different temperature and relative humidity conditions.

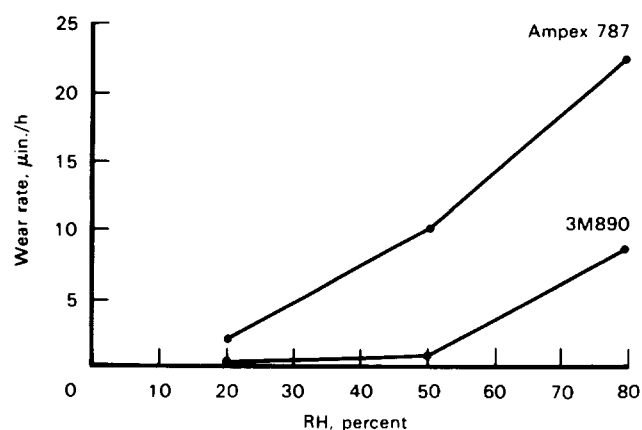

Figure 3-18.—Head wear versus relative humidity.

tive tests of 3M890 and Ampex 787 at different temperatures and relative humidity. Of significance is the dramatic increase in wear of both tapes with increased relative humidity. (See fig. 3-18.)

Conclusion

Table 3-1 summarizes the results of the abrasivity tests of the tapes under study. Average and maximum wear and the wear rate in microinches per hour for the 300-h tests are shown for comparison.

Tests for each tape conducted under conditions of low relative humidity showed lower wear rate as compared with tests under ambient or high relative humidity. Furthermore, wear tests show that increasing relative humidity from 20 to 50 percent causes a 550-percent increase in wear rate. (See fig. 3-19.) It is interesting to note that this phenomenon of increasing wear rate with

Table 3-1.—Results of Abrasivity Tests

Tape	Average, $\mu\text{in.}$	Maximum, $\mu\text{in.}$	Maximum rate, $\mu\text{in./hr}$
3M890.....	107	292	0.97
3M971.....	251	410	1.37
Ampex 797....	291	534	1.78
3M888.....	335	655	2.18
Ampex 787....	1002	1300	4.33

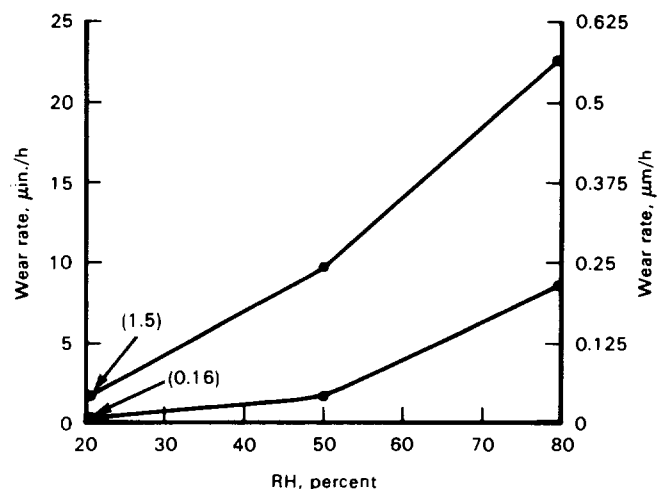

Figure 3-19.—Wear versus relative humidity for a range of different tape brands.

relative humidity is not unique to magnetic heads and magnetic tape. J. Larsen-Basse's paper (ref. 3-3) on three-body abrasion shows striking similarity under the influence of relative humidity in wear of comparable materials to the wear of magnetic heads.

Similar results are also reported by Larry Girard of Honeywell Inc. in his wear tests of ferrite heads presented in the previous section.

APPENDIX 3-A: FEDERAL SPECIFICATION WT-001553

Paragraph 4.5.3.12—Abrasiveity

For each particular type of tape, a 50-KHz signal shall be recorded on a virgin reel of tape at a speed of 60 in./s at standard record level and with the bias current adjusted, as recommended by the recorder manufacturer, to that value which is optimum for the tape type being tested. The recording shall be made on the center and edge tracks. The tape tension shall be 8 ± 2 oz and the measurements shall be made with an unworn set of reproduce heads used only for this test. Following the record pass, the record heads shall be removed from the transport and the reproduce head surfaces carefully and firmly covered with a

0.6 ± 0.1 mil 70/30 (copper/zinc) brass shim stock of knoop hardness of 200 ± 10 percent produced by American Silver Co., Flushing, N.Y.¹ The tape shall be played back over the shim until a minimum of 50 000 ft of tape has passed over the shim in the normal play mode at a tape speed of 60 in./s. The reduced output level caused by the shim spacing shall be at least 20 dB above noise, after filtering, and it must be within 3.0 dB of that output calculated by—

$$\text{reduced level (dB)} = \frac{54.6 \times \text{shim thickness (mils)}}{1.2}$$

The output for each track shall be measured at the same point in the reel at the start and end of the test. The output increase for each track, due to the wearing of the shim, shall be calculated to determine compliance with 3.4.12.

Paragraph 3.4.12

The abrasivity of the magnetic surface of a particular type of tape shall not cause an increase in signal level output greater than the value specified in table IV, when tested in accordance with 4.5.3.12 (2½ dB for both standard and high resolution tape).

APPENDIX 3-B: GLOSSARY

Kovar head characteristics: Kovar is a Carborundum Co. alloy that contains a nominal amount of cobalt (17 percent), which has a short irradiation period, yields abundant gamma radiation, and has a long half-life (5.26 years).

Standard characteristics: The reference standard is prepared from a small weighted piece of Kovar irradiated with the Kovar head. This piece of Kovar with a known weight is dissolved into a mixture of hydrochloric and nitric acids. This solution is then stippled onto a 0.5-in.-wide strip of filter paper 14 in. long and spliced in the center of a 200-ft length of tape. This tape is then wound onto a phenolic instrumentation hub.

REFERENCES

- 3-1. Buchanan, John D.; and Tuttle, John D.: "A Sensitive Radiotrace Technique for Measuring Abrasivity of Magnetic Recording Tapes." *Isotopes, Inc.*, 1967.
- 3-2. Cash, J., and Pagel, R.: "Wear in Recorder Heads by Magnetic Tapes." *Proc. Video and Data Recording Conf. IERE*, Birmingham, United Kingdom, 1976.
- 3-3. Larsen-Basse, J.: "Influence of Atmospheric Humidity on Abrasive Wear—1, 3 Body Abrasion." *Wear* 31: 373, 1975.

¹Editor's note: The American Silver Co. no longer exists.

CHAPTER 4

Magnetic Tape Certification

Al Buschman
Naval Intelligence Support Center

Present day magnetic tape is vastly improved over tape available only a few years ago. It is still the weakest link in most data collection systems where data are recorded at one location and reproduced for analysis at another location. Tape recorders contribute to the degradation of the data but to a much lesser degree than the tape itself. To collect data that are capable of being faithfully reproduced it is therefore necessary to obtain the best possible tape. To obtain this end many collection system managers use only new tape.

New tape has two serious drawbacks. The oxide surface is very rough and therefore abrasive. It is also very dirty. The abrasivity of a rough surface causes excessive head wear and heads are an expensive item to replace. This problem can be removed—all it takes is money. The loss of data caused by the rough surface and the dirt cannot be recovered at any cost and must be eliminated.

It has been demonstrated in every book on magnetic tape recording that a separation between tape and heads produces a space loss upon reproduction that is given by the following expression:

$$\text{space loss} = 54.6 \frac{d}{\lambda} \quad \text{dB}$$

where

d = length of the separation, in.

λ = wavelength of the signal on tape, in.

A 2-MHz tone recorded at 120 in./s has a wavelength of 60 $\mu\text{in.}$. A separation of only 6 $\mu\text{in.}$ produces a loss of 5.46 dB. The average size of a cigarette smoke particle is 25 $\mu\text{in.}$. This would cause a space loss of 22.8 dB. New tape has a surface roughness of 10 $\mu\text{in.}$, with peaks as high as 36 $\mu\text{in.}$. Space losses would be 9.1 and 32.8 dB, respectively.

ABRASIVITY

A very thorough discussion on tape abrasivity is presented in chapters 2 and 3 of this book. It is presented here in an abbreviated form to make a point. Tape abrasivity is

measured by several different test methods. The results of all tests show the effects of various tapes on head wear at several relative humidity values.

All test methods show that the abrasivity of tape decreases with the number of passes of tape over a head or a test fixture representing a head. The more abrasive tapes show a sharp decrease in abrasivity after only a few passes over a head. The better or less abrasive tapes show a slight decrease after a few passes. In every case abrasivity is reduced with usage as long as the relative humidity is between 20 and 45 percent. Although most noticeable during the first few passes, the reduction in abrasivity continues to decrease over the life of a tape.

LIFE

Tape life is a very difficult subject to address because it depends more on the care and handling it receives than on the physical properties of the tape at the time of its manufacture. There are several documents available instructing operators how to extend the life of tape through proper handling and storage. One of the better ones is presented as appendix B of this book.

The Illinois Institute of Technology Research Institute (IITRI) developed a technique of lubricating tapes that greatly increases the life of the tape as well as the head (ref. 4-1). To test tapes a loop tester was constructed that uses a short length of tape. This length was then passed over a simulated head at a speed of 32 in./s.

Lubricated tapes are capable of 5 million passes without head debris or visible oxide shed. The untreated tapes showed oxide shed and head debris after 30 000 passes and had no useful life left. This work not only shows the great potential for lubricated tapes but shows that a reasonable life can be expected from off-the-shelf tapes; 30 000 passes shows there is considerable usage available from tapes if they are handled properly.

DROPOUTS

Goddard Space Flight Center (GSFC) (ref. 4-2) did a study on tape dropouts and their causes. They used a GKI

model magnetic tape tester because it contains a viewing station that permits close observation of the defect causing the dropout. The study consisted of locating and classifying dropouts on 103 used tapes. The results of this study are presented in figure 4-1.

Dropouts are grouped into three major categories. Type I is contamination. Type II is oxide roughness. Type III is back damage. Each type is further divided into subgroups that will be discussed under each type.

Type I-A are temporary dropouts caused by dirt or oxide shed that is not permanently attached to the oxide surface. It is removed from the tape by heads or rollers prior to its arrival at the viewing station. These dropouts are temporary and cannot be repeated if the tape were played in the reverse direction.

Type I-B dropouts are made up of foreign materials that have been deposited on the oxide surface. Materials consist of such things as fine metal chips, liquids deposited on the oxide, particles of fuzz, and almost any particle of material foreign to the tape itself.

Type I-C are chips or pieces of the backing material that have become loosened during the slitting process. They can also come from a ragged tape edge coming in contact with a tape guide or roller. These chips stick to the oxide surface because of the heat generated at the point of contact between tape and the reproduce head.

Type I-D are nodules of tape oxide or chips that have become rigidly attached to the oxide surface. These may result from an inadequate polishing of the new tape or a

fusing of oxide particles that have grown on a head and then transferred to the tape.

Type II-J are scratches on the oxide surface. The scratches not only remove oxide but create a ridge that lifts the tape off the head and causes a space loss on adjacent tape tracks. These scratches are caused by oxide debris that builds upon surfaces that touch the oxide side of the tape. These deposits grow until they scratch the tape and are then removed by the tape when the drag increases enough. In severe cases these scratches run the entire length of the tape.

Type II-K are stretch marks in the backing caused by large oxide particles attracted to the backing by static buildup. These particles cause stretch marks through several layers of the tape because of cold flow in the Mylar.

Type II-L are stretch marks caused by tape markers. They are also caused by operators inserting pieces of paper in a reel to mark a location of interest on the tape. They also flow through several layers.

Type II-N are holes in the oxide. Oxide has been removed in relatively large areas. These dropouts are caused by defects in the binder. Holes span several tracks.

Type II-P are lateral grooves along the full width of the tape and are most likely caused by transports that use pinch rollers. They differ from the two previous types in that the backing is compressed and slightly thinner than the normal backing. At high speed the tape cannot conform to the heads in this area, resulting in a space loss.

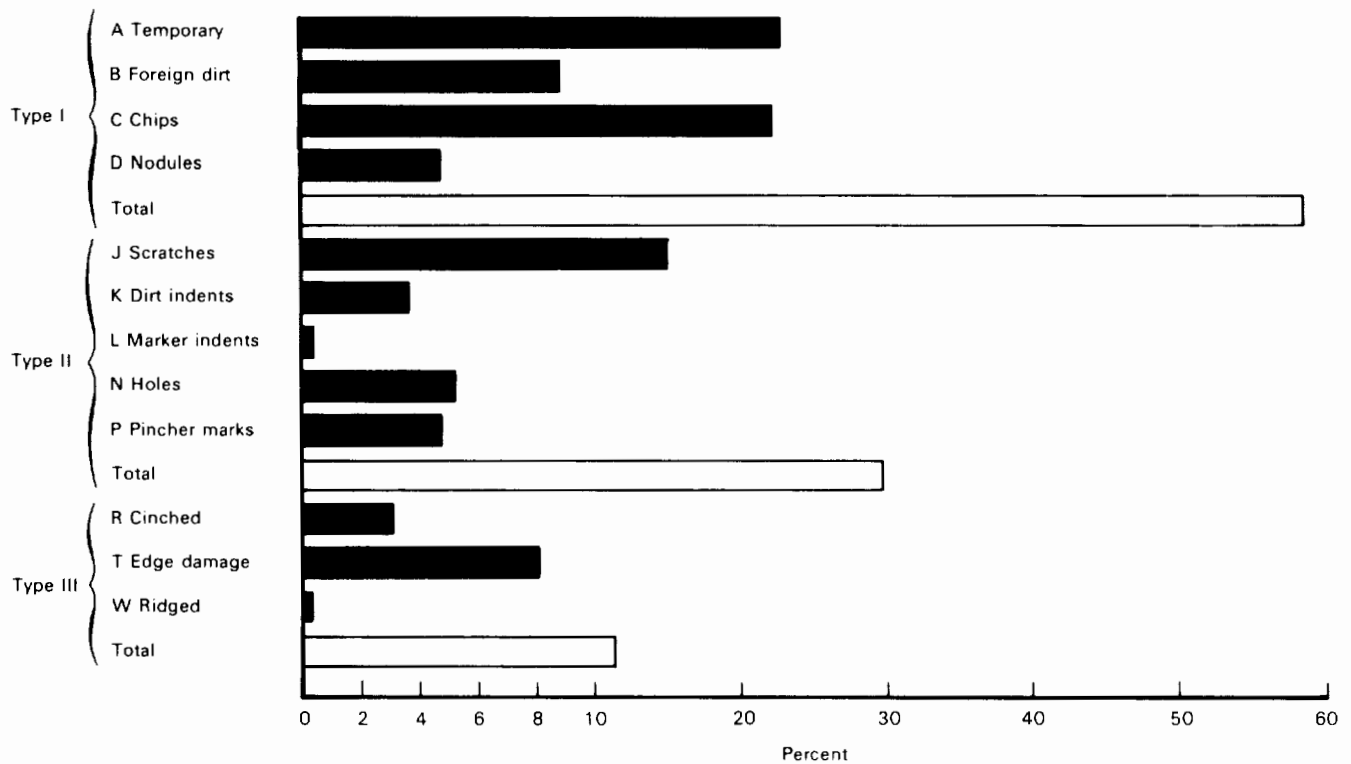

Figure 4-1.—Cause of dropouts.

Type III-R are distortions in the tape caused by cinching. Cinching is caused by insufficient tape tension and usually occurs during fast forward or fast rewind.

Type III-T dropouts are the result of damage along one or both edges. Excessive tape tension causes rippling of the tape along both edges. Poor tape guide alignment causes rippling on either the inside or outside edge. Some edge defects are caused by the slitting process during manufacture.

Type III-W are ridged impressions from a severe scratch a few layers below the impression. They also are caused by the cold flow of the Mylar.

The results of the study show 58.7 percent of the dropouts are type I, 29.9 percent are type II, and 11.4 percent are type III. Only type I dropouts can be removed by proper tape cleaning. Some type II and III dropouts can be improved by cleaning, and, depending on the test procedure, may not be counted as a dropout. GSFC concluded that the cost of rehabilitation was one-third the cost of new tape. A 60-percent yield more than pays for the testing facility as well as the man-hours to operate it.

DROPOUT TESTING CRITERIA

A dropout testing facility must be chosen to match the system that will be collecting the data. Digital systems have different requirements than analog systems, and analog frequency modulation systems have different requirements than amplitude modulation systems. The recording system must be tested to determine the effects of amplitude variations as well as complete dropouts. Some systems can survive a dropout of 6 dB while some cannot handle a dropout of only 3 dB. A testing facility that rejects tapes having dropouts that would not affect the data collected is wasteful and would not be cost effective. If the yield is less than 35 percent, new tapes would be more economical.

HONEYWELL

Honeywell Test Instruments Division (refs. 4-3 and 4-4) presented data from various tape testing programs. The concern of Honeywell was not in certifying tapes but in showing the effects of tape-associated problems in high-density digital recording (HDDR). Three tape types were studied: Ampex 797, 3M971, and Dupont 8740. Three data rates were used: 20 000, 30 000 and 40 000 flux changes per inch. Information was collected by determining the relative number of dropouts on the various tapes. Data were taken by recording at a given rate (20 000 flux changes per inch) and measuring the total time the reproduced signal was 12 dB below a nominal level. Results were presented as part-per-million (PPM) data loss. For a given tape, PPM data loss increases as packing density increases, showing greater resolution is possible with maximum packing density.

Data were also presented showing the output of adjacent tracks on tape. Dropouts large enough to span two data tracks are possible and indicate the number of dropouts of a given dimension are greater for narrow tracks than for wide tracks. Again this shows tape should be evaluated and certified for a given application, and the test should be tailored for that application.

Later testing by Honeywell was an attempt to measure the dropout distribution instead of simply measuring total time reproduce level was 12 dB below the normal reproduce level. This is more meaningful data for HDDR systems because short dropouts can be compensated for quickly by bit synchronization. Dropouts of several hundred bits guarantee bit synchronization problems. The purpose of the Honeywell investigation was to look at various tapes to determine their possible use in HDDR systems under development at their facility. There is a high correlation between bit error rates and tape dropout intervals. Very little data have been published in a form suitable for predicting error rates and for selecting an optimum detection and correction scheme.

Honeywell constructed a dropout tester capable of collecting dropout data in a more suitable form for use in HDDR design. The test consisted of making a nonbias, 1-MH square wave recording at 60 in./s. During playback the reproduced signal was processed through a dropout detector. A dropout was defined as an interval of 1 μ s or longer during which the signal strength falls 16 dB below normal full strength. The interval of the dropout is terminated when the reproduce level returns to 8 dB below full strength. These levels were determined experimentally and were chosen to give consistent results because greater decibel reduction settings cause the dropout detector to be too sensitive to noise and a longer minimum dropout width would not have detected the short burst errors of the tapes.

Figure 4-2 presents the test configuration used by Honeywell. All items used are commercially available except the dropout detector and the chatter proofer. The dropout detector is simply a comparator that monitors the output of the tape recorder. It puts out a pulse whenever the level drops below a preset value. It holds this output level until the level returns to a preset value. Honeywell used the preset values of -16 dB for the turnon point and -8 dB for the turnoff point.

The chatter proofer is required because the test as designed by Honeywell is only interested in dropouts lasting longer than 1 μ s. The interval measurement and totalizer count all dropouts, even those less than 1 μ s. The time constant of the chatter proofer was selected to ignore dropouts shorter than 1 μ s. The chatter proofer performs another necessary function that was introduced by the calculator. The calculator has a processing time of 1.5 ms. This means that if a dropout of 1- μ s duration was followed by several dropouts of longer duration within the 1.5 ms, the second and following dropouts would not be processed. The chatter proofer integrates over a period of 1.5 ms all

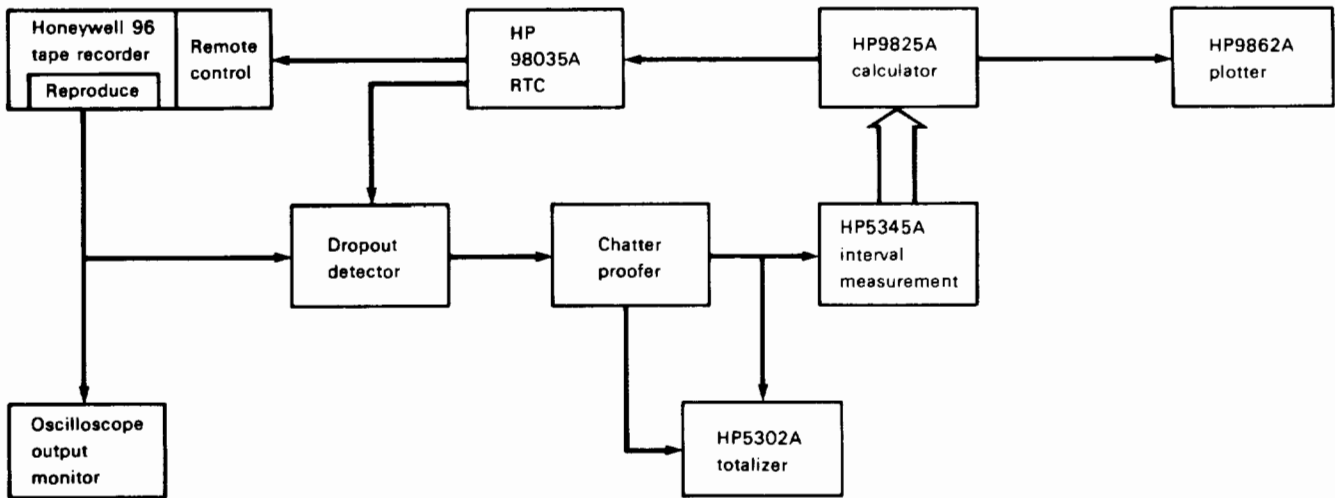

Figure 4-2.—Honeywell dropout test configuration.

dropouts greater than 1 μ s and sends a composite length to the interval measurement meter. All dropouts greater than 1 μ s are counted by the totalizer. In this way data are available comparing total dropouts detected that are greater than 1 μ s with the total dropouts processed by the calculator.

The calculator collects all the data from the interval measurement meter and presents the results to the plotter

in the form of a histogram. The histogram shows the percent of total dropouts as a function of dropout length. The calculator also lists the following information:

- (1) Head type
- (2) Tape type
- (3) Tape track
- (4) Tape speed
- (5) Frequency of test signal

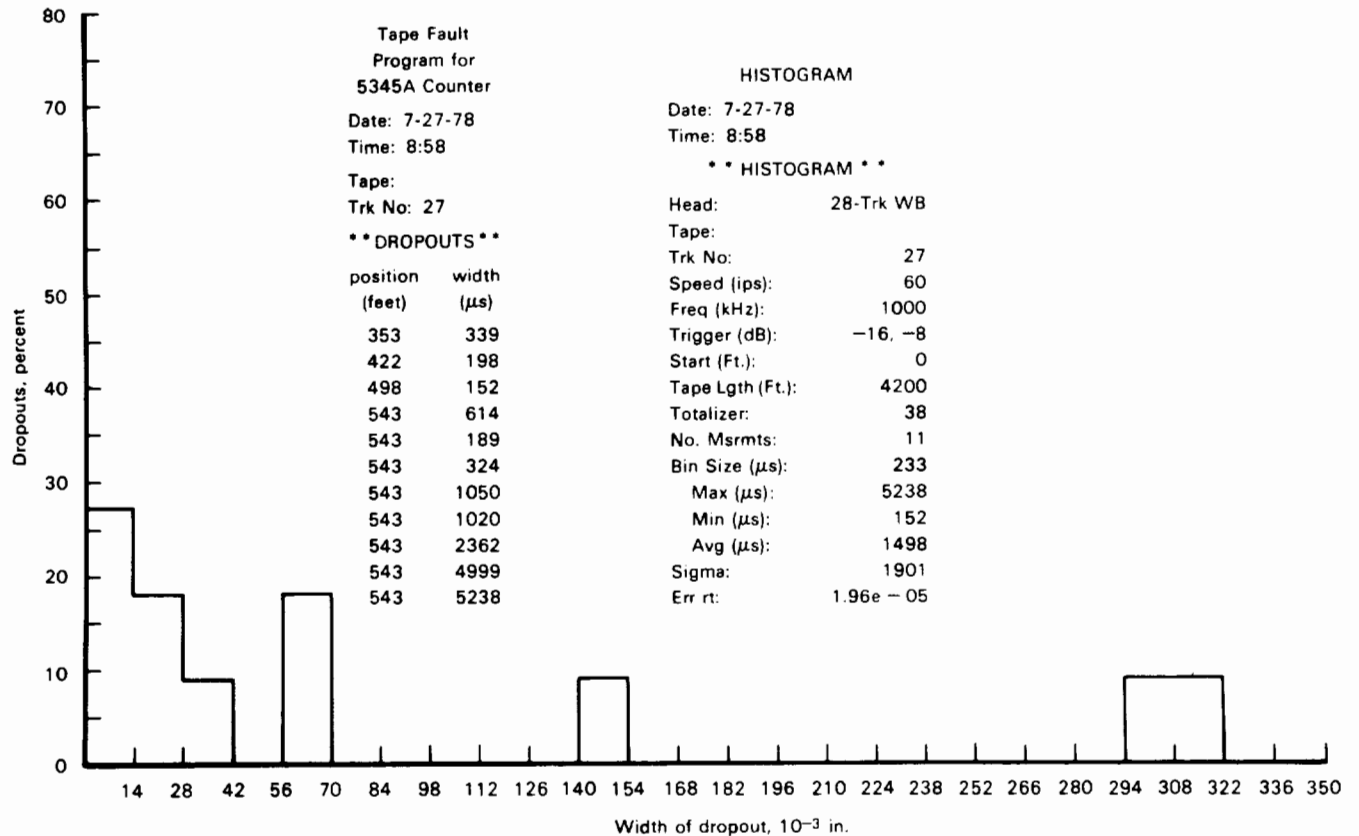

Figure 4-3.—Plotter output.

- (6) Set points of the dropout detection
- (7) Start footage
- (8) Tape length processed
- (9) Total dropouts detected
- (10) Total dropouts processed
- (11) Bin size used for histogram
- (12) Maximum dropout length (μs)
- (13) Minimum dropout length (μs)
- (14) Average dropout length (μs)
- (15) rms dropout length (μs)
- (16) Sum of total processed dropout length as a fraction of total tape footage
- (17) Tabulation of dropout length versus the footage where they occurred.

A sample of the plotter output is shown in figure 4-3. Because the results presented to THIC were preliminary, the tape type has been removed. Tests are continuing and data may be obtained from Honeywell Test Instruments Division, Denver, Colo.

FORD AEROSPACE & COMMUNICATIONS CORP.

Ford Aerospace started investigating the feasibility of certifying used tapes in 1969. The interest was generated by the high cost of new tape that was used only once. There were quality assurance problems at remote data collection stations. It was also difficult to return damaged

tape to the supplier from remote stations. There were no test procedures to identify faulty tapes prior to collecting data. A lack of standard reference tapes for testing tape recorders along with poor quality tapes resulted in a data collection system that was inadequate and unreliable.

In February of 1971 Ford Aerospace (ref. 4-5) began operating its tape certification facility. This facility has more experience than any other facility known at this time. It has demonstrated that a yield of 37 percent pays for the total certification program. Ford Aerospace is currently showing a yield of 75 percent and is, therefore, providing tape of higher quality and lower cost than new tape.

Figure 4-4 is a flow chart of the certification process used by Ford Aerospace. The inspection for outside physical damage covers the flanges as well as the tape. Tapes with protruding layers and cinching are disposed of because tape damage of this type cannot be corrected by the certification process. Experienced operators are capable of removing tapes at this stage that when tested later show a failure rate of nearly 80 percent.

Dry cleaning is performed on a 3M model 310 cleaner/winder. The cleaner/winder has a burnishing cylinder that scrapes the oxide side of the tape and tissues that wipe both sides of the tape following the burnishing process. A packwheel is used to drive tape from the supply reel, which has a slight amount of drag, to a takeup reel that is driven by the packwheel. This drive scheme as originally designed

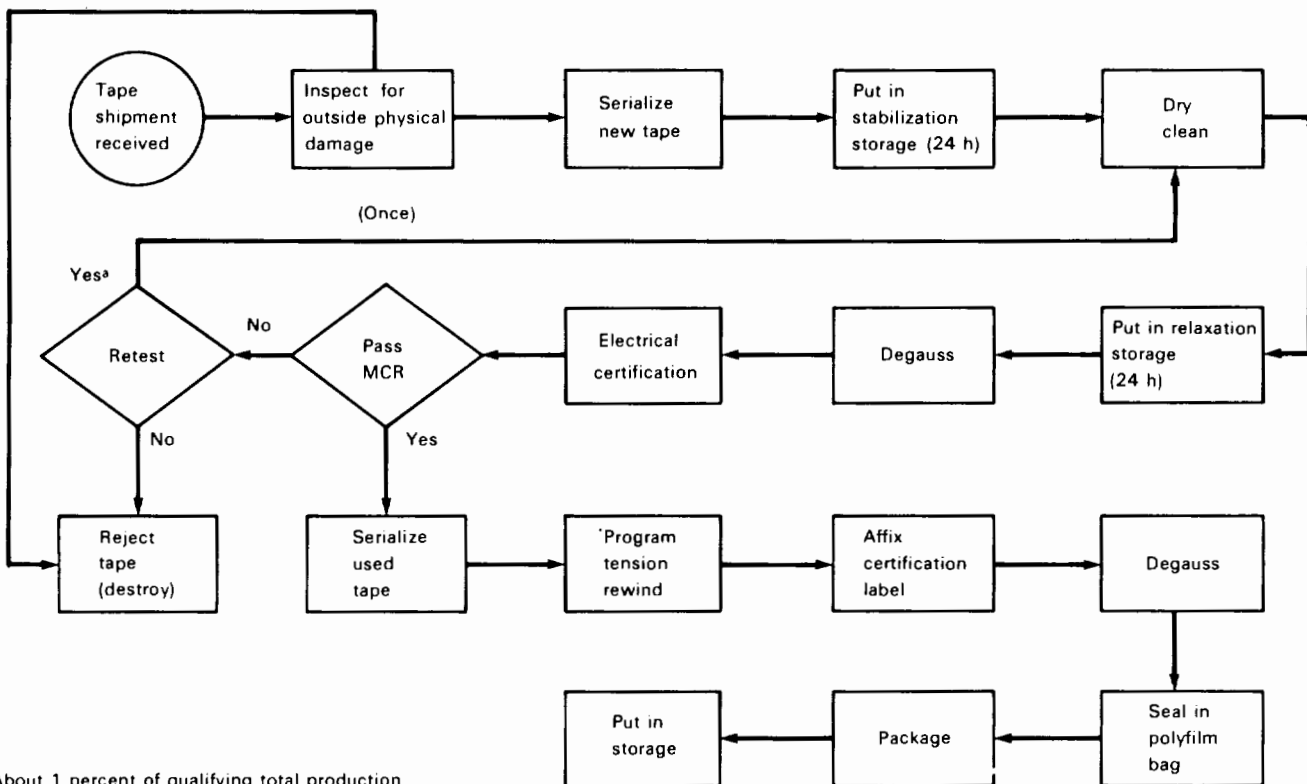

*About 1 percent of qualifying total production.

Figure 4-4.—Certification processing. (MCR = minimum certification requirements.)

is very sensitive to slight dimensional tape variations. The units were modified so that tape is now driven by the takeup reel and the packwheel simply applies pressure to the tape to remove air between layers for a good pack. The packwheel does not give a programmed tension wind but applies a constant pressure throughout the cleaning cycle.

This is only one example of the changes made to have each piece of equipment perform its function better than originally designed. Modifications have been made to reduce the operator's need for constant attention to the certification process. Nearly every piece of equipment in the process has been modified in the continuing effort to improve the end product, certified tapes that are better than new tapes.

The tapes are then degaussed to remove any residual magnetism that may be on the tape from previous use. It is imperative that tapes be magnetically clean prior to electrical certification. If the tape is marginal, it is again cleaned and returned to the electrical test. If the tape does not pass the electrical test, it is rejected and destroyed. If the tape passes the electrical test, it receives a programmed tension rewind to assure its survival during shipping and storage. The final degaussing is required to remove signals recorded during the electrical certification and to obtain maximum signal-to-noise ratio during subsequent data recording.

Table 4-1 shows the electrical certification tests and test criteria. The certification tests were originally established for 0.5-in. tapes that were 9200 ft long and show only seven tracks tested. Since that time Ford Aerospace has been certifying 1 in. tapes for HDDR as well as 1 in. analog tapes. Only the 0.5-in. test criteria will be discussed here.

The edge tracks, track 1 and track 7, are tested by recording a 1-MHz tone at 120 in./s. and at 0 dB and



reproducing during record. The reproduce signals from both tracks are monitored by dropout detectors. A dropout detector consists of a level detector with an integration time constant so that a preset level must be reached for a preset minimum time duration. In this case the reproduce level must be below -6 dB for 5 μs before a dropout is registered. A loss of signal below -6 dB for 10 μs would be counted as two dropouts. Dropouts are accumulated on digital counters. Each track has its own dropout counter.

Tracks 2, 3, 5, and 6 are tested in the same way as tracks 1 and 7 except that the level must fall below -12 dB for the required 5 μs. The interior tracks are prime data tracks and the reject level for dropouts is 1760 over 9200 ft of tape. The edge tracks are used for housekeeping and low rate data, and the reject level for dropouts is 21 120 over 9200 ft of tape. It has been found through years of experience that a higher dropout level and higher dropout reject count on the edge tracks gives an excellent measure of the condition of the tape edges. At this time more confidence is placed on this test than the results obtained by using an optical inspector to observe edge damage.

A frequency response test is performed on track 4. Again experience has shown that tapes rejected for a bad track 4 also are rejected when the same test is performed on tracks 3 and 5. The frequency response of a tape is measured by recording continuously a multiburst tone consisting of five cycles each of 20 kHz, 200 kHz, and 2 MHz. The reproduced tones are monitored on an oscilloscope. The scope face has an overlay marking the 0-dB level and the -3-dB level. An operator simply monitors the reproduce level to determine the frequency response of the tape for each tone recorded.

All tracks except track 4 have a dropout counter that counts the total number of dropouts along the 9200-ft

Table 4-1.—Certification Tests and Test Criteria

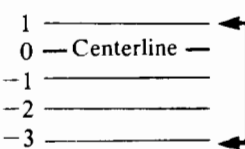
Test signals by track	Test	Accept	Reject	Comments
Track 1 and 7 (dropout test) 1.0-MHz signal		0 to 21 120 dropouts	Over 21 120 dropouts	Track 1 is assigned for house-keeping data; track 7 is generally assigned to low rate data.
Track 2, 3, 5, and 6 (dropout test) 1.0-MHz signal		0 to 1760 dropouts	Over 1760 dropouts	Prime data tracks assigned to PCM data or for 2.0-MHz response.
Track 4 (frequency response test) multiburst tones	20 kHz 200 kHz 2.0 MHz	Zero reference < -3.0 dB	Zero reference > -3.0 dB	Tests have shown that tapes rejected for bad track 4 would also be rejected for bad track 3 or 5.
All tracks except track 4 (long-term signal amplitude test); 1.0 MHz signal		1.0 to -3.0 dB	Over 1.0 and < -3.0 dB	Zero centerline reference set to standard tape.

length of tape. These same tracks also have a long-term amplitude test. This test consists of recording the output of all tracks except track 4 on a strip-chart recorder that has log amplifiers. The tape is accepted if the reproduce level does not exceed 1 dB nor drop below -3 dB. The operator records the dropout count on the strip-chart paper so that a record exists for each tape that passes the certification tests.

To test the complete tape certification facility, standard tapes have been made. These standard tapes have known amplitude stability and dropout count for all six tracks tested. It also has a known frequency response for track 4. These previously recorded tapes are available to test the reproduce functions of the facility including the dropout counters and the strip-chart recorder. Other standard tapes are available to test the record side of the system. They too have known dropout counts, frequency response, and amplitude stability. Standard tapes are run on the system at the start of each shift and at any time the operator feels the facility is suspect.

NAVAL INTELLIGENCE SUPPORT CENTER

The Naval Intelligence Support Center (NISC) became interested in certifying used tape in May of 1975 because of the cost of supplying tape for data collection systems that would use only new tape. Experience had shown that valuable data were lost because of the false economy of recording on used tapes that had not been certified. The tapes were simply degaussed and were not placed on a 3M model 310 cleaner/winder. It was therefore decided to use only new tape and the cost to run the program became excessive.

Two organizations in the Washington, D.C., area were certifying used tapes at that time. They were the National Security Agency (NSA) and the National Aeronautics and Space Administration (NASA) at Goddard Space Flight Center. After visiting both facilities it was decided that the approach used by NSA would best serve the needs of NISC. General Kenetics Inc. (GKI), under contract to NSA, performed the tape certification to NSA specifications. The volume of tapes anticipated by NISC for certification was not large enough to justify a contract with GKI. GKI supplied the hardware to the specification of NISC and the certification was performed by NISC on a part-time basis.

The certification process used by NISC is basically the same as that of Ford Aerospace with one slight difference. Following electrical certification, NISC degausses the tape and then performs another dry clean operation on a 3M model 310. This sequence was chosen because of the violent treatment of a reel of tape by the degaussing step in the process. The degausser loosens oxide particles during the degaussing cycle that must be removed prior to the tape being used for recording data.

The data collection system for which NISC was certifying used tapes employed intermediate band recorders. They used only 1-in.-wide tape that had a 1.5-mil base thickness. Most data are recorded in the FM mode. Some data, time code, and control track were recorded in the direct mode. For this reason all 14 channels were monitored for dropouts during certification. The six channels normally used to record direct were monitored for long-term amplitude stability. The XE70 tape analyzer as designed and fabricated by GKI has two outputs to show the condition of the tape under test. The first is a series of fourteen 6-digit totalizer dropout counters. These counters display the total number of dropouts along the entire length of tape on all 14 channels. The second is a strip-chart recorder that monitors the long-term amplitude stability of six selected channels. Two event markers are also used on the strip-chart recorder. One event marker indicates when a stretched length of tape has been detected. The other event marker indicates when a preselected number of dropouts have occurred on any one of the 14 channels in a 100-ft length of tape.

Tape Width Testing

Data collection recorders use pinch rollers to hold the tape against the capstan so that edge damage in the form of stretches would not cause tape motion problems. Data recorded on edge tracks were generally housekeeping and other low-priority information.

Data reduction tape recorders of the laboratory variety use either a vacuum chamber or a pressure chamber to control tape tension. In addition, a large wrap angle between the tape and capstan assures adequate tape-to-capstan contact eliminating the need for pinch rollers. Tape that has been stretched causes a loss of vacuum or pressure, which stops the tape recorder at low tape speeds. These machines are less susceptible at high tape speeds to a given reduction in tape width because of stretching. A Honeywell 7600 was used to certify tapes during the initial phases of the program because Honeywell 7600's are the most common data reduction tape recorders used at this facility. A Honeywell 7600 employs a light source between the supply reel and the capstan as well as between the capstan and the takeup reel. A light sensor is used on each side of the capstan to position tape at the correct position in the vacuum chamber. The light sensors drive both the supply reel servo and the takeup reel servo.

A stretch mark in the tape causes the supply reel to sense a shortage of tape in the supply vacuum chamber and to rapidly overfill the chamber causing the machine to go into the stop mode. Not only is this very irritating to an operation it also can cause a serious loss of data if the stretch mark exists in the vicinity of data of special interest. To certify tapes that were free of stretch marks that could not be handled by the Honeywell 7600, a series of controlled stretch marks were put on a new tape. These

controlled stretch marks were made as follows: 2-in. length of tape was stretched to 2.5 in., and so on. In this way, a tape was obtained that had stretch marks from 2 to 12 in., and each stretch mark was up to 150 percent of the original length. The tape was then placed on a Honeywell 7600 in the drive mode at 7.5 in./s. Each stretch mark that caused the tape recorder to go into the stop mode was noted. The tape was then played at 120 in./s while monitoring the output of the supply reel servo. It was observed that any stretch mark capable of producing a stop mode at 7.5 in./s would produce a voltage change from a normal 0 V dc to -12 V dc. The lesser stretch marks would produce this voltage change but the duration would be insufficient to produce a stop mode. It was determined, therefore, that any change greater than -6 V dc lasting longer than 6 ms would produce a stop mode.

A tape-width logic circuit was incorporated by GKI in the XE70 tape analyzer to indicate on the strip-chart recorder event marker whenever the supply reel servo output dropped below -6 V dc for more than 6 ms. In this way a record would be obtained indicating the presence of stretch marks of sufficient magnitude to cause a tape recorder to go into the stop mode at normal reproduce speeds of 7.5 in./s or less.

DROPOUT TESTING

Tapes certified by NISC were originally obtained through GSA and were tested to GSA specification WT-001553. This specification (ref. 4-6) defines a dropout for standard resolution tape as an amplitude discontinuity consisting of a 50-percent decrease in average output for a period of 20 μ s. A 50-percent loss for 40 μ s would be counted as two dropouts. WT-001553 further specifies that a maximum dropout count per 100 ft of tape shall be 20 for center tracks and 25 for edge tracks.

The XE70 is capable of counting dropouts in 100-ft tape lengths as well as totaling the dropout count for the entire length of the tape. Each channel has a preset counter that is reset after every 100 ft of tape. If the dropout count exceeds the preset count on any of the 14 channels, a pulse is sent to actuate an event marker on the strip-chart recorder. At the end of the test, the six-digit counters display the total dropout count on all 14 channels of the tape. In this way tapes that marginally pass the maximum count per 100 ft can be rejected because of excessive total dropouts. It is conceivable that a tape could pass the 100-ft test by only a few counts along its entire length and yield a tape that is of unacceptable quality. The totalizer is zeroed at the start of the test. At the end of the test the counters are held on to allow the operator to record the count of all channels on the strip-chart recorder paper.

To obtain a test signal the operator must initiate a record and drive forward command. A phase lock signal is

obtained when the tape recorder comes up to speed. The presence of these three signals, followed by a time delay that allows 1 percent of the tape to pass without testing, produces a test signal. The test signal enables the 14 error detection circuits to begin looking for dropouts. It also resets the 14 totalizer counters and 14 preset counters in addition to lighting the test light as a visual indication to the operator that a test is in progress. If any of the three tape recorder signals (record, drive forward, or phase lock) is lost, the test condition is not valid and the test light is extinguished. A test is concluded when the supply reel contains 1 percent of the normal length of tape. This is monitored by a photocell and light source on the tape recorder supply reel that is adjusted to stop tape motion when the reel is nearly empty.

A 600-kHz tone is recorded on all 14 tracks at a level of 1 V rms at 120 in./s. All 14 reproduce outputs are monitored during record. The output of each channel is monitored by a dropout logic circuit. The dropout logic circuit compares the output of the reproduce signal to the 600-kHz tone driving the record electronics. The 600-kHz tone is divided by 12 to provide a timing signal of 20 μ s. The reproduced signal is conditioned in the error detection logic by applying automatic gain control. In this way, absolute level of the reproduce card is not critical. The signal is then effectively digitized by passing it through a level detector. The level detector puts out a narrow pulse each time the input sine wave exceeds either the positive trigger level or the negative trigger level. These pulses are compared to the 20 μ s timing pulse. To be counted as a dropout the 600-kHz tone must be lost for the entire 20 μ s period. A loss for 40 μ s would be counted as two dropouts.

During the initial phase of certifying tapes, the dropout count per 100 ft was extended beyond the limits set by GSA. The limit on outside tracks was extended from 25 to 60 per 100 ft. The center tracks were extended from 20 to 25 per 100 ft. Table 4-2 shows the preset counter setting for all tracks. The preset counter setting is the allowable dropouts per 100 ft of tape. The table also shows the maximum totalizer reading allowed for standard size reel tape lengths. The acceptable dropout limits were extended for several reasons. The type of data recorded on edge tracks was low priority data and could tolerate a large number of dropouts, hence the increase by a factor of 2.4 over the GSA specifications. An increase by a factor of 1.25 over GSA specifications was selected for the center tracks because of the high-priority data recorded there. To start the certification program, requests went out to a large number of Navy facilities asking them to ship old tapes for evaluation and possible reuse. The tapes received were of very poor quality and required a lot of work to get them into condition to be certified. Tests were conducted to determine a realistic number of dropouts that could be present without degrading the analysis of the data.

Table 4-2.—Maximum Allowable Dropouts

Track	Preset counter setting	Maximum totalizer counter reading by length of tape reel in feet					
		2500	3600	4600	5000	7200	9200
1, 14.....	60	735	1058	1358	1470	2117	2705
2, 13.....	55	674	971	1240	1348	1941	2480
3, 12.....	48	588	847	1082	1176	1693	2164
4, 11.....	42	515	742	948	1030	1483	1895
5, 10.....	36	441	635	811	882	1270	1623
6, 9.....	25	306	441	563	612	881	1126
7, 8.....	25	306	441	563	612	881	1127

Amplitude Stability

Long Term

The GSA specification for long-term amplitude stability for standard resolution tape is 2.0 dB on both edge tracks and center tracks. Amplitude stability is measured by NISC using the strip-chart recorder in the XE70 tape analyzer. Six channels of the reproduced 600-kHz signal are inputted to six chart-driven amplifiers as well as to the dropout detector logic cards. With an input level of 1 V(rms), the strip-chart recorder position control allows the pens to be centered on the graph. The sensitivity control allows the edges of the graph to be set for 6 dB on the right and -6 dB on the left.

A record level of 1 V(rms) should, upon reproducing, provide an output level that will center the pen on the graph. Variations in this level will provide an indication of the long-term amplitude stability of the tape. It will also give an indication of the retentivity of the tape relative to the tape used to set up the record/reproduce functions of the tape machine. This is very important in calibrated data collection systems in which the level recorded on tape is as important as the spectrum of the data collected. Tapes for these systems must be consistent from reel to reel as well as uniform along the length of each reel. The strip-chart recorder will check both requirements.

The need for consistency from reel to reel can be overcome by recording calibration tones on each reel of tape prior to collecting data. This requires some time and effort on the part of the operator but most important is the length of tape required to make the calibration. This reduces the useful length of tape available to collect data and requires more reels for a given application. Another point to consider is that a 2500-ft reel of tape is good for 66 min at 7.5 in./s. Calibration requires nearly 10 min, leaving 56 min available for data collection, which is ample for most situations. There are times when several hours of data may be available and a 10-min loss of data every hour would not be acceptable. For these reasons it is

necessary that reel-to-reel consistency be maintained in given lots when certified tapes are to be used.

Amplitude uniformity along the length of each tape is a more critical requirement. Calibration of each reel, although having shortcomings, is feasible, but this technique is not available to correct longitudinal nonuniformity. An end-to-end calibration can remove recorder system frequency response problems but it requires a tape that is uniform along its entire length. Correction tables that are generated by using calibration tones at the start of the tape can be grossly misleading for data obtained later if the tape exhibits longitudinal nonuniformity. In accordance with GSA specification, a limit of 2 dB has been set for both the reel-to-reel consistency as well as long-term amplitude stability. The operator of the certification equipment can easily measure a change of 2 dB.

Short Term

The strip-chart recorder graph can also be used to observe short-term amplitude stability. In severe cases of short-term amplitude variations, the graph displays a line at the proper position but with excessive width. A good tape will display a graph that has very narrow lines, typically less than 0.2 dB. A low number of short-term variations can be seen as tick marks on the base line indicating a reduction in amplitude. An excessive number of short-term variations can be seen on the graph as a wide line, typically greater than 0.5 dB. Tapes with wide-line displays should be destroyed as no calibration techniques can be used to remove this effect on the data.

Most tapes destroyed by NISC during the initial phase of the certification program were destroyed because of excessive short-term amplitude variations. Dropout counts would be well within the acceptable range and long-term stability would be satisfactory, yet the tapes would exhibit a very wide line indicating short-term amplitude variations. This situation was investigated further to determine whether the indication of large numbers of short-term variations was caused by the tape itself or the certification

hardware. An oscilloscope showed that the reproduced 600-kHz tone had amplitude variations; this eliminated the chart drivers made by GKI and the strip-chart recorder provided by GKI with the XE70 tape analyzer. It was further observed that amplitude modulation could be reduced to a reasonable level by changing the recorded tone from 600- to 300-kHz. This led to the consideration that crosstalk between the record and reproduce heads was the source of the problem. A few simple tests such as placing the recorder in the record mode but not passing tape over the heads showed that crosstalk existed. The record heads were then placed at right angles to the normal position and crosstalk was greatly reduced, indicating that the record and reproduce heads were magnetically coupled.

The Honeywell 7600 has a magnetic shield between the record and the reproduce heads. Additional layers of this shielding were placed between the heads with very little change in crosstalk. It could not be reduced to a satisfactory level by this method. At this point Honeywell was called in to help solve the problem. After 2 days of grooming the tape recorder, Honeywell concluded that it was within specifications because the crosstalk existed only when simultaneously recording and reproducing. It was demonstrated that 14 channels could be recorded, rewound, and reproduced without amplitude modulation. This would require two passes on the certification tape recorder separated by a rewind cycle. This would nearly triple the time required for certification of each tape and was not considered satisfactory. An alternate solution of recording at 300 kHz instead of 600 kHz was chosen while the search continued for a recorder that could simultaneously record and reproduce 14 channels of 600 kHz.

The only manufacturer expressing interest in this problem was SE Labs of EMI Technology, Inc., located in Danbury, Conn. That firm was demonstrating an SE7000 portable tape recorder at the time. SE Labs was told that our only need was for the certification program. Their people were given the history of the problem and a demonstration showing that the SE7000 tape recorder had the same problem at very nearly the same magnitude.

After several months, several demonstrations, and several trips of the tape recorder to Danbury, SE Labs solved the problem. They found a way to shield the heads from each other so that simultaneous recording and reproducing without tape passing over the heads showed a crosstalk of only a few millivolts. Normal simultaneous recording and reproducing still showed some amplitude modulation. It was concluded that the source of the problem was simply tape-to-head contact changes when recording at 120 in./s. At lower tape speeds and constant recording wavelength, the amplitude modulation was reduced to an acceptable level. During the final trip to Danbury, the recorder was fitted with a head with a shorter radius of curvature at the contact point with the tape, and all the problems were solved.

It is now possible to simultaneously record and reproduce 600 kHz on all 14 channels while keeping the amplitude modulation caused by the recorder to an acceptable level. The short-term amplitude variations shown by the strip-chart recorder are now a measure of the tape quality and no longer a measure of the testing hardware.

REFERENCES

- 4-1. Wright, C. D.; and Tobin, H. G.: "Surface Lubrication of Magnetic Tape." Paper presented at meeting, THIC, Apr. 27, 1976.
- 4-2. Byrd, Virgil H.: *Magnetic Computer Tape Rehabilitation Procedures and Results*. Rept. S-534-67-204, National Aeronautics and Space Administration, Apr. 1967.
- 4-3. "A Preliminary Report to THIC Tape Drop Out Distribution Investigation." Paper presented at meeting, THIC, Sept. 1978.
- 4-4. Montgomery, Richard: "Expected Tape Performance for High Density Digital Recording." Paper presented at meeting, THIC, Nov. 1977.
- 4-5. Helander, William: "Magnetic Tape Certification." Paper presented at meeting, THIC, Aug. 24, 1976.
- 4-6. General Services Administration: "Tape, Recording, Instrumentation, Magnetic Oxide-Coated." Interim Federal Specification WT-001553, Amendment 3, May 3, 1976.

Care, Handling, and Management of Magnetic Tape

J. B. Waites
General Electric Co.

The purpose of this chapter is to provide guidelines for the care and maintenance of magnetic data tapes. It is by no means all inclusive—it provides only basic guidelines—and specific data tape management systems will be as varied as the numbers of tape users whose responsibilities include maintaining and safeguarding the integrity of their tapes. (See app. B for more detailed information on instrumentation tape.)

The scope of the chapter will include the following:

(1) Tape types and characteristics, because knowing the makeup of tape mediums is important in providing proper safeguards against their damage

(2) Tape errors and effects—this includes definitions and examples of various error causes and how to preclude them

(3) Tape care and management, which will give specific guidelines on handling the data media

(4) Tape maintenance, which will give a number of methods of keeping tape as error free as possible

TAPE TYPES AND CHARACTERISTICS

Magnetic tape is constructed by coating iron oxide particles that can be magnetized onto a thin ribbon of plastic. The three basic materials used in the manufacture of tape are the oxide, the binder, and the base plastic or Mylar backing. The oxide coating is a magnetic layer of oxide (generally gamma-ferric oxide, Fe_2O_3). It is very important that the coating be both uniform and smooth. If the particles are not uniform in size, the surface of the tape will be rough, making the tape abrasive and causing reduced head life and increased oxide contamination. An ideal oxide particle is acicular (needle-shaped), about 5 to 40 $\mu\text{in.}$ long, and has a length-to-width ratio varying from about 4:1 to 10:1. Generally, long particles are used to record long-wavelength signals and short particles to record short-wavelength signals. Because a tape is designed to suit a particular range of wavelengths, its coating thickness usually is a compromise that accommodates the shortest and longest wavelengths of the specified frequency range. Polyester films (such as Mylar and Scotchpar) are

the most commonly used forms of backing material. The chief advantages of the polyester films are their stability, solvent resistance, tensile and tear strength, toughness at high temperature, and resistance to mildew and fungus.

The binder is usually composed of organic resins used to bond the oxide particles to the base material. The binder must be flexible without having the oxide chip or flake off. If the consistency of the binder is sticky, the individual tape layers will adhere to each other when wound on a reel.

Two basic types of magnetic recording tape are in common use—instrumentation (analog) tape and computer (digital) tape.

Analog (Instrumentation Tape)

Instrumentation tapes are generally designed to record analogous, repetitive “stream” data from the acoustic band to about 2.5 MHz. There are four basic grades of instrumentation tapes:

- (1) Standard resolution (“B” oxide coating)
- (2) High resolution (“E” oxide coating)
- (3) High output (no oxide coating designation)
- (4) High energy (no oxide coating designation)

Standard resolution tapes are used to record low- and intermediate-band signals generally as short as 240 $\mu\text{in.}$ (31 250 Hz at 7.5 in./s). High-resolution tapes are used for wide-band recording to 60 $\mu\text{in.}$ (125 kHz at 7.5 in./s.).

High-output tapes are capable of making recordings with signal-to-noise ratios of 26 to 28 dB. High-energy tapes can record in the same wide-band range with signal-to-noise ratios of 28 to 30 dB. The higher signal-to-noise ratio performance of high-output and high-energy recording tapes is achieved through the use of newer oxides and refinements in the oxide coating.

Two new high-energy oxides are dominant today: chromium dioxide and cobalt-doped gamma-ferric oxide. Tapes with these coatings require higher record and bias current drive, and optimum equalization in the recorder to take full advantage of the high-energy oxide.

Digital Tape (Computer)

Digital tape has design features tailored specifically for the computer application. Its base film thickness is about 1.5 mils compared with the 1.0-mil base film thickness of analog tape. The added thickness enables digital tape to withstand the more strenuous acceleration and deceleration forces inherent to digital computer search, read, and write operations.

Digital tapes are held to much more stringent quality control standards than are analog tapes, particularly with regard to surface blemishes and coating imperfections. The loss of one digital data bit can be far more significant than a brief discontinuity in an analog waveform.

Tape Characteristics

Many factors affect the manufacture of a magnetic tape, and these factors cause differences in either the physical or magnetic properties. It is important for the person responsible for the care and use of tapes to be familiar with some of these characteristics that will vitally affect his operations.

Physical Properties

Layer-to-layer adhesion is the adhesion of the oxide surface to the polyester surface of the next layer on the reel. This may, in unwinding, cause holes in the oxide coating or cinching resulting in errors:

Coating-to-backing adhesion is the force required to remove the oxide coating from the polyester surface. This is essential in preventing oxide coating removal under pressure encountered in the reel.

Cupping (humidity stability) is departure across a tape at right angles to its length from a flat surface because of the different expansion characteristics of the coating and backing material.

Tensile strength (shock tensile or elastic characteristic) is the resistance of the backing to breakage or the ability to withstand the application of high-force loads.

Creepacity (elongation under stress) is the ability of the backing to return to its original length after stretching.

Wear resistance is the ability of the tape to resist the abrading action encountered on a magnetic tape transport.

Stick-slip. Friction may cause a tape to instantaneously stick to the magnetic head; then as friction is overcome the tape will accelerate or slip. This distorts the signal being recorded or reproduced. The stick-slip characteristics of a tape depend upon the susceptibility of the binder to moisture, heat, and pressure.

Oxide uniformity. Tape with high-quality performance characteristics must have an oxide coating of uniform thickness and evenly distributed oxide particles. The size and density of the particles must be consistent with the wavelength or bit packing density that is to be recorded.

Shed. The tendency of a tape to shed particles is related

to its backing and binder composition, and to processing factors such as the slitting techniques that are employed during its manufacture.

Abrasivity is the frictional characteristic of tape that produces wear on the fixed surfaces of the tape transport. Abrasivity of a tape increases as the hardness and roughness of its coating increases. Ineffective lubricants in the coating mixture can also make a tape more abrasive.

Electrical Properties

Coating resistivity is the electrical resistance of the coating, which is an indication of the ability of the tape to dissipate a static charge.

Signal dropouts are a measure of temporary and permanent signal errors in the tape leaving the factory.

Average peak output of a magnetic tape is referenced to National Bureau of Standards Amplitude Reference Tape SRM 3200.

Magnetic flux ϕ and magnetic field strength H are measurements of the ability of the oxide coating to retain the magnetism once the magnetizing force is removed.

Noise means false signals after erasure; it should not be greater than 10 percent of average peak output when the tape is saturated in one direction.

TAPE ERRORS AND EFFECTS

When contaminants come between the tape and magnetic head, the recording system suffers performance degradation. The tape itself is one source of contaminants via shedding. During record and replay, oxide or backing particles that are shed by the tape will be deposited on the fixed surfaces of the tape transport (e.g., the heads and guides) and slowly accumulate to form projecting lumps. Eventually, during subsequent operation, these lumps will be dislodged from the transport and deposited on the surface of the tape—often becoming as firmly attached to the tape as the oxide coating itself. When this contaminated tape is used subsequently, these lumps will cause separations between the surface of the tape and the transport heads that will cause signal dropouts. (See fig. 5-1.) Accumulations of dust, lint, oils, and other contaminants that may adhere to the tape surface can produce the same effect.

Both digital and analog recording systems are vulnerable to signal dropouts caused by contaminants. For example, in a typical digital computer tape drive operating at 800 bpi, a lump protruding only 150 μ in. from the tape surface will cause a 50-percent signal reduction. Spatial separations affect analog recording systems similarly, increasing dropouts, modulation noise, and nonuniform signals, and reducing the system's short-wavelength response. While there are several types of tape errors, the most common is the signal dropout. Other types of tape errors include noise, skew, and signal amplitude changes usually found as marginal errors.

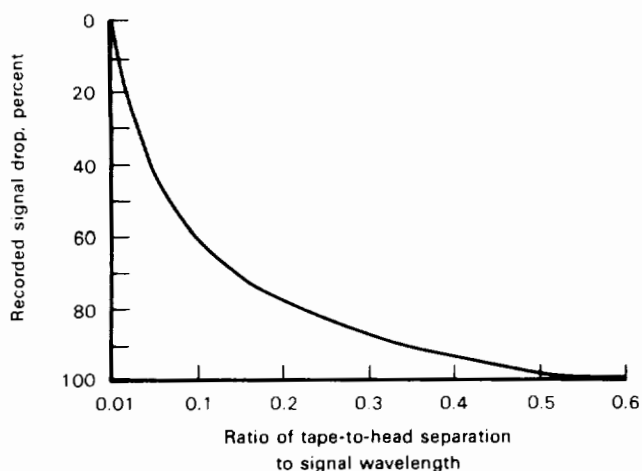

Figure 5-1.—Signal drop versus ratio of tape-to-head separation to signal wavelength. (Signal drop is directly proportional to tape-to-head separation and inversely proportional to wavelength.)

Dropout Errors

As stated, dropout errors result when the strength of the read signal is less than the threshold level (clipping level voltage) that is set into the tape drive. The clipping levels are determined by the specifications of the computer manufacturer but may be adjusted locally by the customer engineer to improve data recovery.

If a tape transport is assumed to have a threshold level of 35 percent when performing a read following a write operation, this means that the read signal from the tape must be at least 35 percent of the normal read signal; therefore, if the normal read signal is 10 V, the actual read signal must be greater than 3.5 V to be accepted.

Noise Errors

Noise errors result when the strength of the read signal is more than the threshold level of the tape drive when no signal should be present as in an interblock gap area. Threshold levels are determined by the computer manufacturer. If the threshold level is set for 10 percent of the standard "1" signal and the standard "1" signal is 10 V, a read signal greater than 1.0 V would be detected as a noise error.

Most noise errors are caused by lack of oxide. A cut in the tape can cause noise errors because the tape has been erased and the polarity of the flux from the tape is in only one direction. Due to a lack of oxide at a cut or scratch, a flux change occurs, and a "1" is read back as a noise error.

Skew Errors

Skew errors are detected by observing the time relationship of the two channels on the opposite edges of the tape. Skew is caused by misalignment of the tape on the drive. If the tape is curved, it will not move by the head in a

straight line. This will cause one of the outside channels to either lead or lag the other with respect to time. This is a serious problem in a computer system because all tapes should be compatible. Skewed tape may be the result of improper control in the tape slitting operation where precise tolerances must be maintained or can result from tape that has been stretched during usage.

Level Errors

Level errors (average amplitude) are of two types: high level and low level. Magnetic tape is required by specifications to have a particular output and this should not vary in any great amount. Specifications generally call for the level to be maintained at ± 10 percent. This would mean a tape with an output of 10 V could not have an output greater than 11 V or any lower than 9 V. The 10 V comes from a master level tape that is used in the calibration of the tape drives. Level errors are the result of oxide coating thickness variations, which can come from the manufacturing process or worn tapes.

There are some permanent errors that cannot be removed by any means; for example, a crease in the tape or a crater in the oxide. Removable errors generally appear as oxide flakes or clumps and may usually be cleaned off the tape. The following is a list of error types:

<i>Cleanable</i>	<i>Permanent</i>
Oxide clump	Coating streak
Loose oxide	Hole in oxide
Fibrous particle	Crater
Metallic particle	Crease
Dirt inclusion	Damaged edge
Backing chip	

Figure 5-2 illustrates the effect of signal loss caused by head-to-tape separation for different recording densities.

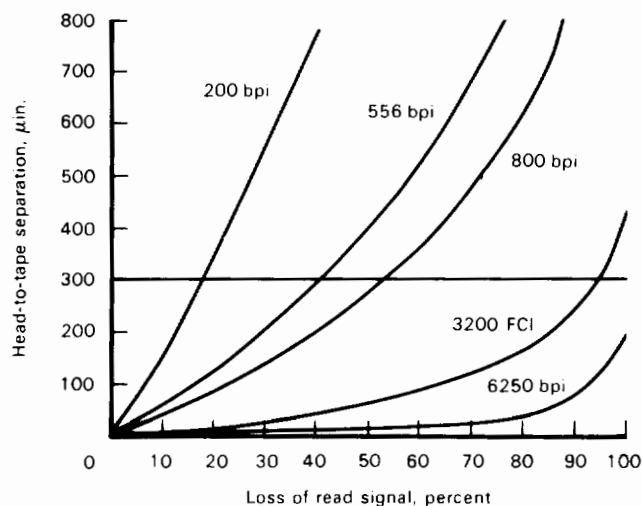

Figure 5-2.—Effect of tape separation on read signal. (FCI = flux changes per inch.)

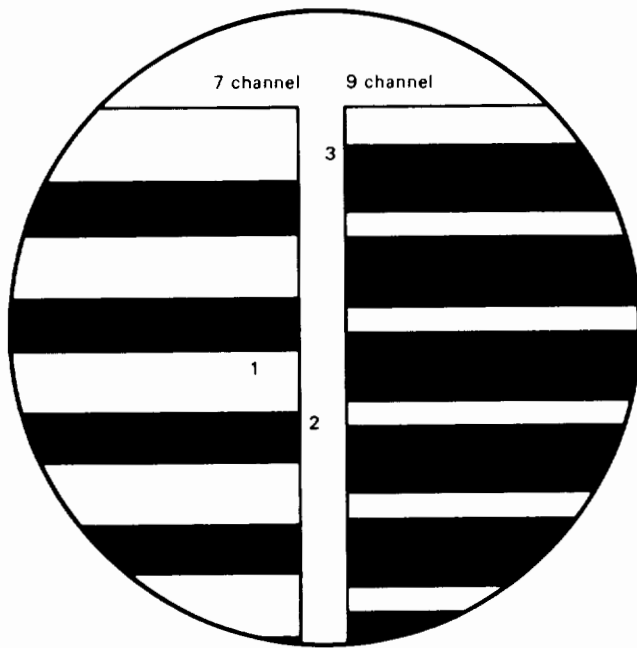

Figure 5-3.—Effects of head format conversion.

Note that separation causes a greater signal loss at higher densities. A tape may fail at 3200 flux changes per inch that performed satisfactorily at 800 bpi if it is not cleaned to remove the smaller dirt particles causing high-density errors.

It is also important to recognize the factors affecting the performance of a tape when converting from 7- to 9-channel operation or vice versa. Example 1 of figure 5-3 shows that dirt particles that escape undetected in a 7-channel format may cause errors in 9-channel usage. Example 2 illustrates the reverse effect. Example 3 points out that the 9-channel write/read format is much closer to the edge of the tape; therefore, edge-damage-caused errors will be more frequently found. The result of these findings is that tapes must be well cleaned and, if older, tested before reliable performance is to be expected from 7-channel tapes converted to 9-channel usage.

TAPE CARE AND MANAGEMENT

Hostile Environments for Tapes

Any discussion on tape care and management must include the negative effects of environmental extremes on tape. Ideally, magnetic tape should be used and stored at a constant temperature of about 70° F. However, if wound properly, high-quality tape can withstand storage temperatures that range from -40° to about 150° F without suffering severe damage. It is mandatory, though, that following such exposure the temperature of the tape be stabilized at approximately 70° F for 24 to 48 h before it is used again. The ideal relative humidity for storing and

using tape is about 45 percent. Appreciable change from 45 percent will cause the tape to expand or contract proportionately and thus affect the uniformity of its oxide coating. (Tape stretches as the relative humidity increases.) High relative humidity also adversely affects the frictional characteristics of the tape, causing increased head wear, head clog by oxide particles, and head-to-tape sticking. Very low relative humidity encourages oxide shedding and increases the static buildup on the tape surfaces, giving the tape a greater tendency to collect airborne contaminants.

There is also a little-understood phenomenon called "brown stain" that occurs at relative humidity values below 30 percent, particularly when tape transports are operated at speeds of 75 in./s or greater. This stain occurs on the face of the head in the area where the tape makes contact. The stain is usually brown, but may also appear to be bluish or greenish. Brown stain is thought to be a chemical reaction within the head material that occurs at low values of relative humidity in the presence of high temperature and friction. Brown stain occurs on most head materials, including mu-metal, but not on ferrites. The stain develops even when the polyester backing alone—without the oxide coating—is passed over the head. It creates a magnetically inactive "bulge" on the head that spoils tape-to-head contact and causes signal loss. At present, the only practical means of removing brown stain is by abrasion.

Other Effects of Environment

Temperature and humidity extremes affect the physical properties of both the tapes and the heads and cause system performance degradation. Some of these affects are explained in the following paragraphs.

Tape Deformation

Magnetic tapes are wound under tension on reel hubs, creating considerable layer-to-layer pressure within the reel pack. Changes in ambient temperature and humidity cause the backing material of the tapes to expand or contract, creating pressure changes within the pack that can be tremendous. The use of aluminum or magnesium reel hubs can help prevent such tape deformation because of the similarity of the coefficients of expansion of the tape and hub. This permits both the reel and the hub to expand and contract at nearly the same rate when temperature variations are gradual.

Oxide Shedding

At temperature extremes of -40° to 150° F, oxide coatings tend to become brittle or soft, respectively. At either temperature the binders free magnetic particles from suspension and, at very low temperatures, the binders themselves may flake off. Oxide particles may be

redeposited as lumps on the oxide surface of the tape and cause tape-to-head separation. Oxide particles also may accumulate on the tape transport head gap areas and magnetically short the heads.

Head-to-Tape Sticking

At higher temperatures, the tape binder material can soften to the extent that the tape will adhere momentarily to the tape transport head (stick-slip). The length of time that the tape remains stuck to the transport head depends upon the temperature differential between the head and the tape. Head-to-tape sticking produces jerky tape motion.

Layer-to-Layer Adhesion

At the upper temperature extreme, the tape binder material can get hot enough to cause one layer of tape to adhere to an adjacent layer. This condition is called "blocking." When blocking is mild, the tape layers will tend to stick to one another slightly as the tape is unwound from the reel. This may cause disturbances in the tape tension control, but will not damage the tape. However, when blocking is severe, the oxide coating of the tape may delaminate from the base film and destroy the tape.

Mechanical Defects in Tape

Mechanical forces associated with winding the tape can also cause tape damage. These deformations are termed "spooling defects" and are generally caused by improper winding practices that apply excessive or uneven energy to the tape pack, and thus deform it. The most common spooling defects are explained in the following paragraphs.

Cinching

When rapid deceleration is applied to a reel, inertia tends to cause the outer layers of tape to continue spinning

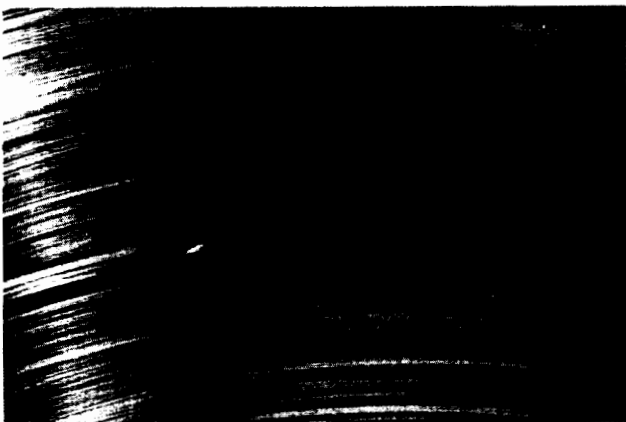

Figure 5-4.—Cinched tape. Note the complete foldover of one tape strand.

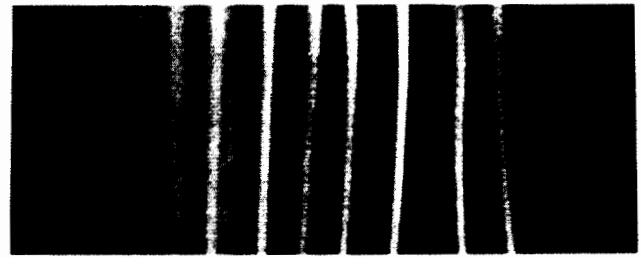

Figure 5-5.—Tape damage caused by cinching. This 1-in.-long strand of 0.5-in. magnetic tape has washboard like wrinkles caused by cinching.

momentarily after the hub and inner tape layers have stopped. This will cause any loosely wound lengths of tape within the pack to unwind and pile up between adjacent layers. (See figs. 5-4 and 5-5.)

Pack Slip

Tapes subjected to vibration or thermal stresses after being wound with too low a tension will shift laterally, causing "steps" in an otherwise smooth winding. Thereafter, when the tape is used, it will unwind unevenly and probably contact the reel flange or transport guide edges. This will usually damage the tape edge (and edge tracks) and encourage the probability of oxide shedding. In addition, skewed tape travel across the transport head will accompany pack slip. Where only single strands of tape slip, their edges become particularly susceptible to damage from compressed reel flanges. (See fig. 5-6.)

Spoking

When a tape is wound initially at relatively low tension, then tension is increased toward the end of the winding, high radial compression forces may buckle the tape pack into a polygonlike shape. This form of pack deformation is called spoking. (See fig. 5-7.) The uneven pressures produced by winding a tape on a distorted hub also can cause spoking, even if the hub distortion is only slight.



Figure 5-6.—Scattered tape wind. Individual tape strands are exposed and vulnerable to damage.



Figure 5-7.—Spoked tape pack.

Spoking can also result from winding tape over a small particle that has been deposited on the hub.

Windowing

Loose windings can lead to voids or “windows” in tape packs (fig. 5-8), especially those packs that are later subjected to temperature or humidity extremes. Windowing can occur independently of other spooling irregularities,



Figure 5-8.—Windowed tape pack. Windows are see-through air gaps in tape winding.

or it can be accompanied by one or more of them. A tape that becomes deformed due to any of these spooling defects will not perform satisfactorily. A deformed tape will not maintain the intimate tape-to-head contact that is needed for the efficient transfer of magnetic energy. In many instances, deformed tape can be rehabilitated by rewinding it into an even pack, then allowing it to stand for 2 days or so in the recommended 70° F and 45 percent relative humidity environment. It should then be cleaned and evaluated before being returned to service.

Reels

The tape reel is an integral part of the recorder tape transport system. Its basic function is to protect the tape from damage and contamination. It is often the reel itself, damaged through mistreatment, that in turn damages the tape. For this reason, some discussion will be given to the design of a reel, the types of reels, and the proper care and handling of reels.

Reel Design

A reel is made up of the hub and two flanges. (See fig. 5-9.) Their design and the moment of inertia of the reel are

crucial aspects that determine how effectively the reel functions as a tape protector.

Flanges

The reel must be designed to enable the tape to wind and unwind without contacting the flanges. Any contact of the tape with the flange will usually result in tape edge damage and loss of the edge recording track. The flanges must be sufficiently rigid to withstand normal handling pressures and resist accidental nicking or gouging. The flanges do not serve to guide the tape or help provide an even reel

pack. Contact with the flanges must be avoided for the reasons stated above.

The Hub

It is vital that the hub be as near a perfect cylinder as possible, both on its inner and outer surfaces. If the hub inner surface is imperfect, the reel will wobble on its spindle and feed the tape erratically onto the transport. This will result in tape edge damage and skewed tape travel across the transport head.

If the hub outer surface is imperfect, the tape will stretch as it is stacked on the reel. When the deformed tape is replayed, signal distortion will occur. The stretching will create unevenly distributed tension within the reel pack and will cause erratic movement when the tape is unwound.

Foreign particles on the reel hub surface can cause the tape to stretch and create unevenly distributed tension within the reel pack. This is why it is imperative that the reel be routinely and frequently inspected and cleaned.

Reel Inertia

During normal tape transport operations, tape reels are subjected to rapid starts, stops, and direction reversals. These rapid changes of rotational movement can create large moments of inertia, especially at the outer circumference of a fast-spinning reel with thick flanges. Excessive reel inertia will also adversely affect rotating and braking components of the tape transport, shortening their service life. Consequently, reel manufacturers generally keep mass to a minimum after other design requirements are satisfied.

Precision Reels

Most modern tape transports require tape reels that are fabricated to close tolerances and have superior stability and flange rigidity. Precision reels meet these requirements and may be classified by their flange material (metal or glass) and by their service rating (instrumentation or heavy duty).

Flange Material

Precision metal reels (Federal Specification W-R-175/4) have precision fabricated metal flanges and accurately machined metal hubs. These features provide better reel-for-reel interchangeability and uniform reel performance.

Precision glass reels (Federal Specification W-R-175/6) have precision fabricated glass flanges and accurately machined metal hubs. The chemically strengthened glass is about 10 times as strong as ordinary glass. Reel flanges made of this material are coated with a tough plastic material that will restrain glass fragments should failure occur.

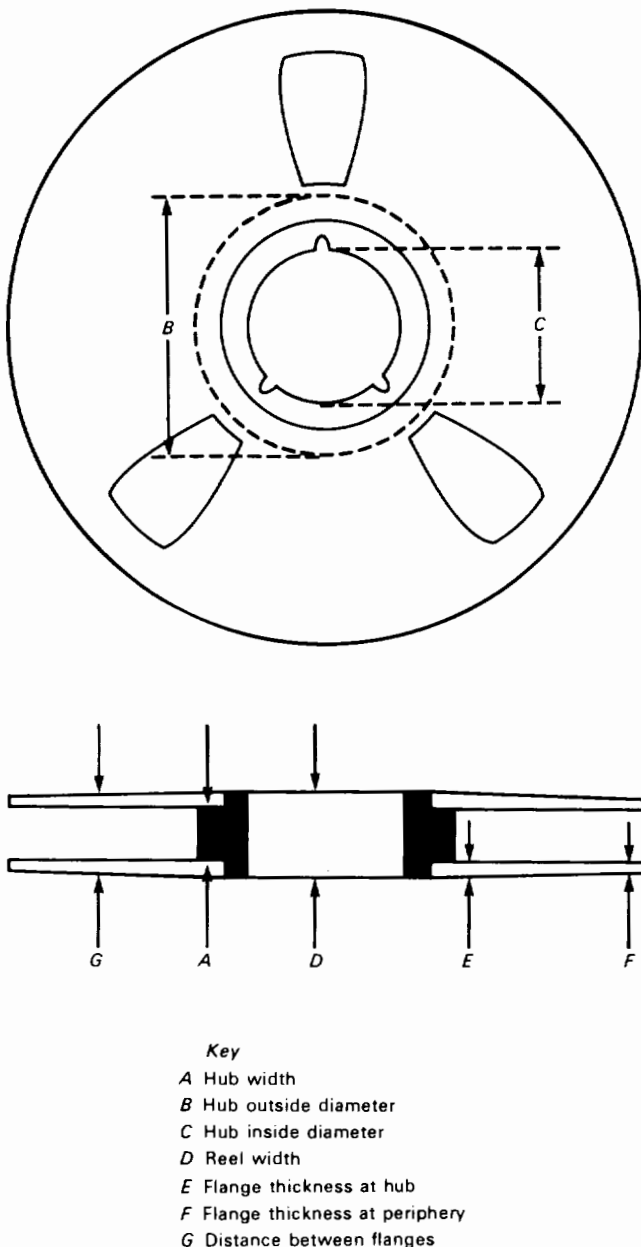

Figure 5-9.—Typical reel components and their reference dimensions.

Service Rating

Metal precision reels are classified as instrumentation reels (IR) or heavy duty instrumentation reels (IRH). IR reel flanges are 90 mils thick at the center and taper on the outside surface to a thickness of 50 mils at the reel periphery. IRH reel flanges are uniformly 90 mils throughout.

The tapered flange design of the IR reel gives it the desired low moment of inertia while still providing adequate flange strength and stability.

The IRH reel is a heavy duty reel with nontapered flanges designed for applications in which the moment of inertia of the reel is not a deciding factor. Maximum strength is inherent in the IRH reel flange design. This flange resists deflection and protects the tape from damage under the most rigorous conditions.

Tape Handling and Storage

Modern magnetic tape coatings can accept intelligence and retain it for an indefinite period. The recorded information is a permanent record that does not fade or weaken with age. It will remain unchanged unless altered magnetically or until the recording medium deteriorates physically. Those who work with magnetic tapes will help prevent needless performance degradation by carefully observing preventive tape handling and storage procedures.

There are only two places that can be considered proper for a tape reel—in use on the tape drive or in storage in its container. Adequate procedures should be established to protect magnetic tape from contamination resulting in decreased machine performance.

Some of the common violations of “good housekeeping” to be avoided are—

- (1) Never leave tape reels or containers exposed. In addition to the possibility of damage, dust in the air can accumulate on the tape or in the container and eventually contaminate tape.
- (2) Do not use the top of a tape unit as a working area. Placing tape reels or containers on top of the drive exposes them to heat and dust from the blowers and interferes with the cooling of the tape unit.
- (3) Erasing the reel identification label is a primary source of contamination. Select a label with an adhesive backing that does not leave a residue and that can be easily applied and removed.
- (4) Never allow a loose end of tape to trail on the floor, even though the end of the tape may not contain data. Dirt picked up can be deposited on the transport areas of the drive and be passed on to other sections of the tape.
- (5) Smoking should not be permitted in areas where tape is in use. Ashes are a source of contamination. Live ashes can produce permanent tape damage if they contact the tape surface.
- (6) When a reel is improperly seated on the tape drive hub, the tape edge receives undue wear and becomes

burred. This burred edge winds to a larger diameter than the undamaged edge. Eventually, the center of the tape collapses and the burred edge of the tape is permanently stretched.

(7) Improper handling while loading and unloading tape on the drive causes tape damage. Any physical contact to the exposed tape through the reel openings or excessive pressure exerted on the reel flange will compress the tape and damage the edges. Tape reels should always be handled by the hub.

(8) Use extreme care while removing the file protect ring. Never remove the ring while tape is in the columns.

Contamination

Prolonged or unnecessary exposure of tape to dust and dirt can contaminate the tape surface and result in signal loss and errors. The following basic rules will help minimize the risk of tape contamination:

- (1) Maintain recommended temperature and humidity conditions in areas where tape is used and stored.
- (2) Thoroughly clean the entire floor area daily using a damp mop. Sweeping, dry mopping, or dusting in areas where tape is used or stored must be avoided.
- (3) Floor waxing should be kept to a minimum. When necessary, the floor should be machine buffed to remove excess wax, damp mopped with cold water to harden the surface, then machine buffed again when dry. Steel wool or other metal abrasives should never be used for buffing.
- (4) Periodically inspect and clean tape drives to remove dirt accumulated during normal tape use.

Reel Protection

All available flange protecting devices should be used whenever possible. The basic protective device is the protective container of the reel, which may be a cardboard box or a plastic or metal canister. Reels, either empty or wound with tape, should always be stored and transported in their protective containers. Special plastic bands have been designed to fit over the reel flanges and protect the tape within. As a rule, it is a good habit to keep the protective band in place. The only time it should be removed is after the reel is mounted on the tape transport. Generally speaking, the reel band serves several important functions:

- (1) It protects the tape from harmful environmental conditions
- (2) It protects the tape and reel flange edges from physical damage
- (3) It helps keep plastic reel flanges from warping
- (4) It helps keep metal reel flanges from bending

When reels of tape are in process (awaiting degaussing, cleaning, or certification), they should be supported by



Figure 5-10.—Reel supporting device.

their hubs with fixtures like those shown in figure 5-10. If such fixtures are not available, the reels of tape should be kept upright and stored in their protective containers. Laying a reel of tape on its side makes the tape and reel vulnerable to three dangers. First, if the tape pack is loosely wound, it will slump down against the bottom flange. Second, there is a good chance that something will be put on the reel and will damage it. Third, if the tape is exposed and the reel flanges have apertures, airborne contaminants will have a broad target to settle upon.

Damaged hubs, while not as prevalent as deformed flanges, also must be reckoned with. Empty reels should be inspected thoroughly for both flange and hub damage before tape is wound upon them. Because many turns of tape are wound upon a reel, even the slightest hub deformation (or dirt particle) will be magnified by its cumulative effect as layer is wound upon layer and will cause the tape pack to stretch and spoke.

Storage

Most reels of tape spend a significant amount of time in storage. During these periods they must be protected from contamination, environmental extremes, and physical damage. This leads to a discussion of tape tension, storage environment, and storage practices.

Tape Tension

Some tape community activities have found that winding the reel pack under constant tension is the best all-around method of avoiding pack damage. Other activities prefer to "program" wind their tape to a tension profile similar to the classic "bathtub curve" (see fig. 5-11), either normal or inverted.

In theory, reduced tension at the center of the wind best allows for expansion and contraction of the tape with temperature variations, which helps avoid the problems of layer-to-layer adhesion, spoking, and windowing. However, at present, insufficient evidence has been brought forward to conclusively demonstrate this theory. Agreement is general that a precision wind that gives a uniform tape pack is essential.

Storage Environment

It has already been established that magnetic tapes fare best in a clean environment that has a relative humidity of about 45 percent and a temperature of about 70° F. The prestorage tape processing area (used for degaussing, cleaning, and certifying tapes) and the storage area should approach, as closely as possible, a "clean-room" environment—one that has a moderate temperature/relative humidity profile and is relatively free of airborne dust and lint. If possible, the air pressure in clean-room processing

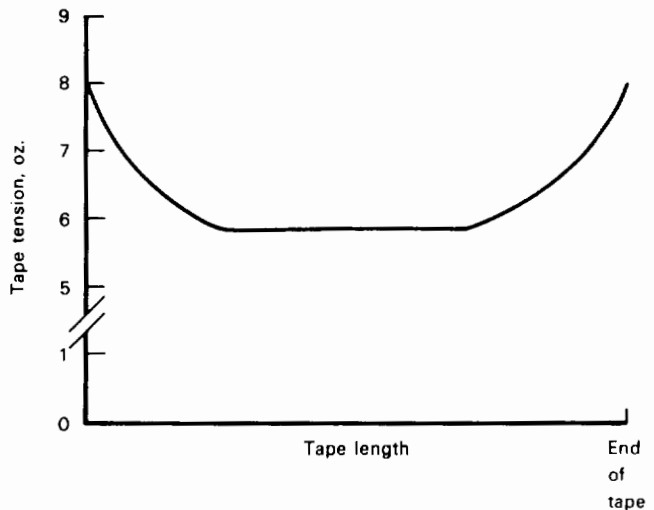

Figure 5-11.—Typical "bathtub curve" of tape wind with programmed tension.

and storage areas should be maintained slightly higher than that of the surrounding area. This positive pressure differential helps keep airborne dust from infiltrating through doors and windows. Between the regular thorough cleanings, the clean-room area should be wet-mopped daily. When vacuum equipment is used for cleaning the area, the exhaust outlet of the equipment should be located outside the room.

Storage Practices

Because the hub is the strongest and most stable part of the reel, it is the best means of reel support during storage. When the reel is supported by the hub, there is little if any weight resting upon its flanges. This protects the flanges from problems such as bending and nicks.

Under no circumstances should a reel be stored resting on its flanges. Paper notes about stored data or other sources of contamination should not be put in the storage container.

For long-term storage, additional protection from dust and moisture should be considered. This can be done by sealing the tape storage container in a plastic bag. When the reel of tape is taken out of storage, accumulated dust should be cleaned thoroughly from the exterior of the container (or plastic bag) before the tape is removed.

To prevent tape contamination and damage during storage, follow these procedures:

- (1) Before a tape is stored, sponge rubber grommets or tape end retainers should be placed on the reel to prevent the free end of tape from unwinding in the storage device.
- (2) Store tape in an upright position. Never store tapes flat or in stacks; accidental damage or reel warp can result.
- (3) Store tapes in a cabinet or shelf elevated from the floor and away from sources of paper and card dust. This minimizes the transfer of dust from the outside of the container to the reel during loading and unloading operations.

Accidental Erasure

Experiments were conducted with a typical ac bulk tape eraser to determine the relationship between magnetic field intensity and magnetic signal erasure. The results are shown in figure 5-12. Some erasure is noticeable at a field intensity of only 100 Oe, and a 6-dB loss (50 percent signal reduction) occurs at 155 Oe.

Accidental erasure of tape can occur from small permanent magnets used as door latching devices or flashlight magnets, which have surface field intensities as high as 1500 Oe. Such a magnet would erase the portion of a tape that came in close proximity to it.

There have been a number of stories that attribute tape erasure to exposure to energy sources that are commonly present at airports. Such energy sources include radar, magnetic antihijacking devices, and X-ray equipment.

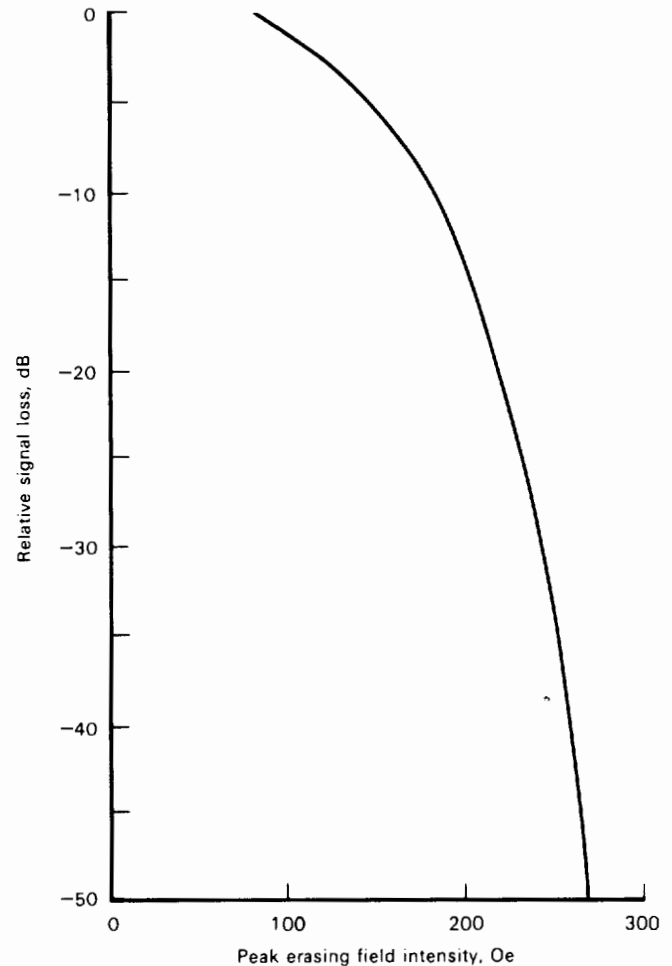

Figure 5-12.—Relative signal loss versus erasing field intensity. (Field intensity was measured at the center of the recorded track; track width = 0.090 in.; $\lambda = 0.015$ in. (500 Hz at 7.5 in./s); 0 dB = 8 dB below level for 3 percent harmonic distortion.)

While the likelihood is small that these energy sources have been responsible for the erasures, the possibility, however remote, exists.

TAPE MAINTENANCE

The service life of a reel of tape can be greatly extended and its performance significantly improved by an effective maintenance program. The elements of the program will differ from one organization to another, based upon unique needs and circumstances. This section, then, will deal with processes such as degaussing, tape cleaning, and precision winding.

Tape Cleaning

Even if it were possible to prevent foreign contaminants from reaching the tape and its transport, the tape still

would require regular cleaning. Although the best of care may be lavished upon the tape, self-contamination (shedding) is unavoidable. The Mylar backing of the tape material is produced in rolls that are several feet wide. After the oxide coating has been applied to the Mylar and dried, the tape is slit to its final width. This slitting process "fractures" the coating and backing material at the edges of the tape. As a result, binder components, oxide particles, and backing material particles will shed continually throughout the lifetime of the tape, with more shedding occurring during the first few uses of the tape.

In addition, tape will also shed debris from both its flat surfaces. This is caused by the constant friction of the tape surfaces with the fixed surfaces of the tape transport. This shedding is accelerated when the tape is exposed to extremes in temperature and relative humidity. Although tape is polished during its manufacture, the oxide coating surface still has some measure of roughness remaining. When the rough protrusions are dislodged from the tape surface, they become debris. As might be expected, the rougher the tape surface, the more debris is shed. The polyester backing of the tape is also a source of debris because polyesters are subject to scratching and chipping. However, with the advent of the texturized back-coatings, there has been a considerable reduction in shedding of tape backing material.

Frequency of Cleaning

Tape cleaner manufacturers hesitate to recommend cleaning the tape after every use because of the increased risk of further damaging tape that has slight deformations. Their primary concern is that the cleaner/scrapper may catch a slightly curled edge or other damaged portion of the tape and tear it. On the other hand, regular cleaning is essential for critical computer applications, which simply cannot tolerate tape recordings with excessive dropouts. Thus, the risk of damaging the tape from cleaning it too often must be weighed against the risk of having a tape with too many dropouts because of inadequate cleaning. In the final analysis, a compromise must be struck.

For a tape that is used in a relatively clean environment and is not degaussed between uses, a good rule of thumb is to clean the tape about every 8 to 10 uses. This rate of cleaning would apply to computer program tapes used exclusively in areas that are relatively free of contaminants. On the other hand, tapes used in "hostile" environments, (such as onboard ship or aircraft) will obviously require cleaning more often because they are exposed to an environment with more contaminants. It should be a general rule to clean a tape immediately after it is degaussed, because degaussing may loosen oxide particles from the tape. Finally, there is the question of whether new tapes should be cleaned. The recommendation is to clean them because the edges of new tapes have only recently been "fractured" (slit during the manufacturing process); there-

fore, they should be fully cleaned with scraper and tissue before first use. This recommendation is based upon tests on two randomly selected tapes that were conducted by E-Systems, Inc., Garland Division. The test results of both tapes were similar. Before cleaning, one tape had a bit error rate of 4.0×10^{-6} , while the other had a bit error rate of 2.5×10^{-6} . After one cleaning pass, the bit error rate of each tape improved to the range of 1.0×10^{-6} , and after a second cleaning pass to about 8.6×10^{-7} , a significant improvement.

Table 5-1 presents various types of tape cleaner/scrapers and their characteristics. This is not an all-inclusive list of scrapers, but it is representative of the major types that are available.

Tape Evaluation and Certification

Tapes may be evaluated or certified after the cleaning process to insure that they have been cleaned properly. Certification usually denotes a stop-on-error type of testing. This allows the operator to view the area of tape where the dropout occurred to determine whether the dropout is temporary (due to a loose or adhered particle) or permanent (due to a hole in the oxide coating or to otherwise damaged tape). If the dropout is temporary, the tape may be recleaned; if the dropout is permanent, the tape may be relegated to less demanding roles (scratch tape) or discarded if too many permanent dropouts are present. Instrumentation tapes generally are permitted many more dropouts than computer tapes.







Evaluation generally means counting the number of dropouts and grading the tapes without stopping to inspect at each point of failure. One tape cleaner/evaluator manufacturer recommends evaluating computer tapes as follows:

<i>Dropouts per reel</i>	<i>Disposition of tape</i>
0 to 5	Refile in library
5 to 15	Scratch
15+	Reject

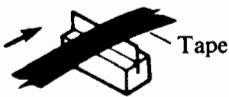
Instrumentation tapes, on the other hand, are acceptable with as many as 40 dropouts per hundred feet because analog signals can be interpreted accurately as long as the dropouts are sufficiently spaced.

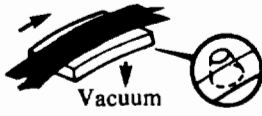
With the evaluation circuitry deactivated, the evaluation/certification process begins by passing the tape through the evaluation section to the cleaning section. Upon entering the cleaning section, the oxide coating of the tape is cleaned by a wiper, then the backing is cleaned by a wiper. Next, the oxide coating is cleaned by the scraper and wiped again. After this, the evaluator section is activated and the tape is run in the reverse direction and cleaned a second time, after which it reaches the evaluation section. Once there, the tape first passes over an erase head to remove any previous recording. A signal is then recorded on the tape at an adjustable wavelength in the

Table 5-1.—*Tape Cleaner/Scraper Types and Their Characteristics*

Type of scraper		Scraper life (number of 2400-ft reels)	Remarks
Blade: stainless steel		1	Best cleaner Loses edge quickest Most danger of destroying slightly deformed tape
Block:		1. 2500 per edge 2. 2500 per edge 3. 400 per edge	Very good cleaner ^f Long life Little danger to tape
Grid: stainless steel		20 000	Good cleaner Very long life (self-sharpening) ^a Least danger to tape
Slotted cylinder (rotating or fixed):		1. 20 000 2. 100 000	Good cleaner Longest life (self-sharpening) ^a Least danger to tape
Band—rotating loop: stainless steel		500	Very good cleaner Moderate life Some danger to tape
Band—cartridge: stainless steel		500	Very good cleaner Moderate life Some danger to tape

^aManufacturer's claim.

range of interest; e.g., from 0.1 to 2.5 mils. The tape then passes over the reproduce head and its output amplitude is measured. If the output drops below a preset percent of the recorded signal level (between 20 and 80 percent) for some preset interval (between 5 and 50 μ s), a dropout is registered on the evaluator's counter.

The cleaner/evaluator has separate counters for monitoring each of a number of recording tracks, usually three—the center and each edge track. Many machines are equipped to make strip-chart printouts that record the number of dropouts per time interval. This value is easily convertible to dropouts per length of tape, which, in turn, is a measure of the usefulness of the tape.

HDDR Recording and Testing

Because of the confusion caused by the varying claims of tape vendors, computer manufacturers, and tape evaluator manufacturers, a brief review is in order on recording and testing 6250-bpi tapes using group code recording (GCR). Such statements as "most existing tapes will run OK at 6250 bpi" or "equivalent performance on a byte for byte basis will be realized at 6250 bpi" are both misleading and partially untrue.

There are many more tape errors at 6250 bpi. The reason for this increase in tape errors may be seen in figure 5-2. For example, 80 percent of the read-head signal is lost with head-to-tape separation of 40 to 50 μ in. at 6250 bpi, whereas it takes debris particles three times bigger—about 150 μ in.—to cause an 80 percent signal loss at 1600 bpi. While the increased electronic signal correction capability of the GCR logic can correct most of these tape errors, the system reliability is reduced because the GCR system can only correct two-track errors. In using tapes with many single track errors, smaller migratory errors will cause read failures and reruns. The problem facing the user is that the system software does not report single-track errors and, therefore, provides no clue of the true condition—and progressing wear of the tapes—until disasters and reruns occur.

Certain kinds of tape errors are worse than others at 6250 bpi. Single-track errors that occur in the data groups can be electronically corrected. Single-track errors that persist or occur in the control character area of the storage data will cause temporary write errors and skips, which waste computer time and money. Because the system software does not report all tape errors, an accurate picture of true tape condition is not obtained. A more

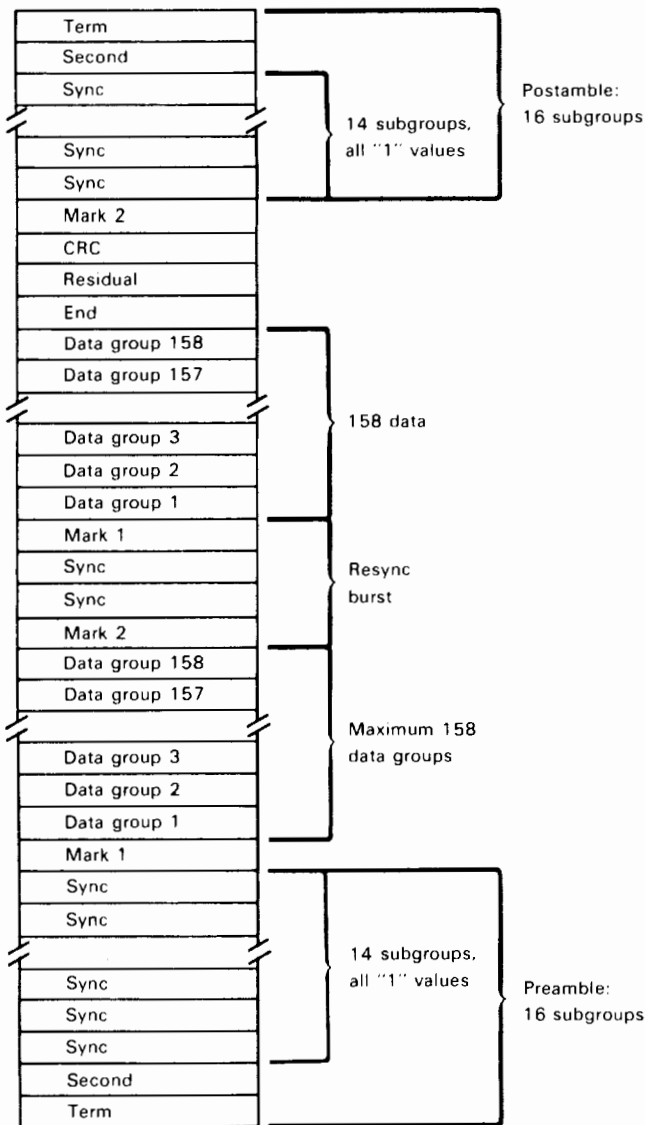

Figure 5-13.—6250 bpi group code format.

comprehensive test prior to usage is required to measure true longer term tape performance. For example, referring to figure 5-13, the data in the resync burst area must be perfect to resynchronize the electronic data correction logic. The data groups (up to 1580 bytes) can have up to two tracks defective and still operate in the read-only mode. The interblock gap (0.3 in.) can have data errors but not noise records without impairing tape performance.

Future reliable tape performance is not guaranteed by a successful read-after-write check on the computer. Because the GCR format can correct single-track errors electronically, but does not correct the actual bits on the tape, any migratory dirt can cause an increase in expensive read errors. A regular tape and drive cleaning program is more necessary at 6250 bpi to reduce loose (transient) debris particles on both tapes and drives. The real problem here is that the operating system does not

collect and report error conditions that do not result in write-skip conditions. As a result, the software input/output error reporting system is not nearly as good a mirror of tape performance and future reliability as it is at 1600 bpi.

Commercially available software tape test programs do not reflect actual operating performance. Conversely to the operating system software of the computer, software-oriented tape test programs test the tape for single-track errors without providing multiple-track error correlation for given faults. This is a 1600-bpi tape test performed at 6250-bpi recording density and not a true measure of the performance of the tape at 6250-bpi GCR. Raw single-track errors can be up to three times greater at 6250 bpi than at 1600 bpi. This will result in unnecessary rejection of tapes that would run reliably on the computer with its single-track error correction logic.

To assure comprehensive testing at 6250 bpi GCR and reliable tape performance, the following parameters should be tested:

- (1) *Marginal errors.* This is physical damage that is not severe enough to consistently result in a dropout.
- (2) *Single-track errors.* These are the non-software-reported write failures on the computer that greatly inhibit the ability of the GCR read logic to overcome tape faults.
- (3) *Three-track errors.* These are hard failures on the computer that result in write or read errors and must be identified by type and location for remedial action.
- (4) *Gross errors.* These are single- or multiple-track errors that extend into the control character area of the data group. Such defects also may result in false end-of-file marks or noise records and should be eliminated from the tape by stripping.
- (5) *Permanent write errors.* These are a cause of aborts (or reruns) in which 5.25 ft of the tape have a continuous error condition. Such areas can be eliminated by stripping.

It can be seen that tape testers that only test for single-track errors will not differentiate between marginal and hard computer errors. Similarly, testers with only three-track error testing will not indicate the condition of the tape in terms of single-track errors and, in fact, are little better than the computer printout. Both types of errors plus those marginal and major errors must be discerned to know that a tape will perform reliably on the computer.

In summary, there is little doubt that a well-administered tape maintenance program will pay dividends. Not only will the performance level of the tape transports rise, but costs resulting from maintenance and tape attrition will decrease. It has been estimated that the life of a tape can be extended by two or more years through regular cleaning. This estimate is based on "normal" usage of the tape—about 20 to 30 times a year. Figure 5-14 gives a life cycle comparison of tapes with and without regular cleaning. Naturally, the life cycle shown on this graph

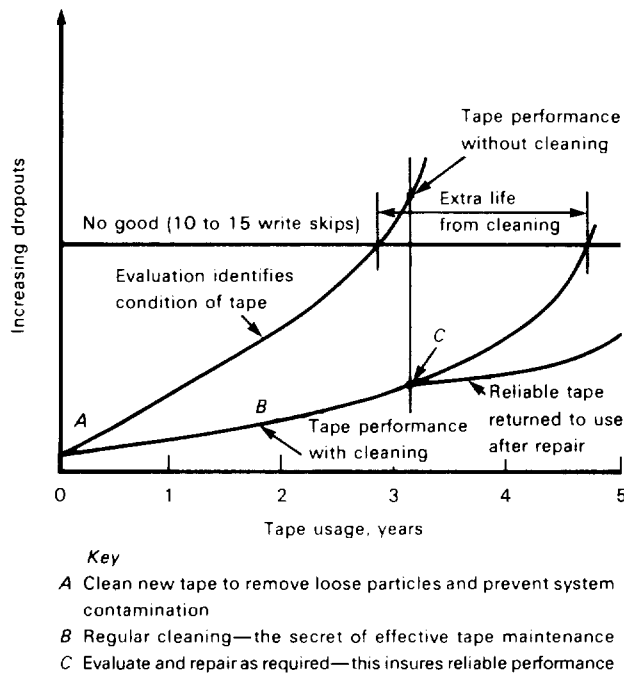

Figure 5-14.—The life-cycle of a computer tape with and without regular cleaning.

must be considered an ideal case. It represents savings that are possible only if the other practices pertaining to good care and handling of the tape and its transport are strictly observed.

Transport Care

We have seen that normal wear causes magnetic tapes to shed minute particles of oxide and base film. These particles accumulate on all of the transport handling surfaces such as guides, rollers, and heads. Subsequent redeposit of these particles on the tape increases the distance between the head and the tape surface, causing signal dropouts. Therefore, high-quality tape recorder performance demands that all tape handler surfaces be cleaned properly and frequently. The requirements for cleaning tape guides, rollers, and heads have been arranged in the following categories: cleaning solvents, cleaning materials, and cleaning practices.

Cleaning Solvents

The characteristics of Freon TF, xylene, isopropyl alcohol, and methyl alcohol (methanol) were investigated to determine their suitability as tape handler surface cleaners. The strong and weak points of each solvent are as follows:

<i>Cleaning solvent</i>	<i>Characteristic</i>
Freon TF	Does not damage polycarbonates, plastics, or neoprene Cuts oil and grease

Xylene

Lowest boiling point of solvents surveyed (dries quickly)
Nonflammable
Low toxicity
Damages polycarbonates and acrylics; does not damage neoprene (AQH-4 pinch rollers are polycarbonate.)

Isopropyl alcohol

Cuts oil and grease very well
High boiling point
Extremely flammable
Toxic

Methyl alcohol (methanol)

Does not damage polycarbonates, acrylics, or neoprene
Limited ability to cut oil and grease
Medium boiling point
Flammable
Does not damage polycarbonates, acrylics, or neoprene
Limited ability to cut oil and grease
Low boiling point
Flammable

None of these solvents damages polyesters (e.g., Mylar). On balance, Freon TF has the most desirable combination of characteristics. It is important, however, that the tape handler surfaces be cleaned regularly, otherwise contaminants may build up to the point where Freon TF loses its effectiveness. If such is the case, use of a stronger cleaner such as xylene may be necessary on a one-time basis. It must be kept in mind that xylene will attack polycarbonates (some pinch rollers), so extreme care must be taken to avoid splashing or spilling xylene onto other surfaces. Also, xylene is flammable and extremely toxic.

Cleaning Materials

The materials used to clean tape transports must be chosen carefully. After chemical and physical analyses, both Kimwipe® tissues and Q-tip® cotton swabs on wooden sticks have been found to be acceptable cleaning materials. The tissues should be used to clean areas where there is sufficient space to apply finger pressure. Often a good deal of pressure is required to remove contaminants that have been deposited under the heat and pressure present during recorder operations. Swabs are useful in cleaning areas with limited access. Swabs with plastic sticks are not recommended; they tend to break when firm pressure is applied. Also, the glue that holds the cotton to the plastic stick has been observed to soften in the presence of the solvent and contaminate the surface being cleaned.

Cleaning Practices

To get the equipment completely clean, begin with the proper cleaning material and solvent. Next, clean the

equipment thoroughly and use the cleaning materials properly. Be certain that once contaminants have been removed, they are not transferred by way of a soiled swab or wiping tissue to the solvent container or to another part of the equipment. The following practices should be observed when cleaning tape transports:

(1) Apply bulk Freon TF to the cleaning material. Do not dip the swab or tissue in the solvent. Instead, transfer the solvent to the cleaning material with a clean dropper or other device. Do not apply so much as to cause it to run

during cleaning. Never pour or spray solvent directly on any component of the tape transport.

(2) Use firm finger pressure on the tissue to "scrub" the heads, guides, and rollers.

(3) While cleaning, discard the cleaning materials as they become soiled. Continue cleaning, changing the swabs and tissues until they show no evidence of dirt or contaminants.

(4) Make the last cleaning pass across the heads in the direction of tape travel.

Cleaning, Packing, and Winding of Magnetic Tape

R. Davis*

EMI Technology, Inc.

This chapter presents those questions most asked by magnetic tape users regarding the cleaning, packing, and winding of magnetic tape. Each question is accompanied by an appropriate answer from those most knowledgeable and experienced in the field.

The chapter closes with a thorough description of an implementation and the theory of an instrumentation magnetic tape cleaner/programmed tension winder.

QUESTIONS MOST ASKED BY USERS

1. *How do you evaluate the tape surface condition with respect to—*
 - a. *Uniformity (output)*
 - b. *Dropouts*
 - c. *Shedding*
 - d. *Slitting (skew)*
 - e. *Etc.*

i.e., what type of hardware and technique is generally employed or should be employed?

BOW Industries, Inc.

a. *Digital uniformity.* This test is rarely performed because it is of little value in digital testing. When the test is performed it is usually done by averaging the amplitude of 10 000 flux changes and presenting the output to a "HI-LO" level meter calibrated so that it indicates 100 on the scale when driven by the output from a "standard tape." The "HI-LO" set points of the meter are then set so that they will activate a light when the average playback level of the tape under test exceeds 105 percent or falls below 95 percent. (Instrumentation recording—as per General Services Administration (GSA).)

b. *Digital dropouts* (as per GSA for new tape). Used tape should be tested to the same criteria as new tape except that the amplitude levels should be 5 percent more

critical than required by the using system. The testing devices should always be designed to duplicate as exactly as possible the tape path of the using system (i.e., tape speed, tension, head wrap, track location, and guide location before and after the test heads should be the same as the using system). Failure to faithfully duplicate these parameters is the major reason why tester results do not agree with using system results and why one manufacturer's tester does not agree with another's. Ignoring these mentioned parameters in designing a tester is to ignore the basic rules of metrology. (Instrumentation dropouts—as per GSA.)

c. *Shedding.* The shedding properties of tape are usually evaluated by comparing the deposits left on wiping tissues of tape cleaners against a standard tape. Running a tape several passes on a cleaner should cause the amount of depositing to decrease with each pass. Leaving the tape stored under a programmed tension wind for 24 h and then recleaning should not cause the deposits to increase appreciably over the last pass run 24 h previously.

d. *Skew.* Skew testing is usually not done on instrumentation tape. When it is done on digital tape the test consists of comparing the time displacement of the inside edge track signal with the outside edge track signal. The skew circuit is calibrated from the "standard" tape, which has no time displacement error between the inside and outside tracks. When the time displacement on a tape under test exceeds a specified amount (usually 2 μ s) an error is recorded. Usually the error indication is simply an illuminated indicator.

Computer-Link Corp.

In general, Computer-Link's (C-L's) philosophy is to evaluate a tape with those techniques that will reliably and accurately predict its performance in the intended application. We see no useful purpose in overtesting a tape only to find many errors that will not appear in actual usage.

The basic mechanism of tape failure is head-to-tape separation. The general causes are two: (1) the presence of particles of oxide, Mylar, or foreign dirt that lift the head

*Formerly with Bell & Howell, Inc.

from the tape but which are generally removable by an effective cleaning program and (2) physical damage; e.g., damage, creases, holes, etc., that produce the same loss of signal but are in general not repairable and tend to increase in severity with subsequent tape usage.

C-L's tape test procedures are designed to provide the operator with enough information to accurately diagnose the types, locations, and severity of the errors detected including the capability of visual examinations of major error areas to determine the exact cause(s) of failure in order to take appropriate remedial action to prevent the recurrence of the observed problem(s).

a. Uniformity. C-L believes that output testing is a part of new tape quality control and is, therefore, not usually necessary for used tape evaluation. A tape output uniformity test capability is optionally available when needed by the user.

b. Dropouts. C-L tests for dropouts with as many as four different simultaneous test procedures to differentiate between dirt-oriented dropouts versus physical damage-oriented areas as well as identifying "safe" or acceptable dropout areas from major dropout areas that are cause for tape rejection. These test criteria are adjustable by length and amplitude depending upon the needs of the particular application (see 6250-bpi example following *e*).

c. Shedding. This is a cause, not an effect, of tape failure. A proper cleaning program will remove normal shed particles before they become embedded in the tape surface. Abnormal shed due to coating problems or old age is not reversible. Such tapes, which are recognized by excess dropout counts, should be rejected.

d. Slitting (skew). C-L furnishes skew test electronics when testing non-self-clocked recording formats. We believe tape-oriented skew to be another cause of tape failure; e.g., dropout caused by physical damage.

e. Etc. C-L has devised additional tape tests based upon the need to monitor both hardware and software error-correcting logic. One example, 6250 bpi, is examined next.

6250-bpi (9042-fci) group code recording (GCR). This is a modified form of NRZ recording in which approximately 1100 bytes of computer data are connected to 1600 bytes of tape data including error correction character (ECC), cyclical redundancy characters (CRC), and resynchronization characters to improve the reliability of the original data. Because of the amount of error correction capability, tape errors, per se, are not a good index of tape performance on the computer. Equally, tape performance on the computer can be misleading in terms of future performance. This is because of error particle building, which can result in tape failure due to exceeding the correction capability of the error recovery logic. These error-causing particles are masked by the computer error correction routine until it is too late to replace or rehabilitate the tape and it becomes involved in a major tape failure resulting in job reruns on the computer. C-L

believes the solution to this problem to be a simultaneous evaluation of tape errors to measure the present performance of the tape on the computer. Quality control limits are then set to insure proper reliability depending upon the application. C-L tests 6250-bpi tapes as follows:

(1) *Single-track dropouts (tape errors).* These are tested at an equivalent rate to 1600 bpi standards to measure tape performance at 1600 bpi as well as its general condition at 6250 bpi. Single- and two-track errors are self-corrected by the 6250-bpi GCR error recovery system.

(2) *Gross errors (computer errors).* These are single-track errors that exceed 1600 bytes in duration and interface with the resynchronization of the GCR error recovery logic. This type of error is also normally associated with physical damage to the tape. The tape evaluator may be programmed to stop upon detection of this type of error.

(3) *Permanent write errors (computer operating system error).* A prolonged defective error section on a tape of 5.25-ft duration causes the rejection of a tape and a job abort with certain computer operating systems. Where applicable, such errors cause the tape to stop for detailed examination of the cause of the problem.

(4) *Three-track errors (computer errors).* Dropouts occurring on three tracks within a 1600-byte resynchronization area will cause a noncorrectable error. C-L does not monitor two-track errors as they are self-correctable and are not well correlated with three-track failures.

(5) *Edge damage (tape error).* Marginal errors caused by physical damage are not severe enough to result in single- or multiple-track errors, yet when located by envelope detection indicate tape sections that may spread due to defective tape drive elements and/or mis-slit tape. Such conditions tend to grow in length with continued usage. Tapes with multiple-edge problem areas are not recommended for critical data applications.

General Kinetics, Inc.

Because we are primarily talking about analog tapes, this reply will not address any other tape and also our reply is intended to apply to tape rehabilitation only.

General Kinetics, Inc. (GKI), feels tape should be tested on a recorder/reproducer of the instrumentation class and if at all possible on the same class and model on which the tape is to be used. There is not much standardization between recorder/reproducer manufacturers. While one model/class configuration with a specified tape path, head geometry, and material could be used as a standard, it has not been done. We have seen dramatic differences in tape performance on the same transport with different head contours.

GKI has developed an analyzer identified as a model XE70. The XE70 is in reality a broad description of a unit that can contain all the elements required to test tape and

is used in conjunction with an instrumentation tape recorder/reproducer. The XE70 includes a chart recorder to observe long-term amplitude uniformity and the necessary electronics and cabling. The number of dropout counters and associated electronics can be as large or as few as requested. We feel six for 1-in tape is adequate. Dropout criteria can be adjustable in each of the three parameters: duration, percent loss, and frequency.

Shedding is observed in the prewind steps of the rehabilitation program.

Slitting or skew problems are discovered in the prewind steps because skewed tapes will not meet the wind requirements, or, if they are short term, they can be corrected in the prewind.

Recortec, Inc.

Tape is first cleaned, then saturation recorded by a full-width write head with a digital signal at 800 bpi. A multitrack read head reads back the signal. A standard tape (one with an average, uniform output) is used to adjust the linearly amplified read amp output to the same voltage for all tracks.

Uniformity of output amplitude is extremely important because it relates to dropout testing. Good transport has better playback signal uniformity than a poor transport.

Dropouts are determined to be present when an individual flux change output pulse from any read amp drops below a predetermined fixed amplitude.

Shedding is not automatically tested by the evaluator except as it interacts with dropout testing. However, it is easily observed by the operator in abnormal deposits of oxide on the cleaning grids and heads.

Slitting (skew) errors are not tested by the standard evaluator except in specially built units per customer requirement.

Edge damage is determined by tests that show dropouts (1b) on the edge tracks fall below an independently set predetermined fixed amplitude for a specific preset distance along the track. (The distance may accommodate from one to many dropouts.) Edge damage testing is frequently omitted in evaluators.

-
2. *How do you relate evaluation criteria of the tape surface to the type of data being recorded?*
- Direct recording*
 - FM carrier*
 - Digital*
-

BOW Industries, Inc.

The answer to this question from Bow Industries was contained in the response to question No. 1.

Computer-Link Corp.

As explained in the answer to question 1, C-L's philosophy is to test each tape in accordance with its

intended usage. This means that the tape tension, head wrap angles, test signal wavelength, error detection criteria, and quality control limits are established to insure accurate and reliable prediction of tape performance in the intended application.

Specifically, the action recording technique (e.g., direct recording—FM or digital) need not be exactly duplicated as long as an acceptable test that will measure equivalent tape performance is used. The effect of tape surface smoothness is certainly a variable factor with respect to the different types of recording, but the necessary reliability of data recovery should be the criteria used in establishing the test parameters and quality limits.

General Kinetics, Inc.

Short cuts do not exist. Digital tape must be tested using a digital format, and analog tape must be tested using an analog format. While someone might disagree, we feel there is no standard for analog tape. The Government was successful with digital tape because there existed a standard created by the existence of IBM standards, and competition was forced to be compatible. Such a de facto standard does not exist in the analog field. Perhaps THIC can help, but it is up to the users to stop looking at analog tape as an individual private product and create some practical standard.

Recortec, Inc.

Because of the wide variation of tapes considered satisfactory by various customers, we make no attempt to relate the evaluation of the tape to the specific use to which the tape is intended. (The terms "evaluation" and "certification" are not synonymous. A perfect certifier would be the same recorder on which the tape is to be used.) The purpose of an evaluator is to provide an instrument that will allow reels of tape to be graded in ladder fashion from good to bad. The user may then use the good tapes first, working down the ladder to tapes of poorer quality, until he reaches a point where the tapes are unacceptable for his particular application. This establishes the cutoff point, and he may safely discard all tapes below that test point as being unsatisfactory.

-
3. *What impact does cleaning speed have on the performance of the various types of cleaning techniques?*
-

BOW Industries

The basic equation for cleaning efficiency of a cleaning blade (any mechanical scraper) is:

$$C_e \approx \frac{(T_2 - T_1) \phi S}{t}$$

where

C_e = cleaning efficiency

$T_2 - T_1$ = tape tension across the blade

ϕ = angle of tape wrap around the blade
 S = tape speed
 t = thickness of the blade at the tape contact point

(See the appendix to this chapter entitled "Mechanical Removal of Particles Adhered to a Magnetic Tape Surface.")

Computer-Link Corp.

Speed in cleaning tapes involves several conflicting factors:

(1) Higher speed increases impact forces between tape dirt particles and blade edge, which normally improves cleaning efficiency.

(2) Tape speed causes increased tendency to fly, resulting in the need for higher tension to insure adequate tape-to-blade contact.

(3) Tape speed sometimes is used as a vendor sales claim when tape cleaning efficiency should be the primary criteria for tape cleaner evaluation.

We have discussed tape-to-blade contact; however, the remarks are also applicable to other cleaning elements that require surface contact with the tape.

C-L's tape cleaner design uses independently driven capstans to isolate the cleaning tension from the tape winding tension. This avoids sacrificing tape cleaning performance for tape winding tension requirements. The tape tension is set at two different levels to optimize both cleaning and winding during any single tape pass.

General Kinetics, Inc.

Cleaning speed must be such as to provide intimate contact with cleaning devices. High speed could cause the tape to fly. This tendency can be rectified by increasing the cleaning-device-to-tape tension. Care must be exercised to develop a cleaning system that will actually clean the tape and without damaging it. The answer is that the maximum speed is that which will fulfill the cleaning function, prevent tape flying, and not require tension that can damage the tape. We are not aware of a tape cleaner transport available that can actually clean efficiently, not damage tape, and transport tape above 150 to 200 in./s.

Recortec, Inc.

Recortec employs two types of tape cleaning devices, neither of which is affected by cleaning speeds up to 360 in./s.

The Recortec vacuum-operated grid-type cleaner holds the tape to the surface of the cleaning grid as it is dragged over the razor-sharp perforations.

The razor blade cleaner is used for cleaning tapes that have been evaluated and determined not to have edge

damage. The blade is changed after each tape to preclude damage to the tape from blade wear.

4. *What effective technique can be employed to clean back-coated tape products?*

BOW Industries, Inc.

Wiping tissues on both sides of the tape and a blade on the oxide side.

Computer-Link Corp.

Back-coated tapes have a soft carbon back-coating to improve winding and reduce particle transfers. Because it is a soft coating, blade cleaning will only remove this coating and its benefits. C-L believes that frequent cleaning is the most practical system of retaining the benefits of back-coated tape. We recommend this use of our standard tape cleaner, model 1011, with a constant speed, automatic advance tissue wiping cartridge for cleaning the back-coated surface. We have found that metal surfaces such as vacuum cleaning grids only serve to scratch the back-coat and thereby defeat the purpose of the coating. Frequent cleaning allows removal of dirt particles before they have become heavily embedded in the surface and thereby virtually impossible to clean without also destroying the back-coating at the same time.

General Kinetics, Inc.

We have not seen evidence of any unique problems related to back-coating involved in cleaning a tape. We have experienced some transport difficulties on single-capstan transports, which were rectified by grooving the capstan. We have also seen some older back-coated instrumentation tapes exhibit a propensity to exude base material in the form of white powder. This problem could be disguised by back-coating, and we do not feel it is caused by back-coating. The answer, however, is best left to the chemist.

Some transfer of back-coating to oxide surface has been observed, usually close to the hub, but this has not usually resulted in a decrease in rehabilitated tape yield, and back-coated tapes seem to be cleanable by the GKI method. Beyond a doubt, vacuum will not clean the back-coating; this surface must be at least wiped vigorously.

Recortec, Inc.

Recortec employs the vacuum-operated grid-cleaner to clean back-coated tapes or the backs of ordinary tapes.

5. *Does temperature and/or humidity affect the cleaning efficiency of currently available tape cleaners?*

BOW Industries, Inc.

No specific evaluation of these effects has ever been made by us.

Computer-Link Corp.

Yes, because humidity greatly affects the relative static charge buildup on the tape surface and consequently the amount of small dust particles to be removed. The lower the relative humidity, the less effective a vacuum-type cleaning element will be as it must overcome a higher static field. We find that tissue wiping of tapes is relatively free from a change in effectiveness due to humidity change.

Temperature range has a less important effect due to tape stability over the normal "room" operating range of 60° to 90° F. Beyond this range there is, of course, a softening of the binder, which will affect tape cleaning.

General Kinetics, Inc.

We normally use our equipment in rooms with reasonable temperature and humidity control. We have not seen anything that would lead us to think that the environment is causing problems. We have not attempted to study this, so we cannot really say. We do know that environment is a factor any time tape is used, but we feel the normal range dictated by human needs and comfort is adequate consideration.

Recortec, Inc.

Tape should be cleaned and tested in the same environment in which it is to be used.

6. *What are the negative effects of the National Security Agency profile tension?*

BOW Industries, Inc.

None.

Computer-Link Corp.

The negative effects of the National Security Agency profile tension relate to the use of a tape on a tape drive that uses a constant-tension wind/unwind profile. Tension difference as the tape is unwound can result in tape cinching or snapping, particularly under conditions of high acceleration.

In fact, there are two requirements for tension winding. The first being to insure reliable shipment of a tape under potentially wide swings of temperature and humidity. The other being to insure that a tape will unwind smoothly on a tape drive. C-L believes that there are valid requirements

for both types of tension winds, and equipment should be available for both. We have also produced a single machine that is a compromise between these two requirements. The wind is basically a constant wind, but tapes will pass the National Security Agency temperature/humidity cycle tests.

General Kinetics, Inc.

We are not aware of any negative effects.

Recortec, Inc.

The only negative effect of profile tension tape packing is to increase the cost of the cleaner/winder. Also see answer to question No. 7.

7. *Is the National Security Agency profile tension curve still relevant? If not, what should be advocated? What do other tape users think?*

BOW Industries, Inc.

Yes. It is the most thoroughly tested and proven technique. All others are speculative and unproven.

Computer-Link Corp.

Refer to answer for question No. 6.

General Kinetics, Inc.

We do not know what tape users think. In instances where recorded data are to be transported, we feel the National Security Agency profile wind is very definitely a requirement.

Recortec, Inc.

At the time the National Security Agency profile tension curve was developed, there were no truly constant tension tape transports. The advent of the vacuum column constant tension tape transport made the National Security Agency profile tension curve obsolete as it achieves a tape pack that overcomes the ill effects that the National Security Agency profile tension curve was designed to overcome.

8. *Dropout terminology:*

- a. *Are the terms in use defined?*
 - b. *Are the terms in use standardized among manufacturers/users?*
-

BOW Industries, Inc.

The terms in use are defined but not well standardized in the digital industry. The instrumentation field is very disorganized and so many different definitions exist that it

has been impractical for tape maintenance equipment manufacturers to try to develop a standard testing device.

Computer-Link Corp.

a. Each manufacturer tends to define a dropout differently in the absence of an industry standard in most applications. Differences relate to amplitude, duration, detection, and frequency of detected dropouts occurring in immediate succession.

b. Only when an industry standard exists; e.g., this IBM/ASCII 1600 bpi (3200 fci) dropout is defined for new tape testing. Terms and their meanings do vary significantly among manufacturers and users. C-L has published a booklet entitled *Magnetic Tape Management* to try to clarify some of these differences.

General Kinetics, Inc.

The tape manufacturers, I am sure, understand the dropout terminology. Unfortunately, each user has his own ideas and there is a lack of cooperation within the user community. Each user can give reasons why his requirement is specific or different. We are aware of three large users and each feels they have the only answer. The Brooks bill has assigned this responsibility; perhaps it is time the users stop looking at only their proprietary interest and find a solution.

Recortec, Inc.

Each manufacturer has defined the term dropout but most of them refer to single bit amplitude loss.

The definition of dropout between manufacturers may vary in detail but not to the extent that the evaluators fail to perform the job for which they were intended. (See answer to question No. 2.)

9. *Scraping blade—type and methodology. State the advantages and disadvantages of the types of scrapers currently used.*

BOW Industries

See the appendix to this chapter entitled "Mechanical Removal of Particles Adhered to a Magnetic Tape Surface," which clearly demonstrates that of all types of blade cleaning devices now being sold, the band type cleaners are the best from the standpoint of cleaning efficiency and consistency of cleaning efficiency. Of the two types of band cleaners now available (continuous loop and cartridge type), the cartridge type is superior because (1) the blade is used only once and then replaced so as not to subject the tape to an edge that was damaged from previous cleaning action (which causes nicks in the cleaning edge), (2) it is less likely to damage tape because it is better supported, (3) it is easier to replace and a

numerical indicator clearly informs the user when replacement is required, and (4) it is less likely to be damaged by accident.

Computer-Link Corp.

All cleaning (scraping) blades have in common a sharpened edge that normally "self-sharpens"; i.e., is honed by the tape while being used to clean a tape. A given hardness, depending upon the material used for the blade, and a tape cleaning wearout pattern create a groove in the blade surface. It is this groove that generally determines blade life as the shoulders at the edge of the groove will cause edge damage including skiving to tapes being cleaned. Therefore, the key questions in evaluating blade performance are the following:

- (1) Initial radius; i.e., sharpness of edge?
- (2) Life of blade until grooving occurs?
- (3) Sharpness at end of life?
- (4) Most important—how is blade life determined?
- (5) Will the blade material become magnetic and degauss data from tapes being cleaned?

C-L's blades are made from sapphire with a special guard edge holder to prevent tape damage resulting from misadjusted blade angle. Blade life is indicated to schedule change of edge at the 80 percent point of statistical life to avoid grooving damage to tapes. Blades have two cleaning edges to reduce costs.

General Kinetics, Inc.

We believe that a razor blade is the best available scraping blade. The disadvantages are obvious; e.g., they are a danger to the operator and because they groove quickly they must be replaced after each and every tape.

Other fixed scrapers can be used but because they are fixed they very logically become less sharp with each pass until they reach uselessness. The number of passes required before the scraper is no longer efficient is a function of the hardness of the scraper, tension over the scraper, and, of course, tape surface.

GKI uses a blade welded into a loop and transported by a clock-motor-driven capstan. This is consistent with our conviction about razor blades, and eliminates the operator problems. The disadvantages are that if the clock motor fails, the blade will groove, and the operator must clean the device periodically.

Recortec, Inc.

Recortec evaluators have two types of cleaners, which represent both ends of a compromise between cleaning efficiency, cleaner wear, and operator interaction with the equipment. At one end is the vacuum-operated, perforated-grid cleaner, which exhibits a long life and reasonably high efficiency tape cleaning with minimal operator

concern for the possibility of tape damage caused by wear of the cleaning device or condition of the tape. At the other end is the razor blade scraper, which the operator replaces after each tape is cleaned, thus insuring maximum cleaning efficiency but with minimum life of the cleaning device. Changing the razor blade with such regularity precludes tape damage caused by scraper wear, but the sharpness of the blade increases the probability of damage to tapes with nicked or rippled edges. Debris is removed by vacuum with both Recortec cleaners. Other manufacturers' cleaning devices fall between these extremes and represent various compromises in resolving the same problems.

10. *Is there a need for further studies on tape cleaning, packing, and tape certification?*

BOW Industries

Yes, further studies are needed. For cleaning we need to improve cleaning efficiency, reduce the time required to clean tape, and eliminate expendable cleaning supplies. Winders or packers need to have the capability to eliminate stretched edges of tape, not just disguise them, and definite formulation must be developed to precisely define a type of wind. For example, to simply say that a winder must wind a tape to the National Security Agency tension profile is extremely incomplete. Nor is it complete to simply specify the test criteria that a tape pack will be subjected to, such as the National Security Agency "Shake & Bake" test, because a winder can wind tape to other than the National Security Agency profile and pass the test occasionally and still not yield results consistent with the actual handling conditions that a tape is subjected to, nor consistently pass the National Security Agency "Shake & Bake" test. The specification on winders is not complete if the parameters of tape speed, pack wheel or no pack wheel, pack pressure, and wheel profile are ignored.

Computer-Link Corp.

Yes, to the extent that tape coating formulations, recording applications, and cleaning technology change. Today's solution are always open to improvement.

General Kinetics, Inc.

Of course studies should be continued on tape cleaning, packing, certification, etc. This should be left to the companies in industry. Provided the user gives the equipment manufacturer defined requirements, competition will cause us to try to find new and better ways.

Recortec, Inc.

It is doubtful that further studies on tape cleaning, packing, and tape certification can be justified. When existing data are examined, it should be apparent that

several manufacturers have developed suitable and economical techniques for cleaning, packing, and evaluation of tapes. This is borne out by the many institutions and agencies that are large tape users and that effectively use these devices on a day-to-day basis.

11. *Can tape that has slight to moderate edge damage be effectively cleaned and repacked?*

BOW Industries

Definitely yes.

Computer-Link Corp.

Tape performance must always be related to the type of drive used, the reliability of the data recovery demanded by the applications, and the frequency of reuse of the tape after initial recording. For example, a test will indicate if a tape with slight edge damage will perform reliably for the next 10 passes or so; it cannot predict reliability if 50 replay passes are required. C-L is happy to work with tape users in suggesting tape test criteria, quality control limits, and tape rejection points.

General Kinetics, Inc.

Tape with slight to moderate edge damage can and should be cleaned and repacked. In fact, this is a vital step in tape rehabilitation.

Recortec, Inc.

The phrase "slight to moderate edge damage" is certainly open to interpretation. However, Recortec would have to answer that if the edge damage is small enough to permit satisfactory reading and writing of the edge tracks, the tape can be effectively cleaned and repacked.

12. *If the tape surface was lubricated, could, or would, it still be cleaned and/or repacked effectively? Would it need it less?*

BOW Industries

This needs investigation.

Computer-Link Corp.

Assuming that dry lubrication were used, a tape would certainly receive less frictional wear including scratching of Mylar and rub off of oxide; however, it probably would tend to attract more foreign dirt particles due to the characteristics of the lubricant. Therefore, the environment and application contemplated would have to be examined to determine whether lubrication would be a net gain or loss.

General Kinetics, Inc.

We have tried, without success, for several months to get information about the surface treatment described at a previous meeting. These questions should be answered, but we have not been able to investigate. We can make a logical assumption that if surface treatment does extend head life, it would then cause less self-generated dirt and would require less cleaning. We see no relationship between the need to repack tape and surface treatment. The only way to see if surface-treated tape can be programmed tension wound is to try it, and we have not been able to do so.

Recortec, Inc.

The answer to this question would depend on the type of lubricant and the method by which it is applied or adhered to the tape surface. However, Recortec's standard cleaners and evaluators are regularly used for cleaning, evaluating, and repacking lubricated tapes, and no difficulties are encountered.

13. What do you recommend should be the tape certification methodology for 28 track recorders; i.e., number of tracks necessary; edge damage detector; localization of faults to the nearest inch, foot, etc. What amplitude level should be used?

BOW Industries

Three track electrical test; optical inspector for edge as well as total surface; location of faults to about nearest 3 in. is good order of magnitude; 10 percent more critical than the using system can tolerate.

Computer-Link Corp.

As we have already explained, tapes should always be tested to insure reliable performance in the intended application. For example, if the 28 tracks of data were each mutually exclusive, then there is no choice but to test each one independently of the rest. If the data are related, then a less severe criteria of so many dropouts per two or three tracks could be selected, etc. Dropout amplitudes should in general be 10 percent above the read detection levels used on the actual recorder. In reporting dropouts, quality control level must match data reliability. Instrumentation is available for reporting dropouts per inch, foot, 10 ft, etc. Normally, the criterion is to identify those areas of the tape with more than a floor limit of so many short or shallow dropouts per inch or foot plus any long or deep dropouts. Display can be visual or printed with optional tape stop for visual observation of major dropouts, if desired.

General Kinetics, Inc.

Recorders with 28 tracks have existed for years. There is really no need to test the tape any differently than the tape manufacturer tested it initially. If there was, if the problems were of such magnitude, this question would not need to be asked today, someone would have specified a test. This should not be a question at all, the user should tell the tape manufacturer and the tape testing people what he needs. If he does not know this requirement, how can anyone else?

Recortec, Inc.

Certification of tape for 28-track recorders should be performed with a 28-track head of identical configuration. (See answer to question No. 2.) An edge damage detector is not specifically necessary as it is usually necessary only to determine that all tracks are suitable for recording and playback. An edge track should have the same recording and playback parameters as other tracks unless some other criteria are dictated by the recorder design.

Accuracy of localization of faults is entirely dependent upon how such information will be used and on error circumvention techniques available in the recorder. Increasing the accuracy of reporting carries the penalty of increasing the cost of reporting, so it is important to know how much information is necessary.

Unless recorder evaluation is deemed necessary by the user, digital evaluation techniques previously described are sufficient.

14. What does the packwheel do with respect to the final tension in the tape pack?

BOW Industries

A tape wound without a packwheel at a speed above 100 in./s will have air entrapped between the layers. The stack will exhibit entirely different distortion characteristics (with changes in temperature and with shock and vibration) than a tape wound at the same tension but with a packwheel, which removes the layer-to-layer air. For example, tape wound to the National Security Agency tension profile without the use of a packwheel will not consistently pass the National Security Agency "Shake & Bake" test, but tape wound to the National Security Agency tension profile with a proper packwheel will consistently pass the "Shake & Bake" test. This, of course, verifies that the final tape tension within the pack is changed by the presence or absence of a packwheel.

Computer-Link Corp.

A properly designed packwheel should not affect the winding tension throughout the tape reel. In practice we

have encountered improperly designed packwheel systems, which serve to increase the tension as the diameter increases. This, of course, completely defeats any constant or variable profile tension curve built into a winder.

General Kinetics, Inc.

Proper design and proper use of the design should have little effect on the final tension of the wind.

15. What would a recommended force at the point of contact between the packwheel and the tape pile be?

BOW Industries

The pressure required is dependent upon the tape speed, tension, and tape width. Pack pressure must be sufficient to squeeze air from more than just the last layer. The volume of air escapes from the stack in an exponential fashion at the packwheel point of contact.

Computer-Link Corp.

The packwheel should use the minimum force necessary to squeeze entrapped air from under the outer tape layer. In addition to the need for a constant torque device, the precise force varies as a result of the tape type, thickness, and environment. Because of these variables, there is no single force that C-L uses for all machines.

General Kinetics, Inc.

Recommended force at the point of contact depends on a large number of variables, not the least of which would be the durometer of the rubber. This question requests proprietary information that cannot be disclosed.

16. With reference to a constant tension, constant torque, or programmed tension wind, should either of these winding techniques be changed with the addition of a packwheel?

BOW Industries

The final tension in the pack without the use of a packwheel is unpredictable at linear tape speeds above 100 in./s because of air entrapment. It is also not possible to consistently stack the tape straight and away from the flanges without a packwheel. Programmed tension wind with a pack device is the only way to wind tape to consistently pass the National Security Agency "Shake & Bake" test.

Computer-Link Corp.

Please refer to our earlier comments regarding the need for a constant torque packwheel assembly correctly set at

the proper force to avoid distortion of any tension wind as a function of tape diameter. C-L specifically recommends the constant tension wind for computer tapes as this profile matches that of the tape drive and has (in C-L's case) passed the temperature/humidity cycle test for tape pack stability. In the case of larger instrumentation or video-tape reels, there are good arguments for a programmed tension wind provided it is not distorted by a packwheel without adequate torque control.

General Kinetics, Inc.

GKI feels, as stated previously, that if the intent is to ship, store, or attempt to reclaim or rehabilitate tape, programmed tension wind is mandatory. We have not seen any evidence that the recommended curve should be changed, with or without a packwheel. If the application is simply to clean and wind tapes to be returned to near immediate use, any of the winding techniques are acceptable.

17. Do you have any comments regarding the shape, diameter, and threading path when considering the use of a packwheel?

BOW Industries

The contour of the packwheel surface is dependent upon whether the winder is to provide straight uniform packs on tape with edge damage. The exact contour for best handling of various tape deformities is proprietary information and cannot be disclosed herein. The diameter of the wheel should ordinarily not exceed 7 in., and the tape should wrap the wheel approximately 180°.

Computer-Link Corp.

The function of any packwheel is to remove the entrapped air from each outermost layer of the tape and to insure that the tape is guided into and remains in place in the center of the reel. The optimum point of contact for the packwheel is at the focus of the point of tangency throughout the reel where the entering tape touches the existing pack. Here there are some compromises in design with the choice of a guiding type packwheel that feeds the tape into the reel but involves a good deal of frictional contact with the tape surface that can increase tape contamination or a fixed entrance tape guide and a simple packwheel that approximately follows the arc focus of tangency with a fixed guide. Tape/packwheel contact and consequent contamination are reduced to a minimum.

Other design points include easy removal of the pack arm for cleaning and tape loading, three-point support device to simplify field alignment when the wheel is accidentally bent by operating personnel, and the largest

possible wheel diameter and thickness to insure stability and guiding consistent with user safety and reliability.

Finally, we believe that the advantages of packwheels cause them to be used improperly. A packwheel is a deterrent to visual inspection of the condition of a tape in terms of its slitting, edge damage, or stretch. As such we recommend that a packwheel not be used during tape testing when the tape is not going to be shipped to a remote location. On the other hand, when tapes are to be handled by several people or shipped to a remote location, the use of a packwheel is mandatory to avoid tape shock damage even when reels are stored in wraparound seals or EZ load cartridges.

General Kinetics, Inc.

Packwheels should be as wide as possible and tape must be threaded over the packwheel and enter the reel from the packwheel. The threading path from the supply reel to the point that the tape is wound on the takeup reel should be as long as possible. This length allows the tape to be gently, directly, and firmly placed in the center of the hub. The shorter the threading distance the more forcefully the tape is directed to the center of the takeup hub, and edge damage or inability to wind anything but nearly perfect tapes is the result.

INSTRUMENTATION MAGNETIC TAPE CLEANER/PROGRAMMED TENSION WINDER

General Kinetics, Inc.

Magnetic tape maintenance is a plan or program that consists of a number of things, such as storage, handling, transport maintenance, and, of course, equipment to clean and wind the tape. Also desirable is a method to test the tape if testing can be justified by volume or the particular mission.

GKI has, for the past 18 years, been involved in both digital and analog magnetic tape testing, cleaning and winding problems, and, in particular, in tape rehabilitation.

GKI feels any magnetic tape cleaning system absolutely must fulfill two functions:

- (1) The oxide and base material sides of the tape must both be wiped in some manner to remove loose debris.
- (2) The oxide side of the tape absolutely must be vigorously worked to remove embedded dirt. The method must not damage the recording surface.

There are several methods employed by tape cleaner manufacturers that meet these basic requirements. GKI chose to use the system shown in figure 6-1, and as I explain the system, I will also explain why we chose this particular method.

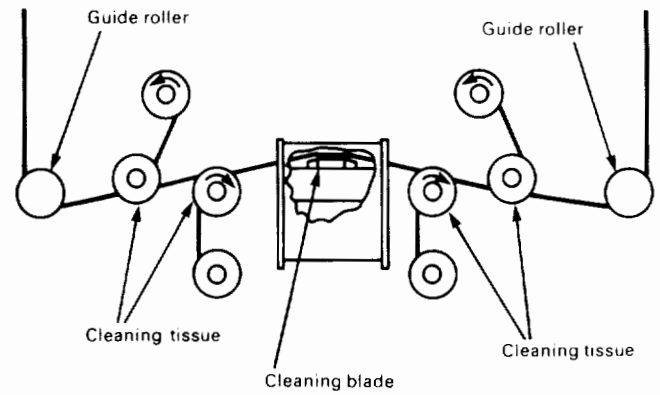

Figure 6-1.—Tape path.

The tape, both base and oxide sides, is wiped by a tissue, which collects the loose particles. The takeup tissue spool is driven by a clock motor, at a very slow speed, in this instance about 3 rph, to prevent redepositing the dirt. The base side of the tape must be wiped because this dirt will be redeposited on the oxide surface of the next layer of tape, making the whole cleaner process useless. Also, 10 wipes are better than 1, but from an economic and practical standpoint, the tape should be wiped both prior to and after the oxide cleaning device.

In our opinion, and GKI has cleaned a multitude of tapes in the past 18 years, the most efficient oxide surface cleaning device is a razor blade. A razor blade at the proper angle will actually shear off and remove embedded foreign particles. The razor blade, however, is a serious safety hazard and must be replaced after each and every tape because it will quickly groove and damage the tape edges. Also, as is the case with any stationary cleaning device, the sharpness, and therefore the cleaning efficiency, is reduced with each and every inch of tape that passes over it.

To meet the requirement, GKI developed and patented the endless loop band blade cleaner. (See fig. 6-2.) This

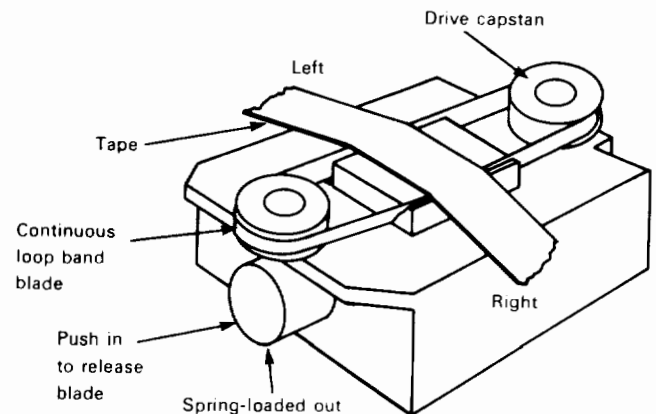

Figure 6-2.—GKI endless loop band blade cleaner.

cleaner consists of a 2-mil-thick blade welded into a loop; the loop is capstan driven and is continuously rotating. The angle is such that the tape is properly cleaned and, when tape passes over the other side of the loop, the blade is honed, resulting in constant uniform sharpness. The width of the blade is reduced uniformly by wear, but the thickness remains a consistent 2 mils.

Hundreds of passes will not degrade the tape or remove sufficient oxide to cause a noticeable reduction in the ability of the tape to absorb and retain recorded information.

The blade will not at any time damage the tape. The blade will, in most instances, point out a tape with a frayed or broken edge by promptly cutting it in two. Of course, any tape that is cut by the blade already contained damage that rendered it useless anyway. GKI has been manufacturing this cleaner for more than 5 years.

The tape winding system is the other vital part of this overall system. GKI feels, and has always felt, that the proper way to wind the tape, if it is to be transported and/or stored, is the programmed tension wind.

Mathematical analyses have been made of the static physics affecting the winding and storage of thin strip materials on reels. These analyses show that when tapes are wound on reels, according to the constant tension or constant torque winding patterns, the elastic storage of energy in the tape roll slowly dissipates by plastic flow in a nonuniform fashion. The tape roll eventually comes apart at a predictable point.

Constant tension winding methods cause the inner portions of the roll to be stored under extreme inward pressures and with negative tension in each lamina of tape. In contrast, the outer portions of the roll enter storage with much lower inward pressures and with positive tension in each lamina. At a point one-fourth to one-third of the distance from the hub to the outer diameter of the roll, the stored tension undergoes a negative to positive transition. It is here that plastic flow of the inner and outer portions occurs in opposing directions, resulting in breakup of the roll. Evidence of this may be seen on stepped packs.

When tape rolls break at the stored tension transition region, additional problems occur as they are put into service. Even under the best conditions these rolls can cinch and produce folds and abrasions due to inertial reaction of the loosened outer portion. Such action, of course, will produce dropouts. In addition, axial slippage of a tape roll, which often occurs spontaneously as the pile is disrupted, produces a skewed length of tape, and attendant time displacement errors.

The basic description of the program wind, and the analysis that resulted in the program wind philosophy, talks of plastic flow. The same plastic flow can cause the tape to develop a lip, and unless something is done the tape can and will be permanently deformed on that lamina or the layers extending out beyond the others.

Under terms of a magnetic tape rehabilitation contract, GKI cleaned, wound, and tested 1-in. by 9200-ft tapes. Any tape with obvious damage was discarded at incoming inspection. A quantity of 300 of these discarded tapes were collected, the only reject criteria were obviously short length or a tape with an obvious splice. These 300 tapes, which would have been discarded as useless, were cleaned and wound on the GKI 740, allowed to stabilize for 24 h, and then were tested. Just under 70 percent of these tapes passed the certification test. The reason they passed was the cleaning, the program tension wind, the unique design of the GKI packwheel that forces the tape into a smooth wind, and the stabilization period, which allowed the plastic to flow back to its original shape.

APPENDIX—MECHANICAL REMOVAL OF PARTICLES ADHERED TO A MAGNETIC TAPE SURFACE

Dale C. Whysong
BOW Industries, Inc.

Evaluation of Requirements

This section is a discussion of some of the basic principles that apply to the mechanical (rather than ultrasonic) removal of oxide buildups (loose particles are easy to remove with a wiping cloth) from the surface.

As can be seen in figure 6-3, if the oxide buildup on magnetic tape is hit by the blade at exactly the tape surface

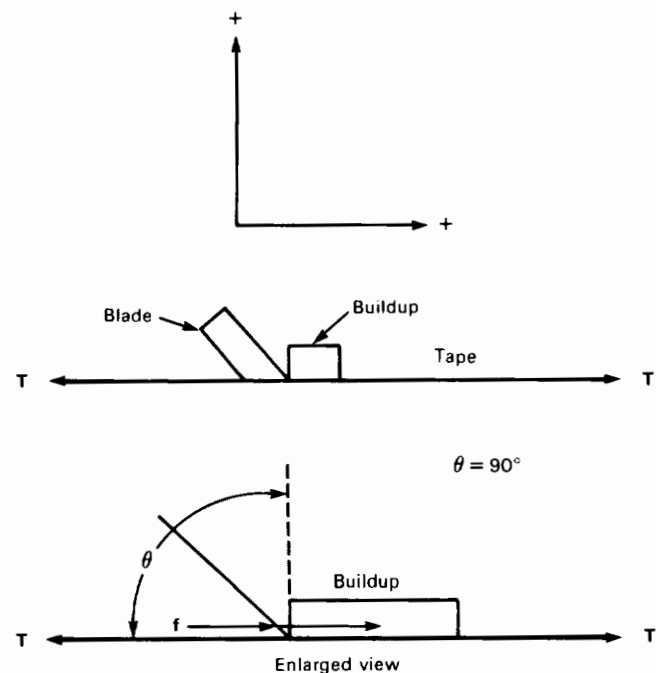
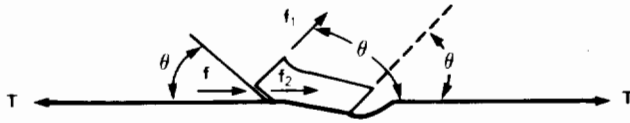

Figure 6-3.—Oxide buildup on tape.

and perpendicular to the nearest face of the buildup, all the force from the blade edge will be applied parallel to the tape surface and the blade will begin to shear the buildup or else the buildup will be knocked from the oxide. If the buildup is not knocked off the tape, the following will occur:



where

$$f \approx f_1 \cos \theta + f_2 + f_3$$

$$f_3 \approx -f_1 \sin \theta + 2T \sin \theta$$

As can be seen, f_3 tends to push the tape down away from the blade, and the following will result:

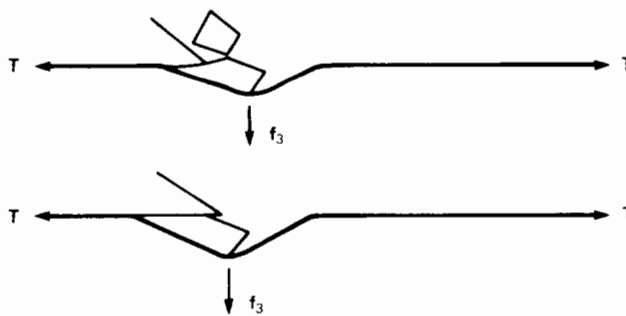

To keep f_3 from pushing the tape away from the blade,

$$T = \frac{f_1}{2}$$

because

$$f_3 = -f_1 \sin \theta + 2T \sin \theta$$

and if $f_3 = 0$ and $\theta = \sin \theta$, then $f_1 = 2T$. The value of f_1 can get quite large because

$$f_1 = Ma$$

where a is large and gets larger as the tape speed is increased. Therefore, for this kind of shaving action, cleaning is inversely proportional to tape speed and proportional to tape tension. If C is the cleaning factor, V_T is the speed of the tape, and K is a constant, then

$$C = \frac{KT}{V_T}$$

Observation also indicates that f_3 increases as θ increases (for this shape of particle), implying that the

smaller θ is the smaller f_3 becomes and

$$C = \frac{KT}{\theta V_T}$$

if θ is small; θ cannot be zero and changes as the blade dulls.

It is obvious that if the tape is not allowed to separate from the blade, the entire force f will be applied to the particle, and the particle will be sheared from the tape.

Consider a particle of the following shape:

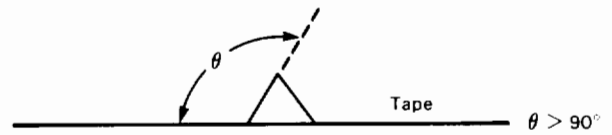

Either this

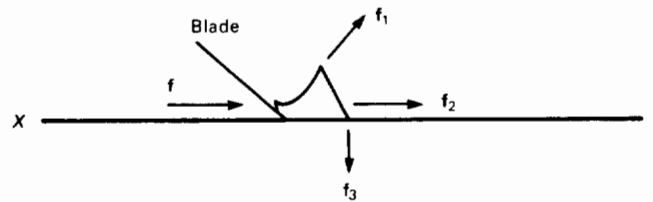

or this

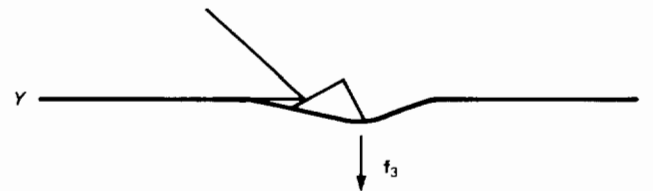

will occur. X is essentially the situation as previously discussed. Whether X or Y occurs, f_3 still occurs and the particle will not be completely removed. Likewise, if a particle occurs where $\theta < 90^\circ$, essentially the same situation is encountered. Therefore, for best cleaning action where shearing must occur (the particle is not knocked off at impact with the blade);

$$C = \frac{KT}{\theta V_T}$$

If the particle is always to be dislodged on impact, cleaning is proportional only to a new constant K_2 and V_T :

$$C = K_2 V_T$$

because the energy put into the particle is proportional to the speed at impact. f_3 can be ignored because by definition the particle is removed at impact because f_3 occurs only when shearing begins. Therefore, $f = f_2 = Ma$. Because shearing and f_3 do not occur, θ is of no significance as long as $\theta < 90^\circ$.

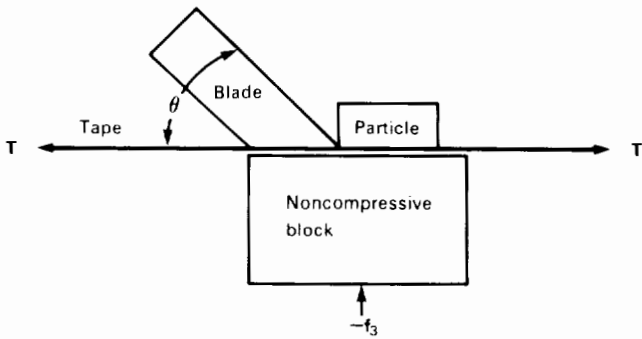
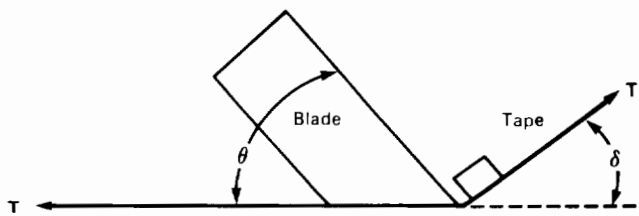

Figure 6-4.—Configuration for efficient cleaning.

Now we can see that if f_3 is nonexistent or its effect not allowed (separation of tape from blade), we can be assured of much more efficient cleaning. This can be accomplished with the configuration of figure 6-4, which shows that θ and T are not very critical to the removal of the particle. Particles will be removed according to the tape speed and the momentum of the system applying the tension. The value of $-f_3$ can be obtained simply by attaching the block to the same rigid frame as the blade, or the block could be of a mass much greater than the mass of any particle and supported by a light spring. This way the block would automatically be adjusted for varying tape thickness and the block mass would oppose any impulse force caused by dirt or oxide particles.

Other means can be devised to prevent or reduce the amount that the tape separates from the blade; for example:



Now as the particle contacts the blade, the following occurs:

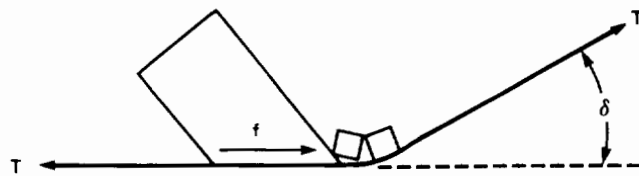

where T now exerts a force opposite to f_3 or

$$T - f_3 = 2T \sin \delta$$

Now we can see that the cleaning factor, C , becomes

$$C = \frac{KT\delta}{\theta V_T}$$

and that complete particle removal will not occur because the tape will still separate from the blade. δ may have to be carefully chosen and maintained (δ is independent of blade sharpness T and the size of the particle). Of course, with this configuration, the tape edges will not make intimate contact with a circular blade.

Let us see what is needed to conform the tape to a rotary disk blade if $\delta > 0^\circ$. Figure 6-5 describes what occurs if the tape is supported by a straight fixed support before entering the blade. The tape will be separated from the blade by a distance b where

$$b = \frac{K_r \delta T}{r l_1}$$

and K_r is a constant. The value of l_1 should be as small as possible to keep T small and, therefore, to keep the separation b of the tape from the blade as small as possible; but as l_1 gets small, b gets large. The best overall solution to reducing b seems to be to make l_1 as small as possible and to shape the support to make the tape conform to the blade curvature. A better configuration is shown in figure 6-6, where f_4 is created by a vacuum and d is held a little larger than the largest particle. Now tape tension T is not so important, and f_4 makes it more difficult for the tape to separate from the blade. In addition, f_4 can be adjusted without affecting tape tension because

$$f_5 = \frac{-f_4}{\tan \delta_1} \quad \delta_1 \rightarrow 0 \quad f_5 \rightarrow 0$$

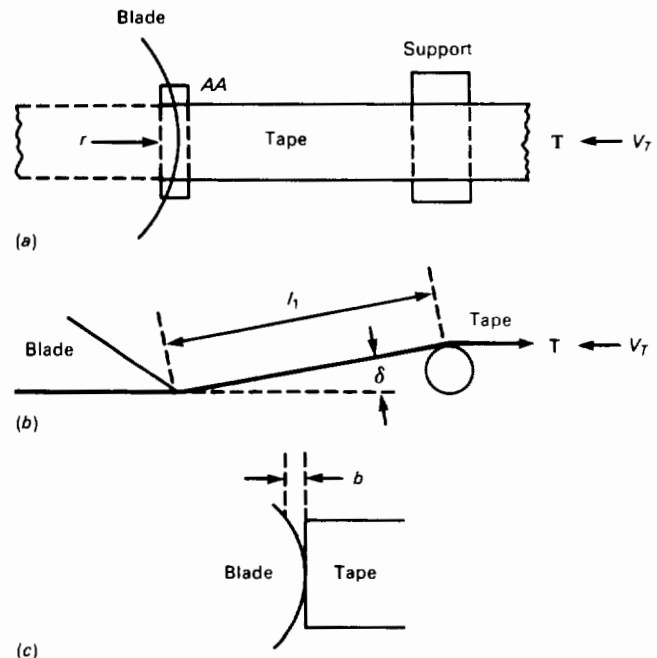

Figure 6-5.—Tape supported by straight fixed support. (a) Top view. (b) Side view. (c) AA.

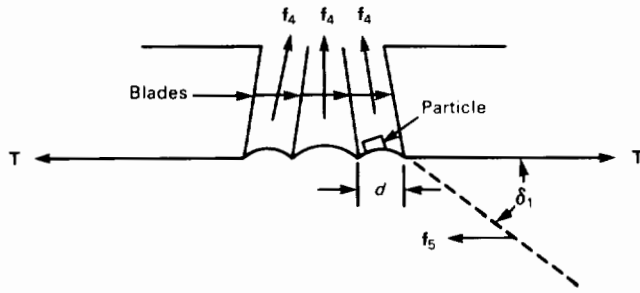

Figure 6-6.—Alternative to configuration of figure 6-4.

This configuration would give us two (more could be added) cleaning blades that the tape sees, in a given direction, and two blades that are being sharpened, and tape speed can be changed without having to be concerned with maintaining a particular tape tension. Angle δ_1 can be changed by changing the vacuum pressure. By adding several blades, the need for rotating the blades so that a sharp blade is always seen can be eliminated. Loosened particles are removed from the blade area by the vacuum.

Different versions, less desirable than the configuration just described, are positive air pressure against the tape instead of vacuum and a material such as rubber to force the tape up against the blade.

Self-Sharpening Nature of Blade

Figure 6-7 illustrates basic blade configuration. As the blade dulls, d_1 gets larger and the cutting point x moves up the blade. With magnification, point x appears in figure 6-8. Distance y is the distance up the blade that a given oxide particle has destroyed the sharp cutting edge of the blade. If another particle were to hit at point x , with the edge damage as shown, this next particle may not be removed. Therefore, x should be removed from the tape path as soon as possible. While it is true that x is much less than tape width W_T , and the chances of another particle hitting at x are not great, it is also true that because $x \ll W_T$, there will be many more particles creating new x 's; therefore, x

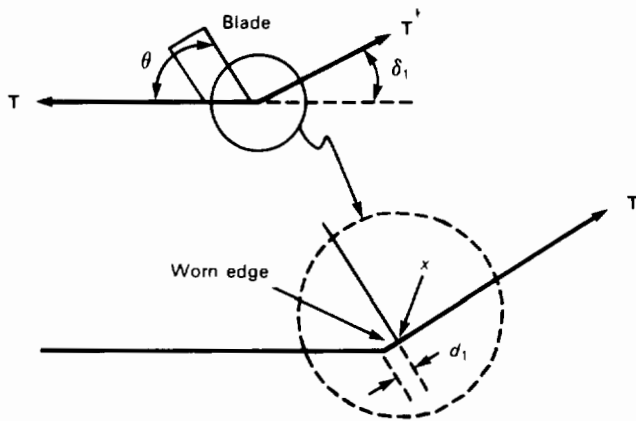

Figure 6-7.—Blade configuration.

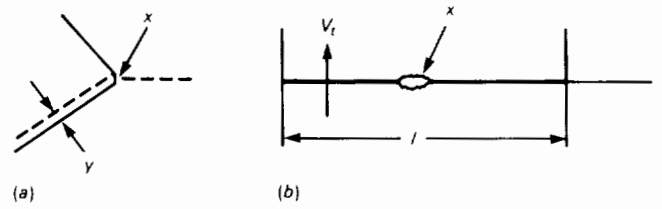

Figure 6-8.—Point x . (a) Side view. (b) Edge view.

should still be in the tape path a minimum length of time. Ideally $V_x/V_T = \infty$, where V_x = velocity of the blade and V_T = velocity of the tape. Of course, another solution would be to position many stationary blades in series. Now I can conclude that the dulling rate

$$D = \frac{K_D V_T T}{V_x d_1}$$

where K_D is a constant containing blade-to-particle hardness ratio and the coefficient of friction.

Examination of this equation leads to the following formula for sharpening rate:

$$S = \frac{K_D V_T T}{V_x (d_1 + \Delta d_1)}$$

where Δd_1 is the change in d_1 resulting from dulling and where the same tape that caused dulling is also used to sharpen. We can see that it is not possible to sharpen at the same rate as dulling occurs,

$$\frac{K_D V_T T}{V_x (d_1 + \Delta d_1)} \neq \frac{K_D V_T T}{V_x d_1}$$

if K_D , V_T/V_x , and T are of the same magnitude in sharpening as in dulling. Because the blade gets dull quicker than it gets sharp, a sharp blade will get dull and stay dull. The following is a list of ways to improve sharpening:

(1) Make the blade of decreasing thickness going up the blade and as thin as possible. (See fig. 6-9.) For a given thickness of blade t_b , the value of d_1 gets larger as the blade wears, but the rate of change in d_1 is reduced as θ increases:

$$\frac{d(d_1)}{dt} = \frac{K_d}{\theta}$$

As $\delta = \theta \rightarrow 90^\circ$, a thin blade becomes difficult to support; therefore, $\delta + \theta$ should be as close to 90° as practical (depending on such factors as blade strength and length). It might also be possible to shape the blade such that Δd_1 is zero.

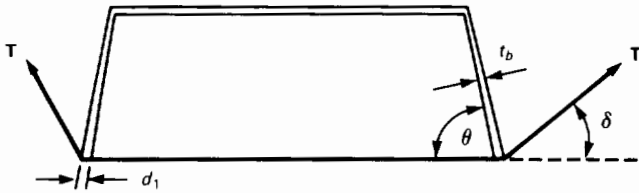

Figure 6-9.—Optimum blade shape.

- (2) Increase the coefficient of friction.
- (3) Increase the ratio V_T/V_x during sharpening.
- (4) Increase tension of the face perpendicular to the blade during sharpening.

Item (1) should be done no matter what techniques are used to accomplish items (2), (3), or (4). Item (3) is inconvenient and difficult to accomplish. Item (2) is a good solution if the coefficient of friction is such that distance y is worn away both in dulling and sharpening. Item (4) can be accomplished in several ways, one of which is shown in figure 6-10.

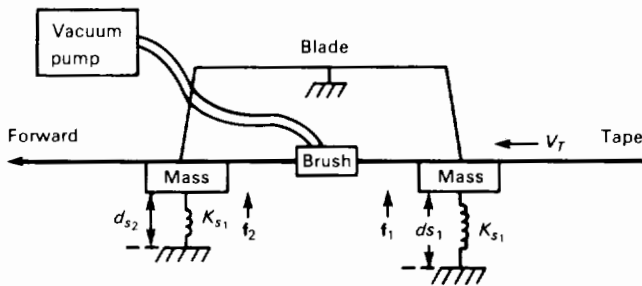

Figure 6-10.—A configuration for increasing tension of the face perpendicular to the blade. Blade is very thin and rotates very fast. ($ds_2 < ds_1$; therefore, in forward $f_2 > f_1$ and in reverse $f_2 < f_1$.)

Care should be exercised in selecting a blade material such that the coefficient of friction between the tape and blade does not make f_2 impractically high and that the depth of blade removed in sharpening is equal to y . It probably is not necessary to sharpen to depth y in one revolution.

Figure 6-10 represents a basic configuration for cleaning, sharpening, and dirt removal from the blade area, but a very long thin blade that is automatically advanced and discarded when dulled may be a better solution (depending on availability of blade material and transporting mechanism).

Summary

Several important rules should be followed in designing a cleaning blade system:

(1) The tape-to-blade separation must be kept to a minimum. If tape is not held rigid at a fixed maximum distance perpendicular to the blade, the following must be considered:

- (a) The distance from the nearest tape support in the tape path to the blade must be kept as small as possible.
- (b) The force opposing f_3 (force perpendicular away from the blade) should be as large as the tape can withstand.
- (c) The product $K_D V_T T / V_x$ in sharpening must be greater than the same product term in cleaning, or $D \leq S$.
- (d) Careful adjustment of the approach angle δ must be made.

(2) The blade should be as thin as possible and of decreasing thickness to impart maximum energy to the dirt particle and to produce uniform wear and therefore uniform sharpening no matter what configuration is used.

CHAPTER 7

Tape Reels, Bands, and Packaging

Ken Townsend
National Security Agency

The degradation of magnetic tape and possible solutions to eliminate or ameliorate these degradations were the basis of a Government study from 1958 to 1960. The objective was to find means of maintaining the quality of recorded data and extending the life of magnetic tape. Accelerated aging of the tape was accomplished by subjecting the wound tape to a temperature/humidity (TH) cycle (fig. 7-1) in an environmental chamber.

A constant amplitude tonal was recorded on four tracks, two inside and two outside, prior to the TH cycle. Playback amplitude variations represent degradation

caused by the TH cycle. To observe amplitude variations, a simple amplitude demodulator was used to monitor the reproduce output of all four tracks. The output of the demodulator was recorded on a strip-chart recorder. Figure 7-2 shows periodic amplitude increases on the two outside tracks while the two inside tracks remain nearly constant. The variations were thought to relate to reel revolutions because warped or bent reels were a common problem. After measuring the period of the pulses as well as their duration, it was realized that the disturbances were caused by the flange openings. The flange on the reel

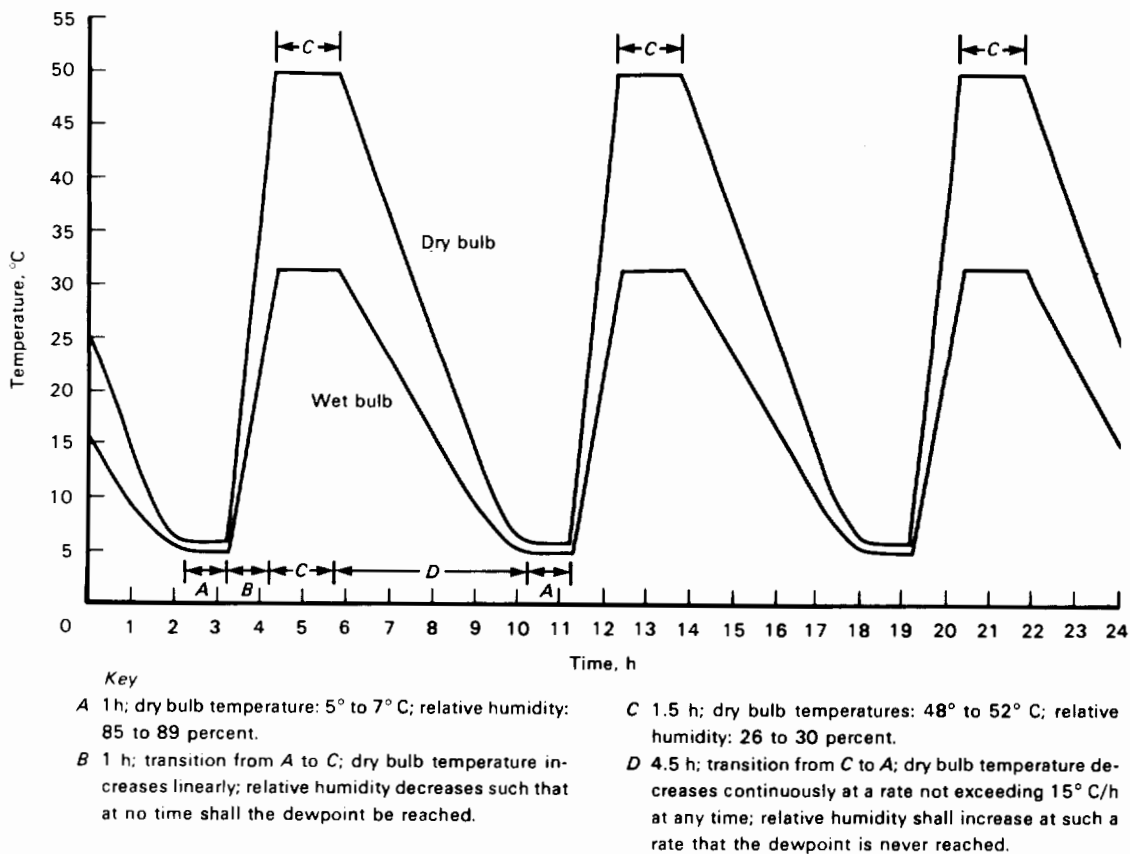

Figure 7-1.—Temperature/humidity cycling of a wound tape.

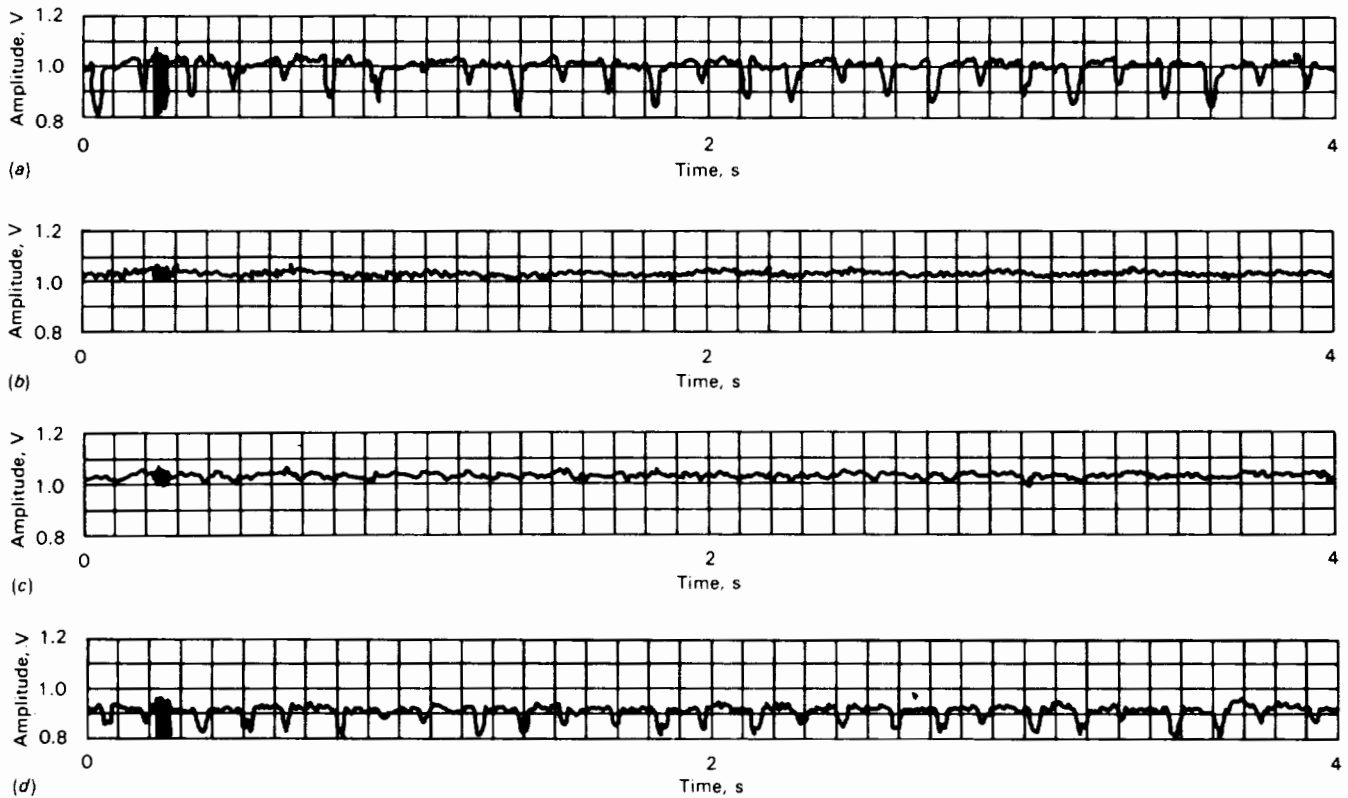

Figure 7-2.—Amplitude demodulator output after TH cycle. (Unwanted, degrading pulses on the outer tracks occur at reel flange openings.) Reproduce speed = 60 in./s; pulse period = 0.16 s; pulse width = 0.04 s. (a) Track 14. (b) Track 9. (c) Track 6. (d) Track 1.

of tape that was used to obtain the data shown in figure 7-2 was the standard flange shown in figure 5-9.

The same test was performed on a reel of tape with flange openings on the innermost portion of the flange. The results are presented in figure 7-3. This figure shows the output of the amplitude demodulator for the entire

3600 ft of tape. Because the flange openings were in the inner portion of the reel, the last 45 percent of the tape showed the effects of the openings. Further tests were conducted with different types of solid flange reels, and there was little effect on the quality of the data after a TH cycle.

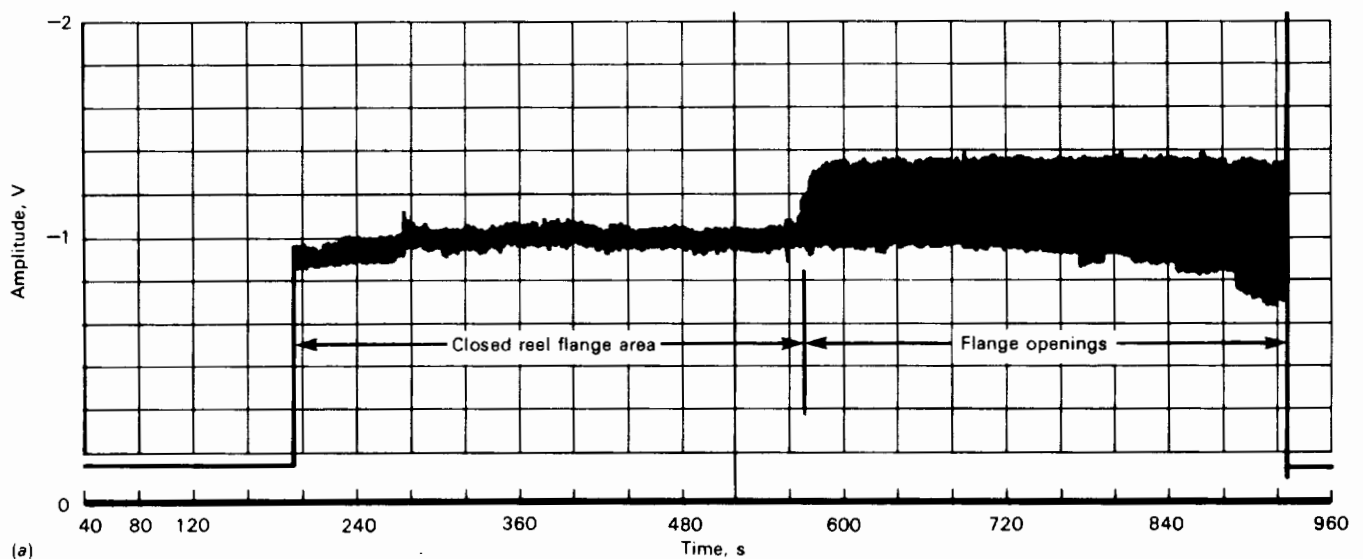

Figure 7-3.—Inverted amplitude demodulator output variations in $\frac{1}{2}$ -in.-wide tape, flange opening versus closed area after TH cycle. (a) Track 1, outer track.

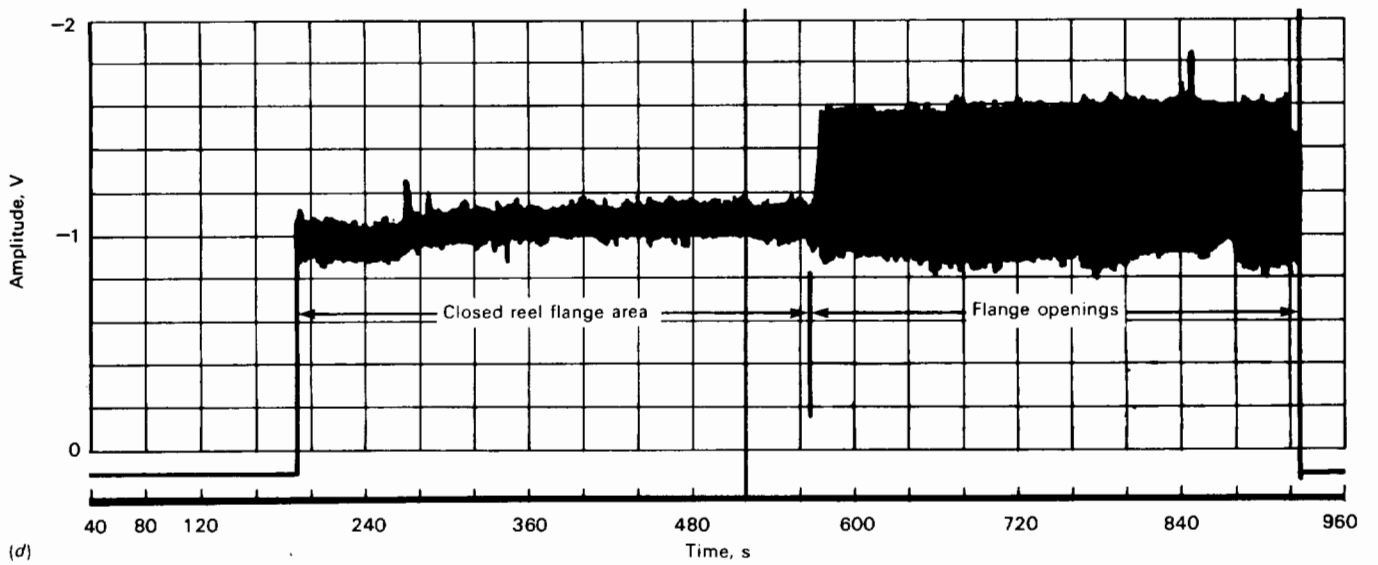
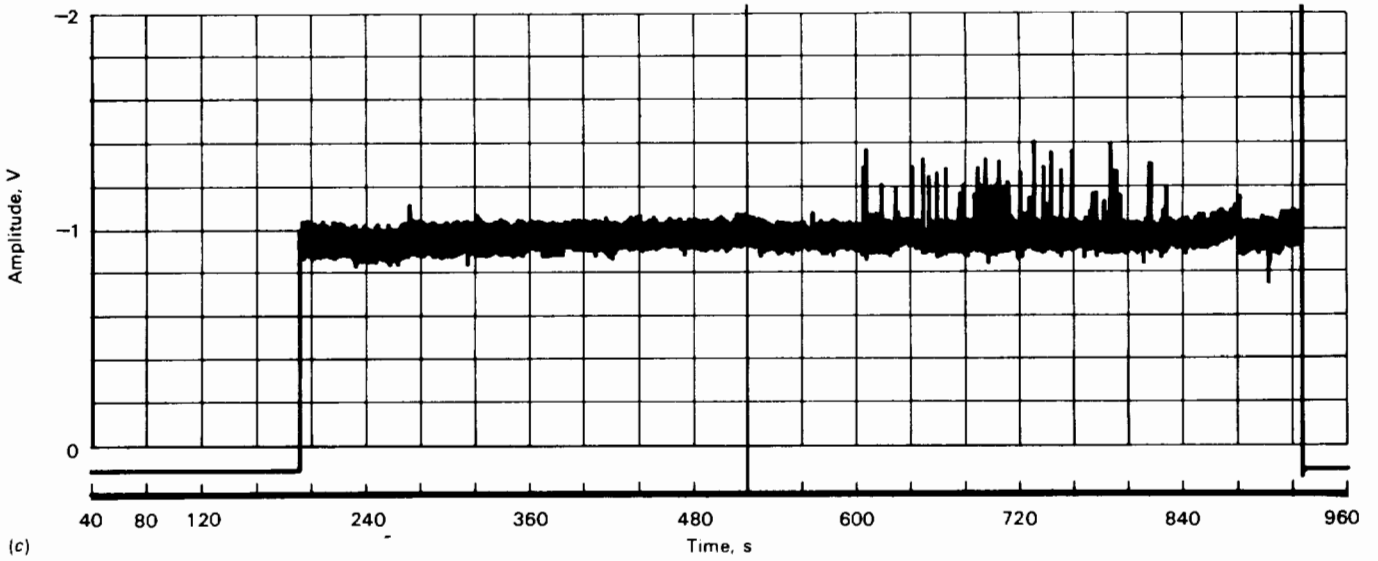
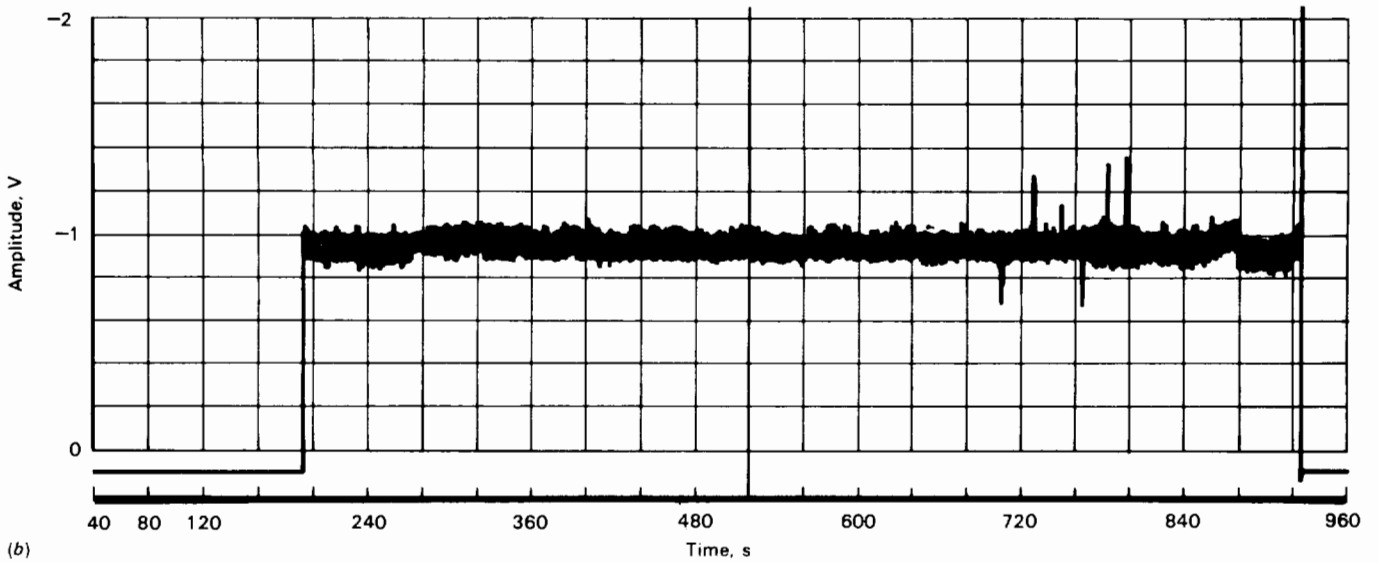

Figure 7-3 (concluded).—Inverted amplitude demodulator output variations in 1/2-in.-wide tape, flange opening versus closed area after TH cycle. (b) Track 2, inner track. (c) Track 7, inner track. (d) Track 8, outer track.

TAPE

Expansion and Contraction

Magnetic tape is a plastic base film on which a dispersed magnetic particle mixture is coated. This is similar in makeup to a bimetal strip, although this is an exaggerated example. The point is that the magnetic particles, binder, and the base film may not expand and contract at the same rate. This problem, coupled with the reel hubs, which expand and contract at a different rate, and the uneven temperature and humidity exposure caused by the flange openings may be a source of tape distortion. Tests have shown that cleaned tapes will again show some oxide buildup on heads after exposure to a TH cycle. This is an indication that the oxide tends to tear away from the binder or base film because of the difference in expansion rate or humidity deterioration. The amount of loose oxide may be slight but over several hundred feet becomes evident. Solid flange reels, on the other hand, provide a more uniform exposure of environment to a wound reel of tape.

Varying Air Pressure During Winding

Many believe that the reel flange openings were placed in reel flanges to allow the air to escape as the tape winds. The openings are not required for air escape because there is sufficient air escape between the flanges. The flange openings cause air to either pump into the wind or let it out, depending on the reel and transport design. This pumping action occurs at a rate depending on the number of flange openings and reel speed. This uneven air pressure does not permit the tape to stack as evenly and normally produces a looser wind, which permits distortions to occur more readily.

Tape Hygroscopic Properties

Because of the moisture absorption properties of tape, distortion and deterioration will take place unevenly on a reel with openings. The frictional properties of magnetic tape vary significantly at different humidities. Figure 2-1 shows variations of abrasivity as a function of wear passes and relative humidity. The samples were stabilized at the humidity level being tested and the equipment used was also maintained at the test humidity. Ampex 787A, 787B, 787D, 787E, and 787F tape samples are from tape that was slit from the same web, so that changes in abrasivity would be primarily a function of humidity and wear passes. Sample 787G was run to verify the 80-percent curve using a tape from another manufacturer's lot.

The uneven exposure of the wound roll on a reel with openings, therefore, can cause variations in friction as the tape passes through a tape transport. This, in turn, can cause signal amplitude and frequency variations.

Wound Pile Stresses

Magnetic tape is elastic, and when it is wound onto a reel under tension, inner stresses become present. These inner stresses will attempt to relieve themselves and may do so especially during expansion and contraction caused by temperature changes. Impact and vibration can also cause these inner stresses to be relieved. The problem is further aggravated by the uneven exposure permitted by flange openings. The combined effects can result in wound tape pile distortions often referred to as spoking.

Dirt and Physical Handling Damage

The flange openings can permit dirt contamination and physical handling damage. The degree of damage will depend on the care and environment of the reel of tape. Because this type of damage is the most obvious, it is generally thought to be the worst; however, it is probably the least when compared to the combined effects of the other four.

While these five causes have their individual damaging effects, they do not occur independently; therefore, the combined effect results in poorer tape performance because a distorted tape will not run straight, flat, and at even tension over the heads; the tape life is reduced; and recorded signal quality degraded.

COMPARISON TESTS OF SOLID FLANGE REELS

Three different comparison tests of solid flange and open flanged reels have been conducted since their development. The results of all three tests were essentially the same; however, the last test run in 1969 was more extensive. This test and the resulting data are presented in this section.

The test conditions were as follows:

- (1) All testing was performed in a class 100 clean room (as specified in Federal Standard Number 209a).
- (2) One experienced operator was assigned to perform all testing.
- (3) There were 14 reels of 3M951 (0.5- by 14-in.) tapes selected from the same batch to use in these tests so that as nearly as possible all tape was identical and of the type typical of our use at that time.

The test procedure was as follows:

- (1) The 14 tapes were wound onto alternating types of reels (metal, glass, metal, etc.).
- (2) The tapes were then recorded at 600 kHz and 60 in./s (0.1-mil wavelength) onto alternating types of reels (glass, metal, glass, etc.).
- (3) The tapes were then placed in a temperature and humidity chamber and cycled. (See fig. 7-1.)
- (4) The tapes were then allowed to relax at laboratory

conditions ($75^{\circ} \pm 5^{\circ} \text{ F}$ and 50 ± 5 percent relative humidity) for a 24-h period.

(5) Four dropout passes were then made on each tape, and the average of the four passes was recorded. (A dropout was described as a 6-dB signal loss for at least $40 \mu\text{s}$. The tapes were tested on alternating types of reels (glass, metal, glass, etc.).)

(6) From these data figure 7-4 was developed to provide a visual representation of the entire test. Each test point represents the average dropouts of all the metal and glass flange reels.

Test passes 1 to 4 were not used in the final evaluation because after pass No. 4, the tapes were rerecorded and a different track (No. 4) was assigned to the testing. We believe the step in the Mincom recorder capstan was damaging the other channels.

Three tapes (metal flange reels) were removed from the tests due to excessive degradation. This was because of (or partly because of) a vibration test to increase tape aging that was performed prior to pass No. 8 on all tapes; however, because of a looser wind in the metal reels the vibrator caused the tape layers to weld together in spots.

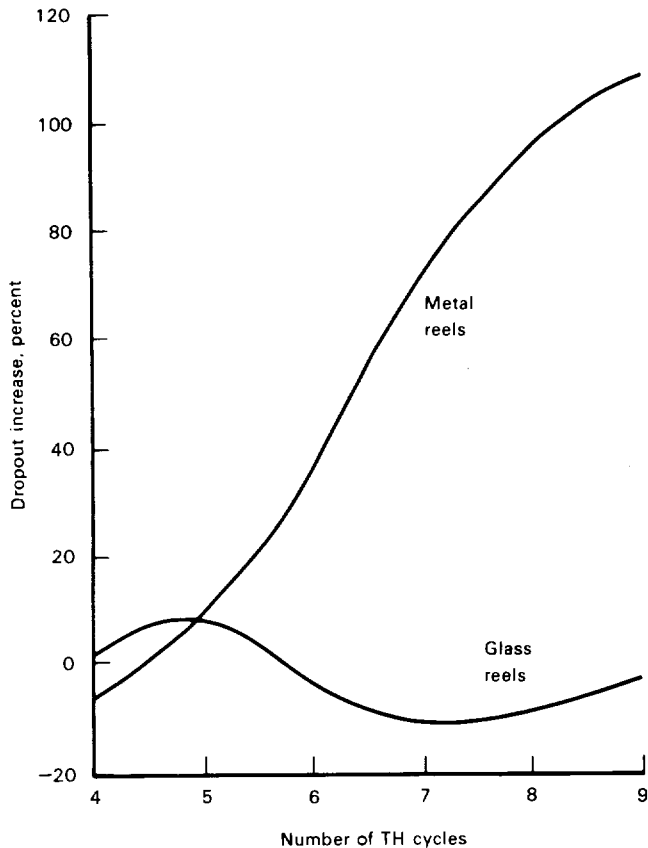

Figure 7-4.—Evaluation of glass and metal flange reels based on temperature and humidity cycling and dropout testing.

PRODUCTION DEVELOPMENT OF SOLID FLANGE REELS

After it had been proven that solid flange reels provided superior tape protection, they had to be effectively developed to replace the reels that were being provided by the manufacturer. This was difficult because the tape manufacturers had already established reel production facilities and were reluctant to change.

The development of solid flange computer reels occurred rapidly because there was a Government development contract with a plastics company to produce a small quantity of $\frac{1}{2}$ - by $10\frac{1}{2}$ -in. reels, in both the computer and analog configurations, and the same company also made reels for IBM. IBM saw the wisdom of the solid flange reel concept, adopted it, and because it set the standards for the computer industry, all the other computer tape manufacturers followed. A computer reel is shown at the right in figure 7-5.

The tape and reel studies also revealed that the plastic hubs were not strong enough to withstand the winding pressure; therefore, the first development contract also required the addition of an aluminum hub for strength. Some manufacturers developed a Fiberglass-filled plastic hub for the additional strength. The analog reel took longer to introduce in production quantities and is still only used in a limited manner. The reel on the left in figure 7-5 shows a $10\frac{1}{2}$ -in.-diameter solid flange glass reel flange with an aluminum hub. This reel is available from Corning Glass Works for either $\frac{1}{2}$ - or 1-in.-wide tape. A plastic sleeve on the hub enables threading.

A solid flange reel for $\frac{1}{4}$ -in.-wide tape was developed for 7- and $10\frac{1}{2}$ -in. diameters; these are shown in figure 7-6. This reel design does not have threading slots in the hub, as do many $\frac{1}{4}$ -in. tape reels. Slots weaken the hub and create tape distortions, as previously discussed. A small fingerhole is provided in each flange to facilitate tape threading.

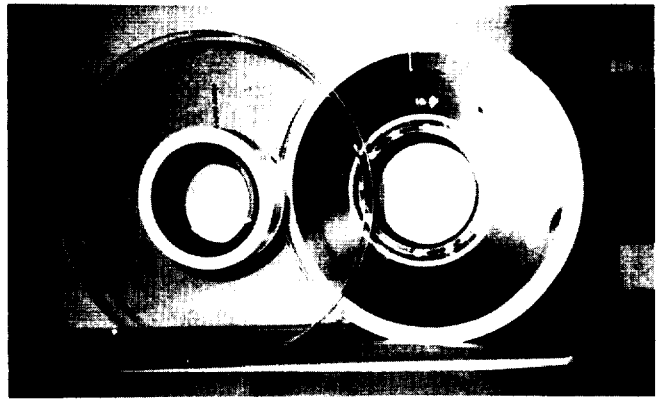

Figure 7-5.—Solid flange $10\frac{1}{2}$ -in.-diameter analog and computer reels.



Figure 7-6.—Solid flange reels of 10½- and 7-in. diameters for ¼-in.-wide tape.

GLASS FLANGE REEL DEVELOPMENT

Plastic has been found to be suitable for reel flanges up to 10½ in. in diameter, but has not been found to be stable enough for the larger precision instrumentation reels. Solid flange aluminum reels would work and have been used to a small degree; however, most users want to see how much tape is on the reel and its conditions. Therefore, a suitable transparent material was needed. Corning Glass Works developed a special type of chemically strengthened glass that is about 10 times stronger than normal window glass, in addition to being somewhat flexible. Specifications were developed for the reel made with chemical strength glass flanges and a contract was established with Corning Glass Works to produce the first prototype glass reels in 1966. The glass flange reels proved to be satisfactory in field testing and since then production quantities have been placed into service, with approximately 300 000 reels in service throughout Government and industry. (See fig. 7-7.) The reel specifications were refined as the development took place and were then added to the GSA reel specifications as W-R-175/6T.

There was great reluctance to accept the glass reel at first because of the fear of breakage. Within the first year of use, a comparison of the percentage of defective reels was made that showed that about 0.25 percent of the glass reels were broken as opposed to about a 38-percent failure rate (bent, dented, etc.) of the metal reels.

Since that time the percentage of defective metal reels has significantly been reduced where plastic reel bands are used. However, the important factor is that the



Figure 7-7.—Glass flange reel.

percentage of broken glass reels has not been a problem and even in rough handling environments has not exceeded a 1-percent failure rate. This is also partly the result of the use of reel bands, good packaging, and the improved handling people tend to give to glass. In addition, due to the stable nature of glass, it always remains in precision form, unlike plastic or metal, which may become warped or bent.

If a glass reel flange is broken, the recommended practice to salvage the tape is to remove the large shattered pieces with gloves and vacuum the loose particles of glass with a soft brush on a vacuum hose. Then the tape should be wound on a tape winder/cleaner or tape transport with the heads protected with lintless wipes. Normally the particles do not get into the wound pack but will cling to the edges of the tape. This is why it is important to clean the wound tape pack prior to winding.

To provide a measure of safety from fracture, a clear plastic coating is applied to the outside of the reel flanges. This retains the shattered particles in case of breakage. The chemically strengthened glass shatters when broken, much like a small explosion, because of the internal stresses in the glass. The flying glass particles do not have sufficient strength to break the skin; however, they would cause damage to the eye. This was the main purpose for adding the plastic coating to the flanges.

The main drawback of the glass reels has been the cost. They presently cost 2 to 3 times more than metal reels. The increased cost is usually justified if the tape is going to be used in a critical application. However, by purchasing the glass reels new, for a period of time, a system can be filled with glass reels. Then, as the tape becomes defective,

it is removed from the reel, cleaned, inspected, and reused for new tape procurement. By reusing the reel in this manner, a cost savings can be realized.

REEL BANDS

Concurrently with the development of solid flange reels, the development of a suitable reel band was under way. Samples of some presently used reel bands are shown in figure 7-8. The reason for the reel band is to seal the tape from environmental damage, provide protection from physical reel and tape damage, and aid in keeping the plastic reels from warping. The use of reel bands on aluminum reels has greatly reduced the number of damaged reels and thus damaged tape. When reel bands are used, the recommended practice is to remove and replace the band only while the reel is mounted on the recorder. This practice helps reduce tape edge damage resulting from crushing the flanges while mounting or removing the reel from the transport. Government specifications (NSAL14-5) describe the design and construction features of a reel band as follows:

The tape reel bands shall be designed to prevent dust, fibers, lint, or other foreign materials from contaminating the interior of the reel or the surface of the tape therein. The tape reel bands shall have a locking type latching mechanism (specific design to be the manufacturer's option) to allow it to be mounted easily on the periphery of the reel and maintain a snug fit. When placed around the peripheral edges of the reel flanges and latched into place, the bands shall fit evenly without pressure points on the flanges and shall protect the tape from physical damage during normal shipment and storage. The inner cylindrical surface of the band should contain parallel molded slots or ribs, shaped to mate with the reel flange edges, and spaced at the appropriate reel flange spacing. These molded slots or ribs will serve to keep the reel flanges parallel and straight during normal handling, shipment, and storage, thus preventing inward flange deflection and damage to tape edges. The protrusion of the ribs or solid

flange support, or any other component of the bands, into the reel flange opening (measured from the outer edge of the flange in a perpendicular direction toward the hub) shall be a maximum of 0.120 in. The design of the bands shall be such that application to the tape reel may be accomplished by hand without requiring the use of tools.

THREADING A SOLID FLANGE REEL

Eliminating the flange openings created a problem in threading the tape onto the reel because the normal procedure is to hold the tape end against the hub with one finger while one or two wraps are made onto the hub. There was a great deal of study that went into discovering a practical way to attach the tape end to the hub. At least two patented special hub threading devices were developed, but both proved impractical. A practical, inexpensive threading method was discovered when we noticed that there was a static attraction of the tape to hubs made of plastic. We then started to use a plastic sleeve that is presently used on the glass flange reels. When the trick of how to use this threading method is understood, it is just as fast or faster than threading a reel with holes in the flange.

TAPE PACKAGING

In the process of studying tape environmental problems and developing improved reels, it was obvious that there were inadequacies in the protection provided by the available packaging. The following is a list of design features that are considered essential in good packaging for magnetic tape:

(1) The packing material used should be designed to serve as insulation to retard severe temperature and humidity changes in addition to serving as protection against impact and vibration. Where fiberboard boxes are

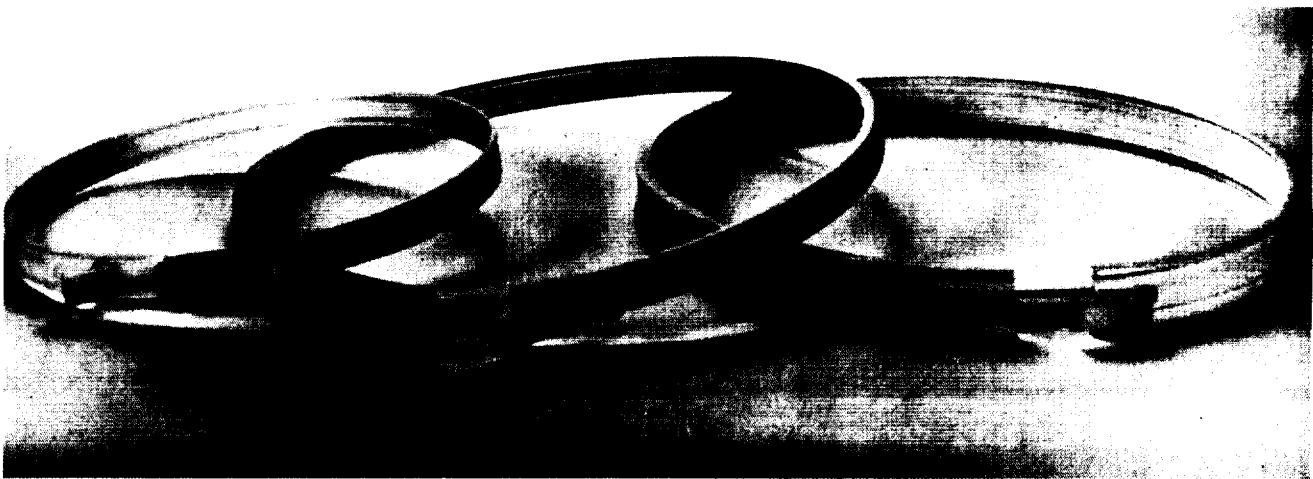

Figure 7-8.—Reel bands.

used, a double wall fiberboard box is recommended as additional protection against the shipping environment.

(2) Packing should prevent undue internal shifting that can create debris from chafing or cause internal crushing.

(3) Packing should be designed so that each reel is supported independently and end reels are not vulnerable to crushing by the other reels in the box when a side drop is encountered.

(4) Containers should be sealed to prevent contamination by foreign material and reduce exposure to temperature/humidity changes.

(5) Sealed plastic bags should be used to protect tape against humidity and debris. If the tape is shipped, used, and returned, and a plastic bag sealer is not available, then a fold-lock type of heavy reusable plastic bag is recommended.

(6) The padding should be designed to withstand the shock and vibration forces normally encountered in the system they are used in.

(7) Reel bands are recommended on all reels being shipped or stored.

(8) The container should be designed so that the normal positioning of the container is with the reels in a vertical position.

(9) Containers should have a minimum number of parts that have to be handled.

These practices are recommended to enhance the recovery of data that has been recorded on the tape and to maintain the tape and reel in good condition.

BIBLIOGRAPHY

- Carothers, Rayburn T.: "Magnetic Tape Abrasivity Test." Paper presented at meeting, THIC, Apr. 26, 1976.
- Cuddihy, Edward F.: "Hygroscopic Properties of Magnetic Recording Tape." *IEEE Trans. Magn.* 12:126-135, Mar. 1976.
- Grozjean, R. D.: "Precision Tape Reels, A Glass Flange Precision Reel." Paper presented at meeting, THIC, Apr. 26, 1977.
- Magnetic Tape Study Contract, Final Report, General Kinetics Inc., Mar. 2, 1959.
- Townsend, K. H.: "Relationship of Reel Design and Winding Practice to Tape Damage." National Security Agency Specification L14-2, 1962.
- Townsend, K. H.: "Solid Flange Reels." Paper presented at meeting, THIC, Apr. 26, 1977.

CHAPTER 8
High-Density Recording

Finn Jorgensen
DANVIK

High-density digital recording (HDDR) represents a leap forward in signal accuracy that can be achieved in recording and playing back data on an instrumentation recorder. Figure 8-1 illustrates how HDDR works: The data signal is converted from an analog to a digital (A/D) pulse code modulated (PCM) signal and then transformed into a code suitable for magnetic recording; the inverse process takes place upon playback.

A signal wave form that is recorded and played back on a direct recording/playback channel suffers from degrada-

tion in these areas:

- (1) Linearity
- (2) Amplitude stability
- (3) Time base stability
- (4) Addition of noise

The signal accuracy is relatively poor because the amplitude accuracy at best is plus or minus a few tenths of a decibel (or, plus or minus a few percent). This is at one frequency only; the average value of the recorder "unity

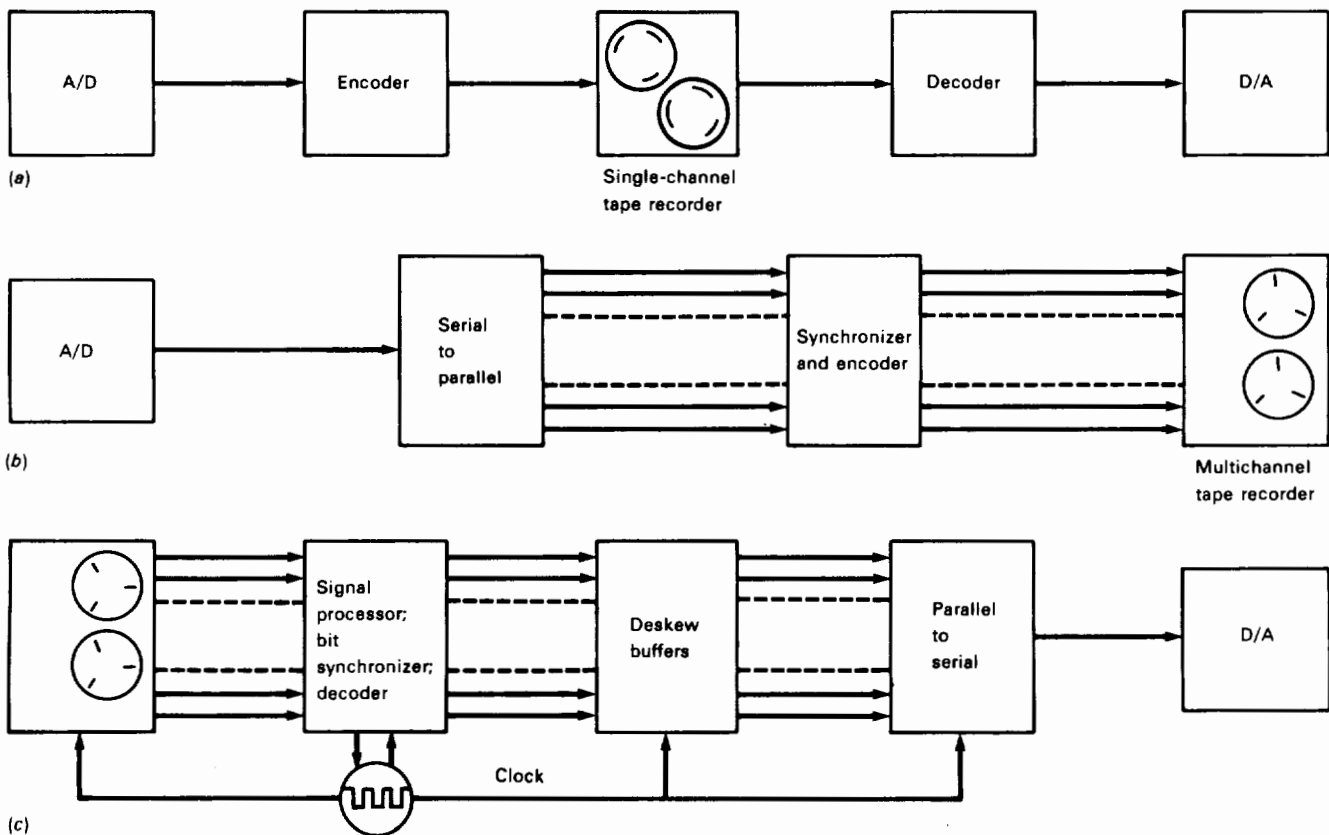

Figure 8-1.—HDDR. (a) Single-channel digital recording. (b) Recording on multitrack tape recorder. (c) Playback on multitrack tape recorder.

gain" changes with signal frequency in accordance with the frequency response. This, in turn, depends upon the tape used and on bias and equalizer settings—assuming noncontaminated heads that are in perfect alignment.

Modulation techniques were introduced in the early days of instrumentation recording to circumvent this problem of accuracy (and/or to extend the frequency response to dc). Frequency modulation was (and is) popular while some of the pulse methods now are obsolete. (Pulse-duration modulation and pulse-width modulation are obsolete. Pulse amplitude modulation was a multiplex scheme that did nothing to improve the signal amplitude accuracy.)

While these earlier methods often solved the amplitude stability problems, they were contaminated by the flutter of the tape transport. This manifested itself as a noise floor that only could be lowered by flutter reduction and/or compensation techniques; the latter could bring about a 10- to 15-dB noise reduction.

When recordings must be done with high accuracy, high signal-to-noise ratio (SNR), and reasonable bandwidth, a solution is found in the marriage of digital coding and the recording technology from instrumentation (or similar) recorders. Rather than recording and reproducing a signal that continuously varies in amplitude and duration (analog), the signal is changed in an A/D converter so that the record signal has discrete levels only. These signals are, in general, limited to a stream of two level signals: "0" and "1" bits (binary).

This digitized signal could be recorded directly as a baseband signal, but it is far better to encode it with one of several coding methods that are optimized for an analog tape recorder channel. This channel is bandwidth limited and without dc coupling "between record and playback."

The output signal from A/D converters is, by property of digital logic circuits, a PCM signal in the no-return-to-zero—low (NRZ-L) format. This implies that all "1" bits are at a high voltage level and all "0" bits are at a zero voltage. This signal contains a dc component that cannot be played back. This component can be blocked away with a coupling capacitor, provided that the overall fairly short time periods are equal numbers of "0" and "1" bits. Some advanced codes have, as we shall see later, no dc component.

We can list several advantages that PCM recording, or HDDR, has over analog recording/playback:

- (1) A high degree of linearity
- (2) Theoretical limitless SNR
- (3) Immunity against data degradation due to changes in the overall tape flux level as occurs after repeated playback passes or duplication
- (4) Errors caused by single dropouts can often be corrected
- (5) Immunity against crosstalk
- (6) Excellent phase and transient response

(7) Complete removal of flutter by clocking the PCM data out of buffers

(8) Computer compatible format

(9) Digital signal processing (prior to digital to analog (D/A) conversion): synchronization, filtering, and data enhancement

(10) Minimum operational adjustments

This is truly an impressive improvement, but everything has its price: HDDR recorders consume a large amount of tape to accommodate the wide bandwidth of PCM data, as compared with analog data. Digitized audio, for example, requires a 600- to 800-kHz bandwidth for a twenty to 20 000-Hz signal with a 90 dB SNR. This PCM signal could be handled by a home video tape recorder. In data collections the bandwidth requirement for the digitized signal may well be in the range of hundreds of megahertz; it is then necessary to split the serial signal into many parallel channels of corresponding lesser bandwidths. These channels are then, upon playback, decoded, clocked into step with each other (through buffer storage), and recombined into a serial stream and converted back to analog.

The tape recorder system engineer will now have to add yet another discipline to his long list of interdisciplinary duties: coding and information theory. It is the purpose of this chapter to introduce and familiarize the reader with the basics of A/D conversion, pulse recording, and some basics of coding and how they apply to HDDR recording. Because each section must be brief, I have included a bibliography organized by HDDR topic. The listing goes back to 1963 and is as complete as possible. Any omissions are accidental and are likely to be found as further references in the listed references.

A/D CONVERSION

A/D converters translate from analog values, which are characteristic of most phenomena in the real world, to a digital word.¹ Each word contains n bits ("0" or "1" bits) and represents a region of the analog signal range.

There are, using words with n bits, a total of 2^n uniquely different words. If n is 1, then the single bit word can be a "1" or a "0"; this is like a coin showing a head (H) or a tail (T). If $n = 3$, then eight combinations of "1" and "0" values are possible, just as there are eight possible outcomes when tossing three coins: HHH, HHT, HTH, HTT, THH, THT, TTH, and TTT.

A four-bit word has 16 possible word values, and each is assigned to a region of the analog signal range. This mapping of a voltage range into a digital word is called

¹The reader may elsewhere find this called a digital code, which in one sense is correct. We will here only use the terms code and coding for changing one word pattern into another, using one of several codes. This process does not alter the information in the word.

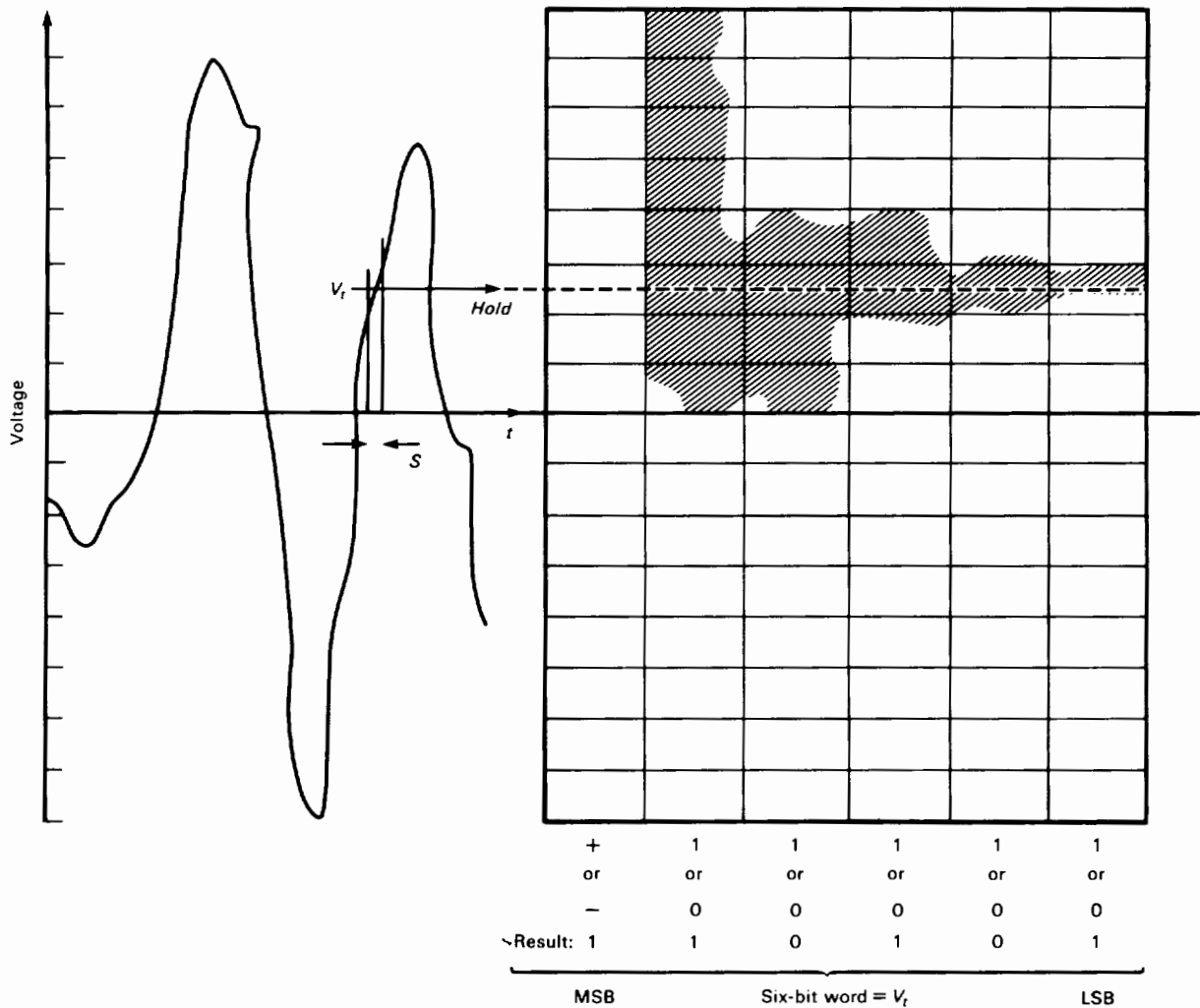

Figure 8-2.—Quantization of voltage level V_t for a six-bit word. (S = sample.)

quantization; the resolution of the mapping increases in direct proportion to n .

Polarity of a voltage requires an additional bit—the “sign bit.” This bit is always the first in the word and is, therefore, called the “most significant bit” (MSB). The next bit indicates whether the voltage is in the upper or lower half on the voltage range; the following bit again divides this assigned range into two, and so forth. The last bit—“least significant bit” (LSB)—is the final location of the quantization interval, which then has a size corresponding to the voltage interval: voltage range divided by 2^{n-1} . This subdivision of ranges is shown in figure 8-2 for a six-bit word.

The MSB, the sign bit, is not used for the value of a voltage, only the remaining $n - 1$ bits are. The ratio of the LSB to the full-scale voltage is therefore 2^{n-1} (2^{-5} , not 2^{-6} in the example). The minimum voltage is therefore $1 \times Q$, where Q is the final quantization interval. The maximum is $2^{n-1}Q$ and the corresponding rms value

$$V_{\text{signal (rms)}} = \frac{Q2^{n-1}}{\sqrt{2}}$$

The error in quantizing a voltage into a range $\pm Q/2$ can be calculated (ref. 8-1):

$$V_{\text{noise (rms)}} = \frac{Q}{\sqrt{12}}$$

We then find

$$\text{SNR} = \sqrt{1.5} \times 2^n$$

or

$$\text{SNR} = 6n + 1.76 \quad \text{dB} \quad (1)$$

Each bit will, therefore, contribute 6 dB to system performance; for the six-bit word the SNR is $36 + 1.76$ dB.

It appears possible to achieve any desired SNR by selecting a word long enough. The A/D converters contain resistance dividers that must be increasingly accurate for higher values of n . Practical tolerances limit n to the order of 15 to 17.

The word generation can be serial or parallel. Serial, or successive approximation, starts with assignment of the MSB and continues in order of descending bit weights until the LSB has been assigned. The conversion time is fixed and is in the range of microseconds or smaller. Eight bits in $1 \mu\text{s}$ or 12 bits in $3.5 \mu\text{s}$ are typical today for standard converters; faster converters are available, at a cost.

The input voltage is, in parallel conversion, applied to $2^n - 1$ comparators in parallel, and the conversion is as fast as the comparators can switch; unfortunately, the number of elements in these converters increases geometrically with resolution, limiting their application.

Figure 8-3 shows the present state of the art in A/D and D/A converters, relating conversion rates to bit resolution. D/A converters produce output voltages that correspond to the assigned range of digital input words. The resolution and speed of D/A and A/D converters are similar; as a matter of fact, A/D converters make use of D/A converters in operation.

The conversion time limits the upper frequency of the analog signal that can be converted. It should be sampled a minimum of once per half cycle (Nyquist rate), preferably at a slightly higher rate, say $2.5f$, where f is the highest analog signal frequency.

The converted signal consists of an n -bit word (plus an enable signal). The sample time is therefore $1/2.5f$, which gives a maximum time of $1/2.5fn$ per bit. This equals a transfer rate of $2.5fn$, and with a minimum of two bits per cycle, the PCM bandwidth (BW) is

$$\text{BW} = 1.25fn \quad \text{Hz} \quad (2)$$

(The theoretical minimum Nyquist $\text{BW} = fn$.) The price we pay for the advantages of PCM is an increase in required BW, or transfer rate, proportional to n (or to the SNR achieved, $\sim 6n$ dB).

The reader will undoubtedly have many questions with regard to the A/D conversion, or PCM data. References 8-1 and 8-2 are recommended sources for the answers, while reference 8-3 gives an up-to-date overview of PCM applications.

DIGITAL RECORDING

The continuous flow of analog data is, after A/D conversion, transformed into a stream of two-level bits having "0" or "1" values. The data rate has simultaneously increased from f cycles per second to a new bandwidth of $1.25fn$ Hz (eq. (2)). Many experimental

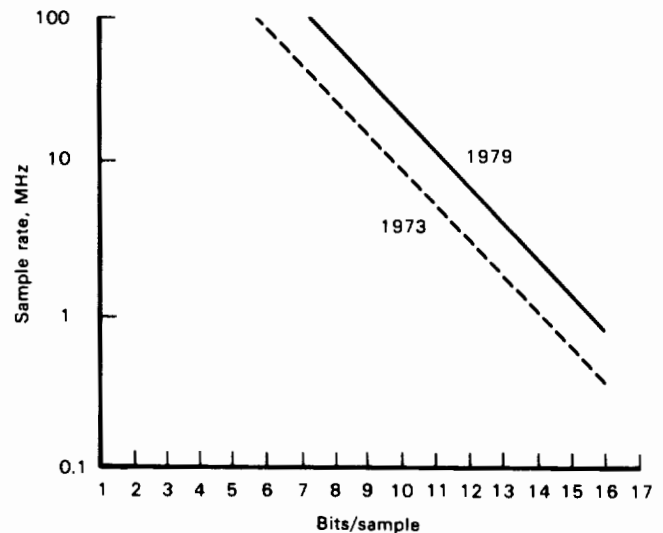

Figure 8-3.—Maximum rates of A/D and D/A converters.

data and their associated resolution (n) will produce bit streams from 20 to 600 MHz.

Such high data rates clearly exceed the bandwidth of existing instrumentation recorders, and the problem of recording them was solved in a straightforward manner by converting the serial stream into parallel streams that would all be within the bandwidth of the recorder. An early illustration (ref. 8-4) shows an example using four parallel streams, three for data and one for synchronization information. (See fig. 8-4.) It is also shown how the sync word is shifted from track to track so it later can aid in track alignment (deskew) and removal of time displacement errors between recorder tracks.

The number of tracks required is determined in a straightforward fashion once the bit rate per channel has been determined. The data stream is normally in the NRZ-L digital logic format, which is not well suited for recording onto an analog recorder channel. The most severe limitation is the absence of response to dc, and it becomes necessary to encode the data stream into a format that is dc free, while keeping the new bit rate as low as possible.

The maximum bit rate per recording channel is limited by upper frequency and SNR. The bit error rate (BER) is a function of the latter, and if a 20-dB SNR is chosen as a minimum, then a BER of better than 10^{-9} is calculated (ref. 8-5), assuming additive white gaussian noise and not including dropouts. In practice, 10^{-6} to 10^{-7} BER is typical for 2-MHz (120 in./s) instrumentation recorders.

The current packing densities are 33 kb/in., which equals 16.5 kHz/in. (2 MHz at 120 in./s). Higher densities (up to 80 kb/in.) are at the laboratory stage, using refined heads (very narrow gaps) and the fore-runners of new tapes.

Two methods of recording are used, direct pulse recording (saturation) and ac bias recording. At band edge

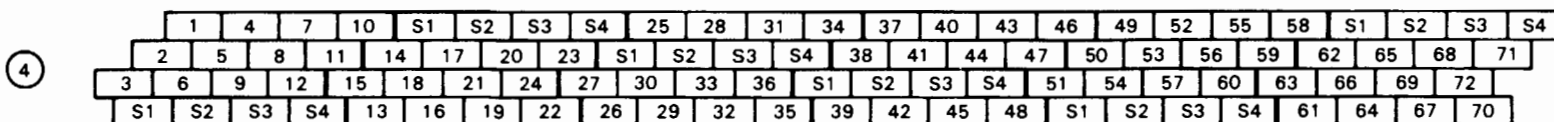
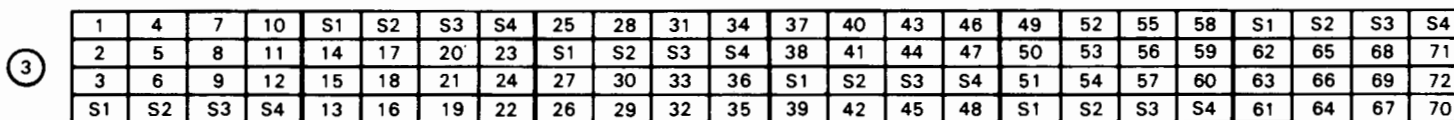
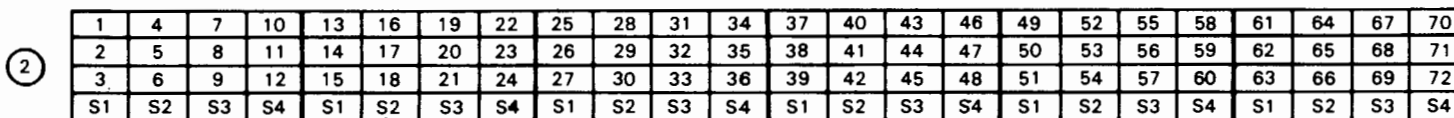
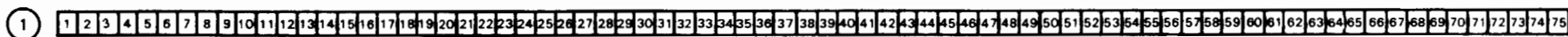
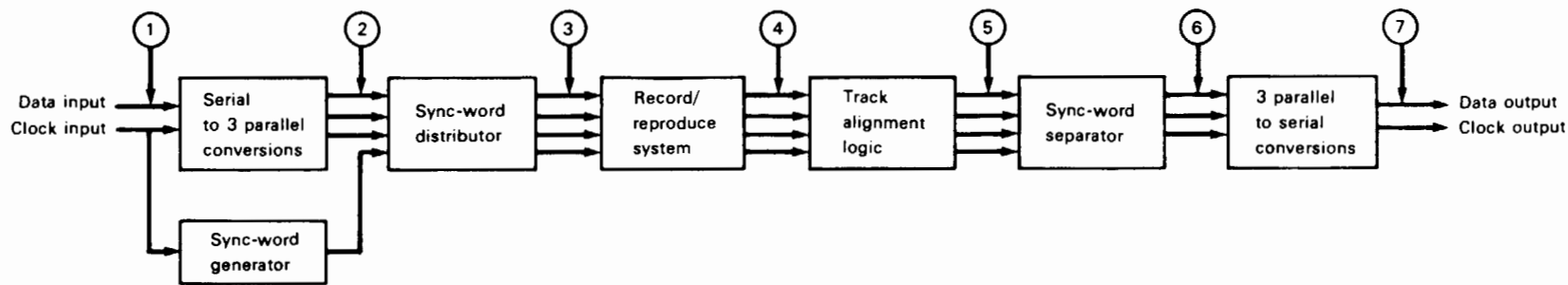

- ⑤ equals ③, plus delay
- ⑥ equals first three lines of ②, plus delay
- ⑦ equals ①, plus delay

Figure 8-4.—Data handling and timing diagram.

there is very little difference between the two methods, and the choice is often for no-bias direct recording because of simplicity (and lower cost). The recording level of the pulse signals is then much higher (approximately 20 dB) than with ac bias and becomes a source of channel-to-channel crosstalk during recording.

When crosstalk must be a minimum, ac bias is used. For instance, this is the case when high-density recording tracks are interleaved with other analog tracks (direct or FM). Proponents of ac bias also claim to have better control over the phase response, which is a more important parameter than amplitude response in pulse recording.

The packing density is in essence limited by the width of transition zones between opposite polarities of magnetization. The voltage induced in the playback head is

$$e = -n_0 \frac{d\phi}{dt}$$

where n_0 is the number of turns of windings on the core and ϕ can be expressed as the product of the tape magnetization j and the reproduce head field H :

$$\begin{aligned} e &= -n_0 \frac{dj H}{dt} \\ &= -n_0 H \frac{dj}{dt} \end{aligned}$$

as the field H is stationary. By rearranging,

$$e = -n_0 H \frac{dj}{dH} \frac{dH}{dt} \quad (3)$$

The first term, dj/dH , represents the change in tape magnetization versus field, and is therefore the same as the slope of the sides of the tape hysteresis loop. A high output voltage will, therefore, result if the sides of the hysteresis loop are steep; i.e. a square loop is ideal. (In an ac-biased recording, this will narrow the recording zone.)

The second term, dH/dt , represents the change in field strength as the tape passes over the recording head. We can write the tape speed $v = x/t$, or $t = x/v$, and substituting (because the speed v is constant),

$$\frac{dH}{dt} = \frac{dH}{dx} \frac{1}{v}$$

where dH/dx is the change in field strength across the head, also called the field gradient. This value is high in a good recording head. Equation (3) holds true for direct pulse recording as well as for ac-biased pulse recording. Figure 8-5 illustrates the recordings of a transition, and the subsequent tape remanence, with transition zones.

A detailed study by Mallinson (ref. 8-6) set the limits for the achievable packing density in high-density recording. The data are for ac-biased recording at a 3-percent

third harmonic distortion level on a tape with 2×10^{15} particles/in.³. Increases in this particle density are desired in newer tapes to shift all curves in figure 8-6 upward. The set of graphs in figure 8-6 with constant SNR as parameter give the number of bits per linear inch along a track and the total packing density on a piece of tape in bits per square inch. The dashed lines on the second graph show the mechanical limits of what can be achieved.

CODING AND DIGITAL CODES

Digital codes are often presented as a bouquet of different flowers of which one or two are singled out as the finest for the occasion. A quick glance at the dates of publication for the papers in the coding section in the bibliography reveals that advanced coding in itself is a new and rapidly advancing technology and that the tape recorder manufacturers must be credited with a very fast adoption of this new knowledge, and often with implementing one or another code with new devices from the semiconductor manufacturers lines. This pioneering effort has, therefore, caused several codes to be adopted by different manufacturers, and this subject is discussed in chapter 9.

Now, because the codes are adopted from the digital tape and disk industry, it is useful to follow the reasoning for the development of the various codes. We have, in a couple of decades, come from a very simple return-to-zero (RZ) code to an entire family of run-length-limited (RLL) codes; the theoretical performance of codes, as derived in the discipline of information theory, must be evaluated in the real world of limited performance of digital hardware and recorders, their complexity and costs.

Foremost in our choice of a code lies the demand for a code that is essentially dc free, because the magnetic recording channel does not reproduce dc. Next is the desire to stuff as much data as possible into a code for maximum use of the recorder signal bandwidth. In our attempts to satisfy these two demands we must still have a code that is easy to manage with respect to detection, clocking, synchronization, and error correction.

The earliest code is the RZ code, which uses a positive pulse for a "1" and a negative pulse for a "0." Each pulse produces two output voltages upon playback, where the first can be used to derive the clock for strobing to see if the pulse is positive (a "1") or negative (a "0"). The code is, in other words, self-clocking. The RZ recording is shown in figure 8-7.

The flux changes, by definition, between a zero level and a polarity twice for each pulse, and a low density results. A practical drawback is the fact that you cannot record over old RZ data with new data; the tape must be erased.

Digital logic circuits, including A/D converters, do not produce separate pulses for "1" and "0" values. The signals are continuous trains of positive pulses for "1"

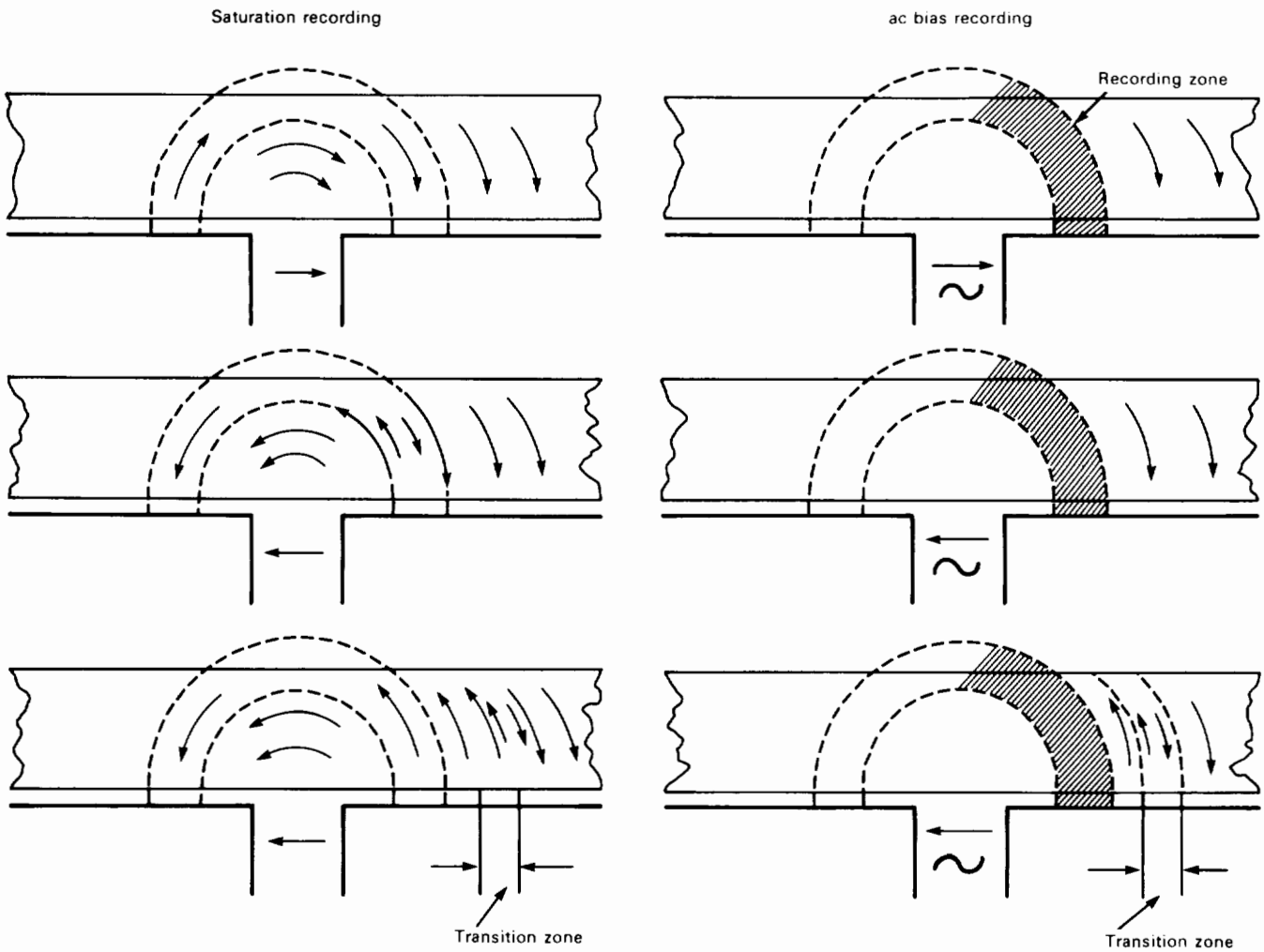

Figure 8-5.—Recording of magnetization transitions.

values and zero for “0” values (or vice versa in some circuits).

We can record this code directly, as shown in figure 8-8, and this method is known as NRZ-L. The L is added to distinguish this code from the next we will discuss, NRZI.

The density of NRZ-L is more than twice RZ, but it is no longer self-clocking—an external clock that is re-phased or synchronized as often as possible is required.

The NRZ-L code is also prone to errors. If no pulse (flux change) is detected by strobing by the clock, the

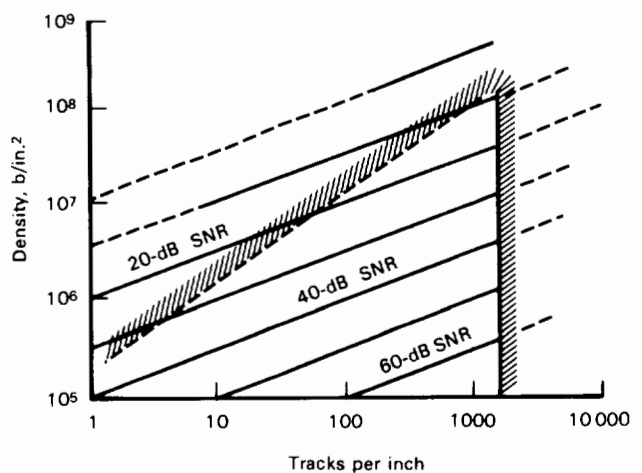
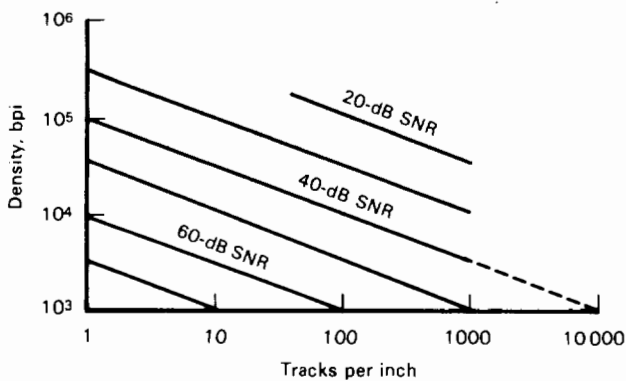

Figure 8-6.—Packing densities (above and right) versus number of tracks per inch. (After Mallinson (ref. 8-6).)

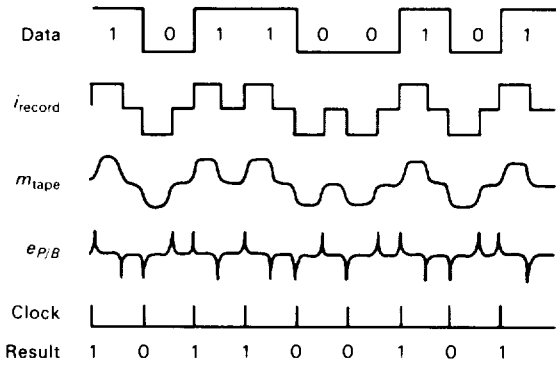

Figure 8-7.—RZ recording. ($e_{p/B}$ = playback voltage; m = tape magnetization.)

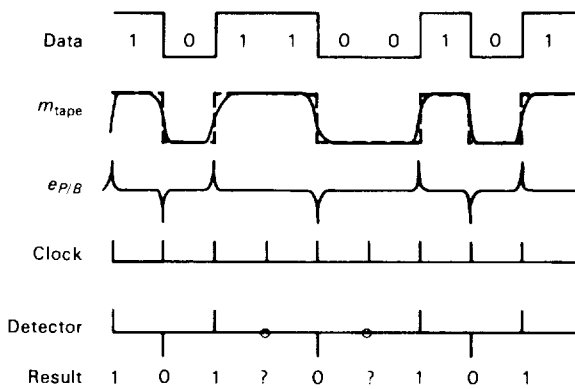

Figure 8-8.—NRZ-L recording.

playback logic assumes that the next pulse is like the preceding. If a string of "1" (or "0") values is recorded, then a spurious noise pulse can make the logic "think" that a "0" ("1") was present. This will continue until the next flux change is read and correctly read. This type of error propagation can be prevented so we can distinguish between "1" and "0" values.

This is done in the NRZI (or NRZ-M (mark)) code by generating a pulse for all "1" and no pulse for "0" values (or vice versa for NRZS (space); see fig. 8-9). The "1" pulse can be generated by a flux reversal, without regard for direction. When the playback logic detects a voltage from a flux change, it "knows" that a "1" is present; no flux change means that the signal is a "0."

This method will only be sensitive to single bit errors because subsequent bit detection is independent of previous polarity. But the NRZI code cannot, like NRZ-L, distinguish between a dropout and a "0," nor is it self-clocking.

The addition of a clock in the form of inserted "1" signals at the beginning of each bit cell leads to one of the double frequency (DF) codes: biphasemark (Bi ϕ M), also called phase encoding-mark (PE-M). This code is shown in figure 8-10.

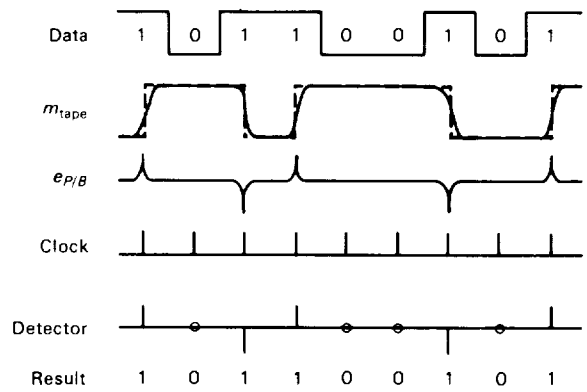

Figure 8-9.—NRZI recording.

This code produces two transitions whenever a "1" is recorded. This is, of course, the double frequency. We can also consider each "1" to be of twice the clock frequency, and a "0" equal to this frequency. We can therefore also name the code frequency shift.

Another double frequency code is the biphasel level (Bi ϕ L), also called phase encoding level (PE-L), in addition to frequency modulation (FM). (Note: The FM designation is, in the computer industry, used synonymously with DF; i.e., Bi ϕ M). With Bi ϕ L, a signal is generated for every bit: "1" is a positive going pulse and "0" is a negative going (or vice versa). (See fig. 8-11.)

We paid a price for including a clock with a code: double bandwidth of the coded signal. It also affected the frequency spectrum of the code. Figure 8-12 shows the power density spectrum of NRZ versus Bi ϕ L (which also is called the Manchester code). We see immediately that Bi ϕ L has no requirement for channel response to dc—which is what we strive for. This explains its popularity, and hence it is common practice in the computer industry to use NRZI only for tapes at low densities; higher

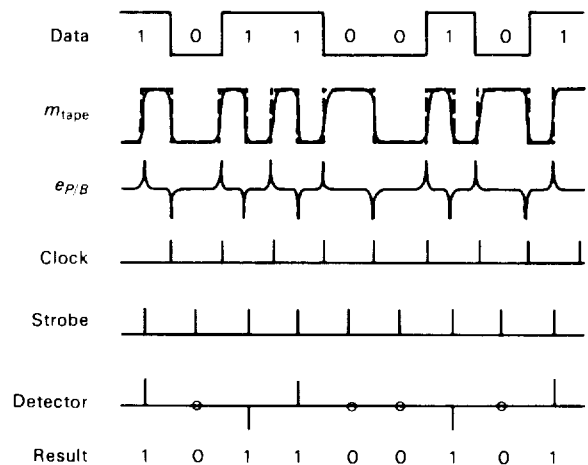

Figure 8-10.—Bi ϕ M recording.

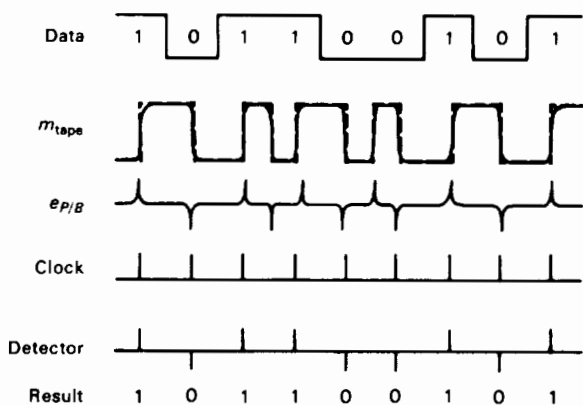

Figure 8-11.—BiφL recording.

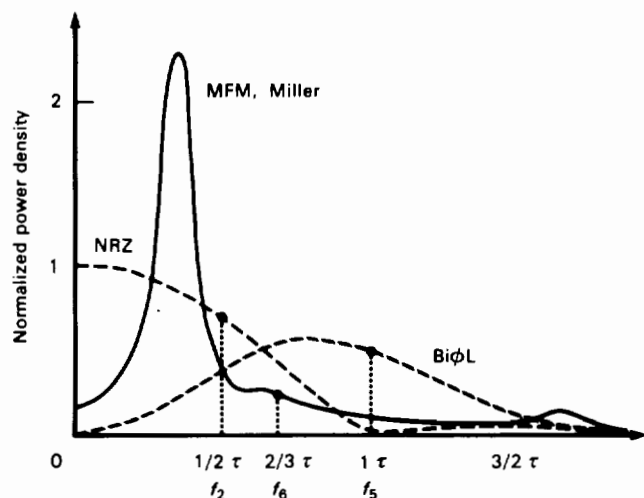

Figure 8-12.—Bandwidth requirements for various codes.

densities use phase encoding (BiφL), while double frequency (BiφM) is common for disks.

If we reexamine figure 8-11, we notice a couple of extraneous pulses we do not really need. It would also be desirable to see whether it would be possible to curtail the bandwidth of BiφM coding, or BiφL.

The clock transitions at the beginning of every bit cell are really unnecessary for cells containing "1" values, but they are desirable for a string of "0" bits. Let us therefore delete all the transitions again, leaving only those between successive "0" bits. We have now arrived at the modified frequency modulation (MFM) code from the DF code. (See fig. 8-13.) This particular code was patented by Miller of Ampex in 1963, and hence is often called the Miller code (refs. 8-4 and 8-7 to 8-9); another name is delay modulation.

The data information from BiφM has been preserved and a potential long string of "0" bits broken up, but the self-clocking feature for each bit has been lost. The major gain, though, is a reduction of about 2:1 in the required

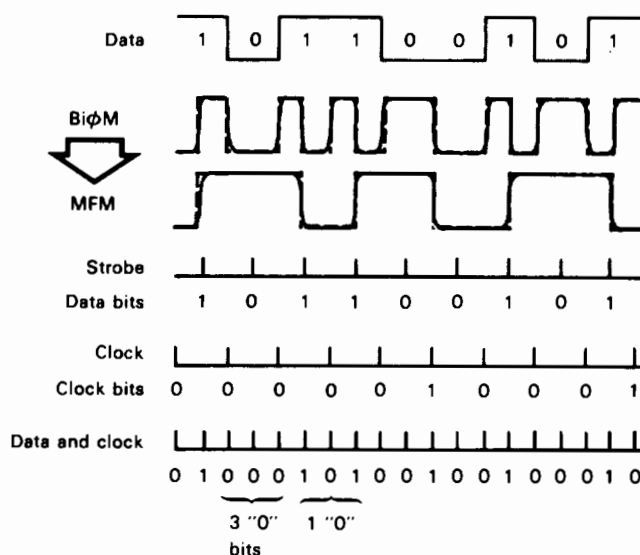

Figure 8-13.—MFM recording.

bandwidth, and a large reduction in the requirement for dc. The spectrum is shown in figure 8-13. The stability of the signal, in comparison with NRZ, is evident from the oscilloscope pictures in figure 8-14. Note the reduction in zero level drift and baseline galloping.

The upper frequencies, f_2 , f_5 and f_6 , respectively, required to faithfully record and reproduce the three basic codes (NRZI, BiφL, and Miller) are shown on the graphs in figure 8-12. The applicability of these band edge frequencies to data recording has been verified by Castle (ref. 8-10).

We should note that the transitions in MFM recording and playback have become more critical; they are no longer spaced equally, but are 1, 1.5, or 2 times the bit cell length. We have deleted the clocking information, which previously reduced the transition spacing to often half the bit cell length; this is why we can increase the packing density to almost double that of BiφM with the same amount of intersymbol interference and bit crowding.

There is another way of looking at the Miller code (ref. 8-11). The bottom line in figure 8-13 shows the interleaved pattern resulting from adding the data and the clock bits to form a continuous stream. Let us now consider this stream to be our storing code. Note that there is a minimum of one "0" and a maximum of three "0" bits between successive "1" bits.

There is no distinction between data and clock transitions, and the decoders must know what the encoder is doing (or did). The maximum of three and the minimum of one "0" could also be a maximum of k and a minimum of d numbers of "0" bits between two successive "1" bits:

$$d \leq z \leq k$$

For the Miller code, $d = 1$ and $k = 3$. These codes

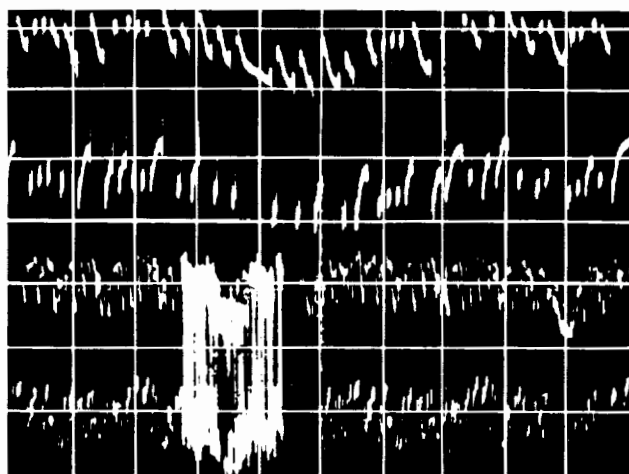

(a)

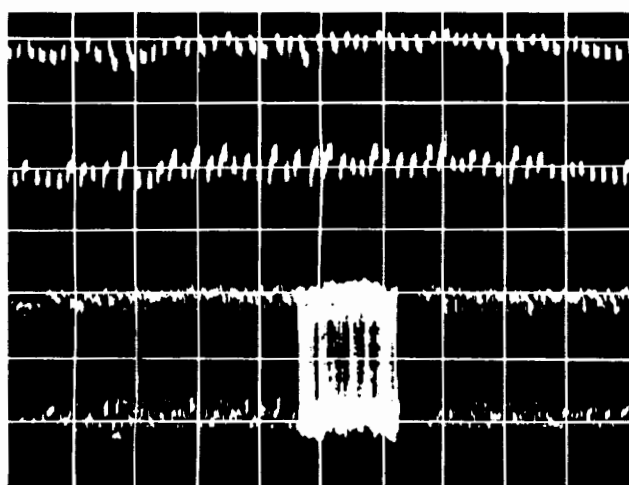

(b)

Figure 8-14.—Oscilloscope pictures of MFM. (a) Code with large $P = (k + 1)/(d + 1)$ ratio (at least d zeros but not more than k zeros between consecutive "1" values); note large spectral dc component. (b) Code with small P ratio.

represent a group of codes called RLL and are beyond the scope of this overview chapter. Several sources are listed in the bibliography of this chapter for the interested reader.

HIGH-DENSITY RECORDING EQUIPMENT TODAY

There are on the market today several recorders with data rate capabilities up to 200 MHz. They do not use the same encoding techniques, however, which makes interchangeability of recordings a major problem. There are at present three codes in use:

(1) Miller² by Ampex is a code that is a modification of the Miller code, or delay modulation code. The remainder

dc in the Miller code is removed by modifying the sequences that have nonzero digital sum variation (DSV) (refs. 8-12 and 8-13).

(2) Enhanced NRZ (ENRZ) by Bell & Howell is a format that consists of adding one bit to each group of seven data bits to be recorded on one track. The bit added is a parity bit such that the total number of "1" bits recorded for the group with its parity is odd (refs. 8-7, 8-14, and 8-15).

(3) *Randomized NRZ* by Sangamo/Weston-Schlumberger is a code that best can be visualized as modulation of the data by pseudonoise. Recovery is done by the inverse process. No extra bits are inserted, and all transitions occur in phase with a 1-cycle-per-bit clock (refs. 8-10, 8-16, and 8-17).

NRZ-L data are recorded by Honeywell and EMI, without encoding (refs. 8-18 and 8-19); this places stringent requirements on dc restoration in the reproduce electronics.

Several individuals have studied the merits of one coding in relation to another, as reported in chapter 9. Further information may be found in references 8-5, 8-12, and 8-21 to 8-24.

Up to now we have been discussing PCM coding techniques designed primarily to conserve bandwidth and/or shape the spectrum to reduce the dc component and thus get around the relatively poor dc response of the recorder. There is in the offing a new coding technology (see ref. 8-25) that serves the dual purpose of spectrum shaping and forward error correction, with relatively low overhead of from 3 to 10 percent of the bits being coding bits. Because of its newness and its proprietary nature, the electronics required to implement it will not be discussed here. With this new technology, information bit packing densities of 60 000 information b/in. on one track (66 000 b/in. including overhead) have been achieved with bit error rates of only 10^{-8} or better, using an Ampex 787 magnetic tape and a standard Bell & Howell VR-3700B tape recorder.

REFERENCES

- 8-1. Blesser, B. A.: "Digitization of Audio: A Comprehensive Examination of Theory, Implementation, and Current Practice." *J. Audio Eng. Soc.* 26: 739-771, Oct. 1978.
- 8-2. Sheingold, D. H.: "Analog-Digital Conversion Notes." Analog Devices, Inc., Norwood, Mass., 1977.
- 8-3. Oppenheim, A. V.: *Applications of Digital Signal Processing*. Prentice-Hall, Inc., 1978.
- 8-4. Spitzer, C. F.: "Digital Magnetic Recording of Wideband Analog Signals." *Comput. Design* 12: 83-90, Oct. 1973.
- 8-5. Bennett, W. R.; and Davey, J. R.: *Data Transmission*. McGraw-Hill Book Co., Inc., 1965.

- 8-6. Mallinson, J. C.: "On Extremely High Density Digital Recording." *IEEE Trans. Magn.* **10**: 368-383, June 1974.
- 8-7. Mallinson, J. C.: "Design Philosophy and Feasibility of a 750 Mega-Bit Per Second Magnetic Recorder." *IEEE Trans. Magn.* **14**: 638-642, Sept. 1978.
- 8-8. Mallinson, J. C.: "Trends in High Rate High Density Digital Recording." *Mil. Electron./Countermeasures Mag.*, May 1977.
- 8-9. Spitzer, C. F.; and Jensen, T. A.: "Getting the Most Out of Your Digital Recording System." *Mil. Electron./Countermeasures Mag.*, Sept. 1975.
- 8-10. Castle, C. A.: "High-Density PCM Tape Recording." *IEEE Trans. Instrum. and Meas.* **24**: 266-271, Sept. 1975.
- 8-11. Matick, R.: *Computer: Storage Systems and Technology*. John Wiley & Sons., Inc., 1977.
- 8-12. Mallinson, J. C.; and Miller, J. W.: "On Optimal Codes for Digital Magnetic Recording." Paper presented at meeting, THIC, Jan. 1977.
- 8-13. Spitzer, C. F.; Jensen, T. A.; and Utschig, J. M.: *Study, Tests and Evaluation for Wideband High-Density Data Acquisition (WHIDDA)*. Final Report (Wright-Patterson Air Force Base AFAL-TR-76-115), Ampex, Apr. 1976.
- 8-14. Wells, J. B.: "High Density Magnetic Tape Recording Using Enhanced NRZ Coding." *Proc. HERE Conf. Video and Data Recording*, 1973, pp. 113-118.
- 8-15. Wells, J. B.: "High Density PCM Magnetic Tape Recording." Vol. 9, *Int. Telemetry Conf., Proc.*, Instrum. Soc. Amer., Pittsburgh, 1973, pp. 66-73.
- 8-16. Castle, C. A.; and Stein, J. H.: "Data Randomizing Shrinks HDR Recording Hardware." *Mil. Electron./Countermeasures Mag.* 1977.
- 8-17. Stein, J. H.: "The Sangamo HDR System." Paper presented at meeting, THIC, Jan. 1977.
- 8-18. Breikss, I. P.: "High-Density Data Recording." *IEEE Spectrum* **12**: 58-62, May 1975.
- 8-19. Honeywell: "Error Control in Multitrack Digital Data Systems." Paper presented at meeting, THIC, Nov. 1978.
- 8-20. Lindholm, D. A.: "Power Spectra of Channel Codes for Digital Magnetic Recording." *IEEE Trans. Magn.* **14**(5): 321-323, Sept. 1978.
- 8-21. King, D. A.: "Comparison of PCM Codes for Direct Recording." *Int. Telemetry Conf., Proc.*, Instrum. Soc. Amer., Pittsburgh, 1976, pp. 526-540.
- 8-22. Montgomery, R.: "Non-Optimal Codes for Digital magnetic Recording." Paper presented at meeting, THIC, Mar. 1977.
- 8-23. Davidson, M.: "A Customer Survey of Binary Codes Used in High Density Digital Recording." Paper presented at meeting, THIC, Jan. 1977.
- 8-24. Davidson, M.: "Results of Testing an Error Correction Encoding/Decoding System With a Bell and Howell VR-3700B High Density PCM Tape Recorder/Reproducer." Appl. Phys. Lab. Paper presented at meeting, THIC, Mar. 1977.
- 8-25. *Advanced Modulation and Coding Techniques Applied to High Density Linear Digital Recorders*. Final Report

(U.S. Army Electronics Command, Fort George Meade, Md, Contract DAAB03-75-C-0333), CNR, Inc., Needham Heights, Mass., Apr. 17, 1978.

BIBLIOGRAPHY

HDDR—General

- Hedeman, W.: "Recorder/Reproducer Model With Respect to High Density Digital Recording." Paper presented at meeting, THIC, Apr. 1977.
- Wood, R. W.; and Donaldson, R. W.: "The Helical-Scan Magnetic Tape Recorder as a Digital Communication Channel." *IEEE Trans. Magn.* **15**: 935-943, Mar. 1979.

Digital Recording

- Chu, W. W.: "Computer Simulation of Waveform Distortions in Digital Recordings." *IEEE Trans. Electron. Comput.* **15**: 328-336, June 1966.
- Hoagland, A. S.; and Bacon, G. C.: "High-Density Digital Magnetic Recording Techniques." *Proc. IRE* **49**: 258-267, Jan. 1961.
- Ichiyama, Y.: "Theoretical Analysis of Bit Error Rate Considering Intertrack Crosstalk in Digital Magnetic Recording Equipment." *IEEE Trans. Magn.* **15**: 899-906, Jan. 1979.
- Lindholm, D. A.: "Spacing Losses in Finite Track Width Reproducing Systems." *IEEE Trans. Magn.* **14**: 55-59, Mar. 1978.
- Mallinson, J. C.: "A Unified View of High Density Digital Recording Theory." *IEEE Trans. Magn.* **11**: 1166-1169, Sept. 1975.
- Middleton, B. K.; and Wisely, P. L.: "Pulse Superposition and High-Density Recording." *IEEE Trans. Magn.* **14**: 1043-1050, Sept. 1978.
- Sebestyen, L. G.: *Digital Magnetic Tape Recording for Computer Applications*. Chapman & Hall, Ltd., London, 1973.
- Sierra, H. M.: "Bit Shift and Crowding in Digital Magnetic Recording." *Electro-Technology*, Sept. 1966.

Coding

- Appel, U.; and Trondle, K.: "Comparison of Different Codes for Transmission of Digital Signal [in German]. *Nachrichtentechnische Zeitschrift* **23**(4): 189-196, 1970.
- Bennett, W. R.: "Statistics of Regenerative Digital Transmission." *Bell Syst. Tech. J.* **37**: 1501-1812, 1958.
- Birch, B.: "The Influence of Data Codes on Peak Shift." *IEEE Trans. Magn.* **6**: 603-604, Sept. 1970.
- Brown, D. T.; and Sellers, F. F., Jr.: "Error Correction for IBM 800-Bit-Per-Inch Magnetic Tape." *IBM J. Res. Develop.* **14**: 384-389, July 1970.
- Cullum, C. D.: "Encoding and Signal Processing." *Ann. N.Y. Acad. Sci.* **189**: 52-62, Jan. 3, 1972.
- Davidson, M.; Haase, S. F.; Machamer, J. L.; and Wallman, L. H.: "High Density Magnetic Recording Using Digital Block Codes of Low Disparity." *IEEE Trans. Magn.* **12**: 584-585, Sept. 1976.

- Franaszek, P. A.: "Sequence-State Methods for Run-Length-Limited Coding." *IBM J. Res. Develop.* **14**: 376-383, July 1970.
- Gabot, A.: "Adaptive Coding for Self-Clocking Recording." *IEEE Trans. Electron. Comput.* **16**: 866-868, Dec. 1967.
- Hecht, M.; and Guida, A.: "Delay Modulation." *Proc. IEEE* **57**: 1314-1316, July 1969.
- Hedeman, W. R.: "Baseband Frequency Response Requirements of an NRZ Pulse Train With Periodic Forced Transitions." *Telem. J.*, Aug./Sept. 1968, pp. 30-31.
- Horiguchi, T.; and Morita, K.: "An Optimization of Modulation Codes in Digital Recording." *IEEE Trans. Magn.* **12**: 740-742, Nov. 1976.
- Jacoby, G. V.: "A New Look-Ahead Code for Increased Data Density." *IEEE Trans. Magn.* **13**(5): 1202-1204, Sept. 1977.
- Kiwimagi, R. G.; McDowell, J. A.; and Ottesen, H. H.: "Channel Coding for Digital Recording." *IEEE Trans. Magn.* **10**: 515-518, Sept. 1974.
- Knoll, A. L.: "Spectrum Analysis of Digital Magnetic Recording Waveforms." *IEEE Trans. Electron. Comput.* **16**: 732-743, Dec. 1967.
- Kobayashi, H.: "A Survey of Coding Schemes for Transmission or Recording of Digital Data." *IEEE Trans. Commun. Technol.* **19**: 1087, Dec. 1971.
- Kobayashi, H.; and Tang, D. T.: "Application of Partial-Response Channel Coding to Magnetic Recording Systems." *IBM J. Res. Develop.* **14**: 368-375, July 1970.
- Mark, J. W.: "Relationship Between Source Coding, Channel Coding, and Equalization in Data Transmission." *Proc. IEEE*, Nov. 1973, pp. 1657-1659.
- Patel, A. M.: "Zero-Modulation Encoding in Magnetic Recording." *IBM J. Res. Develop.* **19**: 366-378, July 1975.
- Peterson, W. W.; and Welden, F. J.: *Error Correction Codes*. 2nd ed., MIT Press, 1972.
- Ringkjøb, E. T.: "Achieving a Fast Data Transfer Rate by Optimizing Existing Technology." *Electronics* **40**: 86-91, May 1, 1975.
- Schulze, G. H.: "A Summary of Enhanced NRZ Code Properties." Paper presented at meeting, THIC, Mar. 1977.
- Schwartz, M.: *Information Transmission, Modulation and Noise*. McGraw-Hill Book Co., Inc., 1970.
- Schwartz, M.; and Shaw, L.: *Signal Processing: Discrete Spectral Analysis, Detection, and Estimation*. McGraw-Hill Book Co., Inc. 1975.
- Tang, D. T.: "Run-Length Limited Codes." *IEEE Int. Symp. Inform. Theory*, 1969.
- Tanura, T.; Tsutsumi, M.; Aoi, H.; Matsuishi, H.; Nakagoshi, K.; Kawano, S.; and Makita, M.: "A Coding Method in Digital Magnetic Recording." *IEEE Trans. Magn.* **8**: 612-614, Sept. 1972.
- Tyler, J.: "Basics of Pulse Code Modulation Telemetry." *Telem. J.* **4**: 42-50, Aug./Sept. 1969.
- Bessette, O. E.: "Recent Advances in Magnetic Recording of Digital Data." *Int. Telem. Conf., Proc.*, Instrum. Soc. Amer., Pittsburgh, 1976.
- Bettis, L. W.: "Double Density Airborne Recording." Paper presented at meeting, THIC, Apr. 1978.
- "Design Study for Multi-Channel Tape Recorder System." Design Study Report 9/4/70 to 5/31/71 (NAS5-21511), RCA.
- Griffin, J. S.: "Ultra High Data Rate Digital Recording." RCA, 1977.
- Hinterigger, H.: "High Density Digital Recording for Very Long Base Line Interferometry (VLBI) or Radio Astronomy Haystack." Paper presented at meeting, THIC, Mar. 1977.
- Jensen, T.; and Starkey, M.: "80 MBPS Recording." *Digital Design*, Sept. 1974.
- Meekes, L.: "SEASET Recorder." Paper presented at meeting, THIC, Apr. 1977.

HDDR in Audio

- "Briefs on Digital Audio: Some Notes on Digital Audio Topics—Incremental Floating—Point Coding—A High-Performance Digital Audio Recorder." *J. Audio Eng. Soc.* **26**: 547-562, July/Aug. 1978.
- Burkowitz, P. K.: "User's Notes on Digital Audio Standard Code and Procedures, Operational Requirements." *J. Audio Eng. Soc.* **26**: 242-246, Apr. 1978.
- Doi, T.; Tsuchiya, Y.; and Iga, A.: "On Several Standards for Converting PCM Signals Into Video Signals." *J. Audio Eng. Soc.* **26**: 641-649, Sept. 1978.
- Heaslett, A.: "Some Criteria for the Selection for Sampling Rates in Digital Audio Systems." *J. Audio Eng. Soc.* **26**: 66-70, Jan./Feb. 1978.
- Iwamura, H.; Hayashi, H.; Miyashita, A.; and Anazawa, T.: "Pulse-Code-Modulation Recording System." *J. Audio Eng. Soc.* **21**: 535-541, Sept. 1973.
- Kosaka, M.: "Sampling Frequency Considerations." *J. Audio Eng. Soc.* **26**: 234-240, Apr. 1978.
- Myers, J. P.: "High-Quality Professional Recording Using New Digital Techniques." *J. Audio Eng. Soc.* **20**: 622-628, Oct. 1972.
- Muraoka, T.; Yamada, Y.; and Yamazaki, M.: "Sampling-Frequency Considerations in Digital Audio." *J. Audio Eng. Soc.* **26**: 252-256, Apr. 1978.
- Ranada, D.: "Digital Technology Promises Audio With Unheard-of Quality Levels." *Electron. Design News* Jan. 20, 1979, pp. 39-43.
- Sato, N.: "PCM Recorder—A New Type of Audio Magnetic Tape Recorder." *J. Audio Eng. Soc.* **21**: 542-548, Sept. 1973.
- Tanaka, K.; and Ishida, Y.: "Sampling Frequency Consideration." *J. Audio Eng. Soc.* **26**: 248-250, Apr. 1978.
- Willcocks, M.: "A Review of Digital Audio Techniques." *J. Audio Eng. Soc.* **26**: 56-64, Jan./Feb. 1978.

HDR in Instrumentation

- Bessette, O. F.: "A High Capacity, High Data Rate Instrumentation Tape Recorder System." Vol. 9, *Int. Telemetry Conf., Proc.*, Instrum. Soc. Amer., Pittsburgh, 1973, pp. 74-79.

HDDR in Video

- Busby, E. S., Jr.: "Principles of Digital Television Simplified." *J. Soc. Motion Pict. Telev. Eng.* **84**: 542-545, July 1975.

- Davidoff, F.: "Digital Video Recording for Television Broadcasting." *J. Soc. Motion Pict. Telev. Eng.* **84**: 552-555, July 1975.
- Diermann, J.: "Digital Videotape Recording: An Analysis of Choices." *J. Soc. Motion Pict. Telev. Eng.* **87**: 375-378, June 1978.
- Gallo, L.: "Signal System Design for a Digital Video Recording System." *J. Soc. Motion Pict. Telev. Eng.* **86**: 749-956, Oct. 1977.
- Heynes, G. D.: "Digital Television: A Glossary and Bibliography." *J. Soc. Motion Pict. Telev. Eng.* **86**: 6-9, Jan. 1977.
- Hopkins, R. S., Jr.: "Progress Report on Digital Video Standards." *J. Soc. Motion Pict. Telev. Eng.* **87**: 391-392, June 1978.
- Jensen, T. A.: "Factors in the Choice of Test Patterns Used to Measure Bit Error Rate in High Bit Rate Recording." Ampex Corp., 1977.
- Maegele, M.: "Digital Transmission of Two Television Sound Channels in Horizontal Blanking." *J. Soc. Motion Pict. Telev. Eng.* **84**: 68-70, Feb. 1975.
- Spitzer, C. F.: "Digital Recording of Video Signals up to 50

MHz." *Military Airborne Video Recording: Requirements, Utilization and Techniques, Proc., Sem., Soc. Photo-Opt. Instrum. Eng.*, 1973, pp. 93-99.

- Welch, J. P.: "Digital Clock Recovery Scheme Masks Tape Error." Paper presented at meeting, THIC, Jan. 1977.

HDDR Tapes and Measurements

- Kalil, F.: "Dropout Considerations for SAR-SEASAT Ground Recorders." Paper presented at meeting, THIC, Apr. 1977.
- Montgomery, R.: "Expected Tape Performance for High Density Digital Recording." Paper presented at meeting, THIC, Nov. 1977.
- Snyder, G.: "The Evolution of High Density Digital Tape." Paper presented at meeting, THIC, Jan. 1977.
- Stein, J. H.: "High Density Recording: Facts Relating to Standardization." Paper presented at meeting, THIC, June 1977.
- Waltz, E. L.: "A Serial Signal Simulator/Synchronizer (S4) for True Measurement of HDDR Bit Error Rates." Paper presented at meeting, THIC, June 1978.



CHAPTER 9 *Tradeoffs of Recording Techniques*

M. A. Perry
Ashley Associates Ltd.

There are many factors to be considered when selecting a coding technique. For instance, one is not only concerned with performance but also with the complexity of implementation. This chapter deals with the various tradeoff considerations for recording techniques employed in the late 1970's. The newer recording techniques will be covered in depth in a later publication.

The modern instrumentation recorder, which evolved from the original audio concept of recording signals with a high-frequency bias to obtain a more linear recording characteristic, has become more and more versatile. The user is nowadays faced with the choice of recording data in three forms if it is analog in nature:

- (1) Direct recording with bias (DR)
- (2) Frequency modulation (FM)
- (3) Pulse code modulation (PCM)

In making a choice the user will be concerned with—

- (1) The dynamic range of the system, which is dependent upon the signal to noise ratio in the channel
- (2) Distortions, both harmonic and time base, being introduced by the recording process
- (3) The frequency response of the channel and its phase characteristics

An additional restraint will be the duration of the recording and the number of individual channels of continuous data required to be recorded.

DIRECT RECORDING

The performance of instrumentation recorders using either DR or FM recording is well documented in the literature (ref. 9-1). In summary it may be said that whereas DR gives the maximum frequency response for a given tape speed, it is fundamentally limited in dynamic range and suffers from instantaneous changes in recorded amplitude caused by nonhomogeneity of the tape, asperities, dust particles, or poor tape contact with the head. Furthermore, the long wavelengths of very low frequencies pose problems on replay when the signal induced into the

head, which is responsive to the rate of change of flux, falls below the noise level of the system.

The unequalized response of this basic recording system is shown in figure 9-1 and demonstrates the wavelength sensitivity of this recording method.

FREQUENCY MODULATION

The deficiencies of DR can be removed, only to be replaced by other problems, by encoding the data signal; e.g., using FM techniques.

Here the data signal controls the instantaneous frequency of a voltage-controlled oscillator and, therefore, any amplitude instabilities that result from recording the signal through a DR channel are now less important (fig. 9-2). The data are carried as the timing of the crossovers of the recorded and reproduced signal. Because linearity no longer has any significance, many FM systems use

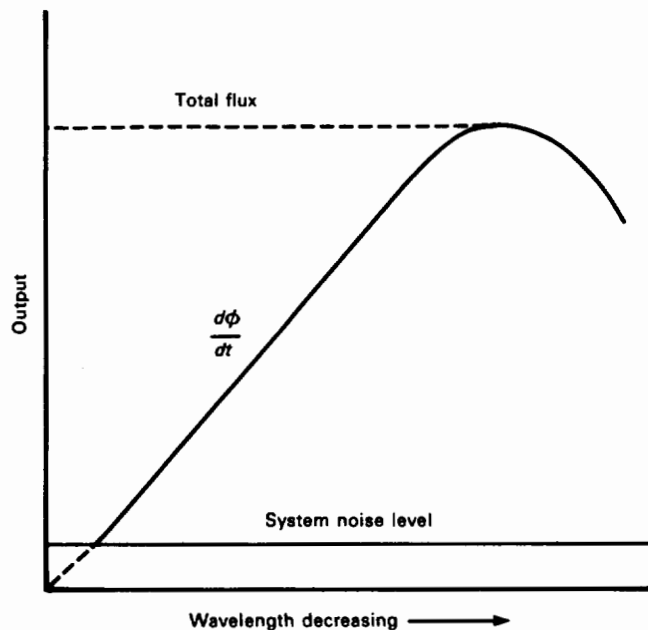

Figure 9-1.—Effect of replay head characteristics.

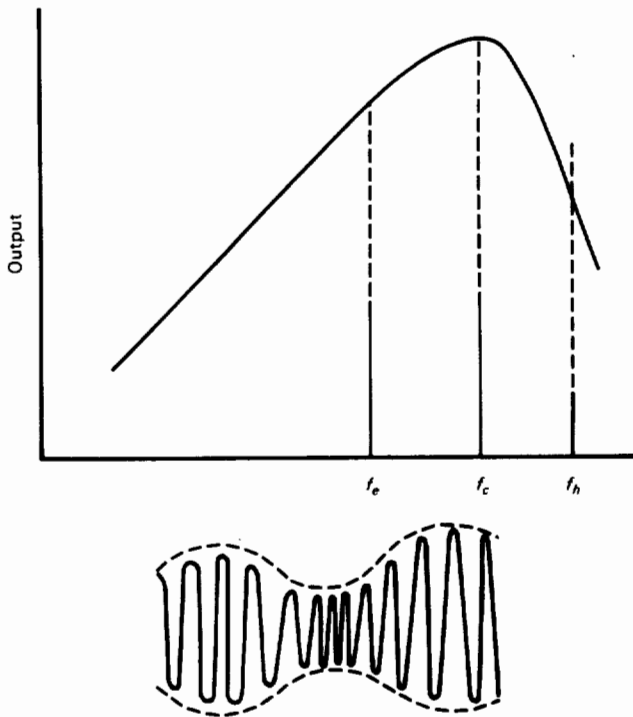

Figure 9-2.—Deviated and undeveloped carrier frequencies for saturation FM recording. (f_c = center frequency; f_e = maximum negative deviation; f_h = maximum positive deviation.)

saturation recording. This considerably simplifies the record circuitry, but makes the performance of mixed DR/FM systems inferior to biased systems because of crosstalk in the reproduce head as a result of higher record currents.

Because the data are now carried in the timing of the crossovers, any speed instabilities in the recording/reproduction process will produce a spurious signal. This signal will affect the amplitude of the replayed data (after demodulation) and will add incoherent noise, thus limiting the signal to noise performance of the channel and make it dependent on the guidance and motion constancy of the tape of the replayed signal.

We have achieved, therefore, the following:

- (1) A response to zero frequency (dc) (carrier undeveloped)
- (2) An amplitude stability in the reproduced waveform (provided the reproduce signal does not drop below the threshold of the discriminator) at the expense of reduced frequency response for a given tape speed (the data signal frequency must always be less than the carrier frequency) and a signal to noise ratio largely dependent on the quality of the tape transport.

Until recently a great deal of effort has been directed toward improving the performance of FM systems because the circuitry for implementing them is comparatively simple. This has been tackled in two ways: first, by

improving the mechanics of the tape transport by attention to such components as bearings, and second, by correcting the reproduce signal for amplitude fluctuation by electronic flutter compensation and for time base error by electronic control of the capstan motor on replay.

Neither technique gives perfect compensation and, of course, each relies on a reference frequency carried on a separate track of the tape recorder. The fact that this track is physically separated from a track that it may be correcting can lead to incoherent correction, which may indeed make the performance worse.¹

We have now reached the point of the very marginal returns for increased costs, and it is for this reason that most instrumentation manufacturers are turning their attention to advanced PCM systems.

PULSE CODE MODULATION

PCM entails sampling the signal and then converting the amplitude of the sample into a binary number, either natural or decimal; passing this signal to an encoder, using a variety of rules to perform the coding; recording the signal, usually by means of saturation signals on the tape; replaying; and decoding.

Decoding may involve reconstructing the replayed signal back to analog form, in which case the intermediate process of digital recording plays the part of storing and reproducing the signal with an accuracy and dynamic range not achievable by the two other techniques. The schematic diagrams of the three encoding methods are shown in figure 9-3 for single-channel operation.

Channel capacity can be increased by multiplexing, and, in the case of FM, by mixing subcarriers (fig. 9-4), or with PCM, because it is a sampling system, by time multiplexing (fig. 9-5).

With PCM systems the process of encoding is often called HDDR, HDR, HBR, and HDRR, all implying high-density digital recording; i.e., recording at longitudinal densities of greater than 10 000 bpi. Throughout this chapter the term HDR which is approved by the Inter-Range Instrumentation Group (IRIG) will be used.

TRADEOFFS

Given that the conventional DR method cannot reproduce dc but FM and PCM can, the true comparison

¹Editor's Note: Some work has been done using time base error correction schemes at the Naval Air Development Center (NADC), Precision Data Inc., and BANCORP Corp. The first two facilities are studying linear interpolation between two servo channels located in the same head stack as the data channel (per Mil Std 1610). The work at the other facility involves recording a tone at band edge in each data channel. Time base error correction is accomplished upon reproducing the data in both schemes, but additional electronics is required. Both methods offer promise of resolving the time base errors associated with analog recording.

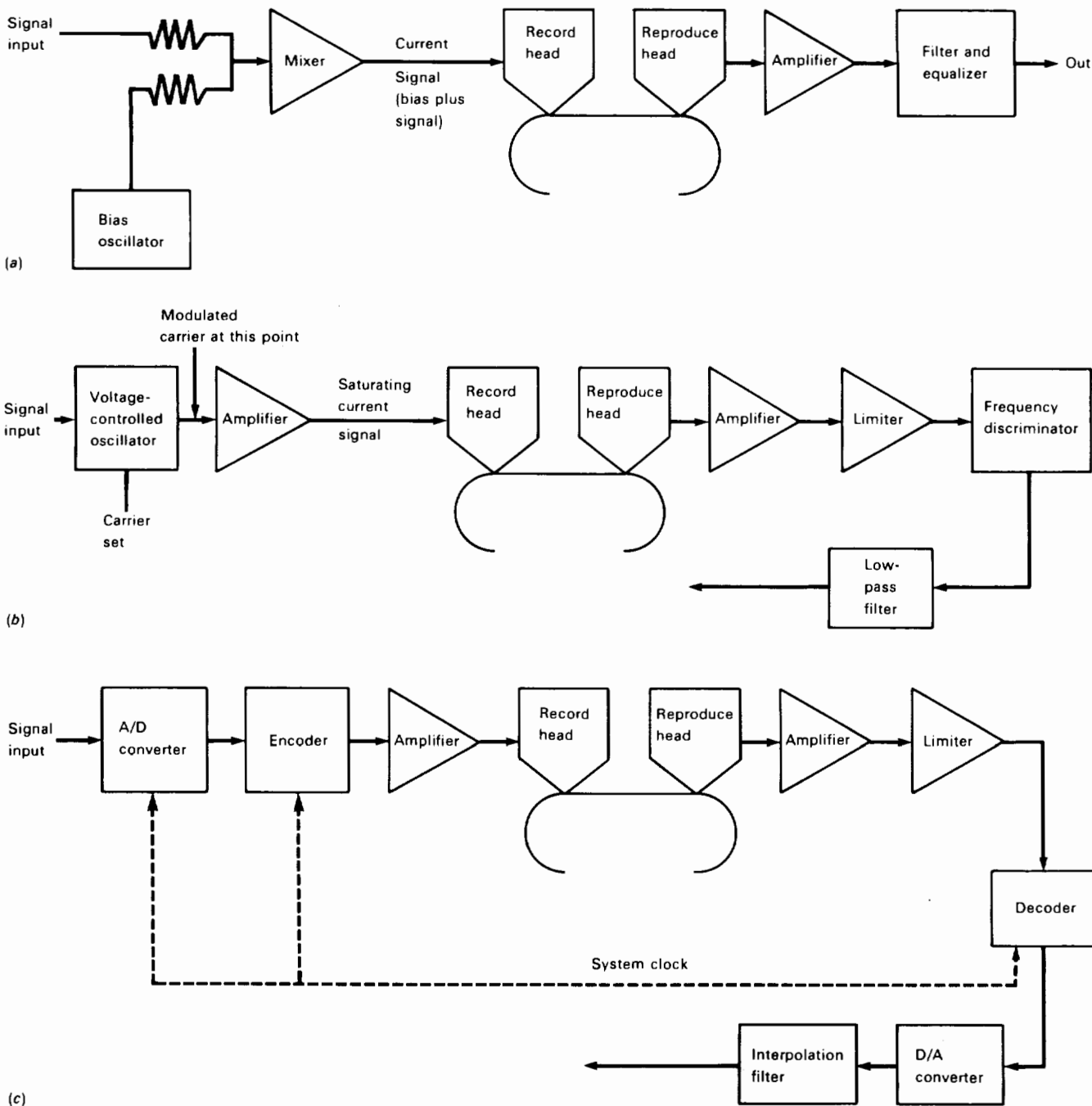

Figure 9-3.—Encoding methods. (a) DR. (b) FM. (c) PCM. (A/D = analog to digital; D/A = digital to analog; clock signal may be carried on separate tape track or interleaved in data signal.)

between the techniques depends on a number of criteria:

- (1) The highest frequency that can be recorded for a given tape speed
- (2) The efficiency of the recording method in terms of tape use per cycle of data recorded
- (3) The dynamic range achievable
- (4) The distortion introduced in the recording process

- (5) The quality of the tape transport mechanism
- (6) The cost of implementation

There are also a number of other minor considerations such as the importance of print through; crosstalk between tracks; and the ease with which bandwidth, signal to noise ratio, and channel capacity can be interchanged.

In ranking the methods, the bandwidth of the recorder

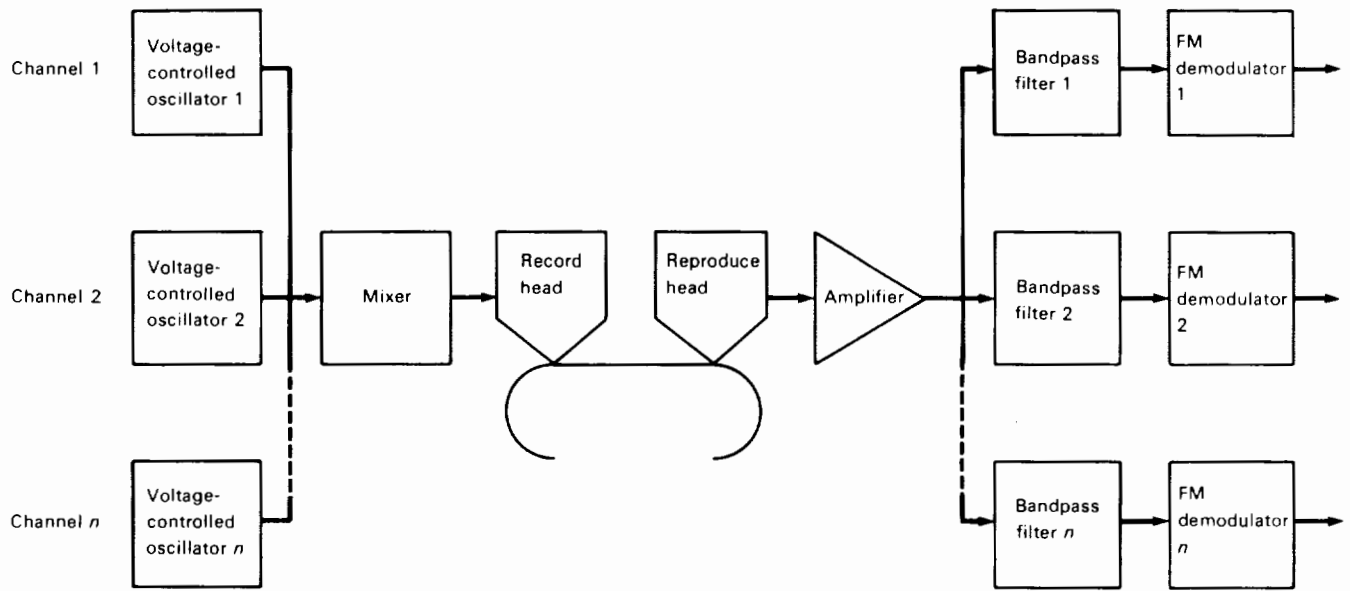

Figure 9-4.—FM multiplex.

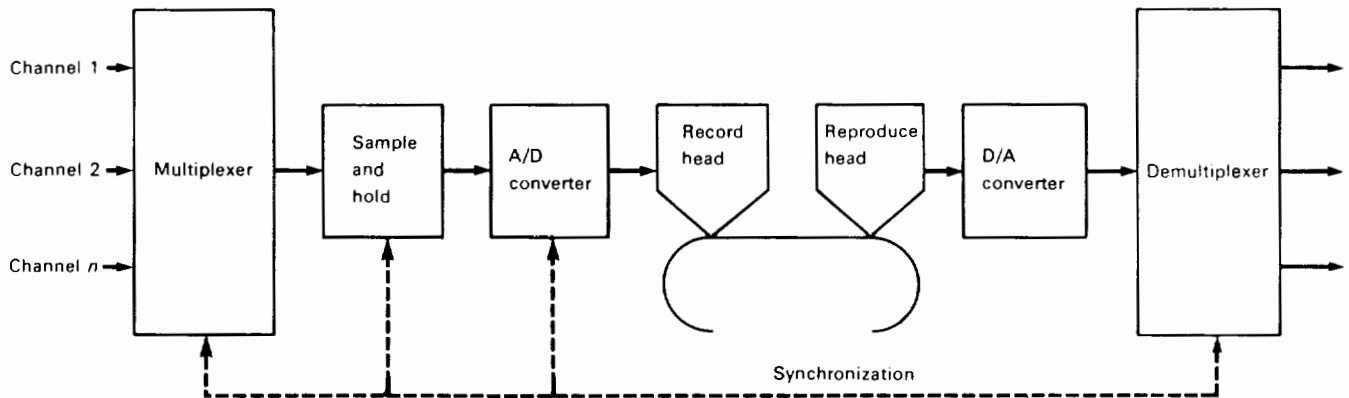

Figure 9-5.—Time multiplex PCM. (Synchronizing signal may be carried on separate tape track or interleaved in data signal.)

for a given tape speed is all important because, together with signal to noise ratio, it is the fundamental parameter upon which to base the comparison, because it represents the information capacity of the channel.

Modern instrumentation recorders have maximum bandwidth defined by the equalized decibel points as set up to the IRIG standards. These are low band, intermediate band, and wide band, corresponding to frequencies of 100 kHz (at 60 in./s) and 600 kHz and 2 MHz at a tape speed of 120 in./s, respectively.

For all practical purposes only intermediate band and wide band are retained today, and these recorders are characterized by the type of record and reproduce heads with which they are fitted. Typically an intermediate-band reproduce head has a reproduce gap of 80 $\mu\text{in.}$ and a wide-band head, 25 $\mu\text{in.}$ A wide-band recorder has a band edge frequency of 2 MHz at 120 in./s and is, therefore, capable of recording $2 \times 10^6/120$ cycles per linear inch of tape

(cpi) per track; i.e., 16 666 cpi. Each sine wave cycle consists of two flux reversals. This can represent two bits of information; therefore, the maximum packing density is 33 000 bpi for a wide-band system.

Of course, this is not the limit of the frequency recording capability, but it serves as a reference for comparing encoding systems, providing it is coupled to the signal to noise ratio achieved in the channel. Our reference point is, therefore, DR, which, for a wide-band machine, achieves a typical signal noise ratio of 25 dB at a maximum linear recording density of 16 666 sine waves per inch (400 Hz to 2 MHz). A comparison of the three recording methods is given in table 9-1.

TAPE USE

HDR comparison of data cycles per linear inch is made by encoding to a resolution that yields approximately the

Table 9-1.—Comparison of 3 Recording Methods

Recording method	Intermediate		Wide band II	
	S/N, dB	Effective sine waves per inch	S/N, dB	Sine waves per inch
DR with bias	40	5000	25	16 600
FM ^a	50	330	35	4 200
HDR.	48	330	30	2 200

^a660 effective sine waves per inch are achievable on type I band recorders designed for wide-band I operation.

same signal to noise ratio. It can be seen that for a track width of 25 mils HDR is much less efficient than DR or FM in its use of the tape based on this simple comparison and, therefore, techniques that can give higher recording densities and allow a greater number of sine waves per inch to be recorded are clearly desirable to make up for the loss in efficiency.

OTHER FACTORS

The deficiencies of DR and FM are inherent in the transport and electronics. In PCM less stringent requirements are placed on the tape transport in some areas.

Moreover, the ability to interchange bandwidth and channel capacities by multiplexing in a PCM system gives this technique extreme flexibility and allows the user to optimize the recording system in a way not achievable using FM and DR.

No matter which system is chosen, faults in the recording process caused by such factors as dirt and asperities, which in turn cause momentary loss of signal, affect the recorded data in different ways according to the encoding technique that has been used.

In DR, total loss of signal simply means the signal level falls to the noise level of the system for the duration of the disturbance. Similarly, for nonhomogeneity of the medium or because of liftoff (separation loss) of the tape, partial disturbances will manifest themselves as amplitude modulations.

In the case of FM, however, amplitude modulation, providing it does not fall below the threshold of the discriminator, will not have any effect. If it does fall below this level, it will be termed a dropout and the effect, depending on the discriminator, could be catastrophic, with a random, full-scale signal probably appearing at the output of the reproduce chain. In FM, therefore, we are concerned not only with the duration of the disturbance but also with its amplitude effect. The random nature of the output with loss of carrier could cause damage to instruments or actuators connected to the output of the

discriminator. Many FM systems are fitted with "squelch." This limits the effect of loss of the FM carrier on the output signal. In general, dropouts are less frequent in FM than in DR, but when they do occur, they are more noticeable.

In the same way, loss of signal in a PCM/HDR system can cause a serious disturbance to the output signal. It will result in a number of bits lost or falsely generated in the decision circuits. These errors are a fundamental measure of the accuracy of the system and are referred to as the bit error rate (BER). How well a digital system performs is expressed as BER, and one bit in error in a million data bits in an HDR system is typical. This, of course, is unacceptable in computing, where considerably lower error rates are required and achieved by using lower packing densities and error correction techniques.

Some years ago intermediate-band recorders (600 kHz at 120 in./s) were only specified as recording 1000 bpi. Now, up to 8000 bpi can be recorded on these recorders, while up to 33 000 bpi can be achieved on wide-band recorders with error rates of 1 in 10^6 under laboratory conditions.

For comparison, one notices that computer tape handlers have only slowly progressed from 200, through 556, 800, 1600, and now 6250 bpi. However, their error rates are reduced to better than 1 in 10^{11} by elaborate error detection and correction techniques using preamble and postamble sequences in the coding method.

Fortunately, because statistical or averaging techniques are used for much scientific and industrial recording, the higher error rates of HDR are acceptable.

In summary HDR with its greater user flexibility has the following qualities and advantages over FM and DR:

(1) The dynamic range is no longer limited by the tape recorder, but more by the problems of high resolution in A/D converters; 80 dB is a practical dynamic range compared with 30 to 50 dB for analog recording.

(2) Timing errors on the tape recorder caused by flutter or skew can be eliminated by retiming on replay using a buffer into which data are placed and then clocked out at a regular rate.

(3) Nonlinear distortion and intermodulation products, due to the tape recorder, are effectively eliminated.

(4) The crosstalk between tracks does not appear to be a real problem, hence more tracks per inch are feasible provided the tape guidance is good enough.

(5) On replay, time base expansion or contraction of the data is possible so that when a computer is used for analysis, the recorder output data rate can be optimized to suit the operating speed of the computer.

(6) Within the overall limit of the maximum bit rate, the dynamic range can be traded for the frequency range of the channel or vice versa.

(7) The use of dedicated PCM amplifiers means that, once set up, the system is reliable and gives repeatable answers to a higher order of accuracy than is achievable with FM or DR methods.

TOWARD THE MAXIMIZATION OF RECORDING EFFICIENCY

Theoretically, if 5000 sine waves per inch can be recorded and reproduced with adequate signal to noise ratio (determined by allowable BER), then because this corresponds to 10 000 flux reversals per inch, a simple NRZ code could be capable of recording 10 000 bpi. In practice, certain deficiencies limit this to about 1.8 times the number of sine waves per inch.

The simple NRZ system suffers from one great disadvantage: if there is a long string of "1" and "0" values (depending on the two alternatives of the code NRZ-L and NRZ-M), then no data transitions occur. There is then a steady flux on the tape and, consequently, a dc component in the wave form. The magnetic tape recorder using biased or unbiased recording cannot reproduce dc because the reproduce head responds to the rate of change of flux, and, therefore, the base line of the wave form shifts. This causes decoding difficulties in the decision circuits unless dc restoration is applied giving baseline correction. A measure of the amount of baseline correction needed by the codes is determined by the amount of dc present or the digital sum variation (DSV) of the code as described by Mallison (ref. 9-2).

The multiplicity of coding techniques adopted by manufacturers has caused interchangeability problems through lack of standardization. Unfortunately, there appears to be little agreement, and comparisons between codes have been argued in some depth (refs. 9-3 to 9-5). There are at least two committees in the United States and two in Europe examining the possibilities of defining a suitable code for standardization. The probability of such an event happening seems to be very low in the short term. In the meantime, a lot of hardware is now in use employing different techniques. Users and manufacturers will be loathe to change. A further complication to standardization is that the methods used for deskewing parallel tracks vary among manufacturers.

In general, coding methods are aimed at—

- (1) Improving the efficiency of the recording method to maximize the number of bits per inch for a specified error rate
- (2) Overcoming the problem of pattern sensitivity because certain streams of digital data produce pattern configurations with high dc contents that, in turn, can produce high error rates
- (3) Minimizing the redundancy in the code for block synchronization, clocking, and deskewing purposes (minimizing "overhead")
- (4) Achieving a low susceptibility to noise and pulse crowding
- (5) Performing encoding and decoding functions at a reasonable cost per channel

To this end a number of codes are suitable and have been

adopted. All codes are usable within their deficiencies and merits, and a comparison is best left to the reading of the various references; however, the next section summarizes the characteristics of these codes.

SUMMARY OF CODE CHARACTERISTICS

Enhanced NRZ (ENRZ)

Run-length-limited NRZ
 High packing density
 Needs a parity bit at regular intervals to be self-clocking and to limit dc content
 Requires dc restoration circuits
 More costly to implement on a per-channel basis than other methods
 Good tolerance to setup procedures

Randomized NRZ (RNRZ)

Run-length-limited NRZ
 High packing density
 Slightly pattern sensitive
 Low "overhead"
 Sensitive to burst errors

Biphase Mark (Bi ϕ M; Manchester Coding)

Simple and reliable
 Requires large bandwidth
 Excellent for high environmental applications
 No dc content or pattern sensitivity

Miller (M; Delay Modulation)

Inexpensive to implement
 Low "overhead" for block marking
 Pattern sensitive
 Lower recording density
 Narrow "eye" diagram
 Sensitive to phase characteristics of channel
 Self-clocking

Miller² (M²)

Removes effects of pattern sensitivity
 Self-clocking
 Similar to M in that it requires 101 sequence to recover from burst error

In general, whereas ENRZ, RNRZ, and M² have found favor in the United States, Europe remains committed, at least in hardware, to Miller.

The practical relative ratios of recording densities that can be achieved are, in general, as follows:

$$NRZ = 1$$

$$M \text{ and } M^2 = 0.75$$

$$Bi\phi M = 0.5$$

At a meeting of the HDR Glossary Committee in 1977, table 9-2 was presented as a response by three American vendors for comparison purposes.

SUMMARY

Clearly the advantages of PCM together with the decreasing cost of large-scale integration to implement the coding and decoding and the wish to produce low-cost tape transport systems means that HDR recording is the way of the future for instrumentation users.

Success will come only, however, by a thorough understanding by the user of the problems in setting up, evaluating, and maintaining HDR systems, a long process of education. Even if the user is unconcerned about the coding technique chosen, much will depend on the house-keeping of the recorder in determining the BER achieved

in practice. It would seem unwise at the moment to expect current systems to achieve packing densities on 25-mil-wide tracks (28-track systems) higher than 33 000 bpi with uncorrected error rates of better than 1 in 10⁶ to 1 in 10⁷.

Standardization and tape interchange remain problems and the more hardware that is produced to different specifications, the more remote is the possibility of reaching an agreement internationally. The controversy that surrounds the choice of coding systems cannot be resolved easily. System behavior to pseudorandom sequences does not reveal some of the deficiencies of coding systems.

Problems will arise as the technique becomes an accepted and standard method for recording on instrumentation recorders alongside FM and DR for general use.

REFERENCES

- 9-1. *Modern Instrumentation Tape Recording*. EMI Technology Inc., 1978.
- 9-2. Mallinson, J. C.; and Miller, J. W.: "On Optimal Codes for Digital Magnetic Recording." Paper presented at meeting, THIC, Jan. 1977.
- 9-3. Stein, J. H.: "High Density Recording—Facts Relating to Standardisation." Paper presented at meeting, THIC, Nov. 15, 1977.

Table 9-2.—Comparison of Codes

Criteria	Vendor response		
	Ampex Miller	Bell & Howell NRZ-E	Sangamo Weston randomized
Effective packing density (serial), kbi	33.3	29.13	33.3
Absolute packing density (serial), kbi	33.3	33.3	33.3
Serial overhead, percent	0	14.3 to 12.5	0
Effective bit rate/bandwidth rate	2	7/4	2
Clock rate, cycles per bit	2 ×	1 ×	1 ×
Minimum transition density (parallel)	1/3	1/14	1/496
Frame length—user bits	480	560	496
Sync word serial (no. of bits)	NA	40	16
Sync word parallel (no. of bits)	32	NA	NA
Sync word overhead (serial)	NA	1/14	1/31
Sync word parallel (additional tracks)	1/13	NA	NA
Total overhead: serial overhead plus sync word	1/13	3/14	1/31
Effective areal packing density, × 10 ⁵	4.3	3.84	4.5
Error rate 10 ⁶ or better?	Yes	Yes	Yes
Encoding clock rate (user clock/system clock)	1	17/14	32/31
Unique sync word?	No	Yes	No
False sync protection?	?	Yes	Yes
Recovery from burst errors (serial without bit slip)	0	0	17
Recovery from burst errors (serial with bit slip)	101 pattern	24	17
Recovery from burst errors (parallel with bit slip)	½ frame	40½ frame	½ frame
System efficiency	13/14	14/17	31/32

NA = not appropriate.

- 9-4. Schulze, G. H.: "Understanding and Specifying High Density Digital Recording Systems." Paper presented at meeting, THIC, Nov. 15, 1977.
- 9-5. King, D. A.: "Comparison of PCM Codes for Direct Recording." Paper presented at meeting, THIC, Apr. 25, 1977.

Introduction to High-Density Digital Recording Systems

M. A. Perry
Ashley Associates Ltd.

SPECIFYING A HIGH-DENSITY DIGITAL RECORDING SYSTEM

The object of any specification is to insure that the system is capable of recording and reproducing reliable analog and/or digital data under the environmental conditions existing during the record and reproduce modes.

The design of the recorder will be conditioned by this environment, especially with regard to tape handling. Accessibility and ease of loading may well have to be traded off against more difficult loading to insure reliable recording in a harsh environment.

High-density digital recording (HDR) places a greater premium on tape handling especially where packing densities are in excess of 10 000 bpi and parallel recording is employed.

Excessive "skew" of the tape will simply compound the difficulties of deskewing the information in the reformatting process.

The fact is that HDR systems require high-quality tape transports, though wow and flutter performance may not be as important as in frequency modulation (FM) systems.

Tape servo, a common feature of instrumentation recorder systems, can also be useful in HDR. The capstan motor can, for example, be made a slave to the incoming clock frequency of the data signal, thus producing constant density recording on the tape and improving tape use.

Above all, flexibility and modularity are required in HDR systems so that the system can be easily configured to suit the incoming data bit rate or the number of individual data channels. As shown in chapter 9, the FM and direct recording (DR) methods of recording data have certain advantages; therefore, it is very likely that any instrumentation recorder converted or specified to have HDR may still be capable of accepting record and reproduce modules using these analog modes for recording. This may be to insure satisfactory recording of other relevant data, such as voice and time code, at the same time as the digital data to facilitate interpreting the events

carried on the digital data stream and to perform first stage editing.

An all-digital recorder is also a possibility, and some machines dedicated to HDR have been produced.

THE NATURE OF THE DATA TO BE RECORDED

In dealing with data from a multitude of sources representing different types of information, the user can be faced with data rates varying from a few bits per second in data logging systems to several hundred megabits per second from satellite telemetry systems. In most cases, the information will be continuous and may or may not contain a periodic synchronization sequence to identify a block or frame of data. This synchronization sequence may appear infrequently or in the limit with every bit transmitted, in which case it represents the clock frequency of the system. The data may appear on one signal line or on a number of lines in parallel with a separate line for the system clock.

Most of the data will be presented in NRZ form, either as NRZ-L, NRZ-M, or NRZS. Long strings of "1" or "0" values represent a period when there is a steady dc level, and, therefore, to make the data acceptable to a tape recorder, an encoder using one of the techniques outlined in chapters 8 and 9 is required.

At this stage a number of questions must be asked:

- (1) Can the bit stream be recorded serially on one track?
- (2) What bit error rate (BER) can be tolerated in the system?
- (3) What degree of bit slip is acceptable?
- (4) How stable is the system clock frequency?
- (5) What duration of recording is required?
- (6) What degree of pattern sensitivity can be tolerated?
- (7) Is parity necessary?

A review of these questions will lead to a definition of the track formatting requirements.

Finally, the overriding question is whether interchange

requirements exist. This is where the current lack of standardization in HDR systems leads to the greatest problem in specifying hardware. Each supplier claims unique advantages for his encoding scheme over others. In general, the main differences are in deskew frame size, deskew synchronization word patterns, packing densities, word parity structure, and encoding method.

It is not surprising, therefore, that at present HDR systems are in a chaotic state and this, in turn, is inhibiting their adoption for general purpose recording.

Any proposed standard should, therefore, aim to specify the following:

- (1) Tape speed and packing densities
- (2) Encoding algorithms
- (3) Record signal level
- (4) Record transfer functions
- (5) Track formats (track width and spacing)
- (6) Deskew synchronization word and frame (block) size
- (7) Word parity format (if used)
- (8) Definition and standardization of performance terms and tests; i.e., bit error rate, pattern sensitivity, bit slip, and dropout susceptibility.

One valuable feature of any system test is the ability to determine how near it is working to the limit of its performance. In simple digital systems the margin between maximum safe level and catastrophic overload is very slim. This can, of course, be disastrous in applications like digital audio recording.

Among the factors to be considered for the encoding would be the following:

- (1) Ability to interchange tapes
- (2) Efficient use of available spectrum
- (3) Susceptibility to tape dropouts, jitter, etc.
- (4) Susceptibility to bit slip and recovery
- (5) Pattern sensitivity
- (6) Maximum packing density
- (7) Hardware complexity and costs

SERIAL OR PARALLEL RECORDING

In many applications such as signal processing satellite telemetry and communications recording, extremely high data rates are required. They may reach 200 to 300 Mb/s.

Most analog instrumentation recorders are longitudinal recording systems conforming to the Inter-Range Instrumentation Group (IRIG) standards. These machines typically contain 14 tracks per inch (TPI) of tape width and offer a bandwidth of 2 MHz record/reproduce using DR at 120 in./s and sometimes 4 MHz at 240 in./s.

Thus even at 240 in./s and with wide-band recording at 33 000 bpi, serial recording capability is limited to around 8 million b/s per track. To record higher bit rates, the

incoming data stream must be "fanned out" over a number of tracks by means of a serial/parallel converter.

For bit rates below 8 Mb/s there is, of course, the tradeoff that occurs if parallel recording is performed, in that a lower linear packing density may be used to improve the integrity of the recording or a greater recording time is possible at the expense of more complexity in the electronics.

With the cost of medium- and large-scale integrated circuits falling to levels that do not inhibit the use of the complex circuits needed for parallel recording, it is necessary to reconsider the benefits that parallel recording can give against system bit error rate, particularly when combined with higher longitudinal packing densities. This combination gives more efficient usage of the area of the tape, that is to say a higher areal density of recording.

IRIG track formats are 14, 28, and 42 TPI width of tape; therefore, the current wide-band instrumentation recorder can accommodate up to $42 \times 33\,000 \times 120 = 166$ Mb/s in a record/reproduce mode. This represents an areal density of 1.83×10^6 b/in.² and is achieved with a track width of 18 mils. One could expect a BER (uncorrected) of between 1 in 10^5 to 1 in 10^6 under favorable conditions with this format.

If IRIG standards are ignored or a different method of recording is used, then higher areal densities may be achieved. The limitations are set by the allowable BER, which depends, among other factors, on the signal-to-noise ratio (SNR) in the channel. SNR, in turn, is dependent primarily upon the physics of the read process because the head senses magnetic flux from a limited volume of tape adjacent to the gap. This volume is proportional to the track width, the reproduce head gap length, and the coating thickness. The head gap length limits the upper frequency response because the wavelength along the tape must not exceed this length. As the wavelength decreases, the penetration into the coating decreases. Thus,

$$\text{SNR} \propto T\lambda^2$$

where T is track width and λ is the wavelength of recording. This leads to the conclusion that halving the track width loses 3 dB in SNR, whereas halving the wavelength loses 6 dB. It is, therefore, much more advantageous to work with a narrower track than to try to decrease the wavelength. Moreover, the areal density A , which is the number of bits per inch times tracks per inch, is given by

$$A \propto \frac{\text{SNR}}{T}$$

In other words, for a given SNR, the narrower the track width, the higher the areal density, as would be expected.

Multitrack systems are to be preferred as against very-high-density recording along one track. There are three ways of increasing the number of tracks or effective tracks per inch:

(1) To depart from IRIG and build heads to a higher track density than 42 TPI—this approach has been adopted by RCA (ref. 10-1)

(2) To use helical scan recording as currently applied to video recording where track widths of 2 to 5 mils are common

(3) To use a combination of multitrack head and helical scan recording (Ampex (ref. 10-2))

One advantage of (2) is that only one channel of electronics is required because it is a serial recording. However, unless precautions are taken, difficulties may be encountered due to head switching transients on conventional video tape recorders (VTR).

Nevertheless, a VTR represents a recorder with an inherent bandwidth capacity of 4 to 15 MHz, giving a potential data rate capacity of some tens of Mb/s and a very good areal density.

By using the technique in (3), 1 Gb/s becomes a practical proposition. It would seem that this is the method most likely to succeed in spite of the fact that some manufacturers are approaching the problem by increasing the number of tracks on longitudinal recorders and simultaneously the width of the tape to obtain megabit data performances.

Two-in.-wide tape versions exist for recording 250-Mb/s, but these machines have as many as 84 to 100 channels of electronics to be set up and are, therefore, relatively cumbersome, expensive, and difficult to maintain.

Even 4-in. tape has been proposed, together with packing densities of 80 000 bpi, but, as will be seen later, the prospect of high-integrity recording at this density remains problematical.

FORMATTING THE INFORMATION

Serial Systems

So far it has been assumed that the nature of the data applied to the recording system is a bit stream that contains only user information.

In practice, the data will often be modified or formatted before recording by adding extra bits for housekeeping; these will be an "overhead" in the system. This overhead can provide synchronization, clock extraction, error correction, and in-parallel systems a means of deskewing. How well a system performs in terms of BER for a given overhead is a measure of its efficiency.

The information may already be formatted. For

example, a telemetry signal will undoubtedly contain a synchronization word to enable a bit synchronizer and demultiplexer to sort out the multiplexed channels.

Contemporary telemetry systems use a synchronizing word that is a pseudorandom pattern of bits between 11 and 32 bits in length. The pattern is chosen so that a majority logic pattern recognizer may be employed to perform a sync strategy, which allows bit errors within sync patterns and requires an accumulation of patterns before the system is said to be in lock.

Such a signal contains all the ingredients for serial recording on magnetic tape with only the need for dc restoration to avoid baseline wandering if it is an NRZ signal. Some telemetry systems are biphase and, therefore, self-clocking with no dc content in the wave form, in which case they are more suited to magnetic recording although at a lower bit packing density than NRZ.

More often than not the original serial bit stream has a bit rate such that either it is too fast to be accommodated on one track (e.g., >4 to 8 Mb/s on current tape recorders) or one is looking for a higher areal density or recording integrity. In either case serial-to-parallel conversion has to be performed to "fan out" the information over several tracks, thus dividing the bit rate by the number of tracks used.

There are, however, adverse tradeoffs. First, more electronic hardware must be employed and, second, precautions must be taken to assemble and reassemble the data, taking into account the deficiencies of the tape recording process when the data are spread over a number of tracks.

Blocking of Continuous Information for Parallel Recording

To reassemble the information and retime because of perturbations introduced by the tape transport, a new framing word or block marker must be introduced into each track of data every few hundred bits of data when parallel recording is used. This will enable the data to be deskewed. The action of deskewing is to remove the timing errors induced by the tape transport, which are due to the dynamic skew of the tape over the heads. In many instrumentation recorders adapted to HDR, the record and reproduce head stacks consist of two interleaved pairs separated by a nominal 1.5 in. Thus there will also be static skew between tracks, particularly when recording on one tape transport and replaying on another. This error can amount to several tens of bits, depending on the packing density.

This frame word or block marker acts as a time reference between tracks and must be available frequently enough to insure the deskew system is kept in synchronization.

There are several ways of inserting this additional word,

most of which add to the overhead of the system (i.e., add bits that contain no data).

Separate Master Channel System

The incoming data stream is fanned out to the required number of channels and typically every 512 bits a framing word is inserted. The data that this word replaces are recorded on a separate track on the tape recorder in parallel (ref. 10-3). In one system one overhead track is used for up to 12 data tracks.

Frame Insertion into Continuous Data

Compressing the incoming data in time by a fixed amount to leave room for a marker or framing word is a common way of inserting a synchronizing word (ref. 10-4). One system takes the input to each track and divides the data into 496 bit blocks. The input clock is increased by the ratio of 32/31. Using the faster clock, 16 extra bits are inserted into the data stream every 512 bits. The resulting 512 bits at the fast rate occupy the same time as the 496 original bits at the input clock rate. The overhead by this method is, therefore, 1/31 or 3.22 percent. The frame word that is inserted is chosen, as far as possible, to avoid being confused with any repetitive patterns in the data. This is, of course, a hazard in such a system.

Code Violation

A very efficient way of introducing a synchronization word is to deliberately violate the encoding rules where the marker is inserted.

In the case of delay modulation, a convenient marker consists of a four-bit sequence, 1001. This would normally be encoded to give three transitions: one in the center of the first and fourth bit periods and one between the second and third periods. This gives a pulse train consisting of two 1½-clock-period spaces. If, however, the central transition between the two zeros is suppressed, the resultant wave form consists of a three-clock-period space, which is not found in normal delay modulation. This is identified in the decoder and used as a marker.

When M² coding is used, the marker must be modified as three-clock-period spaces occur in M², and also the zero dc component must be maintained if the benefits of M² are to be preserved. A suitable marker in this case consists of two consecutive four-clock-period spaces. This requires nine data bits.

DESKEWING

Typical frame or block lengths are 400 to 1000 bits in length; this length is determined by the following factors:

(1) The total skew, both static (tolerance buildup) and dynamic, allowing for tape interchange

(2) The recovery characteristics of the system from burst errors on the tape

(3) Economic considerations of storage in the de-skewer

It has been estimated by Stein (ref. 10-4) that the following tolerance may exist in a practical situation. If the IRIG intergap spacing of 1.5 in. has a tolerance of ± 1 mil on write heads and ± 2 mils on read heads, together with an azimuth tolerance on 1-in.-wide systems of 0.5 mil, the total tolerance is 7 mils. Adding a further 1.25 mils for stress effects, 6.3 mils for humidity, and 1.28 mils for temperature changes, Stein arrives at a total tolerance of 15.83 mils. In a system working at 33 333 bpi this equates to around 500 bits.

Deskewing can be performed by a variety of methods, for example, by whole block storage. Here each block is stored in a memory using the marker/sync word as a reference. Each track has its own store and when the final bit has entered the stack, the readout of the whole parallel block begins. Two storage registers are required per track with this method because the next block will arrive in many cases before readout commences. This technique is sometimes called a "ping pong" buffer (fig. 10-1).

A more elegant method is to use a random access memory (RAM). This memory has to be longer than the maximum expected skew. The channel consists of a frame/marker detector, a counter generating the memory address, and the RAM. When the marker is detected, the counter is reset to zero so that the next data bit is read into address 000 of the memory. This happens on each track although at slightly different times due to the skew. When, one block time later, the system clock reads out the data, the information will be deskewed. The read or write addresses can approach within half of RAM, giving a deskew capability of ± 256 bits with a 512-bit RAM (fig. 10-2).

MEASUREMENT OF PERFORMANCE

At this point it is pertinent to ask two questions of any operating system;

(1) How well is it likely to operate in terms of bit or block error rate?

(2) How near is it to failing to work at the expected performance level? (i.e., what is the safety margin?)

The last question is, perhaps, the most important in implementing an operational system. Most HDR systems need careful attention to setup and good housekeeping if they are to achieve their optimum (predicted) performance.

Channel performance can be investigated by a number of methods. A comprehensive report is given by King (ref. 10-5). The test configuration is shown in figure 10-3. A

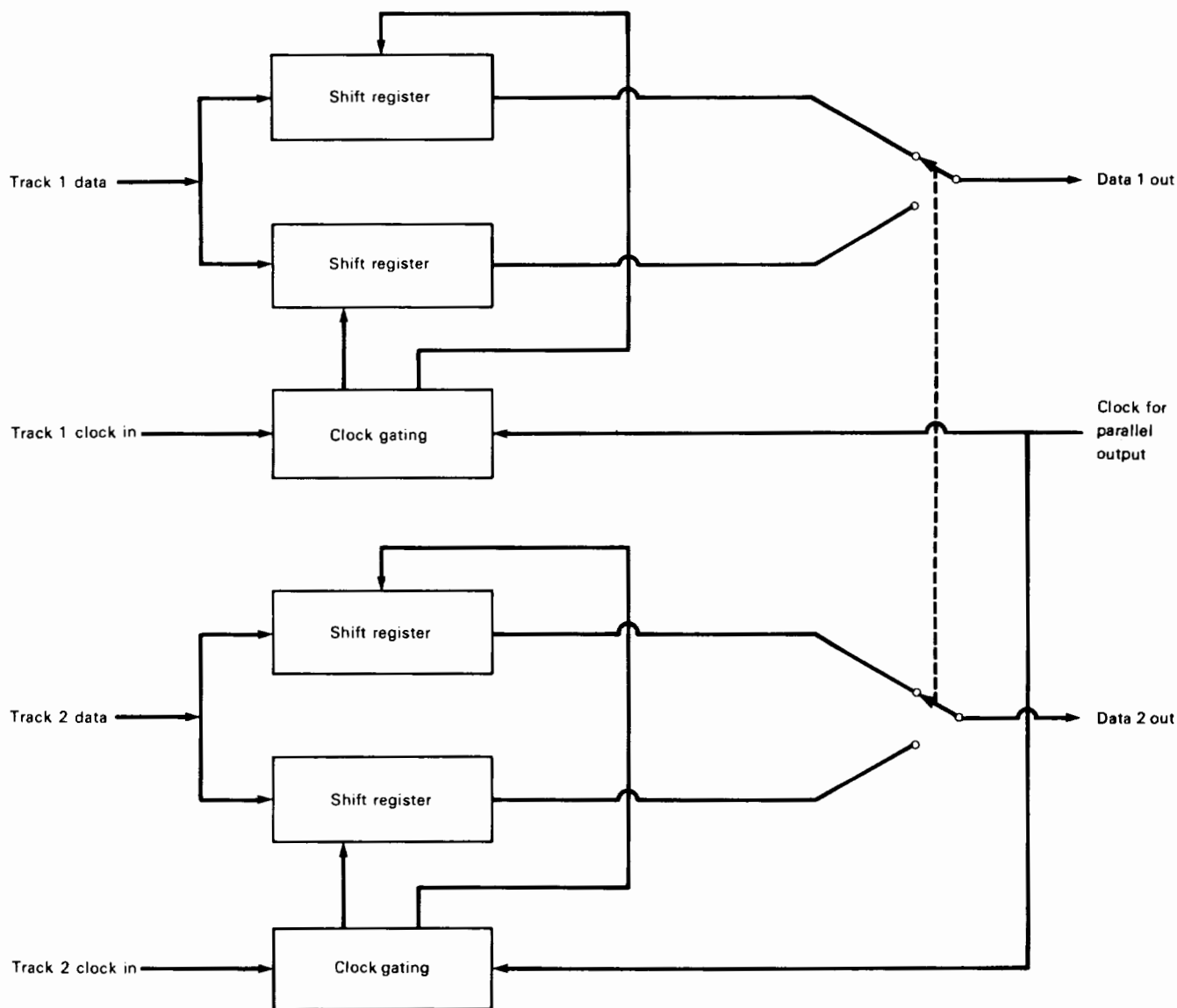

Figure 10-1.—“Ping-pong” buffer.

pseudorandom sequence is used, and this signal is recorded and decoded. Correlation is carried out between the pseudorandom record and the reproduced signal, and errors are detected and counted. The result is quoted as a number of bits in error in a given total number of measured bits and typically results in a number like 1 in 10^6 bits.

Clearly, if the system is working at a high bit rate, 10^6 bits pass through the system very quickly and an updating counter displaying the error will give a frequency measurement. In a slow-speed system it may, of course, take considerable time to clock a million bits. Often block errors are counted on the principle that if there is an error one might as well throw the whole block away.

It can be seen that the interpretation of the error and its impact on the system is very dependent on the use to which

the information is put. If the data are statistical in nature, then it may well not matter if the errors occur in one major burst rather than being spread over a considerable length of tape because signal averaging will ignore this transient disturbance.

Some systems, however, cannot tolerate such error rates and may be very susceptible to burst errors. In this case, methods of error correction or concealment may have to be used.

CHECKING THE QUALITY OF THE CHANNEL

The easiest way to check and adjust a channel is to use the “eye” diagram technique. An oscilloscope display of

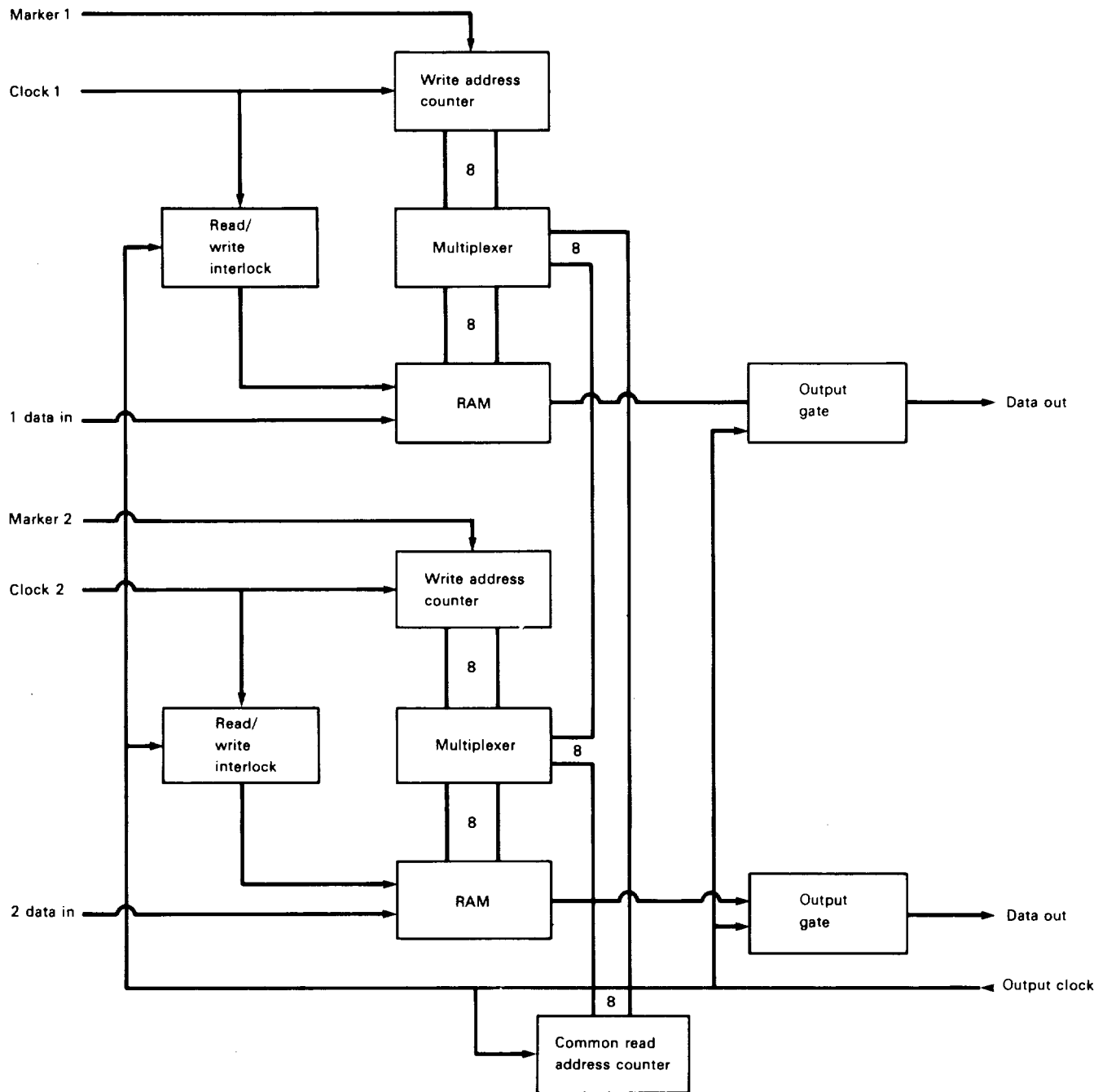

Figure 10-2.—Ram deskewer. ("8" means eight lines rather than two as shown.)

the equalized output of a channel handling a pseudo-random sequence is shown in figure 10-4 for NRZ and figure 10-5 for delay modulation. The time base is run at a submultiple of the clock frequency so that overlapping traces are displayed. The crossovers, representing flux transitions, are the individual bits, and the distance between them corresponds to the time available to make a decision as to whether a transition has taken place in the bit cell period. The overlapping nature of the quasi-sinusoidal signals creates an "eye," and the clarity of that

eye pattern will determine the ease with which decoding will take place. A system of coding that gives an open eye pattern leads to easier and perhaps more reliable detection.

It is for this reason that proponents of run-length-limited NRZ systems claim superiority over systems using $\frac{1}{2}$ -bit periods, such as delay modulation and Miller squared. As can be seen from figures 10-4 and 10-5, delay modulation has twice as many crossing points as a run-length-limited system, and the eye is reduced in width.

What is important is that the margin available for

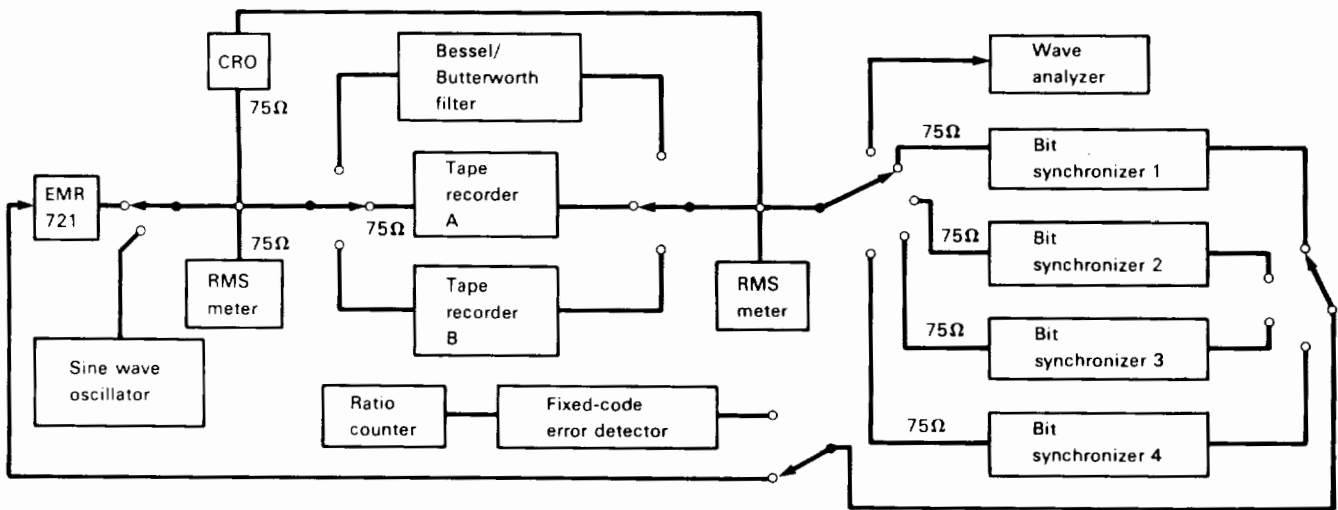

Figure 10-3.—Test configuration (ref. 10-5).

decision detection in a working system is reduced by the effect of tape motion irregularities such as flutter, which tend to close the eye, or channel SNR, which results in a thickening of the trace (fig. 10-6).

A qualitative measurement like this cannot be more than a guide to the operation of the system; however, the oscilloscope trace does have one other advantage in that it

allows the phase and frequency response adjustments in the channel to be optimized for HDR.

Test sets for pulse code modulation (PCM) magnetic recording systems are rare: usually users assemble apparatus designed for communication and telemetry applications. A diagram of a PCM test fixture is shown in Figure 10-7. A test set should produce pseudorandom

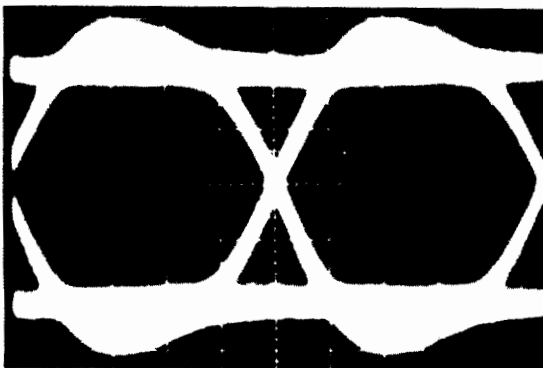

Figure 10-4.—NRZ-L.

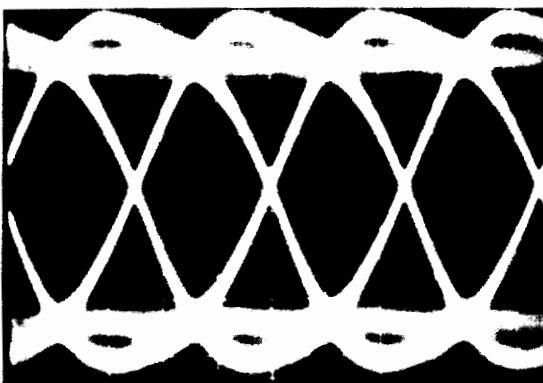

Figure 10-5.—Delay modulation.

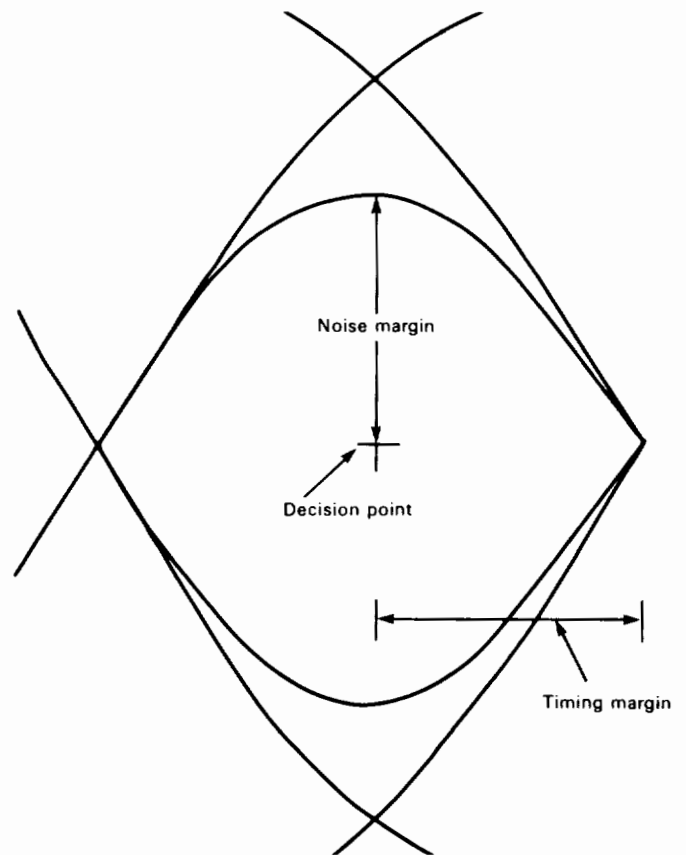

Figure 10-6.—Eye pattern.

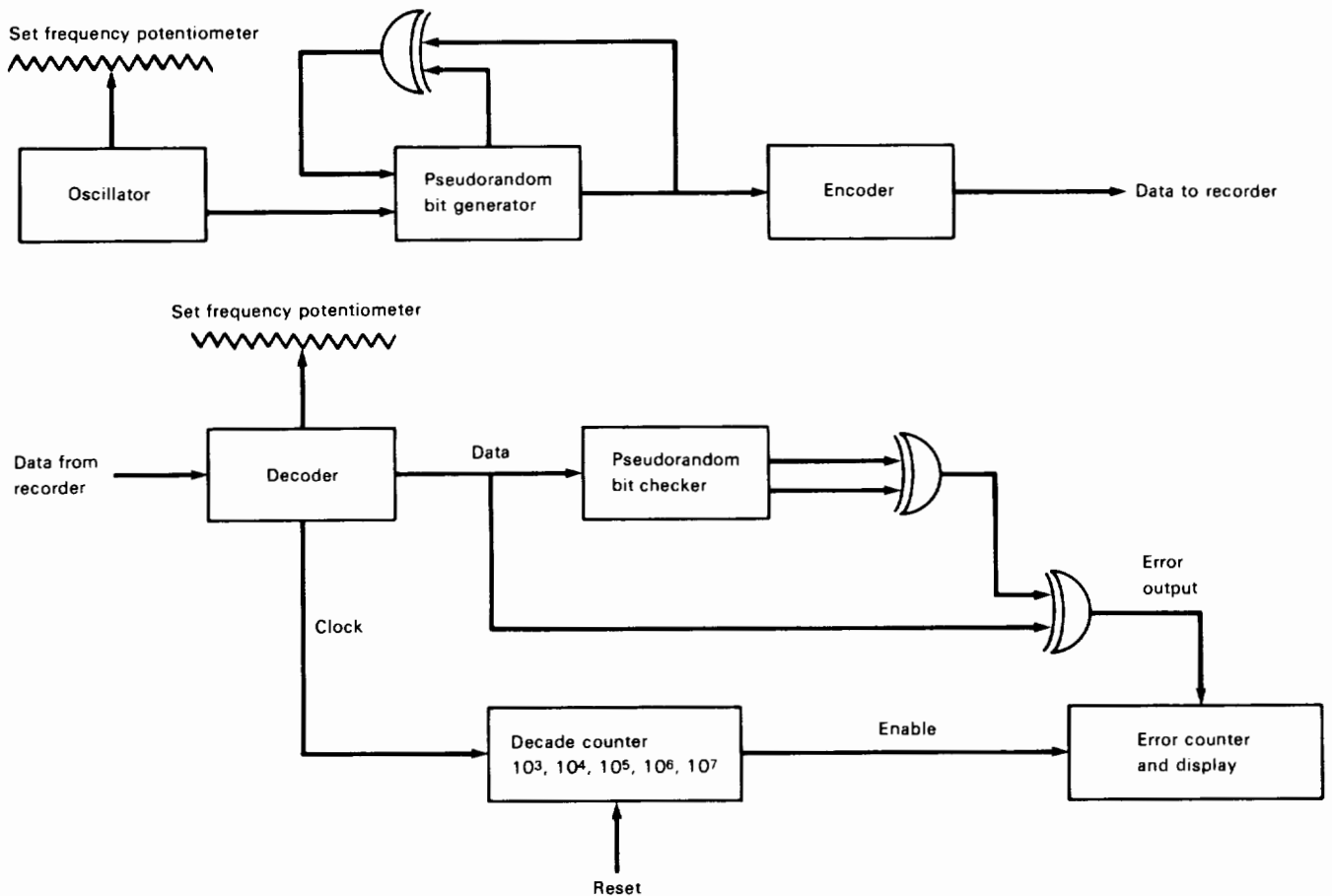

Figure 10-7.—Diagram of PCM test set.

sequences of various lengths, 1023 being typical. Channel quality is assessed by counting the number of bits in error in this sequence when it is recorded and reproduced through the HDR system. The errors in communication are of an impulsive nature and not like those encountered in magnetic recording, which often last for many bits in a burst. For this reason it is often better to have a test set that works in block errors which, due to convenience, is the length of the pseudorandom sequence, and to count any number of errors in a block as a block error. The results obtained in this way can still be expressed as bit error rates by multiplying the block error rate by the block length. This will give the worst-case result as it assumes all bits are in error in the faulty block.

Most HDR systems use a phase-locked oscillator in the bit synchronizer/decoder to recover the clock frequency. The bandwidth of this voltage-controlled oscillator allows the slow speed flutter to be tracked. When the recorder is introduced into the system, these tracking ranges are reduced by various amounts due to noise and flutter in the recorder channels. The range is reduced to zero at the maximum packing density of the system. This reduction of

the tracking range at higher recording densities forms a good method of assessing the channel performance under a given set of conditions (ref. 10-6). This is especially useful for choosing tapes when the "best tape" produces the widest tracking range. This method has certain

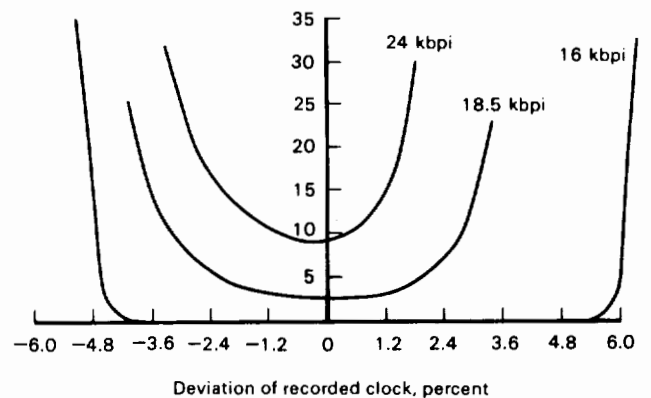

Figure 10-8.—Recovery of clock frequency with Ampex 786 tape. (Error is 10^4 blocks.)

advantages over the alternative method of finding the highest packing density usable for a given tape/system combination. Figure 10-8 shows a typical measurement carried out on a wide-band tape.

TESTING FOR PATTERN SENSITIVITY

Pseudorandom codes will, in all probability, not reveal a system sensitivity to certain data patterns. This sensitivity generally results from the baseline drift caused by the use of codes having a dc component.

Significant spectral energy at low frequency will cause this wander because the DR tape recorder channel has a poor low-frequency performance.

Certain codes restrict this content to a greater or lesser degree, but in some codes (i.e., delay modulation and run-length-limited NRZ), some dc content is still present. Certain bit synchronizers compensate to a greater or lesser degree for this by performing dc restoration; an elaborate circuit will compensate for a peak-to-peak amplitude shift of the wave form at a frequency up to 0.1 percent of the data bit rate. However, this is yet another speed/bit-related piece of circuitry that must have its time constants switched with tape speed/bit rate, therefore complicating the system. Because pseudorandom sequences do not maintain for any reasonable time worst-case patterns, to find pattern sensitivity alternative testing routines must be used. The most common method is to use a ramp sequence. In this test a very slow ramp signal is passed through an A/D converter so that in effect all converter code outputs are inputted to the system under test and remain at steady repeating values for fixed periods of time. It is then necessary to synchronize the playback sequence to look for errors caused by failure of the decoder while handling this selection of code sequences.

QUALITY MEASUREMENT BY PARITY

In a run-length-limited NRZ system, the modification to the incoming NRZ data will be in the form of an extra bit added about every 7 bits. If this bit represents longitudinal parity for these seven data bits, then some measure of quality may be deduced in decoding. One bit in error will flag parity; two bits will not; but a simple quality detector in the form of a flag output or flashing light-emitting diode is all that is required.

This is claimed as one advantage of using a run-length-limited-by-parity system.

Many bit synchronizers have a "lock" indication that is, of course, another indication of data quality.

Such simple visual indications become very important on multitrack systems when the user is confronted with a

rack full of electronics to monitor during the record/reproduce process.

THE NATURE OF ERRORS

Errors in HDR systems are caused by a combination of factors including decoder/bit synchronizer and framing/blocking recovery performance, tape characteristics, machine-induced errors, and coding system parameters. Before examining ways in which error rate performance can be improved, it is probably instructive to examine the likely performance of the systems with respect to dropouts.

A typical bit synchronizer/decoder consists of three parts: a limiter, which converts the equalized output of the channel to a square wave; a phased locked loop, used to reconstruct the clock frequency; and a decoding circuit, which outputs the signal in the desired format, usually NRZ-L.

The limiter is basically an amplifier with high gain and fast recovery time. Its function is to amplify the input signal and clamp it between two levels independent of input level. A good limiter will work over a range of 40 dB at input and will not disturb the crossovers of the wave form. In practice, due to such problems as poor head-to-tape contact and asperities, the signal will fall below the threshold of the limiter. In these circumstances the output will be spurious, and, depending on the rest of the circuitry, wrong decisions on the signal transitions can be made for a length of time corresponding to the time below the threshold. Recovery will again be a complicated process involving the rest of the decoder circuitry, and so the total time of lost signal or spurious output will be greater than the width of the asperity on the tape.

The limiter may also be performing other functions such as dc restoration, all of which will have time constants of recovery.

The effect of dropouts on the decoder depends on the type of code chosen. Randomized NRZ can give rise to an error equal to the randomizer length for each dropout. With enhanced NRZ, if bit slip occurs, then recovery will not take place until word synchronization is established. Similarly, with Miller, synchronization lock problems and the failure to recover until a 101 sequence is established mean that dropouts are elongated and result in a few hundred bits in error.

Regarding frame/marker recovery in parallel systems, if the frame words are not unique, the probability of false occurrence is about $(\frac{1}{2})^n$ where n is the number of bits. For a false frame probability of 10^{-6} , n must be about 20. If an error occurs that causes frame/marker slip, then on the average the errors will be half a frame.

The problem, therefore, is two-fold: (1) to determine the dropout characteristics of the tape in use and (2) to

estimate their effect on the recovery of the system to this input.

TAPE CERTIFIERS AND DROPOUT TESTERS

Tape certifiers and dropout testers are devices designed to provide information about tapes and their likely performance in HDR systems. Attempts have been made to specify a dropout, and for instrumentation recording the IRIG definition is "A dropout is defined as a 6-dB or more fall in signal level for at least 10 μ s for a signal of 1 MHz recorded at 120 in./s."

One dropout is counted for each 10- μ s interval occurring during the duration of the signal loss. The test is made by measurement on the two outside tracks and one center track with track width of 50 mils (14-track recorder). The permitted dropouts are 10 per 100 ft on the center track

and 15 per 100 ft on the two outside tracks. Clearly this would not be good enough for HDR. It is essentially a sine wave test, whereas in HDR the performance of the bit synchronizer is involved as well.

PCM certified tapes often state that a dropout is a 12-dB or greater loss in output of a 1-MHz signal at 120-in./s tape speed for 1 μ s or longer. Each 1- μ s interval of signal loss is counted as a dropout, and only one dropout per 100 ft is permitted per track randomly distributed across the full width of the tape in a 28-track system.

THE DISTRIBUTION OF DROPOUTS AND THE EFFECTS OF TAPE CLEANING

To arrive at a dropout distribution, especially over a large number of tracks, requires special apparatus. Figure 10-9 gives the block diagram of a typical dropout tester.

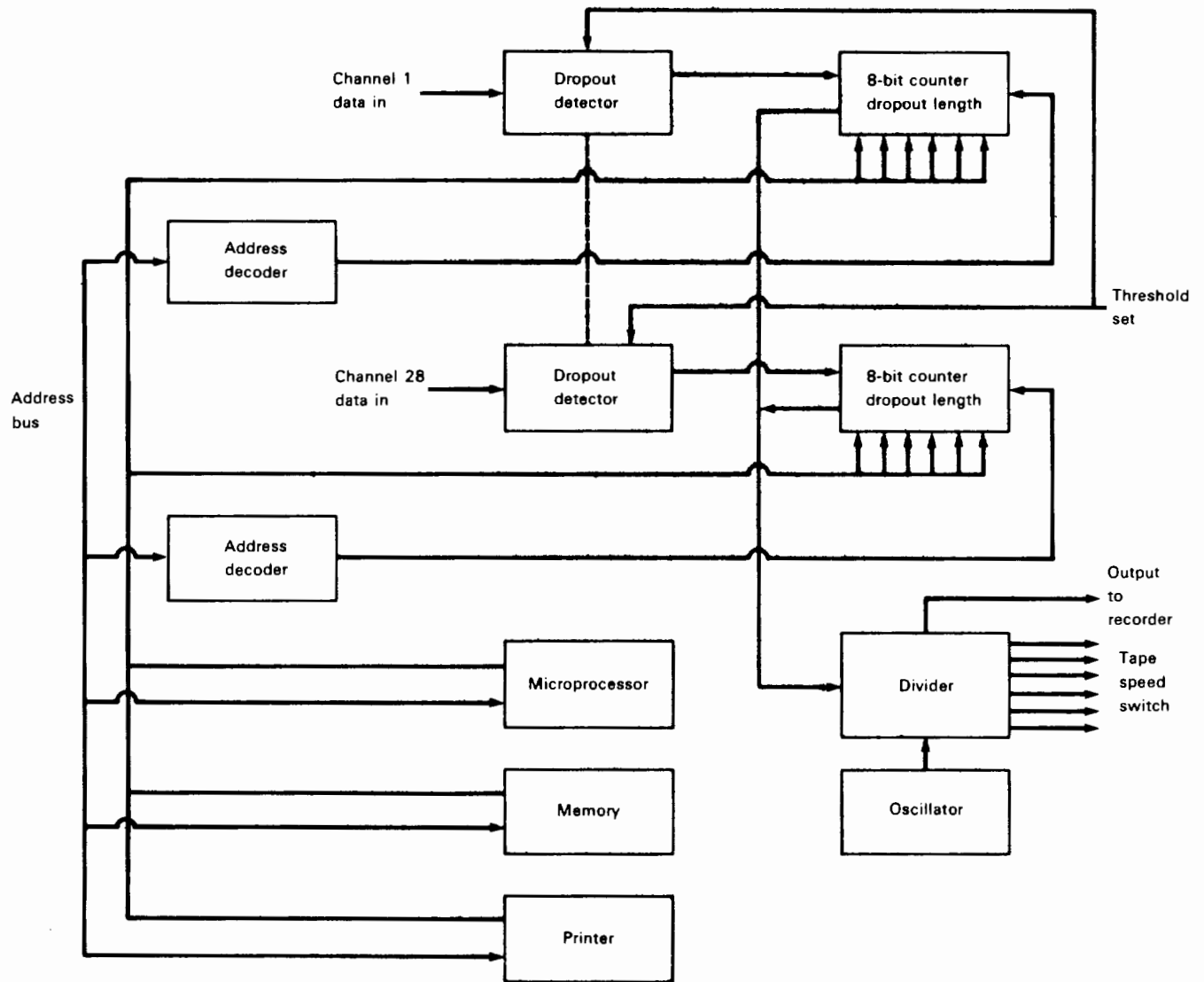

Figure 10-9.—Dropout tester.

Information is collected on the length and position of these dropouts and a printout of the data is given at the end of the run. During the test a preview of the data is available and the whole system is under the control of a microprocessor. Up to 28 tracks may be monitored and the system is flexible enough to adjust the threshold to suit the dropout definition required.

The width of the dropout control is capable of being set at either 1 or 10 cycles of the recorded frequency, and the threshold is set between 6, 9, 12, 15, and 18 dB below a nominal 1 V rms.

The recorded wavelengths are 60, 120, and 300 μ in. For each error event (i.e., the time the signal is below the threshold value) two readings are stored: Dropout length and dropout position. From this information either manually or automatically a graph or histogram is constructed.

Figures 10-10 and 10-11 (ref. 10-7) show the dramatic effect that tape cleaning has upon dropouts. The tape cleaners in use were simple tissue types. Experiments have shown that even unused tapes fresh from the manufacturer can be improved by cleaning.

There are a number of proprietary tape cleaners available, both blade cleaning as well as tissue types. The results given in the two figures were obtained by using a recorder modified to give four tissue wipes on the oxide surface and two tissue wipes on the tape backing for each pass of the tape.

The distribution of dropouts in figure 10-11 shows that a large percent occur in the time period range of 10 to 20 μ s.

Table 10-1 shows a comparison of dropout specifications by two major tape manufacturers against the IRIG specification. There is obviously a lack of standardization, and recent work by Honeywell (ref. 10-8) uses yet another criterion. Honeywell recognizes the nature of the decoder response for testing conditions and makes a nonbiased, 1-MHz square-wave recording, defining a dropout as an interval of 1 μ s or longer during which the reproduced peak-to-peak signal strength falls 16 dB or more below normal full-signal strength. The signal is then said to be recovered at a level of 8 dB below normal signal strength. The settings of -16 and -8 dB were found experimentally to yield consistent results.

Greater decibel reduction settings caused the detector

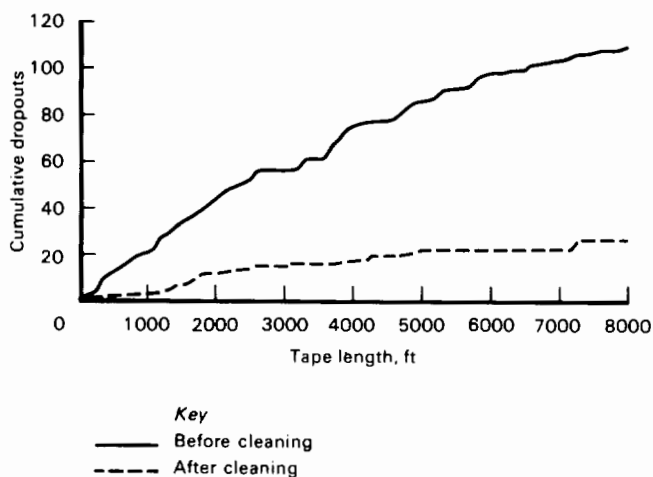

Figure 10-10.—Dropout test on tape (type A) performed at 120 in./s and 1 MHz.

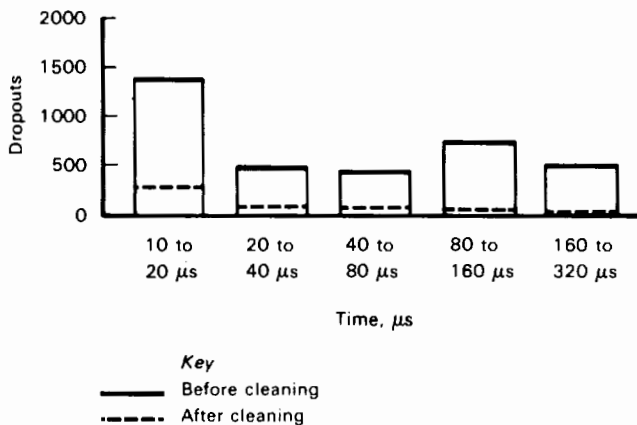

Figure 10-11.—Variations in dropout width from eighteen 8000-ft tapes at 120 in./s and 1 MHz.

to be sensitive to noise, and a longer minimum dropout width setting did not expose the short burst error potential of the tapes.

ERROR DETECTION AND CORRECTION

If error rates better than 1 in 10^6 are required from state-of-the-art HDR systems, then the user must resort to some

Table 10-1.—Comparison of Dropout Specifications

Parameter	IRIG	Ampex	3M
Definition	50 percent signal loss (6 dB); 10- μ s duration	75 percent signal loss (12 dB); 1- μ s duration	75 percent signal loss (12 dB); 0.3- μ s duration
Test frequency	1 MHz at 120 in./s	1 MHz at 120 in./s	2 MHz at 120 in./s
No. of dropouts allowed	Center tracks: 10 per 100 ft Edge tracks: 15 per 100 ft	Less than 1 per 100 ft (average); 14 of 28 tracks tested	Less than 2 in 10^7 bits; 14 of 28 tracks tested
Track width, mils	50	25	25

form of error detection and correction. There is a corresponding premium to be paid in overhead and the cost of additional circuitry.

As mentioned previously, simple longitudinal parity, as introduced by enhanced NRZ systems, can only detect single-bit errors in the word to which it refers. It does not identify which bit is in error and allow it to be corrected. Moreover, two-bit errors in a word go undetected. In any word greater than three bits, longitudinal single-bit parity will detect an odd number of errors and ignore an even number of errors.

Correction techniques employed include the following:

- (1) Longitudinal correction (serial systems)
- (2) Lateral correction (parallel systems)
- (3) Matrix correction (parallel systems)

As an alternative to single-parity schemes, a more complex system may be used such as cyclic redundancy check (CRC or Hamming codes). Here an additional word is added repetitively to the data stream. This word carries a "check sum" that on decoding allows errors in the bits to which it refers to be not only detected but also corrected.

It is a well-known fact that, for a given code rate, the probability of a decoding error can be made arbitrarily small by increasing the error correcting code length. The problem lies in the fact that the dropout distributions have a negative exponential characteristic and the code might have to be made prohibitively long to correct for long dropouts, which occur very infrequently.

We have, therefore, a compromise situation balanced between cost of implementation and desired result. In some applications, such as digital audio, any dropout is unacceptable because it would cause an audible "click." Similarly, a video picture derived from digital information might be unacceptable if it had a spurious black area caused by a dropout in a frame representing a patient's X-ray picture from a computerized axial tomographic (CAT) scanner. In these instances, the tradeoff is to

balance error detection and correction (EDAC) against error concealment. Error concealment might be limiting the rate of change or replacement of a known line in error in a television scan by the average of the two lines on either side, for example. Certainly, a combination of these two techniques often gives an acceptable solution to the problem. A comprehensive review of error correction systems in instrumentation recording is given in reference 10-9.

The remainder of this section describes a typical HDR system employing EDAC, which is capable of improving BER performance to 1 in 10^9 (ref. 10-10). The parallel tracks of data are blocked and checked for longitudinal and lateral parity. The adjacent parallel data tracks are then separated longitudinally along the tape by the use of delay networks (interleavers); the lateral parity information being recorded on a separate track. This lateral parity checking of the data is performed two or more times before the data are recorded. In the reproduce mode, the reproduced data are checked for parity errors stored in memory for eventual identification and correction of bit errors. Following each reproduce parity check, the data are restored one delayed time frame until each track has the same lateral time relationship as the original input data.

The EDAC encoder receives parallel data to be recorded and without modifying it generates the first correction track. Each track of data and the first correction track are then delayed a different amount by means of an interleaver.

From this new staggered format of the data and first correction track, a second correction track is generated. Then, as before, the resulting data and the correction tracks are each delayed by different amounts.

This process is repeated for each correction track generated. Each time an additional correction track is generated, the data plus previous correction tracks are processed through delays of different lengths (fig. 10-12).

The EDAC decoder (fig. 10-13) does two primary

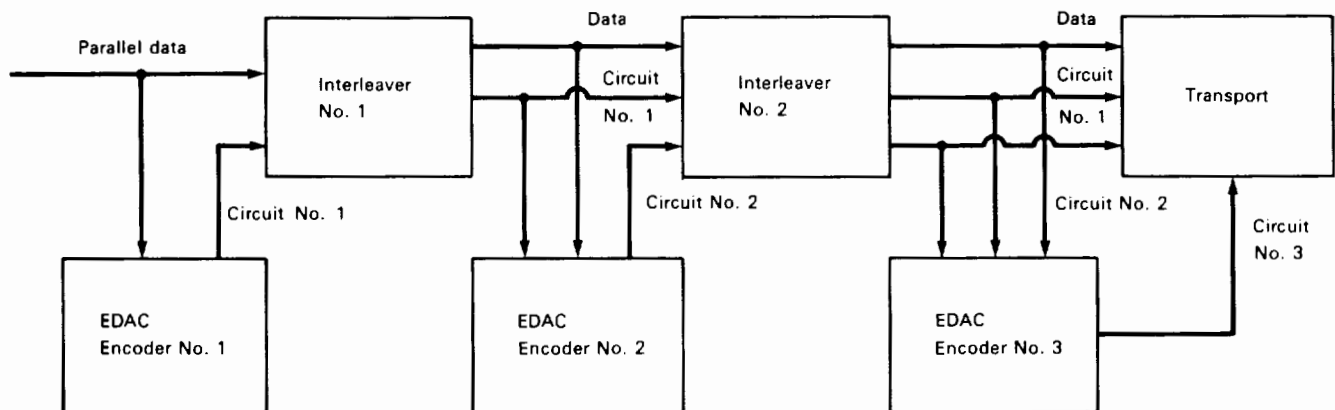

Figure 10-12.—EDAC encoder. (CT = correction track.)

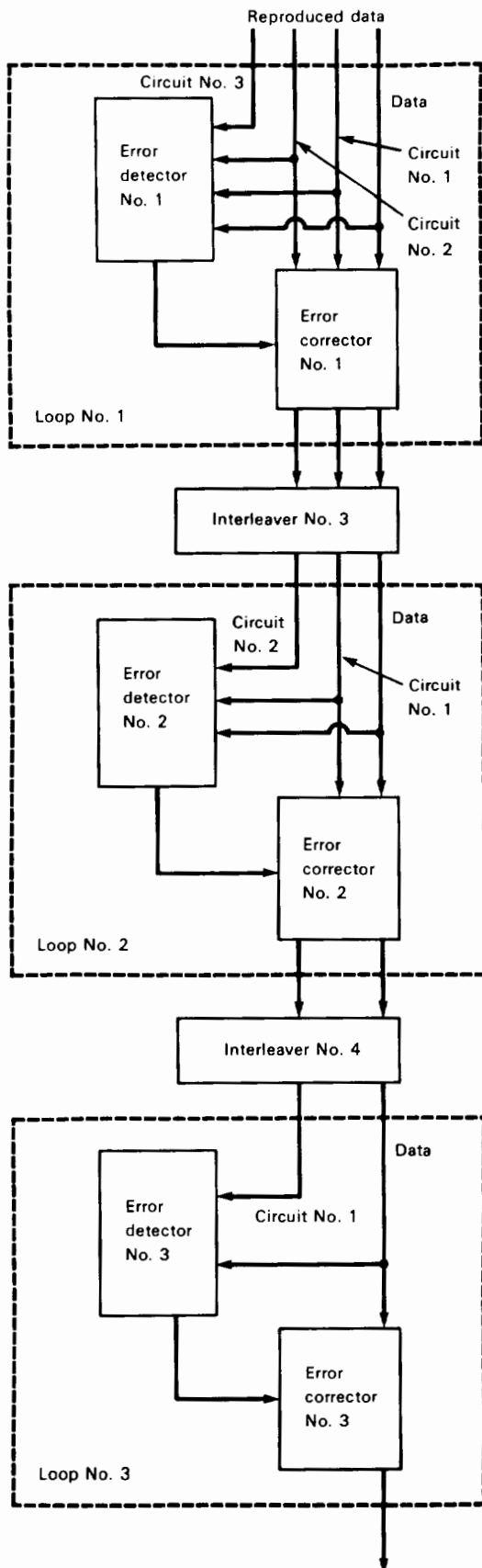

Figure 10-13.—EDAC decoder.

things. First, it senses and corrects the errors in both data and correction tracks, and, second, restores the data to the same format in which it was received by the encoder.

The data are checked in columns and serially for errors upon receipt by the decoder. The results of these tests locate both the tracks and bits that are in error.

The results of the serial checks are stored in a history register, which allows correction of data before and after the recognized errors. If simultaneous errors occur, correction is deferred to the next loop.

The data are then processed through the third interleaver, which does the opposite of the second interleaver in the encoder. The output is then passed along to the next loop for correction.

The second loop has two modes of operation. The first mode is similar to that of the first loop for correction of burst errors. The second mode works in conjunction with the next loop to correct isolated 2-bit errors. The third loop, working in conjunction with the second loop, detects and corrects the presence of the isolated 2-bit errors. The 2-bit errors are corrected by looking for the same unique error pattern in the data after the delay as existed before the delay. This indicates in which track the errors exist so that the proper track and corresponding bits can be corrected.

THE FUTURE

It is clear that analog recording methods are likely to be with us for a considerable time in the general-purpose field, and the pressures toward the use of PCM recording will only be in special spheres. At present a list, by no means comprehensive, of uses for HDR systems reads as follows:

- (1) Satellite imagery systems
- (2) Satellite telemetry systems
- (3) Digital video recorders
- (4) Digital audio recorders
- (5) Infrared line scan recording
- (6) Sonar recording
- (7) Plot extraction radar recording
- (8) Modem recording
- (9) Archival picture recording
- (10) Interferometry recording

The reasons for choosing an HDR system vary from the desire to achieve high SNR, the spectral purity, ability to correct time base errors, the low inherent distortion, the accuracy of time coherence of a number of channels, the lack of print through, ease of copying without degradation of SNR, and the only means of accommodating high megacycle rates on magnetic recorders.

This list is very formidable and one may ask why the demise of the analog recorder has not come about a lot sooner. The answer lies in two areas. So far no recorders

have been made specifically for HDR taking advantage of its characteristics to reduce the costs of the transport and the obvious benefits of cheaper constructional techniques for purely digital hardware, as against wiring analog systems for good values of SNR. Second, there is a whole process of education of the user into handling, house-keeping, and maintenance of a digital system.

The arguments are that it will require less setting up time and be more repeatable, but one must balance against this the problem of diagnosing failure in a complex system. It may be that the microprocessor may help here, not only as a diagnostic tool but also to take advantage of improving the flexibility of a multichannel HDR system.

As discussed in chapter 9, the trend is toward narrower tracks with heads probably based on thin film technology and using modest packing densities on the tape. A further advantage of a low packing density is that an intentional air space between tape and head becomes practical, eliminating head wear and a major source of tape wear. Moreover, the system as a whole is less sensitive to dirt and asperities on the tape.

In multitrack systems there is a corresponding increase in hardware because of the provision of read/write electronics for each channel. The number of channels is, therefore, the major factor controlling the number of adjustments and hence the reliability and costs of the electronics.

Most digital systems need to take advantage of time base expansion to suit computing systems and they must have the ability to change over a 100/1 speed range, preferably continuously.

The normal method is to vary the head-to-tape speed, but this needs an equalizer and filter that is either switched with speed change or is speed conscious.

If a helical scan recorder is used, then it is possible to slow the tape but keep the head-to-tape rotational speed constant. Data are then read out repetitively in blocks and may be loaded into a buffer. Speed changing can then be continuous without change of equalization or low-pass filter. Another advantage of the helical scan approach is

Table 10-2.—*Comparison of Multitrack Longitudinal and Helical Scan Systems*

Parameter	Longitudinal	180° helical
Number of parallel tracks	160	27
Heads per track	1	2
Total number of heads	160	54
Density, kbpj	42	18
Tape speed, in./s.	150	60
Adjustments per track per speed	3	1
Adjustments for 7 speeds	3360	27
Required speed buffer?	No	Yes
Storage on 10 000 ft	8×10^{11}	2×10^{12}

that the start and stop times of the longitudinal recorder are relatively long when conventional instrumentation recorders are used for they do not contain large vacuum buffers and have high-inertia parts.

A multiple-track helical scan can offer instantaneous start and stop. With the tape stationary, one track is read repetitively and a buffer memory loaded. On the command to move, the tape is accelerated to the next track in the time it takes to empty the buffer.

Comparing multitrack longitudinal to multitrack helical (table 10-2) for a 2-in. -wide tape to achieve 1 Gb, it can be seen that several advantages are to be had, not the least being a difference in storage capacity of an order of magnitude. It is probable that this type of recording system (ref. 10-2) may well become an industry standard by dominating the high-megabit rate markets like quadruplex did for analog video tape recorders.

On the general-purpose instrumentation recorder front it will become common to find DR FM and HDR modules available as interchangeable items to suit user configuration, although one must not rule out the possibility of the all-HDR recording system with analog input and possibly analog output.¹

REFERENCES

- 10-1. *Ultra High Rate, 240 Mb/s Magnetic Tape Recorder*. Final Report, NASA contract No. NAS5-20964, RCA Recording Systems, 1978.
- 10-2. Felix, M. O.: "The Next Generation of High Bit Rate Recorders." Paper presented at meeting, THIC, Nov. 1978.
- 10-3. "HBR 3000 System." Ampex.
- 10-4. Stein, J. H.: "The Sangamo HDR System." Paper presented to meeting, THIC, 1977.
- 10-5. King, D.A.: "Comparison of PCM Codes for Direct Recording." Paper presented at meeting, THIC, Apr. 25, 1977.

¹*Editor's Note:* To date neither the Tape Head Interface Committee (THIC) nor the American National Standards Institute (ANSI) has arrived at a consensus on a single recommended standard recording method and format for HDR; instead, six acceptable methods are currently receiving equal consideration by the THIC Users Committee. Although these methods all give an adequate immunity for most purposes to the effects of low-frequency components in high-density digital data as recorded on the tape, their tendency to errors varies depending on a variety of factors. For this and other reasons there is a push to use a standard forward error correction (FEC) method using no more than a just adequate amount of redundancy, which would serve the dual purpose of reducing the dc and low-frequency components in the data to an acceptable level and simultaneously would provide an FEC capability. This approach has the further advantage of increased robustness; i.e., it is more fault-tolerant than an approach that does not use FEC and, therefore, would permit less expensive magnetic tape and/or allow higher bit packing densities. In fact, some of the recording equipment manufacturers have proceeded to develop competing systems using this last approach. These systems have been discussed at THIC meetings and will be the subject of future publication(s).

- 10-6. Vigar, W.: "Assessment of Tapes and Channel Responses for PCM." *Video and Data Recording, Proc.*, Inst. Electron. Radio Eng. (University of Birmingham), 1976.
- 10-7. Blackwell, F.; and Perry, M.A.: "High Density Digital Recording—An Evolving Storage Technology." Paper presented at meeting, THIC, Apr. 25, 1977.
- 10-8. "Tape Drop-Out Distribution Investigation." Preliminary Report to THIC, Honeywell, Sept. 1978.
- 10-9. Montgomery, D.: "Error Control in Multitrack Digital Data Systems." Paper presented at meeting, THIC, Apr. 1978.
- 10-10. White, Less: "Error Detection and Correction (EDAC)." Paper presented at meeting, THIC, April 25, 1978.

The Evolution of High Density Digital Tape

Garry Snyder
Ampex Corp.

This appendix is a summary of the evolution of magnetic tape. It references some of the major Federal specifications for magnetic tape, tape reels, and hubs, including audio, cassette, and instrumentation tapes, and tells where these specifications may be obtained. In addition, it summarizes good practice for the care and handling of magnetic tape, and thus provides a good lead into appendix B, which is a very detailed manual-type reference on the care and handling of magnetic tape and tape recorders.

Magnetic tape recording, as we know it today, was a laboratory curiosity prior to World War II. By the end of the war, state of the art had progressed from steel ribbons and wires to oxide-coated Kraft paper. Faithful reproduction of the human voice was significant but the art did not hold still. Soon oxide-coated films of acetate and polyester appeared. Improvements in recording technology, electronics, and in the important magnetic media led to the faithful reproduction of music; and, finally, even video recording became feasible.

Less glamorous, but no less significant, was the adaptation of magnetic recording to the test and measurement field. A breed of sophisticated machines, known as instrumentation recorders, was developed, and in the process, tape technology was pushed to new levels of performance.

EVOLUTION OF PERFORMANCE STANDARDS

In the very early stages, tape users were satisfied if they could successfully record and play back a signal. Competition for a share of the market forced improvements, but each manufacturer had his own test methods, standards, and point of reference. Major Government users in the instrumentation field wanted consistency of tape media, and interchangeability between user sites was critical.

The Inter-Range Instrumentation Group (IRIG) initiated recording format standards under Document No. IRIG 106 entitled *Telemetry Standards*. The Navy Bureau of Ships initiated the first magnetic tape standards,

identified as MIL-T-21029. NASA issued Specification X-533-63-250. These efforts culminated in the writing of W-T-0070 and the currently used W-T-001553.

Interim Federal Specification W-T-0070 (Navy Ships) was issued in 1963 and consisted of six parts: a general specification that described test methods and five documents detailing specific requirements for various types of tape:

W-T-0070/1	Acetate base audio tape
W-T-0070/2	Polyester base audio tape
W-T-0070/3	Acetate base mid-range instrumentation tape
W-T-0070/4	Polyester base mid-range instrumentation tape
W-T-0070/5	Polyester base wide-band instrumentation tape

This discussion will limit itself to wide-band or high-resolution instrumentation tapes; hence, an examination of the key points of W-T-0070/5 is in order:

- (1) An audio machine, operating at a speed of $7\frac{1}{2}$ in./s, was the standard recorder used for measuring electrical performance.
- (2) The standard reference tape for electrical performance was a $\frac{1}{4}$ -in.-wide, 200-ft-long audio tape. All performance tests were done on $\frac{1}{4}$ -in. tape.
- (3) The shortest wavelength signal examined during performance testing was 750 μ in. (10 kHz).
- (4) Dropout testing was done on a Mincom CM-100 at 60 in./s using a 70-kHz (≈ 850 - μ in. wavelength) signal. Two edge tracks and one center track were measured. A dropout was defined as a 60-percent loss of signal for 40 μ s or longer. A total of three dropouts per 100 ft of tape was allowed on each track.
- (5) A statement at the end of the document was the only concession to true wide-band performance: "This type of tape should provide satisfactory performance on instrumentation recorder-reproducers which have the capability of recording frequencies up to 1 megacycle or 1.5 megacycles."

Today we recognize W-T-0070 as being wholly inadequate for high-resolution tape. When issued, this set of specifications succeeded in establishing industrywide standards of minimum acceptable performance and was key in facilitating ease of tape interchange. W-T-0070 remained a stabilizing influence until 1970 when Interim Federal Specification W-T-001553 (General Services Administration, Federal Supply Service (GSA-FSS)) was introduced.

The most significant change brought about by W-T-001553 was that performance was to be measured on a wide-band recorder under wide-band conditions. A tolerance was given for 2-MHz response. Abrasivity of tape was specified for the first time. Significant improvement was made in the dropout specification.

Here are the details of the more salient points of W-T-001553, again with emphasis on wide-band products:

(1) Only one document is used to specify both mid-range and wide-band tapes.

(2) Testing is done on equipment befitting the end use of the tape. Mid-range testing is accomplished on an Ampex FR-600; wide-band testing is done on a Mincom model 30. Equivalent systems may be used.

(3) Wide-band testing is done at 120 in./s. Wavelength response to 60 μ in. (2 MHz) is specified with a ± 2 dB tolerance.

(4) Performance is referenced to a representative center-line tape supplied by the manufacturer during qualification testing. Thus, the built-in limitation of an audio reference tape is eliminated. W-T-001553 becomes suitable for all types of instrumentation tape from conventional gamma oxide types to the latest in high-energy products. Although this may contribute to some tape interchange problems, the tape manufacturing industry is given the necessary freedom to create next generation products.

(5) Tape abrasivity is measured in terms of brass shim wear. Arguments can and do arise over how direct a relationship exists between brass shim wear and true head wear, but, nonetheless, some limit is established as to just how abrasive a tape may be.

(6) Oxide surface resistivity requirements are improved from 5×10^8 (W-T-0070) to 1×10^8 Ω/cm^2 . This translates itself directly into fewer static electricity problems and improved dropout performance.

(7) Dropout requirements are tightened dramatically.

A dropout is defined as a 50-percent or greater loss in amplitude of a 1-MHz (120- μ in. wavelength) signal for 10 μ s. A dropout is counted for each 10- μ s interval occurring during the duration of the signal loss. Thus, a 50-percent loss of signal for 40 μ s counts as four dropouts. The test is run at 120 in./s, and measurement is done on the two outside tracks and one center track.

Two classes of wide-band tape are established by W-T-001553 (table A-1), the major difference being dropout activity.

To GSA's credit, W-T-001553 pushed the state of the art and continues to be the industry standard satisfying the vast majority of requirements. The magnetic recording industry, however, has systems and tape requirements that already far surpass the demands of W-T-001553, especially in the area of high density digital recording.

FEDERAL SPECIFICATIONS

The following are the presently more widely used Federal specifications, which were developed by the General Services Administration, Federal Supply Services, Office of Standards and Quality Control, Washington, D.C., 20406. These specifications may be obtained from that address:

W-C-1684	Cassettes, Magnetic Tape, Audio Recording (Twin Hub, Coplanar)
W-T-0051C	Tape, Electronic Data Processing, 1/2", Magnetic Oxide-Coated
W-T-001553	Tape, Recording, Instrumentation, Magnetic Oxide-Coated
W-R-175C/ GEN	Reels and Hubs for Magnetic Recording Tape—General Specification for
W-R-175/1C	Reels, Plastic and Fiberglass With 5/16" Center Hole
W-R-175/2C	Reel Hubs, Fiberglass and Metallic, With 3" Center Hole
W-R-175/3C	Reels, Plastic, Fiberglass, Metallic, and Metallic Flange Phenolic Hub, With 3" Center Hole
W-R-175/4C	Reels, Precision, Aluminum, With 3" Center Hole
W-R-175/6-T (GSA-FSS)	Reels, Precision, Glass Flange With Aluminum Hub, 3" Center Hole

EVOLUTION OF TAPE MEDIA

Early magnetic tapes were all essentially designed for audio use. The end application might differ but basically the same formulation and base material were used. In the 1950's and 1960's, both cellulose acetate and polyester were used as base films. Today, almost all precision tape is coated on polyester. A few specialized, high-temperature applications will require a polyimide film, but by and large

Table A-1.—Dropouts per Hundred Feet

Class	Center tracks	Edge tracks
Class E1	15	40
Class E2	10	15

all video, audio mastering, computer, and instrumentation tapes are coated on polyester. In the United States there are four principal suppliers of magnetic tape quality polyester: Dupont (Mylar), Celanese (Celanar), ICI (Melinex), and 3M (Scotchpar).

The binder or glue that holds the magnetic oxides in place and fixes them to the base film has also seen notable improvement. Actually this is more than just a glue, for the binder contains lubricants, fungicides, plasticizers, anti-static agents, dispersants, and wetting agents. Binders are the determining factor for such key parameters as durability, environmental stability, oxide shed, and head clogging. Two principal forms of binders are used: thermoplastic and thermoset. Thermoplastics may be softened by heat and usually are easily attacked by solvents. Thermoset binders are characterized by a curing process. Once curing is complete, a thermoset binder is generally heat and solvent resistant. However, various degrees of thermosetting or crosslinking gives properties similar to a thermoplastic. Today, most precision tapes are of a thermoset formulation. Balancing all the desirable properties of binders with suitable oxides forms the art and science of producing magnetic tape.

Oxides are the key element in a magnetic tape. Each particle must be uniform in shape, size, and magnetic properties. An ideal oxide particle is pencil shaped, is about 5 to 40 $\mu\text{in.}$ long, and has a length-to-width ratio varying from about 4:1 to 10:1. Suitable magnetic oxides are not found free in nature, and magnetic rust—or gamma ferric oxide—must be carefully synthesized by the chemist. End use determines the desired properties of the final oxide particle. Broadly speaking, large particles are used for long-wavelength signals and short particles for high-frequency work. However, particle size is also a factor in tape noise and crosstalk and shows its influence on such things as shed and abrasivity. As with binders, the manufacturer must make certain compromises in selecting an oxide particle to provide a suitable finished tape for a particular end use.

Although gamma ferric oxides have by no means reached their final level of development, another form of magnetic particle is with us today. High-energy tapes hold forth the promise of improved dynamic range and shorter wavelength recording potential. Conventional gamma ferric oxide tapes are characterized by a coercivity of 350 Oe or less. High-energy tapes run the gamut from 325 to 1000 Oe or more. Coercivity is a measure of the force required to record or erase a signal on a magnetic particle and is only one of many magnetic particle parameters.

Two types of high-energy particle are predominant: chromium dioxide and cobalt-doped gamma ferric oxide. As a rule, record and bias current drive must be increased when using high-energy tapes. Full advantage is not achieved unless equalization is optimized. A good many

systems still in use today are incapable of using high-energy tape without modification to the drive and equalization circuitry, and if the tape coercivity is great enough, problems may be encountered in erasing a high-energy tape. However, most, if not all, state-of-the-art recording systems being offered today by recorder manufacturers have been designed with operating room to accommodate these high-energy tapes.

HIGH DENSITY DIGITAL RECORDING—A NEW LEVEL OF PERFORMANCE

Today's instrumentation jargon has shifted to terms such as 30 000 bpi, and a bit error reliability of 10^{-6} . There is a dramatic change taking place in instrumentation recording technology. The high-density digital recorder has come of age. These state-of-the-art recorder systems place the toughest performance requirements ever to be asked of magnetic tape.

The 14-track 2-MHz analog recorder uses 50-mil-track-width heads. The high-density digital recorder demands greater use of tape surface area, forcing track widths of 25 mils for 28-track heads and 15 to 18 mils for 42-track head configurations.

The spectral density of the digital signal is such that the recorded signal relies extensively on the upper frequency limit of the system. Dynamic range and signal-to-noise ratio at these very short wavelengths are a must for a successful error-free reproduction. Dynamic skew, as a function of tape handling, has great significance in final system performance. Tape manufacturers have gone to the use of finely textured, highly conductive, carbon-based back-coating to improve tape performance:

- (1) Back-coating minimizes static electricity problems. The conductive surface minimizes the attraction of airborne debris. Hence, fewer dropouts are present.
- (2) The textured surface of back-coating provides a controlled coefficient of friction. Tape winding and handling characteristics are enhanced. Improved tape packing results, and there is less opportunity for pack slippage or cinching during shipping or environmental changes.
- (3) Abrasion resistance of the back-coating is superior to that of the polyester base. Fewer wear products are generated, and there is less opportunity for damage to the oxide surface from loose debris. This clean running characteristic manifests itself as improved dropout performance.

Cleanliness and tape handling are, by far, the most important factors affecting reliable performance. Even though the highest quality oxides, polyester backing, and thermoset binders are used in high-density digital tapes, all is lost if the utmost care is not practiced in handling magnetic tape.

CARE AND USE OF MAGNETIC TAPE

Proper care and storage of any magnetic tape can be summed up with two simple statements:

- (1) Keep it clean.
- (2) Keep it comfortable.

Tape does not wear out magnetically. Oxide particles do not become senile or impotent. In almost all cases, excessive tape wear, tape damage, or dropout buildup can be traced to improper handling. True, older thermoplastic tapes of early 1960's vintage could suffer from brittleness due to a drying out of the binder, but today's tapes are essentially free from this problem except under very extreme circumstances.

The first 3 to 4 passes of a new tape generate the most debris on a machine. This debris comes primarily from the tape edges and is normally so slight as to be of no consequence, but this does serve to emphasize the need to clean the entire tape path after each pass in critical applications. Loose debris will find its way into the tape pack where it may manifest itself as dropouts, signal instability, increased head wear, and the self-generation of more debris through abrasive action on the tape surface. Contamination and debris may be minimized by following some simple rules:

- (1) Cut off any damaged tape ends.
- (2) Avoid smoking or eating in the vicinity of a machine used in critical data gathering.
- (3) Clean the entire tape path after each pass.
- (4) Avoid the use of adhesives or masking tape to hold the end of the tape in place. These glues tend to work their way into the tape path, where they firmly hold any loose debris.
- (5) Store tape in dust-proof containers. Return the reel to its original box after use. With glass flange reels, be sure to reinstall the reel band.

Keeping tape comfortable is relatively simple if you remember that magnetic tape likes people conditions. Just as most people enjoy a temperature of 70° F and a humidity of 40 percent, tape also works best in this environment. Ideally, tape should be used and stored in a temperature range of 60° to 80° F and a humidity range of 30 to 40 percent. Tape can be, and is, used and stored in conditions vastly different from the ideal, but the degree of risk in damaging the tape increases with the variance from ideal. High operating temperature may weaken the tensile properties of the film, resulting in stretching or edge damage. Low temperature may make the tape brittle and

lead to possible tracking problems or loss of head-to-tape contact. High relative humidity has a direct and adverse effect on head wear. Other problems that may be encountered include sticktion and head clog. Low operating humidity favors shed, smearing of the head gaps, and, again, tape sticktion. It is possible that no deleterious effects will result from operating at environmental extremes, but the degree of risk does increase.

Tape stored or used at environmental extremes should be permitted 8 h or more to become acclimatized to the nonideal conditions. Gradual changes are less severe than abrupt changes. As the tape expands and contracts due to environment changes, tremendous pressure changes occur within the constrained reel pack. These changes result in wrinkling, spoking, and cinching. The coefficients of thermal and hygroscopic expansion are both on the order of 10^{-5} in./in. per degree Fahrenheit or percent relative humidity. A 20° change in temperature in a typical 9200-ft length of instrumentation tape means a change in length of almost 22 in. However, tape also changes in thickness. It is these changes in length and thickness that can produce sufficient pressure to shatter a plastic audio reel hub. The following is a guide for keeping tape comfortable:

- (1) Do try to maintain "people" conditions: 70° F and 40 percent relative humidity are ideal.
- (2) Do try to avoid abrupt changes in environment. Allow at least 8 h for the tape to condition itself to a given environment.
- (3) Always handle a tape reel by the hub, not by the flanges. Squeezing the flanges together leads to tape edge damage.
- (4) Do not handle the tape any more than necessary. Fingerprints and dry skin scales lead to dropouts.
- (5) Do replace bent or nicked reel flanges. This type of easily corrected defect leads to raised or bent tape edges with consequent poor tracking and permanently deformed tape. Glass flange reels are the near ideal tape container and holder. If both flanges are physically there, the reel is in specification.
- (6) Always store tape on the reel edges, not on the flat flange area. When stored flat, the tape pack will shift with time against the lower flange. Then, when first run on a transport, the opportunity for edge damage to the tape is great.

Although significant improvements were necessary in the manufacture and quality of magnetic tapes to allow reliable 30 000-bpi or greater recording systems, the final consideration for success falls on the care and handling of the magnetic tape.

A Care and Handling Manual for Magnetic Tape Recording

This manual is a product of the Tape Head Interface Committee (THIC). This committee is composed of representatives of both Government and industry and is open to the public at large. THIC was created in 1975 as a forum in which ideas could be exchanged that would further the advancement of tape recording and reproduction. This is done largely by educating manufacturers on the needs of users, educating users on available technology, and, in general, disseminating information on the state of the art by those performing research and development studies. Typical agenda items are the presentation of papers on—

Head Wear Testing

Chemical and Physical Properties of Magnetic Tape
Care and Handling of Tapes, Transports, and Reels
High-Density Digital Recording Techniques
Magnetic Tape Rehabilitation and Certification
Signal Performance Under Varying Environmental
Conditions

Committee expenses, primarily consisting of postage and report reproduction costs, are sustained through the voluntary contributions of the following member organizations:

Sustaining Members:

Ampex Corp., Redwood City, Calif.
Bell & Howell, Pasadena, Calif.
EMI Technology, Danbury, Conn.
Honeywell Test Instrument Division, Denver, Colo.
Sangamo-Weston, Sarasota, Fla.

Associate Members:

ESL, Inc., Sunnyvale, Calif.
IIT Research Institute, Chicago, Ill.
Lockheed Electronics Co., Plainfield, N.J.
Odetics Corp., Anaheim, Calif.
Pertec Computer Corp., Chatsworth, Calif.
Precision Data Inc., Mountain View, Calif.
RCA Military Electronics, Camden, N.J.
Spin Physics, Inc., San Diego, Calif.

The purpose of this manual is to recommend methods of caring for magnetic tape, transports, and associated equipment to prolong life and promote optimum per-

formance. This document has been directed specifically toward the use of instrumentation tapes and recorders. Much of the material, however, relates to other applications as well.

To achieve its purpose, this manual discusses in depth the subjects of handling, cleaning, storing, and shipping tape and equipment. Suggestions for carrying out these activities are offered as best practice recommendations. Of course, each user should evaluate his or her own circumstances when applying these recommendations and should feel free to modify them accordingly. However, he should likewise consider that deviations from these recommended practices are likely to be accompanied by some penalty in performance or longevity. Wherever possible, therefore, the manual endeavors to present enough information to help the user make tradeoff decisions. Additional information on the more common types of tapes and reels has also been included as a convenience for the reader.

Modern magnetic tape coatings have the ability to retain the intelligence placed on them during the recording process for an indefinite period. The recorded information does not fade or weaken with age. It is essentially permanent and will remain unchanged unless altered by mechanical, environmental, or magnetic forces. However, none of these forces is likely to affect tapes and equipment if proper handling, storage, and packaging measures are taken.

The problems attendant to improper care and handling are well known to users. The cost of deformed tape, damaged reels, and scratched magnetic heads is all too familiar a burden that many users bear for want of well-informed and properly trained personnel. The cost in lost data, of course, is inestimable.

In view of such waste, THIC feels an obligation to present to the recording community its collective findings on how to prevent unnecessary losses. The membership was asked to submit papers on all facets of magnetic recording. The information gleaned from these papers, in conjunction with other reliable articles written for industry journals, was used to compose this manual. You are likewise invited to contact any of the members of the Care and Handling Manual Subcommittee, who prepared this

manual:

Ampex Corp.

Attn.: Bill Sawhill
401 Broadway
Redwood City, CA 94063
(415) 367-2826

Bell & Howell

Attn.: Hal Book (formerly of Bell & Howell)
300 Sierra Madre Villa
Pasadena, CA 91109
(213) 796-9381

General Electric Co.

Attn.: Joe Waites
1820 NASA Boulevard
P.O. Box 58408
Houston, TX 77058
(713) 332-4511

Goddard Space Flight Center

Attn.: Dennis Maddy, Code 863.1
Greenbelt, MD 20771
(301) 982-4681

Honeywell, Inc.

Attn.: Larry Girard
4800 East Dry Creek Rd.
P.O. Box 5227
Denver, CO 80217
(303) 771-4700

IIT Research Institute

Attn.: Don Wright
10 West 35th St.
Chicago, IL 60616
(312) 567-4468

Lockheed-California Co.

Attn.: Vince Colavitti
P.O. Box 551
Burbank, CA 91520
(213) 347-2904

National Security Agency

Attn.: Frank Heard, L141 (Chairman)
Fort George G. Meade, MD 20755
(301) 688-6306

Attn.: Jim Keeler R423
Fort George G. Meade, MD 20755
(301) 796-6427

Attn.: Ken Townsend S316 (Alternate Chairman)
Fort George G. Meade, MD 20755
(301) 688-6888

RECORDER CARE AND OPERATION

Intimate contact and accurate alignment of the magnetic tape with the heads are essential for high-quality

recording and reproduction. With this in mind, most of the practices recommended here are aimed, either directly or indirectly, at maintaining these critical requirements.

Some of the causes of poor tape-to-head contact are readily apparent; for example, airborne contaminants such as dirt, dust, and cigarette particles. Contaminants that are not readily apparent are those the tape itself contributes, such as loose oxide particles and base film debris, normal wear products generated when the tape contacts transport components. In addition, oxide binder elements are often released when the tape is exposed to high humidity.

It goes without saying that tape deformations such as wrinkles, scratches, dents, and creases will cause severe tape-to-head separation. While such deformation is often caused by abuse to the tape in handling, shipping, and storage, it is also a fact that deformation will result from improper conditions involving the transport. The transport environment and its proper alignment, operation, cleaning, and maintenance are all vital factors in keeping the tape in good physical condition.

The paragraphs that follow give recommended practices for the care of the tape recorder so as to promote the highest data quality and prolong the life of the recorder.

Effects of Tape-To-Head Separation

A universal problem in recording is signal dropouts. A dropout is a reduction in signal amplitude for a given period. The amount of amplitude loss and time duration is usually defined by the user.

This loss of data may occur during either the record or reproduce process and is generally caused by poor tape-to-head contact. The signal attenuation resulting from poor contact is most pronounced at short wavelengths (high frequencies). The effect of poor contact can be expressed by the following formula and is termed spacing loss:

$$\text{loss of signal level} = 54.6 \frac{d}{\lambda} \quad \text{dB}$$

where

d = separation of tape from head, in.

λ = recorded wavelength, in.

This relationship is depicted in figures B-1 and B-2. The wavelength λ in inches is obtained by dividing the tape speed s in inches per second by the frequency f in hertz being recorded or reproduced:

$$\lambda = \frac{s}{f}$$

Figure B-3 illustrates the effect on upper band edge signals being reproduced at Inter-Range Instrumentation

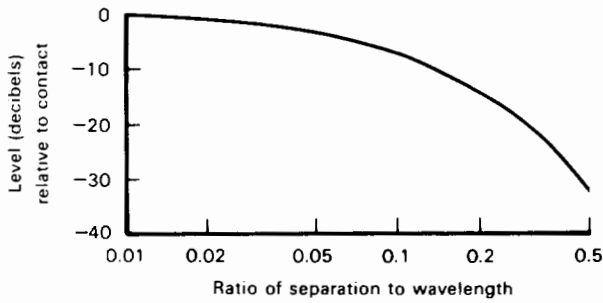

Figure B-1.—Signal drop versus ratio of separation to wavelength.

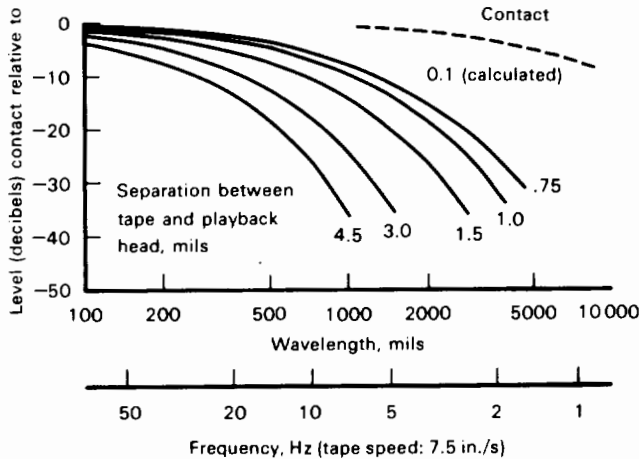

Figure B-2.—Signal drop versus wavelength at any tape speed.

Group (IRIG) wideband group II densities. Also illustrated is the effect on data at the so-called “double density” or “half speed” recording; i.e., 2 MHz at 60 in./s. Figure B-4 illustrates the spacing loss effect on upper band edge signals at IRIG intermediate packing densities. These two figures graphically show the effect of spacing loss versus recorded wavelength.

Recorder Environment

The ideal environment for the tape recorder is 70° F, 40 percent relative humidity, with cleanliness equivalent (again ideally) to at least a class 10 000 clean room.

Allowable departures from this ideal are generally limited by the tape rather than the recorder. For example, relative humidity has a dramatic effect on the abrasivity of tape. The wear rate of magnetic heads at 90 percent relative humidity can be 10 times faster than at 40 percent. For this reason, the upper limit of relative humidity should be set at about 50 percent. On the low humidity side, other phenomena such as gap smear and brown stain can cause loss of signal. To avoid problems of this sort, the lower limit on humidity should be held at about 30 percent.

There are cases, however, where parts of the recorder itself require controlled environmental limits. A case in

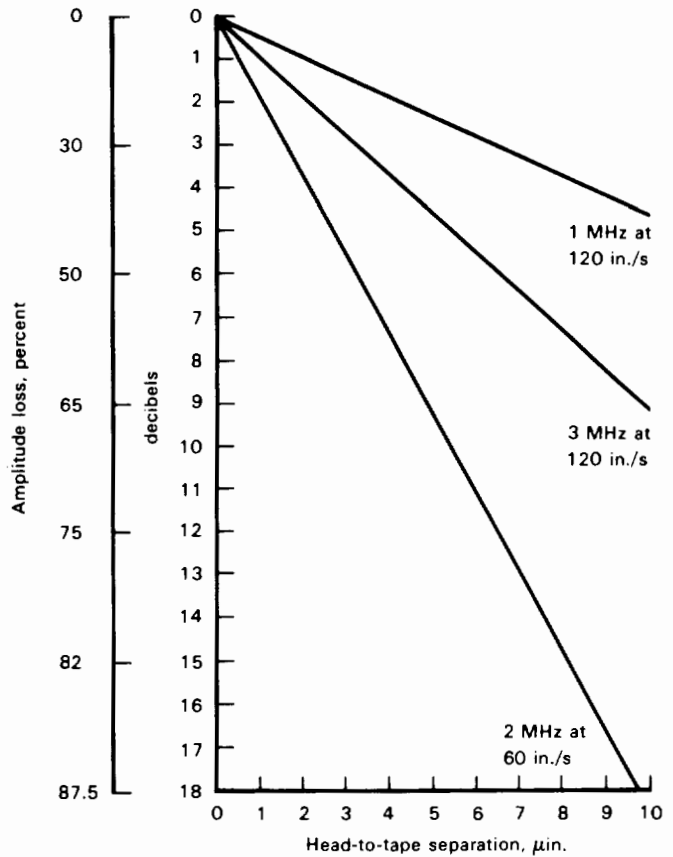

Figure B-3.—Separation loss at upper band edge at wide-band group II densities.

point is the laminated magnetic head, which is temperature limited. This limitation is caused by the differing rates of expansion and contraction of the head elements. After the head has been exposed to extreme temperatures, perhaps outside -30° and 70° C, it may not return to its original shape when brought back to room temperature. This, of course, would distort the head gap and result in signal loss.

In terms of maintaining a clean recorder environment, the following recommendations are offered:

- (1) Operating areas should be kept at a slight positive pressure (0.5 lb/in.²).
- (2) Air conditioning systems should be equipped with electrostatic air filters.
- (3) All dust collecting surfaces should be damp wiped (not dusted) periodically.
- (4) An operating area with a raised floor should have air conditioning fed from the ceiling and exhausted from the floor. This will remove floor dust instead of blowing it up around the equipment.
- (5) Floors should not be waxed.
- (6) Vacuuming, if done, should be with the collecting canister and exhaust outside of the area.
- (7) Floors should be damp mopped, not swept.

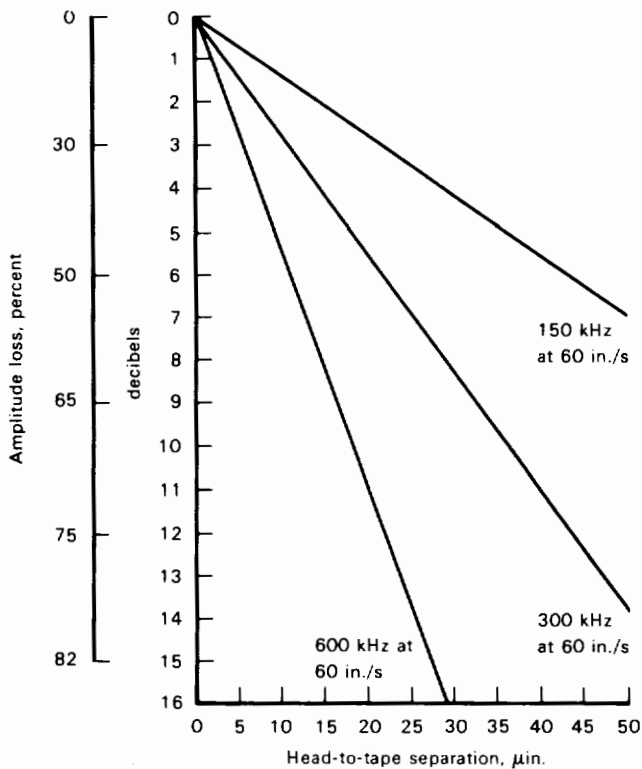

Figure B-4.—Separation at upper band edge at intermediate band densities.

(8) Buffing machines may be used to clean operating area but should be restricted to use only during non-operating hours, if possible. Steel wool pads should never be used with buffing machines.

Operator Precautions

Equipment operators carry the primary responsibility for keeping transports, tapes, and reels in serviceable condition. Because contaminants, reel and tape damage, and transport misalignment are major causes of dropouts, it is a must that the operator take special precautions to guard against them. The following are strongly recommended measures:

- (1) Do not smoke or eat in the same room where the recorder or exposed tape is located.
- (2) Do not handle tape reels by the flanges.
- (3) Do not use damaged reels.
- (4) Do not stack reels full of tape on their sides.
- (5) Keep bands on reels and put the reels in their containers when not using them.
- (6) Keep all transport doors and other covers closed in their intended operating state except when loading or unloading tape.
- (7) Avoid touching the tape with the fingers anywhere except at the ends as required for loading.

These and other common-sense measures will help keep the tape and equipment clean, maintain the integrity of the tape-to-head interface, and minimize the conditions that are conducive to dropouts.

Operator Vigilance

In addition to taking precautions about maintaining an optimum recorder environment and protecting the tape from contamination and damage, the operator must also be alert to signs of impending degradation. Irregularities to look for are such things as rollers not turning freely, tape edges being curled by roller flanges or other edge guides, and oxide and Mylar debris on transport surfaces. Also, any other abnormal behavior of other elements in the tape path such as tension arms or pinch rollers should be checked.

Any of these anomalies can lead to tape damage and/or cause poor quality recording or reproduction even though the transport appears to be working normally in all other respects. For this reason, corrective maintenance should be performed as soon as possible after any of these anomalies is observed.

Another frequently overlooked cause of poor quality data is a permanently magnetized metal part in the tape path, particularly the head. Heads may become magnetized when (1) continuity is being checked with an ohmmeter, (2) record cards are removed while the equipment is in the "record" mode, (3) ac power is lost, (4) a degausser is being used improperly, or (5) large magnetic fields are brought in close proximity.

It is difficult to predict the exact result of magnetized parts on a tape recorder. Effects may vary from a slight decrease in signal-to-noise ratio all the way to magnetic saturation. It is obviously quite important, then, to regularly demagnetize the heads and other metal components of the tape transport. They can be demagnetized by using any of several commercially available handheld degaussers. Some equipment, because of the tape drive configuration, requires a specially designed degausser.

Handheld degaussers usually have a field of sufficient intensity to degauss most magnetized components. However, in some cases the heads or other parts of the recorders may be magnetized by a field larger than that obtained from most handheld degaussers. A head in this condition is commonly referred to as being "permed."

If a component is "permed," it should be removed and cycled through a bulk degausser that is normally rack or table mounted. Bulk degaussers are primarily used to erase reels of magnetic tapes and have much larger fields than do handheld degaussers. When bulk degaussers are used, care must be taken to prevent the magnetic field from pulling the head against the degausser. The head is easily damaged. Also, a protective covering should be placed over the head during any degaussing operation whether using a handheld or bulk degausser.

Cleaning Requirements

As mentioned earlier, normal wear conditions cause magnetic tapes to shed minute oxide particles and base film particles from the tape surface. These particles accumulate at all tape transport surfaces such as the guides, rollers, and record/reproduce heads. Subsequent redeposits onto the tape increase the distance between the head and tape such that dropouts occur. From this it can be seen that all tape handler surfaces should be cleaned at frequent intervals and in the proper manner. Factors to consider for effective cleaning are the following:

- (1) Cleaning solvents
- (2) Solvent containers
- (3) Cleaning materials
- (4) Cleaning practices
- (5) Cleaning intervals

Cleaning Solvents

The following list presents the characteristics of the four commonly used solvents considered as possible candidates for the job of keeping tape handler surfaces clear of contamination:

<i>Cleaning solvent</i>	<i>Characteristic</i>
Freon TF	Does not damage polycarbonates, plastics, or neoprene Cuts oil and grease Lowest boiling point of solvents surveyed (dries quickly) Nonflammable Low toxicity
Xylene	Damages polycarbonates and acrylics; does not damage neoprene (AQH-4 pinch rollers are polycarbonate.) Cuts oil and grease very well High boiling point Extremely flammable Toxic
Isopropyl alcohol	Does not damage polycarbonates, acrylics, or neoprene Limited ability to cut oil and grease Medium boiling point Flammable
Methyl alcohol (methanol)	Does not damage polycarbonates, acrylics, or neoprene Limited ability to cut oil and grease Low boiling point Flammable

These characteristics speak for themselves, indicating the strong and weak points of each solvent. The selection of a given solvent should be made from the standpoint of the environment in which it will be used, its cleaning ability,

and the skill level of the individual using it. Solvents should not come in contact with the tape because, among other things, they may soften the coating and cause shedding. If any doubt exists as to which solvent to use, it is good practice to seek the equipment manufacturer's recommendation.

Solvent Containers

In those instances in which Freon TF is chosen as the cleaning solvent, serious consideration should be given to the merits of using bulk containers in lieu of aerosols. The following list points out their advantages and disadvantages:

<i>Type</i>	<i>Comments</i>
Aerosol can	Allows easy storage and accessibility Difficult to prevent metallic particle contamination in manufacturing process Difficult to localize application
Bulk (bottle)	Requires extra care to keep the cap tight and prevent evaporation or spilling Easier to apply to wiping pads No inherent contamination problems in manufacturing

A major factor that favors bulk container solvent is its purity versus the presence of metallic particles in most aerosol cans. Apparently these particles are inseparable from the manufacturing process of the can.

Another reason for avoiding aerosol cans is the human factor. The aerosol can presents the temptation to spray the solvent directly onto transport components. The spray may then penetrate into bearings and other lubricated areas. Over a period of time, this will inevitably lead to dissolving the lubricant.

It is suggested, then, that the container having the most advantages is the goose-necked squeeze bottle. The solvent can be squeezed onto the cleaning material without the danger of contaminating the remaining solvent in the bottle.

Cleaning Materials

Considering the adverse effect that even minute particles have on the recording and reproducing processes, the materials used to clean the equipment should be soft and lintfree. Normally, where there is sufficient space for applying finger pressure, Kimwipes[®], Tex-wipes[®], Clean-care[®], or similar lintfree materials should be used, especially where contaminants have been deposited under heat and pressure requiring greater force to remove them. In relatively inaccessible places, the only option may be the cotton swab, such as a Q-tip[®]. The swab may also be useful for light cleaning where there is no heavy accumulation of contaminants.

Cleaning Practices

After selecting the proper cleaning material, the next step toward getting the equipment "microinch" clean is to be thorough and to use the materials properly. For example, it is important not to remove contaminants from one place on the equipment and transfer them to another or, perhaps, transfer them to the solvent container. Therefore, the following practices are recommended:

- (1) Remove tape from recorder before cleaning transport.
- (2) Apply solvent directly to the cleaning material. Do *not* apply directly on any component of the transport.
- (3) Use sufficient pressure on the wiping cloth to "scrub" all surfaces that come in contact with the tape.
- (4) Take particular care to clean the flanged edges of guides where debris is likely to accumulate.
- (5) Continue cleaning (changing the swab or wiping cloth when they are soiled) until the cleaning material shows no evidence of dirt.
- (6) Make a last pass across the heads in the direction of tape motion to insure that the head gap is clean.

Any time heads are removed from their operating position they should be protected with an appropriate covering; e.g., wrapped in a tissue held in place by masking tape. Do not allow the masking tape (or any other adhesive, for that matter) to come in direct contact with the head face.

Cleaning Intervals

Frequent cleaning of the tape path is important. Ideally, cleaning should be done after every pass. There are obviously cases where this is not possible, but it should be recognized that cleanliness is critical, and regular cleaning should be scheduled on the most frequent practical basis.

TAPE CARE

History

In 1898 Valdemar Poulsen demonstrated the ability to magnetically record impulses on a steel wire using an electromagnet. During the early 1930's a metal ribbon was used on a recorder developed in Great Britain. Finally, in 1935, the first true "tape" recorder was introduced in Germany, a magnetophone that used an oxide coating on paper.

In 1945 three types of tape were available in Germany: one was on a brown paper backing, one on plastic, and the third and best was an integral mixture of the plastic and oxide cast as a film. In the latter case, there was no right or wrong side of the tape. By 1947 magnetic tape was being manufactured in the United States, and the preferred system used cellulose acetate as a base. It was not until the mid-50's that polyester began making serious inroads as a base film, and the era of sophisticated magnetic tape was

underway. Since then, constantly improving surface smoothness and uniformity of magnetic oxide dispersion have led to improved signal-to-noise ratios. Continuing research in magnetic particles has led to high output and high packing densities, accompanied by still further improvement in signal-to-noise ratios.

The properties most desirable in any magnetic recording tape are summarized as follows:

- (1) The tape must reproduce a signal with good amplitude and signal-to-noise ratio.
- (2) The tape must be capable of accommodating both high and low frequencies without degradation.
- (3) The output of the tape must have short-term and long-term uniformity.
- (4) The tape must be durable to withstand stress and wear factors.
- (5) The tape must be able to work over a relatively wide environmental range of temperature and humidity.
- (6) The tape must be compatible with the mass of tape already in use on the basis of which most recorders have been designed.

Composition and Manufacture

Magnetic tapes are composed of a flexible backing material, magnetizable oxide particles, and a plastic binder compound. The binder compound encapsulates the oxide particles and holds them in place on the flexible backing material (fig. B-5). The binder compound also contains lubricants to reduce abrasion of the magnetic head, fungicides to inhibit fungus growth, plasticizers to provide a flexible coating, antistatic agents to drain static charges and thus reduce dust attraction, and dispersants and wetting agents to evenly distribute the oxide particles.

Briefly, magnetic recording tape is produced as follows: First, the oxide particles are mixed with the plastic binder compound; then this mixture is applied wet to the flexible

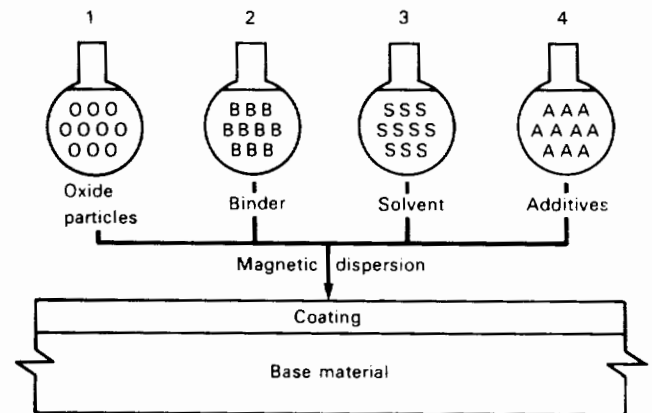

Figure B-5.—Magnetic recording tape composition. (Note that magnetic dispersion solution coating is applied to the film base material.)

backing material. (At this point in production, the coating mixture is viscous and the encapsulated oxide particles can still be moved.) Next, the tape is passed through a magnetic field to physically orient its oxide particles uniformly in a specified direction—longitudinally for use with fixed or helical scan heads, and transversely for use with rotating heads. The coating mixture, with its properly oriented oxide particles, is then dried onto the backing material. The coating is subsequently polished to a relatively smooth finish.

The oxide particles are the key elements in a magnetic tape. Each particle must be as near uniform in shape, size, and magnetic properties as possible. An ideal oxide particle is acicular (needle-shaped), about 5 to 40 $\mu\text{in.}$ long, and has a length-to-diameter ratio varying from about 4:1 to 10:1. Broadly speaking, long particles are used to record long wavelength signals, and short particles to record short wavelength signals.

Oxide coating thickness is another wavelength-related factor that influences tape frequency response. Short wavelengths are recorded near the surface level of the oxide coating, while the longer wavelengths penetrate more and more of the oxide coating sublayers. Because a tape is designed to suit a particular range of wavelengths, its coating thickness usually is a compromise (chosen in conjunction with a given oxide particle size) that accommodates the shortest and longest wavelengths of the specified frequency range.

Traditionally, magnetizable particles have been a form of iron (gamma ferric) oxide. However, since 1965 chromium dioxide particles and cobalt-doped gamma ferric oxides also have been used. Tapes featuring these newer coatings have increased recording density. These tapes also require greater magnetic force (i.e., high energy) to record and erase the signal, which enables the recordings to have higher signal-to-noise ratios.

Another development in more recent years is the widespread use of tape back-coating. It is a finely textured, highly conductive, carbon-based layer that is applied to the back side of the tape in much the same manner as the oxide coating, only thinner. The back-coating serves to (1) minimize static electricity buildup to prevent attraction of dust, (2) provide a controlled coefficient of friction to prevent cinching and pack slip as well as to improve tape tracking, (3) reduce the shedding of base material wear products, and (4) absorb deformation caused by particles trapped in the pack.

Figure B-6 illustrates a cross section of back-coated tape giving the relative dimensions of binder compound layer (oxide coating), film base material, and back-coating layer.

Environmental Conditions

As one might expect, the environment acts both physically and chemically on tape. The further the environment

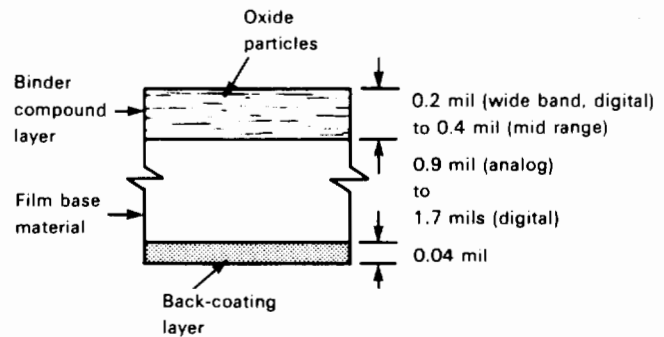

Figure B-6.—Magnetic tape with back-coating.

varies from ideal tape conditions, the greater the effect.

Tape operates best at temperatures between 60° and 80° F, and between 40 and 50 percent relative humidity. Generally, the hotter and more humid the environment, the more the tape tends to stretch and soften, and adjacent layers tend to stick together. (If tape has not been preshrunk, there will be one-time shrinkage at about 50° to 60° C before stretching begins.) The colder and drier the environment, the more the tape tends to shrink and become brittle. In both cases, running the tape over transport heads, rollers, and guides causes shedding from both the oxide coating and the backing material. Further, shedding is usually accompanied by increased abrasion, which will wear out heads early.

It is also true that higher abrasivity accompanies higher relative humidities, usually increasing dramatically at 60 percent relative humidity and above. Further, at higher values of relative humidity, binder elements tend to hydrolyze and become gummy. On the other hand, operation at lower values of RH leads to gap smear and brown stain, a little understood chemical reaction that occurs even with uncoated Mylar tape. It is, therefore, recommended that tape be operated between 40 and 50 percent relative humidity to achieve best performance and increase tape and head longevity.

Obviously, the adverse effects described will lead not only to serious signal degradation but also to severely reduced head life. These consequences can be prevented, however. The chemical and physical processes described are generally reversible. If, then, it is suspected that tapes have been exposed to a relatively extreme environment, they should be stabilized outside their containers in the recommended environment for at least 16 h before using on a transport. Figures B-7 and B-8 reflect the temperature and relative humidity ranges considered safe for tape operation. Figures B-9 and B-10 indicate the adverse effects that accompany excessive excursions out of the safe range.

Instrumentation Tape Types

Just as a magnetic recording system is designed to perform a particular function, so must the tape be designed

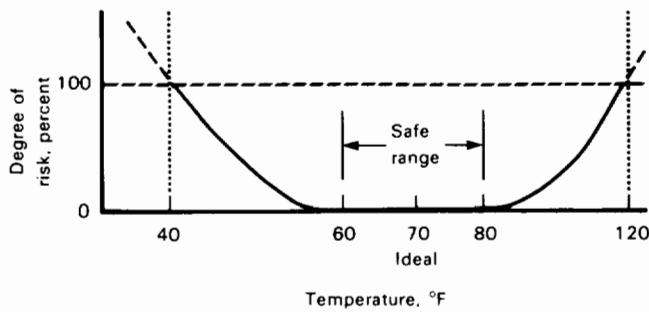

Figure B-7.—Safe temperature range for tape operation.

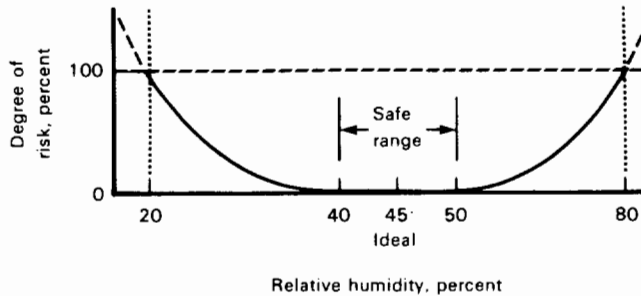

Figure B-8.—Safe relative humidity range for tape operation.

to meet the electrical, magnetic, and mechanical requirements of that recording system. Accordingly, there are two basic types of instrumentation tape identified and specified under Interim Federal Specification W-T-001553 (GSA-FSS):

- (1) Standard resolution (B oxide)
- (2) High resolution (E oxide)

Standard resolution denotes tape intended for use on low-band and intermediate-band recorder/reproducers that have the capability of recording wavelengths as short as 0.6 mil (100 kHz at 60 in./s) and 0.24 mil (250 kHz at 60 in./s; 500 kHz at 120 in./s), respectively.

High resolution denotes tape intended for use on wide-band recorder/reproducers that have the capability of

recording wavelengths as short as 0.08 mil (1.5 MHz at 120 in./s) and 0.06 mil (2.0 MHz at 120 in./s).

Within the "E" category of oxides, tape type is identified as either E-1 or E-2 depending upon its dropout performance characteristics. (Federal Specification W-T-001553 defines a dropout as a 6-dB loss existing for 10 μ s at a record/reproduce speed of 120 in./s and testing frequency of 1 MHz.) Class E-1 may contain an average of 10 dropouts per 100 ft on the center track and an average of 40 dropouts per 100 ft on the edge tracks. E-2 is allowed 10 and 15 dropouts, respectively.

The state of the art in tape manufacturing has surpassed the quality foreseen in these specifications. At present, there are no official Government specifications to define newer generation tapes such as the high-output (HO) and high-energy (HE) types. The HE tapes have much higher coercivities than "B" and "E" oxides and are capable of high signal-to-noise ratio performance. The higher coercivities, however, may require some modification to existing recorder/reproducers to provide the required higher record and bias currents.

The Tape Pack

One of the clear dangers to quality tape performance is, of course, a damaged or dirty tape. One of the easiest and best ways to encourage damage or dirt is to wind the tape carelessly so that strands scatter to the sides or spaces occur between layers. (See figs. 5-6 and 5-8.) Obviously, this is unacceptable. It is, therefore, essential that a tape be wound uniformly onto its reel at the desired tension. The proper tensions for specific purposes are discussed later.

To achieve an optimum wind takes an alert operator and precision winding equipment. If there are shortcomings in either, the tape will sooner or later be contaminated or damaged. Some of the more common defects resulting from a poor wind are pack shifting, spoking, and cinching. Should any of these conditions be discovered, the tape may be salvageable by having its temperature/

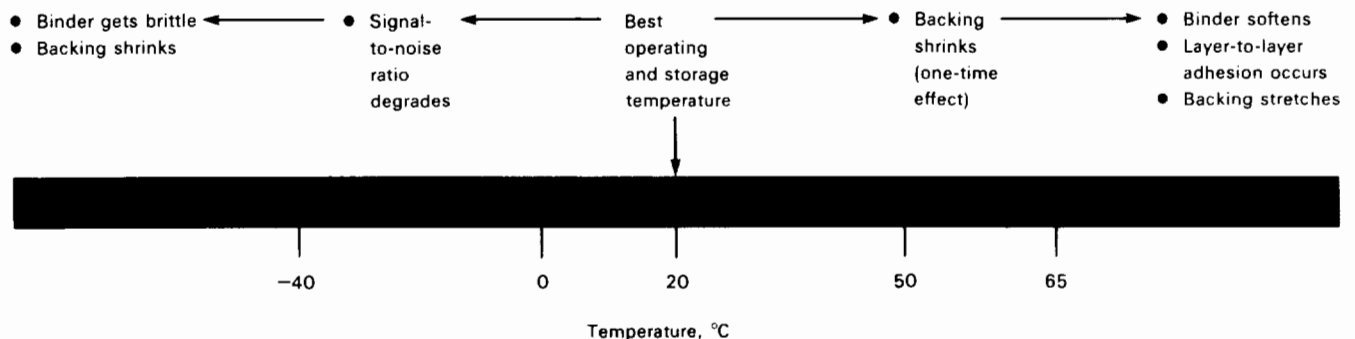

Figure B-9.—Effect of temperature on magnetic tape and transport. (Preshrunk tape will not exhibit shrinkage of the backing.)

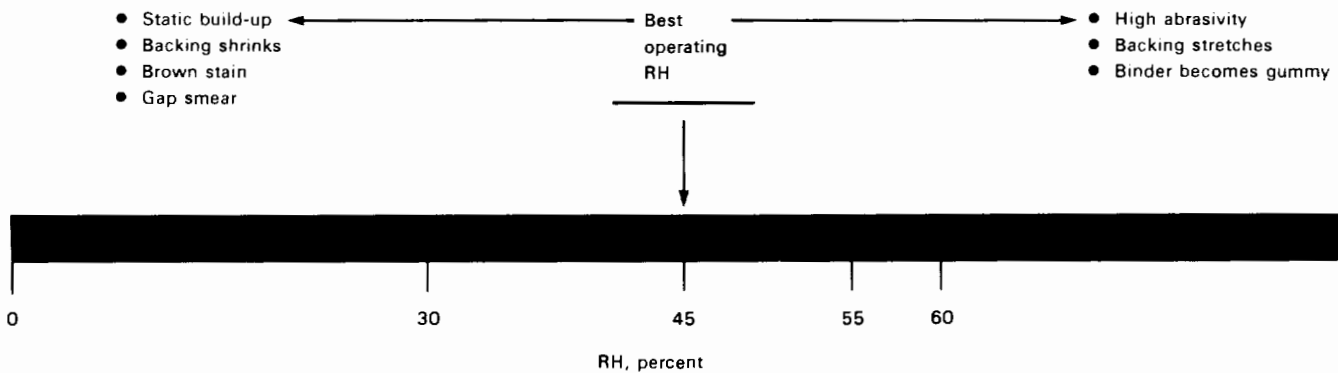

Figure B-10.—Effect of relative humidity on magnetic tape and transport.

humidity stabilized at about 70° F and 40 percent relative humidity for at least 24 h and then rewind.

Pack Shifting

Winding tape at too low a tension is one of the more common causes of pack shifting. However, even a properly wound pack, subjected to an adverse environment, can become a candidate for shifting. For example, very low temperature can cause the reel hub to shrink away from the tape pack, leaving the pack free to shift. Plastic hubs, which contract at a faster rate than the polyester base film, or slotted hubs of any of the materials commonly used, are particularly susceptible to shrinking.

Spoking (Buckling)

Harmful stresses are often introduced in the tape pack when repeated stops and restarts are common modes of operation. When these modes of operation are used, uneven stresses are created in the roll. These uneven stresses attempt to equalize during temperature and humidity changes and may create a series of error-producing folds of various forms termed spoking, as shown in figure 5-7. Spoking may also result from particles trapped in the pack or from a misaligned or folded tape end when the tape is first fed onto the hub. Care should be taken, therefore, to insure a smooth, centered wind on the hub. Severe spoking may also result when poorly wound tape is exposed to extreme temperature/humidity conditions and/or shock and vibration.

When the tape has been subjected to one or more of the foregoing conditions, it should either be repacked at one continuous speed or a precision winder should be used. Many of the winders now available also have tape cleaning devices to further improve the tape condition.

Cinching

Pack shifting, spoking, and cinching are closely related. Cinching, like the others, will result from a loose wind created either by insufficient wind tension, by hub

shrinkage, or by exposure to extreme environments. Then, when the loosened wind is accelerated or decelerated while starting or stopping the tape transport, tape layers can become folded, or cinched. (See figs. 5-4 and 5-5.)

Depending on the condition of the tape and recorder, an acceptable wind can normally be achieved in the record or play mode. On the other hand, fast forward or rewind does not normally produce a smooth or firm tape pile. For this reason, a good practice is to remove the tape from the takeup spindle (after continuous record or playback) and ship or store it in that condition. In operations where good winds cannot be achieved in this manner, a continuous pass at 30 in./s should produce the best wind. Beyond this, a precision winder should be used.

Proper winding tensions depend on the tape width, thickness, coating, winding method, guiding, and reel type. The best known way to insure that the wind method and tension are proper is to wind the tape, then temperature/humidity cycle it in an environmental chamber. If the pack remains uniform and solid, it will have demonstrated its ability to survive shipping or storage under similar conditions. A properly wound tape, on a properly designed reel, should remain firm and smooth with no spoking through the temperature/humidity cycle of 40° to 120° F at a transition time of 1 h, cycled three times in a 48-h period, and allowed to stabilize. A vibration cycle may also be considered.

Tape Contamination, Defects, and Physical Damage

Contamination and Defects

Generally, tape may become contaminated during the manufacturing process itself, by environmental conditions, or by careless handling. And as mentioned earlier, when running tape, wear products consisting primarily of oxide and tape backing material may come loose and build up on the tape path components. With continued use, these contaminants adhere to the tape surface and, from frictional heat and tape pack pressures, become embedded

in the tape surface. These particles not only cause signal loss by separating the head from the tape but also contribute to excessive head wear. Tape conditions that cause reduced performance are listed below in either of two categories, depending on whether the tape can be cleaned:

- (1) Cleanable
 - (a) Oxide clump (adhered or loose)
 - (b) Base film shed
 - (c) Fibrous or hairlike particles (lint)
 - (d) Metal particles
 - (e) Dust and dirt
 - (f) Dandruff
- (2) Noncleanable
 - (a) Coating streak
 - (b) Hole in coating
 - (c) Crater in coating
 - (d) Oxide nonuniformity
 - (e) Creased tape
 - (f) Damaged edge

Physical Damage

The most significant cause of physical damage to tape is a poor wind, compounded by mishandling. Other causes are bent reel flanges or a misaligned machine that allows the tape to rub against the reel flange and worn, defective, or misaligned guides. The most frequent cause, however, involves the operator and not the machine. Many operators are unaware or consider insignificant the fact that tape reels should be handled by the hub and not by the flanges. When the operator handles the reel by the flanges, he will almost certainly squeeze them against the tape pack. Any protruding edges are immediately bent. The same holds true, of course, for reels placed horizontally for storage. In either case, reel bands will minimize damage, especially when mounting and removing reels.

Cleaning and Winding

As discussed earlier, contaminants may originate with the tape itself—through shedding—or by accumulation of foreign particles. With this in mind, users should exercise extreme care in processing and handling tape and associated equipment. When tapes develop too high an error rate due to contaminants, they should be “rehabilitated” before being put to further use. The following steps represent the processing and handling of the tapes at a large recertification (rehabilitation) facility:

- (1) Staging in
- (2) Inspection
- (3) Salvage
- (4) Supply/materials support
- (5) Degaussing
- (6) Cleaning and recertification

- (7) Label identification
- (8) Program tension wind, or precision wind
- (9) Final inspection
- (10) Degaussing
- (11) Packing and sealing of reels and canisters
- (12) Quality assurance
- (13) Staging out

Staging In

Tape is sorted by type (analog or digital), usually onto carts or racks. It is sometimes necessary to sort by manufacturer, density, length, width, and other parameters. Of course, data tapes (those with data to be saved) must be separated from those to be erased and recertified for reuse. The staging-in process also provides the opportunity to environmentally stabilize the tape.

Inspection

All tape is visually inspected for obvious defects such as poor winds and cracked reels or canisters. This inspection reduces equipment running time and enhances tape salvage.

Salvage

A cutting station exists to remove defective tape from reels that are to be reused and to remove good tape from defective reels. Sufficient reels and canisters are kept on hand to replace those that are damaged.

Supply/Materials Support

In addition to a sufficient supply of reels, canisters, tape seals, and tape, it is necessary to have on hand all the items needed to meet specialized needs. Consideration must be given to such items as cleaning agents, reflective markers, labels, boxes, inserts, clean room garments, equipment spare parts, tissue wipes, blades, lintfree cloths, ultraclean plastic bagging, tape seals, and end of tape retainers.

Degaussing

A degaussing station is operated for analog tape and is available for digital tape if requested by the customer. A bulk tape degausser is illustrated in figure B-11.

Cleaning and Recertification

Items to be considered when cleaning tape include (1) the type of blade, such as razor blades, rotating blades, moving blades, sapphire blades and grids, and (2) the type of debris removal, such as vacuum or tissue wipe.

The razor blade, if controlled by purchase of a stainless steel low-wear blade and used for a single pass, offers a high cleaning efficiency. However, it does wear a small edge path and risks tape edge damage. It is not unusual for



Figure B-11.—Bulk tape degausser.

a tape to be destroyed. Grids and rotating blades, while less efficient, are safer for data tapes. Wear patterns also develop with sapphire blades, although not as pronounced as the razor blade. Their efficiency for cleaning is reduced with use as well. Claims of "self-sharpening" blades are doubtful. Observation reveals the blade becoming dull in a

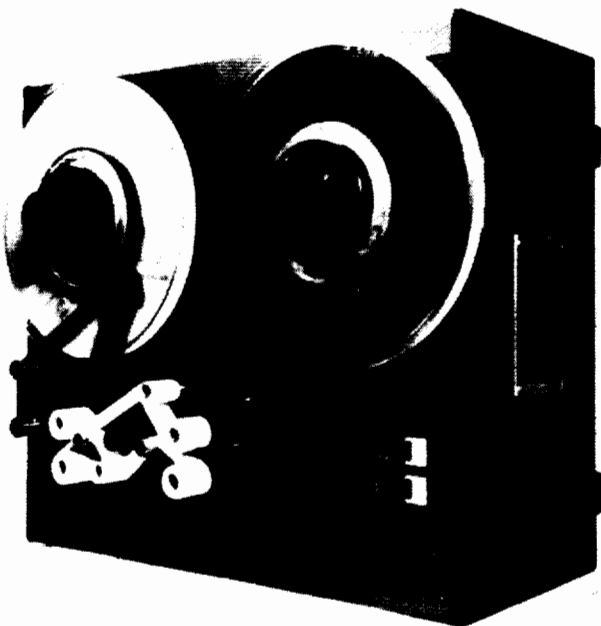

Figure B-12.—Magnetic tape cleaner with advancing tissue wipes.

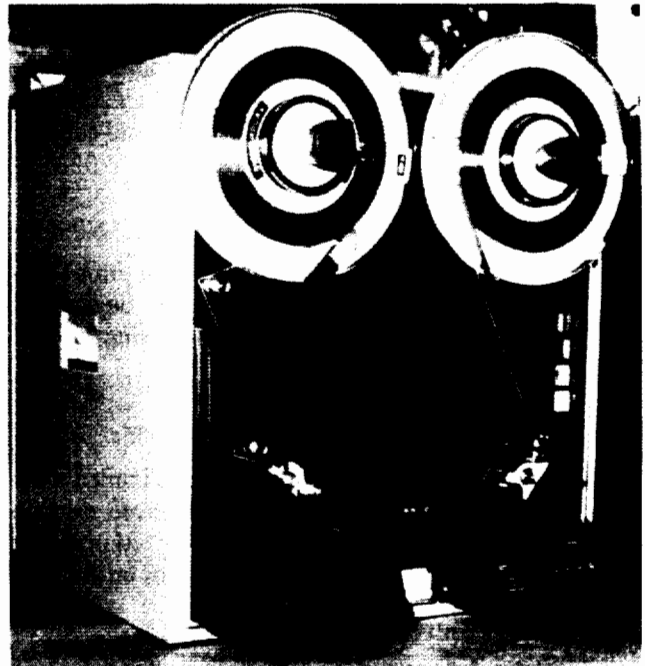

Figure B-13.—Winder/cleaner/certifier.

different area, rather than sharpening a previously used area. See table 5-1 for the various scraper types. Removal of loose debris after blade cleaning can be accomplished with vacuum or tissue wipes. The use of a vacuum is not as efficient as tissue wipes, but has the advantage of no consumable materials to stock. Tissue wipes must be advanced with sufficient speed to prevent redeposit of debris back to the tape. See figure B-12 for a tissue-wipe configured tape cleaner.

Tapes may be rehabilitated on units called winder/cleaner/certifiers or evaluators (fig. B-13), which perform all those functions. In addition, the certification and evaluation functions are adjustable so that dropouts can be counted beginning at almost any desired reduced signal level below an established threshold.

Label Identification

Reel and canister labels are normally removed during rehabilitation, and a new label affixed retaining the tape type, manufacturer, density, and other essential information. If the tape is to be recertified, it is removed from the reel, put onto a clean reel, and the empty reel forwarded to a cleaning station for recycling. Data tapes normally are wound back on their original reel with little or no label attention.

Precision Wind

Either program tension or a constant tension precision wind is used for tape that is to be stored or shipped. The different types of tension profiles used are discussed later.

Final Inspection

The final inspection of a recertified tape or a data tape includes closely examining the physical condition of the wind, cutting off the old reflective marker and installing a new one, and packaging and sealing the reel and canister as required.

Degaussing

All instrumentation tape is degaussed both prior to recertification and afterward. Digital tape degaussing depends on user requirements and the degaussing limits of tape handlers.

Packing and Sealing of Reels and Canisters

All rehabilitated tapes that will not be used immediately are sealed in high-quality plastic bags and placed either in canisters or their original containers for protection. Some facilities make a practice of placing reel bands on the reels

before packing. Temperature and relative humidity are controlled to avoid sealing in excessive moisture. In special cases, air is evacuated from the plastic bag.

Quality Assurance

Depending on customer requirements, a percentage sample plan or a full 100-percent quality assurance plan is implemented to evaluate the effectiveness of the rehabilitation and recertification process.

Staging Out

As in any shipping facility, a staging area exists where reels of tape are placed in protective sleeves, boxed, and stacked for shipping. Care is taken to select boxes with a comfortable margin in bursting strength. Further, stacking heights are carefully limited to prevent crushing.

With regular tape cleaning, and rehabilitation as necessary, tape life and performance can be improved signifi-

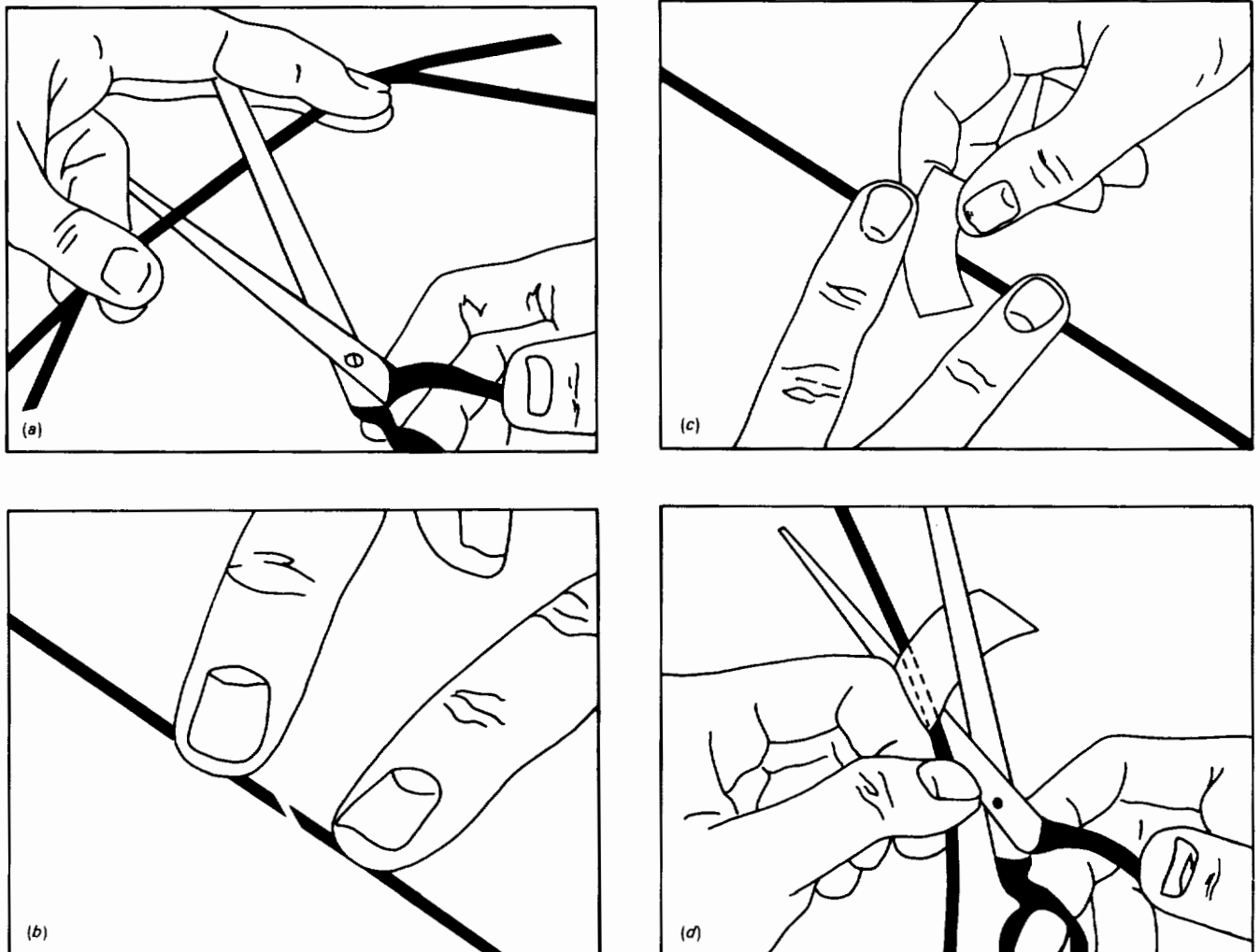

Figure B-14.—Making tight, noise-free splices. (a) Overlap the two ends and cut. (b) Align both ends, uncoated side up. (c) Cover with splicing tape. (d) Trim excess splicing tape.

cantly. Figure 5-14 provides an indication of the improvement that is possible.

Tape Splicing

Splicing of magnetic tape should be avoided whenever possible. Splicing creates distortion in the tape pack, which can create data degradation throughout many layers of tape. It can serve as a trash accumulator and can literally destroy some types of heads. Handling of the tape through the splicing operation is likely to introduce still further contamination. However, if you must splice to recover needed recorded information, there are two methods of splicing available:

- (1) "Thermoweld" splicing technique
- (2) Conventional splicing tape technique

The "Thermoweld" technique uses a heat method of joining two pieces of tape together, but requires an expensive, complicated piece of equipment. The conventional technique is basically joining two pieces of tape together using "splicing tape."

Of the two methods, the conventional splicing technique is readily adaptable for field use, provided that the person performing the splicing pays attention to details and that proper materials are on hand. The following must be adhered to (see fig. B-14):

- (1) Surfaces that the tape comes in contact with must be absolutely clean.
- (2) Magnetized instruments may not be used when splicing.
- (3) The two ends to be spliced should be overlapped and cut diagonally. A diagonal cut minimizes recorder disturbance at the splice. Excessive handling of tape should be avoided. Contamination of tape surface at splicing joint by body oils and/or foreign matter prevents a firmly bonded splice.
- (4) Both ends of the tape to be spliced must be aligned with the oxide side down.
- (5) Aligned tape ends are then covered with polyester base splicing tape, and splicing tape is applied to the back side of the recording tape. A firm bond is created by pressing firmly. Only polyester base splicing tape specifically designed for splicing magnetic tape is to be used because it is designed not to ooze excess adhesive and creates a firm bond that passes easily over recorder heads.
- (6) The excess splicing tape must be trimmed by cutting slightly into the recording tape.
- (7) A label should be attached to the reel flange identifying the tape as "spliced tape."

Commercially manufactured tape splicers, such as the one shown in figure B-15, are available to aid in making good tape splices. Splicing should be done, however, only as a last resort when needed to recover data that would otherwise be lost.

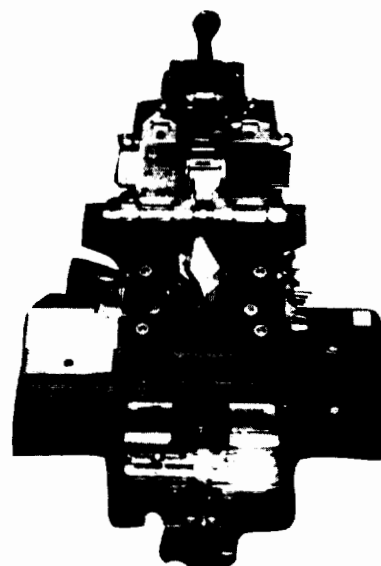

Figure B-15.—Tape splicer.

Tape Degaussing (Erasing)

Tape degaussing, or erasing, is a process whereby the tape is acted upon magnetically such that it is left in a condition suitable for subsequent recording. This may be achieved using a permanent magnet, a dc electromagnet, or an ac electromagnet. The permanent and dc magnetic fields are suitable for erasing digital tapes only. This is because, while they are effective in reducing the amount of magnetization remaining on the tape, the particles will be polarized in one direction, even if only to a slight extent, which would generally produce an unacceptable noise level in a subsequent analog recording. However, digital recordings, which consist of saturating the particles to one polarity or the other, are, therefore, insensitive to any initial, low-level magnetization.

The standard procedure then for degaussing instrumentation tape and leaving it in a neutral magnetic state is to subject it to an alternating field of sufficient intensity to saturate the tape, both negatively and positively, and then slowly withdraw or reduce the alternating field so that the magnetic particles will be left in a random state. This technique will leave the tape in the lowest noise condition possible. Depending on user requirements, an adequate erase level range is considered to be 60 to 90 dB below saturation.

Accidental Tape Erasure

The ability to revise magnetic tape via degaussing is one of its most advantageous features. However, a potential disadvantage accompanies this feature: the possibility that recorded information may be accidentally erased. To evaluate the likelihood of such an accident, a look at the magnetic properties of tapes as well as those of sources of magnetic fields will be helpful.

Most tapes have a coercivity of over 270 Oe, meaning that a magnetic field of at least 270-Oe field intensity at the tape surface is needed to reduce the magnetic induction of the tape from saturation to zero. By comparison, the magnetic field from an electric hand drill is about 10 Oe at the surface of the drill case—too small to affect magnetic tape even if there were direct contact. In fact, tests have shown that field intensities as high as 50 Oe cause no discernible erasure on tapes.

On the other hand, small permanent magnets used as door-latching devices or flashlight magnets have surface field intensities of up to 1500 Oe. Even for such magnets, though, no erasure would occur unless they come in close proximity to the tape. As it is, magnetic field intensity falls off sharply with distance from the source. For example, the 50-Oe point (at which no discernible erasure takes place) is located just 2.7 in. from a 1500-Oe source.

Experiments were conducted with a typical ac bulk-type eraser to determine the relationship between magnetic field intensity and magnetic signal erasure. The results are illustrated in figure B-16. Some erasure is noticeable at a field intensity of only 100 Oe, and a 6-dB loss (50 percent signal reduction) occurs at 155 Oe.

There have been a number of stories that attribute tape erasure to exposure to energy sources that are commonly present at airports. However, the likelihood is very small that these energy sources actually were responsible for the erasures. Such energy sources include radar, magnetic antihijacking devices, and X-ray equipment.

Radar

It is possible for tape erasure to occur in the immediate vicinity of a radiating high power radar antenna, for the magnetic field in this area may be as much as several thousand oersteds. However, while dynamite caps and flashbulbs may be triggered at some distance by the sharply focused electric field of a radar beam, its magnetic field is not so far reaching and, as mentioned, dissipates sharply with distance. In fact, experimentation on tape erasure has been conducted with tape placed just 2 ft away from an X-band radar that had a 250-mile range. After 16 min of exposure, the tape was removed and tested, and no physical or magnetic degradation was found.

Antihijacking Devices

Antihijacking devices at airports fall into one of two categories, either passive or active. The passive devices are designed to detect small changes in Earth's magnetic field that are caused by the presence of some metals. Because passive devices do not generate a magnetic field of their own, they cannot erase magnetic fields from recording tape. Conversely, active antihijacking devices do generate their own magnetic field. Typical of these devices are the doorway and walkway types, most of

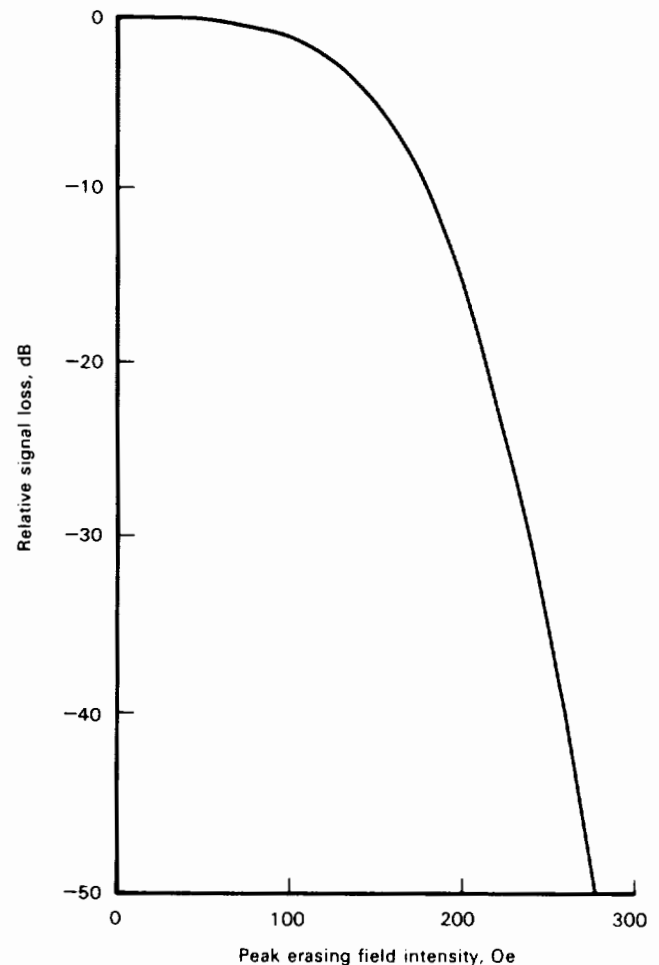

Figure B-16.—Relative signal loss versus erasing field intensity measured at center of recorded track. (Track width = 0.090 in.; $\lambda = 0.015$ in. (500 Hz at 7.5 in./s); 0 dB = 8 dB below level for 3 percent harmonic distortion.)

which operate with magnetic fields of about 20 Oe. These field intensities, in line with our previous discussion, would be harmless to the recorded tape. However, some doorway devices with magnetic fields as strong as 100 Oe have been considered for use, and may now be in service. Exposure of magnetic tape recordings to devices with magnetic fields as strong as this would cause partial erasure of the recording. Because personnel operating these antihijacking stations may not know the magnetic field intensity of their detection equipment, it is suggested that tape recordings be offered for physical inspection rather than be exposed to doorway or walkway detection devices.

X-Ray Inspection

It is theoretically impossible for X-rays to erase tape recordings because they have nonmagnetic properties. To demonstrate this theory, tests were conducted in which

carefully recorded tapes were exposed to X-rays of intensities far in excess of those used for routine package examination. No evidence of signal decay or erasure was found. X-ray equipment manufacturers state that even X-ray-generating equipment would have no magnetic field around it because of the precautions taken in shielding the units. One can only conclude that it is safe to permit X-ray examination of magnetic tape recordings.

Conclusion

When carefully weighed, the foregoing discussion indicates that it is highly unlikely that magnetic tapes will be erased accidentally. This is primarily because the intensity of any magnetic field is weakened considerably by distance. However, even relatively weak magnetic sources can affect magnetic tape significantly if they come in direct contact with it. Thus, the key to preventing accidental erasure of magnetic tapes is to keep them away from suspected magnetic sources.

Packaging and Shipping

Proper packaging plays an important role in protecting magnetic tape from damage. For one thing, tape reels should be packaged such that they are supported by their hubs. This will prevent any pressure from being applied to the flanges that might flex against the tape pack. Where reel bands are affixed to the flanges, there is no need to

support via the hub because the band protects against flexing of the flanges. Even then it is recommended that at least one-third of the reel periphery be used to support its weight. Further, tape should always be shipped in a vertical position to prevent the tape pack from shifting and damaging its edges. Any packaging that is used should be designed to guard the tape against the following potential hazards:

- (1) Temperature extremes and changes
- (2) Humidity extremes and changes
- (3) Vibration
- (4) Impact
- (5) Crushing

These factors will all be present to one degree or another depending on the mode of shipment, geographical location, distance, and shipping time. In most cases, measures should be taken to make the package free from accidental erasure. Because the probability of accidental erasure decreases as the distance between the tape and the surface of the package increases, it is recommended that the packing material completely enclose the tape and be as thick as is feasible. The material should also be of such quality as to protect against impact and vibration and to insulate from temperature and humidity changes. The packing should be dustfree and hold the reels tightly in place so that vibration will not cause chafing debris. Figures B-17 to B-19 are examples of various magnetic tape packaging items.

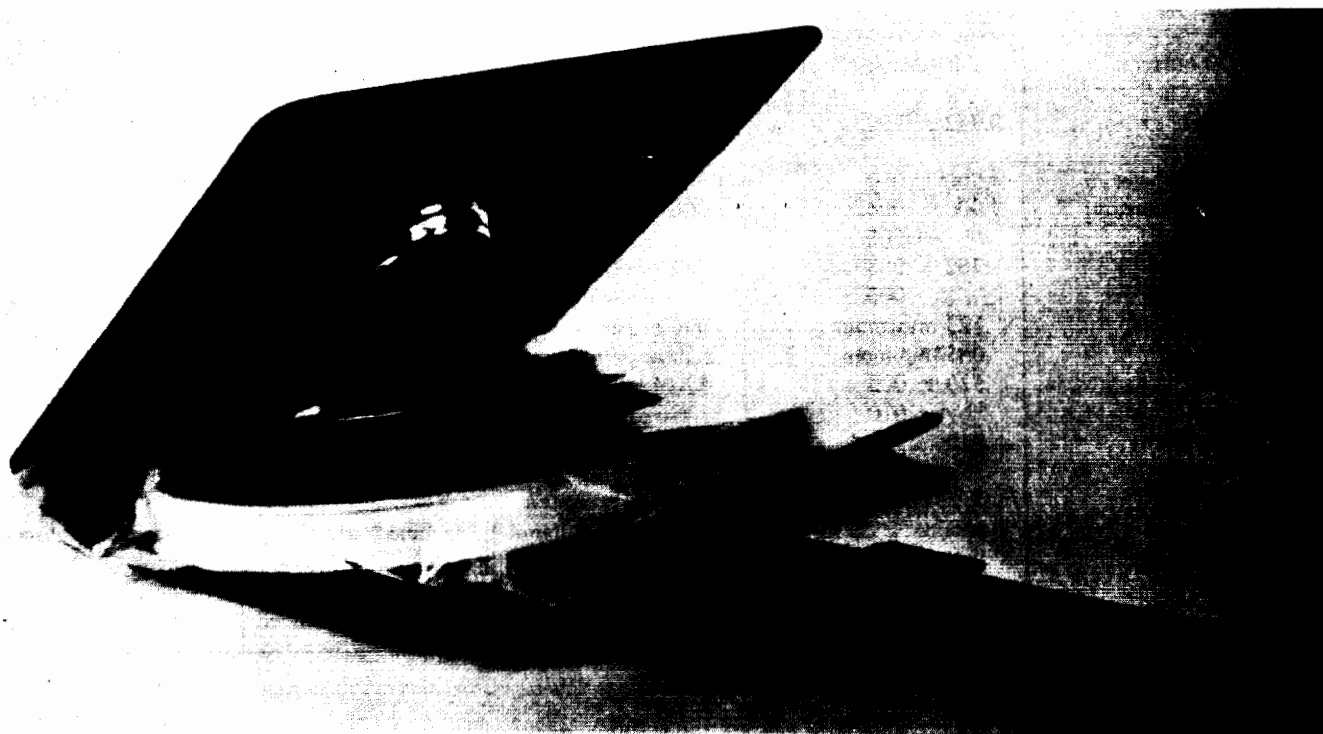

Figure B-17.—Reel box used to protect tape.

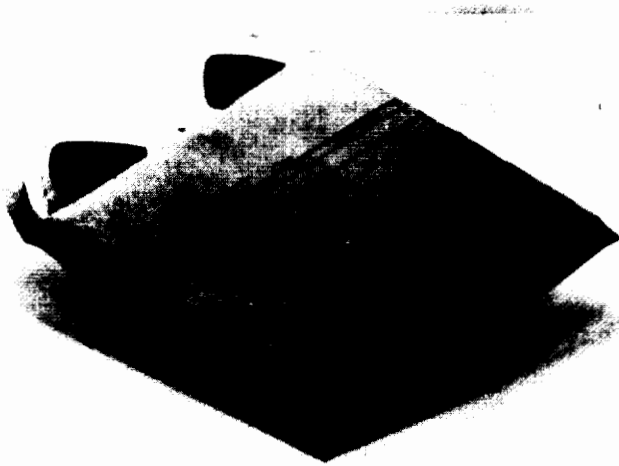

Figure B-18.—Paper envelope for 1/4- by 7-in. tape.

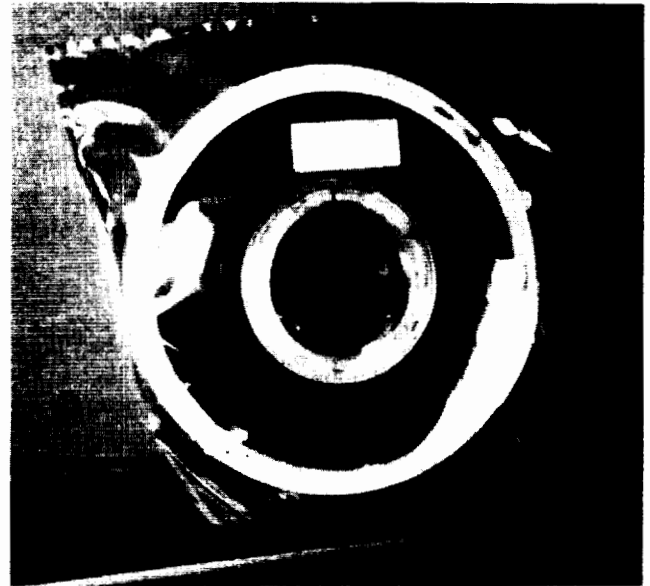

Figure B-19.—Plastic envelope provides protection for tape.

REEL CARE

The importance of the tape reel is often overlooked, for it is generally considered to be merely a tape storage container. However, the fact is that the reel is an integral part of the recorder tape transport system. Its basic function is to protect the tape from damage and contamination. Ironically, it is often the reel itself, damaged through mistreatment, that in turn damages the tape. For

this reason we shall discuss at some length the important design features of a reel and the different types of reels.

Reel Design

A reel is basically made up of the hub and two flanges, which are fastened to the hub by either screws, nuts and

Table B-1.—Specifications for 1/2-in. Reels

Parameter	Precision glass ^a	Precision metal ^b	Semiprecision ^c	NAB ^d
Hub width, in.	0.712 ± 0.003	0.520 + 0.002 - .000	0.530 + 0.012 - .001	0.600 ± 0.020
Hub outside diameter, in.	4.500 ± .010	4.500 ± .005	4.500 ± .010	4.500 ± .010
Hub inside diameter, in.	3.000 + .004 - .000	3.000 + .003 - .000	3.004 + .007 - .000	3.002 + .006 - .000
Reel width, in.	.762 + .003 - .000	.712 + .003 - .000	.712 + .010 - .003	.712 + .020
Flange thickness, in.	.123 maximum .085 minimum	.090 at hub .050 at periphery	.182	.051
Distance between flanges, in.	.520 ± .002 - .010	.520 + .020 - .010	.530 + .012 - .001	.600 ± .020
Flange concentricity	.010	.010	.015	.050
Moment of inertia (full), lb/ft ²	.16	.12 (IR) .16 (IRH)	.08	Not applicable
Flange	Precision; glass; tapered	Machined; aluminum; tapered	Machined; aluminum	Die stamped; aluminum
Hub	Aluminum; machined	Aluminum or magnesium; die cast	Phenolic compression; molded; machined	Die cast

IR = instrumentation reel; IRH = heavy duty instrumentation reel; NAB = National Association of Broadcasters.

^aFederal Specification W-R-175/6T.

^bFederal Specification W-R-175/4B.

^cNo specification.

^dFederal Specification W-R-175/3B.

bolts, or adhesive (fig. 5-9.) Reel design and moment of inertia are the important aspects that determine how effectively the reel will function as a tape protector. Tables B-1 and B-2 give reel specifications.

Flanges

The reel must be designed to enable the tape to wind and unwind without contacting the flanges. Any contact of the tape with the flange may result in tape edge damage and possible loss of the edge recording track. Therefore, the flanges must be spaced evenly and they must be sufficiently rigid to withstand normal handling pressures and resist accidental nicking or gouging.

The Hub

For proper tape travel through the transport, it is vital that the hub be as near a perfect cylinder as possible on both its inner and outer surfaces. Further, the hub should be strong enough to withstand the tremendous pressure that develops within a fully wound reel that may actually deform the hub. For this reason, hubs with threading slots are not recommended.

If the hub inner surface gets out of round, the reel will wobble on its spindle and feed the tape erratically onto the transport. (A similar effect will result from damaged or misaligned pawls.) This will almost certainly result in tape edge damage and skewed tape travel across the head.

If the hub outer surface is out of round, the tape will

stretch as it is stacked on the reel. When the deformed tape is replayed, signal distortion will occur. In addition, the stretching will create unevenly distributed tension within the stacked reel pack. This will cause erratic movement when the tape is subsequently unwound.

Aside from the hub itself being out of round, foreign particles on the hub surface can also deform tape. This is why it is imperative that the reel be routinely and frequently inspected and cleaned.

Reel Inertia

During normal tape transport operations—particularly in computer applications—tape reels are subjected to rapid starts, stops, and direction reversals. These rapid changes of rotational movement can create large moments of inertia, especially at the outer circumference of a fast-spinning reel with thick flanges. Excessive reel inertia will adversely affect rotating and braking components of the tape transport, shortening their overall service life. Consequently, reel manufacturers generally keep mass to a minimum after other design requirements are satisfied.

Precision Reels

High performance tape transports require tape reels that are fabricated to close tolerances and have superior stability and flange rigidity. Only precision reels meet these requirements. Precision reels may be classified by their flange material, either metal or glass. Further, the

Table B-2.—Specifications for 1-in. Reels

Parameter	Precision glass ^a	Precision metal ^b	Semiprecision ^c	NAB ^d
Hub width, in.	1.212 ± 0.003	1.020 + 0.002 - .000	1.030 + 0.012 - .001	1.100 ± 0.020
Hub outside diameter, in.	4.500 ± .010	4.500 ± .005	4.5 ± .010	4.500 ± .010
Hub inside diameter, in.	3.000 + .004 - .000	3.000 + .003 - .000	3.004 + .007 - .000	3.002 ± .006 - .000
Reel width, in.	1.262 ± .002 - .000	1.212 + .003 - .000	1.212 + .010 - .003	1.212 ± .020
Flange thickness, in.	.123 maximum .085 minimum	.090 at hub .050 at periphery	.182	.051
Distance between flanges, in.	1.020 ± .002	1.020 + .020 - .010	1.030 + .012 - .001	1.100 ± .020
Flange concentricity	.010	.010	.015	.050
Moment of inertia (full), lb/ft ²	.17	.13 (IR) .17 (IRH)	.09	Not applicable
Flanges	Precision; glass; tapered	Machined; aluminum; tapered	Machined; aluminum	Die stamped; aluminum
Hub	Aluminum; machined	Aluminum or magnesium; die cast	Phenolic compression; molded; machined	Die cast

^aFederal Specification W-R-175/6T.

^bFederal Specification W-R-175/4B.

^cNo specification.

^dFederal Specification W-R-175/3B.

metal reels are grouped by service rating, either instrumentation or heavy duty.

Flange Material

Precision metal reels (Federal Specification W-R-175/4) have precision fabricated metal flanges and accurately machined metal hubs. These features provide better reel-to-reel interchangeability and uniform reel performance.

Precision glass reels (Federal Specification W-R-175/6) have precision fabricated glass flanges and accurately machined metal hubs. The chemically strengthened glass is about 10 times as strong as ordinary glass. Reel flanges made of this material are coated with a tough plastic material that will restrain glass fragments should failure occur. Precision glass reels provide all the advantages of precision metal reels, plus the added advantage that the flanges will not permanently distort, and there are no flange openings to expose the tape.

Service Rating

Metal precision reels are classified as instrumentation reels (IR) or heavy duty instrumentation reels (IRH). IR reel flanges are 90 mils thick at the center, and taper on the outside surface to a thickness of 50 mils at the reel periphery. IRH reel flanges are uniformly 90 mils throughout.

The tapered flange of the IR reel design gives it the desired low moment of inertia while still providing adequate flange strength and stability.

The IRH reel is a heavy duty reel with nontapered flanges designed for applications where the moment of inertia of the reel is not a deciding factor. One such application is low-speed acoustic recording. Maximum strength is inherent in the IRH reel flange design. This flange resists deflection and protects the tape from damage under most rigorous conditions.

The only types of tape reels recommended for use on high-performance equipment are precision reels—metal

or glass. Reels with glass flanges are preferred because they resist flexing and they have no apertures that would permit contaminants to reach the tape. Recent studies have revealed that signals reproduced from exposed portions of tape mounted on metal-flanged reels have developed variations in amplitude uniformity that correspond to the flange openings. These signal variations were attributed to one or more of the following factors:

- (1) Temperature and humidity changes caused the tape (a) to expand, contract, or deform, and (b) to change frictional characteristics.
- (2) Varying air pressure during pack winding caused uneven tape pack stresses.
- (3) Contaminants accumulated on exposed tape.
- (4) Physical handling caused tape edge damage.

This evidence provides a strong case for mounting tape on glass reels, particularly when the tape must be used in uncontrolled environments.

The manufacturer has anticipated the need to provide a simple means of threading a glass reel, because it has no apertures. A plastic coating has been applied to the outer surface of the reel hub. Drawing the tape end over the reel hub creates a static attraction that causes the tape end to cling to the hub. Initially it may be necessary to loop the tape around the hub and spin the reel to create the electrostatic attraction. (See fig. B-20.)

HANDLING AND STORAGE

Handling

Those who work with magnetic tapes can help prevent needless performance degradation by carefully observing preventive tape handling procedures. Both operator and maintenance technician should observe the highest degree of care when they handle reels of tape and work with recording equipment. It cannot be overemphasized that the slightest defect in the reel, dirt particle on the tape or head, or misalignment of the tape transport will almost certainly cause information to be lost.



Figure B-20.—Simple procedure for threading a glass reel: Electrostatic attraction between tape and reel hub is created by looping the tape around the hub, then spinning the reel.

Reel Handling

Operators should exercise care when they hold, transport, or mount reels of tape. They should always hold the reel by the hub—the strongest and most stable part of the reel. Handling the flanges, on the other hand, will almost always cause them to deflect inward and jeopardize the tape edges. When you consider that the distance from the reel flange to the edge of the tape pack is less than 10 mils, the threat of damaging the tape edge is obvious. The threat becomes almost a certainty in those instances where layers of tape protrude from the pack, an all too common condition. Perhaps the most care is needed when mounting the reel on the transport. Occasionally a good deal of force is needed to do so, and it is then particularly important to apply it to the hub, as shown in figure B-21. This practice will save tape and, at the same time, enhance chances of achieving good reel alignment with the transport pedestal.

Reel Protection

All available flange protecting devices should be used whenever possible. The basic protective device is the reel container, which may be a cardboard box or a plastic or metal canister. The plastic canisters usually consist of two halves, properly pitted together with a tubular plastic seal inserted in one of the halves, and a locking device. Because there are many such canisters in use, it is important to be sure to keep the same two halves together for proper mating and sealing. As with reels and tape, canisters should be frequently inspected and cleaned.

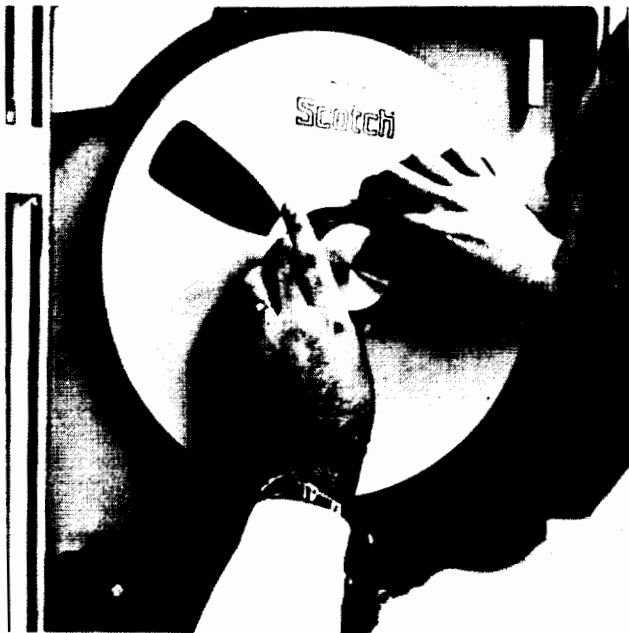

Figure B-21.—Reel mounting procedure.

Reels, either empty or wound with tape, should always be stored and transported in their protective containers.

Special plastic bands have been designed to fit over the reel flanges and protect the tape within. Figure 7-7 shows a protective band fitted onto a glass reel. As a rule, it is a good habit to keep the protective band in place. The only time it should be removed is after the reel is mounted on the tape transport. Likewise, the band should be put in place again before the reel is removed from the transport. Generally speaking, the reel band serves several important functions:

- (1) It protects the tape from harmful environmental conditions.
- (2) It protects the tape and reel flange edges from physical damage.
- (3) It helps keep plastic reel flanges from bending.
- (4) It eliminates the need for hub-supporting packaging.

An added degree of tape protection is afforded by a special type of plastic reel band that has been designed to remain on the reel even after being mounted on some brands of transports. Its locking mechanism is automatically opened by the transport, the tape end picked up by a vacuum and automatically threaded into the transport.

Tape caddies provide the reels with added protection when reels are being transported (still in their protective containers). Figure B-22 shows two tape caddies.

When reels of tapes are in process (awaiting recording, reproducing, degaussing, cleaning, or certification), they should be supported by their hubs with fixtures like those shown in figure 5-10. If such fixtures are not available, the reels of tape should be kept upright, stored in their

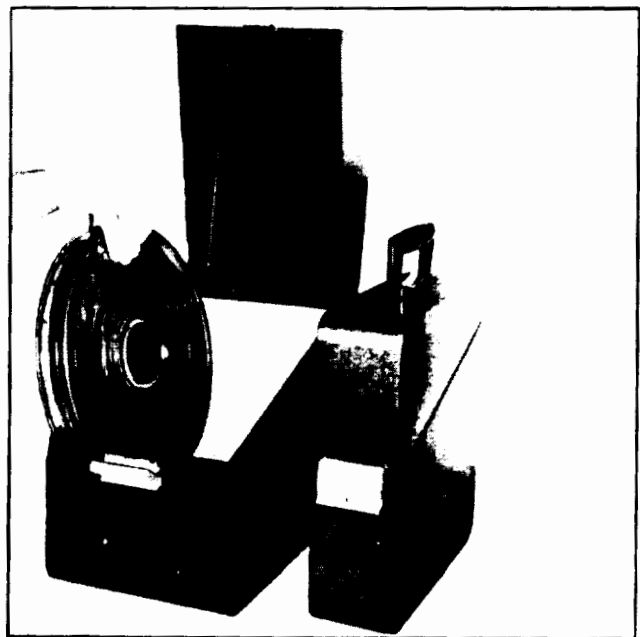

Figure B-22.—Tape caddies.

protective containers. Laying a reel of tape on its side makes the tape and reel vulnerable to three dangers. First, if the tape is loosely wound, it will slip down against the bottom flange. Second, there is a good chance that something will be put on top of the reel and damage it. Third, if the tape is exposed and the reel flanges have apertures (as do those on most metal reels), airborne contaminants will have a broad target to settle upon.

Damaged hubs, while not as prevalent as deformed flanges, also must be considered. Empty reels should be inspected thoroughly for both flange and hub damage before use. Because many turns of tape are wound upon a reel, even the slightest hub deformation (or dirt particle) will be magnified by its cumulative effect as layer is wound upon layer and cause the tape pack to stretch and spoke.

Tape Handling

There are instances when handling the tape itself is unavoidable; e.g., when threading the tape on the transport. Under such circumstances, it is good practice for the operator to wash his or her hands thoroughly before handling the tape. If lintfree gloves are available, they too should be worn.

These precautions should be observed because the slightest amount of oil or other contaminants on the fingers will be transferred to the tape—and fingerprint oils are excellent collectors of airborne dust and lint. Once the tape is contaminated, a lump of dropout-causing proportions will accumulate within a short time.

Even if the contaminants are deposited on only the first few unrecorded turns of the tape, they represent the genesis of dropouts. These contaminants will subsequently transfer from the end of the tape to the transport, and ultimately be redeposited on the inner layers of the tape pack. Consequently, it is equally important to keep the transport tape handling surfaces free of fingerprints.

Storage

Most reels of tape spend a significant amount of time in storage. During these periods they must be protected from contamination, environmental extremes, and physical damage. To do so, particular consideration should be given to the tension at which the tape is wound, the environment in which it will be stored, and the practices employed while it is in storage.

Tape Tension

When tape is being prepared for storage, the tape tension within the reel pack is a most important factor. If possible, tapes should be stored after a record or playback pass rather than after a high-speed rewind. (The latter usually results in a poor quality wind.) This would apply to relatively short-term storage. If a long storage period is

expected, the most desirable course would be to clean and precision wind the tape before storing it.

Some activities have found that winding the reel pack under constant tension is the best all-around method of avoiding pack damage. Other activities prefer to “program” wind their tape to a tension profile similar to the “bathtub curve” shown in figure B-23. However, this school of thought is divided on whether the bathtub tension curve should be as it is shown in figure B-23, or be inverted. The consensus is that the “normal” bathtub curve illustrated “holds the most water.”

In theory, reduced tension at the center of the wind best allows for expansion and contraction of the tape with temperature variations, which helps avoid problems such as layer-to-layer adhesion and spoking. However, at present, insufficient evidence has been brought forward to conclusively demonstrate this theory. All will agree, though, that a precision wind that gives a uniform tape pack is essential.

When tape is stored, it is usually desirable that the pack be wound at a slightly lower-than-normal tension (6 to 8 oz per 1/2 in.). However, care should be taken to insure that the wind tension is no less than 6 oz per 1/2 in. of tape width. Less tension will make the tape susceptible to slip.

If a spooling defect occurs while the tape is being wound, stop the winding process immediately. Unwind the pack promptly so that any induced deformation does not have a chance to set, correct the cause of the defect, then rewind the tape to a smooth, firm pack.

Storage Environment

Magnetic tapes store best in a clean environment that has low relative humidity and a temperature of about 70° F. This climate will preserve the physical and chemical quality of delivered tape. It follows that the prestorage tape processing area (used for degaussing, cleaning, and certifying tapes) and the storage area should approach, as

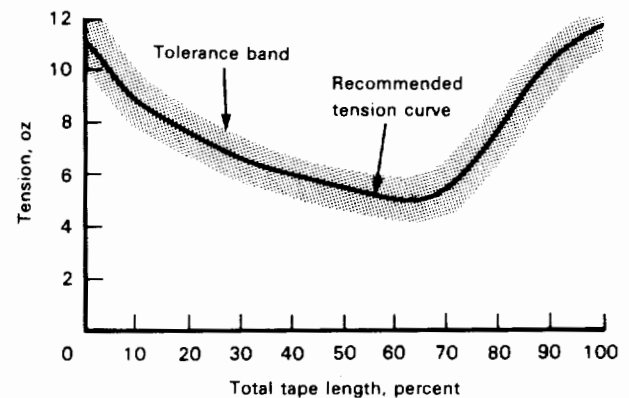

Figure B-23.—Favorable winding tension pattern for 1-in. tape. (The curve shall be smoothly varying and nonoscillatory.)

closely as practicable, a "clean room" environment—one that has a moderate temperature/relative humidity profile and is relatively free of airborne dust and lint. See the section entitled "Recorder Environment" for the best practice recommendations. They apply equally to the tape storage environment.

Special care should be taken to protect stored tape from high temperature and high humidity. Extreme temperatures will cause either pack shrinking or stretching that will inevitably deform the pack. Also, under the influence of high relative humidity, and accelerated by high temperature, hydrolysis breaks down the binder and causes it to become gummy. Obviously, this process renders the tape useless for quality work. Fortunately, though, the process is reversible. So, if it is suspected that tape has been exposed to high temperature and humidity, place the tape in a low humidity environment (no more than 25 percent relative humidity) at room temperature. Moisture will then be given off and the tape will heal itself and equalize internal pressures.

Storage Practices

Because the hub is the strongest and most stable part of the reel, it is the best means of reel support during storage. Do not store an unprotected reel so that it rests upon its flanges unless a plastic reel band is first put in place. The

band provides excellent protection against bending or nicking, while at the same time keeping contaminants out and holding the flanges at a fixed distance apart. If a band is not readily available, the tapes should be placed in a container that supports the reel by its hub, such as special fiberboard boxes, plastic canisters, and metal boxes. When the reel is supported in this manner, there is little if any weight resting upon its flanges.

For long-term tape storage, additional protection from dust and moisture should be considered. This can be done by sealing the tape storage container in a plastic bag. When the reel of tape is taken out of storage, accumulated dust should be cleaned thoroughly from the exterior of the container (or plastic bag) before the tape is removed. Before using, the tape should be rewound to relieve stresses.

Conclusion

Data can be preserved indefinitely on magnetic tapes if the operator observes the proper procedures for winding tapes, protecting and storing them, and maintaining them in a well-regulated, clean environment. Personnel responsible for tape storage should periodically perform a visual check of a random sample of stored tapes. In this manner, the condition of the tape library can be monitored, and tapes can be rewound and reconditioned when necessary.

APPENDIX C

Glossary

Herbert M. Schwartz
RCA

Joe Pomian
CPI

Sanford Platter
Platter Analysis and Design

Abrasivity: The ability of the tape to wear the head.

ac bias: The alternating current, usually of frequency several times higher than the highest signal frequency, that is fed to a record head in addition to the signal current. ac bias serves to linearize the recording process and is universally used in direct analog recording.

Acicular: Needle-shaped, used to describe the shape of oxide particles.

Additive: Any material in the coating of magnetic tape other than the oxide and the binder resins; for example, plasticizers (to soften an otherwise hard or brittle binder), lubricants (to lower the coefficient of friction of an otherwise high-friction binder), fungicides (to prevent fungus growth), dispersants (to uniformly distribute the oxide particles), and dyes.

Amplitude/frequency response: See **Frequency response**.

Amplitude nonuniformity: A term used in connection with magnetic tape testing that refers to the reproduced peak-to-peak voltage and its variation from recorded values.

Analog recording: In the broadest sense, analog recording is a method of recording in which some characteristic of the record current, such as amplitude or frequency, is continuously varied in a manner analogous to the variations of the original signal.

Anchorage: The degree to which the magnetic tape oxide coating adheres to the base film.

Anhysteresis: The process whereby a material is magnetized by subjecting it to a unidirectional magnetic field that is superimposed on an alternating field of gradually decreasing amplitude. One form of this process is analogous to the recording process using ac bias.

Anisotropy: Directional dependence of magnetic properties leading to the existence of easy, or preferred,

directions of magnetization. Shape anisotropy is the dominant form in acicular particles.

Asperities: Small projecting imperfections on the surface of the tape coating that limit and cause variations in head-to-tape contact.

Azimuth alignment: Alignment of the recording and reproducing gaps so that their centerlines lie parallel with one another. Misalignment of the gaps causes a loss in output at short wavelengths.

Backing: See **Base film**.

Bandwidth: The range of frequency within which the performance of a recorder with respect to some characteristic (usually frequency response) falls within specified limits, or within which some performance characteristic (such as noise) is measured.

Base film: The plastic substrate material used in magnetic tape that supports the coating.

Baseline shift: A shift of the dc average of a data sequence relative to the peak value caused by the lack of dc or low-frequency ac response of the recorder.

Binder: A compound consisting of organic resins used to bond the oxide particles to the base material. The actual composition of the binder is considered proprietary information by each magnetic tape manufacturer. The binder is required to be flexible and still maintain the ability to resist flaking or shedding binder material during extended wear passes.

Bit: As applied in magnetic recording, it represents one recorded information cell.

Bit density: See **Packing density**.

Bit error rate: This term, used in high-density digital recording or high-density recording, refers to the number of errors a specific magnetic tape may contain, and is expressed in errors per data bits such as 1 in 10^6 or one error in one million data bits.

Block: A group of contiguous recorded characters con-

sidered and transported as a unit containing one or more logical records.

Break elongation: The relative elongation of a specimen of magnetic tape of base film at the instant of breaking when it has been stretched at a given rate.

Brown stain: A discoloration of the head top surface, usually a chemical reaction between the head surface materials and either the tape binder, tape lubricant, or head bonding materials. The stain is usually very thin ($<2 \mu\text{in.}$). Its origin is not well understood but is known to occur in the presence of low humidity.

Buckling: Deformation of the circular form of a tape pack that may be caused by a combination of improper winding tension, adverse storage conditions, and/or poor reel hub configuration.

Buildup: A "snowballing" effect started by debris and the tape magnetic particles embedded in the contamination; the thickness of this buildup can cause increase in head-to-tape separation as well as increase in coefficient of friction. Solvent cleaning of the head top surface will usually remove the buildup.

Bulk eraser (degausser): Equipment for erasing previously recorded signals on tape a full reel at a time.

Character: Serially transversely related bits recorded on the tape.

Certified tape: Tape that is electrically tested on a specified number of tracks and is certified by the supplier to have less than a certain total number of permanent errors.

Certifier: Equipment that evaluates the ability of magnetic tape to record and reproduce. The equipment normally counts and charts each error on the tape, including the level and duration of dropouts. In the "certify" mode, the equipment stops the tape at an error to allow for visual inspection of the tape to see if the cause of the error is correctible or permanent.

Chicken tracks: A line of small craters in the head top surface running in the direction of tape motion. This is

usually caused by a loose, small hard particle moving with the tape over the head. (See fig. C-1.)

Chips: Cavities or voids at an edge of head track. (See fig. C-1.)

Cinching: Tape folds resulting from longitudinal slippage between the layers of tape in a tape pack caused by uneven tension when the roll is accelerated or decelerated.

Cleaner: See **Winder/cleaner**.

Clean rooms: Rooms the cleanliness of which is measured by the number of particles of a given size per cubic foot of room volume. For example, a class 100 000 clean room may have no more than 100 000 particles $0.5 \mu\text{m}$ or larger per cubic foot, and so on for class 10 000 and class 100 rooms. In addition, a class 10 000 room may have no more than sixty-five $5\text{-}\mu\text{m}$ particles per cubic foot, while class 100 000 may have no more than 700.

Coating: The magnetic layer of a magnetic tape consisting of oxide particles held in a binder that is applied to the base film.

Coating resistance: The electrical resistance of the coating measured between two parallel electrodes spaced a known distance apart along the length of tape. On the specification sheets this is called resistivity.

Coating thickness: The thickness of the magnetic coating applied to the base film.

Coating-to-backing adhesion: See **Anchorage**.

Coefficient of friction: The tangential force required to maintain (dynamic coefficient) or initiate (static coefficient) motion between two surfaces divided by the normal force pressing the two surfaces together.

Coefficient of hygroscopic expansion: The relative increase in the linear dimension of a tape or base material per percent increase in relative humidity measured in a given humidity range.

Coefficient of thermal expansion: The relative increase in the linear dimension of a tape or base material per degree rise in temperature (usually Fahrenheit) measured in a given temperature range.

Coercive force: See **Intrinsic coercive force**.

Conductive coatings: Coatings that are specially treated to reduce the coating resistance and thus prevent the accumulation of static electrical charge.

Contamination: A thin, tacky (viscous) deposit on the head top surface. This deposit causes a large increase in the effective head-to-tape coefficient of friction and may not be removable by solvent cleaning.

Contour pulse (spurious response: little Joe, big Joe): A secondary pulse caused by the contour of the read head. A secondary or virtual head gap is formed by the leading and trailing edges of the core material of the read head. Thus a pulse (called contour pulse) is generated when a recorded tape is passed over this secondary gap.

Contouring head: This is a method of establishing the final head contour and obtaining the proper surface

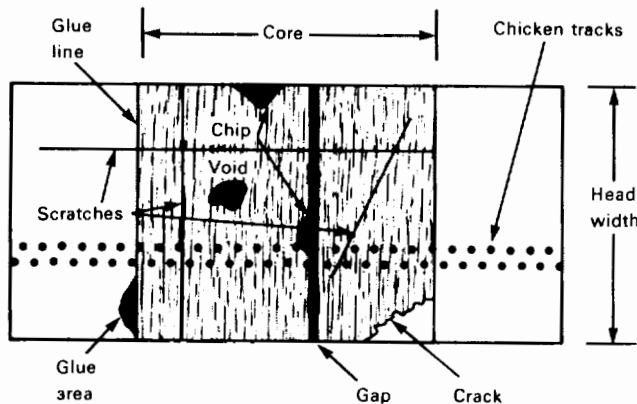

Figure C-1.—Schematic diagram of magnetic tape head chicken tracks, chips, voids, glue area, crack, and scratches—top view.

finish. An abrasive tape is passed over the head. The grit of the abrasive, the lubricant, the tape stiffness, the tape tension, the tape speed, and the amount of tape passed over the head are parameters that will control the final head contour and top surface finish.

Core material, hard: (1) "Hard" metal laminations bonded together to form the core; typical thickness is 0.005 to 0.004 in.; "hard" metal wears much more slowly than "soft" laminations. (2) "Hard" solid metal such as alphenol or sendust; wear rates are much lower than those of "soft" metal laminations.

Core material, soft: "Soft" metal laminations bonded together to form the core; typical lamination thickness is 0.0005 to 0.004 in.; usually a high nickel/iron alloy such as Hy Mu 800. These materials have a relatively poor wear rate.

Crack: A narrow, deep break in the head surface material. (See fig. C-1.)

Creep: Time-dependent strain at constant stress (tape deformation).

Crossplay: The ability to interchange recordings between recorders while maintaining a given level of performance.

Crosstalk: Magnetic coupling from one track to another track in the read/write head on the tape.

Cupping: Curvature of a magnetic tape pack in the lateral direction. Cupping may occur because of differences between the coefficients of thermal or hygroscopic expansion of coating and base film.

Data density (bpi): The number of data characters stored per unit length of tape.

Decibel: A dimensionless unit for expressing the ratio of two powers, or more usually voltages or currents, on a logarithmic scale. If A and B represent two voltages or currents, the ratio A/B corresponds to $20 \log A/B$ decibels. One decibel represents a ratio of approximately 1.1 to 1 between A and B . Other values are as follows:

Ratio	Decibel
1	0
1.4	3
2	6
4	12
10	20
100	40
1000	60

Defect: An imperfection in the tape leading to a variation in output or a dropout. The most common defects take the form of surface projections consisting of oxide agglomerates, embedded foreign matter, and re-deposited wear products.

Density identification area: A recording in the beginning of tape marker to identify the method and density of recording.

Digital codes: See **Digital recording**.

Digital recording: A method of recording in which the information is first coded in a digital form. Usually a binary code is used and recording takes place in terms of two discrete values/polarities of residual flux.

Direct recording: A type of analog recording that records and reproduces data in the electrical form of its source.

Dispersion: Distribution of the oxide particles within the binder of a tape.

Distortion: See **Harmonic distortion**.

Drag: When the tape contacts some element in the tape path (such as the head, tape guides, tape bearings, or column walls), there is a tension differential across the contact area. This tension differential is caused by friction and forces on the edges of the tape and is called "drag."

Dropout: A temporary reduction in output of a magnetic tape of more than a certain predetermined amount expressed in terms of the percentage reduction or decibel loss.

Dropout count: The number of dropouts detected in a given length of magnetic tape.

Durability: Usually expressed as a number of passes that can be made before a significant degradation of output occurs divided by the corresponding number that can be made using a reference tape.

Dynamic coefficient of friction (u_d): When the tape is loaded against a body by a normal force f_N and is moving at a speed of over 5 in./s, a force of f_d is required to move the tape at steady speed; $u_d = f_d/f_N$.

Dynamic range: The bandwidth within which a satisfactory signal-to-noise ratio is obtained. (See also **Resolution**.)

Dynamic skew: The change in skew caused by tape motion.

Dynamic tape skew: See **Tape skew**.

EDAC: Error detection and correction of recorded data using simultaneously recorded correction data either added to the data stream or recorded separately on an auxiliary track.

Edge gutter (groove; cut): Removing the head surface material where the outer edges of the tape would normally touch the head. Prevents head guidance of the tape. (See fig. C-2.)

Edge roll or lift: Caused by head wear. The rolloff or liftup of the outer edges of the head. (See fig. C-3.)

Envelope modulation: Amplitude modulation in the envelope of the peak-to-peak signal amplitude at the maximum flux reversal of the desired recording method due to changing head-to-tape spacing, changing tape velocity, or changing magnetic characteristics of the tape.

Erase: A process by which a signal recorded on a tape is removed and the tape made ready for rerecording. Erasure may be accomplished in two ways: in ac erasure the tape is demagnetized by an alternating magnetic field that is reduced in amplitude from an

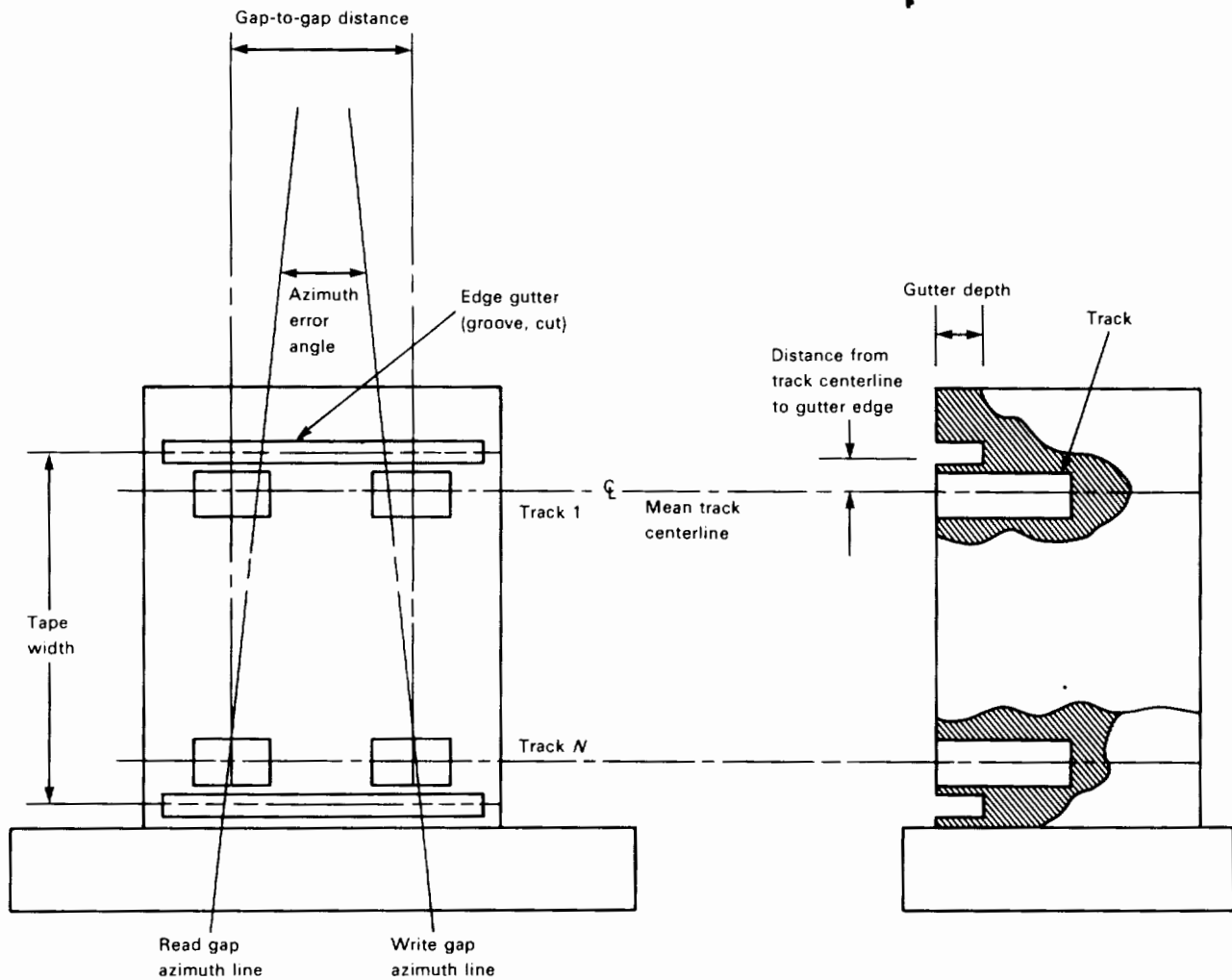

Figure C-2.—Schematic diagram of read/write gap azimuth and edge gutters in a two-gap head.

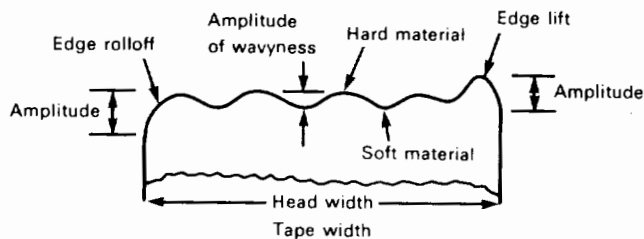

Figure C-3.—Schematic diagram of waviness, edge rolloff, and edge lift.

initially high value; in dc erasure, the tape is saturated by applying a primarily unidirectional field. ac erasure may be accomplished by passing tape over an erase head fed with high frequency ac or by placing the whole roll of tape in a decreasing ac field (bulk erasure). dc erasure may be accomplished by passing the tape over a head fed with dc or over a permanent magnet. Additional stages may be included in dc erasure to leave the tape in a more nearly unmagnetized condition.

Error: In digital recording, a number expressing the count of binary digits (bits) not accurately reproduced within a larger number of bits.

E value: The difference in inches between the radii of the outside layer of tape in a roll and the outside edge of the reel flange.

Evaluator: Equipment, usually provided as an adjunct to a winder/cleaner, that evaluates physical and magnetic quality of tape. In contrast to a certifier, an evaluator does not stop when it detects an error.

Eye pattern: An eye pattern is generated by observing the playback of a PCM recorder and synchronizing the oscilloscope with the regenerated clock. The display eye or window defines the decision time interval over which the decoder must decipher the intended bit identity.

Flux: Lines of magnetic force.

FM: A flux reversal at the beginning of a cell time represents a clock bit, a "1" bit is a flux reversal at the center of the cell time, and a "0" bit is an absence of a flux reversal.

Forward/backward ratio: Forward read signal divided by backward read signal.

Frequency response: The variation of sensitivity with signal frequency. Usually the frequency response of a tape is given in decibels relative to that of a referenced frequency output level.

Gamma ferric oxide: The common magnetic constituent of magnetic tapes in the form of a dispersion of fine acicular particles within the coating.

Gap azimuth: The angle between any gap and the gap azimuth line.

Gap azimuth line: A line drawn through the gap centers of the outside tracks or a least squares fit line through the gap centers in tracks 1 through N (for N tracks). This can be done optically or electronically. (See fig. C-4.)

Gap depth: The dimension of the gap of a magnetic head measured in the direction perpendicular to its surface.

Gap erosion: The read or write gap will effectively increase in length and will retreat below the head surface, usually due to deterioration of core material at the edges of the gap. (See fig. C-5.)

Gap-to-gap distance: Distance from center of read gap to center of write gap on the mean track center line for any track. (See fig. C-2.)

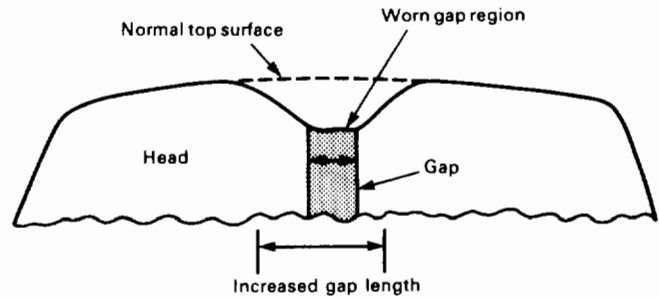

Figure C-5.—Schematic diagram of gap erosion on magnetic tape head—side view.

Gap front: Region of nonmagnetic material between the two sections of the magnetic core that contact the tape. (See fig. C-6.)

Gap height (throat height; pole tip height): The height of the gap. (See fig. C-7.)

Gap height cut (pole tip cut): A cut into the magnetic core that establishes the gap height.

Gap length: The dimension of the gap of a magnetic head measured from one pole face to the other. In longitudinal recording the gap length can be defined as the dimension of the gap in the direction of tape travel.

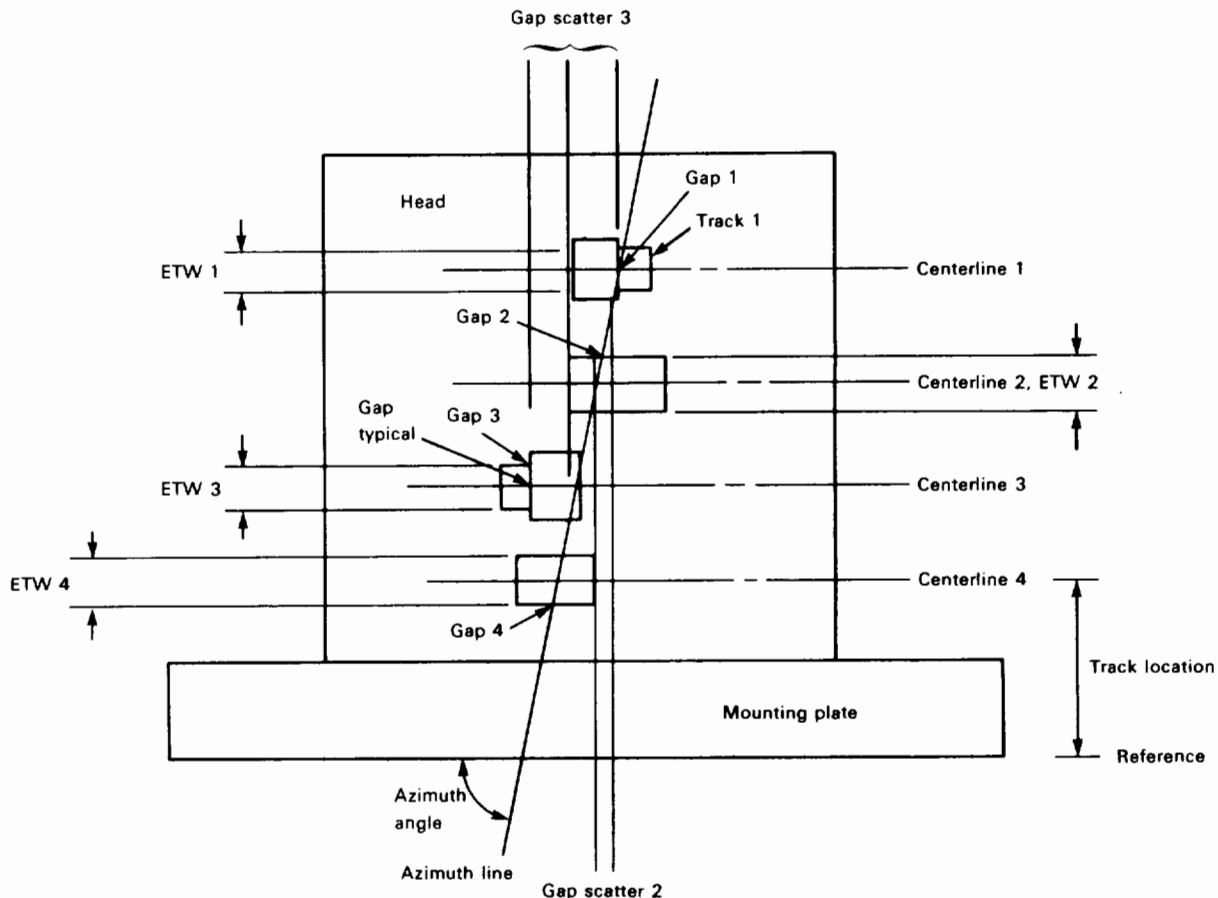

Figure C-4.—Gap scatter, azimuth, effective track width (ETW), and track centerline of a four-track magnetic head.

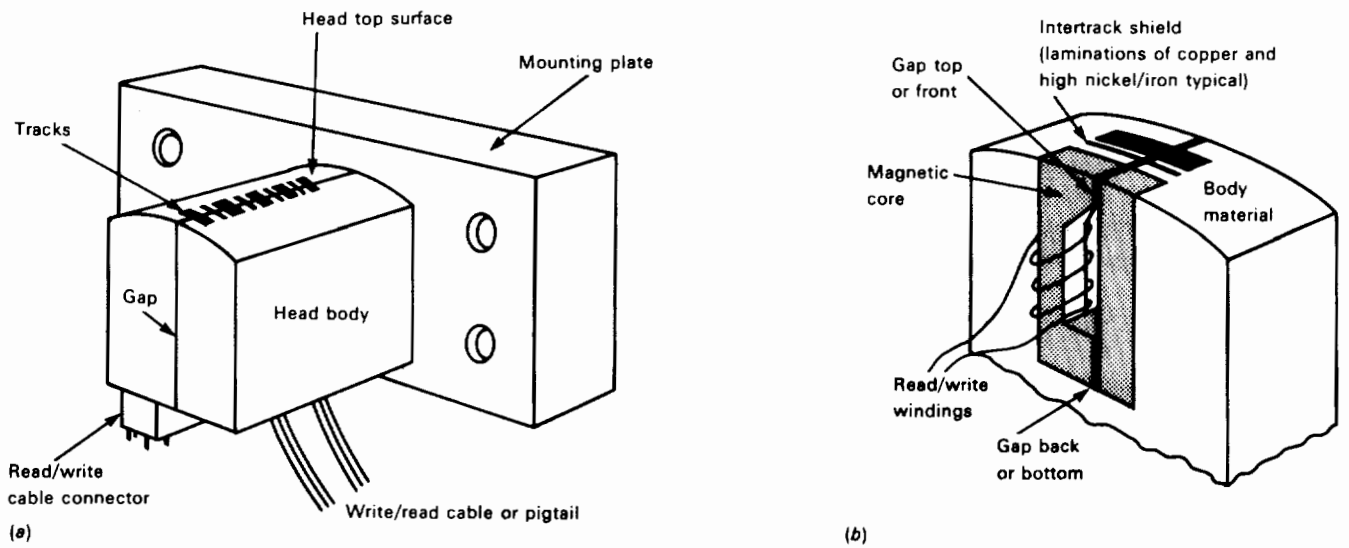

Figure C-6.—Single-gap magnetic head. (a) Diagram. (b) Cross section through the magnetic core.

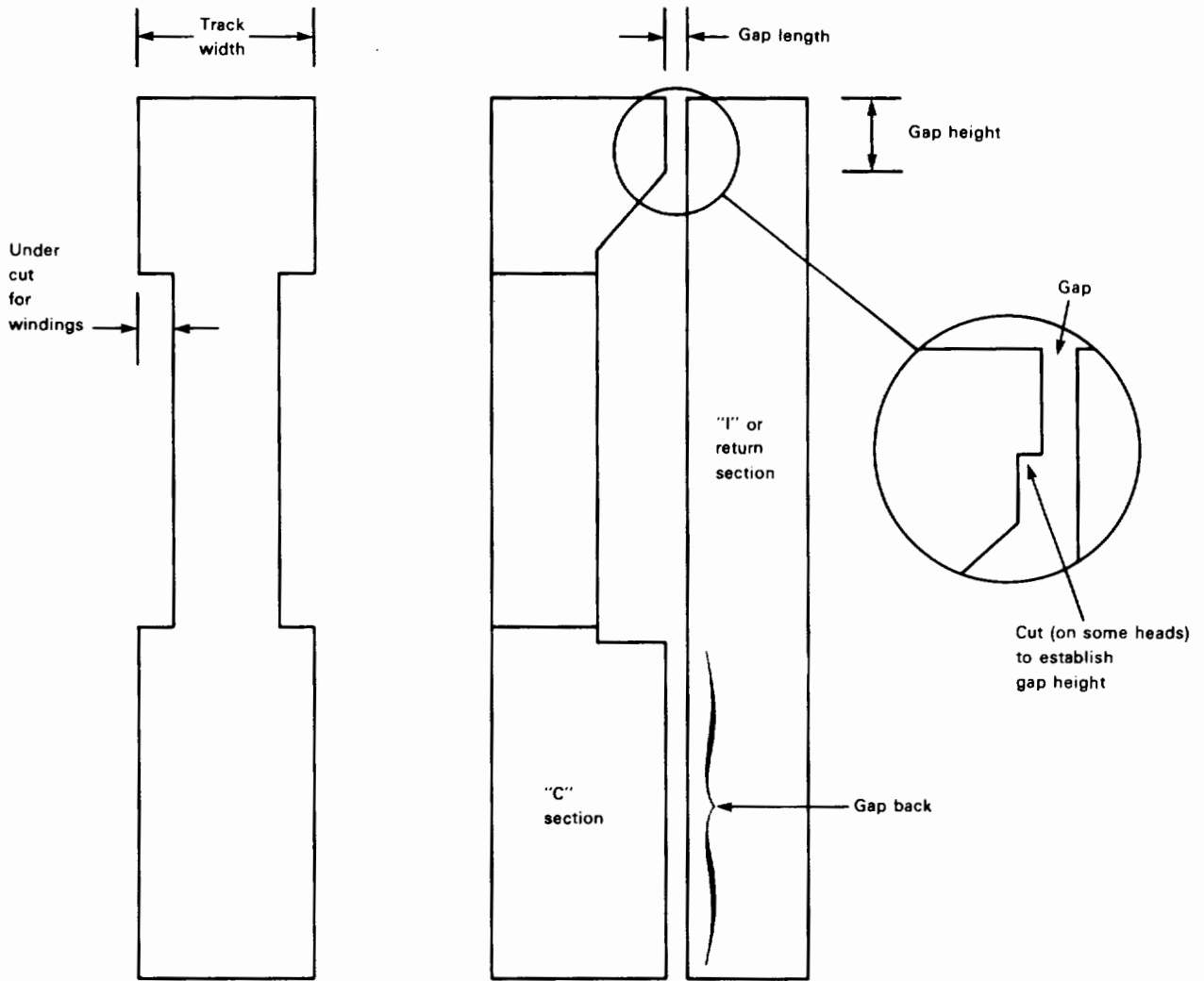

Figure C-7.—Schematic diagram of a magnetic core.

Gap loss: The loss in output attributable to the finite gap length of the reproduce head. The loss increases as the wavelength decreases.

Gap material (shim material): The material in the gap front.

Gap scatter: The variation of the location of the gap position of any track from the azimuth line. This can be done optically or electronically. (See fig. C-4.)

Gap width: The dimension of the gap of a magnetic head measured in the direction perpendicular to the direction of the tape path.

Gauss: The metric unit of magnetic flux density equal to 1 Mx/cm^2 .

GCR: NRZI recording that collects groups of characters and encodes them allowing a maximum of two "0" values in sequence.

Glue lines or glue areas: Glue (or bonding materials) exposed on the top surface of a magnetic head. (See fig. C-1.)

Green tape: An abrasive tape used to clean and lap heads that are unevenly worn, stained, scratched, etc. It should be used with caution and should not be used on ferrite heads. These comments also apply to gray tape.

"Hard" ferrite: With a very-low-wear rate as compared to the "soft" metal laminations.

"Hard" solid metal: Such as alphenol or sendust. These metals have wear rates that are much lower than the "soft" metal laminations.

Harmonic distortion: Signal nonlinearity characterized by the appearance in the output of harmonics of the fundamental when the input signal is sinusoidal.

Head body: The structure that supports the magnetic cores and may form a support for the tape. (See fig. C-6.)

Head coating—conductive: A coating on the top surface of the head to reduce "feed through." (See fig. C-8.)

Head coating—hard (low-wear coating): A coating on the top surface of the head to increase head life and reliability. (See fig. C-8.)

Head coating—exposed core window: The part of the magnetic core that is not coated. It is exposed to the tape. (See fig. C-8.)

Head contour: The complex shape of the contacting surface of a head either a result of manufacturer, head lapping, or wear. The contour of a head is always changing throughout the life of the head and in many cases is responsible for retiring the head. Typical contours and terminology are shown in figure C-9.

Head stack azimuth: See figure C-10.

Head stack gap scatter: See figure C-11.

Head stack tilt angle: See figure C-12.

Head stick; sticktion; stick-slip: Common words for a large increase in head-to-tape friction caused by (1) a sticky byproduct exuded by the tape under certain conditions of tape age, temperature/humidity, and

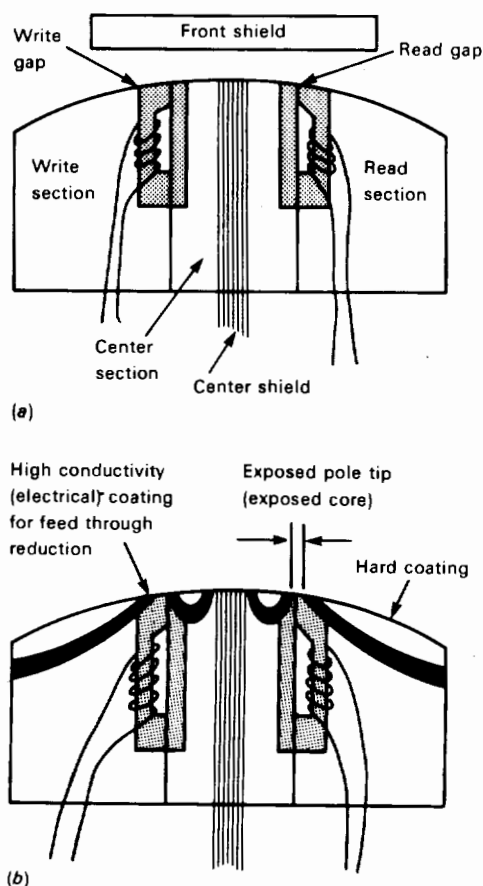

Figure C-8.—Schematic of a two-gap head. (a) Feed-through front shield consisting of permeable and conductive material. (Center shield consists of copper and nickel/iron laminations or ferrite or copper and ferrite.) (b) Surface coating.

head-to-tape pressure; (2) very smooth tapes coupled with large area heads.

Head-to-tape contact: The degree to which the surface of the magnetic coating of a tape approaches the surface of the record or reproduce heads during normal operation of a recorder.

HD³: High-density digital data.

Impact strength: A measure of the work done in breaking a test sample of tape or base film by subjecting it to a sudden stress.

Interblock gap: A section of tape separating blocks of information.

Interlayer transfer: Loose material, such as oxide, that is generated by tape wear or a "head stick" condition which is transferred from the oxide to the back of the tape or from the back side to the oxide when tape is wound on a reel.

Intermodulation distortion: Signal nonlinearity characterized by the appearance of frequencies in the output equal to the sums and differences of integral multiples of the component frequencies present in the input signal.

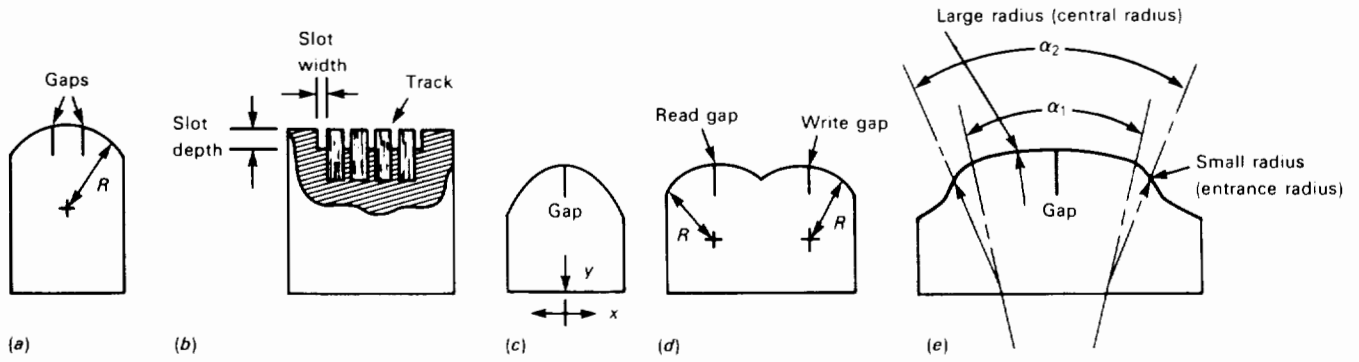

Figure C-9.—Head contours. (a) Simple radius, one or two gaps. (b) Simple radius with slots between tracks (also possibly double radius). (c) Parabolic radius (single gap); $y = Ax^2$. (d) Double radius (two gap). (e) Compound (complex) radius, one or two gaps; tape wraps α_2 . (f) Two-bump (pad) head. (g) Read and write and outboard bumps and bearings, single or compound radius.

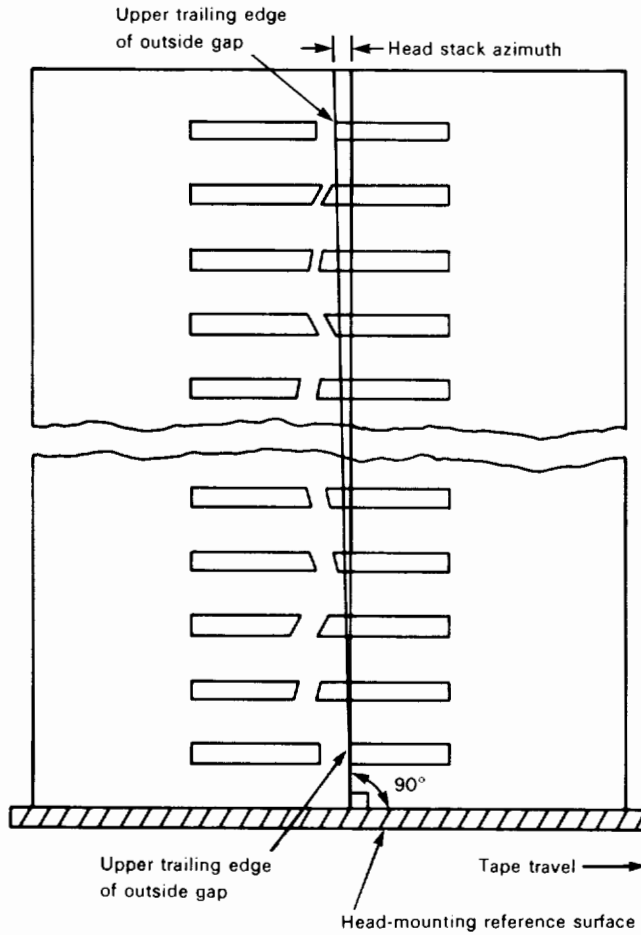
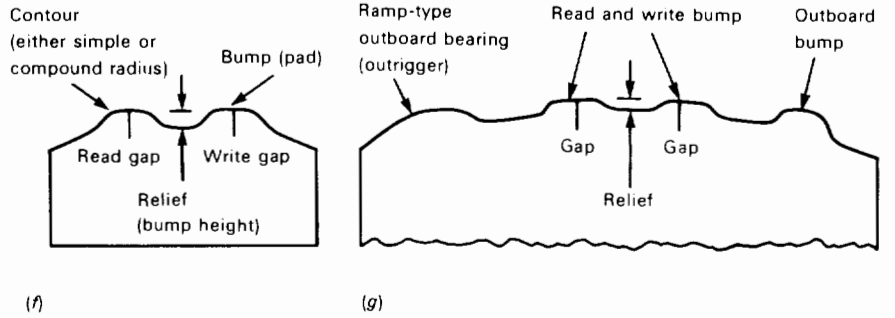

Figure C-10.—Head stack azimuth.

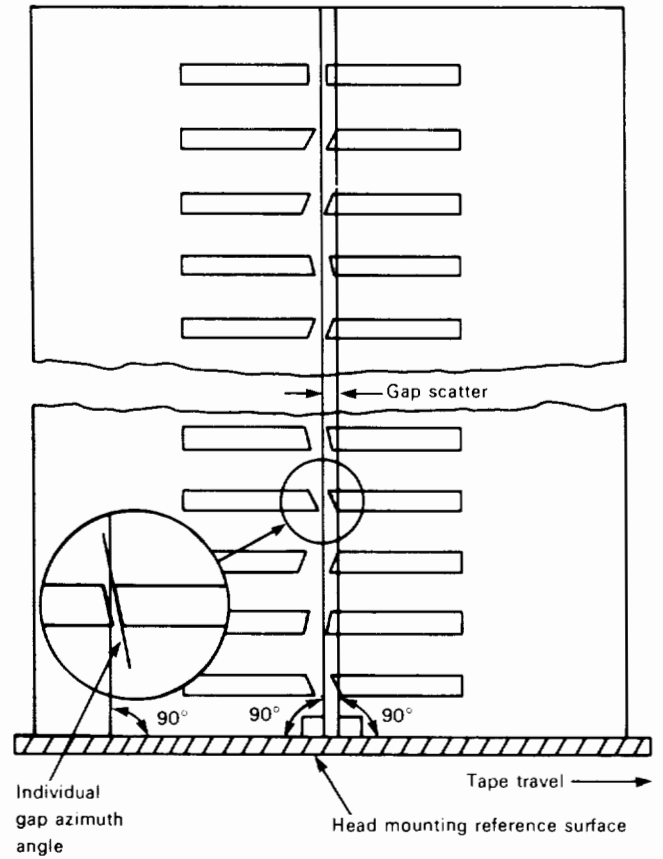

Figure C-11.—Head stack gap scatter.

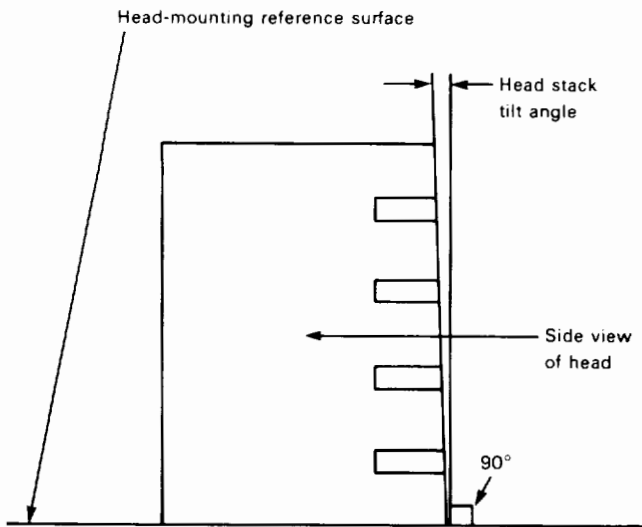

Figure C-12.—Head stack tilt angle.

Harmonics are usually not included as part of the intermodulation distortion.

Intersymbol interference: When a recording system has limited record resolution, a flux transition being recorded will extend beyond its cell boundaries adding or subtracting from the flux in the adjacent bit cells or "symbols." This type of interference will result in phase shift of the cell playback crossover point with respect to the data clock.

Intertrack shields: Laminations of copper and nickel; iron or sections of ferrite placed between tracks to reduce crosstalk between tracks. (See fig. C-6.)

Intrinsic coercive force: The magnetizing field strength needed to reduce flux density from saturation to zero.

Intrinsic flux: In a uniformly magnetized sample of magnetic material, the product of the intrinsic flux density and the cross-sectional area.

Intrinsic flux density: In a sample of magnetic material for a given value of the magnetizing field strength, the excess of the normal flux density over the flux density in vacuum.

IRIG: Inter-range instrumentation group.

Iron oxide: See **Gamma ferric oxide**.

Lateral direction: Across the width of the tape.

Layer-to-layer adhesion: The tendency for adjacent layers of tape in a roll to adhere to one another.

Layer-to-layer signal transfer: The magnetization of a layer of tape in a roll by the field from a nearby recorded layer, sometimes referred to as "print through."

LBE: Lower band edge of the recorder/reproducer response (usually at the -3 -dB point).

Linearity: The extent to which the magnitude of the reproduced output is directly proportional to the magnitude of the signal applied to the input of the recorder.

Longitudinal curvature: Any deviation from straightness of a length of tape.

Longitudinal direction: Along the length of the tape.

Loose debris: Material very lightly bonded to the tape or head top surface, removable by tape motion.

Lubricant: See **Additive**.

Magnetic instability: The property of a magnetic material that causes variations in the residual flux density of a tape to occur with temperature, time, and/or mechanical flexing. Magnetic instability is a function of particle size, magnetizing field strength, and anisotropy.

Magnetic tape: With a few exceptions, magnetic tape consists of a base film coated with magnetic particles held in a binder. The magnetic particles are usually of acicular shape, approach single domain size, and are composed of gamma ferric oxide.

Magnetizing field strength: The instantaneous strength of the magnetic field applied to a sample of magnetic material.

Maximum flux: See **Maximum intrinsic flux**.

Maximum flux density: See **Maximum intrinsic flux density**.

Maximum induction: See **Maximum intrinsic flux density**.

Maximum intrinsic flux: In a uniformly magnetized sample of magnetic material, the product of the maximum intrinsic flux density and the cross-sectional area.

Maximum intrinsic flux density: The maximum value, positive or negative, of the intrinsic flux density in a sample of magnetic material that is in a symmetrically, cyclically magnetized condition.

Maxwell: A unit of magnetic flux.

Mean track centerline: The average centerline of the read and write track. (See fig. C-2.)

MFM (modified frequency modulation or delay modulation): A code that has a "1" and a "0" correspond to the presence or absence, respectively, of a transition in the center of the corresponding bit cell. However, additional transitions at the cell boundaries occur only between bit cells that contain consecutive "0" values.

Microhardness: Hardness of core material measured in knoop or vickers.

Modulated carrier recording: Signal information recorded in the form of a modulated carrier.

Modulus of elasticity: Average slope of the stress/strain curve of the tape when the strain is less than 3 percent and strain is applied at less than 1 percent/s.

Moment of inertia: A measure of the rotational force required to accelerate or decelerate a reel of tape.

Mounting plate: A means of holding the head body and mounting it into the tape transport. It is the reference surface for most mechanical measurements. (See fig. C-6.)

Noise: Any unwanted electrical disturbances other than crosstalk or distortion components that occur at the output of the reproduce amplifier. *System noise* is the total noise produced by the whole recording system

including the tape. *Equipment noise* is the noise produced by all the components of the system, with the exception of the tape. *Tape noise* is the noise that can be specifically ascribed to the tape. The following are typical sources of tape noise:

(1) *Bulk-erased noise*: The noise arising when a bulk-erased tape with the erase and record heads completely deenergized is reproduced.

(2) *Zero-modulation noise*: The noise arising when an erased tape with the erase and record heads energized as they would be in normal operation, but with zero input signal, is reproduced. This noise is usually 3 to 4 dB higher than the bulk-erased noise. The difference between bulk-erased and zero-modulation noise is sometimes termed "bias-induced noise."

(3) *Saturation noise*: The noise arising when a uniformly saturated tape is reproduced. This is often some 15 dB higher than the bulk-erased noise and is associated with imperfect particle dispersion.

(4) *dc noise*: The noise arising when a tape that has been nonuniformly magnetized by energizing the record head with dc, either in the presence or absence of bias, is reproduced. This noise has pronounced long-wavelength components that can be as much as 20 dB higher than those obtained from a bulk-erased tape. At very high values of dc, the dc noise approaches the saturation noise.

(5) *Modulation noise*: It is essentially a modulation of the desired signal by noise that is caused by non-uniform dispersion of elementary magnetic particles in the tape coating material. This noise, which occurs only when a recorded tape is reproduced, increases with the intensity of the reproduced signal. dc noise is actually the low frequency component of modulation noise.

Noise pulse: A spurious signal of short duration that occurs during reproduction of a tape and is of a magnitude considerably in excess of the average peak value of the ordinary system noise.

Nominal bit time (cell time): The average bit time of recording at continuous maximum flux reversals.

Nonreturn-to-zero (NRZ) recording: See **Digital recording**.

NRZI (nonreturn-to-zero inverted): Flux reversal for a "1"; no flux reversal for a "0."

NRZ0 (nonreturn-to-zero): Flux reversal for a "0"; no flux reversal for a "1."

Oersted: A unit of magnetic field strength.

Orientation: See **Particle orientation**.

Orientation direction: The direction in which particle orientation takes place.

Orientation ratio: In a material composed of directionally oriented particles, the orientation ratio is the ratio of the residual flux density in the orientation direction to the residual flux density perpendicular to the orientation direction.

Output: The magnitude of the reproduced signal voltage, usually measured at the output of the reproduced amplifier.

Oxide buildup: The accumulation of oxide or, more generally, wear products in the form of deposits on the surface of heads and guides.

Oxide loading: A measure of the density with which oxide is packed into a coating. It is usually specified in terms of the weight of oxide per unit volume of the coating.

Oxide shed: The loosening of particles of oxide from the tape coating during use.

Packing density: The amount of digital information recorded along the length of a tape measured in bits per inch.

Particle orientation: The process by which acicular particles are rotated so that their longest dimensions tend to lie parallel to one another.

Particle shape: The particles of gamma ferric oxide used in conventional magnetic tape are acicular with a dimensional ratio of about 6 to 1.

Particle size: The physical dimensions of magnetic particles used in a magnetic tape.

Pattern sensitivity: A recorder inability to reproduce certain data stream combinations (patterns).

PCM: Pulse code modulation.

PE (phase encoding): A "1" bit is a flux reversal to the polarity of the interblock gap. A "0" data bit is a flux reversal to the polarity opposite that of the interblock gap. A flux reversal shall be written at the nominal midpoint between successive "1" bits or between successive "0" bits to establish proper polarity.

Peak magnetizing field strength: The positive or negative limiting value of the magnetizing field strength.

Peak shift (pulse crowding): The displacement of a positive or negative peak of a readback pulse from its nominal peak position as if a continuous maximum flux reversal had been written.

Percent peak shift: Peak shift divided by nominal bit time and multiplied by 100.

Permanent elongation: The percentage elongation remaining in a tape or length of base film after a given load applied for a given time has been removed.

Permed: Magnetized to a level that cannot be removed with a handheld degausser.

Perpendicular direction: Perpendicular to the plane of the tape.

Physical recording density: The number of recorded flux reversals per unit length of track (FRPI).

Plasticizer: See **Additive**.

Polyester: An abbreviation for polyethylene glycol terephthalate—the material most commonly used as a base film for precision magnetic tape.

Porosity: The ratio of voids to a solid volume of magnetic material usually expressed in percent.

- Postamble:** Group of special signals recorded at the end of each block on tape for the purpose of electronic synchronization.
- Preamble:** Group of special signals recorded at the beginning of each block on tape for the purpose of electronic synchronization.
- Print through:** See **Layer-to-layer signal transfer**.
- Readback amplitude:** The average peak-to-peak signal amplitude at the maximum flux reversal of the desired recording method.
- Read reduction (self-erase, residual erasure):** Reduction in the average peak-to-peak signal amplitude at the maximum flux reversal of the desired recording method due to residual magnetism in the read and/or write tracks of the read/write head partially erasing the written information on the tape.
- Read/write erase head:** A three-gap head (read, write, and erase gaps) on one body (sometimes the erase head is bolted to the read/write head).
- Read/write head:** A two-gap head (read and write gap) on one body. (See fig. C-8.)
- Record margin:** The change in signal-to-noise ratio achieved by reducing the record level from optimum while maintaining the reproduce level constant to reach a specific bit error rate.
- Reel:** The flanged hub, made of metal, glass, or plastic, on which magnetic tape is wound.
- Reference tape:** A tape used as a reference against which the performances of other tapes are compared.
- Remanence:** The magnetic flux density that remains in a magnetic circuit after removal of applied magnetomotive force. (Note: Remanence is not necessarily equal to residual flux density.)
- Residual erase signal (residual magnetic erase):** The average peak-to-peak signal amplitude at the minimum flux reversal of the desired recording method after dc erase by the write or erase head.
- Residual flux:** In a uniformly magnetized sample of magnetic material, the product of the residual flux density and the cross-sectional area.
- Residual flux density:** The magnetic flux density at which the magnetizing field strength is zero when a sample of magnetic material is in a symmetrically, cyclically magnetized condition.
- Residual-to-maximum-flux ratio:** In tapes consisting of oriented acicular particles, this ratio is an indication of the degree of particle orientation.
- Resolution (dynamic range):** The average peak-to-peak signal amplitude at the maximum flux reversal divided by the average peak-to-peak signal amplitude at the minimum flux reversal at the desired recording method.
- Retentivity:** The maximum value of the residual flux density corresponding to saturation flux density.
- Roll:** A reel wound with a standard length of tape.
- RZ recording:** See **Digital recording**.
- Saturation flux density:** The maximum intrinsic flux density possible in a sample of magnetic material. The intrinsic flux density asymptotically approaches the saturation flux density as the magnetizing field strength is increased.
- Saturation moment:** The maximum magnetic moment possible in a sample of magnetic material.
- Scratch:** A long, narrow, straight defect in the top surface of a head track (see fig. C-1); also applies to tape.
- Self-demagnetization:** The process by which a magnetized sample of magnetic material tends to demagnetize itself because of the opposing fields created within it by its own magnetization.
- Sensitivity:** The magnitude of the output when reproducing a tape recorded with a signal of given magnitude and frequency.
- Separation loss:** The loss in output that occurs when the surface of the coating of a magnetic tape fails to make perfect contact with the surface of either the record or reproduce head.
- Shedding:** The loss of oxide or other particles from the coating or backing of a tape, usually causing contamination of the tape transport and, by redeposit, of the tape itself.
- Shield front:** A magnetic shield close to the front (top) surface of the read/write head to reduce "feed through" (crossfeed). (See fig. C-8.)
- Shock tensile strength:** See **Impact strength**.
- Signal-to-noise ratio:** The ratio of the power output of a given signal to the noise power in a given bandwidth. The signal-to-noise ratio is usually measured in terms of the corresponding root mean square signal and noise voltages appearing across a constant output resistance.
- Single domain particle:** All ferromagnetic materials are composed of permanently magnetized regions in which the magnetic moments of the atoms are ordered. These domains have a size determined by energy considerations. When a particle is small enough, it cannot support more than one domain and is called a single domain particle.
- Skew:** Deviation of a line connecting the average displacement of the read or write track gaps from a line perpendicular to the reference edge of the tape in the direction of tape motion.
- Skew tape:** Continuous strings of "1" values written on a properly adjusted tape drive for the entire recoverable length of the tape; an "all '1'" pattern on all tracks; the write head, write delays, and tape drive adjusted to write with minimum physical skew and gap scatter.
- Specific magnetic moment:** The value of the saturation moment per unit weight of a magnetic material expressed in electromagnetic units per gram. The specific magnetic moment is the most convenient quantity in which to express the saturation magnetization of fine-particle materials.

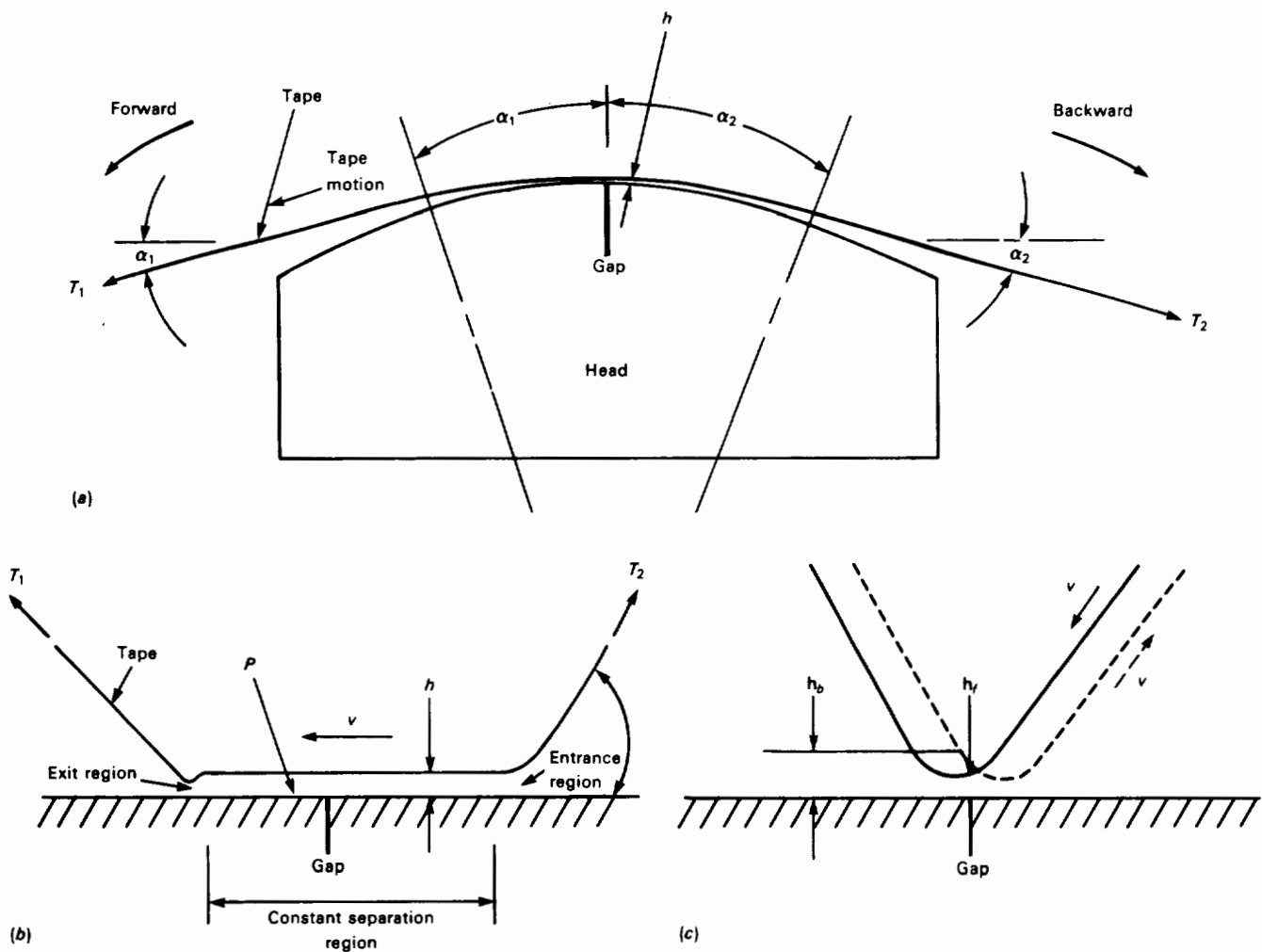

Figure C-13.—Schematic diagrams of tape moving over head. α = wrap angle; h = head-to-tape separation; P = pressure; T = tension (lb/in.); v = tape speed (in./s). (a) Standard. (b) Head flattened out; large $\alpha_1 + \alpha_2$. $T_1 \approx T_2$. (c) Head flattened out; small $\alpha_1 + \alpha_2$. $h_f \neq h_b$.

Spoking: A form of buckling in which the tape pack is deformed into a shape that approximates a polygon.

Spool: See Reel.

Squeal: See Stick-slip.

Standard amplitude reference tape: A tape that has been selected for given properties as a standard for signal amplitude.

Standard measurement current: Standard reference current multiplied by a predetermined constant.

Standard reference amplitude: The average peak-to-peak output signal amplitude derived from the amplitude reference tape recorded at the standard measurement control.

Standard reference current: The minimum current applied to the amplitude reference tape that causes an output signal amplitude equal to 95 percent of the maximum output signal.

Standard reference tape: A tape intended for daily calibration, the performance of which has been calibrated to the amplitude reference tape.

Static coefficient of friction u_s : Assuming the tape is loaded against a body by a normal force f_N , if f_s is the force required to start the tape moving, then

$$u_s = \frac{f_s}{f_N}$$

Stick-slip: Generally a low-speed phenomenon, a relationship between tension, temperature, humidity, wrap angle, head material, binder material of tape, and the elastic properties of the tape. When detected audibly, it is described as squeal.

Sticktion: A term loosely used to describe the phenomenon of tape adhering to transport components such as heads or guides.

Stiffness: Resistance to bending of the tape; a function of tape thickness and modulus of elasticity.

Surface treatment: Any process by which the surface smoothness of the tape coating is improved after it has been applied to the base film.

Symmetrically, cyclically magnetized condition: A magnetic material is in this condition when, under the influence of a magnetizing field cycled between equal but opposite values, its successive hysteresis loops coincide.

Tape mark: A special control block recorded on magnetic tape to serve as a separator between files and file labels.

Tape pack: The form taken by the tape wound on a reel.

Tape skew: The deviation of a tape from following a linear path when transported across the heads. The terms "static" and "dynamic" are used to distinguish the physically fixed and fluctuating components of total tape skew.

Tape speed: The speed at which tape is transported across the read/write head during normal recording or reproduction.

Tape speed—long term: The tape speed averaged over a minimum of 15 in. of tape (in inches per second).

Tape speed—short term: The instantaneous (dynamic) tape speed (in inches per second).

Tape-to-head separation: The separation between a magnetic head and the magnetic tape caused by (1) the foil bearing effect; (2) improper head contour, which generates standing waves in the tape; and (3) surface roughness of the tape surface. These conditions are interrelated and are greatly influenced by tape tension and tape compliancy. In a properly designed system, tape roughness is the limit of head-to-tape separation, usually $<10 \mu\text{m}$. (See fig. C-13.)

Tape-to-head separation—changes:

(1) **Head contamination:** Debris attached to the head, which causes the tape to lift away from the head forming a tentlike deformation of the tape. This tent does not move or change shape until the contamination is removed.

(2) **Tape contamination:** Particles attached to the tape result in a "tent" formed by particles that moves across the head with the tape. (See fig. C-14.)

Tape-to-head separation—effective: The actual distance from the magnetic storage material on the tape to the top of the active magnetic core material at the read or write gap. The effective head-to-tape separation is usually somewhat larger than the mechanical head-to-tape separation. (See fig. C-15.)

Tape tension variation: If the tape tension is reduced, the head-to-tape separation can increase. If the tape tension variation is cyclic, then the separation variation will be cyclic. A typical low-tension condition occurs during "backward start" in a high-acceleration capstan tape drive. (See fig. C-16.)

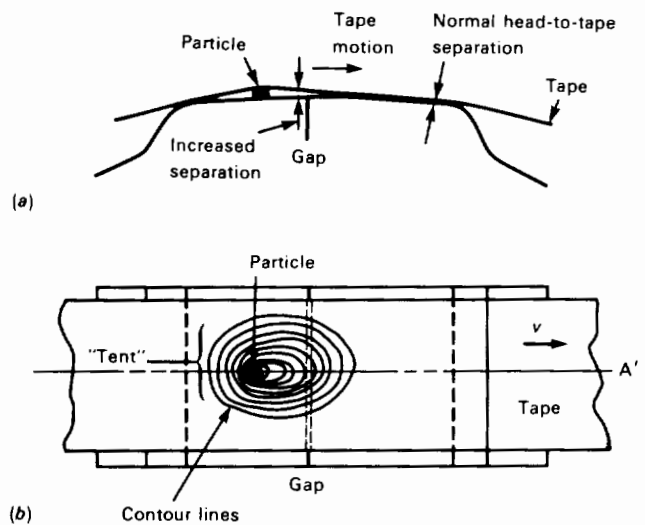

Figure C-14.—"Tent" resulting from particle between head and tape and start envelope. (a) Side view of head section A-A' as seen in (b). (b) Top view of head.

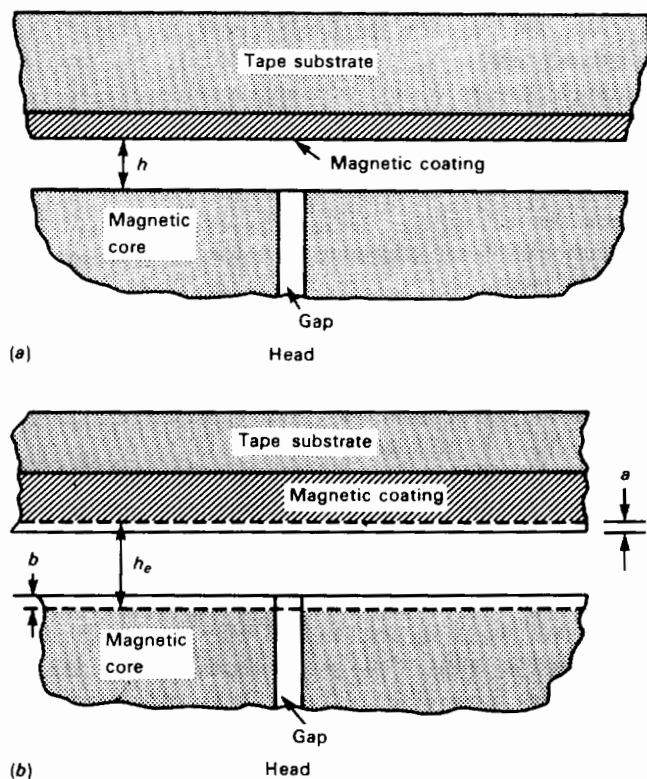

Figure C-15.—Head-to-tape separation. (a) Mechanical. (b) Effective. a = nonmagnetic or low permeability coating on tape surface; b = nonmagnetic coating on head surface; $h_e = h + a + b$.

Tape transport: The mechanism that extracts magnetic tape from a storage device, moves it across magnetic heads at a controlled speed and then feeds it into

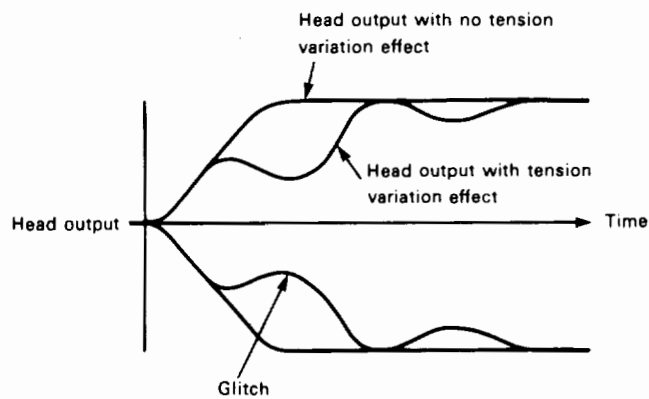

Figure C-16.—Backward start envelope condition.

another storage device. Typical storage devices are tape loops, bins, reels, and magazines (cassettes and cartridges). The tape transport is the part of a magnetic tape recorder/reproducer system that normally consists of magnetic heads, magnetic tape, tape transport, record electronics, and reproduce electronics.

Tear strength: The force required to initiate and/or propagate a tear in a specially shaped specimen of tape or base film.

Total thickness: Normally the sum of the thicknesses of the base film and the magnetic coating as well as back-coating when applied. The total thickness governs the length of tape that can be wound on a given reel.

Track: An area of tape surface that coincides with the location of the recorded magnetization produced by one record gap.

Track width: The width of the track corresponding to a given record gap.

Track width—effective: The width of the core where core material exits on both sides of the gap. (See fig. C-4.)

UBE: Upper band edge of the recorder/reproduce response (usually at the -3 -dB point).

Ultimate tensile strength: The force per unit cross-sectional area required to break a tape or length of base film usually given in pounds per square inch.

Uniformity: The extent to which the output remains free from variations in amplitude. Uniformity is usually specified in terms of the positive and negative deviations from the average output within a roll of tape.

Void: An area where material is missing on the surface of a head track (see fig. C-1); also applies to tape surface.

Washout or undercut: This occurs in a hard-coated head when the magnetic core material has a much higher wear rate than the coating. The radius of curvature of the core material will be larger than the surrounding coating of the softer material, which could even be undercut. This could cause an increase in the head-to-tape separation. (See fig. C-17.)

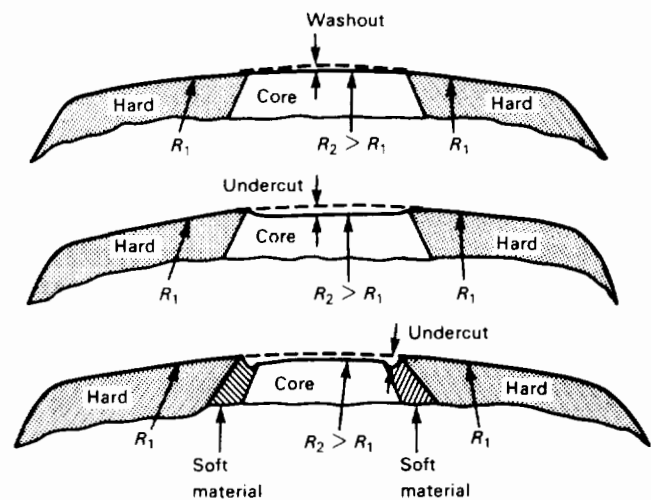

Figure C-17.—Schematic diagram of wavyness, edge roll, edge lift, washout, and undercut.

Wavelength: The distance along the length of a sinusoidally recorded tape corresponding to one cycle.

Wavyness: Nonflat head top surface perpendicular to tape motion due to different wear rates in top surface materials. The “harder” material will be up. This can occur during breakin and field use. The head core is usually the harder material; therefore, there will be increased head-to-tape contact pressure at the cost of tape life. (See fig. C-3.)

Wear ability: See **Durability**.

Wear product: Any material that is detached from the tape during use.

Wear test: See **Durability**.

Wind: The way in which tape is wound onto a reel. An A-wind is one in which the tape is wound so that the coated surface faces toward the hub.

Winder/cleaner: A device designed to wind and clean magnetic tape to restore it to a quality that approaches the condition of a new tape providing the tape has not been physically damaged.

Wow and flutter: Terms used to describe changes in signal output frequency caused by tape speed variations occurring at relatively low and relatively high rates, respectively; however, the term wow is no longer used but is incorporated into the flutter measurement.

Write feedthrough (crossfeed) (feedthrough) (cross-talk): Magnetic coupling from the write tracks to a read track in the read/write head.

Yield point: Stress to produce 3 percent strain.

Yield strength: The minimum force per unit cross-sectional area at which the tape or base film deforms without further increase in the load. Units are pounds per square inch or pounds per tape sample of given width and base film thickness.

Index

- A/D conversion, 1, 3, 85, 86–88, 90, 101, 102, 103, 115
Alcohol (solvent), 28, 58, 131
Aluminum:
 hubs, 81, 124
 recorder case, 18–22
 reels, 83, 124
American Instrument Co., 17
American National Standards Institute, iii, 120
American Silver Co., 34
Ampex Corp.:
 code specification, 105
 dropout specification, 177
 FR-1400 tape transport, 27, 28, 29
 head cleaner, 28
 head wear testing, 8–9
 recorder handling manual, 128
 solid flange reels, 81
 tape abrasivity testing, 23, 27–29
 tape recorder, 124
Amplitude Reference Tape SRM 3200, 46
Amplitude stability, 41–44, 85, 86, 99, 100
Analog signals, 1, 3, 55, 86, 88, 99
Analog systems, 37, 46, 119, 120, 125
Antihijacking devices, 140
Apollo mission, 2
Archiving center, 2
Audio recording, 1, 3, 96, 118, 123, 124
- Balance, analytical, Mettler, 18
BANCOMM Corp., 100
Band edge frequency, 102
Bandwidth:
 direct recording, 1, 101
 FM recording, 101
 ground communications, 2
 HDR code, 93, 104
 use of, 1, 90, 94
 video recording, 109
Baseband signal, 85, 86
Bathtub tension profile, 53, 146
Bell & Howell:
 code specification, 105
 NRZ format, 94
 recorder handling manual, 128
 tape abrasivity testing, 23, 30–33
 VR-3700B tape recorder, 94
Bias, 4, 33, 90, 91, 99, 103, 104, 125, 134
- Bit error rate:
 block data, 110, 114
 cleaning, 55
 dropout, 37
 EDAC, 118–119
 parallel recording, 108
 SNR, 88
 system accuracy, 103, 105, 107, 109, 110, 115
 See also Burst errors
Bit packing density:
 areal, 105, 108, 109
 cell length, 93
 data loss proportional to, 37
 high, 3, 88, 104, 114, 115, 132
 per track, 94
 standard, 108
 track density, 108–109
 track width, 108
 tracking range, 114
Bit rate:
 analog/digital conversion, 88
 computer system, 46, 57, 62
 HDR system, 56, 57, 107
 high, 1, 111
 low, 1, 40, 111
 per channel, 88
 serial-parallel conversion, 1, 89, 109
Bit resolution, 88
Bit slip, 105, 108, 115
Bit stream:
 parallel, 1, 85, 88, 89, 105, 108, 109–110, 118
 pseudorandom, 105, 109, 111, 113, 114, 115
 serial, 1, 85, 88, 89, 105, 107, 108, 118
BOW Industries, Inc., 61, 63, 64, 65, 66, 67, 68, 69
Brass shim abrasivity test, 7, 23, 34, 124
British Broadcasting Corp., 3
Brown stain. *See* Head, magnetic: surface staining
Buffer storage, 85, 86, 120
Burst errors, 105, 110, 111, 114, 119
- Calcium chloride, 18
Carbon, 64, 133
Carborundum Co., 34
Care and Handling Manual Subcommittee, 127
Carrier signal, 1, 100, 101, 103
Cartridges (tape), 4
Cassettes (tape), 1, 4, 123, 124
Celanar, 125
Cellulose acetate, 4, 123, 124

- Channels:
 - capacity, 100, 101, 103
 - direct recording, 85
 - HDR, 85
 - head design, 7, 29
 - high bit packing density systems, 109
 - master system, 110
 - performance, 111-115
- Chatter proofer, 37
- Chromium dioxide, 4, 11, 12, 45, 125, 133
- Clean room:
 - processing, 147
 - storage, 53-54
 - testing, 80
 - See also* Positive pressure
- Clean-care[®] tissues, 131
- Cleaner/scrapper, 56, 63-64, 66-67, 71-75, 117, 136-137
- Cleaner/winder, 39, 65, 70-71, 82, 137
- Clipping level, 47
- Clock:
 - Bi ϕ L code, 93
 - crystal oscillator, 3
 - gating, 111
 - HDR system component, 85, 101, 102, 103, 107, 115
 - MFM code, 93
 - Miller code, 110
 - NRZI code, 92
 - overhead signal, 109
 - PCM test set component, 114
 - playback channel sync, 86, 89, 115
 - ram deskewer component, 112
 - rate, 105
 - RNRZ code, 94
 - self-clocking codes, 90, 92, 93, 104, 109
 - signal sampling, 3
 - strobing, 91
- Cobalt, 4, 12, 34, 45, 125, 133
- Code formats:
 - Bi ϕ L, 93
 - Bi ϕ M, 92, 93, 104
 - DF, 92, 93
 - ENRZ, 94, 104
 - MFM, 93, 94
 - Manchester, 92, 104
 - Miller, 93, 94, 104, 110
 - NRZE, 105
 - NRZL, 86, 88, 91, 94, 104, 107, 113, 115
 - NRZM, 92, 107
 - NRZS, 92, 107
 - RLL, 90, 112, 115
 - RNRZ, 94, 104, 105
 - RZ, 90, 91
- Coercivity, 4, 134, 140
- Communications, 2, 113
- Computer:
 - data format, 86
 - disk memory, 93
 - error correction routine, 62
 - operating system, 57
 - random access memory, 110, 112
 - read mode, 46, 47
 - search mode, 46
 - software, 56, 57
 - tape handling, 58, 103
 - write mode, 46, 47
- Computer-Link Corp., 61, 63, 64, 65, 66, 67, 68, 69
- Computerized axial tomographic scanner, 118
- Constant-tension profile, 65
- Control characters, 56, 57
- Corning Glass Works, 82
- Crossplay, 3
- Crosstalk, 86, 90, 100, 101, 103, 125
- Crowding:
 - bit, 93
 - pulse, 104
- Curie temperature, 4
- D/A conversion, 2, 85, 86, 88, 101, 102
- Data processing center, 2
- dc signal component, 86, 88, 92, 93, 94, 100, 109, 115
- Decoder, 85, 93, 101, 114, 115, 119
- Decoding:
 - cost per channel, 104
 - PCM system, 100, 105
- Degaussing, 39, 40, 54, 130, 136
- Delay modulation, 93, 110, 112, 113. *See also* MFM code
- Demagnetization, 130
- Demodulator, 102
- Deskew, 88, 108, 109, 110, 112
- Detection, 90, 92, 93
- Dicarboxylic acid, 12
- Differential expansion, 46, 48, 80, 126, 129
- Digital counter, 40
- Digital data:
 - block, 107, 109, 110
 - byte, 62
 - frame, 2, 107, 110, 115
 - page, 2
 - word, 2, 86, 87, 88, 109, 110
- Digital recording, 1, 3, 46, 63, 85, 95. *See also* High-density digital recording
- Digital sum variation, 104
- Direct recording, 63, 91, 99, 100, 101, 102, 103, 105, 107
- Dispersants, 125
- Dropout:
 - computer tape, 55
 - counter, 63
 - definition, 46
 - density, 134
 - distribution, 116-117
 - errors, 47
 - instrumentation tape, 55
 - length, 117, 118
 - new tape, 61
 - number for tape rejection, 55
 - temporary, 36, 55
 - testing, 35-44, 61, 63, 68, 123, 137
 - used tape, 61
 - width, 117
- Dupont Co., 12, 13, 125

- Edge damage detector, 68
 EG&G International, Inc., 18
 Elasticizers, 3
 Electron microscopy, 11
 Electron spectrometry, 26-27
 EMI Technology, Inc., 44
 Encoder, 85, 93, 100, 101, 118
 Encoding rules, 100, 103, 104, 107, 110. *See also* Code formats
 Endless loop band blade cleaner, 70-71
 Equalization, 45, 99, 102, 112, 115, 120, 125
 Error correction logic, 57, 62
 Error detection and correction system, 118-119
 E-Systems, Inc., 55
 Event marker, 41
 Eye diagram, 104, 111, 112, 113
- Faraday's law, 4, 90
 Federal specifications:
 W-R-175, 51, 124, 142, 143, 144
 W-C-1684, 124
 W-T-0070, 123, 124
 W-T-0051, 124
 W-T-001553, 7, 23, 33-34, 42, 123, 124, 134
 Federal Standard, 209, 80
 Federal Supply Service, 7, 124
 Fiberboard boxes, 83-84, 147
 Fiberglas hub reels, 81, 124
 Fidelity, 1
 File protect ring, 52
 Fluorinated polymers, 12
 Flutter compensation, 100
 FM recording, 63, 92, 99-100, 103, 105, 107, 110, 112, 113
 Ford Aerospace & Communications Corp., 39, 41
 Forward error correction, 120
 Fracture, moisture-assisted, 10
 Freon TF, 13, 58, 59, 131
 Frequency response test, 40
 Fulmer Research Institute, 8, 9, 23, 26
 Fungicide, 125, 132
- General Kinetics, Inc.
 dropout terminology, 66
 tape analyzer, 35-36, 41, 42, 43, 44, 62-63
 tape cleaning, 64, 67, 68
 tape profile tension, 65, 69
 tape testing, 41, 63
 tape threading, 70
 General Services Administration, 42, 43, 61, 124
 Glass flange reels, 51, 80-82, 124, 126, 144
 Goddard Space Flight Center, 35, 37, 41, 128
 Green tape, 11
 Ground stations, 2
 Group code recording, 56, 57, 62
 GSA Specification W-R-175, 82
- Harmonic distortion, 54, 90
 HDDR. *See* High-density digital recording
- HDR Glossary Committee, 105
 Head, magnetic:
 alfesil, 26
 alignment, 3, 37, 47, 69, 88, 89, 128
 bracket, 29
 design, 7, 28-29, 62
 dummy, 25
 erase, 55
 ferrite, 26, 29, 48
 gap, 7, 12, 28, 88, 102, 108, 129
 mu-metal, 11, 14, 28, 48
 particle shedding, 8, 35
 permalloy, 26, 27
 playback (reproduce), 4, 12, 28, 31, 44, 90, 99, 101, 102, 104
 poletips, 29, 32
 record, 28, 31, 33, 44, 101, 102
 surface staining, 7, 10-12, 17, 48, 129, 133
 transducer, 12, 13
- Headroom, 4
 Head/tape contact, 3, 7, 27, 44, 99, 115, 128
 Head/tape interface, 10, 14, 27
 Head/tape separation:
 head wear, 26
 particle clumps, 49, 56, 58
 signal strength, 7, 12, 35, 47, 56, 128, 130
 tape failure, 61
- Head wear, 3, 7-14, 17, 23-34, 136
 Helical scan recording, 109, 120, 133
 Hewlett-Packard:
 HP9825A computer, 37, 38, 39
 HP9862A plotter, 38
- High-density digital recording, 37, 40, 85-97, 100, 107-121, 124, 125
 HI-LO level meter, 61
 Honeywell Inc., 39, 117, 127, 128
 abrasivity test, 23, 29-30
 dropout specification, 117
 model 96 tape transport, 29, 38
 model 7600 tape recorder, 41, 44
 tape handling manual, 128
 tape testing, 39
- Housekeeping data, 40, 41, 110
 Humidity:
 breath, 26
 brown stain, 10-11, 14, 135
 cycling, 69, 77-79, 135
 head wear, 8-10, 14, 29-33
 high, 23, 135, 141
 ideal range, 133, 134, 135
 low, 10-11, 23, 135, 141
 specification, 14, 17, 20
 static electricity, 135
 tape abrasivity, 80, 129, 135, 144
 tape backing, 135
 tape binder, 135
 tape cleaning, 65
 tape expansion/contraction, 126, 144
 tape hygroscopic property, 15-22
 tape packaging, 141

- tape particle shedding, 14
- tape weight, 15
- Hygrometer, dew-point, 18
- IBM Inc.:
 - solid flange reel, 81
 - tape standards, 63
- IIT Research Institute, 11, 14, 35, 128
- Information theory, 86, 90
- Input signal, 45, 101, 110
- Instrumentation recording:
 - bandwidth, 12, 102, 108, 123
 - BER, 88
 - error correction, 118
 - HDR, 85, 96, 105, 109, 125
 - parallel sequencing, 108
 - start/stop duration, 120
 - telecommunications, 2
 - versatility, 99
- Instrumentation reel, 34, 52, 81
- Instrumentation tape, 23, 45, 55, 61, 64, 124, 133–134, 139
- Integrated circuits, 108
- Interleaving, 102, 118. *See also* Multiplex
- Inter-Range Instrumentation Group, iii, 2, 100, 108, 110, 123, 128–129
- Intersymbol interference, 93
- IRIG standards, 102, 108, 117, 123
- Iron oxide, 4, 12, 45, 133
- Kimwipe[®] tissue, 28, 58
- Kovar head, 23, 24, 34
- Kovar test, 10
- Krytox[®] oil, 13
- Least significant bit, 87
- Level errors, 47
- Level, output, 108
- Light sensor. *See* Photocell
- Light source, 41, 42
- Linearity, 85, 99
- Logic card, 43
- Lubricants, 3, 12–13, 132
- Magnetic contact printing, 5
- Magnetic flux, 4, 7, 37, 46, 90, 91, 99, 108
- Magnetophon, 3, 4, 132
- Melinex, 125
- Metal flange reels, 51, 80–81, 82, 144
- Microbalance, Cahn, 15
- Microprocessor, 117, 120
- Military Standard MIL–T–21029, 123
- Mincom Inc. tape recorder, 81, 123, 124
- Modes, recorder operating:
 - erase, 1
 - fast forward, 29, 37, 135
 - fast rewind, 37
 - forward, 1, 29, 40, 42, 44, 85, 86
 - playback (reproduce), 1, 23, 28, 40, 41, 44, 85, 86, 118
 - rewind, 29, 44, 135
 - stop, 7, 41, 42
- Molybdenum sulfide, 12
- Most significant bit, 87
- Multiplex, 100, 102, 103, 109, 112
- Mylar, 5, 45, 58, 61, 67, 125, 133. *See also* Polyester film
- NASA Specification X–533–63–250, 123
- National Association of Broadcasters, 142
- National Bureau of Standards, 46
- National Security Agency:
 - Specification L14–3–75, 24
 - Specification L14–5, 82
 - tape abrasivity, 7, 8, 23, 25
 - tape certification, 41
 - tape handling manual, 128
 - tape tension profile, 65, 67, 68
 - TH cycle testing, 65
- Naval Air Development Center, 100
- Naval Intelligence Support Center, 41
- Network control center, 2
- Nickel, 27
- Nitrogen, 18, 19, 20
- Noise, background:
 - direct recording, 85
 - dropout detector, 37
 - long-wavelength, 99
 - minimization, 3, 104, 139
 - modulation, 46
 - tape transport flutter, 86
 - tracking range, 114
 - See also* Signal-to-noise ratio
- Noise errors, 47
- Noise reduction circuit, 4
- Nyquist sampling frequency, 88
- Open-flange reels, 77–80
- Oscilloscope, 38, 40, 44, 111, 113
- Output signal:
 - amplitude stability, 43–44, 46
 - center track, 23
 - distortion, 119
 - edge track, 23
 - linearity, 85
 - shim wear test, 23, 34
 - uniformity, 61, 62, 63, 132
 - See also* Dropout; Response; Signal loss; Signal-to-noise ratio
- Overhead data, 2, 94, 104, 109, 110, 118
- Packwheel, 39, 40, 67, 68, 69
- Paper base tape, 5, 123
- Parity, 107, 108, 115
- PCM. *See* Pulse code modulation
- PCM error counter, 114
- Perfluoroalkyl polyether, 13
- Permanent magnets, 54
- Permed heads, 130
- Phase lock, 42, 114, 115
- Phenol, 34
- Photocell, 41, 42
- Ping-pong buffer, 111
- Plastic:
 - bags, 54, 84, 136, 138, 147
 - band, 52

- canister, 147
- coating, 82
- envelope, 142
- reel, 82, 135
- stick, 58
- Plasticizers, 125, 132
- Playback logic, 92
- Plexiglas, 23
- Polyester film:
 - brown stain, 48
 - elasticity, 5
 - hygroscopic property, 14, 15, 16, 21–22
 - instrumentation tape, 123
 - precision tape, 124
 - tape backing, 4
 - thermal expansion, 135
 - See also* Mylar
- Polyethylene terephthalate, 12, 14
- Polyimide, 124
- Polysiloxane, 12
- Polytetra fluoroethylene, 12
- Positive pressure, 54, 129. *See also* Clean room
- Power spectrum, 1, 92, 93
- Precision Data Inc., 100
- Precision winding, 53, 54, 135, 137–138
- Proficorder, 28
- Profilometer, 7, 8, 9, 28, 29, 30
- Programmed tension, 39, 53, 61, 68, 69, 71
- Pulse code modulation:
 - bandwidth, 86
 - data format, 40, 88, 99
 - definition, 2
 - encoding, 101
 - recording, 119
 - signal, 85, 103, 116
 - signal sampling, 100
 - tape requirements, 116
 - tape transport requirements, 103
 - test set, 113–114
- Q-tip® swabs, 58
- Quadraplex, 120
- Quality control, 39, 46, 62, 63, 67, 68, 136, 138
- Radar wave effects, 140
- Radicon tape abrasivity test, 7, 8, 23–25
- Ramp signal, 115
- Recorder/reproducer. *See* Tape recorder
- Recortec, Inc., 63, 64, 65, 66, 67, 68
- Reel:
 - bands, 52, 83, 126, 130, 145, 147
 - care of, 142
 - damage, 77
 - design, 50–51, 142–143
 - diameter, 5, 24
 - entrapped air, 69
 - function, 50
 - heavy-duty, 52
 - identification label, 52
 - loading, 54, 70, 145
 - moment of inertia, 51, 52, 142, 143
 - packaging, 52, 54, 83–84, 145
 - protection, 52–53
 - sealing, 70, 138
 - specification, 51, 124
 - spindles, 51
 - storage, 53–54
 - supply, 13, 39, 42
 - support, 53
 - threading, 69, 81, 83, 144, 146
- Reel flange:
 - compressed, 49
 - design, 51, 142, 143
 - glass, 80–82, 142, 143, 144
 - handling, 145, 147
 - inspection, 39
 - instrumentation, 52, 82
 - metal, 80–81, 142, 143, 144
 - open, 77–79
 - plastic coated, 144
 - precision, 82, 142, 143, 144
 - solid, 80–82, 83
- Reel hub:
 - design, 143
 - expansion/contraction, 48, 80, 135
 - handling, 126, 145
 - inner surface, 51
 - metal, 142, 143
 - particle contamination, 50
 - phenol, 142, 143
 - specification, 124, 142, 143
 - support fixture, 52–53, 147
 - tape threading, 24, 48, 50, 51, 70, 83, 143, 144
- Reel identification label, 52
- Remanence, 4
- Remote control, 38, 39
- Resin, 12, 45
- Resistivity (electrical), 8
- Response:
 - band edge, 7, 10, 11, 93
 - direct current, 94
 - dynamic range, 7, 86, 99, 101, 103, 125
 - flutter, 1, 3, 86, 100, 107, 113
 - high-frequency, 4, 7, 12, 46, 101, 123
 - low-frequency, 1, 99
 - phase, 86
 - steady-tone, 77–79
 - transient, 86
 - wideband, 7, 10, 102, 123, 124, 134
 - wow, 107
- Rotating head recording, 133
- Rotometer, 18
- Sampling, signal, 1, 3, 88, 100. *See also* Pulse code modulation
- Sangamo/Weston Inc., 94, 105
- Scalloping, 29
- Scintillation counting, 23, 24
- Scotchpar®, 45, 125
- SEASAT mission, 2
- Semiconductor devices, 90, 108
- Servomechanisms, 41, 42, 107
- Shake & bake cleaning, 67, 68

- Sign bit, 87
- Signal loss:
 - bit error rate, 103
 - debris, 56
 - dropout definition, 80, 116, 117
 - erasing field, 140
 - head-tape separation, 12, 47, 128, 129, 130
 - tape deterioration, 11
 - wavelength, 129
- Signal-to-noise ratio:
 - A/D conversion, 87–88
 - BER, 104, 108
 - channel, 99
 - direct recording, 102
 - HDR, 102–103
 - head/tape separation, 7
 - high-energy tape, 45
 - high-frequency, 125
 - high-output tape, 45, 132
 - maximum, 40, 86, 119
 - signal sampling, 3
 - stray fields, 130
 - tape transport, 100
 - temperature, 134
- Silicon, 27
- Silicone, 12
- Skew errors, 47
- Solid flange reels, 77–79, 80–81
- Space Shuttle mission, 2
- Spacing loss, 7, 11, 35, 36, 46. *See also* Signal loss
- Spin Physics, Inc., 7, 8
- Spinalloy, 8
- Spooling defects, 49, 146. *See also* Tape pack defects
- Stack, 110
- Steel ribbon recording, 3, 123, 132
- Stop-on-error testing, 55
- Strip chart recording, 25, 41, 42, 43, 44
- Synchronization:
 - bit, 37, 109, 113, 115, 116
 - block, 57, 62, 104
 - coding format, 105
 - frame, 2, 110
 - multiplexed, 102, 109
 - multitrack recorder, 85
 - parallel stream, 88, 89
 - sequence, 107
 - word, 115
- Talcum, 12
- Tape:
 - abrasivity:
 - aging, 35
 - humidity, 35, 80, 129, 135
 - measurements, 23–34
 - particles, 133
 - specification, 124
 - surface hardness and roughness, 35, 45, 46
 - See also* Head wear
 - aging, 15, 16, 17, 35, 43, 52, 57, 58, 77, 81, 127
 - backing:
 - back-coating, 14, 15, 16, 18, 21, 64, 133
 - development, 132
 - elasticity, 5
 - expansion/contraction, 48, 80, 134, 135
 - fabrication, 4, 12, 55
 - fungus, 45
 - high-temperature resistance, 45
 - hygroscopic property, 15, 21
 - particle shedding, 36, 46, 55, 58, 131
 - solvent resistance, 45
 - stability, 45
 - strength, 45
 - thickness, 46
 - See also* Cellulose acetate; Mylar; Polyester film; Vinyl chloride
 - binder:
 - additives, 125, 132
 - expansion/contraction, 80
 - humidity effects, 126, 128, 133, 135, 147
 - lubrication incompatibility, 12
 - particle shedding, 46, 55
 - preparation from liquid, 4
 - resin, 12, 45
 - temperature effects, 134
 - bit resolution, 23, 37, 42, 45, 124, 134
 - brands:
 - Ampex 786, 29, 114
 - Ampex 787, 23, 24, 29, 30, 31, 33, 80, 94
 - Ampex 797, 23, 24, 30, 31, 32, 33, 37
 - Dupont 8740, 37
 - 3M888, 23, 24, 25, 30, 31, 32, 33
 - 3M890, 30, 31, 32, 33
 - 3M951, 80
 - 3M971, 29, 30, 31, 32, 33, 37
 - 3M8390, 23, 24, 25
 - calibration, 43
 - certification, 35–44, 53, 55, 63, 67, 116, 136
 - cleaning:
 - certification, 39, 40, 55, 136–137
 - dropout removal, 37, 116–117
 - dry cleaning, 39
 - error removal, 47, 48, 62
 - materials, 58–59, 131–132
 - preevaluation processing, 63
 - prestorage processing, 53–54
 - scraping, 66–67, 70–75
 - stripping, 57
 - tape maintenance, 54–55, 57, 126
 - wiping, 64–65, 136–137
 - See also* Cleaner/scrapper; Cleaner/winder
 - coating-to-backing adhesion, 17, 46
 - contamination:
 - debris, 8, 11, 14, 35, 52, 70, 126
 - dirt, 8, 11, 36, 46, 80, 128, 146
 - particle shedding, 7, 35, 36, 46, 48, 55, 61, 131
 - creepocity, 46
 - cupping, 46
 - durability, 5, 7, 11, 14, 35
 - edge:
 - curl, 55
 - damage, 40, 52, 67
 - dropouts, 42

- particle cling, 82
 - stretch, 52
 - tracks, 40, 42, 48
- erasure, 1, 2, 4, 46, 54, 136, 137, 139, 141
- errors:
 - cleanable, 47
 - edge track, 62, 63
 - gross, 57, 62
 - hardware, 57
 - marginal, 57, 62
 - multitrack, 57
 - permanent write, 57, 62
 - single-track, 56, 57, 62
 - three-track, 57, 62, 68
 - two-track, 56, 62
- evaluation, 55–56, 61, 63, 66, 80–81
- fault localization, 68
- handling, 35, 45, 52, 70, 80, 107, 125, 126, 127–147
- high-energy, 45, 125, 134
- high-output, 45, 134
- hygroscopic properties, 9, 10, 12, 14–22, 80, 126
- inspection, 39, 62, 70, 81, 138, 147
- layer-to-layer adhesion, 46, 53, 134
- lengths:
 - 100 ft, 26, 42, 116, 117, 123
 - 200 ft, 24, 34
 - 1200 ft, 5
 - 1800 ft, 5, 27, 29
 - 2400 ft, 5
 - 2500 ft, 43
 - 3600 ft, 5, 43
 - 4200 ft, 38
 - 4600 ft, 24, 43
 - 4800 ft, 5
 - 5000 ft, 43
 - 7200 ft, 43
 - 8000 ft, 117
 - 9200 ft, 40, 43, 126
- lubrication, 4, 11–14, 35, 67–68, 125
- magnetic oxide coating:
 - coercivity, 4, 125
 - contamination, 64
 - expansion/contraction, 80
 - fabrication, 132–133
 - head wear testing, 11
 - hygroscopic property, 9, 10, 15, 17
 - impurity-doped, 12, 125
 - magnetic field orientation, 4
 - particle shedding, 131
 - particle size, 45
 - removal, 15
 - retentivity, 4
 - smoothness, 4, 45, 55
 - solvent effects, 131
 - thickness, 4, 45
 - wear, 7, 52, 67, 127
 - See also* Tape binder
- magnetic properties, 4, 43, 46, 90, 91, 133, 134
- packaging, 39, 52, 83–84, 141
- polishing, 3, 7, 13, 28, 36, 55
- reel-to-reel consistency, 43
- resistivity, 46
- reuse, 2, 3, 11, 35, 41, 67, 71, 80
- sealing, 14, 17, 18–21, 39, 84, 145
- shipping, 40, 70, 83–84, 141
- slitting, 36, 37, 46, 47, 55, 61, 62, 63, 70
- speeds:
 - 7.5 in./s, 26, 43, 45
 - 30 in./s, 24
 - 32 in./s, 35
 - 60 in./s, 29, 33, 34, 37, 38, 80, 120, 123
 - 75 in./s, 48
 - 100 in./s, 69
 - 120 in./s, 28, 29, 31, 40, 44, 108, 117, 129
 - 150 in./s, 64, 120
 - 200 in./s, 64
 - 240 in./s, 108
 - 280 in./s, 29
 - 360 in./s, 64
 - See also* Tape transport: drive
- splicing, 71, 138, 139
- static electricity:
 - antistatic agents, 125, 132
 - attraction to reel hub, 83
 - back-coating, 14, 16, 125
 - field strength, 65
 - hygroscopic property, 17
 - low-humidity, 17, 48, 65, 135
 - oxide layer resistivity, 124
- storage, 35, 39, 40, 45, 52, 53–54, 55, 70, 128, 146–147
- tensile strength, 46
- tension:
 - differential, 26
 - distortion, 1, 37
 - head wear testing, 23, 24, 31, 33
 - programmed winding, 40, 53, 61, 71
 - storage, 71, 146
 - water content, 19
 - winding, 48, 64, 80, 134
- thickness, 5, 46, 47
- topography, 12
- virgin, 27, 29, 30, 31, 33, 35
- width test, 41–42
- widths:
 - 0.25 in., 109
 - 0.5 in., 26, 28, 40, 78, 79, 124
 - 1 in., 31, 40, 41
 - 2 in., 109
 - 4 in., 109
- winding:
 - air pressure, 80, 144
 - constant-tension, 65
 - friction, 125
 - precision, 54
 - prewind steps, 63, 82–83
 - programmed-tension, 39, 61
 - spooling defects, 49–50, 146
 - tension requirements, 64, 146
 - See also* Cleaner/winder
- Tape analyzer, 35–36, 41, 42, 43, 44, 63
- Tape caddy, 145
- Tape Head Interface Committee, iii, iv, 39, 63, 120, 127

Tape pack defects:

cinching, 37, 39, 49, 125, 126, 133, 134, 135
 contamination, 8, 46, 52, 54, 58, 80, 84, 128, 130, 135,
 136, 146
 creases, 47, 62, 128
 debris, 8, 11, 14, 35, 36, 55, 57, 70, 84, 125, 130
 deformation, 48, 50, 135, 136
 dirt, 80
 edge damage, 41, 47, 51, 67, 126
 pack slip, 49, 71
 particle shedding, 7, 35, 36, 46, 48, 55, 58, 61, 62, 63, 125,
 126, 131, 133
 skew, 47, 51, 61, 71, 107,
 spoking, 49-50, 53, 80, 126, 135
 sticktion, 10, 48, 49, 126
 stretch, 5, 41, 47, 53
 windowing, 50, 53
 wrinkles, 126, 128

Tape recorder:

development, 1-5
 intermediate-band, 41, 102, 103
 multichannel, 7, 41, 44, 68, 85
 sealed-case, 14, 17-21
 SE7000, 44
 wideband, 7, 10, 102

Tape transport:

acceleration, 135
 alignment, 130, 144
 bearings, 100
 capstan, 13, 28, 41, 64, 66, 71, 81, 100, 107
 care, 58
 cleaning, 59, 64
 contaminants, 54, 131
 data perturbations, 109
 drive, 1, 27, 67
 dropout threshold, 47
 dropouts, 36
 fabrication tolerances, 51
 guide, 13, 24, 28, 36, 58, 61, 131, 133
 head wear testing, 27-28, 30-31, 33
 high-speed, 48
 lintless wipes, 82
 low-cost, 105
 mechanical quality, 100, 101
 performance, 57, 143
 rollers, 28, 29, 36, 41, 58, 131, 133
 turnaround idler, 28
 vacuum column, 13

Telemetry, 2, 107, 113

Temperature:

binder alterations, 134
 cleaner efficiency, 65
 cycling, 77-80, 135

expansion/contraction, 48, 134, 144
 extremes, 129, 141
 head wear testing, 31-33
 ideal, 48, 126, 129, 133, 135
 safe range, 134
 specification, 14
 tape water content, 20-21

Tetrahydrofuran, 17

Tex-wipe[®] tissue, 131TH effects. *See* Temperature; Humidity

Thin film abrasivity test, 23, 25-27

Time base errors, 61, 71, 85, 100, 119

Timing, 89, 99, 109, 113. *See also* Clock; Synchronization

Titanium dioxide, 11

Totalizer. *See* Dropout counter

Tracks (tape):

center, 23, 33, 116, 123, 124
 correction, 118, 119
 data, 110, 119
 density, 91, 109
 edge, 23, 33, 40, 61, 68, 123, 124, 134
 interior, 40
 multiple, 1, 116, 117, 120
 outside, 116
 overhead, 110
 single, 1
 spacing, 108
 width, 37, 108, 120

Trichlorotrifluoroethane. *See* Freon TF

Ultrasonic cleaning, 71

Upstream/downstream effects, 27, 29-30

Vacuum cleaning, 64, 65, 66, 67

Vibration effects, 49, 68, 80, 81, 83, 135, 141

Vickers indentation test, 8

Video recording, 1, 3, 23, 86, 96-97, 109, 118, 123

Vinyl chloride, 5

Voltage-controlled oscillator, 99, 101, 102, 114

Voltage level quantization, 87

Vydux, 12

Wavelength, 44, 45, 47, 54, 55, 99, 108, 129

Wetting agent, 125, 132

Wheatstone bridge, 26

Winder/cleaner, 69, 70-71

Wiping tissue, 59, 61, 70, 82, 117

Wire recording, 3, 123, 132

X-ray effects, 27, 54, 140, 141

Xylene (solvent), 58, 131

1. Report No. RP-1075		2. Government Accession No.		3. Recipient's Catalog No.	
4. Title and Subtitle MAGNETIC TAPE RECORDING FOR THE EIGHTIES				5. Report Date April 1982	
				6. Performing Organization Code	
7. Author(s) Ford Kalil, Editor				8. Performing Organization Report No.	
9. Performing Organization Name and Address Goddard Space Flight Center Greenbelt, MD.				10. Work Unit No.	
				11. Contract or Grant No.	
12. Sponsoring Agency Name and Address National Aeronautics and Space Administration Washington, D.C. 20775				13. Type of Report and Period Covered Reference Publication	
				14. Sponsoring Agency Code	
15. Supplementary Notes This book was prepared as an activity of the Tape Head Interface Committee, a professional society with active members from NASA, other Government agencies, users, and manufacturers of magnetic tape recording media and equipment.					
16. Abstract This book deals with both the practical and theoretical aspects of state-of-the-art magnetic tape recording technology. Topics covered include the following: <ul style="list-style-type: none"> (1) Analog and digital magnetic tape recording (2) Tape and head wear (3) Wear testing (4) Magnetic tape certification (5) Care, handling, and management of magnetic tape (6) Cleaning, packing, and winding of magnetic tape (7) Tape reels, bands, and packaging (8) Coding techniques for high-density digital recording (9) Tradeoffs of coding techniques <p>The chapters in this book are devoted to detailed discussions and/or analyses of these topics, especially as they might affect the serious business, technical, or scientific user of magnetic tape. The contributors are the foremost experts in this country.</p> <p>Users and would-be users of magnetic tape recording will find this book helpful, and, in many cases, essential. This includes individuals as well as organizations—students, technicians, engineers, scientists, educators, libraries, colleges and universities, laboratories, Government, military, and industry. Hobbyists and amateurs would also find it useful.</p> <p>This book was prepared as an activity of the Tape Head Interface Committee (THIC), a professional "society" that cohosts its meetings with the American National Standards Institute (ANSI) and the Inter-Range Instrumentation Group (IRIG).</p>					
17. Key Words (Suggested by Author(s)) Analog recording Coding Digital recording Dropout Signal quality			18. Distribution Statement Unclassified—Unlimited		
19. Security Classif. (of this report) Unclassified		20. Security Classif. (of this page) Unclassified		21. No. of Pages 176	22. Price