



NHTSA Test Reference Guide Version 5

Volume III: Component Tests

Prepared for:

U.S. Department of
Transportation
(DOT)



National Highway
Traffic Safety
Administration
(NHTSA)

Office of the
Associate
Administrator for
Research and
Development

Prepared by:

Vehicle Safety
Research

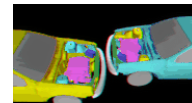
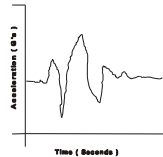
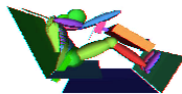

Revision — November 2014

[This page intentionally left blank.]

Table of Contents

Table of Contents	<i>i</i>
List of Figures	<i>vii</i>
List of Tables	<i>vii</i>
Preface	1
Release Notes	4
Content	4
Code Library	5
Introduction	6
Background	6
Data Organization	6
Digital Media Formats and Software Tools	7
Other Media Formats	7
Return Policy	7
Chapter 1 : Media Formats and Software Tools	8
1.1 Media Types and Layout	8
1.2 A Data Entry Software – Entrée V5 for Windows	9
1.2.1 System Requirements	9
1.2.2 A Customer Developed Software	9
1.3 A Database for NHTSA Codes	10
Chapter 2 : File Formats and Information Records	11
2.1 Field Types	11
2.2 Specification Files and Signal Files	12
2.2.1 Structures of Specification Files	14
2.2.2 Specification File Examples	14
2.2.3 Signal Data	17
2.3 General Test Information	19
1. VERNO — Version Number	19
2. TITLE — Contract or Study Title	19
3. TSTOBJ — Test Objectives	20
4. TSTDAT — Test Date	20
5. TSTPRF — Test Performer	20
6. CONNO — Contract Number	20
7. TSTREF — Test Reference Number	20
8. TSTTYP — Test Type	20
9. TEMP — Ambient Temperature	20

10.	TOTCRV — Total Number of Curves _____	21
11.	TSTCOM — Test Commentary _____	21
2.4	Vehicle Information _____	22
1.	VEHNO — Test Vehicle Identification Number _____	22
2.	MAKE — Vehicle Make _____	22
3.	MODEL — Vehicle Model _____	22
4.	YEAR — Vehicle Model Year _____	22
5.	NHTSANO — NHTSA Number _____	22
6.	BODY — Body Type _____	24
7.	VIN — Manufacturer Vehicle Identification Number _____	24
8.	CRTEST — Crash Tested Indicator _____	24
9.	VEHCOM — Vehicle Commentary _____	24
10.	VIMFNO — VIMF Test No. _____	24
11.	LOAD — Test Load _____	24
12.	ENGINE — Engine Type _____	24
13.	ENGDSP — Engine Displacement _____	24
14.	TRANSM — Transmission Type _____	24
15.	FUEL — Fuel _____	24
16.	EQUIP — Optional Equipment _____	24
2.5	Component Information _____	26
1.	VEHNO — Vehicle Number _____	26
2.	CMPNO — Component Number _____	26
3.	CMPNT — Component Tested _____	26
4.	CMPTYP — Component Type _____	26
5.	CMPWGT — Component Weight _____	26
6.	MODIND — Component Modification Indicator _____	27
7.	MODDSC — Modification Description _____	27
8.	OCCTYP — Occupant Type _____	27
9.	DUMSIZ — Dummy Size Percentile _____	27
10.	DUMMAN — Dummy Manufacturer _____	27
11.	CMPCOM — Component Commentary _____	27
2.6	Component Configuration Information _____	28
1.	VEHNO — Vehicle Number _____	28
2.	CMPNO — Component Number _____	28
3.	CNFNO — Configuration Number _____	28
4.	TSTDEV — Test Device _____	28
5.	DEVSPD — Test Device Speed _____	28
6.	DEVCOM — Test Device Commentary _____	29
7.	CONFIG — Test Configuration _____	29
8.	CMPSPD — Component Speed _____	29
9.	CNTANG — Contact Angle _____	29
10.	CNTLOC1 — Contact Location #1 _____	29
11.	CNTLOC2 — Contact Location #2 _____	30
12.	CNTCOM — Contact Commentary _____	31
13.	CFNCOM — Configuration Commentary _____	31

2.7	Instrumentation Information	32
1.	VEHNO — Test Vehicle Identification Number	32
2.	CMPNO — Component Number	32
3.	CNFNO — Configuration Number	32
4.	CURNO — Curve Number	32
5.	SENTYP — Sensor Type	33
6.	SENATT — Sensor Attachment	33
7.	AXIS — Axis Direction of the Sensor	33
8.	XUNITS — Time Units or ‘Independent Axis’ Units	33
9.	YUNITS — Data Measurement Units	33
10.	PREFIL — Pre-filter Frequency	34
11.	INSMAN — Manufacturer of the Instrument	34
12.	CALDAT — Calibration Date	34
13.	INSRAT — Instrument Rating	34
14.	CHLMAX — Channel Maximum Rating	34
15.	INIVEL — Initial Velocity	34
16.	NFP — Number of First Point	35
17.	NLP — Number of Last Point	35
18.	DELT — Time Increment	35
19.	DASTAT — Data Status	35
20.	CHSTAT — Channel Status	35
21.	INSCOM — Instrumentation Commentary	36

2.8	Rollover Information	37
1.	TITYPF — Frontal Tire Type	46
2.	TISIZF — Frontal Tire Size	46
3.	TIPRSF — Frontal Tire Pressure	46
4.	TITYPR — Rear Tire Type	46
5.	TISIZR — Rear Tire Size	47
6.	TIPRSR — Rear Tire Pressure	47
7.	TRACK — Average Track Width	47
8.	TRACKF — Average Front Track Width	47
9.	TRACKR — Average Rear Track Width	47
10.	TRACKFA — Front Track A	47
11.	TRACKFB — Front Track B	47
12.	TRACKFC — Front Track C	47
13.	TRACKFD — Front Track D	47
14.	TRACKRE — Rear Track E	47
15.	TRACKRF — Rear Track F	47
16.	TRACKRG — Rear Track G	47
17.	TRACKRH — Rear Track H	47
18.	WHLBAS — Average Wheelbase	47
19.	WHLBASL — Left Side Wheelbase	47
20.	WHLBASR — Right Side Wheelbase	47
21.	ROOFHT — ROOF HEIGHT	40
22.	GVWR — Gross Vehicle Weight Rating	40
23.	GAWRF — FRONT GAWR	40

24.	GAWRR — Rear GAWR _____	40
25.	WT — Total Weight _____	40
26.	WTLF — Left Front Weight _____	40
27.	WTRF — Right Front Weight _____	41
28.	WTLR — Left Rear Weight _____	41
29.	WTRR — Right Rear Weight _____	41
30.	CGLONG — C.G. Longitudinal _____	41
31.	CGLATE — C.G. Lateral _____	41
32.	CGHT — Average C.G. Height _____	41
33.	CGWT1 — Applied Weight in Run 1 _____	41
34.	CGANGLE1 — Platform Angle in Run 1 _____	42
35.	CGMOTION1 — Relative Motion in Run 1 _____	42
36.	CGHT1 — C.G. Height in Run 1 _____	42
37.	CGWT2 — Applied Weight in Run 2 _____	42
38.	CGANGLE2 — Platform Angle in Run 2 _____	42
39.	CGMOTION2 — Relative Motion in Run 2 _____	42
40.	CGHT2 — C.G. Height in Run 2 _____	42
41.	CGWT3 — Applied Weight in Run 3 _____	43
42.	CGANGLE3 — Platform Angle in Run 3 _____	43
43.	CGMOTION3 — Relative Motion in Run 3 _____	43
44.	CGHT3 — C.G. Height in Run 3 _____	43
45.	CGWT4 — Applied Weight in Run 4 _____	43
46.	CGANGLE4 — Platform Angle in Run 4 _____	43
47.	CGMOTION4 — Relative Motion in Run 4 _____	43
48.	CGHT4 — C.G. Height in Run 4 _____	44
49.	CGWT5 — Applied Weight in Run 5 _____	44
50.	CGANGLE5 — Platform Angle in Run 5 _____	44
51.	CGMOTION5 — Relative Motion in Run 5 _____	44
52.	CGHT5 — C.G. Height in Run 5 _____	44
53.	SSF — Vehicle Static Stability Factor _____	44
54.	POSS — NHTSA Rollover Possibility _____	44
55.	RRS — NHTSA rollover Relative Risk Score _____	45
56.	STAR — Number of NHTSA rollover rating stars _____	45
2.9	High-Speed Video Information _____	46
1.	CAMNO — Camera Number _____	46
2.	TSTREF — Test Reference Number _____	46
3.	VSCFACTOR — Video Frame Number Scale Factor _____	46
4.	VIEWDESC — View Description _____	46
5.	COMMENT — Camera Commentary _____	47
Chapter 3 :	Test Report Format _____	48
Chapter 4 :	Pre- and Post-Event Images _____	50
4.1	Digital Images _____	50
4.2	Processed Film Images _____	50
Chapter 5 :	Event Images, Film, and Video _____	51

5.1	High-Speed Film	51
5.2	High-Speed Digital Video	51
5.2.1	The High-Speed Digital Video Specification File	51
5.2.2	The Sequential Image and Movie Submission Format	52
5.2.3	The Media Format	52
5.3	Other Event Images	54
<i>Appendix A: Data Coordinate System</i>		55
A-1.	Using the Coordinate System Correctly	55
A-2.	Vehicle Global Coordinate System	55
A-3.	Occupant Global Coordinate System	56
<i>Appendix B: Technical Support Information</i>		60
B-1.	Reference Guide Updates and Software Updates	60
B-2.	Requesting Assistance	60
B-3.	Reporting a Problem	61

List of Figures

<i>Figure 0-1 Database selection</i>	2
<i>Figure 2-1 A flowchart for determining component information record sets in an EV5 file</i>	13
<i>Figure 2-2 Reference Points for Contact Locations (CNTLOC1 / CNTLOC2)</i>	31
<i>Figure A-1 Vehicle Global Coordinate System</i>	55
<i>Figure A-2 Occupant Global Coordinate System</i>	56
<i>Figure A-3 Nine-Accelerometer Coordinate System</i>	57

List of Tables

<i>Table 2-1 EV5 information record sets and their keys</i>	<i>14</i>
<i>Table 2-2 Signal Filename Examples</i>	<i>18</i>
<i>Table 2-3 CNTLOC1 and CNTLOC2 Reference Points</i>	<i>30</i>

Preface

This guide and its companion guides are to be used to create formatted submissions of data collected from automotive crash tests.

There are four guides:

Volume I: NHTSA Vehicle Test Reference Guide

Volume II: NHTSA Biomechanics Test Reference Guide

Volume III: NHTSA Component Test Reference Guide

Volume IV: NHTSA Signal Waveform Generator Test Reference Guide (suspended)

You are reading Volume III, the NHTSA Component Test Reference Guide.

The first step in creating a data submission is to determine which database to use for your test data. The design and partitioning of each database is centered upon the focus of the testing. Test programs focused on the evaluation of the **occupant** should be submitted to the Biomechanics Database; tests focused on the evaluation of **vehicles** belong in either the Vehicle Database or the Component Database; and tests focused on the evaluation of the **data acquisition system** belong in the Signal Waveform Generator Database. Refer to the flow chart in **Figure 0-1 Database selection**, on the next page, to determine which database is appropriate for your test.

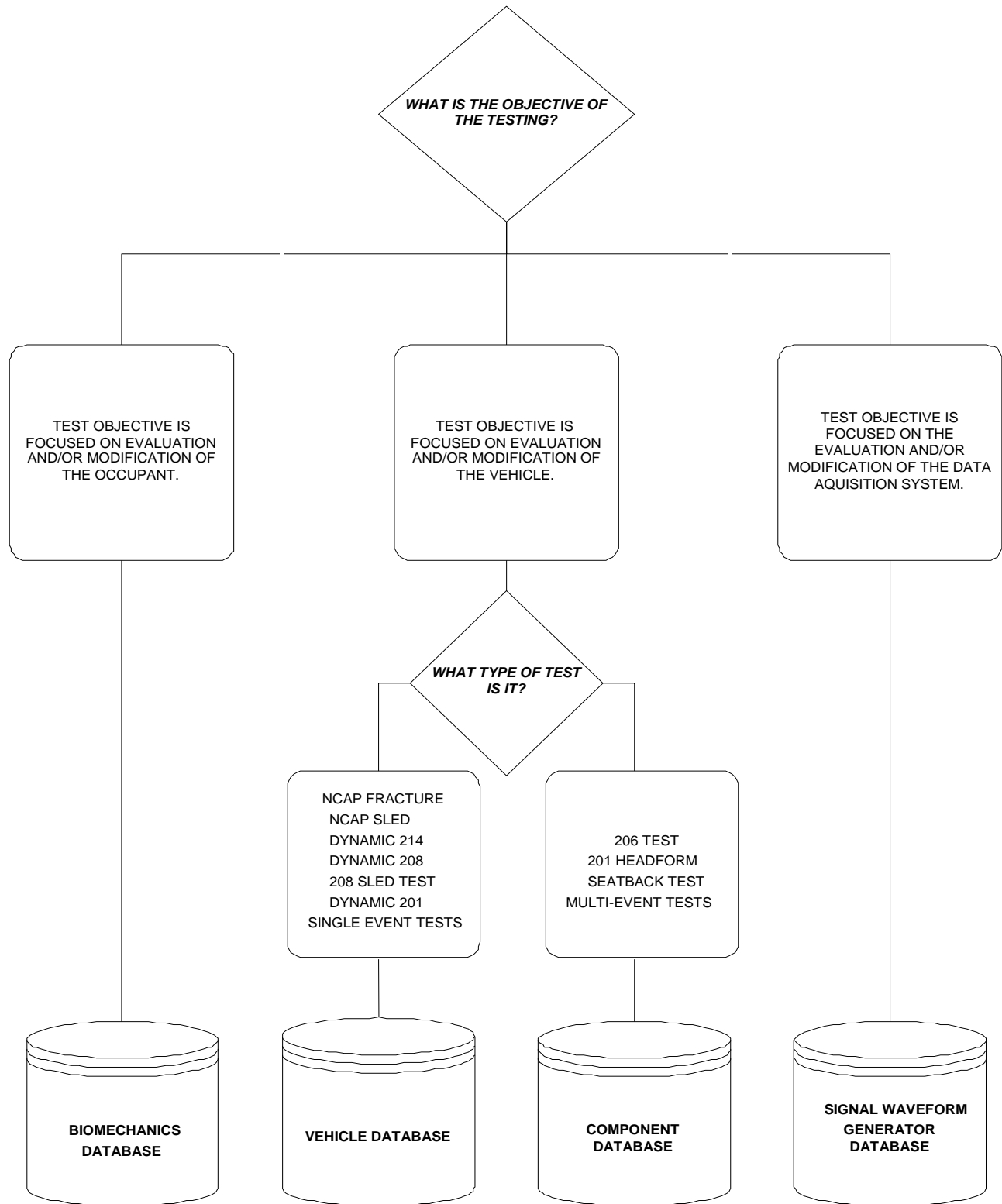

Figure 0-1 Database selection

In Figure 0-1, test types can be found from the NHTSA_TSTTYP table in the NHTSA code library named NCodes.mdb (see [Section 1.3 A Database for NHTSA Codes](#)). Several examples may help to illustrate where certain types of tests fit into the databases:

- All regulatory tests shall be submitted to the Vehicle Database or Component Database.
- Tests that are performed as part of the new car assessment program shall be submitted to the Vehicle Database.
- Forward Collision Warning (FCW), Lane Departure Warning (LDW) and Dynamic Rollover (DRO) Test Data shall be submitted to the Vehicle Database.
- Pendulum tests to cadavers shall be submitted to the Biomechanics Database.
- Lateral vehicle-to-vehicle impacts shall be submitted to the Vehicle Database.
- Sled tests with new dummy designs shall be submitted to the Biomechanics Database.
- Tests featuring a car body on a sled designed to evaluate occupant response should be submitted to the Biomechanics Database, except the 206-sled test.
- Tests featuring a car body on a sled designed to evaluate vehicle response should be submitted to the Vehicle Database.
- Tests to record a standard waveform using new car assessment conditioning amplifiers shall be submitted to the Signal Waveform Generator Database.

In many research cases, it will be difficult to determine whether testing is focused on evaluation of the vehicle or evaluation of the occupant. Always check with the COTR in determining which database tests should be submitted. In all cases where the COTR's advice is contrary to this guide, send email to nrd.softdev@nhtsa.dot.gov.

Release Notes

This section details changes between the current revision of this guide and original version in 2001.

Content

- Update NHTSANO (NHTSA Number) from 6 characters to 9 characters.
- Add rollover information to Component Test Guides.
- NFP and NLP are extended to -99,999 and 999,999, respectively, considering the computational capability of more powerful computers.

Code Library

- The code library, Ncodes.mdb, explaining codes used in the NHTSA Test Reference Guides are now available through the NHTSA Research and Development web site: [Entree for Windows | National Highway Traffic Safety Administration \(NHTSA\)](#). It is also a database employed for validating codes by the Entrée V5 for windows (see [Section 1.3 A Database for NHTSA Codes](#)).

[Return to Table of Contents](#)

Introduction

Background

In September of 1966, the National Traffic and Motor Vehicle Safety Act (15 U.S.C. 1381) was signed into law in the United States. The Act specifies that the Secretary of Transportation shall establish appropriate Federal Motor Vehicle Safety Standards that would lead to the reduction of the number of deaths and injuries resulting from motor vehicle accidents. In prescribing standards, the Secretary was to consider: (1) relevant motor vehicle safety data, (2) whether the proposed standard is reasonable, practical, and appropriate for the particular type of motor vehicle equipment for which it is prescribed, and (3) the extent to which such standards contribute to carrying out the purposes of the Act.

In order to meet the above requirements, the National Highway Traffic Safety Administration (NHTSA) has been mandated to develop safety standards. For each proposed regulation, an extensive research program is undertaken to ensure that the proposed standard satisfies the requirements of the Act. For each test conducted for the agency, data is recorded from various transducers mounted to the test dummies or vehicles, high-speed films or videos are recorded to document the event, still pictures of the test setup are taken, and a written report is generated. Since 1978, these data have been loaded into a single data repository, where NHTSA staff and the public can access the data and conduct analysis.

This reference guide has been written for two reasons. The first is to document the format and content requirements for submission of data, film, video, and reports to the NHTSA database. The second is to encourage the adoption of this standardized format so that the exchange of data by the safety research community is readily accomplished and ultimately leads to new and better ways for reducing the fatalities and injuries in motor vehicle accidents.

Data Organization

Four types of crash test data can be submitted to the NHTSA Component Test database:

- **Electronic Data** (Chapter 2) - General quantitative information about the test setup and results as well as transducer output time-history data.
- **Written Report** (Chapter 3) - A report containing information about the test, such as test setup diagrams and test anomalies. The written report should be submitted in digital form using the Adobe PDF format. Alternatively, a paper copy of the report is acceptable.
- **Pre/Post-Event Images** (Chapter 4) - Pre- or post- event images of the test environment. These may be in the form of film or digital video, time sequenced or still images.
- **Event Images** (Chapter 5) - Film, video, or still images captured during the impact event. The images may be submitted on processed prints from photo-reactive film or on CCD cameras.

Chapters 2 through 5 of this guide provide instructions for formatting each of the above data types.

Digital Media Formats and Software Tools

The digital crash test information should be submitted to NHTSA via CD/DVD ROMs or downloadable web sites. [*Chapter 1 : Media Formats and Software Tools*](#) describes details on acceptable media, the layout of directories and files on the media, and software tools for generating quality formatted specification files.

Other Media Formats

Other media, including high-speed films, VHS or BETA videotapes, paper reports, or X-Rays should be submitted along with the digital media. If you have data that you wish to submit but which is not specified in this guide, please send email to

nrd.softdev@nhtsa.dot.gov

or contact the NHTSA COTR responsible for your submission.

Return Policy

Submissions that cannot be processed, or which have too many errors found by the validation system of the software, [*Entrée V5 for windows*](#), will be returned to the contractor to be corrected and resubmitted.

[**Return to Table of Contents**](#)

Chapter 1: Media Formats and Software Tools

Each submission consists of multiple types of data: descriptive test information defined later in this guide, measurement data digitized from the test instrumentation signal traces, a written report of the testing, and still images and video before, during, and after the test event. Several pieces of physical media may be necessary to record all of this information for submission.

1.1 Media Types and Layout

All submissions should be submitted by CD/DVD ROMs, or posted in a downloadable web site, where there should be a directory structure in accordance with the following:

- 1) **Parent directory name** - All data for each submitted test should be in a directory created in

\<TSTREF>\

<TSTREF> is the value from the TSTREF in Chapter 2 of this guide. So, if TSTREF = 'IMPACT123', then the directory for all data for this test shall be stored in the directory, \IMPACT123\. Users should avoid illegal filename characters ('\', '*', '?') when choosing a value for TSTREF, so as not to interfere with the directory naming convention. Each piece of media should have a printout listing each TSTREF on the media.

- 2) **Electronic Data** - In accordance with the format in Chapters 1 and 2, the EV5 specification file and associated transducer signal files shall be stored in the subdirectory

\<TSTREF>\DATA

- 3) **Written Report** - In accordance with Chapter 3, digital reports in PDF format shall be stored in the subdirectory

\<TSTREF>\REPORT

- 4) **Pre/Post-Event Images** – In accordance with Chapter 4, still images and video captured before and after the impact event shall be stored in the subdirectory

\<TSTREF>\PREPOST

- 5) **Event Images** - In accordance with Chapter 5, still images and video of the impact event, including high speed video files, shall be stored in the subdirectory

\<TSTREF>\EVENT

1.2 A Data Entry Software – Entrée V5 for Windows

NHTSA has developed a data entry software tool, Entrée V5 for Windows, to facilitate preparation of the specification data defined in *Chapter 2 : File Formats and Information Records* . EntréeV5 contains a built-in data validation system. It is highly recommended that specification data be generated using this tool.

In addition to producing new specification files, Entrée V5 for Windows can import ASCII data files generated by previous versions of Entrée, typically of type EV4, EV5, or GR* (EV3). Once one of these files has been imported, it can be written to a new EV5 specification file (an ASCII file in the EV5 format).

1.2.1 System Requirements

The software is a Windows-based application for the Microsoft Windows XP environment with the following operating requirements:

- Hardware (CPU, memory, and disk space) according to Microsoft recommendations.
- 24 MB of disk space to install, and 12 MB of disk space during normal use.
- SVGA display adapter with resolution 1024x768, preferably using font size “small.”
- A CD/DVD ROM driver.
- Database *Ncodes.mdb* that can be downloaded from [the NHTSA Research and Development web site](#).

It may work in Windows NT Workstation 4.0 with Service Pack 6a or later. While the software may run under Microsoft Windows Millennium or Windows 2000, it has not been tested in those environments.

1.2.2 A Customer Developed Software

NHTSA provides access to the source code for the Entrée for Windows program as a separately downloadable package on the Entrée web site (See: *Appendix B-1 Reference Guide Updates and Software Updates*.) This source code package may be used as an educational resource in understanding how the Entrée application works, and the logic used in generating an EV5 file. However, the source code is not suitable for direct inclusion in customer-developed software.

NHTSA does not provide source code for customers to develop their own software to write data compatible with the EV5 specification. This guide and files produced by Entrée V5 for Windows may be conditionally compatible with the specification.

1.3 A Database for NHTSA Codes

The build-in code-validation system of Entrée V5 for Windows is based on the database Ncodes.mdb, defined by NHTSA Research and Development. This database includes more than 80 tables related to all “Search” buttons in Entrée V5 for Windows. For example, the table related to the test type is named NHTSADB_TSTTYP that lists test types for all acceptable tests. A comprehensive reference for currently acceptable codes can be checked out through “Search” buttons of Entrée V5 for Windows.

This database is mainly employed for instant code validations and valid code selections. If an existing data file is loaded into Entrée V5 for Windows, unacceptable codes will be detected and highlighted by the validation system. Neither a page including an unacceptable code can be switched to another one, nor a new data file can be generated, until the invalid code is replaced by one checked out through the related “Search” button.

The user can find a required code from a table in the database directly if the Microsoft Excel is ready. However, it is not a good way to search, especially when the code is indirectly related to multiple tables.

The Entrée for Windows is a friendly code searcher. For example, to determine which test type should be used, open the General Test Information page for an arbitrary database in Entrée V5 for Windows, and click on the search button for test type. Then a pop-up box appears, listing all codes of test types for this database only. If no listed code is acceptable, then switch to another database. If an appropriate code is found, the test type is determined and the data format can be determined.

The database might be updated in accordance with new requirements. The latest version can be downloaded from the NHTSA Research and Development web site: [Entree for Windows | National Highway Traffic Safety Administration \(NHTSA\)](#).

[Return to Table of Contents](#)

Chapter 2 : File Formats and Information Records

As a primer to understanding the following sections please review specification data types. We have categorized specification data so as to make it easier to model specification data and engineering requirements.

A specification data includes its name, type, unit, range, and order number in an information record. For convenience, it is called a field also. The field name is usually a short name of a test parameter, and it is used as the column name in the database of NHTSA. The unit is optional and predefined. The type and range are validated automatically in editing an EV5 file through EntréeV5 for windows. All fields are described from *Section 2.3 General Test Information* to *Section 2.8 High-Speed Video Information*.

2.1 Field Types

- **Text** – A textual string whose content is not strictly governed by a rule, white-space, and a limited set of special characters including [] () , : - + and _ . This data type usually has a maximum length.
- **Code** – A textual string whose content is limited to a predefined set of codes that can be found through a “Search” button in a page of EntréeV5 for windows. A code has a preset length. Codes used in EntréeV5 for windows are defined by the R & D of NHTSA.
- **Integer** – An integer is expressed as one optional sign character (- or +) and one or more numeric characters, or digits, in the range from 0 – 9. The absence of a sign character implies a positive value. An integer in an EV5 file has its limits usually.
- **Real** – A real (floating point or decimal number) is expressed as one sign character (- or +), one or more numeric characters, or digits, in the range from 0 – 9, a decimal point ‘.’, and one or more numeric characters in the range from 0 – 9. The absence of a sign character implies a positive value. A real in an EV5 file has its limits usually.

The representation of a real as a textual string may be governed by a rule that specifies a total text length for placement of the sign and decimal number, and relative sizes and format of the mantissa and exponent.

- **Date** – A textual string whose content represents a calendar date of the format ‘DD/MMM/YYYY’. The maximum length of a Date is limited to 11 characters.

The ‘DD’ portion is the numeric day of the month, padded to a width of two (2) characters with a leading zero, in the range from 1 – 31.

The ‘MMM’ portion is the three-character uppercase alphabetic abbreviation of the month (e.g. ‘JAN’, ‘FEB’, ‘MAR’, ‘APR’, ‘MAY’, ‘JUN’, ‘JUL’, ‘AUG’, ‘SEP’, ‘OCT’, ‘NOV’, ‘DEC’).

The ‘YYYY’ portion is a four-digit year (e.g. ‘2006’).

2.2 Specification Files and Signal Files

A file system for a vehicle test consists of two parts:

- (1) Two specification files whose extensions are .EV5 and .HS5
- (2) A set of signal (curve or channel data) files

An HS5 file records the high-speed video information. Note that the EV5 and HS5 files for the same test must have the same test reference number (see TSTREF in *Section 2.3 General Test Information*). Software Entrée V5 for windows edits and validates specification files only. Signal files can be edited and generated by any available text editors.

2.2.1 Structures of Specification Files

An EV5 file consists of a subset of six (information) record sets named “General Test”, “Vehicle”, “Component”, “Component Configuration”, “Instrumentation”, and “High Speed Video”, respectively. For example, a component test might consist of information record sets: “General Test”, “Component”, “Component Configuration” and “Instrumentation”. An HS5 file consists of a “High Speed Video” record set only.

A component may or may not be from a vehicle. The vehicle information may be empty in a component test.

A record set consists of one or more information records with the same name of the record set. For example, Record set, "General Test", always includes only one record while record set “Instrumentation” always include more than one record.

An information record consists of a sequence of fields (specification data) separated by pipes (|’s); and it is listed in the same line of a specification file. An unavailable specification data is replaced with an empty space or a blank character. For example, a record with a data sequence, $d_1, d_2, \dots, d_{n-1}, d_n$, is expressed as “ $d_1|d_2| \dots |d_n$ ” delimited by a line feed. If d_1 and d_n are unavailable, this record is expressed as “ $|d_2| \dots, |d_{n-1}|$ ” or “ $|d_2| \dots, |d_{n-1}|$ ”.

The flowchart in **Figure 2-1** indicates the logical relation of the information record sets for a component test. It can be used to determine what record sets should be included in an EV5 file.

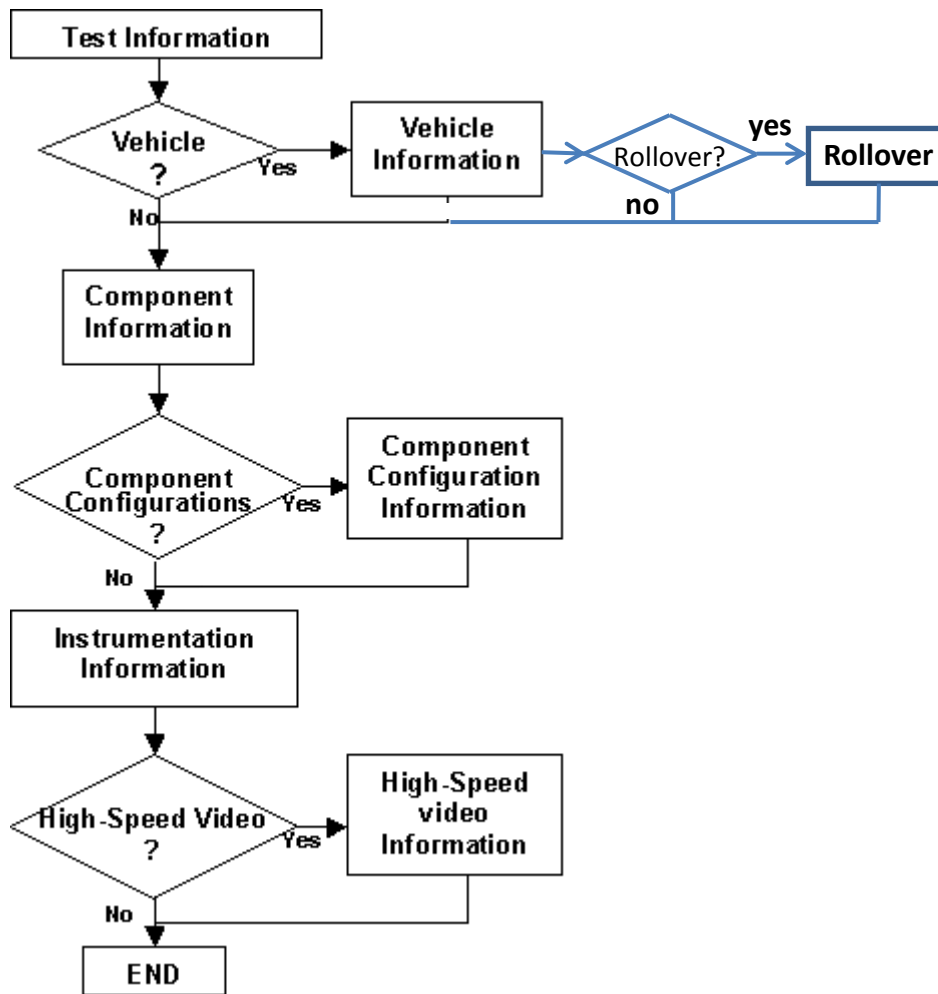

Figure 2-1 A flowchart for determining component information record sets in an EV5 file

If there are no comment lines on the beginning of a specification file, the first line of the file should be the string

“----- *extension* -----”

or

“-----”+space+ “*extension*”+space+“-----”

where *extension* = EV5, or HS5 for EV5, and HS5 files respectively.

A specification file should terminate with the line

“-----END-----”

Record-set keys shown in Table 2-1 are used as identifiers in an EV5 file and its correlated HS5 file.

RECORD (SET) NAME	RECORD SET KEY	NOTE
General Test	TEST	Must be included
Vehicle	VEHICLE	Optional
Rollover	ROLLOVER	Optional
Component	COMPONENT	Must be included
Component Configuration	CONFIGURATION	Optional
Instrumentation	INSTRUMENTATION	Must be included
High-Speed Video	HSVD	Optional, Output to an HS5 file

Table 2-1 EV5 information record sets and their keys

Within the body of a specification file, each section should begin with a record set key line to indicate the beginning of a record set (see Table 2-2). A record set key line is expressed as

“----- RECORD SET KEY -----”

or

“-----”+space+ RECORD SET KEY+space+ “-----”.

Comments within a specification file are allowable anywhere in the file, but must start on a new line with the # (pound) sign and end with a line feed.

2.2.2 Specification File Examples

File examples (not for the same test) are given in the following. Please note that while the records in the EV5 file example appear to span lines, in actuality, they are continuous and have been wrapped to fit this page.

- **An Example for an EV5 file:**

```
# Source: Entree for Windows v5
# Date: <12/5/2005>
----- EV5 -----
----- TEST -----
C5|FMVSS201U OCCUPANT PROTECTION IN INTERIOR IMPACT|UPPER INTERIOR HEAD IMPACT
PROTECTION|24/JUL/2000|CAL|DTNH22-99-C-01005|CY0503FMH|201|23|40|2000 BMW 328I 4-DR SEDAN CY0503
----- VEHICLE -----
1|27|99|2000|CY0503|4D|WBAAM5340YFR17241|N|2000 BMW 328I 4-DR SEDAN CY0503
2| | |2000| | | |
----- COMPONENT -----
```

1|1|PLRR|VE|0|N| |P5|50|APPLIED SAFETY|RP2
1|2|HDDR|VE|0|N| |P5|50|FIRST TECHNOLOGIES|SR3 - RIGHT
1|3|RFIN|VE|0|N| |P5|50|FIRST TECHNOLOGIES|UR2-B
1|4|HDRF|VE|0|N| |P5|50|APPLIED SAFETY|SR2A - RIGHT
1|5|PLBR|VE|0|N| |P5|50|FIRST TECHNOLOGIES|BP3 - RIGHT
1|6|PLBL|VE|0|N| |P5|50|FIRST TECHNOLOGIES|BP2 - LEFT
1|7|PLAL|VE|0|N| |P5|50|APPLIED SAFETY|AP1 - LEFT
1|8|RFIN|VE|0|N| |P5|50|FIRST TECHNOLOGIES|UR1B - LEFT
1|9|HDLR|VE|0|N| |P5|50|FIRST TECHNOLOGIES|RH - LEFT
1|10|HDLF|VE|0|N| |P5|50|APPLIED SAFETY|FH2 - LEFT
----- CONFIGURATION -----
1|1|1|LIN|0| |HDG|23.58|0|0|0|RP2|H 37; V 25
1|2|1|LIN|0| |HDG|18.50|0|0|0|SR3 - RIGHT|H 90; V 17
1|3|1|LIN|0| |HDG|23.30|0|0|0|UR2-B|H 90; V 50
1|4|1|LIN|0| |HDG|23.40|0|0|0|SR2A - RIGHT|H 90; V 32
1|5|1|LIN|0| |HDG|23.30|0|0|0|BP3 - RIGHT|H 81; V 1
1|6|1|LIN|0| |HDG|23.70|0|0|0|BP2 - LEFT|H 270; V 12
1|7|1|LIN|0| |HDG|18.90|0|0|0|AP1 - LEFT|H 260; V 29
1|8|1|LIN|0| |HDG|23.36|0|0|0|UR1B - LEFT|H 270; V 50
1|9|1|LIN|0| |HDG|23.50|0|0|0|RH - LEFT|H 360; V 50
1|10|1|LIN|0| |HDG|23.67|0|0|0|FH2 - LEFT|H 180; V 50
----- INSTRUMENTATION -----
1|1|1|1|TB|OTHR|NA|SEC|SEC|99999|KAYSER-THREDE|24/JUL/2000|999999|999|23.58|-
2000|1999|50|AM|P|TIME CHANNEL
1|1|1|2|AC|HDCG|XG|SEC|G'S|4000|ENDEVCO|01/MAR/2000|501|126|23.58|-2000|1999|50|AM|P|HEAD X
ACCELERATION
1|1|1|3|AC|HDCG|YG|SEC|G'S|4000|ENDEVCO|01/MAR/2000|497|16|23.58|-2000|1999|50|AM|P|HEAD Y
ACCELERATION
1|1|1|4|AC|HDCG|ZG|SEC|G'S|4000|ENDEVCO|01/MAR/2000|498|49|23.58|-2000|1999|50|AM|P|HEAD Z
ACCELERATION
1|2|1|5|TB|OTHR|NA|SEC|SEC|99999|KAYSER-THREDE|24/JUL/2000|999999|999|18.50|-
2000|1999|50|AM|P|TIME CHANNEL
1|2|1|6|AC|HDCG|XG|SEC|G'S|4000|ENDEVCO|01/MAR/2000|496|91|18.50|-2000|1999|50|AM|P|HEAD X
ACCELERATION
1|2|1|7|AC|HDCG|YG|SEC|G'S|4000|ENDEVCO|01/MAR/2000|501|12|18.50|-2000|1999|50|AM|P|HEAD Y
ACCELERATION
1|2|1|8|AC|HDCG|ZG|SEC|G'S|4000|ENDEVCO|01/MAR/2000|494|27|18.50|-2000|1999|50|AM|P|HEAD Z
ACCELERATION
1|3|1|9|TB|OTHR|NA|SEC|SEC|99999|KAYSER-THREDE|24/JUL/2000|999999|999|23.30|-
2000|1999|50|AM|P|TIME CHANNEL
1|3|1|10|AC|HDCG|XG|SEC|G'S|4000|ENDEVCO|01/MAR/2000|499|81|23.30|-2000|1999|50|AM|P|HEAD X
ACCELERATION
1|3|1|11|AC|HDCG|YG|SEC|G'S|4000|ENDEVCO|01/MAR/2000|499|3|23.30|-2000|1999|50|AM|P|HEAD Y
ACCELERATION
1|3|1|12|AC|HDCG|ZG|SEC|G'S|4000|ENDEVCO|01/MAR/2000|498|24|23.30|-2000|1999|50|AM|P|HEAD Z
ACCELERATION
1|4|1|13|TB|OTHR|NA|SEC|SEC|99999|KAYSER-THREDE|24/JUL/2000|999999|999|23.40|-
2000|1999|50|AM|P|TIME CHANNEL
1|4|1|14|AC|HDCG|XG|SEC|G'S|4000|ENDEVCO|01/MAR/2000|501|175|23.40|-2000|1999|50|AM|P|HEAD X
ACCELERATION
1|4|1|15|AC|HDCG|YG|SEC|G'S|4000|ENDEVCO|01/MAR/2000|497|5|23.40|-2000|1999|50|AM|P|HEAD Y
ACCELERATION

1|4|1|16|AC|HDCG|ZG|SEC|G'S|4000|ENDEVCO|01/MAR/2000|498|50|23.40|-2000|1999|50|AM|P|HEAD Z
ACCELERATION

1|5|1|17|TB|OTHR|NA|SEC|SEC|99999|KAYSER-THREDE|24/JUL/2000|999999|999|23.30|-
2000|1999|50|AM|P|TIME CHANNEL

1|5|1|18|AC|HDCG|XG|SEC|G'S|4000|ENDEVCO|01/MAR/2000|496|123|23.30|-2000|1999|50|AM|P|HEAD X
ACCELERATION

1|5|1|19|AC|HDCG|YG|SEC|G'S|4000|ENDEVCO|01/MAR/2000|501|17|23.30|-2000|1999|50|AM|P|HEAD Y
ACCELERATION

1|5|1|20|AC|HDCG|ZG|SEC|G'S|4000|ENDEVCO|01/MAR/2000|494|47|23.30|-2000|1999|50|AM|P|HEAD Z
ACCELERATION

1|6|1|21|TB|OTHR|NA|SEC|SEC|99999|KAYSER-THREDE|24/JUL/2000|999999|999|23.70|-
2000|1999|50|AM|P|TIME CHANNEL

1|6|1|22|AC|HDCG|XG|SEC|G'S|4000|ENDEVCO|01/MAR/2000|496|241|23.70|-2000|1999|50|AM|P|HEAD X
ACCELERATION

1|6|1|23|AC|HDCG|YG|SEC|G'S|4000|ENDEVCO|01/MAR/2000|501|80|23.70|-2000|1999|50|AM|P|HEAD Y
ACCELERATION

1|6|1|24|AC|HDCG|ZG|SEC|G'S|4000|ENDEVCO|01/MAR/2000|494|140|23.70|-2000|1999|50|AM|P|HEAD Z
ACCELERATION

1|7|1|25|TB|OTHR|NA|SEC|SEC|99999|KAYSER-THREDE|24/JUL/2000|999999|999|18.90|-
2000|1999|50|AM|P|TIME CHANNEL

1|7|1|26|AC|HDCG|XG|SEC|G'S|4000|ENDEVCO|01/MAR/2000|501|148|18.90|-2000|1999|50|AM|P|HEAD X
ACCELERATION

1|7|1|27|AC|HDCG|YG|SEC|G'S|4000|ENDEVCO|01/MAR/2000|497|12|18.90|-2000|1999|50|AM|P|HEAD Y
ACCELERATION

1|7|1|28|AC|HDCG|ZG|SEC|G'S|4000|ENDEVCO|01/MAR/2000|498|34|18.90|-2000|1999|50|AM|P|HEAD Z
ACCELERATION

1|8|1|29|TB|OTHR|NA|SEC|SEC|99999|KAYSER-THREDE|24/JUL/2000|999999|999|23.36|-
2000|1999|50|AM|P|TIME CHANNEL

1|8|1|30|AC|HDCG|XG|SEC|G'S|4000|ENDEVCO|01/MAR/2000|499|66|23.36|-2000|1999|50|AM|P|HEAD X
ACCELERATION

1|8|1|31|AC|HDCG|YG|SEC|G'S|4000|ENDEVCO|01/MAR/2000|499|7|23.36|-2000|1999|50|AM|P|HEAD Y
ACCELERATION

1|8|1|32|AC|HDCG|ZG|SEC|G'S|4000|ENDEVCO|01/MAR/2000|498|41|23.36|-2000|1999|50|AM|P|HEAD Z
ACCELERATION

1|9|1|33|TB|OTHR|NA|SEC|SEC|99999|KAYSER-THREDE|24/JUL/2000|999999|999|23.50|-
2000|1999|50|AM|P|TIME CHANNEL

1|9|1|34|AC|HDCG|XG|SEC|G'S|4000|ENDEVCO|01/MAR/2000|496|113|23.50|-2000|1999|50|AM|P|HEAD X
ACCELERATION

1|9|1|35|AC|HDCG|YG|SEC|G'S|4000|ENDEVCO|01/MAR/2000|501|18|23.50|-2000|1999|50|AM|P|HEAD Y
ACCELERATION

1|9|1|36|AC|HDCG|ZG|SEC|G'S|4000|ENDEVCO|01/MAR/2000|494|44|23.50|-2000|1999|50|AM|P|HEAD Z
ACCELERATION

1|10|1|37|TB|OTHR|NA|SEC|SEC|99999|KAYSER-THREDE|24/JUL/2000|999999|999|23.67|-
2000|1999|50|AM|P|TIME CHANNEL

1|10|1|38|AC|HDCG|XG|SEC|G'S|4000|ENDEVCO|01/MAR/2000|501|84|23.67|-2000|1999|50|AM|P|HEAD X
ACCELERATION

1|10|1|39|AC|HDCG|YG|SEC|G'S|4000|ENDEVCO|01/MAR/2000|497|5|23.67|-2000|1999|50|AM|P|HEAD Y
ACCELERATION

1|10|1|40|AC|HDCG|ZG|SEC|G'S|4000|ENDEVCO|01/MAR/2000|498|34|23.67|-2000|1999|50|AM|P|HEAD Z
ACCELERATION

----- END -----

- **An Example for an HS5 File:**

```
# Source: High Speed Video Data
# Date: <11/29/2005>
----- HSVD -----
1|V4537C|0.001|DRIVER FRONT VIEW|NO COMMENTS
2|V4537C|0.001|DRIVER VIEW|NO COMMENTS
3|V4537C|0.001|PASSENGER VIEW|NO COMMENTS
4|V4537C|0.001|REAR SIDE VIEW|NO COMMENTS
5|V4537C|0|MOVIE TC01-202|
----- END -----
```

2.2.3 Signal Data

Each subsequent file after an EV5 file contains unfiltered, digitized signal data collected from the sensors used in the tests. The order of signal files corresponds to the order of the instrumentation information records in the record set. A signal file is made up of ASCII records of 1 data point each, delimited by a line feed character (ASCII decimal 10, hexadecimal \x0a, octal \012). If a X-Y signal in which the independent X coordinate is non-uniformly incremental - is supplied, then each signal data consists of 1 data point each with the X coordinate listed first, followed by a single tab character, followed by the associated Y coordinate, and ending with a line feed character. The following two examples express two types of signal data in signal files.

- **Signal Data Example (Y value only)**

```
-.206786E-02
0.285321E-01
0.285321E-01
-.632679E-01
0.285321E-01
-.206786E-02
0.285321E-01
-.632679E-01
-.632679E-01
-.206786E-02
0.285321E-01
-.206786E-02
-.326679E-01
-.206786E-02
-.206786E-02
-.206786E-02
-.206786E-02
-.206786E-02
-.326679E-01
0.285321E-01
```

- **Signal Data Example (X and Y values)**

```

-0.025000000  0.0
-0.024875002  0.0
-0.024750002  -0.12266
-0.024625001  0.12266
-0.024500001  0.0
-0.024375001  -0.24532
-0.024250000  0.0
-0.024125000  0.0
-0.024000000  -0.12266
-0.023875002  0.0
-0.023750002  0.0
-0.023625001  0.0
-0.023500001  0.12266
-0.023375000  0.0
-0.023250000  0.0
-0.023125000  -0.12266
-0.023000002  0.0
-0.022875002  0.0
-0.022750001  0.24532
-0.022625001  0.0
-0.022500000  0.0
-0.022375000  -0.12266
-0.022250000  -0.12266
    
```

The point specification will allow for any floating-point format, but the preferred format is the C format %12.5E. Thus, each Y-only record will be 12 characters wide (e.g. +1.23456E-01) and each X-Y record will be a maximum of 25 characters wide (e.g. +1.23456E-01<tab>-9.87654E+02). The maximum number of points for one channel is 110,000. There cannot be more than 10,000 data points prior to time zero nor more than 99,999 after time zero.

The title of the ASCII signal files should be the same given to the specification (EV5) file described above followed by a numeric file extension. The file extension should be the curve number of the curve contained in the file, padded on the left with zeroes to three characters, and should correspond to the curve number in the instrumentation information record set.

If the specification file is named TSTABC.EV5, and there are 35 signal (curve) files, the signal files should be named TSTABC.001 through TSTABC.035.

Right	TSTABC.001	TSTABC.012	TSTABC.101
Wrong	TSTABC.T0	TSTABC.12	TSTABCDAT

Table 2-2 Signal Filename Examples

[Return to Table of Contents](#)

2.3 General Test Information

Fields defined below constitute the general test information record. A field includes its order index in the record, name, brief description, type and valid range. For example, in the first data, "1", "VERNO", "Version Number", and " Pre-defined code, 2 characters " are its order index in the general test information record, its name, its brief description, and its type and range, respectively. Any use of the code for "OTHER" should be explained in an appropriate commentary field. If the value or content of the field is undetermined and filling the field is not enforced, leave it blank.

1. VERNO — Version Number

Pre-defined code, 2 characters

VERNO should be chosen for all component crash tests. The number of this version of the NHTSA Test Reference Guide is a special pre-assigned code (C5).

However, it can be another code for identifying the version of the reference guide used to prepare contents of specification files. Therefore, it does not refer to the format of the files within an EV5 file.

For example, it is possible to convert an existing specification file for a biomechanics test from the version 3 format, having GR files, into an EV5 format file. Since the original file was developed using the version 3, VERNO would then have a value of "C3" (see the table below).

CODE	DESCRIPTION
C5	Data prepared according to the version 5 guide.
C4	Data prepared according to the version 4 guide.
C3	Data prepared according to the version 3 guide.
C2	Data prepared according to the version 2 guide.

2. TITLE — Contract or Study Title

Text with or within 70 characters

TITLE is the title of the contract or study.

3. TSTOBJ — Test Objectives

Text with or within 70 characters

TSTOBJ is a description of the purpose of the test.

4. TSTDAT — Test Date

Date, format (DD/MMM/YYYY), 11 characters

TSTDAT is the date the test was performed. *This field **must** be filled with a valid date.*

5. TSTPRF — Test Performer

Code, 3 characters

TSTPRF is the code for the name of the organization performing the test.

6. CONNO — Contract Number

Text with or within 17 characters

CONNO is the Department of Transportation contract number assigned by the sponsoring organization.

7. TSTREF — Test Reference Number

Text with or within 16 characters

TSTREF is an alphanumeric code number assigned to the test by the test performer.

8. TSTTYP — Test Type

Code, 3 characters

TSTTYP indicates the type of test conducted, such as 216 for an FMVSS216 roof crush test and ROV for a rollover test.

9. TEMP — Ambient Temperature

Integer, degrees Celsius, -99 to 99

TEMP is the temperature at the test location at the time of the test.

10. TOTCRV — Total Number of Curves

Integer, 1 to 999

TOTCRV is the total number of recorded instrument channels (curves) in the test.

11. TSTCOM — Test Commentary

Text with or within 70 characters

TSTCOM is used to describe any peripheral test information, for which a code does not exist, including anomalies or problems. The reason for using OTHER or NOT APPLICABLE to a code of this information record should record a commentary as well. If no comments are to be made, enter NO COMMENTS (left justified).

[**Return to Table of Contents**](#)

2.4 Vehicle Information

Fields defined below constitute the vehicle information record. A field includes its order index in the record, name, brief description, type and valid range. For example, in the first field, "1", "VEHNO", "Test Vehicle Identification Number", "integer", and "0 or 1" are its order index in the vehicle information record, its name, its brief description, its type and its range, respectively. Any use of the code for "OTHER" should be explained in an appropriate commentary field. If the value or content of the field is undetermined and filling the field is not enforced, leave it blank.

1. VEHNO — Test Vehicle Identification Number

Integer, 0 to 1

VEHNO is the reference number for a particular vehicle. This number should be 1 unless all components in the test are not from a vehicle. If it is zero, this record is empty. For example, it should be zero if all sensors are attached to a barrier.

2. MAKE — Vehicle Make

Code, 4 characters

MAKE is the manufacturer of the vehicle; for instance, 01 represents a Chevrolet.

3. MODEL — Vehicle Model

Code, 4 characters

MODEL is the model of the vehicle (e.g. a value of 06 represents an Impala.) A model code cannot be input unless MAKE has a valid input.

4. YEAR — Vehicle Model Year

Integer, 1900 to 9999

YEAR is the model year of the vehicle.

5. NHTSANO — NHTSA Number

NHTSA pre-assigned *Code, 6 characters*

NHTSANO is the NHTSA test vehicle numbering system, a nine-character alphanumeric identifier assigned to NHTSA-owned vehicles for the purpose of tracking them through purchase,

testing and disposal. A pre-assigned NHTSA number accompanies all vehicles delivered for testing under NHTSA contract.

The first character is alphabetic; prior to 2001, the first two characters were alphabetic. The first character indicates the purchasing office:

- C – Compliance
- D – Defects
- M – Rulemaking
- O – MFR Optional Test
- P – NCSA
- Q – Test Lab Retest
- R – Research

The second four-characters indicate the 4-digit model year; prior to 2012, the second character was used to indicate modal year.

The last four characters constitute a manufacturer code, and vehicles purchased go into a sequential order by office.

Manufacturer Code:

- 0100 – General Motors Corporation
- 0200 – Ford Motor Company
- 0300 –Chrysler Corporation/Fiat
- 0400 – American Motors/Renault
- 0500 – Imported Vehicles
- 0600 – Medium Trucks
- 0700 – Heavy Trucks
- 0800 – Commercial Buses
- 0900 – School Buses
- 1000 – Low Speed/Electric Vehicles
- 1100 – Trailers
- 1200 – Motorcycles/ Mopeds
- 1300 – Multistage/Altered Vehicles
- 1400 – Campers/Motorhomes
- 4100 – BMW
- 4200 – Hyundai/Kia
- 4300 – Mercedes-Benz
- 4400 – LandRover/Jaguar
- 4500 – N/A
- 4600 – N/A
- 4700 – N/A
- 4800 – N/A
- 4900 – N/A
- 5100 – Toyota

5200 – Nissan
5300 – Honda
5400 – Mazda
5500 – Subaru
5600 – Mitsubishi
5700 – Isuzu
5800 – Volkswagen
5900 – Volvo

Examples:

Code 0200: Ford

Test order: 3rd

Code **M20130203**: Third Ford tested by Rulemaking (NCAP) in 2013

6. BODY — Body Type

Code, 2 characters

BODY is the body type of the vehicle. A four-door sedan would be coded as 4S.

7. VIN — Manufacturer Vehicle Identification Number

Text with or within 20 characters

VIN is the identification number of the vehicle that has been assigned by the manufacturer.

8. CRTEST — Crash Tested Indicator

Code, 1 character

CRTEST is a marker to indicate whether or not the vehicle has been previously crash tested.

9. VEHCOM — Vehicle Commentary

Text with or within 70 characters

VEHCOM is used to describe any special features of the vehicle. The reason for using OTHER or NOT APPLICABLE to a code of this information record should record a commentary as well. If no comments are to be made, enter NO COMMENTS.

10. VIMFNO — VIMF Test No.

Integer

VEHCOM is a test number of Vehicle Inertia Measurement Facility (VIMF).

11. LOAD — Test Load

Integer

LOAD is a test load in a rollover test. Nominal load is “driver”.

12. ENGINE — ENGINE TYPE

Code, 4 characters

ENGINE represents the engine type of the vehicle. 4CEF would represent a four-cylinder inline front engine.

13. ENGDSP — Engine Displacement

Real, liters, 0.0 to 9,999.9

ENGDSP indicates the engine displacement within the vehicle, measured in liters - for instance, 2.2 LITERS.

14. TRANSM — Transmission Type

Code, 2 characters

TRANSM is the type of transmission in the vehicle.

15. FUEL — Fuel

Text with or within 16 characters

FUEL filled in the test rollover vehicle. It is “FULL” if the tank is full of gasoline, or is “Battery” for an electronic engine.

16. EQUIP — OPTIONAL EQUIPMENT

Text with or within 32 characters

EQUIP describes the optional equipment used in the test.

[**Return to Table of Contents**](#)

2.5 Component Information

Fields defined below constitute the component information record. A field includes its order index in the record, name, brief description, type and valid range. For example, in the first field, "1", "VEHNO", "Test Vehicle Identification Number", "integer", and "0 or 1" are its order index in the component information record, its name, brief description, its type and its range, respectively. Any use of the code for "OTHER" should be explained in an appropriate commentary field. If the value or content of the field is undetermined and filling the field is not enforced, leave it blank.

1. VEHNO — Vehicle Number

Integer, 0 or 1

VEHNO is the reference number for a particular vehicle. This number should be 1 unless all components in the test are not from a vehicle. For example, it should be zero if this component is a barrier.

2. CMPNO — Component Number

Integer, 1 to 99

CMPNO is the identifying number of the component being tested. The first such component shall be 1, the second 2, etc.

3. CMPNT — Component Tested

Code, 4 characters

CMPNT is the specific component being tested.

4. CMPTYP — Component Type

Code, 2 characters

CMPTYP is the type of the component being tested.

5. CMPWGT — Component Weight

Real, kg, 0 or positive

CMPWGT is the weight of the component.

6. MODIND — Component Modification Indicator

Code, 1 character

MODIND is a marker identifying whether or not the component has been previously modified.

7. MODDSC — Modification Description

Text with or within 70 characters

MODDSC is a description of any modifications to the component. This data applies to any type of component.

8. OCCTYP — Occupant Type

Code, 2 characters

OCCTYP is the type of dummy being tested.

9. DUMSIZ — Dummy Size Percentile

Code, 2 characters

DUMSIZ indicates the size of the dummy, measured either as a standard size percentile or by age's classification for child dummies.

10. DUMMAN — Dummy Manufacturer

Text with or within 70 characters

DUMMAN is the serial number as well as the manufacturer of the test dummy. The information should be entered as MFG: (manufacturer's name), S/N (dummy serial number). If the component tested was not a dummy part, leave this field blank.

11. CMPCOM — Component Commentary

Text with or within 70 characters

CMPCOM is a descriptive data containing any extraneous information needed to define the component. This commentary should explain any OTHER or N/A assigned in codes.

[**Return to Table of Contents**](#)

2.6 Component Configuration Information

Fields defined below constitute the component configuration information record. A field includes its order index in the record, name, brief description, type and valid range. For example, in the first field, "1", "VEHNO", "Test Vehicle Identification Number", "integer", and "0 or 1" are its order index in the component configuration information record, its name, its brief description, its type and its range, respectively. Any use of the code for "OTHER" should be explained in an appropriate commentary field. If the value or content of the field is undetermined and filling the field is not enforced, leave it blank.

1. VEHNO — Vehicle Number

Integer, 0 or 1

VEHNO is the reference number for a particular vehicle. This number should be 1 unless all components in the test are not from a vehicle. For example, it should be zero if the component is a barrier.

2. CMPNO — Component Number

Integer, 1 to 99

CMPNO is the identifying number of the component being tested. The first such component shall be 1, the second 2, etc.

3. CNFNO — Configuration Number

Integer, 1 to 999

CNFNO is the number identifying the specific test configuration for this component. The first such test configuration shall be 1, the second 2, etc.

4. TSTDEV — Test Device

Code, 3 characters

TSTDEV is the test device, such as a linear impactor, static loading device, etc.

5. DEVSPD — Test Device Speed

Real, km/h, positive

DEVSPD is the speed of the test device at time zero.

6. DEVCOM — Test Device Commentary

Text with or within 70 characters

DEVCOM is descriptive for any extra information needed to define the test device. It should explain reasons for assigning OTHER or NA to TSTDEV.

7. CONFIG — Test Configuration

Code, 3 characters

CONFIG is the specific test configuration, e.g. abdominal compression (static, coded ABD) or guided head-form dynamic impact (coded HDG for FMVSS 201 testing).

8. CMPSPD — Component Speed

Real, km/h, positive

CMPSPD is the initial speed of the component at time zero.

9. CNTANG — Contact Angle

Integer, degrees, 0 to 359

CNTANG is the angle of contact between the travel vector of the test device and the plane tangent to the component at the impact point. A perpendicular impact is defined as 0 degrees, which is also the reference line for the measurement. This data applies to dynamic tests only.

10. CNTLOC1 — Contact Location #1

Integer, millimeters, 0 or positive

CNTLOC1 is the location on the component where contact occurred with the test device. It may also be the attachment location for the test device. CNTLOC1 is the vertical measurement taken from the top of the component to the test device contact point. If the component being tested is a vehicle roof pillar or a dummy component, such as an arm or leg, this measurement may be taken along the local axis of the component.

Table 2-3 lists examples of contact measurements. **Figure 2-2** shows the contact codes for various points on the dash-panel.

COMPONENT (CMPNT)	COMPONENT PLANE OR AXIS*	REFERENCE POINT FOR VERTICAL MEASUREMENT (CNTLOC1 - MM)	REFERENCE POINT FOR HORIZONTAL MEASUREMENT (CNTLOC2 - MM)
<i>Dash Panel</i> DP01 - DP09	Not applicable.	See Figure 2-2 .	See Figure 2-2 .
<i>Doors</i> DRLF DRLR DRRF DRRR DRSL DROT (rear door)	X-Z	Top of window frame or window downward to contact point.	Outside or rearmost edge of window frame, window or door, forward to contact point. Left edge of door, right to contact point
<i>Pillars</i> PLAL PLAR PLBL PLBR	Z	Top of pillar down longitudinal axis to contact point.	Not applicable.
HOOD	X-Y	Front edge of hood backward to contact point.	Left edge of hood, right to contact point.
<i>Seats</i> SEBK	Y-Z	Top edge of seatback downward to contact point.	Left edge of seatback, right to contact point.
SECU	X-Y	Front edge of seat cushion backward to contact point.	Left edge of seat cushion, right to contact point.
<i>Dummies</i> CHST	Y-Z	Top of chest or shoulder downward to contact point.	Left side of chest, right to contact point.
FEMR TIBA	Z	Top of component down longitudinal axis.	Not applicable.

Table 2-3 CNTLOC1 and CNTLOC2 Reference Points

11. CNTLOC2 — Contact Location #2

Integer, millimeters, 0 or positive

CNTLOC2 is the location on the component where contact occurred with the test device. It may also be the attachment location for the test device. CNTLOC2 is the horizontal measurement taken from the left edge of the component being tested to the test device contact point. This data supplies additional location data when CNTLOC1 is not enough to uniquely define the contact point.

Table 2-3 lists examples of contact measurements. **Figure 2-2** shows the contact codes for various points on the dash-panel.

* For structures such as the roof, doors and hood, the plane is approximately parallel to the surface of the component.

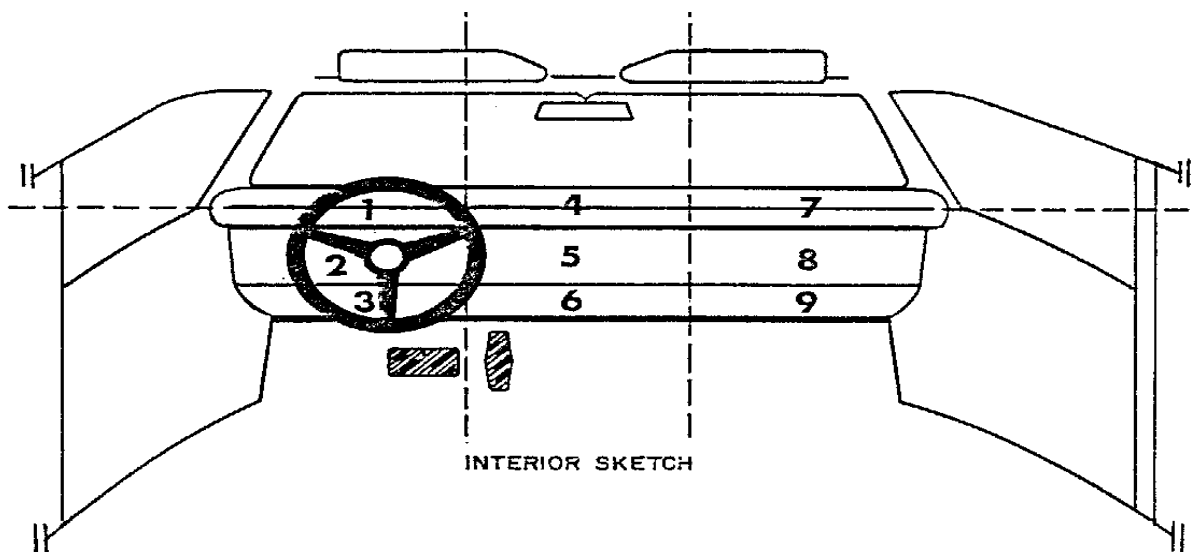

Figure 2-2 Reference Points for Contact Locations (CNTLOC1 / CNTLOC2)

12. CNTCOM — Contact Commentary

Text with or within 70 characters

CNTCOM is descriptive for any extra information needed to explain the contact. It may be used to describe a reference location for CNTLOC1 and CNTLOC2.

13. CFNCOM — Configuration Commentary

Text with or within 70 characters

CFNCOM is descriptive for any extra information needed to define the test configuration. This field should explain reasons for assign OTHER or N/A to CONFIG.

[**Return to Table of Contents**](#)

2.7 Instrumentation Information

Fields defined below constitute the instrumentation information record. A field includes its order index in the record, name, brief description, type and valid range. For example, in the first field, "1", "VEHNO", "Test Vehicle Identification Number", "integer", and "1 or 2" are its order index in the instrumentation information record, its name, its brief description, its type and its range, respectively. Any use of the code for "OTHER" should be explained in an appropriate commentary field. If the value or content of the field is undetermined and filling the field is not enforced, leave it blank.

Approximately twenty milliseconds of data prior to time zero should come with all measurement data; data shall meet the class 1000 specifications of the SAE J211 recommendation; and all data should be truncated at a common time value to avoid extending the pulse well past the period of significant activity.

The minimum sample rate shall be 10000 Hz. A sample rate should be chosen such that the DELT value does not have to be rounded off.

1. VEHNO — Test Vehicle Identification Number

Integer, 0 or 1

VEHNO is the reference number for a particular vehicle. This number should be 1 unless all components in the test are not from a vehicle. For example, it should be zero if sensors generating the signal data described by this record are attached to a barrier.

2. CMPNO — Component Number

Integer, 1 to 99

CMPNO is the identifying number of the component being tested. The first such component shall be 1, the second 2, etc.

3. CNFNO — Configuration Number

Integer, 1 to 999

CNFNO is the number identifying the specific test configuration for this component. The first such test configuration shall be 1, the second 2, etc.

4. CURNO — Curve Number

Integer, 1 to 200

CURNO is the sequential number (1, 2, 3...) assigned to a specific sensor and data curve.

5. SENTYP — Sensor Type

Code, 2 characters

SENTYP indicates the type of sensor used for collecting the measurements at the time of the test, such as AC for accelerometer.

6. SENATT — Sensor Attachment

Code, 4 characters

SENATT is the actual physical attachment point of the sensor. The sensor may or may not be attached to the component being tested.

7. AXIS — Axis Direction of the Sensor

Code, 2 characters

AXIS is the axis direction for sensors measuring vector quantities as described in [Appendix A : Data Coordinate System](#). Specific component axes are local and may be different for every component. Any ambiguous reference for a coordinate system should be explained in the INSCOM.

AXIS is always applicable when the measurement is a vector quantity, such as acceleration, force, velocity, and so forth.

8. XUNITS — Time Units or ‘Independent Axis’ Units

Code, 3 characters

XUNITS indicates either the unit of time for time series sensor data (e.g. 'SEC'), or the units of the independent coordinate of a non-time series signal (e.g. If a load is applied in a controlled fashion to produce a deflection, the load is the independent coordinate, and the deflection is the dependent coordinate).

9. YUNITS — Data Measurement Units

Code, 3 characters

YUNITS indicates the units used to measure the signal of the sensor data.

10. PREFIL — Pre-filter Frequency

Integer, 0 or positive

PREFIL is the cutoff frequency in Hz of a low-pass filter (digital or analog) applied to the signal. This frequency is defined as where filter gain equals 70 percent (-3db.)

11. INSMAN — Manufacturer of the Instrument

Text with or within 70 characters

INSMAN describes the manufacturer of the instrument. The model and serial number should also be included. The format for this data should be: MFG: manufacturer name, S/N: serial number.

12. CALDAT — Calibration Date

Date, format (DD/MMM/YYYY), 11 characters

CALDAT is the most recent calibration date of the instrument. *This field must be filled with a valid date. Don't leave it blank, please.*

13. INSRAT — Instrument Rating

Unbounded integer

INSRAT represents the manufacturer's maximum rated value for the transducer. This value is in the units that the transducer will measure (g's for an accelerometer.)

14. CHLMAX — Channel Maximum Rating

Integer, 0 to 999

CHLMAX represents the full-scale value of the data based upon the actual test setup, including signal conditioning, as a percentage of INSRAT, and may exceed 100%. If the maximum signal that could be recorded was 100 g's (equal to INSRAT) and the peak value of the signal was 85 g's, then CHLMAX would be 85.

15. INIVEL — Initial Velocity

Real, kilometers per hour, - 200 to 200

INIVEL is the initial (time zero) velocity of the sensor along the axis of sensitivity. This data applies to linear accelerometers only.

16. NFP — Number of First Point

Integer, -99,999 to 0

NFP represents the index number of the first point in the data array (less than or equal to 0). Time zero always has an index number of 0. If no data exists prior to time zero, NFP is equal to 0; if 20 data points exist prior to time zero, NFP is equal to -20.

17. NLP — Number of Last Point

Integer, 0 to 999,999

NLP represents the index number of the last point in the data array. If 1,000 points were digitized, and NFP is equal to -100, then NLP is equal to 899.

18. DELT — Time Increment

Integer, microseconds, 0 or positive

DELT is the time increment (step) in microseconds between each data point. DELT is assumed to be constant for all data points for a given sensor (uniform sampling frequency).

19. DASTAT — Data Status

Code, 2 characters

DASTAT indicates the status of the data as it appears in the data submission. This data is used to indicate a signal which is invalid (code MN for meaningless), or which becomes questionable or invalid part of the way through a signal (code CF and explained in INSCOM). If a signal is computed, DASTAT is CM. An example of a computed signal would be the resultant acceleration from a tri-axial accelerometer in a chest form.

20. CHSTAT — Channel Status

Code, 1 character

CHSTAT indicates whether the data channel is primary or redundant. If, for example, any component is instrumented with a backup instrumentation, the primary channels would be coded P and redundant channels should be labeled R.

21. INSCOM — Instrumentation Commentary

Text with or within 70 characters

INSCOM is any further commentary on the instrumentation data, including any unusual conditions affecting the data or a reference to a document that describes problems with a particular curve. The reason for using OTHER or NOT APPLICABLE to a code of this information record should record a commentary as well. If no comments are to be made, enter NO COMMENTS.

[**Return to Table of Contents**](#)

2.8 Rollover Information

Fields defined below constitute the rollover information record. There is only one record in each test, and it is always relative to the vehicle information record with VEHNO=1.

1. TITYPF — Frontal Tire Type

Text with or within 32 characters

TITYPF is the frontal tire type of the test vehicle.

2. TISIZF — Frontal Tire Size

Text with or within 16 characters

TISIZF is the frontal tire size of the test vehicle.

3. TIPRSF — Frontal Tire Pressure

Integer, psi

TIPRSF is the frontal tire pressure of the test vehicle.

4. TITYPR — Rear Tire Type

Text with or within 32 characters

TITYPR is the rear tire type of the test vehicle.

5. TISIZR — Rear Tire Size

Text with or within 16 characters

TISIZR is the rear tire size of the test vehicle.

6. TIPRSR — Rear Tire Pressure

Integer, psi

TIPRSR is the rear tire pressure of the test vehicle.

7. TRACK — Average Track Width

Real, inch

TRACK is the average track width in a rollover test; it is calculated from front and rear tracks.

8. TRACKF — Average Front-Track Width

Real, inch

TRACKF is the average front-track width in a rollover test; it is calculated from front tracks A to D.

9. TRACKR — Average Rear-Track Width

Real, inch

TRACKR is the average rear-track width in a rollover test; it is calculated from rear tracks E to H.

10. TRACKFA — Front Track A

Real, inch

TRACKFA is the width of front track-A in a rollover test.

11. TRACKFB — Front Track B

Real, inch

TRACKFB is the width of front track-B in a rollover test.

12. TRACKFC — Front Track C

Real, inch

TRACKFC is the width of front track-C in a rollover test.

13. TRACKFD — Front Track D

Real, inch

TRACKFD is the width of front track-D in a rollover test.

14. TRACKRE — Rear Track E

Real, inch

TRACKRE is the width of front track-E in a rollover test.

15. TRACKRF — Front Track F

Real, inch

TRACKRF is the width of front track-F in a rollover test.

16. TRACKRG — Front Track G

Real, inch

TRACKRG is the width of rear track-G in a rollover test.

17. TRACKRH — Front Track H

Real, inch

TRACKRH is the width of rear track-H in a rollover test.

18. WHLBAS — Average Wheelbase

Real, inch

WHLBAS is the average wheelbase of the test vehicle; it is calculated from the left- and right-sides wheelbases.

19. WHLBASL — Left Side Wheelbase

Real, inch

WHLBASL is the left-side wheelbase of the test vehicle.

20. WHLBASR — Right Side Wheelbase

Real, inch

WHLBASR is the right-side wheelbase of the test vehicle.

21. ROOFHT — ROOF HEIGHT

Integer, inch

ROOFHT is the roof height of the test vehicle.

22. GVWR — Gross Vehicle Weight Rating

Integer, pounds

GVWR means the gross vehicle weight rating, and is also expressed as GVM (gross vehicle mass). It is the maximum operating weight/mass of a vehicle as specified by the manufacturer including the vehicle's chassis, body, engine, engine fluids, fuel, accessories, driver, passengers and cargo but excluding that of any trailers. It is the sum of front and rear GAWR (Gross Axle Weight Rating).

Road damage rises steeply with axle weight, and is estimated to be proportional to the [fourth power](#) (n^4) of the axle weight for reasonably strong pavement surfaces. This means that doubling the axle weight will increase road damage $2^4=16$ times.

23. GAWRF — FRONT GAWR

Integer, pounds

GAWRF means the front GAWR (Gross Axle Weight Rating).

24. GAWRR — Rear GAWR

Integer, pounds

GAWRR means the rear GAWR (Gross Axle Weight Rating).

25. WT — Total Weight

Integer, pounds

WT is the total weight of the test vehicle; it is the sum of left front, right front, left rear and right rear weights.

26. WTLF — Left Front Weight

Integer, pounds

WTLF is the left front weight of the test vehicle.

27. WTRF — Right Front Weight

Integer, pounds

WTRF is the right front weight of the test vehicle.

28. WTLR — Left Rear Weight

Integer, pounds

WTLR is the left rear weight of the test vehicle.

29. WTRR — Right Rear Weight

Integer, pounds

WTRR is the right rear weight of the test vehicle.

30. CGLONG — C.G. Longitudinal

Real, inch

CGLONG is longitudinal distance of the gravity center (C.G.) from the front axle of the test vehicle.

31. CGLATE — C.G. Lateral

Real, inch

CGLATE is lateral distance of the gravity center (C.G.) negatively toward the driver's side in the test vehicle.

32. CGHT — Average C.G. Height

Real, inch

CGHT is the average height of the gravity center (C.G.) of the test vehicle.

33. CGWT1 — Applied Weight in Run 1

Real, inch

CGWT1 is the applied weight in run 1.

34. CGANGLE1 — Platform Angle in Run 1

Real, degrees

CGANGLE1 is the platform angle in run 1.

35. CGMOTION1 — Relative Motion in Run 1

Real, inch

CGMOTION1 is the relative motion in run 1.

36. CGHT1 — C.G. Height in Run 1

Real, inch

CGHT1 is the height of the gravity center (C.G.) in run 1.

37. CGWT2 — Applied Weight in Run 2

Real, inch

CGWT2 is the applied weight in run 2.

38. CGANGLE2 — Platform Angle in Run 2

Real, degrees

CGANGLE2 is the platform angle in run 2.

39. CGMOTION2 — Relative Motion in Run 2

Real, inch

CGMOTION2 is the relative motion in run 2.

40. CGHT2 — C.G. Height in Run 2

Real, inch

CGHT2 is the height of the gravity center (C.G.) in run 2.

41. CGWT3 — Applied Weight in Run 3

Real, inch

CGWT3 is the applied weight in run 3.

42. CGANGLE3 — Platform Angle in Run 3

Real, degrees

CGANGLE3 is the platform angle in run 3.

43. CGMOTION3 — Relative Motion in Run 3

Real, inch

CGMOTION3 is the relative motion in run 3.

44. CGHT3 — C.G. Height in Run 3

Real, inch

CGHT3 is the height of the gravity center (C.G.) in run 3.

45. CGWT4 — Applied C.G. Weight in Run 4

Real, pounds

CGWT4 is the applied weight in run 4.

46. CGANGLE4 — Platform Angle in Run 4

Real, degrees

CGANGLE4 is the platform angle in run 4.

47. CGMOTION4 — Relative Motion in Run 4

Real, inch

CGMOTION4 is the relative motion in run 4.

48. CGHT4 — C.G. Height in Run 4

Real, inch

CGHT4 is the height of the gravity center (C.G.) in run 4.

49. CGWT5 — Applied Weight in Run 5

Real, pounds

CGWT5 is the applied weight in run 5.

50. CGANGLE5 — Platform Angle in Run 5

Real, degrees

CGANGLE5 is the platform angle in run 5.

51. CGMOTION5 — Relative Motion in Run 5

Real, inch

CGMOTION5 is the relative motion in run 5.

52. CGHT5 — C.G. Height in Run 5

Real, inch

CGHT5 is the height of the gravity center (C.G.) in run 5.

53. SSF — Vehicle Static Stability Factor

Real, dimensionless

SSF is the vehicle static stability factor; it equals $TRACK / (2 \times CGHT)$.

54. POSS — NHTSA Rollover Possibility

Real, dimensionless

RRS is the NHTSA rollover possibility.

55. RRS — NHTSA Rollover Relative Risk Score

Real, dimensionless

RRS is the NHTSA rollover relative risk score.

56. STAR — Number of NHTSA Rollover Rating Stars

Integer, dimensionless

STAR is the number of vehicle rating stars in NHTSA's new car assessment process.

[**Return to Table of Contents**](#)

2.9 High-Speed Video Information

Fields defined below constitute the high-speed video information record. This information record contains data from each camera used in the test.

A field includes its order index in the record, name, brief description, type and valid range. For example, in the first field, "1", "CAMNO", "Camera Number", "integer" and "0 to 99" are its order index in the high-speed video information record, its name, its brief description, its type and range, respectively. Any use of the code for "OTHER" should be explained in an appropriate commentary field.

1. CAMNO — Camera Number

Integer, 0 to 99

CAMNO indicates the order number of cameras used in the test. For example, "1" indicates that the video was taken by camera 1.

2. TSTREF — Test Reference Number

Text with or within 10 characters

TSTREF is an alphanumeric code number assigned to the test by the test performer. It is the same data as TSTREF in the general test information record.

3. VSCFACTOR — Video Frame Number Scale Factor

Positive Real

VSCFACTOR is the scale factor to be applied against the integer frame number of a sequential image file, as described below, in order to convert the integer frame sequence value into a time value in seconds. A value of zero (0) may be entered if sequential frames are not stored at constant intervals of time as with force-deflection data.

4. VIEWDESC — View Description

Text with or within 70 characters

VIEWDESC describes the view of this high-speed video camera (example 'front left view', or 'overhead view')

5. COMMENTS — Camera Commentary

Text with or within 70 characters

COMMENTS comments on this particular camera view.

[**Return to Table of Contents**](#)

Chapter 3 : Test Report Format

A written report should be generated for each test to be submitted. This report shall be saved on the submission physical media under the directory:

\REPORT\

with the filename

R<TSTREF>.pdf

where <TSTREF> has the same value as TSTREF in *Section 2.3 General Test Information* of this guide.

The report shall preferably be in the Adobe PDF document format (www.adobe.com). Alternatively, a report may be submitted in Microsoft Word 2000 or later format if the test site is unable to generate a PDF file.

At a minimum, each report shall contain the following information:

- 1) A cover page including,
 - Title of Study
 - Test Performer
 - Test Reference Number (EV5 specification file - TSTREF)
 - Contract Number
 - Test Date
- 2) In the main body of the test report, the following items shall be included:
 - A text description and diagram/pictures of the test setup.
 - Description of camera views and type of media (film/video).
 - Information which could not be included in the EV5 specification file, and that the test engineer and/or COTR deem appropriate or important to mention.
- 3) In the report Appendix A, the following information shall be included:
 - A diagram describing the coordinate system.
 - A table describing load cell manipulations for positive values.
- 4) In the report Appendix B, a plot of each curve submitted exactly as it should appear in the database. The plots will be compared with the signal data loaded into the database to ensure that

the signals the test laboratory intends to enter into the NHTSA database are not corrupted during the submission and loading process. Each plot should display the maximum and minimum values of the signal and their respective event times.

- 5) In the report Appendix C, a list of the instrumentation associated with each channel, including transducer, sampling rate, signal conditioning, units and axis.

The COTR or test engineer is encouraged to include any other information that they feel is necessary to make the report meaningful and the quality control process easier. However, the COTR or test engineer may not eliminate any of five (5) minimum requirements outlined above.

[**Return to Table of Contents**](#)

Chapter 4 : Pre- and Post-Event Images

Images and video captured before and after the test may be submitted whether they are digital images or processed film images.

4.1 Digital Images

Digital images and videos of the test before and after the event shall be submitted on the submission media as noted in [Section 1.1 Media Types and Layout](#). Video files shall be submitted under the directory \PREPOST\VIDEOS. Still images shall be submitted under the directory \PREPOST\PHOTOS. File names should be descriptive. Naming convention is at the discretion of the COTR, with the exception that standard file extensions shall be applied to all files as appropriate to the content type of each file.

As an example, TIFF format image files should be named with a file extension of

.tif

while JPEG format image files should be named with a file extension of

.jpg

Digital images shall be submitted in one of the following formats: Windows bitmap (BMP), GIF, TIFF, or JPEG.

4.2 Processed Film Images

Hardcopy processed film images shall be included as an appendix in the report.

If you have data that you wish to submit but which is not specified in this guide, please send email to nrd.softdev@nhtsa.dot.gov.

[Return to Table of Contents](#)

Chapter 5 : Event Images, Film, and Video

The procedures for capturing and formatting images of the impact event are described below. Procedures for images captured by high-speed film and high-speed video are outlined below, as well as generic procedures for other event image types.

5.1 High-Speed Film

This section describes procedures for capturing and submitting high-speed film, not digital video. The only content requirements of the high-speed film camera image view specified in this guide are:

- 1) Somewhere in the image view there should be text denoting the TSTREF described in *Section 2.3 General Test Information*.
- 2) Some type of visible time mark should be present to indicate time zero for the test. This time zero should correspond with the time zero on the data acquisition system.
- 3) Somewhere within the image, the time at which the image was captured shall also be displayed. Alternatively, the use of the LED timing mark available on most high-speed cameras is acceptable.

Processed film should be submitted to NHTSA with the test submission. Multiple camera angles may be submitted on a single reel, or multiple reels may be submitted.

5.2 High-Speed Digital Video

This section describes procedures for capturing and submitting high-speed digital video, not film. The only content requirements of the high-speed video camera image view specified in this guide are:

- 1) Somewhere in the image view there should be text denoting the TSTREF described in *Section 2.3 General Test Information*.
- 2) Some type of visible time mark should be present to indicate time zero for the test. This time zero should correspond with the time zero on the data acquisition system.
- 3) Somewhere within the image, the time at which the image was captured shall also be displayed.

5.2.1 The High-Speed Digital Video Specification File

The High-Speed Video specification (HS5) File contains information about the data from each camera used in the test. The file is a delimited text file similar to the EV5 information file (see [Section 2.2.1](#))

Structures of Specification Files) containing information record sets described in *Section 2.9 High-Speed Video Information*. Each high-speed video information record shall be written to an HS5 file on a single line. The line shall be terminated by a carriage return. The HS5 file shall be named <TSTREF>.HS5.

5.2.2 The Sequential Image and Movie Submission Format

High-speed video data should be submitted in two formats, sequential raster image files and AVI movies.

- **Sequential Bitmap Image Files**

Most high-speed video systems output sequential raster image files, with the frame number denoted within the filename of each file. Each file shall be numbered using the following file naming convention:

F<frame number>.<file format extension>

where

<frame number> is the integer sequential frame number of each image. A minus (-) should prefix the <frame number> for images captured before the start of the event.

<file format extension> is TIF for TIFF format image files, JPG for JPEG format image files, GIF for GIF format image files, and BMP for Windows bitmap files.

- **AVI Files**

For each camera view, AVI movie files shall be generated using a widely available codec agreed upon by the laboratory and the COTR. For help with codec selection, send email to nrd.softdev@nhtsa.dot.gov. Each AVI file shall use the following naming convention:

<TSTREF> C <CAMNO>.avi (no spaces in filename)

5.2.3 The Media Format

All high-speed video files shall be stored in the directory \EVENT as described in *Chapter 1 : Media Formats and Software Tools* of this guide.

An HS5 file, <TSTREF>.HS5, shall be stored in the directory \EVENT\HSVIDEO on the test submission media with the filename

High-speed video sequential raster image files and AVI movies shall be placed on the test submission media under \EVENT \HSVIDEO\CAMERA<CAMNO>, where <CAMNO> is a sequential number assigned to each camera, described in the *High-Speed Video Information* section.

Example:

Test lab ABC conducted test T1234 that had 3 high-speed video cameras collecting images, each having views of an impact event from the top, right side, and front. Each camera captured TIFF images from -40 to +500 milliseconds in increments of one millisecond. The digital test submission media would have the following directories:

```
\EVENT\HSVIDEO\CAMERA1\  
\EVENT\HSVIDEO\CAMERA2\  
\EVENT\HSVIDEO\CAMERA3\  

```

The following files would be included (**example only**):

```
\EVENT\HSVIDEO\CAMERA1\T1234C1.AVI    (AVI Movie File)  
\EVENT\HSVIDEO\CAMERA1\F-40.TIF      (Sequential Bitmap Image File)  
...  
\EVENT\HSVIDEO\CAMERA1\F0.TIF        (Sequential Bitmap Image File)  
...  
\EVENT\HSVIDEO\CAMERA1\F500.TIF      (Sequential Bitmap Image File)  
  
\EVENT\HSVIDEO\CAMERA2\T1234C2.AVI  
\EVENT\HSVIDEO\CAMERA2\F-40.TIF  
...  
\EVENT\HSVIDEO\CAMERA2\F0.TIF  
...  
\EVENT\HSVIDEO\CAMERA2\F500.TIF  
  
\EVENT\HSVIDEO\CAMERA3\T1234C3.AVI  
\EVENT\HSVIDEO\CAMERA3\F-40.TIF  
...  
\EVENT\HSVIDEO\CAMERA3\F0.TIF  
...  
\EVENT\HSVIDEO\CAMERA3\F500.TIF
```

The contents of the High Speed Video Specification file named T1234.HS5 would be:

```
# Source: High Speed Video Data  
# Date: <11/29/2005>  
----- HSVD -----  
1|T1234|0.001|TOP VIEW|NO COMMENTS  
2|T1234|0.001|RIGHT SIDE VIEW|NO COMMENTS  
3|T1234|0.001|FRONT VIEW|NO COMMENTS  
----- END -----
```

In this example, the frame number scale factor for each camera is 0.001 second.

5.3 Other Event Images

Other event images, such as BETA or VHS tapes, can be included in the test submission packet. Please send email to nrd.softdev@nhtsa.dot.gov if you have any questions about submitting event images not specified in this guide.

[Return to Table of Contents](#)

Appendix A: Data Coordinate System

Starting with Version 4 of the NHTSA Test Reference Guides, all submissions will conform to SAE J211/1 MAR95 Instrumentation for Impact Test. Please refer to SAE J211 for a complete description of the coordinate system and signal polarities for vehicle occupants.

A-1. Using the Coordinate System Correctly

The rules for determining the sign conventions described below will enable anyone involved in NHTSA-sponsored testing to determine the proper sign and coordinate axis for any measured quantity.

All coordinate systems are orthogonal, three-dimensional, and right handed. The global coordinate systems for the vehicle and the test occupants are shown in *Figure A-1* and *Figure A-2*. The coordinate system for the nine-accelerometer head array is shown in *Figure A-3*, along with the proper SENATT codes. *Table A-1* lists the polarity of the sensor output from various dummy manipulations when using this coordinate system.

A-2. Vehicle Global Coordinate System

- X is positive forward
- Y is positive right (toward the passenger side door)
- Z is positive down

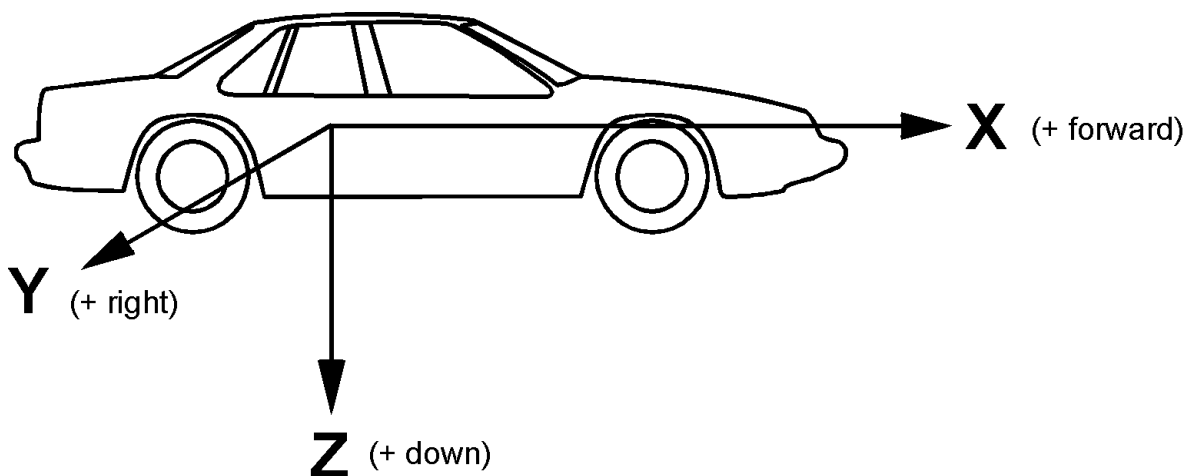

Figure A-1 Vehicle Global Coordinate System

A-3. Occupant Global Coordinate System

- X is positive forward (posterior to anterior)
- Y is positive right
- Z is positive down

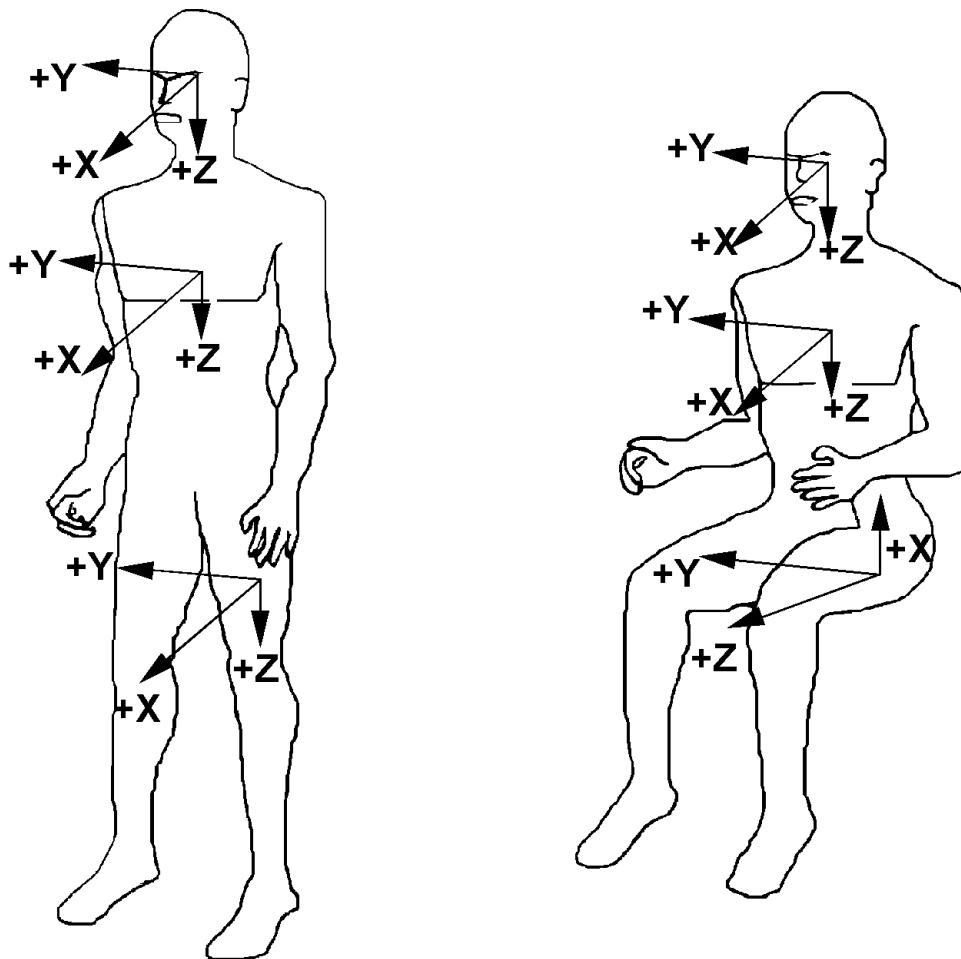

Figure A-2 Occupant Global Coordinate System

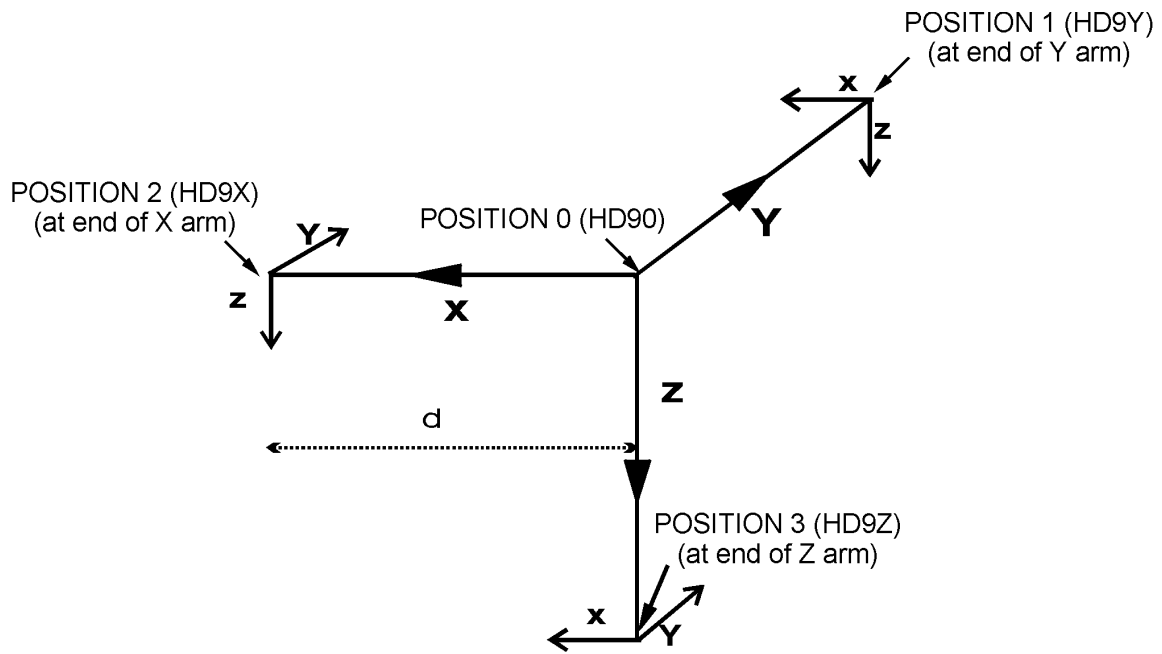

Figure A-3 Nine-Accelerometer Coordinate System

Table A- 1 Dummy Manipulations for Checking Recorded Load Cell Polarity Relative to Sign Convention

Load Cell	Measure	Dummy Manipulations	Polarity
Upper and lower neck loads	Fx	Head rearward, chest forward	+
	Fy	Head leftward, chest rightward	+
	Fz	Head upward, chest downward	+
	Mx	Left ear toward left shoulder	+
	My	Chin toward sternum	+
	Mz	Chin toward left shoulder	+
Left shoulder loads (BIOSID)	Fx	Left shoulder forward, chest rearward	+
	Fy	Left shoulder rightward, chest leftward	+
	Fz	Left shoulder downward, chest upward	+
Right shoulder loads (BIOSID)	Fx	Right shoulder forward, chest rearward	+
	Fy	Right shoulder rightward, chest leftward	+
	Fz	Right shoulder downward, chest upward	+
Clavicle loads	Fx	Shoulder forward, chest rearward	+
	Fz	Shoulder downward, chest rearward	+
Upper and lower lumbar spine	Fx	Chest rearward, Pelvis forward	+
	Fy	Chest leftward, pelvis rightward	+
	Fz	Chest upward, pelvis downward	+
	Mx	Left shoulder toward left hip	+
	My	Sternum toward front of legs	+
	Mz	Right shoulder forward, left shoulder rearward	+
Sacrum load (BIOSID)	Fy	Left H-point pad leftward, chest rightward	+
Left iliac load (BIOSID)	Fy	Left iliac rightward, chest leftward	+
Right iliac load (BIOSID)	Fy	Right iliac rightward, chest leftward	+
Pubic load (side impact)	Fy	Right H-point pad leftward, left pad rightward	(-)
Crotch belt loads	Fx	Pubic rearward, pelvis forward	(-)
	Fz	Pubic upward, chest downward	(-)
Iliac lap belt loads	Fx	Upper iliac spine rearward, chest forward	(-)
	My	Upper iliac spine rearward, chest forward	+
Left side abdominal load (Eurosid-1)	Fy	Left side of abdomen rightward, chest leftward	+
Right side abdominal load (Eurosid-1)	Fy	Right side of abdomen leftward, chest rightward	(-)
Femur loads	Fx	Knee upward, upper femur downward	+

Load Cell	Measure	Dummy Manipulations	Polarity
(dummy in seated position, femurs horizontal)	Fy	Knee rightward, upper femur leftward	+
	Fz	Knee forward, pelvis rearward	+
	Mx	Knee leftward, hold upper femur in place	+
	My	Knee upward, hold upper femur in place	+
	Mz	Tibia leftward, hold pelvis in place	+
Knee clevis	Fz	Tibia downward, femur upward	+
Upper tibia loads	Fz	Tibia downward, femur upward	+
	Mx	Ankle leftward, hold knee in place	+
	My	Ankle forward, bottom of knee clevis rearward	+
Lower tibia loads	Fx	Ankle forward, knee rearward	+
	Fy	Ankle rightward, knee leftward	+
	Mx	Ankle leftward, hold knee in place	+
	My	Ankle forward, bottom of knee clevis rearward	+

[Return to Table of Contents](#)

Appendix B: Technical Support Information

B-1. Reference Guide Updates and Software Updates

NHTSA now maintains web sites for the NHTSA Test Reference Guides and the Entree for Windows software. The latest versions of the guides and the software are made available for download from the sites below:

NHTSA Test Reference Guides

[NHTSA Test Reference Guides | National Highway Traffic Safety Administration \(NHTSA\)](#)

Entree for Windows

[Entree for Windows | National Highway Traffic Safety Administration \(NHTSA\)](#)

Because the NHTSA Research and Development web site is a constantly evolving resource it may happen that the links noted above do not work correctly. In the event that this does occur please utilize the available **SEARCH** feature to search for “NHTSA Test Reference Guides” and “Entrée for Windows”.

B-2. Requesting Assistance

In the event that a user of the Test Reference Guides requires technical support with using the guides, or has questions about the content of the guides, support is offered via Internet e-mail. Simply send a message to the address

nrd.softdev@nhtsa.dot.gov

with a subject line including the text

ATTN: NHTSA Test Reference Guides

To request assistance with the Entree for Windows software send an e-mail to

nrd.softdev@nhtsa.dot.gov

with a subject line including the text

ATTN: Entrée for Windows

A staff person will acknowledge the request, and we will endeavor to provide a complete response within two (2) business days on a first-come, first-served basis.

B-3. Reporting a Problem

To report a problem or potential bug in either the guides or the Entree for Windows software, please send an e-mail to

nrd.softdev@nhtsa.dot.gov

with a subject line including the text

BUG REPORT: NHTSA Test Reference Guides

or

BUG REPORT: Entrée for Windows

for the Test Reference Guides, or Entrée for Windows, respectively.

A staff person will acknowledge the problem report. For simple problems we will endeavor to provide a complete response within five (5) business days on a first-come, first-served basis. In the event that correction of a problem requires more than 5 business days we will notify the user in advance.

[Return to Table of Contents](#)