

1. Report No. TX-00/4913-2		2. Government Accession No.		3. Recipient's Catalog No.	
4. Title and Subtitle GUIDELINES FOR TIMING AND COORDINATING DIAMOND INTERCHANGES WITH ADJACENT TRAFFIC SIGNALS				5. Report Date November 2000	
				6. Performing Organization Code	
7. Author(s) Nadeem A. Chaudhary and Chi-Leung Chu				8. Performing Organization Report No. Report 4913-2	
9. Performing Organization Name and Address Texas Transportation Institute The Texas A&M University System College Station, Texas 77843-3135				10. Work Unit No. (TRAIS)	
				11. Contract or Grant No. Project No. 7-4913	
12. Sponsoring Agency Name and Address Texas Department of Transportation Construction Division Research and Technology Transfer Section P. O. Box 5080 Austin, Texas 78763-5080				13. Type of Report and Period Covered Research: September 1998 – August 2000	
				14. Sponsoring Agency Code	
15. Supplementary Notes Research performed in cooperation with the Texas Department of Transportation. Research Project Title: Operational Strategies for Arterial Congestion at Interchanges					
16. Abstract This report contains guidelines for timing diamond interchanges and for coordinating diamond interchanges with closely spaced adjacent signals on the arterial. Texas Transportation Institute (TTI) researchers developed these guidelines during a two-year project funded by the Texas Department of Transportation.					
17. Key Words Diamond Interchanges, Capacity Analysis, Traffic Signal Coordination, Traffic Congestion, Signalized Arterials			18. Distribution Statement No restrictions. This document is available to the public through NTIS: National Technical Information Service 5285 Port Royal Road Springfield, Virginia 22161		
19. Security Classif.(of this report) Unclassified		20. Security Classif.(of this page) Unclassified		21. No. of Pages 50	22. Price

GUIDELINES FOR TIMING AND COORDINATING DIAMOND INTERCHANGES WITH ADJACENT TRAFFIC SIGNALS

by

Nadeem A. Chaudhary, P.E.
Research Engineer
Texas Transportation Institute

and

Chi-Leung Chu
Graduate Assistant Research
Texas Transportation Institute

Report 4913-2

Project Number 7-4913

Research Project Title: Operational Strategies for Arterial Congestion at Interchanges

Sponsored by the
Texas Department of Transportation

November 2000

TEXAS TRANSPORTATION INSTITUTE
The Texas A&M University System
College Station, Texas 77843-3135

DISCLAIMER

The contents of this report reflect the views of the authors, who are solely responsible for the facts and accuracy of the data, the opinions, and the conclusions presented herein. The contents do not necessarily reflect the official view or policies of the Texas Department of Transportation (TxDOT), The Texas A&M University System, or the Texas Transportation Institute (TTI). This report does not constitute a standard or regulation, and its contents are not intended for construction, bidding, or permit purposes. The use and names of specific products or manufacturers listed herein does not imply endorsement of those products or manufacturers. The engineer in charge of the project was Nadeem A. Chaudhary, P.E. # 66470.

ACKNOWLEDGMENTS

The research team conducted this project under a cooperative program between TTI and the TxDOT. Ms. Angie Ortegán was the TxDOT program coordinator. Mr. Jesus Leal was the TxDOT project director for this research project. His assistance and guidance throughout the course of this research project is acknowledged and appreciated. We would also like to acknowledge the guidance and feedback provided to us by several other members of the TxDOT panel: Mr. Ismael Soto, Mr. Edgar Fino, Mr. Stuart Jenkins, and Mr. Dexter Turner.

TABLE OF CONTENTS

LIST OF FIGURES.....	viii
1. DIAMOND INTERCHANGES	1
INTRODUCTION.....	1
Diamond Interchange Operation.....	1
Useful Software Programs.....	6
GUIDELINES.....	7
Performance of Control Strategies.....	7
Guidelines for Selecting a Control Strategy.....	8
Capacity Analysis of Various Control Strategies.....	8
Guidelines for Selecting the Cycle Length.....	8
2. COORDINATION OF INTERCHANGES WITH ADJACENT SIGNALS	9
PROBLEM DESCRIPTION AND NOTATION.....	9
AN EASY APPROACH TO COORDINATION.....	10
Four-Phase Diamond and Adjacent Signal.....	10
Coordination Guidelines.....	12
Guidelines for Larger Systems.....	14
REFERENCES.....	17
APPENDIX A. INTERCHANGE CONTROL STRATEGIES.....	19
APPENDIX B. A CAPACITY CALCULATION METHOD.....	25
APPENDIX C. CYCLE LENGTH SELECTION GRAPHS.....	29
APPENDIX D. TRAVEL TIME CALCULATIONS.....	39

LIST OF FIGURES

Figure 1. Movements at the Two Intersections of a Diamond Interchange.....	2
Figure 2. Texas Three-Phase Control Strategy.	3
Figure 3. Texas Four-Phase Control Strategy.	4
Figure 4. Separate Intersection Mode.	6
Figure 5. Diamond Interchange with an Adjacent Traffic Signal.....	9
Figure 6. Some Cases in Which Two-way Progression with Adjacent Signal is Possible.	11
Figure 7. An Approach for Coordinating Large Systems.	15

1. DIAMOND INTERCHANGES

INTRODUCTION

A diamond interchange consists of two intersections. Depending on the distance between these two intersections, diamond interchanges can be classified into three types. These types are described below:

1. A conventional diamond interchange is one in which the distance between the two intersections is more than 800 feet. These interchanges are located in rural settings and are generally controlled by stop signs.
2. An interchange is classified as a compressed diamond when the distance between the two intersections is between 400 and 800 feet. These intersections are usually found in suburban areas. In most cases, both intersections of the interchange have signal control with or without interconnection.
3. Tight diamond interchanges are characterized by two signals less than 400 feet apart. These interchanges are located in highly developed areas and are always signal controlled. Because of the close proximity of the two signals, they are and should be designed and operated as one system.

Diamond Interchange Operation

In Texas, most signalized urban diamond interchanges are operated using a single traffic controller using either a three-phase or a four-phase strategy. In addition to these diamond control modes, most modern signal controllers also provide additional modes for operating a pair of signalized intersections. This section describes various phasing schemes that can be used at diamond interchanges.

Figure 1 shows all traffic movements at a diamond interchange. Each signal of the interchange, when considered in isolation, can be controlled using either two or three phases. The number of phases depends on whether the left-turn movement needs a protected phase or not.

High left-turn demand or heavy opposing through traffic requires protected left-turn phase. Since this research project deals with the operation of diamond interchanges facing heavy conditions, it considers only the protected left-turn case. Thus, we assume each signal has the following three phases:

- frontage road phase,
- arterial through phase, and
- left-turn phase.

The protected left-turn phase can be displayed before or after the opposing through phase, resulting in two possible phase sequences for the arterial approaches at each intersection of the diamond. Engineers commonly refer to these phase patterns as leading and lagging phases, respectively.

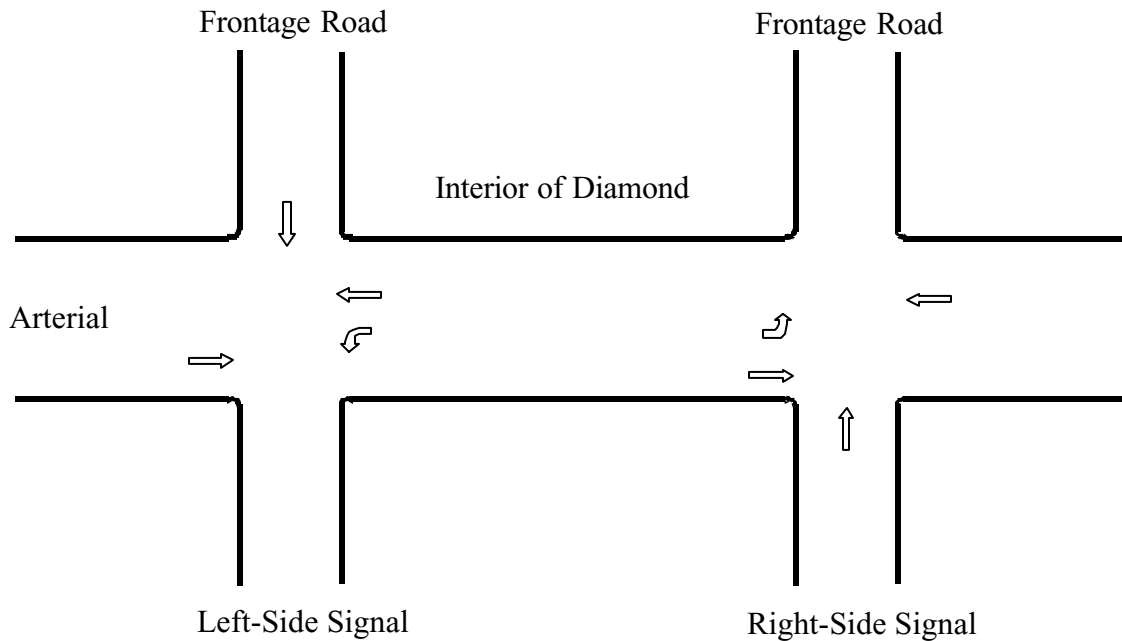

Figure 1. Movements at the Two Intersections of a Diamond Interchange.

In Texas, it is common to operate both intersections of an urban diamond interchange using a single controller. Furthermore, the two intersections of a diamond interchange are referred to as one entity, the interchange. Thus, any reference to signal timing includes not only the joint set of phasing patterns at the two intersections, but also the cycle length and the offset relationship between the two intersections. Combined, the cycle length and the offset establish coordination between the two intersections of a diamond interchange. Regardless of whether the control is pretimed or actuated, the two intersections of the diamond always have the same cycle length, which is a prerequisite for coordination. Combining the phasing patterns for each intersection into one set results in four phasing patterns for the diamond interchange. These patterns are commonly referred to as:

- lead-lead phasing (leading left turns at both intersections),
- lead-lag phasing (leading left turn at the left intersection and lagging left turn at the right intersection),
- lag-lead phasing (lagging left turn at the left intersection leading left turn at the right intersection), and
- lag-lag phasing (lagging left turns at both intersections).

The standard Texas diamond mode permits only a subset of the above phasing options. Furthermore, left-turn phase sequence and offset between the two signals is implicitly taken care of by selecting one of the standard diamond modes of operation. The following subsections summarize these modes.

Texas Three-Phase Strategy

Figure 2 provides an illustration of the Texas three-phase strategy. This strategy uses lag-lag phasing and provides arterial through progression. Three-phase control works well as long as there is balanced demand at the two frontage roads/ramps and when there is sufficient storage space between the two intersections (interchange interior).

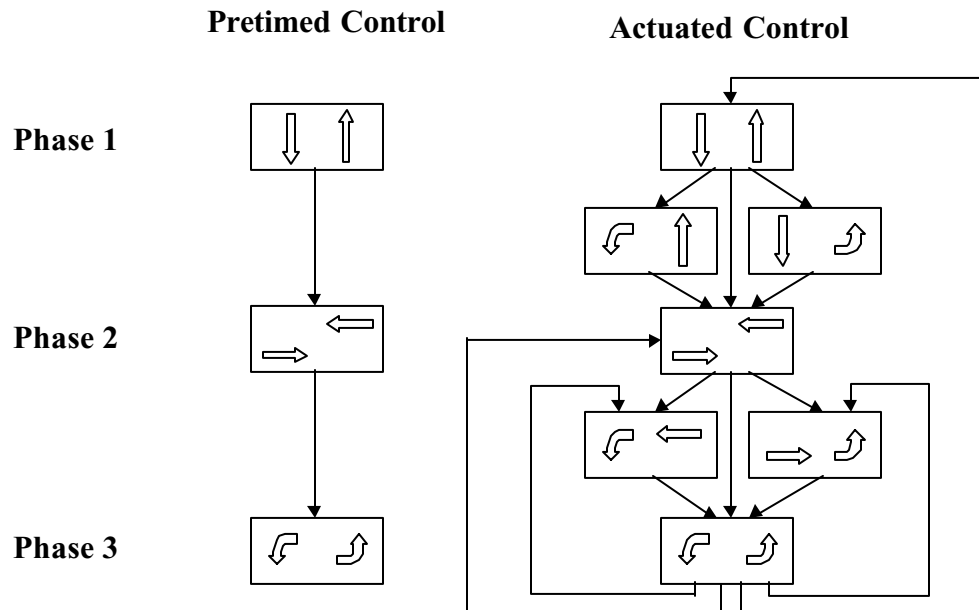

Figure 2. Texas Three-Phase Control Strategy.

For Texas three-phase strategy, the calculation of the green splits for each intersection of the interchange is similar to that for an isolated intersection. The difference is that the green splits for the frontage roads must be the same for both the left and right intersections. Furthermore, these calculations do not take into consideration the distance between the two intersections. Thus, Texas three-phase strategy provides the same timing plan for a particular demand pattern no matter how wide the interchange is. However, in reality, the distance between the two signals does play an important role because of flow dependencies between the two signals.

Detailed analysis of Texas three-phase strategy shows that the wider the distance, the better the performance of the Texas three-phase strategy, as long as both frontage roads have balanced demand. When there is a significant imbalance in frontage road demands, this strategy causes a loss in capacity for the intersection with less frontage road demand. In those cases, a feature called “Conditional Service,” available in most modern traffic controllers, can be used to provide unused green time from the frontage road phase to the interior left-turn phase for the same signal. These findings support previous research and experiences of engineers in Texas that show that Texas three-phase strategy works best when the distance between the two intersections of a diamond interchange is between 400 and 800 feet. Also, research shows that cycle length should be carefully selected to provide an optimum operation.

In summary, we recommend that Texas three-phase operation be used only when there is sufficient space within the interchange to store vehicles. Selecting an optimum cycle length is key to the success of this strategy. For interior distances shorter than 400 feet, engineers can use this strategy for light to moderate traffic conditions if an interchange has U-turn bays and full left-turn lanes.

Texas Four-Phase Strategy

Figure 3 provides an illustration of the Texas four-phase strategy. This strategy is also known as TTI four-phase. TTI four-phase strategy uses a lead-lead phasing pattern and minimizes internal queues.

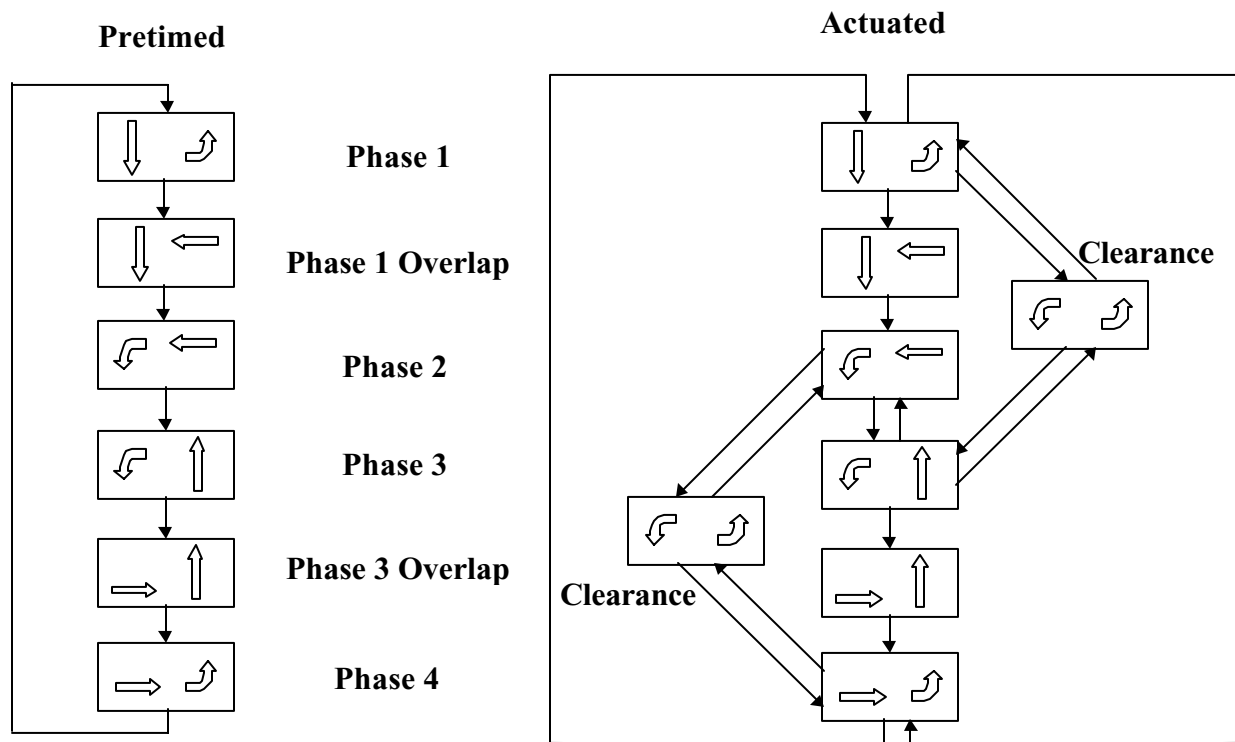

Figure 3. Texas Four-Phase Control Strategy.

The basic objective of this strategy is to coordinate the two signals of the diamond interchange for providing through progression at the downstream signal. To achieve this objective, this strategy requires simultaneous calculation of green splits and internal offsets. Thus, the calculation process treats the two intersections as one system and, in doing so, takes into consideration the interior travel times.

A careful look at the green split calculations (see Appendix A) reveals that as the distance between the two signals increases (that is, travel time increases), the total green split for interior movements reduces, while the total green split for exterior movement increases. Thus, the cycle length must be significantly larger than the total travel time in order to provide reasonable capacity. Also, because of the close proximity of the two intersections, travel time from one

intersection to the next must take into consideration the fact that vehicles stopped at an exterior approach (usually the through vehicles) accelerate as they are traveling toward the next signal. The travel time will depend on the vehicle:

1. still accelerating when it reaches the downstream signal, and
2. achieving the design speed before it reaches the downstream signal. In this case the vehicle will cover the remaining distance to the downstream signal at design speed.

Since calculations of phase times and overlaps guarantee through progression for any given distance, TTI four-phase operation minimizes the lengths of interior queues. Because of guaranteed through progression at the downstream signal, this strategy also conforms to drivers' expectancy. The TTI four-phase strategy is not flawless, however. Since the green times for an interior left-turn movement has a negative relationship with the overlap, the capacities of left-turn phases reduces with increasing distance between the two intersections. Another drawback of this strategy is that all U-turn traffic gets stopped within the interchange. The easiest way to remedy this situation is to provide U-turn bays for sites with short spacing and heavy U-turn traffic. Based on engineers' experience, the TTI four-phase strategy works well for interchanges with widths less than 400 feet. However, since the interior green times decrease as the link distance increases, interchanges with large interior distances require large cycle lengths. Furthermore, large cycle lengths result in large cyclic queues. Therefore, engineers should avoid large cycle lengths.

Separate Intersection Mode

Figure 4 illustrates the separate intersection mode of controlling diamond interchanges. For use in this mode, engineers calculate the green times for each signal as if they were independent entities. In traditional implementations, each intersection requires a separate controller, as for a normal arterial with two traffic signals. Engineers provide coordination between the two intersections by interconnecting the two controllers, using a common cycle length, and specifying an offset relationship between them. The option of using two controllers provides the maximum flexibility because it allows the use of all four phasing patterns for the pair of intersections. Most modern controllers used in Texas are capable of implementing this strategy using a single controller.

The user can select one of two possible ways to implement this strategy with a single controller. The first implementation method is through the separate intersection mode provided by Texas diamond controllers. With this preprogrammed option, the controller uses one ring for each intersection, and allows the user to define an offset relationship (called ring-lag) for the two signals. This mode, however, only allows the use of lead-lead phase sequence. The other, more cumbersome, method is to implement separate intersection control outside the diamond mode. This method requires defining the needed ring structure to achieve this objective. Engineers commonly use this strategy for conventional diamond interchanges. This strategy provides the maximum capacity when sufficient storage space exists.

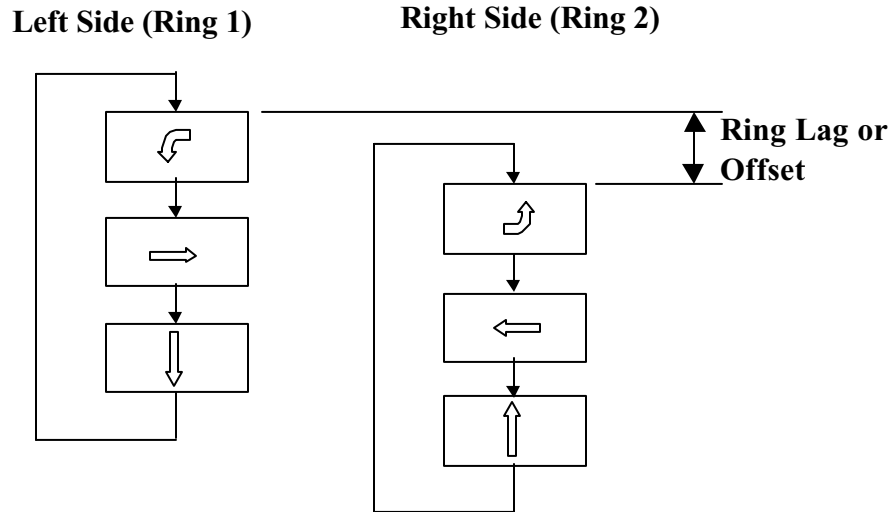

Figure 4. Separate Intersection Mode.

Useful Software Programs

This section describes four programs that can be used for analyzing or optimizing the operations at diamond interchanges.

PASSER III is a program for optimizing or analyzing the operation of diamond interchanges (1). It works well for undersaturated conditions. For saturated or oversaturated conditions, PASSER III can be used to calculate green splits, as long as an appropriate cycle length has been selected.

PASSER II is a program for optimizing signal timings on signalized arterials (2). PASSER II does not consider the flow dependencies between two closely spaced signals. It provides limited capabilities for coordinating diamond interchanges with adjacent signals. PASSER II is useful for interchanges with large interior distances where engineers can treat the two intersections independently. In addition, PASSER II is not applicable to saturated or oversaturated traffic conditions.

PASSER IV is a program for optimizing signal timings in arterials and multi-arterial networks (3). It has a limited capability to provide coordination of diamond interchanges with adjacent traffic signals and adjacent interchanges. For diamond interchange analysis and optimization, its deficiencies are similar to those of PASSER II. However, PASSER IV guarantees equal saturation splits for all critical movements and, thus, produces better results for near-saturated traffic conditions.

Synchro is a fairly recent tool for timing traffic signals (4). It is a delay-based program for optimizing signal timings. Its graphical user interface is better than all programs discussed here. The most recent version of Synchro (Version 4.0) has the ability to time diamond interchanges. Engineers can also use it to coordinate diamond interchanges with adjacent signals on the arterial.

GUIDELINES

Research results from this project pointed to the fact that the effectiveness of diamond interchange control strategies, especially TTI four-phase control, greatly depends on the cycle length. In this section, we look at the effects of cycle length on the capacity of a diamond interchange and present guidelines for timing isolated diamond interchanges.

Performance of Control Strategies

This section presents results of simulation studies conducted by researchers for Texas three-phase and TTI four-phase strategies. Researchers obtained the following information from these studies.

- For 200- and 400-foot spacings, TTI four-phase strategy results in considerably lower delay than the Texas three-phase strategy. The delays for these strategies are similar for a spacing of 600 feet. For TTI four-phase strategy, the internal delays increase as internal space increases. For Texas three-phase strategy, internal delays decrease as spacing increases. The external delays for TTI four-phase strategy were higher than the corresponding Texas three-phase delays for all conditions.
- For 200-foot spacing and balanced scenario, TTI four-phase strategy consistently produces lower delays than Texas three-phase for the internal movements and consistently produces higher delays for the external movements. For 400-foot spacing, researchers observed similar trends for cycle lengths greater than 70 seconds. For some of the volume conditions and lower cycle lengths, Texas three-phase strategy showed lower delays than TTI four-phase strategy. This is because TTI four-phase does not have sufficient internal capacity at low cycle lengths. The external delays for TTI four-phase strategy were higher for all cycle length and volume conditions studied. The trends for 600-foot spacing were similar to the 400-foot spacing trends in that TTI four-phase strategy resulted in higher delays than the Texas three-phase delays for low cycle lengths. Also, the external delays were much higher for the TTI four-phase timing plan.
- The unbalanced scenarios studied by the researchers included low volumes for the left intersection and a range of volumes for the right intersection. An increase in volumes at the right intersection showed that there is a corresponding increase in delays for the Texas three-phase strategy. For the TTI four-phase scenarios, the delays increased with cycle length to an extent (about 90 second cycle length) and then decreased for the intersection with higher internal volumes. TTI four-phase strategy tends to give a greater proportion of the cycle length to the internal greens as the cycle length increases; this increase causes a decrease in the greens of the external movements feeding this internal movement, thus reducing the overall internal delays.
- For both balanced and unbalanced scenarios, the internal delays for a TTI four-phase timing plan become more uniform as the external volumes increase. This is due to natural metering of traffic at exterior approaches. However, traffic that enters the interchange leaves without queuing (except for U-turning vehicles). This process allows the interchange interior to remain clear at the end of each cycle.
- An important factor to consider in selecting a timing plan during oversaturated conditions is the relative importance of the competing movements. From the studies, researchers

observed that TTI four-phase strategy kept the internals clear at all volume conditions (except for low cycle lengths), but this feature comes at the cost of the external movements. Depending on volume conditions and the exit ramp location, TTI four-phase strategy could lead to blocking at the exit ramps. This possibility should be considered before selecting a timing plan.

- PASSER III produces good results for undersaturated cases. Its delay estimates are not correct when blocking occurs on the interior approaches of an interchange.

Guidelines for Selecting a Control Strategy

Research performed under this project confirms the following guidelines for selecting a control strategy:

1. use Texas three-phase strategy for compressed diamond interchanges.
2. use TTI four-phase strategy for tight diamond interchanges.
3. use extended three-phase strategy for conventional diamond interchanges.

Capacity Analysis of Various Control Strategies

In this subsection, we describe the results of a mathematical programming-based methodology for analyzing the capacity of diamond interchanges. [Appendix B](#) provides a complete description of this strategy. In addition, this [appendix](#) provides an example of how to perform capacity calculations. [Appendix C](#) provides capacity analysis graphs for the three control strategies (Texas three-phase, TTI four-phase, and extended three-phase) for a range of cycle lengths, interior distances, and traffic patterns. This analysis shows that the capacity analysis method developed in this research is useful for selecting an appropriate cycle length. In addition, this analysis provides the following information.

- Cycle length selection is an important factor in providing maximum capacity for a diamond interchange.
- Extended three-phase strategy provides the maximum capacity and flexibility; however, sufficient internal storage space must exist in order to use this strategy.
- The maximum capacity for TTI four-phase strategy greatly depends on the selection of an optimum cycle length.
- Texas three-phase strategy works well when frontage road demands are balanced.

Guidelines for Selecting the Cycle Length

The best option is to use the capacity calculation procedure described in [Appendix B](#). A less desirable option is described below:

- identify the demand pattern,
- add demands for the exterior movements to obtain total interchange demand,
- use distance criteria for selecting an appropriate strategy (three-phase or four-phase),
- select the appropriate graph (corresponding to the demand pattern) from [Appendix C](#), and
- from the selected graph, determine the best cycle-length for calculated demand.

2. COORDINATION OF INTERCHANGES WITH ADJACENT SIGNALS

The previous [chapter](#) provided guidelines for selecting the best operation at an isolated diamond interchange. In this chapter, we present simple procedures and guidelines for coordinating diamond interchanges with adjacent traffic signals located in close proximity to an interchange. From a survey conducted in this project, we found that the most common situations faced by engineers in Texas are isolated interchanges or those that have one adjacent signal. Therefore, we consider the case when there is only one adjacent intersection.

PROBLEM DESCRIPTION AND NOTATION

[Figure 5](#) illustrates the interchange plus adjacent signal case we use in this section. For this scenario, we use the letter “D” for diamond and the letter “S” for signal to label the National Electrical Manufacturers’ Association (NEMA) movement numbers for the diamond interchange and the adjacent signal, respectively. In order to provide coordination, the interchange and the signal must be operated as one system with a common cycle length. Furthermore, the side of the interchange adjacent to the traffic signal now becomes an interior approach whose operation depends on the operation of the adjacent signal. Similarly, the eastbound approach to the adjacent signal is also an interior movement. Thus, this system has three external approaches to the interchange and three external approaches to the intersection.

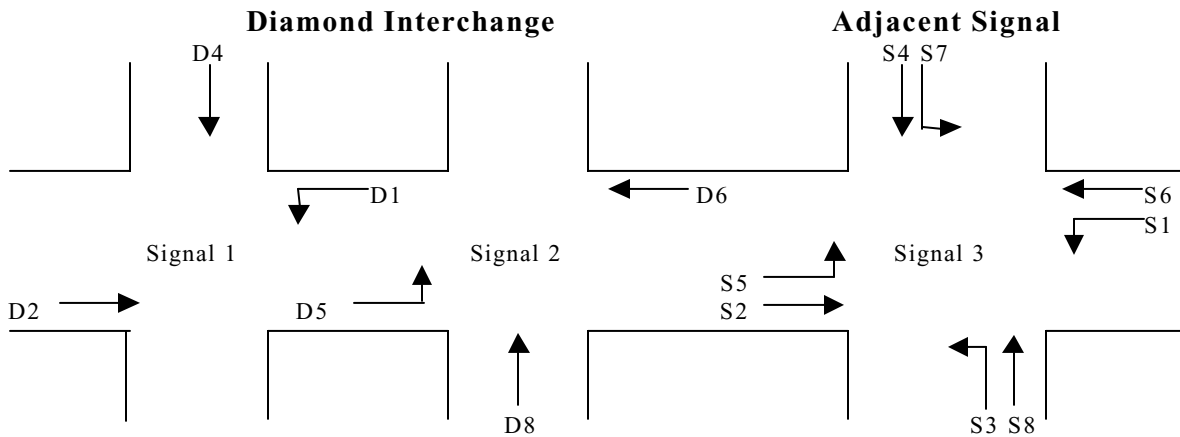

Figure 5. Diamond Interchange with an Adjacent Traffic Signal.

In addition, we use the following notation:

- C : cycle length, seconds
- ϕ_{di} : phase time of movement i at the diamond interchange, seconds
- ϕ_{si} : phase time of movement i at the adjacent signal, seconds
- Φ_d : total overlap (for four-phase diamond interchanges), seconds
- Φ_s : sum of offsets between right signal of interchange and adjacent signal, seconds
- v_i : volumes for movement i , vph

- s_i : saturation flow rate for movement i , vph
 c_i : capacity of movement i , vph

AN EASY APPROACH TO COORDINATION

In this section, we describe a simple approach to coordinating an interchange with adjacent signals on the arterial. The first step in establishing coordination is to determine the best operation (control strategy and cycle length) using guidelines provided in the previous [chapter](#). The second step is to use PASSER III to obtain the green splits. Once the analyst has obtained the green times for the interchange, he or she can use PASSER II or PASSER IV for coordinating the interchange with the adjacent signal. It is a general belief that good coordination with an adjacent signal cannot be provided for a four-phase diamond interchange. In the following [section](#), we provide conditions under which a four-phase diamond interchange and an adjacent signal can be coordinated to provide good coordination. This approach is also applicable to three-phase diamond interchanges.

Four-Phase Diamond and Adjacent Signal

TTI four-phase control guarantees progression for through traffic at interior approaches of the interchange. Thus, the objective of coordination for a four-phase diamond interchange would be to provide progression for these vehicles through the adjacent traffic signal(s). A secondary objective is to provide progression for arterial traffic from the adjacent signal through the diamond interchange. The first step toward achieving this result is to determine the travel times for the two directions linking the interchange and the adjacent signal. For future reference, we will use the term “interface-link” for the link between the interchange and the adjacent signal. For this purpose, engineers can use the three tables provided in [Appendix D](#). Engineers can directly use these tables to obtain travel times for diamond interchanges. To obtain travel times for an interface link, an engineer can use the following guidelines:

- For the signal to interchange flow direction, use the stop-bar to stop-bar distance to calculate the time it will take for a stopped vehicle at the signal to accelerate and reach the diamond interchange.
- For the interchange to signal flow direction, the vehicles will be already moving when the interior phase at the diamond interchange turns green. In this case:
 1. Calculate the interior travel time for the interchange.
 2. Calculate the travel time for a vehicle stopped at the exterior interchange approach to travel through the interior diamond link to the adjacent signal.
 3. Subtract the value obtained in Step 1 from that obtained in Step 2.

The desired offset in a travel direction is equal to the travel time for the associated direction. Whether one can obtain two-way progression for the interface-link depends on travel times on the interface link, phase times at the right intersection of the diamond, and phase times and phase sequence at the adjacent signal. [Figure 6](#) illustrates a subset of cases in which it is possible to achieve good two-way progression for a short interface-link.

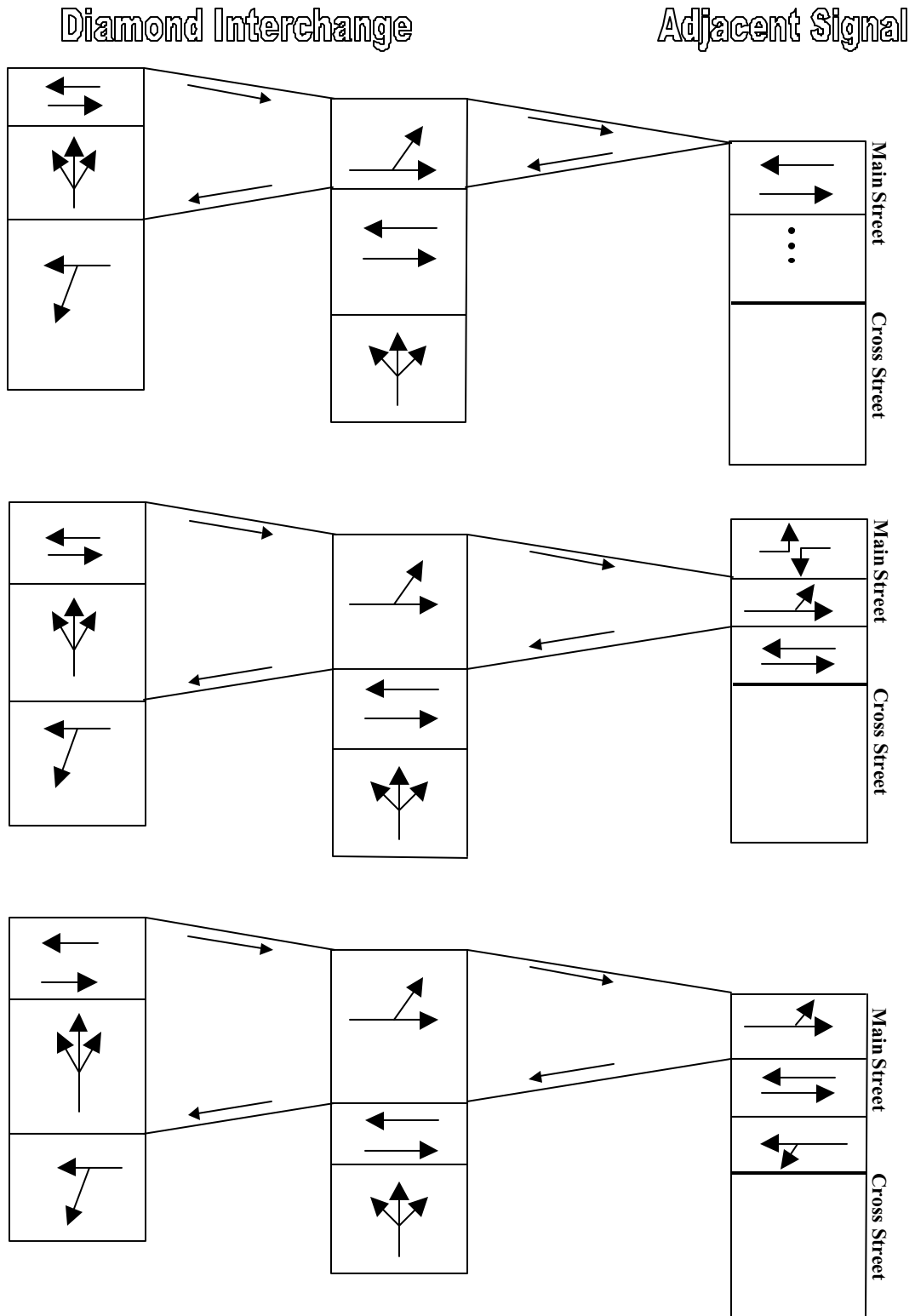

Figure 6. Some Cases in Which Two-way Progression with Adjacent Signal is Possible.

The top part of [Figure 6](#) illustrates the case when the arterial through phases ϕ_{S2} and ϕ_{S6} (phase for movements S2 and S6 in [Figure 5](#)) begin simultaneously. Two possible phasing sequences result in this situation. The first case is when both arterial left-turn phases (for movements S1 and S5 in [Figure 5](#)) lag. The other situation results when both left-turns phases lead but are of same duration. In this situation and in the absence of any queues at the interface-link, the analyst can achieve perfect two-way progression by setting interior left-turn phase at the diamond interchange (ϕ_{d5}) equal to the sum of travel times (Φ_S) for the interface-link. In the presence of queues, a situation that is normally true, one must adjust green splits and offsets to provide needed queue clearance time.

The middle part of [Figure 6](#) illustrates the case when arterial left turns at the adjacent signal lead and when the phase for movement S2 is larger than the phase for movement S6. In this case, the analyst can achieve perfect two-way progression by initially setting ϕ_{d5} equal to the sum of Φ_S and the overlap ($(\phi_{S2} \text{ minus } (\phi_{S6}))$ and then fine tuning the timings and offsets to adjust for queues at the interface-link.

The lower part of [Figure 6](#) illustrates the case when left-turn phase S5 at the adjacent signal leads and left-turn phase S1 lags. In this case, the analyst can achieve perfect progression for traffic traversing the interface-link by setting phase ϕ_{d5} equal to Φ_S plus the difference between the lengths of phases for movement S2 and S1 ($\phi_{S2} \text{ minus } \phi_{S5}$).

The reader should note that the last two cases discussed above require a larger cycle length than the first case. This increase depends on the magnitude of the overlap phase at the signal. The other two cases are:

1. Signal phases for movements S1 and S5 lead, with phase S5 larger than phase S1. In this case, the analyst can achieve two-way progression when ϕ_{d5} is equal to Φ_S minus the overlap ($\phi_{S5} \text{ minus } \phi_{S1}$).
2. Signal phase ϕ_{S1} leads and ϕ_{S5} lags. In this case, $\phi_{d5} = \Phi_S - \phi_{S1}$.

Above, we described the relationships between the length of interior left-turn phase at the interchange and the sum of travel times at the interface-link, for various phase sequences for the arterial at the adjacent signal. An analyst can derive similar relationships for three-phase diamond operations. In the following [subsection](#), we describe two strategies for coordinating a diamond interchange with an adjacent signal.

Coordination Guidelines

Here we assume that the analyst has already determined that TTI four-phase is the best strategy for the diamond interchange. Recall that the engineer can make this decision based on the (stop-bar to stop-bar) distance between the two intersections of the interchange. The next step is to select the best cycle-length range, which includes the cycle length that provides the maximum throughput capacity for the observed pattern of demand at the interchange. One can determine the best cycle length by using the procedure described in [Appendix B](#). The advantage of using the full procedure is that it will also point to the capacity bottleneck. As an alternate,

the analyst can use one of the six plots provided in [Appendix C](#). The following is a summary of steps for using these plots:

1. Determine the pattern of demand (e.g. heavy traffic on left side and light traffic on the right side) and select the appropriate plot.
2. Determine the cycle length that provides maximum throughput capacity. Based on this cycle length, select a range for cycle length.
3. Add the exterior demands to determine if it is an undersaturated or oversaturated case. If it is an oversaturated case, the simple strategy described here will not be appropriate.

Strategy I

This is the simplest strategy and requires the following steps:

1. Select a cycle length from the identified range.
2. Determine travel times for the interchange and the interface-link. [Appendix D](#) provides an example and travel time tables for use by analysts.
3. Use PASSER III to determine timings for the interchange.
4. Obtain travel times for both directions of the interface-link and convert these to speeds (in mph). Note that speed is equal to distance divided by time.
5. Use PASSER IV to coordinate right intersection of the interchange with adjacent signal(s) on the right side. If there are signals on the left side of the interchange, repeat the same procedure for those signals.
6. Repeat the above steps for all cycle lengths in the selected range.
7. Select the timing plan that provides best two-way progression.
8. If this analysis shows that two-way progression is not possible, use the best cycle length for the interchange, and provide one-way progression in the heaviest flow direction. An engineer can provide one-way progression with the adjacent signal in all cases.

The advantage of using PASSER IV is that the analyst can ask it to use a given set of splits and phase sequence(s) for some intersections while asking it to calculate these parameters for the others. In this case, the user will provide phase sequence and splits for the right intersection of the diamond, link speeds (speed for a link can be calculated using the corresponding travel time and travel distance), and volumes for the adjacent signal(s).

Strategy II

1. Select a cycle length.
2. Calculate phase times for the adjacent signal using Webster's formula.
3. Identify the set of possible phasing sequences for the adjacent signal.
4. Use the tables provided in [Appendix D](#) to obtain travel times for the interchange and the interface-link.
5. Use relationships described earlier to find the ideal length of phase ϕ_{d5} for each phase sequence from the above set.
6. Use the following relationships to determine actual length of phase ϕ_{d5} for the selected cycle length and travel times:

$$\phi_1 = \frac{1}{y_2 + y_4 + y_6 + y_8} \times ((C - 2l) \times (y_6 + y_8) - (\Phi - 2l) \times (y_2 + y_4))$$

$$\phi_5 = \frac{1}{y_2 + y_4 + y_6 + y_8} \times ((C - 2l) \times (y_2 + y_4) - (\Phi - 2l) \times (y_6 + y_8))$$

7. Compare the length of phase calculated in Step 6 to each value obtained in Step 5. Select the ideal phase length from Step 6 that is closest to the value calculated in Step 5. Also, select the corresponding phasing sequence at the adjacent signal.
8. Repeat Steps 2 through 7 for each cycle length in the set. Select the best cycle length and adjacent-signal phase sequence combination and calculate the length for external phases of the diamond using equations provided in [Appendix A](#).
9. If no satisfactory combination is found, select optimum cycle length for the interchange and provide one-way progression for the travel direction with the heaviest traffic flow.

Guidelines for Larger Systems

[Figure 7](#) shows an arterial system with multiple signals on one side of the interchange. In such systems, the engineer can use the following steps for providing arterial coordination:

1. Define the signal immediately next to the interchange (or the second next signal if the adjacent signal mostly carries through traffic) as the interface between the interchange and the remaining signals on the arterial.
2. Coordinate the diamond interchange with the interface signal using procedures described in the previous [subsection](#).
3. Retain the timings obtained in Step 2 for the interface signal and coordinate it with the remaining signals on the arterial using PASSER II or PASSER IV.

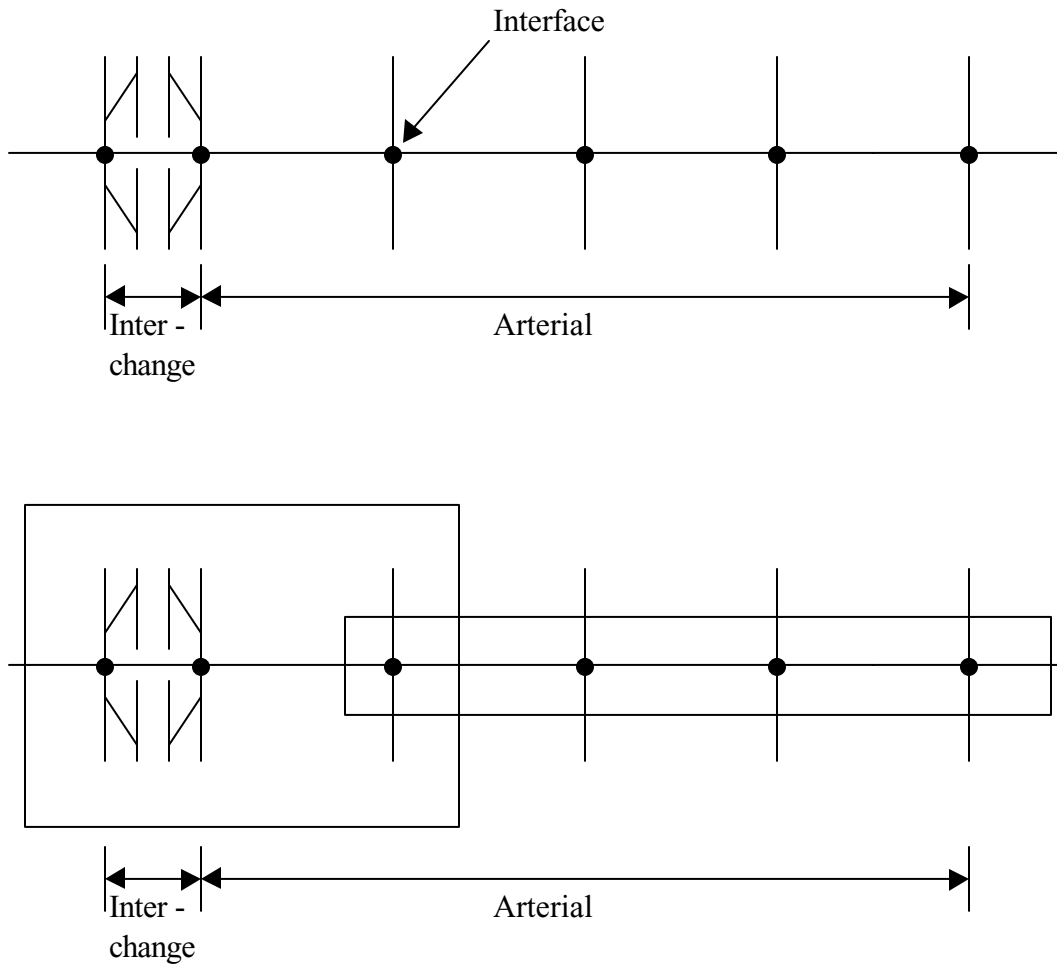

Figure 7. An Approach for Coordinating Large Systems.

REFERENCES

1. Fambro, D.B., N.A. Chaudhary, J.A. Bonneson, C.J. Messer, and L. Arabie. *PASSER III-90 Users Manual and Applications Guide*. Texas Transportation Institute Report, College Station, Texas, March 1991.
2. Chang, E.C., and C.J. Messer. *Arterial Signal Timing Optimization Using PASSER II-90, Program User's Manual*, Report 467-2F, Texas Transportation Institute, College Station, Texas, June 1991.
3. Chaudhary, N.A., and C.J. Messer. *PASSER IV-96 Version 2.1, User/Reference Manual*. Report 1477-1, Texas Transportation Institute, College Station, Texas, October 1996.
4. Husch, D., and J. Albeck. *Synchro 4.0 User Guide*. Albany, California, 1999.

APPENDIX A. INTERCHANGE CONTROL STRATEGIES

This appendix describes various control strategies for interchanges. In addition, it describes how to calculate timings for each strategy.

NOTATION

Figure A1 illustrates the standard NEMA phase numbering scheme for a diamond interchange. We use the following definitions in the following subsections:

- C : cycle length, seconds
- ϕ_i : phase time for movement i , seconds
- y_i : volume to saturation flow ratio for movement i
- Φ_{LR} : overlap from left to right (offset), seconds
- Φ_{RL} : overlap from right to left, seconds
- Φ : total overlap, seconds
- l : lost time per phase, seconds
- x : distance needed for a stopped vehicle to achieve the design speed, feet
- a : acceleration rate, feet/sec²
- s : design speed, mph
- V_{max} : design speed, feet/sec
- d : link distance (stop-bar to stop-bar), feet

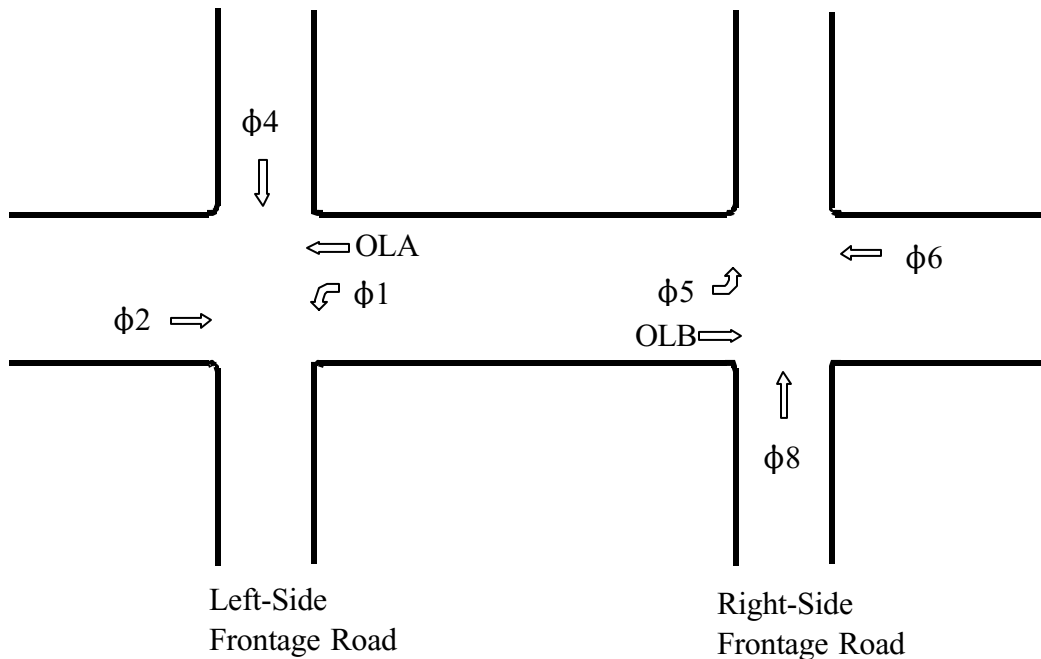

Figure A1. NEMA Phase Numbering Scheme for a Diamond Interchange.

A diamond interchange is a simple case of two closely spaced traffic signals with one-way cross streets (frontage roads or ramp terminals). However, origin-destination distributions of traffic flowing through a diamond interchange are significantly different from that for two signals on an arterial, requiring special treatment. Engineers commonly use Texas three-phase and TTI four-phase operations at signalized diamond interchanges in Texas.

The coordination of the two intersections of a diamond interchange requires that they be operated using a common cycle length. Thus, the following equations always hold:

$$\phi_1 + \phi_2 + \phi_4 = C$$

$$\phi_5 + \phi_6 + \phi_8 = C$$

Texas Three-Phase Strategy

Engineers designed this strategy to provide arterial through progression. Three-phase control works well as long as there is balanced demand at the two frontage roads/ramps and when there is sufficient storage space between the two intersections (interchange interior).

Texas three-phase strategy uses lag-lag phasing sequence, which first serves both frontage roads (ramps) followed by main-street through traffic and then the interior left-turn movements. The engineer can use the following formulae to calculate the green splits for Texas three-phase strategy:

$$\phi_4 = \phi_8 = \frac{\max(y_4, y_8)}{\max(y_1 + y_2, y_5 + y_6) + \max(y_4, y_8)} \times (C - 3l) + l$$

$$\phi_i = \frac{y_i}{y_1 + y_2} \times (C - \phi_4 - 2l) + l \quad i = 1, 2$$

$$\phi_i = \frac{y_i}{y_5 + y_6} \times (C - \phi_8 - 2l) + l \quad i = 5, 6$$

As can be seen, the above calculations do not take into consideration the distance between the two intersections. Thus, Texas three-phase strategy provides the same timing plan for a particular demand pattern no matter how wide the interchange is. However, in reality, the distance between the two signals does play an important role because of flow dependency between the two signals.

Texas Four-Phase Strategy

This strategy is also known as TTI four-phase strategy. TTI four-phase strategy uses lead-lead phasing pattern and minimizes internal queues. This strategy staggers the interior left-turn movements. The basic objective of this strategy is to coordinate the two signals of the diamond interchange for providing through progression at the downstream signal. To achieve this objective, it requires the simultaneous calculation of green splits and internal offsets. Thus, the calculation process treats the two intersections as one system and in doing so, takes into

consideration the interior travel times. The green split calculation for TTI four-phase strategy is as follows.

$$\phi_1 + \phi_5 = C - \Phi$$

$$\phi_2 + \phi_4 + \phi_6 + \phi_8 = C + \Phi$$

where

$$\Phi = \Phi_{LR} + \Phi_{RL}$$

$$= \text{Travel Time from Left to Right} - 2 \text{ sec.} + \text{Travel Time from Right to Left} - 2 \text{ sec.}$$

$$= \text{Travel Time from Left to Right} + \text{Travel Time from Right to Left} - 4 \text{ sec.}$$

A careful look at the above **equations** reveals that as the distance between the two signals increases (that is, travel time increases), the total green split for interior movements reduces, while the total green split for exterior movement increases. Also, the cycle length must be significantly larger than the total travel time in order to provide reasonable capacity. Because of the close proximity of the two intersections, travel time from one intersection to the next must take into consideration the fact that vehicles stopped at an exterior approach (usually the through vehicles) accelerate as they are traveling toward the next signal. The travel time will depend on the vehicle:

1. still accelerating when it reaches the downstream signal, and
2. achieving the design speed before it reaches the downstream signal. In this case the vehicle will cover the remaining distance to the downstream signal at design speed.

It is a standard practice to use an acceleration rate of 4.44 feet/sec² for calculating travel times for use in diamond interchange analysis. [Table A1](#) provides travel times for some speed and distance cases. For example, if the design speed and link-distance are 35 mph and 250 feet, respectively, the travel time will be 9 seconds.

Table A1. Travel-Time Table.

Design Speed (mph)	Link Distance (feet)														
	100	150	200	250	300	350	400	450	500	550	600	650	700	750	800
20	5	7	9	10	12	14	16	17	19	21	22	24	26	28	29
25	5	7	8	9	11	12	13	15	16	18	19	20	22	23	24
30	5	7	8	9	10	11	13	14	15	16	17	18	19	20	22
35	5	7	8	9	10	11	12	13	14	15	16	17	18	19	20
40	5	7	8	9	10	11	12	13	14	14	15	16	17	18	19
45	5	7	8	9	10	11	12	13	14	14	15	16	17	17	18

Once the travel times for both directions, and thus the offsets, have been calculated, the phase times for exterior phases of a four-phase diamond can be calculated as follows:

$$\phi_i = \frac{y_i}{y_2 + y_4 + y_6 + y_8} \times (C + \Phi - 4l) + l \quad \forall i = 2, 4, 6, 8$$

The final step is to calculate the times for the two interior left-turn movements using the following **equations**:

$$\phi_1 = \phi_6 + \phi_8 - \Phi$$

$$\phi_5 = \phi_2 + \phi_4 - \Phi$$

Since the above calculations of phase times guarantee through progression for any given distance, TTI four-phase operation minimizes the lengths of interior queues. Because of guaranteed through progression at the downstream signal, this strategy also conforms to drivers' expectancy. The TTI four-phase operation is not flawless, however. Since the green time of interior left movements have a negative relationship with the overlap, the capacities of left-turn phases reduce with increasing distance. Another drawback of this strategy is that all U-turn traffic gets stopped within the interchange. The easiest way to remedy this situation is to provide U-turn bays for sites with short spacing and heavy U-turn traffic. Based on engineers' experience, the TTI four-phase strategy works well for interchanges with widths less than 400 feet. Since TTI four-phase strategy requires the calculation of phase times and progression simultaneously, unlike Texas three-phase strategy, the timing plan will change as the interior distance changes. A TTI four-phase timing plan may not exist for large link distances and short cycle lengths.

Separate Intersection Mode

This method of operation treats the two intersections of a diamond independently. The analyst can use the following **equations** to calculate the green splits for each intersection of the interchange:

$$\phi_i = \frac{y_i}{y_1 + y_2 + y_4} \times (C - 3l) + l \quad \forall i = 1, 2, 4$$

$$\phi_i = \frac{y_i}{y_5 + y_6 + y_8} \times (C - 3l) + l \quad \forall i = 5, 6, 8$$

In traditional implementations, each intersection requires a separate controller, as for a normal arterial with two traffic signals. Engineers establish coordination between the two intersections by interconnecting the two controllers, using a common cycle length, and specifying an offset relationship between them. The offset depends on travel time between the two intersections. The option of using two controllers provides the maximum flexibility because it allows the use of all four phasing patterns for the pair of intersections.

Most modern controllers used in Texas are capable of implementing this strategy using a single controller. The user can select one of two possible ways to implement this strategy with a single controller. The first implementation method is through the separate intersection control feature of Texas diamond controllers. With this preprogrammed option, the controller uses two rings (one for each intersection) and allows the user to define an offset relationship (called ring-lag) for the two signals. This mode, however, only allows the use of lead-lead phase sequence. The other, more cumbersome, method is to implement separate intersection control outside the diamond mode. This method requires defining the needed ring structure to achieve this objective. Engineers commonly use this strategy for conventional diamond interchanges (interchanges with 800 feet or larger link distances). This strategy provides the maximum capacity when sufficient storage space exists.

APPENDIX B. A CAPACITY CALCULATION METHOD

In this appendix, we present a linear program (LP) to calculate the interchange throughput capacity. We also describe a simple procedure for using this formulation and provide an example to illustrate capacity calculations. This procedure assumes:

1. the origin-destination of traffic flow stays constant for a given analysis period,
2. no blocking (queue spill-back) occurs in the interior of the interchange,
3. ideal saturation flow rates are known, or can be calculated, for each movement, and
4. traffic control strategy and, therefore, the cycle length and green splits are known.

Maximize: V

Subject to:

$$V \leq \frac{g_i \times s_i}{C} \times \frac{1}{p_i} \quad \forall i \in E$$

$$V \leq 0.95 \times \frac{g_i \times s_i}{C} \times \frac{1}{p_i} \quad \forall i \in I$$

Where:

- C : cycle length, seconds
- V : hourly flow rate (demand) for the system, vph
- g_i : effective green time of i^{th} movement per cycle, seconds
- s_i : hourly saturation flow of i^{th} movement, vph
- E : set of exterior movements (left, through and right movements at each frontage road, and through and right movements at each artery approach)
- I : set of interior movements (interior left and through movements)
- p_i : ratio of volume for approach i to sum of exterior volumes

The reader can verify that the above formulation contains one variable and 14 constraints. Furthermore, the constraint with the smallest right-hand side will dictate the system throughput capacity. Therefore, all the analyst needs to do to get a solution is to:

- calculate the ideal saturation flow rate for each movement,
- calculate the green splits for the selected control strategy and selected cycle length,
- calculate the movement-volume to total-interchange-volume ratio for each movement,
- calculate the right-hand side constant for each constraint, and
- select the constraint with the smallest right hand side constant.

The selected constraint identifies the bottleneck movement, and its right-hand side constant is equal to the interchange throughput capacity. The reader should note that it is possible for more than one movement to be a bottleneck. This happens when the right-hand sides of more than one constraint are equal to the smallest value. The engineer can use the procedure described above to obtain the capacity of an interchange control strategy for a given geometric scenario and range of cycle lengths. In addition, the engineer can use the same procedure to compare various control strategies. In the next [section](#), we use synthetic data to

compare various diamond control strategies under different origin-destination scenarios. Also, we provide an example set of calculations to illustrate the use of LP presented above.

Example of Capacity Calculations

In this section, we show how to calculate the throughput capacity using the procedure described in the previous subsection. Here we assume TTI four-phase operation, an interchange with 200-foot spacing, and a cycle length of 70 seconds. We assume a total interchange demand of 1400 vph. Total interchange demand is the sum of all exterior movements (arterial through and frontage road left turns) volumes entering the interchange. For operational analysis, the analyst will obtain these volumes through field studies. Tables B1 and B2 provide the data assumed or calculated for illustration purposes. In the headings of these tables, a number followed by a letter (e.g., 2T, 4L, 4R, etc.) identifies NEMA phase number and movement (left, through, or right) for that phase. The first line provides the volume data. The second line of data provides the ratio of each volume to the total interchange demand at the exterior movements (1400 vph). For instance, the ratio for the arterial through movement (2T) at the left intersection is 0.3571 (shown in Table B1 using bold font), obtained by dividing 500 by 1400. The last two lines provide the saturation flow rates and effective green times (split minus lost time) for each movement.

Table B1. Data for Left Signal of the Interchange.

	Arterial		Frontage			Interior	
	Through (2T)	Right (2R)	Left (4L)	Through (4T)	Right (4R)	Left (1L)	Through (1T)
Volume	500	50	200	100	50	200	500
Volume as Fraction	0.3571	0.0357	0.1429	0.0714	0.0357	0.1429	0.3571
Saturation Flow	5000	500	1770	2346	1173	1770	3725
Effective Green	17	17	19	19	19	22	43

Table B2. Data for Right Signal of the Interchange.

	Arterial		Frontage			Interior	
	Through (6T)	Right (6R)	Left (8L)	Through (8T)	Right (8R)	Left (5L)	Through (5T)
Volume	500	50	200	100	50	200	500
Volume as Fraction	0.3571	0.0357	0.1429	0.0714	0.0357	0.1429	0.3571
Saturation Flow	5000	500	1770	2346	1173	1770	3725
Effective Green	17	17	19	19	19	22	43

The above tables have all the information we need to calculate the right-hand sides (RHS) of capacity constraints for each movement. We illustrate these calculations below for left and right signals of the interchange:

Left Signal:

$$V \leq \frac{g_{2T} \times s_{2T}}{C} \times \frac{1}{p_{2T}} = \frac{17 \times 5000}{70} \times \frac{1}{0.3571} = 3400$$

$$V \leq \frac{g_{2R} \times s_{2R}}{C} \times \frac{1}{p_{2R}} = \frac{17 \times 500}{70} \times \frac{1}{0.0357} = 3400$$

$$V \leq \frac{g_{4L} \times s_{4L}}{C} \times \frac{1}{p_{4L}} = \frac{19 \times 1770}{70} \times \frac{1}{0.1429} = \mathbf{3362}$$

$$V \leq \frac{g_{4T} \times s_{4T}}{C} \times \frac{1}{p_{4T}} = \frac{19 \times 2346}{70} \times \frac{1}{0.0714} = 8918$$

$$V \leq \frac{g_{4R} \times s_{4R}}{C} \times \frac{1}{p_{4R}} = \frac{19 \times 1173}{70} \times \frac{1}{0.0357} = 8918$$

$$V \leq 0.95 \times \frac{g_{1L} \times s_{1L}}{C} \times \frac{1}{p_{1L}} = 0.95 \times \frac{22 \times 1770}{70} \times \frac{1}{0.1429} = 3698$$

$$V \leq 0.95 \times \frac{g_{1T} \times s_{1T}}{C} \times \frac{1}{p_{1T}} = 0.95 \times \frac{43 \times 3725}{70} \times \frac{1}{0.3571} = 6087$$

Right Signal:

$$V \leq \frac{g_{6T} \times s_{6T}}{C} \times \frac{1}{p_{6T}} = \frac{17 \times 5000}{70} \times \frac{1}{0.3571} = 3400$$

$$V \leq \frac{g_{6R} \times s_{6R}}{C} \times \frac{1}{p_{6R}} = \frac{17 \times 500}{70} \times \frac{1}{0.0357} = 3400$$

$$V \leq \frac{g_{8L} \times s_{8L}}{C} \times \frac{1}{p_{8L}} = \frac{19 \times 1770}{70} \times \frac{1}{0.1429} = \mathbf{3362}$$

$$V \leq \frac{g_{8T} \times s_{8T}}{C} \times \frac{1}{p_{8T}} = \frac{19 \times 2346}{70} \times \frac{1}{0.0714} = 8918$$

$$V \leq \frac{g_{8R} \times s_{8R}}{C} \times \frac{1}{p_{8R}} = \frac{19 \times 1173}{70} \times \frac{1}{0.0357} = 8918$$

$$V \leq 0.95 \times \frac{g_{5L} \times s_{5L}}{C} \times \frac{1}{p_{5L}} = 0.95 \times \frac{22 \times 1770}{70} \times \frac{1}{0.1429} = 3698$$

$$V \leq 0.95 \times \frac{g_{5T} \times s_{5T}}{C} \times \frac{1}{p_{5T}} = 0.95 \times \frac{43 \times 3725}{70} \times \frac{1}{0.3571} = 6087$$

From the above calculation, we see that the smallest RHS is 3362 (identified using bold type), corresponding to left-turn movements from the two frontage roads. Thus, the interchange throughput capacity is 3362 vph. In this case, however, the demand (1400 vph) is well below the interchange capacity. Theoretically, the analyst can increase the interchange throughput capacity by increasing the capacity of the frontage road left-turn movements (by changing lane assignments or reallocating the phase times) or by reducing demand. Since our example network did not have U-turn lanes, adding these lanes will reduce demand for this case.

Before proceeding, it is appropriate to offer some additional comments regarding the use of the above procedure using data collected in the field. Due to errors in data collection, the sum of exterior volumes (frontage road left and arterial through) from one intersection may not be equal to the sum of interior volumes (left and through) at the downstream signal. However, since our analysis assumes input-output balance, one must normalize the volumes for the interior movements as follows:

1. Select an interior approach.
2. Find the sum of interior left-turn and through volumes for the selected interior approach.
3. Find the sum of exterior (frontage road left-turn and arterial through) volumes at the upstream signal feeding traffic to the interior approach selected in Step 1.
4. Divide the interior left-turn volume by the sum obtained in Step 2 and multiply this number by the sum obtained in Step 3 to obtain the normalized left-turn volume.
5. Divide the interior through volume by the sum obtained in Step 2 and multiply this number by the sum obtained in Step 3 to obtain the normalized through volume.
6. Repeat Steps 1 through 5 for the other interior approach.
7. Use the normalized volumes from Steps 4 and 5 in the capacity analysis procedure.

APPENDIX C. CYCLE LENGTH SELECTION GRAPHS

For the analysis presented here, we use a diamond interchange shown in [Figure C1](#). This [figure](#) also shows the assumed lane assignments. In addition, we assume that this interchange has no U-turn lane. Furthermore, we assume that it has full interior left-turn lanes. We use six different volume conditions derived from data described in [Tables C1](#) and [C2](#). The following sections describe the findings.

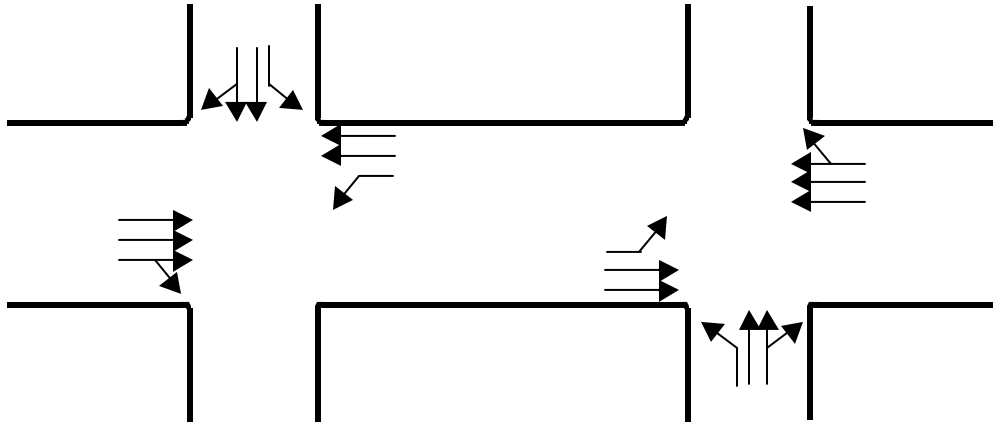

Figure C1. Number of Lanes and Lane Assignments for Test Scenario.

Table C1. Base Volume Conditions.

	Arterial		Frontage Road		
	Through	Right	Left	Through	Right
Light Traffic	500	50	200	100	50
Heavy Traffic	1000	50	900	100	50

Table C2. Interior Left and Through Traffic as Percent of Exterior Movements.

	From Arterial		From Frontage Road	
	Left (%)	Through (%)	Left (%)	Through (%)
Light Traffic	30	70	25	75
Heavy Traffic	20	80	28	72

Balanced Light Traffic on All Exterior Approaches

In this example, we assume light traffic conditions at all four exterior approaches to the diamond interchange. Furthermore, we assume equal demand for the two arterial approaches and equal demand for the two frontage road approaches. The total interchange demand for this case is 1400 vph. [Figure C2](#) provides the analysis results. This [figure](#) provides throughput capacity of three control strategies for a range of cycle length and signal spacing. The horizontal line at the bottom identifies the current demand level for the interchange and shows that all options have more than sufficient capacity to handle this demand. From [Figure C2](#), we obtain the following observations:

- The throughput capacities for Texas three-phase and extended three-phase operations are identical and increase with cycle length. These capacities are also higher than the capacities for all TTI four-phase cases. In reality, this will only be true when there is sufficient storage space and when no blocking occurs.
- The capacity of a TTI four-phase operation increases sharply with an increase in cycle length until it reaches the capacity of the three-phase operation. The capacity decreases for cycle length increase beyond this point.
- For TTI four-phase operation, larger interior spacing requires larger cycle length to achieve optimum capacity. Furthermore, the optimum capacity for TTI four-phase increases with an increase in interior spacing.

Balanced Traffic with Light Arterial Demand and Heavy Frontage Road Demand

[Figure C3](#) shows the analysis for this condition. Note that the interchange demand for this case is twice that for the previous case. All observations from the previous case apply here as well, except that the capacities of TTI four-phase operations for all interchange spacings are slightly below the capacity for three-phase operations. Also, a diamond interchange with 600-foot spacing is the only interchange that has sufficient capacity to handle the demand. In this case, the bottlenecks are the capacities of frontage road left-turn movements. With this pattern of demand, the analyst has the following options:

- Use one of the two three-phase strategies when the interior distance is 400 feet or more. For distances less than 400 feet, these strategies will cause interior blocking, an effect not captured in the above analysis.
- Use TTI four-phase operation for interchange spacing of less than or equal to 400 feet. As shown previously, this operation minimizes internal blocking (which might only occur for U-turn traffic) and guarantees through progression at interior approaches.
- Make changes in frontage road lane assignments to increase the capacities of left-turn movements.
- Build U-turn lanes to reduce frontage road left-turn demand.

Balanced Traffic with Heavy Arterial Demand and Light Frontage Road Demand

Figure C4 shows results of this analysis. In this case, the interchange demand is 2400 vph, and all studied options provide sufficient capacity to handle this situation.

Balanced Light Traffic on Arterial and Heavy Traffic on Left Frontage Road

Figure C5 shows the results of this analysis. Here we used heavy traffic conditions on the left frontage road and light traffic conditions on the right frontage road. The following observations can be made about this traffic pattern:

- As expected, there is a sharp decrease in the capacity of the Texas three-phase strategy. This strategy still provides sufficient capacity for cycle length of 80 seconds or higher.
- The extended three-phase strategy provides sufficient capacity even for a cycle length of 50 seconds.
- If we use an optimal cycle length, TTI four-phase strategy provides sufficient capacity for all link-distances studied. Furthermore, the capacity of TTI four-phase strategy increases for larger cycle lengths, although this increase is marginal.

Heavy Traffic on the Left Intersection and Light Traffic on the Right Intersection

Figure C6 shows the results of this analysis. From this figure, the reader can see that the capacity of Texas three-phase strategy is much below what is needed to handle the total traffic demand. The extended three-phase strategy has sufficient capacity when we use a cycle length of 70 seconds or more. Furthermore, TTI four-phase strategy has sufficient capacity for all link distances when we use a cycle length of 100 seconds or more. Under this type of traffic pattern, engineers should not use Texas three-phase operation. Furthermore, the engineers should use the distance criteria presented earlier to select extended three-phase or TTI four-phase operation.

Heavy Arterial Demand on Left-Side and Light Demand on Other Approaches

Figure C7 shows the results of this scenario. As the reader can see, the total demand is light as compared to the capacities of the three strategies studied. Also, the two three-phase strategies (Texas three-phase and extended three-phase) have identical capacities because of balanced demand on frontage roads.

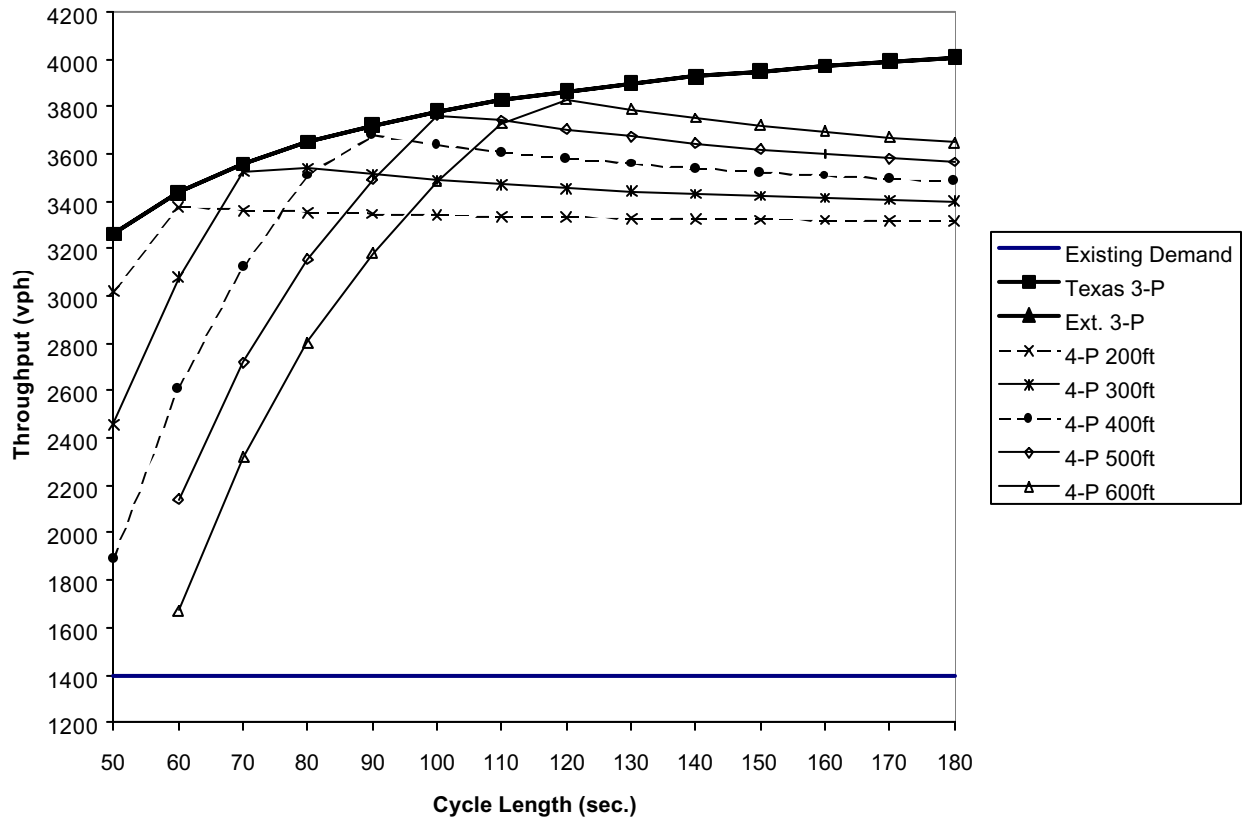

Figure C2. Interchange Throughput Capacities for Balanced Light Demand Case.

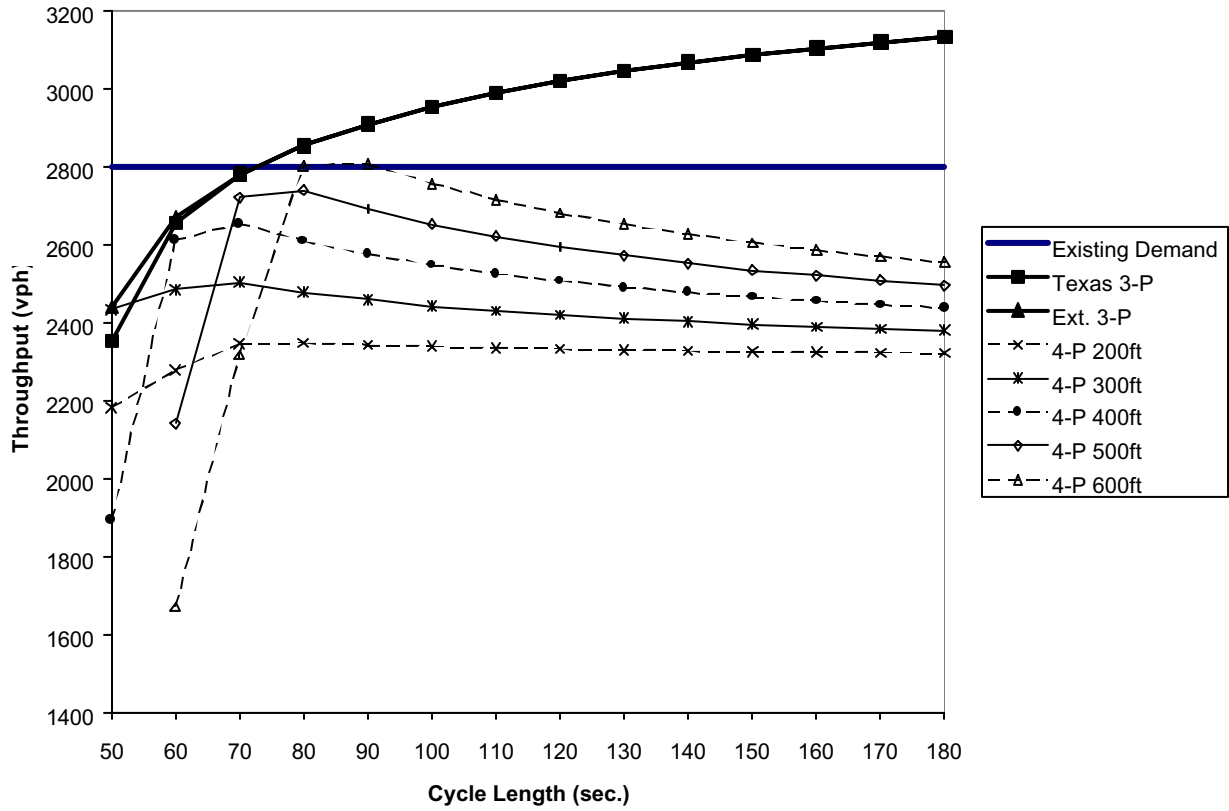

Figure C3. Balanced Traffic with Light Arterial and Heavy Frontage Road Demand.

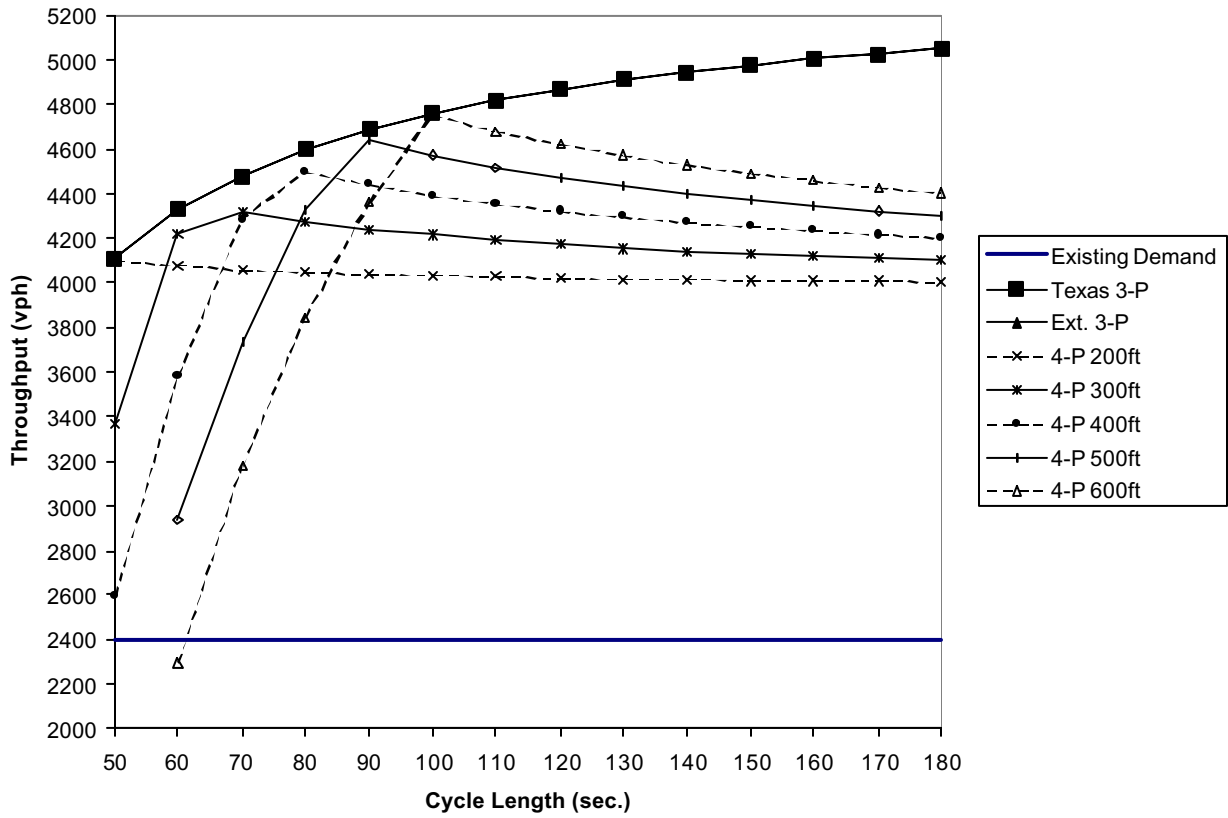

Figure C4. Balanced Traffic, Heavy Arterial, and Light Frontage Road Demand.

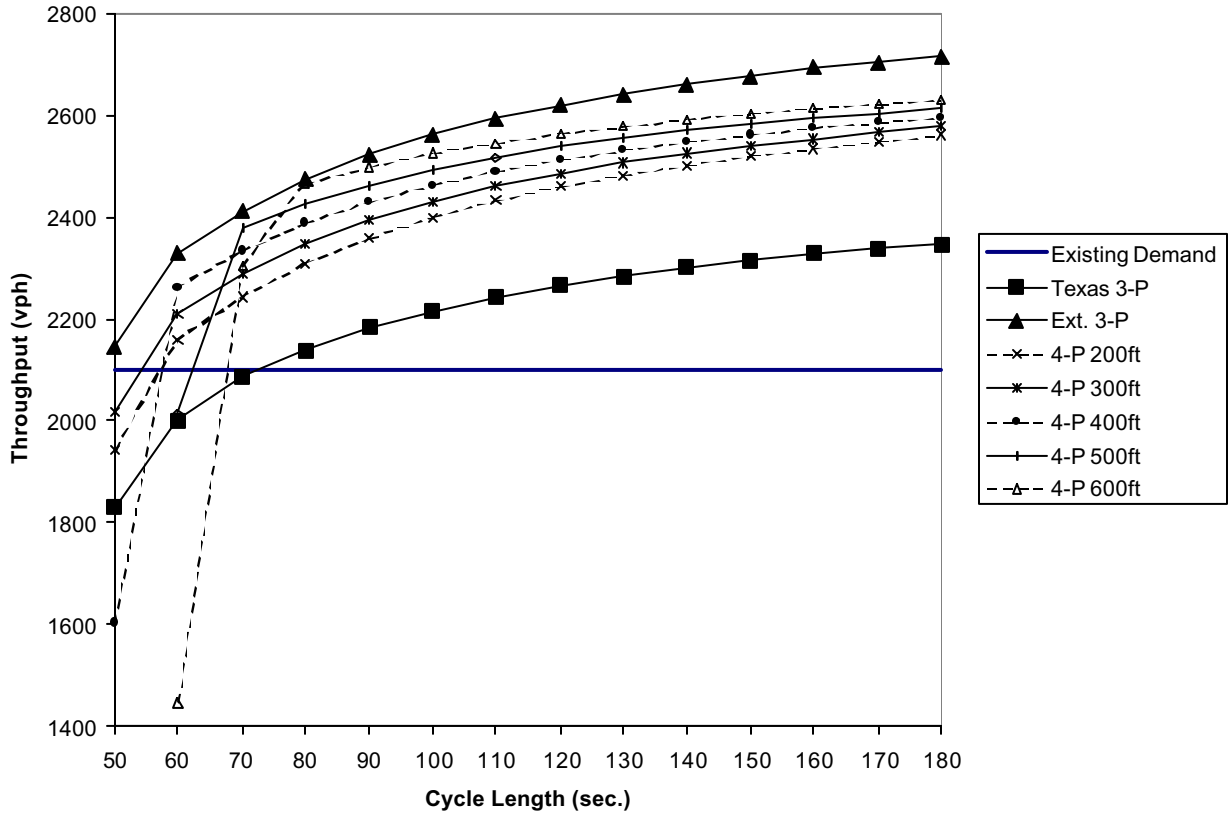

Figure C5. Balanced Light Traffic on Arterial and Heavy Traffic on One Frontage Road.

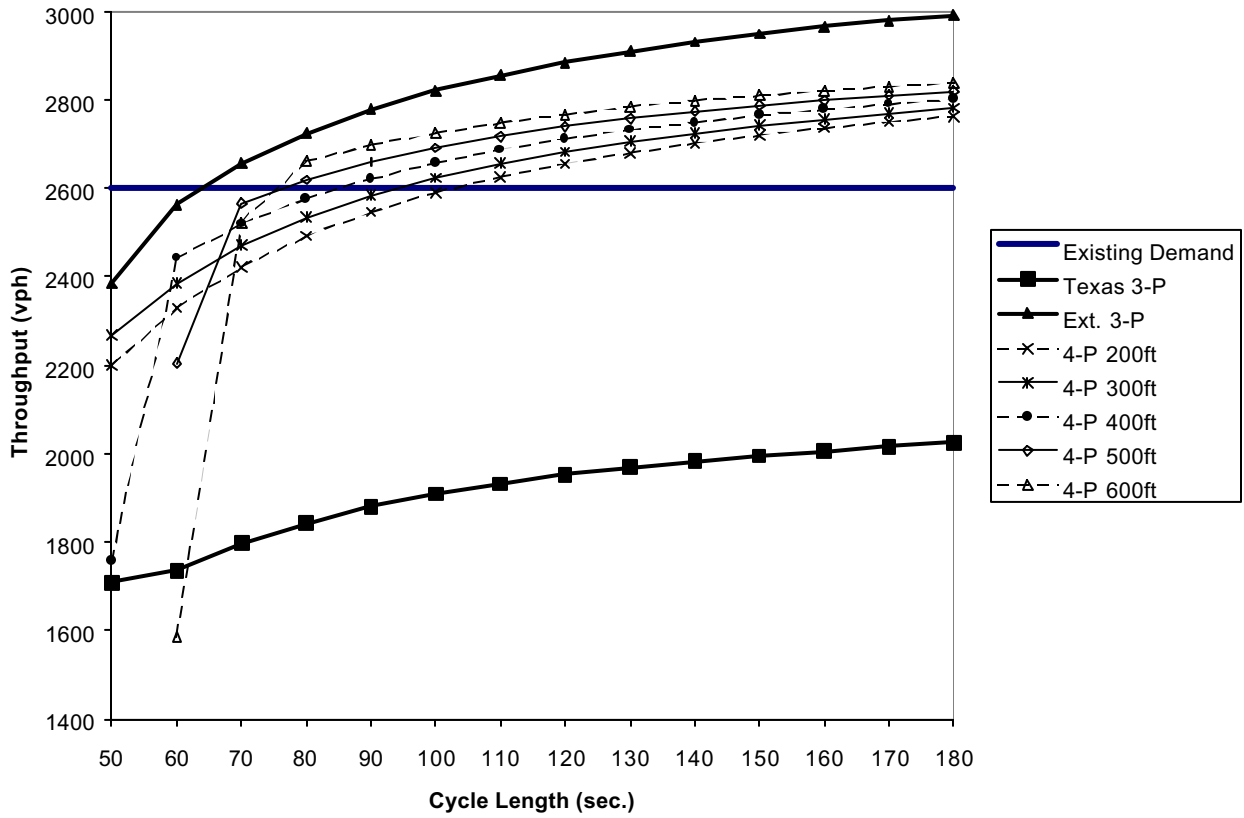

Figure C6. Heavy Demand at Left Signal and Light Traffic at Right Signal.

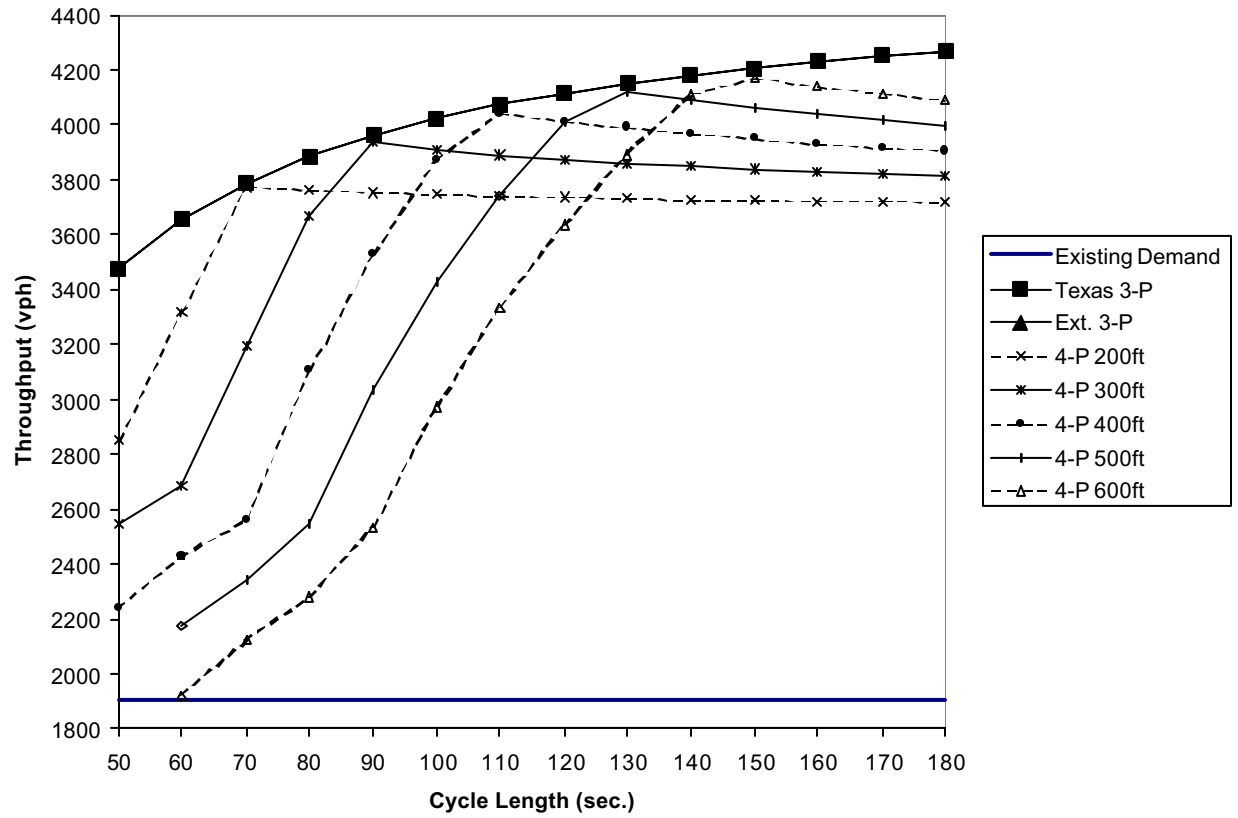

Figure C7. Heavy Demand at Left Arterial Approach and Light Demand at All Other Approaches.

APPENDIX D. TRAVEL TIME CALCULATIONS

The travel time calculations for the interior link of a diamond interchange assume an initial speed of zero. If we use this assumption to calculate the travel time from the diamond interchange to an adjacent signal, we may overestimate the travel time when good coordination exists. This will happen because the vehicles leaving the diamond will be traveling at a certain speed. To obtain a better estimation of travel time in such situations, we must use the vehicular speed at the time it leaves the downstream signal of the interchange. The analyst can achieve this result by using a three-step approach described below using the sample system shown in [Figure D1](#).

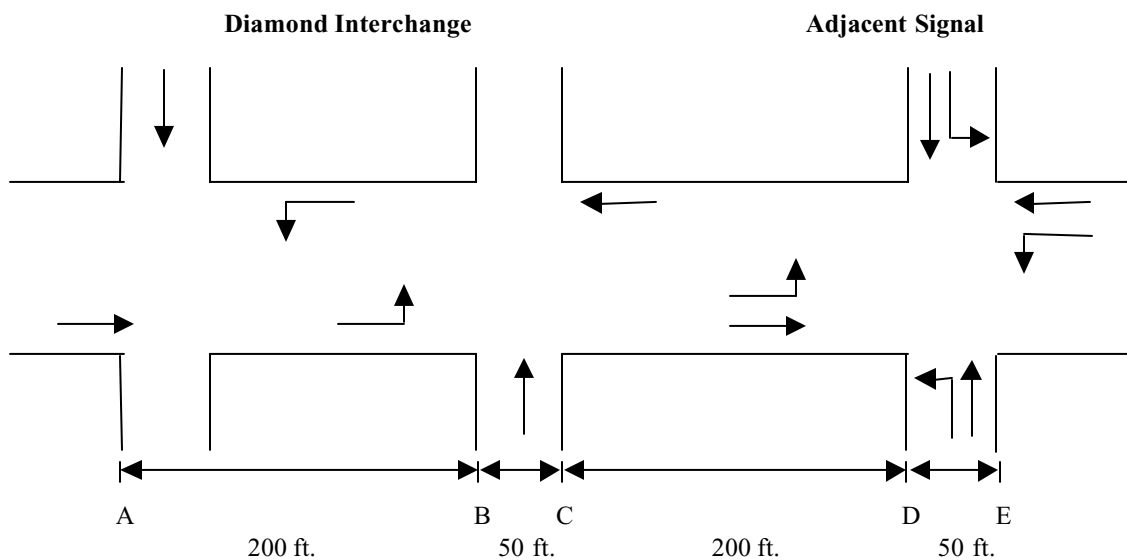

Figure D1. Data for Example Travel Time Calculations.

- Calculate (or obtain) the travel time (t_{Total}) from the left signal of the diamond interchange to the adjacent signal.
- Calculate (or obtain) the travel time (t_D) from the left signal of the interchange to the right signal of the interchange.
- Obtain the interchange-to-signal travel time (t_{DS}) by subtracting t_D from t_{Total} .

The analyst can obtain travel time from the adjacent signal to the diamond interchange by assuming that vehicles stop at the adjacent signal before proceeding. Tables [D1](#), [D2](#), and [D3](#) provide travel times for various speeds and travel distances. In the following, we illustrate travel time determination for distance data as shown in [Figure D1](#).

Table D1. Travel Times for 100- to 600-Foot Links.

Design Speed (mph)	Distance (feet)										
	100	150	200	250	300	350	400	450	500	550	600
20	5	7	9	10	12	14	16	17	19	21	22
25	5	7	8	9	11	12	13	15	16	18	19
30	5	7	8	9	10	11	13	14	15	16	17
35	5	7	8	9	10	11	12	13	14	15	16
40	5	7	8	9	10	11	12	13	14	14	15
45	5	7	8	9	10	11	12	13	14	14	15

Table D2. Travel Times for 650- to 1150-Foot Links.

Design Speed (mph)	Distance (feet)										
	650	700	750	800	850	900	950	1000	1050	1100	1150
20	24	26	28	29	31	33	35	36	38	40	41
25	20	22	23	24	26	27	28	30	31	32	34
30	18	19	20	22	23	24	25	26	27	28	30
35	17	18	19	20	21	22	23	24	25	26	27
40	16	17	18	19	20	20	21	22	23	24	25
45	16	17	17	18	19	20	20	21	22	23	23

Table D3. Travel Times for 1200- to 1700-Foot Links.

Design Speed (mph)	Distance (feet)										
	1200	1250	1300	1350	1400	1450	1500	1550	1600	1650	1700
20	43	45	47	48	50	52	53	55	57	59	60
25	35	36	38	39	41	42	43	45	46	47	49
30	31	32	33	34	35	36	38	39	40	41	42
35	28	29	30	31	32	33	34	35	36	37	38
40	25	26	27	28	29	30	31	31	32	33	34
45	24	25	26	26	27	28	29	29	30	31	32

For this example, we assume a design speed of 30 mph. From [Figure D1](#), we see that the distance between the two intersections of the diamond interchange is 200 feet. Also, the distance between the diamond interchange and the adjacent signal is 250 feet. Thus, the total distance from the left intersection of the interchange to the adjacent signal is 450 feet. Now we can obtain travel times using the above tables.

First, we consider the eastbound traffic. From [Table D1](#), we find that t_{Total} is 14 seconds (30 mph maximum speed and 450-foot travel distance), and t_D is 8 seconds (30 mph speed and 200-foot travel distance). Therefore, the eastbound travel time from the diamond interchange to the adjacent signal, t_{DS} , is 6 seconds (14 minus 8 seconds). Note that this method is only applicable when there is no queue at the interior through approach.

For the westbound traffic, the travel time from the adjacent signal to the right signal of the diamond interchange is 9 seconds (30 mph speed and 250 foot travel time). Assuming that side-street traffic from the upstream signal will be queued at the right signal of the interchange, the traffic time from the right signal to the left signal of the diamond interchange is determined by the traditional way. In this case, it is 8 seconds (30 mph speed and 200-foot link).

