

1. Report No. FHWA/TX-01/2136-2		2. Government Accession No.		3. Recipient's Catalog No.	
4. Title and Subtitle PEDESTRIAN CROSSING GUIDELINES FOR TEXAS				5. Report Date December 2000	
				6. Performing Organization Code	
7. Author(s) Shawn M. Turner and Paul J. Carlson				8. Performing Organization Report No. Product 2136-2	
9. Performing Organization Name and Address Texas Transportation Institute The Texas A&M University System College Station, Texas 77843-3135				10. Work Unit No. (TRAIS)	
				11. Contract or Grant No. Project No. 0-2136	
12. Sponsoring Agency Name and Address Texas Department of Transportation Construction Division Research and Technology Transfer Section P. O. Box 5080 Austin, Texas 78763-5080				13. Type of Report and Period Covered Product: October 1999 - August 2000	
				14. Sponsoring Agency Code	
15. Supplementary Notes Research performed in cooperation with the Texas Department of Transportation and the U.S. Department of Transportation, Federal Highway Administration. Research Project Title: Revising the Pedestrian Warrant for the Installation of a Traffic Signal					
16. Abstract The purpose of this document is to recommend guidance and criteria on the provision of safe and effective pedestrian crossings. The guidelines should be useful to engineers and planners responsible for planning, designing, operating, and maintaining pedestrian facilities in Texas. The guidelines are intended to outline the numerous alternatives that are available to address pedestrian safety problems or public concerns at roadway crossings. The guidelines describe the following crossing treatments:					
17. Key Words Pedestrian Crossing, Crossing Treatments, Traffic Calming			18. Distribution Statement No restrictions. This document is available to the public through NTIS: National Technical Information Service 5285 Port Royal Road Springfield, Virginia 22161		
19. Security Classif.(of this report) Unclassified		20. Security Classif.(of this page) Unclassified		21. No. of Pages 70	22. Price

PEDESTRIAN CROSSING GUIDELINES FOR TEXAS

by

Shawn M. Turner, P.E.
Assistant Research Engineer
Texas Transportation Institute

and

Paul J. Carlson, P.E.
Assistant Research Engineer
Texas Transportation Institute

Product 2136-2
Project Number 0-2136
Research Project Title: Revising the Pedestrian
Warrant for the Installation of a Traffic Signal

Sponsored by the
Texas Department of Transportation
In Cooperation with the
U.S. Department of Transportation
Federal Highway Administration

December 2000

TEXAS TRANSPORTATION INSTITUTE
The Texas A&M University System
College Station, Texas 77843-3135

DISCLAIMER

The contents of this report reflect the views of the authors, who are responsible for the facts and the accuracy of the data presented herein. The contents do not necessarily reflect the official views or policies of the Texas Department of Transportation (TxDOT) or the Federal Highway Administration (FHWA). This report does not constitute a standard, specification, or regulation. Not intended for construction, bidding, or permit purposes. The engineers in charge of the project were Paul Carlson, P.E. #85402 and Shawn Turner, P.E. #82781.

ACKNOWLEDGMENTS

The authors wish to acknowledge the support and guidance of Rick Collins, project director, of TxDOT's Traffic Operations Division. Additionally, the authors acknowledge the members of the project monitoring committee:

- Charles Comparini, San Antonio District, TxDOT;
- Paul Douglas, Transportation Planning and Programming Division, TxDOT;
- David Gerard, City of Austin, Texas;
- James Bailey, Traffic Operations Division, TxDOT; and
- Karen Akins, Trans-Texas Alliance.

The authors also acknowledge the following persons for their respective contributions:

- Suzee Brooks – for providing input on public safety concerns,
- Herman Huang – for providing numerous pictures of pedestrian crossings, and
- Ivan Lorenz – for developing high-quality images and drawings for the guidelines.

TABLE OF CONTENTS

	Page
LIST OF FIGURES	viii
LIST OF TABLES	x
CHAPTER 1. INTRODUCTION	1
Purpose of the Guidelines	1
Primary Design References and Other Resources	1
Organization of the Guidelines	2
CHAPTER 2. DEFINITIONS, TEXAS STATE LAW, AND PEDESTRIAN-VEHICLE CRASH CHARACTERISTICS	3
Definitions	3
Texas Law Pertaining to Pedestrian Crossings	4
Characteristics and Types of Pedestrian–Motor Vehicle Crashes	4
CHAPTER 3. PEDESTRIAN CROSSING TREATMENTS	7
Pedestrian Crossing Treatment Warrants	7
Pedestrian Crossing Examples	7
Basic Pedestrian Crossing Signs and Markings	15
Innovative Pedestrian Crossing Signs, Markings, and Other Treatments	24
Traffic Calming Measures	36
Proposed Revised Warrants for Traffic Signal Control	44
Grade Separation	44
Special Conditions: School Crossings and Special Events	48
Education and Enforcement Activities	51
REFERENCES	53
APPENDIX – TEXAS STATE LAW PERTAINING TO PEDESTRIAN CROSSINGS	57

LIST OF FIGURES

Figure		Page
1	Useful Pedestrian Crossing Guidebooks and References	2
2	Illustration of Terms Used in Pedestrian Crossing Guidelines	4
3	Use of Curb Extensions, Textured Crosswalks, and Median Refuge Islands	9
4	Use of Overhead Crossing Signs, Ladder-Style Crosswalk Markings, and Median Refuge Island	10
5	Use of Pedestrian Activated In-Roadway Lights and Flashing Beacons, Flourescent Yellow-Green Sign, and Median Refuge Island	11
6	Mid-Block Crosswalk Blocked by On-Street Parking and within 200 Feet of Stop- Controlled Intersection	12
7	Mid-Block Marked Crosswalk on Straight, Wide Street with Inadequate Median Refuge	13
8	Mid-Block Marked Crosswalk with Poor Visibility on Arterial Street	14
9	Basic Pedestrian Crossing with Crosswalk Sign and Markings	15
10	Advantages and Disadvantages of Various Crosswalk Marking Patterns	17
11	Crosswalk Marking Patterns in 2000 MUTCD	18
12	Smith and Knoblauch Crosswalk Marking Guidelines	20
13	Pedestrian Ahead/Crossing Sign (W11-2)	22
14	Pedestrian Crossing Sign (W11-2) with Supplemental Plaque (W16-7)	22
15	Use of Overhead Mast Arm and Flashing Beacons for Pedestrian Crossing Sign	23
16	Passive Detection of Pedestrians at Intersection Corners	23
17	Passive Detection of Crossing Pedestrians in Crosswalk	23
18	Schematic of In-Roadway Flashing Lights at a Pedestrian Crosswalk	25
19	In-Roadway Flashing Lights at Pedestrian Crosswalk	25
20	Supplemental Pedestrian Crossing Channelizing Device used in New York State	26
21	First Version of YIELD HERE Sign	27
22	Second Version of YIELD HERE Sign	27
23	Optional YIELD Lines in 2000 MUTCD	28
24	Use of YIELD Lines in Sweden	29
25	Optional Advanced Warning Markings for Speed Humps in 2000 MUTCD	30
26	Optional Pavement Markings for Speed Humps with Crosswalks in 2000 MUTCD ...	31
27	Animated Eyes Display with Pedestrian Signal Head	32
28	“LOOK RIGHT” Pavement Markings Used to Increase Awareness of Crossing Pedestrians – United Kingdom	33
29	Use of Zig-Zag Lines and Belisha Beacons to Warn of Upcoming Pedestrian Crossing – United Kingdom	34

LIST OF FIGURES (Continued)

Figure	Page
30	Use of Belisha Beacons at Zebra Pedestrian Crossings – United Kingdom 35
31	Plan View of Curb Extensions at Intersection (Neckdown) 37
32	Plan View of Curb Extensions at Mid-Block (Choker) 37
33	Curb Extension at an Intersection (Neckdown) – Bryan, Texas 37
34	Curb Extension at a Mid-Block Crossing (Choker) with Textured Crosswalk and Landscaping – Westminster, Maryland 38
35	Use of Median Refuge Island on Eight-Lane Arterial Street – College Station, Texas 39
36	Center Island Narrowing with Speed Cushions – Austin, Texas 40
37	Roadway Narrowing Using Raised Pavement Markings – Arlington, Texas 41
38	Plan View of Raised Intersection 42
39	Plan View of Raised Crosswalk 42
40	Raised Crosswalk Used Near High School Building – Ft. Worth, Texas 43
41	Pedestrian Use of Grade-Separated Crossings 45
42	Pedestrian Bridge over Five-Lane Arterial Street and Active Railroad Tracks – College Station, Texas 46
43	2000 MUTCD School Crossing Traffic Signal Warrant 49
44	Pedestrian Crossing Used Only During Special Events – College Station, Texas 50

LIST OF TABLES

Table		Page
1	Draft Recommendations for Installing Marked Crosswalks and Other Needed Pedestrian Improvements at Uncontrolled Locations	21

CHAPTER 1. INTRODUCTION

Purpose of the Guidelines

The purpose of this document is to recommend guidance and criteria on the provision of safe and effective pedestrian crossings. The guidelines should be useful to engineers and planners responsible for planning, designing, operating, and maintaining pedestrian facilities in Texas.

The guidelines are intended to outline the numerous alternatives that are available to address pedestrian safety problems or public concerns at roadway crossings. It is not the intent of the guidelines to recommend a specific pedestrian crossing treatment exclusive of conditions, nor to recommend specific design dimensions. General criteria and design dimensions used elsewhere may be provided with some treatments, but engineering judgement should be used in applying these criteria and designs.

Primary Design References and Other Resources

The guidelines are intended to supplement the following traffic engineering references:

- *TxDOT Highway Design Division's Operations and Procedures Manual*, 1994;
- *Manual on Uniform Traffic Control Devices (MUTCD)*, 2000 edition;
- Americans with Disabilities Act Accessibility Guidelines (ADAAG) – available at <http://www.access-board.gov/adaag/html/adaag.htm>; and
- Texas Accessibility Standards (TAS) - available at <http://www.license.state.tx.us/AB/tas/abtas.htm>.

The guidelines are largely a compilation of best practices from pedestrian guidebooks and design manuals shown in [Figure 1](#). Interested readers should refer to these guidebooks for additional or supporting information.

Design and Safety of Pedestrian Facilities, Report No. RP-026A, March 1998 (1). Available from the Institute of Transportation Engineers (ITE) on-line bookstore, <http://www.ite.org>, \$38 (\$30 ITE members).

Planning, Design, and Operation of Pedestrian Facilities, a guidebook currently under development in the National Cooperative Highway Research Program (NCHRP), expected publication in 2001.

Pedestrian Facilities Guidebook: Incorporating Pedestrians into Washington's Transportation System, September 1997 (2). Available from the Washington Department of Transportation, <http://www.wsdot.wa.gov/hlrld/PDF/PedFacGB.pdf>, no cost.

Pedestrian Crossing Control Manual, March 1998 (3). Available from the Transportation Association of Canada (TAC) on-line bookstore, <http://www.tac-atc.ca>, \$75 Canadian (\$49 Canadian TAC members).

1995 Oregon Bicycle and Pedestrian Plan, June 1995 (4). Available from the Oregon Department of Transportation, contact Michael Ronkin (michael.p.ronkin@odot.state.or.us) at (503) 986-3555.

Portland Pedestrian Design Guide, June 1998 (5). Available from the City of Portland, Oregon, contact the Pedestrian Transportation Program at (503) 823-7004.

Improving the Safety at Uncontrolled Pedestrian Crossings, an informational report currently under development by the Pedestrian and Bicycle Task Force, Institute of Transportation Engineers, expected publication in 2001.

Figure 1. Useful Pedestrian Crossing Guidebooks and References.

Organization of the Guidelines

The guidelines are organized as follows:

Chapter 2. Definitions, Texas State Law, and Pedestrian-Vehicle Crash Characteristics

This chapter defines terms, summarizes Texas State law as it relates to crosswalks and pedestrian right-of-way, and summarizes the characteristics of pedestrian-vehicle crashes.

Chapter 3. Pedestrian Crossing Treatments

This chapter describes the various treatments that can be used to provide safer and more effective pedestrian crossings. The chapter contains the following sections:

- [Pedestrian Crossing Treatment Warrants](#);
- [Pedestrian Crossing Examples](#);
- [Basic Pedestrian Crossing Signs and Markings](#);
- [Innovative Pedestrian Crossing Signs, Markings, and Other Treatments](#);
- [Traffic Calming Measures](#);
- [Proposed Revised Warrants for Traffic Signal Control](#);
- [Grade Separation](#);
- [Special Conditions: School Crossings and Special Events](#); and
- [Education and Enforcement Activities](#).

Appendix – Texas State Law Pertaining to Pedestrian Crossings

The [appendix](#) contains the full text of state laws related to crosswalks.

CHAPTER 2. DEFINITIONS, TEXAS STATE LAW, AND PEDESTRIAN-VEHICLE CRASH CHARACTERISTICS

This chapter defines terms used throughout the guidelines and summarizes Texas State law as it relates to crosswalks and pedestrian right-of-way. The chapter concludes with a summary of the characteristics of pedestrian–motor vehicle crashes to illustrate the context and need for improved roadway designs that better accommodate pedestrian travel.

Definitions

Texas State law (Transportation Code of Texas, Sec. 541.302) defines a crosswalk as:

“(A) the portion of a roadway, including an intersection, designated as a pedestrian crossing by surface markings, including lines; or

(B) the portion of a roadway at an intersection that is within the connections of the lateral lines of the sidewalks on opposite sides of the highway measured from the curbs or, in the absence of curbs, from the edges of the traversable roadway.”

The law defines a *marked crosswalk* as a pedestrian crossing that is designated by surface markings and an *unmarked crosswalk* as the extension of a sidewalk across intersecting roadways (Figure 2). Thus Texas State law recognizes both marked and unmarked crosswalks but makes no legal distinction between the two in assigning pedestrian right-of-way.

A *mid-block crossing* is a pedestrian crossing that is not located at a roadway intersection (Figure 2). If a mid-block crossing is not designated by a marked crosswalk, then pedestrians must yield the right-of-way to motorists (see following section).

An *uncontrolled location* is a roadway intersection or other mid-block crossing that is not controlled by either a traffic signal or a stop sign. Uncontrolled locations can be the most challenging places to provide a safe pedestrian crossing.

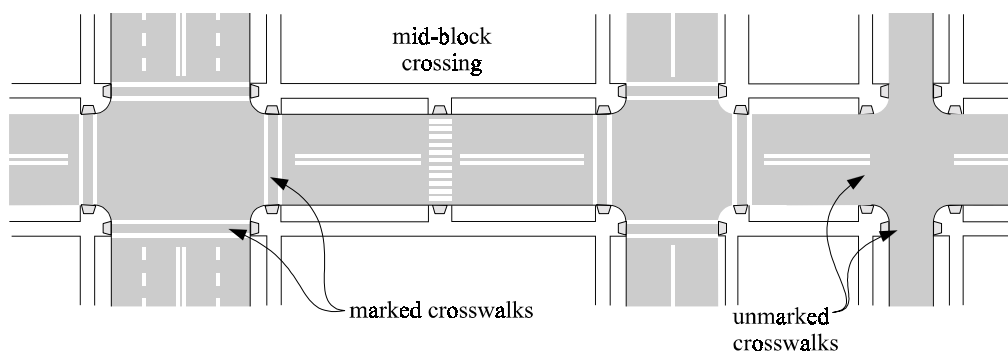


Figure 2. Illustration of Terms Used in Pedestrian Crossing Guidelines.

Texas Law Pertaining to Pedestrian Crossings

Texas State law (Transportation Code of Texas, Sec. 552.003) includes the following regulations regarding pedestrian crossings (see [Appendix](#) for full text of the statute):

- Vehicle operators must yield the right-of-way to pedestrians in a crosswalk if no traffic signal control is in place or in operation (Sec. 552.003(a)).
- A pedestrian may not suddenly proceed into the path of a vehicle so close that it is impossible for the vehicle operator to yield (Sec. 552.003(b)).
- A pedestrian must yield the right-of-way to vehicle operators when crossing the roadway at a place a) other than a marked or unmarked crosswalk at an intersection, or b) where a pedestrian tunnel or overhead pedestrian crossing has been provided (Sec. 552.005(a)).
- When traffic control signals are in operation at adjacent intersections, pedestrians may cross only in a marked crosswalk (Sec. 552.005(b)).
- Vehicle operators emerging from or entering an alley, building entrance, or private road or driveway must yield the right-of-way to a pedestrian approaching on a sidewalk extending across said alley, building entrance, or private road or driveway (Sec. 552.006(c)).

Characteristics and Types of Pedestrian–Motor Vehicle Crashes

To provide safer pedestrian crossings, it is important to understand the characteristics of pedestrian–motor vehicle crashes. Pedestrians are clearly over-represented in crash and fatality statistics. On average, pedestrians account for 14 percent of all motor vehicle–related fatalities in

the United States (6). More striking, however, is that pedestrian travel accounts for only 5 percent of all person-trips and less than 1 percent of all person-miles traveled (7).

The following summary points are from a 1996 pedestrian/bicycle crash typing study (5,000+ crashes) performed in the states of California, Florida, Maryland, Minnesota, North Carolina, and Utah (8):

- **Young persons (under 25 years of age) were over-represented in pedestrian crashes.** The most common types of crashes involving young children (under 14 years of age) were a) pedestrian ran into intersection and/or motorist's view was blocked (7.2 percent of all crashes), and b) pedestrian mid-block dart out/dash (13.3 percent of all crashes).
- **Pedestrian crashes occurred most frequently during the late afternoon and early evening hours, a time when exposure was likely highest and visibility may have been a problem.** Contrasting this conclusion, however, was the finding that the majority of pedestrian crashes occurred during daylight conditions (61 percent of all crashes) and when the weather was clear (71 percent of all crashes).
- **A majority of the crashes occurred on two-lane, undivided roadways where the speed limit was 35 mph or less.** Nearly 42 percent of crashes occurred on local streets, with another 24 percent occurring on county routes.
- **Where traffic controls were present, pedestrian injuries were less severe (presumably due to lower vehicle speeds).** However, no traffic control was present in over 71 percent of all the crashes. Roadway medians were present in less than 3 percent of pedestrian crashes, and researchers associated the presence of a median with higher serious injury rates.
- **Forty-one percent of the crashes occurred at roadway intersections and an additional 8 percent at driveway or alley intersections.**

A local analysis of 1994 to 1996 pedestrian crash data from Travis County, Texas (city of Austin and environs), had different findings in regard to pedestrian crash locations. The Trans Texas Alliance found the following (9):

- **More crashes in Travis county occurred while pedestrians were crossing at locations other than an intersection or crosswalk.** Only 23 percent of pedestrian crashes in Travis county occurred when the pedestrian was attempting to cross the street at an intersection or crosswalk, whereas 42 percent of the pedestrian crashes occurred while the pedestrian was crossing at locations other than an intersection or crosswalk.
- **Fatalities were much higher when pedestrian crashes occurred at locations other than an intersection or crosswalk (presumably due to speed of vehicle).** About 67

percent of all fatalities occurred at locations other than an intersection or crosswalk. This finding is consistent with a finding of the crash typing study summarized above.

These two sets of crash study findings lead to the following important points about providing safe pedestrian crossings:

- **Pedestrian crossings require good visibility for motorists to recognize pedestrians and yield the right-of-way.** Considerations for good visibility include adequate street lighting, removal of on-street parking in the vicinity of crossings, and curb extensions that place the waiting or crossing pedestrian in the motorists' field-of-view.
- **Good design calls for controlled vehicle speeds in the vicinity of pedestrian crossings.** Control of vehicle speeds is most often accomplished through good street design, traffic calming measures, or application of appropriate traffic control devices.
- **Pedestrian crossing design should encourage pedestrian use at designated crossing locations.** Driver expectancy is better met when pedestrians cross the roadway at designated locations. These designated crossing locations should be convenient for pedestrians and should not require undue or circuitous travel.

CHAPTER 3. PEDESTRIAN CROSSING TREATMENTS

This chapter describes the various treatments and alternatives that can provide safer and more effective pedestrian crossings. The chapter contains sections on each of the major types of pedestrian crossing treatments, and the sections are organized into a control hierarchy that moves from least restrictive to most restrictive. The chapter includes the following sections:

- [Pedestrian Crossing Treatment Warrants](#);
- [Pedestrian Crossing Examples](#);
- [Basic Pedestrian Crossing Signs and Markings](#);
- [Innovative Pedestrian Crossing Signs, Markings, and Other Treatments](#);
- [Traffic Calming Measures](#);
- [Proposed Revised Warrants for Traffic Signal Control](#);
- [Grade Separation](#);
- [Special Conditions: School Crossings and Special Events](#); and
- [Education and Enforcement Activities](#).

Pedestrian Crossing Treatment Warrants

Quantitative criteria-based warrants are not provided here for the various pedestrian crossing treatments. The literature shows that “the use of strict engineering criteria, [when used to deal with emotional issues or perceived problems of pedestrian safety], often misses these concerns and leads to public frustration and political unrest” (10). Instead, guidelines and qualitative criteria are given here to provide flexibility in addressing unique problems in local areas. Readers interested in using or applying pedestrian crossing treatment warrants should consult those warrants developed by the Transportation Association of Canada (see [Figure 1](#) for contact information) or by the City of Boulder, Colorado.

Pedestrian Crossing Examples

One approach to creating or designing a safe and convenient pedestrian crossing is to first study good and bad examples. This chapter starts with examples that illustrate good and bad design at pedestrian crossings. All of the good examples contain one or more of the following attributes of a safe and convenient pedestrian crossing:

- **The street crossing task is made simple and convenient for pedestrians.** This approach includes elements such as 1) minimizing the crossing distance by using curb extensions, 2) providing median refuge islands so that pedestrians can cross one direction at a time, 3) adjusting signal timing patterns to minimize pedestrian conflicts with right- or left-turning vehicles, and 4) providing appropriate pushbuttons and walk signals at signalized intersections to indicate when pedestrians may cross.

- **The crossing location and any waiting or crossing pedestrian(s) have excellent visibility.** Advance visibility provides additional reaction time for motorists to recognize pedestrians and yield the right-of-way. Considerations for good visibility include adequate street lighting, removal of on-street parking in the vicinity of crossings, and curb extensions that place the waiting or crossing pedestrian in the drivers' field-of-view. Advance signing and innovative crosswalk marking can also be used to improve visibility of crosswalk locations.
- **Motor vehicle speeds are slowed or controlled in the vicinity of the pedestrian crossing.** Slower vehicle speeds provide more reaction time for the motorist and the pedestrian, as well as translating to less serious injuries if a pedestrian-vehicle crash occurs. A [later section in this chapter](#) describes how traffic calming measures can be used to slow or better control vehicle speeds.
- **Enforcement personnel use periodic enforcement (where and when necessary) to ensure that vehicle drivers yield the right-of-way to pedestrians.** Despite the fact that most states have laws that give the right-of-way to pedestrians in crosswalks, driver disregard for these laws is quite common. Periodic police enforcement can help pedestrians gain more respect from motorists.
- **Pedestrians are encouraged to use designated crossing locations and to obey applicable state and local traffic laws.** Pedestrian disregard for established laws can lead to resentment by motorists and eventual motorist disregard to pedestrian right-of-way.

Figure 3 provides an example of good pedestrian crossing design. All of the intersection corners have curb extensions that reduce the crossing distance and improve pedestrian visibility. The crosswalks are constructed of brick pavers that improve the visibility of the crossing. A wide, landscaped median island provides refuge for pedestrians crossing the four-lane arterial street.



Figure 3. Use of Curb Extensions, Textured Crosswalks, and Median Refuge Islands.
(Photo courtesy of Herman Huang,
University of North Carolina (UNC) Highway Safety Research Center)

Figure 4 provides another example of good pedestrian crossing design. Overhead pedestrian crossing signs and supplemental lighting provide better visibility to this crossing. A median refuge island permits pedestrians to cross one direction of traffic at a time. Ladder-style crosswalk markings lend additional visibility to the pedestrian crossing.



Figure 4. Use of Overhead Crossing Signs, Ladder-Style Crosswalk Markings, and Median Refuge Island.

(Photo courtesy of Herman Huang, UNC Highway Safety Research Center)

Figure 5 shows the application of in-roadway and sign-mounted flashing lights at a pedestrian crossing. This crossing connects a major city government building to its parking lot but has visibility problems because of the tree canopy over the street. Pedestrians can activate in-roadway flashing lights (not visible in this picture) and flashing beacons using a push button at the curb. These flashing lights and the fluorescent yellow-green pedestrian crossing sign improve the visibility of pedestrians using the crosswalk. The median refuge island allows pedestrians to cross one direction of traffic at a time. The in-roadway lights at this location have also helped to increase the number of motorists yielding to pedestrians. Despite the increased yield compliance and the inclusion of in-roadway lights in the 2000 MUTCD, however, there has been some disagreement locally about whether this crossing represents good design.



Figure 5. Use of Pedestrian Activated In-Roadway Lights and Flashing Beacons, Fluorescent Yellow-Green Sign, and Median Refuge Island.

Figure 6 provides an example of things to avoid when designing a pedestrian crossing. This crossing is located on a collector street approximately 200 feet prior to a stop-controlled intersection. Additionally, the crossing does not connect major pedestrian traffic generators—it serves only as an encouraged shortcut for pedestrian trips that would otherwise cross at the nearest intersection 200 feet away. Although generous Americans with Disabilities Act (ADA)-compliant ramps have been provided for the crossing, parked vehicles often make the ramps impossible to use. On-street parking in the vicinity of the crossing also reduces the visibility of pedestrians waiting or proceeding to cross the street.



Figure 6. Mid-Block Crosswalk Blocked by On-Street Parking and within 200 Feet of Stop-Controlled Intersection.

Figure 7 provides an example of a pedestrian crossing that engineers could improve with the addition of several basic design elements. This pedestrian crossing, located along a collector street, connects relatively new suburban development to a shared-use path, a middle school, and a neighborhood park. Although traffic volumes are relatively low at this time, the wide, straight, and flat nature of this street encourages high vehicle speeds (the street is currently posted at 35 mph). A median refuge island could be placed in the center two-way left turn lane to provide pedestrian refuge, and roadway narrowing in the vicinity of the median refuge island would help to control vehicle speeds. If vehicle speeds at this crossing are high and the pedestrian volumes are significant, a raised crosswalk could also be used to control vehicle speeds. If traffic volumes increase and young or elderly pedestrians have trouble finding adequate gaps, in-roadway flashing lights could be installed to encourage motorists to yield to pedestrians.



Figure 7. Mid-Block Marked Crosswalk on Straight, Wide Street with Inadequate Median Refuge.

Figure 8 provides another example of a pedestrian crossing that could be improved with the addition of several crossing treatments. The existing crossing location connects neighborhoods (left side of picture) to a neighborhood swimming pool and park (right side of picture). The crossing is on a four-lane arterial street with a center, two-way left turn lane. The visibility of the crossing could be substantially improved with high-visibility crosswalk markings and overhead signs. Pedestrian-activated (or passive detection) flashers could be used in addition to the overhead signing. A median refuge island could be placed in the center two-way left turn lane to provide pedestrian refuge.



Figure 8. Mid-Block Marked Crosswalk with Poor Visibility on Arterial Street.

Basic Pedestrian Crossing Signs and Markings

The 2000 MUTCD contains basic information on pedestrian crossing warning signs and crosswalk markings. Information is also provided on the application of pedestrian signal heads but is not included here. [Figure 9](#) shows a basic pedestrian crossing, which typically consists of crosswalk markings and side or overhead-mounted pedestrian warning signs (in this [figure](#), the side-mounted sign is partially obstructed by a disabled parking sign). Flashing beacons are sometimes provided with the pedestrian crosswalk signs. The following sections provide specific information on the location and designs of these signs and crosswalk markings.



Figure 9. Basic Pedestrian Crossing with Crosswalk Sign and Markings.

Crosswalk Markings

Texas law recognizes both marked and unmarked crosswalks but makes no legal distinction between the two in defining pedestrian right-of-way (see [Figure 2](#) and discussion in [Chapter 2](#)). Crosswalks are marked to 1) indicate the preferred crossing path to pedestrians, and 2) alert motorists to the presence of pedestrian crossing locations. [Figure 10](#) illustrates various types of

crosswalk markings used in the U.S. and in Europe, and [Figure 11](#) shows the crosswalk marking patterns in the 2000 MUTCD. The standard crosswalk marking consists of two parallel white lines, spaced between six and ten feet apart. Variations include the use of diagonal lines, longitudinal lines, and other marking patterns to increase visibility. The MUTCD ([11](#)) states that crosswalks:

SHALL

- have 6-inch minimum width markings consisting of solid white lines across the roadway.

SHOULD

- have 6-foot minimum crosswalk width,
- be used where substantial pedestrian and vehicle conflicts exist,
- be used at appropriate points of pedestrian concentration or where pedestrians could not otherwise recognize the proper place to cross (e.g., loading islands, mid-block pedestrian crossings),
- not be used indiscriminately,
- be installed based on an engineering study if located other than at a STOP sign or traffic signal, and
- have advance warning signs if installed mid-block where pedestrians are not expected, and allow for restriction of parking for adequate visibility.

MAY

- be marked with white diagonal or longitudinal lines (parallel to vehicle traffic) for added visibility,
- omit the transverse crosswalk lines when the extra markings are added, and
- use unique markings for diagonal crossings at signals when an appropriate exclusive pedestrian phase is used.

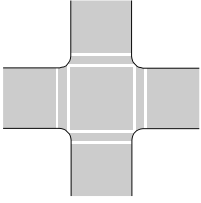
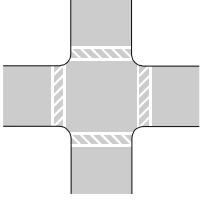
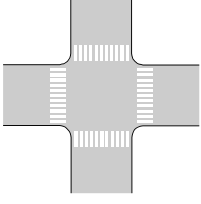
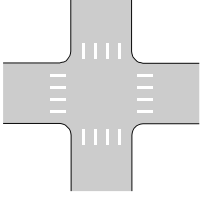
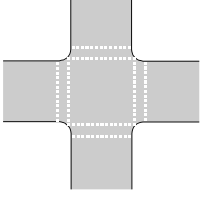
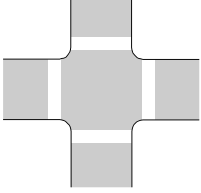
<i>Marking Pattern</i>	<i>Advantages</i>	<i>Disadvantages</i>
	<p>Common practice at stop-controlled intersections, less expensive, easy to install and maintain</p>	<p>Not as visible as some other marking types; bars tend to wear faster than other types; not appropriate for mid-block locations</p>
	<p>Highly visible</p>	<p>More maintenance required since wheel friction rubs off diagonal stripes; surface can be slippery</p>
	<p>Highly visible</p>	<p>Wider stripes rub off with wheel friction but can be placed to minimize this effect; surface can be slippery</p>
	<p>Highly visible and becoming more commonly used; easy to maintain since stripes can be placed outside the wheel friction areas</p>	
	<p>Captures attention because it is not a commonly used pattern</p>	<p>May not define space as well as some of the other choices</p>
	<p>Visible (but may not be as eye catching as other patterns); not commonly used</p>	<p>Expensive; more difficult to install and maintain; surface can be slippery</p>

Figure 10. Advantages and Disadvantages of Various Crosswalk Marking Patterns (2).

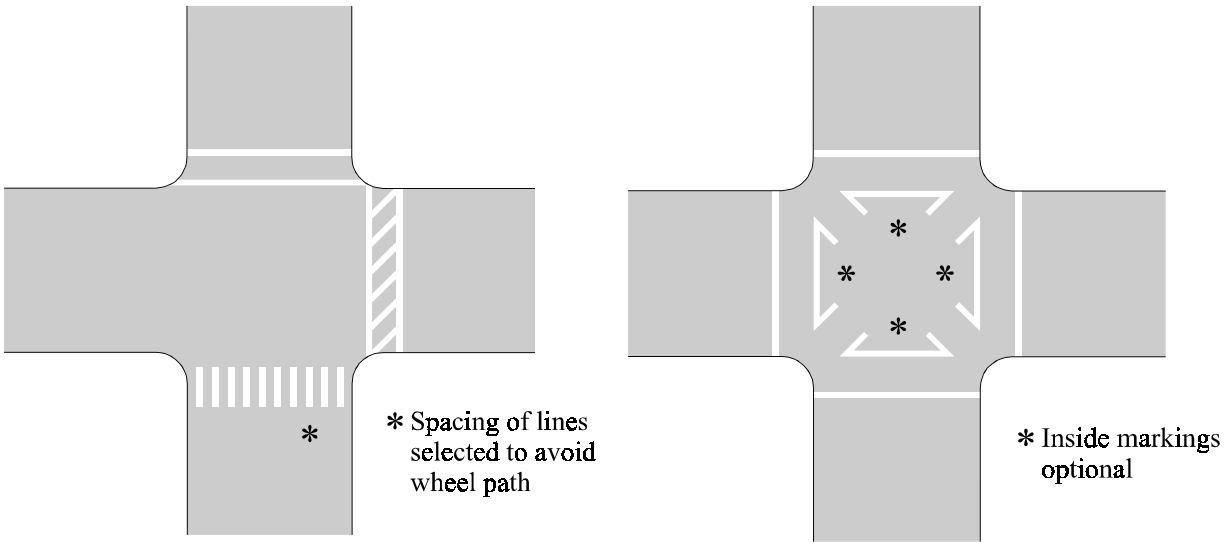


Figure 11. Crosswalk Marking Patterns in 2000 MUTCD (11).

There is considerable and ongoing debate about the safety and effectiveness of marked versus unmarked crosswalks at uncontrolled locations (i.e., no traffic signal or stop sign). Some engineers advocate the conservative use of crosswalk markings at uncontrolled locations because they believe that:

- there are no safety benefits from marking crosswalks, and in some cases, higher pedestrian crash risk can result at marked crosswalks (12,13);
- marked crosswalks provide pedestrians with a false sense of security, thus pedestrians may not use due caution when crossing in a marked crosswalk; and
- marked crosswalks are much less visible to motorists than to pedestrians, and even if they are visible, motorists typically disregard them.

Advocates for marked crosswalks assert that:

- marked crosswalks send an important message that the crosswalk area is a defined pedestrian crossing space that should not be intruded;
- because pedestrians have the legal right-of-way in marked or unmarked crosswalks, they should expect some degree of protection from motor vehicles and should be able to display a sense of security that motorists will obey the law; and

- poor safety records at marked crosswalks are indicative of motorist disregard for traffic laws and should be treated as such with higher levels of police enforcement.

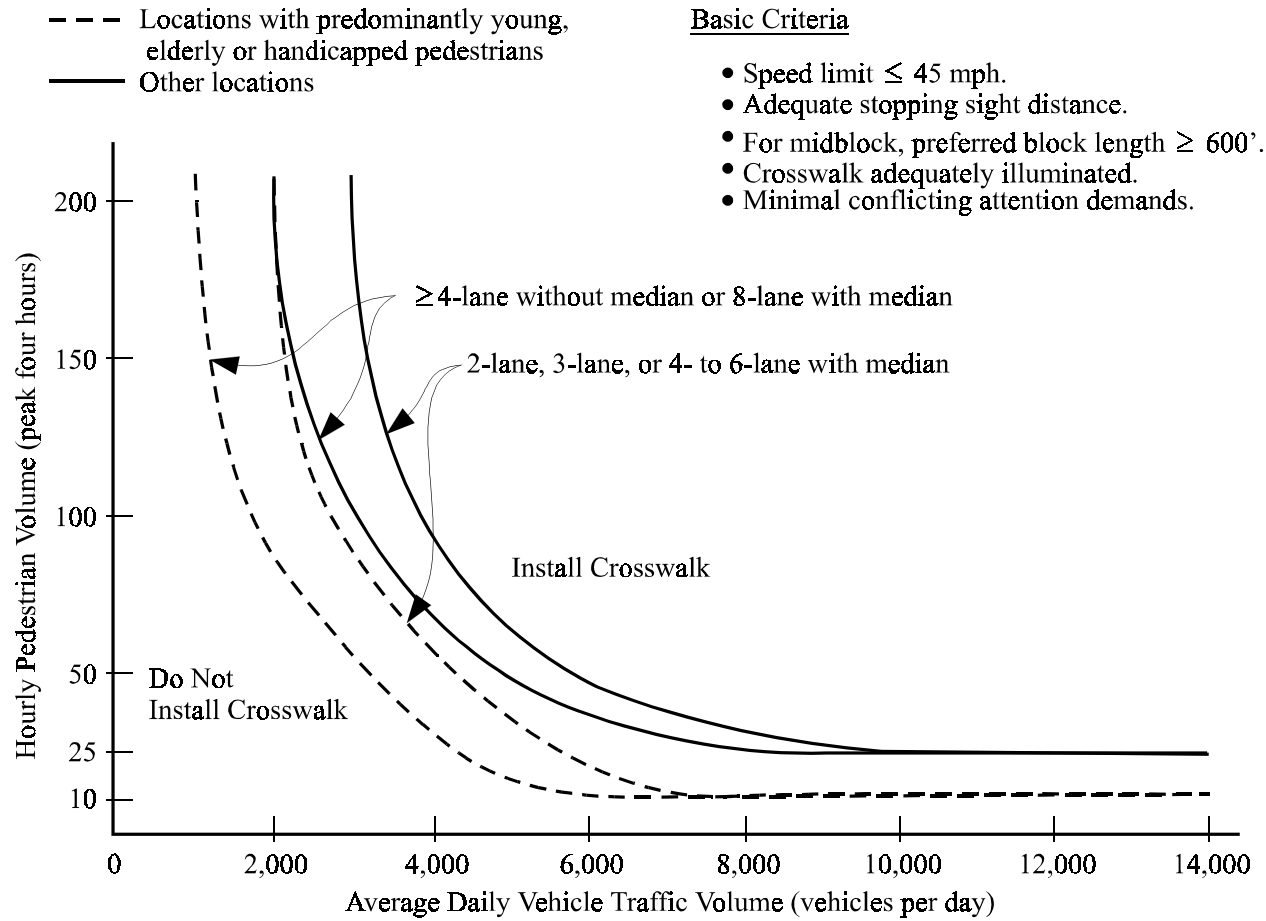
The debate about marked versus unmarked crosswalks will likely continue for quite some time. The recommended philosophy at this time appears in the MUTCD, which says that “crosswalk markings should not be used indiscriminately.” For marked crosswalks to be effective, they should be located and designed using sound engineering judgment and practice. The recommended engineering practice at this time relies on two sets of guidelines:

- Smith and Knoblauch guidelines (*14*), 1987 ([Figure 12](#)) and
- Zegeer, Stewart, and Huang guidelines (*15*), 2000 ([Table 1](#)).

In addition to these two sets of guidelines, the ITE Recommended Practice (*1*) is as follows:

“Marked crosswalks are generally recommended under the following conditions:

- signalized intersections with pedestrian signal indications or substantial pedestrian crossings;
- where a marked crosswalk can concentrate or channelize multiple pedestrian crossings to a single location;
- where there is a need to delineate the optimal crossing location when it is unclear because of confusing geometrics or traffic operations;
- at approved school crossings or for crossings on recommended safe school routes;
- at other locations with significant pedestrian crossings and pedestrian and vehicle conflicts.”



1. If using only peak hour, pedestrian volume threshold must be increased by 1.5.
2. For streets with a median, use one-way (directional) average daily traffic volume.

Other notes: Minimum striping is 6" parallel lines. Consider bolder markings and/or supplementary advanced markings or signing at uncontrolled locations where speed limits exceed 35 mph.

Figure 12. Smith and Knoblauch Crosswalk Marking Guidelines (14).

Table 1. Draft Recommendations for Installing Marked Crosswalks and Other Needed Pedestrian Improvements at Uncontrolled Locations* (15).

Roadway Type	Vehicle ADT: ≤ 9,000			Vehicle ADT: 9,000 to 12,000			Vehicle ADT: 12,000 to 15,000			Vehicle ADT: > 15,000		
	Speed Limit**											
	≤ 30 mph	35 mph	≥ 40 mph	≤ 30 mph	35 mph	≥ 40 mph	≤ 30 mph	35 mph	≥ 40 mph	≤ 30 mph	35 mph	≥ 40 mph
2-lane	C	C	P	C	C	P	C	C	N	C	P	N
3-lane	C	C	P	C	P	P	P	P	N	P	N	N
Multi-lane (4 or more lanes) with raised median	C	C	P	C	P	N	P	P	N	N	N	N
Multi-lane (4 or more lanes) without raised median	C	P	N	P	P	N	N	N	N	N	N	N

* These guidelines include intersection and mid-block locations with no traffic signals or stop sign on the approach to the crossing. They do not apply to school crossings. A two-way center turn lane is not considered a median. Crosswalks should not be installed at locations which could present an increased safety risk to pedestrians, such as where there is poor sight distance, complex or confusing designs, substantial volumes of heavy trucks, or other dangers, without first providing adequate design features and/or traffic control devices. Adding crosswalks alone will **not** make crossings safer, nor necessarily result in more vehicles stopping for pedestrians. Whether marked crosswalks are installed, it is important to consider other pedestrian facility enhancements, as needed, to improve the safety of the crossing (e.g., raised median, traffic signal, roadway narrowing, enhanced overhead lighting, traffic calming measures, curb extensions). **These are general recommendations; good engineering judgment should be used in individual cases for deciding where to install crosswalks.**

C = Candidate sites for marked crosswalks. Marked crosswalks must be installed carefully and selectively. Before installing new marked crosswalks, an engineering study is needed to show whether the location is suitable for a marked crosswalk. For an engineering study, a site review may be sufficient at some locations, while a more in-depth study of pedestrian volumes, vehicle speeds, sight distance, vehicle mix, etc. may be needed at other sites. It is recommended that a minimum of 20 pedestrian crossings per peak hour (or 15 or more elderly and/or child pedestrians) exist at a location before placing a high priority on the installation of a marked crosswalk.

P = Possible increase in pedestrian crash risk may occur if crosswalks are added without other pedestrian facility enhancements. These locations should be closely monitored and enhanced with other pedestrian crossing improvements, if necessary, before adding a marked crosswalk.

N = Marked crosswalks are not recommended, since pedestrian crash risk may be increased with marked crosswalks. Consider using other treatments, such as traffic signals with pedestrian signals to improve crossing safety for pedestrians.

† The raised median or crossing island must be at least 4 ft. wide and 6 ft. long to adequately serve as a refuge area for pedestrians in accordance with MUTCD and American Association of State Highway and Transportation Officials (AASHTO) guidelines.

Pedestrian Crossing Signs

Previous editions of the MUTCD recommended that an advance warning sign (W11-2) be used in conjunction with a pedestrian crossing sign (W11-2a, showing the pedestrian figure in a crosswalk), which was to be placed immediately adjacent to the crossing. Because motorist comprehension of and distinction between these two pedestrian crossing signs was poor, the 2000 MUTCD recognizes a single pedestrian crossing sign (W11-2), shown here as [Figure 13](#). When used in advance of the pedestrian crossing, the sign is intended to warn motorists of an upcoming pedestrian crossing. When the sign in [Figure 13](#) is used at a pedestrian crossing, a diagonal downward pointing arrow plaque (W16-7) ([Figure 14](#)) is required only when the crossing location is not delineated by crosswalk pavement markings.



**Figure 13. Pedestrian Ahead/
Crossing Sign (W11-2) (II).**



**Figure 14. Pedestrian Crossing Sign (W11-2)
with Supplemental Plaque (W16-7) (II).**

The 2000 MUTCD permits the use of fluorescent yellow-green pedestrian and school crossing signs. However, engineers should use a single color scheme (either standard yellow or fluorescent yellow-green) within a particular crossing area or zone.

Engineers in some areas have chosen to mount pedestrian crossing signs on an overhead mast arm to increase the visibility of the pedestrian crossing sign ([Figure 15](#)). Flashing beacons are sometimes used to increase the visibility of pedestrian crossing signs, although many engineers question their effectiveness. It has been suggested that flashing beacons will be most effective if they flash **ONLY** when pedestrians are present in the crosswalk or sidewalk area, although no definitive research could be found. Pedestrian-activated flashing beacons can be used, but the most effective operation can be accomplished by installing microwave, infrared, or other automatic pedestrian detectors ([Figures 16 and 17](#)) that prompt flashing operation only when pedestrians are present. More information on these pedestrian detection devices can be found at the FHWA-sponsored PedSmart web site (<http://www.walkinginfo.org/pedsmart/>).



Figure 15. Use of Overhead Mast Arm and Flashing Beacons for Pedestrian Crossing Sign.

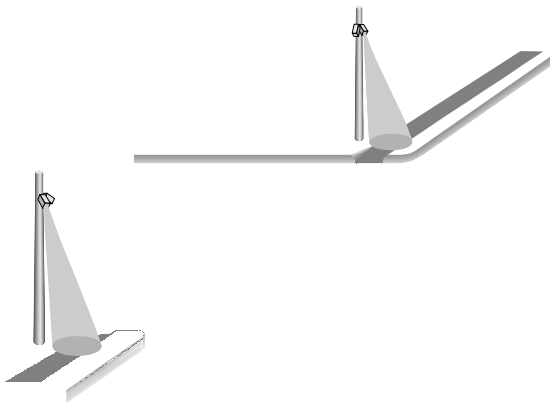


Figure 16. Passive Detection of Pedestrians at Intersection Corners.

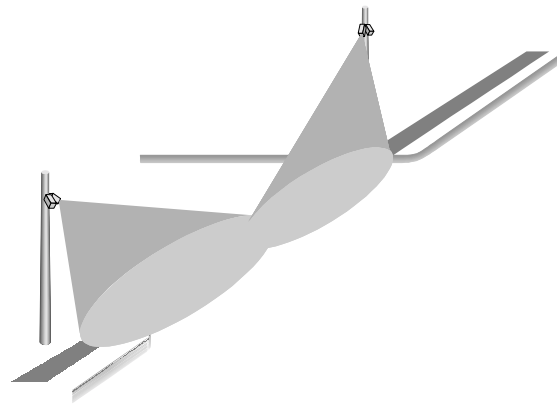


Figure 17. Passive Detection of Crossing Pedestrians in Crosswalk.

Innovative Pedestrian Crossing Signs, Markings, and Other Treatments

This section contains information on innovative signs, markings, and other engineering treatments that can be used at pedestrian crossings. Most of these innovative treatments are intended to improve the visibility of the crosswalk or warn motorists when pedestrians are present at the crossing area. Two of the treatments are intended to improve pedestrian awareness at the crossing location.

The 2000 MUTCD does not contain some of the traffic control devices in this section. Some of the devices, though, have been introduced in the 2000 MUTCD or are contained in other states' or countries' traffic control device manuals. Before using any traffic control device that is not included in the national MUTCD, the interested state or locality should submit a request for permission to experiment to FHWA's Office of Highway Safety (HHS-10), 400 Seventh Street SW, Washington, D.C. 20590. Guidelines for conducting an experiment can be found at the FHWA's Office of Highway Safety web site (http://www.ohs.fhwa.dot.gov/devices/1a_6.html).

In-Roadway Flashing Lights

California first introduced in-roadway flashing lights at pedestrian crosswalks in 1993, and these lights have since been implemented at numerous other locations in California, Washington State, Florida, Maryland, New York, and Texas. Although different vendors offer slightly different products, the basic component of most systems is roadway surface-mounted, amber lights that can flash either upon pedestrian activation or upon automatic pedestrian detection (Figures 18 and 19). The unit costs for systems bid in Kirkland, Washington, in early 1999 were between \$15,000 and \$18,000 (16).

As indicated by the growing pace of their implementation, these systems have been considered effective in terms of increased percentages of motorists yielding to pedestrians at crosswalks. California's Traffic Control Device Committee has recently endorsed in-roadway lighting for crosswalks. In-roadway lights have been added to Section 4L of the 2000 MUTCD. This new section includes both standards and guidance for the design and operation of in-roadway lights (if used). The standards include the following:

- in-roadway lights are installed parallel to the edge of the crosswalk;
- flashing operation is to be based upon pedestrian actuation (either active or passive);
- flashing operation will cease at a predetermined time after actuation, or with passive detection, once the pedestrian clears the crosswalk;
- installation of marked crosswalks requires applicable warning signs; and
- height of in-roadway lights is not to exceed 0.75 inch.

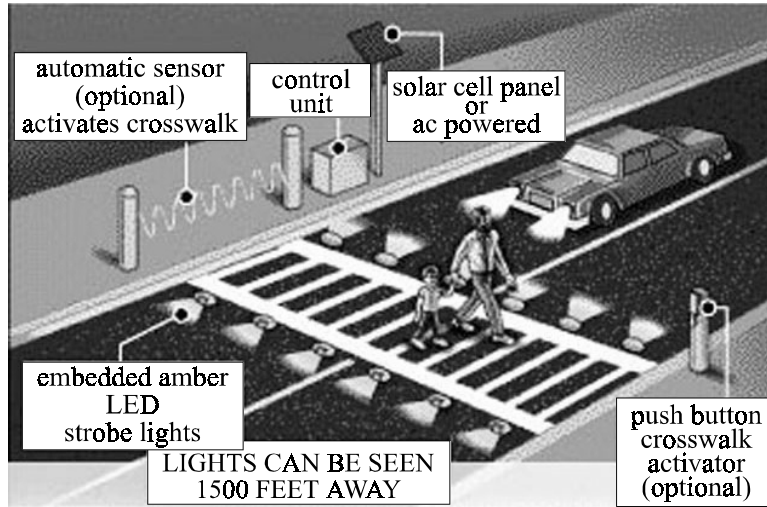


Figure 18. Schematic of In-Roadway Flashing Lights at a Pedestrian Crosswalk.
 (Figure courtesy of Lightguard Systems, Inc.)



Figure 19. In-Roadway Flashing Lights at Pedestrian Crosswalk.
 (Photo courtesy of Lightguard Systems, Inc.)

Supplemental Pedestrian Crossing Channelizing Devices (SPCCD)

The SPCCD is essentially a plastic safety cone that supports pedestrian crosswalk warning signs in the middle of the roadway for improved visibility to motorists (Figure 20). The device is now included in the New York State MUTCD, which specifies that the crosswalk sign can be used on the SPCCD or on a separate roadside sign (17). The SPCCD has been crash-tested by the New Jersey State Police and has been evaluated by the University of North Carolina’s Highway Safety Research Center. In their evaluation (18), Huang and Cynecki found increased percentages of motorists yielding to pedestrians after installation of the SPCCD (69.8 percent yielding before vs. 81.2 percent yielding after).



Figure 20. Supplemental Pedestrian Crossing Channelizing Device used in New York State.
(Photo courtesy of Herman Huang, UNC Highway Safety Research Center)

New Signs and Markings Introduced in or Proposed for the 2000 MUTCD

The 2000 MUTCD introduces or had proposed several new traffic control devices that have applicability to pedestrian crossings:

- “YIELD HERE” signs,
- YIELD lines, and
- advanced warning marking for speed humps.

A review draft of the 2000 MUTCD had proposed “YIELD HERE” signs (Figures 21 and 22) for placement at pedestrian crossing locations. These signs were not included in the final published version of the 2000 MUTCD. It is not known at this time whether any locations have experimented with these signs.



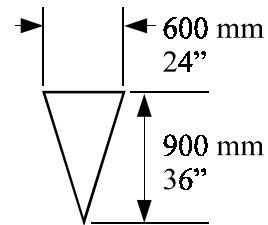
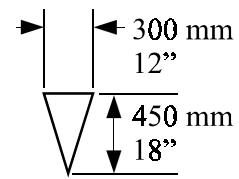
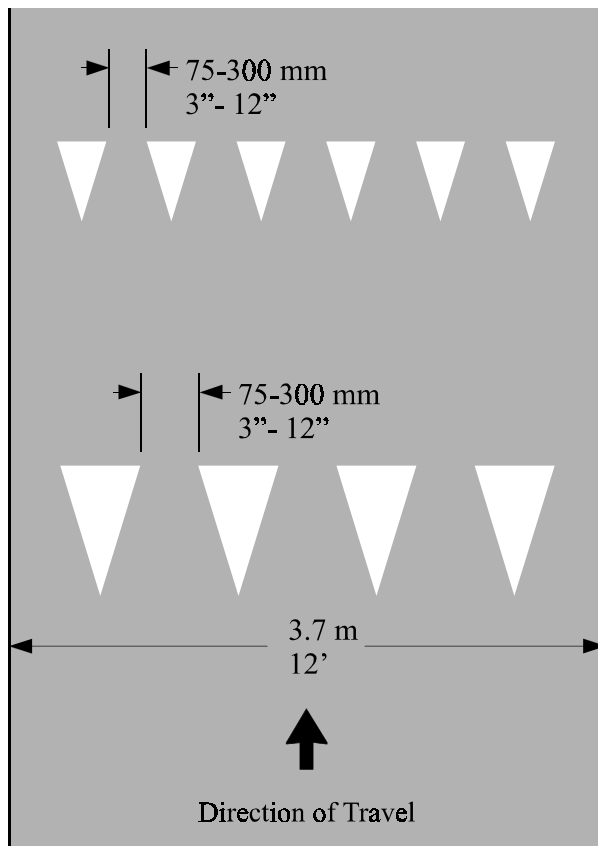
Figure 21. First Version of YIELD HERE Sign (11).



Figure 22. Second Version of YIELD HERE Sign (11).

The FHWA added YIELD lines to the 2000 MUTCD (as an option) to indicate the point behind which vehicles are required to yield. YIELD lines consist of a row of isosceles triangles extending across approach lanes, with one point of the triangles pointing toward approaching vehicles (Figure 23). It is not known at this time whether any locations in the United States have experimented with these signs, although their use is prevalent in Sweden (Figure 24).

The FHWA also added advanced warning markings for speed humps to the 2000 MUTCD (Figure 25). These pavement markings also could be applied where speed humps are used with crosswalks (see Figure 26 for pavement markings for speed humps with crosswalks). Although the advance warning markings have not been proposed specifically for marked crosswalks, these markings could potentially be used as a supplemental device to warn motorists of an upcoming pedestrian crosswalk. The use of pavement markings to warn motorists in advance of a pedestrian crossing has also been used in European countries (see next section).



Notes:

Triangle length is equal to 1.5 times the base dimension.

Yield lines may be smaller than suggested when installed on much narrower, slow-speed facilities such as shared-use paths

Figure 23. Optional YIELD Lines in 2000 MUTCD (11).



Figure 24. Use of YIELD Lines in Sweden (19).

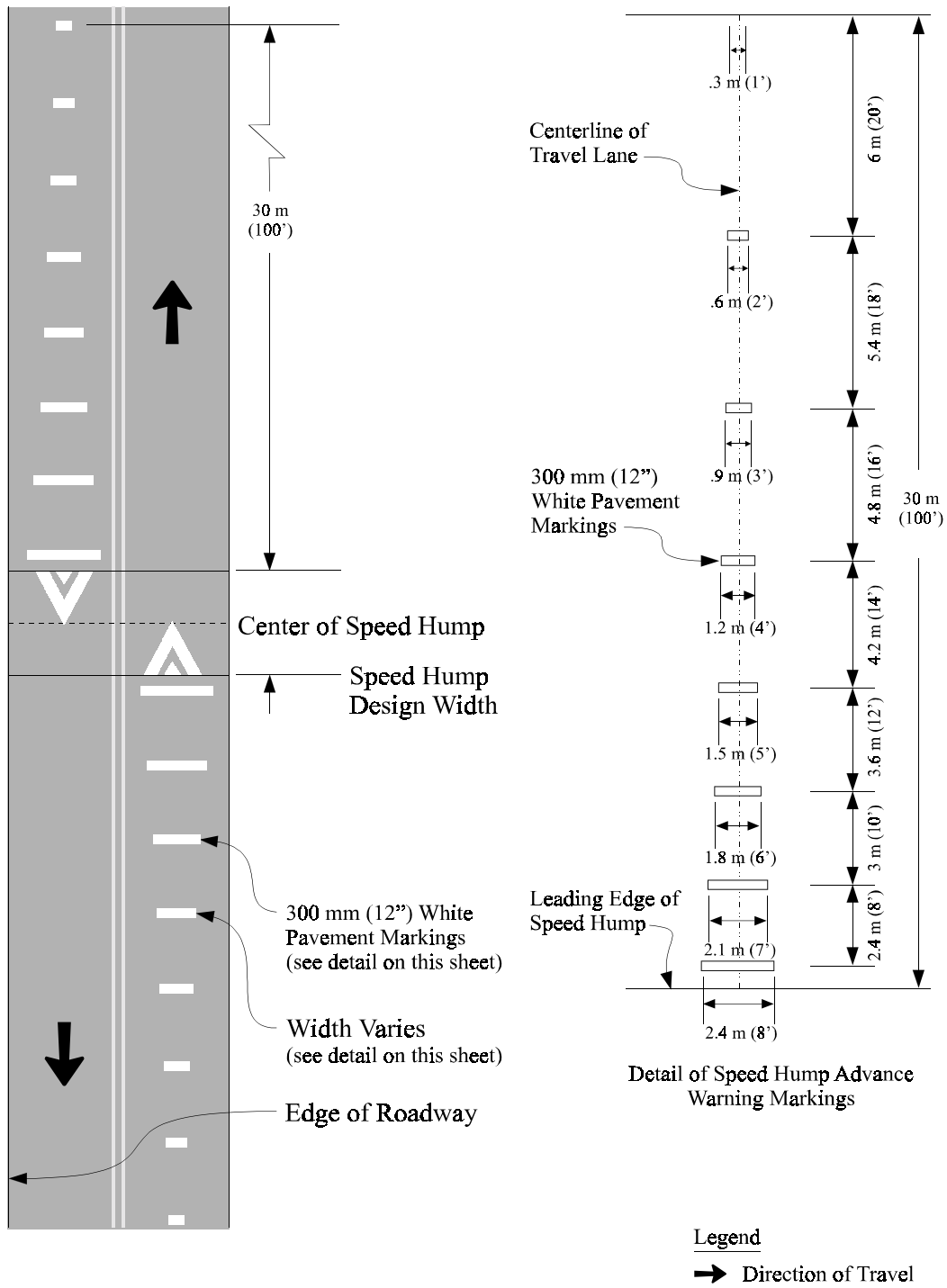


Figure 25. Optional Advanced Warning Markings for Speed Humps in 2000 MUTCD (II).

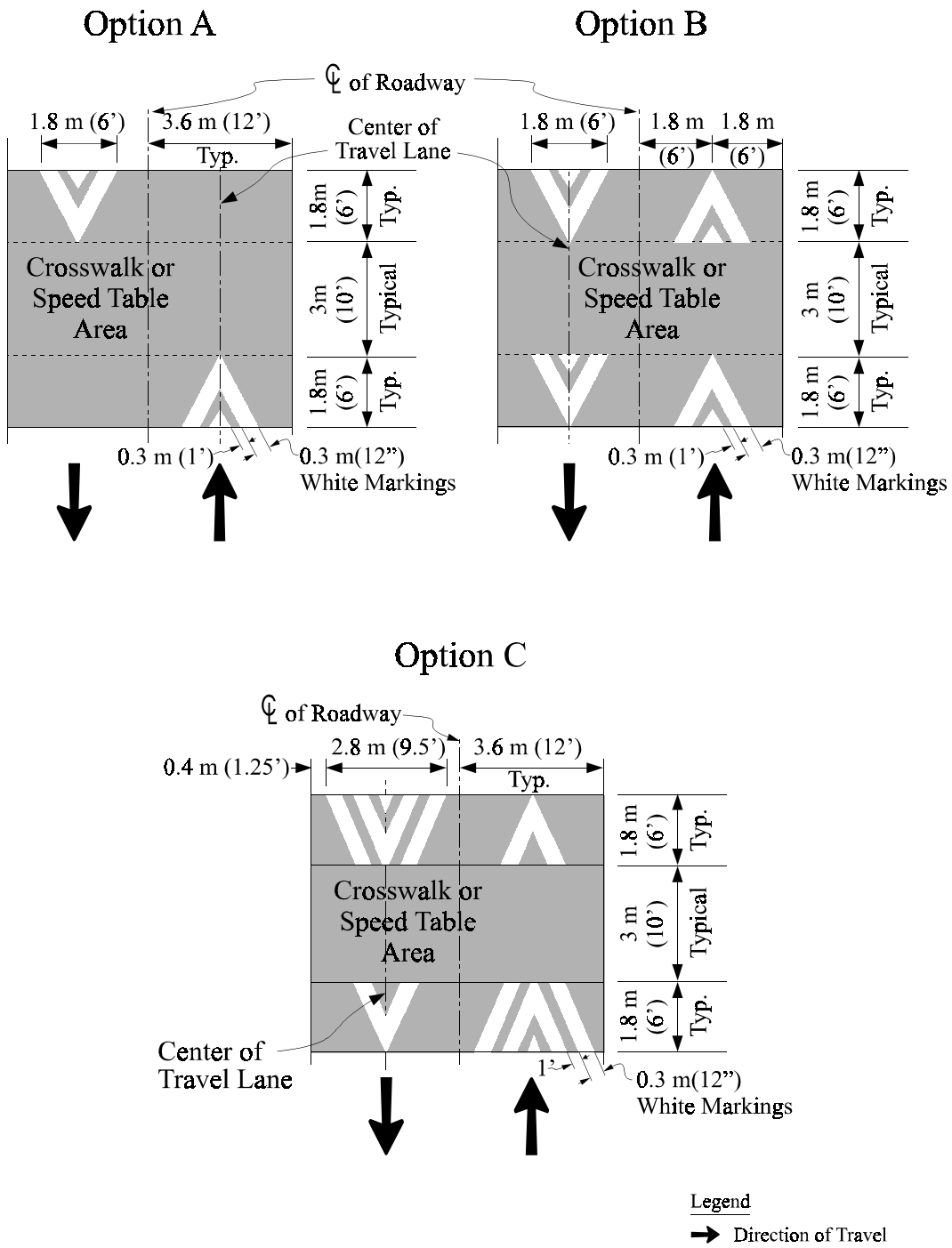


Figure 26. Optional Pavement Markings for Speed Humps with Crosswalks in 2000 MUTCD (11).

Devices to Increase Awareness of Pedestrians

There are two devices that have been used to increase pedestrian awareness at roadway crossings: animated eyes display and text pavement markings in crosswalks. The animated eyes display is an LED signal head that displays “searching” eyes in conjunction with the WALK/DON’T WALK symbols (Figure 27). The animated eyes are designed to “look” in the direction of oncoming traffic, thereby eliciting a response from pedestrians to check for oncoming traffic. The animated eyes display can also be used to elicit motorists to look for pedestrians, such as at blind corners or crosswalks. An animated eyes display has been installed and tested in St. Petersburg, Florida, where the device was found to be effective at reducing pedestrian-vehicle conflicts at intersections (20). The authors concluded that the animated eyes display is most appropriate in locations where it is important for motorists and pedestrians to look for potential threats.

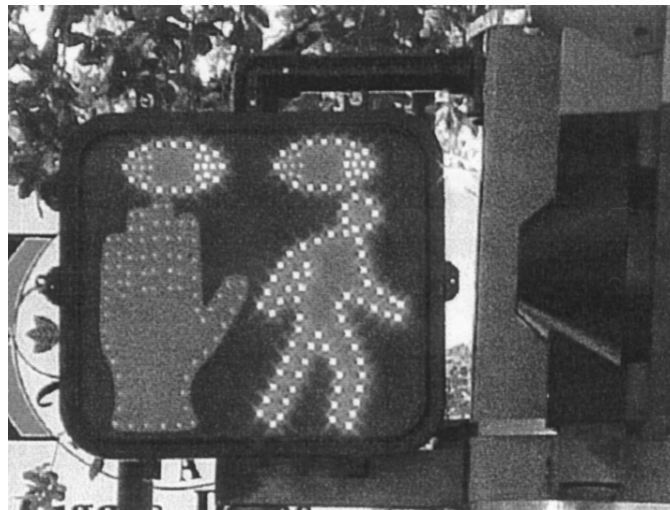


Figure 27. Animated Eyes Display with Pedestrian Signal Head (20).

Text pavement markings that include the text “LOOK LEFT” or “LOOK RIGHT” have been used in Europe to prompt pedestrians to check for oncoming vehicle traffic (Figure 28). Engineers in London use these text pavement markings because many tourists look in the incorrect direction when attempting to cross the street (21).



Figure 28. “LOOK RIGHT” Pavement Markings Used to Increase Awareness of Crossing Pedestrians – United Kingdom.
(Photo courtesy of Gene Hawkins, Texas Transportation Institute)

European Practices at Pedestrian Crossings

The United Kingdom (UK) has designated the following types of mid-block pedestrian crossings, all of which require motorists to yield to pedestrians (21, 22):

- **zebra crossing** – no signal control, only black and white pavement markings (“ladder bar” pattern);
- **pelican crossing** – pedestrian-activated push-button signal, pedestrian signal head indications, dashed pavement markings parallel to crosswalk;
- **puffin crossing** – pedestrian signal activated by push-button, infrared detector, or pressure-sensitive mat; “intelligent” pedestrian signal head indications that can shorten or extend pedestrian crossing time; dashed pavement markings parallel to crosswalk; and
- **toucan crossing** – a pedestrian crossing that is shared with bicyclists, as in “two can” use the crossing.

All of the pedestrian crossings include a zig-zag line located along the upstream edge of the pavement that is used to warn motorists of the crossing (Figure 29). The zebra crossing has been used since the 1950s for mid-block pedestrian crossings. Most engineers and traffic officials consider these crossings inappropriate on high-speed or high-volume roadways, as technical guidance recommends they not be installed on roads where the 85th percentile speed is above 35 mph. Flashing yellow lamps (belisha beacons, see Figures 29 and 30) are used to warn motorists of pedestrians in the crosswalk.



Figure 29. Use of Zig-Zag Lines and Belisha Beacons to Warn of Upcoming Pedestrian Crossing – United Kingdom (19).



Figure 30. Use of Belisha Beacons at Zebra Pedestrian Crossings – United Kingdom.
(Photo courtesy of Herman Huang, UNC Highway Safety Research Center)

In the past 10 years, many of the zebra crossings have been replaced by signal-controlled pelican crossings. Because of the fixed time signal cycle associated with pelican crossings, it is possible for motorists to experience unnecessary delay when no pedestrians are present. The UK added advanced pedestrian detection capabilities to create the puffin (Pedestrian User-Friendly INtersection crossing), which is capable of extending or shortening the pedestrian crossing time based upon the presence or absence of pedestrians in or near the crosswalk.

Traffic Calming Measures

Traffic calming is “the combination of mainly physical measures that reduce the negative effects of motor vehicle use, alter driver behavior and improve conditions for non-motorized street users” (23). Traffic calming measures are used most commonly on local residential and collector streets to better control and manage vehicle speeds. Traffic calming can also be implemented on arterial streets; however, arterial streets will require a balance between improving safety (through traffic calming) and providing mobility.

The focus of this section is on traffic calming measures that can be applied at or near pedestrian crossings to reduce vehicle speeds. It should be noted that although spot traffic calming treatments have been somewhat successful, the most successful traffic calming has been areawide treatments. In these situations, neighborhood traffic calming plans are developed to proactively identify problems and traffic calming solutions.

The traffic calming measures most relevant at pedestrian crossings are:

- curb extensions (neckdowns and chokers),
- center island narrowing and median refuge islands,
- roadway narrowing, and
- raised crosswalks and intersections.

There are numerous other traffic calming measures that can be used in the vicinity of pedestrian crossings to control speeds, such as chicanes, traffic circles, speed humps, etc. Readers can find more information on these and other traffic calming measures in the following references:

- *Traffic Calming: State of the Practice*, ITE/FHWA, August 1999 (also available at ITE’s Traffic Calming web site, <http://www.ite.org/traffic/>).
- *Handbook of Speed Management Techniques*, Report 1770-2, Texas Transportation Institute (TTI), September 1998 (24).
- *State of the Art: Residential Traffic Management*, Report FHWA/RD-80/092, Federal Highway Administration, December 1980 (25).

The following descriptions of traffic calming measures come primarily from the first two references, TTI Report 1770-2 and the ITE/FHWA State of the Practice report.

Curb Extensions

Curb extensions (also referred to as neckdowns [Figures 31 and 33] at intersections and chokers [Figures 32 and 34] at mid-block) narrow a street by extending the sidewalk or widening the planting/grass strip. Curb extensions have been shown to improve pedestrian safety by

shortening the street crossing distance for pedestrians, thereby reducing their exposure to vehicle traffic. Pedestrians waiting to cross at curb extensions also have better visibility to motorists since they are closer to the edge of the travel lane (and not standing behind parked cars).

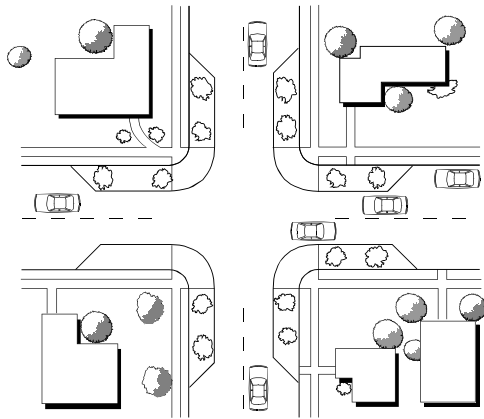


Figure 31. Plan View of Curb Extensions at Intersection (Neckdown) (23).

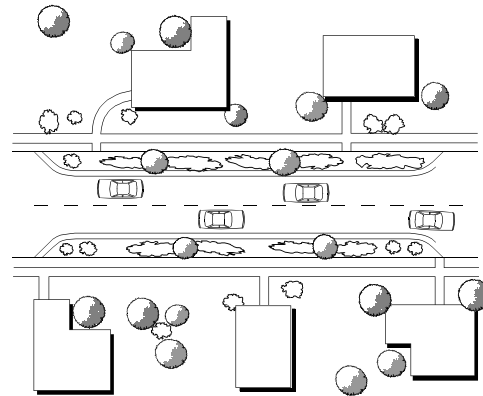


Figure 32. Plan View of Curb Extensions at Mid-Block (Choker) (23).



Figure 33. Curb Extension at an Intersection (Neckdown) – Bryan, Texas.



Figure 34. Curb Extension at a Mid-Block Crossing (Choker) with Textured Crosswalk and Landscaping – Westminster, Maryland (24).

Curb extensions are best applied:

- on local and collector streets or on main roads through small communities; and
- in conjunction with features such as textured or other high-visibility crosswalks, raised intersections, median refuge islands, or on-street parking.

Curb extensions are advantageous because they:

- reduce pedestrian crossing exposure,
- provide better visibility to crossing and waiting pedestrians,
- typically reduce vehicle speeds,
- do not slow emergency vehicles,
- provide opportunity for additional landscaping or “streetscaping,” and
- can be used for transit stop and shelter.

Disadvantages of or other considerations for curb extensions are that they:

- may require parking removal,
- may require bicyclists to share a narrowed space with motor vehicles,

- may require additional drainage provisions, and
- may impede legitimate truck movements.

Median Refuge Islands and Center Island Narrowing

Median or pedestrian refuge islands are typically raised islands located along the centerline of a street (Figure 35). With center island narrowing, the travel lanes are narrowed at the median island location (Figure 36). Median islands should provide a pedestrian refuge area (6 to 8 feet or more) that permits pedestrians to cross streets one direction of traffic at a time if so desired. Median islands are often landscaped for visual enhancement yet still provide adequate visibility for motorists and pedestrians.



Figure 35. Use of Median Refuge Island on Eight-Lane Arterial Street – College Station, Texas.



Figure 36. Center Island Narrowing with Speed Cushions – Austin, Texas.

Median islands are best applied:

- on wide (four or more lanes) streets with moderate to high traffic volumes,
- at locations with a large proportion of pedestrians with slower-than-average crossing times, and
- at signalized intersections where it may be difficult to cross more than one direction of traffic during one pedestrian phase.

Advantages of median islands are that they:

- provide pedestrian refuge in median,
- permit pedestrians to cross one direction of traffic at a time,
- may reduce vehicle speeds because of narrower travel lanes,
- make pedestrian crossings more visible to motorists, and
- provide a location for landscaping and visual enhancement.

Disadvantages of or other considerations for median islands are that they:

- may reduce parking and driveway access,
- may create potential crash obstacle for motorists,
- are more expensive than at-grade islands, and
- may create problems for street sweeping or snow plowing.

Roadway Narrowing

Roadway (or lane) narrowing can be created by geometric features (curb modifications) or traffic control materials (pavement marking or buttons, see [Figure 37](#)) that effectively reduce the width of travel lanes. Roadway narrowing is typically done continuously along a roadway, thus it is differentiated from the location-specific narrowing used with curb extensions and median refuge islands. Narrow travel lanes (no less than 10 feet in width) have been shown to reduce vehicle speeds. The safety impacts of roadway narrowing have been mixed, as past research shows both increases and decreases in collision rates after roadway narrowing.



Figure 37. Roadway Narrowing Using Raised Pavement Markings – Arlington, Texas (24).

Roadway narrowing is best applied:

- on two- or four-lane roadways with wide cross-sections.

Advantages of roadway narrowing are that it:

- provides continuous, visual channelization;
- can be inexpensive to install and/or quickly implemented (depending upon technique);
- does not negatively affect emergency response times; and
- may provide space for on-street parking and/or landscaping.

Disadvantages of and other considerations for roadway narrowing are that it:

- may require regular maintenance of narrowing devices,
- may be unfriendly to bicyclists unless other bicycle provisions are made, and
- increases the cost of roadway resurfacing.

Raised Intersections and Crosswalks

Raised intersections (also referred to as intersection humps or plateaus) are flat, raised areas covering entire intersections (Figure 38). Similarly, raised crosswalks are flat, raised areas covering the surface area of a crosswalk (Figures 39 and 40). Raised intersections and crosswalks have ramps on all street approaches and are often paved with brick or other textured material. Raised intersections have been shown to reduce vehicle speeds in the vicinity of these intersections, as well as making the entire intersection area more pedestrian-friendly.

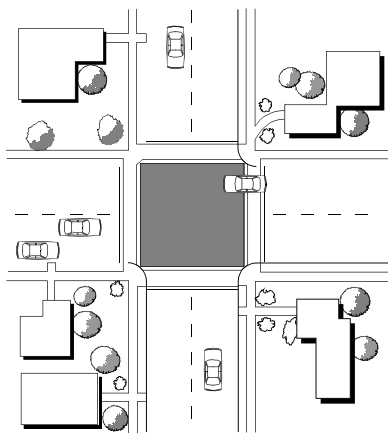


Figure 38. Plan View of Raised Intersection (23).

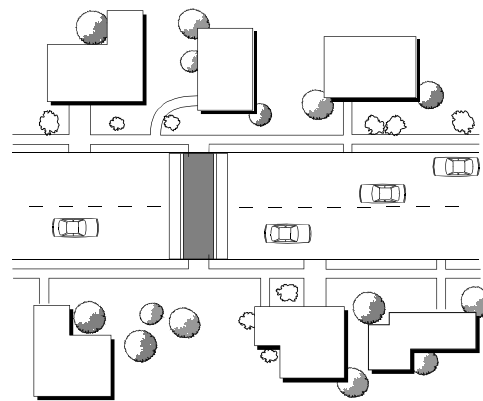


Figure 39. Plan View of Raised Crosswalk (23).



Figure 40. Raised Crosswalk Used Near High School Building – Ft. Worth, Texas.

Raised intersections and crosswalks are best applied:

- as part of an areawide traffic calming scheme involving both intersecting streets,
- in commercial business districts or densely developed urban areas, and
- in conjunction with curb extensions and textured crosswalks.

Advantages of raised intersections and crosswalks are that they:

- reduce vehicle speeds on intersection approaches/crosswalk,
- provide more pedestrian visibility at the intersection/crosswalk, and
- can be used on high or low volume streets.

Disadvantages of and other considerations for raised intersections and crosswalks are that they:

- slow emergency response vehicles to about 15 miles per hour,
- may require storm drainage modifications, and
- may require bollards or other edge delineation at the roadway/sidewalk interface.

Proposed Revised Warrants for Traffic Signal Control

As part of the research project that developed these pedestrian crossing guidelines, the TTI research team also developed proposed revised warrants for traffic signal control. The proposed revisions consist of the following major considerations:

- including pedestrians and bicyclists in all warrants that currently consider only vehicle traffic volumes on minor-street approaches;
- including a reduction factor based upon the presence of certain types of pedestrian trip generators; and
- changing the existing pedestrian warrant to a mid-block pedestrian crossing warrant, removing language about pedestrian crossing speeds, and adding a reduction factor for high-speed roadways or built-up areas.

A full discussion of these proposed warrants, as well as how the research team developed them, is provided in TTI Report 2136-1. Interested readers are encouraged to review this report.

Grade Separation

Grade separation of pedestrian and motor vehicle traffic is typically considered at crossings where the number of pedestrian–motor vehicle conflicts is high and/or the risk to crossing pedestrians is great. The following discussion of grade-separated pedestrian crossings was largely excerpted from the ITE Recommended Practice (1).

Several types of grade-separated crossings can be used (1):

- **pedestrian overpass/bridge** – a passageway for pedestrians (and sometimes other non-motorized users) above the grade of the roadway. An ADA-compliant ramp and stairs are used to provide the elevation necessary to cross the roadway, although in some cases the roadway is depressed and the pedestrian overpass remains at grade.
- **skywalk/skyway** – an elevated walkway (sometimes enclosed) that connects buildings at mid-block locations. A skywalk/skyway permits traveling between buildings without being exposed to inclement weather and is often used in central business districts or large corporate campuses in harsh climates (e.g., Minneapolis in winter or Houston in summer).
- **pedestrian tunnel/underpass** – a passageway for pedestrians below the grade of the roadway. As with an overpass/bridge, ADA-compliant ramps and/or stairs are used to effect the elevation change.

- **underground pedestrian network** – a network of pedestrian passageways below the grade of the roadway. A network of tunnels, like that of skywalks/skyways, is often used to connect several large buildings in a central business district or large corporate campus.

Past research has shown the effectiveness of grade-separated pedestrian crossings depends upon the perceived effort and time to use it. For example, Figure 41 defines a convenience measure, R, and compares it to the percentage of pedestrians likely to use a grade-separated crossing. The figure shows that 95 percent of pedestrians will likely use an underpass and 70 percent will likely use an overpass if the travel times at-grade and grade-separated are equal (i.e., R=1). Similarly, less than 5 percent would use either an overpass or an underpass if it takes 50 percent longer (R=1.5).

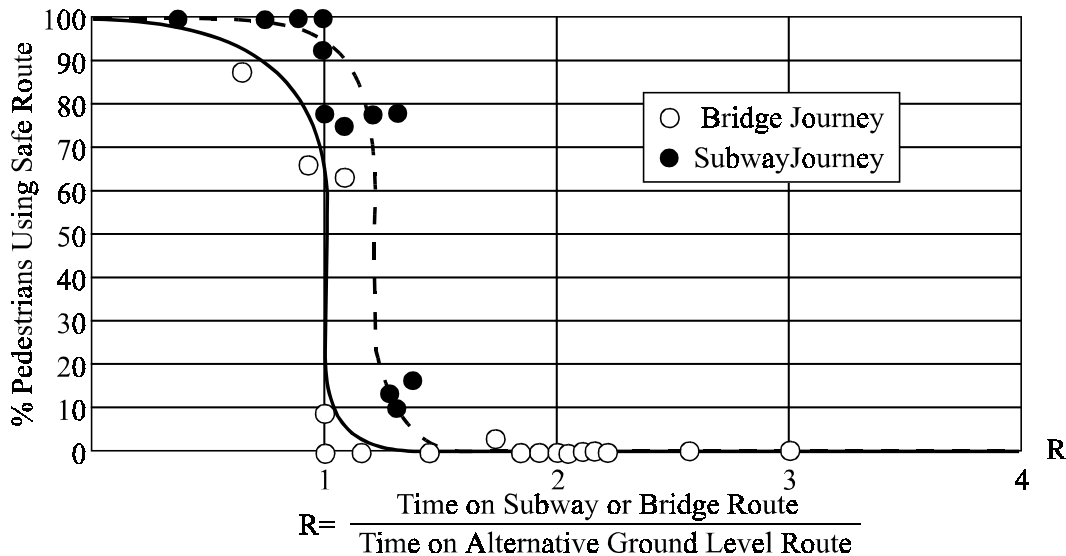


Figure 41. Pedestrian Use of Grade-Separated Crossings (1).

Other studies have shown that pedestrians use grade-separated crossings more often if the elevation change can be minimized or worked into the normal path of pedestrian movement. For example, circuitous ramps are often used for ADA compliance but provide a time-consuming approach for some pedestrians. Although more right-of-way may be required, the site topography at the approaches to the crossing may be able to be modified to better accomplish the elevation change without circuitous ramps.

Figure 42 shows an example of a grade-separated pedestrian crossing. This particular pedestrian overpass is located near Texas A&M University and crosses over a major arterial street and an active set of railroad tracks. The pedestrian overpass is used heavily during special events (e.g., football games, etc.) and during train passings, but only modestly during other times. Future plans at this location involve reconstructing the intersection to provide a pedestrian undercrossing that gradually slopes to below the grade of the surface street.



Figure 42. Pedestrian Bridge over Five-Lane Arterial Street and Active Railroad Tracks – College Station, Texas.

A 1988 synthesis by Zegeer and Zegeer (26) suggested that grade-separated pedestrian crossings are most beneficial under the following conditions:

- where there is moderate to high pedestrian demand to cross a freeway or expressway,
- where there is a large number of young children (i.e., particularly near schools) who must regularly cross a high-speed or high-volume roadway,
- on streets having high vehicle volumes and high pedestrian crossing volumes and where there is an extreme hazard for pedestrians (e.g., on wide streets with high-speed traffic and poor sight distance), and
- where one or more of the conditions stated above exists in conjunction with a well-defined pedestrian origin and destination (e.g., residential neighborhood across a busy street from a school, a parking structure affiliated with a university, or apartment complex near a shopping mall).

Axler suggested more specific warrants and other general considerations for grade-separated pedestrian crossings (27):

- The pedestrian hourly volume should be more than 300 in the four highest continuous hour periods if the vehicle speed is more than 40 mph and the proposed sites are in urban areas and not over or under a freeway. Otherwise, the pedestrian volume should be more than 100 pedestrians in the four highest continuous hour periods.
- Vehicle volume should be more than 10,000 in the same four-hour period used for the pedestrian volume warrant or have an ADT volume greater than 35,000 if vehicle speed is over 40 mph and the proposed site(s) are in urban areas. If these two conditions are not met, the vehicle volume should be more than 7,500 in the four hours or have an ADT greater than 25,000.
- The proposed site should be at least 600 feet from the nearest alternative “safe” crossing. A “safe” crossing is defined as a location where a traffic control device stops vehicles to create adequate gaps for pedestrians to cross. Another “safe” crossing is an existing overpass or underpass near the proposed facility.
- A physical barrier is desirable to prohibit at-grade crossing of the roadway as part of the overpass or underpass design plan.
- Artificial lighting should be provided to reduce potential crime against users of the underpasses or overpasses. It may be appropriate to light underpasses 24 hours a day and overpasses at night.
- Topography of the proposed site should be such as to minimize changes in elevation for users of overpasses and underpasses and to help ensure that construction costs are not excessive. Elevation change is a factor that affects the convenience of users.
- A specific need may exist for a grade-separated crossing based on the existing or proposed land use(s) adjoining the proposed development site that generates pedestrian trips. This land use should have a direct access to the grade-separated facility.
- Funding for construction of the underpass or overpass must be available prior to a commitment to construct it.

In addition to the traffic and pedestrian volume considered in these warrants, a benefit-cost analysis will likely be required for grade-separated pedestrian crossings. Readers interested in conducting a benefit-cost analysis are encouraged to consult NCHRP Report 189 (“Quantifying the Benefits of Separating Pedestrians and Vehicles,” 1978) and NCHRP Report 240 (“A Manual to Determine the Benefits of Separating Pedestrians and Vehicles,” 1981).

Special Conditions: School Crossings and Special Events

Pedestrian crossings at certain locations may require special attention beyond the basic engineering treatments described in the previous sections. Examples include pedestrian crossings near schools as well as near locations where special events are held (e.g., arenas, stadiums). These two special conditions are described below, with guidance provided for each.

As the crash statistics in an [earlier section](#) indicated, children under the age of 14 are the most over-represented age group in pedestrian–motor vehicle crashes. Additionally, the majority of motorists do not reduce vehicle speeds in school zones unless children, adult crossing guards, or enforcement personnel are clearly visible. In response to the special needs of school zones, ITE developed a Recommended Practice in 1984 entitled “School Trip Safety Program Guidelines.” This Recommended Practice describes the steps that can be taken to develop a school trip safety program, including the following elements:

- a committee whose responsibility is to ensure the appropriate and uniform application of school crossing protection measures;
- designation of school routes, identification of route deficiencies and needed improvements, and implementation of route improvements; and
- determining the need for appropriate traffic control, such as school safety patrol, adult crossing guards, or school crossing traffic signals.

The FHWA also provides information and resources for addressing school-age pedestrian safety, in particular a brochure entitled “Pedestrian Safety for School-Age Children” (28). Several states have also developed separate chapters in their traffic manuals that deal with the issues of school area pedestrian safety (e.g., Caltrans example is available at <http://www.dot.ca.gov/hq/traffops/signtech/signdel/chp10/chap10.htm>).

Figure 43 shows the existing 2000 MUTCD traffic signal warrant for school crossings. The ITE Recommended Practice (1) suggests the following warrants for adult crossing guards (comparable to the American Automobile Association’s [AAA’s] Adult School Crossing Guards Manual):

1. At uncontrolled crossings where there is no alternate controlled crossing within 600 feet, and:
 - a. In urban areas where the vehicular traffic volume exceeds 350 in each of any two daily hours during which 40 or more school children cross while going to or from school whenever the critical approach speed exceeds 40 mph, the warrants for rural areas should be applied.

- b. In rural areas where the vehicular traffic volume exceeds 300 in each of any two daily hours during which 30 or more school children cross while going to or from school.
2. At stop sign–controlled intersection crossings:
 - a. Where the vehicular traffic volume on undivided highways of four or more lanes exceeds 500 per hour during any period when the children are going to or from school.
 3. At traffic signal–controlled intersection crossings:
 - a. Where the number of vehicular turning movements through the school crosswalk exceeds 300 per hour while the children are still going to or from school.
 - b. Where there are circumstances not normally present at a signalized intersection, such as crosswalks more than 80 feet long with no intermediate refuge, or an abnormally high proportion of heavy commercial vehicles.

Warrant 5, School Crossing (2000 MUTCD)

The need for a traffic control signal shall be considered when an engineering study of the frequency and adequacy of gaps in the vehicular traffic stream as related to the number and size of groups of school children at an established school crossing across the major street shows that the number of adequate gaps in the traffic stream during the period when the children are using the crossing is less than the number of minutes in the same period (see Section 7A.03) and there are a minimum of 20 students during the highest crossing hour.

Before a decision is made to install a traffic control signal, consideration shall be given to the implementation of other remedial measures, such as warning signs and flashers, school speed zones, school crossing guards, or a grade-separated crossing.

The School Crossing signal warrant shall not be applied at locations where the distance to the nearest traffic control signal along the major street is less than 90 m (300 ft), unless the proposed traffic control signal will not restrict the progressive movement of traffic.

Figure 43. 2000 MUTCD School Crossing Traffic Signal Warrant (11).

Because of the short duration and potentially high pedestrian volumes at special events near stadiums and arenas, the event's traffic management plan should give special consideration to pedestrian crossings. Traffic engineering treatments that are appropriate for modest pedestrian volumes throughout the day may not be well suited for pedestrian traffic at special events. Police or other uniformed officers are most often used in controlling and managing special event traffic. In cases where police traffic control is used, the relative priority of competing pedestrian and vehicle flows should be established and communicated to the directing officers in pre-event coordination meetings.

Figure 44 shows a pedestrian crossing that connects a community amphitheater (shown in left middle of picture) to a parking area across a three-lane collector street. The crosswalk is textured with brick pavers and a pedestrian crossing sign is present. However, police control and additional warning signs are used at this crossing when events are being held at the amphitheater. Pedestrians rarely use the crossing other than during special events, thus no crosswalk markings or other crossing treatments are provided here during non-event times.



Figure 44. Pedestrian Crossing Used Only During Special Events – College Station, Texas.

Education and Enforcement Activities

Engineering treatments may be entirely effective in addressing problems at some pedestrian crossings. In some locations, though, a balance of engineering, education, and enforcement efforts will be the most effective in improving pedestrian safety. This section summarizes several pedestrian education and enforcement programs that interested communities can use.

Pedestrian Safety Roadshow – Developed by FHWA, the purpose of the Roadshow is to assist communities in developing their own approach to identifying and solving the problems that affect pedestrian safety and walkability. It is a four-hour workshop to community officials (e.g. engineering, planning, enforcement, educators, health), concerned citizens (e.g. youth groups, senior groups), and local business leaders (e.g. builders/developers, insurance). The objectives are to increase the awareness of pedestrian safety and walkability concerns, provide participants with information about the elements that make a community safe and walkable, and channel their concern into a plan of action for addressing pedestrian concerns. More information on the Roadshow is available at <http://www.ota.fhwa.dot.gov/walk>.

Pedestrian Safety Roadmap and Resource Catalog – Another program developed by FHWA, the resource catalog has an extensive inventory of information on pedestrian safety education, including numerous educational brochures and pamphlets. The Resource Catalog can be found at <http://www.ota.fhwa.dot.gov/walk/resource/psrdm4.htm>.

Walkability Checklist – The Checklist can be used by community members or others to rate walking conditions and identify deficiencies in their neighborhood. The walkability checklist can be found by searching the National Highway Traffic Safety Administration (NHTSA) web site at <http://www.nhtsa.dot.gov>.

REFERENCES

1. *Design and Safety of Pedestrian Facilities*. ITE Report RP-026A. Institute of Transportation Engineers, Washington, D.C., March 1998.
2. *Pedestrian Facilities Guidebook: Incorporating Pedestrians into Washington's Transportation System*. Prepared by Otak. Washington State Department of Transportation, September 1997.
3. *Pedestrian Crossing Control Manual*. Transportation Association of Canada, Ottawa, Canada, March 1998.
4. *Oregon Bicycle and Pedestrian Plan: An Element of the Oregon Transportation Plan*. Oregon Department of Transportation, Bicycle and Pedestrian Program, Salem, Oregon, June 1995.
5. *Portland Pedestrian Design Guide*. City of Portland, Oregon, June 1998.
6. *Mean Streets: Pedestrian Safety and Reform of the Nation's Transportation Law*. Surface Transportation Policy Project and Environmental Working Group, 1997.
7. *Our Nation's Travel: 1995 NPTS Early Results Report*. Report FHWA-PL-97-028. Federal Highway Administration, Washington, D.C., September 1997.
8. W.W. Hunter, J.C. Stutts, W.E. Pein, and C.L. Cox. *Pedestrian and Bicycle Crash Types of the Early 1990s*. Report FHWA-RD-95-163. Federal Highway Administration, Washington, D.C., June 1996.
9. "What were pedestrians doing when they were injured?" article and analysis by TransTexas Alliance, <http://www.ci.austin.tx.us/trafficsafety/pedwhatdo.htm>, October 1998.
10. *Traffic Calming Primer*. Pat Noyes & Associates, Boulder, Colorado, 1998.
11. *Manual on Uniform Traffic Control Devices (MUTCD) 2000*, Millennium Edition, Federal Highway Administration, Washington, D.C., December 2000.
12. B.F. Herms. Pedestrian Crosswalk Study: Accidents in Painted and Unpainted Crosswalks. In *Highway Research Record 406*. Highway Research Board, National Research Council, Washington, D.C., 1972, pp. 1-14.
13. B.M. Bowman, J.J. Fruin, and C.V. Zegeer. *Handbook on Planning, Design, and Maintenance of Pedestrian Facilities*. Report FHWA/IP-88-019. Federal Highway Administration, Washington, D.C., 1989.

14. S.A. Smith and R.L. Knoblauch. Guidelines for the Installation of Crosswalk Markings. In *Transportation Research Record 1141*. Transportation Research Board, National Research Council, Washington, D.C., 1987, pp. 15-25.
15. C.V. Zegeer, J.R. Stewart, and H.F. Huang. *Safety Effects of Marked vs. Unmarked Crosswalks at Uncontrolled Crossing Locations: Executive Summary and Recommended Guidelines*. Federal Highway Administration, Washington, D.C., July 2000.
16. D. Godfrey and T. Mazzella. "Kirkland's Experience with In-Pavement Flashing Lights at Crosswalks." Presented at the ITE/IMSA Annual Meeting, Lynnwood, Washington, February 8, 1999, available at <http://www.ci.kirkland.wa.us/depart/pw/transportation/flscrswk.htm>.
17. *Improving Conditions for Bicycling and Walking: A Best Practices Report*. Prepared for the Federal Highway Administration by the Rails-to-Trails Conservancy and the Association of Pedestrian and Bicycle Professionals, January 1998.
18. H.F. Huang and M.J. Cynecki. "The Effects of Traffic Calming Measures on Pedestrian and Motorist Behavior." Paper submitted to the Transportation Research Board, Washington, D.C., March 2000.
19. *Innovative Traffic Control Technology and Practice in Europe*. Report FHWA-PL-00-021. Federal Highway Administration, Washington, D.C., August 1999.
20. R. Van Houten, J.E.L. Malenfant, and P. Hochstein. "Animated LED 'Eyes' Traffic Signals." Submitted to the National Academy of Sciences, December 1999.
21. *FHWA Study Tour for Pedestrian and Bicyclist Safety in England, Germany, and The Netherlands*. Report FHWA-PL-95-006. Federal Highway Administration, Washington, D.C., October 1994.
22. D.G. Davies. *Research, Development, and Implementation of Pedestrian Safety Facilities in the United Kingdom*. Report FHWA-RD-99-089. Federal Highway Administration, Washington, D.C., December 1999.
23. R. Ewing. *Traffic Calming: State of the Practice*. Report FHWA-RD-99-135. Federal Highway Administration, Institute of Transportation Engineers, August 1999.
24. A.H. Parham and K. Fitzpatrick. *Handbook of Speed Management Techniques*. TTI Report 1770-2. Texas Department of Transportation, Texas Transportation Institute, College Station, Texas, September 1998.
25. D.T. Smith, Jr., D. Appleyard, et al. *State of the Art: Residential Traffic Management*. Report FHWA/RD-80/092. Federal Highway Administration, Washington, D.C., December 1980.

26. C.V. Zegeer and S.F. Zegeer. *Pedestrians and Traffic Control Measures*. Synthesis of Highway Practice No. 139. Transportation Research Board, Washington, D.C., November 1988.
27. E.A. Axler. *Warrants for Pedestrian Over and Underpasses*. Report FHWA/RD-84-082. U.S. Department of Transportation, Washington, D.C., July 1984.
28. *Pedestrian Safety for School-Age Children*, Report FHWA-SA-98-065. Federal Highway Administration, Washington, D.C., 1998.

**APPENDIX – TEXAS STATE LAW PERTAINING
TO PEDESTRIAN CROSSINGS**

SUBTITLE C. RULES OF THE ROAD

CHAPTER 541. DEFINITIONS

Sec. 541.302. Traffic Areas.

In this subtitle:

...

(2) “Crosswalk” means:

(A) the portion of a roadway, including an intersection, designated as a pedestrian crossing by surface markings, including lines; or

(B) the portion of a roadway at an intersection that is within the connections of the lateral lines of the sidewalks on opposite sides of the highway measured from the curbs or, in the absence of curbs, from the edges of the traversable roadway.

...

(13) “School crossing zone” means a reduced-speed zone designated on a street by a local authority to facilitate safe crossing of the street by children going to or leaving a public or private elementary or secondary school during the time the reduced speed limit applies.

(14) “School crosswalk” means a crosswalk designated on a street by a local authority to facilitate safe crossing of the street by children going to or leaving a public or private elementary or secondary school.

(16) “Sidewalk” means the portion of a street that is:

(A) between a curb or lateral line of a roadway and the adjacent property line; and

(B) intended for pedestrian use.

Acts 1995, 74th Leg., ch. 165, Sec. 1, eff. Sept. 1, 1995.

CHAPTER 552. PEDESTRIANS

Sec. 552.001. Traffic Control Signals.

- (a) A traffic control signal displaying green, red, and yellow lights or lighted arrows applies to a pedestrian as provided by this section unless the pedestrian is otherwise directed by a special pedestrian control signal.
- (b) A pedestrian facing a green signal may proceed across a roadway within a marked or unmarked crosswalk unless the sole green signal is a turn arrow.
- (c) A pedestrian facing a steady red signal alone or a steady yellow signal may not enter a roadway.

Sec. 552.002. Pedestrian Right-of-Way if Control Signal Present.

- (a) A pedestrian control signal displaying “Walk,” “Don't Walk,” or “Wait” applies to a pedestrian as provided by this section.
- (b) A pedestrian facing a “Walk” signal may proceed across a roadway in the direction of the signal, and the operator of a vehicle shall yield the right-of-way to the pedestrian.
- (c) A pedestrian may not start to cross a roadway in the direction of a “Don't Walk” signal or a “Wait” signal. A pedestrian who has partially crossed while the “Walk” signal is displayed shall proceed to a sidewalk or safety island while the “Don't Walk” signal or “Wait” signal is displayed.

Sec. 552.003. Pedestrian Right-of-Way at Crosswalk.

- (a) The operator of a vehicle shall yield the right-of-way to a pedestrian crossing a roadway in a crosswalk if:
 - (1) no traffic control signal is in place or in operation; and
 - (2) the pedestrian is:
 - (A) on the half of the roadway in which the vehicle is traveling; or
 - (B) approaching so closely from the opposite half of the roadway as to be in danger.
- (b) Notwithstanding Subsection (a), a pedestrian may not suddenly leave a curb or other place of safety and proceed into a crosswalk in the path of a vehicle so close that it is impossible for the vehicle operator to yield.
- (c) The operator of a vehicle approaching from the rear of a vehicle that is stopped at a crosswalk to permit a pedestrian to cross a roadway may not pass the stopped vehicle.

Sec. 552.004. Pedestrian to Keep to Right.

A pedestrian shall proceed on the right half of a crosswalk if possible.

Sec. 552.005. Crossing at Point Other Than Crosswalk.

(a) A pedestrian shall yield the right-of-way to a vehicle on the highway if crossing a roadway at a place:

- (1) other than in a marked crosswalk or in an unmarked crosswalk at an intersection; or
- (2) where a pedestrian tunnel or overhead pedestrian crossing has been provided.

(b) Between adjacent intersections at which traffic control signals are in operation, a pedestrian may cross only in a marked crosswalk.

(c) A pedestrian may cross a roadway intersection diagonally only if and in the manner authorized by a traffic control device.

Sec. 552.006. Use of Sidewalk.

(a) A pedestrian may not walk along and on a roadway if an adjacent sidewalk is provided.

(b) If a sidewalk is not provided, a pedestrian walking along and on a highway shall if possible walk on:

- (1) the left side of the roadway; or
- (2) the shoulder of the highway facing oncoming traffic.

(c) The operator of a vehicle emerging from or entering an alley, building, or private road or driveway shall yield the right-of-way to a pedestrian approaching on a sidewalk extending across the alley, building entrance or exit, road, or driveway.

Sec. 552.007. Solicitation by Pedestrians.

(a) A person may not stand in a roadway to solicit a ride, contribution, employment, or business from an occupant of a vehicle, except that a person may stand in a roadway to solicit a charitable contribution if authorized to do so by the local authority having jurisdiction over the roadway.

(b) A person may not stand on or near a highway to solicit the watching or guarding of a vehicle parked or to be parked on the highway.

(c) In this section, “charitable contribution” means a contribution to an organization defined as charitable by the standards of the United States Internal Revenue Service.

Sec. 552.008. Drivers to Exercise Due Care.

Notwithstanding another provision of this chapter, the operator of a vehicle shall:

- (1) exercise due care to avoid colliding with a pedestrian on a roadway;
- (2) give warning by sounding the horn when necessary; and
- (3) exercise proper precaution on observing a child or an obviously confused or incapacitated person on a roadway.

Sec. 552.009. Ordinances Relating to Pedestrians.

A local authority may by ordinance:

- (1) require pedestrians to comply strictly with the directions of an official traffic control signal; and
- (2) prohibit pedestrians from crossing a roadway in a business district or a designated highway except in a crosswalk.

Acts 1995, 74th Leg., ch. 165, Sec. 1, eff. Sept. 1, 1995