

T R A N S I T   C O O P E R A T I V E   R E S E A R C H   P R O G R A M

SPONSORED BY

The Federal Transit Administration

# TCRP Report 59

## **Hybrid-Electric Transit Buses: Status, Issues, and Benefits**

Transportation Research Board  
National Research Council

## TCRP OVERSIGHT AND PROJECT SELECTION COMMITTEE

### CHAIR

PAUL J. LARROUSSE  
*Madison Metro Transit System*

### MEMBERS

GORDON AOYAGI  
*Montgomery County Government*

JEAN PAUL BAILLY  
*Union Internationale des Transports Publics*

J. BARRY BARKER  
*Transit Authority of River City*

LEE BARNES  
*Barwood, Inc.*

RONALD L. BARNES  
*Central Ohio Transit Authority*

GERALD L. BLAIR  
*Indiana County Transit Authority*

ANDREW BONDS, JR.  
*Parsons Transportation Group, Inc.*

ROBERT I. BROWNSTEIN  
*Booz-Allen & Hamilton, Inc.*

SANDRA DRAGGOO  
*CATA*

NURIA I. FERNANDEZ  
*FTA*

RONALD L. FREELAND  
*Maryland MTA*

LOUIS J. GAMBACCINI  
*Rutgers, The State University of New Jersey*

CONSTANCE GARBER  
*York County Community Action Corp.*

SHARON GREENE  
*Sharon Greene & Associates*

KATHARINE HUNTER-ZAWORSKI  
*Montana State University*

JOYCE H. JOHNSON  
*North Carolina A&T State University*

EVA LERNER-LAM  
*The Palisades Consulting Group, Inc.*

DON S. MONROE  
*Pierce Transit*

PATRICIA S. NETTLESHIP  
*The Nettleship Group, Inc.*

JAMES P. REICHERT  
*Reichert Management Services*

RICHARD J. SIMONETTA  
*Prima Facie, Inc.*

PAUL P. SKOUTELAS  
*Port Authority of Allegheny County*

PAUL TOLIVER  
*King County DOT/Metro*

MICHAEL S. TOWNES  
*Peninsula Transportation Dist. Comm.*

LINDA S. WATSON  
*Corpus Christi RTA*

AMY YORK  
*Amalgamated Transit Union*

### EX OFFICIO MEMBERS

WILLIAM W. MILLAR  
*APTA*

KENNETH R. WYKLE  
*FHWA*

JOHN C. HORSLEY  
*AASHTO*

ROBERT E. SKINNER, JR.  
*TRB*

### TDC EXECUTIVE DIRECTOR

LOUIS F. SANDERS  
*APTA*

### SECRETARY

ROBERT J. REILLY  
*TRB*

## TRANSPORTATION RESEARCH BOARD EXECUTIVE COMMITTEE 2000

### OFFICERS

**Chair:** *Martin Wachs, Director, Institute of Transportation Studies, University of California at Berkeley*

**Vice Chair:** *John M. Samuels, Senior VP--Operations Planning & Support, Norfolk Southern Corporation, Norfolk, VA*

**Executive Director:** *Robert E. Skinner, Jr., Transportation Research Board*

### MEMBERS

THOMAS F. BARRY, JR., *Secretary of Transportation, Florida DOT*

JACK E. BUFFINGTON, *Associate Director and Research Professor, Mack-Blackwell National Rural Transportation Study Center, University of Arkansas*

SARAH C. CAMPBELL, *President, TransManagement, Inc., Washington, DC*

ANNE P. CANBY, *Secretary of Transportation, Delaware DOT*

E. DEAN CARLSON, *Secretary, Kansas DOT*

JOANNE F. CASEY, *President, Intermodal Association of North America, Greenbelt, MD*

JOHN L. CRAIG, *Director, Nebraska Department of Roads, Lincoln, NE*

ROBERT A. FROSCH, *Sr. Research Fellow, John F. Kennedy School of Government, Harvard University*

GORMAN GILBERT, *Director, Institute for Transportation Research and Education, North Carolina State University*

GENEVIEVE GIULIANO, *Professor, University of Southern California, Los Angeles*

LESTER A. HOEL, *L. A. Lacy Distinguished Professor, Civil Engineering, University of Virginia*

H. THOMAS KORNEGAY, *Executive Director, Port of Houston Authority*

THOMAS F. LARWIN, *General Manager, San Diego Metropolitan Transit Development Board*

BRADLEY L. MALLORY, *Secretary of Transportation, Pennsylvania DOT*

JEFFREY R. MORELAND, *Senior VP Law and Chief of Staff, Burlington Northern Santa Fe Corporation, Fort Worth, TX*

SID MORRISON, *Secretary of Transportation, Washington State DOT*

JOHN P. POORMAN, *Staff Director, Capital District Transportation Committee, Albany, NY*

WAYNE SHACKELFORD, *Commissioner, Georgia DOT*

MICHAEL TOWNES, *Executive Director, Transportation District Commission of Hampton Roads, Hampton, VA*

THOMAS R. WARNE, *Executive Director, Utah DOT*

ARNOLD F. WELLMAN, JR., *VP, Corporate Public Affairs, United Parcel Service, Washington, DC*

JAMES A. WILDING, *President and CEO, Metropolitan Washington Airports Authority*

M. GORDON WOLMAN, *Professor of Geography and Environmental Engineering, The Johns Hopkins University*

DAVID N. WORMLEY, *Dean of Engineering, Pennsylvania State University*

### EX OFFICIO MEMBERS

MIKE ACOTT, *President, National Asphalt Pavement Association*

JOE N. BALLARD, *Chief of Engineers and Commander, U.S. Army Corps of Engineers*

KELLEY S. COYNER, *Research and Special Programs Administrator, U.S.DOT*

ALEXANDER CRISTOFARO, *Office Director, U.S. Environmental Protection Agency*

MORTIMER L. DOWNEY, *Deputy Secretary, Office of the Secretary, U.S.DOT*

NURIA I. FERNANDEZ, *Acting Federal Transit Administrator, U.S.DOT*

JANE F. GARVEY, *Federal Aviation Administrator, U.S.DOT*

EDWARD R. HAMBERGER, *President and CEO, Association of American Railroads*

CLYDE J. HART, JR., *Maritime Administrator, U.S.DOT*

JOHN C. HORSLEY, *Executive Director, American Association of State Highway and Transportation Officials*

JAMES M. LOY, *Commandant, U.S. Coast Guard*

WILLIAM W. MILLAR, *President, American Public Transportation Association*

ROSALYN G. MILLMAN, *Acting National Highway Traffic Safety Administrator, U.S.DOT*

JOLENE M. MOLITORIS, *Federal Railroad Administrator, U.S.DOT*

VALENTIN J. RIVA, *President and CEO, American Concrete Pavement Association*

ASHISH K. SEN, *Director, Bureau of Transportation Statistics, U.S.DOT*

KENNETH R. WYKLE, *Federal Highway Administrator, U.S.DOT*

### TRANSIT COOPERATIVE RESEARCH PROGRAM

*Transportation Research Board Executive Committee Subcommittee for TCRP*

MARTIN WACHS, *Institute of Transportation Studies, University of California at Berkeley (Chair)*

NURIA I. FERNANDEZ, *FTA U.S.DOT*

LESTER A. HOEL, *University of Virginia*

THOMAS F. LARWIN, *San Diego Metropolitan Transit Development Board*

WILLIAM W. MILLAR, *American Public Transportation Administration*

JOHN M. SAMUELS, *Norfolk Southern Corporation*

WAYNE SHACKELFORD, *Georgia DOT*

ROBERT E. SKINNER, JR., *Transportation Research Board*

# Report 59

## Hybrid-Electric Transit Buses: Status, Issues, and Benefits

NORTHEAST ADVANCED VEHICLE CONSORTIUM  
Boston, MA

M.J. BRADLEY & ASSOCIATES  
Manchester, NH

*Subject Areas*

Energy and Environment  
Public Transit

Research Sponsored by the Federal Transit Administration in  
Cooperation with the Transit Development Corporation

**TRANSPORTATION RESEARCH BOARD**  
NATIONAL RESEARCH COUNCIL

NATIONAL ACADEMY PRESS  
Washington, D.C. 2000

The nation's growth and the need to meet mobility, environmental, and energy objectives place demands on public transit systems. Current systems, some of which are old and in need of upgrading, must expand service area, increase service frequency, and improve efficiency to serve these demands. Research is necessary to solve operating problems, to adapt appropriate new technologies from other industries, and to introduce innovations into the transit industry. The Transit Cooperative Research Program (TCRP) serves as one of the principal means by which the transit industry can develop innovative near-term solutions to meet demands placed on it.

The need for TCRP was originally identified in *TRB Special Report 213--Research for Public Transit: New Directions*, published in 1987 and based on a study sponsored by the Urban Mass Transportation Administration--now the Federal Transit Administration (FTA). A report by the American Public Transportation Association (APTA), *Transportation 2000*, also recognized the need for local, problem-solving research. TCRP, modeled after the longstanding and successful National Cooperative Highway Research Program, undertakes research and other technical activities in response to the needs of transit service providers. The scope of TCRP includes a variety of transit research fields including planning, service configuration, equipment, facilities, operations, human resources, maintenance, policy, and administrative practices.

TCRP was established under FTA sponsorship in July 1992. Proposed by the U.S. Department of Transportation, TCRP was authorized as part of the Intermodal Surface Transportation Efficiency Act of 1991 (ISTEA). On May 13, 1992, a memorandum agreement outlining TCRP operating procedures was executed by the three cooperating organizations: FTA, the National Academies, acting through the Transportation Research Board (TRB); and the Transit Development Corporation, Inc. (TDC), a nonprofit educational and research organization established by APTA. TDC is responsible for forming the independent governing board, designated as the TCRP Oversight and Project Selection (TOPS) Committee.

Research problem statements for TCRP are solicited periodically but may be submitted to TRB by anyone at any time. It is the responsibility of the TOPS Committee to formulate the research program by identifying the highest priority projects. As part of the evaluation, the TOPS Committee defines funding levels and expected products.

Once selected, each project is assigned to an expert panel, appointed by the Transportation Research Board. The panels prepare project statements (requests for proposals), select contractors, and provide technical guidance and counsel throughout the life of the project. The process for developing research problem statements and selecting research agencies has been used by TRB in managing cooperative research programs since 1962. As in other TRB activities, TCRP project panels serve voluntarily without compensation.

Because research cannot have the desired impact if products fail to reach the intended audience, special emphasis is placed on disseminating TCRP results to the intended end users of the research: transit agencies, service providers, and suppliers. TRB provides a series of research reports, syntheses of transit practice, and other supporting material developed by TCRP research. APTA will arrange for workshops, training aids, field visits, and other activities to ensure that results are implemented by urban and rural transit industry practitioners.

The TCRP provides a forum where transit agencies can cooperatively address common operational problems. The TCRP results support and complement other ongoing transit research and training programs.

Project C-10B FY'96  
ISSN 1073-4872  
ISBN 0-309-06651-4  
Library of Congress Control Number 00-131614

© 2000 Transportation Research Board

**Price \$32.00**

## NOTICE

The project that is the subject of this report was a part of the Transit Cooperative Research Program conducted by the Transportation Research Board with the approval of the Governing Board of the National Research Council. Such approval reflects the Governing Board's judgment that the project concerned is appropriate with respect to both the purposes and resources of the National Research Council.

The members of the technical advisory panel selected to monitor this project and to review this report were chosen for recognized scholarly competence and with due consideration for the balance of disciplines appropriate to the project. The opinions and conclusions expressed or implied are those of the research agency that performed the research, and while they have been accepted as appropriate by the technical panel, they are not necessarily those of the Transportation Research Board, the National Research Council, the Transit Development Corporation, or the Federal Transit Administration of the U.S. Department of Transportation.

Each report is reviewed and accepted for publication by the technical panel according to procedures established and monitored by the Transportation Research Board Executive Committee and the Governing Board of the National Research Council.

To save time and money in disseminating the research findings, the report is essentially the original text as submitted by the research agency. This report has not been edited by TRB.

## Special Notice

The Transportation Research Board, the National Research Council, the Transit Development Corporation, and the Federal Transit Administration (sponsor of the Transit Cooperative Research Program) do not endorse products or manufacturers. Trade or manufacturers' names appear herein solely because they are considered essential to the clarity and completeness of the project reporting.

*Published reports of the*

## TRANSIT COOPERATIVE RESEARCH PROGRAM

*are available from:*

Transportation Research Board  
National Research Council  
2101 Constitution Avenue, N.W.  
Washington, D.C. 20418

and can be ordered through the Internet at  
<http://nationalacademies.org/trb/>

# FOREWORD

*By Staff  
Transportation Research  
Board*

This report presents an up-to-date description of emerging hybrid-electric drive technology for transit buses in the United States. The technology and its status, benefits, life-cycle costs, and deployment issues are discussed. The report is intended to provide transit agencies with information to compare the emissions and fuel economy expected from hybrid-electric transit buses with those expected from clean diesel or alternatively fueled buses. The report will be of interest to transit managers, bus manufacturers, operations and maintenance professionals, energy specialists, and others concerned about the deployment of or conversion to hybrid-electric vehicle technology.

---

Hybrid-electric drive systems on transit buses are being aggressively investigated as a means of improving fuel economy, reducing emissions, and lowering maintenance and operating expenses. Several major federally funded research and development projects are testing the viability of these drive systems on buses. In addition, a number of demonstrations are underway or have been recently completed by transit agencies. With the rapid pace of development and improvement of hybrid-electric drive technology, more transit agencies are being asked to evaluate the potential for hybrid-electric drive systems in their fleets. To assist transit managers with this evaluation, this report presents an overview of the emerging hybrid-electric drive technology in the United States. It is intended to provide transit managers with a better understanding of the technology, including benefits, challenges, and life-cycle costs.

Under TCRP Project C-10B, research was undertaken by the Northeast Advanced Vehicle Consortium and, through a subcontract, by M.J. Bradley & Associates to provide the following: (1) definitions and descriptions of hybrid-electric drive systems, including all relevant terminology; (2) information about the status of current hybrid-electric transit bus research and development activities underway; (3) a description and status assessment of hybrid-electric transit bus demonstration programs planned or underway at transit systems around the country; (4) a discussion of the benefits of hybrid-electric technology (quantified where possible), including life-cycle cost benefits; (5) a discussion of the issues and risks associated with the deployment of hybrid-electric drive technology; and (6) a method that will enable transit agencies to compare the expected emissions levels and fuel economy of hybrid-electric transit buses with those of clean diesel and alternatively fueled buses.

To achieve the project objectives, the researchers conducted an extensive assessment of the state of hybrid-electric drive technology in U.S. transit systems. This assessment included a literature search of emerging technology, auxiliary power units, electric-drive motors and inverters, energy storage, systems integration, hybrid bus emissions, bus costs, and fuel economy characterization. The researchers interviewed manufacturers to determine an up-to-date understanding of product plans and market trends for hybrid-electric transit buses and drive systems currently in development or commercially available. Transit agencies that have early experience deploying the tech-

nology were surveyed to obtain specifics on current cost/benefit issues as well as the problems, successes, and failures of their deployment programs.

Findings are presented in terms of the operational characteristics, acquisition costs, fuel economy, and drive cycle emissions associated with hybrid-electric drive systems relative to conventional diesel- and mechanical-drive systems. The report also presents case study descriptions of hybrid bus demonstration programs in New York City, Los Angeles, and Cedar Rapids.

# TABLE OF CONTENTS

<b>EXECUTIVE SUMMARY</b> .....	<b>i</b>
<b>1.0 WHY HYBRID-ELECTRIC BUSES?</b> .....	<b>1</b>
1.1 WHY ARE TRANSIT AGENCIES INTERESTED IN HYBRIDS? .....	1
1.2 WHAT IS A HYBRID-ELECTRIC BUS? .....	4
<b>2.0 HYBRID-ELECTRIC TECHNOLOGY DRIVE SYSTEM STATUS</b> .....	<b>8</b>
2.1 INTRODUCTION .....	8
2.2 TECHNOLOGY CHALLENGES: AN OVERVIEW .....	9
2.3 COMPONENT OVERVIEW .....	13
<b>3.0 HYBRID TRANSIT BUS DEMONSTRATION PROGRAMS</b> .....	<b>31</b>
3.1 INTRODUCTION .....	31
3.2 NEW YORK CITY TRANSIT: LEADING THE WAY IN HYBRID TESTING .....	35
3.3 CEDAR RAPIDS: TESTING HYBRID BUSES IN THE HEARTLAND .....	41
3.4 LOS ANGELES BASIN: MEETING CLEAN AIR GOALS WITH HYBRIDS .....	44
3.5 CONCLUSIONS .....	48
<b>4.0 HYBRID DRIVE LIFE CYCLE COSTS</b> .....	<b>49</b>
4.1 INTRODUCTION .....	49
4.2 CONCLUSIONS .....	55
<b>5.0 OPERATION AND MAINTENANCE</b> .....	<b>56</b>
5.1 OPERATION .....	56
5.2 MAINTENANCE .....	59
5.3 INFRASTRUCTURE .....	66
5.4 HEALTH & SAFETY .....	68
5.5 ENVIRONMENT .....	71
5.6 LEGAL & INSURANCE ISSUES .....	71
5.7 CONCLUSIONS .....	72
<b>6.0 EMISSIONS &amp; FUEL ECONOMY COMPARISONS</b> .....	<b>73</b>
6.1 NAVC HEAVY DUTY VEHICLE EMISSIONS TESTING 1999 .....	73
6.2 METHODOLOGY .....	77
6.3 TEST PROGRAM RESULTS .....	80
6.4 CONCLUSIONS .....	90
<b>APPENDIX A</b> .....	<b>A-1</b>
<b>APPENDIX B</b> .....	<b>B-1</b>
<b>APPENDIX C</b> .....	<b>C-1</b>

## **COOPERATIVE RESEARCH PROGRAMS STAFF**

ROBERT J. REILLY, *Director, Cooperative Research Programs*  
MONICA I. FRANCOIS, *Senior Program Officer*  
EILEEN P. DELANEY, *Managing Editor*  
BETH HATCH, *Editorial Assistant*

## **PROJECT PANEL C-10B**

WINFORD L. TERRENTINE, *Chagrin Falls, OH (Chair)*  
SAM Y. G. ELIAS, *University of Nebraska at Lincoln*  
ROBERT L. GRAHAM, *Northrop Grumman Corporation, El Segundo, CA*  
BRENDON HEMILY, *Canadian Urban Transit Association, Toronto, ON, Canada*  
DANA LOWELL, *New York City Transit Authority*  
JAMES McDOWELL, *NovaBus, Inc., Roswell, NM*  
JAMES L. O'SULLIVAN, *Parsons Brinckerhoff Quade & Douglas, Houston, TX*  
RONALD J. SHIPLEY, *Pierce Transit, Tacoma, WA*  
FRANK W. VENEZIA, *Lea + Elliott, Inc., Naperville, IL*  
SHANG QUEN HSIUNG, *FTA Liaison Representative*  
KAY LUONGO, *FTA Liaison Representative*  
WILLIAM B. MENCZER, *FTA Liaison Representative*  
JERRY TROTTER, *American Public Transportation Association Liaison Representative*  
PETER SHAW, *TRB Liaison Representative*

## **AUTHOR ACKNOWLEDGMENTS**

The research reported herein was performed under TCRP Project C-10B by the Northeast Advanced Vehicle Consortium and M.J. Bradley & Associates. The Northeast Advanced Vehicle Consortium was the contractor for this study. The work undertaken at M.J. Bradley & Associates was under subcontract with the Northeast Advanced Vehicle Consortium.

Sheila A. Lynch, Executive Director, Northeast Advanced Vehicle Consortium, was the principal

investigator. The other authors of this report are Thomas C. Webb, Project Director, Northeast Advanced Vehicle Consortium; Lisa M. Callaghan, Policy Analyst, Northeast Advanced Vehicle Consortium; Brennan Walsh, Intern, Northeast Advanced Vehicle Consortium; Thomas H. Balon, Jr., Senior Project Manager, M.J. Bradley & Associates; and Paul J. Moynihan, Project Manager, M.J. Bradley & Associates. The work was done under the general supervision of Sheila A. Lynch.



# Executive Summary

---

## ➤ **Introduction**

Hybrid-electric drive technology is poised to enter the heavy-duty transit bus market in the United States in the next several years. Public and private investments made over the last two decades have developed the technology to the point where it is viable and competitive with other propulsion technologies. The Orion VI Hybrid bus with the Lockheed HybriDrive™ system became North America's first commercial hybrid product offering from a major transit bus manufacturer in 1998. New York City Transit just announced the purchase of 125 Orion VI Hybrids for delivery in 2002. Hybrid product offerings from Nova BUS, New Flyer, Advanced Vehicle Systems and others are close behind.<sup>1</sup>

Hybrid-electric buses are in demonstration around the globe today. The number of hybrid buses in the U.S. alone is expected to quadruple in the next few years, while the total worldwide fleet may reach the thousands. Besides New York, large hybrid bus demonstrations are underway (or planned) in Cedar Rapids, Chattanooga, Los Angeles, Tampa and Tempe. These demonstrations are proving that hybrid bus technology is real and capable of transporting passengers daily in a variety of demanding locations.

What is a hybrid-electric drive system and why are transit operators so interested in it? What hybrid drive products are available today and where is the technology going in the future? What are the emissions and fuel economy characteristics of hybrid-electric drive buses and how are they measured? What are the issues, risks, and benefits of hybrid-electric drive systems for transit bus applications? What are the life cycle costs of hybrid-electric drive transit buses? These and other questions are the focus of this report.

This report seeks to provide a snapshot of the status of hybrid-electric drive technology in the United States transit bus market today. It starts by defining the hybrid-electric drive system and examining the factors spurring hybrid bus development. The researchers want to provide the reader with a working knowledge of the technology, an understanding of its basic components, and an appreciation for the opportunities and challenges associated with adopting the technology. The report discusses the state-of-the-art of the technology, technology challenges, and probable directions for the future. It includes brief discussions on manufacturers, drive systems, storage devices, and commercialization status. Several case studies are included that explore in depth the experiences of some early adopters. The report discusses benefits and issues relating to operation and maintenance, emissions and fuel economy, and cost drivers. Overall, the report seeks to give a balanced and unbiased overview of the technology and early field results as of late 1999. The reader should bear in mind that some information contained in this report will become outdated as hybrid drive technology matures.

## ➤ **Key Findings**

### ◆ **Definition & Purpose**

Hybrid-electric drive vehicles are often talked about and frequently misunderstood. Unfortunately, the technology defies easy definition. For purposes of this report, a hybrid-electric drive bus is defined as a bus that carries at least two sources of motive energy on board and uses an electric drive motor to partially, or fully, drive the vehicle's wheels. One often hears a dedicated electric or a bi-fuel bus incorrectly referred to as a hybrid-electric bus. A dedicated (battery powered) electric bus does not generate electricity onboard the bus, and a bi-fuel (e.g., gasoline/ethanol) bus does not feature an electric drive.

---

<sup>1</sup> The first light duty hybrid vehicles, by Honda and Toyota, are being introduced to the U.S. mass market in 2000.

Hybrid-electric technology enables more efficient use of any fuel source whether liquid or gas. While it is only part of the hybrid-electric vehicle equation, most heavy-duty hybrid-electric transit buses today attribute their increased fuel economy to the capture of regenerative braking energy.

Why hybrid? Hybrid-electric transit buses are being developed to answer specific challenges faced by today's transit operators, including range, fuel economy, emissions, and safety. However, the greatest incentive is probably the need to improve urban air quality and meet EPA and California emissions standards, especially for nitrogen oxides (NO<sub>x</sub>) and particulates (PM<sub>10</sub>). Just recently, the California Air Resources Board adopted tougher new emission standards for urban buses in California, including more stringent diesel standards of 0.5g/bhp-hr of NO<sub>x</sub> and 0.01g/bhp-hr of PM<sub>10</sub>, effective in 2004. By comparison, current EPA standards for urban bus engines are 2.4g/bhp-hr of NO<sub>x</sub>, effective 2004, and 0.05g/bhp-hr of PM<sub>10</sub>, effective 1996.

There has been a lot of conjecture about the emissions and fuel economy of buses available for use by transit agencies. Many alternate fueled transit buses, including hybrids, have been deployed with claims of low emissions and, sometimes, increased fuel economy. Furthermore, many conventional diesel and CNG buses have been recently updated with state-of-the-art emission controls. Until recently, independent test data showing the emissions and fuel economy of alternate fueled and hybrid buses has been scarce. A new emissions testing program was conducted during 1999 in Boston and New York City, with several different types of conventional and hybrid bus technologies undergoing testing. Results of the emissions and fuel economy characterization program are presented in this report.

#### ◆ **Technology Status**

Hybrid-electric vehicle technology has progressed significantly in recent years as a result of significant investment since the late 1980's. Numerous technical advances have been made in discrete technical areas; however, the greatest steps forward may well have been in the integration of all of the components into a comprehensive system. Hybrid-electric vehicle designs are becoming widespread and, considering the number of choices available for auxiliary power units (APU), energy storage devices, and other systems, no one design has yet risen to the top.

The hybrid-electric vehicle concept is relatively simple and provides real benefits in terms of improved vehicle range and performance as well as producing lower emissions. The critical components to hybrid-electric design are the APU, energy storage system, controller and drive motor. Current APUs are reliable and fuel efficient, but evolution continues with respect to peak operating range efficiency and improved fuel economy while lowering emissions through reduced size and weight.

The single greatest challenge facing hybrid development is battery technology. While current lead acid batteries are relatively cheap and reliable, considerable improvements in energy density, power density, life cycle and cost are still needed. Additionally, motors and generators have a long history of reliability but improvements in power density and reliability are being sought. All of the components necessary to manufacture a hybrid-electric bus exist in the marketplace today, and proper and better integration will lead to a bus that is far more efficient than today's conventional buses with emissions that are far lower as well.

In the near term, hybrids will likely take a form similar to that of a conventional bus with a diesel APU or parallel transmission, induction drive motors, conventional rear differential, and lead acid batteries. Currently, diesel hybrid buses are at the forefront due to the existing infrastructure and emission control technologies. However, hybrid technologies already accommodate most alternative fuels in use around the country and thereby further leverage emission reductions. In the long term, hybrid-electric buses may evolve toward fuel cell APUs, permanent magnet drive motors, direct-drive hub differentials, brake by wire systems and some type of advanced energy storage device.

#### ◆ **Field Demonstrations**

The hybrid-electric drive bus demonstrations underway around the globe show that the technology has moved out of the laboratory and into real-world testing. Demonstrations underway in New York City,

Cedar Rapids and Los Angeles include over 15 active hybrid buses with more than 100,000 fleet miles accumulated in just over a year of revenue service. Transit agencies report that the benefits of hybrid buses include improved fuel economy, acceleration and handling. Some of the vehicles have demonstrated inservice reliability rates as high as 70 percent, and drivers and riders seem to prefer the hybrids too. Early adopters say the learning curve with hybrids is steep and sometimes bumpy, but they are seeing steady improvement. They encourage other transit agencies to try hybrid buses and to prepare for the challenges associated with adopting a new technology.

#### ◆ **Life Cycle Costs**

Hybrid bus life cycle cost analysis is complicated by the fact that the technology is very young and therefore a large body of real world operating and maintenance costs does not exist at this time. Furthermore, social and political considerations that may heavily influence the decision to adopt a new technology are difficult to factor into the cost-benefit analysis. The bottom line is that transit operators can look forward to a net cost reduction associated with operating hybrid buses once the technology matures and economies of scale are reached. However, until then, early adopters will have to accept a net cost increase over conventional diesel technology.

The single largest cost driver at present is capital acquisition. Hybrid transit bus capital acquisition costs have come down considerably in the last several years, from about \$840,000/bus to \$385,000/bus today. Acquisition costs will see another price reduction again once annual production volumes reach 1,000 units and may reach price parity with conventional (mechanical) diesel buses if hybrids gain a large share of the truck market. The second largest cost driver is battery replacement, which adds between \$20,000 and \$50,000 to the cost of owning and operating a hybrid bus. The largest unknown at this time is maintenance cost, which could be significant since maintenance represents a large share of total transit bus operating expenses. Electricity and infrastructure costs are small in the larger context. Hybrids can produce tangible savings in fossil fuel reduction as a result of their 1.0 mpg improvement over mechanical drive. Depending on the price of diesel, this benefit can yield considerable savings over the life of the vehicle. Emissions reductions may help qualify hybrids for incentive and discrete emission trading programs in some states. The market value of these benefits might yield savings of tens of thousands of dollars over the life of the vehicle until such programs end. Most importantly, hybrid transit buses appear to be a good investment given their potential for large reductions in harmful emissions. Depending on their valuation, the social benefits of hybrids may outweigh their costs.

#### ◆ **Operation & Maintenance**

Hybrid drive offers numerous operational advantages such as smoother and quicker acceleration, more efficient braking, improved fuel economy, and reduced emissions. Maintenance requirements may grow slightly however, at least until the technology matures, due to increased complexity of the combined mechanical and electric drive systems. Infrastructure modifications are minor compared to other alternative fuels, and mechanical and safety retraining must occur in light of high voltage components on board the bus. Cold weather performance of hybrids remains to be more fully tested and understood. Hybrids can be used on just about any duty cycle; however, high-speed express type routes and long hills may require design or control optimization. Hybrid technology may win supporters among transit users, elected officials, and environmental constituencies for being quieter, smoother, and greener.

#### ◆ **Fuel Economy & Emissions Characterization**

Hybrid-electric drive buses offer significantly reduced drive cycle emissions compared to conventional mechanical drive buses. These lower emissions are coupled with, and in some cases a function of, increased fuel economy. When operated on stop and go, low-speed service applications, the hybrid technology demonstrates a clear advantage. As the technology improves and matures, hybrid drive cycle emissions and fuel economy will likewise improve.

Hybrid drive technology poses a challenge to conventional engine-based emissions certification. The current method for measuring emissions for certification is to test the engine alone on an engine dynamometer against a standardized load cycle. This method works on conventional vehicles because

vehicle driving speed and engine loads are directly related. In hybrid-electric vehicles, however, a control algorithm is used to control engine operation as a function of vehicle operation, which in turn determines engine load. While CO<sub>2</sub> emissions from a standard diesel engine-powered vehicle rise and fall with power delivered at the rear axle, CO<sub>2</sub> emissions from a hybrid vehicle rise and fall with power delivered by the APU. This issue of the engine being de-coupled from the vehicle load is largely alleviated when the entire vehicle is tested on a chassis dynamometer, as was the case during the 1999 NAVC emission-testing program.

Unlike engine dynamometer testing, chassis dynamometer testing is more representative of actual in-use vehicle operation as it accounts for the losses and operations associated with the specific vehicle into which the engine is installed. Chassis testing can also accurately measure the system benefits of hybrids, including the recovery of braking energy through regenerative braking, greater drive line efficiency and reduced transient operation of the engine powering the APU. However, chassis-based testing represents added cost and introduces the need for a fair, repeatable test protocol.

## 1.0 Why Hybrid-Electric Buses?

---

Hybrid-electric drive vehicles are often talked about, but frequently misunderstood. Unfortunately, the technology defies an easy definition, creating some confusion even among those within the industry. A hybrid-electric drive bus is one that carries at least two sources of motive energy on board the vehicle and uses an electric motor to partially or fully turn the vehicle's wheels. These buses are being developed to answer specific challenges faced by today's transit operators, namely range, fuel economy, emissions, and safety.

Hybrids are being developed to address urban air quality concerns and meet the federal and California emissions standards. The California Air Resources Board recently adopted tougher new emission standards for urban buses in California, which will maintain pressure on urban bus fleets to adopt cleaner technologies in the future. Hybrid-electric technology also enables more efficient use of any fuel source, whether liquid or gaseous. While it is only part of the hybrid-electric vehicle equation, most heavy-duty hybrid-electric transit buses today can attribute their increased fuel economy to the capture of regenerative braking energy.

Often one hears someone mistake a dedicated electric or a dual-fuel bus for a hybrid bus. Or one might hear someone define a hybrid-electric bus as a combination of a diesel engine and electric traction motor drive without reference to energy storage or regenerative braking. While this type of vehicle meets the criteria of a hybrid, there are many other possible hybrid-electric system configurations. Developers design their hybrid vehicles differently, using a myriad of component technologies, fuel combinations and configurations.

This chapter attempts to explain what a hybrid-electric bus is and why transit agencies and manufacturers are interested in them. The goal is to provide the reader with a working knowledge of the technology and an understanding of the basic components of a hybrid-electric bus. It also examines some of the factors spurring hybrid bus development.

### 1.1 Why Are Transit Agencies Interested in Hybrids?

Hybrid-electric buses are being developed to answer specific challenges faced by today's transit operators, namely range, fuel economy, emissions, and safety. Today's conventional buses still exhibit relatively poor fuel economy and moderately high emission levels while today's battery-electric buses cannot handle the demands of most transit duty cycles, specifically with respect to vehicle range. Hybrid buses are being developed in response to these challenges. Many hybrid-electric vehicles have evolved over time from initial work in the electric bus arena with assistance from both government and private programs. Additionally, many urban areas where transit buses operate experience air quality problems that are also driving the decision to adopt alternative technologies. These include both alternative fueled traditional buses and hybrid buses.

Hybrid-electric buses, like conventional buses, run on a wide variety of alternative fuels. In fact, more hybrid-electric buses run on alternative fuels today than on diesel; however, diesel hybrids appeal to many transit agencies because of the ability to utilize existing infrastructure while still significantly reducing emissions. Regardless, the long-term benefit of hybrid-electric technology is that it introduces efficient electric drive that allows for the capture of braking energy and facilitates a variety of engines and other more efficient energy conversion devices.

**No car company will be able to thrive in the 21<sup>st</sup> century if it relies solely on internal combustion engines.**

Jack Smith, CEO General Motors

### 1.1.1 Improved Efficiency

The United States now imports more than half of the oil it consumes annually. The trade imbalance created by oil imports poses a major threat to the nation's economy should foreign sources of fuel become disrupted. Congress has directed federal agencies to implement programs to reduce the nation's consumption of imported fuels. One of the primary strategies has been to support the development of advanced vehicle technologies, like hybrid-electric, that reduce fossil fuel consumption overall and can utilize domestically produced fuels such as natural gas.

A diesel cycle reciprocating engine is currently the most efficient power supply available to the transit industry. In a conventional bus, current diesel engines are about as efficient (~30% overall) as they can get, although direct fuel injection will be used in the future to eke out some small efficiency gains and emission reductions. The reason this increase is expected to be small for conventional transit buses is that engine efficiency is dominated by the operating cycle and excessive idle time and not necessarily by the peak efficiency of the engine. In a hybrid-electric vehicle, however, the engine is not tied mechanically to the wheels and can be operated more efficiently or, in some cases, turned off completely.

Four things need to occur to increase the fuel economy of a 40-foot urban transit bus:

- reduce vehicle mass, e.g., through use of lighter weight materials<sup>1</sup>;
- improve power supply efficiency, e.g., by converting to hybrid optimized engine, turbine or fuel cell;
- improve energy transmission, e.g., introduce electric drive transmission and reduce mechanical drive losses through direct drive; and
- recapture expended energy, e.g., use regenerative braking to capture kinetic energy otherwise wasted as heat.

In a conventional bus only some of these items can be affected, while all four can be used to an advantage in a hybrid-electric vehicle.

Most of today's hybrid-electric buses owe their fuel economy increase to the recapture of kinetic energy through regenerative braking. Presently, heavy duty hybrid designs are capable of recovering about 30 percent of the vehicle's kinetic energy during regenerative braking. An additional fuel economy benefit comes as a result of operating the engine in a more efficient, steady state mode and by eliminating inefficient modes such as idling. The availability of more efficient power sources, such as fuel cells, is still limited at this time, however that will likely change. In the future, further fuel economy benefits from hybrid-electric drive may be realized by improving efficiencies in the drivetrain and by reducing vehicle curb weight.

In transient and slow urban drive cycles, nearly 50% of the energy expended by the vehicle is utilized for acceleration while the remaining energy goes to auxiliary systems and road load. If all the kinetic energy could be captured it would potentially double current transit bus fuel economy. Real world system limitations usually result in a maximum capture of about 50% of the available kinetic energy during

---

<sup>1</sup> A common misconception regarding current hybrid buses as compared to conventional buses is that fuel economy is increased as a consequence of reduced vehicle weight. In fact, the addition of the load-leveling device (e.g. batteries) more than offsets any potential weight savings from reducing the engine/APU size in a hybrid vehicle and generally speaking most hybrids are heavier than their conventional counterparts. Aerodynamic efficiency plays a very small role in road load on a bus in urban stop and go driving. Tire losses comprise a majority of the remaining road load; however, the problem lies not in the tires themselves, as their efficiency has been optimized over the years, but in the weight of the vehicle that the tires are asked to carry. Considerable research is being conducted on lightweight vehicle designs such as carbon fiber chassis and integrated chassis/frames. Because this research is not directly attributable to hybrid-electric vehicles and will in fact increase the efficiency of both conventional and hybrid-electric vehicles, the researchers will leave it for now. It bears repeating, however, that lowering the overall weight of the vehicle will increase its overall efficiency.

regenerative braking. By recapturing 50% of the total kinetic energy (25% of the total expended energy), fuel economy is increased by 33%<sup>2</sup>.

### 1.1.2 Reduced Emissions

Air pollution in the United States is a public health issue that is being addressed at both the federal and state levels. Diesel buses emit significant amounts of volatile organic compounds (VOC) and oxides of nitrogen (NO<sub>x</sub>), which, combined with heat and light, can form ground level ozone. Ozone at ground level is a respiratory irritant that can adversely affect the elderly, children and those with chronic respiratory conditions. In addition, diesel buses emit particulate matter (PM) that have been shown to have adverse health impacts when lodged in the lungs. The California Air Resources Board (CARB) has listed diesel particulate as a potential carcinogen. Particulate emissions can be a very localized problem. The soot at the back of a bus is what the general community sees as the most severe pollution problem with transit buses.

In addition to PM, transit buses also release carbon dioxide (CO<sub>2</sub>) and methane (CH<sub>4</sub>) which are greenhouse gases. Methane has 21 times the CO<sub>2</sub> equivalency in terms of climate change potential. Carbon monoxide (CO) is also released by transit buses, which is a cold weather, cold start issue particularly in urban canyons. Buses also emit sulfur dioxide (SO<sub>2</sub>) in small amounts although much of it is considered as PM. Hybrid transit buses can effectively reduce all of these emissions, as will be shown in Chapter Six.

The EPA has set standards<sup>3</sup> which specify maximum levels of pollutants that may be emitted by urban bus engines on federal transient cycles (see Table 1.1) for sale in the United States. Recently, some health and environmental groups have advocated for tightening PM standards in light of new evidence that PM<sub>10</sub> and PM<sub>2.5</sub> may be toxic. CARB recently adopted new lower emission standards for urban buses in California (see Table 1.2). These standards will encourage bus fleets to adopt alternative fuels such as CNG early, starting in the year 2000. Those who wait until later to adopt advanced technology buses, such as hybrid-electric, would have to meet a more stringent standard of 0.5 NO<sub>x</sub> g/bhp-hr.

**Table 1.1: EPA Urban Bus Engine Standards (g/bhp-hr)**

Model Year	HC	CO	NO <sub>x</sub>	PM
1990	1.3	15.5	5.0	0.25
1991	1.3	15.5	5.0	0.10
1994	1.3	15.5	5.0	0.07
1996	1.3	15.5	5.0	0.05
1998	1.3	15.5	4.0	0.05
2004	0.5	15.5	2.5 (incl. NMHC) or 2.4 NO <sub>x</sub>	0.05

*Source: U.S. EPA*

<sup>2</sup> For example, consider a transit bus that gets 3 mpg on the Central Business District (CBD) cycle. Now, assume this bus recovers 25% of the total energy (50% of the kinetic energy) through regenerative braking. The hybrid-electric version now goes 3 miles on 3/4 of a gallon of fuel. Fuel economy will essentially increase by 33% from 3 to 4 miles per gallon. If all of the kinetic energy could be recaptured, fuel economy would double from 3 to 6 mpg.

<sup>3</sup> 40 CFR Parts 9 & 86.

**Table 1.2: New California Bus Engine Standards (g/bhp-hr)**

Model Year	“Diesel” Path		“Alternative Fuel” Path	
	NOx	PM	NOx	PM
2002	2.5 NOx + NMHC	0.05	1.8 NOx + NMHC*	0.03
2004	0.5	0.01		
2007	0.2	0.01	0.2	0.01
2008	15% of new purchases are Zero Emission Buses (ZEBs) for large fleets (> 200)	same as for NOx		
2012			15% of new purchases are ZEBs for large fleets (> 200)	

Source: CARB – adopted 2/24/2000

\* Although transit agencies on the alternative fuel path are not required to purchase engines certified to these optimal standards, CARB staff expects that they will do so in order to qualify for incentive funding.

### 1.2 What is a Hybrid-Electric Bus?

For the purposes of this report, a hybrid-electric bus is defined as carrying at least two sources of motive energy on board the vehicle, with an electric drive to provide partial or complete drive power to the vehicle's wheels. In most cases the two sources of motive energy will be an electrical energy storage device and an APU. In a conventional bus, the engine generates power that is mechanically transferred to the wheels through the transmission and differential. In a hybrid-electric drive bus, the engine is used to produce electricity and may be de-coupled from the wheels. Power is electrically transmitted to the wheels by a combination of the engine generator set and traction batteries (see Figure 1.1). Although simple, the components of an electric drive system may only be well understood by transit agencies that operate electric trains or trolley buses. These components and their functions are shown in Table 1.3.

Many of today's commercial hybrid-electric transit buses today are essentially retrofit conventional chassis. From a deployment and reliability standpoint this is a necessary evolution because one of the largest benefits of hybrid-electric technology is that it enables the recovery of vehicle kinetic energy via regenerative

**DEFINITION: A hybrid electric bus carries at least two sources of motive energy on board and uses electric drive to provide partial or complete drive power to the vehicle's wheels.**

braking. While there are other mechanical means for recovering energy (e.g., hydraulics), applying that energy back to propulsion becomes too complex in a mechanical system. Electrical energy, however, can be managed and stored in a variety of ways. Hybrid-electric vehicles capture kinetic energy from regenerative braking, store it in an energy storage device and utilize it later for auxiliary systems or propulsion.

The hybrid-electric drive definition problem is exacerbated by the fact that the technology takes many forms and different labels to describe

them. For instance, there are series and parallel hybrids, engine-dominant and battery-dominant hybrids, charge-sustaining and charge-depleting hybrids and dual-mode hybrids. Both series and parallel hybrid designs are currently under development and/or deployment and each has its advantages. Many perceived advantages are actually a function of the electric drive, which results in more available torque at low speed, smoother acceleration, and efficient regenerative braking. In either parallel or series configurations the immediate benefit is increased efficiency due to the capture of kinetic energy through regenerative braking.



The variety of advanced components used in hybrid designs -- fuel cells, turbines, advanced batteries, super capacitors and flywheels -- often adds to the confusion. If and when fuel cells finally achieve their cost

targets, hybrid technology will move toward series configurations and away from parallel designs. The benefits and tradeoffs associated with series and parallel hybrid designs are discussed further in Chapter 2.

**Table 1.3: Hybrid Vehicle Components**

**Chassis:** The body of the vehicle. Its weight and aerodynamic design will influence vehicle efficiency.

**Electric Drive Motor:** Creates mechanical power from electric energy to propel the vehicle.

**Controller and Inverter:** Regulates the amount of DC to AC power that the drive motor provides for acceleration and receives from regenerative braking.

**Energy Storage/Load Leveling Device:** Collects and releases electrical energy and balances the average power requirement of the vehicle with the electric power generated from APU.

**Auxiliary Power Unit (APU):** Converts fuel (CNG, diesel, methanol, etc.) into electrical energy. May take the form of an engine/generator or fuel cell. If APU uses an engine, it could be either an internal combustion reciprocating engine (i.e., diesel cycle) or a turbine engine.

**Auxiliary Systems:** Various components that drain power from the power sources. Includes climate control (heating and air conditioning), lighting, wipers, compressed air and power steering.

The problem of definition is compounded by the fact that people often use the term "hybrid" generically. There are other types of hybrid vehicles that are not hybrid-electric drive vehicles. For instance, dual or flexible-fuel vehicles that burn either ethanol or gasoline are types of hybrid vehicles (i.e., two or more sources of on-board energy). Fuel cell buses with no electrical energy storage are often incorrectly referred to as hybrid even if they do not recover energy through regenerative braking and store it in batteries to be used later. Neither flexible fuel nor pure hydrogen vehicles are hybrid-electric drive vehicles strictly speaking.

**1.2.1 Series Hybrid**

A distinguishing feature of a series hybrid is that the electric drive motor alone drives the wheels. The engine is not mechanically connected to the wheels (see Figure 1.2). The electric drive motors may draw energy from either the energy storage device (battery, flywheel or super capacitor) or from the APU. The main advantage of the series hybrid is that it allows the engine to operate independently from the vehicle. This would theoretically allow the engine/generator to be operated at peak efficiency all the time and could effectively increase a

diesel engine's overall efficiency from 30% to nearly 40%. However, when the engine is operated in this mode, two issues arise. All energy not immediately utilized by the drive motors or other systems will be stored in the energy storage device. Because current battery technologies have a round trip efficiency of about 80%, some of the generated energy is lost as heat. This has the general effect of reducing the overall engine efficiency and affects how many manufacturers will utilize their engines. A second issue is that of regenerative braking.

**Figure 1-1: Mechanical vs. Hybrid System**

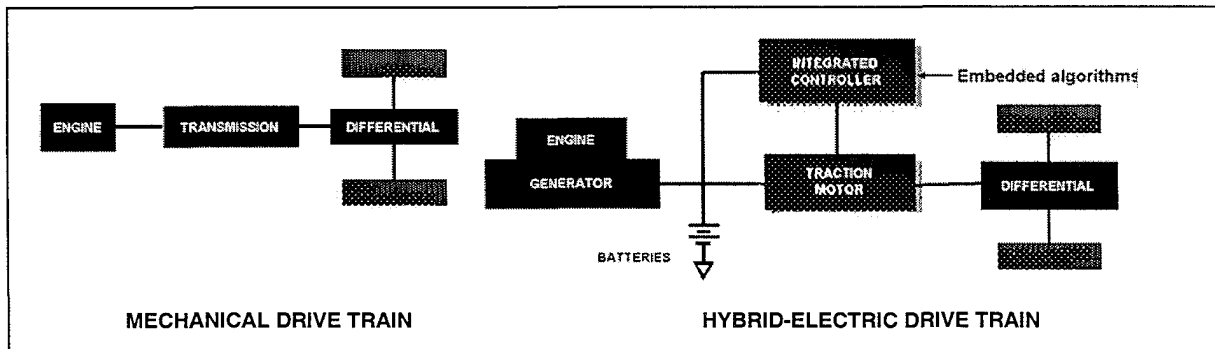

Source: Lockheed Martin Control Systems

Most energy storage devices have specific power ratings that in effect limit the amount of energy they can accept and, as a result, manufacturers will restrict APU operation during braking in order to maximize the amount of regenerative braking energy recovered. Generally speaking, a series hybrid is best in stop-and-go operation.

There are many variants of the series hybrid configuration based on APU type, the energy storage device and the relative size of both. A common description is whether the engine or battery dominates the supply of traction power during the vehicle's duty cycle. In an engine-dominant hybrid, a majority of the drive power is immediately produced by the APU, thus avoiding any unnecessary losses in the energy storage system. This type of configuration may lead to the use of a relatively small-capacity energy storage device in which regenerative braking capture efficiency is reduced and all electric range is minimal. In a battery-dominant series hybrid, primary drive power is provided by the energy storage device (e.g., batteries) and the APU is operated in a steady state mode to provide average cycle power. Battery-dominant hybrids would provide greater all electric range and would absorb regenerative braking power more easily. The downside is greater energy management losses (almost all energy is cycled through the batteries) and greater vehicle weight. Most series hybrid configurations seen in 40-foot buses take a middle path, that is to say they employ an APU that can provide nearly all drive power with small amounts of battery assistance and a sufficiently large battery pack to maximize braking energy recovery. Peak performance and its duration are directly related to the size of the APU and the allowable energy that can be removed from the energy storage device. Lockheed Martin Control Systems, Allison Transmission, Solectria Corporation, ISE Research, Inc. and others are all developing series hybrid drive systems.

### 1.2.2 Parallel Hybrid

A distinguishing feature of a parallel hybrid is the fact that the electric motor and engine are both connected to the vehicle drive wheels (see Figure 1.2). The electric drive motor draws energy from the energy storage device (battery, flywheel or super capacitor) and recovers energy from regenerative braking and supplies this energy back to the energy storage device. Depending on how the engine and drive motor are integrated into the parallel system, the engine may also be used to spin the drive motor as a generator to charge the energy storage device just like a series hybrid. Generally speaking, a parallel hybrid is best at sustained operation at high speeds.

While a parallel hybrid does not facilitate the installation of non-mechanical APUs such as a fuel cell, the reason for a parallel is simple. In a series hybrid, mechanical power from the engine must be converted into electricity and then from electricity back into mechanical power in the drive motor. This can result in as much as a 15 percent loss of energy in the conversion process or more than 35 percent if the energy is cycled through the batteries. Parallel hybrids eliminate this loss while still retaining the ability to recover regenerative braking energy. Parallel hybrids are, however, stuck with the conventional differential and, it appears, the automatic transmission. These components have an overall efficiency similar to the series electric configuration with about 15 percent of the energy being lost as heat. Of course, the parallel will still benefit if series vehicles continue to utilize the conventional differential as well.

While there are fewer APU variants for the parallel hybrid configuration, there is still the issue of engine or battery dominance in the supply of traction power during the vehicle's duty cycle. Since the parallel hybrid's advantage is in the direct application of engine power to the rear wheel, it would seem to make sense that a majority of the parallel hybrid designs are considered engine-dominant. However, in a conventional vehicle the desired acceleration is used to determine the engine's maximum power requirements. In a parallel hybrid vehicle, acceleration is assisted by the electric drive motor, which in turn allows the engine to be sized smaller, usually with the vehicle's top speed in mind. As a result, many parallel hybrids, like their series counterparts, are a compromise and are neither engine- nor battery-dominant. As with engine-dominant series hybrids, engine-dominant parallel configurations may lead to the use of a relatively small-capacity energy storage device in which regenerative braking capture efficiency is reduced.

A battery-dominant parallel hybrid would allow for primarily electric drive for low speeds and acceleration with energy provided by the energy storage device (e.g., batteries). One can expect that most parallel

hybrid configurations seen in 40-foot buses will be more middle of the road, with an engine that can provide all of the drive power necessary for sustained highway speeds and moderate acceleration. One can also expect a moderately sized electric motor able to provide substantial acceleration assistance if necessary since this motor will need to be large enough to handle the available regenerative braking energy. Allison Transmission is developing a parallel hybrid system for the heavy-duty truck and bus market.

**Figure 1-2: Hybrid System Configurations**

**Parallel Hybrid System**

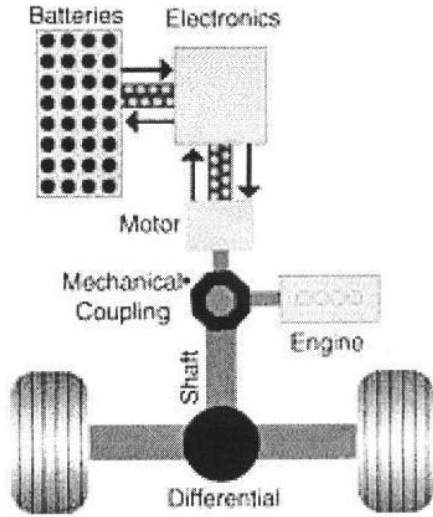

**Series Hybrid System**

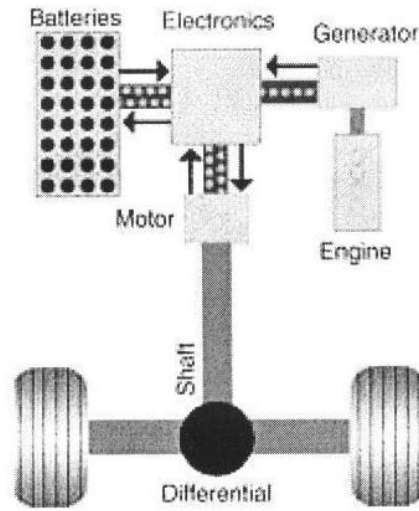

Source: Electric Transit Vehicle Institute

## 2.0 Hybrid-Electric Technology Drive System Status

---

Hybrid-electric vehicle technology has progressed significantly in recent years as a result of significant investment since the late 1980s. Numerous advances have been made in discrete technical areas; however, the greatest steps forward may well have been in the integration of all the components into a comprehensive system.

In the near term, hybrids will likely take a form similar to that of a conventional bus with a diesel APU or parallel transmission, induction drive motors, conventional rear differential, and lead acid batteries. These technologies will likely evolve quickly to include most alternative fuels in order to accommodate operators wanting to see immediate emission improvements. In the long term, hybrid-electric buses may evolve toward fuel cell APUs, permanent magnet drive motors, direct drive hub differentials, brake by wire systems and some type of advanced energy storage device.

This chapter provides an overview of hybrid-electric heavy-duty transit bus vehicle technology and is not intended to act as a design guide. Included are discussions of state-of-the-art technology, technology challenges, and probable directions for the future. Summaries are also provided on manufacturers, drive systems, storage devices, funding and development programs, and commercialization status.

### 2.1 Introduction

The long term benefit of hybrid-electric technology is that it will allow for replacement of the engine with more efficient devices. The biggest technology challenge facing diesel and gasoline internal combustion engines are emissions and efficiency. Turbines in the near term are generating low overall emission rates; however, they are less efficient than a similar capacity diesel engine (heavy-duty bus applications) but more efficient than a throttled gasoline engine (medium-duty buses). Both turbines and fuel cells offer power

**It may be 2-3 years before there's a reasonable introduction of hybrids, with significant market penetration in about 5 years.**

Dana Lowell, MTA New York City Transit

generation at lower emission levels, but high production costs will impede their widespread implementation in the near future (the next five to ten years). But based on a 12-year bus lifetime, fuel cell buses could well be to market by the time one's next fleet turnover is expected. Fuel cells cannot be deployed in conventional buses for the simple reason that they cannot provide mechanical energy.

Electric drive is what facilitates hybrid-electric technology and the ability to de-couple the engine from the vehicle and recover regenerative braking energy. The energy storage device is what makes it all possible in the real world. Recovering the energy from the drive motor and the controller is

actually the easy part, relatively speaking. Getting the energy storage device, typically lead acid batteries, to accept the energy is another problem. Due to internal resistance in the battery, when a large amount of current (flow) is supplied the voltage (pressure) in the system increases. Unfortunately, several components in the hybrid-electric vehicle, such as the controllers, the wiring and the batteries themselves, are limited in the amount of voltage they can handle before damage or failure occurs. To protect against

this, a voltage limit is usually employed that either limits regenerative braking or cuts it entirely. Other controls would typically turn the APU down to minimum power to facilitate maximum regenerative braking recovery. Bear in mind that the ampere and voltage levels encountered during regenerative braking are theoretically higher than those encountered during acceleration as vehicles generally stop faster than they accelerate.

Lead-acid batteries are the most commonly used energy storage system due to their commercial availability and cost effectiveness. However, lead-acid batteries have two major downsides when compared to other types of batteries: the weight of the battery and the short life-cycle relative to the expected life of the vehicle. Future trends in battery technology will be toward lighter and smaller batteries - for example, lithium based batteries, which are in the development stage. Other potential options for energy storage are super capacitors and flywheels.

In the near term, hybrids will likely take a form similar to that of a conventional bus with a diesel APU or parallel transmission, induction drive motors, conventional rear differential, and lead-acid batteries. These technologies will likely evolve quickly to include most alternative fuels to accommodate operators that have opted to adopt immediate emission improvements. In the long term hybrid-electric buses will likely evolve toward fuel cell APUs, permanent magnet drive motors, direct drive<sup>1</sup> hub differentials, brake by wire systems and some type of advanced energy storage device.

## 2.2 Technology Challenges: An Overview

### 2.2.1 System Approach

Overall design goals for a hybrid bus will impact how the system is designed. One way to illustrate this is to consider the duty cycle that the bus will encounter. For example, a duty cycle with frequent stops may be better suited for a series hybrid, which can take advantage of higher power energy systems with capacity for a larger amount of regenerative braking energy. Problems can occur when a systems approach is not employed in designing a hybrid bus. A simple example is reduced efficiency as a result of not choosing a generator that operates in the same peak efficiency range as the engine to which it is coupled, while a more complex example would be battery overheating due to an insufficiently sized battery pack.

**Like a chain, the strength of the hybrid-electric system will only be as good as the weakest link**

To fully optimize the performance of a hybrid bus, from both fuel economy and emissions standpoints, the hybrid system as a whole must be considered. Like a chain, the strength of the hybrid-electric system will only be as good as the weakest link. The manufacturer starts by choosing the individual components that are optimized for their individual tasks. The components that make up a hybrid bus include the chassis, drive motor, controller, energy storage system, APU and auxiliary systems (see Table 1.3 in Chapter 1 for the functions of these components). A hybrid vehicle can be set up as a series configuration, where only the electric motor drives the wheels, or as a parallel configuration,

**When choosing individual components, however, the overall picture needs to be addressed**

where both the electric motor and the mechanical engine can drive the wheels. (See Figure 1.2 in Chapter 1.) Different advantages and tradeoffs exist for each combination of components (see Tables 2.1 and 2.2).

When choosing individual components, however, the overall picture needs to be addressed. For example, in choosing an energy storage device the definition of its optimal performance is dependent upon the system to which it is coupled. For a series system with a small APU, the energy storage device not only has to provide large energy storage capability, but also the ability to absorb and discharge that energy quickly. This application is not unlike that of a pure electric vehicle where the batteries must handle all of the vehicle power.

<sup>1</sup> Direct drive eliminates the differential and, in the case of wheel motors, eliminates the drive shaft.

This also leads to the consideration of energy storage device and APU combination for efficiency and weight considerations. As the two largest single components of the hybrid system, these have the largest impact on performance goals. An energy storage device with a high power rating and sufficient energy capacity has a tradeoff in terms of its weight depending upon the energy storage method chosen (lead-acid battery, nickel-cadmium battery, super capacitor or flywheel). The APU has a direct impact on the fuel economy and emissions goals depending upon how it is optimized (whether for peak power or optimal fuel economy/emissions). Generally speaking, the larger the APU, the more it operates in a load-following capacity to match the energy demands of the cycle, hurting emissions and efficiency. A smaller APU can run at steady state with better emissions and generating efficiency, but more energy is lost passing through the batteries and the system relies more on the batteries for power.

**Table 2.1: Series Hybrid**

BENEFITS	TRADE-OFFS
Fuel cell compatible	Greater energy losses as more energy passes through the energy storage device than in parallel hybrid
Reduced emissions – engine rarely idles and tends to operate in a narrow peak efficiency band	Maximum power at high speeds may only be available with both the APU and energy storage device operating
Improved low speed acceleration – all power is routed through the electric motor providing high torque at low speeds	Lower steady state efficiency as generator is required to convert engine energy to electric energy and back again into mechanical energy
Numerous component layout options, simpler packaging	Increased weight – smaller APU will increase reliance on batteries and may require more batteries (weight) and may shorten battery life

Other systems that have a direct impact on performance goals are auxiliaries and motors. Auxiliary systems include the cooling system, passenger cabin HVAC system hydraulics (e.g., power steering), and the compressed air system. All of these systems must have the ability to operate even when the APU is not operating if the vehicle is intended to have some zero emission range. Research conducted by TNO Road-

Vehicles Research Institute in the Netherlands shows the addition of air conditioning can increase fuel consumption of a hybrid by more than 40 percent<sup>2</sup>. (This is put in perspective in Chapter 6, which deals with emission testing and vehicle efficiency.)

With average gross vehicle weights (GVW) in the 40,000-pound range, an important performance goal for transit buses is acceleration. Hybrid-electric buses improve acceleration as compared to conventional buses due to the electric drive motor. Since the motive power for a hybrid bus is provided at least in part through the electric motor (solely in a series hybrid), greater torque is available at lower speeds when compared to a conventional bus.

A computer controls the engine by monitoring state of charge from the battery pack and input from the driver on

**Table 2.2: Parallel Hybrid**

BENEFITS	TRADE-OFFS
More overall power – both engine and motor can supply power simultaneously	Generator rotor must spin when using energy from engine, adding more mass and rotating inertia
Reduced weight – smaller energy storage capacity possible compared to series hybrid	Less capable of capturing all available regenerative braking energy
Greater energy efficiency during steady state operation – not all energy must go through generator and electric motor as with series hybrid	Not fuel cell compatible
Greater battery life as batteries are used primarily for regenerative braking and acceleration assist, not for primary acceleration	

<sup>2</sup> Mourad, Salem, and C. van de Weijer, "Smart Solutions," *Electric & Hybrid Vehicle Technology*, 1997.

requested power (accelerator pedal) and deciding whether or not to engage the engine or increase its power output. In addition, the driver controls are monitored to determine when to engage the regenerative braking system.

### 2.2.2 Technology Approaches

Two manufacturers with buses currently undergoing in-service testing in New York City offer complete system integration between APU, regenerative braking system, driver controls, and battery packs.

**Figure 2.1: LMCS HybriDrive™ Propulsion System**

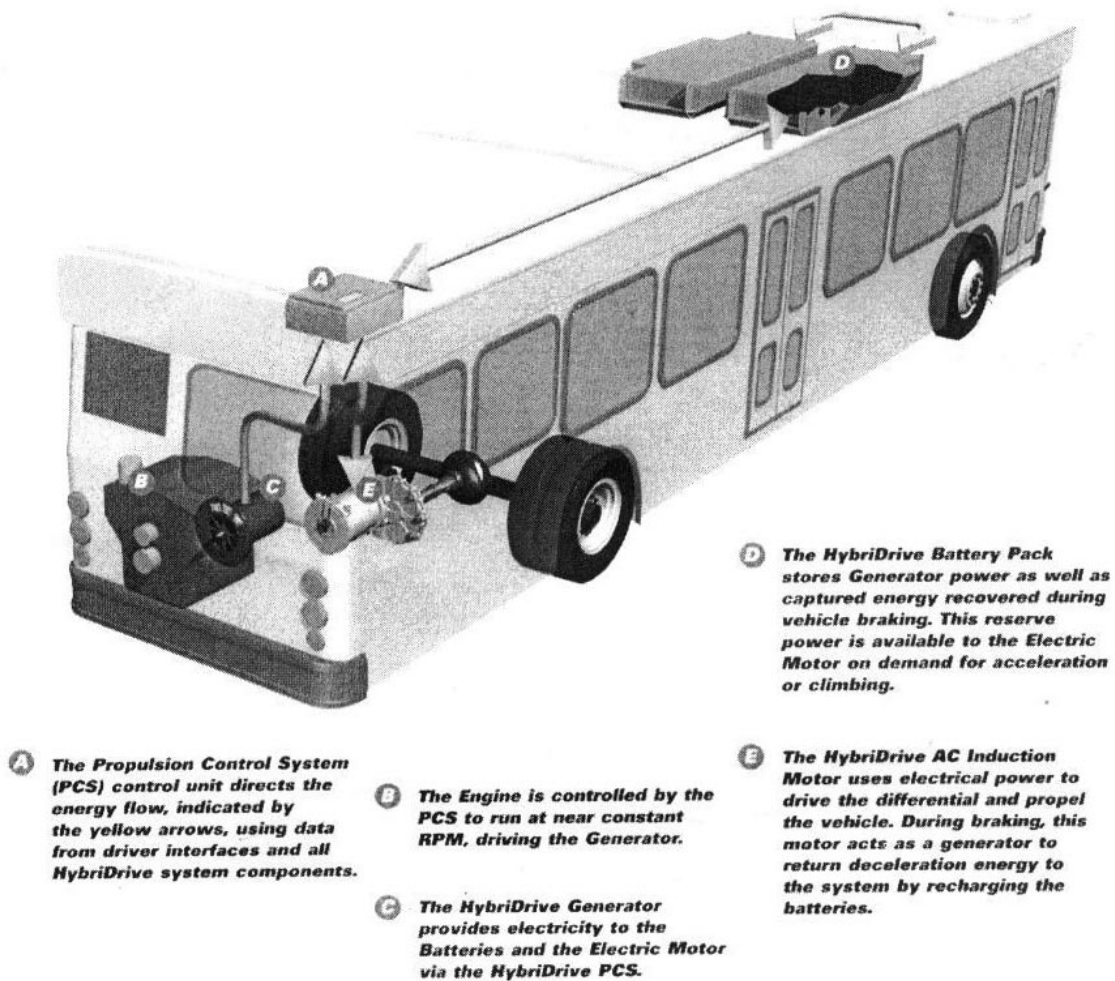

Source: Lockheed Martin Control Systems

LMCS offers the HybriDrive™ system as a "complete propulsion system integrating series HEV components" that can be customized based on the user's specific needs<sup>3</sup>. The system combination of

<sup>3</sup> Grewe, Tim "HybriDrive™ Propulsion System: A Cleaner, More Efficient Way to Go!," APTA, 1998

engine with electric motor, generator and battery pack enables both operation and maintenance advantages over conventional buses. Most notable are the improvements to fuel economy and emissions reductions. Maintenance costs are reduced due to several factors including reduced brake wear as a result of regenerative braking and reduced engine maintenance as the engine operates within a more narrow band than a conventional engine, more closely approaching steady-state operation.

The other manufacturer is Allison Transmission, which is demonstrating its E<sup>V</sup>Drive (see Figure 2.2). Allison is further refining its E<sup>V</sup>Drive system for comprehensive integration. The E<sup>V</sup>Drive system is a torque split, or electric variable drive unit with planetary gears that blend engine and motor torque. This allows for the combination of series and parallel power flow. Additional advantages of the E<sup>V</sup>Drive system over conventional buses are the size, efficiency advantage, and the ability for traditionally belt-driven accessories to be used during pure-electric operation. Regarding maintenance issues, the Allison bus benefits from the regenerative braking with reduced maintenance costs, and the E<sup>V</sup>Drive system has a traditionally configured powertrain which provides a system that would require little additional training or special procedures. Both the LMCS and Allison systems have been retrofitted to conventional bus chassis.

**Figure 2.2: Allison Transmission Parallel Drive Layout**

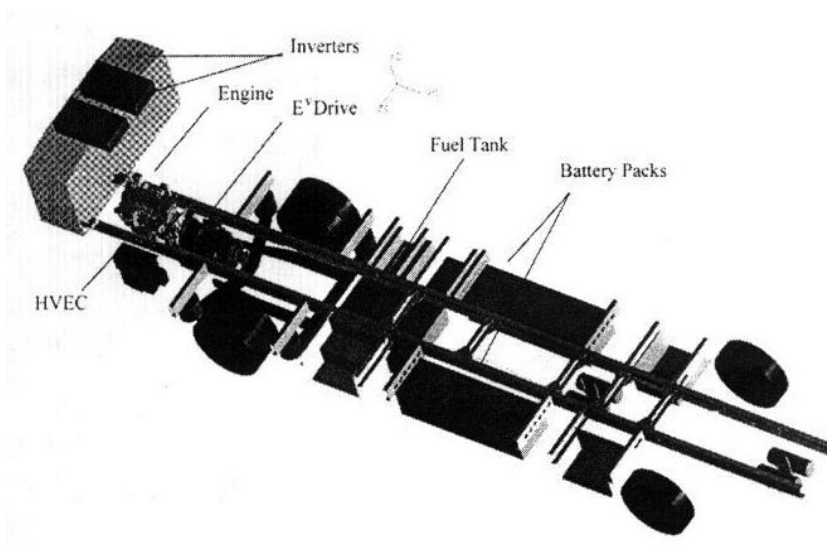

*Source: Allison Transmission Division of General Motors*

Another approach to system design is being taken by Advanced Vehicles Systems (AVS). Like the applications using diesel engines, the AVS/Capstone Microturbine 30/35-hybrid bus uses a compressed natural gas (CNG) powered microturbine APU. However, whereas the Lockheed and Allison systems are retrofit systems fitted to an existing chassis, the AVS hybrid bus is the first purpose built heavy-duty low-floored hybrid bus. According to the AVS web site, "the AVS 30/35 is designed to be a FTA [Federal Transit Authority] 12-year bus, incorporating industry standard components where possible." While the AVS bus will require changes to the maintenance systems of an operator because it doesn't use a conventional internal combustion engine, maintenance costs are reduced

**Figure 2.3: Allison Hybrid Bus in NYC**

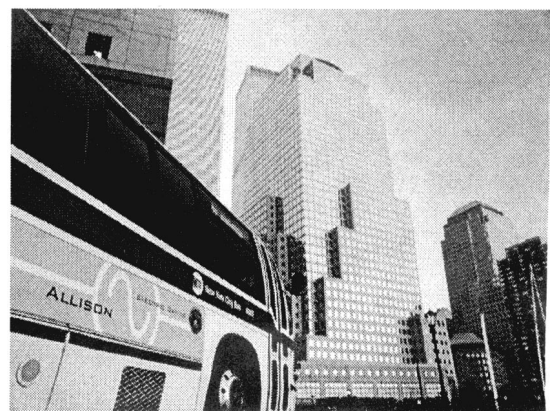

*Source: Allison Transmission Division of General Motors*



with regard to brake replacement due to integration of regenerative braking, and oil and coolant storage costs are eliminated as the bus requires neither of these fluids for operation.

There are a number of manufacturers that currently are developing and/or offer hybrid buses. To date they utilize both series and parallel configurations with a wide range of APUs. Chapter 3 as well as Appendix B provide a summary of ongoing hybrid heavy-duty vehicle projects.

**Figure 2.4: AVS 30/35 Hybrid Bus**

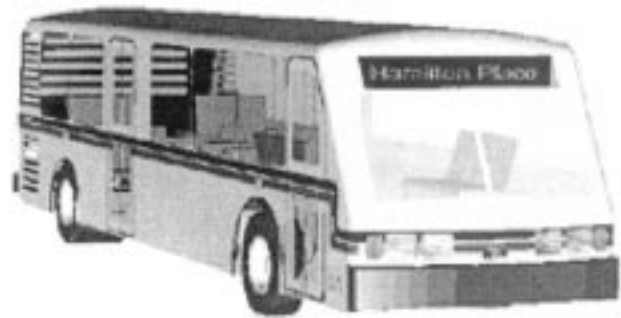

Source: Advanced Vehicle Systems

**2.3 Component Overview**

**2.3.1 Auxiliary Power Unit**

A hybrid bus contains two or more sources of energy. One of these power generators is an APU, which converts fuel into energy. Depending upon the hardware configuration, the APU can either drive the wheels (parallel) or generate energy to be used immediately or stored (series).

**2.3.1.1 Current Status**

Various hybrid bus manufacturers and researchers in APU technology have achieved some significant developments and milestones. These developments have an impact on hybrid bus performance issues like fuel economy, emission control, and vehicle range. Fuel economy improvements on the order of 30 - 50% relative to non-hybrid buses have been realized during federally funded testing programs for hybrid buses. In combination with fuel economy improvements, overall vehicle range improvements have been realized.

Included in the range of improvements is the important aspect of improved vehicle 'electric-only' range. Additionally, reductions in emissions have come from a combination of add-on controls, such as an oxidation catalyst, particulate matter (PM) trap, and engine optimization.

Lockheed-Orion, Lockheed-Nova BUS, and Allison-Nova BUS hybrid buses have been equipped with diesel powered APUs that allow for deployment with no impact on the fueling infrastructure at

**Table 2.3: APUs, Partial List**

Manufacturer	Where Operated	APU Engine
Orion/LMCS	New York City, NY Boston, MA	Navistar 444/Detroit Diesel Series 30, Diesel V8
Allison Transmission	New York City, NY	VM 642, Diesel 6cyl.
EIDorado/ISE	Los Angeles, CA	GM, Propane V8
Blue Bird/Northrup Grumman	Cedar Rapids, IA	Isuzu, Diesel
Blue Bird	Augusta, GA	Ford, Hydrogen LSG0875
AVS	Chattanooga, TN	Capstone, CNG Microturbine
Nova BUS/Ballard	Georgetown University	Ballard Methanol/ Hydrogen, PEM Fuel cell

the depots. The Lockheed-Orion VI buses use a Navistar 444 (Detroit Diesel Series 30 engine). The Allison bus uses a VM Motori VM642 engine on a 1991 Nova BUS (formerly TMC) chassis. The Los Angeles EIDorado buses use a General Motors V8 engine running on propane, although systems are available using CNG, diesel and other fuels. The Department of Energy (DOE) in partnership with the

Augusta-Richmond County Public Transit Agency (Augusta, Georgia) and Blue Bird bus manufacturer has deployed a hydrogen fueled internal combustion hybrid bus. The engine is a Ford LSG-875 industrial engine that underwent extensive modifications to allow for the use of hydrogen fuel.

AVS is currently designing and prototyping 30- and 35-foot heavy-duty, low floored, purpose build hybrid-electric transit buses. These buses use Capstone Micro Turbine technology with a hybrid range of up to 300 miles and an electric-only range of up to 60 miles<sup>4</sup>.

Fuel cell powered transit bus demonstration projects are currently underway in Chicago and British Columbia using Ballard<sup>®</sup> fuel cell APUs. The Ballard fuel cell is a polymer electrolyte membrane (PEM) fuel cell, which is also known as a proton exchange membrane fuel cell, or solid polymer electrolyte fuel cell. The Ballard fuel cell buses operating in Chicago and Vancouver are not strictly hybrid buses as they do not have an energy storage/load leveling device, and therefore, do not carry two sources of power and cannot recapture braking energy. Also, Georgetown University has tested a phosphoric acid fuel cell (PAFC) powered bus.

As the brief overview above shows, there is a lot of experimentation among hybrid bus projects. Several bus manufacturers are working with familiar engine manufacturers such as Cummins and Detroit Diesel, while others are testing unfamiliar technology, such as gas turbines and fuel cells.

### **2.3.1.2 Challenges and Tradeoffs**

APUs (engine and generator) are available in a number of configurations. The choice of APU affects the performance of the bus from several standpoints, including overall vehicle energy efficiency and speed. The overall energy efficiency of the engine has direct correlation to the range and fuel economy of the bus. Ideally an engine would be optimized to operate at peak efficiency during use. The engine as used in a hybrid bus is limited to a narrow operating range that allows for near constant maximum load on the engine for a given operating rpm (when required) with additional power such as acceleration provided by the bus load-leveling device. Parts of the engine-operating range can be eliminated such as excessive idle, low speed lugging (high load at low engine rpm) and high-speed cruise (low load at high engine rpm).

Conventional buses are traditionally diesel fueled with associated moderate levels of NOx and PM emissions and low levels of CO and VOC emissions. An important trade-off arises between the type of fuel utilized and emission levels. More discussion on the correlation between emission levels and fuel type can be found in Chapter 6.

When choosing an engine for a hybrid bus, the hybrid configuration, whether series or parallel, is a key factor. In a series hybrid, the engine can be operated all the time at near constant load, under a load following algorithm or cycled on and off. This provides energy to the energy storage device only when it is most efficient to do so and allows for smoother engine operating transitions. In a parallel hybrid, the engine must be able to withstand frequent transient load changes just like a conventional bus, as well as be able to maintain low emissions throughout the operating range. Electric drive assist can help a parallel hybrid avoid some of the low-speed high load conditions but may not alleviate the high-speed low load conditions.

Another very important consideration in choosing an engine is the optimization for particular performance goals, usually a combination of fuel economy, emissions, and power. Operation at peak engine efficiency may well correlate to an area of high NOx generation. To achieve the best balance between these goals a compromise must be reached. In most cases the engine operating range must be optimized with optimal points for high efficiency and low emissions as well as maximum power output.

Which energy source auxiliary systems utilize for power is another important decision. For example the compressed air system could be linked with a belt driven system to the engine. The advantage of this simple technology is its ease to install; however it would require the engine to be constantly operated. On the other hand, an electricity-driven system does not require the engine to be on all the time, theoretically

---

<sup>4</sup> <http://www.avbus.com>

allows for more efficient operation of the air compressor, and allows for some electric only range, but this type of technology is complex and requires an additional electric motor and controller. Similar tradeoffs exist for the other types of auxiliary systems.

Following is a discussion on the different types of APUs available.

### 2.3.1.3 Internal Combustion APUs

Internal combustion (IC) engines utilize compression ignition (CI) for diesel and spark ignition (SI) for gasoline engines. CNG engines also operate as spark ignition in either high or low compression engine variants. Diesel, CNG and gasoline engines can all operate as direct injection (DI), where the fuel is injected directly into the combustion cylinder and mixed with combustion air as opposed to being premixed prior to introduction into the cylinder.

Differing technology challenges exist for each of the different APUs. For diesel and gasoline internal combustion engines the biggest technology hurdles are engine emissions and energy efficiency, respectively. Emissions can be reduced through design and add-on controls while efficiency improvement is a function of the engine's compression ratio (low due to gasoline preignition limitations), pumping losses (high due to intake throttle plate) and thermal radiation losses (high due to high cylinder surface area to power ratio). For diesel engines, the compression ratio is typically at about 22:1, whereas with a gasoline engine, it is around 10:1. Direct injection promises to allow for increased compression ratio. Diesel engines produce maximum power at about half the rpm of a gasoline engine, which results in lower pumping losses. A diesel engine is not throttle restricted and runs wide open from an airflow standpoint unlike a gasoline engine which must regulate both fuel and air (throttle plate) to maintain a combustible mixture in the combustion chamber.

CNG/LNG engines face challenges such as low efficiency, especially in urban duty cycles, and added cost and complexity of the on-board fuel storage/delivery system. CNG buses also experience increased weight and/or reduced range compared to diesel vehicles due to the significantly lower energy density of gaseous fuels compared to liquid fuels.

### 2.3.1.4 Gas Turbine APUs

A gas turbine engine runs on a Brayton cycle using a continuous combustion process. A heat exchanger and compressor is used to raise the pressure and temperature of the inlet air, which is introduced into the burner with injected fuel. This mixture is then

**Figure 2.5: DDC Series 30 Diesel Engine**

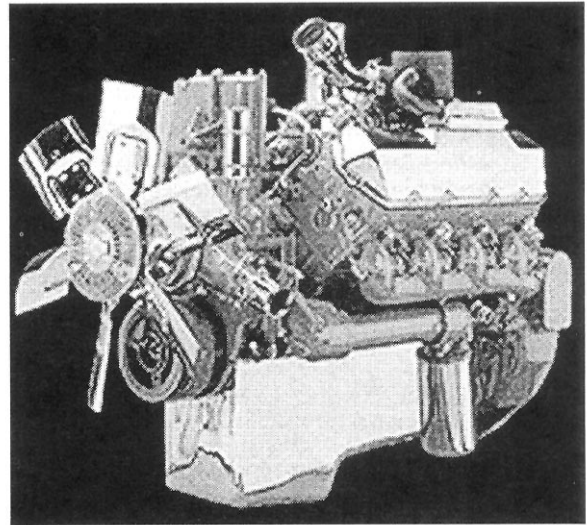

*Source: Detroit Diesel Corporation*

**Figure 2.6: Capstone Turbine**

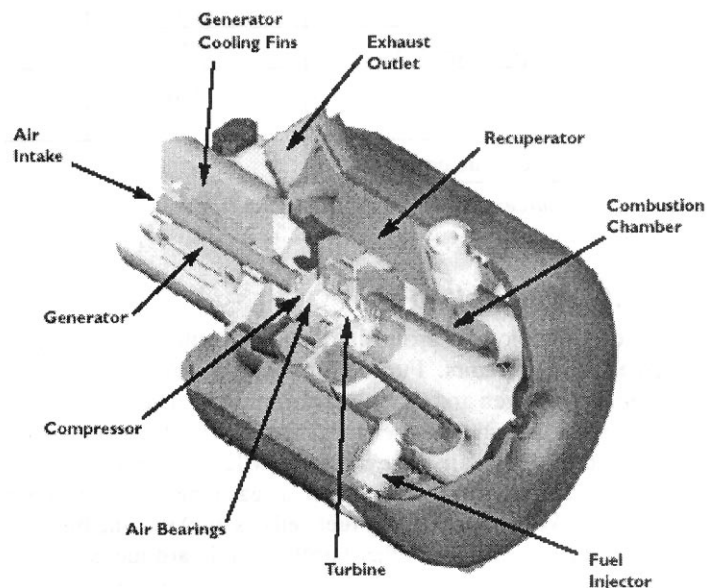

combusted. Power is produced when the heated, high-pressure combustion product mixture is expanded and cooled through a turbine. A heat exchanger on the outlet is then used to lower the exhaust temperature and preheat the inlet air, increasing overall efficiency. Gas turbine engines offer advantages such as being light, having few moving parts and being able to run on different fuels. However, they are challenged by high manufacturing costs, slow responsiveness, and energy efficiency. The high manufacturing costs are a result of small scale and very labor intensive production. Energy efficiency is another area where turbines have shown better results in steady-state operation than transient, such as is required in a hybrid. However, Capstone is developing its Micro Turbine™ to minimize efficiency fluctuations over variable loads. Perhaps the largest factor involved in reaching higher efficiencies is the need for a better heat exchanger, which adds weight and complexity to the hybrid application and a higher compression ratio.

The Chattanooga Regional Transit Authority (CARTA) has tested a single CNG turbine-powered bus manufactured by AVS and equipped with a Capstone gas MicroTurbine™ for several years. CARTA is moving to a dual turbine configuration on a 30-foot bus and has on order a number of hybrid buses, including a 30-foot hybrid bus with dual turbines. Historically, Capstone has focused on stationary applications, but it has agreed to supply AVS hybrid bus production with approximately 40 turbines to meet production demands.

**Table 2.4: Hybrid APU Characteristics**

Drive	Mechanical	Hybrid	Hybrid	Hybrid
-------	------------	--------	--------	--------

*Source: Capstone Turbine*

Make & Model	DDC S-50	DDC S-30	DDC 642	Capstone
Type	DI engine	DI engine	DI engine	Gas turbine
Peak Power	320	230	160	43
Displacement (L)	8.5	7.3	4.2	n/a
Weight (lbs)	2,230	2,046	662	163 w/generator
Electronic controls	√	√	√	√

*Source: Detroit Diesel, Capstone Turbine*

**2.3.1.5 Fuel Cell APUs**

Fuel cell technology is promising in that it could eliminate many of the complications associated with engines and generators. Fuel cells operate by harnessing the energy from a chemical reaction that combines hydrogen and oxygen to form water. During this reaction, electrical energy is released and recovered. Hydrogen can be stored and provided in a number of ways, as a compressed gas, a supercooled liquid and in a nickel metal hydride (NiMH) alloy matrix. Hydrogen can also be made available through storage as a liquid hydrocarbon such as gasoline, diesel, and methanol, and as a solid such as a sodium hydroxide. When considering fuel cells as an APU, the biggest challenge comes from reducing the costs to produce the unit, while another hurdle is on-board fuel storage or alternatively fuel reformation. A great advantage to fuel cell technology, however, is the energy efficiency of the overall system. In May of 1997, Daimler-Benz introduced the NEBUS, which utilizes Ballard® fuel cells with average energy yield of the

fuel cell system of roughly 45 % efficiency, better than that of a diesel engine which is approximately 30% efficient overall<sup>5</sup>.

This technology also holds considerable promise as a clean transportation source since the only byproduct from the hydrogen and oxygen interaction is water. Issues do surround the process by which hydrogen is extracted from another source of fuel as the overall "well to tank" losses can be considerable. These production losses would likely lower the fuel cell efficiency somewhat below the demonstrated level.

There are several types of fuel cells. The most commonly employed stationary source type is a phosphoric acid fuel cell (PAFC) which generates electricity at more than 40 percent efficiency. Georgetown University currently deploys buses equipped with International Fuel Cells (IFC) PAFCs that reform a liquid fuel rather than store hydrogen on-board, which allows for a range of 350 miles. However, a tradeoff in this case is that some fuel is burned in the reformer, which results in some combustion emissions.

Another type is a polymer electrolyte membrane fuel cell (PEMFC). The temperature range over which water is a liquid limits the operation range of these fuel cells. Since the membrane must contain water for the hydrogen ions to carry the charge within the membrane, PEMFCs must be operated at temperatures and pressures where water is a liquid. When higher temperature and pressures are used, the life of the cell is shortened. The obvious challenge that exists with PEMFCs is producing membranes that are not limited by the temperature range of liquid water<sup>6</sup>. Georgetown University is currently testing buses equipped with 100 kW PEMFC by Ballard and IFC.

Fuel cells face several hurdles for implementation into production buses, such as cost, reliability, size and weight. Current PEM fuel cells utilize a platinum catalyst that is expensive and can be easily fouled by impurities in the fuel. Development of alternative catalysts is necessary to minimize the affect of impurity fouling and to increase reliability. To increase the reliability and minimize the cost, a large surface area membrane is needed with a thin layer of catalyst. This leads to consideration of size and weight issues similar to those for battery packs, of fitting into relatively pre-defined engine bays and not increasing the weight of the bus to detract from fuel economy. Some buses are being purpose-built with fuel cells; however, the overall size and passenger capacity requirements for the bus are dictating what room is available for APU storage.

Range is limited to the amount of fuel (hydrogen) that can be stored on-board. These problems include whether or not to store raw hydrogen on-board, or to store another more dense liquid fuel such as methanol and to use a reformer to produce the hydrogen.

A significant hurdle exists in safely and economically storing the hydrogen fuel when stored as a gas at high pressure. Ballard has successfully addressed this issue for its current in-service buses in Chicago and Vancouver. The hydrogen is stored at high pressure in compressed gas cylinders on top of the bus. Another method of addressing this problem is through the use of a reformer to effectively convert an existing, relatively safe fuel into hydrogen on demand. Technically, reformers can operate with a wide variety of existing fuels including diesel and gasoline; however, the most successful on-board reformers to date have used methanol. This would allow for the use of existing technologies for storage of the fuel.

Storage in a NiMH matrix allows hydrogen from an off-board source to be absorbed into the metal and released when needed. The advantage to this process is the elimination of a reformer<sup>7</sup>. The weight of the NiMH storage device is an issue, as added weight impacts the overall efficiency of the bus, but this type of unit may well be used as either a compact energy storage device for a hybrid vehicle or as a buffer between a fuel cell and a reformer to provide for faster fuel cell response times.

---

<sup>5</sup> [http://www.ballard.com/bus\\_intro.asp](http://www.ballard.com/bus_intro.asp)

<sup>6</sup> Thomas, Sharon, and M. Zalowitz, "Fuel Cells - Green Power," Los Alamos National Laboratory Publication LA-UR-99-3231, 1999.

<sup>7</sup> "FCEVs: How and When," EVNews ~ advanced technology vehicles, July 1999.

### **2.3.1.6 External Combustion APUs**

Stirling cycle engines, which use an external combustion process, operate by allowing "heat to be transferred between the system and some regenerative energy storage device which absorbs heat from the system during part of the cycle and returns the same amount of heat to the system during another part of the cycle."<sup>8</sup>

Stirling cycle engines are attractive in theory as a hybrid engine due to their theoretical high thermal efficiency and ability to be run on a variety of fuels. However, development is still ongoing to provide a reliable, efficient and cost effective engine for hybrid application<sup>9</sup>. As of yet, development has focused on the light-duty marketplace and not on integration into heavy-duty hybrid transit buses.

### **2.3.1.7 Future Trends in APUs**

Improvements for APUs will involve refining their peak operating efficiency and improving fuel economy while lowering emissions. Currently available hybrid-electric buses do weigh more than their conventional diesel counterparts and reducing this weight will have a direct impact on fuel economy. Current internal combustion engines have very sophisticated electronic fuel controls that maximize power and efficiency as well as minimize emissions. Because internal combustion engines in hybrids do not typically operate in the same way that the same engine would in a conventional vehicle, these engine control algorithms are not necessarily optimized for hybrid use. Theoretically, an internal combustion engine optimized for hybrid use could provide better performance (improved fuel economy, lower emissions.) These engines will need to be certified by EPA and the California Air Resources Board. (For more discussion of engine certification for hybrid applications, see Chapter 6.)

Other improvements in store for APUs involve size and weight. Many hybrid bus projects are using small displacement diesel and even gasoline engines, while some are using CNG conversion kits for automobile engines. For the smaller engines, durability, performance and emissions deterioration are of concern. These improvements are necessary because current generation conventional diesel engines are designed for a life-cycle of anywhere from 300,000 to 500,000 miles to be deployed into a 12-year bus. Most engines currently utilized for hybrids are smaller and may not be designed for the same life-cycle.

Future developments are also on track to bring fuel cell technology to the commercial marketplace. Ballard plans commercial production of their 205 kW (275 HP) fuel cell engine by 2002. Improvements are required to the fuel cell fueling infrastructure that currently exists. Additional development opportunities are available with alternative membrane catalysts that are less susceptible to fouling due to impurities in the fuel, require less reliance on expensive platinum and use materials that are more efficient with respect to the rate of oxygen reduction and therefore increase fuel cell performance. These developments are expected to decrease cost and improve reliability.

## **2.3.2 Electric Motors and Generators**

### **2.3.2.1 Current Status**

Electric motors and generators are an integral part of a hybrid-electric system to provide electrical power from the APU as a generator and as a drive motor to drive the wheels of the bus. In a series hybrid there are two distinct motors, one attached to the engine APU and another attached to the vehicle driveline. All energy from the APU is first converted by a generator to electrical energy and then provided to the drive motor. Some or all of this energy may pass through the energy storage device. In a parallel vehicle, both the electric motor and APU can provide power simultaneously to the transmission, and the generator and drive motor may be combined into one motor assembly. In general terms, an electric motor is a device that turns electric energy into mechanical energy whereas a generator does the opposite. Both motors and generators vary with permanent magnet (PM), alternating current (AC), and direct current (DC) options

---

<sup>8</sup> Jones, J.B., and G.A. Hawkins, *Engineering Thermodynamics: An Introductory Textbook*, Second Edition © 1986, pages 225-226

<sup>9</sup> <http://www.hev.doe.gov/components/apu.html>

available. A PM motor or generator uses fixed magnets to produce electricity, whereas AC and DC units use electromagnets.

In a conventional IC engine vehicle, the maximum power is not available until the engine reaches high speed. This is because power in an IC engine is limited to the amount of fuel and air combusted. IC engines are air limited based on engine displacement, operating rpm and pumping efficiency. At low rpm (idle) very little combustion air is being provided and, as a result, less than full power is available. Engine power is a combination of rpm and torque, where the torque can be increased at lower engine speed through the use of turbos and superchargers and a transmission or another form of torque multiplier. Electric motors offer benefits to the hybrid system over a conventional system in that all of the torque is available immediately at low rpm. This provides excellent acceleration for the bus off the line.

**Figure 2.7: UQM Permanent Magnet Motor**

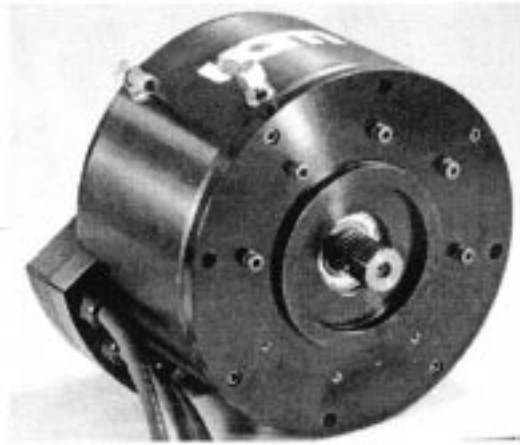

*Source: Unique Mobility*

**Figure 2.8: LMCS AC Induction Motor**

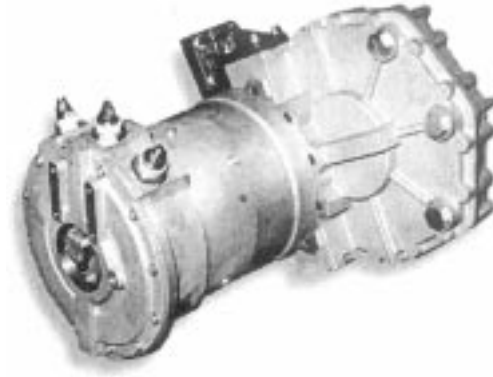

*Source: Lockheed Martin Control Systems*

AC systems have higher efficiency over a broader range but are more expensive than a DC system. DC motors are usually easier to control but tend to be larger and heavier. Permanent magnet drive systems are lightweight, efficient and compact but are also more expensive. AC, DC and PM motors all require the controller to be used as a drive motor but, when used as a generator, an advantage to a PM generator is that it does not need a controller. Most automobiles currently utilize controlled (voltage regulated) AC alternators versus the DC or PM generator. However, many of the current APU manufacturers use permanent magnet generators due to their extremely compact dimensions. Currently, there are wide varieties of motor types, sizes and manufacturers out there. There are few large drive motors yet (e.g., 100-150 kW) and as a result some designs rely on doubled up drive motors to achieve sufficient capacity. Table 2.5 shows a listing of different types of electric motors and their characteristics.

**Table 2.5: Hybrid Motor Characteristics**

Manufacturer	Unique				
	Lockheed	Delphi	Mobility	Siemens	Solectria
Type	AC induction	AC induction	Permanent Magnet	AC Induction (dual motors)	AC Induction (dual motors)
Peak Output (kW)	190	155	100	280	150
Continuous Output (kW)	190	140	N/A	170	136
Max Torque (lbf-ft)	485	N/A	405	454	424
Max. Speed (rpm)	1,500	N/A	4,400	2,200	N/A
Cooling	oil	oil	oil	water/glycol	air
Dimension (in.)	16x25	N/A	15x16	32x20x16	N/A
Weight (lbs)	250	N/A	190	705	496
Power Density (kw/lb)	.76	N/A	.53	.40	.30
Efficiency (%)	90	N/A	90	90	90

Source: Lockheed Martin Control Systems, Delphi, Unique Mobility, ISE Research, Inc., Solectria Corporation

### 2.3.2.2 Challenges and Tradeoffs

The type of generator chosen for a hybrid is based on specific considerations. Efficiency of the generator varies across the rpm range and certain types may be better suited to series or parallel operation. For example if a generator has a limited range of optimal efficiency, it would be better suited to an application where it is not asked to operate outside that range very often.

An additional challenge exists for generators and motors with regard to cooling. Assuming an electric motor is approximately 93% efficient, the remaining seven percent is lost as heat. If this heat is not dissipated, the motor will overheat and burn out or at least operate at a further reduced efficiency. Two methods of removing the excess heat are air or liquid cooling. With both methods, an additional electric or mechanical load may be imposed on the system to power either a fan or a pump. While air cooling is fairly straightforward, there may be a heat rejection issue in warm climates. Air cooling may not provide sufficient or uniform cooling to the spinning rotor portion of the motor. The totally enclosed fan cooled (TEFC) AC motor however has had extensive development in commercial and industrial applications that lends credence to its longevity. Liquid cooling generally results in a more compact drive motor at the cost of increased complexity. For high power drive motors, liquid cooling may be the only option if space and weight are concerns. This system does add an additional maintenance item and potential leak to the vehicle. In many cases the cooling fluid used in these systems is also unique because of the high rotating speeds or special dielectric properties, and may require additional purchases.

While electric motors have existed for a long time, installing these motors into a cramped engine bay does necessitate some design changes that may have effects on reliability. The greatest reliability impact comes from the use on mobile systems, such as hybrid vehicles, where vibration, temperature and exposure to the elements or chemicals (e.g., oils) are different. The major long-term challenges for this technology are reliability and cost.



### 2.3.2.3 Future Trends

The trend may be toward smaller, high-density wheel motors. This is valuable because it eliminates the differential and its associated losses, and increases the mechanical efficiency of the bus in both drive and regenerative modes. Motor and generator developments are being pursued to reduce the size and weight of these components and increase the efficiency. These factors will determine whether the technology will be competitive in the near term with long-term focus on improving reliability and lowering cost. As with most components associated with hybrid buses, the cost is expected to come down as production volume increases.

## 2.3.3 Energy Storage/Load Leveling Devices

### 2.3.3.1 Current Status

The basic function of the energy storage system is to supply and absorb power during acceleration and deceleration. The term energy storage device is best used when referring to a pure electric vehicle or a battery dominant hybrid where some level of electric only range is expected. Another way to look at these devices is as load-leveling devices where the energy storage device is used primarily to capture and store regenerative braking energy for later use in acceleration. This is the case in an engine dominant series and parallel hybrid where the APU is primarily used in vehicle load following mode. The captured energy is then used for initial acceleration from a stop where the engine/APU is least efficient. This allows for a relatively small capacity energy storage device; however, this device must still deal with the kinetic energy equivalent of the vehicle. In practice hybrid-electric vehicles will be somewhere in between the battery dominant and engine dominant extremes, and the energy storage/load leveling device will allow the APU to run somewhere between constant load and load following.

Depending upon the system design requirements the energy storage device may be optimized for total energy capacity, total power or somewhere in between. If the vehicle in question will be operated in electric-only, zero emission mode the energy storage device will need to have significant total energy capacity or the battery life may be degraded because of the increase to the depth of discharge. This will result in increased weight and volume on the vehicle displaced and may have an impact on which fuels can be used (room for either CNG tanks or batteries but not both). This results from drive power and regenerative braking power being relatively fixed for a given vehicle weight.

The key challenges facing these technologies are weight, cost, reliability, maintenance, and efficiency. There are four basic types of energy storage systems for hybrid buses, chemical batteries, segmented hydride batteries, electrostatic super capacitors, and mechanical flywheels. Most hybrid vehicles are using lead-acid batteries. Other common types of energy systems include sealed lead-acid, nickel-cadmium (NiCd) batteries and zinc-air batteries. Less common but viable are super capacitors, flywheels and segmented hydride batteries.

**Table 2.6: Energy Storage Device Suppliers and Affiliated Projects**

Supplier/Developer	Type	Affiliated Projects
Fulmen	Flooded Lead Acid	AVS/Capstone
Electrosources Horizon	Absorbed Electrolyte Lead Acid	Orion IV, VI; Gillig Phantom; Georgetown University Nova BUS Fuel Cell
Saft	Nickel-Cadmium	APS/Calstart, DUETS, New York State Consortium
Hawker, Electrosources	VRLA	Nova BUS/Lockheed
Tavrima	Super capacitors	NASA-Glenn
Sonnenschein	Sealed Lead-Acid	Solectria/New Flyer

### 2.3.3.2 Batteries

The energy produced by the APU and/or regenerative braking system can be stored in electrochemical cells. Different technologies exist for the batteries with current focus on lead acid, nickel metal hydride (NiMH), NiCd, lithium-polymer, and lithium-ion. Additionally, new developments are being made with zinc-air batteries and segmented hydride batteries. Zinc-air batteries operate by using an air electrode to absorb oxygen to generate electrical current on discharge, not requiring heavy metal or bulky oxidizers. However, a disadvantage is that discharged zinc-air batteries cannot be electrically recharged. Segmented hydride batteries are the batteries of choice for use in satellites since there are no standing losses as can be experienced over time with other technologies. However, a major drawback to using them for hybrid bus application is the high cost. Another type of battery being developed is the nickel-salt battery. For lead-acid batteries, emphasis is being placed on bi-polar batteries as they have demonstrated high power and low internal losses with lower mass and lower cost<sup>10</sup>. Most battery development is being directed toward pure electric and battery dominant vehicles and, as such, all previous battery life characterization is based on electric vehicle mode deep discharges. As a result, it is as yet undetermined how long batteries can last in a hybrid application.

Unlike energy storage optimized batteries, batteries for hybrid vehicles would be designed to have a high specific power (kW/kg) rather than a high specific energy (kWh/kg)<sup>11</sup>. Specific power is a key design criteria in determining the amount of regenerative braking power that can be accepted. The energy available will determine how long the system can accept this power and, during conditions of acceleration or operation at peak vehicle performance, how long the bus will operate. In addition to vehicle voltage and maximum desired current characteristics, specific power determines the minimum number of batteries required and therefore, the mass of batteries, affecting both overall fuel economy and the electric-only range. Related to this, the battery technology chosen is a function of bus weight, internal resistance, and cycle life.

Battery technologies face a number of issues including up front cost, life-cycle, ongoing mechanical maintenance (some lead acid and NiCd technologies require frequent watering), equalization and recycling issues. Examples of equalization maintenance are the New Flyer/Solectria buses in Orange County that must be grid connected every night for pack equalization, while the Lockheed HybriDrive™ provides realtime equalization and battery pack conditioning via periodic (monthly or less) grid connection. Lead-acid technologies are relatively low cost and high power, making them the ideal choice for early hybrid vehicles. They also have a significant recycling infrastructure and manufacturing capability. The penalty for lead acid is significant weight, moderate round trip efficiency, low cycle life and the need for regular maintenance (possibly only equalization). As one moves toward other battery technologies, the cost increases due to rarity in construction materials and low production volumes. In exchange for the extra cost, one receives lower weight, greater energy capacity, less maintenance and longer cycle life.

### 2.3.3.3 Super Capacitors

Super capacitors store energy by electrostatically separating and accumulating charges physically between internal plates. The advantages of super capacitors are their round trip efficiency, light weight, ability to accept very high power (i.e., have very high specific power), and requirement of almost no maintenance with long cycle lives. The biggest problems are that voltage varies greatly with state of charge and requires active control, high cost and low specific energy by volume. With respect to a hybrid vehicle, a super capacitor would be considered more of a load-leveling device than an energy storage device, as the total amount of energy stored would probably give the vehicle a pure electric range of less than a mile. Technical integration issues associated with super capacitors center around the fact that they operate over a much wider voltage range in discharge than batteries. This has significant implications for integration into

---

<sup>10</sup> Mourad, Salem, and C. van de Weijer, "Smart Solutions," *Electric & Hybrid Vehicle Technology*, 1997.

<sup>11</sup> C.J.T. van de Weijer, and A. Brunia, "Hybrid Electric CNG Buses," *Electric & Hybrid Vehicle Technology*, 1995.

a hybrid system; either additional power electronics are required to match voltages or the other parts of the system (e.g., motors) need to be designed to operate over this wider range of voltage. However, the biggest roadblock for super capacitors is cost.

#### **2.3.3.4 Flywheels**

Flywheels are different from both batteries and super capacitors in that they store energy mechanically by using a wheel or disk that spins rapidly in a vacuum. Basically the bus's kinetic energy is converted into spinning kinetic energy in the flywheel. Because the flywheel is a mechanical device, an additional motor and controller is required to convert the electrical energy to mechanical and back again.

While flywheel technology is still developmental, advantages exist in that there are no hazardous materials, have only one moving part, and are not affected by temperature. However, in order for flywheels to become commercial products, several significant hurdles must be overcome. These include optimization of construction materials to maximize the ability to store kinetic energy, while not increasing the weight so much as to cause the flywheel to break apart under centrifugal forces. In addition, the flywheel could also break apart during an accident if it experiences sufficient forces. This is a major safety challenge for flywheel technology, as rotor fragments can become dangerous projectiles when the flywheel breaks apart under these forces and the containment system fails. This also requires optimization of containment system materials to reduce risk of injury if the flywheel breaks apart.

#### **2.3.3.5 Challenges and Tradeoffs**

The major challenge that exists for energy storage systems is to minimize size and weight while maintaining or improving performance and efficiency. As energy cycles in and out of the batteries, some is lost due to inherent internal resistance. These inefficiency losses translate into heat, which requires more battery mass to absorb and reject the heat without damage. Most current battery designs are not very good at rejecting heat and, in fact, the plastic cases act as insulators. The addition of heat transfer material is generally considered a waste of space and weight. The number and size of the batteries is usually determined by the voltage of the bus and the minimum available module size required to handle the high current loads of a hybrid bus application. Both of these problems result in the need for large amounts of expensive, heavy batteries despite the fact that the total energy required for load leveling is relatively small. Once the decision to install a significant battery capacity has been made the vehicle will however have some level of electric only range capability.

Most batteries used on hybrid buses are conventional lead-acid types, which add a significant weight penalty<sup>12</sup>. Lead-acid batteries offer some advantages over other technologies in that they are low cost, have high reliability, are readily available and a recycling infrastructure exists. However, they do have some drawbacks, such as low energy density, poor cold temperature performance and low cycle life. Solutions are being sought for these problems with development of bi-polar batteries and use of battery thermal management systems to maintain temperature. Table 2.7 provides a comparison of current level battery technology.

NiCd batteries offer advantages in that they have a higher cycle life in a pure electric vehicle mode than lead-acid and can be recharged more quickly. However, issues exist regarding "high raw material cost and availability, recycle ability, the toxicity of cadmium, and temperature limitations on recharge ability."<sup>13</sup> Another downside to NiCd batteries is that they require watering, while most of the lead-acid batteries are maintenance free (i.e., sealed.) NiMH batteries, similar to lead-acid are recyclable and provide a greater specific energy. On the downside, NiMH batteries have very high costs and high charging temperatures, experience hydrogen loss and have low cell efficiency<sup>14</sup>. NiMH battery costs are high now based on both

---

<sup>12</sup> Mark, Jason, and L.R. Davis, *Shifting Gears: Advanced Technologies and Cleaner Fuels for Transit Buses*, Union of Concerned Scientists, Cambridge, MA, April 1998.

<sup>13</sup> Dr. Raymond A. Sutula, *Hybrid Electric Vehicles – Energy Storage Technologies*, Office of Transportation Technologies, U.S. Department of Energy, May 1996.

<sup>14</sup> Ibid.

low production volumes and material and manufacturing issues (e.g., the interiors are hand riveted.) However, with future production volume increases, the cost is expected to come down to approximately one-third of the current levels. Hydrogen loss leads to the requirement for adequate venting to avoid an explosive atmosphere at or near the batteries.

Regardless of the type of batteries chosen, special consideration must be given to the overall safety issues surrounding the battery pack. Most notable is the potential for arcing between battery modules and between the pack and the bus itself, which presents fire and explosion hazards. To minimize this, proper isolation of not only the pack but also the individual batteries themselves within the pack must occur. Other hazards include the potential for electrolyte spill in the event of an accident or build-up of explosive gases such as hydrogen. With lithium-based batteries, the lithium metals and compounds can ignite or become explosive when exposed to air or moisture. The key to combating this is proper battery management in terms of isolation and containment<sup>16</sup>.

**Next generation heavy duty hybrids are unlikely to have lead acid batteries. Whether it will be nickel metal hydride or supercapacitors isn't known yet. But we expect to see a change in energy storage technology every three years. Therefore, we have to design our system to accept upgrades.**

Tim Grewe, Allison Transmission<sup>15</sup>

Another concern for energy storage devices is placement within the bus. Due to the nature of a bus, the passenger compartment must be maximized resulting in storage occurring either beneath or above the passenger cabin. This can affect passenger seating or handling and servicing

if batteries are placed on rooftop. This system also competes for space with compressed gas cylinders if a gaseous fuel is chosen. With any hybrid bus energy storage system comes the concern over replacement. How often the batteries require changing will impact the long-term costs of operating such a bus.

<sup>15</sup> This quote was provided when Tim Grewe was an employee of Lockheed Martin Control Systems.

<sup>16</sup> <http://www.hev.doe.gov/general/safety.html>

**Table 2.7: Comparison of Energy Storage Options**

	ElectroSource Lead-acid <sup>a</sup>	Ovonic Battery Company Nickel Metal-hydride <sup>c</sup>	Saft Advanced Nickel-Cadmium	Lithium Ion <sup>d</sup>	3M- HydroQuebec Lithium Polymer	Maxwell Super Capacitor	Flywheel <sup>f</sup>
<b>Model</b>	H12N85	HEV 60 Ah Module	STX-600	<sup>d</sup>	119 Ah Module	PC2500	<sup>f</sup>
<b>Specific Power (W/kg)</b>	240	500	350	300	315	3,305	600 – 5,600
<b>Specific Energy (Wh/kg)</b>	42	70	35	90	155	2.48	15 – 132
<b>Estimated Life (full discharge cycles)</b>	700	1,000	2,000	1,000	600	20 - 120 Months <sup>e</sup>	Lifetime of the bus
<b>Cost (\$/kWh)</b>	\$295 <sup>b</sup>	\$200 - \$2,000	\$833	\$1,000 - \$3,000	\$10,526	N/A	150 – 2,000 projected
<b>Maintenance</b>	None	None	Distilled water	None	None	None	None
<b>Recycling</b>	100%	100%	100%	100%	100%	None	100%

*a – Batteries currently used in the Lockheed-Orion hybrid-electric bus*

*b – Cost is based on purchase of a single module; discounts are available for volume purchases*

*c – Specifications for an Ovonic 60Ah battery module; cost range represents target (\$200kWh) and current prototype costs (\$2000/kWh)*

*d – Various manufacturers/models: Information from "1998 Zero-Emission Vehicle Biennial Program Review," California Air Resources Board, July 6, 1998.*

*e – Lifetime of the super capacitor depends upon operating conditions such as temperature and operating voltage.*

*f – Various manufacturers/models: Information from "An Assessment of Flywheel Energy Storage Technology for Hybrid and Electric Vehicles," U.S. Department of Energy, July 3, 1996*

### **2.3.3.6 Future Trends**

Further development is also ongoing for batteries in the areas of battery life, specific power, size and weight. The battery life, or number of discharge/charge cycles it can endure, has a direct impact on the operating and maintenance costs of the user. Additionally, the size and weight of a battery pack influence fuel economy and range. An important consideration is the tradeoff between battery size (and, therefore, range) and its impact on fuel economy. With the battery pack, planned developments also include minimizing energy losses as energy cycles into and out of the pack. Related to the minimization of energy losses is the maintenance of the pack at an optimal operating temperature.

The United States Advanced Battery Consortium (USABC) is a partnership among the domestic auto makers, the U.S. DOE, the Electric Power Research Institute (EPRI) and battery manufacturers. USABC

has developed mid-term and long-term goals with respect to battery technology targets as provided in Table 2.8. To date, the USABC has focused on applications for pure electric vehicles and thus optimization and testing for the charge/discharge cycle for a hybrid vehicle has not been performed.

**Table 2.8: USABC Battery Goals**

<u>USABC Goal</u>	<u>Specific Power *</u>	<u>Specific Energy +</u>	<u>Lifetime</u>	<u>Cost</u>
Mid-term goals	150-200 W/kg	80-100 Wh/kg	5 Years	\$150 or less per kW-hr
Long-term goals	400 W/kg	200 Wh/kg	10 Years	\$100 or less per kW-hr

KEY: \* Watts per kilogram + Watt-hours per kilogram

Source: U.S. Advanced Battery Consortium

Electric Fuel and General Electric are currently developing an innovative hybrid bus that uses a zinc-air battery system as the primary power supply. Although this bus is technically an electric bus because it ultimately gets all of its energy from the grid, its battery innovations are worth mentioning. The zinc-air battery system is used for high energy storage with the auxiliary battery used for its high power and cycling characteristics. The prototype under development is planned to use a NiCd battery as the auxiliary battery to provide acceleration and power absorption during regenerative braking<sup>17</sup>.

The National Aeronautics and Space Administration (NASA) and the Glenn Research Center in Cleveland Ohio have developed a proof-of-concept prototype of a hybrid bus that uses super capacitors as the sole energy storage system. The Metropolitan Transit Authority of Harris County, Texas (Houston Metro) hopes to integrate a flywheel into an Advanced Technology Transit Bus (ATTB) bus.

## 2.3.4 Other Influencing Factors

### 2.3.4.1 Fuel Choice

A variety of fuels are available for hybrid-electric buses, from the traditional, such as gasoline and diesel, to alternatives such as CNG, LNG, propane, methanol and hydrogen. Hybrid drive buses in demonstration today run on a variety of conventional and alternative fuels including diesel, CNG and propane. Each fuel choice involves tradeoffs with respect to supply, cost, weight, performance, emissions and safety. Fuel analysis with respect to hybrid drive is beyond the scope of this report. For further information regarding fuel choices, there are several independent reports available through the Transportation Research Board and the Federal Transit Administration.<sup>18</sup>

### 2.3.4.2 Emissions

A major issue at hand for most transit buses currently in operation is emission of air pollutants. Since most traditional buses are diesel fueled, NO<sub>x</sub> and PM are of primary concern. The development of hybrid buses allows for the range of traditional buses to be realized with lower emissions because the APU engine operates at more consistent loads and certain high emission areas in the load range can simply be avoided. In the long term these engines would be optimized in this range for even lower emissions. Not only does

<sup>17</sup> Brown, Ian, J. Mader, and J. Whartman, "Zinc Air Battery-Battery Hybrid for Power All-Electric Transit Bus," paper presented at the Electric Power Research Institute (EPRI) Electric Bus Users Group semiannual meeting, February 1999, Miami, FL.

<sup>18</sup> For detailed analysis of natural gas and hydrogen refueling requirements for transit, see US DOT-VNTSC-FTA-96-3 (natural gas) and -98-6 (hydrogen); and TCRP Report 38, "Guidebook for Evaluating, Selecting, and Implementing Fuel Choices for Transit Bus Operations."

optimization reduce emissions, but the use of after treatment control devices for the exhaust gases also plays a large role. In addition to optimization, the use of other cleaner fuels, such as CNG, LNG, propane, methanol and hydrogen, dramatically changes the emissions profile of a transit bus as compared to its traditional diesel rival.

For control of NO<sub>x</sub> from the APU, primary efforts center on exhaust gas recirculation (EGR) and retarding of the engine injection timing. Because the NO<sub>x</sub> formed in an IC is thermal in origin due to high peak combustion temperatures (as opposed to fuel bound elemental nitrogen) the goal is to optimize the engine to prevent or minimize NO<sub>x</sub> formation. Catalyst technology does exist for the reduction of NO<sub>x</sub> and is currently used in light duty automobiles, although to date it has not been used on transit buses. Most transit buses are now equipped with oxidation catalysts for the completion of combustion of volatile organic compounds and carbon monoxide emissions.

PM emissions with fuels other than diesel are typically minimal. With diesel powered APUs, control devices do exist to achieve even further reductions. PM control devices, commonly called regenerative traps, are used in conjunction with traditional oxidation catalysts and physically trap the unburned carbon. Because the smaller hybrid APU generally operates at constant load for a given operating point, the exhaust temperature is relatively steady and higher than a conventional engine, running between 200 and 600 °F. Much of the PM emissions from diesel buses consist of unburned carbon and to a lesser extent sulfur compounds. The trap is maintained at a temperature that allows for the eventual burning off of the unburned carbon, therefore reducing the PM emissions. An issue does exist with PM traps with regards to sulfur. Sulfur creates PM emissions, but the sulfur PM cannot be burned off in the trap as it is essentially oxidized already. If the sulfur compounds are in gaseous form, they pass through the trap untreated; if however the sulfur compounds are solid particulate, eventually this will lead to fouling and clogging of the trap. One obvious way to avoid this situation is to use only very low sulfur fuel.

#### **2.3.4.3 Regenerative Braking**

Regenerative braking recovers kinetic energy from a moving bus by utilizing the vehicle drive motors as generators that are driven by the vehicle wheels. This energy is directed to the energy storage device, which allows it to be used later as motive power. Currently, a regenerative braking system is utilized in combination with a conventional system on a hybrid bus. Regenerative braking systems can be controlled in two ways by the bus electronic control algorithms. The control algorithms can be set up to activate regenerative braking when the driver releases the accelerator pedal (typically referred to as simulating engine braking) and/or when the driver depresses the brake pedal.

Potential energy can also be recovered over a downhill route as kinetic energy. A bus at the top of a hill exhibits certain potential energy that will be converted to kinetic energy as the bus descends the hill. During descent, regenerative braking can be applied to maintain the bus at a safe and relatively constant speed and excess energy is captured through the regenerative braking system. Friction braking systems convert kinetic energy to heat, which is lost to the atmosphere and wasted. Regenerative systems brake by wire utilizing the resistance of an electromagnetic field in the drive motor; as a result, the mechanical brakes are not utilized as often and last longer.

Current configurations of regenerative braking systems and energy storage devices have problems recovering all of this energy for several reasons. When a bus decelerates due to the driver's applying the brakes, energy can in theory be recaptured. However, current systems capture little energy during sudden braking. Some of the braking is still accomplished at the front wheels. Most of the current 40-foot buses are rear-wheel driven, with regenerative systems only on the rear brakes. This results in a potential loss of some of the available kinetic energy. Further losses through the regenerative braking system can be attributed to the rear brakes, the rear differential, the drive motor, controller, and finally the batteries. Currently the batteries are the weakest link in the regenerative braking chain. If a bus coasts slowly to a stop, a significant portion of the braking energy can be recovered. The reason current systems can only capture a small amount of the regenerative braking energy under sudden braking is due to limitations of the electrical/electronic systems of the bus. Most notably is the inability of the batteries to quickly absorb the large amount of energy that is generated due to internal resistance. Regenerative systems also pose control system complications to bus manufacturers, because both electronic brake-by-wire and physical air-brake

systems maximize regenerative braking. Once the battery issues are resolved attention will begin to focus on maximizing regenerative losses by eliminating the differential and minimizing friction brake use.

The regenerative braking system has a positive affect on fuel economy performance which is optimized during frequent and gradual slowdown and stopping. The more heavily weighted a stop-start cycle is the greater the increase in fuel economy.

It bears mentioning that during operation a bus also experiences energy losses from several non-recoverable areas. These losses are rolling and wind losses usually referred to as road load. Rolling losses occur as a result of the friction between the tires and the surface of the road and flexing of the tires themselves. The mass of the bus has an affect on the amount of rolling losses incurred. Additionally, as the bus travels, the force required for the bus to push through the air mass surrounding it results in additional unrecoverable losses. These wind losses are a function of the profile of the bus: the more aerodynamic, the less wind losses incurred. In a typical stop and go transit application, wind losses comprise only a small portion of the total road load with tire losses making up the remainder. It is important to note that rolling and wind losses are permanent and that only kinetic and potential energy can be recovered through regenerative braking.

#### **2.3.4.4 Auxiliary Power Systems**

Integrating auxiliary power systems into a hybrid bus is important for maintaining consistent service capabilities. Heating and cooling systems are a major concern because they affect not only passenger comfort, but also bus operations. The easiest way of providing for heating and cooling systems is usually to run these systems off of the engine. However, a downside to this in a hybrid design is that the engine may be required to run solely for that purpose. Different hybrid buses run the accessories either electrically or mechanically. The GM-Allison Nova BUS and Lockheed Nova BUS retrofit buses run the accessories electrically so as to not require constant operation of the APU (i.e., it can operate for a limited range in pure electric mode). The Lockheed bus on the other hand employs mechanical accessories such as the cooling system and air compressor for reliability and commonality between the hybrid and conventional buses.

#### **2.3.4.5 Mechanical/Electrical/Electronic Systems**

Developments are also underway in the area of improving the electric and electronic systems of the hybrids. Not only does this consider such things as energy loss through the differential motors and controllers, but also in software management tools. The software that controls the operation of the APU, regenerative braking capture algorithm and battery pack energy state of charge must be tuned for the particular conditions that a bus will experience. For example, a bus that runs a route with many frequent starts and stops will benefit from greater regenerative braking than would a bus that operates on a route with frequent high speed sections with few starts and stops.

Further energy loss minimization is planned through development of improved transmissions/differential systems for parallel hybrids. A large portion of energy is lost through mechanical friction in the transmission and differential. This also holds for drive systems for all hybrid types. When mechanical losses are reduced, overall fuel economy benefits.

One manufacturer that is developing a system approach to these improvements is Allison Transmission. Allison's E<sup>V</sup>Drive™ is a system whose "controls create the optimum combination of series and parallel power flow"<sup>19</sup> and provides several advantages. Among these are its relative size as compared to conventional engines and its modular construction to allow for quick removal and installation. Additionally, with the Allison E<sup>V</sup>Drive™ system, conventional belt-driven accessories such as cooling fans can be used during pure electric operation, and the powertrain has a traditional configuration to simplify maintenance.

---

<sup>19</sup> Hurst, Kevin, "Technology Trade-offs in a High Performance, Heavy-Duty HEV Powertrain," paper presented in Topical Technical Workshop (TOPTEC) Society of Automotive Engineers (SAE) meeting, Albany, NY, May 1999.



#### **2.3.4.6 Commercially Viable Versus R&D Level Technology**

There are currently several commercially viable hybrid buses available. Manufacturers and partnerships offering them are the Orion/Lockheed, Allison/Nova BUS, AVS/Capstone, ElDorado National/ISE Research and Nova BUS/Lockheed.

At the R&D level, much more activity is underway by different manufacturers exploring the combinations of APUs and energy storage. Some of these include TPI Composites' work with Solectria Corporation using a CNG APU and innovative chassis materials to further capitalize on the ability for fuel economy savings from hybrid buses through weight reduction. Development has concluded on the NASA Glenn super capacitor proof-of-concept bus to provide a turbine-capacitor hybrid that provides excellent performance while doubling fuel economy and reducing emissions<sup>20</sup>. The goal of the NASA Glenn project was to develop technology and assist manufacturers in bringing it to in the commercial marketplace. The NASA Glenn project has lead to successful proof-of-concept vehicle production and discussions are ongoing with a confidential manufacturer to further develop the technology for the marketplace.

Also at the demonstration level is fuel cell technology. Most notably are the demonstration projects that are ongoing in Chicago and Vancouver using Ballard<sup>®</sup> fuel cells and the fleet demonstration at Georgetown University.

While some of the hybrid-electric vehicles in service today are still under development, many are commercial products that are currently in revenue service. Many operators are heard to say only when the technology becomes established and has passed the developmental stage will they consider hybrid-electric vehicles. Several hybrid-electric vehicle designs are very close to jumping the developmental hurdle, and it is likely that the next big hurdle--establishing the technology--cannot be accomplished without operator involvement.

#### **2.3.4.7 Funding for Technology Development Programs**

While significant private investment is occurring in hybrid technologies today, the government has been a major partner in seeding and co-funding projects. Government funded development cost share programs exist for heavy-duty component and system manufacturers through several agencies, the Defense Advance Research Projects Agency (DARPA), the Department of Transportation (DOT), the Department of Energy and NASA. Recently, DARPA and DOT have begun overseeing a joint program between these programs, with eventual responsibility being turned over to DOT with a move toward heavy-duty applications. The Department of Energy is also focusing on the hybrid-electric marketplace. To date most of the focus has been on light-duty systems but a recent program focuses on the development of a hydrogen fueled hybrid bus. NASA has focused on technology development of fuel cell and super capacitor technologies. Fuel cells have been used in the space program for a number of years, and NASA, through their Commercial Technology Network, has provided funding and expertise to bring fuel cell technology down to earth.

#### **2.3.4.8 Epilogue**

Hybrid-electric vehicle designs are becoming widespread and considering the number of choices available for APUs, energy storage devices, and other systems, no single design has yet risen to the top. Different manufacturing partners are benefiting from public and private funding to continually evolve and improve hybrid transit buses. Currently, diesel hybrid buses are at the forefront due to the existing infrastructure and emission control technologies. However, alternatively fueled hybrids are expected to be just as prolific.

The hybrid-electric vehicle concept is relatively simple and provides real benefits in terms of improved vehicle range and performance as well as producing lower emissions. The critical components to hybrid-electric design are the APU, energy storage system, controllers and drive motor. Current APUs are reliable and fuel efficient but evolution continues with respect to peak operating range efficiency and improved fuel economy while lowering emissions through reduced size and weight. The single greatest challenge in the

---

<sup>20</sup> Brown, Jeffery, D.J. Eichenberg, and J.E. Fleet, "Hybrid Electric Transit Bus Project Status and Performance Impressions," SAE International Truck & Bus Meeting & Exposition Slide Presentation, 1998.

hybrid development is battery technology. Whereas current lead acid batteries are relatively cheap and reliable, goals are set for attaining better efficiency and more reliability. Additionally, motors and generators have a long history of reliability but improvements in power density and reliability are still sought. All of the components necessary to manufacture a hybrid-electric bus exist in the marketplace today and proper and better integration will lead to a bus that is far more efficient than today's conventional buses with emissions that are far lower as well.

---

## 3.0 Hybrid Transit Bus Demonstration Programs

Hybrid-electric buses are in demonstration around the globe today. In the U.S., large demonstrations are underway in New York, Cedar Rapids and Los Angeles, and are planned for Chattanooga, Tempe and Tampa. These demonstrations are proving that hybrid bus technology is real and capable of transporting passengers daily in demanding locations like Los Angeles and Manhattan. Operator data shows that hybrid buses significantly reduce NO<sub>x</sub>, HCs, and PM<sub>10</sub> and improve fuel economy. What's more, passengers and drivers prefer hybrid buses to conventional diesel buses. This relatively young technology has demonstrated in-service reliability as high as 70% in some locations, and hybrid bus operators expect the technology will continue to improve rapidly in the coming years. They encourage other transit agencies to try hybrid buses, but also to prepare for the challenges associated with a new technology.

This chapter will provide an overview of hybrid bus demonstration programs underway around the world and in-depth case studies of three major U.S. demonstration programs in New York City, Los Angeles, and Cedar Rapids, Iowa.

### 3.1 Introduction

Hybrid buses are performing transit service around the globe today. We estimate more than 300<sup>1</sup> hybrid buses have been built worldwide as of 1999 (see Figure 3.1). In the United States, about 70 hybrid buses have been tested with transit agencies from New York to Hawaii. Approximately 50 hybrid buses have been deployed for testing throughout Europe, notably Germany, Italy, Sweden and Denmark. In Asia, hybrid buses are being tested in Japan, Thailand, and Australia. Hino Motors in Japan has reportedly sold over 135 heavy-duty hybrid drive systems for buses.

The relatively small size of the worldwide hybrid bus fleet today reflects the fact that hybrid-electric drive technology is in its infancy and has not yet reached full commercial status. These existing hybrid buses prove that the technology is real. Upon closer examination, one can see that considerable progress has been made during the brief time that hybrid drive buses have been under development and there is much that can be learned from the experiences of hybrid bus operators.

This chapter takes an in-depth look at three demonstration programs in the US (New York City, Cedar Rapids, and Los Angeles) and describes their expectations, experiences and lessons to date. All three operate hybrid buses in revenue service today and have accumulated over 100,000 miles of experience.

Figure 3-1: Hybrid Buses Worldwide

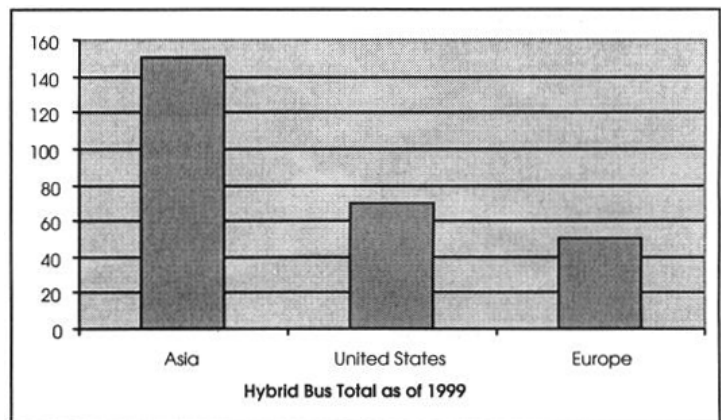

<sup>1</sup> This estimate does not include trolley buses.

They all point to improved handling, reduced emissions, and improved fuel economy as the major benefits of operating hybrid buses. They unanimously agree that the need for improved energy storage technology is the largest obstacle to widespread market acceptance. Overall, they are optimistic about their experiences and expect to see hybrid buses in their future fleets.

**3.1.1 United States**

Hybrid-electric drive buses are now in demonstration in more than 20 cities in the United States. Most of the programs involve one or two hybrid buses, however a few include fleets of five or more. Several transit providers are planning large hybrid bus demonstrations in the near future. Based on an informal survey of operators and manufacturers, it appears that the population of hybrid buses in the U.S. will quadruple during the next 1 to 2 years (see Figure 3.2).

Three transit agencies stand out as having extensive hybrid drive experience to date: New York City Transit, the Los Angeles Department of Transportation and Cedar Rapids' Five Seasons Transportation. Each agency operates at least five hybrid buses in revenue service and has more than 10,000 road miles on its fleet. We chose to examine each of these transit operator's hybrid programs in depth. A brief synopsis of these programs follows:

- **MTA New York City Transit** has been a proving ground for hybrid-electric drive technology for almost 10 years. It is the first transit agency in North America to demonstrate a small fleet of 40' hybrid transit buses in revenue service. These buses are being used to test the operational viability and economic feasibility of hybrid drive technology for large-scale adoption by the MTA. Because of its purchasing power and demanding environment, New York City will have a great influence on the direction and success of the hybrid bus industry. (See Section 3.2 for full report.)
- **Five Seasons Transportation in Cedar Rapids, Iowa** was one of the first transit agencies in the country to begin operating electric drive systems in regular revenue service back in 1995. Today Cedar Rapids operates five hybrid and four battery-electric buses that were built by Blue Bird and Northrop Grumman. The buses operate year round in demanding weather conditions that give hybrid technology a tough test of its performance and reliability. (See Section 3.3 for full report.)
- The **Los Angeles Department of Transportation** and surrounding communities are evaluating the use of hybrid buses as a way of helping the Los Angeles region meet strict air quality standards. LADOT's most recent project involves testing 8 hybrid buses built by EIDorado National and ISE Research. In Orange County two hybrids built by New Flyer and Solectria Corporation are about to enter revenue service. Soon there will be a total of 23 hybrid buses in testing

**Figure 3-2: Changes in U.S. Hybrid Bus Population**

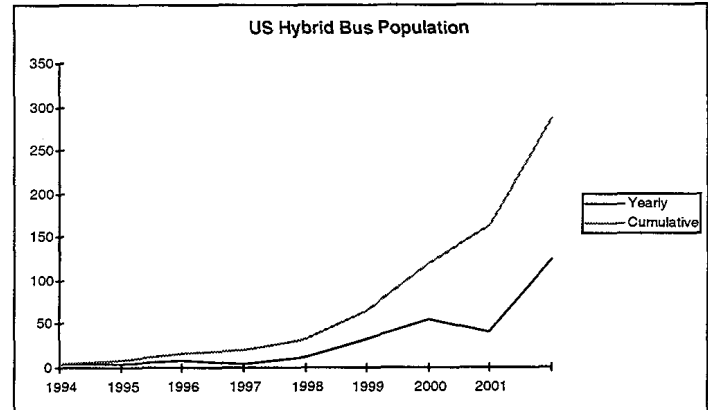

**Figure 3-3: Hybrid Demonstration Sites (US)**

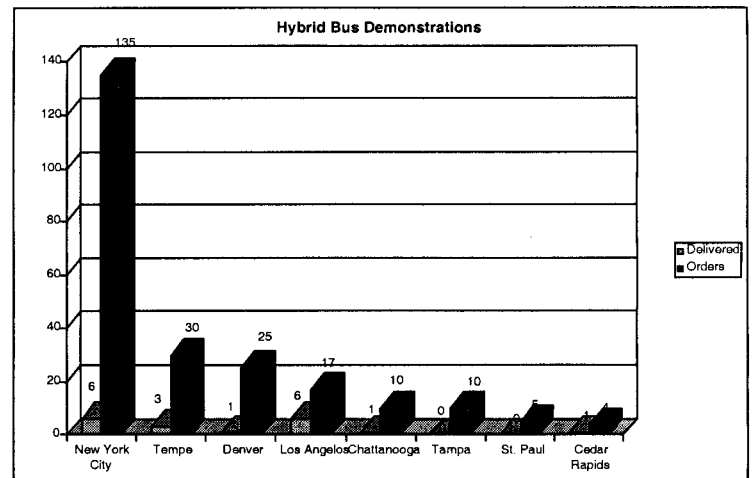

throughout the LA region. At least half of these buses will be used to demonstrate advanced technologies, including turbines and flywheels. Los Angeles will be an important test bed for these technologies. (See Section 3.4 for full report.).

Other communities also have significant experience with hybrid buses or have decided to significantly expand their hybrid programs, most notably:

- **Chattanooga Area Regional Transit Authority (ARTA)** in Tennessee expects to take delivery of 10 hybrid buses from Advanced Vehicle Systems (AVS) early in 2000. ARTA has operated the nation's first turbine-electric hybrid since 1997. The 22-foot hybrid shuttle built by AVS of Chattanooga is a purpose-built electric bus. It uses a 30kW microturbine by Capstone Turbine with natural gas, lead acid batteries, and Solectria electric drive system. The bus achieves highway speeds, and the turbine extends the electric bus's range from 40 to over 80 miles. The bus has been used around the country to showcase the microturbine technology; however, it has also been used in over 8,000 miles of revenue service in downtown Chattanooga. AVS is designing and building a new generation purpose built hybrid bus for ARTA. The first 10 buses, ranging in size from 18' to 35', will go into revenue service next year. The hybrid drive system will include dual Capstone turbines using diesel fuel, dual permanent magnet wheel motors from Unique Mobility, and inverters from PEI. ARTA plans to use the new fleet to demonstrate hybrid technology on all of its current diesel bus routes. The range of the new buses is expected to exceed 150 miles.
- **City of Tempe Transit Division** has the largest order for hybrid shuttle buses as of late 1999. It is converting three battery-electric shuttles to hybrid and purchasing 30 more hybrid shuttle buses. All 33 buses will be built by AVS using the Capstone turbine and Solectria electric drive. Tempe operates its entire fleet of 70 LNG buses today and will use LNG in its hybrids. The City plans to operate the new hybrid buses on its neighborhood feeder routes where it is seeking to offer low environmental impact public transportation.
- **The Denver Regional Transportation District (RTD)** has ordered 26 hybrid buses from Transportation Techniques LLC of Denver for delivery in 2000. These buses are built on a 45' low floor platform and will be powered by dual DC brushless drive motors and a Ford industrial engine modified to run on natural gas. The series hybrids will be used on Denver's downtown mall.
- **Tampa, Florida** has ordered 10 hybrid shuttle buses from AVS for delivery in 2001. Like the Tempe buses, they will have Capstone turbines, Solectria electric drive and burn LNG.
- **MBTA in Boston** is conducting an extensive side-by-side comparison of two hybrids, two CNGs and two diesel buses. The program evaluation runs from May 1999 - March 2000 and will serve as a basis for making purchasing decisions for a fleet of 150 buses in 2000.

Finally, a number of advanced technology hybrid demonstrations underway in the U.S. warrant special mention because they push the hybrid technology envelope. Hybrid technology is still very young and is expected to undergo significant advancement in coming years. Some of the programs that are likely to help further the technology are the following:

- **Advanced batteries** will be tested in a hybrid-electric bus in Reno, NV sometime in 2001 under FTA sponsorship. Nova BUS, General Electric and Electric Fuel will demonstrate a primary zinc-air traction battery and secondary NiCd battery in a transit bus. This battery-battery hybrid will use the high-energy zinc-air battery system with refuelable anode cassettes. A separate NiCd battery will provide power during acceleration and accept regenerative energy during braking, which the zinc-air battery cannot do.
- **Double-layer capacitors** have been tested in a hybrid-electric transit bus in Ohio and compared to conventional batteries. Regenerative braking and acceleration in a heavy vehicle produces voltages that often exceed a conventional battery's capability. NASA sponsored a project to retrofit a Flexible bus with electric drive system, 1.59MJ capacitor bank, and lead acid batteries and for testing. The project demonstrated the feasibility of using capacitors in a heavy hybrid bus and showed their

superiority to batteries at accepting current during regenerative braking and delivering current during acceleration.

- **Flywheel energy storage** devices are planned for demonstration in both Houston and Los Angeles in the next couple of years. In Houston, an ATTB will be outfitted with a flywheel designed by the University of Texas Center for Electro-Magnetics, and in Los Angeles a Nova BUS will be outfitted with a flywheel system designed by Trinity Flywheels. Like the supercapacitor project, these projects will demonstrate the feasibility of using a light-weight, high-speed mechanical flywheel to provide and absorb energy efficiently during acceleration and regeneration.
- **Hybrid fuel cell** buses are being designed and tested by DOE and FTA.<sup>2</sup> The FTA-sponsored Georgetown fuel cell hybrid bus program fielded the first fuel cell hybrid bus back in 1994. The program has gone on to demonstrate the first 100kW phosphoric-acid fuel cell and 100kW PEM fuel cell on transit buses with on-board reformation. The Georgetown programs demonstrated feasibility and near zero-emissions of fuel cells in heavy transit buses. The DOE H2 fuel cell bus used a fuel cell engine, electric drive, and lead-acid batteries and was tested in Augusta, GA in 1997. The bus demonstrated 120-mile range and reduced emissions (<0.2ppm NOx).

### 3.1.2 Europe

Although US transit experience is the primary focus of this report, it would be remiss not to mention the work going on in Europe to demonstrate hybrid buses. Several European cities have been testing hybrid buses for urban transit applications the last decade. For instance:

- IVECO and Ansaldo collaborated to design and build 10 hybrid transit buses for Genoa, Italy. The hybrid design is relatively simple. It uses a small 2.5 liter 50hp diesel engine and 35kW generator. The genset was sized to produce the average power requirement of the duty cycle and operate at a constant speed. The wheels are driven by a single 110kW induction motor with gear reduction. Genoa Transit has operated the hybrid buses in regular service since April 1996. The bus operates under battery power alone for about 30% of its duty cycle through the urban center. As of 1997 the buses had a 60% availability rate. The most troublesome problems were battery and diesel engine related; the electric drive components have proven to be the most reliable. In other results, Genoa found that regenerative braking almost doubles brake lining life. Emissions were reduced by as much as 80% on the European city duty cycle using a chassis dynamometer. However, no measurable improvement in fuel economy has been noted.<sup>3</sup>
- Scania<sup>4</sup>, located in Silkeborg, Denmark, has built a number of hybrid-electric buses. It delivered 6 hybrid buses to the Greater Stockholm Transit back in 1996 and 3 more to Luxembourg. The Luxembourg buses have a series drive system designed by Allison Transmission. The 30' buses use a small 2.0 liter VW engine that operates at a constant speed for emissions reductions and supplies energy to the VRLA batteries. The drive system consists of two induction motors and gear reduction. The bus has top speed of 65km/hour and is capable of operating on batteries alone for short distances.
- Wesel and Stuttgart, Germany operated 20 hybrid-electric buses from 1976 to 1985.<sup>5</sup> The vehicles were standard M.A.N. and Daimler Benz transit buses and used conventional DC commutated motors and generators, lead acid batteries, and a small diesel engine in a series hybrid configuration. The

---

<sup>2</sup> Unlike the Chicago and Vancouver fuel cell buses, hybrid fuel cell buses use an energy storage device to capture regenerative braking.

<sup>3</sup> Trip memo by Dana Lowell, NYCT, 1998 and briefing by ATM Genoa, Italy.

<sup>4</sup> Scania was recently bought by Volvo.

<sup>5</sup> Victor Wouk, Ph.D., Curtis Instruments.

buses were successfully used in revenue service for 10 years. The buses demonstrated benefits like smooth acceleration, low noise, and reduced emissions; however, poor efficiencies of DC motors resulted in no decrease in diesel fuel consumption.

### 3.1.3 Asia

Hino Motors in Japan is a leader in the design and manufacture of heavy-duty hybrid drive systems for trucks and buses. Hino's Hybrid Inverter Controlled Motor and Retarder System (or HIMR) is an integrated design for the truck and bus market. The system uses a three-phase AC motor mounted inside the engine flywheel housing to provide multiple functions including starter, motor, alternator, regenerative braking and retarder. Hino has been producing hybrid-electric drive systems since 1991 and has reportedly sold more than 150 systems for buses and trucks including 3 hybrid buses to Matsumoto Electric Railway Company in Nagano prefecture for \$310,500 per bus. Hino claims the system reduces NO<sub>x</sub> by 20-30%, black smoke by 70% and particulate by 54%. Other claimed benefits include reduced noise, faster deceleration and 5-15% improvement in fuel economy.

## 3.2 New York City Transit: Leading the Way in Hybrid Testing

MTA New York City Transit (NYCT) is on the cutting edge of hybrid drive technology today. It is the first transit agency in North America to demonstrate a small fleet of 40' hybrid transit buses in revenue service. NYCT will have a total of 16 hybrid transit buses in testing by the first quarter of 2000 and is evaluating whether to make a large purchase in the near future. Because of its purchase power and demanding service environment, New York City will have a great influence on the direction and success of the hybrid bus industry.

**Figure 3-4: Orion/Lockheed Hybrid Bus in New York City**



Source: Lockheed Martin Control Systems

emissions (PM<sub>10</sub>) has grown. The agency is taking a number of steps to reduce its fleet emissions including replacing its older diesel buses with advanced technology diesel buses, CNG powered buses, and now hybrid-electric buses. The agency is also conducting a test program involving low sulfur diesel fuel to measure its effect on diesel soot emissions.

### 3.2.1 Background

MTA New York City Transit is the largest transit bus operator in North America. It serves the five boroughs of New York City and carries nearly 500 million passengers a year. Its fleet of 4,300 buses travels over 100 million road miles and burns nearly 40 million gallons of fuel annually. The fleet is currently comprised mostly of 40' transit buses although it also includes some 45' coaches and 60' articulated buses.

Air quality issues have been a top priority of NYCT's planning activities for years. New York City has been a non-attainment area for several of EPA's National Ambient Air Quality Standards (PM<sub>10</sub>, Ozone, & CO) since the standards were first developed. Political pressure on NYCT has increased recently as the public's awareness of the health risks associated with diesel particulate

### 3.2.2 Program Description

New York City has been a proving ground for hybrid-electric drive technology for almost 10 years. It started by testing prototype buses designed to show the operation of a hybrid bus and prove it could reduce emissions and improve fuel economy. The early programs were a success and NYCT has moved on to testing pre-commercial hybrid buses that have been designed for manufacture and sale. These new buses are being tested in revenue service and will demonstrate the operational viability and economic feasibility of the technology.

**The goal of these programs is to encourage the development of a commercially viable hybrid bus with emissions levels equal to or less than a CNG bus.<sup>6</sup>**

#### 3.2.2.1 Prototype Testing

New York City Transit got its start with hybrid buses in the early 1990s when it participated in two prototype demonstration projects. The first bus was built by Orion Bus Industries and the second involved retrofitting a Nova BUS RTS. Both projects involved a collaboration of sponsors.

- The Orion VI prototype hybrid was one of the first 40' diesel-electric hybrid transit buses built in the U.S. Orion Bus Industries built the bus and General Electric designed the drive system to demonstrate the feasibility of hybrid propulsion on a conventional 40' transit bus platform. The bus featured four wheel mounted GE induction traction motors, Cummins engine and Onan generator, and nickel cadmium batteries. The bus entered three months of non-revenue service testing in 1996 and underwent emissions testing on a chassis dynamometer at Environment Canada with encouraging results. The bus demonstrated significant improvements in fuel economy (5.46 mpg) and reductions in emissions including low NOx (13.82 gpm) and PM<sub>10</sub> (0.372 gpm) on the CBD cycle. The program demonstrated that hybrid buses are cleaner and more efficient than conventional diesel buses. It also provided a baseline against which future hybrid demonstration projects could be compared. The sponsors of the \$6.5 million project included the FTA, the New York Power Authority and New York State Energy Research and Development Authority.
- The Nova BUS Hybrid Retrofit is an ongoing project as of late 1999 to retrofit a series hybrid propulsion system onto a Nova BUS RTS chassis owned by NYCT. The project's goal is to demonstrate reduced emissions and improved fuel economy and to evaluate the feasibility of converting NYCT's fleet of 2,800 RTS buses to hybrid drive at the normal mid-life powertrain overhaul. NYCT set aggressive emissions targets for the bus of 0.06 gpm of PM, 15.0 gpm of NOx, and a fuel economy objective

**Table 3.1: Orion & Nova BUS Prototype Hybrid Bus Characteristics**

Bus Type	Orion VI Low Floor	Nova BUS RTS
GVW	44,000 lbs.	44,000 lbs.
Fuel	Diesel	Diesel
Hybrid Drive	General Electric	Allison
Engine	Cummins 5.9L, 190 hp	GM 4.2 L, 160 hp,
Generator	Onan 100 kW	UQM 100kW
Motor(s)	(4) GE PM motors (56 kW each) hub mounted	1 induction motor 140kW
Batteries	NiCad	VRLA
Fleet	1	1

Source: Orion Bus Industries, Allison Transmission.

<sup>6</sup>Research and Development Department, *Emissions Reduction Strategy*, briefing document, New York City Transit Department of Buses, August 1996.



of 4.3 mpg. The series hybrid-electric drive system is designed and integrated by Allison Transmission, a division of General Motors. It features a single high-powered AC induction motor and gear reduction coupled with a genset to maintain voltage in the traction batteries. The bus is fitted with a CRT continuously regenerating particulate trap produced by Johnson Matthey Inc. (JMI). The JMI trap technology is sensitive to fuel sulfur levels, and therefore requires the use of reduced sulfur diesel fuel (less than 50 ppm sulfur). The bus began a six-month revenue service test in 1999 and was emission tested in April 1999. The project sponsors included DARPA, Electricore, and the New York Power Authority; the project cost was \$1.25 million.

**3.2.2.2 Commercial Testing**

Based on the results of its early prototype buses, the MTA Board approved the purchase of a small fleet of 15 hybrid buses for revenue service demonstration, including 10 Orion VI low-floor buses and 5 Nova BUS RTS buses. All 15 have been designed for manufacture and sale by Orion and Nova BUS and are equipped with the Lockheed Martin HybriDrive™ system. The Orion hybrid buses are the first hybrid transit buses to enter revenue service in North America. Design improvements are being made on these buses during the course of the test program to improve the design for commercial sale.

**Table 3.2: Orion & Nova BUS Commercial Hybrid Bus Characteristics**

Bus	Orion VI Low Floor	Nova BUS RTS
GVW	41,640 lbs.	39,500 lbs.
Fuel	Diesel-electric	Diesel-electric
Hybrid Drive	Lockheed	Lockheed
Engine	DDC S30 (7.3 liter, 230 hp, 170kW)	DDC S30 (7.3 liter, 230 hp, 170kW)
Generator	120 kW	120 kW
Motor	Induction (250 hp, 187kW)	Induction (250 hp, 187kW)
Batteries	Lead acid	Lead acid
Fleet	10 buses	5 buses

*Source: Orion Bus Industries & Nova BUS.*

- The Orion VI Hybrid is the first production hybrid transit bus to be offered for sale in North America. It was designed by Orion Bus Industries together with Lockheed Martin. It is the third generation hybrid bus from Orion<sup>7</sup>. It features the Lockheed Martin HybriDrive™ system, a fully integrated series hybrid drive system designed for medium, and heavy duty vehicles. The drive system is configured in series with a single high-powered AC induction motor providing traction

power to the wheels. Energy is stored on board in absorbed electrolyte lead acid batteries built by Electrosorce, and the batteries are recharged using a diesel fueled Detroit Diesel Series 30 engine generator set. The drive system is controlled by Lockheed's power electronics that integrate motor controls, inverters, battery management and APU controls. Of the 10 Orion VI Hybrids NYCT purchased, five entered revenue service in September 1998 and the remainder are to be delivered at the end of 1999. NYCT paid a total of \$5.6 million for the 10 buses or \$560,000 per bus.

- The Nova BUS RTS Hybrid is the first pre-commercial hybrid bus from Nova BUS although the company has produced several earlier hybrid prototypes (see chapter 2). The drive system is identical to that of the Orion VI Hybrid except it uses a different manufacturer's lead acid battery. Another significant difference is that the auxiliary systems including AC will be electrically driven rather than belt driven which is expected to improve system reliability and help reduce emissions. The bus is

<sup>7</sup> Orion first demonstrated a hybrid drive bus with Unique Mobility on an Orion II platform in 1995.

outfitted with after treatment for VOC, CO and PM utilizing an integrated oxidation catalyst and trap. The total value of the project to design and build 5 hybrid buses is \$6.8 million project, or about \$1.4 million per bus. Other project sponsors include New York Power Authority, NYSERDA, and FTA.

### 3.2.2.3 Duty Cycle

All five commercial hybrids are being tested in normal revenue service at an MTA garage located in upper Manhattan, as will the additional 10 once delivered. The buses are assigned to drivers and routes each day in the same way as the rest of the diesel fleet. Neither routes nor drivers are pre-selected to benefit the hybrids. Two duty cycles dominate the service from this garage. The Manhattan routes are characterized by a low average speed (less than 7 mph), frequent stops (20 per mile), low top speeds (<30 mph), and heavy (crush) passenger loads during peak hours. The second route runs from Manhattan over the East River to La Guardia International Airport in Queens. On this route, the bus must climb a grade and maintain higher speeds (50mph) while crossing the bridge to Queens. Buses on all routes typically operate for 12 to 15 hours daily. The average range between refueling is about 150 miles.

### 3.2.3 Project Results

NYCT has done more testing and gained more experience with hybrid transit buses than any organization in North America. It has several thousand miles of experience with its early prototype vehicles and nearly 65,000 (see Figure 3.5) miles and 7,000 hours of revenue service on its five Orion VI hybrids as of September 30, 1999. Each bus has been tested for emissions and fuel economy. What can we learn from NYCT's experience?

**Figure 3-5: Orion VI Hybrid Mileage (5 Buses)**

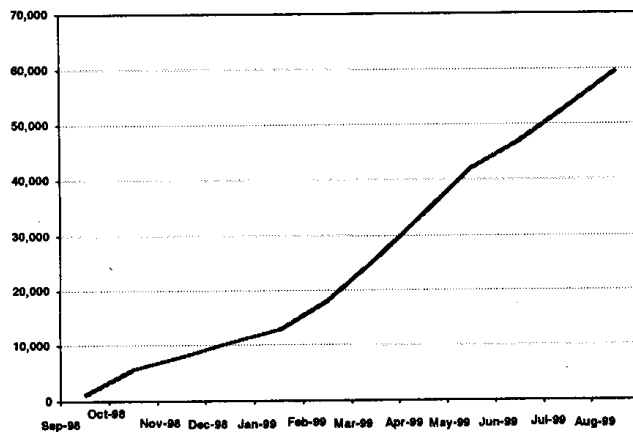

#### 3.2.3.1 Driveline Performance

Orion has vastly improved its hybrid drive performance since its prototype Orion II hybrid was demonstrated back in 1995. The Orion II had a maximum range of about 120 miles, took 17.5 seconds to accelerate from 0 to 30 mph, and had limited hill climbing ability<sup>8</sup>. By contrast, the Orion VI hybrid is a low floor 40' transit bus that is capable of up to 350 miles range, has quicker acceleration than a conventional bus, climbs a 16% grade, and seats 32 passengers.

NYCT has not identified any route or situation in which its hybrid buses could not be modified to operate. When operated on its most challenging route

to La Guardia from Manhattan, the hybrid buses originally had some difficulty maintaining speed up the long incline over the East River. However, with design modifications the buses were able to handle the hills and speeds under load without difficulty. Furthermore, drivers and riders think the hybrid buses are superior to conventional buses in terms of handling characteristics, acceleration and braking. In surveys taken by the NYCT, riders favored the smooth ride provided by the hybrids over the conventional diesel buses.

<sup>8</sup> Dr. Lawrence Hudson, S/EV 1995 conference proceedings.

**3.2.3.2 Reliability**

New York's hybrid buses have achieved a respectable level of reliability especially given the newness of technology. The hybrid buses have an average MDBF<sup>9</sup> of more than 1,000 miles (see Figure 3.6). By comparison, NYCT's diesel buses average about 1,500 miles MDBF for the same routes in Manhattan. NYCT's CNG fleet averages about 1,300 miles MDBF on Brooklyn routes. Diesel buses on the same Brooklyn routes average about 2,000 miles MDBF. Likewise, NYCT's hybrid buses have achieved an average availability<sup>10</sup> rate of about 55% and at times as high as 75% (see Figure 3.7) or close to its diesel fleet.

**Figure 3-6: NYCT Hybrid MDBF**

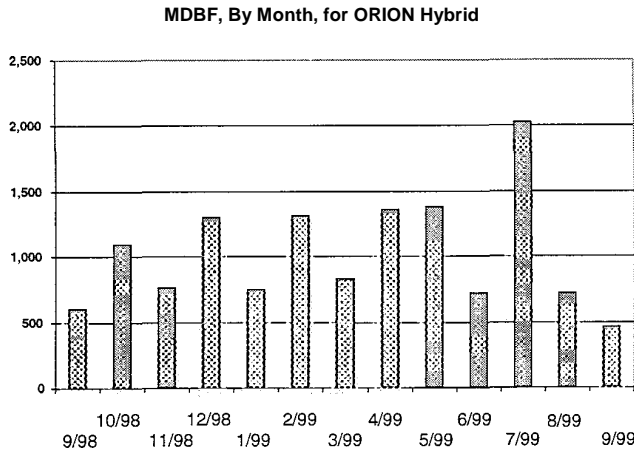

NYCT expected its hybrid buses to encounter technical problems at first. In fact, the buses had several hardware and software issues (see Table 3.3) during the first 13 months of operation that explain why MDBF and availability rates were low periodically. Most of these issues have been addressed and have not recurred; others are still being addressed. Overall, the technology appears to be stabilizing and NYCT expects the hybrids to catch up with its diesel buses.

**Figure 3-7: NYCT Hybrid Availability (Orion VI)**

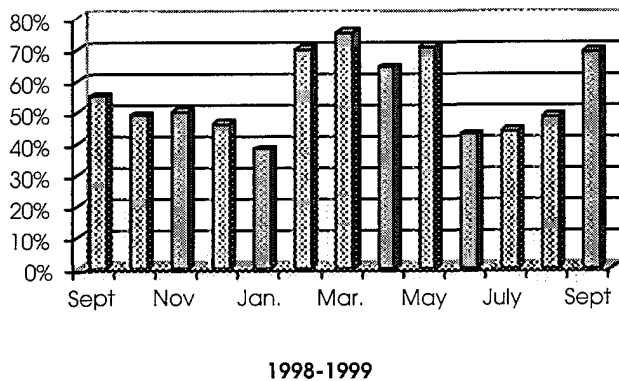

Source: NYCT

<sup>9</sup> Mean Distance Between Failures (MDBF) measures the distance between road calls or the frequency of breakdowns. It is an indication of the technology's stability.

<sup>10</sup> Availability measures the ratio of the days the bus is working (available) out of the number of possible days of bus service during the period excluding holidays (total). The availability index shows how long it takes to get a bus back into service and can reflect the severity of the repair problem or the time it takes to get spare parts.

**Table 3.3: NYCT Hybrid Bus Component Issues**

Component	Problem	Solution	Status
Battery (1)	Premature module failures	Equalize periodically	Resolved
Battery (2)	Low voltage due to cell variation	Periodic conditioning through discharge/charge	TBD
Motor	Overheating & shorting due to oil control problem	Redesign motor	TBD
Controls	System lockup	Software modification	Resolved
Engine	Bogging caused by lack of boost pressure	Generator redesign or modify engine controls	TBD

Source: NYCT.

### 3.2.3.3 Maintenance

The verdict on maintenance is still out at NYCT. During the first 12 months of the program, Orion and Lockheed engineers and technicians performed all vehicle maintenance tasks as part of their engineering validation. However, starting early in 2000, NYCT maintenance personnel will begin performing routine and diagnostic maintenance on the Orion hybrid fleet. Overall, NYCT program managers expect maintenance comparisons between hybrids and conventional diesels to be a wash. They expect to see less maintenance on brakes and transmissions while probably increased maintenance tasks associated with batteries.

### 3.2.3.4 Emissions & Fuel Economy

All New York City hybrid buses have been tested for emissions and fuel economy. The results show that hybrids can significantly reduce emissions of NO<sub>x</sub>, PM, CO, HC and greenhouse gases compared to conventional mechanical drive buses. (For a detailed discussion of the results, see Chapter 6.) In addition, the hybrids show an improvement in fuel economy. NYCT has observed a fuel economy improvement in its in-use data (see Table 3.4).

**Table 3.4: NYCT In-Use Fuel Economy**

Fuel	Manhattanville	Brooklyn
Diesel	2.2	2.7
CNG	n/a	1.6
Hybrid	2.6	n/a

Source: NYCT.

### 3.2.4 Overall Assessment

The New York City hybrid program is breaking important ground for the hybrid bus industry in North America. It is the single largest hybrid transit fleet in operation today and, if procurements go forward as planned<sup>11</sup>, it will continue to be the largest hybrid fleet for the foreseeable future. If NYC makes the decision to convert its fleet to hybrid, they have the purchasing power to single handedly launch the industry. Because of the demands of the NYC duty cycle and environment, many observers believe that if hybrids prove viable in NYC they can be viable anywhere.

In just a little over a year, the first 5 hybrid buses in NYC have shown impressive results, accumulating nearly 65,000 miles and thousands of hours of operation. They demonstrated emissions levels comparable or better than other alternative fuels and significantly improved fuel economy. Drivers prefer the handling of the hybrids and passengers prefer the ride. While reliability remains a challenge, NYCT has surpassed the 50% availability mark in its first year and expects the trend to continue upwards and rival conventional diesel technology in the future.

**You have to be physically & mentally prepared to operate hybrids. It's not like taking a diesel bus out of the box and placing it into service. Our results are very encouraging and we've seen that hybrids are viable and beneficial. But there were bumps in the beginning.**

– Dana Lowell, MTA New York City Transit

### 3.3 Cedar Rapids: Testing Hybrid Buses in the Heartland

One of the earliest hybrid demonstration programs in the country started in Iowa in the early 1990s. Five Seasons Transportation in Cedar Rapids, Iowa operates 5 hybrid and 4 electric buses built by Blue Bird and Northrop Grumman. The first hybrid went into service in November of 1997 and the next four were delivered in mid 1999. Since then, the fleet has logged more than 20,000 miles. Like New York City, Cedar Rapids provides a challenging environment for hybrids because of the cold winters and hot summers.

**Figure 3-8: Blue Bird Hybrid Bus in Cedar Rapids**



#### 3.3.1 Background

In the early 1990s, Alliant Utilities approached the City of Cedar Rapids to propose demonstrating a fleet of electric buses to help the City meet its clean air goals. These discussions led to the formation of the Cedar Rapids Electric Transportation Consortium that today includes the City of Cedar Rapids, Alliant Utilities and Northrop Grumman. Blue Bird, which was a consortium member during phase I, is a sub-contractor to the City of Cedar Rapids in phase 2. Together the project has raised \$9.7 million from the FTA and project partners to implement the program.

<sup>11</sup> In December, 1999, NYCT awarded a contract for 125 hybrid buses to Orion/Lockheed Martin. In addition, NYCT is looking to purchase a significant hybrid fleet (100+) in its future capital program. Interview with Dana Lowell, NYCT.

Cedar Rapids is a medium sized city of about 100,000 people. The City's bus agency, Five Seasons Transportation, maintains and operates a fleet of 35 buses, mostly 35' and 40' Nova BUS RTS buses. The City has tested alternative fuels since 1987, including ethanol, ethanol injection, CNG, LP gas, hydrogen injection, and bio-diesel. The City received its first battery powered electric buses in 1995. Cedar Rapids was in non-attainment for National Ambient Air Quality Standards for ozone as of 1999.

**In the transit field, how we delivered services 30 years ago won't work today. It's better to try and fail than to fail to try.<sup>12</sup>**

- Bill Hoekstra, CRETC

### 3.3.2 Project Description

The scope of the Cedar Rapids Electric Transportation Consortium project includes the design, construction, and testing of 9 buses including 5 hybrids; construction of a 5,000 square feet dedicated facility; substantial charging infrastructure for its electric buses; and training. The first buses to enter revenue service testing were 4 electric buses in 1995. The first hybrid began service in November of 1997; 3 more hybrids began service in March of 1999 and the fifth hybrid is expected in late 1999. The program spans six years after which time the City expects to continue evaluating the feasibility of both electric and hybrid technology.

#### 3.3.2.1 Technology

The Blue Bird hybrid buses use a 40kW genset by Power Technology drive system and 170kW powertrain by Northrop Grumman. The genset was sized for the average power consumption of a city transit application. Currently, the powertrains are governed to only 150 hp in Cedar Rapids to conserve battery life and provide necessary range. The Northrop Grumman powertrain features a high-power induction motor specially designed by Northrop Grumman with two individual three-phase windings. The traction controller contains two independent, three-phase, IGBT based, microprocessor controlled bridges. The first 4 hybrid buses use absorbed electrolyte glass mat batteries; however, the project partners are evaluating whether to use a sealed gel lead acid battery for the fifth bus. All auxiliary systems are electrically driven except for a fuel fired Webasto heater.

**Table 3.5: Blue Bird Hybrid Characteristics**

Bus	Blue Bird Q Bus
GVW	33,500
Fuel	Diesel-electric
Hybrid Drive	Northrop Grumman
Engine	Isuzu fuel-injected, 2.8 liter, 75 hp., 55kW
Generator	Power Tech (35 kW cont.)
Motor	Northrop Grumman Induction (170kW peak/130kW cont.)
Batteries	GNB absorbed electrolyte Pb-acid 37kWh @C-1
Fleet	5 buses

Source: Northrop Grumman.

The buses meet all federal safety standards for transit buses. Additional precautions have been taken to prevent shock or fire to anyone coming into contact with the bus. For instance, each battery pack has a contactor and fuse. An inertial impact switch was installed to quickly disconnect batteries in case of emergency. All high power cables have been routed through the bus frame to isolate them from the passenger cabin. Should power be lost for some reason, the parking brake is automatically engaged. A separate 12v battery was installed to provide for emergency signal and lighting equipment in case of loss of power. The battery management system monitors and displays critical information regarding the traction batteries to the driver. And an interlock system exists to prevent bus operation when systems are being serviced.

#### 3.3.2.2 Duty Cycle

Five Seasons operates its hybrid buses on a

<sup>12</sup> EPRI electric bus case study, 1998.

variety of routes ranging from relatively flat and low speed downtown shuttle service to higher speed and hilly suburban service. On some routes, top speed may be 25 mph while on others it may reach 55 mph. Maximum grades reached in service do not exceed 8 percent. All routes have a layover of about 8 minutes per hour. The buses are recharged after returning from service by running the APU until the battery pack voltage returns to a specified level.

**Table 3.6: CRETC In Use Fuel Economy**

Technology	In service (mpg)
Diesel	4.0
Electric	5.8 <sup>13</sup>
Hybrid	4.6 <sup>14</sup>

Source: Five Seasons.

**3.3.3 Project Results**

The Cedar Rapids hybrid buses have logged nearly 23,000 miles in revenue service as of October 1, 1999. Typically, a hybrid bus will see anywhere from 150-400 miles of service a week depending on routes and availability. Currently, the range of the buses is about 80 miles, which is determined largely by the duty cycle, driver habits, and battery technology. The buses are capable of travelling longer distances. For instance, a prototype configuration of the bus was driven 790 miles at a constant speed of about 50 mph early in the program. Project partners hope that new batteries, driver training, and new APU controllers will enable the buses to provide a full 12 hours of service instead of the present 8 hours. The buses are

also capable of a climbing a 10 percent grade, but acceleration has not been field-tested yet.

After a bumpy first year, the reliability of the hybrid buses appears to be improving. Five Seasons estimates that its hybrid buses averaged about 66 percent availability during 1999, up considerably from 25 percent availability of the pilot hybrid bus during 1998. Most of the downtime the first year was caused by problems associated with the traction batteries. Five Seasons experienced numerous low power events during the first year due to premature battery module failures and problems associated with keeping all batteries at the same state of charge. These troubles led the team to search for a more robust battery. The team is presently evaluating a sealed-gel battery built by Sonnenschein which, if successful, will be retrofitted into all five hybrid buses. Auxiliary components also proved troublesome in the beginning. For instance, an electric pump for the parking brake caused downtime until it was redesigned. The system is working reliably in all buses today. It is worth noting that the bus's electric drive components (motor and controller) have proven to be very reliable thus far. The Consortium expects system reliability to improve in the future as additional changes are implemented.

Five Seasons has seen a fuel economy benefit of about 15% from its hybrid buses as compared to its diesel buses. The numbers in Table 3.7 were recorded during a six-month period in 1999 including summer.

All three buses use air conditioning whose fuel consumption is included in the estimates. The air conditioning units are electrically driven on both the electric and hybrid buses. The hybrid bus data also includes the fuel used by the APU to recharge the batteries at the end of the day but excludes the ACkWh consumed during weekly battery equalization charges. The buses have not been emissions tested.

**We're not trying to give hybrids all of the honey and diesel all of the vinegar. We want them to compete equally to answer questions.**

Bill Hoekstra, CRETC

<sup>13</sup> Using 6.5ACkWhr/mile, 3412 BTU/ACkWhr and 129,000 BTU/gallon of diesel #2.

<sup>14</sup> Using APU to recharge batteries.

### 3.3.4 Overall Assessment

The Cedar Rapids hybrid program is off to a good start. Four hybrid buses are in revenue service at this time and the fifth is expected shortly. After working through a number of technical and operational difficulties in the beginning, the team is beginning to see a payoff for its efforts. The availability rate for the hybrid buses has surpassed the 50% mark and is climbing, and the buses show a 15% fuel economy benefit. Cedar Rapids has invested in facility improvements, infrastructure, new staff, and training to support its program, and it expects to see rewards from these investments as the hybrid program begins its second year of operation. In the future, Cedar Rapids hopes to expand its hybrid fleet as additional funds and technology improvements become available.

**[If you buy a hybrid bus] buy a hybrid drive system that has been designed and integrated by one company.**

- Fred Rossow, Five Seasons

## 3.4 Los Angeles Basin: Meeting Clean Air Goals with Hybrids

The Los Angeles region is one of the most polluted districts in the United States today. The California Air Resources Board has set tough emission standards for cars and light trucks, and recently held two workshops to discuss a proposed regulation setting stricter emission standards for urban buses. Several agencies in the Los Angeles basin have begun to evaluate hybrid drive buses as a strategy for lowering emissions. The Los Angeles Department of Transportation (LADOT), Orange County Transit Authority (OCTA), Foothill Transit Agency in West Covina, and OmniTrans in San Bernardino are each preparing to test hybrid buses. The largest of these demonstrations will be with the LADOT.

### 3.4.1 Project Descriptions

LADOT and OCTA began testing hybrid buses in 1999, and OmniTrans and Foothill Transit will begin testing in mid-2000. All together there will be 10 hybrid buses in demonstration in the Los Angeles basin by mid-2000. Another 13 hybrid buses are expected to begin testing sometime in 2001, raising the region's total to 23 buses. It is interesting to note that all of the buses in demonstration in Los Angeles have drive systems provided by small startup companies dedicated to hybrid and electric propulsion product lines. They are ISE Research based in San Diego, California and Solectria Corporation located in Wilmington, Massachusetts.

#### 3.4.1.1 Los Angeles Department of Transportation

The LADOT began using alternative fuels in the early 1990s. Its fleet of 350 buses uses mostly propane and some natural gas. The agency buys buses and then contracts their operation and maintenance to private vendors. Prior to engaging in its current hybrid bus project, the LADOT attempted to field three hybrid buses, using Hughes motors and a drive system integrated by APS, in 1997. These buses, using EIDorado National chassis, were placed in service in Hollywood but failed to meet operating requirements due to insufficient APU power capacity and several integration issues. These three buses have been sitting idle for most of the past two years.

**Hybrids should help meet our clean air goals from a technical point of view. The goal of our project is to gain experience with the technology and understand life cycle costs.**

--Steve Cannistraci, LADOT

Despite the poor results of the first project, the agency determined to forge ahead with a new team and project. The LADOT contracted with ISE Research in mid-1998 to supply five hybrid-electric 30-foot buses using EIDorado National chassis. The first four of these buses were delivered to the LADOT and entered into revenue service during the first half of 1999. In October 1999, the LADOT entered into a second contract with ISE Research to upgrade the fifth bus in this series to use the EIDorado National "E-Z Rider" low floor chassis and a turbine-based APU system. This second LADOT contract also included funding to retrofit the three inoperable "Hollywood" buses with the ISE Research "ThunderVolt" drive system. These two contracts, valued at a total of approximately \$3



**Figure 3-9: EIDorado National/ISE Research Hybrid Bus**



Source: ISE Research, Inc.

million, will therefore result in deployment of a total of eight EIDorado National-ISE Research hybrid-electric buses in Los Angeles by mid-2000.

Funding sources for these contracts include the LADOT, Los Angeles Department of Water and Power, South Coast Air Quality Management District (Mobile Source Air Pollution Reduction Review Committee), and Federal Transit Administration (via a CALSTART grant). In addition, ISE Research has invested several hundred thousand dollars of its own resources into this demonstration project.

**Technology**

In all eight of the LADOT buses, ISE

Research is installing series hybrid drive configurations using sealed lead-acid batteries, Siemens motors and inverters, and its own customized vehicle controls and accessories. The four buses delivered in 1999 use General Motors 5.7 liter V8 engines, while the four to be delivered in 2000 will each employ two Capstone 30 kW microturbines (see Table 3.7). LADOT expects the turbines to be relatively maintenance free as compared to other engine options. System controls will regulate engine speed depending on load demand. The ISE Research APU control system automatically turns off the engine or turbine during periods of low power usage, thereby reducing fuel consumption and emissions. With the APU turned off, the bus can travel up to 20 miles in a zero emission, electric drive mode (see Table 3.8). The system is also multi-fuel capable although LADOT will burn propane. All eight LADOT buses will be equipped with 6.7

**Table 3.7: EIDorado National/ISE Research & New Flyer/Solectria Bus Characteristics**

Agency	LADOT	LADOT	OCTA
Bus	EIDorado National	EIDorado National	New Flyer
GVW	30,000	30,000	37,920
Fuel	LPG-electric	LPG-electric	Diesel-electric
Hybrid Drive	ISE Research	ISE Research	Solectria Corp.
Engine	GM V-8 (5.7 liter/350hp/260kW)	Dual Capstone Turbines (2 x 30kW)	GM VM-642 (4.2 liter/100kW c.)
Generator	Fisher permanent magnet (80kW c.)	Dual Capstone Turbine (2 x 30kW)	Fisher PM 120kW c.
Motor	Siemens Induction (100 kW c.)	Siemens Induction (100 kW c.)	Dual Solectria Induction (240kW peak, 80 kW c.)
Batteries	Sealed gel Pb-acid (50kWhr)	Sealed gel Pb-acid (50kWhr)	Sealed gel Pb-acid (30kWhr)
Fleet	4	4	2
Year	1999	2000	1999

Source: ISE Research & Solectria Corp.

kW on-board battery charger though ISE Research's drive system can be equipped with either on- or off-board charging with power ratings of up to 40 kW.

**Duty Cycle**

The buses are being operated in the Hollywood and Chinatown (DASH) Los Angeles service. The Hollywood route is a 9-mile loop through the Hollywood area. It is typical of central business district routes where the terrain is flat, the average speed low (<10 mph), stops frequent, and load heavy (standees) during peak hours. The Chinatown route is similar to the Hollywood route, but includes a steep hill, which the hybrid buses seem to climb as easily or better than the other diesel or CNG buses on that route. Total daily range is about 105 miles and service lasts about 12 hours including significant idling time. The buses will be operated and maintained by LADOT's vendor, Ryder ATE.

**Project Results**

Although this program is young, the Department has some encouraging preliminary information. LADOT began testing the pilot bus in revenue service in March of 1999, and buses 2, 3 and 4 began revenue service in June. Between March and mid-October that fleet has more than 10,000 miles in revenue service. During this time, the buses have been used to identify and develop numerous upgrades that will be installed on all five buses before the end of 1999.

**Table 3.8: EIDorado/ISE Drive Specifications**

Test	Predicted
Range (hybrid)	150 mi.
Range (electric)	20 mi.
Accel. (0-55)	45 sec.q
Top Speed	65 mph
Max. Grade	12%

*Source: ISE Research.*

**Table 3.9: EIDorado National Fuel Economy**

30' EIDorado National/ISE Research	Est. mpg
Diesel	3.5
Propane	2.0
Propane-Electric Hybrid	3.5 -3.7

*Source: LADOT/ISE Research.*

The pilot EIDorado National/ISE Research bus has so far proven reliable. Its performance has been adequate to meet the demands of the DASH duty cycle. LADOT observes an improvement in fuel economy as compared with its other 30' propane buses on the same route (see Table 3.9), but it expects efficiency to improve in the future as a result of ongoing engineering changes.<sup>15</sup> The project team hopes to measure emissions on the new hybrids some time in the near future. After consulting with CARB, the team selected an optimized engine that it expects will come closest to meeting CARB standards.

**3.4.1.2 Orange County Transit Authority**

Another hybrid demonstration program is getting underway at this time west of the City. Orange County Transit Authority (OCTA) currently operates a fleet of about 500 transit buses and 250 paratransit buses. Its fleet uses diesel presently, but the OCTA Board recently decided to convert to LNG in the near future. OCTA decided to add two prototype hybrid buses from New Flyer to an order for 117 low-floor diesel buses it was buying at the time. New Flyer and OCTA have partnered to evaluate the technology for emissions, fuel economy, operability, and reliability. Both buses were delivered in 1999 and the first bus began non-revenue service testing over the summer. OCTA expects to place both buses in revenue service testing by the start of 2000.

**Tomorrow's technology is already here and benefiting the public. This enables us to play a leadership role in improving air quality while offering quality service to the people of Orange County.<sup>16</sup>**

- Greg Winterbottom, OCTA Director

<sup>15</sup> ISE Research reports getting 4.1 mpg in its testing.

<sup>16</sup> APTA's *Passenger Transport*, May 10, 1999.

The New Flyer buses have electric drive systems designed by Solectria Corporation, a small manufacturer located in Wilmington, Massachusetts. New Flyer and Solectria together integrated the drive system into the bus. Two air-cooled induction motors independently drive each rear wheel. A diesel genset maintains float voltage of the sealed gel VRLA traction batteries and varies speed depending on load. The bus is equipped with a charger that connects to a 220VAC outlet and is recharged over night to extend battery life. All bus accessories are electrically driven.

The first New Flyer is presently undergoing engineering validation tests at OCTA. The bus has been instrumented for data collection

**Figure 3-10: New Flyer Hybrid Bus**



Source: Solectria Corporation

**Table 3.10: New Flyer Drive Specifications**

Test	Predicted
Range (hybrid)	300 mi.
Range (electric)	6 mi.
Accel. (0-55)	45 sec.
Top Speed	55 mph
Max. Grade	16%

Source: Solectria Corp.

and is being driven under load (sand bags) shadowing a revenue service bus on a variety of OCTA routes. The vehicle is being used to accurately quantify its performance relative to a variety of daily cycles. OCTA plans to perform range, acceleration, grade, and efficiency tests on the bus in coming months. To date about 1,200 test miles have been placed on the test bus. Although results are not yet published, OCTA is encouraged by results thus far<sup>17</sup>. The system appears to have stabilized after initial battery problems were addressed. Early problems included premature battery module failures and overheating of traction motors. In the first instance, the manufacturer reduced current to batteries during regen; and in the second, it began oil cooling the motor bearings. In both instances the problems have not recurred. OCTA is confident the bus can satisfy range and acceleration requirements of most routes. It expects to operate the buses in CBD type routes in which diesel buses are typically the least efficient.

**3.4.1.3 Other L.A. Hybrids**

Several planned hybrid demonstrations are in the works in other parts of Los Angeles.

- The LADOT hopes to purchase 12 more hybrid buses later this year, raising its hybrid bus fleet total to 20. The agency is negotiating with the Los Angeles Department of Water and Power and other state partners to fund the procurement. Nine of the proposed buses would be 30' EIDorado National lowfloor buses with ISE Research drive systems and Capstone turbine APUs, and three would be Nova RTS buses with ISE Research drive systems and conventional APUs.
- OmniTrans in San Bernardino recently purchased three 40' hybrid transit buses from New Flyer that it expects to be delivered sometime in 2000. These buses will feature hybrid-electric drive systems from ISE Research. The drive system configuration will be similar to the EIDorado National buses at LADOT except higher power components will be used. The genset consists of a 6.8 liter Ford engine and 120kW Fisher generator. The traction drive includes a 195kW c. Siemens motor and 50kWhr traction battery of pack.

<sup>17</sup> Interview with Dennis Elefante, OCTA Fleet Analyst, October 1999.

- An advanced technology hybrid transit bus demonstration is planned for Foothill Transit in West Covina sometime in 2001. The 40' Nova BUS will again feature an ISE Research hybrid system; however, the bus will have a high speed mechanical flywheel in addition to the chemical traction battery to assist with acceleration and regeneration. Trinity Flywheel, a leader in mechanical energy storage, will supply the flywheel. This bus will be one of the first to demonstrate a mechanical flywheel onboard a vehicle in the United States.<sup>18</sup>

**If hydrogen is the ultimate goal [for clean energy], then hybrid buses with electric drive seem like the right step. Diesel hybrids should compete well against alternative fuels.**

- Dennis Elefante, OCTA Fleet Analyst

### 3.4.2 Overall Assessment

Transit agencies in California are under intense political pressure to clean up the emissions of their fleets. Several agencies are taking important leadership roles in evaluating the effectiveness of hybrid technology to help them meet clean air goals. Within a year, there will be a fleet of 23 hybrid buses in regular revenue service. That fleet will allow Southern California to evaluate hybrid technology's ability to meet long term transit and air quality goals. California also seems to be willing to work with new manufacturers who are anxious to break into this market. It will be one of several areas testing advanced hybrid technologies, including turbine APUs and flywheels, in the coming years. Los Angeles will be an important test bed for these technologies and for manufacturers to prove themselves.

## 3.5 Conclusions

The hybrid-electric drive bus demonstrations underway around the globe show that the technology has moved out of the lab and into real-world testing. The number of vehicles is expected to quadruple in the U.S. alone during the next couple of years. In another several years, the worldwide hybrid bus fleet may well reach into the thousands or even tens of thousands.

The demonstrations include a variety of drive system configurations, liquid and gas fuels, energy storage technologies and familiar as well as new manufacturers. The Orion VI hybrid is the first hybrid transit bus designed for commercial sale in the U.S. and Lockheed Martin's HybriDrive™ is the first integrated hybrid drive system for commercial sale in the U.S.

Demonstrations underway in New York City, Cedar Rapids and Los Angeles include over 30 active hybrid buses with more than 100,000 fleet miles in just over a year of revenue service. Operators say the learning curve is steep and not without bumps, but hybrids are quickly improving. Operators have measured several benefits of the hybrids, including significantly reduced emissions, higher fuel economy, and improved acceleration and handling. Their drivers and riders seem to prefer the hybrids too.

Significant technical obstacles to larger scale commercial success include a need for improved battery technology to offer better energy storage efficiency, management and life. Advanced technology demonstrations offer glimpses of the future which might include supercapacitors, flywheels or fuel cells. Hybrids are a step in this direction.

---

<sup>18</sup> The University of Texas will demonstrate a mechanical flywheel on an ATTB bus in Houston sometime in the same time frame.

## 4.0 Hybrid Drive Life Cycle Costs

---

**This chapter reviews current and projected costs of purchasing and operating hybrid-electric transit buses. Hybrid bus life cycle cost analysis is complicated by the fact that the technology is young and, therefore, real world operating and maintenance costs are unknown. Furthermore, social and political considerations that may heavily influence the decision to adopt a new technology are difficult to factor into the cost-benefit analysis. The bottom line is that transit operators can look forward to a net cost reduction associated with operating hybrid buses once the technology matures and economies-of-scale are reached. However, until then, early adopters will have to accept a net cost increase over conventional diesel technology.**

**The single largest cost driver at present is capital acquisition. Hybrid transit bus capital acquisition costs have come down considerably in the last several years from about \$840,000/bus to \$385,000/bus. Acquisition costs will see another price reduction once annual production volumes reach 1,000 units, and hybrids may reach price parity with conventional (mechanical) diesel buses if hybrids gain a large share of the truck market. The second largest cost driver is battery replacement, which adds between \$20,000 and \$50,000 to the cost of owning and operating a hybrid bus. The largest unknown at this time is maintenance cost, which could be significant since maintenance represents a large share of total transit bus operating expenses. Electricity and infrastructure costs are negligible in the larger context. Hybrids produce tangible savings in fossil fuel reduction (1.0 mpg improvement) and emissions reductions over the life of the bus. Most importantly, hybrid transit buses appear to be a good investment given their potential for large reductions in harmful emissions. Depending on how they are valued, the social benefits from hybrids may ultimately outweigh their costs.**

### **4.1 Introduction**

The purpose of this chapter is to provide an understanding of the cost drivers involved with owning and operating hybrid-electric drive transit buses. Hybrid-electric drive technology must ultimately prove itself on an economic basis. Transit operators are willing to accept an increase in costs in order to reduce emissions, but are seeking the most cost-effective means available. This willingness can be seen in the increase in sales of other alternative fuels, such as compressed natural gas, liquified natural gas, methanol and propane. Each of these technologies can lower emissions but comes with a cost premium. Hybrid technology, like other alternative fuel technologies, comes at a cost premium today, but its cost structure differs from other technical approaches to reduced emissions.

It is impossible at this time to place hard numbers on the cost to own and operate a hybrid bus fleet. The technology is just emerging from the lab and there is not enough experience at this time to accurately quantify costs. On the other hand, it is important to identify and discuss the most critical cost drivers associated with hybrid drive today and estimate near and long term costs. To do that, the researchers of this report created an analytical framework comparing a conventional mechanically driven diesel bus to a hybrid-electric drive bus. In order to simplify the analysis, the researchers considered a conventional hybrid bus that has a diesel engine auxiliary power unit, single electric traction motor, and lead acid batteries in a series hybrid drive configuration. The analysis does not apply to all hybrid transit buses, including parallel designs, turbine APUs, fuel cell hybrids, or hybrids using advanced energy storage devices. Furthermore, the researchers assumed the bus completes its daily duty cycle without needing to

recharge the batteries on the grid each night. In terms of cost segments, the researchers varied their assumptions to examine the impact on the bottom line. Despite the shortcomings inherent in estimating hybrid bus costs at this time, it is believed that the following analysis provides a reasonable estimate of near and long term costs. The reader should note that all figures are presented in current dollars.

#### 4.1.1 Capital Acquisition Costs

Hybrid-electric drive transit buses are available at a premium today, but prices are expected to come down in the future (see Table 4.1). Recent buyers have paid between \$440,000 and \$840,000 per hybrid transit bus for early generation prototypes. Today's hybrid bus cost premium reflects low production volumes and the fact that components and systems are essentially hand built. According to manufacturers, there is nothing inherent in the materials or fabrication of conventional hybrid components (e.g., AC induction motors and IGBT based inverters) that would prevent manufacturing economies-of-scale from reducing

**Table 4.1: Hybrid Transit Bus Capital Costs**

Volume		Conventional Drive	Hybrid (High) <sup>1</sup>	Hybrid (Low) <sup>2</sup>	Delta (High)	Delta (Low)
Small volume (5-10)	\$/unit	\$ 280,000	\$ 840,000	\$ 440,000	\$ 560,000	\$ 160,000
	\$/mile <sup>3</sup>	\$ 0.69	\$ 2.07	\$ 1.09	\$ 1.38	\$ 0.40
Mid volume (100+)	\$/unit	\$ 280,000	\$ 450,000	\$ 385,000	\$ 170,000	\$ 105,000
	\$/mile <sup>3</sup>	\$ 0.69	\$ 1.11	\$ 0.95	\$ 0.42	\$ 0.26
Production (1,000+)	\$/unit	\$ 280,000	\$ 350,000	\$ 280,000	\$ 70,000	\$ -
	Annual \$/unit <sup>3</sup>	\$ 18,667	\$ 23,333	\$ 18,667	\$ 4,667	\$ -
	Annual \$/unit/mile <sup>3</sup>	\$ 0.69	\$ 0.86	\$ 0.69	\$ 0.17	\$ -

SOURCE: NYCTransit, Orion, Nova

<sup>1</sup> (High) Assumes hybrids do not achieve economies of scale, and production <10K units/year.

<sup>2</sup> (Low) Assumes significant truck market penetration and economies of scale (100k units/year).

<sup>3</sup> Based on 15 year life of 27,000 miles per year.

costs in the future.<sup>1</sup> For instance, New York City Transit will pay \$385,000/bus for an order for 125 hybrid buses approved in December 1999.

Ultimately, hybrids are expected to achieve price parity with conventional, mechanically driven diesel technology assuming hybrids capture a share of the large truck market, where annual volumes are in the hundreds of thousands of units. The annual sales volume for transit buses in the U.S. (about 4,000 to 5,000 units) is not large enough to drive down costs. If annual heavy duty hybrid drive production never gets beyond a thousand units, it will continue to cost \$50,000 to \$70,000 more than conventional drive.

#### 4.1.2 Fuel

By definition a hybrid-electric bus consumes at least two "fuels" that must be counted when estimating lifetime fuel costs. For near term hybrids, the two fuels include a liquid or gas (probably diesel or natural gas) and lead acid batteries. In general, hybrid technology produces fossil fuel savings that must be weighed against cost increases associated with maintaining and replacing traction batteries.

- **Fossil Fuel.** Current diesel hybrid transit buses get about 1.0 mpg more than current mechanically driven diesel buses on urban cycles using a chassis dynamometer (see Chapter 6). In-use fuel

<sup>1</sup> Honda and Toyota are offering hybrid drive passenger cars priced competitively with conventional mechanically driven gasoline cars as of Model Year (MY) 2000.

economy may differ depending on driver habits, duty cycle, and vehicle state-of-tune. Over the life of a typical transit bus this improvement could save \$18,500 (or \$0.05/mile).

- **Traction Batteries.** Manufacturers estimate that traction lead acid batteries will need to be replaced every 3 years or so on a hybrid bus. Lead acid battery total lifecycle cost ranges from \$20,000 to

**Table 4.2: Hybrid Transit Bus Fuel Costs**

Hybrid Transit Bus Fuel Costs						
	Conventional Drive	Hybrid (High)	Hybrid (Low)	Delta (High)	Delta (Low)	
<b>Diesel (No. 1)</b>						
Fuel cost (\$/gal)	\$ 0.72	\$ 0.72	\$ 0.72	\$ -	\$ -	
Fuel Economy (mpg) <sup>1</sup>	3.5	4.5	4.5	(1.0)	(1.0)	
Annual \$/bus <sup>4</sup>	\$ 5,554	\$ 4,320	\$ 4,320	\$ 1,234	\$ 1,234	
\$/mile <sup>4</sup>	\$ 0.21	\$ 0.16	\$ 0.16	\$ (0.05)	\$ (0.05)	
\$/bus life <sup>4</sup>	\$ 83,314	\$ 64,800	\$ 64,800	\$ (18,514)	\$ (18,514)	
<b>Electrical</b>						
Cost (\$/ACkWh)	\$ 0.08	\$ 0.08	\$ 0.08	\$ -	\$ -	
Annual MWhr/bus <sup>2</sup>	0	2.60	0.00	2.60	-	
Annual \$/bus <sup>4</sup>	\$ -	\$ 208	\$ -	\$ 208	\$ -	
\$/mile <sup>4</sup>	\$ -	\$ 0.01	\$ -	\$ 0.01	\$ -	
\$/bus life <sup>4</sup>	\$ -	\$ 3,120	\$ -	\$ 3,120	\$ -	
<b>Traction Batteries</b>						
Replacement Cost (\$/pack) <sup>3</sup>	\$ -	\$ 50,000	\$ 20,000	\$ 50,000	\$ 20,000	
Annual \$/bus <sup>4</sup>	\$ -	\$ 3,333	\$ 1,333	\$ 3,333	\$ 1,333	
\$/mile <sup>4</sup>	\$ -	\$ 0.12	\$ 0.05	\$ 0.12	\$ 0.05	
\$/bus life <sup>4</sup>	\$ -	\$ 50,000	\$ 20,000	\$ 50,000	\$ 20,000	
<b>Total Fuel</b>						
Annual \$/bus <sup>4</sup>	\$ 5,554	\$ 7,861	\$ 5,653	\$ 2,307	\$ 99	
\$/mile <sup>4</sup>	\$ 0.21	\$ 0.29	\$ 0.21	\$ 0.09	\$ 0.00	
\$/bus life <sup>4</sup>	\$ 83,314	\$ 117,920	\$ 84,800	\$ 34,606	\$ 1,486	

SOURCES: NAVC/WVU, NYCT, Orion, Nova.

<sup>1</sup> Assumes 1.0 mpg increase verified by chassis dynamometer testing.

<sup>2</sup> (High) Assumes no electric grid connection required to recharge or maintain the batteries.

<sup>2</sup> (Low) Assumes weekly, grid connected equalization charge of 50 AC kWh/bus.

<sup>3</sup> (High) Assumes Pbacid technology & 3 year life. 4 replacement packs x \$12,500/pack.

<sup>3</sup> (Low) Assumes Pbacid technology & 3 year life. 4 replacement packs x \$5,000/pack.

<sup>4</sup> Based on 15 year life of 27,000 miles per year.

\$50,000 (or \$0.05 to \$0.12/mile) depending on the type of lead acid battery used. Furthermore, lead acid batteries require regular equalization to maintain consistent performance and periodic conditioning to extend life. Equalization may be achieved through on-board, real-time strategies or by

connecting the bus to the grid. Battery conditioning will most likely require grid connection on a monthly or quarterly basis. Even if performed weekly, the total electricity cost associated with battery conditioning is nominal (\$0.01/mile) compared to the battery replacement cost (see Table 4.2).

After accounting for diesel and batteries, it appears that current state-of-the-art hybrid transit buses will have higher life-cycle fuel costs than current conventional buses due to high battery replacement costs. However, hybrid fuel costs will likely decline in the near future as the technology improves. Advanced energy storage devices, improved energy management, and enhancements in overall system design and efficiency will combine to extend battery life, reduce battery costs, and improve fuel economy. Hybrid bus operators would probably save money in fuel costs if lifetime battery costs were kept below \$20,000. An increase in overall system efficiency (1.5 to 2.0 mpg better than diesel) would significantly improve the bottom line, as would an increase in the price of diesel fuel or in vehicle miles traveled. Because one or more of these scenarios is probable, hybrid buses will ultimately have lower lifecycle fuel costs than conventional buses.

**4.1.3 Maintenance**

Hybrid transit bus maintenance costs are not well understood at this time. There is not yet enough operating experience with hybrids to realistically quantify the hours and costs associated with maintaining them. In practice, transit agencies experimenting with early hybrid prototypes report higher than normal maintenance costs (see Chapter 3) which is typical for a new technology. In theory, hybrids should be simpler and less costly to maintain than conventional vehicles once they mature and are understood by shop personnel. Hybrid buses

eliminate transmission repairs and reduce the frequency of brake relinings -- two expenses often ranked high on transit property maintenance lists. There is no change in the engine maintenance schedule between a hybrid and conventional bus (see Table 4.3), although hybrid engines may ultimately last longer because they spend more time operating in a steady state than transient mode.

Conversely, hybrids add new components to the maintenance schedule. Traction motors and inverters require little maintenance, however, and should be highly reliable once mature (see Chapter 5). Traction batteries on the other hand will require some periodic maintenance. In general, today's hybrid buses use sealed lead acid batteries, eliminating the daily "care and feeding" associated with flooded type lead acid batteries. Furthermore, most hybrid drive buses are equipped with energy systems that automatically monitor and manage battery voltage, current, and

**Table 4.3 Hybrid Bus Maintenance Costs**

Component	Hybrid vs. Mechanical (+/-)	Cost Delta
Engine	n/c	TBD
Generator	+	TBD
Traction Motor	+	TBD
Transmission	-	TBD
Traction Batteries	+	TBD
Mechanical Brakes	=	<u>TBD</u>
Net Change	TBD	TBD
\$/mile Diesel bus <sup>1</sup>	\$ 1.60	\$ -
\$/mile Hybrid (High) <sup>2</sup>	\$ 1.76	\$ 0.16
\$/mile Hybrid (Low) <sup>3</sup>	\$ 1.44	\$ (0.16)

SOURCE: NYCTransit & Orion.

<sup>1</sup> Baseline diesel bus maintenance cost provided by MBTA.

<sup>2</sup> Assumes 10% increase in maintenance costs.

<sup>3</sup> Assumes 10% decrease in maintenance costs.



temperature at the module level to maximize life and reduce maintenance. The only maintenance currently associated with traction batteries is periodic equalization, and removal and replacement at the end of the battery's useful life. It may be possible to perform battery equalization coincident with other normally scheduled maintenance procedures so that costs are kept down.

The jury is still out on hybrid transit bus maintenance. Manufacturers and many early adopters argue that hybrid maintenance costs will be comparable to, if not better than, conventional technology once hybrid technology matures. The reason everybody cares is that maintenance costs are a large share of the overall cost structure of bus operations. A five percent change in maintenance costs could affect lifecycle costs by as much as \$20,000/bus.

#### 4.1.4 Infrastructure & Facility

One of the advantages of hybrid technology is that it allows a transit property to achieve significant reductions in emissions without investing in costly new fueling infrastructure. Although hybrids are compatible with natural gas and other alternative fuels, some transit agencies may want to adopt diesel hybrids in order to avoid expensive infrastructure investments. A fleet of 100 diesel hybrid buses can probably be integrated into an existing bus garage for less than \$200,000 in infrastructure modifications (see Table 4.4). Most of this expense would be for electrical equipment and wiring associated with battery

**Table 4.4: Hybrid Bus Infrastructure Costs**

<b>Per 100 hybrid buses</b>	<b>Hybrid (Low)</b>	<b>Hybrid (High)</b>
Diagnostic equipment <sup>1</sup>	\$ 5,000	\$ 10,000
Battery handling & charging <sup>2</sup>	\$ 5,000	\$ 135,000
Electrical service upgrades <sup>3</sup>	\$ 5,000	\$ 25,000
Total \$/100 bus fleet	\$ 15,000	\$ 170,000
\$/bus/year <sup>4</sup>	\$ 10	\$ 113
\$/bus/mile	\$ 0.00	\$ 0.01

SOURCE: NYCTransit & Orion.

<sup>1</sup> Includes laptop computers & high impedance multimeter.

<sup>2</sup> (Low) Charger included in price of bus, and existing forklift used to remove batteries.

<sup>2</sup> (High) Fast chargers purchased and overhead crane installed to remove batteries.

<sup>3</sup> (Low) Install electrical outlets, 208 VAC, 50 amp, 3-phase service.

<sup>3</sup> (High) Install 480VAC service and load management equipment.

<sup>4</sup> Assumes 15 year life

equalization, which may be replaced by other techniques currently under development that eliminate the need for grid connection. However, assuming all 100 buses must be grid connected periodically, it may be desirable to have several stations that can charge several buses at once or possibly provide quick charges.

Battery-related work would require equipment to remove and replace the heavy packs that weigh up to 3,000 lbs. A conventional forklift can be used to remove batteries from the standard high-floor hybrid bus where batteries are stored underneath the bus. However, an overhead crane or adapted forklift would be needed to remove batteries from the rooftop, where batteries are typically mounted on low-floor hybrids. Some amount of secure battery space would be needed to temporarily store batteries during removal and replacement; however, how much space is not known at this time. Rather than build dedicated space to

store and maintain spare battery packs, we assume a just-in-time system of battery removal and replacement would likely develop thereby removing the burden from the operator. Several laptop computers and standard electrical and electronic test equipment would be required to handle most diagnostic repair work associated with the power electronics and traction batteries. Some of this equipment would already be present on site as a result of 24-volt systems on board conventional buses. Training costs are assumed to be included in the vehicle purchase price.

#### 4.1.5 Emission Reductions & Other Social Benefits

The major impetus behind alternative fuels is interest in reducing harmful emissions, improving public health, and conserving energy. Political, social, and environmental pressures are being placed on transit agencies to adopt alternative fuels and technologies including hybrid-electric drive. These pressures may be great enough to overlook the costs associated with adopting new technologies. It has always been difficult to assign an economic value to a social benefit such as emissions reductions. However, a few

**Table 4.5: Hybrid Bus Emissions Credits**

CBD-14	Conventional <sup>1</sup>	Hybrid <sup>2</sup>	Delta	Market Value (\$/ton)
<b>PM</b>				
g/mile	0.24	0.12	0.12	\$ -
ton/year/bus <sup>3</sup>	0.01	0.00	0.00	\$ -
ton/year/100 buses	0.71	0.36	0.36	\$ -
<b>NOx</b>				
g/mile	30.1	19.2	10.9	\$ 1,000
ton/year/bus	0.89	0.57	0.3	\$ 324
ton/year/100 buses	89.40	57.02	32.4	\$ 32,373
<b>VOC</b>				
g/mile	0.14	0.08	0.1	\$ 3,000
ton/year/bus	0.00	0.00	0.0	\$ 5
ton/year/100 buses	0.42	0.24	0.2	\$ 535
<b>CO</b>				
g/mile	3.0	0.1	2.9	\$ -
ton/year/bus	0.09	0.00	0.1	\$ -
ton/year/100 buses	8.91	0.30	8.6	\$ -
<b>CO2</b>				
g/mile	2,779.0	2,262.0	517.0	\$ -
ton/year/bus	82.54	67.18	15.4	\$ -
ton/year/100 buses	8,253.63	6,718.14	1,535.5	\$ -
<b>Total</b>				
\$/bus/year				\$ 329
\$/100 buses/year				\$ 32,908
\$/bus/mile				\$ 0.01

SOURCE: NAVC, WVU, MJBradley & Associates & *Air Daily*

<sup>1</sup> NovaBUS RTS with MY 1999 Series 50 engine and Diesel #1 fuel.

<sup>2</sup> Orion Hybrid VI with MY 1998 Series 30 engine and Diesel #1 fuel.

<sup>3</sup> Assumes 27,000 miles/bus and conversion factor for 1 (short) ton = 908,000 grams.

states have established incentive and discrete emissions trading programs that may allow early hybrid adopters to convert emissions reductions into cash. California<sup>1</sup> and New York have incentive programs to help offset incremental costs of purchasing clean transportation technologies.

Open market emission trading exists for NO<sub>x</sub>, VOCs, and CO in some states, such as Texas, Michigan, Massachusetts and New Jersey. Prices vary and the volume of trades is still low. The market for CO<sub>2</sub> is just emerging, and no market exists yet for particulates, although there are groups taking steps to create one. The markets for NO<sub>x</sub> and VOCs are seasonal, with the rates being higher in the summer (heavy polluting). Transit agencies located in a non-attainment zone and counted in their state's pollution inventory should approach their state department of environmental protection for more information about selling pollution credits.

The bottom line is that hybrid buses offer a social return for emissions inventory reductions; in some states, these emissions reductions translate into a cash return. Other social benefits, such as public health improvements associated with cleaner air, could be factored into a larger cost/benefit analysis of hybrid technology. Politics may also factor into the decision whether to adopt hybrid technology. These factors are best considered in light of each particular situation rather than in a general analysis like this one.

**Table 4.6: Hybrid Bus Annual Cost Summary**

Per bus/year	Conventional	Hybrid (High)	Hybrid (Low)	Delta (High)	Delta (Low)
Capital	\$ 18,667	\$ 23,333	\$ 18,667	\$ 4,667	\$ -
Fuel	\$ 5,554	\$ 7,861	\$ 5,653	\$ 2,307	\$ 99
Maintenance	\$ 43,200	\$ 47,520	\$ 38,880	\$ 4,320	\$ (4,320)
Infrastructure	\$ -	\$ 113	\$ 10	\$ 113	\$ 10
Emissions	\$ -	\$ -	\$ (329)	\$ -	\$ (329)
Total	\$ 67,421	\$ 78,828	\$ 62,881	\$ 11,407	\$ (4,540)
Per 100 buses	\$ 6,742,095	\$ 7,882,800	\$ 6,288,092	\$ 1,140,705	\$ (454,003)
Per bus mile	\$ 2 50	\$ 2 92	\$ 2.33	\$ 0 42	\$ (0 17)

## 4.2 Conclusions

The bottom line is that current hybrid transit buses cost more to own and operate today than conventional buses. However, there is good reason to believe that costs will come down in the near future, making hybrids comparable (if not cheaper) to operate than conventional technology. More importantly, hybrid transit buses appear to be a good investment given their potential for large reductions in harmful emissions. The single largest cost driver at present is capital acquisition. Capital acquisition costs for hybrid transit buses have come down considerably in the last several years from about \$840,000/bus to \$385,000/bus today. Acquisition costs will see another price reduction, to \$350,000, once annual production volumes reach 1,000 units. Hybrids will continue to have a \$70,000 cost premium until significant penetration of the truck market occurs. The second largest cost driver is battery replacement, which adds at least another \$20,000 to the cost of owning and operating a hybrid bus. The largest unknown at this time, maintenance cost, is important because it represents a large proportion of transit operating expenses. Electricity and infrastructure costs are negligible in the larger context. Hybrids produce tangible savings in fossil fuel reduction and emissions reduction over the life of the bus. Depending on how they are valued, the social benefits from hybrids may ultimately outweigh their costs.

<sup>1</sup> California is developing test procedures to help hybrids qualify for the Carl Moyer Program.

## 5.0 OPERATION AND MAINTENANCE

Hybrid-electric drive technology introduces new opportunities and challenges from the standpoint of bus operation and maintenance. Hybrid drive offers numerous operational advantages such as smoother and quicker acceleration, more efficient braking, improved fuel economy, and reduced emissions. Maintenance requirements may increase in the beginning due to energy storage system requirements. However, these requirements may go away once the technology matures. In the long term, hybrid bus maintenance requirements may be less onerous than conventional mechanical technology due to savings associated with transmission and brakes. Infrastructure modifications are expected to be minor. Mechanical and safety retraining is needed in light of high voltage components. Transit providers must understand the issues and risks involved in deploying hybrid-electric drive technology. This chapter explores a range of issues including operation and maintenance, infrastructure, health and safety, and environmental, legal and institutional issues.

### 5.1 Operation

Hybrid bus performance has important implications for route and service planning as well as driver training. Transit managers frequently ask whether a hybrid drive bus can replace a conventional diesel bus without requiring changes to current service plans. They also ask whether a hybrid bus can enhance service in some useful ways. Hybrid-electric drive does offer real operational advantages over conventional mechanical drive technology. The following section highlights some of these benefits and challenges.

#### 5.1.1 Capacity & Weight

As mentioned in previous chapters, hybrid buses are being produced in most size and weight classes today. Orion, Nova BUS, and New Flyer are all demonstrating full sized hybrid transit buses. Hybrid shuttle and paratransit buses are available from Advanced Vehicle Systems (AVS), Electric Vehicles International, Ebus and others. There can be a small increase in vehicle weight mostly due to the addition of heavy, lead acid traction batteries. It is commonly assumed that future hybrid products will be lighter through one or more of the following: advanced energy storage, lightweight composites, or new designs such as parallel hybrid drive that utilize a smaller battery pack.

**Table 5.1: Mechanical Characteristics**

Mechanical	Diesel (Orion V)	Hybrid (Orion VI)	Hybrid (Nova BUS)	Hybrid (New Flyer)	Hybrid (AVS)
Design	40' High Floor	40' Low Floor	40' RTS High Floor	40' Low Floor	30' Low Floor
GVWR (lbs)	40,600	40,600	39,500	37,900	30,000
Curb Weight (lbs)	28,000	30,800	30,600	31,200	23,000
Seats*	40	32	40	36	30
Fuel tank (gal.)	100-150	100-150	100-150	100-150	50

Source: Orion Bus Industries, Allison Transmission of General Motors, Solectria Corporation

\* NYCT seating configuration is shown.

### 5.1.2 Range & Fuel Economy

In general, hybrid drive is desirable because it overcomes the range limitations of pure electric drive while improving the fuel economy and emissions of conventional mechanical drive. A hybrid transit bus is capable, in theory, of outdistancing a mechanically driven truck when driven at a constant 40 mph on the highway. Its range in these test conditions is limited only by the size of the fuel tank. In typical urban bus route situations, the same hybrid buses provide a full day of service or about 350 miles between refueling. In controlled tests, hybrid buses typically see about a 1.0 mpg improvement over conventional mechanically driven diesel buses (see Chapter 6). In the future, hybrid buses with advanced energy storage systems may well exceed 400 miles between refueling. Improved fuel economy reduces operating costs and emissions, and can increase time between refueling or shorten time to refuel.

Not all hybrids are the same, as discussed in Chapter 2. Different performance objectives can be met by varying the hybrid propulsion system design. For example, range extender hybrids like the AVS-22 hybrid shuttle bus have a small APU and large battery pack. This type of hybrid offers improved range (80-100 miles) over its pure battery electric counterpart and reduced tailpipe emissions over its engine dominant counterpart. In addition, it can travel considerable distances (40-50 miles) in pure zero emission mode. This type of hybrid might be ideally suited to low mileage, environmentally sensitive service routes such as airports, national parks, tourist areas, or congested downtown routes.

**Table 5.2: Driveline Characteristics**

Driveline	Diesel (Orion V)	Hybrid (Orion VI Lockheed)	Hybrid (Nova/Allison)	Hybrid (New Flyer Solectria)	Hybrid (AVS-30 UQM)
Range (miles)	350	350	350	300	250
Range (battery only)	0	0	10 (est.)	10	20
Max. Grade (percent)	16	16	16	16	16
Top Speed (mph)	55	55	55	55	55

*Source: Orion Bus Industries, Allison Transmission of General Motors, Solectria Corporation*

The one type of service that might present a challenge to current state-of-the-art hybrid buses is express type service with high speeds and long hills. The energy required for this service route may well exceed what the hybrid drive system can handle effectively in its current configurations. During long uphill grades at highway speeds, the hybrid battery pack voltage will likely be drawn down quickly to the point where the APU is left to power the bus alone without help from the batteries. Most APUs in hybrid transit buses today will not put out enough power to maintain highway speeds (50mph) on a long hill. However, this drawback is likely to be soon overcome with improvements in hybrid technology and design including parallel hybrids that will likely employ a higher power APU.

### 5.1.3 Acceleration & Braking

Hybrid-electric drive offers enhanced handling performance when compared to conventional mechanical drive due to the characteristics of electric traction motors. Hybrid drive provides smooth acceleration without shifting, a feature that drivers and passengers universally like in hybrid bus demonstrations around the country. It is also capable of providing faster acceleration due to the increased low-end torque characteristics of electric motors. An early prototype hybrid transit bus built by Orion Bus Industries and General Electric demonstrated improved acceleration in testing as compared to White Book specifications (see Figure 5.1). Hybrid bus drivers in New York City like the improved acceleration because it helps them pull out into traffic more quickly. Of course, too much torque can negatively affect passenger

comfort, so hybrid bus acceleration is typically electronically tuned to ensure proper balance between safety and performance.

Likewise, hybrid drive offers more efficient braking due to electric regenerative braking. A conventional service brake is actuated by the brake pedal while the electric brake is actuated electronically by throttle and service brake in order to maximize regeneration of kinetic energy through the electric drive motor(s)

**Figure 5-1: Acceleration of Prototype Orion Hybrid Bus**

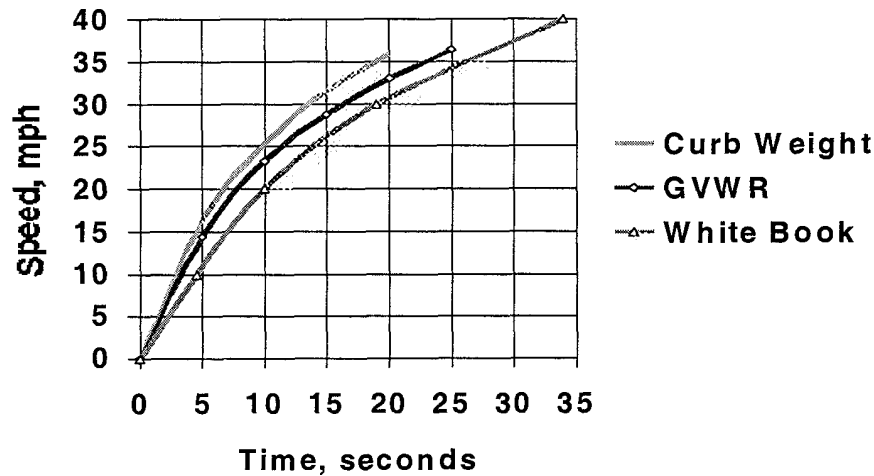

*Source: Orion Bus Industries*

(see Chapter 2). Regenerative braking is generally tuned to mimic the feel of both hydraulic retarder and service brakes on a conventional bus. The Santa Barbara Electric Transportation Institute has shown that energy recovery through regenerative braking can vary greatly from driver to driver. In most cases the regenerative braking system will be transparent; the only consideration will be that drivers limit the number of quick stops, as longer stopping distances will maximize energy recovery. Both hybrids and conventional buses share similar top speed and grade characteristics.

#### 5.1.4 Environmental

**Emissions.** The major impetus behind the development of hybrid drive buses is emissions reduction. Hybrid buses are cleaner and emit fewer grams of pollutants per mile than do conventional diesel buses. Hybrids have been shown to reduce particulates (PM10) and NOx by as much as 50% during testing (see Chapter 6). Hybrid buses may be very desirable in emission sensitive areas where emissions reductions are especially needed such as non-attainment areas, national parks, schools and campuses, and tourist centers.

Dual mode hybrids may allow limited zero emission range for operation in highly sensitive areas. For example, crowded downtown, tourist or historic areas might particularly benefit from pure electric (zero emission) propulsion mode of operation for short distances. In Boston, a new underground bus transitway is being constructed that will require buses to travel a 1.1 mile tunnel without burning fuel. Dual-mode hybrid buses might be particularly well suited to this type of application.

**Temperature.** Normal operating conditions for diesel buses range from -10°F to 115° F. Hybrid buses can perform in similarly demanding conditions; however, this will likely require some type of thermal management of the batteries. Lead acid batteries become less efficient when ambient temperatures drop below 50° F while other batteries such as nickel metal hydride may require active cooling at warmer temperatures. Regardless, hybrid drive system developers are designing thermal management into their

battery management systems. Customers should inquire whether any special requirements apply for operating or storing hybrid buses in either extreme hot or cold temperatures.

*Noise.* Hybrid technology can also have noise reduction benefits over conventional buses. Diesel bus noise standards typically specify that noise levels not exceed 83 dBA at any seat location in the bus at 35 mph. Comparative noise data for hybrid bus was not available, although NYCT reports anecdotally that its hybrid buses are quieter than standard diesel buses in service. Turbines are inherently quieter than conventional diesel engines. AVS reports that the noise level is 60 dBA at 33 feet, and passengers on the AVS turbine-hybrid frequently note the vehicle's quietness.

## **5.2 Maintenance**

Hybrid drive technology introduces new technologies and challenges to the bus maintenance shop. Reliability is critical to transit operation success and must be demonstrated in the real world before any new technology can be accepted. Maintenance personnel frequently ask what life and reliability to expect from hybrid bus components and whether special training is required. The answer is that no one really knows at this time. The technology is just emerging from the laboratory and has not yet matured or been optimized. Hybrid buses have only been in revenue service in New York City for one year and while records show that component failures were not uncommon, these problems may well be solved during the second year of operation (see Chapter 3).

It seems safe to predict that, initially, maintenance requirements for hybrid-electric drive will be higher due to several factors:

- **Technology infancy.** Most hybrid propulsion components are new and essentially hand made, and the technology is rapidly evolving. Conventional mechanical drive systems have had decades to mature into a reliable and durable product. Failures and increased maintenance are expected with any new technology. The fact that hybrid buses achieved 60-70% of the reliability and availability rates typical of conventional mechanical buses in the first year in New York City is considered a success.
- **Increased system complexity.** While hybrid drive eliminates or reduces high maintenance items such as transmission and brake lining repair, it introduces additional electric drive components that create a more complex system for mechanics overall (see Table 5.3). In the short term, this added complexity will likely result in increased maintenance costs.
- **Demanding application.** Transit buses are a demanding application for a new technology. The duty cycles associated with transit bus service are notoriously demanding. Buses in many major cities run almost around the clock in all kinds of weather. The vehicles and subsystems must survive in an environment that repeatedly exposes them to shock and vibration.
- **Technology adaptation & retraining.** Time and training are needed whenever a new technology is introduced. Shops already familiar with trolley buses may adapt more quickly to hybrid-electric drive. However, most shops will need training and time to adapt to hybrid drive technology.

In the longer term, hybrid maintenance requirements will come down as the technology matures. Hybrid maintenance requirements may eventually drop below that of conventional buses due to reduced repairs associated with transmission and brake linings.

**Table 5.3: Drive System Components**

Components	Diesel	Series Hybrid	Direct Drive Hybrid	Parallel Hybrid
<b>MECHANICAL</b>				
Engine	√	√	√	√
Fuel tank	√	√	√	√
Clutch	√	None	None	√
Starter motor	√	√	None	None
Alternator	√	√	None	None
Transmission	√	None	None	None
Gearbox(es)	√	None	√	2
Driveshaft	√	√	None	√
Differential	√	√	None	√
<b>ELECTRICAL</b>				
Generator	None	√	√	√
Traction motor(s)	None	1	2	1-2
Traction controller/inverter(s)	None	1	2	1-2
Traction battery pack	None	√	√	√
On-board charger	None	Optional	Optional	Optional

**5.2.1 Mechanical**

For maintenance shops, hybrid drive poses little challenge in the area of mechanical systems. While there may be differences in engine size and installation, most parts are standard and will be familiar to maintenance personnel. No special equipment or significant retraining is likely to be needed. The major differences are the absence of a conventional transmission and reduced frequency in relining brakes. Transmission and brake repairs often top the list of most frequently maintained drive system items on a transit bus.

**Auxiliary Power Units (APUs).**

Most hybrid transit buses in demonstration today use name-brand diesel or gas engines from Detroit Diesel, Navistar, Cummins, or Ford. They use electronically controlled, direct injection turbo-charged engines and conventional cooling systems. Engine manufacturers have not recommended changes in scheduled maintenance and expect comparable life out of the engine whether installed in a conventional or hybrid vehicle (see Table 5.4).

Maintenance shops will notice several differences in hybrid APUs, including size, configuration, and operating

**Figure 5-2: Diesel Engine/Generator Set (Side View)**

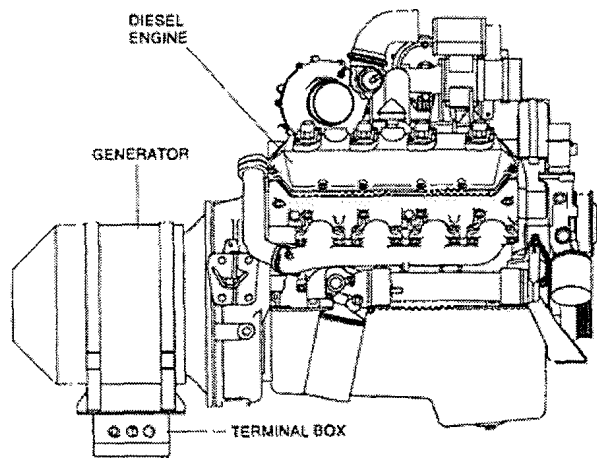

Source: Orion Bus Industries



mode. Hybrid drive buses use smaller, lighter engines that should be easier to handle than the heavy-duty engines shops are used to moving. Secondly, the engines are not mechanically connected to the driveshaft (except in parallel designs which have yet to come to market); mechanics may need some orientation to the mechanical assembly. Thirdly, the hybrid engine (or APU) will spend more time operating in a steady state mode than on a conventional bus where it operates in a transient mode. Whether this difference has any affect on engine life remains to be seen.

The major exception is the gas turbine used in some 30 hybrids today, which introduces another twist for maintenance shops. For instance, the Capstone turbine has one moving part, the main shaft, and air bearings. As such, Capstone expects the turbine to offer long life (40,000 hours) and low maintenance. In Chattanooga, a prototype Capstone turbine has logged 23,000 miles since 1997 with no maintenance to the turbine.

**Table 5.4: Mechanical Maintenance Schedule**

Components	Orion V Diesel	Orion VI Hybrid
	(miles)	(miles)
<b>Engine</b>		
Change oil	6,000	6,000
Replace air filter	30,000	30,000
Replace coolant filter	40,000	40,000
Replace coolant	300,000	300,000
Rebuild	300,000	300,000
<b>Transmission</b>		
Inspect lines & fluids	6,000	n/a
Inspect bolts & mounts	24,000	n/a
<b>Driveshaft</b>		
Lubricate drive shaft	5,000	5,000
Inspect & oil differential	37,000	37,000
<b>Brakes</b>		
Inspect pads & lining	6,000	TBD
Reline brakes	18,000	TBD

Source: Orion Bus Industries

**Electric Transmission.** Hybrid vehicles do not employ a conventional mechanical transmission. There are several ways in which power is transmitted to the wheels in a hybrid design. Each design configuration introduces a different combination of part assemblies for the maintenance shop. However, none is likely to present a problem. For instance, in a conventional series hybrid configuration, the traction motor assembly typically includes an integrated gearbox, and power is transmitted to the wheels through a shortened driveshaft, differential, and transaxle. In a direct drive design, two or more traction motors are mounted inside or next to the wheel hubs, and connected through a small shaft directly to the wheels, eliminating the

differential. In a parallel hybrid, the motor and APU are both directly connected to the wheels, via a conventional differential.

Maintenance personnel will recognize these components even if they are unfamiliar with the particular configuration. Most hybrid designs will take advantage of conventional off-the-shelf components. Maintenance will need drawings, but no special equipment or training should be required. All hybrid power transmission systems will require the periodic inspection of lubricants, seals, gaskets, and linkages as with conventional mechanical drive assemblies.

**Brakes.** Maintenance shops should see a reduction in man hours spent inspecting and relining service brakes on hybrid buses due to regenerative braking by the electric motor. Brake linings should last longer on a hybrid bus than on a conventional bus where all braking is done mechanically. Of course, the difference will also depend on duty cycle and driver habits. Although not quantified, both Genoa, Italy and

**Figure 5-3: Orion VI Hybrid Drive Shaft**

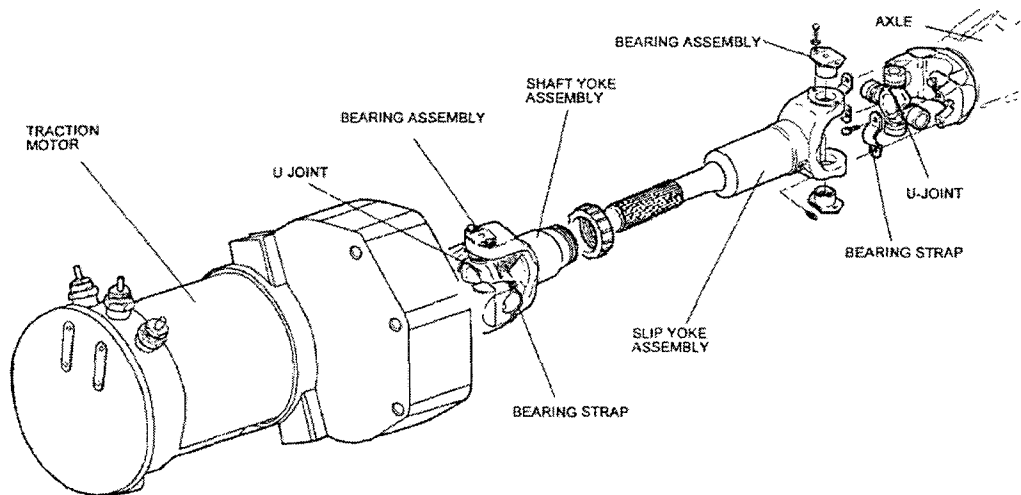

*Source: Orion Bus Industries*

New York City report seeing less wear in brake linings on their hybrid buses than conventional buses at the same point in service life. Once that difference is established, the interval for inspecting linings can perhaps be lengthened too.

### 5.2.2 Electrical

The electrical side of hybrid drive technology presents a greater challenge to maintenance shops because the components and configurations are new. While in theory electric drive components should not require extra care and feeding, in practice this may not be the case while the technology matures. High-powered traction motors, inverters, and high voltage battery packs will be new to most transit properties unless they have operated trolley buses. At this time, hybrid component manufacturers are offering warranties that are comparable to conventional mechanical components (see Table 5.5). However, once the technology is proven in the field they will likely offer improved and extended warranties beyond two years.

**Table 5.5: Orion VI Hybrid Warranty**

Component	Hybrid (Orion VI) Warranty
Engine	3-5 years
Generator	48,000 miles/2 years
Traction motor	
Traction controller/inverter	
Traction batteries	36,000 miles (pro-rated)

Source: Orion Bus Industries

### 5.2.2.1 Traction Motors & Controllers

The heart of the hybrid drive system is the traction motor(s) and controller (see Figure 5.4). The traction motor uses electrical energy generated by the APU to turn the wheels and also acts as a dynamic brake to capture energy. (Note: The generator and traction motor are not mechanically connected; rather, they are installed above one another.) Both AC induction and brushless permanent magnet type motors are found in hybrid buses today (see Chapter 2). The controller regulates energy throughout the entire system including engine, motor, battery and auxiliary drives. Today's controllers typically feature insulated gate bipolar transistors (IGBTs) and have to be designed for very demanding environments and high current (600 amps) and voltage (400v).

Electric motor manufacturing is a mature technology and its products enjoy good reliability and long life. The typical heavy-duty, brushless motor is expected to provide 40,000 hours of service or 300,000 miles. However, the motor designs and applications currently in use in hybrids are new and still experimental. The hybrid-electric drive components on the buses in New York City carry a limited warranty of two years (see Table 5.5). Motors typically require less periodic maintenance than engines (see Table 5.6) and servicing is relatively simple, involving periodic inspection and lubrication of bearings and seals. Some motor designs include permanently sealed, lubricated bearings and are virtually maintenance free.

Because of the high temperatures generated during operation of the traction motor and controllers, both components must be cooled. The Orion VI Hybrid buses feature dedicated cooling systems for both motor and controllers. The motors use a dedicated oil cooling system shared with the engine. The inverter uses a glycol based cooling system on a separate loop to maintain proper temperature. A failure of either motor or

**Figure 5-4: HEV Drive Train (Top View)**

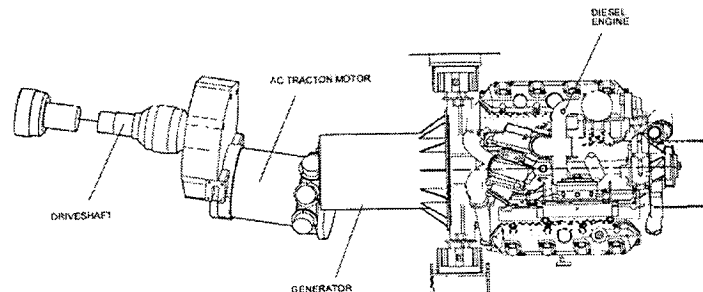

Source: Orion Bus Industries

inverter on a hybrid bus would be serious enough to require a road call. Hence, periodic inspection of system cooling circuits is an important part of preventative maintenance. In theory, removing and replacing a traction motor or motor controller should be a relatively simple matter depending upon mounting and location. No special tools are likely to be required for servicing motors and controllers; however, special training is required when dealing with high voltage components. A laptop equipped with proper software should be an effective diagnostic tool for troubleshooting problems related to traction drive motors and controllers.

**Table 5.6: Electrical Maintenance Schedule**

Components	Orion V Diesel	Orion VI Hybrid
	(miles)	(miles)
<b>Generator</b>		
Inspect wiring & connections	n/a	24,000
Check torque fasteners	n/a	48,000
<b>Traction Motor</b>		
Replace oil & filter	n/a	18,000
Inspect bearings & replace as needed	n/a	24,000
<b>Controller/Inverter</b>		
Inspect connectors/wiring	n/a	6,000
Inspect cooling	n/a	6,000
Replace coolant	n/a	48,000
<b>Traction Battery/Charger</b>		
Inspect rooftop covers	n/a	Regularly
Battery equalization	n/a	Daily <sup>1</sup>
Battery conditioning	n/a	TBD
Charger	n/a	None

Source: Orion Bus Industries

### 5.2.2.2 Traction Batteries

Traction batteries are likely to be the number one maintenance and replacement item in hybrid-electric drives. They constitute a significant upfront capital cost and, in the case of lead acid technology, ongoing cost throughout the life of the vehicle, with replacement expected at least every three years. While advanced energy storage systems with better performance and life characteristics are being developed (see Chapter 2), most commercial hybrid transit buses in the near term will feature valve regulated lead-acid (VRLA) batteries because it is a mature technology, commercially available, and less expensive than most

<sup>1</sup> Equalization is performed automatically on board the bus by vehicle controls during normal vehicle operation. No maintenance intervention is required.

alternatives. Furthermore, VRLA battery modules do not require watering and other maintenance associated with flooded type batteries.

Traction batteries are complex systems that require energy management to provide consistent performance and life. A hybrid battery pack consists of a number of individual battery modules connected in series and/or in parallel to reach a system voltage (300 VDC or more). The duty cycle of a hybrid battery pack requires the batteries to go through multiple charge and discharge cycles. Unless carefully managed, the system can easily become unbalanced with some modules overcharged and others undercharged. The net effect can be loss of capacity or premature failure. When operated on a transit bus, the batteries may be exposed to severe temperatures, moisture, salt and repeated shock associated with the vehicle's duty cycle. Severe heat or cold can damage modules. In order to combat these dangers, traction battery systems must be carefully managed so as to maintain proper charge, current, and temperature during charge and discharge. Ideally, this management should occur automatically for each module in the battery system.

Fortunately, most hybrid system developers realize the need for energy management. Today, the most highly integrated hybrid drive systems come equipped with automatic energy management controls that monitor and manage voltage, current, and temperature in order to reduce maintenance and extend battery life. These systems typically permit a trained technician with a laptop and software to tap into the operating system in order to monitor and diagnose problems that may arise. While battery management systems take much of the work out of battery care for maintenance shops, additional requirements may be required depending on the battery technology, manufacturer, and hybrid system design.

Maintenance shops will have to periodically monitor, service and eventually replace the battery packs on hybrid buses. Regular battery equalization charging is required on a daily basis to ensure proper balance and functioning of the battery system. This procedure may be performed automatically (as is the case with the Orion VI hybrid buses in New York City) or accomplished during battery recharging if the hybrid requires daily grid connected recharge. In addition, periodic battery conditioning involving repeated discharge and recharge may be required to extend battery life. NYCT has implemented monthly conditioning for the time being. The NYCT hopes to decrease the frequency of conditioning in the future if deemed appropriate by the manufacturers.<sup>1</sup> Other maintenance requirements might include a safety inspection of high voltage connectors and cables<sup>2</sup>.

Otherwise, no additional maintenance is needed until the batteries have reached the end of their useful life or when the modules hold only 80% of their original rated Ah capacity. At this point, the batteries are removed with forklift or overhead crane because they weigh in excess of 1,000 lbs. and are replaced with fresh batteries. (Special precautions must be taken when servicing the traction batteries because of the

**Figure 5-5: Batteries on Hybrid Bus Roof**

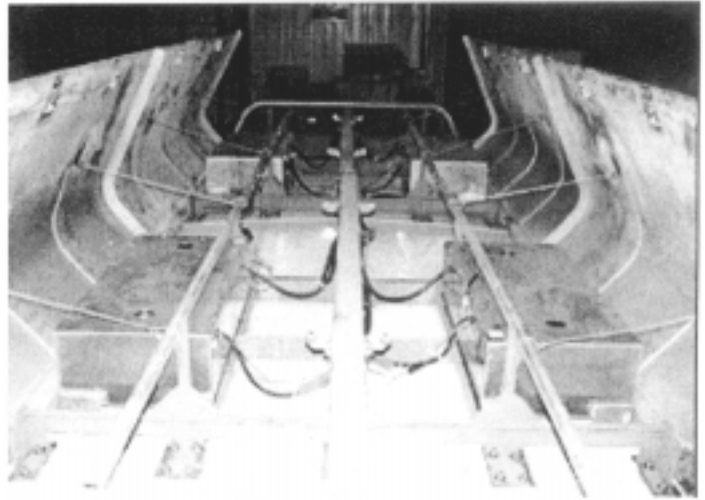

*Source: Solectria Corporation*

<sup>1</sup> Interview with Dana Lowell & Bill Parsley, NYCT, October 1999.

<sup>2</sup> Santa Barbara Electric Transportation Institute (SBETI) currently requires a 30 day maintenance inspection of its battery electric shuttle bus fleet's battery boxes to determine if any changes have occurred to the system or batteries. SBETI has found that, during each 30 day check of the batteries, it has been necessary to replace on the average two battery connectors.

potential for 300 VDC contact.) The old batteries are sent away for recycling. The major drawbacks associated with lead acid traction batteries may decrease once more advanced, hybrid cycle batteries become commercially available.

**Table 5.7: Hybrid Battery Pack Characteristics**

	Orion VI Hybrid	Nova/Allison	New Flyer
Battery type	Advanced Pb Acid (absorbed electrolyte cell)	Pb Acid sealed (gel)	Pb Acid sealed (gel)
Make	Electrosource	Delphi	East Penn
Configuration	1 string	3 strings	2 strings
Mounting	Roof top	Chassis	Roof top
Total modules	46	N/A	48
Total Ah @C-3 <sup>1</sup>	85	N/A	30
Total weight (lbs)	3,400	N/A	3,000

Source: Orion Bus Industries, Allison Transmission of General Motors, Solectria Corporation

### 5.3 Infrastructure

Two sources of refueling are required with conventional hybrid-electric buses. One source involves a liquid or gaseous fuel. It is assumed for purposes of this discussion that the liquid or gaseous refueling infrastructure is already in place and does not require modification. Time between refuelings may be lengthened, or the refill time shortened. The second refueling relates to the batteries and requires electrical recharging for purposes of battery maintenance and life. In the future, fuel cell hybrids will require different fueling schemes. However, it is beyond the scope of this report to discuss these requirements.<sup>2</sup>

**Table 5.8: Hybrid Bus Maintenance Equipment Needs**

Equipment	Purpose	Per 100 hybrid buses
Battery chargers	Battery equalization & conditioning	0 to 100
50A, 208-240VAC, 3-Phase outlets	Electric refueling & battery maintenance	0 to 100
Laptop computer	System diagnosis	4
Forklift or overhead crane	Battery removal from bus	2
Multimeter	High voltage measurement	1

Source: New York City Transit, Orion Bus Industries, Lockheed Martin Control Systems

<sup>1</sup> C-3 refers to the energy content when discharged over three hours.

<sup>2</sup> For detailed analysis of natural gas and hydrogen refueling requirements for transit, see US DOT-VNTSC-FTA-96-3 (natural gas) and -98-6 (hydrogen).

### 5.3.1 Electrical Fueling

At the present time, most hybrid bus manufacturers require some type of periodic electrical recharging of the batteries whether the bus is charge depleting or sustaining. Charge depleting hybrids will obviously require electrical recharging on a daily basis which necessitates a dedicated recharging area equipped with chargers (see Figure 5.6). For instance, the New Flyer hybrid bus is plugged into the grid each night after it finishes its service in Orange County. Even charge sustaining hybrids may require some type of grid connection to maintain health and extend the life of the battery pack as is the case with hybrid buses in New

**Figure 5-6: Cedar Rapids Charging Area and Batteries**

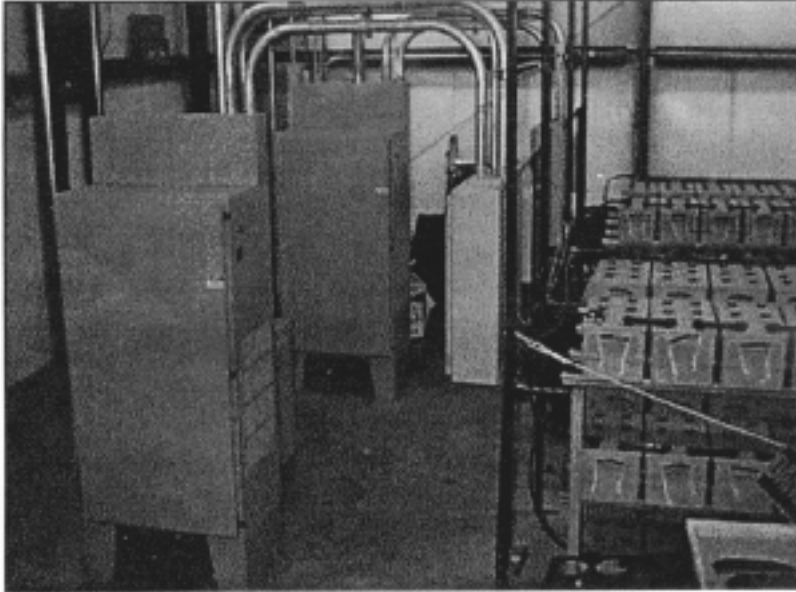

*Source: Cedar Rapids Electric Transportation Consortium*

types of connectors as well. Currently, most hybrid buses use a ferroresonant type of charger with DC output of 20-50kW. The chargers are equipped with a water tight, conductive type connector that mates with a conductive charge port onboard the bus. Chargers should meet NEC, UL and SAE standards (see Appendix C). Charge time is a function of electrical service, charger output, and battery pack design. For instance, the New Flyer hybrid bus is required to be on-charge for about 8 hours per day. New York expects its buses to be on-charge no more than 8 hours each month. A fast charge (1 hour or less) has been demonstrated by the Santa Barbara Electric Transit Institute on battery powered shuttle buses.

### 5.3.2 Facility Modifications

Battery hybrids will require some facility modification to support recharging and battery handling. Depending on fleet size and battery technology, some of these issues could pose significant costs. Eventually, these requirements may be reduced if grid connection goes away and battery energy density and life improves. In the meantime, today's hybrids require some facility modification.

The first requirement of recharging is adequate electrical service. Hybrid buses can be charged using 120-, 240- or 480-volt service. Typically, commercial buildings are configured for 240-volt, 3-phase, 60-Hz, and 100-amperes capacity. However, 480-volt three-phase circuit may be desirable as it reduces charging time, bus down time, and may lower costs if off peak rates apply. A tradeoff between time and infrastructure upgrades must be made.

Power quality and load management can also become a factor if large numbers of chargers are involved. A large load could cause harmonic voltage distortion on the electric distribution system that could damage

York City. One of the issues with grid connected charge equalization is that the bus must be taken out of service; however, it may be possible to combine battery equalization with other scheduled maintenance. It may also be possible to perform battery equalization and conditioning using the on board APU while the bus is in revenue service, or even possibly out of service as done in Cedar Rapids.

Although on-board chargers are available, off-board charging will be more economical for large, centrally fueled fleets. Charging technology and standards are still developing and changing today. There are widely differing approaches to charging depending on battery chemistry and management philosophy. There are different power levels for charging and

other equipment.<sup>1</sup> Charging equipment with low power factor and high harmonic distortion is needed to minimize system losses and other negative effects. To date, power quality standards have not been developed for heavy-duty hybrid-electric vehicles. Planning and modification of the garage's electrical service should be undertaken in consultation with a licensed commercial electrician and local utility. Care must be taken to avoid overloading the power distribution system and to minimize equipment upgrades that would further drive up costs.

Space is another constraint associated with recharging hybrid buses. Hybrid buses will need some place to park during recharging. While recharging can be accomplished outdoors, it still requires space that supports safe use of charging equipment, typically with some type of shed to offer protection from water and snow. Consideration should be given to the fact that it will probably be less energy efficient to charge outdoors in cold weather. While indoor charging is more efficient, it requires space. It may be possible to accomplish charging in the maintenance bay without disrupting other regular maintenance procedures.

Storage and recycling is another facilities issue. Batteries will eventually reach their end of life after 2 to 3 years (VRLA type) at which time they must be removed from the bus and recycled. A large fleet of hybrid buses will therefore require that some amount of space be devoted to temporary storage of fresh and spent batteries. The fresh batteries must be on hand to replace spent batteries, and the spent batteries must be taken away for reclamation. It is possible that a third party might take over the business of hybrid battery handling on a contractual basis thereby reducing the amount of space and disruption in the bus service facility.

Finally, local safety codes may require improvements to be made to building ventilation or the addition of monitoring and detection equipment. Anytime a large number of batteries are present, the potential exists for hydrogen buildup indoors. Out of doors storage is not likely to present a significant safety concern because of the rapid rate of dissipation by hydrogen. The means of prevention is to install hydrogen sensing equipment and an adequate ventilation system in the garage where buses are stored and charged. This modification will be familiar to any fleet operator who uses or has considered using natural gas.

## **5.4 Health & Safety**

The addition of electric drive and large battery packs introduces several new potential hazards to the transit bus workplace. These hazards include electric shock, chemical burn, and explosion due to hydrogen buildup. All three hazards can be managed through a variety of design, monitoring, operational and maintenance procedures. Standards have been developed through National Electric Code (NEC), Federal Transit Authority (FTA), National Highway Safety Transportation Administration (NHSTA), Society of Automotive Engineers (SAE), and others. Committees are working on several areas where holes exist in the standards.<sup>2</sup>

### **5.4.1 Electrical Shock**

There is a danger of electrical shock with any motor vehicle should a mechanic or passenger come into contact with a live circuit under normal or fault conditions. With hybrid-electric buses, contact can come from electricity during battery charging (AC current) or discharging (DC current). If contact is made, the extent of injury will depend on the size, duration, frequency, and waveshape of the current. Conventional diesel buses make use of 12/24vDC and 220/240vAC. Hybrid drive buses operate at levels of power up to 400vDC and 600 amps. However, the risk of electrical shock can be mitigated through proper engineering, labeling, and safe maintenance practices.

---

<sup>1</sup> Beebe & Wheeler, *Safety and Environmental Liability Challenges Facing the Introduction of Electric and Hybrid Electric Vehicles as Viable Transportation Alternatives*, draft copy report, Defense Advanced Research Projects Agency (DARPA), U.S. Department of Defense, 1996, p.31.

<sup>2</sup> A newly formed SAE hybrid electric truck and bus committee will review and recommend appropriate changes to the body of standards and practices already developed for light duty electric and hybrid vehicles.



SAE standards have been developed to minimize electrical hazards associated with the design and manufacture of electric and hybrid-electric vehicles. The NEC and EPRI have developed standards to safeguard against shock from occurring during battery charging. For a complete list of regulations, standards and recommended practices, see Appendix C. These documents make use of critical safety systems such as electrical isolation, insulation, grounding, ground fault circuit interrupters (GFCIs), and personnel protection systems to ensure safety in and around vehicles.<sup>1</sup> Several practices warrant mention:

The Electric Power Research Institute (EPRI) has developed language specific to buses.

*"There shall be no exposed conductors, terminals, contacts or other energized parts with a high-voltage potential to any other exposed conductive material on the bus in normal operating or charging configurations. The use of a key to unlock, or removal of at least one threaded fastener to open, covers or panels shall be required in order to gain access to high-voltage components. The access panels or covers limiting access to high-voltage shall be clearly labeled as such. No single-point failure of hardware, or of software, or of trained personnel to follow documented procedure shall result in an unreasonable safety risk to any person."*<sup>2</sup>

SAE J1766 recommends that electrical isolation be maintained before and after a crash. An automatic disconnect device should disconnect the batteries from the rest of the bus as closely to each battery pack as possible. An electric bus procurement specification issued by EPRI calls for automatic disconnect system, conformity with SAE recommended practices for high-voltage wiring, overcurrent protection, grounding and electromagnetic compatibility.<sup>3</sup>

Both NEC and EPRI have developed safe wiring practices for buildings and chargers. Article 625 of the 1996 NEC, Electric Vehicle Charging System Equipment, covers the wiring methods, equipment construction, control and protection, and equipment locations for automotive-type vehicle charging equipment. In addition, EPRI has developed a basis for specific safety requirements that can be included in product safety standards covering electric vehicle charging systems to meet the 1996 Code.<sup>4</sup>

#### 5.4.2 Fire

Gasoline and diesel are among the most flammable substances in use today. Hybrid buses introduce the presence of new materials that can burn. Although unlikely to cause a fire, sealed lead acid batteries can burn if exposed to heat. Fire can result from a number of sources including improperly charged or vented batteries or from loss of electrical isolation caused by damaged connectors or chafed wires. Some of the safety design issues discussed above can help prevent these dangerous situations from arising or at least detect them early.

It is critical to ensure use of proper fire retardant materials in the compartment walls surrounding the battery boxes. Presently, transit buses must meet fire safety standards called out in FTA Docket 90, where applicable. The same requirement is included in the Draft August 1995 EPRI "Electric Bus Technical Specifications." This requirement is to prevent smoke and toxic fumes from being generated if a fire starts. In addition, at least 2 temperature sensors are installed on conventional vehicles with at least one located in the engine compartment. These sensors activate visual and audible alarms located in the driver's compartment. Bus garages should have the proper fire suppression equipment and electrolyte suppression materials on hand to deal with hybrid bus related fires.

---

<sup>1</sup> Craig Toepfler, Ford Motor Company, presentation to EPRI, Feb. 1999.

<sup>2</sup> Electric Power Research Institute (EPRI), *Procurement Guidelines for Battery-Electric Buses*, (TR-109804), 1997, p. 6-32.

<sup>3</sup> *Ibid.*, pp. 6.32-35.

<sup>4</sup> Electric Power Research Institute (EPRI), *Personnel Protection Systems for Electric Vehicle Charging Circuits*, (TR-105939), 1995, p.iii.

### 5.4.3 Gassing

Under normal operating conditions, well-managed batteries will not produce or release hydrogen. However, should they be heavily stressed or over discharged, certain batteries (e.g., NiMH, and NiCd and flooded lead acid, but not sealed lead acid) can produce and release hydrogen. If the amount of hydrogen is right (i.e., between 4% and 74% by volume at atmospheric pressure), the hydrogen-air mixture can explode.<sup>1</sup> The danger of hydrogen buildup and explosion can be mitigated through use of advanced battery technologies and proper building and maintenance procedures. Common battery technologies of sealing and valve regulation have been designed to prevent hydrogen gassing. Charge cutoff control mechanisms are typically used in charger electronic modules to prevent overcharging, which can potentially lead to hydrogen buildup. NEC Article 625 and NFPA Section 69 and Section 625-29 describe procedures for detecting and ventilating indoor charge ports.

The International Center for Technology Assessment concludes with the following:

*Thus, there are current, comprehensive regulations in place, which eradicate any dangers that may have arisen as a result of hydrogen gassing during charging. Moreover, modern battery technologies to be used in mass produced EVs will be labeled as safe for indoor charging without ventilation due to the unique designs employed to virtually eliminate the release of any hydrogen gas during charging."*<sup>2</sup>

### 5.4.4 Acid Spills

Another safety concern with batteries is the potential for acid spills that can cause burns to the skin. Conventional flooded lead acid batteries contain sulfuric acid as part of their normal electrochemical process. Likewise, nickel metal hydride batteries contain potassium hydroxide. Both chemicals can cause burns if they come into direct contact with skin. SAE J1766 established strict standards regarding the amount of electrolyte that may escape from a light-duty electric vehicle's battery pack. The amount is 5 liters, the same amount of electrolyte contained in one 12 volt battery.<sup>3</sup> As with hydrogen gas releases, modern batteries are designed to limit or exclude electrolyte from spilling through use of either starved or gelled electrolyte.<sup>4</sup> However, if spillage occurs, sulfuric acid spills from lead acid batteries should be contained using non-combustible materials, such as vermiculite, dry sand, or material bags. Lime, soda, or sodium bicarbonate can neutralize sulfuric acid. Potassium hydroxide spills from nickel cadmium or metal hydride can be contained also using vermiculite, dry sand or material bags.<sup>5</sup>

### 5.4.5 Prevention

Most accidents can be prevented and hybrid buses are no exception. Through the combination of automatic detection systems, proper training, and preventative maintenance, most dangers on a hybrid bus can be avoided. Hybrid buses are typically outfitted with indicators located in the driver's area to provide visual or audible alarm to the driver of any system operating outside safe parameters. In some vehicle designs these indications are lumped into a "check system" warning or a "stop system" alarm while in other designs the following indicators are provided:

- Battery state of charge light (indicates low voltage and helps prevent damage to batteries)

---

<sup>1</sup> National Electric Transportation Infrastructure Working Council (IWC), *Electric Vehicle Charging Ventilation Issue*, news brief, Electric Power Research Institute (EPRI), Palo Alto, CA, June 28, 1995.

<sup>2</sup> *The Environmental Impacts and Safety of Electric Vehicles: Report No. 2*, International Center for Technology Assessment, Washington, D.C., 1997, p.14.

<sup>3</sup> This standard is under review by a newly formed SAE hybrid-electric truck and bus committee.

<sup>4</sup> *The Environmental Impacts and Safety of Electric Vehicles: Report No. 2*, International Center for Technology Assessment, Washington, D.C., 1997, p.16.

<sup>5</sup> Beebe & Wheeler, *Safety and Environmental Liability Challenges Facing the Introduction of Electric and Hybrid Electric Vehicles as Viable Transportation Alternatives*, draft copy report, Defense Advanced Research Projects Agency (DARPA), U.S. Department of Defense, 1996, p.47.

- Battery thermal limit light (indicates overheating in the batteries)
- Traction motor temperature light (indicates overheating in the motor)
- Isolation loss detection indicator and automatic shutoff
- Fire detection

Although hybrid vehicles can be designed to be safe, proper operation and maintenance of the vehicle will be critical to preventing accidents. At least three different organizations have developed safety and emergency response training programs for electric vehicles. All three programs focus primarily on all-electric vehicles, and one focuses on buses. Although not specifically developed for heavy-duty hybrid buses, each program contains useful information that could easily be adapted.

- "Crash, Fire, Rescue Training Course" was developed in 1995 by Electricore with support from the Defense Advanced Research Projects Agency (DARPA). The course was developed for emergency responders and includes sections on HEV safety, battery chemistries, high voltage, and natural gas. Materials include manual and video. Contact Electricore at 317-615-0020.
- "Emergency Response to Electric Vehicles" was developed in 1996 by the California Department of Forestry and Fire Protection, Office of the State Fire Marshal. Like the Electricore program, this training program was developed for emergency responders. The course focuses on light duty electric vehicles, but covers relevant topics such as high voltage components, electrical hazards, hazardous materials, extrication, code development, and vehicle storage and recharge. Course materials include a manual and several types of audio-visual aides. For more information, contact the Training Division at 916-445-8444. The program is being revised to include hybrids. Contact Rodney Slaughter at Dragonfly Communications Network at 530-342-9066.
- Santa Barbara Electric Transportation Institute (SBETI) has developed a training program for drivers and maintenance personnel of battery powered electric shuttle buses that includes safety. Although it applies to battery powered electric shuttle buses, many of the concepts are still relevant for hybrid-electric buses. Contact Paul Griffith, SBETI, at 805-568-0985.

## **5.5 Environment**

As with any new technology, transit properties should be aware of the environmental risks associated with hybrid drive technology. The single most common concern is the possibility of electrolyte spillage in the case of an accident. As mentioned earlier, SAE J1766 limits the amount of electrolyte spillage on a light duty electric vehicle to 5 liters. Because gelled or starved lead acid batteries are the most commonly used batteries in hybrid transit buses, the likelihood of electrolyte spillage is reduced. However, should electrolyte spill in an accident, it can be neutralized easily by applying a base material such as baking soda. The risk of an acid spill increases if flooded lead acid batteries are used.

Hybrid buses introduce battery storage, use and disposal issues as well. Transit properties are familiar with the rules regarding the storing, dispensing, and handling of diesel fuel. With hybrid drive, they must develop a strategy for handling, storing, and disposing batteries. Batteries are one of the most highly recycled products in our society today. The infrastructure for recycling lead acid and nickel cadmium batteries is well developed. The infrastructure has not yet developed for nickel hydrides or lithium batteries. Transit properties must have systems in place to handle broken or leaking batteries prior to shipping.

## **5.6 Legal & Insurance Issues**

Hybrid vehicles present a certification challenge. Presently, all transit buses, whether mechanical drive or hybrid drive, must use engines that meet current EPA emission standards for urban buses. The standards

are engine- (not vehicle-) based, and are measured on the Federal Test Procedure's transient cycle. However, as has been explained in Chapter 2, hybrid engines are typically smaller, not necessarily connected mechanically to the drive shaft, and operate very differently from engines in conventional vehicles. Therefore, it is difficult to predict on-road emissions of a hybrid bus by testing the engine alone. Both the EPA and CARB are aware of the challenges posed by hybrids and are working with the industry to come up with a better certification solution.<sup>1</sup>

To date, two hybrids have undergone testing at Altoona: a 22' hybrid shuttle bus built by AVS for the Chattanooga Area Regional Transit Authority and a 45' hybrid transit bus built by Transportation Techniques for the Denver Regional Transit District. Under the FTA sponsored bus testing program, the bus manufacturer must send one bus to the test track in Altoona, Pennsylvania for testing if FTA funds are to be used to pay for any more than five buses of a particular model. Altoona tests durability and reparability through its test procedures and then publishes its report. Any transit agency may request a copy of the report from the Altoona facility. It is likely that Altoona will test a hybrid bus in the near future as large orders for hybrid buses are in the works.

Insurance is another issue facing hybrids. Insurance is the second largest capital expense after depreciation.<sup>2</sup> Because the population and experience base with hybrid buses is small, the insurance industry has little information with which to write a hybrid bus policy. Transit managers have the option to self insure their demonstration vehicles. But ultimately they will want their insurance companies to cover their hybrid bus fleets, ideally at no additional premium above the cost of insuring conventional buses. Insurance rates will be heavily affected by design considerations that determine crashworthiness, durability, passenger safety, damagability and reparability. If design keeps these costs at or below that of conventional technology, then insurance policies should be positively impacted.

## **5.7 Conclusions**

Hybrid-electric drive technology introduces new opportunities and challenges in bus operation and maintenance. Hybrid drive offers operational advantages such as smoother and quicker acceleration, more efficient braking, improved fuel economy, and reduced emissions. Maintenance requirements may initially increase due to energy storage system requirements; however, these may go away once the technology matures. In the long term, hybrid bus maintenance may be less onerous than conventional mechanical technology due to savings associated with transmission and brakes. Infrastructure modifications are expected to be minor. Mechanical and safety retraining is needed in light of high voltage components. Transit providers must understand the issues and risks involved in deploying hybrid drive technology.

Successful introduction of a new technology into the bus fleet ultimately depends on both the commitment from management and a successful management plan. Hybrid drive will present transit managers with new challenges in the areas of operation, maintenance, labor, cost, and public relations. A management plan must address each of these issues and receive the full support of the agency's leadership. Addressing the nuts and bolts of infrastructure, hardware, and operating schedules will ensure success. Other human factors must be addressed as well, such as driver and mechanic acceptance. Employee acceptance can be won through careful training and rewards. Labor-management agreements may create barriers that will have to be negotiated. Customer acceptance and public relations must also be carefully addressed. Hybrid technology may win supporters among transit users, elected officials and environmental constituencies for being quieter, smoother, and better for the environment.

---

<sup>1</sup> The NAVC is facilitating a government-industry working group to explore alternative means to certify heavy duty, hybrid transit buses.

<sup>2</sup> SAE International, Surface Vehicle Recommended Practice, SAE J1555, "Recommended Practice for Optimizing Automobile Damageability," Revised 1993-10-28, p.2.

## **6.0 Emissions & Fuel Economy Comparisons**

---

There has been a lot of conjecture about the emissions and fuel economy of buses available to transit agencies. Many alternate fueled transit buses, including hybrids, have been deployed with claims of low emissions and, sometimes, increased fuel economy. Furthermore, many conventional diesel and CNG buses have been recently updated with state-of-the-art emission controls. Until recently, independent test data showing the emissions and fuel economy of alternate fueled and hybrid buses have been scarce. A new body of emission testing was recently conducted in Boston, MA in the spring of 1999 and New York City in the spring and fall of 1999. The tests involved several different types of conventional and hybrid bus technologies. Results of the emissions and fuel economy characterization program are presented in this chapter.

The results of this program demonstrate that diesel hybrid-electric vehicles offer reduced drive cycle emissions relative to conventional diesel buses. These lower emissions are a function of increased fuel economy and particulate trap technologies. Compared to a conventional diesel bus, PM emissions from the diesel hybrids were 50 percent lower. When low-sulfur diesel was used, diesel hybrid PM emissions reached levels similar to CNG buses. NOx emissions for the diesel hybrids were 30 to 40 percent lower than conventional diesel, and they exhibited the lowest CO emission of any of the buses tested, with a 70 percent reduction from a conventional diesel bus. The hybrids also demonstrated significantly lower total greenhouse gas emissions than that of a conventional diesel or CNG bus.

The current method for measuring emissions for certification by the U.S. Environmental Protection Agency (EPA) is to test the engine alone on an engine dynamometer against a standardized load cycle. This method works on conventional vehicles because vehicle driving speed and engine loads are directly related. In hybrid-electric vehicles, however, a control algorithm is used to control engine operation as a function of vehicle operation, which in turn determines engine load. While emissions from a standard diesel engine-powered vehicle rise and fall with power delivered at the rear axle, emissions from a hybrid vehicle rise and fall with power delivered by the engine. This issue of the engine being de-coupled from the vehicle load is largely alleviated when the entire vehicle is tested on a chassis dynamometer, as was the case during the 1999 emission-testing program.

Unlike engine dynamometer testing, chassis dynamometer testing is more representative of actual in-use vehicle operation as it accounts for the losses and operation associated with the specific vehicle into which the engine is installed. Chassis testing can also accurately measure the system benefits of hybrids including the recovery of braking energy through regenerative braking, greater drive line efficiency and reduced transient operation of the engine powering the APU.

### ***6.1 NAVC Heavy Duty Vehicle Emissions Testing 1999***

The NAVC embarked on this project to produce independent test data demonstrating the emissions and fuel economy of alternative fueled and hybrid buses. To date, much of the emissions data for alternative fuel buses has been collected using disparate methodologies and without peer review. The results of this program demonstrate that diesel hybrid-electric vehicles do offer reduced drive cycle emissions relative to conventional diesel buses, in many cases similar to that achieved by conventional CNG buses. These lower emissions are the result of reduced engine transient operation and improved vehicle fuel economy. Hybrid-electric technology demonstrates a measurable advantage in city driving situations, when operated on stop-

and-go, low-speed service applications. In this environment, regenerative braking can be utilized to recover kinetic energy normally lost to heat during mechanical braking. The testing also verified that over the last decade significant emission reductions have been achieved on conventional diesel and CNG bus technologies through implementation of exhaust aftertreatment oxidation catalysts for the control of CO, HC and PM.

The fuel economy and emission rates (g/mile) of a transit bus have a direct correlation to the duty cycle of the vehicle and other vehicle parameters (e.g., weight, size, and passenger loads.) As such, comparison across buses cannot be made unless testing has been performed using a standardized test protocol and the comparisons are made against the same duty cycle. To alleviate this issue, the NAVC project performed testing on six separate drive cycles with significant differences in their characteristics. These cycles simulated a range of duty cycles from very slow stop-and-go urban driving to higher speed semi-arterial driving. Each cycle is described later in this chapter.

Assessing emissions from hybrid-electric vehicles poses some difficulty in that the source of emissions (the engine) is not directly coupled to the vehicle drivetrain and, unlike light-duty vehicles, heavy-duty engines are certified independent of the vehicle. The current method for U.S. Environmental Protection Agency (EPA) emissions certification includes testing the engine alone on an engine dynamometer against a standardized load cycle. This method works on conventional vehicles because vehicle driving speed and engine loads are directly related. In hybrid-electric vehicles, however, the engine is de-coupled from the wheels and a control algorithm is used, relying on several independent vehicle-operating parameters, which in turn are used to determine engine load. This issue of the engine being de-coupled from the vehicle load is addressed by testing the entire vehicle on a chassis dynamometer, as done in this emission-testing program.

Unlike engine dynamometer testing, chassis dynamometer testing is more representative of actual in-use vehicle operation as it accounts for the losses and operation associated with the specific vehicle into which the engine is installed. Chassis testing can also accurately measure the system benefits of hybrids including the recovery of braking energy through regenerative braking, greater drive line efficiency and reduced transient operation of the engine powering the auxiliary power unit (APU).

Recognizing the need to conduct chassis dynamometer testing of hybrid vehicles, NAVC initiated the "Hybrid-Electric Drive Heavy-Duty Vehicle Testing Project" funded by the DARPA Electric and Hybrid-Electric Vehicle Program<sup>1</sup>. The NAVC designed this program to demonstrate the current energy efficiency and emission performance of "state-of-the-art" hybrid-electric heavy-duty vehicles and to provide for the estimation of hybrid vehicle performance under a variety of operating circumstances. To appropriately benchmark hybrid-electric vehicle performance, a comparison must be made to conventional vehicles, including diesel and CNG buses. To this end, NAVC brought together a number of bus manufacturers and operators to participate in this program. West Virginia University (WVU) College of Engineering and Mineral Resources (CEMR) performed all emission testing under the direction of M.J. Bradley & Associates, Inc. (MJB&A). The WVU Department of Mechanical & Aerospace Engineering operates two transportable heavy-duty vehicle chassis dynamometers and mobile emissions laboratories that are capable of determining the emissions and fuel economy from heavy-duty vehicles. Details about the WVU laboratories are included later in this chapter. The WVU laboratories have been utilized to gather emissions data from a large variety of heavy-duty vehicles throughout North America. Data from the laboratories are submitted to the National Renewable Energy Laboratory (NREL), which maintains a database of emissions from both conventional and alternatively fueled light- and heavy-duty vehicles.<sup>2</sup> A majority of the data collected by WVU is from alternative (CNG, alcohol, biofuel) and conventional diesel fuel transit buses operated in metropolitan and urban areas. The NREL database spans heavy-duty buses

---

<sup>1</sup> A comprehensive discussion of this project has been published by the NAVC in a report entitled "Hybrid-Electric Drive Heavy-Duty Vehicle Testing Project Final Emissions Report", February 15, 2000. A color copy of the final report can be ordered from the NAVC (617) 482-1770 or downloaded at [www.navc.org](http://www.navc.org).

<sup>2</sup> Additional testing was conducted by WVU with funding from the U.S. Department of Energy (DOE), Office of Transportation Technologies, under a separate directive from NREL. This data is included in the NAVC program.

with engines varying from model year 1988 through 1998. A variety of bus and engine manufacturers are represented in the database. A majority of the data for buses is on the Central Business District (CBD) duty cycle.

### 6.1.1 Test Buses and Results

The NAVC project included five, hybrid-electric Orion VI buses from Orion Bus Industries, equipped with Lockheed Martin Control Systems powerplants (Orion-LMCS), and one hybrid-electric RTS bus from Nova Bus Incorporated (NovaBUS), equipped with an Allison Transmission hybrid powerplant (Nova-Allison). Each of the hybrid-electric vehicles is of series configuration and is equipped with an integrated oxidation catalyst/regenerative particulate trap. The Orion-LMCS hybrid-electric bus is a pre-commercial hybrid design with approximately 5 to 10 units in service as of late 1999. The Nova-Allison hybrid is a proof-of-concept prototype demonstration vehicle and is not in production at this time. In addition to the hybrid-electric buses, the project conducted dynamometer efficiency and emissions testing on state-of-the-art closed loop, oxygen sensor feedback, catalyst controlled CNG buses and catalyst controlled diesel buses. Bus emission and fuel economy measurements were performed in Boston, Massachusetts and in Brooklyn, New York during the spring and fall of 1999. Each bus tested during this project was equipped with a recent model year (1997--1999) engine with relatively low mileage. Table 6.1 summarizes key parameters for each bus type tested under this program.

**Table 6.1: 40-Foot Buses Tested Under the NAVC Program**

<u>Bus OEM</u>	<u>Bus Chassis</u>	<u>Drive</u>	<u>Engine / Model Year</u>	<u>Fuel</u>	<u>Aftertreatment</u>
NovaBUS	RTS	3 speed	DDC Series 50 / 1998	Diesel <sup>A</sup>	Oxidation Catalyst
Neoplan	AN440T	5 speed	Cummins L10 280G / 1998	CNG	Oxidation Catalyst
New Flyer	C40LF	5 speed	DDC Series 50G / 1999	CNG	Oxidation Catalyst
Orion	V	5 speed	DDC Series 50G / 1998	CNG	Oxidation Catalyst
Orion	VI Hybrid	LMCS Hybrid	DDC Series 30 / 1997 & 1998	Diesel-Electric <sup>B</sup>	NETT Particulate Filter Trap
NovaBUS	RTS Hybrid	Allison Hybrid	DDCVMM 642 DI / 1991 (1998 engine)	Diesel-Electric <sup>C</sup>	Johnson Matthey Regenerative Particulate Trap

A - The NovaBUS was tested on D1, and MossGas® diesel fuels.

B - The Orion-LMCS bus was tested on D1, low sulfur D1, and MossGas® diesel fuels.

C - The Nova-Allison bus was tested on BP Amoco Ultra Low Sulfur City Diesel fuel.

While not every bus was tested on each cycle, Table 6.2 provides a summary of the test results of this program.

**Table 6.2: Dynamometer Test Results**

	Emission Rate (g/mile)					Fuel Economy	
	CO	NO <sub>x</sub>	NMOC	PM	CO <sub>2</sub>	CH <sub>4</sub>	(mpg)
<b>CBD Cycle</b>							
Orion-LMCS VI Hybrid Diesel	0.1	19.2	0.08	0.12	2,262	0.0	4.3
Orion-LMCS VI Hybrid Diesel (no regen )	0.04	22.0	0.12	0.24	2,625	0.0	3.7
Orion-LMCS VI Hybrid MossGas	0.1	18.5	0.03	0.02	2,218	0.0	4.2
Nova-Allison RTS Hybrid LS Diesel	0.4	27.7	bdl	bdl	2,472	0.0	3.9
Nova-Allison RTS Hybrid LS Diesel (no regen )	1.0	32.1	0.03	0.07	3,010	0.0	3.1
NovaBUS RTS Diesel Series 50	3.0	30.1	0.14	0.24	2,779	0.0	3.5
NovaBUS RTS MossGas Series 50	1.0	32.2	0.05	0.09	2,816	0.0	3.3
Neoplan AN440T CNG L10 280G	0.6	25.0	0.60	0.02	2,392	14.6	3.1
New Flyer C40LF CNG Series 50G	12.7	14.9	3.15	0.02	2,343	17.4	3.1
Orion V CNG Series 50G	10.8	9.7	2.36	0.02	2,785	23.7	2.6
<b>NY Bus Cycle</b>							
Orion-LMCS VI Hybrid Diesel	5.0	40.5	1.13	0.16	4,251	0.0	2.3
Orion-LMCS VI Hybrid Diesel (no regen.)	3.0	50.0	2.00	bdl	5,500	0.0	1.5
Orion-LMCS VI Hybrid MossGas	0.1	32.0	0.50	bdl	3,930	0.0	2.4
Nova-Allison RTS Hybrid LS Diesel	0.6	58.9	0.07	bdl	5,430	0.0	1.7
NovaBUS RTS Diesel Series 50	11.3	72.0	0.60	0.70	7,076	0.0	1.4
NovaBUS RTS MossGas Series 50	6.6	72.3	0.15	0.37	7,272	0.0	1.3
Neoplan AN440T CNG L10 280G	29.0	113.2	4.84	0.14	6,090	65.4	1.2
New Flyer C40LF CNG Series 50G	37.2	26.2	4.35	bdl	5,610	75.1	1.3
Orion V CNG Series 50G	31.7	15.3	6.64	0.11	6,535	66.7	1.1
<b>Manhattan Cycle</b>							
Orion-LMCS VI Hybrid Diesel	0.1	22.6	0.18	bdl	2,841	0.0	3.4
NovaBUS RTS Diesel Series 50	6.0	40.3	0.25	0.48	4,268	0.0	2.3
New Flyer C40LF CNG Series 50G	26.3	21.4	2.10	bdl	3,395	62.3	2.1
<b>NY Composite Cycle</b>							
Orion-LMCS VI Hybrid Diesel	0.2	19.9	0.38	0.14	2,250	0.0	4.2
NovaBUS RTS Diesel Series 50	7.0	31.5	0.22	0.46	3,227	0.0	3.0
Orion V CNG Series 50G	25.7	12.4	4.57	0.03	3,165	50.5	2.2
<b>Route #22 Cycle</b>							
NovaBUS RTS MossGas Series 50	2.0	26.9	0.15	0.10	2,386	0.0	3.9
Neoplan AN440T CNG L10 280G	2.8	24.8	0.87	0.03	1,889	11.9	3.9
Orion V CNG Series 50G	8.9	6.8	1.80	0.03	2,225	17.2	3.3
<b>Route #77 Cycle</b>							
Neoplan AN440T CNG L10 280G	2.7	23.1	0.69	0.05	1,973	11.4	3.7

bdl -- Indicates that the result was below the detection limit of the equipment.



## 6.2 Methodology

### 6.2.1 Transportable Heavy-Duty Vehicle Chassis Dynamometer

West Virginia University designed, constructed and now operates two transportable heavy-duty vehicle emissions testing laboratories. These laboratories travel to transit agencies and trucking facilities where they are set up to measure alternative fuel and diesel control vehicle emissions and fuel economy. A large portion of the research and testing performed by WVU is done under a grant from the U.S. Department of Energy (DOE). The main objective of the research performed is to contribute information to a DOE/WVU database that can be used to ascertain emissions performance and fuel efficiency of alternatively fueled vehicles. Several technical papers have been presented on the design of the two laboratories and on emissions data collected from both conventional and alternatively fueled vehicles<sup>3</sup>. In addition, WVU has performed

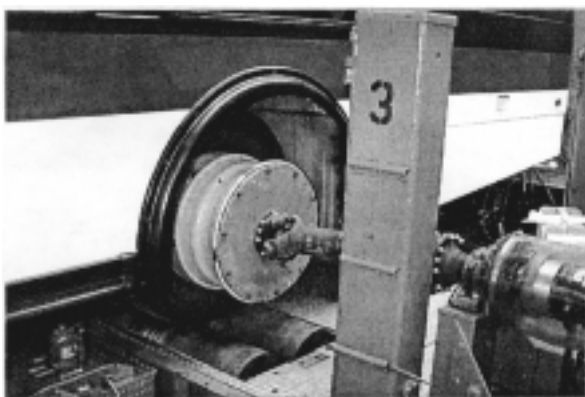

**Figure 6.2: Hub Adapter and Hub Adapter Plate**

extensive work funded by DOE and NREL to support the development of heavy duty driving cycles and to assess emissions from new engine and fuel technologies.

The transportable laboratory consists of a dynamometer test bed, instrumentation trailer and support trailer. The instrumentation trailer holds both the emissions measurement system for the laboratory and the data acquisition and control hardware necessary for the operation of the test bed. Exhaust from the vehicle is piped into a dilution tunnel at the instrumentation trailer where the exhaust is mixed with ambient air, which both cools and dilutes the exhaust. Dilute exhaust samples are drawn, using heated sampling probes and sample lines, and levels of CO<sub>2</sub>, CO, NO<sub>x</sub> and HC are measured continuously then integrated over the complete test time. A sample of the ambient (dilution) air is continuously collected throughout the test in a Tedlar bag and analyzed at the end of each test to establish background. These background measurements are then subtracted from the integrated continuous measurements after taking into account the dilution ratio employed in the tunnel.

In addition to continuous, integrated and background samples, additional exhaust samples are drawn from the dilution tunnel and collected in 3 liter Tedlar bags for test runs on vehicles powered by CNG and LNG. These samples are then sent to the WVU speciation laboratory to determine non-methane hydrocarbon concentration (NMHC) using gas chromatography analysis.

A gravimetric measurement of PM is obtained using 70-mm fiberglass filters. The filters are conditioned for temperature and humidity in an environmental chamber before each weighing to reduce error due to variation in water content per CFR 40, Part 86, Subpart N.



**Figure 6.1: Dynamometer Test Bed and Instrument Trailer**

<sup>3</sup> Chandler, K. et al., "Alternative Fuel Transit Bus Evaluation Program Results," SAE Paper 961082, 1996; Clark, N. et al., "Comparative Emissions from Natural Gas and Diesel Buses," SAE Paper 952746, 1995.

The fuel consumption of the vehicle is estimated based on a carbon balance. The amount of carbon per gallon of fuel (or cubic foot of gas for CNG) is determined by lab analysis, and is then compared against the total amount of carbon measured by the analyzers in the dilution tunnel during a test cycle. The total integrated quantity is then used to calculate fuel efficiency.

### 6.2.2 Drive Cycles

Chassis dynamometer testing was conducted on each vehicle utilizing various drive cycles with varying average speeds and numbers of stops per mile. These cycles include the Central Business District (CBD) cycle; the New York Bus cycle (NY Bus); the New York Composite cycle; the Manhattan cycle; Route #22 and Route #77. The CBD, which appeared as the Society of Automotive Engineers (SAE) recommended practice J1376, is commonly used to evaluate transit buses, but the project team was concerned that the test cycle did not accurately reflect actual service routes in New York City. So in addition to CBD testing, the project team developed the Manhattan cycle which contains patterns similar to the acceleration and deceleration rates used

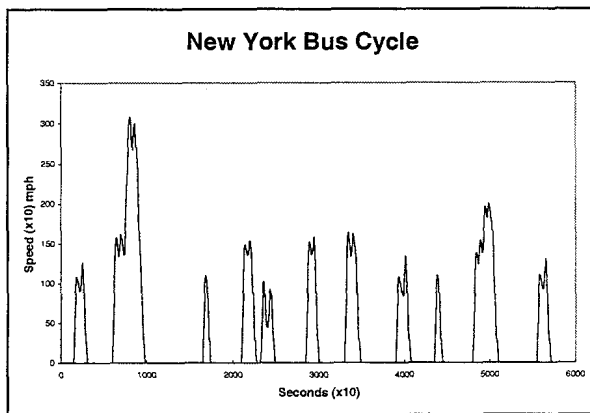
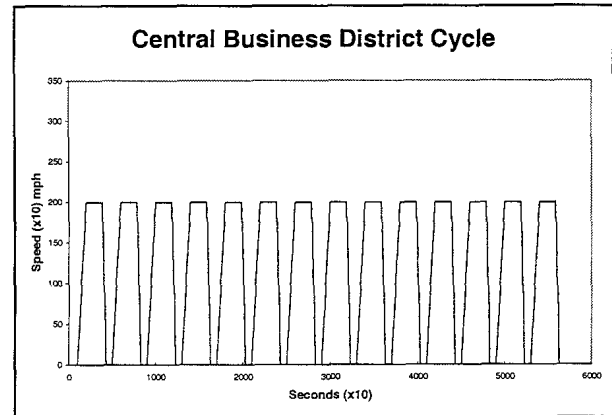

**Figure 6.4: New York Bus Cycle**

acceleration rate is fixed, which tends to favor buses with five speed transmissions and larger engines. The cycle is dominated by the 20-mph cruise, which penalizes buses that are not geared for optimum efficiency at that particular speed. The deceleration from 20-mph is twice as fast as the acceleration to 20-mph, 4.5 seconds versus 9 seconds, which is not typical of actual in-use driving. The average speed for the CBD cycle is 12.6 mph, generally faster than observed by most transit operations.

The NY Bus cycle was developed previously using real-world speed-time data from heavy-duty vehicles in service in New York City. It is a statistically derived cycle, which was developed from data collected from both transit buses and trucks in the 1970's. The NY Bus cycle was used to evaluate greater variation in the acceleration and deceleration rates as well as lower overall speed than the CBD to better represent inner city transit bus use.

During this project, it became apparent that a new cycle was needed to more accurately reflect driving conditions in the New York City Metropolitan area. WVU developed a new cycle utilizing actual in-use route segments data logged from New York City Metropolitan Transit Authority (NYC MTA) buses operating in Manhattan. Speed-time data was collected for both conventional and hybrid-electric buses over several different NYC MTA bus routes. Figure 6.5 shows the first half of the cycle, which is identical



**Figure 6.3: Central Business District Cycle**

during actual in-service use. Four other testing cycles were used during the program. These include the NY Bus cycle (similar to the Manhattan but with a lower average speed), the New York Composite cycle (contains a wider range of acceleration and deceleration rates than NY Bus) and two routes derived from actual in-service airport shuttle routes, Route #22, and Route #77.

The CBD cycle is typically used to evaluate transit buses and is made up of 14 identical sections containing an acceleration to 20 mph, a cruise at 20 mph, braking to a stop, then dwell. While the CBD cycle is repeatable from a driver in the loop standpoint, it has several drawbacks that limit its effectiveness as an evaluation tool. The

to the second half, along a scale that is consistent with the CBD and NY Bus figures. The Manhattan cycle is similar to the NY Bus cycle but with a higher average speed of 6.9 mph. This average speed is consistent with that observed by buses in service for the NYC MTA. The use of this cycle in the testing allowed for the direct comparison of actual in-use fuel economy data, gathered from buses operating in Manhattan, to fuel economy data gathered on the WVU dynamometer.

The New York City Composite cycle is similar to the NY Bus cycle with respect to local inner city

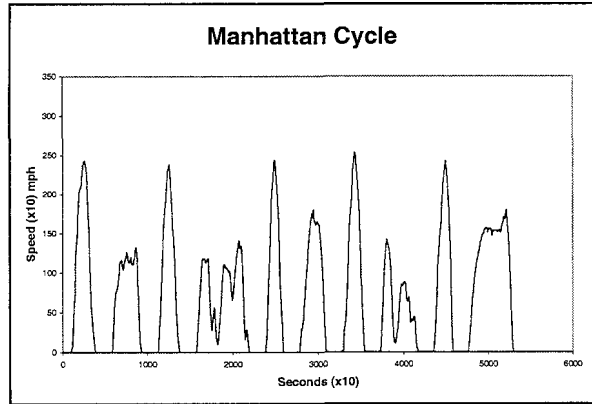

Figure 6.5: Manhattan Cycle

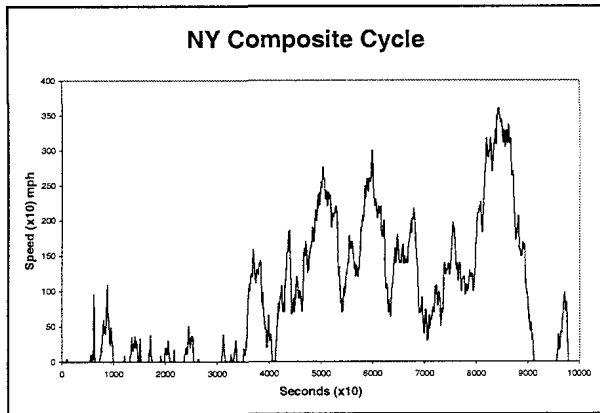

Figure 6.6: NY Composite Cycle

driving in that the acceleration and deceleration rates cover a wider range of variation than the CBD. The NY Composite cycle represents a mix of inner city and urban transit bus use that allows for the bus to reach and sustain greater speeds. The average speed of the NY Composite cycle is 8.8 mph. A very limited number of buses were run on the NY Composite cycle, as it is an extremely difficult cycle for both the driver and the bus itself to follow accurately due to the large number of rapid speed changes. Buses that are powerful enough to follow the cycle are penalized by

following a difficult cycle while less powerful buses effectively cheat the cycle, getting better fuel economy as a result.

Two additional cycles, Routes #22 and #77, were developed specifically for this project. Both were developed using data logged from buses in service along these two service routes at Logan International Airport, in Boston, Massachusetts. The Route #22 cycle is a mix of inter-terminal stop-and-go passenger service and two cruise elements at 30 mph, which represents a round trip to the subway station along the airport access road. The Route #77 is similar to Route #22 except that some additional

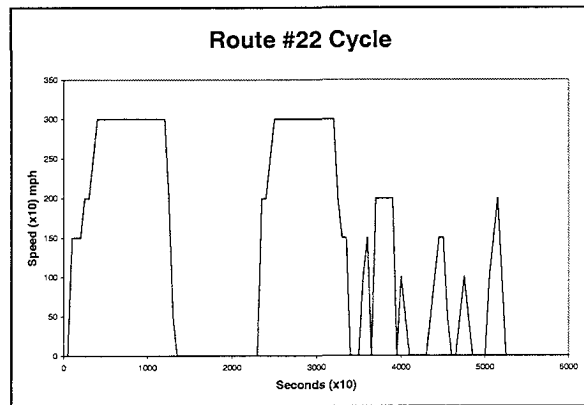

Figure 6.7: Route #22 Cycle

highway cruise and inner city traffic elements are included as the bus leaves the airport and travels to a satellite parking lot. The average speed for Route #22 is 13.9 mph while the average speed for Route #77 is 16.8 mph.

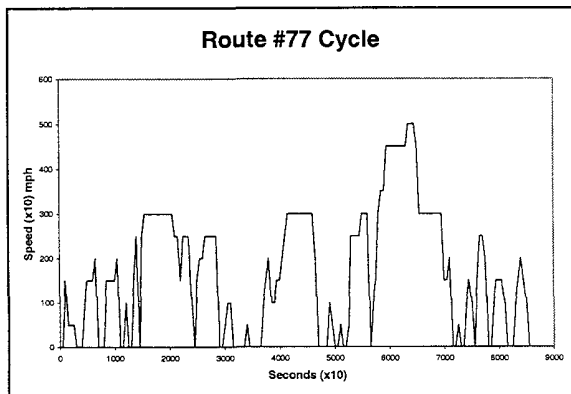

Figure 6.8: Route #77 Cycle

Testing a variety of bus types on a variety of different cycles with varying average speeds provided far more insight than could otherwise have been obtained through extensive testing on a single cycle. The project data gives a feel for how vehicle fuel economy increases as the average speed of the cycle increases and the number of stops per mile decreases.

### **6.2.3 Conventional Fuels and Alternative Fuels**

In addition to conducting testing across a variety of cycles, various fuels, including CNG, D1 diesel fuel (~300-ppm sulfur on average), low sulfur diesel fuel (~20-ppm sulfur) and synthetic diesel fuel (essentially zero sulfur) were also utilized. The low sulfur diesel used was BP Amoco Ultra Low Sulfur City Diesel, conforming to ASTM D-975 diesel fuel specifications. The synthetic diesel utilized during this project was MossGas®, a synthetic diesel fuel (10% aromatic blend), which in this case is manufactured using olefin distillate derived from natural gas.

## **6.3 Test Program Results**

Neither the fuel economy nor emissions of a transit bus can be quantified as a single number because both are highly dependent upon the duty cycle of the vehicle and other vehicle parameters such as weight, size, passenger loads, etc. To this end, a majority of transit buses have been tested on the CBD cycle for relative comparison. There was concern that the CBD may not be the best evaluation tool for transit buses and, to that end, the NAVC project performed testing on six different drive cycles with significant differences in their characteristics. These cycles simulated a range of duty cycles from very slow stop-and-go urban driving to higher speed semi-arterial driving.

### **6.3.1 Particulate Emissions**

Particulate matter (PM) from internal combustion engines is composed of a combination of carbon particles, on the surface of which organic compounds are adsorbed. If there is sulfur in the fuel, sulfur compounds will also be present in the particulate along with some metals from the fuel, lubricating oil and wear products. While sulfur emissions are a concern, it is the adsorbed organic fraction that poses the largest toxic risk associated with the particulate. Because the carbon particles are generally less than 2.5 microns (more than 90 percent, by mass, are less than 1 micron), they typically remain airborne and can be inhaled into the lungs where the adsorbed organic compounds can potentially cause damage. All fuels produce carbon particles as a result of incomplete combustion. The organic fraction is dependent upon the fuel combusted, its combustion residence time, combustion temperature, engine lubricant, and whether an oxidation catalyst or regenerative particulate trap is installed. Several things can initiate the formation of carbon particulate emissions, either separately or in combination, including incomplete combustion from engine over fueling, engine misfiring, lubricant combustion and impurities in the fuel.

PM emissions from the hybrid vehicles were generally 50 to 70 percent lower than a conventional diesel. In several cases, the actual reduction could not be quantified, as the measurement equipment did not have the sensitivity to quantify the mass emissions from the hybrids. Several systems on the hybrid buses are responsible for these PM reductions, the ability to utilize regenerative braking, less transient engine management and regenerative particulate trap control. The Orion-LMCS hybrid was also tested on both the CBD and NY Bus test cycles with its regenerative braking system turned off. Over the CBD cycle, the Orion-LMCS hybrid with its regenerative braking system off and conventional DDC Series 50 diesel engine buses produced roughly equal amounts of PM. No correlation can be drawn from this as additional sulfur compounds can be converted in the trap offsetting potential carbon particulate reductions. This is still a considerable feat considering the smaller engine and greater weight of the hybrid bus. On the NY Bus cycle, without regenerative braking, the Orion-LMCS hybrid bus performed better than the conventional diesel, with PM emissions below the detection limit (BDL) of the measurement equipment.

PM emissions from the CNG buses, powered by DDC Series 50G engines were consistently around 80 to 90 percent lower than a conventional diesel bus. Figures 6.9 and 6.10 provide a graphical comparison of the PM emissions of each bus type tested during this project.

The CNG and hybrid buses had comparable PM performance on each cycle when the hybrids were operated on very low sulfur fuels. When the Orion-LMCS hybrid was operated on conventional D1 diesel fuel (300-ppm sulfur), CNG bus PM levels were 50 to 80 percent lower than the hybrid's levels. The Nova-Allison bus exhibited PM emission rates consistently lower than CNG buses as this bus was

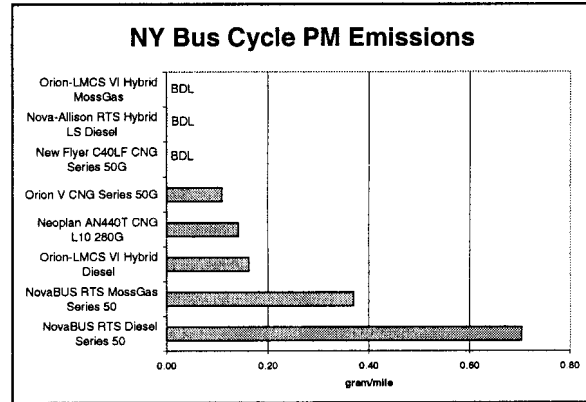

Figure 6.9

operated exclusively on very low sulfur diesel. With the Nova-Allison hybrid buses regenerative braking disabled, hybrid PM emissions increased slightly giving CNG a small advantage.

Anecdotal observations and empirical calculations based on the sulfur content of the fuel indicate that the WVU sampling system does in fact capture some sulfur compounds (sulfuric acid, sulfates). The presence of sulfur compounds was confirmed by back-to-back tests on the same vehicles with different fuels. The particulate data from these back-to-back runs is charted in Figure 6.11 with the upper, darker bars in each pair depicting

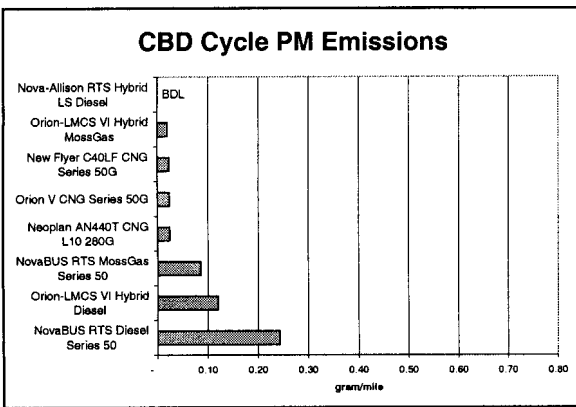

Figure 6.10

results with conventional D1 diesel fuel and the lower bars depicting the PM emission utilizing the zero sulfur MossGas® fuel. The charted results in Figure 6.11 (D1 diesel vs. MossGas®) show a strong correlation between fuel sulfur content and particulate emissions. While sulfate (SO<sub>4</sub>) is considered a particulate it is not listed as carcinogenic<sup>4</sup>. Reducing the sulfur in the fuel can eliminate a significant portion of the PM emissions falling in line with those seen from the cleanest conventional CNG vehicles. Also, low sulfur diesel fuel may encourage better long-term performance of the aftertreatment devices.

The remaining exhaust particulate is comprised

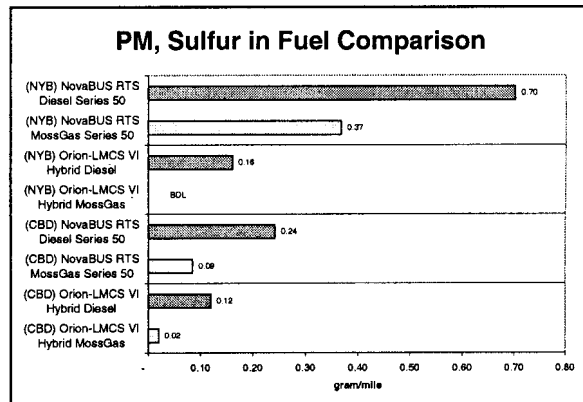

Figure 6.11

<sup>4</sup> California Air Resources Board (CARB) "Proposed Identification of Diesel Exhaust as a Toxic Air Contaminant", April 22, 1998. CARB identified over 40 substances that are listed by the U.S. EPA as hazardous air pollutants or by CARB as toxic air contaminants, many of which were detected or predicted to be present in diesel exhaust. Many of these compounds are polycyclic aromatic hydrocarbons (PAH) and PAH derivatives that have been found to be potent mutagens and carcinogens. The document finds that solid carbon particles comprise a majority of diesel PM<sub>10</sub> composition that facilitate the presence of adsorbed toxic organic compounds. The finding discusses sulfur emissions but does not present a finding that they are a contributing factor to the carcinogenic potential of diesel exhaust.

mostly of unburned carbon, organic compounds and other inert contaminants. The noticeable difference in particulate emissions on the synthetic fuel between the conventional NovaBUS diesel and the Orion-LMCS hybrid is achieved partially by engine management in the hybrid and partially by the use of a regenerative particulate trap on the hybrid-electric buses to burn off and complete the combustion of unburned carbon. While there is very little PM mass remaining, there may still be a significant particle count. These smaller and numerous nanoparticles may pose a greater inhalation risk, and the need to determine the exact composition of this material warrants further in depth testing.

Particulate emissions from several of the hybrid and CNG buses were near or below the detection limit of the WVU PM measuring equipment. On the CBD cycle, the WVU detection limit is approximately 0.01 to 0.02 g/mi. This is not due to the accuracy of the weighing equipment, but is in fact limited by ambient conditions. In the WVU sampling tunnel, ambient dilution air is drawn in unfiltered. To account for ambient particulate, a background filter is recorded and the background filter net change in mass is subtracted from the PM filter mass collected during the actual test runs. As bus PM emissions get lower they begin to fall below the variability of the background PM levels resulting in background readings that are near or higher than filters from actual emission tests.

To place these extremely low PM measurements for both the low sulfur diesel hybrid and CNG buses in context, at 0.02 g/mile over the course of a year, a 40-foot transit bus would emit about 540 grams of particulate (assuming 27,000 mi/yr), or about 1.2 lbs/yr.

**6.3.1.1 Historical PM Emissions**

An historical review of bus PM test data reveals that CNG engines have always produced little PM and diesel PM emissions have declined significantly. The historical emissions from the last ten years were taken from a WVU and DOE data set and compared to the emissions from buses tested under this program. Figure 6.12 illustrates that PM emissions from CNG buses have remained low over the past decade. Because most current CNG engines employ lean burn NOx combustion strategies, a majority of the PM from a CNG engine is from lubricant consumption. This distinction is important as the formation of carbon particulate and adsorption of soluble organic compounds from the lubricant onto the carbon particulate could likely contribute to a particulate make-up from a CNG engine that is very similar to that from diesel fuel combustion. An additional point that should be noted is that lubricant composition for diesel and CNG engines differs somewhat with regard to ash content (higher for CNG engines) and other additives.

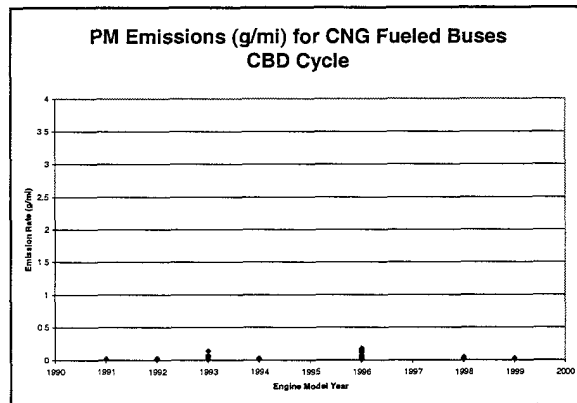

**Figure 6.12**

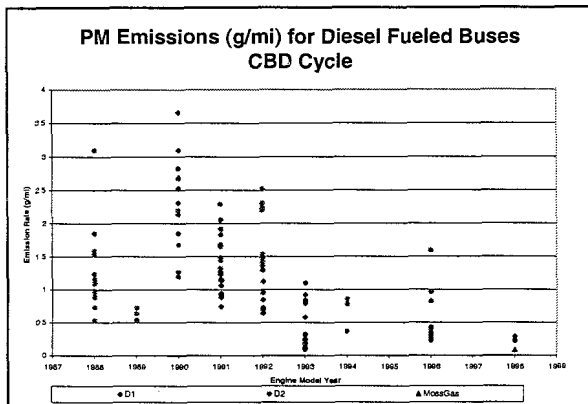

**Figure 6.13**

Figure 6.13 shows that diesel PM emissions have decreased as regulatory drivers have placed more and more stringent limitations on the amount of allowable particulate. The urban bus standard for PM has changed considerably over the last decade. Of particular interest are the results with synthetic MossGas® fuel (zero-sulfur) with values of 0.09 g/mi for a Series 50 diesel on the CBD cycle as compared to the Series 50G CNG values of 0.02 g/mi. This places synthetic diesel fuel within an order of magnitude (just a little over 4x) of CNG versus the two orders of magnitude (100x) from previous generation equipment.

### 6.3.2 NOx and NMOC Emissions

Under the Clean Air Act (CAA), the U.S. EPA is responsible for setting National Ambient Air Quality Standards (NAAQS) for six criteria pollutants; carbon monoxide (CO), lead (Pb), nitrogen dioxide (NO<sub>2</sub>), ground-level ozone (O<sub>3</sub>), particulate matter (PM) and sulfur dioxide (SO<sub>2</sub>). Of these pollutants, ozone is

not attributable to direct emissions but is instead a function of ozone precursor emissions. Oxides of nitrogen (NOx) and volatile organic compounds (VOCs) are regulated as precursors for ozone. Many urban regions of the U.S. are considered non-attainment for the ozone NAAQS.

Each of the vehicles tested under this program was equipped with an oxidation catalyst for the control of CO, HC and PM. In the cases of the hybrid-electric buses a particulate trap integrated with oxidation catalyst material was used. While HC emissions from a diesel engine are already quite low, including the oxidation catalyst helps the

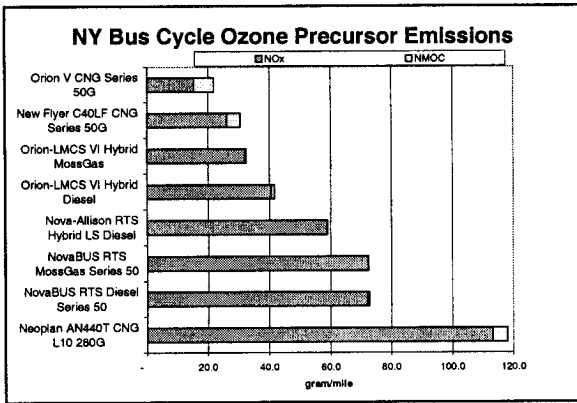

Figure 6.14

particulate trap regenerate by converting nitrogen oxide (NO) in the engine exhaust into NO<sub>2</sub>. The NO<sub>2</sub> then helps oxidize carbon particles caught in the trap. The combined values of NOx and NMOC emissions are charted in Figures 6.14 and 6.15.

NOx emissions from the Orion-LMCS hybrid buses were 30 to 40 percent lower than a conventional diesel vehicle. Approximately one-third of this benefit is attributable to regenerative braking with the remainder attributed to differences in engine operation.

NOx emissions from the DDC Series 50G engine CNG buses were consistently 50 to 60 percent lower than a conventional diesel bus. CNG buses set the ozone precursor benchmark with hybrid-electric buses a close second. The general trend in NOx emissions versus average cycle speed is illustrated in Figure 6.16.

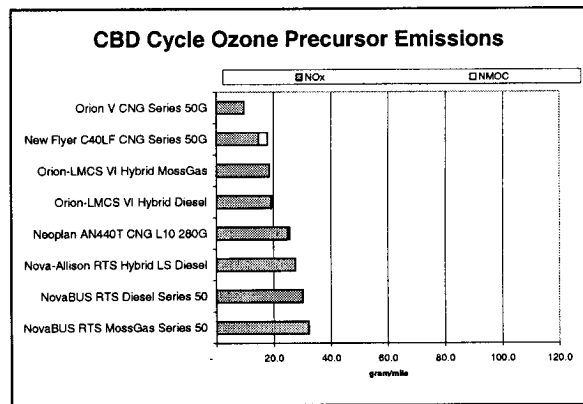

Figure 6.15

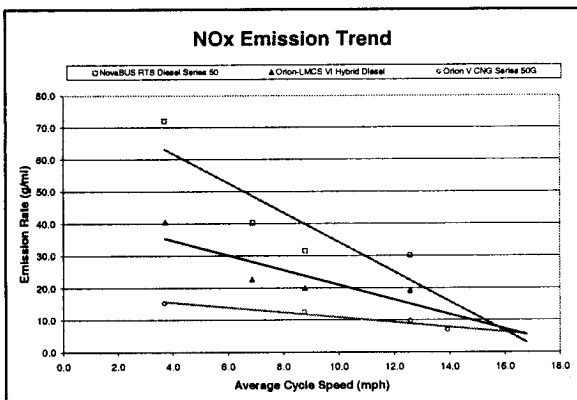
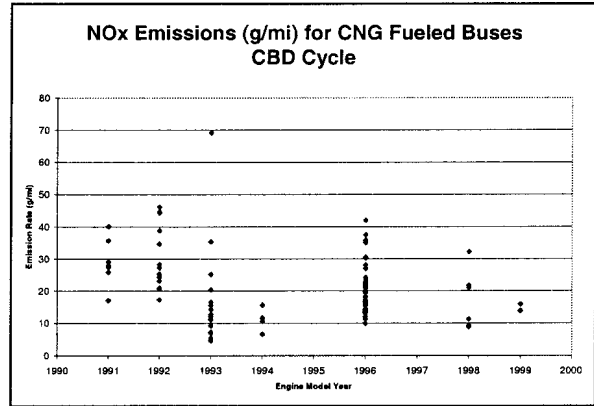

Figure 6.16

However, NOx results for CNG buses were not consistent, as CNG buses tested had both the lowest and highest measured NOx emissions in the NY Bus cycle. CNG buses equipped with the Cummins L10 280G engine demonstrated high NOx over a majority of the cycles, indicating that this engine was tuned more toward stoichiometric operation. CNG vehicles that did exhibit very low NOx levels were accompanied by higher NMOC and CO emissions.

**6.3.2.1 Historical NOx and NMOC Emissions**

An historical view helps put diesel and CNG emissions into perspective and once again shows that there are no absolutes when referring to bus emissions. Only THC historical emissions data are available.<sup>5</sup> The CNG total organic compound (TOC) values are primarily methane. Emissions listed for 1996 and before were measured by WVU on the same test equipment but under previous programs. Emissions values for 1998 and 1999 model year engines were measured during this testing project. Only conventional buses are included in these historical charts.



**Figure 6.17**

The historical NOx data for both CNG and diesel buses in Figures 6.17 and 6.18 indicate a trend towards lower NOx.

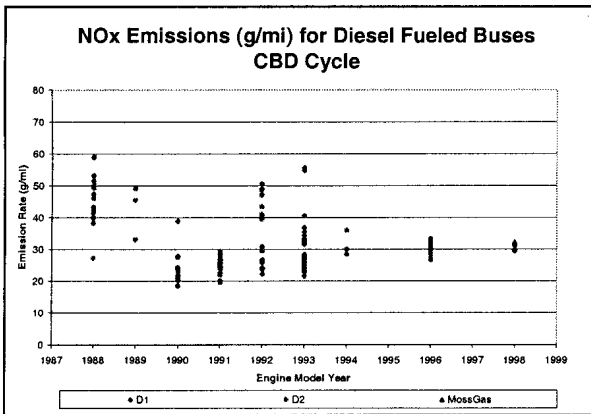

**Figure 6.18**

reduction strategy, the oxygen sensor used for feedback control has limited capabilities. As a result, fuel-lean combustion in a CNG engine which relies heavily on this sensor will typically result in lower NOx emissions at the expense of higher HC and CO emissions.

Figures 6.19 and 6.20 show the emission trend of THC emissions for CNG and diesel buses. While diesel bus THC emissions have fallen dramatically (likely due to the switch from two-stroke to four-stroke technology and the installation of oxidation catalysts), THC emissions from CNG buses have actually increased, due to lean fuel mixture operation to reduce NOx. While the fuel lean combustion mixture is implemented as a NOx

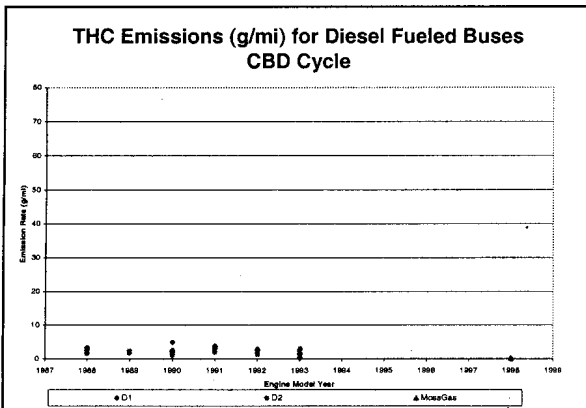

**Figure 6.20**

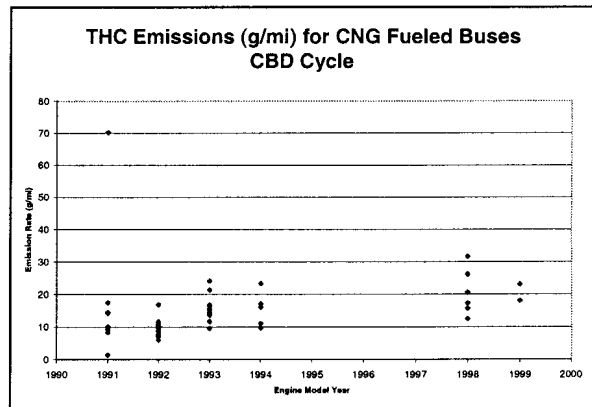

**Figure 6.19**

<sup>5</sup> Emission data from the DOE website can be accessed through a database query at [http://www.ott.doe.gov/ohvt/heavy\\_vehicle/hv/emisbus.html](http://www.ott.doe.gov/ohvt/heavy_vehicle/hv/emisbus.html); West Virginia University collected this data on its transportable dynamometer laboratories, which span heavy-duty buses from 1988 though 1998 on the CBD cycle.



### 6.3.3 Fuel Economy

Transit buses consume energy both to provide motive power and to support auxiliary systems. Factors which ultimately govern the fuel economy of the bus are: vehicle inertia (vehicle and passenger weight) or acceleration (kinetic) energy; vehicle drag coefficient and frontal area, and tire rolling resistance (commonly referred to as road load); and accessory requirements, such as air conditioning, compressed air and power steering. An important additional factor is the efficiency with which power is transferred to the wheels. An example of the estimated energy expended per mile for the NY Bus, Manhattan, and CBD cycles is shown in Figure 6.21. The estimates in this figure are for power delivered to the wheels and auxiliary systems and do not account for drive system or engine efficiency. These last two factors are why two vehicles achieve different fuel economy on the same cycle.

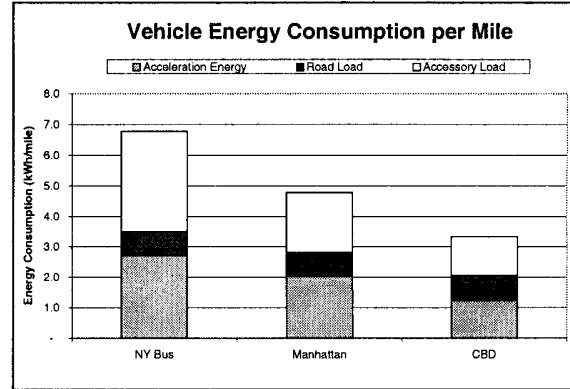

Figure 6.21

The estimates in this figure are for power delivered to the wheels and auxiliary systems and do not account for drive system or engine efficiency. These last two factors are why two vehicles achieve different fuel economy on the same cycle.

Acceleration energy and auxiliary systems such as air conditioning tend to dominate cycles with low average speeds such as the NY Bus and Manhattan cycles. In the CBD cycle, energy consumption is more evenly distributed between accessory load, road load and acceleration energy (kinetic energy). Eventually there is a point during steady state cruise operation, where acceleration energy is near zero and the energy consumption is dominated by road load and accessory load only.

#### 6.3.3.1 Dynamometer Measured Results

The hybrid-electric vehicles tested under the NAVC project are essentially conventional buses with hybrid-electric drive systems. As a result, the hybrid-electric buses weigh more than conventional diesel buses (CNG buses are heavier as well) due to the extra weight associated with the batteries (or CNG tanks in a CNG bus). Much of the additional energy used for accelerating this weight can be recovered via regenerative braking in the hybrid-electric vehicle, although inefficiencies in the drive motors, differential and batteries prevent the capture of all of this energy. Vehicle weight is a continuing concern from a passenger carrying capacity standpoint and needs to be considered so that a fully loaded bus does not exceed its gross vehicle weight (GVW). When reviewing the fuel economy and emission data bear in mind that the weight of each manufacturers' current model offering may differ from the values tested under this project as manufacturers are working to reduce overall vehicle weight. As a result, significant weight differences could have an effect on the emission test values. For comparison purposes, the curb, GVW, and the test weight for each bus tested are listed in Table 6.3.

Table 6.3: Curb, Gross and Test Weight of Buses

OEM/Chassis/Fuel	Curb/GVW (lbs)	Test Weight (lbs)	Passenger Capacity
Neoplan AN440T CNG	29,820/40,600	34,170	56
Nova RTS diesel	28,200/39,500	32,250	52
Orion V CNG	33,225/41,800	37,495	55
New Flyer C40LF CNG	29,600/37,920	33,650	52
Nova RTS Allison Hybrid Diesel	30,600/36,900	34,735	53
Orion VI LMCS Hybrid Diesel	31,315/41,640	35,140	49

The test weight for each bus was determined by multiplying half of the seated and standing passenger capacity (also shown in Table 6.3) by 150 lb and then adding an additional 150 lb for the driver. The amount of CNG consumed during the test has been converted to a diesel equivalent gallon based on a conversion factor of 137 cubic feet of natural gas per gallon of diesel fuel.

The fuel economy benefits of hybrids are borne out in Figure 6.22. The dynamometer data charted here is contained in Table 6.2. Immediately, a general trend is apparent that, as average speed increases, fuel economy also increases. There were consistent fuel economy improvements of nearly one mile per gallon for the Orion-LMCS Hybrid and nearly one half mile per gallon for the Nova-Allison Hybrid over conventional buses on the NY Bus, CBD and Manhattan cycles. While these may seem like small numbers, bear in mind that on the NY Bus cycle the best performing diesel buses only achieved 1.4 mpg

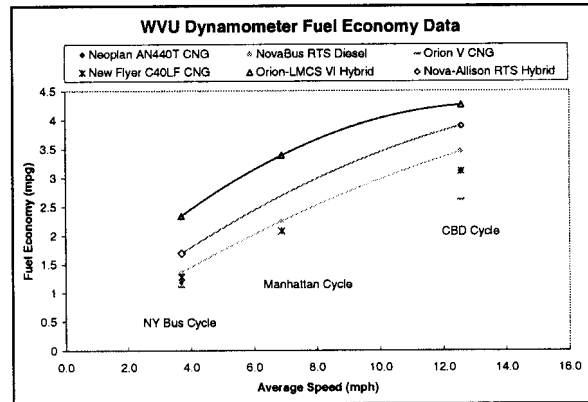

Figure 6.22

fuel economy versus 2.3 mpg for the Orion-LMCS hybrid-electric bus. This equates to about a 65 percent fuel economy improvement for the Orion-LMCS Hybrid on the NY Bus cycle over a conventional diesel.

The results show a clear fuel economy improvement for hybrid-electric technology over conventional diesel and CNG buses regardless of test cycle (see Figures 6.23, 6.24, and 6.25). As expected, conventional diesel buses exhibited better fuel economy than comparable CNG buses, which pay a

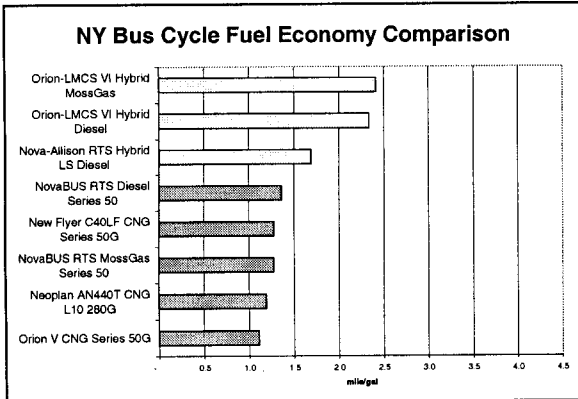

Figure 6.23

fuel economy penalty due to higher vehicle weight and lower overall engine efficiency. CNG engines have a lower compression ratio and are throttled versus diesel engines that are high compression, non-throttled. Not all of the buses were run on the Manhattan cycle due to time and budget constraints but as expected the fuel economy results on the Manhattan cycle lie between the NY Bus cycle and the CBD cycle as shown in Figure 6.25.

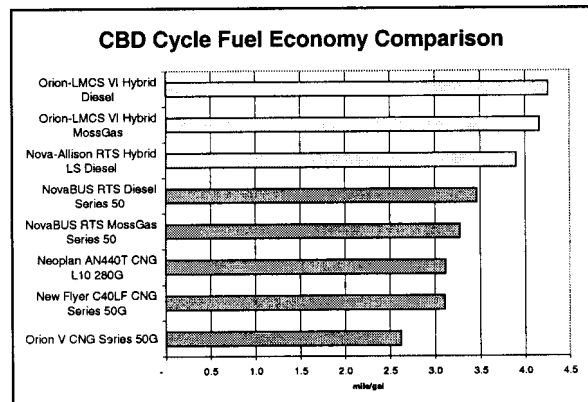

Figure 6.24

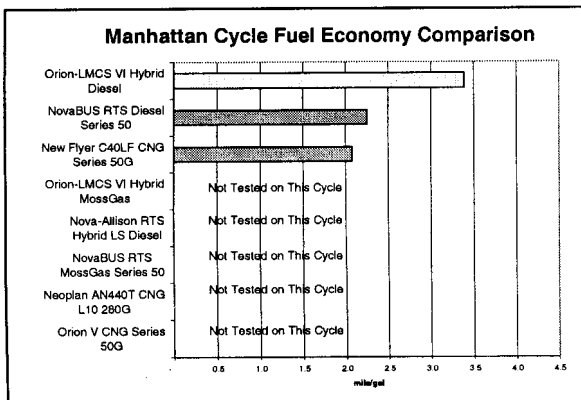

Figure 6.25

### 6.3.4 Carbon Dioxide and Methane Greenhouse Gas Emissions

#### 6.3.4.1 Overview

The United Nations Framework Convention on Climate Change (UNFCCC) uses the term climate change to describe only the change in climate brought about by human activity. The Intergovernmental Panel on Climate Change (IPCC), appointed by the United Nations and the World Meteorological Organization, has issued a series of comprehensive documents assessing the climate change issue and the pollutants (labeled greenhouse gases or GHGs) which contribute to this effect. Research indicates average global temperatures are rising and the rate at which they are rising is also increasing, with the average global temperature higher by nearly 1°F over the last decade.<sup>6</sup> The temperature change coincides with significant increases in global concentrations of GHGs.

The global warming potential (GWP) of a greenhouse gas is the ratio of global warming, or radiative forcing (both direct and indirect), from one unit mass of a greenhouse gas to one unit mass of CO<sub>2</sub> over a period of time.<sup>7</sup> GWPs recommended by the IPCC for nitrous oxide (N<sub>2</sub>O) and methane (CH<sub>4</sub>) are included in Table 6.4. Three additional criteria pollutants, NO<sub>x</sub>, non-methane volatile organic compounds (NMVOC), and CO are also included in Table 6.4. These pollutants do not directly affect global warming but instead have an indirect affect by influencing the formation and destruction of other greenhouse gases (specifically tropospheric and stratospheric ozone). Currently there is no agreed upon method to estimate the contribution of gases that have an indirect affect on global warming, however the GWPs for NO<sub>x</sub>, NMVOC and CO were listed in the IPCC First Assessment Report, 1990 and are included here for reference.

For transit buses there are several ways to reduce GHG emissions:

- improve fuel efficiency;
- shift to lower-carbon fuels (CNG) and advanced vehicle technologies (hybrid-electric); and
- assure more complete combustion or post combustion oxidation.

Despite the fact that emission rates of most pollutants have been dramatically reduced in newer CNG and diesel buses, they remain a large source of criteria pollutants, air toxics and GHGs in many areas. The GHGs most closely identified with the transportation sector include CO<sub>2</sub>, N<sub>2</sub>O and CH<sub>4</sub>.

Emission testing for N<sub>2</sub>O was not conducted during this project. A default emission factor<sup>8</sup> of 0.03 gram per kilometer (0.048 g/mi) for heavy-duty diesel vehicles was used, so that the GHG impact of N<sub>2</sub>O emissions can be characterized in relation to the other pollutants. When multiplied by its GWP (310), the

**Table 6.4: Global Warming Potentials of Selected Pollutants**

Pollutant	Global Warming Potential
Carbon Dioxide (CO <sub>2</sub> )	1
Methane (CH <sub>4</sub> )	21
Nitrous Oxide (N <sub>2</sub> O)	310
Carbon Monoxide (CO)	3
Non-Methane Volatile Organic Compounds (NMVOC)	11
Nitrogen Dioxide (NO <sub>2</sub> )	7

<sup>6</sup> P.D. Jones, et. al., *Global and Hemispheric Temperature Anomalies-Land and Marine Instrumental records* (Oak Ridge National Laboratory, TN), 1999.

<sup>7</sup> This paragraph is paraphrased from the U.S. EPA *Inventory of U.S. Greenhouse Gas Emissions and Sinks: 1990-1997*, April 1999.

<sup>8</sup> U.S. EPA *Inventory of U.S. Greenhouse Gas Emissions and Sinks: 1990-1997*, Annex C, April 1999.

GHG impact for N<sub>2</sub>O is about 15 g/mi as CO<sub>2</sub>. This value is relatively insignificant in relation to the magnitude of CO<sub>2</sub> and CH<sub>4</sub> emissions from buses. To put the GWP contribution of each pollutant in context, all of the pollutants have been shown for comparison in Figures 6.26 and 6.27.

**6.3.4.2 GHG Emission Results**

As seen in Figures 6.26 and 6.27, the hybrid buses exhibited the lowest total GHG emissions. The Orion-LMCS and Nova-Allison hybrid buses exhibited a 20 to 40 percent, and 10 to 20 percent reduction in GHG emissions, respectively, than a conventional diesel bus. This can be primarily attributed to the capture of energy via regenerative braking to reduce the operating load on the engine.

Petroleum fuels such as diesel fuel have hydrogen to carbon ratios of about 2.2 to 1, while natural gas has a ratio of 4 to 1. For every million British Thermal Unit (mmBtu) of heating value there is 31.9 lb of carbon (117 lb CO<sub>2</sub>/mmBtu) for natural gas versus 44.0 lb carbon/mmBtu (161 lb CO<sub>2</sub>/mmBtu) for diesel fuel.

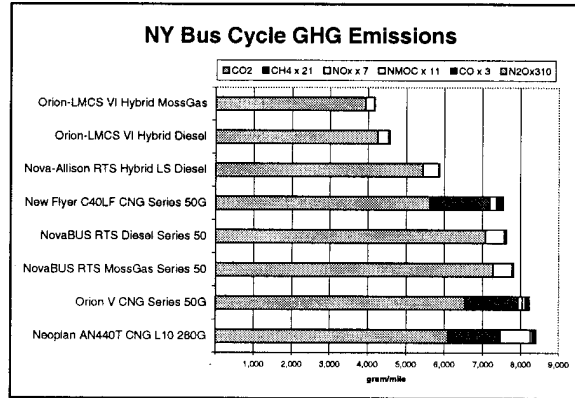

Figure 6.26

As a result of this lower carbon content, carbon dioxide emissions for a CNG bus could be nearly 40 percent lower than a diesel bus. However, several factors conspire to prevent the lower carbon benefit from being as large as it first appears. As shown in Figures 6.26 and 6.27, the percentage reduction in GHG emissions is essentially nil on the NY Bus and CBD cycles. The Orion V DDC Series 50G CNG bus actually had higher total GHG emissions than a Nova RTS DDC Series 50 diesel bus.

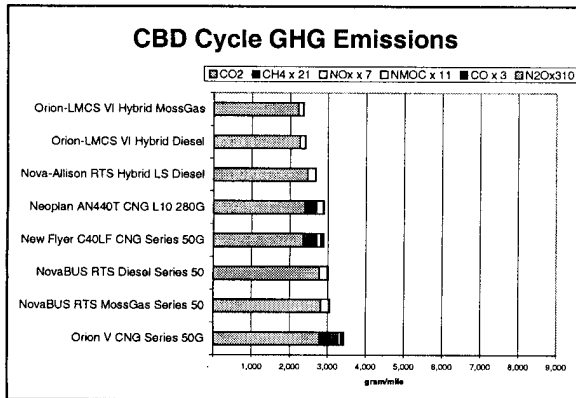

Figure 6.27

rate to determine the overall CO<sub>2</sub> equivalent greenhouse gas impact. So even though the CNG buses emit less CO<sub>2</sub>, the impact from the released methane creates a larger GHG impact.

As a function of their greater fuel economy, the hybrid buses have total GHG emissions far lower than that of a CNG or conventional diesel buses.

CNG buses have roughly 20 percent poorer fuel economy on urban driving cycles. This is due primarily to engine throttling losses under part load operation and greater vehicle weight. CNG buses consume more fuel for the same output, effectively canceling out nearly half of the CO<sub>2</sub> benefit. The second factor is the emission of unburned fuel or methane, which is itself a greenhouse gas with a global warming potential 21 times that of CO<sub>2</sub>.<sup>9</sup> To derive the total GHG impact, the grams per mile methane emission rate from each CNG bus was multiplied by 21 and this value was then added to the total CO<sub>2</sub> emission

<sup>9</sup> STAPPA/ALAPCO, *Reducing Greenhouse Gases & Air Pollution*, October 1999; Also see Table 6.1

### 6.3.5 Carbon Monoxide Emissions

#### 6.3.5.1 Overview

Carbon monoxide (CO) is generally a local emission issue with the impact typically occurring in low lying areas such as urban canyons. CO affects the ability of blood to carry oxygen and results in impaired cardiovascular, pulmonary and nervous systems. While most areas of the U.S. are in attainment for CO, many areas in the Northeast such as New York City, Westchester and Nassau counties in New York State, and the northeastern portion of New Jersey have been designated as moderate CO non-attainment areas. The Code of Federal Regulations lists several areas as serious CO non-attainment areas including, the Los Angeles South Coast Air Basin, CA, Denver-Boulder, CO, Las Vegas, NV, Phoenix, AZ and Spokane, WA. Some of these areas have demonstrated attainment with the CO NAAQS, but have yet to be delisted.

Excess CO emissions are usually associated with cold engine startups and engine operation in open loop mode. Once the engine has warmed to operating temperature the oxidation catalyst is usually sufficient to complete at least partial combustion of excess HC and CO into CO<sub>2</sub>.

#### 6.3.5.2 CO Results

The hybrid-electric buses exhibited the lowest CO emission of any of the buses tested representing a 70 percent reduction from a conventional diesel bus. It appears that a majority of this benefit is attributable to reduced transient operation of the engine with the remainder attributable proportionately to increased fuel economy and potentially more effective aftertreatment control due to reduced engine idle.

As was the case with HC emissions, the CO emissions from the CNG buses (highlighted in Figures 6.28 and

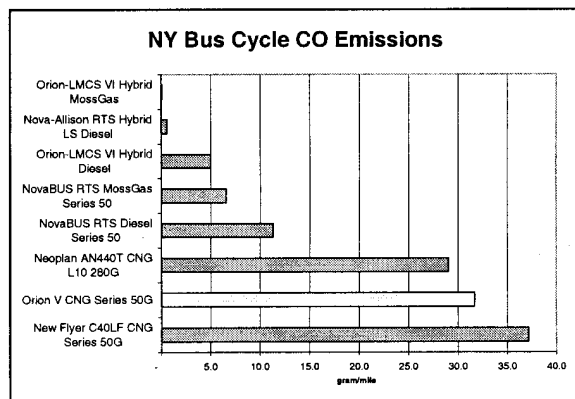

Figure 6.28

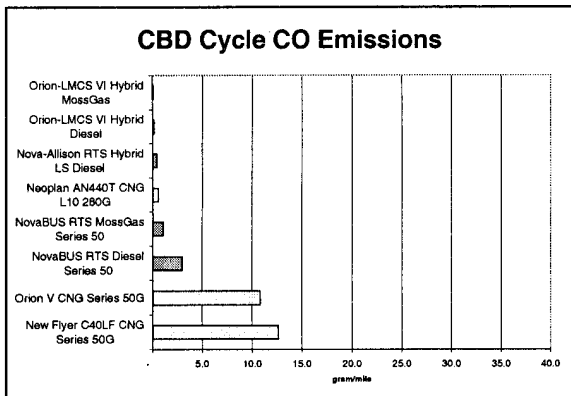

Figure 6.29

operating temperature before they become effective).

CO emission rates follow a general trend where as average cycle speed increases, emission rates decrease, as shown in Figure 6.30. The percentage difference between the CNG buses and the diesel buses was generally proportional to the changes in vehicle fuel economy.

6.29) are roughly 300 percent higher than the diesel buses. The CNG buses tested under this project all employ lean burn combustion strategies that result in excess CO emissions when optimizing for low NO<sub>x</sub> emissions. This type of combustion strategy typically maintains more than sufficient oxygen in the catalyst for oxidation, however, the catalyst operating parameters as well as the catalyst washcoat must be optimized for reducing CO. Catalysts do not approach 100 percent efficiency and have operational temperature requirements (i.e., need to reach

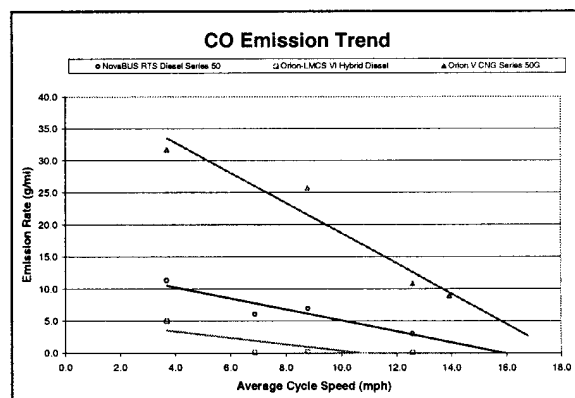
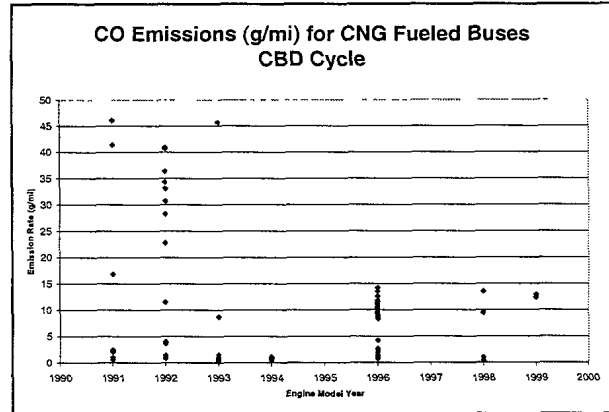

Figure 6.30

**6.3.5.3 Historical CO Emissions**

Historical CO emission data are available from the DOE website for heavy-duty buses ranging in age from 1988 through 1998 model years. This data was collected by WVU on their transportable dynamometer.

As shown in Figures 6.31 and 6.32, CO emissions from diesel and CNG buses have declined over time. As most areas are in attainment for CO, there is currently no driving force to lower these emissions from urban bus fleets.



**Figure 6.31**

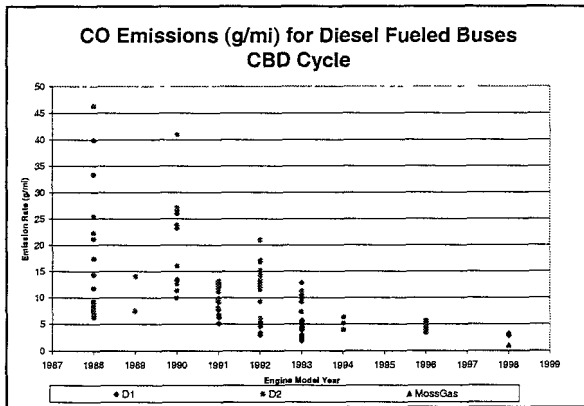

**Figure 6.32**

**6.4 Conclusions**

The results of this program demonstrate that diesel hybrid-electric vehicles offer reduced drive cycle emissions relative to conventional diesel buses. These lower emissions are a function of increased fuel economy and particulate trap technologies. Compared to a conventional diesel bus, PM emissions from the diesel hybrids were 50 percent lower. When low-sulfur diesel was used, diesel hybrid PM emissions reached levels similar to CNG buses. NOx emissions for the diesel hybrids were 30 to 40 percent lower than conventional diesel, and they exhibited the lowest CO emission of any of the buses tested, with a 70 percent reduction from a conventional diesel bus. The hybrids also demonstrated significantly lower total greenhouse gas emissions than that of a conventional diesel or CNG bus.

The project confirmed significant fuel economy benefits for hybrids with 30 to 65 percent fuel economy improvements over conventional diesel across a variety of duty cycles tested. When operated on stop and go, low-speed service applications the hybrid technology demonstrates a clear advantage.

## APPENDIX A: GLOSSARY OF TERMS

---

**Alternative fuels:** According to the U.S. Department of Energy, alternative fuels are substantially non-petroleum (i.e., not traditional gasoline and diesel) and yield energy security and environmental benefits. DOE currently recognizes the following as alternative fuels: methanol and denatured ethanol as alcohol, natural gas (compressed or liquefied), liquefied petroleum gas, hydrogen, coal-derived liquid fuels, fuels derived from biological materials, and electricity (including solar energy). The Department of Transportation has expanded the definition of alternative fuels to include diesel hybrid-electric and fuel cell buses in both TEA-21 and the 1999 appropriations bill.

**Auxiliary power unit (APU):** An APU converts fuel (CNG, diesel, methanol, etc.) into energy. It may take the form of an engine/generator or fuel cell. If the APU uses an engine, it could be either an internal combustion reciprocating engine (i.e., diesel cycle) or a turbine engine.

**Batteries:** Lead-acid batteries are the most commonly used energy storage system today for hybrid-electric buses. Advanced batteries such as lithium based batteries contain these characteristics and are in the development stage.

**Battery-dominant hybrid:** In a battery-dominant hybrid, primary drive power is provided by the energy storage device (e.g. batteries). Battery-dominant hybrids provide greater all electric range and absorb regenerative braking power more easily.

**California Air Resources Board (CARB):** The state agency that regulates air quality in California. Air quality regulations by CARB are often stricter than those set by the federal government.

**Carbon dioxide (CO<sub>2</sub>):** A product of combustion, CO<sub>2</sub> is a "greenhouse gas" which traps the earth's heat and contributes to the potential for global climate change. The output of CO<sub>2</sub> is directly proportional to fuel consumption.

**Carbon monoxide (CO):** A colorless, odorless and tasteless gas produced by the incomplete combustion of fuels with limited oxygen supply. CO is toxic if inhaled.

**Controller and inverter:** A device that manages electricity flow batteries to motor(s). The controller and **inverter** regulate the amount of DC to AC power that the drive motor provides for acceleration and receives from regenerative braking.

**Direct drive hybrid:** Direct drive eliminates the differential and, in the case of wheel motors, eliminates the drive shaft.

**Electric motor:** Electric motors and **generators** are an integral part of a hybrid-electric vehicle. The electric motor turns electric energy into mechanical energy, whereas a generator does the opposite. Both motors and generators vary with permanent magnet (PM), alternating current (AC), and direct current (DC) options available. A PM motor or generator uses fixed magnets to produce electricity, whereas AC and DC units use electromagnets. In AC and DC motors, speed and power is a function of the frequency of the current and voltage, respectively.

**Energy storage device/Load leveling device:** Collects and releases electrical energy and balances the average power requirement of the vehicle with the electric power generated from APU. Examples may be a battery, flywheel or super capacitor.

**Engine-dominant hybrid:** In an engine-dominant hybrid, a majority of the drive power is immediately produced by the APU. This type of configuration may lead to the use of a relatively small-capacity energy storage device in which regenerative braking capture efficiency is reduced and all electric range is minimal.

**Flywheel:** Flywheels store energy mechanically by using a wheel or disk that spins rapidly in a vacuum. Basically the vehicle's kinetic energy is converted into spinning kinetic energy in the flywheel. An additional motor and controller is required to convert the electrical energy to mechanical and back again.

**Fuel cell:** Fuel cells operate by harnessing the energy from a chemical reaction that combines hydrogen and oxygen to form water. During this reaction, electrical energy is released and recovered.

**Gas turbine:** A gas turbine engine runs on a Brayton cycle using a continuous combustion process. A heat exchanger and compressor is used to raise the pressure and temperature of the inlet air, which is introduced into the burner with injected fuel. This mixture is then combusted. Power is produced when the heated, high-pressure combustion product mixture is expanded and cooled through a turbine.

**Generator:** See definition of **Electric motor**.

**Hybrid-electric bus:** A hybrid electric bus carries at least two sources of motive energy on board and uses electric drive to provide partial or complete drive power to the vehicle's wheels.

**Inverter:** Converts DC electricity from batteries into AC electricity for use by a motor. The **controller** and inverter regulate the amount of DC to AC power that the drive motor provides for acceleration and receives from regenerative braking.

**Load-leveling device:** See **Energy storage device**.

**Methane (CH<sub>4</sub>):** A colorless, odorless gas. Methane has 21 times the CO<sub>2</sub> equivalency in terms of climate change potential.

**Nitrogen oxides (NO<sub>x</sub>):** Primarily NO and NO<sub>2</sub> but including other substances in minute concentrations. NO<sub>x</sub> is produced by the combination of nitrogen and oxygen under the high pressure and temperature conditions in an engine. When combined with heat at light, NO<sub>x</sub> are precursors to the formation of ozone. They also contribute to the formation of acid rain.

**Ozone:** Formed when volatile organic compounds (VOC<sub>s</sub>), oxygen and NO<sub>x</sub> react in the presence of sunlight. Ozone at ground level is a respiratory irritant and can have adverse effect on the elderly, children and those with chronic conditions.



**Parallel hybrid:** In a parallel hybrid, both the electric motor and the engine are connected to the vehicle drive wheels. Depending on how the engine and drive motor are integrated into the parallel system, the engine may also be used to spin the drive motor as a generator to charge the energy storage device just like a series hybrid.

**Particulate matter (PM):** Unburned fuel particles that form smoke or soot, PM can stick to lung tissues when inhaled. They are associated with respiratory problems and some may be carcinogenic. PM measurements also include recombinants and after exhaust products that form in the air beyond the tailpipe.

**Regenerative braking:** Means of recharging batteries by using energy created by braking the vehicle. The motor acts as a generator, recovering energy normally lost in braking and feeding it back into the batteries.

**Series hybrid:** With a series hybrid, the electric motor alone drives the wheels. The engine is not mechanically connected to the wheels.

**Sulfur dioxide (SO<sub>2</sub>):** A corrosive acid gas that combines with water to produce acid rain, SO<sub>2</sub> can also cause respiratory problems.

**Supercapacitor:** Super capacitors store energy by electrostatically separating and accumulating charges physically between internal plates. With respect to a hybrid vehicle a super capacitor would be considered more of a load-leveling device than an energy storage device.

**Turbine:** See **Gas turbine**.

**Volatile organic compounds (VOC):** VOC<sub>s</sub> are gaseous compounds made of hydroger and carbon that result from gasoline combustion. Combined with NO<sub>x</sub> and sunlight, VOC<sub>s</sub> form ozone. Ozone at ground level is a respiratory irritant and can have adverse effect on the elderly, children and those with chronic conditions.

*Sources: Electric Vehicle Association of the Americas, U.S. Department of Energy, Northeast Advanced Vehicle Consortium*

Appendix B: US Hybrid Drive Bus Demonstrations

No.	Bus Manufacturer	Drive Integrator	Demonstration Site	State	Deployed (Year)	Buses (No.)	Status	Bus Type
1	AVS	Allison	Chattanooga (CARTA)	TN	1996	2	Inactive	Shuttle
2	AVS	Solectria	Chattanooga (CARTA)	TN	1997	1	Active	Shuttle
3	AVS	Solectria	Chattanooga (CARTA)	TN	1999	2	Active	Shuttle
4	AVS	Solectria	Tempe, AZ	AZ	1999	13	Ordered	Shuttle
5	AVS	PEI/Unique	Chattanooga (CARTA)	TN	2000	6	Ordered	Paratransit
6	AVS	PEI/Unique	Chattanooga (CARTA)	TN	2000	3	Ordered	Paratransit
7	AVS	PEI/Unique	Chattanooga (CARTA)	TN	2000	1	Ordered	Shuttle
8	AVS	Solectria	Falls Church, VA	VA	2000	4	Ordered	Shuttle
9	AVS	Solectria	Tempe, AZ	AZ	2000	20	Ordered	Shuttle
10	AVS	Solectria	Tampa, FL	FL	2001	10	Ordered	Shuttle
11	Blue Bird	Northrup Guman	County Public Transit	GA	1997	1	Inactive	Paratransit
12	Blue Bird	Northrup Guman	Cedar Rapids (Four Seasons)	IA	1999	5	Active	Paratransit
13	Blue Bird	H-Power	Municipal Utility District	CA	2000	1	Ordered	Paratransit
14	Blue Bird	Solectria	TBD	TBD	2001	1	Ordered	School
15	El Dorado	APS	Vandenberg Air Force Base	CA	1994	2	Inactive	Transit
16	El Dorado	APS	Vandenberg Air Force Base	CA	1994	1	Inactive	Paratransit
17	El Dorado	APS	Aloha State Tour & Travel	HI	1996	1	Active	Paratransit
18	El Dorado	APS	Hickam AFB	HI	1996	1	Active	Paratransit
19	El Dorado	APS	Contra Costa (AC) Transit	CA	1998	1	Inactive	Transit
20	El Dorado	ISE	Los Angeles (LADOT)	CA	1999	4	Active	Paratransit
21	El Dorado	ISE	Los Angeles (LADOT)	CA	2000	4	Ordered	Paratransit
22	El Dorado	ISE	Los Angeles (LADOT)	CA	2000	9	(not ordered)	Paratransit
23	El Dorado	APS	City of Lompoc	CA		1	Inactive	Transit
24	Vehicle International	EVI	TBD	TBD	TBD	0	Active	Shuttle
25	Flexible	Green State University	Cleveland (CTA)	OH	1998	1	Active	Transit
26	Genesis	APS	CEC TETAP	CA		1	Inactive	School
27	Gillig		San Francisco (Foothills Transit)	CA	1995	1	Inactive	Transit
28	New Flyer	Solectria	Orange County (OCTA)	CA	1999	2	Active	Transit

Appendix B: US Hybrid Drive Bus Demonstrations

No.	Bus Manufacturer	Drive Integrator	Demonstration Site	State	Deployed (Year)	Buses (No.)	Status	Bus Type
29	New Flyer	ISE	San Bernadino (OmniTrans)	CA	2000	3	Ordered	Transit
30	Northrup Grumman	Unique Mobility	Houston	TX	2000	1	Active	Transit
31	Nova Bus	Kaman	Ohahu (OTA)	HI	1996	1	inactive	Transit
32	Nova Bus	Kaman	Dayton	OH	1997	1	Inactive	Trolley
33	Nova Bus	Booz Allen & Hamilton	Georgetown University, DC	DC	1998	1	inactive	Transit
34	Nova Bus	Kaman/Lockheed	New York (NYCT)	NY	1998	1	inactive	Transit
35	Nova Bus	Allison	New York (NYCT)	NY	1999	1	Active	Transit
36	Nova Bus	dBB (Ballard)	Georgetown University, DC	DC	2000	1	Active	Transit
37	Nova Bus	Lockheed	New York (NYCT)	NY	2000	5	Ordered	Transit
38	Nova Bus	General Electric	Clark County, Nevada	NV	2001	1	Ordered	Transit
39	Nova Bus	ISE	Los Angeles (Foothills Transit)	CA	2001	1	Ordered	Transit
40	Orion	Unique Mobility	New York State	NY	1994	1	inactive	Shuttle
41	Orion	General Electric	New York (NYCT)	NY	1996	1	inactive	Transit
42	Orion	Lockheed	New York (NYCT)	NY	1998	5	Active	Transit
43	Orion	Lockheed	Boston (MBTA)	MA	1999	2	Active	Transit
44	Orion	Lockheed	New York (NYCT)	NY	2000	5	Active	Transit
45	Orion	Lockheed	Metro Transit (St. Paul, Minneapolis)	MN	2001	5	Ordered	Transit
46	Orion	Lockheed	New York (NYCT)	NY	2001	125	Ordered	Transit
47	TBD	Unique Mobility	TBD	TBD	1999	0	Active	n/a
48	TBD	TBD	New York (NYCT)	NY	2002	100	Planned	Transit
49	TBD	Allison	TBD	TBD	TBD	0	Active	n/a
50	TBD	US Electricar	TBD	TBD	TBD	0	Active	n/a
51	TDM	UQM/Siemens	Warner Robbins AFB	GA	1999	8	Active	Shuttle
52	TPI	Solectria	Logan Airport	MA	1999	1	inactive	Paratransit
53	Transteg	Transteg	Denver (RTD)	CO	2000	36	Active	Transit
54	Villager	APS	Santa Barbara (SBMTD)	CA	1995	1	inactive	Paratransit
55			Georgetown University, DC	DC	1995	3	Active	Paratransit

# **Appendix C**

## **Standards & Recommended Practices**

*The following regulations and codes are relevant to the use of alternative fuels in buses and may be relevant to hybrid electric buses.*

### **Regulations**

- Code of Federal Regulations (CFR), Title 49, "Transportation." Part 171-Hazardous Materials Regulations. (U.S. DOT)
- Code of Federal Regulations (CFR), Title 49, "Protection of Environment." Part 86- Control of Air Pollution from New and In-Use Motor Vehicles and New and In-Use Motor Vehicle Engines: Certification and Test Procedure. (U.S. EPA)
- Superfund Amendments and Reauthorization Act (1986), SARA Title III. (U.S. EPA)

### **Standards**

- Code of Federal Regulations (CFR), Title 29. Part 1910 - Occupational Safety and Health Standards (OSHA)
- NFPA 30A - Automotive and Marine Service Station Code. This standard applies to automotive service stations whether inside or outside of buildings.
- NRPA 70 - National Electric Code. The purpose of this code is the practical safeguard of persons and property from the hazards arising from the use of electricity.
- NRPA 88A - Standard for Parking Structures. This standard covers the construction and protection of, as well as the control of hazards in, open, enclosed, basement, and underground parking structures.
- NFPA 88B - Standard for Repair Garages. This standard covers the construction and protection of, as well as the control of hazards in, garages used for major repair and maintenance of motorized vehicles and any sales and servicing facilities associated therewith.
- NFPA 497A - Recommended Practice for Classification of Class I Hazardous (Classified) Locations for Electrical Installations in Chemical Process Areas. This recommended practice applies to locations where flammable gases or vapors, flammable liquids or combustible liquids are processed or handled and where their release to the atmosphere may result in their ignition by electrical systems or equipment.

### **Other Sources**

- EPRI Electric Bus Subscription Purchase Program, 1998.
- EPRI Procurement Guidelines for Battery-Electric Buses.

## SAE EV STANDARDS FORUM DOCUMENTS

SAE NUMBER	TYPE OF DOCUMENT	TITLE	COMMITTEE Contact Person	STATUS
J0551	Standard	Performance Levels and Methods of Measurement of Electromagnetic Radiation from Vehicles and Devices (30 to 1000MHz)	EMI/EMR Committees Paul Anderson (810) 576-4644	EV specific revisions to Part 2 and Part 5 complete
J1634	Rec. Practice	Electric Vehicle Energy Consumption and Range Test Procedure	Light Vehicle Performance & Economy Measurement Ron Peltier (313) 337-5367	Update ballot approved; Awaiting publication 4/99
J1654	Rec. Practice	High Voltage Primary Cable	High Voltage Elec. Distr Sys. Larry Powell (330) 373-3671	Published 6/94; Five-year review due in 1999
J1666	Rec. Practice	Electric Vehicle Acceleration, Gradeability, and Deceleration Test Procedure	Light Vehicle Performance & Economy Measurement Ron Peltier (313) 337-5367	Published 5/93; Update ballot approved; Awaiting Publication
J1673	Rec. Practice	High Voltage Automotive Wiring Assembly Design	High Voltage Elec. Distr. Sys. Ralph Erskine (313) 845-7222	Published 7/96
J1711	Rec. Practice	Hybrid Electric Vehicle Emissions and Energy Consumption Test Procedure	Light Vehicle Performance & Economy Measurement Steve Poulos (248) 857-6427	Ballot approved; Submitted for publication 4/99
J1715	Info. Report	Electric Vehicle Terminology	EV Forum Dell Crouch (317) 579-3773	Published 4/94; Currently being revised
J1718	Rec. Practice	Measurement of Hydrogen Gas Emission From Battery-Powered Passenger Cars and Light Trucks During Battery Charging	EV Battery Systems Joe Allen (847) 272-8800	Published 4/97
J1742	Rec. Practice	Connections for High Voltage On-Board Road Vehicle Electrical Wiring Harnesses	High Voltage Elec. Distr. Sys. Ralph Erskine (313) 845-7222	Published 1/99
J1766	Rec. Practice	Electric and Hybrid Vehicle Battery Systems Crash Integrity Test	EV Safety Committee Mike Beebe (419) 625-5200	Published 5/96; Rev. Pub. 6/98
J1772	Rec. Practice	Electric Vehicle Conductive Charge Coupler	EV Charging Systems Craig Toepfer (313) 323-6272	Published 1/97; Currently being revised
J1773	Rec. Practice	Electric Vehicle Inductive Charge Coupling	EV Charging Systems Mike Steele (310) 517-5546	Published 2/95; Currently being revised

J1797	Rec. Practice	Packaging of Electric Vehicle Battery Modules	EV Battery Systems George Shishkovsky (313) 425-7162	Published 9/97
J1798	Rec. Practice	Performance Rating of Electric Vehicle Battery Modules	EV Battery Systems George Shishkovsky (313) 425-7162	Published 9/97
J2178	Rec. Practice	Class B Data Communication Network Messages	MUX. Committee Mark Zachos (248) 488-2080	Awaiting Publication
J2288	Rec. Practice	Life Cycle Testing of Electric Vehicle Battery Modules	EV Battery Systems Gary Hunt (208) 526-1095	Published 4/97
J2289	Rec. Practice	EV Battery System Functional Requirements	EV Battery Systems Steve Jones (313) 248-5389	Balloted 10/97; Ballot comments being addressed
J2293	Rec. Practice	Energy Transfer System for Electric Vehicles Pt. 1 - Functional Requirements and System Architectures Pt. 2 - Communication Messaging and Functional Requirements	EV Charging Controls Frank Lambert (404) 385-0180	Pt. 1 published 3/97; Pt. 2 published 1/99; (HS-2293)
J2294	Rec. Practice	Test & Performance of Auxiliary Fuses for High Voltage Automotive Wiring Systems Pt. 1 - General Requirements Pt. 2 - 5 to 30 amps Pt. 3 - 40 to 80 amps	High Voltage Elec. Distr Sys. Ralph Erskine (313) 845-7222	Pt. 1 & Pt. 2 ballot approved 9/97; Reballot after testing planned for early 1999; Pt. 3 being drafted
J2344	Info. Report	Guidelines for Electric Vehicle Safety	EV Safety Committee Mike Beebe (419) 625-5200	Published 06/98
J2380	Rec. Practice	Vibration Testing of Electric Vehicle Batteries	EV Battery Systems Gary Hunt (208) 526-1095	Published 1/98
J2390	Rec. Practice	Test & Performance of Main Traction Fuses for High Voltage Automotive Wiring Systems	High Voltage Elec. Distr Sys. Ralph Erskine (313) 845-7222	Preparing Draft
J2464	Rec. Practice	Electric Vehicle Battery Abuse Testing	EV Safety & Battery Systems Gary Hunt (208) 526-1095	Submitted for publication 3/11/99

The **Transportation Research Board** is a unit of the National Research Council, which serves the National Academy of Sciences and the National Academy of Engineering. The Board's mission is to promote innovation and progress in transportation by stimulating and conducting research, facilitating the dissemination of information, and encouraging the implementation of research results. The Board's varied activities annually draw on approximately 4,000 engineers, scientists, and other transportation researchers and practitioners from the public and private sectors and academia, all of whom contribute their expertise in the public interest. The program is supported by state transportation departments, federal agencies including the component administrations of the U.S. Department of Transportation, and other organizations and individuals interested in the development of transportation.

The National Academy of Sciences is a private, nonprofit, self-perpetuating society of distinguished scholars engaged in scientific and engineering research, dedicated to the furtherance of science and technology and to their use for the general welfare. Upon the authority of the charter granted to it by the Congress in 1863, the Academy has a mandate that requires it to advise the federal government on scientific and technical matters. Dr. Bruce M. Alberts is president of the National Academy of Sciences.

The National Academy of Engineering was established in 1964, under the charter of the National Academy of Sciences, as a parallel organization of outstanding engineers. It is autonomous in its administration and in the selection of its members, sharing with the National Academy of Sciences the responsibility for advising the federal government. The National Academy of Engineering also sponsors engineering programs aimed at meeting national needs, encourages education and research, and recognizes the superior achievements of engineers. Dr. William A. Wulf is president of the National Academy of Engineering.

The Institute of Medicine was established in 1970 by the National Academy of Sciences to secure the services of eminent members of appropriate professions in the examination of policy matters pertaining to the health of the public. The Institute acts under the responsibility given to the National Academy of Sciences by its congressional charter to be an adviser to the federal government and, upon its own initiative, to identify issues of medical care, research, and education. Dr. Kenneth I. Shine is president of the Institute of Medicine.

The National Research Council was organized by the National Academy of Sciences in 1916 to associate the broad community of science and technology with the Academy's purpose of furthering knowledge and advising the federal government. Functioning in accordance with general policies determined by the Academy, the Council has become the principal operating agency of both the National Academy of Sciences and the National Academy of Engineering in providing services to the government, the public, and the scientific and engineering communities. The Council is administered jointly by both the Academies and the Institute of Medicine. Dr. Bruce M. Alberts and Dr. William A. Wulf are chairman and vice chairman, respectively, of the National Research Council.

Abbreviations used without definitions in TRB publications:

AASHO	American Association of State Highway Officials
AASHTO	American Association of State Highway and Transportation Officials
ASCE	American Society of Civil Engineers
ASME	American Society of Mechanical Engineers
ASTM	American Society for Testing and Materials
FAA	Federal Aviation Administration
FHWA	Federal Highway Administration
FRA	Federal Railroad Administration
FTA	Federal Transit Administration
IEEE	Institute of Electrical and Electronics Engineers
ITE	Institute of Transportation Engineers
NCHRP	National Cooperative Highway Research Program
NCTRP	National Cooperative Transit Research and Development Program
NHTSA	National Highway Traffic Safety Administration
SAE	Society of Automotive Engineers
TCRP	Transit Cooperative Research Program
TRB	Transportation Research Board
U.S.DOT	United States Department of Transportation

## THE NATIONAL ACADEMIES

*Advisers to the Nation on Science, Engineering, and Medicine*

National Academy of Sciences  
National Academy of Engineering  
Institute of Medicine  
National Research Council