

S.C.R.T.D. LIBRARY

Research Utilization Program

Improving Police Management

Selected Readings

a program of the National Institute of Justice

United States Department of Justice
National Institute of Justice
Office of Development, Testing, and Dissemination

IMPROVING POLICE MANAGEMENT

SELECTED READINGS

Prepared by:

Joseph Kelly

For

National Institute of Justice

Louis A. Mayo, Jr.
Program Manager

This handbook was prepared by University Research Corporation, Sheldon S. Steinberg, Project Director, pursuant to Contract No. J-LEAA-004-79 awarded by the Law Enforcement Assistance Administration, U.S. Department of Justice, Under the Omnibus Crime Control and Safe Streets Act of 1968, as amended. The points of view or opinions expressed do not necessarily represent official policy or positions of the U.S. Department of Justice.

The National Institute of Justice reserves the right to reproduce, publish, translate, or otherwise use, and to authorize others to publish and use all or any part of the copyrighted material contained in this publication.

Copyright 1982
University Research Corporation
Washington, D.C.

ABOUT THE NATIONAL INSTITUTE OF JUSTICE

The National Institute of Justice is a research, development, and evaluation center within the U.S. Department of Justice. Established in 1979 by the Justice System Improvement Act, NIJ builds upon the foundation laid by the former National Institute of Law Enforcement and Criminal Justice, the first major Federal research program on crime and justice.

Carrying out the mandate assigned by the Congress, the National Institute of Justice:

- Sponsors research and development to improve and strengthen the criminal justice system and related civil justice aspects, with a balanced program of basic and applied research.
- Evaluates the effectiveness of federally-funded justice improvement programs and identifies programs that promise to be successful if continued or repeated.
- Tests and demonstrates new and improved approaches to strengthen the justice system, and recommends actions that can be taken by Federal, State, and local governments and private organizations and individuals to achieve this goal.
- Disseminates information from research, demonstrations, evaluations, and special programs to Federal, State and local governments; and serves as an international clearinghouse of justice information.
- Trains criminal justice practitioners in research and evaluation findings, and assists the research community through fellowships and special seminars.

Authority for administering the Institute and awarding grants, contracts, and cooperative agreements is vested in the NIJ Director, who is assisted by an Advisory Board appointed by the President. The Board recommends policies and priorities and advises on peer review procedures.

Reports of NIJ-sponsored studies are reviewed by Institute officials and staff. The views of outside experts knowledgeable in the report's subject area are also obtained. Publication indicates that the report meets the Institute's standards of quality, but it signifies no endorsement of conclusions or recommendations.

James K. Stewart
Director-Designate

04982

HV
7935
.I46

TABLE OF CONTENTS

	<u>PAGE</u>
INTRODUCTION	i
RESEARCH UTILIZATION PROGRAM	1
CUTBACK MANAGEMENT IN AN ERA OF SCARCITY: HARD QUESTIONS FOR HARD TIMES Charles H. Levine, University of Maryland	9
MANAGING STRATEGIC CHANGE James Brian Quinn, Dartmouth College	21
PATROL WORKLOAD MEASUREMENT MANUAL The Commission on Peace Officer Standards and Training State of California	41
POLICY ANALYSIS IN LOCAL GOVERNMENT: A SYSTEMS APPROACH TO DECISION MAKING Kenneth L. Kreamer, Int. City Management Association	101
TEST DESIGN, DIFFERENTIAL POLICE RESPONSE TO CALLS FOR SERVICE U.S. Department of Justice, National Institute of Justice, Office of Development, Testing, and Dissemination	117
IMPROVING POLICE SERVICES THROUGH TELEPHONE OPERATIONS Eric J. Scott and Stephen L. Percy	165
THE COMMUNICATIONS PROCESS, A PERSPECTIVE OF THE STATE-OF-THE-ART James Evans, Public Administration Services	175
MANAGING CRIMINAL INVESTIGATIONS GRANT PROGRAM: HISTORICAL BACKGROUND; CONCEPTUAL GOALS AND OBJECTIVES; ASSIGNMENT OF RESPONSIBILITIES; PROCEDURES City of Peoria, Department of Police	211
INTER-COMMUNICATION BETWEEN POLICE PATROL AND DETECTIVE PERSONNEL Ernest Maldonado and Lyle Knowles	229
EFFECTS OF ORGANIZATIONAL DESIGN ON COMMUNICATION BETWEEN PATROL AND INVESTIGATION FUNCTIONS (PART I) Lt. Col. Joseph J. Staff, Police Division, Cincinnati, Ohio	237
EFFECTS OF ORGANIZATIONAL DESIGN ON COMMUNICATION BETWEEN PATROL AND INVESTIGATION FUNCTIONS (CONCLUSION) Lt. Col. Joseph J. Staff, Police Division, Cincinnati, Ohio	249
THE ULTIMATE MANAGERIAL CHALLENGE--CREATIVE CHANGE David S. Brown, George Washington University	261
IMPLEMENTING INNOVATION Ora A. Spaid	271

INTRODUCTION

The Improving Police Management workshop series has been developed through the Research Utilization Program supported by the National Institute of Justice to provide police executives with specific processes derived from the experiences of departments which participated in the Managing Criminal Investigations (MCI) and Managing Patrol Operations (MPO) field test programs. These experiences, bolstered by recent research and developmental findings, are intended to assist in the successful implementation of responsive and effective police programs. This IPM workshop series represents a continuation and updating of prior programs which have been developed for and delivered to police executives since 1976.

This Selected Readings is produced as a supplemental text for use by workshop attendees. It complements the Participant's Handbook which serves as the foundation for the workshop. In this manual are selected readings from various distinguished researchers and authors on subjects germane to the conduct of Improving Police Management. In several cases, we have also included promotional manuals from police departments which have had substantial experience in implementing program components such as "Directed Patrol" or "Calls for Service Management." All of the materials had been carefully selected on the basis of their importance to the field of police management.

We are grateful to each of the authors whose work appears in this manual. They have been selected because their insights and ideas have proven valid and useful as a result of discussions with hundreds of police executive who have participated in the Improving Police Management workshop series in 1981-82.

We also wish to acknowledge the contributions of the staff and police consultants who contributed to the development of Improving Police Management. Special thanks go to Donald F. Cawley, who developed much of the materials for this program and who served as the Team Leader for much of the life of MCI and MPO programs. Thanks also goes to Dr. Sheldon S. Steinberg, Director of the Research Utilization Program, for his leadership and thoughtful guidance; and, to Michael Chapman and Alice Evans for their fine skills and careful attention to details in the development and production of the materials.

Finally, we wish to acknowledge Messrs. John Bonner, Robert Soady, and Louis A. Mayo of the National Institute of Justice. Their recommendations have proved thoughtful and insightful and their directions both helpful and appreciated.

Joseph A. Kelly
Team Leader
Improving Police Management

July 1982

RESEARCH UTILIZATION PROGRAM

WHAT IT IS

The National Institute of Justice (NIJ), part of the U.S. Department of Justice, supports wide-ranging research in criminal justice, including the testing and evaluation of innovative programs. As new knowledge is gained, the Institute follows through with the essential step of communicating what has been learned and any related policy, program, and research implications.

The Research Utilization Program, administered by NIJ's Office of Development, Testing, and Dissemination, makes research and evaluation results accessible to criminal justice officials, other government executives, community leaders, and researchers. The goal--to influence crime control and criminal justice improvement efforts and map out future research strategies.

HOW IT WORKS

The Research Utilization Program (RUP) consists of three elements: Research Utilization Workshops, Special National Workshops, and Field Test Support.

Research Utilization Workshops (RUWs)

These are workshops held for criminal justice practitioners, government executives, and community leaders on the application of research and evaluation results to public policy and programming.

Research Utilization Workshops address subjects where a body of research findings suggest new program approaches. They are oriented to action or operations and address important needs of state and local governments. The topics chosen are generally based on NIJ Field Tests, Program Models that outline potential program options and the advantages and disadvantages of each, or research/evaluation studies.

Prior to 1981 the RUWs were normally 3-day workshop series held at several locations across the country and attended by 50 to 90 top criminal justice policymakers and administrators in a multistate area. In 1981 the Institute began to look at less costly ways to conduct training and disseminate research findings. One major approach being considered is the use of modern telecommunications technology. This method of delivery seems particularly promising in reaching relatively large, geographically dispersed audiences.

Since its inception RUP has presented workshops on a wide range of topics which were attended by several thousand criminal justice officials, other government executives, community leaders, and researchers. The topics covered in these workshops included:

- Improving Police Management
- Neighborhood Justice Centers
- Compensating Victims of Crime
- Cutback Management in Law Enforcement and Criminal Justice

- Developing Sentencing Guidelines
- Community Crime Prevention Planning
- Management of Stress in Corrections
- Operating a Defender Office
- Improved Probation Strategies
- Maintaining Municipal Integrity
- Managing the Pressures of Inflation
- Managing Patrol Operations
- Health Care in Correctional Institutions
- Victim/Witness Services
- Prison Grievance Mechanisms
- Managing Criminal Investigations
- Juror Usage and Management
- Rape and Its Victims

Participants in RUWs receive summary findings of relevant research, comprehensive bibliographic references, individual program planning guides, self-instructional materials, handbooks, and selected readings. Each participant is awarded a certificate of attendance at the workshop's conclusion. Multimedia packages on most RUW topics are available on request to agencies interested in implementation. Included are videotapes, Institute publications, handbooks, manuals, and other resource documents.

Special National Workshops (SNWs)

Special National Workshops are one-time events designed to establish directions for future research or share information and develop awareness among executives and policymakers.

The SNWs inform researchers and practitioners about important new research and evaluation findings, define appropriate new directions for NIJ research, and meet the needs of groups such as elected officials, planners, and evaluators for information on current research and advanced practices in aspects of criminal justice. These workshops are less operationally oriented than RUWs or Field Tests since they do not represent a particular program design or specific program options. They do, however, have action implications for public policy, present practices, and future research.

The Research Utilization Program assembles a team of nationally recognized experts on each SNW subject. Extensive conference support services are also provided for the workshops, including multimedia development, editing and publication of materials, and logistical support.

Special National Workshops have been held on:

- Research and Evaluation Methods and the Third National Workshop on Criminal Justice Evaluation--An update of recent developments and methods used to investigate and analyze social programs and criminal justice evaluation procedures.
- Historical Approaches to Studying Crime--Modern-day criminal justice problems approached through an historical perspective of violent and non-violent crimes.

- State Legislative Planning for Correctional Reform--Methods and resources for planning and developing appropriate correctional legislation at the state level.
- Prevention and Detection of Fraud, Waste, and Abuse of Public Funds--A conference of state and local practitioners, researchers, and federal officials to assess needs and develop strategies to prevent and detect fraud, waste, and abuse of public funds.
- The Serious Juvenile Offender--Review of research and development needs for planning (in cooperation with the National Institute of Juvenile Justice and Delinquency Prevention).
- Stochastic Modeling--A promising new technique for crime analysis.
- Plea Bargaining--Current issues and new research on this judicial process.
- Second National Workshop on Criminal Justice Evaluation--The entire spectrum of criminal justice research and evaluation issues.
- Forensic Science Services and the Administration of Justice--Interdisciplinary exchange of views among various members of the criminal justice community.
- Mental Health Services in Local Jails--Models for improving service delivery.
- The Career Criminal--Implications of research from the NIJ Career Criminal program.
- Argersinger v. Hamlin--Legal counsel for indigents facing jail.
- Update '77: Update '78--The role of local officials in criminal justice decisionmaking.
- Determinate Sentencing--Implications of this trend for the criminal justice system.
- Pretrial Release--Discussion of a demonstration project with judges from all 50 states.
- Crime Control: State of the Art--An update of criminal justice knowledge for governors and representatives of State Planning Agencies.
- Urban Crisis Planning--Simulated planning of responses to hypothetical crisis situations.
- Performance Measurement--Organizational assessment techniques for police, courts, and corrections.

Additional SNW's will be scheduled as significant research and evaluation results occur and state/local needs are identified.

Field Test Support

Field Test Support provides technical assistance and training for staff and policymakers at sites selected to implement NIJ Field Test designs. These designs represent promising new operational approaches to controlling crime or improving criminal justice.

The Field Tests involve carefully designed program strategies that are implemented in a limited number of sites under controlled or quasi-controlled conditions to determine the effectiveness, transferability, and suitability of the concepts for further demonstration.

Key representatives from the Field Test sites receive training and technical assistance designed to:

- Orient test-site staff on the goals, methods, and requirements of the Field Test project
- Build skills in the particular program technology
- Assist in project implementation
- Assist test agencies in conducting technology transfer conferences to familiarize colleagues in nearby jurisdictions with the test experience.

Field Tests currently in operation or in the planning stage are:

- Employment Services for Ex-Offenders

Boston, Chicago, and San Diego are the sites of this field test to examine the impact of employment services in reducing recidivism and increasing job tenure for ex-offenders. The test will assess the influence of follow-up support services that supplement expanded vocational training, counseling, and job placement in preventing post-release criminal behavior.

- Supervised Pre-Trial Release

This field test provides services to facilitate the release of defendants who are unable to post bail or are ineligible for release on their own recognizance. The goals of the approach include reducing arrests during pre-trial release, insuring court appearances, and reducing jail overcrowding. Participating jurisdictions are Portland (Ore.), Milwaukee, and Miami.

- Differential Police Response to Calls for Service

The increased volume of citizen-initiated calls for service in recent years, coupled with strained police budgets, has made it increasingly difficult for police departments to respond to all calls for service in the traditional manner of sending a patrol unit as quickly as possible while maintaining their current level of activity in other areas. Departments have attempted to meet these competing demands through various approaches, all of which share the common objective of developing

more efficient means of allocating available resources. Three police departments in Garden Grove, California, Toledo, Ohio, and Greensboro, North Carolina will participate in attempting further efficiencies through the development and implementation of a refined call classification scheme, an expanded range of response techniques, and optimal matching of calls to response. The resulting quality of police services will be measured by police effectiveness and costs as well as citizen satisfaction.

- Early Representation by Defense Counsel

Three local public defender offices will participate in this test to determine the effects of early representation on the operations of the participating public defender agencies, the quality of attorney-client relations and the impact on other components of the criminal justice system in processing felony cases. Each participating site will develop procedures for defense counsel representation for indigent clients at or near the point of arrest and sufficiently in advance of the initial court appearance. The test shall determine in a systematic fashion whether the limited research and empirical evidence are valid that indicate early representation will speed the process by which cases are disposed and will improve the overall quality of representation.

- Differentiated Parole Supervision

Parole supervision, which aims at both surveillance and service, has been criticized in recent years for providing neither effectively. Neither style of supervision has had its outcomes carefully observed and distinguished from one another. This field test aims at providing information which will help parole agencies select and implement supervision methods best suited to different types of clients. Models to be investigated include control oriented parole, service oriented parole, traditional supervision, and summary parole.

- Commercial Security

Conducted in St. Louis, Denver, and Long Beach (Calif.), the Commercial Security Field Test will assess the merits of procedures to reduce commercial crime in small retail and service businesses. Aimed at such crimes as robbery, burglary, and larceny, the test program includes security surveys of businesses in selected commercial neighborhoods with high crime rates. Close police-community interaction and follow-up activities to encourage adoption of the security recommendations are also emphasized.

- Structured Plea Negotiation

Though widely criticized and misunderstood, "plea bargaining" accounts for 80 to 95 percent of case disposition in many jurisdictions. This field test will create in participating jurisdictions a structured conference procedure involving not only the defense and prosecuting attorneys, but also a judge, the defendant, and the crime victim. The experiment will analyze whether the approach increases consistency and

fairness of plea bargaining agreements (in fact and in the public's perceptions), speeds case dispositions, and streamlines court operations. Wayne County (Detroit), Michigan, Jefferson County (Louisville), Kentucky and Pinellas County (Clearwater), Florida are conducting the test.

- Multijurisdictional Sentencing Guidelines

Participating in this test are four courts of general jurisdiction representing urban, suburban, and rural areas in Florida and Maryland. The test will study past sentencing decisions in these courts, then use the information to develop sentencing guidelines that judges in the participating courts will follow for a 1-year experiment. The test will determine the feasibility of using sentencing guidelines as a tool for reducing unwarranted sentencing variation and articulating sentencing policy in diverse jurisdictions.

Other Field Tests receiving support from RUP since 1976 are:

- Managing Criminal Investigations
- Juror Usage and Management
- Neighborhood Justice Centers
- Pre-Release Centers
- Managing Patrol Operations
- Improved Correctional Field Services.

Results

The most recent Research Utilization Workshop findings imply long-term potential for change in these areas:

- Compensating Victims of Crime--About three-fourths of the participants indicated that they gained additional insights on basic issues for establishing and operating a victim compensation program.
- Management of Stress in Corrections--The results on actions taken by participants soon after the workshop indicate that at least three-fourths of the respondents perceived the concepts presented at the workshops as appropriate for their systems/institutions. Specifically, impact of the workshops is indicated by actual progress on preliminary steps that should lead to organizational change.

Internal and external evaluations were conducted on selected 1979 topics. Results of both show significant progress in the initial phases of the change process. Both the internal and external evaluation results were consistent with each other.

- Maintaining Municipal Integrity--About half the participants reported a heightened awareness of ethical issues and said they have taken steps to assess their jurisdictions' investigative ability, vulnerability to corruption, and regulatory and enforcement capabilities.

- Operating a Defender Office--Over half the participants reviewed their personnel policies. Almost half evaluated their current scope of services and determined areas where additional staff training was needed.
- Improved Probation Strategies--Over half the probation officials at the workshops have subsequently disseminated strategies for improving probation and evaluated their present services. Almost half have reviewed current caseloads and assessed available resources for planning and implementing a more efficient monitoring system.
- Managing Patrol Operations--Over half the police personnel analyzed their patrol operations using the systematic assessment procedures presented at the workshop.

Results also show that a majority of participants reported positive effects on their activities:

- Health Care in Correctional Institutions--Two-thirds of the medical, correctional, and planning personnel who attended the workshop evaluated their health care procedures and began generating outside support for change. About half revised both their medical record and medication distribution systems and stopped using inmates to deliver health care services.
- Victim/Witness Services--Almost three-fourths of the participants--prosecutors, law enforcement officials, and community organizers--publicized new victim/witness services and sought new advocates for such programs. More than half attempted to increase interagency cooperation in this area.
- Managing Criminal Investigations--Changes in case screening, initial investigations, and management of investigations were reported by about half the participants.
- Juror Usage and Management--Over half the participants instituted changes in their jury selection and use procedures after attending this workshop.
- Rape and its Victims--Over three-fourths of those attending the workshop reported increased cooperation and communication among community agencies providing services to rape victims.

About the Office of Development, Testing, and Dissemination

Within the National Institute of Justice, the Office of Development, Testing, and Dissemination is responsible for distilling research findings, transforming the theoretical into the practical, and identifying programs with measurable records of success that warrant widespread application. As part of its program, ODTD also provides financial and technical assistance in adapting and testing model programs in selected communities. The Office also disseminates information to justice system executives nationwide through a variety of vehicles. The aim is to give justice professionals ready access to promising new approaches in the administration of justice.

ODTD has built a system to bridge the operational gap between theory and practice and the communication gap between researchers and practitioners. The program provides:

- Practical guidelines for model justice system programs
- Research utilization workshops for key executives that explain selected model programs based on promising research and evaluation findings
- Field tests of important new approaches in different communities
- On-site training visits for justice system officials to agencies operating successful, innovative programs
- Clearinghouse and reference services for the international justice community.

CUTBACK MANAGEMENT IN AN ERA OF SCARCITY:

HARD QUESTIONS FOR HARD TIMES

by

Charles H. Levine

University of Kansas

Reprinted with permission of Charles H. Levine.

CUTBACK MANAGEMENT IN AN ERA OF SCARCITY:

HARD QUESTIONS FOR HARD TIMES*

Charles H. Levine

We are entering a new era of public budgeting, personnel, and program management. It is an era dominated by resource scarcity. It will be a period of hard times for government managers that will require them to manage cutbacks, tradeoffs, reallocations, organizational contractions, program terminations, sacrifice, and the unfreezing and freeing up of grants and privileges that have come to be regarded as unnegotiable rights, entitlements, and contracts. It will be a period desperately in need of the development of a methodology for what I call "cutback management."/1/

Let me explain why this will not be an easy time to manage government programs. Writing in 1965--in happier times--Robert Lane, in an article entitled "The Politics of Consensus in an Age of Affluence," observed that support for government and political tolerance were promoted by economic growth and government expansion: "Since everyone is 'doing better' year by year, though with different rates of improvement, the stakes are not so much in terms of gain or loss, but in terms of size of gain--giving government more clearly the image of a regarding rather than a punishing instrument."/2/ In 1969, Allen Schick added to this with an observation of his own:

"If there were losers in American politics, there was no need for concern, for they, too, could look to a better tomorrow when they would share in the political bargains and benefits."/3/

Cast against these observations, the challenge of scarcity and public sector contraction to the viability of our political and administrative systems should be obvious: growth slowdowns, zero growth, and absolute declines--at least in some sectors, communities, regions, and organizations--will increase the probability of rancorous conflict, decrease the prospects for innovation by consensus, and complicate the processes for building and maintaining support for administrative systems and democratic processes. In this potentially turbulent environment, the dominant management imperatives will likely involve a search for new ways of maintaining credibility, civility, and consensus; that is, in an era of scarcity, we will need new solutions to problems of how to manage public organizations and maintain the viability of democratic processes.

I have no ready solutions for these hard questions. I do not know of anyone else with solutions either. For now, I can only pose some questions which may point the way to the development of a methodology for cutback management:

*An earlier version of this article was presented as an address to the American Association for Budget and Program Analysis, Washington, D.C., November 7, 1978.

1. Why cutbacks? What is causing the need to make cuts?
2. What is cutback management? Why is it different and difficult?
3. What are the unique problems and paradoxes of cutback situations?
4. What strategic choices must managers make in cutting back?
5. What do these questions and problems suggest as directions for future research?

Why Cutbacks?

Cutbacks breed an atmosphere of uncertainty and insecurity. Employees, clients, and interested third parties demand that the causes for cutbacks be brought under control, be eliminated altogether, or at least be accurately forecast so their impacts can be anticipated and programmed. A starting point is to understand that cutbacks have a number of different causes that condition the ability of management to forecast, cope, or act on them; that is, some causes of cuts are more traceable and tractable than others.

The most familiar cause of cuts is problem depletion; cuts occur when a problem is solved, alleviated, brought under control, or when the demand that it be solved diminishes. Perhaps the best example of problem depletion has been the effect of demographic changes on the education system. Because our population has aged, schools have been forced to close or curtail activities considerably.

We have also had some problems redefined due to new and emerging technological changes and opportunities. An example is the movement to deinstitutionalize the mentally ill. Whether deinstitutionalization was prompted by cost considerations or humanistic impulses is unclear since both factors were important. The important point is that deinstitutionalization would have been impossible were it not for pharmaceutical advances in the development of tranquilizers and antidepressants. In this case, deinstitutionalization has led to the closing and scaling down of institutions for the mentally ill.

Problem depletion is common and often well publicized. It usually involves a growth and decline cycle where resources are built up and committed in great haste to tackle a public problem and then gradually withdrawn as the problem diminishes. Perhaps the best recent example of a development cycle has occurred in the space program where NASA peaked with the development of the Apollo program and has been drawing down ever since. A similar experience has occurred during wartime when the Department of Defense has rapidly grown and then been reduced during peacetime. The tendency of public problems to go through development cycles and the difficulty of dismantling public programs even after the problems for which they were originally created disappear or become less troublesome has not gone unnoticed^{4/}. Recent experiments with Sunset legislation (where programs are brought under review usually three to five years after their initiation) are aimed at attuning public funding to problem depletion rather than to an agency's survival needs.

A second familiar cause for cuts in public budgets stems from the erosion of the economic base of some of our cities and States. The litany of problems in our older cities and in the Northeast in general over the past 20 years

underlines the agony of managing decline: The growth of dependent populations, the suburbanization of business and industry, and the shifts in economic activity to the Sunbelt from the Frostbelt have put some areas in the impossible position of needing to do more but being forced by declining tax bases to do less. The well-publicized fiscal problems of New York City and Cleveland and the retrenchment of their bureaucracies represent just the most advanced cases of a widespread national problem.

The third type of cause for cutbacks is inflation. The cost of government has risen rapidly over the past ten years -- at least doubling in most cases -- and has really taken off over the last five years. Because of its service nature, most government costs are incurred by personnel. In an environment of leveling or declining economic growth, something has to give. This means that in order to make any appreciable savings, cuts must be made in personnel and subsequently in the services government agencies offer.

Taxpayer revolts, a fourth cause of cutbacks has surfaced recently along with much speculation -- mostly tied to Proposition 13 -- about their causes. These explanations usually include reference to the difficulty of tracing the well-being of individual taxpayers to specific government services, the desire of voters to alleviate the impact of inflation on their personal disposable incomes, the backlash of taxpayers against the salary increases of unionized public workers and the services offered to the poor and minorities, and the cumbersomeness of financing local services through the mechanism of the property tax. In combination, these explanations seem to capture much of the cause for taxpayer discontent with government. Assessment increases, linked to inflation in the price of housing, in particular, have made tax limitation and roll-back initiatives attractive alternatives to the financially pressed homeowner (irrespective of their future implications for service delivery).

A fifth cause of cutbacks -- limits to growth -- directly or indirectly overarches the others. Our dependence on depletable resources and foreign energy sources has created a severe imbalance between exports and imports, and it is not clear whether we will be able to find substitutes or additional sources of energy by the end of this century. We can also anticipate a further slowing down in the rate of economic growth (at least for the next decade or two) as our work force ages, our rate of productivity growth continues to decline, and the rate of growth in innovations (as expressed in patent applications) continues to level off. Besides these factors there are numerous other indicators that suggest that the contraction of the public sector has been caused in part by problems which are deeply rooted in the structure and functioning of our culture and economic system.

What is Cutback Management? Why is it Different?

Cutback management means managing organizational change toward lower levels of resource consumption and organizational activity. Cutting back an organization involves making hard decisions about who will be let go, what programs will be scaled down or terminated, and what clients will be asked to make sacrifices. These are tough problems that are compounded by four aspects of resource scarcity. First, behavioral scientists have demonstrated that change is most easily accomplished when the people affected have something to gain, but under conditions of austerity the acceptance of change will be unlikely because the rewards required to gain cooperation and build consensus will be unavailable. Second,

public organizations are confronted with norms, civil service procedures, veteran's preference, affirmative action commitments, and collective bargaining agreements which constrain the ability of management to target cuts. Third, organizational contraction produces some serious morale and job satisfaction problems which make it difficult to increase productivity to make up for the cuts. Fourth, cutbacks reduce the enjoyment of working and managing in an organization because nearly everyone is forced into a position of having to do with less. Under these conditions, creativity diminishes, innovation and risk-taking decline, and the sense of excitement that comes from doing new things disappears. Simply put, it just is not as much fun managing a contracting organization as it is an expanding one.

A declining organization confronts its management with several unique problems. The first problem I call "The Paradox of Irreducible Wholes." This problem refers to the fact that an organization cannot be reduced piece by piece by simply reversing the sequence of activities and resources by which it was built. The "lumpiness" of public organizations stems from the growth process in which critical masses of expertise, political support, facilities, equipment, and resources are assembled. Taking a living thing like an organization apart is no easy matter; a cut may reverberate throughout a whole organization in a way no one could predict by just analysing its growth and pattern of development.

The criminal justice system provides one example of the complexity of scaling down public services. Over time, the criminal justice system has become increasingly interpenetrated and interdependent so that functional agencies like the police, courts, parole, corrections, and juvenile services continually interact and depend on one another. Yet each of these units are often controlled and funded by different decisionmaking bodies -- local governments, State and Federal agencies, independent boards, etc. If a cut is made in one function or funding source, it will likely impact on the other units in the system; but because of the fragmentation of political and managerial decisionmaking, coordinating and planning these cuts on a multiunit basis will likely be extremely difficult, if not impossible.

The second problem is "The Management Science Paradox". This problem is caused by the way public organizations invest in and use their data systems and analytic capacity. When organizations have slack resources, they often develop elaborate management information systems, policy analysis capabilities, and hardware and software systems. But when resources abound, this capacity is rarely used because public agencies usually prefer to spend slack resources building and maintaining political constituencies. In a decline situation, on the other hand, maintaining and using this analytic capacity often becomes impossible for a number of reasons. The scenario goes something like this: First, the most capable analysts are lured away by better opportunities; then freezes cripple the agency's ability to hire replacements; and finally, the remaining staff is cut in order to avoid making cuts in personnel with direct service responsibility. All the while, organizational decisions on where to take cuts will be made on political grounds with important constituencies fully mobilized to protect their favorite programs. Therefore, in brief, the management science paradox means that when you have analytic capacity you do not need it; when you need it, you do not have it and cannot use it anyway.

The third quandary is "The Free-Exiter Problem." Economists have identified what they call "free riders," i.e., people who take advantage of an organization's collective goods without contributing their share to achieving the organization's goals. When an organization is growing, the problem for management is how to prevent (exclude) free riders from enjoying the fruits of growth such as promotions, travel, training opportunities, and other available slack resources. During contraction, however, organizations must find ways to limit (include) free exiters, i.e., people who seek to avoid sharing the "collective bads" produced by the necessity to make sacrifices by either leaving the organization or avoiding its sacrifices. Some potential free exiters, like skilled technical people and talented managers, are vitally needed if the organization is to function well through a contraction. Yet these people have the greatest employment mobility, and their replacements are usually the hardest to attract to a declining organization. The problem which declining organizations have to solve is how to design mechanisms to limit free exiters and reward valuable people for remaining in the organization through its difficult times.

The fourth problem is "The Tooth Fairy Syndrome."/5/ In the initial stages of contractions, few people are willing to believe that the talk of cuts is for real or that the cuts will be permanent. The initial prevailing attitude in the organization will usually be optimistic, i.e., that the decline is temporary and the cuts will be restored soon by someone -- in some cases as remote as the tooth fairy. Under these conditions, management's credibility suffers and resistance, cynicism, and sarcasm tend to dominate responses to calls for voluntary budget cutting. Top management appeals for voluntary sacrifice tend to be met with a "you first, then me" response from middle and lower levels in the organization. The preferred tactical response for nearly everyone is to delay taking action while waiting for someone else to volunteer cuts or for a bailout from a third party.

The fifth problem is "The Participation Paradox." The field of organization development teaches that the best way to manage change is to encourage the maximum amount of participation by all affected parties. But a rational cutback process will require that some people and programs be asked to take greater cuts than others. By encouraging participation, management also encourages protective behavior by those most likely to be hurt the most. The participation paradox confronts management with a nearly insoluble problem: How does one single out units for large sacrifices who have people participating in the cut process? The usual answer is to avoid deadlocks or rancorous conflict and allocate cuts across the board.

"The Forgotten Deal Paradox" is the sixth problem. Ideally, an organization or unit should be able to plan cuts and attrition on a multiyear basis. Such an optimum arrangement would allow an organization to plan its cuts so that six months, two years, or further on it will be allowed to fill some vacancies, replace some equipment, or restore some services when needed. In the private sector it is possible to make bargains for restoring some cuts later on knowing that they will likely be honored by the management team in the future. This kind of arrangement is much less likely in the public sector because the top management team usually lacks the continuity required to make and keep bargains with a long time frame. Most managers will resist multiyear bargaining if they fear that the other party to the bargain will not be around when the cuts are to be partially restored.

The seventh problem is "The Productivity Paradox." Briefly stated, when dealing with productivity, it takes money to save money. Productivity requires up-front costs incurred by training and equipment expenses. Under conditions of austerity, it is very difficult to find and justify funds to invest in productivity improvement, especially if these funds can only be made available by laying off employees or failing to fill vacancies.

These seven problems are illustrative of the difficulty involved in managing cutbacks. They tend to force management to rethink the process of organizational development and growth; and they force managers to make new kinds of strategic choices in the face of perplexing uncertainty.

What Strategies?

At the present stage of our knowledge about cutback management, strategies are easier to describe than prescribe. So, at this point, we need to be satisfied to raise appropriate questions and hope that later their answers can help managers cope with austerity. A proper start, therefore, is to investigate the major steps in the cutback process, that is, the strategic choices that an organization must make about confronting, planning, targeting, and distributing cuts.

Resist or smooth cuts? When confronting possible cuts, managers and political leaders will have to choose between resisting these cuts or smoothing them out by limiting their impact on the organization's most important functions, procedures, and long-term capacity. Since no organization accedes to cuts with enthusiasm, some initial resistance is likely. But resistance is risky because "stonewalling" financial stress may ultimately force the need to make cataclysmic cuts like massive layoffs; missed paydays; defaults on loans, bonds, and notes; and the selling off of physical facilities and equipment. No responsible manager or public official wants to be caught in that kind of a situation with its unpredictable long-term consequences and embarrassing short-term implications. Sometime, usually quite early in the planning process, an organization's or government's leadership will have to make the choice between struggling to resist cuts or struggling to minimize their negative effects.

Deep gouge or small decrements? This choice is affected by The Forgotten Deal Paradox, that is, the utility of taking deep cuts initially in order to rebuild the organization later is limited by the risk that the resources needed to build back capacity later will not be available. The alternative strategy is to take the cuts year by year in small decrements to minimize their impact in the hope that public support for the agency will increase and the cuts will stop. NASA, an agency which has had 11 straight years of budget cuts in real dollar terms, chose to follow the small-decrement strategy. People familiar with NASA in the late 1970's and who know something about the agency during the 1960's often comment about the detrimental effect the small-decrement strategy has had upon the organization's management systems and some of the management innovations, which it pioneered, like project management. The deep-gouge strategy tends to make the most rational management strategy, but the small-decrement strategy may make the only rational political strategy.

Share the pain or target the cuts? Sharing the pain of cuts by allocating them across the board to all units may minimize pain, help to maintain morale,

and build a good team spirit in the organization; but it is not responsible management. Not every unit in an organization or every agency in a government contributes equally to the goals, purposes, and basic functions of that organization or government. In the initial stages of austerity, however, the preference of public officials will be to avoid conflict by asking for across-the-board cuts from every unit -- usually to be absorbed by vacancies and voluntary attrition. Eventually, however, if an austerity situation gets bad enough, some leadership will emerge to identify and rank priorities and allocate cuts to units based on them. These hard choices will be accompanied by intense debates over such matters as the importance of different services, the method of ranking priorities, and the difficulty of maintaining excellence in an organization when it is declining. Targeting cuts is a difficult job that tends to be avoided by all but the most brave or foolhardy public officials. But if things get bad enough, and the across-the-board strategy is no longer feasible, somewhere along the path of decline top management will have to switch from across-the-board to targeted cuts.

Efficiency or equity? Perhaps the most difficult strategic choice to make in the cutback process involves the tradeoff between efficiency and equity. This dilemma stems from both the cost of delivering services to different populations and the composition of the public workforce. The most dependent parts of our population -- minorities, the poor, the handicapped, and the aged -- are often the most costly to serve. Blind cost-cutting calculated on narrow productivity criteria could do grave harm to them. The dilemma is also compounded by the recent rises in minority public employment and the salience of seniority criteria in laying off public employees; last-in, first-out criteria for layoffs usually means that minorities and women will be differentially hurt -- irrespective of their productivity. Since there will always be a tendency to allocate cuts disproportionately to the politically weak, and productivity criteria could be used to disguise such an intent, we can expect cutbacks to spark much litigation as they become more widespread. The outcome of this litigation will, of course, greatly constrain, but never completely eclipse, managerial and political discretion over the locus and extent of cuts.

Directions for Future Research

To begin to answer these hard questions, a commitment must be made to develop a research program on the management of fiscally stressed public organizations. We know almost nothing about what works best under different kinds of cutback conditions. So the first thing we need to develop is a baseline inventory of tools and techniques for managing cutbacks along with case studies of their application. With this information we can begin to sort out methods for scaling down public organizations and make some judgments about their appropriateness to solve cutback problems of different types and severity.

Second, we need to find methods for solving the credibility, civility, and consensus problems that plague organizations and governments during periods of large-scale cutbacks. We need to invent and perfect democratic processes for allocating cuts which will make cuts effective yet equitable.

Third, we need to devote a great deal of thought to the ethical dimensions of cutbacks. We need to ask, for example, what the ethical responsibility of an organization is to its terminated employees and decoupled clients. No one to my knowledge has systematically struggled with this problem yet.

Finally, we need to understand how cuts affect public expectations and support for government, i.e., whether expectations about government performance will be lowered and tolerance for poor services will be increased. If the post World War II era has been until recently characterized by rising expectations and optimism about an active public sector's ability to solve public problems, will this new era produce a downward spiral of expectations and a pessimism about the efficacy of government to help create a better society? On a similar, but more narrow note, how long and to what depths will Americans tolerate the effects of reduced public services on their lives? For example, how much will roads have to deteriorate from deferred maintenance before potholes become more than a minor irritation? At what point will drivers abandon poorly maintained highways and roads? How irregular and undependable will services become before there develops a movement in the citizenry to reorganize and reassign functions or refund and rebuild public services and facilities? In other words, if support for government services swings back and forth like a pendulum, how poor will services have to become before support for their improvement begins to build?

These are some hard questions we need to worry about. These, I predict, will be some of the dominant issues of public management in the decade ahead.

Austerity, Innovation, and Change

Changes in many of the causes of financial stress are beyond local control or may require long time horizons and enormous public support. Clearly, the redevelopment of a city's economic base cannot be accomplished overnight. Likewise, inflation in the price of energy is mainly a problem of international relations. Even statewide tax limitation initiatives are difficult for local officials to influence.

On the other hand, local officials do not have their hands completely tied. Some functions, like zoos, jails, and local universities, can be reassigned to county or State government. Some services can be "privatized" by installing fees, user charges, and contracting arrangements for special skills, and some services can be consolidated to achieve economies of scale. Services can be "civilianized" through the use of volunteers and nonsworn personnel. Some services can be reduced or eliminated by careful monitoring of the differences between citizen "needs" and citizen "wants." And expenses can be trimmed through overtime control, "downtime management," self-insurance, and new pension arrangements.

More importantly, financial stress promises to force local governments to engage in new ways of thinking about old practices. In the budget area alone, austerity has prompted the adoption of prioritization methods like ZBB to be instituted in cities where only a few months ago line item budgeting seemed immutable.

The enemies of responsible management in these difficult times are complacency, convenience, and wishful thinking. The reluctance of public officials to "bite the bullet" of retrenchment and instead to cope with stress by absorbing attrition and vacancies when they occur may only put off the day when they are forced to lay off valuable employees and sell off city property.

Convenience leads to making cuts across the board. This practice implicitly assumes that all units, agencies, and programs are equally valuable to the community. If the practice of cutting programs across the board were explicitly stated, it would likely produce an ordering of public priorities that would please few people. Somewhere along the line of decline, officials will have to prioritize.

Wishful thinking causes immobility. Hoping, often in the face of overwhelming evidence to the contrary, that the present state of financial stress will only be temporary or that there will be a Federal or State Government bail out, freezes up initiatives. In a climate dominated by wishful thinking, building a realistic approach to financial stress is not easy, but it is a requisite for successfully managing a governmentwide contraction. "Stonewalling" resource scarcity by ignoring it or denying it will only precipitate crisis sometime in the future.

Perhaps the most troublesome aspects of severe financial stress are its political dynamics. Under conditions of the acute resource scarcity, "normal" budgeting -- adding new increments to last year's base appropriations and initiating a few new programs from a large number of feasible ideas -- will no longer be appropriate. In order to provide a new program for a client group, some other programs will have to be discontinued -- and some other client group deprived. This condition is what academic game theorists call "zero-sum politics," that is, taking from Peter to pay Paul. In zero-sum politics at the local level, entrenched interests and neighborhood groups fight to maintain services at prevailing levels against emerging groups with new demands. For local government officials, politics of this kind is likely to produce tension and frustration. Faced with these unattractive consequences, many officials may choose to follow Harry Truman's advice and "get out of the kitchen" rather than face the heat. For some local governments, resource scarcity may therefore also mean a decline in the quality of public servants -- just at the time when cities most need to attract the best leaders with the most imaginative minds and the strongest wills.

The way out of this downward spiral is to adopt a posture of aggressive and imaginative public management. To begin to cope with financial stress, a number of management actions could be taken to alert the public to the problem and prepare employees and clients for its consequences.

The first step must be to assume a positive attitude toward innovation and to help create a citizenry and a bureaucracy willing to experiment with new ideas and methods of providing public services. There are a variety of ways of doing things. With the experience of other governments to draw upon and a willing citizenry and bureaucracy, officials should be able to discover and implement many cost-saving innovations.

The second step is to become convinced that fiscal stress can be managed, i.e., that a rational process for generating new resources, cutting expenses, and finding new sources of productivity gains can be combined with cutbacks to preserve those services most valued by the community. Rational retrenchment will require the prioritization of services and projects, and while the ranking process threatens to produce conflict, the spectre of financial collapse may enable the process to proceed more smoothly than skeptics might at first predict.

The third step involves a marketing strategy to sell taxpayers on the importance and quality of public services. Many problems of financing public services come from the lack of understanding of the public of the complexities of government operations and the difficulties involved in trying to cut costs. Aggressive marketing can build greater citizen appreciation for the efficiency of government agencies and for the fact that most public servants are doing their best to provide quality services at least cost. This understanding may, in turn, yield two more dividends: citizens may accept fewer services when resources are obviously scarce, and taxpayers may eventually vote to provide more revenues to support their government and civil servants.

By engaging in this three step process, local officials may be more than prepared for the hard times ahead; they may also be prepared for the time when resources may flow more freely. And they may also learn once again that courageous management makes good politics.

-
1. For another explication of this theme see Charles H. Levine, "Organizational Decline and Cutback Management," Public Administration Review (July/August 1978), pp. 316-325.
 2. Robert E. Lane, "The Politics of Consensus in an Age of Affluence," American Political Science Review (December 1965), p. 893.
 3. Allen Schick, "Systems Politics and Systems Budgeting," Public Administration Review (March/April 1969), p. 142.
 4. See, for example, Herbert Kaufman, Are Government Organizations Immortal? (Washington, D.C.: The Brookings Institution, 1976).
 5. I credit Robert W. Wilson of Montgomery County (Maryland) Government for first labeling this syndrome for me.

MANAGING STRATEGIC CHANGE

James Brian Quinn
Dartmouth College

Reprinted with permission of James Brian Quinn.

MANAGING STRATEGIC CHANGE

James Brian Quinn
Dartmouth College

In two articles published previously in the SMR, the author described the process of "logical incrementalism" for strategic planning and how it is used effectively in several large corporations. This third and final article in the series analyzes this approach to management--a sort of purposeful "muddling"--in greater detail, delineating the steps which successful managers generally follow in inaugurating and executing strategic change. Ed.

"Just as bad money has always driven out good, so the talented general manager--the person who makes a company go--is being overwhelmed by a flood of so-called professionals, textbook executives more interested in the form of management than the content, more concerned about defining and categorizing and quantifying the job, than in getting it done.... They have created false expectations and wasted untold man-hours by making a religion of formal long-range planning."/1/ H.E. Wrapp, New York Times.

Two previous articles have tried to demonstrate why executives managing strategic change in large organizations should not--and do not--follow highly formalized textbook approaches in long-range planning, goal generation, and strategy formulation./2/ Instead, they artfully blend formal analysis, behavioral techniques, and power politics to bring about cohesive, step-by-step movement toward ends which initially are broadly conceived, but which are then constantly refined and reshaped as new information appears./3/ Their integrating methodology can best be described as "logical incrementalism."

But is this truly a process in itself, capable of being managed? Or does it simply amount to applied intuition? Are there some conceptual structures, principles, or paradigms that are generally useful? Wrapp, Normann, Braybrooke, Lindblom, and Bennis have provided some macrostructures incorporating many important elements they have observed in strategic change situations./4/ These studies and other contributions cited in this article offer important insights into the management of change in large organizations. But my data suggest that top managers in such enterprises develop their major strategies through processes which neither these studies nor more formal approaches to planning adequately explain. Managers consciously and proactively move forward incrementally:

- To improve the quality of information utilized in corporate strategic decisions.
- To cope with the varying lead times, pacing parameters, and sequencing needs of the "subsystems" through which such decisions tend to be made.
- To deal with the personal resistance and political pressures any important strategic change encounters.
- To build the organizational awareness, understanding, and psychological commitment needed for effective implementation.

- To decrease the uncertainty surrounding such decisions by allowing for interactive learning between the enterprise and its various impinging environments.
- To improve the quality of the strategic decisions themselves by
 - (1) systematically involving those with most specific knowledge,
 - (2) obtaining the participation of those who must carry out the decisions, and
 - (3) avoiding premature momenta or closure which could lead the decision in improper directions.

How does one manage the complex incremental processes which can achieve these goals? The earlier articles structured certain key elements;^{5/} these will not be repeated here. The following is perhaps the most articulate short statement on how executives proactively manage incrementalism in the development of corporate strategies:

Typically you start with general concerns, vaguely felt. Next you roll an issue around in your mind till you think you have a conclusion that makes sense for the company. You then go out and sort of post the idea without being too wedded to its details. You then start hearing the arguments pro and con, and some very good refinements of the idea usually emerge. Then you pull the idea in and put some resources together to study it so it can be put forward as more of a formal presentation. You wait for "stimuli occurrences" or "crises," and launch pieces of the idea to help in these situations. But they lead toward your ultimate aim. You know where you want to get. You'd like to get there in six months. But it may take three years, or you may not get there. And when you do get there, you don't know whether it was originally your own idea--or somebody else had reached the same conclusion before you and just got you on board for it. You never know. The president would follow the same basic process, but he could drive it much faster than an executive lower in the organization.^{6/}

Because of differences in organizational form, management style, or the content of individual decisions, no single paradigm can hold for all strategic decisions.^{7/} However, very complex strategic decisions in my sample of large organizations tended to evoke certain kinds of broad process steps. These are briefly outlined below. While these process steps occur generally in the order presented, stages are by no means orderly or discrete. Executives do consciously manage individual steps proactively, but it is doubtful that any one person guides a major strategic change sequentially through all the steps. Developing most strategies requires numerous loops back to earlier stages as unexpected issues or new data dictate. Or decision times can become compressed and require short-circuiting leaps forward as crises occur.^{8/} Nevertheless, certain patterns are clearly dominant in the successful management of strategic change in large organizations.

James Brian Quinn is the William and Josephine Buchanan Professor of Management at The Amos Tuck School of Business Administration, Dartmouth College. Dr. Quinn holds the B.S. degree in engineering from Yale University, the M.B.A. degree from the Harvard Business School, and the Ph.D. degree in economics from Columbia University. He is a well known lecturer and consultant to major U.S. and foreign corporations, U.S. Congress, the State Department, and foreign nations. Dr. Quinn has written widely on corporate and national policy questions, particularly in the technological realm. His new book, Strategies for

Change: Logical Incrementalism, has just been published by Dow Jones-Irwin.

CREATING AWARENESS AND COMMITMENT--INCREMENTALLY

Although many of the sample companies had elaborate formal environmental scanning procedures, most major strategic issues first emerged in vague or undefined terms, such as "organizational overlap," "product proliferation," "excessive exposure in one market," or "lack of focus and motivation."/9/ Some appeared as "inconsistencies" in internal action patterns or "anomalies" between the enterprise's current posture and some perception of its future environment./10/ Early signals may come from anywhere and may be difficult to distinguish from the background "noise" of ordinary communications. Crises, of course, announce themselves with strident urgency in operations control systems. But, if organizations wait until signals reach amplitudes high enough to be sensed by formal measurement systems, smooth, efficient transitions may be impossible./11/

NEED SENSING: LEADING THE FORMAL INFORMATION SYSTEM

Effective change managers actively develop informal networks to get objective information--from other staff and line executives, workers, customers, board members, suppliers, politicians, technologists, educators, outside professionals, government groups, and so on--to sense possible needs for change. They purposely use these networks to short-circuit all the careful screens/12/ their organizations build up to "tell the top only what it wants to hear." For example:

Peter McColough, chairman and CEO of Xerox, was active in many high-level political and charitable activities--from treasurer of the Democratic National Committee to chairman of the Urban League. In addition, he said, "I've tried to decentralize decisionmaking. If something bothers me, I don't rely on reports or what other executives may want to tell me. I'll go down very deep into the organization, to certain issues and people, so I'll have a feeling for what they think." He refused to let his life be run by letters and memos. "Because I came up by that route, I know what a salesman can say. I also know that before I see (memos) they go through fifteen hands, and I know what that can do to them."/13/

To avoid undercutting intermediate managers, such bypassing has to be limited to information gathering, with no implication that orders or approvals are given to lower levels. Properly handled, this practice actually improves formal communications and motivational systems as well. Line managers are less tempted to screen information and lower levels are flattered to be able "to talk to the very top." Since people sift signals about threats and opportunities through perceptual screens defined by their own values, careful executives make sure their sensing networks include people who look at the world very differently than do those in the enterprise's dominating culture. Effective executives consciously seek options and threat signals beyond the status quo. "If I'm not two to three years ahead of my organization, I'm not doing my job" was a common comment of such executives in the sample.

AMPLIFYING UNDERSTANDING AND AWARENESS

In some cases executives quickly perceive the broad dimensions of needed change. But they still may seek amplifying data, wider executive understanding of issues, or greater organizational support before initiating action. Far from accepting

the first satisfactory (satisficing) solution--as some have suggested they do--successful managers seem to consciously generate and consider a broad array of alternatives./14/ Why? They want to stimulate and choose from the most creative solutions offered by the best minds in their organizations. They wish to have colleagues knowledgeable enough about issues to help them think through all the ramifications. They seek data and arguments sufficiently strong to dislodge preconceived ideas or blindly followed past practices. They do not want to be the prime supporters of losing ideas or to have their organizations slavishly adopt "the boss's solution." Nor do they want--through announcing decisions too early--to prematurely threaten existing power centers which could kill any changes aborning.

Even when executives do not have in mind specific solutions to emerging problems, they can still proactively guide actions in intuitively desired directions--by defining what issues staffs should investigate, by selecting principal investigators, and by controlling reporting processes. They can selectively "tap the collective wit" of their organizations, generating more awareness of critical issues and forcing initial thinking down to lower levels to achieve greater involvement. Yet they can also avoid irreconcilable opposition, emotional overcommitment,/15/ or organizational momenta beyond their control by regarding all proposals as "strictly advisory" at this early stage.

As issues are clarified and options are narrowed, executives may systematically alert ever wider audiences. They may first "shop" key ideas among trusted colleagues to test responses. Then they may commission a few studies to illuminate emerging alternatives, contingencies, or opportunities. But key players might still not be ready to change their past action patterns or even be able to investigate options creatively. Only when persuasive data are in hand and enough people are alerted and "on board" to make a particular solution work, might key executives finally commit themselves to it. Building awareness, concern, and interest to attention-getting levels is often a vital--and slowly achieved--step in the process of managing basic changes. For example:

In the early 1970s there was still a glut in world oil supplies. Nevertheless, analysts in the General Motors Chief Economist's Office began to project a developing U.S. dependency on foreign oil and the likelihood of higher future oil prices. These concerns led the board in 1972 to create an ad hoc energy task force headed by David C. Collier, then treasurer, later head of GM of Canada and then of the Buick Division. Collier's group included people from manufacturing, research, design, finance, industry-government relations, and the economics staff. After six months of research, in May of 1973 the task force went to the board with three conclusions: (1) there was a developing energy problem, (2) the government had no particular plan to deal with it, (3) energy costs would have a profound effect on GM's business. Collier's report created a good deal of discussion around the company in the ensuing months. "We were trying to get other people to think about the issue," said Richard C. Gerstenberg, then chairman of GM./16/

CHANGING SYMBOLS: BUILDING CREDIBILITY

As awareness of the need for change grows, managers often want to signal the organization that certain types of changes are coming, even if specific solutions are not in hand. Knowing they cannot communicate directly with the thousands

who would carry out the strategy, some executives purposely undertake highly visible actions which wordlessly convey complex messages that could never be communicated as well--or as credibly--in verbal terms./17/ Some use symbolic moves to preview or verify intended changes in direction. At other times, such moves confirm the intention of top management to back a trust already partially begun--as Mr. McColough's relocation of Xerox headquarters to Connecticut (away from the company's Rochester reprographics base) underscored that company's developing commitment to product diversification, organizational decentralization, and international operations. Organizations often need such symbolic moves--or decisions they regard as symbolic--to build credibility behind a new strategy. Without such actions even forceful verbiage might be interpreted as mere rhetoric. For example:

In GM's downsizing decision engineers said that one of top management's early decisions affected the credibility of the whole weight-reduction program. "Initially, we proposed a program using a lot of aluminum and substitute materials to meet the new 'mass' targets. But this would have meant a very high cost, and would have strained the supplier's aluminum capacity. However, when we presented this program to management, they said, 'Okay, if necessary, we'll do it.' They didn't back down. We began to understand then that they were dead serious. Feeling that the company would spend the money was critical to the success of the entire mass reduction effort."/18/

LEGITIMIZING NEW VIEWPOINTS

Often before reaching specific strategic decisions, it is necessary to legitimize new options, which have been acknowledged as possibilities, but which still entail an undue aura of uncertainty or concern. Because of their familiarity, older options are usually perceived as having lower risks (or potential costs) than newer alternatives. Therefore, top managers seeking change often consciously create forums and allow slack time for their organizations to talk through threatening issues, work out the implications of new solutions, or gain an improved information base that will permit new options to be evaluated objectively in comparison with more familiar alternatives./19/ In many cases, strategic concepts which are at first strongly resisted gain acceptance and support simply by the passage of time, if executives do not exacerbate hostility by pushing them too fast from the top. For example:

When Joe Wilson thought Haloid Corporation should change its name to include Xerox, he first submitted a memorandum asking colleagues what they thought of the idea. They rejected it. Wilson then explained his concerns more fully, and his executives rejected the idea again. Finally Wilson formed a committee headed by Sol Linowitz, who had thought a separate Xerox subsidiary might be the best solution. As this committee deliberated, negotiations were under way with the Rank Organization and the term Rank-Xerox no longer seemed so strange. "And so," according to John Dessauer, "a six-month delay having diluted most opposition, we of the committee agreed that the change to Haloid-Xerox might in the long run produce sound advantages."/20/

Many top executives consciously plan for such "gestation periods" and often find that the strategic concept itself is made more effective by the resulting feedback.

TACTICAL SHIFTS AND PARTIAL SOLUTIONS

At this stage in the process guiding executives might share a fairly clear vision of the general directions of movement. But rarely does a total new corporate posture emerge full grown--like Minerva from the brow of Jupiter--from any one source. Instead, early resolutions are likely to be partial, tentative, or experimental./21/ Beginning moves often appear as mere tactical adjustments in the enterprise's existing posture. As such, they encounter little opposition, yet each partial solution adds momentum in new directions. Guiding executives try carefully to maintain the enterprise's ongoing strengths while shifting its total posture incrementally--at the margin--toward new needs. Such executives themselves might not yet perceive the full nature of the strategic shifts they have begun. They can still experiment with partial new approaches and learn without risking the viability of the total enterprise. Their broad early steps can still legitimately lead to a variety of different success scenarios. Yet logic might dictate that they wait before committing themselves to a total new strategy./22/ As events unfurl, solutions to several interrelated problems might well flow together in a not-yet-perceived synthesis. For example:

In the early 1970s at General Motors there was a distinct awareness of a developing fuel economy ethic. General Motors executives said, "Our conclusions were really at the conversational level--that the big car trend was at an end. But we were not at all sure sufficient numbers of large car buyers were ready to move to dramatically lighter cars. Nevertheless, GM did start concept studies that resulted in the Cadillac Seville.

When the oil crisis hit in 1973, the company responded in further increments at first merely increasing production of the existing small car lines. Then as the crisis deepened, it added another partial solution, the subcompact "T car"--the Chevette and accelerated the Seville's development cycle. Next, as fuel economy appeared more saleable, executives set an initial target by removing 400 pounds from B-C bodies in 1977. As fuel economy pressures persisted and engineering feasibilities offered greater confidence, this target was increased to 800-1000 pounds (three mpg). No step in itself shifted the company's total strategic posture until the full downsizing of all lines was announced. But each partial solution built confidence and commitment toward new direction.

BROADENING POLITICAL SUPPORT

Often these broad emerging strategic thrusts need expanded political support and understanding to achieve sufficient momentum to survive./23/ Committees, task forces, and retreats tend to be favored mechanisms for accomplishing this. If carefully managed, these do not become the "garbage cans" of emerging ideas, as some observers have noted./24/ By selecting the committee's chairman, membership, timing, and agenda, guiding executives can largely influence and predict a desired outcome, and can force other executives toward a consensus. Such groups can be balanced to educate, evaluate, neutralize or overwhelm opponents. They can be used to legitimize new options or to generate broad cohesion among diverse thrusts, or they can be narrowly focused to build momentum. Guiding executives can constantly maintain complete control over these "advisory processes" through their various influences and veto potentials. For example:

IBM's Chairman Watson and Executive Vice President Learson had become concerned over what to do about: third generation computer technology, a proliferation of designs from various divisions, increasing costs of developing software, internal competition among their lines, and the needed breadth of line for the new computer applications they began to foresee. Step by step, they oversaw the killing of the company's huge Stretch computer line (uneconomic), a proposed 8000 series of computers (incompatible software), and the prototype English Scamp Computer (duplicative). They then initiated a series of "strategic dialogues" with divisional executives to define a new strategy. But none came into place because of the parochial nature of divisional viewpoints.

Learson, therefore, set up the SPREAD Committee, representing every major segment of the company. Its twelve members included the most likely opponent of an integrated line (Haanstra), the people who had earlier suggested the 8000 and Scamp designs, and Learson's handpicked lieutenant (Evans). When progress became "hellishly slow," Haanstra was removed as chairman and Evans took over. Eventually the committee came forth with an integrating proposal for a single, compatible line of computers to blanket and open up the market for both scientific and business applications, with "standard interface" for peripheral equipment. At an all-day meeting of the fifty top executives of the company, the report was not received with enthusiasm, but there were no compelling objections. So Learson blessed the silence as consensus saying, "OK, we'll do it"--i.e., go ahead with a major development program./25/

In addition to facilitating smooth implementation, many managers reported that interactive consensus building processes also improve the quality of the strategic decisions themselves and help achieve positive and innovative assistance when things otherwise could go wrong.

OVERCOMING OPPOSITION: "ZONES OF INDIFFERENCE" AND "NO LOSE" SITUATIONS

Executives of basically healthy companies in the sample realized that any attempt to introduce a new strategy would have to deal with the support its predecessor had. Barring a major crisis, a frontal attack on an old strategy could be regarded as an attack on those who espoused it--perhaps properly--and brought the enterprise to its present levels of success. There often exists a variety of legitimate views on what could and should be done in the new circumstances that a company faces. And wise executives do not want to alienate people who would otherwise be supporters. Consequently, they try to get key people behind their concepts whenever possible, to co-opt or neutralize serious opposition if necessary, or to find "zones of indifference" where the proposition would not be disastrously opposed./26/ Most of all they seek "no lose" situations which will motivate all the important players toward a common goal. For example:

When James McFarland took over at General Mills from his power base in the Grocery Products Division, another serious contender for the top spot had been Louis B. "Bo" Polk, a very bright, aggressive young man who headed the corporation's acquisition-diversification program. Both traditional lines and acquisitions groups wanted support for their activities and had high-level supporters. McFarland's corporate-wide "goodness to greatness" conferences (described in earlier articles) first obtained broad agreement on growth goals and criteria for all areas.

Out of this and the related acquisition proposal process came two thrusts: (1) to expand--internally and through acquisitions--in food-related sectors and (2) to acquire new growth centers based on General Mill's marketing skills. Although there was no formal statement, there was a strong feeling that the majority of resources should be used in food-related areas. But neither group was foreclosed, and no one could suggest the new management was vindictive. As it turned out, over the next five years about \$450 million was invested in new businesses, and the majority were not closely related to foods.

But such tactics do not always work. Successful executives surveyed tended to honor legitimate differences in viewpoints and noted that initial opponents often shaped new strategies in more effective directions and became supporters as new information became available. But strong-minded executives sometimes disagreed to the point where they had to be moved or stimulated to leave; timing could dictate very firm top-level decisions at key junctures. Barring crises, however, disciplinary steps usually occurred incrementally as individual executives' attitudes and competencies emerges vis-a-vis a new strategy.

STRUCTURING FLEXIBILITY: BUFFERS, SLACKS, AND ACTIVISTS

Typically there are too many uncertainties in the total environment for managers to program or control all the events involved in effecting a major change in strategic direction. Logic dictates, therefore, that managers purposely design flexibility into their organizations and have resources ready to deploy incrementally as events demand. Planned flexibility requires: (1) proactive horizon scanning to identify the general nature and potential impact of opportunities and threats the firm is most likely to encounter, (2) creating sufficient resource buffers--or slacks--to respond effectively as events actually unfurl, (3) developing and positioning "credible activists" with a psychological commitment to move quickly and flexibly to exploit specific opportunities as they occur, and (4) shortening decision lines from such people (and key operating managers) to the top for the most rapid system response. These--rather than pre-capsuled (and shelved) programs to respond to stimuli which never quite occur as expected--are the keys to real contingency planning.

The concept of resource buffers requires special amplification. Quick access to resources is needed to cushion the impact of random events, to offset opponents' sudden attacks, or to build momentum for new strategic shifts. Some examples will indicate the form these buffers may take.

For critical purchased items, General Motors maintained at least three suppliers, each with sufficient capacity to expand production should one of the others encounter a catastrophe. Thus, the company had expandable capacity with no fixed investment. Exxon set up its Exploration Group to purposely undertake the higher risks and longer-term investments necessary to search for oil in new areas, and thus to reduce the potential impact on Exxon if there were sudden unpredictable changes in the availability of Middle East oil. Instead of hoarding cash, Pillsbury and General Mills sold off unprofitable businesses and cleaned up their financial statements to improve their access to external capital sources for acquisitions. Such access in essence provided the protection of a cash buffer without its investment. IBM's large R&D facility and its project team approach to development assured that it had a pool of people it could quickly shift among various projects to exploit interesting new technologies.

When such flexible response patterns are designed into the enterprise's strategy, it is proactively ready to move on those thrusts--acquisitions, innovations, or resource explorations--which require incrementalism.

SYSTEMATIC WAITING AND TRIAL CONCEPTS

The prepared strategist may have to wait for events, as Roosevelt awaited a trauma like Pearl Harbor. The availability of desired acquisitions or real estate might depend on a death, divorce, fiscal crisis, management change, or an erratic stock market break./27/ Technological advances may have to await new knowledge, inventions, or lucky accidents. Despite otherwise complete preparations, a planned market entry might not be wise until new legislation, trade agreements, or competitive shake-outs occur. Organizational moves have to be timed to retirements, promotions, management failures, and so on. Very often the specific strategy adopted depends on the timing or sequence of such random events./28/ For example:

Although Continental Group's top executives had thoroughly discussed and investigated energy, natural resources, and insurance as possible "fourth legs" for the company, the major acquisition possibilities were so different that the strategic choice depended on the fit of particular candidates--e.g., Peabody Coal or Richmond Insurance--within these possible industries. The choice of one industry would have precluded the others. The sequence in which firms became available affected the final choice, and that choice itself greatly influenced the whole strategic posture of the company.

In many of the cases studied, strategists proactively launched trial concepts--Mr. McColough's "architecture of information" (Xerox), Mr. Spoor's "Super Box" (Pillsbury)--in order to generate options and concrete proposals. Usually these "trial balloons" were phrased in very broad terms. Without making a commitment to any specific solution, the executive can activate the organization's creative abilities. This approach keeps the manager's own options open until substantive alternatives can be evaluated against each other and against concrete current realities. It prevents practical line managers from rejecting a strategic shift, as they might if forced to compare a "paper option" against well-defined current needs. Such trial concepts give cohesion to the new strategy while enabling the company to take maximum advantage of the psychological and informational benefits of incrementalism.

SOLIDIFYING PROGRESS--INCREMENTALLY

As events move forward, executives can more clearly perceive the specific directions in which their organizations should--and realistically can--move. They can seek more aggressive movement and commitment to their new perceptions, without undermining important ongoing activities or creating unnecessary reactions to their purposes.

Until this point, new strategic goals might remain broad, relatively unrefined, or even unstated except as philosophic concepts. More specific dimensions might be incrementally announced as key pieces for information fall into place, specific unanswered issues approach resolution, or significant resources have to be formally committed.

CREATING POCKETS OF COMMITMENT

Early in this stage, guiding executives may need to actively implant support in the organization for new thrusts. They may encourage an array of exploratory projects for each of several possible options. Initial projects can be kept small, partial, or ad hoc, neither forming a comprehensive program nor seeming to be integrated into a cohesive strategy. Executives often provide stimulating goals, a proper climate for imaginative proposals, and flexible resource support, rather than being personally identified with specific projects. In this way they can achieve organizational involvement and early commitment without focusing attention on any one solution too soon or losing personal credibility if it fails.

Once under way, project teams on the more successful programs in the sample become ever more committed to their particular areas of exploration. They become pockets of support for new strategies deep within the organization. Yet, if necessary, top managers could delay until the last moment their final decisions blending individual projects into a total strategy. Thus, they were able to obtain the best possible match among the company's technical abilities, its psychological commitments, and its changing market needs. By making final choices more effectively--as late as possible with better data, more conscientiously investigation options, and the expert critiques competitive projects allowed--these executives actually increased technical and market efficiencies of their enterprises, despite the apparent added costs of parallel efforts./29/

In order to maintain their own objectivity and future flexibility, some executives choose to keep their own political profiles low as they build a new consensus. If they seem committed to a strategy too soon, they might discourage others from pursuing key issues which should be raised./30/ By stimulating detailed investigations several levels down, top executives can seem detached yet still shape both progress and ultimate outcomes by reviewing interim results and specifying the timing, format, and forums for the release of data. When reports come forward, these executives can stand above the battle and review proposals objectively, without being personally on the defensive for having committed themselves to a particular solution too soon. From this position they can more easily orchestrate a high-level consensus on a new strategic trust. As an added benefit, negative decisions on proposals often come from a group consensus that top executives can simply confirm to lower levels, thereby preserving their personal veto for more crucial moments. In many well-made decisions people at all levels contribute to the generation, amplification, and interpretation of options and information to the extent that it is often difficult to say who really makes the decision./31/

FOCUSING THE ORGANIZATION

In spite of their apparent detachment, top executives do focus their organizations on developing strategies at critical points in the process. While adhering to the rhetoric of specific goal setting, most executives are careful not to state new goals in concrete terms before they have built a consensus among key players. They fear that they will prematurely centralize the organization, preempt interesting options, provide a common focus for otherwise fragmented opposition, or cause the organization to act prematurely to carry out a specific commitment. Guiding executives may quietly shape the many alternatives flowing

upward by using what Wrapp refers to as "a hidden hand." Through their information networks they can encourage concepts they favor, let weakly supported options die through inaction, and establish hurdles or tests for strongly supported ideas with which they do not agree but which they do not wish to oppose openly.

Since opportunities for such focusing generally develop unexpectedly, the timing of key moves is often unpredictable. A crisis, a rash of reassignments, a reorganization, or a key appointment may allow an executive to focus attention on particular thrusts, add momentum to some, and perhaps quietly phase out others./32/ Most managers surveyed seemed well aware of the notion that "if there are not other options, mine wins." Without being Machiavellian, they did not want misdirected options to gain strong political momentum and later have to be terminated in an open bloodbath. They also did not want to send false signals that stimulated other segments of their organizations to make proposals in undesirable directions. They sensed very clearly that the patterns in which proposals are approved or denied will inevitably be perceived by lower echelons as precedents for developing future goals or policies.

MANAGING COALITIONS

Power interactions among key players are important at this stage of solidifying progress. Each player has a different level of power determined by his or her information base, organizational position, and personal credibility./33/ Executives legitimately perceive problems or opportunities differently because of their particular values, experiences, and vantage points. They will promote the solutions they perceive as the best compromise for the total enterprise, for themselves, and for their particular units. In an organization with dispersed power, the key figure is the one who can manage coalitions./34/ Since no one player has all the power, regardless of that individual's skill or position, the action that occurs over time might differ greatly from the intentions of any of the players./35/ Top executives try to sense whether support exists among important parties for specific aspects of an issue and try to get partial decisions and momenta going for those aspects. As "comfort levels" or political pressures within the top group rise in favor of specific decisions, the guiding executive might, within his or her concept of a more complete solution, seek--among the various features of different proposals--a balance that the most influential and credible parties can actively support. The result tends to be a stream of partial decisions on limited strategic issues made by constantly changing coalitions of the critical power centers./36/ These decisions steadily evolve toward a broader consensus, acceptable to both the top executive and some "dominant coalition" among these centers. As a partial consensus emerges, top executives might crystallize issues by stating some broad goals in more specific terms for internal consumption. Finally, when sufficient general acceptance exists and the timing is right, the goals may begin to appear in more public announcements. For example:

As General Mills divested several of its major divisions in the early 1960s, its annual reports began to refer to these as deliberate moves "to concentrate on the company's strengths" and "to intensify General Mills's efforts in the convenience foods field." Such statements could not have been made until many of the actual divestitures were completed, and a sufficient consensus existed among the top executives to support the new corporate concept.

FORMALIZING COMMITMENT BY EMPOWERING CHAMPIONS

As each major strategic thrust comes into focus, top executives try to ensure that some individual or group feels responsible for its goals. If the trust will project the enterprise in entirely new directions, executives often want more than mere accountability for its success--they want real commitment./37/ A significantly new major thrust, concept, product, or problem solution frequently needs the nurturing hand of someone who genuinely identifies with it and whose future depends on its success. For example:

Once the divestiture program at General Mills was sufficiently under way, General Rawlings selected young "Bo" Polk to head up an acquisition program to use the cash generated. In this role Polk had nothing to lose. With strong senior management in the remaining consumer products division, the ambitious Polk would have had a long road to the top there. In acquisitions, he provided a small political target, only a \$50,000 budget in a \$500 million company. Yet he had high visibility and could build his own power base, if he were successful. With direct access to and the support of Rawlings he would be protected through his early ventures. All he had to do was make sure his first few acquisitions were successful. As subsequent acquisitions succeeded, his power base could feed on itself--satisfying both Polk's ego needs and the company's strategic goals.

In some cases, top executives have to wait for champions to appear before committing resources to risky new strategies. They may immediately assign accountability for less dramatic plans by converting them into new missions for ongoing groups.

From this point on, the strategy process is familiar. The organization's formal structure has to be adjusted to support the strategy./38/ Commitment to the most important new thrusts has to be confirmed in formal plans. Detailed budgets, programs, controls, and reward systems have to reflect all planned strategic thrusts. Finally, the guiding executive has to see that recruiting and staffing plans are aligned with the new goals and that--when the situation permits--supporters and persistent opponents of intended new thrusts are assigned to appropriate positions.

CONTINUING THE DYNAMICS BY ERODING CONSENSUS

The major strategic changes studied tended to take many years to accomplish. The process was continuous, often without any clear beginning or end./39/ The decision process constantly molded and modified management's concerns and concepts. Radical crusades became the new conventional wisdom, and over time totally new issues emerged. Participants or observers were often not aware of exactly when a particular decision had been made/40/ or when a subsequent consensus was created to supersede or modify it; the process of strategic change was continuous and dynamic. Several GM executives described the frequently imperceptible/41/ way in which many strategic decisions evolved:

We use an iterative process to make a series of tentative decisions on the way we think the market will go. As we get more data we modify these continuously. It is often difficult to say who decided something and when--or even who originated a decision....Strategy really evolves as a series of incremental steps....I frequently don't know when a decision is made in General Motors. I don't remember being in a committee meeting when things came to a vote. Usually someone

will simply summarize a developing position. Everyone else either nods or states his particular terms of consensus.

A major strategic change in Xerox was characterized this way:

How was the overall organization decision made? I've often heard it said that after talking with a lot of people and having trouble with a number of decisions which were pending, Archie McCardell really reached his own conclusion and got Peter McColough's backing on it. But it really didn't happen quite that way. It was an absolutely evolutionary approach. It was a growing feeling. A number of people felt we ought to be moving toward some kind of matrix organization. We have always been a pretty democratic type of organization. In our culture you can't come down with mandates or ultimatums from the top on major changes like this. You almost have to work these things through and let them grow and evolve, keep them on the table so people are thinking about them and talking about them.

Once the organization arrives at its new consensus, the guiding executive has to move immediately to insure that this new position does not become inflexible. In trying to build commitment to a new concept, individual executives often surround themselves with people who see the world in the same way. Such people can rapidly become systematic screens against other views. Effective executives therefore purposely continue the change process, constantly introducing new faces and stimuli at the top. They consciously begin to erode the very strategic thrusts they may have just created--a very difficult, but essential, psychological task.

INTEGRATION OF PROCESSES AND OF INTERESTS

In the large enterprises observed, strategy formulation was a continuously evolving analytical-political consensus process with neither a finite beginning nor a definite end. It generally followed the sequence described above. Yet the total process was anything but linear. It was a groping, cyclical process that often circled back on itself, with frequent interruptions and delays. Pfiffner aptly describes the process of strategy formation as being "like fermentation in biochemistry, rather than an industrial assembly line."/42/

Such incremental management processes are not abrogations of good management practice. Nor are they Machiavellian or consciously manipulative maneuvers. Instead, they represent an adaptation to the practical psychological and informational problems of getting a constantly changing group of people with diverse talents and interests to move together effectively in a continually dynamic environment. Much of the impelling force behind logical incrementalism comes from a desire to tap the talents and psychological drives of the whole organization, to create cohesion, and to generate identity with the emerging strategy. The remainder of that force results from the interactive nature of the random factors and lead times affecting the independent subsystems that compose any total strategy.

AN INCREMENTAL--NOT PIECEMEAL--PROCESS

The total pattern of action, though highly incremental, is not piecemeal in well-managed organizations. It requires constant, conscious reassessment of the total organization, its capacities, and its needs as related to surrounding environments. It requires continual attempts by top managers to integrate these actions

into an understandable, cohesive whole. How do top managers themselves describe the process? Mr. Estes, president of General Motors, said:

"We try to give them the broad concepts we are trying to achieve. We operate through questioning and fact gathering. Strategy is a state of mind you go through. When you think about a little problem, your mind begins to think how it will affect all the different elements in the total situation. Once you have had all the jobs you need to qualify for his position, you can see the problem from a variety of viewpoints. But you don't try to ram your conclusions down people's throats. You try to persuade people what has to be done and provide confidence and leadership for them."

FORMAL-ANALYTICAL TECHNIQUES

At each stage of strategy development, effective executives constantly try to visualize the new patterns that might exist among the emerging strategies of various subsystems. As each subsystem strategy becomes more apparent, both its executive team and top-level groups try to project its implications for the total enterprise and to stimulate queries, support, and feedback from those involved in related strategies. Perceptive top executives see that the various teams generating subsystem strategies have overlapping members. They require periodic updates and reviews before higher echelon groups that can bring a total corporate view to bear. They use formal planning processes to interrelate and evaluate the resources required, benefits sought, and risks undertaken vis-a-vis other elements of the enterprise's overall strategy. Some use scenario techniques to help visualize potential impacts and relationships. Others utilize complex forecasting models to better understand the basic interactions among subsystems, the total enterprise, and the environment. Still others use specialized staffs, "devil's advocates," or "contention teams" to make sure that all important aspects of their strategies receive a thorough evaluation.

POWER-BEHAVIORAL ASPECTS: COALITION MANAGEMENT

All of the formal methodologies help, but the real integration of all the components in an enterprise's total strategy eventually takes place only in the minds of high-level executives. Each executive may legitimately perceive the intended balance of goals and thrusts differently. Some of these differences may be openly expressed as issues to be resolved when new information becomes available. Some differences may remain unstated--hidden agendas to emerge at later dates. Others may be masked by accepting so broad a statement of intention that many different views are included in a seeming consensus, when a more specific statement might be divisive. Nevertheless, effective strategies do achieve a level of understanding and consensus sufficient to focus action.

Top executives deliberately manage the incremental processes within each subsystem to create the basis for consensus. They also manage the coalitions that lie at the heart of most controlled strategy developments./43/ They recognize that they are at the confluence of innumerable pressures--from stockholders, environmentalists, government bodies, customers, suppliers, distributors, producing units, marketing groups, technologists, unions, special issue activists, individual employees, ambitious executives, and so on--and that knowledgeable people of goodwill can easily disagree on proper actions. In response to changing pressures and coalitions among these groups, the top management team constantly forms and reforms its own coalitions on various decisions./44/

Most major strategic moves tend to assist some interests--and executives' careers--at the expense of others. Consequently, each set of interests serves as a check on the others and thus helps maintain the breadth and balance of strategy./45/ To avoid significant errors some managers try to ensure that all important groups have representation at or access to the top./46/ The guiding executive group may continuously adjust the number, power, or proximity of such access points in order to maintain a desired balance and focus./47/ These delicate adjustments require constant negotiations and implied bargains within the leadership group. Balancing the forces that different interests exert on key decisions is perhaps the ultimate control top executives have in guiding and coordinating the formulation of their companies' strategies./48/

ESTABLISHING, MEASURING, AND REWARDING KEY THRUSTS

Few executives or management teams can keep all the dimensions of a complex evolving strategy in mind as they deal with the continuous flux of urgent issues. Consequently, effective strategic managers seek to identify a few central themes that can help to draw diverse efforts together in a common cause./49/ Once identified, these themes help to maintain focus and consistency in the strategy. They make it easier to discuss and monitor proposed strategic thrusts. Ideally, these themes can be developed into a matrix of programs and goals, cutting across formal divisional lines and dominating the selection and ranking of projects within divisions. This matrix can, in turn, serve as the basis for performance measurement, control, and reward systems that ensure the intended strategy is properly implemented.

Unfortunately, few companies in the sample were able to implement such a complex planning and control system without creating undue rigidities. But all did utilize logical incrementalism to bring cohesion to the formal-analytical and power-behavioral processes needed to create effective strategies. Most used some approximation of the process sequence described above to form their strategies at both subsystem and overall corporate levels. A final summary example demonstrates how deliberate incrementalism can integrate the key elements in more traditional approaches to strategy formulation.

In the late 1970s a major nation's largest bank named as its new president and CEO a man with a long and successful career, largely in domestic operating positions. The bank's chairman had been a familiar figure on the international stage and was due to retire in three to five years. The new CEO, with the help of a few trusted colleagues, his chief planner, and a consultant, first tried to answer the questions: "If I look ahead seven to eight years to my retirement as CEO, what would I like to leave behind as the hallmarks of my leadership? What accomplishments would define my career as having been successful?" He chose the following as goals:

1. To be the country's number one bank in profitability and size without sacrificing the quality of its assets or liabilities.
2. To be recognized as a major international bank.
3. To improve substantially the public image and employee perceptions of the bank.
4. To maintain progressive policies that prevent unionization.

5. To be viewed as a professional, well-managed bank with strong, planned management continuity.
6. To be clearly identified as the country's most professional corporate finance bank, with a strong base within the country but with foreign and domestic operations growing in balance.
7. To have women in top management and to achieve full utilization of the bank's female employees.
8. To have a tighter, smaller headquarters and a more rationalized, decentralized corporate structure.

The CEO brought back to the corporate offices the head of his overseas divisions to be COO and to be a member of the Executive Committee, which ran the company's affairs. The CEO discussed his personal views concerning the bank's future with this Committee and also with several of his group VPs. Then, to arrive at a cohesive set of corporate goals, the Executive Committee investigated the bank's existing strengths and weaknesses (again with the assistance of consultants) and extrapolated its existing growth trends seven to eight years into the future. According to the results of this exercise, the bank's foreseeable growth would require that:

1. The bank's whole structure be reoriented to make it a much stronger force in international banking.
2. The bank decentralize operations much more than it ever had.
3. The bank find or develop at least 100 new top-level specialists and general managers within a few years.
4. The bank reorganize around a "four bank" principle (international, commercial, investment, and retail banks) with entirely new linkages forged among these units.
5. These linkages and much of the bank's new international thrust be built on its expertise in certain industries, which were the primary basis of its parent country's international trade.
6. The bank's profitability be improved across the board, especially in its diverse retail banking units.

To develop more detailed data for specific actions and to further develop consensus around needed moves, the CEO commissioned two consulting studies: one on the future of the bank's home country and the other on changing trade patterns and relationships worldwide. As these studies became available, the CEO allowed an ever wider circle of top executives to critique the studies' findings and to share their insights. Finally, the CEO and the Executive Committee were willing to draw up and agree to a statement of ten broad goals (parallel to the CEO's original goals but enriched in flavor and detail). By then, some steps were already under way to implement specific goals (e.g., the four bank concept). But the CEO wanted further participation of his line officers in the formulation of the goals and in the strategic thrusts they represented across the whole bank.

By now eighteen months had gone by, but there was widespread consensus within the top management group on major goals and directions.

The CEO then organized an international conference of some forty top officers of the bank and had a background document prepared for this meeting containing: (1) the broad goals agreed upon, (2) the ten major thrusts that the Executive Committee thought were necessary to meet these goals, (3) the key elements needed to back up each thrust, and (4) a summary of the national and economic analyses the thrusts were based upon. The forty executives had two full days to critique, question, improve, and clarify the ideas in this document. Small work groups of line executives reported their findings and concerns directly to the Executive Committee. At the end of the meeting, the Executive Committee tabled one of the major thrusts for further study, agreed to refined wording for some of the bank's broad goals, and modified details of the major thrusts in line with expressed concerns.

The CEO announced that within three months each line officer would be expected to submit his own statement of how his unit would contribute to the major goals and thrusts agreed on. Once these unit goals were discussed and negotiated with the appropriate top executive group, the line officers would develop specific budgetary and nonbudgetary programs showing precisely how their units would carry out each of the major thrusts in the strategy. The COO was asked to develop measures both for all key elements of each unit's fiscal performance and for performance against each agreed upon strategic thrust within each unit. As these plans came into place, it became clear that the old organization had to be aligned behind these new thrusts. The CEO had to substantially redefine the COO's job, deal with some crucial internal political pressures, and place the next generation of top managers in the line positions supporting each major thrust. The total process from concept formulation to implementation of the control system was to span three to four years, with new goals and thrusts emerging flexibly as external events and opportunities developed.

CONCLUSION

In recent years, there has been an increasingly loud chorus of discontent about corporate strategic planning. Many managers are concerned that despite elaborate strategic planning systems, costly staffs for planning, and major commitments of their own time, their most elaborately analyzed strategies never get implemented. These executives and their companies generally have fallen into the trap of thinking about strategy formulation and implementation as separate, sequential processes. They rely on the awesome rationality of their formally derived strategies and the inherent power of their positions to cause their organizations to respond. When this does not occur, they become bewildered, if not frustrated and angry. Instead, successful managers in the companies observed acted logically and incrementally to improve the quality of information used in key decisions; to overcome the personal and political pressures resisting change; to deal with the varying lead times and sequencing problems in critical decisions; and to build the organizational awareness, understanding, and psychological commitment essential to effective strategies. By the time the strategies began to crystallize, pieces of them were already being implemented. Through the very processes they used to formulate their strategies, these executives had built sufficient organizational momentum and identity with the strategies to make them flow toward flexible and successful implementation.

REFERENCES

1
See H.E. Wrapp, "A Plague of Professional Managers." New York Times, 8 April 1979.

2
This is the third in a series of articles based upon my study of ten major corporations' processes for achieving significant strategic change. The other two articles in the series are:
J.B. Quinn, "Strategic Goals: Process and Politics," Sloan Management Review, Fall 1977, pp. 21-37;
J.B. Quinn, "Strategic Change: 'Logical Incrementalism,'" Sloan Management Review, Fall 1978, pp. 7-21.
The whole study will be published as a book entitled Strategies for Change: Logical Incrementalism (Homewood, IL: Dow Jones-Irwin, 1980).
All findings purposely deal only with strategic change in large organizations.

3
See R.M. Cyert and J.G. March, A Behavioral Theory of The Firm (Englewood Cliffs, NJ: Prentice-Hall, 1963), p. 123. Note this learning-feedback-adaptiveness of goals and feasible alternatives over time as organizational learning.

4
See:
H.E. Wrapp, "Good Managers Don't Make Policy Decisions," Harvard Business Review, September-October 1967, pp. 91-99;
R. Normann, Management for Growth, trans. N. Adler (New York: John Wiley & Sons, 1977);
D. Braybrooke and C.E. Lindblom, A Strategy of Decision: Policy Evaluation as a Social Process (New York: Free Press of Glencoe, 1963);
C.E. Lindblom, The Policy-Making Process (Englewood Cliffs, NJ: Prentice-Hall, 1968);
W.G. Bennis, Changing Organizations: Essays on the Development and Evolution of Human Organizations (New York: McGraw-Hill, 1966).

5
See respectively:
Quinn (Fall 1977);
Quinn (Fall 1978).

6
See J.B. Quinn, Xerox Corporation (B) (copyrighted case, Amos Tuck School of Business Administration, Dartmouth College, Hanover, NH, 1979).

PATROL WORKLOAD MEASUREMENT MANUAL

A Guide For Deployment of Patrol Personnel in
Law Enforcement Agencies

The Commission on Peace Officer Standards and Training
State of California

Patrol Workbook Measurement Manual, A Guide for Deployment of Patrol Personnel in Law Enforcement Agencies, February 1980. Reprinted with permission of The Commission on Peace Officer Standards and Training, State of California.

State of California
Department of Justice

COMMISSION ON PEACE OFFICER STANDARDS AND TRAINING

Chairman

Kay Holloway Chief of Police, Coalinga

Vice Chairman

Nathaniel Trives Criminal Justice Education, California
State University at Los Angeles -
(On Leave)

Commissioners

Al Angele General Manager, California Organization
of Police and Sheriffs (C.O.P.S.)

Robert A. Edmonds Assistant Sheriff
Los Angeles Sheriff's Department

Brad Gates Sheriff, Orange County

Jacob J. Jackson Sergeant of Police, Sacramento

William B. Kolender Chief of Police, San Diego

Rodriguez, Jay Manager, Press/Publicity & C.R.
KNBC-4, Los Angeles

Louis L. Sporrer Assistant Chief of Police--Retired
Los Angeles

John Van de Kamp District Attorney, Los Angeles County

Joe Williams Councilman, City of Fresno

Ex Officio Member

George C. Deukmejian Attorney General, Sacramento

Administration

Norman C. Boehm Executive Director, Sacramento

PREFACE

Law enforcement agencies vary greatly in their information needs, data processing capabilities, and organizational characteristics. Accordingly, there is no precise step-by-step workload study system which is universally applicable to every patrol operation. This manual describes those information gathering requirements which are common to most patrol workload studies and the more frequent problems encountered in collecting and analyzing the data.

A concluding section of the manual addresses the analysis and use of workload data. Analysis is a particularly unique process because each agency must consider and weigh local conditions and assumptions relating to training, supervision, policies and patrol officer work habits. Some of these factors, which can impact the validity of the workload study, are not easily identified. For this reason, agencies without prior experience in collecting consumed time information for workload measurement may wish to enlist the assistance of POST when undertaking a patrol workload study.

A recapitulation of the tasks which must be completed before collection of study data can begin is provided in Appendix D.

The Patrol Workload Measurement Manual is a product of the Management Counseling Bureau, Operations Division, Commission on POST, John B. Davidson, Bureau Chief. It was written by Palmer Stinson, Senior Consultant. Additional information regarding patrol workload measurement may be obtained by writing:

Norman C. Boehm
Executive Director
Commission on Peace Officer Standards and Training
7100 Bowling Drive, Suite 400
Sacramento, CA 95823

September 1979

INTRODUCTION

Procedures for measuring workload and devising patrol plans date back to O. W. Wilson's pioneering studies in Kansas and Texas. Wilson's notion of distributing patrol manpower according to a workload formula has been greatly modified over the years and it is now possible to achieve a very close correlation between the need for service and work schedules.

In spite of the attention given the deployment issue by the authors of law enforcement texts, there are many police forces in which the patrol officer's work hours and days off are inadequately correlated with the ebb and flow of citizen's calls for service.

Many departments, of course, increase staffing levels during the busier times of the day. These arrangements, however, are often based on intuition or out-dated information. It is also still fairly common for departments to field the same number of officers every day around the clock even though workload varies considerably from shift-to-shift and day-to-day.

As a consequence of the 1978 property tax reforms, most California law enforcement agencies are facing increased workloads with static or reduced budgets that preclude the hiring of additional personnel. Under such circumstances, police service will be reduced unless there is a more efficient use of the existing pool of officers. In many agencies, substantial improvements in the response capability of field units would occur if the patrol force were proportionally redeployed, according to workload study results. This POST publication is designed to familiarize interested police managers with a process whereby improved deployment may be achieved.

PATROL WORKLOAD STUDY, PURPOSE AND DESCRIPTION

The purpose of this manual is to present updated processes for solving patrol deployment problems which have been successfully tested in California law enforcement agencies. It also includes suggestions for measuring response capability and evaluating the numerical adequacy of a patrol force.

The manual is based on the premise that a patrol force should be deployed according to the time and area distribution of service demand and that deployment efficiency is best judged in terms of response capability, i.e., promptness in providing service.

Deployment

In a workload study, the periods of time expended in various patrol activities and the delays which occur when officers are unavailable for assignment are measured and averaged by time of day, day of week and area.

The data collection products include a series of bar charts (histograms), which are used to develop and judge the merits of alternative *chronological* deployment plans. There will be a minimum of eight 24-hour charts: one for each day of the week and a composite of all days.

The data display formats used in studying area deployment vary in complexity according to the size and number of beats and reporting districts. Ordinarily, there should be beat maps or tables which reflect, in percentages, the area distribution of workload for each shift during the week and a composite of the totals. If the beat load is seriously unbalanced, it may be necessary to prepare more detailed tallies of workload by reporting area in order to redesign the beat boundaries.

When these products are properly used, the patrol force will be deployed so that a uniform level of service is provided around the clock to all neighborhoods and each officer's workload is equalized.

Allocation

Many law enforcement administrators encounter difficulty each year in trying to persuade city councils or boards of supervisors to approve requests for more officers. In many jurisdictions, the problem is compounded by the absence of good management information and valid law enforcement performance standards.

Commonly, requests for personnel increases are based on comparisons with staffing levels in other agencies* and/or statistical increases in the number of crimes being reported. Personnel justifications based on these rationales are weak because they do not give appropriate consideration to the multitude of demographic, environmental, economic, and management variables, such as:

- Kinds and extent of crime
- Population of the city
- Composition of the population
- Density of the population
- Mobility of the people
- Quality of police management and service
- Attitude of the people toward the police
- Area of the city
- Geographical location in relationship to other communities
- Commerce and industry of the city
- Policy of local government

* The staffing relationships examined are ordinarily police officer ratios to population and/or crime rates.

Arguments for personnel increases based on burgeoning crime rates assume that the police have some control over the causes of crime. The crime studies of the last decade offer a mass of contradictory findings on this issue. One recent controlled experiment,* however, suggests that increasing the size of the patrol force does not significantly reduce crime rates.

For these reasons, determining the numerical adequacy of a patrol force should be considered in the context of the community's police service expectations and its ability or willingness to meet policing costs.

The patrol manpower allocation question (is the number of officers assigned to the patrol function adequate?) cannot be considered solely in the context of patrol workload. An in-depth allocation study would require the analysis of many important issues which are beyond the scope of this manual. Some examples include:

- Service Policies

Is the Patrol Unit providing services which do not require peace officer status and can paraprofessionals do the job as well?

- Organizational Arrangements

How large and productive are the support units and do specialized units relieve patrol of traffic, vice and juvenile responsibilities?

- Patrol Strategies

Are patrol officers assigned to a crime suppression program and, if so, can their activities be easily interrupted in order to respond to calls for service?

* E.g., George L. Kelling, et al., The Kansas City Preventive Patrol Experiment: A Summary Report, Washington, D.C., Police Foundation, 1974.

The workload study process, however, does provide a useful by-product for judgments about allocation in the form of reports which furnish an objective, quantified basis for judging the adequacy of the major patrol function--responding to demands for service. These reports, based on queuing (call stacking) data collected during the study period, measure the response capability of the patrol force.

WORKLOAD CONCEPTS

The sections that follow establish a frame of reference for several of the more common, and occasionally controversial, workload study concepts.

Response Time

Response time is frequently calculated for management information purposes as the time period between receipt of the request for service and arrival of the Patrol Unit at the assignment location. Travel time and queuing time together are logically parts of the total response time. These two elements of the response time total, however, are manifestations of different kinds of problems, and for analytical purposes, they should be measured and considered separately.

Queuing time measurements express a relationship between officer availability and the volume of service demand. The measurement of queuing in time stamp card and CAD* systems is very accurate because quality controls are easily maintained in a police communication environment.

Travel time, on the other hand, is dependent on the size and geographic character of the area being patrolled, population and traffic density, and occasionally, the officer's initiative. Furthermore, the accurate recording of travel time can be adversely affected by several factors: one is radio channel congestion--particularly on the more urgent calls--because an officer can't wait for the air to clear in order to announce his arrival at the scene; another is poor radio discipline. For these reasons, agencies which collect travel time data should measure and analyze them independently from the queuing times.

* Computer Assisted Dispatch

Unobligated Patrol Time

Unobligated patrol time can be calculated by subtracting all of the time consumed in each activity category from the available patrol time figures. In years past, there have been attempts to relate the numerical adequacy of the patrol force to an arbitrarily established, unobligated patrol time standard. The measurement and analysis of call queuing patterns and, in some situations, travel time patterns, however, is a more direct way to make judgments concerning the numerical adequacy of a patrol force. (Information concerning the amount of unobligated patrol time available and its chronological distribution is, of course, helpful whenever a department is planning a specific, directed patrol strategy or program beyond providing a basic response capability.)

Report Writing Time

Patrol report writing systems can differ greatly in their impact on patrol officer availability. Common variations employed by law enforcement agencies include the "one-write" system (reports are handwritten in the field, usually while on an assignment), dictated reports (over the telephone to a stenographer or in the field to a cassette recorder device), typewritten station reports by the officers, and combinations of the foregoing.

In one variation of a "one-write" system, for example, patrol officers complete the structured portion (boxes) of their report while they are out of service on an assignment. Narratives are then completed later in the police vehicle when the officer is in service and available for assignment but not otherwise occupied.

In other "one-write" systems, officers may be required to complete all but the more complicated reports before returning to in-service status.

Analyzing the impact of report writing on the patrol function is difficult when departmental policies are inconsistently enforced or inadequately defined. Reporting practices should therefore be examined before the study begins. If the agency perceives a system compliance problem or does not know whether the report writing system seriously impacts officer availability, the study should include data concerning the amounts of time expended exclusively on report writing (i.e., those periods of time when the officer, at his own initiative or under direction, goes out of service for report writing purposes). This information should be tallied and charted independently from called-for service consumed time data. It can then be subsequently determined if the report writing task is adversely affecting the response performance of patrol and whether the problem is caused by the system itself, the management and supervision of the system, or an excessive workload.

Because time out-of-service for report writing purposes can be controlled administratively, it is best defined as an administrative activity and included in that category for study purposes.

Reporting Areas and Beat Survey Considerations

Many departments have divided their jurisdictions into reporting areas. If the areas are logically established and appropriately sized, they will be suitable for the beat design portion of a study. In the absence of unique circumstances, smaller departments which routinely only field two or three patrol units per shift can function with beats as the basic reporting area. Agencies which need to design reporting areas will find detailed procedures for doing so in Appendix B.

Most experienced police administrators agree that beat boundaries established as the result of a survey should remain static as long as circumstances permit. The traditional reasons for maintaining beat stability are: (1) to foster area responsibility at both the operating and management levels, (2) to provide a statistical baseline through which officers can be held

accountable for the discharge of their responsibilities, and (3) to encourage the growth of rapport between officers and neighborhood residents. The attainment of these objectives may be adversely affected when a beat structure is frequently changed.

The configuration of beats, accordingly, should only be modified when *substantial* workload disparities, excessive travel distances or environmental* changes make boundary adjustments necessary. In the older established metropolitan areas, demographic factors tend to slowly impact police workload and a decade or more may pass before changes in beat boundaries are justified. Rapid changes in the area distribution of workload ordinarily occur as a consequence of the annexation process. Some jurisdictions must consider travel distances when establishing beat boundaries. In some instances a relatively small increase in workload, in an area that is distant from headquarters or substations, may justify the creation of a new beat.

Generally, the size of each beat should be based on the workload occurring in the beat. Equitable workloads can be developed by grouping the reporting areas so the percentage of the workload of one beat is approximately equal to each of the other beats.

A description of the beat workload measurement procedure and a map illustrating a typical sector, beat and reporting area plan appear on page 13.

Achieving a balanced beat design is complicated by a common situation encountered in many jurisdictions. The problem is that different beats are busy at different times of the day. Entertainment areas and industrial parks, for example, create police service requirements which differ dramatically according to the time of day.

Altering beat boundaries on each shift to precisely balance workload would ignore the previously enumerated benefits derived from stable beats.

* A new freeway or man-made lake, for example, may bisect a beat and isolate the officer from part of his beat.

The situation created by widely diverse temporal workload patterns is best addressed by developing beat assignment schedules which compensate for the shift load differences. An industrial area comprising two beats might have one Patrol Unit assigned to both beats on the evening and early morning shifts. A single beat, on the other hand, which features many entertainment establishments might justify the assignment of two Patrol Units during the evening hours. The beat survey procedures will provide the information required to develop appropriate beat assignment plans for each shift.

SECTOR, BEAT AND REPORTING AREA PLAN

The map illustrates a 58.7 square mile police jurisdiction divided into two sectors, 10 beats and 127 reporting areas. The reporting areas are census tracts which vary in size according to population density.

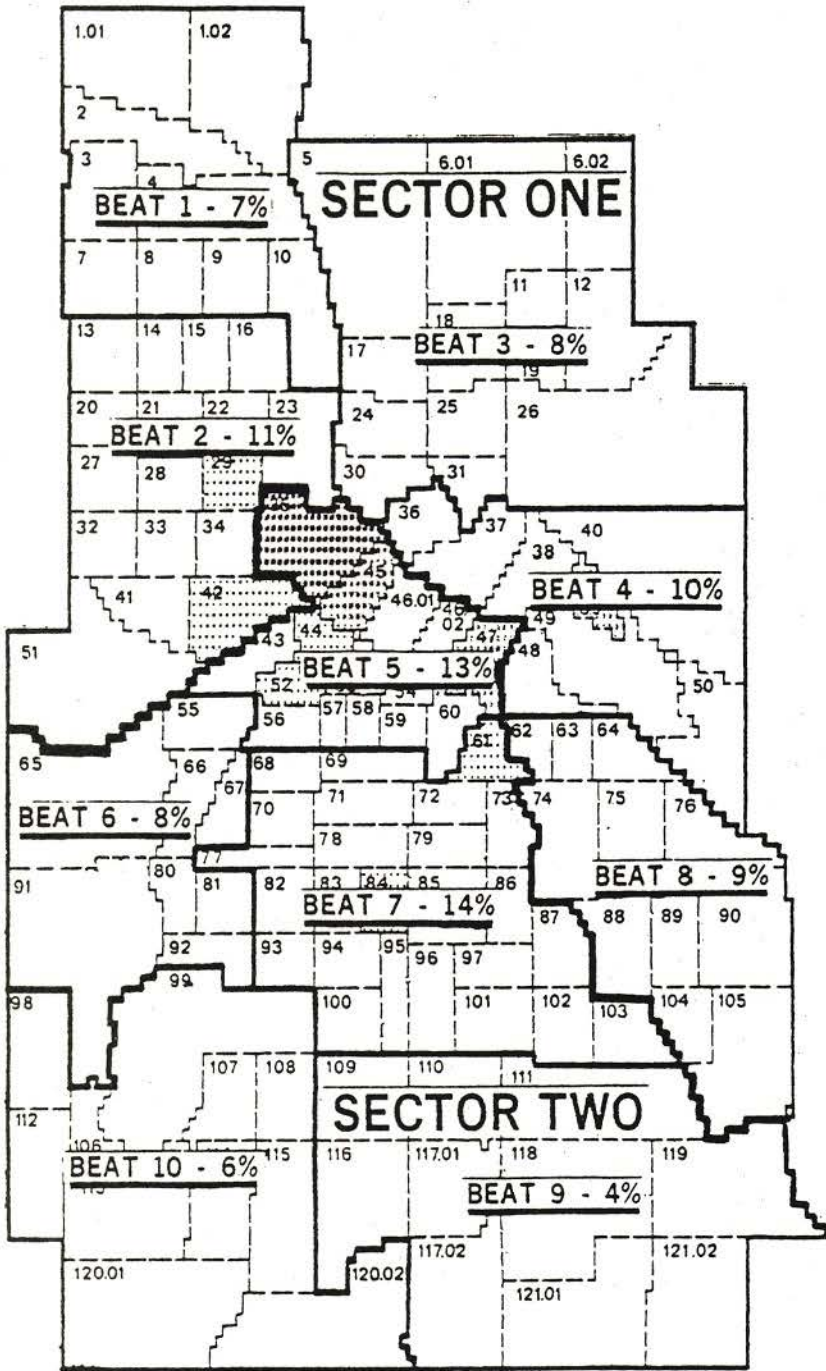

Beat Workload Procedures - The around-the-clock beat workload is expressed as a percentage of the jurisdictionwide workload. The beat percentage figure is obtained by adding the consumed time totals for each reporting area in beat (not shown on map) and dividing this sum by the grand total of all reporting areas.

Ideally, in a 10 beat jurisdiction, each beat should have 10% of the workload. In the adjoining example, the core area (beat 5) clearly could lessen its workload by a boundary adjustment which shifted some of its peripheral reporting areas to neighboring beats. The two least busy beats (9 and 10) could well be combined into a single beat. Travel distances or geographic barriers, however, may justify retention of the two outlying beats with workload differences within the range shown on the map.

Beat workload should be calculated for each shift and beat officer assignments on each shift schedule should be made on the basis the beat workload for that particular shift.

DATA COLLECTION

Data collected during a patrol workload study falls into two categories. First, there is the information essential to making and evaluating deployment plans, i.e., shift schedules, beat assignments. A supplementary data group is useful for task analysis and patrol time management purposes. Many departments need to know, for example, how much patrol time is consumed on specific types of services, e.g., responding to false alarms, performing follow-up investigations.

Basic Data Categories

Called-for Services* Consumed Time

The time expended in servicing each assignment must be computed, tallied, and credited to the hour of day in which the call was received**. Consumed time in this category begins when the radio dispatcher assigns the call and ends when the assigned patrol unit clears the assignment.

Queuing Time

This is the time that elapses between the receipt of a request for service and the assignment of a patrol unit to respond to the request. The elapsed times in this category are divided and tallied in emergency and non-emergency groups. Low priority requests for service, for which a delayed response is permissible, should be excluded from queuing time calculations, e.g., abandoned vehicles.

* Requests from the public for police services--usually received through the police communications center.

** Consumed time should be credited to the hour in which the service was requested because deployment planning must be based on the time of day that service is needed, not when it is provided.

Supplementary Data Categories

A department should also collect supplemental data during the study period which can provide important management information. For example, a management control system over directed patrol programs will require ongoing measurements of the following consumed time categories:

Administrative - Out-of-service periods for crime prevention services, roll-call training, equipment servicing, firearms practice, court appearances, office assignments, follow-up investigations, report writing, etc.

Personal - The time expended by patrol officers taking care of personal needs, e.g., meals, coffee breaks.

Officer-Initiated - Time spent on activities initiated by officers which are directly related to the patrol function, e.g., on-view arrests, investigations, field interviews, traffic arrests.

Travel - The elapsed time between receipt of a radio dispatched assignment and arrival at the scene.

Patrol Shift Charts

Charts depicting the current shift schedule must be made. At the end of the study period they will be used in the analysis of correlations between the shift plan and service demand.

Shift bar charts are constructed by indicating the scheduled number of patrol officers on duty each hour of the day for each day of the week (seven 24-hour charts with the vertical axis scaled in hours or minutes). Ordinarily, field supervisors are not included in measurements of patrol field deployment unless they are routinely assigned to handle calls for service. If the

relative scales permit, the daily deployment pattern should be drawn on the consumed time charts for corresponding days. Combining the information in this manner makes examination of the correlations between the two factors easier. An example appears on page 41.

It may also be advisable to prepare a set of charts based on *actual* daily attendance rosters during the study period. These charts can reveal the extent to which administrative practices governing the granting of compensatory days off, vacations, etc., contribute to delayed response problems. The overall impact of absences due to on-duty court appearances, sickness and injury will also be reflected. The actual number of officers available each day *must* be calculated and charted if the agency conducting the workload study intends to analyze the distribution of unobligated patrol time.

Study Period

The workload data sample should cover at least 13 consecutive weeks to eliminate the data skewing effect of unusual events. When deciding the beginning and ending dates of the study, consideration should be given to the seasonal aspects of workload. Characteristically, for example, workload goes up during the summer school vacation. A study which began when school was in session and ended midway through summer vacation would not isolate and measure the impact of summer vacation on patrol workload.

Dispatch Assignment Records

Dispatch cards, or computer printout logs in the case of a computer assisted dispatch system, are the source documents* for the incremental tallies of elapsed times in the workload study.

Many departments have successfully completed workload studies using hand tallies of the time periods. Electronic data processing assistance, however, is recommended for developing printouts which can be used to prepare daily or composite workload bar charts and beat surveys. Examples of simple workload data processing formats, suitable for use by smaller agencies with limited computer programming resources are shown on page 19 and 21.

* Workload studies should not employ daily activity reports submitted by officers or handwritten entries on a radio dispatch log as data source documents. Time estimates on the activity reports are too error prone. Furthermore, the data on both the radio log and activity reports are too difficult to categorize and tally.

COMPUTER GENERATED DISPATCH LOG

Saturday 3/17/79

DEPARTMENTAL DAILY DISPATCH LOG

Page No.

R.A. #	Report #	Address	Crime Code	Code	Complaint	Recd Time	Dispat Time	Arrv Time	Queue Mins	Resp Mins	Clear Time	Consum	1-off	2-off	Dispo
09	00000	1074 Fairview	867		Req Area Ck	0002	0029	0038	0027	0036	0047	0018	14774		2
02	00000	1306 N. Main	008	-	Alarm	0008	0009	0011	0001	0003	0029	0020	7461		4
00 A	00000	930-13 Acosta Pl	867		Loud Party	0009	0023	0025	0014	0016	0030	0007	35191		8
18	00000	150 Sherwood	867		4150	0010	0021	0025	0011	0015	0045	0024	80632		8
02	00000	1306 N. Main	008	1	Alarm	0010	0010	0010	0000	0000	0029	0019	37171		4
18	00000	150 Sherwood	867	1	4150	0021	0021	0021	0000	0000	0045	0024	82521		8
00 A	00000	930-13 Acosta Pl	867	1	Loud Party	0023	0023	0023	0000	0000	0030	0007	76362		8
21	00000	18816 Eisenhower	001		Car Stuck	0024	0028	0036	0004	0012	0129	0061	37171		8
10 B	94037	Sanborn & Abbott	001	0	ACC	0031	0031	0031			0050		56042		7
13	00000	Columbia Motel	867		647F 415	0040	0042	0046	0002	0006	0101	0019	7461		8
13	00000	Columbia Motel	867	1	647F 415	0042	0042	0042	0000	0000	0101	0019	75232		8
13	00000	Columbia Motel	867	2	647F 415	0042	0042	0042	0000	0000	0101	0019	75372		8
09	00000	Disco Depot	867		415	0045	0050	0050	0005	0005	0058	0008	38001		8
09	00000	Disco Depot	867	1	415	0051	0051	0051	0000	0000	0058	0007	50611	47022	8
17	00000	717 St Anne	832		Veh on Lawn	0054	0055	0103	0001	0009	0106	0011	80632		8
07	00000	824 Garner	867		Juve 415	0057	0057	0100	0000	0003	0121	0024	35191		8
07	00000	824 Garner	867	1	Juve 415	0057	0057	0057	0000	0000	0121	0024	76362		8
07	00000	824 Garner	867	2	Juve 415	0057	0057	0057	0000	0000	0121	0024	14774		8

***** TOTALS THIS HOUR ***** #CALLS *** 9 65** 105** 335

17	00000	Archer	015		Susp Cir	0107	0113	0115	0006	0008	0129	0016	80632		8
11	00000	315 Alameda	039		Speeding	0124	0126	0123	0002	0004	0144	0013	58112		2
09	94088	Fairview	001		Hit Run	0131	0131	0136	0000	0005	0205	0034	56042		7
17	00000	330 Central	810		Loud Music	0152	0201	0201	0009	0009	0224	0023	80632		5
17	00000	330 Central	810	1	Loud Music	0152	0201	0201	0009	0009	0224	0023	75372		5
07	94039	Sanborn & Garner	867	0	Traffic	0154	0154	0154			0215		35191		7
07	94039	Sanborn & Garner	867	1	Traffic	0154	0154	0154	0000	0000	0215	0021	38001		7
05	94040	Marions Club	237		Hit Run	0157	0227	0236	0030	0039	0242	0015	8161		8
08	00000	104 Bardin	867		Loud Music	0158	0211	0212	0013	0014	0217	0006	76362		8

***** TOTALS THIS HOUR ***** #CALLS *** 6 69** 88** 156

Explanation of selected column headings:

R.A. #	Reporting area number
Crime Code	Types of events are coded so that the computer can generate special reports for crime and task analysis.
Code	Additional coding is needed to identify call priority, cover/assist assignments, etc.
Queue Mins	The elapsed time in minutes between call received and dispatch (broadcast) time. (Often referred to as "call stacking time".)
Resp Mins	The queue time plus travel time, e.g., elapsed time in minutes between the call received time and arrival time.
Consum	Consumed time in minutes is the total time the Patrol Unit is out of service on the assignment, e.g., the time period between dispatch time and clear time.
1-Off, 2-Off	Officer's identification number
Dispo	Dispositions are coded: e.g., "2" means gone on arrival or unable to locate; "4" false alarm; "7" report on file; "8" matter adjusted; no report on file.

Note regarding hourly totals: Each assignment, including cover/assists, is reported on a single line. Only the first unit assigned, however, is counted in the "# of calls" total.

Dispatch Card and Computer Log Formats

The design of the dispatch record form is ordinarily dictated by the agency's data processing configuration. Some departments use an additional form to record officer-initiated activities, name and license checks, etc. (Examples of complaint/dispatch and special activity cards appear on page 25.)

The dispatch record format is only an issue in that it must provide for the following data elements which are essential to a patrol workload study:

1. I.D. of assigned unit (Officer I.D.'s are used to discriminate between one and two officer units and also to develop reports on individual officer activities.)
2. Nature of assignment (There should be a coding scheme for the various kinds of police services and tasks which will facilitate sorting into the following categories: administrative, called-for, personal, officer-initiated, and cover/assist assignments.)
3. Location (used to determine reporting area and beat)
4. Reporting area and beat designations
5. Assignment priority*
6. Date and time call for service received (or activity initiated by officer)
7. Date and time assignment broadcast
8. Date and time arrived at scene
9. Date and time assignment cleared

* Each agency should have written criteria for assigning dispatch priorities to calls for service. A classification arrangement suitable for workload study purposes is described in Appendix A.

Figure 1 Complaint Dispatch Card

UNIT	NATURE OF INCIDENT		REPORT AREA	QUEUE TIME	UNIT TIME
	LOCATION				
COMPLAINT DISPATCH CARD PRIORITY	1	DATE/TIME RECEIVED	BROADCAST	ARRIVED	CLEARED
	2	CALLER'S NAME		ADDRESS	PHONE
	3	DETAILS			
Card completed by:					
DISPOSITION:					
<input type="checkbox"/> UTL/GDA <input type="checkbox"/> REPORT <input type="checkbox"/> COUNSEL ASSIST <input type="checkbox"/> ARREST <input type="checkbox"/> CITE <input type="checkbox"/> FI					

Figure 2 Special Activity Card

DISPATCH CARD - SPECIAL ACTIVITY					
UNIT	NATURE OF COMPLAINT			DATE - TIME CLEARED	
	LOCATION OF COMPLAINT				
BEAT	1. ON VIEW		PERSON NOTIFIED	DATE - TIME START	
	2. CITATION		DETAILS		
	3. FIELD INTERVIEW				
	4. CAR/WALKING STOP				
REPORTING AREA	5. SECURITY CHECK			TIME EXPENDED	
	6. WARRANT				
	7. OFFICE ASSIGNMENT				
DAY	8. TRAINING/BRIEFING/CONFERENCE				
	9. EQUIPMENT MAINTENANCE/SERVICE				
	10. COURT/D.A. CONFERENCE				
	11. MEAL/COFFEE BREAK				
	12. PERSONAL TIME				
	13. OTHER-DESCRIBE UNDER DETAILS				

Agencies planning to manually perform the workload study tallies should have communications personnel calculate and note on each dispatch record the queue time and consumed time. This procedure will simplify the hand tallying process. (A computer can perform the calculations for departments with EDP support.)

The consumed time information from the dispatch cards (for each category being measured) should be summarized daily. Doing so will facilitate the task of converting the information into bar charts at the conclusion of the study period.

POST forms suitable for hand tallies of time consumed on called-for services, officer-initiated activities, personal convenience and administrative activities are shown on pages 29 and 31.

Data Quality Control

The accurate* recording of data by complaint operators and dispatchers is a critical concern during a patrol workload study. Poorly trained or supervised communications personnel can make errors which, cumulatively, will weaken or invalidate the study. Data validity will also be adversely affected to the degree that patrol officers are careless in meeting the requirements of radio discipline. Over-reporting of time expended on cover/assist assignments, for example, can occur if officers provide unwarranted backup assistance on their own initiative. Over-reporting of time consumed on called-for services can also occur during quieter periods if officers delay their return to service or spend more time than necessary on routine assignments.

Radio discipline problems and related supervisory deficiencies are sometimes manifested in workload studies by unusually large amounts of time being expended on activities grouped within the administrative category. In general, a need for improved control of the administrative activities exists whenever the consumed time totals in this category begin to approach or exceed the called-for service consumed time totals.

Many problems can be avoided if, before the study starts, a project coordinator is appointed and there is a general strengthening of those communications and operating procedures which affect the collection of accurate data. Employee cooperation, can be fostered by describing the study's purpose and requirements in a departmental directive (see Appendix A for example).

Experience gained in prior POST supervised studies suggests that virtually all data processing systems will require some modification before data collection for study purposes begins. Although the new programming or coding requirements are usually minor, there should be a trial data run to insure that the necessary changes have been properly implemented. At least seven days of data

* Departments which do not currently use date/time recording equipment in the Communications Section should obtain a date/time stamp clock before initiating a patrol workload study.

should be displayed in workload study format to confirm the ability of the data processing system to provide the required information. During the test period and throughout the actual study period, the person responsible for conduct of the study should regularly examine the source documents for completeness and accuracy.

ANALYSIS AND UTILIZATION OF DATA

Organizing and Displaying Workload Data

Depending upon the scope of the study undertaken, at the conclusion of the data collection period(s), there will be thousands of subtotals of consumed time in each measurement category, e.g., administrative activities, called-for services, queuing times, officer-initiated activity. It is very difficult to interpret the voluminous output recorded on computer printouts or manual tallies in tabular form and, for this reason, the use of bar charts (and maps in the case of beat surveys) is necessary. These graphic displays will greatly simplify the analytical process and speed up the design of deployment schedules.*

The first chart to be considered is a 24-hour composite of all called-for services data. This chart is used to determine the best squad relief points in the 24-hour cycle and compute the initial temporal distribution of patrol officers by shift. An example of the composite chart appears on page 37.

The relief points are established to coincide with the periodic declines in the volume of called-for services that occur in the morning and afternoon. In most law enforcement jurisdictions, these breaks, or low points, occur between 6 a.m. and 9 a.m., 3 p.m. and 5 p.m., and again between 10:30 p.m. and 1 a.m.

When the shift periods have been established in this manner, the next step is to tally the hour-by-hour consumed time averages for each shift period and then convert the shift totals into percentage parts of the composite day total. The available patrol manpower pool

* Small handheld calculators are often used by employees making manual computations for workload studies. Unless the calculator produces a tape for verification of the totals, every series of tabulations should be performed twice, or more if necessary, to insure that the data has been correctly entered.

is then divided among the three shifts according to the percentage of workload on each shift. This procedure is illustrated on the composite chart illustration.

Seven 24-hour bar charts, one for each day of the week, are used to develop patrol shift schedules. The scheduling process is described in the next section.

PATROL WORKLOAD DISTRIBUTION
(Composite of All Days)

Study Period: February 1 - May 2 (91 Days)

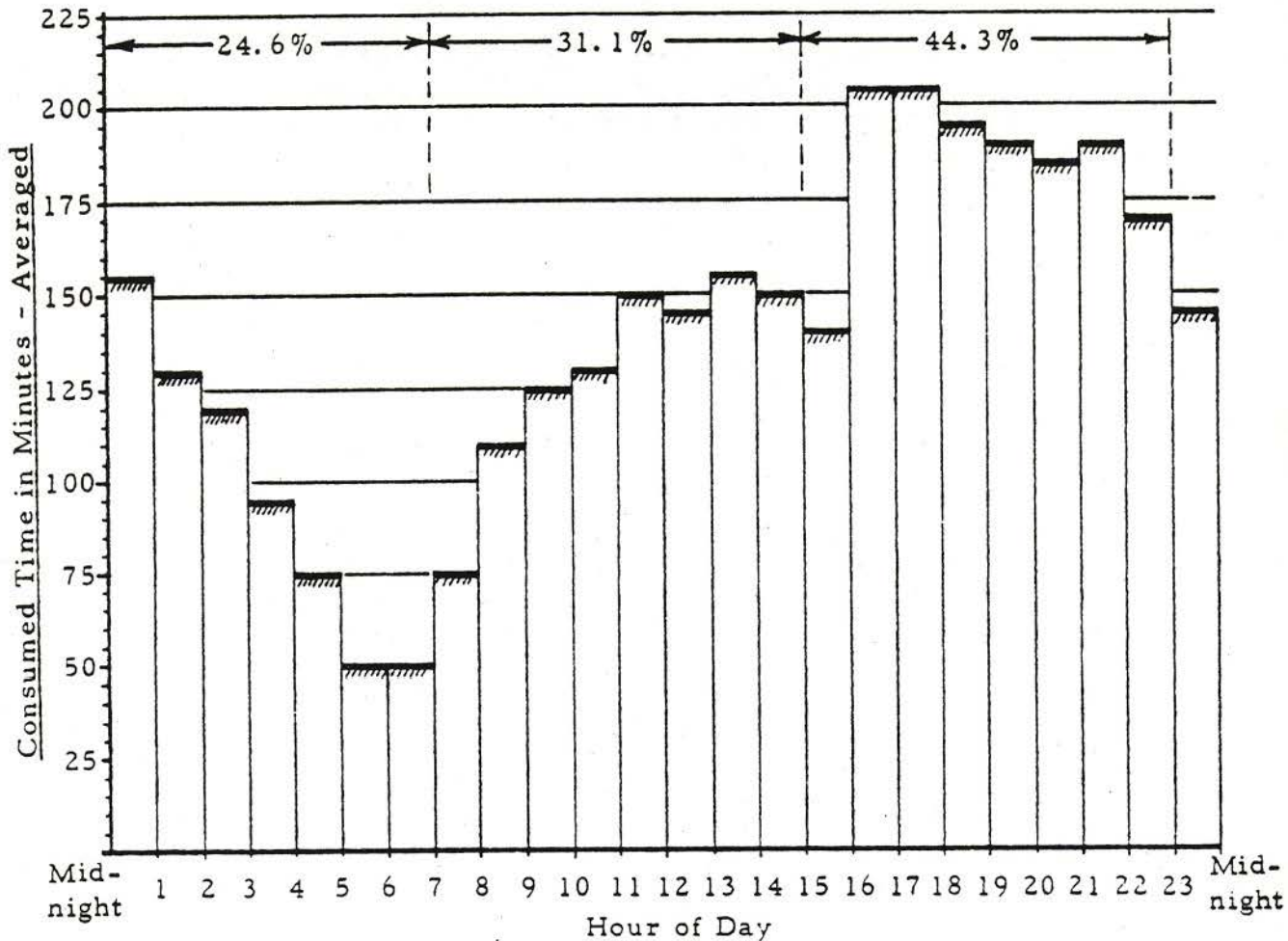

Each vertical bar on the composite chart represents the average amount of time consumed that hour on called-for services. In the first column, the total number of minutes expended on CFS between midnight and 1 a.m. during the study period was 14,105. This sum divided by 91 (days) equals 155 minutes, the average value shown on the bar chart. All hours in the composite chart are calculated in the same manner. On a bar chart for a single weekday, the average value of each hourly column is determined by dividing the total consumed time for that hour and day of week by 13 (the number of weeks in the study period). In the above example, which reflects a pattern in an urban jurisdiction, the declines in service demand occurring at 6 a.m. to 7 a.m., 3 p.m. to 4 p.m. and 11 p.m. to midnight are convenient relief points for eight-hour shifts. The shift distribution of workload is 24.6% - 11 p.m. to 7 a.m., 31.1% - 7 a.m. to 3 p.m. and 44.3% - 3 p.m. to 11 p.m. (Note: The percentage distribution of workload by shift will vary significantly from one jurisdiction to another.)

Preparing Work Schedules

The primary objective in a scheduling exercise by a service agency should be to provide the service when it is needed. Although the most important design factor is the service demand cycle, there are often conflicting values and needs, within the law enforcement agency and the community it serves, which must be considered along with other limiting factors, e.g., equipment shortages, contract working conditions.

The team or squad system is an example of a potential constraint on scheduling, which might be imposed as a consequence of an administrator's values. There are both good and bad aspects to a team arrangement which gives squad members and the supervisor the same days off. The development of team spirit may be encouraged and a single supervisor can be held accountable for squad performance. On the other hand, squads are blocks of manpower which are very difficult to deploy efficiently, i.e., according to service needs*.

In recent years both management control and deployment efficiency have been adversely affected by shift schedules designed to provide day off equity and/or a shorter work week for officers. One of the more troublesome schemes is the four-ten plan. Management surveys have uniformly found that the potential for improving patrol efficiency through workload studies and scheduling adjustments is substantially reduced in departments which operate with ten-hour shifts. Equally counter-productive is the shift practice of scheduling rotating days off for all officers assigned to the patrol force. The patrol workload pattern can vary as much as 20% from one day to another, and assigning a fixed number of officers to a progression of rotating days off to achieve equity inevitably results in a mismatch between patrol coverage and service demand.

* Very large agencies, by establishing relatively large patrol officer pools and an overlapping fourth shift may minimize the inefficiency inherent in giving squad members the same days off. Often, however, the fourth shift creates new deployment inefficiency because the overlap may only be justified on two days of the week.

At maximum efficiency, the percentage of work force on duty should precisely match the workload for the same hour. The best scheduling solution should approach this ideal as closely as the rising and falling cycles of activity permit. Although problems of varying degree accompany most conventional shift arrangements, the five-day work week, with its eight-hour shifts, ordinarily can be staffed to most closely meet the cyclical variations in police service demand. A fixed pattern of two days off for each patrol officer also can be more closely adjusted to accommodate day-to-day workload variations than either progressive days off or the four-ten plan's three-day off arrangement.

As noted earlier in the discussion of shift bar charts, alternative scheduling plans can be easily analyzed by displaying each proposed shift plan on shift charts for each day of the week. The relative efficiency of different work schedules is readily apparent when the schedule chart for a particular day is superimposed above a consumed time chart for the same day. (See the chart on page 41.)

In Appendix C, an example of a scheduling process based on three conventional watches (shifts) per day is shown. It should be parenthetically noted that busier jurisdictions may experience peaks of service demand which cannot be accommodated within the constraints of conventional shift arrangements. These conditions become apparent when the patrol workload (consumed time) consistently exceeds 50% of the available patrol time during peak periods. When this occurs, it may be advisable to assign a fourth overlapping shift to cover peak periods.

The scheduling example in Appendix C is based on an assumption that all patrol units are staffed by one officer. When an agency has a mixture of one- and two-officer units, the task of maintaining a uniform response capability around the clock becomes more complex because an agency's overall response capability is correspondingly improved or impaired according to the number of units fielded.

PATROL OFFICER DEPLOYMENT AND SERVICE DEMAND PROFILES

Figure 1: Typical weekday work schedule comprised of 10-hour shifts (4/10 plan) compared with a characteristic workload distribution for the same day.

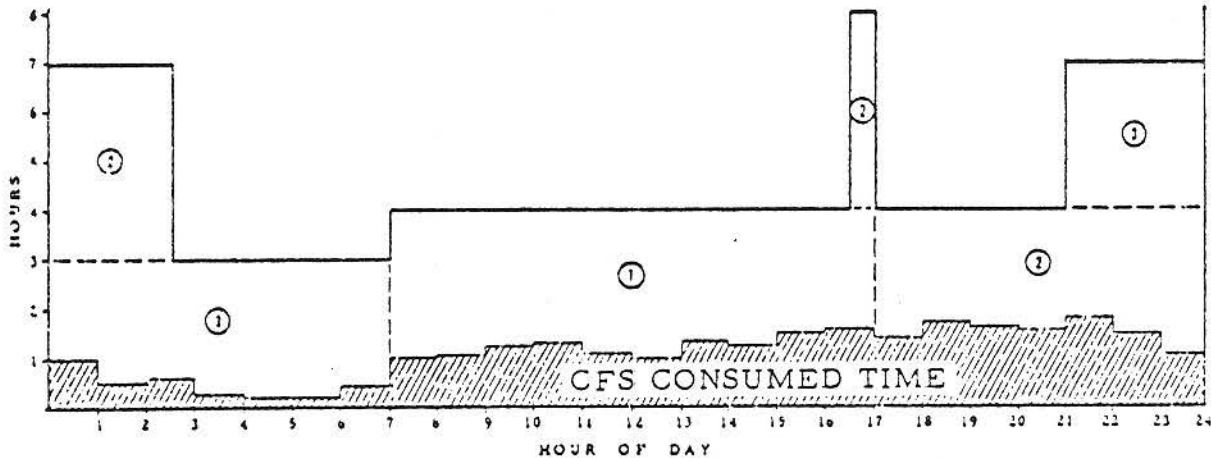

The circled numbers identify the on-duty squads, e.g., (1) 0700-1700 (2) 1630-0230 (3) 2100-0700 Scheduled work hours for the day total 110.

Figure 2: Typical weekday work schedule comprised of 8-hour shifts (5/8 plan) compared with a characteristic workload distribution for the same day.

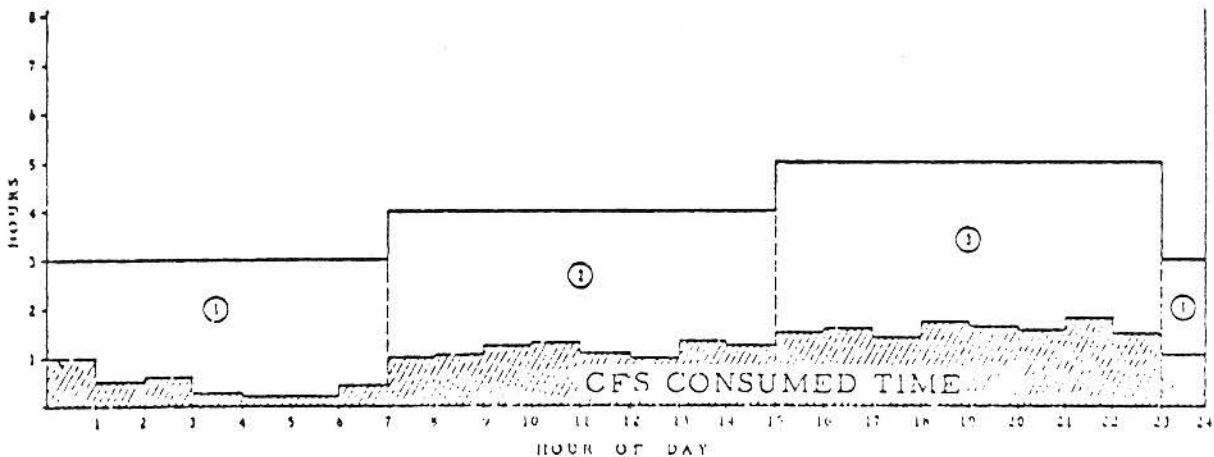

The circled number identify on-duty squads, e.g., (1) 2300-0700, (2) 0700-1500, (3) 1500-2300. Scheduled work hours for the day total 96.

This scheduling problem can be solved in several ways. If the number of two-officer units is variable but ordinarily small, personnel adjustments can be made on an ad hoc basis after a conventional schedule for one-officer units is prepared. Other departments may wish to re-examine their two-officer unit system and proceed to develop a one-officer unit schedule with selected two-officer units being added only if adequate, updated justification is provided.

Agencies which do not intend to re-evaluate the justification for two-officer units must reserve sufficient personnel to provide a second officer for each two-officer patrol unit *before* proceeding with the scheduling exercise. If, in the hypothetical example provided in Appendix C, an agency precondition was to schedule three two-officer units on the nighttime shifts, four or five officers (depending on the relief factor used) would have to be withheld from the group of officers to distribute according to workload, i.e., either 49 or 48 officers would comprise the distribution pool.

Measuring Response Capability

The impact upon response performance of management decisions which will increase workload or reduce manpower cannot be reliably predicted. For this reason each agency's management information system should regularly provide patrol response data.

Changes in service policies, increased workloads occasioned by population growth or economic conditions, or changes in the numerical strength of the patrol force can influence officer availability and the agency's ability to promptly respond to calls for service. The measurement of *queuing times* provides a direct and accurate way to evaluate the impact of these factors on the patrol function.

Two response standards should be established. One for emergency or potential emergency assignments and the other for calls where the citizen wants service as soon as possible. (These two priority classes have been defined on page A-1.)

Response standards will necessarily vary widely according to the type of community and its police service expectations. Suburban towns with moderate crime problems will usually experience fewer call-stacking problems than urban core cities, and each agency, accordingly, must set its own patrol service objectives. The levels should be sufficiently demanding as to leave room for improvement (it may be necessary to make changes if the original standards are too high or too low).

Patrol response capability and patrol performance are not synonymous terms. A complete evaluation of patrol performance should address productivity, in addition to response capability, e.g., citations, arrests in both qualitative and quantitative contexts, as well as community perceptions of police service quality.

Queuing Report Formats

Police management information systems commonly report stacking time in overall averages. This statistical practice limits the utility of queuing data because the existence of serious periodic delays in dispatching assignments ordinarily cannot be detected by overall averages. The adequacy of an agency's response performance, accordingly, should be initially analyzed by examining its call queuing patterns on bar charts averaged for each hour of the day on each day of the week.

An example of a computer printout format used to analyze queuing patterns and prepare bar charts is shown on page 47.

The queuing pattern bar charts are time consuming to prepare and they need not be incorporated into the ongoing routine management information system. Queuing information, however, should be regularly reported in a percentage chart which reflects the patrol force's success in maintaining a predetermined departmental response standard.

Initially, the queuing times should be analyzed in small incremental amounts. An illustration of how response delays ranging from one through twenty minutes can be reported appears on page 49. This detailed breakdown can be modified, after analysis, to a more concise report which measures success in meeting the agency established service standards for Priority 1 and 2 calls. At least three benchmark time delay periods should also be included in this report to measure the distribution of calls not serviced promptly. An example of the abbreviated management information report appears on page 51.

PRIORITY I*
CALLED-FOR SERVICES
QUEUING REPORT

Reporting Period _____

Department _____

	Monday	Tuesday
0000-0059	2.5	4.0
0100-0159	1.5	etc.
0200-0259	.4 etc.	/
2300-2359	3.8	⚡
Daily Average	2.05	etc.

Sunday	Hourly Average
etc.	3.1 etc.
/	/
⚡	⚡
Overall Average:	

Program Notes:

All computations on this printout are recorded in minute and decimal fractions averages. The zeros recorded on cards where both time stamps (date and time received, time of broadcast) are the same will cause a data skewing problem. One way to cure this is to have the computer program assign a .5 (half minute) value to all zero times. This would overcome the skewing effect in a rational manner because the writing and broadcasting process ordinarily consumes at least 30 seconds.

* Priority II calls should be separately reported in the same format as Priority I.

Queuing Distribution Table

Incremental Percentages of Calls Dispatched--One through Twenty Minutes

DEPARTMENT

PERIOD 3/11/79 to 04/28/79
FRIDAY PRIORITY 2 DIST/SJ8 ALL

<u>WATCH 1</u>		<u>WATCH 2</u>		<u>WATCH 3</u>		<u>TOTAL</u>	
0 MIN	55.6	0 MIN	20.3	0 MIN	44.9	0 MIN	40.4
1 MIN	64.4	1 MIN	29.7	1 MIN	52.9	1 MIN	49.0
2 MIN	71.1	2 MIN	39.1	2 MIN	58.1	2 MIN	55.5
3 MIN	75.6	3 MIN	43.8	3 MIN	64.7	3 MIN	61.2
4 MIN	77.8	4 MIN	48.4	4 MIN	67.6	4 MIN	64.5
5 MIN	86.7	5 MIN	54.7	5 MIN	69.1	5 MIN	68.6
6 MIN	86.7	6 MIN	54.7	6 MIN	70.6	6 MIN	69.4
7 MIN	86.7	7 MIN	62.5	7 MIN	72.8	7 MIN	72.7
8 MIN	88.9	8 MIN	68.8	8 MIN	76.5	8 MIN	76.7
9 MIN	88.9	9 MIN	71.9	9 MIN	78.7	9 MIN	78.8
10 MIN	88.9	10 MIN	71.9	10 MIN	79.4	10 MIN	79.2
11 MIN	88.9	11 MIN	75.0	11 MIN	80.9	11 MIN	80.8
12 MIN	88.9	12 MIN	78.1	12 MIN	82.4	12 MIN	82.4
13 MIN	88.9	13 MIN	81.3	13 MIN	83.1	13 MIN	83.7
14 MIN	88.9	14 MIN	82.8	14 MIN	85.3	14 MIN	85.3
15 MIN	88.9	15 MIN	85.9	15 MIN	85.3	15 MIN	86.1
16 MIN	88.9	16 MIN	85.9	16 MIN	85.3	16 MIN	86.1
17 MIN	88.9	17 MIN	85.9	17 MIN	86.8	17 MIN	86.9
18 MIN	88.9	18 MIN	85.9	18 MIN	88.2	18 MIN	87.8
19 MIN	88.9	19 MIN	85.9	19 MIN	88.2	19 MIN	87.8
20 MIN	91.1	20 MIN	87.5	20 MIN	88.2	20 MIN	88.6

Reporting Format for Patrol Service Objectives

A patrol force should have service objectives for Priority 1 and 2 calls for service. A regularly scheduled computer printout will provide administrators with up-to-date information concerning the department's success in meeting its service standards.

Priority 1 Calls for Service (Emergencies)

	<u>This Month</u>	<u>Last Month</u>	<u>Year to Date</u>	<u>Last Year To Date</u>
Percent of calls dispatched within				
*One minute	72.09	69.45	68.01	70.60
*Three minutes	87.03			
*Five minutes	93.88	etc.	etc.	etc.

Priority 2 calls for service (Prompt response desired)

Percent of calls dispatched within				
*Five minutes	44.13	etc.	etc.	etc.
*Ten minutes	55.04			
*Fifteen minutes	72.19			

Validity of Queuing Reports

Called-for service queuing problems and a department's response capability can be adversely influenced by both formal policies of management and informal practices by radio dispatchers.

Watch commanders, for example, will sometimes instruct dispatchers to hold one or more patrol units in reserve for emergency calls. Not infrequently, they will also direct that nonemergency calls be held until the officer assigned to the beat is available. Although these instructions occasionally have some temporary justification, the practice should not become a standard part of the system. Law enforcement officials should avoid institutionalizing such procedures because they too often result in assignments being delayed 10, 20 or 30 minutes - or longer when an officer from a neighboring beat is belatedly given the assignment.*

When supervisors or commanders do exercise their authority to delay assignments, they should do so only on an incident by incident basis. For example, if the only officer available is 10 miles from the scene of a non-urgent service request, there would be ample justification for holding the assignment after giving the caller an explanation and estimate of the waiting period.

Several unofficial dispatching procedures which delay the assignment of service requests have also been noted in prior surveys by POST consultants. The most common situation involves called-for service assignments which come into the communications center during the last hour of a shift. It is not unusual for dispatchers to arbitrarily hold the nonemergency requests until the

* Calls for service arrive at random intervals. If a beat officer is busy 25 to 40% of the time, the likelihood of a service request on his beat arriving when he is unavailable for assignment is very high. It would be a misuse of data, moreover, to justify a request for more patrol officers on information which indicated a poor response capability, if the problem was caused by inefficient operating procedures rather than a lack of officers.

new shift reports on duty. Many of these assignments could be easily serviced within the time available without the payment of overtime. In the more involved situations, field reliefs can be arranged when the shifts change.

Some dispatchers have also been observed unnecessarily delaying the assignment of urgent calls until a second cover unit becomes available. There are occasional circumstances where good judgment will require the coordination of multiple units in order to avoid unnecessary risk to patrol officers; however, the central objective of much patrol officer training is to equip them to respond, alone if necessary, to situations involving some personal hazard. Administrators should provide clear policy guidance to dispatchers in this area.

As service demand increases in a jurisdiction the number of unnecessarily delayed assignments can proliferate and seriously damage a departmental reputation for efficiency. When one or more delaying practices exist, queuing information loses its validity and utility as a management tool.

A P P E N D I X A

DIRECTIVE TO COMMUNICATIONS PERSONNEL

_____ Department

The department is developing a new management information system which will provide the data needed for patrol workload and response capability studies.

All communications personnel shall accordingly familiarize themselves with the following procedures which become effective _____.

Each dispatch card will be classified according to priority. The Number 1, 2, or 3 will be entered in _____ (specify location on card) pending the redesign and printing of new dispatch record forms. This priority designation is not necessarily the manner in which the unit is to respond, and the priority used for record keeping purposes shall not be given over the air. Existing departmental regulations governing the mode of response, e.g., red light siren, are not affected by these priority designations.

Priority 1 calls in this group are emergencies or potential emergencies or otherwise urgent calls that require an immediate response. A list of examples follows:

- a. Intrusion or 211 alarms
- b. Disturbances or potential disturbances involving the threat of violence
- c. In-progress crimes or suspect(s) in the area
- d. Suspicious or unknown circumstances
- e. Prompt response required to avoid injury to person or damage to property.

Priority 2. This category includes calls that do not require an urgent response for protection of life and property. A response should be made, however, as soon as possible or practical. (Examples include noninjury accidents, missing persons, "cold" burglaries, etc.)

Priority 3. These calls include all situations where a *delayed response is permissible*. Calls for service in this group can wait for a period of time until it is more convenient for an officer to respond. (Examples include abandoned vehicles, meet citizen at specified later time, etc.)

Nearly all assignments will be classed as either 1 or 2 priority calls. The Priority 3 classification, however, is necessary to prevent deliberately delayed assignments from affecting the analysis of the department's response capability.

Another important procedural change will require the completion of separate dispatch cards for each unit assigned to cover or assist the primary assigned officer. It will not be necessary to repeat all the original dispatch information on the cover/assist card. Cover/assist dispatch cards need only show the identity of the unit being assisted or covered (indicate appropriate boxes for these entries), the personal identification number and assigned beat of the covering officer, and the location code where the cover or assistance will be rendered. (The assigned beat number* will appear on all dispatch cards in the lower portion of the box provided for the officer's personal identification number.) Dispatchers should note that the time received box will not be time stamped on cover/assist dispatch cards.

Whenever the daily beat roster indicates that two officers are riding in the same patrol car, the dispatcher shall enter the second officer's personal identification number in (indicate appropriate location for this entry).

Signed:
Commanding Officer

cc: All patrol lineups

* NOTE: Recording the officer's beat number, as well as the beat or reporting area in which the service is provided, facilitates the analysis of cross beat dispatch patterns.

A P P E N D I X B

GEOGRAPHICALLY DIVIDING A LAW ENFORCEMENT JURISDICTION

Not all law enforcement jurisdictions need to be geographically divided into areas smaller than beats. Cities and counties with irregular population density patterns or extensive land areas, however, will find it advantageous to establish relatively small reporting areas which are proportional to population density.

Very large jurisdictions may need three geographical subdivisions for reporting purposes. In declining order of size, the subdivisions are ordinarily identified as district or sector, beats and reporting areas.

Some police agencies use the federal census tracts for statistical reporting purposes. Census tracts, however, are usually drawn only in jurisdictions which have a population of 50,000 or more, and in some cities, they may be too large for crime analysis or deployment planning purposes.

Drafting the Reporting Areas

Mount a large map of the jurisdiction which clearly shows all streets and natural boundaries (a scale of 800 feet to the inch is suitable). Cover it with a transparent plastic overlay.

Using a grease pencil and writing on the overlay, divide the jurisdiction into reporting areas. Natural or man-made boundaries will generally form the boundaries for reporting areas (streets, railroad tracks, freeways, etc.). The specific size of a reporting area should be dependent upon population density, type of general area (i.e., business, residential, rural, etc.) and previous police activity, if such data is available.

In a business district or densely populated residential area where block sizes are uniform, reporting areas may be comprised of 12 or fewer square blocks. In thinly populated residential areas and areas with irregular or no block designations, reporting areas may vary in size up to one square mile. Sparsely populated sections with no development potential may, of course, exceed a square mile; however, reporting areas should not be too large or their value as location indicators will be defeated. Consideration may also be given to assigning individual reporting areas to areas with unique police service needs, e.g., shopping centers, public parks, industrial parks, schools.

Numbering the Reporting Areas

In a small city, reporting areas may be numbered in consecutive order. However, in a large city it may be desirable to reference the reporting area by beat or district. This facilitates the locating of reporting areas. First, number consecutively each beat or district, then number each reporting area, prefixing the reporting area number with the beat or district number.

If there are large undeveloped open areas within the city that do not have natural barriers or dividers (rivers, railroad tracks, streets, highways), such areas may be assigned a single reporting area number. In such cases it is suggested that several sequential numbers be unassigned for additional numbering of reporting areas, which may be established at a later date if the area is developed and divided into reporting areas.

If the total number of reporting areas approaches or exceeds 99, the numbering should begin with 001. If not, the numbering may begin with 01.

Reference File for Reporting Areas

A street number index should be developed for larger jurisdictions, which lists each street alphabetically or by number. Under the named street, list street address numbers by block with corresponding reporting area number. For example, all the reporting areas for Main

Street are listed under "Main Street". See example of a street numbering index on Appendix B-5. It is convenient to utilize a "visible listing file" at the dispatcher's desk to facilitate locating the reporting areas and making appropriate entries on the complaint/dispatch record. If a computer is to be utilized, it can be programmed to tie each address to the reporting area in which police activity occurs, as well as compute and accumulate officer time expended in each reporting area.

Conclusion

Permanent statistical reporting areas are essential to program evaluation and workload trend standards. The design process, accordingly, must be carefully and logically executed.

Street Number Index with Reporting Area

MAIN STREET		2901 - 5200
Address		Reporting Area
2901 - 2999	odd	433
2900 - 3100	even	434
3001 - 3299	odd	429
3100 - 3300	even	430
3301 - 3599	odd	419
3300 - 3400	even	424
3400 - 3600	even	420
3601 - 3799	odd	414
3600 - 2800	even	414
3801 - 3999	odd	408
3800 - 4000	even	409
4000 - 4100	all	403
4100 - 4300	all	244
4300 - 4400	all	243
4400 - 4600	all	237
4600 - 4650	all	233
4650 - 4800	all	232
4800 - 4900	all	226
4900 - 5000	all	225
5000 - 5200	all	221

A P P E N D I X C

PATROL SCHEDULING METHOD*

This hypothetical patrol scheduling process deploys a patrol force of 52 officers. The magnitude of the called-for service consumed time totals are typical of police jurisdictions serving eighty to one hundred thousand people.

By examining consumed time data derived from a twenty-four hour composite chart, the percentage distribution of workload for each shift can be determined. For this exercise it is assumed that:

Shift 1	11 p.m. to 7 a.m.	= 19%
Shift 2	7 a.m. to 3 p.m.	= 35%
Shift 3	3 p.m. to 11 p.m.	= 46%

The number of patrol officers to be assigned to each shift is established by multiplying the number of officers available (52) by the percentage of workload on each shift:

Shift 1	19% X 52 =	9.9 (10)
Shift 2	35% X 52 =	18.2 (18)
Shift 3	46% X 52 =	23.9 (24)

The next computations are based on the seven daily 24-hour charts. These charts reflect the hour-by-hour workload (averaged) for each day of the week. The objective is to determine the daily percentages of workload on each shift and prepare correlated work schedules.

* As previously noted, there are significant seasonal differences in the amount and distribution of workload. In some urban and rural areas the summertime police service demand can increase 10 to 15%. Jurisdictions which experience obvious seasonal population changes should collect and analyze workload data for the appropriate periods to determine if adjusted schedules are necessary.

At this point it is known that Shift 1 has 19% of the total workload and that 19% of the work force equals 10 officers. Ten officers working 5 eight-hour shifts per week provide 50 workdays to be distributed throughout the week on Shift 1. The number of officers scheduled to work each day of the week is calculated by multiplying the number of officer workdays available during a one-week period by the daily percentage of workload. The table that follows illustrates how the average daily workload data for Shift 1 is organized to calculate the daily work schedules. It has been structured to illustrate conditions which occasionally may arise and require small schedule adjustments.

Shift 1 (11 p.m. - 7 a.m.) 10 officers (9.9)

	<u>Sun</u>	<u>Mon</u>	<u>Tues</u>	<u>Wed</u>	<u>Thurs</u>	<u>Fri</u>	<u>Sat</u>
Service Demands (Hrs.)*	12.8	8.5	7	6	7.2	8.5	13.3
Daily Percentage	20.2	13.4	11.1	9.5	11.4	13.4	21

Staffing (Daily percentage x 50)

Arithmetic Optimum	10.1	6.7	5.6	4.8	5.7	6.7	10.5
Rounded Optimum	10	7	6	5	6	7	11
Adj. Staffing Level	9	7	6	6	6	7	9

In the foregoing example, the workload on Saturday justifies 11 officers on duty--one more than the entire shift complement. It also presents a workload pattern that cannot be perfectly matched because of the need to provide sequential days off.

* Service demand (workload) can be expressed either in hours and fractions of hours as shown, or in minutes. Ordinarily, computer programs will convert minutes to hours; if manual tallies are employed in a workload study, however, it is not necessary to convert minutes to hours because the time values are only used to calculate the daily percentages or workload.

A schematic device* simplifies the scheduling of days off by quickly identifying deployment plans which do not provide sequential days off for all officers assigned to a shift as in the example under consideration.

Days off are indicated on the "day off scheduling wheel" by circles bisected by a spoke representing a day of the week.

In the Shift 1 table, all but one of the fractional values representing the arithmetic optimum staffing level would be rounded upward according to standard practice. Doing so, however, would add up to 52 workdays, two more than the 50 per week provided by 10 officers. Usually in this situation the problem would be corrected by arbitrarily rounding downward Saturdays and Tuesdays figure (5.6) to arrive at the correct total number of scheduled workdays. This "solution" is tested in Figure 1. (NOTE: The figure for Tuesday will return to 6 when another adjustment described in the paragraphs that follow is made.)

Figure 1

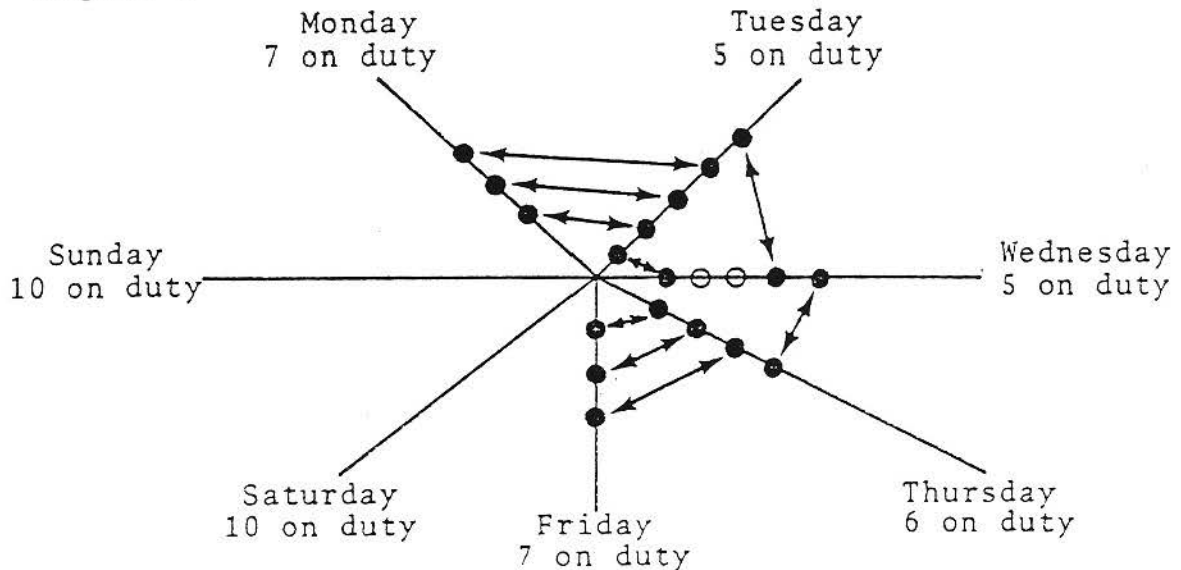

* For a more detailed description of cyclic graphs (wheels) see: Work Schedule Design Handbook: The Institute for Public Program Analysis, St. Louis, MO 1978.

By pairing the twenty days off to be assigned the 10 officers as shown, it becomes quickly apparent that the two day-off slots on Wednesday cannot be paired up with adjoining days. Other alternative pairings are possible but each one merely moves the unpaired days off to other days.

One solution to this problem is to restore the one work-day to Tuesday which had been arbitrarily rounded downward to make a total of 50 shifts and increase the Wednesday work force by one. Two of the days off must then be shifted to Saturday and Sunday thereby reducing the work force on those days to nine officers on each day. As can be seen in Figure 2, all days off can now be paired with these minor adjustments to the workload based schedule.

Figure 2.

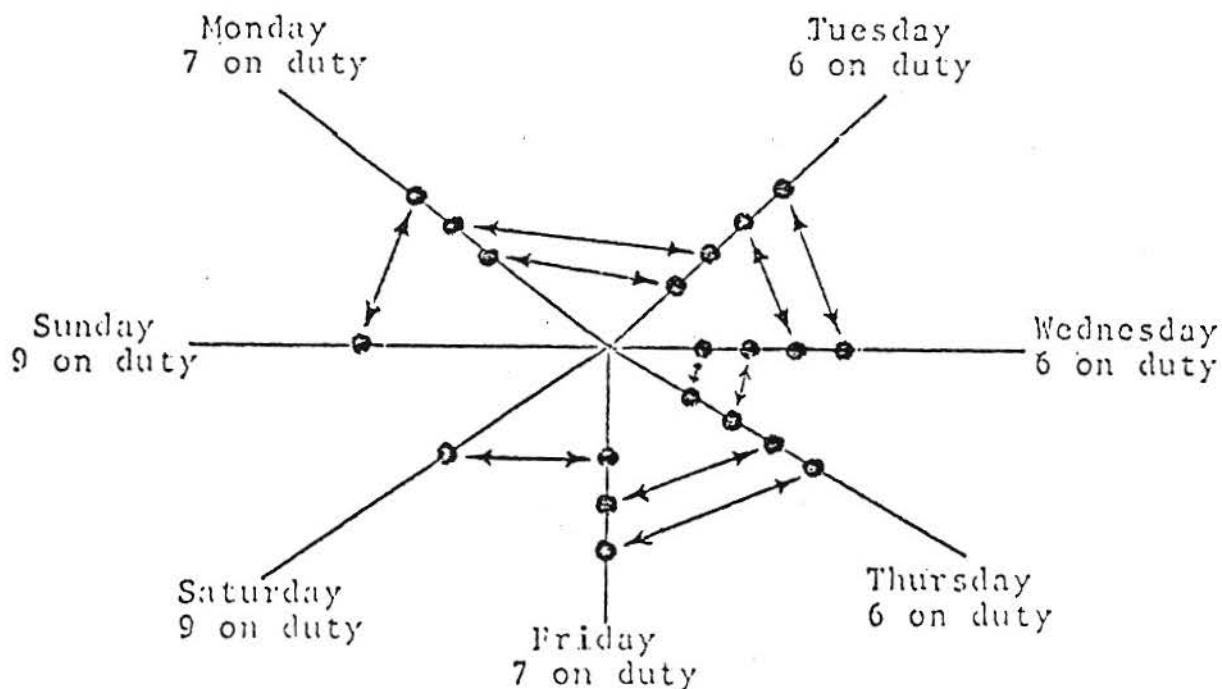

A Shift 1 assignment sheet based on the above pairings appears on the next page.

SHIFT ASSIGNMENT SHEET

Pos.	Officer's Name	Sun	Mon	Tues	Wed	Thur	Fri	Sat
1		DO	DO	X	X	X	X	X
2		X	DO	DO	X	X	X	X
3		X	DO	DO	X	X	X	X
4		X	X	DO	DO	X	X	X
5		X	X	DO	DO	X	X	X
6		X	X	X	DO	DO	X	X
7		X	X	X	DO	DO	X	X
8		X	X	X	X	DO	DO	X
9		X	X	X	X	DO	DO	X
10		X	X	X	X	X	DO	DO
	On Duty Total	9	7	6	6	6	7	9

The tables used to design the work schedules for Shift 2 and Shift 3 appear below:

Shift II (7 a.m. - 3 p.m.) 18 officers (18.2)

<u>Workload (35%)</u>	<u>Sun.</u>	<u>Mon.</u>	<u>Tues.</u>	<u>Wed.</u>	<u>Thur.</u>	<u>Fri.</u>	<u>Sat.</u>	<u>Total</u>
Service Demand (Hrs.)	15.3	18.4	16.1	15.3	14.7	16.9	19.1	115.8
Daily Percentage	13.2	15.9	13.9	13.2	12.7	14.6	16.5	100%
<u>Staffing</u>								
Arithmetic Optimum	11.9	14.3	12.5	11.9	11.4	13.1	14.9	
Adj. Staffing Level	12	14	13	12	11	13	15	

Shift III (11 p.m. - 7 a.m.) 24 officers (23.9)

<u>Workload (46%)</u>	<u>Sun.</u>	<u>Mon.</u>	<u>Tues.</u>	<u>Wed.</u>	<u>Thur.</u>	<u>Fri.</u>	<u>Sat.</u>	<u>Total</u>
Service Demand (Hrs.)	22	20.7	22.5	18.9	19.8	25.2	23.2	152.3
Daily Percentage	14.5	13.6	14.8	12.4	13	16.6	15.2	100%
<u>Staffing</u>								
Arithmetic Optimum	17.4	16.3	17.8	14.9	15.6	19.2	18.2	
Adj. Staffing Level	18	16	18	15	16	19	18	

It is useful to create a patrol officer pool to deal with the inevitable absences due to sickness, injuries on duty, terminations and administratively required leaves (vacations, training, special assignments). The pool should consist of at least 10% of the patrol force. During periods of low absenteeism, pool officers should be used for special crime reduction programs.

A P P E N D I X D

PATROL WORKLOAD STUDY RECAP

1. Appoint a patrol workload study coordinator (page 33).
2. Decide on scope of study; i.e., will study include a beat workload survey requiring the design of new reporting areas? Will more than one study period be used (page 9 and Appendix B)?
3. Decide on beginning and ending dates of data collection period(s). Allow sufficient lead time to complete training and implement required procedural changes (page 17).
4. Examine patrol dispatch record system to ascertain whether all the workload information is being collected. Develop procedures for computing and/or recording any new data items needed for the study (page 23).
- 5a. For agencies with Electronic Data Processing (EDP) support: Review data input, programming and output reporting requirements with EDP staff. Coordinate the study starting date with the EDP lead time requirement (page 19 and 21).
- 5b. For agencies dependent on manual data processing: Estimate the number of daily clerical hours needed to record and tally data items. Obtain supply of data tally sheets. Identify and train person(s) responsible for the data collection task (page 29 and 31).
6. Issue a directive describing the purpose, starting date and period of workload study as well as any new procedures to be followed by officer and civilian personnel (page A-1).
7. Establish quality control procedures whereby routine reviews of source documents occur and the manual tallies, or computer printouts, are verified for accuracy and completeness (page 33).
8. Begin data collection program.

9. Test the data collection system and its products (the manual tallies or printouts) for utility. This involves taking the data collected during a one-week test period to calculate queued call and beat workload percentages and construct bar charts for called-for services consumed time and officer shifts (page 37).
10. Make any procedural adjustments indicated by the tests and then begin the regular workload data collection period.

POLICY ANALYSIS IN LOCAL GOVERNMENT:
A SYSTEMS APPROACH TO DECISION MAKING

Kenneth L. Kraemer
Int. City Managers Association
1973

Chapter 4, "The Process of Analysis," in Policy Analysis in Local Government: A System Approach to Decision Making, Kenneth L. Kreamer, ed. (Washington, D.C.: International City Management Association, 1973), pp. 30-39. Reprinted by permission of publisher.

The Process of Analysis

AN OVERVIEW /1/

The process of analysis can be described simply as involving three interrelated activities: perception, design, and evaluation. In the first perception, the issues are clarified, the extent of inquiry is limited and the objectives identified in a way that is helpful to picking an alternative. The second, design, involves identification of existing alternatives, design of new alternatives, and gathering of information for comparison of alternatives. Finally, in evaluation, the alternatives are examined for feasibility and compared in terms of their benefit and cost, with time and risk taken into account.

Analysis seldom proceeds in this simplified and orderly fashion. Often the objectives are multiple, conflicting, and obscure; the alternatives are not adequate to attain the objectives, the measures of benefit do not really measure the extent to which the objectives are attained, the predictions from evaluation models are full of uncertainties, and other criteria that look almost as plausible as the ones chosen may lead to a different order of preference. When this happens, a modification of the above approach is required, for a single pass or attempt at a problem is seldom enough. In such an instance, the key to successful analysis is a continuous process of formulating the problem, selecting objectives, designing alternatives, collecting data, building models, weighing costs against benefits, questioning assumptions and data, reexamining the objectives, opening new alternatives, building better models, and so on, until a satisfactory solution is obtained.

In this chapter each of the major activities comprising the process of analysis is examined in detail. An attempt is made throughout to emphasize (1) the interrelatedness of each activity, (2) the notion that analysis is interactive and may involve working through each activity or the whole process several times, and (3) the fact that, while models and quantitative technique may be utilized extensively, the process of analysis is permeated with numerous judgments. The aim is not to provide a step-by-step procedure for performing policy analysis. Rather, it is to indicate in some detail the nature of the process and the kinds of considerations involved.

PERCEPTION

Analysis may start at any point in the policy making process. Usually, however, analysis is initiated by someone's perception of disparities or opportunities in the present scheme of things. Perception, as used here, refers to the apprehension of the existence of some situation requiring policy decision and action it involves two steps: (1) problem formulation, (2) identification and clarification of objectives.

Problem Formulation

"What is the problem?" is the first question to be asked. It may be satisfactorily answered only upon completion of the analysis. That is, most problems

of any complexity can seldom be comprehended clearly at the start. The decision makers and analysts usually have some general notions about the problem, but as the analysis proceeds these notions may be revised or rejected. Additional information developed in the analysis may change their understanding of the situation, the alternative courses of action considered possible, or the objectives deemed appropriate. For example, in the East Lansing case study described in Chapter 5 the city manager and analysts gained a clear perception of the fire station location problem only after a first round of analysis had been completed.

Problem formulation involves an attempt to (1) isolate the questions or issues involved in a situation; (2) fix the context within which the issues are to be realized (that is, define a system and its boundaries). This latter task may also involve an attempt to discover, in preliminary fashion, the variables operating in a situation and the relations among them.

Determining the issues. Not everything in the environment of an organization is relevant to decision and action. What is relevant are those things which aid or prevent the attainment of objectives, or which permit the adoption of new objectives and programs for their implementation issues are identified by perceived disparities or opportunities in the environment. Thus, someone perceives a need for low-income housing, improved police protection or garbage collection, or a better way of recruiting and selecting municipal employees. Or, perhaps, new revenue sources are discovered, a chance to attract a major industry develops, or a new federal program is enacted for training of the hard-core unemployed.

Which problems and opportunities are identified for decision and action is a matter of valuation. Such valuations are made continuously by people throughout government and the community. Some valuations are routine in that the issues or questions involved have arisen before and perceptions of what is important have been defined. Other valuations are ad hoc and require considerable investigation in order to determine whether a particular issue shall be the subject of analysis and decision.

For example, the reduction of crimes by juveniles is frequently identified as a problem. Preliminary fact-gathering may show that projected changes in age groups make it likely that the crime rate for the juvenile population may decline over the next several years. Thus, a situation initially seen as a problem may come to be regarded as neither urgent nor important for governmental action and will require no further analysis. Were the obverse the case, some unit within government might be required to take actions to reduce juvenile crime. Which actions can be taken becomes the subject of further analysis. The actions possible will depend in part upon the conceptualization of the system in which juvenile crime exists and the relationship of government actions to controlling it.

Conceptualizing a System. To proceed further in analysis, then, some area of activity must be conceptualized as a system. Systems are rarely known in advance. They are almost always contrived. That is, system is a mental

construct which is applied to some entity. For example, an individual, an organization, or a community may be considered as a system. The advantage of the concept is that it provides a common language for communicating about the entity and a framework for analyzing it.

The following features are said to be characteristic of and essential to any system:

1. The system constitutes a whole set of related things or events;
2. The whole is seeking to fulfill a set of goals;
3. The whole is composed of differentiable elements or subsystems, and the elements or subsystems are integrated in a patterned or structured form;
4. The elements or subsystems are in interaction, mutually affecting one another;
5. The whole system exists within an environment which is distinct and definable from the system itself;
6. A boundary differentiates the system from its environment;
7. The system is in constant interaction with its environment receiving inputs from the environment and producing outputs in exchange;
8. The system processes inputs into outputs through internal transactions in accordance with established needs;
9. The whole system seeks to maintain a state of dynamic equilibrium internally with its subsystems and externally with its environment. Feedback is the process by which the system maintains equilibrium and steers towards the system's objectives;
10. To maintain dynamic equilibrium, the system is in a state of constant flux or change;
11. The system has some mechanism for the control of its activities.

The task of conceptualizing a system, therefore, involves describing some existing activity in these terms and identifying the boundaries, goals, and objectives, elements, or subsystems, inputs and outputs and the relations between them, and those environmental factors which seem to affect the system in some important way. The task of analysis as it proceeds is to operationalize this conceptual model by developing symbolic representations for each of the important elements. As will be seen, this requires empirical observation and measurement of the elements and their integration into a mathematical, logical, verbal, or other model.

Defining system boundaries. In problem formulation one has to decide what seems to be part of the system under consideration and what does not. This is

the boundary question. At the extreme, everything relates to everything else and therefore nothing can be isolated as a system. However, problems of global scope are never solved. Simplification is essential--both to highlight what is relevant and to reduce the complexity of reality to the scope of analytic ability. Further, it is inevitable that not all decisions can be made at the highest level or by one individual or group; some must be delegated to others. Decision makers and analysts usually must consider actions that pertain to only part of a problem. Other choices are set aside temporarily, possible decisions about some things being neglected and specific decisions about others being assumed. This process of breaking a larger problem into component parts for the purposes of analysis is referred to as factoring.

In setting boundaries for the system to be studied, three considerations are important:

1. Whether the boundaries encompass at least that area of activity where some knowledge of system relationships exists or can be readily determined
2. Whether the boundaries encompass all of the relevant elements (variables) under control of the governmental system
3. Whether the boundaries delimit a system that can be effectively studied within the time and monetary constraints of the situation requiring decision and action.

In the case of juvenile crime the juvenile population, their families, the police, the courts, the welfare agencies, and the schools may all be said to constitute relevant parts of a system. Or, if such an all-inclusive definition seems beyond the scope of analysis or beyond the control of a particular governmental unit, the system may be defined to encompass only those parts over which that government has direct control. In this case the system might be defined as the juvenile population, the police and the schools. The other factors would constitute the environment of the system and would be treated as factors outside any model developed.

Formulating as a system the interactions of activities considered to be vaguely related to each other in a way that permits useful analysis is a difficult task. It is probable that any initial formulation will change as the analysis proceeds. The city as a system is difficult to distinguish by a single boundary, as it can be characterized by numerous noncoterminous boundaries on the basis of, for example, natural or man-made features; homogeneity of some characteristics of the area or its population; service patterns of local service agencies (such as stores, hospitals, churches, telephone companies, schools); local governmental units; and felt sense of community identification. The boundary most often chosen by governmental analysts is the legal-jurisdictional one. When one deals with problems of the individual city as a functional entity this boundary is extremely useful. For example, municipal boundaries are often adequate for problems of policing, fire protection, library service, and building regulation. They are probably inadequate for problems of waste disposal (but not waste collection) air pollution, transportation, and social welfare.

The San Francisco Community Renewal Program (CRP), discussed in Chapter 6, is a case in point. As part of the CRP study the planners and analysts developed a computer simulation model of the housing market and defined the boundaries of the system modeled as coterminous with the city and county of San Francisco. They chose this boundary because this unit was paying for the study and because it was felt that the city could neither exert control over other governmental units nor elicit their cooperation in the study. The San Francisco Bay Area was considered the environment of the system studied. When the system was being modeled this environment was treated as a population pressure creating certain demands and constraints on the San Francisco housing market. At the time the analysis began the character of this demand was not known. Therefore, population projections were developed. When these projections were compared with the housing stock available in the region it became apparent to the planners and analysts that housing needs of blacks, the poor, and the aged would not be met by suburban developments. As a result, a large influx of the above groups was predicted for San Francisco, which contained housing within their economic range and which already contained a high percentage of these groups in its total population.

Because the analysts had limited the study boundaries to the city's jurisdiction, they were limited to those alternatives which the city could itself influence in attempting to develop alternative courses of action. Many options less costly politically, socially, and economically were closed out. More important, the projections suggested an even greater division than already existed between black and white, rich and poor, central city and suburbs. From the standpoint of broad social policy, therefore, the system boundaries and governmental base for action were simply inadequate. Had the analysts extended the study boundaries to include the region, the resultant analyses could have produced information that would have indicated a greater range of possible action alternatives made possible equitable means of handling the problem population.

Identification and Clarification of Objectives

The next step in formulation is identifying and clarifying objectives. Objectives are an operational specification of general goals, which in turn are an externalization of internal values and preferences held by individuals in the community. Values can be specified and ordered to various degrees. At one extreme they are specified only by such general terms as the public interest and are ranked only subjectively, often implicitly and inconsistently. At the other extreme they are reworked into fully operational objectives that have a clear order of priority and even have some quantitative basis for determining how various trade-offs might be made between them.

It is generally supposed that goals should, and can, be set independently of the plans to attain them. Yet there is considerable evidence that operationally significant objectives are often the result of opportunities that possible alternatives offer rather than a source of such alternatives. There are at least two reasons for this. First, it is impossible to select satisfactory objectives without some idea of the cost and difficulty of attaining them, and such information can only come as part of the analysis. Second, only some of the possible consequences of different alternatives can be anticipated before

the analysis, and some of the consequences discovered may become goals. A chief characteristic of policy analysis is that solutions are often found in a set of compromises which seek to balance and to reconcile conflicting objectives and questions of value. It is more important to make the right choice among alternatives. The choice of the wrong alternative may merely mean that something less than the best system is being chosen. Choice of the wrong objective means that the wrong problem is being solved.

Objectives and their order of priority are determined largely by value judgments rather than by rational analysis. These judgements should be made explicitly. And, they should be based upon examination of the consistency, social consequences, and feasibility of the objectives. /2/

Interrelation of Perceptual Activities

The process of perception involves an interrelation between defining the issues, conceptualizing a system, defining its boundaries, and identifying and clarifying objectives--all of which serve to clarify the problem. Which conditions in the environment are considered issues for decision and action is a matter determined in part by the values and objectives of the participants. Values and objectives also influence definition of the relevant system and the boundaries that can or must be set.

The perception phase of analysis requires much interaction between policy makers and analysts. The frequent tendency of policy analysts is to accept the decision makers' original statement of the problem without much thought as to whether that statement is correct or how an answer to the statement will contribute to the decisions it is meant to assist. Because the concern of policy analysis is often with the future, the analyst's major job may be to decide what the policy maker should want to do.

On the other hand, policy analysts are seldom capable of defining problems alone. They may choose simplifications which are useful in bringing a problem within the bounds of analytic feasibility but which make the resulting analysis irrelevant to the real concerns of the policy makers. Initial attempts at analysis are frequently false starts resulting from wrong definition of problems. Some iteration of analysis is desirable in policy analysis, but that resulting from wrong problem definition is to be avoided.

But how are the policy maker and the analyst to know that their formulation of the problem is adequate? One answer is analysis. That is, the process of problem formulation should itself be subjected to analysis. With the use of the few facts and relationships that are known at an early stage and assuming others, an initial attempt can be made to solve the problem. This attempt will provide a basis for better problem formulation and permit preliminary testing of possible solutions.

Primarily as the result of discussion and intuition, the original effort to state a problem should suggest one or more possible solutions or hypotheses. As the study progresses, these original ideas are enriched and elaborated

upon, or discarded, as new ideas are found. The process of analysis is iterative. Each hypothesis serves as a guide to later work--it tells us what we are looking for while we are looking. As a result, the final statement of conclusions and recommendations in policy studies usually rests on a knowledge of facts about the problem which the analysts and policy makers lacked at the start. In the early stages it is not a mistake to hold an idea as to the solution; the error is to refuse to abandon such an idea in the face of mounting evidence.

An Example of the Perceptual Process

The following example illustrates several of the above points about perception. The decline of the central business district (CBD) is considered a problem in many cities. The traditional definition of the problem is in terms of deteriorated physical structures, lack of parking, congested streets, lack of pedestrian areas, lack of amenity decline in retail sales, and the like. Recently, a group of planners and public administrators working in a Los Angeles community were asked to develop recommendations to solve the problem of the declining CBD. In approaching this problem, they looked at the entire economic system of the community (particularly the business component) the population characteristics, tax policy, land use and housing trends, and the transportation network. The group found that the declining CBD was only an outward expression of a much more significant change taking place in the community. It was changing from an essentially suburban residential community of young families and a slight mixture of land uses to a more intensive and confined residential development pattern of older households, extensive industrial land use, and service-type retail stores. In addition, the imminent construction of freeways which would surround the community suggested a future reinforcement of the developing trend.

Thus, the initial definition of what was happening in the CBD was translated into a more fundamental change in the entire structure and functioning of the community. However, even this change could not be considered a problem until the community or its political leaders decided what they wanted the community's future to be (inasmuch as they could exercise control over that future). Several alternative futures were developed. The political leaders decided that they wanted to maintain the traditional image of the city as a suburban community. This then became the problem, and developing a CBD that would relate to their conception of a suburban community shopping district became one component of the overall problem. Other components involved attracting young families to the community, arresting industrial growth, building recreation programs and facilities, and initiating new tax policies. Had the political leaders chosen not to attempt to forestall the developing trend, the problem might have been defined as that of attracting industry to further the demise of residential land uses and to develop a strong secondary or service business center to serve the industrial uses.

Several points are brought out by this example. First, manifest problems are different from latent problems. Very often the manifest problem is only a symptom of a more basic latent problem. Second, problems are not unitary. The problem of the declining CBD was not simply a matter relating to commercial

business but also involved issues of transportation tax policy, industrial development, and population growth. Third, a problem is not a problem until it is defined as such. Until the decision makers choose to make some objective condition the subject of their attention, and desire to alter that condition, it is not a problem. Thus, problem definition is essentially subjective. The task of the policy analyst is to try to achieve a greater correlation between objective and subjective problems. Finally, in analysis, the problem never remains static. Interplay between a growing understanding of what a problem involves now and might involve in the future forces a constant redefinition.

DESIGN

The design phase is basically concerned with finding alternatives and the data on which their comparison is to be based. It is as important to look for new alternatives (and the data to support them) as it is to look for ways to compare them. If there are no alternatives or ideas about them, there is nothing to compare or to choose between. If a preferred course of action is to be designated, it must be discovered earlier that such a course exists, even if the alternative is to take no action.

Finding Alternatives

Usually, analysis is concerned with comparing an existing system with other systems. The purpose is to compare systems in a way that is relevant to a choice between them and that helps to decide which is better. Generally, only one of the systems compared will be an existing one, for the object is to try out innovations and new proposals in the comparisons. Existing systems may fail to meet the desired objectives in some way, or may be totally unacceptable. In other instances, existing alternatives may be suitable for the present but do not meet requirements predicted for the future. Or the problem may be to determine what the future might be and what it should be. Here the invention of alternatives becomes important. These, then, are design problems. Design in policy analysis is the process of inventing new elements and recombining known or existing elements in such a way as to produce a desired whole. A particular configuration of elements intended to accomplish a particular objective is an alternative.

Design is involved in a wide range of different types of human activity. The architect or engineer, for example, invents forms and occasionally structural methods and recombines rooms, spaces, and materials. These may all be regarded as elements. The final product of his efforts is judged as more satisfactory or less satisfactory according to the budget and program of his client and according to certain ill-defined canons of aesthetics and functional efficiency. In the urban realm the city official, the city manager, or the department head may be regarded as policy designers. Their elements may be people, physical resources, financial resources, capital investments, modes of organization, laws, regulations, or taxes. Their problem in designing a coordinated set of policies is to maximize the overall quality of life in the community. On a smaller scale, the process of designing a budget involves inventing new elements and combining existing elements (in this case various programs), so as to maximize the quality of service in a community within certain financial limits.

Much of the process of design is intuitive and is the product of creative individuals. However, systematic analysis can assist the design process by helping the designer to order the elements logically and by allowing the designer to try out many possible combinations of the various elements and to test their impacts. /3/ Simulation is a particularly useful tool here. If there is a model of a system, this model can be processed incorporating successive changes which correspond to alternative designs or combinations of the elements in the system. The influence of various designs on the desired objectives can be traced. The policy maker then has a basis for selecting the design which most effectively achieves the desired result or system output. This process was used with the San Francisco housing market model which is discussed in Chapter 6. The model was used to allow decision makers to compare existing public policies and various combinations of these policies in order to determine their relative impacts on the housing market. These impacts could then be related to the objectives of the decision makers as an aid to choice among the alternatives.

The possible number of alternatives in any problem is virtually unlimited. While it is technically possible in many cases to consider all possible alternatives and their impacts, the costs time, and relevance of so doing is often prohibitive. And such an undertaking is not necessary. The policy analysts and decision makers generally have some basis for judging which alternatives seem more relevant than others. Real world constraints also limit the number of feasible alternatives to a few. The key danger, though, is that some important alternatives will be overlooked. One approach to this problem is to define alternatives in a series of stages, starting with a complete list, eliminating the obviously impracticable alternatives, developing new ones by combining those already known, eliminating still others and so on, until a reasonable set is obtained.

Finding the Data

In some analyses the data needed for comparing alternatives are available or can be collected from existing records. This is often the case when comparing existing systems. For example, in a study to establish the optimum location of new fire stations to be built in the city of East Lansing, Michigan, the following data requirements were developed:

1. Estimated travel time for fire equipment over each block-long segment of the street network, including the ideal estimate and estimates under conditions of traffic congestion and other trip variables
2. The fire generation potential of each city block as indicated by the population density and by the structure type, density, condition, and use
3. The damage potential for each block, including the cost of damage in terms of life and property loss
4. The fire spread potential of each block. /4/

These data were unavailable in the form specified, but were obtained from existing records in the fire, public works, building, and planning departments.

Sometimes the data needed for analysis must be developed by experimentation, as when comparing new systems or when data on current systems are nonexistent. For example, in comparing alternative transportation systems data are needed on the implications of each system for users (e.g., accessibility, convenience, safety, cost), for nonusers (i.e., the opportunity costs), for the environment, for urban structure and functioning, and for an urban area as a whole. Data on users are available from transportation and related studies, so are data on opportunity costs. Data are scarce on such matters as the impact of various transportation systems on environmental factors of noise, air pollution, or water pollution. Still fewer data are available for the impact of transportation on urban structure and functioning (economic conditions, location patterns, and sociopolitical factors such as redistribution of population or the splitting of communities). Some of these facts can be collected through experimentation with parts of the overall problem. Thus, performance data on various transportation vehicles can be obtained through theoretical and empirical studies of the hardware. User reactions to new systems can be obtained through experiments which modify existing systems or which use prototypes. These same kinds of experiments can be used to test out environmental and other factors.

However, in still other cases the judgment of experts may be required. Expert opinion may be called on when it is necessary to use numerical data or assumptions that cannot be based on theory or experience. Experts may be helpful, for example, in determining the impact of various transportation systems on political and social structures. The Delphi technique is a method for obtaining the judgments of experts systematically and is described in Chapter 10.

The Role of Theory and Empirical Research. When theory exists, it provides a guide in looking for data. For example, in the fire station location problem, network theory was used. In the San Francisco housing market model, market theory provided a guide to data collection. The theory utilized may be highly formal (network and market theory), or it may be simply a hunch or a hypothesis--for example, that fire station location should be related in some way to the characteristics of the area to be served (fire incidence) and to the operational procedures of getting to a fire.

Whether theory exists or not, data collection is necessary. Where theory exists, the data provide a means of testing the theory. Both the theory and the data help to solve the problem. When theory does not exist, data collection may be necessary so that relevant theory can be built. The difficulty of achieving a balance between theoretical analysis and empirical research is indicated by D. M. Fort, who says that

the proper balance between theoretical analysis and fact-gathering depends on the problem. It is important, of course, to get the facts on the proper subject a preliminary theoretical analysis can be very useful to this end in pointing out what information is lacking and most needed. Much effort can be and often is wasted gathering the wrong data, for failure to do the necessary theoretical homework first. On the other hand, much effort is also wasted applying sophisticated analytical techniques to inadequate data, trying to make silk purses out of sow's ears. Physical experiments

and data gathering in general are expensive making plans and decisions in the face of uncertainty, even if aided by the best possible systems analysis can also be expensive. A proper balance may well call for much more emphasis on fact-gathering than has been customary. /5/

Any analysis will be heavily supported by component studies of cost, engineering, human factors, and political and social considerations. Therefore, the data gathering phase of analysis will generally be the most time-consuming and costly. To assure adequate attention to all parts of the policy study, a balance must be struck between theoretical analysis and fact-gathering and between the design phase and other phases in the process of analysis. For example, extensive data gathering in the San Francisco Community Renewal Program (CRP) study left insufficient money and time to adequately evaluate the results of the housing market model. Evaluation and interpretation of the model results was completed after the CRP was completed. In this case the judgment and experience of the planners was utilized to make the CRP recommendations. When later tested with the aid of the model, the recommendations were found to be sound.

EVALUATION

As an intellectual process the evaluation phase of policy analysis involves predicting the consequences of selecting various alternatives as a basis for choosing from among them. It may simply require the judgment of an individual expert. It may involve using a single quantitative or format model such as an elaborate computer program which combines in a single computation all the various submodels for determining dollar cost, environmental forecasts, and goal achievement. Or it may involve a variety of processes, including quantitative and qualitative models, political gaming, and intuition. What is common to all evaluations is that they are done with the aid of some kind of model which is used in an experimental fashion to try out various alternatives.

The Role of Models in Evaluation

Models are used because the real thing often is not available for experimentation. Modeling involves ignoring many of the actual features of a problem under study and abstracting from the real situation certain variables and their interaction. The set of interacting variables makes up an idealized version of the real situation that concerns the decision makers. This idealization is called a model. The model is then operated on or experimented with. The aim is to obtain answers to specific questions, which will provide clues to aid in dealing with that part of the real world to which the model corresponds.

Modeling is used in policy analysis to provide a framework, a way of organizing the thinking and communicating about a problem. It is also a guide to data gathering and computation. Finally, modeling is an aid to the process of evaluation, that is, to examination of the implications and costs of various alternatives so that they can be compared. For many important problems, simple comparisons of outcomes without any indication of which outcome is best

may be the most that can be done. This may be all that is necessary. Quantitative and formal models may not be required or applicable. Usually evaluation can go beyond this minimum, although it may not be possible initially to abstract the situation to a mathematical model or series of equations. Nevertheless, some way can be found to represent the consequences that follow from particular choices.

A Crude Example

The following example is used to illustrate the role of models in analysis. Suppose the problem is to advise decision makers on alternatives to urban redevelopment in order to meet the housing demand of an increasing population in a central city. The analysis could take two forms:

1. Some level of housing supply is fixed and an attempt is made to determine the alternative which will attain the desired effectiveness at minimum cost
2. The budget level is fixed and an attempt is made to maximize effectiveness, that is, to get the most housing for the least cost (assuming an existing mix of housing types, income levels, population groups, etc.)

Let us pursue the first form. For the analysis to be carried out, the environment must be forecast. This forecast includes the population increase expected over the time period in question and the housing demand generated by that increase. It also includes an effort to determine those factors which influence purchase decisions on the part of householders and those influencing private investment decisions in new or upgraded housing.

The second step is to model the interactions of supply and demand in the housing market that is, "Under what conditions will householders choose various types of housing?" and "What is the likelihood of various types of housing being available under various private investment assumptions?"

The third step is to model the influence of public interventions (code enforcement, rehabilitation, tax policy, etc.) in the housing market and to develop a cost model which measures the relative amounts of public and private investment under various public interventions.

A fourth step might be to develop an analytic scenario (model) to describe political and social forces operating in the environment over the time period in question. The scenario would start with the present state of the world and illustrate, step by step, how, in one or more future situations, racial tensions might erupt, political power might be redistributed, the middle class might return to the central city, and similar changes might occur. The scenario will probably not provide a clear way of weighing consequences, nor will it indicate a preferred rating of alternatives. Rather, it will serve to bring factors to bear on the decision which could not be accounted for in the previous models but which might be relevant to the decision at hand and might otherwise be overlooked.

How then might these various evaluative steps be put together? From the quantitative models would come comparison of alternatives such as those indicated in Table 4-1.

However, individual decision makers might each choose different alternatives. And usually there are a number of decision makers. What is needed, therefore, is a collective judgment from these men and the analysts who advise them. One technique for pooling judgements is to ask each decision maker and analyst to fill in an array of alternatives such as that illustrated in Table 4-2. Each individual would then rate the various alternatives (using, say, a number between 0 and 10), indicating his preference or his conception of the worth of each alternative relative to the various considerations pertinent to the decision. A numerical measure could then be worked out which would indicate the decision makers' preferences.

Table 4-1. Hypothetical housing market outcomes for three alternatives for an urban redevelopment project.

Expected housing market outcomes	Alternatives		
	A	B	C
Private market residential investment (in millions)	\$ 575	\$ 200	\$ 1,000
Number of substandard structures	36,922	70,000	10,000
Dwelling unit increase	24,000	15,000	70,000
Public investment in various programs (in millions)	\$100	\$40	\$200
Household increase	70,000	70,000	70,000

Table 4-2. Sample form for evaluating decision makers' preferences regarding three alternatives for an urban redevelopment project.

Considerations	Rating of alternatives		
	A	B	C
Private market residential investment	_____	_____	_____
Number of substandard structures	_____	_____	_____
Dwelling unit increase	_____	_____	_____
Public investment	_____	_____	_____
Household increase	_____	_____	_____
Segregation	_____	_____	_____
Flexibility	_____	_____	_____
Growth impact	_____	_____	_____
Political desirability	_____	_____	_____

This technique obviously leaves uncertainty as to the outcomes listed in the table. It fails to eliminate moral and value uncertainty as to which combination of outcomes would be preferable. But the simple act of displaying systematically the opinions and judgements of each decision maker for his own use is likely to be helpful to him. When the judgments of other decision makers are presented along with each one's arguments, the information may be more valuable. In fact, such feedback information may help bring about a consensus among the decision makers. Whether the group preference (as indicated by the scaled rating) is utilized or not (and sometimes it should not be, for the alternative which comes out on top may do so by default), the comparison is likely to be helpful.

The Outputs of Models and Judgment

Assuming a study has been done properly, the analysis may still not be ended. The outcomes from a model must be interpreted in the light of considerations which may lie outside those incorporated in the model. The "state of the art"

of policy analysis is not sufficiently advanced to include social and political considerations in the formal evaluation models. Since major decisions in the field of public policy are part of a social process as well as an intellectual process, these must be accounted for in the analysis. Considerations other than those of cost effectiveness are important. Included here are custom, tradition, morale, aesthetics, and individual and organizational behavior. Some of these considerations may be treated in models. Generally, the integration of such considerations with the results of models is a task for the decision makers, and it is a task that is essentially a judgmental one.

Decision makers receive several aids in their attempt to interpret the results of policy analysis studies. The policy analyst supplies recommendations on the basis of what he thinks the study implies. However, it is important to distinguish between what a study actually shows and the conclusions or recommendations drawn by the analyst. That is, when new minds--particularly those of the decision makers--review a problem, they bring new information and insight. Even though results obtained from a model are not changed, recommendations for action based upon the results may be changed because of this review. For example, one experienced user of analysis in the military states the following:

Simply said, the purpose of an analysis is to provide illumination and visibility--to expose some problem in terms that are as simple as possible. This expose is used as one of a number of inputs by some "decision maker." Contrary to population practice the primary output of an analysis is not conclusions and recommendations. Most studies by analysts do have conclusions and recommendations even though they should not since invariably whether or not some particular course of action should be followed depends on factors quite beyond those that have been quantified by the analyst. A "summary" is fine and allowable, but "conclusions" and "recommendations" by the analyst are, for the most part, neither appropriate nor useful. Drawing conclusions and making recommendations (regarding these types of decisions) are the responsibility of the decision-maker and should not be preempted by the analyst."

A model, even the most sophisticated mathematical optimizing model, is only an indicator. It is not a final judge. While an analysis may compare alternatives under a great many different assumptions, using various models, decisions are not made on the basis of these comparisons alone. This would hold true even if an immensely more complicated version of the study were to be carried out.

NOTES

¹A more extensive, slightly different, and excellent discussion of the process of analysis is E. S. Quade, "Principles and Procedures of Systems Analysis" in Systems Analysis and Policy Planning: Applications in Defense. ed. by E. S. Quade and W. I. Boucher (New York: American Elsevier Publishing Co., 1969). pp. 30-53. In fact, the entire book is recommended reading for those interested in pursuing the subject further. For a different but equally important work, see Alfred J. Kahn, Theory and Practice of Social Planning (New York Russell Sage Foundation, 1969).

²Various techniques for assessing preferences and various process approaches to determining goals are discussed in Kahn, Theory and Practice of Social Planning, Chapter 4.

³Britton Harris describes three ways in which alternatives are presently developed and suggests ways of improving the process as well as ways of testing various designs (Britton Harris, "The City of the Future: The Problem of Optimal Design." The Regional Science Association Papers, XIX (1967), 185-95). See also Christopher Alexander, Notes on the Synthesis Form (Cambridge, Mass.: Harvard University Press, 1966).

Two very useful works describing design considerations and ways of generating alternatives are Selma Mushkin and Brian Herman, The Search for Alternatives: Program Options in a PPB System (Washington, D.C.: The George Washington University, 1968), and Kahn, Theory and Practice of Social Planning, particularly Chapters 5-8.

⁴East Lansing Project Team, "East Lansing: A Facilities Location Analysis," East Lansing, Mich., 1968 (Mimeographed).

⁵D. M. Fort, Systems Analysis as an Aid in Air Transportation Planning (Santa Monica Rand Corporation, 1966). p. 10; also cited in Quade and Boucher, Systems Analysis, p. 42.

⁶Glenn A. Keat, "On Analysis," Air University Review. XVIII (May-June, 1967), 50; also cited in Quade and Boucher, Systems Analysis, p. 52.

TEST DESIGN

DIFFERENTIAL POLICE RESPONSE TO CALLS FOR SERVICES

U.S. Department of Justice
National Institute of Justice
Office of Development, Testing and Dissemination

Reprinted with permission of the National Institute of Justice.

Program Test Designs are developed by design groups composed of representatives of the National Institute of Justice and LEAA. The documents are prepared with contractual assistance, and are reviewed by a panel of experts conversant with the critical research and operational issues in the topic area.

The design group for the Differential Police Response to Calls for Service Program Test Design consisted of the following individuals:

National Institute of Justice

Jim Gardner, *Chairman*
John Bonner
Shirley Melnicoe
W. Phillip Travers

Law Enforcement Assistance Administration

Peter Xenakes

Advisory Committee members were:

Allen Andrews, Chief, Peoria Police Department, Peoria, Illinois
William Bieck, Director, Integrated Criminal Apprehension Program, Bureau of Police, Reading, Pennsylvania
Paul Earls, Captain, Communications Bureau, Charlotte Police Department, Charlotte, North Carolina
Tony Pate, Police Foundation, Washington, D.C.
Reese Robinson, Department of Planning, Wilmington, Delaware

The Design document was prepared by: Bonnie Lewin and Raydean Acevedo, Abt Associates Inc., Cambridge, Massachusetts.

October, 1980

Harry Bratt
Acting Director
National Institute of Justice

PREFACE

As part of its research and development mandate, the National Institute of Justice designs field test programs based on research findings. The knowledge and action goals of the Field Test Program are:

- To add to the knowledge base in law enforcement and criminal justice.
- To develop information on the effectiveness of specific criminal justice practices.
- To contribute to improved policy-making in the areas being tested.
- To identify those criminal justice practices in need of further development.
- To generate hypotheses for further research.

Each individual field test is an experiment, conducted in a limited number of sites, to determine the effectiveness of a concept or program strategy under controlled or quasi-experimental conditions, and to assess the transferability of the concept to other jurisdictions.

The goal of this particular field test is to develop and assess the utility of a comprehensive differential response system for managing the calls for service function of police departments. The design consists of program elements that will be uniformly implemented in three city police departments in the 100,000 to 500,000 population range and evaluated by the National Institute. This test has three primary evaluation objectives:

- To assess the impact of a differential response system on police practices.
- To assess the impact of a differential response system on citizens.
- To assess the transferability of the program.

Each site selected to develop and implement the field test will be required to adhere to the administrative guidelines and program components detailed in this document. Both process of development and implementation as well as effects of the field test will be evaluated by the Institute in accordance with the experimental evaluation design contained in this document. Sites will be chosen on the basis of the selection criteria presented in the final section of this document.

I. INTRODUCTION

A. Rationale for Managing Citizen Calls for Service

The increased volume of citizen-initiated calls for service in recent years, coupled with strained police budgets, has made it increasingly difficult for police departments to respond to all calls for service in the traditional manner of sending out a patrol unit as quickly as possible while maintaining their current level of activity in other areas. Departments have attempted to meet these competing demands through various approaches, all of which share the common objective of developing more efficient means of allocating available resources. These approaches include computerized communications systems to simplify and expedite public access to the police, computerized resource allocations plans, and efforts to return more officers to patrol duty.

The National Institute of Justice has been actively involved in this search for ways to improve the efficiency of various aspects of traditional patrol practices, and has sponsored two previous field tests in related areas: The Managing Criminal Investigations Test sought to increase the efficiency of the investigation process by various techniques, including expanding patrol officer involvement in investigations. The Managing Patrol Operations Test sought to increase directed patrol activities by systematically matching deployment to workload conditions.

The field test experiences in both of these programs, along with findings from other research efforts, has made the NIJ critically aware that the efficiency of patrol is dependent on the efficiency of the calls for service function. Improving the management of this function is not only necessary to provide departments with sufficient uncommitted time to perform non-calls for service activities, such as directed patrol or increased involvement of patrol officers in the investigative process, but equally important, is essential to assure that departments can rapidly respond to the increasing number of critical or emergency calls for service.

¹ Sumrall et al., Differential Police Response Strategies Study, Birmingham Police Department and Police Executive Research Forum, 1980, p. 2.

The current workload difficulties faced by many departments stem from three prevalent premises underlying the calls for service function. First, it is necessary to respond to virtually all citizen calls for service by sending out a patrol car; second, most calls cannot be delayed and must be answered as quickly as possible; and third, responding to calls for service takes precedence over other activities performed by patrol officers.² These traditional beliefs are based on the assumption that rapid field response is necessary in order to apprehend suspects, secure evidence, locate witnesses, reduce injuries, and assure citizen satisfaction.

However, this devotion to rapid response is questionable for two reasons. First, in light of rising levels of calls for service, many departments are simply unable to respond to all calls immediately. As a result, departments are forced to stack calls during peak periods, including critical calls which require an immediate response. Yet, oftentimes, citizens are still promised that a patrol unit will be sent immediately. When the patrol unit is not forthcoming, citizen satisfaction may be jeopardized. Further, patrol officers may be forced to reduce the amount of time they spend on responding to some--often critical--calls for service. Equally important, officers may be frequently interrupted from performing essential non-calls for service activities.³

Second, there is now a growing body of research and some program experience which challenges the belief that rapid mobile response is the most appropriate way to respond to all calls for service. This literature suggests that greater efficiency can be achieved in the calls for service function and other areas of police activity through the implementation of differential response systems which use call classification and prioritization techniques in applying a broad range of response strategies to calls for service.

Various studies on the composition of calls for service have shown that only a small percentage of calls received by the police (approximately 15 percent) are for crimes in progress or medical emergencies where a rapid mobile response is thought to be necessary to prevent or treat injuries or illness or to attempt to arrest suspects. The remaining 85 percent of the calls

²Gay et al., Improving Patrol Productivity, Vol. 1, Routine Patrol, Prescriptive Package, National Institute of Law Enforcement and Criminal Justice, 1977.

³A crucial finding in the Managing Criminal Investigations (MCI) Field Test was that in the test sites where the calls for service function placed constant demands on response units, police departments were unable to assign patrol officers to continuing investigations and could not provide sufficient time to patrol officers for initial investigations. The Managing Criminal Investigations Program Design recommends improved call screening procedures as an essential element for future MCI approaches. Greenberg and Wasserman, Managing Criminal Investigations, Program Design, National Institute of Law Enforcement and Criminal Justice, 1979.

are either crime incidents which are no longer in progress, and where suspects or evidence are unavailable, or non-crime related calls. Many of the non-crime related calls can be handled by various non-mobile responses. And, many of the crime related calls do not require an immediate mobile response, but rather can be delayed for a certain period of time or can be handled by non-sworn officers. It has been suggested that roughly 30 percent of the calls for service can be handled by non-mobile alternatives and 55⁴ percent of the calls for service can be handled by delayed mobile response.

Further support for the utility of differential response strategies comes from research on the effectiveness of rapid response on crime related incidents. The Kansas City Response Time Study, for example, found that rapid response led to an arrest in only 3.7 percent of the Part I offenses sampled. On scene arrests for discovery (not⁵ in progress) crimes, which comprised 62.3 percent of the sample, were rare.

Moreover, the traditional notion that citizens expect an immediate mobile response to all calls for service has also been called into question. The findings from several studies suggest that citizens are willing to accept delayed responses for certain calls provided that they are informed of an estimated arrival time and the officer arrives within the designated time. Pate's study on police response time indicates that the single most important determinant of citizen satisfaction is the difference between citizen expectations of police response time and citizen perceptions of actual police response time. If response times are no longer than expected, they can be quite long without reducing citizen satisfaction. However, if response times are longer than expected, satisfaction is reduced even though actual times are fairly short.⁶ Also, the Differential Police Response Strategies (DPRS) survey of citizen attitudes showed that for certain calls for service, citizens are willing to accept various non-mobile responses such as telephone reporting, walk-in reporting, and referrals to other agencies.

These findings suggest that police departments can exercise considerable flexibility in designing alternative approaches for responding to citizen calls for service without jeopardizing the traditional objectives of assisting the sick and injured, apprehending suspects, and assuring citizen satisfaction. Through the implementation of differential response systems, departments should be able to systematically manage the calls for service demand and ensure that critical calls are answered immediately.

⁴Gay et al., op. cit., Ch. 3.

⁵Kansas City Police Department, Response Time Analysis, Executive Summary, National Institute of Law Enforcement and Criminal Justice, 1978.

⁶Pate et al., Police Response Time: Its Determinants and Effects, Police Foundation, 1976, p. iii.

⁷Sumrall et al., op.cit., p. 71.

B. Current Use of Differential Response Systems

Although many police departments use some alternative response strategies for certain calls for service, few departments have developed comprehensive differential response systems in which the full range of possible responses is considered for the full range of citizen calls. The implementation of such a system is dependent upon four elements. These elements include:

- Call Classification Schemes
Departments must devise ways of classifying calls based on information critical to subsequent dispatching decisions. Two types of information appear to be critical to determining reasonable responses: the nature of the incident and the time of occurrence. The classification scheme must be sufficiently precise to make fine distinctions among calls; the wider the range of responses, the greater the precision required.
- Response Alternatives
Departments must determine the appropriate response for each of the categories in the call classification scheme. The range of responses includes immediate mobile response, delayed mobile response, and non-mobile responses such as telephone reports, mail-in and walk-in reports, and referrals to or responses by other agencies.
- Training and Supervision of Communications Personnel
Training and supervision of communications personnel are essential to ensure that they collect information from citizens necessary to evaluate each call for service and assign it to the appropriate priority category and adhere to department policy on response alternatives.
- Non-mobile Response Capability
Departments must assign personnel to handle non-mobile responses such as telephone reporting, walk-in reporting, mail-in reporting, and referrals.

The DPRS study on current police practices in the areas of call classification, call intake, and use of alternative response techniques indicates that, with few exceptions, the importance attached to rapid response has limited the present capability of police departments to implement the elements of a differential response system.⁸ These findings, based on a mail survey of 175 police departments and other pertinent findings on current police practice in call screening, are reviewed below:

⁸ Ibid.

1. Current Call Classification Schemes in Police Departments

The DPRS survey indicates that, while 71 percent of the surveyed departments make some attempt to prioritize calls according to the urgency of the situation, these classification schemes make only general distinctions between calls that obviously require an immediate mobile response and those for which mobile response can be delayed. In many departments, the calls for service workload is still handled on a first come, first served basis.

Many departments also classify calls for service in terms of signal codes which reflect legal categories set by state statute or local ordinance. While these codes are theoretically designed to highlight the nature of each call for service, in practice they subsume a variety of different situations, each of which may require different responses. Further, in many departmental schemes, large numbers of calls are assigned to a miscellaneous or unclassified category.

The reliance on signal codes, as well as the importance attached to rapid response, results in complaint operators collecting minimal information from citizens before passing the call on to dispatchers. However, several studies have shown that the type of information collected by complaint operators has significant implications for the decision-making of dispatchers and patrol officers. The dispatcher's selection of the appropriate response strategy is constricted by the meager information collected by the operator.¹⁰ In turn, the information provided to patrol officers by the dispatchers influences not only the responding officers' preparation for appropriate response at the scene of the incident, but their reporting behavior as well.¹¹

2. Call Intake Procedures

The importance traditionally attached to expeditious report taking and dispatching is also reflected in the way in which complaint operators and dispatchers are prepared to carry out their jobs. The DPRS study survey found that complaint operators and dispatchers received little training or supervision. Thirty-one percent of the departments provided no training to

⁹ Ibid., p. 30.

¹⁰ Antunes and Scott, Calling the Cops: Police Telephone Operators and Citizen Calls for Service, Indiana University, 1980.

¹¹ Pepinsky, "Police Patrolman's Offense-reporting Behavior," Journal of Research in Crime and Delinquency, Vol. 13, No. 1, January 1976, pp. 33-47.

operators, while 25 percent of the departments provided no training to dispatchers. Departments which trained complaint operators and dispatchers provided only a minimal amount. Also, operators were seldom given much guidance on how to respond to calls for service. Only 35 percent of the departments gave telephone operators written instructions on how to deal with varying types of citizen calls. Only 41 percent of the departments used a standardized set of questions to ask citizens who requested service.¹²

The limited training, supervision, and guidance provided to complaint operators and dispatchers, coupled with the widespread use of civilians who often have little knowledge of police practices, result in their exercising considerable discretion in determining the type of responses citizens will receive.¹³ Studies have shown that communications personnel cope with their largely unguided discretion by sending out a patrol unit to the majority of calls. As Antunes and Scott note, this response enables communications personnel to "shift the ultimate decision about what action should be taken to the officer dispatched to the scene who presumably will have more information about the particular incident, and in any event is professionally trained to make such decisions."¹⁴

The lack of supervision and training also influences the manner in which operators interact with callers. Antunes and Scott found that complaint operators were often terse and abrupt with citizens, and unless specifically asked, provided little information to citizens on the nature of the police response. Citizens were not informed on the length of time they would have to wait before a unit would arrive and often were not provided with explanations for police unwillingness to respond to certain calls.¹⁵

¹²Sumrall et al., op. cit., p. 32.

¹³The DPRS survey found that 44 percent of the departments exclusively employ civilians as dispatchers and 64 percent of the departments exclusively employ civilians as operators. Ibid., p. 31.

¹⁴Antunes and Scott, op. cit., p. 28. Maxfield found that the switch from sworn to civilian dispatchers in San Francisco in 1972 resulted in an increase in the number of patrol cars dispatched and a decrease in the number of calls handled over the phone. Civilians were less likely to resolve the situation themselves than sworn officers who had training and street experience. Further, patrol officers frequently refused calls from the civilian dispatchers asking for reassignments, and civilians more frequently granted their requests, resulting in an increase in service times for incidents. Maxfield, Service Time, Dispatch Time, and Demand for Police Services: Helping More by Serving Less, Indiana University, 1979, p. 8.

¹⁵Antunes and Scott, op. cit., p. 30.

3. Use of Alternative Response Strategies in Police Departments

The DPRS survey indicates that only 20 percent of the departments send a sworn officer to all calls for service. The remaining 80 percent of the departments use some type of alternative response mechanisms such as delayed mobile response (71 percent), telephone reporting (62 percent), station house reporting (54 percent) and appointment scheduling (25 percent).¹⁶ However, these responses are only used for a small proportion of calls for service. Few departments have systematically applied the full range of alternative response strategies to the full range of citizen calls.

Antunes and Scott's analysis of police responses to calls for service in the metropolitan areas of Rochester, St. Louis, Tampa, and St. Petersburg further confirms the frequent use of mobile response. Overall, a patrol unit was promised for 49 percent of the calls. A unit was promised in over 70 percent of the calls about violent crimes, interpersonal conflicts, public nuisances, suspicious circumstances, nonviolent crimes, and medical assistance. Referrals to outside agencies and internal units of the police department were made in 15 percent of the calls.¹⁷

C. Effectiveness of Differential Response Systems

Since so few police departments have implemented comprehensive differential response systems, and even fewer departments have undertaken rigorous evaluations of their efforts, there is a paucity of information on the effectiveness of these procedures in managing the calls for service demand. To date, empirical documentation on the impact of differential response procedures is limited primarily to evaluations undertaken on programs in the Wilmington, Delaware and Kansas City, Missouri Police Departments.

The Wilmington Police Department has undertaken two projects in recent years to increase their efficiency in managing the calls for service demand. The first project, the Wilmington Split-Force Experiment, involved two components: a patrol component and a communications related component. In the patrol component, patrol resources were divided into two units: a basic unit, responsible for responding to calls for service, and a structured unit, responsible for undertaking directed activities and, if necessary, responding to critical calls for service. The communications related component involved three procedures. The first procedure involved the implementation of a

¹⁶ Sumrall et al., op. cit., p. 35.

¹⁷ Antunes and Scott, op. cit., p. 23.

prioritization scheme for classifying calls for service. Three priority designations were used: in-progress calls, which required an immediate response by either the basic or structured unit; basic patrol critical calls, which required a response by the first available basic unit; and basic patrol, which required an eventual response by the basic unit. The second procedure involved the dispatch of calls on a first come, first served basis within each of the three priority designations, irrespective of whether the calls originated in the unit's designated response sector. The third procedure involved formally advising callers if responses to non-critical calls for service were to be delayed, and the amount of time that it would take for the patrol unit to arrive. When all basic units were busy, callers were informed that their call would be delayed for 30 minutes.

The findings from the evaluation of the Split-Force Experiment provide varying levels of support¹⁸ for the effectiveness of the three communications related procedures. The study indicates that:

- Complaint takers and dispatchers were often confused about the three priority designations. They tended to categorize calls for service as either critical or non-critical. However, the delay time (time between the receipt of a call and the dispatch of a unit) and travel time were shorter for critical calls than for non-critical calls, demonstrating that the department was able to respond appropriately to these requests.
- The first come, first served dispatch within each priority designation had both positive and negative effects. Although it resulted in decreased delay times and decreased workload imbalances among units, it increased travel time and increased intersector dispatches. As a result, response time was unchanged. The increased number of intersector dispatches had an adverse effect on patrol officers who felt a lack of sector identity since calls were dispatched to the first available unit, regardless of which sector the call originated in.
- The formalized delay procedure was implemented with some success but was often underutilized. The evaluation suggested that greater use of the formalized delay procedures could serve to reduce the lack of sector identity mentioned above which resulted from the first come, first served dispatching procedures.

¹⁸ Tien et al., An Alternative Approach in Police Patrol: The Wilmington Split-Force Experiment, National Institute of Law Enforcement and Criminal Justice, 1978.

- Analysis of citizen satisfaction with the formalized delayed response, based on telephone surveys of a sample of residents who had called for police service on a non-critical matter before and during the program, indicated that citizens were just as satisfied with a response time of less than 10 minutes as they were with a response time of 20 minutes, provided that they were advised of the delay.

The second project, Management of Demand for Police Services, undertaken as a follow-up to the Split-Force Experiment, sought to further increase the efficiency of the calls for service response by implementing a reactive system of managing calls for service. This system involved the use of call prioritization techniques and a range of responses, including immediate response; formalized delayed mobile response, including the use of appointment responses by field units; and non-mobile responses, including referrals, telephone reporting based on a call back system, and walk-in reporting. Preliminary, unpublished findings from the evaluation of this project indicate that the department has met its overall objectives of decreasing the number of complaints dispatched to the Basic Unit by 20 percent and decreasing the number of basic patrol units by 20 percent. These findings indicate that the managing demand for service concept is viable and productive, but also that it may be utilized to a greater extent.¹⁹

The Kansas City, Missouri Police Department implemented a call prioritization system as part of its Directed Patrol Project to ensure that uncommitted blocks of time were available for directed patrol assignments. Under the call prioritization system, call intake personnel screened incoming calls for service in terms of three response alternatives: immediate response, delayed response of up to 40 minutes for non-emergency calls, and call diversion for non-urgent calls including walk-in reporting, telephone reporting, and referrals to other agencies. The effectiveness of these procedures was evaluated by the Kansas City Police Department.²⁰

The findings on the use of formalized delay parallel those of the Wilmington Split-Force Experiment. A total of 10.2 percent of the calls for service were delayed, for an average of 22 minutes. While the use of delayed response assured patrol unit availability for emergency calls during peak workload periods, the evaluation indicates that the percentage of calls handled by delayed response was smaller than originally anticipated and that

¹⁹ Presentation by Dr. Michael Cahn, Public Systems Evaluation at NIJ Special National Workshop on Research Methodology and Criminal Justice Program Evaluation, March 17, 1980.

²⁰ Kansas City Police Department, Directed Patrol Project, Final Evaluation Report, January - December 1979, Kansas City Police Department, 1980.

the percentage of calls handled in this manner could be increased. Analysis of data on walk-in and telephone reports, which accounted for 26.8 percent of all reports handled, yielded similar findings. While the use of these two alternatives resulted in a time savings of 32,124 hours, equivalent to 17 patrol man years, an analysis of the types of calls handled by walk-in and telephone reports indicates that there is a greater potential for the expanded use of these strategies. The evaluation suggested that continued success of the three alternatives is dependent upon the ability of dispatch personnel to screen incoming calls for service and to determine the appropriate response.

D. Research Questions for Testing

Although these studies provide varying levels of support for the utility of differential response systems involving call prioritization techniques and alternative response strategies as mechanisms for managing the calls for service demand, they also raise numerous questions for future research:

- First, the optimal use of alternative response techniques has not been demonstrated. While it has been suggested that as much as 55 percent of the calls for service can be handled by delayed mobile responses and 30 percent of the calls for service can be handled by various non-mobile responses, the available evaluations indicate that the percentage of calls for service handled by these responses is much lower.
- Second, it has yet to be determined what types of alternative response techniques are appropriate for what types of calls for service.
- Third, it is not clear what procedures are necessary to increase the use of alternative techniques. It has been pointed out that the call classification schemes which are based on existing signal codes do not provide sufficient information to determine the appropriate police response. Also, it appears that communications personnel are not adequately trained to use these simple call classification schemes, let alone more sophisticated models. Both of these factors may contribute to the underutilization of alternative response techniques.
- Fourth, in light of the limited use of comprehensive differential response systems, minimal attention has been focused on their impact on police patrol practices. Further, information is needed on the extent to which patrol resources devoted to responding to calls for service can be decreased and used for non-calls for service activities. Information is also needed on patrol officer acceptance of alternative responses.

- Finally, the costs of implementing alternative response techniques have not received adequate attention. While it has been suggested that alternative responses will be less costly than the traditional responses of sending out a mobile unit, the anticipated savings must be weighed against the costs of training communications personnel and other affected personnel in the new procedures, in assigning additional personnel to carry out the non-mobile techniques, and in terms of citizen attitudes and patrol officer acceptance of the new response techniques.

In light of the current need of police departments to improve the efficiency of the management of the calls for service function, and the need for further empirical documentation on the impact of differential response systems on police practices and citizens, the National Institute of Justice is supporting a field test of a comprehensive differential response system for managing citizen-initiated calls for service. This test will be administered under controlled conditions involving the random assignment of non-critical calls for service to traditional and new response alternatives. (As will be discussed in later sections of the Test Design, if a citizen refuses the alternative response called for under the experimental design, the department should provide the type of response requested by the citizen.) The specific action goals and scope of the test effort are described in Section II of this document. Section III presents the programmatic components of the test and Section IV, the evaluation issues to be addressed. The implementation schedule and site selection criteria can be found in Sections V and VI, respectively.

II. GOALS AND SCOPE OF THE FIELD TEST PROGRAM

A. Action Goals

There are two primary action goals of the program to be field tested and several objectives associated with each goal.

The first goal is to increase the efficiency of the management of the calls for service function. Through the implementation of a comprehensive differential response system, it is expected that departments will be able to rapidly respond to the increasing number of critical or emergency calls for service and have sufficient uncommitted time to perform non-calls for service activities. The objectives associated with this goal are:

- To assure that calls for service of greater urgency receive priority treatment;
- To reduce the rate of non-critical calls for service handled by immediate mobile responses;
- To increase the rate of non-critical calls for service handled by delayed mobile responses;
- To increase the rate of non-critical calls for service handled by non-mobile responses; and
- To increase the amount of officer time available for non-calls for service activities.

The second goal of the program is to maintain or improve citizen satisfaction. In many departments, call intake personnel fail to provide sufficient information to citizens on the nature of the police response for their calls. Citizens are often not informed that their calls will be delayed, but rather promised a patrol car immediately, and are not informed of the length of time it will take a patrol unit to arrive. As part of this test program, communications personnel will receive training and supervision to ensure that citizens receive adequate explanations on the nature of the police response and to ensure that the designated response is delivered. It is anticipated that these activities will facilitate citizen satisfaction with the differential response program. Objectives associated with this goal are:

- To provide satisfactory explanations to citizens at call intake on the nature of police response to their calls; and
- To provide satisfactory responses to citizens for resolving their calls for service.

B. Scope of the Test Program

Participating departments will engage in a variety of activities for the purposes of developing and implementing a differential response system. It is anticipated that the implementation of the differential response system will, over time, reduce the number of calls for service which are dispatched. As such, departments would have increased patrol resources which could be used for addressing crime and service-related problems. This freed up time could be used for various directed patrol options, including crime prevention activities, such as community education, security surveys, target hardening, and property marking techniques; crime deterrence activities, such as saturation patrol and field interrogation; criminal apprehension activities, including decoys and stakeouts and suspect identification; and involving patrol officers in the investigative process.

However, departments are strongly encouraged not to undertake formal new programs for using the freed up time during the field test period. This limitation is suggested for three reasons. First, it is expected that the full field test period would be required to ensure that findings regarding calls for service patterns and resultant workload reductions are valid (for example, changes in the calls for service workload might occur as a result of seasonal variations). Second, new programs might jeopardize achievement of the goals of the programs. For example, a new community education program might result in an increase in the volume of calls for service and thus reduce the extent to which efficiency in the calls for service function can be achieved. Finally, new programs might confound the evaluation of the differential response program. For example, it would be difficult to determine whether changes in levels of citizen satisfaction are a result of the differential response system or of other new activities.

III. PROGRAM COMPONENTS OF THE FIELD TEST PROGRAM

Overview

This section describes the administrative guidelines and activities to be undertaken for the development and implementation of a differential response system in the departments selected to implement the field test. The differential response system ultimately involves the use of:

- a new call classification scheme to categorize calls for service along certain dimensions;
- the application of a range of response techniques, including immediate mobile responses, delayed mobile responses, and non-mobile responses; and
- various changes in call intake procedures, including the establishment of an Expeditor Unit to handle the bulk of calls which are eligible for non-mobile responses.

The development and implementation of the differential response system will be accomplished by undertaking three sequential program components: 1) development of a differential response model for classifying citizen-initiated calls for service and for determining the types of response alternatives for call categories; 2) development of a differential response system capability; and 3) implementation of the differential response system. The first two components will be addressed during an eight month pre-implementation period and the third component will occur during a ten month implementation period. The implementation schedule is summarized in Section V.

As noted in the Introduction and explained more fully in Section IV, Evaluation Issues, the differential response system will be administered under controlled conditions, involving the random assignment of non-critical calls for service to traditional and new response alternatives in order to determine the effect of the program on police practices and citizens. The implications of the evaluation for the development and implementation of the differential response system are also noted in the following discussion of the program components.

A. Development of a Differential Response Model

Implementation necessitates first that departments develop a differential response model. The model includes three elements: developing a classification scheme which will enable calls to be categorized along certain dimensions; determining the types of response alternatives; and determining the appropriate response alternative for each call category.

Departments participating in the test program will be required to implement a call classification system that is uniform across sites and will be required to implement similar types of responses for similar categories of calls. This level of uniformity is necessary to ensure that the field test provides an adequate basis for determining the comparative effectiveness of the differential response program in multiple settings. The evaluation findings of this field test will be strengthened under this approach since if there are consistent results in all sites, they provide complementary evidence of the effectiveness of the selected approaches. If the elements of the model are not implemented with a suitable degree of uniformity and the evaluation findings are inconsistent, it will not be possible to determine whether the findings are a function of unique site characteristics or the variation in the program components.

Following grant award, the managers of each police department will engage in a joint planning effort to obtain consensus on a uniform call classification scheme and on the types of responses to be used for given categories of calls. To facilitate this planning process, a technical assistance contractor will provide consultant services in the area of organizational development. The issues to be addressed during this planning effort are discussed below, according to the elements of the differential response model:

1. Call Classification Scheme

In order to determine the appropriate police response for the full range of citizen-initiated calls for service, the classification scheme must be sufficiently precise to make fine distinctions among the calls for service, and thus, must be based on information which will permit communications personnel to determine the dynamics of the specific incident. Current classification schemes based on signal codes do not provide this level of information. While the particular call classification scheme to be used in the field test cannot be specified at this time, the scheme to be developed by the three departments will include, at a minimum, two types of information --the nature of the incident and its time of occurrence.

The DPRS study, which included the development of a model for classifying calls, provides some guidance on the dimensions that departments might

consider for classifying calls in terms of the nature and time of occurrence. This project suggests that in determining the nature of the incident, three factors need to be considered. The first factor is whether an incident has already happened or potentially could happen. For example, a call for a prowler who could be a potential robber is more important from the standpoint of the requirement for a quick response than a burglary that has already been committed.²¹ The second factor is whether the incident involved property or persons. This categorization reflects the two basic distinctions made by criminal law and provides the police with some idea of the type of event they will be handling. The third factor is whether the call is of a service nature. These calls could involve minor crimes or simply the provision of some form of assistance. Based on these three factors, eight categories of incident types are suggested. These include: major personal injury; major property damage/loss; potential personal injury; potential property damage/loss; minor personal injury; minor property damage/loss; other minor crime; and other minor non-crime. As indicated by the developers of this classification scheme, however, these are not the only factors which departments may consider pertinent. Other factors could include the age of the victim, the geographical location of the incident, or calls from different types of institutions (i.e., schools, banks, hospitals).²²

The time interval between the occurrence of the incident being reported and the actual report to the police department is also an important element in determining the appropriate police response. Many incidents are reported hours or days after the incident occurred. In many of these cases, the delay in citizen reporting of the incident negates the value of immediate mobile response. Even for certain calls which are in-progress, immediate mobile response may not be required. The DPRS study suggests three time intervals by which incident types could be divided: in-progress; proximate, defined as those incidents that occurred less than one hour before the citizen contacted the department; and cold, defined as reports received more than one hour after their occurrence.

By considering the various dimensions regarding the nature and time of occurrence of incident, it is expected that the police managers in the test sites will be able to develop a uniform call classification system which will be acceptable to all parties. Consensus will be necessary regarding the definition and number of incident categories included in the classification scheme; the types of calls which fit into the classification categories; the number of time categories to differentiate calls within the incident time categories; and the definition of the time categories.²³ It

²¹ Sumrall et al., op. cit., p. 52.

²² Ibid., p. 51.

²³ While it is expected that agreement on a uniform call classification scheme will reduce the number of calls which are classified as miscellaneous, it is recognized that a certain percentage of calls may remain unclassified

is recognized that the percentage of calls for service within the various categories in a uniform call classification scheme might vary across the three selected departments based on the current nature of the calls for service workload. However, as previously noted, a uniform call classification scheme is necessary in order to facilitate cross-site comparisons among the departments.

2. Types of Responses for Managing Calls for Service

There are three basic classes of responses and additional options for each class of response which can be considered in developing a differential response model for calls for service. These are as follows:

- Immediate Mobile Responses
 - one vs. two officer units
 - one or more units
 - sworn vs. non-sworn personnel

- Delayed Mobile Responses

In addition to the options specified for immediate mobile responses:

 - calls would be delayed for a set period of time
 - calls would be responded to by scheduling an appointment with the citizen

- Non-Mobile Responses
 - telephone reports
 - referrals to other agencies
 - mail-in reports
 - walk-in reports in response to police direction
 - no response

The selected police departments will be required to implement the three basic classes of responses. However, the departments will have some latitude in choosing among the various options under each basic class of response. For calls requiring immediate mobile response, it is anticipated that the departments will vary regarding the use of sworn versus non-sworn personnel, one or more units and one vs. two officer units. Decisions regarding vehicle preference (i.e., first come, first served, irrespective of the beat where the call originated) may also vary across the departments for these calls.

due to differences among the cities. This percentage should be kept to a minimum level, to be determined jointly by the managers from the three departments, and to be monitored as part of the study.

For calls requiring delayed mobile responses, the departments will be expected to respond to these calls within 30-40 minutes.²⁴ It is strongly encouraged that these calls be responded to by the car assigned to the beat where the call originated.²⁵ However, if the call can not be responded to within this time frame by the beat car, cars from other beats should be dispatched so as to prevent a delay period exceeding 30-40 minutes. Departments will have latitude regarding whether to use appointment scheduling in which a mobile unit would respond to a call for service at an appointed time. If appointment scheduling is used, the maximum delay time would not be applicable.

For calls requiring non-mobile responses, all departments will be expected to implement a minimum of three response options. Two of these options, telephone reporting and referrals to other agencies, will be uniformly implemented in each selected department. Departments may vary on their choice of a third option or additional options, such as walk-in reports or mail-in reports.

3. Matching Calls for Service with Selected Responses

The three police departments will be required to agree to a certain level of uniformity regarding the types of responses which will be used for given categories of calls. Consensus should be obtained among the departments on the types of calls requiring immediate mobile responses; delayed mobile responses; and non-mobile responses. This level of uniformity is necessary to ensure that similar categories of calls receive the same class of response. However, it is recognized that there may be departmental circumstances which necessitate different responses for similar categories of calls. For example, a department which has the capability to process and use evidence may place a higher priority on sending a patrol unit to a delayed burglary report than a department without such capability.²⁶ The extent to which this variation will occur will be addressed in the planning effort.

²⁴This time frame is based on the findings reported earlier on citizen satisfaction on formalized delays and the suggestion that patrol officers need at least 30 minutes of uninterrupted time to take any constructive preventive crime measures (Gay, op.cit., p. 74). However, if this time frame is not feasible, it may be modified in negotiations between NIJ and the test sites.

²⁵The preference for assignment of the beat car for calls requiring delayed mobile response is based on the findings reported earlier on the Wilmington Split-Force Experiment.

²⁶ Sumrall et al., op.cit., p. 70.

Although a level of uniformity in matching calls for service with selected responses will be required, the individual departments will have latitude in selecting the particular response options under each of the three basic classes of responses for given categories of calls. For example, drawing on the DPRS study classification scheme of incident types, a call which has been categorized across the sites as proximate, minor property damage/loss, might be handled in one police department by taking a telephone report, while in another department, the same call might be handled by requiring the citizen to walk-in to the police department to file a report.

For illustrative purposes, Figure 1 presents an example of a format for a differential response model (the classification categories are those developed by the DPRS project). The X's indicate possible responses for calls which have been categorized by nature of the incident and the time of occurrence. By the end of the planning process, it is expected that the test sites will devise a similar model based on their joint judgments regarding the type and number of classification categories and type of responses for given categories of calls.

B. Development of a Differential Response Capability

Following the development of a differential response model, the selected departments will undertake a variety of planning, training, and data collection activities to prepare for the implementation of the differential response system and to facilitate the evaluation of the program. This component includes eight elements.

1. Revise Call Intake Procedures

Implementing a differential response system is obviously a more complicated process than the traditional practice of immediate mobile response for all calls for service, and as such, will require significant changes in the call intake procedures in communications.

The use of a differential response model places increased responsibility on complaint operators and dispatchers. The current devotion to immediate mobile response usually requires that complaint operators collect minimal information from citizens to classify the call according to signal codes before passing the information on to the dispatchers. Under a differential response system, complaint operators will be required to collect an expanded range of information from citizens in order to evaluate each call in terms of the dimensions of the call classification scheme--nature and time of occurrence of the incident and other appropriate criteria--and assign each call

FIGURE 1
TYPE OF INCIDENT/TIME OF OCCURRENCE

	MAJOR PERSONAL INJURY			MAJOR PROPERTY DAMAGE/LOSS			POTENTIAL PERSONAL INJURY			POTENTIAL PROPERTY DAMAGE/LOSS			MINOR PERSONAL INJURY			MINOR PROPERTY DAMAGE/LOSS			OTHER MINOR CRIME			OTHER MINOR NON-CRIME		
	IN-PROGRESS	PROXIMATE	COLD	IN-PROGRESS	PROXIMATE	COLD	IN-PROGRESS	PROXIMATE	COLD	IN-PROGRESS	PROXIMATE	COLD	IN-PROGRESS	PROXIMATE	COLD	IN-PROGRESS	PROXIMATE	COLD	IN-PROGRESS	PROXIMATE	COLD	IN-PROGRESS	PROXIMATE	COLD
<u>RESPONSE ALTERNATIVES:</u>																								
Immediate Mobile Response	X	X	X	X			X	X					X			X								
Delayed Mobile Response																								
• Based on Set Time Period					X	X			X	X				X	X			X	X			X		
• Based on Scheduled Appt.					X	X								X				X						
Non-Mobile Response																								
• Telephone					X	X					X	X					X	X			X		X	X
• Walk-In																								
• Mail-In																								
• Referral																								
• No Response																						X	X	X

to the appropriate classification category. Based on the selected departmental response strategies for given categories of calls, the complaint operator will also have to inform the citizen of the appropriate response.

A differential response system will also place increased responsibility on dispatchers who must ensure that departmental policies regarding the handling of emergency calls are carried out. Dispatchers will also be required to manage the calls which are being handled by delayed mobile response to assure that departmental policy regarding the length of time a call will be delayed and citizen expectations are met. Participating departments will be required to closely monitor dispatchers' adherence to departmental policy in these areas.

Participating departments will be expected to undertake several procedures to ensure that call intake personnel are adequately prepared to implement the differential response techniques. First, departments will be required to develop written guidelines on the new call classification procedures. Second, departments will need to review the types of information currently collected by complaint operators to determine how much additional information will be required to classify calls along the dimensions determined through the planning process. Third, departments will be required to develop a set of standardized questions to facilitate the classification of calls and thereby enable complaint operators to quickly determine which calls require an immediate mobile response. Fourth, departments will be required to develop standardized explanations for informing citizens of the appropriate response. Finally, departments may need to develop new call intake forms to address the elements of the call classification scheme and to facilitate the evaluation of the program. (Program requirements for facilitating the evaluation are discussed on pp. 24-25.) The technical assistance contractor will assist departments in addressing the first four areas.

2. Training of Call Intake Personnel

Following the development of the call intake procedures, the technical assistance contractor will assist in the development of training for communications personnel on the new procedures. The training will focus on communication skills, including how to ask the standardized questions for complaint evaluation and instructions for classifying calls according to the uniform call classification scheme.

3. Pre-Testing of Call Intake Procedures

Following the training sessions, complaint operators will pre-test the new call classification techniques for a short time period, but will still

respond to calls for service in the department's traditional manner. Complaint operators will use the standardized questions in their conversations with citizens; will classify each call in terms of the dimensions of the uniform call classification scheme; and will record the appropriate information on each call using the new call intake forms. This pre-test period will provide the complaint operators with the opportunity to indicate any operational problems regarding the new call intake procedures so that appropriate modifications can be made. In addition, observation of complaint operator-citizen conversations will be undertaken during this period to assure that operators are properly carrying out the new procedures.

It is anticipated that the three elements described above will be completed by the end of the second month of the program period.

4. Data Collection and Analysis of Citizen-Initiated Calls for Service

Over the next six months, complaint operators will classify citizen-initiated calls for service according to the new call classification procedures in order to establish baseline data on the calls for service workload. However, during this time period, they will still respond to calls for service in the department's traditional manner. The establishment and subsequent analysis of these baseline data will serve several purposes. First, it will enable the departments to accurately determine the volume and nature of various types of calls received over various time periods and the percentage of calls which will be handled by immediate mobile response, delayed mobile response, and non-mobile response. Second, this data base will permit departments to determine the required organizational changes to respond to calls according to the new procedures, including, for example, whether adjustments in the staffing levels for complaint operators and dispatchers are necessary; how many personnel will be required to staff the Expeditor Unit which will handle the bulk of non-mobile calls for service; and the volume of calls which can be referred to outside agencies. Third, the data base will permit the evaluator and the departments to determine the duration of the field test's experimental design phase by providing an indication of the calls for service workload. (Lower workloads will require a longer test period.)

5. Preparation and Submission of Preliminary Program Plan

Each department will be required to submit a preliminary program plan to the NIJ for review. The plan will describe the department's progress in undertaking the above mentioned activities and the anticipated organizational changes to respond to calls according to the new procedures, based on a preliminary analysis of calls for service workload. This plan will be submitted by the end of the sixth month. While NIJ is reviewing this plan,

the departments will undertake the other activities described below to prepare for the implementation of the differential response system.

6. Develop Procedures for Facilitating Implementation of the Differential Response System

a. Develop Relationships with Outside Referral Agencies

Since departments will be required to use outside referral agencies for certain calls for service, several activities will be necessary to establish working relationships with these agencies. These include: identifying the available non-police public and private agencies, such as animal control, crisis intervention units, detoxification centers, and utility companies; establishing communications with the appropriate managers of these agencies; determining the range of services they currently offer, their hours of availability, and their capacity for handling referred calls; and establishing agreements pertaining to the operating procedures for diverting calls to these agencies. The baseline data developed during this phase will permit the departments to estimate the percentage and types of calls which the outside agencies can anticipate receiving once the differential response system is implemented. Following the establishment of agreements with these agencies, each department should develop a directory of referral agencies to be used by complaint operators and staff of the Expeditor Unit in referring calls. The directory should specify the operating procedures, eligibility criteria, and hours of availability of the outside agencies. The department should also develop procedures for amending this directory as services provided by the referral agencies change or are no longer available and as new agencies are added.

b. Develop Procedures for the Expeditor Unit

Each department will be required to develop procedures for the operations of an Expeditor Unit (i.e., complaint report writing unit) comprised of individuals who will be responsible for handling calls screened by complaint operators as appropriate for non-mobile responses. Staffing and appropriate supervision of the Expeditor Unit will be the responsibility of each police department. Staffing options might include use of sworn officers, civilian employees, or volunteers. (While the NIJ test funds cannot be used to pay for the salaries of the Expeditor Unit, some of the test funds can be used to support the equipment-related expenses of the Unit such as telephone lines.) The location of the Expeditor Unit (i.e., within communications or another division) will be left to the discretion of each department. However, departments will be required to implement procedures to facilitate close working relationships between the Expeditor Unit and the communications division.

The Expeditor Unit will, at a minimum, be responsible for handling calls which have been screened by the complaint operators as eligible for telephone reporting. Additionally, it is anticipated that the Unit may handle calls eligible for referrals to outside agencies which cannot be completed by the complaint operators at call intake. Diversion of these calls to the Unit would occur in situations where the information requirements necessary to make a referral by the complaint operators are lengthy. In addition, if a department selects mail-in reports as an option, the Unit would be responsible for mailing out the appropriate forms and reviewing the completed forms. Also, if the department uses walk-in reporting, the Unit would be responsible for taking these reports. However, placement of the responsibility for walk-in reporting within the Unit would only appear appropriate if the department does not have neighborhood precincts. Departments which use appointment scheduling as an option for delayed mobile response may want to consider having the Unit schedule an appointment with the caller and then refer this information to the appropriate dispatcher, who would inform the patrol units of the calls requiring this response.

Departments which have used Expeditor Units for telephone reporting have handled these calls in one of three ways. First, some departments request that citizens call the Unit directly after the complaint operator has determined that the call is appropriate for the Unit. Second, in some departments, appropriate calls are referred directly by the complaint operator to the Unit at the initial point of contact with the citizen. This mechanism assures that contact with the citizen is maintained. And third, in some departments, a call back system is used whereby the complaint operator obtains the phone number of the citizen and advises him that the Unit will call him back. This mechanism avoids the problem of having too many telephone reports at a given period of time and too few at other periods of time and thus enables the Unit to better manage the workload. The test departments have the option of selecting the appropriate mechanism for taking telephone reports. However, since a critical feature of alternative response techniques is citizen convenience, the first option, in which the citizen must call the department twice, would appear to be less preferable than the other two options for telephone reporting.

7. Coordination of Data Needs

It is anticipated that the departments will need to revise the call intake forms used by complaint operators to reflect the elements of the new call classification scheme and the new response alternatives. They will also need to develop forms for the Expeditor Unit. Since much of the data required for the evaluation of the program will be extracted from these forms, the evaluator will collaborate with the departments in developing the data elements to be included in these forms. This will prevent unnecessary duplication of data collection efforts and will ensure that special data needs related to the evaluation can be integrated into the departments' regular data collection process. For example, as part of the evaluator's effort to develop a

data base useful for interpreting the results of the test program and to ensure the integrity of the experimental evaluation, it would be important to require each complaint operator to record on the call intake form whether the designated response under the experimental procedures was provided to the citizen. This information would provide a useful check on complaint operator adherence to experimental procedures and citizen acceptance of the designated response.

8. Preparation and Submission of Final Program Plan for NIJ Review

The concluding activity of this component involves the preparation of a final plan by each department for the administration of the differential response system for NIJ review. The plan will describe the department's overall progress in undertaking the task activities called for in this component. It would include, for example, any suggested modifications in program procedures based on NIJ's review of the preliminary program plan; the final analysis of the baseline data; a description of the structure, functions, and staffing levels for the Expeditor Unit, and the department's efforts to establish agreements with outside referral agencies; and the new forms developed in consultation with the evaluator.

C. Implementation of the Differential Response System

Implementation of the differential response system over the ten month implementation period involves three elements: generating support for the program; training of personnel; and monitoring the activities of communications personnel and the Expeditor Unit in administering the differential response system.

1. Generating Support for the Program

The departments will be required to undertake appropriate activities to facilitate acceptance of the program by personnel within the departments. This would involve briefing all command personnel and units within the police department on the scope of the program and the resultant changes in operating procedures.

2. Training of Personnel

Training will be provided to complaint operators, dispatchers, staff of the Expeditor Unit, and first line supervisors of patrol officers. Complaint

operators will receive training on the evaluation design procedures for assigning the appropriate type of response to calls, and on communication skills to assure that citizens are provided adequate explanations of the designated response. Training of dispatchers will focus on assuring that they understand department policy on the time frame and procedures for dispatching calls requiring immediate and delayed mobile responses. The training of the Expeditor staff will focus on report writing skills and communication skills. Also, training for communications staff and Expeditor staff might involve field observation of patrol officer responses to calls for service. Training of the first line supervisors of the patrol officers is necessary to ensure that they have a clear understanding of the types of calls which will be handled by field officers under the new procedures.

3. Differential Response System Activities

Following completion of the training activities, each department will implement the differential response system. During this period, complaint operators will be required to evaluate each citizen-initiated call for service in terms of the dimensions of the call classification scheme in order to assign the call to the appropriate classification category and determine the appropriate response. All calls which are classified into categories which require an immediate mobile response will be referred to the dispatchers. As indicated in the Evaluation Issues section, the remaining non-critical calls for service will be randomly assigned to receive either the new response alternatives (experimental group) or traditional response alternatives (control group). Calls which are classified into categories which are eligible for delayed mobile response will either receive a delayed mobile response (experimental group) or an immediate mobile response (control group). For those calls which will be delayed, the complaint operator would inform the citizen of this response and the expected arrival time of the unit and refer the call to the dispatcher, who would then dispatch a unit within the designated time frame. Similarly, for those calls which will be handled in the traditional fashion, the complaint operator would inform the citizen that his call will be responded to immediately and would refer the call to the dispatcher for immediate dispatch.

Calls classified into categories which are eligible for non-mobile responses will either receive the appropriate non-mobile response option (i.e., telephone reporting or referral) or the department's traditional response (either immediate mobile response or delayed mobile response, depending upon current policy). For those calls which will be handled by the non-mobile response options, the complaint operator would inform the citizen of the appropriate procedures, and where appropriate, divert the call to the Expeditor Unit. For example, the caller would be requested to walk in to the station house to file a report or would be referred to the Expeditor Unit for a telephone report. For those calls which will receive the traditional response (i.e., immediate mobile response), the complaint operator would inform the citizen of the designated response and refer the call to the dispatcher. Procedures

for implementing the random assignment process will be developed at each site through negotiations with NIJ, site representatives, and the evaluator.

The dispatch or communications supervisor will be required to continually monitor the calls which have been assigned to receive either immediate mobile responses or delayed mobile responses to ensure that departmental policy for these responses is met.

The Expeditor Unit will handle the calls which have been screened by the complaint operators as appropriate for their unit. At a minimum, this will include telephone reports and referrals which cannot be processed by the complaint operator. Depending upon departmental procedures, the Unit might also handle calls eligible for mail-in reporting, walk-in reporting, and appointment scheduling.

It is anticipated that citizens might refuse to receive the response alternative called for under the experimental design. For example, a citizen might demand that a patrol unit be dispatched for a non-critical call which under the random assignment procedures is designated to receive a non-mobile response. In these cases, the complaint operator should provide the response alternative requested by the citizen, either an immediate or delayed response, as deemed appropriate.

The first month of the program activities (month nine) will serve as a pre-test period of the experimental procedures. During this period, any necessary modifications in the call classification scheme, response alternatives, and random assignment procedures will be made. Following this pre-test period, the departments will be required to provide supervision and in-service training to ensure that communications personnel and staff of the Expeditor Unit adhere to the new call classification and response procedures. In order to maintain the integrity of the evaluation design, complaint operators will be required to provide written explanations of calls for service which result in deviations from the experimental procedures. The supervisor of the communications unit should periodically monitor complaint operators' conversations with citizens to ensure that citizens are provided adequate explanations of the response alternatives. In-service training should be provided to address any problems which might arise. Ongoing supervision of the Expeditor Unit and in-service training will be required to ensure that the staff of the Unit has adequate phone communications and report writing skills and adequate knowledge of the existing referral agencies' procedures.

IV. EVALUATION ISSUES

The purposes of this section are to present the analytic framework and evaluation objectives of the field test program and to provide a discussion of the evaluation design requirements. An independent organization will be selected by the NIJ to conduct the evaluation. The evaluation grantee will work closely with the program staff in each site to collect the data required by the evaluation design. A full description of the evaluation effort will be set forth in the NIJ solicitation for the evaluation of the field test.

A. Analytic Framework

Through the implementation of a process and outcome evaluation in each site, the evaluation will examine the extent to which the test sites achieved the action goals and objectives of the differential police response to calls for service field test as delineated in Section II.

The primary purpose of the process evaluation will be to document the degree to which the differential response system was implemented as planned. While it is anticipated that the departments selected to implement the field test are those best suited to achieve the goal and objectives of the program (based upon the current needs of their police departments and their demonstrated willingness to undertake the program requirements), past field test experiences have shown that the process of program implementation often results in changes in the program design. While some of these changes may be necessary to improve the feasibility of the design based on local variations across departments, others may result from unexpected changes in a jurisdiction--for instance, an increase in the volume of calls for service --and essentially are expected to represent necessary compromises. The process evaluation, in providing detailed documentation of the process of implementation and changes which occurred in test sites, is critical for determining whether the program is responsible for the observed outcomes. Also, the process evaluation is essential for identifying factors which are related to goal attainment and those which impede program implementation; and unanticipated side effects of the program. The identification of these issues is important for an understanding of the necessary conditions for implementing similar programs in other jurisdictions.

The primary focus of the outcome evaluation will be on improvements in the efficiency of the calls for service function and effects of the differential response system on citizen satisfaction. The evaluation will involve establishing the linkages between the findings of the process and outcome evaluation. Of special concern will be the consideration of possible non-programmatic interpretation of observed outcomes.

B. Evaluation Objectives

There are three primary evaluation objectives of the field test program:

1. To Assess the Impact of the Differential Response System on Police Practices

It has been a recurrent theme of this test document that the development and implementation of a differential response system for managing calls for service will have a significant impact on current operations of police departments. While a differential response system should be expected to have a major impact on the communications division of a department, it will also affect patrol operations. To the extent that the communications division is able to successfully implement differential responses and thereby achieve greater efficiency in managing the calls for service demand, patrol resources traditionally devoted to calls for service activities should be reduced and, in turn, can be used for other activities. The evaluation will be concerned primarily with assessing the changes which occur in the communications division and the associated changes in patrol activities related to responding to calls for service. However, the evaluation will also document the ways in which individual officers make use of freed up time for non-calls for service activities which might occur as a result of the implementation of the differential response system. As noted in Section II, departments are strongly encouraged not to undertake formal new programs for using freed up time during the field test period. Should departments undertake such programs, the evaluation will not be concerned with assessing their impact. Rather, the evaluation activities in this area will be limited to describing the nature of these programs.

Both process and outcome measures will be collected by the evaluator to address this evaluation objective.

- a. Process Component

The process component will encompass the activities undertaken during the pre-implementation and program implementation periods. During the pre-imple-

mentation period, the evaluator will observe the planning activities undertaken to develop a uniform differential response model and new call intake procedures; the training sessions provided to police managers, communications personnel, and staff of the Expeditor Unit; the efforts undertaken by each department in implementing the new call classification procedures; establishing and analyzing the baseline data on the calls for service workload; and developing the procedures, guidelines, and organizational modifications for facilitating program implementation. Three issues are of particular interest during this phase of the evaluation. The first is the nature of the call classification scheme developed by the police managers and the extent to which it differs from the traditional classification schemes used by these departments. The evaluator will also identify the factors that contribute to the development of a new call classification scheme and any constraints which impede its development. The second area of interest is the extent to which the response alternatives selected by the police managers differ from the traditional responses used by these departments. The third area of interest is the adequacy and types of training provided to personnel on the new call intake procedures and the nature and ramifications of the organizational modifications undertaken to facilitate the implementation of the differential response system.

During the implementation period, the evaluator will document the process of implementation and the degree to which the differential response model, as developed during the pre-implementation period, was implemented as planned. Several issues are of particular interest during this phase of the evaluation. The first involves communications personnel adherence to the new call classification scheme and experimental procedures for assigning response alternatives, as indicated by the percentage of calls which receive a response which deviates from policy guidelines. The second area of interest is the extent to which the call intake procedures result in more accurate classification of calls as indicated by the percentage of calls which are reclassified upon officer arrival at the incident. The third area of interest is the degree of understanding and acceptance of the program by communications personnel, Expeditor staff, and patrol officers.

The fourth area of interest is adequacy of the in-service training and supervisory practices of communications personnel and staff of the Expeditor Unit. The final area of interest is the identification of other factors which might account for any modifications in the differential response system. These might include, but are not limited to, changes in the volume and nature of citizen-initiated calls for service, communications and Expeditor personnel turnover, the way in which supervisory personnel communicate the goals and requirements of the program to both communications personnel and patrol officers, citizen resistance to the new procedures, and changes in the referral practices of outside agencies.

b. Outcome Component

Under this component, the evaluator will address the extent to which the test sites achieved the first program action goal:

- To increase the efficiency of the calls for service function, through attainment of the following objectives:
 - To assure that calls for service of greater urgency receive priority treatment;
 - To reduce the rate of non-critical calls for service handled by immediate mobile responses;
 - To increase the rate of non-critical calls for service handled by delayed mobile responses;
 - To increase the rate of non-critical calls for service handled by non-mobile responses; and
 - To increase the amount of officer time available for non-calls for service activities.

The types of questions to be addressed in examining this goal and its objectives include, but are not limited to:

- Does the program result in a reduction in the rate of calls for service traditionally, but no longer, handled by immediate mobile response?
- Does the program result in an increase in the rate of calls for service handled by delayed mobile responses?
- Does the program result in an increase in the rate of calls for service handled by non-mobile responses?
- Does the program result in quicker response times (both delay and travel time) for calls of greater urgency?
- Does the program result in a change in service time (travel time and time on scene) for given categories of calls?
- Does the program result in a change in patrol unit utilization (fraction of time patrol unit is committed to responding to calls for service during its tour of duty)?

- Does the program result in a change in officer workload utilization (ratio of calls for service workload to number of available officer hours or patrol unit utilization factor divided by the number of officers per unit)?
- Does the program result in an increase in the amount of time available for non-calls for service activities?
- Does the program result in changes in the frequency of calls for service for various categories of calls?
- Does the program appear to have an effect on arrest and clearance rates?
- What are the costs of implementing a differential response system?

2. To Assess the Impact of the Differential Response System on Citizens

The evaluator will address the extent to which the test sites achieve the second program action goal:

- To maintain or improve citizen satisfaction, through the attainment of the following objectives:
 - To provide satisfactory explanations to citizens at call intake on the nature of police response to their calls; and
 - To provide satisfactory responses to citizens for resolving their calls for service.

The types of questions to be addressed in examining this goal and its objectives include, but are not limited to:

- Are citizens satisfied with the handling of their calls by complaint operators at call intake?
- How does citizen satisfaction with the differential response strategies compare to citizen satisfaction with the traditional response strategies, for given categories of calls?

- For similar categories of calls, does citizen satisfaction with the differential response strategies vary by type of response option used?

The evaluator will assess citizen responses to the program by conducting surveys of citizens who requested police services and by analyzing the frequency of citizen refusals of alternative responses and the frequency of citizen complaints to the police departments. This assessment will provide further empirical documentation of citizen satisfaction based on actual experience with a range of alternative responses for a range of citizen calls.

3. To Assess the Transferability of the Program

In assessing the transferability of the differential response system to other police departments, the evaluation will determine whether the test sites achieved the action goals and objectives of the field test and identify the conditions which facilitated or impeded goal achievement. As noted at the outset of this section, the process evaluation will document the extent to which the differential response system was implemented as planned. Should any of the test sites experience implementation problems which cannot be overcome, the process evaluation would identify the characteristics of sites and departments which should be avoided in future replication efforts. At the same time, the process evaluation would serve to identify the characteristics of departments or cities which would be favorable settings for the implementation of a differential response system. In addition, through the analyses of process and outcome measures, the evaluation will be able to determine any necessary refinements in the elements of the differential response system.

C. Evaluation Design

In order to assess the effects of the differential response to calls for service program on police practices and on citizen satisfaction, an experimental design will be implemented in each police department during the program implementation period. Under this design, non-critical calls for service will be randomly assigned to receive either the new response alternatives (experimental group) or the traditional response alternatives (control group). The use of this experimental design involving random assignment is required since it is the only method for ensuring that the evaluation yields definite conclusions about the program effects. It minimizes the chance that significant pre-program differences, such as variations in the characteristics of complaint operators, will exist in the two groups, and it assures that these groups will be exposed to the same environmental changes except for the treatment conditions. Therefore, it reduces the possibility that non-program factors, such as changes in citizen composition of neighborhoods

or changes in non-calls for service police practices, will be interpreted as program effects.

Under this design, each complaint operator will use both the new response alternatives and traditional response alternatives on a random basis during the course of the experiment for responding to non-critical calls for service. As calls are received, each complaint operator will collect the necessary information from citizens to classify calls according to the dimensions of the uniform call classification scheme. Calls which are classified into categories which require an immediate mobile response (critical calls) will be referred to the dispatcher and will not be part of the experiment. The remaining non-critical calls which are classified into categories for which the response alternatives of delayed mobile response or non-mobile responses are available will serve as the starting point of the experiment. Based on a random number system, calls which have been classified by the complaint operator into categories which are eligible for delayed mobile response will either receive a delayed mobile response (experimental group) or the department's traditional response of immediate mobile response (control group). Similarly, calls which have been classified by the complaint operator into categories which are eligible for non-mobile responses will either receive the appropriate non-mobile response (experimental group) or the department's traditional response, such as immediate mobile response.²⁷

For example, referring to the differential response format on p. 20, an incoming burglary call would be classified into the major property loss/cold category for which a delayed mobile response is possible. If, based on the random number system, this call falls into the experimental group and thus is to receive a delayed mobile response, the citizen would be informed that an officer will arrive within a certain time interval (i.e., within 30-40 minutes). The complaint operator would record this response on the call intake card and transmit it to the dispatcher, who would then dispatch a unit within the designated time period. On the other hand, if a similar burglary call is received by the same complaint operator, for example five minutes later, and based on the random number system, the call falls into the control group and thus is to receive an immediate mobile response, the citizen would be informed that a unit will be dispatched immediately (as if the delayed mobile response does not exist). The complaint operator would record this response on the call intake card and transmit it to the dispatcher, who would send a unit immediately.

²⁷ It is likely that the definition of "traditional" response might vary across departments according to current procedures for handling calls. For example, if under the new call classification procedures, it is determined that a larceny could be handled by a non-mobile response and Department A currently responds to this type of call by immediate mobile response, then this response would be its "traditional" response. However, if Department B currently responds to a larceny by delayed mobile response, then this response would be its "traditional" response.

Similarly, an incoming larceny call would be classified into the minor property loss/cold category for which a non-mobile response such as telephone reporting is possible. If based on the random number system, this call falls into the experimental group and thus is eligible for telephone reporting, the citizen would be informed that his call will be referred to the Expeditor Unit. On the other hand, when a similar larceny call is received by the same complaint operator, for example ten minutes later, and based on the random number system, the call falls into the control group and is to be handled in the traditional manner of immediate mobile response, the citizen would be informed that a unit will be dispatched immediately (as if the Expeditor Unit does not exist). This information would be transmitted to the dispatcher, who would then dispatch the call immediately. Drawing from the differential response format, the experimental design procedures are illustrated in Figure 2.

The implementation of this evaluation design will permit reliable comparisons between non-critical calls handled in the traditional manner and non-critical calls handled by the alternative response techniques in terms of the police efficiency measures and citizen satisfaction measures indicated on pp. 31-32. These comparisons will address the question of whether greater efficiency in the calls for service function can be achieved without jeopardizing citizen satisfaction.

It is anticipated that the experimental design will be in effect during the day and afternoon shifts. However, the extent to which it will occur on the midnight shift depends upon whether the participating departments choose to operate the Expeditor Unit during this shift. The duration of the experiment will depend on the time frame necessary to generate the requisite number of calls within each category of the classification scheme to provide for an adequate level of statistical power for the analyses to be conducted. The final sample sizes within each category might be reduced as a result of citizen refusals to accept the designated response. The baseline data developed by each department during the pre-implementation period will serve as the basis for determining the duration of the experimental design.

To facilitate implementation of this evaluation design, during the pre-implementation period activities all complaint operators will receive appropriate training on the design requirements. In addition, the evaluator will assist the police departments in devising a random number system for complaint operator assignment of non-critical calls to either the experimental or control groups. In departments which do not have computer aided dispatch, possible mechanisms might involve either having stacks of pre-coded labels or pre-printed radio cards which indicate the appropriate response for each of the call categories. In departments which have computer aided dispatch, the assignment of calls to either the experimental or control groups could be accomplished through programming changes.

FIGURE 2
EXPERIMENTAL DESIGN PROCEDURES

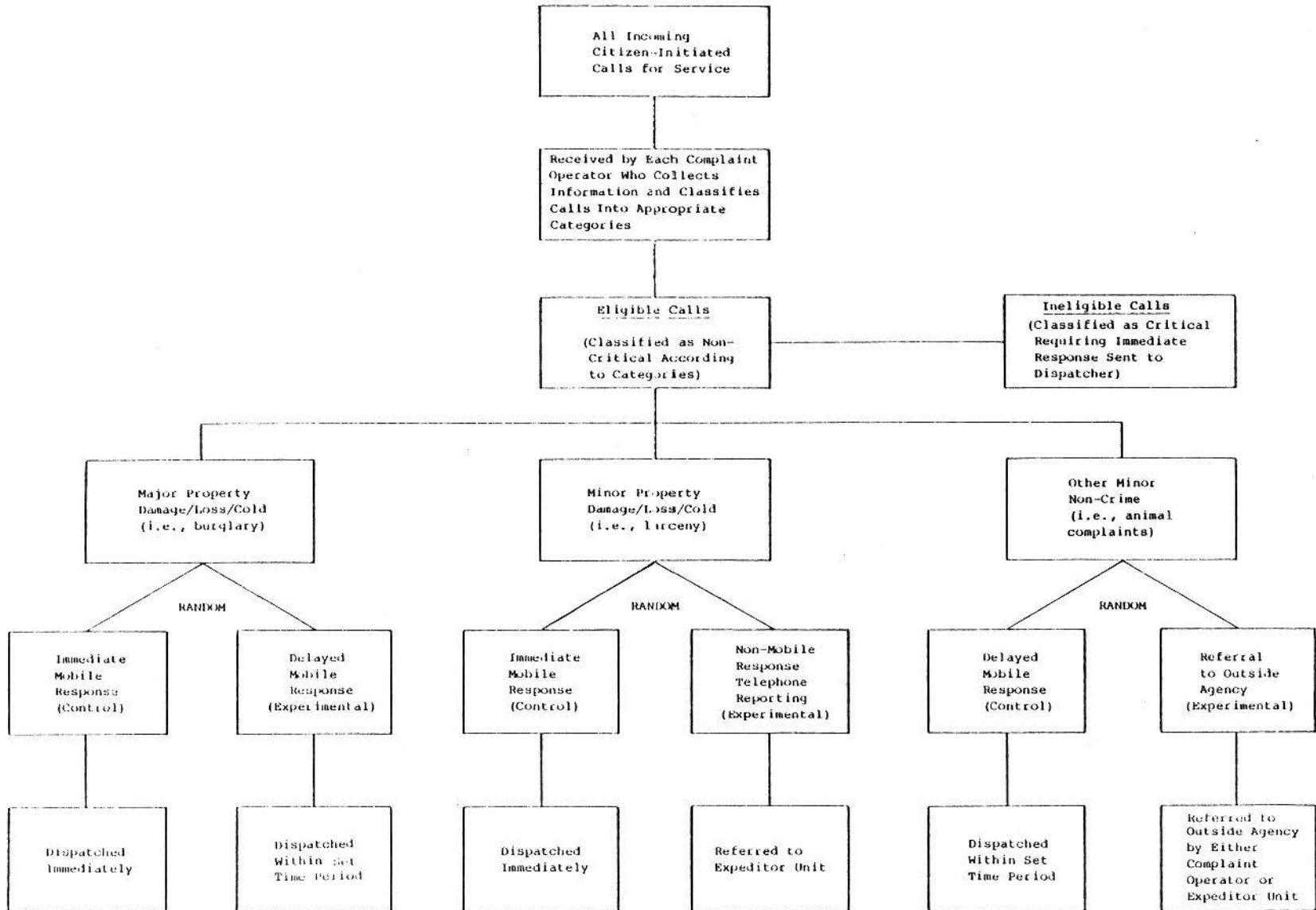

V. IMPLEMENTATION AND NIJ SUPPORT

A. Implementation

The proposed test effort has been designed for implementation within three jurisdictions. The test is designed in two stages over an 18-month period (see Figure 3). The initial stage, the pre-implementation stage, will involve up to eight months of planning, training, data collection activities, and program plan review by the NIJ, for the purposes of developing a differential response model and developing a differential response capability. The second stage will involve implementing the differential response activities and will extend over a maximum of ten months.

A separate grant will be awarded by NIJ to an independent firm to evaluate the field test. The evaluation will extend for 24 months. This time frame will enable the evaluators to observe both phases of the program and spend an additional six months analyzing the data and preparing the final report.

B. NIJ Support to Participating Departments

NIJ support will be provided in the form of training and financial assistance. A consulting firm will be retained by the Institute to provide implementation assistance to the participating departments. Support will include training for communications personnel (operators and dispatchers), staff of the Expeditor Unit, and field supervisory personnel; consultant services to aid the departments in the planning and implementation of the program components; and various conferences and meetings to enable selected program participants from each department to discuss problems and issues of mutual concern. Funds will also be included to support research utilization efforts such as hosting visiting police officials so they may observe program operations.

Funds will be made available to each participating department for the 18-month period to cover a project director and management analyst; telephone service costs to support the Expeditor Unit; participation of police managers, communications personnel, staff of Expeditor Unit, and field supervisory personnel in training provided by the NIJ training contractor; and other

**FIGURE 3
TIMETABLE AND TASKS FOR FIELD TEST**

TEST PROGRAM	CUMULATIVE TIME IN MONTHS																								
	1	2	3	4	5	6	7	8	9	10	11	12	13	14	15	16	17	18	19	20	21	22	23	24	
PRE-IMPLEMENTATION PHASE																									
• Develop Differential Response Model																									
- Planning Session		—																							
• Develop Differential Response Capability																									
- Revise Call Intake Procedures		—																							
- Train Personnel			—																						
- Pre-test Call Intake Procedures				—																					
- Baseline Data Collection and Analysis				—	—	—	—	—	—	—	—	—	—	—	—	—	—	—	—	—	—	—	—	—	—
- Submit Preliminary Program Plan to NIJ							—																		
- Develop Procedures for Expeditor Unit and Referral Agencies								—																	
- Coordinate Data Needs with Evaluator		—							—																
- Submit Final Plan for NIJ Review										—															
IMPLEMENTATION PHASE																									
• Implement Differential Response System																									
- Generate Internal Support										—															
- Train Personnel										—															
- Pre-test Experimental Procedures										—															
- Implement and Monitor Random Assignment Procedures											—	—	—	—	—	—	—	—	—	—	—	—	—	—	—
EVALUATION: PRE-IMPLEMENTATION PHASE																									
• Collaboration on Design of Forms for Evaluation		—							—																
• Assist in Quality Control of Baseline Data Collection			—	—	—	—	—	—	—	—	—	—	—	—	—	—	—	—	—	—	—	—	—	—	—
• Determine Sample Sizes and Length of Experiment										—															
• Data Collection for Process Component		—	—	—	—	—	—	—	—	—	—	—	—	—	—	—	—	—	—	—	—	—	—	—	—
IMPLEMENTATION PHASE																									
• Develop Random Assignment Procedures										—															
• Train Program Staff on Procedures										—															
• Monitor Pre-test of Random Assignment Procedures										—															
• Oversee Random Assignment											—	—	—	—	—	—	—	—	—	—	—	—	—	—	—
• Data Collection for Outcome Analysis												—	—	—	—	—	—	—	—	—	—	—	—	—	—
• Data Collection for Process Component												—	—	—	—	—	—	—	—	—	—	—	—	—	—
• Analysis													—	—	—	—	—	—	—	—	—	—	—	—	—

training costs not provided by the training contractor. The Institute will determine the amount of funding to be provided to each site based on an assessment of several factors, including the current state of development of the department's call screening system and the volume of call for service workload.

VI. SITE SELECTION

The site selection criteria are divided into two categories. The first category consists of those criteria which are considered essential for the successful development and implementation of the differential police response to calls for service field test program. The second category consists of a criterion which, while not essential, would enhance the validity of the evaluation findings of the field test program.

A. Criteria Considered Essential to Program Development and Implementation

- The prospective site must be a city police department serving a population between 100,000 to 500,000.
- The prospective department must have direct control over dispatch operations for police services.
- The prospective department must not currently be in the process of implementing either computer aided dispatch or 911 and must not be anticipating implementing either of these during the field test period. This criterion does not preclude departments which already have these systems operational.
- The prospective department must not have any organizational, political, or legal constraints that would impede the process of implementation. These include, but are not restricted to: contractual prohibitions; opposition from the local police union; and absence of an approved Equal Employment Opportunity Plan.
- The prospective department must not have, or be in the process of implementing, any other programs which would impede the evaluation of the field test.
- There must be an indication of interest and cooperation and written commitment from key officials (mayor or city manager) supporting the police chief's interest in the program.

- The prospective department must agree to provide necessary personnel for staffing the Expeditor Unit and for supervising the Unit.
- The prospective department must provide a profile of its citizen-initiated calls for service workload, preferably for the most recent 12-month period. At a minimum, this profile should include:

- The number and percentage of calls for service for each signal code used by the department by time of day (by hour, if available, or by watch); and

- The types of response strategies presently used.

It is also desirable that the departments provide the following data elements, if available:

- Response time defined by two intervals: delay time (time between receipt of call and dispatch of a unit) and travel time (time between dispatch of a unit and arrival of the unit) for calls, by signal code; and

- The number and percentage of calls for service (by signal codes, if available) handled by immediate mobile, delayed mobile, and non-mobile techniques.

- The prospective department must agree to participate in a planning process with the other selected sites following grant award for the purposes of obtaining consensus on a uniform call classification scheme and on a certain level of uniformity in the types of responses for given categories of calls.
- The prospective department must agree to participate in the evaluation of the field test and adhere to the evaluation design requirements.

B. Criterion Facilitating Evaluation of the Field Test Program

The following criterion, while not considered essential, would greatly enhance the validity of the program findings. It should be considered as a preferred criterion which will be applied if there are a number of candidates who meet the essential criteria spelled out above.

- Preference will be given to departments which agree not to undertake formal new programs during the field test period for using the freed up time which might result from the implementation of a differential response system.

GLOSSARY

Appointment Response: Response by a patrol unit at a designated time arranged with the citizen.

Beat: A designated geographic area to which a single patrol car is assigned. Also called sector in some departments.

Calls for Service Workload: Number of calls for service responded to by a patrol unit weighted by corresponding service times.

Citizen-Initiated Calls for Service: All requests for police assistance made by citizens, including alarms, and received by the communications center. For purpose of the field test, this definition does not include on-view incidents requiring police intervention.

Critical Calls: Calls for service where an immediate or emergency police response is necessary to prevent or treat injuries or interdict criminal activities. Most in-progress calls where suspects or evidence are available would be considered critical. These are time critical calls where an officer can take some kind of prevention, deterrence, or apprehension action, or provide other emergency services.

Delay Time: Length of time between when a call for service is received by the police and when a radio dispatcher dispatches a patrol unit to handle the call. It includes two intervals: the length of time between when a call is received by the complaint operator and when sent to the dispatcher, and the length of time between when the dispatcher receives the call and dispatches a patrol unit.

Delayed Mobile Response: Response to a call for service by a patrol unit which is not an immediate response. There are two options for delayed mobile response: 1) response within 30-40 minutes, or 2) appointment response.

Efficiency: Extent to which citizen-initiated calls for service workload can be handled at a minimum cost in resources.

Expeditor Unit: A unit within the department which will handle calls requiring non-mobile responses. At a minimum, the unit will handle telephone reports and referrals to non-police agencies. It might also handle mail-in and walk-in reports.

Immediate Mobile Response: Response to calls for service by a patrol unit as soon as possible.

Mobile Response: Response to calls for service by a patrol unit.

Non-calls for Service Activities: Patrol resources which are not used for responding to calls for service. Includes administrative tasks; officer-initiated activities; and preventive or directed patrol activities.

Non-critical Calls: Calls for service which require a response by either police or other non-police agency but not on an immediate or emergency basis.

Non-mobile Response: Response to calls which can be handled by telephone reports, walk-in reports in response to police direction, mail-in reports, and referrals to non-police agencies.

Officer Workload Utilization: Ratio of calls for service workload to number of available officer hours or, equivalently, the patrol unit utilization factor divided by the number of officers per unit.

Patrol Unit: Any police vehicle or other unit normally assigned to call response, i.e., cruiser, wagon, foot, mounted, scooter, motorcycle, marine unit.

Patrol Unit Utilization: Fraction of time a patrol unit is responding to calls for service during an eight hour tour or, equivalently, the ratio of calls for service workload to number of available unit hours.

Response Time: Length of time between when a call for service is made and when a patrol unit arrives at the scene of the incident. It includes delay and travel time.

Service Time: Length of time between when a dispatcher sends a patrol unit to handle a call and when the unit indicates that the service is completed. It includes travel time and on-scene time.

Travel Time: Length of time between when a dispatcher sends a patrol unit to handle a call and when the unit arrives at the scene of the incident.

SOURCE MATERIAL FOR THE DIFFERENTIAL POLICE RESPONSE
TO CALLS FOR SERVICE PROGRAM TEST DESIGN

- Antunes, George, and Scott, Eric J. Calling the Cops: Police Telephone Operators and Citizen Calls for Service. Bloomington, Indiana: Indiana University, 1980.
- Colton, Kent, and Brandeau, Margaret. A National Assessment of Police Command, Control, and Communications Systems, An Interim Report. Cambridge, Massachusetts: Public Systems Evaluation, 1979.
- Gay, William; Shell, Theodore; and Schack, Stephen. Improving Patrol Productivity, Vol. 1, Routine Patrol, Prescriptive Package. Washington, D.C.: National Institute of Law Enforcement and Criminal Justice, 1977.
- Greenberg, Ilene, and Wasserman, Bob. Managing Criminal Investigations, Program Design. Washington, D.C.: National Institute of Law Enforcement and Criminal Justice, 1979.
- Kansas City, Missouri Police Department. Directed Patrol Project, Final Evaluation Report, January - December, 1979. Kansas City, Missouri: Kansas City Police Department, 1980.
- Kansas City, Missouri Police Department. Response Time Analysis, Executive Summary. Washington, D.C.: National Institute of Law Enforcement and Criminal Justice, 1978.
- Maxfield, Michael G. Service Time, Dispatch Time, and Demand for Police Services: Helping More by Serving Less. Bloomington, Indiana: Indiana University, 1979.
- Pate, Tony; Ferrara, Amy; Bowers, Robert; and Lorence, Jon. Police Response Time: Its Determinants and Effects. Washington, D.C.: Police Foundation, 1976.
- Pepinsky, Harold E. "Police Patrolmen's Offense-reporting Behavior". Journal of Research in Crime and Delinquency, Vol. 13, No. 1, January, 1976, pp. 33-47.
- Scott, Eric J. Case Disposition: An Assessment of Literature on Police Referral Practices. Washington, D.C.: National Institute of Law Enforcement and Criminal Justice, 1979.
- Sumrall, Raymond; Roberts, Jane; and Farmer, Michael. Differential Police Response Strategies Study. Washington, D.C.: Birmingham Police Department and Police Executive Research Forum, 1980.
- Tien, James; Simon, James; and Larson, Richard. An Alternative Approach in Police Patrol: The Wilmington Split-Force Experiment. Washington, D.C.: National Institute of Law Enforcement and Criminal Justice, 1978.

IMPROVING POLICE SERVICES THROUGH TELEPHONE OPERATIONS

Eric J. Scott
and
Stephen L. Pery

Eric J. Scott and Stephen L. Percy, "Improving Police Services Through Telephone Operations," Police Chief Magazine, July 1980. Reprinted with permission of the publisher.

IMPROVING POLICE SERVICES THROUGH TELEPHONE OPERATIONS

Telephone operators in American police agencies receive and process thousands of calls for service daily. The verbal exchange with operators is the first citizen contact with police in most service requests. This initial contact can significantly affect the demeanor of citizens who may later interact with officers, citizen expectations and evaluations of police, the quality of information received by the police, and officers who respond to the call. In many calls for service, such as provision of information to callers, the police operator handles the request without further action by patrol or other units; the operator provides a service directly to the caller. Their direct, service-providing contact with citizens and their potential impact on citizen demeanor and evaluations indicate that telephone operators are an important part of policing.

Police officials, however, have traditionally held departmental telephone operators in low esteem, viewing them simply as internal support personnel necessary for dispatching patrol units. Many officials do not consider that operators provide services directly to citizens and that operator responses can affect both citizen attitudes and police performance. The neglect of telephone operators is evidenced by minimal operator training and supervision, and the general inattention given by officials to this area of communications.

Telephone Operator Activities, Staffing and Training

The complaint operator is the first police contact for most citizens requesting police service. Operators screen all calls, categorize the problems, recode them into police-relevant terminology, and determine the proper response. Operators, regardless of the sophistication of the technology employed for processing calls for service, are generally instructed to obtain from the caller the nature of the problem, the location to which a police unit might be sent, and the caller's name and phone number. Operators must quickly ascertain the appropriate police response and convey it to the caller.

Police telephone operator activity precedes initial response by patrol units. Operators also handle many calls themselves or refer them to other offices or agencies; these calls never enter the dispatch queue. What many police chiefs forget is that for a substantial proportion of a department's calls, the phone operator is the only police official with whom a citizen has contact. The way in which the operator handles such a call will likely influence caller perceptions and evaluations of police.

Operators are often civilians, although some departments employ a combination of sworn and civilian personnel. Use of civilians in radio communications positions has been promoted as a means of decreasing costs and freeing trained officers for other assignments. Occasionally, sworn officers are assigned as complaint operators as punishment for internal rule violations or because they have been taken off duty for reasons of infirmity or incompetence. Females predominate, perhaps because the operator's job has been conceptualized by police planners as largely clerical in nature; some departments label their operators "complaint clerks."

Perhaps because of this perspective, police operators are usually poorly trained, receiving little formal instruction. Most of the departments we observed instituted only minimal training programs for their operators; we believe this to be common practice. Operators are instructed about operating the phone console or call director, and are given rudimentary guidelines for telephone behavior and directions on the kinds of information they should seek from callers. Beyond these instructions and review of written guidelines, few entry-level training programs or courses for operators exist. Inservice training is also scant, sometimes consisting of an occasional directive from the communications section head. This does not mean that considerable on-the-job training does not occur. On the contrary, some operators become quite skilled in interpersonal communications and become extremely proficient even in the absence of formal training programs.

Not only are formal training programs rarely used, but telephone operators are infrequently supervised. Although a supervisor may be present in the complaint room during most shifts, he or she rarely monitors operator handling of calls for service. Work content is generally not reviewed, job performance is not analyzed, and improper behavior is left uncorrected. The usual reason offered for lack of supervision is that the job is highly discretionary, that calls must be answered rapidly and continuously, and that there is simply no time to review performance. Implicit in the lack of supervision is the view that complaint room procedures are not important enough to justify either adding manpower for performance review or removing operators from the console long enough to suggest improvements in behavior. Operators are thus largely free to decide whether to promise a caller that a unit will be sent, and therefore whether a call will enter the dispatch queue.

Operators may also determine the priority of a call by their wording on the complaint card. An operator's decision to code a call as "see complaint" rather than as "prowler reported" may have significant impact on the position of the call in the dispatch queue and thus on response time. Operator's decisions set the stage for all further police activity in response to a call. Once a call has been categorized, the appropriate police response is routinely invoked. Thus one of the lowest positions in a police department (in terms of both status and remuneration) possesses a significant agenda-setting role for the entire department.

Of course, not all calls are subject to operator discretion. Departmental policies may exist to cover most situations that arise. Some departments have regulations stipulating that all citizen requests for assistance by an officer must be honored. But, since there is normally so little direct departmental oversight of operator behavior and only infrequent monitoring of operator call handling procedures, operators by first exercise their own judgment about the type of response appropriate for most citizen calls to police.

Police Operator Responses to Callers

In the summer of 1977, the authors participated in a major study of police patrol and referral practices in 24 departments located in three metropolitan areas.¹ As part of that study, we observed departmental call handling procedures and monitored incoming calls for service. Trained observers either listened to citizen calls as they were answered by operators or reviewed tapes of the citizen-operator exchange. Information was collected on more than 26,000 calls for service recorded during all three daily shifts and on each day of the week.

Observers noted the nature of the problem as presented by the citizen as well as the operator's response.

The overriding view of complaint operators is that they act only as a conduit of information between citizens and responding patrol officers. We found, however, that operators performed many more functions than simply channeling a citizen's request to a dispatcher for transmission to an officer in the field. Operators provided information and processed service requests themselves without further action being taken by other police officers. In many calls, operators were the sole police contact for the citizen requesting service; operators provided services directly to callers.

Table 1 presents a breakdown of operator responses to callers. The table shows that police operators promised that a unit would be dispatched in about half of the observed calls (with units actually being dispatched in most of the cases). In these calls, the operator acted as an information conduit routing the service request from the citizen through the dispatcher to the responding officer in the field. The primary task of operators in these calls is to obtain sufficient information so that appropriate police units can be quickly routed to the problem or crime scene to assist the caller.

In about 20 percent of observed calls for service the operator either referred or directly transferred the caller to another unit or agency. Referrals and transfers were made both to internal police units (e.g., detectives, juvenile officers, chief's office) and to outside agencies (e.g., community service organizations, other municipal departments, private service providers such as attorneys or insurance companies). When referring or transferring callers, operators acted as intermediate service providers, linking callers with other internal or external service providing units.

In another one fourth of observed calls for service, police operators acted as direct service providers and generally were the only police contact callers had concerning an incident. In more than half of these calls, operators took information from citizens; they did not always take action on the caller's behalf, however. Sometimes callers merely wanted to inform the police of a specific situation (such as the presence of a night cleaning crew in a building whose lights were usually off). In other calls, operators took reports from citizens for filing with the detective division. Sometimes citizens were told that police would take care of the matter, but were not told specifically that a unit would be sent.

Among other types of calls that were directly handled by operators were those in which information was provided to the citizen. information provision is a common but often ignored operator activity. Operators provided information on both police related and non-police related matters. Calls requesting general information on travel conditions, street directions, parking regulations, and other matters were frequently received. Operators often explained the circumstances surrounding a caller's particular problem or explained departmental policies. They also listened to complaints about general police or specific officer conduct and attempted to placate callers.

Effects of Operator Responses

The effects of operator response can have substantial implications for both the police and the public. Obviously an operator's response has important consequences for callers requiring immediate assistance in life-threatening situations or for those who are in need of essential information. Operator's responses can also affect citizen evaluation of their police. Many callers request information that is at best only marginally related to policing ("Why are the flags flying at half mast today?"). Operators must separate calls requiring a timely police response from a heterogeneous assortment of calls. This is frequently a difficult task. Yet operators are often the only police representative available to citizens. Their response may be the basis upon which many citizens form their opinions of their local police. Operators may foster strong citizen evaluations of police through prompt and courteous response, or they may create ill will with abrupt, impersonal, or incorrect answers. Operators can also influence citizen demeanor by their responses, which in turn may influence the interaction between citizens and responding officers in cases where units are dispatched.

Another effect of operator responses is their influence over patrol officer behavior. It is the operator who assigns an incident type to a citizen's request and determines the language on the complaint card. Dispatchers generally broadcast the nature of the call as they receive it from the operator. The operator, therefore, creates a set of expectations that may affect how an officer proceeds to the scene, prepares himself mentally for the encounter, and acts toward citizens.

Operator Treatment of Callers

We found that either because of the need to answer a call as quickly as possible, fatigue, or a lack of understanding of the caller's problem, police complaint operators were at times terse or abrupt. They were rarely expansive in their exchanges with citizens, answering curtly with responses like: "Yup," "OK," or "Huh." They were occasionally rude or hostile toward callers. Sometimes these responses were a citizen's only reply from the police!

A polite, professional manner that provides citizens with sufficient information to let them know what to expect from their police or that expresses appreciation for their taking the time to call may well increase public support for local police.

Unless specifically asked, complaint operators provided very little information about what callers could expect from the police. In about half of the 26,000 observed calls, citizens were promised that a unit would be sent to handle their problem. Yet in less than 1 percent of dispatched calls were citizens told how long to expect to wait before a police unit would arrive. Citizens requesting police assistance may not only want to know if an officer will be sent, but when he is likely to arrive. Waiting for an event that occurs much later than expected (or not at all) can seem endless. Police delay in responding to any particular call may of course result from the urgency of other pending calls, the lack of priority of a specific call, a personnel shortage, an equipment malfunction, or any number of additional factors. Nevertheless, the caller's information is inadequate to make this judgment unless he or she is given some prior information by the telephone operator.

Lack of information from operators may also be aggravating to callers who are not promised a unit or to whom no information is provided. In 5 percent of the calls we observed, citizens were told that police could not handle the call; in one third of these, operators offered no explanation for the lack of police response. If a report is being taken by phone, citizens may wish to know why the call is being handled in this manner and what the police will do about the problem. Callers may want to know if the department appreciates their effort to report something suspicious in the neighborhood or to report an accident. We observed that frequently operators made no indication of appreciation for the citizen's effort in calling; instead, they were extremely curt, especially in cases where a problem was reported several times. Citizens may view curtness as an indication that they should not bother to take the time and trouble to call again if they observe similar events in the future.

A key point that is often overlooked by police chiefs, communications sections heads, and complaint operators is one that needs constant reinforcement: what may seem trivial to police is often of major importance to callers. There is a great gap between the perceptions of complaint operators and those of citizens that must be bridged. There is likely to be a dramatic contrast between the way a citizen views a problem such as a drunk on the front porch and the way the operator perceives that problem. The presence of the drunk seems commonplace to the operator, but to the citizen it may be new and very disturbing. Operators sometimes fail to recognize that many problems reported to police are often perceived as urgent or threatening to the person making the call. Given this contrast in perceptions, police complaint operators should reflect a concern for the caller's problems.

Policy Recommendations

In too many police departments, the communications center has been viewed narrowly as an internal support unit useful only as a means of routing a patrol unit to the problem or crime scene. However, as described above, police operators themselves have direct contact with citizens and often handle the service request without further police action. The fact: (1) that operators have the first contact with citizens; (2) that this preliminary contact can influence citizen actions and demeanor prior to meeting the responding officer in cases where a unit is dispatched, as well as citizen evaluations of police; and (3) that operators handle many kinds of service requests themselves, indicates that operators perform a crucial police function. Police officials need to recognize these important dimensions of police telephone operations when making decisions concerning staffing, training, departmental policies, and resource allocations.

Certainly some police officials recognize the importance of communications operations. However, our experience indicates that many agencies have long neglected telephone answering activities and operator training. Recent innovations in communications have generated new technologies and equipment systems that are receiving widespread attention. These technological innovations include computer-aided dispatching (CADs), automatic vehicle monitors (AVMs), and others, all of which have received great fanfare in recent years.² These systems offer several advantages, yet they do not diminish the importance of either telephone or dispatcher activities. In all of these new systems, the telephone operator is still responsible for gathering information from the caller, recording and coding it, and responding to the caller.

Based upon the arguments above and our observations in several police agencies, we raise the following policy recommendations for consideration by police officials. Each police agency will have different priorities and needs, and no set of recommendations is appropriate for all agencies. However, these recommendations may be useful to departments desiring to re-evaluate and upgrade their communications operations.

1. Police telephone operators should receive formal training prior to commencing work. No major telephone company would consider assigning individuals to work in their telephone communications section without training them about the equipment, company policies, communications skills, and appropriate treatment of callers. Yet, police agencies that routinely receive calls about critical matters generally do not employ highly trained personnel as telephone operators. As noted above, the personnel assigned to police telephone operations are all to often poorly trained, underpaid, and/or working there on temporary assignment (often as a result of disciplinary action). Many operators have become skilled at their job as a result of practical experience. This type of self-training, however, requires a fairly long time period and will likely result in departments having communications personnel with very different skills levels.

Departments should be able to increase the skills and abilities of operators through formal training programs. Training periods need not be long, involving a week or two prior to starting work; inservice training components could be built into the program. Training courses include instruction on departmental policies and regulations concerning communications (e.g., what information to collect from the caller,) interpersonal communication skills, handling crisis or emergency situations (e.g., how to calm an hysterical or suicidal caller), and appropriate treatment of callers. Operators could also be trained about the existence of internal units and community agencies to which callers with particular types of problems might be referred.

2. Police telephone operators and other communications center personnel should be more closely supervised. Supervision of telephone operators and dispatchers is minimal in many American police agencies. Supervision of patrol officers in the field, in comparison, is more generally recognized as an important aspect of patrol operation. The low level of operator supervision likely stems in part from the image of communications as a relatively unimportant, internal function. It may also be the result of difficulties in establishing strict supervision over operators who handle high volumes of calls for service, where each call is generally quite brief. Yet operators deal directly with citizens, affect the demeanor and evaluations of callers, and provide them with information and other services. Recognizing these "public service" dimensions of telephone operator functions, it is evident that supervision is important to communications as well as to patrol operations.

The equipment available in many police agencies offers unique opportunities for operator supervision. Supervisors can listen to live exchanges between operators and callers on a phone extension. Many police agencies tape incoming calls for service, offering supervisors the capacity to review an operator's performance over several calls for service. Supervisors might review the taped calls with operators at a later time, offering suggestions for improvement where appropriate. Increased supervision should encourage greater adherence to departmental guidelines, increased quality of information obtained from callers, and improved

treatment of callers. Operators need continuous reminders that what they consider a routine situation may be new and dramatic to the caller. Operators must be instructed to provide a clear indication of what callers can expect from the police. Only through careful supervision will improved service quality be assured.

3. Departments should provide citizens with the opportunity to protest perceived poor treatment by telephone operators. Operator performance might be improved through means other than supervision. If operators were required to identify themselves to the caller (Riverview Police, Operator Jones"), and if departments established methods of registering caller complaints, then citizens would have recourse if they received poor treatment from operators. Operator performance might be significantly improved if a citizen complaint about rudeness or lack of helpfulness could be registered, and if the department took the complaint seriously and followed through. The possibility of supervisory review of complaints alone should improve operator performance, especially if departments were willing to examine a complaint by reviewing the tape recording of the call in question. If the operator was found at fault, disciplinary action could ensue and hopefully the problem could be prevented in the future. In either case, a return call from the supervisor to the citizen could result in improved caller satisfaction with police.

4. Whenever possible operators should provide callers with relevant information about police response. Our experience observing police telephone operators in several departments suggests that operators often provide terse responses that offer callers little information about what they can expect the police to do. Callers are often very concerned or upset and want to know how the police will resolve their problem. Without taking much more time, operators could explain whether or not a police unit will respond; if no police unit will be sent they can explain why not, why the department cannot handle the matter, and/or who else might be able to provide assistance. With this information, citizens can form more realistic expectations about police response and perhaps understand why police cannot handle certain calls. In a limited number of calls, the operator might be able to instruct the caller to take actions that will assist police. Operators might direct the caller, for example, to protect a crime scene or to request witnesses to remain at the scene until the police officer arrives.

In cases where a patrol unit is to be dispatched, operators might provide an estimate of police response time. Other research has found that citizen expectations about response time have a stronger impact on evaluations of police response than the actual time it takes the police to arrive at the scene.^{/3} The City of Wilmington, Delaware, has instituted a system of formalized call delay where callers are informed that there will be a 30-minute delay in police response when all patrol units in the area are busy. Callers in a study of the Wilmington system were satisfied with a slower police response, provided they were informed of the delay by the operator at the time of their call to police.^{/4} Although operators may not be able to provide callers with precise estimates of response time, they may be able to inform callers that delays are likely during busy periods, explain the reason for the delay, and reassure them that the police will eventually respond.

5. Police officials and supervisors should encourage telephone operators to be courteous and polite to callers. Certainly, the departmental guidelines of most police departments contain some statement that telephone operators should be

courteous to callers. During field experience, we observed many operators who were polite and courteous to callers, while others were at times brusque and even hostile. Callers may interpret a brusque response as indicating police do not want their assistance; in the future they may be reluctant to assist police. The expense of spending a few seconds longer with each caller should not unduly burden departmental budgets, nor should it significantly reduce police response time. In our experience, patrol officers in the field who have face-to-face contact with citizens generally make a greater effort than do operators to be polite and courteous in practically all situations. Greater supervision and training might increase operator courteousness and politeness, and improve citizens' attitudes toward the police.

Conclusion

These five recommendations are offered as a means to evaluate and improve police telephone operations. They are not exhaustive and agencies should seek other ways to upgrade their communications center. To reiterate, the first step is for police officials to fully recognize the intermediate and direct services that operators provide. Once this is recognized, informed changes in telephone operations can occur. These changes might include greater selectivity in choosing operators, instituting formal training programs, increasing supervision, improving treatment of callers, and greater attention to providing information on police response. These reforms should improve citizen attitudes and evaluations as well as police performance in responding to service requests.

FOOTNOTES

1. Police patrol and telephone operations were studied in 24 police agencies located in the Rochester, New York; Tampa-St. Petersburg, Florida; and St. Louis, Missouri, metropolitan areas. Some of the ideas and analyses in this article are drawn from earlier reports based on this study. These include George Antunes and Eric J. Scott, "Calling the Cops: Police Telephone Operators and Calls for Service" (Bloomington, IN; Indiana University, Workshop in Political Theory and Policy Analysis, 1979); and Eric J. Scott, Calls for Service: Citizen Demand and Initial Police Response (Washington, D.C.: U.S. Government Printing Office, forthcoming).
2. For a description of some major technological advances in police work see Kent W. Colton, ed., Police Computer Technology, Urban Public Safety Systems, Volume 3, (Lexington, MA: D.C. Heath and Company, 1978).
3. Studies showing a relationship between expectation about response time and citizen evaluations of police include: Tony Pate, et al., Police Response Time Analysis: Its Determinants and Effects (Washington, D.C.: Police Foundation, 1976); Kansas City Police Department, Response Time Analysis: Executive Summary (Washington, D.C.: National Institute of Law Enforcement and Criminal Justice, Law Enforcement Assistance Administration, U.S. Department of Justice, 1977); and Stephen L. Percy, "Response Time and Citizen Evaluation of Police." Journal of Police Science and Administration, forthcoming, 1980.
4. James M. Tien, James, W. Simon, and Richard C. Larson, Evaluation Report of an Alternative Approach to Police Patrol: The Wilmington Split Force Experiment (Cambridge, MA: Public Systems Evaluation, Inc., 1977).

THE COMMUNICATIONS PROCESS
A PERSPECTIVE ON THE STATE-OF-THE-ART

James Evans
Public Administration Services

"The Role of Communications in Managing Patrol Operation," August, 1978. Law Enforcement Assistance Administration, U.S. Department of Justice. Prepared by Richard G. Grassie, et al. Reprinted with permission of U.S. Department of Justice.

1. Introduction

The implementation of a process requires a plan or procedure to ensure the fulfillment of that process. The communications process involves the formation of a plan or design to successfully transfer a citizen's call to the proper law enforcement officer in the minimum amount of time.

The communications planning process should provide, at a minimum, adequate procedures for policy, system, and personnel development. Those detailed procedures are discussed in this appendix. Figure 1 is a flow chart illustrating the major steps for implementing a communications process.

2. Policy Development

To reach the desired goal of providing an effective communications system, policy must be developed in several areas, including:

- Planning (short- and long-range).
- Administration.
- Operations.
 - Interface between patrol and communications supervisors.
 - Disagreements between communications and patrol.
 - Problem resolution.
 - Procedures for taking complaints.
 - Dispatch policies relative to call stacking and/or priority of calls
 - Standard operating procedures.
 - Interface with citizens regarding complaints about calls-for-service (CFS).

2.1 Planning

Planning for communications can be defined as an analytic process that includes an assessment of future needs, targeting towards desired objectives, development of alternatives to the objectives, and selection of an implementation plan that coincides with both objectives and budget. Figure 2 illustrates the major communications planning steps.

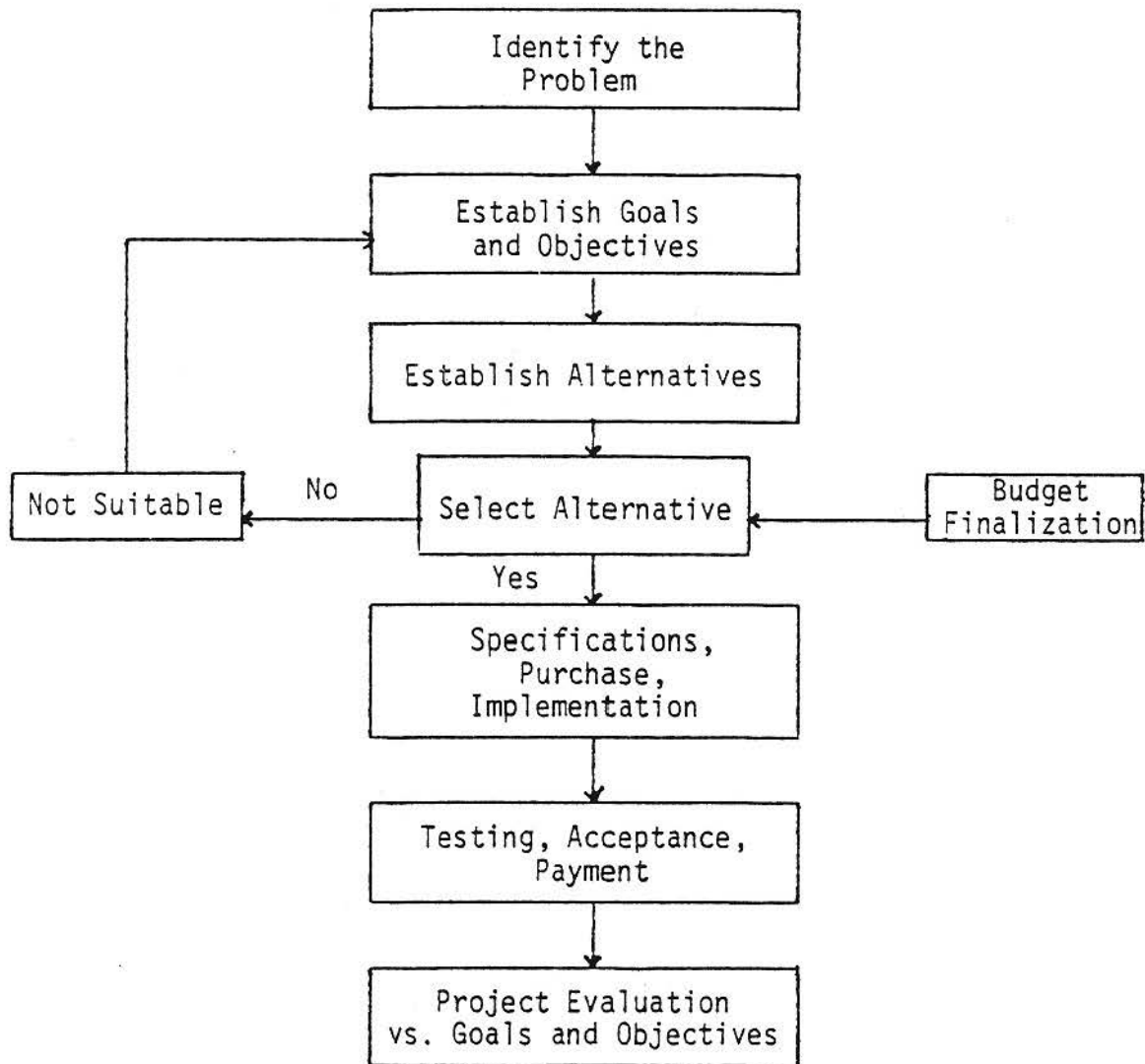

Figure 1. Implementing a Communications Process

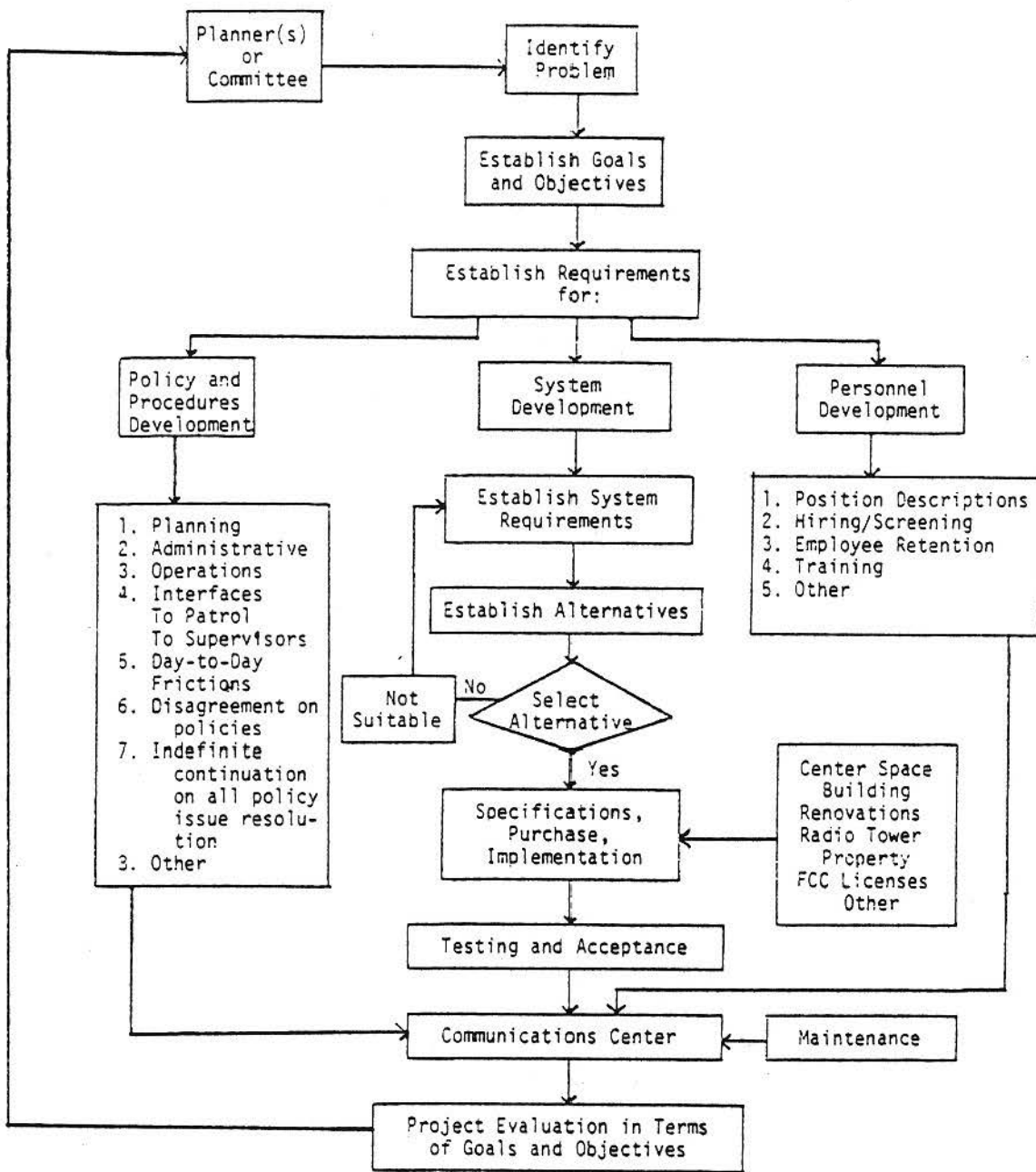

Figure 2. Event Flow Chart for Communications Planning

The department or agency should develop a planning policy that provides guidelines for implementing the communications process. The policy should cover the detailed requirements of identifying the problem, establishing goals and objectives that will provide an absolute answer to the problem, and developing, designing, purchasing and implementing the system. The policy clearly should define the duties of all involved personnel and the expectations of the design. It also should identify the funding source to determine: The amount of funds required and the amount available; restrictions, if any, that may be placed upon the use of the money; and how payment will be made. If Federal funding is involved, the policy will set forth all requirements that must be met to comply with Federal policies.

Communications planning must consider both short- and long-range goals.

2.1.1 Short-Range Planning

Short-range planning includes obtaining necessary licenses (e.g., Federal Communications Commission licenses, building permits), purchasing property, and taking other preliminary steps that facilitate long-range planning.

Short-range plans should establish objectives and requirements. These plans normally are project-oriented rather than broad system concepts. For example, short-range planning policies may be designed to complete limited projects such as the addition of one or more accessories to a communications center. These projects normally require budget consideration, but can be implemented without affecting the entire communications process.

Short-range plans should establish planning assumptions that will cover situations where long-range plans suddenly develop into immediate action plans. Alternatives also are needed, as in long-range planning, so that changes necessitated by rising costs or budget adjustments can be made.

The short-range plan requires selection of a system concept, implementation, testing, and acceptance. Evaluation of the project against the objectives is sometimes provided informally in this planning area.

2.1.2 Long-Range Planning

Long-range planning policy is more structured than short-range planning. The long-range planning process can be classified into definite steps:

- Identify the problem.
- Establish goals and objectives.

- Establish system requirement.
- Determine budget requirements.
- Establish alternatives.
- Develop specifications.
- Purchase and implementations.
- Test and acceptance.
- Evaluation of program in terms of goals and objectives.

Planners first must identify the problem and, in the case of the communications process, this may be a need to upgrade the communications design, to reduce response time, or to automate an existing dispatching system.

The goals and objectives that are established during the planning function usually are quite broad and may change during implementation. Multiyear implementation during periods of budget change sometimes necessitates a change in objectives. System requirements either may be controlled by the size of the budget available or they may determine a budget allotment.

Alternatives are always necessary in the planning process. Solutions will develop during the various phases, based on feedback from previous decisions. Each alternative will be evaluated against the system requirements to establish a minimum number of solutions meeting the goals and objectives.

After the final selection is made and the system design is determined, the planner should address the following areas:

- System Engineering.
- Facilities:
 - Operating space.
 - Supervisory space.
 - Equipment space.
 - New building or enlargement of existing facilities.

- Radio transmitter building.
- Personnel:
 - Requirements.
 - Selection process.
 - Salaries.
 - Training.

Long-range planning for communications has become a more difficult task in the past decade because technology is moving at such a rapid pace. Deliveries and installations take longer periods, and rising costs of hardware and software create additional problems for the planner.

2.2 Administration

Administrative policy must completely define specific requirements in the following areas:

- Interface between police command personnel and communications personnel.
- Continuing operation of the center in the face of budget constraints.
- Hiring, staffing, and training.
- System maintenance.
- Guidelines for all future improvements.
- Interface with citizens regarding complaints about control center call handling.

2.3 Operations

Operational personnel require policy guidelines that are of sufficient detail to guide them on day-to-day problems that occur in the communications center.

A policy governing the interface of the communications supervisors with patrol officers is of prime importance, since daily problems occur between officers in the field and dispatch personnel. These problems frequently amount to a dispute over what the dispatcher said, or thought he said, and how it was interpreted by the patrol officer. An "airing" of daily problems will help to eliminate friction between the communications center and the field.

A policy concerning shifts also is necessary. The normal structure is 8 a.m. to 4 p.m., 4 p.m. to midnight, and midnight to 8 a.m. However, if these periods coincide with the patrol shifts, they should be adjusted by one hour to provide for continuity of calls and workload with minor confusion.

A policy relative to continuing problems and their resolution is crucial. Further operational procedures that must be controlled by policy are:

- Message priorities and message stacking:
 - To patrol units.
 - To other agencies.
 - To data banks.
- Network discipline.
- Procedural codes.
- Message security.
- Radio log requirements and retention.
- Taped telephone and radio information and retention.
- Reports to bureaus, divisions, and other agencies.
- Equipment maintenance.
- Telephone courtesy.
- Answering alarms.

3. System Development

System planning and organization is the first important step in the development of a communications system. This planning will vary considerably, depending upon the departmental need. A small department probably will use ideas provided by a vendor or a neighboring community. The medium-sized city will require more defined planning, including subsystems and alternatives. This will require a higher level of technical expertise than the small department.

In the large city, system development will require a systematic approach, with alternatives and probably with assistance from outside sources (such as consulting firms, communications design engineers, telephone engineers, and data personnel), as well as multiple frequency assignments from the FCC.

The main goal of the department during this stage is to receive the citizens' calls-for-service and dispatch the calls to the area patrol officer for response within a minimum amount of time and with a predetermined degree of system reliability.

Some of the parameters of system engineering required in medium-sized and large departments involve detailed engineering planning to determine proper radio coverage for mobile and portable equipment over the entire area of jurisdiction. This involves decisions about transmitter power for base stations, power requirements for mobile and portable units, antenna heights and locations of radio towers for effective radiation and, in many cases, precise propagation measurements. Engineering also involves telephone studies to ensure that sufficient trunk lines are available to serve the community, together with control center console design to ensure efficiency and minimum fatigue of operating personnel. Subsystems must be engineered into the communications concept with one major objective -- to transfer information in a minimum amount of time with minimum effort.

System development in a broad sense will require a discussion of the following areas:

- Equipment (system hardware).
- System procurement and implementation.
- Subsystems in communications.
- System alternatives.
- Organizational alternatives.

3.1 Equipment

As defined in the communications area, equipment includes both hardware and software items. When properly connected, they operate according to the objectives of the project -- primarily receiving an emergency message or call for assistance and transferring (transmitting) it to the responding officer for execution. The integrated components of the system are functional and responsive to this objective only when properly engineered and connected. Beyond the simple objective of receiving and transmitting a citizen's call for help, there are many equipment options that make the police officer more flexible during his tour of duty.

The system components or hardware items normally used in communications include telephone equipment. This will vary in its flexibility, capability, and size from the small department desk-type installation to the large department, where a separate equipment room is necessary. The instruments may be dial or touch-tone, with incoming trunks and substation button calling. The dispatch office should be provided with single button and direct line calling to other agencies or departments. This function greatly increases the calling speed.

The dispatch control console(s) in the communications center are the second major hardware item. A small department may have a single console for transmitting to and receiving from mobile and portable units, while the medium-sized to large departments may require several multiple frequency control consoles, depending upon the patrol area configurations and the number of police units requiring contact. At a minimum, the large console will have the following features:

- Transmit switch with foot controls.
- Frequency switches or control modules.
- Microphone (panel-mounted and/or lip-type).
- Headset jack.
- Clock.
- Alert tone for important transmissions.
- Receiver muting function.
- Volume controls.
- Simultaneous selection of transmitting channels.
- Accessory switch panels.

The control console is connected to the base station transmitter and receiver by means of direct or leased telephone lines, or microwave or other radio-controlled equipment. Associated with the base station is the radio tower for supporting the antenna. The remote base stations vary in output power from a few watts to several hundred, depending upon the range required of the radio system.

Other electronic items used in the control center include:

- Logging tape recorders for telephone and radio channels.

- Instant-recall telephone recorders for each complaint taker position.
- Phone-patch unit for interfacing the telephone and radio equipment.
- Speech scramblers for certain radio channels.
- Direct line telephones to other agencies or departments.
- Status indicators for mobile status.
- Maps of jurisdictions and patrol areas.
- Alarms from business places.
- TV monitors from jail areas, parking lots, and other critical areas.
- Paging frequency for command personnel.
- Other departmental frequencies (such as fire, ambulance, public works, adjacent cities, counties, State) to be used during emergency situations or interdepartmental contacts.
- Data terminals for computer-aided dispatch (CAD), city, regional, State or Federal records.
- Printers terminals for computers.
- Teletype terminals for weather information.

3.2 System Procurement and Implementation

The planner will be responsible for system procurement and implementation, with the assistance of the system design engineer, the purchasing agent, and the communications supervisor. Figure 3 presents guidelines for this process. The implementation process begins with the selected alternative and includes the preparation of specifications and the purchase, installation, and system acceptance. The specifications may be functional, technical, or a combination of both

During the bid procedure, the purchasing agent may hold a vendors conference to ensure complete agreement and understanding of the proposed system parameters. On large system installations, it is well to consider the use of a project supervisor, who will be responsible for coordinating deliveries, installations, work problems, permits, and testing

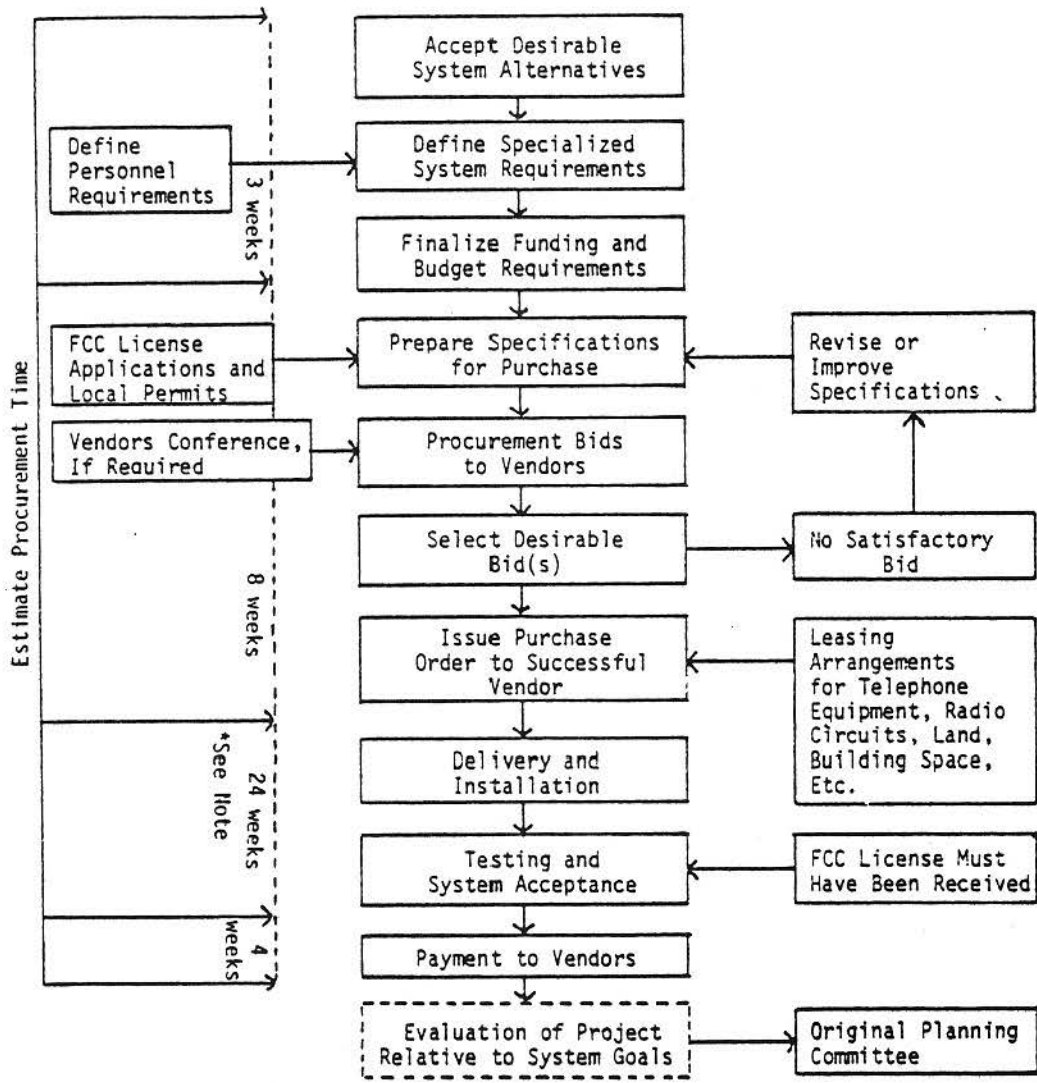

*Note: If the delivery and installation involves extremely complicated radio system design, tower or building construction, or computer hardware and software, add more time. Vendors and contractors will provide estimates.

Figure 3. System Procurement and Implementation Guidelines

procedures. The final step in the process is system acceptance, after testing has indicated that the project meets the original goals and objectives.

3.3 Subsystems in Communications

During system development or after a system is installed, a department may find it desirable to add subsystems to the basic communications operation. A communications subsystem is a secondary or subordinate operation that is not required to receive and transmit emergency information but that enhances the communications operation. A few of the major subsystems include:

- Computer-aided dispatch (CAD).
- Automatic vehicle location (AVL).
- Mobile digital data devices (MD).
- 911 emergency telephone number (911).

Each of the above systems has advantages and disadvantages that are discussed in the following sections.

3.3.1 Computer-Aided Dispatch

Computer-aided dispatch is becoming an important subsystem in the communications centers of medium-sized and large departments. A CAD system provides an easier, less complicated, and improved organizational approach to dispatching. Technical advances in the hardware and software areas are producing mini- and micro-computers that are smaller, more reliable, less costly, and much more powerful than earlier, full-sized computers. The programming (software) has become more sophisticated and specialized, and many preprogrammed (canned) systems are available. Figure 4 illustrates a basic CAD subsystem integrated with the communications control center.

The CAD system components include a digital computer, a terminal device with a cathode ray tube (CRT) display and a keyboard (these are used rather than a Teletype machine because of the higher operating speed), and magnetic-medium storage devices, employing drums, discs, and tape. The CAD system assists the dispatcher with the assignment of vehicles, since it can store and display immediately the status of every departmental vehicle. The special tactical patrol units of a department that carry two officers and extra equipment also can be displayed immediately; therefore, the dispatcher can organize the available units for any action in any major crime area. In assessing the incident, the dispatcher considers the location of the incident, the time required to respond to the incident,

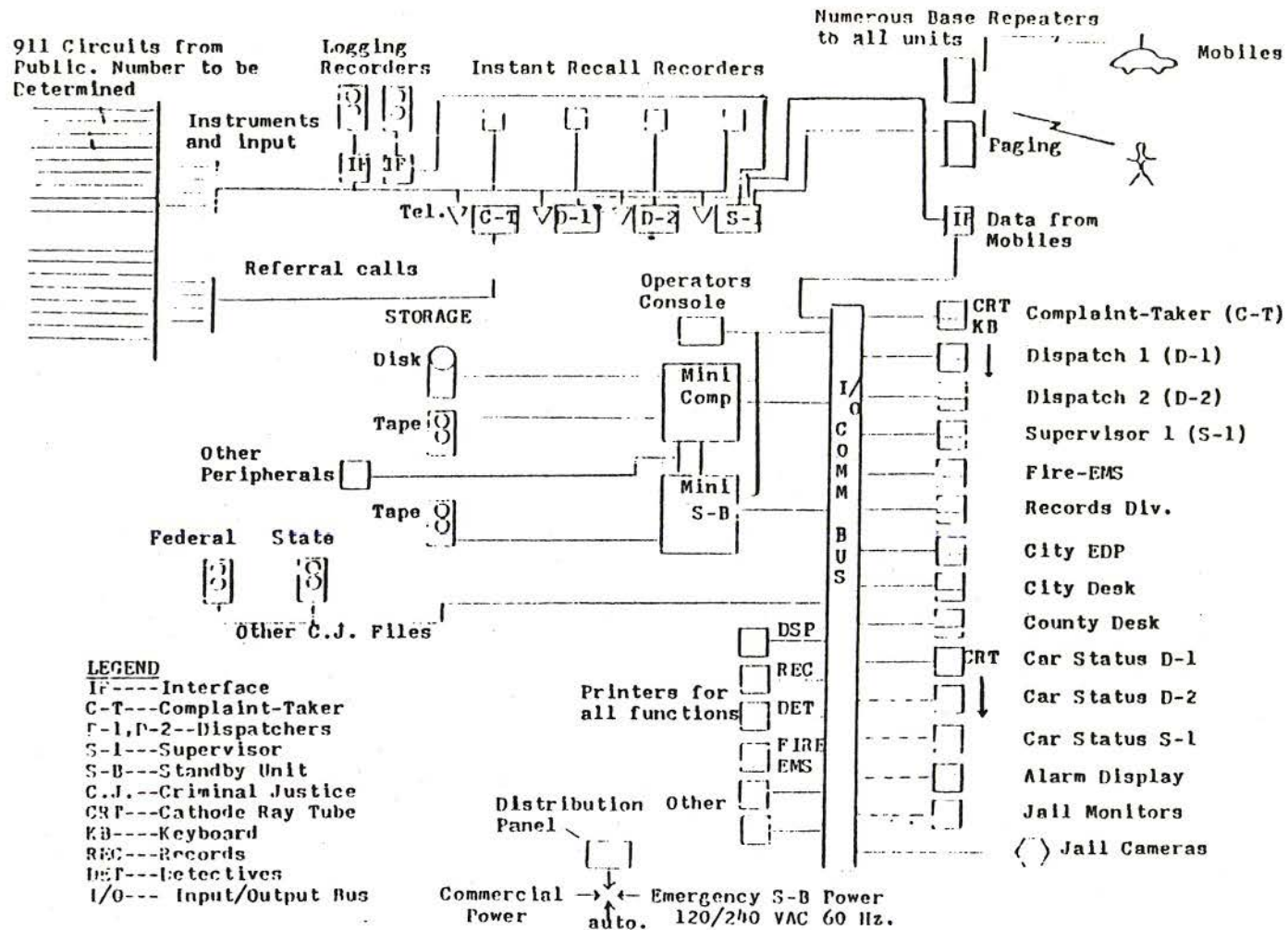

Figure 4. Communications Control Center with CAD

the location of the various surrounding police vehicles, the importance of this incident relative to other incidents occurring in the surrounding area, how many units should be dispatched, and whether special tactical or officer capability is required from other precincts or districts. This CAD system capability has greatly enhanced the dispatcher's role as a strategic planner.

Other system benefits include the automatic assignment of event or incident numbers by the computer and the management information available from the computer storage bank. Many report tasks in the communications center can be streamlined by using the computer memory and storage facilities. For example, CAD can provide terminals in the department's record section for entry of information from the officers' reports that is necessary for the monthly Uniform Crime Reporting (UCR) submission. Additional management information becomes available from these entries.

The implementation of CAD systems in public safety departments is increasing rapidly where a need can be justified, as new technology in hardware and lower costs in software prevail. A major disadvantage has been the system implementation and maintenance costs.

3.3.2 Automatic Vehicle Location

Another trend towards automation in the police communications area is the development of the automatic vehicle location (AVL) or monitoring (AVM) system. The system concepts have been in existence for over a decade, but the advent of the microcomputer has resulted in improved technology that makes the application a feasible reality.

There is a growing interest in AVL systems for improving both the management of mobile operations and police responses to community needs. AVL enhances the patrolman's safety and provides data for evaluation of operational strategies.

Several technologies are available for selection. The types can be divided into three broad categories: Proximity types, dead reckoning, and radio frequency positioning. Each category has specific advantages and disadvantages, and the selection of a system to meet the departmental needs and budget is dependent upon a significant number of technical and nontechnical factors. During the selection process, characteristics of the overall communications operation, the layout of the city, and the topographical parameters should be considered. A comparison of the various AVL systems was made in a paper presented at the IEEE Vehicular Conference in Denver, Colorado, by Geoffrey D. Wilson of the Aerospace Corporation. Mr. Wilson's paper identifies a variety of applications, in

addition to the dispatching function and officer safety factors.* These are as follows:

- Tactical Direction -- Overall control of vehicle deployments can be provided in situations such as major raids, riots, or natural disasters.
- Emergency Deployment -- Assistance can be provided to units unfamiliar with the neighborhood.
- Supervision -- Vehicle location can be determined when direct verification is desired or when a patrol officer fails to respond.
- Covert Operations Support -- Close supervision can be maintained in "trailing" operations with unmarked cars and without apparent officer communication.
- Resource Use Analysis -- Patrol operations can be analyzed to document the number and allocation of resources.
- Patrol Strategy Development -- Vehicle assignments and instructions can be evaluated and improved through analysis and correlation of beat patterns and crime events.
- Training -- Real situations can be reenacted for training purposes.
- Legal Evidence -- Substantiating time and location information can be provided for incidents when legal implications subsequently arise.
- Disciplinary Action -- Objective data can be provided in situations where vehicle location at a given time is in question.
- Prorating of Billing Costs -- Billing charges to individual communities can be calculated where

*Paper presented at IEEE Vehicular Technology Conference, 1978, Denver, CO, by Geoffrey D. Wilson, Aerospace Corporation.

the agency is providing police services to several communities under contractual arrangements.

AVL systems under consideration should be compared with existing system parameters, and the cost-effectiveness of this subsystem weighed in comparison to other improvements that might be made in the communications area.

3.3.3 Mobile Digital Communications

Mobile digital communications for use in police and other public safety departments is another subsystem that utilizes the computer as the focal point for storage and for switching to State and Federal files.

The term *mobile digital communications* identifies a specific electronic system that allows messages to be transmitted to and from the police vehicle by data bits rather than using the standard voice communications.

Historically, it has been possible to send digital messages from a mobile unit to a base station operator since the mid-1920's when police departments first started to use radio transmission from the dispatcher to the police car. Early Teletype transmissions from mobile to base used data bits. However, it was not until the age of computers that criminal data centers were implemented and extremely fast answers could be obtained by police departments from the data storage bank. Recent electronics technology has allowed such miniaturization of components that a mobile terminal, including storage capabilities, easily can be fitted into a small area in a police car.

Data transmission is many times faster than voice transmission.* Therefore, a message that would require several minutes by voice can now be sent and received in digital form in a few seconds. In addition to the advantage of increased transmission speed, a mobile digital unit provides automatic vehicle identification and privacy of communications.

Information requests from computer files account for a significant portion of the present mobile communications. This activity contributes to the present channel congestion.

The officer equipped with a mobile digital unit simply pushes the transmit key on his terminal and the message is sent automatically. Depending on the format used on the mobile terminal, a message may be sent

*Digital transmission of messages is 10 to 20 times faster than voice, with virtually no chance of error.

to the local dispatcher or relayed to another mobile unit or to the State and Federal data banks.

If there are no delays, the response from the computer file is received on the mobile terminal almost instantly, since there is no manual operation at the dispatch center. Delays in the system usually are caused by use of the assigned frequency for other messages (in the case of shared use of the radio channel) or delays in accessing the data bank.

The system provides the officer in the field with direct and rapid access to the computerized data files. One system disadvantage is the system cost versus total advantages (see Figure 5 for a basic mobile digital diagram).

3.3.4 911 Telephone Number

Another subsystem that is being implemented across the Nation in increasing numbers is the 911 emergency telephone number. The implementation of 911 has grown to over 700 installations since the first major system was installed in New York City in 1968. The major advantage of 911 is a reduction in response time for the citizen in his call for help, since valuable time is not lost in looking up a 7-digit number for the police, fire, or ambulance service. Figure 6 indicates the estimated saving of time during the emergency response cycle. One disadvantage is the high conversion cost for the telephone companies. Some major utilities foresaw the future requirement and have made progress towards central office conversion to electronic switching and computerization.

Some of the problems involved in implementing 911 are:

- Frequent noncongruent boundaries of the police, fire, and ambulance services in relation to the telephone central office jurisdictions.
- Switching between different telephone companies, different area codes, and boundaries to be established.

Establishment of a 911 subsystem usually occurs through the action of a committee representing the users and the utilities involved. This committee establishes boundaries, answering points, and estimated system costs, as well as selecting the desired operational features. Some of these features include:

- Direct Dispatch -- The point of reception and dispatch.
- Relay -- The relay of the received 911 call information to the proper agency for emergency action.

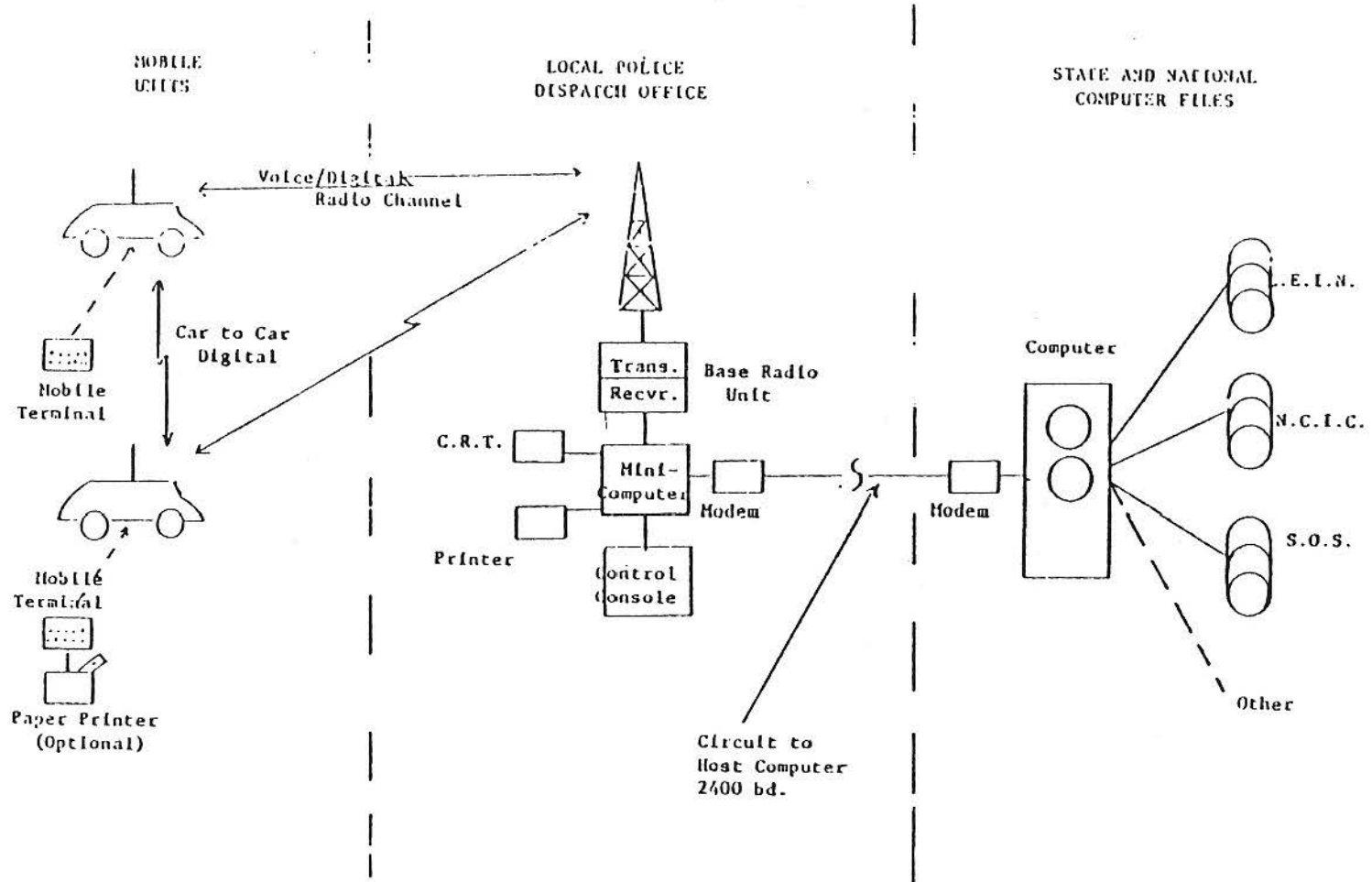

R.J.E
10-75

Figure 5. Mobile Digital System

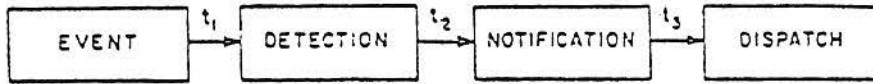

RESPONSE CYCLE DEFINITION

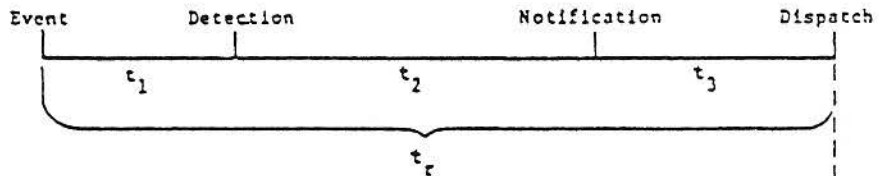

RESPONSE CYCLE TIMING WITHOUT 911

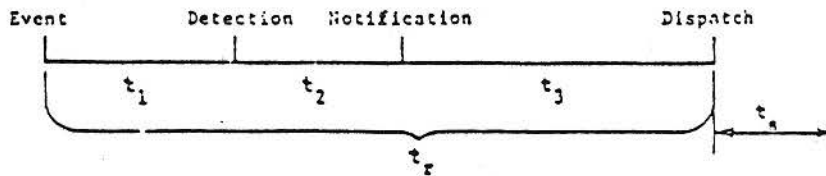

TIMING WITH CENTRAL DISPATCH AND 911

Note: From report of Franklin Institute Research Laboratories on Single Emergency Telephone Number, March 1970.

Figure 6. Emergency Response Cycle

- Transfer -- The transfer of the call to the proper responding agency.
- Referral -- The 911 call is referred to a central receiving point which determines the proper agency to respond. (This may require giving the caller a 7-digit number for reinitiation of his call.)
- Called Party Hold -- The capacity to hold the connection of a 911 call for confirming or tracing.
- Distinct Tone -- Indicates to the answering operator if the 911 calling party has incorrectly called and subsequently hung up. This usually requires dedicated trunk lines.
- Forced Disconnect -- Allows the answering operator to force release of the 911 line and avoid jamming of incoming calls.
- Call Recording -- Provides the opportunity to evaluate citizens' complaints, and serves as a training guide.
- Ring Back -- Allows the answering operator to ring back the 911 caller who has hung up his phone.
- Selective Routing -- Allows a 911 call to be automatically routed to a predetermined answering point, regardless of the telephone boundaries. This option is not available in all telephone jurisdictions since it requires some degree of computerization and/or electronic switching.
- Automatic Number Identification -- Automatically displays the telephone number of the calling party.
- Automatic Location Identification -- Displays the street address of the caller.
- Coin-free Dialing -- Allows the 911 caller to place an emergency call to the public safety department without insertion of a coin.

Some of these options are generally available, some are still in the experimental stage, and others are available at additional cost. The usual responsibility of the 911 committees is to analyze the needs of the agency

or community, cost factors, availability of options, volume of calls, proposed boundaries and other critical factors. This information then is weighed against the desired features.

3.4 System Alternatives

During the system development stage, it is customary to select system alternatives that are necessitated by cost or other system parameters. These alternatives can include:

- Multiple base stations throughout the service area versus one powerful station at a central point.
- Base-repeater stations versus operator-controlled base stations.
- Mobile-repeater units versus base-repeater units.
- Satellite receiver locations versus higher towers and gain antennas.
- Microwave radio for base station control versus leased land-line control.

Other problems will require technical expertise in reaching decisions and making proper selections.

3.5 Organizational Alternatives

The planner also must select alternatives in considering the organization structure. These usually are determined by such factors as departmental requirements, cost-effectiveness, urgency, and the improved use of man-hours. Some organizational alternatives are as follows:

- Hand printed or written reports versus typed reports. The report may not require typing for data entry if the legibility is sufficient for both entry and microfilming.
- Mail-in reports versus an officer on the scene. The mail-in type of report is a method used to reduce officer and dispatcher workload when personnel budgets impose it.
- Telephone-processing is a method of report handling that has two distinct advantages. First,

it allows information to be entered into the data bank immediately after crime investigation and, second, the report is made while factors are fresh in the officer's mind.

- Consolidation of city or county communications versus agency-operated systems. The major advantage of consolidation is saving of manpower in the telephone and dispatch area. A major disadvantage is the loss of local departmental control over communications personnel. Both of these factors must be considered carefully prior to selection of an alternative.

4. Personnel Development

4.1 Personnel Selection

The screening and hiring of communications personnel is one of the major elements in the planning and execution process. Figure 7 indicates the major steps for personnel selection.

It is extremely important to have capable and experienced personnel in the telephone and dispatch positions, since these persons represent the entire department to the public. The professionalism and effectiveness of communications system operations depends as much upon its personnel as upon its hardware, software, and other equipment.

A telecommunications center may contain the latest and most sophisticated hardware but, if the operating personnel lack the necessary professional qualities, the center will be substandard. This high degree of professionalism must be assessed during the application and screening process. It will be dependent upon individual loyalty, dedication, initiative, and a sense of responsibility. Other objective desirable qualities are the ability to spell accurately, type, write legibly, utilize basic arithmetic, and maintain personal cleanliness and grooming. He or she should have excellent physical, emotional, and mental health. Effective functioning and a high level of stability in all three areas determines a good operator. The operator who loses control of his emotions while handling difficult situations will probably lose his self-esteem and effectiveness. Allowing operators to spend off-duty hours riding in the patrol car will tend to alleviate some of the emotional stress and to acquaint the operator with some of the problems experienced by patrol officers.

Some departments select operating personnel from within the organization. This has certain advantages, including the fact that it eliminates some element of the screening process because the person's capabilities

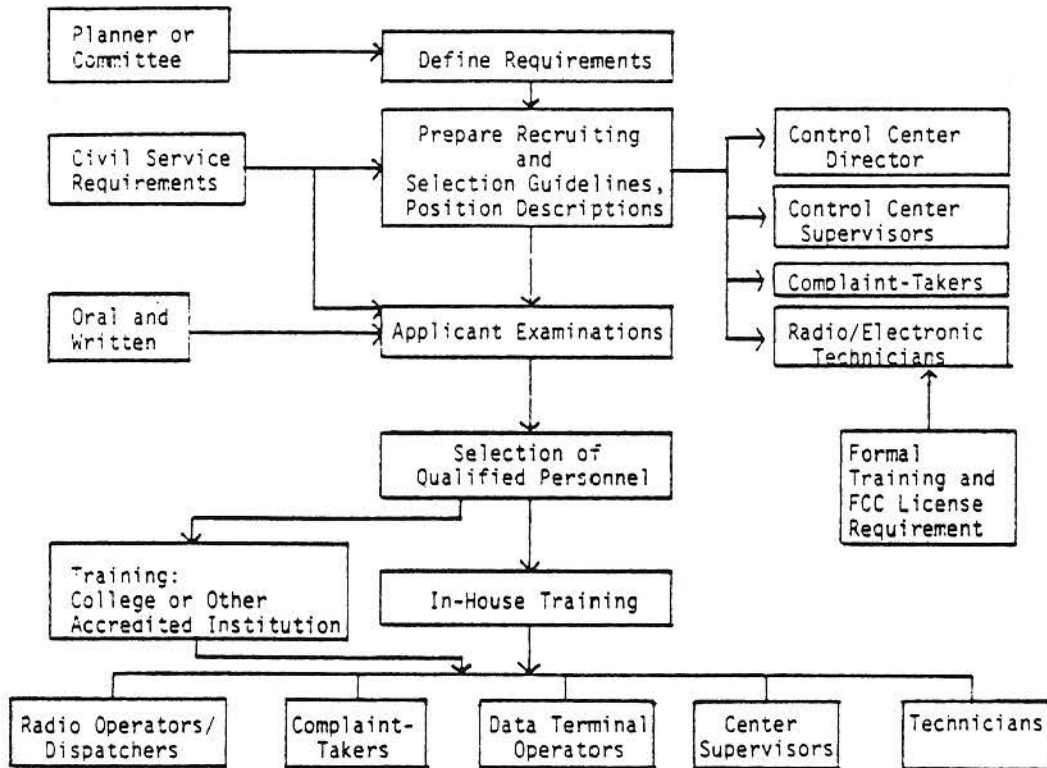

Figure 7. Communications Personnel Selection Process

are already known. In addition, it represents an opportunity to advance a good employee into a more responsible position. The selection and screening of all new employees should be carried out with some vision and objectivity and should be a part of the objectives of the planning personnel in their long-range missions.

The recruiting and screening process for communications operators will, of course, depend upon the existing civil service examinations and qualifications. However, the department should have input to the selection guidelines to maintain a high standard of operation.

The modern communications center is many times more sophisticated and complicated in its operation than those of just a decade ago. A modern control console may have multiple-frequency operation, with switches for mute receivers, tone alert, simulcast, intercom, and other functions. Computer terminals require fast and intelligent operation to access formats in a matter of seconds while telephone calls are being answered or vehicles dispatched. Requests for information from patrol officers must be handled with accuracy and speed or the entire service delivery function will deteriorate with time.

The prospective candidates should be in excellent health and physical condition and should be required to take a physical examination prior to hiring, including a hearing test. Young or middle-aged persons can perform more efficiently in a dispatch position due to the consistent frequency response of their hearing ability. Older persons may have frequency problems at the low or high portions of the audible spectrum, thus creating problems in a work assignment of this nature.

If the civil service examination does not address the needs specific to the selection of communications personnel, the department should request the addition of at least the following items to assist them in the selection:

- Intelligibility -- Does the candidate have voice defects, does he choose his words carefully when answering questions; is his pronunciation correct; does he slur words, speak incoherently, or have other speech problems?
- Fluency -- Is his vocabulary adequate; is his sentence structure good; does he use words properly, pronounce words correctly, use slang expressions, pronounce words too rapidly?
- Understanding or Coherence -- Does he speak coherently; does he understand questions and listen intently?

- Attitude -- Does he have an enthusiastic attitude; is he friendly in answering questions; is he quiet or talkative; does he take over conversation; is he discourteous, argumentative, confident, or confused?
- Stability -- Does the candidate appear tense or nervous and seem to get upset easily; is he slow to understand questions; does he display unsound judgment?

The answer to some of these questions should provide the examining officer with a better understanding of the applicant's qualities.

4.2 Personnel Retention

Turnover in the communications section and the long-range retention of operating personnel will depend largely upon proper staff selection, promotion opportunities, and the pay scale relative to comparable jobs in the area. Pay scales should be researched by the planner to arrive at a standard that will attract capable personnel. Many departments have a scale fixed by civil service. It always is advisable to hire personnel who have a previous background in law enforcement communications if possible. Candidates from outside the State or general area will not know street names and addresses; therefore, some value should be placed upon local personnel with desired qualifications.

4.3 Determining Position Descriptions

After the department communications planner has defined the requirements for personnel selection, it will be necessary to prepare position descriptions for each of the related tasks in the communications center. Many departments will find adequate position descriptions on file at the local civil service department of the city, county, or State, especially in the medium-sized and large jurisdictions. Another excellent source is the use of material from other departments that have established communications control centers.

The positions selected will depend upon the size of the operation. For instance, a small department may require only one person to take the emergency calls and dispatch to the patrol cars, while medium-sized and large departments with more sophisticated control centers will require several complaint-takers (telephone operators for emergency calls) and a number of dispatchers along with shift supervisors. The large consolidated control centers for public safety dispatching usually require a center director, shift supervisors, complaint-takers, dispatchers, and, probably, maintenance personnel.

Each communications control center will have a specific requirement, and the planner will be responsible for determining the size of the staff required. This can be based upon the number of emergency telephone calls received daily and the number of messages dispatched, the number of police or public safety vehicles that are radio-equipped, subsystem equipment (such as computer terminals, television monitors, alarm systems, and tape recorders), number of radio frequencies to be monitored, walk-in traffic (if applicable), and other duties. Figure 8 estimates the staffing required to answer calls within 10 seconds.

The center usually will be staffed to meet normal requirements and, therefore, must have some arrangement for answering calls during major incidents. Many departments use the center supervisor and/or the dispatching staff to answer the overflow calls. Staffing for the dispatch operation will vary according to workload requirements in the control room. As an average, one dispatcher should be able to handle 50 radio-equipped units during normal operation. Patrol officers need procedural training as rookies in the area of communications to ensure that messages are kept short and concise, 10-codes are used whenever possible, and other methods are used to conserve air time.

The following are sample position descriptions that are generally applicable to communications center needs and may be adjusted to meet specific requirements.

4.3.1 Control Center Director

The control center director should be a sworn officer of a police department, usually with the rank of captain. He may report to a senior manager (such as the Division Commander of Staff Services) or directly to the executive.

The control center director will be responsible for direct control of the center, the operators, supervisors, and technical personnel. He will have direct interface with the patrol commanders and division and bureau commanders. He also will be required to interface with outside departmental personnel. He will be responsible for carrying out all departmental policy and implementing new policies for improvement in his area of responsibility. He must have had an extensive background in law enforcement or public safety operations. He should have a comprehensive and successful background in supervising personnel.

4.3.2 Communications Supervisor

The communications supervisor (in consolidated or centralized systems) is responsible for scheduling of communications personnel, including all shift assignments and changes required for optimum utilization of personnel. He will be required to cooperate with other agencies and organizations to ensure maximum public safety effectiveness. He must comply,

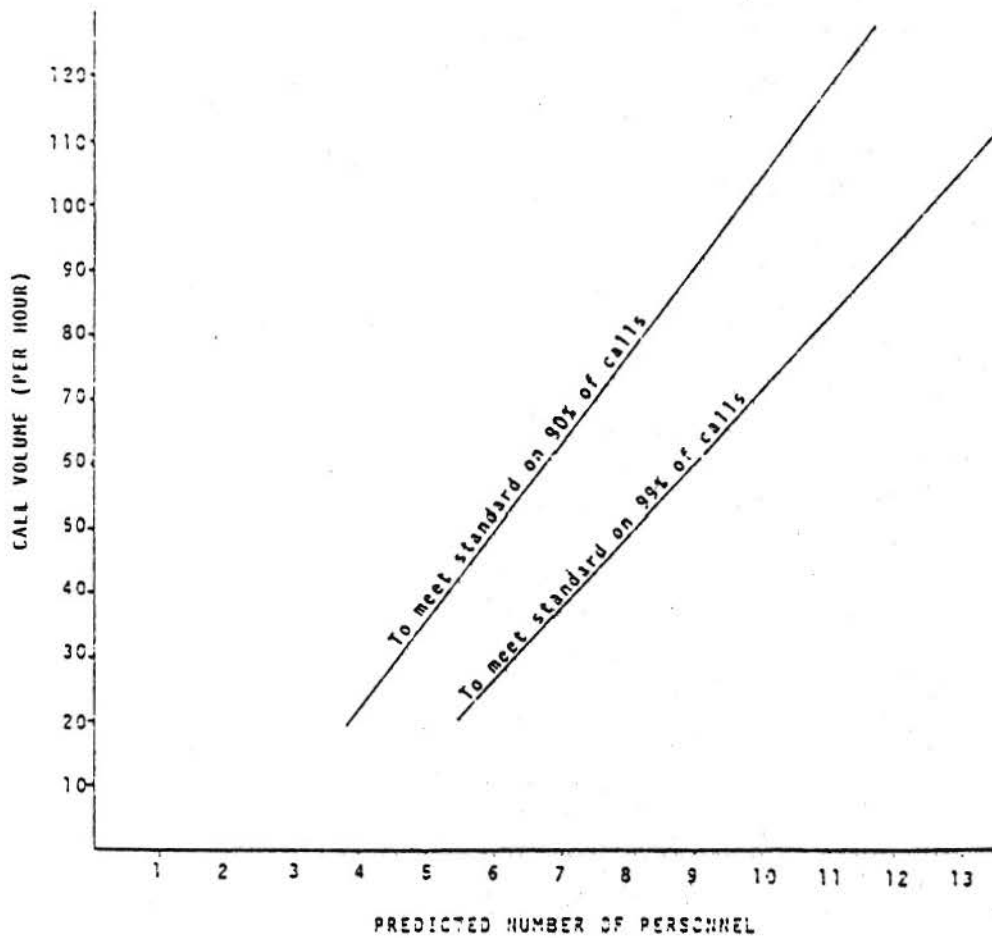

Figure 8. Estimated Staffing Required to Answer Calls within 10 Seconds

and be assured that all of his employees comply, with the policies, regulations, procedures, and recordkeeping assignments of the communications center. He should have a comprehensive background in public safety communications and in the supervision of personnel. He may be either a sworn officer, usually with the rank of lieutenant, or a civilian.

4.3.3 Complaint-taker and/or Dispatcher

The complaint-taker and/or dispatcher should be thoroughly screened and a carefully selected applicant. (These assumptions are made on a basis that these two positions are interchangeable or are combined into a single position.) He must be willing to accept the necessary responsibility to fulfill his position. He must be prompt and accurate and have a capability in handling all communications tasks in a professional manner, resulting in courteous, accurate, coordinated, and unemotional dispatch effort. He will be responsible for receiving emergency telephone calls and entering all required information on the event sheet, card, or data terminal, transmitting the information to the proper patrol unit, and recording all followup information, while simultaneously prioritizing and stacking calls in sequential order by time of receipt and seriousness. He must be capable of handling all Teletype and data entries and keeping all information confidential.

All positions in the communications center have standard civil service qualifications, and also should include the following:

- Graduation from high school.
- Excellent health, good physical condition.
- Good emotional stability.
- Eyesight corrected to 20-20.
- Good hearing (relatively flat response from 500 to 3000 cycles).
- General maturity for sound judgment.
- Good personal habits.
- Good command of the English language.
- Legible handwriting or printing.
- Ability to type (speed to be determined).

- Willingness to work irregular shift assignments or overtime, if required.
- Must agree to undergo a personal security background examination before acceptance.

Salaries for each position in the communications center will be determined from like positions in similar positions in the general area. Fringe benefits and step raises will also be determined at a comparable level to attract desirable and dependable employees.

4.4 Personnel Training

The training needs of the communications personnel for a control center will vary considerably among small, medium-sized, or large departments. The small department usually trains new telephone and radio operators by the onsite observation method for a few days to a week. This method is used because of limited budgets and the lack of capable training personnel. While effective to an extent, the department would find funds well spent to send the prospective employee to a communications course for intensive training. Formal training generally is used by medium-sized and large departments. Depending upon the circumstances, the formal training may be furnished inhouse' or outside.

There are few positions in the police department subject to more scrutiny than that of the communications dispatcher or operator. It is a position where an even disposition and qualified performance must be the rule rather than the exception. Performance in this position usually is in direct relation to his training, his ability to cope with any and all situations, and his devotion to his position.

Accepting the responsibility of the position for which the employee applies must be one of the hiring requirements. He must be prompt, accurate, and courteous to the public and to police officers. Carelessness, a poor attitude, and disregard for supervision or policy cannot be tolerated.

The development of professional training courses for communications operators is relatively new, and several colleges and community colleges have instituted programs that fulfill this need. The Associated Public Safety Communications Officers, Inc. (APCO), has promoted training in communications in an effort to increase professionalism in police and public safety departments.

The technicians who are hired by departments for maintenance of equipment must have prior training in electronic trade schools or in college engineering courses. Usually, these courses provide the training necessary to obtain the required FCC license. A Second-Class Radiotelephone license is required to repair police-type radio transmitters.

Figure 9 indicates the steps that the planner must take to provide guidance if the department is to provide the training. As stated previously, the depth of training will depend upon the size of the department and the sophistication of the control center equipment.

After the requirements are defined, a decision is necessary as to the type and location of the training. If trained at a college, the employee moves directly to the departmental communications center for hands-on training for a prescheduled period prior to being assigned to a shift.

If inhouse training is chosen, it will be necessary to select appropriate personnel to provide the training. These may be chosen from various departments within the department and/or outside, depending upon the exact requirements. Training personnel can include:

- A police training officer to provide law enforcement instruction.
- A command officer for police policy and regulations.
- A data processing representative to provide training on data terminals such as Teletypes or CRT displays and the various formats used for all accessible data banks.
- A communications director or supervisor to provide training on the telephone and dispatch functions, including center operating procedure, 10-codes, etc.
- A telephone company representative to discuss the proper use of the equipment, available resources, etc.
- A radio technician to provide a broad overview of the equipment, subsystems, and their operation, as well as whom to call for maintenance, and such matters as FCC rules and regulations.
- A representative from the local emergency services office of the city or county to provide information on procedures during any extreme emergency.

The training site usually will be at the existing police or public safety training area or academy. The advantage to this is that equipment is already available (e.g., chairs, tables, projectors, screens, blackboards).

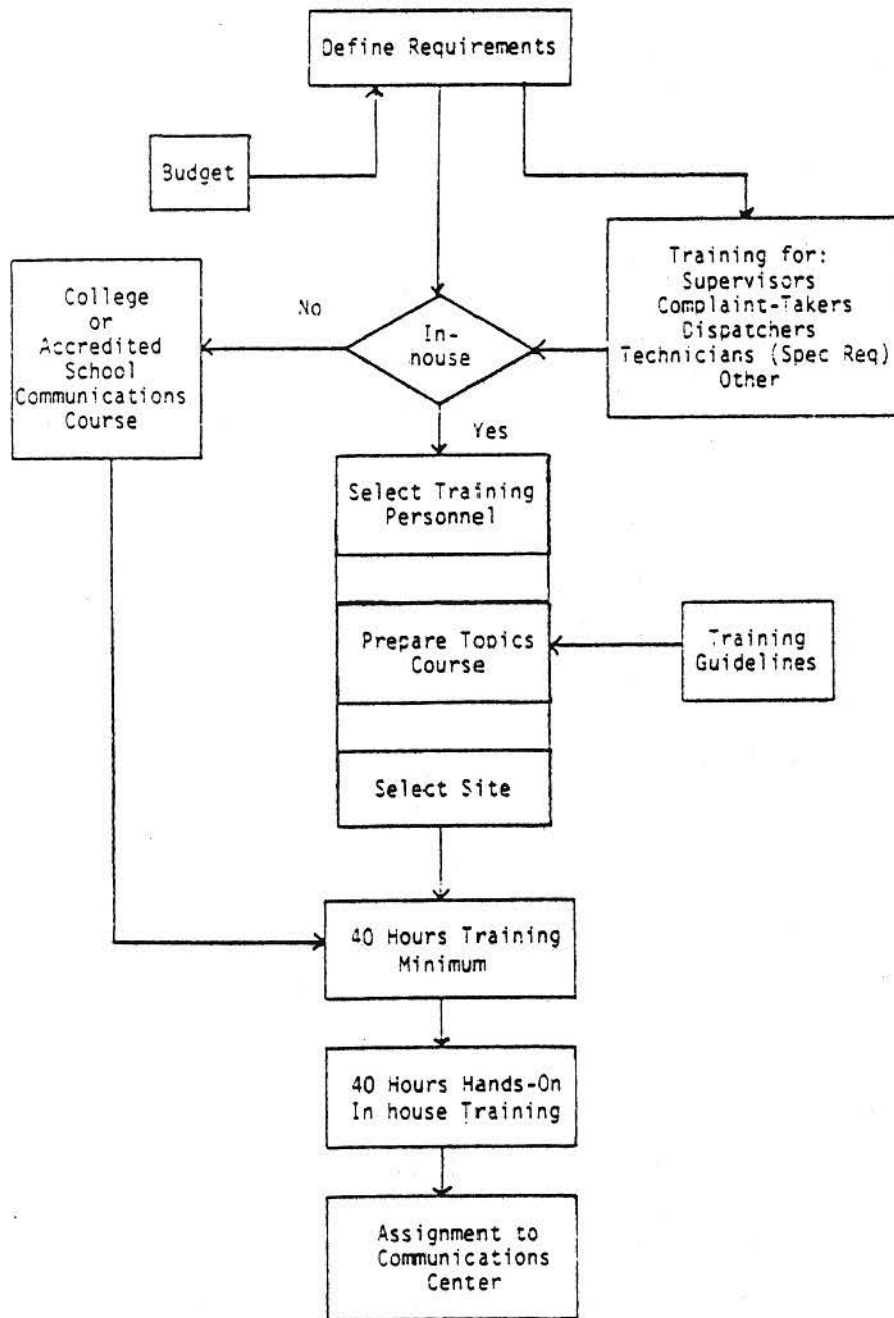

Figure 9. Communications Training Guidelines

The course guidelines are one of the more important parts of the training preparation. Generally a meeting with the proposed instructor will indicate their material content and the time to be allocated to the subject matter. Some references for material for instruction include:

- Copies of departmental rules and regulations.
- Data terminal guidelines for Federal, State, regional, local, and CAD systems.
- Telephone company training guidelines.
- Vendor assistance and equipment usage guidelines.
- FCC rules and regulations.
- APCO Public Safety training manuals, available from the national office of APCO, New Smyrna Beach, Florida.

The training course should include a minimum of 40 hours of class instruction and some period of time in the control center for hands-on instruction.

Whether departmental employees or outside personnel, the instructors should be carefully selected based upon their ability to express themselves and past success in the training area, in addition to being knowledgeable in their field. The time to be devoted to each subject or topic should be carefully evaluated relevant to the subject and its subsequent value to the student.

The course topics will vary to some extent depending upon the subsystems that are to be used. A standard list of topics are suggested below:

- Student orientation.
- Law enforcement and public safety basics.
- Communications procedures and techniques.
- Departmental records.
- Data systems.
- FCC Rules and regulations.
- Equipment and subsystems.

- Telephone systems.

Some detailed explanation of the topic areas follows to guide instructors in the proper content of topics, since the selected instructor may not be oriented towards the exacting requirements and duties of the public safety communications center.

4.4.1 Student Orientation

This should include rules of conduct for the employee, course objectives, necessary outside class study materials (such as formats, signals used, street locations and names) formats and policies governing the center, the course outline and a list of the proposed instructors, a brief review of the course materials, records used in the center and their importance, and the role of the student in relation to the communications director, supervisor, complaint-taker, dispatcher, and technician. The interface of center personnel with police officers, patrol supervisors, command personnel and citizens outside of the department also should be covered. These relationships vary depending on whether the center serves the police department only or is a consolidated public safety communications center. The class supervisor will normally be in charge of the orientation and will introduce each class instructor.

4.4.2 Basics of Law Enforcement and Public Safety

The instructor for law enforcement should have a police background and be able to provide a basic understanding of the police officer's role as it relates to the dispatch office. Material to be covered includes: Basic statutes, warrant information, court procedures, jail procedures, problems on the street that create problems for patrol officers, patrol deployment, management reaction to crime patterns, departmental shift management, the use of tactical and special units, how detective and investigative units assist patrol officers on the crime scene, the role of the police department during disasters, and interface with civil defense, State police, and other public safety departments.

4.4.3 Communications Procedures and Techniques

The instructor for this unit must have a good background in communications center operation. Specific areas of instruction should include: Preparation of messages, proper terminology, the art of command and control, standard communication procedures, abbreviations used, 10-codes (their purpose and need), and the use and value of the phonetic alphabet, proper procedure for talking into a microphone, what calls-for-service are to be dispatched and which are transferred, prioritization of messages, stacking of nonemergency messages, the need to dispatch crime-in-action messages without delay, handling information requests from the public and from the patrol officer, point-to-point message handling, paging of command

personnel, and emergency or civil defense message handling. The details of all communications center records, such as event cards, logging recorders, instant playback recorders, retention of tapes, normal and special case retention, filing, and permission to release any center information, also should be covered in this part of the training.

This section of instruction covers the actual communications center requirements and, if available, a mock-center control unit is of great assistance to the student in understanding the material. A field trip to the civil defense center also is important in this area of instruction.

4.4.4 Departmental Records

The instructor for this unit will normally be an employee of the department records section and will provide basic information on all records in the department, including how they are received, stored, and accessed, together with who may receive information. Fingerprint files, mug files, Part I and Part II crimes (UCR), arrest reports, criminal and noncriminal reports, property and evidence (receipt, storage, and disposal), jail records, and data access to other local, regional, State, and Federal record files are areas to be discussed. It is important for the communications center personnel to have a complete understanding of the records system. This will emphasize the importance of properly recording information received from a citizen regarding a crime.

4.4.5 Data Systems

If such a system is implemented, the data systems instructor will normally spend a considerable part of his instruction period on the CAD concept, what storage files are available, size of files, formats to be used, types and number of terminals and their capability and speed, terminal switching to other data banks in use in the department (such as city, county, regional, State, and Federal). A basic computer theory orientation should be provided, together with instruction in the use of other terminals and formats that may be used in the center. The instructor also will discuss security relative to law enforcement computers.

4.4.6 FCC Rules and Regulations

This important element of instruction can be handled either by the communications procedures instructor or the equipment and subsystems instructor. Each student should receive a copy of Part 89 of the FCC rules and regulations. Class instruction should be provided on all of the operating portions.

4.4.7 Equipment and Subsystems

This portion of the training program should be handled by a competent radio technician or, if not available, by a communications supervisor with

a technical background. Instruction should cover the console equipment, tape recorders, status board operation, transmitting and receiving base station equipment, system design (i.e., how the dispatch message gets to the mobile, portable, and pager units), expected range of the units, who to call for maintenance on a 24-hour basis, and other system factors.

4.4.8 Telephone Systems

This phase of the training can best be handled by a representative from the local telephone company, if available. If not, the communications procedures instructor should accept this responsibility. The telephone instruction will include proper use of instrument, proper method of answering, courtesy to callers, 911 emergency number (if in use), call switching, available accessories, and who to call for maintenance.

MANAGING CRIMINAL INVESTIGATIONS GRANT PROGRAM;
HISTORICAL BACKGROUND; CONCEPTUAL GOALS AND OBJECTIVES;
ASSIGNMENT OF RESPONSIBILITIES; PROCEDURES

City of Peoria, Department of Police

Reprinted with permission of the Police Department, City of Peoria.

City of Peoria
Department of Police

OFFICE OF SUPERINTENDENT

GENERAL ORDER NO. 342-80, PART I

July 2, 1980

TO: ALL PERSONNEL

FROM: SUPERINTENDENT OF POLICE

SUBJECT: MANAGING CRIMINAL INVESTIGATIONS GRANT PROGRAM; HISTORICAL BACKGROUND;
CONCEPTUAL GOALS AND OBJECTIVES; ASSIGNMENT OF RESPONSIBILITIES;
PROCEDURES

I. HISTORICAL BACKGROUND OF MCI

In 1976 the National Institute of Law Enforcement and Criminal Justice (NILECJ) designated the topic Managing Criminal Investigations (MCI) as the principal police subject for its initial offering in the National Criminal Justice Executive Training Program (NCJETP). At that time the police training team of NCJETP conducted the necessary research, design and development of a management system which would be useful and practical for municipal police agencies who wished to improve the effectiveness and efficiency of the operation and management of the criminal investigation process. This MCI system was then translated into a training program which was delivered throughout the United States during the period 1976-1979. More than 700 police executives representing more than 400 police agencies participate in workshops conducted in more than 40 different locations. Subsequent evaluations of these workshops indicated that as many as 90% of the participants returned to their local police agencies and installed various changes in the operations and management of their criminal investigation processes as a result of what had been learned and acquired at these workshops. Simultaneously, the National Institute sponsored a test of the system in five selected police agencies for a period of 18 months. These agencies, known as MCI Field Test Agencies, were the Birmingham, Alabama Police Department; the Montgomery County, Maryland Police Department; the Rochester, New York Police Department; the St. Paul, Minnesota Police Department; the St. Paul, Minnesota Police Department; and the Santa Monica, California Police Department. This field test attempted to evaluate carefully the impact and efficiencies created in these departments as a result of the insertion and planned use of the MCI system in each agency.

As a result of many of the successes associated with the MCI system, both in field test agencies as well as in other police agencies, the Office of Criminal Justice Programs (OCJP) of the Law Enforcement Assistance Administration (LEAA) decided in 1979 to transfer the findings and results of this system to other police departments. This transfer was to be accomplished partially by the use of a new type of joint funding or companion funding program which would involve for the first time new financing arrangements between LEAA, state governments and local governments. The joint funding program became known as the MCI Incentive Grant Program.

Many police agencies who had participated in the original MCI workshops were invited to present to LEAA concept papers which would outline the manner by which these agencies would implement in a major way the entire MCI system. Based upon both the concept paper and the willingness of the state and local governments in question to participate in the new joint financing arrangement, LEAA selected more than a dozen police departments as suitable candidates for the MCI Incentive Grant Program.

The Peoria Police Department applied for and was awarded a grant for the period October 1, 1979 through March 31, 1981 (this could be extended due to problems encountered in getting the program started) to implement the MCI program. The amount of the grant is \$168,888, with the City contributing 10%.

II. CONCEPTUAL GOALS AND OBJECTIVES

It is the policy of the Department that all personnel will make a conscientious effort to achieve the following goals and objectives to:

- increase the Patrol officer's investigative responsibilities in specific crimes
- investigate certain crimes that are not now being investigated due to manpower constraints;
- increase the rate of arrests and successful prosecutions in felonies;
- screen out nonsolvable cases early in the investigative process;
- establish a management information system to be used specifically in the Criminal Investigation Division (CID) for assignment, case tracking and other administrative controls to increase the efficiency and effectiveness of investigators;
- reduce the CID investigator work load so that resources can be made available to concentrate on major crimes and other criminal activities not now being concentrated on due to lack of resources;
- expand and improve the police/prosecutor relationship to improve case preparation and acceptance of cases for prosecution, which should lead to a higher rate of successful prosecutions.

To achieve the goals and objectives the program is divided into five components.

A. Enhancement of the Patrol Officer's Investigative Role

Enhancement of the Patrol officer's investigative role will be the most visible and dramatic change:

1. Patrol officers will be given a thorough training course.
2. Patrol officers will be issued a camera, fingerprint equipment and a dictator.

3. Patrol officers will assume complete investigatory responsibility for certain crimes, including:
 - a. preliminary investigation, including evidence search and photography;
 - b. follow-up investigation, including:
 - (1) follow-up of leads
 - (2) arrest
 - (3) interrogation
 - (4) lineups
 - (5) statement taking
 - (6) court testimony
4. An experienced investigator will be assigned for the first 12 months to assist the Patrol officers in their expanded investigatory responsibilities.
5. The program will be initiated in the Richwoods Police Districts 13, 14, 15, 16, 18 and 19. The reason the program is being started in Richwoods is that past research has indicated these districts have a greater amount of "patrol time," i.e., uncommitted time, than do the other police districts. Therefore, it is felt the program can be tested in these districts without adversely affecting the Department's call response time. After testing the program in the Richwoods Districts, a decision will be made as to whether it will be expanded to other parts of the City.

B. Case Screening

Case screening involves the review of each initial investigation in terms of the probability of case solution through investigation. On the basis of a set of solvability criteria, one of two courses of action is selected: if the potential for successful closure appears to be high, the case is assigned for continued investigation; if further field investigation is likely to be unproductive, the complainant is informed accordingly and an attempt is made to link the case with others having similar suspect characteristics or M.O.'s. The screening out of cases having little chance of solution is intended to substantially reduce the detective case load and thereby make additional resources available for productive continuing investigation, case preparation or reassignment to other functions.

The Peoria Police Department has developed a set of unweighted solvability factors to be used by the Patrol officer in his initial investigation. The Investigative Decision Sheet (IDS), which contains the solvability factors, is attached as Appendix 1. Based upon the solvability factors, present or absent, the officer will decide to suspend or investigate further. If the decision is to suspend, the victim will be notified by mail. If the decision is to investigate further, the officer will either investigate the case himself/herself until a successful conclusion or all the criteria of assignment of cases. The officer's decision will be reviewed by his/her supervisor (sergeant) and a sergeant in the Detective

Bureau for agreement or nonagreement with the decision. Cases investigated further will be pursued until they are successfully concluded, or suspended due to the absence of further leads or the unlikely chance of a successful conclusion.

C. Management of the Continuing Investigation

Establishment of a management information system to increase the efficiency and effectiveness of investigators with the objectives of:

1. improving the case tracking system;
2. establishing priorities for the types of cases which should be more heavily pursued than others by monitoring the progress of the case investigations;
3. assigning case investigations more effectively;
4. decreasing repetition of tasks performed by various individuals;
5. improving the quality of case investigation and preparation;
6. evaluating results on the basis of investigation outcomes;
7. providing ongoing analysis of suspended (or inactive) cases so that patterns can be recognized.

D. Police/Prosecutor Relationship

The goal in this component is to improve the quality of case investigation and preparation in order to lead to a greater number of prosecutable cases. The major elements to be initiated to achieve this goal are:

1. increased cooperation between executives of the agencies (we have benefited from this element prior to MCI);
2. increased cooperation among supervisory personnel of the agencies (this element has been present for some time);
3. the use of the liaison officer to communicate filing standards to police personnel;
4. improved case preparation procedures;
5. a system of feedback of case dispositions to the police;
6. improved quantity and quality of police training in the areas of case investigation, preparation and court testimony, with the assistance and involvement of the prosecutor's office.

E. Evaluation and Monitoring

Evaluation is to be done by the Crime Reduction Council.

To recap, the Department's general goals in this program are:

- more effective utilization of all personnel;
- investigation of crimes not now being investigated;
- better case investigation and preparation;
- increased acceptance of cases for prosecution;
- increased arrests and convictions in felonies;
- reduction of case loads for investigators so greater attention can be given to other criminal activities;
- better trained officers;
- a larger pool of experienced investigators.

III. ASSIGNMENT OF RESPONSIBILITIES

A. All Peoria Police Department Personnel

To make a conscientious effort to achieve the goals and objectives aforementioned in this order; to adhere to the procedures as set forth in this order, bringing to the immediate attention of their supervisors any procedural problems encountered that could have an undesirable effect on the efficiency and effectiveness of the Department's basic responsibilities.

B. Patrol Officers

To accept complete investigatory responsibilities for the following crimes (some residential and commercial burglaries might be added later):

1. battery simple
2. reckless conduct
3. assault simple
4. burglary from vehicle--all and attempts
5. auto theft--all
6. theft--all
7. criminal damage to property
8. criminal damage to vehicle
9. vandalism--all

Complete investigatory responsibilities are defined as follows: To conduct a complete, thorough and accurate preliminary and follow-up investigation, including:

1. complete and thorough interviews of all complainants, victims and witnesses;

2. complete and thorough crime scene search for possible physical evidence;
3. taking necessary photographs of the crime scene, fingerprints and other evidence;
4. collection, marking, preservation, transportation and secure storage of all collected evidence;
5. interrogation, lineup and statement taking of any on-scene or follow-up arrests;
6. complete, thorough and accurate documentation (police report) of the preliminary and follow-up investigations;
7. providing victim/complainant with a business card containing the investigating officer's name, days off and shift hours;
8. immediate follow-up of the crime as time and call response allow;
9. initiation of case file folder and other case documentation as required;
10. follow-up of cases assigned;
11. periodic review of cases for suspension, additional follow-up or referral to CID;
12. presentation to court of evidence and testimony.

On all other crimes the Patrol officer's responsibilities are to:

1. conduct a complete, thorough and accurate preliminary investigation;
2. use present department policy regarding the request or notification of the Crime Scene Unit or CID;
3. make recommendation for suspension or follow-up of the case based upon solvability factors--CID will still review for pattern, etc.;
4. ensure that the report is routinely forwarded to CID;
5. provide any assistance to the Crime Scene Unit or CID personnel requested in the initial or follow-up investigation;
6. testimony in court, as directed;
7. any other duties assigned by superiors or subsequent addition to this order.

C. Sergeants

1. to provide assistance and first-line supervisory support to Patrol officers;

2. to ensure that procedures are adhered to;
3. to ensure that call response and responsibilities to all citizens are not diminished by this program;
4. to encourage a close working relationship on investigations between Patrol officers and CID investigators;
5. to assign investigating responsibility to officers;
6. to keep closely informed of the progress of the program;
7. to keep superiors closely informed of problems and progress;
8. any other duties assigned by superiors or subsequent additions to this order.

D. Lieutenants

1. to provide administrative assistance and support to sergeants and officers;
2. to ensure that a conscientious effort is being made to attain goals and objectives;
3. to ensure that other department responsibilities to citizens are not being diminished due to this program;
4. to keep closely informed of problems and progress with the program and communicate the information immediately to the division head;
5. any other duties assigned.

E. Captains

To provide executive support for all subordinates.

F. Investigative Coach

1. to provide investigatory assistance to all Patrol officers assigned to the program;
2. to keep closely informed of problems and progress of the program and communicate the information immediately to a sergeant or the program coordinator.

G. Program Coordinator

1. to perform administrative duties as required by grant guidelines;
2. keep department administrators advised of problems and progress of the program;

3. devise new or modified procedures as needed.

H. All Other Personnel

To perform duties as outlined in procedures, or as directed by supervisors.

IV. PROCEDURES

A. Roll Call

Sergeants will check the case files retained by the Patrol Division for investigation, the case bulletin board and the case log clipboards to familiarize themselves with current investigations being conducted. The computer terminal will also be checked for "message waiting" indication and if there is a message, obtain a "hard copy" printout and attach it to the appropriate district bulletin board. Case review dates will be checked and sergeants will discuss the case with the assigned officer and if they feel there is no further investigative work possible, refer it to CID for review by ensuring that it is placed in the appropriate tray in the information office. Case investigatory responsibility will then be assigned to the officers, ensuring that cases being worked by officers who are on days off, sick, vacation, etc., are checked and assigned if necessary.

It is important that cases having no further investigative work to be done are transferred to CID and not allowed to accumulate in the Patrol Division files.

Officers reporting for duty will familiarize themselves with the cases under investigation and ensure that there is a free flow of information among the district officers. After receiving assignments officers will check and sign out their equipment, which will consist of:

1. tool box containing fingerprint supplies
2. Porelon Fingerprinting Kit
3. camera kit
4. pocket dictator
5. MCI Manual

Sergeants will ensure that the "equipment check-out log" is signed by officers using the equipment.

Officers will ensure that they contact, either by telephone at the station or in person after leaving the station, any victim/complainant who has left a message requesting that the officer contact him.

B. Preliminary Investigation

Upon arrival at the scene of a crime call, the officer will have to make the decision as to the investigatory responsibility of the call--the choices are:

1. normal department procedures apply
2. referral to CID
3. Patrol Division investigation

Number 2, referral to CID, is for cases that would normally be investigated by Patrol but due to unusual circumstances or likelihood of extensive notoriety, they will be referred to CID. The referral can only be made with the approval of the sergeant and/or the commanding officer of the Detective or Juvenile Bureau. After making the decision, the officer will proceed with the investigation, keeping in mind the duties outlined in "Assignment of Responsibilities." The IDS and Investigative Guides will be followed to ensure a complete and thorough investigation. If the officer determines that crime scene processing is necessary, the dispatcher should be informed on PREP so they will be excused from all but emergency calls. Officers may call upon the Investigative Coach or the Crime Scene Unit for assistance until self-confidence is attained through experience.

Before leaving the scene the officer will either give the victim a business card (if it is a Patrol Division investigation) or inform him that he will be receiving a mailing from the Department in a few days informing him of the status of his case. Evidence collected should be properly packaged and placed in the trunk of the car when leaving the scene in the event another call is received before having an opportunity to take it to the station and secure it in the evidence lockers, to ensure that the evidence is not contaminated.

C. Leaving the Crime Scene

The following is a list of possible actions officers should take upon leaving the immediate crime scene area; they are only advisory and the officer's and/or sergeant's judgement as to conditions at that time should be exercised in prioritizing them:

1. follow-up of urgent leads that could lead to case solution;
2. respond to calls as directed;
3. write or dictate reports and take them to the station or turn them in to the sergeant for timely entry into the report system;
4. take collected evidence to the station and process it;
5. follow-up investigations of previous cases;
6. preventive patrol.

D. Follow-up Investigations

Officers will be responsible for the total follow-up investigations of the crimes listed in "Assignment of Responsibilities" and for all others as assigned. It is critical that officers give the dispatcher the case number when going out of service on follow-up investigations so that it can be connected with the preliminary investigation. Any action taken on the case after going back in service following the initial investigation is to be considered a follow-up investigation.

In the event an officer has a follow-up lead and it necessitates going out of the assigned district, permission should be obtained from the sergeant. Where the need is present to talk to someone in another part of the City, e.g., District 4, the officer should contact the district officer, inform him of the case and ask him to make a supplementary report after obtaining the information. The possibility of making an arrest out-of-district should be discussed with the sergeant and a detective, if necessary. Officers should continually review their cases and immediately inform their sergeants of any that have no further investigation possible. Sergeants will check case review dates on each tour of duty and ensure that cases having no further investigation possible are transferred to CID.

Officers will not direct or take victims, witnesses or suspects to the Richwoods station under any circumstances.

E. Reports

Officers will ensure that crime investigation reports follow the criteria as outlined in "Assignment of Responsibilities, Section III, Paragraph 2, Patrol Officers." Officers will complete the IDS on all crime calls, including on-scene arrests or response of detectives or the Crime Scene Unit to the initial investigation.

Officers will make a preliminary case screening judgment by so indicating on the IDS, i.e., recommend suspension, assignment to Patrol or CID for further investigation. The recommendation should be based upon solvability factors present and the officer's experienced judgement.

In the event of an on-scene arrest or other conclusive solution of the case, officers will complete the back of the IDS indicating how the case was solved.

If the case is kept by Patrol for further investigation and the officer develops new solvability factors, i.e., factors not present on the initial IDS, he should take a blank IDS and note only those factors developed in the follow-up investigation; the case number is the only other information necessary on the additional IDS. Example: if a suspect was not present at the initial investigation but was developed during the follow-up, a new IDS should be used and marked in the appropriate box(es) and the case number placed on the form.

Cases kept by Patrol for investigation where all leads have been exhausted without an arrest or other conclusive solution will require a supplementary report by the investigating officer stating that all investigative work possible has been done and a recommendation made that the case be considered "open--inactive." The entire supplementary report should be placed in the file and if the CID Case Screening Officer agrees with the officer's recommendation, he will turn in the original copy of the supp.

Officers may dictate the entire report, fill out the front and dictate the narrative, or write the entire report; however, it is important that the reports (originals especially) be turned in prior to the end of the shift. This would necessitate officers getting dictated reports to the

clerk for transcribing and signing prior to the clerk's end of shift or days off. Follow-up or supplementary reports that don't contain urgent information can be dictated and left for later transcribing; however, the officer should be available to sign the report when it is transcribed.

Sergeants will review all crime reports for conformance with the criteria set forth in this order. Those not meeting the criteria should be returned for correction.

Sergeants will make a secondary screening decision by indicating their agreement or nonagreement of the officer's decision on the IDS, with an explanation of the decision on the back of the form. It is important that sergeants indicate their disagreement, even though the officer corrects the reason for the disagreement. If the officer's recommendation is for suspension or assignment to CID for further investigation and the sergeant disagrees, the report should be allowed to continue through the reporting process to the Case Screening Officer in CID. The final decision will be made at this point and the case reassigned to the Patrol Division for further investigation, if necessary.

There will be two trays at the Richwoods station, one for reports to be turned in to the information office and one for Patrol investigations that will necessitate copying and the initiation of a file folder. After completing the latter the original reports and IDSs should be placed in the first tray. Sergeants will be responsible to see that reports are copied and file folders initiated in the absence of the clerk.

Sergeants will also check the Richwoods box in the information office for messages or cases reassigned to Patrol.

F. Information Office

Clerks will ensure that the following report routing is accomplished:

1. original IDS is attached to the original report;
2. two copies of the IDS accompany the CID report;
3. IDSs attached to supplementary reports coming from CID are attached to the original copy of the supp;
4. copies are made of all Richwoods district reports, supps and IDSs for the Crime Reduction Council (they have been charged with monitoring the program and must have the reports);
5. ensuring all Patrol Division case folders being referred to CID are promptly forwarded to CID.

A special telephone number has been obtained for use in the MCI program (692-3040) and appears on both call directors in the information office. The officers and informational leaflets will be instructing victims to call this number if they have additional information on the case or need to contact them. Information Office clerks will be responsible for answering this number when the clerk is not on duty at Richwoods.

If a victim calls and wants to contact the investigating officer or has important information, the clerk will transmit the case number, victim's name, address and phone number and message to the appropriate officer by using the computer terminal and the administrative message mode. If the investigating officer is in Patrol, messages will be directed to the Richwoods terminal (PO2) and if the officer is in CID, it will be directed to the CID terminal (CO1). If the computer system is down, MCI message pads have been provided and they will be used. If a victim calls in to register a complaint about the program, it will be logged in the computer by putting it on a supp screen, with appropriate case number.

G. Case Screening Officer

Reports arriving in CID will be screened by the sergeant assigned; in-custody cases may be assigned by this sergeant. The screening officer will make one of the three decisions concerning screened cases:

1. assign the case to an investigator
2. suspend the case
3. reassign to the Patrol Division for further investigation.

The present BIDMORE screening system will still be used for burglaries only.

While screening the cases the screening officer will document his decisions by placing them on the Case Assignment Log, which will contain the following information:

1. date of screening
2. case number
3. screening decision
4. officer assigned
5. screening officer

After the screening process is completed the sergeant will follow the below listed procedures:

1. ensure that a copy of the Case Assignment Log is promptly placed in the Richwoods box in the Information Office (the Richwoods clerk will use this for the mailing of informational leaflets to victims);
2. direct CID clerks to enter the information on the IDS into the computer system;
3. forward cases to be assigned to the appropriate section sergeant, i.e., violent crimes, etc.;
4. direct CID clerks to update IDS information in the computer system when a conclusive decision is made in assigned cases, i.e., solved or changed to "open--inactive."

The screening officer will also reassign reopened cases, either to CID or Patrol.

H. CID Investigators

Investigators will work all cases assigned and fill out the back of the IDS on all solved cases. They will also log their beginning and ending times of activities on supplementary reports on individual cases, which will be used for case management purposes. Investigators will update the solvability factors on the IDSs in the same manner as Patrol investigators (see Reports procedures for Patrol).

Investigators will make every effort to work harmoniously with Patrol Division officers investigating cases and will offer their assistance when needed. Investigative procedures will be evolving during the implementation of this program and it is the responsibility of investigators to keep themselves closely informed of the progress of the program and offer assistance or suggestions for improvement.

I. Radio Dispatchers

As previously noted in this order, officers performing follow-up investigations must give the case number to the dispatcher when going out of service. Dispatchers will enter the case number in the "nature of incident" field by placing the year prefix first and then a five digit case number, e.g., 3001234. Dispatchers will be alert to any call response problems caused by this program and bring it to the immediate attention of the CDIC Sergeant.

J. Richwoods Clerk

The Richwoods clerk's responsibilities are to:

1. initiate and maintain case folders;
2. ensure that case bulletin board and case log clipboards are accurate;
3. place "hard copy" printouts of messages to officers on the appropriate district bulletin board;
4. transcribe dictated reports;
5. mail appropriate informational pamphlets to victims;
6. answer the MCI telephone number (692-3040) during their tour of duty and direct messages to the appropriate officer;
7. notify Information Officer clerks when they are arriving or departing from work so they know when to answer MCI phone;
8. log any citizen complaints about the program into the computer;
9. any other duties assigned.

July 2, 1980

K. General

Any employee who becomes aware of any citizen complaint concerning the program will ensure that it is entered into the Department's computer system by using a supplementary report screen with appropriate case number. Officers and employees should be alert to addendums to this order, due to the complexity of the procedures and the likely need for changes. Unless notified differently, this program will be commencing with the day shift on Monday, July 7, 1980.

The specific procedures for Management of the Continuing Investigations (CID) and Police/Prosecutor Relationship (State's Attorney Liaison) components of the program are being formulated and will be made addendums to this order as they evolve.

Allen H. Andrews, Jr.
Superintendent of Police

AHA/DQ/nw
Attachment

INCIDENT CODE
DATE OF REPORT

VICTIM _____

ADDRESS _____ PHONE NUMBER _____

SOLVABILITY FACTORS:

- | | | |
|---|---|--|
| N | Y | 1) Time reported minus time occurred: More than 24 hours <input type="checkbox"/> 12-24 hours <input type="checkbox"/> 1-12 hours <input type="checkbox"/> Less than 1 hour <input type="checkbox"/> |
| N | Y | 2) Was this crime discovered on view by the officer? |
| N | Y | 3) Was there a witness to the crime? |
| N | Y | 4) Can a suspect be named? |
| N | Y | 5) Can a suspect be located? |
| N | Y | 6) Can a suspect be described? |
| N | Y | 7) Can a suspect be identified? |
| N | Y | 8) Is a suspect vehicle identified or partially described? |
| N | Y | 9) Is stolen property traceable? |
| N | Y | 10) Is there a significant M/O? |
| N | Y | 11) Does this crime fit a pattern of other crimes? |
| N | Y | 12) Is there significant recovered physical evidence present? |
| N | Y | 13) Are there recovered usable latent prints? |
| N | Y | 14) Was there a definite limited opportunity for anyone except the suspect to commit the crime? |
| N | Y | 15) Does investigating officer have personal information that could possibly solve this crime (explain on back)? |
| N | Y | 16) Does investigating officer believe this crime can be solved w/REASONABLE amount of investigative effort? |
| N | Y | 17) (Other specific--explain.) |
| N | Y | 18) (Other specific--explain.) |

INVESTIGATIVE OFFICER DECISION SECTION:

SUSPEND Investigate further by: Patrol CID Follow-up Inactive Case solved (fill out back)
 Officer _____ Badge Number _____ Date _____

SERGEANT/SUPERVISOR DECISION SECTION:

Agree Disagree w/officer's recommendation (explain on back)
 Sergeant/Supervisor _____ Badge Number _____ Date _____

CASE SCREENING OFFICER DECISION SECTION:

Agree Disagree w/officer's recommendation SUSPEND Return to Patrol for further investigation (explain on back) Assign to Patrol investigator (explain on back) Assign to CID Investigator (explain on back) Officer assigned _____ Badge Number _____ Case reopened (fill out back)
 Case Screener _____ Badge Number _____ Date _____

- 1) Suspend: Attach sheet to original report.
- 2) Patrol Investigation: a) Attach sheet to original report; b) Make copy for Patrol use.
- 3) CID Investigator: Attach sheet to original report.

(See Back)

If this case was solved, what solvability factors were present that caused solution? (List solvability factors by number).

If this case was solved and none of the listed solvability factors was present or if other factors significantly contributed to the solution, explain how the case was solved.

REOPENED CASE SECTION:

Case Reopened due to: Confession by suspect in other case Suspect arrested in other case Suspect arrested by other jurisdiction Informant information Additional witness information New witness information Additional victim/complainant information Information provided by police officer M/O fits pattern of active investigation Pattern fits crime(s) of active investigation Other reason(s) (Explain) _____

Use the following sections for explanations as requested on front side:

City of Peoria
Department of Police

OFFICE OF SUPERINTENDENT

GENERAL ORDER NO. 342-80

JULY 29, 1980

TO: ALL PERSONNEL

FROM: SUPERINTENDENT OF POLICE

SUBJECT: MANAGING CRIMINAL INVESTIGATIONS GRANT PROGRAM; ASSIGNMENT
OF BURGLARY INVESTIGATIONS FOR MCI TRAINED OFFICERS

RE: GENERAL ORDER NO. 342-80 - PART I - SECTION III,
ASSIGNMENT OF RESPONSIBILITIES - SUBSECTION B,
PATROL OFFICERS

Effective with the issuance of this order MCI trained officers will perform crime scene processing duties on those burglaries where the Crime Scene Unit is unable to respond due to other commitments. Officers will determine the Crime Scene Unit's unavailability by checking with the Crime Scene Technician on duty.

Officers will make a preliminary screening decision on burglaries, i.e., recommend suspension, or further investigation by Patrol or CID; however, their decision is subject to review by the CID Case Screening Officer and might be reversed, e.g., connected to other cases under investigation, possession of information unknown to the patrol officer, etc.



Allen H. Andrews, Jr.
Superintendent of Police

AHA/DQ/csk

INTER-COMMUNICATION BETWEEN POLICE PATROL AND
DETECTIVE PERSONNEL

A Challenge for Police Managers

Ernest Maldonado
and
Lyle Knowles

E. Maldonado and L. Knowles, "Inter-Communication Between Police Patrol and Detective Personnel," Police Chief Magazine, January 1981. Reprinted with permission of the publisher.

INTER-COMMUNICATION BETWEEN POLICE PATROL AND DETECTIVE PERSONNEL

A Challenge for Police Managers

By ERNEST MALDONADO And LYLE KNOWLES

ERNEST MALDONADO is an operations sergeant with the Los Angeles Sheriff's Department, Pico Rivera Sheriff Station, 6631 Passons Boulevard, Pico Rivera, California 90660. During his 12-year career with the sheriff's department, Maldonado has worked patrol, detectives, and administration divisions. He holds the B.S. degree in public management and M.P.A., both from Pepperdine University, Los Angeles; and is currently pursuing the Ph.D. in criminal justice at Claremont College.

LYLE KNOWLES is a visiting professor in the doctoral program in criminal justice at the Claremont Graduate School. Professor Knowles holds a B.S. degree in psychology and mathematics, University of Arizona, and M.S. and Ph.D. in education psychology, University of Southern California.

Police managers are being called upon to continue providing quality law enforcement services, often with reduced budgets, and to control the activities of today's more sophisticated and mobile criminal. Since direct delivery of services and crime control efforts take place at the bottom levels of the typical police organization, it is paramount that cooperation and communication be optimal between patrol officers and detectives in the investigation of reported crimes.

The Problem Statement

As many police officers have observed, however, communication and information sharing between patrol and detective personnel is not always effective, particularly in middle-sized and large agencies where these areas of assignment are separate. Lack of cooperation can lead to an inefficient investigation since both patrol officers and detectives contribute to this process. /1/ As Bormann et al. have noted, "Within the system of interdependent and overlapping units that form any modern organization are points of competition and conflict." /2/ The foregoing suggests that man, as well as other creatures, has a territorial instinct.

In addition to sharing overlapping areas of responsibility, another contributor to the problem can include the strongly held belief that to transfer from patrol to detectives is often considered a "step up" and not just a change in jobs. Although a patrol officer is involved with the investigation of crimes much of the time, he or she is viewed as subordinate to station detectives.

Detectives usually work general supervision day shift assignments. They dress in coat and tie or in casual clothes, and are generally free to come

and go from the office at their pleasure. Patrol officers work under close supervision, shift assignments, and they must dress in an appropriate uniform which is subject to inspection by superiors at any time. They are required to attend regularly scheduled pre-shift briefings, and must continually advise superiors of their whereabouts and activities.

Since detectives tend to work under an open, laissez-faire management system and patrol officers work within a more controlled, autocratic environment, frustration often evolves which promotes elements of envy and jealousy where the jobs of detectives and patrol officers overlap.

As mentioned earlier, the investigation process involves intercommunication and information sharing between detectives and patrol officers. If the interaction between these units is strained or hostile, the quality of communication will be marginal, and the groups may become competitive and even seek to undermine the other's activities, thus becoming a liability to the organization as a whole. /3/ As Hanneman and McEwen /4/ and others have noted, the management and operations of an organization are heavily dependent upon effective communication.

Thus a number of questions arise in the current situation.

- Do patrol officers and detectives view intercommunication and information sharing as effective?
- If not, who is responsible for improving the situation?
- Do these two groups view their own group and the other group as being effective and competent in their respective investigative activities?
- Is management aware of any existing problem?

Methodology

In addressing the above questions, a questionnaire was developed, pilot tested, and distributed to 182 randomly selected patrol officers and detectives in a large Southern California law enforcement agency. Two relatively large police stations and one middle-sized station were used in the study. Each large station employs over 200 sworn personnel, and together provide law enforcement services to approximately one-half million residents within 74 square miles that includes a mixture of residential, industrial, and commercial areas. The middle-sized station employs less than 100 sworn personnel and services 72,000 residents in an area of about 13 square miles.

The anonymous questionnaires were distributed and collected by the authors, and the participation rate was 81 percent. The hypothesis examined was that a difference in perceptions and attitudes would exist between patrol officers and detectives in the areas of communication, information sharing, and effectiveness of the investigation process.

The Findings

The data were summarized and processed through a computer. Since no differences were found in response patterns between any of the three police stations, the data were combined for further analysis. In addition to the findings presented below, cross-tabulations were made for age, sex, rank, years in law enforcement, current shift assignment, and years in patrol and detectives. Several important differences were found in relation to these independent variables and are discussed later as they pertain to the major findings in comparing perceptions of patrol officers and detectives. In considering the findings discussed below, it should be remembered that patrol officers, as a group, tended to be younger, had fewer years in law enforcement than detectives, and worked three shifts. Responses from 74 patrol officers and 65 detectives were included in the data analysis.

Survey participants were given response options of agree, undecided, or disagree to 15 attitude statements. Regarding whether intercommunications was adequate between officers and detectives, almost 70 percent of the officers disagreed, as did 60 percent of the detectives. However, when asked if intercommunication was effective between these two functional groups, 54 percent of the patrol officers disagreed, while 55 percent of the detectives agreed. Of particular interest was the finding that of the 48 lieutenants and sergeants surveyed, 58 percent felt that communication was effective.

Seventy-six percent of the officers and 69 percent of the detectives felt that detectives should improve intercommunication. Forty-two percent of the officers and 45 percent of the detectives agreed that patrol officers should improve intercommunication.

Survey participants were then asked if patrol officers provide detectives with adequate information on cases being investigated. Officers responded--31 percent agree, 34 percent undecided, and 35 percent disagree. Detectives answered--22 percent agree, 20 percent undecided, and 58 percent disagree. When asked if detectives give adequate information to patrol officers, officers responded--9 percent agree, 14 percent undecided, and 77 percent disagree, compared to detectives who replied--22 percent agree, 29 percent undecided, and 49 percent disagree.

Fifty-three percent of the officers agreed that patrol should give more information to detectives, as did 71 percent of the investigators. Ninety-three percent of the officers and 68 percent of the detectives said that investigators should give more information to patrol.

Concerning competency, 77 percent of the patrol officers and 55 percent of the detectives agreed that patrol officers are competent investigators. Seventy-six percent of the officers agreed that detectives are competent investigators, and 85 percent of the detectives agreed. When asked, however, if patrol officers are effective and thorough in investigating crimes, 28 percent of the patrol personnel agreed, 36 percent were undecided, and 36 percent disagreed. Among detectives, 11 percent agreed, 15 percent were undecided, and 74 percent disagreed. Concerning whether detectives are effective and thorough in investigating crimes, 32 percent of patrol officers agreed, 49 percent were undecided and 19 percent disagreed, compared to detectives of whom 63 percent agreed, 25 percent were undecided, and 12 percent disagreed.

In response to the statement that an effective working relationship exists between patrol and detectives at their station, 22 percent of the officers agreed, 27 percent were undecided, and 51 percent disagreed. Forty-six percent of the detectives agreed, 28 percent were undecided, and 26 percent disagreed. Interestingly, lieutenants and sergeants reported that the working relationship between the groups was effective.

When asked if administrators at their station realized that an intercommunication problem existed between patrol and detectives, the response patterns of both survey groups were similar, providing combined totals of 33 percent, 39 percent and 28 percent.

Fifty-three percent of the patrol officers said that one of their goals was to be assigned to the detective bureau, and 71 percent of the investigators agreed that one of their goals was to remain assigned to the detective bureau.

Discussion

Generally, the results of this study show that patrol officers and detectives are aware that intercommunication and information sharing problems exist; and to a large extent, both groups perceive each other's competency in a positive light. Both groups see a need for improved cooperation, particularly in the form of feedback from detectives to patrol officers.

Regarding lack of information sharing at the police stations under study, both supervisors and detectives, generally speaking, are provided with sufficient information by patrol officers to complete a work assignment. This is usually in the form of a police report or memorandum. Patrol officers, on the other hand, continually want more information than they receive from both detectives and supervisors. They feel that a lack of certain kinds of information detracts from the effectiveness of their work performance. This has the potential of causing frustration and resentment which, in turn, can inhibit a cooperative working relationship and effective intercommunication.

In determining who should improve the process, several day-to-day realities should be noted. For instance, patrol officers believe that the police report, which is given to detectives, together with an occasional short verbal report, is adequate intercommunication. They also believe detectives should be more aggressive in their dissemination of information to patrol. Requests are frequently made for investigators to attend patrol briefings, but they are seldom present. Detectives feel that if patrol officers want more information, it is always available in the detective bureau office. In addition, the demands of the investigative function, which often take a detective away from the police station, can preclude attendance at scheduled patrol briefings. Their work hours also do not allow them the convenience of regularly attending shift briefings.

An important outcome of the current study was the question of whether or not administrators were aware of a communication problem. Management should not only determine whether a problem is present, but also realize that investigative personnel perceive that there are difficulties.

Determining a solution to the intercommunication problem between police patrol and detective bureau personnel is difficult for the police manager since the problems of bureaucracy, as well as communication and interpersonal relationship deficiencies, must be addressed. However, as the rate of crime and the demands on law enforcement increase and police budgets decrease, police administrators will be forced to consider these problem areas.

Corrective efforts should include the three commonly defined organizational levels of administration, supervision, and line operations. The remedial actions should involve orientation and training of personnel, as well as policy and procedural changes and modification of work processes.

Station administrators are one of the keys to successful problem solution. Realistically speaking, however, these people may be discouraged from addressing the problem because of several factors. First, much of their authority is restricted by superiors or city officials. They must also consider police officer morale as a major issue from the standpoint of labor-management relations. In addition, emphasis on patrol force deployment, resulting from community pressures, may tend to deemphasize the investigative function.

A proper orientation for superiors, city officials, and other administrators should assist in developing their acceptance of corrective action. Showing these people that there is a more productive and cost-effective method of conducting police business should help achieve their positive support.

Police station supervisors, both lieutenants and sergeants, are in the most influential positions in a police organization to effect change in operations, once they receive appropriate direction. A major change emphasis must be directed toward this group.

Thorough and continual orientation and training of police supervisors must be a part of any plan to improve intercommunication, since this group sets the day-to-day attitude pattern for the majority of police personnel. If resistance, apathy, dissatisfaction, and mistrust are voiced by these supervisors, it is usually reflected by their subordinates.

Provisions should also be made to increase the interaction between patrol and detective bureau supervisors. Policy and procedural changes can help provide for more frequent face-to-face contacts, ensuring, for example, that they work together on portions of investigative assignments, such as at the time of arrest approval. In addition, frequent staff meetings could be held to discuss and solve problems between the two groups.

The area of line operations offers the greatest opportunity for effecting changes. This is, truly, the heart of the problem; and all of the previously recommended changes only facilitate action being taken at this level. It is here that the overlapping of functions occurs, that competition is most notable, and negative attitudes of one group for the other can become prevalent.

The survey results revealed that, although patrol officers and detectives view some inefficiency in each other's work, both groups believe the characteristic of competence is present. Furthermore, both groups are willing to improve the intercommunication process.

It is suggested that combining the work proximity of those performing overlapping functions could yield a productive result. People who work in close physical proximity with one another often report very positive feelings toward each other. Taking this "teamwork" concept into consideration, a logical step would be to assign detectives to each of the patrol shifts. This is, indeed, a radical change; however, it is by no means impossible or impractical. A sufficient number of investigators would, of course, remain on the day shift to contact victims and witnesses and to handle the filing of cases at court. In relation to this notion, another interesting possibility would involve the assignment of deputy district attorneys to be available on all shifts. In this way, cases could be filed at any time of the day or night, and would allow patrol officers, detectives, and district attorneys to be closely involved in an entire work process which could foster great understanding and improved communication.

Patrol personnel and detectives perceive that communication and information sharing problems exist; however, both groups are willing to assist in solving these difficulties. Management, therefore, could well take advantage of the positive aspects of the situation and provide the guidance and directions required in confronting and correcting the problem.

/1/Joseph Staff, "Effects of Organizational Design on Communication Between Patrol and Investigative Functions," FBI Law Enforcement Bulletin (May, June 1980).

/2/Ernest Borman, W.S. Howell, R.G. Nichols, and G.L. Shapiro, Interpersonal Communication (New Jersey: Prentice-Hall, Inc., 1969).

/3/Edgar Schein, Organizational Psychology (New Jersey: Prentice-Hall, Inc., 1965).

/4/G.S. Hanneman and W.J. McEwen, Communication and Behavior (Reading, Mass.: Addison Wesley Publishing Co., 1975).

EFFECTS OF ORGANIZATIONAL DESIGN ON COMMUNICATION
BETWEEN PATROL AND INVESTIGATIVE FUNCTIONS
(Part 1)

By LT. COL. JOSEPH J. STAFF
Police Division
Cincinnati, Ohio

Lt. Col. Joseph J. Staff, "Effects of Organizational Design on Communication Between Patrol and Investigative Functions (Part I)," FBI Law Enforcement Bulletin, June 1980. Reprinted with permission of the author and the FBI.

EFFECTS OF ORGANIZATIONAL DESIGN ON COMMUNICATION
BETWEEN PATROL AND INVESTIGATIVE FUNCTIONS
(Part 1)

By LT. COL. JOSEPH J. STAFF
Police Division
Cincinnati, Ohio

A major concern for the administrator of any large organization is that of maintaining harmonious relations, open channels of communication, and coordinated activities among his agency's subunits. The vary nature of the executive function is to promote cooperative effort. /1/ While a free flow of information is essential in any organization, the problem is more critical in a police agency. By far, the greatest bulk of work depends on its ability to process information effectively.

One of the most critical intra-agency interfaces in a police department is that of the investigative and patrol functions. To operate efficiently, each function should be highly dependent on the other. Yet, this is often one of the most strained points of exchange within law enforcement agencies.

The problem of maintaining cooperation and exchange of information between uniformed patrol officers and plainclothes investigators is not a recent one. As early as 1926, the Missouri Crime Survey reported on the problem, stating:

"The ancient rivalry between the uniformed and plainclothes forces has a substantial basis. It arises from the fact that in a given case the patrolman is often the first to risk life and limb. With the arrival of detectives, however, he is automatically displaced. The plainclothes operative takes command of the situation, and the patrolman returns to his beat. This condition inspires a natural resentment, which sometimes leads to a series of retaliatory acts by the two branches. In the maneuvers which follow, the public functions of the officer are lost sight of. Their energies are directed at causing each other confusion, discomfort, and discouragement." /2/

Later comment on the same point was made in a 1962 consultant's report, which reads:

"The lack of coordination between detective and uniformed divisions leads to duplication of effort, unarticulated field work, and the loss of some cases, and the missing of arrests which might otherwise be made." /3/

It is not likely that difficulties in investigative-patrol coordination are confined to only a few police departments. Most police administrators would have to admit to experiencing some communication problems between these units, although differences would likely be in degree, not in kind.

Several contemporary observers of police behavior have commented on oft-times strained relationships between police patrol and investigative forces. Professor Egon Bittner of Brandeis University writes, "The hostility and information denial between bureaus and details of department is occasionally admitted. But that every individual officer has important information that he does not share with anyone is virtually never mentioned in the literature. Yet this is a central fact of police work and every officer learns it in the first year of his practice." /4/ Professor Arthur Niederhofer of John Jay University comments that when the patrolman uncovers a felony from which the suspect has fled, the case is turned over to the detectives who, if they find the culprit, get all the credit. /5/ Harvard University Professor James Q. Wilson, in his study of police behavior, has much to say about differences between the patrol and investigative functions. /6/ The patrolman functions in an uncertain, hostile atmosphere with the ambiguous, often unpopular, mandate to "maintain order." The detective, however, usually enjoys higher prestige and higher pay, more interesting work and more freedom, and has a better sense of what is expected of him. When one reflects upon these differences, it does not seem strange that conflicts may arise between operational units.

Factors Influencing the Problem

The difficulties in maintaining cooperation and coordination between the patrol and investigative functions can be grouped into three general classes of interrelated problems: Organizational problems, social problems, and inadequacy of information systems.

The Presidential Task Force Report on the Police describes the manner in which organizational structure can adversely effect coordination of activities between the investigative and patrol functions.

"In almost all large police departments there is a considerable amount of organizational fragmentation. Traditionally and almost universally, patrol and investigative forces have separate lines of command and tend to be isolated from one another; often they keep separate sets of records; frequently they work different shifts or are based in different places so that there is a minimum of contact between patrolmen and detectives. In addition, investigators are more often than not divided at both headquarters and precinct levels into squads--vice, robbery, burglary, fraud, homicide, and so forth--that may themselves keep separate records, use separate informants and remain more or less isolated from each other in other ways. At both the staff and the field levels, this over-separation of functions, or overspecialization, can have undesirable results. When intelligence is not centralized and coordinated, staff planning for the purpose of either apprehending specific criminals, or solving crime problems such as, for example, an outbreak of burglaries in some neighborhoods, is almost impossible. When lines of command are kept rigidly separate, it is difficult to bring the full resources of a department to bear on crime solution." /7/

Rigid and separate lines of command imply equally rigid and separate channels of communication. If each bit of information relevant to solving or suppressing crime must travel up the chain of command to a common point, then back down to the affected unit, little information, indeed, could be processed.

Competition between units can be a very useful tool for motivation and morale, if the competing units can operate independently of one another. However, when tasks are interdependent and exchange of information is critical, competition becomes counterproductive. Intergroup conflict probably dissipates more energy and money than any other single organizational disease. /8/ Competition can produce "win-lose" intergroup orientation, dysfunctional loyalty to subunits instead of the overall organization, and cognitive distortions of behavior of competing group members. Communication processes are impeded. If organizational rewards, such as promotion and preferential assignments or unit and individual prestige, are bestowed on the basis of "who gets credit" for arrests, case closures, and the like, a situation develops which encourages officers to keep information to themselves and withhold aid to other officers or units competing for "credit" for the arrest or closure. The organizational reward system should not induce competition which is so intense that it frustrates rather than furthers organizational goals.

The manner in which responsibility for investigation of cases is assigned can also affect task performance and cooperation between units. Traditionally, patrol units have been given responsibility only for preliminary investigations or complete responsibility for investigation of "minor" offenses. At some point prior to the conclusion, responsibility for investigation of serious crimes is handed off to the investigative specialists. Hence, the patrolman feels he is left with only routine and mundane investigations, while the detective investigates the interesting or spectacular cases. The patrol officer, relegated to the role of "report taker," may see little personal incentive to conduct a thorough and meticulous preliminary investigation or to forward any information not specifically required by procedure when he knows he has no responsibility for the ultimate closure and will receive no credit for a subsequent arrest made by the detective bureau.

Social Problems

It was suggested previously that the functions of the detective and patrol officer differ somewhat. Both Wilson and Bittner comment at length on "...organizational structure can adversely affect coordination of activities..." these differences. The patrolman is concerned with "keeping the peace," a very ambiguous and uncertain job description. The range of incidents with which he must deal is very wide. He often lacks the legal tools to "keep the peace," and the controversial nature of the tasks prevents common public support of his activities. The detective, however, has a fairly certain task, that of identifying and arresting the perpetrators of crimes. His task does not begin until a crime has been committed. The legal domain in which he functions is clearly documented, and there is general public support for the arrest and prosecution of felons. /9/

In addition to differences in assigned tasks, the status and prestige of the patrol and investigative officers differ. The detective enjoys higher prestige and usually higher pay than the patrolman. His task is more interesting and glamorous, at least as perceived by the public. His hours are better, he has greater freedom in his work, and he is under less public scrutiny than his uniformed counterpart. The patrolman, however, is subject to a strong hierarchical command structure, tightly restricted by rules, bound by military discipline, and under constant public scrutiny. /10/

Unfortunately, the news and entertainment media, particularly television and the movies, has reinforced the glamorous image of detective work as opposed to patrol duties, which are often portayed as being dull and routine, requiring little initiative or mentality. These real and perceived differences in role and image create a cleavage between two groups of men who should be working together toward a common cause. The lack of a common identity may result in a "we vs. they" relationship between the groups. This relationship clearly is not conducive tho close cooperation and exchange of information needed for combined crime reduction efforts.

Bittner feels strongly that because of the nature of the officers' tasks, they feel a great need to maintain an atmosphere of secrecy in respect to disclosing information to "outsiders." /11/ He feels this subcultural trait then carries over into intradepartmental relationships, resulting in an unwillingness to share information even with fellow officers.

The unique nature of the relationships between the officer and his informants also contributes to the need for secrecy. Because police informants are part of, or on the fringe of, criminal activity, and because of the mutually beneficial nature of the exchanges between the informant and officer, it is in the best interests of both to maintain the confidentiality of their arrangement. If the informant felt that his identity might be compromised to another officer with no vested interest in the informant's welfare, that important source of information might dry up. /12/

Even if all members of a police organization were willing to share all information at their disposal with all other law enforcement officers, it would not be possible without adequate information systems. Information systems include national, regional, and local computer systems, electronic data processing systems, telephone and teletype networks, formal records systems, established channels for routing information, and personnel to operate these systems.

Even though creation of the systems might be far simpler than inducing personnel to feed information into them, the mechanics of providing the systems must not be overlooked. These systems should be considered when examining communication capabilities of a police organization.

Implications of Organizational Design

Perhaps the greatest single factor which affects the information processing capability of an organization is its formal structure. Reporting and authority relationships between subunits of an organization have significant impact on the development and maintenance of formal and informal information channels.

In any viable organization, information must flow (1) from top to bottom, (2) from bottom to top, (3) laterally or horizontally, and (4) between the organization and its environment (including cooperating agencies).

Throughout the history of organizational design, a wide range of concepts, generally classified as classical, human-relations, or modern approaches, have emerged. /13/ There are advantages and disadvantages of each type of organization as it relates to improving communication between investigative and

patrol personnel, and no attempt should be made to prescribe an organizational strategy suitable for any or all police agencies. Rather, an attempt has been made to document some of the organizational trade-off costs and benefits to be considered when examining the issue of patrol-investigative cooperation. The following "contingency theory" /14/ of organization is commended to the reader; however, there is no one best way to organize, and any way of organizing is not equally effective.

Classical Approach

Classical organizational theorists have differed somewhat in details of their theories. To grossly generalize, however, let it suffice to say that the classical approach generally suggests that the tasks of an organization be divided among one or several bases of specialization, subunits be created to accomplish each of the specialized tasks, and coordination of the subtasks be attained through a hierarchical authority structure with each superior manager coordinating the activities of the persons and units beneath him in a rigid chain of command.

The organizational principles of business scholars Bulick and Urwick /15/ are perhaps the most representative of the traditional approach most police departments have taken toward organization. Both advocate the division of labor because men are limited in their abilities. The range of knowledge and skills required in a modern police department is so great that one man could not possibly become expert in all areas in his entire lifetime. Therefore, some division of labor, or specialization, must occur.

Specialization offers certain advantages to a police agency. It permits precise placing of responsibility, more intensive training of specialists, development and maintenance of skills through continual experience, creation of esprit de corps, and increased support from certain public special interest groups. /16/ Consideration of these advantages would certainly be justified when contemplating establishing or eliminating specialized investigative units. However, for each of these advantages, there are corresponding disadvantages, which will be noted later.

After a decision has been made to specialize within an organization, the classical theorist would provide means by which activities can be coordinated. Bulick and Urwick contend that coordination of effort can be achieved through organization, i.e., interrelating subdivision of work by allotting them to men who are placed in the structure of authority so that the work may be coordinated by orders of superiors to subordinates, reaching from the top to the bottom of the organization, or by dominance of an idea, i.e., intelligent singleness of purpose of all in the group so each worker will fit his task into the whole with skill and enthusiasm. These two methods are not mutually exclusive; in fact, effective organizations must have both. /17/

In applying the preceding to the organization of investigative and patrol functions, the chief would first determine the scope of the investigative responsibility assigned to his agency, "To operate efficiently, (investigative and patrol functions) should be highly dependent on the other." and then the nature and number of specialized work units required, e.g., crimes against person or property squads, vice squad, patrol precincts, etc. Following this, he

would create an appropriate organizational and authority structure, with authority flowing down through clearly identified chains of command and responsibility.

Some other principles the classical theorist would consider are span of control, unity of command, development of technical efficiency, and authority commensurate with responsibility.

Gulick and Urwick suggest the division of labor in an organization be based on purpose, process, clientele, and/or place. /18/ Other writers include specialization by time. Examples of each of these basis of specialization can be found in the organization of the investigative function of contemporary police agencies, and each has inherent strengths and weaknesses which must be considered when relating organization to communication capabilities among members of a police agency.

Examples of police subunits organized on the basis of purpose of function are investigative bureaus, homicide, robbery, burglary or vice control squads, traffic enforcement details, etc. Each of these units is responsible for some function or purpose of the police mission, e.g., detection, apprehension and prosecution of robbery suspects, prevention of traffic accidents and apprehension of violators, suppression of vice activity, etc. Organization by purpose facilitates the accomplishment of certain assigned objectives by bringing trained specialists and specialized resources together under a single manager who can be held accountable for attainment of a desired state of affairs. The unit can be judged by what it accomplishes, not by its methodology. This type of organization is effective for gaining energies and loyalties of assigned officers because their purpose is clearly understood.

Difficulties arise when purposes overlap or conflict. A patrol unit and a specialized investigative unit may be jointly charged with responsibility for the same task. For example, a local patrol precinct and a specialized robbery squad may share responsibility for reduction of the robbery rate in a certain high-crime area. Each of the units reports to a separate commander, both of whom are at least informally evaluated by how effectively robberies in that area are reduced. Each of the commanders may have his own ideas how this might be accomplished and each wishes to receive credit for improving the crime situation. This type of core-responsibility for the same results negates the advantage of specialization by purpose. It may result in the two units working at cross-purposes, refusing to share critical leads, and duplicating efforts. In this case, competition becomes dysfunctional and cooperation and communications between the patrol and investigative units are impaired.

An equally dysfunctional situation exists when subunit purposes conflict with other subunit or agency goals. Often, when personnel over-concentrate on purposes of their own subunits, they lose perspective of the overall goals of the agency. A vice control specialist, through much personal effort, may develop an informant who advises him of habits and whereabouts of narcotics dealers, illicit gambling or liquor establishments, or other vice-related activity. The vice officer may learn that the informant himself is involved in criminal activity, but may be sorely tempted to withhold this knowledge from fellow officers rather than lose his personal source of information.

Organization by process is most advantageous for grouping skills which require a high degree of technology or long periods of training and experience to gain proficiency. Specialists of this type would include police helicopter pilots, traffic radar operators, canine handlers, identification specialists (fingerprint and photography experts), evidence technicians, etc. Advantages accrue by permitting highly trained specialists to share expensive equipment, exchange technical information, and keep abreast of the latest innovations in their field. They are grouped into single units that can be supervised and coordinated by one supervisor who possesses the specialized knowledge needed to direct and evaluate his subordinates. Process specialization permits attainment of the highest levels of proficiency in technical (and perhaps infrequently used) skills.

Specialization by process offers little advantage if the frequency of need for a particular skill is not great enough to justify at least one man being assigned full time. Any given process can accomplish only a small part of the overall goals of a police organization. Coordination problems are increased each time a new specialized process is added onto the organizational structure. Process specialists may become so engrossed with perfecting their technical skills that they lose sight of the reason for performing the function. For example, a canine handler may become more interested in interdepartmental canine competitions than in suppressing criminal activity, or a scientifically oriented evidence technician may be more interested in publishing articles in scientific journals than assisting field officers with processing crime scenes or identifying perpetrators. The police administrator must insure that the process specialist contributes to the organizational effort by cooperating with line units rather than practicing his art in the vacuum of his own subunit specialty.

Certain police functions are grouped according to the clientele they serve or upon whom they focus their investigation. The most obvious example of this would be a police juvenile unit. Juvenile officers, through special aptitude, long and frequent experience, and specialized training, become uniquely qualified to handle cases involving juvenile victims or suspects. Some cities have initiated specialized units to handle victims of rape. Intelligence squads concentrate investigations on suspected organized crime figures. Any unit organized by type of crime somewhat implies that it will deal with certain clientele groups. For instance, a check and credit card squad deals primarily with community merchants and personnel of credit agencies on an ongoing basis and frequently encounters recurring suspects. Clientele become known to the investigator. Faces and M.O.'s of bad check artists become familiar to the investigator who benefits from the relationships developed with his clientele over a period of time.

Organizing by clientele, however, means the loss of some advantages of other specializations. Obviously, a juvenile squad could not afford to maintain its own evidence technician, narcotics expert, or identification specialist, even though all these skills might be needed in an investigation involving a juvenile. The clientele-based unit must depend on cooperation of the process specialists for assistance.

There is the danger that clientele-oriented groups may form stronger allegiances with its target group than with its own agency. An example of this type of coopted behavior is a check squad investigator who acts in the special records are available, some consideration must be given to the need for the investigator

interest of a merchant by emphasizing only restitution of financial loss in lieu of apprehension and prosecution of criminal offenders.

Due to differences in orientation, goals, and values of the specialist, he may experience difficulty in communicating with other members of the department. Sarcastic references to "kiddie kops" (juvenile officers), "do-gooders" (community relations officers), or "pencil-pushers" (desk or administrative officers), are not uncommon. Uniformed field patrol officers understandably may not identify with the specialized officers and may not feel a fraternal obligation to share street-acquired knowledge with the specialists. Clearly, the situation also works in the reverse direction, i.e., specialized investigators also withhold information from patrolmen.

Gulick and Urwick consider organization by area to be tertiary or secondary. /19/ Division of work by geographical area occurs in all but the very smallest of police departments, however. Most large departments are divided into patrol districts or precincts which are responsible for providing police services to a given area of the city. Precincts may or may not have their own investigative personnel. To the extent that patrol officers and investigators can be assigned within the same geographical boundaries without competing against each other, communications and cooperation can be improved. The mere fact that the patrol officers and investigators are likely to have frequent face-to-face contact encourages exchange of information. Additionally, both the patrol and investigative officers may feel a common responsibility for providing service to the same geographical area. If cotermination of boundaries does not exist, however, geographical organization in itself will have little effect on improving patrol-investigation interaction. A uniformed beat officer may possess enormous amounts of information about an area within his beat boundaries, but if a detective has responsibility for investigating cases throughout the city, it is likely that the investigator will fail to solicit information from the officer which might assist his investigation.

Specialization by area presents many of the same hazards as other forms of specialization. By emphasizing effective and efficient law enforcement in one particular area, an officer may fail to consider the department's overall problems. Crime and criminals seldom restrict themselves to neat geographical boundaries. Whenever a police function is specialized by area, provisions must be made to coordinate the flow of information across intracity and intraorganizational boundaries.

Any agency which operates beyond an 8-hour shift, 5 days a week, must consider coordination by time. Police departments are responsible for effective performances of the law enforcement function 24 hours a day, 7 days a week. The same officer who initially investigates an offense may not necessarily be the same officer assigned to the follow-up investigation. In fact, the assigned investigator may be working a different time period than the officer who possesses information relevant to the investigation, complicating the task of communication. While much of the investigator's work must be performed during "business hours" when witnesses, victims, and records are available, some consideration must be given to the need for the investigator to communicate with the officer who made the original report and did the initial investigation. That officer is likely to have intimate knowledge of the area where the offense occurred and of the people who frequent the area. He may even have specific information or ideas relating to the crime under investigation which does not

appear on the report. It appears obvious that the reporting patrol officer should be a primary source of information for the investigator. Conversely, the investigator may turn up suspects or descriptions of suspects which would be invaluable to the patrol officer seeking to prevent recurrences of criminal activity on his beat. Yet, due to differences in working hours, the exchange of information may never occur.

Division of labor by time further complicates coordination, because a supervisor who is responsible for a given function or area cannot always be physically present to direct activities of subordinates or to act as a facilitator for inter and intragroup communications. If duty hours prevent face-to-face communication between officers, information exchange must depend on written reports or relay by a third person. Neither of these forms of communication is as effective as personal dialogue.

In summary, a police agency which is solely dependent on the classical form of organization limits development of critically needed channels for lateral communication between patrol officers and investigative specialists. As each specialized subunit is created, additional communication problems develop. Subunits are likely to become preoccupied with their own objectives instead of working toward the agency's overall goals, they may fail to volunteer assistance and information to another subunit, or even worse, they may deliberately frustrate efforts of competing subunits.

Footnotes

/1/ Chester I. Bernard, The Functions of the Executive (Cambridge, Mass.: Harvard University Press, 1968), p. 216.

/2/ "The Missouri Crime Survey" (New York: The MacMillan Co., 1926), pp. 46-47; in Task Force Report The Police (Washington, D.C., 1967), p. 53.

/3/ Public Administration Services of Chicago, "Police and Fire Services in Meriden, Conn., (Chicago, Ill.: Public Administration Service, 1962), p. 36; in Task Force Report The Police, p. 53.

/4/ Egon Bittner, The Functions of the Police in Modern Society (Chevy Chase, Md.: National Institute of Mental Health, Center for Studies of Crime and Delinquency, 1970), p. 65.

/5/ Arthur Niederhofer, Behind the Shield: The Police in Urban Society (Garden City, N.J.: Doubleday and Co., 1967), p. 68; in James Q. Wilson, Varieties of Police Behavior (New York: Atheneum, 1970), p. 68.

/6/ Wilson, pp. 16-56.

/7/ Task Force Report The Police, p. 53.

/8/ Warren G. Bennis, Changing Organizations (New York: McGraw-Hill Book Co., 1966), pp. 57-58.

/9/ Wilson, pp. 16-53.

/10/ Bittner, p. 58.

/11/ Ibid., p. 63-71.

/12/ Ibid.

/13/ John C. Buechner, Public Administration (Belmont, Calif.: Dickenson Publishing Co., 1968), p. 24.

/14/ Jay Galbraith, Designing Complex Organizations (Reading, Mass.: Addison-Wesley Publishing Co., 1973), p. 2.

/15/ Luther Gulick and L. Urwick, Papers on the Science of Administration (New York: Institute of Public Administration, 1937).

/16/ Municipal Police Administration, Esther M. and George D. Eastman, ed., (International City Management Association, 1971), ch. 3.

/17/ Gulick and Urwick.

/18/ Ibid.

/19/ Ibid.

EFFECTS OF ORGANIZATIONAL DESIGN ON COMMUNICATION BETWEEN
PATROL AND INVESTIGATIVE FUNCTIONS
(CONCLUSION)

Lt. Col. Joseph J. Staff
Police Division
Cincinnati, Ohio

Lt. Col. Joseph J. Staff, "Effects of Organizational Design on Communication Between Patrol and Investigative Functions (Part I)," FBI Law Enforcement Bulletin, June 1980. Reprinted with permission of the author and the FBI.

Effects of Organizational Design
on Communication Between
Patrol and Investigative Functions
(Conclusion)

by LT. COL. JOSEPH J. STAFF
Police Division
Cincinnati, Ohio

Part I of this article focused on the various organizational structures of police departments which can affect the level of cooperation between patrol and investigative personnel. As stated, each design has inherent advantages and disadvantages. The conclusion of this article will consider approaches which can be taken to induce and foster cooperative efforts between members of a department.

The Human Relations Approach

Human relations-oriented theoreticians minimize the importance of rational, formal organization and emphasize social relationships among workers as factors conducive to efficiency. Perhaps the founding fathers of the human relations approach to organization and management were Professors Fritz Roethlisberger and William Dickson of the Harvard School of Business. In their much-publicized Hawthorne study, /20/ they found relationships between workers, ideals, personalities, beliefs, habits, and tradition to be greater influences on productivity than physical working conditions. /21/ They also found that the small work group exerts a great deal of pressure on the individual employee to conform to the group standards of production levels. This was found to be true, even if the individual's nonconforming behavior or increased productivity would result in financial benefits for the entire group. If these findings can reasonably be transferred to address the problem of patrol-investigative cooperation, it would seem that the willingness of a police officer to work toward organizational goals, including willingness to share information, would be more dependent on his values, attitudes, and relationships with other members of the department than on the nature of the formal organizational structure. It would appear reasonable to suspect that if group attitudes or norms within a patrol unit opposed cooperation with the investigative units, great pressure would be exerted on an individual patrol officer desiring to assist an investigator by volunteering helpful information. Conversely, if established relationships between the patrol and investigative groups were harmonious and cooperative, the individual officer would be supported and encouraged by his fellow workers to assist the detectives' investigative effort. Again, cooperation is a two-way street, and the same reasoning applies to investigators supplying information to their uniformed counterparts. The human relations school would argue that the influence of the group is stronger than organizational rewards encouraging exchange of information. Thus, in an effort to improve patrol-investigative communications, the administrator should consider ways to alter group norms and attitudes, depend on informal as well as formal leadership to encourage cooperation, and not rely exclusively on formal organizational channels to process information.

Modern Approach

The modern or revisionist school of organization attempts to synthesize the classical and human relations schools. Revisionists recognize that various types of social groups interact and may or may not cooperate or share the same values. They examine interrelationships of the organization and its environment, the structure of informal groups, and question the value of material rewards in improving employee morale and performance. /22/ In general, they recognize that organizational theory must take into account such factors as purpose, goal, status, power differentials, and hierarchy. /23/

Within the parameters described, modern theorists differ somewhat in their approach to organizational design. The works of Professors Paul R. Lawrence and Jay W. Lorsch /24/ of the Harvard University Graduate School of Business Administration and Dr Jay W. Galbraith /25/ of the European Institute for Advanced Studies in Management have provided the basis for the purpose of relating modern organizational techniques to the central concern of improving communications between police patrol and investigative personnel.

The Lawrence and Lorsch theory of organizational design is known as the Differentiation-Integration (D&I) model. /26/ They acknowledge the need for division of labor among a variety of bases, but associate trade-off costs and benefits with each form of specialization. Each subunit develops characteristics which are consistent with its mission.

The concept of differentiation can perhaps be clarified by comparing operational characteristics of a patrol unit with those of an undercover intelligence unit. In the patrol unit there must be a heavy emphasis on military discipline to permit rapid and effective response to emergency situations. Dispositions of recurring situations are standardized by formal rules and procedures, and freedom of movement is restricted because the patrol officer is usually responsible for enforcement activities within strictly defined beat boundaries. The emergency nature of patrol service requires a relatively short-time orientation toward its problems. In contrast, the intelligence unit must adopt relatively informal methods of operation, avoid the standardized appearance and behavior styles which would compromise their undercover missions, be free to travel or react spontaneously to follow the course of investigations, and assemble information and build cases over a long period of time. The mission of the patrol force dictates high visibility; the opposite is true of the intelligence unit. The differences, of course, are more numerous than those just described, but the comparison serves as an example of differentiation required by the nature of the tasks each group performs.

The problem of achieving integration between differentiated units becomes crucial. Each group evolves its own task-related characteristics and different points of view which complicate the coordination process. This often generates serious intergroup problems symptomized by destructive competition, secretiveness, and hostility. The integration process must cope with these issues to achieve unity of effort. /27/

There is a strong inverse relationship between differentiation and integration. When units (because of their particular tasks) are highly differentiated, it is more difficult to achieve integration than when the individuals have

similar ways of thinking and behaving. /28/ This accounts for the relative ease with which adjacent patrol districts may coordinate activities, as opposed to the difficulty encountered in trying to achieve close cooperation between uniformed patrol and plainclothes investigative units.

The D&I model then focuses on the degree of differentiation required among units responsible for varying tasks and the degree of integration needed. In considering the integration issue, the police manager must determine which units need to work together and how tight the requirement for interdependence is. If, as in the case of patrol and investigative functions, there is a requirement for close cooperation, emphasis must be placed on the problem of achieving high integration.

The normal means of integrating activities of subunits within a police organization is through the hierarchical structure. As subunits become more differentiated, however, the formal hierarchy is no longer sufficient to provide necessary coordination, process the required amount of information, or achieve unity of effort. Additional integrative devices must then be built into the system.

Galbraith describes a wide range of integrative devices which are used by various organizations. Included are formal rules, programs and procedures, hierarchy, creation of lateral relations through direct contact or by creating liaison roles, task forces, and teams. /29/ A final method of aiding the integration process is through use of lateral transfers. While Galbraith does not relate these integrative devices to police operations, their applicability is clearly apparent.

The simplest way of coordinating interdependent subtasks is to specify the necessary behaviors in advance of their execution in the form of rules or programs. /30/ Police departments coordinate information and activities required for successful investigations by creating formal rules stated in a procedure manual. A typical procedure would indicate which unit is responsible for the preliminary and follow-up investigations, what information must be included on the offense report, how many copies of the report are to be made, how they are routed, etc. These rules are adequate to direct much of the information flow required for routine investigations. However, to rely solely on the use of rules and procedures as a method of providing the required information exchange between patrol and investigative officers presumes that it will be known in advance what information is needed by each. In all but the simplest investigations, this is not the case.

The next method for processing information between units is through a formal hierarchy. The manager of each unit is the point through which all information flows into or out of the unit. He decides which information should be transmitted up or down the chain of command. Besides being able to control the information exchanged, he knows who is feeding information into the system and can bestow appropriate rewards. Hierarchical communications must travel up the organization to a common manager, then back down to the intended receiver. Hierarchy is used in addition to, not instead of, rules and procedures. Repetitive situations are covered by rules, exceptions by hierarchy. /31/

The weakness of this system is that the information channels quickly become overloaded. Delays result, and information is received too late to be useful. The originating officer may receive no feedback on the value of his input and consequently fails to volunteer information in the future.

To prevent overloading of hierarchical channels, lateral information channels must be developed. The simplest form of lateral relations is direct contact between two people who share a problem, /32/ that is, simply permitting direct contact and dialogue between officers assigned to patrol and those assigned to investigations. Yet, simply saying that direct communication is permitted does not assure that it will happen. Organizational impediments discussed earlier inhibit meaningful exchange, e.g., officers assigned to different time periods and physical locations, long-standing hostilities between organizational units, etc. These barriers must be removed, or at least reduced, if useful exchange of information is to increase. Additionally, an officer possessing relevant information simply may not realize that it could aid in another's investigation, or the officer needing certain information may not know which, if any, fellow officers might be able to provide it. All too often, when investigative and patrol units are separated, investigators fail to solicit information actively and patrol officers fail to volunteer it. Thus, no communication takes place. Mutual exchange of criminal information benefits both investigative and patrol units in completing their missions, but if the organization does not allow for direct exchange between members of individual units, little communication is likely to occur.

Liaison roles may be created to handle important interunit contacts. /33/ Each patrol unit might have one representative who meets daily or weekly with members of the investigative unit, or an officer assigned to the detective bureau might appear at patrol officers' briefings once a week to discuss mutual problems or transmit and receive information of common interest. Psychologist Rensis Likert suggests creation of a "linking pin" role to facilitate integration among interrelated units. /34/ The incumbent of such a role would be a member of both the investigative and patrol units and would promote common purposes and attitudes and provide a point for exchange of information.

British police forces have created a kind of liaison role in the form of a "collator." The position of collator was introduced in England with the advent of unit beat policing in 1967. The function of the collator is to collect, assess, store, and disseminate local criminal intelligence. He is to gather information previously possessed only by individual officers and make this knowledge available to all members of the department. The primary focus is on assembly of intraunit criminal information, but he also provides a valuable service in making this information available to investigative and other patrol units. The British collator is a sworn officer, but at least one American police department has assigned civilian personnel to the role. /35/ The collator serves to exchange information with centralized investigative personnel, outside law enforcement agencies, and among locally assigned patrol officers.

To gain even greater capability for exchanging information between patrolmen and investigators, they can be assigned to the same organizational unit. This can be done on a temporary basis by creating task forces, or more permanent teams can be formed. The task force or team under the direction of a single superior can be responsible for both the patrol and investigative function.

Task forces are usually created to attack specific problems. They may have full-time or part-time members and are temporary groups, existing only as long as the problem remains. When a solution to the problem is reached, or the problem no longer exists, each participant returns to his normal assignment. /36/ Task forces, comprised of both patrol and investigative personnel, may be created to address such problems as a sudden increase in residential burglaries in a particular area, a regional gang problem, or an annual increase of armed robberies during the Christmas holiday season. The important point is that the task force functions as one unit with a specific, common purpose. Briefings should include both the uniformed and plainclothes officers, and all members should meet at a central location to provide the opportunity to exchange information. Relationships developed between individual patrol and investigative officers can remain useful long after the task force is terminated.

A more permanent means of establishing strong personal and operational relationships between patrol and investigative personnel is the adoption of a team policing model. The term "team policing" has come to have many meanings. For this purpose, it means combining the patrol and investigative functions within one geographically based organizational unit. An essential element of the team policing programs in effect in seven cities studied by the Police Foundation /37/ was maximum interaction among team members, including close internal communication among all officers assigned to area-based teams. The Police Foundation reported that interaction was evident among team members in all of the cities studied, but considerable varying degrees existed. Critical factors which influenced the exchange of information were regularly scheduled team conferences, the nature of the physical building facilities shared by team members, and the behavior of team leaders. When the team leader encouraged sharing of information and was able to instill a sense of teammanship, the members communicated more frequently and informally. /38/ The most comprehensive study of the effectiveness of team police techniques attempted to date was initiated by the Cincinnati, Ohio, Police Division in March 1973. Initial observations of team operations were encouraging, particularly as related to interaction among team members cooperating in criminal investigations. After 6 years' experience and evaluation of this investigative structure, it has become apparent that additional mechanisms are required to facilitate exchange of criminal information between investigators assigned to different teams.

As with all forms of organization, there are certain costs attached to self-contained teams. /39/ Due to the wide scope of functional responsibilities assigned to the team, a reduction in levels of specialized skills may result. Functional specialists assigned to generalist teams have less opportunity to interact with other specialists of the discipline, thus less opportunity to exchange current information related to their function. Expensive equipment, practical for a functionally centralized unit, is not available to a generalist team. Opportunity for a career path within one functional area is reduced. A certain amount of duplication of effort is likely to occur when responsibilities are divided among teams. If a department opts for area-based, self-contained teams, it would seem prudent to maintain a small, centralized core of personnel to collate information pertinent to interteam crime patterns, trends, and activities.

The final form of organizational structure designed to force integration to be discussed here is matrix organization. This form of organization requires

that dual reporting relationships be established. For instance, an investigative unit might be assigned to an area-based precinct station. Under a matrix system, the supervisor of that unit would report to, receive direction from, and be evaluated by both the precinct commander and the investigative bureau commander. The supervisor is therefore required to coordinate his activities and information with both the investigative bureau and the patrol precinct. Variations of the matrix might establish this dual reporting role higher, e.g., at the precinct commander level, or lower, e.g., at the individual investigator level.

Seen through the eyes of a police administrator who has been seasoned by the classical principles of organization formulated by Gulick, Urwick, Mooney, et al., the dual reporting structure appears to be a blatant violation of the "sacred" principle of unity of command. Upon reflection, however, the matrix is not too different from the staff or functional supervisory relationships used by many police agencies. Secondary reporting relationships are merely strengthened and formalized. This form of organization has been proven effective in many private sector organizations, especially in the aerospace industry, where there is a need for tight integration among interdependent subunits to accomplish tasks.

Use of Lateral Transfers

Galbraith reports on the use of lateral transfers as an integration device. /40/ His comments present significant implications for police managers seeking ways to improve patrol-investigative communications. Lateral transfer, or job rotation, has been used for some time by both private and public sector agencies as part of management development programs. Findings of studies conducted at M.I.T. have shown the effect of lateral transfers on interdepartmental (relationships between subunits within the same organization) communications. While the studies focused on managers of organizations, they suggest that similar techniques might be equally effective for improving communications among first-line operational personnel. The findings of one study clearly indicate that managers having interdepartmental experience communicate laterally to a larger number of colleague managers than managers not having interdepartmental experience. /41/ Similar findings were reported for a Japanese R&D organization. /42/ In the second study, it was discovered that the effects of the transfer diminish with time. People transferred 10 years ago behave the same way as individuals who have had no experience.

A second finding is that individuals with interdepartmental experience use more informal means to communicate when engaging in lateral contact. They will use a telephone call, face-to-face contact, or an informal meeting. Those not having the experience are more likely to use a memo. Therefore, the transfer increases probability of problem-solving dialogue rather than less effective one-way communication. Finally, the studies indicated that relationships established by managers with interdepartmental experience tend to be reciprocal, that is, they receive as many contacts as they initiate. Reciprocal relationships are the most satisfying and are likely to be the most productive for the organization.

Lateral transfers improve communications by reducing impersonality. It is much easier for an individual to call someone he knows to solicit or volunteer information than to address a memo to an impersonal organizational unit.

That is why the effect of transfer diminishes over time. Promotions, transfers, and turnovers cause loss of personal contact.

Galbraith concludes that lateral transfers result in more lateral contacts and more effective contacts. In addition, the organization gets something for nothing if it already uses lateral transfers. The only thing needed is to transfer personnel often enough to offset the diminishing time effect. If lateral transfers are not used currently, they should be evaluated against the costs of lost specialization and lost productivity due to learning time.

Frequent rotation between patrol and investigative units has not been the general custom in most police departments. Uniformed officers often welcome a transfer to the detective bureau, but the reverse is seldom true. In many departments, civil service regulations protect the detective's tenure in the investigative unit. Even if not prescribed by formal rules, long-standing practices and custom usually militate against transferring personnel out of the detective unit, except those transfers caused by promotion or imposed as a disciplinary measure.

One-way transfers or "creaming" of the most experienced and able officers out of the patrol unit consequently leave a greater proportion of inexperienced or less competent officers in the patrol branch, reinforcing the perceived image of the patrol force as the "dumping ground" for the incompetent or a place to work only until one can arrange a transfer out. This phenomenon hardly gives credibility to the oft-repeated phrase that the patrol force is the "backbone of the police department."

As long as the detective enjoys higher prestige and pay than his uniformed counterpart, this situation is not likely to change. Although certain task characteristics require that the detective be given greater flexibility in his work, nothing appears inherent in his job that would justify higher pay for an investigator than for a patrol officer. In fact, according to Wilson, the detective works in a less hostile, more certain environment than his uniformed coworkers. /43/ When assigned to an investigative unit, the officer has a better idea of what is expected of him and enjoys greater public support than when he is assigned to the uncertain patrol task of "keeping the peace." This would seem to indicate that financial incentives are not necessary to induce officers to accept investigative assignments and in fact serve to widen the "prestige gap" between the two roles.

The pay differential issue is raised here to illustrate the effect it has in discouraging routine lateral transfers. Municipal Police Administration endorses rotation of vice-control personnel to maintain undercover effectiveness and transfers out of the detective bureau to prevent it from becoming a "sinecure for the incompetent." The text suggests that intradepartmental transfers should not necessarily be a reflection of a police officer's inability to do investigative work. /44/ In the same volume, however, it is recommended that when the officer is returned to uniform assignment, he lose the "incentive" pay he enjoyed while assigned to investigations. /45/ The loss of pay hardly seems congruent with the idea that the officer was performing his work effectively and is not being penalized by the transfer.

If use of lateral transfers is to be an effective means of improving cooperation and communications between the patrol and investigative forces of

a police department, status and pay differentials must be reduced or eliminated, and officers must not be stigmatized by a transfer from an investigative to a patrol assignment.

Summary

The problem of inducing cooperation between the patrol and investigative forces is long standing and is present in varying degrees in all police agencies. Interrelated factors contributing to the situation are organizational problems of structure, competition, and assignment of responsibility; social problems of role and status differentiation and subcultural values; and maintenance of adequate information systems.

Organizational structure affects the level of cooperation among members of an organization. The organizational approach most commonly observed in police departments is the classical design. Tasks are divided among subunits in the organization and coordination is achieved through a formal hierarchy. Each base of specialization (purpose, process, clientele, area, and time) has inherent advantages and disadvantages to be considered when designing a structure which will permit adequate communication to occur between interdependent subunits. Human relations theorists minimize the importance of formal structure and concentrate on individual and group norms as means for inducing cooperation. Modern practitioners of organization design attempt to synthesize the classical and human relations approaches.

The patrol and investigative functions develop differential characteristics due to the nature of their tasks. As organizational subunits become more differentiated, integration becomes more difficult to achieve. High integration is necessary if high interdependency exists between units.

Integrative devices include use of rules, procedures, and programs; hierarchy; lateral relations, including direct contact; liaison rules; task forces; teams and matrix structure; and lateral transfers.

There is no one best way for a police department to organize which will insure effective communication between patrol and investigative elements. All forms of organization are not equally effective, however, and each police executive must consider the trade-off costs and benefits attached to the described organizational techniques when searching for the optimal design for his own agency.

FOOTNOTES

²⁰Fritz Roethlisberger and William Dickson, Management and the Worker (Cambridge, Mass.: Harvard University Press, 1939).

²¹John C. Buechner, Public Administration (Belmont, Calif.: Dickenson Publishing, 1969), pp. 27-29.

²²Ibid., p. 35.

²³Warren G. Bennis, Changing Organizations (New York: McGraw Hill Book Co., 1966), p. 70.

²⁴Paul R. Lawrence and Jay W. Lorsch, Developing Organizations: Diagnosis and Action (Reading, Mass.: Addison-Wesley Publishing Co., 1969).

²⁵Jay Galbraith, Designing Complex Organizations (Reading, Mass.: Addison-Wesley Publishing Co., 1973), p. 2.

²⁶Lawrence and Lorsch, p. 11.

²⁷Ibid., p. 6.

²⁸Ibid., p. 13.

²⁹Galbraith, op. cit.

³⁰James G. March and Herbert A. Simon, Organizations (New York: John Wiley, 1958); Richard Cyert and James G. March, A Behavioral Theory of The Firm (Englewood Cliffs, N.J.: Prentice-Hall, 1963); Galbraith, p. 10.

³¹Galbraith, pp. 11-12.

³²Ibid., p. 18.

³³Ibid.

³⁴Rensis Likert, New Patterns of Management (New York: McGraw-Hall Book Co., 1961).

³⁵Cincinnati, Ohio, Police Division, Community Sector Team Policing Model.

³⁶Galbraith, p. 51.

³⁷Lawrence W. Sherman, Cathenne H. Milton, and Thomas V. Kelly, Team Policing (Washington, D.C.: Police Foundation), 1973).

³⁸Ibid., p. 4

³⁹Galbraith, pp. 27-28.

⁴⁰Ibid., pp. 49-50.

⁴¹William M. Newport, "The Interdepartmental Transfer: An Integrative Strategy," (Cambridge, Mass.: M.I.T., 1969), unpublished M.S. thesis, in Galbraith, p. 49.

⁴²M. Kanno, "Effects on Communication Between Labs and Plants of the Transfer of R & D Personnel" (Cambridge, Mass.: M.I.T., 1968), in Galbraith, pp. 49-50.

⁴³James Q. Wilson, Varieties of Police Behavior (New York: Atheneum, 1970), p. 68.

⁴⁴Municipal Police Administration, Ester M. and George D. Eastman, ed., (International City Management Association, 1971), p. 161.

⁴⁵Ibid., pp. 142-143.

THE ULTIMATE MANAGERIAL CHALLENGE--
CREATIVE CHANGE

David S. Brown
Professor of Public Administration
George Washington University
Washington, D.C.

Reprinted with permission of David S. Brown.

THE ULTIMATE MANAGERIAL CHALLENGE--
CREATIVE CHANGE

By David S. Brown*

Professor of Public Administration, George Washington University, Washington, DC

Management has outgrown primary concern with procedures and methods to encompass understanding and appreciation of growth and change.

The American penchant for method and system has, without doubt, been responsible for much of the world bountiful we have gathered about us. The attention we have given to such mundane matters as organizational design, position specification, work simplification and measurement, and methods and procedures has rewarded us with a level of productivity that is the marvel of much of the rest of the world. Anyone who has the opportunity to examine the approaches of others, particularly those in the areas we call "underdeveloped," will be at once impressed by the differences between their production processes and ours. He will also be impressed by the extent to which system and order have become a part of the American soul.

Now, I am not against orderliness, or at least a certain amount of it. What I am opposed to is the notion many seem to have that orderliness is the same as godliness and that the systematized way is necessarily the only one or even the best one.

* EDITORS' NOTE: Professor Brown has served with several federal and state agencies, including the Mutual Security Agency, the Economic Cooperation Administration, and the New York State Education Department. He has written extensively on management and administration and has been a discussion leader for the Advanced Management Training Program sponsored by the International City Managers' Association. This article was presented as a paper at a general session on "Urban Leadership Challenges" at the 49th annual conference of the International City Managers' Association held in Denver, October 13-16, 1963.

Indeed, there is growing evidence that we have permitted management to become much too mechanical, much too catechistic. There is evidence that we have put too much emphasis on method rather than on goal; that we have given more attention to form than to substance. We have accepted too readily precise and symmetrical organization charts, standardized patterns of delegation and subdelegation, foolproof (or nearly foolproof) systems of accountability, and new and costly mechanical devices, such as the computers, which are of course the ultimate in systems. In the past few months, several city managers, for example, have shared with me their sense of frustration and failure that they have not been able to take some of the steps the management blueprints seem to prescribe. Some of you may feel privately selfconscious because you are only on your first Univac or have not yet been able to install a PERT /1/ which, I gather, makes you feel less pert about city hall. The responsibility for such failures, I have no doubt, really belongs to your councils, but as managers you have, nevertheless, bravely assumed the shame.

Too great a preoccupation with the tools and methods of management is of course evidence of dysfunction, or the opposite of what the results are intended to be. Dysfunctional also are ways of thinking and habits of acting that find us more concerned with the "fine print" of administration than with the achieving of societal and organizational goals.

FUNCTIONS OF MANAGEMENT

Let us see how this applies to the area of management. Let us begin by asking who the manager is and what he really does. If we take the narrow view of it, he is someone who manages. (Some, of course, do precisely that they just manage.) As every school boy knows (I am talking about graduateschool boys) the manager is someone who plans, organizes, staffs, directs, coordinates, budgets, and, occasionally, reports. And who is the best manager? Why he whose organization runs most smoothly, purrs least noisily, is least conspicuous or troublesome, and runs on the least gas. The latter is particularly important. People who are insensitive to nearly everything else are often quite sensitive to gas.

Such a gauge of management effectiveness is, of course, nonsense. The best manager is no more the manager who is, mechanically speaking, the most orderly or the best organized than the best physician is the most sterilized one, or the best navy, the most recently painted.

The manager's job is much broader than what the name implies--which may be why we might consider giving him another title. His job is that of helping others to achieve goals. The "others" may be within the organization, or they may be outside it. Men achieved goals long before modern ideas of management were heard of, before "principles of management" were invented, and, unlikely as it may seem, even before punched cards made their appearance. Management should be thought of as a method--not a goal. When it helps us, let us welcome it. When it gets in the way, let us revise it. "Are we not," Barnard asks, "more interested in influence than in control?" This is a pertinent question perhaps the most pertinent in all of management literature. It answers itself.

/1/ Editors' Note: Program Evaluation and Review Technique, one of the more advanced methods of charting and measuring a program.

ROLE OF CHANGE AGENT

Let us see what happens when we define the manager's role broadly. Let us see how we behave when we think of ourselves as leaders rather than as directors, as counselors--not city councilors, please--rather than as commanders, as change agents rather than as supervisors and controllers. How differently do we do things? What different kinds of verbs do we use in fulfilling our missions? In recent years we have given increasing attention to the processes of change, so let us examine the "change agent" concept. What happens when we see ourselves as agents of change?

For one thing, we behave in a quite different way than when we see ourselves as directors or manipulators. We recognize the "authority" of those at all levels in the organization. We know that the job which has to be done will not be done unless others do it. Instead of ordering them about, we try to encourage and inspire them. We seek to help them find ways by which it will be done on a continuing, self-sustaining, and self-correcting basis. Any father of growing children knows how limited are the real bounds of his control. He seeks to perpetuate his influence by doing the kinds of things that will enable those younger than he to make use of the best not only of what he and others have to offer but also the best of what they have within themselves. This is the real change agent role.

The change agent concept has implications for the total organization. The manager focuses "downward" along carefully drawn organizational lines toward "subordinates" or, more specifically, those in the suborders beneath him. The change agent, on the other hand, is bound by no such rigid codes. He has no vested control over anyone. The members of his board of directors or his council, the public, those in other organizations, or even subordinates two or three times removed are as fit objects of his concern as are those who report directly to him.

This is hardly a new concept we are talking about. On the contrary it is quite an old one, but one that we are not accustomed to thinking of in the terms we are now discussing. We know, however, the values our society has placed on its innovators, its instigators, its trail blazers, its agents of change. We know the debts we owe them for their ideas and their discoveries. Is it unreal to suggest that they have also an important place in the office or the shop?

When someone cast doubt on the role he saw for the presidency, Woodrow Wilson replied: "The President is at liberty, both in law and conscience, to be as big a man as he can." If there is nothing in the Constitution to limit the greatness of a President, I submit that there is nothing either in the city charter to keep the city manager from being as big as he is able to be. As to the need for being changed, the police chief or the city treasurer is undoubtedly a proper subject. But so also are those who work at levels beneath them, and so are the members of the public at large and even the members of the city council. I'm sure you have more solid convictions on this point than have I and so there I leave the matter.

There is another advantage to the change agent role, and that is the scope or range of its application. The manager is limited. Like the Maine farmer whose tombstone reported, "He et what was sot before him," the manager is limited by precedent and rule to a circumscribed agenda. The change agent, on the other hand, is controlled only by what others will have from him. If he is intelligent

and considerate in the way he approaches his task, this may be quite a lot. If he is a city manager, he might conceivably give a part of his time and attention to such matters as urban renewal, city planning, encouragement of industrialization, reduction of juvenile delinquency, human rights and integration, civil defense, improvement of community health, and development of recreational and cultural facilities. Certainly these are as important to the life of the city as a tax billing system, a new method of examining fire department recruits, a zoning hearing, or a parking program.

Now I do not mean to suggest that the manager should pre-empt the functions of others or assume that his is the only responsibility for good government. If the functions mentioned above are the responsibility of others--in the city, say, the council or the planning board--they will always be involved. But let the manager be sure he has fulfilled his part in the process by helping them and others to perceive and understand the nature of the situation, to hear what the experts are saying about it, to see what those elsewhere are doing, and always to provide the support, both moral and material, that will be needed. These are certainly managerial responsibilities. They are also a part of the change agent role.

I can well imagine that some of you are already remarking that it is much easier to talk about such things than it is to do them. No one will dispute you: this is, of course, why some of us prefer to be university professors rather than administrators.

I can imagine, also, some of you reflecting bitterly on your own experience in encouraging the most modest of urban improvements. Perhaps you are thinking of specific people back home--men such as Adlai Stevenson described as having been dragged "kicking and screaming into the Twentieth Century"--men of little vision but of strong will and large power. I can imagine you asking a number of pertinent questions: How are we going to go about becoming change agents? How can we get others to do things differently than they are now doing them? How can we be the leaders we want to be and still survive?

GUIDELINES FOR CHANGE

You will find no simple or easy answers to these questions--no "principles" in the sense that Fayol and others have attempted to suggest principles of management. There are, however, guidelines which can be followed. The processes by which people change--not only changes within the group but, more importantly, in the ways individuals themselves behave--have received a great deal of study in the last few years. From this research and observation useful ideas are beginning to emerge.

We know, for example, that the individual's conscious behavior is grounded upon a set of satisfactions which in turn is based upon established value patterns. We know also that a given action may be judged against more than one value. For example, we desire to satisfy our superiors, but we also want to satisfy others--the public, or specific persons in it; professional associates whose approval we value; and even our subordinates. We also have personal standards which we feel should be met. When there is agreement among all of these, there is no problem. Much of the time, however, there is disagreement. So we are forced to choose among values. Such knowledge is useful to us in understanding why people do what they do.

We must be aware also of the variety of factors that relate to action and, in particular, our own role in it. These will include:

- A general understanding of goals.
- An appreciation of the costs of change; what, in effect, the changed relationships will mean in terms of time, loss of present values, retraining, and actual monetary outlays.
- A knowledge that a change in one part of the organization, or even in one person's role in it, will have an effect on other parts as well.
- An awareness that once change has taken place it must be helped to establish itself, so that it does not revert.
- An understanding of the need for establishing effective client-change agent relationships.
- The need for helping others to help still others to change.

Let us look at some of these precepts a bit more closely.

Understanding Goals. More and more, as we come to understand the nature of complex organizations, we realize that those who make them up have differing needs and, consequently, varying goals and objectives. Sometimes these fit reasonably well together; sometimes they are in open conflict. The change agent must understand this. He must understand also what the objectives of the organization are and must help to keep them before the group he is working with.

Costs of Change. Inducing change can be costly--costly in time spent in encouraging it, in outright money outlays, in loss of existing values, in the opposition that is likely to be encountered. It is well to understand this before embarking upon a change program. One should understand also that the failure to change, or the pursuit of irrelevant courses of action, can be even more costly.

Effects of Change. Life is a process of trying to adjust to environment. When change is made, the environment is altered and new relationships must be created. Sometimes this will be easy to do; sometimes it will be difficult. Much depends upon how those within the organization react to change. Is it seen as needed and welcome? Is it self-serving? Have the opinions of those concerned been sought before action took place? Or was it foisted upon them? Answers to such questions as these will have marked bearing on the manner in which change is accepted.

Preserving Change. Once change has taken place, it must be given an opportunity to establish itself lest it revert. This is an important point, but one that is often overlooked. New behaviors that are unsatisfactory will be abandoned. Compromise is always a possibility. Once change has been abandoned, the possibility of future change is endangered. So it is up to the change agent to understand the need for a stabilization of the new behavior pattern until the time is ripe for the next step forward. This calls for reinforcement and support until the change is a matter of habit and practice. Only then can thought be given to going on to new goals.

Establishment of Effective Change Agent--Client Relationships. Studies of change agents in our society--doctors, teachers, psychiatrists, consultants, and others--have revealed the importance of effective relationships between the change agent and the client. The doctor himself cannot heal the patient. The patient will follow the doctor's advice only when he has faith in him and in it. So it is with the teacher and the student, and the manager and his associates. Influence is enhanced as each increases his basic trust in the other; as a climate for discussion and inquiry is provided; and as the free acceptance, or rejection, of ideas that are put forward is made possible.

Helping Others To Help Still Others. This is probably the most difficult task of all. Not only must the change agent establish effective relationships with those with whom he works, but he must also help them to do the same with others. In the case of the city manager, it is not enough to be on good terms with the city council. The council members themselves have clients, and their failure to work effectively with them will have repercussions in their relationships with the manager. The manager, if he is to be an effective change agent, must understand this and, as part of his strategy of change, help to create a framework where the council member can work easily and freely with those to whom he is responsible.

STRATEGY FOR CHANGE

Given such factors as these as a starting point, a general strategy of change can be constructed. One such strategy, put forward by the eminent social psychologist, Lewin, focuses upon an analysis of the "forces for" and the "forces against" which are present in all social situations. The traditional approach to change is to add to the "pro" forces--the power factors such as reward, punishment, praise, ridicule, and the like--which move the individual to take certain courses of action. Lewin points out that emphasis on these often feeds the "anti" forces instead, which now rise to carry the day. Is it not more reasonable, he asks, to try to remove the anti forces? No strengthening of the pro forces will then be needed. Such a course calls for an understanding not only of the reasons why the change should be desired but also why it is likely to be resisted. Thus the individual or the group is encouraged, in keeping with its own sense of values, to find a more satisfactory solution to the problem.

Other students of change see the individual as assuming a variety of social roles. Each is likely to call for a different pattern of behavior. Contemplate, for a moment, the roles you as a city manager assume in a day's time: your role toward a member of the council; toward the head of a department; toward an ineffective subordinate worker; toward an influential member of the public; toward a hostile member of the press; or toward your clergyman or your wife and family. Perhaps the role that has been used is not a satisfactory one. Why should not a different role be tried? Need we play only the role that custom has established? The change agent is willing to experiment with roles and to help reinforce others in support of the change that takes place.

There is another major approach to change. This is by way of the training function. Training, of course, is the process of helping others to find ways of improving their skills, knowledge, attitudes, and behavior to the end that they can more adequately do what is needed of them. I will not dwell upon it here. It is sufficient to remark that training is among the more important of all our societal tools. It helps the individual as it helps the organization. Surely

self-improvement is an established aspect of our culture. It can be profitably used in hundreds of different ways.

There are other approaches to the inducing of change. They have in common the fact that the role of the change agent is one of encouragement, of clarification, and of support rather than of direction or command on which traditional management concepts rely.

AWARENESS OF SURROUNDINGS

Two more suggestions may be of value. The first of these is a reminder to the manager to be alert to the forces already at work in our society. The city hall, to those of you who occupy it, may seem so completely the political arena that you fail to realize that sometimes it can be a political fallout shelter instead. An illustration of such a phenomenon is the current concern for civil rights. This idea has burgeoned not through our political institutions but around them. It is no less significant a fact because of it. Its germination and development could have been observed in the press and literature, through TV, and in the shaping of individual points of view--in short, in the growing sensitivity of our times to the needs of all men.

These are the kind of factors the keen observer is alert to. His ears and eyes are as finely attuned to what is taking place nationally and internationally as they are to what is happening locally. He is also aware of what ought to be. The last entry in Victor Hugo's diary was this: "There is one thing stronger than all the drives in the world--and that is an idea whose time is come." Those of us who serve the public weal need be aware of the ideas that are about to be born. Such sensitivity will always do yeoman work for us.

I would urge you also to think in terms of broad rather than limited perspectives, the longrange rather than immediate goals. I would hope you would be neither ebullient in success nor jarred by failure. I was recently reminded by a friend of mine how often we lose the victory but salvage the defeat. We are familiar with the comment that "So-and-so snatched defeat out of the jaws of victory," but we are less likely to recall Frederick the Great's lament that "another victory like this one and I am undone."

Too often, such things happen in our own affairs. Defeat can ever lead to victory depending upon how one accepts it more. The solid case, the good fight, and the graceful recognition that the choice has gone against us can reset the stage for a more satisfactory ending another day. Indeed it is important for the manager, like the lobbyist, to realize that one of his most precious assets is his ability to be heard again. When asked the secret of managing armies and conducting campaigns, old General Kutuzov, who commanded the Russian forces against Napoleon, replied in War and Peace: "Time and patience." This is good advice for moderns, too.

The role of city manager, as all of you know well, is hedged by rules and covenants which prescribe, often in elaborate detail, his place in the city hierarchy. This may, during the founding years of the profession, have been its strength; it can now be its weakness. Too large an attention to orderliness and method can lead to rigidity, and rigidity circumscribes and restricts us. It is the dysfunction of today's administration.

It is essential, in terms of the large needs we have today, to see the manager as a major partner in the governmental processes, to see him as a leader as well as an administrator, and always as an agent of change. No less, as I view it, will really do.

IMPLEMENTING INNOVATION

Ora A. Spaid

IMPLEMENTING INNOVATION

by Ora A. Spaid

Summary

Innovation is bringing something into new use, as contrasted to invention, which is bringing something new into being. The diffusion and adoption of innovation can be difficult, but certain practices and actions in implementing innovation have been empirically shown to be more effective than others. Importantly involved are the characteristics of the actors who bring the innovation and those who will participate in its implementation, the norms and conditions of the organization or system that is offered the innovation, and the preceptions of the innovation. The process of adoption follows a fairly predictable evolution through stages. Responses by actors also are open to reasonable categorizing. Resistances to change can be identified and specific actions taken to overcome resistances. Innovation, or social change, has received considerable research attention by social scientists. This article reviews some of the generalizations about innovation from the literature on social change.

A simple innovation in the way hospitals admit patients has produced a system that could save billions of dollars a year in hospital costs.

In a dozen demonstration hospitals, the system has not only cut costs, but has increased the hospitals' occupancy rates, reduced their waiting lists, and improved the quality of patient care.

Although development of the Admissions Scheduling and Control System by the University of Michigan's Bureau of Hospital Administration involved simulation by computer, the innovation is based on a simple idea. By scheduling short-stay elective-surgery and medical-workup patients at times when the hospital is least crowded, such as on weekends, fuller and more efficient use can be made of the hospital's beds, facilities and personnel.

One hospital, which invested \$17,000 to have the system developed for its use, estimates that it will save about \$750,000 a year, about \$6 a day per patient. This hospital had sought permission to expand, to accommodate staff demands for beds at peak operating times, at the same time that the hospital's overall occupancy rate was 88 percent. Permission to expand was denied, but adoption of the new admissions system increased the occupancy rate to 91 percent.

An official of HEW's National Center for Health Services Research, which funded Michigan's work on the new system, said the "vast majority" of American hospitals could use the system and "billions" could be saved annually.

Although hospital administrators are pleased with the innovation, they encountered early resistance from medical staff. One administrator's strategy for dealing with that opposition was simply to begin using the system. "We just did it and afterwards told everybody how wonderful it was," he said. "And by then it was. -1-

Definition and Characteristics of Innovation

The example of the hospital admissions system fits the definition of an innovation as bringing something into new use, as contrasted to invention, which is bringing something new into being. -2-

Generally, an innovation may be described as any idea perceived as new by an individual or organization--a novel idea or practice, a new way of doing things. -3- Implied is a new use or rearrangement of present resources or practices. The hospitals in the above example merely rearranged existing admission practices.

Innovations may be only momentary, or they may have long-range effect.

One winter shortly after the 747 airplane was introduced for passenger travel, a blizzard swept through the Midwest, closing airports and stranding passengers. When the storm lifted somewhat, one airline deployed a 747 to gather up waiting passengers at several upper Midwest cities and fly them to Chicago. After deplaning at Chicago's O'Hare International Airport, the passengers were held up an inordinate time waiting for their baggage to arrive on two small delivery carrousel, the normal number assigned to each plane. More than 300 passengers vied for a chance at finding their bags, effectively shutting each other out. After long minutes of delay, one passenger suggested to the airline officials, simply "Why don't you use more than two carrousel?" It was an innovation, because it was contrary to the airline's customary practice. but the idea was adopted, and while passengers bumped and scurried from one to the other of ten additional carrousel put into use, their frustration was broken by the activity and soon all had retrieved their bags.

Once institutionalized, innovations lose their definition as being novel. The field of athletics has seen numerous innovations of the kind which began as unusual variations. The so-called "jump shot" in basketball--during which a player merely jumps as high as he can and releases the ball at the top of his leap--was a revolutionary alteration of the common "set shot" of many years back when a player seldom left his feet when shooting the ball at the basket. An innovation in track and field by a high jumper by the name of Fosberry introduced the "flop," a way of jumping over the bar backwards. It gained him greater heights, even though it was not as graceful a maneuver as the standard style. Today, most world-class jumpers use the flop. In a years-ago football game with Army, Coach Knute Rockne of Notre Dame pulled victory from defeat by employing a device which, while permitted under the rules, had never been tried--the forward pass.

Some innovations come from novel uses of new inventions. Television was introduced as a sight medium for public communication, an improvement on radio--but very soon found novel use in closed circuit systems which update airline schedules for airport travelers, allow medical students to observe surgical techniques in operating theaters, permit students who have missed a class to catch up by viewing video tape, and enable engineers to inspect sewers for leaks. The range of innovative uses of computers keeps broadening, reaching into the lives of citizens like a commercial relative, who totes up your bills and plays chess with you. Supermarkets in some cities now employ computers to scan and count up the cost of customers' groceries at check-out counters.

Probably because of the striving to increase productivity in order to increase profit, business and industry have taken a forerunner role in innovation. Examining the work processes of production employees, such as in time and motion studies, has permitted the adoption of new practices of increased efficiency and output. The growth of industry and the increasing complexity and breadth of its operations gave rise to a new way of examining processes--systems analysis.

While applied in an ever expanding scope, systems analysis is essentially a new look at old practices. Only in recent decades has systems analysis turned attention to the practices of public and social institutions--moving from the so-called hardware of industrial technology to the "software" of human services delivery.

The innovations which can result from such a disciplined, systematic scrutiny of traditional practices range from changing the color of the familiar "blackboard" to green (necessitating a change in name to "chalkboard"), improving its visibility for students, to experiments in "flextime" hours under which employees are required to be in their places of work for four to five set hours of the day and may fill in the additional work hours at their own convenience. This innovation makes it possible for individuals to adjust their commuting schedules to avoid the rush hours of traffic.

Such a new look at old practices in search of better technology for the criminal justice system has been the mission of research and demonstration projects of LEAA's National Institute of Law Enforcement and Criminal Justice. Once research has been fruitful in discovering potentially effective new practices, an endeavor is made by the Institute's Office of Development, Testing, and Dissemination to introduce them across the country.

An example of such a new technology is the improved usage and management of juries. Systematic analysis of the present practices of courts showed that far fewer jurors are needed than are presently being called. Studies to show the average and peak needs for jurors, the effect of staggering the starts of voir dire and trial procedures, and the results of improved methods of notifying and selecting jurors came from the research. The transfer of this technology to courts throughout the nation has resulted in saving hundreds of thousands of dollars in juror fees.

Technology in human service organizations has been defined as "a series of complex sets of techniques used to alter objects in appropriate manner." The term "objects" could involve both human behavior and work processes.

To satisfy this definition, technology should meet these criteria:

1. Knowledge of random cause-effect relationship
2. Feedback such that the consequences of acts can be assessed objectively
3. Possibility of repeated demonstrations of efficacy
4. Proportion of successes that can be estimated
5. Techniques communicated easily and performed under acceptable limits of tolerance. -4-

Resistance to Change

Resistance to change is normal. All that contributes to stability in personality or social systems can be regarded as resisting change. Culture, values, and institutions are preserved by resisting unwarranted change.

Nor is resistance to change rightly perceived as simple inertia in human nature. Most human beings are eager for some changes--better health, more money, more freedom, more work satisfaction. -5-

The human tendencies to preserve what is present and to return to equilibrium when what is present is disturbed have corresponding behavior in social systems or organizations sometimes described as norms, the customary and expected ways of behaving. Norms make it possible for people to work together, to know what to expect of each other. When norms are shared by many individuals in an organization, they cannot easily be changed.

Resistance comes in many forms and from a variety of motivations. Following are some generalizations on resistance to change which appear with some regularity in the literature:

- Change is resisted by force of habit.

Humans are creatures of habit. The time we get up, the way we dress, the route we take to work, where we carry our money, the place we sit in meetings or at home--all are habitual behavior. Changing any of these habits makes us uncomfortable. Routine seems safe, known. If by demand or circumstances we are forced from habit, anxiety results.

- Change disturbs what is regarded as normal.

What is customary, what is old (the "good old days," the "old-fashioned way") are assumed to be "normal" while change is deemed "abnormal." The status quo is protected because it represents a known norm with which we can deal. Organizational norms are accepted as "the way we do things here" and are interpreted as tried and true simply because of their existence.

- Change is contrary to first-learned patterns.

Our primary experiences carry throughout life. The familiar music we first heard and learned to love, the foods we were "brought up on," the "way we were taught" was proper to dress or behave--these form an impervious pattern. Patterns in organizations often continue, in the absence of effective challenge, largely because "that's the way we have always done it."

- Some norms or values become sacrosanct.

Values or norms which have attributes of moral or religious significance are protected tenaciously from change. Organizational or professional codes of ethics, formal or informal, become "sacred cows." Negative patterns take on the form of a taboo, as practices which "just aren't done" because they were prohibited in early experience. Persons who first learned to read the King James Version of the Bible view it as the only authorized version. Liturgical changes in church are fiercely resisted.

- Change may be perceived as an admission of failure or the judgment of inadequacy.

A new procedure which could save money can be resisted because making the change would appear to be an admission that money is now being wasted. Training is resisted because acceptance seems to be an acknowledgment of ignorance. The advocacy of change takes on the weight of an indictment that "something is wrong."

- The reasons for change may be unclear, or misunderstood or conflict with personal goals.

Motivation for change may be suspected. An assumption can be made that the advocate of change would benefit inordinately from the change. Some changes which might be given superficial or "professional" acceptance are resisted because they conflict with personal attitudes or goals. The police officer may resent some service duties as being "social work." A change may interfere with an opponent's desire to press for some other change.

- Change can be resisted for its ripple effect.

When the full implications of change are not known or acknowledged by proponents, changes can be resisted because of the interrelationships or consequences involved. Change at one level may require changes at other levels--increased budget, more personnel, training, approval by authority figures, new policies or procedures, amended legislation.

- Change can represent a challenge to authority.

Change sometimes is perceived as an invasion of "turf," which could mean loss of control by an authority figure. Change initiated from outside may infer to a resister that "somebody is trying to tell me how to do my job." The "good guy" privileges of a leader may be diminished by change, robbing him or her of the opportunity to dispense rewards.

- Anything "not invented here" may be resisted.

Local pride resents suggestions from an "outside agitator" or the "interference" of "the feds" or others not part of the local or organizational structure. Ideas which originate in other communities, especially competitive cities or those which carry a stereotyped antipathy, such as New York, are resisted by the contention that "it won't work here." Opposition to change is often justified by the uniqueness of the resisting community, because it is smaller, more rural, or different in some way.

- Change may increase or decrease workloads.

Fear that a changed practice will require more work is expected, but sometimes change is resisted from fear that less work will result. Trade unions resist automation and computerized operations for the possible reduction in need for labor. Professional associations may resist new technology out of concern for a reduction in fees.

- People may feel powerless to make changes.

Traditional and bureaucratic organizations are perceived as immovable and hope for change as useless. A sense of impotence comes when accountability for change rests upon vague, faceless forces--"They ought to do something about it." The anonymous community, public, or "society" is held responsible for lack of change, such as in the view that "People get the kind of government they deserve." These statements represent a sense of powerlessness. Describing problems or causes in all-encompassing terms such as "racism," "sexism," "the bureaucracy" or stating solutions in unmanageable terms like "public education" or "interagency cooperation" are subtle resistances to change which render change agents powerless.

The Process of Implementing Innovation

The way an innovation is implemented has been described by some writers as the change process. Several different kinds of change processes have been defined, based upon the characteristics of the persons involved, their participation in the process and the distribution of power among them, and the setting for the change and the change itself.

- Planned change

In this kind of process, change is derived through mutual goal setting and equal distribution of power and deliberateness among all persons involved. An example would be a task group in which all members hold equal responsibility and authority for solving a problem by determining the change action necessary and participating in implementation of the change.

- Indoctrination

Goals are assumed to be mutually accepted but power and deliberateness are unbalanced. A new recruit in a military service could be said to accept the goals of the service and thereby submits to indoctrination deliberately done by superiors.

- Coercive change

Goals are not mutually set, power is unbalanced, and deliberateness is one-sided. The ideological process of brainwashing is an example, or any change which is forced.

- Technocratic change

In this process, change comes from the superiority of data, new and expert information which prevails over any other considerations. An airline which adopts computerized procedures for passenger reservations would rely on computer experts in making the changes necessary.

- Interactional change

Mutual goals, fairly equal power, but no deliberateness among persons involved. A married couple change by virtue of their interaction with each other or a professional changes approach or practices through interaction with peers.

- Socialization change

In this process, change comes through kinship with hierarchical controls, as in the socialization of a child. Relations with parent or teacher result in change.

- Emulative change

The subordinate employee who identifies with and seeks to emulate a superior changes behavior or practices through emulation. Power figures and role models determine this kind of change, either positively or negatively.

- Natural change

No goals are set, no deliberateness to change is present. In this process, change results through accidents, quirks of fate, acts of God, so the process is spontaneous.

Theorists who deal with innovation generally agree that the implementation of innovation occurs in a staged process.

Kurt Lewin has had substantial influence on change theory with his force field concept. This holds that an organizational structure or situation is not static, but dynamic--an equilibrium which is maintained by a balanced field of forces working against each other. When an innovation is introduced, its proponents and opponents and conditions which support them array themselves into driving forces (seeking the innovation) and restraining forces (opposing the innovation). The implementation of innovation calls for change agents to increase the strength of the driving forces or to reduce the strength of the restraining forces, or both.⁷

Lewin postulated a process of change much like that of Carl Rogers, the famous formulator of nondirective therapy. Change begins with a period of "unfreezing," during which defenses and resistances are minimized and a climate of openness is sought. Change can then occur. Once change has been adopted, a "refreezing" takes place, to consolidate the change.

The process in behavioral change moves from an external motivation for the change to an internalized motivation.

Psychologist Norman Maier has stressed the interdependence between the innovator and those who must implement the innovation in his concept of synergistic decisionmaking. Effective decisions (or implementations) are the product of quality thinking (ideas) multiplied by acceptance of the decision by the people who must carry it out.

Maier cast his concept in a mathematical formula: Effective Decisions equals Quality Thinking times Acceptance. The thinking behind a particular decision (the idea or innovation) may be highly rational and extremely creative (Q equals 10). However, if the people who have to implement the decision do not accept it (A equals 0), the decision will suffer in its implementation (10 times 0 equals 0).

Irrational or unimaginative thinking (Q equals 0) may lead to an inappropriate decision that is very acceptable to the people (A equals 10) who proceed to implement it. In that instance, a poor decision is effectively executed (0 times 10 equals 0).

The ideal combination, of course, is high quality thinking (a fine idea) (Q equals 10) which is very acceptable to those who must implement it (A equals 10). This produces the synergistic effect (10 times 10 equals 100) which leads to results beyond what could be expected from the total of the separate entities.

Maier's concept of the interdependence between change bringers and change implementers has been offered as a caution against the view that authority figures can bring about effective change by direct order. Those required to implement the ordered change who do not accept it can damage or sabotage it.

One of the most influential thinkers on the subject of innovation is Everett Rogers, whose book, Diffusion of Innovations, is generally considered a classic in its field. -8-

Rogers' formulations have been diagrammed in a paradigm (Figure 9.1) and generalizations from a review of the literature on social change have been presented as they interpret Rogers' constructs by Jack Rothman. -9-

Antecedents

Adoption of an innovation by an individual is contingent upon two primary antecedents--the actor's identity and his or her perceptions of the situation.

Factors which influence the actor's (or group of actor's) reception of innovation include his or her present security-anxiety state, values, mental ability and conceptual skill, social status, cosmopolitanness (interest in, association with, and openness to information and influences outside his or her own group, organization, or community) and readiness to be influenced by opinion leaders.

Generalization: The innovativeness (tendency to adopt innovations) of an individual is directly related to his or her level of social participation. Persons who are active in formal organizations are more innovative than persons who are not.

Perceptions of the situation into which an innovation is introduced are vitally influenced by the membership of the actor in a social system, organization, or economic condition. That which affects the system to which he or she belongs marks the actor's perceptions.

Generalization: The innovativeness of a system is inversely related to the extent to which that system adheres to traditional norms. Systems with more modern orientation are more innovative. Generally, indices of receptivity to innovation include:

1. An urban character or orientation
2. A nuclear family structure
3. A high level use of mass media
4. A high level of residential mobility
5. A more heterogeneous population
6. A high level of scientific knowledge

Generalization: The innovativeness of a system is directly related to its socioeconomic status. High socioeconomic systems are more innovative.

FIGURE 9.1 PARADIGM OF THE ADOPTION OF AN INNOVATION BY AN INDIVIDUAL WITHIN A SOCIAL SYSTEM

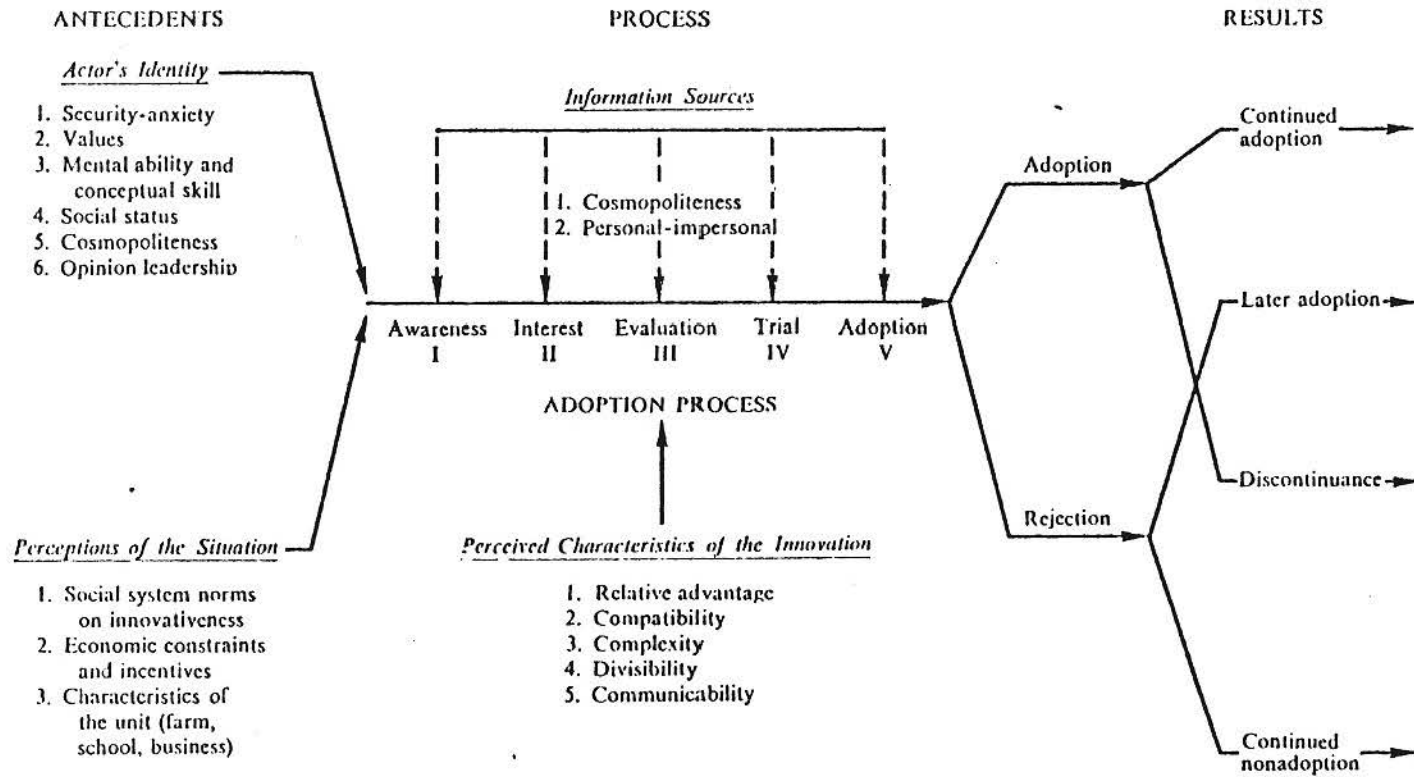

Generalization: The innovativeness of a system is directly related to previous experience with innovation. Systems that have previously experienced successful innovations are more innovative than those which are not.

Generalization: The innovativeness of a system is directly related to the extent to which it feels a need for change. Discontented systems generally are more innovative than contented ones.

Generalization: The innovativeness of a system is directly related to its supportive value orientations. Conservative, fatalistic, and authoritarian systems are less innovative.

Adoption Process

The adoption process is affected by the perceived characteristics of the innovations themselves and by the sources from which the actor receives information about the innovations.

Characteristics of the innovation which are important to the actor are relative advantage, compatibility, complexity, divisibility, and communicability.

Generalization: The rate of adoption of an innovation is related to people's perception of its advantages relative to other innovations or to the status quo. A crisis situation may emphasize the relative advantage of an innovation. The adoption rate will be higher during or shortly after a crisis period.

Generalization: Adoption of an innovation is related to the degree to which it is seen as compatible with the existing values of the system. More compatible innovations will have a high adoption rate. Compatibility is a judgment made by the system, by standards such as cultural values, previously accepted practices, and professional standards of conduct.

Generalization: Innovations which can be explained or demonstrated with ease will have a higher adoption rate than those which are difficult to explain or demonstrate. Oral transmission of technical information about innovations may result in distortion. Oral communication should be supplemented by visual aids or experiential exposure, or with feedback interactions. Generally, the closer the communication to the system's language or vernacular, the better.

Generalization: The rate of adoption of an innovation is inversely related to its degree of perceived complexity. Less complex innovations will have a higher adoption rate.

Rogers characterized the manner in which information about an innovation is communicated as the diffusion process. Factors of importance in this process are whether the communication is personal or impersonal; that is, face-to-face communication or by media, and whether communication originates within the system or from an external source.

Generalization: Innovation adoption is directly related to the extent to which it is diffused in a manner that is compatible with the system's norms, values, and customs. Innovations diffused in a compatible manner have a higher adoption rate. Innovations communicated with the cooperation of the system's power structure generally have a higher rate of adoption. In some systems, informal and personal exchange of information is traditional. The rate of adoption of innovation in such a system is related to the use of the informal, personal mode of communication.

Generalization: The adoption rate is related to the extent to which innovations are supported by the peers of a system. The adoption rate is also related to the amount of discussion of the innovation and informed discussion prompts a higher innovation-adoption rate.

Generalization: The innovation-adoption rate is directly related to the extent to which opinion leaders, persons from whom others seek advice, promote the innovation. Opinion leaders are not necessarily innovators themselves.

Generalization: Generally, innovations communicated with a clear and unambiguous message are more likely to be adopted than those subject to unclear and confusing interpretations.

Rogers lists five stages in the adoption process--awareness, interest, evaluation, trial, and adoption. Behavior associated with each of these stages: exposure to innovation, increased interest and information gathering, decision whether to try innovation, trial for the innovation, and decision as to further continuation.

Actors involved in the process are categorized by Rogers as falling into five groups: innovators, early adopters, early majority, late majority, and laggards. Innovators are the first to adopt innovations and laggards are the last.

Results

The adopted innovation may be altered. An adopted innovation may be continued after some experience with it or discontinued. An innovation which was rejected may later be adopted.

Axioms For Action

The implementation of an innovation is a creative, dynamic, and practical process. Many successful innovators are not informed by the literature of social change, but move intuitively to achieve results. From the experience, certain commonly accepted empirical guidelines emerge, which are presented here as axioms for action.

- Gather complete, precise information.

A carefully thought-through statement of the problem which the innovation seeks to resolve is necessary, one which is fully documented, describes the situation in all its ramifications, the results expected, and the possible impact of the innovation, as a rationale for action. More bluntly: Know exactly what you are talking about.

Caution: Information alone will not bring change. A report or study, diffused or not, needs active support. Information is, however, the beginning of an innovation. People with the same information tend to move in the same direction.

- Know exactly what innovation is sought.

The innovation you want adopted should be stated in the language of goals and objectives--clear, simple, and concise. Ambiguity and complexity should be avoided at all costs. Reducing your goal to a simple statement is a useful discipline and prepares your description of the innovation to stand up in interactive discussion.

- Enlist the support of power figures.

Authority persons usually cannot produce change simply by ordering it, but innovations are rarely adopted without their approval. While change can occur in spite of resistance from power figures, implementation of innovation is more rapid and smooth with their support, particularly when that support is observable to others.

- Inform and involve all concerned.

While this activity may be time consuming, the involvement of all who might conceivably be concerned is ultimately the shortest route to innovation. Keeping everyone up to date, touching base with both advocates and opponents will prevent the outcropping of resistance which comes from misinformation or not being informed.

Try to give everyone--even those of lesser concern--the same information. Informed people tend to assume responsibility for action simply because they were "let in on what is going on."

- Know your opposition.

Analyze the resistance the innovation is apt to encounter. Identify the actors--who must be convinced if the innovation is to succeed and what their response to it is likely to be, whether they are part of the driving or restraining forces, as Lewin's force-field analysis terms them. Put most emphasis on reducing the restraining forces; that is, minimizing the opposition.

- Focus on the local level.

Innovation should be justified as valid and needed in the home community, where the benefits will accrue. How another city made use of an innovation may stir resentment. Appeal to local pride.

- Let others take the credit.

Nothing impedes the progress of change more than concern over who gets the credit. The copybook rule that there is no limit to what can be accomplished if a person does not care who gets the credit is a prescription for successful innovation.

- Provide feedback on both success and setbacks.

Frequent progress reports, intended to convey "how we are doing" should not only update progress, but describe delays, setbacks, and rejections as well. Negative news has value. By sharing reverses, all become aware of problems encountered and obtain the idea that all are in the process together. Help can come on setbacks from those least expected to give it if they are informed.

- Listen to the resisters.

Respect those who oppose the innovation and take their views seriously. Listen hard to what they are saying. Paying close attention may disclose openings for you to reduce their resistance. Obstacles may not be as severe as you suspect. Resistance is uneven; sort that which is hard from that which is soft. Work in the soft spots in your opposition.

- Remember that piecemeal changes are more easily accepted.

Small parts of the innovation may not meet your goal, but they form a breakthrough. Change begets change. Be willing to accept a partial adoption of innovation now, because it is possible, in the hopes of gaining more later.

- Be mindful that people seldom change immediately under pressure, but they seldom change without pressure.

Intensive striving to have an innovation adopted, applying pressure, increases tension and resistance. Withdraw pressure after the innovation has been introduced. Allow time for defenses to drop and for the innovation to germinate. When "saving face" is no longer a factor, acceptance of a new idea can come in more abundant form than first expected.

- Do not expect adoption to come in the form or at the time you anticipated.

Because the process of adoption of innovation has a dynamic of its own, the equilibrium of the process will evolve differently as time goes on. When new factors arise, they may signal change occurring. Be ready to modify your timetable and your expectations. The innovation may not be adopted in the manner or form in which it was first presented. Learning to recognize success requires the ability to change perceptions.

- Acknowledge that adoption of innovation will occur at the pace of the person or organization.

Some people or organizations are more open to change and move more rapidly toward adoption than others. Adjust the expectations of the rate of adoption to those concerned. Do not expect all to move at the same pace. Pushing for implementation too rapidly may generate additional resistance.

- When you confront a stalemate, look for higher ground.

If forces for and against an innovation become locked in immovable position, seek some new action or objective which rises above the frozen situation and offers something more for each side. An enlarged goal which "sweetens the kitty" for each set of forces can sometimes break the inertia. Try to move from a win-lose condition to a win-win proposition.

The Change Agent

The impetus for innovation--particularly the kind of innovation that is undertaken--usually comes from a source outside an organization or system. The conditions or climate of receptivity to innovation, however, generally require a combination of internal dissatisfaction and an external stimulation.

Customary practices may fail to produce acceptable results and this failure may be noticeable to both those within the organization and persons or forces outside the organization to whom there is some accountability. Fear of

criticism or demands for improvements may prompt a search for innovation. An organizational crisis or even a noncritical but continuing history of problems may open the way to consideration of new practices. Unfavorable coverage by the news media, disenchantment among citizens, and, in the case of business organizations, a falloff in profit can create a climate for change. Sometimes, innovation is mandated from the outside. In the criminal justice system, organizational practices are changed by court decisions or the passage of new legislation.

Whatever the stimulus for innovation, the role of change agent is vital, although the role is not always sought; it sometimes falls accidentally on some unsuspecting member of an organization. When an organization is under some compulsion to improve, the charge to seek out new ideas may be assigned to persons whose prior role has been to protect and maintain present procedures. Or, simple exposure to an innovative concept may be enough to drop the mantle of change agent upon a person. He or she may learn of a new idea by attending a conference, reading a periodical, or visiting a comparable organization in another city.

The change agent role has been given multiple definitions in the literature. Enabler, demonstrator, stimulator-innovator, broker, advocate, activist, analyst, planner, organizer, initiator, and transmitter are some of the titles attributed to change agents. Most titles describe a function or role set that is carried out by the change agent. Social scientists seem to be moving away from this characterization of the change agent by function, however, toward an interpretation that the role requires a repertoire of many functions. In recent years, for instance, the once popular description of the change agent as primarily an enabler has been regarded as too limiting. -10-

Performance of the role varies in time, place, and circumstances and sometimes requires a mix of overlapping functions.

The change-agent role is beset with limitations. One study of consultants who served as change agents disclosed that the approach or focus orientation of the consultant was a major determinant in his or her diagnosis of problems in an organization. The organization-development-oriented consultant saw problems in the norms and practices of the organization, while the people-change-oriented consultant could detect problems in the way individuals functioned. Out of different perceptions, the different consultants advised diverse solutions for the same organization. -11-

Perhaps the most misconstrued perception of the change agent's role involves his or her standing as a power figure. The assumption is often made that authority figures or "decisionmakers" have the power to almost automatically implement innovation, purely by virtue of that power. The assumption follows that persons with less or no authority do not have the power to require change. While this is traditionally described as the top-down or the bottom-up flow of influence, most change-agent functions by persons not in positions of authority are a lateral influences of peers, a side-to-side activity.

Earlier, discussion of Maier's concept of synergistic decisionmaking was cited as a concept which illustrates the dependency of power figures who seek to make changes on the subordinate persons who must implement the changes.

The notion that authority figures are able to order change is based upon a limited definition of power and its effect. Yet power, or influence upon others, derives from a variety of bases with different degrees of effect.

French and Raven have defined six sets of power bases which grow from the interaction of persons and groups and their belief systems.-12-

- Referent power

Two individuals in constant reference to each other through friendship, love, respect, or worship may be regarded as having almost inadvertent power over each other. One may act as he or she thinks the other wishes, without overt attempt at influence. The power or influence of one over the other is not perceived negatively, if at all. It grows from the unity of their reference to each other. Referent power generally is confined to individuals.

- Legitimate power

Power is legitimately attached to certain persons by virtue of the office or position they occupy. This vested authority, when accepted by others, becomes legitimate power as individuals and groups act out of an obligation to be influenced. The authority figure is regarded as having the "right" to have influence. Acceptance of this power by those who are influenced is what makes it legitimate.

- Expert power

The strength or superiority of special knowledge of expertise gives persons who possess such expertise a power over others. Expert power can be attributed to groups and organizations, as well as individuals. It is dependent upon the recognition of superiority in expertise.

- Reward power

The capacity of persons or groups to reward others carries power. Behavior can be influenced by the promise of reward, if the rewards are those which are valued. Reward power must be exercised to be effective.

- Coercive power

The capacity to punish is a power often used as a corollary to reward power. The strength of coercive power depends upon the subordinate's fear of punishment if he or she does not conform. Coercive power is also limited to the behavior which the individual believes is observable to the power figure. An individual's past experiences with punishment and circumstances away

from the influence of power figures--such as independent support--also limit the strength of coercive power.

- Information power

The concept that "information is power" is legitimate, particularly in situations where information is vital to effective functioning. The withholding of information, as well as its sharing, is a base of power.

The important implication to be drawn from the delineation of different bases of power is that more activity is required of the authority figure than implementing innovation decree. Rewards, expertise, information, and recognition of legitimacy are necessary for the full power of the authority figure to be effective. Coercive or punishment power is seldom sufficient to generate change.

Probably the most human, yet dysfunctional, temptation of the change agent is to expect all change to come from others. An essential for the effective innovator is the willingness to change himself or herself.

Change itself can evoke change in others through interaction. The skilled innovator views change as a sharing in which each side moves toward the other in the process of changing. The proponent of innovation who refuses to change is modeling a behavior of no-change, which is contrary to his or her purpose.

Ignoring Innovation

Jean-Henri Fabre, the noted French naturalist, conducted some experiments with processionary caterpillars which have significance for attitudes about innovation.

Processionary caterpillars are called so because of their habit of moving through trees in a long procession, feeding upon needles. One leads and the others follow, each with eyes half closed and head snugly fitted against the rear extremities of his predecessor.

Fabre put a large group of processionary caterpillars in a flower pot and enticed them to the rim of the pot. With great patience, he got the first one connected to the last one, so that all the caterpillars formed a circle, moving around the rim of the flower pot in an unending chain.

He placed a supply of food close at hand and visible just outside the range of the circle and expected that after a time the caterpillars would break out, start off in some new direction.

Not so. Through sheer force of habit, the creeping circle kept moving relentlessly around and around the rim of the pot, for seven days and seven nights. Ultimately, the caterpillars died of starvation or exhaustion.

FOOTNOTES

- ¹"Reducing Hospital Costs: Basic Business Tools Cut Red Ink," The Washington Post, July 18, 1977.
- ²Mohr, "Determinants of Innovation in Organization," American Political Science Review, Vol. 63, No. 1, pp. 11-126 (March 1969).
- ³Rothman, Planning and Organizing for Social Change (New York: Columbia University Press, 1974).
- ⁴Perrow, "A Framework for the Comparative Analysis of Organizations," Administrative Science Quarterly, Vol. 32, 2, pp. 194-208.
- ⁵Watson, ed., Concepts for Social Change (Washington: National Institute of Applied Behavioral Sciences, 1967).
- ⁶Bennis, Changing Organizations (New York: McGraw-Hill Book Company, 1966).
- ⁷Lewin, Field Theory in Social Science (New York: Harper & Row, 1951).
- ⁸Rogers, Diffusion of Innovations (New York: Free Press, 1962).
- ⁹Rothman, op. cit., pp. 442-482.
- ¹⁰Rothman, "An Analysis of Goals and Roles in Community Organization Practice," Social Work, Vol. 9, No. 2, pp. 24-31 (April 1964).
- ¹¹Richy and Horestein, "Stand Up When Your Number Is Called: An Empirical Attempt to Classify Types of Social Change Agents," Human Relations, Vol. 29, No. 10, pp. 945-967 (1976).
- ¹²French and Raven, "The Basis of Power," Group Dynamics, Cartwright and Zander, eds. (New York: Harper & Row, 1968).

SELECTED REFERENCES ON INNOVATION

- Bennett, The Leader Looks at Planning for Change (Washington: Leadership Resources, 1961).
- Bennis, Changing Organizations (New York: McGraw-Hill, 1966).
- Hage and Aiken, Change in Organization (New York: Random House, 1969).
- Lassey, Leadership and Social Change (Iowa City: University Associates, 1971).
- Lawrence, "How to Deal With Resistance to Change." Harvard Business Review (January-February, 1969).
- Lewin, Field Theory in Social Science (New York: Harper & Row, 1951).
- Lippett, The Dynamics of Planned Change (New York: Harcourt, Brace, 1958).
- McClelland, The Process of Effecting Change (Washington: American Psychological Association, 1969).
- McGregor, The Human Side of Enterprise (New York: McGraw-Hill, 1960).
- Morris, Feasible Planning for Social Change (New York: Columbia University Press, 1974).
- Rothman, Planning and Organizing for Social Change (New York: Columbia University Press, 1974).
- Tichy, "How Different Types of Change Agents Diagnose Organizations." Human Relations, Vol. 28, pp. 771-799, (1975).
- Watson, ed., Concepts for Social Change, (Arlington, Va.: National Institute of Applied Behavioral Science, 1967).

