

S.C.R.T.D. LIBRARY

S.C.R.T.D. LIBRARY

Pratt, R. H.  
LOW COST URBAN  
TRANSPORTATION  
ALTERNATIVES

# LOW COST URBAN TRANSPORTATION ALTERNATIVES:

A Study of Ways to Increase the Effectiveness of  
Existing Transportation Facilities

## VOLUME II

# RESULTS OF CASE STUDIES AND ANALYSIS OF BUSWAY APPLICATIONS IN THE UNITED STATES

Prepared by

R.H. Pratt Associates, Inc.  
Kensington, Maryland

January 1973



Prepared for  
Office of Urban Transportation Systems  
Assistant Secretary for Policy, Plans, and International Affairs  
U.S. Department of Transportation  
Washington, D.C.



TECHNICAL REPORT STANDARD TITLE PAGE

1. Report No.	2. Government Accession No.	3. Recipient's Catalog No.	
4. Title and Subtitle A Study of Low Cost Alternatives to Increase the Effectiveness of Existing Transportation Facilities-Results of Case Studies and Analysis of Busway Applications in the United States.		5. Report Date January 1973	6. Performing Organization Code
		8. Performing Organization Report No.	
7. Author(s) John H. Dupree, Richard H. Pratt		10. Work Unit No.	11. Contract or Grant No. OS-20034
9. Performing Organization Name and Address R. H. Pratt Associates, Inc. 10400 Connecticut Avenue Kensington, Maryland 20795		13. Type of Report and Period Covered  Volume II	
		14. Sponsoring Agency Code	
12. Sponsoring Agency Name and Address U. S. Department of Transportation Office of the Secretary Washington, D. C. 20590		15. Supplementary Notes	
16. Abstract Volume II details the results of case study investigations and analyses of seven operating exclusive bus lanes. Three of the exclusive bus lanes operate as contraflow facilities on freeways, three as contraflow bus lanes on arterial streets, and one as a specially constructed bus lane. The study found that exclusive bus lanes were capable of processing large volumes of passengers often with substantial time savings over competing modes. Findings indicate that busways offer the potential for substantial gain in total capacity to move people. There is strong evidence that commuters are attracted to public transportation such as can be provided via an exclusive bus lane if travel time saving is achieved. Bus lanes can be made operable in a matter of weeks at a cost that can often be absorbed within operating budgets. A variety of technical, institutional and operating experiences associated with the various bus lanes now operational are detailed. In addition, the potential for bus lanes in five diverse urban environments is analyzed. Data is provided on Federal funding appropriate to establishing bus lanes.			
17. Key Words low cost alternatives exclusive bus lanes reverse bus lanes		18. Distribution Statement	
19. Security Classif. (of this report)	20. Security Classif. (of this page)	21. No. of Pages	22. Price

01167

HE  
305  
JRS  
V-2

PROJECT STAFF

Principal in Charge	Richard H. Pratt
Project Director and Chief Investigator	John H. Dupree
Chief Research Associate	Janet K. Nemvalts
Key Contributors	Gordon W. Schultz
	Francis P. D. Navin

The contents of this report reflect the views of R. H. Pratt Associates, Inc. which is responsible for the facts and the accuracy of the data presented herein. The contents do not necessarily reflect the official views or policy of the Department of Transportation. This report does not constitute a standard, specification or regulation.

## PREFACE AND ACKNOWLEDGEMENTS

The purpose of Volume II of this study is twofold:

- . To report the results of case study examination of seven operating busway facilities and to briefly summarize results of examinations of application possibilities in five additional cities.
- . To consolidate the actual busway implementation experiences of planners, highway officials, transit operators, and other involved parties into a useful document for other cities to use in weighing the merits of, or actually implementing, an exclusive bus lane.

In accomplishing these objectives, the study drew on the experiences of numerous local officials actually involved in planning, implementing, and operating bus lane. The study staff wishes to extend its sincere appreciation and acknowledge the contribution of these individuals. Following is a partial list of those individuals and agencies who were kind enough to spend a substantial amount of time assisting with the development of the material presented in Volume II:

Dr. William C. Habig, Executive Director, Mid-Ohio Regional Planning Commission, Columbus, Ohio.

Angel Santiago Matos, Assistant Executive Director for Planning, Highway Authority, Commonwealth of Puerto Rico.

Edilberto Lopategui, President and General Manager, Metropolitan Bus Authority, San Juan, Puerto Rico.

Harvey Samuelson, Chief Bureau of Plans and Surveys, Department of Traffic, City of New York.

Joseph Reichert, Staff Engineer, Bureau of Plans and Surveys, Department of Traffic, City of New York.

V. J. Cantone, Traffic Engineer, Massachusetts Department of Public Works.

Joseph Schraffra, Staff Engineer, Massachusetts Department of Public Works.

Joseph C. Corradino, Schimpler-Corradino Associates, Louisville, Kentucky.

B. Douglas Coomer, Schimpler-Corradino Associates, Louisville, Kentucky.

Wilbur Watkins, Executive Director of Falls of Ohio, Council of Governments,  
Louisville, Kentucky.

James Cox, Chief Traffic Engineer, Department of Transportation, City of  
Indianapolis, Indiana.

Gene Hatheway, Staff Engineer, Department of Transportation, City of  
Indianapolis, Indiana.

Leon Goodman, Port of New York Authority.

Donald A. Morin, Federal Highway Administration, U.S. Department of  
Transportation.

Edward Fleischman, Federal Highway Administration, U.S. Department of  
Transportation.

Robert D. Radics, Federal Highway Administration, U.S. Department of  
Transportation.

Ronald Fisher, Urban Mass Transportation Administration, U.S. Department  
of Transportation.

James Bautz, Urban Mass Transportation Administration, U.S. Department  
of Transportation.

FIGURE		PAGE NO.
1-1	Relative Hourly Volumes if Highway Lane Used Normally or as Exclusive Busway	3
3-1	Map of Exclusive Bus Lane on I-495 Approach to Lincoln Tunnel	15
3-2	Lane Divider, Typical Traffic Post and Post Hole Detail	17
3-3	Detail of Specially Designed Cone Laying Vehicle	19
3-4	Police Officer Activating Hinged, Changeable Bus Lane Guide Sign	20
3-5	Remote Controlled Signs to be Installed on I-495	24
3-6	Schematic Map of Long Island Expressway Facility	34
3-7	Long Island Expressway Manually Changeable Control Signs	35
3-8	Long Island Expressway Operator Instructions	37
3-9	Boston Southeast Expressway and Exclusive Bus Lane	44
3-10	Boston Southeast Expressway Permanent Lane Signs	46
3-11	Boston Handout to Bus Operators	47
3-12	Louisville Reverse Bus Lane in Louisville Urban Corridor	55
3-13	Total Peak Hour Bus Patronage	61
3-14	Exclusive Bus Lane in Indianapolis	64
3-15	Location of Exclusive Bus Lane Project (San Juan)	70
3-16	Monthly Ridership and Revenue Trends, San Juan	75
3-17	Shirley Highway Exclusive Bus Lane Facility with Travel Time for Segments and Entire Facility	79
3-18	Auto and Bus Person Trips on Shirley Highway	83
3-19	Portion of Potential Bus Market Using Transit (Market Share)	83

LIST OF FIGURES (continued)

FIGURE		PAGE NO.
4-1	North Freeway Express Bus Concept, Columbus, Ohio	110
4-2	AM Southbound Bus Operation Downtown Portion, Columbus, Ohio	113
4-3	PM Northbound Bus Operation Downtown Portion, Columbus, Ohio	114
5-1	Metro-Mode Exclusive Right-of-Way Single Lane Flow Capacities	117
5-2	Ratio Comparison of Accidents	141
6-1	Two Lane Specially Constructed Busway in Median of Limited Access Highway	149
6-2	One Lane Facility with Emergency Pulloff	150
6-3	Contraflow Reserved Lane on Existing Freeway	151
6-4	Major Arterial Contraflow Bus Lane Shown	153
6-5	Contraflow Lane on One-Way Street	154
6-6	Two Lane Arterial, One Lane for Exclusive Use of Buses	155



LIST OF TABLES

TABLE		PAGE NO.
3-1	Exclusive Bus Lane Facility Accidents on New Jersey I-495	22
3-2	Implementation Costs for Exclusive Bus Lane on Long Island Expressway	39
3-3	Estimated Daily Operating Costs on Long Island Expressway	39
3-4	Long Island Expressway Exclusive Bus Lane, Number of Buses Using Lane	41
3-5	Initial Implementation Costs: Boston Southeast Expressway Exclusive Bus Lane	49
3-6	Boston AM Bus Lane Operation Statistics	51
3-7	Travel Time Comparisons for Three Routes in Louisville	59
3-8	Reasons for Switching from Auto to Bus (Choice Riders)	84
3-9	Shirley Highway Screenline Counts	84
3-10	Shirley Highway Bus and Auto Commuter Profiles	86
3-11	Shirley Highway Bus Survey Results	87
3-12	Shirley Highway Bus Travel Data	88
3-13	Shirley Highway: Major Reasons for Switching from Bus to Auto	89
3-14	Shirley Highway Auto Survey Results	90
3-15	Summary Statistics on Bus Lanes in Six Non-Case Study Cities	94
4-1	Selected Characteristics of Certain Roadways with Potential for Busways in City "A"	100
4-2	Selected Characteristics of Certain Roadways with Potential for Busways in City "C"	105

## LIST OF TABLES (continued)

TABLE		PAGE NO.
4-3	Selected Characteristics of Certain Roadways with Potential for Busways in City "D"	108
4-4	Traffic Count Data for Columbus North Central Freeway Peak Hour Traffic Volumes	111
5-1	Maximum Actual and Theoretical Volumes by Mode	118
5-2	Volumes Carried on Six Selected Bus Lane Projects	121
5-3	Changes in Link Travel Time Before and After Establishment of Exclusive Bus Lane	123
5-4	Value of Link Travel Time Saved	127
5-5	Ranges and Types of Costs Associated with Implementation of Various Types of Bus Lanes	128
5-6	Roadway Building Cost Estimates for Busways	130
5-7	Daily Operating Cost Components	134
5-8	Accident Experience on Seven Bus Lane Projects	135
5-9	San Juan Average Monthly Number of Accidents Before and After Establishment of Exclusive Bus Lane	140
5-10	Percentage Change in Numbers of Accidents Eleven Months After Exclusive Bus Lane Operation Was Put Into Effect	140
5-11	Indianapolis Accident Data Before and After Bus Lane Establishment	142
5-12	Comparison of Social Impacts	144
6-1	Signal Delay as a Percentage of Total Trip Time on a Heavily Utilized Bus Route in Washington, D.C.	163
8-1	Congressional Funding Authorization for the Federal-Aid Highway Program, Fiscal Years 1972 and 1973	174

PREFACE AND ACKNOWLEDGEMENTS

LIST OF FIGURES

LIST OF TABLES

INTRODUCTION AND BACKGROUND	1
CHAPTER I OVERVIEW AND CONCLUSIONS	2
CHAPTER II BUSWAYS BRIEFLY DEFINED AND DESCRIBED	8
CHAPTER III CASE STUDIES OF SEVEN OPERATING BUSWAYS	12
CHAPTER IV OPPORTUNITIES FOR BUS LANES IN FIVE SELECTED CITIES	97
CHAPTER V BUSWAY FUNCTIONAL EVALUATIONS	116
CHAPTER VI KEY TECHNICAL ISSUES SURROUNDING IMPLEMENTATION AND OPERATION OF BUS LANES	148
CHAPTER VII INSTITUTIONS AND IMPLEMENTATION	165
CHAPTER VIII SOURCES OF FEDERAL FUNDING APPLICABLE TO BUSWAYS	172



## INTRODUCTION AND BACKGROUND OF THE STUDY

### SCOPE AND PURPOSE OF THE CONTRACT

This report is Volume II of a broader study funded to study "Ways of Utilizing Existing Transportation Facilities More Effectively". The objective of this study was to "...identify and describe, through the use of appropriate case studies and recommendations, methods whereby existing transportation facilities (all modes) could be more effectively utilized to accommodate increased demand for service, as an alternative to constructing new facilities."

The effective scope of the study was such that a wide range of concepts, techniques and technologies related to solving land transportation needs of urban areas were investigated. The study proceeded in two sequential phases to achieve its objective:

- (1) First, a survey and analysis of twenty-one "low cost" or "no cost" transportation concepts was carried out. The survey examined both the literature of theory and practical experience in order to achieve an understanding of the utility of each concept. All twenty-one concepts were reviewed according to thirteen common criteria which were felt to be effective correspondents to the key questions asked by transportation decision makers. Substitutability of the concept for new capital intensive transportation facilities was a basic requirement for favorable ranking. A complete listing, description, and summary of the evaluations of the twenty-one concepts is contained in Volume I.
- (2) The second phase of investigation called for an in-depth case study of one or more of the most promising techniques uncovered in phase one. These case study investigations were designed to probe all facets of the selected concepts from technical issues to the institutional climate, so as to develop as much practical information on implementation as possible.

### CASE STUDY INVESTIGATIONS

Selected as the most promising of the twenty-one initially investigated techniques were busway applications. These were found to combine the ubiquity of both buses and urban streets into a superior mass transportation service once limits on roadway lane use by automobiles were accepted and implemented.

The case study evaluations were carried out through a series of field visits, interviews and reviews of published literature supplemented by independent research. The material from these investigations is presented in several ways. First, a general discussion and definition of busways is provided. The actual case studies are presented next. Then material drawn from each case study is used to develop and support discussion of key topics. Finally, a short section on sources of Federal funding is provided.

## CHAPTER 1

### OVERVIEW AND CONCLUSIONS

Chapters 2 through 7 provide a detailed examination and elaboration of technical, operational, and institutional issues, as well as description of actual and hypothetical applications. Before turning to these analyses, it seems useful to briefly summarize the principal findings and set forth the conclusions of the study. This summary and review also effectively serves to demonstrate why busways were ranked so favorably among the concepts surveyed in Volume I.

Of all the characteristics of busways, six stand out as being chiefly responsible for the high ranking and evaluation. These are initially and briefly discussed below and are detailed in Chapter 5.

- (1) Order of magnitude capacity improvements: Unlike most concepts studied, busways offer opportunities to increase the volume of persons carried on a lane of highway by several orders of magnitude. Figure 1-1 illustrates the difference between potential passenger-carrying capacity of a traffic lane used as a busway, and maximum levels under normal circumstances. As indicated, peak hour passenger volumes as high as 25,800 have been observed on a limited access busway lane. Theoretical studies indicate that it may be possible to carry as many as 70,000 passengers per hour. In contrast, 2,600 persons per hour is the normal maximum passenger volume expected on a mixed traffic limited access lane with no buses. (If average occupancy of a predominantly auto-oriented lane were increased to four passengers per vehicle through mandatory car pool rules then potential capacity per lane would be about 8,000 people per hour.)

The potential passenger volume which can be accommodated is so great that there are few known corridors where demand would exceed this theoretical busway capacity. And a survey of existing busways quickly reveals that these facilities are nowhere near being fully utilized.

The substantial increases in capacity available from busways are theoretically available from any wholesale substitution of mass transportation for private automobile use. A key problem with bus mass transportation to date is that it has not been possible to attract riders in the volumes necessary to capitalize on potential bus capacity. Unlike most other inexpensive mass transportation improvements, service on busways can prove more attractive than private automobiles, chiefly due to increases in speed. Busway service therefore offers definite opportunities to more fully realize the capacity potential of bus mass transit.

The volumes that can be processed on busways represent the chief contribution of these techniques toward improving the productivity of existing capital facilities. In five of the seven case study cities there is evidence to indicate that busways serve as direct substitutes for more traditional capital

**Figure 1 - 1**  
**RELATIVE HOURLY VOLUMES IF HIGHWAY LANE**  
**USED NORMALLY OR AS EXCLUSIVE BUSWAY**

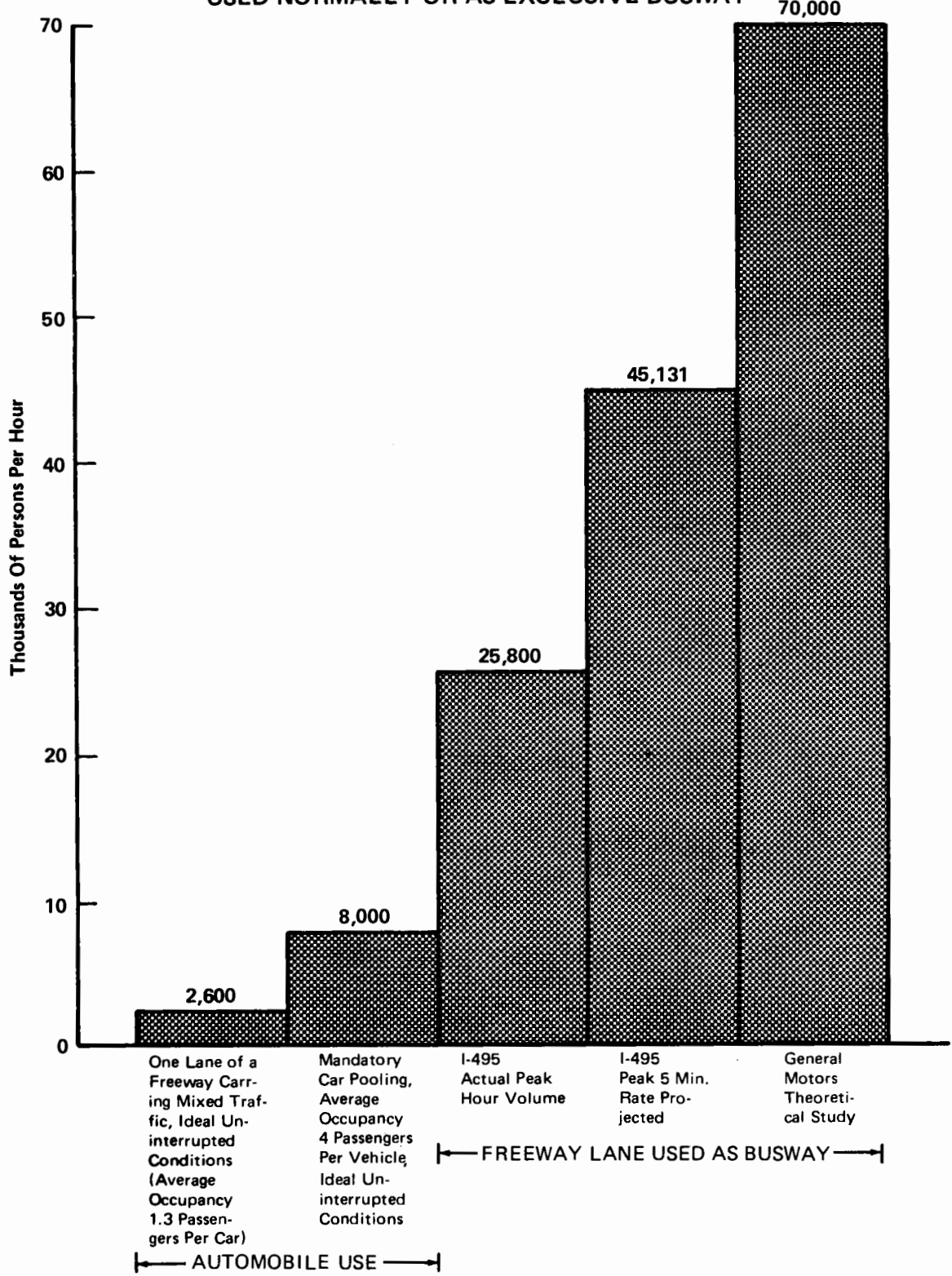

See Text of Chapter 5 For More Detail and Sources.

intensive auto or rail facilities. In several cases busways represent alternatives to highway construction which the community refused to permit. In other cases, traditional approaches were too expensive when compared with available funds. (More detail can be found in conclusion 6 below.)

- (2) Substantial commuter time savings: Unlike most transportation improvements studied during this investigation and others that are often recommended, busways do generate substantial savings in travel time during peak periods. For example, savings of as much as fifteen minutes were reported for trips that would normally be taken in heavily congested traffic; this time savings represented as much as 85% of former link travel times. While unfortunately there are no thorough studies of changes in door-to-door trip time, there is some evidence to indicate that travelers can reduce their total travel time commitments each morning and evening. More studies are needed to document this saving. Time savings are a major factor in persuading commuters to use mass transit.

Both substantial travel time savings and high volumes of passengers carried can be achieved when buses operate at an average speed of thirty-three miles per hour. Thus, the substantial advantages of busway operations do not accrue from the attainment of unrealistically high operating speeds.

- (3) Inexpensive solution: Busways provide an inexpensive way of avoiding peak period congestion and the attendant inconvenience and frustration. While a number of planned or proposed busways utilize separate specially constructed capital intensive facilities it is obvious from this study that substantial capacity for busways is available from existing roadway systems. In a great many cases there are elements of existing systems which are underutilized during times of peak period travel and are quite acceptable for busway use. In other cases, a full lane of excess capacity does not exist, but it may be more cost efficient and socially desirable to subject mixed traffic to marginal penalties in order to obtain the substantial advantages of an exclusive busway than to further endure present conditions.

In either of the latter cases, the capital facility is available at no capital cost of any consequence. Preparation of the facility for bus lane use has proved quite inexpensive, usually involving only striping and signing, and can normally be accommodated within the operating budget of the local highway agency. In some cases, it may prove necessary to go beyond striping and signing to establish the busway facility. Improvements such as lane dividers, raised platform bus stops or shelters, permanent pulloffs or ramps, etc., may either be desirable or necessary for most effective operation. The cost, however, is still minor when compared with other alternatives. Daily operating costs on facilities which are switched during the day to accommodate other uses may require extra budgeting, however.



(4) Immediate Implementation: If existing roadways are utilized, busways can be operable in a matter of weeks. As a result, no time consuming design or construction lead times need be anticipated. Planning lead time can be minimal if existing bus service does not need to be rerouted. In addition, the non-permanent, flexible nature of busways will allow changes in demand and traffic conditions to be accommodated easily and quickly with new patterns of transportation service.

(5) Universal Application: Almost any existing street type, design configuration or traffic system can be adapted to busway use. The primary concern in deciding whether or not a particular roadway should be developed into a busway is not one of design but of the relative merits of removing a lane from general traffic use.

It is clear from this study that busways may offer solutions to urban transportation problems in all but the smallest cities. The chief reason is, of course, that all cities have an extensive urban highway network. By virtue of both design and by the nature of urban useage patterns, these highway networks are well suited to adaptation as busways.

(6) An Attractive Mode: Unlike most inexpensive transportation improvements which involve mass transportation service, indications are that commuters significantly appreciate the benefits of mass transportation as provided by an effective exclusive busway. This has been documented in changes of travel mode both from other mass transit service as well as from private automobiles.

These mode choice influences appear to be directly related to the trip time advantage for commuters in buses on exclusive rights-of-way. This is further discussed below in the review of conditions under which busways might be expected to be successful; however, it is important to note here that these mode choice changes are induced and not forced. In a time when consideration is being given to various schemes which would reduce automobile use through absolute prohibitions, it is useful to point out that there are measures available which need not be so drastic nor politically and socially unpopular.

In addition to the above major advantages, a number of minor benefits should be mentioned:

- . Improved vehicle and driver productivity due to the absence of congestion delay
- . Reduction in vehicle wear and tear as evidenced by more miles between brake, clutch and engine overhauls
- . Substantial collective user time savings which may be valued in the millions of dollars annually

The advantages summarized above far outweigh the slight disadvantages associated with busways. Most often mentioned as a disadvantage are the penalties imposed on other traffic after the removal of a highway lane from

general use. However, under certain plans of operation, the existing facility lane involved is never missed. In other cases, it is reported that non-bus lane traffic moving in the same direction as the bus lane often improves in rate of flow after the buses have been removed. This improvement is greater than might be expected if another lane were simply added for mixed traffic.

Despite the unusual and often seemingly dangerous operating patterns that have been developed, safety is not jeopardized after installation of exclusive bus lanes. The Long Island Expressway and Boston AM contra-flow freeway bus lane along with the Shirley Highway facility have reported no accidents. In New Jersey police report that accident rates on I-495 have declined since the facility was placed in operation. Studies of contra-flow arterial application also indicate that safety, in some instances, has been improved after installation of the exclusive bus lane.

If bus lanes become widely accepted it will be necessary in certain cases to provide distribution facilities to handle the volumes of passengers carried. This may require provision of capital intensive terminal facilities.

This study does not conclude that busways are automatically useful and successful for all cities and in every transportation situation. For busway service to prove a more attractive mode than either the private automobile or other forms of mass transportation, it would appear that the service must be competitive in terms of travel time, showing an absolute time savings over competing modes for at least the busway link of the journey.

In urban environments where the application of an exclusive bus lane would not provide a time advantage, it may be concluded that serious congestion does not exist. The bus lane provides a time advantage only when it can circumvent congested queues. In cases of minimum congestion there is really no need for the bus lane since existing commuting patterns are well accommodated by the existing capital facilities. It would not be expected, therefore, that such cities would find it to their immediate advantage to establish bus lanes, nor could such cities expect to attract much commuter demand from private vehicles. Further, it would appear that as the time spent commuting declines (as in the case of smaller cities), the proportion saved must increase in order for busway service to prove attractive. This is felt to be true since if the time spent commuting is slight there will be less significance attached to commuting time savings.

Secondary but important characteristics of well-designed reserved bus lane service include convenience, reliability and low cost to the user. Nevertheless, under circumstances where these advantages alone exist, bus service has not proven more attractive than other modes.

Busways seem best suited to radial corridor applications under most circumstances. The reasons for this are related to the nature of mass transportation. It is time consuming when the bus must wander around a dispersed area of trip origins and transport them to widely separated destinations. Patterns of commuting where at least one end of the trip is highly concentrated in space are likely to be associated with trips to the central area, and these of course are best served by radial routes.

There is some reluctance by highway agencies to remove a highway facility lane from general use and reserve it for the exclusive use of buses. Several rules of thumb have been developed as guides to rationalizing removal of such facilities from general use. One rule offered is that when the number of passengers carried in buses utilizing a street equals or exceeds the number of passengers carried in automobiles by a lane of traffic, then this is ample justification for the reservation of one lane for exclusive bus use.

Farsighted planners, however, may want to think in other terms. In many cities present demand for mass transit service does not provide the obvious justification for the reservation of an exclusive bus lane. Yet, unless improvements like reservation of bus lanes are accomplished before demand alone is great enough to justify it, mass transportation service may disappear completely. Reservation of highway lanes and perhaps concurrent subsidization of bus service will help to insure that useful transportation alternatives exist when more stringent measures are taken to control auto travel or when communities decide not to relieve congestion by providing more capital facilities.

The study found that the effectiveness and attractiveness of an exclusive bus lane can be substantially enhanced by the provision of certain complementary techniques and facilities. Good bus route design is clearly necessary to insure convenient access to the bus, otherwise it cannot be made an attractive alternative to the private automobile. In most cases this means that the bus service must penetrate close to the origin and destination of the traveler. In larger cities this penetration can be supplemented by park-n-ride or kiss-n-ride facilities established at convenient locations. In this way, convenience, one of the major influencing factors in the eventual mode choice decisions, will not be violated by the establishment and operation of an exclusive bus lane.

It appears that the ability to control traffic signals on arterials can provide a time advantage which is significant in the specific instance of exclusive bus lane operation. Data indicate that savings up to ten percent of total busway trip time may be obtainable when other traffic conditions are favorable.

In summary, bus lanes are a very promising addition to the range of techniques available for urban area transportation management. The opportunity to implement and operate bus lanes with little or no cost means that only marginal benefits need to be shown initially in order to justify action. Response to bus lanes has been favorable from bus passengers and auto drivers alike. There appear to be no insurmountable institutional problems to impede their installation or operation.

## CHAPTER 2

### BUSWAYS BRIEFLY DEFINED AND DESCRIBED

#### PRINCIPAL CHARACTERISTICS

The term "busway" can claim many definitions and applications ranging from simple freeway ramps to lengthy stretches of limited access roadways dedicated to the exclusive use of buses. All definitions have these operational characteristics in common:

- . When in operation, only buses and, in some special cases, taxis, carpools, and emergency vehicles, may use the facility. Prohibition against general use of such lanes are effectively enforced.
- . Busways are primarily oriented towards relief of peak period congestion and buses operating on exclusive bus lanes are not subject to congestion delays. Frequently these facilities are in operation only during the peak hours. In some cases twenty-four hour operation reflects the more extensive round-the-clock congestion experienced in that particular environment.
- . The facility is usually intended to provide the bus rider with a transportation advantage over commuting by auto.

While most busways have the above characteristics in common, the ubiquitous nature of buses combined with a diversity of urban planning constraints resulted in a wide variety of actual applications. As a result, several distinctive operating patterns have developed in response to different resources and needs. These major operating distinctions are summarized below.

#### (1) Use of New Capital Facilities vs. Existing Roadways

A major point of differentiation between various types of busways relates to the nature of the capital facility used. A new capital facility built specially for and dedicated to the exclusive use of buses is one solution. Usually such facilities are in addition to capacity available for mixed traffic. In the case of power line or abandoned railway rights-of-way, paving the right-of-way is an effective way of establishing a busway.

Construction of separate lanes of pavement for the exclusive use of buses is a high priority item in the planning of transportation improvements in a number of cities. These facilities cost about the same as a similar width automobile facility. In some cases, special exit and entrance ramps are planned.

Contrasted with new capital facility busways are line haul busway facilities which use existing roadways. Two types predominate in applications to date:

- . Reversal of an under-utilized freeway lane which normally carries traffic in the opposite direction.
- . Reversal of one lane on a typical arterial one-way street.

Other possibilities include reservation of a lane on a multi-lane arterial either with or against the flow of traffic for use of mass transit vehicles or reservation of a complete street.

Costs are much higher and lengthy periods of construction are involved when a specially constructed bus lane is built. A busway using an existing facility can be established at low cost and be operational in a matter of weeks.

A major finding of this study was that few cities or transportation planners were able to recognize the extent to which existing roadways are both under-utilized and suitable for establishing exclusive busways.

### (2) With Flow vs. Against Flow

Bus lanes can operate as a separate lane with the normal flow of traffic or operate against the flow of traffic in a separate lane. Under conditions of mixed traffic and in the absence of physical separation, the more successful of these have tended to be those where the bus operates against the flow of traffic.

The success of a contraflow lane is largely due to its intrinsic self-enforcing nature which keeps the lane exclusive and uncongested. Motorists are reluctant to drive in lanes which normally carry traffic in the opposite direction. It seems likely that further intimidation can be attributed to the size and weight of buses using the contraflow lanes. This self-enforcing operation has been observed even in those urban environments where public disregard for traffic laws is notorious.

With flow bus lanes, carrying large volumes of bus traffic, making frequent stops to discharge and pick up passengers, do not invite encroachment by other vehicles as the buses move very slowly and trap other vehicles. For this same reason bus lanes of this type are not likely to offer significant speed or time advantages to transit users. Where with flow lanes do not trap other vehicles, encroachment violations are likely to be frequent.

### (3) Freeways, Arterials, One-Ways

Busways have been implemented on all types of roadways. As mentioned earlier, two examples predominate:

- . Reversal of one lane on a multi-lane freeway
- . Reversal of one lane on a multi-lane one-way street

Busways on freeways provide uninterrupted line haul trips frequently under free flow conditions. Such facilities are rarely subject to delays on the bus lane portion of the trip and are, there-

fore, likely to save the most trip time for users. They are often designed to bypass the queues which frequently develop around freeway bottlenecks during peak hours such as when lanes converge and demand remains unchanged, or when tunnels or bridges are encountered.

Arterials can also be converted to busway use if conditions warrant. Unfortunately, the time advantages of such facilities are usually less than for freeways since the bus, in most cases, is subject to delays occasioned by stops to discharge and pick up passengers as well as to respond to control devices.

One-way street systems are among the best candidates for use as arterial bus lanes since:

- . They are usually set up in pairs, with one of the pair heavily used in each peak and the other street often under-utilized during the same time period.
- . Loading and unloading is safer in that passengers are discharged directly onto the sidewalk as in normal operations, rather than, say, onto a median strip.
- . Conversion to a bus lane is essentially converting the street back to a modified version of traditional two-way operation.
- . Normal traffic has less difficulty in making turns.
- . Signal timing is often easier to effect.

Other types of streets may be converted to busways and are discussed under Design and Geometrics in Chapter 6.

#### COLLECTION AND DISTRIBUTION

Busways may serve either line haul or collection and distribution functions. Line haul applications are the chief concern of this report; however, exclusive facilities for collection and distribution service can often provide a useful solution to a particularly aggravating bottleneck or other special circumstance involving a very small segment of the roadway. For example, special transportation facilities are often established around terminals within the CBD, or serving other points where transportation demand is very high, and transit vehicles would be subject to inordinate delay if not exempted from normal congestion.

Such collection and distribution busway facilities tend to be tailor-made to the specific situation. Some examples noted are as follows:

- . Special Access Ramps: The Port of New York Authority operates the Mid-Manhattan bus terminal which connects directly to the adjacent Lincoln Tunnel by means of a series of dedicated ramps. In Seattle, a special access and exit ramp permits vehicles on I-5 to enter and leave the CBD very close to the principal collection and distribution areas (Blue Streak).

- . Curb Lanes: In a number of CBD terminal areas special curb lanes on urban streets are reserved for the use of buses so that they may load and unload in congested areas. In some urban areas long stretches of these curb lanes are reserved for buses and right-turning vehicles only. Enforcement is not easily accomplished for the latter except where heavy volumes of buses use the facility.
- . Special Off-Street Terminal and Loading Facilities: Occasionally urban areas will construct special pull-off bays, or channels, adjacent to the street system so that buses may load and unload with advantages to both bus patrons and the general motorists.

This report does not examine these special collection and distribution facilities in great detail. It seems sufficient to note that they fall into the category of good traffic engineering and there are other sources which can provide more detail.

The following chapters present more details on the operation and implementation of line haul type busway facilities.

## CHAPTER 3

### CASE STUDIES OF SEVEN OPERATING BUSWAYS

#### BACKGROUND TO CASE STUDY INVESTIGATIONS

An important part of this study involved collecting data on a number of representative busway applications through field visits, interviews with officials, studies of project documents and other means.

In all, seven sites were selected. The examples chosen were divided about equally between arterial and freeway applications. A more-or-less specially constructed facility in operation was included. These sites were:

#### Peak Period Contraflow Lanes on Freeways:

- . New Jersey - I-495 Approach to the Lincoln Tunnel
- . New York City - Long Island Expressway
- . Boston - Southeast Expressway

#### Contraflow Lanes on Arterials:

- . Louisville - Second and Third Streets, a one-way pair
- . Indianapolis - College Avenue, a one-way street
- . San Juan - Fernandez Juncos and Ponce de Leon, a one-way pair

#### Specially Constructed Busway Facility:

- . Washington, D.C. - Shirley Highway  
(Northern Virginia Suburbs)

These sites were selected since:

- . The applications were judged to encompass the more important operating examples at this time.
- . In some cases extensive data collection efforts had been made (most busways, including some visited, are poorly documented).
- . They have been the subject of substantial public interest.

Each of the following case studies is described according to a common format which is listed here for quick reference:



- . Description
- . Reason for Busway
- . Operational Details
- . Safety Considerations
- . Costs
  - User Costs
  - Implementation Costs
  - Operating Costs
- . Results
  - Speed or Time
  - Volume
  - Other Results, including mode choice behavior
- . Institutional Background
- . Publicity and Public Relations
- . Public Response
- . Future Possibilities

The format and the content was chosen and arranged in accordance with the observed interests of community officials, planners and others who were visited during the project.

A brief tabular summary of several prominent examples of bus lane applications in cities which were not visited is also included at the end of this chapter.

## PEAK HOUR RESERVED LANES ON FREEWAYS

### CASE STUDY 1: I-495 APPROACH TO THE LINCOLN TUNNEL (NEW JERSEY)

#### DESCRIPTION

I-495, in New Jersey, is a 2.5 mile, six-lane, divided expressway. The facility begins with an interchange at the New Jersey Turnpike and terminates at the Lincoln Tunnel, the principal crossing point from New Jersey into central Manhattan. Normally, three lanes of traffic flow in each direction through the Lincoln Tunnel into New Jersey from Manhattan. During the period from 7:30 AM to 9:30 AM each weekday morning, the lane next to the median normally flowing westbound is reserved for the exclusive use of inbound (east-bound) buses. The facility is illustrated in Figure 3-1.

Planning and implementation was funded partly by a \$500,000 grant from the U.S. Department of Transportation's Urban Corridor Development Program. The Urban Corridor Development Program combines Federal Highway Administration and Urban Mass Transportation Administration funds into a special program designed to demonstrate new techniques for improving travel in certain pre-selected corridors. The grant was made to the Tri-State Transportation Commission (now Tri-State Regional Planning Commission). Actual project direction was the responsibility of the staff of the Port of New York Authority. The various agencies involved in the project contributed additional staff time and money.

The facility itself operates only in the AM peak. In the evening, vehicles travel from the Port Authority bus terminal to the Lincoln Tunnel on exclusive bus ramps. The congestion point is the tunnel itself and after the tunnel has been cleared, the so-called "reverse funnel effect" takes place and traffic moves freely, i.e., sufficiently few vehicles can enter the tunnel on the New York side so that there is more than adequate roadway west of the tunnel to handle the demand. As a result, congestion occurs before the tunnel, not after it.

The Port Authority staff are preparing comprehensive reports on the implementation and operation of the facility; this was by far the most thoroughly documented of the projects studied.

#### REASON FOR BUSWAY

Three reasons are given for the establishment of the bus lane facility:

- (1) Severe Congestion. Before the bus lane went into operation, speeds of four m.p.h. on the Route 3 merge into the I-495 route were typical. After the establishment of the lane, speeds for non-busway vehicles increased to forty m.p.h. Before opening of the bus lane, both approaches from the New Jersey Turnpike were impeded by severe congestion and speeds of approximately ten m.p.h. These speeds have now increased to thirty m.p.h. for non-busway vehicles. Simi-

**Figure 3 - 1**  
**MAP OF EXCLUSIVE BUS LANE ON I-495 APPROACH TO LINCOLN TUNNEL**

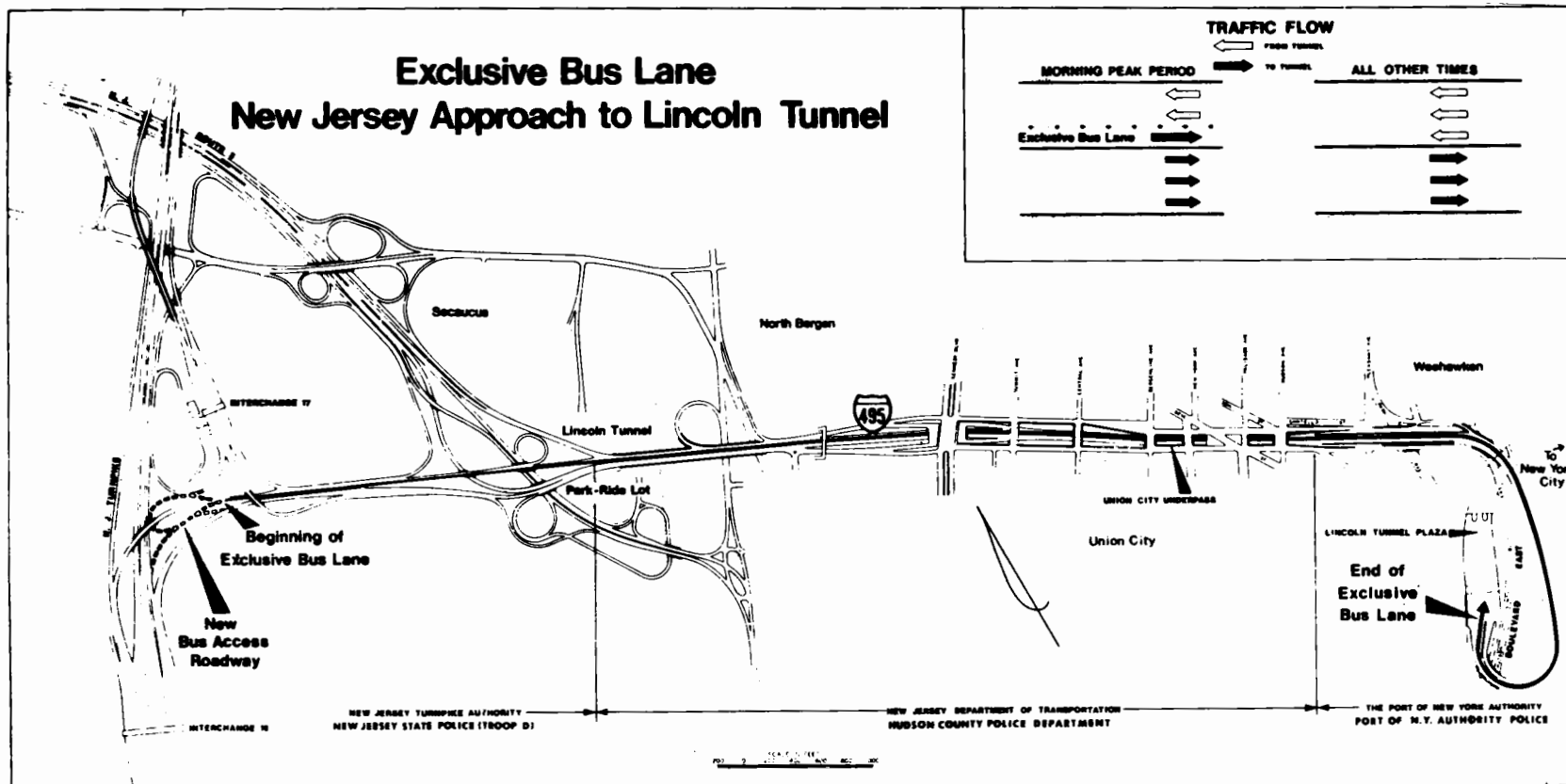

15

Buses use the exclusive lane on the Interstate Route 495 approach to the Lincoln Tunnel during the morning peak period of each work day. The additional eastbound lane, for buses only, is one of the three lanes which ordinarily carry traffic in the westbound direction. These lanes have light use during the period of 7:30 to 9:30 a.m. on weekdays when the exclusive bus lane is in operation. This change provides four lanes for New York-bound traffic. Jurisdictional limits of maintenance and police agencies are shown at bottom.

SOURCE: Tri-State Regional Planning Commission, Exclusive Bus Lane, I-495, Interim Report No. 2, Jan.-Sept., 1971.

larly, on the North Bergen Viaduct approach, prior speeds were about ten m.p.h. They are currently approximately twenty m.p.h. Congestion was so severe as to slow down essentially the entire 2.5 mile long I-495 access route to the Lincoln Tunnel.

- (2) Desire to Encourage Mass Transit. It was expressed in meetings with various project and traffic officials that it is the general objective of the Tri-State Regional Planning Commission and associated governmental bodies to encourage the use of mass transit for peak period travel in the New York metropolitan area.
- (3) Reluctance to Build More Roads. Among the alternatives considered before the bus lane was put into effect were the widening and building of more roadways. It was felt that this was not politically the most acceptable approach to solving traffic congestion problems. One estimate on widening the roadways was \$40 million.

Another alternative considered was ramp metering and the use of controls in order to provide buses with priority access to the inbound lanes. Unfortunately, since very few buses entered the facility from the various ramps downstream from the beginning of I-495, it was not felt that this would be very effective.

#### OPERATIONAL DETAILS

The central reason for the severe congestion on I-495 is that three major routes feed into I-495. The New Jersey Turnpike feeds vehicles into I-495 from both a north and south interchange; Route 3, a major east-west arterial expressway, feeds into I-495 to the east of the New Jersey Turnpike; and the North Bergen entrance ramp brings additional heavy traffic onto the facility.

Access to the bus lane actually involves use of a short stretch of specially designed bus access roadway. This roadway, shaped like a teardrop, allows vehicles from Turnpike Interchanges 16 and 17, from New Jersey Route 3, from Patterson Plank Road, and from the Lincoln Tunnel park-n-ride lot, to use a grade separated access facility to the exclusive bus lane. There is an escape hatch roadway that allows off-route buses or other vehicles to re-enter the regular eastbound traffic flow if they accidentally wander into the exclusive lane access route. For vehicles approaching the facility from the north and east, it is necessary to actually proceed westward for a short distance in order to gain access to the eastbound exclusive bus lane. The extra time lost in this doubling back to gain access is more than regained from the time savings resulting from use of the bus lane itself (see Figure 3-1).

The bus lane is separated from the remaining two lanes of westbound traffic by cylindrical traffic posts which are dropped into small holes drilled into the roadway (see Figure 3-2). The traffic posts are placed at forty foot intervals and are aligned with the lane divider paint stripe. "Special attention was devoted to the design of the required hole in pavements to

**Figure 3 - 2**  
**LAND DIVIDER**  
**TYPICAL TRAFFIC POST & POST HOLE DETAIL**

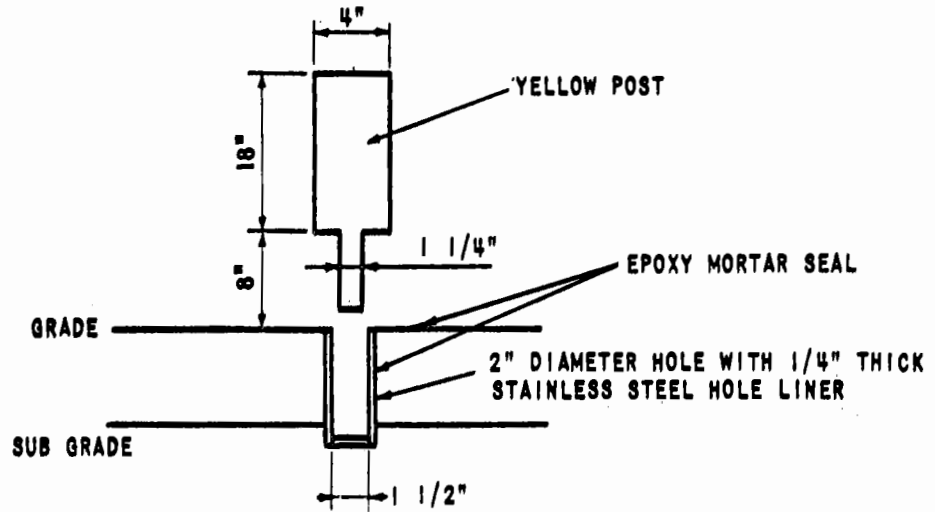

**NOT TO SCALE**

**SOURCE: Tri-State Transportation Commission, Interstate 495 Exclusive Bus Lane,  
Interim Report No. 2, Jan.-Sept. 1971, p. 23**

minimize maintenance and cleaning problems."<sup>1</sup> On the Lincoln Tunnel helix roadway "where there are significant horizontal curves," the posts are situated in the center of the second lane from the median, thus creating a closed buffer lane between the bus lane and the opposite westbound traffic flow.<sup>2</sup>

A custom-modified truck is responsible for placing and retrieving the three hundred fifty, 1.5 foot posts both before and after the period of operation of the bus lane (see Figure 3-3). The vehicle has a special braking control which allows the post placer to control the vehicle's speed. The placer sits in a special cab on the side of the truck. "The complete system allows completion of all post placements within a half hour."<sup>3</sup>

In addition to the posts, a system of manually and electronically changeable signs is used to control traffic in and around the lanes. "The sign plan is structured on the assumption that any vehicle may accidentally stray into the bus lane. The signs are therefore designed to be read by the average motorists, not just the professional bus driver."<sup>4</sup> There are about fifty of these traffic signs which are manually activated in the morning by the Port Authority Police (see Figure 3-4). These signs are used on the lane leading up to the special roadway which provides access to the bus lane, as well as on the overhead bridges crossing I-495. Typically, westbound traffic is confronted with a red, electronically activated "X" over the lane used by the buses. On overpasses which do not have electronically activated lane signs, manually changeable hinged signs are used to indicate whether the bus lane is open or closed.

A small manually activated gate at the access road leading to the bus lane is left closed during non-bus lane operating hours in order to discourage eastbound traffic from accidentally wandering onto the bus lane when it is handling its normal complement of westbound traffic.

Police are stationed at the entrance to the bus lane and at the tunnel. In addition, a patrol car with one man in it constantly patrols the facility. The police have the responsibility of limiting use of the facility to appropriate vehicles. All regular transit buses are permitted to use the facility. School buses are not permitted use of the facility because of their less experienced drivers. Buses are defined as vehicles carrying sixteen or more passengers.

Several tow trucks are on duty to assist in removing any vehicles which break down while using the facility. The record of stoppages causing an interruption or delay in operation of the facility is reasonably good. "Exclusive bus lane stoppages caused by flat tires, brake problems, engine problems, and other factors occurred at the rate of less than three a month through 1971 with three months (April, September and October) having no recorded stoppages. Stoppage-handling procedures are working satisfactorily,

---

<sup>1</sup>Tri-State Regional Planning Commission, Interstate 495-Exclusive Bus Lane, Interim Report No. 2, January-September 1971, p. 19.

<sup>2</sup>Tri-State Regional Planning Commission, Interstate 495-Exclusive Bus Lane, Interim Report, October 1970-March 1971, p. 17.

<sup>3</sup>Ibid., p. 19.

<sup>4</sup>Ibid., p. 17.

Figure 3 - 3  
DETAIL OF SPECIALLY DESIGNED CONE LAYING VEHICLE



Port Authority Personnel, in Specially – Equipped Vehicle, Inserting Plastic Traffic Posts Into Pavement Holes. The Vehicle was Designed by the Authority's Central Automotive Division.

SOURCE: Tri-State Transportation Commission, Urban Corridor Demonstration Program, Interim Report Oct. 1970 – March 1971, p. 20.

Figure 3 - 4  
POLICE OFFICER ACTIVATING HINGED, CHANGEABLE BUS LANE GUIDE SIGN



SOURCE: Tri-State Regional Planning Commission, Exclusive Bus Lane, I-495  
Interim Report No. 2, Jan.-Sept., 1971.



with the typical incident lasting about seven minutes."<sup>5</sup> In order to reduce the rate of stoppages, it is the feeling of the operations staff that the bus companies must upgrade their maintenance procedures. It appears that a number of bus companies, as might be expected in this marginal industry, do not have the latest or best-maintained equipment.

A special shuttle bus serves a park-n-ride lot which is located in the area surrounding the Turnpike interchange. This shuttle bus runs from the PATH terminal to the lot and returns (see Figure 3-1).

Before the bus lane was opened, a twenty-five page booklet was prepared which explained every stage of operation, from opening to closing, and explained the rules, regulations, signing, special provisions, and identified other pertinent operating characteristics. This booklet was distributed to all operating personnel so that each of the many agencies with responsibilities for operations would be able to integrate their functional responsibilities around a common set of procedures and terminology.

### SAFETY CONSIDERATIONS

In 1971, four accidents were recorded in conjunction with the bus lanes, two involving minor personal injury. For the first six months of 1971, the Port Authority staff furnished the specific data shown in Table 3-1 on accident incidence.

In 1972, no accidents had been reported in the first six months, although a strike affecting a major carrier had somewhat reduced miles traveled. Port Authority studies indicate that on Port Authority property (the Lincoln Tunnel and the helix approach from Pleasant Avenue) there has been no change in overall accident rates.

Police reports indicate that for the entire I-495 facility overall accident rates dropped as a result of segregating buses on a separate lane. (This has not been quantified).

### COSTS

#### (1) User Costs

There are approximately twenty-five bus companies using the exclusive lane as a means of access to the Lincoln Tunnel and mid-Manhattan. There is no evidence that any of these operators are charging different fares as a result of providing service through the exclusive lane facility.

#### (2) Implementation Costs

The initial work on this project was funded under a \$500,000 Urban Corridor Demonstration Grant. Additional funds and staff support in lieu of cash were contributed by the local participating agencies.<sup>6</sup> The major capital ex-

---

<sup>5</sup>Leon Goodman, P.E. and Carl S. Selinger, The Exclusive Bus Lane on the New Jersey Approach to the Lincoln Tunnel, 51st Annual Meeting of the Highway Research Board, Washington, D.C., January 19, 1972, p. 7.

<sup>6</sup>These were: Port of New York Authority, New Jersey Department of Transportation, New Jersey Turnpike Authority, and Tri-State Regional Planning Commission.

TABLE 3-1: Exclusive Bus Lane Facility Accidents on New Jersey I-495

The following summary shows accidents in the period January 1-June 30, 1971 compared to the average of the same period in the two previous years for the facility locations.

<u>In New Jersey</u>	Actual Accidents 6 Months <u>Before and After</u>
. Eastbound Approach (Pleasant Ave. to Booths)	15 to 12
. Westbound Departure (Booths to Pleasant Ave.)	2 to 7*
. Plaza (Booths to Center and South Tube Portals)	12 to 9
 <u>In New Jersey - New York</u>	
. Center Tube (Portal to Portal)	0 to 1
. South Tube (Portal to Portal)	4 to 6
 <u>In New York</u>	
. Dyer Plaza	6 to 4
Total Accidents on Facility Property	40 to 39
Total Bus Accidents on Facility Property	10 to 10

XBL ACCIDENTS - PORT AUTHORITY PROPERTY

Of the 10 bus accidents on facility property, only 1 involved a bus in the XBL. This was on 3/1/71 and involved a tractor trailer (driver unknown) sideswipe; damaging the bus side view mirror only.

XBL ACCIDENTS - OFF P.A. PROPERTY

No bus accidents were reported off facility property in the XBL in the last 3 months. In the first 3 months of operation, 2 accidents were reported:

- . 3/10/71 Bus-tractor sideswipe at Ramp C (Rt. 3, Northbound entrance ramp). The driver and one passenger suffered minor injuries. The bus had extensive front end damage.
- . 3/30/71 Bus-car sideswipe at Ramp C. No personal injuries and minor property damage occurred. Bus out of control for short period after impact, crossed opposing lanes and stopped in grass.

Recommendations to improve the traffic control signing in this area were implemented by the New Jersey Turnpike Authority.

\*Toll booths are in the process of being removed - new signing and pavement markings will be installed which should improve the safety of this area.

---

SOURCE: Tri-State Transportation Commission, Interstate 495-Exclusive Bus Lane, Interim Report No. 2, January-September, 1971.

pense items associated with implementation of this bus lane are not adequately itemized such that a detailed price list can be prepared for each improvement. However, some major components of the costs associated with implementation are listed as follows:

- . The exclusive lane access road, leading from the normal eastbound roadways to the westbound lane, cost \$134,000.
- . Development and design of an operating and traffic control plan was costed out at \$60,325.
- . The actual implementation stage which involved fabrication, purchases, installation, and public information, as well as training, cost \$342,317. An additional \$10,000 was spent for the special post-laying truck.

Apparently there were additional costs, but these are not available in a single accounting.

In addition to the above costs associated with the Phase I operating plan for the New Jersey exclusive bus lane facility, estimates are also available on costs for the development of more advanced and permanent traffic control and operational facilities. These are:

- . Sign bridges which will span six lanes and provide overhead support for electronic signals cost an average of \$30,000 each.
- . Signs which allow the speed limit to be changed by remote signal cost about \$7,000 each.
- . Communications and television equipment which would be used to monitor the exclusive lane facility is estimated to cost \$818,000.
- . Signs with simple remotely switchable indications of whether the bus lane is open or not (Type A signs) cost about \$8,000 each. Type B signs with several message options cost about \$12,000 apiece. Type C signs, which also provide message options, cost about \$11,000 each. Type A, B, and C signs are illustrated in Figure 3-5.
- . An automatic gate which can be electronically controlled to open or close access to the facility, replacing the manually activated gate currently used, would cost about \$13,200.

### (3) Operating Costs

The initial operation of the I-495 expressway cost \$176,000 during 1971. This cost includes wages of five new full-time crew members. Because of the peculiarities associated with shifts, it was not possible to utilize existing roadway crews. Regular shifts run from twelve midnight to eight in the morning; therefore, the hours of operation of the exclusive lane facility span two shifts. The duties of the men that were employed to assist in the operation of the exclusive bus lane facility are as follows:



- . One man posted at the entrance to the Lincoln Tunnel.
- . One man posted at the entrance to the bus lane facility at the western-most end of I-495.
- . One man who continuously patrols the exclusive lane facility in the patrol car.
- . Two men in the post-laying truck plus driver. The men who operate the post-laying truck also operate a tow vehicle.

These men have overlapping duties during the course of the exclusive bus lane operation hours.

For the permanent Phase II operation of the exclusive bus lane, with extensive electronic and remote controlled equipment, changes in operating costs are expected. For example, it is thought that it would be possible to eliminate several of the guards. Estimates have been prepared on the operation of the remote equipment. These include \$286 a month for TV equipment cable leasing and \$150 a month for leasing a roof-top for the antenna. Further breakdowns were not available.

## RESULTS

### (1) Speed or Time

Initial publicity and planning tended to over-exaggerate the time advantage attributable to the bus lane. For example, an article in one newspaper published the day bus lane operations began said, "Six buses loaded with officials made the 2.5 mile run yesterday with police escort and took the usual twenty-five minute trip in seven minutes."<sup>7</sup> After a full year of operation the estimate of time saving has been substantially refined. Results from a ground observation survey indicate that the exclusive bus lane saved the average bus 7.75 minutes during the morning peak. This data was obtained from the point where the bus approached the vicinity of the exclusive bus lane to the Lincoln Tunnel plaza. "During the 8:15-9:15 AM hour of peak congestion, the bus lane saved each bus an average of more than ten minutes of travel time."<sup>8</sup> Greater time savings were recorded on a regular basis when exceptional traffic congestion or other delays were incurred on the normal eastbound traffic lanes. Because of the congested nature of this roadway, these stoppages and delays can be expected at a rather frequent rate.

Average bus travel time savings are slightly deceptive since some buses have to double back to use the special access road from their normal approach. However, it is reported that all vehicles had a net time advantage by virtue of the use of the exclusive bus lane.

---

<sup>7</sup> Interim Report, October 1970-March 1971, Op. Cit., p. 42.

<sup>8</sup> Goodman and Selinger, Op. Cit., p. 11.

Total time for door-to-door travel apparently is favorably affected by the exclusive bus lane, according to an attitude survey performed by the project staff. Fifteen selected riders were checked. "Eight showed a tendency to leave home later, while seven others either left home the same time or slightly earlier. For those who did leave later, they were apparently satisfied that the reliability and time saving of the buses using the exclusive bus lane allows a four to ten minute later start from their homes. Those leaving home at the same or slightly earlier times, perhaps constrained by limited bus schedules, also benefited from the exclusive bus lane in that they arrived consistently earlier at the bus terminal."<sup>9</sup>

In the wider ridership attitude survey, patron groups indicated that they saved between ten and nineteen minutes by virtue of the exclusive bus lane. Some exaggeration and distortion of actual time savings may be expected in such surveys. However, thirty-eight percent of the riders surveyed said that they could leave home later now that they were traveling on a bus utilizing the exclusive bus lane.

Savings were also reported for eastbound motorists not using the exclusive bus lane. Careful analysis revealed that this savings is primarily due to the removal of queues around entrance ramps leading to I-495. For example, the Route 3 - New Jersey Turnpike interchange which had recorded ramp speeds of five to ten m.p.h. and heavy congestion had improved to a thirty to forty m.p.h. free flow condition. From Route 3 proper, speeds had increased from four m.p.h. to forty m.p.h. The New Jersey Turnpike ramps themselves had increases in speed from ten m.p.h. to thirty m.p.h. The North Bergen Viaduct entrance had increased from ten to twenty m.p.h.

These improvements affected the first mile of I-495. From Kennedy Boulevard east, backups still occurred. Nonetheless, seventy-five percent of eastbound motorists surveyed said that they saved time by virtue of having the buses operating on their own exclusive lane. Apparently, the facility has generated sufficient capacity to reduce queues but not to eliminate them entirely.

Interestingly enough, one-third of the westbound motorists surveyed also said that they saved time, while nineteen percent of these same drivers actually experienced longer travel times.

In the overall analysis of travel time savings, the project staff concluded that no time savings could be attributed to any other portion of the trip except that which was taken on the exclusive bus lane facility.

## (2) Volume

Perhaps the most impressive of conclusions drawn from this demonstration are those related to the capacity potential revealed by the operation of this exclusive bus lane. Daily peak period volume was in excess of 700 buses. For the peak hour, 400 plus buses were recorded using the lane. In certain peak five minute periods, between sixty-two and sixty-eight buses were reported. This rate of flow projects to an hourly volume of between 745 and 817 buses. Some studies have shown that with platooning there may be even greater capability than 800 vehicles per hour (see Volume discussion, Chapter 5).

As can be seen in Table 6-1, tremendous numbers of people can be carried using a system of exclusive bus lanes. Projections of the five minute period of observed maximum frequency of buses on I-495 (sixty-eight), based on the

---

<sup>9</sup>Interim Report No. 2, January-September 1971, Op. Cit., p. 17.

actual peak hour passengers-per-vehicle occupancy rate (44.1) indicates that it is reasonable to expect that 35,985.6 passengers per hour could be accommodated on the exclusive bus lane. Perhaps even more buses could use this facility without severely degrading speeds, but there has been no opportunity to observe larger numbers of vehicles in operation.

The improvement in overall eastbound traffic capacity is particularly worthy of note. Vehicle flow improved forty percent from 3,287 vehicles in three lanes to 4,529 vehicles in four lanes. The additional space released by removing buses from the normal eastbound traffic lane was filled up with trucks and automobiles. Specifically, before the bus lane went into operation, 2,324 eastbound autos were recorded on the facility, while afterwards 3,227 autos were able to use the facility during the same time period. Trucks able to use the eastbound lanes increased from 248 to 494 during a comparative time period, thus showing an improvement of almost 100 percent.

The improvement in eastbound traffic can be attributed largely to the removal of awkward and space-consuming buses from the normal traffic stream and the general decrease in travel time for vehicles using the three eastbound lanes. The benefit associated with the removal of the buses from the normal eastbound lanes is greater than would be expected from the normal addition of one or more lanes of traffic. Thus, at least in this case the total vehicular traffic flow appears to have improved more by virtue of adding an exclusive bus lane than it would by simply adding an additional lane for the general use of mixed traffic.

### (3) Mode Choice Behavior

Manhattan-bound travelers in the New York metropolitan area are heavily dependent upon transit for access during the peak periods. Thus, the potential for mode switching is less than it might be in other major metropolitan areas. However, some interesting results were noted in the first year of operation of the I-495 exclusive bus lane. Of all bus riders, nineteen percent had not used the bus route traveling the exclusive bus lane before. These nineteen percent can be further broken down as follows:

- . 4 percent from car or carpools
- . 3 percent did not travel to Manhattan previously
- . 1.5 percent former rail transit users
- . 1.5 percent former PATH bus transit users
- . 7 percent had merely switched bus routes
- . 2 percent had formerly used the bus service to the George Washington Bridge

Of those switching to their current bus route, fifty-nine percent indicated the reason for it was the availability of service on the exclusive bus lane.

It was observed that the majority of the bus companies did report small increased patronage. Conclusive data on improvements in ridership (and revenue), however, is not available.

(4) Other Results

Extensive attitude surveys were performed during the first year of the project. Additional interesting benefits and advantages are revealed by this data:

- . The frequency of trips by bus increased: That proportion of bus patrons traveling four or more times a week by bus increased substantially from: eighty-two percent to ninety-two percent. (Changes in trip frequencies of westbound and eastbound motorists were less significant).
- . Safety and relaxation: Eighty-eight percent of the bus drivers felt more relaxed and seventy-five percent felt safer while driving to Manhattan than before the exclusive bus lane was implemented.<sup>10</sup>
- . Trip reliability and pleasantness: "Practically all bus patrons (ninety-five percent) said they experienced more reliable travel times...some eighty-six percent indicated that their trips were more enjoyable, while fourteen percent said that there was no change."<sup>11</sup>
- . Bus company operations: "Reductions in driver overtime costs were recorded by three-fourths of the bus company managements due to travel time savings. A majority of bus company managers indicated generally improved utilization of the equipment and also that their bus patrons and drivers were more satisfied and cooperative since the lane began operating."<sup>12</sup> As in other projects, these benefits have not been quantified.
- . Westbound speeds: It is reported that there was no substantial negative impact on westbound speeds. Unfortunately the actual speed limit was reduced when the left median lane was closed for the bus lane operation, and therefore, meaningful before-and-after observations were not feasible. However, observation indicates that the range of speeds is thirty to forty-five m.p.h. and higher during the morning peak period. It is concluded that the exclusive bus lane has resulted in westbound speeds that are, at worst, only a minor time inconvenience due to the shortness of the stretch of roadway to which they apply.

---

<sup>10</sup>Ibid., p. 20.

<sup>11</sup>Ibid., p. 20.

<sup>12</sup>Ibid., p. 20



- . Park-n-ride lot utilization: A substantial increase in usage of the Lincoln Tunnel park-n-ride lot occurred during 1971. The growth is 11.1 percent for the first seven months. This increase in park-n-ride lot usage is probably largely attributable to the exclusive bus lane, which has considerably improved operation of the shuttle bus service from the lot to the Port Authority bus terminal.<sup>13</sup>
- . Access for emergency vehicles: One of the less obvious advantages of the exclusive bus lane is that in an emergency, police and fire vehicles along with wreckers and ambulances, can use it to speed to the site of an emergency without the usual congestion delays.
- . Overall reaction: In general all eastbound travelers, including motorists, were extremely favorable toward the implementation and operation of the exclusive lane. "Only a rather small number of westbound motorists, who gained least from the lane, expressed some reservations."<sup>14</sup>

#### INSTITUTIONAL BACKGROUND

Of all the projects surveyed, the I-495 experiment required the most inter-agency coordination and cooperation. For this reason, serious delay was experienced in actually implementing the facility. The initial studies on the exclusive bus lane were authorized in 1963. In December of that year, the Port Authority prepared a report evaluating several bus lane schemes and recommended essentially the plan that was implemented. In 1964 and 1965 field tests were held to test out the impact on traffic and safety.

"Based on the significant success of the field test, a January, 1967 report outlined and strongly recommended the exclusive busway plan."<sup>15</sup> The plan itself was not immediately implemented. According to sources associated with the development of the system, the primary reason for delay between 1967 and 1970 was that some key staff members of the New Jersey Department of Transportation were still skeptical of the safety of such an operation. Also at that time financing the operating and implementation of the lane had not been secured.

"In early 1970, John Kohl was appointed Commissioner of the New Jersey Department of Transportation; he determined that, based on a July, 1970 report by his division of research and evaluation, the exclusive bus lane should be implemented as soon as practical."<sup>16</sup> Subsequent to that decision, Federal funding and the authorization to go ahead was obtained.

Four principal agencies were involved in planning, implementing and now are operating the exclusive bus lane facility:

---

<sup>13</sup>Ibid., p. 14.

<sup>14</sup>Ibid., p. 19.

<sup>15</sup>Interim Report, October 1970-March 1971, Op. Cit., p. 6.

<sup>16</sup>Ibid., p. 7.

- . The Port of New York Authority
- . Tri-State Transportation Commission (now Tri-State Regional Planning Commission)
- . New Jersey Department of Transportation
- . New Jersey Turnpike Authority

As a result, peculiar patterns of responsibility emerged. Tri-State received the grant from the U.S. Department of Transportation for general administration of the project. Tri-State, in turn, delegated the day-to-day planning and operation of the exclusive bus lane to the Port of New York Authority. The New Jersey Department of Transportation, in turn, reimbursed the Port Authority for two-thirds of the actual cost of operation. The New Jersey Turnpike Authority built the access road and maintained the roadway within its jurisdiction.

The police and/or maintenance personnel associated with the day-to-day operation of the facility are employees of the Port of New York Authority. The Port Authority staff also conducts the surveys, and performs other analytical functions.

The project was supervised by a project technical committee, composed of key technical personnel from the participating agencies. This technical committee established operating procedures, regulations, and safety rules.

A project policy committee, composed of top level agency representatives, reviewed and supervised the technical committee. Their function included contract negotiation, reviewing and passing on the technical committee's operating recommendations, and review of materials submitted to Tri-State and the U.S. Department of Transportation.

Several police units in addition to the Port Authority police are involved in policing the facility. The Hudson County Police Department is responsible for New Jersey Department of Transportation roadways. The New Jersey State Police, Troop D, are responsible for turnpike roadway policing.

#### PUBLICITY AND PUBLIC RELATIONS

An extensive public information program was carried out prior to the initiation of the exclusive bus lane. News releases were issued at periodic intervals following funding. Coverage by the news media was excellent and a preview of bus lane operations for the press and public officials was conducted on the day prior to opening.

Special handouts were distributed to motorists, bus drivers, and bus passengers as detailed below:

- . Motorists: At toll plazas and the tunnel entrance, two weeks prior to the opening (scheduled for December 18, 1970), motorists were given a general handout describing the bus lane operation. A few days in advance of the actual opening of the facility, motorists at the same points were given specific operating details on the bus lane and instructions on how to use the other lanes during the time of bus lane operations. This last-minute handout included pictures of what the motorists would encounter both east and westbound.

- . Bus Drivers: A special effort was made to inform bus operators of the rules and regulations of the exclusive bus lane. Individual drivers were given handouts specifying the rules, explaining signs and signals, and including a map. In addition, a large map illustrating the approaches and the facility itself was posted in each bus garage.
- . Bus Passengers: Bus passengers were generally alerted to the impending operation of the bus lane through normal media publicity. In addition, an issue of "Terminal Topics" (published by PATH) was devoted exclusively to explaining the bus lane and its operation. This issue was distributed the day before the opening of the bus lane.

#### PUBLIC RESPONSE

The public response to the exclusive bus lane facility has been very favorable. It was reported that some bus passengers actually applauded as they pulled into the terminal on their first days. As noted earlier, seventy-five percent of the eastbound motorists using normal lanes said that they achieved a substantial time advantage over former operating plans. One-third of the westbound travelers said they saved time against only nineteen percent of westbound travelers reporting their trip took longer (in the latter case this may reflect irritation at removal of a lane - no actual travel time studies have been made and these responses are purely subjective).

#### FUTURE POSSIBILITIES

While specifics were not revealed, it appeared that there is additional unused capacity which might be effectively utilized by buses on exclusive lanes in the New York metropolitan area. In some cases, these may have more potential carrying capacity and speed advantage than more costly capital alternatives, including both highways and fixed rail facilities. Thus, it would seem that in this city, as noted in others, a more effective utilization of existing capital investment could be obtained through additional exclusive busway facilities.

CASE STUDY 2: LONG ISLAND EXPRESSWAY CONTRAFLOW BUS LANE  
(QUEENS, LONG ISLAND, NEW YORK CITY)

DESCRIPTION

The Long Island Expressway exclusive bus lane consists of 2.2 miles of a normally outbound lane reversed for use by Manhattan-bound buses in the morning peak: It operates from just east of the Brooklyn Queens expressway interchange with the Long Island Expressway, to the eastern entrance of the Queens-Midtown Tunnel. The Queens-Midtown Tunnel is a main thoroughfare from Queens and eastern Long Island into Manhattan. The Long Island Expressway itself is primarily a six lane, east-west freeway. At the entrance to the tunnel, the Long Island Expressway spreads out into twelve feeder lanes to twelve toll booths. In the AM peak period, all but three of these toll lanes are used for peak period directional flow. The tunnel itself carries four lanes of traffic, with one lane reversed to handle extra peak hour demand. The bus lane facility operates only in the AM peak, from 7:00 AM until 9:00 AM, since the afternoon flow is nearly balanced in both directions.

Buses approach the toll plaza on the exclusive bus lane and at the end of the exclusive lane are waved into the normal stream of traffic by the attending policeman. Unfortunately, buses are prohibited from using the left-hand traffic lane of the tunnel. Therefore, the bus must weave across several lanes of traffic in the plaza in order to get into a toll booth corresponding to a right-hand tube lane. The reason given for the refusal to permit buses to use the left-most tunnel lane (the reversed lane in the AM peak) is that since it faces on-going traffic and is very narrow, the probability of accidents would increase. Questions have been raised as to whether this is a valid concern.

The initial funding for the work carried out under this express lane facility was derived from internal New York City Department of Traffic sources. The city has applied for TOPICS funding to improve and automate the signaling control techniques.

Public and private carriers from all areas are permitted use of the facility. The express bus service is, of course, not the exclusive mass transit service into mid-Manhattan. Subway and other bus lines also serve this corridor. Interestingly enough, fares on the subway and local bus are thirty-five cents while fares on express buses using the exclusive lane facility range between \$1.00 and \$1.15 a trip.

Despite demand, the New York City Department of Traffic is reluctant to grant permission for additional buses to utilize the facility. It is stated that there is inadequate terminal loading and unloading space in Manhattan to accommodate additional buses.

REASON FOR BUSWAY

The chief factor responsible for the institution of the bus lane was the severe congestion experienced each morning at the toll booths for the Queens-Midtown Tunnel. This congestion typically backed up traffic for over a mile. It is interesting to note that the congestion was so severe that experienced express bus drivers were actually using local streets in preference to the Queens-Long Island Expressway approach to the tunnel.

A second factor is the generally-accepted policy in the New York Metropolitan area not to build any more freeway facilities. The possibility of building a dedicated bus lane has been discussed, but at this date no action has been taken.

It also would seem that the success of the I-495 exclusive bus lane on the west side of the metropolitan area was graphic proof of the workability and usefulness of such a concept and served as a stimulus to New York City planners.

#### OPERATIONAL DETAILS

Vehicles approach the bus lane in three westbound traffic lanes. A 140 foot gap in the median rail allows the buses to maneuver into the normally opposing lane next to the median which has been reserved for these express buses. Figure 3-6 shows the actual layout of this facility.

The lane itself is separated from the other two lanes of the eastbound trafficway by traffic posts placed in holes along the dividing line between the median lane and the middle lane. Both free-standing cones and cylindrical posts placed in holes have been used. The cylindrical posts appear to be superior to the free-standing cones since substantially greater stability is experienced when back-drafts from heavy vehicles are generated by traffic, or a bus or car actually brushes against a cone. Some loss of the placed cylinders is attributed to buses striking the posts directly, breaking them off at the base.

At the western terminal of the bus lane, a TBTA policeman holds up the normal three lanes of inbound traffic and permits the bus to merge back into the waiting lines prior to the toll plaza. As already noted, because buses are prohibited from using the far left inbound tunnel lane, they unfortunately must weave across several lanes of traffic to get into the right-hand tube traffic lanes.

Approaches westbound on the Long Island Expressway are well signed to indicate the upcoming bus crossover. Similarly, vehicles eastbound are warned by signs and traffic posts of the loss of the lane (Figure 3-7).

PM operation is somewhat different. Buses return to Queens and Long Island via the 59th Street Bridge. This bridge is a bi-level facility. Originally all buses and trucks were restricted to the lower level since it was thought that the upper level could not handle the extra weight of heavier vehicles. Then in 1971, express buses were permitted to utilize the upper deck on the return trip from mid-Manhattan to Queens and Long Island. These are essentially the same express bus routes that use the exclusive bus lane inbound during the AM peak. It is the opinion of project officials that opening up this facility provided the additional capacity needed to achieve good rates of speed in the evening. Again, once the bridge and Manhattan bottlenecks have been cleared, the so-called reverse funnel effect takes place. That is, substantial capacity exists once these bottlenecks are cleared, so that high average operating speeds are realized. There is some question as to whether buses will be allowed to continue to utilize the upper deck of the 59th Street Bridge.

At this time all signs and other facilities are manually operated. In the morning starting at about 5:30, a standard highway maintenance truck with

Figure 3 - 6  
SCHEMATIC MAP OF LONG ISLAND EXPRESSWAY FACILITY

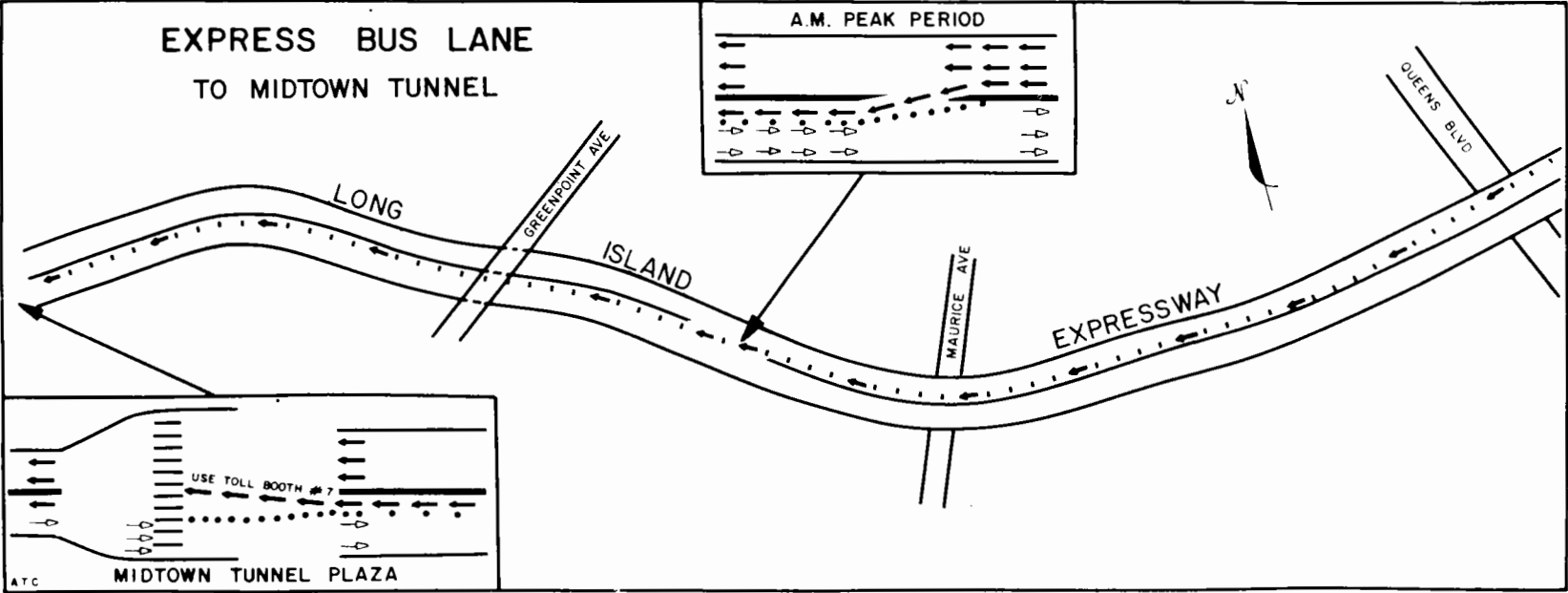

SOURCE: New York City Department of Transportation

**Figure 3 - 7**  
**LONG ISLAND EXPRESSWAY MANUALLY CHANGEABLE CONTROL SIGNS**

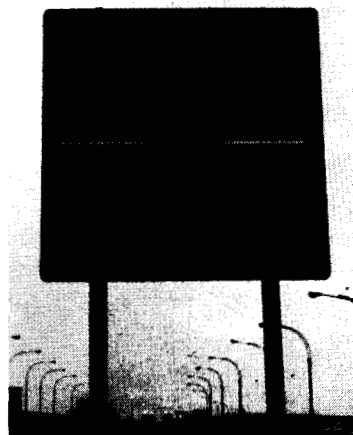
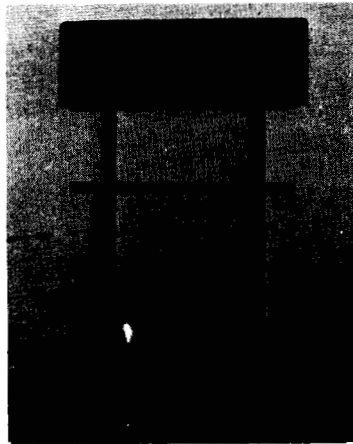
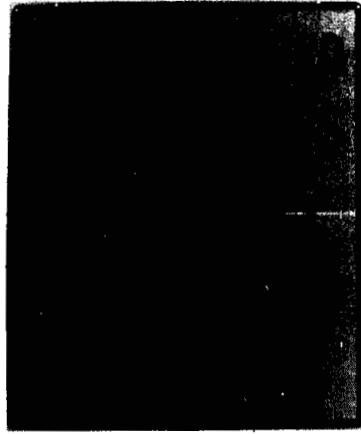
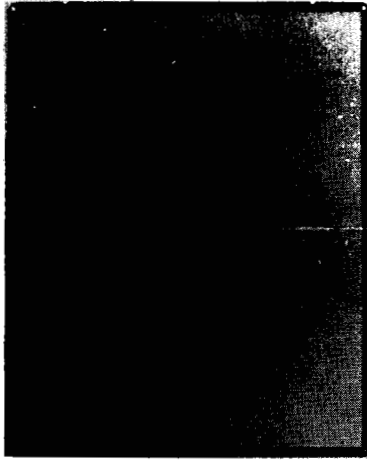

SOURCE: New York City Department of Transportation

a hydraulic lift gate proceeds along and drops the traffic posts into the holes. Three men are involved: one drops the posts, one man is in the truck feeding the dropper, and one man drives the truck.

In the original plan of operation, two men plus a foreman constituted a crew. Two back-up crews were on duty at all times. One of the crews laid the traffic posts, while the other crews handled the signs. At first there were some difficulties in scheduling these crews since the shifts ran from 12:00 to 8:00 and 8:00 to 4:00. This necessitated assigning different crews to the morning duties of placing the posts and putting the signs into position, while a new crew had the responsibility of restoring the roadway to its normal operating condition after 9:30 AM. Negotiations with the representative union resulted in permission for one crew to handle the entire job.

As in the case of I-495, the project officials would like to improve the efficiency of the operation. This would involve automating the signing and control devices and purchasing a special truck for placing the cylindrical posts into the roadway holes.

To date, there has been little or no need to actively enforce the prohibition against any vehicle except buses utilizing the facility. However, the buses have required some policing. Speeds of fifty and fifty-five m.p.h. have been recorded on the exclusive lane facility. The posted limit is thirty-five m.p.h. Vehicles were instructed to operate with the headlights on; unfortunately, this regulation is not well observed.

A complete set of instructions for bus drivers and operators were passed out prior to the beginning of operations. These are reproduced in Figure 3-8.

To date, no stoppages have been recorded due to bus breakdowns. In the event of such stoppages, the lane would be sealed off at the initial merge point. A tow truck is kept on duty.

It is interesting to note that prior to the establishment of the Long Island Expressway exclusive bus lane, few buses utilized the facility. Experienced bus drivers were able to make better time and preferred the use of local streets in their approach to the Queens-Midtown Tunnel. Recorded volumes of vehicles on the Long Island Expressway before establishment of the bus lane were about forty vehicles in the AM peak. Currently about 170 busses are using the facility in the AM peak.

#### SAFETY CONSIDERATIONS

To date there has been no accident involving the exclusive bus lane facility. The facility has been in operation since October 1971. While this is not a very long time to observe the operation, the volumes of vehicles using both the bus lane and the adjacent regular traffic lanes are such that had serious safety deficiencies existed, accidents would have materialized by now. Table 5-8 compares the accident record with mixed roadway experience and other busways.

Contributing to the general safety of the operation, undoubtedly, is the simplicity of the facility itself. Unlike other facilities, there are no entrance ramps involved. Buses proceed along essentially a no-access lane, and opposing traffic similarly operates on a straightaway. Roadway operating under free-flow conditions exists prior to the point of divergence at the eastern end of the facility. This allows buses weaving from the right-hand to the left-hand or median lane in their approach to the point of divergence to do so with little risk.



Figure 3 - 8

LONG ISLAND EXPRESSWAY OPERATOR INSTRUCTIONS

Announcing!

AN EXCLUSIVE LANE FOR BUSES  
ON THE LONG ISLAND EXPRESSWAY  
APPROACH TO THE MIDTOWN TUNNEL

One of the three lightly-used, eastbound traffic lanes of the LIE will shortly be converted to a two-mile, exclusive, westbound bus lane during the morning rush hours.

Where:

Signs notifying authorized buses to move left will start at a point west of Woodhaven Boulevard.

The entry point to the exclusive bus lane -- in the vicinity of the LIE-BQE interchange -- will be indicated by this sign .....



When:

Weekday Mornings -- 7 AM to 9:30 AM

Why:

To provide four lanes for Manhattan-bound traffic -- reduce congestion -- give you a quicker, more agreeable trip.

For Your Driving Safety

These operating rules must be observed

1. Headlights On.
2. Speed Limit - 35 MPH.
3. Maintain at least 200 foot spacing.
4. No Passing ...  
Stay in bus lane ...  
Don't pass disabled vehicles ...  
Tow truck will respond immediately.
5. If traffic cone appears in your lane, drive over it.

The most modern traffic control devices are being used to assure safe and efficient bus lane operation. For the ultimate success of the project, however, we ask your cooperation.

If you have any problem, questions or comments please talk to your dispatcher without delay.

Transportation Administration  
N.Y.C. Traffic Department

SOURCE: New York City Department of Transportation

At the western end of the facility, traffic is usually backed up waiting to pay tolls before entering the Queens-Midtown Tunnel. With a policeman to let buses in and out, and traffic at a crawl, it is easy to accomplish the remerge to normal traffic lanes with a minimum of incidents.

## COSTS

### (1) User Costs

The charges levied for express bus service between Queens and Long Island into downtown Manhattan are substantially greater than for similar trips by local bus service or subway. On private carriers the express bus fee is \$1.25 per trip. On public express buses the fare is \$1.00 per one-way trip. Subway and local bus fares are 35¢. Patrons seem more than willing to pay the cost since they are guaranteed a seat and generally have a reasonably comfortable trip into mid-town Manhattan. There does not appear to be any shortage of demand for this service. This is the only instance observed where user charges were substantially higher as compared to competing transit service. Given the high cost of parking in Manhattan (minimum all-day charges are now \$3.00) and the tunnel toll of 50¢ each way, the service is still less expensive than driving for many commuters.

### (2) Implementation Costs

The initial cost associated with construction and operation of the bus lane was minimal. Table 3-2 shows the breakdown of these costs which in the aggregate amounted to \$29,100. Later on \$13,000 was spent to drill holes in the roadway for the cylindrical traffic posts. The traffic posts cost about \$8.00 each.

### (3) Operating Costs

Table 3-3 shows the breakdown of daily operating costs. These are apparently estimates based on the cost associated with use of in-house personnel. They total about \$500 per day. All costs for the installation and operation of the facility are borne by the New York Department of Transportation.

## RESULTS

### (1) Speed or Time

Precise studies of travel times are not yet available. Under the generally heavy congestion which previously prevailed during the morning peak, average speeds of five m.p.h. were not atypical. Buses moving in the exclusive lane recorded average speeds between thirty and forty m.p.h. despite the thirty-five m.p.h. limit. This speed advantage is estimated to save bus passengers fifteen minutes of travel time each morning.

If this reported time savings is representative, it illustrates the significance of bypassing a key bottleneck on a relatively short facility and suggests that major time savings are possible from very minor changes. This is significant when decisions on the withdrawal of highway lanes from normal use are being considered.

TABLE 3-2: Implementation Costs for Exclusive Bus Lane on Long Island Expressway

1.	<u>INITIAL COST</u>		
	<u>Department of Highways</u>		
	a) Box Beam Barrier Removal		\$16,000
	b) Barricade Fabrication		600
	<u>Department of Traffic</u>		
	a) Fabrication and Installation of Signs		3,500
	b) Planning and Engineering		5,000
	c) Surveys and Evaluation (5 days)		2,000
	d) Cones		2,000
		SUBTOTAL	<u>\$29,100</u>
11.	<u>SUBSEQUENT COSTS</u>		
	a) Traffic posts to replace free-standing cones		2,000
	b) Drill holes for traffic posts		13,000
		SUBTOTAL	<u>15,000</u>
		TOTAL	<u>\$44,100</u>

---

SOURCE: The City of New York, Department of Transportation

---

TABLE 3-3: Estimated Daily Operating Costs on Long Island Expressway

<u>OPERATING COSTS (per day)</u>			
a)	Personnel - 7 TDMS - One foreman		
	1 Senior foreman		\$300
b)	Equipment - 3 Trucks		
	2 Suburbans		200
		TOTAL	<u>\$500/day</u>

---

SOURCE: The City of New York, Department of Transportation

(2) Volume

A maximum volume of 102 buses has been recorded in the peak hour. Table 3-4 shows daily variations.

From the available data it would appear that the limiting factor on volume is not the bus lane facility itself, as it can apparently absorb many hundreds of buses more per hour (see Volume discussion, Chapter 5). N.Y.C. Department of Transportation officials feel the number of buses which can be accommodated on Manhattan streets, where loading and unloading space is needed curbside, is the effective limit on the number of buses entering Manhattan. Pending some resolution of this terminal problem, the city apparently will grant no additional permission to use the bus lane facility.

(3) Other Results

There is no data at this point to indicate the degree of mode switching taking place. It appears that increases in ridership are occurring, but whether this may be attributable to switching from other transit modes (as suspected) or from auto is not determinable. Increases in ridership were noted long before the bus lane was implemented and are traceable to the advantages of the express bus service itself.

No data is available to clearly indicate that bus operators were able to realize operating efficiencies as a result of being able to utilize the exclusive lane facility. In a few cases it is reported that buses were able to make more trips during the peak periods due to higher operational speeds. This was not documented. Undoubtedly, there are also other savings of a marginal nature, but these have not been documented either.

There is little or no social impact from the project, as it serves largely middle and upper income Queens-Long Island residential areas. The environmental impacts are minimal if any.

INSTITUTIONAL BACKGROUND

A sole agency controls operation of the highway facilities in New York City. This agency is the New York City Department of Transportation. Within this agency, the Department of Traffic is responsible for managing actual traffic operation on the city's street system. Once a decision was made to establish a busway, component agencies of the Department of Transportation were able to implement the decision entirely "in-house". No additional approvals were necessary, no additional agencies were involved, and no multiple jurisdictional problems resulted.

Another department within the Department of Transportation is responsible for the physical maintenance of the streets. This agency, the Department of Highways, is in charge of the day-to-day maintenance and operation of the bus lane facility (attending to signs and posts).

The Tri-Borough Bridge and Tunnel Authority operates the Queens-Midtown Tunnel. Cooperation of the TBTA was sought so as to improve operation of the bus lane at the tunnel end. This was not completely successful insofar as obtaining the desired tunnel routing was concerned. Ideally, the buses might have used the far-left inbound traffic lane through the Queens-Midtown Tunnel. In the AM peak this is a normally eastbound lane which has been reversed to handle the heavier traffic. The TBTA was reluctant to permit large buses to travel through the tunnel while other traffic was coming through in the normal

TABLE 3-4

LONG ISLAND EXPRESSWAY  
EXCLUSIVE BUS LANE .

Number of Buses Using Lane  
(Five Days Over Period November 22 - Dec. 7, 1971)

Time (AM)	Mon. 11/22	Tues. 11/23	Wed. 11/24	Fri. 11/26	Tues. 12/7
7:15-7:30	3	9	8	11	5
30-7:45	12	19	19	22	16
45-8:00	10	19	15	25	10
8:00-8:15	34	32	41	29	32
15- 30	25	30	31	23	28
30- 45	missed	16	16	10	25
45-9:00	12	16	13	10	18
9:00-9:15	9	10	7		9
15- 30	12	8	14		12
30- 45	6	12	6		8
45-10:00	8	9	5		9
10:00-10:15					
TOTAL	<u>131</u>	<u>180</u>	<u>176</u>	<u>130</u>	<u>172</u>
Lane Opened	7:15	7:15	7:15	7:15	7:15
Lane Closed	9:45	10:00	10:15	9:00	10:00
Weather	C&C	C&C	C&C	C&C	Cloudy

C&amp;C=Clear &amp; Cold

New York City  
Department of Traffic  
1/13/72

---

SOURCE: Wilbur Smith & Associates, Interim Report The National Cooperative Highway Research Program, Planning and Design Guidelines for Efficient Bus Utilization of Highway Facilities, March, 1972, p.B-104.

eastbound direction in the opposite lane. The TBTA did assign a policeman to assist in merging buses into the right-hand toll booth lanes.

The operators of the transit service in the area were simply told that the facility was available. The time savings realized was ample incentive to insure that these companies would fully utilize the facility.

#### PUBLICITY AND PUBLIC RELATIONS

The press release to the mass media was the principal medium of communication to the general public concerning the restrictions on lane use. Significantly, New York officials did not feel it was necessary to pass out informational brochures to motorists in advance.

Bus drivers were given informational brochures which explained the operation of the facility and operator regulations. These are reproduced in Figure 3-8.

The costs associated with this public relations campaign were very low. Costs for preparation of all handouts, publicity, and related materials were borne exclusively by the New York City Transportation Department. Substantial free publicity provided by the newspaper articles assisted in holding down public cost of information dissemination. Despite this media campaign, however, it was not felt that a very large number of affected motorists were aware in advance of exclusive bus lane plans. However, whatever the level of incompleteness of public information, there was little or no indication that the effective operation of this facility was hindered as a result.

#### PUBLIC RESPONSE

Public response has been favorable. The usual newspaper publicity was provided; news stories covering the opening and first few days of operation reported substantial enthusiastic response by patrons. To date, negative response from motorists penalized by the removal of one lane in the eastbound direction has been minor.

#### FUTURE POSSIBILITIES

In discussions with Department of Transportation officials in New York City, it was learned that additional possibilities for bus lanes and busways do exist within the city. Conditions may not be as optimal or as ideal as those surrounding the Queens-Midtown Manhattan Tunnel situation, but these officials viewed busways as one answer to continued demand for better commuter facilities. Although there are no plans in the immediate future for establishment of additional bus lanes, these officials did indicate that several sites did seem promising and were being considered.

CASE STUDY 3: CONTRA FLOW LANE ON SOUTHEAST EXPRESSWAY  
(BOSTON METROPOLITAN AREA)

DESCRIPTION

The Massachusetts Department of Public Works has instituted an 8.4 mile long exclusive bus lane on the Southeast Expressway serving the Boston metropolitan area. The actual facility is a lane normally used by southbound (outbound) motorists, which is now reversed for use by public transportation buses during the AM peak. The facility starts just north of Braintree, Massachusetts where Route 128, the circumferential highway, intersects with the Southeast Expressway. The facility merges back into the regular inbound lanes just south of East Berkley Street at the edge of the Boston CBD (see Figure 3-9). Buses then weave through three inbound traffic lanes in order to use normal exit ramps as they proceed to their usual collection and distribution destinations.

The inaugural service began on May 24, 1971 and was terminated in October of 1971. Service was terminated in order to avoid placing and retrieving traffic cones in winter darkness. (The maintenance personnel in the Department of Public Works who actually set out and retrieved the cones felt their safety was jeopardized.) Service was reinitiated on April 10, 1972 when daylight hours were longer.

The initial operation in 1971 utilized both an AM and PM lane. In 1972 only the AM reverse lane was reinstalled. The PM service was felt to be unnecessary due to the previously discussed "reverse funnel" effect which causes the mixed traffic to flow fairly fast. Current operation is from 7:00 AM to 9:30 AM.

In the mornings vehicles pile up waiting to use limited exit facilities and congested downtown distribution and circulation streets. Buses using the exclusive bus lane circumvent the queues, avoiding the delay caused by too many vehicles trying to use inadequate CBD capacity. In the evening once the vehicles have cleared the low capacity streets and entry ramps onto the freeways, traffic is essentially free flowing.

REASON FOR BUSWAY

The reverse lane busway was initiated primarily as a response to heavy peak hour congestion on the Southeast Expressway. The freeway was designed for an average daily traffic handling capacity of 65,000 vehicles. Levels as high as 105,000 cars were frequently recorded. Engineers interviewed indicated that the extreme congestion could be relieved only by the building of an additional expressway, the Southwest Expressway, which has been held up pending the Governor's review of all transportation plans for the Boston metropolitan area. An alternative idea was to double-deck the existing Southeast Expressway. Project engineers also indicated that they were thinking in terms of building a dedicated bus lane facility on existing or planned roadways. Indications are, however, that current transportation planning in the Boston metropolitan region will lead to little new expressway building in the future.

**Figure 3 - 9**  
**BOSTON SOUTHEAST EXPRESSWAY AND EXCLUSIVE BUS LANE**

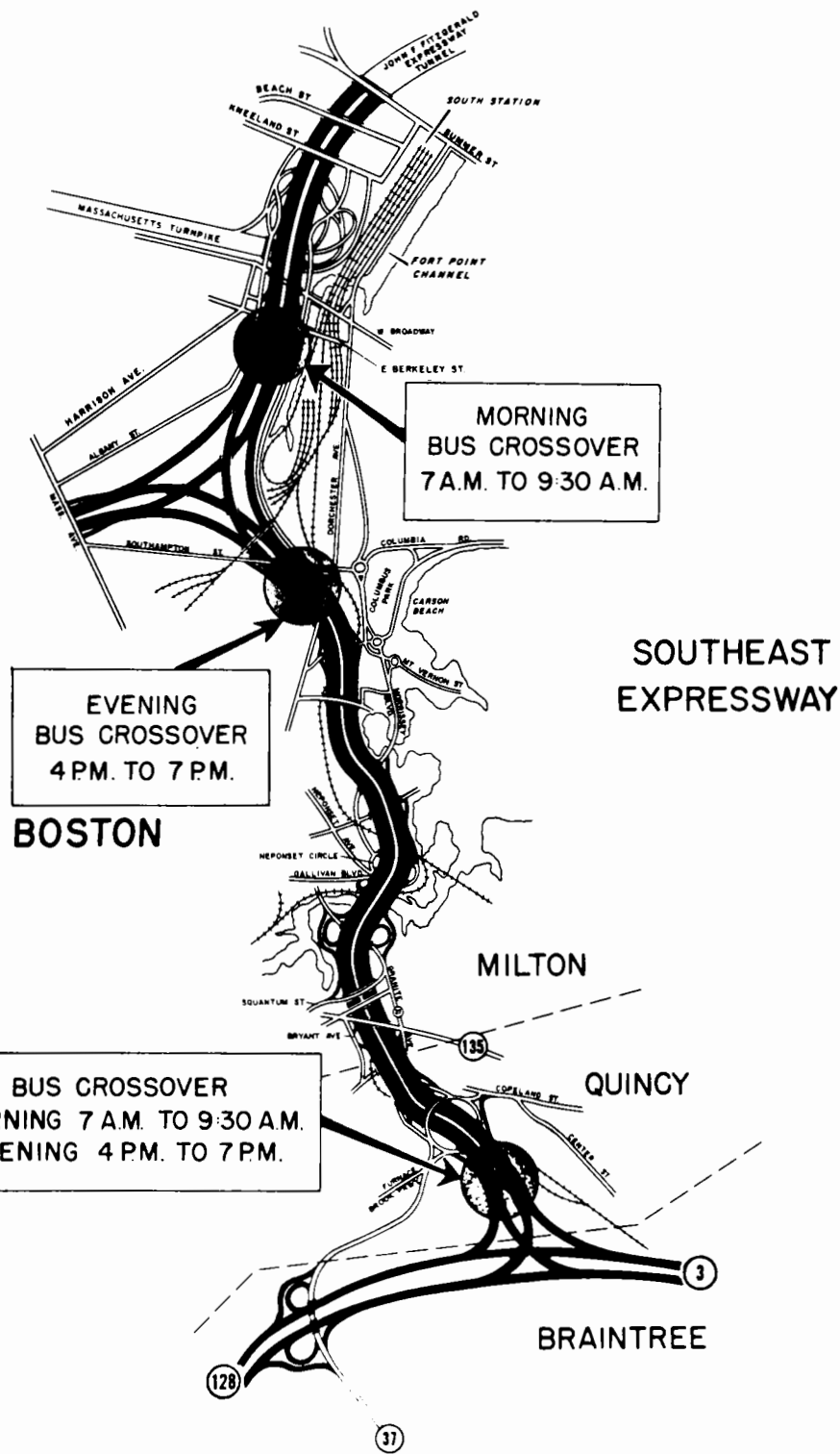

SOURCE: Massachusetts Department of Public Works



## OPERATIONAL DETAILS

The Boston area bus lane is controlled by cones placed at eighty-foot intervals along the entire length of the facility. At both ends of the bus lane facility, sections of the fixed metal guard rail in the median have been removed.

Originally cones were placed at forty foot intervals, but it was decided that this was unnecessary. The cones are heavy duty, free-standing units, twenty-eight inches high and weighing nine pounds. They were designed to withstand sixty m.p.h. winds. In actual practice these cones have had a thirty-five percent knockdown rate. This was felt to be due to back-drafts of passing heavy trucks. Some relief was obtained by cutting off the top twelve inches of each cone. It is still observed that numerous cones are knocked down during the course of a morning's operation.

The cones are placed in position by two trucks. In the early morning the trucks start at the south end and the mid-point of the lane and each truck covers approximately one half of the 8.4 miles. The pick-up operation is slightly different. The two trucks follow each other from the south or beginning point of the bus lane all the way to the terminal point. Each truck picks up cones but the lead truck picks up every other cone with the following truck picking up the in-between cone. This technique allows the vehicles to maintain a reasonably rapid pace.

Trucks used in the cone placing and retrieving operation are essentially standard canvas-covered, heavy duty highway trucks with hydraulic gates. A man sits on the gate to pick up or place a cone into position and another man is in the body of the truck to organize the cones.

At the CBD end, flashing arrow signs have been placed to warn approaching outbound traffic that the median lane has been closed to normal traffic. At each overpass a standard overhead traffic sign has been placed over the actual lane warning oncoming traffic that the cone-separated lane is in use by buses from 7:00 AM to 9:30 AM (see Figure 3-10).

Occasionally, a policeman is stationed at the merge point at the north end to assist buses in negotiating the return to the main stream of traffic. The policeman observed during the field study visit was not actively involved in any assistance to the buses. A wrecker is on duty at all times during the bus lane operation and this vehicle is financed by the four bus companies now using the bus lane. In case of a bus breakdown, a procedure has been established whereby all the passengers from the inoperable vehicle immediately board any vehicles following until all these passengers have been absorbed. In the meantime, the wrecker is summoned and proceeds to haul the bus away. The facility is patrolled by both air and ground police so that information on disabled vehicles can be relayed quickly to the wrecker, thus minimizing disruptions.

All bus companies in the State of Massachusetts were notified that permission must be requested in advance for use of the bus lane. Essentially this permission is required so that the Massachusetts Department of Public Works can familiarize operators with the bus lane operation and rules. Figure 3-11 reproduces the informational handout used to accomplish this. Operators who have obtained permission to use the facility display a plaque in the bus window.

Figure 3 - 10  
BOSTON SOUTHEAST EXPRESSWAY PERMANENT LANE SIGNS



SOURCE: Massachusetts Department of Public Works

Figure 3 - 11

## BOSTON HANDOUT TO BUS OPERATORS

# Instructions for Bus Lanes

Monday, May 24th, the exclusive bus lane demonstration on the South-east Expressway between Quincy and Boston starts. Northbound it will be effective from 7 to 9:30 A.M. and Southbound from 4 to 7 P.M. Northbound buses cross into the Southbound roadway at an opening just north of 128 junction (opposite HOJO's) and use the Southbound lane next to the median strip, traveling against the traffic. They re-enter the Northbound lane at another cross-over at the old Berkeley St. off-ramp on the Central Artery.

Southbound buses between 4 and 7 P.M. cross into the Northbound roadway at an opening just south of Southampton St., using the lane next to the median strip, traveling against the traffic. Buses will re-enter the Southbound roadway at the cross-over just north of the 128 junction.

There will be constant surveillance at all times by air and ground police to assist in case of problems. Your cooperation is needed for the success of this program.

Heavy duty traffic cones will set off the bus lane from opposing traffic.

Entry to the exclusive bus lane will be indicated by the sign below.



Bus lane will be closed when you see this barrier below at cross-over.



For your driving safety, these operating rules must be strictly observed:

### BUS LANE RULES:

1. KEEP 4-WAY EMERGENCY FLASHERS ON.
2. SPEED LIMIT 45 M.P.H. (Maintain at least 400 ft. spacing).
3. NO PASSING (stay in bus lane - don't pass disabled vehicles; police will respond immediately).
4. IF CONE APPEARS IN LANE, DRIVE OVER IT.
5. AFTER EXITING EXCLUSIVE LANE, operator must stay in extreme left lane, next to median strip. Crossing to right will take place after you gain speed and your coach is parallel with traffic.

If you have any problems, questions or comments, please talk to your dispatcher without delay.

=====*Safety*=====

=====*Safety*=====

=====*Safety*=====

## SAFETY CONSIDERATIONS

As was found in most of the other field study investigations, concern about safety within the highway agency was the primary factor which retarded quick implementation of the reverse bus lane concept.

Actual experience has been very favorable. Only one accident has been reported and that was a sideswiping incident on the PM outbound lane. This happened because of the high speed merge that occurs beyond the point of dense traffic concentration. With the elimination of the PM lane facility, there is much less likelihood of a similar accident occurring.

Policemen were initially stationed at both ends. It soon became obvious that these officials were not necessary to insure smooth diverging and merging.

It should be noted that in bad weather the lane may not be operated if it is felt that this would degrade the general safety of the highway or bus lane.

## COSTS

### (1) User Costs

As in the case of most busways, normal transit fares are charged to riders served by vehicles which utilize the busway.

### (2) Implementation Costs

Implementation costs on the Boston area facility were very low. Table 3-5 shows the itemized breakdown of these costs. The less than \$50,000 total implementation cost figure is consistent with most other busway applications surveyed in the study. It should be noted that the Department of Public Works funded these costs within their normal operating budgets.

### (3) Operating Costs

Operational costs on a daily basis principally involve placing and removing the cones before and after the operation of the facility. Seven men have this responsibility: a driver and two men are assigned to two trucks and a foreman supervises the entire operation. It is also necessary to flip overhead signs and a separate crew has this responsibility. The Massachusetts Department of Public Works estimates these costs at \$542 a day. These cost figures do not include costs for police assistance or the wrecker which is funded directly by the bus companies.

## RESULTS

### (1) Speed or Time

A number of investigations have been made to determine the relative time savings for users of the exclusive bus lane. While these reports are not entirely consistent, there seems to be general agreement on a substantial time saving for that portion of the trip which is undertaken on the bus lane. For example, morning inbound car travel time was generally estimated at twenty-two minutes for travel adjacent to the bus lane. In some of the reports on this project, it is noted that without the exclusive lane the buses

TABLE 3-5: Initial Implementation Costs: Boston Southeast Expressway  
Exclusive Bus Lane

1.	<u>IMPLEMENTATION COSTS</u> (March 29 through May 23)	
	<u>Materials</u>	
	1. Traffic Cones	\$ 4,380.00
	2. Expressway Bus Signs	9,799.65
	3. Materials for Crossovers	611.68
	Force Account	
	<u>Contract</u>	
	Crossover at Braintree	6,800.00
	<u>Equipment</u>	
	District 8	784.95
	<u>Labor</u>	
	District 8	10,538.11
	<u>Design</u> (Boston)	
	Design of Crossovers	<u>700.00</u>
	SUB-TOTAL	\$ 33,614.39
11.	<u>STUDY AND EVALUATION COSTS</u>	
	<u>Planning</u> (Boston)	
	Studies and Vehicle Counts	5,400.00
	<u>Traffic</u> (Boston)	
	Engineering Costs	<u>692.00</u>
	SUB-TOTAL	<u>\$ 6,092.00</u>
	<u>TOTAL</u>	\$ 39,706.39

---

SOURCE: Commonwealth of Massachusetts, Department of Public Works,  
"Report of the Exclusive Bus Lane Demonstration on the South-  
east Expressway," June, 1972, p. 13.

took twenty-four minutes to travel the same route. Bus travel time for the same length trip on the exclusive bus lane is ten minutes. Therefore, as much as fourteen minutes or fifty-eight percent is saved over previous link times.

During the morning peak after initiation of the bus lane, the travel time for cars over the same distance dropped from twenty-two minutes to 17.5 minutes. This is presumably due to the removal of buses from the primary traffic stream, but considering that "after" data was gathered in summer, the improvement might be traceable to the normal drop-off in commuter traffic during summer months.

During the evening, bus times were cut by a much smaller amount. In one report there was little or no savings reported and another report indicated that the buses saved only four minutes over prior times. Thus, there seems to be substantial support for cancellation of the PM facility.

## (2) Volume

A series of traffic counts were taken by the Department of Public Works. These counts were designed to determine if cars were removed from the roadway in response to the better service available by bus. Unfortunately, results are clouded by the fact that the Massachusetts Bay Transportation Authority inaugurated a new rapid transit line during the same time period to serve the same general corridor. Table 3-6 shows the actual recorded auto volumes for various hours and at various stations along the Southeast Expressway. Conclusions from these data are mixed. Some reductions at the northern-most point (near the CBD) are indicated for the morning peak hour use, but this cannot be attributed to bus diversion since these express buses do not pick up patrons from close-in areas. The outlying area volumes continue to increase, indicating that either the advantage of the service did not attract very many outlying commuters or else that any diversion has been counter-balanced by area growth.

Studies were made of changes in the number of passengers riding buses in the corridor. Unfortunately, these studies were limited to buses that actually used the exclusive lane facility, so, as a result, transit usage patterns as a whole could not be analyzed. These data, reproduced in Table 3-6, shows that vehicles increased fourteen percent and ridership increased exactly the same percentage. What is not known is whether any new passengers were attracted to mass transit use by virtue of the facility provided. That is, it could be argued that additional vehicles with the same average load simply changed routes to utilize the exclusive lane because it was more convenient than their normal route.

An interesting statistic is the average vehicle occupancy rate reported for automobiles using the normal freeway lanes. This indicates a decline in the occupancy rate (see Table 3-6). However, it is difficult to draw meaningful conclusions since the change is minor and so many other conflicting explanations are possible. For example, it may be that some automobile riders or carpoolers were attracted to the new bus facility, but it may also be possible that they were attracted to the new MBTA rail transit service. No detailed analysis of these factors has been performed in conjunction with this demonstration project.

It was estimated before the experiment began that the southbound AM lanes, after removal of one lane from service, would show a level of service degradation from Class B to C. The actual recorded delay time southbound in the AM peak was one minute six seconds. In the PM peak on the northbound portion of

TABLE 3-6: Boston AM Bus Lane Operation Statistics

	Before	After	Change		%Change
			Plus	Minus	
Vehicles (Quincy)	4997	5003	--	--	0
Vehicles (Boston)	4554	4201		353	-8
Buses	57	65	8		+14
Bus Passengers	2152	2454	302		+14
Travel Time (Car)	22:00	17:28		4:32	-21
Travel Time (Bus)	24:00	10:00		14:00	-58
Vehicle Occupancy					
(Quincy)	1.35	1.32		.03	-2
(Boston)	1.48	1.43		.05	-3

SOURCE: Commonwealth of Massachusetts, Department of Public Works, "Report of the Exclusive Bus Lane Demonstration on the Southeast Expressway," June, 1972, p. 4.

the freeway a ten second delay was reported. Therefore, it can be concluded that the portion of the freeway which lost a lane was not severely affected by this decrease in capacity.

### (3) Other Results

Social and environmental impacts to date are minor, if any.

The management of one transit company reports, but cannot document, that vehicles are subject to less wear and tear as a result of avoiding heavy congestion areas where buses normally experience stop-and-go delays.

Changes in mode choice have not been adequately studied.

## INSTITUTIONAL BACKGROUND

In interviews and discussions in conjunction with the Boston area reverse bus lane, it became apparent that institutional resistance and inertia constituted the major reasons why the project took over two years to be approved. It is reported that the concept was the creation of the Department of Public Works under the former chief engineer, Tad Horgan. A number of the staff members of the Department of Public Works initially opposed creation and operation of the lane. It is reported that new objections and continued resistance typified weekly staff meeting discussions of the subject. The representatives of the safety and maintenance departments were particularly reluctant to undertake the experiment. Maintenance department opposed it because of possible danger that their men and vehicles would be exposed to when placing and collecting cones in busy traffic lanes. After two years, internal acceptance was achieved.

It was necessary to coordinate three police jurisdictions. The State Police, under the Massachusetts Department of Safety, were asked to police the outlying end of the exclusive lane operation. The Metropolitan District Commission Police had to be brought in since the CBD end fell within their jurisdiction. In addition, the local municipalities through which the bus lane passed had to be considered in all planning. Cooperation of these police agencies was readily obtained.

The Massachusetts Bay Transportation Authority participated in the initial planning. It later dropped out, seeing little value in participating in a plan which would be directly competitive with the new South Shore Rapid Transit Line. At this point no MBTA buses use the facility.

It is important to note that the entire responsibility for the initiation, financing, and operation of the exclusive lane facility fell within one agency, the Massachusetts Department of Public Works. In this way it was not necessary to proceed to other independent or autonomous agencies for major approvals or cooperation. Therefore, it can be said that once the concept was accepted within the Massachusetts Department of Public Works, the project could be implemented.

## PUBLICITY AND PUBLIC RELATIONS

Extensive favorable publicity was received from the news media. This was accomplished through numerous public relations handouts which were provided by the Massachusetts Department of Public Works. These handouts were



graphic and extremely thorough in their explanation of the objectives and operation of the facility. As a result, coverage was good and comment was favorable. Attempts to contact bus passengers or motorists directly were not thought to be necessary, although the Department of Public Works did send letters to all bus operators advising them of the facility and how to take advantage of it.

#### PUBLIC RESPONSE

Initially there were a number of letters complaining about the provision of special privileges for buses. These gradually disappeared as the public began to understand the purposes and objectives of the program. Two radio station traffic reporters ("our copper in the copter") blamed the bus lanes for certain delays at merge points. These criticisms seem hard to justify.

The response of bus passengers and operators was extremely favorable. A random sampling from a great number of passenger response sheets indicate that one hundred percent were favorably impressed. Comments included "makes commuting easier," "more reliable," "more advantageous," and "keeps people from being late." One passenger noted that the PM service was not needed, as was later confirmed by the Department of Public Works.

#### FUTURE POSSIBILITIES

In discussions with the Massachusetts Department of Public Works staff, it was learned that serious consideration was being given to other routes which might be utilized to provide busways. They had concluded that additional under-utilized capacity existed as a result of heavy peak directional flows on other highways in the metropolitan region. They were able to specifically point to several roads under active consideration. It was also noted that one reason why such plans as exclusive busways were being considered is in response to the environmental impact requirements of present Federal funding programs.

## RESERVED LANES ON ARTERIALS

### CASE STUDY 4: EXCLUSIVE BUS LANE PROJECT (LOUISVILLE)

#### DESCRIPTION

In June of 1971, the U.S. Department of Transportation funded an Urban Corridor Demonstration project in Louisville. The most important component of this program was the establishment of an exclusive bus lane running against the flow of traffic on a one-way pair of arterials in a north-south corridor of the city. Three routes of the Louisville transit service (2, 4 and 6) were re-routed to use the specially created lanes. A new route, Route AA, was also to be initiated to utilize these bus lanes. This route, however, was never actually operated because of high costs. The bus routes include collection and distribution (local service) and express route segments. All three routes utilize the same street for the express portion of each trip. The bus routes are between 6.5 and 9.1 miles in length while the exclusive lane portion is approximately 2 miles long.

The routes operate from the south suburban areas of Louisville along a north-south corridor directly into the CBD. In outlying areas, the routes operate over secondary residential and collector streets. The express portion of the route was designed to use a residential one-way pair approximately four lanes wide. The actual exclusive bus lane in the morning runs on Third Street between Avery and Breckinridge. In the evening, originally the express bus route utilized an exclusive bus lane on Second Street running from Kentucky to Avery. Several blocks of the CBD portion of the AM and PM trips do not provide for exclusive bus lane operation (Figure 3-12).

When the service began operation on October 19, 1971, all three routes were in service. It quickly became apparent that there were experimental design deficiencies adversely affecting ridership. The first and major problem was evening operation. Patronage in the evening period was only running about half of morning peak period levels. Project officials, after a review of operations, believed that this was due to extensive detours incurred in traveling from the CBD to the exclusive outbound bus lane and then, at the end of the line-haul express route, returning to the area of distribution. The bus, so to speak, had to go out of its way to utilize the PM exclusive bus lane and the resulting route deviation was very time consuming.

The second major problem was low ridership experienced on Route 2. This was traced to the fact that Route 2 originated at an industrial plant. There was little demand for service from the factory to the CBD in the AM (and vice versa in the PM). In addition, most of the previous riders of local service in the area had been students. These students' destinations were located along the routes where no stops were made after the bus began the express route portion of the trip. Therefore, these students were unable to take advantage of this service and were lost.

Figure 3 - 12  
 LOUISVILLE REVERSE BUS LANE IN LOUISVILLE URBAN CORRIDOR

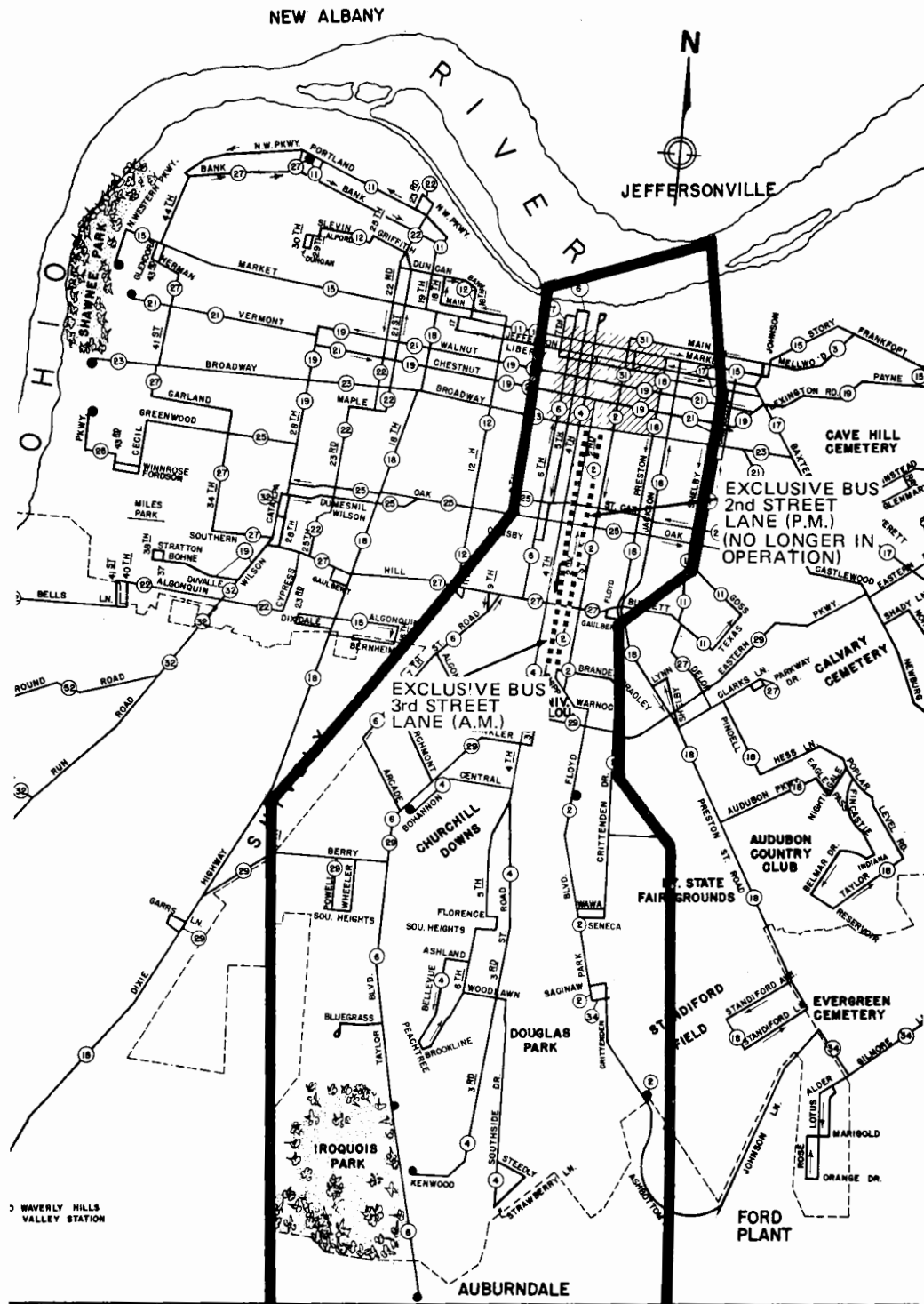

SOURCE: Louisville Urban Corridor Application

On November 29, 1971, one month and ten days after the start of service, two drastic changes were made. The exclusive bus lane in the PM was eliminated by routing service onto a with-flow one-way street more convenient to the travel corridor. Results indicate that the buses actually saved time using with-flow facilities. Service on Route 2 was drastically curtailed also on November 29th. Six of the eight runs were eliminated and on December 31, 1971 the last two of these runs also were cut.

A park-n-ride lot serves as the terminal for one route. The Auburndale Shopping Center (without officially sanctioned parking) serves as a terminal for the other remaining route. These terminal facilities, it is felt, contribute to the effectiveness of the two remaining bus lines.

#### REASON FOR BUSWAY

It is not inaccurate to state that a key reason an exclusive bus lane was inaugurated in Louisville was Federal interest in establishing such service. Originally the Falls of Ohio Regional Council of Governments had submitted an omnibus application covering a variety of transit, traffic engineering, and miscellaneous improvements for the identified urban corridor in Louisville. Since it was impossible to fund the entire package of improvements, the resulting negotiations tended to concentrate on innovative service. The exclusive bus lane was one of the most innovative improvements of the original application.

Other factors considered influential included the usual morning and evening peak hour congestion around the CBD and arterials leading to and from the CBD. However, in all fairness it should be said that this congestion is not nearly so great as experienced in many other cities. (See Time and Speed discussion).

#### OPERATIONAL DETAILS

The operation of the exclusive bus lane facility is reasonably standard. Buses leave either the Iroquois parking lot facility or the Auburndale Shopping Center and proceed along normal collection Routes. After collection of passengers is completed the bus, in the AM peak, turns onto Third Street against the flow of traffic. The bus utilizes the lane on the far right. Normally this lane would be used for parking. Thus, establishment of the bus lane did not remove a lane previously in use by other traffic. The roadway on the exclusive bus lane is striped with diagonal stripes to indicate its special nature. Adjacent to the lane are signs indicating that between 6:00 AM and 9:00 AM no stopping is permitted and that the curb lane is reserved for buses only. These signs face normal flowing traffic. In addition, at cross streets special signs warn crossing motorists that buses proceed in the opposite direction of the one-way street.

Provision has been made for the towing away of vehicles which remain in the bus lane after 6:00 A.M. For several weeks preceding operation it was necessary to heavily ticket vehicles and actually tow some vehicles away to insure that the lane would be clear when operations began. This was apparently successful as no towing has been required since operation began.

Preferential traffic signal controls are used for selected intersections. The objective of these control devices is to reduce delay for buses especially where an unusually long signal cycle would penalize them. These were installed very late in the project and no data is available on their utility or effectiveness.

The City of Louisville Police Department provides police escort service which precedes the first bus in the morning and follows the last transit vehicle at the end of the AM peak. The police department also maintains a tow vehicle to tow away any illegally parked vehicles in the reversed direction lane.

#### SAFETY CONSIDERATIONS

Two accidents have been recorded since the bus lanes went into operation. Both occurred during the first two weeks of the project. In each accident the driver backed out of his driveway, failing out of force of habit to look for the buses coming up the reversed bus lane. No accidents have been recorded since the initial two weeks of operation. A comparison of these accident rates and general accident rates is shown in Table 5-8 discussed in Chapter 4.

#### COSTS

##### 1. User Costs

The operation of the exclusive bus lane service has not imposed any special charges on the riders. The normal system fare of forty cents is charged riders of the service.

##### 2. Implementation Costs

The costs associated with establishing the bus lane were slight. Striping 4.6 miles of both AM and PM buslane was estimated to cost \$6,000. 50 signs to be used on each one-way street were estimated to cost \$1,200, per street. Additional signs were placed on side streets. The park-n-ride lot for 175 cars cost about \$13,000 to pave. A relatively high cost item in this project was the pre-emption signal devices. Receivers at intersections cost \$775 each. Bus transmitters cost \$500 each. Eight intersections were signalized and nine buses equipped with transmitters. A larger quantity purchase may reduce these costs.

##### 3. Operating Costs

The operating costs of maintaining this roadway and serving it are very low. Police assistance is accomplished through reassignment of vehicles and men normally available.

It should be noted that the bus company charges the project for service according to a very costly formula. In negotiations between project officials and the transit operator, an attempt was made to show that the operating costs of the exclusive bus lane would be less than the average for the system as a whole because of higher average operating speeds. This line of reasoning was never accepted by the transit operator. A strict \$1.00 a mile charge was the only basis under which they would lease service to the project.

In addition to the arbitrary charge, which by itself is not extremely unreasonable, the project is required to pay for a substantial amount of dead-head mileage. Mileage from the garage to the start of the route is charged at \$1.00 a mile, mileage from the end of each trip back to the start point is charged (only half of each round trip being revenue generating); and mileage from the end of the block of work to the garage is charged. This non-revenue generating mileage distorts costs substantially. Had this service been better integrated into the Louisville transit service program, it might be expected that the overall cost revenue data would be more favorable.

## RESULTS

### 1. Speed or Time

One of the original objectives of the project was to expedite the travel of persons in the corridor to and from the CBD. Initial estimates were made prior to the beginning of service that it would cut twenty-five percent off the time required for a normal automobile trip. Actual experience was somewhat less heartening. In the evening, because of the initial confusion and congestion surrounding use of the outbound exclusive bus lane, travel times were actually longer when compared with former local bus service. After adjustments had been made in the evening, some improvements in time for the express bus service were shown as compared with the former local bus service.

Comparisons with auto trip times were not nearly as favorable. The automobile proved between four and twenty minutes faster than the express bus service. Table 3-7 shows the comparative travel time for local bus service prior to the implementation of the project, express bus service after implementation of the project and normal auto travel times.

The travel time data provided by the project is for the entire route, only a small portion of which uses the exclusive bus lane. No evidence has been presented, however, to indicate that buses on the exclusive lane travel faster than automobile traffic on parallel routes.

It is significant to note that in this city there seems to be minimal traffic congestion. The establishment of a bus lane did not offer much opportunity to speed travel to and from the CBD for those who would normally use an auto. It is the hypothesis of this study that unless such time savings are shown as the result of bypassing congestion, little or no mode switching behavior will be observed.

### 2. Volume

It is difficult to arrive at a good estimate of volume potential because of the hybrid nature of operations in Louisville. It seems reasonable to expect that these volumes could be substantially increased over levels of usage now recorded. The establishment of the exclusive bus lane did not penalize normal automobile traffic. A "lanes available" analysis performed prior to implementation indicated there would be no effective loss of capacity since only two of the four lanes on Third Street were needed for normal traffic.

TABLE 3-7: Travel Time Comparisons for Three Routes in Louisville

AM (Exclusive Bus Lane)					
ROUTE LENGTH (in miles)			TRAVEL TIME (in minutes)		
Route Number	Local	Express	Local	Express	Auto
2	6.6	6.8	43.0	37.6	17.8
4	7.2	7.4	40.5	30.0	26.4
6	8.7	9.1	41.0	35.3	31.9

PM (No Exclusive Bus Lane)					
2	6.4	6.5	43.0	26.6	16.2
4	7.2	7.4	42.0	31.5	24.6
6	8.1	8.9	43.5	38.5	31.3

---

SOURCE: Schimpeler-Corradino Associates, Urban Corridor Demonstration Program: Early Implementation Phase, Louisville, Kentucky, April, 1972, pp. 6,8,10.

### 3. Other Results

With the exception of some changes in mode of travel, other results are either insignificant or not documented. No data has been presented to indicate that the reliability of schedules has improved or that the operator is able to reduce his costs. The social and environmental impacts are probably slight. While the south corridor is essentially a low and middle income area, it does not seem that any special transportation opportunities for the disadvantaged have been presented by the establishment of this service.

Figure 3-13 shows trends in ridership in the corridor as a whole. It would appear that there are some new riders attracted to the service. However, no distinction has been made between those who were former auto users changing their mode and those who may be new riders for other reasons. At this time data is not adequate to establish the true pattern of ridership changes.

#### INSTITUTIONAL BACKGROUND

The institutional background of the exclusive bus lane project in Louisville is a cooperative one. A number of semi-autonomous agencies were essential to approving and implementing service. The Falls of Ohio Council of Governments was the principal agent responsible for designing the study and preparing an application for Federal funding. The COG formed a committee of relevant agencies to supervise the preparation of the application. Members of the Louisville and Jefferson County Traffic Engineering Department, the State Highway Department, the Regional Transportation Study Staff, and the consulting firm of Schimpler-Corrandino Associates formed the technical coordinating committee to oversee the project. It was generally agreed by all that the consultant played a major role in preparing the application and effecting its timely submittal.

Of most importance in the implementation of this innovation was the genuine cooperation achieved between all of these agencies. Some resistance did exist in the beginning from traffic and highway department officials since they were concerned about the safety implications. These obstacles were finally overcome, and the Traffic Engineering Department now concedes that the accident rate is much less than was expected.

The Louisville Transit Service is the operator of the bus lines. Louisville Transit is a private carrier which may soon be publicly acquired. Faced with the impending deadline for start up of service and approval of the application, the negotiations by the city with Louisville Transit did not produce favorable results. In the end project officials capitulated to the fairly high cost demands of the transit company.

#### PUBLICITY AND PUBLIC RELATIONS

A substantial program of publicity and public information was generated in advance of the inauguration of the service. Substantial media publicity was obtained at the time of grant approval in August of 1971. Flyers were



**Figure 3 - 13**  
**TOTAL PEAK HOUR BUS PATRONAGE**

<u>Month</u>	<u>Patronage</u>		<u>Total</u>
	<u>Express</u>	<u>Local</u>	
October *	3,255	6,240	9,495
November	9,768	15,581	25,349
December	11,088	12,900	23,988
January	11,626	11,192	22,818
February	11,564	10,155	21,719
March	11,979	11,296	23,275
<b>TOTAL</b>	<b>59,280</b>	<b>67,364</b>	<b>126,644</b>

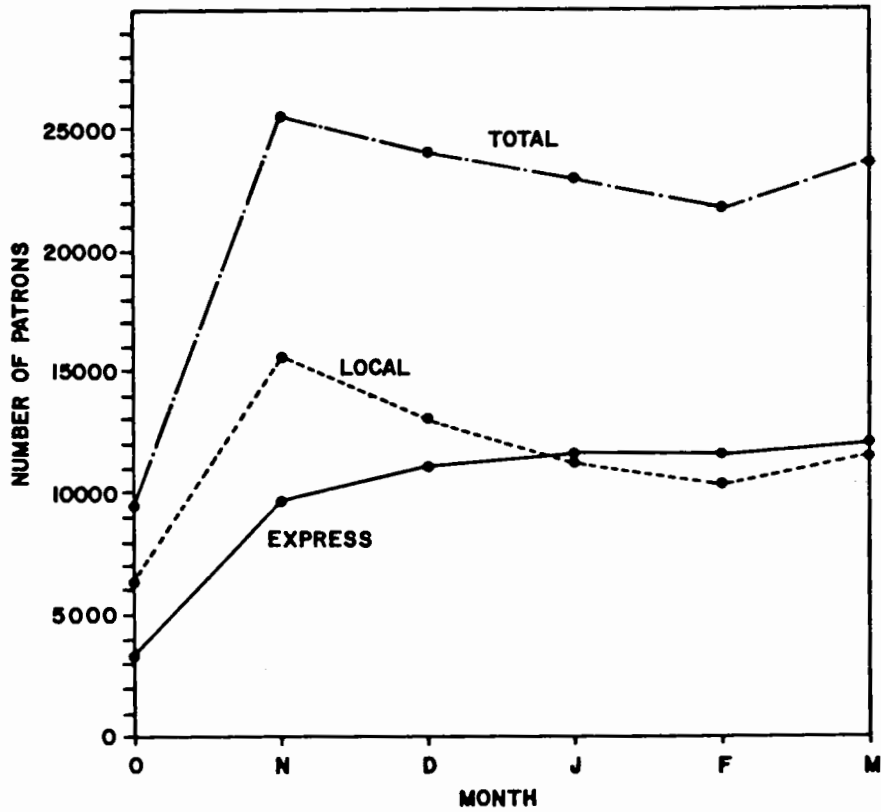

\* Service began on October 19

SOURCE: Schimpeler-Corradino Associates, Urban Corridor Demonstration Program: Early Implementation Phase, Louisville, Kentucky, April, 1972, p. 81.

distributed in September on a door-to-door basis in the corridor area. These flyers were also placed in public establishments in the areas that would accept them. Special route and schedule flyers were printed and distributed again throughout the south corridor. An information booth was established in the CBD to provide information on the service. The consultant made personal efforts to disseminate information at the Iroquois parking lot and the Auburndale Shopping Center. Other flyers were prepared describing the operation of the reversed bus lane and the safety precautions that would be taken to protect vehicles parked at the Iroquois parking lot. These also were distributed on a door-to-door basis to residents and business establishments in the south corridor.

Full page coverage was provided one day prior to the start up of bus service, in the Sunday newspapers of October 17 including route and schedule information. After the initiation of service, the consultant volunteered to address any group interested in the project.

This project undertook by far the most extensive public relations and information program of any of the exclusive lane projects reviewed. There is not a great deal of evidence to indicate that this was effective in attracting new ridership.

#### PUBLIC RESPONSE

The public response to the new and improved service was not overwhelming. Three-quarters of the spaces in the park-n-ride lot are still unused. Buses are not full and there are plenty of seats available for additional riders. As was indicated earlier, there may be some increase in ridership but this is hardly a significant growth in demand for transit in that corridor.

#### FUTURE POSSIBILITIES

Several groups involved in the establishment and operation of the existing bus lane were contacted about the possibility of establishing additional exclusive bus lanes in the Louisville metropolitan area. Highway and traffic agency officials were very reluctant to conclude that there were any opportunities for the use of exclusive bus lanes in other parts of the city. Several other one-way pairs were mentioned as having possibilities. On the other hand, planning officials felt that there were substantial opportunities to introduce bus service by exclusive lanes to other areas of the city.

DESCRIPTION

College Avenue is a major north-south arterial serving the near north side of Indianapolis. For a distance of 2.9 miles one of the four traffic carrying lanes on this roadway has been designated for the exclusive use of buses. The facility allows buses to travel southbound between Fairfield Avenue and Massachusetts Avenue to the edge of the CBD (see Figure 3-14). All other vehicles travel northbound on the remaining three lanes. Thus, a contra-flow arterial bus lane operates for approximately twenty-five blocks. The facility is permanent and operates twenty-four hours a day. Nearly 100 buses use the southbound lane daily and College Avenue is one of the major transit routes in the city.

The origination of this facility is interesting and somewhat atypical from that of other similar busway applications. Prior to 1959, College Avenue was a normal two-way street. In 1959 it was converted to a one-way street northbound from the downtown area out to Fairfield Avenue. For the usual local reasons, considerable controversy was stirred up about the one-way operation. As a result, in 1965 the left northbound lane was converted to a southbound lane for the use of all traffic. However, with three lanes northbound and one lane southbound, the accident rate increased substantially. "Records indicate that in 1967 only ten percent of the daily traffic volumes on College Avenue were in the southbound lane, but twenty-five percent of the accidents involved southbound vehicles."<sup>17</sup> Based on this higher accident frequency, studies were performed by the Mass Transportation Authority (MTA), the forerunner of the Department of Transportation in Indianapolis, and the Bureau of Traffic Engineering. The latter recommended elimination of the southbound lane entirely. Hearings were held on converting the street back to a one-way operation.

The bus operator notified the authorities that in the event the street was returned to its former one-way status, they would be forced to cancel service in that corridor. Reasons given were the lack of adequate parallel streets in the immediate area of College Avenue that would have served as an alternative to the use of College Avenue itself. The nearest complementary one-way southbound street adequate to the transit load was about three-quarters of a mile walking distance.

As the result of these studies and considerable citizen complaints and pressure, it was decided to retain the existing southbound lane between Massachusetts and Fairfield but to bar all vehicles except buses from using it. In this way it was felt that a high level of transit service could be maintained in this corridor and at the same time accident rates could be reduced.

Currently, buses proceed southbound in the exclusive lane facility between Fairfield on the north and Massachusetts on the south. Northbound buses use the three regular outbound traffic lanes with no special reservation feature. It should be noted that congestion is not especially prevalent in Indianapolis, and the College Avenue section utilized for the busway is not an exception to this general consideration.

---

<sup>17</sup>Edward K. Ratulowski, "Report on College Avenue Exclusive Bus Lane," Internal F.H.W.A. Report, January 20, 1971.

Figure 3 - 14  
**EXCLUSIVE BUS LANE IN INDIANAPOLIS**

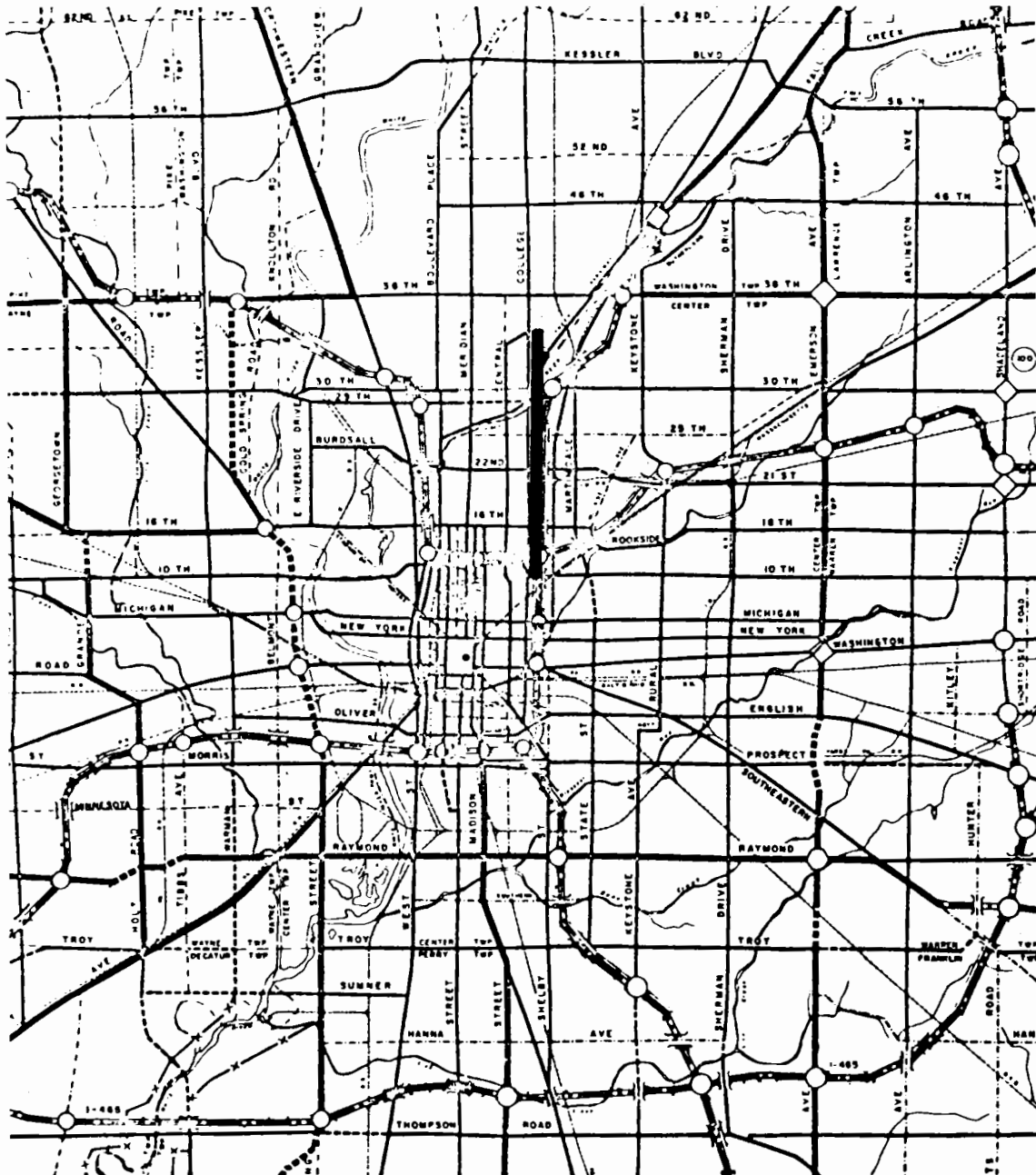

- |                     |          |          |   |
|---------------------|----------|----------|---|
| FREEWAYS            | EXISTING | PROPOSED | SECTION OF COLLEGE AVENUE WITH EXCLUSIVE BUS LANE |
| EXPRESSWAYS         | =====    | =====    |   |
| PRIMARY ARTERIALS   | =====    | =====    |   |
| SECONDARY ARTERIALS | =====    | =====    |   |
| INTERCHANGES        | =====    | =====    |   |

SOURCE: Edward K. Ratulowski, Report on College Avenue Exclusive Bus Lane  
 January 20, 1971.

## REASON FOR BUSWAY

The major factor responsible for establishment of this bus lane facility was the prospect of banning bus service in this important transit corridor. The alternatives considered were principally relocation of the bus route on out-of-the-way roads; abandonment completely of the bus service, making College Avenue one-way; and continuation as before the controversy developed (i.e., with motorists and transit vehicles utilizing the one southbound lane). Since public reaction was strong and unfavorable to the relocation of the bus route and/or possible elimination of the bus service, the ultimate adopted design seemed to be the most expedient technique for reducing the generally unsatisfactory accident rate and preserving bus service.

## OPERATIONAL DETAILS

The actual operation of the exclusive bus lane is a model of simplicity and under-control. The lane is separated from the balance of traffic by a double yellow line which at points is completely erased from the pavement. There are no special signs warning the normally-flowing northbound traffic to avoid the far left lane.

Signing at the beginning of the bus lane consists of overhanging directional arrows along with overhead warning signs. The overhead warning reads: THIS LANE BUSES ONLY, with a downward-pointing arrow designating the bus lane. All other southbound traffic is required by overhanging lane signs (arrows) to turn left or right onto Fairfield.

Cross street traffic is directed by NO LEFT TURN or NO RIGHT TURN signs. Northbound automobiles are warned by standard END ONE-WAY signs hanging over the solitary southbound lane. It generally is agreed by all that some additional signing would be useful and improve the safety of operations.

At present, about ninety-five inbound buses use the exclusive southbound daily and ninety-nine outbound buses use the northbound lanes. Recent traffic counts indicate that there are between 150 and 200 vehicles per day using the bus lane illegally. The Indianapolis police will not ticket unauthorized motorists found using the bus lane unless the motorist is actually observed making an illegal maneuver to enter the bus lane. "The police department has taken this position because signs designating the southbound lane exclusively for buses have not been erected along the route. The I-DOT plans to erect these signs in the near future."<sup>18</sup>

## SAFETY CONSIDERATIONS

The principal reason for establishment of the bus-only lane was to reduce the accident rate on College Avenue. Previous to the operation of the exclusive bus lane, the single lane for all traffic southbound resulted in a much higher accident rate than when the facility was exclusively one-way or prior to that, two-way. Accident figures compiled for the southbound lane (bus lane) of College Avenue both before and after implementation of the exclusive bus lane facility show that in 1968, before the southbound lane was put into

---

<sup>18</sup>Ibid.

operation, there were fifty-five accidents involving the southbound lane. In 1969, after the bus-only prohibitions were inaugurated, there were twenty-one such accidents; in 1970 there were nineteen; and in 1971 there were twenty accidents. This is about a sixty-five percent decrease since 1968.

The number of bus-involved accidents as a proportion of these accidents has been high. In 1968 ("before") there were six bus-involved accidents. In 1969 and 1970 there were eleven and thirteen accidents respectively. In 1971 the figure dropped to six again. The absence of a drop in accident rates for buses is explained by the poorly marked side streets which are not properly advising motorists that buses can be expected along the bus lane.

An impressive improvement of the accident rate for College Avenue as a whole was reported. Total accidents in all lanes decreased fifty-one percent between 1968 and 1970. The figures in absolute terms are 216 in 1968 before the lane went into operation and 105 in 1970 after the lane went into operation. No data were available for 1971.

## COSTS

### (1) User Costs

User costs did not change with the implementation of this bus lane. Standard forty-cent bus fares are charged, with additional five-cent cost on any express bus routes.

### (2) Implementation Costs

Costs were extremely low. Signs and striping were the chief costs associated with implementation of the facility. Originally, plans called for signs along the bus lane indicating the facility was reserved for bus lanes only. These were estimated to cost \$1,500 for the 2.9 mile distance. The latter signs were not actually installed. The few signs that were installed, the overhead warnings and a few additional cross street signs, were relatively inexpensive, although actual cost figures are not available.

### (3) Operating Costs

The operating costs associated with maintaining the bus lane were not available. The Indianapolis officials do not separate these costs from more general data on roadway maintenance. The principal items of operating costs are stripes and sign maintenance. These costs are very minimal.

## RESULTS

### (1) Speed or Time

Observation of this bus lane and discussions with traffic engineers failed to reveal that there was any appreciable speed or time differences as a result of operation of the exclusive bus lane facility. However, it was noted that prior to operation of the exclusive bus lane facility or even the one-way street, severe congestion was experienced in peaks at several of the intersections. Presumably the relief of this congestion has worked to the advantage of both transit and non-transit users alike.

(2) Volume

Presently 100 buses use the facility over each twenty-four hour period. The potential volume of buses that could be accommodated is somewhat greater than is actually recorded, as is evidenced on other facilities (see Table 5-2).

(3) Other Results

The principal reason for establishing the bus lane was the desire to maintain transit service in this heavily transit-oriented corridor. The route passes through what might be considered a low income area and is necessary to the welfare of many of the low income residents of that area. It would appear that this service had minimal environmental impact. No evidence was presented to indicate that operator efficiencies were realized.

INSTITUTIONAL BACKGROUND

The examination of the background of the Indianapolis bus lane shows that a single critical agency was responsible for the implementation of the facility. The newly unified local government of Indianapolis has as one of its sub-agencies the Department of Transportation (I-DOT). The Board of the Mass Transportation Authority (forerunner of I-DOT) is authorized by state law to pass general ordinances. On July 18, 1968 a resolution was introduced to the MTA Board "Whereby when studies by the Authority's traffic engineers show it is warranted and upon petition by the Executive Director, the Board of the Authority may, by resolution, designate transit lanes for transit vehicles exclusively...and may further authorize the Executive Director or traffic engineer or both to mark or post appropriate signs or signals to designate such transit lanes." (Public Ordinance No. 40, 1968, 1901). The ordinance was passed. Given the authority, the MTA requested traffic engineering studies and recommendations on how to handle the proposed changes.

During the period of these studies various groups were heard from such as:

- . The Safety Board which received a petition from citizen groups concerned about the high accident rate on the modified two-way street (one lane southbound, three lanes northbound).
- . The Bureau of Traffic Engineering which recommended a return to the 100 percent one-way operation.
- . The Indianapolis Transit System which indicated that it would discontinue transit service if the roadway was returned to one-way operation.
- . Citizen Groups most of which were concerned about the possible loss of transit service.

After review of various alternatives, it was felt that the most efficient way of handling the problems presented was to retain the one southbound lane but to limit it exclusively to the use of buses. When this recommendation was presented to the Mass Transportation Authority, it was passed.

## PUBLICITY AND PUBLIC RELATIONS

No special program of publicity or public information accompanied the introduction of the facility. Normal newspaper publicity was accorded to the hearings surrounding the proposed changes.

## PUBLIC RESPONSE

While there was considerable outcry about the operation of the street as a one-way street or as a street with only one general traffic southbound lane, after the establishment of the bus lane there has been little or no public interest.

## FUTURE POSSIBILITIES

The potential for busways in the Indianapolis area is tempered by the fact that there is a minimum of traffic congestion. Average operating speed is 12.3 m.p.h. It is not thought that there are either conditions similar to those which brought about this exclusive lane facility or other difficulties in traffic flow throughout the city for which additional bus lanes would be one solution. However, in interviews with local officials it did appear that there was substantial unused capacity which might be put to work if the need arose for establishment of more exclusive bus lane facilities.



## CASE STUDY 6: SAN JUAN, PUERTO RICO EXCLUSIVE BUS LANE

### DESCRIPTION

San Juan, the largest metropolitan area in Puerto Rico with a population of close to one million crowded into a small geographic area, has established exclusive bus lanes on two major arterials in the CBD.

The older and more densely developed portion of San Juan is shaped somewhat like a banana in that it curves around a bay. The resulting lineal development patterns are served by two major arterial streets - Ponce de Leon and Fernandez Juncos (see Figure 3-15). These two arterials are four lanes wide and run from Old San Juan to the expanding metropolitan area to the southwest of the narrow neck previously described. At this southern terminus major bus routes originate at the Rio Piedras terminal which is near the University of Puerto Rico. Three lanes of these two major boulevards are used by normally flowing traffic as a one-way arterial. The fourth lane is reversed for use by buses only. These bus lanes operate over about 10.8 miles of a 15.8 mile route on these two avenues. The reversed lane corresponds to a normal two-way street configuration except that only one lane is available to opposite direction traffic. All vehicles except buses and police scooters are explicitly excluded from the single reversed lane portion of these routes.

The bus lane operates twenty-four hours a day and handles between 1,300 and 1,500 bus trips per day. Normal traffic regulations prevail and no special traffic controls have been put into effect for the buses. Normally flowing traffic is reminded of the exclusive bus lanes by signs which face the on-going motorists and inform them of the exclusive bus lane. Cross streets are similarly signed. No other special provisions are used to warn motorists. A number of the actual lanes are very narrow, causing vehicles to weave slightly out of the lane to bypass structures such as leaning telephone poles, etc.

San Juan is somewhat atypical of American cities in that there has been no major freeway building program in the past twenty years. The rapidly growing automobile travel in the metropolitan area has extensively overburdened the existing street system. The resulting severe congestion, experienced at all hours of the day but particularly during the peak periods, has resulted in substantial time loss to travelers who must depend on either automobile or traditional public transit. Establishment of a one-way bus lane on these two key arterials, even when subject to the usual delays from stopping to load and unload passengers as well as to obey normal traffic signals, has resulted in a substantial savings of time and an improvement in the efficiency of operation of public transport in Puerto Rico. In comparison with other urban arterial busways this facility stands out as an important success.

### REASON FOR BUSWAY

The principal factor responsible for establishment of the busway was continuous severe traffic congestion experienced on the inadequate highway system within the CBD. In addition, it should be noted that San Juan is heavily dependent upon public transportation to serve its normal transportation needs. While patronage has declined in recent years, it is estimated

Figure 3 - 15  
 LOCATION OF EXCLUSIVE BUS LANE PROJECT

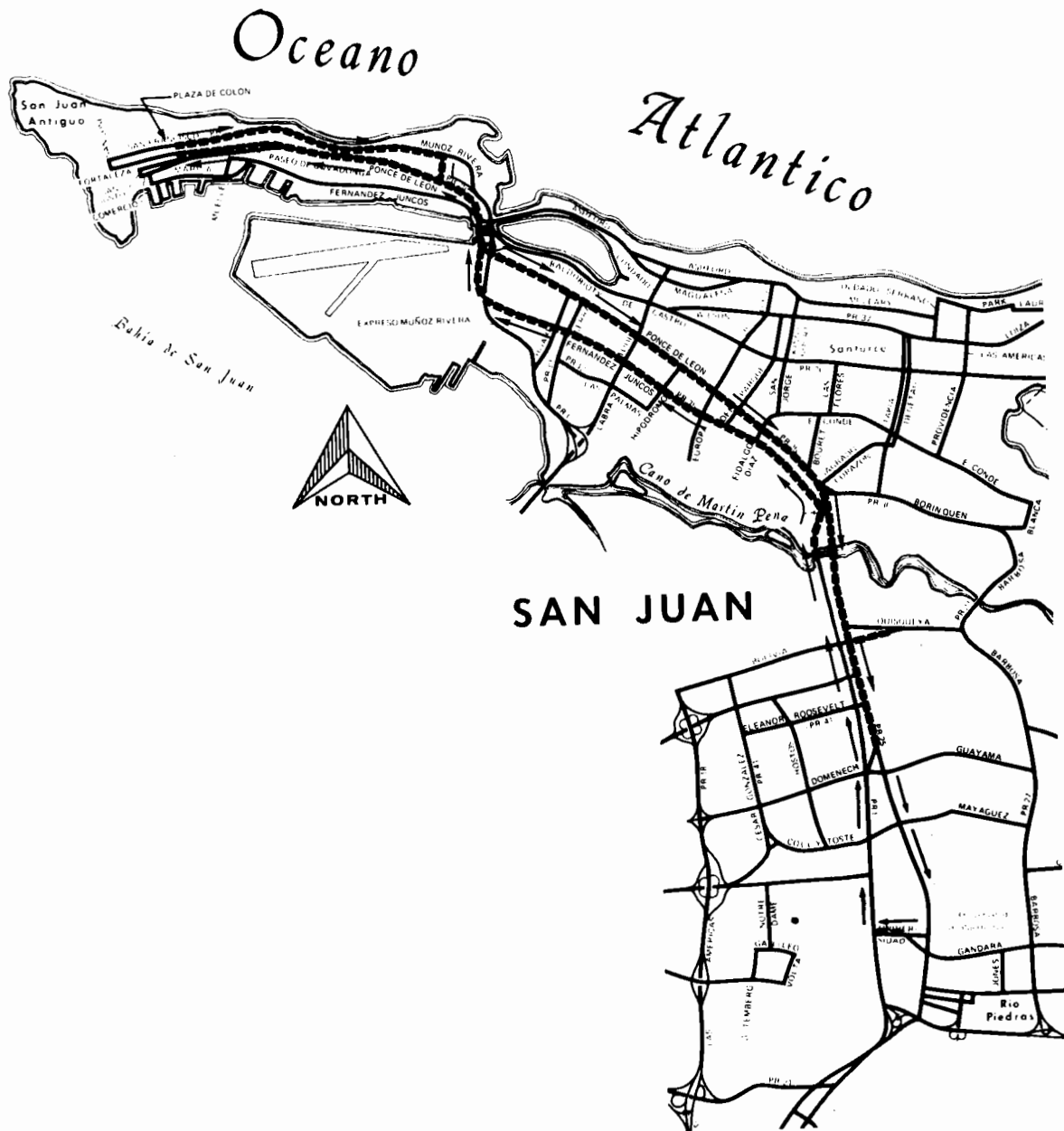

that public transportation of all kinds still carries about twenty percent of all trips.

It should also be pointed out that there are severe limitations imposed by existing land use and geographic barriers to the further construction of roadways. There simply is no place to put them in many parts of San Juan without extensive displacement of private homes and commercial interests. Consideration has been given to a fixed rail transportation system for San Juan. These do not appear to be financially feasible in the near future. Thus, establishment of busways is currently a most appropriate solution to the increased need for more transportation facilities in the San Juan area.

#### OPERATIONAL DETAILS

Buses operate over the exclusive bus lane for both line haul and collection and distribution functions. In two instances where the two principal arteries cross major streets or freeways, a special roadway has been cut for the busway to use in gaining access to the reversed lane operation. On a portion of the route the buses flow with traffic for about one mile before taking a special cutoff to continue the exclusive bus lane. In this latter instance, that portion of the highway where the buses flow with the traffic is a very lightly-used cutoff to a freeway facility. Thus, there is very little congestion to impede bus progress.

The exclusive bus lane was originally planned as a longer facility. Had the full planned bus lane been put into operation, buses would have had to discharge passengers, because of the geometrics of the roadway, onto narrow median strips on busy multi-lane arterials. These patrons would then have to cross several traffic lanes to reach sidewalks. Therefore, in the interests of safety the contraflow portion of the exclusive lane operates only in areas where it can discharge passengers directly onto the sidewalk.

Buses in Puerto Rico are granted the right-of-way in non-signalized intersections or other points of conflict by virtue of a peculiar historical precedent, thus further improving their efficiency.

There has been little or no observed incidence of drivers utilizing the wrong way bus lane. This is all the more significant because of the very lightly marked nature of the facility.

The Highway Authority has taken a number of pictures of vehicles which have parked in the bus lane or otherwise used it in violation, and these have been used to identify the offending motorists. With this information the police department has assisted in prosecution of such violations. At this point there seems to be little or no problem with violations and enforcement efforts tend to be minimal.

Buses are forced to halt and/or wait while buses ahead of them stop to discharge or pick up passengers. This results in a slower average operating speed than might be obtained if the vehicle operated without the need to stop and pick up passengers. The streets on which they operate are heavily signaled and buses are given no priority with traffic signals, nor are the signals timed to the buses' advantage. This means that the delay occasioned by stops to pick up and discharge passengers are compounded by traffic signal lights which on the green typically permit a bus only to pass from one intersection to the next bus stop. After completing the stop function, sufficient time usually has passed so that the next intersection light has turned red.

The operation of this exclusive bus lane could be improved with traffic signal preference controls or even signal progression which favors bus operations. However, it was pointed out that substantial additional penalties would be incurred by the motorist who is using the other three lanes of traffic and is already subject to severe penalties. Additional delay was not felt to be justified for other motorists.

Schedules as such are not really observed in the operation of this facility. Instead vehicles operationally available are simply sent out on the routes according to some intuitive assignment process. The major reason for the failure to observe schedules is simply that the buses are not sufficiently maintained so that enough vehicles are operating to fill schedule needs.

To aid in enforcement, the police maintain two trucks in the area of the busway which can be utilized to tow away any illegally parked vehicles. The bus authority (A.M.A.) also operates tow trucks which are available to remove any illegally parked vehicles blocking the bus lane.

Street cleaning is accomplished in a fairly unique way. Since the lane operates on a twenty-four hour basis, it is necessary to occasionally disrupt the lane in order to accomplish the street cleaning. A truck moves in the direction of the bus lane on the second lane out from the curb. This truck moves well in advance of the street cleaning vehicle, also traveling in the direction of the buses. Buses approaching the street cleaner device are able to pass the cleaner and return to the bus lane by virtue of the traffic gap created by the truck traveling well in advance of the street cleaner. Oncoming normally-flowing non-bus traffic is warned away from the second lane by flashing lights on the advancing truck.

Permission for carpools to use the exclusive lane facility was not granted. It was thought that the additional traffic would slow down the transit vehicles and the unfamiliar operating pattern would increase the possibility of accidents.

Private bus companies and semi-transit vehicles have been prohibited from using the exclusive bus lane. Apparently there are problems in enforcing franchise rights, and allowing non-franchised vehicles to use the facility would simply provide more incentive for violations of franchise regulations.

It is useful to point out here that about the time the exclusive bus lanes were implemented one or two adjacent freeway facilities were opened. While these are not complete yet and thus do not provide substantial additional capacity, it must be considered that they do provide roadway alternatives for vehicles which would have normally utilized the two key arterials.

#### SAFETY CONSIDERATIONS

Only one fatality has been recorded since the exclusive bus lane went into effect. The fatality occurred when a woman suddenly dashed out into the street immediately in front of a speeding bus. This fatality probably cannot be attributed to the mechanics of the exclusive bus lane operation.

Numerous accidents have occurred on the bus lane. The bus operators claim that over the last five months, as people have gotten used to the bus lane, accidents have declined below rates experienced before the bus lane was put into operation. A special statistical check of these data was made and seems to confirm their findings. This is shown in Figure 5-2 and discussed in Chapter 5.

Thus, the favorable impact on accident rates often experienced when two-way streets are changed to one-way streets does not seem to be negated by a reverse bus lane.

## COSTS

### (1) User Costs

The bus authority in San Juan has two charges for bus use: fifteen cents for nonair-conditioned vehicles and twenty-five cents for air-conditioned vehicles. The charges for the vehicles using the exclusive bus lane are no different from those buses using other streets in the metropolitan area. However, a higher proportion of air-conditioned buses are scheduled on these routes because they serve many middle and upper income neighborhoods. The bus authority tends to assign nonair-conditioned vehicles to neighborhoods and routes which primarily serve the low income users.

### (2) Implementation Costs

Costs associated with inauguration of this service were moderate. An estimated \$70,000 was spent on signing, some right-of-way acquisition, minor paving, and striping. These costs included direction and placement of signs. Some channelization and curbing was built for the special lanes, linking up various portions of the route. An additional \$30,000 was spent on publicity, administration costs, and engineering. The total \$100,000 cost was absorbed by the Puerto Rico Highway Authority within its normal operating budget. The value of additional staff time spent on work related to this project but part of normal day-to-day activities was estimated at \$50,000.

### (3) Operating Costs

Day-to-day operating costs for the bus lanes are assumed by the Highway Authority in their normal roadway maintenance budgets. Specific breakdowns associated with maintenance of the exclusive lane facility were not available. There is no evidence that any additional costs were incurred as a result of providing an exclusive bus lane. Normal roadway operating and maintenance budgets were utilized to provide care needed.

## RESULTS

### (1) Speed or Time

Substantial time savings are alledged as a result of the adoption of an exclusive bus lane policy in San Juan. This, if verifiable with further study, is by far the most significant result of this particular project. Discussions with project officials and transit operators indicate that the former one-way trip time was scheduled at fifty-five minutes. Actual trip times were closer to one hour and twenty minutes. After implementation of the exclusive bus lane, trip time was cut down to fifty actual minutes. This is a savings of some thirty minutes or about thirty-five percent over former conditions.

In speed terms, the one-way average trip speed changed from 5.37 m.p.h. to an average speed of 8.6 m.p.h. It was reported that for a shorter section further speed improvements were noted.

(2) Volume

Bus volumes on the exclusive bus lane facility vary by time of day and according to the number of vehicles that are operational. No accurate statistics were available to indicate the present peak-hour load. Similarly, no analysis has been done to determine what maximum theoretical volume could be attained. It should be pointed out that the potential volume of an exclusive bus lane on an arterial is much less than that on a limited access highway facility, due to the fact that the bus must make stops and respond to traffic signals. These interruptions substantially increase the delay and therefore lower average speeds for all vehicles. Studies performed for San Juan predicted that about 200 buses per hour could use the facility, carrying about 9,000 passengers per hour.<sup>19</sup> San Juan routes are such that high turnover of passengers per hour is expected and standees are frequently encountered. These may increase passengers carried per hour by as much as a factor of 2.

(3) Other Results

No studies are available to support this contention, but it seems reasonable that trip reliability must have been improved due to the avoidance of traffic tie-ups and other congestion-induced delays. It is reported, although not documented, that other significant benefits include reduced wear and tear on buses, leading to less maintenance and fewer street breakdowns.<sup>20</sup>

The social impacts of this project are moderately significant. While it can be said that the primary users of mass transit in San Juan are low and middle income individuals, the routes served by the exclusive bus lane tends to serve comparatively more middle class neighborhoods. Still, the service serves a large number of students, domestics and other low income or captive riders. There is no evidence that any favorable environmental impacts have been recorded.

The San Juan Metropolitan Bus Authority does not have an extensive program for collection of data on bus ridership characteristics. Data on changes in the ridership patterns of the bus company were observed for the operating system as a whole. A graph of actual ridership before and during the period of operation of the exclusive bus lane shows that the rate of decline in ridership has been decreasing since the introduction of the service (Figure 3-16). Data has been prepared showing that revenues have actually risen since the introduction of the exclusive bus lane (Figure 3-16). However it is difficult to accept total system revenue data as a meaningful indication of the effectiveness of the bus lane since other factors have worked to improve revenue. Specifically, the ratio of air-conditioned buses to nonair-conditioned buses has been rising in recent years. Since air-conditioned buses charge twenty-five cent fares and nonair-conditioned buses charge fifteen cent fares, it might be expected that even if ridership was declining, total system revenue would continue to increase.

It does seem reasonable to attribute some portion of the improvement in the rate of ridership to the bus lanes. The officials of the Metropolitan Transit Authority and the Highway Planning Authority feel that this is the major factor responsible for this change in the rate of decline. Unfortunately

---

<sup>19</sup>"Exclusive Bus Lane, A Demonstration Project," (produced by various public agencies in San Juan), July 1971, p. 15.

<sup>20</sup>Ibid., p. 19.

Figure 3 - 16  
**MONTHLY RIDERSHIP AND REVENUE TRENDS, SAN JUAN, PUERTO RICO**  
 (Note: Available Figures On System Wide Ridership and Revenues Only)

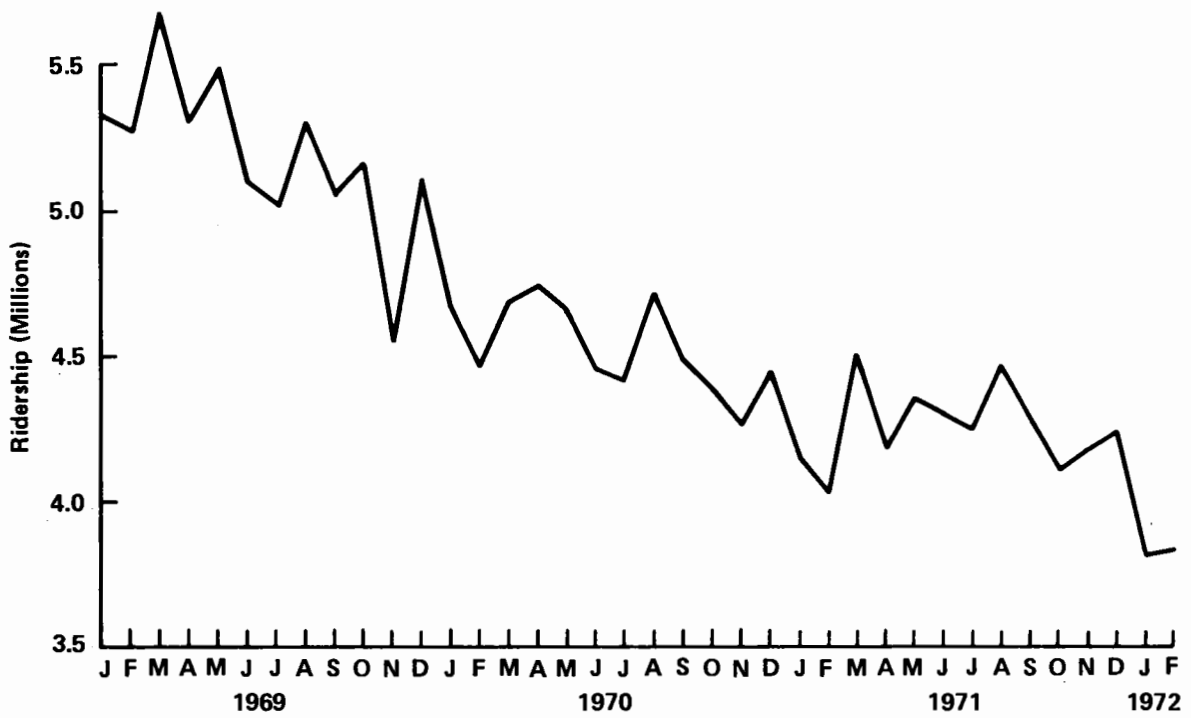

SOURCE: Metropolitan Bus Authority, San Juan, Internal Report.

no data are available to indicate the characteristics of current and previous ridership, i.e., whether auto diversion is taking place.

#### INSTITUTIONAL BACKGROUND

In the case of the San Juan exclusive bus lane a number of fairly autonomous agencies needed to achieve agreement in order to implement the exclusive bus lane. There were four principal agencies involved from the planning to the implementation and operational stages of this project. These four agencies are: The Puerto Rico Planning Board, Puerto Rico Highway Authority, Metropolitan Bus Authority, and the Puerto Rico Department of Public Works. Of course, the cooperation of the police department was also necessary.

The actual plan of exclusive bus lanes was recommended in an interim report produced by the San Juan Transit Study funded under the Urban Mass Transportation Administration's Technical Study Program. It is generally agreed by all participants that after this interim report's recommendations were made, it was the Governor's Office that was instrumental in effecting implementation. In effect, the Governor ordered the bus lane implemented. After receiving this mandate, the four involved agencies met and worked out the details of the plan.

The order originally came down in February of 1971 and the service was implemented and operating by May 17, 1971. This is rapid implementation considering the many improvements needed before operation could begin.

The Highway Authority had the responsibility of preparing engineering plans for the physical improvement of the roadway wherever necessary. This involved placement of signs, acquisition and paving of short sections of roadway, moving overhanging telephone poles where possible, and other physical improvements.

The Department of Public Works is responsible for the operation of the highways. Changes in regulations for enforcement of existing ordinances and traffic signal revisions were accomplished with their assistance. The Metropolitan Bus Authority changed their schedules as required.

The Puerto Rico Planning Board has the responsibility of administering Federal funds used in conjunction with this program. While the initial improvement plan did not require Federal funds, Phase 2 is expected to be Federally funded.

All interviewed stressed that the venture was undertaken with a degree of urgency and a spirit of inter-agency cooperation. This seems to be critical in this particular instance to the effective implementation of such a plan. Currently discussion is underway among these agencies concerning other types of improvements. There does not appear to be, at this time, substantial agreement among the various agencies as to what these improvements should be.

#### PUBLICITY AND PUBLIC RELATIONS

Publicity of the exclusive bus lane was handled entirely by the Puerto Rico Highway Authority's Office of Public Relations. The short advance notice limited preparations to news releases, broadcasts by radio and TV stations, and articles in the local newspapers. This was probably too little notice and may have been partly responsible for the slight increase in accidents reported over the first six months (see Figure 5-2).



## PUBLIC RESPONSE

No data or studies are available to indicate the nature or extent of public response. Ridership figures would suggest that the public is generally in favor of such a facility. The absence of violations or public outcry indicates that the bus lane has been accepted as a necessary traffic improvement.

## FUTURE POSSIBILITIES

Initially the proposed plan of improvement envisioned a more extensive busway program. For various reasons, including roadway geometrics, a portion of the original plan was not implemented as an exclusive bus lane. It was pointed out by the Highway Department official interviewed that to extend the one-way service further may involve loading and unloading passengers from very narrow median strips in the middle of busy multilane highway facilities.

Mr. A.S. Matos, Assistant Executive Director for Planning of the highway Authority in Puerto Rico, indicated that his office views any decision on future busways as one which must be balanced between the interests of motorists and the transit patrons. That is, when there is sufficient bus traffic to warrant removing a lane from other traffic, then a busway can be justified. His estimate is that forty-five to fifty buses per hour are needed before one lane can be eliminated from normal traffic. This requirement coupled with an absence of ideal candidate roadways and/or roadway geometrics limits, according to Mr. Matos, future possible busways in the San Juan region.

On the other hand, Mr. Edilberto Lopategui, President and General Manager of the Metropolitan Bus Authority, felt optimistic about future possibilities. A similar response was shown by the planning agency.

The conservative point of view held by the Highway Department and the more optimistic views held by planners and operators is reasonably typical of other case studies.

## SPECIALLY CONSTRUCTED BUSWAY FACILITY

### CASE STUDY 7: THE SHIRLEY BUSWAY (ALEXANDRIA, VIRGINIA - WASHINGTON, D.C. METROPOLITAN AREA)

#### DESCRIPTION

The Shirley Highway exclusive bus lane is approximately nine miles long and is located on the expressway running between Springfield, a northern Virginia suburb, and Washington, D.C. Shirley Highway is a portion of Interstate 95. (See Figure 3-17 for map). In the median of the freeway is the exclusive busway consisting in its permanent form of two twelve-foot wide reversible highway lanes. The two lane busway section begins at Springfield and presently extends northward for only about 4.5 miles. The remaining 4.5 mile busway which extends the service to Washington, D.C. is a temporary single seven-foot wide highway lane, also in the median, which serves while the permanent roadway is being constructed. The entire nine mile bus lane is operational both in the AM and PM peak periods.

#### REASON FOR BUSWAY

Certain long range planning considerations and short range coincidences and contingencies are chiefly responsible for the implementation of the Shirley Highway busway. From a long range point of view, planners realized that even with the planned major reconstruction of Shirley Highway, congestion would continue to plague this crowded, rapidly growing urban corridor. Similarly, the lack of and the high cost of facilities to handle and park more automobiles in the downtown Washington business district suggested that an all-automobile oriented Shirley Highway corridor would not completely alleviate suburban commuting needs.

From a short range point of view, certain construction contingencies combined with a pronounced interest in busways by the Federal Highway Administration in 1967 provided a golden opportunity to implement an "instant" busway on a separate roadway facility.

The idea for a bus lane first originated in 1964 discussions between local highway departments, transit companies, a transit regulatory agency, the transit authority and the Federal Highway Administration of the U.S. Department of Transportation. Studies done in the previous two years had suggested that express bus service be operated on the Shirley Highway but not on exclusive lanes.

A separate two-lane reversible roadway in the median for use by peak period traffic was already included in the construction plans for rebuilding Shirley Highway. As the outlying 4.5 miles neared completion, the fact that the additional capacity of the newer portion could not be absorbed by the older sections of Shirley Highway near the CBD became painfully obvious as a staging problem requiring positive remedial action. Opening the entire new portion of the freeway during the AM peak would, for example, have required five lanes to eventually merge into two lanes. At that time, too, the 14th Street Bridge approaches to Washington from Shirley Highway were inadequate to handle anticipated demand.

**Figure 3 - 17**  
**SHIRLEY HIGHWAY EXCLUSIVE BUS LANE FACILITY WITH TRAVEL TIME**  
**FOR SEGMENTS AND ENTIRE FACILITY**

Total Travel Time For Vehicle Traveling Full Link Length  
 Total Bus Time as Percent of Total Auto Time

AVERAGE TIME IN MINUTES						
BUS AM & P.M. - 3	5	3	3	3	17	
AUTO - A.M. - 3	7	14	6	10	40	42%
P.M. - 3	5	3	6	20	37	45%

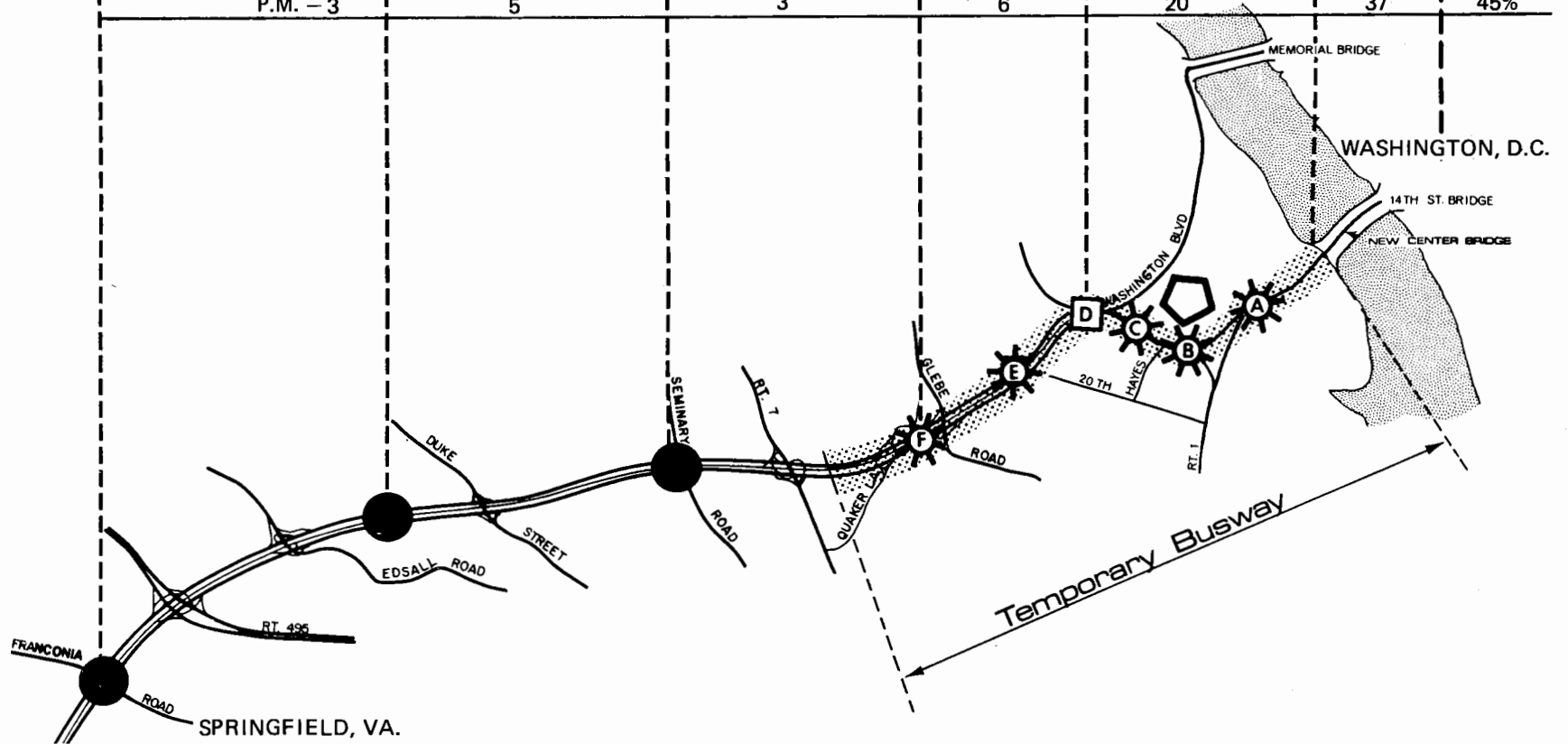

SOURCE: Ronald J. Fisher, Program Manager, Urban Mass Transportation Administration, "Shirley Highway Express Bus on Freeway Demonstration Project," Jan., 1972, p. 4.

At about this time, the FHWA announced the important policy position of supporting construction of bus lanes in conjunction with construction of new highway facilities. Soon afterward, the FHWA sponsored a "Feasibility Study of Bus Rapid Transit in the Shirley Highway Corridor", whose recommendations are chiefly responsible for the present operation.

Two changes in prepared plans were needed to accommodate the busway: first, three interchanges had to be redesigned for buses to permit exclusive access to the reversible lanes; second, construction of a temporary busway from the completed newer section of the facility to the Potomac Bridges was necessary until this older portion of Shirley Highway was completely rebuilt.

#### OPERATIONAL DETAILS

Initial portions of the Shirley Highway reversed bus lanes were opened in September of 1969. The lanes then only extended from Edsall Road (Springfield, Virginia) for about 4.8 miles northward, ending about 4.5 miles south of the Potomac River bridges and were used only in the morning peak. In September of 1970, an additional 1.5 mile section of temporary bus lane was opened at the northern terminus of the permanent reversible exclusive bus lanes then in operation. At this time, outbound evening peak hour service was also initiated.

In April of 1971, 2.5 miles of additional temporary bus lanes were opened. The bus lane now extended all the way from Springfield, Virginia to an exclusive lane on the new 14th Street Bridge. The D.C. Department of Highways also established exclusive curb bus lanes along 14th Street and other major bus route streets in the downtown Washington area to complement the Virginia bus lane. These curb bus lanes were with-flow and also were to be used by right-turning vehicles.

The operation of the exclusive bus lane per se is extremely simple except for entrances and exits: buses merely run along their own roadway until they reach their exit point. The bus roadway is segregated from the other vehicular roadways by continuous traffic separators with median-type barrier rails.

Entrances are managed in one of three ways. Certain ramps pass directly over the normal freeway lanes and down into the median exclusive bus lane. The ramps can be used exclusively by buses to enter the median bus lane in the morning or for exiting in the evening. A second type of ramp facility available for buses entering the Shirley Highway is a normal but specially marked two-lane ramp. In areas of congestion, the left-hand lane of the entrance ramp is reserved for buses only. Buses quickly enter the freeway via the special lane while cars are backed up on the ramp. The bus then weaves across regular traffic lanes to an entrance into the median reversible lanes. "YIELD TO BUSES" signs and warnings in advance of these bus weaving areas allow buses to cross the regular lanes and enter the exclusive bus lane with little difficulty. A major reason why buses are able to weave across lanes so successfully is that traffic is generally moving quite slowly. Auto drivers have also proven cooperative. This pattern of cooperation was established very early in busway operations, when incomplete bus lanes required merging of buses back onto the regular roadway amid congestion delayed bumper-to-bumper traffic. State police were stationed at the merge points during the first few days of operation to insure that cars allowed buses to merge safely.

They did, and after the first few days police were no longer needed on the scene. Use of the bus lanes by unauthorized vehicles has been almost non-existent and policing for this reason has been unnecessary.

A third way that buses enter the exclusive bus lane facility is by using a normal entrance and exit ramp, mixing with other traffic and weaving across two or three lanes of traffic to a gap in the median barriers. Once the buses have entered the exclusive bus lane facility, they proceed directly to the terminal point of the exclusive bus lane on the D.C. side of the 14th Street Bridge or else exit earlier to reach some major destination on the Virginia side of the Potomac River such as the Pentagon or Crystal City. A number of D.C. streets have been set up with curb lanes reserved for bus traffic. Heavy bus traffic on these lanes makes it a relatively effective with-flow curb lane. PM operation is essentially the reverse of AM operation.

#### SAFETY CONSIDERATIONS

To date there have been no accidents related to normal operation of the bus lane. A construction workman was struck, but this cannot be considered a true busway-induced accident.

Naturally, one would expect a barrier-separated, dedicated lane with no opposing traffic to be very safe. Weaving from entrance ramps on the right to gaps in the median barrier on the left has introduced no accidents. In part this is traceable to the often very slow-moving traffic at such points.

#### COSTS

##### (1) User Costs

To date users have not been charged any special fares when traveling on buses using the Shirley Highway facility.

##### (2) Implementation Costs

Busway construction costs for the 4.5 mile temporary busway were \$2.8 million or about \$620,000 a mile; \$200,000 was spent on the Feasibility Study mentioned previously in this report.

##### (3) Operating Costs

The Shirley Highway busway facility operates essentially as a permanent facility. As a result, daily operating costs outside of normal roadway maintenance are not incurred.

#### RESULTS

##### (1) Speed or Time

Figure 3-17 includes travel time data for the Shirley Highway and busway. The last column indicates that a bus can travel the entire length of the bus lane in about forty-two percent of the time required for an auto trip in the AM peak, and about forty-five percent of the time required for an auto trip in the PM peak. Thus, bus usage results in substantial link travel time savings. Comparative door-to-door trip times are not yet available.

Time savings are an important factor in the success of the lanes. Table 3-8 shows comparative reasons for Shirley and non-Shirley bus riders who switched from auto to bus. The principal reason for switching given by Shirley riders was time savings (thirty-five percent), while for new non-Shirley bus riders time savings were a minor factor.

### (2) Volume

Actual change in AM peak period bus passenger volumes on Shirley Highway is shown in Figure 3-18. This figure also provides comparative data on auto person trips before and after the exclusive bus lanes were opened. The figure reveals a fairly steady increase in AM peak period bus lane volumes since the exclusive lanes were opened and a decline in auto person trips.

Potential passenger capacities on busways are shown in Table 5-1. Comparisons with volumes presently carried on the Shirley Highway and this table indicate quite a bit of unused capacity.

### (3) Other Results

A complete analysis of mode shift in connection with the busway has not yet been completed although investigations are currently underway. While available data shows dramatic increases in total numbers of passengers carried (see Figure 3-18), this is most readily explained by increases in scheduled service using the Shirley Highway facility. Efforts are underway to pin down the degree of mode switching attributable to the different aspects of the improved transit service.

One data source currently available for assessing mode choice behavior is the screenline counts begun in April of 1970 (Table 3-9). The percentage of person trips by bus crossing the screenlines throughout the corridor was about twenty-two percent during 1970, but increased in 1971 to a little over twenty-seven percent.

Not all persons crossing the screenline are potential Shirley bus users in that not all persons are taking trips that start and end in locations served by the Shirley buses. To take this into account, the evaluation team adjusted the statistics and estimated that about sixty-six percent of automobile person trips crossing the screenline are potential express bus riders. Persons making these sixty-six percent of total trips are called the "market", and those who use the buses become the "market share". Growth of the "market share" is about nine percent, slightly higher than overall growth in bus ridership (see Figure 3-19). Again, caution must be used in interpreting this data since so much service was added during this period and, due to a lengthening of the lane, more bus routes were able to use the facility to advantage.

Conclusive survey data on mode choice behavior is not expected to be available until 1974. At the moment project officials estimate that between 1,300 and 1,500 private vehicles per day have been eliminated by the service available on the exclusive bus lane.

Car occupancy rates have declined, but only slightly, since the opening of the exclusive bus lanes. Investigations are being conducted on the relationship between exclusive bus lane service and carpools, but no conclusions have been reached yet.

**Figure 3 - 18**  
**AUTO AND BUS PERSON TRIPS ON SHIRLEY HIGHWAY**  
**A.M. PEAK PERIOD (6:30 - 9:00)**

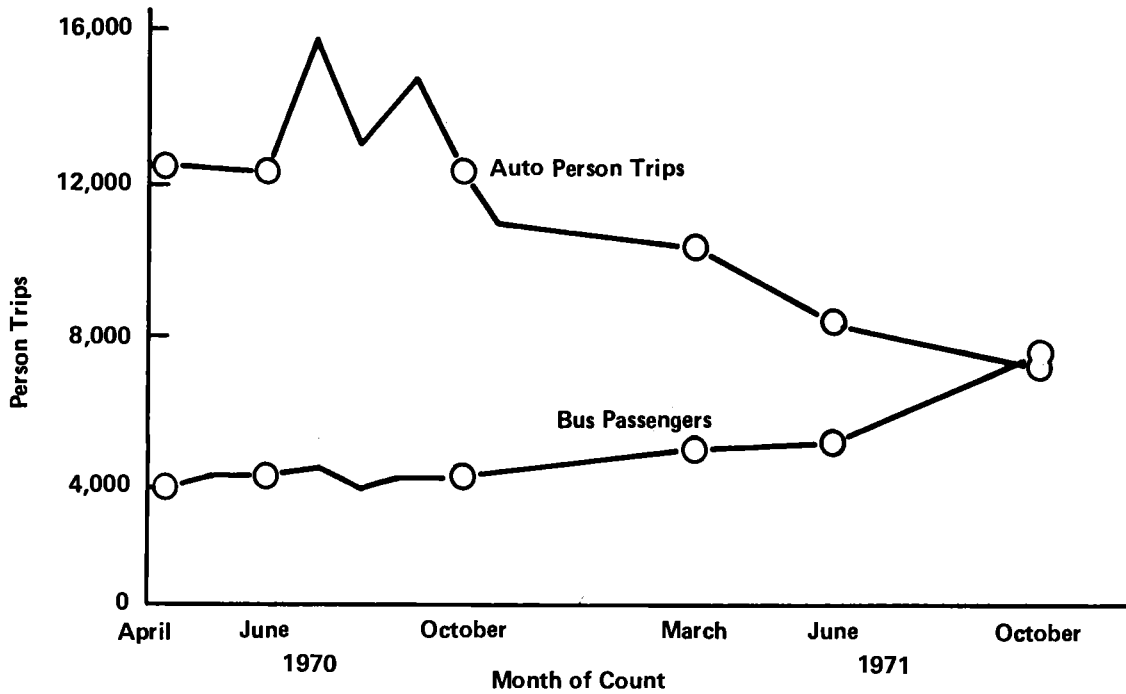

SOURCE: R. Fisher, Urban Mass Transportation Administration, "Shirley Highway Express Bus on Freeway Demonstration Project," Jan., 1972, p. 12a.

**Figure 3 - 19**  
**PORTION OF POTENTIAL BUS MARKET USING TRANSIT**  
**"MARKET SHARE"**

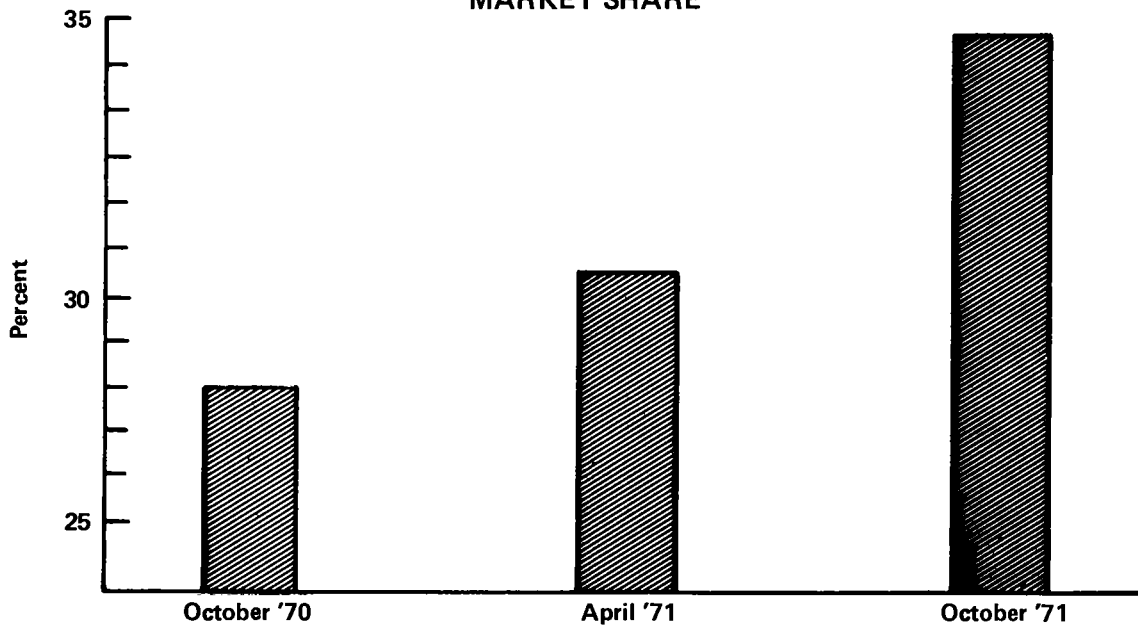

SOURCE: R. Fisher, Urban Mass Transportation Administration, "Shirley Highway Express Bus on Freeway Demonstration Project," Jan., 1972, p. 11a.

TABLE 3-8: Shirley Highway: Reasons for Switching From Auto to Bus  
(Choice Riders)\*

Shirley		Non-Shirley	
Bus Faster	35%	Carpool Dissolved	25%
Traffic	24%	Traffic	22%
Auto Cost	9%	Moved, Changed Jobs	20%
Parking Cost	7%	Parking Cost	19%
Car Pool Dissolved	9%	Auto Cost	8%
Moved, Changed Jobs	<u>16%</u>	Bus Faster	<u>6%</u>
Total	100%	Total	100%

\*Person who had an automobile available for the trip.

SOURCE: Ronald J. Fisher, "Shirley Highway Express Bus On Freeway Demonstration Project," Prepared for Presentation at Highway Research Board 51st Annual Meeting, January, 1972, p. 17.

TABLE 3-9: Shirley Highway Screenline Counts

	Auto Persons	Total Vehicles	Auto Occupancy	Bus Passengers	Total Persons	Bus Percent
Shirley Highway Screenline Station						
Oct. 1970	12,210	8,906	1.37	4,353	16,563	26.28
Oct. 1971	<u>7,564</u>	<u>5,662</u>	<u>1.34</u>	<u>7,824</u>	<u>15,388</u>	<u>50.84</u>
Difference	-4,646	-3,244	-0.03	+3,471	-1,175	+24.56
Total Screenline						
Oct. 1970	50,508	35,724	1.41	14,248	64,756	22.0
Oct. 1971	<u>42,937</u>	<u>31,740</u>	<u>1.35</u>	<u>16,308</u>	<u>59,245</u>	<u>27.5</u>
Difference	-7,571	-3,984	-0.06	+2,060	-5,511	+5.5

SOURCE: Fisher, p. 11.



Important characteristics of bus and non-bus users are reproduced in Tables 3-10 through 3-14. The most significant perhaps is that data reporting higher incomes and more car availability for Shirley bus users (see Tables 3-10 and 3-11), and that data noting that of all AM corridor bus users over eighty percent walk to the bus, and over eighty percent walk from the bus to their destination (see Table 3-12). Very little transferring between buses or use of park-n-ride or kiss-n-ride occurs (facilities for this are not very readily available).

The survey of auto users who have tried transit on occasion but use auto showed that inconvenience or slowness of the bus comprised thirty-six percent of the major complaints against bus service (see Table 3-13). However, the leading reason for switching from auto to Shirley bus was that the bus was faster (see Table 3-8). This has two important considerations:

- . First, people are reluctant to be inconvenienced in using bus service even when provided on an exclusive lane with substantial time savings. Park-n-ride facilities or stops close to one's home and destination must be provided to maximize ridership.
- . Second, ridership on other local service in the metropolitan area would probably respond to decreases in trip time where the service is already convenient but very slow when compared to competing modes.

The second most numerous complaint against the bus by auto users who tried bus but switched back was that the bus was too expensive (see Table 3-13). Significantly, fifty percent of auto users making this complaint had zero parking cost (see Tables 3-13 and 3-14). Change in parking policy and/or imposition of various parking tax schemes for purposes of equity or regulation would influence these individuals to some extent.

To date, no economic efficiencies have been reported for transit operators, but this does not mean that they may not exist.

The environmental and social impact is minor.

#### INSTITUTIONAL BACKGROUND

Details on the sequence of events leading up to implementation of the bus lane were provided in the Description section at the very beginning of this case study discussion.

Since a number of autonomous agencies at the local, state and federal level were involved, a "cooperative environment" was necessary to achieve implementation. Participating organizations included:

- . A.B. & W. Transit Company (private)
- . Bureau of Public Roads (now Federal Highway Administration)
- . D.C. Department of Highways
- . Metropolitan Washington Council of Governments
- . Northern Virginia Transportation Commission

TABLE 3-10: Shirley Highway Bus and Auto Commuter Profiles

	Bus		Auto	
	April	October	April	October
Percent Male	49	54	73	74
Household Income	\$15,500	\$16,400	\$19,500	\$19,100
Cars/Household	1.1	1.3	1.7	1.7
<u>Attitude Score</u> (1.0 Very Positive)	1.9	1.6	2.7	2.4
Captive (no Auto)	33%	24%		
Choice (Auto Available)	52%	57%		
Auto Available but Hardship*	14%	16%		

\*The person had an auto available for his trip, but at some inconvenience to others.

---

SOURCE: Fisher, p. 14.

TABLE 3-11: Shirley Highway Bus Survey Results

Shirley Passenger is	Shirley		Non-Shirley	
	April	October	April	October
Richer	\$16,300	\$16,900	\$15,200	\$16,100
Favorable to Bus	1.7	1.5	1.9	1.8
More Cars/HH	1.2	1.3	1.1	1.2
More Choice	59%	62%	44%	48%
Less Captive	24%	21%	37%	36%
More Park-Ride	8%	16%	7%	9%
<u>Previous Mode:</u>				
Drove alone	23%	18%	16%	12%
Car pooled	12%	13%	11%	11%
Another bus	17%	20%	13%	14%
No trip	48%	49%	60%	62%
Began Bus After June 1971		52%		26%

---

SOURCE: Fisher, p. 15.

TABLE 3-12: Shirley Highway Bus Travel Data

---

Work Trip:		92%
Access Mode:	Walk	83%
	Driven	8
	Drive/Park	8
	Bus	1
Egress Mode:	Walk	87%
	Transfer	12
	Taxi, etc.	1
Five Days/Week:		88%
Date Began Busing:	After 1/1/71	18%
	After 5/1/70	45
	After 5/1/69	65
Seat Availability:	Always	55%
	Usually	34
	Seldom	9
	Never	3

---

SOURCE: Urban Mass Transportation Administration Notice No. 3, "Shirley Express Bus Demonstration Statistics, "October 1, 1971, p. 6.

TABLE 3-13: Shirley Highway: Major Reasons for Switching from Bus to Auto

Percentage Responding	Reason
19	Inconvenient
18	Bus too expensive (50% have zero parking cost)
17	Bus slower
16	Car comfort, privacy
8	Weather
8	Irregular hours
6	Car pool formed
4	Evening service poor
4	Other
100	Total

SOURCE: Fisher, p. 18.

TABLE 3-14: Shirley Highway Auto Survey Results

Sub Mode:	April	October
Drive alone	50%	51%
Alternate Driver	14%	13%
Driver with passengers	13%	12%
Passengers	23%	24%

Vehicle Parking Cost:	April	October
Zero	55%	55%
Paying average	\$1.15	\$1.10
Need car during day	19%	24%
Have made trip by bus	19%	24%

---

SOURCE: Fisher, p. 16.

- . Virginia Department of Highways
- . Urban Mass Transportation Administration
- . Washington Metropolitan Area Transit Authority
- . Washington Metropolitan Area Transit Commission
- . W.V. & M. Coach Company (private)

Analysis of the events leading up to implementation show that Federal participation was essential. The FHWA provided the expertise and the broad base of support needed to reassure local agencies that the then novel concept was workable and justifiable.

UMTA support was needed to insure that transit service would be provided in the corridor. The local transit operator was unwilling to invest in additional buses or to risk financial loss from the radical changes in routings needed to assure adequate service in the corridor.

This latter situation is to be expected in communities with unsubsidized operators. The transit operator is able to sustain service only on a marginally profitable basis or under terms of a specific subsidy. Extension of service necessitates jeopardizing the security of these operations.

It does not seem unreasonable to expect these fears to frequently manifest themselves, and resolution may require government assurance that undue financial losses will not be incurred.

#### PUBLICITY AND PUBLIC RELATIONS

Presence of the buses speeding along Shirley Highway while commuter auto traffic was delayed was probably the best publicity for the new lanes. Lack of car and bus interaction reduced the need for public information from a safety viewpoint. However, where bus weaving or merging was necessary, adequate signing plus presence of police during the first few days of operation led to smooth-running operations.

Aside from informing motorists, potential and current busway users had to be alerted. Publicity was important in both initial opening of the exclusive lanes to buses and in the openings of northerly extensions of the bus lane. Publicity included ribbon cutting ceremonies and speeches by top transportation officials, including the Secretary of the Department of Transportation. Press announcements were released days before the ceremony. Handbills, including maps depicting bus route changes and new bus route schedules were mailed to corridor residents in neighborhoods covered by the new service. Thirteen thousand such handbills were mailed to corridor homes to announce the September 1970 busway extension and 4,000 additional handbills were placed aboard buses throughout the corridor. Printing and mailing charges for the handbills were about seven cents per item, or \$70 per thousand items. Considerable press, TV, and radio coverage was received due to the unique nature of the service innovation.

#### PUBLIC RESPONSE

Public response to the busway has been fairly positive. This is shown by the increase in bus passengers and decline in auto passengers on Shirley

Highway. Scarcity of complaints from motorists and their willingness to yield to buses when they merge indicate general acceptance by non-bus users. In Table 3-10, the category "Attitude Score" shows that auto drivers were fairly positive in their attitude towards the Shirley busway concept. Although they were not as positive as bus riders, it is important to note that their attitude is becoming more positive over time.

#### FUTURE POSSIBILITIES

Despite success of this busway, the Washington, D.C. area has not yet installed busways or reverse lanes on highways or arterials in other locations in the city. An exclusive bus lane is being contemplated for a frontage road along an arterial, Arlington Boulevard, which is also in the northern Virginia suburbs.



## CONCLUSION

Funding only permitted study of the above seven cities in detail. While the study staff attempted to concentrate on the most representative and significant U.S. examples, other bus lane projects exist in this country and abroad. A summary of several U.S. examples is included in Table 3-15.

Numerous exclusive bus lane projects have been implemented abroad. A recent special three-day symposium on busways in Crowthorne, England emphasized the commitment being placed on this technique for relieving urban transportation crises overseas and especially in England.

Unfortunately, the scope of this study did not permit in-depth analysis of these overseas applications. More on European examples can be found in two recent studies:

- . An Analysis of Urban Highway Public Transportation Facility Needs, Report of the Secretary of Transportation to the United States Congress, April, 1972, prepared by Alan M. Voorhees & Associates, Inc.; Peat, Marwick, Mitchell, & Co.; Simpson & Curtin, Inc., 1971.
- . Planning and Design Guidelines for Efficient Bus Utilization of Highway Facilities, Wilbur Smith & Associates, 1972. (Prepared for the National Cooperative Highway Research Program).

TABLE 3-15: Summary Statistics on Bus Lanes in Six Non-Case Study Cities

CITY	<u>Baltimore</u>	<u>Chicago</u>
TYPE OF FACILITY	Reserved, with-flow bus lane	Reserved lanes, with-flow and contra-flow, in selected applications
NUMBER OF FACILITIES	8	At least 9 preferential bus treatment facilities citywide
LENGTH	Total of 51 blocks, individual facility lengths from 3 to 18 blocks	Probably the most important bus facility is a .6 mile reserved lane on Washington St. in the CBD
NO. BUSES USING FACILITY IN PEAK HOUR	In 1963, on all 8 facilities, 314 buses daily during the peak hour	Various numbers depending on which facility, volumes in excess of 100 are not unusual
NO. BUSES USING FACILITY ALL DAY	In 1963, on all 8 facilities, 629 buses daily	Not available
HOURS OF OPERATION	During AM and/or PM peak period; exact times vary for each facility	Used during all hours of bus operations, i.e. twenty-four hours in some instances
TIME SAVED	No significant reduction in running times, but exclusive lanes have increased reliability through meeting of existing transit schedules	Peak hour travel time for .5 miles of the lane was 4.3 mins., compared to 6.3 mins. for the same distance on a parallel st.
IMPLEMENTATION, USER MAINTENANCE COSTS	User costs remained the same; implementation costs are believed to have been small with maintenance costs met through normal operating budgets	
OPERATOR EFFICIENCIES	Apparently insignificant	One bus run during peak hours was eliminated due to time saving with the exclusive lane
AGENCIES RESPONSIBLE FOR IMPLEMENTATION	Department of Transit and Traffic, Baltimore	Chicago Transit Authority, Chicago Street Commission
SAFETY AND ENFORCEMENT RECORD	No safety problems; signs say "Buses only," but are not enforced vigorously	No safety problem, lane is self-enforcing due to its location in the <u>center</u> lane with occasional lane barriers in the form of raised passenger loading strips, cement dividers, etc.
YEAR ESTABLISHED	1958	1956

TABLE 3-15: Summary Statistics on Bus Lanes in Six Non-Case Study Cities, (cont'd.)

CITY	<u>Dallas</u>	<u>Madison, Wisconsin</u>
TYPE OF FACILITY	Reserved, with-flow bus lanes on two one-way arterials	Reserved, contra-flow bus lane on one-way arterial
NUMBER OF FACILITIES	2 (on a one-way pair)	one
LENGTH	5 and 10 blocks	Approx. 10 blocks
NO. BUSES USING FACILITY IN PEAK HOUR	Approximately 70-75 buses on each facility	Not available
NO. BUSES USING FACILITY ALL DAY	Not available	170 daily
HOURS OF OPERATION	7-9 AM and 4:30 PM on both facilities	Used during hours of bus operation
TIME SAVED	During AM peak: official estimates 5-10% increase in speed for buses over previous speeds, during PM peak 10-20% increase (30 secs saved AM, 45 secs PM)	No data available
IMPLEMENTATION, USER MAINTENANCE COSTS	User costs remained the same; implementation costs are believed to have been small with maintenance costs met through normal operating budgets	
OPERATOR EFFICIENCIES	Dallas Transit System claims operating efficiencies but has not documented same	None known to date
AGENCIES RESPONSIBLE FOR IMPLEMENTATION	Not available	Transit company, and the City of Madison
SAFETY AND ENFORCEMENT RECORD	No safety problems, some enforcement difficulties	A one-way street pair was created along with the bus lane--these changes resulted in some reduction of accidents along with an increase in traffic flow on the sts., currently few enforcement problems, although there have been problems
YEAR ESTABLISHED	1957	1966

TABLE 3-15: Summary Statistics on Bus Lanes in Six Non-Case Study Cities, (cont'd)

CITY	<u>San Francisco-Oakland Bay Bridge</u>	<u>Seattle, Washington</u>
TYPE OF FACILITY	Special Facility	Special Facility Involves bus use of freeway
NUMBER OF FACILITIES	One	One
LENGTH	A 2700 ft. approach to a toll-booth, with the lane extending beyond the booth to the bridge	An exclusive on-off bus ramp on a freeway in the CBD, plus non-exclusive use of up to about 8 miles of reversible center lanes on I-5
No. BUSES USING FACILITY IN PEAK HOUR	500 buses during the 2 hr. peak	Not available
No. BUSES USING FACILITY ALL DAY	500	81
HOURS OF OPERATION	Not available	7 am to 7 pm
TIME SAVED	Approx. 5-15 minutes	On one 9-mile route, 10-20 mins. is saved over time required for non-express bus service, with savings attributable principally to use of I-5
IMPLEMENTATION, USER, MAINTENANCE COSTS	User costs remained same; implementation costs believed to be minimal, with maintenance costs met through normal operating budgets	\$1.29 m. was used to purchase new buses, development of park-N-ride lot, and operational expenses. Actual ramp and freeway facility provided when I-5 built
OPERATOR EFFICIENCIES	Buses were running 5-15 mins. late during AM peak, but were brought up to their schedules with this lane	Not known; new ridership did grow with establishment of these routes
AGENCIES RESPONSIBLE FOR IMPLEMENTATION	AC Transit, San Francisco-Oakland Bay Bridge Authority	Wash. State Dept. of Highways, City of Seattle Traffic Engineering Dept., Seattle Transit System, plus Federal funds from UMTA and FHWA
SAFETY & ENFORCEMENT RECORD	No enforcement problems, and it was stated that sideswipe accidents have decreased since the lanes opened	No safety problems evident; enforcement problems existed initially, but appear to have been resolved
YEAR ESTABLISHED	Mid 1970	September, 1970

OPPORTUNITIES FOR BUS LANES IN FIVE SELECTED CITIESINTRODUCTION

Having studied and reviewed bus lanes currently operational, the study next sought to assess how universal the applicability of bus lanes might be for significant reduction in metropolitan transportation system deficiencies. Five cities were selected for analysis. Four of the cities have no exclusive bus lanes, while the fifth city has an important exclusive lane operating. This lane is discussed fully elsewhere in this final report.

These five metropolitan areas were chosen because they were of varied size and character. All types of public and private transportation service were represented and their development patterns ranged from dense to dispersed. One secondary criterion which limited possible cities selected was accessibility of the city to the research team. This still allowed investigation of a sufficiently wide range of suitable examples.

In addition, discussions of further bus lane development possibilities are explored in each of the case study cities (see Chapter 3). Thus the study has a fairly broad basis on which to discuss the universality of bus lane applications.

A two-step approach was used in this portion of the study:

- (1) Obtaining, where possible, directional traffic count data (to identify those routes with traffic flow directional imbalance during the peak hours), total volumes, highway geometrics, and other characteristics of key routes in the metropolitan areas, along with the current pattern of bus routes. These were used in a preliminary assessment of individual facility potential.
- (2) Reviewing the theoretical and abstract conclusions derived from Step 1 with representatives of key transportation agencies in each metropolitan area. The purposes of these conversations were threefold:
  - . To learn something of the direction of transportation improvement planning in each area.
  - . To discuss the possibility of bus lanes as one possible answer to transportation needs.
  - . To determine if certain local characteristics of the highway system or transportation service were obvious impediments to installation of bus lanes and thus would contradict Step 1 conclusions.

None of the cities studied except one are mentioned by name. This is done to avoid generating public controversy over transportation plans which

may now be under consideration or prejudice to future actions in case this perusal overlooks important planning considerations. In a few cases, officials would not discuss the subject unless anonymity was promised.

#### SUMMARY OF FINDINGS

The principal finding of this phase of the investigation was that all five cities investigated for potential bus lane locations do have roadways which appear to be under-utilized in peak hours due to highly directional peak hour flows. Preliminary research indicates that these favorable flows exist on expressways, on major arterials leading from outlying areas to the CBD's and on CBD streets, some of which are two-way and others one-way. However, this data is only preliminary. Additional data would have to be collected for each of the street types mentioned to clarify whether special exclusive lanes (probably of the reverse type) would be feasible.

A second major finding was that official reaction to the possibility of busways in most cases was quite negative. Apparently highway and planning officials have decided that other transportation improvements are more desirable and have dismissed bus lanes, often with little consideration, as a possible solution to transportation needs.

The balance of this chapter is a discussion of each of these five cities.

## CITY "A"

### METROPOLITAN AREA CHARACTERISTICS

City "A" had a central city 1970 population of about two million. Typical of many older cities, it has a very high density - over 15,000 people per square mile. For those people outside city limits, commuting to the CBD involves travel through densely populated areas.

A variety of fixed rail facilities are well-developed and well-used alternatives to motor vehicle travel in the area. They serve nearby satellite cities as well as other corridors. The rail facilities have needed upgrading and improvement and local groups have focused their time and money on this priority.

It is interesting to note that in two broad corridors of City "A", PM peak motor vehicle movement has no pronounced directional flow in several instances. This finding, which makes reverse bus lanes rather impractical on the affected routes, may be due to several factors:

- (1) The high degree of commuter use of fixed rail facilities, thus increasing the proportion of non-commuter traffic on the highway. Non-commuter traffic may be less directional during peak hours. Calculations seem to bear out this hypothesis.
- (2) The presence of industry in these corridors with many factories located at some distance from the CBD. From the data studied, it appears that the reverse commuter represents a substantial proportion of all peak hour trips and thus tends to counterbalance the usual heavily directional peak hour flows.
- (3) Incomplete Interstate limited access facilities, thus requiring through traffic to use some of the roads commuters also use.

Table 4-1 describes the various routes surveyed and provides some indications of bus lane potential for various corridors in City "A". It should be noted that not all corridors or routes were surveyed. Conceivably more appropriate routes exist and might even prove more desirable than those isolated in this admittedly hasty survey.

### OFFICIAL REACTION TO POSSIBLE BUSWAYS IN THE AREA

Official reaction to the possibility of busways in the metropolitan area of City "A" was somewhat negative. Existence of viable fixed rail facilities serving most of the area was generally mentioned as the reason. The response was negative to suggestions of bus lanes on arterials, one-ways, and expressways both within the CBD and serving corridors leading to the CBD from the suburbs.

TABLE 4-1: Selected Characteristics of Certain Roadways with Potential for Busways in City "A"

Roadway Description	Current Status Transit Service	Peak Period Directional Ratios		No. of Lanes Avail- able	Lim- ited Ac- cess	Comment
		AM	PM			
1. Arterial from sub-urban township to CBD	Has transit service	68:32	Balanced	N.A.	No	AM excess capacity
2. Major intercity freeway	Rail line adjacent	58:42	Balanced	N.A.	Yes	As above
3. Major radial arterial within city limits	Bus service	58:42	57:43	N.A.	No	Careful consideration needed before final decision
4. Major radial arterial	Bus service	59:41	Balanced	10-12	Semi	High No./lanes suggests many possibilities even in PM
5. Radial arterial	Bus service	N.A.	59:41	4	No	
6. Freeway, mostly within city limits	Adjacent commuter rail line	80:20	68:32	6	Yes	Greatest potential
7. Freeway, suburbs	As above	62:38	Balanced	6	Yes	
8. Multi-lane bridge to CBD	Rail service	78:22	70:30	6	No	
9. Major arterial	Subway service	66:34	60:40	N.A.	No	
10. One-way arterial pair	Bus service	61:39	64:36	N.A.	No	
11. Intown expressway	Bus service	57:43	63:37	6	Yes	Careful study needed on AM potential
12. CBD expressway	Bus and subway	75:25	Balanced	6	Yes	AM potential



One Interstate route was seen by local officials as the most likely location for a (reverse) bus lane if any were to be implemented. This study, however, would contend that the potential for busway applications may well exist beyond the limited prospects suggested by planners in the area.

#### ON-GOING TRANSIT OR PLANNING ACTIVITIES IN THE AREA

TOPICS projects will improve 500 miles of streets in the area. Planned improvements, all non-capital intensive, include synchronization of traffic signals along two of the routes with peak hour directional flows favorable to bus lanes.

The biggest program of transit improvements planned for the city at this time, however, is that sponsored in one corridor by the Urban Corridor program. Busways may be considered in one or two instances as candidate corridor improvements, but planners indicate subway and rail transit facility improvements are more probable.

#### COMMENT

Clearly, more transit options exist in City "A" than in most other cities as the result of a major system of fixed rail facilities. Busways offer opportunities to develop service in areas not now served by rail. In addition, busways have the added advantage of providing major transit improvements quickly and inexpensively.

## CITY "B"

### METROPOLITAN AREA CHARACTERISTICS

City "B" and the contiguous metropolitan area had a 1970 census population of about 400,000. There are no major cities nearby. Growth is focused in the suburban areas. Two major Interstate highways cross-cross the city.

### POTENTIAL FOR BUS LANES

As in City "A" directional imbalances exist on both the aforementioned freeways and on key arterials. The real question facing planners, however, is whether sufficient delay is encountered such that busways would provide a transportation advantage to bus travelers.

Within the CBD delay does not appear to be excessive. A study conducted on a major one-way arterial in the CBD suggested that arterial bus lanes would not result in significant time savings for current transit users or auto drivers. In this experiment, a bus was timed on its route along a major arterial in the CBD. Timings were taken, during the AM peak period, by personnel in an automobile which followed the buses. The timings indicated that the buses were traveling, on the average, between eighteen and twenty m.p.h. The only delays recorded were due to stops at traffic signals, rather than any congestion-caused delays. The lack of congestion on this major CBD route, plus the relatively high speed of the bus (buses generally average about thirteen m.p.h. on urban routes) suggests that establishment of arterial bus lanes cannot significantly increase bus speeds through this corridor. Marginal transportation time advantages are more likely to be achieved on line haul portions of the trip to and from the CBD.

A major transportation corridor, for example, shows imbalances in peak hour flow between sixty to forty and sixty-five to thirty-five on two key arterials. It is suspected that where local service is not necessary, express runs could be made on a separate lane with time advantages to bus patrons. Since both arterials already support numerous transit routes, experimentation is not likely to jeopardize the private carriers' interests.

A second corridor consisting of a one-way arterial pair (three lanes each way) and an expressway are also candidates for improving line haul portions of bus trips. Once again, extensive bus travel is reported in this corridor with some trips originating from far out areas. The expressway in this corridor drops a lane close to the CBD and more intense congestion is experienced.

While in both corridors unused capacity exists, careful studies would have to be made to determine whether routings of current bus service on exclusive bus lanes would result in significant travel advantages.

Given the fact that existing bus service utilizes these roadways with unused capacity, it would not appear that there are either severe risks or disadvantages associated with establishment of exclusive bus lanes. Establishment of exclusive busways on various portions of the radial network leading into the city would probably work to the advantage of bus patrons while at the same time preserving transportation alternatives for the future. Continued stress on roadways and auto travel could prove troublesome.

Currently only one type of transit improvement is planned for the near future. With Federal funding, land has been acquired for building fringe parking lots at suburban locations adjacent to the two major interstate routes running through the city. Money has not yet been acquired to actually build the fringe parking lots or to purchase buses needed if suburban service is to be extended to serve these lots. In addition to providing vehicles, the city will also have to persuade the transit operator to operate this new service. Calculations by the highway department show that within six months the bus company should break even on the operation; however, this argument has not swayed the private transit operator.

The buses to be used in connection with the fringe lot would generally run with other traffic on the expressway. At this time, despite heavy AM congestion on one of these expressways and light use of the opposing lanes, serious consideration has not been given to use of a contraflow lane because of alleged safety problems. (The safety problems mentioned here have been successfully resolved elsewhere with no added cost or other penalties). However, a local planner who was interviewed indicated that a specially-constructed bus lane might be advantageous in this corridor.

#### COMMENT

Bus lanes appear to be most valuable in applications which would speed suburban buses to the CBD. CBD congestion is not so great as to seriously impede buses which are already slowed by the necessity to stop to load and discharge passengers. The principal advantage for City "B" in establishing bus lanes, aside from possible but undocumented marginal time advantages on line haul portions of the trip, would be in presenting and preserving viable public transportation service in this heavily automobile-dependent city. Local planners apparently have dismissed busways for local application for reasons that do not appear entirely well considered.

## CITY "C"

### BACKGROUND

The CBD of this city is located near the CBD of another much larger city. Within its city limits, City "C" had a population of slightly over 80,000 according to the 1970 census.

The city appears to have several roadways which are candidates for bus lanes. Most of the corridors represented by these roadways already have transit service, thus increasing their attractiveness as bus lane candidates. Exclusive bus routes could be five or even more miles in length, as extensive line haul journeys are involved in many routes. Candidate routes having a sixty-five to thirty-five or greater peak hour directionality are summarized in Table 4-2. The locations given are only a few of the many potential locations for the routes. Detailed analysis might indicate many more streets and locations that might be served by bus lanes.

### ON-GOING TRANSIT OR PLANNING ACTIVITIES IN THE AREA

A transit study is currently underway in this city. The agencies involved in this study are:

- . The transportation branch of the highway/trans-  
portation department.
- . A public agency which operates transit service.
- . A transportation consulting firm.

The official supplying information suggested that some situations may develop for using reverse bus lanes. The city has a well-developed one-way street pattern which would facilitate busways, although some one-way streets may be changed after the transportation plan is implemented. Apparently, there is little congestion in the metropolitan area at this time. Congestion does occur within the CBD, with patterns of congestion beginning to appear on the interstate highway which runs through the city. On this route, the congestion extends approximately one-half mile beyond the CBD at times.

The transit study contains both short and long range elements. Final transportation plan improvements must mesh with extensive new government offices and shopping mall development planned for the CBD. Newly designed transportation facilities to serve the renovated CBD are being considered. Personalized rapid transit, for example, is a possibility. If this is not feasible then bus improvements may be advocated.

### COMMENT

This city had by far the most positive interest in busways and is seriously considering implementing several. The absence of severe congestion, however, may result in little or no travel time savings at first.

TABLE 4-2: Selected Characteristics of Certain Roadways with Potential for Busways in City "C"

Roadway Description	Current Status Transit Service	Peak Period Directional Ratios		No. of Lanes Avail- able	Lim- ited Ac- cess	Comment
		AM	PM <sup>(a)</sup>			
1. Radial arterial ex- tending beyond city limits	Bus service	70:30		N.A.	No	Possible application
2. CBD radial arterial	Bus service	70:30, ex- cept nr. CBD		"	"	"
3. Arterial stretching .75 miles beyond city limit	None	70:30		"	"	
4. 1.5 miles of radial arterial extending from city limits	Bus service	60:40		"	Some por- tions	
5. 2 miles of arterial extending from city limits	Bus service	70:30		"	No	"
6. 4 mi. major arte- rial extending out from city limits	Bus service	70:30		"	"	"
7. 4.5 mi. arterial extending from city limits	Bus service	70:30		"	"	"
8. Major CBD-bound ar- terial w/2 feeder trunks	Bus service	70:30		"	"	"

(a) Peak hour maximum ratio, either AM or PM, is given for each roadway.

This city was the smallest surveyed. It indicates that busway applications are not always solutions only for the problems of larger cities.

## CITY "D"

### BACKGROUND

City "D" had a 1970 census population of 750,000 within its city limits. It has a high population density (12,000 per square mile) and the metropolitan area population is approaching three million. In 1970, two-thirds of City "D" residents reported to census takers that they worked within the city limits. The only mass transit facilities are buses routed principally to serve in-bound-outbound radial travel. Crosstown and cross-suburb service is quite limited.

After reviewing traffic patterns on a number of streets, it was concluded that one interstate highway and several major arterials have peak hour directional flow patterns suitable for reverse bus lane operations without undue hinderance of other traffic. Table 4-3 gives details on these routes, indicating location, transit service, peak period split and other key data. Again, it should be emphasized not all possible routes have been analyzed and other highways may be equally suitable for inclusion in any plan of busways.

### OFFICIAL REACTION TO POSSIBLE BUSWAYS IN THE AREA

Official reaction toward reverse bus lanes was somewhat negative. In at least one instance, it was observed that planning, traffic and transit operating officials were not aware of that exclusive bus lane concept involving reversing a lightly-used lane on a local freeway.

The city experiences severe congestion during peak hours. Buses operate mixed with normal auto traffic and both are substantially delayed. The city clearly has need of additional measures to alleviate transit trip delays.

### ON-GOING TRANSIT OR PLANNING ACTIVITIES IN THE AREA

A major planning effort in the area is being sponsored by the Urban Corridor program. The proposed project will improve one major corridor, probably including bus pre-emption of signals, a special bus ramp at a congested facility, and some roadway improvements. The bus ramp facility is very short and does not qualify as an exclusive bus lane. No reverse bus lane is planned, although a curb lane may be reserved for buses along one crosstown street.

### COMMENT

City "D" appears to overlook the potential benefits of bus lanes on major commuter corridors. This appears to be largely because planners are not familiar with opportunities which might be presented by busways.

TABLE 4-3: Selected Characteristics of Certain Roadways with Potential for Busways in City "D"

Roadway Description	Current Status Transit Service	Peak Period Directional Ratios		No. Lanes Available	Limited Access	Comment
		AM	PM			
1. CBD to suburbs freeway	Bus service	60:40 (CBD) 70:30 (outer)	-- --	6 (CBD) 4 (outer)	Yes	Good potential AM only
2. Major radial arterial (counts taken 7.5 miles from CBD)	Bus service	75:25	55:45	Variable	No	
3. CBD to suburbs arterial radial route (counts taken 7.5 miles from CBD)	Bus service	70:30	70:30	Variable	No	Suburban service most promising
4. CBD to suburbs arterial radial route	Bus service	70:30 (CBD) 60:40 (city limits)	60:40	N.A.	No	Possible arterial facility
5. Major radial arterial route leading out from CBD	Bus service	70:30 (CBD) 60:40 (outer CBD) 80:20 (past city limits) 60:40 (extreme suburbs)	70:30 (CBD to beyond suburbs) 50:50 (extreme suburbs)	N.A.	No	AM and PM possibilities



CITY "E"

(COLUMBUS, OHIO)

METROPOLITAN AREA CHARACTERISTICS

Columbus actively assisted the study staff in this investigation. Since what is being described is an officially-proposed community development, the name of the city and sources of data are included.

Columbus, Ohio is a fairly large landlocked midwestern city with a metropolitan population of just under 1,000,000. The city has a low population density of 4,138 persons per square mile. Development has been primarily along a north-south and east-west axis, although completion of an inner and outer beltway may change development patterns in the future.

Travel demand is concentrated in several corridors corresponding to the main axis of development. Work trips are heavily oriented towards the CBD. As a result, heavy peak hour demands are generated inbound in the morning and substantial outbound demand exists in the evening, although the PM flow is more balanced.

A CANDIDATE BUSWAY

The circumstances surrounding this analysis were slightly different from those surrounding other simulated application cities. After contacting community planners, it was learned that the city was seriously considering establishment of a contra-flow lane on a heavily congested north-south freeway. It was decided that the study staff would place primary emphasis on working with local planners on developing a specific plan for this corridor.

This application was useful as an in-depth test of the general hypothesis of this study that substantial unused capacity exists in many cities which could be converted into effective busways.

A map of the facility is shown in Figure 4-1. Traffic count data for the 7.7 mile facility is shown in Table 4-4.

It will be noted that a substantially imbalanced directional split exists in the AM peak such that in all cases the lanes remaining after bus lane reservation will operate well below the 2,000 vehicles per lane possible traffic capacity.

In the evening peak, traffic is more balanced and the inbound lane which might be used for a busway does not uniformly contain excess capacity. A major factor in the decision to opt for a PM lane, however, is the severe congestion and delay on normal outbound lanes which occurs as the result of lanes being dropped well before demand has appreciably diminished. Thus, despite some possible delays to inbound traffic, the very real need to circumvent serious outbound congestion resulted in the decision to plan a PM bus lane. The resulting volume per lane of PM inbound travel would, according to Table 4-4, exceed maximum free-flow sustainable volumes only in one instance - 17th Street - where the lane volume would be about 2,102 per hour maximum.

The proposed operating plan is, by virtue of circumstances and design, fairly unique and worth detailing.

Figure 4 - 1  
 NORTH FREEWAY EXPRESS BUS CONCEPT  
 COLUMBUS, OHIO

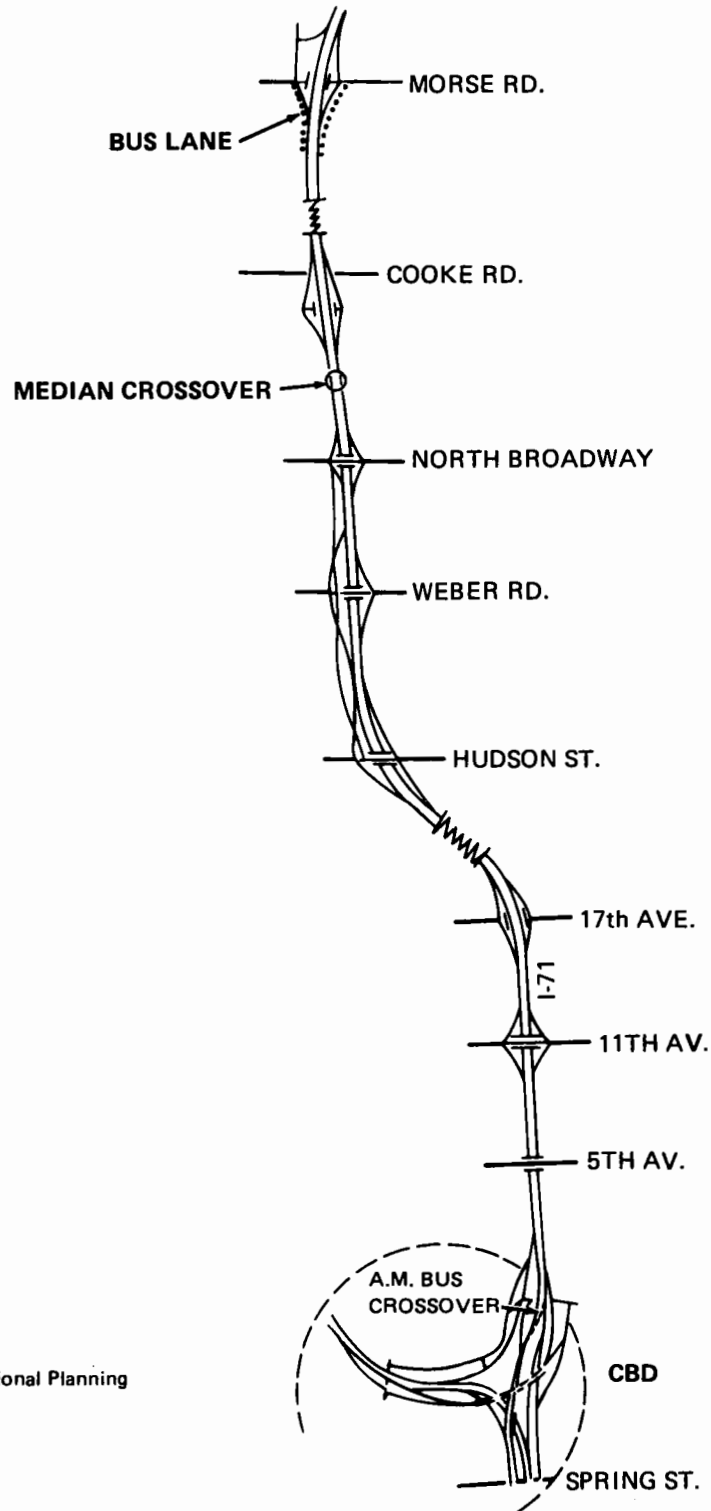

SOURCE: Mid Ohio Regional Planning Commission

TABLE 4-4: Traffic Count Data for Columbus North Central Freeway Peak Hour Traffic Volumes

Direction	Location	Time	Directional Split	Off-Peak Volume	Residual No. of Lanes	Off-Peak Vehicle/Lane
AM	S. of Fifth	7-8 AM	7753/10,174=.76	3421	3	1140
	S. of 17th	"	5730/9,068=.63	3338	2	1669
	S. of N. Brdwy	"	5420/8139=.67	2719	2	1360
	S. of S.R. 161	"	2364/3981=.59	1317	2	658
PM	S. of Fifth	4-5 PM	4840/8933=.54	4093	3	1367
	S. of 11th	"	4796/8669=.55	3873	3	1291
	(ATR)					
	S. of 17th	"	5100/9304=.55	4204	2	2102
	S. of Hudson	"	4511/8631=.52	3120	2	1560
	S. of Weber	"	5003/9440=.53	3437	2	1718
	S. of Morse	5-6 PM	3832/5854=.65	2022	2	1011
S. of S.R. 161	"	2837/4912=.58	2075	2	1038	

SOURCE: Mid-Ohio Regional Planning Commission

At the outer end, Morse Road, the intersecting street passes under the freeway. The median strip between lanes is wide enough to accommodate a pavement lane. It was proposed that this median be dug out and a traffic signal placed at the Morse Road intersection. Then buses in both the AM and PM could enter and exit on this special median ramp without having to weave across three traffic lanes. Such weaving would be particularly hazardous in the PM when the lane for initial merge is also the lane which is moving at the highest speed outbound in the evening (a Boston PM lane, when operating in 1971, had its lone accident at this type of high-speed merge).

By virtue of being able to dig out a roadway, costs were expected to be lower than if an aerial structure were built. The bulk of the route would be a standard reversed lane, cone-separated facility running the length of the freeway to the Spring Street interchange at the edge of the CBD.

AM inbound buses would merge into the normal traffic flow and exit with flow on the normal exit ramp at Spring Street. It was noted that the Spring Street ramp is lightly used and Spring Street, a one-way westbound street, is not heavily used in the AM peak. Therefore, no delays are anticipated for AM exits.

PM outbound buses would travel against the flow of traffic on Spring Street and enter the ramp used as an exit in the morning. This plan would mean blocking the Spring Street off-ramp from inbound use in the PM peak. CBD exit and entrance configurations are shown in Figures 4-2 and 4-3.

The facility would utilize shopping center parking lots in the corridor as park-n-ride lots. Unfortunately, it is not expected that very many transit trips would be using the facility initially. Local planners were of the opinion that, if this were the case, carpools ought to be permitted on the facility at least until demand justified a bus-only policy.

The proposed design would permit swift access and egress from the bus lane with minimum interference with the normal lanes of traffic. The excellence of the design appears to be possible due to the particular configuration of the key interchanges at Spring Street and Morse Road. Other cities might not find such favorable circumstances.

#### OTHER POSSIBILITIES

Discussions with community planners and a review of traffic flow characteristics in the peak periods indicated that several other routes offer possibilities for contra-flow bus lanes on existing roadways. In particular, one-way major arterial pairs running east and west of the city offer opportunities for transit to circumvent queues on roadways near the CBD. A south-east area freeway is also a logical candidate when demand increases sufficiently to overcrowd the facility.

As an unfortunate sequel, it must be reported that in May 1972, a transportation-related bond issue was defeated. The bond would have funded public take-over of the transit operations and provided for a plan of improvements, among which was the above bus lane project. The defeat may well mean that transit service will be curtailed in Columbus and such improvements indefinitely postponed.

Figure 4 - 2  
A.M. SOUTHBOUND BUS OPERATION  
DOWNTOWN PORTION  
COLUMBUS, OHIO

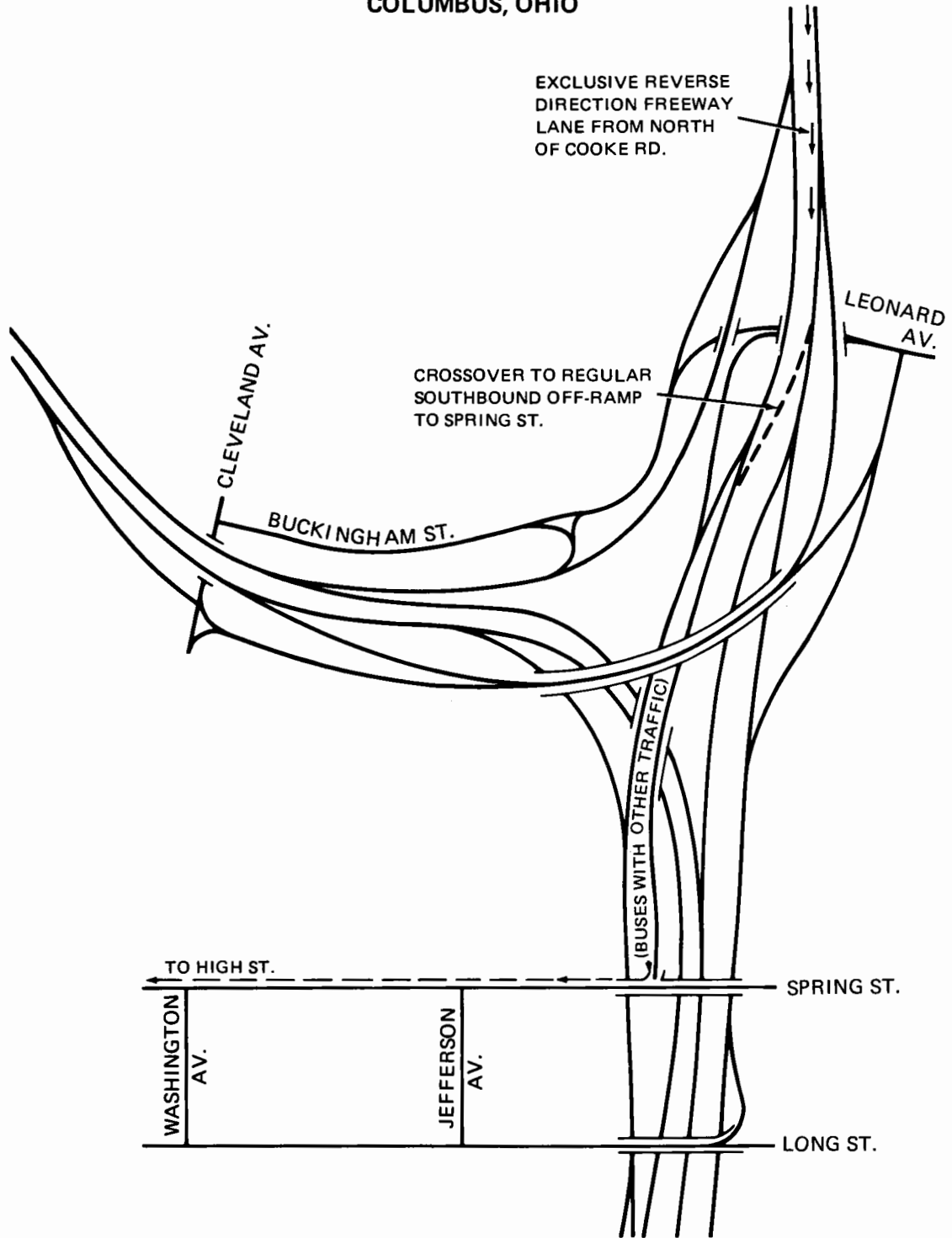

SOURCE: Mid Ohio Regional Planning Commission.

Figure 4 - 3  
P.M. NORTHBOUND BUS OPERATION  
DOWNTOWN PORTION  
COLUMBUS, OHIO

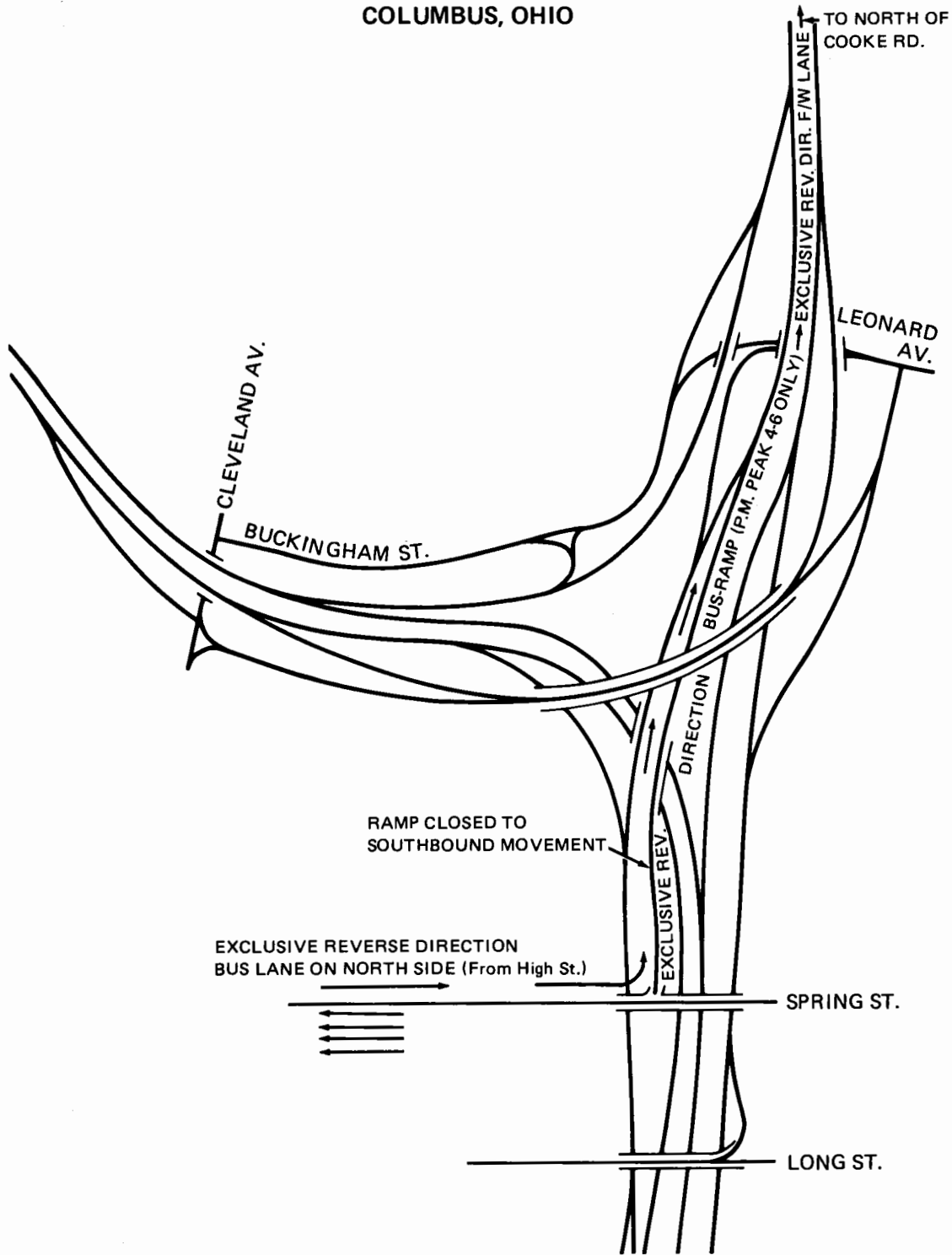

SOURCE: Mid Ohio Regional Planning Commission

COMMENT

The study staff felt fortunate to be able to examine one corridor in substantial detail to test out the key hypothesis that where substantial under-utilized capacity exists, these roadways are logical candidates for busways. Aided by the competent staff of the Mid-Ohio Regional Planning Commission, the study was able to participate in the design process, even if only peripherally, and see the final design and plan accepted by engineers and other community decision makers.

BUSWAY FUNCTIONAL EVALUATIONSBUSWAY CAPACITIES AND VOLUMES

The most important attribute of busways is related to their capacity to increase the volume of persons carried per lane of roadway facility.

Empirical studies of highways carrying mixed traffic indicate that the maximum sustained volume possible is approximately two thousand cars per lane, per hour.<sup>1</sup> If the standard occupancy index of 1.3 passengers per vehicle is used, then the maximum free flow passenger volume on a lane of highway is about 2,600 persons per hour. Under maximum occupancy plans, with an average of 4 passengers per car, volume would be about 8,000 passengers per hour.

Table 5-1 shows actual and estimated theoretical maximum volumes associated with various modes. The most impressive empirical data on bus lanes is that from the I-495 project. Peak flows of sixty-eight buses per five minute period were observed. This observed rate of flow projected on an hourly basis indicates that as many as 817 buses could physically use the facility. Assuming fifty-two passenger buses, this means that 42,484 bus passenger seats per hour could be provided per lane of busway. No reason has been presented to suggest that these hourly volumes could not be sustained if sufficient demand existed.

A 1969 theoretical study by the General Motors Research Laboratories indicated that when vehicles were able to operate on an exclusive bus lane without being required to discharge passengers or to observe traffic control devices, capacities between 60,000 and 70,000 seats per lane per hour could be achieved. Headways would be about 3.5 seconds.

Figure 5-1 shows the relationship between the speed of buses and carrying capacity. It indicates that the maximum optimum speed is about thirty-three miles per hour and that these theoretical volumes are not a function of attaining unrealistically high operating speeds.

By way of comparison, rail rapid transit volumes of 61,400 passengers per hour per track are achieved only under conditions of severe crowding (204 persons per car) as is shown in Table 5-1. Of course, the single rail track accommodates passenger terminal facilities (stations) in addition to its line haul functions, whereas the busway lane does not.

The significance of the busway volume figures lies in the fact that "...there appear to be very few transportation corridors with traffic demands in excess of 60,000 passengers per hour in either direction."<sup>2</sup> Accordingly, it seems reasonable to conclude that a single lane of pavement used as an exclusive busway should be adequate to the peak period line haul commuting needs of almost any radial corridor. This is in sharp contrast to the amount of

---

<sup>1</sup> Highway Capacity Manual, Highway Research Board Special Report 87, Washington, D.C., 1965, p.66.

<sup>2</sup> Jerold W. Scheel and James E. Foote, GM Research Laboratories, "Bus Operation in Single Lane Platoons and their Ventilation Needs for Operation in Tunnels," September 20, 1968, Revised January 28, 1969 (Unpublished Paper), p. 4.



**Figure 5 - 1**  
**METRO-MODE EXCLUSIVE RIGHT-OF-WAY SINGLE LANE FLOW CAPACITIES**

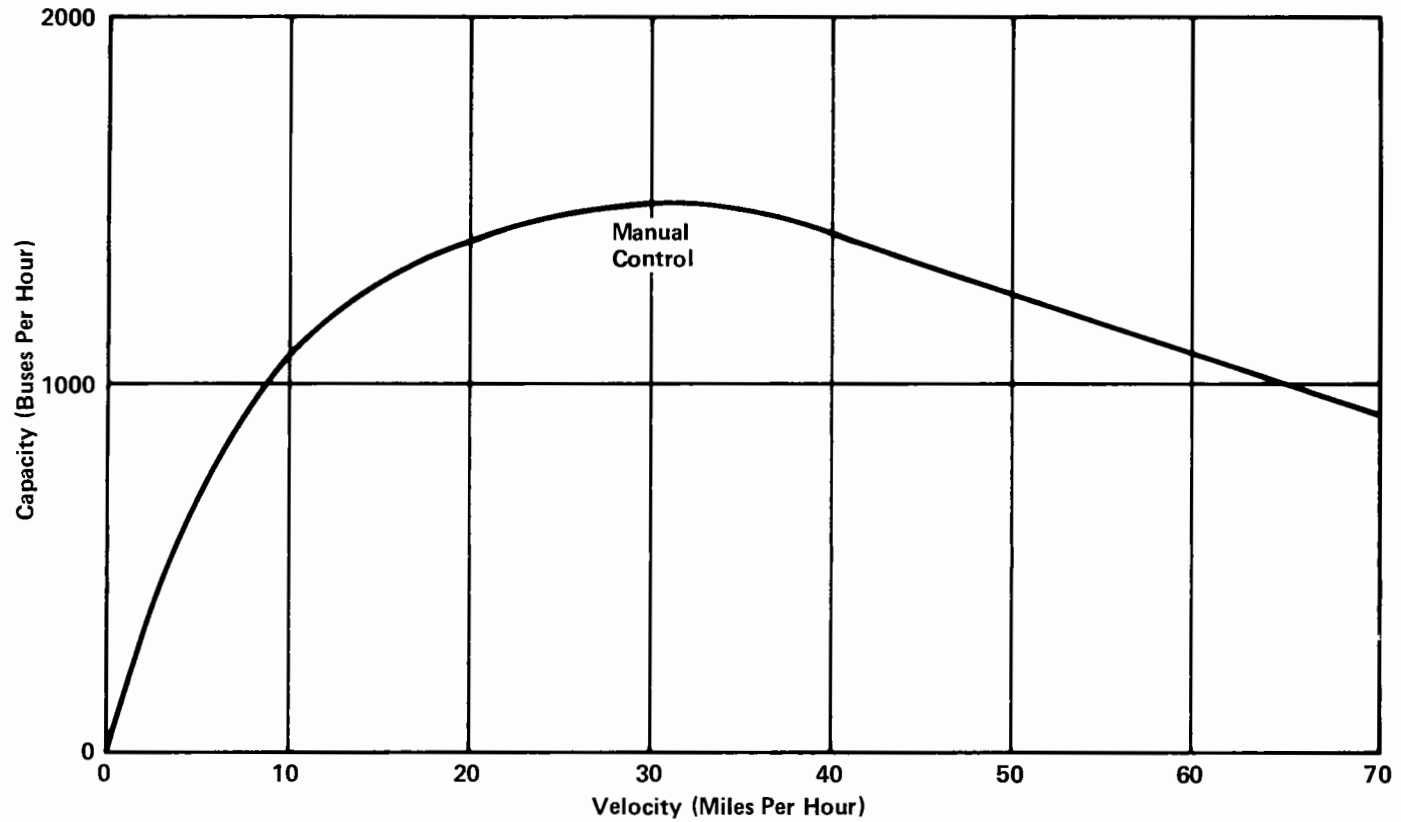

SOURCE: Rothery, Silver, Herman & Torner, "Analysis of Experiments on Single-Lane Bus Flow", Operations Research, Vol. 12, No. 6, Nov.-Dec, 1964,

as Adapted by Jerold W. Scheel and James E. Foote, Research Laboratories, "Bus Operation in Single Lane Platoons and Their Ventilation Needs for Operation in Tunnels," Sept. 20, 1968, Revised Jan. 28, 1969, p. 5.

TABLE 5-1: Maximum Actual and Theoretical Volumes by Mode

Mode	Service Conditions	Speed	Vehicles/ Hour	Passengers/ Vehicle	Capacity/ Hour
Auto	Mixed traffic on arterial <sup>(a)*</sup>	Variable	Abt. 500/ lane	1.3	650 passen- gers
Auto	Freeway, free flow operation, optimum circumstances (a)	25-30 mph	2000/lane	1.3	2,600 pas- sengers
Rail (h)	Theoretical seated passenger maximums, 10-car trains (b)	--	30 trains	75 (c)	22,550 seats (d)
Rail (h)	Same as above except 2.0 load factor (50% standees)	--	30 trains	150	45,000 pas- sengers
Rail (h)	Actual peak volumes record- ed 11-car trains, 60-ft cars, 204 passengers/car (e) (in- tense crowding)	--	32 trains	204	61,400 to 71,790 (e) passengers
Bus	Arterial volumes, actual data (f)	Variable	175	51 seats	9,000 pas- senger seats
Bus	Exclusive bus lane, actual data (I-495)	45 mph limit	573	44.1 avg. occupancy peak hour	25,269.3 passengers
Bus	Exclusive bus lane, projec- tion of peak 5-min. rate (I-495)	45 mph limit	817	52 seats	42,484 pas- senger seats
Bus	Theoretical studies (g) manu- al control, no stops, on ex- clusive busway	33 mph average	1,450	50 seat buses	70,000+ pas- senger seats

\* For footnotes, see next page

TABLE 5-1, continued

Footnotes

- (a) Derived from Highway Capacity Manual studies
- (b) Derived from Stover and Glennon, "A System for Bus Rapid Transit on Urban Highways," in "Traffic Quarterly," October, 1969, p. 465.
- (c) Large train cars designed for load factors approaching 2.0 (floor space allocated for one standee per seated passenger)
- (d) Seated capacity as measure of maximum comfort
- (e) IND Line, New York City, see Wolfgang S. Homburger (editor), Urban Mass Transit Planning, Institute of Transportation and Traffic Engineering, University of California, Berkeley, p. 33.
- (f) Seats per hour available as observed on Michigan Ave., Chicago, and reported by J. Scheel and J. Foote, "Bus Operation in Single Lane Platoons and Their Ventilation Needs for Operation in Tunnels," General Motors Research Laboratories, Jan. 28, 1969, p. 2. See also Highway Capacity Manual, 1965, p. 340.
- (g) Scheel and Foote, Ibid., p. 2-9.
- (h) Including terminal facility constraints (stations); see text for discussion of bus land terminal requirements.

capital facilities that would be required to satisfy the same level of auto commuting demand. Actual demand has resulted in volumes well below theoretical maximums. On the I-495 approach to the Lincoln Tunnel, volumes in excess of 400 vehicles during the peak hour and in excess of 700 vehicles for the entire peak period have been recorded. This is by far the most heavily concentrated level of service known. The corresponding observed passenger volume is 25,000 per peak hour. Table 5-2 compares the relative volumes and frequency of service on the seven bus lane projects studied in the United States.

It is noted in the GM study that "the very high capacity of this single lane roadway must eventually be related to a terminal facility."<sup>3</sup> The large number of vehicles moving over an exclusive roadway eventually must terminate their trip and discharge their passengers at points convenient to their destination. Some special provision must be made to receive these vehicles and accommodate loading or unloading.

The I-495 project terminates in the PATH terminal and patrons are distributed within the city by subway. It is the only project with such a terminal facility.

The volumes recorded on the Long Island Expressway are not nearly so great as theoretical studies indicate could be accommodated or as are actually recorded on I-495. Yet even at the existing volumes, officials are extremely reluctant to authorize more buses to use the bus lanes, because they claim there is inadequate unloading space in mid-town Manhattan to accommodate the extra vehicles.

A terminal requires an internal distribution facility. This is currently available to bus passengers arriving at the PATH terminal from the Lincoln Tunnel in the form of the subway. Other candidate solutions include downtown shuttle service, people movers, mini-bus loops, or some similar techniques.

This study would suggest qualifying the GM conclusion that a terminal facility is needed in all cases of heavy demand, to the extent that not all buses using a line haul facility necessarily need to unload at a single facility. Under some circumstances, such as when there is a long lineal stretch of terrain which is common to a great many bus routes, the bus may serve as its own distribution vehicle. In such instances, the bus would traverse the line haul portion of the journey and then drop off patrons along several distribution routes and at many destination places. Similarly, buses are ideal vehicles to collect passengers at dispersed origins before proceeding to the line haul portion of the trip.

The relatively high volumes of buses utilizing the San Juan facility illustrate this principle. Buses collect on one part of the route from many "origins" and drop people off on another part of the route in a pattern of dispersed "destinations". This results in manageable, if not short, queues at bus stops, and therefore has not yet necessitated a special terminal facility. Nonetheless, line haul capacities must be matched by adequate discharging capacity, whatever the nature of the eventual destinations.

Despite the tremendous volume potential of bus lanes, a serious planning paradox exists which restricts further initiation of such facilities. In most cities, transit service has seriously deteriorated over the last twenty years. Where heavy congestion exists and serious time delays are experienced, reservation of a lane for buses would do much to speed transit trips. However, it is difficult to justify reserving a lane for the expected small number of transit

---

<sup>3</sup>Scheel and Foote, Loc. Cit.

TABLE 5-2: Volumes Carried on Six Selected Bus Lane Projects

Project	Speed (MPH)	Maximum Vehicles	Time Period	Passengers/Vehicle	Maximum Passengers/Time Period
New Jersey--I-495 (Lincoln Tunnel approach)	45 limit	1,096	Approx. 7:30-9:30 (peak AM period)		47,800 peak period
		597	8:00-9:00 AM	44.1	25,980 AM peak hour
New York City, Long Island Expressway	30-45 (posted limit is 35)	180	7:15-10:00 AM	N.A.	Estimated 7,500 AM peak period
		103	8:00-9:00 AM	N.A.	N.A.
Boston--South-East Expressway	45 posted limit	82	7:00-9:30 AM		3,160 AM peak period
Louisville	N.A.	24	AM peak hours	Approx. 13-20	156-240 peak hour
San Juan	15	N.A.	--	N.A.	N.A.
Washington, D. C. Shirley Busway	40-60	275	2.5 hour AM peak period	43 (est.)	11,300 during 2.5 hour AM peak

vehicles that would initially use the facility. The justification is particularly difficult if the lane to be reserved is normally heavily utilized by other traffic.

Yet this study would contend as one of its major findings that unless low capital transit alternatives which genuinely improve commuting through time savings are made available, communities will have no choice except continued heavy investment in capital facilities whether they be highways or rail. A single highway lane established as a bus lane does provide a genuine alternative to heavy investment in other capital facilities.

#### SPEED OR TIME ADVANTAGES

The second major advantage of busway service is that passengers can save significant amounts of time during peak hour commuting. From analysis of the seven busways studied in-depth here, travel time improvements tend to be most appreciable when:

- . Severe peak period congestion, with attendant time delays exists on roadway sections bypassed by the exclusive lane facility.
- . The exclusive lane facility is indeed exclusive.
- . The lane operates under non-stop, free flow conditions, i.e., no traffic intersections or stops to discharge or receive passengers.

Table 5-3 summarizes the measured time savings which are attributable to the seven exclusive bus lanes studied in-depth. Times shown are for the link of the trip transferred from mixed traffic to the busway.

In all cases where a freeway was involved, it is interesting to note that there was substantial time savings over auto travel times as well as former bus travel times for the same journey. Among the arterial examples, only the San Juan case is suspected (but not proven) to have improved travel times over autos.

This should not be construed as indicating that only freeway facilities offer opportunities to realize travel time savings when compared to automobiles making the same link trip. On the contrary, the absence of severe congestion in either Louisville or Indianapolis combined with the heavy congestion on the more successful freeway facilities is a more likely explanation of the relative success of these facilities.

A second important conclusion is that bus lane time savings for the busway link are not marginal. In several cases, time savings were in excess of ten minutes and as high as twenty minutes over auto travel. This should be considered a major commuter improvement.

An important relationship, which has been neglected in studies to date is that of changes in portal-to-portal travel time. Only one project attempted to assess this. Fifteen I-495 patrons were asked if the availability of service enabled them to leave home any later. Eight were able to leave later, while seven left at the same time or earlier.

TABLE 5-3: Changes in Link Travel Time Before and After Establishment of Exclusive Bus Lane

Location	Length of Exclusive Lane Facility (Miles)	Travel Times				Bus Time Savings Over Auto		Bus Time Saving Over Former Bus Travel Times	
		Before		After		Mins.	%	Mins.	%
		Auto	Bus	Auto	Bus				
<u>Freeway Facilities</u>									
1. New Jersey I-495	2.5	--	--	--	--	--	--	7.5-10 <sup>(a)</sup>	--
2. New York City Long Island Exy.	2	--	--	16-20	3.5-4	4.5-15.0	22-75	--	--
3. Boston -- South East Expressway	8.4	22	24	17.5	10	7.5	42	14.0	58
<u>Arterial</u>									
1. Louisville <sup>(b)</sup>									
Route 4 AM	2	26.4	40.5	26.4	30.0	Slower		10.5	26
Route 4 PM	2	24.6	42.0	24.6	31.5	Slower		9.5	23
Route 6 AM	2	31.9	41.0	31.9	35.5	Slower		5.5	13
Route 6 PM	2	31.3	43.5	38.5	31.5	Slower		12.0	28
2. Indianapolis		----- N O D A T A -----							
3. San Juan	10.4 (One Way)	--	80	--	50	--	--	30	38
<u>Specially Constructed</u>									
1. Washington D. C. (Shirley Hwy.)									
AM	9	--	--	40	17	13	33	--	--
PM	9	--	--	37	17	20	54	--	--

(a) Increases in speeds were reported for all eastbound traffic whether traveling on the buslane or not. No statistics were available to indicate before and after travel times so that meaningful percentages could be calculated.

(b) All times shown for Louisville are for total bus route; data is not available for the portion of trip on exclusive bus lane.

An important consideration in the decision on when to leave home is the probability of arriving when expected. Buses on the exclusive bus lane are able to provide more reliable service thus avoiding the frequent extreme variations in arrival time due to congestion delays. Over time, increased schedule reliability combined with genuine time savings should lead to substantial changes in the planning of individual trips.

Data from traffic and busway studies alluded to earlier indicate that operating speeds should be about thirty-three m.p.h. to sustain maximum through-put under manual vehicle operations. Thus, appreciable time savings are the result not of attaining high operating speeds (in excess of thirty-five m.p.h.) but rather from avoiding the slow downs or complete halts in traffic which are often associated with normal peak period travel on principal urban arteries and freeways.

Mode choice calculations consider relative travel times between available travel modes as one of the key factors influencing the decision on the use of bus versus auto in trip making. Provided all other variables remain unaffected, improving travel time for bus service through the use of busways presents community decision makers with the opportunity to induce transportation mode changes in a relatively quick, inexpensive, and non-controversial manner. However, if service frequency or convenience, for example, are simultaneously degraded (as happened in Louisville) resulting ridership declines may offset or exceed any gains due to time savings.

#### PRINCIPAL ECONOMIC BENEFITS

There are three major areas where worthwhile savings are possible:

- . Avoiding capital intensive investment.
- . Reducing transit operator costs.
- . Value of time saved.

#### Avoiding Additional Capital Investment

At five of the seven sites visited, the busway project provided a direct alternative to new investment in traditional fixed capital facilities such as rail lines or highways. In these four cases the planning and transportation authorities were either unwilling or unable to afford the additional investment associated with such traditional solutions. The four projects were I-495, the Long Island Expressway, the Boston Southeast Freeway experiment, and the San Juan, Puerto Rico exclusive bus lanes.

In the two New York cases, apparently a policy decision has been made that no more freeways will be built into Manhattan. In the Boston case the bus lane was installed in response to pressures against an additional freeway in the southwest corridor. In the case of San Juan no money is available to expand existing capital investment facilities substantially beyond that which is now under construction or immediately available. San Juan is hopeful of eventually building a rail line facility, but this does not appear likely in the foreseeable future.



Such a clear relationship did not exist in conjunction with bus lanes in Indianapolis and Louisville or the Shirley Highway project in Washington, D.C. The Shirley Highway corridor is being rebuilt essentially as a highway oriented transportation corridor. The bus lane may serve as an alternative to rapid rail in that corridor. In Louisville and Indianapolis the busway has only a minor influence on transportation capacity needs and it is unlikely in the foreseeable future that it would have any impact on capital facility planning.

#### Reducing Transit Operator Costs

There are two types of operator savings which can be traced to operation on an exclusive bus lane facility. Unfortunately while these advantages are known and can be theoretically projected, they have for various reasons not been documented at this time. Following is a brief discussion of each.

- . Improved Driver and Vehicle Productivity. There is some evidence that the higher operating speeds enjoyed by transit vehicles utilizing exclusive bus lanes will enable the driver and vehicle to operate more revenue miles per unit of time. While there is no data to accurately document this impact, it is reported that on the Long Island Expressway Project buses making short haul trips from Long Island to mid-Manhattan are now able to schedule two trips whereas before they were only able to operate one. In San Juan the dramatic reduction in the time required for a bus to travel its route means that, in this vehicle-deficient system, buses are more quickly turned around to cover schedules. This may be one reason why revenues are not declining as rapidly as had been previously experienced. It has also been reported that in the instance of the I-495 project the absence of congestion-induced delays which would normally slow or substantially delay transit trips has markedly reduced paid driver overtime. Unfortunately little or no documentation is available to support these claims.
  
- . Vehicle Wear and Tear. There is some evidence to suggest that the absence of continuous stop and go driving, such as is experienced under heavy congestion situations, leads to a reduction in the wear and tear on vehicle parts. Specifically, engines, clutches, and brakes tend to last longer. This has been reported, but not documented, in two instances: the Boston and San Juan projects. It seems reasonable to expect that these impacts could be documented in terms of the number of miles obtained between overhauls.

#### Value of Time Saved

A third major economic impact is the value of the time saved by patrons utilizing the swifter service available from exclusive bus lanes. A number of

projects have attempted to justify the expense of implementation and operation of this type of facility chiefly on the basis of time saved by users. Calculations of this nature for all bus lanes have been developed and are shown in Table 5-4.

## DIRECT COSTS

### User Charges

User prices have not changed as a result of improved service from bus lanes. The low cost associated with implementation has been borne almost exclusively by non-transit agencies and thus operators have not been faced with rising costs. Indeed there is some evidence that operating costs have declined because of high speed service.

In only two cases were higher fares even remotely related to operation of the exclusive bus lanes. In one case, on the Long Island Expressway, \$1.00 to \$1.25 one-way fares are charged. These fares are much higher than the local bus service and subway fare of thirty-five cents. This appears to be a long standing premium charge which existed before the bus lane went into operation. In the other case, San Juan, the exclusive bus lane is operated with a proportionally larger number of air-conditioned busses which charge a higher fare and tend to serve more of a middle class commuter market than do other routes in San Juan.

This data suggests that there is little basis for change in commuter transit fares as a result of bus lane institution. Of course, some operators may attempt to justify a higher fare on the grounds that preferential service is provided patrons. Precedents exist for such charges in the U.S.

### Implementation Costs

A major advantage of certain types of busways is that they can be very inexpensively implemented. Where existing roadways are utilized, these costs are in some cases so minor that they have been entirely absorbed in the day-to-day operating budget of the local highway department. Even when dedicated roadways are built, the cost for a simple two lane facility is far cheaper than any comparable automobile facility when costs are distributed over potential peak volume of persons moved.

The following discussion briefly analyzes the costs of implementation. A summary chart of these costs is shown in Table 5-5.

#### Class A - Essential Costs

##### 1. Right-Of-Way Acquisition

In some cases of busway construction, particularly for new facilities, it may be necessary to purchase right-of-way if public ownership does not already exist. This in most larger urban areas is costly, even though the actual amount of land needed may be far less than that required to build a new automobile facility.

It has been proposed that rail rights-of-way be purchased or leased for busways, as usually these facilities are too narrow for a typical auto-

TABLE 5-4: Value of Link Travel Time Saved

Project	Minutes Saved Per Passenger (One Way Trip Times) (a)	No./Passengers Per Day	Daily Savings @ \$2.82/hr. Val. of Time (b)	Annual Aggregate Savings (255 work days/year)
New Jersey I-495	7.75-10 mins. over prior bus times (c)	35,000	\$12,740-16,450	\$3,248,700-4,194,800
New York City Long Island Exy.	12-20 mins. faster than car times	7,500	4,230-7,050	1,078,600-1,797,800
Boston--South-East Expressway (d)	7.5 mins. over car, 14 mins. over former bus times	2,454	866-1,614	220,800-411,600
Louisville	5.4-10.5 mins. as compared w/former local bus service(e)	250 (approx.)	64-124	16,200-31,500
Indianapolis	- - - - - NO TIME SAVINGS DEMONSTRATED - - - - -			
San Juan	20 mins. as compared to former bus times	No Data	No Data	No Data
Washington--Shirley Hwy.	17 mins. average (f)	16,500	13,184	3,361,800

- (a) Refers to time saving as compared to either automobile time through the link, or to previous bus time.
- (b) The figure for the value of commuter time was based on work recently done by the Stanford Research Institute of California, and seems to be reasonable when compared with other studies. Leon Goodman, "The Exclusive Bus Lane on the New Jersey Approach to the Lincoln Tunnel," Port of New York Authority January, 1972, p.5.
- (c) Evidence indicates that buses travel on I-495 faster than autos though, this has not been established.
- (d) Figures available only for AM peak.
- (e) Car still substantially faster than transit (see Table 5-3).
- (f) Average time saving derived from Figure 3-17.

TABLE 5-5: Ranges and Types of Costs Associated with Implementation of Various Types of Bus Lanes

	Specially Constructed Facilities	Existing Roadway (Freeway)	Existing Roadway (Arterial)
<u>CLASS A: Essential Costs</u>			
1. Right-of-Way Acquisition	Variable	- 0 -	- 0 -
2. Roadway Building	See Table 5-6	- 0 -	- 0 -
3. Special Structures (Tunnels & Bridges)	Variable	- 0 -	- 0 -
4. Median Crossovers (a)	\$2,000	\$2,000	\$2,000
5. Lane Separation			
- Cones	- 0 -	\$300-500/mi.	- 0 -
- Permanent Metal "W" Barriers	\$60-80,000/mi.	- 0 -	- 0 -
6. Basic Signing	\$20/sq. ft.	\$20/sq. ft.	\$20/sq. ft.
7. Removal of Median Barriers (b)	\$16,000	\$16,000	- 0 -
<u>CLASS B: Optional Costs</u>			
1. Remote Control Lane Signs (See Fig. 3-5)	\$8-12,000 ea.	\$8-12,000 ea.	- 0 -
2. Sign Bridges(c)	\$25,000	\$25,000	- 0 -
3. Tele-communication Equipment(d)	\$800,000	\$800,000	- 0 -
4. Special Cone-laying Vehicles	- 0 -	\$10,000	- 0 -
5. Separate Entrance or Exit Ramps (Constructed) (f)	\$100,000	\$100,000	- 0 -
6. Automatic Gate(d)	\$13,000	\$13,000	- 0 -
7. Traffic Signal Controlers(g)			
- Bus Activators	- 0 -	- 0 -	\$500 ea.
- Intersection Controls	- 0 -	- 0 -	\$775 ea.

(a) Based on about 4,000 square feet of pavement plus a 150 ft. temporary medium barrier as constructed in Boston.

(b) Long Island Expressway--removal of 140 feet of barrier bolted into a footed base, and removal of concrete median.

(c) Spans six freeway lanes, derived as an average from several sources

(d) Specific estimate from I-495.

(e) Truck built especially for use on I-495.

(f) Alan M. Voorhees, et al., An Analysis of Urban Highway Public Transportation Needs, November, 1971, p. B-6.

(g) Based on Louisville purchase price to equip eight intersections and nine buses. Prices would vary according to quantity, etc.

mobile roadway. There is a minor example of such a busway in the western Philadelphia suburbs.

In some instances sufficient land is available in the median or shoulders for construction of special dedicated bus lanes within the right-of-way of existing expressways. In these cases no purchase of land is required. Occasionally in conjunction with implementation of any of the arterial or freeway bus lane applications discussed in this report it may be desirable to purchase small bits of right-of-way for construction of access facilities or special loading or unloading ramps.

No specific figures are presented on right-of-way costs since land costs are highly dependent on local circumstances.

## 2. Special Roadway Building Costs

For specially constructed busways it is necessary to build and pave roadways. Cost estimates presented here include the following fairly universal elements:

- . Clearance and site preparation
- . Paving
- . Fencing and landscaping

The cost estimates exclude several specific costs which may or may not be necessary depending upon existing conditions. These are:

- . Special retaining walls
- . Relocation of housing, utilities or other facilities
- . Other special structures (bridges, tunnels, etc.)

The estimates were prepared from actual comparison of cost projections for several proposed or actual dedicated busways. These estimates are shown separately in Table 5-6.

## 3. Special Structures (Bridges And Tunnels)

These costs are highly dependent upon local circumstances. It seems reasonable to expect that in some instances entire new structures will be needed. In other cases, adequate leeway may exist between structure abutments and paving so that no additional new structures are needed. Individual site surveys will have to be made before final decisions can be made about a particular highway.

## 4. Median Crossovers

Costs for median crossovers are incurred when no special exit or entrance ramp into the actual bus lane is provided for buses. In these cases, buses enter through common mixed traffic lanes as other vehicles do, weave across lanes into the median lane and then, at the designated spot, cross into the exclusive bus lane.

TABLE 5-6: Roadway Building Cost Estimates for Busways

Site	Length	No. Lanes	Lane Width (ft.)	Shoulder Provided (ft.)	\$ Per Mile Costs		
					Clearance & Site Prep.	Paving	Fencing & Landscaping
Los Angeles-San Bernardino Freeway (1967 estimates)	6.6 mi.	1	17	10 each side (a)			
	3.8 mi.	2	8 + 4				
	10.4 mi. total				\$190,384	\$124,579	\$13,364
Milwaukee	8 mi.	2	13	4 each side	120,750	51,750	122,000
Washington, D. C. Conversion of B. & O. tracks to busway							
A. Tracks still useable (temporary busway)	5.9	1	12	8	Included in paving costs	111,864	Included in paving costs
	2.7	1	12	8	Included in paving costs	129,629	
	8.6 total						
B. Permanent, with tracks eliminated	5.9	1	12	8	Included in paving costs	192,375	Included in paving costs
	2.7	1	12	8	Included in paving costs	209,259	Included in paving costs

(a) Shared with freeway

Costs are very low for paving between 100 and 200 feet of roadway. Based on the Boston and Long Island project data, it is estimated that paving costs should be less than \$1,000. Construction of temporary median barriers to be used to restore the median when the bus lane is not in use would also cost under \$1,000.

This low cost explains why, if weaving across lanes can be tolerated, median crossovers are a very simple solution to requirements for access and egress to the exclusive bus lane.

#### 5. Lane Dividers

The principle device now in use on freeways to separate general traffic lanes from bus lanes are standard traffic cones or posts. This allows the lane to be returned to its former status if not in use more than several hours each day.

Cylindrical traffic posts which are dropped into pavement holes cost about \$8 each. Free-standing cones come in various sizes so as to enable them to withstand varying degrees of vehicle backdraft and winds. High speed cones such as are used in Boston cost \$4 to \$6 each.

In some cases it may be desirable to install metal or other fixed barriers to permanently segregate the bus lane from other traffic. "W" style barriers cost about \$12 to \$15 a foot (\$63-\$80,000 a mile), while box beam barriers cost about \$20 to \$25 a foot (\$110-\$132,000 a mile). These estimates include installation costs, using the driven post method.

Lane barriers are not used on arterial application of bus lanes.

#### 6. Basic Signing

A rule of thumb estimate for signs including application of the message, construction, and installation is the \$20 a square foot cost assigned this element. This takes into account the trade-offs between sign size and frequency of installation.

#### 7. Removal Of Median Barriers

Median barriers will have to be removed in order to develop crossovers on expressways. The cost figure presented here was provided by the New York Department of Transportation for the removal of 140 feet of median barrier on the Long Island Expressway.

#### Class B - Optional Costs

Optional costs have been loosely defined as those costs which seem not to be essential to quick start up and initial operation of an exclusive lane facility, but which will be desirable for effective long range operation.

Most of the data is derived from an application for additional funding from state and Federal sources submitted by the Port of New York Authority. The major purpose of such equipment and facilities is to introduce efficiencies into the operation of a peak period only busway. These components are discussed below.

### 1. Remote Control Lane Signs

Remote control signs posted adjacent to the roadway or hung from overhead sign bridges and connected to a central control are normally the red "X" or green "arrow" type. Other types include those with more than one lane control message option. Approximate costs for purchase and installation of such signs as are needed for the I-495 project are \$8-\$12,000 each (these signs are illustrated in Figure 3-5).

### 2. Sign Bridges

Sign bridges are needed if an overhead lane signal system is to be installed. These costs are figured by the pound and thus would differ depending on the size and weight of the structure erected. Other costs are associated with the foundations and support structures. The structure priced at approximately \$25,000 would span six lanes.

### 3. Tele-Communication Equipment

Linking the system together with radio communication and TV monitoring may be desirable under certain conditions. The I-495 project cost for accomplishing this is about \$800,000.

### 4. Special Cone Laying Vehicle

The I-495 project modified a standard highway maintenance truck so that it would be safer and easier to place and retrieve cones. This is shown in Figure 3-3. The cost for the truck with modifications was \$10,000 based again on the I-495 experience.

### 5. Building Of Special Entrance Or Exit Ramps

An on-off ramp may be constructed to permit fast and safe entrance and exit from the facility. These costs will vary, but are estimated to average \$100,000 each.<sup>4</sup> The vast differences in local circumstances and design characteristics will cause estimates to vary substantially from project to project.

### 6. Automatic Gates

Entrance and exit controls for bus lanes could be activated by remote control. This may be desirable for use in particular when a blockage occurs on the facility. It is less than fully effective to order a crew member to drive to and manually block the entrance. The time delay associated with manual operation would trap a large number of vehicles in the system behind the blockage. Again, this estimate is from I-495.

---

<sup>4</sup> Alan M. Voorhees & Associates, Inc., Peat, Marwick, Mitchell & Co., Simpson & Curtin, Inc., Analysis of Urban Highway Public Transportation, Facility Needs, Volume II, November 1971, p. B4.



## 7. Traffic Signal Controllers

Signal pre-emption equipment has its primary utility on arterial busway applications. The Louisville project purchased such equipment and this estimate was based on purchase of eight intersection devices and nine bus transmitters.

### Maintenance And Operating Costs

Day-to-day operating costs are a function of both maintenance requirements and any extraordinary tasks involving control and operation of the busway by roadway crews.

Roadway maintenance costs have not been isolated for bus lane projects to date. This is at least partly due to the fact that there seems to be no reason to expect these costs to be higher by virtue of the bus lane being in operation. Maintenance costs for the case study cities were absorbed in normal daily operating budgets of highway agencies.

Day-to-day "special" operating requirements are a different matter. Operating procedures differ from application to application and therefore the number of men, equipment, and hours worked also vary. Table 5-7 shows the operating cost elements which have been incurred in certain circumstances. In some cases these costs are incremental to existing budgets and in others they merely represent a budget re-alignment with no net increase in agency operating costs.

The Boston project used a five man crew, including foreman, and estimated their daily cost at \$542 a day. This is consistent with cost figures provided for the Long Island Expressway operations.

### SAFETY

A major point of concern encountered in establishing bus lanes has been the previously unknown effect such facilities would have on highway safety. For example, bus lanes which operate contra-flow on one-way roadways run the risk of dangerous head-on collisions. Where freeways are utilized, contra-flow operations negate the basic theoretical safety advantage of divided highways. On one-way streets, the potential of confusing cross street traffic and the introduction of an unexpected variable into traffic poses serious questions concerning public safety. Weaving across lanes of traffic to or from on-off ramps represents another potentially hazardous traffic maneuver necessitated by some types of busways, including the safest design of all, the dedicated busway.

In nearly all the case study cities visited, such safety considerations were the major source of resistance to implementation. It can also be said that these fears tend to be exaggerated, if the evidence to date is reliable.

Table 5-8 shows the comparative accident rates for all bus lanes studied. This chart also attempts to compare the safety records of bus lanes with normal mixed traffic facilities in order to provide perspective on safety records. This is admittedly difficult since:

TABLE 5-7: Daily Operating Cost Components

	Dedi- cated	Reversed Lane On Freeway	Arte- rial
Three cone layers (driver plus 2 men in back of truck)	C (a)	A	C
Police Officer at entrance	B	B	C
Police Officer at exit	B	B	C
Patrol car	C	B	B
Wrecker on standby	B	A (high volume usage, otherwise B)	C
Crew to change signs, move barriers, etc.	B	A	C
Supervisor	B	B	C

(a) CODE

- A. Usually necessary
- B. Has been used, but not proven essential
- C. Unnecessary or not a special requirement of the busway

TABLE 5-8: Accident Experience on Seven Bus Lane Projects

Facility	Facility Length (Miles)	Bus Trips	No. Passengers	No. Accidents	Vehicle mi. Accident Rate (a) *
Shirley Highway (AM and PM operation)	9 (avg. trip 4 est.)	350/day (est.)	14,000/day (est. avg.)	None <sup>(d)</sup> (through 6/20/72)	.0
Long Island Exy. (AM operation only)	2	158/day AM peak	7,500 (est. average)	None (through 6/30/72)	.0
Boston--South-East Exy. (AM operation only)	8.4	65/day AM peak	2,454	None (through 6/30/72)	.0
New Jersey (I-495) (AM operation only)	2.5	270,050 <sup>(e)</sup>	11,538-666 <sup>(e)</sup>	4 (thru 6/30/72)	4.6
San Juan	10.8 one way	1,400/day (avg. est.)	(f)	452 1 <sup>st</sup> 5 mos. 401 last 6 mos.	119 85
Indianapolis	2.9	100 day (24 hour operation)	(f)	6 (1971)	78
Louisville	16.5 <sup>(g)</sup> one way	16 (AM peak)	6,344 (month)	2	457 <sup>(h)</sup>

\* For footnotes, see p. 137

TABLE 5-8, continued

Facility	Passenger Mile Acci- dent Rate <sup>(b)</sup> *	Date Began Operation	Experience Compared to Other Similar Facilities <sup>(c)</sup>
Shirley Highway (AM and PM operation)	.0	September, 1969	One accident would be expected every 33 weeks on comparison expressway with this volume traffic
Long Island Exy. (AM Operation only)	.0	October, 1971	One accident expected every three years on comparison expressway with this volume traffic
Boston--South- East Exy. (AM operation only)	.0	April-Oct., 1971, April- Oct., 1972	One accident expected every 85 weeks with this volume on comparison expressway
New Jersey (I-495) (AM operation only)	.14	December, 1970	Police report over-all accident rates have declined on facility as a whole
San Juan	N.A.	May, 1971	Accident rate is said to have declined as citizens became familiar with facility (see text)
Indianapolis	N.A.	September, 1968	Vehicle mile accident rate higher than average (see text)
Louisville	6.04	October, 1971	See text for more complete discussion

\* For footnotes, see next page.

TABLE 5-8, continued

Footnotes

- (a) Number of recorded bus lane accidents per million vehicle miles of travel (all accidents)
- (b) Rate given is per million passenger miles (accident rate is divided by product of number of passengers carried times mileage to date)
- (c) For expressways and arterials, data on 1958 accident rates for street types in Chicago is used where direct before and after data is not available:
- 12 accidents per million miles of arterial street  
4.3 accidents per million miles of expressway travel
- Based on this data, calculations would indicate that one accident could be expected on a typical expressway every 232,558 vehicle miles and one accident could be expected on arterials every 83,333 miles. Projections of the number of weeks of exclusive lane useage needed to achieve these benchmark levels are used for comparison comments. (Urban Research Section, Illinois Department of Public Works and Buildings, Accident Rates by Street Type, December 18, 1961, p. 25.)
- (d) No accidents related to normal operation
- (e) 1971 annual figure used to estimate 18-month total; first six months of 1972 estimated at one-third of 1971 miles due to bus strike on one major line
- (f) No ridership figures available for purposes of calculating accidents per passenger mile
- (g) Includes some local (non-express) portions of the route
- (h) Very high figure is traceable to low mileage on service and two accidents at the very beginning. One would expect this figure to drop substantially over time as mileage accumulates and the effect of start-up accidents declines.

- . Generalized accident rate data may not compare with "before" data on a particular facility because of other concurrent changes affecting traffic.
- . Many bus lanes have not accumulated enough vehicle miles to permit meaningful generalization on "after" conditions.
- . Buses as a class of travel experience somewhat different accident rates because of their professional drivers and preponderance of travel in peak hours, both of which are not directly comparable with circumstances generating over-all accident data.

Of the seven observed busway operations, three had reported no accidents to date. The Long Island Expressway is a significant example to cite. The operation is illustrated in Figure 3-6. The buses approach at high operating speeds, merge through a short 140 foot median opening and travel against the flow of traffic in the lightly used off peak portion of the freeway.

The lane is very narrowly separated at the paint stripe by traffic posts placed in holes and vehicles may not stray very far in each lane without jeopardizing vehicles in the other lane. Undoubtedly, the fairly light use of the outbound lanes reduces the possibilities of accidents.

Another example is the Boston AM contra-flow bus lane on the Southeast Expressway which operates essentially the same way except that the lane is longer (eight miles versus two). [One accident occurred on the PM bus lane in 1971 at the outbound high speed merge point. However, the PM lane has since been discontinued].

The final essentially accident free example is that of the specially constructed Shirley Highway in Washington, D.C. One minor injury accident did occur involving a workman, but because of its unusual nature is unlikely to reoccur once construction is completed. One would expect specially constructed, physically separated lanes to be the safest of all facilities.

Four accidents were reported on the I-495 exclusive bus lane through June of 1972. Two of these accidents involved minor personal injury. These accidents involved both sideswipe and head-on. None were serious. The higher number of accidents on I-495 can be attributed to the greater number of buses using this facility as compared to other bus lane projects (see Table 5-1).

The Port Authority has reported that "during the first six months of 1971, there has been no significant change in the overall accident records on the Lincoln Tunnel and its New York and New Jersey approaches." Police responsible for I-495 feel that accident rates are actually lower as a result of removing buses from mixed traffic. The safety record is considered quite satisfactory by the project staff.

The arterial bus lane projects also show favorable accident rates. In Louisville, two accidents were reported in the first two weeks of operation. This was directly traceable to unfamiliarity with the bus lane; drivers simply did not think to look in the opposite direction. Since these incidents, no other accidents have been reported.

The San Juan experience is difficult to interpret. Table 5-9 shows the average monthly number of accidents before and after establishment of the exclusive bus lane.

San Juan officials pointed out that a higher accident rate was to be expected initially since people were not used to the change in operating procedures. Therefore, the accident rate should decline after an initial rise. Table 5-10 provided by these officials verifies this conclusion. In order to provide a check on this conclusion, an index was created whereby the average monthly rate for the twenty-two month period (eleven months "before", eleven months "after") was set at one. Using this as a base, the ratio of the actual number of accidents each month to the average number of accidents for the twenty-two month span was calculated. In turn, a new ratio was derived as the ratio of each after six months was compared with the ratio for each before month. This new ratio tended to be less subject to seasonal variations. The results are shown in Figure 5-2 and tend to support conclusions of San Juan officials.

It should be remembered that the San Juan facility handled between 1,300 and 1,500 bus trips per day and the gross number of accidents may well be expected to be higher.

In Indianapolis the exclusive bus lane on the arterial facility was created for the express purpose of reducing accident rates. Former configurations of (a) two lanes each direction and (b) three lanes one direction with one lane the other direction produced very unsatisfactory accident rates. (See Table 5-11).

Numerous complaints were received from citizen groups. The actual plan of an exclusive bus lane was a compromise arrived at after several opposing positions were reconciled (see Indianapolis case study discussion). The accident rate has declined since initiation of the busway, but accidents are still prevalent.

Perhaps the most remarkable aspect in Indianapolis, from a safety viewpoint, is that signing and striping were non-existent in places at the time of the field investigation. For example, there were no signs lining the route to notify motorists that the lane is closed to all except buses. The double yellow line, separating the lane from other traffic, was obliterated on one or two long stretches of the facility. Side street signs, indicating a one-way street and prohibiting a right or left turn, did not indicate the presence of the bus lane or that it is necessary to watch for transit vehicles, i.e., to look both ways.

It is thought that better cross street signs would definitely reduce accidents. According to one report, "the majority of these (bus lane) accidents are the result of conflicts between southbound buses and eastbound traffic on the cross streets. Apparently some eastbound motorists are not anticipating the southbound buses. The NO RIGHT TURN signs and three lanes of northbound traffic on College Avenue may be misleading them into believing that the street is one-way northbound only."

The Indianapolis route handled about 100 buses daily.

It is interesting to note that, as a concession to safety conscious elements, each case study developed operating regulations designed to minimize accidents. In some cases these requirements may well be unjustified.

TABLE 5-9: San Juan Average Monthly Number of Accidents Before and After Establishment of Exclusive Bus Lane

	Pedes- trians	Vehi- cles	Total
Eleven months, before	27.32	43.91	71.73
Eleven months, after	32.36	45.18	77.54

TABLE 5-10: Percentage Change in Numbers of Accidents Eleven Months After Exclusive Bus Lane Operation Was Put into Effect

	Pedes- trians	Vehi- cles	Total Acci- dents
First five months	+30%	+18%	+23%
Last six months	-9%	+2.5%	-5%



**Figure 5 - 2**  
**RATIO COMPARISON OF ACCIDENTS IN EACH MONTH AFTER BUS LANE PUT INTO**  
**OPERATION TO SAME MONTH BEFORE BUS LANE IMPLEMENTED**  
 (See Text For Explanation)

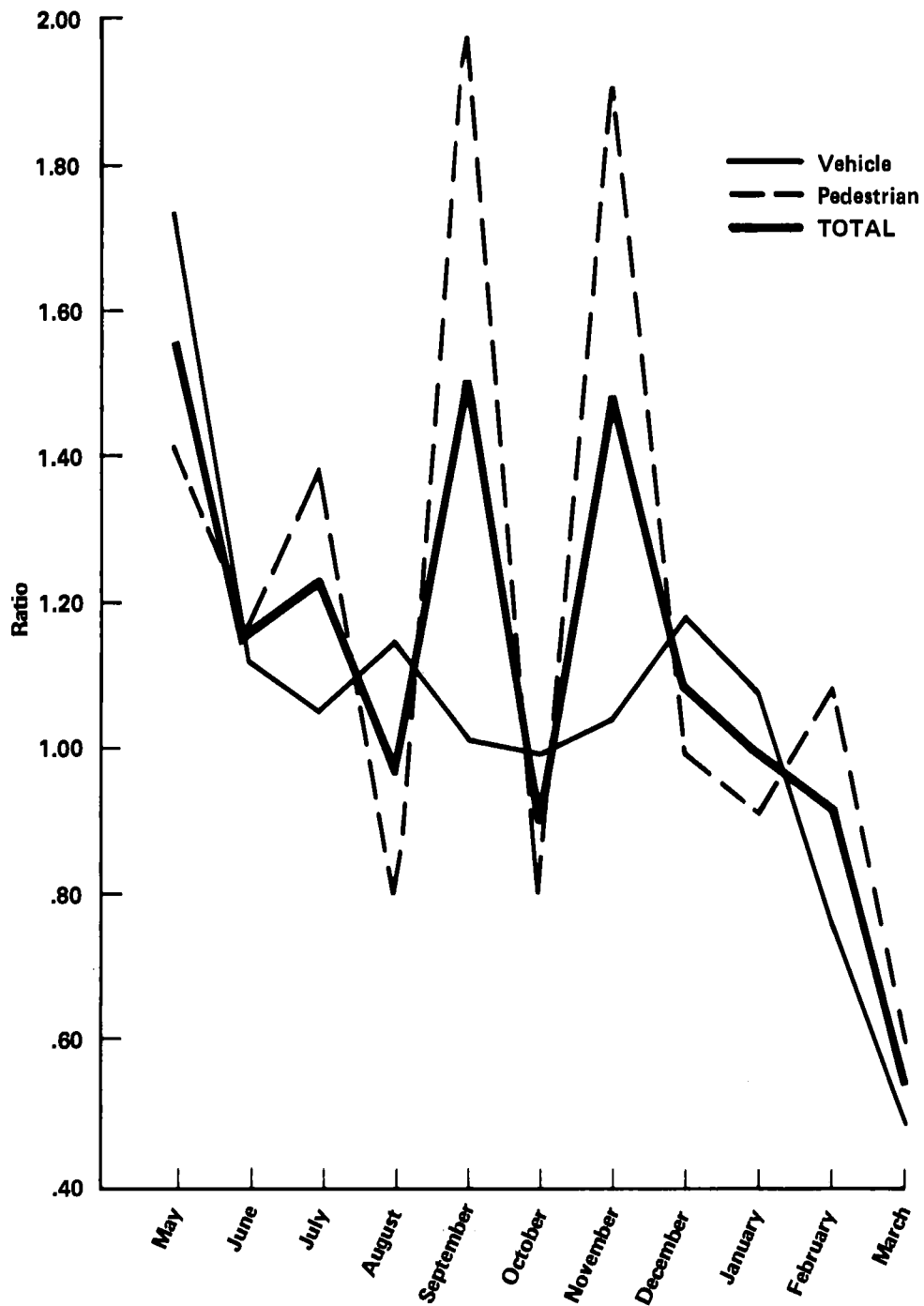

SOURCE: Metropolitan Bus Authority, San Juan.

TABLE 5-11: Indianapolis Accident Data Before and After Bus Lane Establishment

	1968 (Before)	1969 (After)	1970 (After)	1971 (After)	Per Cent Increase
Total Accidents Present Bus Lane	55	21	19	20	-63 (3 years)
Total Accidents All Lanes	216	174	105	N.A.	-51 (2 years)
Bus Accidents Bus Lanes	Not com- parable	7	9	6	Not com- parable to before condition

See text for description of before and after operating circumstances

For example, to protect road crewmen responsible for placing and retrieving cones, Boston does not operate in the winter when these operations would have to be performed in darkness. Other projects placing traffic posts do not take such precautions and cone laying or retrieving accidents have not been reported to date.

Rules on speeds, requirements for such measures as headlights or flashers on, and policies on striping and signing are other examples of diverse requirements. It did appear that some operating requirements were extra precautions developed to reassure particularly concerned individuals and agencies in the decision making process. More operating experience under varying conditions would certainly be expected to reveal which measures are essential to safe operation, and which ones can be gradually abandoned.

In general, safety is not severely degraded by bus lane applications reviewed here. While some accident experience does seem to be higher than comparative standard mixed traffic situations, others appear somewhat more favorable.

One would expect that careful monitoring of the frequency of such incidents over a two year period would lead to more consistent general conclusions. In the meantime, hesitation on the grounds of safety does not seem justified.

#### SOCIAL AND ENVIRONMENTAL IMPACTS

Exclusive bus lanes do not have, at this time, substantial social and environmental impact.

Most bus lanes operate in radial corridors. Typically these corridors connect the CBD to the outlying suburban areas. Trips tend to originate in the higher income suburban fringe and terminate in the CBD. In only a few cases are return trips made which might benefit low income center city residents who work in outlying areas.

This is not to say that low income and middle income residents of suburban areas do not use bus service from the suburbs to the CBD. Mixed suburban environments such as San Juan, New Jersey and Louisville do generate such trips. Table 5-12 reviews the social impacts as far as can be discerned for existing bus lanes.

All things being equal, improvements in transit service tend to help low income and other disadvantaged citizens since so many are dependent on public transportation for travel. However, the suburban orientation of exclusive bus lane projects tends to diminish this impact.

Environmental impacts are also slight at this time. The degree to which buses replace automobiles is also the degree to which favorable environmental impacts might be expected. To date the small number of total urban area trips served by exclusive bus lanes and the relatively small number of automobile users switching to such transit service would indicate that little impact is currently being experienced.

As noted earlier, a primary criterion for establishing bus lanes should be to provide actual or potential time savings over competing modes. An urban area which combats growth in congestion and/or automobile produced

TABLE 5-12: Comparison of Social Impacts

Site	Principal Socio-Economic Groups Served	Extent to Which Low Socio-Economic Groups are Served
New Jersey (I-495)	Middle-Upper	Moderate
Long Island Expressway	" "	Slight
Boston--South-East Expressway	" "	Slight
San Juan	Low-Middle	Substantial
Louisville	" "	Slight
Indianapolis	" "	Substantial

pollution with establishment of a network of free flowing bus lanes could be expected to show diversion of travel from auto to transit as the bus option becomes comparatively more desirable. Depending on how such an arrangement is implemented, and in particular on how it is integrated with other programs favorable to transit use, the resulting long term environmental impact could be very favorable. (In plans being prepared for the achievement of 1975 air quality standards in the Washington metropolitan area, development of busways is recommended as the low pollution alternative for serving the transportation needs of those prohibited from using cars).

#### PUBLIC RESPONSE

Investigation of demand characteristics has in this study been limited to assembling and interpreting available information on the public response to exclusive lane bus service. The work has not included any examination or development of demand estimating techniques.

The data gathered in this study indicates a positive response to exclusive bus lane service when one or preferably both the following conditions are in evidence:

- . Demonstration of a significant time saving over normal auto travel (this was the most important factor).
- . Provision of other non-economic benefits not shared by other modes (comfort as in the case of choice between subway and bus; a relaxed ride as compared to stop and go driving in heavy traffic congestion, etc.).

It is truly unfortunate that better data is not available with which to compare the ridership response to exclusive bus lane service. Nonetheless, positive if not definitive evidence is available that improvements in service made possible through the use of bus lanes has attracted new patrons to transit.

The Shirley Highway project has had a very dramatic rise in ridership since it began operation in September of 1969. A similar dramatic drop in auto travel has been reported (see Figure 3-18). Unfortunately, too many factors are responsible for these gross changes to allow easy assignment of the cause. For example, the addition of bus service, the recent curtailment of jobs in Washington, the shifting of job sites to several major suburban locations, and the turmoil surrounding the reconstruction of Shirley Highway itself all contribute their effect to these gross changes.

Project officials have attempted to discount these influences in order to arrive at an estimate of the number of vehicles removed from Shirley Highway as a direct result of opening the busway. This estimate is 1,300 to 1,500 vehicles per day. The reason why these vehicles have been removed is not clearly established.

The other example for which some empirical support is available is the I-495 project. A breakdown of new riders is shown below:

- . 4 percent from car to carpools
- . 3 percent new travelers to Manhattan
- . 1.5 percent former rail transit users
- . 7 percent merely switched routes
- . 2 percent formerly used bus service to the George Washington Bridge

Of those switching to their current route, fifty-nine percent indicated that the factor chiefly responsible was the availability of service on the exclusive bus lane. In the New York metropolitan area, eighty-five percent of Manhattan bound peak hour commuters are already transit users, and there are thus few auto users who would be available to switch modes.

Some notes on other cases studied are provided below.

San Juan. Changes in system revenues and ridership are shown in Figure 3-14. San Juan has been experiencing a continuing patronage loss from traditional routes, especially in low income areas. The slowing of the rate of overall decline is explained by local transit officials as due to a counterbalancing rise in ridership on bus routes using the exclusive lane facility. It should be noted that the number of vehicles in service has not been constant. Many new vehicles have been put into service over the past few years, and many older vehicles have broken down completely. The rise in revenue is explained by the relative increase in the number of buses charging twenty-five cents. These are air-conditioned vehicles which are more likely to be assigned to routes utilizing the exclusive bus lane. More data is needed on the San Juan operation for clarification of these changes in revenue and ridership patterns.

Boston. In Boston the percentage of new patronage is exactly equal to the percentage increase in the number of vehicles using the service. This could be attributed to the addition of service in response to new demands, or to mere rerouting of vehicles to use the facility with no net gain in patronage. Survey comments from riders are overwhelmingly favorable with emphasis placed on the time advantage provided by the service.

Long Island. The growth in express bus service from Long Island to Manhattan was observed long before the bus lane project was placed in operation. Since establishment of the lane, demand for new bus franchises has continued unabated. At the present time, the New York City Department of Transportation does not feel that additional buses can be accommodated in Manhattan because of the scarcity of loading and unloading space. The Long Island data is important because patrons are paying \$1.00 a ride in private carriers when the same transportation service is available for thirty-five cents on subway or local bus. This acceptance of a premium fare has been explained as being caused by the guarantee of a comfortable seat, a reasonably good chance of not being molested, and the direct trip offered.

Transit officials, however, cannot pinpoint effects on ridership that can be directly traced to the express bus lane facility.

Louisville. There were some observed indications of new riders and probably some switching of travel mode in Louisville, but studies have not satisfactorily quantified or explained the derivation of such new ridership. It is of critical importance to note that while there has been an observed increase in the use of express routes, overall transit ridership in the travel corridor has apparently continued to decline. Again the reasons are not available, but one logical conclusion would be that the overall service design in Louisville may have resulted in an effective reduction of service for more local residents than have received express service benefits (see Figure 3-11).

From these data one can reasonably derive support for the usual finding that significant improvement of a transit service relative to other modes will indeed cause users to be attracted to the new service. The findings specifically indicate that motor bus service offering advantages over other modes can divert users from the auto or competing transit services, and that reserved bus lanes often can markedly assist in the provision of such advantages.

However, in smaller cities where bus lanes have been tried, the current absence of heavy traffic congestion, high parking charges, or other disadvantages to auto use results in little or no bus service advantage to riders.

KEY TECHNICAL ISSUES SURROUNDING IMPLEMENTATION AND OPERATION OF BUS LANESDESIGN AND GEOMETRICS

There is some disagreement among planners about the roadway design requirements for busways. The following discussion covers a variety of roadways which are generally thought acceptable for busways. There are undoubtedly other roadway configurations that may prove feasible, and some applications suggested here may prove unacceptable because of local conditions or constraints. The applications covered here illustrate the basic operating principles and constraints on busways.

Specially Constructed Bus Lane Facilities

If roadways are to be specifically built for use by transit vehicles, it seems desirable to plan a two lane facility with ample lane width and shoulders (see Figure 6-1). However, a one lane facility is thought acceptable for bus lanes. In the latter case, it is desirable to include a shoulder or turnout for pull-offs to discharge and pick-up passengers or for use in case of a breakdown (see Figure 6-2). Experience on certain temporary facilities indicates that a shoulder can be dispensed with if it cannot be easily provided.

This single lane configuration has been suggested for abandoned rail rights-of-way or other instances when only the narrowest of rights-of-way are available. Naturally, operation would be one-way corresponding to the direction of demand during peak periods.

It would be most desirable if access and egress could be achieved through exclusive access ramps to and from the specially constructed facility, when operated in conjunction with an existing freeway (see Figure 6-1). Access and egress could also be accomplished by weaving through gaps in the freeway median barriers and across lanes of traffic (see Figure 6-3).

In cases where the busway is the only facility using the right-of-way, access and egress may be accomplished by simply turning into adjacent arterials or other streets which may intersect with the busway.

Shared Facilities - Limited Access Highways

Busways may operate as separate reserved lanes on existing freeways. A counter flow lane of this type, similar to several now in operation, is shown in Figure 6-3. One report indicates that for such a facility to be successful a two-thirds to one-third directional split of traffic should exist and at least three lanes each way should be presented.<sup>1</sup> This is perhaps too

---

<sup>1</sup> Alan M. Voorhees & Associates, Inc., Peat, Marwick, Mitchell & Co., Simpson & Curtin, Inc., An Analysis of Urban Highway Public Transportation, Facility Needs, Volume II, Appendix, (Preliminary Draft Report), prepared for Federal Highway Administration, Washington, D.C., 1972, p. B-7.



Figure 6 - 1

TWO LANE SPECIALLY CONSTRUCTED BUSWAY IN MEDIAN OF LIMITED ACCESS HIGHWAY  
SHOWS EMERGENCY PULLOFF LANES AND SEPARATE ENTRANCE AND EXIT RAMP  
(Actual Lanes May Function One Way or Two Way as Shown)

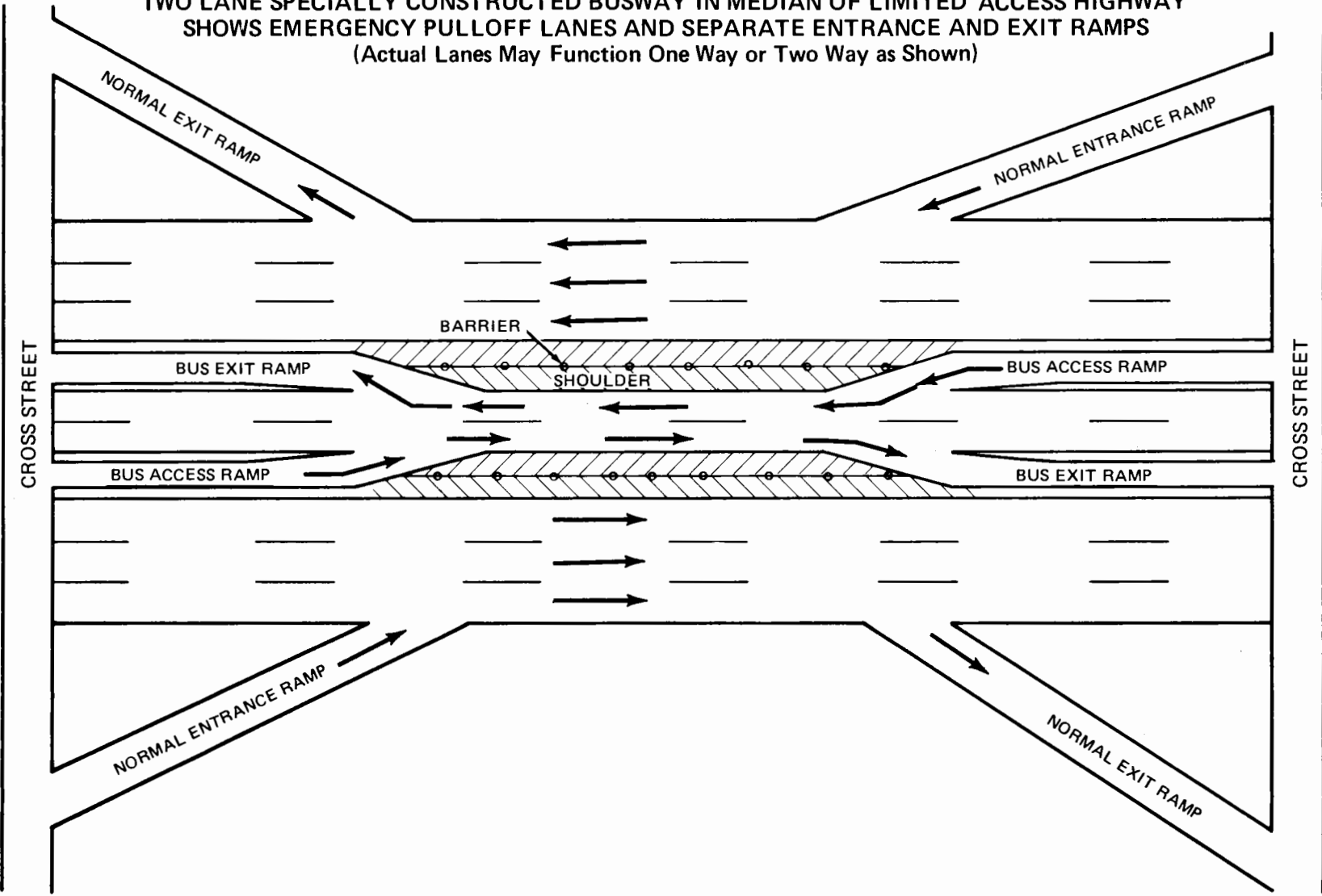

Figure 6 - 2  
ONE LANE FACILITY WITH EMERGENCY PULLOFF AS MIGHT BE PROVIDED  
ON AN ABANDONED RAIL RIGHT-OF-WAY

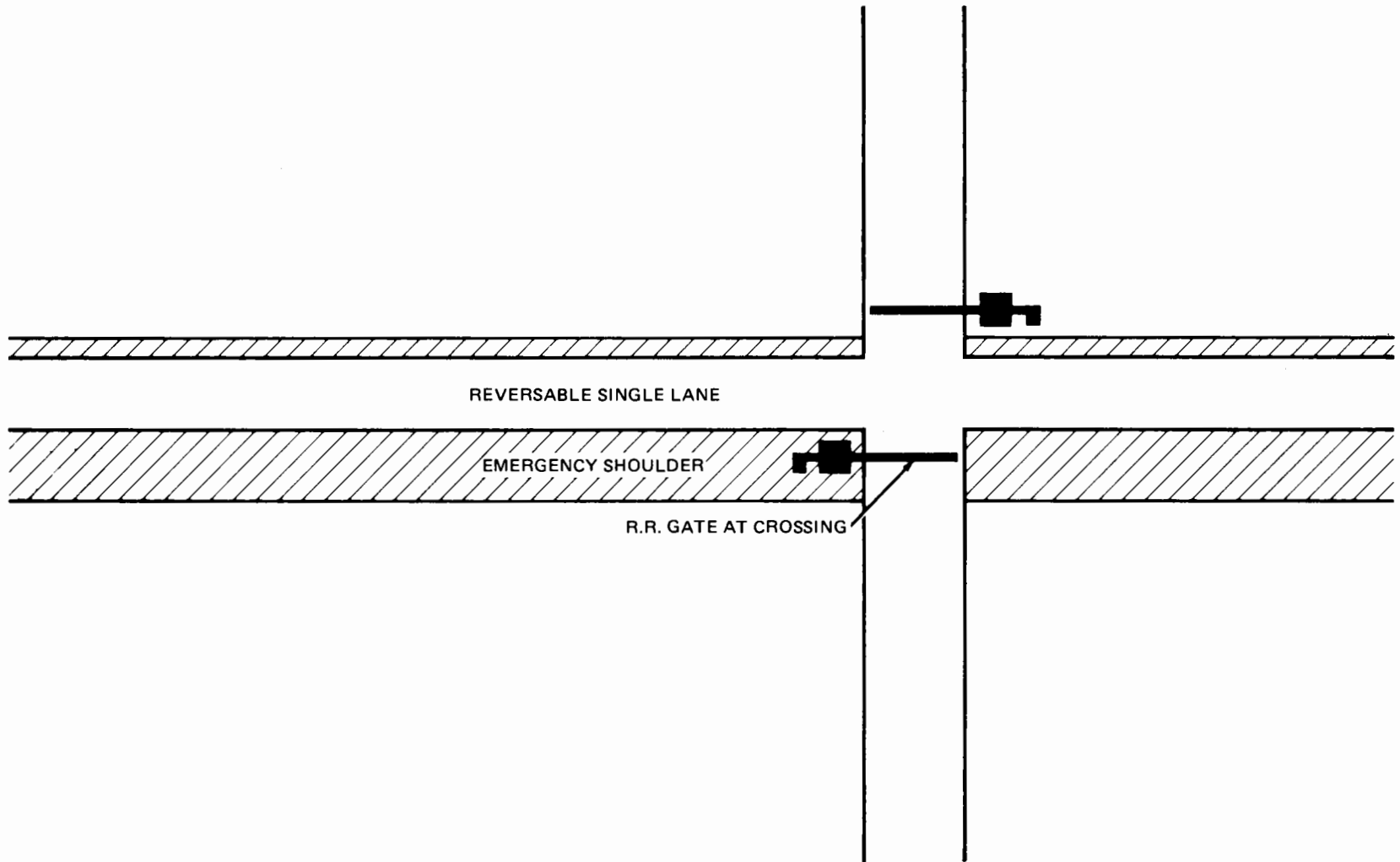
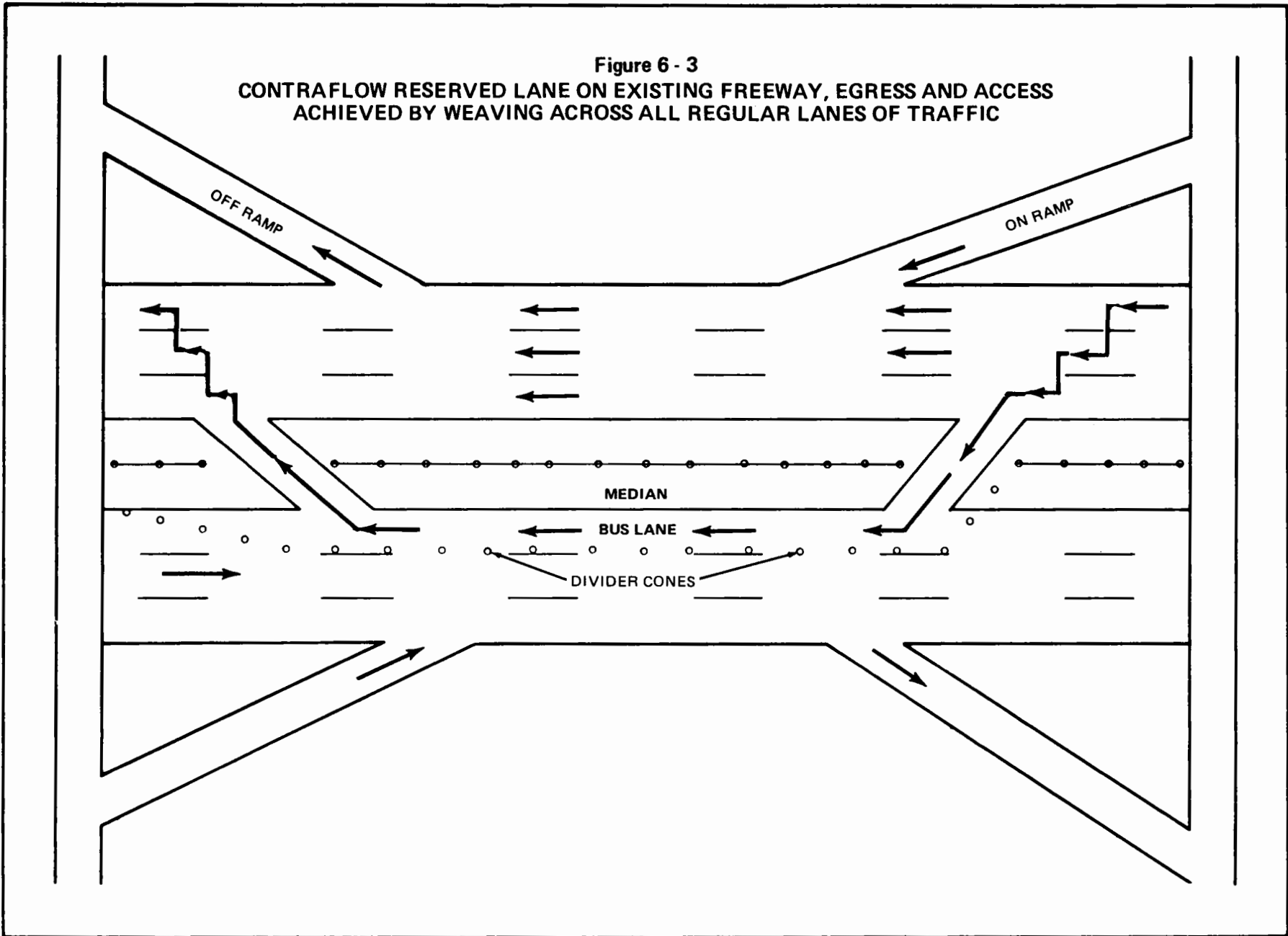

Figure 6 - 3  
CONTRAFLOW RESERVED LANE ON EXISTING FREEWAY, EGRESS AND ACCESS  
ACHIEVED BY WEAVING ACROSS ALL REGULAR LANES OF TRAFFIC



rigid a requirement. A two lane facility with light reverse flow demand and adequate shoulders for emergencies would be a suitable candidate if the highway authorities thought that the value of the busway warranted the slight degradation in operating efficiency experienced by the penalized traffic flow. Such conditions are now imposed where one lane of two lanes in each direction is under repair.

The reservation of an existing lane with a special on-off ramp has merit in that it would avoid the weaving problem associated with crossing the medians to use the normal curb lane exit and entrance ramps.

Although it has not been done, if adequate space existed in the median and a bridge or other special walkway to the bus stop was available, it would be possible to place bus stops in the median. Depending on the bus volume, buses could stop in the lane or pull off into special bays.

The reverse bus lane design shown in Figure 6-3 is simple, quickly implemented and inexpensive. It appears this type of busway can be implemented on any freeway which:

- . has unused reverse flow capacity so that the removal of a lane does not cause a degradation of flow in the lightly used portion, or
- . highway policy makers can justify the amount of traffic system degradation imposed by the value of the improved transit service.

In conclusion, it would appear that there are few, if any, design related reasons why most freeways could not support a bus lane.

#### Shared Facilities - Urban Arterials

Urban arterials, of course, exist in all shapes, sizes and operating configurations. Three generic types are considered here:

- . A major arterial with two or more lanes in each direction
- . A minor arterial with two traffic lanes
- . A one-way street

The major difference between limited access and arterial streets is the interaction of traffic on perpendicular streets. The resulting traffic plans and operating patterns are complex. The problem of intersecting traffic is the major factor deterring the establishment of bus lanes on arterials.

A major two-way arterial can support a busway either moving with or against traffic. Common examples of with flow lanes are the curb lane facility in the CBD of many cities.

Other with flow possibilities include reservation of lanes in the middle of the street or next to a median. It should be noted that the "with flow" lane is very hard to enforce although vehicles which get into a heavily used bus lane are often trapped behind slow buses.

Figure 6 - 4  
MAJOR ARTERIAL, CONTRAFLOW BUS LANE SHOWN: LEFT TURNS MAY BE ACCOMPLISHED IN TWO WAYS SHOWN OR PROHIBITED COMPLETELY

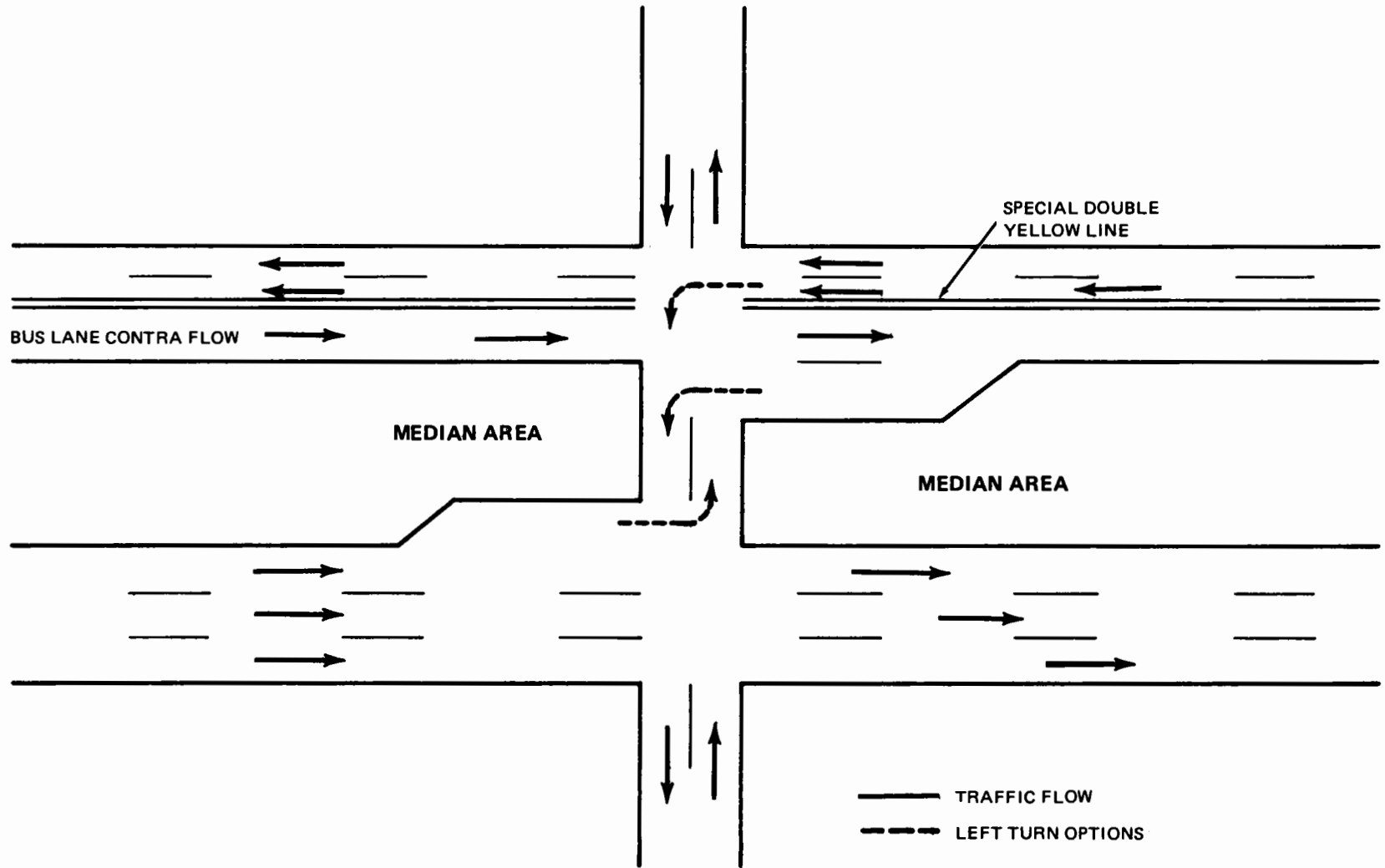

Figure 6 - 5  
CONTRAFLOW LANE ON ONE WAY STREET

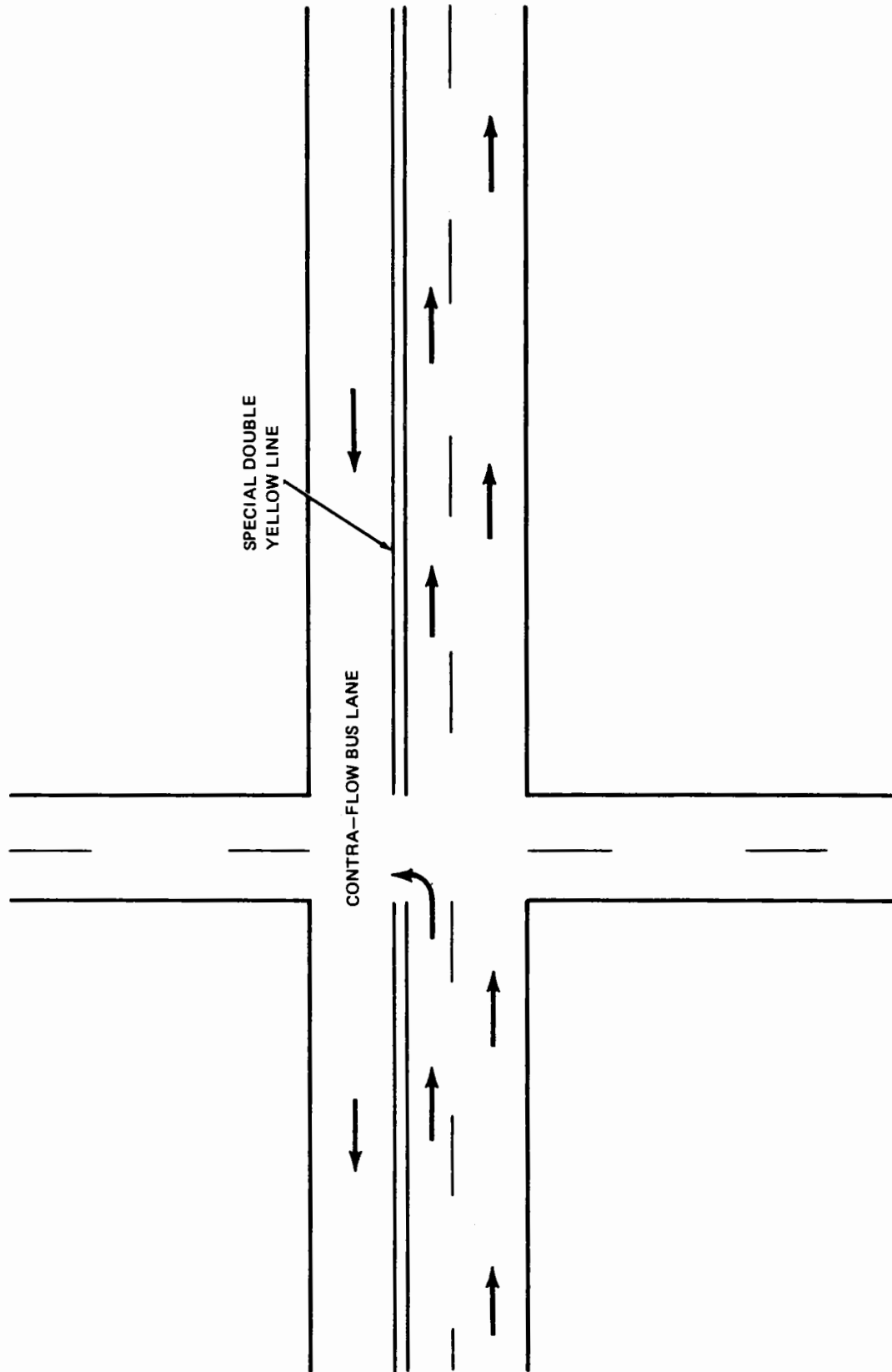
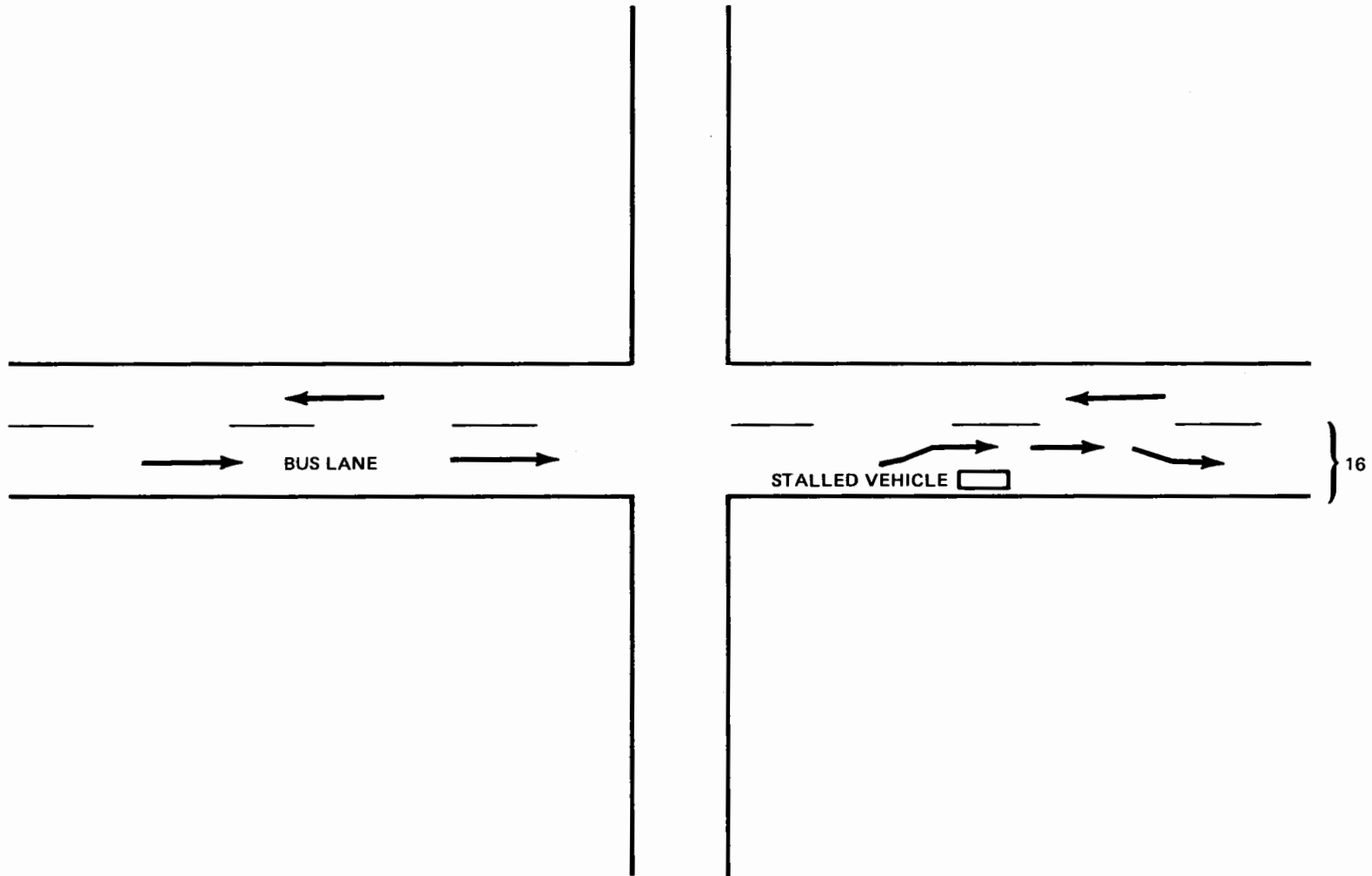

Figure 6 - 6

**TWO LANE ARTERIAL, ONE LANE FOR EXCLUSIVE USE OF BUSES**  
(Note: Adequate Lane Width Needed To Bypass Stalled Vehicles)



In cases where stops are necessary on part of the route, it may be advisable to provide pull-offs so that buses behind are not delayed. If such pull-offs are not possible, planners may want to consider a two lane exclusive bus facility, one for non-stop vehicles, the other for stopping vehicles.

#### Enforcement Procedures

With the exception of with flow lanes on arterials, violation of bus lanes is not significant. Reverse bus lanes tend to be fairly self-enforcing due to the possibility of a head-on collision.

In several cases, active efforts to discourage illegal parking were necessary at the start up of bus lanes on urban arterials. This was accomplished through an aggressive ticketing and towing policy for the first few weeks. The San Juan Traffic Department, in order to stimulate police assistance, photographed illegally parked cars and had tickets issued by mail.

The Indianapolis operation, a reversed lane on an urban one-way street, has the worst violation record. Between fifty-five and 105 illegal vehicles use the lane each day. The police are unwilling to actively enforce prohibitions on the grounds that the route is too poorly marked. There is no evidence that the violations significantly affected bus operations and this was the worst case noted involving exclusive bus lanes.

Bus lanes and curb lanes for buses and right turning vehicles which operate with flow on arterials are the most difficult to enforce. Vehicles other than buses can find many reasons to use the empty lane. There is little danger of accidents since all vehicles are moving in the same direction.

#### Conclusion Regarding Design And Geometrics

Perhaps the most obvious technical conclusion of this report is that nearly any existing street may be converted to busways. In some cases this may be accomplished with little or no penalties to other traffic. In other instances, general traffic will be exposed to certain penalties in the interests of passenger flow. Obviously, the traffic flow costs and benefits must be weighed in each case. In any event, sufficient traffic engineering and technical expertise exists to insure that operational problems can be resolved and smooth day-to-day operation maintained.

#### SIGNING AND CONTROL DEVICES

Signing and control is a second technical area of important concern. Signing and control devices are the critical element in maintaining smooth day-to-day operation of an exclusive bus lane. There is sufficient evidence to suggest that when properly undertaken, the resulting unusual operating patterns do not unduly disturb either the bus operators or other motorists. Where signing and control devices are inadequate, there appears to be a direct correlation between this inadequacy and increases in certain types of accidents.

On freeways and exclusive access highways, the major necessary precaution is to alert motorists to the changes in usual operating patterns. In the



case of signing for mixed traffic approaching the start of a bus lane, it is usually only necessary to mark well in advance that the initial point of divergence is ahead (one-quarter mile, 2,500 feet, 500 feet, etc.) and to place several flashers at points on the median immediately before the gap for buses. A short break in a median barrier is not easy for the bus drivers to see when they are traveling parallel to the barrier. Policemen have been stationed at this point but this has proven unnecessary in at least two cases.

The merge point at the termination of the bus lane is similar. Usually, in the case of AM travel inbound, this point occurs in heavily congested areas in the CBD. In two case study examples, it occurs at toll plazas immediately preceding entrance to congested mixed traffic tunnels. In all cases a slow speed merge is effected. Policemen have been stationed at these points to assist in the operation but this does not appear vital since most motorists tend to cooperate and the size of the bus is intimidating.

Signing at such points consists essentially of warning motorists in both directions of changes in traffic flow. The motorist outbound is usually first confronted with a series of warning signs. These may lead up to a large flashing arrow such as are used in certain maintenance situations to indicate that the median lane is closed and all traffic should merge right.

Motorists in the normal inbound lanes are warned well in advance by signs that buses are merging into the crowded lane next to the median. At this point no one has made a special attempt to clear the inbound median lane of normal traffic leaving it clear for buses. Apparently, there is thought to be too much demand to permit this luxury.

PM outbound operations have essentially the same requirements at the point of bus lane access. However, the outbound merge is considered a more difficult situation when the vehicles are traveling at fairly high speeds. In the one operating example, Boston, the vehicles at full speed merge at will through the median opening. Other outbound vehicles are warned in advance to move to another lane to avoid risking interference with the merging buses. The one accident in Boston occurred at this high speed merge point.

Two alternative approaches for such outbound high speed merge points would include:

- . Using stop sign control at the termination point of the bus lane, forcing the bus to stop before merging. This may be dangerous and disruptive to traffic because of the slow acceleration of buses.
- . Coning and signing to indicate that the median lane ahead is closed to all normal traffic and thus allowing buses to merge, pick up speed, and then mix with other traffic. This might have an effect on total capacity.

Another area of concern involves the weaving across lanes needed to reach standard right-hand lane exit ramps from the median position. It would be more desirable to use separate exit ramps. Such capital intensive facilities have been provided for the Shirley Highway operation.

In Columbus (and certainly other cities) the cross street passes under the expressway. A fairly low cost digging out of the passage between lanes to permit buses to exit (or enter) the lane without using normal ramps is possible.

Approaches which provide separate exit and/or entrance facilities appear to be more desirable than those which require weaving across lanes. Where this must be accomplished in a short distance with high speed traffic, it could be very dangerous or delay producing without proper design and adequate signing and control. In cases where traffic is slow, such as at the inner portion by the CBD, then the problem is manageable.

Cars traveling adjacent to the bus lane itself need to be warned of the likelihood that vehicles will be approaching head on. This seems to be best accomplished by overhead signs indicating the lane is closed to oncoming traffic, along with whatever lane divider technique is used. Unfortunately, most facilities are not adequately equipped with overhead sign bridges. In this case, the next best technique is to place signs in the median warning oncoming traffic that the median lane is not to be used as it is reserved for oncoming buses.

Such warning signs should be placed at frequent enough intervals so that the motorist has at all times in his line of sight a warning sign. The importance of such continuous reminders is emphasized by the fact that cones and other portable devices get knocked down on a frequent basis. Without constant reminders, motorists may become confused.

Signs are used also to regulate the rate of speed of buses once they are in the lane. This is done because it is felt that high operating speeds by buses are not safe given the operating configuration of the bus lane. Oncoming traffic is also subject to lower speed limits although this varies from thirty-five m.p.h. (I-495) to fifty m.p.h. (Boston). Maintenance of thirty-five to forty m.p.h. speeds by buses is quite adequate. Time lost on commuting is due to excessive congestion delay and once this delay is removed average operating speeds of thirty-five m.p.h. to forty m.p.h. are quite adequate to provide a speedy trip.

Enforcement of bus speed limits on bus lanes, as elsewhere, is somewhat difficult. It may be necessary to issue traffic violations. These can be accomplished best by radar clockings and license plate notation. Severe problems may result if vehicles are stopped in the lane.

Arterials with bus lanes also require special signing, especially if a reverse lane is used. Such signs are usually of two types:

- . guides to adjacent lane motorists
- . guides to vehicles on cross streets

Adjacent lane signs tend to be the simple prohibition type as are used on expressways. These are usually placed on posts and placed next to the curb. Overhead signs would be more desirable, but most cities do not have adequate facilities.

Double yellow lines would appear to provide all the warning necessary to keep cars from crossing the lane for passing or other purposes. Louisville authorities cross-hatched the exclusive bus lane, but this does not appear necessary.

Suggested contraflow lanes are shown in Figure 6-4. The major operating problem with contraflow lanes on arterials is that turning vehicles must execute complex maneuvers to avoid conflict with the bus lane (Figure 6-4). This may be avoided to some extent by the standard traffic procedure of banning left or right turns.

Under most circumstances it does not seem advisable to place bus stops anywhere except along the curb lane, although under special conditions safety islands have been provided for loading in other lanes.<sup>2</sup> However, these require additional expense and may use needed street space. Due to lack of left-hand bus doors, medians cannot be used unless the bus lane is within the median or contraflow adjacent to the median. In many cities, the median may be too narrow to accommodate such loadings.. Thus, only express portions of transit trips would seem to be candidates for bus lanes not immediately adjacent to the curb.

The reversal of a lane on a one-way street is the major example to date of an arterial busway. The major factors responsible for this tendency are:

- . Most cities establish one-way streets in pairs and one street in each pair is often flowing opposite to peak direction travel, and therefore, is lightly used.
- . The implementation of a reverse bus lane gives the appearance of and operates much like a normal two-way street.
- . All boardings and alightings are curbside.
- . The reversal of a lane makes the facility self-enforcing to a great degree.
- . The operating configuration is less confusing than two-way patterns.

Figure 6-5 illustrates a typical example.

Busway applications on arterial street systems may or may not be restricted by the number of lanes available. The governing factor undoubtedly would be the degree of delay or interference generated for other traffic by the removal of one lane and/or the amount of such interference (if some is inevitable) that could be tolerated. In some cities, no or very little penalties will be tolerated. In others, it may be established that busways do warrant penalizing other motorists. A possible operating configuration for the simplest of all roads, a two lane, two-way arterial, is shown in Figure 6-6.

The most difficult geometry for development of a bus lane is that of a multi-lane, two-way, undivided arterial. In such cases it may be necessary, if stops are involved, to operate with flow. Physical separation through the use of cones or other barriers may then be necessary to insure separation from other traffic.

---

<sup>2</sup> Installations in downtown Seattle and Chicago are not covered by the field investigations of this study.

Cross street traffic needs to be notified that:

- . the street is one-way for normal traffic
- . entrance to the curb lane is prohibited
- . buses can be expected along the curb lane in the opposite direction of one-way traffic

The last provision is especially critical. Motorists will look to the direction of one-way traffic and forget that buses travel in the opposite direction. This "blindness" has resulted in several accidents and the absence of signing on cross streets in Indianapolis has been blamed by highway officials for a number of accidents with buses there.

As in the case of freeways, other traffic must be forewarned of the change in lane operating characteristics at the start and completion of the busway lane. Simple DO NOT ENTER signs (as used with most normal one-way streets) are usually adequate.

These are the primary signing and control techniques in use on existing busways. In cases where the busway is used only part of the day, the signs are hinged and changeable so that different messages may be displayed at different times as required.

It would be desirable from an operating cost point of view to install remote controlled signs so that road operations could be switched at will where lanes are not in use all day. Such signs are discussed on pages 23 and 25. However, manual signs appear to satisfy the functional requirements for safety and smooth operation.

#### CONES AND BARRIERS

A third area of technical concern is the manner of separation of traffic from bus lanes.

In order to achieve exclusiveness, it is often desirable to use physical means of separating bus lanes from other traffic, as contrasted to use of signing alone. In instances of high speed freeways, physical barriers serve as constant reminders that general traffic is prohibited from using these lanes, and therefore, reduce the possibility of high speed collision. In most arterial applications it has not been necessary to physically separate bus lanes (one exception is Madison, Wisconsin) and this is probably attributable to the fact that operation is much like a normal two-way street.

Two kinds of barriers are generally used:

- . Temporary barriers consisting of free-standing cones or cylindrical traffic posts dropped into holes drilled in the pavement.
- . Permanent metal barriers attached to posts imbedded in the roadway or median.

Permanent barriers are, of course, not usable for bus lanes held exclusive for only part of the day.

## Cones

Free-standing cones are available in various sizes to withstand different wind levels. To date, free-standing cones no matter what the size have not been equal to the turbulence normally associated with high speed freeway operations. The 8.4 mile stretch of highway used as a bus lane in the Boston metropolitan area serves as an ideal test bed. Use of unmodified high speed cones proved unsatisfactory and even after the tops were cut off to lower the profile, these cones still experienced a thirty-five percent knockdown rate.

In part, this is due to continuous high speed vehicle passage on both sides which differs from the typical maintenance usage of cones where vehicles often pass slowly and only on one side. In addition, if a cone is struck, no one is near to retrieve it.

Cylindrical traffic posts appear far preferable. These posts are easily dropped into small holes in the pavement and can withstand all but direct hits. If a choice exists, experience to date would support use of cylindrical traffic posts even though some loss should be expected as these traffic posts occasionally will be directly struck by vehicles.

A discussion of cone costs is included in Chapter 4 under implementation costs.

## Permanent Barriers

Immovable metal barriers which are placed on roadways are now generally either the "W" type or "box beam" type. Both provide substantial protection from vehicles crossing into another lane. It is stated that "box beams" are better able to absorb collision forces than are "W" beams. The "Box beams" cost considerably more, however, than a "W" barrier. (See Chapter 4, Implementation Costs).

A number of technologically innovative schemes have been proposed for temporary barriers. These include hydraulically operated barriers which would rise out of the pavement (in use for years on Chicago's Lake Shore Drive), and pop up cones put into use by a blast of air. To date, high capital costs and questions of technical feasibility along with high maintenance costs have kept these concepts from being widely accepted.

## COMPLEMENTARY TECHNOLOGY

There are two important technological innovations which have been suggested for use in conjunction with busways:

- . Traffic signal preference controls
- , Freeway entrance ramp preference for buses

In addition to these, a host of minor technological improvements may be useful. These generally fall into three categories:

- . Remote controlled information and control signs and devices (see I-495 discussion in Chapter 3).

- . Remote controlled automatic lane dividers (see Chapter 6, Section D).
- , Television monitoring or communication systems

These minor improvements are not further discussed due to the absence of real operational data. By their nature, these improvements offer marginal advantages and do not substantially change the operational characteristics of the busway.

The following is a discussion of the two major areas of complementary technology.

#### Traffic Signal Preference Controls

Traffic signal preference controls are useful in applications where signalized intersections are involved. In most cases this would include only arterial busway applications.

Two types of bus traffic signal priority systems can be implemented:

- , Bus Pre-emption Systems

A bus traffic signal pre-emption system allows buses approaching an intersection to transmit a signal which will hold a green light green or else change, after suitable time for clearance, a red signal to green. In effect, the bus driver independently controls signals. As mentioned in Volume I, such a pre-emption system has little value in congested mixed traffic since it tends to severely penalize traffic on side streets and may be useless if downstream traffic is backed up and buses have no place to go once the light has been pre-empted.

- . The Bus Priority System

The bus priority technique is designed to hold a light green for the bus or shorten a red indication facing the bus. This system will not immediately change a red light and will only hold a green or shorten a red if other conditions are favorable; i.e., when there are no severe cross street queues and ample roadway space is available ahead.

This application of traffic signal priority as discussed for mixed traffic in Volume I, was thought to save buses about three percent of total trip time which is relatively insignificant.

In the case of contraflow busways, the pre-emption technique is probably the more valuable of the two techniques. This in part is because on most contraflow busways, ample downstream capacity exists for the bus to use when a green light is shown, since buses alone will use the lane. Penalization of side street traffic can be held within tolerable bounds when the contraflow bus lane shares signal time with the minor direction of peak hour traffic flow, a situation which will normally occur during the time of peak bus lane usage.

Table 6-1 shows the typical delay experienced on a principal bus street in Washington, D.C. (16th Street). These figures showing that eight to eleven percent of a bus trip time is due to signal delay are consistent with figures for delay in other cities.

A bus pre-emption system used in conjunction with a bus lane would perhaps save a substantial portion of such signal delay time since the only instance

TABLE 6-1: Signal Delay as a Percentage of Total Trip Time on a Heavily Utilized Bus Route in Washington, D. C. (a)

Direction	Period	No. of Buses	Signal Delay (Seconds)	Total Time (Seconds)	Signal Delay As % of Total Time
Northbound	7-9 am	11	44	391	11
Southbound	7-9 am	18	34	297	11
Northbound	4-6 pm	16	34	385	8
Southbound	4-6 pm	14	31	303	10

(a) This excludes K Street data which favors cross-street traffic

SOURCE: Sperry Rand Corporation, Advanced Control Technology in Urban Traffic Control Systems, Vol. IA: Bus Priority System Description, March, 1970, p. 3-51

When such vehicles would have to stop would be where it was necessary to wait for an intersection to clear from, say, left turning vehicles. The pre-emption transmitter could be triggered well enough in advance to largely insure that green indications would be given bus traffic.

This maximum benefit, about ten percent of total trip time, might well be possible on one-way streets where only light traffic is experienced in the off peak direction and the bus lane is contraflow. As the level of mixed traffic flowing in the opposite direction builds, the necessity to impose limits on green time permitted buses will cut down the efficiency of the bus pre-emption devices and reduce the time savings from the maximum ten percent expected.

### Freeway Ramp Controls

Bus preference at freeway ramps was discussed briefly in Volume I under the topic of "Freeway Metering." Essentially freeway ramp preference for buses involves separate approaches, if not ramps, so buses can "get around" automobile queues. Some studies have recommended separate timing cycles on the metering device to allow for the slow acceleration of buses and the need for larger gaps. As is noted below in one application this was not necessary.

The objective of such schemes is to reduce delay for buses which utilize freeway facilities for all or part of their trips. Unfortunately too few bus routes utilize freeways, and ramp delay is typically only a small portion of total congestion delay. This study would conclude that taken alone, freeway ramp controls offer little transportation advantage.

In conjunction with systematic reduction of other delays, as would be experienced with an exclusive busway, such ramp preference schemes are more likely to be useful. When bus routes use an exclusive lane, overall travel time is shortened, and ramp delays may become a more significant percentage of overall delay. Ramp preference offers psychological advantages, i.e., waiting at entrance ramps is disturbing to the bus patrons; moving into a freeway with other traffic (non-preference) is not disturbing, but a bus being granted preference over a queue of cars is definitely pleasing.

The Shirley Highway project is the only case study project which attempted to provide ramp priority for buses. This was done by creating a two-lane ramp and reserving the left lane for buses. This scheme apparently functions quite satisfactorily and does not require the use of sophisticated traffic signal and timing devices.

A similar system is in use on the metered ramps of the Harbor and Hollywood freeways in Los Angeles. In this case the bus proceeds to the head of the queue and accepts the next green signal instead of the first in line automobile. Motorist have not particularly resented these pre-emptions. The Southern California Rapid Transit District has not observed any increase in the overall speeds of buses using the freeway.<sup>3</sup> Only fifteen to eighteen buses use the facility and there is no reserved bus lane on the freeway itself.

---

<sup>3</sup>Planning and Design Guidelines for Efficient Bus Utilization of Highway Facilities, Interim Report to the National Cooperative Highway Research PROGRAM, Wilbur Smith & Associates, New Haven, 1972.



INSTITUTIONS AND IMPLEMENTATION

Analysis of the institutional environment surrounding busway projects discloses an obvious and immediate relationship. In instances where a single agency or authority is empowered to effect roadway improvements and this agency decides that a bus lane is to be implemented, it is implemented quickly and effectively. In instances where the authority for such decisions is shared, such as when neighboring states or autonomous jurisdictions are involved, progress is slow and results often reflect concessions and political trade-offs.

Both the single authority and cooperative multiple authority approach were well illustrated by the seven case study cities and are discussed in the following pages.

SINGLE AUTHORITY SITUATIONS

In four cities, it can be said that a single authority or single agency was principally responsible for, and had direct authority to implement the bus lane:

- . San Juan, Puerto Rico (The Governor's Office)
- . New York City, The Long Island Expressway (The N.Y.C. Department of Transportation)
- . Boston (The Massachusetts Department of Public Works)
- . Indianapolis (Indianapolis Department of Transportation)

These are briefly discussed below:

San Juan

Consultant's studies served as the idea generator in San Juan. An interim report prepared under an UMTA funded Technical Study was responsible for suggesting establishment of exclusive bus lanes. The transit study was undertaken to provide an action plan for relief of an urgent transit and traffic crisis which had as its elements:

- . A steadily worsening transit financial deficit
- . Increasing severe traffic congestion
- . General deterioration in the operation of the bus company

There were four relatively autonomous agencies which were involved in implementing the service system:

- . The Puerto Rico Planning Board

- . Puerto Rico Highway Authority
- . Metropolitan Bus Authority
- . Puerto Rico Department of Public Works

These groups had differing opinions on the desirability and effectiveness of bus lanes. Had the agencies been left to make and implement a decision themselves, progress might have been very slow. As it was, the Governor ordered that the lanes be implemented, and as a result the bus lanes were operating three months after the decision was made.

Currently the four agencies are not in agreement as to whether or how to extend bus lanes. This seems to indicate that some delay will be experienced before other improvements are implemented unless another higher level mandate is forthcoming.

#### New York City

It is not all together clear where the idea of the Long Island Expressway exclusive bus lane originated. It may have been from the noticeable success of the cross town I-495 experiment, or it may have been generated by a member of the city administration or the traffic department itself. Once the Mayor's Office expressed interest in the concept, the New York City Department of Traffic was able to implement an exclusive bus lane facility without requiring approval or cooperation by any other agency.

The Department of Traffic, a component agency of the New York City Department of Transportation, was able to accomplish this because it has the sole responsibility for actual traffic operation on the city streets. The Department of Highways, within the Department of Transportation, is responsible for the day-to-day maintenance and operation of the bus lane facility.

The New York City Department of Transportation has its own planning organization and it was not necessary to seek ratification of plans beyond this organization. Since no Federal funds were involved, and the project was entirely within the city limits of New York, coordination and cooperation with other governmental bodies was not necessary. The bus companies were more than eager to utilize the facility once it was available and so no prior agreements or negotiations were needed to insure their cooperation.

The one area where more cooperation would have been desirable was with the Tri-Borough Bridge and Tunnel Authority which controls the tunnel operation and is independent of the city government. The resulting operating arrangement did slow the buses somewhat through the toll plaza and tunnel.

#### Boston

The Massachusetts Department of Public Works is responsible for the operation of the expressways in the Boston metropolitan area. The idea for the exclusive bus lane originated within the Department of Public Works. The former Chief Engineer, Tad Horgan, is credited with originating the concept. However, a substantial amount of time passed from origination to final implementation. The cause of this was the substantial opposition of Department of Public Works' staff members who were for specific technical reasons opposed to creation and operation of such a lane. The project took two years to move

from the idea stage to the approval stage because of this internal resistance. Once the decision had been made internally, the bus lane was quickly implemented.

It was necessary to coordinate three police jurisdictions; the State Police, the Metropolitan District Commission Police, and police within the various municipalities through which the freeway passed. This apparently was accomplished with little difficulty.

### Indianapolis

As has been mentioned earlier, the Indianapolis arterial bus lane was created in direct response to a local traffic safety condition. The Indianapolis Department of Transportation, which at the time operated as the Mass Transportation Authority, enacted an ordinance which permitted it to designate certain traffic lanes for the exclusive use of buses. A designation of an exclusive bus lane had to be supported by the Traffic Engineer within the Indianapolis Department of Transportation.

Before coming to a decision to reserve a bus lane on the street in question, the I-DOT heard several conflicting opinions and expert testimony as to how the traffic safety situation could be resolved. The most pertinent of this testimony was from the Bureau of Traffic Engineering (I-DOT) which wanted to return the street to complete one-way operation. The bus company countered this testimony with the assertion that it would have to abandon bus service completely in that corridor as there were no adjacent parallel streets which could handle the bus traffic. The I-DOT resolved the issue by simply retaining the one southbound lane but reserving it for the exclusive use of buses. Once the I-DOT had reached this decision, it was quickly implemented.

### SHARED AUTHORITY SITUATIONS

Three case study examples can be classified as shared authority situations since several relatively autonomous agencies were required to agree on operating policies and procedures in order to achieve implementation. These Were:

- . Shirley Highway, Washington, D.C., Metropolitan Area
- . Louisville, One way contra flow lanes
- . I-495, New Jersey

#### Shirley Highway, Washington, D.C., Metropolitan Area

The Shirley Highway bus lane experiments can be said to have grown out of a series of discussions, committee meetings, and inter-agency coordination efforts. Discussions began early 1964 between the District of Columbia and the Virginia highway departments, two bus companies, a transit regulatory agency, the transit authority, and the Federal Highway Administration. These discussions centered around the rebuilding of the Shirley Highway corridor.

The reconstruction called for rebuilding the existing controlled access route, which had two lanes in each direction separated by a median, into an

eight lane freeway with three lanes each way and two reversible lanes in the median. Inter-agency discussions led to the redesign of three outlying interchanges to allow separate access to the reversible lanes, but without determination at this point of what other types of traffic might be allowed on these lanes. After the reversible central lanes were completed on the outer sections of Shirley Highway, it was realized that these lanes could not be opened to general traffic at that stage of highway completion because of the lack of capacity downstream closer to the CBD. One of a number of studies done on this project recommended that a temporary reserved bus and emergency vehicle roadway be constructed from the terminus of the completed portions of the two lane reversible roadway all the way into the District of Columbia. The Steering Committee composed of the aforementioned agencies plus the Washington Metropolitan Area Council of Governments and the Urban Mass Transportation Administration approved this recommendation and set about to implement it.

Before operation of the Shirley Highway began a number of decisions and actions were necessary by various agencies. These included:

- . Establishing Transit Service: The transit companies would not operate any special service on the Shirley Highway facility without being provided additional vehicles and an assurance that costs would be reimbursed. The Urban Mass Transportation Administration through the Northern Virginia Transit Commission provided these vehicles and the necessary financial guarantee.
- . Building Temporary Roadways: In order that vehicles could travel from the terminus of the already completed reversible bus lanes to the District of Columbia on their own separate roadway, the Virginia Highway Department and the Federal Highway Administration had to build a temporary bus roadway through the construction areas between the Shirlington interchange and the 14th Street Bridge.
- . Providing A Bridge Facility: The D.C. Department of Highways and Traffic had to make special provision so that buses could use the new center bridge before it was completed and open to general traffic.

The D.C. Department of Highways and Traffic also instituted a system of priority curb lanes on city streets in the downtown Washington area to help expedite the movement of buses.

### Louisville

In Louisville a number of semi-autonomous agencies were involved in the planning and implementation of a reversed bus lane on an arterial street. The Falls of Ohio Council of Governments was the principal agent responsible for preparing an application for federal funding and designing the project. It was necessary for the Council of Governments to establish a committee of

those agencies in the Louisville area who would be responsible for some phase of implementation. Members included the Louisville and Jefferson County Traffic Engineering Departments, the State Highway Department, the Regional Transportation Study Staff, and the consulting firm of Schimpeler-Corradino Associates. Representatives of these groups formed a technical coordinating committee to oversee the project. Each of the public agencies had to cooperate in order to achieve implementation. The Louisville and Jefferson Traffic Engineering Departments had the responsibility for making the physical changes in the roadway which were necessary to accommodate the bus lane facility. The transit company had to agree to provide the service needed and to change schedules accordingly. Other agencies acted in an advisory capacity.

It was generally agreed by all interviewed that the implementation of the exclusive bus lane depended upon a positive and cooperative environment among all the principal agencies. Agreement had to be reached between agencies before implementation was possible.

#### New Jersey I-495

The I-495 project may well be one of the most successful bus lane projects. It was also one of the most difficult to implement. Initial studies to analyze the potential of an exclusive busway were authorized as far back as 1963.

The Port of New York Authority in December of that year prepared a report evaluating several bus lane schemes and essentially recommending the plan that was ultimately adopted. Based on field tests held in 1964 and 1965, a January 1967 report outlined and strongly recommended the exclusive busway plan. However, the plan was not immediately implemented. Some three years of delay were experienced because one of the critical agencies, the New Jersey Department of Transportation, was unwilling to concede that such a facility could operate safely. The appointment of John Kohl as Commissioner of the New Jersey Department of Transportation in early 1970 was instrumental in changing the look of the New Jersey Department of Transportation. He asked that a special study be done within his agency on the feasibility of such an exclusive bus lane. This report was favorable and subsequently approval from the N.J.-DOT was given. After that, with the addition of some federal funding, the authorization to go ahead was obtained.

There were four principal agencies involved in the planning, implementing, and now the operation of the exclusive bus lane facility. These are:

- . The Port of New York Authority
- . Tri-State Transportation Commission  
(Now Tri-State Regional Planning Commission)
- . New Jersey Department of Transportation
- . New Jersey Turnpike Authority

The major reason for the number of agencies involved is that the actual highway facility crosses a number of jurisdictional boundaries and state lines.

The day-to-day operating responsibilities were split up among these various agencies. More details on these responsibilities can be found on the discussion on the I-495 project.

In reviewing the institutional background of the various bus lane projects, it is clear that one particular agency plays a critical role in the implementation of a bus lane. Other agencies tend to play secondary and non-critical roles. The agency that plays the critical role is the one that controls highway operations. This is usually the Department of Traffic or the Department of Highways for the jurisdiction involved.

While the Traffic Department is the critical agency, it has also been the one most difficult to convince to support busways. A natural reluctance to provide priority to buses, combined with a sincere professional skepticism about the safety of some of the operating plans that have been developed, has often developed into substantial agency inertia. Even when the highway department conceived or originated the concept, cautious elements within the agency often serve to counterbalance agency busway advocates.

Two other agencies usually played a secondary, but important, role in the implementation of bus lanes. The first of these is the local planning agency. If federal funds are involved, usually the local planning organization or Council of Governments will be involved in preparing and administering an application for federal funds. Generally, such organizations tend to coordinate planning for transportation improvements throughout the metropolitan area affected. It was the general experience of this study that these organizations were extremely predisposed towards improvements such as busways. They tended to be somewhat over-optimistic about the possibilities for application. While these planning agencies were both highly supportive and reasonably essential to the process leading to the implementation of the exclusive bus lane, it was clear that they were not the critical decision making unit.

The other essential but secondary agency involved in the implementation was the transit operator himself. In most cases the busway improvement corresponded with the natural routing and scheduling of buses. Operators were more than eager to use the facility realizing that it had potential advantages to their operation.

In two instances the cooperation of the transit operator was obtained only after financial inducement. The first of these cases occurred in Louisville where the operator insisted on being paid \$1.00 per mile for every mile of bus service as well as for all mileage to and from the routes. In addition, the buses were required at the end of their routes to return empty to the starting point to begin another run. This, in effect, amounted to the city chartering all bus service associated with the exclusive bus lane. As a result it was extremely costly.

The second instance of financial inducement to an operator occurred in the case of the Shirley Highway busways. The operators were unwilling to add the additional service without a guarantee that all their costs would be met. The Federal government guaranteed that these costs would be met over and above revenues generated by the service.

The reluctance of the two operators involved is fairly easy to explain. In both cases the operators contended that they were losing money. Given the absence of positive support for transit, and the requirement that they change their routes and schedules, most operators would probably respond similarly in that they would be apprehensive about the costs associated with such unproven routes.

In the other cases studied, there was essentially no need to re-route buses. Existing operations with existing levels of patronage and revenues were simply to be facilitated without any change in the operating pattern. For these particular companies there could be nothing but advantages associated with utilizing the bus lanes.

This financially rooted resistance of transit operators in those cases where loss is a distinct possibility is expected to pose problems for many cities, especially those of smaller size. However, if transit service is to be preserved, especially in smaller cities, it must develop new and more attractive patterns of service. Busways do offer this promise. In some cases it will be necessary to obtain these objectives through subsidization, at least initially.

## CHAPTER 8

### SOURCES OF FEDERAL FUNDING APPLICABLE TO BUSWAYS

Two Federal agencies are sources of support for transportation projects which involve busways:

- . The Federal Highway Administration (U.S. Department of Transportation)
- . The Urban Mass Transportation Administration (U.S. Department of Transportation)

Programs of aid as administered directly or indirectly by these agencies are briefly discussed below.

#### FEDERAL HIGHWAY ADMINISTRATION (FHWA) PROGRAMS

Many types of projects related to busways and public transportation are supported by present congressional policies and by administrative regulations and guidelines of the Department of Transportation and its Federal Highway Administration. The Federal-Aid Highway Program is administered in accordance with Title 23, U.S. Code 101-511, and many other legal provisions. The program also is administered cooperatively with several other Federally aided programs.

#### Busway Related Funding Programs

Yearly appropriations can be used for these transit related programs:

1. Exclusive or preferential bus lanes.
2. Highway traffic control devices.
3. Bus passenger loading areas and facilities.
4. Fringe and transportation corridor parking facilities to serve bus and other public mass transportation passengers.

Legal constraints on using Federal-Aid highway projects to develop urban highway public transportation are relatively minimal. Urban highway public transportation related projects have equal priority with other highway projects. The definition of "motor vehicle" includes buses as well as automobiles. Reserved bus lanes are defined as part of a highway. Purchase of rolling stock (the buses themselves) must be financed from non-FHWA funds; chiefly UMTA plus local funds.



Many states generally interpret their present codes as permitting use of State funds for construction and operation of busways. Most other states have specific legislation authorizing busways.

#### Specific Programs and Funding Levels

Table 8-1 indicates the funding authorizations for the Federal-Aid Highway Program for fiscal years 1972 and 1973. The table shows both:

- . The dollar amounts of Federal money available, and
- . The amount of state funds that must be generated as matching funds in order to obtain a Federal grant.

A highway public transportation project may be supported by any of these programs.

No study has been done to determine how much Federal-Aid highway funds have been spent primarily to assist highway public transportation. Apparently the amount is small but increasing.

#### Relationship of Federal, State, And Local Governments

While historically the Federal-Aid Highway Program has been a "partnership" between the Federal and state governments, substantial changes in programs have occurred. Congress has attempted to overcome, in part, the divisions in responsibility between state and local governments and their respective agencies. Federal laws stress "coordination" and "cooperation." Recent changes in national policy have become much more specific as to how coordination and cooperation are to be achieved. For example, Congress has amended the law concerning the urban transportation planning process to add a new sub-section:

No highway project may be constructed in any urban area of fifty thousand population or more unless the responsible public officials have been consulted and their views considered with respect to the corridor, the location, and the design of the project.

FHWA officials stress that local groups must take the initiative in devising feasible transit oriented plans and in developing these plans for funding. The local group seeking to implement a public transportation related idea should begin by consulting with the regional planning group, expected to be familiar with plans being considered throughout the area, and therefore, able to provide a fair assessment of the merit of the new proposal. The State Highway Department, which administers all highway funds, must also be contacted. To win funding, a project must:

1. Fit in with a comprehensive area wide transportation plan currently supported by the political and planning jurisdictions of the metropolitan area.

TABLE 8-1: Congressional Funding Authorizations For The Federal-Aid Highway Program, Fiscal Years 1972 And 1973

Program	Federal-State Funding Split	FY 1972	FY 1973
Interstate System	90-10	\$4.055 billion	\$4.055 billion
ABC System	50-50	\$1.1 billion	\$1.1 billion
(Rural Primary)	50-50	(\$495 million)	(\$495 million)
(Rural Secondary)	50-50	(\$330 million)	(\$330 million)
(Urban Extensions)	50-50	(\$275 million)	(\$275 million)
Rural Primary and Secondary (Exclusive of Urban Extensions)	50-50	\$125 million	\$125 million
Urban System	50-50	\$100 million	\$100 million
TOPICS	50-50	\$100 million	\$100 million
Others	50-50	\$219 million	\$269 million

2. Must be on a Federal-Aid system route.

More information can be obtained by contacting a State Highway Department or the FHWA Division Offices in each State Capital.

#### URBAN MASS TRANSPORTATION ADMINISTRATION (UMTA) PROGRAMS

The three major funded programs of the Urban Mass Transportation Administration are all potential sources of support for busway related planning and implementation efforts.

##### Technical Studies Grants

Planning efforts related to busways may be funded under Section 9 of the Urban Mass Transportation Act of 1964 as amended. As described in official literature:

Under the technical studies program the Department of Transportation is authorized to make grants to state and local public bodies and agencies to plan, engineer, and design urban mass transportation projects. The technical studies and the projects themselves must relate to a program for the unified or officially coordinated urban transportation system, which must be part of the comprehensively planned development of the urban area. Studies must promote the sensitive integration of mass transit location and design with the overall development and redevelopment goals of local communities and neighborhoods.

The activities that may be assisted include studies relating to management, operations, capital requirements and economic feasibility; preparation of engineering and architectural surveys, plans and specifications; and similar activities in preparation for the construction, acquisition, or improved operation of mass transportation systems, facilities and equipment.

Grants authorized under this program must be matched by state and local financial participation of at least one-third of the cost of the grant project.

Generally, it would be expected that busway related planning efforts would be funded as part of an overall transportation plan. At the present time, it would be difficult to obtain a grant solely for the purpose of planning a specific busway.

##### Grants For Capital Facilities

Capital facilities may be financed under the Capital Grant Program.

Eligible projects include the acquisition, construction, reconstruction, or improvement of facilities and equipment for use in urban mass transportation service in urban areas and in coordinating such service with highway and other transportation in urban areas. Repairs, maintenance, and other operating costs, and ordin-

ary governmental or non-project operating expenses are not eligible as part of project costs.

The term facilities and equipment includes land (but not public highways), buses and other rolling stock, and other real or personal property.

A grant may be made for not more than two-thirds of that part of the cost of the project which UMTA determines cannot reasonably be financed from revenues (the 'net project cost').

Grants are made only to public agencies, though a public agency may lease or otherwise make available to a private firm through contractual means equipment or capital facilities funded under this program.

There is precedent to suggest that capital facilities needed to establish and operate busways, including buses, may be specifically funded under this program.

#### Research, Development And Demonstration Grants

The final relevant operating program is the Research, Development and Demonstration Program funded under Section 6 of the Urban Mass Transportation Act of 1964 as amended, which reads as follows:

Section 6. (a)The Secretary is authorized to undertake research, development, and demonstration projects in all phases of urban mass transportation (including the development, testing, and demonstration of new facilities, equipment, techniques, and methods) which he determines will assist in the reduction of urban transportation needs, the improvement of mass transportation service, or the contribution of such service toward meeting total urban transportation needs at minimum cost. He may undertake such projects independently or by grant or contract (including working agreements with other Federal departments and agencies). In carrying out the provisions of this section, the Secretary is authorized to request and receive such information or data as he deems appropriate from public or private sources.

Generally speaking, a wide range of projects can be considered for funding. No specific local sharing of costs is expected although often a local share is a condition of a grant. Both private firms and public agencies are eligible to receive contracts and grants, although the latter has, to date, been confined to public agencies.

Busways have received support from Section 6 of the Urban Mass Transportation Act during initial development stages. Continued support is less likely since the demonstration value will decline as research data is generated on the practicality, costs and benefits of busway applications.

Information for applicants may be obtained by writing:

U.S. Department of Transportation  
Urban Mass Transportation Administration  
Washington, D.C. 20590