

SOAC

STATE-OF-THE-ART CAR DEVELOPMENT PROGRAM

VOLUME 1: DESIGN, FABRICATION AND TEST

Boeing Vertol Company
(A division of The Boeing Company)
Surface Transportation Systems Branch
Philadelphia, Pa. 19142



APRIL 1974
FINAL REPORT

Availability is unlimited. Document may be released to the
National Technical Information Service, Springfield, Virginia
22151, for sale to the public.

Prepared for
URBAN MASS TRANSPORTATION ADMINISTRATION
Office of Research and Development
Washington, D.C. 20590

NOTICE

This document is disseminated under the sponsorship of the Department of Transportation in the interest of information exchange. The United States Government assumes no liability for its contents or use thereof.

| | | | | | |
|-----------------------------------------------------------------------------------------------------------------------------------------------------------------------------------------------------------------------------------------------------------------------------------------------------------------------------------------------------------------------------------------------------------------------------------------------------------------------------------------------------------------------------------------------------------------------------------------------------------------------------------------------------------------------------------------------------------------------------------------------------------------------------------------------------------------------------------------------------------------------------------------------------------------------------------------------------------------------------------------------------------------------------------------------------------------------------------------------------------------------------------------------------------------------|--|--------------------------------------|---------------------------------------------------------------------------------------------------------------------------------------------------------------------------------------|----------------------------------------------------------------------------------------|-----------|
| 1. Report No. UMTA-IT-06-0026-74-1 | | 2. Government Accession No. | | 3. Recipient's Catalog No. | |
| 4. Title and Subtitle SOAC STATE-OF-THE-ART CAR DEVELOPMENT PROGRAM, Vol 1. Design, Fabrication and Test | | | | 5. Report Date April 1974 | |
| | | | | 6. Performing Organization Code | |
| 7. Author(s) | | | | 8. Performing Organization Report No. D174-10031-1 | |
| 9. Performing Organization Name and Address Boeing Vertol Company (A Division of The Boeing Company) Surface Transportation Systems Branch Philadelphia, Pa. 19142 | | | | 10. Work Unit No. (TRAIS) IT-06-0026 | |
| | | | | 11. Contract or Grant No. DOT-UT-10007 | |
| 12. Sponsoring Agency Name and Address Department of Transportation Urban Mass Transportation Administration Office of Research and Development Washington, D.C. 20590 | | | | 13. Type of Report and Period Covered Final Report (June 1971 to August 1973) | |
| | | | | 14. Sponsoring Agency Code | |
| 15. Supplementary Notes | | | | | |
| 16. Abstract As systems manager for the Urban Mass Transportation Administration's Urban Rapid Rail Vehicle and Systems Program, the Boeing Vertol Company is supervising the design, fabrication and test of two new State-of-the-Art Cars (SOAC) whose objective is to demonstrate the current state-of-the-art in rail rapid transit vehicle technology. Passenger convenience and operating efficiency are primary goals for the cars. Built by the St. Louis Car Division of General Steel Industries, the SOAC features a DC-DC chopper in the propulsion system, separately excited DC traction motors, all-steel construction (with molded fiberglass ends), and vandal-resistant and fire-retardant materials in the interior. This volume, Volume 1 of a two-volume report, covers the development program through engineering testing; including data on design and performance, propulsion and braking, subsystems, test program, mockup and demonstration programs, and economic analysis. Volume 2 will report on operational tests and evaluations to be performed in revenue service in New York, Boston, Cleveland, Chicago and Philadelphia. | | | | | |
| 17. Key Words SOAC Report State-of-the-Art Car UMTA URRV Program Modern Rapid Transit | | | 18. Distribution Statement Availability is unlimited. Document may be released to the National Technical Information Service, Springfield, Virginia 22151, for sale to the public. | | |
| 19. Security Classif. (of this report) UNCLASSIFIED | | 20. Security Classif. (of this page) | | 21. No. of Pages 182 | 22. Price |

01742

TF
455
.S61
v.1
c.1

Contents

| <u>Section</u> | <u>Page</u> |
|-----------------------------------------------------|-------------|
| 1. INTRODUCTION..... | 1 |
| 1.1 Urban Rapid Rail Vehicle and Systems Program... | 1 |
| 1.2 State-of-the-Art Car (SOAC) Program..... | 2 |
| 2. SOAC DEVELOPMENT..... | 4 |
| 2.1 Scope..... | 4 |
| 2.2 Program History..... | 5 |
| 3. DESIGN AND PERFORMANCE..... | 18 |
| 3.1 General..... | 18 |
| 3.2 Exterior..... | 21 |
| 3.3 Structure..... | 21 |
| 3.4 Interior..... | 22 |
| 4. PROPULSION AND BRAKING SYSTEMS..... | 28 |
| 4.1 Basic Propulsion System..... | 28 |
| 4.2 Propulsion Equipment..... | 29 |
| 4.3 Equipment Descriptions..... | 29 |
| 4.4 Propulsion System Operation..... | 50 |
| 4.5 Traction and Braking Characteristics..... | 57 |
| 4.6 Detailed Chopper Operation..... | 60 |
| 4.7 Brake Systems..... | 67 |
| 5. SUBSYSTEMS..... | 79 |
| 5.1 Trucks..... | 79 |
| 5.2 Resilient Wheels..... | 81 |
| 5.3 Heating, Ventilating, and Air Conditioning..... | 81 |
| 5.4 Coupler and Draft Gear..... | 84 |
| 5.5 Doors and Door Operators..... | 86 |
| 5.6 Communications..... | 90 |
| 5.7 Automatic Power Changeover..... | 91 |
| 5.8 Power Collectors..... | 91 |
| 5.9 Lighting..... | 93 |
| 5.10 Hostler..... | 95 |
| 5.11 Windows..... | 95 |
| 5.12 Monitor Panel..... | 97 |
| 5.13 Motorman's Control Panel..... | 97 |

| <u>Section</u> | <u>Page</u> |
|----------------------------------------------------------|-------------|
| 6. TEST PROGRAM..... | 101 |
| 6.1 Component and Subsystem Tests..... | 101 |
| 6.2 Acceptance and Engineering Tests at HSGTC..... | 108 |
| 6.3 Acceptance Test Results..... | 110 |
| 6.4 Engineering Test Results..... | 114 |
| 6.5 Simulation Demonstration Test Results..... | 149 |
| 7. ENGINEERING DESIGN CHANGES AND CORRECTIVE ACTIONS.... | 154 |
| 7.1 Design Changes..... | 154 |
| 7.2 Corrective Actions..... | 156 |
| 8. MOCKUP AND TEST AND EVALUATION PROGRAMS..... | 158 |
| 8.1 SOAC Mockup..... | 158 |
| 8.2 Operational Test and Evaluation..... | 161 |
| 9. ECONOMIC ANALYSIS..... | 164 |
| 9.1 Introduction and Summary..... | 164 |
| 9.2 Production Cost Estimate..... | 165 |
| 9.3 Propulsion Controls Tradeoff Study..... | 169 |
| REFERENCES..... | 182 |

Illustrations

| <u>Figure</u> | | <u>Page</u> |
|---------------|---------------------------------------------------------------|-------------|
| 1-1 | Major SOAC Milestones..... | 3 |
| 2-1 | State-of-the-Art Car Development Team..... | 6 |
| 2-2 | SOAC Construction, March through May 1972..... | 13 |
| 2-3 | SOAC Construction, July 1972..... | 14 |
| 2-4 | SOAC Rollout, August 1972..... | 15 |
| 2-5 | SOAC Acceptance Ceremony, October 1972..... | 15 |
| 2-6 | USDOT High Speed Ground Test Center, Pueblo, Colorado..... | 17 |
| 3-1 | Performance and Design Characteristics..... | 19 |
| 3-2 | SOAC Vehicle Operating Profile..... | 20 |
| 3-3 | Noise Control Features..... | 20 |
| 3-4 | Exterior..... | 21 |
| 3-5 | Frame Construction..... | 23 |
| 3-6 | Roof Construction..... | 24 |
| 3-7 | Seating Plans..... | 25 |
| 3-8 | Interior..... | 26 |
| 4-1 | Propulsion and Braking System Block Diagram..... | 30 |
| 4-2 | Propulsion Equipment Location..... | 31 |
| 4-3 | Traction Motor..... | 33 |
| 4-4 | Motor and Drive System..... | 34 |
| 4-5 | Propulsion System Functional Schematic..... | 35 |
| 4-6 | DC Chopper..... | 38 |
| 4-7 | Chopper Schematic..... | 39 |
| 4-8 | Transient Voltage vs Transient Duration..... | 40 |

| <u>Figure</u> | <u>Page</u> |
|---------------------------------------------------------------------------|-------------|
| 4-9 Propulsion Power Control Unit Plug-In Card Locations..... | 42 |
| 4-10 Motor Alternator..... | 44 |
| 4-11 Auxiliary Power Subsystem Block Diagram..... | 46 |
| 4-12 Cooling System - Fan Inlet..... | 47 |
| 4-13 Master Controller Panel..... | 49 |
| 4-14 Speed Maintaining Buttons..... | 51 |
| 4-15 Tractive Effort Control Block Diagram..... | 53 |
| 4-16 Time History of Typical Initial Acceleration..... | 55 |
| 4-17 Time History of Typical Blended Braking..... | 58 |
| 4-18 Traction and Braking Characteristics (Single-Car, 600 volts)..... | 59 |
| 4-19 Chopper Operation: Main-Q1 "Off"..... | 61 |
| 4-20 Chopper Operation: Main-Q1 "Fired On"..... | 62 |
| 4-21 Chopper Operation: Main-Q1 "On", Commutator-Q2, "Fired On"..... | 63 |
| 4-22 Chopper Operation: Main Q1 "On", Commutator-Q2 "Off"..... | 64 |
| 4-23 Chopper Operation: Main-Q1 Commutated "Off"..... | 65 |
| 4-24 Chopper Operation: Main-Q1 "Off", Load Free Wheel..... | 66 |
| 4-25 Brake System Schematic..... | 69 |
| 4-26 Air Compressor..... | 69 |
| 4-27 Type "A" Analog Electro-Pneumatic Unit..... | 70 |
| 4-28 Brake Actuator (Non-Handbrake Unit)..... | 73 |
| 4-29 Air Brake Control..... | 74 |
| 4-30 Friction Brake Pressure and Application Characteristics..... | 76 |

| <u>Figure</u> | | <u>Page</u> |
|---------------|---------------------------------------------------------------------------|-------------|
| 4-31 | Emergency Brake Control..... | 78 |
| 5-1 | Truck..... | 80 |
| 5-2 | Truck and Suspension Unit..... | 80 |
| 5-3 | Acousta-Flex Wheel..... | 82 |
| 5-4 | Heating, Ventilating and Air-Conditioning System..... | 82 |
| 5-5 | Overhead Heating, Ventilating, and Air- Conditioning Installation..... | 83 |
| 5-6 | Coupler and Draft Gear..... | 85 |
| 5-7 | Electric Coupler Boxes..... | 87 |
| 5-8 | Door Operator..... | 89 |
| 5-9 | Pantograph (Partially Extended)..... | 92 |
| 5-10 | Third Rail Power Pickup..... | 94 |
| 5-11 | Hostler..... | 96 |
| 5-12 | Monitor Panel..... | 98 |
| 6-1 | Propulsion and Drive System Test Cell..... | 103 |
| 6-2 | Typical Truck Frame Test Setup..... | 105 |
| 6-3 | Interior Noise Levels..... | 113 |
| 6-4 | Wayside Noise Levels..... | 113 |
| 6-5 | Ride Quality..... | 115 |
| 6-6 | Electromagnetic Field Test Data..... | 116 |
| 6-7 | Acceleration and Speed Response to Tractive Effort Response..... | 118 |
| 6-8 | Control Linearity ("P" Signal)..... | 119 |
| 6-9 | Effect of Car Weight on Acceleration and Braking..... | 120 |
| 6-10 | Effect of Car Weight on Time and Distance to Speed..... | 122 |

| <u>Figure</u> | | <u>Page</u> |
|---------------|-----------------------------------------------------------------------------------------|-------------|
| 6-11 | Effect of Third Rail Voltage on Acceleration and Braking..... | 123 |
| 6-12 | Effect of Third Rail Voltage on Time and Distance to Speed..... | 124 |
| 6-13 | Traction Resistance..... | 125 |
| 6-14 | Wheel Temperature..... | 127 |
| 6-15 | ACT-1 Synthetic Transit Route..... | 128 |
| 6-16 | Wheel Adhesion..... | 131 |
| 6-17 | Ride Quality Test Baseline Data..... | 135 |
| 6-18 | Ride Quality Baseline Comparison: Effect of Speed..... | 137 |
| 6-19 | Ride Quality Baseline Comparison: Effect of Speed..... | 138 |
| 6-20 | Ride Quality Baseline Comparison: Effect of Speed..... | 139 |
| 6-21 | Comparison of Interior Noise Levels With Goals... | 142 |
| 6-22 | Effect of Wheel Configuration on Interior Noise..... | 143 |
| 6-23 | Comparison of Rail Surface Roughness on Noise.... | 144 |
| 6-24 | Comparison of Wheel Surface Roughness on Noise... | 146 |
| 6-25 | Effect of Speed on Wayside Noise..... | 147 |
| 6-26 | Comparison of Wayside Noise Levels with Goals.... | 148 |
| 6-27 | Simulated Demonstration Route at HSGTC..... | 150 |
| 6-28 | Mileage Accumulation During Simulated Demonstration (23 July to 11 August 1973)..... | 152 |
| 6-29 | Daily Miles Per Car During Simulated Demonstration (23 July to 11 August 1973)..... | 153 |
| 8-1 | SOAC Mockup on Display..... | 159 |
| 9-1 | Maximum Tractive Effort vs Speed..... | 174 |

| <u>Figure</u> | | <u>Page</u> |
|---------------|-----------------------------------------------------------------------------|-------------|
| 9-2 | Electric Current Usage (at Maximum Tractive Effort) vs Speed..... | 175 |
| 9-3 | Electric Current Usage (at Maximum Tractive Effort) vs Time from Start..... | 177 |

Tables

| <u>Table</u> | | <u>Page</u> |
|--------------|----------------------------------------------------------------------------------------------------|-------------|
| 4-1 | Propulsion System Components..... | 29 |
| 6-1 | Truck Frame Stress Results..... | 104 |
| 6-2 | Truck Bolster Maximum Recorded Stresses..... | 106 |
| 6-3 | Performance Requirements..... | 110 |
| 6-4 | Acceptance Test Results (105,000-Pound Car)..... | 112 |
| 6-5 | Summary of Friction Brake Duty Cycle Tests..... | 129 |
| 6-6 | Summary of SOAC Energy Consumption on ACT-1 Synthetic Transit Route..... | 132 |
| 6-7 | Summary of Undercar Equipment Temperatures for Synthetic Transit Route (105,000-Pound Car)..... | 133 |
| 6-8 | Summary of Wheel Spin-Slide System Efficiencies (90,000-Pound Car)..... | 134 |
| 8-1 | Mockup Display Activities..... | 160 |
| 9-1 | Estimated Prices for Purchased Hardware (300 Cars)..... | 166 |
| 9-2 | Recurring Manufacturing Manhour Summary (300 Cars)..... | 167 |
| 9-3 | Estimated Production Price (300 Cars)..... | 168 |
| 9-4 | High-Density Route Properties..... | 171 |
| 9-5 | Motor and Control Combinations | 171 |
| 9-6 | Compilation of SOAC Weights with Various Propulsion and Control Combinations..... | 173 |
| 9-7 | Weight and Power Consumption of the Five Combinations..... | 178 |
| 9-8 | Electric Power Costs (in Four Cities)..... | 179 |
| 9-9 | Average Annual Mileage per Car..... | 180 |

1. INTRODUCTION

In June 1971, the Boeing Vertol Company was awarded a contract (DOT-UT-10007) for systems management of the Urban Rapid Rail Vehicle and Systems Program (URRVS), whose overall objective is to enhance the attractiveness of urban rail transportation. Sponsored by the U.S. Department of Transportation's Urban Mass Transportation Administration (UMTA), the program builds upon and accelerates the technical evolution of rail rapid transit so that new urban rail systems and system extensions can benefit from improved operating economics and enhanced passenger appeal.

1.1 URBAN RAPID RAIL VEHICLE AND SYSTEMS PROGRAM

Boeing is performing eight tasks under the Urban Rapid Rail Vehicle and Systems Program:

1. Provide program management in implementing UMTA efforts toward improving high-speed, frequent-stop urban rail systems.
2. Monitor the testing of the BART prototype cars for input to the program.
3. Using BART as a baseline, and using current (1971-72) technology in car building, direct the design and construction of two new State-of-the-Art Cars (SOAC), representative of the best available technology; demonstrate these cars to the transit authorities and the riding public in five major cities.

4. Conduct an industry-wide design competition and award contracts to produce a two-car Advanced Concept Train (ACT-1), representative of the next generation of rail transit cars; demonstrate these cars to the transit authorities and the riding public in five major cities.
5. Concurrently, conduct an industry-wide design competition and award contracts for alternative advanced subsystems under the Advanced Subsystem Development Program (ASDP).
6. Plan for an operational demonstration of the ACT train in revenue service.
7. Perform an economic analysis of the SOAC and ACT cars leading to estimates of life cycle costs in production quantities.
8. Perform a human factors evaluation of the SOAC, and ACT cars.

1.2 STATE-OF-THE-ART CAR (SOAC) PROGRAM

The objective of the SOAC task is to demonstrate the current state-of-the-art in rail rapid transit vehicle technology. This objective is being fulfilled by the development, test, and demonstration of two rail rapid transit cars embodying the best available in current (1971-72) technology. Passenger convenience and operating efficiency are primary goals for the cars which are designed to be capable of operation on at least one line of the rapid transit systems in New York, Boston, Cleveland, Chicago and Philadelphia.

The two SOAC cars were designed, fabricated, functionally tested and delivered to the U.S. Department of Transportation's High Speed Ground Test Center (HSGTC) in Pueblo, Colorado, 11-1/2 months after contract go-ahead by the St. Louis Car Division of General Steel Industries. In August 1972, the cars were shipped to the HSGTC at Pueblo; on September 26, the first day on the UMTA Rail Transit Test Track, one SOAC achieved a speed of 65 mph. On October 12, SOAC was unveiled and demonstrated to the public, to the Secretary of Transportation, John Volpe, and to other officials.

During 1973, the SOAC vehicles underwent an extended period of engineering testing. A delay in operational testing and evaluation was caused by a switching accident in August, 1973 necessitating major repairs to one of the two cars. These repairs were completed in December, 1973. Systems testing on UMTA's 9.1-mile Rail Transit Test Track was resumed in

January 1974 and completed on April 10, 1974. Operational test and evaluation will be conducted in New York, Boston, Cleveland, Chicago and Philadelphia.

During the operational test and evaluation phase (to be reported in Volume 2), the contributions of current rail rapid transit technology to the goals of increased passenger convenience and operating efficiency will be demonstrated to the transit industry, public officials, and the riding public.

Major milestones of the SOAC program are shown in Figure 1-1; a detailed program history is presented in Section 2.

| SOAC ACTIVITY | 1971 | | | | 1972 | | | | | | | | | | | | 1973 | | | | | | | | | | |
|---------------------------------------------|------|---|---|---|------|---|---|---|---|---|---|---|---|---|---|---|------|---|---|---|---|---|---|---|---|---|--|
| | A | S | O | N | D | J | F | M | A | M | J | J | A | S | O | N | D | J | F | M | A | M | J | J | A | | |
| ST. LOUIS CAR CONTRACT AWARD | ▼ | | | | | | | | | | | | | | | | | | | | | | | | | | |
| AIRESEARCH PROPULSION SYS SUBCONTRACT AWARD | ▼ | | | | | | | | | | | | | | | | | | | | | | | | | | |
| UNDERFRAME LAYDOWN | | | | ▼ | | | | | | | | | | | | | | | | | | | | | | | |
| CAR SHELL COMPLETED | | | | | ▼ | | | | | | | | | | | | | | | | | | | | | | |
| PROPULSION SYSTEM COMPLETED | | | | | | | | | | | ▼ | | | | | | | | | | | | | | | | |
| TRUCK COMPLETED | | | | | | | | | | | | ▼ | | | | | | | | | | | | | | | |
| CARS ASSEMBLED | | | | | | | | | | | | | ▼ | | | | | | | | | | | | | | |
| CARS SHIPPED TO HSGTC | | | | | | | | | | | | | ▼ | | | | | | | | | | | | | | |
| PUBLIC DEMONSTRATION RUN | | | | | | | | | | | | | | ▼ | | | | | | | | | | | | | |
| COMPLETION OF SYSTEMS TESTING | | | | | | | | | | | | | | | | | | | | ▼ | | | | | | | |
| ACCEPTANCE TEST COMPLETED | | | | | | | | | | | | | | | | | | | | | ▼ | | | | | | |
| ENGINEERING TEST COMPLETED | | | | | | | | | | | | | | | | | | | | | | | | ▼ | | | |
| ACCIDENT | | | | | | | | | | | | | | | | | | | | | | | | | | ▼ | |

Figure 1-1. Major SOAC Milestones

2. SOAC DEVELOPMENT

2.1 SCOPE

The efforts of the UMTA, Boeing and industry team during the two years of the SOAC program have included:

- Evaluation of the BART prototype car and incorporation of selected technical and human factors findings in two totally new State-of-the-Art Cars.
- Design, construction and delivery of the SOAC cars in less than one year.
- Acceptance testing to the guarantee points listed in the SOAC specification.
- Engineering testing to completely evaluate the SOAC in all normal and failure modes.
- Establishment of baseline technical data which, in the future, will be used for comparison with new transit vehicles to measure growth.
- Simulated demonstration testing to ensure vehicle reliability prior to the operational test and evaluation tour.
- Evaluation of the human factors involved with the SOAC cars in passenger appeal, crashworthiness and maintenance.

- Design, construction, and display of a mockup of the SOAC vehicle.
- Preparation of an "as built" specification format which may be used by all transit properties in ordering new cars.
- Analysis of the SOAC accident of August 1973, and determination of:
 - a. Vehicle crashworthiness of the SOAC.
 - b. Human factors involved (i.e., safety of passengers).
- Performance of an economic analysis of the SOAC, using the cost information developed during the program.

2.2 PROGRAM HISTORY

The challenge of building two totally new cars incorporating new and relatively untried systems, and delivering the same within one year was one which had never been faced in the rail transit car industry. In addition to the physical and technical constraints of such a program, the problems of "marrying" an old line car builder with a company long experienced in aerospace management techniques had to be faced and solved. (The industry team which participated in the development of the SOAC vehicle is shown in Figure 2-1.)

Prior to releasing the RFP (Request for Proposal) for SOAC car construction, Boeing Vertol, as Systems Manager for UMTA, was obligated to determine the feasibility and desirability of incorporating the following types of systems representing the latest state of the art.

- DC chopper control
- AC propulsion
- Air suspension
- Light weight trucks
- Improved air conditioning
- Regenerative braking
- Vandal-resistant materials

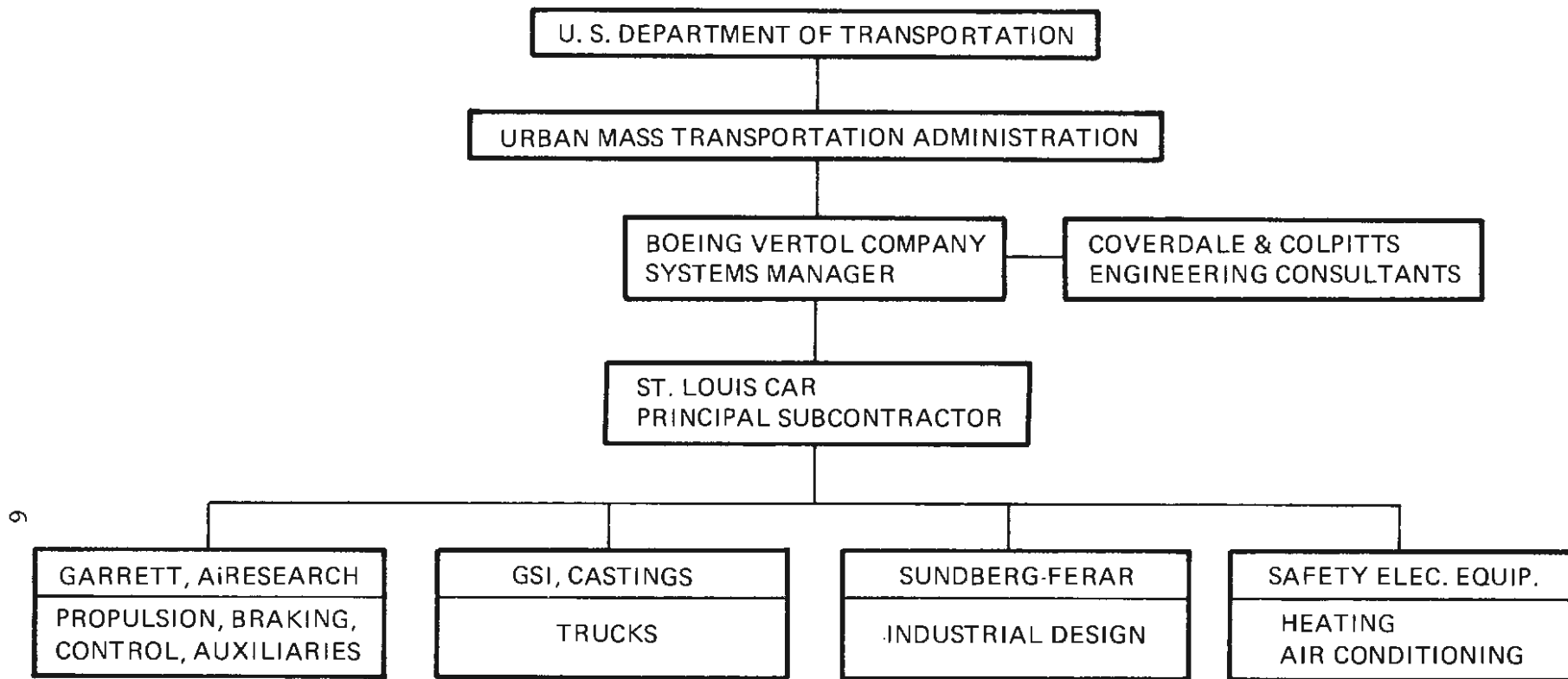

OTHER SUPPLIERS:

ADAMS & WESTLAKE – SASH
 AMERICAN SEATING – SEATS
 O. M. EDWARDS – DOORS
 EILCON-NATIONAL – STANCHIONS
 ESB, EXIDE – BATTERIES
 GRIMES MFG – LIGHTING
 LIBBEY-OWENS-FORD – WINDOWS
 MOTOROLA – RADIO, INTERCOM
 OHIO BRASS – MECHANICAL COUPLER

REPUBLIC STEEL – STAINLESS STEEL
 RINGSDORF – PANTOGRAPH
 SALLEE CARPET – CARPETING
 SOUND SYSTEMS – PUBLIC ADDRESS SYSTEM
 STANDARD STEEL, B-L-H – WHEELS, AXLES
 SWEDLOW – WINDSHIELD
 VAPOR – DOOR OPERATORS
 WALTON PRODUCTS – ELECTRIC COUPLER

Figure 2-1. State-of-the-Art Car Development Team

- Diagnostic status and maintenance concepts
- Advanced styling

Test and evaluation of the SOAC on at least one line in five major cities also had to be considered. Boeing first evaluated the problems of program scheduling, technical achievement, and demonstration in the five cities to determine where problems might occur.

At the time of contract award, two new 75-foot rapid transit cars were being produced in the United States. These cars were the BART car being manufactured by Rohr Industries for the Bay Area Rapid Transit District (San Francisco), and the R-44 cars being manufactured for the New York City Transit Authority (NYCTA). Preliminary data showed that the BART car which incorporated many technical achievements would require extensive modification for the SOAC operational test and evaluation phase, because of its nonstandard gauge and wide car body. The R-44 car was standard gauge, but the production version had few of the new systems considered to be representative of the best in currently available technology.

The Boeing/UMTA team felt that these two companies (and others) should be given the opportunity to bid for the SOAC contract, the winner to be chosen on the basis of response to an RFP in the areas of technical content, schedule and cost.

Consideration was also given to the five properties where the SOAC was to be operated, which varied widely in the areas of:

1. Station height: floor height from top of rail
2. Power collection: pantograph or third rail
3. Acceptable car length (40 to 75 feet) and car width
4. Fare collection
5. Operating speeds
6. Automatic train operation

Preliminary data indicated that differences in these areas could be resolved.

Source Selection Phase

The procurement cycle for the State-of-the-Art Car was initiated on June 18, 1971 with a survey of the railcar industry to obtain an expression of interest in the project.

Based on the results of this survey, Boeing issued an RFP on July 6, 1971 to the Budd Company, Pullman-Standard, Rohr Industries, St. Louis Car, and Vought Aeronautics.

On July 14, 1971 a Bidders Conference was held in Philadelphia. Prospective bidders and potential propulsion suppliers attended. Questions were solicited, and written answers were forwarded to all bidders. Proposals were received on August 8, 1971 from Pullman-Standard, Rohr Industries, and St. Louis Car.

Resulting evaluation and negotiation resulted in the award of the subcontract for the State-of-the-Art Cars to the St. Louis Car Division of General Steel Industries. The award was made on September 14, 1971.

Propulsion

In compliance with specification requirements, St. Louis Car's bid incorporated two competitive advanced solid state propulsion systems, the Garrett AiResearch and Westinghouse Electric chopper systems.

A chopper controlled system provides stepless and essentially infinite control of traction (drive) or braking effort from zero to full capability, which results in smoother and more efficient operation than the conventional DC-operated step cam controlled systems currently in wide use throughout the world.

Based on technical, schedule, and financial considerations (and with Boeing approval), St. Louis Car selected the Garrett AiResearch system. Contract award was made in September, 1971. (See Section 9 for the trade-off analysis between chopper and cam control.)

Trucks

During the proposal stage, General Steel Castings had proposed a cast-steel, four-wheel, inside-roller-bearing, lightweight (14,500-pound) truck. The truck assembly as designed would have been capable of supporting either of the propulsion system motors and gear cases under consideration. Based on test data taken on similar trucks for ride quality, and realizing the weight advantages, St. Louis Car awarded the truck contract to General Steel in November 1971.

Car Interior/Exterior

The industrial design firm of Sundberg Ferar was retained by St. Louis Car early in the proposal stage. Sundberg had

prime responsibility for designing a car interior more comfortable and appealing than any previous car. Formal contract award to Sundberg Ferar was made in November 1971 for the design and installation of the interior furnishings. In addition Sundberg was responsible for the exterior styling.

AC Air Conditioning

It was desirable to take advantage of higher reliability and reduced weight available in an AC-powered air conditioning system. St. Louis Car undertook a survey of the available equipment and determined that a Safety Electric Company system of four 8-ton units for the two cars should be selected. The contract was awarded in October 1971.

Summary of Features

Major features of the SOAC car proposed by St. Louis Car were:

- Stainless steel body construction
- Impact-resistant windshield
- Human-engineered motorman's console
- Separately excited field DC motors
- Forced air constant flow motor ventilation with inertial separators
- Lightweight air suspension truck with chevron primary springs
- Solid-state DC chopper control
- Carpeted floors
- AC auxiliaries
- High-flow-capacity AC air-conditioning system
- Tinted tempered safety glass windows
- Human-engineered passenger-oriented interiors
- Reduced noise levels (interior and exterior)

St. Louis Car Project Management Office

In order to achieve the extremely short fabrication schedule, St. Louis Car established a separate project office

to manage and coordinate the SOAC program entirely apart from two production contracts then in-house, and special procedures for the handling of material, cost accounting, manpower, etc. were instituted by the project team. Members of each operating department were assigned to the SOAC project with "on-time, within-budget" completion as their major goal. The project manager's authority stemmed directly from the president of St. Louis Car making it possible to cut through functional lines when necessary. The advantage of having a single contact point with the power to respond quickly was a key reason for the overall success of the program.

Design Phase

Upon contract award and major propulsion system award, it became obvious that major design changes to the basic design of an available car body and shell would have to be accomplished within a very short time. With the cooperation of AiResearch and the use of full-scale wooden mockups, St. Louis Car was able to release the underframe for production as scheduled in November 1971.

With the underframe in production, the next major area of concern was the roof assembly. The entire roof structure required special attention because of the use of the new air conditioning and the requirement for installation of a pantograph, the newly designed nose bonnet, and the additional fresh air requirements. In parallel with these efforts, major attention was paid to the gauge of material used in the sides, and many engineering hours were spent in this detailing.

From October 4, 1971 through delivery, Boeing conducted twenty formal design reviews with St. Louis Car and other suppliers concerning various SOAC subsystems. These reviews were initiated with the establishment of design requirements, progressed through individual subsystem design reviews, and culminated in a complete vehicle system critical design review on May 9 and 10, 1972. Significant technical contributions to the SOAC design were made through these reviews, including:

- Ventilating air for SOAC is 4000 cfm at 40 to 50 percent fresh air at 75 fpm and produces a desirable interior comfort level.
- Traction motor cooling and filtering on SOAC is accomplished with blowers driven by separate motors and provides a continuous supply of cooling air for the traction motors as well as the propulsion controls. Additional benefits of a constant air flow are self-cleaning inertial (swirl type) filters and an optimized blower system for efficiency and reduced noise.

- The SOAC air conditioning system incorporates two independent compressor-condenser blower units, each serving as an evaporator-blower unit, thereby providing redundancy in case of failure of one unit.
- SOAC equipment tray removal has been improved by providing tray slides equipped with rollers to facilitate removal by one man. Tray weight has also been reduced to a maximum of 90 pounds.

Production Plan

Construction of the SOAC cars started with release of the underframe in November, 1971. Between November 1, 1971 and January 3, 1972 (when car shells were completed) the following areas were designed, redesigned, or re-evaluated to verify the configuration:

1. Roof

Evaluations were made of the possible use of thicker materials than the .022-inch stainless steel from which the SOAC roof is constructed; however, schedule and tooling constraints prevented use of thicker material.

2. Sides

The SOAC sides are constructed of .0745-inch stainless steel material. The sides are spot- and seam-welded to the Cor-Ten frames.

3. Underframe

The SOAC underframe required considerable work because of the many different types of equipment which must be mounted to it.

4. More than 3500 detailed parts were manufactured and put into the car shells when they were moved from the erection area to the first of two water tests.

The second phase of production was accomplished in a secure area within the St. Louis car shops. Because of the special nature of the cars, the area had been fenced in and only those employees directly associated with the program were permitted inside. As SOAC materials were received, they were transferred directly into the area. Because of the limited quantity of this material, its control was thereby greatly simplified.

Program team meetings were held by the program manager on a weekly basis through June 1972; thereafter they were held almost daily to ensure on-time delivery of the SOAC vehicles. (Figures 2-2 and 2-3 show the SOAC cars during construction.)

Functional testing (described in detail in Section 6) was accomplished concurrently with fabrication. These tests culminated on August 20, 1972 when SOAC No. 1 was moved under its own power; SOAC No. 2 was powered the following week. The two-car train was then made up, and detailed system testing was conducted.

The period August 28 through 31, 1972 was used primarily to "sell-off" the cars to Boeing and UMTA officials. Minor rework was required and several tests were rerun. Some equipment changes were also requested, and this work was scheduled for completion at the High Speed Ground Test Center in Pueblo, Colorado.

The two SOAC cars were pulled from the St. Louis Car Shops at 3:30 p.m. on August 31, 1972 (Figure 2-4), coupled between two Norfolk and Western Railway transition cars, and prepared for pickup by the Santa Fe Railroad. Shortly before midnight, The Santa Fe picked up the cars for the run to Pueblo - a record-breaking 11-1/2 months after program go-ahead.

Test Phase

The SOAC cars arrived in Pueblo on Sunday, September 3, 1972. They were transferred to the Pueblo Army Depot (PAD) on Monday, where they were stored awaiting the arrival of test crews.

Test crews arrived at PAD on September 11, and, after conducting an inspection which revealed broken shear pins in the coupler, started setting up the cars for test. Pit space was available for only one car at a time. Car No. 1 was powered on September 14 and Car No. 2 on September 19. Modification work, and minor electronic problems prevented movement of Car No. 1 to the UMTA Rail Transit Test Track oval until 9:30 a.m., September 26.

At 11:30 a.m. on September 26 the first third-rail power application was made using power from DOT Diesel locomotive DOT 001. This resulted in smoke and flame from an insulation breakdown on truck No. 1. Repairs were minor and were accomplished by 1:30 p.m.

At 2:36 p.m. on September 26, SOAC No. 1 started rolling on its system checkout test. Its first run around the oval was made at 4 mph. All systems on board appeared to be



Figure 2-2. SOAC Construction, March through May 1972



Figure 2-3. SOAC Construction, July 1972

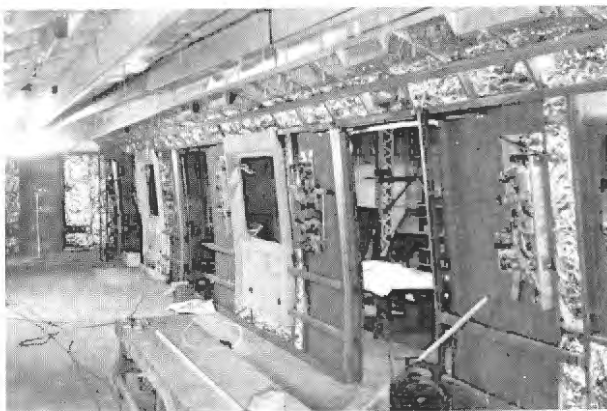

Figure 2-2. SOAC Construction, March through May 1972



Figure 2-3. SOAC Construction, July 1972



Figure 2-4. SOAC Rollout, August 1972

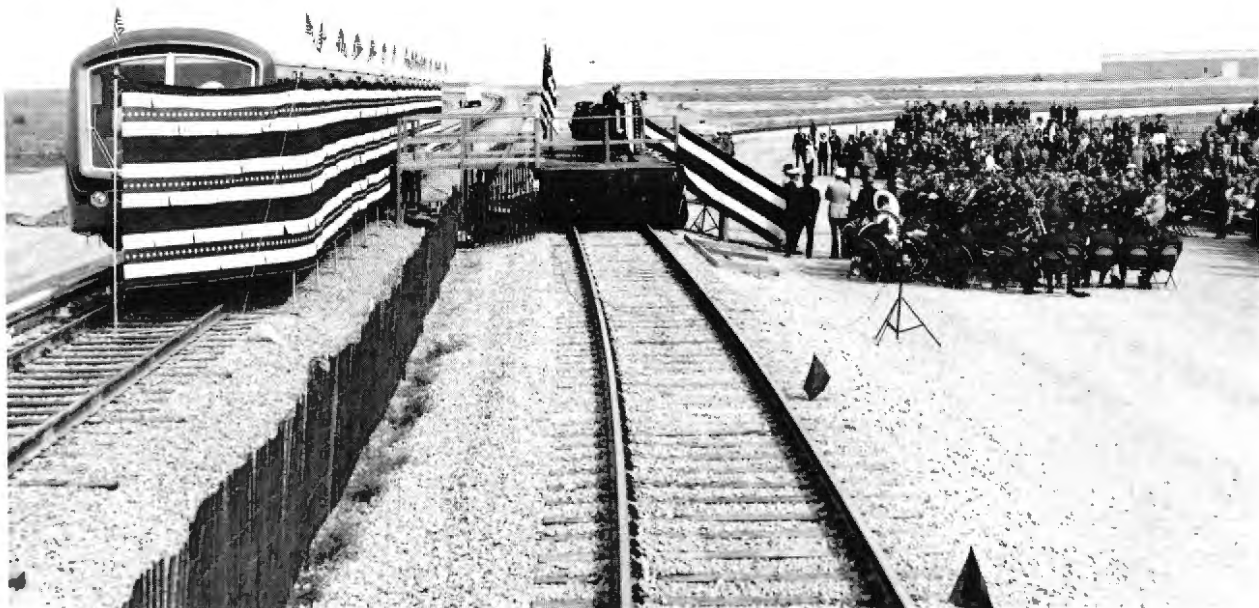

Figure 2-5. SOAC Dedication Ceremony, October 1972

working normally and speeds were slowly increased to 65 mph (at 4:00 p.m.). SOAC No. 2 was checked out under power on October 5 and 6, and two-car operations were begun on October 7, 1972.

On October 12, SOAC was unveiled by Secretary of Transportation John Volpe and was demonstrated to the public and to other Government and industry officials (Figure 2-5). Speeds of 80 mph were attained and more than ten round trips were made around the transit oval to accommodate the 1400 people at the dedication.

Throughout 1972 and 1973, SOAC acceptance and engineering testing continued at the High Speed Ground Test Center (Figure 2-6).

The SOAC cars were within two days of completing the test program (described in Section 6) when they were involved in a serious switching accident on August 11, 1973. This accident, which resulted in the death of the motorman, caused major damage to the forward portion of Car No. 2 and necessitated returning the two-car train to the Boeing Vertol plant in Philadelphia for repairs. Car No. 1, the second car in the two-car train at the time of the accident, received only superficial damage to its anticlimber.

Repairs were complete on December 21, 1973 and the two-car SOAC train was returned to the HSGTC for an accelerated post repair test program. It is anticipated that the SOAC cars will begin the operational test and evaluation program (described in Section 8) in Spring, 1974. Results of this operational program will be presented in Volume 2 of this report.

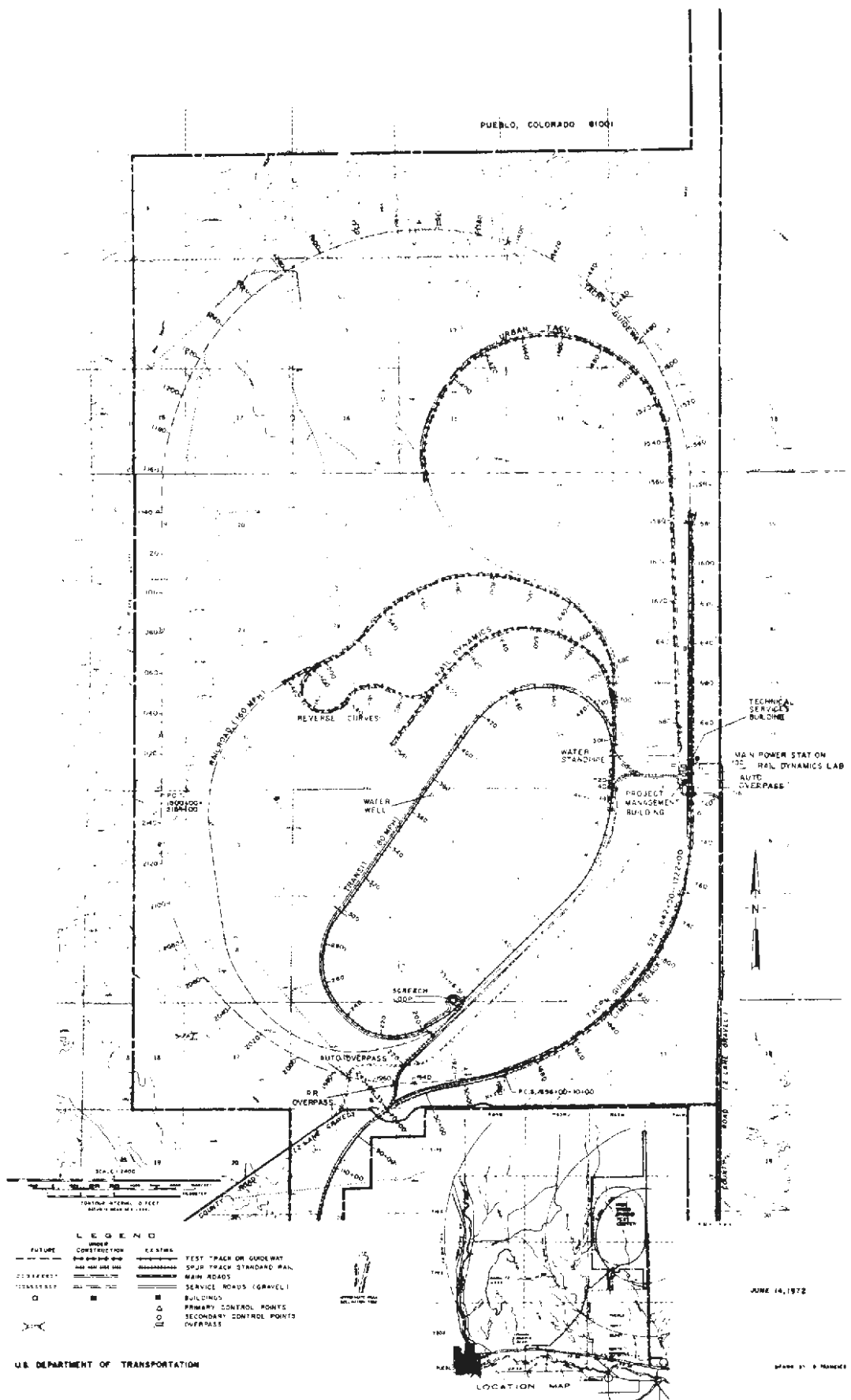

Figure 2-6. USDOT High Speed Ground Test Center, Pueblo, Colorado

3. DESIGN AND PERFORMANCE

3.1 GENERAL

The 90,000-pound SOAC cars are designed for use in frequent-stop, high-speed, intra-city mass transportation. They are both configured as "A" cars, (i.e., may be operated independently or as a two-car unit), and are powered by 600 volts dc which may be picked up with either third rail collectors or a pantograph. Passenger comfort and operating efficiency are featured in the car design.

Figure 3-1 details the SOAC performance and design characteristics. The car's 75-foot length and 9.75-foot width are the maximum outside dimensions compatible with prevailing subway clearances (tunnels, platforms). The cars are capable of 80 mph speeds with an initial acceleration rate of 3.0 mph/sec. (As shown in Figure 3-2, the SOAC can achieve 80 mph in 60 to 65 seconds.) Braking from 80 mph may be accomplished with either dynamic or friction braking (or a blended combination) and is accomplished in under 1700 feet. A unique feature of the SOAC is its ability to brake from 80 mph using dynamic braking only. In high-speed, frequent-stop service this would save brake shoe wear, and reduce maintenance costs.

Normal conversation between passengers is possible due to the car's quiet interior. Figure 3-3 illustrates some of the features contributing to SOAC's quiet ride. Data taken to date have shown that the SOAC has an interior noise level of as low as 63 dBA at a speed of 50 mph (outside of a tunnel, with all equipment, air-conditioning, etc. on line). In addition, exterior noise is minimal, since little noise is generated by the onboard equipment.

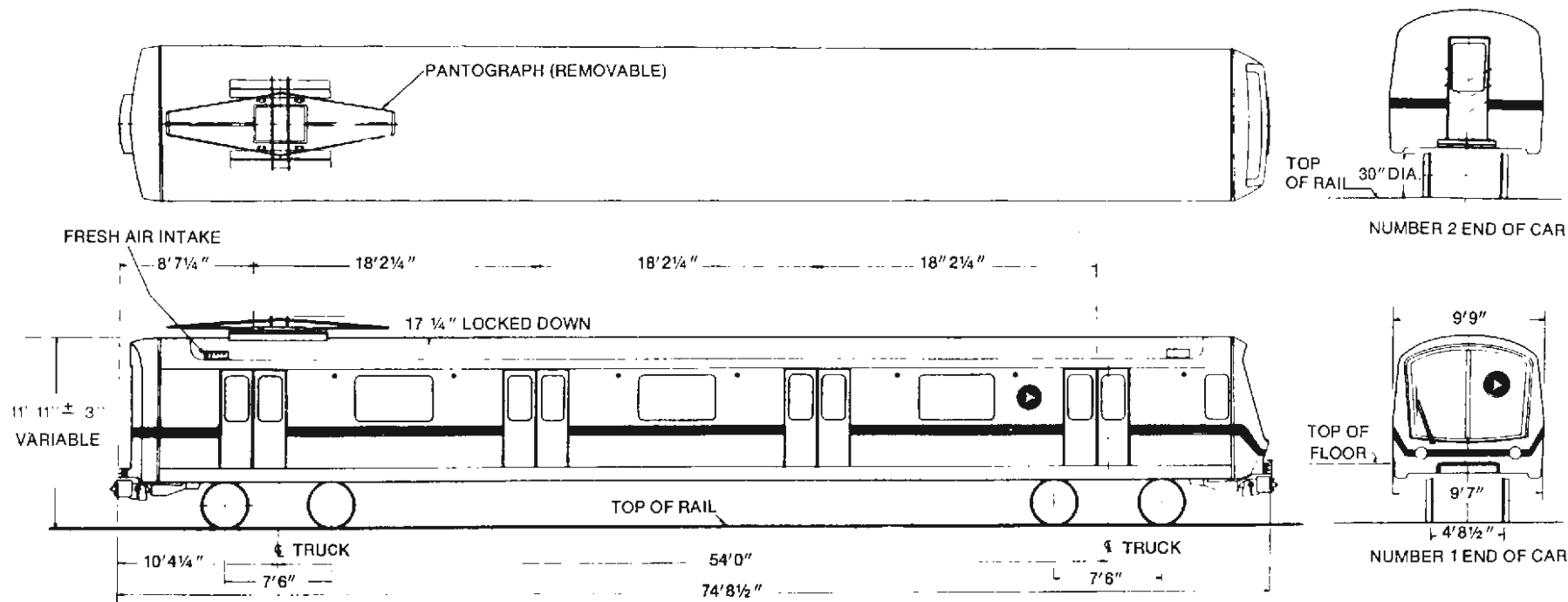

| | |
|--------------------------------------|------------------------------------------------|
| Length | 75 Feet |
| Width | 9.75 Feet |
| Minimum Track Curve Radius | 145 Feet |
| Speed | 80 MPH |
| Acceleration, initial | 3.0 MPH/Sec. |
| Jerk Rate | 2.5 MPH/Sec. ² |
| Power | 600 VDC Nominal |
| Noise Level, interior. | spec 75 dBA @ 50 MPH actual 63 dBA @ 50 MPH |
| Noise Level, 50 ft wayside | 78 dBA @ 50 MPH actual 73 dBA @ 50 MPH |

| | |
|--------------------------------|-----|
| Passenger Capacity (No. 1 car) | |
| Seated | 62 |
| Nominal | 100 |
| Maximum | 220 |
| Passenger Capacity (No. 2 car) | |
| Seated | 72 |
| Nominal | 100 |
| Maximum | 300 |

Figure 3-1. Performance and Design Characteristics

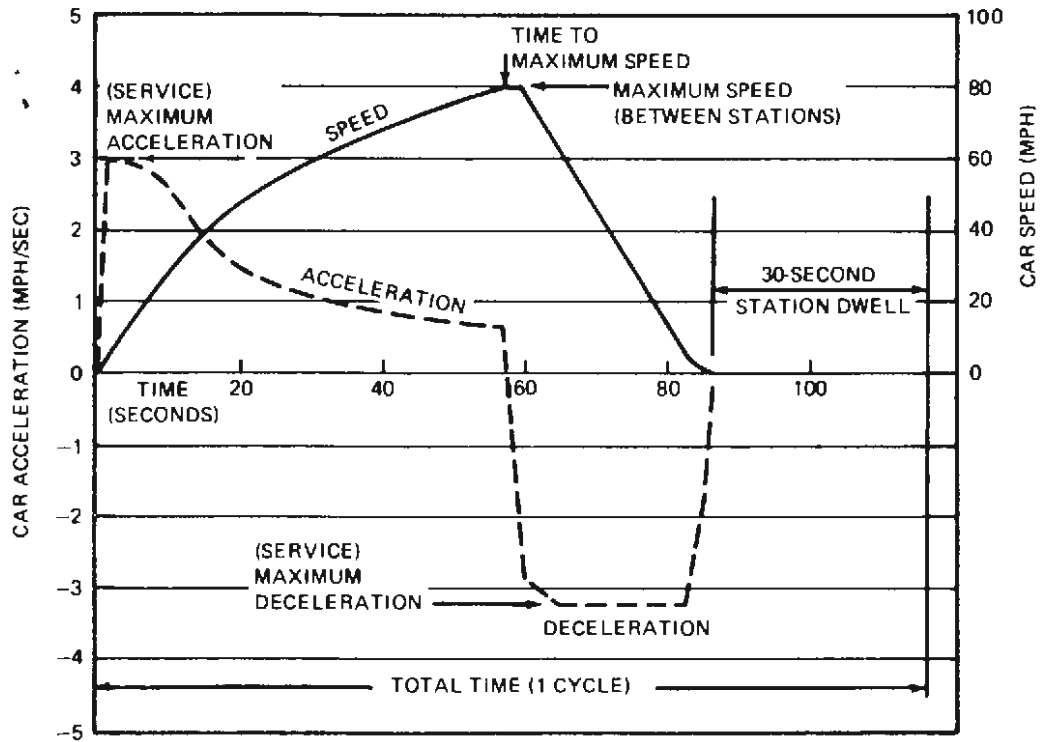

Figure 3-2. SOAC Vehicle Operating Profile

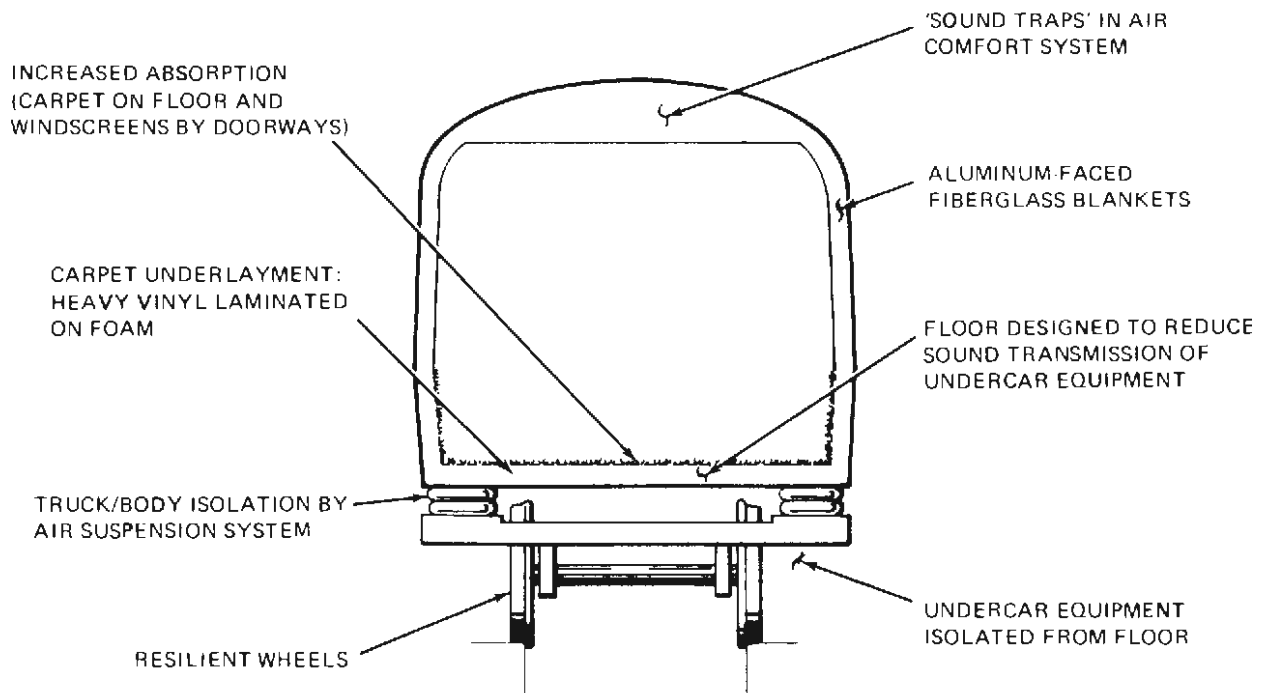

Figure 3-3. Noise Control Features

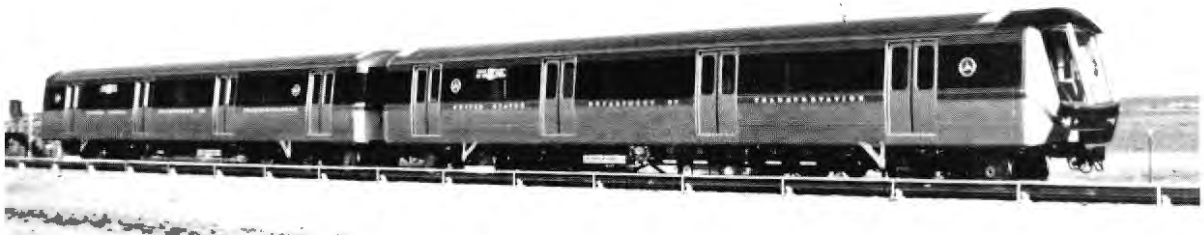

Figure 3-4. Exterior

The cars are adaptable to test and operation in New York, Boston, Cleveland, Chicago and Philadelphia by raising or lowering the car body up to 5 inches from the top of the truck, by the use of shims. In addition, the third-rail collectors may be raised or lowered to suit various third rail heights. When necessary, the SOAC is equipped with a pantograph, and an automatic power changeover device to change power sources between overhead and third rail "on the fly".

3.2 EXTERIOR

The styled exterior (Figure 3-4) features smooth, brush-finished stainless steel materials and molded fiberglass ends. The car structure features all-steel construction.

Four pairs of biparting 50-inch sliding doors per car side are designed to safely handle maximum passenger interchange within the desired 20-second station stop dwell time. Safety features of the door system include propulsion system interlock, restricted push-back leaves, soft door edges, and a 3-second warning chime prior to door closing.

3.3 STRUCTURE

The underframe is fabricated of high-strength, low-alloy steel with full-length side sill rolled channels and formed cross bearers between bolsters. The cross bearers (floor support beams) used for undercar equipment mounting are locally reinforced and stabilized to resist the primary and secondary loads imposed by the heavier items. Some of the original mounting provisions were reinforced after the cars were delivered, primarily based on field experience with the NYCTA R-44 cars. A further local modification made during testing at Pueblo involved substantial stiffening of three cross bearers and a longitudinal interconnecting beam, plus the addition of two diagonal horizontal support members. The purpose was to raise the natural vibration frequency of the motor-alternator installation to a frequency above that experienced within the car's operating speed range.

The underframe ends incorporate the body bolster, which transfers vertical and lateral loads between the car body and the truck bolster, and the draft sill structure, which mounts the draft gear and anticlimber. Two heavy I-section transverse beams joined by shear plates and rolled channels make up the body bolster. The draft sill structure consists of two rolled channels joined by the anticlimber, the center portion of three cross bearers, shear plates, and the draft gear mounting members. This structure terminates at the body bolster and is joined to the side sills by shear panel assemblies and the cross bearers. The underframe end construction is shown in Figure 3-5.

The sides and roof of the car are constructed of formed low-alloy, high-strength framing members, welded together, and spot-welded stainless-steel skins. (This construction is shown in Figure 3-6.) Side frames are joined to the side sills through angle clips while the side sill cover is fusion-welded to the sill bottom flange and spot-welded to the side skin. The junctions between the sides and the roof are made through the formed side plate channel and the formed cove (as shown in Figure 3-6).

Increased car body torsional strength, primarily required to withstand cross-corner jacking loads, is provided by structural bulkheads located just inboard of the end side doors. As shown in Figure 3-6, these bulkheads are built up of low-alloy, high-strength steel tubing; vertical portions are concealed within the windscreens.

The car body end closures are fiberglass-reinforced polyester-resin moldings reinforced with steel framing around the openings for the windshield (No. 1 end) and door (No. 2 end).

3.4 INTERIOR

The design of the SOAC interior is oriented towards passenger comfort and appeal. Two different car interiors have been developed (Figure 3-7). Car No. 1, the "low-density" car, has 62 cushioned, upholstered seats designed for maximum comfort (Figure 3-8). A lounge area complete with tables is located near the cab, a conversational type area is located near the No. 2 end, and a normal seating arrangement is represented by the middle section. Maximum capacity of this low-density car is 220 passengers.

The No. 2 car interior is representative of a more standard subway car configuration with seats for 72 and increased space for standees (see Figure 3-8). One-piece molded fiberglass seats are fitted with padded replaceable cushions. Maximum capacity of this "high-density" car is 300 passengers.

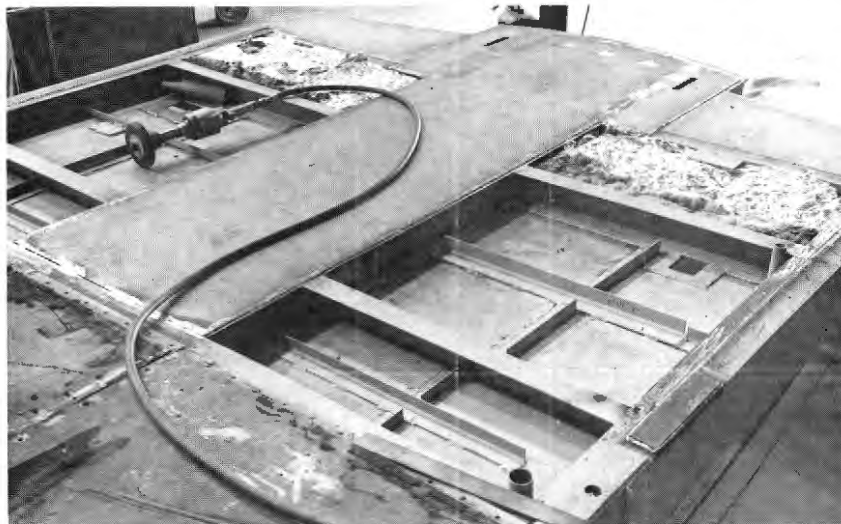
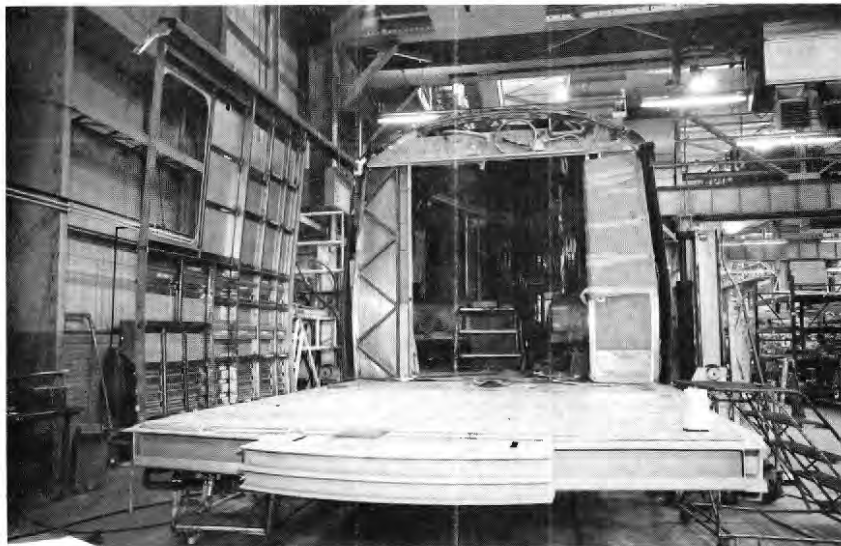

Figure 3-5. Frame Construction



Figure 3-6. Roof Construction

No. 1 CAR-SEATING PLAN

SEATED PASSENGERS 62
NOMINAL CAPACITY 100
MAXIMUM CAPACITY 220

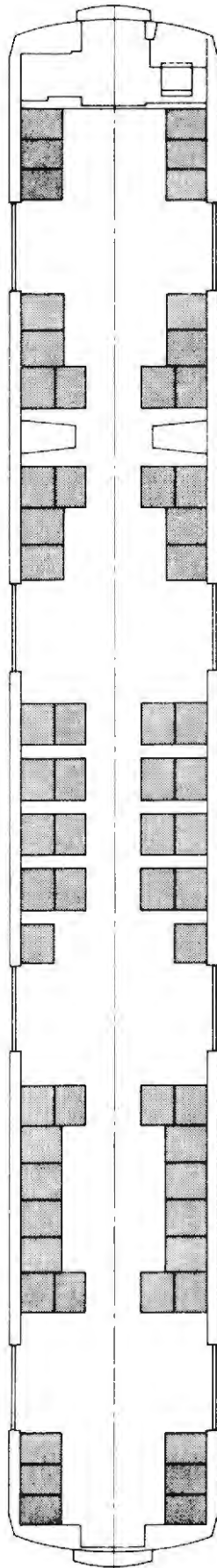

No. 2 CAR-SEATING PLAN

SEATED PASSENGERS 72
NOMINAL CAPACITY 100
MAXIMUM CAPACITY 300

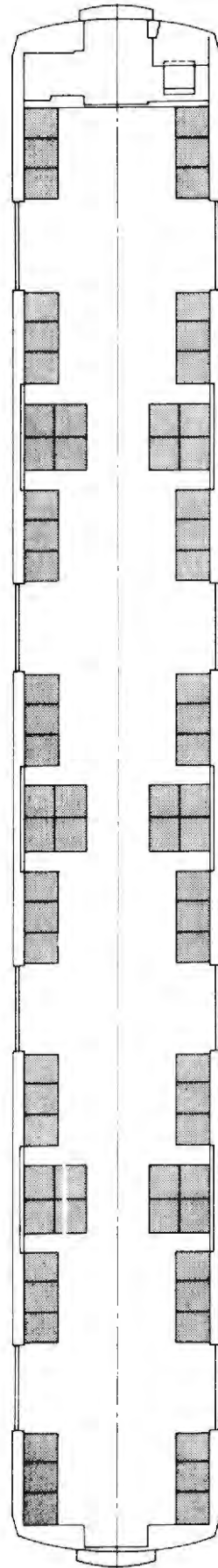

Figure 3-7. Seating Plans



"LOW DENSITY" (62 SEATS)



"HIGH DENSITY" (72 SEATS)

Figure 3-8. Interior

Seat materials of both cars can be readily cleaned and are resistant to vandalism. Floors and windscreens are completely covered with carpet of dense (81 ounces per square yard) velvet weave, level-loop pile wool with synthetic rubber latex back coating.

Special emphasis has been placed on making the car interiors as colorful, quiet, and safe as possible. The usual advertising space along both sides of the cars has been replaced by lighting fixtures to provide greater illumination at passenger level. Wall panels are formica 417 with a honey tone teak suede finish.

Safety of the SOAC interior has been improved by a process termed "delethalization," to reduce the consequences of accidents, particularly collisions. A delethalized interior tends to have a softer, more rounded, more yielding, and less brittle quality. Instead of fatal injuries, either survivable injuries or mere discomfort may result, depending on the seriousness of the accident.

Padded stanchions and handholds are installed to enable standees to prevent falls caused by car accelerations during both normal operating and accident conditions. Stanchion padding reduces the probability of injury in the event that a passenger accidentally strikes a stanchion. Similarly, the padded seats and cushioned floor carpet will reduce the consequences of accidental falls. The stanchion and handhold spacing of the SOAC is close enough so that even a small woman can span adjacent stanchions or handholds through the length of the car.

Protection against thrown missiles (stones, etc.) coming through the large side windows is provided by laminated safety glass with a tough plastic core. In the event of a missile strike sufficient to break the glass on the passenger side of the plastic core, tempering of the inner lamina results in a glass failure mode characterized by small granular pieces rather than sharp splinters or large jagged pieces.

The motorman's windshield is designed to withstand the impact, without penetration, of a 5-pound stone at 50 mph and a 1-pound stone at 80 mph.

During design, emphasis was placed on the use of fire-retardant materials throughout the car, meeting FRA 203 specification as a minimum.

4. PROPULSION AND BRAKING SYSTEMS

The SOAC propulsion system consists of the traction motors, gearboxes, and associated high and low voltage power supply and control systems necessary to allow controlled operation in both drive and brake conditions. The following paragraphs detail the various components and functions of the SOAC propulsion system as supplied by the AiResearch Manufacturing Co., Division of the Garrett Corporation, Torrance, California. The friction air brake subsystem (also supplied by AiResearch) is described in Section 4.7.

4.1 BASIC PROPULSION SYSTEM

The SOAC is powered by four axle-mounted separately excited field DC traction motors. The motors are fully compensated and are connected two in series on each truck with the two trucks in parallel. The motors also provide most of the braking force during deceleration; they are reconnected as separately excited DC generators with the dynamic brake resistor grids as electrical loads.

Control of the traction motors is by a force commutated DC-DC chopper in the armature circuit and by AC-DC phase-delay rectifiers (thyristors) in the separate field circuits. AC power is supplied by the auxiliary power motor alternator set. DC power to the armature is supplied by the third rail shoes (or pantograph) through the input inductor-filter capacitor. This type of motor control system provides stepless and essentially infinite control of tractive (drive) or braking effort from zero to full load capability. Control subsystems provide for load weight, jerk rate, and wheel spin-slide compensation,

as well as for dynamic-friction brake blending. A block diagram of the SOAC propulsion and braking systems illustrating the various interfaces is shown in Figure 4-1.

4.2 PROPULSION EQUIPMENT

A list of major propulsion system components is presented in Table 4-1. Each of the several control units contains various functions which will be described in later paragraphs.

TABLE 4-1. PROPULSION SYSTEM COMPONENTS

| Item | Estimated Weight (lb) |
|--------------------------------------|-----------------------|
| Traction motors (4) | 6,240 |
| Gearbox; coupling; suspension (4) | 4,560 |
| Chopper | 975 |
| Power control unit (PCU) | 800 |
| Propulsion power control unit (PPCU) | 200 |
| Auxiliary power control unit (APCU) | * |
| field power | |
| Input reactor | 440 |
| Motor smoothing reactor | 940 |
| Braking resistor grids (2) | 650 |
| Line switch (main) | 100 |
| Blowers and cooling equipment (2) | <u>280</u> |
| Total | 15,185 |

*Weight of APCU is included in the 3800-pound weight estimated for the auxiliary power, motor-alternator set.

Figure 4-2 shows the location of the above propulsion equipment as well as other major car subsystems.

4.3 EQUIPMENT DESCRIPTIONS

The traction equipment listed in Table 4-1 is as follows:

Traction Motor

The traction motors are designed for operation with the undulating currents supplied by the chopper. The motors are force-ventilated by separate blowers and are fully compensated with interpoles. The armature, yoke, and field poles are

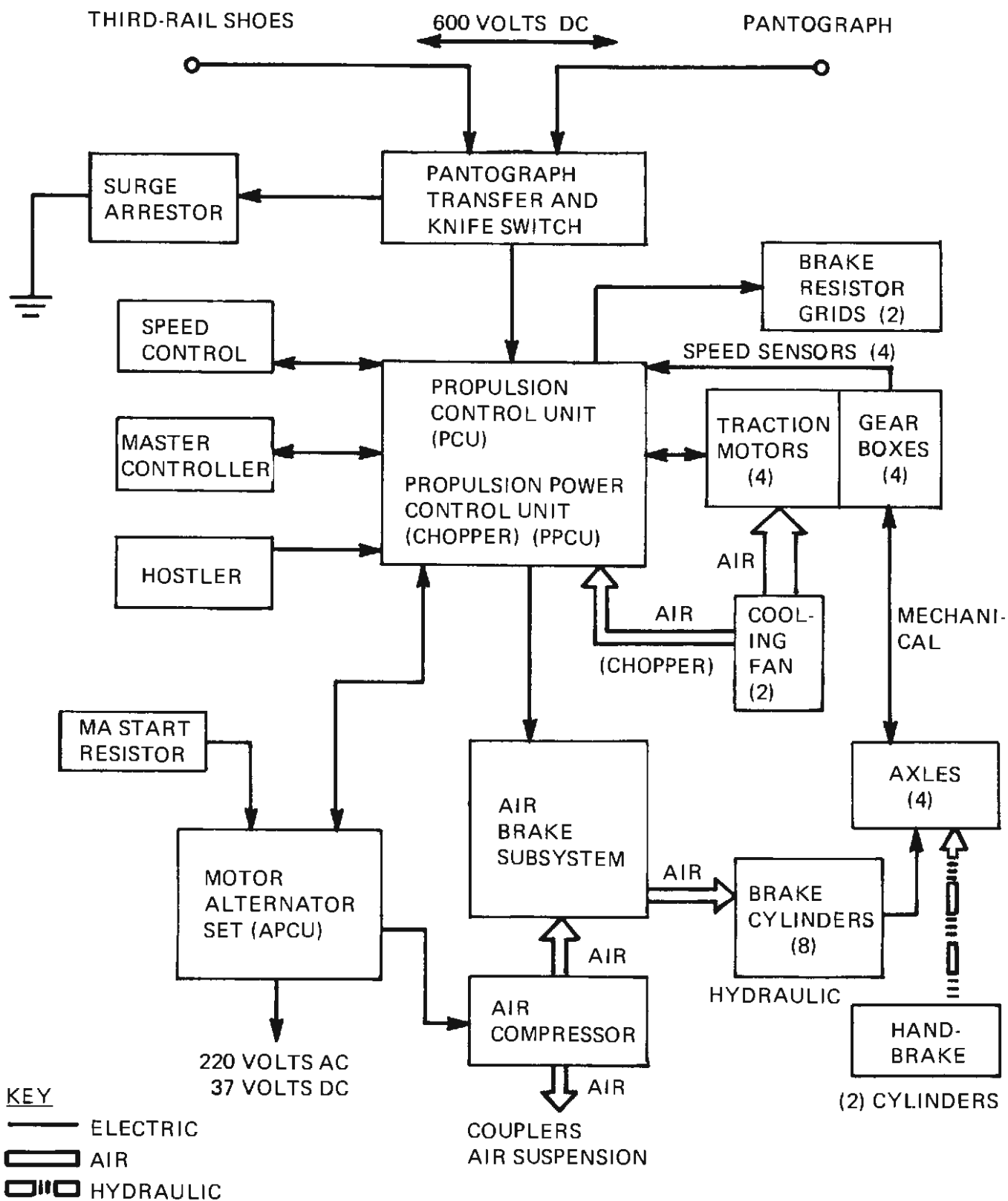

Figure 4-1. Propulsion and Braking System Block Diagram

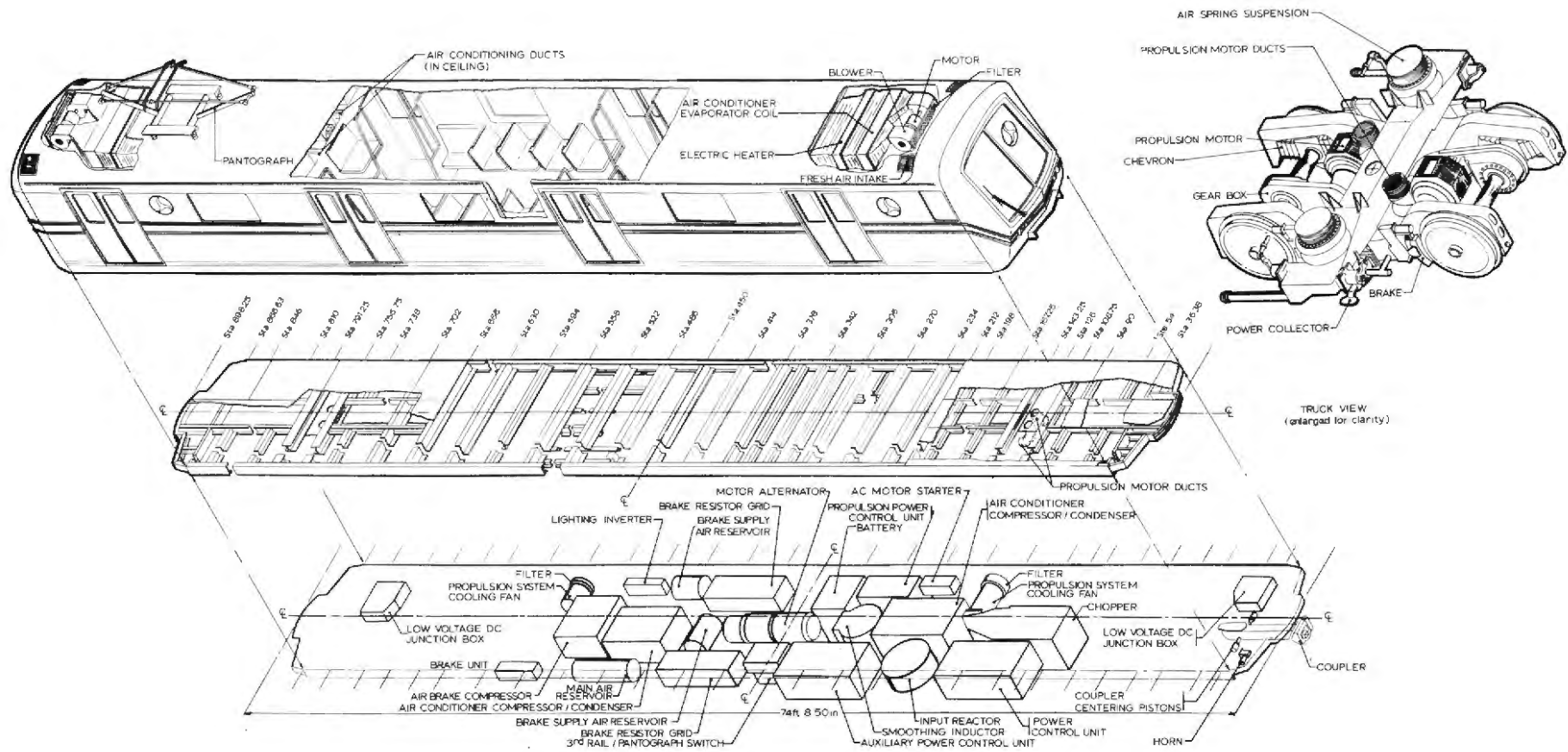

Figure 4-2. Propulsion Equipment Location

laminated. The motors are permanently connected in series on each truck with the trucks in parallel. Motor ratings are as follows:

| | |
|-------------------------|--------------------------------------------|
| Continuous power | 175 hp at 1560 rpm (460 amps) |
| One-hour power | 230 hp at 1560 rpm (600 amps) |
| Maximum drive power | 283 hp from 1560 to 4300 rpm (750 amps) |
| Maximum braking power | 575 hp |
| Maximum braking voltage | 600 volts |
| Maximum braking current | 915 amps |

The motor is designed to a duty cycle of repetitive 0 to 80 to 0 mph operation at the 105,000-pound design weight.

Each motor has 12 sets of Grade 2755 pure carbon split brushes with pigtails. The brushes are 1.25 inches long when new and have a 15-degree top angle. Brushes are mounted in Ringsdorff-supplied holders having negator springs which provide constant steady brush pressure over the range of brush wear. The traction motor is shown in Figure 4-3.

Gearbox and Coupling

A quillshaft coupling connects the motor to the gearbox. The gearbox is parallel-drive with a flexible rubber coupling between the output bull gear and the axle. The gearbox contains double-reduction helical gears designed for minimum noise.

All bearings are the tapered-roller type. Gears are partially immersed with supplemental directed flow lubrication. The gear ratio has been selected to produce a maximum speed of 80 mph with 30-inch-diameter wheels and a motor shaft speed of 4300 rpm. This corresponds to a gear ratio of 4.78.

A flexible rubber coupling is provided between the output gear and the axle. A reaction torque arm, resiliently linked to the truck frame, stabilizes the gearbox. Magnetic pickups are provided on the input gear for input into the car speedometer and spin-slide detection systems, one per axle. Figure 4-4 shows the SOAC motor and drive system.

System Schematic

The functional schematic shown in Figure 4-5 illustrates the circuit locations of the various components (the key

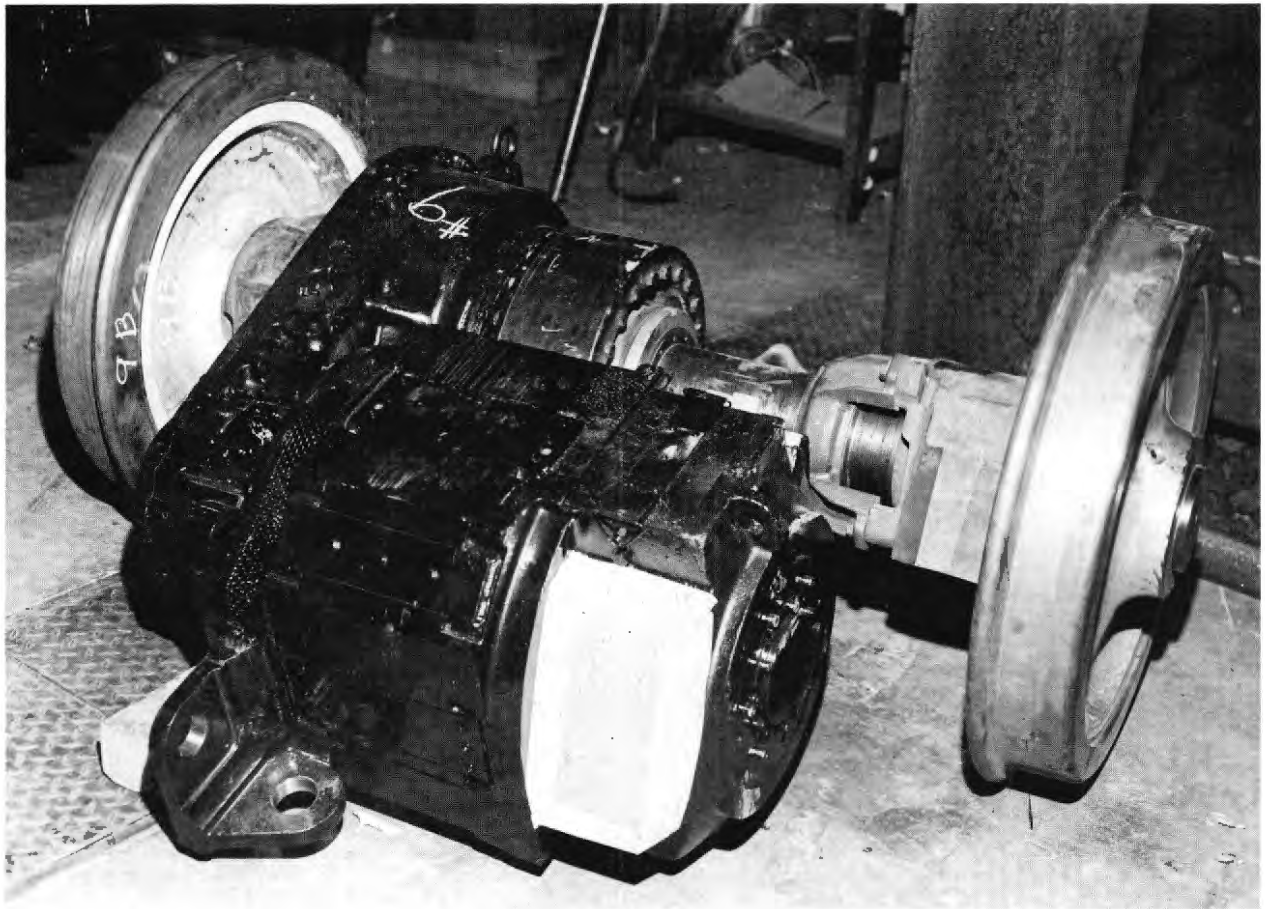
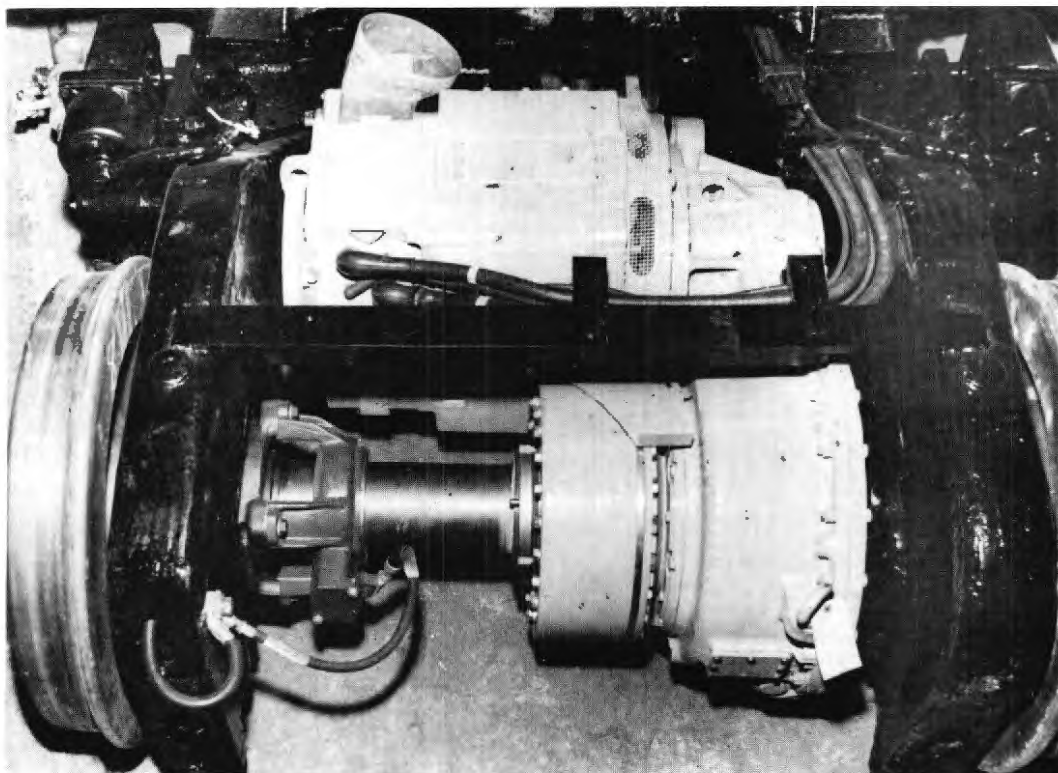
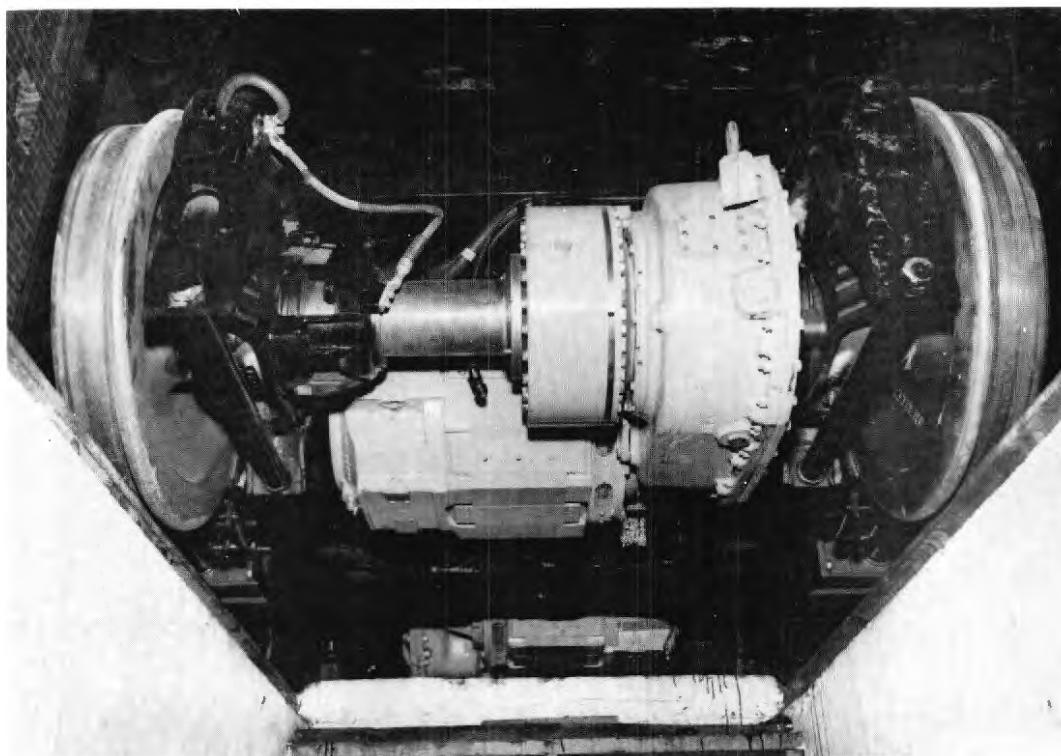

Figure 4-3. Traction Motor



TOP VIEW



BOTTOM VIEW

Figure 4-4. Motor and Drive System

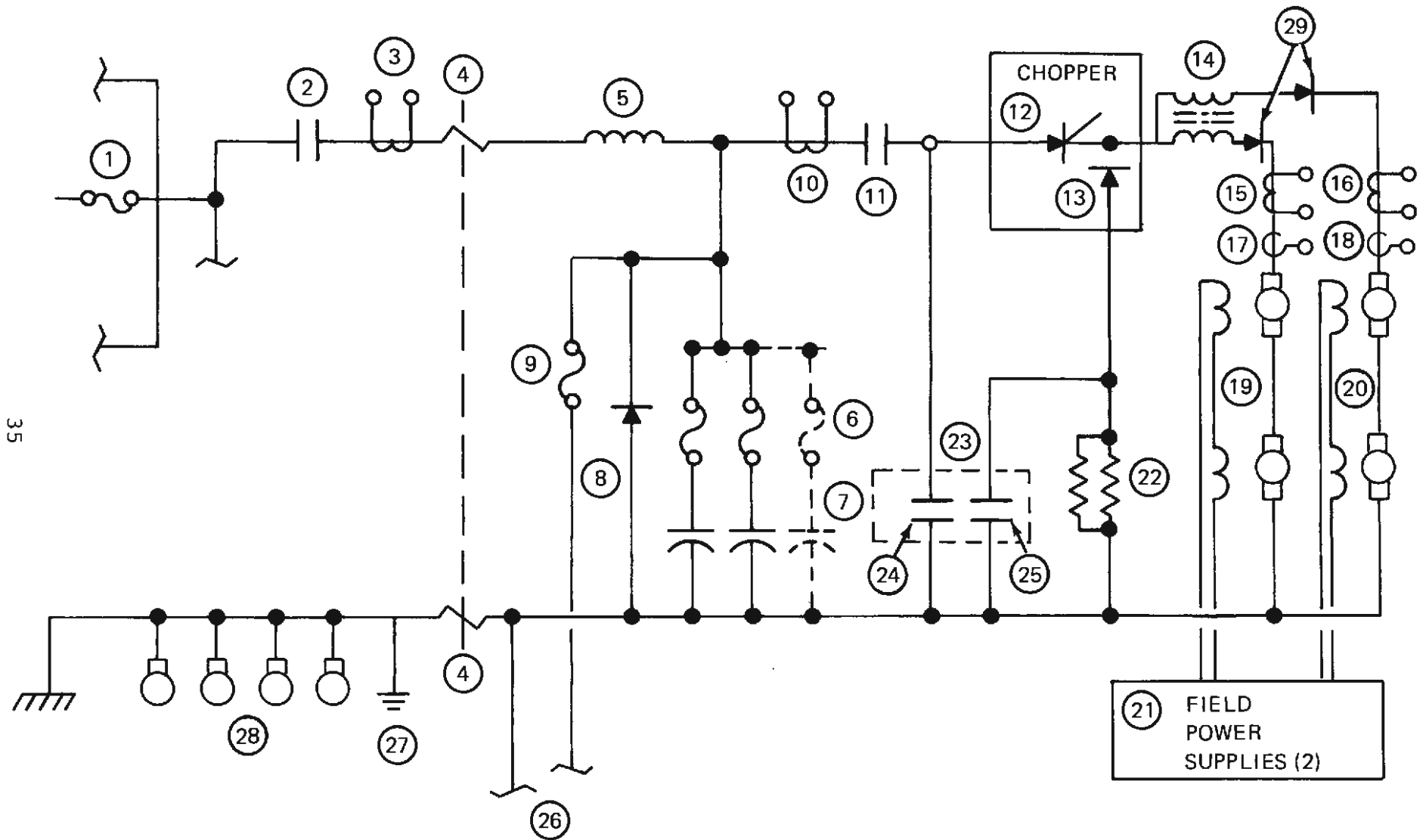

Figure 4-5. Propulsion System Functional Schematic (Sheet 1 of 2)

NOMENCLATURE KEY AND VALUES

| | |
|------------------------------------------------------------------------------------------|---------------------------------------------------------------------------------------------------------------|
| 1. Main Fuse | 1500 amps |
| 2. Main Contactor | 1000 VDC, 1000 amps (two in parallel) |
| 3. Overcurrent Sensor | Set at 3000 amps |
| 4. Differential Current Sensor | 125 amps nominal |
| 5. Input Inductor | 0.3 millihenrys, air core, 1230 amps DC RMS |
| 6. Filter Capacitor Fuses (11) | 700 VDC, 50 amps, fast blow current limiting |
| 7. Filter Capacitors (55) | 6000 MFD, 300 VDC electrolytic (11 parallel strings of 5 in series per string) |
| 8. Diode for Voltage Suppression | 2000 VDC, 1000 amps avg |
| 9. Motor Alternator Fuse | 700 V, 400 amps |
| 10. Overcurrent Sensor | Set at 3000 amps |
| 11. Drive Contactor | 1000 VDC, 1000 amps (two in parallel) |
| 12. Main Thyristors (12) | 1200 V, 1000 amps avg (6 parallel strings of 2 in series per string) |
| 13. Free-Wheel Diodes (4) | 2000 V, 1000 amps avg (2 parallel strings of 2 in series per string) |
| 14. Smoothing Reactor | 1.0 millihenrys air core, 1360 amps RMS, bifilar wound, "V" connected |
| 15. No. 2 Truck Overcurrent Relay | Set at 1200 amps |
| 16. No. 1 Truck Overcurrent Relay | Same as Truck No. 1 |
| 17. No. 2 Truck Armature Current Sensor | Hall effect type sensor: 0-1500 amps DC input, analog 0-10 VDC output |
| 18. No. 1 Truck Armature Current Sensor | Same as Truck No. 2 |
| 19. No. 2 Truck Armatures and Fields | Armature: 600 amps RMS at 312 VDC (1 hr rating), 900 amps at 600 VDC (peak rating) Fields: 0-43 amps DC |
| 20. No. 1 Truck Armatures and Fields | Same as Truck No. 2 |
| 21. Field Power Supplies (2) | 230 V 3-phase 60 Hz input, 0-50 amps DC output (phase delay rectifier type with reversing contactor) |
| 22. Dynamic Brake Resistor Grids (2) | 1.5 ohms, 1.2 megawatts peak power dissipation per leg (connected in parallel) |
| 23. Brake Contactor (1) | 1000 VDC, 1000 amps DC (DPDT, center-off, non-interrupting type) |
| 24. Contactor (Open in "Drive", Closed in Brake") | One throw of brake contactor |
| 25. Contactor (Open in "Brake", Closed in "Drive") | Opposite throw of brake contactor |
| 26. 600 VDC Power and Return for Motor Alternator Set | No. 4/0 wire (85°C rating) |
| 27. Car Body Ground (2) | 373 MCM wire (85°C rating) |
| 28. Axle Ground Brushes (4 axles) | |
| 29. Diodes to prevent Armature Current "Swapping" during Series-Parallel Dynamic Braking | 2000 V, 1000 amps avg |

Figure 4-5. Propulsion System Functional Schematic (Sheet 2 of 2)

identifies each component). The circuit components are described in the following paragraphs.

Chopper

The DC chopper provides smooth control of armature current and tractive/braking effort when the system is operating below motor base speed. This control is achieved by varying the motor terminal voltage (and armature current) using a variable relation between the on and off times of the chopper semiconductor devices. Once base speed has been attained, the chopper is "full-on" and motor control is passed to the motor field control (field weakening). Chopper operation is described later in this section.

The chopper box shown in Figure 4-6 consists of four pullout drawers of semiconductors and load-sharing resistor-capacitor networks, commutating reactor and capacitors, and thyristor gate drives. Figure 4-7 illustrates the basic chopper circuit and load-sharing networks. There are 12 main thyristors (2 series, 6 parallel), 6 commutator thyristors (2 series, 3 parallel), 2 commutator diodes (2 series), 4 free-wheeling diodes (2 series, 2 parallel), and 38 commutator capacitors (all in series).

The chopper box is approximately 51 inches long, 36.8 inches deep, and 23.5 inches high. It is force-ventilated by the traction motor blower for the forward truck at a flow rate of approximately 2000 cfm, and is designed for an inlet ambient air temperature of 125°F. A temperature sensor is located in a critical portion of the chopper.

The chopper is designed for a normal voltage of 600 volts dc and transients of 2400 volts dc. The combination of input inductor and filter capacitors (described in later paragraphs) provides a transient energy absorption of 20,000 joules (watt-seconds). The normal capacitor charge at 600 volts dc is approximately 2000 joules. The SOAC input filter provides two times the energy absorption provided for a similar chopper operated successfully on the Long Island Rail Road. Figure 4-8 illustrates the range of transient voltage-time durations for which the SOAC input filter was designed.

Power Control Unit

The Power Control Unit (PCU) is a two-section box 80 inches long, 26 inches wide, and 19 inches high. It contains the 600-volt input power conditioned equipment and provides conditioned power to both the propulsion and auxiliary equipment (motor-alternator set). The functions it provides are listed below (and shown in Figure 4-5).

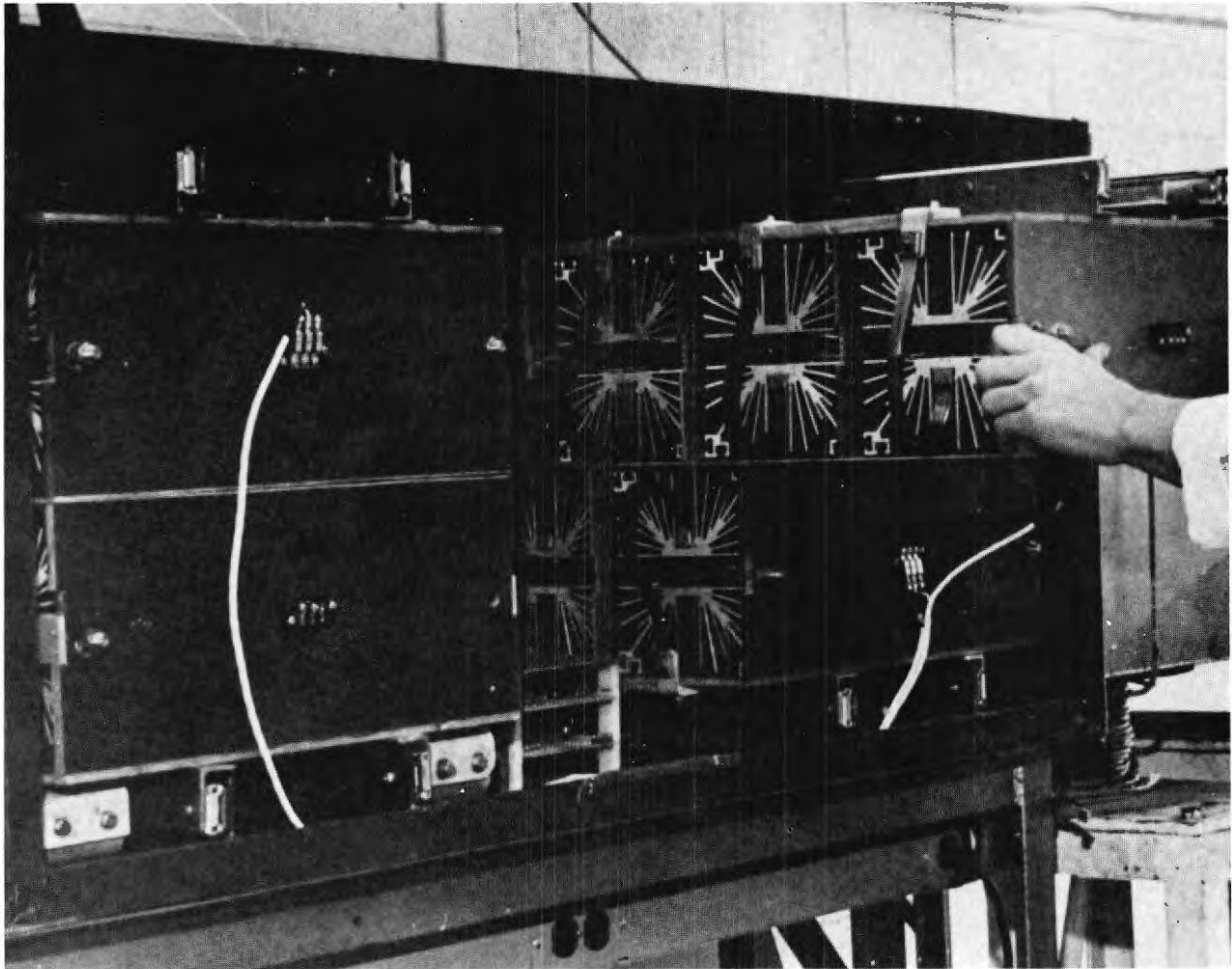
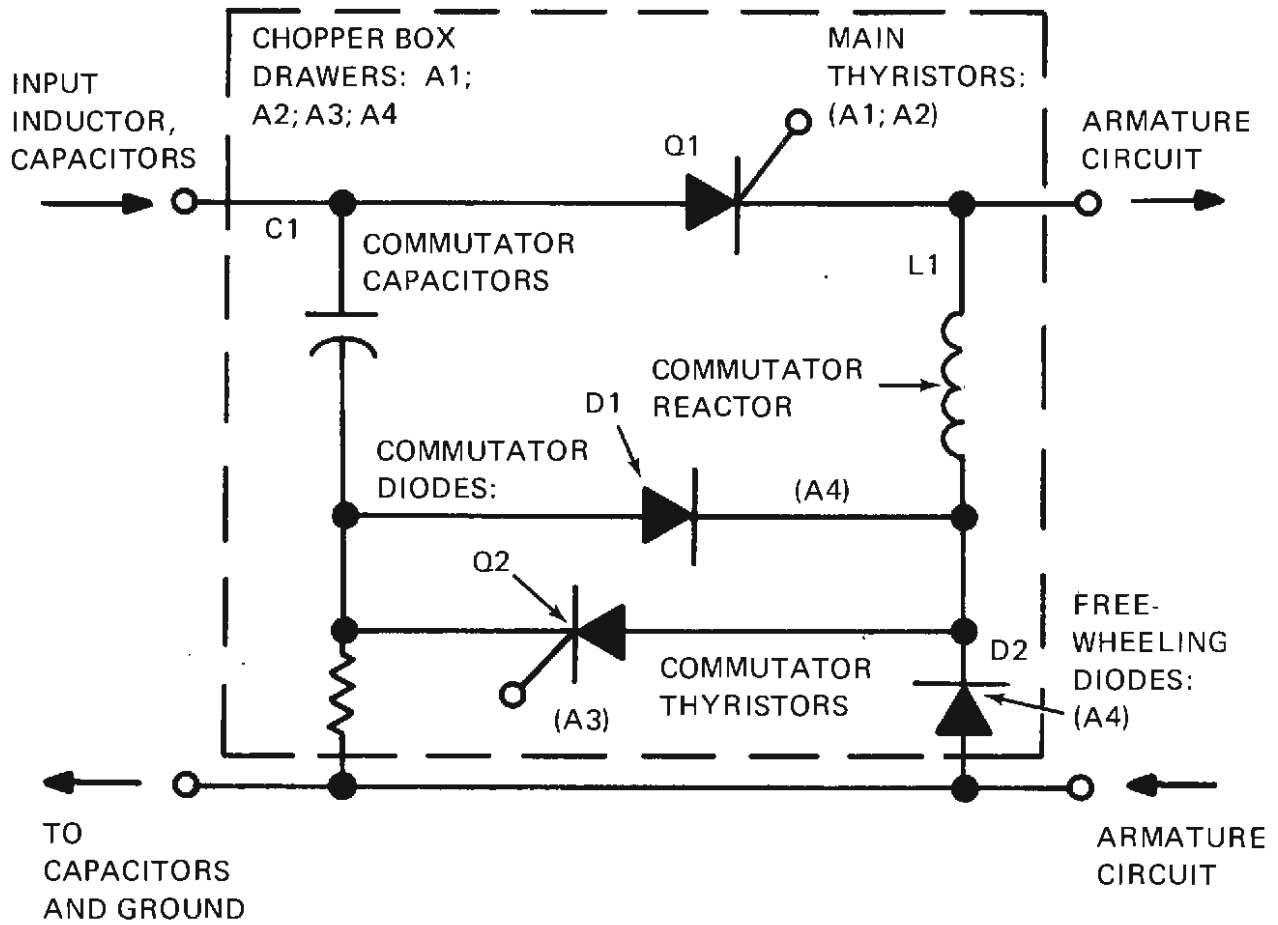

Figure 4-6. DC Chopper

BASIC POWER NETWORK



SEMICONDUCTOR VOLTAGE AND CURRENT SHARING NETWORKS

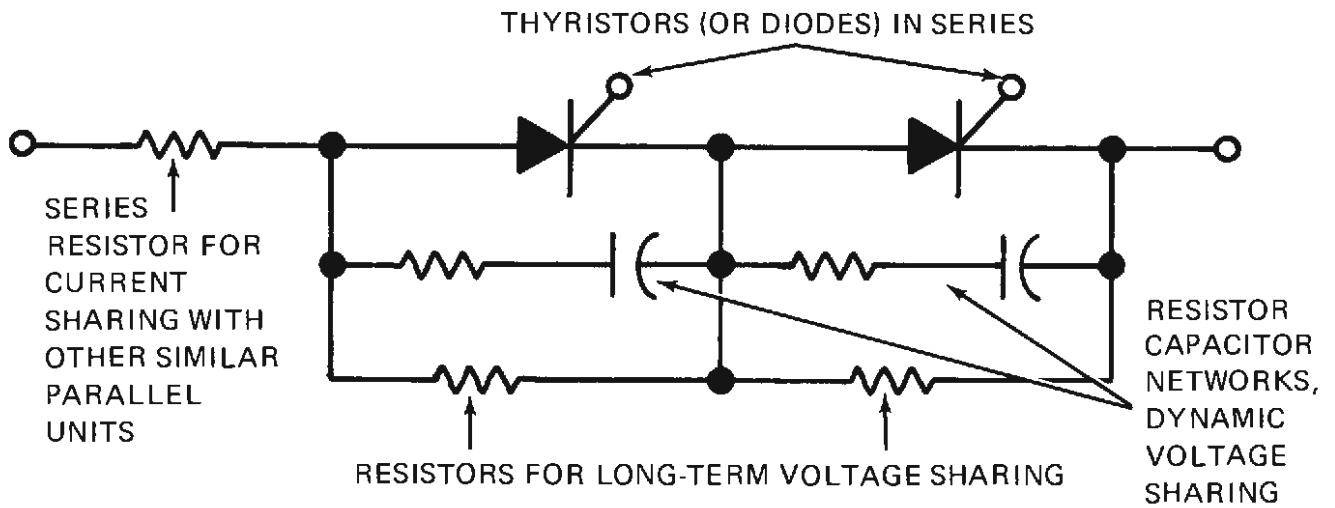

Figure 4-7. Chopper Schematic

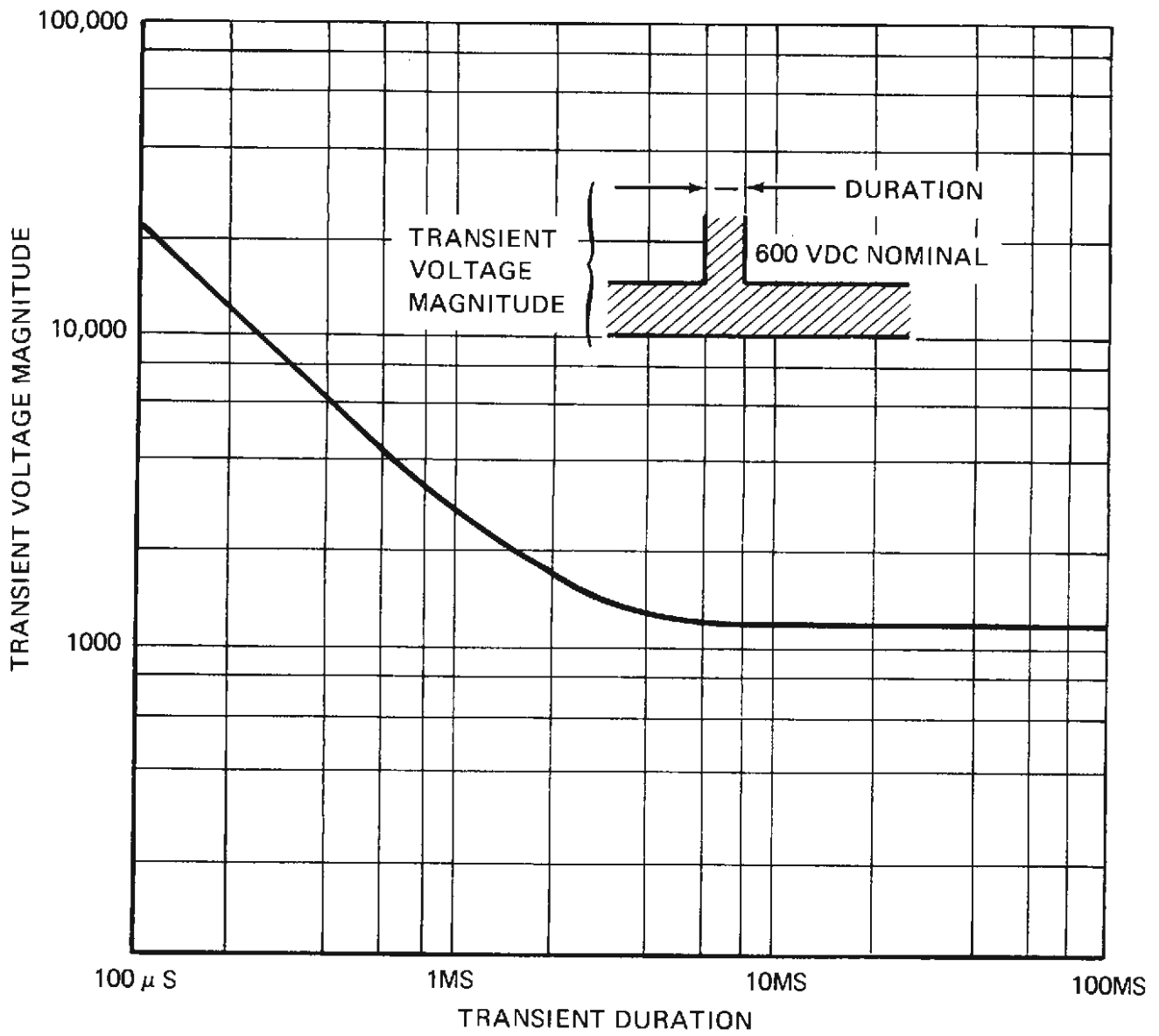

Figure 4-8. Transient Voltage vs Transient Duration

The right-hand section contains the following functions:

- Traction power switch gear (i.e., drive, brake, and main contactors)
- Overcurrent relays (3)

The left-hand section consists of the input filter capacitor bank (6000-microfarad, 300-volt capacitors: 5 in series, 11 in parallel) consisting of:

- Capacitor-bank fuses (22)
- Capacitor-bank fuse trip sensor
- Primary traction motor armature current sensors
- Capacitor-bank and motor-armature voltage sensors
- Traction motor series (sharing) diodes and cooling fans (2)
- Capacitor-bank cooling fans (3)
- Overcurrent relay (1)
- Motor-Alternator and dead-battery-start 600-volt fuses
- Dead-battery-start series regulator resistors

Propulsion Power Control Unit

The Propulsion Power Control Unit (PPCU) measures 40 by 20 by 19.5 inches. It contains solid-state plug-in circuit cards which provide the analog and logic control functions for the propulsion and friction brake systems. The various card functions are summarized below and illustrated in Figure 4-9. (Also see Figure 4-5.)

- Propulsion and brake P-signal transducers
- Jerk limiting
- Armature current program, regulation and balance
- Tractive effort program and regulation
- Load weight compensation
- Axle speed cards (4)
- Spin-slide cards (2)

| | | | | |
|----------------------------------------------------|------------------------------------------------------|------------------------------------------------------|---------------------------------------------------|-------------------------------------------------|
| POWER SUPPLY PRE REGULATOR 2002633 J11 | TRAIN LINE LOGIC NO. 1 2015221 J21 | (PROPULSION) P-TRANSDUCER 2015219 J31 | (SPARE) J41 | POWER SUPPLY PRE REGULATOR 2002633 J51 |
| REGULATOR ± 15V 2002635 J12 | TRAIN LINE LOGIC NO. 2 2015223 J22 | P-W JERK 2015209 J32 | (SPARE) J42 | REGULATOR ± 15V 2002635 J52 |
| POWER SUPPLY MONITOR 2002665 J13 | I _A PROGRAM 2002667 J23 | TE PROGRAM 2015207 J33 | (SPARE) J43 | TRUCK 1 BLENDER 2002661 J53 |
| QSD LOGIC 2002673 J14 | (SIMULATOR INPUT) J24 | TE REGULATOR 2002643 J34 | (SPARE) J44 | TRUCK 2 BLENDER 2002661 J54 |
| (SPARE) J15 | TE PAUSE LOGIC 2015235 J25 | I _A REGULATOR 2002645 J35 | (BRAKE) P-TRANSDUCER 2015219 J45 | LOAD COMPENSATOR 2002651 J55 |
| CHOPPER & FUSE FAULT DETECTOR 2015213 J16 | DETECTION CONTROL SPIN-SLIDE 2015211 J26 | I _A BALANCING 2015205 J36 | (AXLE 1) SPEED DETECTOR 258-501-9001 J46 | (AXLE 1) SLIP-SLIDE 2002653 J56 |
| ANALOG MONITORING 2015231 J17 | CONTACTOR SIGNAL CONDITIONER 2002669 J27 | CHOPPER CONTROL LOGIC 2015201 J37 | (AXLE 2) SPEED DETECTOR 258-501-9001 J47 | (AXLE 2) SLIP-SLIDE 2002653 J57 |
| OPERATION ANNUNCIATOR 2015233 J18 | CONTACTOR SIGNAL CONDITIONER 2002669 J28 | CHOPPER GATE PULSE GENERATOR 2015203 J38 | (AXLE 3) SPEED DETECTOR 258-501-9001 J48 | (SPARE) J58 |
| FAULT INDICATOR 2015217 J19 | CONTACTOR CONTROL LOGIC 2002663 J29 | DR/BK CONTROL 2002671 J39 | (AXLE 4) SPEED DETECTOR 258-501-9001 J49 | (SPARE) J59 |

BOTTOM FRONT VIEW

Figure 4-9. Propulsion Power Control Unit Plug-In Card Locations

- Dynamic/friction blending per truck
- Various monitor, detection, and system-shutdown logic

Auxiliary System Power

Motor Alternator Set - A 125-kw motor alternator (Figure 4-10) supplies 230-volt 3-phase 60-cycle power to all auxiliary motors on board each car as well as power for the traction-motor field control. The auxiliaries include air conditioning, recirculation fans, traction cooling fans, low voltage power supply, battery charger, and the car air compressor. All of these auxiliary systems use AC motors, which results in lighter weight and improved reliability over conventional DC machines.

The 125-kw rated performance is obtained when line voltage is 550 volts dc or greater. At the 450-volt minimum continuous operating voltage of the SOAC, the motor alternator set provides approximately 82 percent of its rated output, which is sufficient to power the normal running load of the SOAC (35 to 40 kw). This derated condition is due to the fact that the 125-kw motor alternator set was designed to provide power for two cars, but was installed on each SOAC to allow for single-car operations. The auxiliary power system is provided with a priority load-shedding capability: the air conditioners are shed first with brake air compressor, motor blowers, and traction motor field supplies last. Restart is in reverse priority. The motor alternator set was designed for shutdown at 400 to 425 volts and normal restart at line voltages above 550 volts. A separate starting system using 600-volt line power instead of 32-volt battery power is provided for dead-battery starting.

The DC motor receives conditioned power from the PCU and has both a series field and a separate shunt field powered by the output of the alternator. A solid-state thyristor control on the shunt field regulates the DC motor speed to 1800 rpm ± 90 .

The output voltage is regulated to ± 0.5 percent from no load to full load within the above speed range (60 Hz ± 3).

The AC alternator is a three-wire wye-connected system with ungrounded neutral. Rotating rectifiers (diodes) are used in place of sliprings and brushes for rotor excitation. Solid-state voltage regulation is used along with load current sensing for load shedding and overcurrent protection.

The motor alternator set is self-ventilated by an integral fan through an inlet filter, as shown in Figure 4-10.

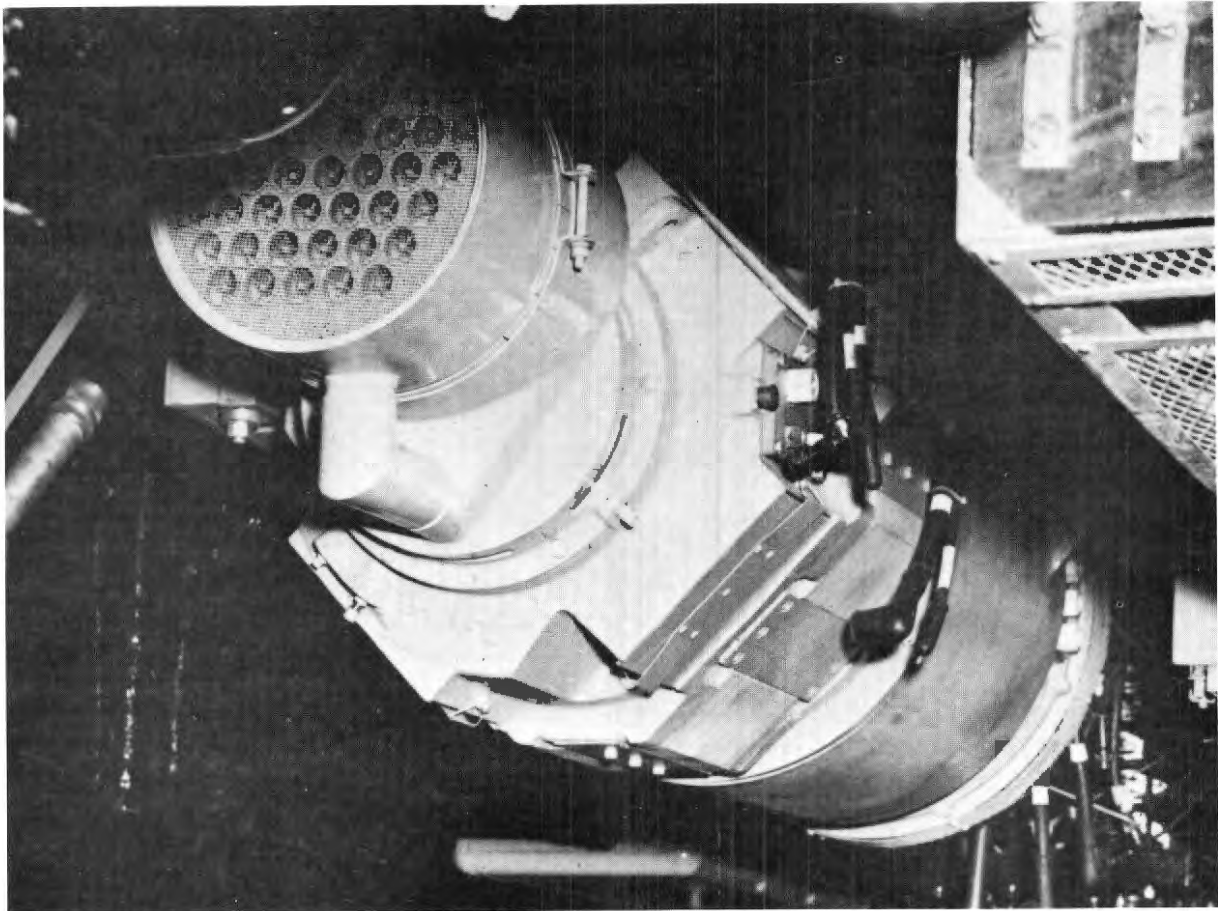

Figure 4-10. Motor Alternator

Auxiliary Power Control Unit - The Auxiliary Power Control Unit (APCU) is an 81 by 25 by 19-inch box having two access panels. Figure 4-11 is a block diagram of the auxiliary power subsystem.

The right-hand section contains the following functions:

- Motor alternator set starting and control logic
- Transformer rectifier
- Load-shed contactor(s)
- EMBC 164 battery charger
- Dead-battery start regulator

The left-hand section contains the following functions:

- Motor alternator set field power supply
- Motor alternator set voltage regulator and speed control
- Traction motor field power supplies (2)
- Motor alternator set switch gear and time-delay relays

Each of the two traction motor field power supplies provides field current to one series pair (truck set) of separately excited motors. The power supplies provide DC current up to 43 amps at approximately 155 volts DC using 3-phase AC-DC conversion by solid-state phase-delay rectifiers.

Reactors

Two large reactors are used to protect the chopper and to smooth its output current. The undercar and circuit locations of these reactors are shown in Figures 4-2 and 4-5, respectively. Both reactors are air-core, self-cooled devices of primarily aluminum construction.

The input reactor, of approximately 0.3-millihenry inductance, operates in conjunction with the input filter capacitors to limit voltage and current transients into the chopper and auxiliary power supply and from the chopper back to the line. This reactor is rated at 1230 amps RMS with ripple current of 100 amps RMS at the 400-Hz chopper frequency.

The motor smoothing reactor limits the magnitude of the traction motor ripple current due to operation of the chopper

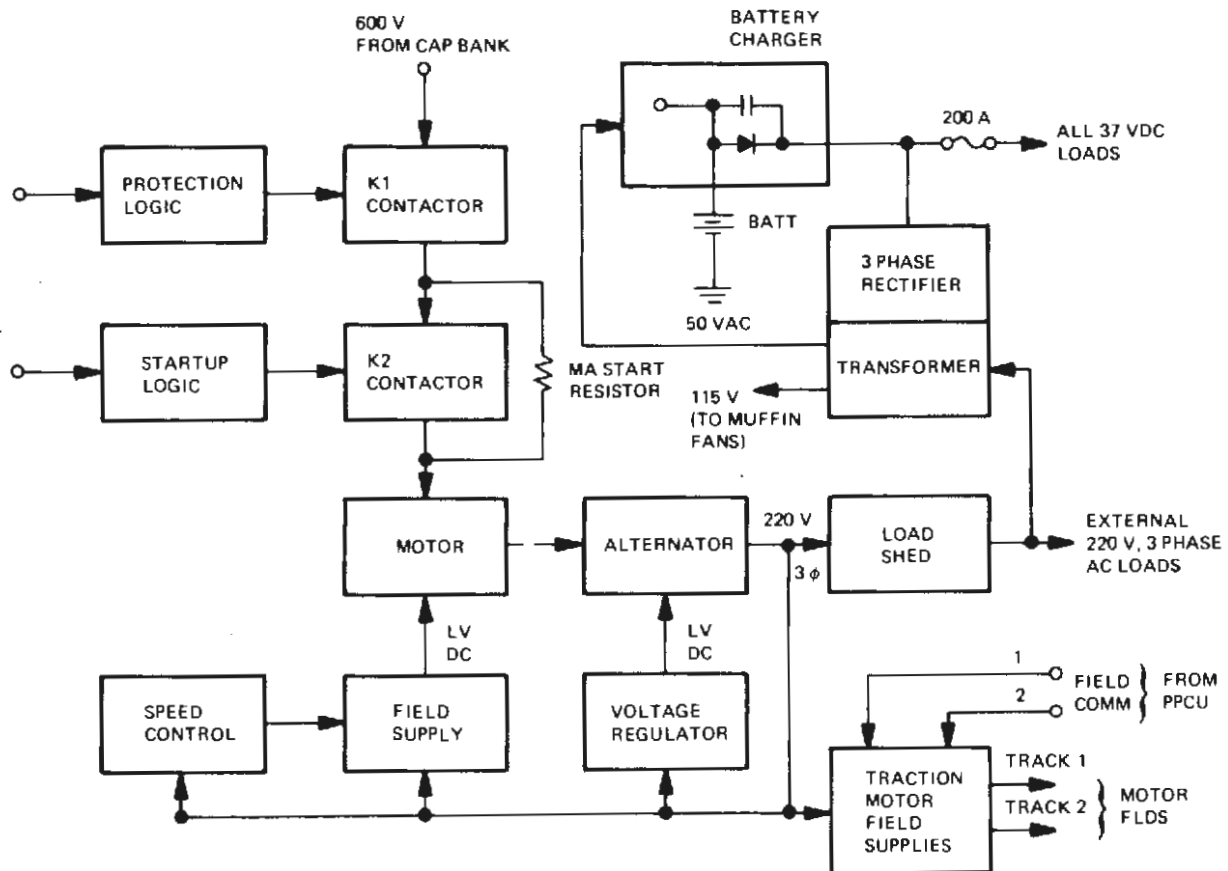

Figure 4-11. Auxiliary Power Subsystem Block Diagram

during power and brake modes. The reactor has an inductance of approximately 1 millihenry and is rated at 1360 amps RMS with a 400-Hz ripple current of 190 amps RMS.

Brake Resistor Grids

Two brake resistor grids in parallel and one motor alternator set starting resistor grid are mounted on the SOAC. Each brake resistor grid provides an electrical load of 1.5 ohms for the traction generators during dynamic braking. The armature circuit chopper is reconnected in parallel with the brake resistors and intermittently shorts the traction motors through the smoothing reactor, which bypasses the brake resistors and provides the commanded deceleration rate (braking effort). The brake circuit is shown in Figure 4-5.

The brake resistors, manufactured (for AiResearch) by the Guyan Machinery Company, are a coil configuration with each grid rated for an average power dissipation of 110 kw. Each grid contains 10 coils approximately 58 inches long with 84 turns each. The wire size is approximately 0.36 inch, coil diameter is 1.6 inches, and the resistor material is nichrome.

During tests of a repetitive 0-to-60-to-0 mph duty cycle, the peak coil temperature determined from measured thermocouple data was 1250°F, which is well within the 1830°F allowable temperature. Use of these high temperature resistor coils on the SOAC allows a weight saving of more than 1400 pounds over the more conventional edge-wound dynamic rake resistors.

The four traction motors and the DC chopper are forced-air cooled by two motor-driven two-stage vane axial fans with inertial filters and dirt separators. Figure 4-2 shows the location of each fan unit; the cab-end unit cools both chopper and front truck traction motors, while the non-cab-end unit cools the rear truck motors only.

The ducting from both fan units contains differential pressure airflow sensors which assure normal cooling flow ($\Delta P = 6$ inches of water above ambient) prior to allowing operation of the traction system. Loss of airflow during car operation results in a shutdown of the traction system until flow is restored. The airflow sensor switch was used as the means of failing the traction system during dynamic/friction braking tests; an open switch inhibits propulsion operation.

The fan motors are 3-phase 230-volt 60-Hz AC units with input power requirements of 6.3 kw each. The vane axial fan supplies a total pressure rise of 14 inches of water at 2140 scfm.

Fan inlet air contamination particles are filtered to 5-micron nominal through inertial air cleaners mounted on the side of the cars just below the floor line (see Figure 4-12).

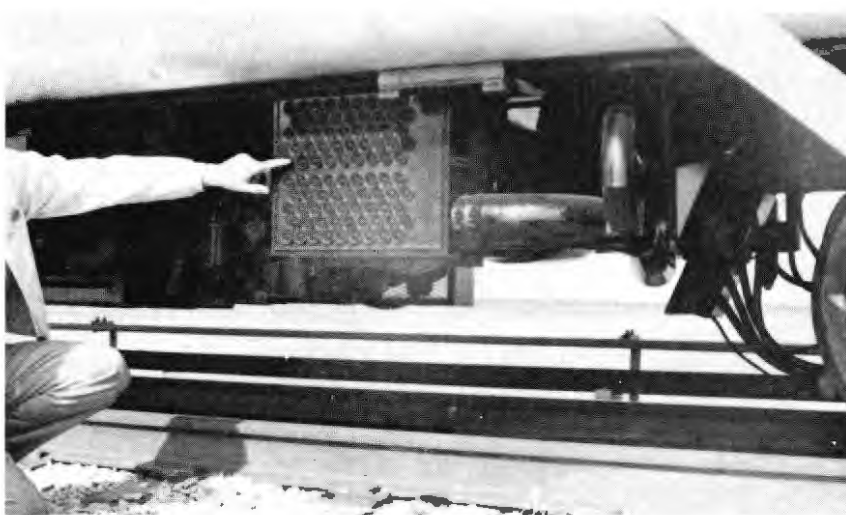

Figure 4-12. Cooling System — Fan Inlet

These air cleaners are active-nature filters rather than barrier type. Heavier-than-air particles are concentrated in the outer layer of air through centrifugal energy caused by spinning the air as it passes through static vanes. The outer layer of contaminated air is removed through an annulus by the pumping action of a jet pump.

The use of these dynamic filters is required by the location of the cooling air source underneath the car. These filters are a significant improvement over previous traction systems which have experienced severe problems in powder-snow conditions. The SOAC cars have been operated in Pueblo throughout the winter and in all types of snow conditions without malfunction.

Cab Master Controller

The master controller panel (shown in Figure 4-13), located on the right half of the lower control console panel, contains three controls: the master controller (tractive effort) handle, the direction control switch, and the emergency brake pushbutton. The direction control switch is key-operated and turns its master controller on. The turn-on operation is interlocked with the master controller handle position and, via the trainlines, with the master controller in the other SOAC car. The interlocks prevent more than one controller from being turned on at one time and require that the controller handle be in the emergency brake detent in order to be turned on. The direction control switch selects the direction of operation and, in the OFF position, allows the brake pipe to be charged.

The master controller handle is the primary control for operation of the car. Its function is analogous to the throttle and brake pedals on an automobile. In the full forward position, maximum acceleration is commanded and the car will accelerate at maximum rate to the maximum speed allowed by the speed limiting control. In the middle position, the car is in the coast mode with the propulsion system configured for braking but without any braking effort applied. In the full aft position (without passing through the emergency brake detent), maximum service braking effort is commanded. Moving the handle through the emergency brake detent applies the emergency brakes and results in an irretrievable stop.

The handle of the master controller also has a deadman control feature. This handle must be held against a light spring, in a horizontal position, or the full-service brakes will be commanded. Once the handle is returned to the horizontal position, the deadman feature is turned off, and the master controller command once again corresponds to the fore and aft position of the handle. On the right side of the



Figure 4-13. Master Controller Panel

master control panel is a red mushroom-shaped emergency-stop button. Depressing this pushbutton applies the emergency brakes and results in an irretrievable stop.

In addition to the emergency-stop pushbutton and the emergency-stop detent on the controller, a pull cord is located along the forward corner post of the cab directly above the emergency-stop pushbutton. This pull cord directly operates an air valve that vents the brake pipe.

Speed Maintaining

The speed-maintaining pushbuttons (Figure 4-14) located immediately below the speedometer readout allow the motorman to select a maximum car speed to which he can accelerate, and which, when reached, may not be exceeded unless the system is turned off or a higher speed is selected. As long as the controller handle is far enough forward for the car to reach the maximum speed, that speed will be maintained. Speed maintaining buttons are provided for the following speeds: 3, 15, 25, 35, 50, 70, 80 mph, and OFF. These lighted buttons stay depressed until another button is depressed. The speed associated with each button may be changed by changing the value of a resistor on the controlling circuit card.

Additionally, there is an overspeed correction mechanism which is independent of the speed maintaining system. Whenever the car reaches 83 mph, three events occur:

1. A warning buzzer sounds,
2. The speed fault indicator lights, and
3. Full-service brakes are applied.

The brake rate is jerk-limited during application. The brakes remain on and cannot be overridden. When the car reaches 77 mph, control is returned to the motorman.

4.4 PROPULSION SYSTEM OPERATION

The operation of the DC chopper, its control subsystems, and the resulting SOAC propulsion and service braking characteristics are as follows:

Basic Control

The control of tractive and braking effort with the master controller is achieved using a tractive effort program which accepts input commands, car weight, etc., and controls the motor torque developed to the desired values. Closed-loop

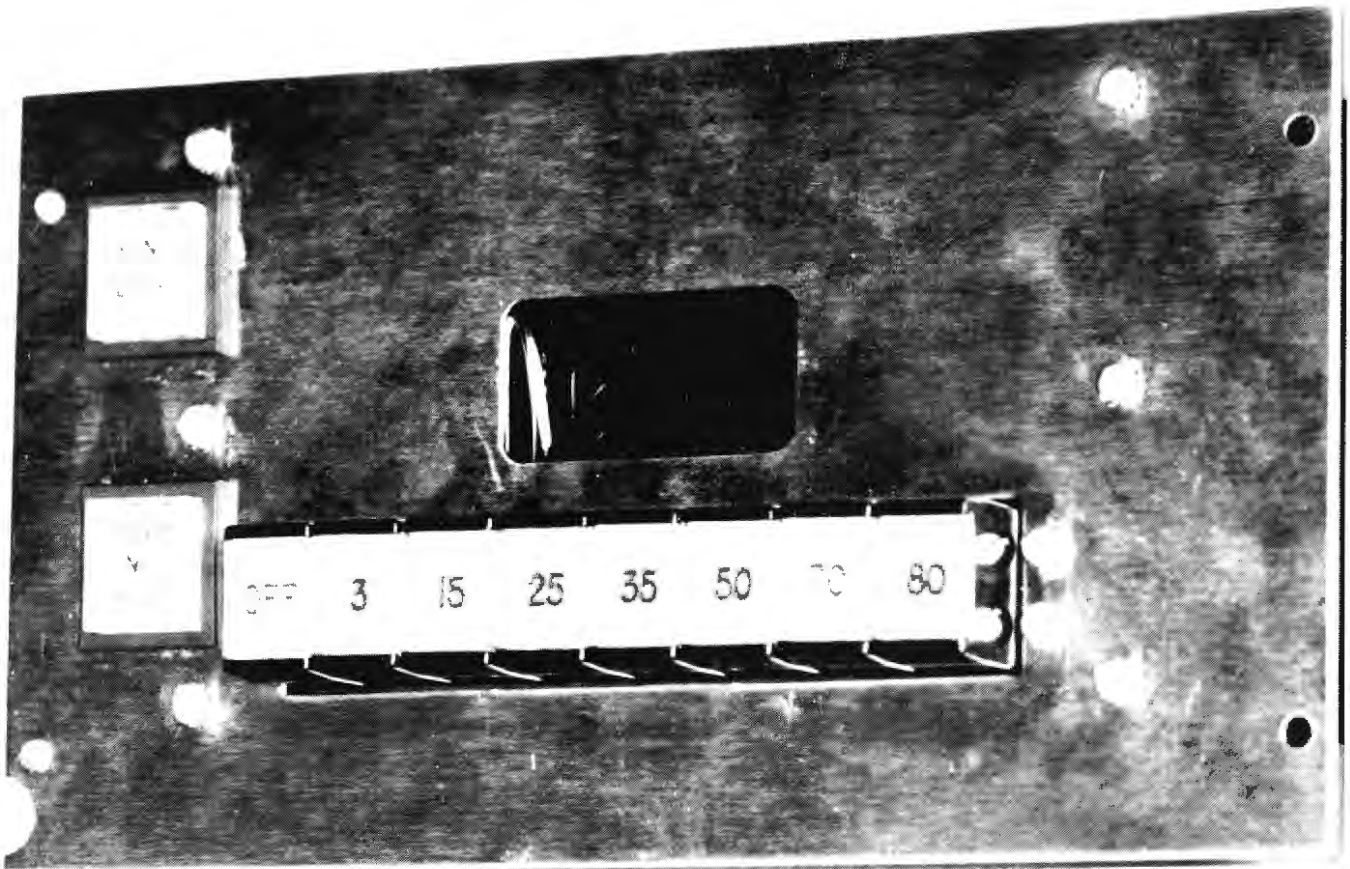

Figure 4-14. Speed Maintaining Buttons

control of motor armature current is the primary method utilized. Figure 4-15 illustrates the control system. Performance testing (described in Section 6) was designed to fully test the characteristics of this control system throughout the allowable range of input parameter values.

Input Commands

As noted in Figure 4-15, the P-generator receives input commands from three sources: master controller, speedometer (speed limiter system), or car hostler. When activated, the speed limit subsystem and master controller are used together as control inputs, that is, the P-signal generated corresponds to the lesser command of the master controller or speed limiting system. The P-generator produces an analog signal from 0 to 1.0 amps which is trainlined.

Each car of the train will interpret the P-signal and convert it to a voltage level; the sense of the P-signal is interpreted for either propulsion or brake modes. The propulsion and brake systems operate using independent circuits for commanding tractive/braking effort. The command to the control system is in terms of tractive effort per ton of car weight (TET).

Load Weigh Compensation

The above propulsion command is modified by actual car weight as sensed by air suspension pressure. The TET command is modified by car weight so that acceleration or braking rates are essentially constant at varying car weight. The design logic of the load-weighing system is such that failure of load-weigh signal will result in a tractive/braking effort command for an empty car weight. The emergency brake system contains a separate pneumatic load-weigh capability.

Once the weight factor is factored into the TET input, the tractive effort input enters the tractive effort program.

Tractive Effort Program

This analog program uses a variety of inputs from controller, car parameters, and calculated operational limits. The program equates 100 percent tractive effort (drive) to full-forward position of the master controller independent of actual car speed. Tractive effort is reduced above motor base speed along a constant horsepower characteristic; 100-percent tractive effort corresponds to maximum power. The input command is modified for line voltage, current limits, car speed, etc., by the tractive effort program and the resulting tractive effort command (TEC) is sent to a limiting subsystem.

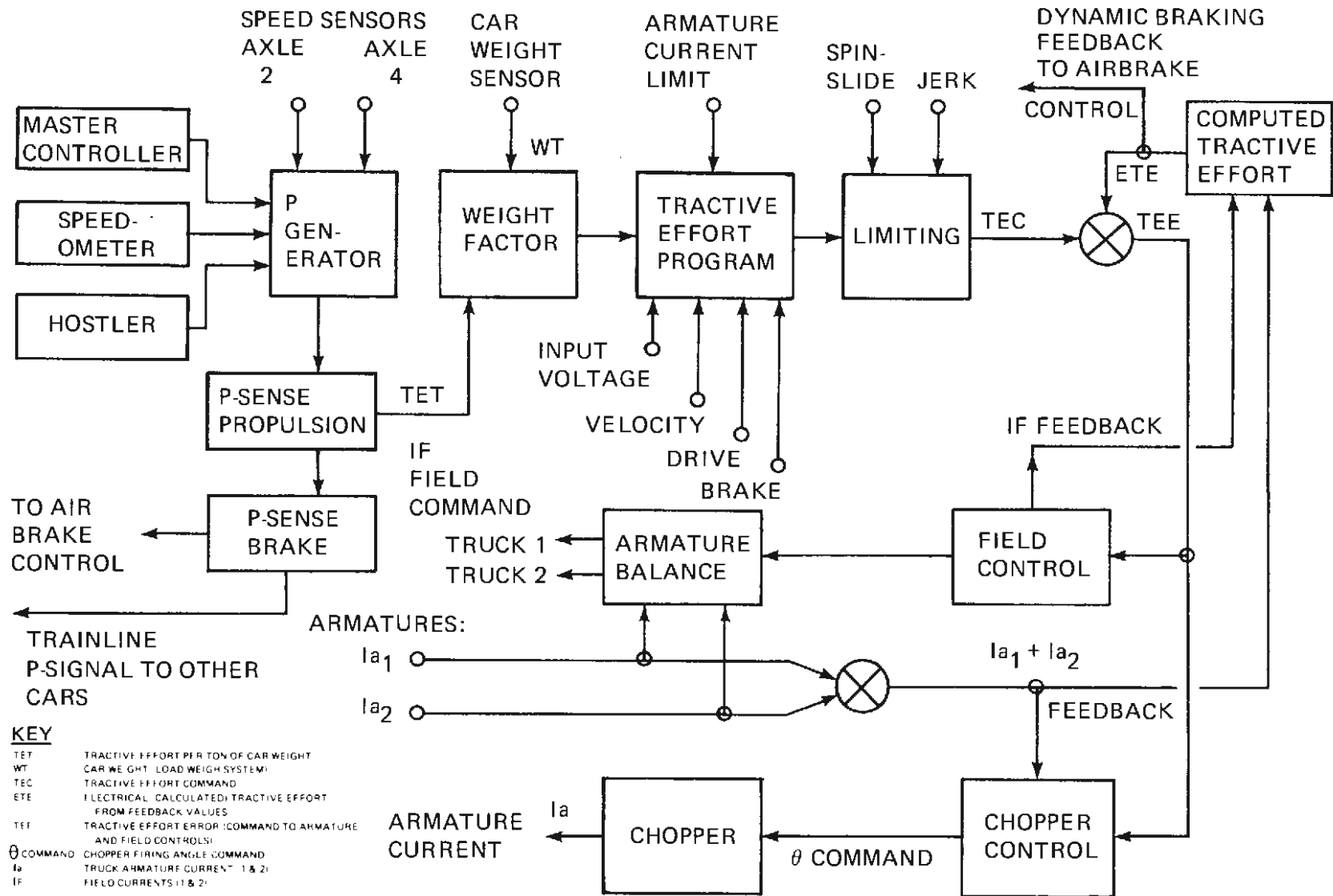

KEY

- TET TRACTIVE EFFORT PER TON OF CAR WEIGHT
- WT CAR WEIGHT LOAD WEIGH SYSTEM
- TEC TRACTIVE EFFORT COMMAND
- ETE ELECTRICAL CALCULATED TRACTIVE EFFORT FROM FEEDBACK VALUES
- TEE TRACTIVE EFFORT ERROR (COMMAND TO ARMATURE AND FIELD CONTROLS)
- θ COMMAND CHOPPER FIRING ANGLE COMMAND
- I_a TRUCK ARMATURE CURRENT (1 & 2)
- IF FIELD CURRENTS (1 & 2)

Figure 4-15. Tractive Effort Control Block Diagram

Jerk Rate Limiting and Spin-Slide Protection

The time rate of change of tractive effort command is controlled to a maximum value to limit the rate of change of car acceleration to ± 2.5 mph/sec². Thus a step input at the master controller results in a ramp output of the limiting system (TEC). This subsystem also controls release and re-application of tractive/dynamic braking effort in response to wheel spins and slides detected by the four axle speedometer systems. The TEC output of the jerk limiter forms the propulsion command sent to the chopper and field current control systems (Figure 4-15). This command is passed through a summing point where "command" and "computed" tractive effort are compared. Computed tractive effort is a result of armature and field current feedback discussed in later paragraphs.

Chopper and Field Control

The chopper control determines the thyristor gate firing commands sent to the chopper semiconductors. This firing angle (θ) determines the average voltage out of the chopper and the load (or motor armature) current. During acceleration or dynamic braking below the motor base or full-field speed, the chopper is the controlling device.

Above base speed the chopper is gated full on, and tractive effort control is passed to the motor field control. Based on speed and tractive effort command, the fields are varied such that constant armature current is maintained. The current feedback values provide a closed-loop control. The sequence of control operations is outlined in the following paragraphs.

Operation in Drive Mode

Figure 4-16 illustrates a typical initial acceleration from a stop. The data is a time history of data taken during the SOAC test program. The following sequence of events takes place during the acceleration (as marked by locations on the figure):

- Event 1. Vehicle stopped, traction system ready, line breaker closed, chopper and field power supplies off.
- Event 2. Step input from master controller; full acceleration command, $P = 1.0$ amp.
- Event 3. Chopper turned on to its minimum value at 40-Hz frequency.

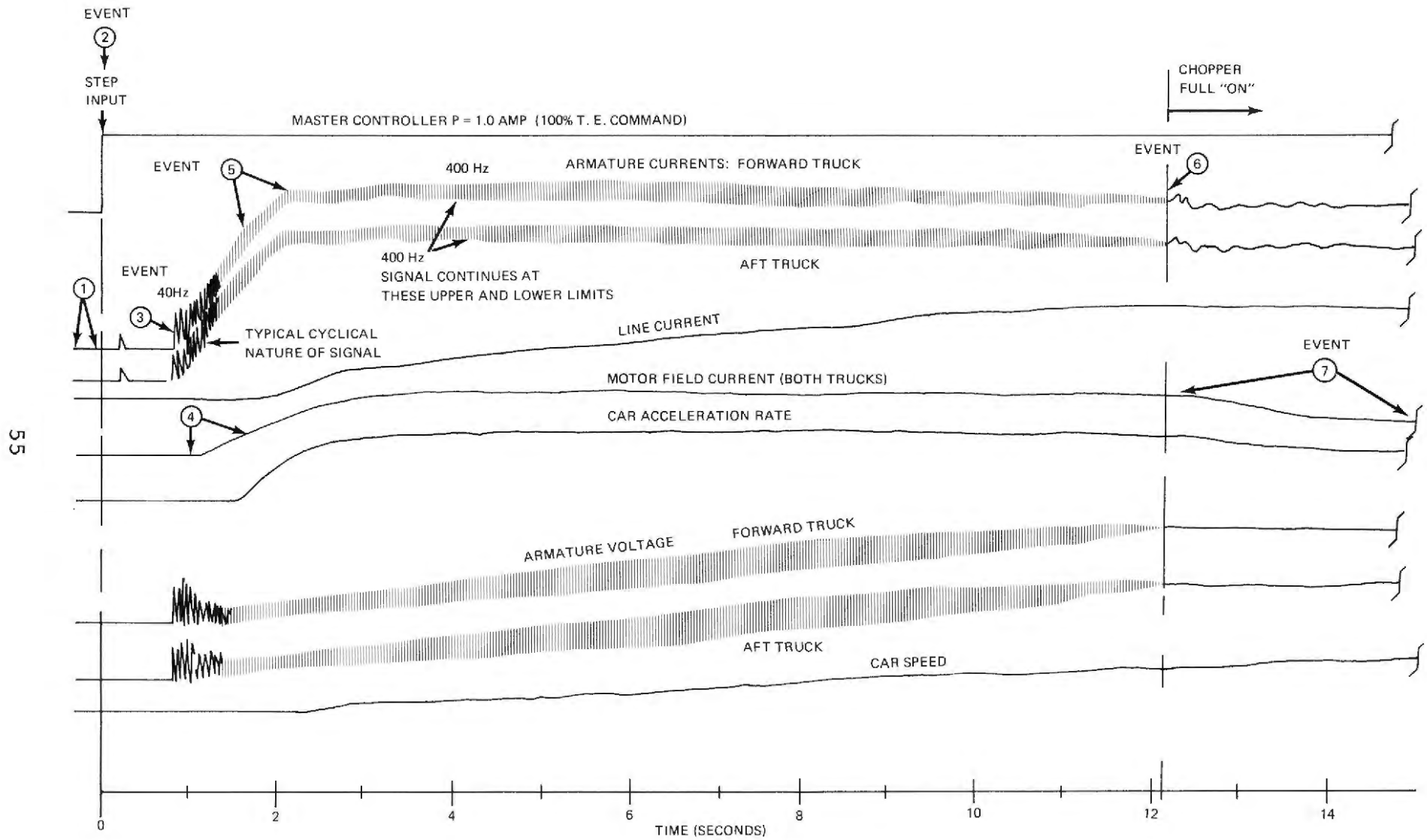

Figure 4-16. Time History of Typical Initial Acceleration

- Event 4. Traction motor fields are ramped from 0 to full field (approximately 38 amps) in response to the jerk-limited tractive effort command.
- Event 5. Traction motor fields increasing to full field current; control passes to the chopper which feeds controlled current to the motor armatures. This rise in armature current is jerk limited. Chopper frequency is quickly increased from 40 Hz to 400 Hz during this time. Armature current is then controlled at the value which corresponds to tractive effort command. Motor torque is the product of armature current and field flux. The low initial chopper frequency (40 Hz) is dictated by the low power required when ramping the fields on smoothly.

Since the chopper has a finite minimum output current characteristic at its 400-Hz normal frequency, the current to the motors during initial startup would not be of low enough magnitude to prevent an initial jerking start when the motor fields are brought up to full. To alleviate this problem the chopper frequency is lowered to 40 Hz initially on a transient basis, and quickly phases up to 400 Hz as the car accelerates.

- Event 6. Motoring base speed: With traction motor fields at maximum value, motoring base speed corresponds to the vehicle speed at which the terminal voltage of the parallel motor branches and the smoothing reactor is equal to the voltage measured across the line filter. This speed is 28 or 30 mph, depending on line voltage and tractive effort command. When motoring base speed is reached, the chopper is full on and can no longer serve as a control on armature current.
- Event 7. Motoring above base speed: Chopper full on, armature current controlled by field current as supplied by variable field power supplies. Field power is much less than armature power at this point, and infinite low-power control of armature current is available up to the maximum speed of the car. To maintain constant armature current above base speed, the field current must be reduced (field weakening) due to the increasing back emf generated by the motor as speed increases. Motor torque is reduced in inverse proportion to increasing speed.

Operation in Dynamic Brake Mode

Figure 4-17 illustrates a typical transition from drive to full-service braking. This time history is from SOAC test data. The following sequence of events takes place:

- Event 1. Car is in drive mode at 80-mph constant speed.
- Event 2. Master controller deadman is released calling for full-service blended braking in a step input.
- Event 3. Traction motor current is reduced to zero at jerk limited rate.
- Event 4. The armature current is zero; drive contactor is opened and brake contactors are closed/opened opposite to drive positions (see Figure 4-5, locations 11, 23, 24, and 25). Motor fields are reversed (in current sense) by the field power regulators.
- Event 5. Motor fields are increased up to the value required to control the armature current at the command level. The chopper is full on. Braking effort is increased at a jerk limited rate.
- Event 6. As speed is reduced, motor field current is increased to maintain the braking command.
- Event 7. Base speed in brake is reached when full motor field current (approximately 40 amps) is being supplied to the motors. The chopper turns on and varies the effective value of the brake resistors while maintaining constant armature current. I^2R decreases linearly with speed for constant braking effort.
- Event 8. Chopper maintains constant armature current down to dynamic brake fadeout speed of approximately 3 mph.

4.5 TRACTION AND BRAKING CHARACTERISTICS

Figure 4-18 shows the car tractive and braking effort characteristics associated with the SOAC control system over the complete operating range. This figure is based on data recorded during the SOAC Engineering Test Program at Pueblo, Colorado. As noted, the figure illustrates the various combinations of controller input, armature and field currents, and resulting tractive or braking effort.

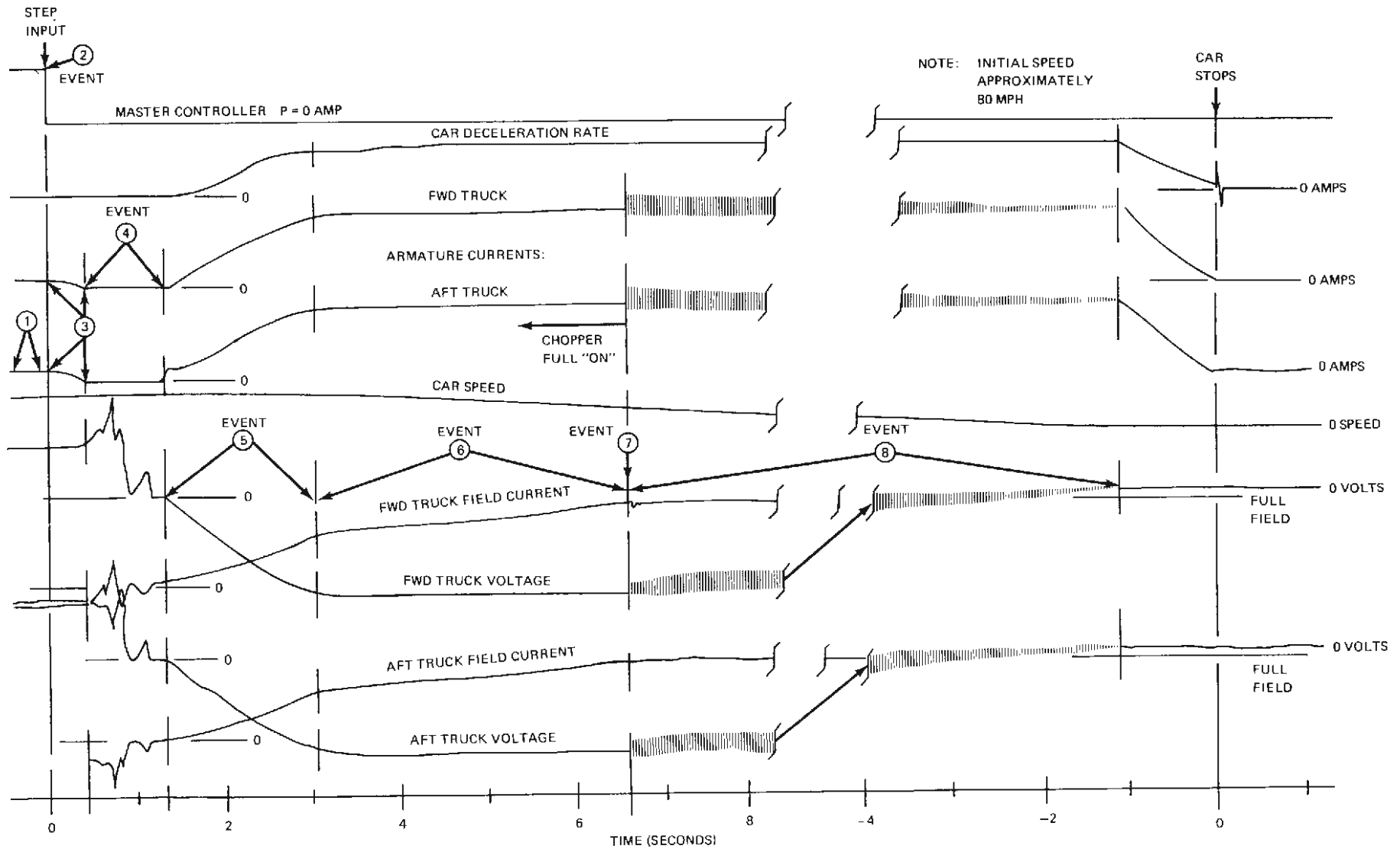

Figure 4-17. Time History of Typical Blended Braking

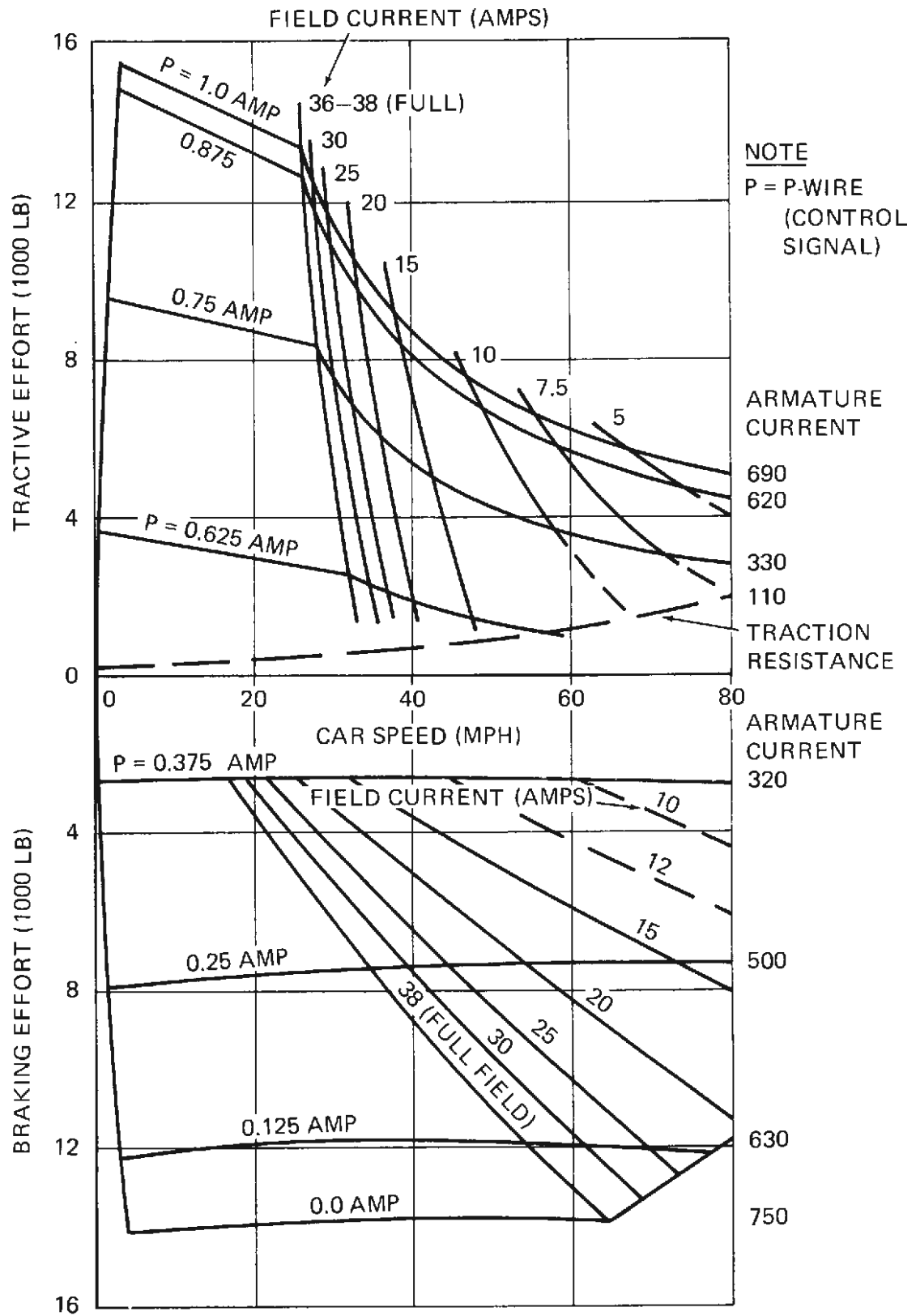

Figure 4-18. Traction and Braking Characteristics (Single-Car, 600 Volts)

4.6 DETAILED CHOPPER OPERATION

In the motoring mode, the chopper provides an efficient switching capability for control of the current in the motor armature circuits below motoring base speed. In the braking mode, the chopper provides an effective variable resistance as a load on the traction generators.

The basic chopper schematic and the associated voltage and current sharing networks are shown in Figure 4-7. The following paragraphs and figures illustrate the step-by-step operating conditions.

- Interval 1. (Figure 4-19) Prior to initiation of any switching sequence; main thyristors (Q1) are off, commutator capacitors (C1) are charged to input voltage through resistor to ground, no load current in free-wheeling path (D2).
- Interval 2. (Figure 4-20) Main thyristors (Q1) gated on by chopper control system; load current flows through the smoothing reactor and armature circuits to ground.
- Interval 3. (Figure 4-21) Commutator thyristors (Q2) are gated on creating a resonant LC circuit (L1-C1) which discharges through the main thyristors (Q1), the commutator reactor (L1) and the commutator thyristors (Q2) to the other side of the commutator capacitors (C1). The polarity on C1 has been reversed, and it is charged in the opposite potential.
- Interval 4. (Figure 4-22) The commutator capacitors (C1) now discharge in the opposite direction through the commutator diodes (D1) and reactor (L1) to the load (motors). The commutator thyristors (Q2) are back biased by the voltage reversal and turn off.
- Interval 5. (Figure 4-23) The main thyristors (Q1) are also back biased by the voltage reversal and turn off. The commutator capacitors (C1) continue to discharge through the commutator diode (D1) to the load until it is recharged up to its original value and polarity by the input voltage.
- Interval 6. (Figure 4-24) When the commutator capacitors (C1) have fully recharged, the current flow will be back through the free-wheeling diode (D2) and recirculated through the load. The

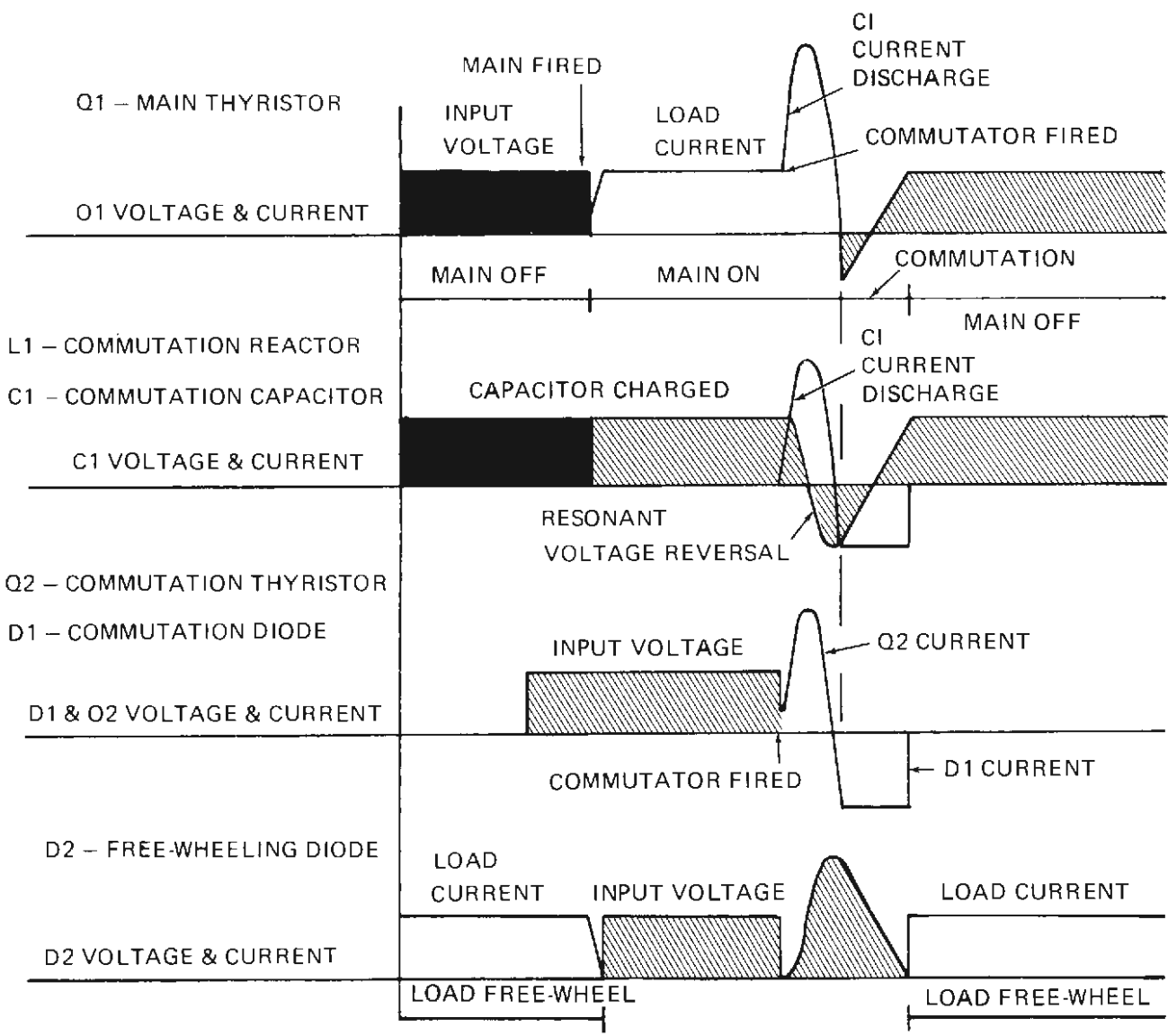
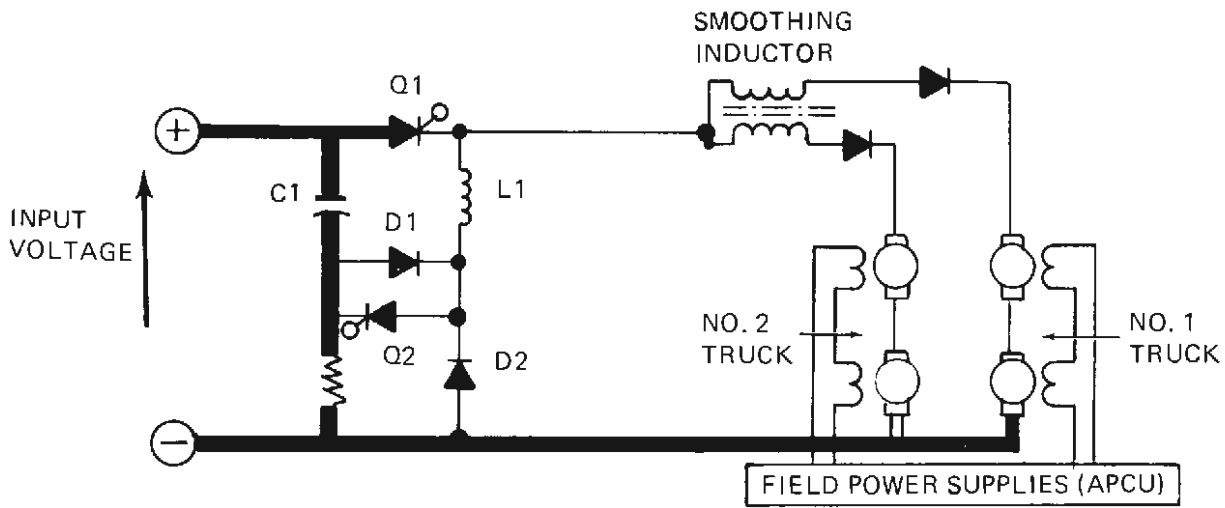

Figure 4-19. Chopper Operation: Main-Q1 "Off"

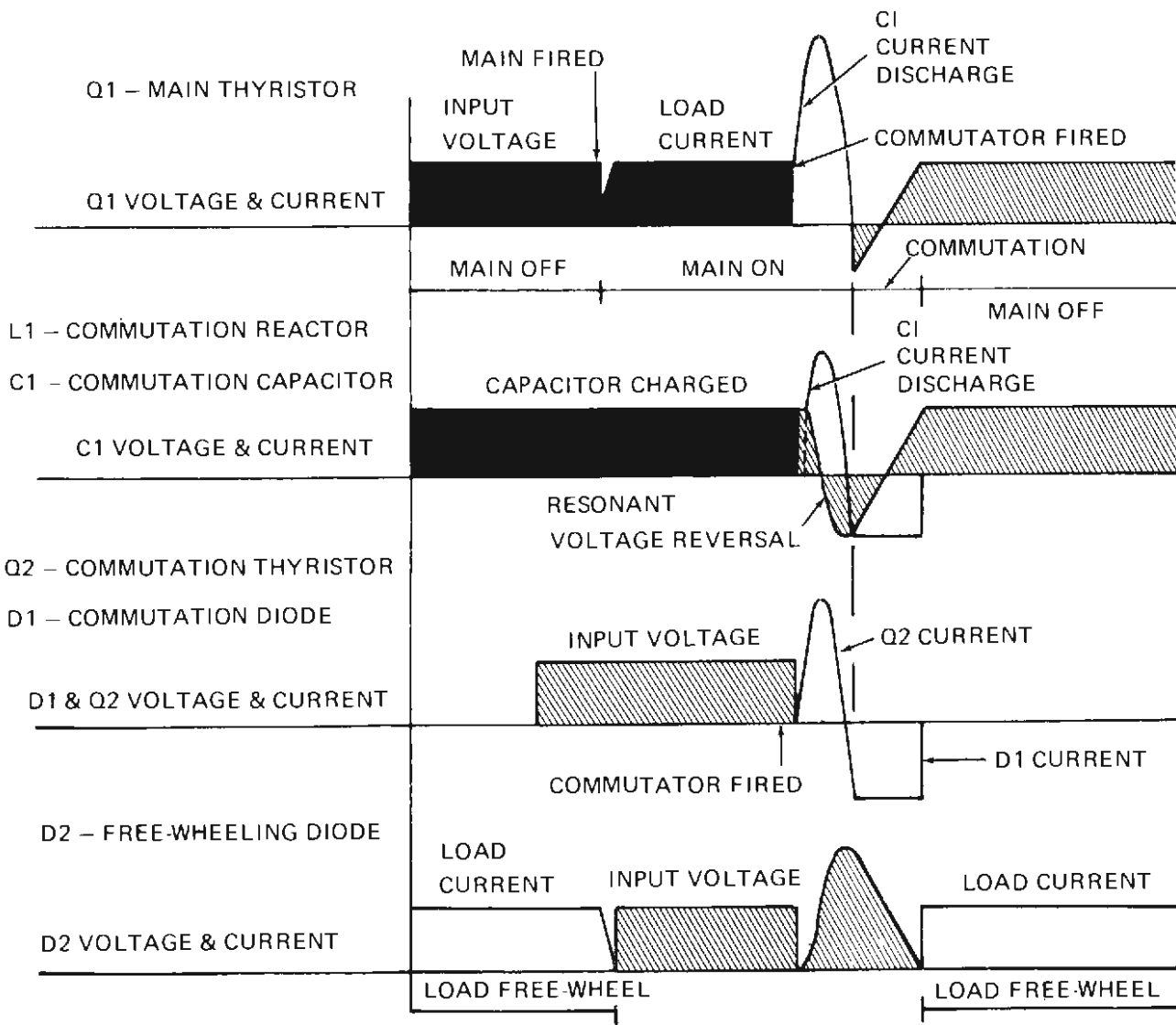
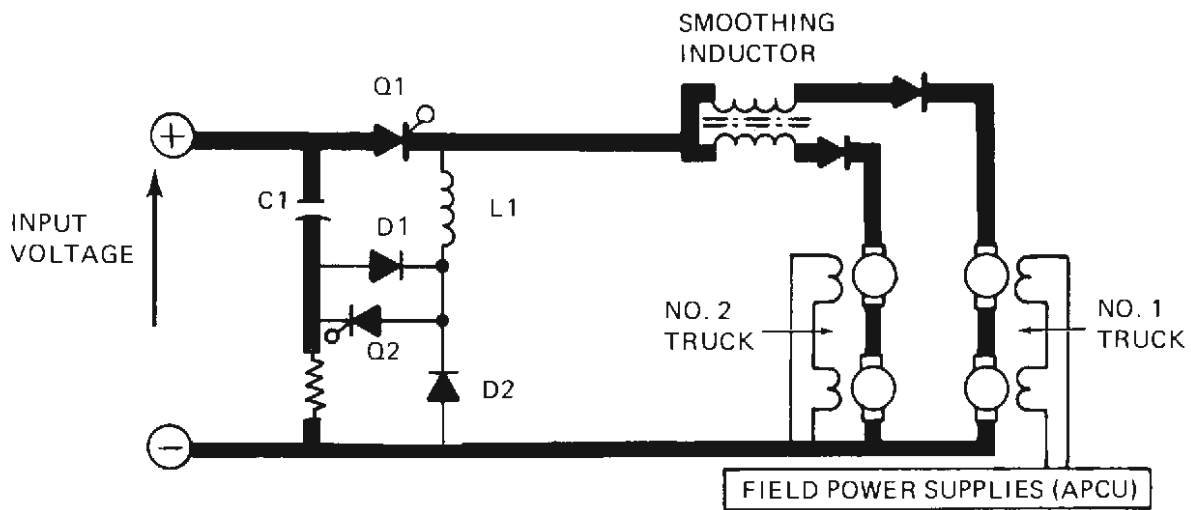

Figure 4-20. Chopper Operation: Main-Q1 "Fired On"

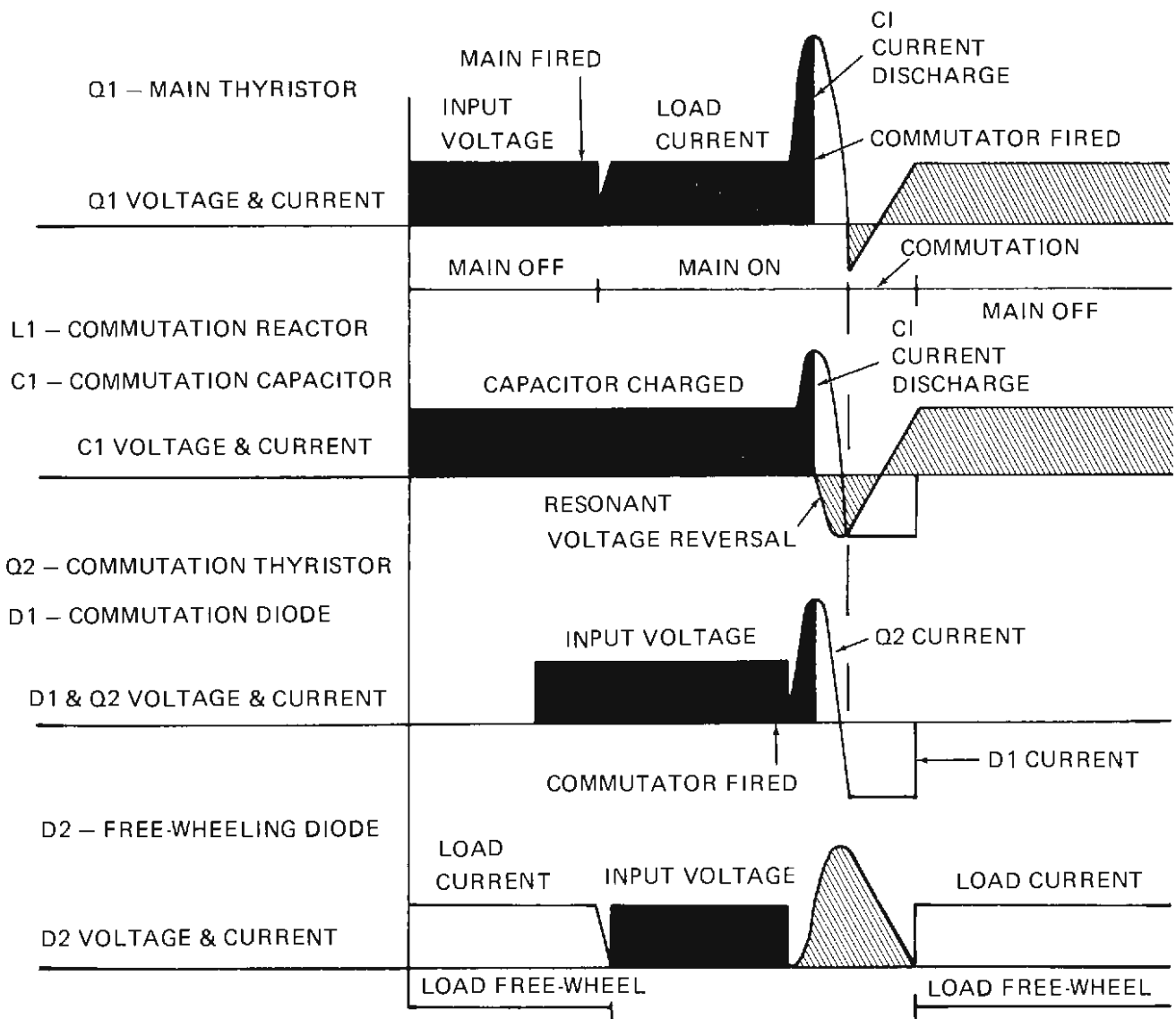
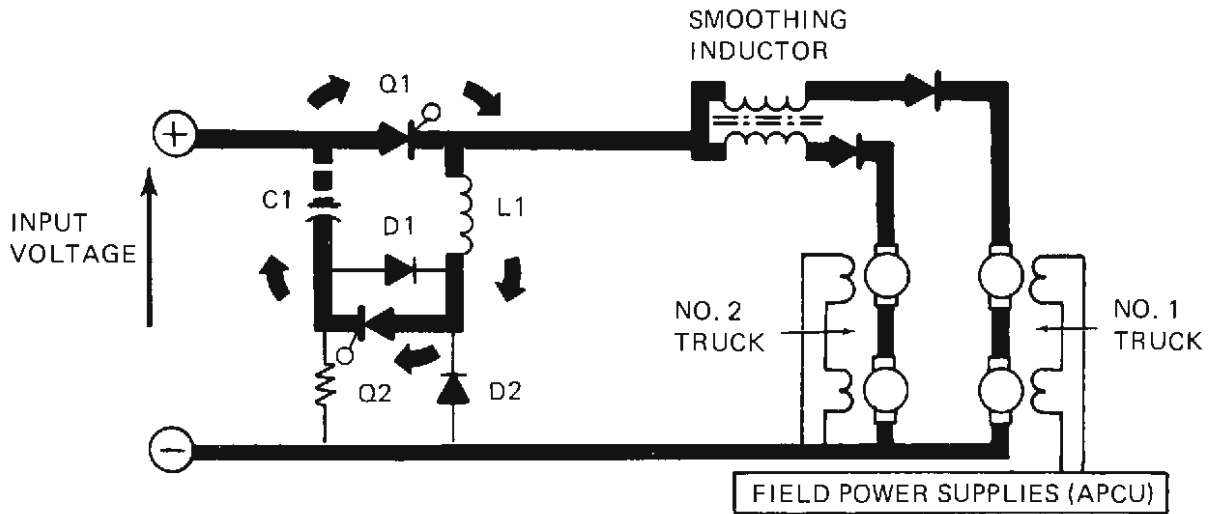

Figure 4-21. Chopper Operation: Main-Q1 "On", Commutator-Q2 "Fired On"

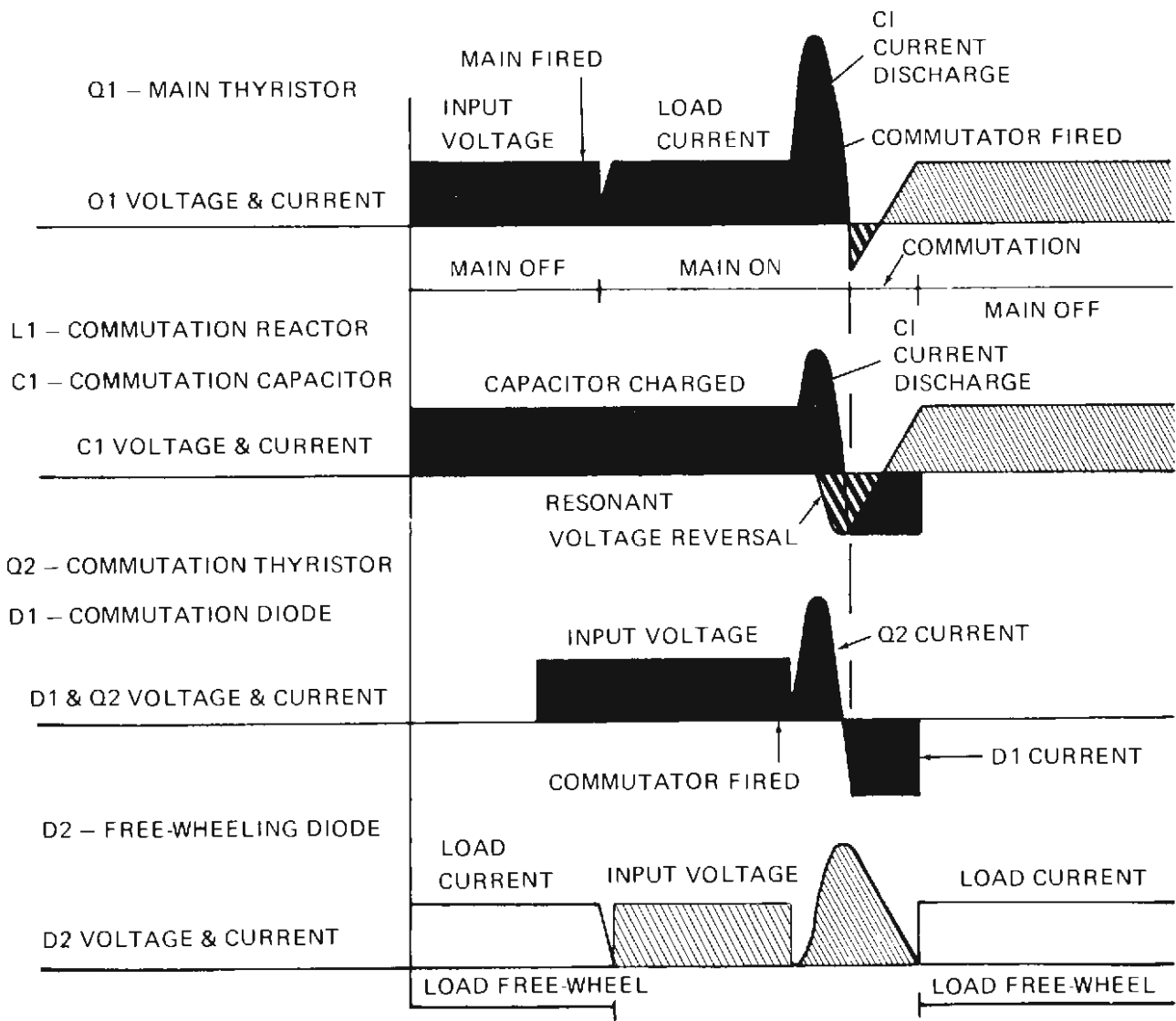
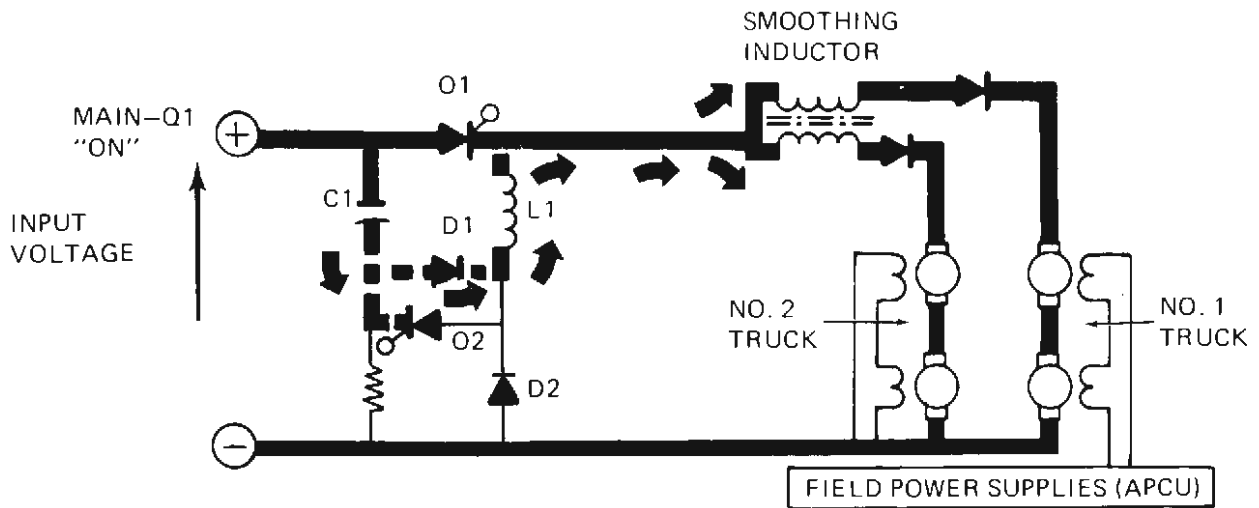

Figure 4-22. Chopper Operation: Main-Q1 "On", Commutator-Q2 "Off"

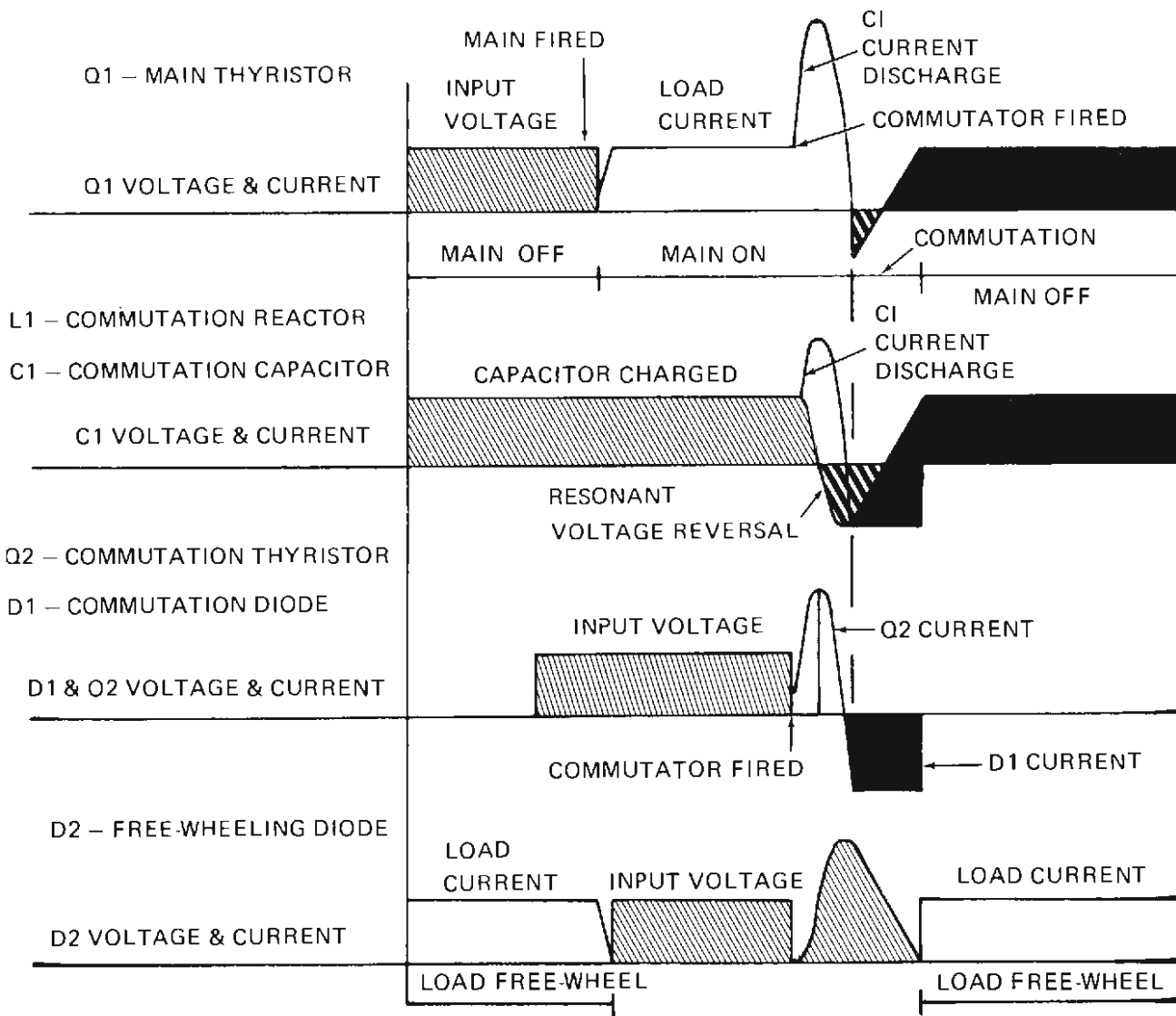
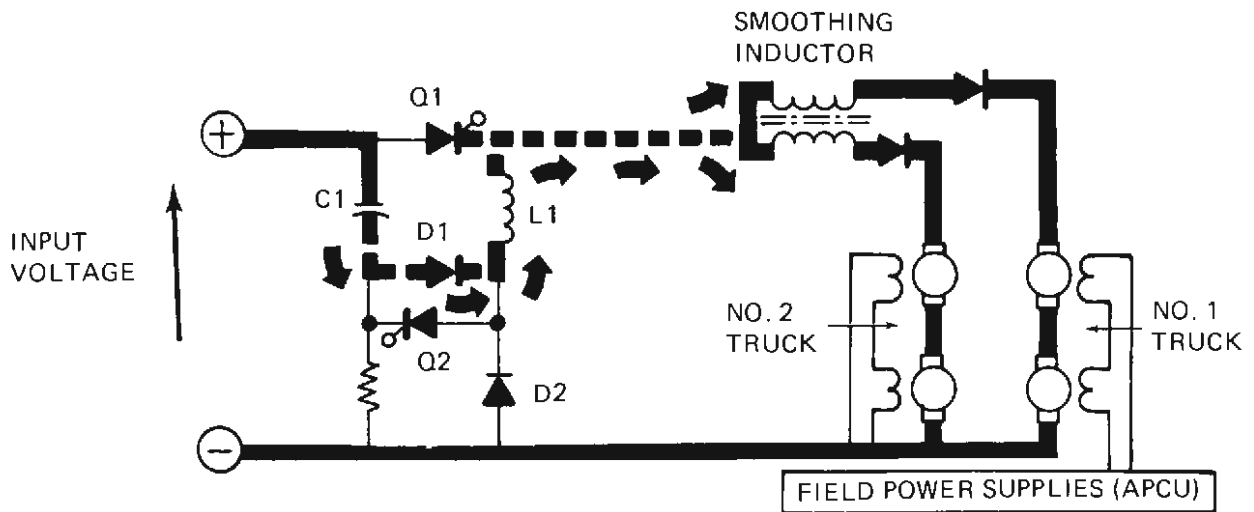

Figure 4-23. Chopper Operation: Main-Q1 Commutated "Off"

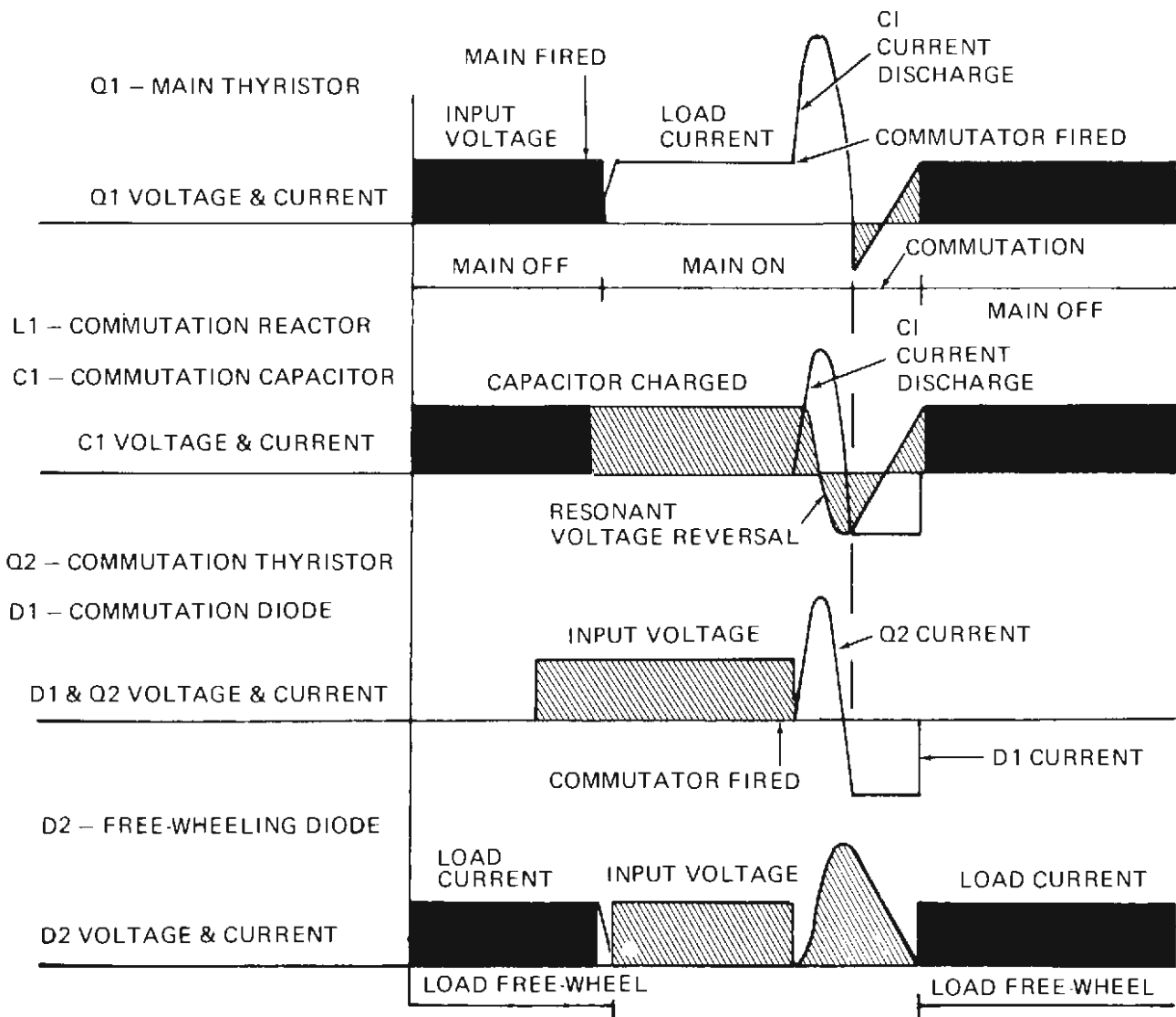
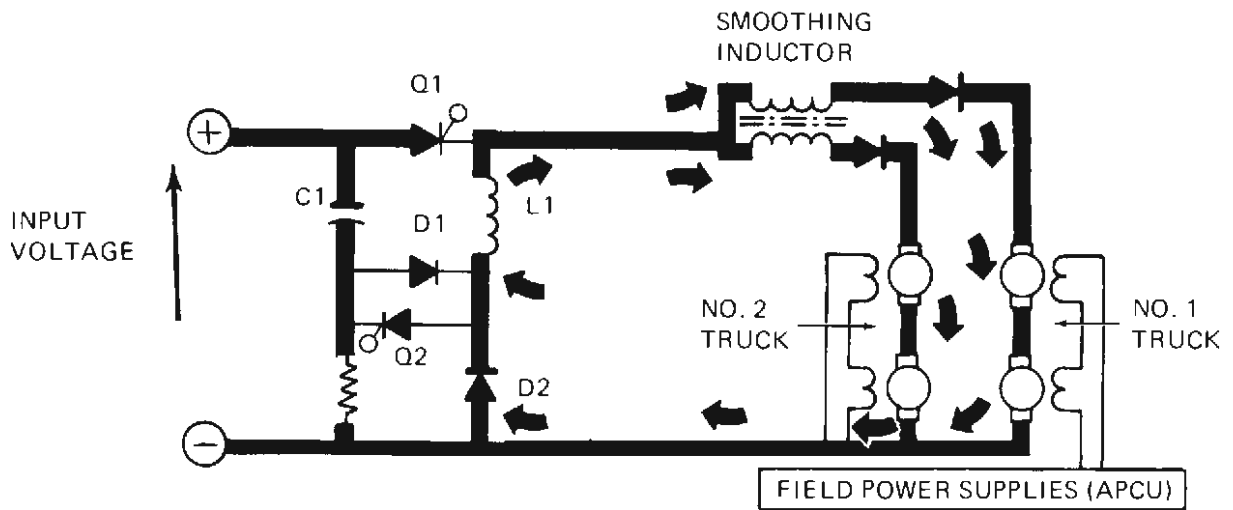

Figure 4-24. Chopper Operation: Main-Q1 "Off", Load Free Wheel

input side of the chopper is now in a state similar to Interval 1. with the exception of the load current.

The relationship of the Q1 on gate, Q2 on gate, and the time when both Q1 and Q2 are off determine the chopper on/off ratio and the average current delivered to the load. (Q1-on to Q2-on equals chopper on time.)

4.7 BRAKE SYSTEMS

The SOAC vehicle has four essentially separate braking systems (see Figure 11):

- Dynamic (electrical) brake system
- Service friction air brake system
- Emergency friction air brake system
- Hydraulic parking brake

Dynamic Brake System

The dynamic brake system provides most of the braking effort from 80 mph down to 3 mph. This system consists of the traction motors connected as generators producing controlled power, which is absorbed in the brake resistor grids under the car. Data taken during test programs has indicated that the SOAC dynamic brake system alone (without friction brake blending) is capable of bringing the car to a complete stop. Incorporated in the SOAC dynamic brake design is a slip-slide system with an extremely rapid response that results in an efficiency of over 77 percent in achieving available adhesion on wet rails. This system also functions during car acceleration with an efficiency of over 80 percent. (A discussion of the sequence of events during dynamic braking was previously presented in "Operation in Dynamic Brake Mode" under PROPULSION SYSTEM OPERATION, Section 4.4.)

The dynamic brake circuit is made up by opening the drive contactor DK (item 11 in Figure 15) and opening contactor BK (item 25) while closing contactor BK (item 24). The chopper then shunts the brake resistor grid as necessary to control armature current (braking effort). Figure 4-18 illustrates the braking effort characteristics of the electrical brake system.

Air Brake System Equipment

The friction brake consists of an electronically controlled air brake system, with control on a per-truck basis,

which actuates truck-mounted brake cylinders that apply Cobra composition shoes to all 8 wheels (1 shoe per wheel). Wheel slide protection is provided in service friction braking. Figure 4-25 illustrates the air brake subsystem; brake equipment is as follows.

Air Compressor - The air compressor supplies conditioned air to the main reservoir and brake supply reservoirs. This pneumatic system provides air for air suspension, trainlined and main reservoir brake pipes, pneumatic couplers, and the air brake system.

The air compressor is a 2-stage reciprocating unit driven by a 230-volt 3-phase 60-Hz motor mounted on the compressor crankshaft. The motor is rated at 7.5 horsepower nominal at 1170 rpm operating speed. The compressor is oil cooled and has its own oil filters. The intake air is conditioned by a combined silencer-filter; both intercooler and aftercooler units have safety valves. The compressor supplies air to the main reservoir at a rate of 30 cfm at 150 psi. The estimated weight of the compressor unit (shown in Figure 4-26) is 680 pounds.

Air Reservoirs - Three air reservoirs are mounted on the SOAC, one main and two for brake supply. The main reservoir, of 4.8 cubic feet capacity, is charged by the air compressor to a pressure between 130 psi (compressor cut-in) and 150 psi. The reservoir contains an automatic drain valve and a release valve.

The two brake supply reservoirs, of 2.0 cubic feet capacity each, are charged by the main reservoir through a check valve in each analog brake unit.

Analog Brake Units - The SOAC is equipped with two electropneumatic analog brake units, one per truck. An A and a B unit are provided for each car, with the A unit equipped with a charging and emergency magnet valve. Figure 4-27 shows an A unit with its various valve and control components:

- Electropneumatic Control Valve - This valve provides air pressure inversely proportional to the electrical control current: full release of brakes for full current. The output of the built-in pilot valve is used to control the relay valve.
- Relay Valve - This valve accepts low-volume pressure signals from the electropneumatic control valve (service) or the emergency variable load valve (emergency) and relays the required high-volume pressure to the four brake cylinders on one truck. A control-to-output pressure ratio of 1.1 is maintained.

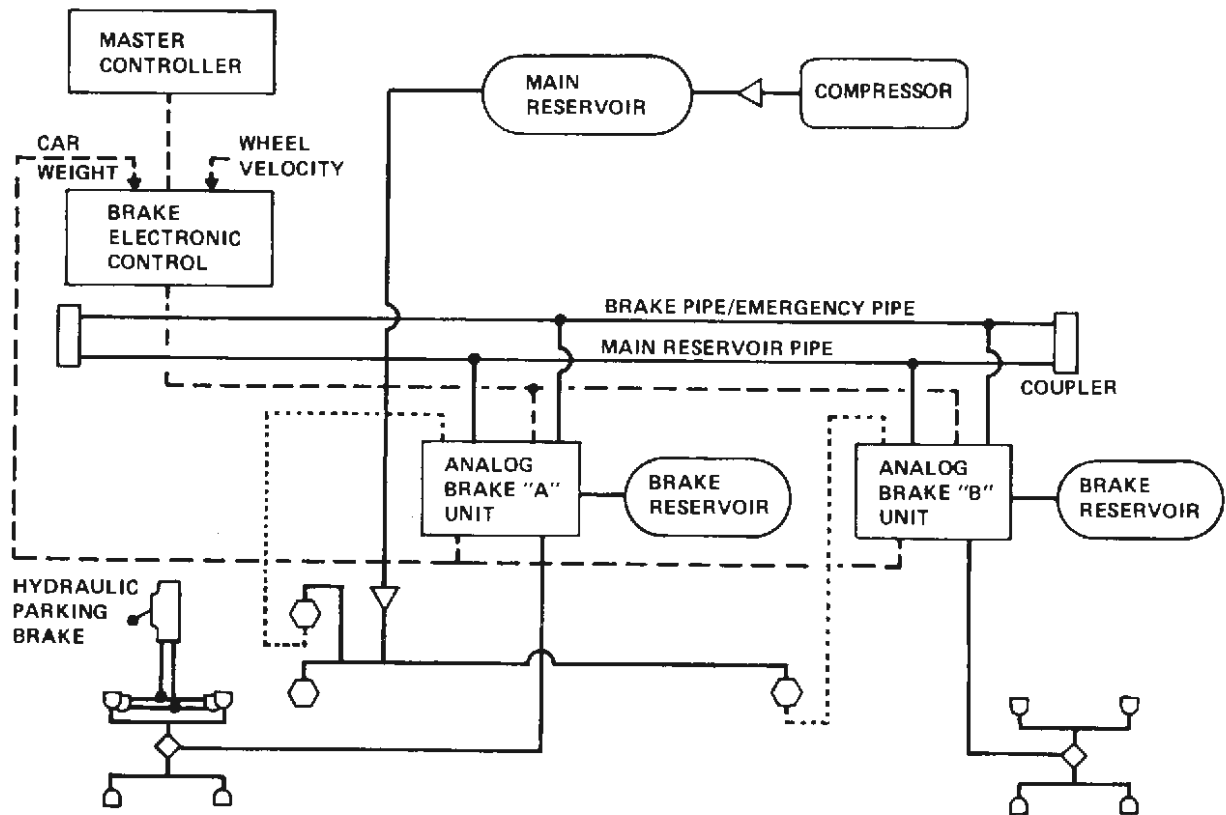

LEGEND

- SUPPLY AIR
- - - - PNEUMATIC PRESSURE SIGNAL
- · - · ELECTRICAL SIGNAL
- ⬡ LEVELING VALVE
- ⬢ BRAKE CYLINDER
- ⬠ CHECK VALVE
- ⬠ TWIN CHECK VALVES/CHOKED BYPASS

Figure 4-25. Brake System Schematic

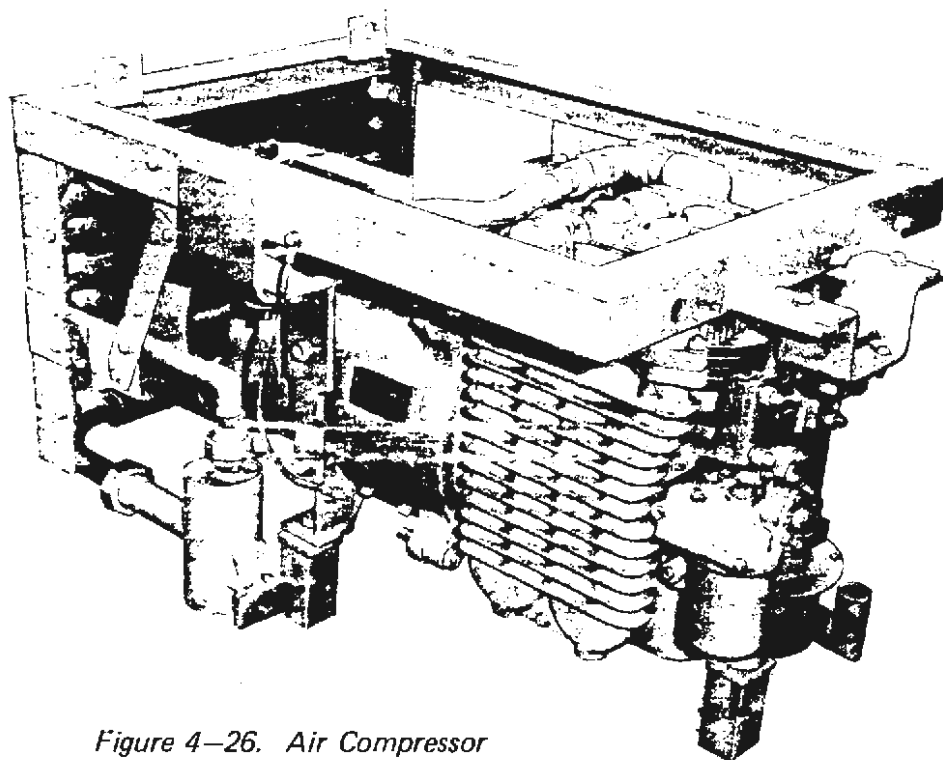
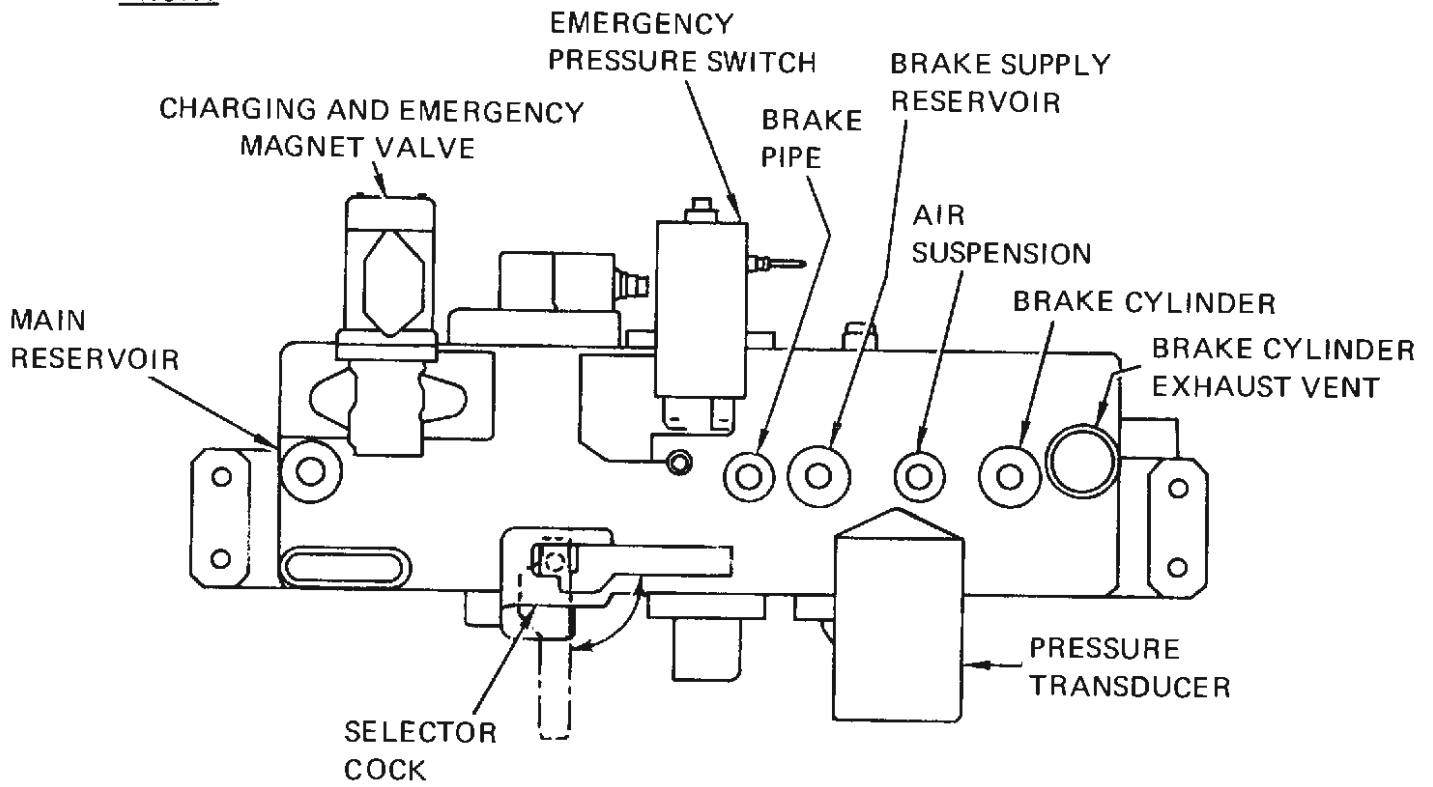

Figure 4-26. Air Compressor

FRONT



BACK

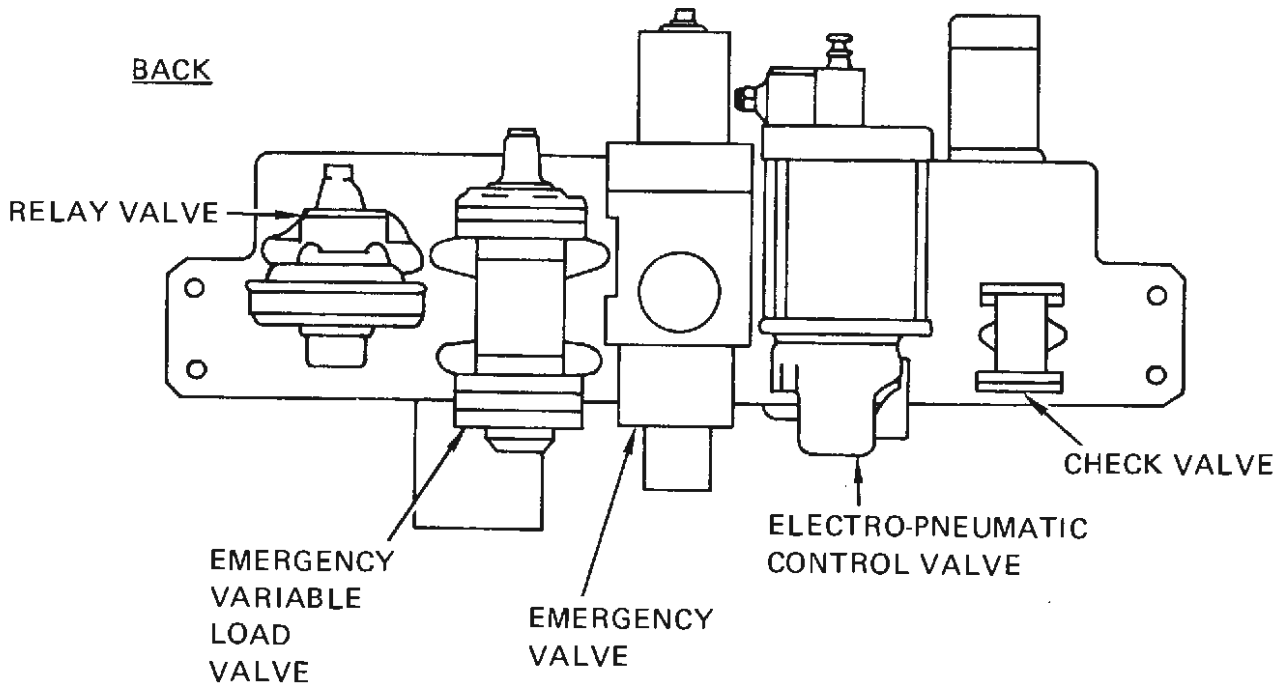

Figure 4-27. Type "A" Analog Electro-Pneumatic Unit

Two diaphragms are provided, operating in series since the relay valve functions in both service and emergency braking.

- Emergency Valve - This valve detects a predetermined rate of pressure drop and upon operation causes the emergency brake pipe to vent. Air from the supply reservoir then passes through the emergency variable load valve to the relay valve and the brake cylinders. A timing reservoir is provided which provides an irretrievable stop feature: the brake pipe cannot be recharged until the 30-second delay time is fulfilled.
- Emergency Variable Load Valve - This valve functions during emergency brake applications to limit the pilot air pressure to the relay valve in proportion to car weight as sensed by air suspension pressure. The valve does not affect the electronically load-weighted service brake pilot pressure.
- Charging and Emergency Magnet Valve - This valve connects the main reservoir to the emergency pressure (knockout) switch, the emergency valves, and the emergency brake pipe. It is normally energized open and when deenergized (closed) causes rapid venting of the brake pipe. The valve then isolates the main reservoir line. When reenergized, the valve allows the brake pipe to charge from the main reservoir.
- Emergency Pressure Switch - This switch is maintained energized by the emergency pipe pressure and interrupts either propulsion or dynamic braking in the event of emergency pipe venting. Emergency braking is then accomplished using friction air brakes alone.
- Pressure Transducer-Load Weight - This transducer produces an electrical output proportional to its input air suspension pressure. The linear electrical output is proportional to car weight, and is sent to an electronic unit (PPCU) where it modulates the control P-signal in both propulsion and service braking.
- Check Valve with Filter - This valve supplies main reservoir air to the relay valve, the emergency valve and the electropneumatic control valve (by the selector cock).
- Selector Cock - This control allows isolation of the service brake components while retaining the emergency brake function. The electropneumatic control valve is vented through this cock.

Tread Brake Units - The high volume air pressure from the relay valve on the analog unit is sent to the brake cylinder mounted on each of the four brake actuator units. Figure 4-28 shows a brake unit and its various components. The brake actuators are mounted between the wheels on the trucks and apply the controlled air pressure to each wheel through COBRA composition brake shoes. Automatic slack adjustment for shoe wear is provided using a helical ratchet and combination push-rod and adjusting screw within the actuator housing. A resetting handwheel and latch are also provided for manual slack adjustment following shoe replacement.

The two actuator units on the motorman's side of the cab end of the cars are provided with a hydraulically applied and released handbrake. The selector valve, handpump, fluid reservoir, ON-OFF indicator, and relief and check valves are contained in a cab-mounted unit supplying the two brake actuator hydraulic units. The hydraulic unit applies braking force to lever A in Figure 4-28 at a point between the brake cylinder rod and the fulcrum pin.

Additional Air Brake Equipment - In addition to the items discussed above, the following indication and control equipment is provided:

- Control logic (PPCU box)
- Cab duplex air gauge (brake pipe and brake cylinder)
- Cab brake panel (ON-OFF) indicator lights for air brake, snow brake, and handbrake and snowbrake switch
- Conductor's valve (vents brake pipe; applies emergency brakes)
- Trip cocks on trucks (vent brake pipe and apply emergency brakes when activated by track trip; resets automatically)

Air Brake System Control

The air brake system derives its input command from the master controller. During service braking, the air brake provides inshot pressure as well as any braking effort in excess of the dynamic brake effort required to meet the input braking command. During emergency braking, the traction system dynamic braking is disabled and all-friction air braking is utilized.

Service Friction Braking - A block diagram of the service air brake control system is shown in Figure 4-29. During normal service stops using blended braking, the air brake is held

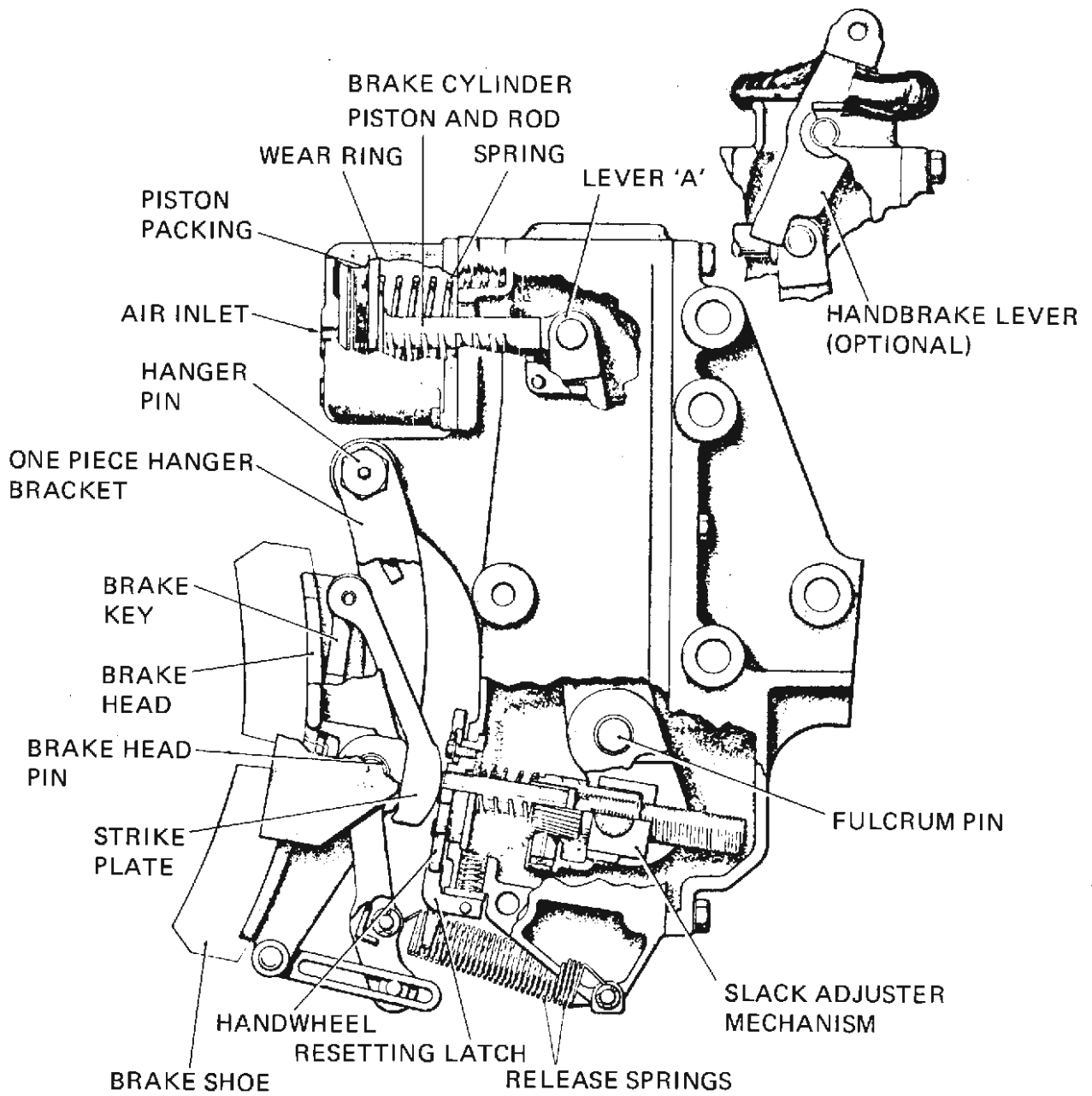

Figure 4-28. Brake Actuator (Non-Handbrake Unit)

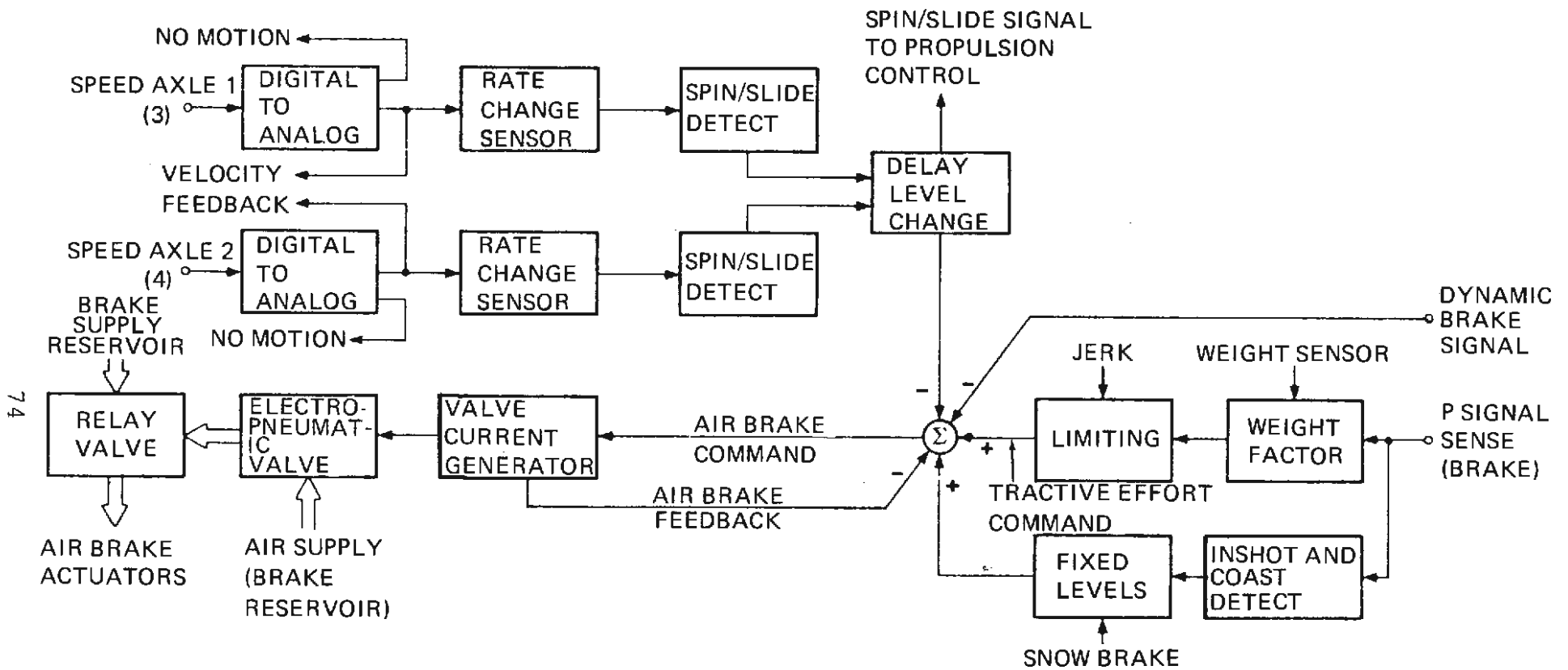

Figure 4-29. Air Brake Control System (on Each Tank)

off by the dynamic brake feedback signal (DB signal in Figure 4-30). At high car weights where the dynamic brake effort cannot meet the full-service brake command, the air brake will receive a command from the blender, and friction brakes will be applied so that the commanded rate is achieved. If the dynamic brake is disabled, the air brake will receive the full brake effort command, and the stop will be completed on air brakes alone under control from the master controller. The friction brake is applied to inshot pressure (6 to 8 psi) under all conditions where dynamic braking can achieve the desired rate. This reduces the response time required to perform any brake blending.

Loss of third-rail power during blended braking (e.g., rail gaps or sudden loss of dynamic braking) will result in automatic transfer to service friction braking with full-service deceleration reestablished within approximately 1.3 seconds. When third-rail power is established following a gap, the control system will revert to dynamic braking. This transfer to service friction braking occurs because third-rail power is required for the two traction motor field power supplies, and the energy stored in the capacitor bank and motor alternator inertia may not be sufficient to power the fields in a long track gap.

Figure 4-30 illustrates the response to a step controller input of the service friction brake without dynamic braking for a 90,000-pound car. The nominal brake cylinder pressures associated with the various car weights are also shown in this figure (based on engineering test program data). The step command for full-service brake from the master controller is translated into a jerk-limited current command at the electropneumatic analog valve after a time delay associated with mode switching. Application of brake cylinder pressure and increase of deceleration rate retard the analog valve current due to the volume of air required to fill the brake cylinders. A nominal rate of 3.0 mphps \pm 10 percent is achieved following a jerk rate of 2.4 mphpsps. Brake cylinder pressure remains constant at 57 to 58 psi throughout the completion of the stop.

Spin-Slide Control - Both service friction and dynamic brake systems are provided with spin-slide protection systems which operate to reduce braking effort and correct wheel slides. The spin-slide detection system is illustrated in the upper portion of Figure 4-29. The spin-slide signal output is sent to the tractive-braking effort control loop (Figure 4-15) and acts to reduce the P-signal or brake command, which enters from the right in Figure 4-30. The brake system then cycles between high and low brake effort according to wheel slip condition with a resulting frequency of 1.8 Hz for the dynamic brake or 0.6 Hz for friction brakes alone, as required during

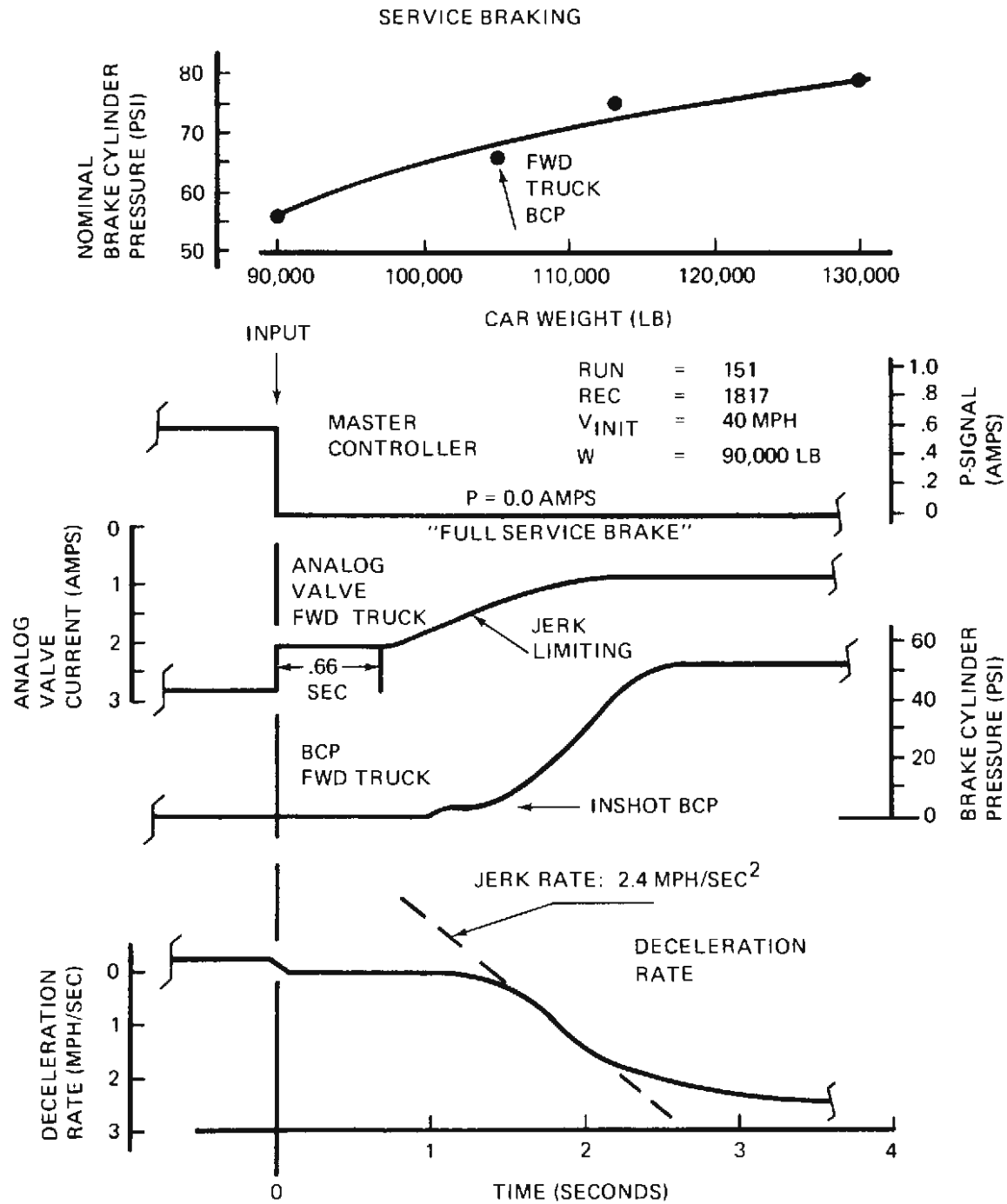

Figure 4-30. Friction Brake Pressure and Application Characteristics

a continuous sequence of slides. The service friction brake achieves an efficiency of approximately 63 percent of available adhesion or deceleration rate. This compares to an efficiency of over 77 percent for the faster responding dynamic brake system alone.

Emergency Friction Braking - The emergency air brake uses the same brake cylinders, piping to the electropneumatic valve unit, and relay valve as the service brake. However, the electropneumatic control valve and its control loop are bypassed, and the venting of the brake pipe by the emergency magnet valve (followed by emergency load-weigh valve) causes the relay valve to provide the desired brake cylinder pressure. Figure 4-31 illustrates the brake control. An irretrievable stop is obtained using a 30-second timing reservoir to prevent rapid brake pipe recharge. The wheel spin-slide system is locked out in emergency braking. The brake rate of 3.2 mphps nominal is achieved within 1.4 seconds from brake command.

Emergency braking is commanded in several ways: power lever, emergency stop pushbutton, cab and conductors' pull cords, loss of brake pipe pressure (broken pipe, decoupled cars, etc.) and total power loss (third rail or battery). All these conditions result in dumping pressure from the brake pipe, sealing reservoirs from brake pipe venting, cutting all traction power, and applying emergency brake pressure to the cylinders and brake shoes.

Remote Brake Cutout - Provisions for disconnecting and venting the brake cylinder air lines from inside the car were incorporated after the cars were delivered. Since the SOAC has a brake cutout cock for each truck, a separate inside-the-car control was installed for each truck, thus providing additional flexibility and avoiding excessive control run length. Each control consists of a pull-to-release handle accessible through a swing panel (No. 2 for the forward truck; No. 10 for the aft truck) connected to a push-pull control cable passing through the edge of the floor and undercar insulation cover. A sliding link attached to the lower movable end of the control cable connects (at an appropriate distance from the cutout cock) to a pinned link which connects to a handle adapter on the cock.

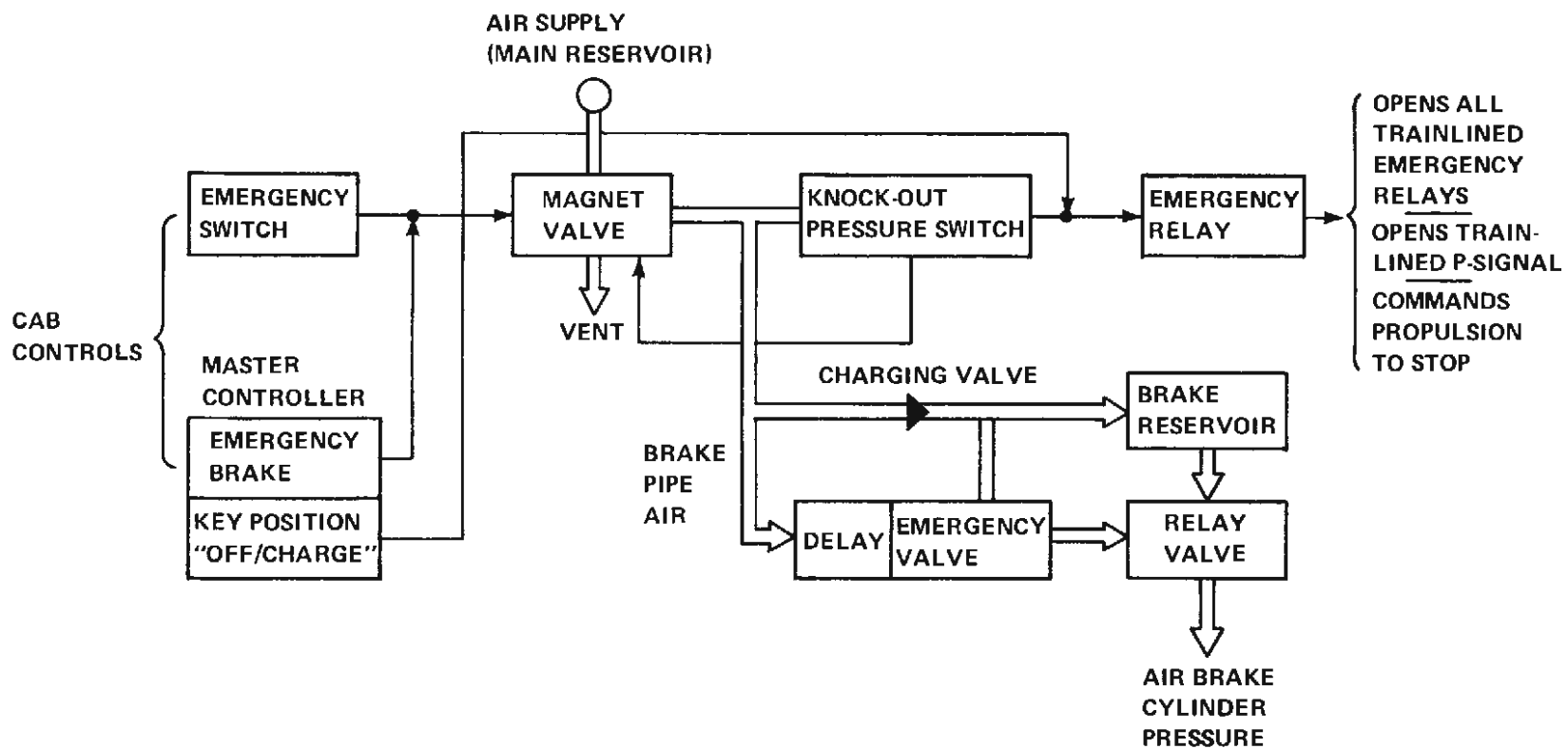

Figure 4-31. Emergency Brake Control

5. SUBSYSTEMS

5.1 TRUCKS

The SOAC truck and suspension system, (Figures 5-1 and 5-2) provides improved ride quality and reduced noise. The trucks are of the inside-bearing-equalized "General 70" type with full air suspension. Assembled weight of the cast alloy nickel steel truck is 14,500 pounds. It has a 7-foot 6-inch wheel-base for standard gauge track and is designed for a maximum load on top of the bolster spring of 41,500 pounds.

The truck frame supports a cast steel truck bolster by means of side bearings. The frame and bolster are protected against separation at the center pivot by a 2-inch diameter locking center pin. An air spring is mounted at each end of the truck bolster to support the car body. The truck bolster is connected to the car body through two longitudinal anchors, one at each side of the car. Truck bolster and car body can move vertically and transversely relative to each other but cannot swivel or move longitudinally. Two safety straps suspended from the car body pass beneath the truck bolster to protect against accidental separation of truck and car body.

The air suspension system consists of one Firestone Airide spring at each corner of the car. When passenger load is added to or removed from the car, the air pressure in the springs is adjusted automatically by the action of leveling valves at each end of the car, thereby maintaining a constant floor height. Truck bolsters are sealed to form reservoirs for the air springs.

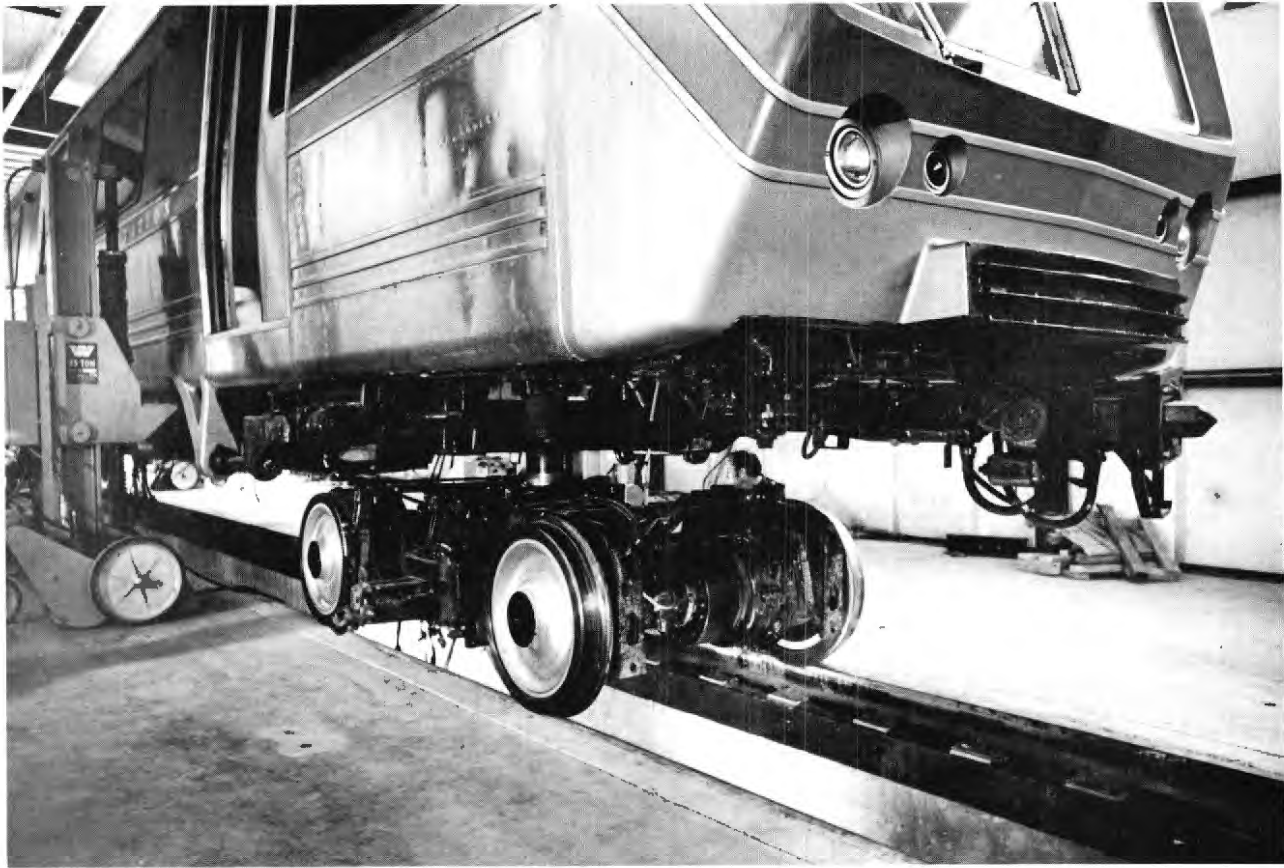

Figure 5-1. Truck

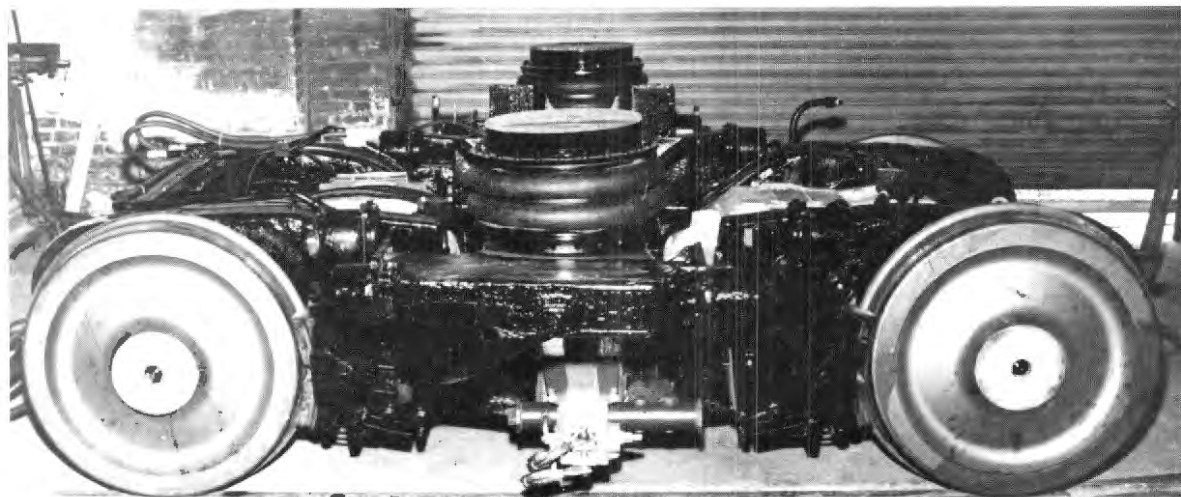

Figure 5-2. Truck and Suspension

Vertical vibration damping is accomplished with removable orifices inside the air springs, supplemented by external hydraulic shock absorbers. Resilient stops mounted on the car body contact the bolster to limit excessive lateral movements of the car body. Additional resilient stops are mounted inside the air spring to limit vertical movement of the car.

The total range of adjustment to accommodate various platform heights in service is 5 inches. Adjustment is made through the use of shims.

5.2 RESILIENT WHEELS

Resilient, retreadable Acousta Flex wheels (Figure 5-3), manufactured by the Standard Steel Division of Baldwin-Lima-Hamilton Corporation, were installed prior to completion of the engineering tests. These wheels have an aluminum hub, a steel rim, and a steel (tread-flange) tire. A layer of silicone rubber separates the rim and the hub sections. Wheel sections are connected by a multipoint shunt for electrical continuity.

The wheel is 30 inches in diameter, weighs 462 pounds, and has a 1:20 tread contour. The hub has porting for the use of hydraulic assist when it must be removed from the axle. When the condemning limit diameter of 28 inches has been reached, the steel (tread-flange) tire can be removed from the rim and a replacement installed by shrink-fitting.

The primary benefit of the resilient wheels is a significant reduction in squeal, especially when the cars negotiate low radius curves. Other anticipated benefits are reductions in the higher frequency vibrations and roar and impact noises induced by the wheel/rail interface. The weight of the wheels is also considerably less than conventional steel wheels.

Braking tests described in Section 6 were made with these resilient wheels.

5.3 HEATING, VENTILATING, AND AIR CONDITIONING

The SOAC heating, ventilating, and air conditioning system is illustrated in Figure 5-4. The system, provided by the Safety Electric Company, consists of two independent 8-ton AC systems per car, each separately controlled by its own temperature control panel and thermostat.

Each 8-ton system consists of a compressor-condenser unit mounted under the car, and an evaporator and blower unit mounted overhead at the end of the car (Figure 5-5). Motor

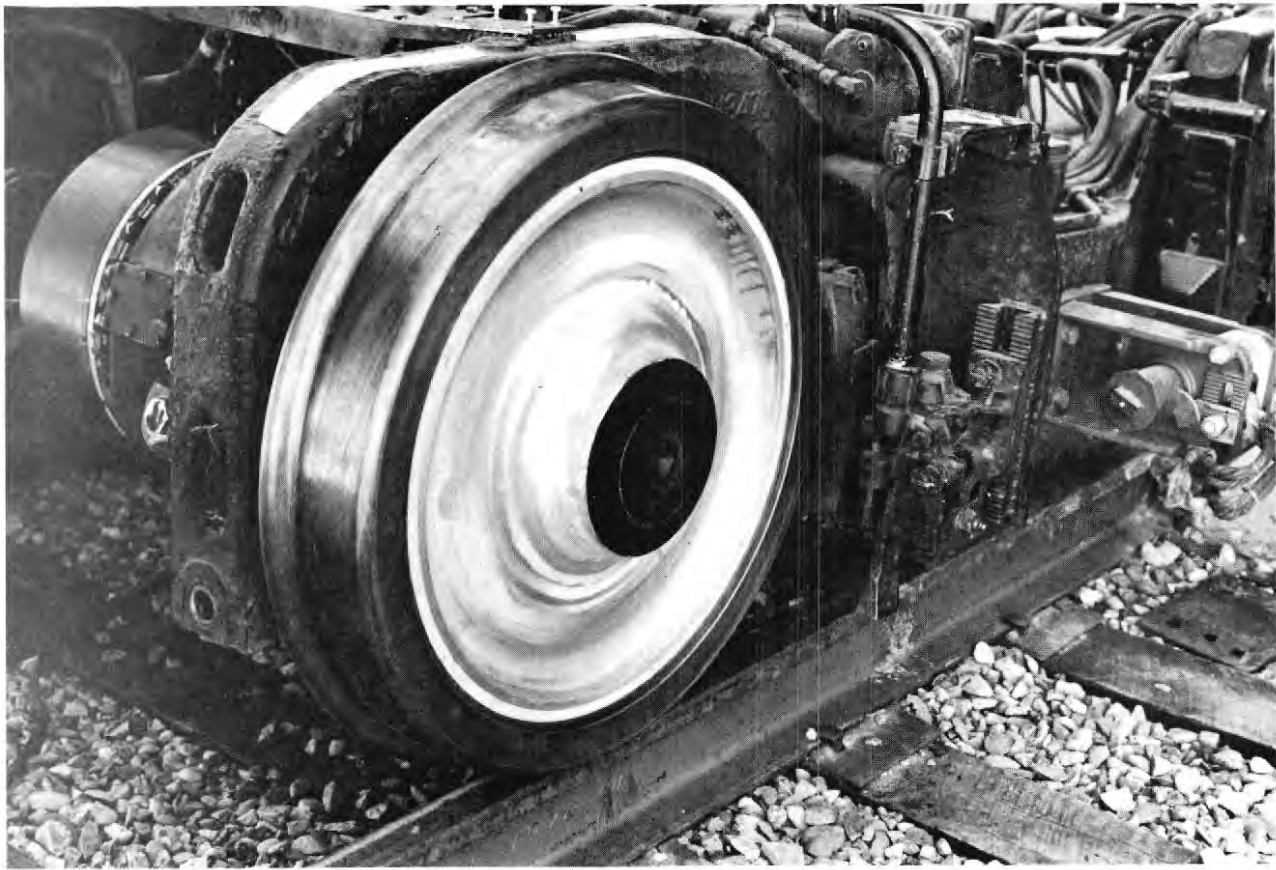

Figure 5-3. Acousta-Flex Wheel

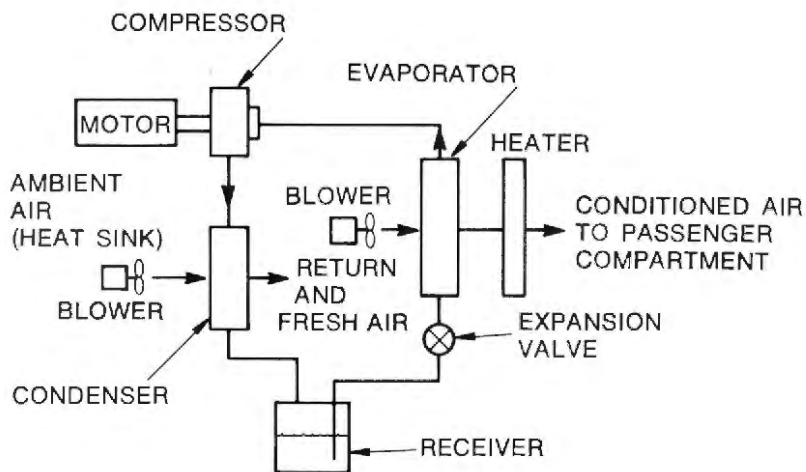

Figure 5-4. Heating, Ventilating and Air-Conditioning System



Figure 5-5. Overhead Heating, Ventilating, and Air-Conditioning Installation

controls and protective devices are mounted on a single panel to conserve space. The individual systems use R-12 refrigerant and are rated at 96,000 Btu/hr.

A centerline air duct has a diagonal splitter for mixing the two airstreams from the two air conditioners within the car body. Within a total of 4000 cfm (per car) air circulation, 1800 cfm of fresh air is mixed in during warm weather operation. The system is designed to maintain a 75°F maximum interior temperature over an outside temperature range of -15 to 105°F.

The overhead electric heat assembly is mounted downstream of the evaporator coil. It is an open design, employing corrosion-proof bare wire elements with ceramic insulators. The heater is arranged for two-stage operation of 9 and 16 kw at 600-vdc power supply. Each stage of heat is distributed over the entire heater face. The 9-kw or first stage of overhead heat is used to provide a sensible heat load for the reheat cycle during summer operation and to temper the outside air during winter operation. At 35°F (outside temperature) 25 kw of electric heat is used. To provide protection against excessive heat buildup, a single-pole double thermoswitch with silicone rubber overmold is set to open at 150°F; an automatic reset to close contacts at 135°F is mounted at the top of the heater casing.

5.4 COUPLER AND DRAFT GEAR

Mechanical Coupling

The SOAC coupler and draft gear system (see Figure 5-6) as supplied by the Ohio Brass Company, provides automatic, tight-lock, hook-type coupling. Side-mounted electric couplers are provided on the No. 2 ends only. The coupler has a lateral lineup or gathering range at the face of the coupler to permit automatic coupling if it is 3-3/8 inches to the left or to the right of the centerline of the opposing coupler. The coupler has a vertical lineup or gathering range at the face of the coupler of 6 inches (3 inches up or down) from standard height. The coupler, drawbar and anchorage have a minimum strength of 225,000 pounds in pull and 400,000 pounds in buff. The drawbars at both the No. 1 and 2 ends are provided with an automatic air action centering device which maintains the coupler in its center position.

Electric Coupling

Electrical coupling equipment supplied by Walton Products provides electrical coupling between the cars. The electric coupler box assemblies consist of two carbon steel boxes

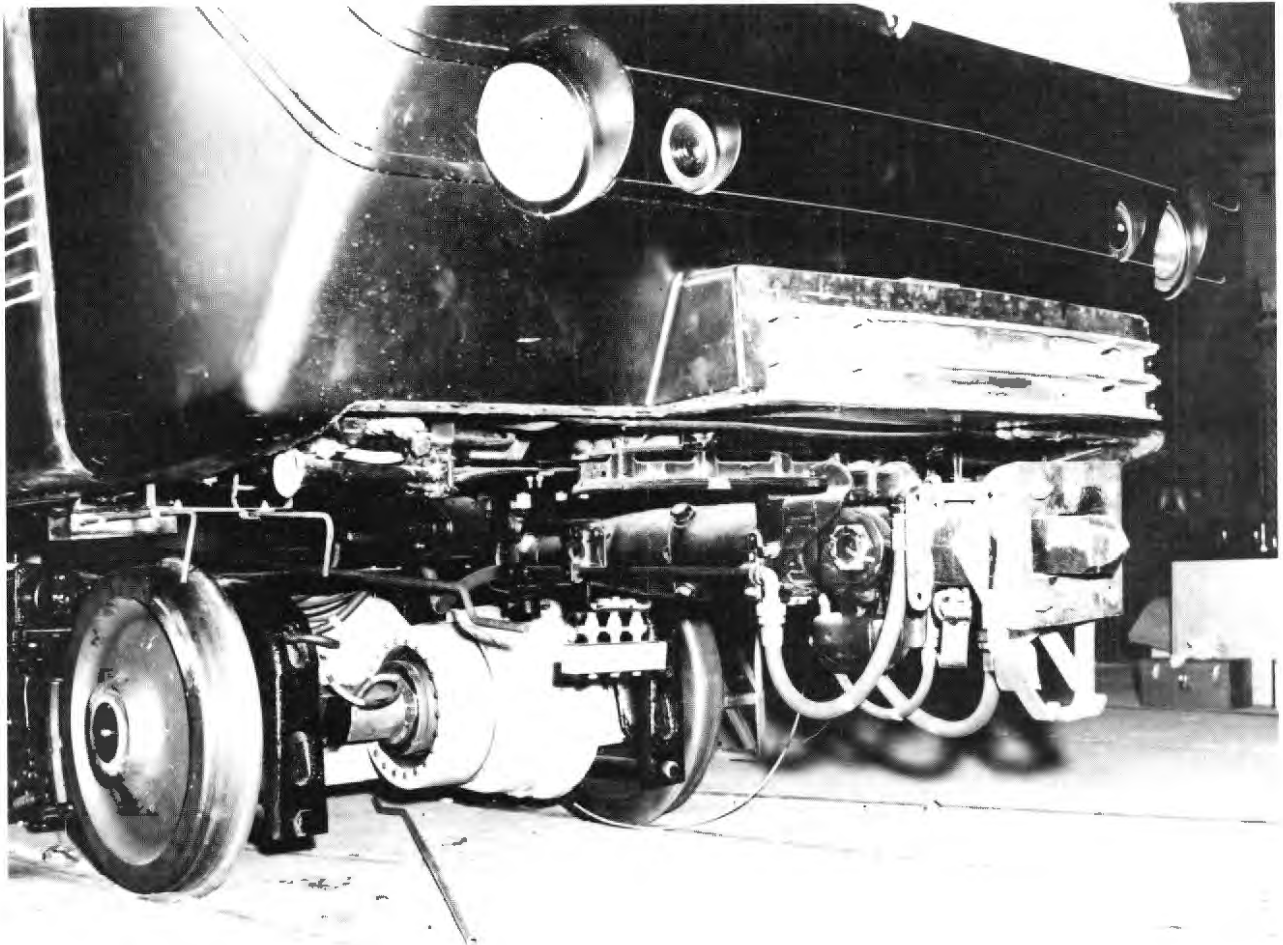

Figure 5-6. Coupler and Draft Gear

(Figure 5-7) mounted one on each side of the mechanical coupler. Each electric head contains 59 springloaded contacts: 15 fixed in the projected position, and 44 retractable.

If proper air pressure of 125 pounds is not available, electric coupling may be made manually by using a hand crank.

Key electrical trainline functions which go through the coupler are:

1. Public address
2. Intercom
3. Radio
4. Coupler
5. Side doors
6. Lights
7. Emergency valve loop
8. P-wire
9. Propulsion control
10. End doors
11. Side signs
12. Brake control
13. Handbrake indicator
14. Air comfort
15. Battery power (B1+ and B2+)

5.5 DOORS AND DOOR OPERATORS

Side Doors

The 6-foot high, 50-inch wide side doors are of hollow construction with honeycomb filler; stainless-steel exterior surfaces have No. 4 brushed finish. The doors are fully insulated with fiberglass insulation; interior surfaces are treated with sound- and vibration-damping material. The doors are hung on steel ball-bearing hangers so designed that the eccentric loading of the door does not spread the track or misalign the door.

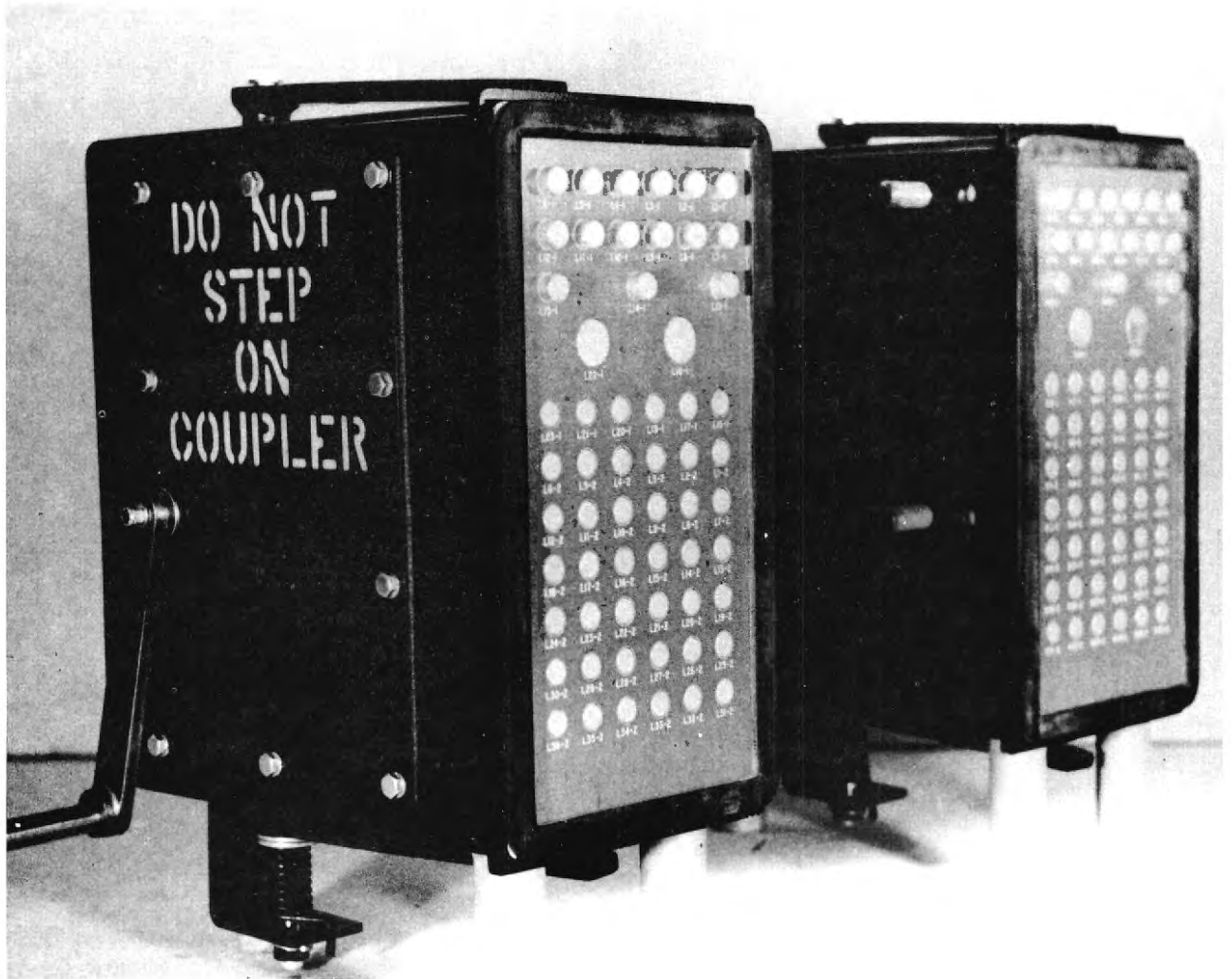

Figure 5-7. Electric Coupler Boxes

Door Operators

The door operator, control, and system signaling circuits provided by the Vapor Corporation are designed for operation from the car's 36-vdc battery. The complete system is designed to function within each car or via trainlines in the two-car train.

Each of the four double-leaf doors is activated by its own operator (16 per car). In normal system operation, the door operators (see Figure 5-8) are activated to open or close upon receipt of the proper command from the door control unit mounted in the cab. The door control unit cannot be activated unless the train has stopped and the speed sensor contacts have closed in a series-connected zero-speed relay contact.

Each door operator motor is protected against thermal overload by means of a temperature-activated cutout switch which automatically opens and causes a high wattage resistor to be connected in series with the motor DC 1 line. The motor is designed to withstand a stalled condition with the opening of the thermal cutout.

The mechanical design of the door operator linkage is such that it provides an overcenter locking feature when the door panel is moved to the closed position. This prevents the door panel from being opened manually unless the overcenter-lock is released either electrically, through rotation of the operator motor, or manually through action of the emergency operating lever. The emergency operating lever, an integral part of each door operator, permits manual opening of the door panel, if required. Actuating the emergency lever also opens an emergency switch which removes electrical power and prevents an electrical closing.

Each door operator circuit includes a four-pole, toggle-type switch, whose center OFF/CUTOUT position provides a means of electrically disconnecting the operator function when it is desired to perform maintenance or cut the operator from service in the event of a malfunction. For normal system operation, the operator is connected in the NORMAL position. To test door operation, a spring-return TEST position will close an open door (if the open signal is applied in the door control unit mounted in the cab). The door will open again when the switch lever returns to NORMAL.

Components of the door control and signaling system are wired to various system relays mounted on the door control relay panel for the corresponding car side. One panel per car side is located at the No. 1 end of the car; the relay panel is located in an area near its respective door control unit. The door control units include a master key switch assembly,

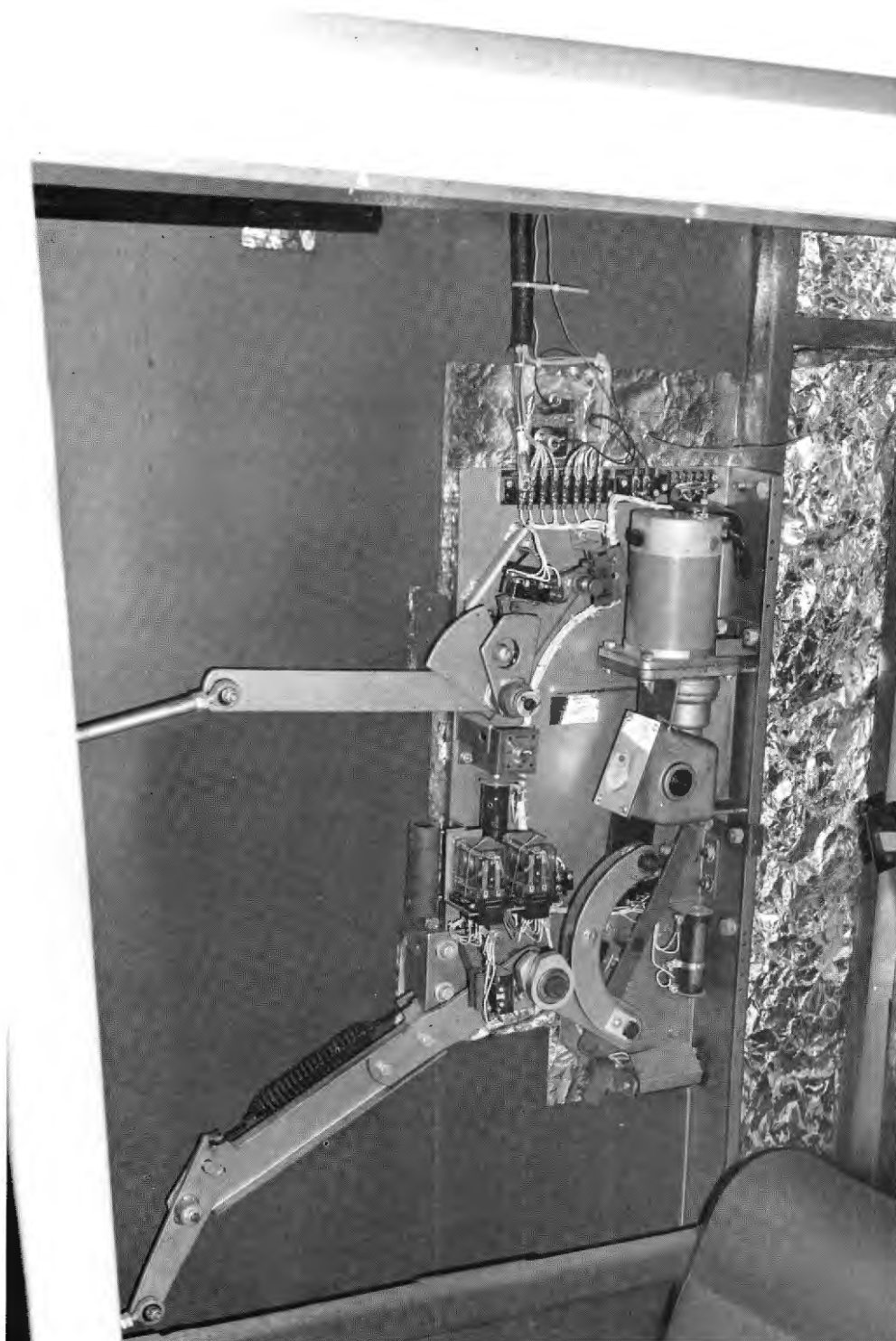

Figure 5-8. Door Operator

two OPEN and two CLOSE pushbuttons, and two red zone signal lights.

A signal light assembly with a red lens is located outside the car, adjacent to each door panel. Two parallel-connected 6-watt 40-volt lamps are lit as the adjacent door panel moves to an open position. "Hung" doors are therefore easy for the crew to locate.

Door operators are designed to prevent slamming at the completion of travel in either direction. Pressure buildup on the door edge measured at midtravel will not exceed 22 pounds when energized by 36 volts.

Operating time for opening the doors (including cushioning) is 1.2 seconds maximum; closing speeds are adjustable from 1.5 to 3 seconds.

An audible, solid-state electronic chime, interconnected with the public address system, is provided for each car. It is activated to sound a door closing signal approximately one second before the door closing cycle is started.

In the event of an emergency involving the loss of power, each door operator is equipped with handles which permit the mechanical opening of the side doors. In addition, each door operator contains an electrical cutout feature which permits isolation of a troublesome leaf and continued train operation.

5.6 COMMUNICATIONS

The following communication and public address systems are installed on each SOAC car.

Public Address System

The public address system on each car consists of a telephone handset mounted on the motorman's console, two wall mounted microphones, one transistor amplifier unit and eight loudspeakers. The system is designed to permit the crew to conduct private communications using the handsets, or make public announcements through either the handset or the wall microphones.

Train to Wayside

Radio communications between the train and wayside are conducted using a two-way radio specifically designed for heavy-duty railroad application. Two antenna systems are provided: one mounted on the roof (for greater range where clearance permits), the other mounted in the cab. Frequency changes can be made by changing crystals.

The motorman can communicate directly with the command center; and, by use of a mode selector switch, can permit the command center to make announcements to the passengers. Power for radio communications is provided directly from the battery.

5.7 AUTOMATIC POWER CHANGEOVER

Since power will be provided from either an overhead or third-rail source during the SOAC operational demonstration, a special unit was designed to accomplish this changeover "on the fly".

The changeover unit, which weighs 450 pounds consists of two specially designed NEMA size 8 DC contactors rated at 1500 amperes continuous duty. The contactors are mounted in an enclosure which in turn mounts directly to the underside of the car.

Whenever one of the power sources (third rail or pantograph) is energized, a contactor automatically connects this power source to the knife switch input terminal and excludes the opposite power source. If this power source terminates and the opposite source becomes energized, the unit automatically transfers to the new source and excludes the other.

5.8 POWER COLLECTORS

Pantograph

A lightweight pantograph installation has been designed to allow the SOAC vehicle to operate on selected transit lines in Cleveland and Chicago.

Structural modifications to the No. 2 end of each car provide for the weight of the pantograph, as well as a wooden walkway on both sides of the car to support three or four workmen.

The pantograph (Figure 5-9) may be raised or lowered in 4 to 6 seconds using a DC series motor in conjunction with a driving spring force which maintains contact pressure against the catenary. Provision is also made for manually raising or lowering the pantograph.

After the master controller has been made operative, the pantograph is controlled through trainlines from the operating cab. Both pantographs may be raised or lowered from the operating cab; a red warning light illuminates when they are in the elevated position.

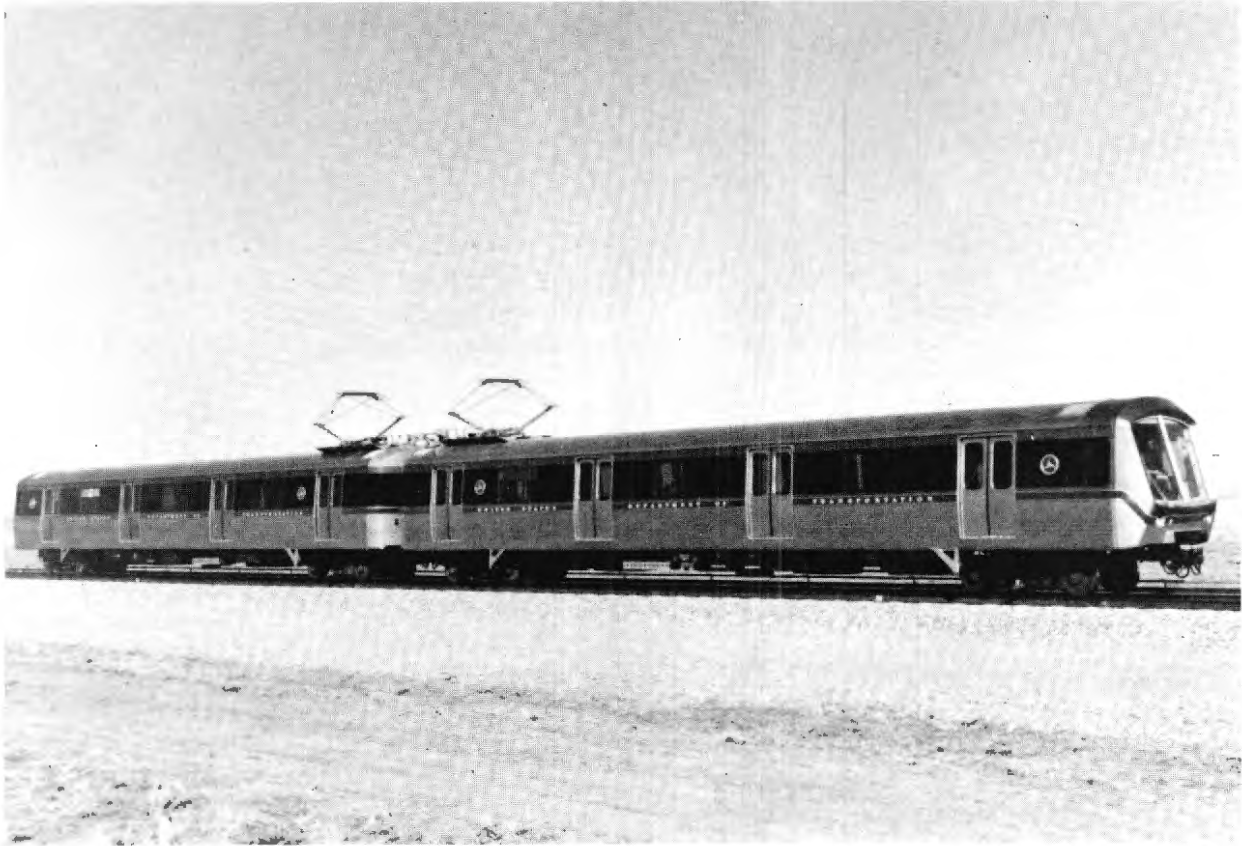

Figure 5-9. Pantograph (Partially Extended)

The weight of each pantograph is 775 pounds. They are capable of operation through a span of 11 feet, from maximum elevation down to within 3 inches of the locked-down position. Insulation has been provided to insure that when the pantograph is in the locked-down position, inadvertent application of 1000 volts to the pantograph will not result in arc-over to the car frame.

Third-Rail Collector

The third-rail power collector shown in Figure 5-10 was designed and supplied by the Ohio Brass Company. Weighing less than 40 pounds, it has a rubber torsional unit which eliminates most of the bouncing and provides additional spring forces to aid the natural shoe weight in response to rail height variations. The collector paddle is adjustable for height and contact rail pressure by loosening fasteners and rotating the torsion shaft to the desired level. Two collector mounting brackets weighing approximately 7 pounds each are required for each collector.

The collector will operate on systems using 600 to 1000 vdc at speeds up to 80 to 100 mph. The malleable iron shoe is readily replaceable if damaged.

5.9 LIGHTING

Interior Lighting

The passenger area of each car is illuminated by a fluorescent lamp system consisting of 37 fixtures. Light levels in the car vary from a peak of 50 foot-candles, measured 20 inches laterally from the centerline of each door on the A side of the car 36 inches above the floor, to a minimum of 35 foot-candles measured at the seated reading plane. Together with the attractive colorful interior, the lighting gives the interior a general appearance of comfort. Lamps are protected by lenses designed to prevent the accumulation of moisture or dust, and are easily removable for service.

Cab Lighting

Two fluorescent fixtures in the operating cab area provide a well illuminated, glare-free area for the operator. Cab lights and main lights are controlled by separate circuit breakers.

Headlights and Tail Lights

Two sealed-beam, 60-watt headlights and two taillights in recessed, weathertight housings are provided in the No. 1 end

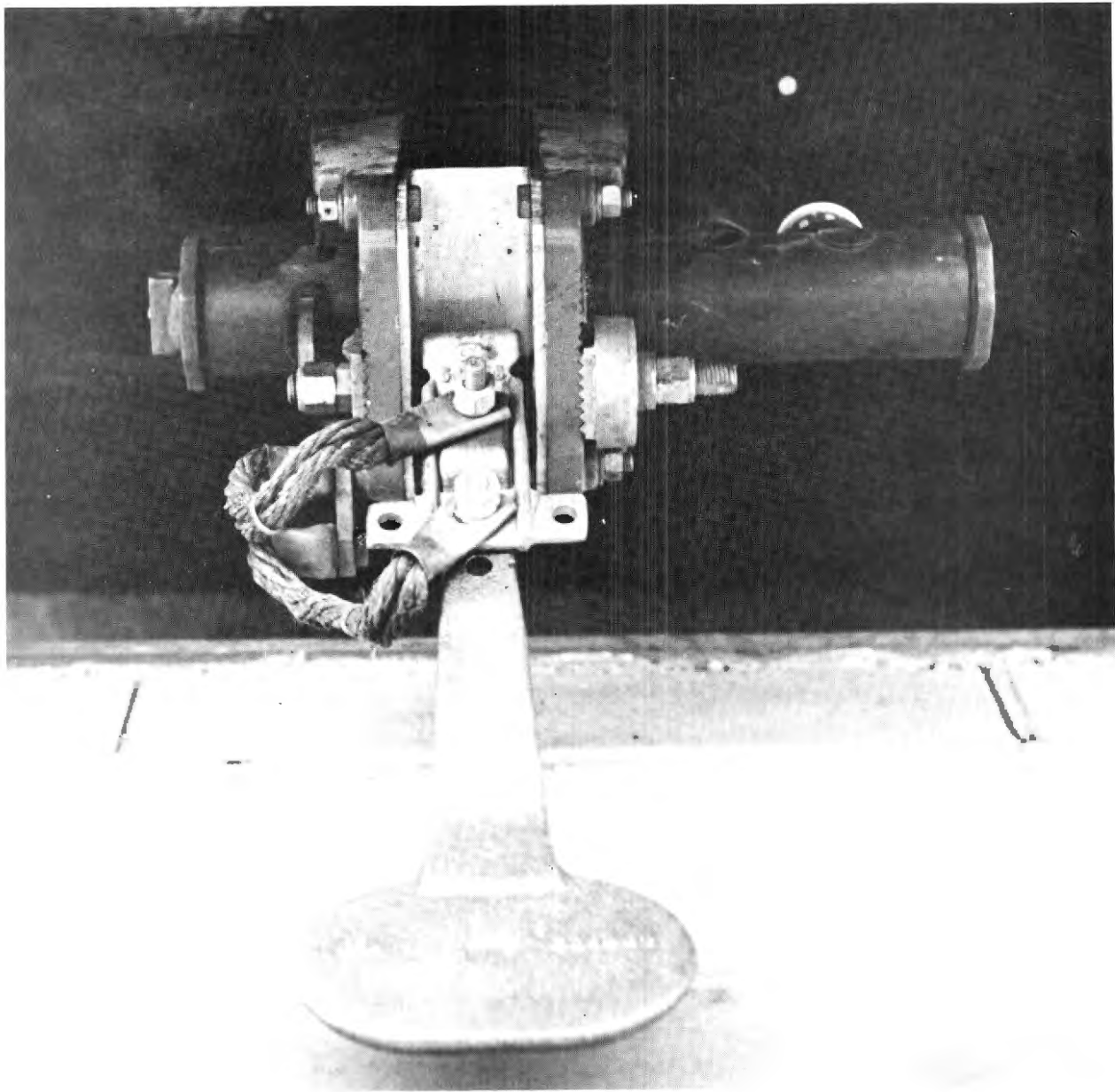

Figure 5-10. Third Rail Power Pickup

of each car. In addition, two 15-watt red lens taillights are mounted on the No. 2 end.

Hostling and Marker Lights

Two 15-watt hostling lights are provided on the No. 2 end of each car. They have clear lenses and are activated by a separate circuit breaker.

Emergency Lights

Each SOAC car has eight incandescent emergency lamps powered by the car battery. Emergency lights are automatically energized if the main light circuits are interrupted when the main light switches are on. Six emergency lamps are located in the overhead centerline of the lighting fixtures: two in each end fixture, two in the center fixture, and the remaining two emergency lamps in a fixture in the dropped ceiling area of each car end.

If primary power is interrupted, headlights and taillights remain lighted by emergency power.

Main Lighting Power

Main lighting power is provided by an inverter unit mounted under the car. The inverter takes the battery voltage and converts it to 500 volts at 1500 cps.

5.10 HOSTLER

A hand-held hostling control box (Figure 5-11) is provided for each SOAC car. The unit is stored at the No. 2 end of the car behind a locked panel. The three-position switch permits selection of DRIVE, COAST, or OFF, and enables the operator to move the car in either direction at 2 mph. The hostler also provides an emergency stop control.

5.11 WINDOWS

The windshield, supplied by Swedlow Corporation, is formed from laminated stretched-acrylic safety glass. It has been tested to withstand a pressure loading equivalent to a car speed of 175 mph and will withstand the impact of a 5-pound stone at 50 mph or a 1-pound stone at 80 mph.

The side windows are of two types. The low-density car features 1/4-inch thick dual-laminated safety glass supplied under the original car contract by Libby-Owens-Ford. The high-density car side windows are 3/8-inch thick tinted plexiglass acrylic supplied by Rohm and Haas for demonstration.



Figure 5-11. Hostler

5.12 MONITOR PANEL

The SOAC cars have a "built-in" troubleshooting capability for the important propulsion and braking system parameters. This monitoring unit is housed in a metallic case and contains the display console board, the solid-state circuitry necessary to drive the display monitors, and a 50-foot interconnection cable to couple the unit to the Propulsion Power Control Unit (PPCU).

The display board (Figure 5-12) is divided into four sections:

1. Operation Annunicator Section

This section displays the digital logic functions of the drive and brake system. Each of the display functions is equipped with an amber lamp, and a plug jack for external instrumentation.

2. Parameter Monitor Section

This section functions in conjunction with the channel selection knobs and the meters at the top of the display board. The green parameter lamps indicate the parameter selected by the channel selector knob for display on the appropriate meter. Each parameter is also equipped with a plug jack for external instrumentation.

3. Shutdown Monitor Section

This section of red lamps indicates the initial event in a series shutdown caused by a system fault. A logic monitor card located in the propulsion control unit contains first event memory circuitry which latches on to the first event and clamps out all of the secondary events, preventing their display.

4. Power Supply Monitor

This section provides a self-contained +15 or -15 volt calibration power supply to monitor external instrumentation or check scale deflection on the display.

5.13 MOTORMAN'S CONTROL PANEL

The motorman's control panel contains the following control switches, buttons and indicators.

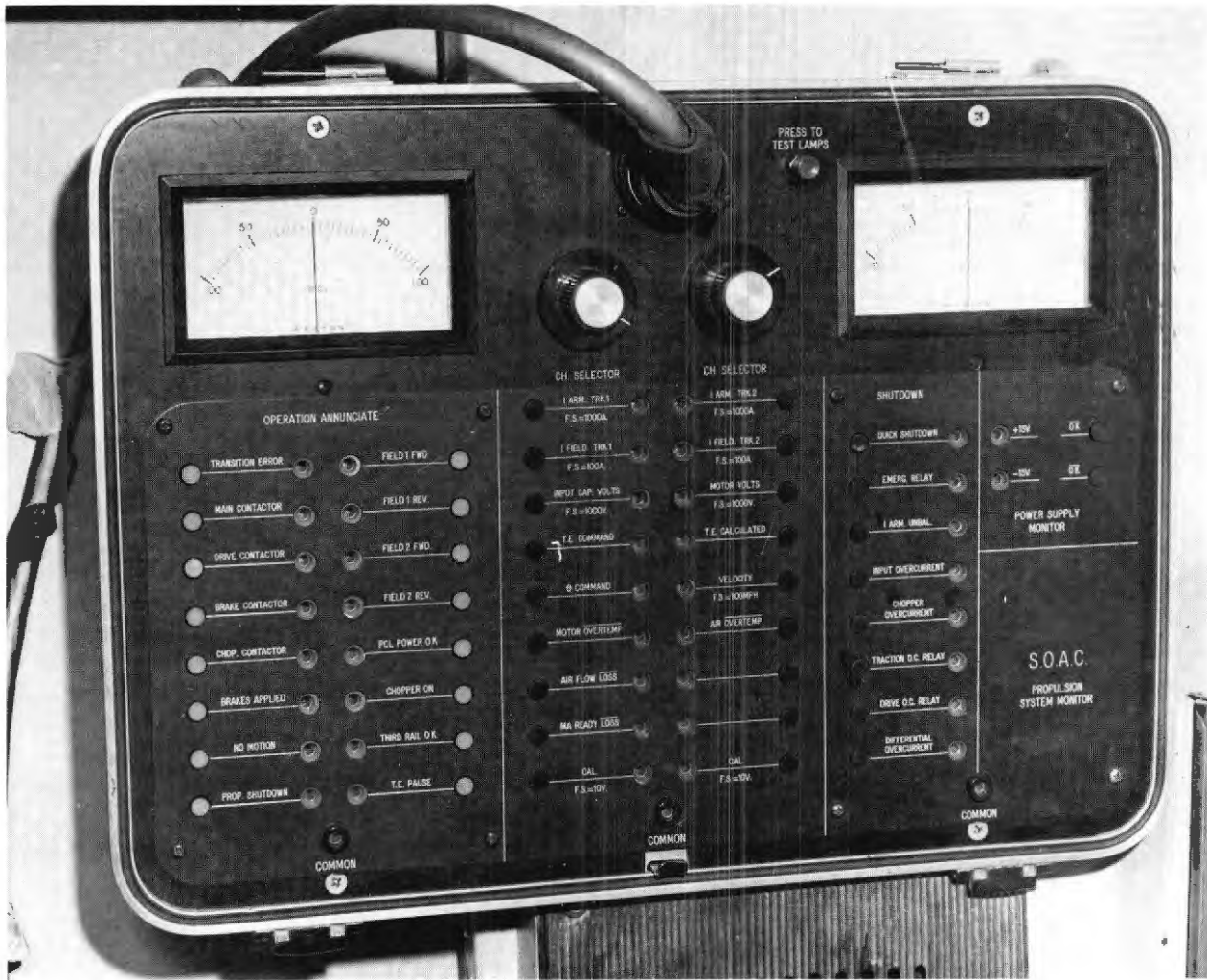

Figure 5-12. Monitor Panel

Pantograph

A switch on the console controls the position and operation of the pantographs, through trainlines, on both cars. The control positions are DOWN, OFF and UP. If both the pantographs and the third-rail shoes are installed and the pantograph is in the UP position, power collection is automatically switched to the source that has power or the source that first supplied power if power is available from both sources.

Horn

The horn push bar located at the bottom of the lower control panel operates the pneumatic horn at the operating cab end.

Reset

The reset pushbutton is used to reset propulsion system and motor-alternator trips from the cab.

Brake Lights

The brake panel consists of three indicator lights and a two-position knob to turn the snow brakes on or off. The lights indicate when the snow brakes and air brakes are on (air pressure in the brake cylinder) and the handbrake is applied.

Coupler Control

The coupler control is unlocked by its key switch. The air line blowout is used to blow out dirt from the end of the pneumatic lines prior to coupling. Mechanical coupling is automatically achieved by buffing the two cars together. Electrical coupling is accomplished by depressing the ADVANCE button, holding it down for 20 to 30 seconds, and then releasing it; a procedure which advances the electrical pins in the electrical coupler. Uncoupling is effected by retrieving the pins in a manner similar to advancing, but using the RETRIEVE button, depressing and holding the UNCOUPLE button, buffing the cars together, and then pulling them apart.

The ADVANCE and RETRIEVE buttons also operate the drum switch at the coupler that switches the trainline circuits into an end-of-consist or middle-of-consist configuration.

The coupler control in the cab operates only the coupler at that end of the car. An identical control, located at the B end (behind a locked swing panel), controls the B-end coupler. On the SOAC cars only the B-end couplers have electrical couplers.

Communications

This panel allows the motorman to control the mode of operation of the car's communications system. The motorman can select radio, intercom or public address modes; the handset is used in all three modes of operation. The buzzer pushbutton signals to the person in the other cab to answer the intercom. The radio transmitter light indicates when the transmitter is on. The cab/train switch allows radio messages to be broadcast directly over the public address system, or only over the cab speaker.

End Doors

The B-end door can be either locked or unlocked from the cab by use of the key switch. This function is trainlined; the indicator light is on when the doors are unlocked.

Side Doors

The Side Door Closed light is on when all side doors are closed; until the light is on the train cannot start. The Side Door Bypass pushbutton provides a means to move the train if one of the doors does not give a proper closed signal. After verifying that the door is safely closed the motorman may use this button to override the Door-Open interlock. The bypass button must be pushed each time the controller handle is moved back into coast or brake to reestablish the bypass.

Defroster

A two-speed electrically operated defroster mounted behind the motorman's console supplies warm air to the windshield.

Window Washer and Wiper

A two-position rotary console switch mounted near the top of the motorman's control panel operates the electrically operated window washer and wiper. Stops are provided to limit the wiper blade in both directions.

Speed Indicator

The SOAC cars are equipped with a digital readout ± 1 mph speed indicator. The speed indicator panel also contains the spin-slide and speed-fault indications.

6. TEST PROGRAM

The SOAC Test Program was designed to assure that SOAC systems function as required and that specified performance is achieved. These tests consisted of component and subsystem tests and vehicle performance tests. The component and subsystem tests were completed at St. Louis Car prior to delivery of the vehicles to the High Speed Ground Test Center in September 1972; acceptance tests were completed in April 1973.

An additional Engineering Test Program was conducted (under Transportation Systems Center (TSC) Contract DOT-TSC-580) to provide an engineering data gathering system and to conduct additional tests using the SOAC vehicle. These tests provided an opportunity to acquire a common baseline of data at HSGTC and in each of the five cities where the car will operate. Parameters such as noise levels, ride quality, truck loads, and vehicle performance characteristics were measured and will be used to compare or establish criteria for future systems such as the Advanced Concept Train.

An endurance test, called Simulated Demonstration, was initiated at the completion of the Engineering test program (Project No. IT-06-0026, Contract DOT-UT-10007). The accident which occurred during this phase of testing on August 11, 1973, prevented completion of the Simulated Demonstration until April 1974.

6.1 COMPONENT AND SUBSYSTEM TESTS

Component tests performed and/or analytically substantiated prior to the factory rollout are as follows:

Component Tests

Component tests performed prior to factory rollout (AiResearch Report No. 73-9363, Reference 1) included:

1. Propulsion and Drive System

- Traction motors
- Smoothing reactor
- Input reactor
- DC-DC chopper
- Resistor
- Blower cooling
- Hostling control
- Truck connector
- Knife switch
- Speed indicator
- Jet pump
- Power control unit
- Gearbox and coupling
- P-signal generator
- Filters and ducts
- Master controller
- Propulsion control
- Auxiliary power control
- System testing
- Motor alternator

Upon completion of the above component testing the entire system was installed in a laboratory test cell and tested as a system (see Figure 6-1).

2. Truck and Bolster

SOAC truck frame GSI 34701 S/N1, which had been cast in March 1972, was selected for determination of the structural adequacy of the truck frame. Testing was conducted during the period from May 19 to June 9, 1972.

During the stress coat test a portion of the truck frame wheel piece adjacent to the side bearing displayed a marginal stress level. This section of the truck frame was reinforced on one side of the truck frame, and on the center portion of the other side. Also, the radius of the side bearer adjacent to the top surface of the truck frame was determined to be too sharp, and was chipped and ground to obtain a better blending of the side bearer into the top surface of the casting prior to the strain gage test.

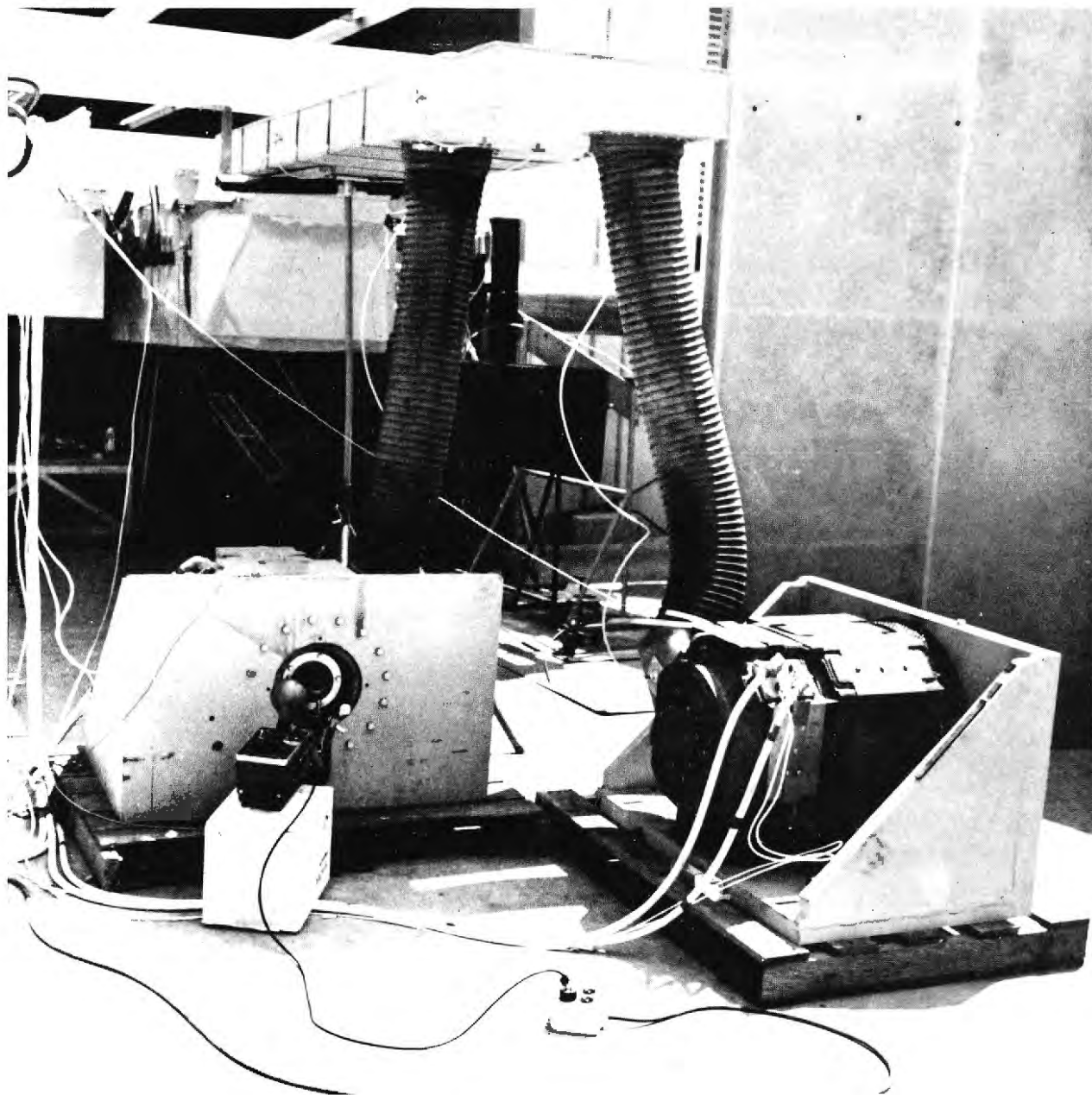

Figure 6-1. Propulsion and Drive System Test Cell

Strain gages were then mounted, and loads were applied with hydraulic rams and read out on calibrated hydraulic gauges and load cells (see Figure 6-2). Table 6-1 shows the maximum stress levels recorded at various applied loads.

TABLE 6-1. TRUCK FRAME STRESS RESULTS

| Loading Condition | Applied Load (lb) | Maximum Recorded Stress (1000 psi) | |
|----------------------------------------------------|----------------------------|------------------------------------|-------------------------|
| | | Tension | Compression |
| Vertical load | | | |
| ● With tie bars | 47,760 | +14.1 | -16.1 |
| ● Loose tie bars | 47,760 | +15.0 | -16.1 |
| Lateral load applied to non-serial side | | | |
| ● With tie bars | 7,164 | + 2.7 | - 1.8 |
| ● Loose tie bars | 7,164 | + 2.7 | - 1.8 |
| Lateral load applied to non-serial side | | | |
| ● With tie bars | 7,164 | + 2.1 | - 2.7 |
| ● Loose tie bars | 7,164 | + 2.1 | - 2.7 |
| Outward longitudinal load | | | |
| ● With tie bars | 24,500 | + 4.8 | 0 |
| ● Loose tie bars | 24,500 | + 9.3 | 0 |
| Downward vertical load on motor mount | 10,351 17,811 24,137 | + 4.8 + 8.4 +11.3 | -15.9 -27.3 -37.2 |
| Upward vertical load on motor mount | 10,351 17,811 24,137 | +18.6 +32.1 +43.8 | - 5.4 - 9.6 -12.9 |
| Lateral load on motor mount toward non-serial side | 6,720 11,600 | -12.0 -20.8 | +14.7 +25.5 |
| Lateral load on motor mount toward serial side | 6,720 11,600 | -13.5 -23.4 | +12.3 +21.3 |

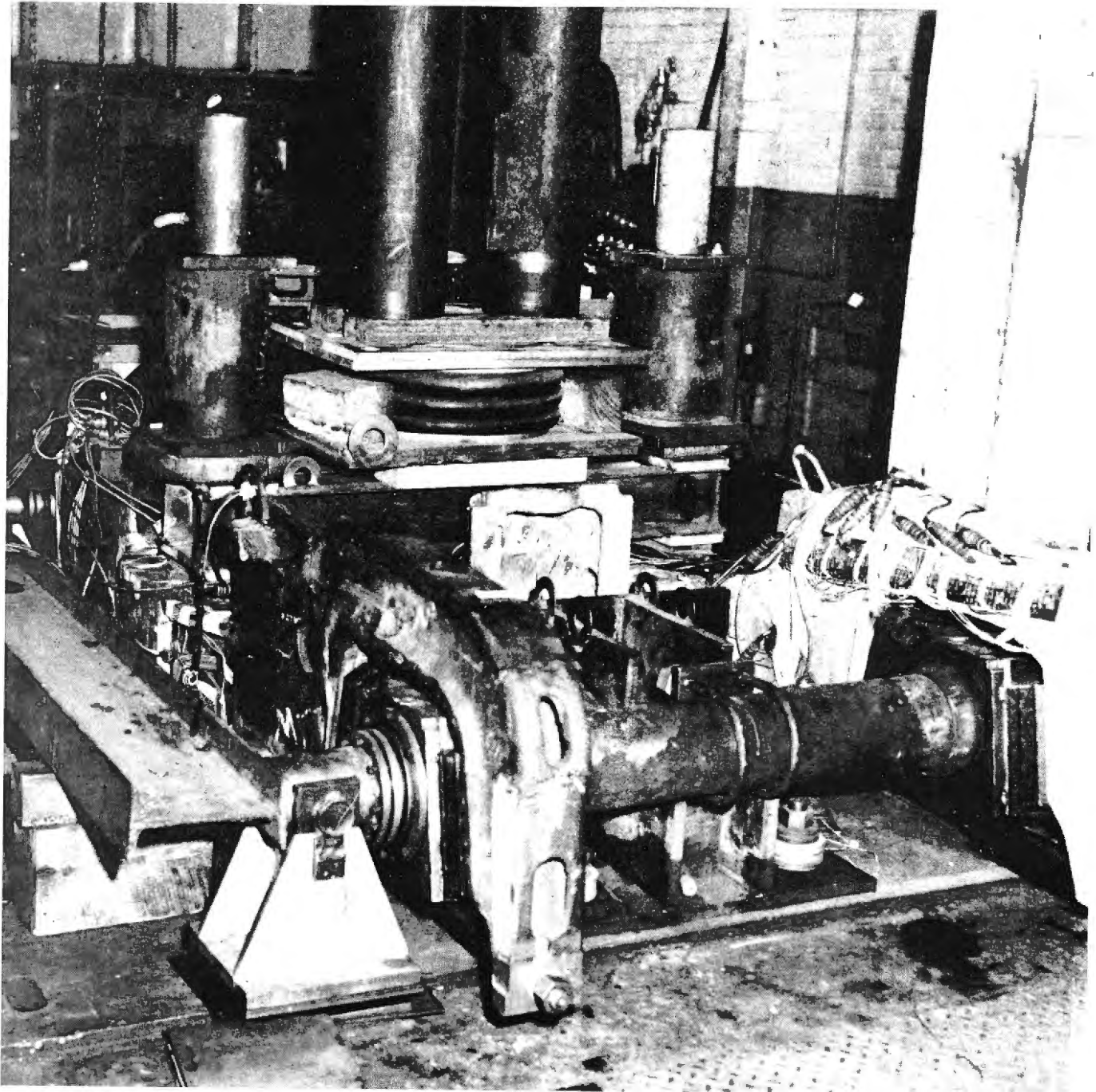

Figure 6-2. Typical Truck Frame Test Setup

3. Truck Bolster

A static test was conducted on the SOAC bolster (GSI 34702, serial 2, cast date April 1972) to determine its structural adequacy.

The recorded stresses were concluded to be satisfactory; maximum recorded stresses for the test under the agreed upon loading conditions are shown in Table 6-2.

TABLE 6-2. TRUCK BOLSTER MAXIMUM RECORDED STRESSES

| Loading Condition | Applied Load (lb) | Maximum Recorded Stress (1000 psi) | |
|---------------------------------|-------------------|------------------------------------|-------------|
| | | Tension | Compression |
| Vertical load | 42,600 | +16.8 | - 7.2 |
| Lateral load normal car height | 6,225 | +14.1 | - 8.1 |
| Lateral load shimmed car height | 6,225 | + 7.5 | -13.5 |
| Longitudinal | 6,390 | + 4.8 | - 5.7 |

Note: Detailed information may be found in Volume 1 of the Component Test Report (Reference 2).

4. Windshield

The SOAC windshield, similar to that on the BART Cars, was qualified by Sweddlow Incorporated in 1970.

Qualification testing consisted of:

- a. Dropping a bag of lead shot weighing 11 pounds from a height of 16 feet on five windshield panels. Some delamination occurred upon impact but the panels remained completely intact.
- b. Firing aluminum balls (simulating stones) at two panels at speeds of 50 and 80 mph. No fractures or ejected spalling of the acrylic structural ply occurred. Vision through the windshield was not impaired by the impact.

Based on the successful testing of these panels, Boeing and St. Louis Car waived additional testing. (Additional information may be obtained from Sweddlow Report No. ETR-010, Reference 3.)

5. Seats

SOAC seats in the low-density car were manufactured by the American Seating Company. These seats are similar in design to those in the BART car. Consequently, no additional testing was performed. Test data on seats representative of the SOAC configurations reported no failure or deformation when 40-pound weights were dropped on the seats from heights of 6, 8, 10 and 12 inches.

6. Fire Resistance of Materials

All major interior materials were tested for fire resistance. The seat upholstery met the requirements of Federal Highway Administration Standard No. 302, Flammability of Vehicle Interior Materials, as tested by the American Seating Company. Remaining interior items were tested by the Boeing Vertol Quality Assurance Laboratory to a more stringent specification, Federal Standard No. 901.

The three items which failed to meet Federal Standard No. 191 were not considered to be potential fire hazards because of their limited usage (i.e., Mylar side signs and window glazing rubber) or method of installation (i.e., leaded vinyl sheathing, although combustible, was sandwiched between the floor panels and the carpeting, neither of which support combustion).

Subsystem Functional Tests

Subsystem Functional Tests performed prior to factory rollout are as follows:

1. Car body: Including jacking, car height adjustment, water test, curve clearance, and camber. The underframe although modified considerably for SOAC was shown analytically to be similar to the R-44 underframe which had been successfully tested at a compression of 250,000 pounds with less than 50-percent yield and at 400,000 pounds with less than 80-percent yield.
2. Lighting
3. Wiring: Continuity and hypot

4. Main propulsion control
5. Weight
6. Pantograph
7. Air system
8. Communications including public address system
9. Door operators
10. Air comfort (hot and cold room tests): When the testing of each system on each car was completed, the two-car train was made up and retested as a system.

6.2 ACCEPTANCE AND ENGINEERING TESTS AT HSGTC

The UMTA Rail Transit Test Track

All of the systems tests described in this section were performed on UMTA's Rail Transit Test Track at the DOT High Speed Ground Test Center in Pueblo, Colorado. The primary objective of this Track is to facilitate the evaluation of rapid rail vehicles.

The Test Track is an electrified 9.1-mile oval of six different track construction types. For performance testing, a 4000-foot straight and level section was marked and used to facilitate the repeatability of test points as required. Ride quality, truck loading, and noise tests were performed at various locations on the track in order to ascertain track construction effects (if any) on test results. The simulated demonstration tests used the entire oval.

Power was supplied to the test vehicle from the third rail distribution system powered by a modified GE U30C locomotive. The temporary power source was barely adequate for all single-car tests; consequently, no two-car train maximum performance tests could be completed.

The Rail Transit Test Track is almost a laboratory testing facility for transit vehicles. The key to laboratory testing is environmental control and this was the "modus operandi" for the acceptance and engineering test procedures. As far as possible, all test conditions such as track location, power settings, and ancillary system operations were consistently maintained; and only the parameter under investigation was varied. Operational test and evaluation, on the other hand, will take place in the "real world", where many conditions will be varied simultaneously. As a result, operational test

and evaluation test procedures and reporting systems will be different.

Systems Testing

The systems test program was divided into four phases: vehicle systems testing, vehicle acceptance testing, engineering testing, and simulated demonstration. The purposes and methods for each of the test phases were as follows:

1. Vehicle Systems Tests

These were the initial tests at the HSGTC designed to functionally check and evaluate each subsystem as it was integrated into the overall vehicle operation. To perform these evaluations it was necessary to set up each car to its specified limits (e.g., acceleration, deceleration, braking speeds). During this process numerous design and fabrication discrepancies were identified and subsequently corrected. This period or phase of the program was completed in February 1973.

2. Vehicle Acceptance Tests

Having set up both cars to their correct operating limits and/or specifications, it was then necessary to formally compare the vehicle performance to specification and guarantee parameters. The evaluation was performed on ride quality, noise, acceleration, deceleration, braking, speed limiting, service duty cycle, and radio frequency interference. These evaluations were based on a single-car criteria at an operating weight of 105,000 pounds per car. The SOAC met or exceeded all specification guarantees. Tests were completed in April 1973.

3. Engineering Test Program

Immediately following the acceptance tests a comprehensive engineering test program was initiated to develop a data base for understanding vehicle performance and operation when subjected to the environment and characteristics of the operating properties. This data base was also to be developed to measure improvements achieved during the ACT program. The program was designed to obtain a good technical understanding of the SOAC operating limits and extremes, in various operational conditions such as supply voltage variation from 450 to 650 vdc and vehicle weight ranges from 90,000 to 130,000 pounds. Vehicle acceleration, deceleration, speed, braking, ride quality and noise

level data were obtained in all operating conditions. In addition to a variety of operating limitations imposed by facilities and environmental conditions, the vehicles were evaluated in numerous failure modes (e.g., propulsion and brake failures were tested at each test weight). The engineering test phase was completed in July 1973.

4. Simulated Demonstration Testing

This phase of the test program started in July, 1973 immediately following the engineering test program. The objective of the program was to ensure (to the extent practical at HSGTC) that the cars, equipment and procedures will provide trouble-free operation at the proposed demonstration sites.

Whereas previous testing had been mainly experimental, this test was intended as a rehearsal of the procedures and proof test of the hardware as configured for the five demonstration properties. Testing was halted before completion by an accident in August 1973.

6.3 ACCEPTANCE TEST RESULTS

The SOAC was designed to meet the performance requirements of the specification shown in Table 6-3. Design car weight (empty) is 90,000 pounds, loaded weight with 100 passengers is 105,000 pounds.

TABLE 6-3. PERFORMANCE REQUIREMENTS

| | |
|--------------------------------------------------------------------------------|------------------|
| Maximum speed (level tangent) | 80 mph |
| Initial acceleration (nominal) | 3.0 mphps |
| Nominal deceleration: | |
| Blended braking (80 to 60 mph) | -2.7 mphps |
| Blended braking (60 to 6 mph) | -3.0 mphps |
| Service friction braking (40 to 0 mph) | -3.0 mphps (avg) |
| Emergency friction braking (40 to 0 mph) | -3.2 mphps (avg) |
| Maximum combined dynamic friction braking, limited to | -3.3 mphps |
| Jerk rate, normal acceleration and braking | 2.5 mphps |
| Balancing speed on 6000 feet, 3% adverse grade | 70 mph |
| Distance travelled in 20 seconds from standing start on level tangent track | 700 feet |

Compliance with the specified requirements was demonstrated during the acceptance tests on both high- and low-density cars. A brief description of each test follows:

Acceleration

Acceleration from a standing start to 700 feet ranged from 18.6 to 20.0 seconds and reached acceleration peaks to 3.16 mphps.

Both cars were checked individually and in a train configuration. The test data (Table 6-4) indicate that both cars have essentially the same acceleration characteristics within the accuracies of the instrumentation. Testing of the train configuration during acceleration tests was inhibited by the HSGTC temporary locomotive generator power source which could not maintain a minimum 600-vdc line voltage during two-car train acceleration tests. However, testing showed that acceleration could be as high as (or higher than) 3.0 mphps.

Braking

Braking tests were conducted on the level tangent portion of the HSGTC test oval. All brake systems (i.e., dynamic, friction, blended and emergency) were tested in both single-car and train configuration. Cars were also tested in both directions to conform to the symmetry of the configuration. Test data are summarized and compared to the specification in Table 6-4.

Service Duty Cycle

A severe service duty cycle test performed on the traction system and friction brake systems consisted of 24 cycles of alternate maximum acceleration to 80 mph and deceleration, with a 30-second dwell time between cycles. Brake tread temperatures were monitored throughout the test program, and, although there was evidence (smoke) of hot brake shoes because of the severity of the test, the maximum observed wheel tread temperature was not over 280°F.

Tests were performed on both SOAC cars. Tests were also planned for the two-car train, but because of the limitations of the HSGTC 600-vdc power source, two-car train testing was not performed.

Noise

Interior noise levels were obtained for both a single-car and a two-car train. Figure 6-3 summarizes test data and compares the test data to SOAC specifications.

TABLE 6-4. ACCEPTANCE TEST RESULTS (105,000-POUND CAR)

| Test Parameter | Specification Requirement | Results | | |
|-----------------------------------------------------------------------------|---------------------------|-----------|-----------|-------------|
| | | Car No. 1 | Car No. 2 | 2-Car Train |
| 1. Peak (initial) acceleration rate | 2.7-3.3 mph/sec | 3.0** | 3.16** | 3.0** |
| 2. Time to travel 700 feet from a standing start, level tangent track, 600V | 20 sec | 19.4 | 19.0 | 20.0 |
| 3. Speed on a 3% adverse grade | 70 mph | >75 | >75 | N/A |
| 4. Maximum speed* | 80 mph | 80 | 80 | 80 |
| 5. Deceleration rates (peak) | | | | |
| ● Blended service | 2.7-3.3 mph/sec | 3.2 | 3.2 | 3.2 |
| ● Dynamic only | 2.7-3.3 mph/sec | 3.0 | 3.0 | 3.1 |
| ● Service friction | 2.7-3.3 mph/sec | 3.1 | 3.2 | 3.2 |
| 6. Jerk rate | | | | |
| ● Acceleration | 2.5 mph/sec ² | 1.9 | 2.3 | 1.8 |
| ● Braking | 2.5 mph/sec ² | 2.9 | 2.6 | 2.6 |
| 7. Stopping distance (from 40 mph) | | | | |
| ● Blended service | 450 ft | 430 | 445 | 430 |
| ● Service friction | 450 ft | 440 | 425 | 420 |
| 8. Stopping distance (from 80 mph) | | | | |
| ● Blended service | 2250 ft | 1650 | 1660 | 1660 |
| ● Service friction | 2250 ft | 1960 | 2000 | 1925 |
| 9. Emergency braking | | | | |
| ● Stop from 40 mph | 425 ft | 365 | 350 | 335 |
| ● Stop from 80 mph | 2200 ft | 1630 | 1600 | 1635 |
| ● Deceleration rate | 2.88-3.52 mph/sec | 3.5 | 3.4 | 3.5 |

*Maximum speed reached during testing was 92 mph.

**Car acceleration rates were adjusted to this level.

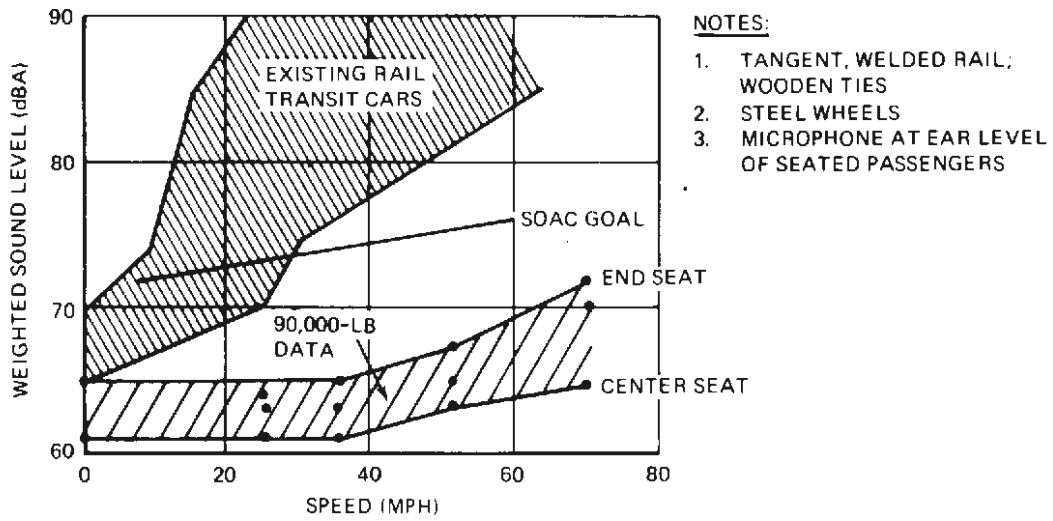

Figure 6-3. Interior Noise Levels

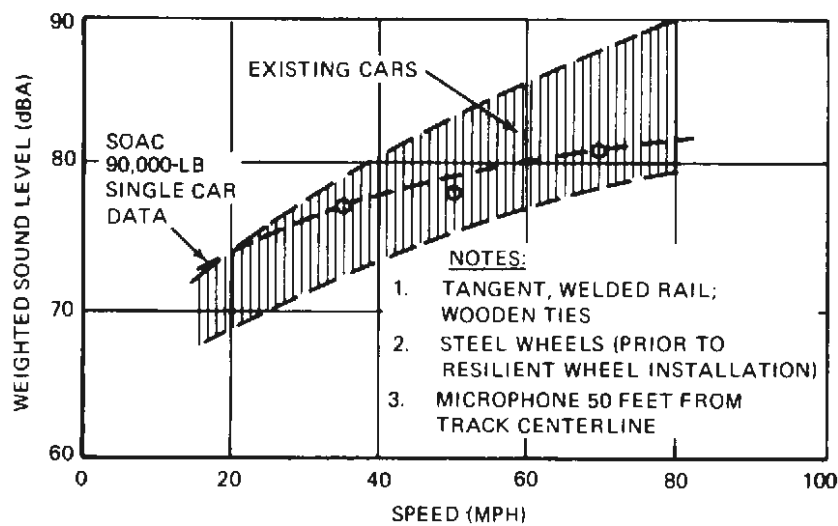

Figure 6-4. Wayside Noise Levels

The SOAC noise levels were below the noise goals established during the design phase. These levels, shown in Figure 6-3, were attained with little or no direct penalty in cost or weight.

Wayside noise produced by the car was also controlled in the design in order to minimize the effect on the environment (Figure 6-4). Noise levels measured during test confirm that this objective was met.

Ride Quality

Ride quality values were based on measurements taken on the HSGTC test oval which consists of variations of welded and jointed rails, concrete as well as wooden ties, and different ballast configurations. These values are defined in terms of acceleration versus frequency and are compared to a constant comfort design goal. The values shown in Figure 6-5 were obtained through improved truck and suspension system design.

Radio Frequency Interference

Testing to determine the electromagnetic field strength inside the SOAC as well as at the wayside was performed at the HSGTC on April 2 and 3, 1973. As shown in Figure 6-6, test data indicate the SOAC is within field limits from a frequency range of 150 KHz to 400 MHz. Since there was no substantial noise peak within the car body, it was not necessary to track down corresponding sources.

6.4 ENGINEERING TEST RESULTS

A series of Engineering Tests was initiated at the HSGTC in April 1973 and completed in July 1973. During this period the SOAC was operated throughout the range of its capabilities and vehicle responses were measured in the following technical areas:

- Performance
- Ride quality
- Noise levels
- Truck loading
- Voltage transients and spikes

Details of the tests and results may be found in the State-of-the-Art Car Engineering Test Report (Reference 4). A series of tests will also be conducted on the transit properties.

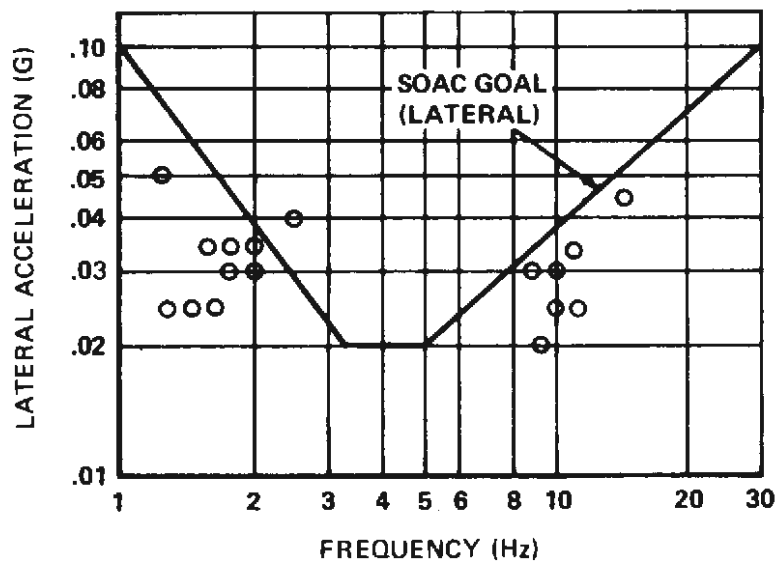
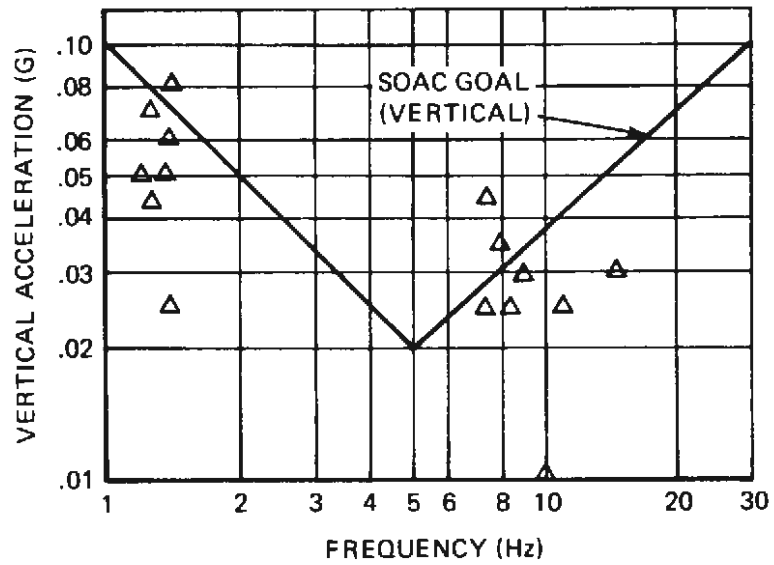

Figure 6-5. Ride Quality

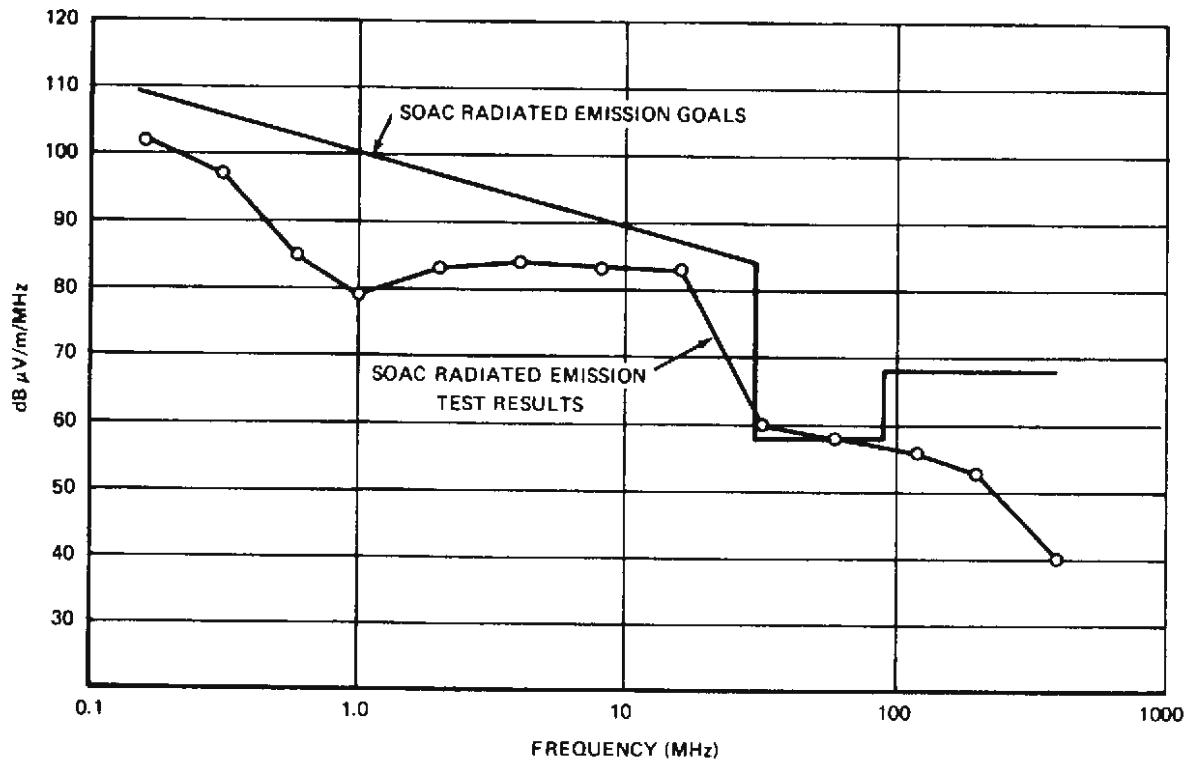

Figure 6-6. Electromagnetic Field Test Data

Performance Test Results

The SOAC car was tested throughout its operating range of weight, line voltage, controller level and brake subsystem, as well as in sample service tests to define power consumption, friction brake temperatures, and undercar equipment temperatures. Adhesion levels and performance of spin-slide control systems were also tested. Summaries of the performance testing follow:

- Acceleration and Service Braking Control Characteristics

Figure 6-7 illustrates the results of control linearity tests for acceleration and blended braking at a car weight of 105,000 pounds.

The control logic of the SOAC provides essentially proportional control of tractive effort (acceleration) throughout the speed range in both drive and brake. In the drive mode the tractive effort above about 28 mph is proportional to the maximum capability of the system as represented by the P-signal of 1.0 amperes.

Braking rate is essentially constant throughout the speed range. The curved trend is due to the tractive resistance of the car at speed. The maximum capabilities of the car as represented by $P = 1.0$ and 0.0 amperes are within the specification requirements.

Figure 6-8, a cross-plot of Figure 6-7 to illustrate the control linearity, shows weights from 90,000 to 113,000 pounds as well as both blended and friction brake data. The linearity of control is within the ± 10 percent (full-scale) band desired for the 105,000-pound car (and generally considered desirable for all weights). The test points illustrate the accuracy of the closed-loop tractive effort control logic of the Garrett traction system.

- Acceleration and Service Braking Load-Weight Compensation

The results of acceleration and braking tests at car weights from 90,000 to 130,000 pounds are shown in Figure 6-9 for full service acceleration and braking. Figure 6-8 shows the accuracy of the load-weight system for weights from 90,000 to 113,000 pounds at both full and one-half input commands. When not limited by tractive power (acceleration), the system maintains car performance within the desired 10-percent tolerance band. The full acceleration power capability of

NOTES

1. CAR WEIGHT: AW1 105,000 LB (SINGLE CAR)
2. LEVEL TANGENT TRACK
3. 30-INCH WHEELS
4. SOAC HSGTC ENGINEERING TESTS: RUNS 102, 142

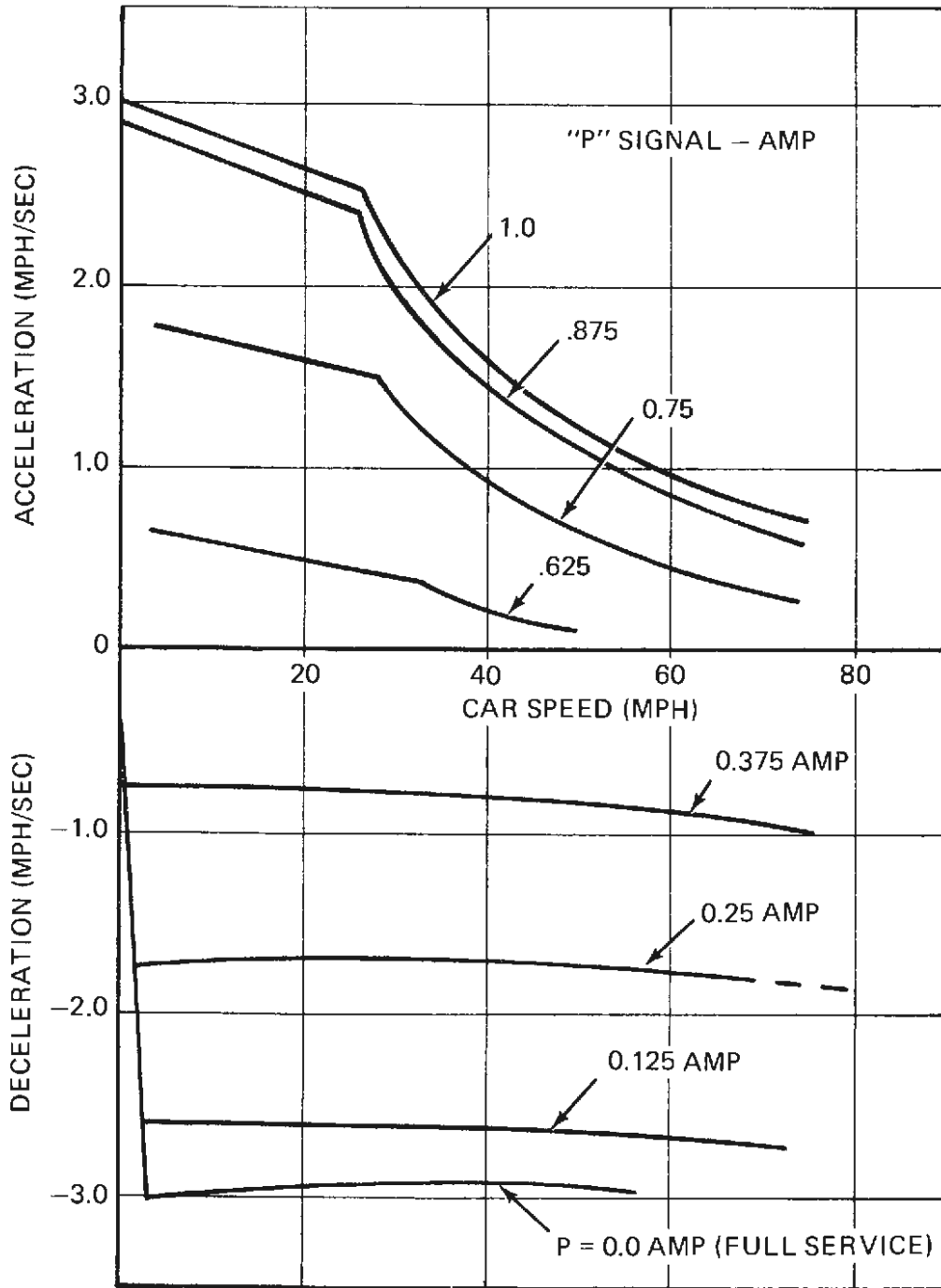

Figure 6-7. Acceleration and Speed Response to Tractive Effort Response

NOTES

1. CAR SPEED 10 MPH
2. LEVEL TANGENT TRACK
3. 30-INCH WHEELS
4. SOAC HSGTC ENGINEERING TESTS:
RUNS 96, 102, 126, 142, 144, 146, 148, 151

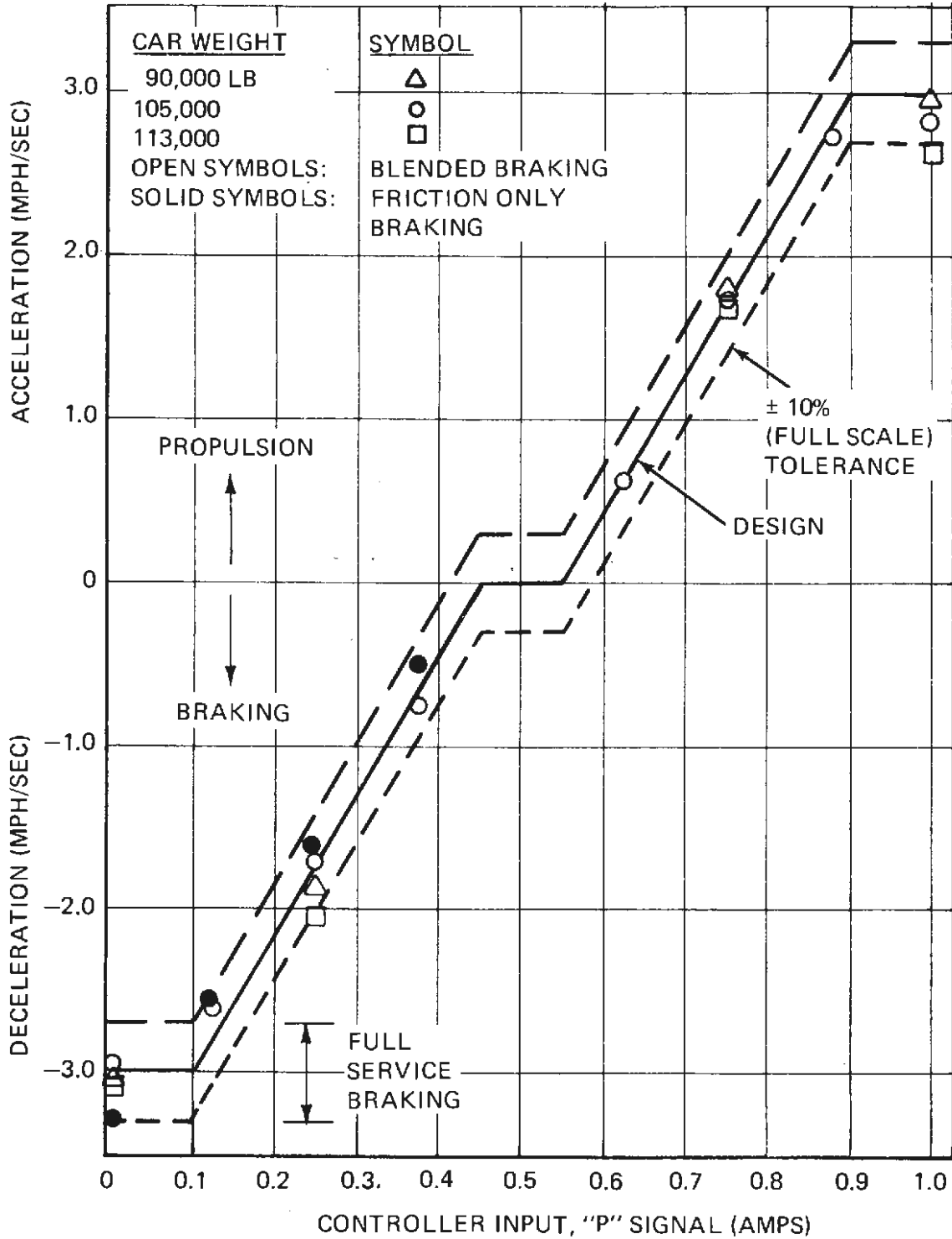

Figure 6-8. Control Linearity ("P" Signal)

NOTES

1. CAR WEIGHT AS NOTED (SINGLE CAR)
2. LEVEL TANGENT TRACK
3. 30-INCH WHEELS
4. SOAC HSGTC ENGINEERING TESTS:
RUNS 96, 102, 126, 142, 146, 148, 151
5. "P" SIGNAL = 1.0 AMP

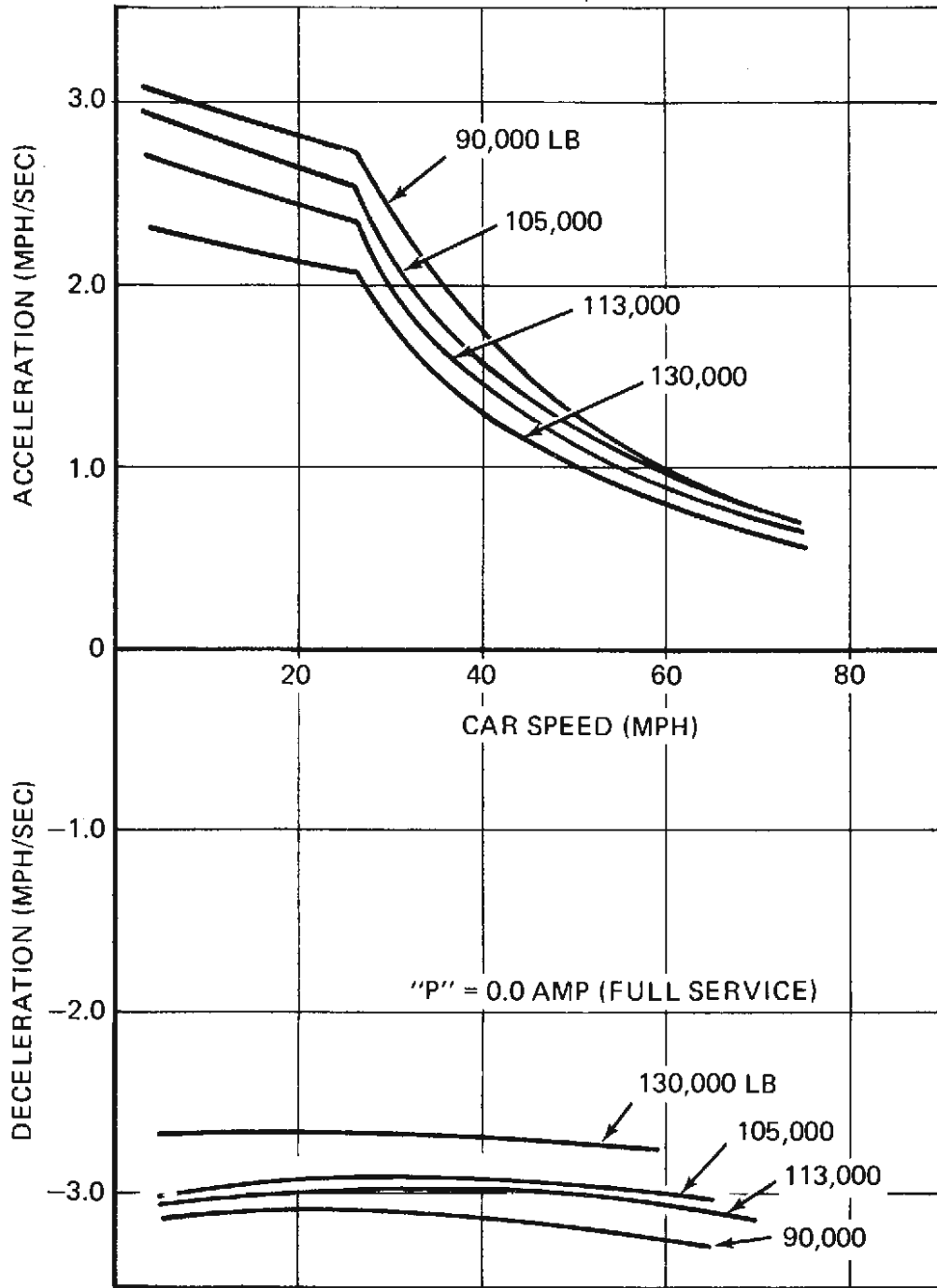

Figure 6-9. Effect of Car Weight on Acceleration and Braking

the SOAC is represented by the 105,000-pound curve of Figure 6-9; above this weight acceleration capability is reduced in proportion to car weight for $P = 1.0$ -ampere commands. For one-half acceleration command ($P = 0.75$) the acceleration rate for all tested weights is essentially equal as shown in Figure 6-8.

Figure 6-10 illustrates the resulting time-speed-distance characteristics recorded during acceleration tests; the data shown are for full-service acceleration capability.

- Acceleration and Service Braking Line Voltage Sensitivity

The SOAC was tested at line voltages of 475, 600 and 650 volts. Figure 6-11 illustrates the acceleration and braking test results. Figure 6-12 presents the associated time-speed-distance data.

The SOAC traction control system uses line voltage, as measured across the input filter capacitors, to determine the traction motor current (torque) limit. The system was designed for 600-volt operation, and armature currents are limited at that voltage. Unlike the existing series-wound traction motors, the SOAC's separately excited motors (and control system) will not increase their output at higher than 600-volt line input. As a result, the 600- and 650-volt acceleration rates are similar.

Below 600 volts the armature current limit is recalibrated by the control system in proportion to the voltage. This results in the reduced performance shown in Figure 6-11 at 475 volts. However, the top speed of the car will not be reduced below 80 mph. The blended braking rate is unaffected by line voltage, as noted in Figure 6-11.

- Traction Resistance - Drift Test

Drift tests were performed to determine the traction resistance (force versus speed) characteristic for use in the analysis of wheel-rail adhesion test data and to develop the traction forces associated with measured acceleration and deceleration rates.

Figure 6-13 presents the final faired curves of single-car and two-car test data. The single-car data is the primary requirement for adhesion and performance data analysis. The existence of considerable scatter in the basic data may be due to data reduction

NOTES

1. CAR WEIGHT AS NOTED (SINGLE CAR)
2. LEVEL TANGENT TRACK
3. 30-INCH WHEELS
4. SOAC HSGTC ENGINEERING TESTS:
RUNS 96, 102, 126, 142, 146, 148, 151
5. "P" SIGNAL = 1.0 AMP

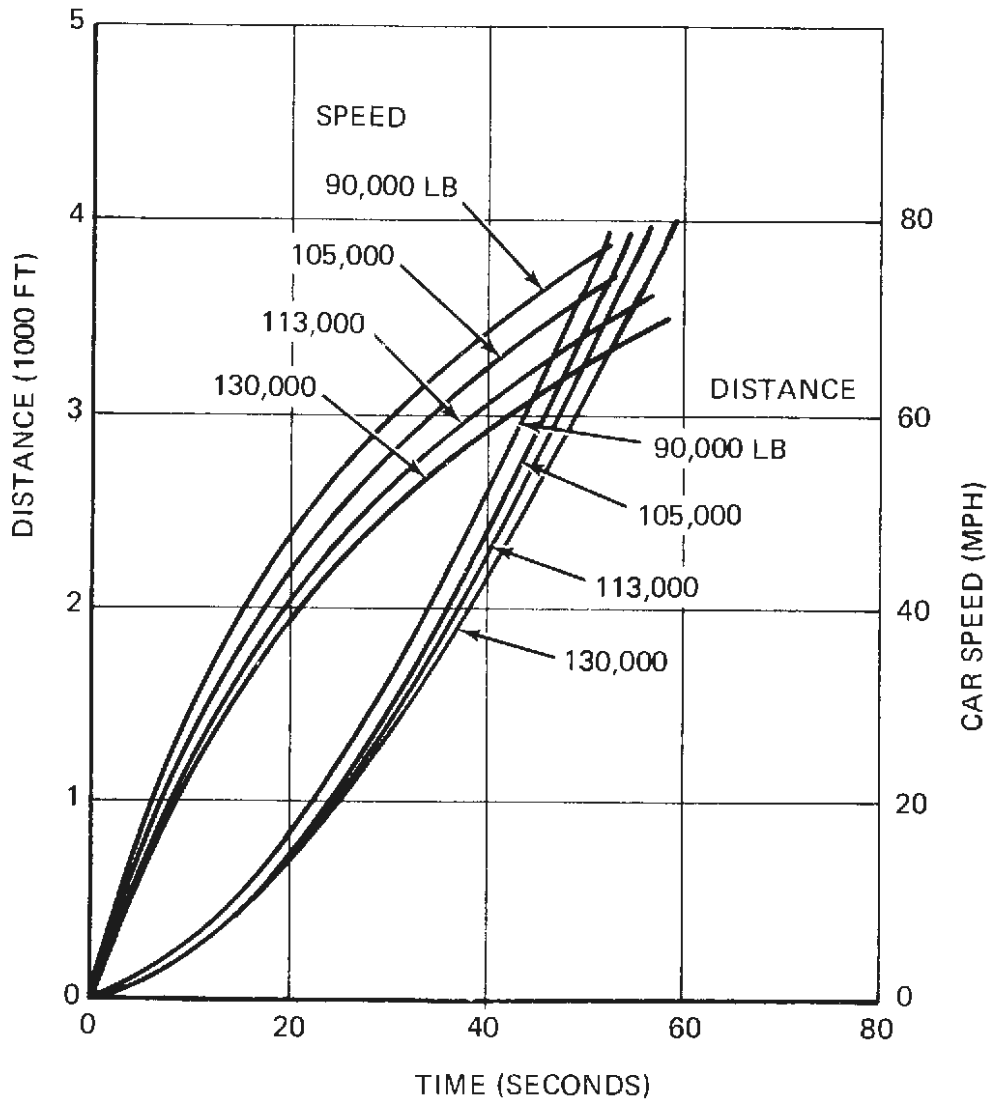

Figure 6-10. Effect of Car Weight on Time and Distance to Speed

NOTES

1. CAR WEIGHT AW1 105,000 LB (SINGLE CAR)
2. LEVEL TANGENT TRACK
3. 30-INCH WHEELS
4. SOAC HSGTC ENGINEERING TESTS:
RUNS 102, 103, 104, 142, 143
5. "P" WIRE = 1.0 AMP
6. NOMINAL THIRD RAIL VOLTAGE

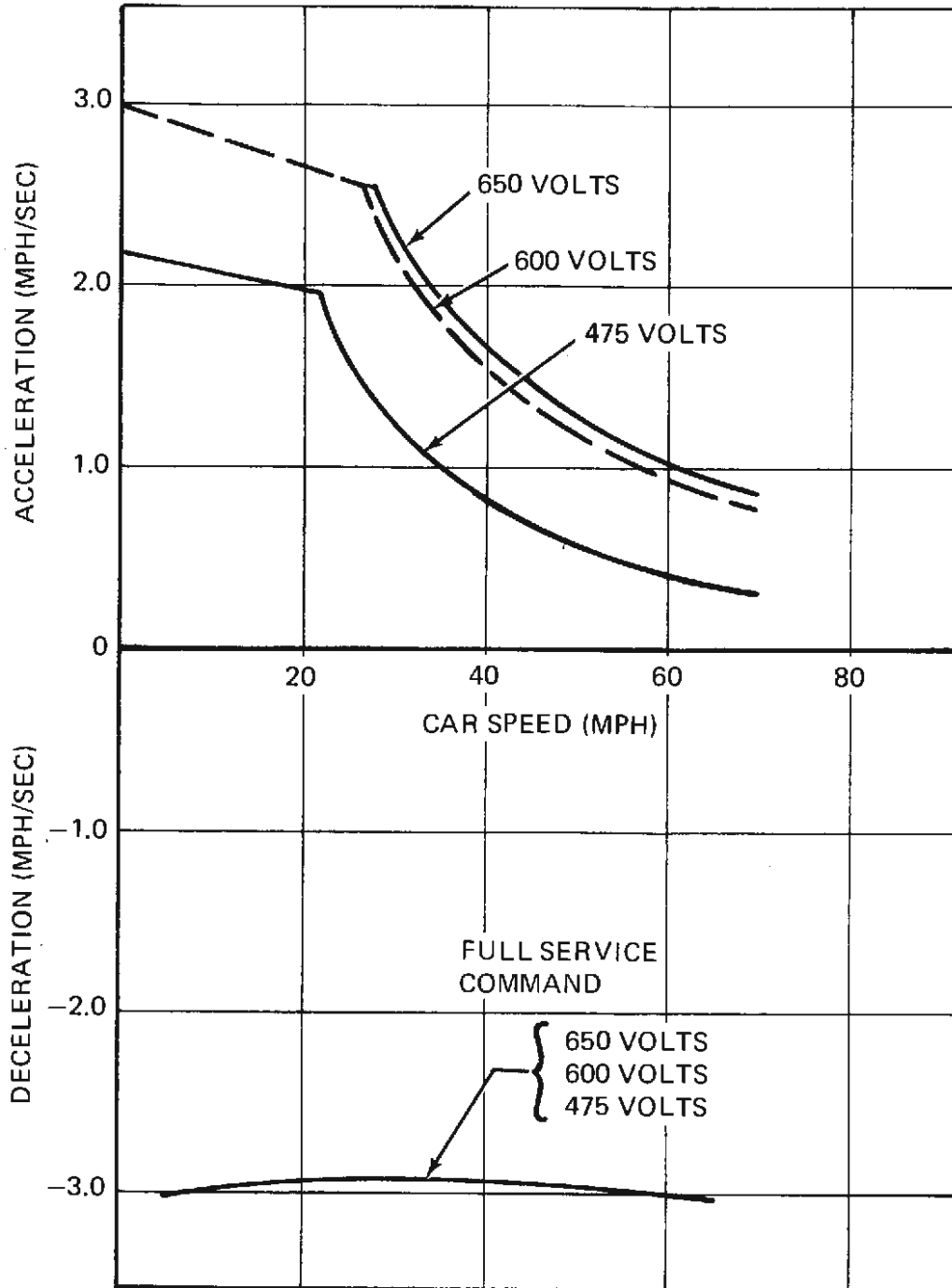

Figure 6-11. Effect of Third Rail Voltage on Acceleration and Braking

NOTES

1. CAR WEIGHT AW1 105,000 LB (SINGLE CAR)
2. LEVEL TANGENT TRACK
3. 30-INCH WHEELS
4. SOAC HSGTC ENGINEERING TESTS:
RUNS 102, 103, 104, 142, 143
5. NOMINAL THIRD RAIL VOLTAGE

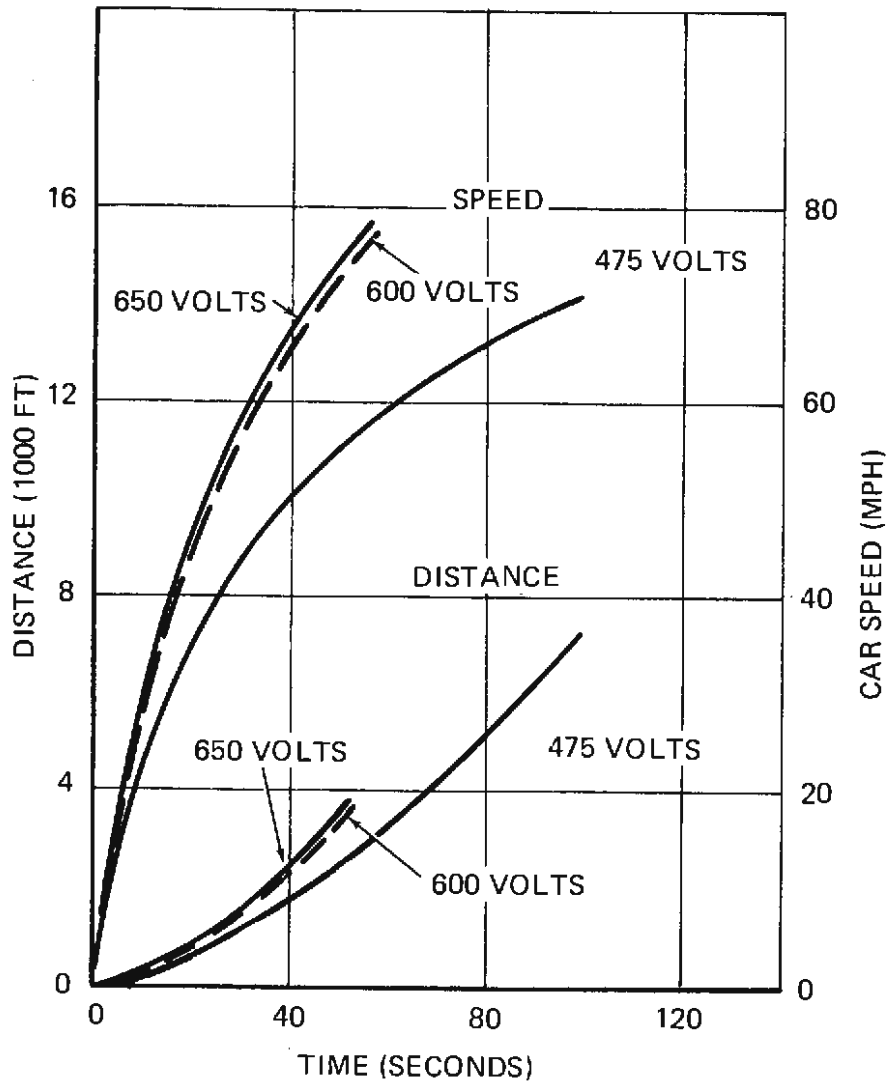

Figure 6-12. Effect of Third Rail Voltage on Time and Distance to Speed

NOTES

1. CAR WEIGHT 105,000 LB
2. AVERAGE OF BI-DIRECTIONAL RUNS
3. LEVEL TANGENT TRACK
4. 30-INCH WHEELS
5. SOAC HSGTC ENGINEERING TESTS:
RUNS 102, 121
6. ZERO WIND

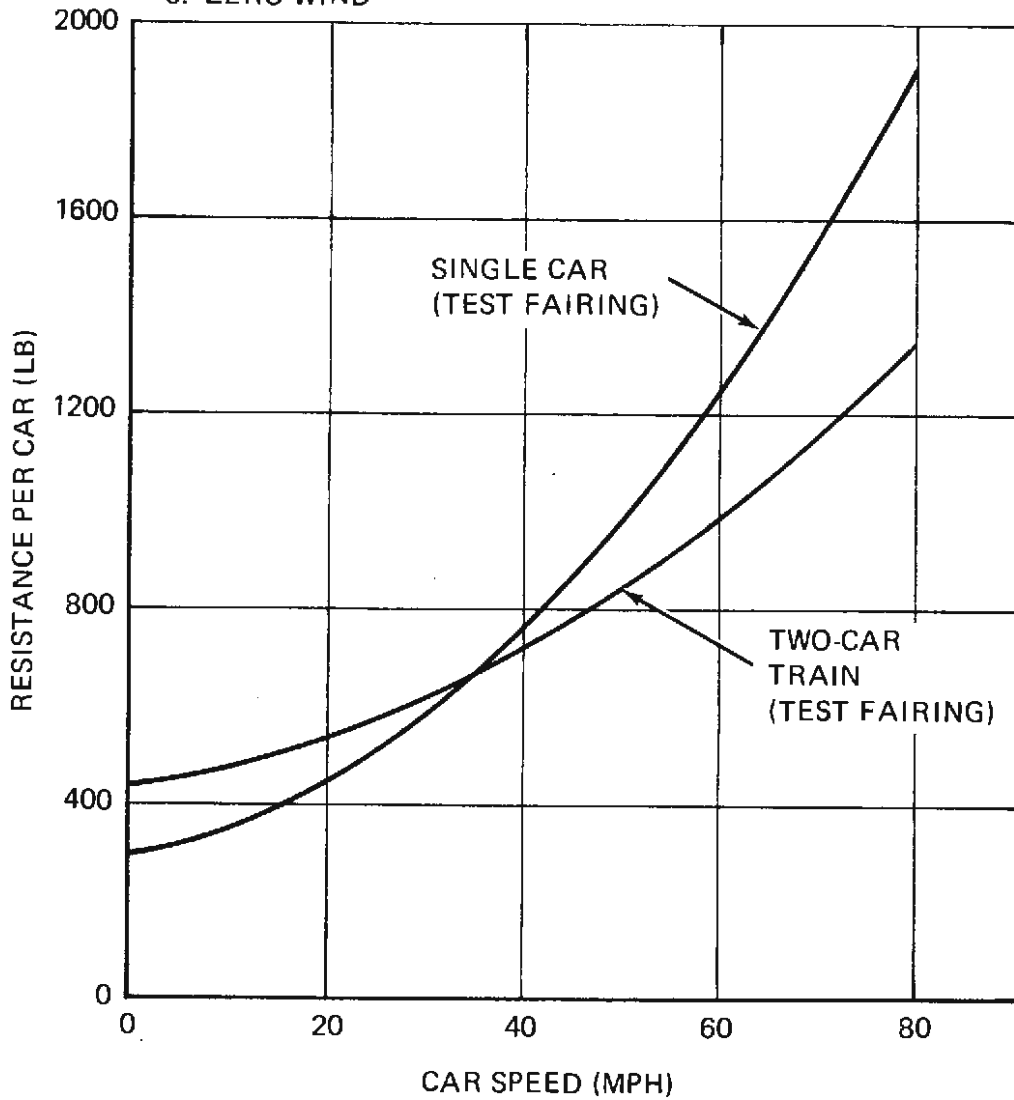

Figure 6-13. Traction Resistance

details of the tape recorded time-speed data. The test fairing is considered sufficiently accurate for use with adhesion data. The 1890 pounds of resistance at 80 mph represents a coasting deceleration rate of 0.37 mphps for the 105,000-pound car.

- Friction Brake System - Duty Cycles

These tests consisted of decelerations at various controller inputs and car weights and simulated schedule service using duty cycles similar in severity to those found on the SOAC test and evaluation routes in New York and Cleveland. A summary of service brake control linearity was shown in Figure 6-8 for three car weights and several controller inputs. The system accuracy is within the desired 10-percent band.

The two duty cycles tested are summarized in Table 6-5, along with the two routes simulated. Results of tests with Duty Cycles I and II with solid steel and resilient aluminum-center wheels are shown in Figure 6-14. As noted, the maximum temperature difference between wheel types occurs early in the simulated service route and is between 30 to 40°F. Final temperature differences are less than 20°F at the end of the cycles. For the two routes simulated, the resilient wheels have sufficient thermal capacity for normal service operation with disabled dynamic brakes.

Energy consumption was recorded during both duty cycles and is presented in Table 6-5.

- Power Consumption - Synthetic Transit Route

Schedule service performance in terms of power consumption, schedule speed, and undercar equipment temperatures were evaluated during sample service runs on a 9.25-mile, 15-station transit route at HSGTC. (Figure 6-15 shows the structure of the synthetic route.) Station spacings vary from 0.25 to 1.5 miles; top speeds from 40 to 80 mph. The route was run from Station A to Station O and return for each round trip. Table 6-6 presents the results for each station spacing and for each round trip. SOAC power consumption averages 12.43 kw-hr per car mile for the route, including approximately 34 kw of auxiliary power. This same route will be used during testing of the ACT-1 vehicles which are expected to reduce the power consumption by as much as 40 percent at an equal performance level.

NOTES

1. 30-INCH WHEELS
2. SOAC HSGTC ENGINEERING TESTS:
RUNS 117,141

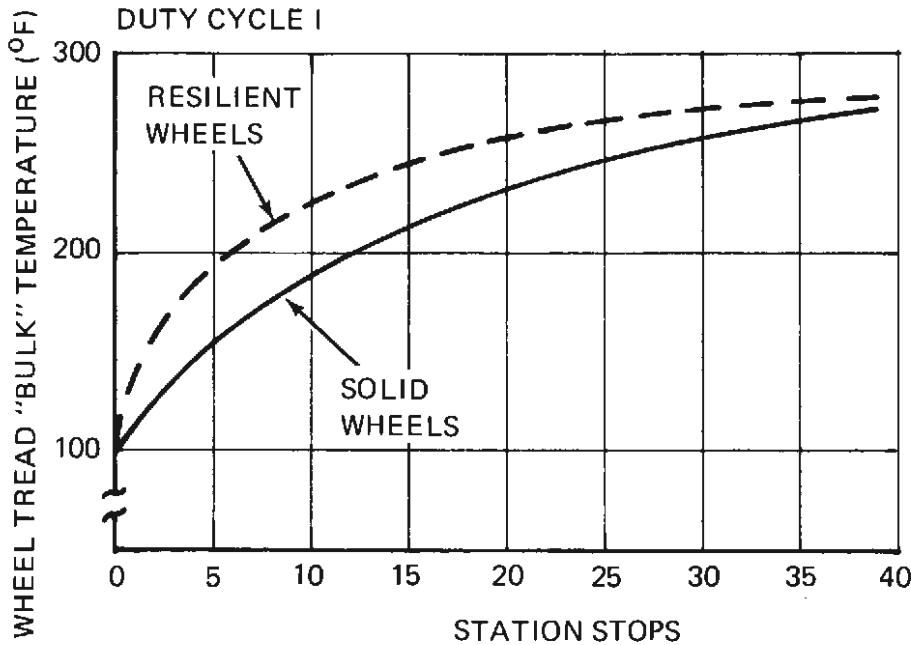

DUTY CYCLE

1. ACCEL TO 35 MPH AT SERVICE RATE
2. MAINTAIN 35 MPH FOR 45 SECONDS
3. APPLY FULL SERVICE FRICTION BRAKING
4. STATION DWELL 30 SECONDS
5. REPEAT TO STABILIZE TEMP OR MAXIMUM 38 STOPS

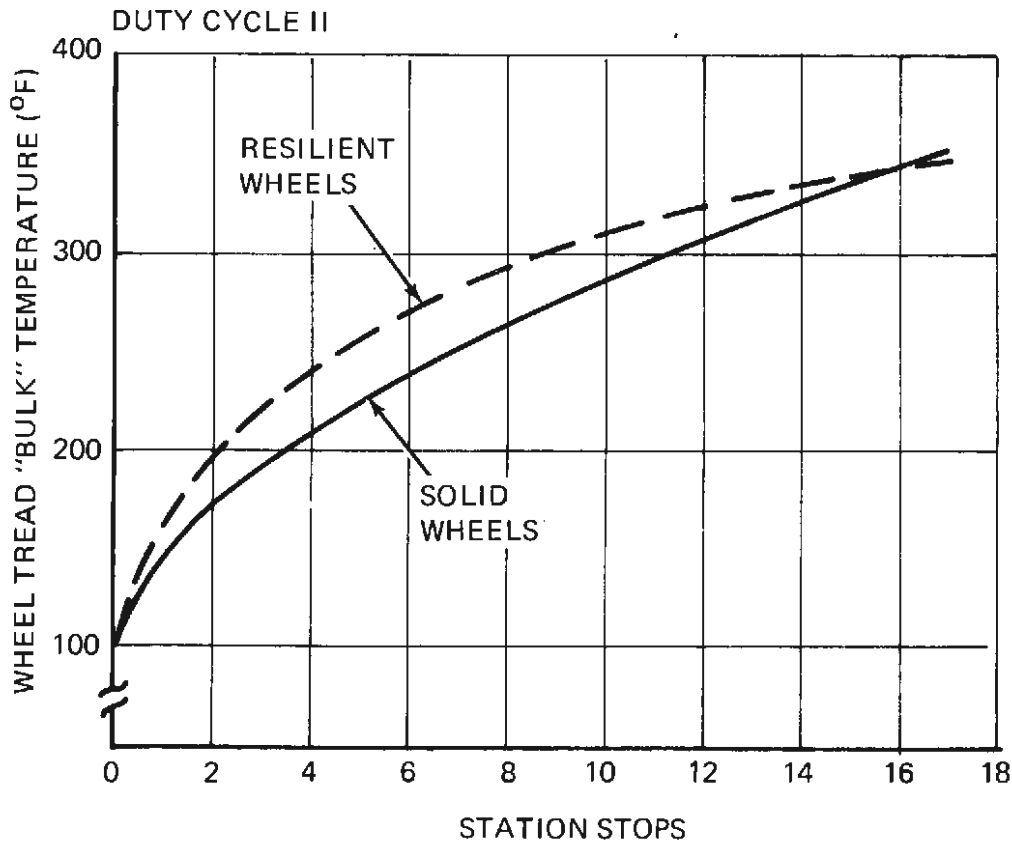

DUTY CYCLE

1. ACCEL TO 50 MPH AT SERVICE RATE
2. MAINTAIN 50 MPH FOR 55 SECONDS
3. APPLY FULL SERVICE FRICTION BRAKING
4. STATION DWELL 30 SECONDS
5. REPEAT TO STABILIZE TEMP OR MAXIMUM 17 STOPS

Figure 6-14. Wheel Temperature

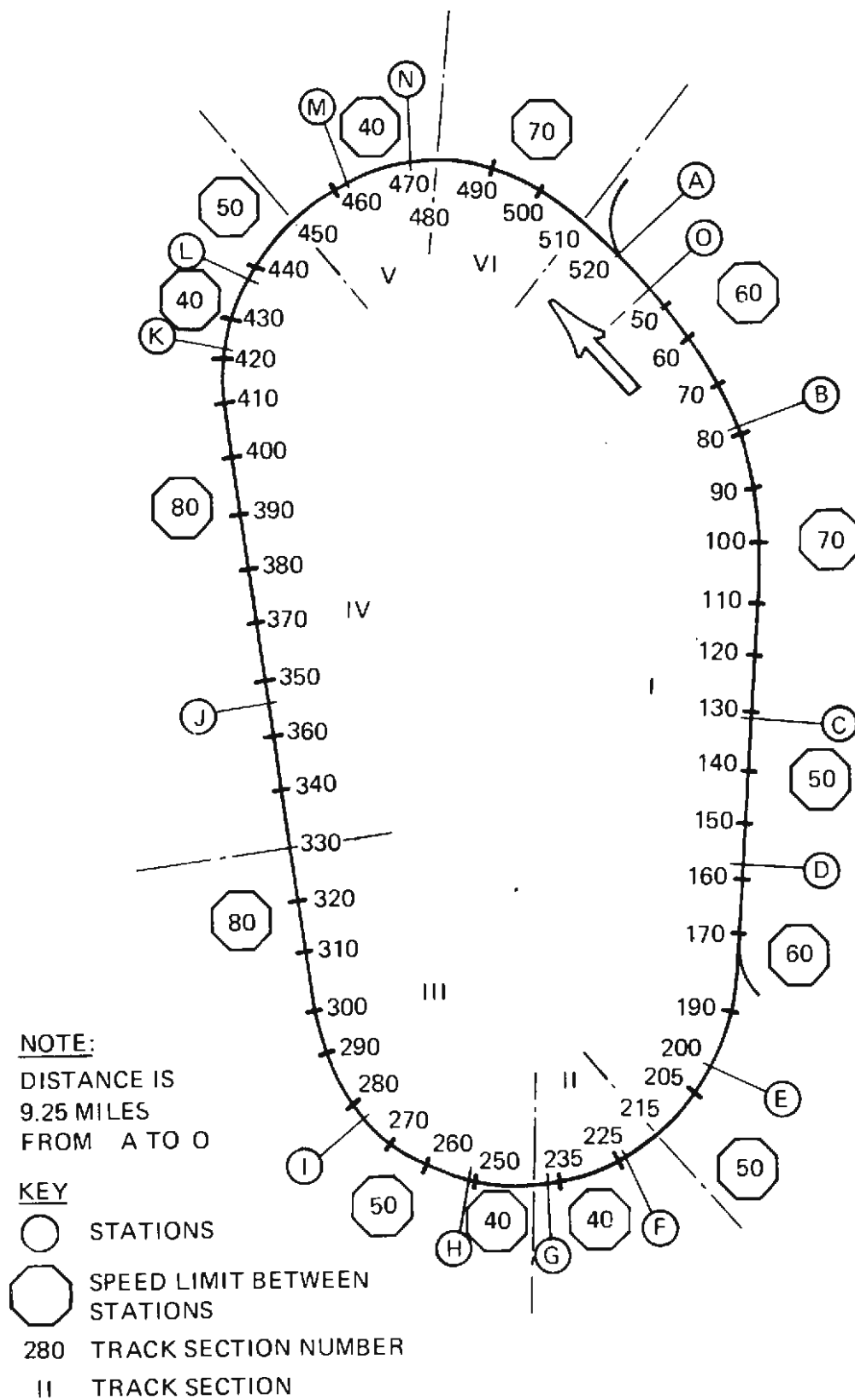

Figure 6-15. ACT-1 Synthetic Transit Route

TABLE 6-5. SUMMARY OF FRICTION BRAKE DUTY
CYCLE TESTS

| Test Parameter | Route | | | |
|-----------------------------------------------------|---------------------------------|---------------------------|-------------------------------|----------------------------|
| | New York (NYCTA) 8th Ave. | Pueblo Duty Cycle I | Cleveland (CTS) Airport | Pueblo Duty Cycle II |
| Distance (miles) | 22.5 | 21.8 | 19.0 | 17.9 |
| Scheduled time (minutes) | 68 | 65 | 36 | 38 |
| No. of start-stop cycles | 38 | 38 | 17 | 17 |
| Stops per mile | 1.69 | 1.74 | 0.9 | 0.95 |
| Maximum speed (mph) | 35 (est avg) | 35 (actual) | 52 (est avg) | 50 (actual) |
| Schedule speed (mph) | 19.8 (est) | 20.1 | 31.6 (est) | 28.2 |
| Measured maximum tread bulk temperatures (°F) | | | | |
| • Solid | N/A | 264 | N/A | 350 |
| • Resilient | N/A | 282 | N/A | 350 |
| Energy consumption (kw-hr/car-mile) | - | 6.70 | - | 6.60 |

Equipment temperatures within undercar enclosures were measured during the power consumption test cycles. Peak recorded temperatures are shown in Table 6-7 corrected to a 125°F ambient air temperature (SOAC design specification).

The reduced power consumption recorded during friction brake duty cycles (see Table 6-5) can be expected during the SOAC demonstration on existing properties.

- Spin-Slide Protection System Performance

Tests of spin-slide system characteristics were conducted in drive and brake modes on wetted rails using blended braking, dynamic only, and service friction brakes.

Table 6-8 summarizes the efficiencies of the spin-slide systems in various modes, covering averages of many test runs initiated at speeds from 80 to 20 mph in braking. From an initial speed of 40 mph the average efficiency of the blended braking system is greater than 82 percent, which exceeds the 80 percent goal of the design specification. As noted the efficiency is also greater than 80 percent in the acceleration mode.

The lower efficiency of the service friction air brake subsystem is primarily due to the slower response of the air-operated tread brake units.

- Wheel-Rail Adhesion

The level of adhesion associated with the SOAC on the HSGTC test oval was measured during single-truck friction braking tests on wetted jointed rails. The wetting agent used was similar to that used during spin-slide tests. (Details are contained in Part 8.)

The two levels of adhesion noted on Figure 6-16 are due to different mixing criteria with the same wetting agent. These results suggest the level of caution to be exercised during any future wetted rail adhesion or spin-slide testing. Since spin-slide performance calculations are relative to the actual adhesion obtained, the efficiency values of Table 6-8 are considered valid as averages.

The design acceleration and deceleration rates of the SOAC (± 3.0 mphps) represent an adhesion demand of 0.1367. This level is not obtainable on an oiled-wetted rail as represented by "complete mixing" (Figure 6-16) but is available up to about 38 mph on an essentially clean, wet rail as represented by "Incomplete Mixing of Wetting Agent."

NOTES

1. CAR WEIGHT AWO 90,000 LB
2. WET RAILS
3. LEVEL TANGENT TRACK
4. 30-INCH WHEELS
5. SOAC HSGTC ENGINEERING TESTS:
RUNS 100, 151
6. ENTRY SPEED SYMBOL

| | |
|--------|---|
| 20 MPH | △ |
| 40 MPH | □ |
| 60 MPH | ○ |
| 80 MPH | ◇ |

OPEN SYMBOLS: RESILIENT WHEELS
SOLID SYMBOLS: SOLID WHEELS

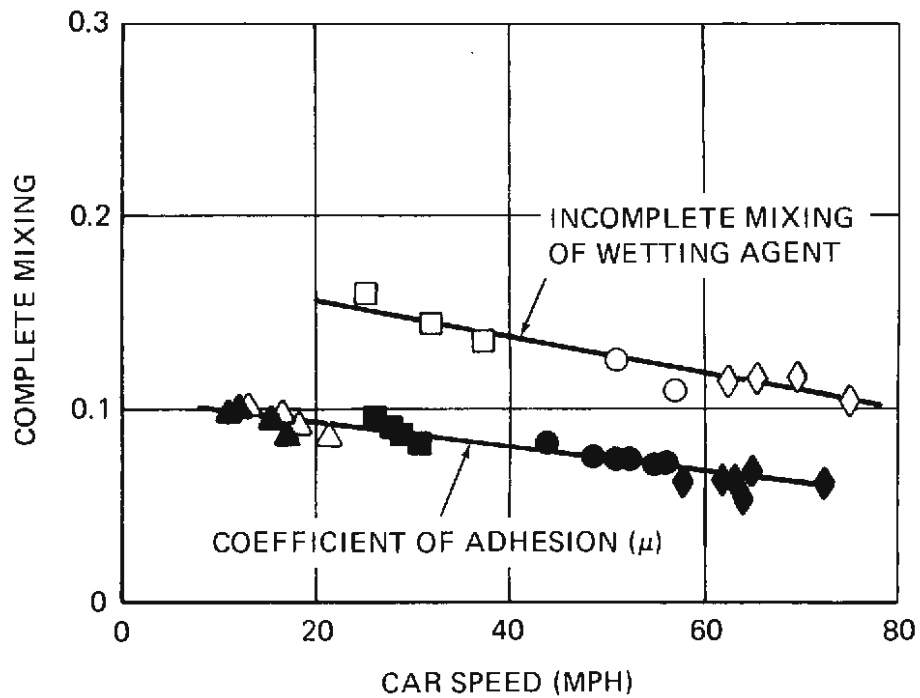

Figure 6-16. Wheel Adhesion

TABLE 6-6. SUMMARY OF SOAC ENERGY CONSUMPTION ON ACT-1
SYNTHETIC TRANSIT ROUTE

Data From Test Run 153

| Station (Two Directions) | Maximum Speed (mph) | Distance (Miles) | Two-Way Energy (kw-hr*) | |
|--------------------------|---------------------|------------------|-------------------------|--------------|
| | | | Total | Per Car-Mile |
| A to B | 60 | .75 | 9.35 | 12.47 |
| B to C | 70 | 1.00 | 11.55 | 11.55 |
| C to D | 50 | .50 | 6.25 | 12.50 |
| D to E | 60 | .75 | 9.15 | 12.20 |
| E to F | 50 | .50 | 6.25 | 12.50 |
| F to G | 40 | .25 | 4.00 | 16.00 |
| G to H | 40 | .25 | 4.00 | 16.00 |
| H to I | 50 | .50 | 6.20 | 12.40 |
| I to J | 80 | 1.50 | 16.20 | 10.80 |
| J to K | 80 | 1.25 | 14.70 | 11.76 |
| K to L | 40 | .25 | 4.10 | 16.40 |
| L to M | 50 | .50 | 6.55 | 13.10 |
| M to N | 40 | .25 | 4.40 | 17.60 |
| N to O | 70 | 1.00 | 12.25 | 12.25 |
| | 18.5 Mile | Total (x2) | 229.9 | 12.43 |
| Schedule Speed: | 27.8 mph | | | |

Data From Test Run 149

| | | | | |
|-------------------------------------|-----------|-------|-------|-------|
| | 18.5 Mile | Total | 235.1 | 12.71 |
| Schedule Speed: | 27.3 mph | | | |
| (Numerous spin-slides on wet rails) | | | | |

*Includes 34 kw auxiliary power.

TABLE 6-7. SUMMARY OF UNDERCAR EQUIPMENT TEMPERATURES
FOR SYNTHETIC TRANSIT ROUTE (105,000-POUND CAR)

| Parameter | No. | Peak Temperature (°F) | |
|---------------------------------------|-----|--------------------------|--------------------|
| | | Run 149 | Run 153 |
| Propulsion Blower, Outlet Air | 4 | 135 | 146 |
| Chopper Box, Interior Air | 8 | 141 | 150 |
| Chopper Box, Outlet Air | 3 | 142 | 148 |
| Traction Motor, Outlet Air | 12 | 183 | 182 |
| Traction Motor, No. 3 Frame | 1 | 151 | 151 |
| PCU, Interior Air | 6 | 147 | 156 |
| PPCU, Interior Air | 9 | 178 | 177 |
| APCU, Interior Air | 10 | 155 | 165 |
| Motor Smoothing Reactor | 7 | 167 | 166 |
| Brake Grid Air | 5 | 820 ⁽²⁾ | 850 ⁽²⁾ |
| Motor-Alternator, Outlet Air | 11 | 169 | 168 |
| Air Conditioner, Condenser, Input Air | 2 | 162 | 157 |
| Test Ambient Air | | 75 | 79 |

NOTES

- (1) Adjusted to 125°F ambient SOAC design goal.
- (2) Peak recorded temperature during brake applications.
- (3) Performance level - Duty Cycle: approx 1-hour rating
 PCU = Power control unit
 PPCU = Propulsion power control unit
 APCU = Auxiliary power control unit

TABLE 6-8. SUMMARY OF WHEEL SPIN-SLIDE SYSTEM EFFICIENCIES* (90,000-POUND CAR)

Braking Mode (Speed Range 80 to 10 mph)

- Blended Braking 78.5%
- Service Friction Braking 63.4%
- Dynamic Braking Only 77.4%

Accelerating Mode (Speed Range 0 to 35 mph)

- Full Power Acceleration (solid wheels) 82%

$$\text{Efficiency} = \frac{\text{Actual Deceleration Rate}}{\text{Average Available Deceleration Rate}}$$

*Based on solid and resilient wheel data.

Ride Quality Test Results

The ride quality vibration data were recorded on analog tapes and later digitized to obtain spectrum analysis and power spectral density curves. The purpose for this series of tests was to provide an understanding of the car body motions during operations. Spectrum analysis and a power spectral density permits identification of vibration contribution from known modal characteristics of the car body structure. The spectrum analysis and power spectral density curves for the midcar centerline vertical location are shown in Figure 6-17. Both curves indicate that peak amplitudes occur at the following frequencies:

- Response from a rigid body suspension mode 1.5 Hz
- First car body vertical bending mode 7.5 Hz
- Second car body vertical bending mode 15.0 Hz
- Component induced vibration 30.0 Hz

NOTES

1. SPEED 80 MPH
2. TRACK SECTION I
3. GROSS WEIGHT 105,000 LB
4. HIGH-DENSITY CAR
5. RESILIENT WHEELS

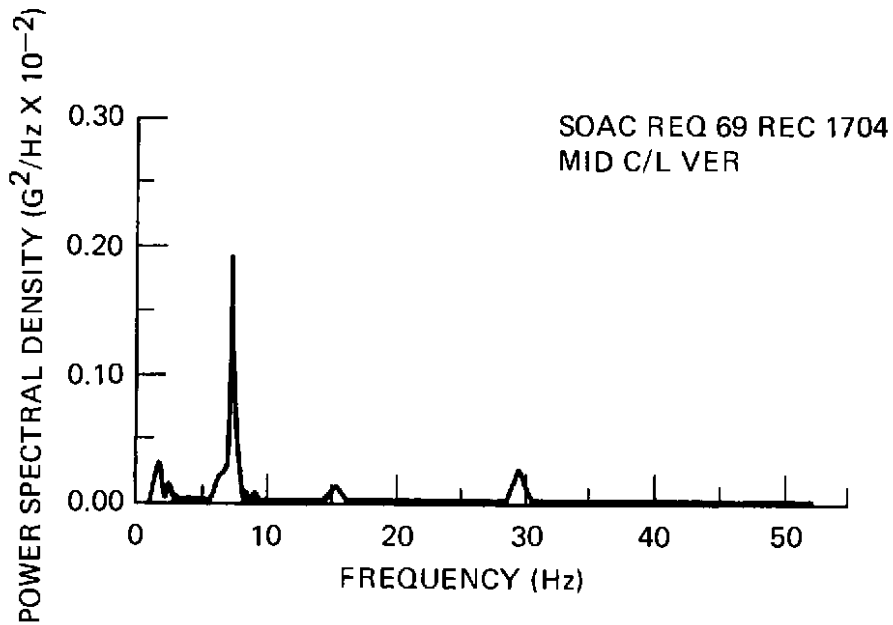
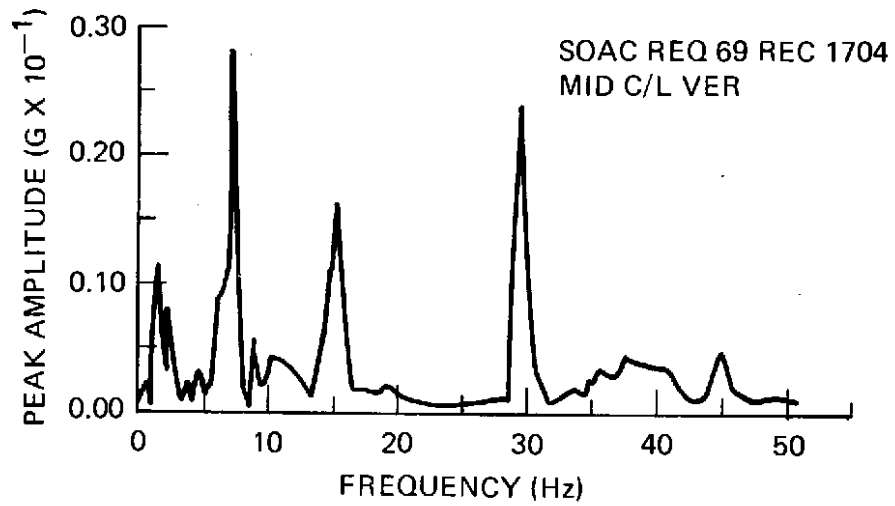

Figure 6-17. Ride Quality Test Baseline Data

The filter bandwidths for the spectral density and spectrum analysis were 0.20 Hz in the 0 to 10-Hz range and 1.0 Hz for frequencies above 10 Hz.

These comparison plots show the effect on vehicle vibration levels of speed, track section, car weight, and train consist.

Results of the SOAC testing show that for the HSGTC test track, the car body vertical g levels provide the best indicators for evaluating the effects of speed, weight, and other variables on passenger ride quality. Car body lateral accelerations are low and generally insignificant, as are the longitudinal accelerations. This situation is reversed for the truck where the lateral accelerations are much larger than the vertical. The car body underframe is very rigid laterally, however, and shows very little response to lateral inputs from the trucks.

- Speed Effects

Figure 6-18 is representative of the SOAC midcar vibration characteristics at various speeds. The vertical vibration resulting from the 15-Hz second vertical bending mode increases significantly at 80 mph while the response from the first vertical bending mode is predominant at 45 mph.

Forward car vibration characteristics are shown in Figure 6-19. Response to the rigid body suspension frequency (1.5 Hz) increases significantly at 55 mph. Although the rigid body suspension mode is predominant here, responses from the first (8 Hz) and second (15 Hz) vertical bending modes which dominate the midcar characteristics are evident at 45 and 80 mph, respectively.

Vertical journal box accelerations are not affected by speed. Lateral acceleration levels, however, are significantly higher than vertical levels and reach their peak amplitudes at 80 mph. Figure 6-20 shows the effect of speed on journal box accelerations.

- Weight Effects

Midcar vertical accelerations are significantly reduced with increased car weight.

The effect of increased car weight on the predominant forward car (rigid body) frequency (1.0 to 1.5 Hz) is opposite to the effect on the predominant midcar frequencies.

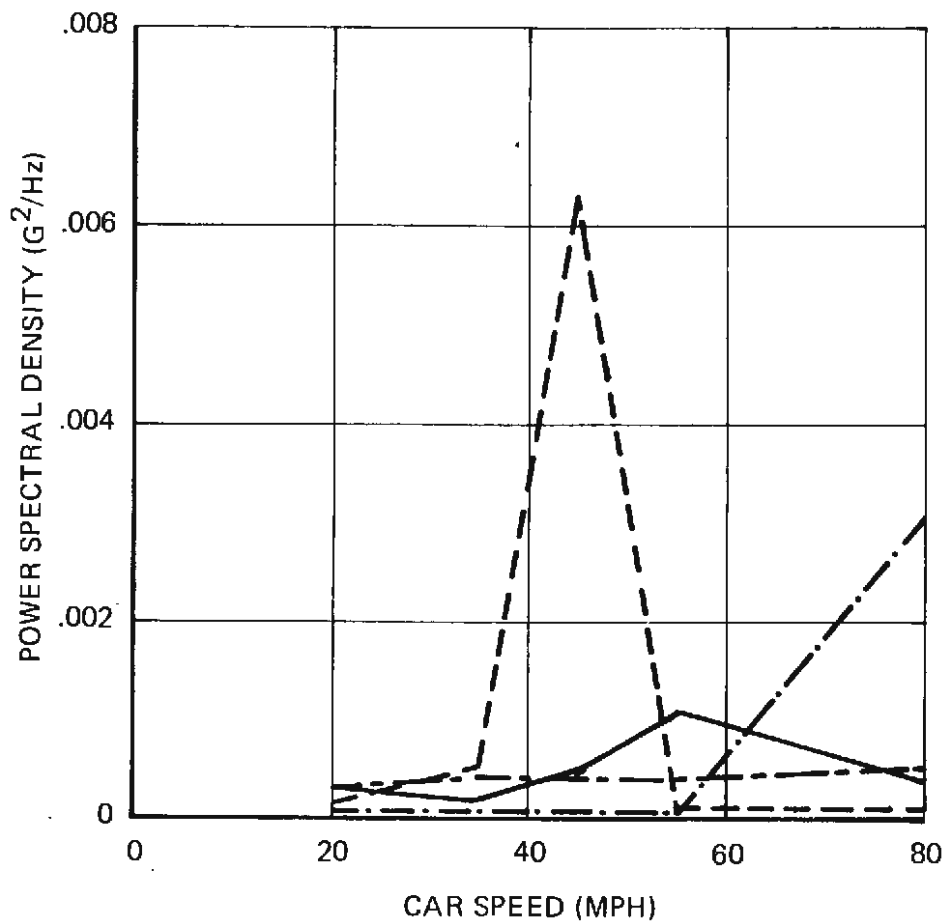
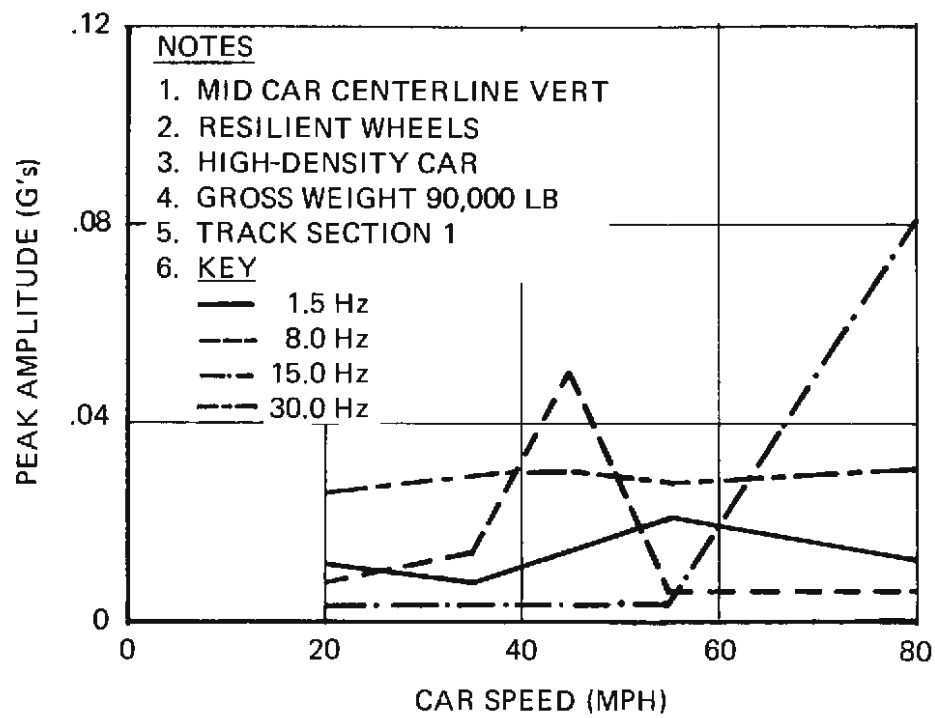

Figure 6-18. Ride Quality Baseline Comparison: Effect of Speed

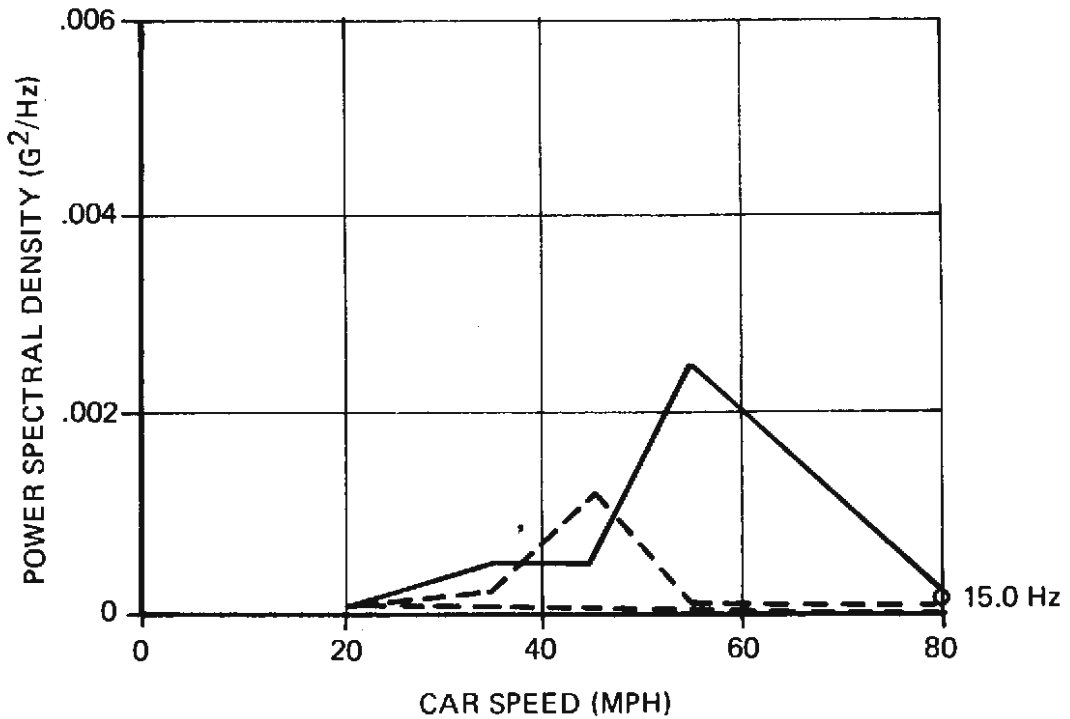
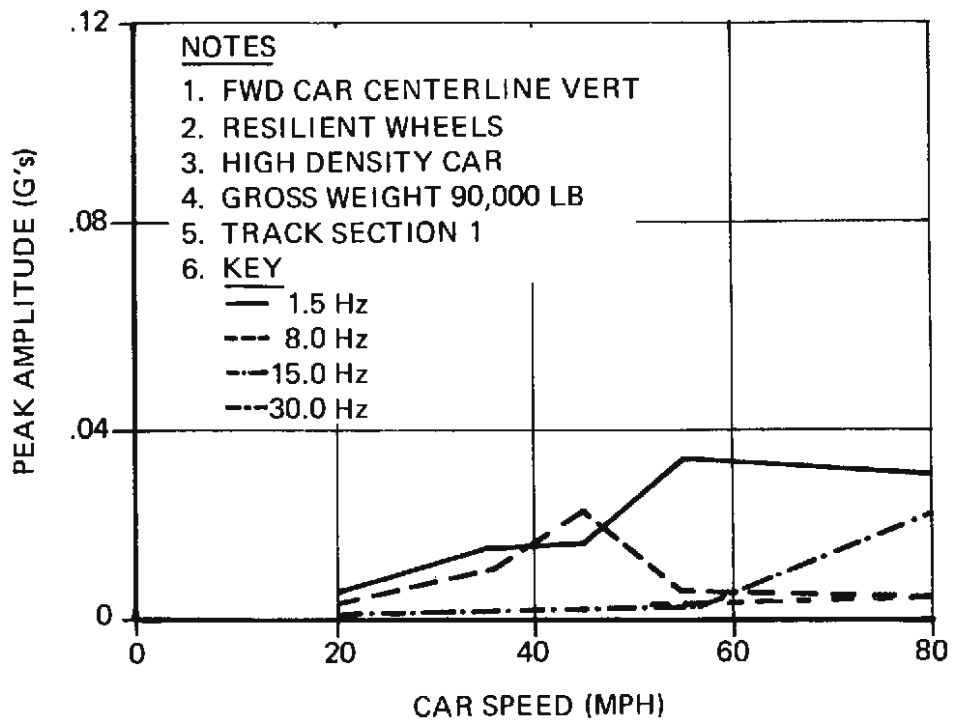

Figure 6-19. Ride Quality Baseline Comparison: Effect of Speed

NOTES

1. FWD AXLE R/H JB FRONT TRK. LAT.
2. RESILIENT WHEELS
3. HIGH DENSITY CAR
4. GROSS WEIGHT 90,000 LB
5. TRACK SECTION I
6. KEY

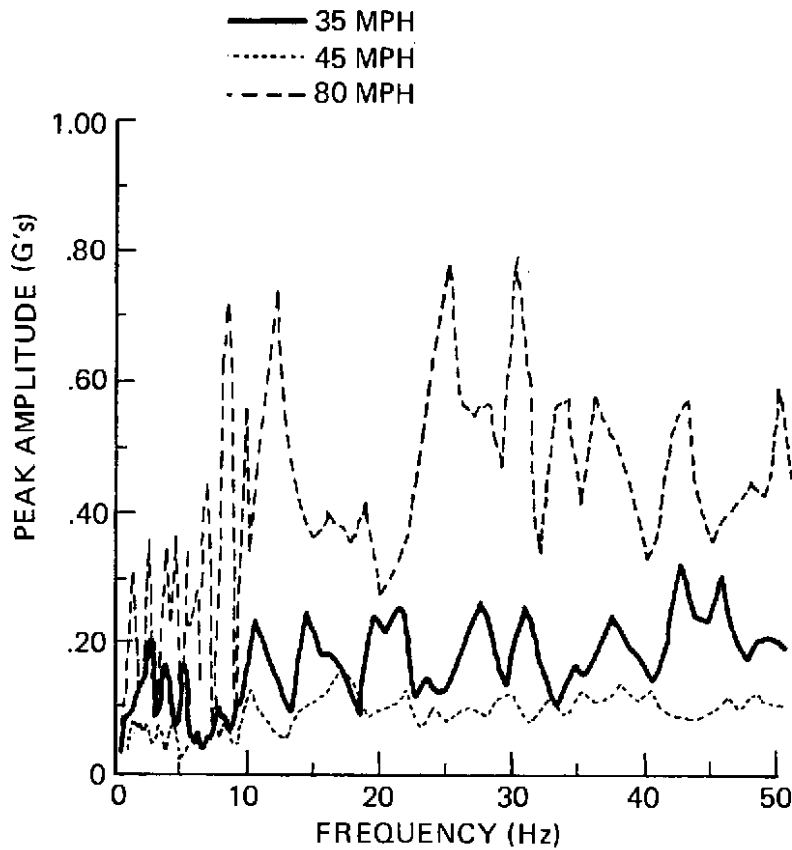

Figure 6-20. Ride Quality Baseline Comparison: Effect of Speed

Journal box accelerations showed little change with car weight variation except for lateral acceleration at 45 mph which increased at a weight of 105,000 pounds compared to 90,000 pounds.

- Track Effects

The UMTA test oval at HSGTC employs six different track, tie, fastener, and ballast combinations. Comparative vibration data was taken for each track section. No identifiable trend in ride quality was attributable to the type of track, ties, fasteners or ballast. Track Section I gave the lowest midcar vertical vibration and the highest forward car vertical vibration.

- Train Consist Effects

Comparative vibration data was taken for the single (high-density) car and for the two-car train. In examining the car body vertical accelerations and looking at the predominant frequency or frequencies for six cases, three show lower vibration levels for the two-car train, one shows a lower level for the high-density car and two show no difference:

| <u>Sensor Location</u> <u>(in Car)</u> | <u>Predominant</u> <u>Frequency (Hz)</u> | <u>Lower</u> <u>Vibration</u> |
|-------------------------------------------|---------------------------------------------|----------------------------------|
| Forward | 1.5 | Same |
| Middle | 7.5 | Train |
| Middle | 15.0 | Same |
| Forward | 1.5 | Train |
| Middle | 7.5 | Train |
| Middle | 15.0 | High density car |

As previously noted, the lateral accelerations on the truck are much larger than the vertical accelerations. Comparing lateral acceleration data on the front truck journal bearing for the single high-density car and the two-car train at 35, 45, and 80 mph, the 35 and 80-mph conditions show significantly lower truck lateral vibration for the two-car train across the frequency spectrum. The 45-mph condition shows essentially the same vibration level for the two consists from 0 to 25 Hz, with the single high-density car lower at frequencies from 25 to 50 Hz.

In general, running with two cars coupled together appears to reduce vibration levels and to improve ride quality.

Interior Noise Levels

Interior noise level measurements of the SOAC were made to define its acoustical characteristics. These tests resulted in the accumulation of over 500 data points showing the contribution of speed, track construction, wheel configuration and equipment on noise levels at various interior locations. Some of the data points were subjected to one-third octave band and narrow band analysis in order to determine the composition of the associated noise levels.

The analyses showed that the interior noise levels are a function of undercar equipment, the air comfort system blowers, and the wheel/rail interaction. When the car is at rest or below 25 mph, the undercar equipment and blowers are the predominant contributors in the "A" weighted noise spectra. Above 25 mph the wheel/rail interaction becomes significant and is a function of wheel construction and tire surface quality. The effect of speed on noise levels for four different car interior locations is shown in Figure 6-21. It is significant that the SOAC vehicle falls 5 to 7 dBA below the design goals.

The effect of wheel configuration on noise levels is shown in Figure 6-22. Below 25 mph, all the wheel configurations are within 1 to 2 dBA of each other. As speed increases, the flats on the steel wheels become a major noise source.

The full advantage of the Acousta Flex wheels is not evident in this figure: the data shown was obtained at steady speeds on tangent track, and the Acousta Flex wheel is designed to damp high frequency noise, such as generated in tight turns. The full effect of the resilient wheels will be measured in the cities.

Wayside Noise Levels

As with the interior noise, the wayside noise measurements were made to determine the SOAC characteristics and to identify the primary noise contributors. The "A" weighted noise levels were recorded for over 100 data points.

Since the major noise contribution in wayside noise comes from the wheel/rail interaction, an effort was made to understand this contribution. Figure 6-23 shows the effect of rail surface roughness. Since February 1973 when the HSGTC transit track was ground smooth, track Sections II through VI had generally carried only test vehicle traffic; while Section I carried all the rail traffic to Test Center. Since the data in Figure 6-23 was obtained in May and June 1973, the effect of this traffic on rail roughness and noise levels was readily determined.

NOTES

- 1. INTERIOR OF CAR 1
- 2. GROSS WEIGHT 90,000 LB
- 3. CAR LOCATION

KEY

- CAB
- OVER FRONT TRUCK
- ◇ MID CAR
- △ OVER REAR TRUCK

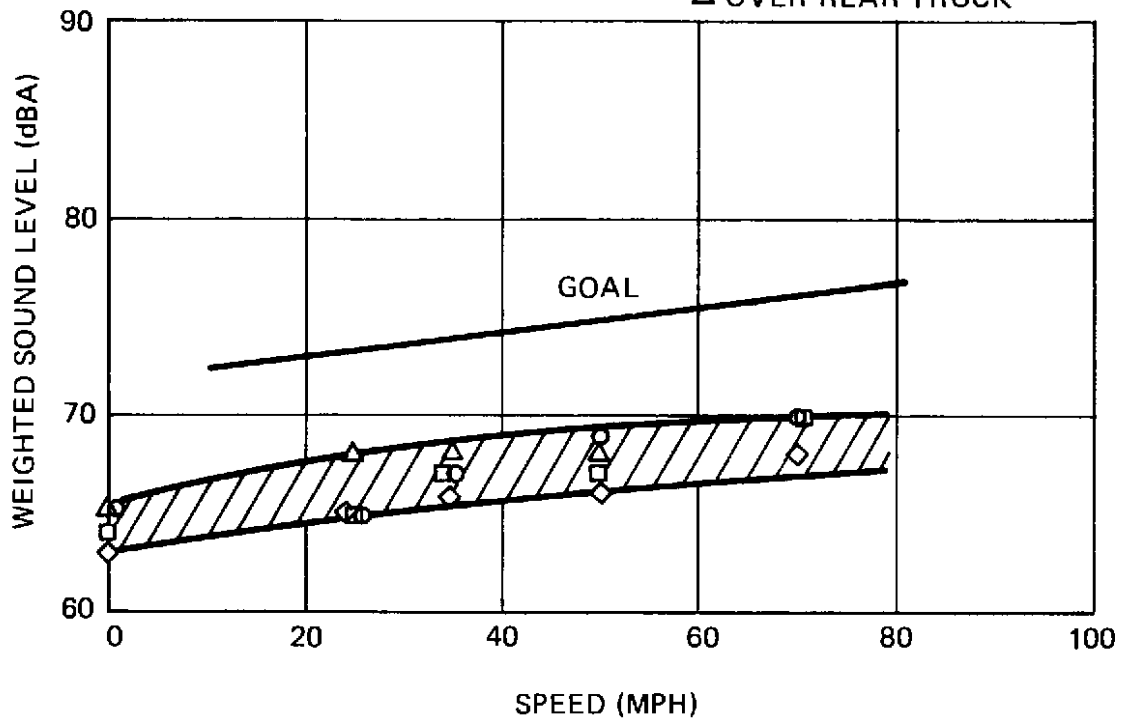

Figure 6-21. Comparison of Interior Noise Levels with Goals

NOTES

- 1. INTERIOR OF CAR 1
- 2. GROSS WEIGHT 90,000 LB
- 3. TRACK SECTION I

KEY

- STEEL FLATS
- △ STEEL TRUED
- ACOUSTA FLEX

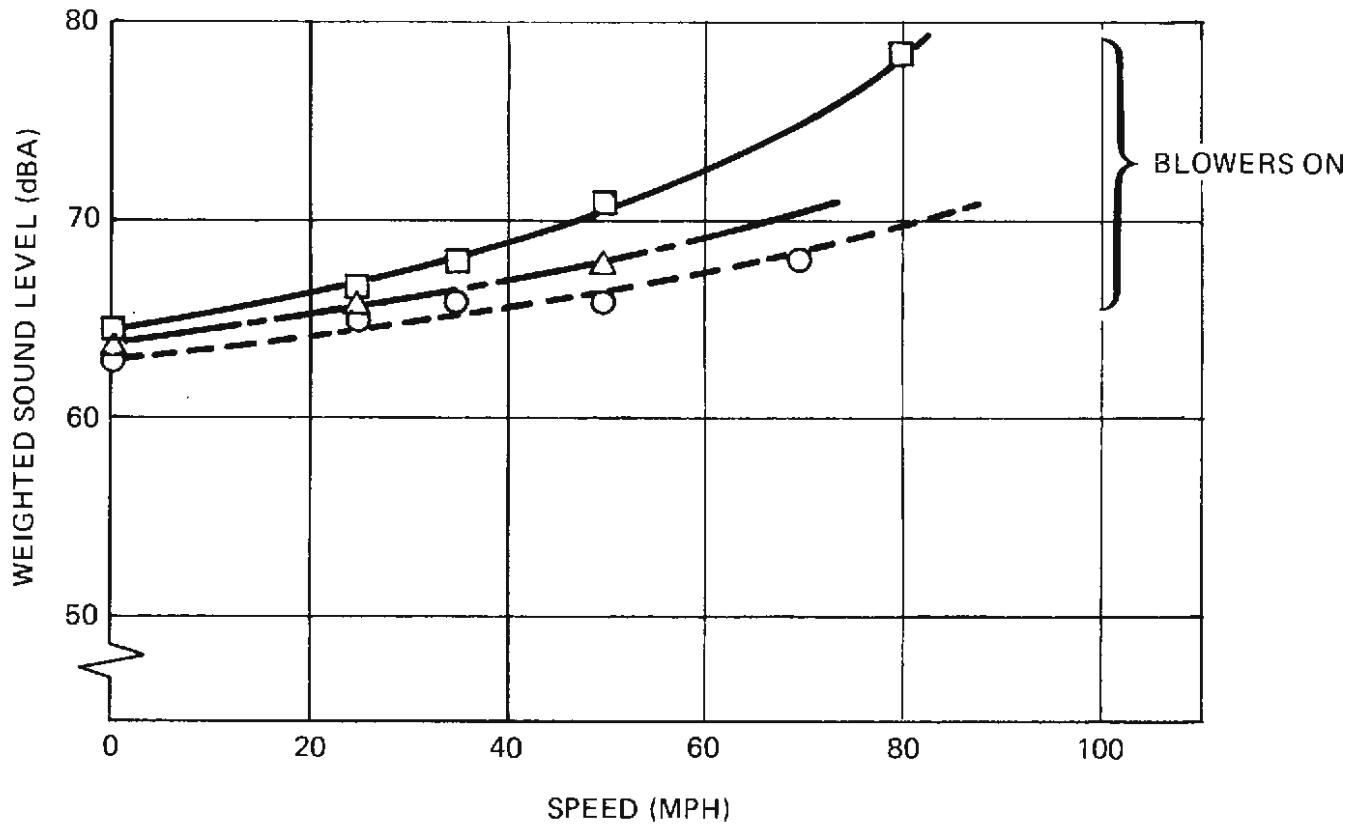

Figure 6-22. Effect of Wheel Configuration on Interior Noise

NOTES

1. INTERIOR OF CAR 1
2. GROSS WEIGHT 90,000 LB
3. 50 FT FROM TRACK CENTERLINE
4. TRUED STEEL WHEELS

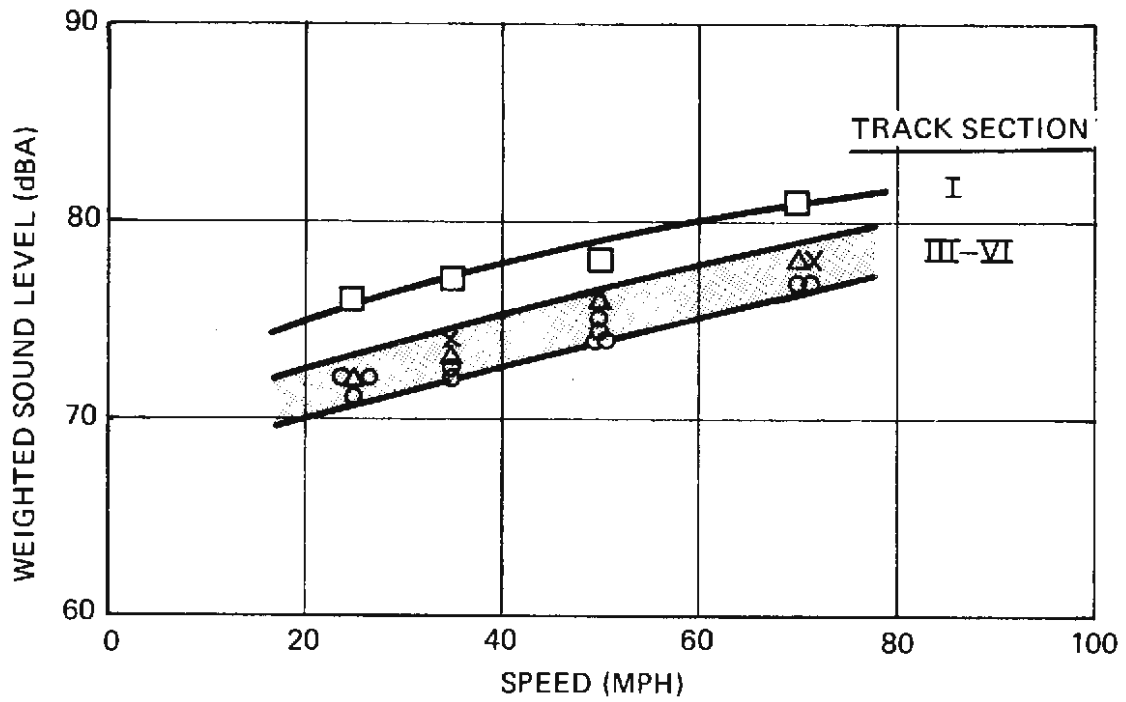

Figure 6-23. Comparison of Rail Surface Roughness on Noise

Figure 6-24 shows the effect of wheel roughness on noise levels. Since Car No. 1 has a larger number of wheel flats than Car No. 2, it has a slightly higher noise level for this condition.

Figure 6-25 compares the speed effect of two-car and single-car operations. The predicted 3 dBA spread for doubling the number of cars is verified over most of the speed range; the divergence at the 70 mph points is probably attributable to wheel flats on Car No. 2 (the single car data was taken on Car No. 1).

Figure 6-26 compares the wayside noise level of the SOAC vehicle with the design goal which was met or bettered at all speeds above 35 mph. Subsequent noise analyses showed the traction motor blowers to be the major noise contributor below 35 mph.

Radio Frequency Interference (RFI)

A series of measurements was made to determine the broadband radiated electromagnetic emissions of the SOAC vehicles. (This program was identical to one performed on the BART vehicles and was completed during SOAC acceptance testing.) The maximum measured RFI emissions under different operating conditions are compared with the SOAC goals in Figure 6-6.

SOAC measurements were in compliance with the accepted accuracy of ± 3 dBA for this type of emission.

Structures

Review of the structural test data reveals that the instrumentation produced data that can be used to determine magnitude, phasing and frequency of truck loads. The data shows that the truck frame stress levels measured at the HSGTC test oval are low in magnitude. Comparative data to be obtained on the five transit properties will show whether the low loads are peculiar to the HSGTC track conditions or are also representative of revenue service on older transit systems.

Although the SOAC Detail Specification does not address the specific question of truck fatigue allowable stresses, the levels apparently existing during testing are considered non-damaging to the truck structure.

The data clearly show the levels of loads that are experienced in equipment items such as the dampers and the suspension elements. Data from these tests have been reviewed on a preliminary basis only. For definitive test results, considerable effort remains to develop the methodologies for

NOTES

1. GROSS WEIGHT 90,000 LB
2. 50 FT FROM TRACK CENTERLINE
3. TRACK SECTION IV

WHEEL SURFACE KEY

- CAR 1 FLATS
- CAR 2 FLATS
- △ CAR 1 SMOOTH

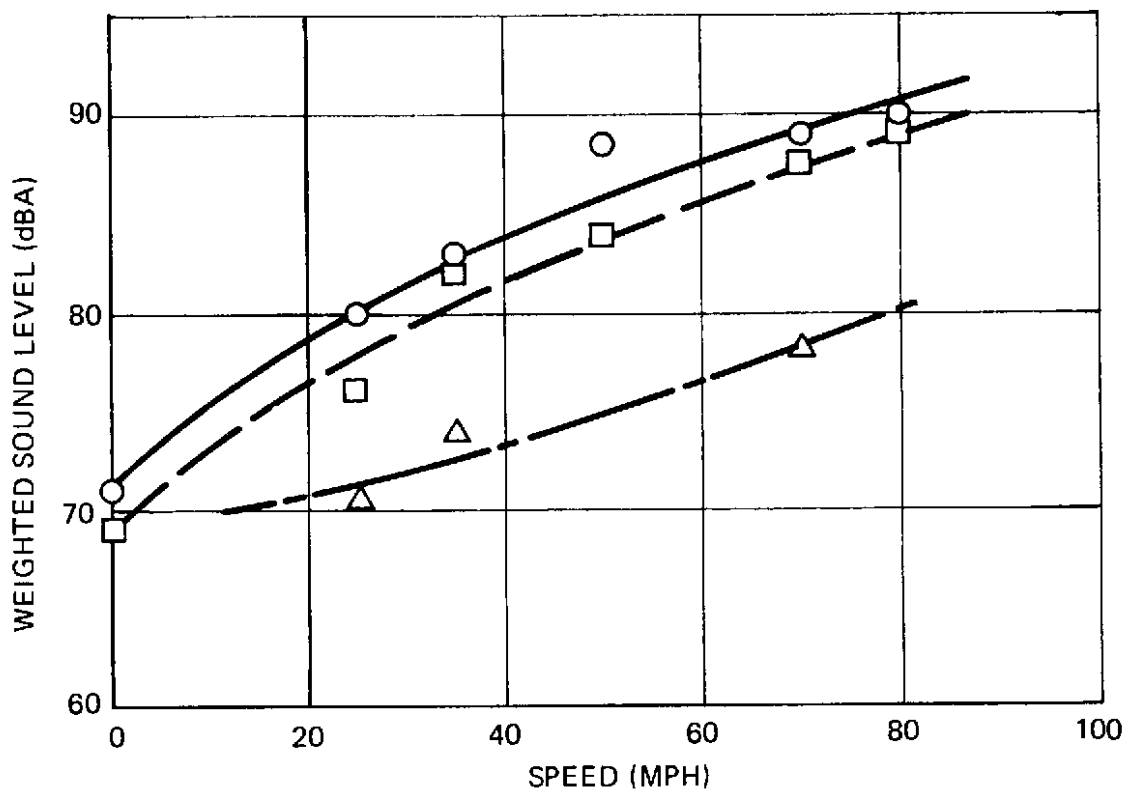

Figure 6-24. Comparison of Wheel Surface Roughness on Noise

NOTES

1. ACOUSTA FLEX WHEELS
2. GROSS WEIGHT 105,000 LB
3. TRACK SECTION I
4. 50 FT FROM TRACK CENTERLINE
5. LEVELS NORMALIZED TO STANDARD CONDITIONS

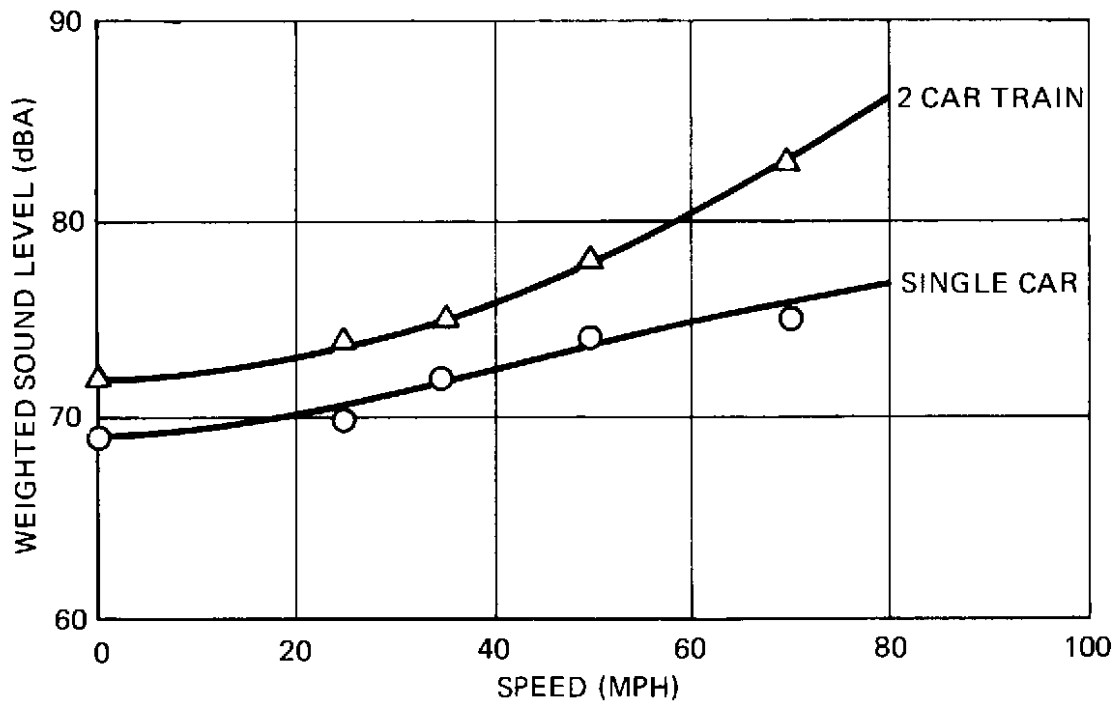

Figure 6-25. Effect of Speed on Wayside Noise

NOTES

1. ACOUSTA FLEX WHEELS
2. GROSS WEIGHT 105,000 LB
3. 50 FT FROM TRACK CENTERLINE
4. LEVELS NORMALIZED TO STANDARD CONDITIONS
5. DATA POINTS

○ 2-CAR TRAIN
△ SINGLE CAR

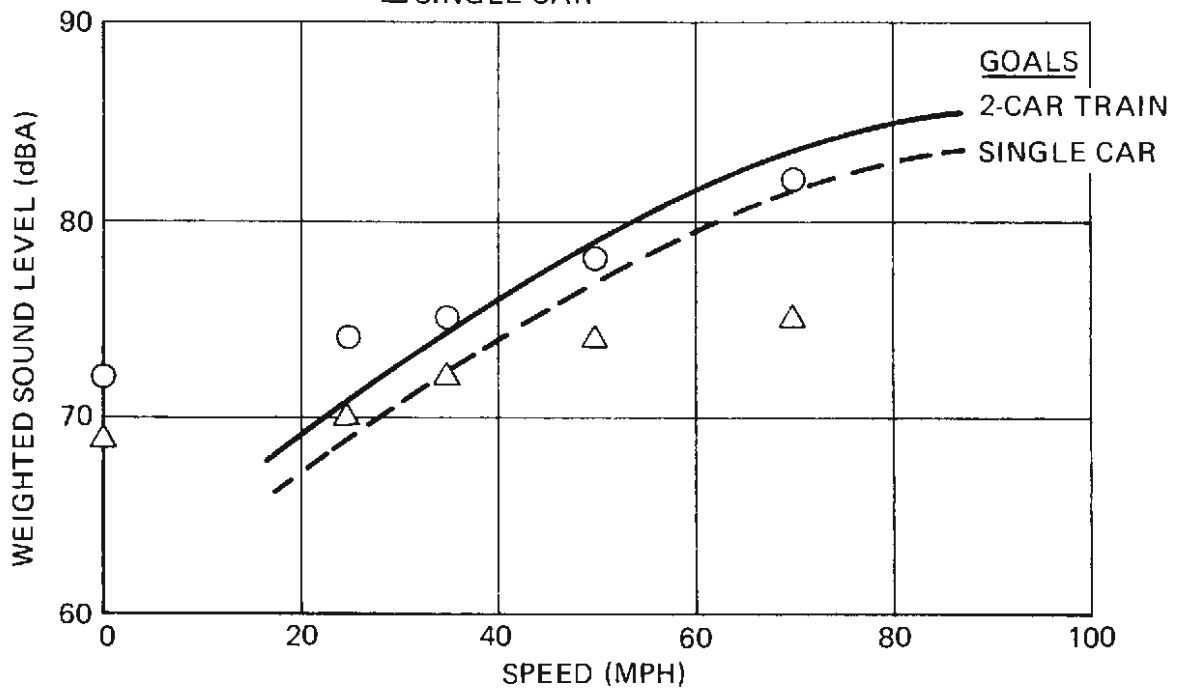

Figure 6-26. Comparison of Wayside Noise Levels with Goals

reducing, displaying, analyzing, and interpreting the test data. Once this has been accomplished, data of the type obtained on this program can provide useful information for improved truck design.

Voltage Transients and Spikes

A test program was conducted to obtain voltage transient and spike data on the SOAC vehicle. This program was similar to that accomplished during the summer of 1972 by the University of Missouri on the five demonstration properties. The results of the property tests may be found in Investigation of Voltage Transients and Spikes in Direct Current Rapid Transit Systems (Reference 5).

Unfortunately the power source at the HSGTC was not representative of the sources at the various properties which exhibited a range of voltage spikes from -2700 to +2500 volts. At the HSGTC, positive spikes never exceeded +1600 volts and there were no negative spikes. The HSGTC locomotive also generated short transients in the +800 to +1600 volt range, not typical of the properties. Some long duration transients below +520 volts were also experienced during the performance tests. These can be a function of the SOAC acceleration and the response characteristic of the locomotive power source.

6.5 SIMULATION DEMONSTRATION TEST RESULTS

Test Program

A total of 6000 miles (3000 per car) was established as a goal of the simulated demonstration test program. Testing was conducted with each car ballasted to 105,000 pounds (representing a load of 100 passengers).

Train configuration for most of the testing was a two-car train running 8 hours a day, 6 days a week. The simulated transit route (see Figure 6-27) is a composite of routes in the five cities and consists of 16 stations at an average distance of approximately 1/2 mile (from a range of 1/4 mile to 1-1/4 miles) with various run speeds between stations. In order to simulate actual operation on the transit properties, the SOAC was operated on simulated trips consisting of:

1. Two laps of the oval stopping at each station for door opening and closing on each side of the car sequentially. The prescribed run speeds between stations were achieved with the SOAC speed limiting system, using maximum acceleration and full-service brake rates.

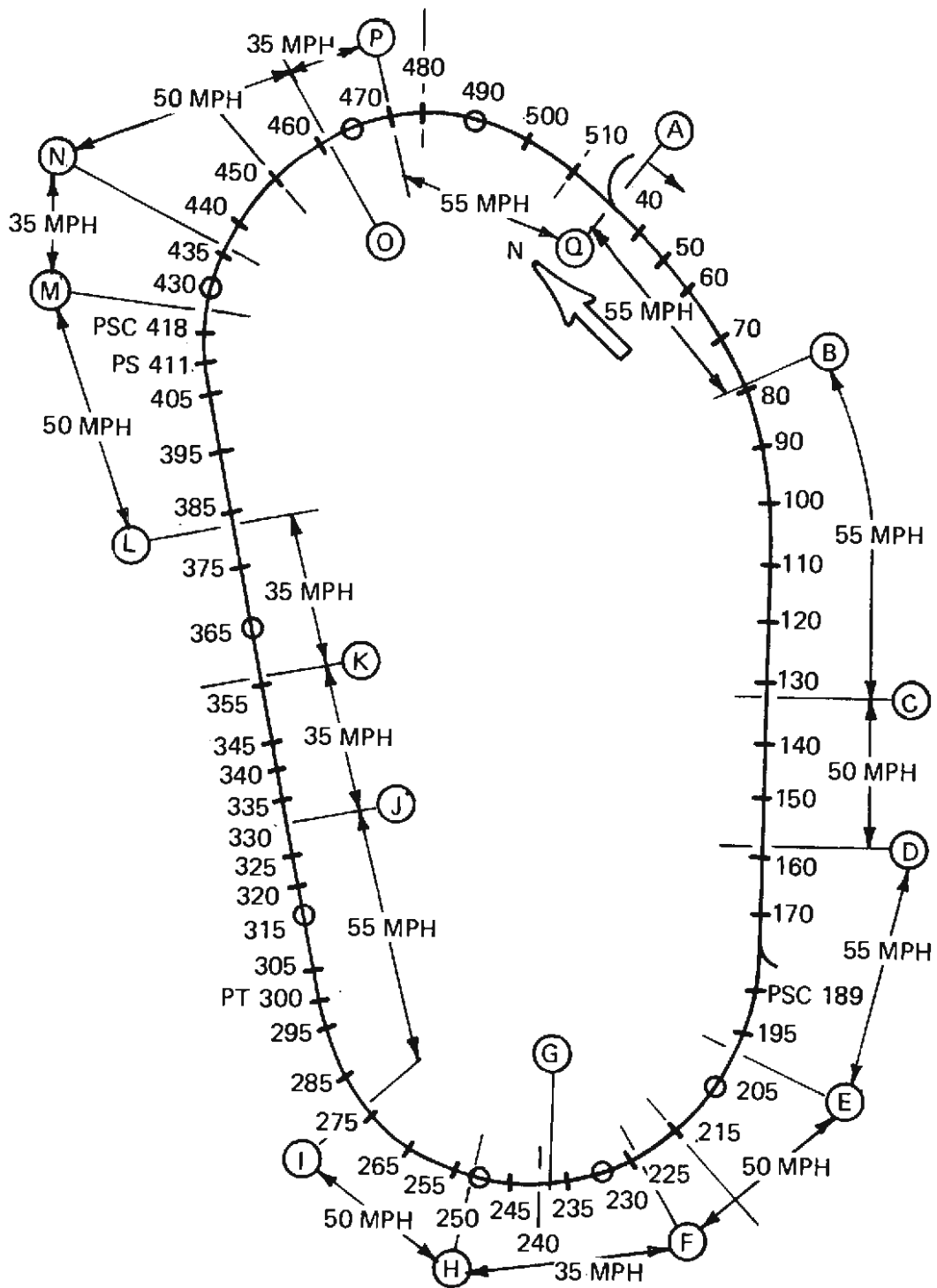

Figure 6-27. Simulated Demonstration Route at HSGTC

2. Two non-stop laps of the oval at 80 mph.

After a 5-minute layover the same run profile was made in the opposite direction.

The first test run was conducted on July 23, 1973 and the last on August 11, 1973 when the accident occurred. Thirty-five test runs were made and a total of 4,197 car miles were accumulated (see Figure 6-28), 1,573 in single-car operation. On five occasions the test objective of operating the SOAC as a two-car train could not be met because of malfunctions which forced a car out of service (see Figure 6-29).

Test Results

The most significant car problem uncovered during testing was that excessive oil leaking was occurring from the gearboxes. The problem was discovered because of the frequent inspections performed during and after daily testing. The leakage rate during 500 miles of testing varied widely among the 8 gearboxes in the two-car train, the lowest was 0.1 quart and the highest was 1.2 quarts.

A laboratory test conducted by Garrett-AiResearch traced the oil leakage problem to the omission of oil drain holes between the labyrinth seal and the tapered roller bearing adjacent to it. The effectiveness of the labyrinth seal decreases with decreasing shaft speed. When this gearbox was operated under repetitive stop-start conditions, oil leaked out through the labyrinth seal.

The gearbox was modified by adding two 3/4-inch drain holes at the labyrinth seal and at the seal cavity on the cover side of the gearbox. The holes permit oil accumulating in the seal cavity during operation to drain back into the sump when the car stops. When tested the modified gearbox had an oil leakage rate of only 0.88 ounce per 600 stops, an acceptable oil leakage rate.

Details of the simulated demonstration testing may be found in the SOAC Simulated Demonstration Test Report (Reference 6).

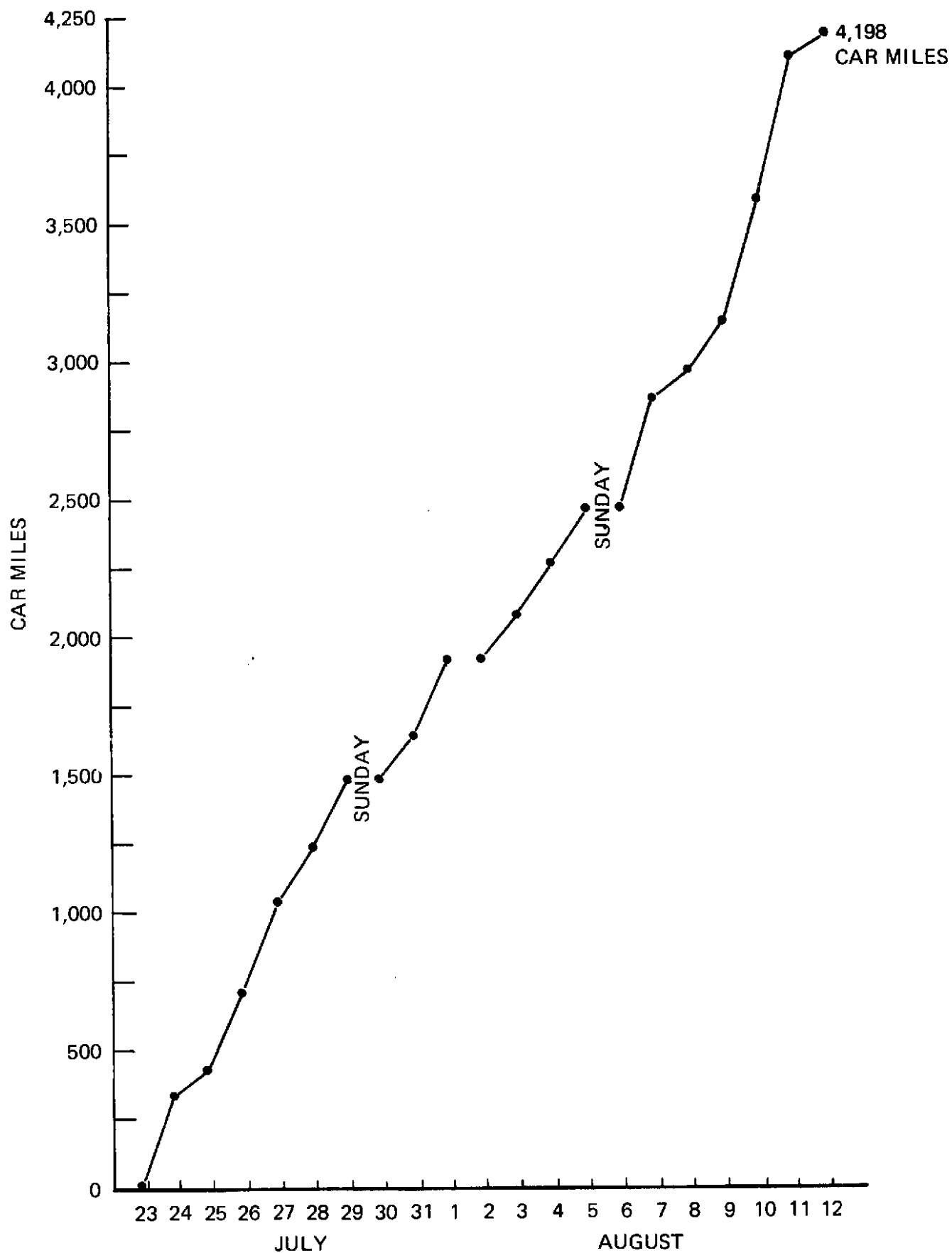

Figure 6-28. Mileage Accumulation During Simulated Demonstration (23 July to 11 August 1973)

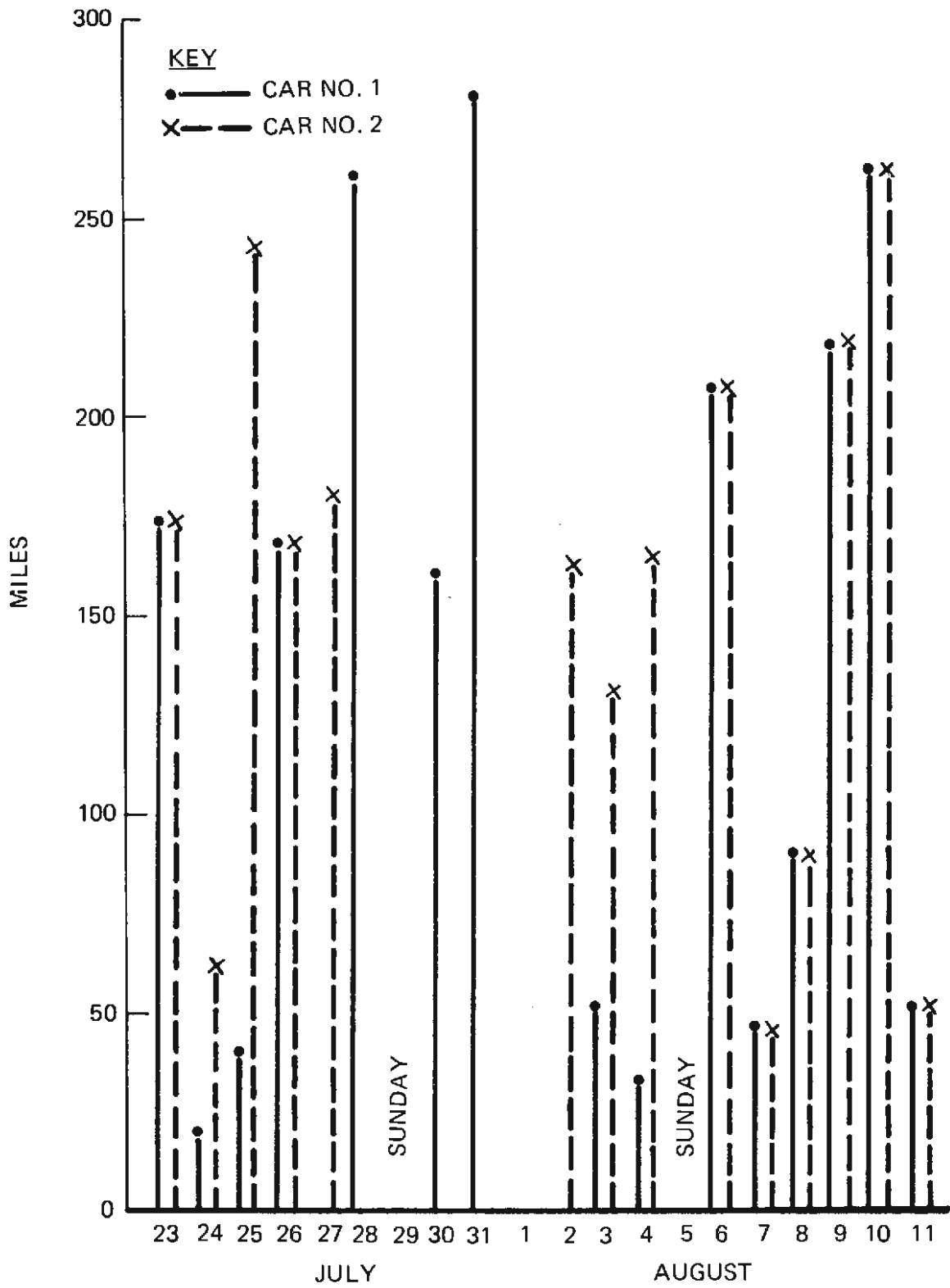

Figure 6-29. Daily Miles Per Car During Simulated Demonstration (23 July to 11 August 1973)

7. ENGINEERING DESIGN CHANGES AND CORRECTIVE ACTIONS

During the SOAC Engineering Test Program, problem-solving activities were initiated for problems requiring design changes or corrective actions. As the testing phase progressed, a number of subsystem malfunctions occurred: some necessitating design changes; others, isolated events, requiring only corrective action. Both types are reported in this section - as a sample of the problems encountered, and a description of the manner in which these problems were solved.

7.1 DESIGN CHANGES

Propulsion System

Although the highest risk element of the propulsion and control system was thought to be the chopper, only one chopper malfunction occurred on the SOAC program. This was caused by an open circuit in a control logic connector as a result of a maintenance error.

For the modification described in the following paragraphs, the motors were removed from the cars the week of December 4, 1972 and returned to AiResearch. By February 12, 1973, all modifications were confirmed, all rework was completed, motors were reinstalled in both cars, and systems testing was continued.

- Current Instability During Drive-to-Brake Transition

Considerable current swapping occurred between the two parallel truck systems after transition to brake from the

drive mode, when the separately excited fields were zero. This was apparently a series generation mechanism. The effect of the swapping during transition was eliminated by inserting diodes in series with each pair of traction motors.

- Current Instability During Normal Motoring

This problem was caused by a rising motor speed characteristic (an increase rather than a decrease in motor speed with an increase in motor load). This increase in speed with load was caused by interpole overcompensation. The problem was corrected by increasing the effective interpole air gap by machining material from the interpole faces. Non-magnetic bolts were also incorporated to reduce the flux leakage from the interpole to the frame. A motor with increased air gap was tested on January 16, 1973. The tests indicated that with proper brush and brush holder design, a drooping speed characteristic with load was repetitively obtainable. All motors have been modified and are performing satisfactorily.

- Current Instability Immediately After Reversal of Car Direction

This problem was caused by mechanical instability of the brush in the holder as the direction of rotation of the motor was reversed. Brush friction at the commutator surface caused the brush to tilt and its mechanical and electrical neutral, with respect to the poles in the stator, to change. The direction of the change was such that as load was increased, the load current caused a decrease in the main field flux which in turn increased the speed of the motor. The brushes and brush holders were redesigned to correct this mechanical instability. All brush holders were reworked and installed with negator springs. Carbon brushes with pigtail shunts and a top angle of 15 degrees were tested in the motors and performed satisfactorily.

- Motor Arcing to Ground

This problem was caused by excessive brush dusting (wear) combined with ionization of the carbon particles in the air by electrical "streamers" from the brushes, both caused by poor commutation. The original brushes and brush holder configuration did not use pigtails to conduct current from the brush to the box, but relied on the contact between the finger and the top of the carbon brush.

After new brushes with pigtails were installed and brush grade was changed, there was a vast improvement in commutation, brush dusting and streamers were eliminated, and brush sparking was drastically reduced. This eliminated the arcing-to-ground problem.

To reduce the damage from any future arcing to ground, the inside ends of the motor external terminals were covered with insulating material; all grounded metal parts were coated with an insulating material; all sharp corners of grounded and live metal parts were removed; and the clearance between the commutator insulating band and the arcing studs was increased.

Car Body Vibration

In April, 1973 a ride quality survey indicated a degradation of the SOAC car vibration levels at speeds over 55 mph. These vibrations at high speeds were not observed in early phases of the test program. An investigation revealed that two characteristics of the car had changed. These changes, which could have altered the response of the vehicle, were:

- Wheel flats had developed during performance testing.
- There was insufficient clearance between the mounting brackets and the motor alternator hard points to allow the elastomer mounts to function correctly.

It was determined by a vehicle shake test and analysis that the undercar motor alternator support beams had a resonance frequency at the 80-mph wheel-rotational one-per-revolution frequency. The car underframe was locally reinforced on June 20, and tested June 29, verifying acceptability of the change.

7.2 CORRECTIVE ACTIONS

Other problems encountered during the program were attributed to quality, infant mortality, and maintenance practice. The following four problems of that nature required corrective action but no design changes.

Motor Armature Short

A motor failure occurred on SOAC No. 2 during the engineering test program in May 1973. The failure was not attributed to any unusual test being performed. Subsequent teardown inspection at AiResearch indicated a short circuit had occurred between two adjacent armature coils. This failure was classified as random, due probably to either random insulation breakdown or insulation damage during assembly of the motor.

Geabox Bearing

A failure of the input pinion bearing in the No. 2 gearbox of the No. 1 SOAC occurred during a routine test in May

1973. Subsequent investigation of the failed gearbox indicated the input pinion bearing failed from oil starvation. Bench testing on another gearbox indicated that if a low oil state exists below recommended levels, the input pinion bearing will overheat and ultimately fail. This failure was attributed to insufficient oil in the gearbox prior to running. An indicating dip stick has been installed in each gearbox.

Chopper Sharing Resistor

During the final stages of the Acceptance Test Program in April 1973, a failure occurred with the sharing resistors in one of two main thyristor drawer assemblies in SOAC No. 2. This was caused by lack of proper thyristor gate drive to the failed thyristor drawer and resulted in removal of 50 percent of available chopper capability; the remaining main thyristor assembly experiencing an effective 100-percent overload. This current overload produced excessive heating in each of the three current sharing resistors, which then fused open.

The control cards which perform the gate drive function were carefully inspected and found to be functional; therefore, the conclusion was that the connector which transmits the drive pulse to the main thyristors contained film barriers or misalignment which prohibited proper signal propagation. Improper alignment could have been caused by vibration of the control cards which had been operated without the benefit of the hold-down bar specifically designed to hold the control cards firmly in the proper connector alignment position.

The chopper system demonstrated complete, proper operation when the thyristor drawers were replaced and the control card connector was cleaned; therefore, no further actions were taken except to make certain the tiedown bars were installed prior to any operations.

Motor Commutator High Bar

After systems testing was resumed in February 1973, it was noted there was excessive brush wear on the No. 4 motor of SOAC No. 1. Inspection of the commutator indicated that a high bar existed and the commutator segments were not chamfered. An AiResearch factory modification team accomplished the stoning and chamfering of the commutator while the motor was installed on the car. This corrected the excessive wear problem and no further action was required.

8. MOCKUP AND TEST AND EVALUATION PROGRAMS

8.1 SOAC MOCKUP

In order to demonstrate the SOAC exterior and interior design to a larger segment of the public than will see the cars during operational testing in the cities, a full-scale mockup of the SOAC vehicle was designed and built by Sundberg Ferrar.

The two-section mockup has been designed to be transportable over regular highways with each section separately built onto a complete flatbed trailer. The mockup is air conditioned and equipped with heating, lighting and public address systems. Commercial 60 Hz electric power must be provided at each display site.

The first public display of the SOAC mockup was at the U.S. International Transportation Exposition (TRANSPO 72) at Dulles International Airport, Washington, D.C. from May 26 through June 4, 1972. Since TRANSPO the mockup has been displayed in Washington, D.C.; Pueblo, Colorado; and Rochester, Buffalo and Syracuse, New York. More than 400,000 people have visited the mockup. (Figure 8-1 shows the mockup on display; Table 8-1 summarizes the display activities.)

At each display site Boeing Vertol personnel staffed the mockup and provided technical data describing the project to members of the public. A questionnaire-type opinion survey has been and will continue to be taken at each display site to obtain public reaction to the SOAC.



COLORADO STATE FAIR, PUEBLO, COLORADO



ROCHESTER, N.Y.

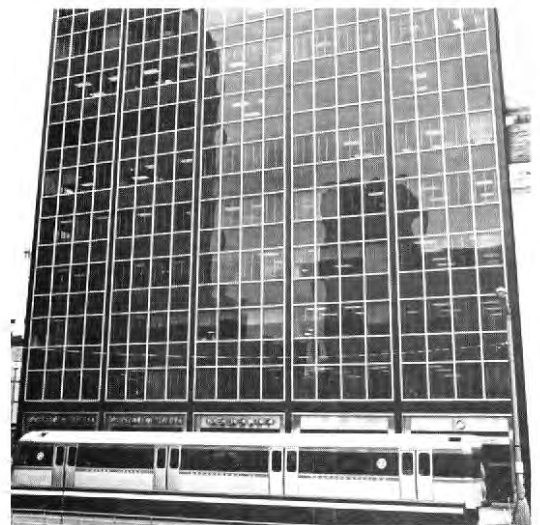

BUFFALO, N.Y.



WASHINGTON, D.C.

Figure 8-1. SOAC Mockup on Display

TABLE 8-1. MOCKUP DISPLAY ACTIVITIES

| Dates | Display Site | Days | Attendance |
|-----------------------------|------------------------------------------------------------------|------|------------|
| 1972 | | | |
| May 26 to June 4 | Washington, D.C., Transpo 72, Dulles International Airport | 9 | 145,000 |
| June 19 to July 5 | Washington, D.C., Downtown | 14 | 2,500 |
| August 25 to September 4 | Pueblo, Colorado, Colorado State Fair | 10 | 120,000 |
| 1973 | | | |
| May 3-12 | Rochester, N.Y., Downtown | 9 | 20,000 |
| May 18-27 | Buffalo, N.Y., Downtown | 10 | 35,000 |
| August 28 to September 3 | Syracuse, N.Y., New York State Fair | 6 | 82,000 |

Current plans are that the mockup will be displayed in Boston, Cleveland, Chicago, and Philadelphia in conjunction with the SOAC operational test and evaluation.

8.2 OPERATIONAL TEST AND EVALUATION

An operational test and evaluation plan has been developed and coordinated with each of the five selected cities.

Details of this phase will be presented in Volume 2 of this report.

The public relations aspects of the overall plan are being discussed in detail with each city. In conjunction with this, a Human Factors Task is being performed by interviewing SOAC passengers to establish criteria for comfort and safety. A questionnaire has been developed by Chilton Company (under a Boeing Subcontract) for use in the conduct of these interviews; the questionnaire has been coordinated with all concerned parties.

Additional details of the planning with each city are as follows:

New York

Upon completion of the engineering test program at the HSGTC, the SOAC will be shipped to New York where, upon arrival, it will be taken to the 207th Street maintenance shop and will be set up for running on the lines of the NYCTA (New York City Transit Authority). When setup is completed the SOAC will be tested on the NYCTA test track at 207th Street. After completion of qualification tests, instrumentation will be installed on the SOAC and tests will be conducted over the lines on which SOAC will run in revenue service. In addition to basic performance measurements, this testing will include ride quality, noise and structural tests. During the test program NYCTA motormen will be trained to operate the SOAC.

"Very important person" (VIP) runs will be conducted at the conclusion of the testing and the SOAC will then be placed in a two-week period of revenue service on the A Line from 207th Street to Lefferts Boulevard and Far Rockaway, the E Line from 179th Street to Hudson Terminal, the D Line from 205th Street to Coney Island, and the N Line from 57th Street to Coney Island. These runs will give the SOAC exposure in Manhattan, Queens, Brooklyn and the Bronx.

This same general procedure of qualification tests, engineering tests, VIP runs and revenue runs will be followed in each of the five demonstration cities.

Boston

From New York, the SOAC will travel to Boston where the cars will be set up at the MBTA (Massachusetts Bay Transportation Authority) Cambridge shops; with testing, VIP runs, and revenue service to be conducted over the Harvard-Quincy, Harvard-Ashmont, and new South Shore Lines. A clearance car has been run over these lines to assure clearance for the SOAC. An automatic train operation (ATO) cab signaling system is in use on the Harvard-Quincy Line. In order to run on this line, it is planned that the SOAC will use a portion of the MBTA cab signaling system and its own speed maintaining system to provide ATO. The marriage of these two systems is being accomplished with the assistance of the MBTA Signal and Communications Department and will permit the SOAC to operate like any other MBTA car.

Cleveland

From Boston, the SOAC will travel to Cleveland, where the cars will be set up at the CTS (Cleveland Transit System) Windermere shops. Testing, VIP runs, and revenue service will be conducted over the Airport-Windermere Line. No special problems are anticipated in Cleveland. An analysis was made of a recent clearance car run which determined that minor relocations of equipment are required along the line to assure SOAC clearance.

The SOAC will be equipped with a gap filler at the door thresholds to narrow the gap between the SOAC and the CTS platforms. For CTS revenue operation the SOAC side door circuitry will be modified to permit selection of either single- or three-door set operation. Single-door operation will permit the motorman to collect fares in low traffic areas and during off-peak hours when there are no platform attendants. Three-door operation is required during peak hours when station fare collection is used.

Chicago

From Cleveland the SOAC will be shipped to Chicago where the cars will be set up at the CTA (Chicago Transit Authority) Skokie shops. Testing, VIP runs, and revenue service will be conducted on the Skokie Swift Line which runs from Dempster to Howard Street.

A major problem in Chicago is that the SOAC is wider than the CTA cars. Since this would cause interference problems at the platforms, various solutions have been offered to permit the SOAC to operate on the same line as the CTA cars. Discussions and evaluations are still being conducted to determine the best method to accommodate SOAC.

Philadelphia

From Chicago the SOAC will travel to Philadelphia. The set-up will be accomplished in the SEPTA (Southeastern Pennsylvania Transportation Authority) Fern Rock shops. Testing, VIP runs, and revenue service will be conducted on the Broad Street Line from Fern Rock to Pattison.

9. ECONOMIC ANALYSIS

9.1 INTRODUCTION AND SUMMARY

One of the eight separate tasks to be performed under the Urban Rapid Rail Vehicle and Systems Program is the economic analysis task relating to the SOAC and ACT cars. The study deals with a production version of the SOAC and covers two major topics:

- An estimate of the production cost
- A tradeoff analysis dealing with the selection of the propulsion control system

The production cost estimate includes the cost of purchased equipment and in-house assembly. Planning prices for production quantities of the purchased equipment were requested from the SOAC prototype suppliers. Assembly costs are based on an industrial engineering estimate.

The tradeoff analysis identifies the benefit resulting from use of chopper control rather than switched-resistor for the propulsion control system. Since the analysis considers life cycle costs, all the costs and benefits expected over the entire life of the vehicle are compared, not only the initial investment cost.

Production Cost Estimates

Production cost estimates have been derived for the SOAC vehicle in both married pair and self-sufficient single-car configurations (and a 300-car production quantity). For the

self-sufficient car, \$220,245 of purchased equipment are identified; while for the married pair, \$203,705 of purchased items are identified per car. Non-recurring costs, administrative overhead, and profit bring the total price in 1973 dollars to \$351,673 for a self-sufficient car and \$333,115 for each car of a married pair.

Tradeoff Analysis - Chopper vs. Cam Control

The tradeoff analysis evaluating the use of solid state chopper control rather than switched resistors for the propulsion control system concludes that 0.857 kilowatt-hours of electrical energy per vehicle mile can be saved. This translates into an annual saving of \$800 per car. Additional savings in maintenance may also result; however, insufficient data make this uncertain and difficult to quantify. Since it appears that transit vehicles with solid-state control systems will cost no more to purchase than the switched-resistor type, the critical energy saving benefits of chopper control make that choice even more effective.

9.2 PRODUCTION COST ESTIMATE

Two configurations of the SOAC are considered in estimating the costs of a production run of 300 SOAC vehicles: the married pair and the self-sufficient car.

With the married-pair configuration, cars must always operate in pairs since an individual car does not contain a complete set of equipment. Production cost and weight may be reduced if equipment placed on one car alone serves both members of the pair, but some of the shared items must be placed on each car to maintain the weight distribution and to keep space utilization from being too far out of balance between cars. It is not possible to operate single-car trains or an odd number of cars with the married-pair configuration.

The self-sufficient car configuration, contains all necessary operating equipment. Consequently, a single-car train or any odd (or even) number of self-sufficient cars may be operated. Self-sufficient cars cost more than married-pair cars, but offer greater flexibility in tailoring train length to varied passenger loads. A mix of the two configurations may be desirable for certain circumstances.

In recognition of the advantages of being able to separate the cars during the testing and evaluation programs, the two SOAC prototypes were built as self-sufficient cars.

Table 9-1 contains the prices of the purchased items for the SOAC, based on planning estimates requested from prototype

suppliers. While not firm quotes, realistic prices were requested for this study. For the married pair configuration, the pantograph, auxiliary power, batteries, and brake-system air compressor are shared between the two cars.

The production manhour estimate developed by Boeing's industrial engineers is presented in Table 9-2. Table 9-3 is a compilation of the complete price, including engineering, overhead, and administrative costs. The price estimate for a self-sufficient car is \$351,673; the per-car price for the married pair configuration is \$333,115.

TABLE 9-1. ESTIMATED PRICES FOR PURCHASED
HARDWARE (300 CARS)

| Item | Self-Sufficient Car (dollars) | Married Pair (dollars) |
|----------------------------------------------------|-------------------------------|------------------------|
| Motors, gearbox, chopper control | 80,000 | 80,000 |
| Auxiliary power | 20,000 | 10,000 |
| Brake system | 15,000 | 12,500 |
| Batteries | 1,090 | 700 |
| Pantograph | 3,650 | 2,000 |
| Truck-frame, suspension and bearings | 17,000 | 17,000 |
| Wheels and axles | 7,500 | 7,500 |
| Couplers | 10,000 | 8,000 |
| Windshield | 3,105 | 3,105 |
| Windows | 620 | 620 |
| Sash | 4,250 | 4,250 |
| Doors | 4,405 | 4,405 |
| Door operators | 10,520 | 10,520 |
| Lighting | 3,180 | 3,180 |
| Seats | 5,650 | 5,650 |
| Temperature control equipment and air conditioning | 13,075 | 13,075 |
| Stanchions, straps, and windscreens | 3,500 | 3,500 |
| Carpet | 700 | 700 |
| Radio, intercom and public address system | 4,000 | 4,000 |
| Raw material | 12,000 | 12,000 |
| Miscellaneous | 1,000 | 1,000 |
| Total of Purchased Items per Car | 220,245 | 203,705 |

TABLE 9-2. RECURRING MANUFACTURING MANHOUR SUMMARY (300 CARS)

| Activity | Side Super- Structure | Roof | Under- Frame | No. 1 and No. 2 Ends | Passenger Section | Final Assembly | Totals |
|-------------------------|-----------------------------|--------|-----------------|-------------------------|----------------------|-------------------|-----------|
| Activity | 62,862 | 32,115 | 40,328 | 35,590 | 149,732 | -- | 320,627 |
| Assembly | 44,119 | 39,274 | 95,293 | 68,863 | 70,021 | 178,056 | 495,626 |
| Installation | -- | -- | -- | 49,173 | 364,011 | 287,114 | 700,328 |
| Tooling | 2,139 | 1,427 | 2,712 | 3,072 | 11,675 | 9,304 | 30,329 |
| Tool Service | 3,491 | 2,330 | 4,426 | 5,014 | 19,054 | 15,184 | 49,499 |
| Planning and Liaison | 2,728 | 1,820 | 3,458 | 3,917 | 14,885 | 11,862 | 38,670 |
| Production Services | 7,916 | 5,282 | 10,035 | 11,368 | 43,198 | 34,424 | 112,223 |
| Totals (300 cars) | 123,255 | 82,248 | 156,252 | 176,997 | 672,576 | 535,974 | 1,747,302 |

TABLE 9-3. ESTIMATED PRODUCTION PRICE (300 CARS)

| Item | Self-Sufficient Car (dollars) | Married Pair (dollars) |
|----------------------------------------------------------------------------------------------------------------|-------------------------------|------------------------|
| Cost of purchased items | 220,245 | 203,705 |
| Recurring cost: manufacturing, labor fringe benefits, overhead (\$16 x 1,747,302 manufacturing manhours ÷ 300) | 93,189 | 93,189 |
| | <hr/> | <hr/> |
| | 313,434 | 296,894 |
| Engineering, mockup, tooling planning and liaison (2%) | 6,269 | 5,938 |
| | <hr/> | <hr/> |
| | 319,703 | 302,832 |
| Administrative overhead and profit (10%) | 31,970 | 30,283 |
| | <hr/> | <hr/> |
| Total Price per Car | 351,673 | 333,115 |

9.3 PROPULSION CONTROLS TRADEOFF STUDY

Background: Life-Cycle Costs

A cost-effectiveness tradeoff analysis was conducted of the life-cycle costs of a major subcomponent in the propulsion control system: the DC-DC chopper control unit using thyristors.

When the net benefit or cost of a particular component is evaluated, all identifiable costs and benefits affected by the component during the entire life cycle of the vehicle must be considered, since a savings in investment cost is not worthwhile if it results in a much greater increase in operating costs.

Some qualifications must be noted. It is desirable to defer expenses so long as deferral does not increase them. Furthermore, a slight increase in costs may be acceptable if it facilitates postponement of expenses. Therefore, it may or may not be preferable to spend an extra \$25,000 now, rather than incur an expense of \$1000 per year for 30 years. In order to compare major capital expenditures with annual operating costs, the capital investment can be expressed as an equivalent annual cost by multiplying it by a capital recovery factor. The equivalent cost equals the amount of interest and principal that would have to be paid each year if the capital funds were borrowed. The interest rate to be used is the rate at which the transit authority can borrow money. Once all costs and benefits are expressed annually, the net annual cost or benefit can be determined as the overall result of using the component under analysis. In an alternative approach future costs and benefits can be multiplied by present worth factors to obtain equivalent present values. These are compared with the initial investment cost. (For a detailed explanation of equivalent annual cost and present value calculations, see Grant and Ireson, Principles of Engineering Economy, Reference 7.)

For comparative purposes it is generally necessary to estimate or assign dollar values for costs or benefits not initially expressed in dollars (otherwise the comparison of dissimilar nonmonetary items may not be readily understood). Conversely, if it seems unreasonable to attach a monetary value to a particular item, its importance must be otherwise determined.

Life-cycle cost analysis using equivalent annual costs is a logical method for dealing with cost analysis problems in the transit industry.

Propulsion Control Systems

The tradeoff analysis evaluated the use of chopper control, rather than switched-resistor (or cam) control for the SOAC propulsion system. Heretofore, most transit vehicles have employed cam controllers to vary motor torque and speed output. As resistors are switched in and out, motor speed and power output vary with the voltage. However, electrical energy is wasted because power is consumed by the resistors. Furthermore, frequent failure of the switches causes a significant portion of maintenance costs.

Chopper control uses electronic circuitry to pulsate the current input to the motors. By varying the duration of the on-pulse, the average current is varied. Compared to switched resistors, the electronic circuits provide better use of electrical energy and do not require as much maintenance.

The energy waste from the resistors of a cam system occurs when the train is leaving a station. The resistors are not used above a base speed which is often about 20 or 25 mph; therefore, the power loss does not occur when the train is at normal cruise speeds. Consequently, the amount of energy wasted per mile is a function of the number of stops per mile.

Additional differences in power consumption would also arise from differences in weight between a cam and chopper, since power consumption is a function of the total weight of the vehicle.

Energy Consumption

The difference in energy consumption between chopper and cam control systems was evaluated by means of computer-simulated test runs. The simulation model was developed to evaluate the proposals for the Advanced Concept Train (ACT-I). During the simulated run, a train travels along a 20-mile route with grades and curves, stopping at stations, and carrying various passenger loads. The ACT-I high-density route has the properties shown in Table 9-4.

To identify properly the energy consumption differences, five control systems and two motors were evaluated. The various combinations of motors and controls are listed in Table 9-5.

Two motors were considered because a cam control is not normally used on a motor with separately excited fields such as the Garrett motor on the SOAC. It is normally used with a series motor where it serves both the armature and the field. With a separately excited field motor, two separate cam controls would be needed: one for the armature and one for the

TABLE 9-4. HIGH-DENSITY ROUTE PROPERTIES

| | |
|----------------------------------|------------------------------------------------------------|
| Length | 20 miles |
| Stations | 32 |
| Station dwell time | 20 seconds |
| Number of peak-hour passengers | 60,000 (one way) |
| Train length | 8 cars maximum (188 passengers per car maximum) |
| Minimum headway | 90 seconds |
| Station spacings | 0.25-mile minimum, 1.50-mile maximum |
| Maximum speed limits | 50 mph minimum, 75 mph maximum |
| Maximum grade | 2 percent |
| Substation total capacity | 202,500 kw (2-hour peak), 405,000 kw (5-minute peak) |
| Nominal voltage | 600 volts |
| Maximum potential schedule speed | 29.6 mph (for ± 3 mphps acceleration and deceleration) |

TABLE 9-5. MOTOR AND CONTROL COMBINATIONS

| Combination No. | Motor | Field | Control | Comments |
|-----------------|---------|----------|--------------|-------------------------------------|
| 1 | Garrett | Separate | Chopper | Actual SOAC system |
| 2 | WE-1462 | Series | Chopper | BART chopper, motor similar to BART |
| 3 | WE-1462 | Series | Advanced cam | Cam similar to PATCO |
| 4 | WE-1462 | Series | Chopper | Reduced weight |
| 5 | Garrett | Separate | Chopper | Reduced weight |

field. This would increase the complexity, unnecessarily penalizing cam control in comparison.

Combination No. 1 (in Table 9-5) is the actual SOAC system. Combination No. 2 includes an off-the-shelf series motor (Westinghouse 1462) and the same chopper control used on BART. The WE-1462 has current consumption and torque-versus-speed characteristics similar to those of the Garrett motor and also resembles the WE-1463 which is used on the Bart vehicles. Combination No. 2 was proposed by Westinghouse for the SOAC program.

Combination No. 3 used the same series motor with an advanced cam-control system, similar to that used on the PATCO (Lindenwold) vehicles. The term "advanced" refers to the large number of steps or gradations of resistance and voltage applied to the motor. A cam with fewer steps would be lighter and would probably save some energy, but would not produce the smooth acceleration provided by the chopper and required by the performance specifications of the newest transit systems.

Comparison of Combinations No. 2 and 3 provides a reasonable estimate of the energy saved using chopper control instead of switched resistors. Additional energy can be saved, however. The chopper controls of Combinations No. 1 and 2 are heavier than necessary. An evaluation of the two systems identified significant weight savings that could be made on production versions using some components of each chopper.

Combination No. 4 was a hypothetical, lightweight chopper used with the WE-1462 series motor, while Combination No. 5 was a hypothetical version used with the Garrett separate field motor. Both of these are realistic targets that can be readily achieved in a production design.

Table 9-6 presents a compilation of the weights for each combination. Figure 9-1 shows maximum tractive effort as a function of speed, and Figure 9-2 shows current consumption (for maximum tractive effort) as a function of speed for the two motors. The weights and performance characteristics were taken from the manufacturers' specifications. With the weights and tractive effort curves, the simulation model determined the ratio of maximum acceleration capability to speed for each combination and then developed the speed profiles for the complete hypothetical route.

Once the speed profiles were determined, the schedule speed (or average speed including stops) for a 20-mile run was determined for each combination. On the basis of maximum short-duration power capabilities, any one of the combinations could reach a 28.8-mph schedule speed; but the 175-hp, one-hour RMS power rating at motor output shaft was exceeded for

TABLE 9-6. COMPILATION OF SOAC WEIGHTS WITH VARIOUS PROPULSION AND CONTROL COMBINATIONS

| <p>COMBINATION NO. 1: <u>ACTUAL SOAC VEHICLE WITH SEPARATE FIELD MOTOR AND CHOPPER CONTROL</u></p> <p>● Assumed vehicle weight: 89,000 lb (approx weight of SOAC car)</p> | <p>COMBINATION NO. 4: <u>WESTINGHOUSE 1462 SERIES FIELD MOTOR AND LIGHTWEIGHT CHOPPER</u></p> <p>Vehicle weight determined by comparison of items differing between No. 4 and No. 1:</p> | | | | | | | | | | | | | | | | | | | | | | | | | | | | | | | | | | | | | | | | | | | | | | | | | | | | | | | | | | | | | | | | | | | | |
|------------------------------------------------------------------------------------------------------------------------------------------------------------------------------------------------------------------------------------------------------------------------------------------------------------------------------------------------------------------------------------------------------------------------------------------------------------------------------------------------------------------------------------------------------------------------------------------------------------------------------------------------------------------------------------------------------------------------------------------------------------------------------------------------------------------------------------------------------------------------------------------------------------------------------------------------------------------------------------------------------------------------------------------------------------------------------------------------------------------------------------------------------------------------------------------------------------------------------------------------------------------------------------------------------------------------------------------------------------------------------------------------------------------------------------------------------------------------------------------------------------------------------------------------|----------------------------------------------------------------------------------------------------------------------------------------------------------------------------------------------|----------|--------------------------|---------------------|----------------------|----------|------------------------------------------------------------------------|-----|--------------------|--------------------------------------------------|--------------------------------------------------------------------------------------------------------------------------------------------------------------------------------------------------------------------------------------------------------------------------------------------------------------------------------------------------------------------------------------------------------------------------------------------------------------------------------------------------------------------------------------------------------------------------------------------------------------------------------------------------------------------------------------------------------------------------------------------------------------------------------------------------------------------------------------------------------------------------------------------------------------------|------------------|----------------------|------------------------------|-------|------------------------------|-------|----------------------|-----------------------|------------------------------------------|-------------|----------------------------|-----|-------|--------------------|-----|-----|--------------------|-----|-----|--------------------------|-----|-----|------------------------|-------|-------|-----------------------|-----|-------|-------------------------------------------------------|--------|--------|---------------------------------------------------------------------------------------------------------------------------------------------------------------------------------------------------------------------------------------------------------------------------------------------------------------------------------------------------------------------------------------------------------------------------------------------------------------------------------------------------------------------------------------------------------------------------------------------------------------------------------------------------------------------------------------------------------------------------------------------------------------------------------------------------------------------------------------------------------------------------------------------------------------------------------------------------------------------------------------------------------------------------------------------------------------------|-----------------------------------------------------|----------|-----------------------------------|--|-------------------|-----|-------------------------|-----|-----------------------------------|----|----------------------------|-----|----------------------------------|-----|------------------------------|-----|-----------------------|-----|---------------------------|-----|------------------------|-------|---------------------------|-----|-------|--------|
| <p>COMBINATION NO. 2: <u>WESTINGHOUSE 1462 SERIES FIELD MOTOR AND BART CHOPPER</u></p> <p>Vehicle weight determined by comparison of differing No. 2 and No. 1 propulsion system weights, as follows:</p> <table border="1" data-bbox="196 688 820 1197"> <thead> <tr> <th>Item</th> <th>No. 1</th> <th>No. 2</th> </tr> </thead> <tbody> <tr> <td>Traction motors (4)</td> <td>6,240 lb</td> <td>5,600 lb</td> </tr> <tr> <td>Field power supply (portion of auxiliary power 15 kw/125 kw x 3100 lb)</td> <td>372</td> <td>-</td> </tr> <tr> <td>Gearbox; coupling, suspension, stabilization (4)</td> <td>4,560</td> <td>3,880</td> </tr> <tr> <td>Motor group subtotal</td> <td>11,172</td> <td>9,480</td> </tr> <tr> <td>Choppers/semi-conductors</td> <td>975</td> <td>1,575</td> </tr> <tr> <td>Motor control (power)</td> <td>800</td> <td>1,100</td> </tr> <tr> <td>Propulsion control (logic)</td> <td>200</td> <td>90</td> </tr> <tr> <td>Input/line reactor</td> <td>440</td> <td>420</td> </tr> <tr> <td>Line switch (main)</td> <td>100</td> <td>330</td> </tr> <tr> <td>Blowers and cooling fans</td> <td>280</td> <td>505</td> </tr> <tr> <td>Control group subtotal</td> <td>3,735</td> <td>4,825</td> </tr> <tr> <td>Braking resistors (2)</td> <td>650</td> <td>2,120</td> </tr> <tr> <td>Propulsion total (motor, controls and braking groups)</td> <td>15,557</td> <td>16,425</td> </tr> </tbody> </table> <p>No. 2 minus No. 1: 16,425 - 15,557 = 868 lb</p> <p>● Weight of No.2: 89,000 + 868 = <u>89,868 lb</u></p> | Item | No. 1 | No. 2 | Traction motors (4) | 6,240 lb | 5,600 lb | Field power supply (portion of auxiliary power 15 kw/125 kw x 3100 lb) | 372 | - | Gearbox; coupling, suspension, stabilization (4) | 4,560 | 3,880 | Motor group subtotal | 11,172 | 9,480 | Choppers/semi-conductors | 975 | 1,575 | Motor control (power) | 800 | 1,100 | Propulsion control (logic) | 200 | 90 | Input/line reactor | 440 | 420 | Line switch (main) | 100 | 330 | Blowers and cooling fans | 280 | 505 | Control group subtotal | 3,735 | 4,825 | Braking resistors (2) | 650 | 2,120 | Propulsion total (motor, controls and braking groups) | 15,557 | 16,425 | <p>No. 4:</p> <table border="1" data-bbox="820 567 1437 913"> <tbody> <tr> <td>Motors, gearboxes, suspension, etc suspension, etc.</td> <td>9,480 lb</td> </tr> <tr> <td>Controls group (weight optimized)</td> <td></td> </tr> <tr> <td>Chopper (Garrett)</td> <td>975</td> </tr> <tr> <td>Motor control (Garrett)</td> <td>800</td> </tr> <tr> <td>Propulsion control (Westinghouse)</td> <td>90</td> </tr> <tr> <td>Field control (est GE cam)</td> <td>500</td> </tr> <tr> <td>Input/line filter (Westinghouse)</td> <td>420</td> </tr> <tr> <td>Motor reactor (Westinghouse)</td> <td>805</td> </tr> <tr> <td>Line switch (Garrett)</td> <td>100</td> </tr> <tr> <td>Cooling blowers (Garrett)</td> <td>280</td> </tr> <tr> <td>Control group subtotal</td> <td>3,970</td> </tr> <tr> <td>Brake resistors (Garrett)</td> <td>650</td> </tr> <tr> <td>Total</td> <td>14,100</td> </tr> </tbody> </table> <p>No. 1 propulsion total 15,557</p> <p>No. 4 minus No. 1: 14,100 - 15,557 = -1,457 lb</p> <p>● Weight of No. 4: 89,000 - 1,457 = <u>87,543 lb</u></p> | Motors, gearboxes, suspension, etc suspension, etc. | 9,480 lb | Controls group (weight optimized) | | Chopper (Garrett) | 975 | Motor control (Garrett) | 800 | Propulsion control (Westinghouse) | 90 | Field control (est GE cam) | 500 | Input/line filter (Westinghouse) | 420 | Motor reactor (Westinghouse) | 805 | Line switch (Garrett) | 100 | Cooling blowers (Garrett) | 280 | Control group subtotal | 3,970 | Brake resistors (Garrett) | 650 | Total | 14,100 |
| Item | No. 1 | No. 2 | | | | | | | | | | | | | | | | | | | | | | | | | | | | | | | | | | | | | | | | | | | | | | | | | | | | | | | | | | | | | | | | | | | |
| Traction motors (4) | 6,240 lb | 5,600 lb | | | | | | | | | | | | | | | | | | | | | | | | | | | | | | | | | | | | | | | | | | | | | | | | | | | | | | | | | | | | | | | | | | | |
| Field power supply (portion of auxiliary power 15 kw/125 kw x 3100 lb) | 372 | - | | | | | | | | | | | | | | | | | | | | | | | | | | | | | | | | | | | | | | | | | | | | | | | | | | | | | | | | | | | | | | | | | | | |
| Gearbox; coupling, suspension, stabilization (4) | 4,560 | 3,880 | | | | | | | | | | | | | | | | | | | | | | | | | | | | | | | | | | | | | | | | | | | | | | | | | | | | | | | | | | | | | | | | | | | |
| Motor group subtotal | 11,172 | 9,480 | | | | | | | | | | | | | | | | | | | | | | | | | | | | | | | | | | | | | | | | | | | | | | | | | | | | | | | | | | | | | | | | | | | |
| Choppers/semi-conductors | 975 | 1,575 | | | | | | | | | | | | | | | | | | | | | | | | | | | | | | | | | | | | | | | | | | | | | | | | | | | | | | | | | | | | | | | | | | | |
| Motor control (power) | 800 | 1,100 | | | | | | | | | | | | | | | | | | | | | | | | | | | | | | | | | | | | | | | | | | | | | | | | | | | | | | | | | | | | | | | | | | | |
| Propulsion control (logic) | 200 | 90 | | | | | | | | | | | | | | | | | | | | | | | | | | | | | | | | | | | | | | | | | | | | | | | | | | | | | | | | | | | | | | | | | | | |
| Input/line reactor | 440 | 420 | | | | | | | | | | | | | | | | | | | | | | | | | | | | | | | | | | | | | | | | | | | | | | | | | | | | | | | | | | | | | | | | | | | |
| Line switch (main) | 100 | 330 | | | | | | | | | | | | | | | | | | | | | | | | | | | | | | | | | | | | | | | | | | | | | | | | | | | | | | | | | | | | | | | | | | | |
| Blowers and cooling fans | 280 | 505 | | | | | | | | | | | | | | | | | | | | | | | | | | | | | | | | | | | | | | | | | | | | | | | | | | | | | | | | | | | | | | | | | | | |
| Control group subtotal | 3,735 | 4,825 | | | | | | | | | | | | | | | | | | | | | | | | | | | | | | | | | | | | | | | | | | | | | | | | | | | | | | | | | | | | | | | | | | | |
| Braking resistors (2) | 650 | 2,120 | | | | | | | | | | | | | | | | | | | | | | | | | | | | | | | | | | | | | | | | | | | | | | | | | | | | | | | | | | | | | | | | | | | |
| Propulsion total (motor, controls and braking groups) | 15,557 | 16,425 | | | | | | | | | | | | | | | | | | | | | | | | | | | | | | | | | | | | | | | | | | | | | | | | | | | | | | | | | | | | | | | | | | | |
| Motors, gearboxes, suspension, etc suspension, etc. | 9,480 lb | | | | | | | | | | | | | | | | | | | | | | | | | | | | | | | | | | | | | | | | | | | | | | | | | | | | | | | | | | | | | | | | | | | | |
| Controls group (weight optimized) | | | | | | | | | | | | | | | | | | | | | | | | | | | | | | | | | | | | | | | | | | | | | | | | | | | | | | | | | | | | | | | | | | | | | |
| Chopper (Garrett) | 975 | | | | | | | | | | | | | | | | | | | | | | | | | | | | | | | | | | | | | | | | | | | | | | | | | | | | | | | | | | | | | | | | | | | | |
| Motor control (Garrett) | 800 | | | | | | | | | | | | | | | | | | | | | | | | | | | | | | | | | | | | | | | | | | | | | | | | | | | | | | | | | | | | | | | | | | | | |
| Propulsion control (Westinghouse) | 90 | | | | | | | | | | | | | | | | | | | | | | | | | | | | | | | | | | | | | | | | | | | | | | | | | | | | | | | | | | | | | | | | | | | | |
| Field control (est GE cam) | 500 | | | | | | | | | | | | | | | | | | | | | | | | | | | | | | | | | | | | | | | | | | | | | | | | | | | | | | | | | | | | | | | | | | | | |
| Input/line filter (Westinghouse) | 420 | | | | | | | | | | | | | | | | | | | | | | | | | | | | | | | | | | | | | | | | | | | | | | | | | | | | | | | | | | | | | | | | | | | | |
| Motor reactor (Westinghouse) | 805 | | | | | | | | | | | | | | | | | | | | | | | | | | | | | | | | | | | | | | | | | | | | | | | | | | | | | | | | | | | | | | | | | | | | |
| Line switch (Garrett) | 100 | | | | | | | | | | | | | | | | | | | | | | | | | | | | | | | | | | | | | | | | | | | | | | | | | | | | | | | | | | | | | | | | | | | | |
| Cooling blowers (Garrett) | 280 | | | | | | | | | | | | | | | | | | | | | | | | | | | | | | | | | | | | | | | | | | | | | | | | | | | | | | | | | | | | | | | | | | | | |
| Control group subtotal | 3,970 | | | | | | | | | | | | | | | | | | | | | | | | | | | | | | | | | | | | | | | | | | | | | | | | | | | | | | | | | | | | | | | | | | | | |
| Brake resistors (Garrett) | 650 | | | | | | | | | | | | | | | | | | | | | | | | | | | | | | | | | | | | | | | | | | | | | | | | | | | | | | | | | | | | | | | | | | | | |
| Total | 14,100 | | | | | | | | | | | | | | | | | | | | | | | | | | | | | | | | | | | | | | | | | | | | | | | | | | | | | | | | | | | | | | | | | | | | |
| <p>COMBINATION NO. 3: <u>WESTINGHOUSE 1462 SERIES FIELD MOTOR AND ADVANCED CAM CONTROL</u></p> <p>Vehicle weight determined by comparison of items differing between No. 3 and No. 2:</p> <p>No. 3 - GE PATCO Car Equipment:</p> <table border="1" data-bbox="196 1501 820 1648"> <tbody> <tr> <td>Inductive shunt</td> <td>395 lb</td> </tr> <tr> <td>Main control group logic</td> <td>1,250</td> </tr> <tr> <td>Cam controller group</td> <td>1,700</td> </tr> <tr> <td>Auxiliary control group (field)</td> <td>525</td> </tr> <tr> <td>Cam group subtotal</td> <td>3,870</td> </tr> </tbody> </table> <p>No. 2 controls group subtotal 4,825</p> <p>No. 3 minus No. 2: 3,870 - 4,825 = -955</p> <p>● Weight of No. 3: 89,868 - 955 = <u>88,913 lb</u></p> | Inductive shunt | 395 lb | Main control group logic | 1,250 | Cam controller group | 1,700 | Auxiliary control group (field) | 525 | Cam group subtotal | 3,870 | <p>COMBINATION NO. 5: <u>SOAC SEPARATE FIELD MOTOR AND LIGHTWEIGHT CHOPPER</u></p> <p>Vehicle weight determined by comparison of items differing between No. 5 and No. 1:</p> <p>No. 5:</p> <table border="1" data-bbox="820 1344 1437 1585"> <tbody> <tr> <td>Motors (Garrett)</td> <td>6,240</td> </tr> <tr> <td>Field power supply (Garrett)</td> <td>372</td> </tr> <tr> <td>Gearbox, etc. (Westinghouse)</td> <td>3,880</td> </tr> <tr> <td>Motor group subtotal</td> <td>10,492</td> </tr> <tr> <td>Control group (above) less field control</td> <td>3,970 - 500</td> </tr> <tr> <td>Brake resistors (above)</td> <td>650</td> </tr> <tr> <td>Total</td> <td>14,612</td> </tr> </tbody> </table> <p>No. 1 propulsion total 15,557</p> <p>No. 5 minus No. 1: 14,612 - 15,557 = -945 lb</p> <p>● Weight of No. 5: 89,000 - 945 = <u>88,055 lb</u></p> <p>NOTE: Weights are from manufacturers' specs.</p> | Motors (Garrett) | 6,240 | Field power supply (Garrett) | 372 | Gearbox, etc. (Westinghouse) | 3,880 | Motor group subtotal | 10,492 | Control group (above) less field control | 3,970 - 500 | Brake resistors (above) | 650 | Total | 14,612 | | | | | | | | | | | | | | | | | | | | | | | | | | | | | | | | | | | | | | | | | | | | |
| Inductive shunt | 395 lb | | | | | | | | | | | | | | | | | | | | | | | | | | | | | | | | | | | | | | | | | | | | | | | | | | | | | | | | | | | | | | | | | | | | |
| Main control group logic | 1,250 | | | | | | | | | | | | | | | | | | | | | | | | | | | | | | | | | | | | | | | | | | | | | | | | | | | | | | | | | | | | | | | | | | | | |
| Cam controller group | 1,700 | | | | | | | | | | | | | | | | | | | | | | | | | | | | | | | | | | | | | | | | | | | | | | | | | | | | | | | | | | | | | | | | | | | | |
| Auxiliary control group (field) | 525 | | | | | | | | | | | | | | | | | | | | | | | | | | | | | | | | | | | | | | | | | | | | | | | | | | | | | | | | | | | | | | | | | | | | |
| Cam group subtotal | 3,870 | | | | | | | | | | | | | | | | | | | | | | | | | | | | | | | | | | | | | | | | | | | | | | | | | | | | | | | | | | | | | | | | | | | | |
| Motors (Garrett) | 6,240 | | | | | | | | | | | | | | | | | | | | | | | | | | | | | | | | | | | | | | | | | | | | | | | | | | | | | | | | | | | | | | | | | | | | |
| Field power supply (Garrett) | 372 | | | | | | | | | | | | | | | | | | | | | | | | | | | | | | | | | | | | | | | | | | | | | | | | | | | | | | | | | | | | | | | | | | | | |
| Gearbox, etc. (Westinghouse) | 3,880 | | | | | | | | | | | | | | | | | | | | | | | | | | | | | | | | | | | | | | | | | | | | | | | | | | | | | | | | | | | | | | | | | | | | |
| Motor group subtotal | 10,492 | | | | | | | | | | | | | | | | | | | | | | | | | | | | | | | | | | | | | | | | | | | | | | | | | | | | | | | | | | | | | | | | | | | | |
| Control group (above) less field control | 3,970 - 500 | | | | | | | | | | | | | | | | | | | | | | | | | | | | | | | | | | | | | | | | | | | | | | | | | | | | | | | | | | | | | | | | | | | | |
| Brake resistors (above) | 650 | | | | | | | | | | | | | | | | | | | | | | | | | | | | | | | | | | | | | | | | | | | | | | | | | | | | | | | | | | | | | | | | | | | | |
| Total | 14,612 | | | | | | | | | | | | | | | | | | | | | | | | | | | | | | | | | | | | | | | | | | | | | | | | | | | | | | | | | | | | | | | | | | | | |

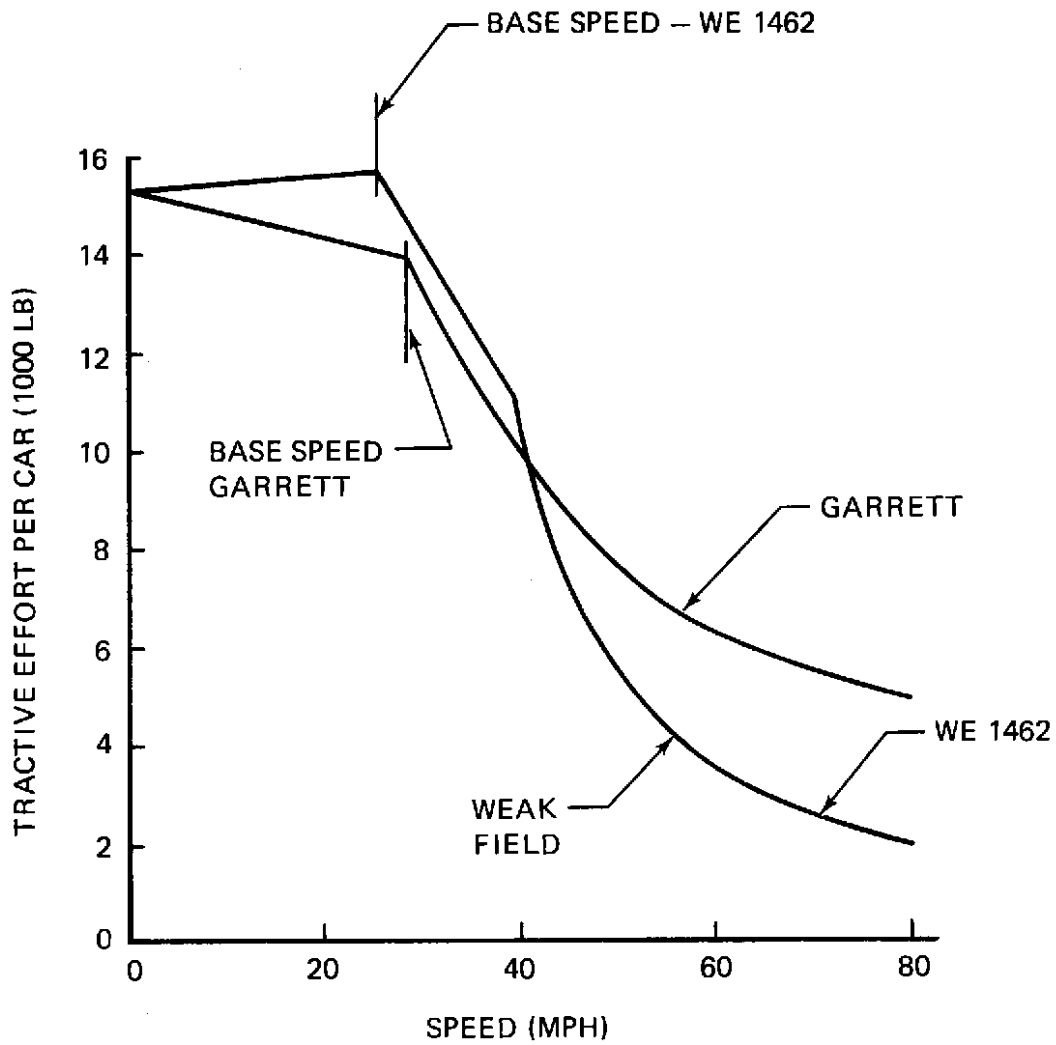

Figure 9-1. Maximum Tractive Effort vs Speed

NOTE

THIRD RAIL CURRENT IS 600 VOLTS

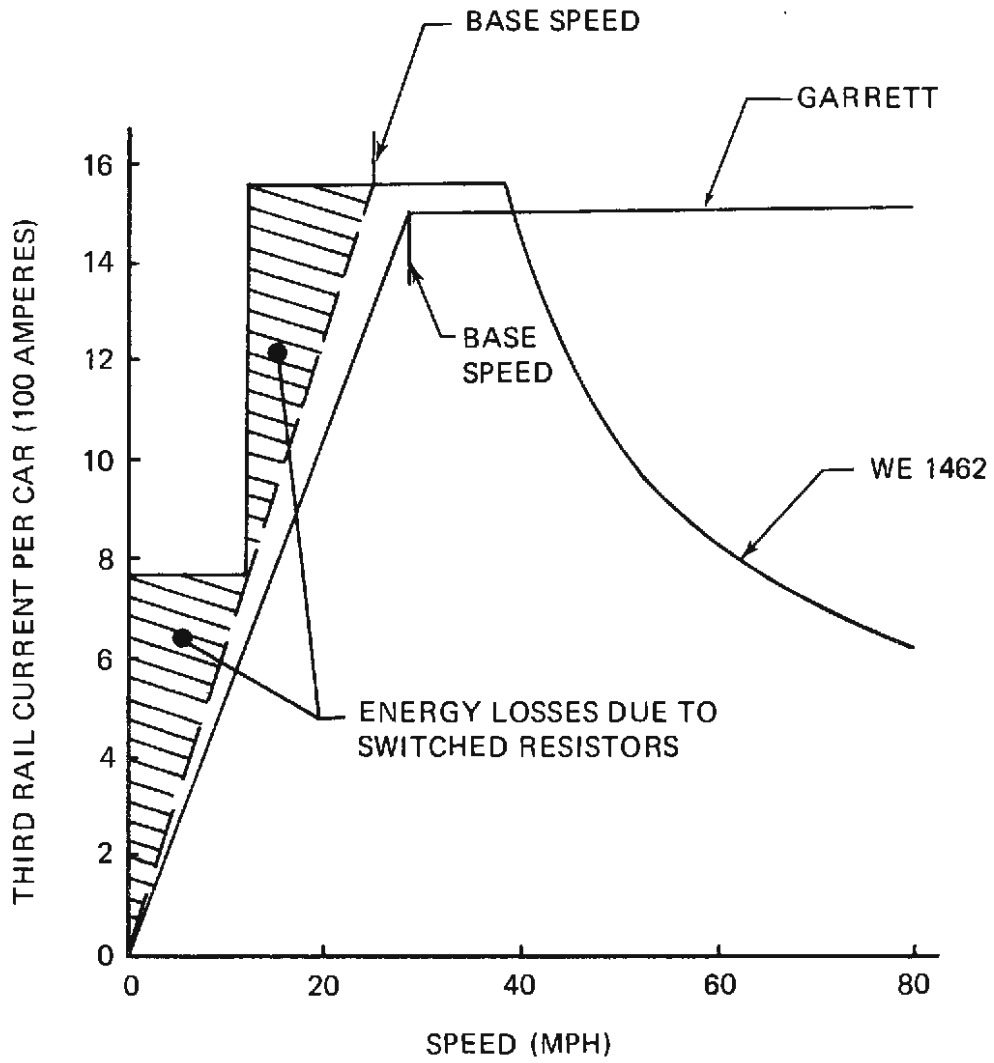

Figure 9-2. Electric Current Usage (at Maximum Tractive Effort) vs Speed

the series motor in Combinations No. 2, 3, and 4. The 230-hp, one-hour rating of the separate field motor was not exceeded. To make a relevant comparison, all combinations must be evaluated at a schedule speed at which any of them could operate in revenue service. The highest speed for the WE-1462 was 27.5 mph. Operating the Garrett motor at 27.5 mph instead of 28.8 mph reduced its energy consumption. By comparing all combinations at 27.5 mph, the motors were subject to the same demands.

The higher speed capability of the separate field motor constitutes an additional net benefit, if the resulting time saving is more valuable than the cost of the additional energy consumption. Revised speed profiles were developed for the 27.5-mph schedule speed and, using the current consumption characteristics, the energy consumption per mile was determined for each combination.

The energy losses from the resistors in the cam system are represented by the two triangles shown in Figure 9-2. In Figure 9-3, the same curve is plotted as a function of time instead of speed. The time is the number of seconds of acceleration from zero mph at maximum tractive effort. On this graph, the starting energy loss is precisely the area of the two triangles, 0.502 kw-hr per start. With 32 stations or 31 starts on the 20-mile route, there was an average of 1.55 starts per mile; $1.55 \times 0.502 \text{ kw-hr} = 0.778 \text{ kw-hr per mile}$, the average starting energy losses.

Table 9-7, summarizing the results of the energy comparison, shows that Combinations No. 1 and 2 had the same energy consumption, 8.264 kw-hr per car-mile. This indicates that, coincidentally, the differences in weight and power characteristics compensate for each other. The energy consumption for Combination No. 3 (the cam) was 0.729 kw-hr per car mile higher than Combination No. 2 and 0.857 kw-hr per car-mile higher than Combination No. 4 (the lightweight chopper with series motor). A car-mile figure of 0.857 kw-hr most accurately isolates the energy saving from use of chopper control in place of switched resistor. This resulted from the comparison of existing or readily achievable versions of both control systems used with the same motor on the same route.

Combination No. 5 appears to be inferior to No. 4, but this may not actually be the case. The weight saving evaluation for lightweight chopper systems was cursory. A production design program would save additional weight and further reduce power consumption. Also, the higher schedule speed capability of No. 5 (from the higher one-hour power rating) may outweigh the cost of the extra energy. It can be concluded that the advantage of chopper over cam must be greater than or equal to the advantage of No. 4 over No. 3; therefore,

NOTES

- 1. THIRD RAIL CURRENT IS 600 VOLTS
- 2. VEHICLE HAS 100 PASSENGERS
- 3. LEVEL TRACK

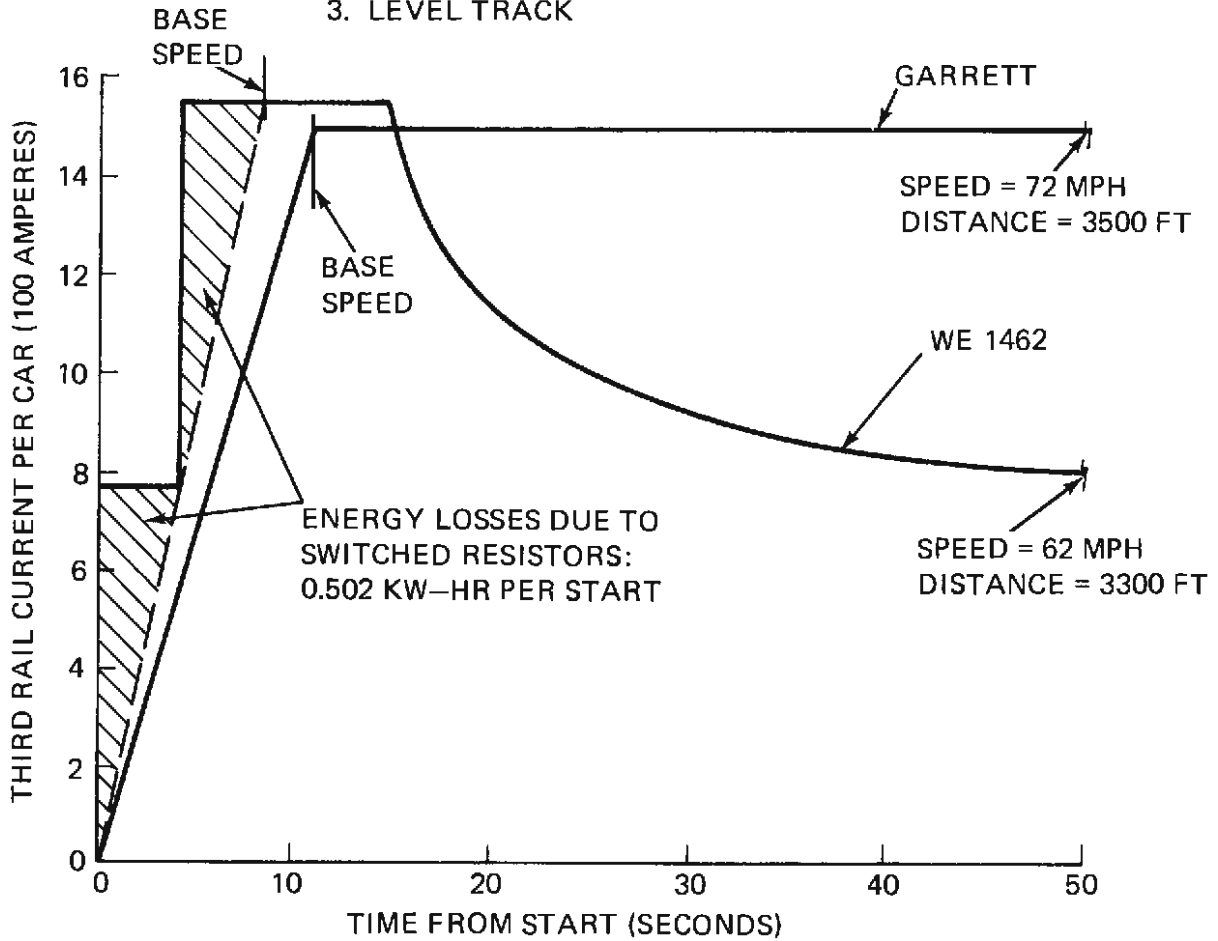

Figure 9-3. Electric Current Usage (at Maximum Tractive Effort) vs Time from Start

TABLE 9-7. WEIGHT AND POWER CONSUMPTION OF THE FIVE COMBINATIONS

| Propulsion Configuration Parameter | No. 1 | No. 2 | No. 3 | No. 4 | No. 5 |
|------------------------------------------------------------------------------------------------|-----------------------------------------------------------------------|-------------------------------|-------------------------------|--------------------------------------|--------------------------------------------------|
| | Actual SOAC system chopper control and separately excited field motor | BART chopper and series motor | Advanced cam and series motor | Lightweight chopper and series motor | Lightweight chopper and separately excited field |
| Total weight of vehicle (lb) | 89,000 | 89,868 | 88,913 | 87,543 | 88,055 |
| Energy consumption of motor and control system, not including starting losses (kw-hr/car-mile) | 6.809 | 6.809 | 6.760 | 6.681 | 6.757 |
| Starting resistance losses, cam only (kw-hr/car-mile) | - | - | 0.778 | - | - |
| Auxiliary power (kw-hr/car-mile) | 1.455 | 1.455 | 1.455 | 1.455 | 1.455 |
| Total energy consumption (kw-hr/car-mile) | 8.264 | 8.264 | 8.993 | 8.136 | 8.212 |
| Saving in comparison with No. 3 (kw-hr/car-mile) | 0.729 | 0.729 | - | 0.857 | 0.781 |

0.857 kw-hr per car-mile was used for the purpose of this study.

Energy Cost Saving

Electrical power costs obtained from the American Transit Association's 1972 Transit Operating Report (Reference 8) are shown in Table 9-8.

TABLE 9-8. ELECTRIC POWER COSTS (IN FOUR CITIES)

| Item | City (and System) | | | |
|-----------------------------------------------------------------|---------------------|------------------|-------------------------|--------------------|
| | New York (NYCTA) | Chicago (CTA) | Philadelphia (PATCO) | Cleveland (CTS) |
| Kilowatt hours consumed (in millions) | 1898.3 | 240.4 | 39.35 | 32.09 |
| Cost of power purchased and generated (in thousands of dollars) | 43,165 | 4,322 | 731 | 551 |
| Cost per kw-hr | \$0.0228 | \$0.0180 | \$0.0186 | \$0.072 |

Using a cost of 1.9¢ per kilowatt-hour, the electrical energy cost for the cam system (Combination No. 3) is 17.1¢ per car-mile, while the cost for the lightweight chopper (Combination No. 4) is 15.5¢. This is a saving of 1.6¢ per car-mile.

Maintenance Cost Saving

The SOAC testing program has not progressed far enough to obtain significant data on the maintenance savings of chopper control. Estimates based on European data have indicated that maintenance of control switches would be reduced by 0.3¢ per car-mile. Additional savings would be associated with other components; however, the available data is not considered sufficient for predicting savings on the SOAC vehicle.

An additional problem in predicting maintenance cost savings is that reductions in actual maintenance may not be translated into cash savings. Most existing systems have union contracts that guarantee a fixed number of manhours of

maintenance per vehicle mile. Reducing the amount of maintenance written into the contract would be difficult.

Due to these uncertainties, savings in maintenance costs are not included among the quantified benefits of chopper control; consideration of the energy saving alone constitutes a conservative approach to the problem.

Annual Operating Cost Saving

Average annual mileage per car is shown in Table 9-9.

TABLE 9-9. AVERAGE ANNUAL MILEAGE PER CAR

| City (and System) | Average Annual Mileage per Car |
|----------------------|--------------------------------|
| New York (NYCTA) | 51,386 |
| Chicago (CTA) | 43,146 |
| Philadelphia (PATCO) | 54,882 |
| Cleveland (CTS) | 32,627 |

Using an annual mileage of 50,000 miles, the energy saving of 1.6¢ per vehicle mile becomes an annual saving of \$800 per car.

Initial Investment Cost

American manufacturers have believed that chopper control systems were more expensive to produce than switched resistor systems. For example, in February 1973, LTV Aerospace Corporation's bid for a Light Rail Vehicle with chopper control was \$18,158 higher than with cam; Rohr's differential was \$47,913. Bids on other vehicles in recent years have exhibited comparable premiums for chopper control.

These differentials were generally considered too large to be justified by an annual energy saving in the neighborhood of \$800 per car. For example, the present value of an \$800 per year saving during a 20-year vehicle life is \$8440, using a 7 percent interest rate. Increasing the initial investment cost by more than \$8440 does not appear to be worthwhile. Conversely, due to inflation and the increasing cost of new electric power sources, the (per kilowatt-hour) cost of power is likely to rise, resulting in an increase in the value of any savings. For example, if the cost of energy rises by 6

percent per year, the present value of the increased 20-year savings would be \$20,700, using the same increasing cost of energy and interest rate. This indicates that paying up to \$20,000 extra for chopper control may actually be worthwhile, since it could result in an overall saving during the total life of the vehicle.

Net Benefit of Chopper Control

The annual benefit in energy saving due to the use of solid-state chopper control rather than switched resistors is about \$800 per vehicle. This figure can be expected to rise as energy becomes more costly. Additional savings may also be experienced in maintenance. Given an equal purchase price for each system, chopper control offers a net benefit during the total life of the vehicle.

References

1. Component Test Report, Document D174-10024-1, Volume I, Appendix I, Boeing Vertol Company, Philadelphia, Pa., October 1973.
2. Ibid., Appendix II.
3. Ibid., Appendix III.
4. State-of-the-Art Car Engineering Test Report, Document D174-10026-1, Boeing Vertol Company, Philadelphia, Pa., March 1974.
5. Investigation of Voltage Transients and Spikes in Direct Current Rapid Transit Systems, DOT Report No. IT-06-0026-73-3, Urban Mass Transportation Administration, Washington, D.C., June 1973.
6. SOAC Simulated Demonstration Test Report, Document D174-10028-1, Boeing Vertol Company, Philadelphia, Pa., October 1973.
7. Grant, E. L. and W. G. Ireson, Principles of Engineering Economy, Fourth Edition, The Ronald Press Company, New York, 1964, pp 35-157.
8. 1972 Transit Operating Report, American Transit Association, Statistical Department, 465 L'Enfant Plaza West, Washington, D.C.