

RECEIVED  
SEP 2 1976  
S C R T D  
OFFICE OF  
MGT. RAPID TRANSIT DEPT.

S.C.R.T.D. LIBRARY

# TUNNEL MANUAL (DOSSIER PILOTE DES TUNNELS)

The original preparation of this document was by:  
CENTRE d'ETUDES DES TUNNELS DU M.A.T.E.L.T.  
(FRANCE) DATED MAY 1970



JULY 1975

Translated By Robert J. Matthews for  
U.S. DEPARTMENT OF TRANSPORTATION  
Office Of The Secretary  
Washington, D.C. 20590

The contents of this report reflect the views of the Centre d'Etudes des Tunnels du M.A.T.E.L.T (France) which is responsible for the facts and the accuracy of the data presented herein. The contents do not necessarily reflect the official views or policy of the Department of Transportation. This report does not constitute a standard, specification or regulation.

1. Report No. DOT-TST-76-40	2. Government Accession No.	3. Recipient's Catalog No.	
4. Title and Subtitle Tunnel Manual (Dossier Pilotes Des Tunnels)		5. Report Date	
		6. Performing Organization Code July, 1975	
7. Author(s)		8. Performing Organization Report No.	
9. Performing Organization Name and Address Centre D'Etudes Des Tunnels du M.A.T.E.L.T. (France)		10. Work Unit No. (TRAIS)	
		11. Contract or Grant No.	
12. Sponsoring Agency Name and Address		13. Type of Report and Period Covered	
		14. Sponsoring Agency Code TST-45	
15. Supplementary Notes			
16. Abstract <p>This document is a translation of a French manual on tunneling. The manual was written to provide a source of information as associated with highway tunnel construction and to provide a guide in the design and construction of highway tunnels. The manual consists of a summary description and four volumes, which are outlined in the summary. Permission to translate the manual was obtained from the issuing agency in France by the Federal Highway Administration in November, 1973.</p>			
17. Key Words Tunneling, Highway Tunnels, Tunnel Design		18. Distribution Statement	
19. Security Classif. (of this report) None	20. Security Classif. (of this page) None	21. No. of Pages	22. Price

01295

Regional Technical  
Agency of Lyons

Ministry of Equipment and Housing

Tunnel Service

TUNNEL MANUAL

(Dossier Pilote des Tunnels)

Study Group on Tunnels

May 1970

(Translated by Robert J. Matthews)

All comments on the material contained  
in this manual should be addressed to:

Organe Technique Regional de Lyon  
Service des Tunnels  
109, Chemin Saint-Jean  
69 -- Bron, France

FOREWORD

During the last ten years about 30 kilometers of tunnels and other underground passages have been opened to vehicular traffic or placed under construction.

Owing to the aggravation of the problems of urban transportation, to the development of highways in more difficult sites, and to the increase in international commerce, it is not unreasonable to foresee a significant increase in the total length of tunnels under construction or planning during the next ten years. Rough forecasts suggest that approximately 70 kilometers of highway tunnels will be completed in the next decade, with planning being initiated for an equal length.

The projected highway tunnel construction encompasses a great variety of projects in very diverse geological and environmental situations, and of differing lengths (from a few meters to several kilometers). These predictions, it should be pointed out, are restricted only to highway tunnels, and thus exclude both railway and hydraulic tunnels.

## PREVIEW OF THE TUNNEL MANUAL

### Objectives of the Tunnel Manual

Since tunnel construction is complex and little understood, it would seem desirable to develop without further delay a manual based on experience acquired over the last few years by engineers in governmental agencies.

The group working on these problems was striving to satisfy three major objectives:

- \* To inform engineers of the important problems associated with highway tunnel construction and to shed some light on the nature of these problems.
- \* To guide engineers in the design and construction of highway tunnels, i.e., in defining, classifying, and dealing with the problems associated with tunnel design and construction.
- \* To standardize the essential elements, in other words:
  - the terminology peculiar to underground construction.
  - the classification of soil and rocks.
  - the cross-sections of tunnels.
  - the procedures and contents of the studies to be prepared and presented to higher-level administration.
  - the costs.

### Composition of the Manual

To facilitate the solution of these problems, the manual has been divided into 5 separate documents according to the following scheme:

- \* The present Summary Document which provides a brief synthesis of the four other documents and which gives general information on:
  - the general characteristics of highway tunnels (costs, risks, utilization, etc.)
  - the elements to be taken into consideration by the more detailed studies.
  - the articulation and composition of files and studies to be presented to higher-level administration.



\* Volume I: Geometry - which indicates how the tunnel should be adapted to traffic needs, with particular concern for proper layout of the tunnel. This document treats the following problems:

- elements of layout.
- longitudinal profile.
- cross-sectional profiles.

\* Volume II: Civil Engineering - divided into 5 sections:

- Section no. 1: Geology and Geotechnology presents a detailed methodological discussion of the required preliminary design studies, and should therefore aid the project engineer and his study team in their organization of the various exploratory studies.
- Section no. 2: Construction defines the criteria to be considered in choosing between construction procedures, and evaluates those difficulties peculiar to tunnel construction.
- Section no. 3: Lining discusses the factors influencing the nature, dimensions, and construction of tunnel linings.
- Section no. 4: Water-tightness defines the methods and factors to be considered for preventing the penetration of water into the tunnel.
- Section no. 5: Roadway discusses the principal characteristics of tunnel roadbeds, and provides a characterization of the different types of road surfaces.

\* Volume III: Equipment and Exploitation - divided into 3 sections:

- Section no. 1: Ventilation - Ventilation constitutes a novel and very important element of highway tunnels. This document gives information on the following points:
  - \* choice and dimensioning of ventilation system. Definition of criteria useful for this choice.
  - \* sample designs.
- Section no. 2: Lighting.
- Section no. 3: Exploitation - discusses the influence of future exploitation considerations on preliminary design of the tunnel, and shows the degree of complexity which tunnel exploitation can achieve in certain cases.

- \* Volume IV: Costs - Designed for rapid and practical use, this document specifies the pertinent categories for cost estimation and gives some general information about the important variations in the standard costs.

#### Limitations in the Use of the Manual

The Tunnel Manual deals with all types of underground highway construction, regardless of their form or method of construction:

- \* Tunnels excavated in soil or in rock, generally of circular or vaulted cross-section.
- \* Covered trenches, generally of rectangular cross-section (whether they be trenches that are covered at the completion of construction or simply open cuts).
- \* Tunnels of immersed caisson construction, generally of rectangular cross-section.

Four important precautions must be observed in using this manual:

- \* the degree of knowledge and the available experience are not the same for each category of tunnel, and even if the manual is applicable in most cases, care must be observed with regard to Volumes II and IV on the following:
  - covered trenches involving considerations that require reference to classical soil mechanics.
  - immersed tunnels posing special problems (topography of the subsoil, flow characteristics of water, installation of the construction site, constructions techniques, etc.).
- \* due to the complexity and diversity of these problems, and due as well to the limited experience at one's disposal, not to mention the rapid evolution of construction techniques, the information furnished in this manual is provisional and subject to revision.
- \* an attempt has been made both to provide elements of choice for the engineer as well as to define all the parameters to be considered when undertaking tunnel design. Nevertheless, it is not possible to foresee all possible situations. It is left to the project engineer, faced with his particular project, to adapt the furnished information in such a way as to take into account the full weight of the relevant parameters.

This manual therefore constitutes a framework that does not prohibit, but on the contrary facilitates, the reanalysis of certain aspects of the manual, when the particular project at hand may require it.

- \* Finally, it hardly needs mention that the present Manual is in no way definitive. The Tunnel Manual can in no way replace the various studies and explorations that are necessary in every case.

## SUMMARY

### Chapter 1. Characteristics Peculiar to Tunnels

- 1.1 Tunnel Costs
- 1.2 Risks and Construction Time Requirements
- 1.3 Equipment and Exploitation
- 1.4 Consequences

### Chapter 2. Major Objectives of Studies

- 2.1 General Rules
- 2.2 Determination of Layout and Longitudinal Profile
- 2.3 Determination of Cross-sectional Profile
- 2.4 Estimation of Costs and Construction Time
- 2.5 Cost Studies

### Chapter 3. Articulation of Studies and Composition of Documents

- 3.1 Composition and Articulation of Studies
- 3.2 Composition of the Proposal Document (Dossier d'Inscription)
- 3.3 Composition of the Preliminary Project Summary  
(Avant-Project Sommaire)
- 3.4 Contract Specifications Document for Contractors  
(Dossier de Consultation des Entreprises)

Chapter 1. CHARACTERISTICS PECULIAR TO TUNNELS

1.1 Tunnel Costs

1.11 Numerical Data

For a two-lane tunnel, the total cost per linear meter generally falls within the range of 10,000 to 50,000 francs [\$2,000-10,000]. In less favorable cases, even the higher figure may be conservative.

The average comparison with open highway, four lanes wide, is established in the table below. (Only the costs of construction are taken into account, to the exclusion of all real-estate costs).

<u>Type of Project</u>	<u>Cost</u> (in thousands of francs per linear meter)
Tunnel . . . . .	20-100
Bridges, viaducts. . . . .	15-40
Open highway in unfavorable terrain. . . . .	5-10
Open highway in favorable terrain. . . . .	2.5-5

Thus, in comparison to open highway, tunnels seem to be:

- \* More costly to construct. This characteristic is inherent in the very nature of tunnels.
- \* More variable in cost, stretching across a much wider cost range.

### 1.12 Decomposition of Costs and Consequences

A more detailed study of the different categories of tunnel costs yields the following distribution (see Volume IV):

<u>Category</u>	<u>% of Total Cost</u>
Civil Engineering . . . . .	40-90
Ventilation . . . . .	2-50
Lighting. . . . .	3-25
Installations Necessary for Tunnel Exploitation . . . . .	3-15

The ENGINEERING category -- the most weighty of all the categories -- is subject to great variations in cost, depending on project size, geological conditions, and construction conditions.

The VENTILATION category depends most heavily on tunnel length, site location (urban or not), nature of the approaches, and on the anticipated traffic flows.

For the most part, it is the same unavoidable factors that determine both the general level of costs and the degree of uncertainty of these cost estimates. Very detailed studies should, however, permit selection of the best possible tunnel location, thus reducing to some degree the uncertainty of these estimates.

## 1.2 Risks and Construction Time Requirements

### 1.21 Construction Risks

Tunnel construction is difficult: tunnels must be adapted to the terrain traversed, and this terrain is only rarely homogeneous in character. The consequences of encountering various heterogeneities in the course of construction are many (collapse, accidents, delays, recourse to entirely new methods, etc.).

Very detailed preliminary studies should permit:

- \* selection of the best possible tunnel location.
- \* anticipation of the difficulties and appreciation of the uncertainties.

In spite of careful preliminary studies, major difficulties may arise during construction. These difficulties involve great risks; they may lead to significant losses of time and to radical modifications in the cost of construction.

Particular importance must therefore be attached during the course of study to:

- \* prediction of the general behavior of the terrain being excavated.
- \* localized difficulties (faults, brecciated zones, underground obstacles).
- \* ground-water problems.
- \* the portals, approaches, and the methods of underground entry.
- \* problems posed by urban environments (risks of settlement or upheaval of buildings, perturbations, etc.).

#### 1.22 Time Requirements for Construction

In spite of precautions, and even in the absence of difficulties, time requirements often become the crucial factor in construction planning, because of:

- \* the necessarily restricted number of headings.
- \* the slow rates of advance (see Volume II, section 2).
- \* the multiplicity and interdependence of the different construction phases.

It is therefore important to take the greatest care in construction planning, allowing sufficient time margins and envisioning, if necessary, an earlier initiation of tunnel construction relative to the construction of the exterior connecting road system.

#### 1.3 Equipment and Exploitation

For the user and, consequently, for the tunnel management, tunnels are difficult points on a travel itinerary because of the limited environmental quality, visibility, and opportunities for emergency stopping. Tunnels are essentially linear constructions where traffic flow is well-guided and where access to the tunnel is generally limited to the two tunnel entrances.

Finally, in comparison with open highways tunnels exercise special constraints on maintenance and exploitation, notable because of ventilation requirements (in certain cases) and lighting requirements (in most cases).

Complete and detailed information is provided on this subject in Volume III.

### 1.31 Primary Consequences

The exploitation of a tunnel or series of tunnels imposes certain rules:

- \* On the choice of tunnel layout, longitudinal profile of the approaches, and location of highway interchanges (see Volume I, section 3, and Volume III, section 3).
- \* For the interior dimensions of the tunnel and for its overall geometric characteristics, both of which must take into account safety, traffic capacity, and maintenance requirements (see Volume I, section 3 and Volume III, section 3).
- \* For ventilation and lighting equipment requirements (see Volume III, sections 1 and 2).

Failure to consider these different factors may result in the construction of a poorly designed tunnel which is both dangerous and difficult to operate.

Because of the very great difficulty, if not impossibility, of enlarging or refitting a tunnel after completion, such faults in planning are irreparable.

### 1.32 Secondary Consequences

After being placed in service, the operation of a tunnel requires an annual allocation (sometimes very sizable) of monies to meet operating expenses.

As a rough indication, the total annual operating expense per kilometer of four-lane highway is about:

- \* 0.5-1.0 million francs for a tunnel (depending upon traffic density, length, and site).
- \* 0.05 million francs for open highway.

The above figures are approximately doubled if amortization costs for equipment replacement is taken into account.

It is therefore necessary to consider these expenses when making studies of a proposed tunnel's feasibility.

## 1.4 Consequences

### 1.41 First Rule: Avoid Tunnels (possible in numerous cases)

Under this somewhat extreme heading is hidden an essential truth that should guide the engineer in charge of preliminary layout studies. Because of their technical and financial consequences,

tunnels should generally be avoided, and all other solutions leading to open highways should be carefully studied along with tunnel solutions.

The decision to construct a tunnel (or series of tunnels) on an itinerary should therefore result only from an economic calculation that establishes the tunnel's feasibility. This calculation should consider all elements of the tunnel solution (advantages for user, land acquisition and aesthetic problems, investment costs, operating costs, etc.).

In certain cases the construction of a tunnel will show itself to be the best solution (e.g., in an urban area where the cost of subsoil acquisition is only 1 franc/m<sup>2</sup>, or in the case of a mountainous barrier), but one must be certain that more advantageous solutions have not been neglected.

#### 1.42 Second Rule: Evaluate the Consequences

If a tunnel is unavoidable, it is necessary to be able to evaluate all the relevant factors -- technical, geometrical, and financial.

This evaluation can be effected only with the aid of detailed studies. Consultation of the present Summary Document, along with the following four Volumes, should permit the successful undertaking of these studies.

---



## Chapter 2. MAJOR OBJECTIVES OF STUDIES

### 2.1 General Rules

#### 2.11 Final Objectives of the Studies

Tunnel studies do not lend themselves easily to the presentation of a unique schema that is applicable to all tunnels. This is due to the complexity, the large number of different techniques employed, and the variable characteristics of the terrain traversed.

Nevertheless, the final objective can be roughly characterized in terms of two distinct aspects, both of which should aid the project engineer in defining at each stage in the planning process the content and degree of precision required of the studies. They are:

- \* to choose - the location and type of tunnel best adapted to this location.
  - the characteristics of this tunnel.
- \* to determine - the subsequent studies requirements.
  - the potential construction difficulties.
  - the cost of both studies and construction.

#### 2.12 Requirements for a Good Study

- \* Except in certain cases (e.g., in the case of a long international tunnel), a tunnel is only one element in a larger system; and by virtue of this fact, the determination of the tunnel's layout should result from a study of the entire system's layout.
- \* Sometimes for topographical, geological, or environmental reasons (e.g., in urban sites), certain potential tunnel layouts may have to be ruled out from the outset as unacceptable. In these cases, it is the acceptable tunnel layouts that must determine the overall layout of the connecting system.

In any case, there should at the outset be no arbitrary restriction of possible layout solutions. It is best to consider a large number of possible solutions (if possible, solutions that do not require the construction of a tunnel, solutions that require a tunnel of only short length, etc.)

- \* Given the number of factors to be considered, the studies should proceed by progressive stages, each partial decision correcting, or refining, preceding decisions, and so on.
- \* Finally, studies of tunnels should be organized according to the following principles (which are equally applicable for layout studies for open highways):
  - a very close working relation should be established between the project engineer and the individuals charged with the various studies.
  - recourse to teams made up of several specialists is often indispensable (e.g., geologists, soils experts, ventilation specialists, electrical engineers, etc.).
  - in the majority of cases, detailed studies should be undertaken from the outset of project planning, since one of their purposes is to confirm that there is no technical or financial barrier to the proposed tunnel construction, and also since it will be necessary in all cases to undertake a study of the tunnel's profitability.
  - representative costs and durations of the various studies are summarized in the table below:

<u>Study Type</u>	<u>Duration</u> <sup>1</sup>	<u>% of Total Tunnel Cost</u>
Proposal Document	1 year	1%
Summary	1-2 years	1.5-2.0%
Project Specifications for Contractors	1 year	1%
<sup>1</sup> Durations are representative for a major or difficult tunnel project.		

## 2.2 Determination of Layout and Longitudinal Profile

### 2.21 Steps to Be Followed in the Course of Preliminary Studies

#### (PROPOSAL DOCUMENT [PD])

The choice of a tunnel location constitutes the essential phase of the preliminary studies. In practice it develops out of the search for the best solutions.

In general the following steps comprise the initial location studies:

- \* Envisage and classify all the types of possible solutions, taking into account:
  - general topographical conditions.
  - the expected consequences of tunnel (traffic patterns, population densities, regional development planning, etc.).
  - various constraints:
    - \* urban constraints (if location very urbanized).
    - \* general geometric constraints (type of route the tunnel would serve, speed limits, general longitudinal profile, etc.).
    - \* major geological difficulties.
- \* Retain several solutions, and for each one make a preliminary decision on both the tunnel's location and type (driven, cut-and-cover, immersed).
- \* Make a preliminary cost estimate for each solution (in terms of actualized costs); determine the actualized benefits for user and management; and undertake a preliminary study of each solution's profitability, thus providing a rough plan which will permit a provisional classification of the various solutions.
 

Determine the proportional cost of tunnel construction itself (relative to total project cost) for each solution; and more generally, determine for each solution the importance of the tunnel relative to the total project (relative importance will be a function, therefore, of the length of the tunnel, construction difficulties due to site conditions, etc.).
- \* For the more promising solutions, begin the necessary studies for both tunnel and exterior layout (cf. 2.22 below).
- \* Refine the profitability estimates and calculations.

It is not always possible to adhere to the foregoing procedure; in particular, preliminary studies may have to be bypassed (or postponed) if detailed studies of tunnel and layout solutions are necessary in order to permit their comparison.

## 2.22 Factors in the Choice of Layout and Longitudinal Profile

At the level of PD as well as that of the PPS (but with a different degree of precision in the two cases), three important factors should determine the placement of the tunnel. These factors, succinctly outlined below, are discussed in detail in Volumes I, II, and III.

\* Exploitation

The geometrical definition of tunnels cannot be dissociated from that of their approaches; it must remain homogeneous with that of the connecting route. To this end, the following points should be given particular attention in tunnel design:

- Curves (in plane) and visibility (presence of tunnel walls, dazzle-effect at portals).
- Grade limitations in order both to minimize ventilation requirements and to avoid the necessity of a supplementary climbing lane in the tunnel for slow vehicles, as well as to avoid a diminished traffic flow capacity.
- Placement of interchanges and, more generally, design of the approaches (speeds, fluidity, intersections, curves in the exterior layout adjacent to tunnel etc.).

\* Construction

Four elements should be given special consideration:

- Location of tunnel portals (which often poses very difficult problems).
- The presence of ground-water (which is advisable to avoid as much as possible).
- The nature of the terrain to be traversed (avoid the worst), including any geological irregularities (which should be avoided if possible).
- The nature of the surrounding area (urban site or not, heavy or light soil covering, nature of surface terrain) which can often determine, from the outset, the construction procedures and, therefore, even the type of tunnel (driven, cut-and-cover), its cross-section, its cost, the construction time requirements, and construction precautions.

\* Ventilation

Ventilation requirements increase with the tunnel's grade, length, and traffic flow.

- It is therefore necessary to study with care the fresh-air replenishment requirements with a view to discovering the latitude at one's disposal for determining the longitudinal profile, without being forced, for example, to increase the tunnel's cross-section.
- Furthermore, the choice of ventilation system, its placement, and the number of stations are important elements in the choice of layout and longitudinal profile.

## 2.3 Determination of Cross-section

In contrast with most surface structures, the choice of tunnel cross-section is severely constrained, for the following reasons:

- \* The transverse dimensioning is final; in general it is impossible to enlarge or redesign an underground structure after completion. Foreseeable changes in traffic flow and space requirements for equipment placement should, therefore, be considered from the outset.
- \* Every decision affecting the road width produces irremediable consequences for the tunnel cross-section; furthermore, construction difficulties generally vary directly with the cross-sectional area.

### 2.31 Steps to Be Followed in the Course of Preliminary Studies (PD)

Inasmuch as the envisaged tunnel will often be only one part of an entire road system, which must fulfill certain functions, it is fitting to choose a roadway for the tunnel that will be compatible with that of the connecting system. In particular, the tunnel roadway must be comparable in terms of flow characteristics, safety, and serviceability.

- \* Two questions generally should be asked:

- Is it necessary to conserve the road width provided on the approaches?
- Is it necessary to provide lane dividers, and, if so, of what width?

The answers to these questions are provided in Volume I. In certain cases tunnel costs may significantly influence the response to these questions.

- \* Once an initial answer to these questions has been provided, the determination of tunnel cross-section proceeds progressively, along with the various studies.

A rough estimate may be made however on the basis of the following considerations:

- The type and site of the tunnel largely determine whether the tunnel cross-section will be vaulted, circular, or rectangular in form. Geological and hydrogeological considerations will further refine this determination.
- The interior space defined by this form is divided into two smaller spaces, one reserved for traffic, the other for ventilation.

The detailed studies determine the best organization of these two sub-spaces, taking into account certain accompanying constraints (e.g., the placement of lighting and traffic-control apparatus).

- In the case of a tunnel wider than three lanes, driven in soil or rock, it is generally preferable to divide the tunnel into two tubes.

The discussion of various profiles provided in Volume I takes up these different considerations.

## 2.32 Factors in the Choice of Cross-section

More concretely, those factors that merit careful study in the choice of cross-section are listed below. These factors are examined with differing degrees of precision depending on whether they are to be included in the PD or in the PPS.

### \* Form and type of tunnel (Volumes I and II)

- Ascertain whether the type of tunnel has been determined or whether the choice remains to be made (between tunnel or covered trench, or between driven or immersed tunnel).
- Ascertain the geological and hydrogeological factors that will determine the cross-sectional form (e.g., circular cross-section in cases of high ground-water pressure, or covered trench at entrances in cases of light soil covering).
- Insure that the cross-sectional form is compatible with envisaged construction procedures.
- Determine the dimensions of the tunnel vault, and determine the effect of water-proofing treatments on the proposed dimensions.

### \* Space reserved for traffic circulation (Volumes I and III, section 3)

- Ascertain the sensitivity of tunnel costs to increases in road width.
- Verify the compatibility of the tunnel roadway with that of the approaches (shoulders, supplementary lane with slow vehicles, etc.).
- Ascertain the modalities of tunnel exploitation (traffic capacity and the probability of breakdown or accident in tunnel; maintenance requirements within tunnel; risks to user; placement of lighting and traffic-control apparatus).

### \* Space reserved for ventilation (Volume III, section 1)

- Ascertain that all factors that tend to limit ventilation requirements are being considered.
- Ascertain that the required cross-sectional area for ventilation system is available in the tunnel cross-section. If it is not, then ascertain the required increase in tunnel cross-section.

- Determine location of ventilation stations in such a manner as to optimize both energy requirements for ventilation and investment costs. (Cf. 2.5 below.)

## 2.4 Estimation of Costs and Construction Time

### 2.41 Estimation of Costs

To aid in the estimation of tunnel investment and operating costs, Volume IV has been prepared on the basis of very complete studies of recently completed tunnels.

Despite its straightforward appearance, this volume necessitates two very important remarks:

- \* The sample (exclusively French) is rather restricted because of the small number of French tunnels opened for service at this time. The various cost categories are therefore provisional, and it is necessary, especially when making quasi-definitive cost estimates for the PPS, to utilize any supplementary information which may be available.

It should be noted, however, that the prices quoted in Volume IV are, for the most part, statistical averages, which therefore absorb contingent fluctuations in price. Consequently, these quotations constitute a much more reliable basis for cost estimation than would raw cost data assembled without similar precautions.

- \* The price quotations provided in Volume IV -- even flat rate estimates for major construction categories -- should not be accepted without very detailed study. For tunnels in particular, it would be vain -- and even dangerous -- to utilize Volume IV without first proceeding with a thorough study of the geological conditions or ventilation equipment requirements (to cite only the most important categories).

### 2.42 Estimation of Construction Time

Estimation of the time required for project completion presupposes a prior decision on the methods of construction.

By way of example, in order to facilitate the elaboration and presentation of preliminary planning studies, two examples have been provided below.

SIMPLIFIED EXAMPLE OF CONSTRUCTION PLANNING FOR PROPOSAL DOCUMENT

Tunnel 4 kilometers in length, roughly divided into 2 categories of terrain  
 Geological irregularity detected, but not completely evaluated

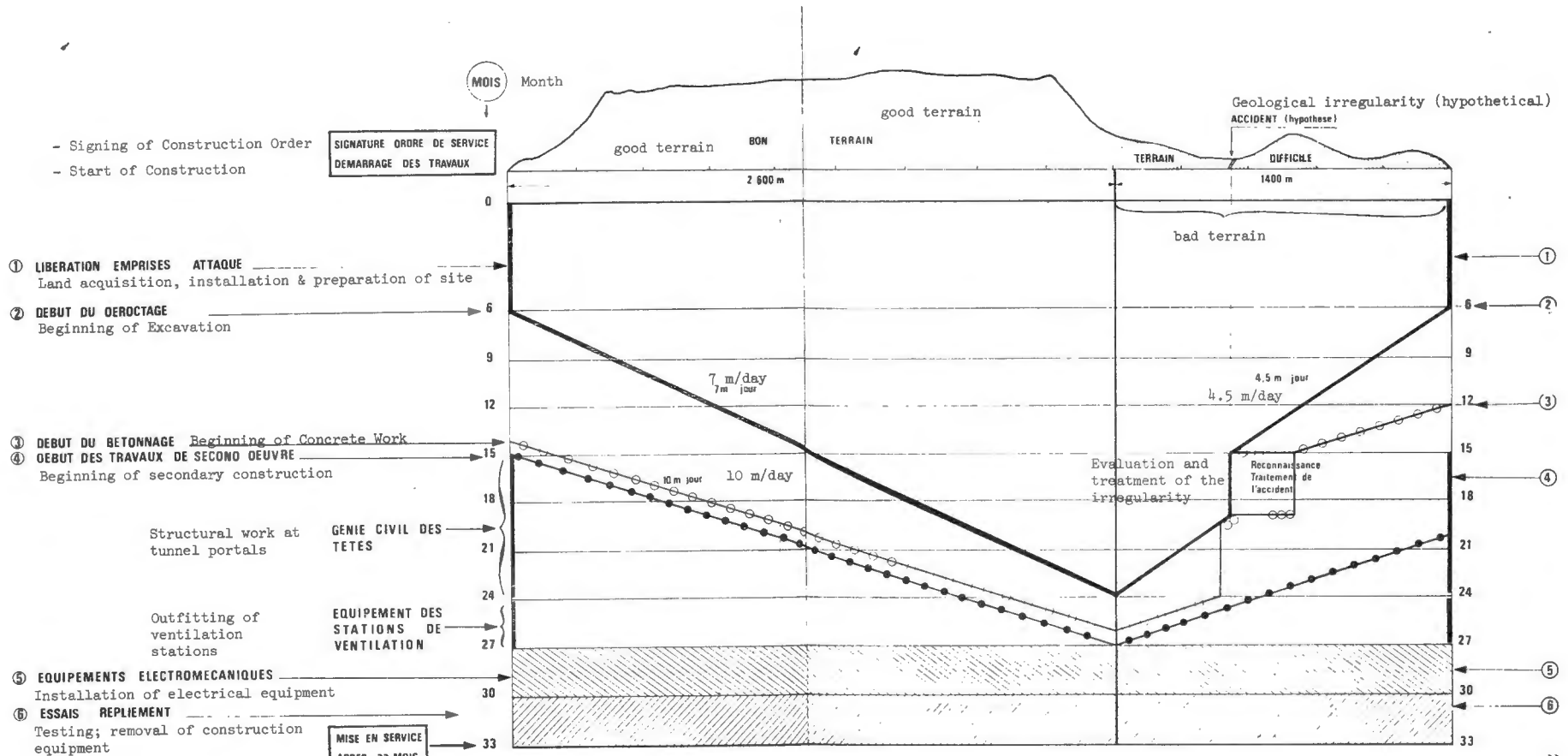

Opened to service after 33 months.



EXAMPLE OF CONSTRUCTION PLANNING FOR PRELIMINARY PROJECT  
SUMMARY

Signature **ORDRE DE SERVICE**  
démarrage des travaux

Signing of Construction Order;  
Start of Construction

HYPOTHESES:

- \* Tunnel 1 km long.
- \* North portal: bad terrain; support ribbing spaced closely enough not to require that placing of concrete lining proceed with advancement of heading.
- \* South portal: very bad terrain with difficult heading.
- \* No significant ground-water problems.
- \* 1 month = 22 work days, with 3 shifts per day.

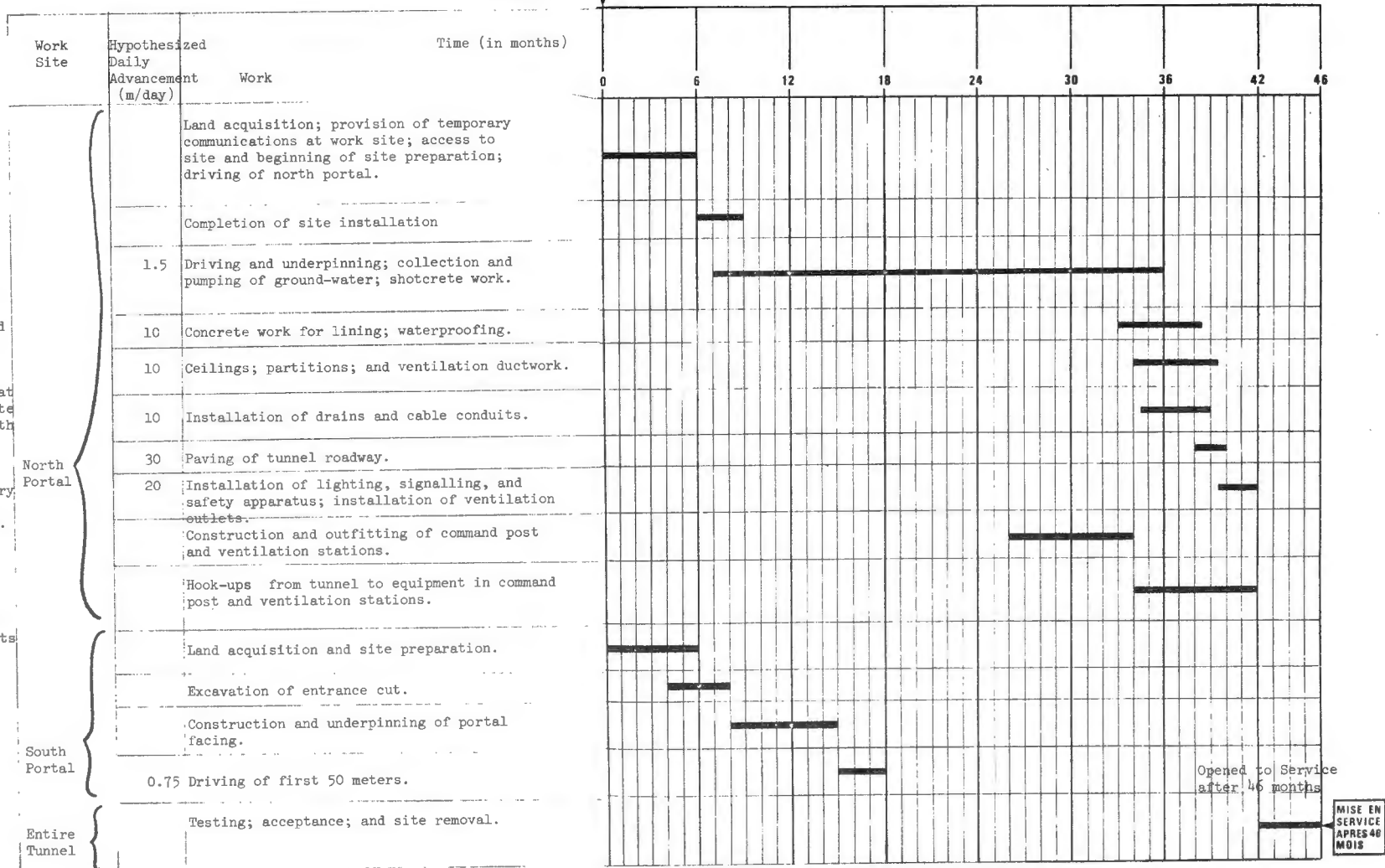

The following should be considered in every case:

- \* Sufficient leeway between the projected construction completion date and the date on which the tunnel and connecting road system are to be put into operation should be provided in cases where a delay in the opening date would have particularly undesirable consequences.
- \* A preliminary period for the installation and preparation of the construction site.
- \* Time allowance for excavation -- will vary according to the type of terrain. (This time allowance is based on average advancement rates, which are slower at the outset than they are later on when the construction is well underway.)
- \* Time allowances for each successive operation, as well as for the lag time between operations.
- \* A final period for acceptance (by inspectors), testing, and removal of construction equipment.

## 2.5 Cost Studies

### 2.51 Cost-Benefit Studies

Calculations should take the following into account when evaluating proposed solutions:

- \* The actualized benefits for the user.
- \* The actualized costs of not only the tunnel (which is but a part of an entire system), but also of the entire road system connecting with the tunnel.

### 2.52 Comparative Studies of Variations on Particular Solutions

Depending on the relative importance of the planned tunnel construction, it may be desirable to make comparative studies in order to choose between several technical variations on a single solution. Of course, the necessity of undertaking these studies will vary, depending on the type of tunnel, for example:

- \* A single, short tunnel that presents only a moderate financial burden in comparison to the total investment cost.
- \* A series of short tunnels on a difficult route.
- \* A long tunnel that largely determines the cost of the entire project.

The first step should therefore consist of a determination of the relative weight of tunnel construction costs in the total project investment cost.

Depending on the case at hand, therefore, the studies described in the following paragraphs may or may not be necessary.

### 2.53 Staggered Opening of Tunnels

Given the high cost of tunneling and taking budgetary considerations into account, an attempt should be made, whenever possible, to defer a part of the investment costs using a timetable based upon the predicted increase in tunnel traffic. This situation may be possible in the following cases:

\* The case of a tunnel with a single roadway

The only deferment possible here would involve the installation of ventilation (and very possibly, lighting); no similar deferment in structural work is possible.

- The first possibility consists of planning for the progressive installation of the electromechanical equipment for ventilation. The savings will, however, be small.
- A second possibility consists of planning for a second phase of installation, during which new ventilation stations are added to the system. The savings here will be more significant, but in most cases this solution poses difficult problems which should be carefully studied before a decision is made (construction of an underground station after completion of the tunnel proper, connection to tunnel).

\* The case of two parallel tubes on a super-highway

A progressive installation may be obtained here by initially opening only one tube, which has been carefully chosen, and postponing the opening of the second tube until later.

Of course, the advantage of this solution consists in being able to defer a part of the cost. Its cost justification must incorporate the following considerations:

- Cost of the first tube, which must be of adequate size to satisfy safely the traffic needs during the interim period until second tube is opened (including the various operating emergencies that may arise during operation).
- Cost of construction necessary during the first phase, even though it concerns the second tube (as is often the case for the tunnel portals and approaches, as well as for certain common elements such as ventilation stations, command post, etc.).

- Supplementary construction costs for each tube, due to the fact that contracts for their separate construction are smaller.
- Actualized cost of the second tube.
- Actualized cost of supplementary precautions required in the construction of a second tube in close proximity to the first.
- \* The case of two parallel tubes on a super-highway capable of being enlarged, for example, to three lanes

As a first phase two two-lane tunnels could be constructed, and then during a later enlarging stage, a third two-lane tunnel could be constructed. The transition between a tunnel configuration of three two-lane roadways and an approach configuration of two three-lane roadways may present substantial difficulties both in the design of the tunnel portals and in the management of the tunnel. For these reasons this solution is generally avoided.

#### 2.54 Optimization of the Ventilation Sections

In either very long or urban tunnels, both of which require substantial ventilation, a balance should be established between the following:

- \* The cross-sectional area of the ventilation ducts in the tunnel, and consequently, the total excavated section.
- \* Energy requirements, which increase directly with the velocity of air in the ducts.
- \* The number of ventilation stations.

Concise design criteria on this subject is given in Volume III, section 1.

---

Chapter 3. ARTICULATION OF STUDIES AND  
COMPOSITION OF DOCUMENTS

3.1 Composition and Articulation of Studies

3.11 Content of Studies

Tunnel planning should always include the following 7 categories of studies, with varying detail depending on the administrative stage of the planning studies:

\* Traffic predictions and geometrical definition of the tunnel (Vol. I)

All information on traffic should be obtained for the PD; it should permit:

- a determination of vertical clearances.
- a determination of the layout and of longitudinal and cross-sectional profiles.
- an initiation of profitability studies.

A detailed geometrical definition of the tunnel should be prepared for the PPS.

\* Geology and Geotechnology (Volume II, section 1)

- Geological and hydrogeological studies are conducted for both the PD and PPS. With only limited exceptions (e.g., the completion of an exploratory tunnel), these studies must be terminated with the delivery of the PPS.
- The distribution of these studies between the PD and the PPS depends on the difficulties peculiar to the project; to take two extreme cases, the studies for the PD may be limited to a visual site study (combining site surveys with the use of documentation on nearby underground construction), or, on the other hand, these studies may involve a major program of borings and seismic tests.
- Geotechnical studies are principally contained in the PPS and, if necessary, may be continued during the preparation of the contract specifications. Specific geotechnical studies may in

certain cases prove necessary for the PD if the choice of tunnel solution is dependent on them (predictions regarding swelling rocks, passage under buildings, etc.)

\* Methods of Construction and Tunnel Lining (Volume II, sections 2 and 3)

- Construction methods should not be studied in the PD except for the following reasons:

- \* to verify that construction is not technically impossible.
- \* to determine the required tunnel geometry (e.g., adoption of a circular section).
- \* to ascertain any unusual circumstances eventuated by these methods (e.g., the installation of a workshop for the pre-fabrication of caissons).

- In the course of the PPS, the influence of construction methods on both the dimensioning and costs of the tunnel should be carefully examined.

- Subsequently, a detailed study should be made with a view to preparing the Contract Specifications Document for Contractors (CSDC)

\* Watertightness (Volume II, section 1)

Because of its relatively high cost as well as its influence on the cross-section, watertightness should be studied briefly during the PD stage, in combination with hydrogeological studies. A precise study should be made for the PPS.

\* Roadway (Volume II, section 5)

Drainage, sidewalks: a cursory examination of these elements will suffice for the PD. A precise dimensioning of the drainage system and roadway is necessary for the PPS.

\* Ventilation (Volume III, section 1)

- In the course of the PD, a cursory examination of ventilation requirements should be undertaken, in order to fulfill the following objectives:

- \* to determine the necessity of ventilation and the system to be employed.
- \* to determine the geometric dimensions of the tunnel cross-section.
- \* to evaluate roughly the environmental impact of the proposed system (zones to be reserved for the installation of ventilation stations, etc.).

\* to permit the estimation of competing ventilation designs.

- The PPS studies should result in a precise definition of all the elements having an influence on the tunnel design and the surrounding environment.
- Detailed ventilation studies that do not bear on the studies of other construction categories may be undertaken subsequently (e.g., soundproofing, choice of ventilators, meteorological studies).

\* Lighting (Volume III, section 2)

Until the completion of the PPS, the lighting studies are limited to consideration of the required clearances of lighting apparatus, the choice of illumination levels and sources, the necessary structural accommodations for lighting, and a sufficiently precise estimation of costs.

\* Electric Power

At the PD stage, only the possible location of power lines need be studied. Detailed studies may be delayed until the PPS and subsequent studies.

\* Operation (Volume III, section 3)

- At the PD stage, estimations must be made of:
  - \* the technical aspects of operating the proposed tunnel.
  - \* its influence on the tunnel geometry.
  - \* the cost of operations, including both the initial investment costs and annual operating expenses.
- Detailed studies of tunnel operation should be made in the PPS.

\* Estimation of Profitability (Volume IV)

- At each stage in the planning process, one should undertake sufficiently precise estimations of the various cost categories, including both tunnel and ancillary categories (exterior and provisional construction, land acquisition, etc.): within about 20% for the PD; within about 5% for the PPS. (Note: the figure of 20% given for the PD is meant to be only indicative; it is necessary only that a comparison of different solutions be possible at the PD stage.)
- A profitability study is especially necessary for the PD. It should be completed and made more precise during the course of PPS, taking into account the factors determined during that stage of the planning process.

\* Diverse Studies (for memorandum)

The following studies should be started in preparation of the PD as soon as they are seen to exert an influence on the location or cost of the proposed solution:

- expropriations
- nuisances and urban constraints
- tunnel approaches and temporary structures, etc.

### 3.12 Articulation of Studies

As has already been stated, the studies are progressive, and constitute an entire series of steps that finally converge, dialectically, towards essential decisions.

According to the official directives in effect at this date, the planning studies are divided into four administrative stages, each one corresponding to a precise administrative objective:

- \* Proposal Document ["Dossier d'Inscription"] -- PD
- \* Preliminary Project Summary ["Avant Projet Sommaire"] -- PPS
- \* Detailed Preliminary Project Document ["Avant Project Detaille"] -- DPPD
- \* Contract Specifications Document for Contractors ["Dossier de Consultation des Entreprises"] -- CSDC

Circular no. 69-68 of June 6, 1969, dealing with highway projects and the simplification of planning procedures is not entirely applicable to tunnels, which, depending on the case at hand, should be considered as:

- \* the "non-typical structures" cited in the circular.
- \* unusual structures not dealt with in the circular.

In the case of tunnels, the circular must be modified through addition of the following considerations:

\* Object of the PD

The PD serves as the basis for programming; consequently, it should conclude with the choice of one of the possible tunnel solutions.

- The PD should specify the layout, longitudinal profile, and cross-sectional profile for the chosen solution.



- Estimation of costs should be sufficiently precise (within 20%) in order (1) to permit the choice of a solution, and (2) to permit an informed, realistic upper-level administrative decision.

\* Object of the PPS

Approval of the PPS permits the opening of an inquiry into public utility of the proposed project. The PPS should therefore conclude with a very detailed study of the solution retained in the PD.

- The tunnel layout, particularly the location of the portals, should be precisely determined -- to within about 30 meters for a tunnel in open country; to within only a few meters in an urban location.
- Estimation of costs should be accurate to within 10%.

\* Object of DPPD

For tunnels, the DPPD is not a part of the planning process; the submission of a formal document is not required.

\* Object of the CSDC

The CSDC should compile all the preceding studies, separating them in terms of the nature of the work involved (cf. 3.4), and supplementing them with certain detailed analyses, so as to provide contracting firms with a complete document detailing:

- the contract specifications imposed by the administration.
- the tentative specifications which may lead to change orders.

The studies to be undertaken at this stage are, therefore, simple complements to the PPS studies. They should not condition either the location or cost estimation of the tunnel project; consequently these studies will deal chiefly with the general conception of the project (e.g., plans for iron work, sound-proofing, choice of ventilators, etc.).

\* Sample Outline of Studies

A simplified outline of the required studies for a tunnel is given below. It indicates how, in the average case, studies for a tunnel should be articulated and carried out. While actual studies will not always correspond to this outline, it should nonetheless prove a useful guide for the engineer.

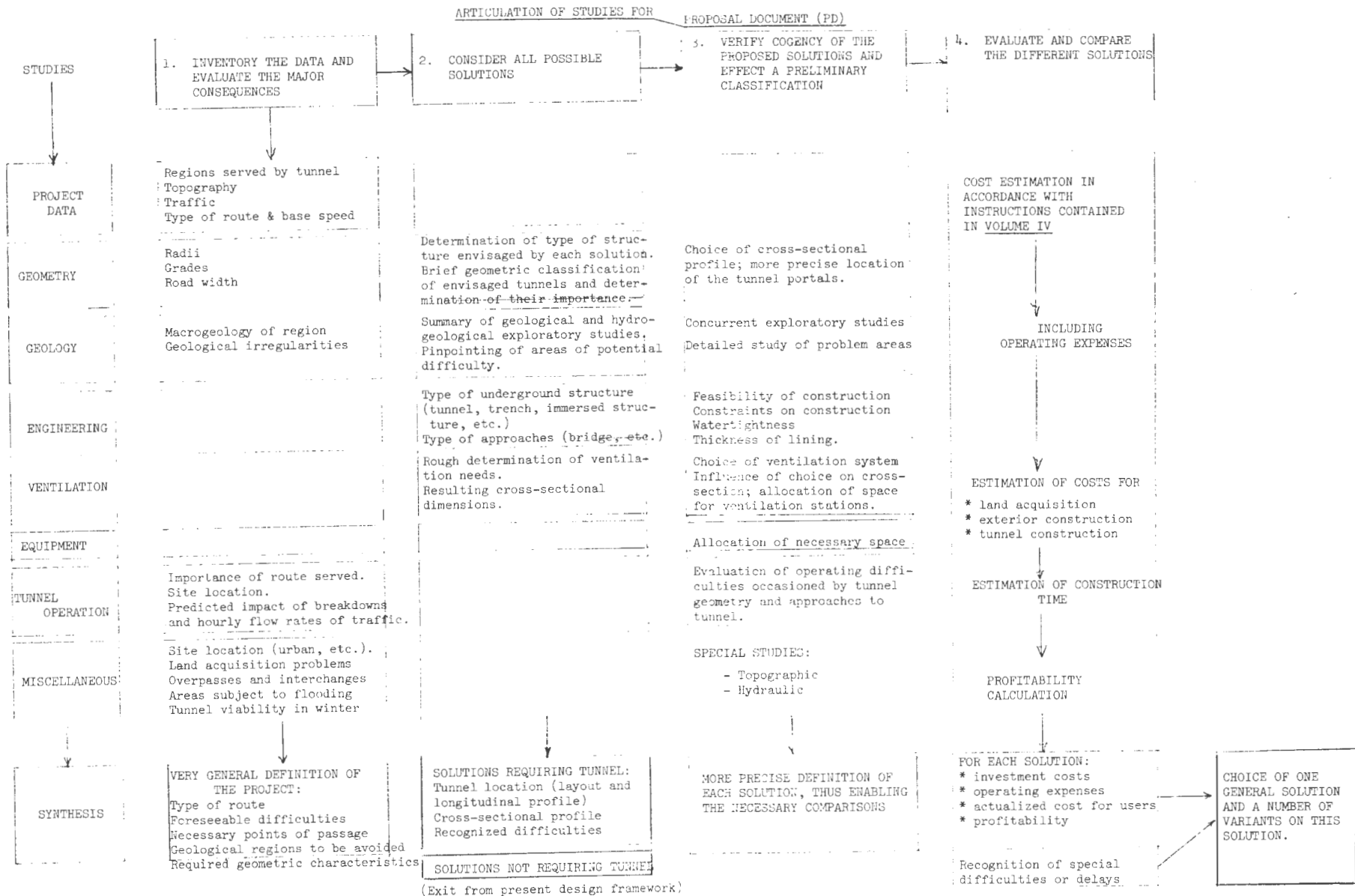

ARTICULATION OF STUDIES FOR PRELIMINARY PROJECT SUMMARY (PPS)

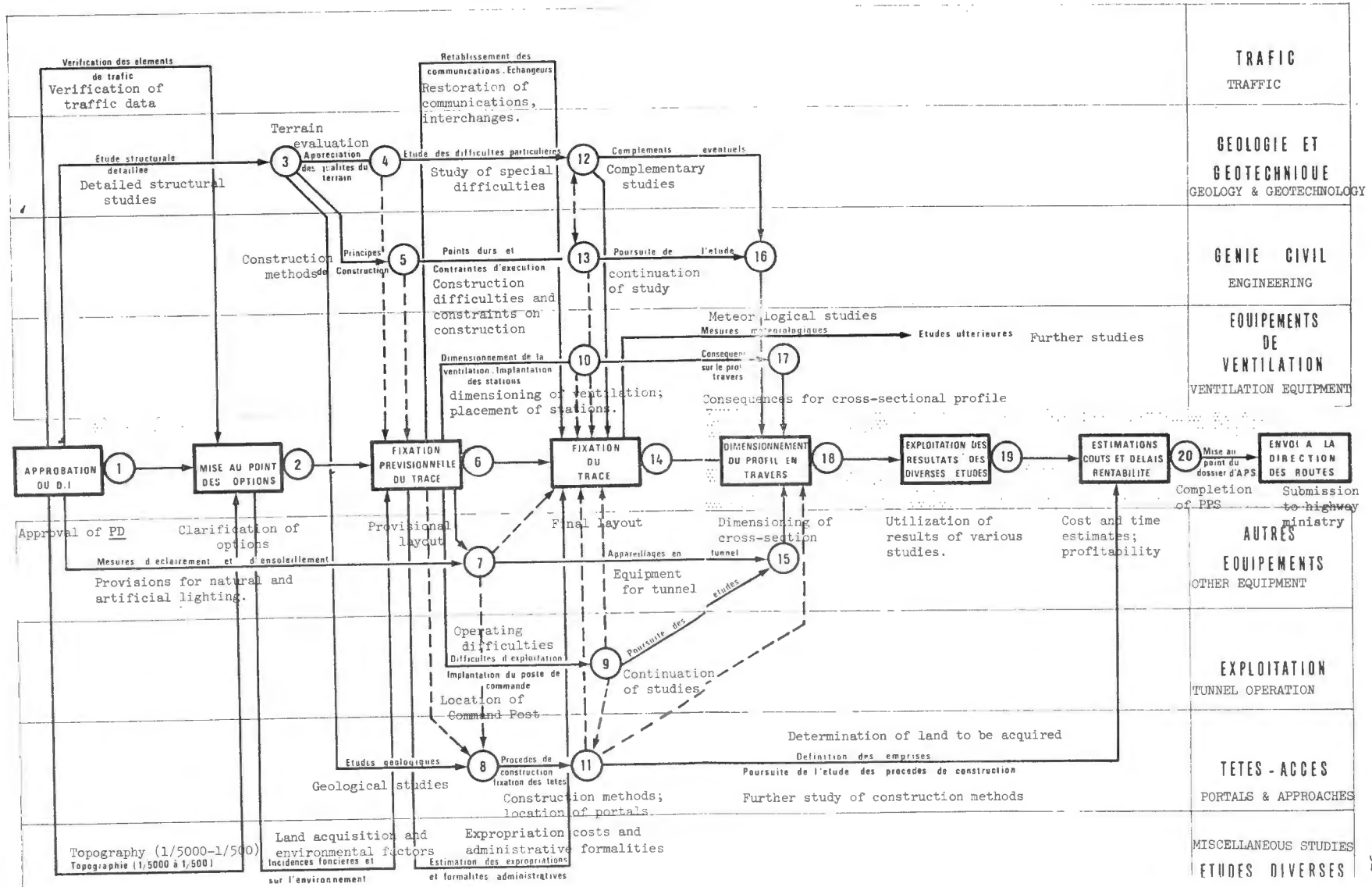

### 3.2 Composition of the Proposal Document

#### 3.21 Drawings

- \* Location Plan: scale of 1/100,000.
- \* General Plan: scale of between of 1/2000 and 1/500 depending on the difficulty of the project and site conditions.
- \* Longitudinal Profile:
  - length: scale of the General Plan.
  - height: scale ten times that of length.
- \* Cross-sectional Profile: scale of 1/100.

#### 3.22 Explanations and Justifications

- \* General Characteristics
  - Length of sections of homogeneous cross-section.
  - Characteristics of these sections (base speed, visibility, etc.).
  - Vertical clearances.
  - Type of route that tunnel will serve.
- \* Geological Study adapted to the complexity of the project and including:
  - a geological map of the surface at the scale of the General Plan.
  - a geological map at the level of the tunnel, at the same scale.
  - a geological section at the scale of the longitudinal profile.
  - an interpretive report indicating the predicted terrain quality, geological irregularities, and major difficulties.
- \* Justification of the cross-sectional and longitudinal profiles, taking into account the following elements:
  - traffic and tunnel operation.
  - geology and construction.
  - ventilation.
  - other elements.

\* Elements of traffic design

- present and predicted volumes.
- percentage of truck traffic.
- daily and annual flow distribution (hourly and daily flow rates).

\* Equipment Justification

- ventilation: (1) choice of the system and air flows.  
(2) possible location of ventilation stations.
- equipment for lighting and traffic control.

\* Administrative and Financial Factors

- Total cost of the operation and cost per kilometer compared to the average national cost for operations of the same type.
- Methods of financing.
- Present status of project.
- Payment schedule for project.

\* Summary of estimated costs, broken down as follows:

- Studies, borings, excavation, construction, and supervision.
- Land acquisition.
- Existing buildings at site and relocation costs.
- Displacement of existing utilities and relocation costs.
- Cost of temporary provisions for traffic maintenance.
- Cost of the tunnel or tunnels (engineering, equipment, operation).
- Cost of portals and very difficult sections of the tunnel.
- Predicted annual operating costs.

\* Profitability study. This is obligatory for all tunnels and must include all exterior works as well as actualized operating costs.

### 3.3 Composition of the Preliminary Project Summary

#### 3.31 Drawings

- \* Location Plan: scale of 1/100,000
- \* General Plan: scale of between 1/2000 and 1/500, depending on the difficulty of the project and on whether the site is located in urban area.
- \* Longitudinal Profile:
  - length: scale of the General Plan
  - height: scale ten times that of length
- \* Cross-sectional Profile: scale of 1/100
  - in mid-section
  - at portals.
  - adjacent to emergency pull-offs, turning areas, and emergency exits.
- \* Detailed drawings
  - to a scale of 1/20 for drawings showing installation details in the cross-section.
  - to a scale of 1/100 for drawings of the ventilation stations and connecting structures.

#### 3.32 Restoration of Traffic, Interchanges, and Intersections

- \* Plan to a scale of 1/2000, including longitudinal profile.

#### 3.33 Geological and Geotechnical Studies Document

It should contain:

- \* Geological maps and sections to the same scale as the General Plan and longitudinal profile.
- \* A general geological report and special reports for each difficult zone.
- \* A geotechnical report.

#### 3.34 Statement about Construction Procedures and the Time Required for Construction

- \* General report indicating construction planning.

- \* Special reports on portals and difficult zones
- \* Report on problems and constraints on construction exercised by the environment (site, possible subsidence of surface, blasting).

3.35 Special Studies Documentation

- \* Ventilation.
- \* Lighting and sun-screens.
- \* Watertightness and drainage.
- \* Roadway.
- \* Tunnel Operation (including envisioned operating conditions).

3.36 Profitability Study, conforming to circular above.

3.37 Detailed Cost Estimates, including:

- \* Specification of pricing basis on which estimates are made.
- \* Complete quantification of work to be performed.
- \* Payments schedule (showing program authorizations and credits).
- \* A statement of both the reliability and precision of the estimates.
- \* A determination of annual operating costs.

For super-highways, this information must be presented in the SETRA format.

3.38 Transmittal Statement must conform to the circular cited above.

3.39 Proposals for Complementary Studies

- \* Exploratory tunnel to be driven or terminated.
- \* Detailed studies.

### 3.4 Contract Specifications Document for Contractors

This document should be compiled in accordance with requirements stated in Circular no. 69-68 of June 6, 1969.

It should be remembered that in general:

- \* The preferred contracting procedure for tunnels lets the project for bid on the basis of the PPS, with the possibility of subsequent change orders. Documentation provided bidders should, therefore, be both very complete and very detailed.

The outline of possible variants to the PPS should be well defined in the CSDC and should primarily concern itself with the choice of construction procedures or the organization of the construction site.

- \* Important savings can be expected both in the case of unified bidding by general contractors and in the case of simultaneous bidding on a series of different projects.

Bidding should be restricted to clearly qualified firms.

- \* Considering the very different specializations required, construction will normally be subdivided as follows:
  - Preparatory work, approaches.
  - Structural work.
  - Roadways.
  - Ventilation installation.
  - Electrical supply.
  - Lighting installation.



Regional Technical  
Agency of Lyon

MINISTRY OF EQUIPMENT AND LODGING

Tunnel Service

TUNNEL MANUAL

(Volume I: Geometry)

Study Group on Tunnels

May, 1970

(Translated by Robert J. Matthews)

SUMMARY

Chapter 1. Foreword

- 1.1 Characteristics of Tunnels
- 1.2 Objective of this Volume

Chapter 2. Applicability of Present Volume

- 2.1 Categories of Tunnels
- 2.2 Type and Method of Construction
- 2.3 Conformity to the Technical Specifications for the Planning of Highways and Superhighways

Chapter 3. Traffic Data

- 3.1 Base Flow and Congestion Threshold
- 3.2 Results of Traffic Studies
- 3.3 Tunnel Dimensioning
- 3.4 Factors in the Determination of Benefits
- 3.5 Determination of Tunnel Speed Limit

Chapter 4. Layout of Tunnels

- 4.1 Factors to Be Analysed
- 4.2 Layout of Approaches and Portals
- 4.3 Visibility in Curved Tunnels

Chapter 5. Longitudinal Profile

- 5.1 Tunnels of Continuous Grade or of Anticlinal Grade
- 5.2 Tunnels of Synclinal Grade

Chapter 6. Cross-section of Tunnel Roadway

- 6.1 Definitions
- 6.2 Floor
- 6.3 Roadway
- 6.4 Insulators
- 6.5 Shoulders
- 6.6 Traffic Lanes
- 6.7 Supplementary Lanes for Slow Vehicles
- 6.8 Superelevation
- 6.9 Vertical Clearance
- 6.10 Cross-sectional dimensioning

Chapter 7. Typical Cross-sections

- 7.1 Underground Connecting Ramp, One Lane Wide
- 7.2 Tunnels on Superhighways
- 7.3 Tunnels on Urban Expressways
- 7.4 Tunnels on Slower Urban Routes
- 7.5 Tunnels on Undivided Highways in Open Country or  
in the Mountains

Chapter 1. FOREWORD1.1 Characteristics of Tunnels

1.11 From the point of view of the consequences, the geometric definition of tunnels and underground passages does not pose the same problems as those posed by open highways.

\* Consequences for the individual. Tunnels always constitute a difficult point on an itinerary, due to both the environmental changes and the gravity of the consequences which generally result from a traffic accident or obstruction in the tunnel. A sufficiently large cross-sectional geometry thus becomes all the more important.

\* Consequences for the community. Once constructed, tunnels generally present no possibility for expansion or subsequent modification. This places additional importance, from the very beginning, on a careful geometrical design which takes into consideration both immediate and future needs.

On the financial side, tunnels constitute a costly investment in open country (about 8 times that of an open highway), but they often become competitive in urban areas.

1.12 Given both the relative importance of the related investments and their very great sensitivity to the geometrical dimensioning of the tunnel, this dimensioning must from the very outset of preliminary design be conducted judiciously so as not to falsify the comparative economic analyses that must follow.

The decision to construct a tunnel should normally result from an economic calculation which demonstrates its profitability. In principle, the tunnel should be found to be the least costly solution of all those considered.

These considerations emphasize, if there were need to do so, that the engineer must know from the beginning how to adapt the characteristics of the tunnel to its intended function. And once the decision to construct the tunnel has been made, this function should not, under any circumstances, pass into the background.

## 1.2 Objective of the Volume

The present volume supplies a certain number of standardized rules whose application should yield a well-adapted and economic dimensioning.

### 1.21 Continuity

Particular attention must be paid to problems of continuity between the planned geometric characteristics of the tunnel and those of the itinerary on which it is situated. These rules will vary depending upon (1) the relative importance of the tunnel construction costs, and (2) whether there is a single tunnel or a succession of tunnels.

### 1.22 Versatility

The present volume preserves a certain versatility, proposing a variety of cross-sections. It formulates a doctrine that permits, in each case, the adaptation of the geometric characteristics to the particular function of the tunnel.

As a general rule, it is wise to conform to the present recommendations, if only in order to standardize tunnel profiles -- a result that will be a source of savings for the future.

---

## Chapter 2. APPLICABILITY OF THE PRESENT VOLUME

The present volume treats those problems connected with the geometry of underground highway constructions, whatever their category, type, or method of construction.

In the definition of tunnel cross-sections, it does not, however, take into account the extra cross-sectional area that will in certain cases be required by tunnel ventilation provisions. (The required additional area is often provided "free of charge" by the surplus area in the circular or vaulted cross-section.)

### 2.1 Categories of Tunnels

There are 5 categories of tunnels, depending on the nature of the route on which they are located:

- I) Non-urban superhighway
- II) Urban Expressway
- III) Undivided highway in open country (Categories 1 & 2 of National Routes)
- IV) Mountain routes (Categories 3 & 4 of National Routes)
- V) Slower urban roads.

The first two categories are, in principle, twin-tube tunnels, each carrying traffic in a single direction; the other three are single-tube tunnels with two-way traffic.

### 2.2 Type and Method of Construction

The following different types are considered in the present volume:

- \* Excavated (driven) tunnels, generally of vaulted cross-section (i.e., circular or horseshoe-shaped) -- constructed by traditional methods or with the aid of drilling machines.
- \* Immersed tunnels (under rivers or oceans), generally of rectangular caisson construction.
- \* Covered trenches, usually of rectangular cross-section.

### 2.3 Conformity to the Technical Specifications for the Planning of Highways and Superhighways

With regard to the road width, tunnels should at least conform to the technical specifications for the planning of:

- \* roads (Circular MEL 69, in preparation)
- \* non-urban superhighways (Circular MTP 62-17 of March 1, 1962)
- \* urban expressways (Circular MEL 68-115 of December 1, 1968)

On certain topics (notably the road width, as defined in Circular MEL 68-115), the present volume constitutes a refinement of those specifications in light of the peculiar and costly nature of tunnels.

For all questions which are not exclusively treated, or for clarifications of terminology, the ministerial circulars cited above should be consulted.

---

### Chapter 3. TRAFFIC DATA

In all cases a very complete traffic study is necessary, which will take into account the location of the tunnel, its function, the approaches, and the conditions of the future operation of the route.

#### 3.1 Base Flow and Congestion Threshold

All the data in this paragraph depend exclusively on the characteristics of the proposed cross-section of the tunnel under study.

3.11 For a given tunnel, the hours of heaviest traffic flow may be defined as per the circular on expressways:

- \* A base flow ( $q_b$  - in equivalent passenger vehicles/hr)<sup>1</sup> corresponding to the maintenance of a continuous but interrupted (stop-and-go) flow (a 10% chance of having to slow down or stop for a few seconds, then accelerate) for considerable periods of time (1/2-, 1 hour or more).
- \* A congestion threshold ( $q_c$  - in equivalent passenger vehicles/hr)<sup>1</sup> corresponding to a rupture of continuous flow (50% chance of being caught in a line of vehicles immobilized for several seconds or even several minutes) for considerable period of time (1/2- to 1 hour).

Heavier flows, under even worse conditions, may certainly be observed after the base date, and sometimes even before; but there is a physical limit called the capacity of 2200-2400 epv/hr-lane that cannot last more than 30 minutes. This situation corresponds to an intermittent flow that is generally followed by a generalized and prolonged congestion of the entire road system served by the tunnel. In addition, the presence of vehicles at a standstill in the tunnel poses ventilation problems, and the need for a plan to alleviate this situation should be foreseen.

---

<sup>1</sup>For the correspondence between real and equivalent passenger vehicles, see paragraph 6.71.



### 3.12 Suggested Values of $q_b$ and $q_c$ for tunnels.

Expressed in equivalent passenger vehicles (epv), the following chart gives the values of  $q_b$  and  $q_c$  for one-way and two-way tunnels consisting of from one to four lanes, with possibilities for emergency stopping (yet still maintaining the original number of lanes of traffic).

These data are to be completed, or even modified, according to the operating conditions in the tunnel and on the approaches. They can be refined after the tunnel is put into service by means of traffic studies.

Roadway	Number of lanes	Base flow - $q_b$ (epv/hr)	Congestion threshold - $q_c$ (epv/hr)
one-way	2	2000	3000
	3	3000	4500
	4	4000-5000	6000
two-way	1	1700	2000
	2	3500	4000
	3	5000	6000
	4	6500	8000

The above table should be used subject to the following reservations:

- \* The figures given suppose that the approaches to the tunnel have geometrical characteristics at least equivalent with those of the tunnel itself.
- \* In characterizing the tunnel as a two-way roadway with two lanes, one assumes that the direction of the two lanes is permanently fixed. The traffic flow figures take into account the unbalance between traffic flows in the two directions.
- \* In characterizing the tunnel as a two-way roadway with three lanes, one assumes that there is a suitably controlled center-lane which is assigned during long periods to the most trafficked direction.

The change of assignment of the center lane required to satisfy these traffic needs poses control problems which are analyzed in the Exploitation volume.

### 3.2 Results of Traffic Studies

#### 3.21 Base Year

Depending on the circumstances, the base year may be:

- \* That of the connecting route, if the tunnel only constitutes one element of it.
- \* A variable date (depending on the project being considered), if the tunnel constitutes the principal element of the road-system investment.

#### 3.22 Average Daily Traffic Flow Rate $J_H$ in the Base Year

This is expressed in epv/day and determined by classical methods of analysis which study the circulation of traffic in a network where one of the segments of that network contains the tunnel.  $J_H$  is predicted on the basis of the traffic analyses by allowing for both the increase in traffic between date of analysis and the chosen base year (as a function of the average rate of increase) as well as the increased traffic flow induced by the tunnel.

#### 3.23 Normal Rush-hour Flow $Q_N$

This is the portion of the  $J_H$  (in the base year) flowing during the normal working-day rush-hours.  $Q_N$  is expressed in epv/hr.

#### 3.24 Rush-hour Factor $F_H$

The rush-hour factor  $F_H$ , usually rather stable over long periods, is the quotient  $Q_N$  divided by  $J_H$ . This factor may be considered as a constant over a period of several years, with a tendency to decrease as the population that is served increases.

For lack of a more precise direct determination, the following table will serve as a guide giving the order of magnitude of  $F_H$  as a function of the tunnel's location and of the population served (expressed in millions of inhabitants Mh):

Situation of the tunnel (population served)		Open country		Small Town (less than 0.1 Mh) or sparse suburb	Medium town (0.1-0.3 Mh)	Town of 1/2 mill. (0.3-1 Mh)	Town of one mill. (1-3 Mh)
Value of the $F_H$	Rapid routes	0.25	0.20	0.17	0.14	0.12	0.07
	Other routes	0.25	0.22	0.18	0.16	0.14	0.10

## Actual Examples

- \* Tunnel on superhighway with two lanes in each direction, town of about one million, average daily flow being on the order of 33-66,000 epv/day:

$$F_H \text{ varies between } \frac{4,000}{33,000} = 0.12$$

$$\text{and } \frac{6,000}{66,000} = 0.09$$

- \* Tunnel on five-lane superhighway used asymmetrically as 2+3 lanes in a city of several million inhabitants.  $Q_N$  is on the order of 3,500 epv/hr on 2 lanes and 6,000 epv/hr on 3 lanes.

The average daily flow being 43,700 epv/day on 2 lanes and 85,700 epv/day on 3 lanes,  $F_H$  varies between

$$\frac{3,500}{43,700} = 0.08 \text{ and } \frac{6,000}{85,700} = 0.07$$

## 3.25 Asymmetry Factor D for Rush-hours

This is the fraction of  $Q_N$  flowing in the most crowded direction. One is concerned primarily with the flow  $DQ_N$  when designing four-lane divided highways. For a given arrangement, D decreases in the course of several years.

3.3 Tunnel Dimensioning

A cross-section of n lanes carrying traffic in either one or both ways is suitable if, for the base year, the normal rush-hour flow  $Q_N$  (for two-way traffic) or  $DQ_N$  (for one-way traffic) falls between the base flow  $q_b$  and the congestion threshold  $q_c$ .

The longevity and the serviceability of the tunnel are increased as the  $Q_N$  (or  $DQ_N$ ) approaches  $q_b$ . By contrast, the increased traffic control is necessitated as  $Q_N$  or  $DQ_N$  approaches  $q_c$ .

## 3.31 Reduction in Flow Capacity Caused by Tunnel

Passage into the tunnel and the presence of tunnel walks will not reduce the traffic flow capacity of the route as long as the following conditions are simultaneously realized:

- \* Width of circulation lanes = 3.50 meters.
- \* Minimal width of the shoulders separating the lanes from tunnel walls = 0.50 meters.

- \* Proper lane-marking in the tunnel.
- \* Well-marked curbing or sidewalks (12-15 cm. maximum), sufficient lighting, and sufficient ventilation.

The last-mentioned condition must always be fulfilled. In cases where the first two conditions are not fulfilled, rather than a reduction of traffic capacity there may be a lowering of the level of service and speed of traffic flow (changing from about 50 to 35 km/hr for traffic flows attaining the base flow rate).

3.32 It is particularly important that the level of service of the tunnel be adapted to the type of tunnel. On this subject one can distinguish:

- \* Major isolated tunnels that require a high level of service but which may be dimensioned more parsimoniously if investment cost considerations should demand it. In such cases the tunnel will as a consequence determine the general level of service provided by the route on which the tunnel is located.
- \* Short isolated tunnels or tunnels located on a route of intermediate importance, which must offer a level of service analogous to that of the approaches.
- \* Tunnels on urban routes where it is best to take particular care in the design of the tunnel portals and approaches in order to avoid congestion in those areas.
- \* Series of tunnels in a difficult site which will control to a or lesser degree the general level of service of the connecting route, depending on the relative proportion of investment costs represented by the tunnels.

### 3.4 Factors in the Determination of Benefits

3.41 Optimal Year for Opening Tunnel for Service and Economic Capacity  $J_0$

The economic capacity  $J_0$  of a highway system at its optimal opening date is the average daily traffic which must flow through the system in its first year in order to satisfy the profitability criterion.

In general, this criterion is set so that annual revenues used for the amortization of the initial investment attain the minimum immediate profitability rate required for a highway system (presently 14% unless otherwise specified).

- \* In the case of a tunnel on an older route, the actual traffic flow  $J$  implies a traffic flow  $J_H = f(J)$  for the chosen year, where  $f$  is a function based on the annual rate of increase in the traffic on the connecting route.

The normal flow  $Q_N = F_H J_H$  determines both the dimensioning and cost  $C = C(Q_N)$  of the tunnel.

For a year of average daily traffic  $J$ , traffic benefits  $A = A(J, Q_N) = A_1(J)$ .

The economic capacity  $J_0$  (the traffic profitability) is defined by  $A_1(J_0) =$  the immediate profitability rate.

This determines the optimal year for opening the tunnel for service.

- \* In the case of a tunnel on a new route, it is the entire route that must satisfy the profitability criterion. During the first year of operation, one can expect a heavy induced traffic flow through the tunnel amounting to 25-35% of the flow through the connecting road system in the year preceding the tunnel opening.

### 3.42 Direct Benefits of Tunnel Traffic

- \* The classical economic benefit calculations for the profitability of a highway system (described by the pertinent circulars) takes into account direct traffic benefits (duration of the trip, gains efficiency, security, and comfort), notably by considering the traffic conditions for a uniform flow which is carefully chosen in order to represent the distribution of hourly flows throughout the year (in general this uniform flow is  $J/16$  in open country and  $J/19$  in a city of about one million inhabitants). It does not in any way take into consideration the costs of congestion, i.e., the cost of time lost during the obstruction of the tunnel.

Such losses in the part of the highway system influenced by the tunnel depend on the frequency and the duration of the traffic jams as well as on the maximum number of users affected. Summary estimations may be attempted in order to appreciate the benefits of operation with and without an emergency stopping lane, with and without emergency detours avoiding the tunnel, etc.

- \* The principal factor is the duration of the trip, i.e., the speed of traffic circulation.

In closely regulated tunnels, this is the speed limit imposed on the vehicles (cf. table 3.53). In other cases, this is the average of profitability for highway investments).

### 3.5 Determination of Tunnel Speed Limit

The entry of motorists into the tunnel is necessarily accompanied by a brutal modification in both the atmosphere and environment. For economic reasons it is generally impossible to maintain the road-width of the approaches through the tunnel itself; nor is it possible to provide the same level of lighting.

In the chronology of effects on the motorist traversing a tunnel, the entry and exit phases constitute the points of maximum difficulty.

### 3.51 First Consequences

For tunnels of two lanes and wider which are not at different levels, it is necessary to:

- \* Prohibit all passing by trucks and slow vehicles inside the tunnel and on the approaches.
- \* Consider the possibility of imposing a speed limit in the tunnel (this does not lead to any diminution of the capacity as long as the imposed speed is greater than 50 km/hr). Of course, the regulation of speed is necessary in the case of an intersection or interchange located just below the tunnel exit.

In order to insure the safety of the users and to avoid risk of collision at the beginning of the speed zone, very strict rules for presignalling must be observed.

### 3.52 Regulation of Speed

On this subject it is not possible to formulate a general law; however, it is necessary in each specific case to consider the following distinction between isolated short tunnels, isolated long tunnels, and series of tunnels:

- \* Short, rectilinear tunnels (length less than 100-150 meters) do not constitute, in principle, an important difficulty since their short length permits good visibility, by silhouetting obstacles on the tunnel roadway against the exit.
- \* Very long tunnels generally incite the user, once he is adapted to the tunnel environment, unconsciously to increase his speed to a level not warranted by his visibility. It is, therefore, generally necessary to limit the speed for passage through the tunnel and on the approaches.
- \* Series of tunnels always pose difficult traffic problems; however, it is not desirable to impose speed limits which vary too frequently through the short sections. If, for example, there is a series of tunnels on a stretch of highway several kilometers in length, it is best to undertake a detailed analysis of traffic conditions, safety, and driver fatigue for the tunnel before proceeding with tunnel dimensioning and layout. It may be necessary to adopt a slower but more consistent base speed for the entire section than the speeds dictated by safety considerations for the individual tunnels taken separately.

### 3.53 Quantitative Factors

The determination of tunnel speed limits should in every case take into account the following 7 elements:

- \* Class and category of the connecting route.

- \* Flow characteristics, structure, and distribution of traffic.
- \* Operation and maintenance of the tunnel.
- \* Nature and flow characteristics of the approaches (position of interchanges above and below tunnel, presence of intersections with stoplights, longitudinal profile of tunnel, etc.).
- \* Tunnel cross-section.
- \* Dazzle-effect at the entrances and exits.
- \* Visibility in the tunnel (ventilation, lighting).

In certain cases (non-urban superhighways or urban expressways) it is often preferable to impose a permissible range of speeds rather than solely a maximum permissible speed. If a minimum speed limit is prescribed, it must be possible to insure that the geometrical characteristics (longitudinal profile and layout) of the tunnel and its approaches permit attainment of the required speed range before entering the tunnel.

As an example, the recommendations of the table below may be used subject to the reservations cited above:

SPEED IN TUNNEL		
Category	Base Speed of route	Maximum recommended speed through tunnel (km/hr)
Non-urban superhighway or urban expressway (one-way traffic in each tube)	140	100 or range of 80-120
	100	80 or range of 70-90
	80	60-68
	60	60
Three-lane roadway with two-way traffic	variable	60 (a function of the approaches)
Two-lane roadway with two-way traffic	variable	40-60(a function of the approaches)

Volume III, section 3, discusses these problems within the general context of tunnel operation and management.

## Chapter 4. LAYOUT OF TUNNELS

### 4.1 Factors to be Analyzed

- \* Only the geometrical factors that affect the layout are treated here, although determining the tunnel layout is a complex operation that takes into account geological factors as well as operating and equipment considerations.
- \* The tunnel's layout depends on that of the entire route on which the tunnel is situated. It is especially necessary to consider both the stability of the vehicles using the tunnel and the minimum visibility conditions corresponding to the base speed in the section of highway where the tunnel will be situated. Nevertheless, tunnel layout may be dictated by site requirements; the layout of the approaches will be determined by the minimum values imposed by the base speed.
- \* The tunnel layout is often curved, for different reasons:
  - to bypass bad terrain, geological faults, and other potential sources of difficulty.
  - to connect the portals whose placement has, for example, been constrained by site or soil conditions.
  - to avoid the dazzle-effect of a brightly lighted exit set at the end of a rectilinear tunnel longer than 150 meters.

### 4.2 Layout of Approaches and Portals

#### 4.21 Precautions in the Layout near the Tunnel Entrances

- \* Near the tunnel entrance, the approaches should be laid out in such a way as to insure that the tunnel is visible at least fifteen seconds in advance under all circumstances. This condition is indispensable in open country and very desirable in urban areas.
- \* Near the tunnel exit, long tunnels should be laid out with a gentle curve to avoid dazzle-effect from the brightly lighted exit. If layout requires a curve just below the tunnel exit, then that curve should be initiated in the tunnel itself.
- \* The axes of the two tubes for a superhighway or expressway of two or three lanes in each direction should be separated by a distance of at least three times the width of each tube, measured at the



level of the roadway. In those cases where this rule cannot be observed, it is necessary to examine the methods of construction of two tubes so close together. The construction of two tunnels of curved layout is then recommended, the two tubes separating as they penetrate the earth.

#### 4.22 Positioning of interchanges and intersections

If the tunnel is on an ordinary route, all intersections should be placed at least 200 meters from the entrances to the tunnels. Special precautions must be taken to prevent the back-up of vehicles into the tunnel.

In general, underground interchanges are to be avoided. If necessary, converging or diverging roadways are permissible only if the distribution of vehicles on different lanes is made before entering the tunnel, and if the number of lanes below the convergence point can easily absorb the increased traffic.

It is necessary to emphasize that all other solutions will lead to poor tunnel operating characteristics (congestion, slowdowns, risk of accident, etc.)

#### 4.23 Entry Ramps from an Interchange above the Tunnel; Exit Ramps at an Interchange below the Tunnel<sup>1</sup>

##### \* Entry Ramps

The location of entry ramps immediately above the tunnel entrance should be avoided as much as possible, as this requires a transition section of decreasing road-width that will have to be maintained for 150-200 meters depending on the particular case at hand.

On the one hand, this results in a significant increase in the construction costs of the entry zone (which is generally the area that presents the greatest difficulties), while, on the other hand, it results in a significant increase in the construction risks.

Depending on the site and conditions of the approaches, it may also require:

- the installation of a system of tunnel lighting and ventilation that is substantially more powerful (and costly) than the system that would otherwise be required.
- the installation of special traffic control equipment above the tunnel in order to minimize risks of congestion and accident.

---

<sup>1</sup> For a precise definition of the terms used here, refer to the General Instruction of December 1, 1968.

\* Exit ramps

The placement of an interchange directly below the tunnel leads to analogous construction difficulties, but poses even more complex operating problems.

- The existence of an exit ramp necessitates lane changes that are detrimental to both the safety and fluidity of traffic in the region above the interchange -- i.e., in the tunnel itself. The changing of lanes leads to substantial diminution in the level of service of the tunnel.
- Depending on the importance of the planned interchange, the nature of the connecting routes, and the general design of the interchange, the presence of exit ramps may create traffic congestion that backs up into the tunnel.
- Finally, these ramps require presignalling equipment whose placement into the tunnel is often quite difficult (cf. Vol. III, section 3); in the event of equipment malfunction, the risks of accident are multiplied even further.

\* As far as possible the following rules should be observed:

- (1) The entry ramp should have a merging lane of 150-200 meters in length with the earliest point of entry onto the tunnel approach located as far as possible from the tunnel -- at least 300 meters above the tunnel entrance.
- (2) The exit ramp should have a exit lane of at least 75 meters in length, with the earliest point of exit located at least 300 meters below the tunnel exit.

In certain exceptional circumstances, notably in heavily urbanized areas, smaller distances <sup>1</sup> may be adopted on the basis of detailed studies of the following:

- The predicted flows of both through traffic and of traffic using entry and exit ramps.
- Visibility, speed limits, and traffic control procedures in the tunnel. Design of signalization must be initiated at this point.
- Feasibility of constructing a tunnel of enlarged cross-section.
- Storage capacity of the exit ramps in the event of congestion; this capacity should be large.

---

<sup>1</sup> At very least the minimal requirements prescribed in the circular MEL 68-115 of December 1, 1968, on the design of urban expressways should be adopted.

#### 4.24 Zone for Changing Lanes

Lane changing should be avoided as much as possible. In cases where it is inevitable (e.g., in an urban site), it is best to comply with the minimal requirements prescribed in the Ministerial Circular of December 1, 1968 on the design of urban expressways.

#### 4.25 "Unloading Interchanges"

Except in cases where the placement of interchanges near the tunnel is necessitated for other reasons, it may be necessary in urban sites or in the case of long tunnels to plan for "unloading interchanges" in order to cope with exceptional circumstances which could require temporarily closing the tunnel.

#### 4.26 Placement of Toll Plazas

\* On a single roadway carrying two-way traffic, the number of booths and the size of the queuing area, as well as the modalities of operation, depend upon the normal rush-hour flow in the base year. Design should be such as to prevent either the slowing or stopping of vehicles inside the tunnel.

\* On a one-way roadway (e.g., one direction of a superhighway), the toll plaza should be located at least 300 meters above the tunnel entrance. (On an uphill grade it may be desirable to increase this figure in order to allow slower vehicles to gain the required speed before entering the tunnel.) If it is possible to place the toll plaza below the tunnel (thereby serving both roadways with a single plaza), the design should be based on the same considerations as for two-way roadways (namely, no back-up of vehicles into the tunnel during rush-hours during the base year).

#### 4.3 Visibility in Curved Tunnels

##### 4.31 Visibility Distance as a Function of Base Speed

The table below gives required visibility distance as a function of the base speed of the route.

Base Speed (km/h)	120	100	80	60	40
Visibility distance (m)	230	160	120	80	50

#### 4.32 Lateral Visual Clearance

- \* Relative to the traffic lane, the eye of the driver is assumed to be 2 meters from the right edge and 1.5 meters from the left edge if the lane is 3.5 meters in width, 1 meter from the left edge if it is only 3 meters in width.
- \* For the eye in this position, in a curve of radius R (in meters, measured to the axis of the lane), the relationship between the required visibility distance d (in meters) and the lateral visual clearance (in meters) existing between the eye and the concave sidewall is effectively expressed by the formula:

$$R = \frac{d^2}{8e}$$

- \* Depending upon whether R is fixed or subject to modification, this formula can be used either to determine the visual distance d for a given radius R or to determine a minimal radius R for a given base speed and lateral visual clearance.
- \* When the radius R is fixed, the value of the lateral clearance for a given cross-section yields the realized visibility distance d. Either it exceeds the required visibility distance for the chosen base speed (cf. table 4.31) or it is insufficient. In the latter case it will be necessary to lower the base speed to the level imposed by d or to recess the sidewall (i.e., increase e to the value  $d^2/8R$ ). A lowering of the base speed is generally preferable to enlarging the cross-section in the curve, except in certain cases where such structural changes present minor construction difficulties. In such cases we are concerned with the available options in the geometrical definition of the tunnel.
- \* When the radius R is not imposed, the formula permits verification that each curve of the tunnel allows a visibility distance corresponding to that required by the postulated base speed. When a curve does not allow the required visibility, its radius is increased accordingly so that it will.

#### 4.33 Special Conditions Imposed on Tunnels

- \* The provisions indicated above are strictly minimal in that they do not take into consideration those perceptual difficulties which are greater in tunnels than in open air (pollution, limited lighting, etc.).
  - \* Radii that are too small (less than 500 meters) pose particular construction difficulties: control of drilling machines and erection of supports. One should, therefore, attempt to stay above this 500 meter design limit.
-

## Chapter 5. LONGITUDINAL PROFILE

### 5.1 Tunnels of Uniform or Anticlinal Grade

#### 5.11 Gradients

Natural drainage of the tunnel requires a minimum gradient of 0.2-0.4%. The gradient to be adopted depends in each case on the length of the tunnel, the foreseeable groundwater intrusion, as well as the excavation methods employed (one or several headings).

It is desirable not to exceed 1%, and never 2% in rather long tunnels, because the volume of exhausted pollutants increases very rapidly with increasing gradient, and thereby necessitates greater ventilation. In addition, steep gradients have an undesirable effect on slow vehicles that increases with the length of the grade. (Cf. paragraph 6.71.)

Steeper gradients may be necessitated by various elements associated with the general longitudinal profile of the connecting route, the geology, the placement of the tunnel portals, or with the site itself. In such cases it is best to consult the "Costs" volume which gives the necessary elements for an evaluation of the financial consequences of such a choice, and thus allows an economic judgment of the feasibility of modifying the longitudinal profile of the approaches. It must not be forgotten that a supplementary lane for slow vehicles will be necessary if these vehicles will be unable to maintain a certain minimum speed.

Finally, the analysis of the longitudinal profile of a tunnel must not be dissociated from the study of the longitudinal profile of the approaches (fluidity of the traffic flow, speed limits, estimated truck speeds, etc.).

For one-way tunnels, the necessity of ventilation may be diminished. But steep grades will cause trucks to slow down, thus decreasing the capacity of the tunnel. The standards for open-air highways may be used here.

## 5.2 Tunnels with Synclinal Grade

In tunnels that slope down towards the center from both portals (generally tunnels in urban areas or under rivers and oceans), it must be insured that the ceilings do not reduce longitudinal visibility below those values given in table 4.31.

---

Chapter 6. CROSS-SECTION OF TUNNEL ROADWAY

6.1 Definitions

The cross-section of the tunnel floor, indicated in the figure below, is broken down as follows:

- \* Right insulator, consisting of a sidewalk or curb.
- \* Right shoulder, which can serve (completely, partially, or not at all) for emergency stopping by certain categories of vehicles.
- \* Traffic lanes.
- \* Left shoulder.
- \* Left insulator, consisting of either a sidewalk or a curb.

Composition of Tunnel Floor

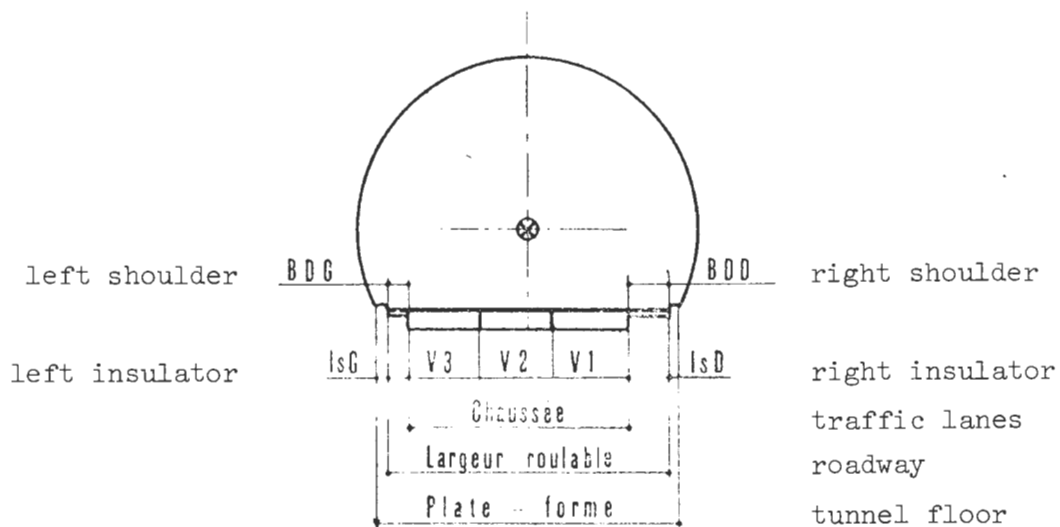

## 6.2 Floor

- 6.21 In excavated tunnels of vaulted cross-section, a road-width of greater than 3 lanes is generally not recommended. In very exceptional cases, i.e., in very good terrain, it is possible to deviate from this rule if there are compelling reasons for going to 4 lanes.

As a result, tunnels for superhighways or urban expressways are divided into two separate tubes, each carrying 2 or 3 lanes of traffic in a single direction.

- 6.22 In tunnels of rectangular section, there is no theoretical objection to designing tunnels of up to 5 or 6 lanes.

## 6.3 Roadway

Roadway is defined as the space physically available to light or heavy vehicles; it is the total width of the traffic lanes and the two shoulders bordering them.

The required width of the roadway (the road width) constitutes the fundamental element determining the width of the tunnel floor. Road width is particularly crucial in tunnels since an increase in floor width requires an increase in the total excavated cross-section and therefore in tunnel cost.

In every project, once the relevant traffic data are available, road width requirements should be determined, prior to any specification of floor dimensions.

### 6.31 Necessary Road Widths under Different Traffic Conditions

Figures A through I below specify the necessary road widths for 9 different cases of traffic flow on a two-lane roadway.

- \* Case A is appropriate for rapid and perfectly fluid flow at 100 km/h.
- \* Cases B, D, E, and F are appropriate for safe flow at 50 km/h.
- \* Cases C, G, H, and I are appropriate for very slow flows that avoid the obstruction of the tunnel that might, for example, result from the breakdown of a vehicle.
- \* The table on page 28 gives the road width necessary in each case to insure the maintenance of traffic flow in all lanes (with or without loss of capacity) when a vehicle breaks down.
- \* These figures and tables do not imply that it is always necessary to insure the maintenance of traffic flow in all lanes during such exceptional circumstances. From the data provided, one can determine the consequences for both safety and traffic flow of such circumstances in tunnels not equipped with shoulders.



ROAD WIDTH DESIGNS FOR THREE DIFFERENT TRAFFIC CONDITIONS

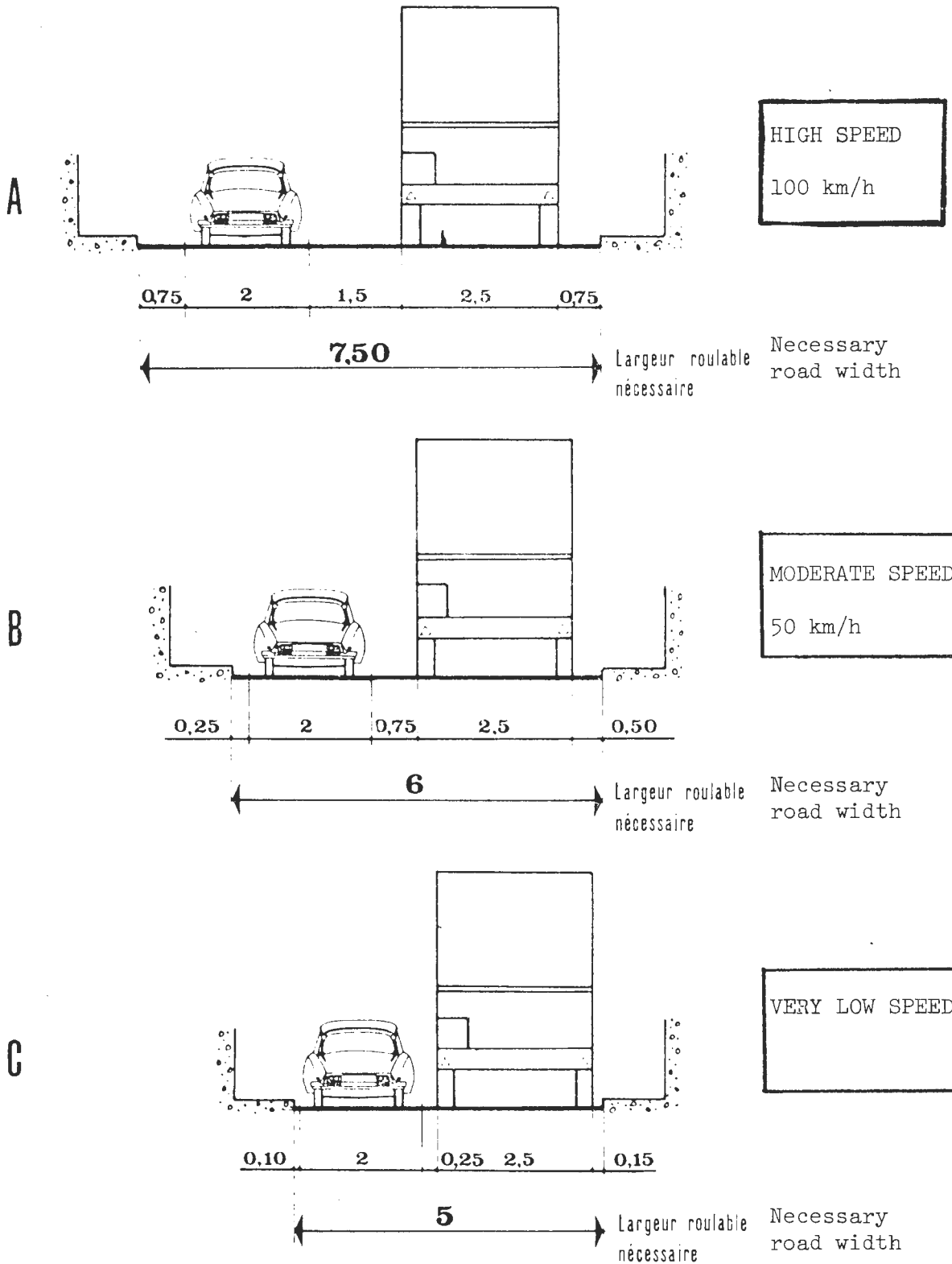

Note: The 2-meter width of passenger vehicles corresponds to that of the largest passenger vehicles presently in use, actually rather rare in France. For medium-sized vehicles, this width provides the driver with an added margin of safety.

ROAD WIDTH DESIGNS

No Loss of Capacity (50 km/h) in Case of Emergency

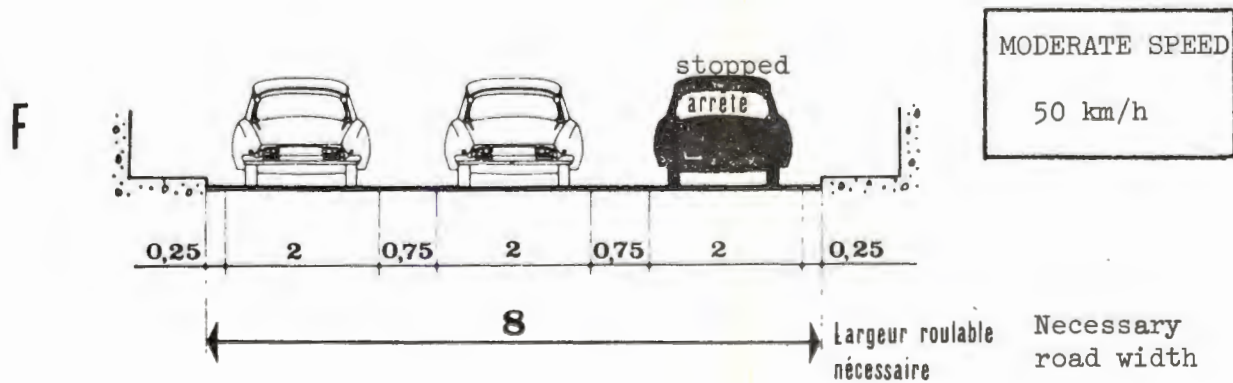
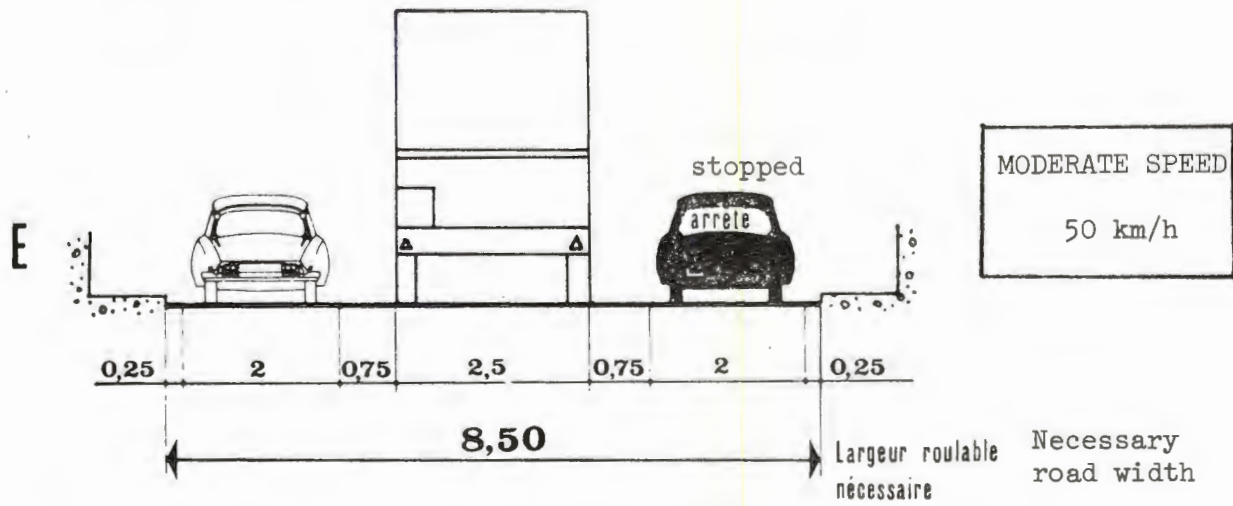
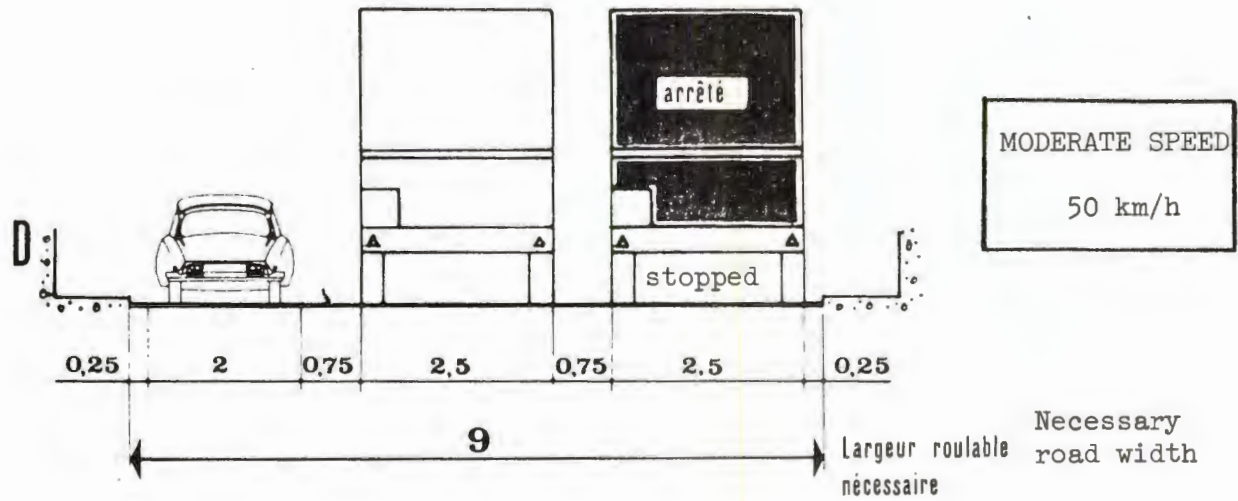

ROAD WIDTH DESIGNS

Very Low Speed in Case of Emergency

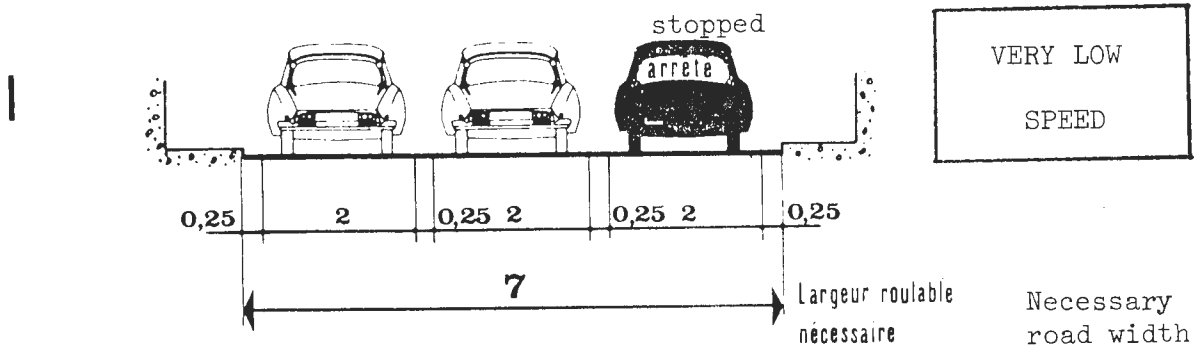
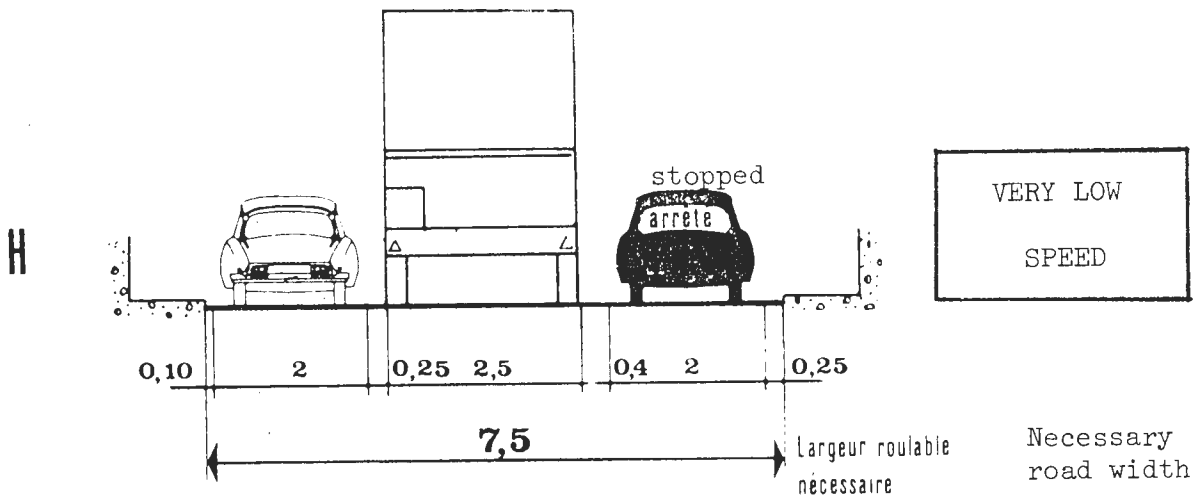
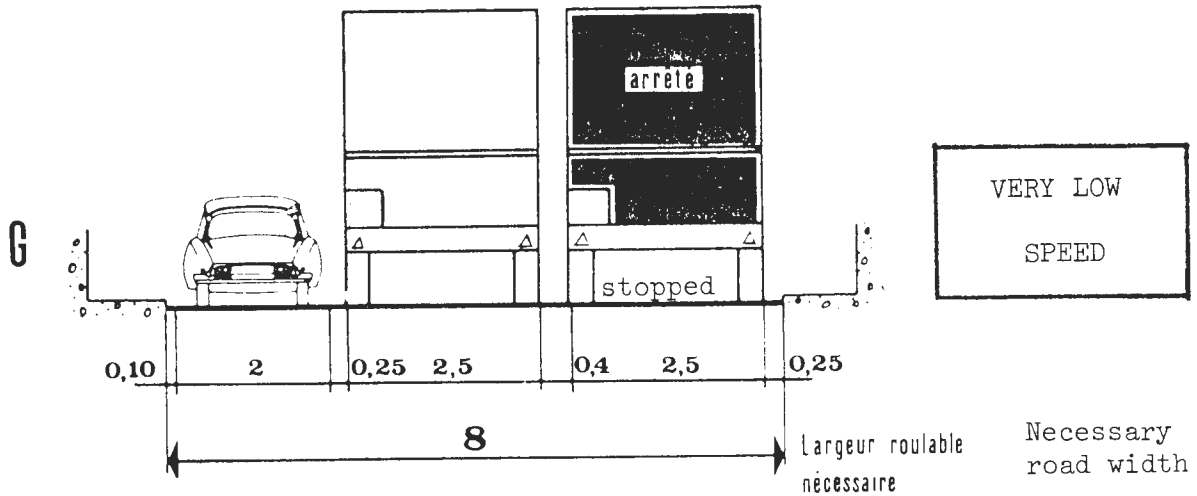

REQUIRED TUNNEL ROAD WIDTHS  
FOR DIFFERENT TRAFFIC CONDITIONS

Traffic direction	Number of lanes during normal operating conditions	Traffic Patterns		Road width (in meters) for moderate flows at 50 km/h w/o loss of capacity	Road width (in meters) for very slow traffic flows
		----- Moving vehicles	Stopped vehicle		
One-way	1	PV	PV	5.5	4.5
		HT	PV	6	5.5
		HT	HT	6.5	6
	2	PV PV	PV	8	7
PV HT		PV	9.5	7.5	
PV HT		HT	9	8	
3	PV PV PV	PV	11	9.5	
	PV PV HT	PV	11.5	10	
	PV PV HT	HT	12.5	10.5	
4	PV PV PV PV	PV	14	12.5	
	PV PV PV HT	PV	14.5	13	
	PV PV PV HT	HT	15.5	13.5	
Two-way	2	PV PV	PV	8	7
		PV HT	PV	8.5	8
		HT HT	PV	9	8.5
		HT HT	HT	9.5	9
	3	PV PV PV	PV	11	10
		PV PV HT	PV	11.5	10.5
		HT PV HT	PV	12	11
		HT PV HT	HT	12.5	11.5
	4	PV PV PV PV	PV	14	12.5
		PV PV PV HT	PV	14.5	13
		HT PV PV HT	PV	15	13.5
		HT PV PV HT	HT	15.5	14

Notes: 1. PV = passenger vehicle  
HT = heavy trucks

2. The various combinations not considered here are excluded by the prohibition of truck passing.

3. For two-way roads, very strict arrangements for signalling and presence of police are assumed, thus safely permitting changes in lane direction.

## 6.32 Procedure for Choosing the Road Width

The preceding considerations indicate a great flexibility in the choice of road width. It is necessary in each case to take into consideration the four following factors:

- \* Uniformity with the approaches. This does not necessarily mean maintaining the same road width, but rather it means maintaining a functional continuity. A distinction is made between the isolated tunnel (whether it be long or short) whose characteristics are determined by the characteristics of the approaches because of the relatively greater cost of the latter, and the case of a series of tunnels which, because of their greater relative costs, determine the cross-section of the approaches, the base speed, and the level of service of the route.
- \* Satisfaction of traffic requirements. This requires a thorough understanding of the type of route, the predicted traffic flow, and the proportion of truck traffic during normal and rush hours.
- \* Maintenance of the level of service. This depends on the importance of the route and the risks occasioned by breakdown or congestion (the probability of breakdown in the tunnel increases with tunnel length, type of service equipment, etc.).

The table below indicates the frequency of breakdowns and accidents; it is based on data from French tunnels presently in service. (For a detailed discussion, see Vol. III, section 3.)

Event	Frequency
Breakdowns      85-95%	} → 20 emergencies per one million vehicle-kilometers
Accidents        5-15%	
Fires	Very rare
Electrical Failures	About 10/year, not including strikes.

- \* Cost of tunnel. Attention must be paid to the financial consequences that could result from an excessive increase in road width.

## 6.4 Insulators

### 6.41 Tunnels with Sidewalks

In tunnels where pedestrian traffic is permitted, it is necessary to provide insulators in the form of sidewalks of sufficient width and height above the roadway (0.20 m. minimum) in order to insure the safety of the pedestrians. Special precautions should be taken to separate the pedestrians from vehicular traffic.

### 6.42 Tunnels Normally Banned to Pedestrian Traffic

In the majority of tunnels, pedestrian traffic is banned, and a specially-marked bevelled-edge curbing is used as an insulator.

This curbing, whose width should be at least 0.50 meter, is located so as to insure the required vertical clearance in all parts of the tunnel accessible to traffic; as well, it should be located so as to facilitate maintenance and allow pedestrian movement of motorists who are victims of a breakdown or accident.

It must be noted that an insulator is incapable of stopping a vehicle from leaving the roadway. Its use is essentially optical and psychological. In any case, recent experience seems to show that if there is a lane for emergency stopping, curbing is not necessary. Therefore, insulators on the side where there is a sufficiently wide emergency lane (1-2 meters) may be replaced by flattened or painted insulators of a reduced width (25 cm). This option requires, however, that traffic control signalization be located on tunnel ceilings rather than walls. Further evidence will show whether the total elimination of the insulators is feasible.

### 6.43 Exceptional Circumstances

- \* In those cases where maintenance work and pedestrian traffic will likely be significant, a larger geometric dimensioning can be adopted; the width of the insulators can be increased to 0.75.
- \* For rectangular cross-sections where constraints on the available vertical clearances necessitate locating signalization on the walls, an insulator width of 0.75 m. can also be adopted.

## 6.5 Shoulders

As a general rule the shoulders may only take the following values:

Shoulder Width (in meters)		
	One-way Tunnel	Two-way Tunnel
Right shoulder	0, 0.25, 1, or 2	0.25, 0.50, 0.75, or 1
Left shoulder	0, 0.25, or 0.50	0.25, 0.50, 0.75, or 1

In no case should the width of the shoulder be 1.50 meters; this is a dangerous width, since it encourages use of the shoulder but is insufficient for emergency stopping of vehicles and creates a hazard for passenger safety.

## 6.6 Traffic Lanes

Traffic lanes may only be 3.0 or 3.5 meters in width.

- \* As a general rule, the 3-meter width is exclusively reserved either for constrained urban sites where problems of subsoil acquisition require a restriction of cross-section or, if necessary, for mountain tunnels with reduced traffic (especially those having only light truck traffic).
- \* In urban sites, where it is necessary to design for lanes of both 3.0 and 3.5 meters in one-way tunnels, a width of 3.5 m. should be maintained preferentially in the following order: lane no. 2, 1, 3, 4, etc., the shoulders being the first to suffer any reduction in width. (Lanes are numbered consecutively from right shoulder.)

## 6.7 Supplementary Lane for Slow Vehicles

### 6.7.1 Study of a Supplementary Lane for Slow Vehicles

The following elements should be assembled:

- \* Predicted traffic flow and the percentage of slow vehicles at those hours when the tunnel is likely to experience congestion as a result of its grade.

- \* Longitudinal profile of the tunnel and of its approaches.
- \* Study, with the aid of SETRA simulation models, of the speed curves for the entire road section being studied.
- \* etc. ...

Attention must be paid to the grave financial consequences occasioned by the addition of a supplementary lane in the tunnel. It is therefore necessary to study with special care those solutions that eliminate the necessity of a special supplementary lane in the tunnel. These solutions may require a radical modification of the approaches.

The adoption of a supplementary lane for slow vehicles must, in every case, be justified by an economic study. The elements for this study are specified in the provisional instructions for profitability calculations for highway investments.

The epv (equivalent passenger vehicles) values to be assigned to different types of vehicles as a function of the grade are given in the following table:

Type of vehicles	Cycle	Motorcycle	Car or truck less than 3.5 metric tons	Bus or truck greater than 3.5 metric tons
Value in epv	0.5	1	1	2k

Value of k as a function of the grade:<sup>1</sup>

Grade (%):	1	2	3	4
k:	1	2	2.5	3

The figures given above are merely indicative. In particular, they do not take into account the constantly improving performance of the "average slow vehicle," nor do they take into account the length of the grade -- parameters whose effect should be carefully studied. If necessary, SETRA possesses models that will simulate truck behavior. These models should be utilized in cases of complex longitudinal profiles.

---

<sup>1</sup>k applies only to the percentage of trucks at rush hours ( $Q_N$ ) and not to the average daily volume J. At rush hours the percentage of trucks is on the order of 5%, while in daily volume it can vary between 12% and 30%.



## 6.72 Merging Problems

In cases where the construction of a supplementary lane seems inevitable, it is absolutely necessary to avoid (1) any merges in the tunnel that might, for example, arise from the ending of the supplementary lane inside the tunnel, and (2) any merges of the supplementary lane in 300 meters immediately preceding or following the tunnel portals.

## 6.8 Superelevation

### 6.81 Straight Alignments (not superelevated)

Since underground tunnels are normally protected from precipitation, the superelevation of the road surface in straight alignments should not exceed 1%. In 2- or 3-lane tunnels, the superelevation is normally to one side only, and varies between 0.3-1%.

In large tunnels or in certain other special cases, the cross-section of the roadway may be crowned.

### 6.82 On Curved Sections

Superelevation takes the values indicated in the following table; these values are based on general laws of vehicle kinematics.

These standards permit some deviations in cases where superelevation in the curved section would have dangerous consequences (see 6.84 below). In this type of tunnel, a layout of larger radius always proves to be preferable.

### 6.83 Precautions for Maintaining Clearance

The presence of the roof, walls, lighting apparatus or other equipment, and, in some cases, of a ventilation ceiling requires special precautions for maintaining the required clearances through the superelevated sections of the tunnel.

The following figures indicate the applicable precautions to be observed in each case, namely:

- \* In the case of a semi-circular or circular tunnel, rotation of the cross-section about the tunnel axis.
- \* In the case of a rectangular tunnel, rotation of the roadway about the centerline of the roadway. Because the side walls remain vertical, a greater tunnel width is required through the superelevated section in order to accommodate the inclination from the vertical of trucks moving through the superelevated section.

SUPERELEVATION IN CURVES

As a Function of Base Speed  $V_b$  and Radius of Curvature R

$V_b$ (km/h) R (m)	60 km/h	80 km/h	100 km/h	120 km/h	140 km/h
180	6 %				
320	4 %				
400	3 %	5 %			
500	2 %	3,6 %			
600	1 %	2,8 %			
700	Non déversé Non-superelevated	2 %	4 %		
900		Non déversé Non-superelevated	2,5 %		
1000			2 %		
1300			Non déversé Non-superelevated		
1500				2,5 %	
1600				2 %	
1800				Non déversé Non-superelevated	
2850					1,5 %
3000					Non déversé Non-superelevated

LEGEND



Prohibited radii of curvature, failing to meet minimal conditions of visibility (see paragraph 4.32).



Radii of curvature that are not recommended ( $R < 500$  m.).

Non-superelevated = 0.3-1.0%

# PROFILS AVEC DEVERS

Superelevated Cross-sections

Dévers en alignement  
droit

Superelevation  
through straight  
alignment

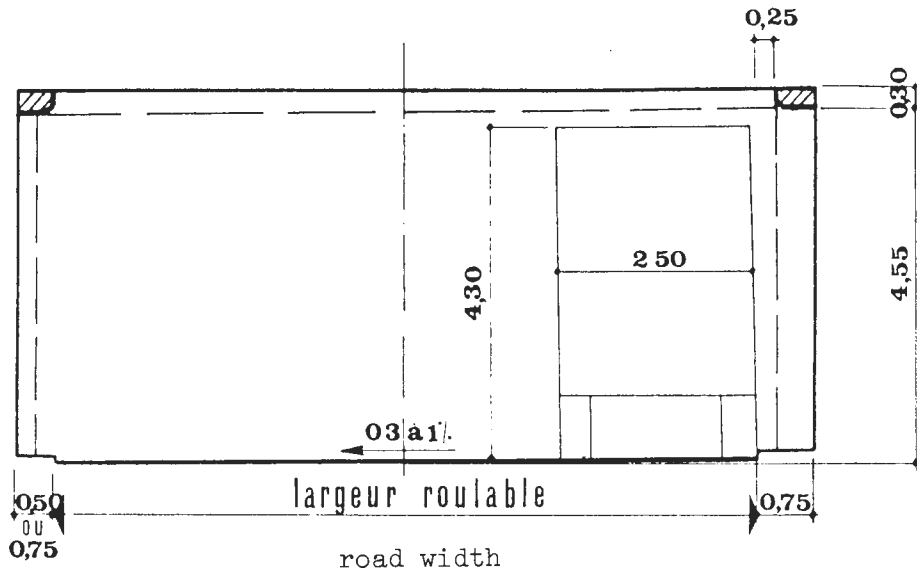

Dévers à 4% en courbe

4% superelevation  
through curve

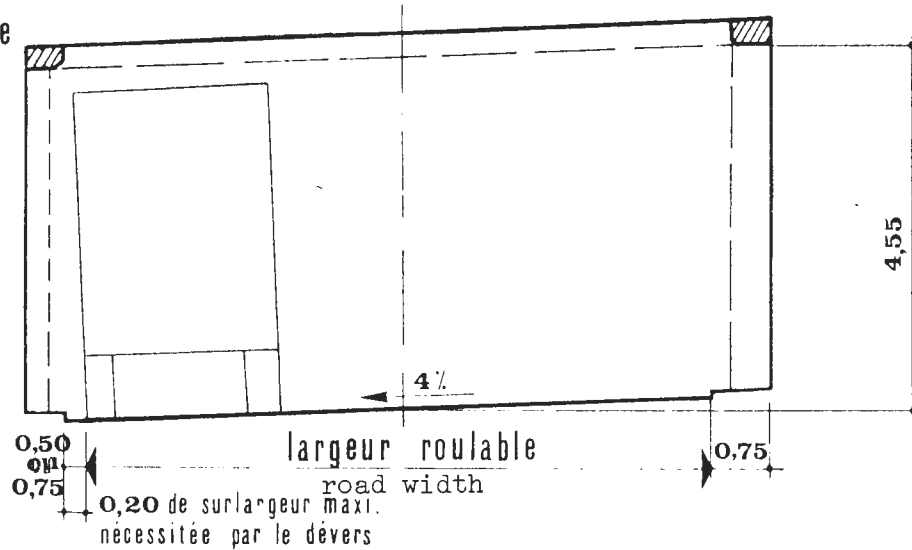

0.20 m. maximum increase  
in horizontal clearance  
necessitated by superelevation

# PROFILS AVEC DEVERS

Superelevated Cross-sections

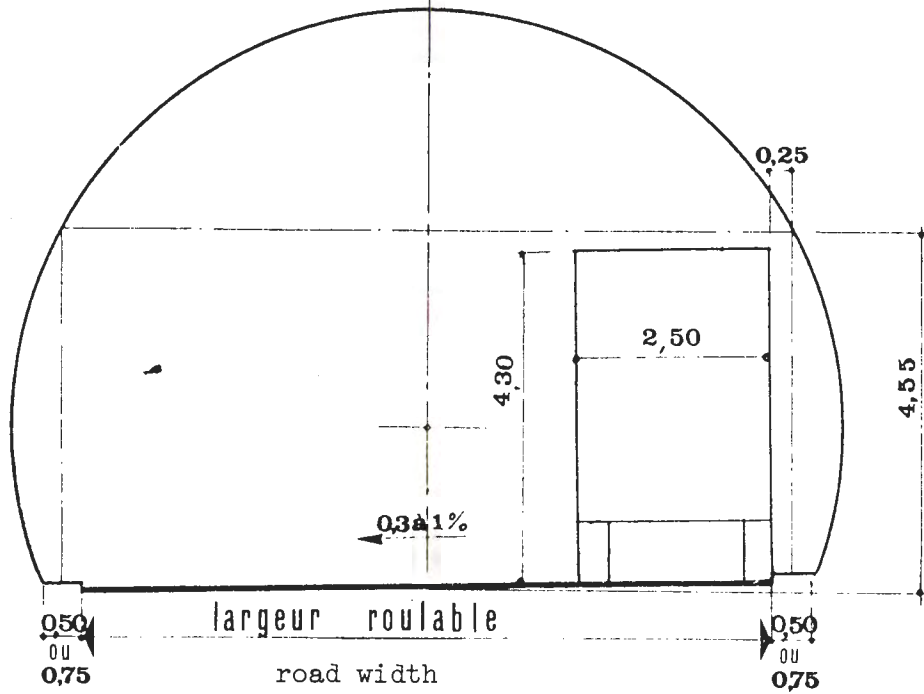

Dévers en alignement droit.

Superelevation through straight alignment

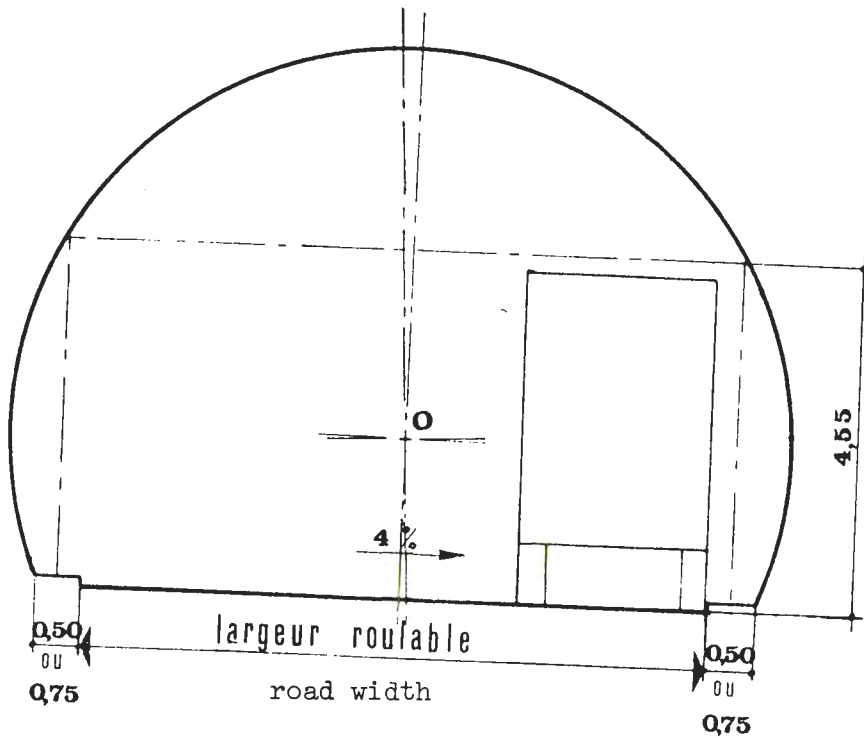

Dévers à 4% en courbe  
rotation autour du point O

4% superelevation through curve, achieved by rotation of cross-section about O.

## 6.84 Transitions in Superelevation

Curvature and superelevation are generally introduced progressively by means of clothoidal arcs of such a length that the variation of superelevation does not exceed 2% per second when traversed at the base speed  $V_b$  of the route.

In very difficult cases, it is possible to go to 3% per second and introduce the superelevation through the straight section preceding the curve. In the case of special tunnels (e.g., tunnels having ventilation ducts under the roadway), circular arc transitions may be used. These cases are exceptional.

## 6.9 Vertical Clearance

Vertical clearance must be maintained across the full width of the roadway. In addition, a supplement of 0.25 meters is reserved laterally on both sides. This margin of 0.25 meters while increasing the safety is also intended to minimize wall effect as well as to prevent projecting or unbalanced loads from catching on the wall or on apparatus attached to it.

A vertical clearance of 4.55 meters is generally adopted (4.50 m. + 0.05 m. for later repaving). Depending on the military importance of the route, clearance of 4.85 m. may be required (4.75 m. + 0.10 m. for repaving) in order to allow the passage of special convoys during war time. In the case of vaulted tunnels without ventilation ceilings, this 4.85 m. clearance may be obtainable on a part of the road, even though it is designed for a 4.55 m. clearance across the full road width. The clearance made available in this way is generally sufficient to allow the passage of military convoys. Consultation with the Highway Administration is recommended in this matter.

# GABARIT EN HAUTEUR

Vertical Clearance

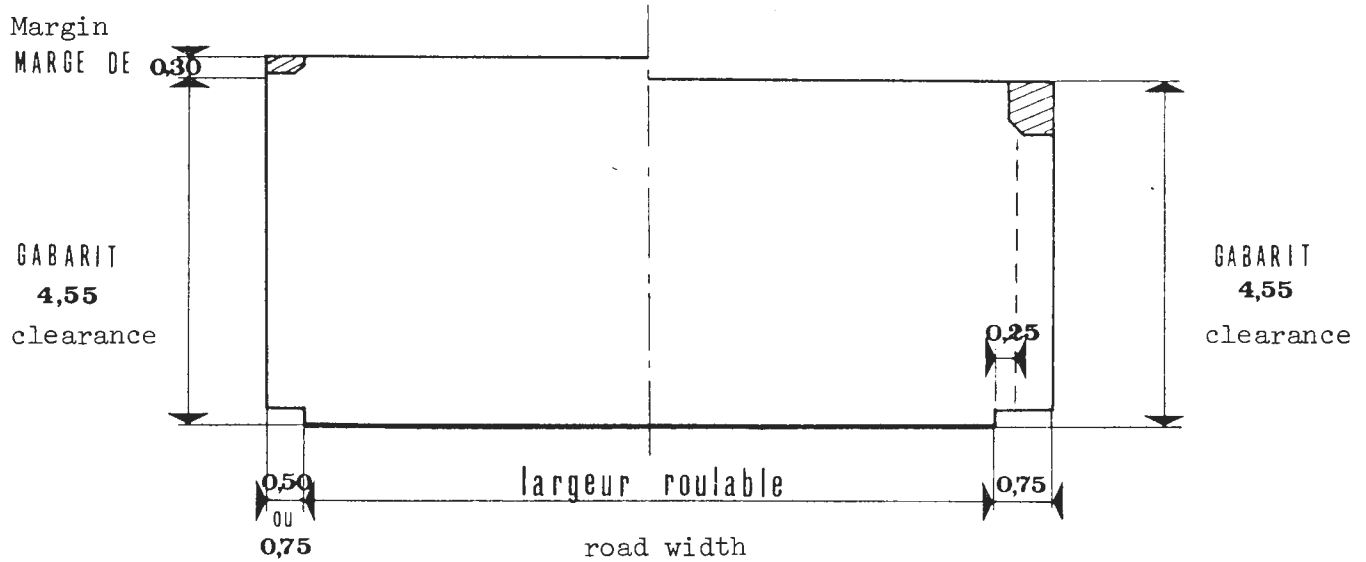
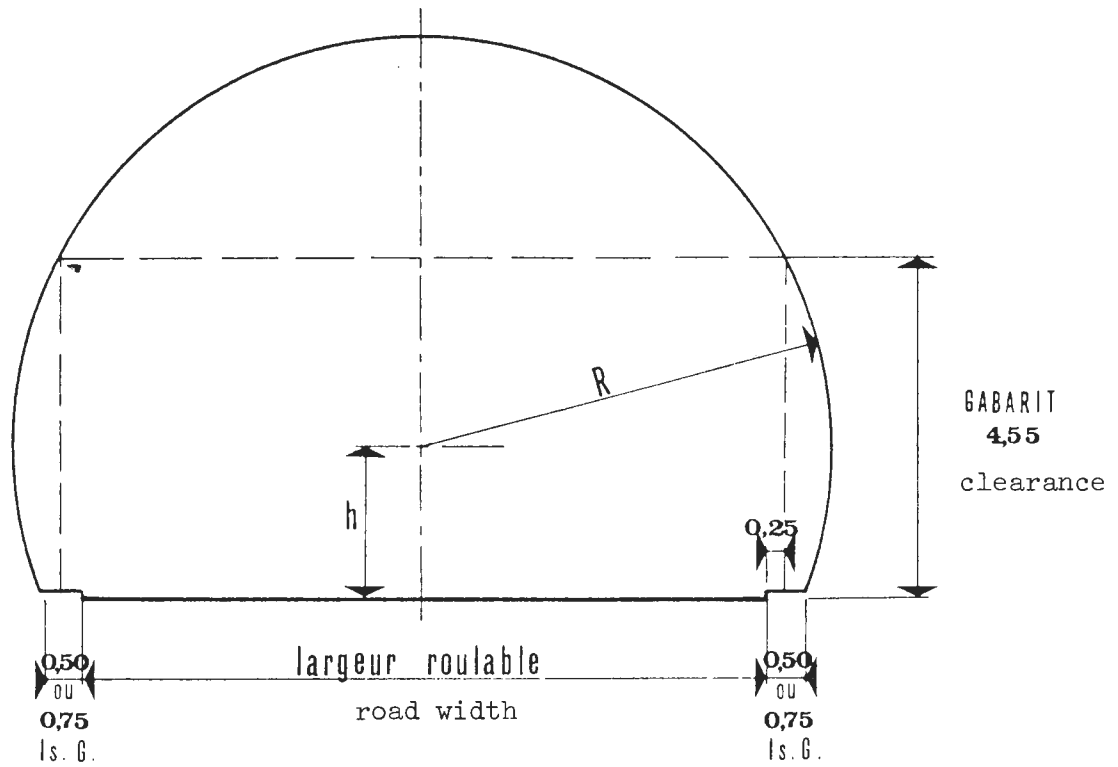

## 6.10 Cross-sectional Dimensioning

The following table gives the geometrically defined parameters of the interior cross-section of a semi-circular tunnel as a function of the road width and the width of the sidewalks or curbing:

Vertical Clearance (m.)		4,55		
Insulator width		2 x 0,5	2 x 0,75	0,5 et 0,75
Road width				
8,00 (m)	R (m)	4,939	5,073	5,050
	h	2,035	1,780	2,028
8,50	R	5,162	5,299	5,275
	h	2,021	1,753	2,024
9,00	R	5,388	5,527	5,501
	h	2,007	1,726	2,000
9,50	R	5,616	5,756	5,730
	h	1,993	1,698	1,987
10,00	R	5,845	5,988	5,961
	h	1,980	1,671	1,973
10,50	R	6,077	6,221	6,193
	h	1,966	1,643	1,959
11,00	R	6,310	6,456	6,427
	h	1,952	1,616	1,945
11,50	R	6,544	6,691	6,661
	h	1,938	1,588	1,932
12,00	R	6,779	6,928	6,897
	h	1,925	1,561	1,918
12,50	R	7,015	7,166	7,134
	h	1,911	1,533	1,904

## Chapter 7. SAMPLE CROSS-SECTIONS

The objective of this chapter is to present some cross-sections that are currently in use. Given by way of example, they are evaluated in terms of their optimal utilization. This chapter does not in any way excuse the designer from considering the adaptations necessary in order to accommodate unusual circumstances (nature of the traffic, modes of operation, etc.).

### 7.1 Underground Connecting Ramp, One Lane Wide

These connecting lanes should be used only rarely. In extreme cases the following profiles may be adopted:

Profile no. 1: connecting ramp reserved exclusively for cars.

Profile no. 2: connecting ramp normally used by trucks.

Intermediate designs may be possible, based on a precise analysis of the approach conditions, the capacity of approaches to absorb a vehicle backlog, and the geometrical characteristics of the ramp (radii of curves, slope, and length).

### 7.2 Tunnels on Superhighways (One-way traffic)

The essential considerations here are the maintenance of a smooth traffic flow and the safety of the motorist in case of an emergency stop.

One should use:

Profiles no. 3 or 8 as a general rule; always in the case of short tunnels.

Profiles no. 4 or 9 in cases where all heavy vehicles are prohibited at all times or where they are prohibited during hours when the traffic surpasses 1,700 epv/h in one direction (in the case of a two-way tunnel) or 3,400 epv/h in one direction (in the case of a one-way tunnel). The use of these profiles supposes the regulation of vehicle speeds through the tunnel.



### 7.3 Tunnels on Urban Expressways (one-way traffic)

On this type of route, vehicle speeds are normally limited; speed is not, therefore, the prime objective. The dimensioning of the roadway should on the contrary insure the uninterrupted flow of traffic.

Profiles no. 3, 8, and 13 may be adopted for routes of category B or C. (See General Instructions of December 1, 1968.)

Profiles no. 5 or 10 may be used on these routes when truck and bus traffic is prohibited during rush hours.

### 7.4 Tunnels on Slower Urban Routes (two-way traffic)

Poor quality approaches (exits into an urban road system, presence of traffic lights and intersections, etc.) usually lead to heavy and uneven traffic flows on these routes. As a result, the dimensioning of the cross-section depends primarily on the nature of the approaches and the surface traffic conditions.

Profiles no. 6, 11, and 14 may be adopted for tunnels that have little truck or bus traffic and for tunnels where traffic can, if necessary, be detoured around the tunnel through the surface road system.

Profiles no. 7, 12, 15, and 16 may be adopted in cases where this is not possible.

The choice may also depend on engineering considerations (subsoil obstructions, land acquisition problems, maintenance of traffic during construction, etc.), cost, length, and ventilation requirements for the tunnel. For tunnels longer than 300-500 m., the widest possible profile is generally adopted.

### 7.5 Tunnels on Undivided Highways in Open Country and in the Mountains (two-way traffic)

Very long tunnels are outside the framework of the present directives.

In a general way the dimensioning of the tunnels discussed in this paragraph depends essentially on their function: international route, tourist route, important route for the transportation of merchandise, etc.

It is also necessary to take into account the fact that, because they are often situated on less travelled routes or in areas of low population, these tunnels may require less constant

1 VOIE

ONE LANE

2 VOIES

TWO LANES

42

1

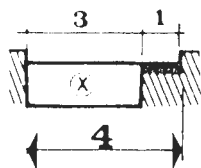

2

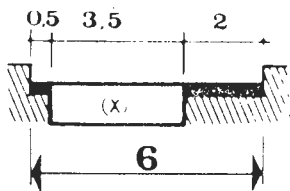

CIRCULATION A SENS UNIQUE  
ONE-WAY TRAFFIC

3

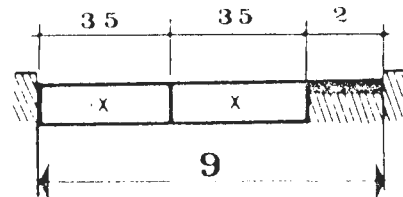

4

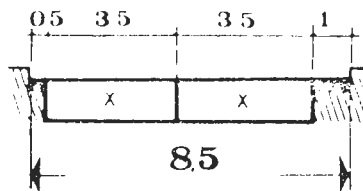

5

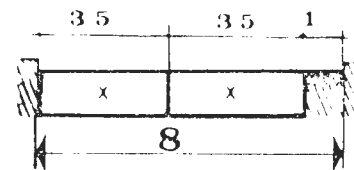

6

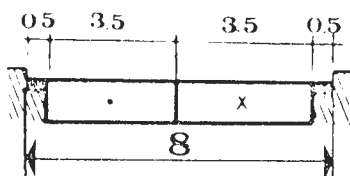

7

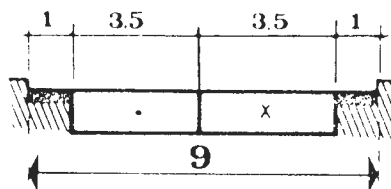

CIRCULATION A SENS UNIQUE  
ONE-WAY TRAFFIC

CIRCULATION A DOUBLE SENS  
TWO-WAY TRAFFIC

# TROIS VOIES

THREE LANES

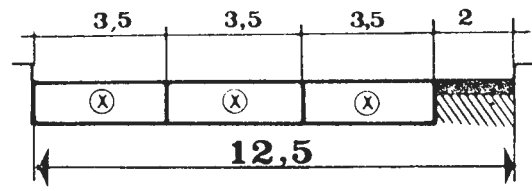

8

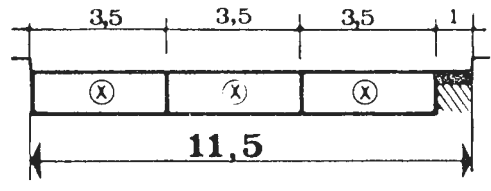

9

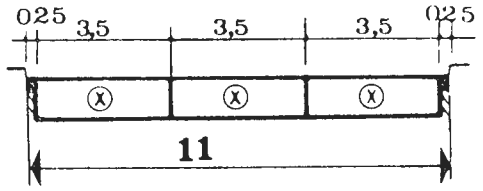

10

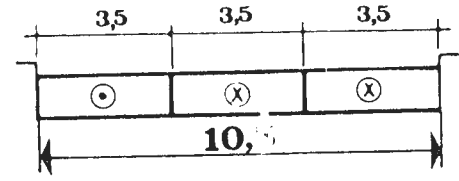

11

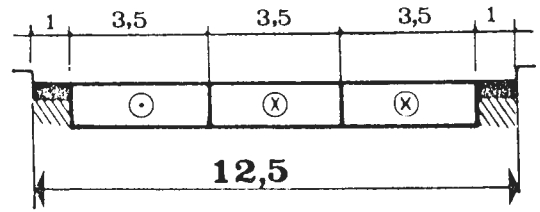

12

CIRCULATION A  
SENS UNIQUE

ONE-WAY TRAFFIC

CIRCULATION A  
DOUBLE SENS

TWO-WAY TRAFFIC

**QUATRE VOIES**

FOUR LANES

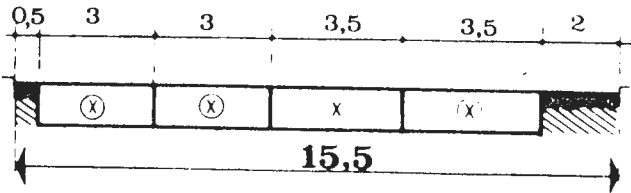

**13**

CIRCULATION A  
SENS UNIQUE  
ONE-WAY TRAFFIC

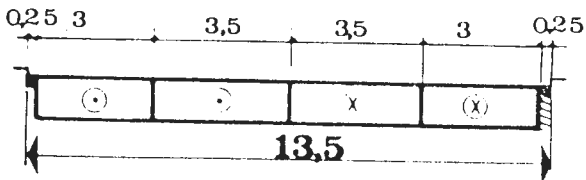

**14**

CIRCULATION A  
DOUBLE SENS  
TWO-WAY TRAFFIC

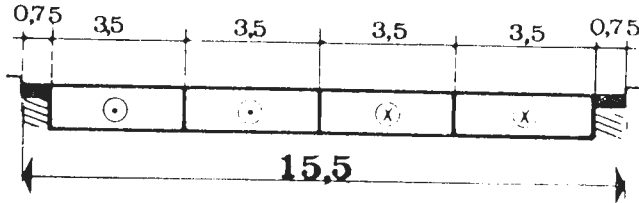

**15**

**CINO VOIES**

FIVE LANES

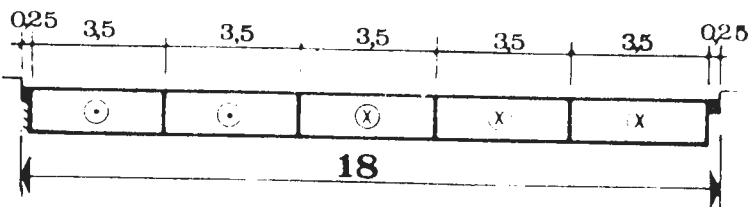

**16**

CIRCULATION A  
DOUBLE SENS  
TWO-WAY TRAFFIC

supervision after being opened for service. This necessitates the adoption of a wider cross-section.

Depending on the case, profiles no. 6, 7, or 11 are used. Other narrower profiles may be adopted, especially on routes used exclusively for touristic purposes.

---

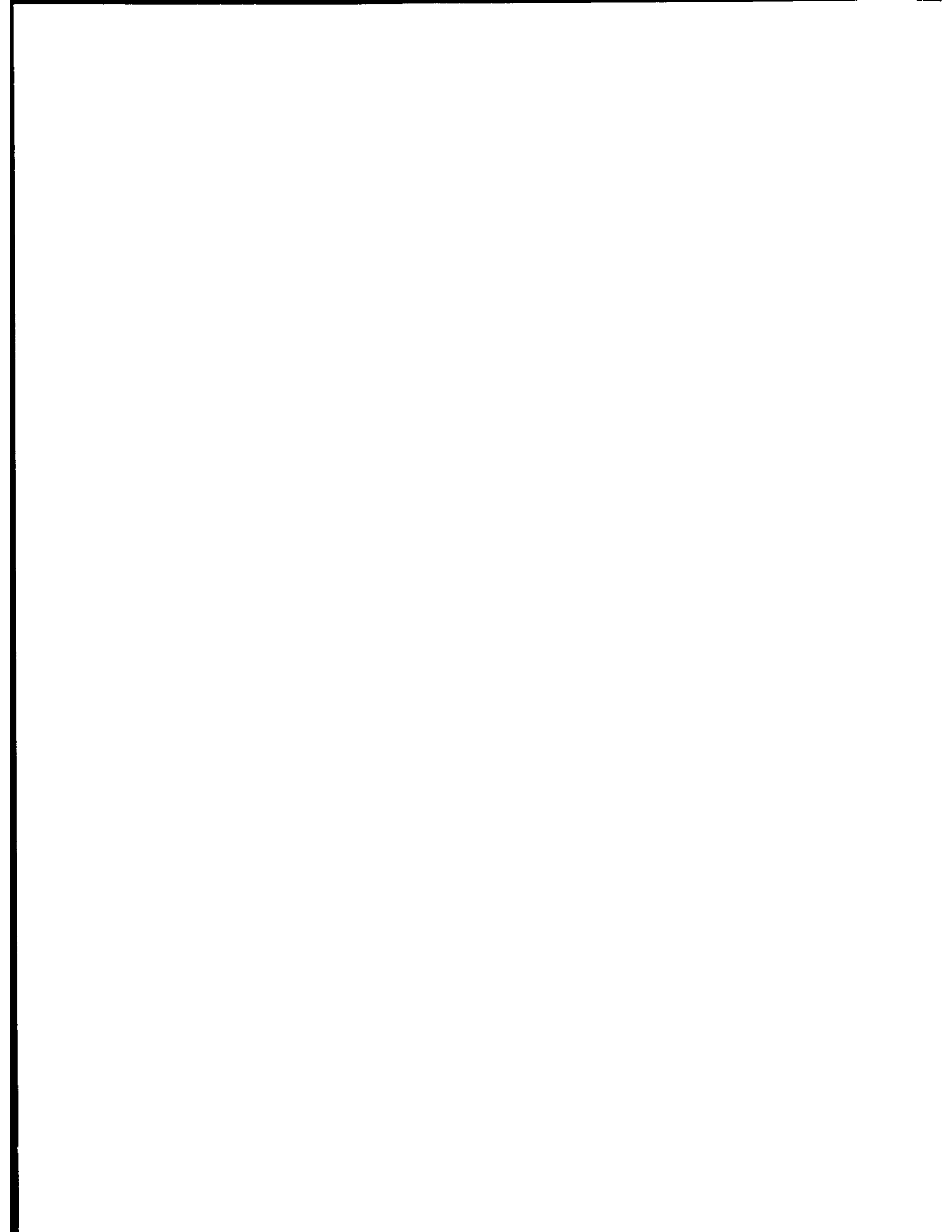

Regional Technical  
Service of Lyons

Ministry of Equipment and Housing

TUNNEL MANUAL

(Volume II: Engineering)

Study Group  
on Tunnels

May, 1970

(Translated by Robert J. Matthews)

## Foreword

Within the framework described in the Summary Volume, which should have been read first, this particular volume deals essentially with the engineering of excavated tunnels. Problems that arise with regard to immersed tunnels and covered trenches are discussed only in the appendices to this volume.

The volume is divided into five sections: Geology and Geotechnology, Construction, Lining, Watertightness, and Roadway. The first three sections, which treat the bulk of the work to be done by the engineer, consider essential principles that are for the most part applicable to all underground construction. On the other hand, the last two sections treat questions peculiar to highway tunnels.

This division into five separate sections should not mask the interdependence of these five aspects during the various stages of project planning and construction. (See Chapter 3 of the Summary Volume.)

It is advisable, therefore, that the chief project engineer read this volume through once in order to get an overview of the problems that are considered. He can then proceed to examine in more detail those problems that apply to his particular subject.



1 - GEOLOGY AND GEOTECHNOLOGY

---

2 - CONSTRUCTION

---

3 - LINING

---

4 - WATERTIGHTNESS

---

5 - ROADWAY

---

TABLE OF CONTENTS

- Section 1. Geology and Geotechnology
- Chapter 1. Preface
- 1.1 Object of the Section
  - 1.2 Importance of Geological and Geotechnical Studies
  - 1.3 Major Problems
- Chapter 2. Utilization of Experience Acquired in Underground Construction
- 2.1 Conceptual Differences between Former and Present-Day Structures
  - 2.2 Reference Structures
- Chapter 3. Goals of Geological and Geotechnical Studies
- 3.1 General Principles
  - 3.2 Tunnel Layout, Longitudinal Profile, Cross-sectional Profile, and Supports
  - 3.3 Ground-water Problems
  - 3.4 Follow-up Studies during Construction -- Verification
- Chapter 4. Content of Geological and Geotechnical Studies
- 4.1 General Principles
  - 4.2 Geological Studies
  - 4.3 Hydrogeological Studies
  - 4.4 Geotechnical Studies
- Chapter 5. Articulation of Geological and Geotechnical Studies
- 5.1 Goals and Limitations of Present Chapter
  - 5.2 Articulation of the Studies

Appendix 4. Ground-water Tests

- 4.1 Le Franc Method
- 4.2 Lugeon Method
- 4.3 Pumping Tests

Appendix 5. Galleries

- 5.1 Value of Galleries
- 5.2 Location of Galleries Relative to the Construction Site
- 5.3 Relative Value of Exploratory Galleries and Core Samples

Appendix 6. Model Studies

- 6.1 General Considerations
- 6.2 Mathematical Models
- 6.3 Photoelastic Models
- 6.4 Scale Models

Appendix 7. Glossary of Terms

Section 2. Construction

Chapter 1. Preface

- 1.1 Importance of Studying Construction Methods
- 1.2 Significance of the Modalities of Construction
- 1.3 Object of this Document

Chapter 2. Choice of Construction Method

- 2.1 Selection Factors
- 2.2 Selection Process
- 2.3 Applicability of Construction Methods

Chapter 6. Special Study for Tunnel Portals

- 6.1 General Remarks
- 6.2 Special Characteristics of Tunnel Portals
- 6.3 Choice of Location of Tunnel Portals
- 6.4 Content of Studies
- 6.5 Available Means of Study

Chapter 7. Special Studies for Urban Tunnels

- 7.1 Special Characteristics of Urban Tunnels
- 7.2 Content of Studies
- 7.3 Study of Blasting Shock

APPENDICES

Appendix 1. Surface Geophysical Methods

- 1.1 Limitations of Surface Geophysical Studies
- 1.2 Domain of Application
- 1.3 Advantages of Geophysical Surveys

Appendix 2. Corings

- 2.1 Value of Corings
- 2.2 Nature of Corings
- 2.3 Domain of Application of Coring
- 2.4 Advantages and Disadvantages of Core Sampling

Appendix 3. Diagraphy

- 3.1 Definition of Diagraphy
- 3.2 Uses of Diagraphy
- 3.3 Advantages of Diagraphy

Chapter 3. Nature of Terrain

- 3.1 Classification of Terrains
- 3.2 Studies to Be Undertaken to Identify Possible Construction Methods

Chapter 4. Urban Sites

- 4.1 Tunnel Location
- 4.2 Parameters to Be Considered in the Choice of a Construction Method
- 4.3 Terrain Disturbances
- 4.4 Excavating Using Explosives
- 4.5 Maintenance of Surface Traffic
- 4.6 Portals and Approaches

APPENDICES

Appendix 1. Full-section Excavation

- 1.1 Description
- 1.2 Domain of Applicability
- 1.3 Safety Precautions
- 1.4 Performance

Appendix 2. Upper Half-section Excavation

- 2.1 Description
- 2.2 Domain of Applicability
- 2.3 Precautions
- 2.4 Performance

Appendix 3. Divided-section Excavation

- 3.1 Description
- 3.2 Domain of Applicability

3.3 Precautions

3.4 Performance

Appendix 4. Boring

4.1 Description

4.2 Domain of Applicability

4.3 Advantages and Precautions

4.4 Performance

Appendix 5. Driving Shields

5.1 Description

5.2 Domain of Applicability

5.3 Precautions

5.4 Performance

Appendix 6. Covered Trenches

6.1 Description

6.2 Domain of Applicability

6.3 Precautions

6.4 Performance

Appendix 7. Prefabricated Caissons

7.1 Description

7.2 Domain of Applicability

Appendix 8. Special Treatments

8.1 Drainage during Advancement

8.2 Lowering of Water Table

8.3 Injections

8.4 Soil Freezing

8.5 Electro-osmosis

8.6 General Remark

Appendix 9. Excavation of Shafts

9.1 Description

9.2 Domain of Applicability

9.3 Precautions

9.4 Performance

Appendix 10. Glossary of Terms

Section 3. Lining

Chapter 1. Preface

Chapter 2. Role and Importance of the Lining

2.1 Relation between Support and Lining

2.2 Role of the Lining

Chapter 3. Shape and Dimensions of the Lining

3.1 Factors Influencing the Establishment of Stresses in the Lining

3.2 Dimensioning and Design of the Lining

3.3 Proposed Lining Thickness

Chapter 4. Composition of Lining

4.1 Materials Used and Constraints on Use

4.2 Watertightness and Drainage

4.3 Decisions concerning Support and Lining during Construction

Section 4. Watertightness

Chapter 1. Preface

- 1.1 Ground-water Problems during Construction
- 1.2 Ground-water Problems Once Tunnel Is in Service
- 1.3 Consequences for Project Design

Chapter 2. General Principles

- 2.1 Deficiencies in the Watertightness of the Vault Itself
- 2.2 Diversity of the Problems
- 2.3 Diverse Requirements
- 2.4 Three Principles of Waterproofing

Chapter 3. Waterproofing Methods

- 3.1 Dewatering
- 3.2 Tunnel Lining
- 3.3 Injections
- 3.4 Layers of Waterproofing

Chapter 4. Choice of Waterproofing Method

- 4.1 Relatively Unimportant Tunnels
- 4.2 Moderately Important Tunnels
- 4.3 Major Tunnels

Section 5. Roadways

Chapter 1. Preface

- 1.1 Longevity
- 1.2 Importance of Drainage



1.3 Other Necessary Qualities

1.4 General Design Conditions for Tunnel Roadway

Chapter 2. Construction of Roadway

2.1 General Information

2.2 Roadway Built on a Concrete Slab

2.3 Roadway Built on Solid Rock

2.4 Roadway Built on Soil or Alterable Rock

2.5 Roadway Built on Countervaulted Inverts

Chapter 3. Delineation of Traffic Lanes

3.1 Differentiation of the Shoulders

3.2 Curbing

Section 1. GEOLOGY AND GEOTECHNOLOGY

---

1. Preface . . . . .	13
2. Utilization of Experience Acquired in Underground Construction . . . . .	16
3. Goals of Geological and Geotechnical Studies. . . . .	19
4. Content of Geological and Geotechnical Studies. . . . .	31
5. Articulation of Geological and Geotechnical Studies . . . . .	52
6. Special Study for Tunnel Portals . . . . .	57
7. Special Studies for Urban Tunnels . . . . .	65
Appendices . . . . .	71

Chapter 1. PREFACE1.1 Object of this Section

- 1.11 Some recent documents, mostly published by the Central Laboratory for Bridges and Highways, have given consideration to geological and geotechnical problems associated with the construction of highways, foundations, etc.

Tunnels and underground highways are, for the most part, correctly considered as singularities along a highway route, and thus fall within the purview of special studies.

Although excellent documents concerning excavations have been published, the geological and geotechnical studies applicable to highway tunnels have failed to take account of recent methodological developments of importance.

Thus, it is the object of this section, which treats only highway projects, to define the manner in which geological and geotechnical studies should be conducted. This will be done both from the point of view of the project engineer and from the point of view of laboratory personnel such as geologists, hydrogeologists, soil mechanics specialists, etc.

For purposed of clarity, it has appeared useful to clearly differentiate these points of view. We realize that there are similarities and that repetitions will inevitably occur. Indeed, such similarities demonstrate the necessity of a mutal interchange of information between the project engineer and laboratory personnel, during both planning and construction stages.

This section treats excavated tunnels and must be adapted somewhat for studies of covered trenches. The objectives are quite different in each case; however, the studies are analogous.

Submerged tunnels are not treated here as they present problems of a very special nature.

## 1.2 Importance of Geological and Geotechnical Studies

### 1.21 What is the role and importance of geological and geotechnical studies in underground construction?

Recent experience in such construction permits an unambiguous response:

- \* Despite the many uncertainties, the project engineer must be able to define his project accurately in both physical and financial terms. He must also be able to determine the effects of the construction on the environment, understanding and defining both the risks and methods of construction.
- \* Starting from observations that are often limited to those obtainable at the surface (when, in fact, this is possible), the geologist must be able to extend his observations in depth so as to be able to characterize the subsurface terrain, as well as to determine its hydraulic characteristics. Only then will the soil mechanics specialist (with whom the geologist must work closely throughout the project) be able to make realistic predictions and recommendations regarding excavation methods and precautions to be taken.

### 1.22 Needless to say, these studies are now viewed quite differently than they have been in the past.

This section will explain how we think geological investigations should be conducted, thus demonstrating what we feel to be the fundamental importance to be accorded to them. All that needs to be said here is that the knowledge gained from such investigations is motivated by two considerations:

- \* Respect for rigorous safety standards (protecting both surface environment and structures, and the tunnel itself).
- \* Concern for precision, thus leading to a very extensive study-effort from the very outset of preliminary planning, through to the very completion of the project.

## 1.3 Major Problems

On a practical level, special attention should be paid to the following problems:

## 1.31 In soils:

- \* Surface deformation (occasioned by the excavation and by changes in drainage provoked by the tunnel).
- \* Ground-water and permeability.
- \* Complete identification of soil structures.

## In rocks:

- \* Heterogeneity of terrain.
- \* Faulting and joints.
- \* Ground-water circulation.
- \* Behavior of adjacent terrain after excavation.

These brief enumerations do not signify that the studies should be limited to these problems, but rather that these are the major problems around which the fundamental options in each case should be organized.

1.32 Finally, it is imperative that a qualified representative of the project engineer always be present at the working face in order to make the necessary geological identifications and in order to analyze any problems that may rise, notably those that require the correction of study results, such as the location of irregularities and interfaces between different types of terrain. Such a precaution will insure maximum efficiency and safety for the project.

The use of geology as a construction aid stems, perhaps here more than elsewhere, from systematic observations and measurements in the field. Such experience increases with every project and is the single most important requirement for a realistic and well-executed study.

---

## Chapter 2. UTILIZATION OF EXPERIENCE ACQUIRED IN UNDERGROUND CONSTRUCTION

In underground construction, geological studies proceed on the basis of analogies with previous projects. It is reassuring to know that we very often have data on previously completed projects that make an essential contribution to our understanding of the sites and construction problems encountered in those projects.

### 2.1 Conceptual Differences between Former and Present-Day Structures

It is always important to use the greatest care in interpreting the data from previous projects; their construction procedures and problems must be subjected to a careful historical analysis. Modern highway tunnels differ in two important ways from the excavations carried out in the past.

2.11 Their cross-sectional profile, generally falling between 60 and 100 m<sup>2</sup>, poses an extremely important problem of scale in relation to the older tunnels of smaller cross-section. In general, the major construction difficulties (internal support and surface deformation) increase very rapidly with excavated cross-section. In the case of massive rock formations, these problems are closely linked to the spacing of internal discontinuities (fractures, joints, etc.): the smaller the spacing of the discontinuities relative to the dimensions of the cross-section, the greater the construction difficulties.

2.12 In the past few years, construction methods have undergone important changes (see Section 2):

- \* Founded for the most part in a legitimate concern for greater speed and profit, these methods result in greater disturbance of the surrounding rock. This creates new tunnel-support problems.
- \* This trend will continue in future years through the more regular and systematic use of boring machines, thus giving rise to fundamentally new problems.
- \* Techniques of support, terrain consolidation, and heading have, therefore, little relation to those of the past. Side-drift headings, followed by the erection of a masonry lining, once so popular a technique, is now reserved only for very special circumstances.

## 2.2 Reference Structures

Although it is always wise to refer back to previous projects in order to strengthen one's own experience, the use of these data must be subjected to the following constraints:

- 2.21 Hydroelectric tunnels are by their very nature less subject to environmental constraints (urban zones, location of tunnel portals, etc.). Their relative flexibility in the choice of layout provides a high adaptability to geological problems (by allowing for small radii of curvature, steep grades, avoidance of geological irregularities, etc.). In fact, these problems can often be resolved while construction is underway.

In addition, their cross-section is small (usually less than  $25 \text{ m}^2$ ), while, on the other hand, their length may be quite considerable (several kilometers).

- 2.22 Railway tunnels are usually more severely constrained geometrically than are highway tunnels. Nevertheless, their cross-section rarely exceeds  $50 \text{ m}^2$ , and they are generally built using traditional methods.

- 2.23 Subway tunnels built in urban areas have a cross-section comparable to that of a railway tunnel. The average cross-section at a station, on the other hand, is on the order of  $100 \text{ m}^2$  (with the exception of such special structures as those for the stations on the East-West Regional Express in Paris which exceed  $300 \text{ m}^2$ ). The constraints on location and construction methods are those typically associated with urban sites (underground obstacles, location of headings and work sites, constraints on layout of system, etc.) and with surface geological characteristics (soils of varying characteristics and quality, presence of ground-water, etc.).

Many of the relatively older tunnels were excavated using methods that are now outdated; nevertheless, they serve as an interesting source of information concerning the local geology and the behavior of different terrains.

Recent subway construction, on the other hand, including construction now in progress, is fairly extensive and can provide particularly useful data for the study of urban highway tunnelling.

- 2.24 Only those mining galleries that are driven through solid rock can be assimilated to tunnels. These galleries are typically of small cross-section, and usually located in geologically complex massifs that have been greatly disturbed by adjacent mining operations. In addition, they are generally provisional structures in which long-term deformation is not of concern. As such they differ conceptually from highway tunnels.

- 2.25 Public Works projects (major sewers and drainage galleries) can also provide information about the nature and behavior of local terrains, but the construction methods have for the most part been traditional. Very recent construction, however, exhibits very interesting characteristics.
- 2.26 Old highway tunnels furnish information analogous to that furnished by railway tunnels. Recently constructed tunnels that have been subjected to continued scrutiny are relatively few in number. Experience in other countries adds some very valuable information because of their number and the diversity of the terrains traversed.
-



### Chapter 3. GOAL OF GEOLOGICAL AND GEOTECHNICAL STUDIES

#### 3.1 General Principles

##### 3.11 Role of Geological and Geotechnical Studies

The factors that must be considered in tunnel project planning are multiple and tightly intertwined. We can nevertheless attempt to order them in accordance with a schema which allows the project engineer to appreciate the importance of different geological and geotechnical studies, even though this schema does not accord perfectly with reality:

- \* The constraints levied by the topography, the proposed location of tunnel approaches, the relative importance and function of the tunnel within the connecting road system, the nature of the environs (urban site, ground-water, etc.) constitute the basic data for the schema.
- \* The economic benefits of the tunnel for the user -- based on investment cost, operating expenses, and design of the connecting road system -- constitute the background against which the schema should be evaluated.

Once these constraints have been ascertained and the economic benefits determined, the geological and geotechnical studies should be the very next step, for they provide information essential to the cost benefit analysis of the project.

Of course, these studies do not always have a controlling influence, especially if certain constraints carry considerable weight (e.g., land acquisition costs); nevertheless, they do constitute a necessary step that, from the outset of preliminary studies, will permit:

- \* A rough determination of the tunnel's location (layout, profiles, location of portals and approaches, etc.).

- \* A broad definition of potential difficulties (ground-water, terrain quality, envisaged construction methods,<sup>1</sup> and natural constraints on construction such as faults, etc.).<sup>2</sup>
- \* A provisional estimate of cost and required construction time.

### 3.12 Conditions Necessary for a Successful Study

A successful geological study for a tunnel should obey the following rules:

- (i) The geologists and geotechnicians in charge of the study should have previous experience with underground construction as well as a good knowledge of the local geology and hydrogeology. In most cases this rule will require the collaboration of several specialists from the same or from complementary disciplines.
- (ii) They should be completely briefed by the project engineer concerning any constraints on the project (urban environment, feasibility of layout and portal location, existence of nearby tunnels, etc.
- (iii) The exploratory investigation should be directed towards a complete inventory of:
  - \* faults.
  - \* geological zones presenting special construction difficulties.
  - \* different kinds of terrain to be traversed and their potential behavior during excavation.

The financial consequences of an oversight or a mistake committed in the preliminary stages of project planning can be very considerable.

- (iv) The studies should be detailed enough to allow the complete compilation of data with maximal certainty. The margin of possible error in the results should always be specified.

Geological irregularities (e.g., faults) are often located some distance from the tunnel portals and cannot therefore be evaluated only by surface observations. Extrapolation

---

<sup>1</sup>Problems relating to tunnel construction are treated in Section 2.

<sup>2</sup>It is during the second phase of planning, during the preparation of the PPS, that detailed complementary studies are conducted in order to define more precisely the methods that have to be implemented in order to surmount these difficulties.

error increases with depth, so that we must often resort to very expensive exploratory procedures (e.g., an exploratory gallery).

The true behavior of the terrain traversed during excavation is also very difficult to predict from surface explorations.

- (v) Sufficient time for these explorations should be set aside by the project engineer from the outset of preliminary planning, thus insuring that the observations can be made under the most favorable conditions.

### 3.13 Limitations of this Chapter

This chapter contains an analysis of the influence of geological and geotechnical conditions over the principle parameters defining the proposed tunnel.

Some particularly important questions are studied in greater detail elsewhere in this volume:

- \* Tunnel portals, headings, and approaches in Chapter 6 of this section.
- \* Problems peculiar to urban sites in Chapter 7 of this section.
- \* Construction methods in Section 2 of this volume.
- \* Lining in Section 3 of this volume.

### 3.2 Tunnel Layout, Longitudinal Profile, Cross-sectional Profile and Supports

This paragraph examines the geological criteria that must be taken into account when determining tunnel geometry. It also discusses the geological and geotechnical studies that should be undertaken in order to ascertain these criteria.

### 3.21 Factors in Choosing the Layout and Longitudinal Profile

The choice of an optimal layout demands a thorough knowledge of the geological history of the area, the nature and disposition of the formations, the location of any faults, and the position and seasonal variation of water table.

More precisely, the tunnel's layout and longitudinal profile are dependent upon the following conditions:

- \* Location of portals (taking into consideration constraints imposed by the approaches). They should be located so as to conform closely to the conditions specified in Chapter 6.

- \* The nature of the terrain traversed:
  - Fissured or altered rock, as well as poorly consolidated or plastic soils, should be avoided as much as possible.
  - In the case of horizontal stratification, the tunnel should be located within the most desirable stratum, so as to avoid instabilities in the tunnel vault and compaction under the tunnel sidewalls.
- \* Orientation of the tunnel relative to the principal directions of discontinuities (bedding planes, schistosity, fractured zones, joints, etc.). A perpendicular orientation is most favored; a parallel orientation the least favored.
- \* Presence of faults, often accompanied by a brecciated zone and ground-water circulation.
  - In general, it is best to avoid them entirely, or to cut across them perpendicularly.
  - In the presence of horizontal or slightly inclined faults, the longitudinal profile should be planned so as to stay as far away from the faulted zone as possible.
- \* Presence of ground-water, which should be avoided by locating the tunnel in dry or impermeable rock.
  - In soils it is best to remain, if at all possible, above the water table, thereby minimizing problems of support, excavation, dewatering, swelling pressures, watertightness, etc.
  - In rock it is important to choose massive and impermeable formations rather than those which are fissured (and which would allow for ground-water circulation). Karst zones should also be avoided (as there is the risk of intercepting substantial and dangerous ground-water flows).
- \* Predictable flows of ground-water. A steep grade facilitates excavation if a significant flow of ground-water is to be drained. In any case, it is advisable to adopt a longitudinal profile having a minimal gradient of 0.2-0.4% sloping towards the portal.
- \* Nature and thickness of overlying rock. In general, the terrain quality increases with depth, and surface irregularities become less pronounced. It is necessary to take special precautions if the thickness of the overlying cover is less than 7-8 meters. This is, of course, an average minimum depth that varies as a function of the tunnel cross-section, the nature of the terrain, and the surrounding environs.

INFLUENCE OF THE ORIENTATION OF STRATIFICATION  
ON THE STABILITY OF THE GALLERY FACING

1. Subhorizontal bedding: overbreak and risk of collapse of the vault  
[bolting necessary].

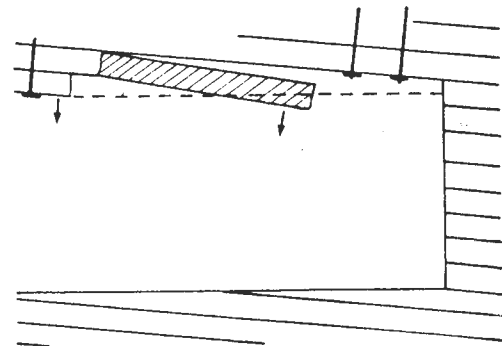
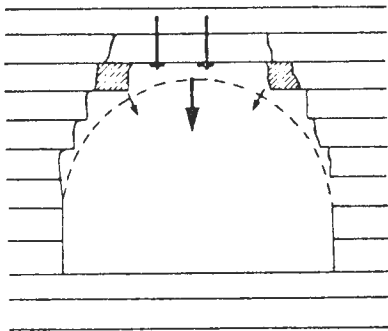

2. Gallery parallel to strike: (a) oblique bedding, (b) vertical bedding:

- significant overbreak
- flexion of exposed beds tangential to profile
- risk of collapse of large slabs (in case of vertical bedding)

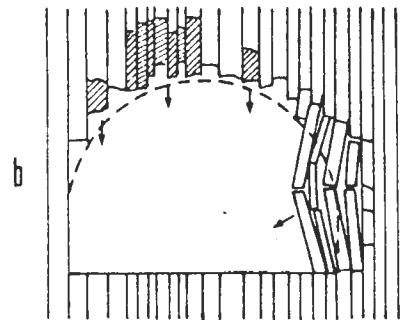
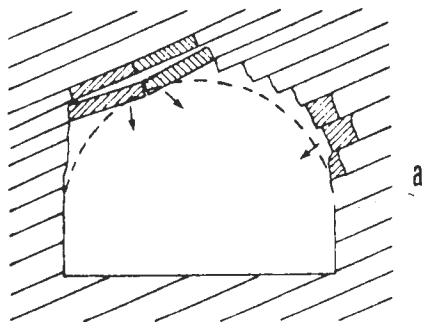

3. Gallery perpendicular to strike: the more vertical the bedding,  
the less the overbreak:

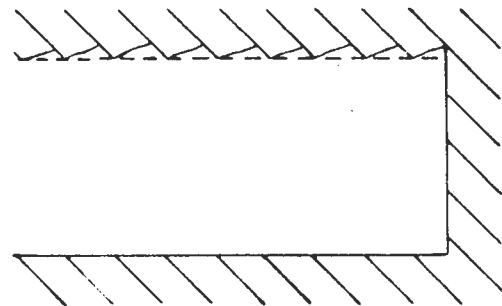
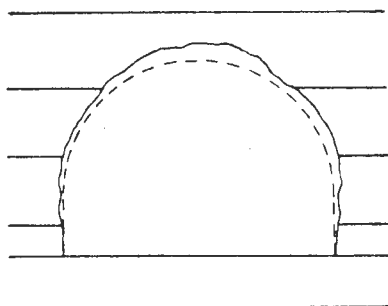

### 3.22 Factors in Choosing the Cross-sectional Profile

The essential questions which concern the project engineer deal with the shape and dimensions of the tunnel cross-section.

The following factors should be considered:

- \* Presence of ground-water. It is best to choose a circular cross-section (especially if there exists a strong piezometric head) or at least a vaulted-arch (horseshoe) cross-section with a countervaulted invert (floor).
- \* Intrinsic properties of surrounding terrain
  - In the case of terrain susceptible to the development of expansive pressures (marls, clays, anhydrite), a circular cross-section should be adopted, or if the troublesome zone is of short length, a countervaulted profile.
  - In the case of solid or only moderately fractured rock, a vaulted-arch cross-section can be adopted, or perhaps even a more flattened profile if the rock is sufficiently massive.
  - In the case of soil or decomposed rock, several shapes are permissible, including elliptical ones with the primary axis being horizontal or vertical, if they are economically feasible. The choice of cross-section is closely tied to the choice of construction method.
- \* Geometrical structure of the terrain traversed
  - Stratification, fracturing, and the transverse heterogeneity of the massif may require different construction methods and may in certain cases determine the tunnel cross-section.
  - The longitudinal heterogeneity of the terrain traversed can also require changes in method or cross-section (or both). For economic reasons, it is advisable to adopt a cross-section that is as uniform as possible throughout the length of the tunnel.
- \* Excavation methods (see Section 2). It should simply be remembered that the construction method exerts an important influence on the choice of cross-section (cross-section is usually circular when a boring machine is used; usually rectangular in other cases).

### 3.23 Support of the Excavation during Construction

A detailed classification of the various terrains in terms of their primary geotechnical characteristics, the stability of the excavation, and the excavation methods employed is presented

in Section 2, Chapter 3. In view of the influence of supports on the construction methods to be adopted, the duration of the construction, and tunnel cost, it is important that the project engineer have sufficiently precise information concerning the particular type of supports to be used. This presupposes a good knowledge of the formations and terrain to be traversed.

### 3.24 Studies to Be Undertaken

- \* The choice of layout and longitudinal profile necessitates a general knowledge of the entire zone in which the tunnel may be situated.

Thus, the primary goals of the geologist are the following:

- To determine the inner structure of the massif:
  - i) nature and disposition of the formations.
  - ii) opinions on their amenability to excavation.
  - iii) position and variations of water table.
  - iv) major faults
- To indicate the most favorable locations for the tunnel portals.

These data can be determined with the help of:

- Existing documentation (see 4.23 and 4.33).
- Geological and hydrogeological observations covering a sufficiently wide area.
- Geophysical testing and, if necessary, accompanying core samples, especially near the tunnel portals.

These results should be presented in a very clear and concise manner, with the aid of cross-sections, scale-models, or sketches. They should indicate the most favorable areas for construction, location of aquifers and faults, and the recommended location of portals.

- \* The choice of cross-sectional profile and the various provisions for support require a refinement of the geological studies along the chosen layout:
  - Complete identification of the formation along the proposed layout, with a determination of their longitudinal and transverse heterogeneity.

- Hydrogeology: behavior of water tables, direction and speed of flow, seasonal variations, etc.
- Internal structures (only in rock): Orientation and spacing of discontinuities, location and spacing of joints, etc.

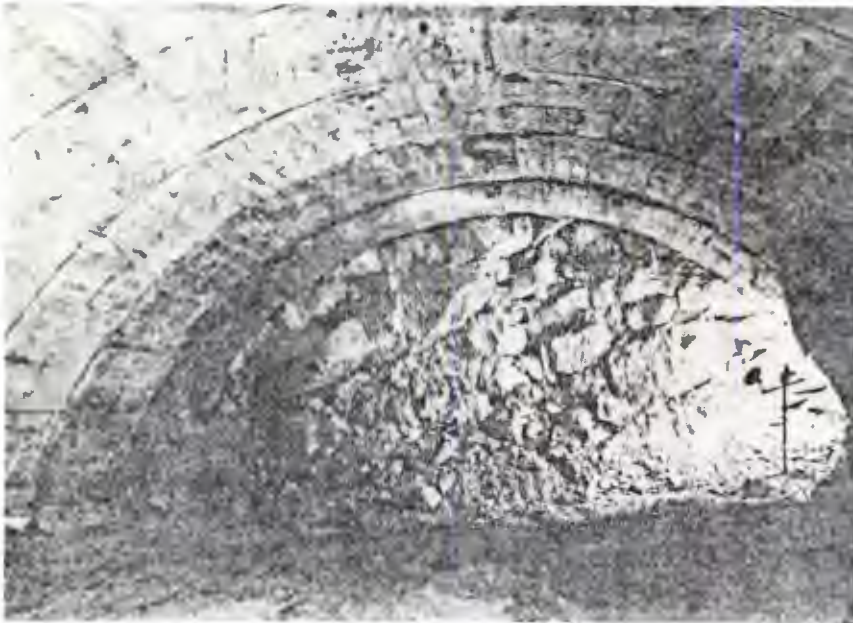

Dislocated calcite without cohesion at joints, requiring a cast-in-place underlining.

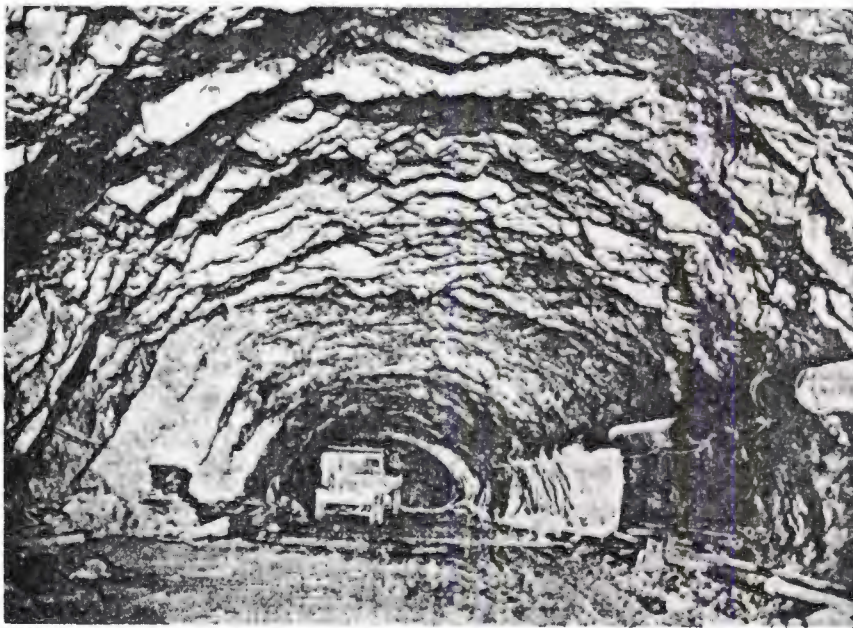

Overbreak resulting from diaclases in a gneiss formation.



- Geotechnical studies, especially in soils.
- Possibilities of special treatment, perhaps with full-scale in situ testing.
- Excavation of an exploratory gallery if there are any major uncertainties concerning the structure of the massif, the behavior of the terrain to be excavated, or of its developmental properties (swelling, alteration, etc.).

The conclusions of these studies are closely linked to those concerning envisaged construction methods. The latter are in turn closely linked, for example, to the cross-sectional profile and the chosen type of support.

### 3.3 Ground-water Problems

#### 3.31 Factors to Consider

The problems caused by the presence of ground-water are usually of major importance to the project engineer.

\* In soils. The presence of a water-bearing stratum near the proposed site poses various difficulties:

- Unfavorable short-term modifications to the mechanical characteristics of the soil.
- Instability of the excavation due to the hydraulic gradient created by drainage of surrounding terrain. In poorly consolidated soils, there is a danger of collapse and piping.
- Construction difficulties caused by subsidence or insufficient support for walls.
- Generalized surface subsidence resulting from a flattening of the bed: compaction resulting from dewatering of the bed; consolidation of clays.

Special construction methods (using driving shield in pressurized environment, etc.) are necessary, regardless of whether long, tedious preliminary treatment has been carried out (compaction, dewatering, soil treatment).

\* In rock. The presence of significant quantities of ground-water in highly fissured rock formations following rainstorms can constitute a major hindrance to the advancement of excavation. Collapse of the excavated section can occur in the brecciated zones that accompany major faults.

Karstic water circulation is dangerous because of the potential risk of large quantities of rapidly flowing water. There is the double problem of safeguarding both the construction site and personnel.

In addition, the strength of the rock can be affected in the following ways:

- Rock with acceptable mechanical properties and good strength when first excavated can be rapidly altered upon contact with water (marls, calcite containing marl or clay in the joints); such rock can be protected only by the rapid placement of a protective lining (e.g., shotcrete).
- Upon contact with water, some rock develops substantial expansive pressures (anhydrites, some diorites and clays).
- Certain rock that have good strength when dry (e.g., gypsum, anhydrite) may require major support and even preliminary treatment when wet (e.g., dewatering, injections).

### 3.32 Studies to Be Undertaken

Because of the importance of these problems, it is important to know well the hydraulic characteristics of the terrain, as well as to anticipate as precisely as possible the problems that will arise, thus allowing an accurate appraisal of the following:

- \* The necessity of special treatments or construction methods.
- \* The investigations to be conducted during construction.
- \* The type and dimensions of the cross-section, as well as the location of drainage equipment (e.g., pumps, wellpoints, etc.).
- \* Waterproofing method to be used.
- \* The type of cement to be used in the lining (depending on the chemical properties of the ground-water).

Hydrogeological studies should try therefore to define the following parameters:

- \* Hydraulic characteristics of the terrain.
- \* Types of ground-water sources.
- \* Flow rates.
- \* Dewatering or compaction methods.

- \* Chemical nature of the ground-water (corrosiveness for concrete or steel, possibility of using water in mixing the concrete, releasing of noxious gases, etc.).

It is important to note that very detailed studies and properly executed tests do not always provide precise answers to the questions raised. In situ testing can contribute to more precise results.

### 3.4 Follow-up Studies during Construction -- Verification

It is necessary that the activities of the geologists and soils mechanics specialist continue during construction so that they can:

- \* Refine the studies and make concrete recommendations.
- \* Undertake a systematic research program, first through observation and then through measurements.

#### 3.41 The continued observation during construction permits:

- \* Verification of the accuracy of geological predictions, timely rectification of any discrepancies.
- \* Insure the proper conduct of the excavation, advising the project engineer as to the nature of the terrain, the proximity of faults and problem areas, and corrective measures to be taken.

#### 3.42 These observations also permit the collection of important complementary information on the following points:

- \* Hydrogeology. A detailed study of ground-water characteristics (flow, temperature, chemical composition, location) permits a more precise decision concerning size of drains, necessary waterproofing, type of cement to be used, etc.
- \* Surface deformation. Precise, systematic observations should permit accurate information regarding the risk of deformation, and should therefore allow ample time to make the required accommodations (restricted construction, special procedures).
- \* Behavior of excavated section. Observed decompression of adjacent terrain, deformation in tunnel walls and vault, or movement of the lining, can all necessitate a modification of the construction methods originally proposed on the basis of preliminary geotechnical studies.

- 3.43 Observations should result in a very detailed report. The purpose of this report is to summarize clearly the knowledge acquired during planning and construction of the tunnel, thereby providing a useful source of information for similar future construction.
- 3.44 The whole of these observations can be advantageously used in the future since they contribute to potential theoretical developments (e.g., measurement of stresses and deformation in the lining).

These measurements and observations thus make a significant contribution to the planning of future tunnels.

---

Chapter 4. CONTENT OF GEOLOGICAL AND GEOTECHNICAL STUDIES

4.1 General Principles

4.1.1 Necessary Conditions for a Successful Study

The effectiveness of the geologists and geotechnicians in tunnel planning and construction presupposes the satisfaction of four preliminary conditions:

- \* The laboratory must be fully informed regarding all aspects of the project: the amount of flexibility in the proposed layout, environmental or land acquisition problems, desired tunnel dimensions, etc.
- \* The studies should not limit themselves to a restricted perspective, but rather should encompass all potential solutions (thus, the need to know the internal structure of the massif, ground-water circulation characteristics, etc.).
- \* Geological analysis is largely analogical. The geologist must base his conclusions on information gathered from previous projects; therefore he must exercise appropriate caution.

As mentioned earlier, one cannot emphasize enough the importance of the geological observations that are to be made during construction. The geologist should capitalize on this fundamental source of information.

- \* Sufficient time for the studies should be provided from the start. One year seems to be the minimum time required for carrying out a preliminary study. In the case of numerous solution variants, or in the case of a complex terrain formation requiring core samples or an exploratory gallery, or in the case of complicated hydro-geological factors, a minimum delay of two years should be anticipated.

4.1.2 The goal of the present chapter is to outline schematically a framework for the studies to be undertaken. In an effort to gain maximum clarity, the geological, hydrogeological, and geotechnical studies have been separated; it is of course evident that the schematization does not correspond to the real nature of the studies, since the studies complement each other and are intimately interdependent.

In addition, the more precise definitions of the available study methods have been saved for an appendix.

Finally, the special problems posed by the tunnel portals and urban sites are the object of a more detailed discussion in Chapters 6 and 7.

## 4.2 Geological Studies

### 4.21 Objectives

The goal of a geological study is to bring into consideration the following:

- \* A classification of the various geological structures encountered, in terms of the categories described in the second part of Chapter 3.
- \* A complete description of all geological irregularities.

In order to achieve this, the study rests on the following basic elements:

- \* Geological and tectonic history of the massif.
- \* Structure of the massif.
- \* Description of the terrain along the tunnel layout, according to (1) their petrographic and mineralogical properties, (2) their geotechnical properties, (3) their quality (degree of alteration and alterability after construction), and (4) the size and spacing of joints, and the location of discontinuities (only in rock).
- \* Location of other geological irregularities (faults, brecciated zones, etc.)

### 4.22 Results to Be Expected

The interpretation of these different elements, based on experience gained from excavation in analogous sites and terrain, should lead first to a choice of layout, and then to predictions (of greater or lesser accuracy depending on the circumstances) regarding the following:

- \* Behavior of terrain during excavation.
- \* Possible evolution of the properties and structure of the formations with time.

- \* Optimal cross-sectional profile for the tunnel.
- \* Type of support and possible construction methods.

The geologist should first use the most simple and rapid methods of investigation, then moving to more tedious and time-consuming ones, observing the following order of investigation:

- \* Inventory of existing data.
- \* Survey of surface.
- \* Complementary investigation (in situ testing and measurement).

#### 4.23 Inventory of Available Geological Data

We should always consider as indispensable to the preparation of a study for a proposed tunnel an exhaustive compilation of all available geological data. This data should include information concerning the site, its geology and regional morphology, and other underground construction completed in the area.

The compilation of documents and studies normally includes:

- \* Reports of previous work (railway or public utility galleries, mines, roadway tunnels, drainage systems, borings, foundations, driven piles, etc.) already carried out in similar formations and, if possible, not too distant from the proposed site.
- \* Geological documentation furnished by various colleges and institutes (stratigraphic, structural, and petrographic studies and core samples).
- \* Maps, photographs, and especially aerial photos, which are vital in identifying major geological irregularities, hydraulic characteristics, and preferred tunnel layouts.
- \* Documentation, as complete as possible, regarding surface structures (building foundations) and existing underground excavations and obstacles (drainage systems, sewage systems, backfilled excavations, etc.).
- \* Meteorological (average rainfall, snowfall, etc.).

It is important to remember that this information should be used with care, and does not obviate the need for further studies. First of all, these earlier geological studies may not have been carried out with underground construction in mind. Second, they deal with excavations that differ in conception and construction method from those considered in this document.

## 4.241 Scope of the Survey

Once an optimal layout solution has been adopted, the study can be narrowed from its originally wide scope. The narrowed scope will depend in large part upon the geological complexity of the site.

- \* In the case of horizontal sedimentary strata without faulting, a survey encompassing a total width of about one hundred meters will be sufficient.
- \* In cases where the geological complexity requires it, a fairly detailed survey may cover several kilometers on each side of the proposed trace.

## 4.242 Content of Survey

It is imperative that the surface geological survey include the following:

- \* Study of all the outcrops with an indication of their geological significance.
- \* Inventory of all tectonic features (folding, faulting, etc.).
- \* Determination of orientation of all discontinuities in rock (bedding planes, diaclasses, schistosity, jointing, etc.).<sup>1</sup>
- \* Description of surface phenomena:
  - Alteration (fissures, eroded material).
  - Fissuring in relation to surface contouring.
  - Landslides.
  - Collapses (resulting from underground excavation or karstic dissolution).
- \* Hydrogeological observations (cf. 4.3).
- \* Morphological interpretation.
- \* An especially detailed examination of possible sites for the portals (Chapter 6).

---

<sup>1</sup>Predicting the degree of underground fissuring is often difficult if only surface observations are available. These observations are nevertheless important as they can be used to estimate the stability and overbreak of the excavation, and ultimately the type of spacing of the supports.



## 4.243 Presentation of the Results of the Geological Survey

The results should be presented in the following form:

- \* Map of all outcrops, with an indication of their significance.
- \* Geological map whose scale will depend upon the precision that is attainable and upon the importance of the project (1/20,000 in mountainous terrain when project is of major size, 1/5,000 or 1/2,000 for a short tunnel in a region where there are numerous outcrops).
- \* Geological cross-sections along the axis of the tunnel and possibly in other planes of particular importance (with the same horizontal and vertical scale).
- \* Geological plan of surrounding terrain.
- \* Interpretation of these results, indicating in particular their reliability (certain, probable, uncertain) as well as those points on which it was not possible to comment or on which no predictions can be based.
- \* In geologically complex regions, an accurate geometrical reconstruction of the beds using a three-dimensional model.

When sufficient precision cannot be obtained on the basis of a geological survey of the surface (in areas with no outcrops, in urban areas, etc, it will be necessary to undertake the studies outlined in 4.25 below at the very outset of preliminary planning, once existing documents and excavations have been examined.

SAMPLE PRESENTATION OF THE RESULTS OF A GEOLOGICAL SURVEY

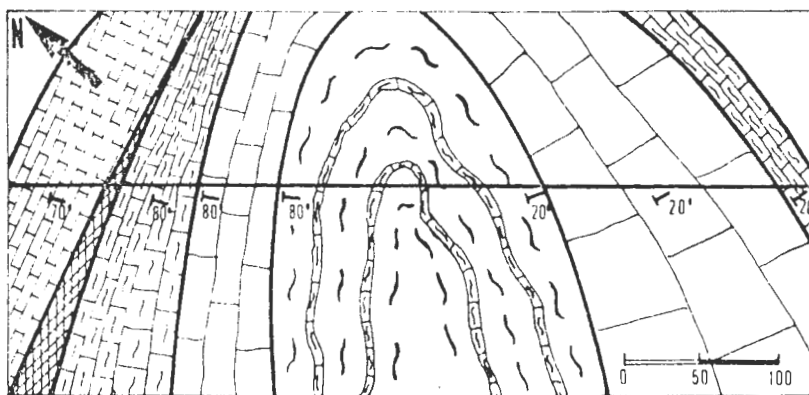

Geological Plan of  
Terrain Traversed  
by the Tunnel

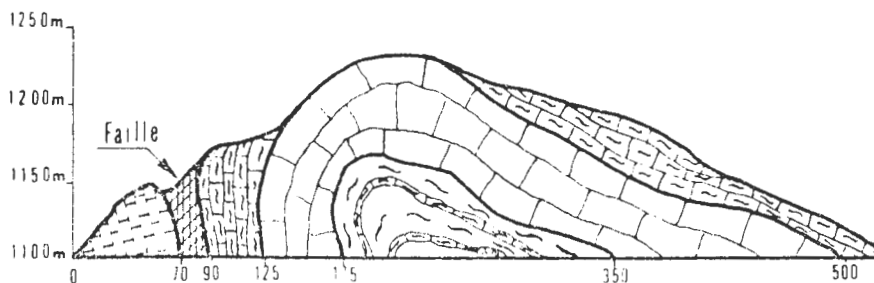

Longitudinal Profile

SAMPLE PRESENTATION OF THE RESULTS OF A GEOLOGICAL STUDY (continued)

Longitudinal location (m.)	0-70	70-90	90-125	125-175	175-350	350-500	500+
Lithological description	limestone beds	brecciated zones	chalky limestone	karstic limestone in large blocks	chalk (60%) and chalky limestone (40%)	karstic limestone in large blocks	
STRATIFICATION:	* strike	75° ↘ 70°	65° ↘ 80°	65° ↘ 80°	55° ↘ 80° 30° ↘ 20° variable (folding)	30° ↘ 20° 20° ↘ 20°	↘ 20° 20°
	* thickness of beds	5-10 cm	20-40 cm	200-500 cm.	10-30 cm.; chalky joints in chalky limestone	200-500 cm.	20-40 cm.
JOINTS:	* orientation	25° ↘ 165° ↘ 65°	10° ↘ 65°	0-10° ↘ 65°	two families perpendicular to stratification in chalky limestone beds	70° ↘ 20°	70° ↘ 30°
	* spacing	30-40 cm.	30 cm.	300-800 cm.		500-800 cm.	30 cm.
	* type	open, unfilled		calci-ferous	lithified	variable orientation, filled with limestone (average spacing 20 cm.)	closed
Anticipated ground-water	diffuse, related to amount of rainfall	under head (≈ 2 bars)	none	pointwise sources, variable outflow	none	pointwise flows, variable to weak in chalk	weak
Support (temporary)	Ribbing (with 1 m. spacing)	plating, special treatments	shotcrete with some plating	some bolting	chalk: ribbing and cast concrete underlining. chalky limestone: shotcrete	none	ribbing (with 1 m. spacing)
Special exploratory surveys and studies		test borings near the fault zone		exploratory drilling in order to locate cavities and ground-water flows	measurement of convergence		

SAMPLE PRESENTATION OF THE RESULTS OF A GEOLOGICAL STUDY (continued)

Detailed Sections of Geological  
Structure of Block Limestone  
(Longitudinal location: 125-175 m.)

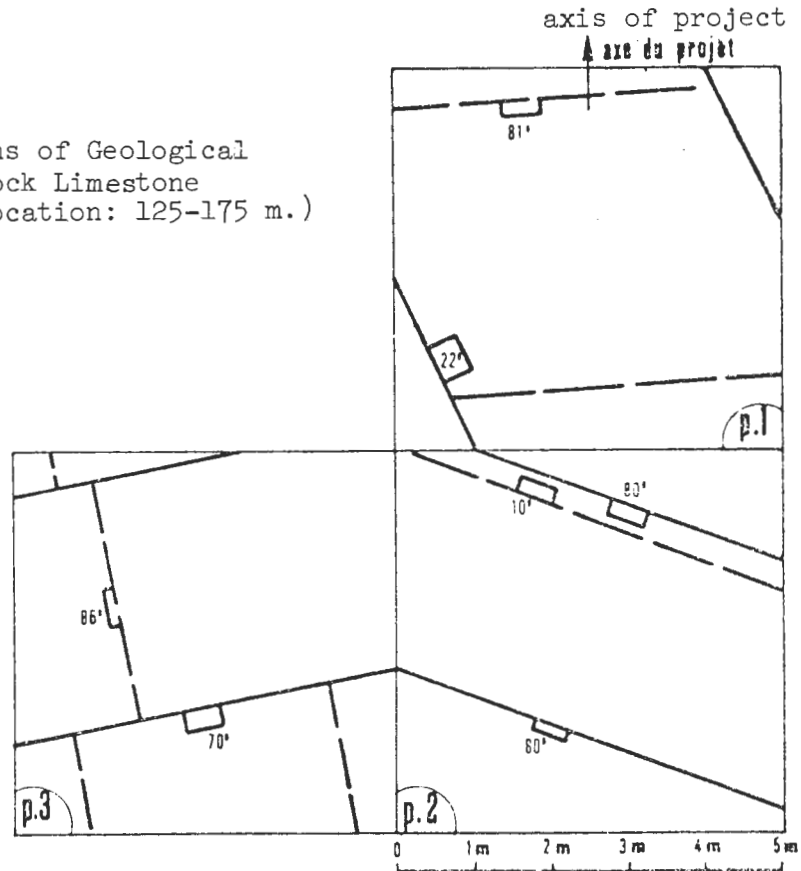

The detailed sections depict the orientation and spacing of discontinuities in different planes. In the example presented here, the chosen planes are:

- P1: Vertical and perpendicular to the tunnel axis (thus coinciding with the working face of the excavation).
- P2: Horizontal and parallel to the tunnel axis (thus coinciding with tunnel ceiling).
- P3: Vertical and parallel to the tunnel axis (thus coinciding with the tunnel sidewalls).

The geological structure is presented in a horizontal plane by projecting P1 and P3.

The angles between the plane of discontinuity and P1, P2, and P3 is inscribed in a rectangle that is, by convention, the projection on P1, P2, and P3 of a square surface contained in the plane of discontinuity, and of which one side is identified with the intersection of the plane of discontinuity and the plane of projection.

#### 4.244 Time Required for the Geological Surveys

The necessary geological studies should be initiated as early as possible.

- \* The compilation of existing data, notably from reports on previous underground construction, and the necessary consultation with the project engineers or interested government agencies can take several months.
- \* The completion of the geological survey by one or two geologists will require varying amounts of time, depending on the topographic conditions and the complexity of the local geology. Climatic conditions should also be considered, since they may extend the geologist's work over several years (e.g., when the tunnel is built in high mountains).

Generally speaking, the time required for the geological survey increases rapidly with tunnel length, depth, and geological complexity. For example, a detailed geological survey of a tunnel 3 km. long, situated in complex topographic and tectonic area, will require six months of work.

#### 4.25 Complementary Studies

A great variety of means is available to the geologists for completing, interpreting, organizing, and possibly even correcting the results of the surface geological survey.

As will be seen in the appendices, geophysics, core samples, and exploratory galleries can make important contributions.

#### 4.3 Hydrogeological Studies

These studies constitute a very important element in tunnel planning.

#### 4.31 Objectives

Hydrogeological studies are usually carried at the same time as are geological studies, namely during the early stages of planning. Employing comparable methods of investigation, these studies should determine:

- \* The location of aquifers and aquitards.
- \* The presence of ground-water (water tables or underground circulation).

- \* The hydraulic characteristics of ground-water (sources, flow, head, seasonal variations, etc.).
- \* The permeability of the terrain.
- \* The possible presence of karsts.

#### 4.32 Expected Results

The interpretation of these findings should permit a more or less accurate definition of the following:

- \* The general nature of ground-water intrusion to be expected along the length of the proposed tunnel.
- \* The head and flow rate of these ground-water sources.
- \* The possibility of drainage or special treatments (especially in the case of soils).
- \* The precautions to be taken regarding the watertightness of the tunnel.

The study of a water table in soils is usually possible and permits a fairly accurate solution to the questions posed above. On the other hand, the hydrology of fissured massifs is less well understood. This complication is exacerbated by the difficulty of determining the exact pattern of the internal fissuring of the massif.

Roughly speaking, a hydrogeological study includes the following elements:

- \* Inventory of existing data.
- \* Surface hydrogeological survey.
- \* Piezometric levels.
- \* In situ experimentation and data collection using core sampling or exploratory galleries.

A minimum delay of one year should be provided in order to allow the observations to cover a complete climatic cycle.

#### 4.33 Inventory of Existing Data

Just as in the geological survey, it is desirable to collect information in the following areas during the early stages of the survey:

- \* The hydrogeology of analogous formations in sites comparable to the one being studied.
- \* Ground-water intrusion encountered during the excavation of similar formations. In this regard, we should bear in mind that certain formations are fairly consistent in their hydrogeological characteristics. Thus, analogical reasoning can be very fruitful here.

The individual in charge of the study should also seek the following:

- \* Information concerning aquifers and the hydraulic characteristics of well understood sedimentary soils similar to those being studied (theses, results of core samples, results of pumping tests, summary documents from the Bureau of Geological and Mining Research or the French Petroleum Institute, etc.).
- \* Examination of reports and analyses of underground excavation in analogous sites (public utilities, railway tunnels, sewers, etc.), indicating the type, frequency, and flow of ground-water.
- \* Inventory of ground-water circulation (geothermal flows, karsts, etc.). It is necessary first to inventory known caves (there is a listing of all known caves in France, published by the BGMR) and then to try to determine the location and flow of underground streams (consult with local spelunking clubs). Visits to these caves can provide the geologist with a fairly precise understanding of the local tectonic and stratigraphic features as well as of local hydrogeological characteristics.

#### 4.34 Surface Hydrogeological Survey

4.341 Carried out at the same time as the surface geological survey, the hydrogeological survey includes:

- \* The location of springs, wells, and other water sources.
- \* The location of infiltration zones (fissured zones, karsts, etc.)
- \* General observation of all phenomena that can contribute to a more accurate determination of ground-water pathways, location of aquifers, type of flow, and flow rate.
- \* Various other measurements (of the outflow from springs, tests to determine the flow rate of wells, determination of ground-water pathways using tracers, etc.). The flow measurements should be taken several times so as to account for seasonal variations.

The synthesis of these results can be fruitful when integrated with geological data.

- 4.342 Predictions concerning the proposed project are usually qualitative and cursory for any site that is not well known, but they can be quantitative and fairly precise in certain homogeneous terrains where information on earlier underground construction is available.

The study should at least bring attention to the difficulties that are specifically attributable to ground-water intrusion (presence of water, location and description of aquifers, risk of encountering underground streams, possible risk of ground-water under head, which can cause the collapse of poorly consolidated or unconsolidated terrain).

#### 4.35 Placement of Piezometers

Exploratory core sampling can provide a good occasion for the placement of piezometers whose proper functioning will have to be verified periodically. It is necessary to employ this technique systematically in soils in order to locate aquifers and determine the shape of the water table. Such information is essential.

The following data should be made as precise as possible:

- \* The height and extent of the water table in the terrain to be traversed by the tunnel.
- \* Interdependence of water tables in various aquifers.
- \* Piezometric levels of water trapped in permeable terrain surrounded by the impermeable soils traversed by the tunnel.

Piezometric measurements should be conducted regularly over a period of at least one year.

The piezometers placed for purposes of project planning can be used during and after construction to monitor hydraulic changes resulting from the excavation.

#### 4.36 In Situ Testing and Data Obtained Using Core Sampling and Exploratory Galleries

A careful study of the core samples usually provides information useful in refining certain hydrogeological data:

- \* Possibility of loss of injected fluids.
- \* Ground-water intrusion in the corings.
- \* Signs of ground-water circulation in the rock fissures, etc.

#### 4.362 In Situ Testing

The quantitative study of aquifers requires in situ testing to determine more precisely the hydraulic characteristics of the terrain (permeability) and of the aquiferous strata themselves (extent, coefficient of stored water, etc.).<sup>1</sup>

From data on drawdown characteristics, it is possible to determine the effective radius of wells, the flow to be expected during construction, the number of wellpoints required to carry out dewatering.

Also, in certain heterogeneous formations (e.g., confined aquifers), these tests will indicate whether there exist any limited reservoirs that are susceptible to rapid draining or if there exist major aquiferous strata that require special treatment.

#### 4.363 Data Obtained from Exploratory Galleries

Data obtained from these galleries are most useful because of their direct applicability. For each formation encountered they permit a determination of the following:

- \* Type of ground-water source (localized, diffuse, etc.).
- \* Flows.
- \* Delays in appearance and location of ground-water movement as a function (especially) of exterior precipitation.
- \* The effect of ground-water intrusion on terrain strength.
- \* Chemical properties of the ground-water and its temperature.

From these exploratory galleries, we can draw conclusions concerning the probable speed of advancement, the necessity of using a boring machine, acceptable delays in erecting supports, and choice of waterproofing method.

#### 4.37 Study of Ground-water Chemistry

The petrographic nature of the terrain encountered will inform us of the presence of any dissolved chemical salts (ground-water in triassic deposits is almost always sulfated; ground-waters in crystalline terrains are usually rich in carbonic acid. Very soft waters can also be very aggressive).

---

<sup>1</sup>See appendices for discussion of Le Franc, Lugeon, and pumping tests.



Examination of the lining of existing tunnels for corrosion or concrecence provides additional information regarding the presence of calciferous, sulferous, or ferrous ground-water.

Samples can be taken from corings or exploratory galleries and then submitted to chemical analysis, thereby permitting a determination of the ground-water's corrosiveness for concrete or certain metals. Such an analysis will also establish the utilizability of the collected ground-water for construction purposes.

The choice of type of cement will be determined by the corrosion resistant properties required of the concrete.

Generally speaking, high shrinkage cements should be avoided.

#### 4.38 Special Case of Karsts

Karsts present difficult problems and thus merit special attention.

##### 4.381 Problems Occasioned by Karsts

- \* Ground-water sources very irregular both in location and flow rate, thus necessitating punctual treatment in order to assure water-tightness of the tunnel.
- \* Risk of intercepting underground streams, an immanent danger to the safety of both personnel and equipment, possibly requiring very substantial drainage, perhaps even a diversion gallery.
- \* Risk of encountering cavities filled with alluvial or clay deposits that can fall into the tunnel gallery.
- \* Risk of advancing tangentially to a major cavity without detecting it, thereby giving rise to the possibility of collapse of the excavation (the principal danger being collapse of vault or floor).

#### Problems Occasioned by Karsts

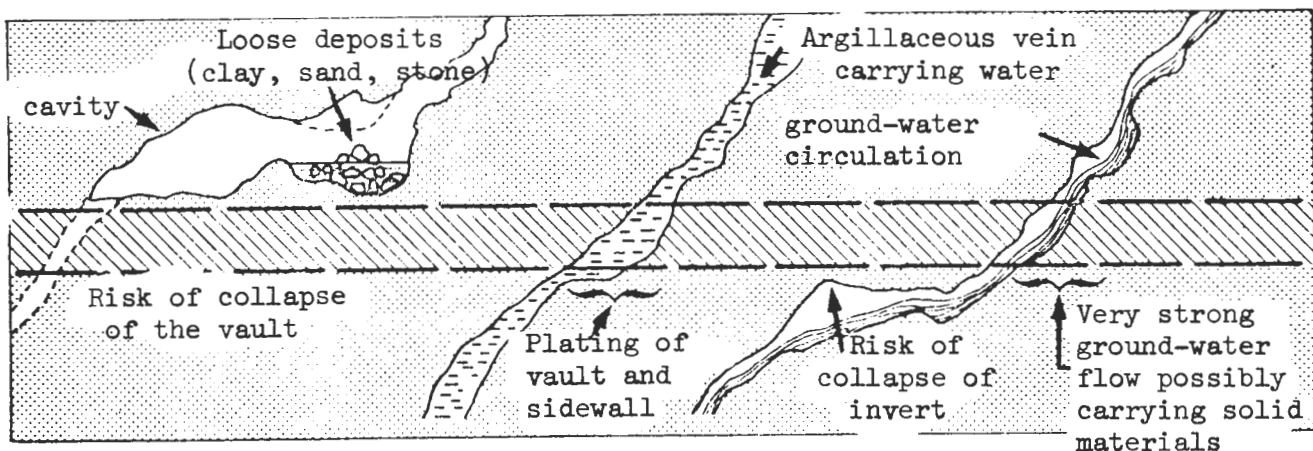

## 4.382 Investiation of Karsts

Before construction, one attempts to locate cavities and underground streams by:

- \* Inventorying and visiting subterranean systems.
- \* Gravimetry, to the extent that this is possible.
- \* Using tracer techniques.
- \* A detailed knowledge of the stratigraphy and principal systems of discontinuity of the massif helps greatly in understanding and locating these underground streams.

During construction, one identifies the more important ground-water flows and karstic cavities,

- \* Ahead of the working face by means of core samples taken through the working face.
- \* Along the periphery of the tunnel by means of core samples taken along radii perpendicular to the tunnel axis, especially through the tunnel vault and floor.

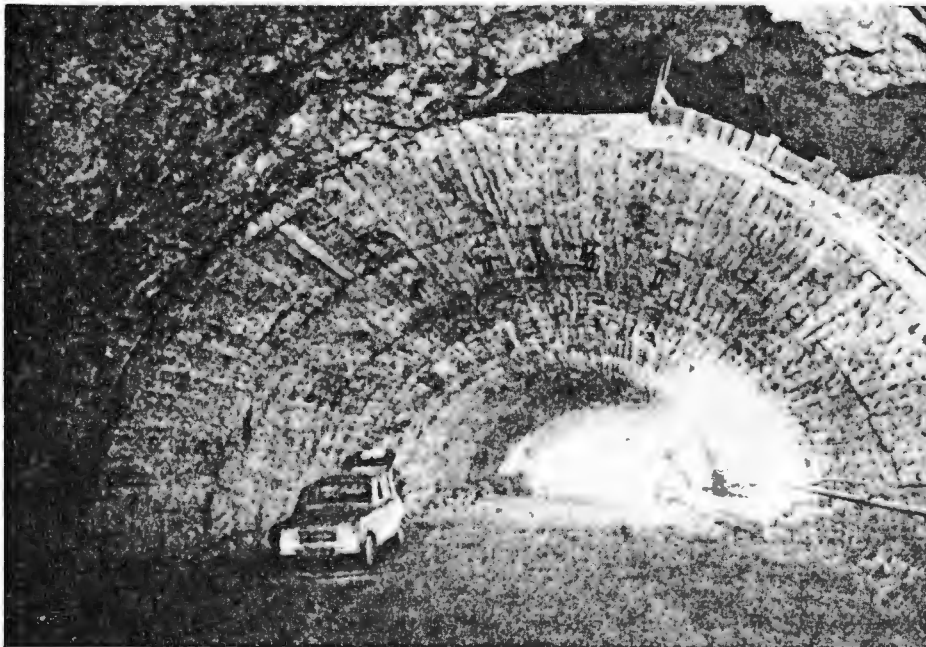

Karstic cavity located in tunnel vault, requiring a cast-in-place concrete underlining.

#### 4.4 Geotechnical Studies

##### 4.41 Objectives

The geological, hydrogeological, and geotechnical studies constitute three complementary aspects of the study of the terrains to be traversed by the tunnel.

The nature and disposition of the terrain traversed by the tunnel are revealed by the geological study which provides a preliminary classification of the terrains. Nevertheless, geological definitions are often imprecise and tend to group under the same heading terrains that are actually quite diverse.

Geotechnical studies should permit:

- \* A more precise description of the terrain.
- \* Predictions regarding both the behavior of the terrain as well as the stability of the excavation during the various phases of construction and after its completion.

In particular, geotechnical studies should provide the data required for the definition of:

- \* Possible construction methods.
- \* Shape and dimensions of the tunnel.
- \* Special precautions that should be taken during construction.

Although the parameters determining the interaction of the terrain and the proposed tunnel are multiple and often poorly understood, and depend not only on geological factors but also on the construction methods employed, it is nevertheless possible to outline in a general fashion the studies to be undertaken for different types of terrain.

##### 4.42 Terrain Classification

The second section of Chapter 3 provides a purposefully simplified classification based on the principal difficulties associated with tunnel excavation and support. Terrains are divided there into three categories: (1) soils, (2) rock that is either soft, heterogeneous, or susceptible to rapid evolution, and (3) hard rock.

#### 4.43 Studies to Be Effectuated in Soils

The major problems posed by the construction of tunnels in soils are related to:

- \* Mechanical characteristics of the terrain traversed.
- \* Presence (or absence) of water-bearing soils at the level of the tunnel.
- \* Consequences of subsidence caused by tunnel excavation, particularly surface subsidence in urban sites.

The classic tests for identifying soils (in particular, granularity, moisture content, Atterberg limits, etc.) should be complemented by the studies discussed below.

#### 4.431 Studies of Mechanical Characteristics

##### (i) Pulverulent soils

- \* The internal angle of friction is the single characteristic that must be measured in order to determine the forces that the tunnel lining must withstand.
- (ii) Very plastic soils, and argillaceous soils of low or moderate plasticity
- \* Short-term characteristics must be ascertained in order to determine the stability of the excavation during successive phases of construction, particularly in order to determine the load-bearing capacity of the soil foundations for the temporary vault supports (for tunnels excavated by half-section method) or for the sidewalls.

Short-term characteristics are determined using triaxial tests on undisturbed samples.

- \* Long-term characteristics provide more precise data on the long-term behavior of soils. In particular, long-term characteristics must be ascertained in order to determine the forces to which the completed tunnel will be subjected, based upon a study of the long-term stability of the soil.

Long-term characteristics are determined using triaxial tests that also measure interstitial pressure.

##### (iii) Highly overconsolidated soils

- \* The most serious problem is that of swelling pressure exerted on the tunnel supports and lining because of an increase in the moisture content of the overconsolidated soil. Generally speaking, one should avoid any modifications in the moisture content of these soils.

In order to estimate the potential swelling pressures, it is wise to conduct compression tests. Nevertheless, the results of these tests cannot be successfully extrapolated in order to deduce swelling pressures of the terrain under consideration, as the in situ conditions will be quite different.

- \* If swelling is expected to be significant, swelling pressures should be determined experimentally in situ by means of a test section in order to estimate potential pressures on the tunnel lining. The rigidity of the test section will influence the measured pressures; by using a sufficiently rigid test lining, the maximum potential pressure can be determined.

(iv) Granular soils

- \* As in the case of plastic soils, shear stress characteristics must be determined.

#### 4.432 Permeability Studies

Terrain permeability is important in determining:

- \* Techniques for treating water-bearing aquifers.
- \* Techniques for improving the mechanical characteristics of (1) foundation soils (stability of tunnel during and after construction), and (2) terrain overlying the tunnel (limitation of surface disturbance, particularly in urban areas).

These two complementary aspects influence the choice of construction method.

The following tests must be conducted:

(i) In situ permeability tests

Permeability tests on samples are unreliable as indicators of the average permeability of the terrain traversed.

In pulverulent or cohesive soils it is necessary to conduct in situ water tests (see Appendix 4). In the case of very plastic soils that are practically impermeable, these tests are of no value.

Depending on the case at hand, these tests will (1) establish the possibility and efficacy of drainage, or possibly of lowering the water table, or (2) guide the choice of soil treatment techniques.

(ii) Possible treatment tests

When the importance of the tunnel or external constraints (e.g., urban site) justify the use of a soil treatment procedure

(injection, electro-consolidation, or a special treatment in the case of very plastic, humid soils -- usually freezing), in situ treatment tests must be conducted in order to ascertain and verify the efficacy of the procedure. Preferably the terrain treated should be observed by means of an excavated shaft or gallery.

#### 4.433 Study of Problems Related to Surface Subsidence

These problems are of three principal types:

- (i) Generalized subsidence occasioned by a lowering of the water table, which can result from a pumping drawdown, or more generally, from the drainage action of the tunnel.

This type of subsidence results both from an increase in effective stresses in the dewatered strata, and in adjacent strata, and from the consolidation of clays.

The prediction of subsidence is difficult, but it is nevertheless possible, using certain simplifying hypotheses, to estimate the order of magnitude on the basis of compression and consolidation tests. In practice these tests are necessary only in the event that a substantial drop in the water table is expected.

- (ii) Instantaneous subsidence, in contrast to the above, results directly from disturbances caused by excavation. Such subsidence is directly linked to delays in placing supports and to the insufficient rigidity of these supports.

Model studies (see Appendix 6) will aid in determining the order of magnitude of this type of subsidence. Yet, because instantaneous subsidence depends heavily on the construction method utilized, successful prediction depends heavily on acquired experience.

- (iii) Localized subsidence of soil foundations.

This type of subsidence is partially included in the preceding types; nevertheless, it is useful to distinguish localized subsidence inasmuch as one is interested in limiting it as much as possible.

Localized subsidence concerns the soil foundations for the tunnel supports, or perhaps temporarily for the vault, sidewalls, and abutments. Moreover, the possibility of deformation of the foundations may necessitate modifications in the construction method for the tunnel lining.

Generally, compression tests on soils of low cohesivity ( $R_c < 2$  bars) are necessary in order to determine the order of magnitude of this subsidence, thus ascertaining its acceptability. In addition, when the predicted short-term subsidence is relatively significant, in situ loading tests should be conducted in a test shaft or gallery on the soil that will provide the foundation for the sidewalls or abutments.

#### 4.44 Studies to Be Effected on Rock That Is Soft, Heterogeneous, or Susceptible to Rapid Evolution

##### 4.441 General Characteristics

###### (i) Characteristics of the Rock

Resistance to simple compression is the principal characteristic. Dry density and moisture content are also important factors.

A petrographic study of the rock along with a determination of its hardness and abrasivity should be made where use of a boring machine is envisaged. These characteristics have an essentially comparable value, and permit an appraisal of the relative merits of various boring machines that have been used in similar situations.

###### (ii) Study of discontinuities

The different types of discontinuities (joints, faults, diaclasses) have a determining influence on the stability of the excavation. Their study is generally conducted in the course of geological studies.

These discontinuities constitute surfaces of least mechanical resistance.

When their unfavorable orientation threatens the stability of the tunnel (particularly in the case of tunnels of large cross-section: rock falls and slides, instability of facing), shear-stress tests should be conducted on samples.

These tests only establish the order of magnitude of the resistance of the joints.

##### 4.442 Special Studies

Some rock poses special problems, and for this reason merits special study.

## (i) Creep

Some rock is subject to creep when subjected to the redistribution of stresses normally encountered near the excavation.

Certain varieties of chalk present this problem, although others are quite fragile even under weak stresses.

Other rock (marls, marly limestones, altered shales) behave similarly, though to a lesser degree.

When there is the possibility of significant deferred deformation, a measurement of terrain pressure should be effected in a test gallery by means of a test section.

## (ii) Alterable Rock

This rock must be submitted to alteration tests.

Subterranean alteration is typically the result either of efflorescence or of internal decohesion caused by the swelling of certain minerals.

The tests involve heating and exposure to oxygenated water; nevertheless, the interpretation of test results is difficult and should be left to a specialist.

## (iii) Marls

Depending on the nature and proportion of swelling clays (argils) that they contain, marls may be susceptible to swelling resulting from an increase in their moisture content. A minerological analysis should be conducted in order to determine (1) the  $\text{Ca CO}_3$  content, and (2) the nature and proportion of argil present.

The minerological analysis in conjunction with compression tests provides data for estimating the swelling potential of the marl.

When swelling will be significant, measurement of swelling pressure should be effected using a test section constructed in a test gallery. This will permit a determination of the pressure that will probably be exerted on the tunnel lining.

## (iv) Anhydrite

The transformation of anhydrite into gypsum is accompanied by an increase in the volume of the rock.

This swelling can result in pressure on the tunnel lining. The significance of these pressures is disputed; however, swelling is not to be feared in a massive anhydritic formation that is free of ground-water.



In all other cases it is wise to conduct swelling pressure tests in a test gallery in the same manner as for marls.

Generally speaking, anhydrite adjacent to the excavation should be protected from contact with water, and no attempt should be made to drain anhydritic formations.

#### 4.45 Studies to Be Effected in Hard Rock

The tests for soft rock described in 4.441 are equally applicable to hard rock.

Nevertheless, a new problem appears in the case of hard rock, when the overlying covering above the excavation is great (i.e., several hundred meters; this figure varies as a function of the nature of the rock and increases with the rock's resistance to compression). The stresses on the excavation facing may exceed the rock's resistance to rupture, causing the rock facing to spall violently. Bolting may be necessary to prevent the spalling of large slabs of rock.

The risk of such decompression can be anticipated by measuring pre-existing stresses in the rock. The most current procedure involves the use of core samples taken from an exploratory gallery. A platform jack can also be used to measure stresses in the immediate neighborhood of the excavation facing. Nevertheless, because this zone has generally been fractured by blasting and thus decompressed, it is difficult to draw any conclusion from jacking tests regarding the pre-existing stress distribution in the undisturbed rock.

For hard rock, the possibility of using the excavated material in the roadway or in concrete should be examined.

---

## Chapter 5. ARTICULATION OF GEOLOGICAL AND GEOTECHNICAL STUDIES

### 5.1 Objectives and Limitations of Present Chapter

In Chapters 3 and 4 above, certain criteria for tunnel design were discussed, as were the studies required of the geologist in order to define those criteria.

#### 5.11 Need for Timetable

From the project engineer's perspective, project planning progresses by successive stages corresponding to the various administrative phases.

The individual responsible for the geological and geotechnical studies should organize these studies in such a way as to assure that at each stage the required information is ready at hand.

#### 5.12 Objective of the Chapter

The present chapter attempts to outline the geological and geotechnical studies within the framework of the planning chronology.

It goes without saying that these remarks are not universally and invariably applicable. On the contrary, it is necessary at each stage of the planning process to review and possibly modify the plans for further studies, considering the possible delays, the possibility of conducting the studies after construction begins, the design and cost of the tunnel, etc.

It is in this spirit that the remarks contained in this chapter are to be understood.

#### 5.13 Limitations of the Chapter

The following tables can be used in the majority of cases (excluding immersed tunnels which require special studies of a different sort).

The uniqueness of each tunnel (length, site, surrounding terrain, covering, etc.) will nevertheless lead the project engineer and the various study groups to emphasize certain aspects of the studies to the neglect of others.

## 5.2 Articulation of the Studies

The studies are divided into three stages, corresponding to the administrative chronology:

- \* The preliminary studies (for the Proposal Document) must identify the various problems associated with the project and provide a rough estimate of costs. Preliminary studies culminate in the choice of a single base solution, and possibly a limited number of variations on that solution.
- \* The Preliminary Project Summary issues from the phase in which a precise solution emerges from the choices between major design options. On the basis of these decisions a more precise estimate of costs is also achieved. These studies must be very comprehensive in order to eliminate the possibility of error in these estimates.
- \* The Detailed Preliminary Project Summary and actual construction no longer represent distinct stages.

The following tables define the content of the studies for each of the stages.

## PRELIMINARY STUDIES

No.	Study Phase	Tasks	Required Results
1	Geometrical study of possible solutions	Envisage every possible solution within a wide band of terrain: <ul style="list-style-type: none"> <li>- no tunnel.</li> <li>- covered (uncovered) trench.</li> <li>- tunnel.</li> </ul>	<ul style="list-style-type: none"> <li>* Geological map (1/20,000 or 1/5,000).</li> <li>* Anticipated longitudinal profile.</li> <li>* General evaluation of possible layouts.</li> </ul>
2	Geological and hydrogeological investigations and analyses	<ul style="list-style-type: none"> <li>* Inventory of existing data.</li> <li>* Study of underground structures in similar sites.</li> <li>* Summary of geological and hydrogeological surveys.</li> </ul>	<ul style="list-style-type: none"> <li>* Inventory of difficulties inherent in each layout.</li> <li>* Difficulties that do not compromise the project, for which approximate cost can be estimated.</li> <li>* Location of portals and approaches.</li> <li>* Major problems affecting the feasibility of the project.</li> </ul>
3	Special study of major difficulties	<ul style="list-style-type: none"> <li>* Precise terrain survey.</li> <li>* Geophysical study.</li> <li>* Core samples.</li> <li>* Study of analogous cases.</li> </ul>	<ul style="list-style-type: none"> <li>* Description of difficulty</li> <li>* Proposed technical solution and its estimated cost.</li> </ul>
4	Choice of possible solutions	<ul style="list-style-type: none"> <li>* Cost estimate for each solution.</li> <li>* General estimate of cost of entire road system.</li> </ul>	<ul style="list-style-type: none"> <li>* Presentation of (1) a base solution, and (2) possibly a limited number of variations on that solution.<sup>1</sup></li> </ul>

<sup>1</sup>As the geological studies cannot consider all relevant factors, the project engineer must determine which variations are feasible.

## STUDIES FOR THE PRELIMINARY PROJECT SUMMARY

No.	Study Phase	Tasks	Required Results
1	Geometrical study of layout for possible variations		<ul style="list-style-type: none"> <li>* Plan (1/5,000).</li> <li>* In urban sites, a more detailed plan (1/2,000-1/500).</li> </ul>
2	Geological, hydrogeological, and geotechnical study of massif:  a) General study:	<ul style="list-style-type: none"> <li>* Detailed geological and hydro-geological surveys:               <ul style="list-style-type: none"> <li>- study of outcrops; core samples; geophysics at the portals; piezometry.</li> <li>- very precise location of geological irregularities.</li> <li>- study of internal geometry of massif (fissuration, stratification, etc.).</li> <li>- geotechnical study (testing of samples).</li> <li>- exploratory or test gallery.</li> </ul> </li> </ul>	<ul style="list-style-type: none"> <li>* Plan, longitudinal profile, and various sections of anticipated geology. Models.</li> <li>* Complete evaluation of water tables and ground-water circulation.</li> <li>* Longitudinal profile with geotechnical identification of terrains.</li> <li>* Proposal regarding the general method of construction and estimate of its cost.</li> </ul>
	b) Study of special problems:	<ul style="list-style-type: none"> <li>* Additional investigations:               <ul style="list-style-type: none"> <li>- core sampling.</li> <li>- exploratory gallery.<sup>1</sup></li> </ul> </li> <li>* Special geotechnical studies:               <ul style="list-style-type: none"> <li>- behavior of terrain.</li> <li>- study of possible treatments (consolidation, waterproofing, dewatering, freezing, special construction methods).</li> </ul> </li> </ul>	<ul style="list-style-type: none"> <li>* Investigation of base solution and estimate of its cost.</li> </ul>
3	Study of approaches	<ul style="list-style-type: none"> <li>* Geological and geotechnical study of portals.</li> <li>* Study of approaches (layout and structures).</li> </ul>	<ul style="list-style-type: none"> <li>* Intersection of layout with terrain.</li> </ul>
4	Precise definition of chosen layout	<ul style="list-style-type: none"> <li>* Synthesis of studies for 1, 2, and 3.</li> </ul>	<ul style="list-style-type: none"> <li>* Layout specified to within 50 meters.</li> <li>* Estimate of construction time and cost</li> </ul>

<sup>1</sup>An exploratory gallery may have been necessary for the preliminary studies.

STUDIES FOR DETAILED PPS AND FOR ACTUAL CONSTRUCTION

No.	Study Phase	Tasks	Required Results
1	Detailed study of portals	<ul style="list-style-type: none"> <li>* Geological and geotechnical studies.</li> <li>* Construction techniques (anchorage, slurry walls, heading methods, etc.)</li> </ul>	<ul style="list-style-type: none"> <li>* Exact location of portals</li> <li>* Time required for preparatory work.</li> </ul>
2	Additional study of terrain quality and construction methods	<ul style="list-style-type: none"> <li>* Additional geological and geotechnical studies:               <ul style="list-style-type: none"> <li>- specification of design assumptions.</li> <li>- strength of terrain traversed.</li> <li>- nature and extent of anticipated support.</li> <li>- presence of ground-water, anticipated solutions.</li> <li>- excavation difficulties.</li> <li>- design and dimensioning of lining and cross-section.</li> <li>- evaluation of injection requirements</li> </ul> </li> </ul>	<ul style="list-style-type: none"> <li>* Detailed study of construction methods and precautions.</li> <li>* Estimated cost based on foregoing (basis for the <u>Request for Proposals</u>).</li> <li>* Required construction time.</li> <li>* Efficacy of possible soil treatments.</li> </ul>
3	Additional study of difficult zones	<ul style="list-style-type: none"> <li>* Experimentation with different methods of handling the problem (<u>in situ</u> tests).</li> </ul>	<ul style="list-style-type: none"> <li>* Proposal of a base solution and estimate of the construction time and cost.</li> </ul>
4	Study of special work-site conditions	<ul style="list-style-type: none"> <li>* Identification of difficulties that will be encountered during construction:               <ul style="list-style-type: none"> <li>- constraints on size of work-site presence of other structures, limited land availability).</li> <li>- limitations on disturbance (surface subsidence, shock).</li> </ul> </li> </ul>	<ul style="list-style-type: none"> <li>* Formulation of relevant clauses for <u>Contract Specifications Document</u>.</li> </ul>
5	Final project study	<ul style="list-style-type: none"> <li>* Synthesis of foregoing studies.</li> </ul>	<ul style="list-style-type: none"> <li>* Initiation of final project review.</li> <li>* Preparation of <u>Request for Proposals and Contract Specifications Document</u>.</li> </ul>

Chapter 6. SPECIAL STUDY OF THE TUNNEL PORTALS6.1 General Remarks

- 6.11 It would be possible to cite a large number of projects where initial estimates of construction time and cost have proved grossly inaccurate because of inadequate portal studies.<sup>1</sup> In some instances the lack of these studies has necessitated a complete change in construction method, indeed in some cases even a modification in the tunnel's layout after construction has begun.

Moreover, by fact of their position, delays in construction of the portals generally delay all other construction as well.

For these reasons, a very detailed study of the portals (and any related problems) must be undertaken simultaneously with the geological and hydrogeological studies of the entire tunnel layout.

A full understanding of the problems presented by the portals is an important factor in determining the choice of layout. At very least these problems are a crucial factor in fixing the extremities of the tunnel.

- 6.12 The study of the tunnel portals, while conducted simultaneously with studies of the tunnel itself, must be treated separately from those studies, because of:

- \* The special problems posed by the portals (strength of the vault in a zone of light cover, which is often unconsolidated; foundations for portal structure; stability of embankment adjacent to the heading).
- \* The means of investigation that are available (more core samples because of the shallow depth, surface geophysics, mechanical tests, etc.).

---

<sup>1</sup>Let us mention, for example, the case of an apparently routine tunnel heading that because of landslides ended up costing an additional 7 million Francs (not including indirect costs resulting from construction delays).

## 6.2 Special Character of the Portals

Tunnel portals must be considered as complex structures whose construction is rendered all the more difficult because a smooth, confident construction routine has not yet been developed. Portal construction typically coincides with the period during which the contractor is testing and refining his construction methods and techniques.

### 6.21 Stability Problems

The portals are very often located in geologically disturbed sites where the nature of the terrain, orientation of planes of discontinuity, and hydraulic characteristics do not favor the different types of stability being sought:

- \* Stability of terrain overlying the heading and of the embankments on either side of the entrance cut.
- \* Stability of foundation terrains for the portal structure itself (sidewalls, revetment, etc.): terrains are usually of poor quality and subject to slides.
- \* Stability of terrain covering the vault when of shallow depth (several meters): Loose soils; highly fractured, altered rock.

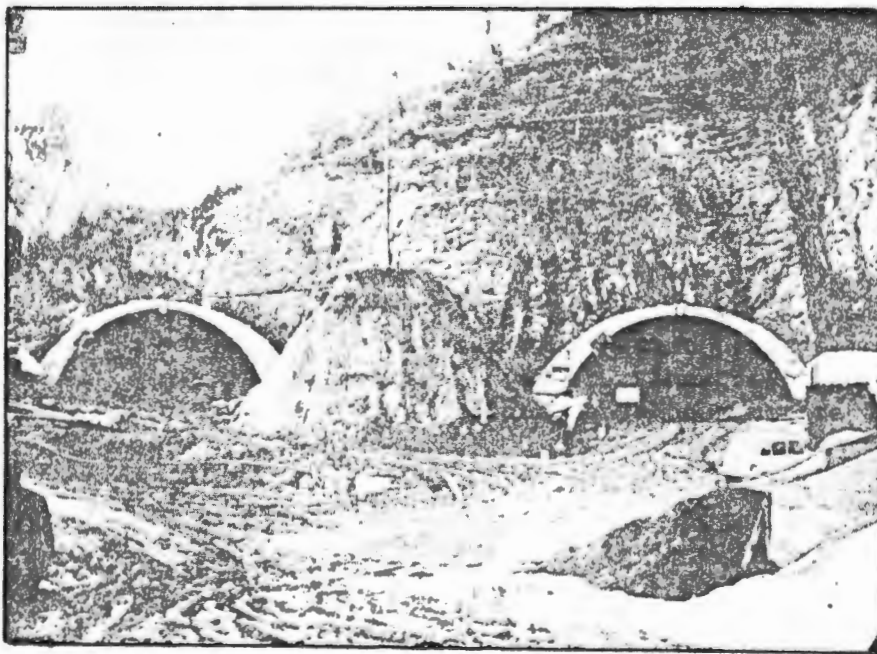

Heading in flysch  
(alternating strata  
of marl and sandstone  
running parallel to  
strike. Instability  
of the apex of vault.



Experience indicates that the major problem is generally that of the stability of the entrance cut to the tunnel.

## 6.22 Types of Headings

There are two major categories of headings:

- \* Headings that are perpendicular to the elevation contours of the slope; this is the most favorable case, as potential problems are limited to the terrain directly overlying the heading.
- \* Headings that are very biased relative to the elevation contours of the slope; in this case major terracing will be necessary, particularly in the case of tunnels having two parallel tubes. Stability of the entrance cut will in such cases be the major concern.

## 6.23 Factors to Be Examined in Every Case

Given the possible consequences of construction in such unfavorable conditions, special attention should be paid to the following factors during construction:

- \* Modifications in the hydraulic equilibrium of the adjacent terrain resulting from the excavation of the heading and entrance cut.
- \* Modifications in the mechanical equilibrium resulting from this excavation.
- \* Effect of shocks caused by blasting.
- \* Very unfavorable consequences of the fact that such a large area is being excavated (e.g., incorporation of ventilation stations into the portal structure, conjoining of portals for each of the two tubes to form a single structure).

## 6.3 Choice of Location for the Portals

The choice of location proceeds chronologically through two distinct stages:

- \* Choice of possible sites (in plan and in elevation) compatible with the general layout of the tunnel.
- \* Choice of actual location for the portal, once the layout has been fixed in plan and in elevation.

### 6.31 Choice of Possible Sites

The general layout of the route served by the tunnel delimits the area in which the best sites for the portals should be sought (in the case of tunnels in open country).

An area that is uniformly unfavorable should in principle be avoided, even if this means a small increase in the length of the route.

The choice of sites is then based on the following criteria:

#### 6.311 Avoid as much as possible:

- \* Avalanche corridors in high mountains; examination of vegetation (often uprooted by avalanches) and advice from mountain guides and specialists provide very reliable information.
- \* Naturally unstable zones that show signs of superficial or massive slides.

Periodic leveling of elevation marks may be necessary in order to detect such instability.

- \* Humid zones. It is wise to avoid the bottoms of thalweg or areas of ground-water sources, for the presence of ground-water can be very troublesome (instability of embankments, loss of grouting or refrigeration, etc.).
- \* In built-up areas, proximity to water services or other such improvements susceptible to damage, with the resulting risk of inondation of the work-site and terrain.

#### 6.312 Seek:

- \* Terrains having good strength near the surface.
- \* A steep slope, where the tunnel covering will increase rapidly with advancement into the mountain.
- \* Favorably oriented formations as regards excavation and stability of slope (if possible, the strike parallel to contour lines, the dip towards the mountain).

### 6.32 Choice of Actual Location for the Portal

This choice arises from the interaction of topographical, geological, and geotechnical data, construction methods, and various other factors:

## 6.321 Topography

A minimal covering of 7-8 m. is generally necessary if one wishes to avoid major difficulties caused by the proximity of the surface (collapse, subsidence, etc.).

## 6.322 Geology and Geotechnology

The nature and disposition of the terrains and ground-water movement are factors in the choice of:

- \* The minimal covering, which depending on the circumstances may be increased (soils, presence of structures) or reduced (good rock in thick beds, or with favorable dip).
- \* The importance of the entrance cut which may be long in good terrains that do not require support or short in unstable terrains covering good rock at a shallow depth.

## 6.323 Construction Methods; Other Factors

The final choice of location can only be the result of a close collaboration between the project engineer and the geologist or geotechnician for the purpose of evaluating many factors:

- \* Direction of tunnel excavation (it is easier to exit than to enter unfavorable terrain).
- \* Construction method for the portals (ground-wall support, grouted soldier piles, timber piles, slurry walls, soil treatments, covered trench, anchorage of rock).
- \* Ancillary structures (ventilation stations, sunscreens).
- \* Possibility (or impossibility) of using certain machinery.
- \* Aesthetic considerations.

6.4 Content of the Studies

Two principal criteria can be retained as the basis of a simple classification:

- \* The environment and site (urban or rural).
- \* The nature of the terrain traversed (debris, loose soil, or rock).

The special problems posed by tunnels in urban sites are treated in detail in Chapter 7. Only those problems related to the nature of the terrain traversed will be mentioned here.

Regardless of where it is located, the portal sites should always be the object of a very detailed geological and geotechnical study that reveals:

- \* The geometry of the relevant formations.
- \* Their geotechnical characteristics.
- \* The discontinuities (fissuration and stratification in rock).
- \* The hydrogeology (as it relates to the geotechnical characteristics).

The various terrain mentioned above will require more detailed studies in order to elucidate the following points:

#### 6.41 For Portals Located in Debris

- \* Nature of the debris -- stone with or without mortar, nature of mortar -- consolidation as breccia.
- \* Depth of debris and topography of slope.
- \* Nature of substratum.
- \* Hydrogeological conditions (catchment basin, sources, water table).
- \* Mechanical characteristics of debris, determined by in situ testing when the granularity of debris permits it (loading tests with the aim of determining the correct dimensions for the sidewall foundations).
- \* Mechanical characteristics of the substratum (in the case of a soil).

These studies will provide practical solutions to the following questions:

- \* Stability of the slope and of the pile of debris.
- \* Behavior of vault, foundations, and sidewalls.
- \* Construction methods and precautions.

## 6.42 For Portals Located in Loose Soils

- \* Mechanical characteristics of the soils and extent of formation.
- \* Location and nature of substratum.
- \* Hydraulic conditions and extent of permeable and impermeable zones.
- \* Possibility of soil treatment.

The desired goals are identical to those mentioned above.

## 6.43 For Portals Located in Rock

- \* Petrographic nature and disposition of different rock.
- \* Orientation and spacing of the stratification and of the different fissures and discontinuities. Thickness of beds.
- \* Depth and nature of alteration.
- \* Mechanical characteristics of the rock.
- \* Hydraulic conditions.

These studies will permit the determination of:

- \* The stability of the portal revetment and entrance cuts.
- \* The strength of the vault, which determines the exact location of the portal along the trace.
- \* Necessary reinforcement.

6.5 Means of Study

The means of study available to the geologists and geo-technical are described in Chapter 4 and in the appendices.

These studies differ essentially from those of the tunnel gallery itself in requiring very precise knowledge of the structure and mechanical qualities of the terrain in question. As a consequence, the exploratory investigation must be much more fine-grained (comparable to that for a major bridge or building).

- \* The geological and hydrogeological surveys must extend over a very large area if they are to ascertain the risk of major landslides.

- \* The geological and geophysical studies, possibly including several core samplings or an exploratory gallery, permit the choice of possible sites during the preliminary studies phase.
  - \* A very detailed study including many core samples, possibly an exploratory gallery, and in situ and laboratory tests is generally necessary during the PFS phase. In many cases full-scale tests of the proposed terrain treatments are also advisable.
-

## Chapter 7. SPECIAL STUDIES FOR URBAN TUNNELS

### 7.1 Special Characteristics of Urban Tunnels

Urban sites and environments usually pose a variety of obstacles to tunnel construction that must be given careful attention during project planning. These peculiarities require special methods of investigation.

#### 7.11 It is useful to recall briefly the special characteristics of urban tunnels:

- \* The tunnel route generally fixed from the outset, at shallow depth, and often located in soil.
- \* Existing structures near the portals and directly above the proposed tunnel trace.
- \* A variety of underground artifacts (e.g., cellars, reservoirs, utilities, subways, etc.) in close proximity to the tunnel.

#### 7.12 These special studies for urban tunnels must, therefore, take account of the following factors:

- \* The urban environment renders surface observations and geophysical studies unreliable.
- \* Rather, exploratory procedures relying on core sampling, shafts, and galleries must be utilized.
- \* Special attention must be paid to the safety of existing structures and services. The studies must therefore:
  - ascertain the risk of subsidence caused by excavation and dewatering (cf. 4.433).
  - specify the means of limiting subsidence (e.g., soil treatments).
  - specify the maximum explosives charge compatible with acceptable vibration thresholds (when explosives will be used during construction).

## 7.2 Content of Studies

From the foregoing it should be apparent that the essential goal of these studies cannot be the choice of the best layout, for that is usually fixed from the outset.

Rather, these studies treat the following four categories of problems:

- \* Structure of the terrain: extent of particular formations, thickness and dip of strata, faults or fractures, etc.
- \* Characteristics of the terrain: nature, strength, permeability, deformation and consolidation characteristics, etc.
- \* Often very important: a study of the water tables and the sources of ground-water.
- \* Location of buried masonry foundations, mapping of utility services and abandoned galleries -- in a word, identification of all underground obstacles.

### 7.21 Geological Study

#### 7.211 Inventory of Existing Data

These data are particularly useful in the case of urban tunnel construction:

- \* First, a map showing the location of underground services, building foundations, etc. is necessary and should be as precise as possible.
- \* Second, voluminous data on the city's subsurface environment (sewers, building foundations, underground parking, shafts, drainage galleries, abandoned quarries, etc.) are generally available. Careful analysis of these data, including any related data on their construction, can be helpful in providing information regarding the geological structure of the terrain, its mechanical characteristics, its behavior during excavation, the hydrogeology of the area, methods of soils treatment, lowering of the water table, etc.

#### 7.212 Surface Geological Surveys

Although the survey should be conducted, most often it will provide little information, since any outcrops will have been masked and the original morphology of the terrain greatly modified by surface development.



### 7.213 Geophysical Investigation

Normally such investigations cannot be employed, or at least they can be employed only under certain special conditions.

- \* Electrical analyses cannot be employed because existing underground conduits and conductors distort the induced electrical field so severely as to render the results uninterpretable.
- \* Seismic analyses are also distorted by existing underground structures, as well as by vibration caused by vehicular traffic, machinery, etc.

Nevertheless, during periods of low traffic density, usually during the night, seismic analyses can be conducted underground between boreholes. (Sensors are lowered into one hole to record the results of a shot in another.)

### 7.214 Core Sampling

This is the best means of gathering data for tunnel projects at shallow depths when knowledge of the mechanical and hydraulic properties of different formations is necessary. These samples can be collected without causing serious inconvenience, as they are constrained only by the location of underground services and certain surface constraints.

- \* During preliminary studies, their spacing should be about the same as for rural tunnels in analogous terrain (approximately one coring per 100 meters).

It is nevertheless possible that the corings will need to be more closely spaced at certain points along the tunnel trace (portals, near large buildings that may be damaged by the tunnel construction, etc.).

- \* For the PPS, the heterogeneity of the terrain may require spacing the corings every 50 m.

For tunnels of sufficient length, transverse profiles of 3-4 corings may suggest modifications in the layout that will take the tunnel through more favorable terrain.

### 7.215 Diagraphy

The use of diagraphy is clearly justified when it is necessary to obtain very detailed information on the structure of the massif to be traversed by the tunnel (see Appendix 3).

## 7.216 Exploratory Gallery or Shaft

Insofar as fiscal constraints do not preclude their construction, exploratory galleries and shafts provide very valuable information to the project engineer who, besides geological and geotechnical data, must collect information on the possibilities of limiting surface disturbance and damage.

The following information can be expected:

- \* Quality of the terrain: a better interpretation of the core samples is possible, as the terrain can be inspected first hand.
- \* Hydraulic changes in the massif (piezometers, interstitial pressure sensors, and pumping tests may provide data that corrects results of the surface surveys).
- \* Surface subsidence (placing of elevation marks that can be periodically leveled during and after construction).
- \* Measurement of shock if explosives will be used in construction.
- \* Possibility of conducting in situ tests (deformability of terrain, etc.).
- \* Possibility of undertaking treatment tests, if such procedures will be necessary.
- \* Pre-drainage of the terrain.

## 7.22 Hydrogeological Study

Besides those general problems related to construction of the tunnel, the hydrogeological study should help resolve questions regarding subsidence caused by consolidation. For this reason, the hydrogeological study is intimately related to the geotechnical studies.

- 7.221 In situ Le Franc and pumping tests are necessary for determining the required treatments (injections, dewatering, etc.) and for predicting the drainage action induced by the tunnel.

If pumping tests may cause subsidence by lowering the water table, surface elevations must be monitored closely during the tests.

- 7.222 In systematic piezometric studies, the use of tracers is helpful in characterizing the water table.

It should be remembered that in urban sites ground-water circulation may be completely unlike that found in rural sites. Theoretically the coefficient of infiltration should be very low, since all precipitation is supposedly collected in storm sewers. In fact, it is necessary to take account of abandoned wells, reservoirs, and water services that are far from watertight. Moreover, there may be considerable industrial pumping during certain seasons of the year.

A complete inventory and inspection of these various circumstances, complemented by piezometric data and chemical analyses of the ground-water, represents the best means of reducing uncertainty in these matters.

### 7.23 Geotechnical Study

The geotechnical study must permit an estimate of the order of magnitude of the anticipated surface subsidence (cf. 4.433).

In the case of soils, the geotechnical study must also provide more precise information on:

- \* The possibilities of consolidation
  - by injection
  - by freezing or electro-consolidation (for very plastic soils having a high moisture content).
- \* The possibilities of waterproofing, where a lowering of the water table is not possible.

Generally speaking, a well-monitored experimental site provides the best means for studying soil treatment methods.

### 7.3 Study of Blasting Shock

If the use of explosives in construction will be necessary, the project engineer should make certain that the blasts will neither cause damage to nearby structures<sup>1</sup> nor cause any subsidence by compaction of the adjacent soils, notably in loose alluvial soils.<sup>2</sup>

- \* During the preliminary studies phase, several shots should be conducted in boreholes, or preferably in a gallery (a better approximation of actual construction conditions). Sensors located

---

<sup>1</sup>Several geophysical firms, private laboratories, and the Agency for Bridges and Highways are equipped to conduct this type of study.

<sup>2</sup>The driving of piles can have similar effects and will, therefore, require similar precautions. Indeed, in many cases pile driving must not be permitted.

at the base of the endangered buildings will provide data establishing the maximum unit charge compatible with the safety of the building.

### MEASUREMENTS OF SHOCK

Recordings of Vibration Velocity  
from Several Different Sensors

Vibration velocity



time

Arrival of shock waves corresponding to the successive micro-retardation of the shots comprising the blast.

The most commonly used criterion is the maximum velocity of the particles during passage of the seismic wave set off by the shot. Depending on the type of structure considered, the maximum velocity permissible will fall somewhere between 10 and 50 mm/sec.

These preliminary studies do not obviate the need for the following two controls:

- \* Verification of condition of adjacent structures before construction begins.
  - \* Measurement of shocks actually produced by the construction blasting.
-

APPENDICES

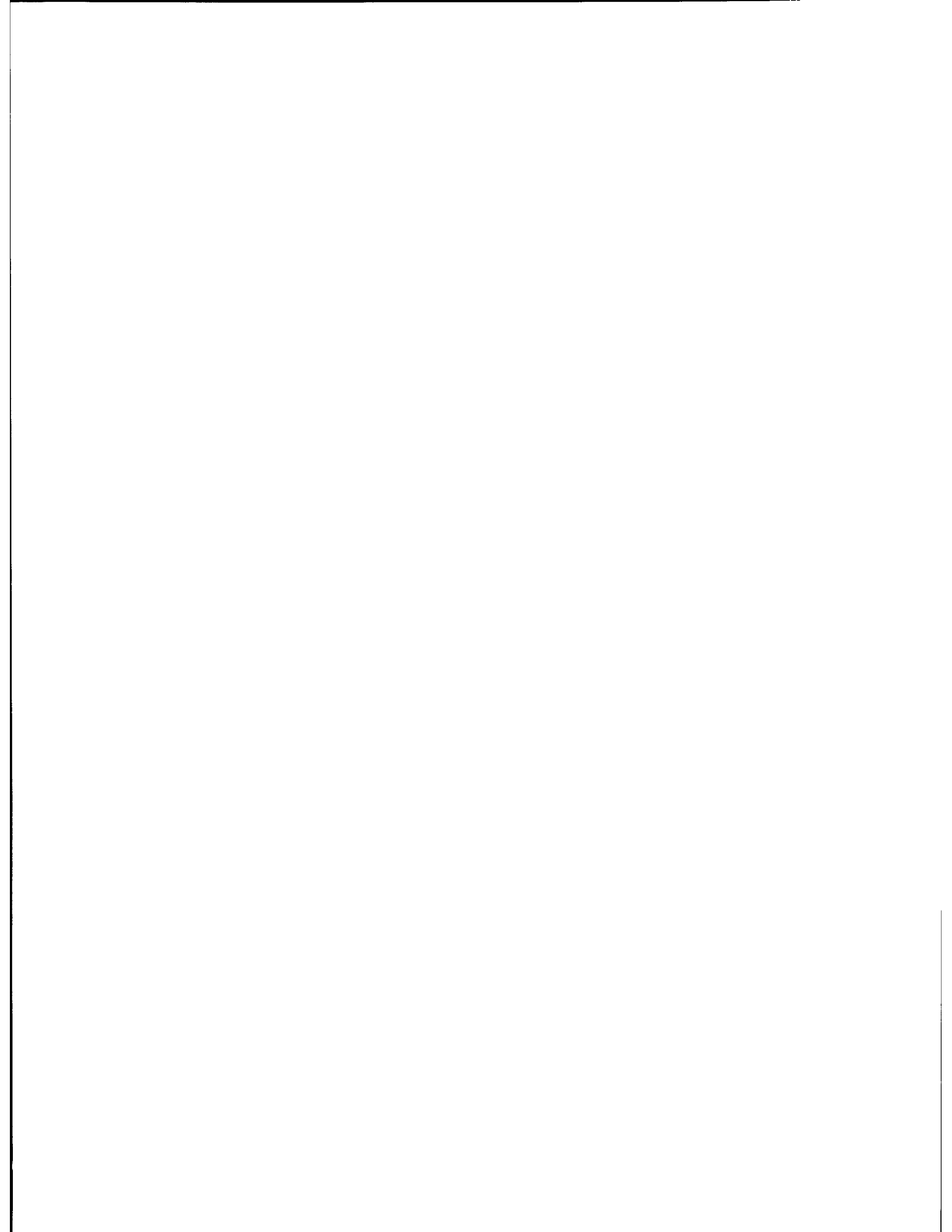

## Appendix 1. SURFACE GEOPHYSICAL METHODS

Within the chronology of studies, geophysical investigation enters as a complement of the geological survey which it refines and completes. As a general rule it provides information on the following problems:

- \* Prediction of the thickness of the altered zone at the portals.
- \* Determination of the geometry of a fault that brings two very different terrains into contact.
- \* Preliminary structural sketch in the case of a site having no outcrops.
- \* Evaluation of consistency of underlying rock.
- \* Facilitated interpretation of subsequent studies.

### 1.1 Limitations of Surface Geophysical Studies

Before indicating the focal interest of the methods currently in use, it must be reiterated that geophysics is unable to provide detailed information. The techniques employed and the distances involved provide only a global perspective on the disposition of the terrains (when they are differentiated).

Although these methods may detect a localized anomaly, they cannot define it with any precision. This is also the case for complex structures that are characterized by small-scale irregularities or variations in the nature of the terrain.

- 1.11 These anomalies are more likely to be detected if they are close to the surface, for their influence on the measuring equipment decreases with increasing depth. For similar reasons, their characterization improves as the contrast of the measured physical property becomes greater.

- 1.12 Generally speaking, geophysical methods are used only in investigations reaching to a maximum depth of about one hundred meters, depending on the required precision.

A geophysical analysis must be systematically calibrated:

- \* On outcrops or in zones whose structure is well known, located in terrains identical to those being studied.
- \* By core sampling.

These methods can hardly be used in urban areas because of parasitic problems (traffic, electric lines, various utility services).

Depending on the problem posed, it is up to the study Agency to decide whether geophysical studies are warranted, and if so what type.

## 1.2 Domain of Application

### 1.21 Electrical Studies

- 1.2-1 These studies measure the thickness or resistance of each stratum, the latter being related to the moisture and mineral contents of the stratum (argillaceous soils exhibit the lowest resistance).

- 1.212 Such studies can be used, for example, to:

- \* Determine the nature and thickness of the soil covering.
- \* Detect a major irregularity in rock, which is filled with argil.
- \* Characterize the different strata (nature and thickness) in soils or in rock and marls.

### 1.22 Seismic Studies

- 1.221 These studies measure the velocity of sound propagation in different strata as well as the thickness of each strata.

Seismic refraction techniques only permit exploration of strata the celerity of which increases with successively deeper stratum. A stratum having a celerity greater than that of the adjacent stratum below will preclude exploration below that depth.



Seismic velocity increases with compactness in soils, and with decreased fissuration and increased hardness in rock.

1.222 Seismic studies can be used, for example, in the following cases:

- \* Search for bedrock under an alluvial covering.
- \* Measurement of the thickness of rock alteration.
- \* Measurement of the compactness of rock (accurate results require calibration against analogous, well known rock or against data from existing underground structures).
- \* Evaluation of a family of fissures by laying out seismic lines parallel with or perpendicular to these fissures and then observing the differences in celerity.
- \* A more refined approach to the problem is obtained by the direct transmission of sound waves between coreholes in the rock to be tested (similar techniques are applicable in any case where as precise an analysis as possible is desired of the properties of a given rock).
- \* Detection of major irregularities (major faults and fractures are marked by a drop in celerity).
- \* Determination of the dynamic modulus (coefficient) of the rock, by measuring the velocity of longitudinal and transverse waves in the rock.
- \* Let us point out that elaborate equipment is necessary for these tests, which is different from the conventional equipment used by laboratories.

1.23 Gravimetry

In certain special cases, gravimetry can be used to detect moderately large cavities located at shallow depths. Remember that this procedure is still in the experimental stage, but has nevertheless provided some useful results in the Parisian Basin.

1.3 Advantages of Geophysical Surveys

Geophysical surveys present three major advantages:

- \* Non-destructive: There is no site installation involved, and when completed, there remains no evidence of the crew's passage (except for the large seismic shots).
- \* Rapid: Depending on the difficulties and the length of the lines, a crew can conduct 205 soundings per day.

\* Low cost: An electric or seismic sounding costs 200-500F for an exploration depth of 50-200 m.

For all these reasons, it is wise to use these techniques whenever possible. The results are obtained quickly and cheaply, thus permitting better organization of the studies and a reduction in the number of more costly explorations that follow.

---

## Appendix 2. CORINGS

### 2.1 Value of Corings

As a general rule, recourse to mechanical coring should be considered only when geological and geophysical techniques have been fully exploited (except in the case of portal studies and for certain very shallow structures).

Let us recall, however, that in certain cases, coring is the only means of terrain exploration (notably in urban zones where terrain surveys and geophysical methods are not practical, or in terrains that cannot be differentiated by geophysical techniques).

### 2.11 Expected Results

The use of corings can resolve the following problems:

- \* Calibrate or refine the results of terrain surveys or geophysical studies.
- \* Provide data on the structure and nature of the terrain if the geological and geophysical studies have not been able to provide these data.

### 2.12 Tests to Be Undertaken

- \* Obtain samples, in order to:
  - determine the nature of the rock or soil.
  - analyze the degree of fissuration and the dip of the fissures, diaclasses, and stratification in rock.
  - conduct certain laboratory tests on the samples (rock and soil mechanics, mineralogical and chemical analyses, etc.).
- \* Conduct diagraphic studies (see Appendix 3).
- \* In situ measurement of stress coefficients and levels.
- \* In situ measurement of permeability, using Le Franc and Lugeon tests (see Appendix 4).

## 2.2 Nature of Corings

### 2.21 Coring Angle

2.211 Vertical corings. These are the most traditional and the easiest. They are generally used in the exploration of:

- \* Tunnels in soils.
- \* Portals.
- \* Shallow tunnels (when data is required at specific points along the proposed trace).
- \* The cover overlying the tunnel.

2.212 Horizontal corings. For the exploration of relatively short tunnels (up to 400 m.) or of irregularities near the portals, this type of coring is very useful. Such reconnaissance parallel to the tunnel axis is useful so long as knowledge of the terrain overlying the tunnel trace is not required.

These corings are economically feasible for distances up to 200 m. using core drills guided by cables in such a way as to limit deviations in the trajectory. The price is about 1.5 times that for vertical corings.

2.213 Inclined corings. In the case of dipping, homogeneous strata, inclined corings perpendicular to the bedding planes will traverse the relevant strata but through a shorter distance. At present, however, horizontal and inclined corings do pose certain guidance problems.

### 2.22 Core Samples

Depending on the research objective, the boreholes may be:

- \* Cored totally or only partially (depending on the location in which one wants to retrieve a sample).
- \* Bored using a drilling tool (triple-headed rotary bit or a non-coring pneumatic drill):
  - if one wants a cheap borehole without samples for in situ diagraphic tests.
  - in zones where the core samples would be of little interest (well known terrain, covering, etc.).

Generally speaking, it is very useful to preserve the corings in order that they be available to contractors during bidding.

## 2.3 Domain of Application of Coring

2.31 For tunnel studies, one should always begin by asking the value of the corings.

Depending on the research objectives, the depth of the tunnel, and the location of underground obstacles, it may be better to excavate an exploratory gallery (cf. Appendix 5 below).

2.32 Nevertheless corings are justified in certain cases:

- \* Terrain stability studies at the portals.
- \* Soil studies for a shallow, urban tunnel (generally about 50 m. in depth, maximum of 100 m.).
- \* When it is necessary to know the nature of all the terrain above the tunnel (e.g., project concerned only with soils, where it is necessary to know mechanical and hydraulic properties of entire massif).
- \* When it is necessary to undertake a detailed diagraphic analysis of a complex structure.

## 2.4 Advantages and Disadvantages of Core Sampling

2.41 Remember that as a linear sampling method, coring can normally provide only punctual (i.e., pointwise) information concerning the tunnel trace.

2.42 The core samples permit visualization of the terrain traversed, providing precise evidence of the terrain geometry and permitting certain identification and mechanical tests.

They are, however, very costly (200F per linear meter for depths less than 100 meters, up to 1000F per linear meter for depths of several hundred meters) and require a construction site that will hinder traffic circulation (in cities) or inconvenience the property owner during the coring operations.

2.43 As a result it is wise to:

- \* Utilize them judiciously, and only after having fully exploited surface geological and geophysical means.

\* Improve their profitability by conducting all useful tests that may be required during later stages of project planning. In particular, the boreholes should be systematically equipped with piezometers, even if they have not been drilled for this purpose.

2.44 The spacing of the corings is determined by the problem at hand, the heterogeneity of the terrain, the depth of the corings, and availability of drilling locations.

By way of example, a shallow tunnel, located in soil at a depth of 50 m., requires a coring approximately every 75 m.

---

### Appendix 3. DIAGRAPHY

#### 3.1 Definition of Diagraphy

This term designates certain exploratory methods that make use of boreholes; the resulting measurements are called "logs."

The types of diagraphic analysis most frequently used in civil engineering applications are:

- \* Sonic log: Measure of the seismic velocity of the formation traversed by the borehole.
- \* Electrical log: Measure of the resistance of the formation.
- \*  $\delta$ -ray log: Measure of the natural radioactivity of the soil, related to the presence of radioactive isotopes absorbed by argil.
- \* Neutron log: Measure of volumetric moisture content, based on neutron absorption rate.
- \*  $\delta\delta$  log: Measure of the specific density of the soil, based on a  $\delta$ -ray diffusion principle.

#### 3.2 Uses of Diagraphy

These measurements can be conducted in boreholes from which no core samples were taken in order to provide information on the different physical characteristics of the terrain traversed.

Their major value, however, lies in their use as a less costly means of locating geological irregularities or providing more detailed information regarding a particular structure, using less costly drilling techniques that do not require taking a core sample.

Remember that they must be calibrated in boreholes where core samples were taken; hence they do not eliminate the need for core sampling altogether. Rather they allow for its limited use.

### 3.3 Advantages of Diagraphy

Non-cored drilling is very cheap (20-30F per linear meter); therefore diagraphic techniques can be effectively used in detailed studies where it is necessary to evaluate a complex structure at many points.

Diagraphic equipment is very light and can be easily transported in a light vehicle. The diagraphies are completed very rapidly (a crew can complete several hundred meters per day).

---



## Appendix 4. GROUND-WATER TESTS

The most commonly employed techniques fall under the following three types of tests:

### 4.1 Le Franc Tests

These tests are in principle quite simple, allowing a determination of soil permeability using boreholes. In practice, however, the tests are quite sensitive, and their interpretation can be difficult. They require the presence of competent personnel.

### 4.2 Lugeon Tests

These tests were conceived as a means of evaluating the potential watertightness of rock underlying dams that could be expected as a result of injection treatment. They are presently used in other civil engineering areas in order to evaluate the water absorption characteristics of rock, thereby yielding an indication of its permeability, degree of fissuration, and the nature and behavior of the materials filling the fissures. This very simple test can be conducted simultaneously with coring.

### 4.3 Pumping Tests

These are the only tests that provide an accurate characterization of aquiferous water tables. They require a large diameter borehole (200-600 mm.), powerful pumping equipment, and the placement of many piezometers. They comprise the final step in a hydrogeological study and should be carefully positioned on the basis of a synthesis of all data gathered in earlier investigations.

The results of the pumping test provide an overall evaluation of the characteristics of the water table in the aquifer, one that is more representative than that provided by the LeFranc test.

---

## Appendix 5. GALLERIES

There are two general types of galleries:

- \* An exploratory gallery constructed in order to locate or characterize a difficult zone, or in order to provide data indispensable for an understanding of the terrain's structure. The gallery need not be situated directly on the trace of the proposed tunnel; indeed, it may be constructed during preliminary planning for the purpose of helping determine the layout of the proposed tunnel.
- \* A pilot gallery constructed along the tunnel axis for the purpose of verifying and completing the preliminary studies. It can be excavated before construction begins, or before construction has advanced into a region of geological irregularity that may present serious difficulties.

### 5.1 Value of Galleries

Generally speaking, these galleries have the following advantages:

- \* The terrain can be observed under conditions corresponding to those of the proposed construction (fissuration, strength, ground-water circulation).
- \* The cost -- 700-1500F per linear meter -- is comparable to that per linear meter for corings at depths of several hundred meters.
- \* The test samples are much more representative.
- \* Very important in situ tests can be conducted:
  - tests of full-section excavation methods.
  - tests of blasting techniques.
  - examination of behavior of alterable or evolving terrain.
  - treatment tests on unstable soils (drainage, injections, etc.).
  - geotechnical tests (stress measurements, etc.).
  - measurement of stress on a test section of concrete lining.

\* The gallery may prove useful during construction for:

- transporting materials.
- drainage (e.g., in a karstic area).
- ventilation (e.g., in a very long tunnel).
- intermediate headings.
- treatment of zones of poor terrain.

## 5.2 Location of Galleries Relative to the Proposed Tunnel

In most cases the galleries are situated parallel to the axis of the proposed tunnel. There seems to be no favored position relative to the cross-section itself of the proposed tunnel.

The cross-section of the exploratory gallery is so small (5-8 m<sup>2</sup>) as to be almost negligible compared to that of a highway tunnel. Thus, any savings in excavation costs that might be realized by situating the gallery within the cross-section of the proposed tunnel will be fully outweighed by the problems that can arise if the gallery is badly situated within that cross-section.

It seems advisable, therefore, if a construction method for the tunnel has not been adopted, to situate the gallery outside of the proposed cross-section, at a sufficient distance to avoid all mutual interference.

It is also possible that construction of the exploratory gallery can be justified precisely because of its location outside of the tunnel cross-section (e.g., on the lower side of the tunnel if there is risk of major ground-water flows, or on the upper side of the tunnel if there is need to drain an aquifer situated above the tunnel).

## 5.3 Relative Value of Galleries and Corings

Each case is unique, and the choice of a gallery or corings for exploratory purposes can depend on many factors.

Nevertheless, it seems that:

- \* For rather shallow tunnels, corings are preferable, since it is important to know the nature of all terrain situated above the tunnel.
- \* For very deep tunnels in rock (more than 100 m.), a gallery is preferable if important uncertainties remain regarding the terrain.

Other considerations are also relevant:

- \* A shallow coring (less than 100 m.) is about 3 times cheaper per linear meter than a gallery in good terrain and about 8-10 times cheaper than a gallery in poor terrain, although the quality and quantity of the results to be expected are much poorer.
  - \* A deep coring (several hundred meters) is no cheaper than a gallery in rock; as well it provides only punctual (pointwise) data that are often difficult to interpret.
-

## Appendix 6. MODEL STUDIES

### 6.1 General Considerations

- 6.11 Models can be used in studying certain problems posed by major underground construction (large cross-sections, long tunnels) or difficult construction conditions. On a theoretical plane, model studies provide more precise data on stress and deformation conditions obtaining in terrains as a result of excavation, as well as on the forces to which the structures will be subjected.

Their value is not in providing quantitative results, for the simplifying hypotheses (that one is obliged to adopt) render such results unreliable. Rather, the models permit an evaluation of the relative importance of different parameters, and thereby provide a better basis for the different choices that will be required during the planning and construction of the tunnel.

- 6.12 The following major problems are amenable to model study:

- \* Instantaneous or deferred surface deformation: this problem is important only in the case of urban tunnels constructed at shallow depths in soils.
- \* Stress concentrations that develop around tunnels. This problem is unique to unusual structures (large cross-sections, special cross-sectional profiles) under heavy covering.
- \* The mutual interaction of two neighboring tunnels, including a study of their relative positions.

### 6.2 Mathematical Models

These models employ methods of finite element analysis. They permit a determination of the distribution of stress and deformation around a tunnel situated in what is generally assumed to be an elastic, homogeneous terrain. The results are applicable to a set of discrete points corresponding to the intersections in the grid that constitutes the model. These models require the use of a computer of sufficient storage capacity. Although possible, the modelling of heterogeneous terrains (strata having different coefficients of elasticity) greatly complicates the analysis.

### 6.3 Photoelastic Models

Unlike the foregoing models, these are continuous models. They can provide without added complication a good description of the stresses on the gallery facing, assuming that the photoelastic material used in the model meets certain conditions. These models are well suited for studies of elasticity problems.

It is also possible to represent the forces of masses, and in particular to take account of the weight of overlying terrain in the case of shallow tunnels. Nevertheless, the use of these models is more difficult.

### 6.4 Scale Models

Although widely used in other civil engineering applications, scale-modelling techniques still enjoy only a limited use in the study of terrain equilibrium. These techniques are more advanced in certain foreign countries.

The major difficulties center on the similarity conditions, and require substantial research in modelling and material science.

---

Appendix 7. GLOSSARY OF TERMS

<u>Consolidation:</u> (treatment for)	Procedures for improving the mechanical characteristics of terrains, either temporarily (e.g., by freezing) or permanently (by injection treatments).
<u>Diaclases:</u>	Surface of fragile rupture, but without any relative displacement along the rupture surface.
<u>Discontinuities:</u> (in massive rock)	Surfaces separating the juxtaposed blocks that constitute the massif (whether faults, diaclases, stratification, schistosity).
<u>Facing:</u> (of an excavation)	Interior surface of the excavated gallery.
<u>Fault:</u>	Rupture surface accompanied by relative displacement of the two rock surfaces. Often accompanied by brecciated zone.
<u>Irregularity:</u> (geological)	Localized zone of very poor terrain characteristics relative to adjacent terrain: brecciated zone, ground-water under head, fault, etc.
<u>Joints:</u>	Term designating both the discontinuity, taken as a geometric surface, and any materials filling the discontinuity.

Karst:

Result of dissolution phenomena in limestone massifs: enlargement of discontinuities, creation of large cavities as a result of ground-water infiltration. Ground-water often flows freely in underground streams.

Schistosity:

Discontinuity in metamorphic rock (schist, gneiss, micaceous schist) related to the anisotropic transformation of the original rock, or to pre-existing discontinuities in that rock.

Test Section:

Supported section of a gallery, generally several meters in length, used for conducting certain geotechnical tests and measurements.

Terrain Sealing:

Treatment procedure that results in a significant lowering of a terrain's permeability, but without effecting any noticeable improvement in its mechanical characteristics.

---



Section 2. CONSTRUCTION

---

1. Preface . . . . .	90
2. Choice of Construction Method . . . . .	92
3. Nature of Terrain . . . . .	98
4. Urban Sites . . . . .	107
Appendices . . . . .	112

## Chapter 1. PREFACE

### 1.1 Importance of Studying Construction Methods

This document will establish that there are strong interactions between the adopted method of construction and the following factors:

- \* Nature of surrounding terrain
- \* Urban sites and environments
- \* Geometry of tunnel and approaches

1.11 An analysis of these factors (which vary in importance depending on the circumstances) serves to limit the range of acceptable construction methods.

1.12 Conversely, recourse to any one construction method will require certain precautionary measures (often fundamental and costly) that cannot be defined without preliminary study, and, indeed, will often necessitate full-scale in situ testing (e.g., test galleries, testing of terrain treatments, etc.).

1.13 If, in practice, numerous technical arrangements -- even, perhaps, the construction method itself -- are often defined or modified in the final stages of construction planning, it should be remembered that the analysis of technical and financial studies for the tunnel project cannot be dissociated. In fact, it is important that planning for the project make use of synthetic studies capable of furnishing clear and concrete information.

### 1.2 Significance of the Modalities of Construction

#### 1.21 Preliminary Operations

Once the general method of construction has been defined, it is imperative to know that the modalities of this method are subject to modification during construction if contingencies should require it.

Thus, it is important during the study stage to anticipate the potential difficulties that may be encountered, even if it is not yet possible to localize or define them with any degree of precision.

Thus, it is also important to select a construction method that can be adapted to the anticipated difficulties.

#### 1.21 During Construction

Attention should be directed towards both the modalities and phases of construction.

It is wise to remember that the transitory phases of construction are typically the most threatening to the stability of the tunnel (e.g., clearing operations at the working face, underpinning of the vault, stability of abutment foundations prior to installation of inverts, etc.).

It should be added that inattention to geological data, disorder, and negligence during excavation may have a significant affect on the quality and cost of the project.

#### 1.3 Object of this Document

This document cannot provide the engineer with all the answers to questions arising from the study and construction of underground tunnels. Such a goal would be pretentious, and, in any case, there are specialized texts dealing with these subjects.

It should be further stated that a detailed study of construction methods is the responsibility of the contractor, since the government agency's role is limited to defining the general character of a base solution and then evaluating the different proposed solutions.

Consequently, persons using this document will find a rapid analysis of the reasoning process and the relevant factors entering into it. Information contained in the appendices will provide some understanding of construction methods currently in use.

As a result of rapid technological progress, this information must be revised and augmented regularly. Only the more conventional excavation methods are considered here, though this focus is in no way meant to prejudice those innovative procedures which are presently in the experimental stage.

---

## Chapter 2. CHOICE OF CONSTRUCTION METHOD

The choice of a construction method (or family of methods) does not follow any simple rule; in each case it results from the combination of a certain number of interdependent factors that determine a limited group of possible solutions.

### 2.1 Selection Factors

Among these factors, whose relative importance varies depending on the circumstances, three can be distinguished by fact of their influence on tunnel design and construction method. As well, both have a direct influence on tunnel cost. It is therefore important that each of these factors be the object of a systematic analysis from the very outset of preliminary planning.

#### 2.11 Nature of Terrain

This is the prime factor, encompassing not only the geology of the terrain to be traversed, but also the hydrogeological conditions of that terrain. The latter are of special importance in soils.

Terrain considerations will be discussed in detail in Chapter 3.

#### 2.12 Tunnel Site and Environment

Constraints imposed by the site are especially marked in an urban area, where recourse to special construction methods and precautionary measures will generally be necessary.

This factor will be discussed in detail in Chapter 4.

#### 2.13 Tunnel Geometry

Various considerations are likely to guide the dimensioning of the tunnel floor, the choice of layout, longitudinal profile, and cross-sectional profile. Information on this subject is provided in the Summary volume.

2.131 Choice of a construction method may have a decisive influence on:

- \* The longitudinal profile, notably in the following cases:
  - Subfluvial or submarine passages (see Appendix 7).
  - Projects anticipating substantial ground-water infiltration (requires an ascending heading).
  - Projects remaining above the water table (e.g., a covered trench) and consequently obliged to conform to variations in the height of the water table along the tunnel trace.
- \* The cross-sectional profile. Whatever the construction method adopted, it is generally desirable to seek a tunnel cross-section that will be as compatible as possible with fiscal and geological constraints.

Once these factors have been taken into consideration, the chosen construction method will to some extent dictate the cross-sectional profile, as the following table indicates:

Construction Method	Typical Cross-section	Cross-section Acceptable in Unusual Circumstances
Full-section	Horseshoe <sup>1</sup>	Flattened arch
Half-section	Horseshoe	Flattened arch
Divided-section	Horseshoe, circular, or flattened arch	
Boring machine	Circular	
Driving shield	Circular	Vaulted arch
Covered trench	Rectangular	Vaulted arch
Prefabricated caissons	Rectangular	Circular

<sup>1</sup>It should be reiterated that a "horeshoe" cross-section is not generally recommended for tunnels of more than 3 traffic lanes.

2.132 Conversely, inasmuch as the geometric characteristics of the tunnel are fixed from the outset by criteria other than those dictated by the construction method, the choice of construction method may well be determined by these other criteria.

Such is the case, for example, when passage through aquiferous terrain cannot be avoided.

It is necessary in every case to decide at the very outset of preliminary planning on the function and geometric characteristics of the projected route.

This presupposes that the project engineer will have a thorough knowledge of the consequences of his decisions as regards possible construction methods, and vice-versa.

## 2.2 Selection Process

### 2.21 First Phase

In the first phase, selection results from a dialectical consideration of the following exigencies:

- \* Surrounding terrain
- \* Site and environment
- \* Geometry
- \* Construction method itself

The resulting reasoning process, deriving more from successive approximations than from a well-defined deductive logic, should at each stage lead to an evaluation of the economic feasibility of the entire investment (including approaches, expropriations, user costs, etc.).

This process will be more or less detailed depending on the complexity of the project under consideration; it results in two or three acceptable technical variants.

### 2.22 Second Phase

At this point the study should focus primarily on those variants that will best assure the following conditions, in order of decreasing importance:

- \* Uniformity of method along the entire length of the tunnel (as changes in method are invariably time-consuming and costly). It should be reiterated that in France heterogeneous terrain is the rule rather than the exception.

- \* Flexibility of use (in such a way as to be adaptable to unforeseen difficulties).
- \* Limitation of damage to the environment, notably in urban sites.

### 2.23 Third Phase

Finally, at the time of final selection, further criteria come into play, such as those linked to market conditions, the technical capabilities of contractors, project costs, etc.:

- \* General market conditions and the size of the proposed construction.
- \* Technical capabilities of competing bidders (specialized personnel, jumbos, boring machinery, and availability of materials).
- \* Overall allowed construction time.
- \* Cost of chosen solution.

In the case of underground construction, the selection process must remain flexible, as the solution proposed by the project engineer is rarely the only possible one. In certain cases it is advisable to authorize bidders to submit variant solutions. In order to assure sufficient technical quality of the different submitted proposals, the principal characteristics of acceptable variants should be specified in the contract specifications document. For example, in an urban zone the project engineer should specify the maximal allowable disturbance consistent with the environment, and bidders should be required to show that their proposed variants meet the required safety standards. This presupposes that possible solutions have been sufficiently examined during preliminary planning to permit the project engineer to evaluate accurately each bidder's proposal. A detailed study of the different solutions (construction method and organization of the work site) remains the responsibility of each bidder.

It is evident that the quality of the solutions offered by the various bidders, and consequently the quality of the completed tunnel, the adherence to safety standards, and the required construction time are a direct result of both the quality of the studies furnished by the government agency and the time granted bidders for submission of their proposals.

### 2.3 Applicability of Construction Methods

Considering the complexity of the problems under study, the information provided in this document cannot but be very general, limiting itself to a succinct explanation of the essential characteristics of each method.

- \* Covered trench:
  - Provides great flexibility in urban zones. Can be used at entrances of excavated tunnels in the event of terrain instability.
  - Does not avoid difficult problems of structural subsidence and stability, which are typically encountered in all underground construction.
- \* Prefabricated caissons:
  - Used in subfluvial or submarine passages.
  - Avoid the difficult and often ruinous problems of passage through an aquiferous terrain.
  - Major difficulty is with foundations for the caissons.
  - Impossible to use if there are overly strong fluvial or marine currents.
- \* Special Treatments:
  - Often indispensable in soils below the water table. Because they are usually very costly, required treatments should be taken into account in early cost estimates.
  - Enable the use of a more economical excavation method, by inducing a greater strength in the surrounding terrain.
  - Reduce risk of collapse.
  - Always require consultation with appropriate specialists.
- \* Full-section:
  - Suitable for very good terrain, requiring no systematic support, except possibly bolting, which consequently results in low excavation costs.
  - Permits the use of heavy construction equipment, thus enabling more rapid advancement.
  - Adaptation is sometimes difficult if a major geological irregularity is encountered (depends on machinery employed).



- \* Half-section:
    - Suitable for terrains that require systematic support (bolting or steel ribbing), consequently results in higher costs. (Terrains usually classified good to difficult.)
  
  - \* Divided-section:
    - Suitable for very heterogeneous terrains of poor or very poor quality, which in any event necessitate delicate and onerous operations.
    - Very slow advancement as construction safety is the prime objective.
  
  - \* Boring machine:
    - Presently well-adapted for small and large cross-sections in terrains ranging from soft to moderately hard ( $R < 1200$  bars). Well-suited for urban zones and long tunnels in homogeneous terrain.
    - Extremely inflexible in the face of geological irregularities or in heterogeneous terrain.
    - Significant advancement rates, but at the present time there are lengthy manufacturing delays and substantial transportation difficulties.
    - At present, operating expenses are difficult to estimate.
  
  - \* Driving shield:
    - Slow, cumbersome method used in poor or very poor terrains, whether pulverulent or plastic, aquiferous or otherwise. As a consequence, use of a driving shield results in very costly and slow advancement.
    - Often indispensable when for various reasons preliminary treatment of the terrain has not been provided for.
-

## Chapter 3. NATURE OF TERRAIN

### 3.1 Classification of Terrains

By limiting this study to excavated tunnels, which are at once the most common and, generally speaking, the most difficult, it is possible to establish a correspondence between geological and geotechnical characteristics, on the one hand, and construction methods and difficulties, on the other.

A schematic classification in the form of three tables is provided below; this presentation is in no way intended to cover the multiplicity of cases which abound in nature.

The indicated thresholds ( $R_c$ ) are provided by way of illustration; in particular, the 300-bar threshold may be greatly exceeded in the case of rock susceptible to evolution, whose resistance to compression is in this case not the principal criterion to be considered.

The last column of each table gives the terrain classification from the point of view of construction costs (see the Cost volume).

Classification of soft rock:  $5 \text{ bars} < R_c < 300 \text{ bars}$ , or rock susceptible to rapid evolution

Nature of rock	Stability of excavation	Usual excavation methods	Classification of terrain
<p><u>Soft rock</u>: chalk, soft sandstone, marly limestone</p> <ul style="list-style-type: none"> <li>- non-aquiferous massifs</li> <li>- fractured,<sup>1</sup> non-aquiferous</li> <li>- Fractured,<sup>1</sup> aquiferous</li> </ul>	<p>Excavation is generally easy. Support is not obligatory (depending on depth and section).</p> <p>Support during excavation is necessary.</p> <p>Excavation rendered difficult by presence of ground-water, which impairs mechanical resistance of rock and can turn rock to mud under tunnel floor. Support with lagging is usually necessary. If there is significant water pressure, lagging above working face may prove necessary.</p>	<p>Half-section. Ideal terrain for boring.</p> <p>Half-section.</p> <p>Divided-section or use of a driving shield. Consolidation methods sometimes used.</p>	<p>Very good to good.</p> <p>Difficult.</p> <p>Poor to very poor.</p>

<sup>1</sup>"Fractured massifs" refer to formations where average distance between the various fracture planes is very much less than the width of the gallery.

Nature of rock	Stability of excavation	Usual excavation methods	Classification of terrain
<p><u>Altered rock:</u></p> <p>- non-aquiferous</p> <p>- aquiferous</p> <p><u>Marls,<sup>2</sup> Anhydrites:<sup>3</sup></u></p> <p>- non-aquiferous</p> <p>- aquiferous</p>	<p>Excavation usually easy. Support necessary.</p> <p>Support with lagging; rapid protection after excavation in order to avoid evolution.</p> <p>If there is significant water pressure, lagging above working face may prove necessary.</p> <p>In general, good consistency for excavation.</p> <p>Apt to develop swelling pressure on tunnel support and lining. Need for immediate protection after excavation.</p>	<p>Half-section.</p> <p>Divided-section. Use of a driving shield. Consolidation methods sometimes necessary.</p> <p>Half-section.</p> <p>Half-section.</p>	<p>Difficult.</p> <p>Poor to very poor.</p> <p>Good.</p> <p>Difficult to poor.</p>

<sup>2</sup>In the case of marls, the most expedient work-site precautions include eliminating ground-water in tunnel invert, providing for the rapid placement of an underlining, and choice of a cross-section capable of withstanding exerted pressures (circular section or vaulted section with countervaulted invert, possibly reinforced).

<sup>3</sup>Anhydrites are more controversial, as they are not well-known. In the event one expects to encounter anhydrite during construction, it is advisable to drive a test gallery in order to observe its behavior. The precautions to be taken during the course of construction are analogous to those indicated in (2) above, although an underlining will not always be needed. Excellent results have been obtained without recourse to an underlining by painting the rock surface with a bituminous product.

Nature of rock	Stability of excavation	Usual excavation methods	Classification of terrain
<p><u>Sedimentary formations</u> with alternation of rocks of differing hardness (e.g., marl-limestone, flysch, certain sandstones, etc.)</p> <p>Terrain is generally diaclastic (particularly the harder strata).</p> <p>- non-aquiferous</p> <p>- aquiferous</p>	<p>Support necessary during course of excavation.</p> <p>The softest parts may evolve rapidly. Need for support and immediate protection after excavation.</p>	<p>Half-section.</p> <p>Half-section or divided-section.</p>	<p>Difficult.</p> <p>Difficult</p>

General observations regarding soft rock:

- These terrains require erection of support soon after excavation, and sometimes of an underlining (cast-in-place or shotcrete).
- They can be worked with a pneumatic drill or boring machine (cutting type) without recourse to explosives.

Soils:  $R_c < 5$  bars

Nature of rock	Stability of excavation	Usual excavation methods	Classification of terrain
Pulverulent soils below water table (soil lacking cohesive strength with high permeability).	Requires: - complete lagging (including above working face). - or preliminary treatment of terrain. (This allows subsequent use of any construction method.)	Soil treatment and conventional methods. Driving shield with lagging above working face. Recourse to compressed air in the event of untreated terrain.	Very poor.
Very plastic soils with high moisture content.	Difficult treatment. Special methods (freezing, electroconsolidation, etc.).	After freezing, use of driving shield or possibly boring machine). Divided-section heading.	Very poor.
Dry pulverulent soils	Forepoling and lateral lagging.	Soil treatment (injections). Divided-section. (Driving shield.)	Poor.
Argillaceous soils, low or moderate plasticity, moderately consolidated.	Forepoling and lateral lagging.	Divided-section. (Driving shield.)	Poor.
Rocky soils (debris, rocky clays, eroded zones).	Forepoling and general lagging.	Divided-section.	Poor.
Highly overconsolidated soils ( $r_c > 2$ bars)	Good strength during construction for tunnels which are not deep. Risk of swelling pressure on linings.	Divided-section. Half-section.	Good to difficult.

Hard rock:  $R_c$  300 bars

Nature of rock	Stability of excavation	Usual excavation methods	Classification of terrain
Highly fractured rock (numerous discontinuities cutting into contiguous blocks).	Requires ribbing, the spacing of which will depend on the fracturation of the massif. Underlining recommended.	Half-section.	Difficult.
Solid, stratified, or schistose rock	<p>Requires bolting perpendicular to strata or to planes of schistosity.</p> <p>Density and length of bolts depend on spacing of secondary diaclases and on cross-sectional dimensions of excavation.</p> <p>Ribbing is sometimes necessary.</p>	Half or full section.	Good to difficult.
Massive rock	<p>Does not require systematic support so long as stresses on rock facing do not exceed the rock's resistance to rupture.</p> <p>Bolting will be necessary when this condition is not met.</p>	Full section.	Good to very good.

General observation regarding hard rock:

- Excavation of hard rock should generally be accomplished by means of explosives. Use of boring machines requires powerful machinery with rotating cutting disks.

### 3.2 Studies to Be Undertaken to Identify Possible Construction Methods

The following tables, though schematic, indicate the elements upon which the analysis should focus. Only the essential aspects of construction, i.e., excavation and support (whether temporary or permanent), are discussed herein.

Remember that geological and geotechnical studies are treated in detail in the first section of this volume.



## EXCAVATION

Nature of Work	Problems Posed	Studies to Be Undertaken in order to Determine Construction Methods
<p>1.</p> <p>Improvement of Terrain Quality (Waterproofing, dewatering, consolidation, freezing.)</p>	<p>To permit a normal excavation method.</p> <p>To limit collapses.</p> <p>To assure prior stability of surrounding terrain.</p>	<p>Diversion of existing ground-water pathways.</p> <p>Study of the water table (source, flow rate, pressures, seasonal variation).</p>
<p>2.</p> <p>Demolition (With or without use of explosives)</p>	<p>Excavation with or without use of explosives.</p> <p>Evaluation of drilling difficulties.</p> <p>Evaluation of blasting plan and over-break.</p> <p>Limitation of blast shock.</p> <p>Use of boring machine.</p> <p>Available means for excavating without explosives (machine or manual excavation).</p>	<p>Hardness and abrasivity of rock.</p> <p>Patterns of discontinuities in rock (importance and orientation, stratification, schistosity, fracturation).</p> <p>Longitudinal heterogeneity of terrains.</p> <p>Transverse heterogeneity of terrains.</p> <p>Presence of ground-water under head (condition of working face).</p> <p>Presence of ground-water not under head (water table).</p> <p>Mechanical properties of terrain (condition of working face in soil).</p>
<p>3.</p> <p>Mucking (Rubble removal)</p>	<p>Ease of loading.</p> <p>Limitations on distance of transport underground.</p> <p>Possible recycling of rubble.</p>	<p>Presence of ground-water.</p> <p>Fracturation characteristics.</p> <p>Organization of work site and number of headings.</p> <p>Possible use of rubble in concrete.</p>

## STABILITY OF EXCAVATION

Nature of Work	Problems Posed	Studies to Be Undertaken in order to Determine Construction Methods
<p>1. Temporary support</p>	<p>Stability of excavation and acceptable delay before erecting supports.</p> <p>Stability of supports.</p> <p>Limitation of terrain collapses.</p> <p>Required work to strengthen existing structures.</p>	<p>Mechanical behavior of terrain, including overlying cover and taking note of presence of ground-water:</p> <ul style="list-style-type: none"> <li>- compressive rupture in the case of heavy cover.</li> <li>- slow deformation in the event of squeezing terrain</li> <li>- soil pressure</li> </ul> <p>Pattern of discontinuities (strata and fractures, spacing and orientation).</p> <p>Transverse heterogeneity.</p> <p>Stability of terrain at portals.</p>
<p>2. Lining</p>	<p>Necessity and dimensioning.</p> <p>Acceptable delay before installation, and resultant phasing of construction work.</p> <p>Longevity of lining.</p> <p>Waterproofing.</p>	<p>Same studies as for temporary support</p> <p>Evaluation of stresses that lining must resist:</p> <ul style="list-style-type: none"> <li>- decompressed zone</li> <li>- soil pressure</li> <li>- swelling or squeezing terrain</li> <li>- acceptable delay before installation,<sup>1</sup> depending upon deformation in surrounding terrain.</li> </ul> <p>Presence of ground-water (water table or localized sources under pressure).</p> <p>Corrosiveness of ground-water.</p>

<sup>1</sup>Particularly when the deferred deformations are substantial (in the case of swelling or squeezing terrains). The phasing of other different aspects of construction are also affected.

## Chapter 4. URBAN SITES

This chapter is most especially concerned with the urban or suburban environments, where inconveniences to local residents become significant. The following considerations can, of course, be extended to any other location where analogous problems might be posed.

### 4.1 Tunnel Location

Generally speaking, the choice of geometric characteristics for tunnels in urban locations does not follow the same rules as for rural locations, due to constraints related to the environment, expropriation, transportation needs, portal location, approaches and work site installations, etc... In brief, tunnel location is less flexible.

Because of the generally less favorable conditions, particularly geological conditions (terrain is often heterogeneous, frequently altered, with presence of ground-water), delicate and onerous construction methods are often required.

Constraints on construction may lead to the adoption of very different measures in the definition and location of the tunnel.

According to circumstances, the following may be necessary, in order to limit risks:

- \* Recommend an underground layout directly below existing roadways, using covered trenches. In this case, layout is severely constrained.
- \* Envisage a more flexible, and often more direct, layout at greater depth, using a compressed air driving shield in cases of aquiferous terrain, or more traditional methods in other cases. This solution may lead to difficulties of another nature: for example, difficulties related to portals.

In each case, the profitability and utility of the tunnel may be quite different.

In each case, it is a question of being able to adopt from the very beginning a basic solution regarding the route, the chosen solution presupposing a thorough knowledge of pertinent technical and financial data.

#### 4.2 Parameters to Be Considered in the Choice of a Construction Method

The choice of construction method should take into account the following principal factors:

- \* Covering is generally light, and terrain is often aquiferous.
- \* Close proximity of other underground structures (highway, railing, subway tunnels, sewers, technical galleries).
- \* Presence of buildings or other structures in the immediate vicinity of the layout whose safety must be guaranteed.
- \* Obligation to locate portals in built-up area, and to begin tunnel excavation under very light cover (often only a few meters).
- \* Lack of space for work-site installation.
- \* Difficulty of reaching work site (delivery of materials, removal of rubble).

The absolute necessity of minimizing temporary inconveniences (damage to property, discomfort of local residents, disruption of traffic) as well as permanent inconveniences (surface subsidence, hydrogeological disturbance) demands the imposition of technical constraints on the selected construction methods:

- \* Limitation of surface subsidence.
- \* Limitations on the use of explosives.

#### 4.3 Terrain Disturbances

##### 4.31 Limitation of Surface Subsidence: Special Precautionary Measures

Studies relating to the problems posed by terrain subsidence have been discussed in Section 1, paragraph 4.433.

Underground excavation at shallow depths (as is generally the case in an urban location) always provokes surface subsidence of varying degrees depending on the nature of the terrain, the width and depth of tunnel, and the construction method employed.

This subsidence disturbs structures bordering the excavation because of the differential movement of their foundations. It is generally agreed that modern buildings (a few stories high) can tolerate a differential subsidence (or upheaval) corresponding to a topographical surface rotation of less than 1/1500 of the radius without visible damage. This is not the case for structures resting on deep foundations which are more sensitive, and for which it is necessary to take special precautions.

4.311 Structures bordering the excavation site should be the object of a general inspection before construction in order to:

- \* Determine the depth of the foundations.
- \* Certify the condition of buildings and structures prior to construction, reporting any evidence of existing cracks.
- \* Affixing of elevation marks to masonry exterior of each structure so as to be able to measure subsidence.
- \* Affixing of similar marks on ground surface and at different depths in order to measure terrain subsidence.
- \* Inventory of existing pipes and sewers.
- \* Strengthening for most exposed structures, including:
  - Chain-bonding of foundations and underpinning
  - Vertical protective curtains in the form of slurry walls or sheet piles, etc...

4.312 During construction, a periodic leveling of subsidence marks and inspection for cracking will permit the close monitoring of deformation, thus enabling a timely intervention if required. Particularly sensitive structures should be the object of a more detailed observation.

4.313 It is also desirable to watch for large-scale deformations that may appear following landslides, particularly at portals.

It is recommended that passage under buildings, which requires underpinning of the foundations, be avoided as this work is generally time-consuming and costly. The trace of the tunnel should therefore conform to what can be expropriated, except for buildings which are too costly, in which case underpinning will be inevitable. If possible, construction should be combined with urban renewal and renovation. In addition, it should be noted that financially speaking, repair of limited damage is often less costly than are precautionary measures required to prevent damage.

#### 4.32 Factors in Choosing a Construction Method

In choosing a construction method (the location is assumed to be rigidly fixed), one should seek to combat the major causes of subsidence:

- \* Subsidence caused by modification of hydrogeological characteristics of terrain (lowering of water table by pumping or by draining action of excavation).

In this case attention should focus on those methods that do not disturb (or disturb only slightly) the hydraulic characteristics of the terrain traversed (e.g., driving shield or boring machine with use of compressed air, preliminary waterproofing treatment, freezing, excavation of a tunnel with watertight sidewalls, etc.). (See Appendices.)

- \* Subsidence caused by driving of timber-pile lining. When this risk has been recognized at the time of geotechnical studies, other methods of ground-wall support should be adopted (e.g., Berlin method, slurry walls, etc.).
- \* Instantaneous collapse caused by excavation. These collapses advance with the working face of the excavation.

It is essential to note that the nature and density of support are not the only parameters to be considered, that the rapidity and the quality of its erection are also important. Especially in "very poor" or "difficult" terrains, i.e., in soils, rapid support erection, sufficient rigidity of the supports, and proper lagging are three factors that will limit collapse. Rapid placement of lining and proper blocking are similarly important. In certain especially delicate cases special methods may be adopted (e.g., erection of support and lining with terrain kept under compression by jacking).

- \* Localized compaction under footings for ribs or under supports for vault during transitory phases of construction. Such compaction reduces the efficacy of the support. It is recommended that this be limited as much as possible by providing temporary (or permanent) supports with sufficient surface (e.g., longitudinal or transverse beams as bases for ribbing, possibly prior construction of permanent sidewall foundations or abutments).

#### 4.4 Excavation Using Explosives

In general, the presence of surface dwellings or nearby underground structures greatly restricts the use of explosives in urban sites.

In this regard, it is customary to limit the maximum rate of vibration of foundation soils to about 10-50 mm/s. This limit may in some cases be lower, particularly in the case of blasting in an aquiferous environment.

These restrictions lead to a severe limitation of the instantaneous charge, generally necessitating the use of micro-retards.

Divided-section headings using prepunching or boring machine may prove preferable.

#### 4.5 Maintenance of Surface Traffic

In this respect the best solution involves an almost total liberation from surface problems -- for example, by increasing tunnel depth and resorting to conventional excavating techniques. In this way surface interference will be limited to shafts or access areas.

In many cases, for various geological reasons or because of the close proximity of the tunnel to building foundations, it is possible to envisage a covered-trench solution, which will permit maintenance during construction of a certain fraction of normal surface traffic. Normal traffic can usually be fully restored in a relatively short time. Such solutions do not obviate the need to take the customary precautions against risks of subsidence.

#### 4.6 Portals and Approaches

Subsurface entries are generally required in terrain having an altered or disturbed surface. These entries may require the adoption of costly special construction methods (treatments, anchorages, etc.).

Refer to Section 1 for more details.

---

Appendix 1. FULL-SECTION EXCAVATION1.1 Description

Full-section excavation is a traditional advancement technique whereby the entire cross-section of the tunnel is advanced with a single blast.

Although also based on the principle of full-section excavation, those methods involving special techniques or tools (driving shields, boring machines, etc.) have been excluded from the present discussion.

The advancement cycle can be broken down roughly into the following phases:

- \* First phase: Drilling. For the cross-sections normally encountered for highway tunnels ( $60-100^+$  m<sup>2</sup>), the first phase involves drilling 80-150 shot-holes, approximately 4 meters in depth, across the entire working face.

The blasting plan should take into account the fragility and fracturation of the rock, and should be adapted to variations in the quality of the surrounding terrain.

- \* Second phase: Clearing. After charging the shot-holes with explosives, blasting follows. Typical blasting plans first clear a central core, with the peripheral blasting following after a brief retard. This permits cutting the working face in such a way as to achieve the desired excavated profile.<sup>1</sup>

---

<sup>1</sup>The present trend is to blast in this order: the center plug, the peripheral charges, and lastly, the charges in the intermediary ring. This procedure, still in the experimental stage, should limit the propagation of shocks in the surrounding terrain, and should also yield a much more regular profile.

The future application of this procedure will require various complementary studies (arrangement of micro-retards, economic influence on advancement cycle, and drilling precautions, etc.).



- \* Third phase: Mucking. Once the clearing has been completed, clearing of the roof and working face necessarily precedes any removal of rubble or possible support of unstable blocks and beds. These two latter phases do not follow any systematic chronology, as existing conditions and methods peculiar to the particular contractor will in each case determine the most productive chronology commensurate with elementary safety requirements.

It should be remembered that the foregoing is but a very schematic description of the method. Numerous ancillary operations enter into the advancement cycle (ventilation by exhaustion after blasting, then by blowing just before mucking, removal of machinery before blasting, etc.).



Example of tunnel  
excavated by full-section method

## 1.2 Domain of Applicability

Among the factors influencing choice of the full-section method, the following deserve special attention:

- \* Quality of surrounding terrain
- \* Tunnel geometry
- \* Environment

### 1.21 Quality of Surrounding Terrain

The full-section method can be used (in highway tunnels) only in good terrain that requires only bolting for support.

The preferred domain of application is therefore:

- \* Massive rock (granite, hard limestone, massive sandstone).
- \* Hard stratified rock or strong schistose rock having few fractures.
- \* Certain marls that are highly compacted and insensitive to hygrometric variations.

### 1.22 Tunnel Geometry

Full-section headings are desirable because of their higher efficiency: the method permits the employment of large crews on the working face and results in the most systematic advancement cycle. Each cycle corresponds roughly to an eight-hour shift. These two factors effect significant reductions in cost and construction time.

The full-section method also permits the use of heavy machinery at the working face.<sup>1</sup> Generally speaking, amortization of this equipment requires a tunnel of moderate length (a minimum length of 3-4 km for a tunnel cross-section of 100 m<sup>2</sup>).

In shorter tunnels when the surrounding terrain permits, mechanized full-section excavation can often be effected in other, less specialized ways (e.g., using a "jumbo" consisting of pneumatic drills mounted on a double-bed truck).

---

<sup>1</sup>The jumbos presently in use carry up to 20 pneumatic drills working simultaneously on the working face. The weight of these machines is on the order of 100 metric tons.

In tunnels of smaller cross-section ( $40-50 \text{ m}^2$ ), the full-section method is generally more feasible; in galleries of very small cross-section ( $10-15 \text{ m}^2$ ), full-section excavation is employed regardless of the terrain.

### 1.23 Environment

The close proximity of structures to the excavation (particularly in urban sites) may limit the use of explosives (cf. 4.4), thus compromising one of the conditions for profitable use of the full-section method.

## 1.3 Safety Precautions

### 1.31 Terrain

Generally speaking, it follows from the foregoing remarks that terrains requiring the use of steel rib supports are not amenable to full-section excavation. The use of ribbing of great span and height (10 m wide by 7 m high) requires a reduction in the strength of blast-shots, thereby inhibiting the advancement cycles and requiring the utilization of special procedures.

### 1.32 Heterogeneity of Terrain

Moreover, tunnels are rarely situated in homogeneous geological formations. Although most of the terrain traversed by the tunnel may fall into one of the terrain categories specified in 1.21, limited zones of fractured or unstable terrain may be encountered, notably near the tunnel portals and through heavily folded zones.

In every case it is wise to evaluate as precisely as possible the importance and extent of these unstable zones, thereby permitting a judgment regarding the general viability of the full-section method for the project.

The excavation of difficult zones will have to be effected using a half-section method or, if necessary, using a divided-section method or some sort of terrain treatment (see Appendices 2 and 3). Such changes in method of excavation usually require major modification of construction equipment, if not replacement.

#### 1.4 Performance

The analysis of construction time requires a preliminary specification of terminology. "Daily advancement" refers to the distance excavated on one work-day across the entire cross-section;<sup>1</sup> the work-day is usually composed of three 8-hour shifts; the work-month is usually composed of 22 work-days.

Generally speaking, the following are to be distinguished:

- \* Maximal advancements, which are obtained under ideal conditions as a result of a favorable coincidence of relevant factors (terrain, labor, smooth rotation of crews and materials, etc.).
- \* Average advancements, which take into account accidents on the work-site, and include rest periods for crew and equipment. These periods should be anticipated during preliminary planning.

Finally, 3 to 6 months are generally necessary for work-site installation, and constitute a supplementary delay which should be considered in planning.

##### 1.41 Advancement

Using the full-section method of excavation, high daily advancements can be obtained in good terrain for cross-sections of 90-100 m<sup>2</sup>:

- \* Maximal advancements of up to 15 m/day
- \* Average advancements of 8-12 m/day

On the other hand, excavation through difficult zones is always very time-consuming.

##### 1.42 Costs

Within the limits of the domain of applicability defined above (good terrain), the cost of full-section excavation proves to be lower than for half-section excavation (see Cost volume).

---

<sup>1</sup>The casting of the tunnel vault, which is not dealt with here, requires varying amounts of time depending on both the equipment used by the contractor and the anticipated construction cycles. One can assume an average advancement of 10 m/day.

The choice of this rather inflexible but highly efficient method of excavation should result from a compromise between:

1. Its advantages in terms of construction cost and time.
  2. Risks involved in the event unfavorable terrain is encountered.
-

## Appendix 2. UPPER HALF-SECTION EXCAVATION

### 2.1 Description

This method is distinguished from the preceding one by the addition of a supplementary phase of construction. The following procedure is followed:

- \* First, clearing and possible support of upper half-section, following the same principles mentioned for full-section excavation.
- \* Then, after a lag that will vary greatly (20 to several hundred meters, depending on the circumstances), clearing and possible support of lower half-section (second phase).

Depending on the nature of the terrain traversed, the tunnel lining may be cast after excavation of the entire section, or it may be cast in two sections (upper half, and then lower half).

The excavation of the lower section is relatively uncomplicated (analogous to conventional open-air excavation, sometimes permitting the use of rippers in favorable terrain).

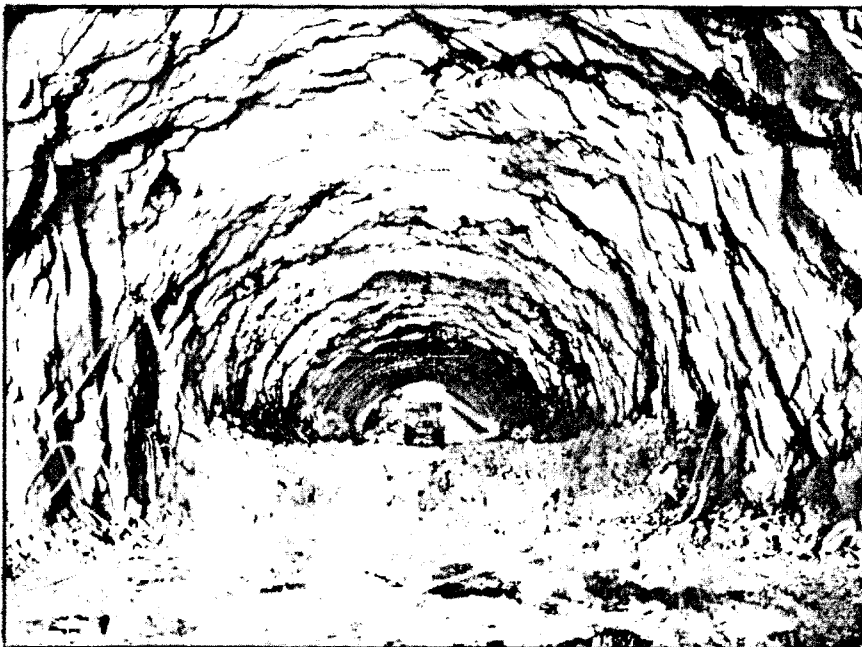

Example of  
highway tunnel  
excavated by  
half-section  
method

# EXEMPLES DE TRAVAIL EN DEMI-SECTION SUPERIEURE

EXAMPLES OF CONSTRUCTION USING UPPER HALF-SECTION METHOD

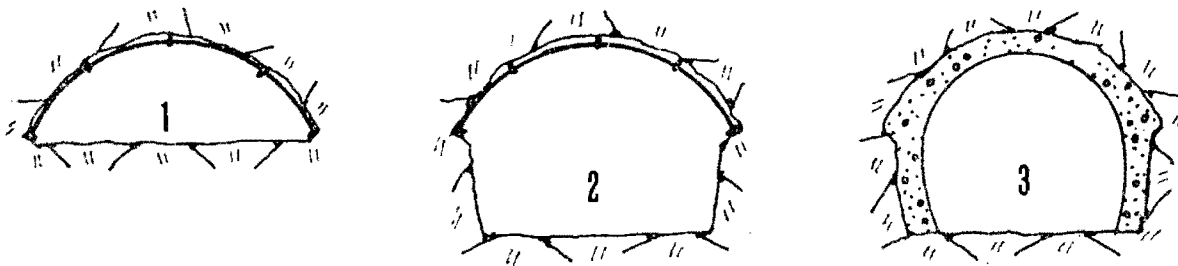

## GREUSEMENT PAR DEMI-SECTION ET BETONNAGE DU REVETEMENT COMPLET

EXCAVATION BY HALF-SECTION AND CASTING OF ENTIRE LINING

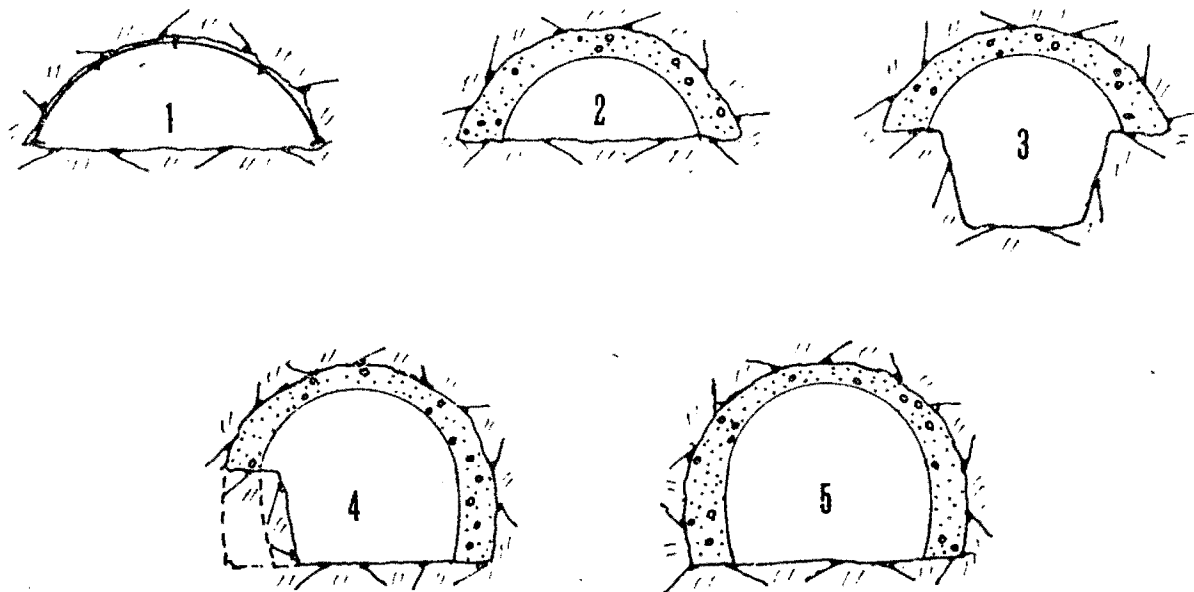

## GREUSEMENT PAR DEMI-SECTION, BETONNAGE DE LA VOUTE ET EXECUTION EN SOUS OEUVRE DES PIEDROITS PAR PLOTS ALTERNES.

EXCAVATION BY HALF-SECTION, CASTING OF VAULT AND UNDERPINNING OF SIDEWALLS

## 2.2 Domain of Applicability

In highway tunnels of usual dimensions, the upper half-section method is particularly flexible, permitting its use in a broad range of terrains, especially in difficult and heterogeneous terrains that require rib support.

### 2.21 Flexibility of Use

In the first phase, the excavation of a reduced cross-section (10 m by 4 m) permits the installation of steel ribbing, simultaneously allowing the utilization of highly efficient equipment. As this equipment is quite conventional, the half-section method proves to be more economical for short tunnels, since it can be favorably combined with light and rapid support techniques (bolting, shotcrete, lightweight ribbing).

In the event that poor terrain is encountered (highly over-consolidated soils, rocky soils), it is possible to use conventional forepoling techniques in order to provide support above the working face. The support for the upper half-section are completed by the rapid placement of the first thickness of the concrete lining, even before excavating lower half-section.

### 2.22 Quality of Surrounding Terrain

Because of its great adaptability, this method should be favored when terrain quality may vary along the length of the tunnel. In fact, it is customary (except in the event of very localized, minor irregularities) to adopt a single construction method requiring the same equipment and techniques. (But not necessarily the same support techniques.)

Thus, excluding cases involving ground-water pressure, the method is applicable in the following terrains:

- \* Hard or massive rock, insofar as it does not fall within the domain of applicability for full-section excavation (Appendix 1).
- \* (Very) fractured rock.
- \* Soft rock (marly limestones, flysch, certain molasses, soft sandstone, marls, altered rock, etc.).
- \* In exceptional cases, hard or rocky soils.



## 2.3 Precautions

### 2.31 Terrains

Application of this method should be strictly limited to the aforementioned terrain categories. In particular, it should be used only rarely in poor terrain requiring systematic forepoling.

### 2.32 Stability of Excavation during Construction

The upper half-section method requires certain precautions in order to avoid disturbances of the vault support or lining during both the excavation of the lower half-section and the construction of sidewalls (rupture under rib or lining footings, cracking of the lining). These risks are greatest in soils. They are augmented by the presence of squeezing terrains and by ground-water intrusion.

It is necessary in this case to take certain precautions during construction:

- \* For the upper section (longitudinal bracing of ribs and firm seatings, placement of primary lining, etc.).
- \* For the lower section (underpinning of support, careful and effective underpinning sidewalls, excavation of alternating sections, placement of inverted floor to counteract pressure, etc.).

### 2.33 Environment

Because of the large cross-sectional arch excavated during the first phase, it is necessary when excavating soils or fragmented rock to attend to the risks of terrain subsidence or collapse.

These risks are particularly grave in urban zones.

In summary, the value of this excavation method depends chiefly on the organization of excavation phases and on the precautions taken during the course of excavation.

## 2.4 Performance

Because this method requires an additional phase for excavating the lower section, and possibly further phases for casting the lining of the upper section, the divided-section method is significantly slower than the full-section method.

Depending on terrain traversed, and on nature and spacing of the required supports, average advancement rates for the entire cross-section can be estimated at 2-6 meters per day.

---

### Appendix 3. DIVIDED-SECTION EXCAVATION

#### 3.1 Description

The "divided-section" method includes all those procedures where clearing of the tunnel cross-section is effected in more than 2 distinct phases (see figure below).

First, parallel galleries of small section (5-12 m<sup>2</sup>) are dug; these may be situated at the vault springs, at the base of the sidewalls, or at the tunnel summit.

- \* Spring galleries require an intermediary phase for each half-section. They may be placed within the future profile of the tunnel, or may project laterally.
- \* Base galleries may permit subsequent full-section clearing, protected by either:
  - a conventional rib and lagging support, in which case they provide a rigid footing for the support;
  - a driving shield rolling on benches;
  - or a vault of prestressed prefabricated concrete, supported by abutments.<sup>1</sup>
- \* The summit gallery, which is useful during clearing phases, may also be used for advance terrain reconnaissance, and for possible treatment of surrounding terrain, if necessary.

---

<sup>1</sup>Method used by Paris Metro for construction of very wide underground subway stations.

# EN SECTION DIVISEE

## EXAMPLES OF CONSTRUCTION IN DIVIDED-SECTION

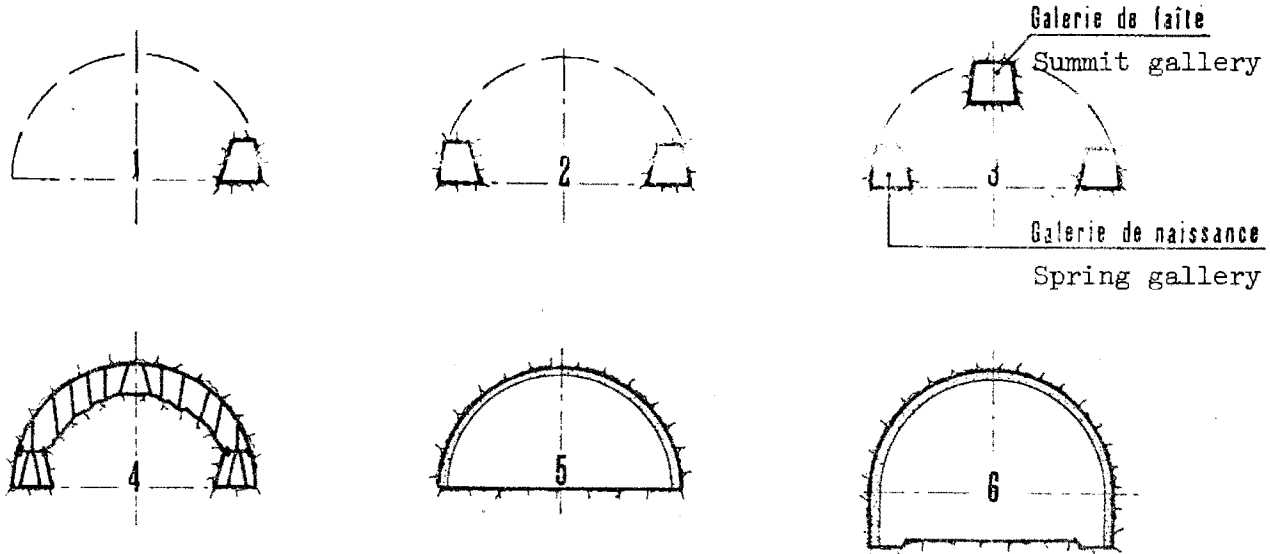

Travail manuel  
Manual labor

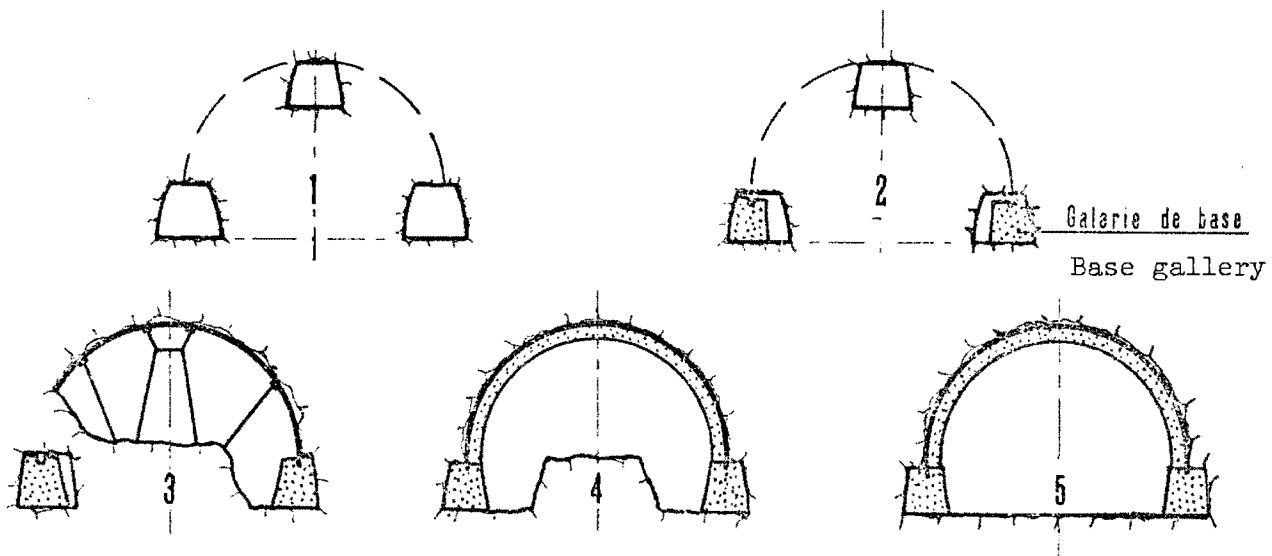

Voûte sur appuis préalables  
Vault on previously cast footings

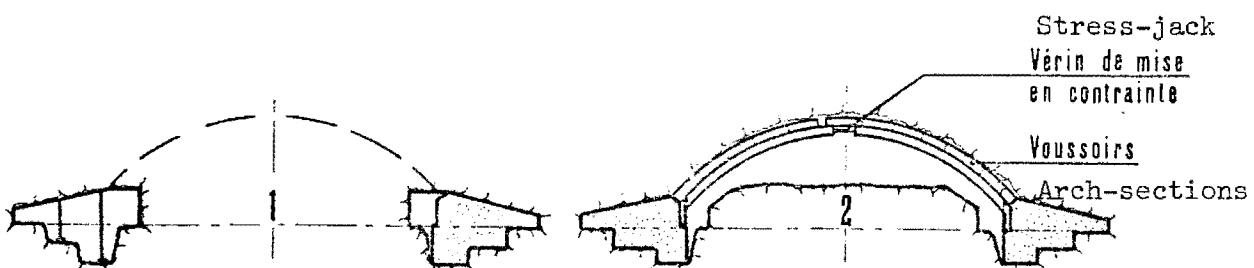

Voûte sur culées  
Vault on abutments

### 3.2 Domain of Applicability

The divided-section method, which is both time-consuming and costly, is the traditional and most reliable method for excavating large cross-sections (such as highway tunnels) in poor terrain.

#### 3.21 Geometry and Site

Large cross-sections often involve risk of instability of the excavation, and, in the case of light covering, serious risks of surface subsidence.

The divided-section method, a faithful imitation of very traditional procedures, mitigates these difficulties, as the excavation of a very small section permits best and most rapid limiting of decompression of adjacent terrain. In an urban site, the combination of divided-section with preliminary treatment of terrain or recompression at the time of vault placement, permits a significant limitation of surface subsidence.

This method thus may be selected for use in difficult sites (urban zones) under light covering. It can most certainly be applied as well in other locations, depending on the quality of terrain encountered.

#### 3.22 Quality of Surrounding Terrain

When approaching identified and localized geological irregularities, this method permits advance terrain reconnaissance, and thereby limits construction risks.

Generally speaking, the divided-section method is well suited to terrains requiring support and lagging:

- \* Rocky soils (scree, moraine, altered rock).
- \* Hard soils
- \* Argillaceous soils of low or moderate plasticity
- \* Dry pulverulent soils
- \* Eroded rock of very low strength.

### 3.3 Precautions

In case of soils below the water table, or for very plastic soils, it is necessary to employ other methods (driving shield, terrain treatment, freezing).

The critical phase, to which special attention should be directed, is that of enlarging to full-section from the advancement galleries.

### 3.4 Performance

The excavation of small galleries requires manual labor under difficult conditions; consequently, there can be no question of rapid advancement, since safety must take precedence over all other considerations.

Daily advancements to be expected for excavation of the entire section can range from about 0.25 to 1 meter per day, depending on the circumstances.

Excavation costs are quite high in these poor terrains (see Cost volume), and may be greatly increased as a result of work-site accidents, or when recourse to yet more complex procedures (such as terrain treatments) proves necessary.

---

## Appendix 4. BORING MACHINES

### 4.1 Description

This heading subsumes all machines that bore or cut surrounding terrain, thereby replacing manual excavation or blasting for this task (cf. figure below).

### 4.11 Form of Excavated Cross-sections

According to the heading method used on the working face, the following cases can be distinguished:

- \* That in which terrain is attacked by one or several cutting heads attached to mobile arms. This type of machine permits working in either a circular or non-circular cross-section.
- \* That in which cutting tools are carried on a rotating circular disk. These tools may be knives, picks, cutting wheels, or rotary drills, the last two rotating in an opposite direction to that of the disk itself.

This type of machine is presently the most widely used in Europe; it only permits working in circular cross-sections.

### 4.12 Possible Accessory Equipment

- \* In pulverulent or plastic soils, the boring machines may be protected by a steel driving shield in order to insure the support of the excavation as advancement progresses. In this case, the casting of the lining closely follows the driving shield.
- \* In aquiferous soils, the boring machine and driving shield may operate in a pressurized environment in order to permit work to continue in water depths of up to 25 cm.

# MACHINES FOREUSES

BORING MACHINES



Schéma de principe

Operating Scheme

1 - Creusement  
Excavation

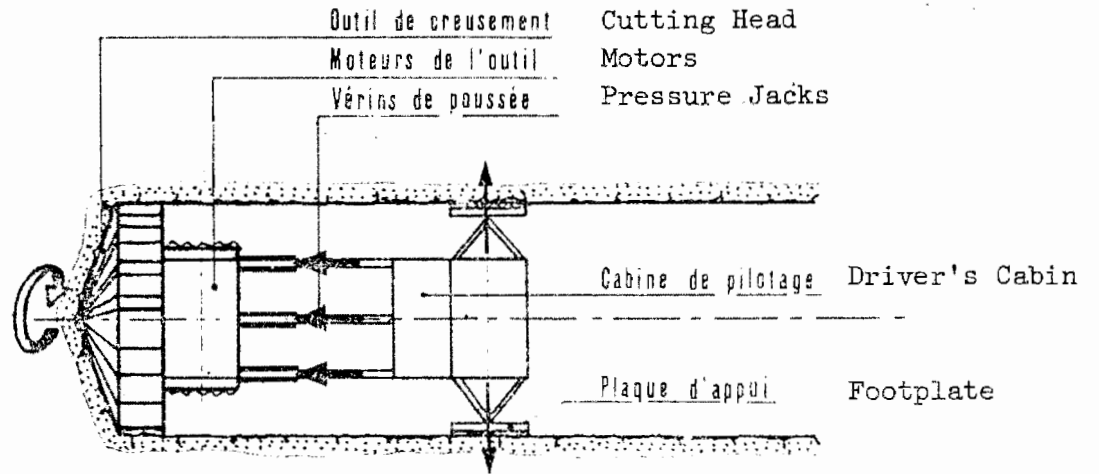
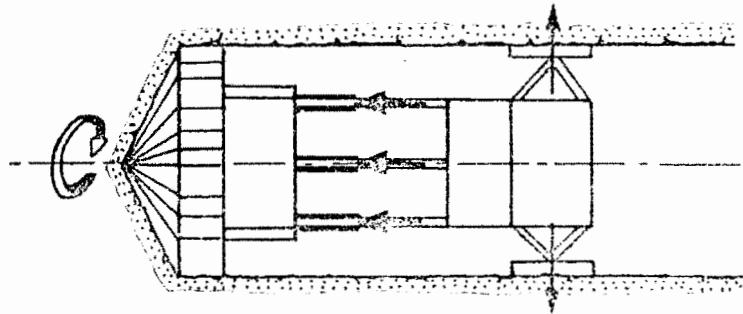

2 - Fin de creusement  
Completion of  
Excavation

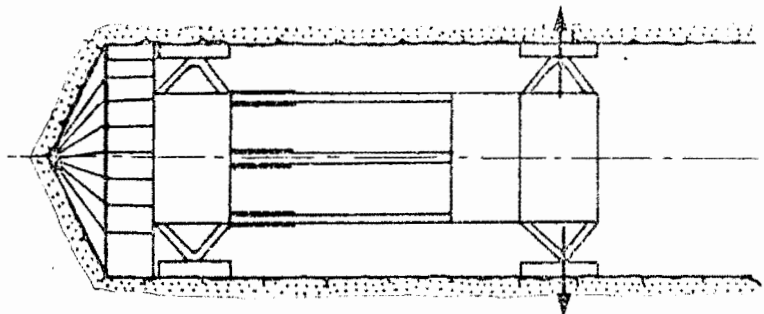

3 - Avancement  
Advancement

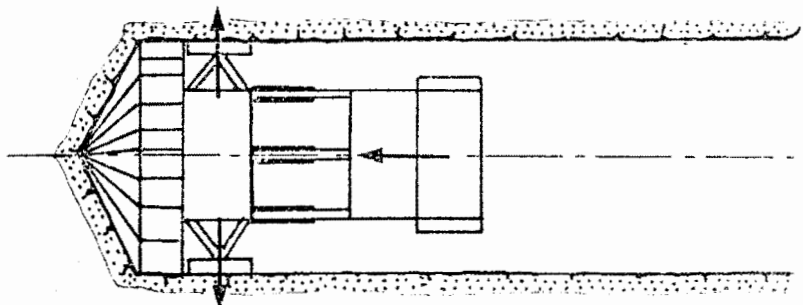



#### 4.13 Functioning of Machine

The machine must be able to exert a force of several thousand tons on the working face. In order to develop this force, the machine can be braced laterally against the rock facing of the excavation (if the mechanical characteristics of this facing will permit it), or longitudinally against the previously cast lining.

Advancement is effected in a caterpillar-like fashion. The mobile cutting head can move forward a meter or two, while the body of the machine and the support jacks remain stationary.

Guidance of the machine, which is especially important because of high advancement rates, is presently accomplished by means of lasers.

#### 4.2 Domains of Applicability

As will be seen below, boring machines are still in the experimental stage in Europe. Their use is presently limited to certain soils or soft terrains, and in certain cases, to hard terrains of small cross-section. Progress in this field is, however, very rapid, and it may be assumed that with the growth of underground construction and the standardization of cross-sectional profiles, these machines will in coming years gradually replace traditional methods of excavation.

#### 4.21 Quality of Surrounding Terrain

Numerous parameters affect the amenability of a terrain to mechanical boring. Although not the sole criterion, compressive strength is a simple criterion that is commonly used.

Presently (1970), boring machines are capable of working in rock whose compressive strength reaches 2,000 bars (in highway cross-sections 8-10 m. in diameter) and even exceeds this limit for small cross-sections (approximately 3 m. in diameter).

Other criteria linked to the internal geology and geometry of the surrounding terrain intervene in the applicability, advancement rates, and profitability of these machines:

- \* Hardness and abrasivity of the rock (wear of cutting tools represents an important portion of operating expenses).
- \* Density and moisture content of terrain.
- \* Schistosity and fissuring; material filling fissures.
- \* Bedding.
- \* Longitudinal and transverse heterogeneity.

#### 4.22 Environment

Elimination of blasting eliminates shock both adjacent to and at a distance from the excavated section. Also, the boring machine disturbs the terrain traversed to a much lesser extent, considerably diminishing need for support and lining. To a certain degree, it helps in limiting surface subsidence, assuring that cavities between lining and rock facing are properly blocked.

As a result, use of boring machines in urban zones is a preferred domain of application.

In consideration of the preceding, and in view of the high cost of these machines, boring machines are also appropriate for homogeneous terrains located in rural areas.

#### 4.23 Geometry

Machines that cut a section 3 m. diameter have already been used to drill horizontal galleries, sloping galleries, and shafts. One possible technique in an urban zone, when density of surface structures is great and covering light, consists of excavation by divided-section method using 3 advancement galleries dug by machine.

In a 10 m. diameter, machine-dug excavations are currently of circular cross-section. This shape may be disadvantageous to other phases of construction, and in every case it requires the installation of a roadway deck. On the other hand, this method is well-suited in cases of high hydrostatic pressure or in terrains likely to develop expansive pressures.

#### 4.3 Advantages and Precautions

The primary advantage of these machines, already mentioned above, lies in their very minimal disturbance of the terrain traversed, coupled with total elimination of explosives, which renders its use especially appealing in urban sites.

Secondly, these machines reduce to a bare minimum both the quantities of support to be installed and the thickness of the lining. Elimination of blasting in favor of sustained boring results in an accurate cutting of the working face, in most cases yielding a tunnel with the appearance of a smooth, regular cylinder. The financial savings that accrue from these reductions of support and lining can be expected to be substantial (see Cost volume).

A third advantage is their increased advancement rate in favorable terrain; this advantage should be qualified somewhat: the machinery and crews require substantial periods of time for rest and maintenance.

#### 4.32 Precautions

- \* In the event that heterogeneous terrain is encountered, especially in the case of transverse heterogeneity, machine performance may be considerably reduced. In extreme cases, encountering of a major obstacle (a very hard layer, a fault, etc.) may require recourse to a traditional method of excavation which, in turn, may cause a major delay, if not the complete shut-down of operations.
- \* In soils that will not provide the necessary lateral support for the machine, it is necessary to install the tunnel lining (generally in the form of prefabricated concrete or cast-iron sections) immediately after passage of the machine in order to provide the necessary longitudinal support. These measures require a rigorous organization of construction, as well as special, costly materials (the machine must be protected by a driving shield).
- \* The cost of these machines is presently very high, as is the replacement of worn cutting tools.

The profitable use of these machines requires tunnel lengths that are great enough to insure an amortization of the machinery.

- \* In open country, 5-6 km seems to be the minimal length (3 km for a double-tube tunnel).
- \* In urban locations, the machines may prove profitable for even shorter lengths, because of the difficulties normally encountered using traditional methods (terrain treatments, rigorous limitation of blasting, etc.). Experience within this domain is, however, still limited in France.

#### 4.4 Performance

##### 4.41 Advancements

It is necessary to distinguish maximal possible advancement from the average advancement for the entire project. Because of the time required for tool changing and maintenance, actual working time of the machines generally does not exceed 50 to 60% of the time that they are physically on the job. Moreover, machines may be

specially manufactured and adapted for a particular tunnel project; the normal period required for manufacture and delivery varies from 8 to 12 months.

With this in mind, the following average hourly advancements can be anticipated:

- \* 3 m. diameter: 2.5 m/hour for  $R_c \sim 250$  bars  
0.3 m/hour for  $R_c \sim 2,000$  bars
- \* 8 m. diameter: In soft and homogeneous formations (soft limestones, sandstones, argillaceous marls, shales) advancements of 30 m/day have been obtained -- and even higher advancement rates in certain very favorable circumstances.

In difficult locations (notably, in excavation below the water table) advancements are much lower than the figures cited.

#### 4.42 Costs

At the present time it is not possible to furnish a precise characterization of boring costs.

The purchase cost of a machine is generally high:

2,500,000 F for a 3 m. diameter machine

10,000,000 F for a 8 m. diameter machine

Also, tool-changing costs amount to about one-fourth the boring cost.

---

## Appendix 5. DRIVING SHIELDS

Strictly speaking, driving shields do not constitute either a boring or excavation method, but rather a support technique which insures protection of the work site.

### 5.1 Description

The driving shield is usually a steel cylinder (slightly larger in dimension than the tunnel, equipped with a cutting head at the front and a protective skirt at the rear. The driving shield is propelled forward by means of a ring of jacks pushing against that part of the lining already installed (see figure below).

The forward thrust imparted by the jacks, generally very high, must force the driving shield into the terrain, overcoming lateral frictional resistance.

The method of propulsion makes it necessary for lining to follow advancement and to be able to sustain immediately the forces exerted by the jacks. The lining, generally of prefabricated cast-iron or reinforced concrete sections, is installed inside the protective skirt of the driving shield.

Depending on the difficulties encountered, a driving shield may be equipped with:

- \* Only heavy excavating machinery (for loose but coherent soils).
- \* A forepoling apparatus (for swelling terrains).
- \* A jumbo for minor blasting.
- \* A boring machine.
- \* Compressed air equipment (for excavation below the water table).

# PROPULSION D'UN BOUCLIER

PROPULSION OF THE DRIVING SHIELD

134

Schéma de principe  
Design

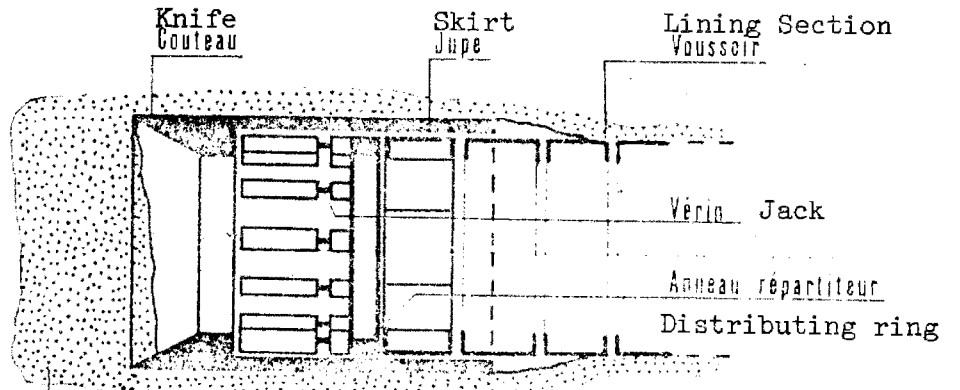

1 - Creusement  
Excavation

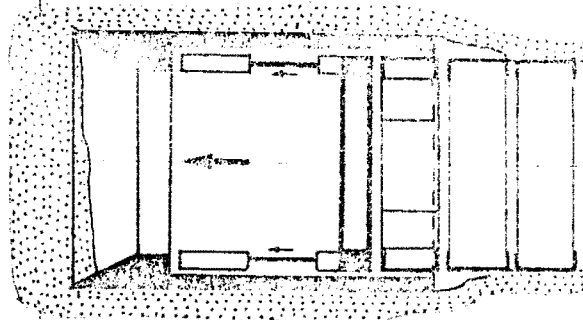

2 - Fin de creusement  
Completion of  
Excavation

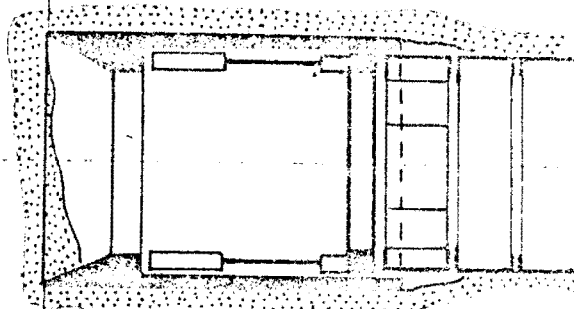

3 - Pose des voussoirs  
Placement of  
Lining Sections

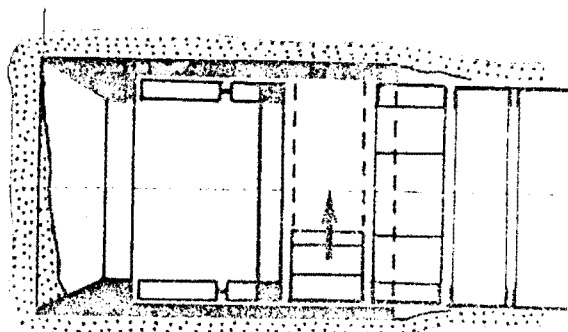

## 5.2 Domain of Applicability

### 5.21 Quality of Surrounding Terrain

By their very design, driving shields are especially well suited for use in poor terrain or in very poor terrain that requires immediate support, even lagging above the working face (i.e., soils and altered rock).

In aquiferous zones, the compressed-air driving shield remains the only possible method when, for diverse reasons, the following techniques are not possible:

- \* Terrain treatment (lowering of water table, injections, freezing).
- \* Solutions employing covered trenches (cf. Appendix 6).
- \* Solutions employing prefabricated caissons (cf. Appendix 7).

### 5.22 Environment

Use of a driving shield limits soil decompression to some extent, provided that immediate, effective blocking between the lining and terrain facing is assured, so as to allow no cavities to remain. Special care must be taken to fill the ring-shaped cavity left by the advancing driving shield.

## 5.3 Precautions

The driving shield is a heavy machine (weighing several hundred tons) that progresses well only in loose soils. Passage through more resistant terrain may lead to great advancement difficulties and possibly to a difficult and expensive change of excavation method. Moreover, guiding this machine is always very difficult in heterogeneous formations.

Use of a driving shield below the water table is limited for reasons of worker physiology to depths of less than 25 m. of water. Moreover, the use of compressed air requires a minimal terrain covering of 10 meters. (Otherwise, it may be necessary to use special treatments on overlying terrain to minimize air loss).

As a result, solutions using a driving shield have a very restricted domain of application.

## 5.4 Performance

### 5.41 Advancement

Driving shield advancement depends primarily on the lateral pressures exerted by the surrounding terrain. Yet advancement is relatively insensitive to changes in terrain quality because of the systematic procedure that characterizes its advancement.

Possible advancements in the range of 0.5-3 m/day can be anticipated.

### 5.42 Costs

The cost of the driving shield itself is quite high. The cost of the required hydraulic equipment and the production of compressed air, and sometimes that of the boring machine that it protects, leads to the conclusion that such equipment is profitable only in very poor terrain, for sufficient lengths, or when the difficulty of an urban site seems to justify it.

---



## Appendix 6. COVERED TRENCHES

### 6.1 Description

When the proposed longitudinal profile of a tunnel results in only a light covering above the vault (less than 10 meters), it may be more economical to adopt a covered trench construction, assuming that the surface is free of any structures or buildings. The trench covering enables aesthetic constraints to be respected or surface traffic to be restored.

This method also permits limitation of excavation depth to 6 or 7 meters, and in many cases avoids excavation in water-bearing terrain especially in urban sites where the water table is commonly quite high.

Covered trenches provide a rectangular cross-section.

#### 6.11 Types of Structures

The following profiles are most common:

\* Self-supporting box of reinforced concrete

This structure is well-suited to cases where the tunnel is located below the water table. It can be employed if construction of a second tunnel at a lower level is anticipated in the future.

\* Trough with covering slab

This structure can be adopted if the tunnel is in contact with the water table, but not submerged. It is currently used with temporary supports (timber piles) or when supports are not an important factor in the stability of the tunnel (Berlin and Hambourg methods).

# TRANCHEES COUVERTES

COVERED TRENCHES

138

## TYPES DE STRUCTURE TYPES OF STRUCTURE

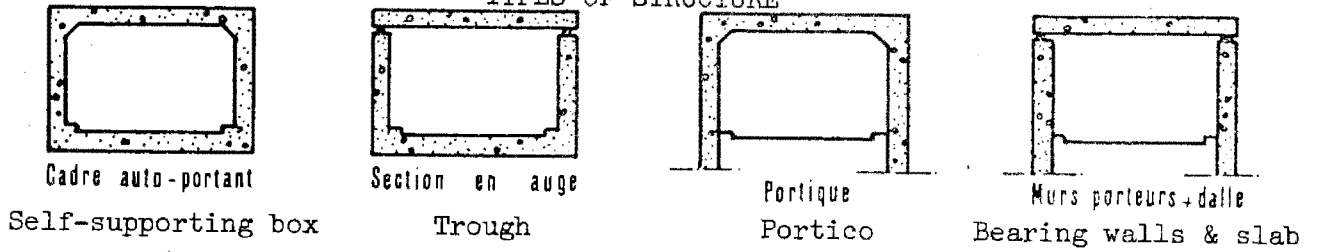

## Berlin and Hambourg Methods METHODES BERLINOISE ET HAMBOURGEOISE

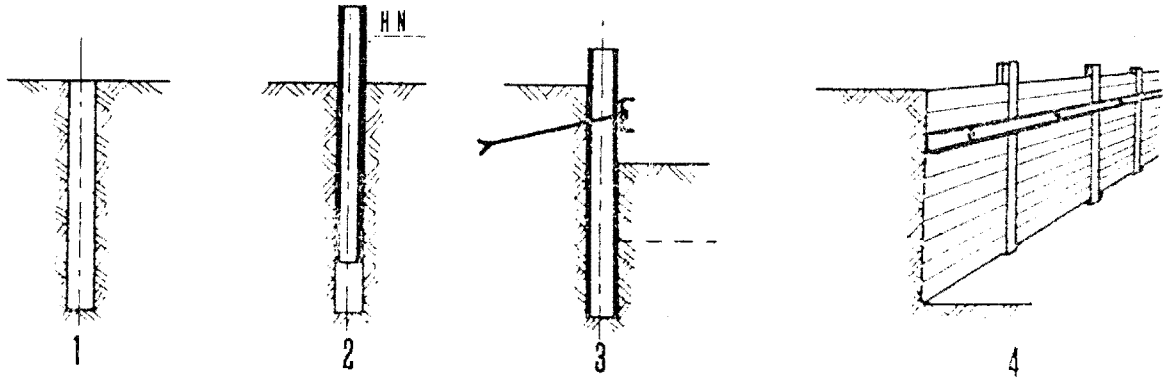

## PHASES D'EXECUTION DU SOUTÈNEMENT PHASES OF SUPPORT CONSTRUCTION

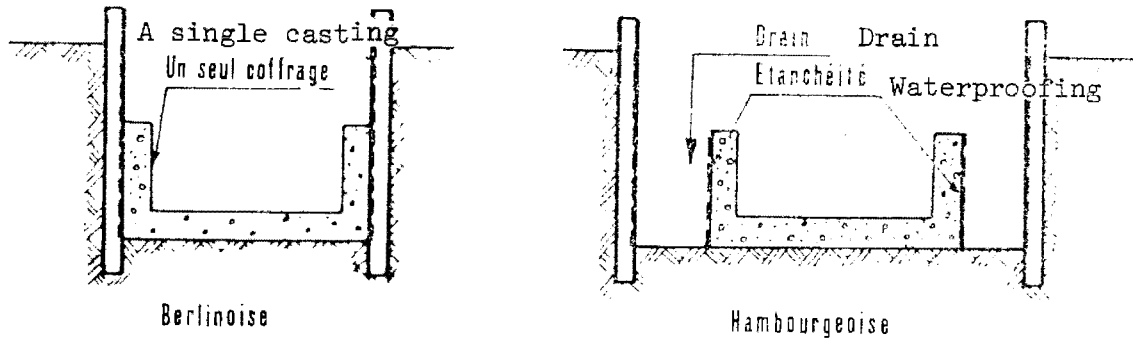

## SLURRY WALLS PAROIS MOULEES

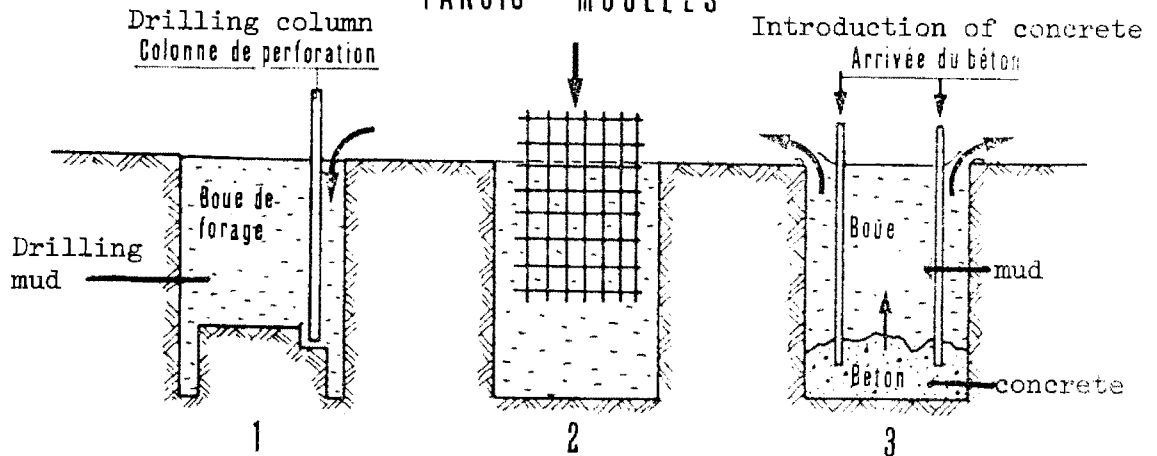

## PHASES D'EXECUTION D'UN PANNEAU Phases for construction of a panel

\* Reinforced prestressed concrete portico

Although generally used when tunnel is entirely above the water table, it is nonetheless possible to use this structure when ground-water is present, if a watertight box can be constructed of longitudinal and transverse partitions resting against an impermeable substratum.

\* Bearing sidewalls with covering slab

This solution is very similar to the preceding one. Although easier to construct, it has more joints that will require sealing.

## 6.12 Support of the Trench

In cities, the narrow widths available for shallow passage of a tunnel or trench requires the excavation of vertical cuts in often loose soil. In excavating these cuts, different methods or combination of methods may be used (see figure above):

\* Lined trenches, 1 to 3 meters wide.

\* Pile-plank walls.

\* Slurry walls.

Injection treatments effected before excavation may eliminate need for support if the terrain coheres fairly well. Such treatments also reduce soil permeability sharply.

\* Interlocking, secant, or closely spaced piles.

Their diameter generally varies between 80 cm and 3 m. The large diameter piles are necessary in the case of heavy loading (e.g., large adjacent buildings).

In the case of spaced piles:

\* A continuous, reinforced concrete beam located high on the piles will reduce differential displacement.

\* A protective wall tying piles to each other, installed after excavation.

\* Berlin or Hambourg methods

These methods make use of a support of soldier piles tied together, and anchored at different levels by means of tie-backs or cross-lot struts.

\* Slurry walls

This method has, for good reason, been in vogue now for several years. Narrow vertical trenches 50 cm to 1.20 m. in width are dug to the desired depth by means of clam-shell buckets, trepans in hard terrain), or rotary-percussion machinery.

From time to time during excavation they are filled with permanently circulating bentonite which assures:

- rubble removal (in the case of trepan drilling).
- watertightness and integrity of the walls of the excavation.
- hydrostatic equilibrium with exterior water table.

After excavation of a panel to the required depth, reinforcing steel is lowered, and then the concrete is placed. Alternate panels are completed, then intervening panels are placed, and finally joined with original panels. The stability of these panels, after excavation of the trench, is assured by tie-back anchorages and by butting in the covering slab.

It should be mentioned that prestressed or reinforced anchorages are much more costly than struts. In many cases it is possible to use cross-lot struts.

### 6.13 Excavation

The choice of excavation method is based primarily on the need (if there is one) in urban sites to maintain surface traffic circulation. Depending on the circumstances, excavation may be accomplished in the following ways:

- \* Open air excavation of sections between the previously constructed support walls.
- \* Underground, after having placed the covering slab over the section to be excavated.

### 6.14 General Structure

#### 6.141 Invert

An invert is often necessary, even if tunnel is above the water table, when differential subsidence or swelling is feared.

The invert is usually of reinforced concrete, and is designed depending on the circumstances:

- \* To resist the upward pressure of ground-water, when tunnel is located below the water table.

- \* To support entire tunnel (as in case of a box or trough).
- \* To behave like a beam supported on deep foundations (as is the case of pile or slurry wall foundations).

If invert is to satisfy several of these conditions simultaneously, its thickness may be considerable (1.50 m. and more).

#### 6.142 Covering slab

The slab is made of reinforced or prestressed concrete.

Depending on the load and span, the slab is either of constant thickness (perhaps honeycombed) or else ribbed. In the latter case the transverse beams are of prestressed concrete.

#### 6.143 Median partition (in the case of a tunnel with divided roadway):

- \* Continuous section: continuous cast partition, simple partition in a trough section, etc.
- \* Discontinuous cast-in-place or prefabricated sections: discontinuous cast partitions, columns resting on large diameter piles, etc.

In the latter case, it might be wise to fill the interstices between the columns, thus creating a solid partition between the two roadways. This will allow for the full development of vehicle "piston-effect," thus engendering important economic savings in the "Ventilation" category.

#### 6.15 Watertightness

Tunnel construction waterproofing methods are closely related to the chosen method of construction. Furthermore, depending on the circumstances, either a partial or total waterproofing may be required.

For each section of the tunnel two traditional waterproofing techniques are available:

- \* Extrados waterproofing: bituminous coatings, multiple layers, etc.
- \* Intrados waterproofing: mortars, resins, etc.

## 6.16 Surfaces

The following are generally used:

- \* For ceilings: white, blue, or black resin-epoxy paints.
- \* For sidewalls: light-colored glazed clay tiles.

At the tunnel portals, the sidewalls are usually covered with a mortar or cut-stone facing.

## 6.2 Domain of Applicability

### 6.21 Quality of Surrounding Terrain: Nature of Various Support Methods

The following table details various methods of ground-wall support for trenches, specifying the terrains to which the particular methods are suited, as well as the principal characteristics of these methods and the type of foundations which they require.

As a rule, these methods can, when necessary, be combined with a lowering of the water table. In the case of pile-plank or slurry walls, it may be worthwhile to anchor their base in an impermeable layer when this is economically feasible. If the permeable terrain extends to a great depth, it may be necessary to employ an injected sub-invert for anchorage of the walls.

Method of support	Nature of soil	Advantages	Disadvantages	Type of foundation
Lined trenches	Dry terrains	Flexibility of method (heterogeneous soils, backfill).  Enables covering before excavation of full-section	Serious delays.	Bedplate
Pile-plank	Loose soils	Soils not decompressed.  Wall can be water-proofed if necessary.	Risk of damage to buildings from adjacent pile driving.  Encumberment of construction site.  Major delays.  Requires forming for tunnel sidewalls.	Bedplate
Thin injected screens	Permeable terrains ( $10^{-2}$ to $10^{-1}$ m/s)	Permanent improvement of mechanical characteristics of terrain.	Expensive, difficult method.  Requires forming for tunnel sidewalls.	Inverts
Soldier piles	Both loose and relatively hard terrains.	Possibility of descending to great depth (inviting if substratum is firm).	Major delays.  Requires forming for tunnel sidewalls.	Piles
Berlin and Hambourg methods	Dry terrains	Collapse reduced to a minimum.  Possibility of exterior waterproofing in case of Hambourg method.	Requires forming for tunnel sidewalls.	Invert
Slurry walls	Not suitable for very permeable soils ( $k < 10^{-2}$ or $10^{-1}$ m/s) or for heterogeneous fill or soils.	Minimal work-site encroachment.  Watertight partition.  Enables covering before excavation of full-section	Machines are often quite tall.  Soils are decompressed.  Risks of bentonite leakage.  Need for rapid and continuous placing of concrete.	Slurry walls

## 6.22 Environment

Covered trenches are used mostly in urban zones, but require a surface site free of all structures. Thus in the center of cities, implantation of such covered trenches is strictly limited to the subsurface of roadways.

Protection of scenic sites may, in open country, require the concealment of certain roadways using covered trenches.

## 6.3 Precautions

- \* The major difficulty lies more in the site than in the method: in urban zones, operations dealing with construction, rubble removal, and concrete work, are always complicated. Moreover, maintenance of surface traffic requires rapid completion of the project, as well as expensive temporary structures.

For these reasons, an excavated tunnel solution is often competitive, as it avoids surface problems (assuming that the necessary precautions for soil treatment and stability of buildings are taken) and permits a much more flexible and direct layout.

- \* Other difficulties may arise during construction of support walls, notably when underground obstacles are encountered (unexpected utility services, old foundations, collapses, etc.). In this regard, every effort must be made to improve the precision of data regarding existent service networks.
- \* Resorting to covered trenches in the proximity of dwellings does not eliminate risks of subsidence, and consequently requires taking all possible precautions in this matter (sufficient rigidity of excavation supports, underpinning of building foundations, soil treatments, etc.)

## 6.4 Performance

The time required for the excavation and support of the trench varies greatly depending on the construction techniques employed and the terrain encountered. By way of illustration, using present techniques a single crew can construct 25-80 m<sup>2</sup> of slurry wall per day.

---



## Appendix 7. PREFABRICATED CAISSONS

### 7.1 Description

For subfluvial, submarine, or extremely aquiferous passages, several methods can be used:

- \* Injection, electro-osmosis, or freezing of terrain, followed by any other construction method.
- \* Traditional excavation methods if there is an underlying impermeable layer.
- \* Using a driving shield.

Prefabricated steel, reinforced concrete, or prestressed concrete caissons can also be included in this list.

These caissons are of circular or, more commonly, of rectangular cross-section. Overall dimensions are quite large (20 m. wide, 6 m. high, 100 m. long). They are installed in 3 ways:

- \* In shallow depths (approximately 20 m.), underwater construction in a pressurized chamber (or diving bell).
- \* Construction of caissons inside a coffer dam.
- \* Prefabrication of caisson in a dry enclosure and then floating to construction site, where caissons are sunk into a previously excavated trench (possibly resting on bedplates, shafts, or piles).

The design should insure that the caissons can withstand forces that might be occasioned by differential collapse of the excavation, by their own weight, by water pressure, and by possible loading of the caisson. The caissons must be adequately ballasted or anchored to prevent their refloating.

## 7.2 Domain of Applicability

### 7.21 Subfluvial or submarine passage

The choice of method for traversing a river or ocean inlet requires a difficult comparative analysis of the economic trade-offs between a bridge, excavated tunnel, or submerged caisson tunnel.

Various tunnel solutions are possible:

- \* The nature and permeability of underlying strata are major geological parameters.

Existence of an impermeable layer may permit traditional excavation methods (full, half, or divided-section excavation, boring machine), thus avoiding the procedures discussed in 7.1 above.

Shallow water depths may permit the use of a driving shield in a compressed-air environment.

Generally speaking, a detailed geological study of approaches and shoreline is indispensable in the choice of a solution.

- \* The topography of the shore, approaches, and depths are extremely important geometrical parameters.

If traffic predictions (or anticipated regulations) permit steep grades a solution that makes use of submerged caissons will usually yield a tunnel of shorter length.

### 7.22 Precautions

Submerged caissons constitute a possible solution only on the condition that they leave sufficient draft for fluvial or maritime traffic.

Technically speaking, they involve numerous difficulties:

- \* Excavation, treatment, and maintenance of excavation bottom.
- \* Stability of footings on steep river banks.
- \* Positioning of caissons (strong marine currents, etc.).
- \* Assembly caissons and waterproofing of joints.
- \* Adequate waterproofing of caissons requires very careful pre-fabrication, very limited shrinkage.

At present, the last two difficulties are almost totally surmounted.

---

## Appendix 8. SPECIAL TREATMENTS

It is not possible to discuss, even briefly, tunnel construction methods without mentioning special treatments which, while remaining highly specialized techniques, should be ever-present in the engineer's mind at the time of project planning.

Included under this heading are all methods or techniques destined to improve terrain quality, before tunnel construction begins or in the event a major irregularity is encountered. The terrains treated are generally aquiferous, or dry pulverulent terrains. Treatment permits use of traditional excavation methods.

As a general rule, five categories for the mass-treatment of terrains may be distinguished:

- \* Drainage during advancement (during the course of construction).
- \* Lowering of water table (preliminary treatment).
- \* Injections (preliminary or during construction).
- \* Soil freezing (preliminary treatment).
- \* Electro-osmosis (preliminary or during construction).

This appendix constitutes a simple reminder. In addition, it is intended to draw the attention of engineers to the existence of and the specific difficulties associated with these treatments, rather than to provide a detailed description and analysis.

### 8.1 Drainage during Advancement

In the event that water-bearing permeable soils are encountered during construction, it is possible to lower the interstitial pressures by draining the terrain during advancement.

This drainage should be accomplished by drilling, through the working face (about 10 meters) and laterally.

## 8.2 Lowering of Water Table

Lowering of the water table is especially useful in pulverulent soils, sands, and highly permeable gravels ( $k > 10^{-3}$  cm/s).

Economically speaking, this procedure is generally deemed profitable when there exists an impermeable layer at a maximum depth of approximately 30 m.

Particular attention should be focused on the risk of surface subsidence with resultant damage to structures in urban zones. In such sites, lowering the water table is often ruled out if the compressible layers are thick.

## 8.3 Injections

The criteria for use of terrain injections are clearly similar to those for lowering the water table (here again soil permeability is an important criterion<sup>1</sup>). There are different types of injections, depending on their function and nature.

It will suffice here to reiterate that in practice tunnel injections are used in two situations:

- \* Before construction, in order to consolidate surrounding terrain. Their objective is to provide sufficient cohesion and to diminish permeability, prior to excavation. The injections may be effected from the surface or from exploratory galleries. There are also waterproofing injections, which are only slightly effective in improving mechanical characteristics, but which greatly reduce permeability.

These injections involve risks of building upheaval in urban zones.

- \* During the course of construction, as a means of negotiating zones of geological irregularity (particularly faults filled with sand or clay, under strong water pressure, possibly reaching 60-80 bars). These injections are usually accomplished during advancement from the working gallery, and should produce a continuous cylinder several meters in thickness around the gallery. In the event of a strong hydrostatic pressure, it is possible to combine injections and drainage.

In every case, these are extremely delicate operations requiring the service of highly specialized firms. When recourse to this procedure is anticipated, efforts should be made to arrange for in situ testing before calling for proposals or initiating bidding.

---

<sup>1</sup>Determined by means of pumping or Le Franc tests.

#### 8.4 Soil Freezing

In pulverulent aquiferous soils and in very plastic soils with a high moisture content, the stability of the surrounding terrain may be assured by freezing, when other methods are not technically or economically feasible.

The utilization of this procedure requires extensive precautions (drilling precision, monitoring of freezing process, etc.) and is extremely time-consuming, requiring several months.

It involves risks of terrain distension, detrimental to adjacent buildings.

#### 8.5 Electro-osmosis

Electro-osmosis is applicable to very plastic, humid soils. The treatment may be used for construction of covered trenches in very plastic aquiferous terrains in which no other method except freezing is possible. It permits the artificial drainage of terrain adjacent to the excavation without disturbing the hydraulic character of adjacent terrain.

#### 8.6 General Remark

When the problem of mass-treatment of surrounding terrain is posed, the following elements should be given priority consideration:

- \* Nature of ground-water sources: Head, velocity, and origin of ground-water.  
  
Flow, pressure, and material filling fissures.
  - \* Terrain permeability; existence of impermeable layers.
  - \* Safety of proposed treatment methods.
-

## Appendix 9. EXCAVATION OF SHAFTS

### 9.1 Description

The methods used in excavating shafts are extremely diverse. They vary especially in relation to the nature of the terrain, the presence or absence of ground-water, the depth of the shaft, available equipment, etc. Nevertheless, they can be grouped in three categories:

- \* Direct methods of shaft excavation (from above).
- \* Methods of chimney excavation (from below).
- \* Combined methods using a fore-shaft.

#### 9.11 Direct Methods of Shaft Excavation

These methods include all shaft excavation in full section from top to bottom, with rubble being removed to surface by means of an extraction machine. Beyond a certain depth, the shaft must be so equipped to permit continued advancement.

Excavation is generally accomplished manually or with the help of machinery in soils or explosives in rock.

Shafts up to 2 m. in diameter can be bored with a trepan equipped with a cutting wheel. (For larger diameter shafts, the smaller diameter fore-shaft is reamed out to the required diameter.) It is also possible to proceed by coring with the help of a large-section coring machine (up to 3.50 m. in diameter) equipped with a device permitting cutting and removal of the coring whose weight reaches approximately one hundred tons. The machinery used in these two cases are, however, heavy and used only rarely; they are, in addition, extremely uncommon.

In aquiferous formations, freezing is generally employed if the thickness of the aquifer is great (100-300 m.); if not, injection treatments are used (if possible).

- \* Support is emplaced as excavation advances. Its importance is dependent on the nature of terrain. In particular, the terrain may require the placement of a concrete underlining, generally including some sort of waterproofing. The underlining is installed in sections of up to 20 or 30 m.

#### 9.12 Methods of Chimney Excavation

In these methods one strives for the most effective possible use of gravity to assure rubble removal. These methods require the preliminary installation of a gallery at the foot of the shaft for access to the work-site and for removal of debris. They are suitable for excavation of vertical or sloping shafts (depending on the excavated material, a slope greater than 80-90% is necessary in order to assure gravity clearing of rubble; for less steep slopes, rubble must be removed by scraping or by hydraulic mucking.

Current methods commonly use a mobile platform permitting transport of personnel and material into the chimney, also serving as a construction platform for the work crew. The platform is removed to the gallery below before blasting. Such devices may be used for shafts whose height does not exceed 300 m. They are suitable for the excavation of vertical or sloping shafts in good or very good terrain that does not require support. The excavated section generally falls between 2.5 and 10 m<sup>2</sup>.

#### 9.13 Combined Methods Using a Fore-shaft

These methods combine the advantages of the preceding methods: excavation of a fore-shaft from bottom to top, either by drilling or by mining (cf. above); the fore-shaft is then reamed out from top to bottom, with rubble being removed through the gallery below. If the fore-shaft is bored, several successive borings will generally be necessary in order to provide a fore-shaft of sufficient diameter to permit passage of rubble without risk of blockage.

While facilitating rubble removal, these methods also improve the rate of advancement for shafts of large cross-section, thus leading to substantial savings on mucking costs.

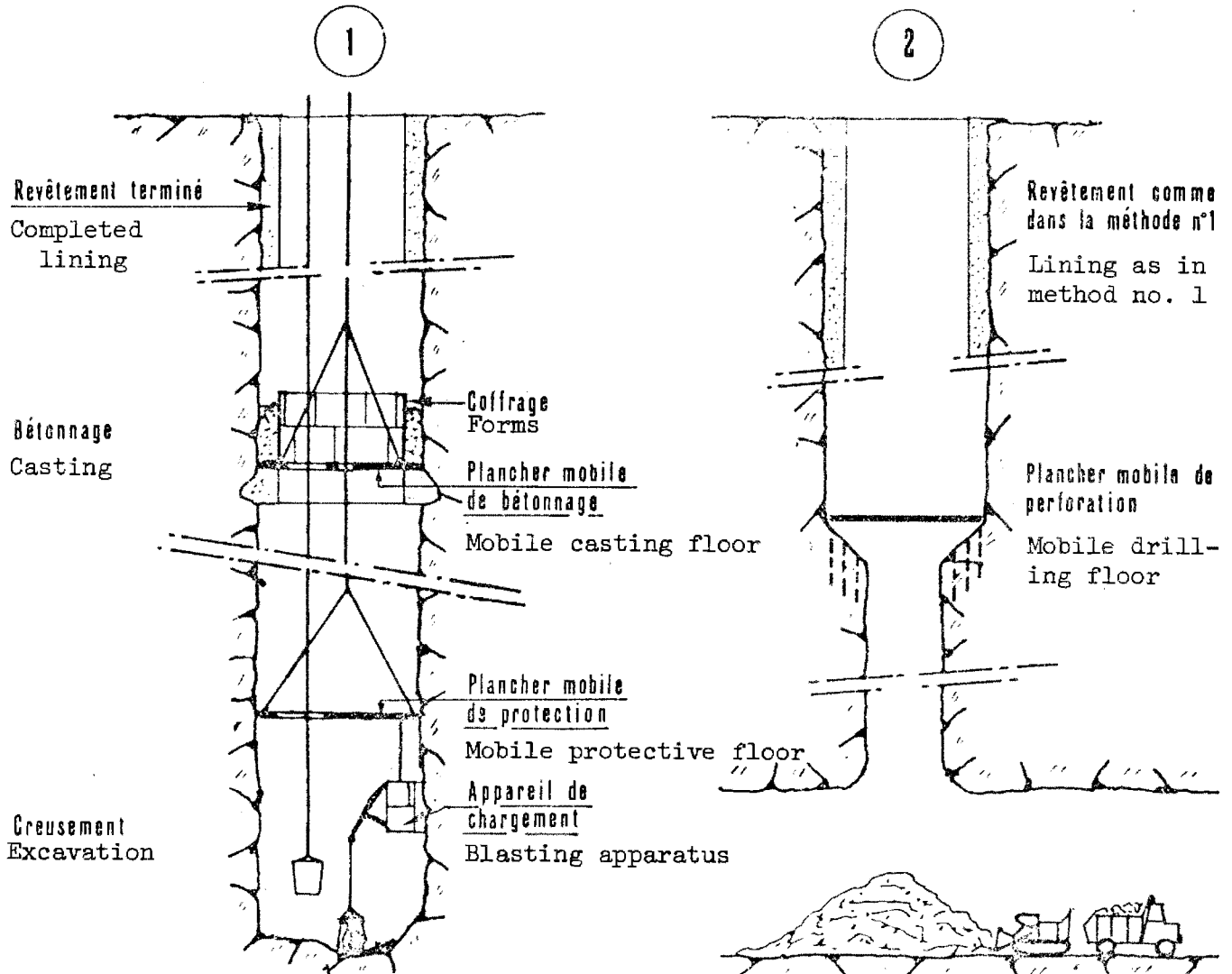

METHODE DE CREUSEMENT EN PUIS

Direct Method of Shaft Excavation

METHODE MIXTE UTILISANT UN AVANT-PUITS

Combined Method Using a Fore-shaft

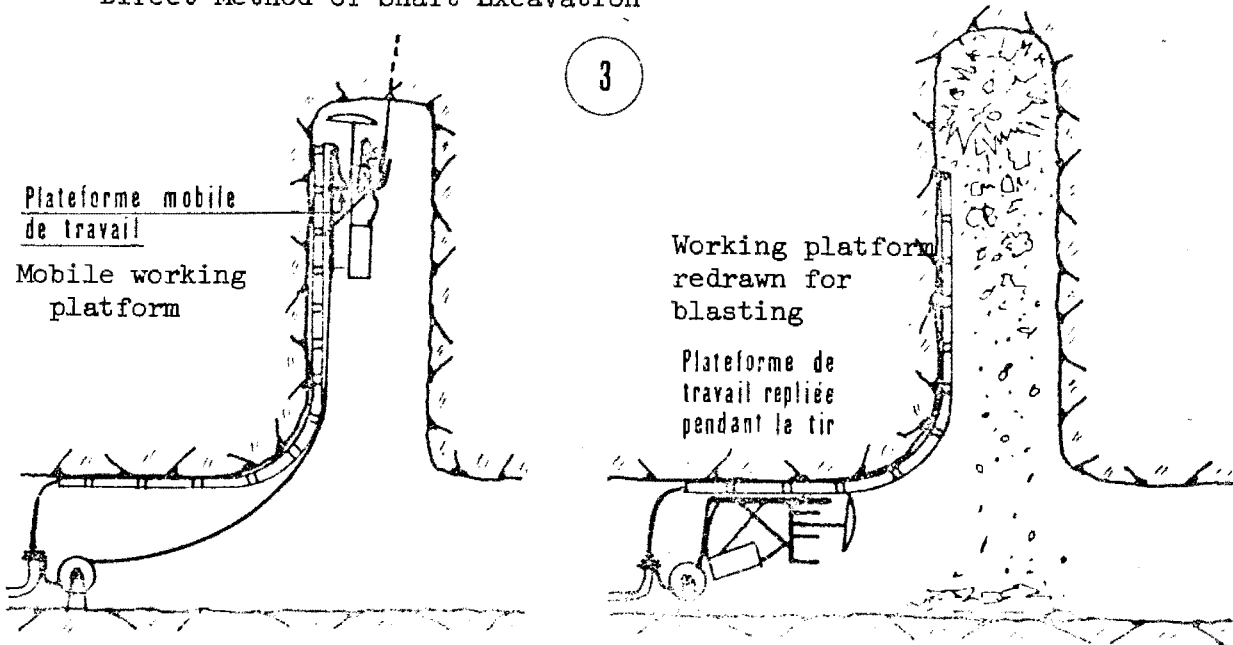

Method of Chimney Excavation (Alimsk System)



## 9.2 Domain of Applicability

Methods of chimney excavation are applicable to good terrains that do not require support and which present no ground-water problems. The practical limits are approximately 300 m. in height and 10 m<sup>2</sup> in cross-section.

The applicability of combined methods is quite similar, though they allow for larger cross-sections.

When the fore-shaft is bored, mixed methods can be used in poor terrains, so long as the stability of the bore-hole is assured.

In aquiferous formations or in poor terrain, only direct methods of shaft excavation are suitable. They may be combined with freezing or injections. They permit the placement of support and waterproofing, as well as the rapid emplacement of a lining.

## 9.3 Precautions

Shaft excavation methods generally lead to a superposition of different operations (excavation, support and possibly temporary lining, casting of permanent lining), thus necessitating special precautions in order to assure personnel safety.

In methods which make use of a bored fore-shaft, deviations in direction are often a source of difficulties. These problems increase with depth. Particular attention should be directed to proper guidance of the boring operation.

## 9.4 Performance

Advancements in shafts are usually much smaller than in galleries. On the average, advancements in the range of 40-70 m./month may be anticipated. Boring methods achieve higher rates (sometimes greater than 200 m./month) but they require heavy equipment of a sort that is rarely used; in fact only a few are in existence. Moreover, they are suitable only for small cross-sections (2 to 3 m. in diameter) and cannot be used in all terrains.

---

Appendix 10. GLOSSARY OF TERMS

<u>Daily Advancement:</u>	Length of tunnel excavated across entire cross-section in one day. See Appendix 1.
<u>Clearing:</u>	Operation that consists of excavating terrain, either on working face or laterally, with or without explosives.
<u>Decompression;</u> <u>decompressed zone:</u>	Phenomena accompanying a modification in the natural stresses in the terrain adjacent to the excavation. In hard rock under heavy cover decompression may result in an explosive spalling of rock from the tunnel facing.
<u>Driving shield:</u>	Special excavation and support procedure. See Appendix 5.
<u>Excavation;</u> <u>excavated tunnels:</u>	Totality of operations required to remove terrain located within the profile of the projected tunnel. In a more general use, excavation can also include support erection.
<u>Forepoling:</u>	Supports driven into the terrain above the working face, thus forming a protective visor against terrain collapse until ribbing is erected.
<u>Invert:</u>	Bottom of tunnel between two sidewalls, consisting either of the terrain traversed or of cast concrete.
<u>Countervaulted invert:</u>	Concrete invert in the form of an inverted vault, the lowest point of which is located on the tunnel axis.
<u>Jumbo:</u>	Machine used for drilling shot-holes in working face.
<u>Lagging (n.):</u>	Used to protect tunnel gallery from rock falls and, as a temporary support, to limit terrain evolution.

- Lagging (v.): Operation which consists of restraining the terrain adjacent to excavation. Lagging is usually of metal or concrete plates, more or less interlocking, that are wedged behind support ribs against terrain facing.
- Overbreak: Cross-sectional area bounded on inside by the theoretical profile of excavation and on the outside by the actual profile of the excavation. Generally the result of fracturation and shock caused by blasting.
- Mucking: Loading and removal from the working face of terrain cleared by blasting. Sometimes refers to the rubble itself.
- Vaulted Profile: Tunnel cross-section whose upper section is vaulted rather than rectangular.
- Full-arch profile: Semi-circular vaulted profile.
- Ribbing: Steel arches placed against tunnel facing to support terrain by means of intermediary lagging.
- Sidewalls: Vertical portion of tunnel's cross-sectional profile, located between vault and foundation.
- Support: Totality of arrangements insuring stability of excavation and safety of construction: bolts, ribbing, lagging, etc. Also refers to erection of these items.
-

Section 3. LINING

---

1. Preface . . . . .	157
2. Role and Importance of the Lining . . . . .	159
3. Shape and Dimensions of the Lining . . . . .	161
4. Composition of Lining . . . . .	165

Chapter 1. PREFACE

1.1 The lining of a tunnel is generally considered to be the element essential for its stability. In reality things are much less simple, and it is necessary to consider the surrounding terrain, the support, and the lining as a single complex of which the combined equilibrium assures the long life of the entire structure. It is in this sense that it can be said that, with tunnels, it is much less a question of making an underground structure than of "constructing" a cavity.

This remark stresses the fact that for underground structures, the behavior of the structure and that of the terrain are closely linked. Problems of support and lining are thus necessarily complex, and the methods of resolving them always uncertain and often empirical.

The lining constitutes an important aspect of the tunnel engineering. For tunnels excavated using standard methods (excluding tunnels bored by machine), construction costs generally represent 40-90% of the total cost, depending on the circumstances. The lining constitutes approximately 30% of construction costs. Construction costs vary greatly depending on the geological conditions encountered. Lining costs vary similarly, usually representing 10-30% of the total cost for the tunnel.

1.2 On a practical level, the geology of the terrain traversed, the methods of construction, dewatering, and waterproofing, all enter into the design of the tunnel lining. The principal risks to avoid are the following:

- \* Structural instability during the temporary phases and after completion of construction.
- \* Superficial or deep disturbances (subsidence, disturbances in nearby structures).
- \* Cracking of lining once tunnel is in service (cracking affects watertightness, cleaning, and lighting).

To this end, consideration of the following points must be given priority:

- \* Terrain pressures.
- \* Pressure from possible swelling of alterable rocks.
- \* Hydrostatic pressure.
- \* Possible loading by a nearby structure.
- \* Deformation of foundation.

In more difficult cases, special model studies are useful for evaluating the distribution of stresses in the vault during the successive phases of construction.

Second, the current empiricism in the dimensioning and design of the lining demands extensive consultation with specialists having the requisite experience. Moreover, the resulting lining is directly related to the quality of both construction and concrete. It is therefore very important to provide for in situ monitoring of both construction and concrete. Such monitoring permits continued observation of the behavior of the terrain, support, and lining, thus insuring prompt action to correct any problems that may appear.

---

## Chapter 2. ROLE AND IMPORTANCE OF THE LINING

### 2.1 Relation between Support and Lining

The excavation of a gallery generally requires erecting supports, the extent of which varies depending on the nature of the terrain, the cross-section of the excavation, and the construction method used.

Support may not even be necessary in favorable conditions (machine-bored gallery in homogeneous, unfractured rock); in other cases support may include forepoling above the working face or perhaps the use of a driving shield in very poor terrain.

The purpose of the support is:

- \* To guarantee the safety of personnel working in the gallery.
- \* To assure the stability of the excavation.
- \* By its rigidity, to limit the propagation to the surface of deformations caused by excavation, particularly in urban sites.
- \* To avoid an overly rapid deterioration of the strength of certain terrains by progressive deconsolidation or alteration, by assuring immediate protection for the excavation facing.

The different methods of construction presently in use commonly lead to the use of supports of metal (bolts, metal ribbing, cast-iron arch-sections) or of concrete (cast concrete underlining with or without ribbing, reinforced concrete arch-sections). The supports are left in place and the permanent lining is cast over it.

The supports assure the stability of the gallery during construction, but also play a part in the final stability of the tunnel along with the lining, which is applied to the intrados of the supports. It is clear, therefore, that planning of the supports (nature, extent, erection, durability) generally has a direct influence on the size of the stresses which the outer lining will have to withstand.

## 2.2 Role of the Lining

The preponderance of considerations relative to the stability of the excavation, which have been stressed in order to justify the necessity of an outer lining in traffic tunnels, should not be taken to imply that these are the only factors involved: safety imperatives (protection against falling rocks), waterproofing; ventilation, lighting, aesthetic factors, which vary in importance according to the nature of the structure (traffic level, length, quality of the site, etc.) also figure in the decision.

The role of the lining in assuring the stability of the structure varies according to the nature of the terrain and the construction method used. Nevertheless it is possible to distinguish the following principal cases:

### 2.21 Tunnel Constructed in Soil

The lining contributes actively in assuring the equilibrium of the terrain in the vicinity of the excavation.

### 2.22 Tunnel in Soft or Alterable Rock

These rocks have a variable makeup; in some cases they are comparable to soils, while in other cases they are comparable to hard rock.

When they can be categorized as "squeezing rocks" (through development of a plastic zone, through swelling or through alteration), the lining is acted on as if by a soil. Still, because of the depth of covering, which is generally much greater than that in the case of soils, and because the development of squeezing pressures is generally a slow phenomenon, the forces set at work are much greater and can compromise the security of the structure. A complete lining (including the invert), often reinforced, is necessary.

### 2.23 Tunnel in Hard Rock

The lining is not generally subject to any major stresses. It essentially constitutes a protection against the possibility of rock falls. Strengthening the more or less fractured zone around the excavation (the extent of this zone depends on the geological structure, the depth of the covering, the method of excavation, which has already been stabilized by the supports, sets only rather limited stresses at work.

It is possible in these cases, at least on certain routes of lesser importance, to replace the cast concrete lining with a less costly protective lining of shotcrete.

---



### Chapter 3. SHAPE AND DIMENSIONS OF THE LINING

#### 3.1 Factors Influencing the Establishment of Stresses in the Lining

The establishment of a particular stress distribution in the lining is a complex phenomenon, involving numerous parameters that are related not only to the geology of the terrain, but also to the method of construction.

Predicting the stress distribution in the lining is in fact a three-dimensional problem, into which time enters as a function of the rheological behavior of the terrain and the succession of the different phases of construction.

3.11 It is possible, however, to distinguish the following major factors:

- \* Load of the terrain on the lining. This pressure is quite variable, depending upon the nature of the terrain and on the construction method used, as was indicated above.
- \* Swelling pressure caused by the alteration of certain rocks, such as anhydrite, marls, or swelling clays.
- \* Hydrostatic pressure when the tunnel is situated below the water table.
- \* The weight of the lining itself.
- \* Possible loading induced by nearby structures.
- \* Deformation of the lining resulting from deformation of the surrounding terrain, especially displacements of the footing in vaulted tunnels. These deformations are negligible in the case of hard rock, though they can become important in alterable rock or soils (terrain types generally classified as poor to very poor).
- \* Linear variations due to differential loading, concrete shrinkage, metal creep, and thermal variations.
- \* Internal stresses occasioned by a thermal gradient across the thickness of the lining.

3.12 Of all these factors, the weight of the lining itself and the hydrostatic pressure are the only ones that may be known with real precision.

The most important are:

- \* Terrain loading.
- \* Possible swelling pressure from alterable rock.
- \* Hydrostatic pressure.
- \* Possible load induced by nearby structures.
- \* Possible deformation of the lining footings.

With the exception of the hydrostatic pressure, these factors are also the least well known. Yet the stability of the structure is dependent upon them.

Linear variations are generally negligible compared to displacements of the lining footing (except in the very special case of a loaded vault on a rigid footing).

The internal forces caused by a high thermal gradient across the thickness of the lining are very rare, but nevertheless worth pointing out. It need only be considered in the case of a structure under a heavy covering, for which geothermal phenomena lead to a natural temperature of the rock which is substantially higher than the interior temperature of the tunnel gallery (15 to 20° C or more).

A lowering of the ambient temperature in the tunnel, caused by the establishment of a current of natural cold air at the moment when the tunnel headings join, provokes a differential thermal contraction across the thickness of the lining which has already been constructed. This contraction can cause some serious cracking.

These two phenomena, linear variations and thermal gradient, do not threaten the stability of the structure. They are rather expressed through the sudden appearance of cracks, which are the cause of major defects in the watertightness of the lining.

### 3.2 Dimensioning and Design of the Lining

The dimensioning of the lining (as well as of the supports) remains largely empirical. The essential difficulty lies in the choice of design hypotheses. Major factors such as terrain loading, possible swelling pressures, and possible deformation of the tunnel footings are not at all well understood. Also, in most cases the relative precision of the calculations must not be deceiving.

In any event, assessing the choice of suitable hypotheses at the beginning (for lack of being able to choose them with precision), dimension studies (calculations or model studies) are particularly useful with terrain types classified from "very poor" to "difficult". These studies permit a determination of the mechanical behavior of the structure and, in the most favorable cases, they permit a determination of the order of magnitude or upper limit of the stresses on the lining.

Geological, hydrogeological and geotechnical studies lend a certain degree of precision to these hypotheses. Nevertheless, because the validity of these studies depends essentially on the choice of hypotheses, it will be prudent to consult a competent specialist.

The calculations must take into account the main factors indicated above, which are:

- \* Terrain loading
- \* Deformability of footings

and possibly:

- \* Swelling pressure
- \* Hydrostatic pressure
- \* Loading induced by nearby structures

The calculations must establish that the structure will be stable not only after completion, but also during the different phases of construction, which are often less favorable in this respect.

As a general rule, by way of a safety factor, the contribution of the abandoned temporary supports (i.e., ribbing and lagging) is taken into account only insofar as its durability is guaranteed (e.g., by a concrete undervault, underlining, prefabricated sections). This rule leads to an important but unknown increase in the safety coefficient.

### 3.3 Proposed Lining Thicknesses

In practice, a semi-circular vaulted lining with vertical sidewalls is suitable in most cases when no major problems are anticipated (weak loading, absence of swelling and hydrostatic pressure, etc.). In particular, this is the case for rocks classified from "difficult" to "very good," with the exception, however, of marls and anhydrites which can swell under certain conditions.

As a first approximation, the following lining thicknesses can be adopted:

Type of terrain	Thickness at the Keystone
Very good	0.30 m.
Good	0.40
Difficult	0.60
Poor	0.80

In very good terrain, this thickness of 30 cm is imposed by the traditional methods of concrete placement, although in theory a lesser thickness, or even none at all, is possible. For example, use of a slurry pump for the concrete requires a minimum thickness of 25 cm between the bottom side of the support and the forming for the intrados of the lining.

These thicknesses are valid for cross-sections having an interior diameter of 10 m. For the same terrain but a different cross-section, the thicknesses should be multiplied in proportion to the diameters.

For terrain classified as "poor" or "very poor", or when the hydrostatic head is considerable, adoption of a cross-section different from the typical profiles may be necessary: construction of a countervaulted invert that is possibly reinforced, circular profile, vault resting on abutments, etc. These solutions clearly deviate from the norm and must be the object of a special study by a competent specialist.

Special structures of large cross-section (interior width greater than 15 m. or excavated section greater than 150 m<sup>2</sup>) will also require a special study.

---

## Chapter 4. COMPOSITION OF LINING

### 4.1 Materials Used and Constraints on Use

Depending on the terrain quality and the construction method, the materials most typically used in the construction of linings are:

- \* Shotcrete.
- \* Cast concrete.
- \* Reinforced concrete, cast-in-place or in prefabricated sections.
- \* Cast-iron (also in prefabricated sections).

Roughstone masonry must be cited as a historical reminder, although in present construction it is practically never used. Reinforced concrete, less expensive and now of excellent quality, takes precedence over cast-iron in prefabricated sections.

- 4.11 Linings constructed from prefabricated sections are used in conjunction with mechanized methods (cf. Section 2, Appendices 3, 4, and 5). Their construction is generally easy, quick, and regular; under good conditions the quality of prefabricated products gives them excellent mechanical strength. Furthermore, watertightness can be guaranteed. On the other hand, the regular contour of the prefabricated sections leaves substantial cavities resulting from overbreak that must be very carefully packed by injections of a suitable grouting.

Underground construction with reinforced concrete is encumbered by supporting struts, which complicates both the ironwork and the proper placement of the concrete behind the forming. The use of cast-in-place reinforced concrete must remain an exception in underground construction, used only in crossing geological irregularities or for zones of very localized difficulty.

When used as an outer lining, shotcrete is generally reinforced by a metal mesh secured to the supports (most often by bolting). This reinforcement augments its mechanical strength and assures its continuity and its anchorage to the terrain. If it is applied in several successive layers, shotcrete can attain a total thickness of between 0.10 and 0.20 meters. As its essential function is to provide protection, its mechanical resistance is very low. It can only be used as an outer lining in terrain classified as "very good" or "good" having no hydrostatic head (otherwise its lack of watertightness would not allow its use).

Cast concrete is the most commonly used material. Its use, however, runs up against certain difficulties that are related to its placement in the tunnel. The mechanical resistance of the lining concrete is practically always sufficient. The disorders that appear are generally caused by tensile stresses. The judicious use of some reinforcement would eliminate cracking, but at the price of a complication that is rarely justified by the increased stability of the structure (it is an altogether different matter with shearing stresses, which may require some reinforcement in order to handle these stresses).

4.12 Casting difficulties generally lead to poor compaction of the lining concrete (and as a result, to a mediocre degree of watertightness). The major difficulties are:

- \* Difficulties in placing concrete into the forms and inadequate filling behind ribbing.
- \* Difficulties in using vibrator.
- \* Inadequate filling around the keystone.
- \* Concrete shrinkage.
- \* Inadequate joining of the different sections of the lining.

A proper concrete mix, suitable means of transporting and placing the concrete (not allowing any segregation), most especially, the smooth placement of the concrete in the forms under sufficient pressure will improve the quality of the lining.

The concrete mix must also take into account any corrosive properties of the local ground-water, and perhaps the possibility of reusing the excavated rubble as aggregate.

The mix should also limit shrinkage.

#### 4.2 Watertightness and Drainage

(See the section on Watertightness.)

#### 4.3 Decisions concerning Support and Lining during Construction

The necessity of rapid response when difficulties arise is a particular characteristic of underground construction. It is sometimes possible to stabilize limited terrain movement if appropriate measures are taken immediately. Moreover, construction safety requires constant vigilance. The decisions can often be facilitated by careful observation of the phenomena: evolution of surface subsidence, terrain movements at level of tunnel, deformation of supports, cracking of lining, etc.

When these observations indicate more extensive movement, immediate measures must be taken: reinforcement of supports, construction of concrete lining sections, possible halting of advancement, modification or change in construction method. These possibilities stress the importance of the observations that must be made while the construction is in progress and which allow an in situ evaluation of the actual behavior of the terrain.

Decisions concerning the lining derive primarily from these observations. As a general rule, in soils, especially in urban sites, surface subsidence can be limited by the rapid construction and blocking of the lining. Under other conditions, the conclusions may be different, depending on the nature of the forces at work. Problems related to deferred forces (caused by swelling, alteration, or metal creep) are not well understood, and it is wise in this case to secure the advice of competent specialists.

Quality control in the construction of the lining is important. It is necessary to exercise very careful control over the quality of the concrete placed in order to be able to act swiftly to correct any observed defects, especially in order to modify the composition of the concrete in order to obtain better placing characteristics. Monitoring must focus not only on the quality, but also on the placing (complete filling behind the ribbing, at the keystone, quality of the curing, and especially the joining of the sidewalls to the vault when they are constructed after completion of the vault).

---

Section 4. WATERTIGHTNESS

---

1. Preface . . . . .	169
2. General Principles . . . . .	172
3. Waterproofing Methods . . . . .	174
4. Choice of Waterproofing Method . . . . .	181



Chapter 1. PREFACE

Underground environments are rarely dry.

Soils are frequently plagued by ground-water problems (phreatic water table, suspended aquifers) which may or may not be continually resupplied.

In fact it is more common to encounter ground-water sources, which may be either localized (faults, fractures, karsts) or diffuse (generally supplied by infiltrating waters of meteoric origin which often follow a very complex pathway).

The problems caused by ground-water are clearly quite diverse, depending especially on whether the water is under head, but it is possible to draw up a concise list of them.

1.1 Ground-water Problems during Construction

Sections 1 and 2 of this volume present detailed analyses of the construction procedures normally used if ground-water is present (terrain treatments or driving shield for the construction below the water table; augmented support in the case of decomposed, evolving or growing rock subjected to diffuse ground-water infiltration; special treatments for localized ground-water intrusion under pressure at a fault).

For clarification purposes, the consequences of encountering ground-water during construction can be summarized as follows:

- 1.11 Subsidence or major modification of the mechanical characteristics of the surrounding terrain, regardless of its type.
- 1.12 Necessity of resorting to special prodedures which are most often very costly or, in the more favorable cases, necessity of collecting and draining water from the work site.

- 1.13 Necessity of considering the modifications in hydrological equilibrium engendered in the surrounding terrain by the excavation, and the consequences of these modifications (terrain consolidation, surface subsidence, possible slides at the tunnel portals depending on bedding planes, etc.).

1.2 Ground-water Problems Once Tunnel is in Service

The presence of water in highway tunnels presents problems of differing importance depending on the type of tunnel. As a general rule, however, it is not recommended to allow the infiltration of more ground-water than can normally be cleared by evaporation.

A list can be made of the problems that result if ground-water is allowed to accumulate; these problems take on a greater or lesser importance depending on the type of route, the geographic site, and the nature of the environment.

1.21 Effect on the Life of the Structure

- \* The flow of water across the concrete lining can, through mechanical and chemical action, damage the vault. This phenomenon is still more pronounced in the event of freezing.
- \* Running water also leads to a deterioration of the roadway if the flow is permanent and localized, and to corrosion of the equipment as well.

1.22 Effect on the Safety of Tunnel Users

With water running on the intrados of the lining, there will always be water on the roadway; this causes an increase in traffic difficulties.

In the event of freezing, the possibility that icicles on the ceiling might fall further increases the risk of accidents.

If there is water in the ventilation ducts, they may become clogged with ice; there is in this case also the possibility of fogging.

1.23 Effect on the Tunnel Appearance

Water running on the inner surfaces of the tunnel results in the formation of permanent stains on the vault and walls, and to an accelerated rate of soiling, a factor which decreases both visibility and comfort.

### 1.3 Consequences for Project Design

It follows from the preceding remarks that ground-water intrusion is always of prime importance in tunnels and must be given careful consideration.

The method of waterproofing the tunnel must be at least briefly considered during preliminary planning, as it affects:

- 1.31 The geometric design of the tunnel (longitudinal profile facilitating the natural drainage, cross-sectional profile adapted to the risks of terrain pressures, dimensioning of drainage channels).
- 1.32 The definition of the construction method: Construction under the water table, ground-water sources under head, terrain that evolves in the presence of water, etc.
- 1.33 The definition of the structure: As is explained later, available waterproofing methods have an effect on the design and construction of the vault.
- 1.34 Preliminary estimate of the construction costs of which waterproofing represents an important aspect (several percent of the total tunnel cost).

This document attempts to provide general information on the common waterproofing methods and their effects. Experience is still quite deficient in this area, so that only a few suggestions can be made; more definitive advice cannot be given at the present time.

---

## Chapter 2. GENERAL PRINCIPLES

As a preliminary to detailed information about water-proofing methods currently being used and the resulting expenses, four essential principles should be articulated.

### 2.1 Deficiencies in the Watertightness of the Vault Itself

A tunnel vault is never, in itself, perfectly watertight. There are always weak points due to discontinuities (joints, cracks), deformations of the structure, or variations in the quality of the vault (greatest difficulty around keystone). It would therefore be a mistake, at the present state of technical development, to count too heavily on the watertightness of the vault itself.

Generally speaking, the watertightness of a structure is defined in terms of its weakest points, and special attention should be paid to construction joints in the vault.

### 2.2 Diversity of the Problems

Watertightness problems rarely arise uniformly along the entire length of the structure. Rather:

- \* Structure may intersect the water table or geological irregularities at several locations.
- \* The formations encountered are never homogeneous.
- \* The risks are not the same at every point along the length of the tunnel (ice or frost near the portals or in the ventilation ducts, obstruction of storm sewers at the low points, etc.).

### 2.3 Diverse Requirements

The aim may be to provide for the perfect watertightness of the tunnel, in which case it is a matter of thoroughly water-proofing the entire length of the tunnel; or the aim may be only

to provide for the partial watertightness of the tunnel, in which case it is a matter of limiting infiltration.

According to the chosen aim, different procedures will be in order.

#### 2.4 Three Principles of Waterproofing

Generally speaking, three attitudes are possible with regard to ground-water intrusion:

##### 2.41 Accelerating its discharge by means of collection and removal (drainage of adjacent terrain, diversion gallery, etc.).

The rate of ground-water flow is the important factor to be considered in dimensioning the drainage system.

##### 2.42 Construction of a barrier at one point along the path of the intruding ground-water that is absolutely or partially watertight (layers of waterproofing) or concentration of ground-water head loss through a very short distance (e.g., lining, injections, etc.).

Total hydrostatic pressure is therefore the major factor to consider in the choice and dimensioning of the cross-section, particularly the vault.

##### 2.43 Allowing unhindered ground-water circulation, but sheltering tunnel from it (e.g., use of canopy).

Because of the free-flow condition of ground-water around the tunnel, the dynamic pressure of the flowing water on the tunnel becomes the major factor.

Depending on the chosen aims, whether it be one of the three attitudes mentioned above or a combination, very different measures will be taken.

---

### Chapter 3. WATERPROOFING METHODS

#### 3.1 Dewatering

As the term is understood here, "dewatering" does not refer to the temporary draining or lowering of the water table that may be effected during construction.

Generally speaking, there are three different dewatering techniques:

##### 3.11 Pre-drainage

Pre-drainage of the surrounding terrain is always obligatory after excavation and in order to facilitate placement of the lining. It consists in tapping the major ground-water sources and channelling this ground-water into conduits running parallel to the tunnel. This drainage system is maintained after the completion of the tunnel, becoming part of the tunnel's system for ground-water control.<sup>1</sup>

Pre-drainage can be effected in various ways:

- \* Ground-water intrusion localized in fissures is collected by means of flexible tubing buried in the concrete vault.
- \* Major flows of ground-water (karsts, faults) are diverted around the tunnel by sealing and lateral channelling. In very difficult cases, a diversion gallery may be required.

##### 3.12 Drainage after Placement of the Vault

Gutters can be provided along the inside of the lining at the transverse joints or along the largest cracks, either through construction of a special gutter or through the use of a wire mesh that acts as a peripheral drain. The water thus collected is sent, as in pre-drainage, to a collector situated under the tunnel invert.

---

<sup>1</sup>This assertion needs qualification, for the conduites often become obstructed over the course of time.

This hasty waterproofing method must be seen as a palliative. Experience shows that peripheral drains have a tendency to become obstructed in time and that other fissures appear, often accompanied by very unpredictable modifications in the paths of ground-water in the surrounding terrain.

### 3.13 Drainage "Canopies"

3.131 This technique involves placing a self-supporting, impermeable ring along the intrados of the excavation (in the case of an unlined tunnel) or along the intrados of the vault (in the case of a lined tunnel), leaving a free space around its periphery.

The ground-water flowing around the ring is collected at various points along the roadway in gutters and drains.

3.132 Very many solutions are possible:

- \* In solid rock a simple canopy can fulfill this function. It must then be dimensioned so as to resist possible shocks (falling rocks, grazing by vehicles), and mechanical stresses (formation of ice between the canopy and the rock facing).
- \* In lined works, this system is generally used only on the tunnel sidewalls as it is possible to assure the watertightness of the vault by another method. Lining the sidewalls in this fashion serves other functions: soundproofing, aesthetics, support of ventilation ceilings, etc.

## 3.2 Tunnel Lining

### 3.21 Recommendations

- \* Generally made of concrete, tunnel linings should be designed and constructed so as to provide the best compaction available. Insofar as is possible, expansion joints should be equipped with flexible seals.
- \* The addition of water repellants will increase the impermeability of the concrete. In any event, cracks, joints, and certain special areas (notably at the keystone or at the junction between the vault and the walls in the case of a two-phase process of concreting) constitute weak points in the lining, which will become preferred paths of ground-water infiltration.
- \* In every case, the mix of the concrete used in the vault must take into account the corrosiveness of the ground-water (see Section 1).

### 3.22 Limits

Weak points can be treated after construction either by use of gutters, as is indicated in 3.12, or by localized injection of waterproofing materials.

The permanent evolution of terrain fissuration and the unpredictable pathways of the ground-water lead us, however, to view these methods as provisional means, better suited for temporarily draining the vault (e.g., in order to permit installation of a layer of final waterproofing).

### 3.3 Injections

- 3.31 In lined tunnels, injections of grouting (mixture of sand and cement) can be used to block the lining against the surrounding terrain, thereby distributing the stresses that are likely to develop in the lining.

These injections are particularly useful in soils where localized forces and stresses are to be expected.

In certain cases grouting can be complemented by sealing injections, effected under great pressure.

- 3.32 Injections increase the head loss of ground-water flow in the vicinity of the tunnel, thereby reducing the volume of ground-water infiltrating the gallery. In this manner injections play a role in waterproofing the tunnel.
- 3.33 In less typical cases, when a reduction of ground-water flow is particularly necessary in order not to disturb the existing water table or when the surrounding terrain is likely to evolve as a result of ground-water circulation, it is possible to proceed with sealing injections of pure cement (containing resins, clay, etc.) in the terrain itself, under high pressure (12 to 20 bars).

As a general rule, however, the injections are not advisable as the sole means for waterproofing the tunnel.

They have unpredictable effects and often lead to expenses that are difficult to anticipate, though they are generally substantial.



### 3.4 Layers of Waterproofing

The final principle of waterproofing to be considered, and one which has not yet been tested much in France, consists of attaching a layer of waterproofing material (which may or may not be totally impermeable) to the lining of the tunnel or to the excavation facing.

There are typically four categories of products suitable for application that should be mentioned:

- \* Hard glazes, which are the only kind not to be intrinsically impermeable.
- \* Flexible prefabricated sheets (PVC, butyl, rubber, metal foils, etc.).
- \* Synthetic products (resins, epoxy, poly-urethanes, polyesters, etc.).
- \* Bituminous products in the form of prefabricated or multi-layered coverings.

Depending on the desired results, the product used can be positioned at different points in the cross-section bounded by the surrounding terrain and the lining intrados (see figure below). The location of the waterproofing can be explained functionally.

#### 3.41 Extrados Waterproofing

- 3.411 The waterproofing is applied directly onto the surrounding terrain, or indirectly onto a layer of shotcrete or mortar projected onto the terrain in order partially to fill the overbreak, thus smoothing the surface to be treated.

The lining of the tunnel, constructed soon after, provides resistance to hydraulic pressures.

- 3.412 Well suited for this procedure are sprayed water-repellant coatings (with a thickness of about 4 cm), sprayed polyesters reinforced with fiberglass (0.3 cm), or flexible sheets tacked to the surrounding terrain.<sup>1</sup> In the special case of a tunnel lining made of prefabricated sections, other synthetic products can be pre-applied to their extrados, accompanied by a complementary treatment of the section joints, thus providing a continuous waterproofing.

---

<sup>1</sup>Flexible sheets are, in fact, not recommended for use on geometrically irregular surfaces having hollows and bumps. A perfectly smooth surface is most desirable; this can be obtained by using a drilling machine, or in certain soft terrains that can be easily excavated (marls, chalks, clays).

**ETANCHEITE  
EXTRADOS**

EXTRADOS

Waterproofing

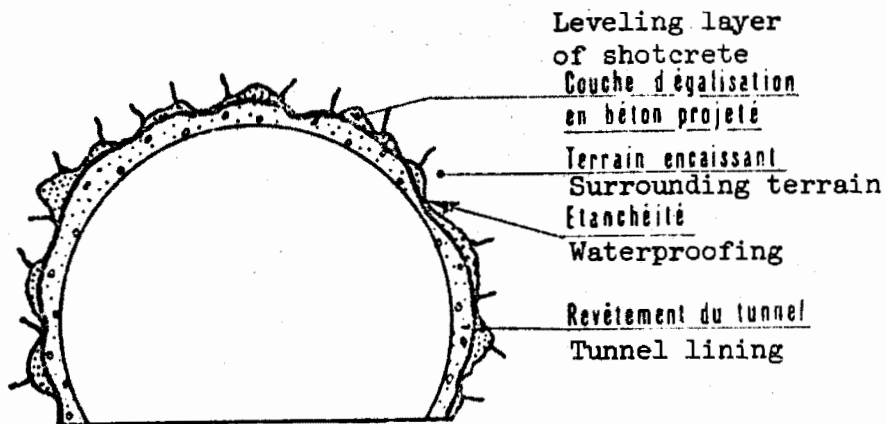

**ETANCHEITE  
INTERCALAIRE**

INTERCALARY

Waterproofing

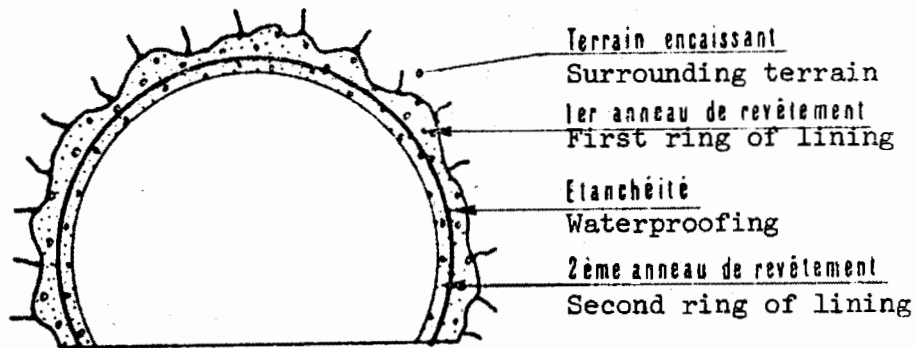

**ETANCHEITE  
INTRADOS**

INTRADOS

Waterproofing

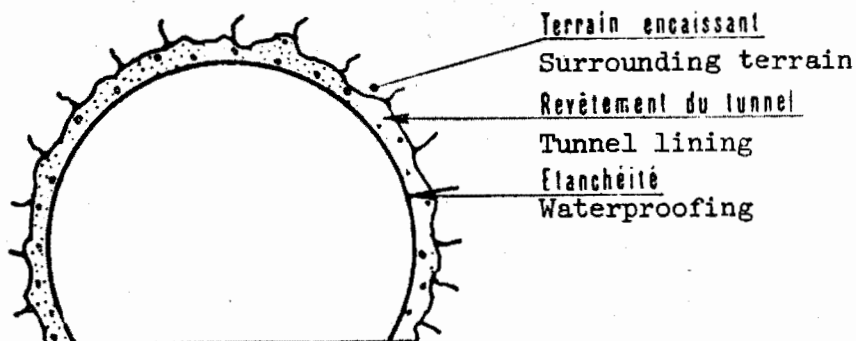

Soils or fractured rock require metal ribbing, and, a fortiori, lagging as well. The aforementioned solution is not applicable, unless the ribbing and lagging are first covered with a thick layer of shotcrete.

### 3.42 Intercalary Waterproofing

- 3.421 The waterproofing material (0.15-0.30 cm. thick) is applied onto the first ring (cast concrete, prefabricated sections, etc.) that strengthens the excavation facing.

A second, interior ring that is placed at a later time (reinforced or non-reinforced concrete) has a thickness of at least 25 cm., and provides resistance to hydrostatic pressure.

In this case, the waterproofing product should be chosen during preliminary design, for it affects the design of the vault.

- 3.422 It is with this procedure that use of flexible sheets, multiple layers, and polyester resin coatings is most preferable. The easier control of the quality of the support surface (the intrados of the first ring) permits a continuous attachment that will hold at least until the second ring is cast.

- 3.423 This procedure is seemingly the safest since it does not require that the layer of waterproofing be permanently attached. In fact there are two disadvantages:

- \* Difficulties in repairing the waterproofing in the event that it is torn during construction of the second, inner lining.
- \* Higher cost resulting from waterproofing itself as well as the second ring of lining.

As a result, this procedure is used only on tunnels subjected to high ground-water pressure; use of this procedure is almost always accompanied by a lining for the tunnel walls as well.

### 3.43 Intrados Waterproofing

- 3.431 Once the tunnel lining is in place, the waterproofing material is applied to the lining intrados. It can be (but does not have to be) protected from the tunnel interior by means of a sprayed coating.

3.432 Well suited to this procedure are coatings (about 4 cm. in thickness) and synthetic products (2 cm.), usually reinforced by mesh or fiberglass. With this type of waterproofing, it is the waterproofing material itself which must withstand any hydrostatic pressure, without interior mechanical support. Use of this procedure is as a result restricted to tunnels where the hydrostatic pressure is rather weak,<sup>1</sup> where there is not risk of ice formation, and where equipment installations in the tunnel can be treated using a sealing technique that assumes the integrity of the waterproofing layer.<sup>2</sup>

With this technique it is wise to provide a sufficient number of expansion joints in the lining, since the waterproofing material is applied to the lining and may be compromised by any cracking (from shrinkage or deformation) in the lining.

---

---

<sup>1</sup>In general, 1-2 bars can be considered as a maximal limit not to be exceeded.

<sup>2</sup>There now exist resins which provide waterproof sealing.

## Chapter 4. CHOICE OF WATERPROOFING METHOD

Given both the great differences of method and the very limited experience with waterproofing treatments, the choice of a procedure is difficult. Each tunnel is in fact experimental at the present time.

In every case, while construction is in progress, it is advisable to proceed with the pre-drainage as described above. In the choice of the waterproofing method itself, it is necessary to consider the type of structure, the nature of the ground-water sources, and the construction method employed.

### 4.1 Relatively Unimportant Tunnels

The minor mountain tunnels that carry a relatively small flow of traffic can probably be treated with the simplest of procedures. Water must not be permitted to run on the roadway; otherwise, the roadway will deteriorate very quickly, also constituting a driving hazard during cold weather. The entire roadway must be protected from falling icicles.

Bearing in mind the (typical) absence of a concrete lining, the following methods are most appropriate:

- \* Canopy drainage for heavy ground-water flows.
- \* Waterproof coating attached to a shotcrete "pre-vault" if there is only a very slight fissuring of the rock.
- \* Still, when there is a major risk of ice, coupled with significant ground-water intrusion, it may be necessary to line the tunnel with an extrados or intercalary waterproofing material.

### 4.2 Moderately Important Tunnels

In tunnels of moderate importance in open country or in cities, one or another of the systems described in the preceding pages can be utilized.

These are the essential parameters of the choice:

- \* The nature and strength of the ground-water sources.
- \* The type of equipment to be installed in the tunnel (which determines in part the choice of an intrados method).

#### 4.3 Major Tunnels

Superhighway and urban tunnels with a heavy flow of traffic must provide high levels of comfort and safety. Because of the presence of much equipment in the tunnel, intrados water-proofing should be used only with the greatest caution, because of the great amount of sealing that will be necessary. Only short tunnels that do not require a ventilation ceiling can, as a rule, adopt this system satisfactorily.

- \* For tunnels under the water table, subjected to high heads (higher than about 20 meters), intercalary waterproofing is generally advisable. In the event that the construction method involves prior treatment of the land, extrados water-proofing can be considered.
  - \* In the case of weak heads or in terrain with very diffuse ground-water sources, one can consider extrados waterproofing combined with a tunnel sidewall lining. This possibility can be particularly attractive when acoustic or aesthetic treatment of the walls is desirable.
  - \* In the case of very weak ground-water sources (without the risk of ice), it is possible simply to block the lining well by grouting injections, followed by superficial treatment of joints and cracks.
-

Section 5. ROADWAYS

---

1. Preface . . . . .	184
2. Construction of Roadway . . . . .	187
3. Delineation of Lanes . . . . .	196

Chapter 1. PREFACE

There is no major reason why tunnel roadways should be differentiated, in their overall design, from other roadways. Nonetheless, certain variables take on special importance here.

1.1 Longevity

1.11 Repair of tunnel roadways involves many more constraints than repair of open roadway. Tunnels are essentially conceived as passages across natural obstacles that are otherwise either difficult or impossible to circumvent.

1.12 Because the possibilities of reinforcing the roadway are limited by the vertical clearance of the tunnel, it is understandable that roadway longevity is an essential design objective.

A long life span is all the more difficult to assure, because of the generally stricter channelling of the traffic (especially heavy trucks), thus accentuating the fatigue of the lining and roadbed.

1.2 Importance of Drainage

1.21 Though tunnel roadways are usually protected from running water, they are situated in environments having permanently higher levels of humidity coupled with major risks of ground-water intrusion through the tunnel lining. Complete drainage of surface water and protection against ground-water intrusion from the bottom and sides of the excavation is therefore imperative.

1.22 When the tunnel vault has not been waterproofed, the constant dripping of water, localized in areas several dozen centimeters in diameter, has a rapid destructive effect. Beginning with the traveled surface, this water very quickly attacks the entire roadbed.



### 1.3 Other Necessary Qualities

The quest for mechanical excellence should not sacrifice either the appearance or superficial roughness of the paved surface.

- 1.31 It is wise to choose a roadway of the lightest possible color, as this will result in major savings (15-40%) in lighting costs and operating expenses. This choice also results in superior visibility and comfort. Of course, a comparative analysis of the costs for the various available road surfaces should be undertaken in every case.<sup>1</sup>

- 1.32 Road surfaces are most slippery when wet. This might seem to be a minor problem in tunnels; however, since the tunnel roadway is not cleaned by rain, slippery materials and dust collect on them. The condensation common in tunnels is then likely to cause the roadways to become slippery or covered with frost.

Finally, the motorist is led by the invariably poorer atmosphere and visibility to brake more sharply in tunnels than on open highway, thereby increasing the risk of skidding.

For these different reasons, the road surface should have and maintain a sufficient geometric roughness (Class C in the pamphlet of June 11, 1969 on slippery roads, or a sand depth of between 0.4 and 0.8 mm).

- 1.33 In the vicinity of the tunnel portals, of course, the problems with slippery road surfaces are analogous to those arising on open highways; this occurs either from the natural penetration of rain water, or when water is brought into the tunnel by vehicles. These problems are further aggravated when lighting conditions are such as to momentarily blind the motorist.

When there is a particularly great risk of frost, special precautions should be taken at the entrances to the tunnel, e.g., the use of a very rough road surface having sharp, uneven ridges, or perhaps the installation of a system for heating the roadway. It should be noted, however, that the devices proposed here have not actually been proven effective.

---

<sup>1</sup>At present there are relatively little data on the savings in lighting costs to be expected from a lighter road surface. For the moment, therefore, it is safe to count on a savings of about 25% over a typical black-top surface when using a cement concrete or a specially treated road surface.

1.4 General Design Conditions for Tunnel Roadway

1.41 Except near the portals, tunnel roadways are not subject to high thermal gradients, which is a doubly favorable factor:

- \* For greater long-term resistance of dark pavements, notably, to grooving by heavy traffic.
- \* For the non-cracking of the treated roadbed.

1.42 The working conditions for tunnel roadway construction are different from those for open highway:

- \* More favorable meteorological conditions.
- \* Special construction difficulties (long transport distances for materials, difficulties in eliminating water and mud from the tunnel floor, vertical clearance restricts use of equipment, difficulties occasioned by limited lateral clearances, etc.).

1.43 As a result of these conditions:

- \* Tunnel roadways will have to be designed more conservatively relative to similar open-air roadways.<sup>1</sup> Due to the high cost of excavation, the over-design is preferably achieved by using treated materials.
- \* The road surface should preferably be light in color, either by using a cement concrete slab or by using a bituminous concrete with light-colored synthetic aggregate.

Of course, these rules will be too rigid for short tunnels, isolated structures, or when there is a very little truck traffic. In these instances, the rules should be adapted to the circumstances at hand, depending on available materials and equipment, and especially on the kind of roadway planned for the tunnel approaches.

---

<sup>1</sup>The reduction of vertical clearances resulting from repaving is anticipated to be very slight (5 cm). This allows for renovation of the road surface, but not for its reinforcement.

Chapter 2. ROADWAY CONSTRUCTION2.1 General Information

2.11 Tunnel roadways can be grouped into four different types depending on the characteristics of the roadbed:

- \* Type 1: Roadways built on a concrete slab (which generally covers ventilation galleries) which are related to the roadways across viaducts, bridges, and related structures.
- \* Type 2: Roadways built on rock.
- \* Type 3: Roadways built on soil or alterable rock.
- \* Type 4: Roadways built on countervaulted inverts.

2.12 Special attention should be paid to the theoretical basis of this classification:

- \* Within a single tunnel, it is possible to encounter types 2, 3, and even 4, depending on the quality of the terrain traversed. If possible, a single roadway cross-section, suitable for the zone presenting the greatest problem, should be adopted for the entire length of the tunnel, unless a cost analysis establishes the profitability of using several different cross-sections. Of course, in the event several sections are adopted, it is the thickness of the roadbed that will be modified from one section to the next; the composition of the roadbed and the road surface itself should remain the same through each section.
- \* It may be necessary to compromise between types 2 and 3, depending on the quality of the rock, its condition, or its alterability, and on the amount of ground-water intrusion.

Finally, it must be remembered that the provision for the removal of ground-water cannot be dissociated from the roadway: the related design and construction cannot be mediocre (see drawings below).

- 2.13 In every case, the vertical clearance is designed with an added 5 cm. in order to allow for later repaving of the roadway.

2.2 Roadways Built on a Concrete Slab

This type of **roadway** differs from others that are currently in use in tunnels, as there are no particular problems associated with making the slab-road surface interface impermeable.

- 2.21 By way of illustration, let us consider several cross-sections of roadway on concrete slab:

- \* 7 cm. of bituminous concrete 0/10.
- \* 3.5 cm. of asphalt poured onto 5 cm. of bituminous concrete.
- \* two layers of poured asphalt (3.5 cm. each).
- \* bituminous or improved tar-like concrete.

etc.

- 2.22 It is important, however, to try to use light-colored aggregate in the bituminous concrete. The aggregate can be of natural rock supplemented with artificial granules. Considering the fragility of certain kinds of light-colored aggregate, and their higher cost, it is advisable to limit the proportion used. We must point out that as of the date of publication of this document, experience with the utilization of light-colored aggregate on very heavily travelled roads is rather limited; more detailed study of the proper proportions is needed.

2.3 Roadway Built on Solid Rock

By "solid rock" we mean a hard rock which will not alter over the life of the tunnel.

- 2.31 Preparation of the Roadbed

The roadbed should be as smooth as possible.

If the rock is very solid and non-alterable and ground-water intrusion minor and localized, it is not necessary to provide a slope for the roadbed different from that of the road surface, so long as infiltrating ground-water is properly collected by transverse gutters that connect with the lateral drains.

In most cases, it is advisable to plan for a transverse slope of about 4% toward the gutter. The lateral drains should be sufficiently deep to produce a general reduction in interstitial pressure in the adjacent terrain.

### 2.32 Roadway Cross-sections

- \* For black-top surfaces, one chooses the cross-section specified in the structures manual of the Central Laboratory of Bridges and Highways corresponding to the highest terrain category and the heaviest traffic category.

By way of example, and taking into account the information contained in this catalog when the Tunnel Manual was being written, two types of roadway cross-sections can be cited:

- \* 8 cm. of topping, an average thickness of 25 cm. of milky gravel, and possibly 20 cm. of untreated gravel.
- \* 14 cm. of topping, an average thickness of 20 cm. of cement gravel, and possibly 20 cm. of untreated gravel.

In these examples, the thicknesses of the layers in contact with the rock are calculated on the assumption that the roadbed is suitably leveled, or more precisely, that points of rock penetrate no more than 10 cm. into the body of the roadway.

- \* For a concrete topping, one should plan for a slab 15 cm. thick on a foundation 15 cm. of milky gravel.

### 2.4 Roadway Built on Soil or Alterable Rock

The roadbed should be given a slope of 4% toward the drains. Infiltrating ground-water should be properly collected: this may require deepening of the lateral drains.

### 2.42 Roadway Cross-sections

The structures manual of the Central Laboratory of Bridges and Highways provides a basis for choosing the soil classification of the terrain (taking into account the remarks contained in 2.12) as well as the traffic category (which should be conservative). It is usually advisable to design for the heaviest traffic category cited in the manual.

Working from this hypothesis, and taking into account the information contained in the structures manual when the Tunnel Manual was being written, the following examples of roadway cross-sections can be cited:

\* For S1 soils (very poor quality)

- 8 cm. of topping, 25 cm. of milky gravel (base-layer quality), and 25 cm. of milky gravel (foundation-layer quality).
- 8 cm. of topping, 25 cm. of milky gravel, and 30 cm. of milky sand.
- 14 cm. of topping, 30 cm. of cement gravel, and 40 cm. of gravel.

\* For S2 soils (poor quality)

- 8 cm. of topping, 20 cm. of milky gravel (base-layer quality), and 20 cm. of milky gravel (foundation-layer quality).
- 8 cm. of topping, 20 cm. of milky gravel, and 25 cm. of milky sand.
- 14 cm. of topping, 30 cm. of cement gravel, and 25 cm. of gravel.

\* For S3 soils (moderate)

- 8 cm. of topping, 20 cm. of milky gravel (base-layer quality), and 15 cm. of milky gravel (foundation-layer quality).
- 8 cm. of topping, 20 cm. of milky gravel, and 20 cm. of milky sand.
- 14 cm. of topping, 20 cm. of cement gravel, and 20 cm. of gravel.

## 2.5 Roadways Built on Countervaulted Inverts

A countervaulted invert is necessary in the following cases:

- \* Risk of hydrostatic under-pressure or swelling of the surrounding terrain.
- \* Risk of instability of the sidewalls, during and after construction.

### 2.51 Drainage

The watertightness of the entire structure must be assured.

The lateral drains bordering the roadway assure drainage of water on the road surface; they are made entirely of impermeable concrete.

### 2.52 Roadway Cross-sections

The countervaulted invert must be filled with self-draining materials. Roadways constructed on inverts correspond to those for an S2 category soil.

In most cases, it is advisable to plan for a transverse slope of about 4% toward the gutter. The lateral drains should be sufficiently deep to produce a general reduction in interstitial pressure in the adjacent terrain.

### 2.32 Roadway Cross-sections

- \* For black-top surfaces, one chooses the cross-section specified in the structures manual of the Central Laboratory of Bridges and Highways corresponding to the highest terrain category and the heaviest traffic category.

By way of example, and taking into account the information contained in this catalog when the Tunnel Manual was being written, two types of roadway cross-sections can be cited:

- \* 8 cm. of topping, an average thickness of 25 cm. of milky gravel, and possibly 20 cm. of untreated gravel.
- \* 14 cm. of topping, an average thickness of 20 cm. of cement gravel, and possibly 20 cm. of untreated gravel.

In these examples, the thicknesses of the layers in contact with the rock are calculated on the assumption that the roadbed is suitably leveled, or more precisely, that points of rock penetrate no more than 10 cm. into the body of the roadway.

- \* For a concrete topping, one should plan for a slab 15 cm. thick on a foundation 15 cm. of milky gravel.

### 2.4 Roadway Built on Soil or Alterable Rock

The roadbed should be given a slope of 4% toward the drains. Infiltrating ground-water should be properly collected: this may require deepening of the lateral drains.

### 2.42 Roadway Cross-sections

The structures manual of the Central Laboratory of Bridges and Highways provides a basis for choosing the soil classification of the terrain (taking into account the remarks contained in 2.12) as well as the traffic category (which should be conservative). It is usually advisable to design for the heaviest traffic category cited in the manual.

Working from this hypothesis, and taking into account the information contained in the structures manual when the Tunnel Manual was being written, the following examples of roadway cross-sections can be cited:

\* For S1 soils (very poor quality)

- 8 cm. of topping, 25 cm. of milky gravel (base-layer quality), and 25 cm. of milky gravel (foundation-layer quality).
- 8 cm. of topping, 25 cm. of milky gravel, and 30 cm. of milky sand.
- 14 cm. of topping, 30 cm. of cement gravel, and 40 cm. of gravel.

\* For S2 soils (poor quality)

- 8 cm. of topping, 20 cm. of milky gravel (base-layer quality), and 20 cm. of milky gravel (foundation-layer quality).
- 8 cm. of topping, 20 cm. of milky gravel, and 25 cm. of milky sand.
- 14 cm. of topping, 30 cm. of cement gravel, and 25 cm. of gravel.

\* For S3 soils (moderate)

- 8 cm. of topping, 20 cm. of milky gravel (base-layer quality), and 15 cm. of milky gravel (foundation-layer quality).
- 8 cm. of topping, 20 cm. of milky gravel, and 20 cm. of milky sand.
- 14 cm. of topping, 20 cm. of cement gravel, and 20 cm. of gravel.

## 2.5 Roadways Built on Countervaulted Inverts

A countervaulted invert is necessary in the following cases:

- \* Risk of hydrostatic under-pressure or swelling of the surrounding terrain.
- \* Risk of instability of the sidewalls, during and after construction.

### 2.51 Drainage

The watertightness of the entire structure must be assured.

The lateral drains bordering the roadway assure drainage of water on the road surface; they are made entirely of impermeable concrete.

### 2.52 Roadway Cross-sections

The countervaulted invert must be filled with self-draining materials. Roadways constructed on inverts correspond to those for an S2 category soil.



## 2.6 Drainage

2.61 The purpose of the drainage is to collect and remove:

- \* The water circulating around the lining extrados (see pre-drainage, section 4).
- \* Water condensation from the lining intrados, which is eventually channelled into trenches (see waterproofing, section 4).
- \* Water on the roadway resulting, for example, from washing the tunnel.
- \* Water under the roadway (removal of this water constitutes the drainage of the roadway).

2.62 The excavated bottom of the roadway must be treated in order to prevent any accumulation of water; in general, a minimum transverse slope of 4% is required; irregularities in the excavated bottom where water might accumulate are then linked together by transverse gutters.

2.63 The water is channelled into a drain having a permeable upper part, which must be located below the level of the lower side of the roadway bottom. It must be possible to clean this drain. Man-holes are positioned approximately every 50 m., and at every change of direction. These man-holes should not, if possible, be located in one of the traffic lanes. Rather, they can be located:

- \* Under an emergency stopping lane (which are 1-2 m. wide).
- \* Under sidewalks that are sufficiently wide (75 cm. minimum).

2.64 A single drain is usually sufficient (see cross-section 1a and 2).

However, in the following cases a drain on each side of the roadway may be required:

- \* If the superelevation of the roadway changes direction somewhere along the length of the tunnel.
  - \* If the vertical clearance requires imposition of a center crown.
  - \* If the terrain is especially poor and there is significant level of ground-water intrusion.
-

# SOLUTION 1

## SOLUTION 1

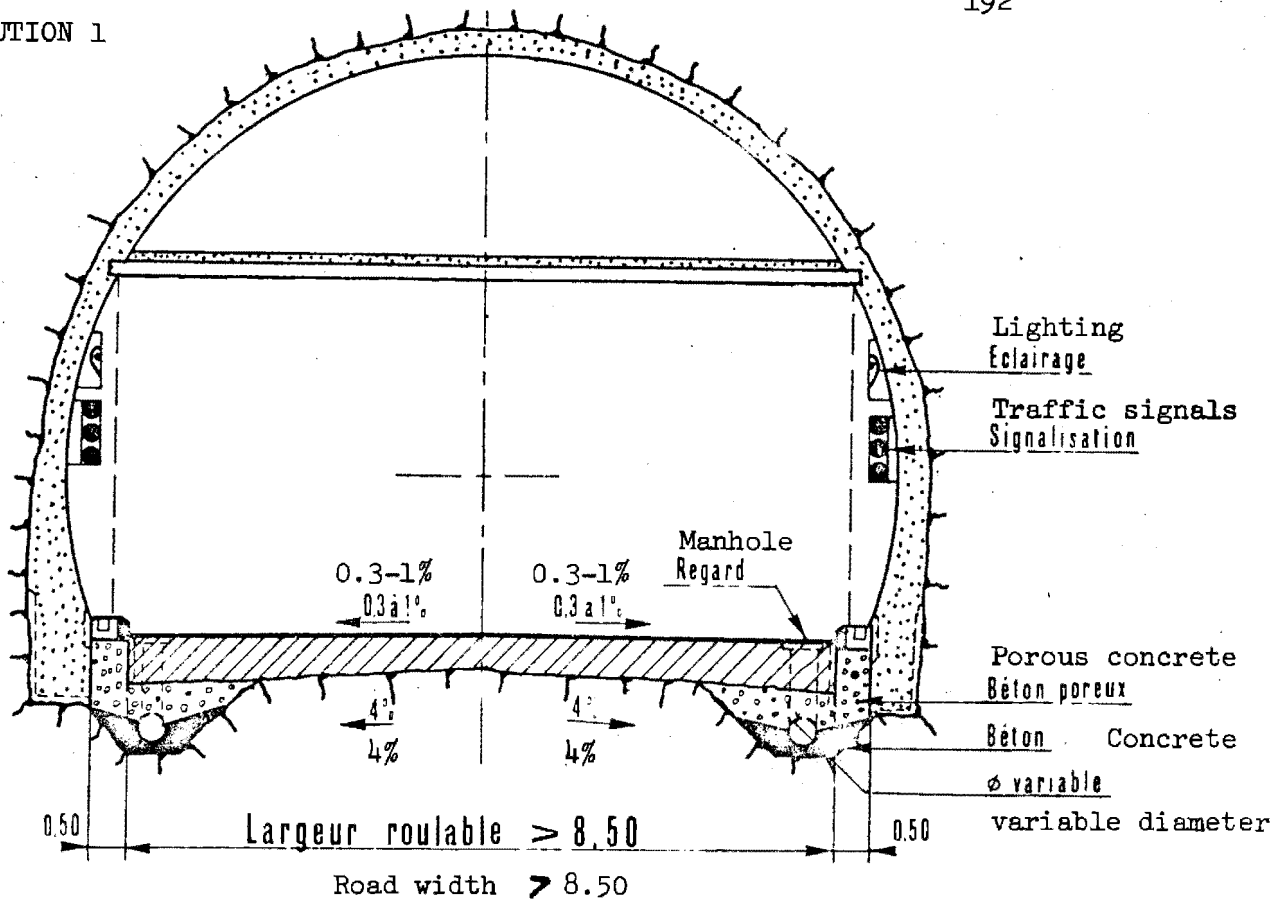

# SOLUTION 1Bis

## SOLUTION 1a

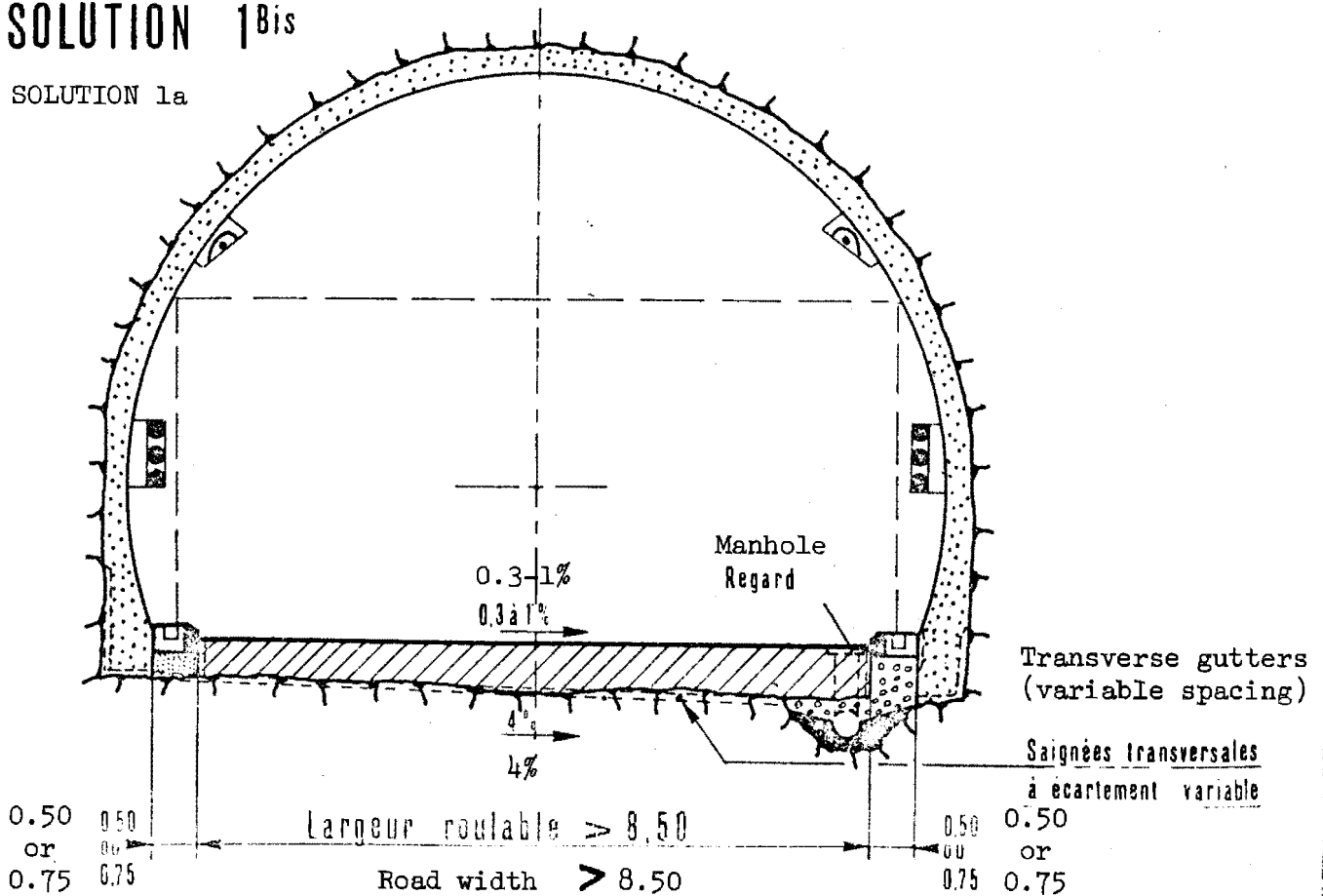

# SOLUTION 2

SOLUTION 2

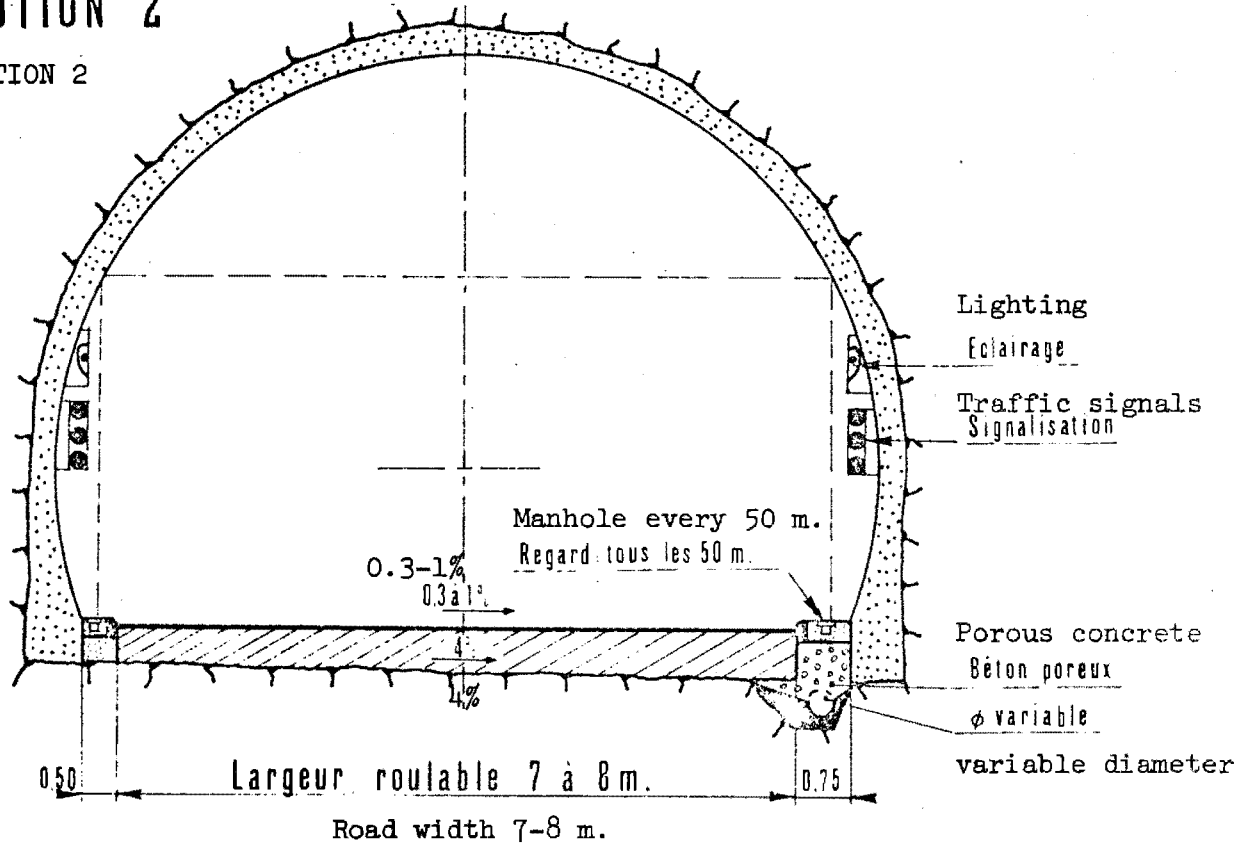

# SOLUTION avec contre-voûte

SOLUTION with countervault

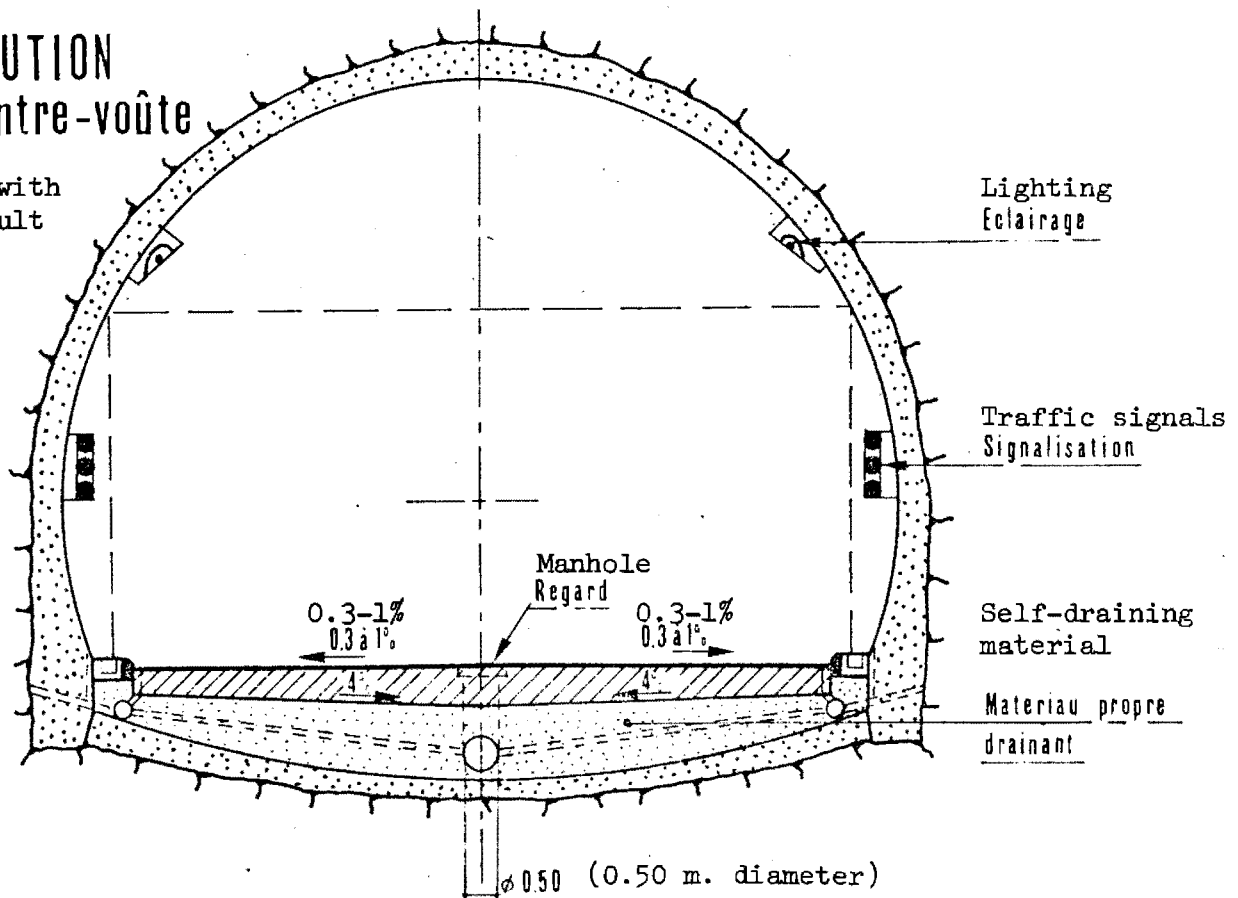

PAGE LEFT BLANK

# SOLUTION 1 : détail

SOLUTION 1: detail

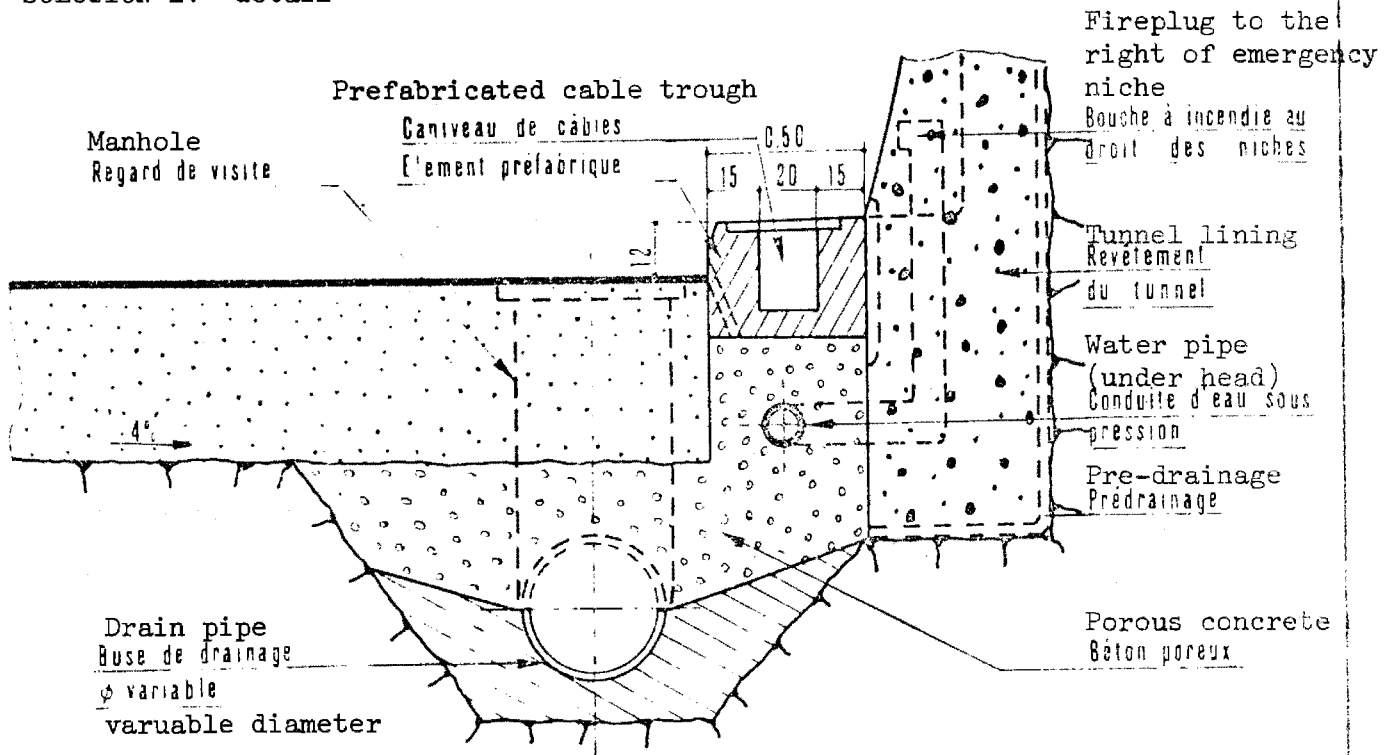

# SOLUTION 2 : détail

SOLUTION 2: detail

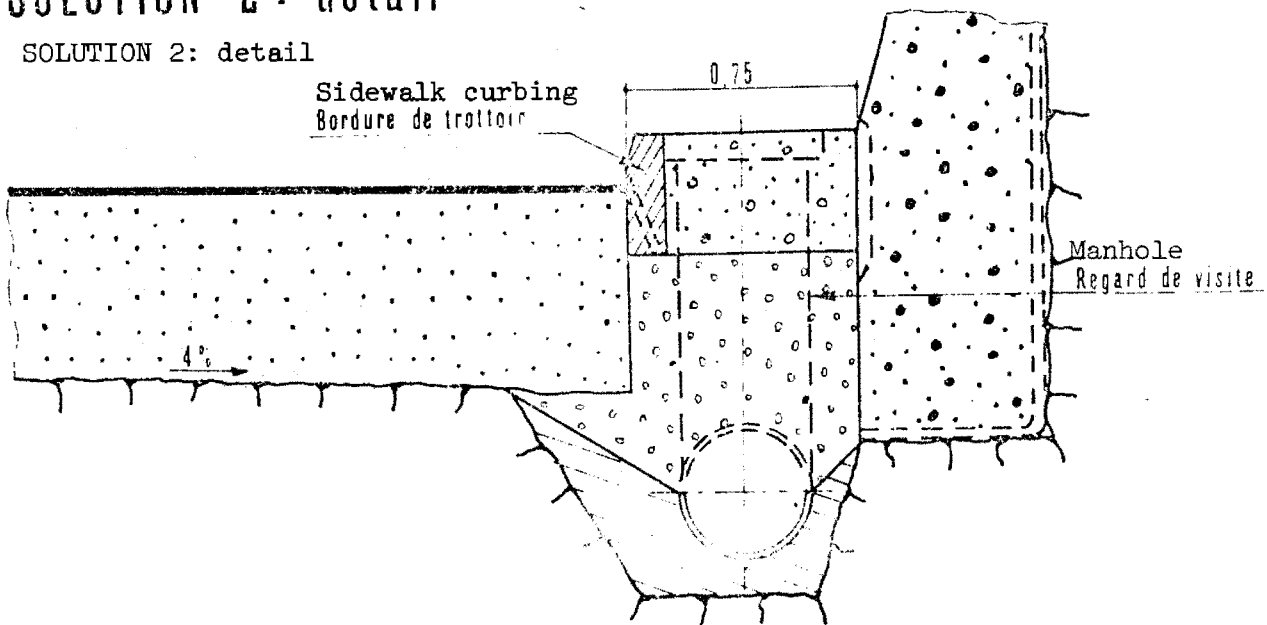

### Chapter 3. DELINEATION OF THE TRAFFIC LANES

The accumulation of deposits of soot or mud occasioned by the lack of systematic washing of tunnel roadways by rain necessitates a clear delineation of the traffic lanes.

The motorists should be able to distinguish the traffic lanes from the shoulders on each side that are not normally used for traffic circulation. The distinction should in all circumstances be either visual or tactile.

It is equally important that the prefabricated curbing guide the motorists unambiguously.

#### 3.1 Differentiation of the Shoulders

##### 3.11 After Usage

The wear and tear caused by vehicular traffic usually lightens black-topped roadways, by uncovering the lighter-colored aggregate. Thus, after sufficient usage, the traffic lanes and the shoulders for emergency stopping become clearly distinguishable.

##### 3.12 When the Tunnel is First Opened to Service

Given the paving difficulties in tunnels, it is not advisable to introduce different techniques of road fabrication (e.g., traffic lanes in black and shoulders in white concrete, or of different aggregates).

However, if the width of the tunnel requires that the road surface be paved in three passes, it may be possible to call for two wide passes spanning the traffic lanes and a third, narrower pass (using different aggregate) on the shoulder. Of course, to be profitable, the tunnel must be sufficiently long.

As a general rule, the traffickable road surface should be delineated using the following methods:

- \* Different superficial treatment of the traffic lanes and the shoulder (varied striping, painting of the shoulders).
- \* Special divisor between traffic lanes and shoulder (prefabricated adhering strips, reflectorized studs that are raised very slightly, placed at intervals, etc.).

### 3.2 Curbing

In order to protect the tunnel walls and the apparatus installed in the tunnel, it may be necessary to install curbing along the edge of the roadway that will serve as a visual and tactile guide for the motorists.

In order to limit the "wall effect" that they might engender low curbs (about 0.12 m. high), which are prefabricated, beveled, and have perceptible grooves on their inclined surface, should be used.

This curbing is painted white, and must also include reflectorized studs.

---

1. The first part of the document discusses the importance of maintaining accurate records of all transactions.

2. It is essential to ensure that all entries are supported by proper documentation and receipts.

3. Regular audits should be conducted to verify the accuracy of the records and to identify any discrepancies.

4. The second part of the document outlines the procedures for handling disputes and resolving conflicts.

5. It is important to maintain open communication and to seek mediation when necessary.

6. The document concludes with a summary of the key points and a call to action for all parties involved.



Regional Technical  
Agency of Lyons

Ministry of Equipment and Housing

TUNNEL MANUAL

(VOLUME III: EQUIPMENT)

Study Group on Tunnels

May 1970

(Translated by Robert J. Matthews)

### Foreword

Within the context defined by the summary document which ought to be read first, the present document is composed of three sections which treat the ventilation, lighting, and utilization of highway tunnels.

The foreword of the summary document and introductions to each section of the present document indicate the precise content and objectives of each.

In order to clarify the studies discussed in Chapter 3 of the summary document, it is necessary to make two important remarks:

First, ventilation sometimes presents difficult civil engineering problems (installation of large subterranean stations, excavation of shafts and adits, etc.). Because of the necessity of added excavation for air ducts and the installation of adits, ventilation sometimes becomes a controlling engineering consideration.

Second, if at the time of preliminary design lighting requirements are considered only in terms of their costs, then it must be recognized that proper design and location of tunnels can lead to substantial savings on ventilation and utilization costs.

It is necessary, then, that the planner bear in mind from the outset of project planning the constraints imposed by the proposed equipment, and that furthermore he take into consideration throughout the design phase the future utilization of the tunnel.

To this end, a complete first reading of this document is highly recommended. This will allow a grasp of the posed problems, permitting consideration of those problems which will determine the general design of the tunnel.

## TABLE OF CONTENTS

### Section 1. Ventilation

Chapter 1.	<u>Introduction</u> . . . . .	
Chapter 2.	<u>General Considerations</u> . . . . .	
	2.1 Vehicular Emissions	
	2.2 Factors Influencing Ventilation Design	
Chapter 3.	<u>Description of Ventilation Systems</u> . . . . .	
	3.1 Natural Ventilation	
	3.2 Longitudinal Ventilation	
	3.3 Semi-Transversal Ventilation	
	3.4 Transversal Ventilation	
	3.5 Mixed Ventilation Systems	
Chapter 4.	<u>Ventilation Design</u> . . . . .	
	4.1 Fresh-air Replenishment Flows	
	4.2 Air Speed in Ducts	
	4.3 Duct Lengths	
	4.4 Cross-section and Shape of Ducts	
Chapter 5.	<u>Choice of Ventilation System</u> . . . . .	
	5.1 Preliminary Rules	
	5.2 Choice Factors	
	5.3 Choice of Ventilation System	
Annex 1.	<u>Design of Ventilation System</u> . . . . .	
	1.1 Calculation of Fresh-air Flows	
	1.2 Design of Ventilation Circuits	
Annex 2.	<u>Sample Design for a Semi-Transversal System</u> .	
	2.1 Tunnel Characteristics	
	2.2 Fresh-air Flows	
	2.3 Choice of Ventilation System	
	2.4 Number of Ventilation Sections and Stations	
	2.5 Design of Ventilation Circuits	

Annex 3. Sample Design for a Pseudo-Transversal System

- 3.1 Tunnel Characteristics
- 3.2 Air Flow and Choice of Ventilation System
- 3.3 Number of Ventilation Sections and Stations
- 3.4 Design of Ventilation Circuits

Annex 4. Longitudinal Ventilation Using Accelerators .

- 4.1 General Considerations
- 4.2 Design Factors
- 4.3 Charts
- 4.4 Sample

Annex 5. Structural Considerations . . . . .

- 5.1 Inside Work
- 5.2 Outside Work

Annex 6. Ventilators . . . . .

- 6.1 Classification
- 6.2 Centrifugal or Radial-Flow Ventilators
- 6.3 Helicoidal or Axial-Flow Ventilators

Annex 7. Problems Unique to Urban Tunnels . . . . .

- 7.1 General Considerations
- 7.2 Location of Ventilation Stations
- 7.3 Noise and Sound Reduction

Annex 8. Glossary of Terms . . . . .

Section 2. Lighting

Chapter 1. Introduction . . . . .

Chapter 2. Principle of Tunnel Lighting . . . . .

- 2.1 General Considerations
- 2.2 Types of Tunnels

Chapter 3.	<u>Illumination Levels in Long Tunnels</u> . . . . .
3.1	Entrance Zone
3.2	Exit Zone
3.3	Interior Zone
Chapter 4.	<u>Illumination Levels in Short Tunnels</u> . . . . .
4.1	Urban Tunnels
4.2	Expressway Tunnels
4.3	Rural Tunnels
Chapter 5.	<u>Improving Tunnel Visibility</u> . . . . .
5.1	Tunnel Exterior
5.2	Tunnel Interior
Chapter 6.	<u>Installation</u> . . . . .
6.1	General Considerations
6.2	Location of Fixtures
6.3	Light Sources
Chapter 7.	<u>Electric Power Supply</u> . . . . .
7.1	Hook-up with Utilities
7.2	Distribution Point
7.3	Emergency Power
Chapter 8.	<u>Sunscreens</u> . . . . .
8.1	Advantages
8.2	Structural Conditions
8.3	Photometric Conditions
8.4	Types of Screens
Chapter 9.	<u>Glossary of Terms</u> . . . . .

## Section 3. Tunnel Utilization

- Chapter 1. Introduction . . . . .
- 1.1 Purpose of Section
  - 1.2 Important Considerations
  - 1.3 Limitations of Present Document
- Chapter 2. Factors Determining Utilization . . . . .
- 2.1 Nature of the Route
  - 2.2 Nature of the Approaches
  - 2.3 Traffic
  - 2.4 Emergencies
  - 2.5 Road Width and Pull-offs
  - 2.6 Grades and Length
  - 2.7 Ventilation
  - 2.8 Surveillance
- Chapter 3. Traffic Control . . . . .
- 3.1 Objectives
  - 3.2 Means
  - 3.3 Consequences
- Chapter 4. Operation of Ventilation and Lighting . . . . .
- 4.1 Ventilation
  - 4.2 Lighting
- Chapter 5. Pull-offs and Emergency Passageways in Tunnels
- 5.1 Pull-offs
  - 5.2 Emergency Passageways
- Chapter 6. Emergency Control Procedures (Examples)
- 6.1 Objectives of Present Chapter
  - 6.2 Essential Principles
  - 6.3 Rush-hour Traffic Congestion
  - 6.4 Accident or Breakdown Partially Blocking Traffic in One Direction
  - 6.5 Accident or Breakdown Totally Blocking Traffic in One Direction
  - 6.6 Fire
  - 6.7 Power Failure
  - 6.8 Changing the Direction of a Lane

Chapter 7. Tunnel Maintenance . . . . .

- 7.1 Necessary Precautions
- 7.2 Structural Maintenance
- 7.3 Equipment Maintenance
- 7.4 Signalization -- Control and Alarm Devices
- 7.5 Miscellaneous

Chapter 8. Organization of Utilization Service . . . . .

- 8.1 Unified Command
- 8.2 Automation -- Control Provisions
- 8.3 Unified Command Center
- 8.4 Emergency Intervention and Maintenance Posts
- 8.5 Vehicle Requirements
- 8.6 Personnel Requirements

Chapter 9. Tunnels without a Utilization Service . . . . .

- 9.1 Object of Present Chapter
- 9.2 Ventilated Tunnels
- 9.3 Non-ventilated Tunnels

Chapter 10. Traffic Regulation in Tunnels and on Approaches

- 10.1 Behavior of Motorists in Tunnel
- 10.2 Traffic Regulations for Motorists
- 10.3 Presignalization

## Section 1. Ventilation

1. Introduction
2. General Considerations
3. Description of Ventilation Systems
4. Ventilation Design
5. Choice of Ventilation System

Annexes



## Chapter 1. Introduction

- 1.1 Highway tunnels constitute a point of singular importance for the motorist. Whether it be a question of the quality of the air, the restriction of lateral clearances, or the severe environmental changes, the comfort and safety of the motorist, and therefore the viability of the tunnel itself, is always at stake.

The present document offers both general and specific information on the ventilation of tunnels which can help insure their viability.

This document furnishes engineers with the elements for undertaking the often necessary feasibility studies.

- 1.2 Three essential points should be learned from this section:

- \* Ventilation is a fundamental element of tunnel design.
- \* Ventilation design for a tunnel must take into consideration from the very beginning:
  - traffic (flows, speeds, truck traffic, etc.)
  - environment (rural or urban site) and tunnel approaches
  - geometry of tunnel (longitudinal and transverse profiles).These factors are often important in tunnel design.
- \* The multiplicity of design parameters confer on each tunnel its own special character. For this reason the present document can in no way replace the specific studies which will be necessary in each case.

- 1.3 Ventilation design parameters are evolutionary in character: one can assume that while vehicular emissions will decrease in the future, demands for comfort and safety will increase. Consequently, the present recommendations are only provisional. Nevertheless, given the present state of the art, they should permit the engineer to undertake tunnel design fully cognizant of the pertinent design requirements.

- 1.4 For greater clarity, the general considerations that are indispensable for preliminary design of the ventilation system of a tunnel have been assembled in the following chapters. More detailed considerations and sample designs are presented in the annexes.
-

## Chapter 2. General Considerations

### 2.1 Vehicular Emissions

#### 2.11 Carbon Monoxides and Smoke

Because they are vented to the exterior only at their extremities, highway tunnels experience disagreeable -- often dangerous -- accumulations of vehicular emissions.

Among the many components of these emissions, carbon monoxides and smoke are usually singled out as representative. These two emissions vary in proportion depending upon the type of vehicle.

- \* Carbon monoxide constitutes a significant proportion (2-8%) of the exhaust gases from a gasoline engine. Because of its toxic effects on living organisms, carbon monoxide levels must be strictly limited in all circumstances.
- \* The smokes discharged from diesel engines reduce visibility and cause serious nasal irritation.<sup>1</sup> High levels of smoke constitute a safety hazard as well as an obstacle to good maintenance service. Smokes must for these reasons also be limited to reasonable levels.

#### 2.12 Influence of Traffic Conditions

The foregoing remarks emphasize the fact that the composition of exhaust gases varies greatly with traffic conditions. The most unfavorable conditions are the following:

- \* Congested traffic with irregular stop-and-go progression, averaging about 10 km/h. Such a situation could be due to:
  - a lack of smooth flow into the tunnel
  - a breakdown or accident in the tunnel
  - a nearly congested traffic flow.

---

<sup>1</sup>These smoke emissions depend upon engine load. They are particularly significant when starting the engine or when the engine is operating in excess of 80% of its maximum load. When carburetors are not well adjusted, smoke will be emitted even under light loadings of the engine.

- \* A steep grade in the tunnel (vehicular emissions rise rapidly with steepening grade).

As a consequence, this suggests that to the fullest extent possible, projected traffic and access conditions should be taken into consideration in ventilation design. One should attempt to insure:

- \* Good design of the longitudinal profile (level or slight grade) as well as of the transverse profile of the tunnel.
- \* Good design of the tunnel approaches, and above all a smooth transition between tunnel and its approaches.
- \* Good traffic control in tunnel and on approaches.

### 2.13 General Principle of Ventilation

The technique presently used for controlling vehicular emissions consists in diluting the tunnel atmosphere through the continual introduction of fresh air, thus maintaining an admissible level of air quality. This level takes into account the combined effects of carbon monoxide, smoke, and various other pollutants.

### 2.2 Factors influencing Ventilation Design

From the very outset of the project ventilation design requires a close coordination of geometrical, technical, and financial studies.

#### 2.21 Influences on Project Conception

Provisions for tunnel ventilation exert a strong influence on project conception. Experience shows that failure to consider ventilation requirements from the outset often creates serious difficulties which greatly increase construction costs, in some cases to the point of rendering completion of the project impossible.

The following factors are strongly influenced by ventilation requirements:

- \* Layout of the approaches, positioning of the interchanges, and, in a general way, the traffic flow characteristics on the tunnel approaches. (Ventilation requirements have in turn a direct influence on tunnel geometry and costs.)

- \* The longitudinal profile of the tunnel and its approaches.
- \* The transverse section of the tunnel and, more generally, on the fact that the design must very often reserve, in addition to the space allotted to vehicular traffic, sufficient space for the transmission of air necessary for replenishment. These ventilation galleries increase the transverse section of the tunnel.

This factor is particularly important in the case of long tunnels or urban tunnels where space limitations or expropriation problems can become serious.

- \* Finally, the ventilation system itself sometimes presents serious difficulties. For example, problems associated with locating:
  - shafts or subterranean stations, which require careful studies for the intakes and for geological and hydrogeological conditions above the tunnel
  - surface stations at tunnel entrances
  - stations in an urban setting that present special environmental difficulties (noise, vibration, etc.).

These difficulties may require relocation of the tunnel, perhaps leading to a new traffic pattern in the tunnel or on its approaches. In certain unusual cases, it may even result in a substantial reduction in the tunnel's traffic capacity.<sup>2</sup>

## 2.22 Ventilation Equipment

For technical and economic reasons,<sup>3</sup> as well as the need to keep the tunnel in service,<sup>4</sup> it is generally not possible, once the tunnel is put into service, to effect major repairs or modifications in the tunnel.

<sup>2</sup>This would be the case, for example, for a very long tunnel where it is impossible to construct intermediary ventilation stations. A limitation in the tunnel's traffic capacity would thereby be required, as traffic capacity is determined by ventilation capability.

<sup>3</sup>The subsequent excavation of intermediary ventilation shafts runs the risk of damaging the tunnel; in such cases careful study and experimentation will be required.

<sup>4</sup>Tunnels are most often points of obligatory passage, such that traffic cannot be easily rerouted.

- \* The initial ventilation design must, therefore, be adequate for projected levels of traffic usage in the future.
- \* The later modification of equipment (ventilators, motors, etc.) is much easier. However this presupposes that the galleries, shafts, and ventilation stations have been designed to accommodate such a substantial increase in air flows.

### 2.23 Influences on Tunnel Utilization

After being placed in service, ventilation will involve costs for maintenance, energy, and equipment replacement amounting to about 3-10% of the total operating cost for the tunnel.

These considerations require that a cost-optimization study be conducted at the time of preliminary design, as soon as the general options are known. This analysis should include:

- \* construction costs
  - \* equipment replacement or modification costs  
(See Table of Content and Cost Document)
  - \* operating costs (See Cost Document).
-

## Chapter 3. Description of Ventilation Systems

### 3.1 Natural Ventilation

3.11 Ventilation is termed natural when there is a longitudinal displacement of the air in the tunnel caused by:

- \* Either a difference of air pressure between the two tunnel entrances, due to meteorological effects (atmospheric disturbances, temperature and hygrometric differentials resulting from different exposures, etc.).
- \* Or as a consequence of traffic flow, where vehicles are moving at a constant speed and where traffic flow is predominantly in one direction. In one-way tunnels this effect is particularly noticeable.

3.12 These two effects can exist separately or together. Experience shows, however, that:

- \* The first effect (pressure differential between entrances) is generally very irregular and unstable, even though it may be very significant at certain even in tunnels several kilometers in length. This is because the movement of atmospheric disturbances tend first to annul and then reverse the direction of flow. These reversals can last several hours because of the very small pressure difference and the inertia of the moving air. The longitudinal air velocities are, as a consequence, very low, and the tunnel atmosphere is practically stagnant.
- \* The second effect (the piston effect of vehicles moving through the tunnel) is sufficient only in short tunnels where the traffic flow remains smooth.

3.13 As will be seen later on, the fresh-air replenishment requirements for tunnels can range from 60-280 m<sup>3</sup>/s per kilometer-lane.

In the following cases, ventilation needs can be satisfied by one or the other of the cited effects:<sup>5</sup>

---

<sup>5</sup>These remarks are quite general. Many factors related to the surrounding topography, climatic conditions, and traffic characteristics may necessitate some type of artificial ventilation.

- \* One-way tunnels where there is no risk of congestion:
  - up to 500-600 m. in length, where roadway is at ground level at tunnel entrances.
  - up to 300-400 m. in length, where roadway enters tunnel through a cut.
- \* For urban tunnels with high traffic flows and risk of congestion, the critical limit may be as low as 150-200 m. in length.

### 3.2 Longitudinal Ventilation

#### 3.2.1 Description of System

In cases where the natural air currents prove to be insufficient or independable, a longitudinal ventilation can be provided which will artificially accelerate the air current passing through the tunnel.

The air circulates in a single direction from one end of the tunnel to the other.

Systems which draw air from each end of the tunnel toward the center, and then exhaust this air through a centrally located shaft, are completely unacceptable.

Techniques used in longitudinal ventilation involve:

- \* Either injectors located in a short duct at the tunnel mouths which inject air into the tunnel at high velocity (30 m/s). (See Figure 1.)

According to site conditions and traffic, only one mouth of the tunnel may have to be so equipped.

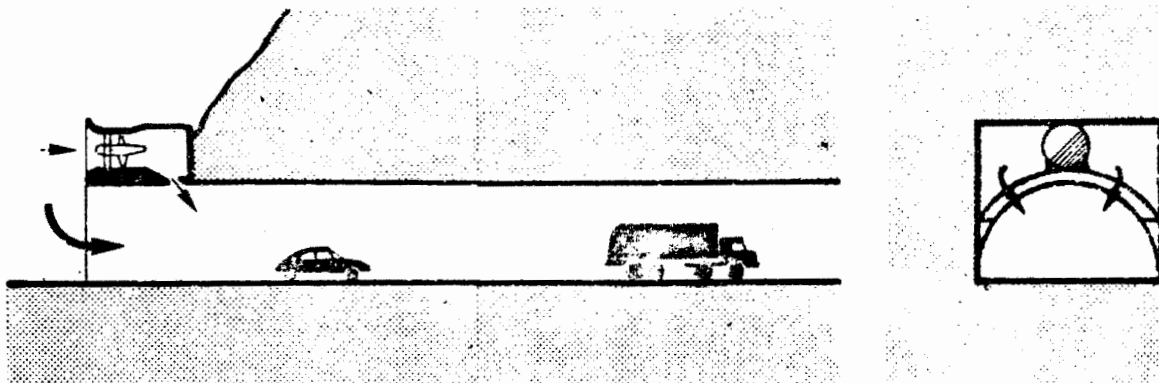

Figure 1. Longitudinal Ventilation Using Injectors



- \* Or accelerators spaced the length of the tunnel, hung on the ceiling or above the pedestrian way in such a manner as to be clear of vehicles. In general, the ventilators should be reversible so that in the event of two-way traffic, the direction of forced ventilation would never oppose that which would be naturally set up.

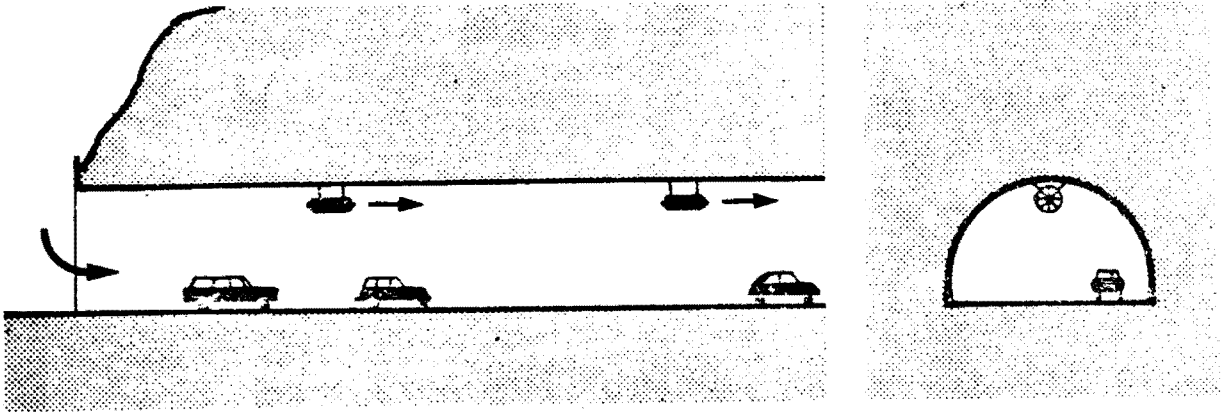

Figure 2. Longitudinal Ventilation  
Using Accelerators

### 3.22 Advantages, Inconveniences, and Limitations of System

These devices are very simple and do not require special ventilation ducts in the tunnel mid-section. The entry injector usually requires construction of a small building, along with the design of a special connecting duct. Accelerators are simply hung on the ceiling at a spacing greater than 60 m. (this spacing is necessary in order to insure a uniform ventilation between accelerators).

The cost of these systems is on the order of 2-8% of the total cost of the tunnel.

Their use is, however, limited:

- \* Injectors are limited by a maximum injection velocity of 25-30 m/s; higher velocities cause discomfort to tunnel users.
- \* Accelerators are limited by the minimal spacing of 60 m. They can only be used in long tunnels having very light traffic or in short tunnels (several hundred meters long) having heavier traffic.

### 3.3 Semi-Transversal Ventilation

#### 3.31 Description of the System

The fresh air required for tunnel ventilation is provided to the entire length of the tunnel by means of a special ventilation duct. Fresh air is introduced at regular intervals into the traffic gallery. The polluted air escapes through the tunnel mouths.

This system insures a uniform and constant dilution of the air in the tunnel; at each point along the length of the tunnel, the densities of pollutant and dilutant are always equal.

- \* In the case of mined tunnels (Figure 3), the fresh-air duct is generally located at the roof of the tunnel, separated from the traffic area by a false ceiling. Fresh air is injected directly into the traffic gallery by openings in the ceiling spaced from 1-10 m.

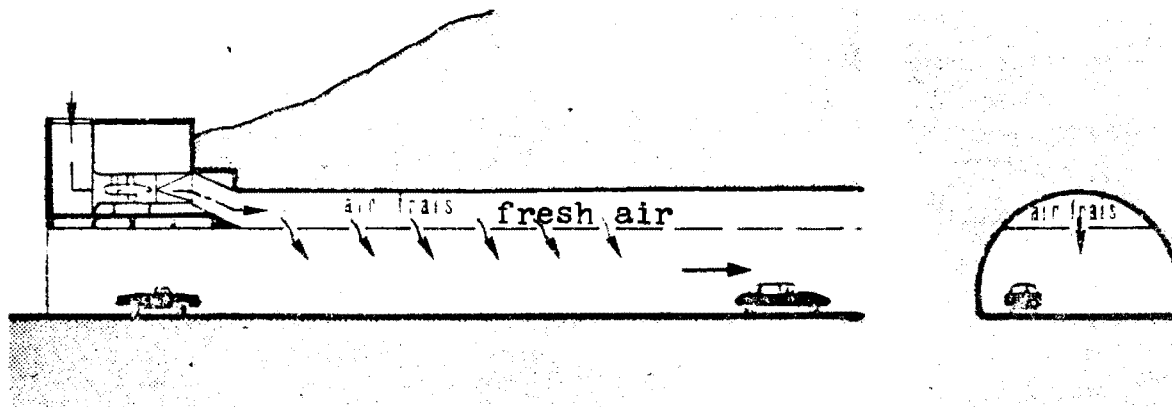

Figure 3. Semi-Transversal Ventilation

- \* In tunnels of rectangular cross-section (e.g., cut-and-cover tunnels), fresh-air ducts are generally located on one side. These ducts are constructed by means of a simple enlargement of the cut. (See Figure 4.)

The air flow in the ducts is maintained by use of accelerators installed at the ventilation stations and connected to the atmosphere by shafts.

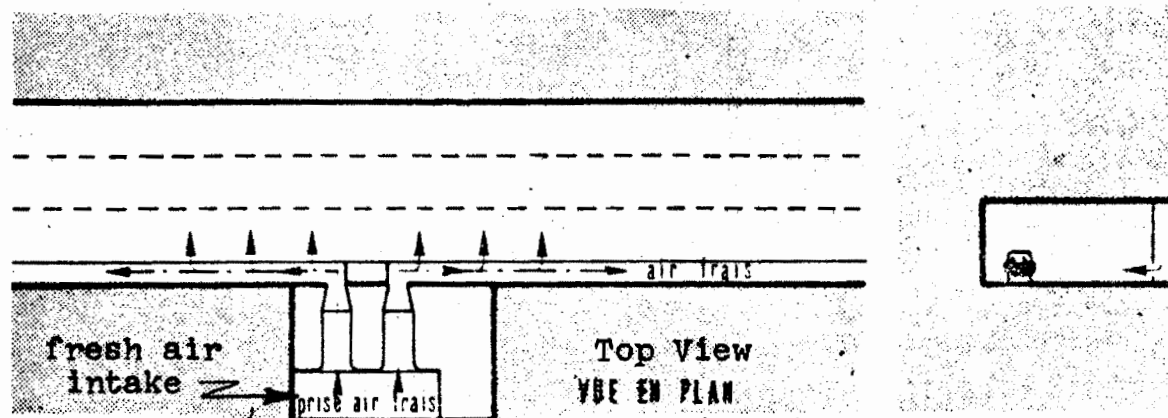

Figure 4. Semi-Transversal Ventilation

- \* In mined or submerged tunnels, ventilation stations are usually located at the tunnel entrances. When the cover is slight, the advantages of intermediary supply shafts should be investigated.
- \* In rectangular-section tunnels, which are often located close to the surface, stations can be placed along the length of the tunnel. The multiplication of stations decreases the required number of duct sections of the tunnel; however it boosts the tunnel's costs by requiring an enlarged cut and the installation of more ventilation stations.

### 3.32 Advantages and Inconveniences of the System

This system is more complex than the longitudinal system, but it is also superior. It requires internal accommodation of the tunnel structure. During preliminary design, the system should be the object of a careful study -- simultaneous with the choice of tunnel layout and transverse section.

- \* Installation of the longitudinal air ducts and connecting adits requires either a duct or a false ceiling. The design of the transverse section must be carefully studied. (It is particularly important to bear in mind the difficulties encountered in locating ventilation stations in urban areas. See Annex 7.)
- \* It is also necessary to provide space for the required electrical machinery, which is more bulky and expensive than in the preceding system.

- \* The cost of this system of ventilation is variable, depending upon whether or not it is necessary to enlarge the tunnel cross-section. On the average, the system will cost around 15-30% of the total cost of the project.

### 3.4 Transversal Ventilation

#### 3.41 Description of the System

Transversal ventilation is distinguished from semi-transversal ventilation by the addition within the tunnel of a duct for the collection of polluted air. The design must accommodate a flow of polluted air equal to that of the fresh-air flow. The dilution of the pollutants and the evacuation of polluted and diluted air takes place, in principle, across a transverse section.

In fact, a longitudinal circulation is superimposed upon the transverse circulation. This is due to meteorological conditions and the circulation of traffic predominantly in one direction.

- \* In mined tunnels, the polluted-air duct is located in the tunnel vault above a false ceiling.

The fresh-air duct can, depending upon the transverse section, be situated below the roadway (Figure 5) or in the false ceiling (Figure 6). In the latter case one must insure the integrity of the partition separating the two ducts.

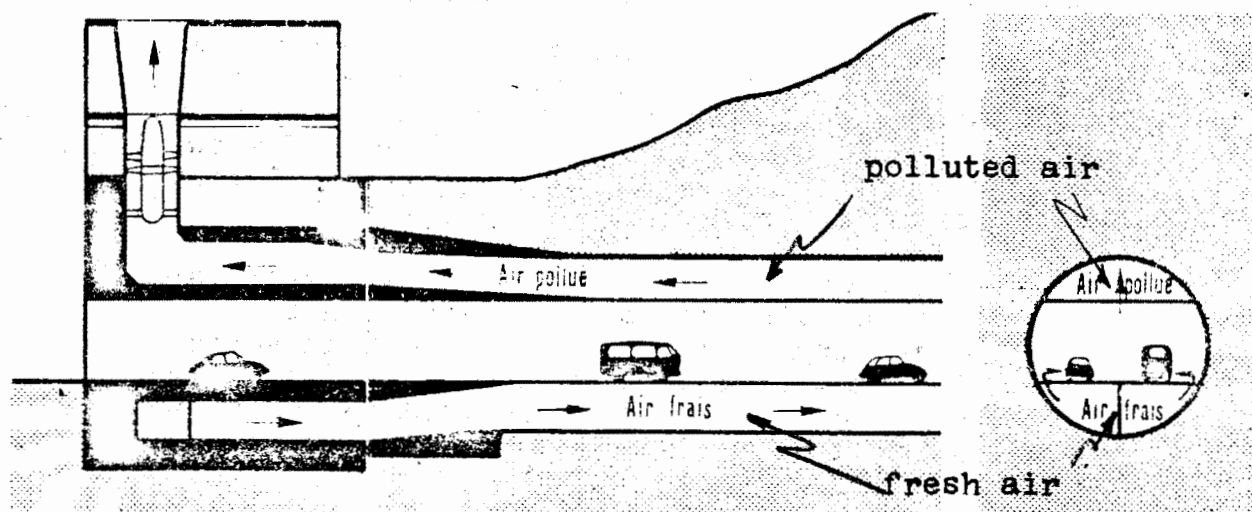

Figure 5. Transversal Ventilation  
(Circular Cross-section)

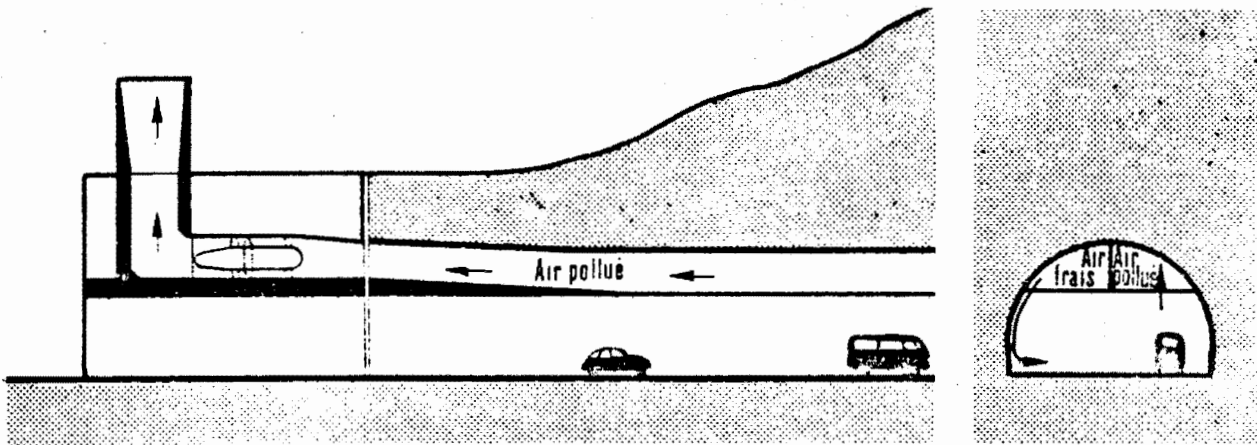

Figure 6. Transversal Ventilation  
(Horseshoe-shaped Cross-section)

- \* In tunnels of rectangular cross-section, the ducts are located on the tunnel sides. The polluted-air intakes are spaced evenly along the length of the tunnel, always as high as possible in the traffic gallery. (Figure 7.)

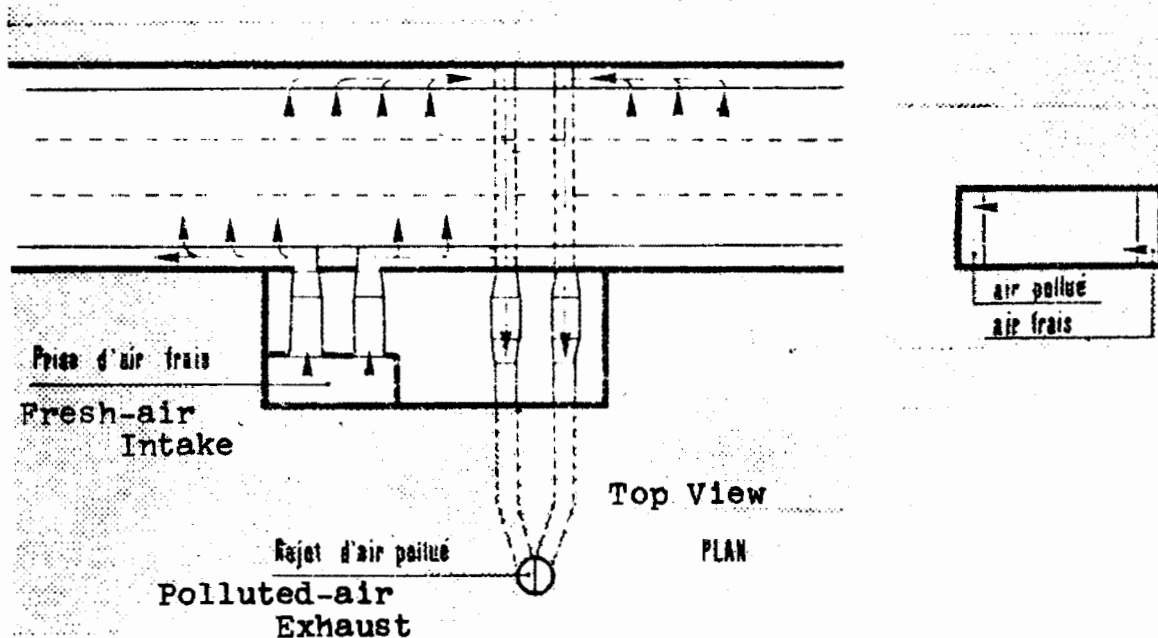

Figure 7. Transversal Ventilation  
(Rectangular Cross-section)

### 3.42 Advantages and Inconveniences of the System

This is the most complete system since dilution conditions cannot be affected by exterior conditions. Accommodation of ducts does, however, impose serious design requirements on the transverse section.

As with the semi-transversal system, it is necessary to pay attention from the very beginning of project planning to the location of the ventilation stations, and, in urban areas, to the discharge points for polluted air. Location of intermediary stations linked to atmosphere by shafts or adits must be equally well studied from the outset.

The cost of this system can be estimated to run about 25-50% of the total project costs, according to ventilation demands (tunnel length, volume and composition of traffic, etc.).

### 3.5 Mixed Ventilation Systems

The systems described above can be combined in such a way as to minimize costs while still meeting ventilation requirements for the tunnel.

Nevertheless, attention must be drawn to the complexity of the problem under consideration; the foregoing remarks can be accorded only an illustrative value. Each particular case will require design by a competent specialist.

- 3.51 It is necessary to mention the pseudo-transversal system, in which fresh air is introduced along the entire length of the tunnel, but where the removal of polluted air is only partial.

Such a system is satisfactory up to a certain point (Cf. Chapter 5). An intermediary system between the transversal and semi-transversal systems, it is in wide use because it permits substantial savings over the former while it affords a better air quality than the latter.

- 3.52 Other systems are possible, but this is a question for the specialists. In all cases, the introduction of fresh air is definitely favored over systems which only remove polluted air.

## Chapter 4. Ventilation Design

### 4.1 Fresh-air Replenishment Flows

#### 4.11 Givens

The determination of fresh-air flows necessary for the ventilation of a tunnel is based upon a thorough and systematic analysis of two (2) categories of data:

##### 4.111 Traffic data

- \* Volume and direction of traffic flow
- \* Fluidity of traffic flow on approaches; risk and frequency of congestion in the tunnel.
- \* Composition of traffic (% heavy trucks, % diesels, peak hours, etc.).
- \* Traffic speed in different lanes.

##### 4.112 Layout data

- \* Longitudinal profile and altitude of the tunnel.
- \* Longitudinal profile of the approaches.
- \* Transverse section of tunnel (possibility of emergency parking -- See Layout Document).
- \* Presence of other tunnels on the same route, immediately above or below.

4.113 The remarks offered in the present chapter concern traffic, grade, altitude, and percentage of heavy trucks. These conditions are summarized in the following table. For all other conditions, refer to Annex 1 for the necessary correction coefficients.

Table 1. Domain of Applicability for Data Presented in this Chapter

Nature of Traffic		One-way Traffic (two lanes)	Two-way Traffic (single lane each way)
TRAFFIC	Base Flow and Speed	1700 veh/hr-lane 55 km/hr	2000 veh/hr for 2 lanes 55 km/hr
	Congestion Threshold and Speed	2000 veh/hr-lane 40 km/hr	3000 veh/hr for 2 lanes 40 km/hr
	Total Congestion and Speed	1000 veh/hr-lane 10 km/hr <sup>6</sup>	2000 veh/hr for 2 lanes 10 km/hr
Maximum Number of Diesels/hr-lane		150 (average/lane)	90 (average/lane)
Grade		Between -0.5% and 0.5%	
Altitude		Less than 400 meters	

#### 4.12 Air Flows to be Considered

Within the above-indicated limits, we will adopt the levels of pollution<sup>7</sup> indicated in the following table. These levels are based upon carbon monoxide levels, but they also take into account smoke and other types of pollutants.

<sup>6</sup>This is an average speed; the traffic movement is actually a very irregular stop-and-go type of progression.

<sup>7</sup>Pollution levels measured in ppm = parts per million of CO.



Type of Tunnel	Rural Expressway	Urban Expressway	Urban Expressway	City Street	City Street	Country Highway
Traffic Direction	One-way (two lanes)			Two-way (one lane each way)		
Nature of Traffic	Normally Uncongested	Sometimes Congested (usually not)	Normally Congested <sup>8</sup>	Sometimes Congested (usually not)	Normally Congested	Normally Uncongested
Uncongested (base flow)	130 ppm	75 ppm	45 ppm	45 ppm	30 ppm	150 ppm
Threshold of Congestion	Not permitted (400 ppm)	250 ppm	150 ppm	250 ppm	150 ppm	Not permitted (700 ppm)
Required Fresh-air Flows (m <sup>3</sup> /s)	100	175	280	175	280	60

Table 2. Pollution Levels and Required Fresh-air Flows  
(based on assumptions set forth in Table 1).

<sup>8</sup>One understands here a recurrent rush-hour congestion which takes place daily.

The pollution levels enclosed in boxes are those that determine ventilation design and dictate the figures in the last row which represent the necessary replenishment flows of fresh air. The ventilation system must be designed, then, to provide these fresh-air flows.

Situations of total congestion in rural tunnels have been excluded, as this can occur only as a result of a breakdown or accident in a poorly designed tunnel during a rush-hour period. But even with such a poorly designed cross-section, appropriate tunnel management should permit its avoidance (See Section 3).

In urban tunnels, on the other hand, these situations must be envisaged. Although uncommon occurrences, they constitute a serious problem, since no management technique will permit the clearing of the systematic congestion of the tunnel resulting daily during rush hours.

It goes without saying that these remarks should be used in preliminary design only. Detailed studies required at a later stage in the design process should be conducted by the competent Agency.

#### 4.2 Air Speed in Ducts

There is no theoretically well-defined limit on air speed<sup>9</sup> in ventilation ducts, but because the electric power requirements grow roughly as the square of the speed for a given flow, one is led to limit air speed to levels less than 30 m/s.

Each increase in maximum speed is accompanied by a corresponding decrease in the transverse section required for the ducts. In other words, with higher air speeds the excavated section is smaller.

Thus there is reason to effect a cost-analysis on the trade-off between:

- \* The marginal cost reductions, on the one hand, which result from the reduced excavated sections of the tunnel and the connecting shafts and adits.
- \* The corresponding increased costs, on the other, which result from costs for the more powerful equipment as well as for the increased energy consumption.

---

<sup>9</sup>We are considering the speed of air entering the distribution ducts, whether it be fresh or polluted -- that is to say, in the immediate vicinity of the ventilators.

There is no general law in this matter; the results of the cost analysis depend upon the relative weight of construction expenses, necessary air flows, and various other related expenses -- all of which will vary from one project to the next.

In practice, for preliminary design purposes, a maximum speed of between 15 and 25 m/s should be adopted, as experience indicates this to be the optimal range.

In certain projects where there will be future expansion, the air speeds for the initial project will be lower in order that more powerful equipment can be installed later, thus allowing for increased ventilation for a reasonable price should it become necessary.

#### 4.3 Duct Lengths (Fresh or Polluted)

When a duct transmits air without intervening distribution, for example in feeding a distant ventilation section, one can plan for lengths of several kilometers. The only obstacle will be the necessarily powerful ventilators and other related equipment, including, for example, the intake shafts connecting the subterranean ventilation stations to the surface.

When a duct serves both for transmission and distribution of air, the length of the duct is limited to 2 km; longer runs risk serious problems with the uniformity of distribution and regions of weak supply.

#### 4.4 Transverse Section and Shape of Ducts

##### 4.41 Transverse Section

Generally speaking, one tries to use the available portions of the tunnel cross-section, out of the path of traffic, for the passage of the air ducts.

- \* In mined tunnels having a vaulted profile (horseshoe-shaped profile), the available cross-sectional area is located in the top of the vault or perhaps under the roadway.
- \* In tunnels of rectangular cross-section, it is necessary to provide for an enlarged cross-section, either laterally or vertically in order to accommodate the ventilation ducts.

In general, ducts are designed with constant cross-sectional area. Air speed in the duct thus decreases linearly along the duct as air is distributed into the tunnel (or grows linearly in the case of withdrawal of polluted air from the tunnel). The required cross-sectional area for the duct is the quotient of the required air flow divided by the chosen air speed.

#### 4.42 Shape of Ducts

Insofar as is possible, ducts should be designed with maximum hydraulic diameter. In practice, it is sufficient to avoid forms with sharp angles or shapes which are very elongated.

---

## Chapter 5. Choice of Ventilation System

### 5.1 Preliminary Rules

#### 5.11 Safety

Although tunnel fires have until now been relatively rare, the possibility has such serious consequences that it merits special attention.

When the risk of fire is particularly great (very heavy traffic, impossibility of prohibiting heavy trucks carrying inflammables, etc.) or when the consequences of a fire are particularly serious (presence of many users, a very long tunnel, etc.), it is necessary to observe the following rules:

- \* A capability for withdrawal of polluted air of at least  $80 \text{ m}^3/\text{s}$  per 1 km of tunnel length is necessary. This withdrawal must be from the top of the tunnel, above the traffic area.
- \* An artificial replenishment of fresh air from the lower part of the tunnel cross-section is also mandatory.

These requirements penalize longitudinal and semi-transversal systems in these situations. This general rule will permit of exceptions, on permission of proper Agency, in cases where specific tunnel utilization procedures will insure user safety.

#### 5.12 Level of Service and Comfort

The circulation of polluted air in the traffic gallery, such as is encountered in longitudinal, semi-transversal, and pseudo-transversal systems, can have two undesirable effects on the tunnel's comfort and level of service.

- \* In the first place, it can lead to serious physical irritation for users exposed to an overly violent flow of this polluted air.

As a result, air speed in the tunnel is limited to about  $10 \text{ m/s}$  in cases where the traffic circulation is two-way or where the tunnel is open to cyclists or pedestrians.

- \* The circulation of polluted air can as well have an undesirable effect on visibility in the tunnel, by permitting the accumulation of smoke from an unusually high concentration of trailer trucks.

## 5.2 Choice Factors

There are four categories of parameters which should in principle insure the proper choice of the most appropriate ventilation system.

This determination cannot be systematic, inasmuch as these different parameters can assume a relative importance which differs significantly from case to case.

### 5.21 Route Category

This first factor effectively determines the choice of the maximum tunnel length for the different ventilation systems. The various systems vary greatly in cost and quality of service. It is necessary to adapt the ventilation according to:

- \* the site (urban, country, mountain, etc.).
- \* the nature of the route (expressway, secondary road, etc.).
- \* the number of users affected by the project.

The required levels of safety and comfort are also influenced by these different factors. It is necessary, for example, that an urban expressway not be less safe and comfortable than a rural expressway.

### 5.22 Traffic

This second factor effectively determines the choice of fresh-air flows, as indicated in 4.12. There are three traffic-related parameters which must be taken into account:

- \* Volume of traffic (See Table 1.).
- \* Fluidity of traffic flow. This depends upon the continuity between approaches and tunnel. In cases where traffic flow is not fluid, the necessary volume of air required to ventilate the tunnel is considerably increased.<sup>10</sup>

---

<sup>10</sup>It is necessary to take into account here all of the temporary situations, such as lack of fluidity, that can be expected in the event the tunnel will be put into service in successive stages before overall completion of the tunnel and its approaches.

- \* Congestion frequency. On frequently congested routes, notably in urban areas, a design of greater capacity will be required.

### 5.23 Environment

The third factor (congestion frequency) may lead either to the choice of a different system or to a modification of the initial system. Environmental factors influence the design of urban tunnels in essentially two ways:

- \* The presence of dwellings always poses delicate problems for the location of ventilation stations (See Annex 7).
- \* Urban tunnels must very often conform to rigorous constraints on layout, both vertically and laterally. The difficulties in enlarging the cross-section can, in these cases, lead to a limitation of the cross-sectional area available for the ventilation ducts or to a subdividing of the ventilation system, thus multiplying the number of ventilation stations.<sup>11</sup>

### 5.24 Costs

The overall costs for total ventilation fall within the following ranges:<sup>12</sup>

<u>Ventilation System</u>	<u>% of Total Cost for Tunnel<sup>13</sup></u>
Longitudinal	2-8
Semi-Transversal	15-30
Pseudo-Transversal	20-40
Transversal	25-50

<sup>11</sup>By way of example, an urban expressway tunnel of four lanes each way, 1 km long, requires a fresh-air flow of about 1400 m<sup>3</sup>/s. This requires for the fresh-air supply alone: the setting aside of a significant cross-sectional area for the transmission and distribution of air in the tunnel; the allocation of about 350 m<sup>2</sup> at ground level for the air intakes; and the allocation of substantial space along the length of the tunnel for the subterranean ventilation stations.

<sup>12</sup>Because construction costs vary greatly, these figures are only approximate.

<sup>13</sup>These figures indicate the total cost of the ventilation, including structural work, enlarging the cross-section, etc.

It is important that the quality of service be adequate for the predicted traffic flows both at the time the tunnel is first put into service as well as for the foreseeable future.

The savings to be achieved by a progressive upgrading of ventilation equipment, proportional to the increasing use of the tunnel, is not as significant as might first be believed. It should be remembered that all installation work that can disrupt traffic flow through the tunnel should be effected before the tunnel is put into operation. Notably, all interior structural work should be done initially, so that it will not require subsequent modification.

The only savings which can be effected by a system of progressive modification involve machinery and the possible addition of supplementary stations which, if carefully located, can in certain cases permit a substantial augmentation of ventilation capacity without affecting either the safety or traffic flow in the tunnel. The procedures and means for effecting such modifications must in every case be the object of a thorough study before the first phases of construction.

### 5.3 Choice of Ventilation System

#### 5.31 General Character of the Systems

- \* Longitudinal ventilation systems (natural or artificial):
  - best accommodated to one-way traffic.
  - practical for long tunnels where traffic is smooth.
  - in urban locations, these systems are feasible only in tunnels of much shorter length.<sup>14</sup>
- \* Pseudo-transversal and transversal systems are required in situations where the tunnel lengths are quite long or where the risk of congestion and heavy usage are significant (namely, in urban areas).
- \* Semi-transversal systems are employed in situations falling between these two extremes.

---

<sup>14</sup>For urban tunnels where a ventilation system of the longitudinal type is envisaged, it is necessary to consult the appropriate Agencies.



### 5.32 Choice of System

As a general rule, the parameters given below in Table 3 are used in determining the proper system. The results of this calculation should be regarded as approximate; nevertheless, they constitute a framework for the further study and design which will be necessary in every case.

It should be remembered that the use of this table must be accomplished within the limits prescribed by Table 1. For all other conditions, refer to Annex 1.

Type of Route	Traffic Direction	Character of Flow	Ventilation System and Applicable Lengths (m.)		
			Longitud. (nat'l/art.)	Semi-Trans.	Pseudo-Trans. and Trans.
Rural Expressway	one-way	normally uncongested	0-1800	1500-2800	2500 & up
City Expressway	one-way	occasionally congested	0-700	500-1800	1000 & up
City Expressway	one-way	regularly congested			
City Street	two-way	regularly congested	0-250	200-800	600 & up
City Street	two-way	occasionally congested	0-500	400-1200	800 & up
Rural Highwat	two-way	normally uncongested	0-1500	1200-3000	2500 & up

Table 3. Choice of Ventilation System

**ANNEXES**

## Annex 1. Design of Ventilation System

### 1.1 Calculation of Fresh-air Flows

#### 1.1.1 Base Flows

The theoretically required flows of fresh air, already discussed in 4.12 above, are recalled in the following table. Their determination is based upon results for tunnels already in service.

Type of Tunnel		Traffic	Fresh-air Flows per kilometer of traffic lane (m <sup>3</sup> /s)
<u>One-way</u>	rural expressway	normally uncongested	100
	city expressway	occasionally congested	175
		normally congested	280 <sup>1</sup>
<u>Two-way</u>	city street	occasionally congested	175
		normally congested	280 <sup>1</sup>
	rural highway	normally uncongested	60

<sup>1</sup> Design should be undertaken in this situation only after it has been determined that there is no feasible solution for avoiding this systematic congestion.

## 1.12 Correction Coefficients

The flows indicated in the foregoing table are, it was pointed out, subject to the limitations indicated in 4.112 (Table 1). For different grades, altitude, and number of diesels, it is necessary to apply the following correction coefficients:

### 1) Grade coefficient

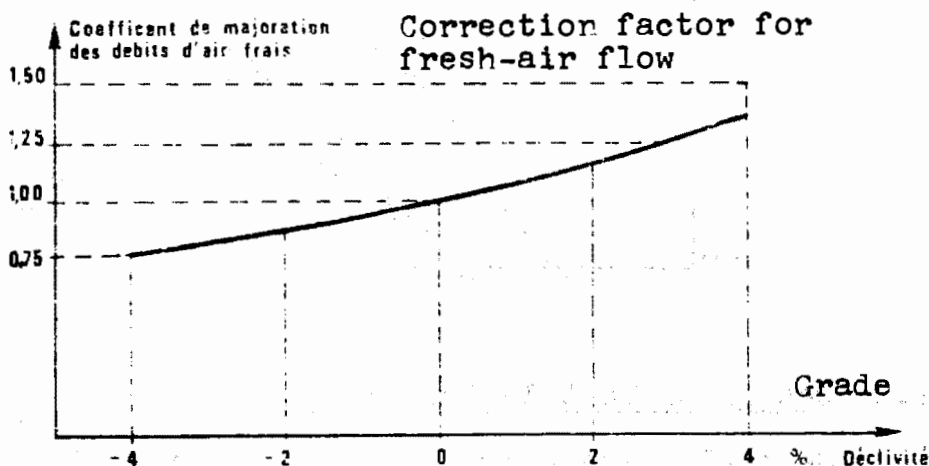

### 2) Altitude coefficient

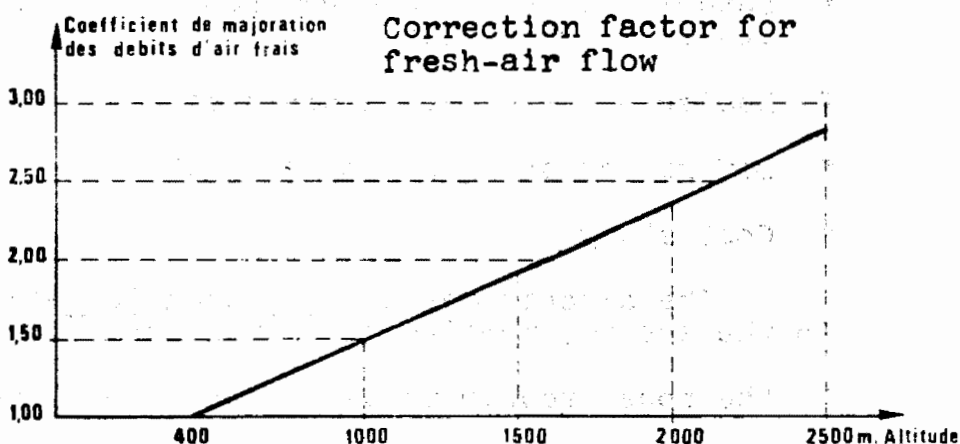

### 3) Coefficient for the number of diesels

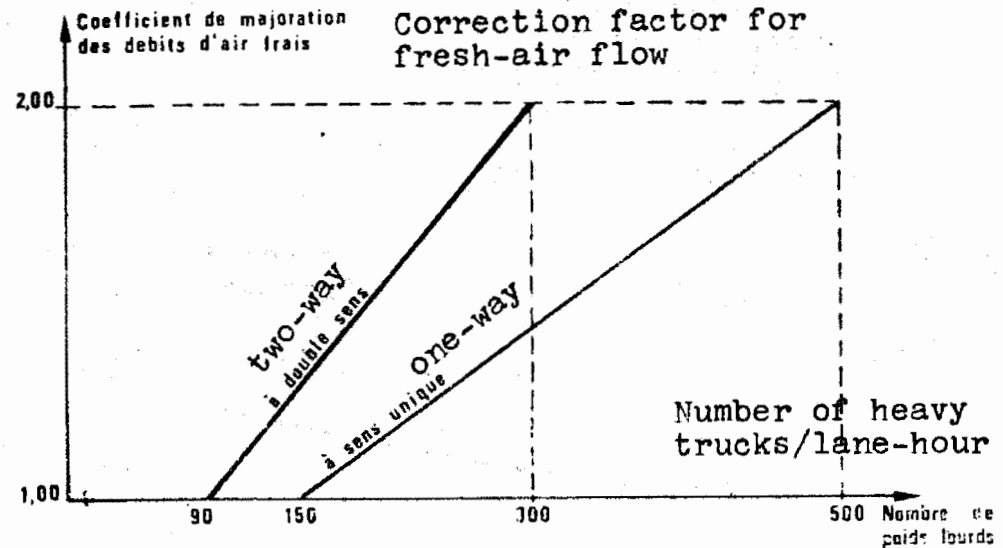

#### 1.2 Design of Ventilation Circuits

Generally speaking, once the required fresh-air flows have been determined, the sequence of design is as follows:<sup>2</sup>

- \* Choice of ventilation system (See Table 3).
- \* Determination of required number of ventilation stations and sections.
- \* Design of ventilation circuits.
- \* Definition of equipment and materiel.
- \* Cost study.

The circuit design, effected for each ventilator in the system, permits a calculation of:

- \* the power requirements for the whole system.
- \* estimated costs of the project.

Although it has been purposely simplified, the present model should in the majority of cases permit reasonably accurate design of the ventilation circuits.

<sup>2</sup>We are not considering longitudinal systems here.

## 1.21 Definition of the Circuit

The following schema represents a theoretical circuit for the intake of fresh air and its subsequent transmission through a duct to the tunnel for distribution. The same schema (reversed) is applicable to the collection and exhaust of polluted air.

Four subsections of the circuit, numbered 1 - 4 from right to left, have been distinguished for later reference:

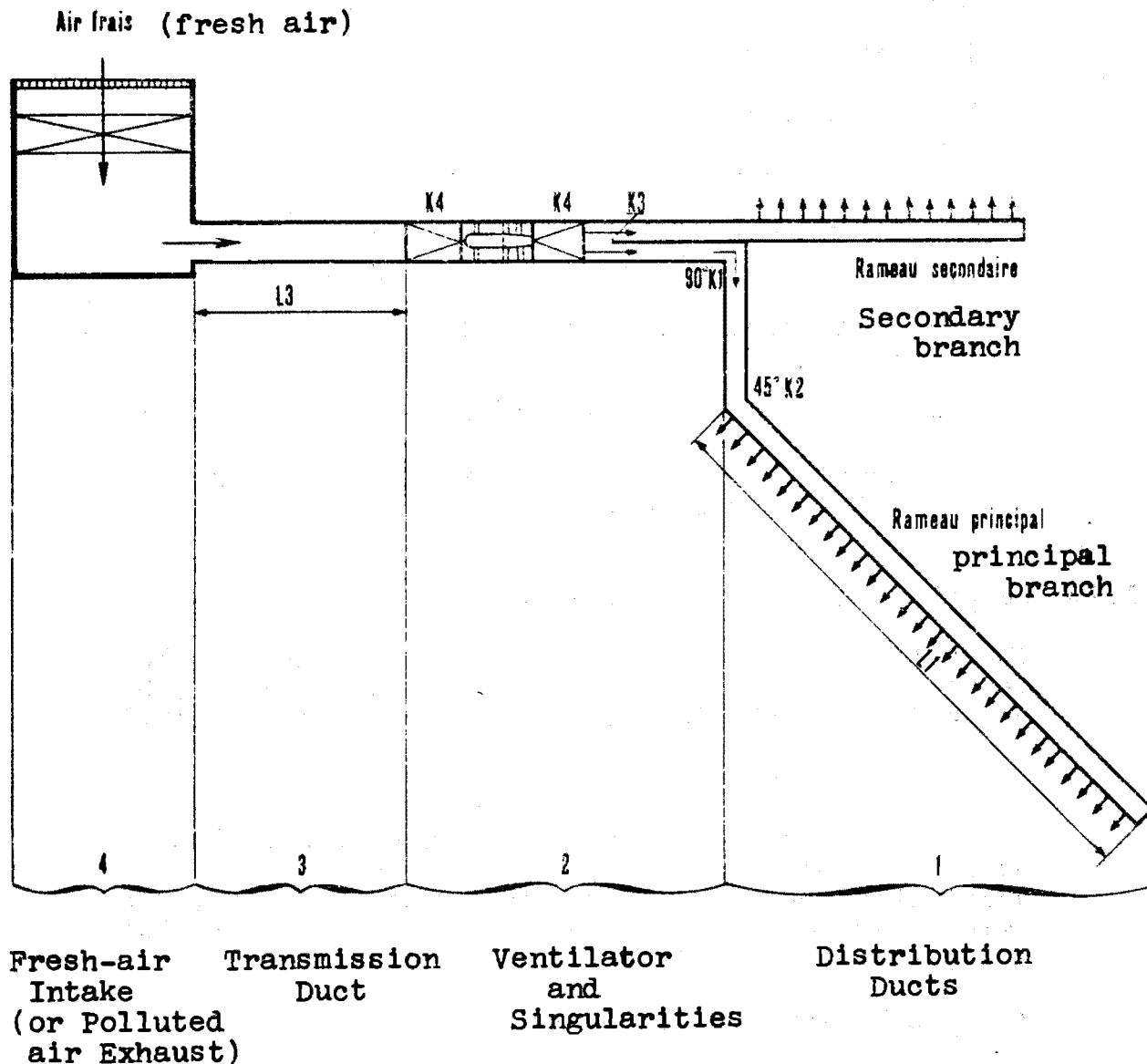

NOTA: For reasons of simplicity we have assumed that air speed  $S$  is constant in the different transmission ducts.

## 1.22 Definition of Parameters

### \* Geometrical parameters of the circuit

L = length (m.)

S = cross-sectional area (m.<sup>2</sup>)

D = hydraulic diameter (m.)

(D = 4S/p, where p = perimeter of cross-section)

### \* Aerodynamic parameters of the circuit

Q = ventilator flow (m<sup>3</sup>/s)

V = air speed in ducts = Q/S (m/s)

- V<sub>3</sub> = air speed in transmission duct

- V<sub>1</sub> = air speed at entry to distribution duct; generally 15-25 m/s.

H = total pressure in pascals (1 mm of water = 9.81 pascals)

P = power in kW =  $\frac{QH}{n} \times 10^{-3}$  (where n = 0.7 -- a coefficient which takes into account the efficiency of motors and ventilators)

## 1.23 Calculation of Total Pressure

The total pressure H that must be furnished by the ventilator is equal to the sum of the losses H<sub>1</sub>, H<sub>2</sub>, H<sub>3</sub>, and H<sub>4</sub> of the four subsections of the circuit.

$$H = H_1 + H_2 + H_3 + H_4$$

In cases where the circuit has several branches, as in the above diagram (or in the cases where one ventilator supplies two separate duct systems), the calculation of H should be made for the branch that is most heavily loaded.

\* Calculation of H<sub>1</sub>: losses in the distribution duct.

$$H_1 = 33.5 \times 10^{-4} \frac{L_1}{D_1} V_1^2 + 160$$

(The coefficient 33.5 x 10<sup>-4</sup> holds for sea level; it is accurate to within 10% at 1000 meters.)



- \* Calculation of  $H_2$ : losses due to singularities (elbows, transitions, etc.)

$$H_2 = k_i V_1^2$$

using the following values for the parameter  $k_i$ :

$k_i$ Designation	Value of $k_i \times 10^3$
$k_1$ (90°-elbow)	160
$k_2$ (45°-elbow)	80
$k_3$ (partition)	120
$k_4$ (transition)	60

Coefficients are for sea level; they are accurate to within 10% at 1000 meters.

- \* Calculation of  $H_3$ : losses in transmission duct

$$H_3 = 10^{-2} \frac{L_3}{D_3} V_3^2$$

Again coefficient is for sea level; accurate to within 10 % at 1000 meters.

- \* Calculation of  $H_4$ : losses in intake or exhaust, including noise abatements

$$H_4 = 200 \text{ pascals}$$

---

## Annex 2. Sample Design for a Semi-Transversal System

### 2.1 Tunnel Characteristics

The assumed conditions are the following:

#### 2.11 Type of Route

City expressway with four lanes in each direction.

#### 2.12 Traffic

- \* Heavy traffic expected from date the tunnel is put into service, particularly during morning and evening rush-hours.
- \* Approaches to and from tunnel normally uncongested except during peak rush-hours.
- \* Heavy truck traffic less than 150/lane-hour.

#### 2.13 Geometry

- \* Length: 680 m.
- \* Altitude: 200 m.
- \* Grade: level
- \* Cross-section: rectangular (covered trench with continuous centerwall -- cf. figure below)

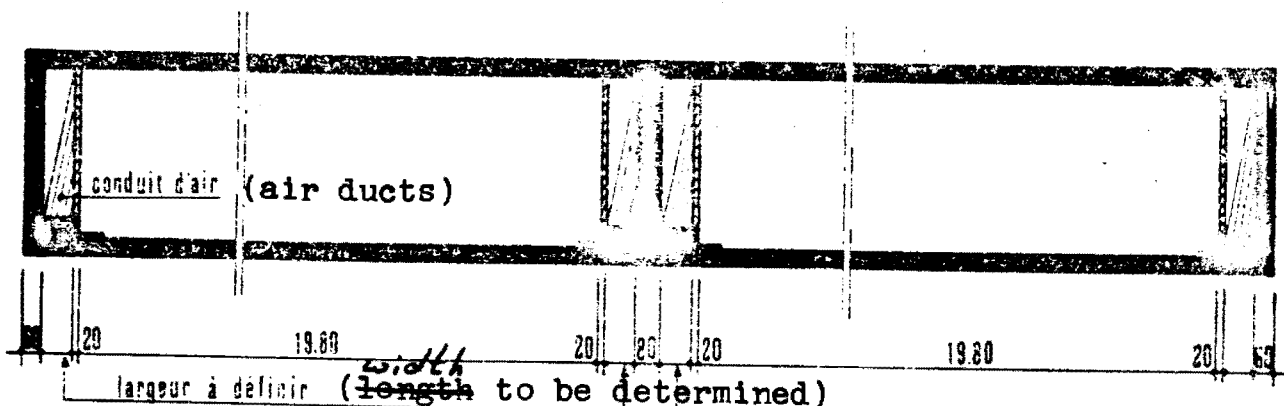

## 2.14 Environment

- \* Tunnel situated just above the water table.
- \* Surface environment:
  - urban residential area
  - schools in area
  - limited right-of-way because of costs and expropriation difficulties

## 2.2 Fresh-air Flows

From the tunnel geometry and predicted traffic characteristics, the necessary fresh-air flow is 175 m<sup>3</sup>/s per km of lane, or about 475 m<sup>3</sup>/s per tube.

## 2.3 Choice of Ventilation System

Given the type of route which the tunnel will service, the strong possibility of frequent congestion, and various safety considerations, the chosen system is semi-transversal.

The use of accelerators would, because they are suspended from the tunnel ceiling, require a deepening of the tunnel trnech. Because of the proximity of the water table, such a design would necessitate lining the tunnel for a greater part of its length, thereby significantly increasing the cost of the tunnel.

## 2.4 Number of Ventilation Sections and Stations

Various parameters constrain the choice of possible solutions.

Several possible solutions are presented in the following figure. These solutions are based on the simplifying assumption that the tunnel is divided into ventilation sections of equal lengths, thus permitting a uniformity in materiel and circuitry.

### 2.41 Tunnel Cross-section

Given the tunnel cross-section and the constraints imposed by the water table, the air ducts must be located laterally. This will require an enlargement of the tunnel in relation to the utilized traffic area. This enlargement will in turn necessitate an augmentation of the span of the covering panels as well as of the required right-of-way.

These considerations argue for an increase in the number of ventilation stations. A single station located at the end of the tunnel (Solution 1) would, if we assume a constant air velocity of 25 m/s, require an enlargement of:

$$\frac{475}{25 \times 4.85} = 4 \text{ meters per tube,}$$

or 8 meters total in the width of the tunnel. This eliminates Solution 1. Similarly, we can eliminate Solutions 4 and 7 which would suppose, in the central ventilator section, a very substantial enlargement.

#### 2.42 Surface Environment

The fact that there is a residential area with schools requires that no ventilation stations be located in the area. Thus, Solutions 2 and 9 must be dismissed as they would locate a station in this area, engendering a serious environmental nuisance.

#### 2.43 Aerodynamics

Given the great width of each tube (20 meters of roadway), it seems desirable to feed each tube simultaneously from both ends. Solutions 8 and 10 both lead to distribution ducts of a very bad design which would be difficult to enter after being put into service:

\* Height: 4.85 m.

\* Width:  $\frac{475}{4 \times 25 \times 4.85 \times 2} = 0.5 \text{ m.}$

#### 2.44 Economic Considerations

After an economic analysis, the choice finally falls upon Solution 3 which, although comparable to Solutions 5 and 6 in terms of construction and maintenance costs, presents (in the particular case studied) added advantages:

- \* Easier land acquisition (only two surface disturbances)
- \* Greater ease of access for maintenance

Solution      Ventilation Stations

Fresh-air Distribution Scheme

Station de ventilation

①

1

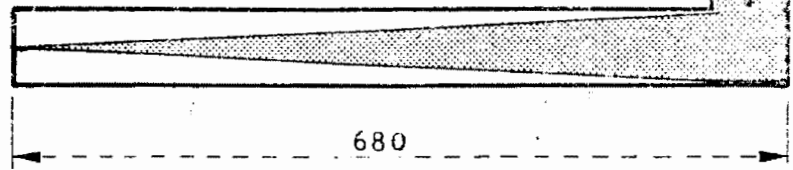

②

2

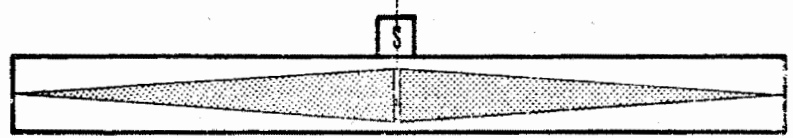

③

2

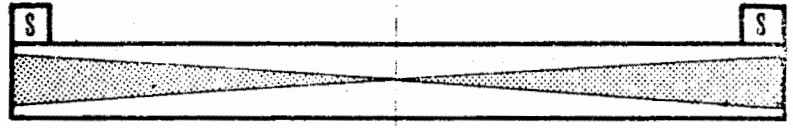

④

3



⑤

3

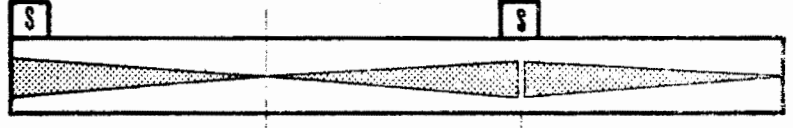

⑥

3

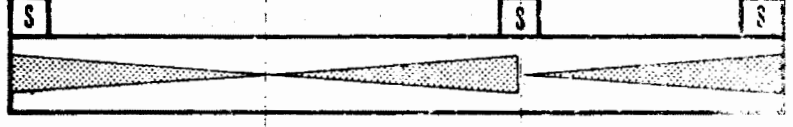

⑦

4

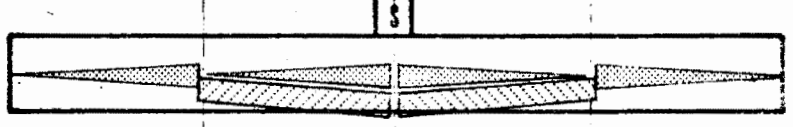

⑧

4

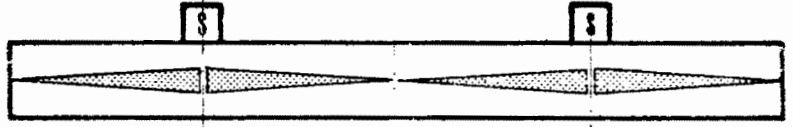

⑨

4

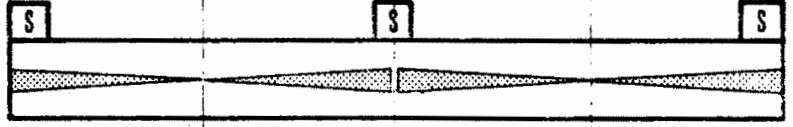

⑩

4

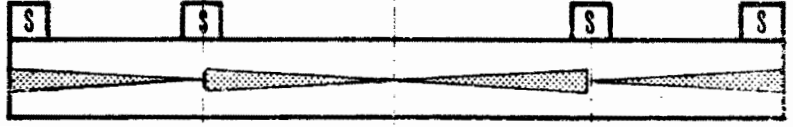

## 2.5 Design of Ventilation Circuits

The complete calculation of the circuits presupposes the choice of a certain number of options regarding ventilation stations and connecting ducts, as indicated below. The distribution schema for the ventilators takes into account certain safety and aerodynamic considerations.

The calculations are carried out separately for each ventilator, using the factors given in Annex 1.

In preliminary design calculations we neglect the small differences existing between the circuits for each ventilator in station 1 and station 2.

### 2.51 Numerical Values for Parameters

Total required flow for the tunnel:  $475 \text{ m}^3/\text{s}$

$Q = \text{flow for each ventilator} = 475/4 = 119 \text{ m}^3/\text{s}$

$S = 4.85 \text{ m}^2$

$V = 24.5 \text{ m/s} = V_1 = V_i = V_2$

$L_1 = 340 \text{ m.}$

$L_3 = \text{varies with each ventilator}$

$D = 1.66 \text{ m.}$

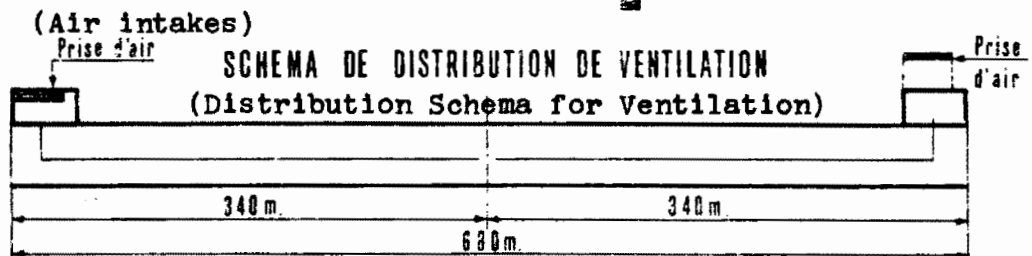
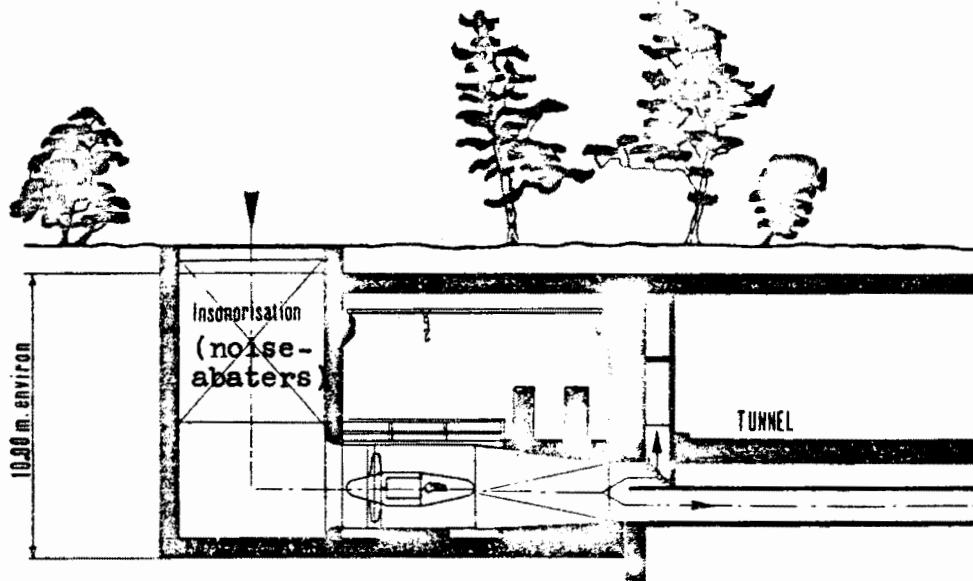
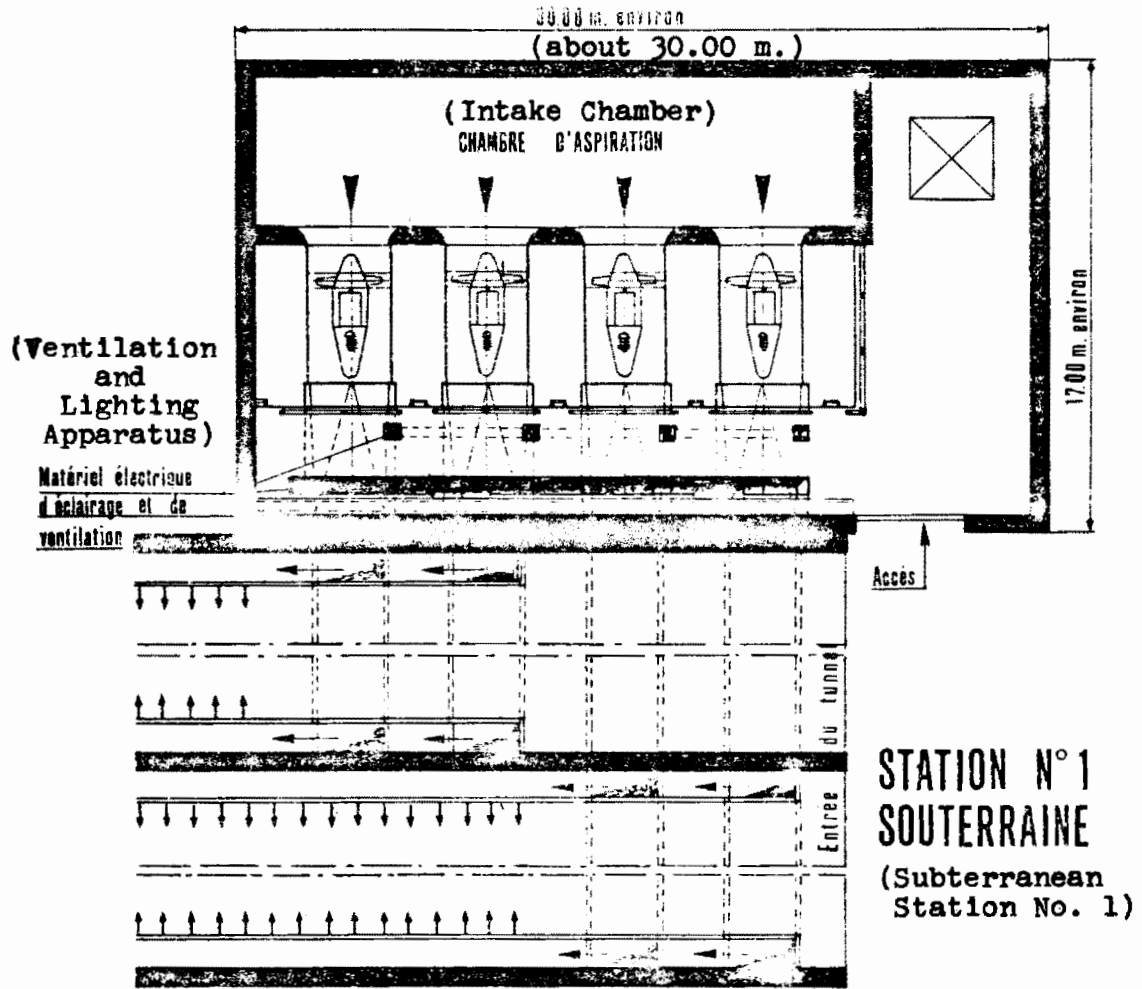

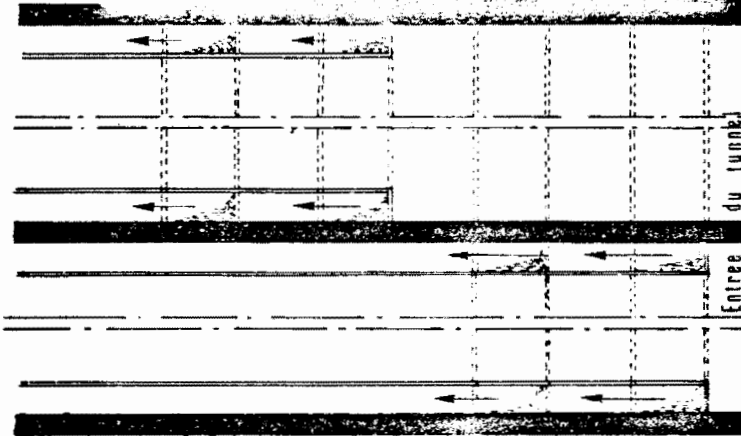
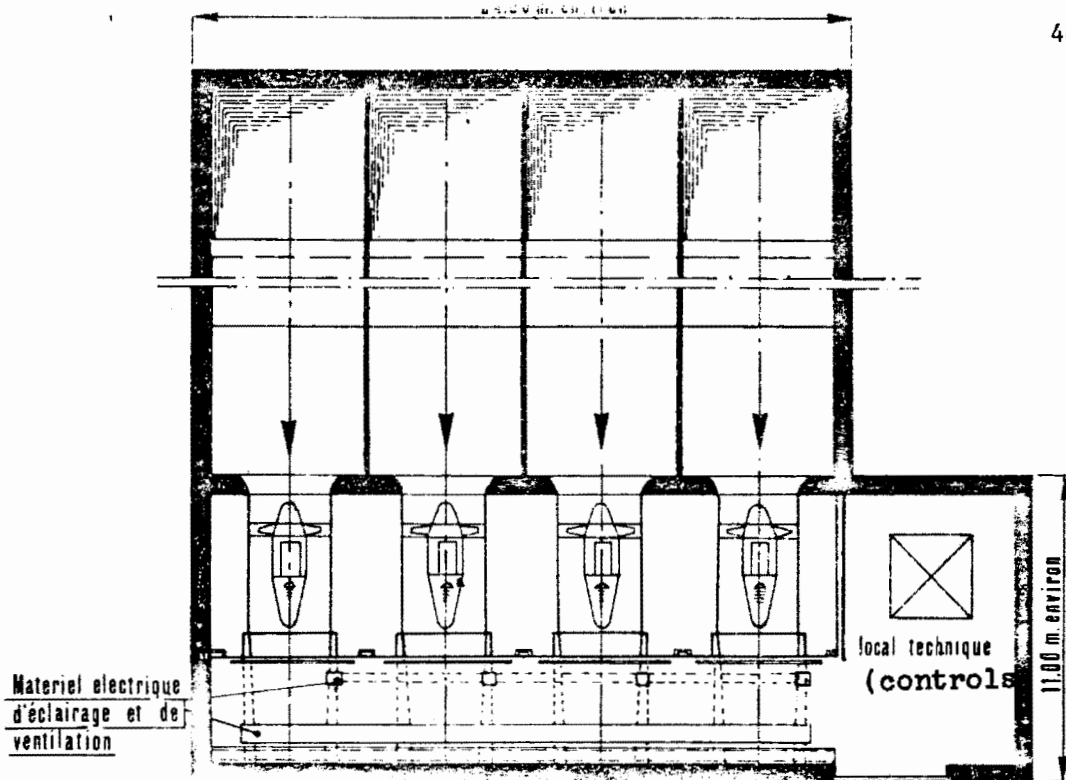

### STATION N° 2 SOUTERRAINE

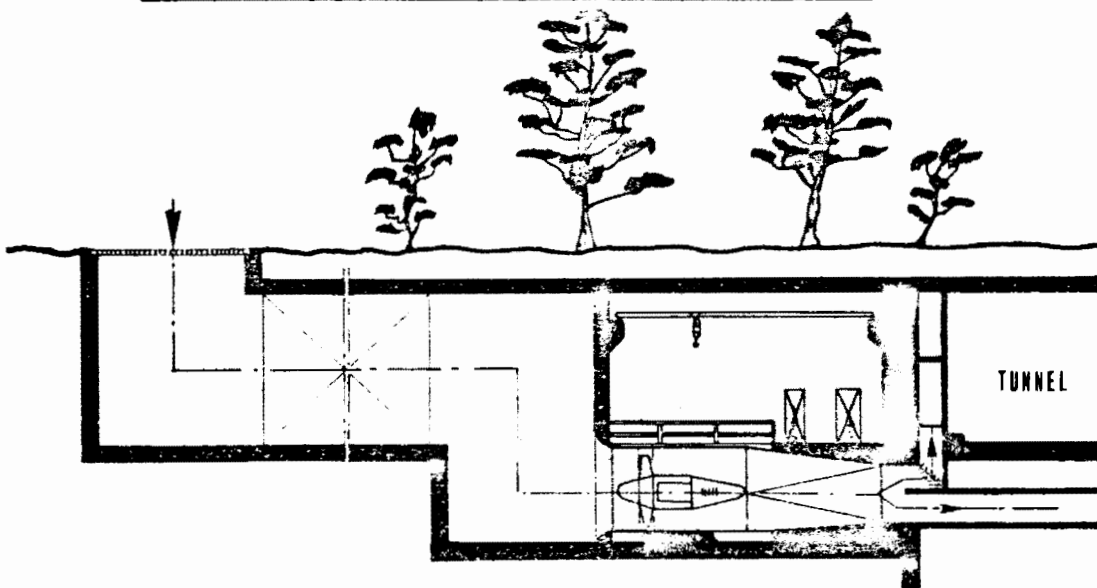



2.52 Calculation of Total Pressure H

Table of Losses (in mm. of water) [*]				
Ventilator No.	1	2	3	4
H <sub>1</sub> distribution	572	572	572	572
H <sub>2</sub> singularities				
$2k_1V^2$	192	192	192	192
$k_3V^2$	72	72	72	72
$k_4V^2$	36	36	36	36
H <sub>3</sub> transmission duct between ventila- tor and the beginning of distribution	158	167	82	91
H <sub>4</sub> intake	200	200	200	200
Total loss H (in pascals)	1230	1240	1155	1165

[\*Presumably this should read "in pascals." -- Editors]

2.53 Calculation of the Installed Power

Calculation is conducted separately for each ventilator:

Ventilator No.	1	2	3	4
Flow Q (m <sup>3</sup> /s)	119	119	119	119
Loss of H (pascals)	1230	1240	1155	1165
Power (kW)	209	211	196	198
Total Installed Power:		814 kW (Approximate)		

Thus the total power for the two tubes will be about 1600 kW.

### Annex 3. Sample Design for a Pseudo-Transversal System

#### 3.1 Tunnel Characteristics

The assumed conditions are as follows:

##### 3.11 Type of Route

Two-lane rural highway.

##### 3.12 Traffic

Assumed to reach saturation at 90 heavy trucks/lane-hour

##### 3.13 Geometry

- \* Length: 3600 m.
- \* Grade: uniform 1%
- \* Altitude: 1200 m.
- \* Cross-section: Horseshoe shape, corresponding to transverse section no. 7 of the Geometry Document, with two side-walks of 0.50 m. and a road width of 10.00 m.

##### 3.14 Environment

- \* Well-defined mountain range with limited zones of good quality limestone.
- \* Soil cover varying between 10 and several hundred meters.
- \* Rural area.

### 3.2 Air Flow and Choice of Ventilation System

Given the site conditions, the base air-flow is 60 m<sup>3</sup>/s per kilometer of lane. Taking into consideration the necessary corrections for altitude and tunnel grade (Cf. Annex 1.), the total air flow must be about 720 m<sup>3</sup>/s.<sup>3</sup>

The cross-sectional area below the false ceiling forming the ventilation ducts is about 47 m<sup>2</sup>. Because a longitudinal or semi-transversal system would require high air speeds in the tunnel, it is best to adopt a pseudo-transversal system.

Consequently, one chooses an exhaust flow of 80 m<sup>3</sup>/s per kilometer, or about 280 m<sup>3</sup>/s total. (This takes into account necessary safety factors for fire and the like.)

### 3.3 Number of Ventilation Sections and Stations

- 3.31 The 1,000 m<sup>3</sup>/s flow in the cross-sectional area reserved for ventilation demands the best possible utilization of space in the tunnel not given over to traffic use, i.e., that space located in the vault of the tunnel cross-section.



The area of this space will be about 15-18 m<sup>2</sup>. Thus, in order to accommodate the required air-flow to this area, at least two ventilation sections will be necessary in order to achieve an air speed of 20 m/s.



- 3.32 At this point we can proceed with the preliminary design which considers the various distribution schemas. There are four possible solutions (See following schemas). For each, one considers the effect of a variation in the chosen air speed for the ducts (from 15-25 m/s). Depending upon the schema, one is led:

- \* Adopt a different tunnel cross-section (increased from 85 to 110 m<sup>2</sup>).
- \* Install different ventilation stations (stations at entrances and subterranean stations connected to surface by ventilation shafts).
- \* More powerful installations.

---

<sup>3</sup>For the grade correction, one assumes that 2/3 of the vehicles (or 1300 veh/hr) are moving up the grade; 1/3 are moving downgrade.

 Air pollué (polluted air)  
 Air frais (fresh air)

Station de tête  52  
 Station souterraine et puits 

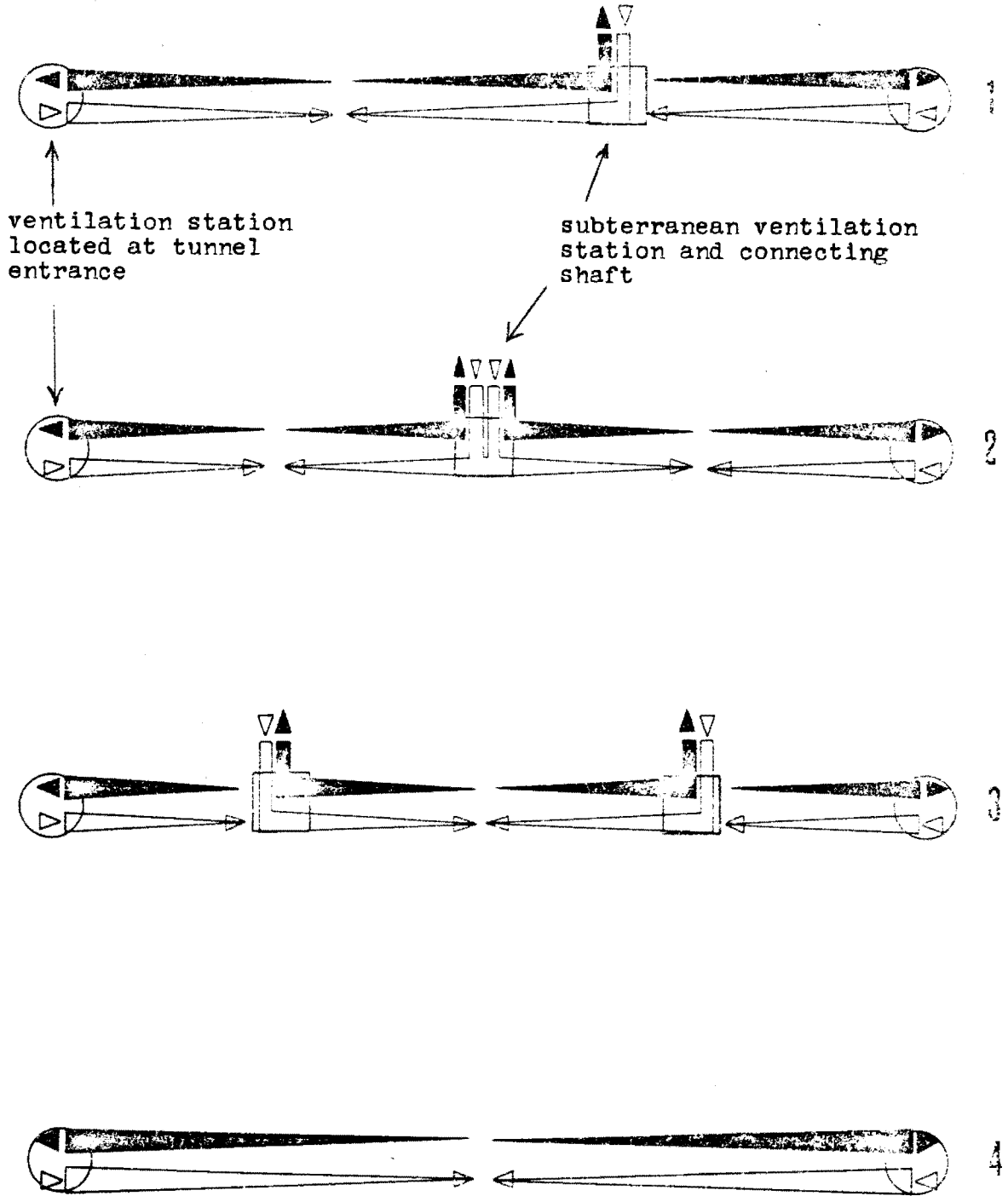

**SCHEMAS DE DISTRIBUTION**  
 (Distribution Schemas)

For the assumed site conditions, the installation of ventilation shafts will be very difficult because of the required length, inclination, and the surrounding terrain which would make excavation and excess very difficult. A ventilation shaft could, therefore, be located only at one or both of the third-points on the tunnel trace.

The optimal solution must be based on the following considerations:

- \* Initial costs.
  - tunnel excavation and finishing
  - ventilation stations and shafts
  - ventilation equipment and materials
- \* Operating costs for ventilation system.

The results of such a cost analysis indicate that Solution no. 1 is the best:

Solution No. <sup>4</sup>	1	1a	1b	2	3	4	4b
% increase over Solution No. 1	-	7%	3%	2%	4%	6%	9%

Note that these solutions are based upon lengthy studies that require a good knowledge of the geological conditions and their influence on construction costs.

### 3.33 The Characteristics of the Chosen Solution

<sup>4</sup>Solutions 1a and 1b differ from 1 only with respect to air speed in ventilation ducts.

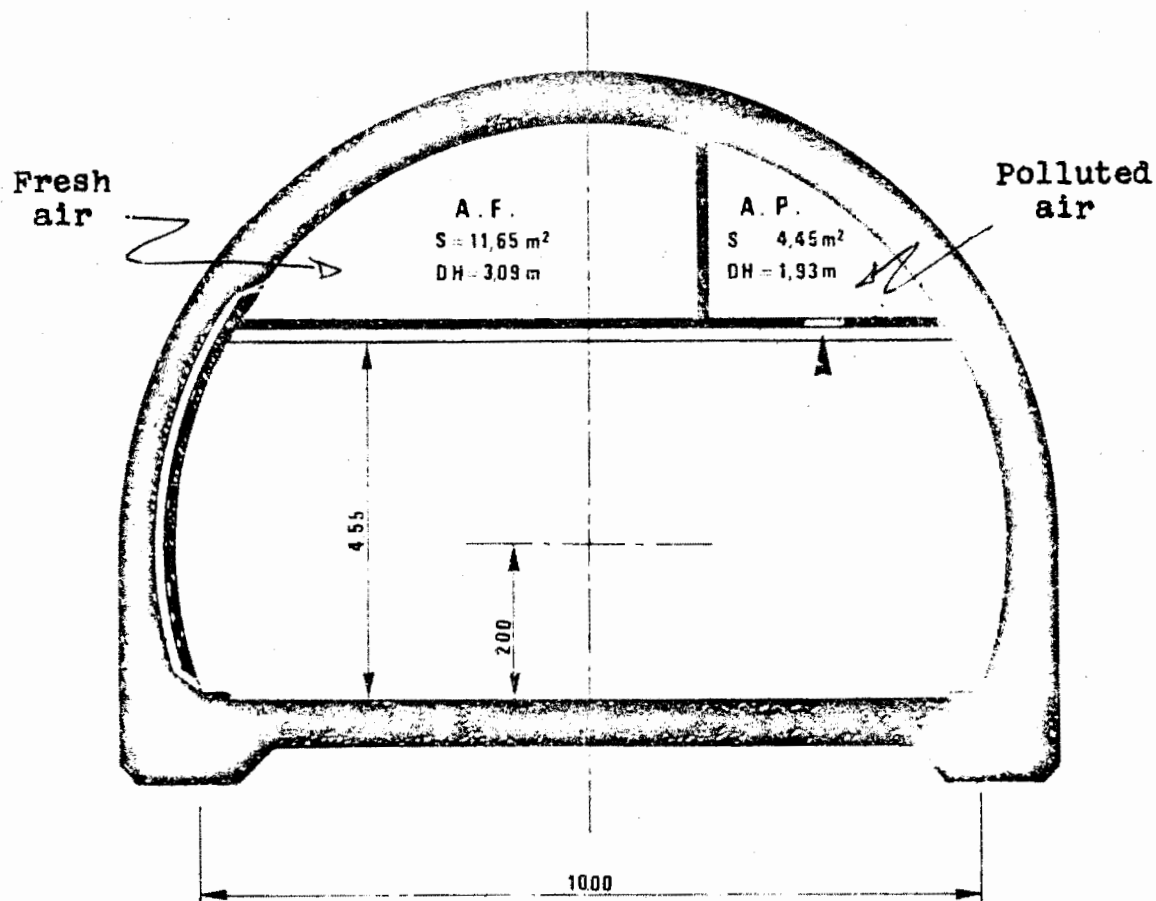

### SCHEMA DE DISTRIBUTION DE VENTILATION

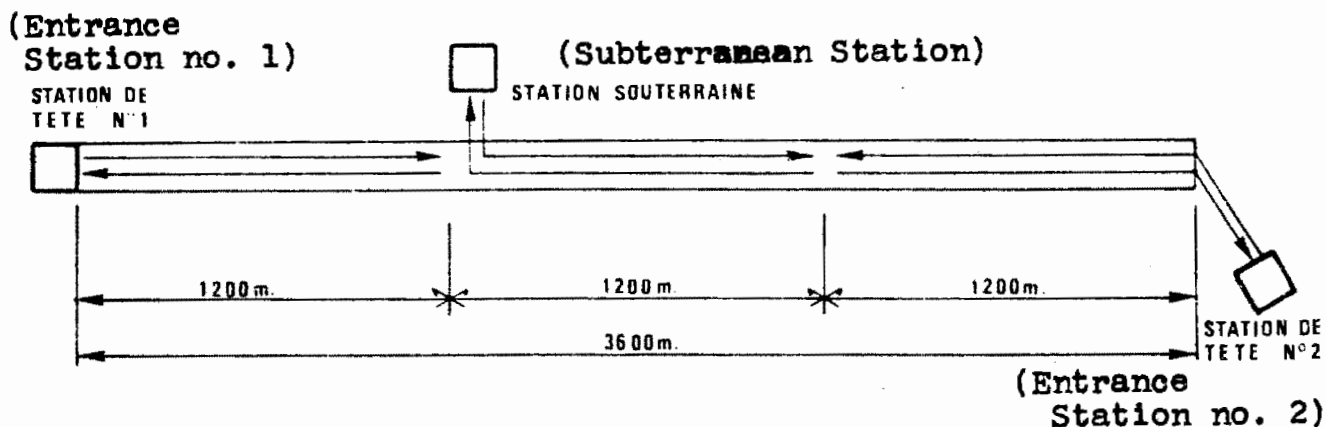

# STATION N°1

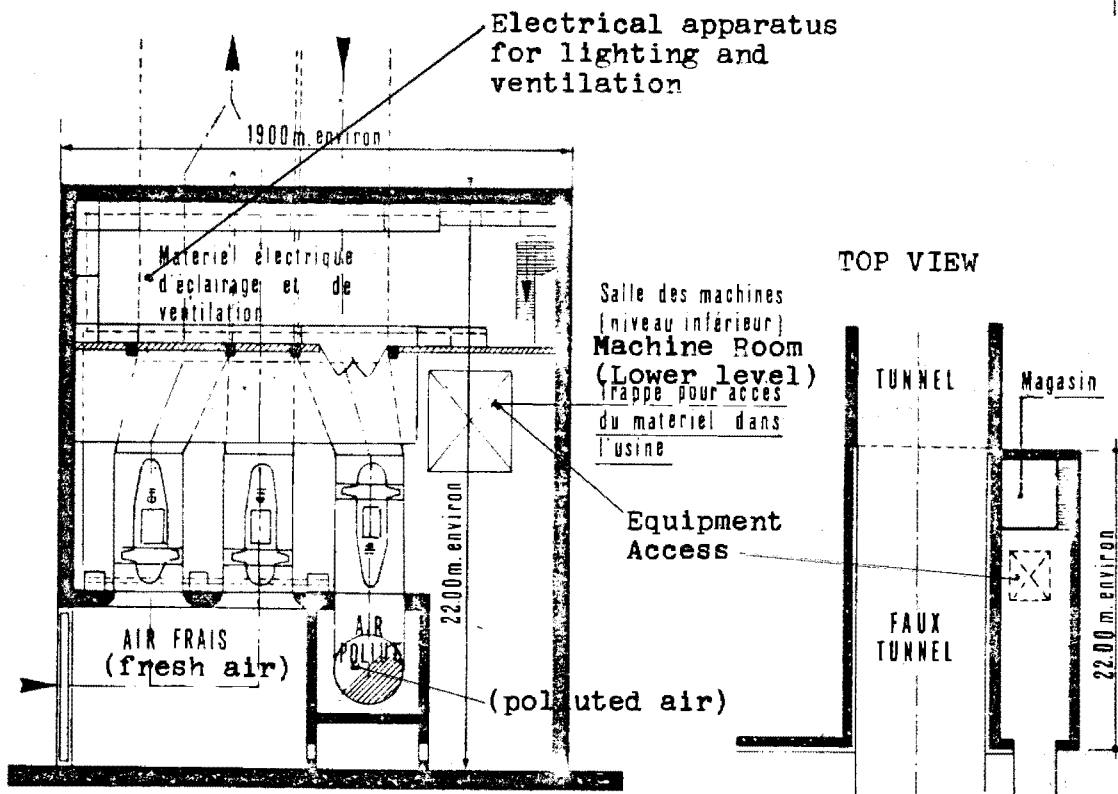
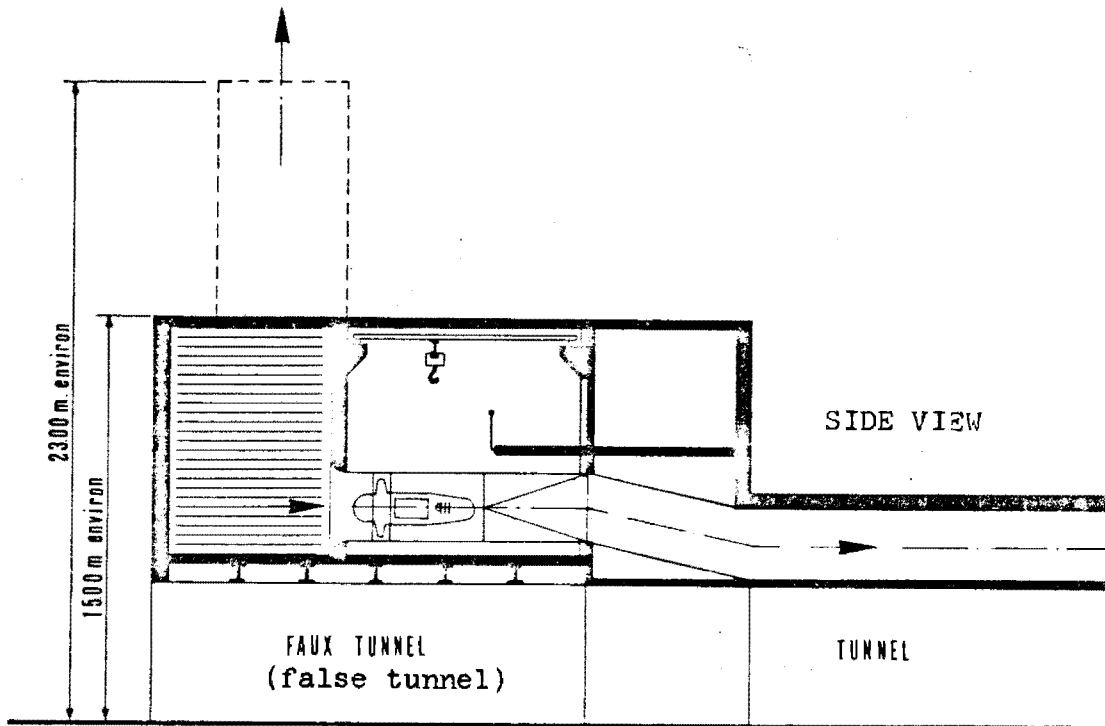

# STATION N°2

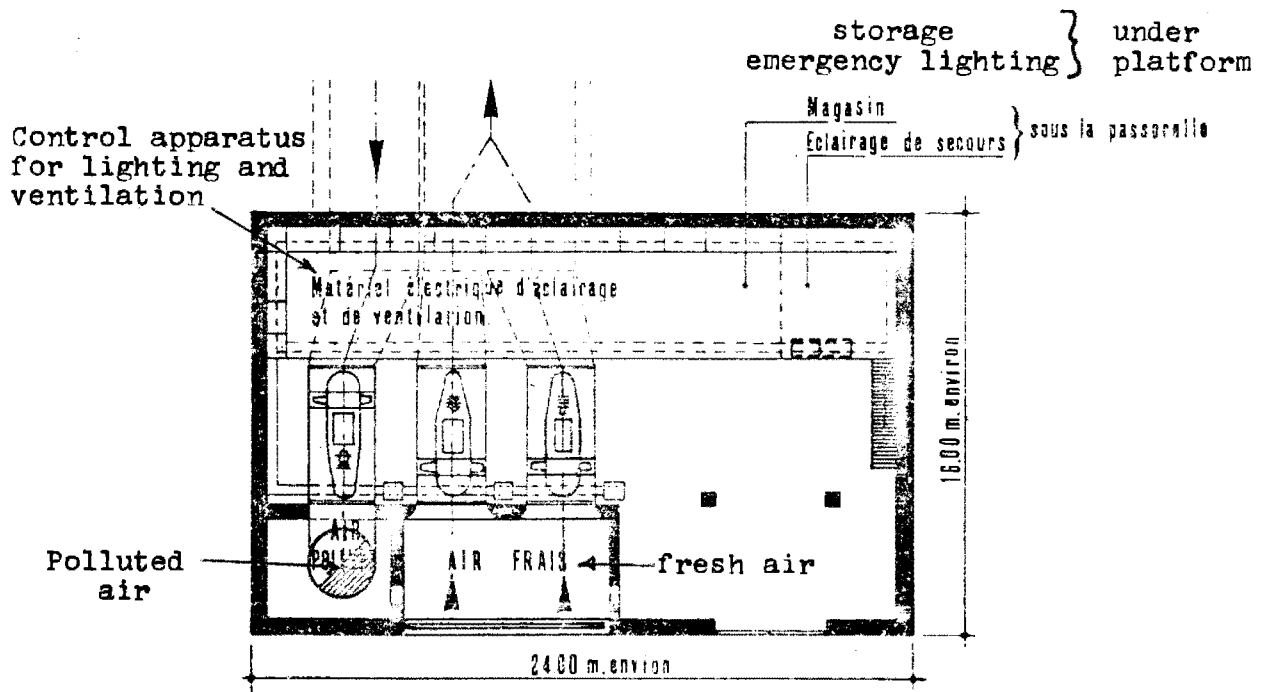
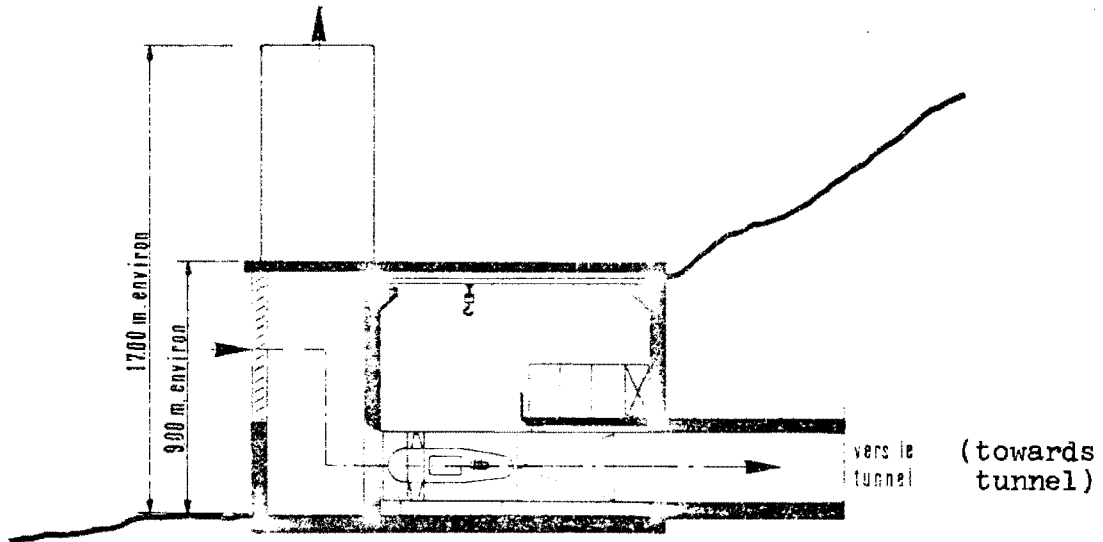
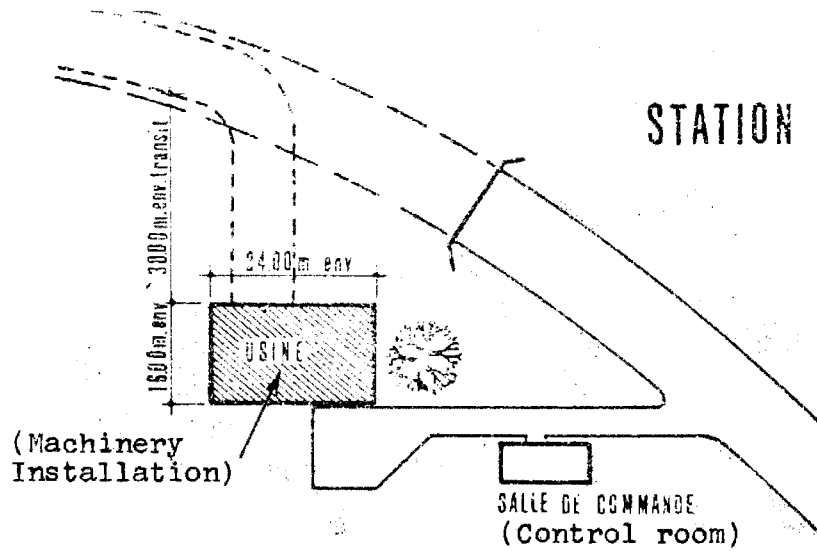



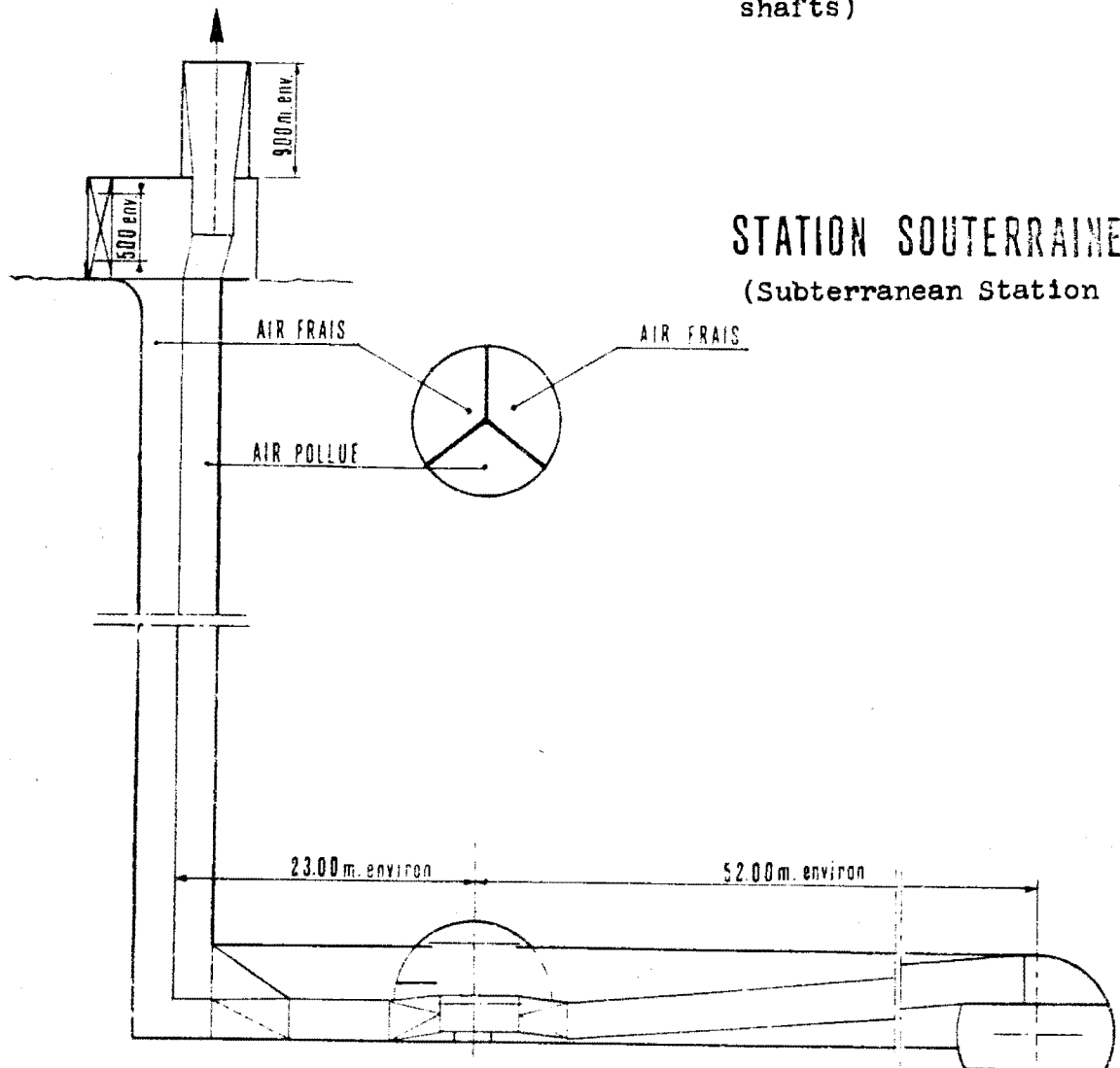
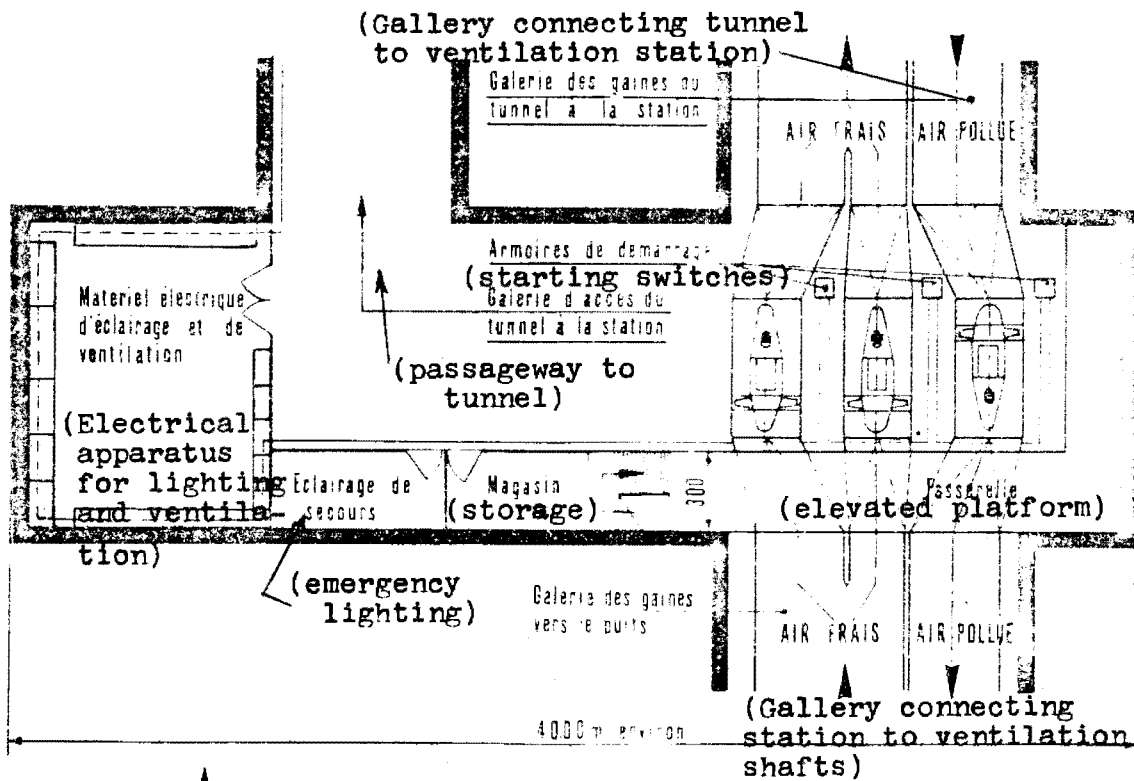

### 3.4 Design of Ventilation Circuits

#### 3.41 Numerical Values of Parameters

The application of the formulas given in Annex 1 can provide only approximate solutions. Certain parameters vary as a function of altitude, type of tunnel wall surface, etc. Because these further factors would only introduce added complications, they will be neglected in our example.

Parameters	Distribution ducts in tunnel		Ventilation shaft with 3 transmission ducts, formed by partitions	Transmission ducts (for Station #2 and Subterranean Station)
	Fresh	Polluted		
S (m <sup>2</sup> )	11.65	4.45	5.70/4.45	11.65/4.45
D (m)	3.09	1.93	2.38/2.11	3.09/1.93
L (m)	1200	1200	fresh: 420 polluted: 435	Sta. #2: 30 S. Sta: 55
V (m/s)	20.6	21	21	20.6/21

#### 3.42 Calculation of Total Pressure

Type of Station	Stations at Entrance				Subterranean Station	
	No. 1		No. 2		Fresh	Polluted
Ventilator	Fresh	Polluted	Fresh	Polluted		
H <sub>1</sub> distribution ducts	712	1078	712	1078	712	1078
H <sub>2</sub> singularities	161	168	161	168	348	247
H <sub>3</sub> transmission ducts	---	---	41	69	854	1035
H <sub>4</sub> Intakes or Exhausts	200	200	200	200	200	200
Total loss H (pascals)	1075	1445	1115	1515	2115	2560

### 3.43 Calculation of Power Requirements

Type of Station	Entrance Stations				Subterranean Station	
	No. 1		No. 2			
Ventilator Function	Fresh	Polluted	Fresh	Polluted	Fresh	Polluted
Air Flow per Ventilator Q (m <sup>3</sup> /s)	120	93.3	120	93.3	120	93.3
Loss H (pascals)	1075	1445	1115	1515	2115	2560
Ventilator Power (kW)	184	193	191	202	363	341
Number of Ventilators	2	1	2	1	2	1
Power per Station	560		585		1065	
Total Power (kw)	2210					

## Annex 4. Longitudinal Ventilation Using Accelerators

### 4.1 General Considerations

With the longitudinal system, ventilation is accomplished not by means of a direct introduction of air into the tunnel, but by means of a longitudinal induction of the air in the tunnel using injectors at the tunnel entrances and accelerators along the length of the tunnel interior.

In the following discussion we will limit our discussion to ventilation using accelerators as this is the most common type of longitudinal ventilation.

The accelerators are placed out of the way of tunnel traffic, either on the ceiling or sidewalls depending upon the tunnel cross-section. The accelerators move the air in the direction of traffic flow (generally the case for one-way tunnels), or in either of two directions depending upon the natural circulation tendency of the air in the tunnel (generally the case for two-way tunnels).

It is normal to place the accelerators a minimum of 60 m. apart along the length of the tunnel, with no more than 2-3 accelerators in the same cross-section. These constraints are imposed by aerodynamical considerations.

### 4.2 Design Factors

4.21 The longitudinal movement of air in the tunnel is opposed by the following natural forces:

- \* Friction forces exerted by tunnel walls, increasing as the square of the air speed.
- \* Differences in pressure between tunnel entrances, due to wind or other climatic conditions.
- \* Piston effect of vehicles, which is positive or negative depending upon the speed of the vehicles relative to the air.

### 4.22 Operating and Static Thrusts of the Accelerators

Longitudinal ventilation is not characterized by its flow capacity, but by the thrust to be transmitted to the air in order to maintain a given air speed in the tunnel. The operating thrust provided by the accelerators is calculated as follows:

$$F = p n Q (W_s - W)$$

where:  $F$  = thrust (Newtons)

$p$  = specific mass of the air in the tunnel ( $\text{kg/m}^3$ )

$n$  = number of accelerators

$Q$  = flow from each accelerator ( $\text{m}^3/\text{s}$ )

$W_s$  = air speed through accelerator (m/s)

$W$  = induced air speed in tunnel (m/s)

Clearly the operating thrust is a function of the induced air-speed  $W$ . For convenience in rating the accelerators, one normally speaks of the static thrust of an accelerator, calculated for standard conditions ( $p_0 = 1.2 \text{ kg/m}^3$ ;  $W = 0$ ). The static thrust  $H$  for a single accelerator is  $p_0 Q W_s$ .

#### 4.23 Calculation

A detailed study is very complex and thus impossible here. For preliminary design purposes, one can be satisfied with the charts given below, understanding that final design requires recourse to the appropriate Agency.

#### 4.3 Charts

4.31 The first two charts represent the effect of tunnel length on the required operating thrust. Two different types of tunnels are considered:

- \* Two-way traffic (accelerators blowing in one direction or the other).
  - horseshoe-shaped cross-section:  $67 \text{ m}^2$
  - road width:  $10 \text{ m}^2$
  - ~~maximum~~ capacity: 1000 veh/hr-lane with 90 heavy trucks/ hr-lane (speed: 55 km/hr)
  - altitude: less than 400 m.
  - grade: none
  - site: rural

- \* One-way traffic (accelerators blowing in direction of traffic flow).
- horseshoe-shaped cross-section: 67 m<sup>2</sup>
  - road width: 10 m.
  - maximum capacity: 1700 veh/hr-lane with 150 heavy trucks/hr-lane
  - altitude: less than 400 m.
  - grade: none
  - site: rural

In the last case, the influence of variations in atmospheric pressures is significant; in some instances it will be necessary to take this into account using the provided curves.

- 4.32 The following charts represent the coefficients of correction to be applied to the calculation of operating thrust in order to account for particular conditions (altitude, number of heavy trucks, grade, etc.). The correction for altitude takes into account both the variation in air density (standard air at 0°C) and the variations in vehicular emissions with altitude.
- 4.33 Knowing the static characteristics of an accelerator ( $H$ ,  $Q$ ,  $W_s$ ), operating thrust can be calculated as follows:

$$f = H (W_s - W) / W_s$$

The required number of accelerators is therefore:

$$n = F/f$$

The power requirements can be easily deduced:

$$P = 10^{-3} n Q H^* n^*$$

where:  $P$  = required power (kW)

$n$  = number of accelerators

$Q$  = unit flow of accelerators

$H^*$  = operating pressure (about 2 dynes or  $p W_s^2$ )

$n^*$  = efficiency (about 0.6)

## Total Operating Thrust as a function of Tunnel Length

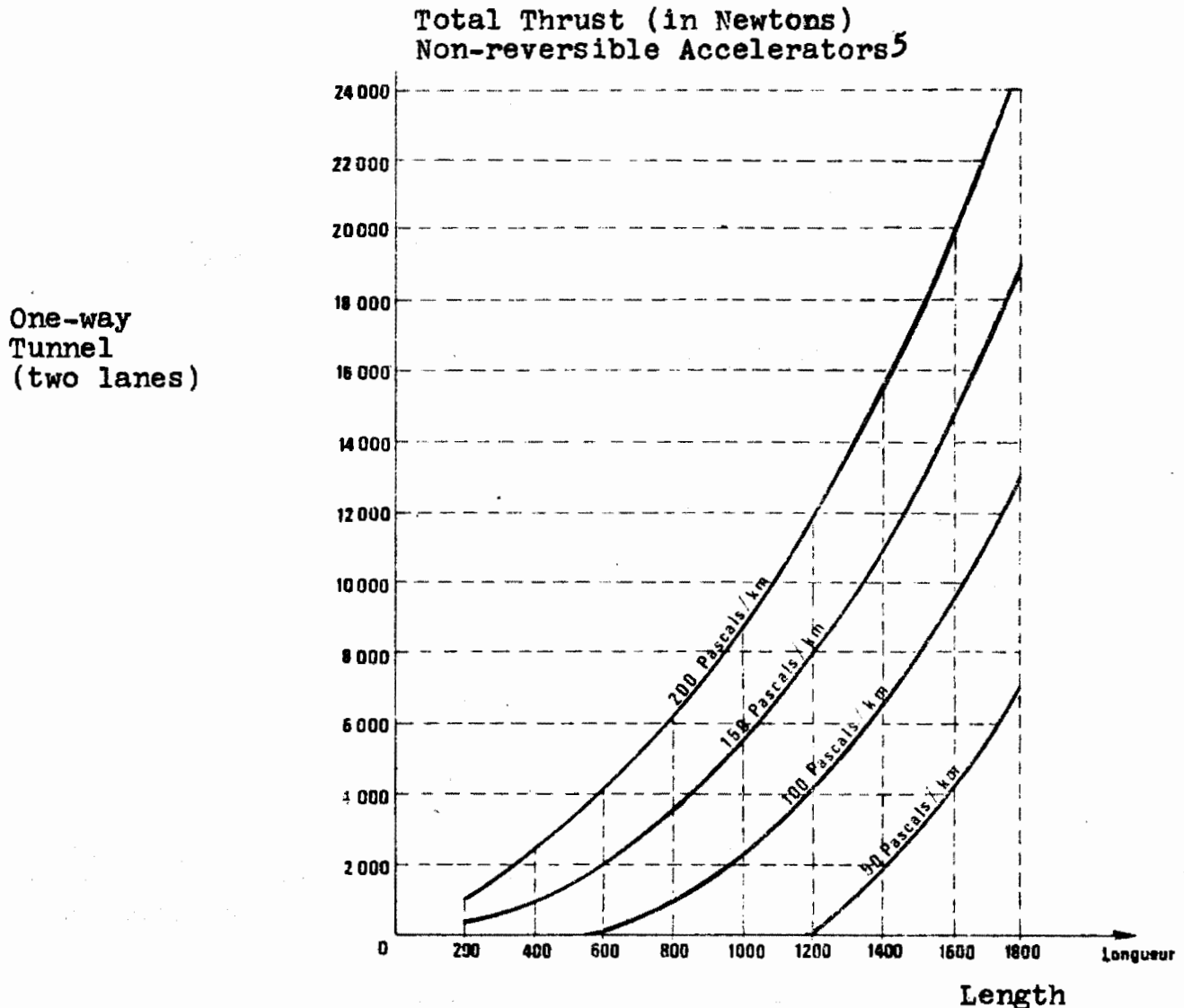
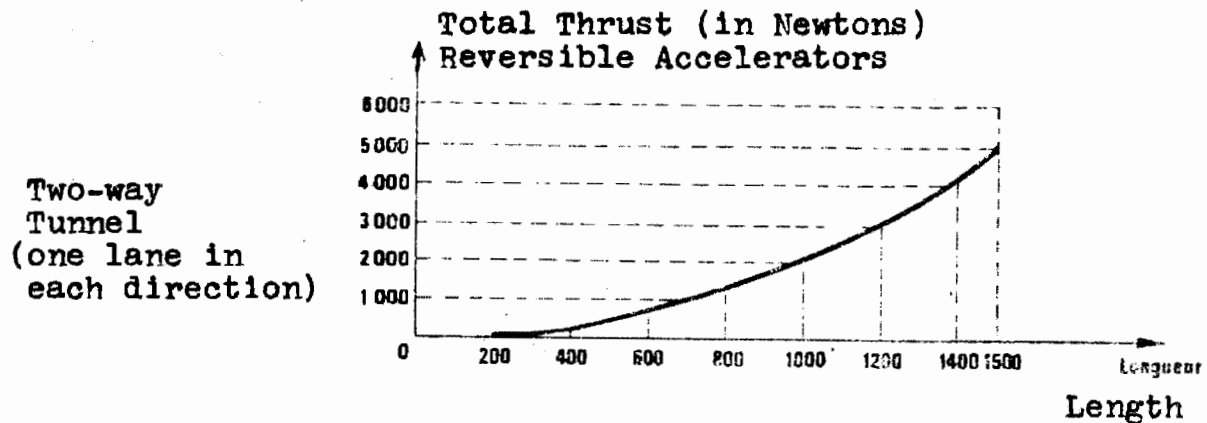

<sup>5</sup>Thrust is given for unfavorable external pressure differentials (between tunnel entrances), varying between 50 and 200 pascals per km of length. For tunnels in rural sites this counterpressure varies from 50 to 100 pascals/km. For a shallow tunnel (e.g., cut-and-cover construction), this counterpressure is due only to wind effect. In such cases counterpressure is independent of tunnel length and can sometimes attain a value of 200 pascals.

Correction Coefficients for Total Thrust  
(Two-way tunnel; one lane each way; L = 1000 meters)

Correction for Altitude:

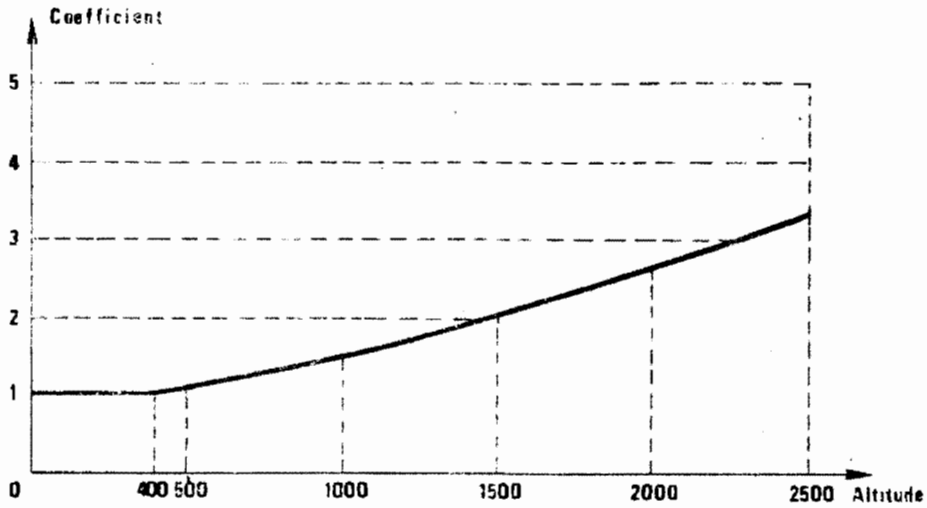

Correction for Number of Heavy Trucks:

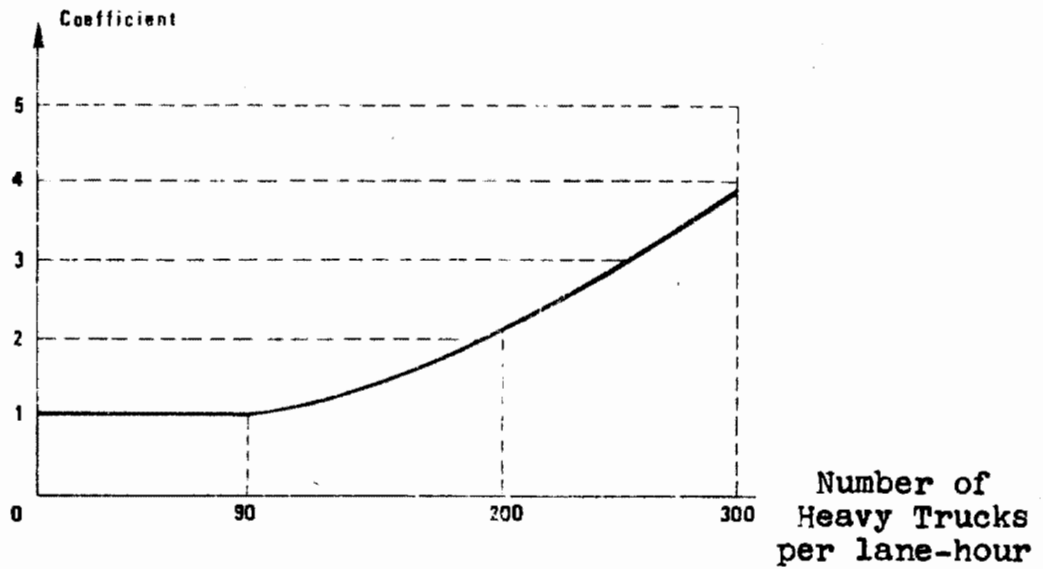

Note: Variation of tunnel width or grade are not significant.



Correction Coefficients for Total Thrust  
(Two lanes, one-way, L = 1000 m.)

Correction for Altitude

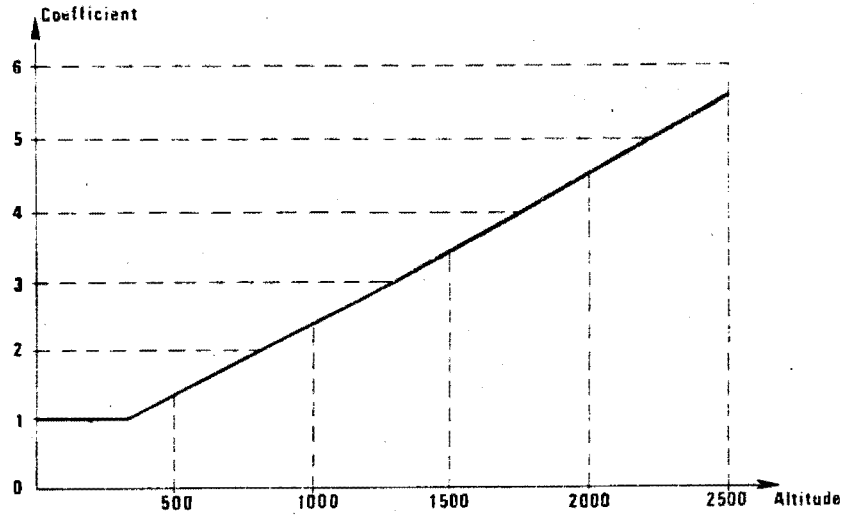

Correction for Heavy Trucks

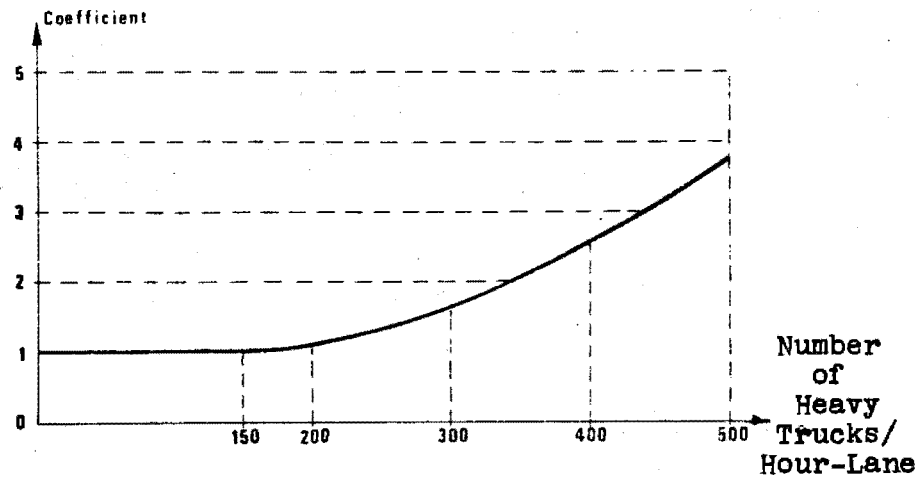

Correction for Grade

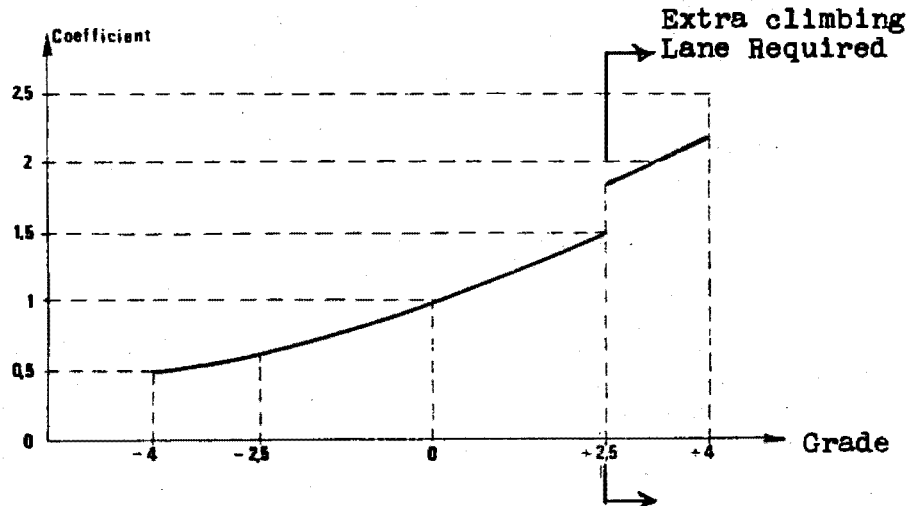

Note: Variation of tunnel width is not significant

#### 4.4 Example

##### 4.41 Tunnel Characteristics

- \* Type of route: rural expressway (2 lanes each direction, each in different tubes)
- \* Traffic: 1700 veh./hr-lane maximum with 150 heavy trucks/hr-lane (speed: 55 km/hr)
- \* Geometry: length: 1000 m.  
grade: 1%  
altitude: 300 m.  
horseshoe-shaped cross-section (67 m<sup>2</sup>)  
road width (2 lanes): 9 m.
- \* Environment: rural

##### 4.42 Air Flow and Choice of Ventilation System

The uncorrected fresh-air flow would be 100 m<sup>3</sup>/s-km-lane (for expressway with normally uncongested traffic). The 1% grade introduces a 1.07 correction factor for the ascending tube, a 0.94 factor for the descending tube.

The necessary fresh-air flows are then:

- \* for the ascending tube: 215 m<sup>3</sup>/s
- \* for the descending tube: 190 m<sup>3</sup>/s

A detailed study would show that natural ventilation is insufficient for ventilating a tunnel of this length, particularly when climatic conditions are taken into account. Such a study would also show that the ventilation requirements are such as to make a semi-transversal system unnecessary.

The system to be adopted will, therefore, be a longitudinal system using accelerators hung from the ceiling.

We suppose that by experimentation on the site it has been determined that atmospheric counterpressures will amount to a supplementary resistance of 100 pascals. Using the foregoing charts we discover that the operating thrust must be 2750 Newtons in the ascending tube and 2000 Newtons in the descending tube. We choose ventilators having a flow of 8.5 m<sup>3</sup>/s at 25 m/s. This type of ventilator is quite representative of existing equipment -- its size and noise characteristics are quite acceptable. The use of larger ventilators will be necessary only in order to cut costs by eliminating power and control cables, but only in larger installations.

The unit operating thrust of these accelerators is given by:

$$f = p Q (W_s - W) \quad (\text{in Newtons})$$

or,

$$* \text{ in the ascending tube: } f = 1.2 \times 8.5 \times \frac{(25-215)}{67} = 222$$

$$* \text{ in the descending tube: } f = 1.2 \times 8.5 \times \frac{(25-190)}{67} = 226$$

As the number of ventilators is given by  $n = F/f$ ,

$$* \text{ in the ascending tube: } n = 2750/222 = 12$$

$$* \text{ in the descending tube: } n = 2000/226 = 9$$

The required electric power is:

$$P = 10^{-3} \times 21 \times \frac{8.5 \times 1.2 \times 625}{0.6} = 220 \text{ kW}$$

The ventilators are placed in pairs as indicated in the following drawings. In the present case, a single transformer room will suffice, as the required cable length is not great (300 m. and 360 m.).<sup>6</sup>

Necessary ventilation control equipment is installed in the room adjoining the transformer room.

---

<sup>6</sup>The maximum possible length for low tension cables is about 400-450 m.

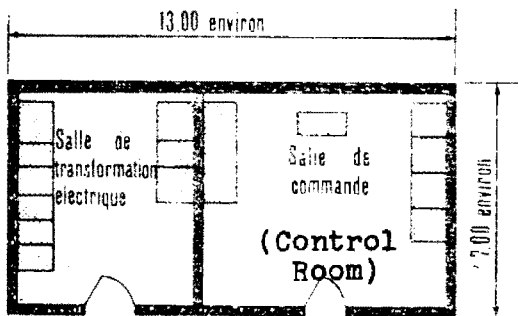
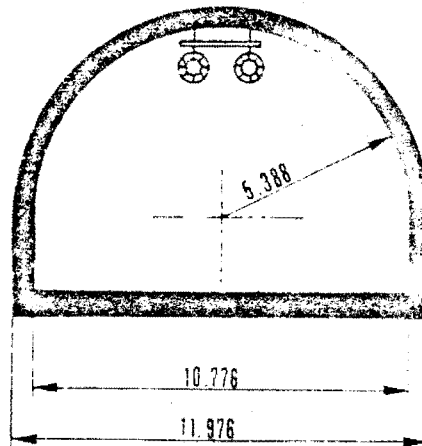
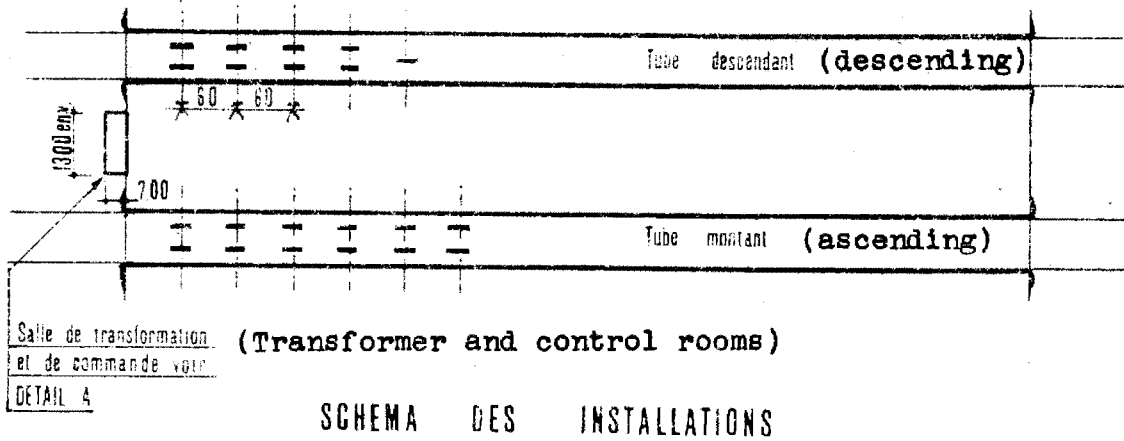

DETAIL A (Side View)



SALLE DE COMMANDE ET DE TRANSFORMATION ELECTRIQUE  
(Control and transformer Rooms)

## Annex 5. Structural Considerations

Although concerned only with the definition of system requirements, Annexes 2 and 3 demonstrate clearly the importance of sound engineering design from the very inception of the project. Structural considerations impinge on the project not only because of construction costs, but also because of the various studies which these structural considerations necessitate (geological, environmental, etc.). These considerations are normally grouped as follows:

- \* Structures located in the tunnel itself:
  - false ceilings and partitions
  - ventilation ducts
- \* Structural work outside the tunnel:
  - shafts and adits for air supply
  - connecting adits to the tunnel
  - ventilation stations

### 5.1 Inside Work

#### 5.11 False Ceilings and Partitions

Their design must take into account the effects of air-pressure differentials across the ceilings and partitions. Moreover, the ceilings must be able to support maintenance crews who will have to work inside the ducts.

Ceilings and partitions are normally designed for:

- \* a uniform loading of  $200 \text{ kg/m}^2$  on the partition separating fresh-air and polluted-air ducts.
- \* a uniform loading of  $200 \text{ kg/m}^2$  plus a variable pointwise loading of  $100 \text{ kg/m}^2$  on the false ceiling.

Both ceiling and partition can be prefabricated or poured in place, the choice being dictated by site or economic considerations.

There are various ways of hanging the ceiling:

- \* Rest ceiling on precast supports set in wall.
- \* Lateral anchorage of the ceiling.
- \* Anchorage of ceiling to tunnel roof by means of vertical partitions.
- \* Rest ceiling on supports extending along walls to floor.

The choice here depends upon the type of tunnel lining employed, the possible presence of an impervious layer, and on the loading of the false ceiling.

In the case of transversal and pseudo-transversal systems, one must be careful to insure the integrity of the polluted-air gallery on the one hand and the fresh-air gallery on the other.

#### 5.12 Connecting Ducts

These are the secondary ducts connecting the principal distribution ducts with the tunnel's traffic gallery.

Depending upon the type of system utilized, the type of tunnel, the number of vehicular lanes, various ways of providing these connections are possible:

- \* In tunnels of rectangular cross-section, connecting ducts are generally replaced by simple openings in the separating partitions.
- \* In vaulted tunnels using a semi-transversal system, simple openings are made in the false ceiling.
- \* In vaulted tunnels employing a return duct for the polluted air, openings for the polluted air are in the ceiling, while fresh air is transmitted from the distribution ducts through connecting ducts to openings located at road level. This insures an even fresh-air dilution.

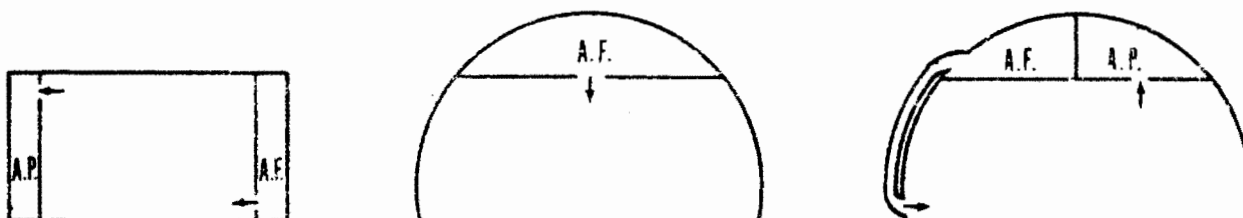

## Annex 5. Structural Considerations

Although concerned only with the definition of system requirements, Annexes 2 and 3 demonstrate clearly the importance of sound engineering design from the very inception of the project. Structural considerations impinge on the project not only because of construction costs, but also because of the various studies which these structural considerations necessitate (geological, environmental, etc.). These considerations are normally grouped as follows:

- \* Structures located in the tunnel itself:
  - false ceilings and partitions
  - ventilation ducts
- \* Structural work outside the tunnel:
  - shafts and adits for air supply
  - connecting adits to the tunnel
  - ventilation stations

### 5.1 Inside Work

#### 5.11 False Ceilings and Partitions

Their design must take into account the effects of air-pressure differentials across the ceilings and partitions. Moreover, the ceilings must be able to support maintenance crews who will have to work inside the ducts.

Ceilings and partitions are normally designed for:

- \* a uniform loading of  $200 \text{ kg/m}^2$  on the partition separating fresh-air and polluted-air ducts.
- \* a uniform loading of  $200 \text{ kg/m}^2$  plus a variable pointwise loading of  $100 \text{ kg/m}^2$  on the false ceiling.

Both ceiling and partition can be prefabricated or poured in place, the choice being dictated by site or economic considerations.

There are various ways of hanging the ceiling:

- \* Rest ceiling on precast supports set in wall.
- \* Lateral anchorage of the ceiling.
- \* Anchorage of ceiling to tunnel roof by means of vertical partitions.
- \* Rest ceiling on supports extending along walls to floor.

The choice here depends upon the type of tunnel lining employed, the possible presence of an impervious layer, and on the loading of the false ceiling.

In the case of transversal and pseudo-transversal systems, one must be careful to insure the integrity of the polluted-air gallery on the one hand and the fresh-air gallery on the other.

#### 5.12 Connecting Ducts

These are the secondary ducts connecting the principal distribution ducts with the tunnel's traffic gallery.

Depending upon the type of system utilized, the type of tunnel, the number of vehicular lanes, various ways of providing these connections are possible:

- \* In tunnels of rectangular cross-section, connecting ducts are generally replaced by simple openings in the separating partitions.
- \* In vaulted tunnels using a semi-transversal system, simple openings are made in the false ceiling.
- \* In vaulted tunnels employing a return duct for the polluted air, openings for the polluted air are in the ceiling, while fresh air is transmitted from the distribution ducts through connecting ducts to openings located at road level. This insures an even fresh-air dilution.

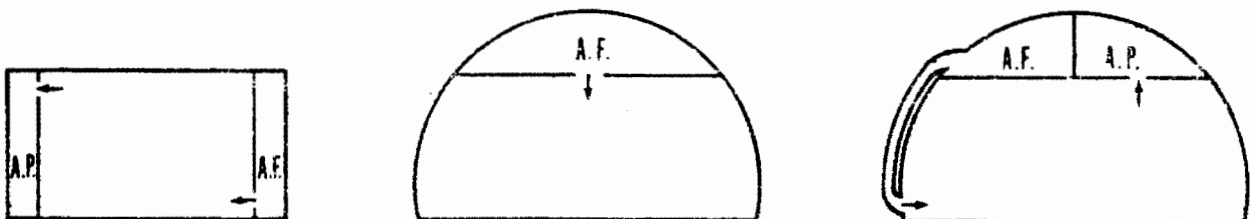



### 5.121 Design Considerations

It is difficult to give a general law for the placement of connecting ducts as this depends upon flow requirements and other considerations.

For initial design, one can figure that at 10 m/s a 20cm x 50 cm rectangular opening will pass 1 m<sup>3</sup>/s.

### 5.122 Effect of Connecting Ducts on Tunnel Design

As was pointed out, in many cases connecting ducts are replaced by simple openings in the ceiling.

When the connecting ducts are indispensable, they are generally made of fibro-cement, and can therefore:

- \* Be cast into the tunnel lining. In this case they are sectioned so as to allow at least two separate pourings of tunnel walls (vault and then lower wall); the minimal width of these ducts should be 15 cm.
- \* Or they can be exposed, simply placed against the tunnel walls. Running from floor to ceiling, exposed ducts are not very aesthetic, nor are they easily cleaned.

## 5.2 Outside Work

### 5.21 Shafts and Adits

The location of ventilation shafts requires a very careful study of the geology and hydrogeology of the traversed terrain, and of the accessibility during construction of the shaft openings. These considerations are treated in more detail in the section on this subject in the Structure Document (Section 2, Annex 9).

Generally speaking, one seeks to choose vertical shafts which are as short as possible, attempting at the same time to keep connecting adits as short as possible. The link-up with the tunnel should be effected, if possible, in geologically suitable terrain.

### 5.22 Ventilation Stations

Their design and location requires from the very beginning of project planning a good understanding of geological and environmental problems. Annexes 2 and 3 indicate size requirements, while Annex 7 discusses some of the difficulties related to their implantation in urban areas.

### 5.221 Subterranean Stations

Because of their large cross-section, these stations pose major design problems. They can only be located in geologically suitable terrain. The choice of a vaulted or rectangular cross-section is dictated by geological considerations, as is also their orientation relative to the tunnel trace.

### 5.222 Surface Stations

Design and location of these stations is dictated by architectural considerations; however care should be taken to insure that the connecting ducts to the tunnel (i.e., transmission ducts) are as simple as possible and that a passageway connecting the station to the tunnel is provided.

---

## Annex 6. Ventilators

The object of the present chapter is to present ideas about the choice of ventilators (types, operating characteristics, advantages and disadvantages, etc.).

### 6.1 Classification

There are two ways of classifying ventilators:

- \* The ventilator is either centrifugal or helicoidal, depending upon the trajectory of the air through the ventilator.
- \* Depending upon their utilization, it is customary to distinguish shrouded ventilators (enclosed in a duct), wall ventilators (set in wall), and hurricane fans (which merely circulate the air in a given area).

For the ventilation of highway tunnels, shrouded ventilators (mounted in ducts or cowlings) are the most common; in parking areas, wall ventilators are often effective.

For the user, a ventilator is essentially a device which "furnishes" a flow of air  $Q$  ( $m^3/s$ ) under a pressure  $H$  (pascals). It is these two values which characterize the ventilator.

### 6.2 Centrifugal (Radial-Flow) Ventilators

#### 6.21 Definition

These ventilators are composed of one or two wheels mounted on a horizontal axis and a volute which develops about this axis. The air enters the wheel parallel to the axis of rotation and exits radially into the volute, and then moves on into the duct connecting to the volute. The air supply for the ventilator can either be drawn directly from the locale of the ventilator, or it can be drawn first through a hood, thus insuring a smooth flow transition into the ventilator.

## 6.22 Operating Characteristics

Roughly speaking, centrifugal ventilators are characterized by a relatively weak flow, but a relatively high pressure. Thus, within the range of ventilators available to constructors, there exists ventilators having a flow of less than  $2 \text{ m}^3/\text{s}$ , but with pressures of 10,000-15,000 pascals.

Because installations in most highway tunnels require high flows ( $80\text{-}200 \text{ m}^3/\text{s}$ ) under relatively low pressures ( $500\text{-}2,000$  pascals), this type of ventilator is not widely used.

## 6.23 Advantages and Disadvantages

As the ventilator is driven by a motor coupled directly to the fan shaft, different ventilation regimes are obtained by use of a variable speed motor.

The chief advantage of these ventilators is their good acoustical characteristics and their stability of performance. They have a noise level of 10 dB less than comparable helicoidal ventilators of the same flow and pressure. Moreover, the noise spectrum of these ventilators is such that most of the output is in the lower and thus less audible frequencies.

On the other hand, these ventilators are bulky. The volute of a double-wheel ventilator occupies a volume roughly two wheel-diameters on a side, not counting the space required by the motor. By way of example, a ventilator of  $75 \text{ m}^3/\text{s}$  and 4,000 pascals, driven by two two-speed motors, will cover an area  $4.4 \text{ m.} \times 10 \text{ m.}$ , and will require a clearance of 6 m. at the centerpoint of the wheel.

## 6.3 Helicoidal (Axial-Flow) Ventilators

### 6.31 Definition

These ventilators are composed of a propellor, including a hub and several blades, turning inside a cowling which constitutes part of the ventilation duct. Smooth air-flow through the ventilator is usually facilitated by use of a fairing of the same diameter as the hub, located upstream of the propellor, and by use of a similarly cone-shaped fairing downstream of the hub. This tends to encourage a non-turbulent flow through the ventilator.

These ventilators may be mounted vertically or horizontally.

Depending upon the intended use, different design and fabrications are possible:

- one piece construction, with hub and blades molded in a single piece
- blades attached to hub in such a way as to allow either a fixed or variable blade angle, adjustments being made with ventilator shut off.
- blades of variable angle, adjustable while machine is in operation.

### 6.32 Operating Characteristics

The operating range for these ventilators is quite wide as regards flows; however the pressures are quite low. Thus, very large diameter propellers (in excess of 10 m.) are able to furnish a flow of 1,000 m<sup>3</sup>/s at pressures of less than 100 pascals. Even for flows of less than 200 m<sup>3</sup>/s, the maximum pressure usually will not exceed 1500-2000 pascals. For greater pressures the solution requires either special construction techniques or the use of several ventilators in series. The latter solution is most common, the ventilators being mounted as needed along ducts, thus insuring a constant flow under the mounting pressures. Except in exceptional cases, this type of ventilator always permits satisfaction of ventilation needs for a highway tunnel.

In longitudinally ventilated tunnels, the accelerators are placed on the vaulted ceiling. If the equipment is designed to move air in only one direction, the propeller is mounted on the end of the motor shaft, and the propeller blade angles are set to attain the best efficiency. Silencing rings are mounted on the cowling from one end to the other. In the case of a reversible installation, the simplest solution, although it results in a lower efficiency, is a symmetrical propeller. The change in direction is then accomplished by reversing the motor rotation (by means of a phase inversion).

### 6.33 Advantages and Disadvantages

The ventilator can be driven in several ways; however the best solution from the point of view of space utilization is a direct coupling of the ventilator to the motor shaft.

Flow variation necessitated by traffic density can be effected in stages (4 regimes can be achieved by use of 2 two-speed motors) or in a continuous fashion by variation of the blade angle of the propeller, driven by a one or two-speed motor.

Helicoidal ventilators are generally more noisy than centrifugal ventilators, but they present the advantage of requiring less space since they are easily integrated into the duct system. By way of example, a ventilator furnishing  $75 \text{ m}^3/\text{s}$  at 1000 pascals has a diameter of about 2 m., a space requirement of  $10 \text{ m}^2$  and a clearance of 4 m.

---

## Annex 7. Problems Unique to Urban Tunnels

### 7.1 General Considerations

Subterranean construction in urban sites is characterized by the following:

- \* Implantation difficulties (right-of-way limitations, encombrances, etc.).
- \* Greater difficulty and cost of construction (problems with water table, proximity of habitations, maintenance of surface traffic circulation near site, cost of expropriations, etc.).
- \* Heavy traffic flows through the tunnel and greater risks of congestion which require major ventilation installations.

These different characteristics demand a careful analysis from the very beginning of project planning of all types of influences involved in urban construction. Those directly related to ventilation are discussed in this annex.

The following remarks cannot possibly answer every conceivable problem which might arise; as a consequence these remarks should be regarded as merely indicative.

### 7.2 Location of Ventilation Stations

In urban sites, it is not possible, even during preliminary design, to be guided by typical solutions. Even before considering the various criteria of economic comparison, one finds oneself limited by various constraints which in many cases may put the entire future of the project into question. It is therefore essential to have a clear view of all ventilation requirements from the very outset. These requirements are of three types, all closely interrelated.

### 7.21 Intake and Exhaust Bays

Their location can give rise to serious difficulties for a variety of reasons:

- \* Because of the required surface area for the bays. The areas necessitated by the tunnel's traffic load is generally disproportionate to the available surface area for such structures.<sup>7</sup>
- \* Because of the nuisance created by the bays, which is of two sorts:
  - pollution engendered by exhausted air. This air must, of course, not be harmful either to inhabitants or to neighboring structures. Polluted air should be vented at a safe distance from both, perhaps by using sufficiently high chimneys. It is also necessary to locate the fresh-air bays in such a manner as to insure that there is no recycling of the polluted air.
  - noise from the ventilators, transmitted by both intake and exhaust bays. (See 7.3 below).

### 7.22 Galleries for Air Distribution

Their design depends upon the available right-of-way for the tunnel.

In more complicated situations, it is often very difficult to find a continuous solution. The design must in these cases find a ventilation circuit that will accommodate those points along the tunnel trace that interrupt a continuous distribution of air along the length of the tunnel.

### 7.23 Ventilation Stations

Generally speaking, even in more complicated situations, it is always possible -- if one takes the time -- to find the underground space for subterranean ventilation stations.

---

<sup>7</sup>In principle the surface area of the intake bays must permit a passage of air at speeds of 2.5-3 m/s. A two-lane roadway 1 km in length requires a surface area of about 100 m<sup>2</sup> for the intake bays (and about 50 m<sup>2</sup> for exhaust bays which can have a higher exit velocity).



### 7.3 Noise and Sound-Abatement

Noise problems associated with highway tunnels are of two different sorts.

#### 7.31 Nuisance to Tunnel Users

Noise levels in the tunnel are always very high, simply because of the traffic circulation in a passageway of high reverberance. Nevertheless, the user's sensitivity to this nuisance is greatly reduced both because of their short exposure to it and because they have a simple means of reducing it -- namely, by rolling up the windows.

Acoustical treatment is necessary only in major urban tunnels. These treatments do not attempt to reduce the noise levels themselves, but to diminish reverberation. The former would be prohibitively expensive. User comfort is thus achieved by suppressing reverberation and localizing noise.

Acoustical treatment of the tunnel walls and ceiling involves the use of absorbent panels, resonant panels, and resonators.

Acoustical studies are the business of experts. In preliminary design, it is necessary only to evaluate the repercussions of such treatments on the overall costs of the project as well as to plan tunnel dimensions to accommodate such treatments should they be necessary. (Acoustical treatments add about 10-15 cm to walls and ceiling.)

#### 7.32 Nuisance to Local Populace

These nuisances can have two sources:

- \* Noise from tunnel entrances. As a rule, the sound energy radiated by the entrances is no greater than that of a normal roadway. It is, nevertheless, possible to treat these entrances in a fashion similar to that employed in the tunnel interior.
- \* Noise from ventilation stations. This is a major problem in urban sites as the cost of acoustical treatment can constitute a major part of the total cost of the project. Moreover, such treatments generally require increased space allocation.

### 7.33 Development of Studies

Acoustical studies involve two distinct phases:

- \* Determination of admissible noise levels. This must be accomplished at the very beginning and without regard to the actually available means of noise-abatement.

There are two possible situations:

- the predicted base noise level is high (due to predicted traffic density): then noise level of the ventilators must be limited to a value lower than the base level.
  - the predicted base level is quite low: then noise level of the ventilators must be limited to a value judged experimentally to be acceptable for the particular locale (residential, office, pedestrian area, etc.). (See 7.35 below.)
- \* Determination of available mean of noise abatement. Attenuation of noise levels can be achieved in two ways:
    - by proper geometrical design of ducts connecting ventilators to intake and exhaust bays: use of 90°-elbows, damping chambers, long ducts, etc. These structures are, however, effective only if they are properly treated with absorbent materials.
    - by use of silencers.

Baffle-type silencers are every effective, but they require considerable space (the gross cross-sectional area must permit a passage of air at 5-10 m/s; the length usually varies from 1.5-4.0 m. depending upon the desired attenuation). For very high attenuations, two silencers can be placed in series; however the head loss through these silencers will be on the order of 100-200 pascals for each one.

The ring-shaped silencers used on helicoidal ventilators lengthen the ventilator cowling one or two meters, but they usually achieve only a minor reduction in noise. On the other hand, head losses are negligible and their dimensions are quite modest.

### 7.34 Required Actions during Preliminary Design

- \* Ascertain (or have ascertained by specialists the extent of the problem. A preliminary determination of the existing noise levels is generally very useful if these levels are sufficiently representative of future noise levels.
- \* To the extent possible, locate ventilation stations in areas where they will create less of a nuisance, choosing an orientation of the intake bays that create the least noise. In urban tunnels, the acoustical aspects of the design can determine both the choice and design of the ventilation system.
- \* Insure that the structural design for the ventilation is sufficiently roomy to permit the installation of noise-abating equipment.

### 7.35 Admissible Values

Acoustical design is tied to a spectral analysis of the principal noise sources. Nevertheless, a first approximation can be achieved by use of total noise values which are weighted in such a way as to take into account the sensitivity of the human ear over the entire sound spectrum. These total values are expressed in dB (A).

#### 7.351 Admissible Sound Levels

- \* Desirable values in very quiet areas having negligible background noise:

Exteriors of dwellings: 35 dB (A)

Exteriors of office-buildings: 45 dB (A)

- \* When the background level is not negligible, the ventilation system should be designed to operate at sound levels below the background level, thus rendering the system nearly inaudible.

By way of example, the noise level of a two-lane roadway, for a traffic density of 2000 veh/hr<sup>8</sup> is on the order of:

75 dB (A)	at	3 m.
71 dB (A)	at	20 m.
69 dB (A)	at	40 m.
64 dB (A)	at	100 m.

- \* The level of sound power  $N_w$  of a ventilator is expressed by the following:

$$N_w = 10 \log k H^2 Q$$

where:  $N_w$  expressed in dB,  $H$  the total pressure of the ventilator,  $Q$  its flow, and  $k$  a coefficient that depends upon the nature of the ventilator.

By way of an example, the noise emanating from a ventilator having a flow of 100 m<sup>3</sup>/s under a pressure of 1000 pascals is about:

105 dB	at	2 m.
85 dB	at	20 m.
79 dB	at	40 m.
71 dB	at	100 m.

- \* The noise-abatement obtained through use of silencers depends, of course, on their construction (design and materials). A baffle-type silencer 2.0 m. in length (flow area 50% of total cross-sectional area) will provide an attenuation of about 20 dB.

---

<sup>8</sup>This level varies as ten times the logarithm of the flow of vehicles. If the flow is only 1000 veh/hr, the noise level will be 3 dB below the indicated levels; if it is 4000 veh/hr, then it will be 3 dB greater.

Annex 8. Glossary of Terms

## Section 2. Lighting

1. Introduction
2. Tunnel Lighting Principle
3. Illumination Levels in Long Tunnels
4. Illumination Levels in Short Tunnels
5. Improving Tunnel Visibility
6. Installation
7. Electric Power Supply
8. Sunscreens
9. Glossary of Terms

## Chapter 1. Introduction

- 1.1 Lighting is not only a factor in tunnel safety and comfort; it is also an essential condition for a tunnel's viability.

Although it is not necessary during preliminary design to undertake a detailed study of lighting requirements, it is nonetheless useful at that time to make a reasonable estimate of these requirements, bearing in mind the following considerations:

- \* Lighting usually represents an important part of the total project costs (3-10%). In certain cases however, notably for short tunnels, the costs are negligible.
- \* Lighting involves continuing costs for operation and maintenance, once the tunnel is put into service, which can be significant. Long-term costs must, therefore, not be neglected.
- \* The constraints imposed on maintenance procedures once the tunnel is in service must be considered during the initial planning of the tunnel.

- 1.2 As a general rule, it is necessary in lighting design to take into account the following factors:

- \* Type of tunnel (route, traffic density, and direction of traffic).
- \* Tunnel site (urban or rural).
- \* Ambient luminance of tunnel approaches.
- \* Vehicle speeds.
- \* Tunnel layout (grades, etc.).
- \* Tunnel length.
- \* Width and number of lanes.

These different factors all have a more or less direct effect on the lighting design. The following remarks are, of course, only general indications.

These remarks are sufficient for choosing the principal characteristics of the lighting, but these characteristics must be detailed and refined at a later stage in planning.

The Cost Document contains all the necessary elements for making preliminary cost estimates.

---



## Chapter 2. Tunnel Lighting Principle

### 2.1 General Considerations

- 2.11 The normal penetration of natural light from outside the tunnel is about 30-40 m. Beyond that point, natural lighting is insufficient to insure visibility of obstacles or proper guidance of vehicles.

Thus, it is indispensable that the tunnel be equipped with artificial lighting which will provide visibility conditions which are homogeneous with those outside the tunnel. It is particularly important to suppress the so-called "black hole effect" which confronts the motorist entering an unilluminated or insufficiently illuminated tunnel. The transition must provide for a progressive adaptation to changes in luminance levels.

- 2.12 As it is not possible, economically speaking, to provide lighting conditions in the tunnel strictly identical to those on the outside, lighting is designed in such a way as to progressively accustom the motorist to lower luminance levels, until in the tunnel interior the luminance level is finally very low (several thousandths of exterior levels).

There are as a result two distinct zones in the tunnel: one corresponding to the transition period at the entrance (called the transition or reinforcement zone) where the luminance levels are progressively decreasing; and the other corresponding to the rest of the tunnel (called the interior zone) where luminance levels are constant.

It is as a result possible to distinguish two types of tunnels:

- \* Short tunnels, where the interior zone is practically non-existent.
- \* Long tunnels, which have both zones.<sup>1</sup>

---

<sup>1</sup>The terms "short" and "long" are to be understood from the point of view of lighting. As one will soon see, all geometrically short tunnels are not necessarily short from this point of view.

In designating long tunnels, it is often advisable to consider a third zone -- the exit zone. Provisions are made in this zone for readapting the motorist to higher levels of exterior luminance by means of an increased artificial illumination approaching the tunnel exit.

## 2.2 Types of Tunnels

### 2.21 Short Tunnels

2.211 As a first approximation, one can assume that in very short tunnels (maximum length of 80 m), the penetration of natural light through the tunnel portals is sufficient for the illumination of the entire tunnel. Detailed studies are still necessary in order to insure the sufficiency of natural lighting.<sup>2</sup>

2.212 Above this length, one considers as short those tunnels wherein a motorist located at one entrance can recognize the presence of obstacles on the tunnel roadway by silhouetting these obstacles against the luminous background of the tunnel exit.<sup>3</sup>

Geometrically short tunnels with lateral curves or changing grade (e.g., subaqueous tunnels) do not belong to this category.

For preliminary design purposes, all straight tunnels (straight both in profile and plan), 100-300 m. in length, are generally considered to be short, assuming that they obey the above silhouetting condition.

2.213 Short tunnels differ from long tunnels in having poorer visibility conditions as well as higher percentage costs for lighting:

- \* Their short length requires that the transition zone extend the length of the tunnel.
- \* The exit is visible from the entrance thus permitting the silhouetting of obstacles, but it also leads to faulty depth perception (due to contrast inversion).

<sup>2</sup>One normally considers the environmental conditions at the tunnel entrances, the height and width of tunnel portals, and the type of route and traffic density.

<sup>3</sup>The obstacle here will have a size of a cube not less than 20 cm. on a side.

- \* The bright exit constitutes a patch of high luminance in the motorist's visual field, which is both dazzling and irritating.

## 2.22 Long Tunnels

Long tunnels are defined by their exclusion from the foregoing categories. They are characterized by:

- \* An entrance zone corresponding to the period of adaptation.
- \* An interior zone.
- \* An exit zone corresponding to the period of readaptation.

In tunnels where traffic is two-way, the exit zone is simply treated as an entrance zone.

In one-way tunnels, the transition zone at the exit poses problems different from those encountered in the entrance zone as adaptation to higher luminance levels is much quicker than is adaptation to lower levels. Because of the problems associated with the exit discussed above (namely, contrast inversion and dazzlement), it is often necessary to provide for an increased lighting for a distance of 60-80 m. ahead of the exit.

---

## Chapter 3. Illumination Levels in Long Tunnels

### 3.1 Entrance Zone

#### 3.11 Influencing Factors

Lighting in the entrance zone must take the following two factors into consideration:

- \* Luminous environment at the tunnel entrance. This permits the establishment of the maximal level of entrance zone lighting necessary in order that every obstacle situated at less than braking distance be perceptible.

This first factor encompasses the luminous surfaces surrounding the tunnel portal. Depending upon their luminance and location, they may produce a more or less pronounced dazzlement of the motorist.

- \* Vehicle speed. This determines the total required length of the entrance zone through which increased illumination must be provided in order to facilitate the transition between ambient exterior luminance and the chosen luminance level in the interior zone.

This factor determines the accommodation conditions of the eye to the various luminous sources which successively enter the visual field, insuring that there is never any loss of vision.

#### 3.12 Choice of Illumination Levels

Because of the great variability of luminous environment with tunnel location and the season of the year, preliminary design of entrance zone lighting is based upon the following table.<sup>4</sup>

---

<sup>4</sup>Electric power requirements are directly proportional to the illumination (in lumens). Luminance is related to the illumination by an average coefficient of reflection for the walls and roadway (here taken equal to  $\pi/10$ ). Illumination levels given here are understood to be for devices in operation for 1500 hours and between cleanings of the fixtures. (Depreciation factors: due to dirt: 20%; aging of the lamps: 5% for sodium vapor, 10% for florescence.)

Accommodation to different luminances varies from individual to individual, thus accommodation times for calculating transition lengths are based on statistical evidence. Lengths shown in the table are based on the accommodation time for 75% of individuals; lengths in parentheses are for 50% of individuals.

SITE		SOMBER (vegetation, sunscreens, somber sur- faces, etc.)	CLEAR (walls, sky)	VERY BRIGHT (white chalk bluff, very bright, sunny sky)
Maximal Illumination Level in Entrance Zone		1000 lux	1500 lux	3000 lux
Illumination Level in Interior Zone (lux)	Entry Speed (km/hr)	Length of Transition (meters)		
50 (rural)	60	170 (110)	215 (150)	250 (170)
	80	245 (165)	305 (215)	350 (245)
	100	320 (220)	395 (280)	450 (320)
	120 <sup>5</sup>	395 (275)	485 (345)	550 (395)
120 (urban)	60	105 (65)	155 (100)	180 (120)
	80	160 (100)	225 (150)	260 (180)
	100	215 (135)	295 (200)	340 (240)
	120	270 (170)	365 (250)	420 (300)

Note: Illumination levels measured at the roadway.

<sup>5</sup>Tunnel speeds will probably be limited below this figure; however, it is useful to provide figures for this higher speed as motorists unfamiliar with the route or surprised by the tunnel may very well enter the tunnel at this higher speed.

### 3.13 Remarks on Application

- \* The rate of decrease in illumination through the entrance zone will not be uniform. The effect of the luminous environment at the entrance, corresponding to a spatial adaptation, is the controlling factor in the first part of the entrance zone. The effect of the vehicle's speed, corresponding to a temporal adaptation, is the controlling factor in the final part of the transition zone.
- \* The illumination levels specified under "Maximal Illumination Level in Entrance Zone" correspond to differing maximal exterior luminances. Because, for a given tunnel, these exterior conditions are variable with the season, provision must be made for intermediate levels of illumination which will correspond to the most commonly encountered levels of exterior luminance.

### 3.131 Preliminary Design

As a first approximation, the preliminary design should provide for the maximal illumination level (as defined in the above table) for a length of 30-50 m. from the entrance, followed by a linear decrease in illumination through the remainder of the entrance zone, until the chosen value for the interior zone is reached at the end of the entrance zone.

- \* The following schema offers an example of such a design. We are here concerned with what might be termed a simplified method, destined to facilitate preliminary design requirements. (The results of this method are conservative.)

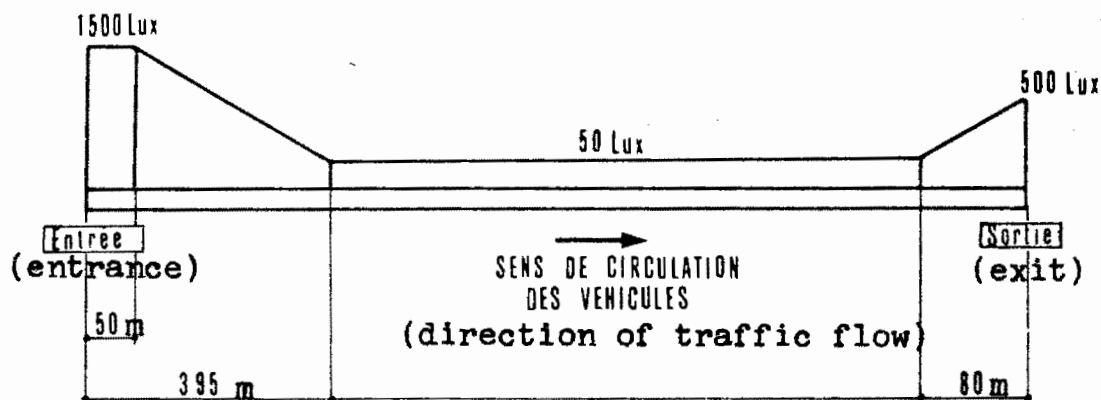

Entry Site: Clear                      Speed: 100 km/hr  
 Sample Lighting Scheme  
 (Rural expressway)

- \* When the illumination level for the interior zone is neither 50 or 120 lumens, the length given in the table can be interpolated or extrapolated to yield proper entrance zone lengths.

### 3.132 Advanced Preliminary Design

The decrease in levels of illumination through the entrance zone is usually not linear, but rather it is discontinuous by stages.

It is generally necessary to make actual site tests in order to determine the precise levels of exterior luminance as well as their seasonal variation. Such tests will determine the required intermediate levels for the entrance zone and may possibly cause modification of the maximal level of entrance lighting. The measurements must be spread out over several seasons and completed after the project is underway.<sup>6</sup>

### 3.2 Exit Zone (for One-way Tunnels)

The accommodation required to pass from the low level of interior illumination to the higher level of exterior illumination is very rapid and does not pose any problems for user safety.

In addition to the dazzlement which is due to the luminous exit, it is necessary to mention that in all one-way tunnels, regardless of the type of ventilation there is an induced flow of air in the tunnel towards the exit. Illuminated by the high intensity exterior illumination, these emissions form a luminous haze which further decreases the motorist's visibility.

In order to attenuate these irritations, it is desirable to make provision for an augmentation of illumination levels beginning about 60-80 m. ahead of the exit (constituting the so-called exit zone). The illumination level must increase linearly from the level of the interior zone to a value of about 500 lumens at the exit.

---

<sup>6</sup>Remember that the construction of the tunnel (creation of luminous surfaces above the portals, removal of vegetation, etc.) will modify the luminous environment of the entrance, possibly leading to an under-estimation of lighting requirements.

The foregoing remarks must be adapted to the type of ventilation system used in the tunnel. A curve in the tunnel near the exit will, on the other hand, permit lower levels of exit zone illumination as there will be no problem with dazzlement of the motorist.

### 3.3 Interior Zone

Once the adaptation of the motorist has been effected in the entrance zone, lighting in the interior zone must satisfy the following needs:

- \* Visibility. Any object of the roadway must be easily visible at a distance greater than the vehicle's braking distance.
- \* Guidance of vehicles. Lighting must be sufficient to permit proper guidance of vehicles in the tunnel.
- \* Quality of lighting.

Various factors combine to provide these three qualities, among which, of course, is the adopted level of illumination.

#### 3.31 Rural Sites

In rural sites, it is safety considerations which are most important for the determination of the proper level of illumination.

These levels in the interior zone depend in a complex fashion on the speed of vehicles, air quality in the tunnel, and the nature of the lighting.

Nevertheless, considering typical traffic speeds, lighting installations, and ventilation systems, a level of 50-100 lumens at the roadway will be very satisfactory.

#### 3.32 Urban Sites

The traffic density, air quality, and use-frequency by individual motorists leads to a higher level of illumination in the interior zone of urban tunnels.

It is necessary to place great importance on the uniformity of lighting and light sources, as well as on the general luminous environment in the tunnel.<sup>7</sup>

---

<sup>7</sup>The type of lighting, for example, influences the comfort of the user: continuous lighting avoids the disagreeable flicker-effect of lighting which is discontinuous or unaligned.



In these cases, one normally adopts an illumination level of about 100-200 lumens in the interior zone.

### 3.33 Reduced Lighting

Economic considerations notwithstanding, it is necessary to reduce the illumination level during the night because the tunnel approaches are generally less well lighted at night (if they are lighted at all). One plans for two intermediary regimes in addition to those discussed in 3.31 and 3.32:

- \* Dusk and evening (hours of heavy traffic).
- \* Night (hours of light traffic).

In general these intermediary regimes are obtained by powering the lighting equipment through several independent circuits, thus permitting their independent operation. In order to equalize their operating lives, the equipment should be utilized on a rotating basis. Lighting during dusk and evening periods should be about half that of the daylight period, while lighting during the night-time period should be 15-30 lumens depending upon the lighting of the approaches. (The lower limit is for unlighted approaches.)

In tunnels equipped with continuous strings of lights, it is sometimes wise to conserve the uniformity of the lighting in the low and intermediate regimes by varying the intensity of all the lights in such a manner as to acquire the proper illumination levels. (This be accomplished using rheostats and multi-power ballasts.) This technique has certain drawbacks and should not be employed except in limited cases.

---

## Chapter 4. Illumination Levels in Short Tunnels

More than for long tunnels, the illumination of short tunnels presents problems which are unique to each tunnel. Environment and traffic characteristics (nature and density) play a determining role. In each these considerations require a detailed analysis.

One may distinguish:

- \* Urban tunnels which are in fact underpasses of great length.
- \* Expressway/thruway tunnels.
- \* Two-way rural tunnels.

### 4.1 Urban Tunnels

Generally located on a major artery, these tunnels constitute a point of considerable importance for the smooth flow of traffic along the artery.

- \* At the extremities of the tunnel it is necessary to adopt the aforementioned criteria for the entrance and exit zones for long tunnels. Even in cases of low vehicle speeds, this will result in an almost total suppression of the interior zone of the tunnel.

The illumination level in the tunnel should not, in any case, be less than 200 lumens.

- \* A very good luminous environment must be provided in the tunnel, not only through the choice and location of lighting, but as well through the use of diffusive wall surfaces and light-colored roadways.

### 4.2 Expressway Tunnels

From a technical point of view it would be very desirable to treat all these tunnels as urban tunnels; any attempt in this direction cannot be criticized on technical grounds. Nevertheless, investment costs demand more economical solutions. Because of higher vehicle speeds, the short length of the tunnel does not permit, by customary means, the desired accommodation. This problem is further complicated by the fact that the exit appears (from the tunnel entrance) as a very bright spot.

Because of the nature of the traffic, it is much more important to insure proper vehicle guidance through the tunnel than to provide a high level of illumination in the tunnel. The tunnel walls are generally left in a rough, unpolished state in order to prevent reflection. Studies presently under way have, however, been directed towards installations involving:

- \* Batteries of floodlights at the tunnel entrance, directed with the traffic in such a manner as to illuminate the entrance as well as provide a very intense vertical illumination of possible obstacles on the roadway.
- \* Continuous line lighting in the interior zone, located along the length of the tunnel walls, and oriented in such a manner as not to blind the approaching motorists.

Experimentation will determine the feasibility of this type of installation.

It is necessary in these cases to consult the appropriate Agency in every case.

#### 4.3 Rural Tunnels

In rural tunnels the speed and density of the traffic are low because of the limited capacity of the approaches.

The level of illumination at the entrances can be reduced to a third that of permissible levels for long tunnels. Vehicular guidance through the rest of the tunnel can also be insured by use of continuous line lighting.

---

## Chapter 5. Improving Tunnel Visibility

### 5.1 Tunnel Exterior

- 5.11 The illumination of the entrance zone of the tunnel constitutes, in general, a significant part of the total lighting costs.<sup>8</sup> If cost reductions are necessary, the effort should be directed towards the entrance zones, taking care not to fall below minimal levels of illumination.

The importance of the luminous environment at the tunnel entrances in determining the required level of illumination in the entrance zone requires that an effort be made to decrease the luminance of this environment.

Insofar as it is possible, it is worthwhile to:

- \* Treat or mask concrete facades, walls, and other light-colored surfaces surrounding the portal with vegetation and dull coverings.
- \* Make provision for a dark road surface of a bituminous material, including the use of dark aggregate.
- \* Provide for rows of trees or screens which will mask to the extent possible the sky and distant horizons, thus blocking out the sun, particularly when it is low on the horizon.<sup>9</sup>
- \* Use sunscreens (cf. Chapter 8).

- 5.12 By way of illustration, the following table gives representative values for the luminance of a tunnel entrance, under similar site and light conditions, for a variety of different environments. The table permits a comparison of the relative influence of the different environments.

---

<sup>8</sup>For example, the entrance zone for a tunnel 1 km in length may comprise 60-80% of the tunnel length.

<sup>9</sup>Similar considerations obtain for tunnel exits.

Because of the nature of the traffic, it is much more important to insure proper vehicle guidance through the tunnel than to provide a high level of illumination in the tunnel. The tunnel walls are generally left in a rough, unpolished state in order to prevent reflection. Studies presently under way have, however, been directed towards installations involving:

- \* Batteries of floodlights at the tunnel entrance, directed with the traffic in such a manner as to illuminate the entrance as well as provide a very intense vertical illumination of possible obstacles on the roadway.
- \* Continuous line lighting in the interior zone, located along the length of the tunnel walls, and oriented in such a manner as not to blind the approaching motorists.

Experimentation will determine the feasibility of this type of installation.

It is necessary in these cases to consult the appropriate Agency in every case.

#### 4.3 Rural Tunnels

In rural tunnels the speed and density of the traffic are low because of the limited capacity of the approaches.

The level of illumination at the entrances can be reduced to a third that of permissible levels for long tunnels. Vehicular guidance through the rest of the tunnel can also be insured by use of continuous line lighting.

---

## Chapter 5. Improving Tunnel Visibility

### 5.1 Tunnel Exterior

- 5.11 The illumination of the entrance zone of the tunnel constitutes, in general, a significant part of the total lighting costs.<sup>8</sup> If cost reductions are necessary, the effort should be directed towards the entrance zones, taking care not to fall below minimal levels of illumination.

The importance of the luminous environment at the tunnel entrances in determining the required level of illumination in the entrance zone requires that an effort be made to decrease the luminance of this environment.

Insofar as it is possible, it is worthwhile to:

- \* Treat or mask concrete facades, walls, and other light-colored surfaces surrounding the portal with vegetation and dull coverings.
- \* Make provision for a dark road surface of a bituminous material, including the use of dark aggregate.
- \* Provide for rows of trees or screens which will mask to the extent possible the sky and distant horizons, thus blocking out the sun, particularly when it is low on the horizon.<sup>9</sup>
- \* Use sunscreens (cf. Chapter 8).

- 5.12 By way of illustration, the following table gives representative values for the luminance of a tunnel entrance, under similar site and light conditions, for a variety of different environments. The table permits a comparison of the relative influence of the different environments.

---

<sup>8</sup>For example, the entrance zone for a tunnel 1 km in length may comprise 60-80% of the tunnel length.

<sup>9</sup>Similar considerations obtain for tunnel exits.

Type of Environment	Luminance (lux/m <sup>2</sup> )
Sea	6000
Light-colored cliff	5000
Clear sky	4000
Gray rock	3000
Sunny road surface	3000
Vegetation (trees)	1000
Shaded road surface	300

The foregoing data (which is only approximate) suggests that substantial savings in entrance zone lighting can be achieved by a proper treatment of the entrance environment. Such a treatment is cost effective because it lowers the required Maximal Illumination Level (cf. table in 3.12).

On a rural expressway, for example, the placement of dark screens and vegetation can achieve a savings of 20-50% on lighting costs.

## 5.2 Tunnel Interior

In the tunnel interior, various techniques are available for improving conditions of visibility and vehicle guidance, while at the same time limiting investment costs on necessary lighting.

### 5.2.1 Some of these possibilities are enumerated below:

- \* An appreciable diminuation of the dazzlement due to the tunnel exit can be achieved simply by designing the tunnel with a very slight curvature near the exit. The same curvature at the entrance will also contribute to a diminuation of required lighting in the entrance zone because the luminance of the tunnel walls (particularly when they are lighted) is generally greater than that of the tunnel interior.
- \* This same wall effect should be exploited in cases where it is necessary that the tunnel have a very pronounced curvature, particularly when the tunnel is short. In these cases, it is necessary not only to improve the luminous environment in the tunnel and to combat the dazzle effect of the exit, but above all it is necessary to provide positive guidance for the motorist. Besides a higher luminance of the concave wall, the light sources must signal very clearly the curvature of the tunnel, permitting the motorist to perceive this curvature before entering the tunnel.

- \* The adoption of a light-colored roadway in the tunnel can effect a reduction in lighting of about 30%. There are several possible ways to achieve this effect (concrete, light or translucent aggregates, special treatment of surface, etc.). Use of light-colored, diffusive coverings on the walls will also achieve a significant improvement in tunnel visibility.
- \* Good vehicular guidance will always contribute to user safety, if not always to an improved visibility. This guidance may be achieved -- and maintained during tunnel use -- by means of lights or reflectors or painted stripes that will guide the motorist through the tunnel.

5.22 While the foregoing recommendations are applicable to all tunnels, particular attention must nevertheless be paid to tunnels which have ascending and descending grades.

- \* In the case of subaqueous tunnels, it is necessary to pay particular attention to the ceiling of the entrance zone (when the grades are steep), for the ceiling will limit the visual field of the motorist and must be sufficiently well illuminated.
- \* Conversely, tunnels having a humped (convex) grade suddenly present the motorist coming over the rise with the very bright exit zone. In these cases as well it is necessary to treat the ceiling, beginning exit zone from the point where the tunnel exit first becomes visible.

As usual, these remarks are meant only as general indications; each case will require a detailed study.

---



## Chapter 6. Installation of Lighting

### 6.1 General Considerations

The choice and location of lighting in tunnels obeys constraints that are quite different from those encountered in open-air lighting.

#### 6.11 Design of Lights

Generally speaking, light sources should not be bare; rather they should be enclosed in fixtures for the following two reasons:

- \* In order to direct the light radiation unto the roadway and walls (up to a height of 2 m.).
- \* In order to protect the light source from pollution deposits (the transparent parts of the fixtures are more easily cleaned than the source itself; also these parts do not have the same electrostatic properties as the source and therefore do not tend to attract these deposits).

#### 6.12 Economy

To the extent possible, lighting should be located within the available space in the tunnel cross-section, avoiding if possible any additional excavation for lighting alone.

In certain cases however, particularly in major urban tunnels carrying heavy traffic flows, it may be necessary to locate the lighting in special galleries which will require added excavation. Technically speaking, this plan greatly facilitates maintenance, but it also increases initial and long-term investment costs because it requires higher powered equipment and thus leads to increased energy consumption. The increased comfort for tunnel users demands a careful cost-benefit analysis in each case.

### 6.13 Requirements

The lighting must possess the following characteristics:

- \* High luminous output.
- \* Uniform illumination of the tunnel interior.

Over and above the photometric characteristics of each fixture, which is of course important, it is necessary from the very beginning to plan for an installation which will provide a uniform illumination. The visibility of obstacles is greatly enhanced if they are perceived against a uniform background having no shaded areas.<sup>10</sup>

This requires in effect that the fixtures be rather closely spaced.

- \* Non-dazzling to motorists.

This problem is posed by the low height of the fixtures. Although the problem is practically non-existent for florescent lighting, more luminous sources require special accommodation -- either with respect to location, or with respect to the design of the fixture itself. Recessing the light fixture into the ceiling often takes care of this problem.

- \* Imperviousness of the fixture.

This is absolutely necessary in order to preserve both mechanical and optical properties. In street lighting this characteristic is often considered (perhaps mistakenly) to be of secondary importance. Nevertheless, the fouling of an open-air fixture is much less rapid than that of a tunnel fixture, primarily because the amount of powder and soot in the open air is much less. Moreover, the motorist is much less sensitive to a deterioration of street lighting because of the great diversity in the types of installations presently in use.

### 6.14 Maintenance

Maintenance is a major consideration both because of the number of hours required each year for the task as well as because of the frequency of maintenance operations which are rendered very difficult by traffic circulation, jeopardizing the safety of both motorist and maintenance personnel. From the time of preliminary design, it is

---

<sup>10</sup>In practice, luminance is difficult to measure; therefore one takes into account the uniformity of illumination.

necessary to consider alternatives that will facilitate lighting maintenance (e.g., a slight widening of the roadway).

Whatever the technique adopted, except in the case of special lighting galleries, maintenance in the tunnel is possible only by means of a vehicle having a platform which permits direct access to the lights. It is important that this vehicle create as little disruption as possible of the traffic circulation; the strings of light fixtures should be located accordingly.

## 6.2 Location of Fixtures

Apart from the general cross-section of the tunnel, which is chosen on the basis of a variety of criteria (geology, ventilation, function of the tunnel, cost, etc.), the location of light fixtures is conditioned by maintenance requirements, the photometric characteristics of the fixtures, and the power of the sources themselves. These considerations combine to limit the possibilities of location.

### 6.21 Vaulted Tunnels

For structural reasons these tunnels are limited to two and three lanes. The installation of two lateral strings in the interior zone of the tunnel will give the necessary illumination. Even in a two-lane tunnel it is unwise to install only a single string of fixtures, not only because of the resulting maintenance difficulties, but also because of the guidance effect which tends to draw motorists toward the center of the roadway since the center will be better lighted than the extremities.

The solution here is to locate the fixtures on the tunnel walls, at a height of 4-5 m.

The installation of reinforcement lighting in the transition zones (entrance and exit zones) creates no problem because of the available space.

### 6.22 Tunnels of Rectangular Cross-section

Included in this category are those vaulted tunnels having a ventilation gallery in the upper portion of the cross-section. The false ceiling results in the same rectangular cross-section.

### 6.221 Special Lighting Gallery

It is possible to make provisions for a special gallery by enlarging the tunnel cross-section. The gallery is formed by installing a glass partition between the roadway and the tunnel wall. The lighting is attached to the tunnel wall, thus leaving a space between the fixtures and the glass partition which permits easy access.

As was indicated in 6.12, although this solution is satisfactory from both a technical and aesthetic point of view, it is quite costly. The solution should be adopted only where the resulting convenience outweighs the added costs. Normally such a solution is employed only in heavily travelled urban tunnels. The added cross-sectional area necessitated by the gallery is about 1.0-1.5 m. in width and about 2.0-2.5 m. in height. The gallery is located about 2.0 m. above the roadway.

In the case of a ventilated tunnel, ventilation galleries are located above the lighting galleries, thus significantly decreasing the added costs of this solution.

A single gallery along one side of the tunnel can furnish an illumination level in excess of 2,000 lumens for a two-lane tunnel. For three or four-lane tunnels, it is necessary to have a second lateral gallery on the opposite side of the tunnel.

### 6.222 Traditional Solutions

#### (1) Two and three-lane tunnels

The installation of a continuous line lighting in each of the corners (wall-ceiling) permits an easy solution of the lighting requirements in the interior zone of these tunnels. For two-lane tunnels, this solution will also suffice for the transition zones if one or two additional strings are added. For three-lane tunnels, two additional strings can be installed above the outside lanes.

These installations require no increase in tunnel cross-section, as the fixtures are located above walkways or curbs.

(11) Four and five-lane tunnels

Here the lateral strings located in the corners are insufficient, even in the interior zone, unless one is willing to cover the entire tunnel wall with lights, at which point a special lighting gallery becomes preferable.

It is nevertheless possible, even in the transition zones, to locate the lighting in continuous strings above the two outside lanes.

Installation of lighting above the center lanes is extremely unsatisfactory if the fixtures are accessible only from the roadway, unless there are certain hours during which maintenance can be effected without disturbance or risk to the motorists.

### 6.3 Light Sources

#### 6.31 Criteria

Light sources must be adapted to:

- \* The needs of the motorist, as regards color, guidance effect (linear sources are preferred to point sources), and uniformity of illumination.
- \* The required level of illumination. Because higher illumination levels require more powerful sources, it is necessary that the sources be efficient.
- \* The available locations for the fixtures which will condition the photometric characteristics of the sources.
- \* The operating conditions in the tunnel (maintenance and operating expenses, annual use of about 6,000 hours, etc.).

Except in special cases, these considerations eliminate:

- \* Incandescent lamps.
- \* Florescent lamps of the bulb-type.
- \* Halogen or iodide lamps.

### 6.32 Choice of Sources

6.321 Generally speaking, the florescent tube-type lamp is the best source for the interior zone for reasons of visual comfort and appearance. Sodium sources are, on the other hand, more economical.

6.322 In transition zones, on the other hand, there are a variety of possibilities; however, space requirements prevent the use of florescent lamps except in vaulted tunnels.<sup>11</sup> As a result, low-pressure sodium vapor lamps are generally used, despite their monochromatism.<sup>12</sup>

Because of the requirement that illumination be uniform, 180W sodium vapor sources are generally not used for providing illuminations of less than 250 lux.

The following table shows the principal sources which are presently being employed in tunnel lighting.

---

<sup>11</sup>For a three-lane tunnel, two continuous strings of florescent lamps can give an average illumination of 150 lux. Twenty (20) strings would be required to obtain the average 1500 lux illumination level for the transition zone!

<sup>12</sup>High pressure sodium vapor lamps have a more agreeable appearance, as they approximate daylight conditions more closely than do the low pressure lamps. At present, the technology is not well developed and they are available only in very high powers. Their use in the future will pose delicate problems regarding uniformity and linearity.

Tunnel Light Sources in Current Use				
Source	Power (with ballast) (watts)	Luminous Flux (lux/100 hr)	Total Efficiency (lux/watt)	Guaranteed Life (hours)
Quick-Start Florescent Tube 40 W-1, 20m	55	2900	52	7000
Quick-Start Florescent Tube 65 W-1, 50m	90	4800	53	7000
Low Pressure Sodium Vapor Lamp 35 W-0, 31m	54	4400	81	6000
Low Pressure Sodium Vapor Lamp 90 W-0, 53m	115	12500	109	6000
Low Pressure Sodium Vapor Lamp 135 W-0, 78m	165	21000	127	6000
Low Pressure Sodium Vapor Lamp 180 W-1, 12m	210	30000	143	6000
High Pressure Sodium Vapor Lamp 400 W-0, 28m	450	40000	90	5000

## Chapter 7. Electric Power Supply

Besides the equipment located inside the tunnel, lighting requires special provisions for the supply of the necessary electric power.

### 7.1 Hook-up with Utility Services

A distribution point should be established at the head of each tunnel for providing the energy needs of the tunnel. The system's security will be greatly enhanced if each tunnel entrance can be supplied from different sources.

### 7.2 Distribution Point

Depending upon the length of the tunnel, it may be necessary to install several transformers. It is desirable not to exceed runs of about 1000 m. for low tension lines. In each case a careful study must be conducted.

### 7.3 Emergency Power

Even if power is drawn from two different branches of the local utility's network, this does not provide a satisfactory degree of security. It is absolutely necessary to be able to maintain power to at least a limited number of fixtures, providing at very least a definition of the tunnel's roadway. This requires an emergency source of power. At present a battery operated emergency system, under constant charge, is expensive, yet still much cheaper than a diesel generator system (which must be run continuously). As well, it provides a greater security as the battery systems are relatively trouble-free.

If ventilation requirements necessitate the installation of a diesel system with automatic starting, the battery system should still be utilized. But because this system will be under load only during start-up of diesel generator, the capacity of the batteries can be significantly reduced.

The emergency illumination will be on the order of 1/6 of the normal interior zone level, but not less than 20 lumens.



## Chapter 8. Sunscreens (Paralumes)

Achieving high levels of illumination at the tunnel entrances by means of artificial lighting is always very costly. When the site lends itself to it, the use of sunscreens is particularly effective as a means of attenuating exterior luminance, permitting only a part of the incident luminous flux to reach the roadway.

### 8.1 Advantages

Investment in sunscreens is, as a general rule, more economical than is recourse to a reinforcement of the artificial lighting in the transition zones in order to achieve the same level of illumination on the roadway.

Sunscreens lead to important savings in operating costs, permitting the use of florescent lights in the transition zone -- something that is often advantageous in urban sites.

The use of sunscreens at the tunnel exit is less necessary than at the entrance, but in certain cases their use permits the avoidance of dazzlement.

### 8.2 Structural Considerations

Direct sunlight should not be permitted to strike the roadway through the sunscreen. This condition is easily satisfied when one is in possession of the proper solar diagrams which permit a graphic determination of sun angle.<sup>13</sup> But it is necessary as well to take into consideration the tunnel grade at the entrance (or exit), as well as the surrounding environment.

Neither should direct sunlight be permitted to strike the roadway laterally (around the sides of the sunscreens). Where the tunnel entrance is in a cut, this condition is satisfied almost automatically. Where the tunnel entrance is exposed, it is necessary to increase the area covered by the screens, or else to use vertical screens (walls or plantings).

---

<sup>13</sup>French Government Documents #51 and #52 (Cahiers 407 and 414 of October 1961) of the Comité Scientifique et Technique du Bâtiment, 49 Avenue Recteur Poincaré, Paris 16e, are applicable to any latitude whatsoever.

### 8.3 Photometric Considerations

Sunscreens must:

- \* Have the same coefficient of transmission whatever the luminance of the sky. The extremes here are, on the one hand, a clear blue sky (the incident luminous flux coming directly from the sun alone) and, on the other hand, a sky where the sun is entirely hidden by clouds or fog (the luminous flux coming uniformly from all points in the sky).
- \* Have a coefficient of transmission which is at first constant, then decreasing as one approaches the tunnel entrance. This decrease must obey the previously discussed laws for proper accommodation to the decreasing luminance. The maximal coefficient of transmission at the extremity of the sunscreen is on the order of 10-13%.

### 8.4 Types of Sunscreens

- \* Closed type: constructed of a translucent material, often plastic or fiberglass. Their coefficient depends largely on their dirtiness, thus they require constant attention. As a result, their use is very limited and not recommended.
  - \* Open type: constructed of grills composed either of only vertical surfaces (honeycomb or lathing laid across beams), or of a combination of vertical and inclined surfaces (made of concrete, aluminum, or plastic).
-

## Chapter 8. Sunscreens (Paralumes)

Achieving high levels of illumination at the tunnel entrances by means of artificial lighting is always very costly. When the site lends itself to it, the use of sunscreens is particularly effective as a means of attenuating exterior luminance, permitting only a part of the incident luminous flux to reach the roadway.

### 8.1 Advantages

Investment in sunscreens is, as a general rule, more economical than is recourse to a reinforcement of the artificial lighting in the transition zones in order to achieve the same level of illumination on the roadway.

Sunscreens lead to important savings in operating costs, permitting the use of florescent lights in the transition zone -- something that is often advantageous in urban sites.

The use of sunscreens at the tunnel exit is less necessary than at the entrance, but in certain cases their use permits the avoidance of dazzlement.

### 8.2 Structural Considerations

Direct sunlight should not be permitted to strike the roadway through the sunscreen. This condition is easily satisfied when one is in possession of the proper solar diagrams which permit a graphic determination of sun angle.<sup>13</sup> But it is necessary as well to take into consideration the tunnel grade at the entrance (or exit), as well as the surrounding environment.

Neither should direct sunlight be permitted to strike the roadway laterally (around the sides of the sunscreens). Where the tunnel entrance is in a cut, this condition is satisfied almost automatically. Where the tunnel entrance is exposed, it is necessary to increase the area covered by the screens, or else to use vertical screens (walls or plantings).

---

<sup>13</sup>French Government Documents #51 and #52 (Cahiers 407 and 414 of October 1961) of the Comité Scientifique et Technique du Bâtiment, 49 Avenue Recteur Poincaré, Paris 16e, are applicable to any latitude whatsoever.

### 8.3 Photometric Considerations

Sunscreens must:

- \* Have the same coefficient of transmission whatever the luminance of the sky. The extremes here are, on the one hand, a clear blue sky (the incident luminous flux coming directly from the sun alone) and, on the other hand, a sky where the sun is entirely hidden by clouds or fog (the luminous flux coming uniformly from all points in the sky).
- \* Have a coefficient of transmission which is at first constant, then decreasing as one approaches the tunnel entrance. This decrease must obey the previously discussed laws for proper accommodation to the decreasing luminance. The maximal coefficient of transmission at the extremity of the sunscreen is on the order of 10-13%.

### 8.4 Types of Sunscreens

- \* Closed type: constructed of a translucent material, often plastic or fiberglass. Their coefficient depends largely on their dirtiness, thus they require constant attention. As a result, their use is very limited and not recommended.
  - \* Open type: constructed of grills composed either of only vertical surfaces (honeycomb or lathing laid across beams), or of a combination of vertical and inclined surfaces (made of concrete, aluminum, or plastic).
-

## Chapter 8. Sunscreens (Paralumes)

Achieving high levels of illumination at the tunnel entrances by means of artificial lighting is always very costly. When the site lends itself to it, the use of sunscreens is particularly effective as a means of attenuating exterior luminance, permitting only a part of the incident luminous flux to reach the roadway.

### 8.1 Advantages

Investment in sunscreens is, as a general rule, more economical than is recourse to a reinforcement of the artificial lighting in the transition zones in order to achieve the same level of illumination on the roadway.

Sunscreens lead to important savings in operating costs, permitting the use of florescent lights in the transition zone -- something that is often advantageous in urban sites.

The use of sunscreens at the tunnel exit is less necessary than at the entrance, but in certain cases their use permits the avoidance of dazzlement.

### 8.2 Structural Considerations

Direct sunlight should not be permitted to strike the roadway through the sunscreen. This condition is easily satisfied when one is in possession of the proper solar diagrams which permit a graphic determination of sun angle.<sup>13</sup> But it is necessary as well to take into consideration the tunnel grade at the entrance (or exit), as well as the surrounding environment.

Neither should direct sunlight be permitted to strike the roadway laterally (around the sides of the sunscreens). Where the tunnel entrance is in a cut, this condition is satisfied almost automatically. Where the tunnel entrance is exposed, it is necessary to increase the area covered by the screens, or else to use vertical screens (walls or plantings).

---

<sup>13</sup>French Government Documents #51 and #52 (Cahiers 407 and 414 of October 1961) of the Comité Scientifique et Technique du Bâtiment, 49 Avenue Recteur Poincaré, Paris 16e, are applicable to any latitude whatsoever.

### 8.3 Photometric Considerations

Sunscreens must:

- \* Have the same coefficient of transmission whatever the luminance of the sky. The extremes here are, on the one hand, a clear blue sky (the incident luminous flux coming directly from the sun alone) and, on the other hand, a sky where the sun is entirely hidden by clouds or fog (the luminous flux coming uniformly from all points in the sky).
- \* Have a coefficient of transmission which is at first constant, then decreasing as one approaches the tunnel entrance. This decrease must obey the previously discussed laws for proper accommodation to the decreasing luminance. The maximal coefficient of transmission at the extremity of the sunscreen is on the order of 10-13%.

### 8.4 Types of Sunscreens

- \* Closed type: constructed of a translucent material, often plastic or fiberglass. Their coefficient depends largely on their dirtiness, thus they require constant attention. As a result, their use is very limited and not recommended.
  - \* Open type: constructed of grills composed either of only vertical surfaces (honeycomb or lathing laid across beams), or of a combination of vertical and inclined surfaces (made of concrete, aluminum, or plastic).
-

**Chapter 9. Glossary of Terms**

### Section 3. Utilization

1. Introduction
2. Factors Determining Utilization
3. Traffic Control
4. Operation of Ventilation and Lighting
5. Pull-offs and Emergency Passageways
6. Emergency Control Procedures -- Examples
7. Tunnel Maintenance
8. Organization of Utilization Service
9. Tunnels without a Utilization Service
10. Regulations for Tunnels and their Approaches

Drawings



## Chapter 1. Introduction

### 1.1 Purpose of Section

Even before the tunnel is put into service, when the project is still in the design phase, it is important that the financial and technical aspects of tunnel utilization be taken into consideration. Failure to do so may result in a poorly designed tunnel that is dangerous to the user, incapable of carrying required traffic volumes, and both difficult and expensive to operate.

From the very inception of the project, certain considerations of a very beneficial nature must be borne in mind.

#### 1.11 Design Considerations

Utilization considerations impinge upon tunnel design at three points:

- \* Dimensioning of the tunnel geometry (emergency pull-offs and clearances) and design of the approaches (on which depend the safety of the user, and the modalities of maintenance and surveillance).
- \* Structural provisions for pull-offs, shoulders, and command centers.
- \* Special equipment required in tunnel or on approaches.

#### 1.12 Utilization Considerations

- \* The purpose of a well designed tunnel is to insure the safe passage of the traffic flows for which the tunnel has been designed. It is necessary, then, to determine the modalities of utilization and make provision for all possible emergency situations which may arise, irrespective of their gravity and expected frequency.

These deliberations should lead to the writing of a manual which delineates the responsibilities for tunnel utilization.

- \* Putting a tunnel into service generally involves major expenses, except in the case of very short tunnels. These operating costs should be borne in mind from the outset of project planning.

At the time of preliminary design, studies of short and long-term costs for the tunnel should be undertaken in order to determine the most economical design. Savings in the initial construction costs should be weighed against the long-term operating costs in order to make sure that short-term savings are not later counteracted by greatly increased operating costs.

## 1.2 Four Important Considerations

- 1.21 Every decision regarding the construction of the tunnel is final. If proper provisions are not made at the outset, skilled management techniques will not be able to remedy the difficulty.
- 1.22 The utilization of the tunnel cannot be divorced from that of its approaches (and sometimes even from that of the adjacent highway network), whether it be a question of traffic control, proper functioning of the tunnel itself, or problems of traffic signalization.
- 1.23 Because of the complexity and multiplicity of sources of information (data), measurements, and control instructions, it is absolutely necessary for major tunnels that they have a centralized point of surveillance and control.

The complexity of the procedures and instructions in emergency situations (breakdown, fire, accident, etc.) requires an automated system of control and surveillance in major tunnels.

- 1.24 Despite the obvious complexity of the required provisions, it should be pointed out that excepting the special difficulties presented by safety, ventilation, and accessibility requirements, tunnels are rather simple systems in which traffic is particularly well controlled.

## 1.3 Limitations of Present Document

- 1.31 As it is impossible to foresee every possible problem which may arise, only the most complex problems of tunnel utilization -- the limiting cases, as it were -- will be considered.

In Chapters 3-8, therefore, we consider only those more difficult problems encountered in tunnels which meet the following three conditions:

- \* Constant surveillance of traffic.
- \* Ventilation.
- \* Having its own Utilization Service.

By way of example, our discussion will concern reasonably important urban tunnels (e.g., longer than 1000 m.), heavily travelled rural tunnels (e.g., longer than 3000 m.), and very long tunnels in mountainous areas (e.g., longer than 4000 m.).

Such an orientation of the discussion will provide the reader with the required information, as well as permit him an appreciation of the degree of complexity that can characterize the utilization of these limiting cases -- an appreciation which is difficult to achieve from the successive study of particular cases.

- 1.32 Of course, the provisions discussed in Chapters 3-8 are not applicable in their totality to all types of tunnels. Certain allowances can be made, notably in the traffic control systems, for less complex cases. The remarks in Chapter 9 are directed towards those cases in which the tunnel does not have its own Utilization Service.
- 1.33 As a general rule, there should be a continuity of traffic control and regulations between tunnel and the rest of the route on which the tunnel is located.

Nevertheless, it is necessary to bear in mind that tunnels often constitute a potential bottleneck on the route (due to tunnel geometry and the adverse environment); also they always pose special problems (limited emergency accessibility, special equipment requirements, necessarily rapid detection of breakdowns and accidents, etc.).

---

## Chapter 2. Factors Influencing Tunnel Utilization

The utilization conditions for a tunnel depend on a number of factors that may be considered as inherently given for the particular tunnel (e.g., the nature of the route, predicted traffic flows, location of approaches, probability of breakdowns or other emergency situations, ventilation requirements, and, to a certain degree, the tunnel geometry itself).

It is, therefore, necessary to be completely knowledgeable of these parameters. If certain equipment purchases can be deferred until increasing traffic necessitates the purchase of this equipment, then very favorable provisions can be made at the time of preliminary design for the rational and economic utilization of the tunnel.

The present chapter will describe the adverse consequences for tunnel utilization that result from poor design, enumerating those factors that require careful consideration in tunnel design.

### 2.1 Nature of the Route

There are four essential aspects of this first factor which should be borne in mind:

- \* Type of tunnel (whether rural or urban, the degree and extent of surveillance of the route, speed limits, and traffic regulations).
- \* Utilization of the Route on which the tunnel is located (thruway, isolated tunnel on heavily travelled route, etc.).
- \* Direction of traffic in tunnel (one-way or two-way).
- \* Relative usage of different lanes as a function of traffic density (e.g., center lane may be relatively unused).

At a certain point in the planning process these four aspects constitute the immutable givens for the project, determining to a greater or lesser degree the complexity of tunnel utilization.

Tunnels having the following characteristics are subject to the most rigorous constraints on utilization:

- \* Urban site.
- \* Located on a route not kept under surveillance.
- \* Two-way traffic, with a rarely used center lane.

It is necessary to be aware of such constraints from the very beginning when provisions for surveillance and utilization are put into operation.

## 2.2 Nature of Approaches

From the point of view of tunnel utilization, the tunnel itself should not be dissociated from its approaches or, for that matter, from the routes that connect to these approaches.

Even at the time when decisions are being made about the tunnel's location, special attention must be given to the layout, proximity, and availability of approaches.

### 2.21 Situations to be Avoided

Insofar as is possible, the following situations (in order of decreasing importance) should be avoided in the tunnel or on the adjacent approaches:

- \* Insufficient distance between tunnel exit and first interchange below the tunnel, or any other potential bottleneck that might back traffic into the tunnel.
- \* Influx of slower moving traffic too close to the tunnel entrance (e.g., from an entrance ramp).
- \* Lane changing by vehicles in tunnels or on immediate approaches.

Besides considerations of capacity, fluidity, and increased engineering costs, these situations create serious safety problems and require increased ventilation, lighting, and signalization in the tunnel. As well they require an increased capability for surveillance and emergency intervention.

## 2.22 Recommendations

As a general rule, it is necessary to follow the recommendations outlined in Document 1 (Chapter 4) as regards the positioning of interchanges; however,

- \* In long tunnels or in urban tunnels subject to high traffic flows, supplementary interchanges must be located above the tunnel in order to cope with situations which require closing the tunnel, even if closing is temporary. The alternative routing for detoured traffic must be preplanned and carefully marked.
- \* Interchanges above and below the tunnel, if they are well placed, are useful -- indeed, indispensable -- for proper tunnel utilization. In the case, for example, where an interchange had not been located in close proximity to one or the other of the tunnel mouths on a thruway tunnel, the emergency cross-overs could be used to move traffic from one roadway to another.
- \* It is useful, insofar as is possible, to provide emergency parking along the approaches and in the medians
  - below the tunnel, in order to permit the stockpiling of vehicles between the tunnel exit and the first interchange (or other possible bottleneck), thus allowing better traffic control in the tunnel itself.
  - above the tunnel, so that when the tunnel is closely integrated in the surrounding road network, there will be a storage area in case of bottleneck in the tunnel, thus preventing an immediate back-up into the rest of the system.

## 2.3 Traffic

A general discussion of the problem of traffic circulation can be found in Document 1.

The following points are, however, particularly noteworthy and should be taken into consideration:

- \* The peak flows are of varying importance depending upon the nature of the route. It is when flows approach the congestion threshold that accidents and blockages in the tunnel become particularly likely.
- \* Amount of heavy truck traffic, particularly if there is a significant grade.

Depending upon the projected traffic flows, notably during rush hours, tunnel utilization will be more or less closely supervised (Cf. Chapter 3 below).

Special regulations can be put into effect during periods of peak flow, for example:

- \* Prohibition of heavy trucks.
- \* Use of alternative routings around tunnel.

## 2.4 Emergencies

### 2.41 General Remarks

Incidents taking place in the tunnel itself can be exceptionally serious because of the potential risks for the motorists (as well as for the tunnel itself).

It is useful to recall that subterranean sites are distinguished from surface structures in the following respects:

- \* Access is limited to the two tunnel mouths (and possibly to intermediary accesses for pedestrians).
- \* Visibility and other ambient conditions are quite different, usually of poorer quality than in open air.
- \* Restricted lateral clearances with continuous rigid walls.
- \* Often high accumulations of pollutants.

As a result, utilization conditions must be analyzed with respect to all possible emergency situations that can take place in the tunnel, considering as well their expected frequency and their perturbing effect on the traffic.

These factors are a function of the tunnel geometry (width of roadway, shoulder width, pull-offs, etc.). Cf. paragraph 2.5 below.

### 2.42 Quantitative Data

#### 2.421 Causes

Generally four categories of emergency situations are distinguished; their causes (determined from an analysis of French tunnels presently in service) are given in the following table. The relative frequencies are given where known.

Causes of Emergencies in Tunnels			
Vehicle Breakdown	Accident	Fire	Loss of Power
Out of gas 20-30%	Passing 5-10%	Collisions (in two-way tunnels)	Storm or snowfall
Flat tire 10%	Braking 20-80%	Motor or tire fires, sometimes spreading to cargo.	Utility breakdown
Electrical or mechanical problems 50-60%	Speeding 0-60%		Strikes
Cooling system 10%	Disregarding traffic signals 10-15%		
Total 100%	100%		

#### 2.422 Frequency of Occurrence

The following can be used for planning purposes:

Event	Frequency
Breakdown 85-95%	20 incidents/million vehicles per kilometer of tunnel
Accident 5-15%	
Fire	
Loss of power	
	Very rare
	12 times/year, not counting strikes.

Breakdowns and accidents, comprising the great majority of emergencies, constitute (depending upon the grade, length, site, and nature of the approaches) about 12-30 incidents/million vehicles-kilometer of tunnel. The 20 incident figure given above is only an average.

#### 2.423 Example

An urban tunnel 1800 m. in length, having 4 lanes (2 in each direction), and an average traffic flow of 60,000 vehicles/day, can expect an average of about 800 emergencies/year, or about 2/day (i.e., several per week during rush hour).



## 2.5 Road Width and Pull-offs

### 2.51 Importance of Problem

Refer to Document 1 for a detailed discussion of the notion of road width.

- \* Road width is a fundamental element affecting tunnel utilization. The viability of and level of service in the tunnel is decisively affected by it.
- \* The choice of road width will depend upon the type of route, the tunnel approaches, the composition and volume of traffic, and on the probabilities of emergency stopping for the various types of vehicles using the tunnel.

### 2.52 Consequences of Choice of Road Width

At the time of preliminary design, there is good reason to consider the savings on first investment costs which would result from a decrease in road width; however, such an action can have the following consequences:

#### 2.521 Consequences for Traffic

- \* Safety
  - multicar accidents resulting from untimely braking or lane changing.
  - danger for motorist whose vehicle has broken down.
  - limited accessibility for emergency service, with a resulting increase in disruption time.
- \* Level of Service
  - slowdowns and bottlenecks in event of a breakdown.
  - permanent reduction of maximum tunnel flows or speeds.
  - required diversion of tunnel traffic to adjacent road system whenever there is an accident or breakdown in the tunnel, with a resulting traffic problem on those roads.

#### 2.522 Consequences for Utilization and Investment Costs

- \* Requires an ultra-rapid detection of breakdowns and accidents.
- \* Requires a substantial emergency service.
  - teams in state of permanent readiness.
  - very complex signalization.

- \* Increased ventilation and lighting requirements.
- \* Necessity for emergency pull-offs (Cf. Chapter 5).

While these requirements cannot be quantified using traditional techniques, the figures given in 2.42 on breakdowns and accidents permits some appreciation of these consequences.

## 2.6 Grade and Length

### 2.61 Tunnel Grades

Insofar as possible, grades should not be in excess of 1% in long tunnels. Although not always feasible in practice, this recommendation certainly embodies the spirit within which tunnel design is to be pursued.

- \* Excessive grades diminish the tunnel's traffic capacity, necessitating a supplementary lane for slow-moving vehicles, thereby augmenting ventilation and other costs.
- \* Changes in the longitudinal profile, such as those encountered in subaqueous tunnels, introduce discontinuities in the traffic flow, even for lighter vehicles.

Special provisions for traffic control are, in such cases, necessary both at the entrance and throughout the tunnel in order to maintain a smooth flow at full capacity.

### 2.62 Grades on Approaches

- \* At the entrance, excessive grades must be avoided as they slow heavy trucks, increase exhaust emissions, decrease capacity, etc.
- \* At the exit as well grades must be avoided, as they create slowdowns and bottlenecks which can propagate back into the tunnel.

### 2.63 Tunnel Length

Ventilation requirements, the risk for the user in case of emergency, and the difficulties attendant to emergency intervention all increase with tunnel length.

Tunnel length is, therefore, an important factor in determining the degree of surveillance to be maintained.

## 2.7 Ventilation

Whether or not the tunnel is ventilated is an important factor in the determination of the modalities of tunnel utilization. (Ventilation requirements were discussed in Section 1 of this document.)

- \* The fact that a tunnel is ventilated does not require that the tunnel be the object of constant surveillance. The ventilation system can easily be automated.
- \* In rural tunnels that carry light traffic, the operation of the ventilation system can be automated, and the tunnel need not be under constant surveillance. In urban sites, on the other hand, all ventilated tunnels must be kept under constant surveillance.
- \* Operation of the ventilation system is necessarily accompanied by various ancillary activities such as measuring traffic flows and pollution levels; this requires the presence of at least part-time surveillance and maintenance personnel, even in cases where full-time surveillance is not required.

## 2.8 Surveillance

In the foregoing discussion, the following seven (7) factors have been singled out as operative in determining the modalities of tunnel utilization:

- 1- nature of the route
- 2- nature of the approaches
- 3- traffic
- 4- emergencies
- 5- road width
- 6- grades and length
- 7- ventilation

Faced with the impossibility of envisioning all possible cases, Chapters 3-8 of the present document will be concerned only with utilization problems in tunnels meeting the following three conditions:

- \* Permanent surveillance of traffic.
- \* Ventilation.
- \* Having its own Utilization Service.

The problems associated with unventilated tunnels as well as ventilated tunnels, but not having their own Utilization Service, are analyzed in Chapter 9.

### Chapter 3. Traffic Control

As was explained in the previous chapter, the tunnels discussed below do not permit the dissociation of tunnel utilization from that of its approaches or of the adjacent road system.

The expected frequency of emergencies demands the adoption of very thorough provisions for their control and disposition. Efficiency and quickness are essential in order to avoid the serious consequences that any tunnel emergency may engender.

#### 3.1 Objectives

3.11 Safety - The maintenance of safety under all circumstances supposes that the following conditions are respected:

- \* Rapid detection, localization, and interpretation of the nature of the emergency (breakdowns, accidents, fires, etc.).
- \* Insured accessibility of emergency equipment to the site of the incident, something that is not easy in the case of one-way tunnels carrying heavy traffic.
- \* Necessary means for insuring that the initial incident does not create others.
- \* Capability of limiting the flow of traffic in the tunnel in the event maximum acceptable pollution levels are exceeded.

3.12 Capacity - The maintenance of traffic capacity supposes the following conditions:

- \* Rapid detection and disposition of emergencies.
- \* Surveillance of traffic flow during normal circumstances in order to insure that the point of optimum flow on the speed-volume curve is not exceeded. Where this point will be exceeded, the control procedure consists of a partial or total closure of the tunnel in a carefully studied cyclic manner, either by holding the traffic above the tunnel or by diverting it through alternative routes.

- \* Provisions for changing the direction of flow in certain lanes in order to adapt to variations in traffic directionality.
- \* In cases where an incident partially or totally blocks the tunnel, provision for freeing vehicles blocked in the tunnel as well as for the redirection of traffic arriving at the tunnel.

### 3.13 Operation of Tunnel Equipment

Here it is essentially a matter of insuring the presence of those factors necessary for the automated operation of the following systems:

- \* Ventilation, which requires the constant regulation of traffic flows (and perhaps speeds).
- \* Lighting, which must be adapted to traffic flows.

### 3.14 Statistical Needs

These are less important for the immediate functioning of the tunnel than for predicting future points and dates of saturation of existing facilities.

## 3.2 Means of Traffic Control (Drawings 1 and 2)

### 3.21 Means of Detecting Anomalies -- Sensors (Drawing 1)

Measures of traffic characteristics must be effected at several points along the route, both in the tunnel and on the approaches.

#### 3.211 In the Tunnel

- \* Depending upon the importance of the tunnel and the gravity of the effects which could result from sudden congestion or an emergency incident, the traffic conditions must be known, at each moment, with a varying degree of precision.
- \* The procedure consists of dividing the tunnel into successive "blocks" [as per railroad signal blocks] 150-300 m. in length, preferably averaging about 200 m. as this is the maximum effective range of television cameras (cf. 3.22).

- \* At the ends of each block, there should be means for detecting any abnormal slowdowns or concentrations of traffic for each lane in the block.

Measurements can be of two sorts:

- \* Differential measurements effected at both ends of the block (e.g., flow measurements).
- \* Direct measurements of speed, density, concentration, and vehicle heights (using radar, etc.).

### 3.212 Above the Tunnel

- \* Sensors for the above measurements should be installed 200 m. above the tunnel entrance. Sensors can also be installed at 400 m. if it is likely that an accident in the tunnel or traffic control procedures effected at the tunnel entrance will back traffic that distance.
- \* At the "unloading" interchange where traffic can be diverted from the tunnel approach, identical measurements will have to be made in order to provide a constant monitoring of the diverted traffic. Sensors should be located both on the exit ramp itself as well as on the adjacent road system (perhaps along the entire length of the detour).
- \* Above this same interchange and on that interchange's entrance ramp leading to the tunnel, an overhead portico which measures vehicle clearances can be installed and suitably signalized.

This measurement is particularly recommended in cases where the tunnel has only a limited clearance or where the tunnel is longitudinally ventilated.

### 3.213 Below the Tunnel

- \* Measurements of traffic flow and speed for each lane must also be effected 200 m. below the tunnel exit and possibly on other routes depending upon the closest interchange below the tunnel.
- \* Identical measurements must also be made on exit ramps and on the adjacent road system in such a manner as to have a close surveillance and control of traffic flow in the area of the tunnel exit. It may, for example, be necessary to regulate the traffic at the tunnel entrance in order to prevent a backlog in the tunnel itself.

### 3.22 Monitoring Traffic by means of Television

The visual monitoring of the tunnel interior as well as its approaches by means of television cameras is an indispensable element for grasping the nature and extent of the problem such as to permit its rapid resolution.

#### 3.221 Limitations

In long tunnels the continual surveillance of several television receivers is both fatiguing and unreliable. Moreover, it is costly in terms of personnel requirements and system maintenance.

Technically speaking, the number of cameras to be installed in a tunnel depends upon the level of illumination. For usual levels of lighting and traffic density, one normally assumes that the cameras have a range of less than 200 m. It is necessary, therefore, to plan for a major installation.

#### 3.222 Utility

The installation of a closed-circuit television system should as a result be considered as permitting:

- \* Very possibly the detection of the incident, if by chance the controller happens to be viewing the proper block.
- \* In every case, the observation of the incident, once it has been detected by the sensors discussed in 3.211.

When anomaly is detected in a block of the tunnel or on its approaches, the activation of the appropriate camera should be accomplished automatically.

### 3.23 Means of Communicating Instructions to Users: Signalization

One distinguishes between permanent and emergency signalization. In neither case should the signs and signals admit of any ambiguity of interpretation. Moreover, the instructions to the motorists must be timely.

#### 3.231 Permanent Signalization in the Tunnel (Drawing 1)

It is composed of the following signs:

- \* Speed limits. There are several arrangements, depending upon the requirements:

- Fixed-indication illuminated signs which simply remind the motorist of the posted speed. Spacing can be relatively great (e.g., 600 m.).
- Signs which are linked to radar so as to flash when the maximum authorized speed is exceeded.
- Variable-indication signs which permit a complex regulation of traffic (e.g., during peak rush hours, when there is a risk of bottleneck at the tunnel exit).

These signs can either be hung from the ceiling of the tunnel above the area swept by the traffic (sign height is 0.5 m.), or they can be located on each wall.

- \* No passing signs are similarly located in the tunnel cross-section, with a regular spacing along the length of the tunnel.<sup>1</sup>
- \* Direction signs in the case of a subterranean interchange or one that is very close to the tunnel exit (less than 300 m.). These signs are the illuminated expressway-type:
  - necessarily located on the tunnel ceiling (thus requiring an increased ceiling height, perhaps quite substantial: 0.30-1.0 m. depending upon information mentioned on the sign).
  - spacing according to the regulation in force.

### 3.232 Emergency Signalization in Tunnel

This is composed of tricolored signals and illuminated instructions provided for each lane.

#### \* Signal lights

The tricolored signals (red, green, and flashing yellow) must meet the following conditions:

- they must be complemented by illuminated instructions (in white) specifying lane changes, and possibly including a siren when the signal changes to red.
- they may also involve a red-and-flashing-yellow indication for effecting changes in lane direction.

<sup>1</sup>In order to permit a proper regulation of traffic in case of breakdown or accident.



- location of signals in the cross-section: they can be located laterally, on each wall, in the case of a two-lane tunnel (or on the ceiling). For tunnels having more than two lanes, they must be located on the ceiling (added ceiling height to accommodate signals: 0.3 m. minimum).
- the lights are located at the end of each block (i.e., about every 200 m.). In cases where the blocks are of greater length, the spacing of the signal lights should obey the following conditions: (i) spaced at a distance of less than maximum visibility (curves in tunnel geometry, smoke, etc.), and (ii) insure a minimum of one signal per ventilation section, as well as a light at the head of the tunnel.

\* Illuminated indications (in white)

- For giving instructions to the motorist, provision should be made for signs requiring the motorist to change lanes.<sup>2</sup> These signs should be located to the right of the signals for each lane, either reading "Change Lane Here" or showing a green arrow with red light (or perhaps both). The illumination of this sign should be tied to that for the lights in the preceding block.
- For giving explanations to the motorist, the following two signs should be located in the middle of every other block, illuminated and flashing as needed:

"Accident Ahead"

"Workmen Ahead"

These explanations may also be given to the motorist using a loudspeaker, but this requires special study.

### 3.233 Signals on Approaches leading to Tunnel (Drawing 2)

Drawing 2 provides an example of the disposition of signals for a complex situation (urban expressway). These drawings permit an appreciation of the complexity of the required installations.

Without going into details (cf. Drawing 2), the following points should be emphasized:

---

<sup>2</sup>Alone the red light requires a total stop.

- \* Directions signs must be located at two points: at the interchange above the tunnel and in the tunnel itself.

The first attempts to direct the motorist into the correct lane before he enters the tunnel, so as to limit changing of lanes in the tunnel (in cases where there is a special lane for slow vehicles or where there is an interchange situated just after the exit from the tunnel).

- \* Presignalling must be very efficient and must be carefully studied in conjunction with subsequent direction signs in order to insure that signs are intelligible (e.g., care must be taken to insure a sufficient spacing between signs, making sure that there are not several signs to be read at the same time).
- \* Emergency signals must permit a proper and instantaneous response to several types of situations: partial or total closing of the tunnel.

In these cases proper diversion of the traffic from the tunnel as well as a careful signalization of the detour are imperative.

### 3.24 Means for Motorist Communication or Action

Is it desirable to induce the motorist to leave his vehicle to go to a call-box? Or can one count on the efficiency of the Utilization Service to persuade him to remain in his vehicle until help arrives?<sup>3</sup>

The motorist can be expected to remain with his vehicle only in the case of a poorly dimensioned tunnel (i.e., one that does not make provision for emergency parking) in which every anomaly in the traffic circulation is registered by sensors. In the circumstances that we have considered (and assuming that the television surveillance has only a complementary character), it seems necessary to permit the user to communicate his problem to the Utilization Service. (For if the tunnel is poorly dimensioned, it probably is not equipped with a rapid detection capability.)

Provisions should, therefore, be made for the following installations:

---

<sup>3</sup>This is the practice in the United States in their urban tunnels, in which there is no possibility of emergency parking. Guards reach the scene of the incident on motorized carts, moving along an elevated sidewalk.

### 3.241 Call-buttons

- \* In the case of call-buttons, the spacing depends upon the road width (possibility of emergency parking) and upon the safety of pedestrians walking to the call-button (i.e., on the existence and width of sidewalk; width of shoulder).

Spacing can vary from 50-200 m., depending upon the circumstances.

- \* In one-way tunnels, these buttons are installed on only the right-hand wall.
- \* In two-way tunnels, the buttons must be placed on each wall, directly across the roadway from one another.
- \* These buttons can permit the specification of the type of emergency (e.g., three buttons on a single panel marked Breakdown, Accident, Fire). Location of the buttons should be conspicuously marked, usually with a small light.

### 3.242 Telephones

Emergency telephones should also be installed, in the same fashion as the call-buttons, but with a greater spacing (100-300 m.).

A special soundproofed alcove must be provided in the tunnel wall to shelter the phone.

The system can be arranged so that picking up the phone receiver activates the flashing yellow of certain signals (this is particularly useful in tunnels of narrow road width where a breakdown will not permit a free flow of traffic past the point of breakdown).

### 3.243 Extinguishers

Portable fire extinguishers should be provided in the telephone alcoves.

## 3.3 Consequences

It should be apparent from the above discussions that effective traffic control requires the rapid processing of data from a variety of sources (including measuring,

transmitting, and analyzing these data), followed by the instantaneous transmission of instructions to motorists or to tunnel emergency personnel.

As will be seen in Chapters 4 and 6, there is even further data and instructions which must be dealt with (concerning the operation of tunnel equipment). This demands that complete sets of instructions for all types of emergency situations must be prepared before the tunnel is put into operation.

Two consequences from the foregoing considerations will be considered in Chapter 8:

- 3.31 The command must be centralized in order to insure coherent, coordinated instructions and actions both in tunnel and on approaches.
  - 3.32 The installation must be automated, partially or totally depending upon the circumstances, if response time is to be short, and if actions are to be well organized.
-

## Chapter 4. Operation of Ventilation and Lighting

The remarks offered in this chapter are illustrated in Drawing 3.

### 4.1 Ventilation

#### 4.11 Sensors in Tunnel

##### 4.111 Objectives

Sensors are located in the tunnel for the following purposes:

- \* In order to permit the completely automated operation of the ventilation system and possibly in order to anticipate ventilation needs in such a way as to insure the system's economical operation.
- \* In order to signal anomalies (exceeding admissible pollution levels) so that the tunnel can be evacuated immediately.
- \* In order to collect useful statistical information for use in future ventilation design.

##### 4.112 Devices to be Installed in the Tunnel

- \* Carbon monoxide analyzers located near tunnel portals and at least one per ventilation section (cf. Section 1).
- \* Opacity meters located at the same points in the tunnel, but which, in contrast to the former, provide results on the visibility and smoke levels in the tunnel that require careful interpretation.
- \* Anemometers located at each portal, along the periphery. Here again there is a very delicate problem of interpretation. These devices monitor the longitudinal speed and direction of air in the tunnel.

These devices are located out of the area of the tunnel cross-section swept by traffic, either above the sidewalks or on the ceiling.

- \* Traffic sensors (measurements of flows and vehicle heights -- in order to count truck traffic) serve to regulate the operation of the ventilation system in function of traffic demands. The devices mentioned in 3.2111 are used for these purposes.

#### 4.12 Installations in Ventilation Stations

Ventilation stations require much equipment (ventilators, motors, transformers, etc.).

Refer to Section 1. where specific requirements are outlined.

#### 4.13 Automated Operation of Ventilation Stations

##### 4.131 Modalities of Regulation

Operation of ventilation can be continuous or discontinuous, depending upon needs.

- \* Continual operation requires the use of ventilators with variable pitch blades which allows the instantaneous choice of the optimal regime.
- \* Discontinuous operation uses ventilators with a fixed blade angle, but with several different rotation speeds.

For the major tunnels treated here, notably in urban tunnels where ventilation is required several hours per day, substantial savings can be effected by using the first solution.

##### 4.132 Automation

Complete automation is necessary in order to insure the following:

- \* Collection and transmission of data concerning pollution and traffic.
- \* Processing of this data and forwarding of instructions to the ventilation stations.
- \* The continual technical control of operations of ventilation stations and the maintenance of acceptable pollution levels in the tunnel.

- \* Automatic start-up and shutdown of certain ventilators in the event of emergency (breakdown, fire, etc.) in accordance with pre-established procedures.

The first two functions presume a cyclic routine for monitoring the operation of the ventilation stations.

Ventilation studies insure the second function: different regimes of the ventilators are keyed to certain threshold-levels of pollution in the tunnel. Optimal operation requires that all preliminary calculations be programmed into the system.

The second and fourth functions suppose that complete series of instructions can be given in complete safety and within a reasonable period of time; presumably these instructions will be perfectly coordinated with traffic control signalization and the emergency interventions effected in the tunnel.

Only a centralized, automated command center, using pre-established procedures and programs, can deal satisfactorily with emergency situations as well as optimize costs for normal operation.

## 4.2 Lighting

### 4.21 Regulation of Lighting

Because of the high energy costs for lighting, it is necessary to adapt levels of illumination in the interior zone and in the transition zones to the real needs of the users (cf. Section 2).

For this reason, lighting must be keyed to the traffic, the level of opacity in the tunnel, and to exterior luminance.

### 4.22 Tunnel Sensors

- \* Necessary measurements for the regulation of lighting in function of traffic and tunnel opacity are effected by the devices mentioned in 3.1 and 4.1.
- \* Exterior luminance is measured by means of photoelectric cells located at the tunnel entrances.

## Chapter 5. Pull-offs and Emergency Passageways in Tunnel

Because of the complexity of the considerations involved in these types of facilities, the remarks in this chapter are necessarily schematic. Actual design requires very detailed studies of numerous problems (construction, utilization during construction, dimensioning of tunnel cross-section, structural continuity, ceiling, signalization, analysis of clearances and type of heavy trucks using the tunnel, and regulations governing the use of these facilities).

### 5.1 Pull-offs

#### 5.11 Desirability

The diruption of traffic caused by a vehicle breakdown on the oradway depends upon:

- \* The tunnel's road width.
- \* The predicted frequency of breakdown or accident.
- \* Traffic density at time of accident.

In general, there is reason to make provisions for these situations by providing a sufficiently wide roadway. But there are situations where, for economic or other reasons, this arrangement is not possible.

#### 5.111 The desirability of pull-offs at spaced intervals along the length of the tunnel can be summarized as follows:

- \* In tunnels having a sufficient road width, they permit the complete removal of brokendown or damaged vehicles from the tunnel roadway.
- \* In tunnels having an insufficient road width, they are a satisfactory remedy, permitting the removal of these vehicles from the roadway, either under their own power or by use of service vehicles. Nevertheless, this remedy still requires the very rapid detection and reaction by emergency service personnel.



5.112 The economic desirability of pull-offs in the tunnel is in each case a matter of determining the relative costs of several different solutions which must be considered at the time of tunnel design:

- \* A tunnel having a road width permitting light vehicles to stop.
- \* A tunnel having a road width permitting heavy vehicles (trucks) to stop.
- \* A tunnel having a narrower road width, but with pull-offs spaced the length of the tunnel.

The following considerations come into play:

- \* The severity of the disruption to traffic caused by the situation.
- \* Geological considerations and the differing construction costs.
- \* Length and grade of tunnel.
- \* Utility of these pull-offs during construction.

## 5.12 General Configuration of Pull-offs

5.121 The pull-offs must in general have the following characteristics:

- \* Their spacing should be about 300-1000 m. (cf. Drawing 4).<sup>4</sup> They are located on the right-hand side of one-way tunnels; on both sides of two-way tunnels, alternating from one side to the other.
- \* Their dimensions must permit heavy trailer trucks (length less than 18 m., width less than 2.5 m.) to get completely out of the traffic lanes.
- \* The pull-offs should be equipped with telephones, call-buttons, and fire extinguishers.

5.122 Required dimensions are shown in Drawing 4. But roughly speaking, one can assume that:

- \* When the road width is very narrow, the width of the pull-off should be 3.0 m.; it can be less in cases where the tunnel is better dimensioned.

<sup>4</sup>A cost analysis, it should be remembered, is necessary in every case.

- \* When the tunnel is used by many trailer trucks, the length of the pull-offs must be 40 m. (including the aprons). This length can be reduced to 20 m., depending upon the amount of truck traffic.
- \* The clearance in the pull-offs must be the same as for the rest of the tunnel.

## 5.2 Passageways

For safety reasons it is desirable, particularly in long tunnels, to make special provisions for the evacuation of vehicles blocked in the tunnel by an emergency.

There are three possible courses of action, depending upon the objectives:

- \* In two-way tunnels, there can be provisions for transverse turning galleries which will permit vehicles (including trailer trucks) to turn around (cf. Drawing 5).
- \* In two-tube tunnels, each tube one-way, provision can be made for transit between the tubes. (cf. Drawing 6.) These passageways can either be for vehicles or for pedestrians.

These facilities permit vehicles and/or users trapped in one of the tubes to be evacuated to the other, or else they permit refuge in case of a very serious emergency (serious accident or fire). They can also serve as an access for emergency equipment.

These passageways are, moreover, often necessary during tunnel construction in order to permit a better organization of the construction site.

### 5.21 Geometry

- \* Passageway for vehicles must have a minimal width of 6 m. and a clearance equal to that of the tunnel. Their spacing can vary between 300-600 m.

The passageways can be either perpendicular or at an angle to the tunnel axes.

- \* Pedestrian passageways having a dimension of 2 m. x 2 m. can be spaced between 150-300 m.

## 5.22 Equipment

These passageways must be fed with fresh air and furnished with standard emergency equipment (telephone, call-buttons, and fire extinguisher). They can also be equipped with fire doors.

## 5.23 Utilization

- \* During normal use these passageways should be sealed (e.g., by use of sliding doors).
- \* The opening of the doors, in case of need, should be effected only after closing and evacuating the other tube. The use of these passageways should be studied carefully, leading to a set of procedures for their use in situations that will be quite unlike the typical breakdowns or accidents.

## 5.24 Turning Galleries

Turning galleries, when deemed necessary, should be located directly across from the pull-offs.

Their cross-sectional profile should be identical to that of the tunnel, with a length of about 15 m.

---

## Chapter 6. Emergency Control Procedures -- Examples

### 6.1 Objectives of Present Chapter

- 6.11 A brief discussion was offered in 2.4 of the causes and occurrence frequencies of various sorts of emergencies.

The consequences of these emergencies on the flow of traffic and the safety of the motorist depend upon two essential factors:

- \* The roadwidth of the tunnel and, in a general fashion, on the availability of emergency parking in the tunnel.
- \* The traffic density at the time of the emergency.

- 6.12 The risks involved justify exceptional steps on the part of the Utilization Service in order to prepare for such emergencies. The complexity of these problems requires:

- \* Automation of the management system.
- \* Unified control.
- \* Development of procedures for dealing with specific problems (traffic signals, emergency interventions, lighting, ventilation).

- 6.13 The present chapter touches on these problems. After setting forth a number of important principles, the chapter goes on to consider several rather typical situations, all exemplary of those faced in tunnel utilization.

In this discussion, consideration has been limited to the case of an urban expressway tunnel, because it lends itself well to consideration (because of the clear separation of the route from the adjacent road system, the separated roadways, etc.).

The analysis of these different situations should not cause one to forget the possibility of simultaneous incidents at several different places in the same tube or in both tubes. This possibility only underscores the need for adequate emergency procedures.

## 6.2 Essential Procedures

### 6.21 The tunnel is only one element in the route (and in the connecting road system).

Procedures must be designed to deal with traffic not only in the tunnel itself but also on the approaches. In the event of a serious accident in the tunnel, one must be able to close off the tunnel approach at the interchange above the tunnel as well as at the tunnel itself.

### 6.22 The motorist must be informed of the incident before arriving on the scene.

Only in this way can an aggravation of the original incident be prevented (by a progressive reduction of speeds, use of detours, etc.).

### 6.23 Emergency intervention can be effected from above or below.

In a one-way urban tunnel, it may be difficult, particularly during rush hours, to reach the scene of the emergency from above, except by using special vehicles that can travel on the right shoulder -- when the shoulder exists, when it has the required dimensions, and when it is free of obstacles.

It is necessary, then, in one-way urban tunnels, to make use of the possibility of entering the tunnel from below. Because of the direction of traffic flow in the other tube, as well as the possibility of a simultaneous accident in this second tube, it is necessary to maintain two sets of the emergency equipment and personnel so that the incident can be reached quickly.

In slack periods, on the other hand, it is easier and safer to enter the tunnel from above.

In the present chapter it is entrance from below that is discussed. Adaptations must be made to these remarks to make them applicable to other cases.

## 6.3 Rush-hour Traffic Jams

These do not include those arising from an emergency incident. They are the normal, daily rush hour congestion, usually resulting from an improper design of the tunnel or its approaches.

### 6.31 Primary Objective

Utilization techniques and procedures must insure the maximum stable flow through the tunnel as well as avoid any congestion in the tunnel itself, thus limiting pollution risks and not exceeding the optimal point on the flow-speed curve.

These procedures involve the regulation of the flow of traffic into the tunnel.

### 6.32 Traffic Control

Several different techniques can be used, possibly in combination:

- \* Exclusion of heavy truck traffic during these periods, thus insuring a homogeneous traffic flow.
- \* Diversion of some of the approaching traffic to alternative routes, thus limiting traffic on the tunnel approaches to flows that the tunnel can accommodate.
- \* Control of traffic at the tunnel entrance. There are several possible techniques, the important requirement being that procedures be effected outside of the tunnel:
  - Control by means of signal lights which periodically halt the approaching traffic, causing it to bunch together for movement into and through the tunnel. The procedure is controlled by the data gathered by sensors that measure traffic density.
  - Smooth flow without stops, but with very strict control of traffic speeds or of the road width available to the motorist, thus insuring an optimal flow regime.
- \* Control of traffic in tunnel. As a precaution signal lights should be placed on flashing yellow and speed limit signs illuminated. These measures are, of course, complemented by the continual surveillance of the tunnel by means of sensors and television.

### 6.33 Conditions for Proper Traffic Control

The aforementioned provisions are difficult to foresee in detail during project planning and design. They are generally developed as a result of observations made after the tunnel is put into operation (perhaps as a result of measurements of traffic speed and volume).

This underscores the need for the proper layout of the tunnel and its approaches (proper design of interchange above the tunnel, locating it a sufficient distance from the tunnel entrance; continuity in layout and road width).

If it is suspected that traffic congestion will be inevitable, provisions should be undertaken at the time of initial planning and design that will facilitate the utilization of appropriate control procedures and techniques. This might include provisions for signalization of the tunnel approaches, complete control of tunnel traffic by means of smaller signal blocks, proper design of the "unloading" interchange, development of detours, etc.

#### 6.34 Ventilation Control

In cases where because of their complexity, the traffic control measures may possibly be ineffective -- at least during a period of shakedown when the tunnel is first put into operation -- there will be a substantial risk of congestion in the tunnel itself, thus raising the possibility of inadmissible pollution levels.<sup>5</sup>

The control of pollution levels in the tunnel must be such as to permit the required actions (diversion of tunnel traffic, temporary halting of traffic at tunnel entrance).

#### 6.4 Accident or Breakdown Partially Blocking Traffic in One Direction (Drawing 7)

This circumstance can arise in situations where there is little or no provision for emergency parking, namely in those situations in which an accident immobilizes vehicles in one lane. In the hypothetical situation discussed below, a single lane of traffic has been temporarily blocked.

##### 6.41 Detection and Location of the Breakdown or Accident

The usual chronology for the detection and location of the emergency conforms to the following schema:

- \* Detection in the command center by one of the following means, depending upon the equipment and level of surveillance maintained in the tunnel:
  - Indications from traffic sensors of an abnormal concentration of vehicles in one of the blocks (or of an abnormally low speed in part of the tunnel).

---

<sup>5</sup>Unless, of course, the ventilation system has been designed to accommodate these situations.

- Notification by tunnel surveillants (who are, perhaps, equipped with motorcycles).
  - Notification by motorist using call-buttons or telephone.
  - Observation of the incident on closed-circuit television (when the site of incident happens to be under surveillance).
- \* Location of the emergency follows directly from above.
- \* Observation by tunnel surveillants on the scene and by closed-circuit television.

#### 6.42 Traffic Control Procedures

6.421 Change signal lights to red for both lanes above the scene of the emergency. Change signal lights to red for obstructed lane below and instruct motorists to move from that lane. This will permit emergency equipment a free access to the scene.

Illuminate the "Accident" signs ahead of the emergency; there should be no need to limit the speeds as well.

At the interchange above the tunnel, illuminate the "Accident in the Tunnel -- One lane Open" sign, thus encouraging motorists to leave the autoroute, though not requiring it.

6.422 Empty the signal block in which the incident is located. The lights for both lanes above that block will be red. The traffic in the unobstructed lane can be permitted to move past the incident, followed by traffic from the obstructed lane, thus clearing the block. It may be necessary to have tunnel personnel supervise the movement of this traffic past the scene of the incident.

6.423 The entire tunnel above the scene of the incident can now be emptied, by illuminating the green lights for the unobstructed lane, then illuminating the green with a lane-change instruction for the obstructed lane.



6.424 When the tunnel is emptied, allow one lane of traffic and then the other to enter the tunnel, alternating in a cyclic fashion, using signal lights and lane-change instructions at the tunnel entrance. From then on, the merging into a single lane is effected outside of the tunnel, not inside.

It is always necessary to inform the motorist with an "Accident in Tunnel" indication on the overhead portico over the tunnel approach.

#### 6.43 Ventilation Procedures

When functioning of the ventilation system is automated (e.g., regulated by CO levels in tunnel), direct intervention is not necessary.

Generally speaking, the steps to be taken consist of an augmentation of fresh-air supply to the ventilation section in which the incident is located -- and perhaps to adjoining sections as well if the incident leads to an accumulation of vehicles in those sections.

#### 6.44 Lighting Procedures

Illumination in the area of the incident should be increased to the highest possible level.

#### 6.45 Emergency Intervention

##### 6.451 Nature of Intervention

Interventions are of two sorts:

- \* When the incident is first detected, motorcycle policemen should be dispatched to the scene in order to supervise the clearing of the tunnel.
- \* A tow truck should be quickly dispatched (from below, in accordance with our hypothetical situation).

Depending on the time and seriousness of the incident, the vehicle may be repaired in place, towed out of the tunnel, or temporarily moved into a pull-off.

## 6.452 Response Times

### \* Alarm

The chronology of the different phases of the alarm, along with the corresponding lapsed time, is as follows:

- detection: 30 seconds.
- television observation: 15 seconds.
- activation of the automated signalization and motorist response time: 5 seconds (there is a necessary transition through the flashing yellow).

From the moment of the incident there is a time lapse of 50-50 seconds before the tunnel is closed and motorists are notified. Calculated in terms of the instantaneous flow at a point, this means that in a two-lane tunnel, where the incident takes place 800 m. from the entrance, more than one hundred vehicles may be blocked in the tunnel above the scene of the accident or breakdown.

### \* Emergency intervention

To this time lapse between incident and alarm, there must be added the delay in notifying the emergency teams and that time required entering the tunnel, as well as that required for clearing the disabled vehicle(s).

The total lapsed time will most certainly be in excess of 8-10 minutes.

In a heavily travelled urban tunnel, such delays during rush hours are simply inadmissible. This makes very clear the need for a well designed tunnel which permits moving the disabled vehicles onto the shoulder or into a pull-off until the traffic slackens.

## 6.5 Accident or Breakdown which Totally Blocks Traffic in One Direction (Drawing 8)

### 6.51 Detection and Location (Cf. 6.41)

### 6.52 Traffic Control Procedures

- 6.521 \* Change all signal lights to red above the scene of the incident, and illuminate the flashing "Accident" sign.

- \* As the scene of the incident must be reached from below, it is necessary to empty the portion below the incident as quickly as possible. As the tunnel empties (of vehicles that were ahead of the disabled vehicle or vehicles), the signal lights should be changed to red. If this lower portion of the tunnel clears too slowly, the signal lights for the lane that will be used by emergency equipment can be changed to red and the motorists using that lane instructed to change lanes, thus freeing the lane for emergency equipment.
- \* Signal the accident before the "unloading" interchange, encouraging approaching traffic to leave the expressway.

If the incident turns out to be serious, then it will be necessary to close the tunnel approaches immediately, directing all traffic off the approach at the "unloading" interchange.

- \* Evacuate vehicles blocked in the tunnel above the incident (see below).

6.522 There are several possible ways of evacuating trapped vehicles:

- \* If the vehicles are stopped outside the tunnel,
  - depending upon the terrain and possible provisions at the tunnel entrance, it may be possible to move these vehicles across the median to the other roadway, sending them back the other direction. These procedures necessarily presuppose that at least one lane of the other tube has been completely closed using the appropriate signals and instructions.
  - If this is not possible, then under police supervision traffic must be turned around on its own roadway.
- \* If vehicles are stopped in the tunnel, then the police will have to take charge of the situation when they arrive, utilizing either of two procedures:
  - using the passageways to the other tube, after an either partial or total closure of the second tube (depending upon the obliquity of the passageways relative to the second tube). (Cf. Chapter 5.)
  - or by backing traffic out of the tunnel, or by turning it around in the tube.

- 6.523 Note that the evacuation of blocked vehicles can, in certain cases, require the partial or total closing of the other tube.

This requires provisions for the control and diversion of traffic heading in the opposite direction.

6.52 Ventilation and Lighting Procedures (Cf. 6.43 and 6.44)

6.6 Fire

6.61 Detection and Location

Remarks offered in 6.41 are applicable here.

In addition, there are three series of special alarms which can be provided:

- \* Special call-button marked "Fire" -- located on the emergency telephone.
- \* Automatic warning system which sounds when the ambient temperature surpasses a certain threshold.
- \* Automatic alarm which sounds when a fire extinguisher is lifted from its mount.

6.62 Traffic Control Procedures

- 6.621 The first action must be to close the tunnel to all traffic as soon as the fire is discovered. In the case of parallel tubes, the second tube must also be closed (Change signals to red in both tubes, with exception of those lights below the point where the fire is located).

- 6.622 As a second step, the following measures are in order:

- \* Rapid evacuation of vehicles situated below the point where the fire is located. Arrival of surveillants on the scene; summoning of fire equipment from below.
- \* In the event of a serious fire, it will be necessary to evacuate motorists blocked in the tunnel above the point of the fire.
  - either on foot, after having backed vehicles closest to the fire as far away as possible and shut off motors.

- or by vehicle, using passageways, if they exist, or by turning the vehicles around in the tunnel, if the tunnel authorities deem this possible.

6.623 From the very outset of planning for tunnel utilization, it is necessary to bear in mind the following considerations:

- \* Every possible situation, notably the conjunction of an accident and a fire, thus rendering access difficult, regardless of whether tunnel entered from above or below.
- \* Problems of access and location of the emergency services.
- \* Highest possible degree of automation of measures for closing the tunnel, control of access to the tunnel, and for evacuating motorists.

#### 6.63 Ventilation Procedures

A fire will create a great amount of smoke, at a temperature that is initially higher than that of the tunnel atmosphere. Under certain conditions,<sup>6</sup> this smoke can be expected to propagate along the roof of the tunnel for several hundred meters, then diffusing throughout the tunnel cross-section as thermal equilibrium is achieved.

It is useful to encourage this laminar situation separating the layers of air of different temperatures, as this will permit the fire equipment to reach the scene of the fire. The following measures are generally in order:

6.631 In cases of transversal or pseudo-transversal ventilation,

- \* Introduce a limited flow of fresh air (at least equal to that being exhausted) from the base of the tunnel walls, in order to maintain in the area of the fire, the clearest possible separation between the hot smoke and the cold atmosphere.
- \* Draw out as much polluted air as possible for several hundred meters on either side of the fire, thus evacuating as much smoke as possible.

---

<sup>6</sup>The longitudinal speed of the air in the tunnel must not be too strong, so as not to create a turbulent flow which would induce mixing.

- 6.632 In cases of semi-transversal ventilation, introduce a limited flow of fresh air.
- 6.633 In cases of longitudinal ventilation, there is little data to indicate precisely what should be done. It is probably best to stop the ventilation.

#### 6.64 Lighting Procedures

- 6.641 It is important to avoid (if possible) a total loss of lighting in the tunnel as this could provoke a panic among the motorists, seriously complicating the emergency firefighting operations.

Location of the electric cables in a secure area of the cross-section (notably under a protected sidewalk) will offer a further safety factor in this respect.

It is also a good idea to separate circuitry supplying adjacent sections of the lighting system. These sections are generally 300-400 m. in length.

- 6.642 In the sections adjacent to the fire, lighting should be as bright as possible.

#### 6.7 Power Failure

##### 6.71 Traffic Control Procedures

- 6.711 When loss of power can be foreseen to take place at a certain time (as in the case of a strike), it is necessary to take steps to insure that by diverting some tunnel traffic, the volume of traffic using the tunnel during this period will be compatible with:

- \* The predicted duration of the power loss.
- \* Maximum admissible pollution levels without ventilation.
- \* Safety of motorists driving in the darkened tunnel.

- 6.712 When the power failure is unexpected, these same steps of diverting some traffic or closing the tunnel must be taken instantaneously.

## 6.72 Conditions Necessary for Insuring a Limited Flow of Traffic During the Period without Power

### 6.721 Lighting

The abrupt and total loss of lighting in the tunnel must be avoided. 3/10 second is the maximum acceptable period between total loss of lighting and its partial or total restoration.

This immediate re-illumination is achieved by means of batteries and an alternator.<sup>7</sup> The level of emergency illumination should not be less than 1/10 the original.

The first phase of emergency illumination should last about 2 minutes, until the emergency generators come on line. At present these generators should be able to provide power for at least 2 hours.

### 6.722 Other Installations Requiring Emergency Power

Besides the lighting, the following installations must receive emergency power:

- \* Traffic signs and signals
- \* Traffic sensors
- \* Pollution sensors
- \* Telecommunications
- \* Command Center lighting

### 6.73 Ventilation Procedures

Generally speaking, ventilation equipment will not receive emergency power when conventional power is lost. It is possible, however, to make provision for a limited ventilation capability during power loss in such a way that this limited ventilation is restored within several minutes of the power loss.

Nevertheless, this service is not essential, and it is more reasonable simply to close the tunnel when inadmissible pollution levels are reached. As mentioned, however, the devices for measuring pollution levels must necessarily be served with emergency power.

---

<sup>7</sup>Needless to say, it is wise to receive electric power from a priority system, channeled, if possible, through two different substations.

## 6.8 Change in Lane Direction (Drawing 9)

When formulating procedures for tunnel utilization, it is necessary to envision certain exceptional circumstances that will require changing the usual direction of traffic in certain lanes. For example,

- \* In two-way tunnels having three lanes, the direction of the center lane may be changed during certain hours in order to accommodate rush hour traffic.
- \* In expressway tunnels (normally one-way), maintenance or an emergency in one tube may temporarily require two-way traffic in the other.

The remarks that follow take as an example the case of a two-lane expressway that is normally one-way.

### 6.81 Traffic Control Procedures

The essential thing is to insure that the lane which will carry traffic in the opposite direction is free of all traffic. The following procedures are to be followed:

- \* Change the signal lights to red for the left lane of the tunnel approach. Above the "unloading" interchange, indicate single lane traffic in the tunnel, thus encouraging motorists to exit onto the adjacent road system. This will help insure that the traffic flow reaching the tunnel will not be in excess of the smooth flow capacity of the single lane. If necessary, steps should be taken to divert the proper volume of traffic at the unloading interchange.
- \* Set out mobile barriers marking the two extremities of lane change.
- \* Change signal lights to red in tunnel left lane as the remaining traffic using that lane moves through the tunnel.
- \* Change lights to flashing yellow in the tunnel right lane, and illuminate the no-passing signs the length of the tunnel.
- \* Visually verify (by television) that the left lane is completely free of traffic.
- \* Open the left lane to traffic moving in the opposite direction, illuminating the flashing yellow provided for this purpose on the back of the tricolored signals.



## 6.82 Ventilation and Lighting Procedures

- \* Lighting should be monitored continually.
  - \* Lighting should be set on maximum intensity throughout the length of the tube.
-

## Chapter 7. Tunnel Maintenance

Tunnel maintenance constitutes an important task for the Utilization Service. After having defined several preliminary principles, the present chapter details the nature of this task, as well as the means for accomplishing it.

### 7.1 Necessary Precautions

Work within the tunnel always involves risks, both for the traffic as well as for the maintenance crews. When very major work is necessary, it is wise to close the tunnel and detour the traffic along alternative routes designated for such eventualities.

#### 7.11 Night Work

Major work that necessitates the complete closure of one lane is generally effected during the night when traffic will not be seriously disturbed.

- \* The closed lane should be well signalized on the tunnel approach and bouyed the length of the tunnel -- or at least ahead of and including the work zone. The use of specially marked service vehicles, parked in the closed lane, ahead of the work site, provides an added degree of safety.
- \* The closing of a center lane (in cases of tunnels having more than two lanes) is strictly prohibited.
- \* In two-way tunnels having a single lane in each direction, it is best to regulate traffic circulation by means of lights located at the tunnel entrances, thus permitting an alternating flow of traffic through the tunnel.

In the case of a very long tunnel carrying light traffic, this alternating flow can be regulated at the work site itself, as long as maximum pollution levels are respected.

#### 7.12 Day Work

In certain tunnels where night-time traffic is heavy, it may be necessary to work during the day.

In all tunnels various sorts of light work can, under certain conditions, be effected during the day.

### 7.13 Precautions

Four precautions must be taken in all cases where work is being effected in the tunnel.

- \* Effective presignalization on the tunnel approaches, speed reductions (on tunnel approaches as well), illumination of flashing yellow, posting of proper instructions, and complete bouying of the work zone.
- \* Levels of carbon moroxide must not exceed 70-100 ppm.
- \* In the work zone, lighting must be as bright as possible.
- \* Work should be conducted behind a clearly marked service vehicle.

### 7.2 Structural Maintenance

The nature and frequency of required structural maintenance is indicated in the following table. Needless to say, these indications will vary from tunnel to tunnel.

The systematic maintenance of the tunnel infrastructure requires a permanent surveillance team whose size varies according to the nature of the tunnel.

- \* For normal maintenance of a two-lane tunnel, the number of required personnel per kilometer of tunnel can be estimated to be:
  - 1 persor/km in rural tunnels
  - 2 persons/km in urbar tunnels
- \* For major or specialized repairs, outside specialists should be called in.

<u>Part of Tunnel</u>	<u>Task</u>	<u>Frequency</u>
General surveillance of the tunnel	<ul style="list-style-type: none"> <li>- Removal of obstacles from roadway</li> <li>- Curb repair, sign changes</li> </ul>	Daily
Buckling or Subsidence of tunnel sections	<ul style="list-style-type: none"> <li>- Cross-sectioning of tunnel</li> </ul>	Variable
Tunnel lining	<ul style="list-style-type: none"> <li>- Control of movement (fissures, deformation, joints, etc.)</li> </ul>	Biannually
Watertightness of shafts, galleries, and tunnel portals (and possibly of entire tunnel)	<ul style="list-style-type: none"> <li>- Inspect for leaks, seeps, ice, and stalactites</li> </ul>	Every 2 mo.
Conduits (drainage, electrical, etc.)	<ul style="list-style-type: none"> <li>- Presence of water, debris, etc.; cleaning</li> </ul>	Every 3 mo.
Ventilation galleries	<ul style="list-style-type: none"> <li>- Examination of partitions, anchors, joints, etc.</li> <li>- Cleaning of galleries</li> </ul>	Every month Biannually
Roadway	<ul style="list-style-type: none"> <li>- Superficial inspection for grooving, slipperiness, etc.</li> <li>- Measures to counteract slipperiness</li> <li>- Cleaning</li> <li>- Road striping</li> </ul>	Monthly Variable Variable Yearly
Approaches	<ul style="list-style-type: none"> <li>- Snow Removal</li> </ul>	Variable
Control devices in immersed tunnels	<ul style="list-style-type: none"> <li>- Feeler gauges (for measuring changes in length of caissons)</li> <li>- Extensometers (for measuring spread between caissons)</li> <li>- Pressure sensors (pressure on joints)</li> </ul>	Variable

### 7.3 Electrical Machinery

#### 7.31 Parts of the Tunnel to be Serviced

The following table spells out quite succinctly the nature and frequency of the tasks to be effected. Preventive maintenance is very important as it can reduce equipment breakdowns by about 80%.

#### 7.32 Necessary Means

##### 7.321 Utilization Service Personnel

Personnel charged with the inspection and maintenance of ventilation and lighting installations must be well qualified.

The supervisor in the Command Center must have an especially good understanding of these installations if he is to properly diagnose the data conveyed to him from these installations.

##### 7.322 Outside Personnel

Outside specialists can be contracted for the following tasks:

- \* Dismantling and inspection of motors
- \* Measurements of the constancy of air flow in the tunnel
- \* Renovation of lighting equipment (takedown, internal and external cleaning, inspection of joints and ballasts, replacement of corroded parts, inspection of outlet and wiring, replacements of lamps, reassembly and rehanging).

##### 7.323 Special Materials

Special vehicles are needed to effect tunnel maintenance, notably that of lighting. These vehicles must be specially designed and equipped so as to encumber the roadway as little as possible (e.g., vehicles of reduced width).

<u>Part of Tunnel</u>	<u>Task</u>	<u>Frequency</u>
<u>Ventilation:</u> Ventilators, including emergency ventilators	- Test of all ventilators not in constant use. - Test of emergency ventilation system.	Every 15 days
Equipment	- Inspection of duct registers	Every 15 days
Motors	- Greasing to prevent freeze-up - Dismantling and inspection	Every 15 days Yearly
Shafts (particularly polluted-air shafts)	- Cleaning	Biannually
Air flow at tunnel portals (in case of long tunnels)	- Measurement of constancy of flow	Every 15 days
<u>Lighting:</u> Lamps & tubes	- Adjustment and possible replacement	Every 15 days
Battery-Alternator system	- Test run.	Every 15 days
Emergency generator system	- Test run.	Every 15 days
Fixtures	- Cleaning	Every 1-3 mo.
Illumination levels at roadway	- Measurement	Every 3 mo.
Electrical circuits and junction boxes	- Inspection	Every 3 mo.
Complete replacement of lamps and tubes	- This period can be lengthened if the lighting is used intermittently	Yearly
<u>Electrical Supply:</u> Distribution boxes and batteries	- Inspection	Every 15 days

## 7.4 Signalization, Alarms, and Control Devices

### 7.41 Parts of Tunnel to be Serviced

The following table specifies the necessary tasks of inspection and maintenance:

<u>Parts of Tunnel</u>	<u>Tasks</u>	<u>Frequency</u>
Traffic control devices: - Sensors/counters - Television system	Continuous checks	Complete inspection yearly
Signalization: - Signs and signals in tunnel and on approaches	Maintenance and cleaning	Every week
Pollution: - Opacity meters - CO analyzers - Anemometers	Check accuracy and calibration	Every week; complete inspection yearly
Lighting: - Luxmeters/sensors	Check	Every week
Safety: - Call buttons - Telephones - Fire extinguishers	Check for proper operation	Every month; complete inspection yearly
Telecommunications:	Very frequent inspection of Command Center console	Every 2 days; complete inspection yearly
Automated equipment:	Complete inspection by specialists	Variable
Fire: - Extinguisher, alarms - Emergency firefighting equipment	Check for proper operation	Frequently

### 7.42 Necessary Means

Maintenance can be effected specialists from the Utilization Service, under guidance and supervision of equipment manufacturers.

For technical inspections or overhauls, specialists should be brought in. Contracts can be let for the following installations:

- \* Illuminated signalization of the Command Center.
- \* Radar in tunnel (if applicable).
- \* Closed-circuit television system.
- \* Telephones and extinguishers in tunnel.
- \* Testing of measuring devices for pollution.
- \* Automated equipment (computers, calculators).

## 7.5 Miscellaneous

The following is a list of various maintenance operations which did not appear in the previous categories:

### 7.51 Signalization of Work Zones

Monthly inspection of the portable equipment used to mark work zones.

### 7.52 High and Low-tension Electrical Equipment (grounds, distribution points, etc.)

Maintenance must be effected by personnel who are qualified for high-tension work (this work may be contracted to a specialist).

### 7.53 Cleaning

The maintenance of the roadway and tunnel walls as well as the approaches to the tunnel must include maintenance of sidewalks, the various conduits, and possibly even the ceiling.

#### 7.531 Frequency and Technique

The cleaning of the traffic gallery of the tunnels (walls and roadway) must be undertaken systematically and regularly because of the soiling caused by soot from engines and powder from wearing tires. The required frequency of these cleanings depends upon the traffic; however the interval between cleanings can vary from 15 days for very heavily travelled tunnels (close to



saturation -- heavy truck traffic) to every 2 months for lightly travelled tunnels (e.g., in mountains).

In addition to these complete cleanings, it is necessary to sweep the roadway more frequently in order to remove stones and other objects which can cause accidents (breaking windshields, puncturing tires). The required frequency varies from 2-15 days.

The same safety considerations apply here as elsewhere (signalization, protection of work crews).

#### 7.532 Means of Effecting Cleaning

The cleaning of the traffic gallery is generally accomplished by a special vehicle that projects a water-detergent solution onto the walls and roadway, brushes them, and then rinses. This vehicle is usually shared by several tunnels (if possible) so as to cut its rather high initial and operating costs.

The more frequent sweepings of the roadway are effected by the Utilization Service personnel.

---

## Chapter 8. Organization of Utilization Service

### 8.1 Unified Command

#### 8.11 Responsibilities

In order of decreasing importance, the Utilization Service is responsible for the following four aspects of tunnel utilization:

##### 8.111 Traffic Safety

- \* Emergency intervention in the tunnel in case of breakdown or accident (police, fire, and vehicle repairing and towing).
- \* Traffic control and signalization.
- \* Enforcement of traffic regulations in tunnel and on approaches.
- \* Adequate ventilation and lighting.

##### 8.112 Operation of Installations

- \* Ventilation
- \* Lighting

##### 8.113 Maintenance

- \* Tunnel structure (vaults, shafts, galleries).
- \* Infrastructure (roadway, drainage, ceiling, buildings).
- \* Installations (electrical machinery, lighting, and various other equipment).

##### 8.114 Administration

- \* Vehicle parking
- \* Offices
- \* General administration (accounting, personnel, statistics, contracts, purchases, etc.)
- \* Various installations (e.g., tolls)

## 8.12 Assignment of Responsibilities

Responsibilities for traffic safety are usually delegated to the Police, or at least placed under their control. These responsibilities should be considered the most important of all.

Other responsibilities (dealing with the technical operation, maintenance, and administration of the tunnel) cannot be delegated to the Police for the simple reason that they have neither the technical competence nor the equipment to fulfill these responsibilities. Only a Technical Service (part of the Utilization Service), comprised of competent personnel and technicians, can assume these duties.

## 8.13 Recommendations

While the Technical Service does not present any special problems, police jurisdictional questions can. The following factors should be considered:

- 8.131 Presently, traffic safety in tunnels is, depending on the situation, the responsibility of:
- \* the Gendarmerie in rural areas.
  - \* the city police in urban areas.
  - \* the CRS (national police) or city police in the case of an urban tunnel integrated into a major national highway.
- 8.132 In all cases, the Police having jurisdiction over the tunnel must also have jurisdiction over the route on which the tunnel is located, or at least over the adjacent interchanges above and below the tunnel.

It is equally desirable that they have jurisdictional control over the routes that will be used as detours in the event the tunnel is closed. At very least the Police having authority over these routes should have sufficient communication with Tunnel Police in order to allow them to act rapidly and knowledgeably in the event of emergency.

8.133 There is no question but that the control of traffic at an urban tunnel site is a very complex operation, particularly when actions at the tunnel have a significant impact upon the utilization of the connecting road system (as, for example, when traffic is diverted from tunnel approaches).

It is, therefore, absolutely necessary to know very early on, from the inception of the project, what police authority will have jurisdiction over the tunnel and the connecting road system, in order to discuss with them the necessary organization of the Utilization Service, necessary electrical and electronic equipment, and any structural or building requirements.

#### 8.14 Unified Command -- Possible Solutions

8.141 This duality of the Police, on the one hand, and the Technical Service, on the other, usually presents serious complications for the delineation of responsibilities and jurisdiction.

It is inconceivable that in major tunnels the decision-making authority should be divided. Unified command is an indispensable condition for (1) safety in the tunnel, and (2) coherent tunnel management.

The governmental authority responsible for the tunnel must find ways of insuring this unified command. In the case of a tunnel administered by a municipality, it should, for example, be possible to create a Utilization Service responsible for the utilization of the tunnel, into which are integrated, under the authority of the Utilization Service's Director, the assigned city police personnel.

8.142 There are two conditions that are essential to the proper functioning of such administrations; they must be fulfilled in all cases:

- \* The Director of the Service, irrespective of his background, must assume responsibility and authority in all of the following areas:
  - traffic control
  - technical control (ventilation, lighting, etc.)
  - management and administration
- \* Law-enforcement personnel (whether from city police, Gendarmerie, or CRS) must be attached to the Utilization Service on a permanent and not temporary basis.

## 8.2 Automation -- Command Provisions

For major tunnels, meeting conditions laid down in 2.9, it becomes evident from the foregoing chapters that tunnel utilization involves great complexity in procedures, tasks, etc. It is, therefore, necessary that the initiation, synchronization, and concatenation of operations be automatic.

The following figure presents in schematic form the arrival of pertinent data, followed by the issuing of appropriate orders and instructions.

### 8.21 Data Arriving at the Command Center

The various data arriving from the tunnel, its approaches, and from the various equipment installations is, of course, not all of equal importance:

- \* Of primary importance is the data arriving from the sources designated Alarms, Television, Traffic Control, and Electric Supply.
- \* There must be a continuous monitoring of all the data sources; however, certain of these sources do not require checking with the same frequency as do others. Checks on equipment functioning, pollution levels, or lighting can, for example, be only periodic.

TUNNEL AND APPROACHES

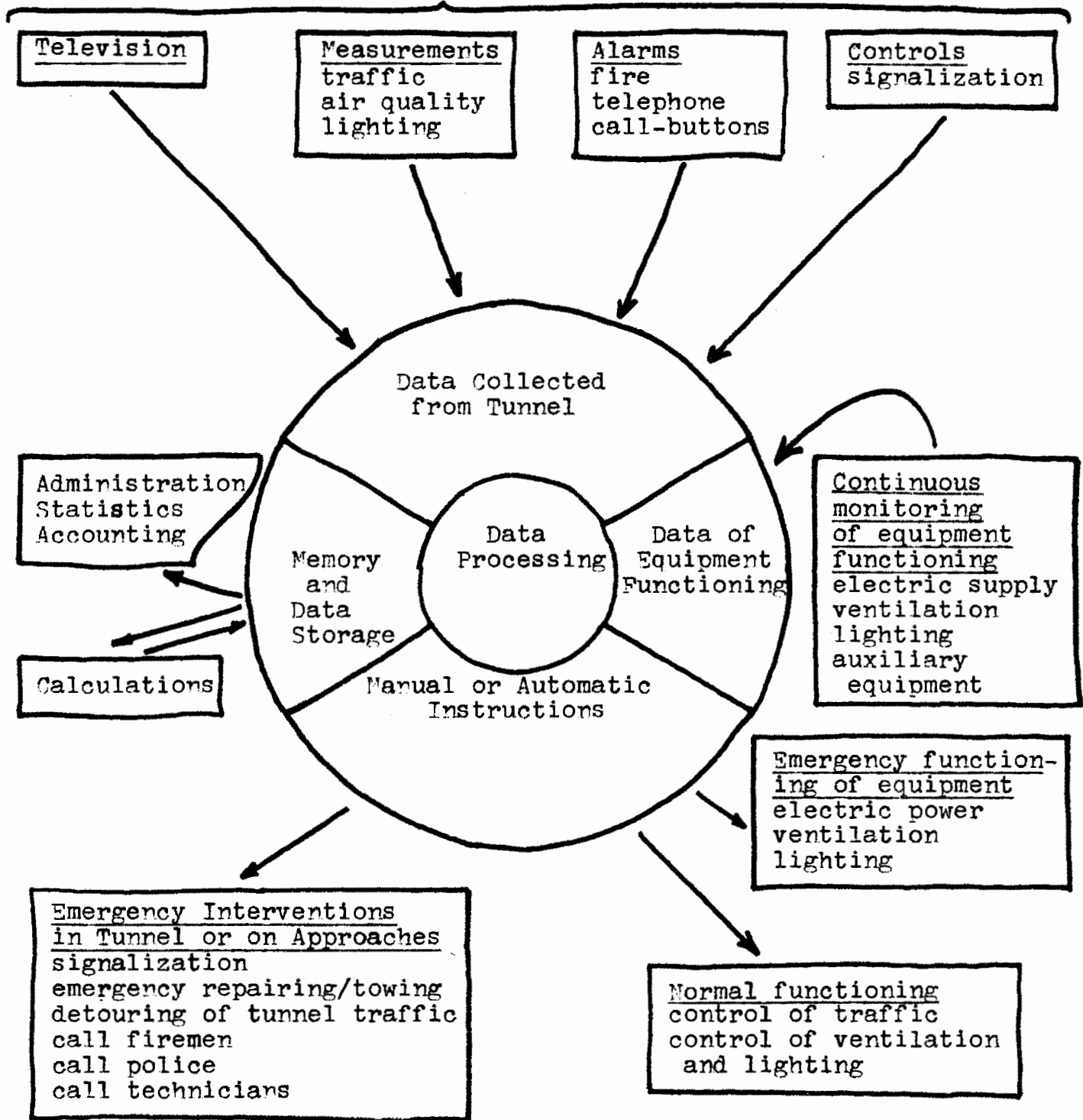

Television

Measurements  
 traffic  
 air quality  
 lighting

Alarms  
 fire  
 telephone  
 call-buttons

Controls  
 signalization

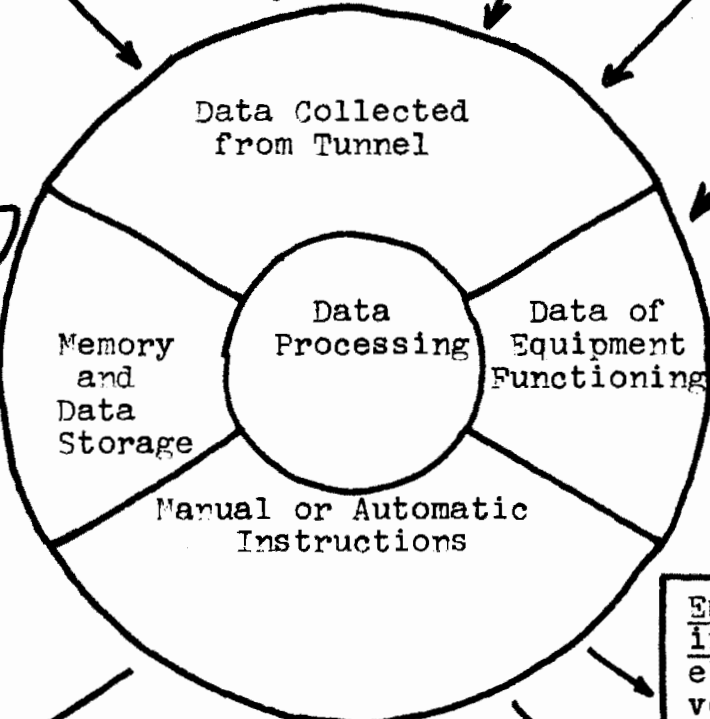

Administration  
 Statistics  
 Accounting

Calculations

Continuous monitoring of equipment functioning  
 electric supply  
 ventilation  
 lighting  
 auxiliary equipment

Emergency functioning of equipment  
 electric power  
 ventilation  
 lighting

Emergency Interventions in Tunnel or on Approaches  
 signalization  
 emergency repairing/towing  
 detouring of tunnel traffic  
 call firemen  
 call police  
 call technicians

Normal functioning  
 control of traffic  
 control of ventilation and lighting

## 8.22 Data Analysis

### 8.221 Extent of Data

- \* Given the amount of data to be collected and analyzed, as well as the necessity that the responses to these data be both rapid and coherent, it is necessary to have the entire operation computerized (and otherwise automated as fully as possible).
- \* The following table offers a schematic enumeration in plain text (i.e., not encoded) of the various data that must be transmitted continuously to the Command Center.

This enumeration is nevertheless incomplete as an indication of the complexity of the required programming, because it excludes all technical data arriving from equipment installations in the tunnel, and the instructions based upon these data which are sent back the other way.

The application of these data requirements to a one-way tunnel, having two lanes, 1800 m. long, and having two ventilation sections, requires (according to this partial enumeration) the transmission of 920 pieces of data from the tunnel to the Command Center (probably even more, once the data are encoded).

Partial enumeration (in plain text) of the data that must be transmitted to the Command Center, for a one-way tunnel, two lanes, of length L, with n blocks and N ventilation sections.			
<u>Type of Data</u>	<u>Item</u>	<u>Position</u>	<u>Number of data</u>
<u>from tunnel:</u>			
Alarm	Vehicle count Measure of speed Fire detectors Telephones Extinguishers Call-buttons (3 indications)	each block each block every 5 m. alcoves alcoves every 40 m. (each side)	2n 2n L/5 n n 30n
Signalization	Tricolored signals (5 indications) Lane-change signal Work-Ahead sign Accident sign Speed limit signs (3 indications) No passing sign	every block every block every other block every other block every block every block	10n+10 2n+2 n n 6n 2n
Ancillary traffic controls	Television camera  Measure of vehicle clearances	every block, 20 m. before signal lights and at tunnel portals each lane before entrance	n+2 2
Air quality control	CO analyzers Opacity meters Anemometers	Each ventilation section (at center) 3 at portals	N N 6
Exterior lighting	Photoelectric cells	Each portal	2
<u>from equipment:</u>			
Electric supply	Circuit-breakers, transformers, etc.		Not Calculated
Lighting	Switches, etc.		
Ventilation	Operating levels Temperatures Motor speeds, flows, etc.		
<u>Total</u>	59n + 2N + L/5 + 24		



8.222 Utilization of pre-established programs. This is necessary for the following operations (cf. Drawing 10):

- \* For normal operations
  - Efficient operation of ventilation system.
  - Control of tunnel illumination.
- \* In emergency situations (breakdown, accident, fire, loss of power, change of lane direction, etc.).
  - Automated emergency intervention programs (signalization, alarm, ventilation, lighting) for every kind of accident or combination of accidents.
  - Emergency intervention in the event admissible pollution levels or vehicle clearances are exceeded.

## 8.23 Instructions and Command

### 8.231 Manual and Automatic Command

- \* The instructions from the Command Center to either the tunnel or equipment are of two sorts:
  - In normal situations: start-up instructions for ventilators.
  - In emergency situations: emergency intervention orders in the following chronological sequence: signalization, assistance calls (to police, fire, technicians), and lighting and ventilation.
- \* As a general rule, these instructions should be entirely automated, at least insofar as the initial operations are concerned.

In the case of an accident blocking only one lane, the sequence of operations at the Command Center should require only the following actions of the console operator (once the alarm has been received and visual verification made by television):

- Designation (to computer) of lane blocked (Right or Left).
- Designation (to computer) of the number of the affected block.
- Initiation of operation described in 6.421, at the same time calling upon police to enter the tunnel.

- Initiation of operation described in 6.423 (emptying tunnel above incident, and at the same time calling upon repair-towing service to enter the tunnel from below).
- Finally initiation of operation described in 6.424 (organization for one-lane traffic through tunnel).

The last two operations can either be automatic or manual:

- All automated operations must, for safety reasons, be backed up by manual controls, in the event that something unexpected happens.

#### 8.232 Compatibility of instructions issued by the Command Center with those issued by emergency personnel on the scene.

There will be no difficulty in this respect if the following conditions are observed:

- \* The intervention of tunnel Police is necessary in every emergency situation.
- \* Telephone liaison between police on the scene and the Command Center must be continuous during the clearing operation.
- \* Control over all signalization must be unified; all modifications in the signalization must be effected by the Command Center, after checking with police in the tunnel, since only the Command Center is able to have a general knowledge of the entire tunnel situation, including the approaches.

### 8.3 Unified Command Center

#### 8.31 Reasons for the Centralization of Command

The unification of command has numerous advantages; only a unified command permits:

- \* Unity of control, i.e., coherence in the instructions given and coordination in emergency actions taken.
- \* Adequate facilities (a computer) for the processing of incoming data.
- \* As a consequence of the foregoing, a global view of the operation of the tunnel, permitting rational decisions on necessary emergency actions.

- \* Economical operation of the tunnel, notably by reducing personnel requirements for surveillance.

### 8.32 Location of the Command Center

#### 8.321 Different Functions

It is necessary to distinguish between the following:

- \* The Command Center itself where all data is collected and all decisions taken.
- \* Emergency Intervention Stations (police, fire, repair-towing, etc.) which act only on order of Command Center.
- \* Maintenance Stations (technical teams and materiel) which also obey instructions from Command Center.
- \* Administrative headquarters.

#### 8.322 Location of the Command Center Itself

- \* For the type of tunnel being discussed here, i.e., those tunnels equipped with an entirely automated and centralized command, it is theoretically speaking unimportant whether the Center is situated close to the tunnel. (This would not be true for a smaller tunnel where the Command Center was not equipped with closed-circuit television; in those cases it is wise to locate the Command Center so as to be able to watch one of the tunnel approaches.)
- \* Nevertheless, it is wise, when possible, to locate the entire installation of the Utilization Service (Command Center, Emergency and Maintenance Stations, etc.) near one of the tunnel portals. This location has several advantages:
  - better functioning and liaison between different groups.
  - better personnel administration.
  - saving in investment costs (consolidation of buildings and accesses, shorter lines of communication, etc.) as well as in operating costs (office expenses, etc.).
- \* Drawing 11 depicts a typical arrangement of the Utilization Service complex.

### 8.33 Equipment for an Automated Command Center

8.331 The Command Center will include the following elements (cf. Drawing 12):

- \* 2 visual displays of the tunnel (which register and display incoming data and alarms):
  - traffic flow and signalization
  - ventilation, lighting, and electric supply
- \* Closed-circuit television receivers. A single tunnel, for example, may have:
  - 4 screens that scan particular areas on request
  - 2 screens reserved monitoring emergencies
- \* 1 computing center (possibly air-conditioned):
  - computer, data banks, etc.
  - relay cabinets, automated equipment, etc.
- \* 1 command console with telephone connections to outside as well as to the closed system in the tunnel. Console has two parts:
  - manual controls for all installations:
    - electric power and distribution
    - ventilation
    - lighting
    - signalization (all)
    - alarms (police, fire, repair-towing, technicians)
  - automatic of two sorts:
    - all emergency action/intervention programs
    - designations of all signal blocks and traffic lanes

8.332 Required floor space for the Command Center (not including Emergency Intervention Stations, administration offices, etc.).

As a general rule, the computer center is located in an adjoining room, all other functions are grouped in the command room. The necessary floor space is as follows:

Command room	200-250
Computing and relay room	120
Director's office	25
Archives and work room	15
Restrooms	20
Heating and air-conditioning	20
	<u>400-450</u> m <sup>2</sup>

(A sample layout is depicted in Drawing 11.)

### 8.34 Telecommunications

#### 8.341 Importance

- \* The Command Center must have direct contact with the following groups:
  - public and tunnel telephone systems
  - tunnel and its approaches
  - possibly with adjacent road systems
  - emergency stations
  - maintenance stations
  - administrative headquarters
- \* The voluminous data to be communicated is of two sorts:
  - telemetry data (analogical) that must be encoded before transmission
  - state data (all or nothing binary data)

#### 8.342 Safety

Telecommunications constitute a vital function for the tunnel's utilization; therefore, they must as a result conform to the following conditions:

- \* Possess their own emergency power source.
- \* Possess an internal alarm that signals malfunctions of the telecommunications system.
- \* Permit the priority transmission of certain data:
  - alarms
  - television
  - electric supply

### 8.4 Emergency and Maintenance Stations (police, repair-towing, fire)

These two stations are usually grouped in order to facilitate their operations (cf. Drawing 11).

#### 8.41 On-duty hours

8.411 The present paragraphs do not attempt to enumerate personnel requirements (cf. 8.6 below). Rather the night-duty personnel requirements are outlined.

- \* At the emergency station:
  - 1 police team
  - 1 light towing team (for light vehicles)
  - 1 fire-rescue team

- \* At the maintenance station:
  - 1 electrical machinery technician

8.412 As a general rule, the Utilization Service is responsible for the repair or towing of light vehicles. The towing of heavy vehicles is generally contracted.

Tunnels represent a difficult and dangerous point along a highway route. As a result, towing procedures presently employed on the open highway are not necessarily satisfactory in the tunnel without some modification.

Having a rapid and efficient emergency road service does not dispense with need for signalization in the tunnel; quite the contrary, such road service is heavily dependent upon well-conceived signalization procedures.

8.413 It is also the Utilization Service's responsibility to provide initial firefighting service. Recourse to surrounding firefighting capabilities will be necessary in the case of a serious fire.

#### 8.42 Proximity and Access to the Tunnel

There are two fundamental problems that govern the choice of the location of these installations.

The access to the two tunnel portals (in the case of an expressway tunnel having two tubes) must be direct, and the passage from one roadway to the other must be secured either by interchanges located close above and below the tunnel or by special service exits.

In the case of a long tunnel or a tunnel in an urban location, police and emergency road service capabilities will have to be doubled, with teams placed at either end of the tunnel.

#### 8.43 Technical Installation and Exterior Aprons (Not including Toll Stations)

The following installations are depicted in Drawing 11 as typical requirements:

- \* If possible, there should be a parking apron at each tunnel portal to accommodate disabled vehicles.
- \* Vehicle garage 200 m<sup>2</sup>

* Workshop and materiel storage	100 m <sup>2</sup>
* Watch room for repair-towing crews	20
* 2 offices (accounting, administration, and statistics)	40
* Restrooms	20
* Heating installation	<u>20</u>
Approximate Total:	400 m <sup>2</sup>

## 8.5 Vehicle Requirements (for a major tunnel)

### 8.51 Emergency Road Service

- \* A minimum of 1 light tow truck/ entrance = 2 light tow trucks
- \* Possibly 1 heavy tow truck for the tunnel

### 8.52 Fire

- \* 2 rescue vehicles equipped with powerful foam extinguishers (one for each tunnel entrance).
- \* Possibly one pumper.

### 8.53 Police

- \* 6 motorcycles

### 8.54 Maintenance

- \* 1 specially equipped vehicle for cleaning tunnel walls and roadway.
- \* 1 specially designed vehicle of reduced width and equipped with special work platform for servicing lighting.
- \* 2-3 light trucks.

## 8.55 Administration

- \* 3 or 4 passenger cars

Thus a total of 15 vehicles are required, of which 8 are specially equipped, plus several motorcycles.

The vehicles must be well lighted (with revolving lights) and painted with a very visible color, and having if possible a reduced width.

## 8.6 Personnel Requirements

We are here concerned with all those tunnels which by reason of their length, the amount of traffic they handle, or the nature of the route, require constant surveillance.

- \* Certain tasks have to be effected by specialists; thus the best solution is to contract this work.

For less specialized work, various solutions are possible, and the extent to which work will be contracted by the Utilization Service will vary, thus influencing significantly the personnel requirements of the Service.

- \* By way of illustration, the following minimal list indicates personnel necessary for the maintenance and surveillance of this type of tunnel. The list is established for a major tunnel, of which all installations are automated and centralized.

The list is subject to a possible lengthening depending upon the tunnel length; it is approximately correct for a two-lane tunnel of 2-3 km in an urban location, 4-6 km in a rural location.



<u>Function</u>	<u>Duty hours</u>	<u>Minimal personnel requirements</u>	<u>Actual staff requirements</u> <sup>8</sup>
Director, Utilization Service	day	1	1
Surveillance at Command Center	24 hr	3	4
Surveillance of ventilation and lighting	day	2	3
Maintenance of electrical machinery	day	1	1
Traffic surveillance	24 hr	3	4
Normal maintenance	day	5	5
Police	24 hr	<u>6</u>	<u>8</u>
TOTAL		21	26

In the case of a non-automated tunnel, it is necessary to increase the surveillance in the tunnel as well as at the various stations.

It is difficult to give a precise figure, but it will necessarily be greater than 30 people.

---

<sup>8</sup>This is the actual number of individuals to be carried on the payrolls. It takes account of leave, sickness, night duty, etc.

## Chapter 9. Tunnels lacking a Utilization Service

### 9.1 Object of Present Chapter

Chapters 3-8 have been concerned only with tunnels meeting the following conditions (enumerated in 1.31):

- \* Continuous surveillance of traffic.
- \* Ventilation.
- \* Having their own Utilization Service.

The present chapter undertakes to define the more modest provisions which can be taken for two other types of tunnels.

- \* Ventilated tunnels which are under continuous surveillance but which are not provided with a Utilization Service of their own. This is generally the case for short urban tunnels (400-1200 m.) and rural or mountain tunnels carrying relatively light traffic, 800-4000 m. in length.
- \* Unventilated tunnels which are not under continuous surveillance, either because the only installations requiring attention is the lighting or because these tunnels are located on an expressway where the surveillance and maintenance is effected for the entire route by a single authority. This is the case for most mountain tunnels and for most short expressway tunnels (length less than 800 m.).

Given the range of possibilities, the present discussion is necessarily very general. These remarks must, therefore, be adopted to specific cases by means of an analysis of risks and costs involved in each possible solution. The principles discussed herein are, it will be noted, applicable to tunnels of all types -- suitable adaptations being made for the materials and equipment to be provided, as well as for the maintenance operations to be effected. As a general rule, the provisions for control and regulation of traffic should be homogeneous with those for the rest of the route on which the tunnel is located.

## 9.2 Ventilated Tunnels

9.21 For this type of tunnel, the absence of a Utilization Service leads to the rejection of certain provisions (enumerated in Chapters 3-8) by virtue of certain mandatory procedures for traffic control in the event of an emergency, these procedures being necessary in order to insure absolute safety.

### 9.22 Traffic Control

The required provisions here are similar to those developed in Chapter 3 for tunnels subject to continuous surveillance. The tunnels under discussion here are generally heavily travelled, and it is therefore necessary to act rapidly and effectively whenever there is any emergency that can affect traffic flow. The tunnel is divided into successive blocks whose length is on the order of 400 m. (cf. 3.211). Each block has a tricolored signal light for each lane as well as the various provisions discussed in 3.24 for permitting the motorist to communicate or act. Closed-circuit television and traffic speed control is generally not necessary; however, sensors for measuring traffic flow are. Tunnel equipment is complemented on the approaches by a portico-type sign located at tunnel entrance and at the "unloading" interchange, mentioning traffic conditions in the tunnel (speed limit, clearance, etc.).

### 9.23 Ventilation and Lighting

The absence of a Utilization Service requires that these installations be completely automatic, determined by pollution levels in the tunnel and exterior illumination. All remarks in Chapter 4 are still applicable.

### 9.24 Emergencies

\* The important point here is that these tunnels, despite their relative importance, are not under continuous surveillance. The manner of management and in particular the handling of emergencies must be effected by the nearest police station in which there is a 24-hour watch. The watch officer receives all alarms from the tunnel, alerts the appropriate emergency services, and supervises the emergency intervention until the situation is cleared up.

\* Alarms transmitted to the police station are of two different sorts:

- those which require an immediate response. These concern traffic circulation (telephone calls from motorists, exceeding maximum pollution levels, etc.) or tunnel equipment (serious electrical breakdowns, etc.).
- those which do not require immediate action (emergency equipment can be sent when it is available).

Depending upon the route, alarms concerning traffic circulation may or may not be automatically accompanied by a change of signal lights to red at the tunnel entrance and at the interchange above the tunnel, as well as a change of ventilation and lighting regimes to their maximum levels.

\* The instructions to be given to service personnel in the case of an alarm involving traffic circulation are the following:

- immediate police action in situ. The police should have some means of manually controlling the signals in the tunnel and on the approaches in order to be able to regulate the traffic as the emergency requires.
- possibly the maintenance service will have to be called, particularly when tunnel equipment requires attention. In this case the police should control signalization in the tunnel through the agency of the maintenance foreman.
- in the case of a prolonged disruption of traffic, traffic should be detoured at the unloading interchange using procedures outlined in 9.22.

#### 9.25 Tunnel Maintenance

Periodic visits should be effected by the local services responsible for the tunnel's maintenance. The maintenance of electrical machinery and the cleaning operations are generally insured by contracts with private enterprises (cf. remarks in Chapter 7).

#### 9.26 Tunnel Utilization

As can be seen, the absence of a true Utilization Service requires recourse to various external organizations:

- normal maintenance for the tunnel structure is effected by the local Highway Department or Public Works Department; maintenance of electrical machinery is contracted to private enterprises specializing in this work.
- local police maintaining a 24-hour watch are responsible for handling emergencies arising in the tunnel, notifying as necessary other emergency services (fire, repair-towing, etc.).

In every case, the manual control of lighting, ventilation, and signalization must be provided at a single point located at the tunnel. In the case of a relatively major urban tunnel, a command building of reasonable size (about 200 m<sup>2</sup>), located close to the tunnel, should be provided. Such a structure will include:

- a Command Post which can be temporarily activated by the maintenance service in order to insure surveillance of the tunnel during an emergency. The Command Post will have a console and displays of all tunnel installations.
- a service building and an area for storing maintenance equipment and materiel. Depending upon the situation it may also be necessary to provide a maintenance vehicle.

### 9.3 Unventilated Tunnels

The utilization of these tunnels differs little from that of the approaches except for the maintenance of the lighting installation. It is necessary only to install telephones, connected to the local police station, and fire extinguishers, particularly in narrow and isolated tunnels. Maintenance is generally provided by the local Highway Department or Public Works Department.

---

## Chapter 10. Traffic Regulation in Tunnel and on Approaches

### 10.1 Behavior of Motorists in Tunnels

Studies of motorist behavior in tunnels are very lengthy and require a wealth of experimental data, either real or laboratory simulated. The following remarks based upon limited observations should be regarded only as general tendencies.

#### 10.11 Experimental Results

The following observations can be noted:

- \* In very short, straight tunnels (60-80 m. long), the behavior of the motorist is closely analogous to that on the adjacent open-air sections of the route.
- \* In short, straight tunnels (200-300 m. long), the average speed falls about 20 km/hr, while dispersion of vehicle speeds is attenuated. In other words, there is an automatic clustering of speeds around a lower average value than that obtaining on the approaches.
- \* In long tunnels, traffic speed first drops at the tunnel entrance, and then tends to increase again after several hundred meters when the motorists adapt to the tunnel environment.

The observed dispersion in traffic speed is of particular importance. (Speeds up to 110-130 km/hr have been observed in tunnels with posted speed limits of 60 or 80 km/hr.)

#### 10.12 Consequences

On the basis of these indications -- very partial and in any event insufficient for drawing any formal conclusions -- several tendencies can be noted:

- \* Very short, straight tunnels do not require any limitation of speeds different from that obtaining on adjacent sections of the route, since these tunnels do not introduce special adaptation phenomena.

- \* Short tunnels or successions of short tunnels support well (on expressways) a speed limitation which accords with the speed reduction normally observed in motorists in the absence of regulations (reduction of about 20 km/hr).
- \* Long tunnels require the posting of speed limits along the entire length of the tunnel in order to maintain speeds judged admissible.

## 10.2 Traffic Regulations for Motorists

### 10.21 Uniformity with Approaches

Traffic in the tunnel must obey the same restrictions as that on the approaches (clearances, vehicle categories, pedestrians, etc.).

In the case of expressways, the porticos notifying motorists of maximum vehicle clearances should be posted ahead of the last interchange before the tunnel.

### 10.22 Specific Regulations

#### 10.221 Pedestrians, Cyclists, Motorcyclists

- \* As a general rule, pedestrians are prohibited from the tunnel, as are unlicensed vehicles having a total engine displacement of less than 50 cm<sup>3</sup>.

These provisions are, however, compatible with observed behavior; the pedestrian is generally little inclined to enter subterranean tunnels which are open to light and heavy vehicles.

- \* In cases where the tunnel is used by pedestrians, it is necessary to make special provisions:
  - proper design of sidewalks, physically separating vehicles and pedestrians
  - increased ventilation
  - increased lighting (should not use sodium vapor lights in the interior zone)
  - access

### 10.222 Prohibition of Certain Categories of Vehicles

- \* As a general rule, all vehicles transporting dangerous (or noxious) materials are prohibited (petroleums, corrosives, explosives, and gas propelled vehicles).
- \* Also prohibited from the tunnel are those vehicles that endanger either other motorists or the tunnel itself (heavy construction equipment, caterpillars and other tracked vehicles, vehicles with oversized or unstable loads, towed vehicles, etc.).
- \* Provisions should be made in the regulations for special convoys, depending upon whether they occupy the entire roadway or only one lane.
- \* In certain cases, heavy trucks may be prohibited from using the tunnel during rush hours or perhaps totally in the case of tunnels with special problems (e.g., limited clearances).
- \* These prohibitions and restrictions should be considered from the outset of project planning, notably:
  - in order to insure that the tunnel provides necessary service (industrial zones, difficulty in detouring prohibited traffic, military routes, etc.).
  - in order to insure a proper design of the tunnel as required (vertical clearances, road width, parking and waiting areas at tunnel entrances, special precautions for safety, etc.).

### 10.223 Regulation of Manoeuvres

- \* Parking must be prohibited in the tunnel and on the approaches. Precise instructions must be posted concerning emergency parking (e.g., illuminated signs located on tunnel walls, bearing the instruction "Parking Prohibited Except In Emergency").
- \* Passing manoeuvres must, in general, obey the following rules:
  - completely prohibited for all vehicles in two and three-lane tunnels which are two-way (instructions posted the length of the tunnel).
  - trucks prohibited from passing in all one-way tunnels (except possibly in level tunnels of more than two lanes).



- \* The access of vehicles to the tunnel can be limited, or perhaps prohibited, when the maximum flow capacity of the tunnel is reached (particularly for ventilation) or in the case of an accident in the tunnel.
- \* Motorists can be required to shut off motors in the event of a prolonged stop in the tunnel (use loudspeakers).

#### 10.224 Lighting of Vehicles

- \* Signs requiring motorists to turn on their lights should be clearly posted ahead of the tunnel entrance.
- \* Use of headlights should be reserved for cases of power failure in the tunnel lighting system. At night, the headlights should be turned off when entering the tunnel.
- \* Use of driving lights or high beams should be prohibited.

#### 10.3 Presignalization

In all cases, tunnel should be preceded by signs announcing the tunnel, followed by signs mentioning:

- \* Dangers (slowdowns for work zones, etc.).
- \* Speed reductions.
- \* Prohibitions (no passing, etc.).
- \* Instructions (turn on fog lights, change lanes, etc.).

These signs should, however, not be multiplied to the point that the motorist is unable to read them. They must be located at a sufficient distance from tunnel entrances and repeated at the entrances.

---

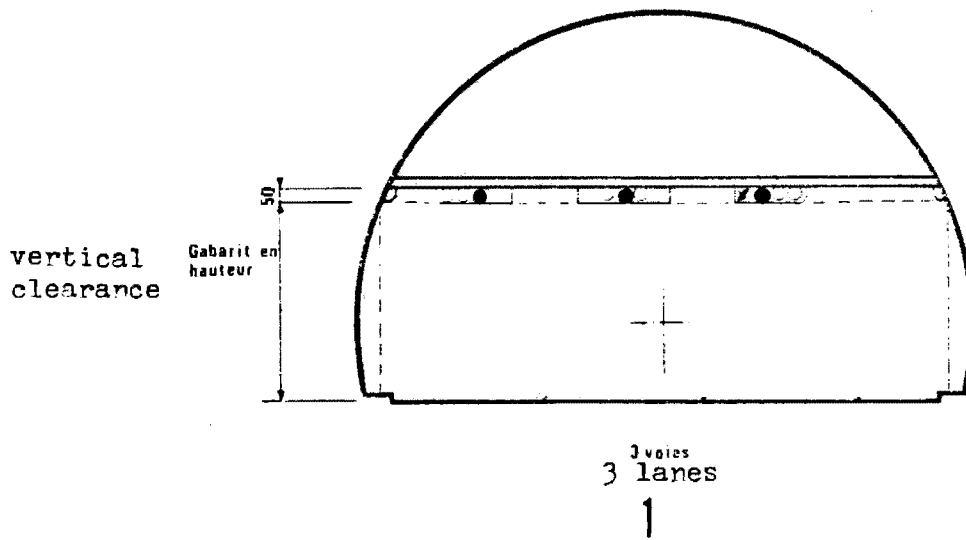
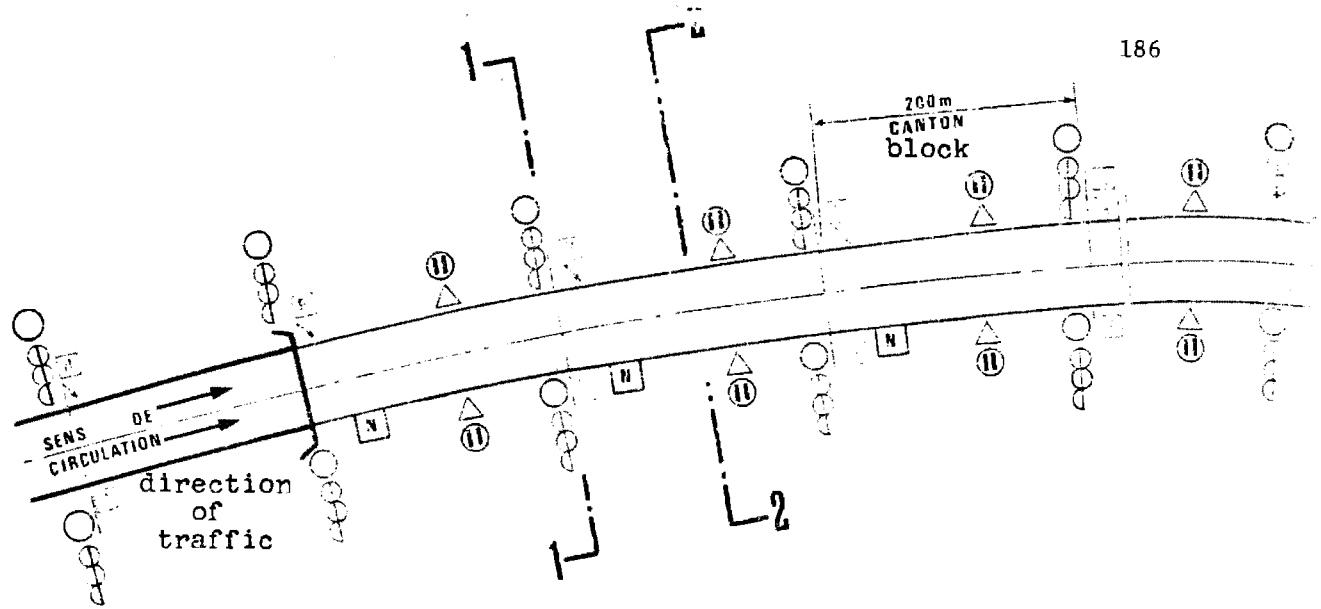

**LEGENDE**  
Key

- |   |  |   |
|---|--|---|
| <p> Niche (extincteur, téléphone, alcove, boutons d'appel)</p> <p> Radars ou houles</p> <p> Camera de télévision et orientation</p> <p> Limitation de vitesse</p> <p> Interdiction de dépasser</p> <p> Feux</p> <p> Indication de changement de file (éteinte)</p> <p> Accident ou travaux (en avant)</p> | <p>} MOYENS A LA DISPOSITION DE L'USAGER</p> <p>} CONTRÔLE ET SURVEILLANCE DU TRAFIC</p> | <p>Means available to motorist</p> <p>control and surveillance of traffic</p> <p>speed limit sign</p> <p>no-passing sign</p> <p>signal lights</p> <p>change of lane instruction (turned off)</p> <p>Accident or Work Ahead sign</p> |
|---|--|---|

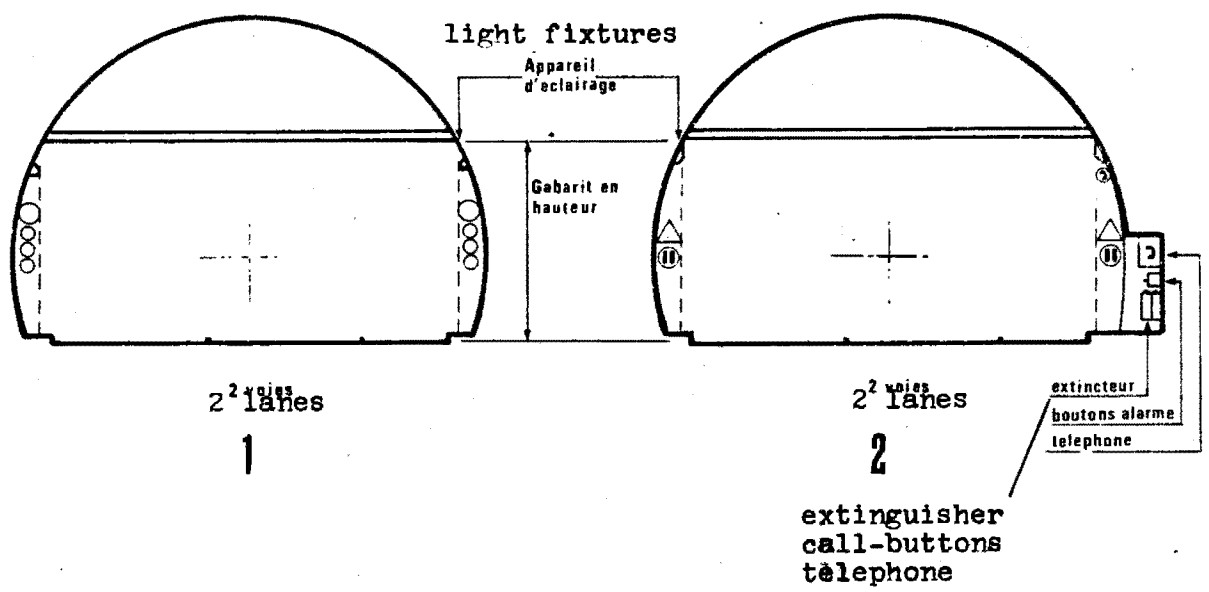
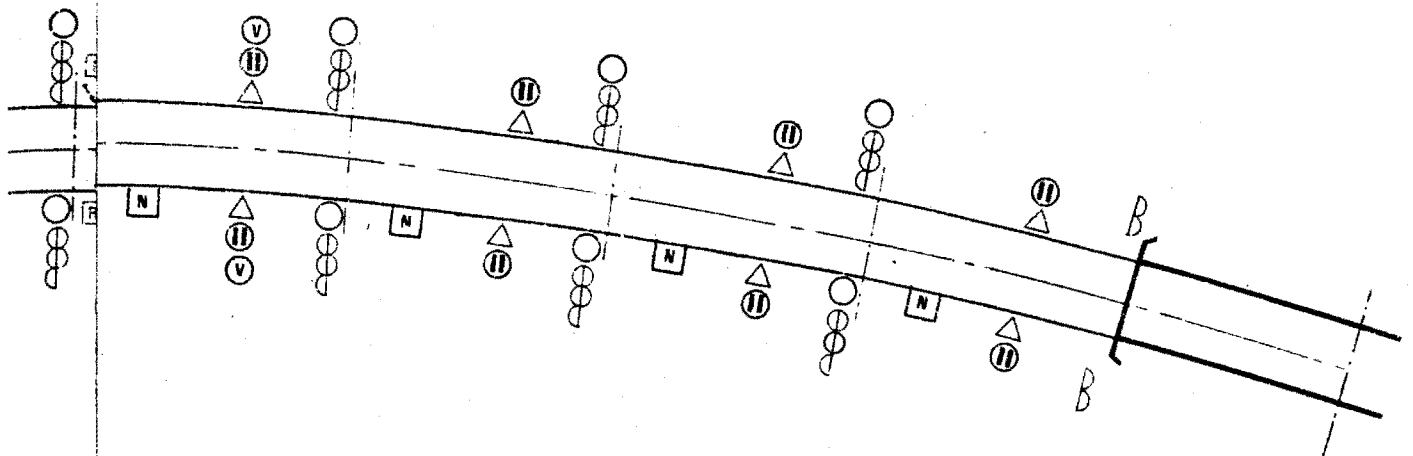

Control of Tunnel  
Traffic Circulation  
(Sample Installation  
for an Expressway tube)

**CONTROLE DE LA  
CIRCULATION TUNNEL**

**1**

Exemple des installations à  
prevoir pour un tube autoroutier

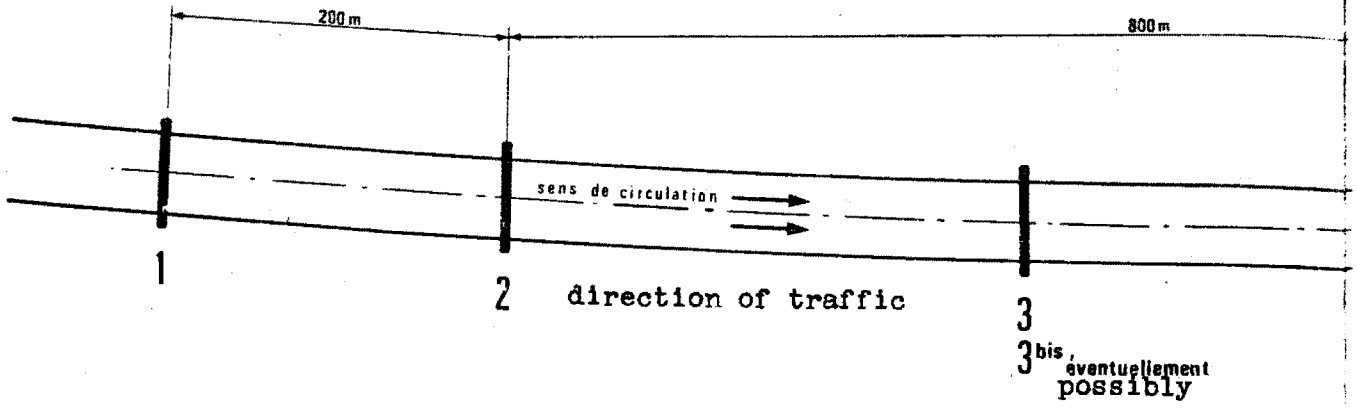

Speed Zone  
Obey signals

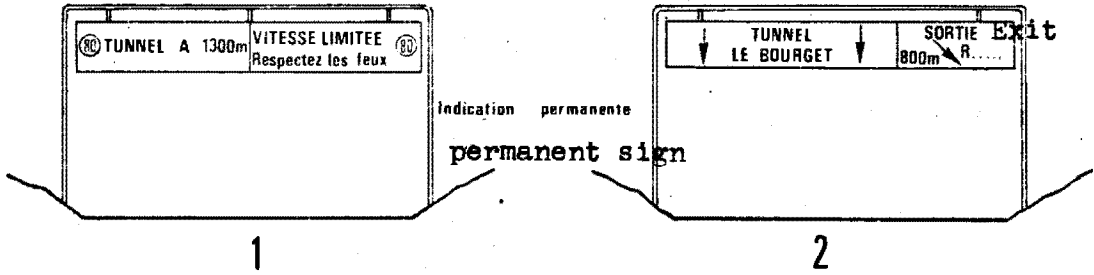

(rotating sign)

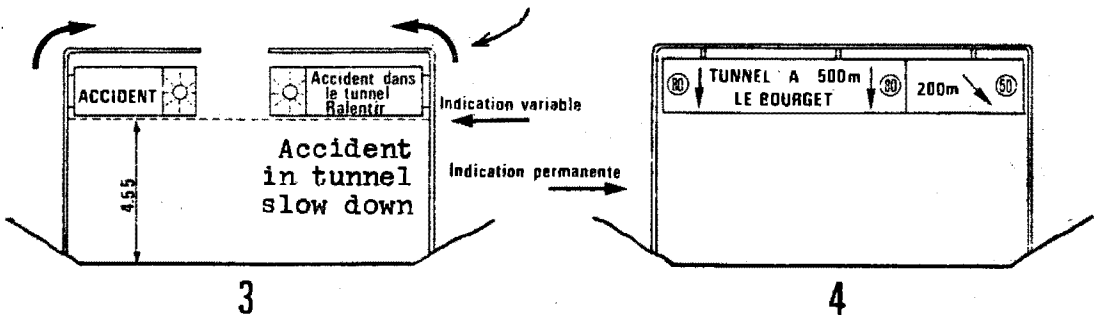

3 bis comporte en plus un controle optique du gabarit en hauteur

(includes a visual control for vertical clearance)

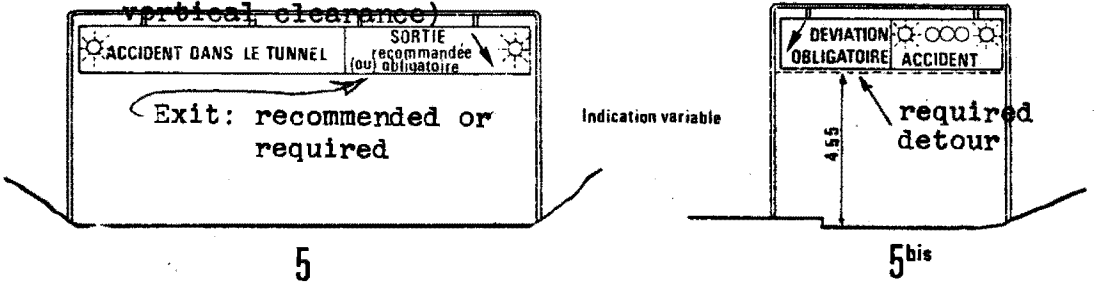

ECHANGEUR DE  
DELESTAGE AMONT

Unloading interchange  
above tunnel

189

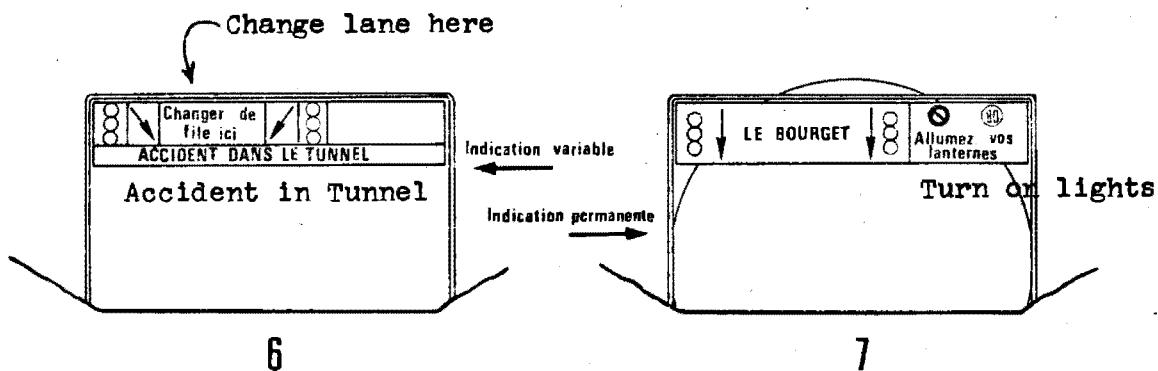
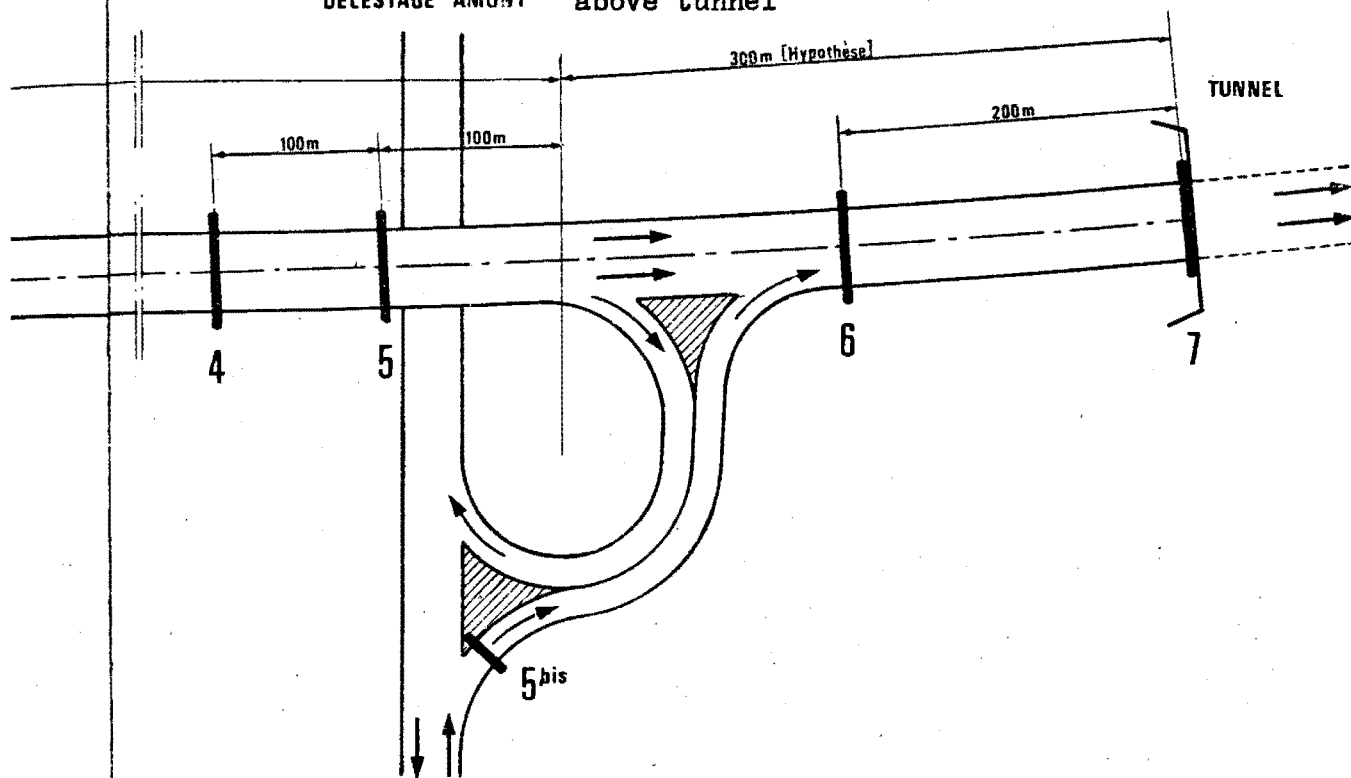

Control of Traffic at  
Interchange above Tunnel

CONTROLE DE LA CIRCULATION  
ACCES AMONT **2**

Note : UNE ADAPTATION EST A EFFECTUER SUR  
LA SIGNALISATION PRESENTEE ICI EN FONCTION  
DES REGLEMENTS FUTURS QUI POURRAIENT  
INTERVENIR

Signalization presented here  
may require adaptation as  
traffic regulations change  
in the future.

Exemple dun tube autoroutier  
(A l'exclusion des panneaux de réglementation courante)

LEGENDE

- GO PRELEVEMENT CO      CO-analyzer
- UP OPACIMETRE      Opacity meter
- A ANEMOMETRE      Anemometer
- CELLULE PHOTOELECTRIQUE      Photoelectric cell
- S STATION DE VENTILATION
- R RADAR

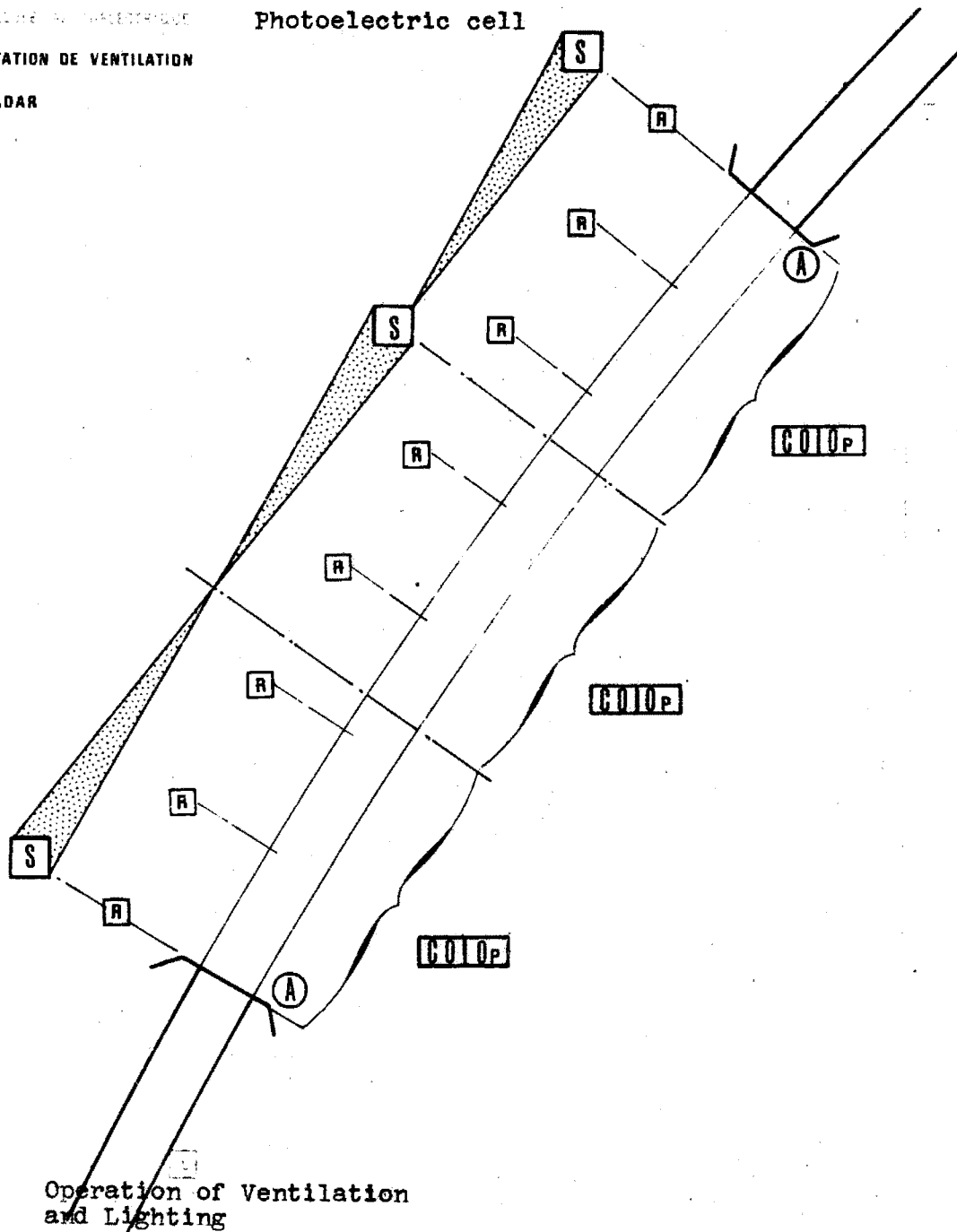

# 3 FONCTIONNEMENT DE LA VENTILATION ET DE L'ECLAIRAGE

Exemple des installations nécessaires d'un tunnel  
 Sample of necessary installations for a tunnel

GARAGES

pull-offs

Disposition en plan

Top View of Tunnel

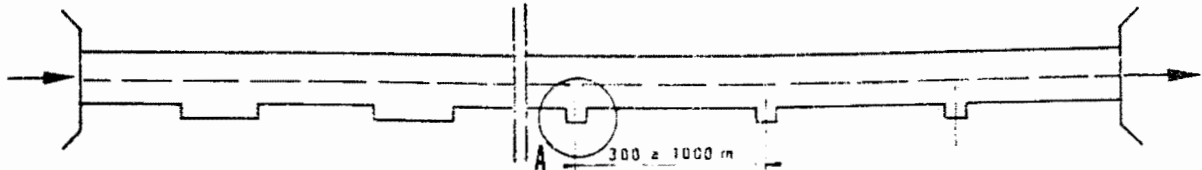

300 ± 1000 m  
env. selon le cas  
depending upon situation

A - Vue en plan

Top View (Detail)

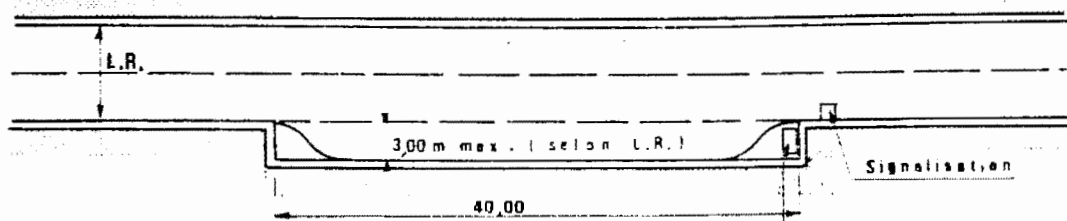

extinguishers  
call-buttons  
telephone booth

Extincteurs  
Boutons d'alarme  
Coffret téléphonique

A - Vue en travers.

Cross-section

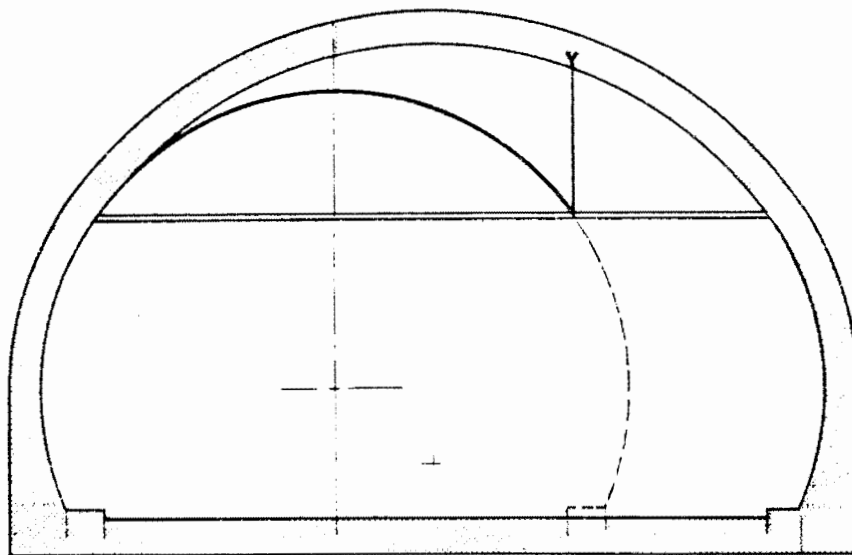

Isolateur    Largeur Roulable    Isolateur  
curbing    road width    3,00    0,50



S  
|

GALERIE de RETOURNEMENT  
TURNING GALLERY

192

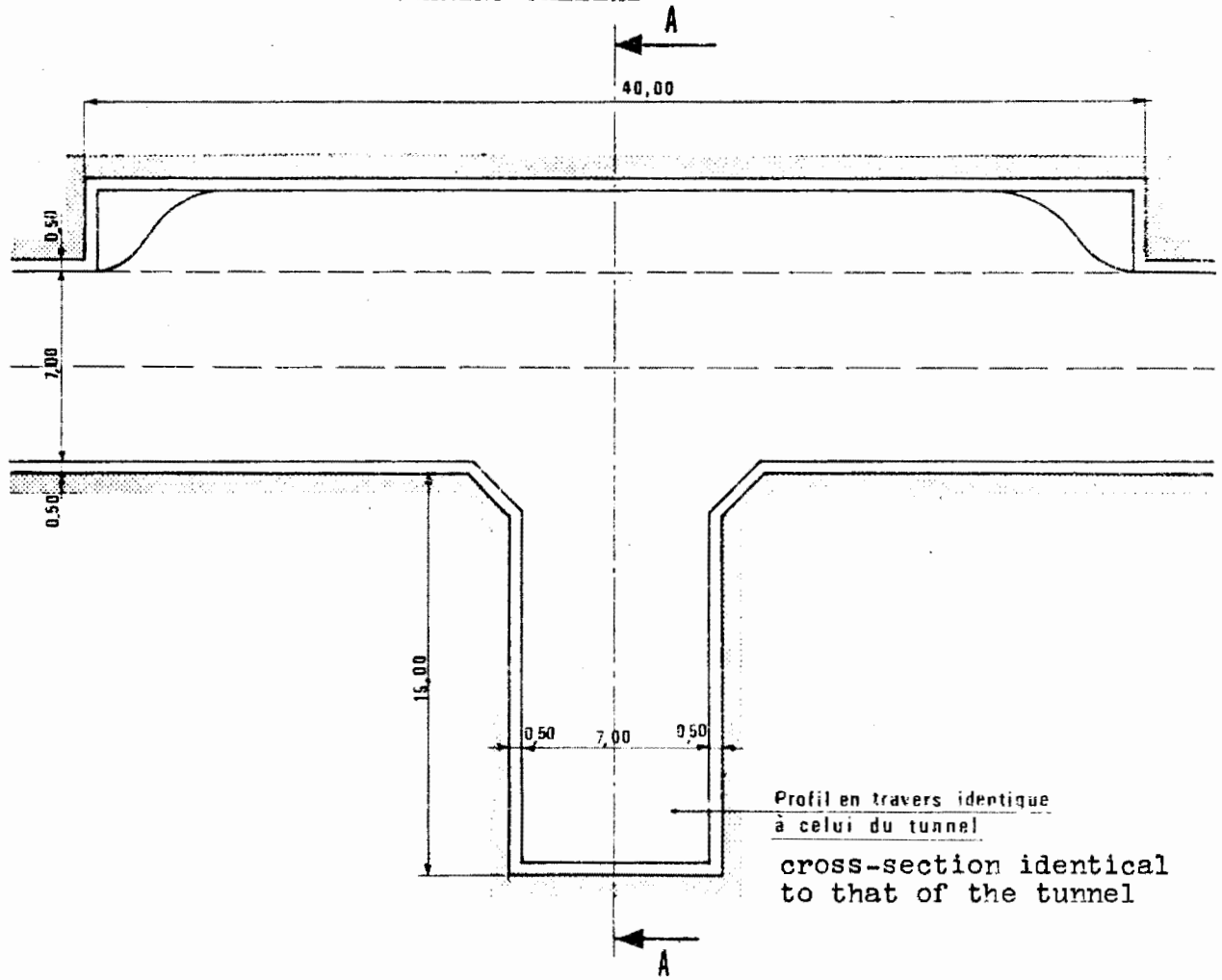

COUPE AA

Section AA

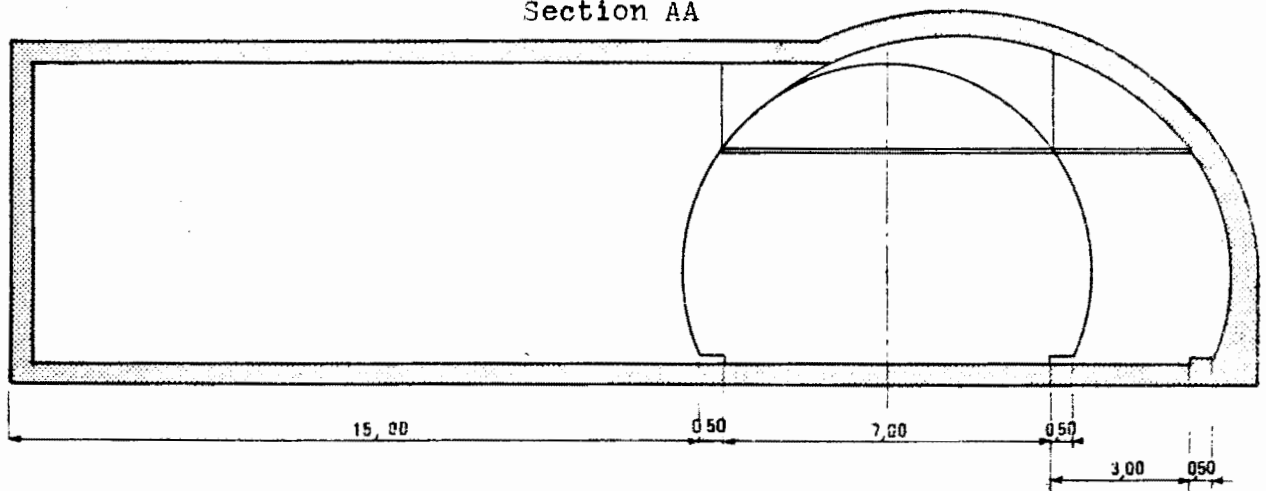

**5** GALERIES DE  
RETOURNEMENT

TURNING GALLERIES



PASSAGES DE SECOURS SUR AUTOROUTE (2 tubes paralleles) 193  
 Emergency Passageways (Expressway tunnel) [2 parallel tubes]

Variantes possibles  
 Possible variations

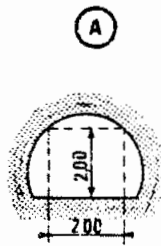
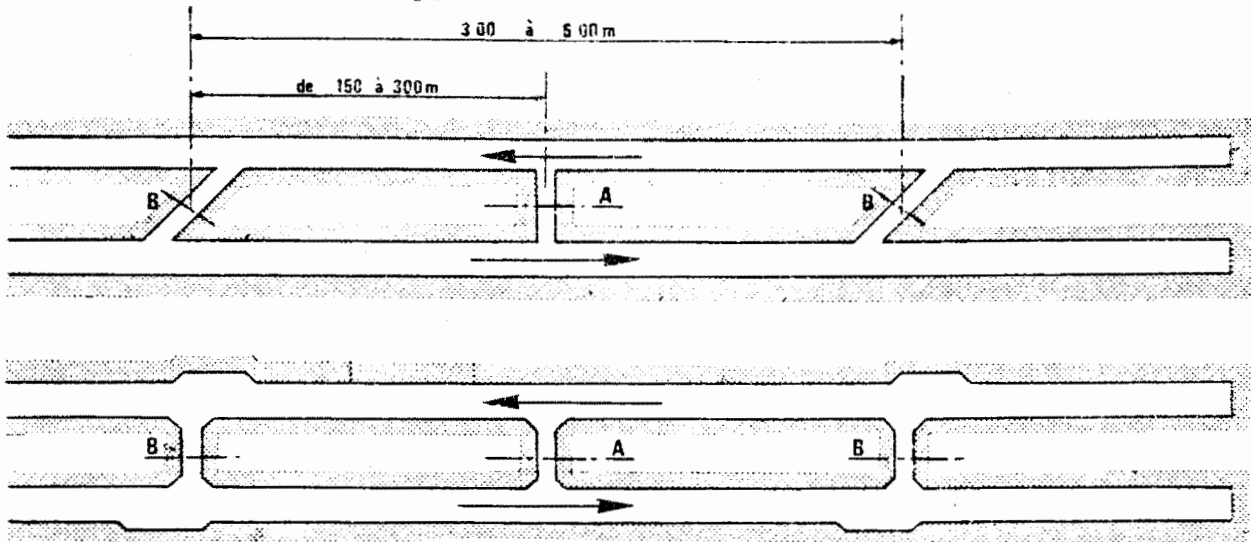

GALERIE PIETONS  
 pedestrian gallery

vertical  
 clearance  
 of tunnels

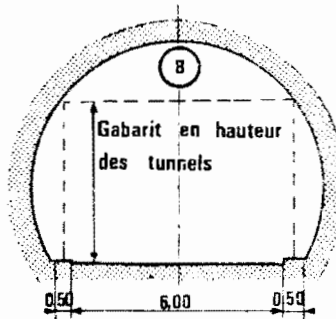

GALERIE CARROSSABLE  
 vehicle gallery

EXEMPLE D'UTILISATION  
 Example of utilization

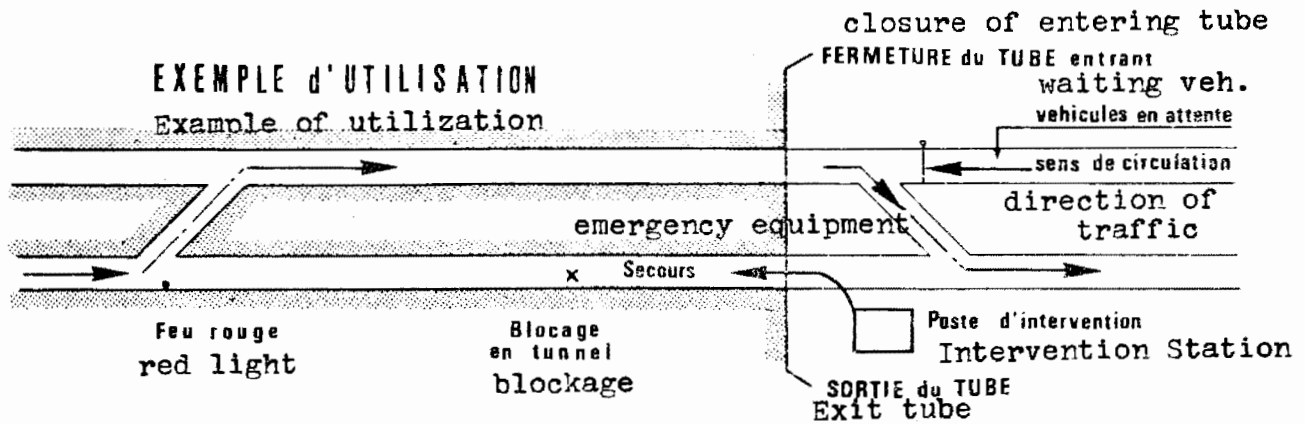

EMERGENCY PASSAGeways

PASSAGES DE  
 SECOURS

6

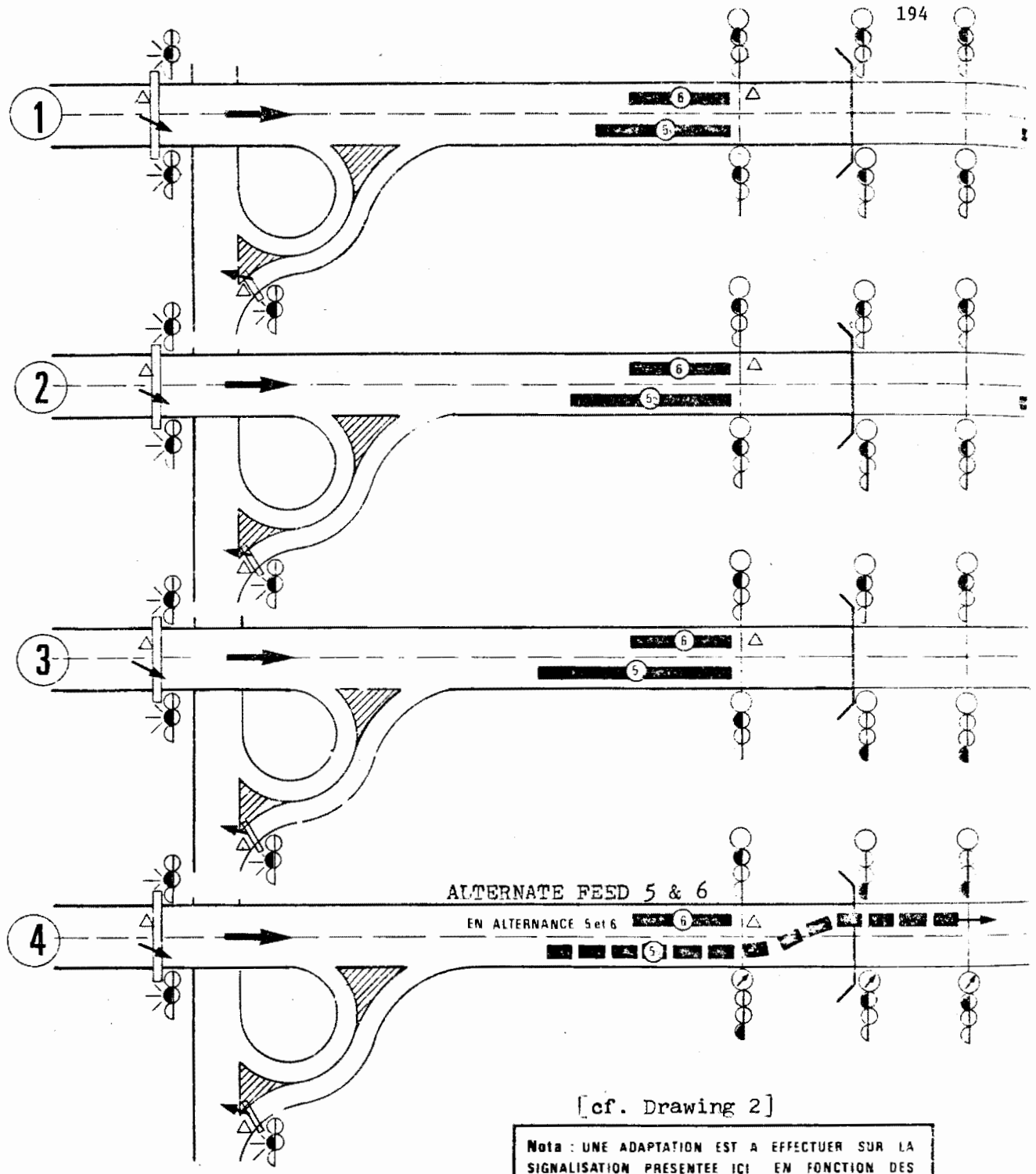

[cf. Drawing 2]

Nota : UNE ADAPTATION EST A EFFECTUER SUR LA SIGNALISATION PRESENTEE ICI EN FONCTION DES REGLEMENTS FUTURS QUI POURRAIENT INTERVENIR

- ① First step: Change signals to red -- operation entirely automatic. Mesure de première urgence. Allumage des feux. Opération entièrement automatisée.
- ② Clear block where accident located; emergency equipment enter from below. Dégagement du bantou concerné par l'accident et pénétration des secours par laval.
- ③ Clear blocked vehicles from tunnel. Dégagement des usagers bloqués dans le tunnel.
- ④ Alternate feed of vehicles waiting on approaches -- entirely automatic. Ecoulement alterné des usagers stockés à l'extérieur. Opération entièrement automatisée.

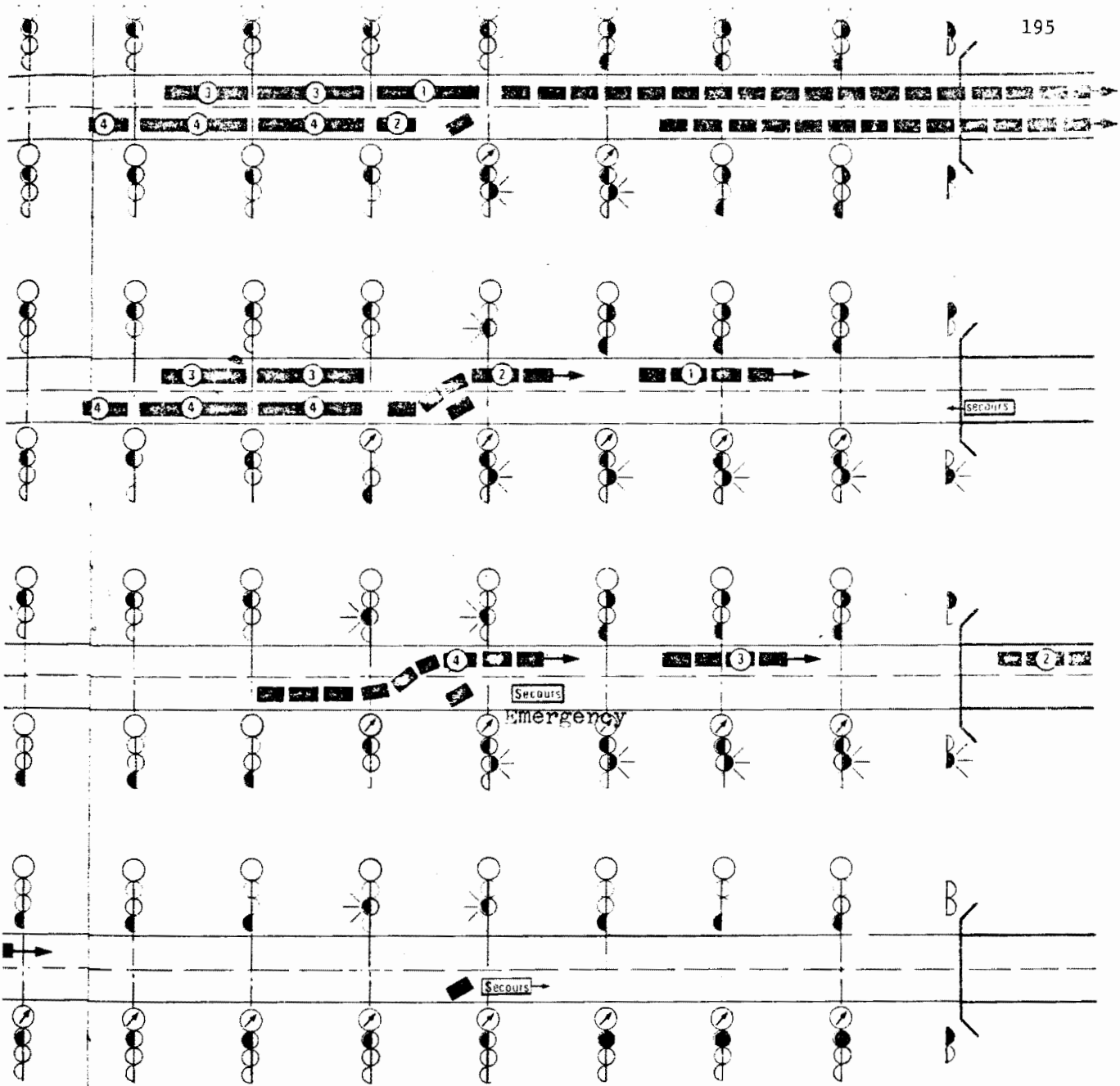

LEGENDE

- △ ACCIDENT DANS LE TUNNEL Accident in Tunnel
- ↙ DEVIATION RECOMMANDEE Recommended detour

■ VEHICULES ARRETES Stopped vehicles

▬ VEHICULES EN MOUVEMENT moving vehicles

○ FEUX signals

○ ALLUMEE } FLECHE D'OBLIGATION DE }  
 off } CHANGEMENT DE FILE }  
 ○ ETEINTE }

ACCIDENT OU PANNE BLOQUANT  
 PARTIELLEMENT UN SENS DE CIRCULATION

Accident or Breakdown  
 Partially Blocking  
 Traffic in One  
 Direction

Example for Expressway  
 tube

Regulation of Signals & traffic  
 Régulation des feux et du trafic



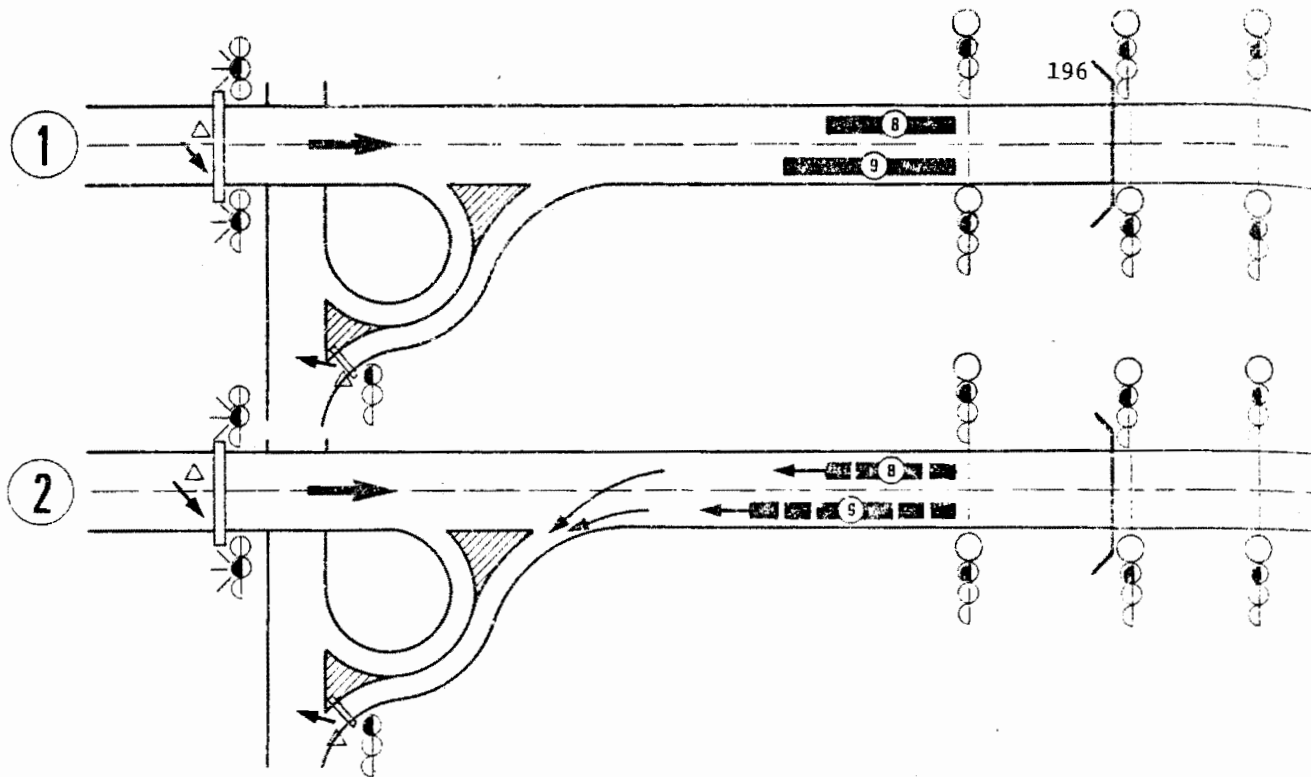

3 POSSIBILITES D'INTERVENTION SUR LES VEHICULES ARRETES EN TUNNEL  
 3 possible actions for the vehicles blocked in tunnel

3<sup>1</sup> ATTENTE (PANNE DE COURTE DUREE) → 4  
 wait (if minor breakdown)

3<sup>2</sup> UTILISATION DES PASSAGES DE SECOURS LORSQU'ILS EXISTENT (APRES FERMETURE)  
 use emergency passageways if they exist (after closing other tube)

3<sup>3</sup> SI NON DEMI-TOUR APRES MARCHE ARRIERE  
 If no passageways, U-turn in tube after backing traffic.

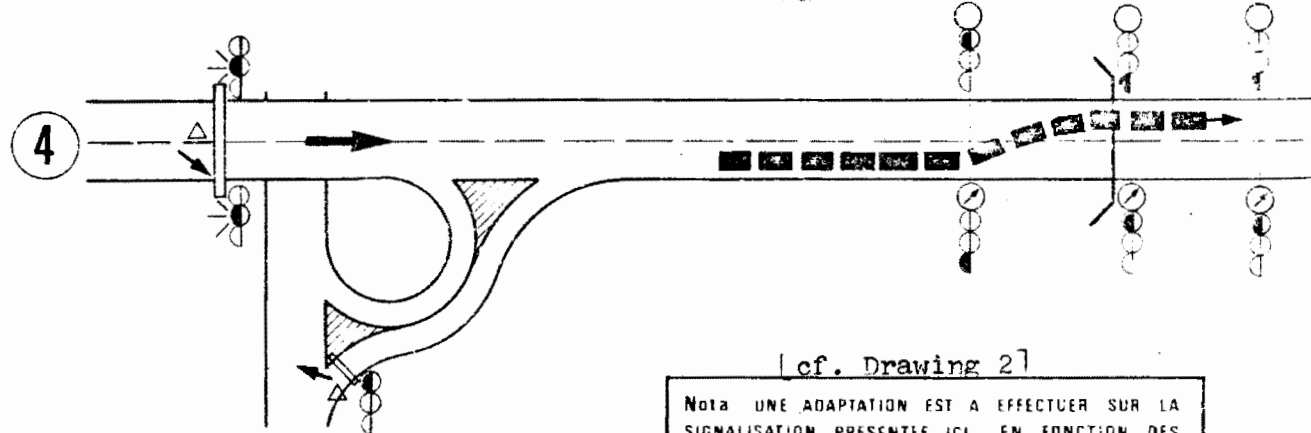

[cf. Drawing 2]

Nota UNE ADAPTATION EST A EFFECTUER SUR LA SIGNALISATION PRESENTEE ICI EN FONCTION DES REGLEMENTS FUTURS QUI POURRAIENT INTERVENIR

- Step One: Change signals to red -- automatic
- 1 Mesures de 1<sup>re</sup> urgence. Allumage des feux: phase automatique
  - 2 Emergency intervention; determine the seriousness of problem. Acces des secours et constatation de la gravite de l'accident. Evacuate users from tunnel.
  - 3 Evacuation des usagers bloques en tunnel.
  - 4 Evacuate emergency equipment (and disabled vehicle); permit waiting Evacuation des secours. Ecoulement des usagers stockes a l'exterieur vehicles to move.

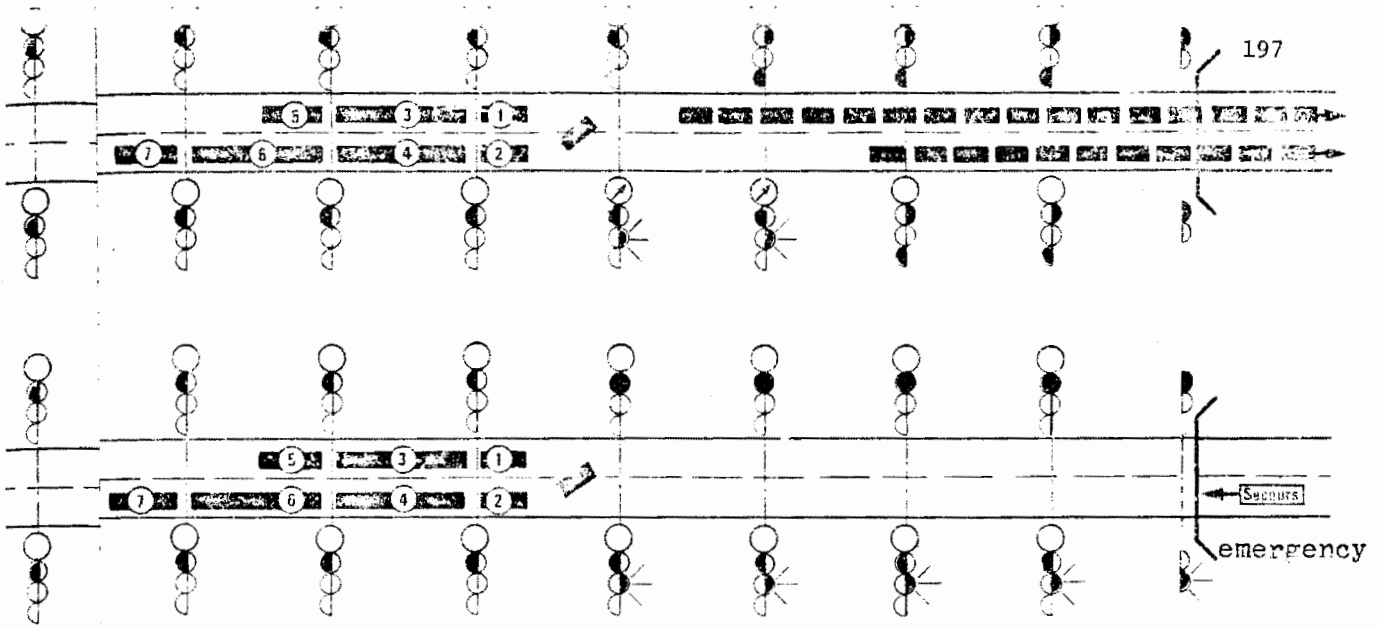

FERMETURE DE L'AUTRE TUBE.

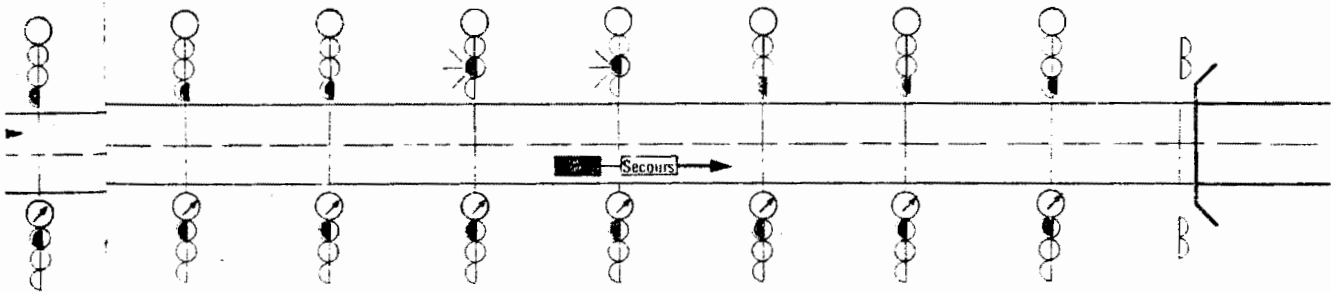

LEGENDE :

- △ ACCIDENT DANS LE TUNNEL Accident in tunnel Accident or Breakdown
- ↙ DEVIATION OBLIGATOIRE required detour Totally Blocking Traffic in One Direction
- VEHICULES ARRETES stopped vehicles
- VEHICULES EN MOUVEMENT moving vehicles
- FEUX signals
- on
- ALLUMÉE } FLECHE D'OBLIGATION DE lane change
- off } CHANGEMENT DE FILE instruction
- ÉTEINTE } Regulation des feux et du trafic

**ACCIDENT OU PANNE BLOQUANT  
TOTALEMENT UN SENS DE CIRCULATION**



Exemple d'un tube autoroutier  
Regulation des feux et du trafic

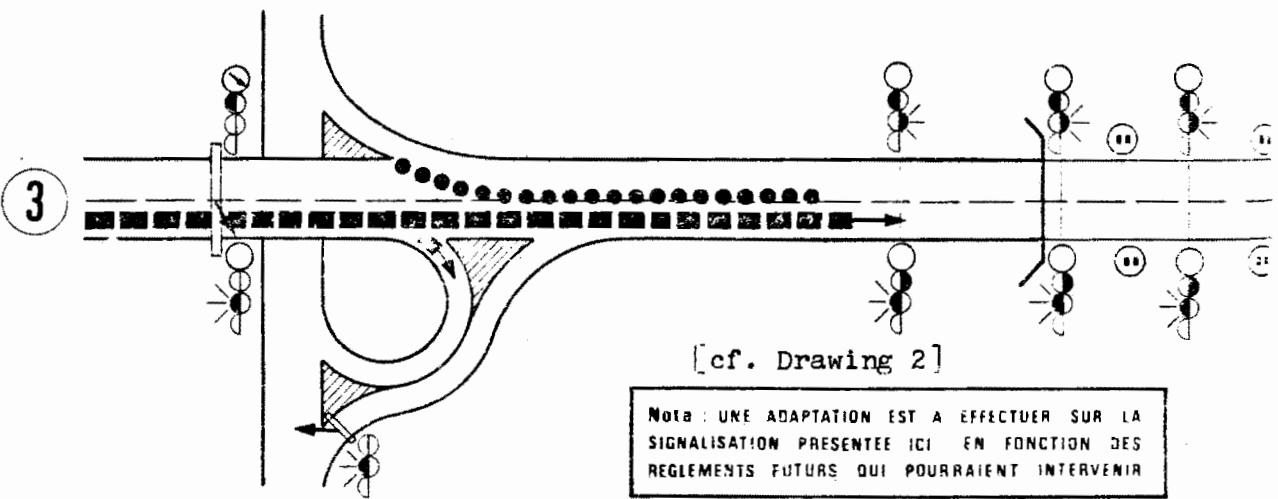
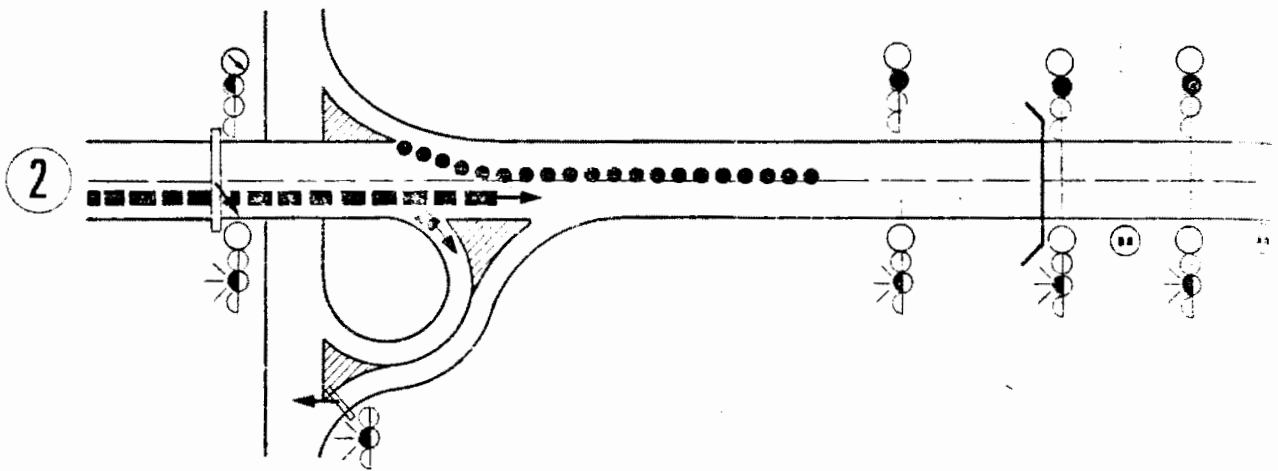
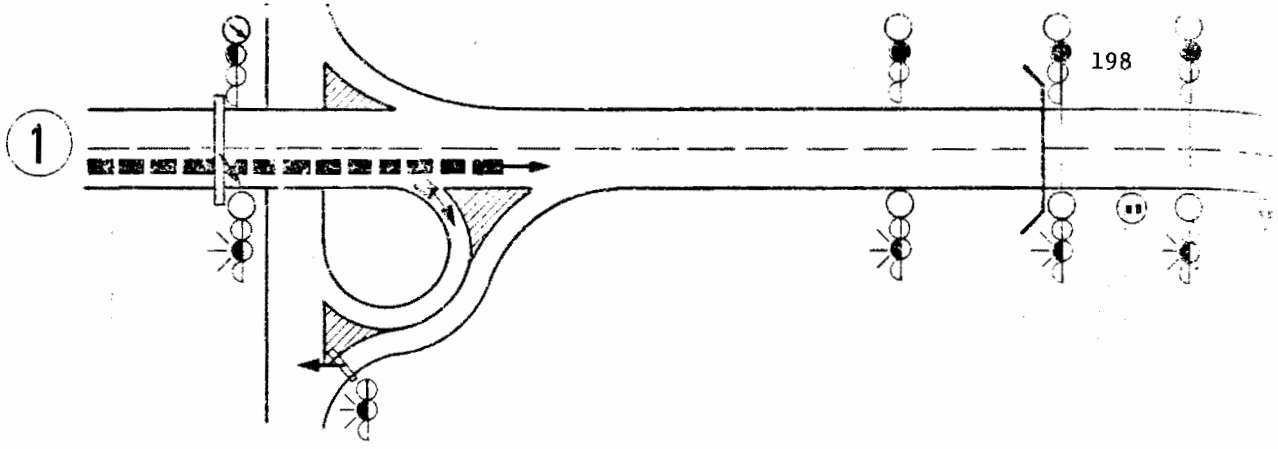







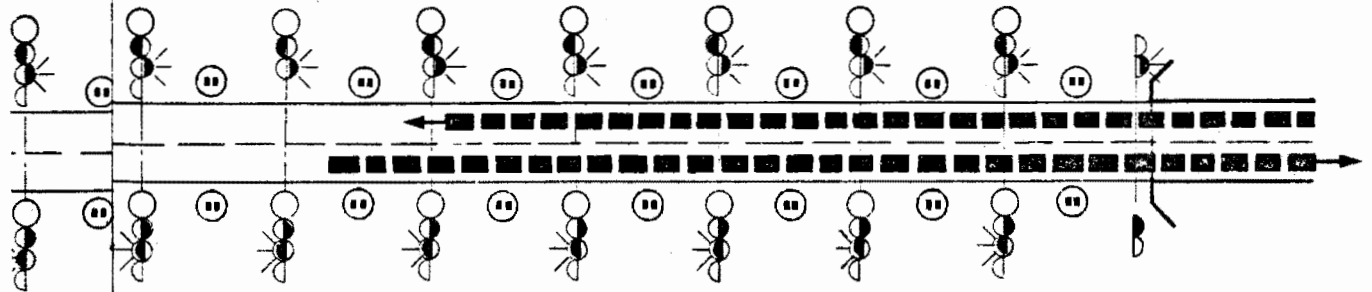
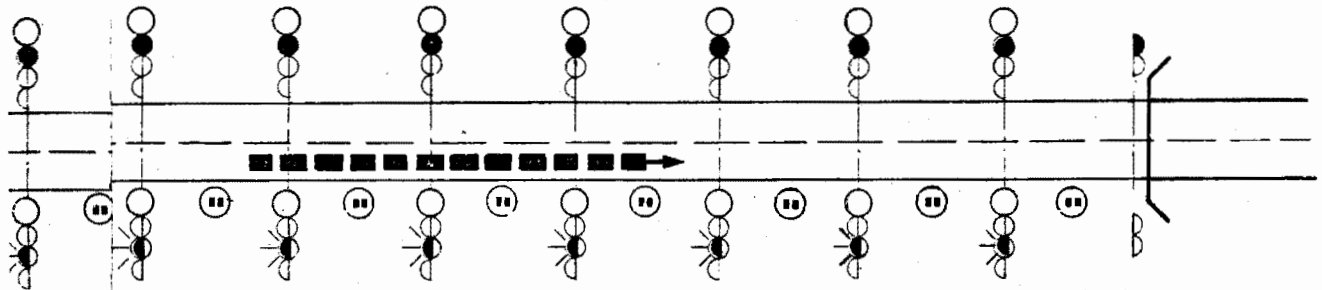
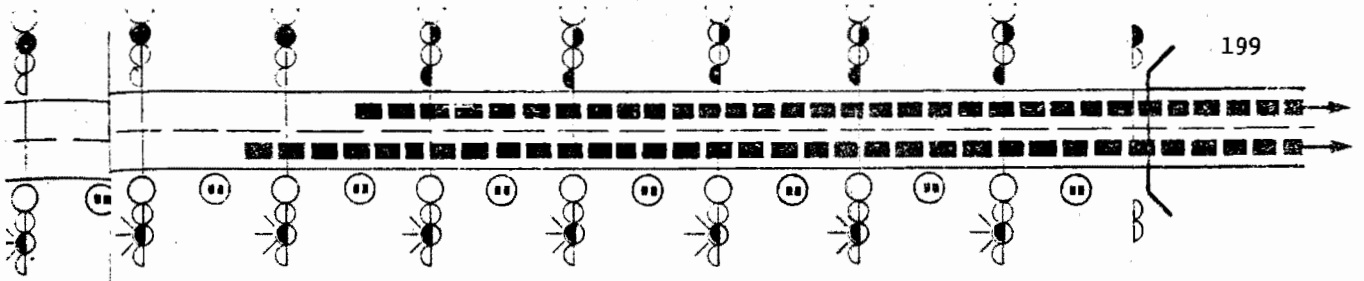

[cf. Drawing 2]

NOTE : UNE ADAPTATION EST A EFFECTUER SUR LA  
 SIGNALISATION PRESENTEE ICI EN FONCTION DES  
 REGLEMENTS FUTURS QUI POURRAIENT INTERVENIR

- ① Clearing lane whose direction will be changed.  
Evacuation de la voie devant être mise à contre sens.
- ② Erecting mobile barriers.  
Mise en place des barrages mobiles.
- ③ Opening lane to traffic in opposite direction.  
Ouverture à contre sens.



**LEGENDE**

-  DEVIATION RECOMMANDEE Recommended detour
-  BARRAGE MOBILE mobile barrier
-  DEPASSEMENT INTERDIT No passing sign
-  VEHICULES ARRETES stopped vehicles
-  VEHICULES EN MOUVEMENT moving veh.
-  FEUX signals
-  on } FLECHE D'OBLIGATION DE lane change
-  off } CHANGEMENT DE FILE instruction
-  ETEINTE }

Adapting Normally  
One-way Tunnel to  
Two-way Traffic

**MISE A DOUBLE SENS D'UN TUNNEL  
NORMALEMENT UNIDIRECTIONNEL**

**9**

Régulation du trafic

Data Arriving from Tunnel

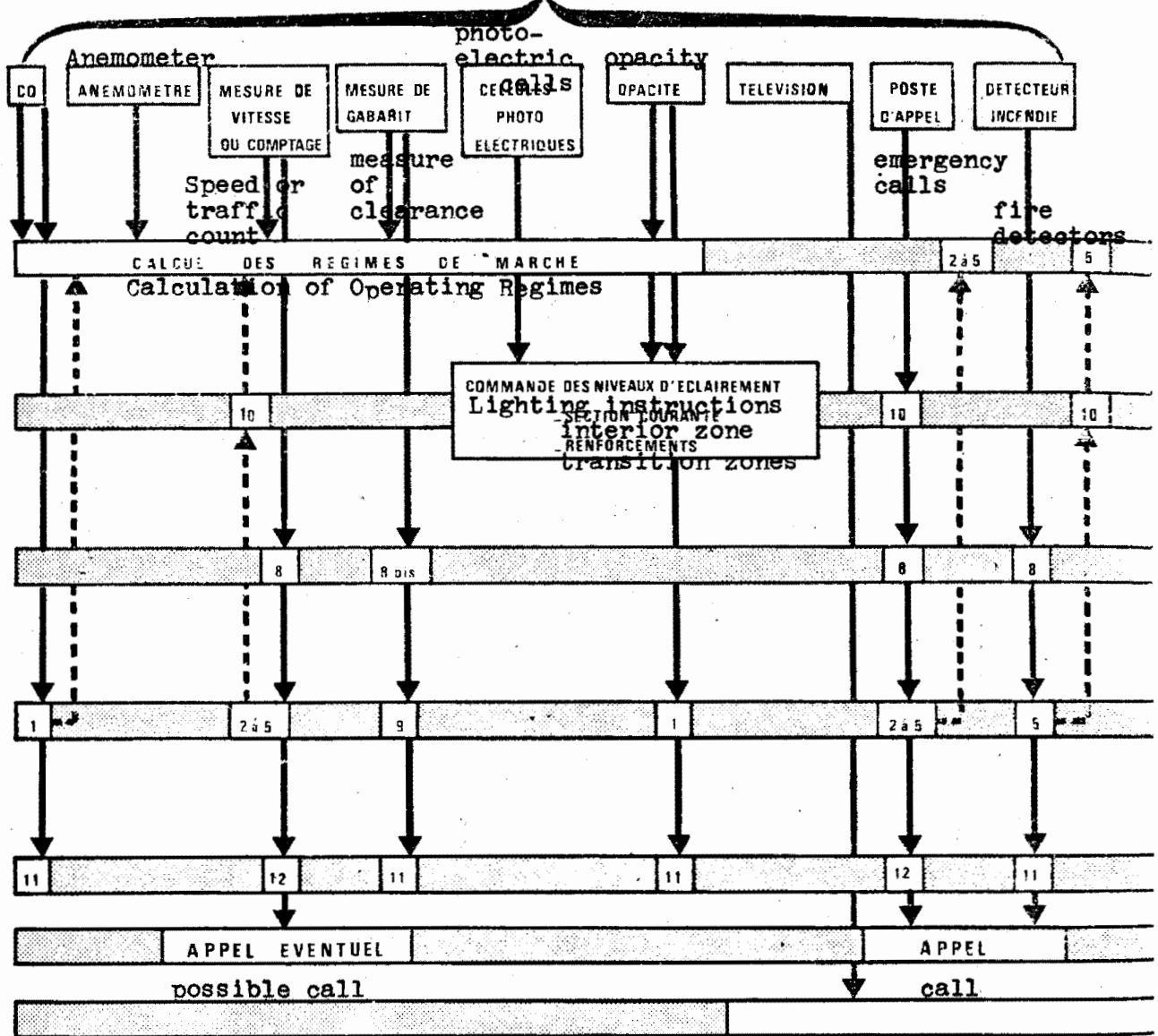

Exemples de  
 Examples of  
 PROGRAMMES  
 Intervention,  
 D'INTERVENTIONS  
 Ventilation, and  
 SIGNALISATION ET  
 Lighting Programs  
 VENTILATION  
 instructions to police

- 1 DELESTAGE SEUL (dépassement des seuils de pollution en situation exceptionnelle) diversion of traffic (exceeding pollution levels)
- 2 BUCHEON Congestion
- 3 ACCIDENT PANNE PARTIELLE accident/breakdown partially or totally blocking traffic
- 4 ACCIDENT PANNE TOTALE
- 5 INCENDIE fire
- 6 COUPURE COURANT loss of power
- 7 MISE A DOUBLE SENS change to two-way traffic
- 8 COMMUTATION AUTOMATIQUE DU MONITEUR DE TELEVISION SUR LE CANTON automatic scanning by television monitor of block from which data is received
- 9 DEPASSEMENT DE GABARIT A L'ECHANGEUR (signalisation sur l'accès) vehicle exceeding maximum clearance at interchange
- 10 ECLAIRAGE RENFORCEMENT DANS LE CANTON change(signals)
- 11 CONTROLE DE POLICE A L'ECHANGEUR AMONT ET A L'ENTREE DU TUNNEL increased lighting in block
- 12 CONTROLE DE POLICE DANS LE TUNNEL instructions to police at interchange & entrance



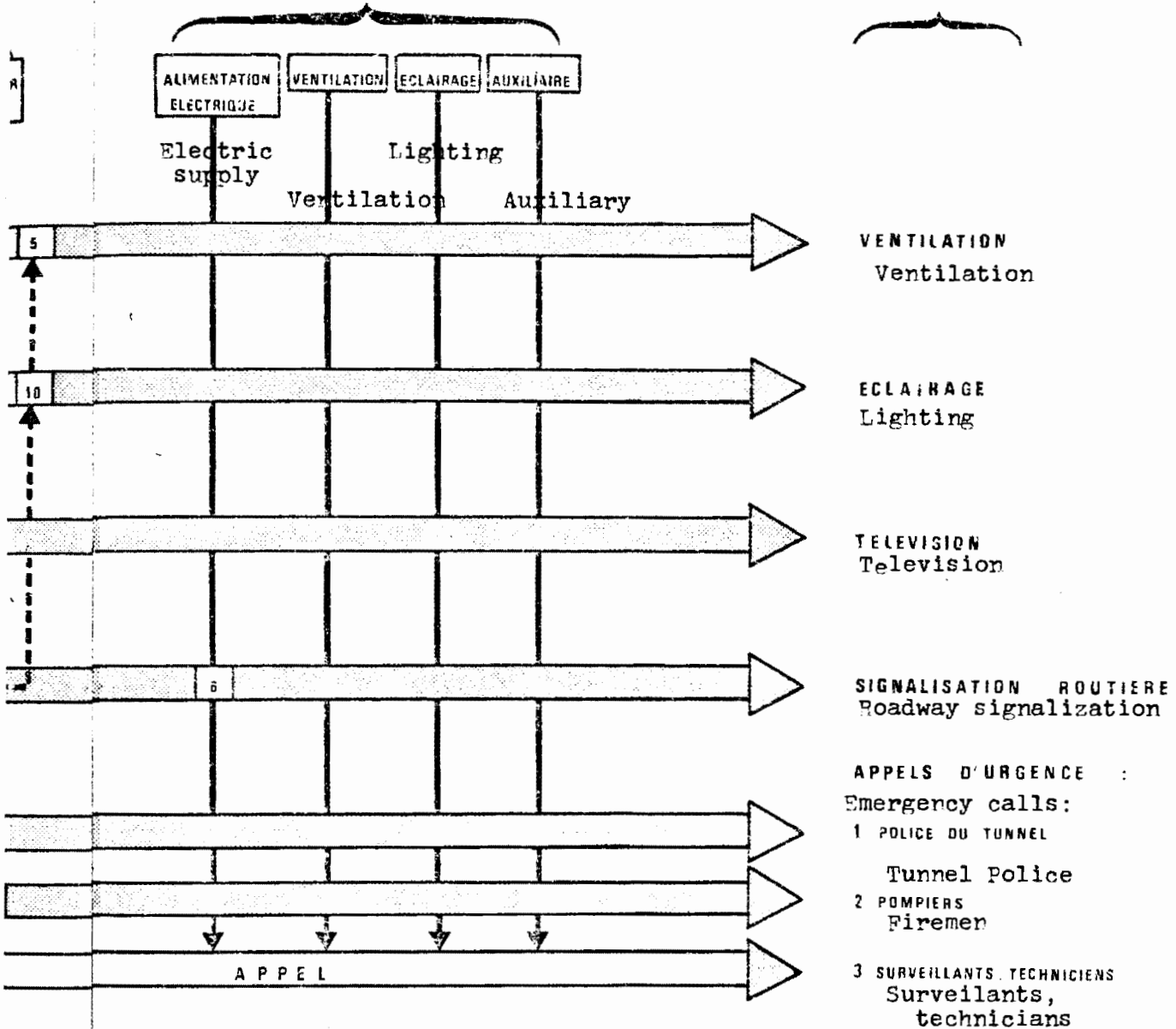

LEGENDE :

- OPERATIONS D'URGENCE A N'EFFETUER QU'APRES CONTROLE  
 Emergency operations to be effected only after television verification, or reports from surveillants
- VISUEL PAR T.V., COMPTE-RENDU DES SURVEILLANTS  
 normal operations, continuous monitoring, and collection of data
- OPERATIONS NORMALES ET PERMANENTES DE CONTROLE ET DE RASSEMBLEMENT DES DONNEES  
 normal operations, continuous monitoring, and collection of data
- INDICATIONS D'ALARME :  
 alarms: for tunnel installations and required immediate actions
- DEPASSEMENT DE LA CONCENTRATION NORMALE EN VEHICULES  
 abnormally high concentration of vehicles, traffic speeds abnormally low, alarms, fire detectors, exceeding clearance.
- VITESSE ANORMALEMENT BASSE  
 detectors, exceeding clearance.
- ALARME CO, OPACITE.  
 CO, OPACITE.
- DETECTEUR INCENDIE  
 DETECTEUR INCENDIE
- DEPASSEMENT DE GABARIT  
 DEPASSEMENT DE GABARIT
- CO, OPACITE  
 CO, OPACITE

**INFORMATIONS**

**ORDRES ET PROGRAMMES**

Data, Orders, and Programs

10

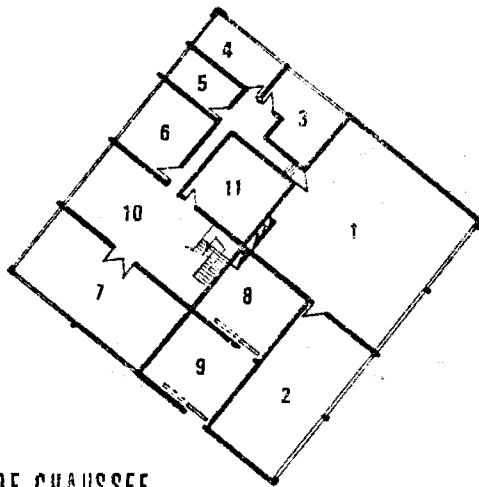

REZ DE CHAUSSEE  
Ground floor

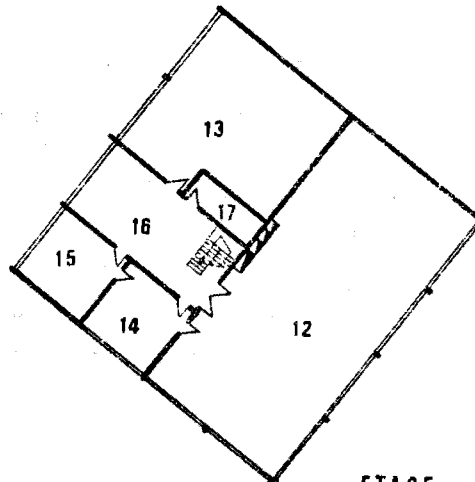

ETAGE  
2nd floor

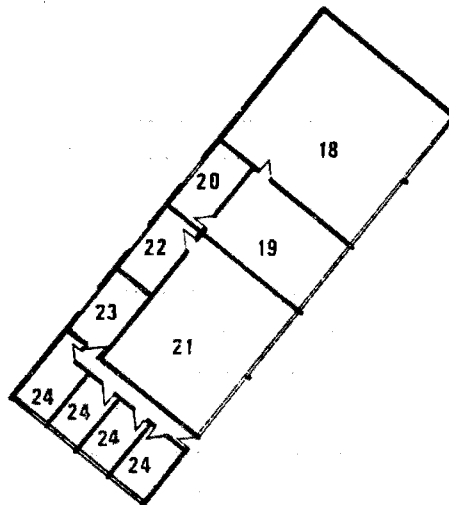

BATIMENT ANNEXE  
Annex building

REZ DE CHAUSSEE (ground floor)

- 1 Garage (vehicules de premiere urgence) emergency veh. garage
- 2 Garage (vehicules de liaison) garage for liaison vehicles
- 3 Salle de veille watch room
- 4 Salle police police room
- 5 Salle pompiers firemen's room
- 6 Infirmerie-chambres sickbay/bedroom
- 7 Salle de conference conference room
- 8 Chaufferie heating/boiler room
- 9 Batterie de secours emergency batteries
- 10 Hall hallway
- 11 Sanitaires restrooms

ETAGE (2nd floor)

- 12 Salle de commande Command room
- 13 Salle de calcul computer room
- 14 Bureau du directeur Director's office
- 15 Gestion archives admin/records
- 16 Hall hallway
- 17 Sanitaires restroom

BATIMENT ANNEXE

- 18 Garage garage
- 19 Atelier workshop
- 20 Stockage storage
- 21 Refectoire dining hall
- 22 Cuisino kitchen
- 23 Sanitaires restrooms
- 24 Chambres bedrooms

Echelle: 1/400 em

scale- 1:400

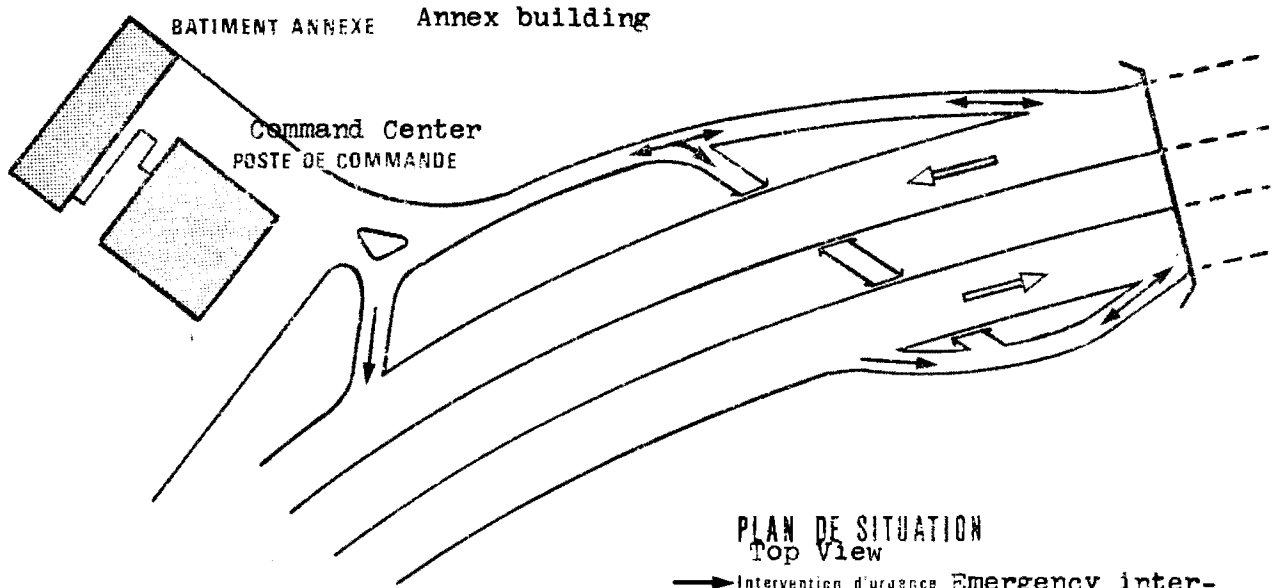

→ Intervention d'urgence Emergency inter-  
 → Sens de circulation des vehicules traffic direction  
 Un service léger d'intervention de premiere  
 An emergency intervention  
 capability is also envisioned  
 at other tunnel entrance  
 (less fully equipped).

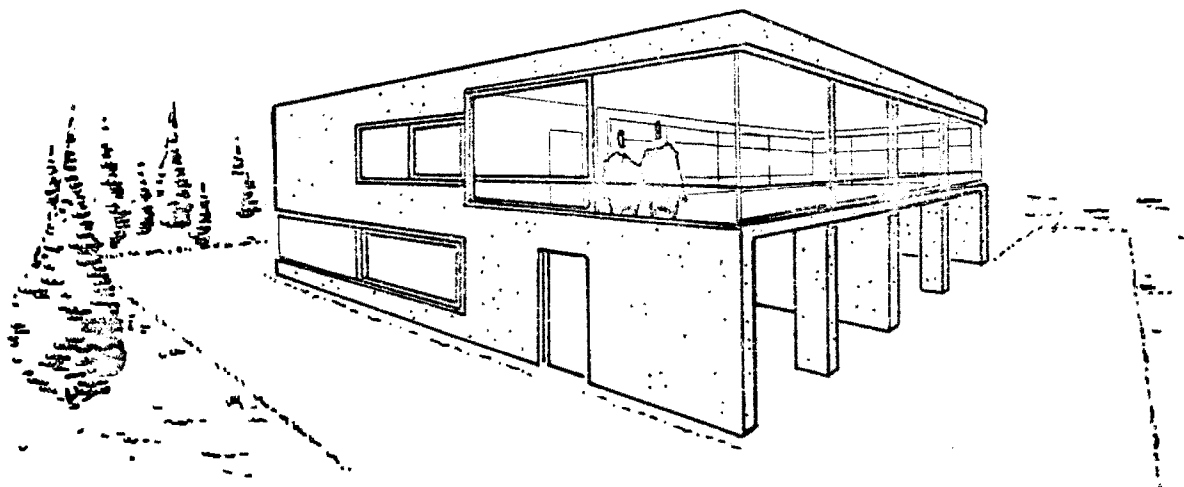

Installations for  
Utilization Service

INSTALLATIONS  
D'EXPLOITATION

Sample Provisions for an  
Expressway tunnel

Exemple de dispositions à retenir  
(cas d'un tunnel sur autoroute)

Displays  
**TABLEAU SYNOPTIQUE**  
 (visualisation et enregistrement)

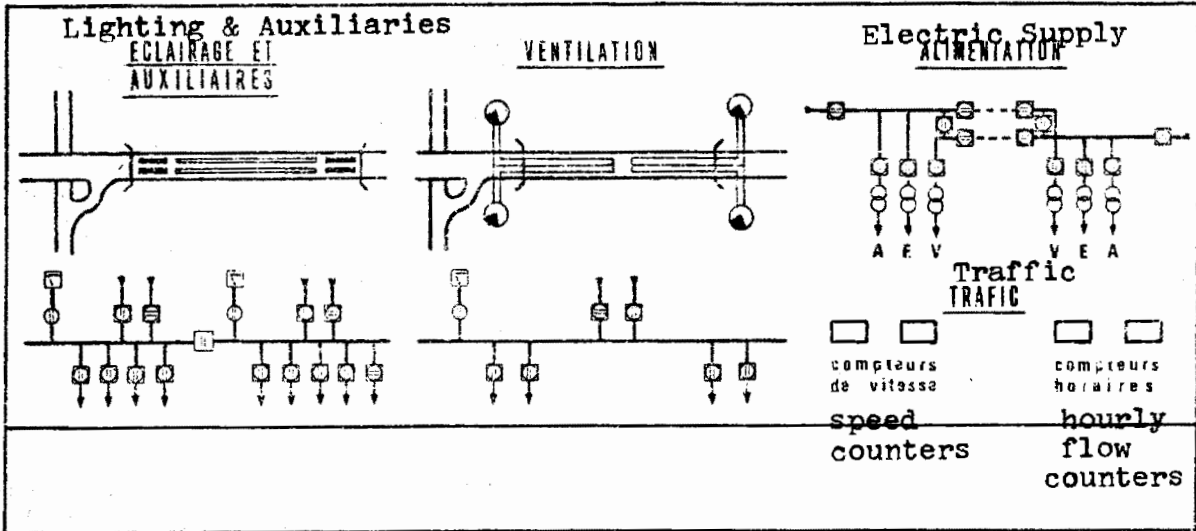

**PUPITRE DE COMMANDE**  
 Command Console

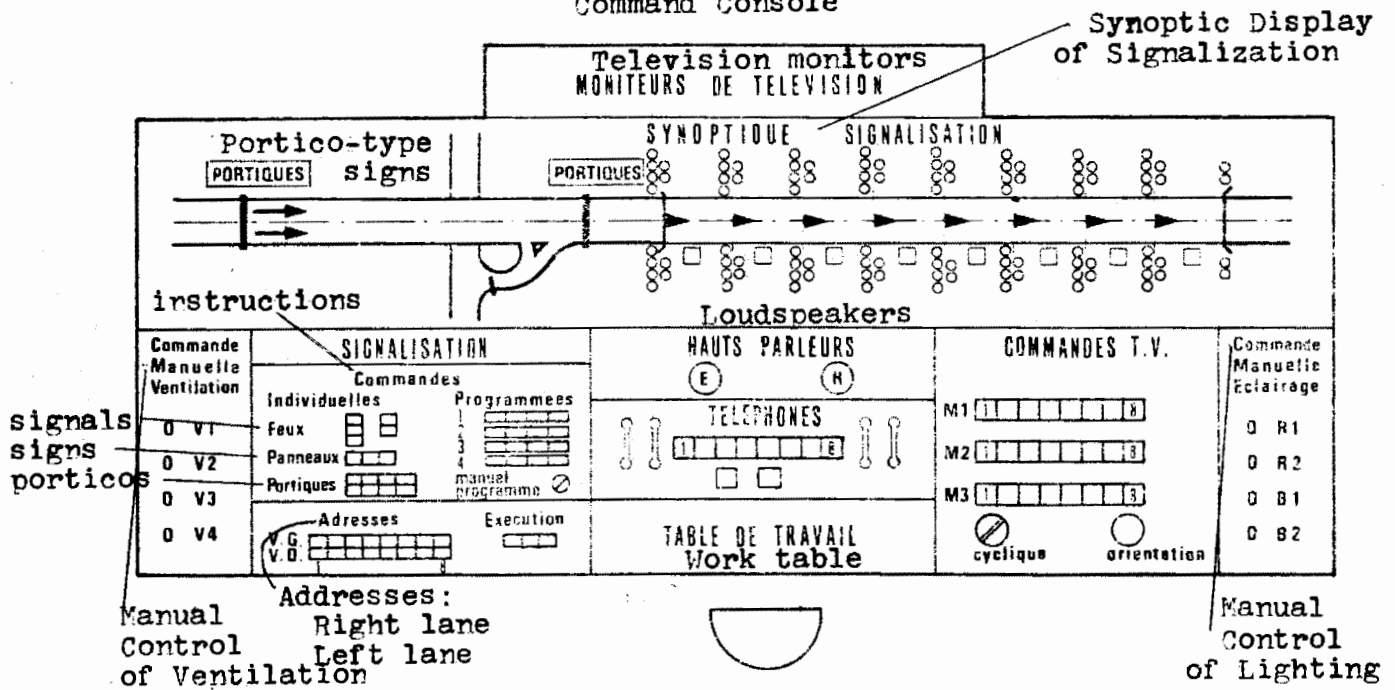

**12** POSTE DE COMMANDE  
 Tableau synoptique et pupitre de commande

Command Center (Displays and Command console)

Regional Technical  
Service of Lyons

MINISTRY OF EQUIPMENT AND LODGING

TUNNEL MANUAL

(Volume IV: Costs)

Study Group  
on Tunnels

May, 1970

(Translated by Robert J. Matthews)

1. Object and Limitations of this Volume

TO BE READ IN ITS ENTIRETY BEFORE USING THIS VOLUME

---

2. Construction

---

3. Ventilation

---

4. Lighting

---

5. Installations Necessary for Exploitation

---

6. Annual Operating Expenses

---

7. Applied Examples - Project Cost Variations

---

8. Geometric data - Numerical values

---

## Chapter 1. OBJECT AND LIMITATIONS OF THIS VOLUME

### 1.1 Object of this Volume

- 1.11 The financial data necessary for an estimate of tunnel construction costs and operating expenses have been compiled in this volume of the Tunnel Manual. These data are based on cost/price studies of recent construction.

THEY PERTAIN ONLY TO EXCAVATED (DRIVEN) TUNNELS.

- 1.12 At the preliminary design stage, these elements are intended to be of assistance as follows:

\* In order to choose among several layouts that may, or may not, involve one or several tunnels.

After adopting one of the variants,

\* In order to establish the approximate layout of tunnel, in conjunction with geological considerations.

\* In order to make a preliminary choice of tunnel cross-section, taking into account not only construction considerations and resultant financial consequences, but also the route's function and predicted level of service (traffic load).

- 1.13 At the end of Chapter 7, several examples are presented; they should permit an evaluation of the economic influence of geological and geometric parameters on the final cost of excavated tunnels. These examples ought to be considered as simple illustrations of the data furnished in the preceding chapters.

### 1.2 Tunnel Cost Analysis

#### 1.21 Itemization of Cost Categories

The list of items to be taken into account in the financial estimate of tunnel cost is lengthy and disparate, due to the numerous techniques involved.

Chapters 2, 3, 4, and 5 provide a complete itemization of construction costs necessary for cost estimation, broken down as follows:

- \* CONSTRUCTION: - Excavation and Support  
(Chapter 2)
  - Lining and Underlining
  - Forming (for concrete)
  - Waterproofing
  - Flooring:
    - Roadway
    - Sidewalks and curbing
    - Drainage
- \* VENTILATION: - Major Construction:  
(Chapter 3)
  - Stations
  - Shafts
  - Connecting adits
  - Secondary Construction in Tunnel:
    - Ceiling and partitions
    - Connecting ducts and vents
  - Electromechanical installations
    - Equipment (ventilators, motors, & equipment closets)
    - Power supply
    - Outfitting of ventilation ducts
- \* LIGHTING  
(Chapter 4)
- \* EQUIPMENT NECESSARY FOR TUNNEL EXPLOITATION
  - Emergency Pull-off, Recesses, and  
Emergency Exits in Tunnel
  - Command Post
  - Surveillance, Security, and Signalization
  - Equipment in Tunnel, and Power Source

## 1.22 Relative Importance of these Various Categories

1.221 The evaluation of the relative importance of these four major cost categories should derive from studies specific to each individual case; nevertheless, it is possible to indicate three essential principles:



- \* The Construction category is both the most important (40-90% of total cost, depending on the circumstances<sup>1</sup>) and the most amenable to analysis.
- \* The Ventilation category, non-existent in tunnels that are short or little trafficked, can rise to 50% of total tunnel cost in certain cases (urban site where traffic is heavy, extremely long tunnels, etc.).
- \* The Lighting category generally falls within a range of 3-25% of total tunnel cost. In certain specific cases, notably for short tunnels, this proportion may be much higher.
- \* The Equipment Necessary for Exploitation category may reach 15% of tunnel cost for those tunnels having their own management service. This includes related construction costs.

1.222 On the average, it should be acknowledged that studies and site surveys for these projects comprise 7% of construction costs (approximately 3.5% for studies and 3.5% for site surveys). These are substantial percentages (which may, however, decrease in proportion to the length of the tunnel), but they are justified by the complexity of the problems involved in tunnel construction, as well as by the necessity of accurate estimates.

### 1.3 Job Prices and Unit Prices

The high cost per kilometer of tunnels is affected by a dual imprecision that reflects:

- \* In part, uncertainties linked to geological factors and to the actual formation of the terrain.
- \* In part, variations linked to price fluctuations in a restricted market.

Thorough geological studies, however, are capable of limiting the importance of the first factor.

#### 1.31 Definition of Job Prices

In order to limit the second factor of imprecision, a thorough analysis has been made, over a considerable period of time, of job prices; these prices have been obtained for all tunnels constructed in France in recent years.

---

<sup>1</sup>And sometimes more, if exceptional construction difficulties arise. Moreover, the Construction category will obviously reach 100% when no equipment is involved (e.g., in an extremely short tunnel).

Job prices are defined in the following manner:

- \* They are lump-sum prices: they differ therefore from unit prices, and furthermore attempt to group related operations into major categories. They include fixed contractual charges for the installation and removal of the work site.
- \* They are total prices, calculated upon the termination of construction, once extras, claims, and revaluations have been included in the expenditure. For this reason, they do not as a general rule (except in the case of exceptional difficulties) require the withholding of a contingency reserve.
- \* Finally, they are statistical averages, based on the analysis of a large number of projects, and are therefore applicable to future projects (while taking certain very important precautions).

### 1.32 Itemization of Job Prices

Of the list presented under 1.21 above, the follow items are to be estimated in terms of job prices:

- \* Construction: - Excavation  
- Lining  
- Framing (for concrete)
- \* Ventilation
- \* Lighting

### 1.33 Itemization of Unit Prices

For other items, the available data remain insufficient to establish job prices; it is necessary therefore to consider them as traditional unit prices -- specifically, it is necessary in each case both to effect a separate analysis taking into consideration the particular circumstances at hand and to set aside monies for a contingency reserve fund.

The following items are to be estimated in terms of unit prices:

- \* Construction: - Waterproofing  
- Flooring
- \* Ventilation: - Major Construction  
- Secondary Construction
- \* Equipment Necessary for Tunnel Exploitation

### 1.34 Precautions in the Use of Job Prices

#### 1.341 Critical Remarks

The apparent simplicity and precision of job prices in no way obviates the necessity of undertaking those studies that will be required in each particular case.

For example, with regard to the cost of excavation and support, any application of job prices without prior geological and geotechnical studies would be destined to failure.

Job price is, of course, never more than a simple multiplying coefficient. In practice, it is important to be as precise as possible, both in the evaluation of the quantity of work and in anticipation of possible construction difficulties.

#### 1.342 Reserve Funds for Contingencies

As a general rule, all of the items defined in 1.32, for which job prices are available, do not require a reserve fund.

A reserve fund is necessary only in case of uncertainty about technical estimates. For example, in the application of the previously cited job prices for excavation, a reserve fund should not be anticipated for a section of homogeneous terrain, except where major uncertainties about the actual formation of the terrain to be excavated still remain after detailed geological studies have been carried out.

Finally, these remarks in no way preclude the necessity of setting aside contingency funds based on the total estimated cost of the highway project encompassing the tunnel. Such funds may be necessary in order to cover construction that has not been anticipated.

### 1.4 Structures or Parts of Structures Considered in this Volume

#### 1.41 Structures Considered

The present document is applicable to:

- \* Both equipment (ventilation, lighting, equipment necessary for exploitation) and operation of all types of tunnels regardless of function or method of construction.
- \* Structural work, solely for excavated tunnels (excluding machine-drilled tunnels, immersed caissons, and covered trenches), whose lining (when there is one) is fabricated of cast-in-place concrete.

#### 1.42 Parts of Structures Considered

All aspects of construction in the traffic gallery are considered in this document.

Construction of tunnel portals and unusual tunnel sections (enlargements, subterranean interchanges, etc.) and construction through very difficult geological zones (very poor terrain) should be the object of separate studies, as the data furnished herein are not generally applicable.

It therefore follows, to take a simple case, that construction cost estimates for an excavated tunnel should be comprised of three distinct parts:

- \* The entire traffic gallery -- for which the data provided in Chapters 2, 3, 4, and 5 should be used.
- \* Tunnel portals and entrance cuts -- to be estimated separately on the basis of individual studies and measurement.
- \* Tunnel sections passing through zones of very poor terrain -- to be estimated separately.

#### 1.5 Price Updating

All prices indicated in the present document are valid, as of January 1, 1969, under existing economic conditions in France. As indicated, they include all taxes.

These prices will require systematic revision each year by the appropriate agency.

#### 1.6 Directions for Use of this Volume

1.61 Tunnel construction costs can be defined as the sum of all cost items enumerated in Chapters 2, 3, 4, and 5. In addition, construction of tunnel portals and sections passing through very poor terrain must, as was indicated in 1.4, be considered separately.

1.62 This document defines for each cost category to be taken into account, the formulae, charts, and cost figures that are generally applicable up until the PPS stage. (In those cases where the data are too imprecise to be used in the PPS, this fact is indicated.)

For certain categories, these items have been provided in the form of detailed cost itemizations; this should permit undertaking more detailed cost studies.

## Chapter 2. CONSTRUCTION

### 2.1 Defintion of Construction Category

The Construction category includes, within the limits of the structures or parts of structures indicated in 1.4, the following cost items:

Excavation, including temporary supports

Permanent reinforced concrete linings

Possibly a reinforced concrete underlining

Framing (for pouring of concrete lining)

Waterproofing

Flooring (Roadway, sidewalks, drainage)

Miscellaneous Supplementary Costs

### 2.2 Estimation Process

#### 2.21 General Outline of Process

Geological and geotechnical studies, as well as dimensioning studies, should permit the following:

- \* To delineate along the entire length of the tunnel those zones presenting similar excavation and support difficulties (See the 5 terrain categories specified in 2.22).
- \* To define for each zone thus specified the lining, underlining, and waterproofing deemed necessary.
- \* To arrive at all the geometric quantities required for the estimate of costs for each zone (See 2.23).

## 2.22 Definition of Terrain Categories

The job prices of excavation and support are dependent on the nature and difficulties of excavating the terrain. As indicated in the following table, 5 different categories of terrain are distinguished; these categories are defined both by the temporary support requirements and by the envisaged construction method.

<u>Terrain Category</u>	<u>Nature of Supports</u>	<u>Possible Construction Methods (type of headings)</u>
Very good terrain	No support.	Full-face
Good terrain	Bolting and possibly	Full or half-face
Difficult terrain	Ribbing & lagging; shotcrete or underlining; no support above working face.	Half-face or side drift
Poor terrain	Support work progresses with advancement of the working face; plating above working face if necessary.	Side drift
Very poor terrain (not estimated in terms of job price)	Preliminary treatment of terrain; complete plating.	Extremely variable

## 2.23 Definition of Geometric Quantities

The definition of the theoretical sections of excavation, lining, and underlining, as well as of the evolute of the forming for concrete -- in short, of all the geometric quantities necessary for application of job or unit prices -- is based on a combination of:

- \* The geometric dimensioning envisioned for the tunnel (road width, vertical clearance, width of insulators, and circular cross-section of tunnel vault).
- \* The category of the terrain in question generally dictates:
  - the necessity of an underlining.
  - the total thickness of the lining to be constructed.

Information pertaining to the definition of these geometric quantities and to the choice of lining thickness, which depends upon the category of the terrain in question, is to be found in Chapter 8.

#### 2.24 Formulae for the Calculation of Construction Costs:

In order to obtain the estimated construction cost per linear meter of tunnel, it is convenient to apply one of the two following formulae:

<u>Hypothesis</u>	<u>Cost per Linear Meter</u>
Excavation without underlining	$C_d S_d + C_r S_r + C_c D_c + C_e D_e + C_{pl}$
Excavation with underlining	$C'_d S'_d + C_{rs} S_{rs} + C_{ri} S_{ri} + C_p S_p +$ $C_c D_c + C_e D_e + C_{pl}$

where notation is defined as follows:

<u>Symbol</u>	<u>Definition</u>	<u>Unit</u>	<u>Reference</u>
$S_d$	Theoretical section for excavation	$m^2$	Chapter 8
$S_r$	Theoretical section for lining	$m^2$	
$S_{rs}$	Theoretical section for lining of upper half of cross-section	$m^2$	
$S_{ri}$	Theoretical section for lining of lower half of cross-section	$m^2$	
$S_p$	Theoretical section for underlining	$m^2$	
$D_c$	Evolute of forming for concrete work	$m^2$	
$C_d$	Job price for excavation	$F/m^3$	2.3
$C'_d$	Job price for excavation with underlining	$F/m^3$	2.3
$C_r$	Job price for lining	$F/m^3$	2.4
$C_{rs}$	Job price for lining upper half of cross-section	$F/m^3$	2.4
$C_{ri}$	Job price for lining lower half of cross-section	$F/m^3$	2.4
$C_p$	Job price for underlining	$F/m^3$	2.5
$C_c$	Job price for forming	$F/m^2$	2.6
$C_e$	Unit price for waterproofing	$F/m^2$	2.7
$C_{pl}$	Unit price for flooring	$F/m$	2.8

### 2.3 Job Price for Excavation

#### 2.3.1 Composition of Job Price

2.3.1.1 The fixed job price per linear meter of tunnel includes:

- \* Subterranean excavation.
- \* Mucking and removal of rubble to a point 1 km from tunnel portal.



- \* Furnishing and installation of temporary supports, including all related expenses.
- \* Backfilling of overbreaks.
- \* Installation and removal of work site & equipment.

2.312 Job price does not include supplementary costs arising from an increase in:

- \* Length
  - \* Gradient
  - \* Ground water intrusion
- } See 2.9

2.313 Job prices are a function of the category of terrain traversed (very good, good, difficult, poor). The terrain categorization should be based on exploratory studies.

#### 2.32 Applicable Job Prices

Job prices for excavation are provided by the following curves. [The accompanying table provides information necessary for entering the figure.]

<u>Nature of Terrain</u>	<u>Curve</u>	<u>Minimal Thickness of Concrete Lining at Apex of Vault</u> (see Chapter 7). This dimension used for calculating $S_d$ .	<u>Comments</u>
Very good terrain	1	0 or 30 cm	
Good terrain:  * Systematic bolting in arch (1 bolt per 2 m <sup>2</sup> ).  * Heavy bolting over entire section (1 bolt per m <sup>2</sup> ).	2	40 cm	
Difficult terrain without reinforced underlining.  Interval between ribs:  * 1.5 m  * 1.0 m  * 0.5 m	3	40 cm	Job price includes all construction problems that may arise -- e.g., problems with supports. It also includes cost of shotcrete lining when there is one.
Difficult terrain with reinforced underlining	4, 5 or 6	$C'_d = 0.9 C_d$ should be used	
Poor terrain	7	80 cm	See 2.332
Very poor terrain	Departs from the limits of present data on job prices. Extremely detailed exploratory studies are necessary.		

# PRIX D'ORDRE DE DEROCTAGE : $C_D$

15

JOB PRICE FOR EXCAVATION:  $C_d$

Prix d'ordre en Francs (1-1-70)

Job price in Francs (as of Jan. 1, 1970)

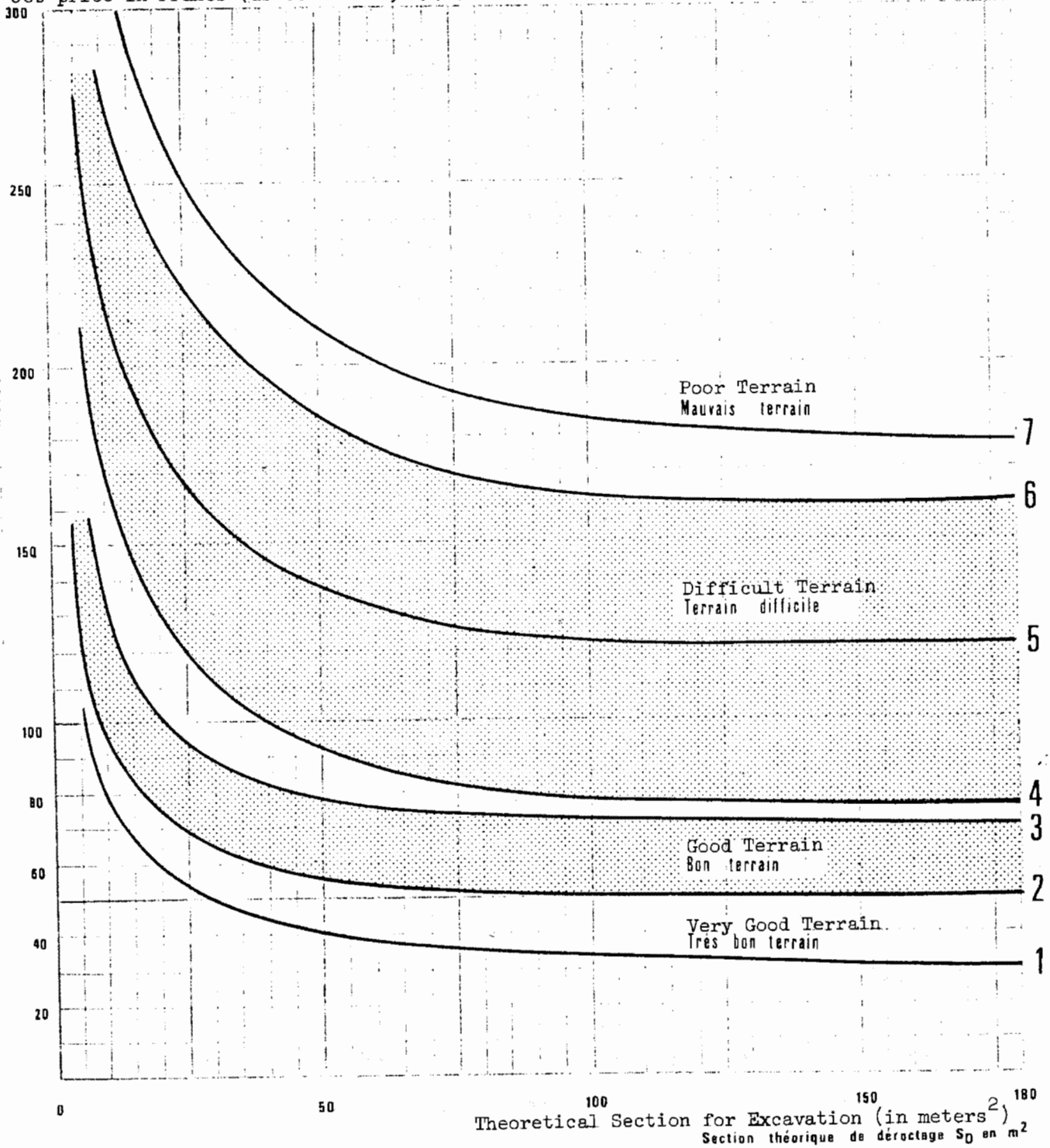

## 2.33 Critical Remarks

- 2.331 Concrete thickness. The figures provided in column 3 of the preceding table are only representative. If the zone in question is short in length, the lining thickness of adjacent zones should be adopted if it is of a greater thickness.
- 2.332 Poor Terrain. Curve no. 7 is meant only to indicate the order of magnitude of the job price. For a precise cost estimate, detailed studies must be made of the excavation techniques to be employed (type of heading, supports, etc.). This will lead to separate estimates for the different phases of construction. The various curves shown in the figure can be used for estimating the cost of these different phases.
- 2.333 Very poor terrain. In those cases where the zone of very poor terrain is short relative to the entire tunnel length, it will usually suffice for Proposal Document studies to predict a cost doubling for construction in the zone of poor terrain. A precise estimate can only be reached through a detailed study of proposed excavation techniques.

## 2.4 Job Price for Lining

### 2.41 Contents of Job Price

2.411 The fixed job price per linear meter of tunnel includes:

- \* Furnishing and placing of concrete.
- \* Filling of overbreak.
- \* Grouting and packing.
- \* Installation and removal of work site and equipment.

2.412 Job prices are valid for a concrete having a 300 kg mix proportion of CPA or CLK cement, placed using a submerged nozzle technique.

2.413 Job prices do not include:

- \* Extras (see 2.9).
- \* Forming costs (see 2.6).
- \* Special concrete mixes requiring more concrete or special additives; they should be covered by supplementary estimate.
- \* Filling unusually large bells (cavities).

2.42 Theoretical Section for Lining:  $S_r, S_{rs}, S_{ri}$

Theoretical sections are determined in accordance with instructions contained in Chapter 8, using data provided in Table 2.32 (lining thickness of 0, 30, 40, 60 or 80 cm at apex of vault depending on the terrain category).

2.43 Job Price for Given Theoretical Section

The following values are applicable:

Job Price per $m^3$ of Cast-in-Place Concrete Lining (in Francs per $m^2$ of theoretical section)	
If there is no cast concrete underlining:	$C_r = 224$
If there is a cast concrete underlining:	$C_{rs} = 187$ (in such a case there will be no filling of overbreaks.)  $C_{ri} = 224$

2.5 Job Price for Cast Concrete Underlining

2.51 Contents of Job Price

2.511 The fixed job price per linear meter of tunnel includes:

- \* Furnishing and pouring of underlining concrete.
- \* Temporary forming (including coffer dams).
- \* Filling of overbreak.
- \* Installation and removal of work site and equipment.

2.512 Job prices do not include the filling of large bells or cavities when irregularities in the terrain are encountered.

2.52 Theoretical Section for Cast Concrete Underlining:  $S_p$

Theoretical sections are determined in accordance with instruction contained in Chapter 8. In many cases,  $S_p$  will be the cross-sectional area between the extrados and intrados of the ribs on the entire upper half section.

Exact dimensions are calculated on the basis of hypotheses about the loading and stability of the tunnel vault.

### 2.521 Job Price for a Given Theoretical Section $S_p$

The following value is to be used:

Hypothesis	<u>Job Price for Cast-in-Place Concrete Underlining per m<sup>3</sup></u> (in Francs per m <sup>2</sup> of theoretical section $S_p$ )
Minimal thickness of 20 cm	375

### 2.6 Job Price for Forming

#### 2.61 Contents of Job Price

The fixed job price per linear meter of tunnel includes the cost of furnishing and erecting forms, including the possible construction of necessary runways to allow delivery of concrete.

#### 2.62 The Evolute of the Forming $D_c$

The evolute of the forming, expressed in meters, is defined in Chapter 8.

#### 2.63 Job Price for Given Evolute $D_c$

The following graph expresses job price as a function of the length of tunnel section over which the same forms can be used.

PRIX D'ORDRE EN FRANCS PAR M<sup>2</sup>  
DE COFFRAGE (1.1.1970)

Job Price for Forming (in Francs/m<sup>2</sup>)

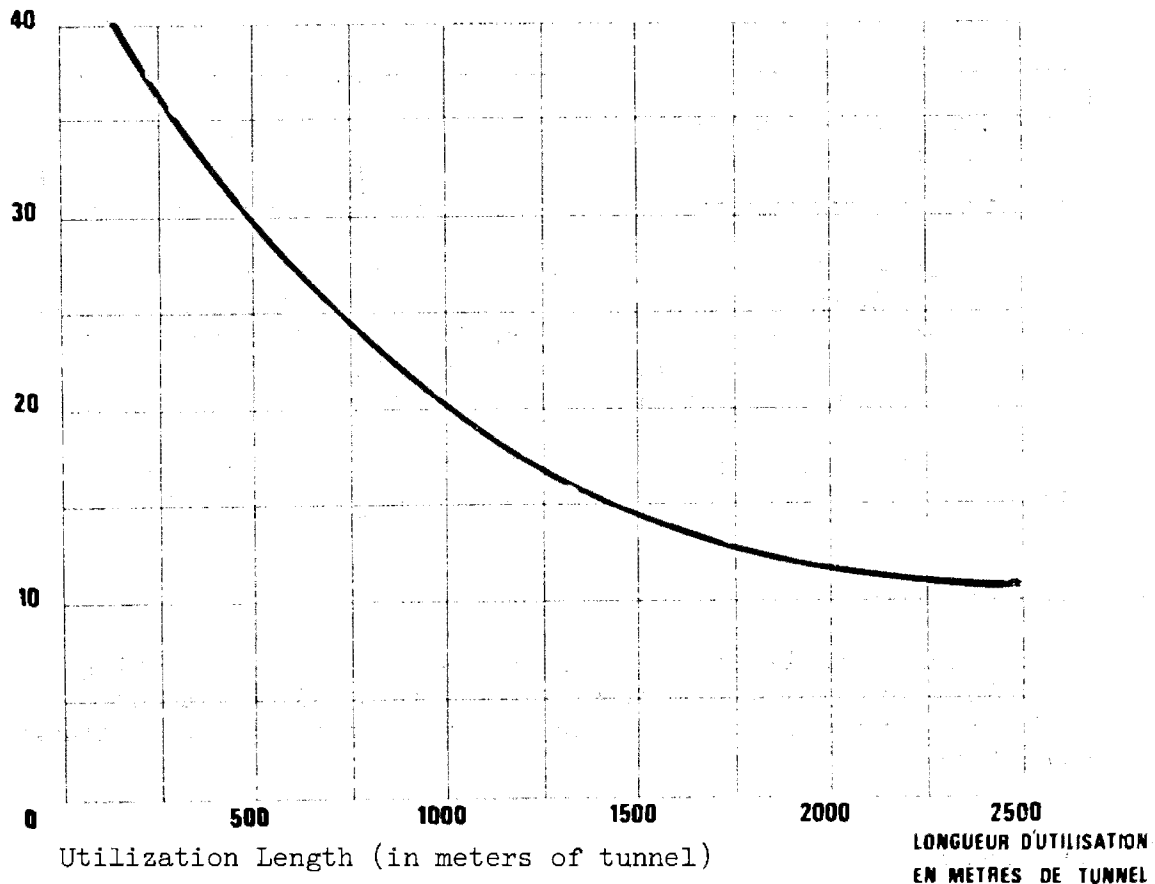

## 2.7 Waterproofing Estimate

2.7.1 The waterproofing estimate for a traffic tunnel requires detailed studies in each case, as costs vary greatly depending on the type of waterproofing in question:

- \* The cost of an umbrella drainage system (for the vault) can vary from 60-90 F/m<sup>2</sup>.
- \* The cost of extrados waterproofing varies from 25-50 F/m<sup>2</sup>, not including the cost of shotcrete (15-50 F/m<sup>2</sup> depending on the thickness).
- \* The cost of waterproofing interposed between linings varies from 25-50 F/m<sup>2</sup>, not including the cost of the interior lining, which must be estimated separately.
- \* The cost of intrados waterproofing can vary from 15 F/m<sup>2</sup> for simple painting to 60-80 F/m<sup>2</sup> for resins or thick reinforced glazes.

- 2.72 As a first approximation, one can expect the following average cost:

Unit Price in Francs per m <sup>2</sup> of surface treated	50
--	----

In cases of serious groundwater problems, or in the case of construction below the water table, this figure should be considerably augmented, especially if one considers the indirect costs related to waterproofing under these conditions: e.g., the required double lining, etc. A detailed study should be made in each case.

An adequately precise cost estimate can only be obtained after choice of type of waterproofing (see Volume II, section 4).

## 2.8 Flooring Estimate

Information is furnished in this section for calculating  $C_{p1}$ , the flooring cost per linear meter of tunnel. This cost is in each case a function of road width and the type of drainage and sidewalks.

### 2.81 Detailed Prices

Roadway dimensions should be derived from a detailed study of each case. Selected sample sections for tunnel roadways are described in Volume II, section 5. In each case, a supplementary economic study is necessary in order to weigh the increased costs of light-colored aggregate against the added investment and operating costs necessitated by a darker road surface. Availability and cost of the lighter aggregate will be an important factor here.

The unit prices given below include furnishing and installation, and take into account the special difficulties encountered in tunnel paving. If large quantities of these materials are used (e.g., paving of an entire section of highway), then the costs will be lower.



<u>Materials</u>	<u>Cost per metric ton</u>	<u>Density</u>	<u>Cost per m<sup>3</sup></u>
Bituminous concrete (B 0/10 or B 0/14)	70 Francs	2.3-2.4	150 Francs
Bituminous concrete (60% light-colored aggregate)	200	2.3-2.4	500
Light-colored topping	45	2.3	105
Slag aggregate	35	2.27	80
Cement aggregate	40	2.20	90
Untreated aggregate /40	15	2.2-2.3	35
Cement concrete	--	2.45	135

2.812 Job Price for Use up until and including the PPS

As the excavation of the roadway is included under the Excavation category, the Pavement category includes only the paving itself.

By way of example, the cost per m<sup>2</sup> of pavement, for which plans are provided in Volume II, section 5, varies between:

45-56 F on sound rock

56-65 F on altered rock

(this includes both the cost of filling any cavities in the roadbed and the cost of a 4% superelevation).

For preliminary studies up to and including the PPS, and barring a more precise study having been carried out during this stage, the following job price is applicable:

Job Price for Pavement in Francs per m <sup>2</sup> of pavement (over entire road width)	60
--	----

## 2.82 Drainage

2.821 The precise dimensioning of the drainage system for the tunnel is dependent upon the extent of the groundwater problem (flow and location) and on the longitudinal profile of the tunnel. These factors can be definitively established only after completion of major construction; however, it is advisable, once preliminary studies have been completed to draw up various contingency plans on the basis of information available from these studies.

### 2.822 Job Prices Valid up until and including the PPS

The Drainage category includes:

- \* Furnishing and installing all elements necessary for drainage of the tunnel floor (channels, drains, manholes, porous concrete, etc.).
- \* Effecting necessary enlargements in cross-section to accommodate these elements.

Job prices do not include drainage system for vault itself (flexible tubing, etc.) that are included under the Construction category.

For preliminary estimates, up until and including the PPS, and in the absence of more precise studies, the following job prices are applicable:

Job Price for Drainage (in Francs per linear meter of tunnel)	
For case of sidewalk 50 cm wide with drainage channel located under roadway	300
For case of sidewalk 75 cm wide with drainage channel located under sidewalk	350

### 2.823 Detailed Prices

By way of example and for lack of more precise information, the following prices are applicable for detailed cost studies:

<u>Drainage Structure</u>	<u>Cost in Francs</u>	<u>Unit</u>
Channel	3 + 0.12D	Linear meter of channel (D = inside diameter of channel in mm.)
Vertical drain embedded in concrete	13	Linear meter of drain
Manhole	400	A piece (furnishing and installing)
Porous concrete	110	m <sup>3</sup>

### 2.83 Cableways and Sidewalks

2.831 The cableway-sidewalk assembly is usually composed of a prefabricated sidewalk curbing and a concrete cableway covered with small removable flagstones. Various solutions are possible, so it is recommended that a detailed study be devoted to each case.

### 2.832 Unit Prices Valid up until and including the PPS

For preliminary estimates up until and including the PPS, and in the absence of more precise studies, the following prices are applicable:

Cost of Cableway-Sidewalks in Francs per linear meter	
Construction Category	Unit Price
Sidewalk curbing	40
Cableway (for a sidewalk 75 cm wide)	75
Cableway (for a sidewalk 50 cm wide)	50

## 2.9 Miscellaneous Increases in Price

The job prices furnished above depend solely upon a limited number of parameters (quality of terrain, tunnel cross-section, thickness of tunnel lining).

It is necessary to increase certain of these prices in order to take into account the length or grade of the tunnel or special groundwater intrusion problems.

### 2.91 Tunnel Length

In short tunnels, construction costs are relatively independent of tunnel length; however, in long tunnels, protracted transport distances and increased ventilation requirements augment excavation and concrete-work expenses.

The following increases are applicable to the prices  $C_d$ ,  $C'_d$ ,  $C_r$ ,  $C_{rs}$ ,  $C_{ri}$ , and  $C_p$ :

#### PRICE INCREASES DUE TO LENGTH

To Be Applied to Job Prices for  
Excavation, Lining, and Underlining

% increase

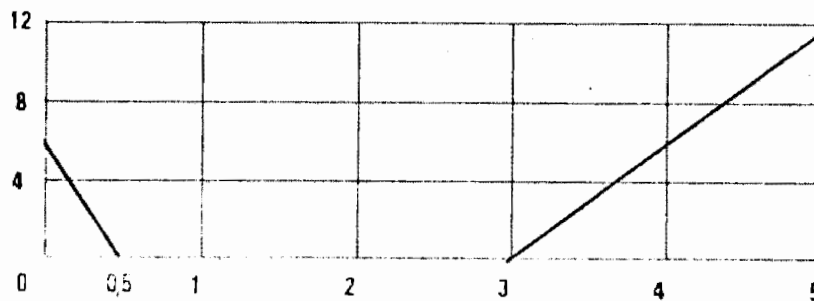

distance from portal  
to heading in kilometers

### 2.92 Tunnel Grade

#### 2.921 Ascending Heading

Steep grades slow down transport operations in the tunnel. Increases are applicable to the prices  $C_d$ ,  $D'_d$ ,  $C_r$ ,  $C_{rs}$ ,  $C_{ri}$ , and  $C_p$  (see figure below).

## 2.921 Descending Heading

A fixed increase of 4% is applicable to the prices  $C_d$ ,  $C'_d$ , and  $C_p$  in order to take into account dewatering operations and the required deepening of drainage channels.

This increase is to be added to the preceded increase for ascending headings.

## PRICE INCREASES DUE TO GRADE

To Be Applied to Job Price for  
Excavation, Lining, and Underlining

% increase

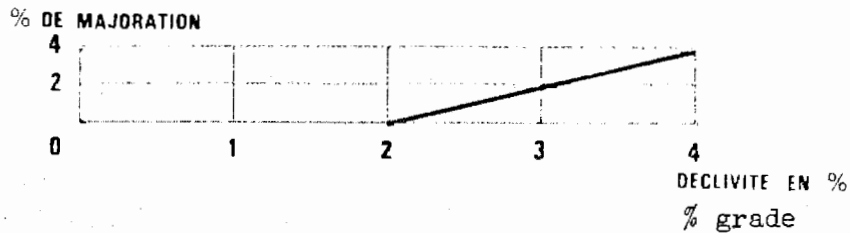

## 2.93 Serious Groundwater Intrusion

Estimates of groundwater flow should be made over sections of tunnel 100 meters in length.

The following price increases are applicable to the job price for excavation.

Price Increases for Groundwater Intrusion To Be Applied to Average Excavation Costs $C_d$ and $C'_d$	
Estimated groundwater flow over a 100 meter length	% increase
Less than 20 liters/sec	0
20-50 liters/sec	5
50-100 liters/sec	10
100-200 liters/sec	15

These increases are comprehensive, including costs for preliminary dewatering.

They should be added to the increases envisaged in 2.91 and 2.92, when these last are equally applicable.

#### 2.94 Construction in Urban Sites

In general, construction in urban sites is more expensive than in rural sites. Consequently, it is necessary to:

- \* Carefully estimate the cost of excavation that often necessitates expensive methods (side-drift headings, forepoling, etc.).
- \* Evaluate separately the often high costs of transporting excavated material from the work site.
- \* Study the price increases due to possible limitations on blasting.

As a result of the diverse situations that may be encountered, it is not possible to furnish the price increase coefficients for construction in urban sites, but it is imperative to be well aware of these difficulties.

#### 2.10 Precision of Estimates

The financial importance of the Construction category requires that it be evaluated with the greatest possible precision.

##### 2.101 PD and PPS

For these two stages, the resultant precision depends heavily on the quality of the antecedent exploratory studies.

The agency responsible for geological and geotechnical studies should be closely involved with cost estimation, for it alone can effectively evaluate the potential impact of unresolved uncertainties. Consequently, it can be invaluable in establishing the amount of contingency monies to be included in the estimates. It should be remembered that these contingency funds are included only in order to limit risks of subsequent cost over-runs, particularly in zones of very poor terrain that remain poorly evaluated or perhaps wrongly evaluated, or in zones where terrain quality is not known.

Taking these conditions into consideration, the prices furnished above are applicable for the PD. They are equally applicable for the PPS, subject to qualifications in 2.332 for poor terrain, 2.333 for very poor terrain, and to specific studies dealing with waterproofing.

2.102 DPPS and CSDC

During the final stage of the DPPS and when contract specifications are being drawn up, a very complete and detailed estimate should be made.

The concern is less with the precision of the estimate than with an accurate estimate of possible error.

This consideration does not enter into the scope of the present document, but pertains to the drawing up of the CSDC and the schedule of prices.

---

Chapter 3. VENTILATION3.1 Definition of the Ventilation Category

As indicated in Volume III, section 3, ventilation includes the following cost items:

- \* Heavy Construction:
  - Ventilation Stations
  - Ventilation Shafts
  - Connecting Adits (between station, tunnel, and surface)
- \* Secondary Construction:
  - Ventilation Ceilings
  - Ventilation Partitions
  - Connecting Ducts and Air Vents
- \* Electromechanical Installation:
  - Equipment (ventilators, motors, and equipment closets)
  - Outfitting of Ventilation System (ducts, transition sections, catwalks, outfitting of elbows, shutter assemblies for intake bays, control apparatus for stations).
  - Soundproofing of Ventilation Stations.
  - Power Supply (transformers, cables).
  - Ancillary construction (cableways, sealing, lighting and heating of stations, office equipment).



### 3.2 Prices for Heavy Construction

The number and location of the ventilation stations should be based on ventilation studies, as well as on the dimensions of envisioned stations.

#### 3.211 Surface Stations

Each case introduces its own particular problems. The dimensions can vary according to the number of ventilators, the available space, the environment (urban or rural), the characteristics of the soil and sub-soil, etc. As for the costs, they will depend on the site, the terrain costs, etc.

A separate study should be made for each case.

By way of example, the cost of a surface station having three ventilators varies, on the average, between 1.5 and 2.0 million Francs.

#### 3.212 Subterranean Stations

In general (though not always), there exists sufficient latitude for implanting subterranean stations in terrain favorable to excavations of large cross-section.

For cross-sections of less than  $180 \text{ m}^2$ , the price data furnished in Chapter 2 (Construction) are applicable.

For sections which exceed this  $180 \text{ m}^2$  figure, a study should be made in each case, based on the envisaged construction procedure.

#### 3.22 Ventilation Shafts

Cost figures for estimating ventilation shafts are practically non-existent. Consequently, in order to estimate the cost of shafts (whether vertical or oblique) it is necessary to undertake specific studies, engaging the assistance, if necessary, of the appropriate specialists (e.g., from Electricité de France -- [the national utility]).

A simplified method of estimating the cost of vertical shafts involves treating as if they were horizontal galleries for estimating purposes, then adding:

\* For excavation, a surcharge of  $0.20 h^2/2$  Francs per  $m^3$  excavated for cases where excavation is from below, and a surcharge of  $0.50 h^2/2$  Francs per  $m^3$  for cases where excavation is from above.

\* For the lining, a surcharge of  $20+50h$  Francs per  $m^3$  of concrete. (h = the total height in meters of the shaft.)

For estimation purposes, structures implanted at the top of shafts fall under the category of open-air structures.

### 3.23 Connecting Adits

This refers both to air ducts and to passageways for tunnel personnel.

In the case of a subterranean adit, the costs figures provided in Chapter 2 are applicable. In the case of an above-ground adit, it is necessary to refer to fixed base prices for open-air structures.

### 3.24 Longitudinal Ventilation

Heavy construction for longitudinal ventilation includes:

- \* Anchorage of ventilators: 1,000 F per ventilator
- \* The electric power substation: 0.10-0.20 million Francs

## 3.3 Prices for Secondary Construction

### 3.31 Ventilation Ceilings

The design of ceilings depend on their span and the loading to which they will be subjected (see Volume III, section 1).

For preliminary studies up until and including the PPS, the following cost is applicable:

Average Ceiling Cost	
in Francs per $m^2$ of installed ceiling	150

### 3.32 Ventilation Partitions

These are not generally considered as supporting structures. But if the partition is to be loaded, a specific study should be undertaken.

For preliminary studies up until and including the PPS, the following cost is applicable:

Average Partition Cost	
in Francs per m <sup>2</sup> of installed partition	80

### 3.33 Connecting Ducts and Air Vents

In order to determine their number and location, it is necessary to refer to Volume III, section 1. As a first approximation, each of these should allow for the distribution or collection of one m<sup>3</sup> per second.

For preliminary studies, up until and including the PPS, the following unit costs are applicable:

Unit Costs of Connecting Ducts and Air Vents	
in Francs (furnishing and installation; all costs included)	

### 3.4 Job Prices for Electromechanical Installation

#### 3.41 Items to Be Considered

- C<sub>1</sub>: Equipment (ventilators, motors, equipment closets)
- C<sub>2</sub>: Outfitting of ventilation system (ducts, transition sections, catwalks, outfitting of elbows, shutters for exhaust bays, control apparatus in stations).
- C<sub>3</sub>: Soundproofing of ventilation stations.
- C<sub>4</sub>: Power supply (transformers, cables).
- C<sub>5</sub>: Ancillary construction (cableways, sealing of ducts, lighting and heating of ventilation stations, office equipment).

## 3.42 Longitudinal Ventilation Using Accelerators

## 3.421 Parameters to Be Determined

m: number of groups of accelerators

L: length of tunnel or tunnels (in Meters)

P: total power installed (in kw)

z: force on ventilator mounting (in newtons)

## 3.422 Cost Evaluation Formulae for Electromechanical Installation

The following formulae are applicable:

Cost of Electromechanical Installation (in Francs)		
	One-way traffic	Two-way traffic
$C_1$	$70z$	$100z$
$C_2$	0	
$C_3$	0	
$C_4$	$350P+75mP$ (if $m < 7$ ) $350P+75mP+150L$ (if $m > 7$ )	
$C_5$	15,000-20,000 per Control Room	

## 3.43 Semi-Pseudo-Transversal Ventilation

## 3.431 Parameters to Be Determined

L: length of Tunnel (in meters)

P: total power installed for ventilation (in kW)

Q: total ventilation flow of fresh and polluted air (in  $m^3/s$ )

N: total number of ventilation stations

n: total number of ventilators at each station

## 3.432 Cost Evaluation Formulae for Electromechanical Installation

The following formulae are applicable:

Cost of Electromechanical Installation -- in Francs	
$C_1$	$\frac{6.5PQ+40,000n}{n} \quad (\text{if } PQ/n^2 < 10,000)$ $\frac{4.5PQ+60,000n}{n} \quad (\text{if } PQ/n^2 > 10,000)$
$C_2$	400-800Q depending on the relative amounts of steel and concrete used.
$C_3$	200-300Q in rural sites 400-600Q in urban sites
$C_4$	$200P+150L$ (see fn 1)
$C_5$	15,000-20,000 per control room + 10,000n

<sup>1</sup>For an emergency power source of k% of P, 500kP should be added to this formula.

## Chapter 4. LIGHTING

### 4.1 Definition of the LIGHTING category

As indicated in Volume III, section 2, lighting includes the following equipment:

Lighting apparatus in tunnel (in interior and reinforced entrance zones), including light sources (flourescent or sodium).

Electric power distribution system, connecting with public utility's high-voltage system (and including transformers, etc.).

Sunscreens.

### 4.2 Sample Application

#### 4.21 Calculation Procedure

Application of the job prices furnished below in 4.3 pre-supposes a knowledge of:

- \* Road surface  $S$  to be lighted (in  $m^2$ ). For calculation purposes the width of the roadway is increased by 2 meters in order to take into account lighting required for sidewalks, curbing, and walls.
- \* Chosen intensity of lighting  $E$  (in lux) for each zone.

The evaluation procedure consists of calculating the product  $ES$  for each of the lighting zones in the tunnel, taking into consideration the fact that the lighting apparatus used in the tunnel's interior section should be extended through the zone of reinforced lighting to the tunnel portals in order to assure continuity of tunnel lighting when the reinforcing lighting at the tunnel extremities is not in service.

The required illumination levels have been specified in Volume III, section 2.

4.22 Sample Application

In the following diagrams, the tunnel is presumed to have a total length of 1 km and a road width of 10 m.

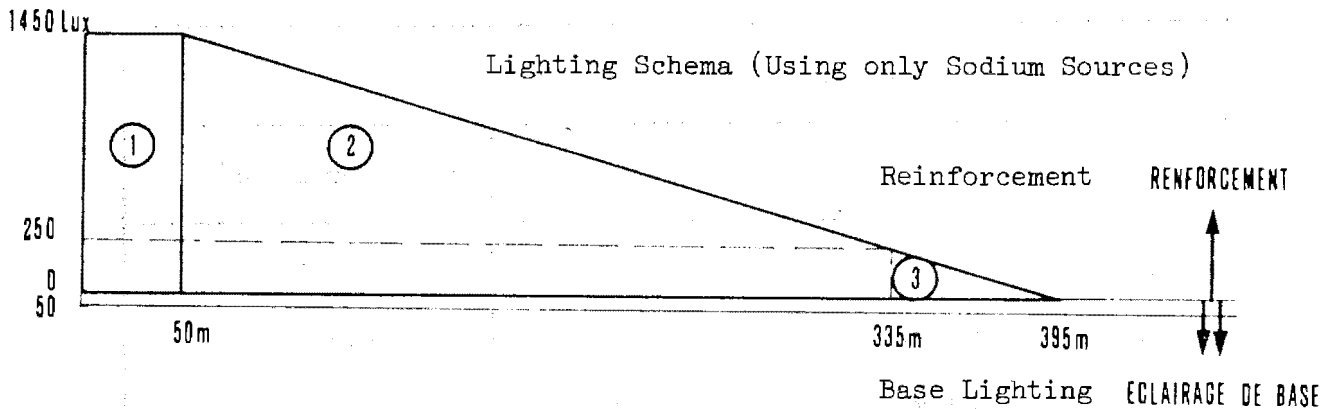
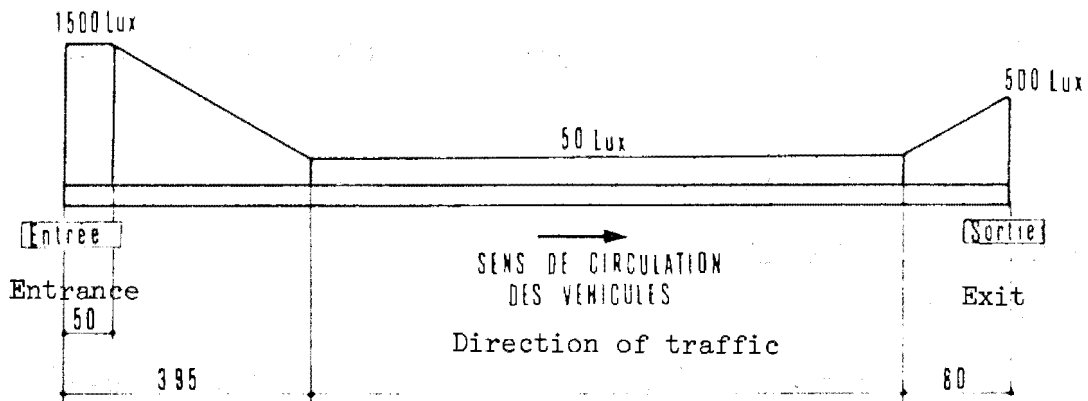

The calculation procedure is as follows:

\* Base lighting (flourescent tubes)

$$1000 \text{ m.} \times (10+2) \text{ m.} \times 50 \text{ lux} = 600,000 \text{ lux-m}^2$$

\* Entrance-zone reinforcement

① Sodium 180 W:

$$50 \text{ m.} \times (10+2) \text{ m.} \times 1,450 \text{ lux} = 870,000 \text{ lux-m}^2$$

② Sodium 180 W:

$$285 \text{ m.} \times (10+2) \text{ m.} \times \frac{(250+1200)}{2} \text{ lux} \times 0.8^1 = 2,320,000 \text{ lux-m}^2$$

③ Sodium 90 W:

$$60 \text{ m.} \times (10+2) \text{ m.} \times \frac{(250)}{2} \times 0.8^1 = 72,000 \text{ lux-m}^2$$

\* Exit-zone reinforcement

Sodium 90 W:

$$80 \text{ m.} \times (10+2) \text{ m.} \times \frac{(450)}{2} \text{ lux} = 216,000 \text{ lux-m}^2$$

4.3 Job Price for Lighting; Cost of Sunscreens

4.31 Job Price for Lighting Installation

The following job prices are applicable up until and including the PPS (beyond this point, special studies are necessary):

Job Price for Lighting in Francs	
Type of Source	Cost per lux-m <sup>2</sup>
Flourescent tube	1.0 F
Low-pressure sodium 90 W	0.3
Low-pressure sodium 180 W	0.2

<sup>1</sup>Because the model reinforcement calculation is overly conservative a 20% reduction should be applied to the estimates obtained for reinforcements in the zone of decreasing illumination (i.e., ② & ③).



In certain cases (very low entrance speeds, short tunnels, etc.), the lighting estimate may not enter within the scope of the present volume. In such cases it will be necessary to consult the appropriate agency.

#### 4.32 Cost of Sunscreens

The costs of lighting installation determined on the basis of the aforementioned prices should be considered as a conservative maximum; the use of sunscreens will, in certain cases, permit a reduction of the required lighting intensities at the tunnel entrances.

Sunscreens, in the form of self-supporting panels of an aluminum alloy laminate, will cost somewhere in the range of 150-180 F per m<sup>2</sup>. Because it is necessary to prevent the direct incidence of sunlight onto the roadway, the width of the sunscreen above the roadway should extend a minimum of 2.5 m. on either side of the roadway, except where side walls will shield the roadway from lateral rays.

In the case of a two-lane tunnel, the supporting structure for the screens will cost nearly the same as the sunscreens themselves.

Up until and including the PPS, and in the absence of a more precise study, the following unit cost is applicable:

Average Cost of Sunscreens in Francs per m <sup>2</sup> of horizontal surface	350
--	-----

## Chapter 5. INSTALLATIONS NECESSARY FOR EXPLOITATION

### 5.1 Definition of the Installations Necessary for Exploitation Category

As indicated in Volume III, section 3, this category includes all of the apparatus necessary for tunnel exploitation, namely:

- \* Pull-offs, recesses, and emergency exits in tunnel.
- \* Headquarters for tunnel authority, including buildings, equipment, afferent road system, and the following items: control, intervention and maintenance, and power.
- \* Control and security equipment in tunnel: traffic control equipment (sensors, closed-circuit television, signalization, alarms, etc.) and control and monitoring equipment.

### 5.2 Average Price of Entire Installation

The category in question varies greatly depending on the type and importance of the tunnel served. Consequently, it is necessary to employ the greatest possible discretion in estimating its cost.

For preliminary studies (i.e., the PD), the following curves, which pertain to three quite different cases, are applicable.

For the PPS, a much more detailed analysis must be undertaken; this analysis should focus both on the definition of the entire installation as well as on the various unit prices specified in 5.3.

COST OF INSTALLATIONS  
NECESSARY FOR EXPLOITATION

COUT DE L'INSTALLATION  
NECESSAIRE A L'EXPLOITATION

Results to Be Applied  
Only during Development  
of the Proposal Document

Résultats à n'appliquer qu'au stade  
du dossier d'inscription

Coût en Millions de Francs  
Cost in millions of Francs

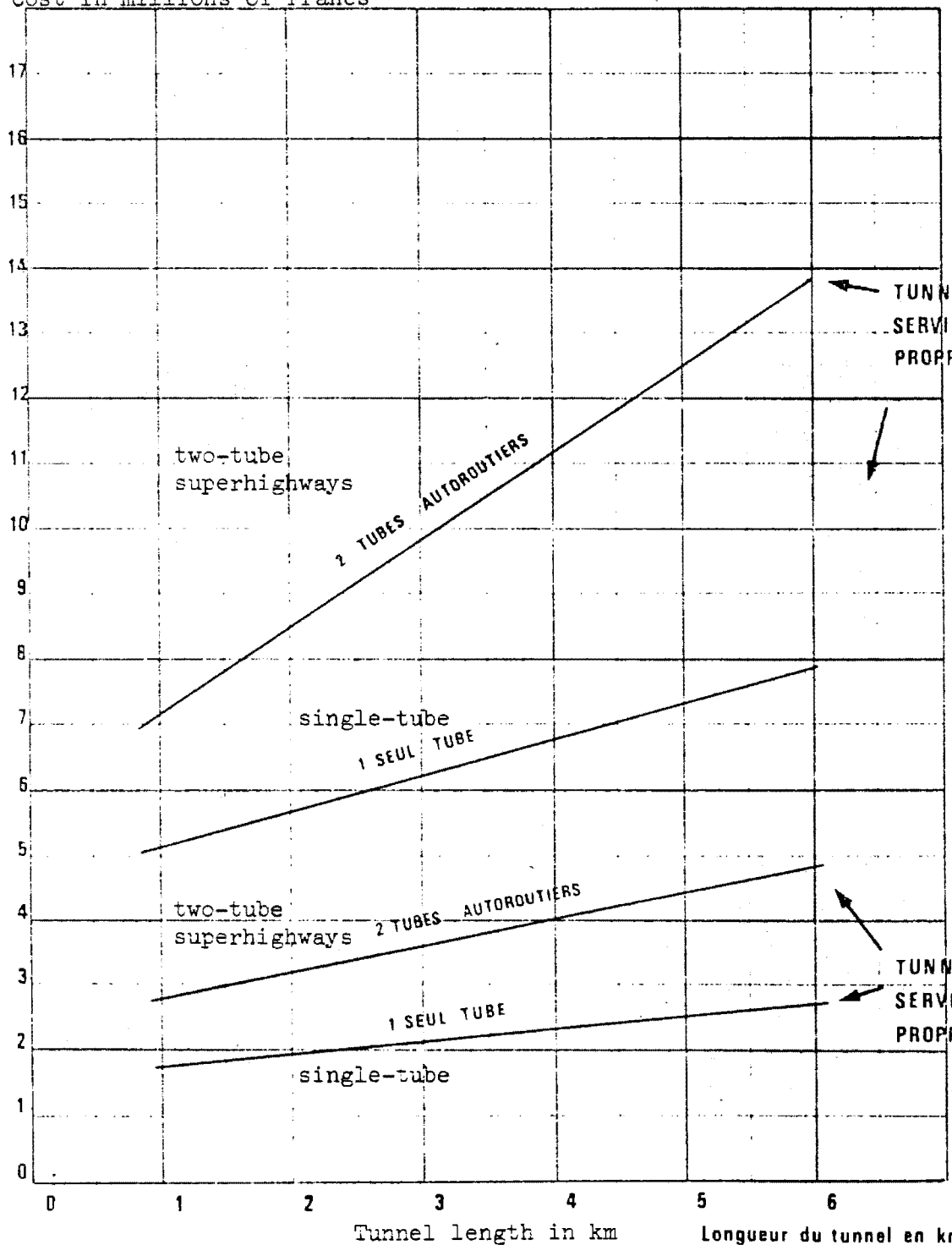

Tunnels having their own tunnel exploitation service

TUNNELS NON DOTES D'UN SERVICE D'EXPLOITATION PROPRE.

Tunnels not having their own tunnel exploitation service

### 5.3 Detailed Prices

For the PPS, the data furnished below will require verification and perhaps even modification. In effect this list should be considered as a detailed memory aid for the envisaged installations.

#### 5.31 Structures

Administration buildings .....	1,500-2,000 F/m <sup>2</sup> per story (will vary greatly depending on site)
Vehicle garages .....	500 F/m <sup>2</sup> (will vary greatly depending on site)
Access roadways .....	0.3-1.0 million F/km (will vary greatly depending on site)
Recesses in tunnel wall.....	Negligible
Emergency pull-offs .....	Identical in price per linear meter with tunnel excavation (except in difficult or poor terrain)
Turning galleries; emergency exits .....	Will vary from 0 to the full price for excavation, depending on their usefulness during construction
Fire control system .....	Will vary greatly depending on site.

#### 5.32 Traffic Signalization and Control (including cables)

Fully equipped signal portico .....	50,000 F for 2 lanes
Vertical clearance monitor .....	25,000 F for 2 lanes
Tri-color traffic signal .....	5,000 F each
Luminous sign .....	1,500 F each
Speed-detection radar .....	10,000 F each/ traffic lane
Closed-circuit television camera (with ancillary equipment) .....	} 35,000 F/camera
Television monitors .....	
Cyclic programmer and switching apparatus	

## 5.33 Alarm and Security Systems

Telephone callbox in tunnel .....	} 7,000 F apiece
Fire extinguisher .....	
Alarm box (pushbutton type) .....	

## 5.34 Measurement Apparatus (including wiring, but not recording devices)

Carbon dioxide analyser .....	25,000 F each
Opacity meter .....	25,000 F each
Anemometer .....	7,000 F each
Photoelectric cell .....	2,000 F each
Meteorological measuring devices .....	Variable
Hourly traffic counter .....	20,000 F each/lane

## 5.35 Command Post

Telephone switchboard .....	Variable
Teletype equipment .....	0.5-1.5 million F
Synoptic Display Board .....	} 4,000,000 F (approx)
Fully equipped Console .....	
Computer and related ADP system .....	0.5-1.5 million F
Office furniture and equipment .....	Variable

## 5.36 Exploitation Vehicles

Light passenger vehicles .....	8,000 F each
Heavy maintenance truck .....	80,000 F each
Heavy tow truck .....	300,000 F each
Fire truck (pumper) .....	100,000 F each
Tunnel washing Vehicle .....	200,000 F each
Emergency Rescue Vehicle.....	40,000 F each
Light Maintenance Vehicles.....	20,000 F each
Motorcycles .....	8,000 F each

## 5.37 Possible Installation of Toll Plaza Including Related Offices .....

Variable

#### 5.4 Miscellany

A certain number of additional items may sometimes be necessary, and should in each case lead to a specific study.

In particular, the following can be cited:

- \* Placement of prefabricated panels on tunnel walls, whether for the purposes of waterproofing, soundproofing, or perhaps both.

These panels can cost from 50 to 250 Francs per m<sup>2</sup>, depending on their nature and function.

- \* Placement of pavement heating equipment on approaches.
  - \* Installations related to toll collection.
  - \* Pumping and other dewatering installations, in cases where tunnel is below water table.
-

## Chapter 6. ANNUAL OPERATING EXPENSES

### 6.1 Simplified Graphs

For preliminary studies, possibly up until and including the PPS, and if no detailed study of this subject has been made, the following graphs are applicable.

These graphs furnish the overall maximum anticipated expenses, indicating only their order of magnitude.

For more detailed studies, the data supplied below in 6.2 can be used as a starting point.

(See next page for graph of annual operating expenses.)

### 6.2 Detailed List of Operating Expenses

For detailed studies, an exact study should be made, taking into consideration the following information, which may be rectified and added to, if necessary:

#### 6.21 Detailed List

##### 6.211 Personnel

Director of Tunnel Exploitation Service

Watch Officer for Command Post

Inspector (ventilation, lighting, etc.)

Mechanic for electromechanical maintenance

Mechanic for routine maintenance

Traffic police

Firemen

Toll collectors

Administrative personnel involved in toll collection

Electronic maintenance (by contract)

} 25,000 F/yr average

## ANNUAL OPERATING EXPENSES IN MILLIONS OF FRANCS

This graph furnishes overall maximum anticipated expenses.

M.F. 1970 Millions of Francs (1970)

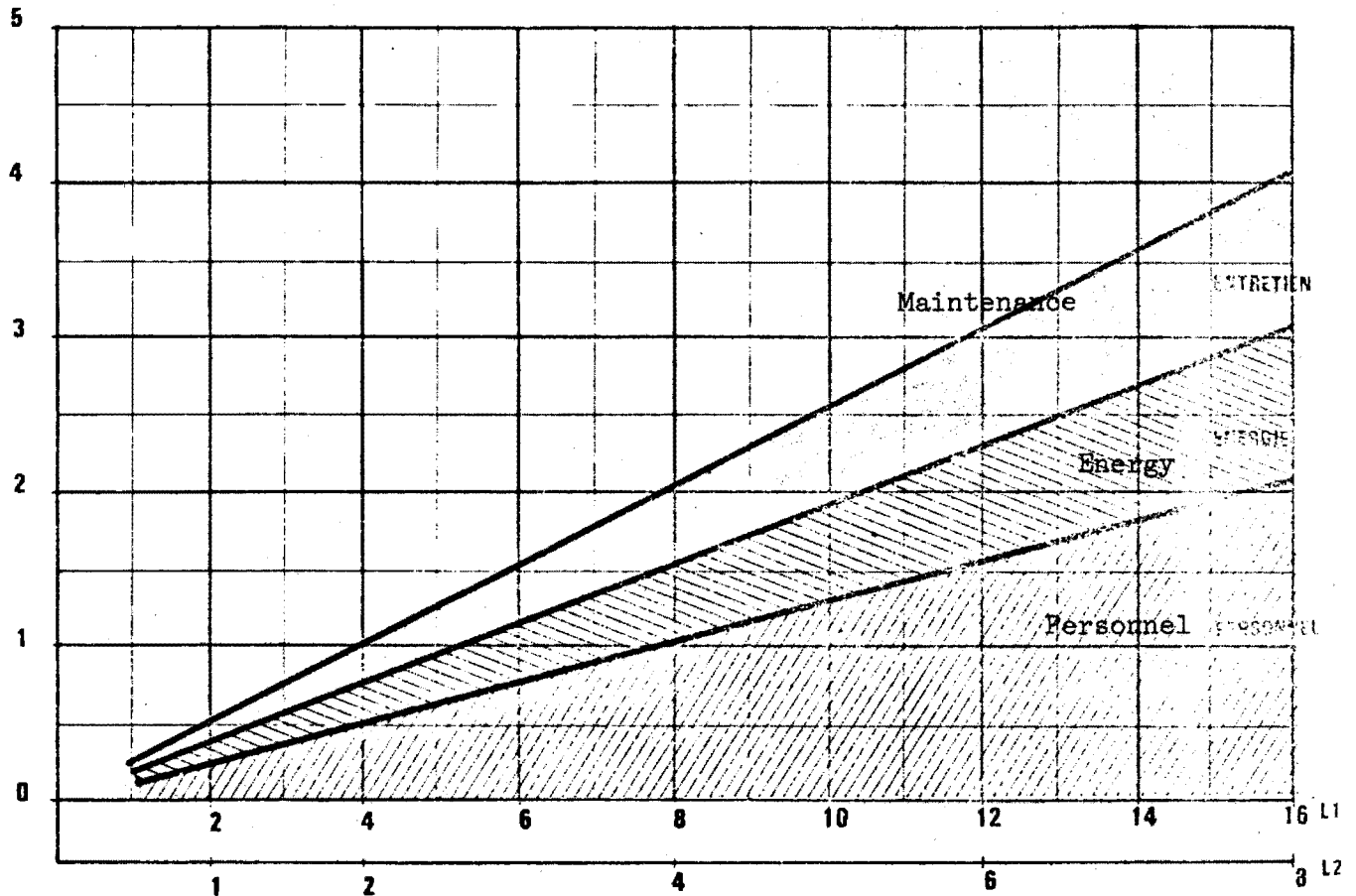

## Notes:

- These curves pertain to a two-lane tunnel of  $L_1$  and  $L_2$ :
  - \*  $L_1$ : Length (in km) of a two-lane tunnel in open country, carrying heavy traffic.
  - \*  $L_2$ : Length (in km) of a two-lane tunnel in urban area, carrying heavy traffic.
- These expenses do not include those stemming from the presence of a toll plaza.
- For small, lightly trafficked tunnels without ventilation, a study should be made for the particular case in question as the total operating expenses are generally low.



## 6.212 Energy

Ventilation .....	}	cf. 6.22 below
Lighting of interior zone .....		
Lighting of reinforced zone .....		
Miscellany .....		Variable
Dewatering (pumping) .....		Variable
Heating of pavement .....		Variable

## 6.213 Maintenance

\* Structural

Cleaning of roadway and gutters .....	}	20,000-30,000 F per km of two-lane tunnel
Cleaning of ventilation system .....		
Washing of tunnel walls .....		
Service buildings .....		
Ventilation ducts .....		
Gantries .....		

\* Maintenance of electromechanical installations  
(in percentage of initial investment costs)

## Ventilation:

Control closets .....	}	1% maximum
Motors .....		
Ventilators .....		

## Electric power supply:

High-voltage equipment .....	}	1% maximum
Cables .....		
Low-voltage equipment .....		
Inverters .....		

\* Maintenance of telecommunications and security installation  
(in percentage of initial investment costs)

Measurement apparatus .....	}	1% maximum
Teletype .....		
Signalization and alarm systems .....		
Firecontrol system (by contract) .....		negotiable
Television .....		10%

- \* Maintenance of lighting apparatus ..... 10,000 F/km
- \* Maintenance of miscellaneous equipment ..... Variable
- \* Office maintenance ..... Variable
- \* Maintenance of toll collection installations .. Variable

#### 6.214 Equipment Amortization and Replacement

- \* Ventilation

Equipment .....	}	100% amortization over a 20-year period
Motors .....		
Ventilators .....		

- \* Lighting Apparatus ..... 20-40 F/1,000 lux-m<sup>2</sup>  
per year (cf. 6.22)

- \* Electrical

High-voltage equipment .....	}	100% amortization over a 15-year period
Cables .....		
Low-voltage equipment .....		

- \* Telecommunications & Security

Measurement apparatus .....	}	100% amortization over a 10-year period
Teletype .....		
Signalization and alarm system .....		

- \* Television

Coaxial cables .....	}	100% amortization over a 10-year period
Electronic equipment .....		
Cameras .....		

- \* Service vehicles

Light passenger vehicles .....	}	100% amortization over a 5-year period
Motorcycles .....		
Emergency vehicles .....		

Heavy maintenance vehicles .....	}	100% amortization over a 10-year period
Heavy tow trucks .....		
Fire truck .....		
Cleaning vehicle .....		
Light maintenance vehicle .....		

\* Miscellaneous Material ..... Variable

6.215 Miscellany

\* Vehicle towing ..... 20,000-30,000 F/km  
of tunnel

\* Liability insurance ..... Variable

\* Operation of Tunnel Administration ..... Variable

\* Office operations ..... Variable

6.22 Comments

6.221 For the calculation of annual ventilation energy expenses, the following information can be considered in the absence of more detailed studies:

\* The number of hours of operation, calculated on the basis of maximum power, amounts to:

500-1000 hours	for a tunnel in open country
1000-1500 hours	for a short urban tunnel
1500-2000 hours	for a major urban tunnel

\* The cost per kWh is dependent on the contract negotiated with the public utility, Electricité de France; however, it can vary from 0.086-0.138 Francs.

6.222 For the calculation of annual energy, replacement and lighting maintenance expenses, the following values are applicable:

Annual Operating Expenses for Lighting, in Francs			
Designation	Type of Light Source		
	Flourescent	Sodium 90 W	Sodium 180 W
Annual replacement of light sources (Cost per 1000 lux-m <sup>2</sup> )	40	30	20
Cleaning <sup>1</sup> of glass fixtures (per tunnel kilometer)	10,000	10,000	10,000
Annual energy expenses (Cost per 1000 lux-m <sup>2</sup> )	40	7	5

---

<sup>1</sup>Depending on the circumstances, the number of cleanings per year can range from 1-12; the frequency of these operations will vary with the importance and location of the tunnel.

## Chapter 7. SAMPLE APPLICATIONS: VARIATIONS IN TUNNEL COSTS

### 7.1 Object and Limitations of this Chapter

#### 7.1.1 Object

The present chapter contains some useful general information regarding variations in tunnel construction costs. These variations are dependent on geological conditions, length, width, grade, and vertical clearance of the tunnel.

The information should enable those who use this volume:

- \* To better comprehend the relative importance of the financial items analysed in the preceding chapters.
- \* To undertake or initiate such broad preliminary studies as, for example, the choice of elimination of certain layouts involving more or fewer tunnels, the evaluation of consequences arising from a decision about the longitudinal section or road width, etc.
- \* To recognize that the different items and parameters are rarely independent and that any effort to reach an optimal technical solution or layout will in each case necessitate a global cost estimate for the tunnel(s).

#### 7.1.2 Limitations

The information contained in the present chapter has been obtained through the rigorous application of job prices, unit prices, and estimation methods mentioned in Chapters 2, 3, 4, and 5 above.

Consequently, this information is intended to be merely illustrative, and represents sample applications of the preceding data, and should under no circumstances be used for PPS estimates.

For this reason, and in order to reinforce its strictly illustrative nature, the proofs furnished in support of the hypotheses have been reduced to bare essentials.

## 7.2 Definition of the 5 Tunnel Categories Chosen as Examples

### 7.21 Selected Hypotheses

7.211 For purposes of simplification, 5 tunnel categories have been chosen and hypotheses have been made as to the geological conditions which they are assumed to encounter.

Although these 5 categories have been established following a detailed analysis of recent construction in France, it is imperative to reiterate that we are here dealing with hypotheses and that barring some very unusual coincidence no future construction will match them perfectly.

7.212 The 5 tunnel categories have been designated A, B, C, D, and E. The related geological and geometrical conditions assumed for each category are shown in the following table:

Hypotheses for the 5 Tunnel Categories Chosen as Examples							
Category			A	B	C	D	E
Geology	Terrain Quality (% of each along tunnel length)	very good	20	0	20	0	50
		good	30	30	30	30	30
		difficult	40	40	40	40	20
		poor	10	30	10	30	0
Geometry	Length (m)		3000	1500	3000	750	500
	Grade (%)		0	0	0	0	0
	Width (m)		10	10	10	9	9
	Vertical clearance (m)		4.55	4.55	4.55	4.55	4.55

## 7.22 Commentary

Merely by way of indication and in order to be more concrete, the different categories chosen can be considered as examples corresponding to the following cases:

- A: One-way tunnel on a superhighway.
- B: One-way tunnel on an urban expressway.
- C: Very long two-way tunnel on rural highway or on international highway linking two countries.
- D: Two-way tunnel on urban route.
- E: Short, two-way tunnel in mountains or on rural highway.

## 7.23 Costs per Linear Meter

The cost per linear meter of these 5 tunnel categories, as is indicated in the following table, have been derived according to the following process:

### Construction

- \* Choice of model cross-section, as per Volume I, and the determination of the pertinent geometric quantities for each section and each terrain quality zone (see Chapter 8 below).
- \* Application of job prices set forth in Chapter 2 above.
- \* Average cost per linear meter of tunnels will depend on the percentage of different terrain qualities encountered.

### Ventilation

- \* Definition of ventilation system, choice of air flow and number of ventilation stations (Volume III, section 1) based on certain hypotheses about traffic.
- \* Application of costs defined in Chapter 3 above.

### Lighting

- \* Definition of installations, with aid of Volume III, section 2.
- \* Application of costs defined in Chapter 4 above.

### Installations Necessary for Exploitation

- \* Definition of installations, with aid of Volume III, section 3, based as well on certain hypotheses about the site, traffic, and speed.
- \* Application of costs defined in Chapter 5 above.

Approximate Total Cost per Linear Meter, in Francs					
Tunnel Category	A	B	C	D	E
Construction	12,300	15,800	12,300	14,800	8,400
Ventilation	4,200	5,000	3,800	4,800	0
Lighting	1,000	1,800	1,500	2,300	1,800
Installations Necessary for Exploitation	1,700	3,000	700	2,200	0
Total cost	19,200	25,600	18,300	24,100	10,200

Although the 5 envisaged tunnel categories are not geometrically comparable (the lengths, cross-sections, and vertical clearances are different), the estimate for the Construction category does permit an evaluation of the influence of geological variations (.e.g., compare A and B, or D and E).

### 7.3 Influence of Tunnel Geometry on Cost

In order to elucidate the economic consequences of variations in grade, width, and length, analyses of the following kind have been performed for each of the 5 tunnel categories:

- \* The geological hypotheses defined in 7.21 remain unchanged.
- \* Of the 4 geometric hypotheses defined in 7.21, 3 are permitted to remain constant while the fourth is varied. This analysis is performed for each hypothesis except vertical clearance.

Although purposefully simplified, the graphs provided below, along with the related commentary, indicate the dependency of total tunnel cost per linear meter on the tunnel's geometric dimensions. The great simplification is purposeful. (Total tunnel cost is taken as the sum of the following categories: Construction, Ventilation, Lighting, and Installations Necessary for Exploitation.)



7.31 Variation of Total Tunnel Cost (per linear meter) as a Function of Grade

The following hypothesis is set forth: that for categories A and B a separate lane for slow vehicles becomes necessary when the slope exceeds 2.5%, which consequently requires an increase in road width, and hence in tunnel section.

The effect of grade is manifested:

- \* For the Construction category, in the cost increases specified in 2.8.
- \* For the Ventilation category, in increases in required air flows for a positive grade, and in decreases in required air flows for a negative grade.

Total Tunnel Cost per Linear Meter  
(in thousands of Francs)

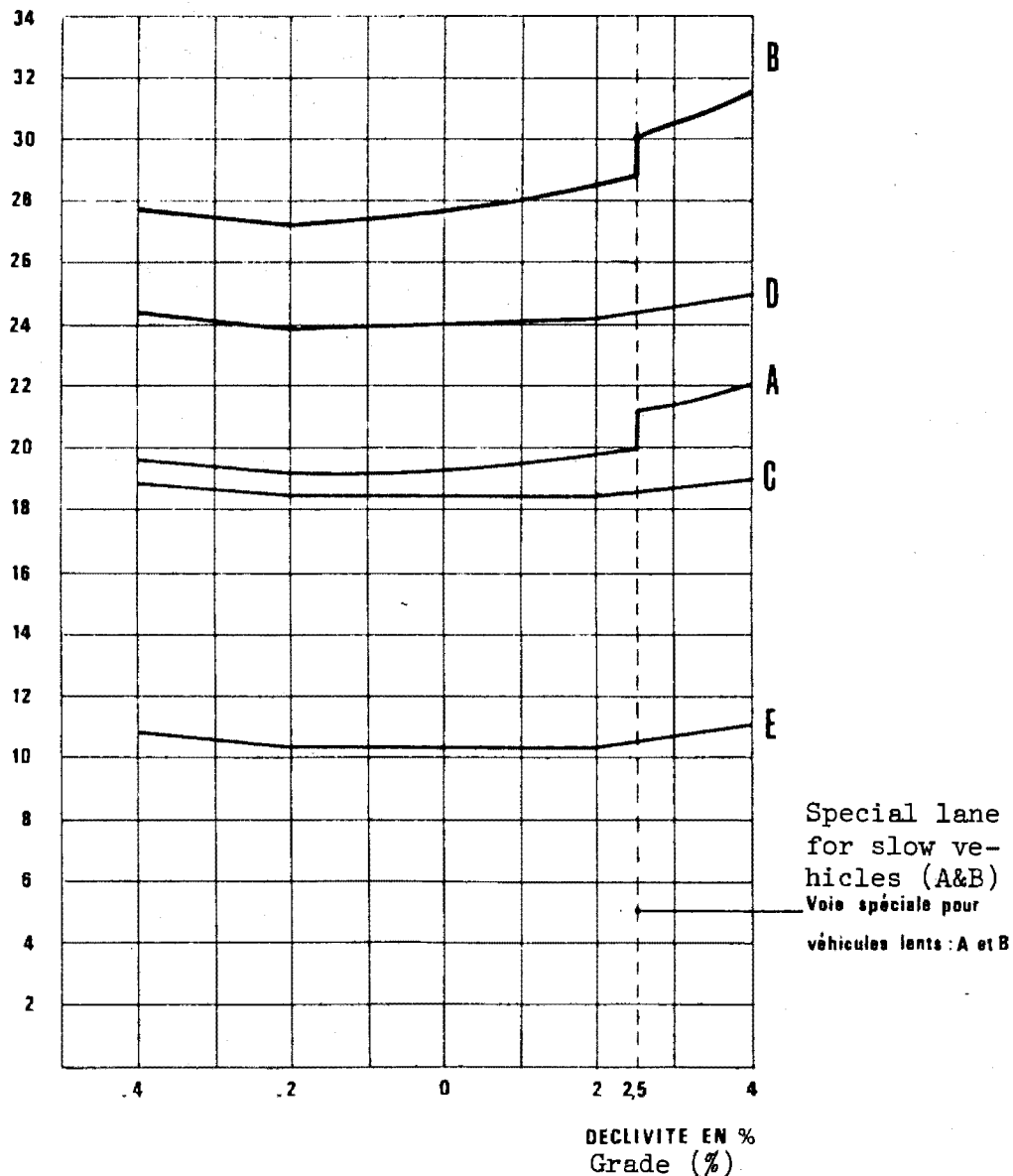

### 7.32 Variation of Total Cost (per linear meter as a Function of Tunnel Width

The increase in width results:

- \* For the Construction category, in an increase in geometric quantities (excavation and lining) and a decrease in job price for excavation.
- \* For the Ventilation category, in an increase in the required cross-sectional area of the ventilation ducts, and therefore a corresponding decrease in the power required to maintain the same flows.

Total Tunnel Cost per Linear Meter (thousands of Francs)

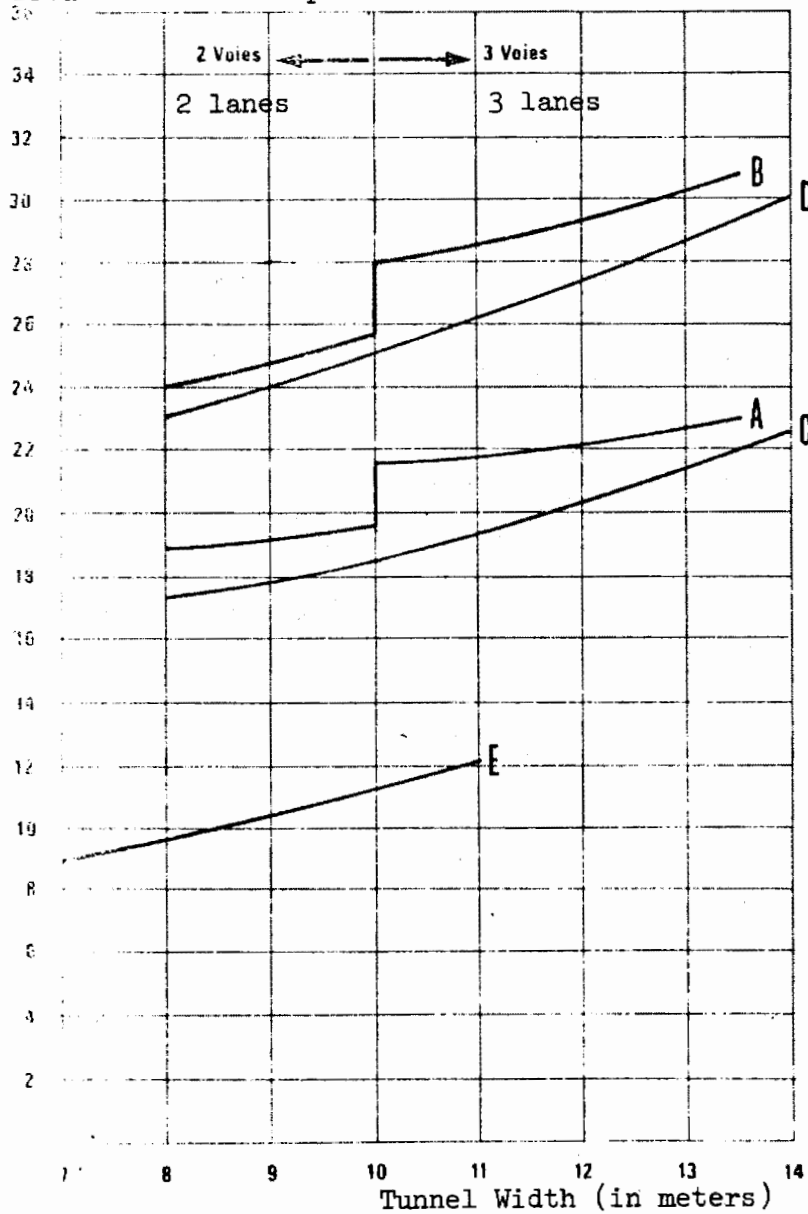

### 7.33 Variation in Total Tunnel Cost as a Function of Length

#### 7.331 An increase in tunnel length effects:







- \* For the Construction category, the increased costs predicted in 2.8, and certain variations in job price for forming. (These consequences are in fact very complex, depending most notably on the length of headings.)
- \* For the Ventilation category, the choice of ventilation system and installed power.
- \* For the Lighting and Installations Necessary for Exploitation categories, an overall increase in anticipated installations.

#### 7.332 The graphs furnished below are in no way applicable to any particular tunnel estimate. Their sole importance lies in elucidating discontinuities and major variations in tunnel cost, due primarily to:

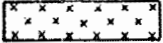
- \* The need to alter the ventilation system or the number of ventilation stations when a certain length is exceeded (or when certain traffic levels are exceeded, etc.).
- \* The varying importance of certain items, depending on length.
- \* Miscellaneous increases.

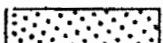
#### 7.333 Beyond these simple observations, the graphs indicate those items that deserve careful study, depending on the tunnel category in question. And finally, they give an idea of the relative importance of different items.

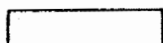
## LEGEND FOR GRAPHS

Construction GENIE CIVIL	Excavation DEROCTAGE -----	
	Lining REVETEMENT -----	
	Floor PLATEFORME -----	
VENTILATION	Major Construction GROS DEUVRE -----	
	SECOND OEUVRE Secondary Construction	
	INSTALLATION ELECTROMECHANIQUE -----	
	Electromechanical Installation	
Lighting ECLAIRAGE -----		
Installations Necessary for Exploitation INSTALLATION NECESSAIRE A L'EXPLOITATION --		

- 
- a: No ventilation, lighting, or exploitation equipment
- b: No ventilation or exploitation equipment
- c: Longitudinal ventilation with or without exploitation equipment
- d: Semi-transverse ventilation with 1 station
- e: Semi-transverse ventilation with 2 stations
- f: Partial transverse ventilation with 2 stations
- g: Partial transverse ventilation with 3 stations
- h: Partial transverse ventilation with 4 stations
- i: Full transverse ventilation with 3 stations
- j: Full transverse ventilation with 4 stations
- k: Full transverse ventilation with 6 stations
-

Total Tunnel Cost per Linear Meter  
(in thousands of Francs)

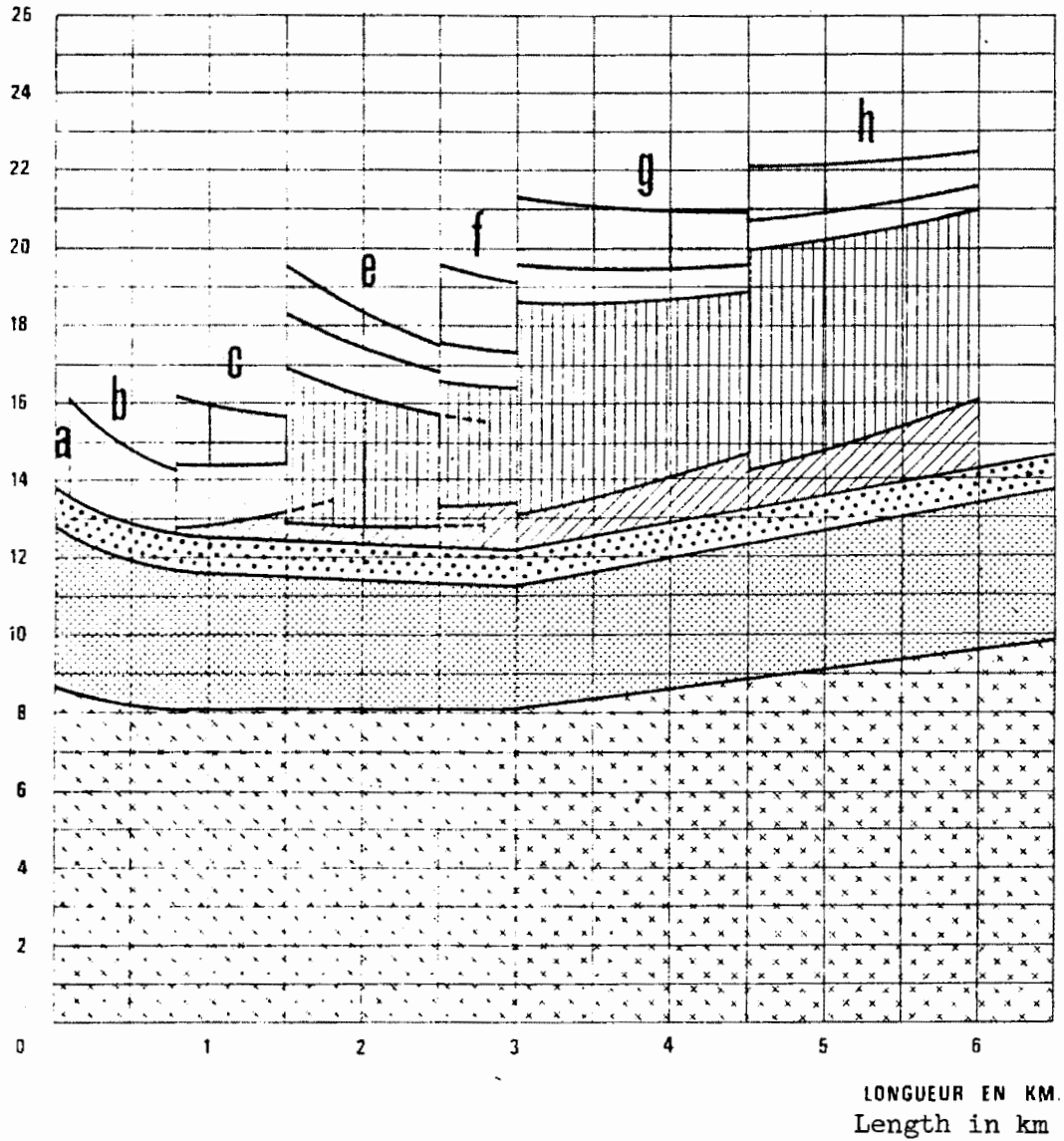

LES COURBES SONT STRICTEMENT INDICATIVES

These curves are strictly illustrative.

INFLUENCE OF LENGTH

CATEGORY A

INFLUENCE DE LA LONGUEUR

CATEGORIE A

Total Tunnel Cost per Linear Meter  
(in thousands of Francs)

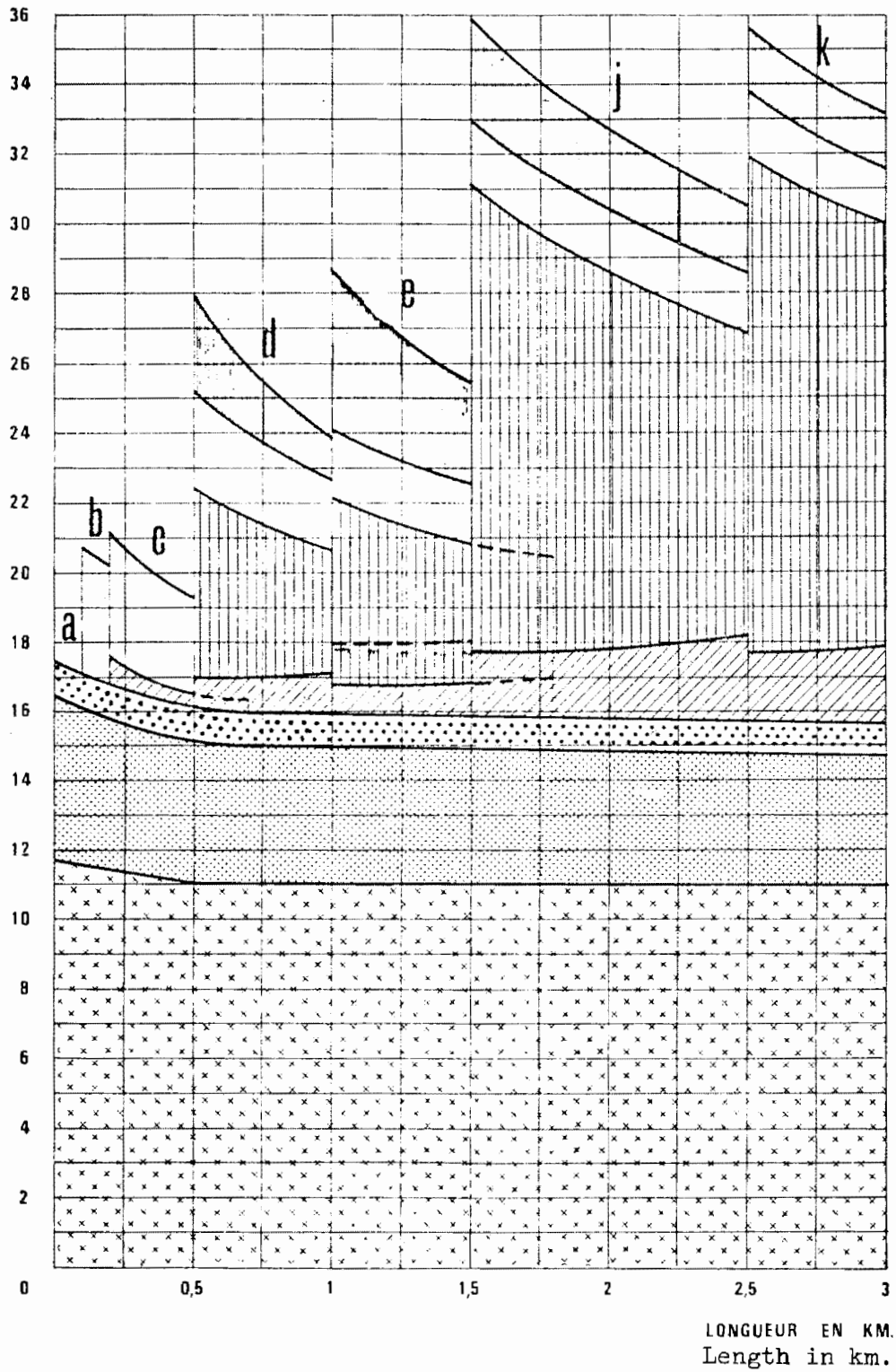

LES COURBES SONT STRICTEMENT INDICATIVES  
These curves are strictly illustrative.

INFLUENCE OF LENGTH  
CATEGORY B

INFLUENCE DE LA LONGUEUR  
CATEGORIE B

Total Tunnel Cost per Linear Meter  
(in thousands of Francs)

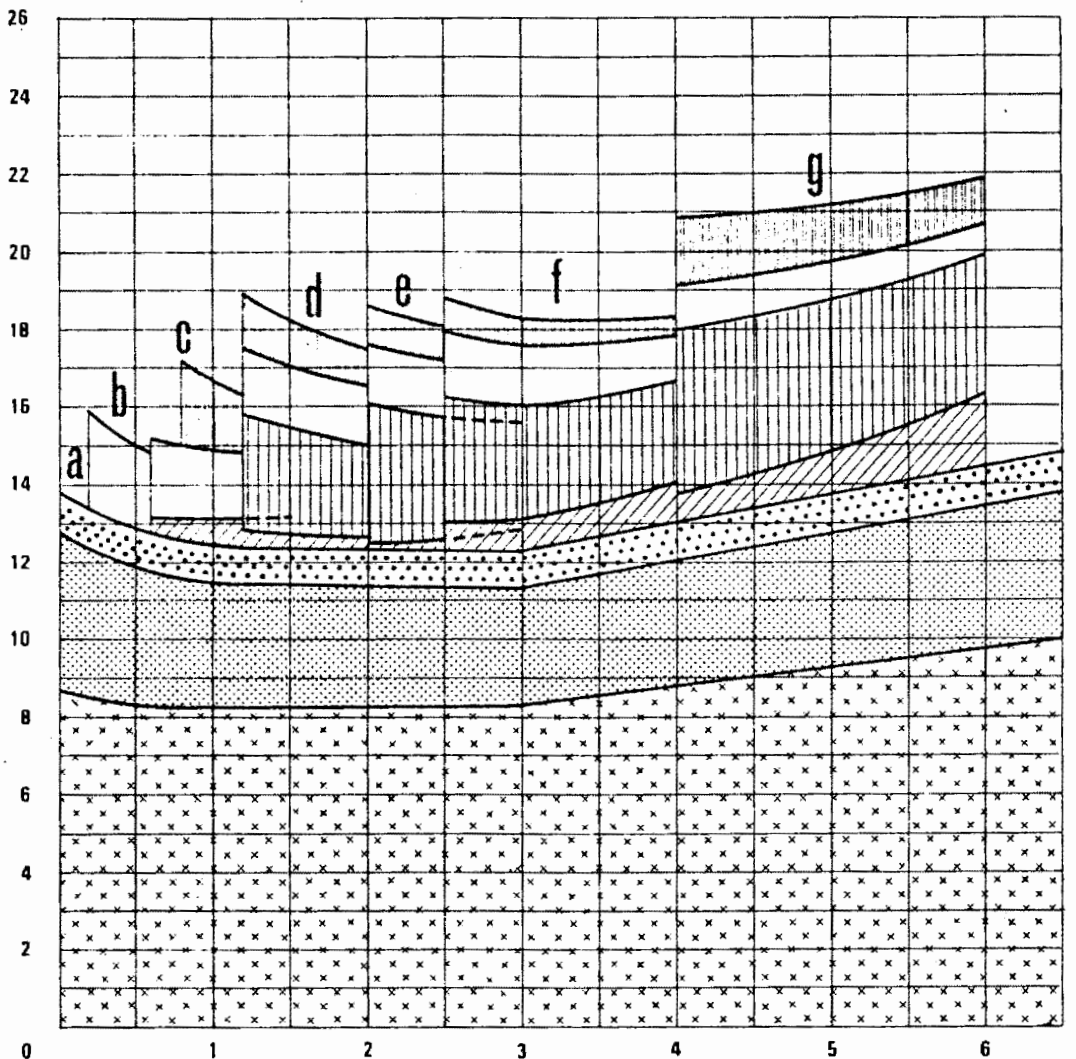

LONGUEUR EN KM.  
Length in km.

LES COURBES SONT STRICTEMENT INDICATIVES

These curves are strictly illustrative.

INFLUENCE OF LENGTH

CATEGORY C

INFLUENCE DE LA LONGUEUR

CATEGORIE C

Total Tunnel Cost per Linear Meter  
(in thousands of Francs)

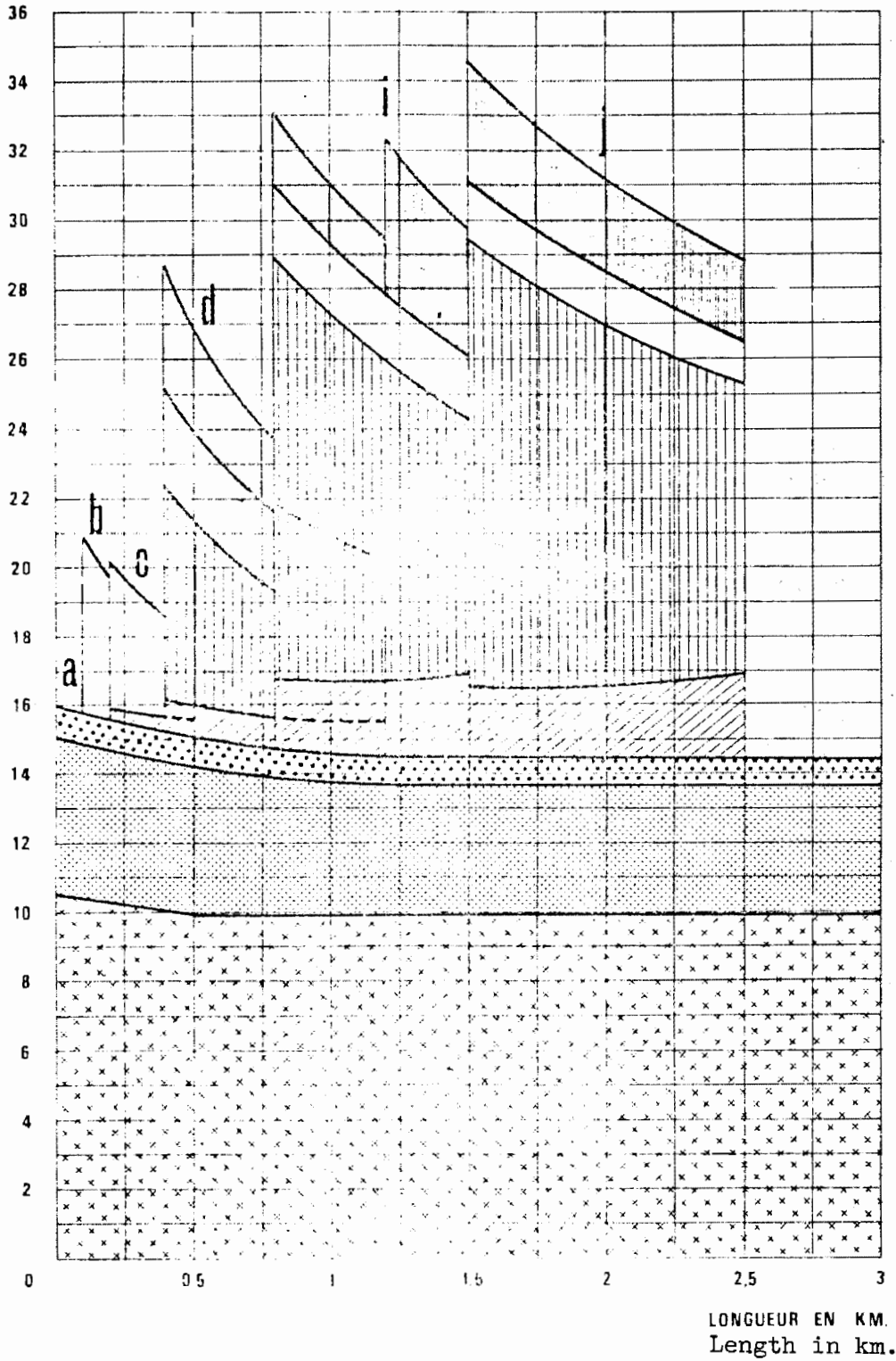

LES COURBES SONT STRICTEMENT INDICATIVES  
These curves are strictly illustrative.

INFLUENCE OF LENGTH  
CATEGORY D

INFLUENCE DE LA LONGUEUR  
CATEGORIE D



Total Tunnel Cost per Linear Meter  
(in thousands of Francs)

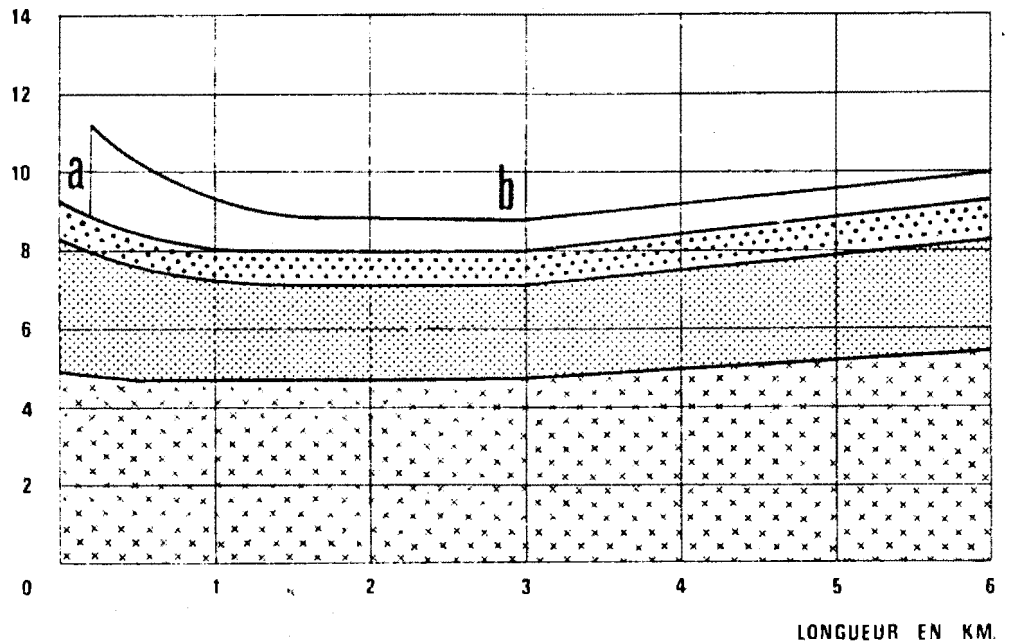

LONGUEUR EN KM.

Length in km.

LES COURBES SONT STRICTEMENT INDICATIVES

These curves are strictly illustrative.

INFLUENCE OF LENGTH

CATEGORY E

INFLUENCE DE LA LONGUEUR

CATEGORIE E

Chapter 8. GEOMETRIC DATA; NUMERICAL VALUES

8.1 Definition of Geometric Data

8.11 Lining (see 8.2 for choice of thickness)

8.111  $S_r$  = Theoretical Lining Section; case of excavation without underlining:

- \*  $S_r$  is the section included between lines A and C (see figure below).
- \*  $S_r$  includes neither overbreak (area beyond line B) nor the fixed section A-B of overbreak which may be included in the cost schedule. It therefore corresponds to the minimal pointwise lining thickness.
- \*  $S_r$  does not pertain to possible concrete inverts, gutters, or other miscellaneous structures.

8.112  $S_{rs}$ ,  $S_{ri}$ , and  $S_p$  in case of excavation with underlining:

In the event of an excavation with underlining, upper and lower half-sections are considered separately, as the average lining cost for each will be different.

- \*  $S_{rs}$  = Theoretical Lining Section for Upper Half-Section: Equal to the section included between the underlining intrados and the permanent lining intrados (line C).
- \*  $S_{ri}$  = Theoretical Lining Section for Lower Half-Section: There is generally no underlining in this half-section.
- \*  $S_p$  = Theoretical Underlining Section: This does not include overbreak areas. It is therefore a minimal section whose intrados varies according to the thickness judged necessary for the stability of the excavation, and whose extrados coincides with line A.

8.12  $S_d$  = Theoretical Excavation Section

This is equal to the following sum, corresponding to the circumference designated by line A:

$$S_d = \text{empty section of tunnel} + \left\{ \begin{array}{l} S_r \\ \text{or} \\ S_{rs} + S_{ri} \end{array} \right\} + S_p + \text{Theoretical Section of Roadway } S_c$$

The theoretical section of pavement  $S_c$  is obtained by multiplying the average roadway thickness by the road width.

8.13  $D_d$  = Evolute of Forming

This is equal to the perimeter of the intrados of the concrete lining, including the vertical portion below level of the pavement surface.

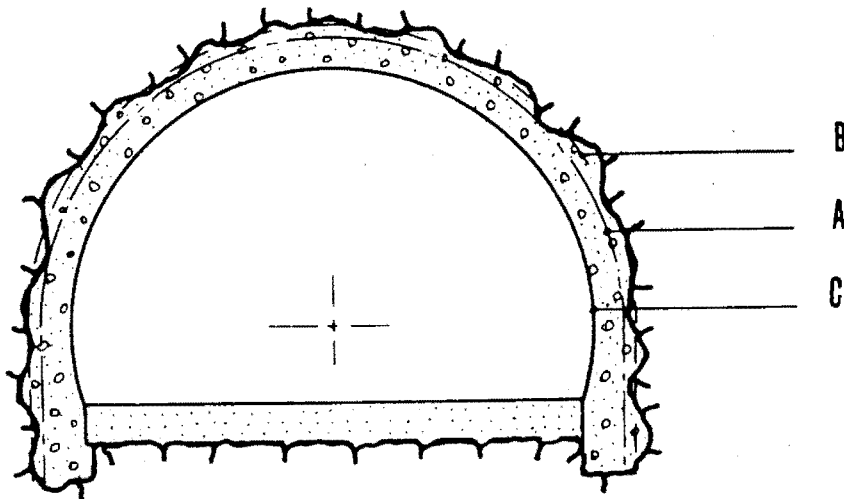

A: Theoretical excavation line

B: Fixed payment line for overbreak

C: Line for intrados of lining

If there is no lining,  $A = C$ ; if there is no payment for overbreak, then  $A = B$ .

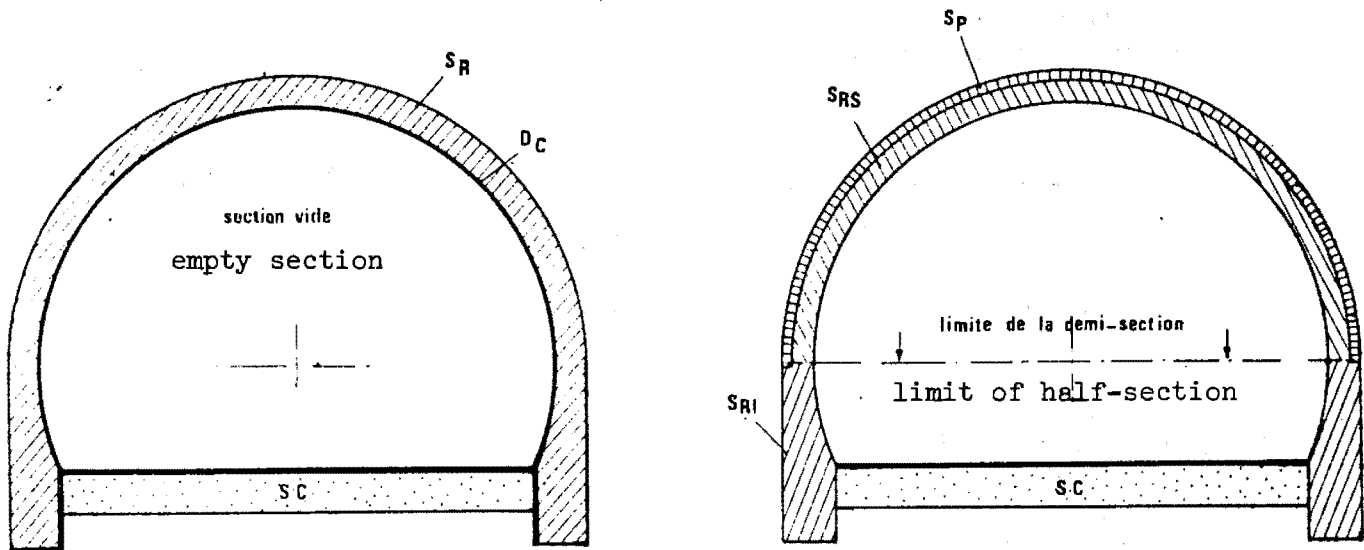

Excavation without underlining

Excavation with underlining

## 8.2 Choice of Lining Thickness

In order to apply job prices for lining, and also in order to define the theoretical excavation section  $S_d$ , it is necessary to establish the required lining thickness.

In lieu of a more exact study, the following values can be adopted as preliminary approximations:

Nature of Terrain	Minimal Thickness of Lining at Apex of Vault (in cm)
Very good	0 (unlined tunnel) 30 (lined tunnel)
Good	40
Difficult	60
Poor	80

These thickness are meant only to be illustrative. If, for example, the zone in question is of short length, then it will be necessary to adopt the thicker lining of adjacent zones.

Elsewhere, lining dimensions may have to be determined on the basis of a stability calculation.

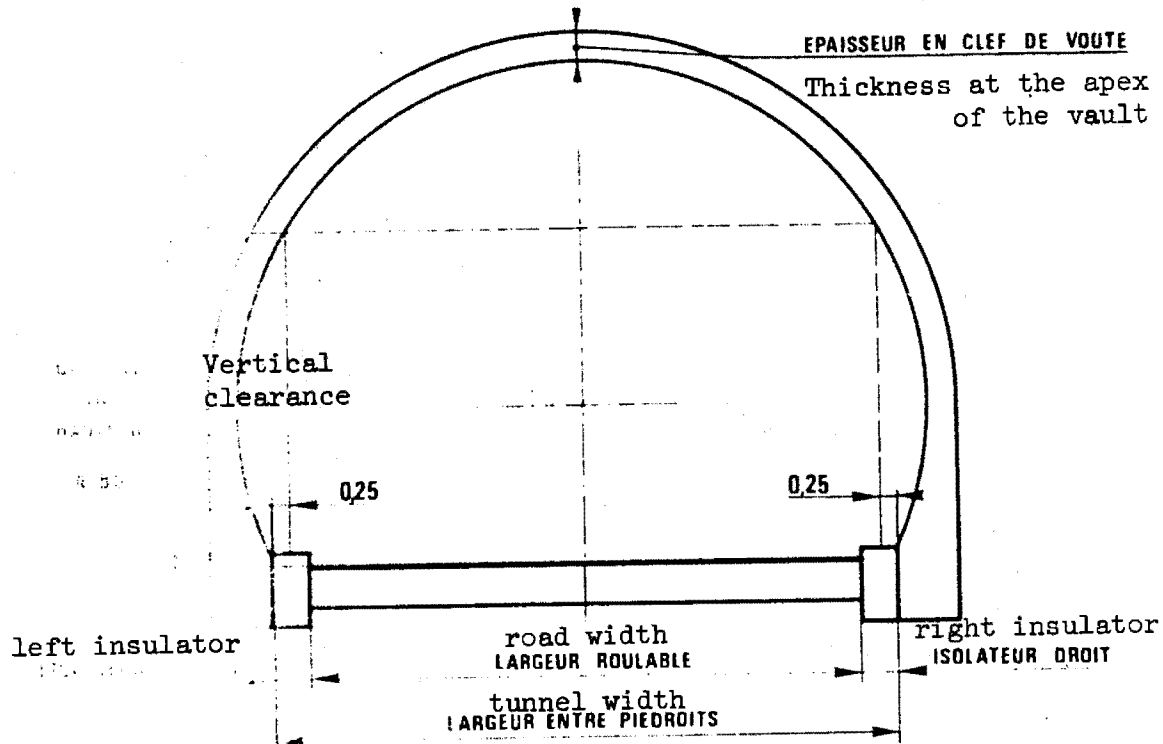

### 8.3 Numerical Values

This paragraph furnishes numerical values for the theoretical excavation and lining sections, as well as for the evolute of forming, as a function of tunnel width.

The values provided are applicable to a typical cross-sectional profile of the sort shown above. Values are given for lining thicknesses at the apex of the vault of 30, 40, 60, and 80 cm.

## NUMERICAL VALUES

Tunnel Width	Theoretical Excavation Section $S_d$				Theoretical Lining Section				Evolute of Forming
	30	40	60	80	30	40	60	80	
8.00	61.59	63.72	68.09	72.58	7.84	9.98	14.34	18.84	20.44
8.50	65.89	68.10	72.59	77.22	7.98	10.18	14.68	19.30	21.06
9.00	70.41	72.68	77.31	82.07	8.07	10.34	14.97	19.73	21.71
9.50	75.11	77.45	82.21	87.11	8.19	10.52	15.29	20.18	22.37
10.00	80.03	82.43	87.34	92.36	8.31	10.71	15.61	20.64	23.04
10.50	85.14	87.62	92.66	97.82	8.44	10.91	15.95	21.12	23.72
11.00	90.44	92.98	98.16	103.46	8.60	11.13	16.31	21.61	24.40
11.50	95.96	98.57	103.89	109.33	8.72	11.33	16.65	22.10	25.10
12.00	101.66	104.34	109.80	115.39	8.87	11.55	17.01	22.60	25.80
12.50	107.55	110.30	115.90	121.63	9.03	11.78	17.38	23.11	26.50
13.00	113.62	116.45	122.19	128.06	9.20	12.02	17.76	23.63	27.20
13.50	119.89	122.79	128.67	134.68	9.38	12.27	18.16	24.17	27.91
14.00	126.34	129.31	135.34	141.50	9.55	12.52	18.55	24.71	28.62