

S.C.R.T.D. LIBRARY

REPORT NO. DOT-TSC-1238

LORAN
AUTOMATIC VEHICLE MONITORING SYSTEM

TELEDYNE SYSTEMS COMPANY
19601 Nordhoff St.
Northridge, Calif. 91324



PHASE I
FINAL REPORT

VOLUME I
TEST RESULTS

MARCH 1977

Availability is unlimited. Document may be released to the Clearinghouse for Federal Scientific and Technical Information, Springfield, Virginia 22151, for sale to the public.

Prepared for
U. S. DEPARTMENT OF TRANSPORTATION
TRANSPORTATION SYSTEMS CENTER
CAMBRIDGE, MASS. 02142

Technical Report Documentation Page

| | | | |
|--|--|---|---|
| 1. Report No. DOT-TSC-1238 | 2. Government Accession No. | 3. Recipient's Catalog No. | |
| 4. Title and Subtitle LORAN Automatic Vehicle Location System | | 5. Report Date March 1977 | 6. Performing Organization Code |
| | | 8. Performing Organization Report No. 50463 | |
| 7. Author(s) R. Stapleton and F. Chambers | | 10. Work Unit No. (TRAIS) PPA UM711 R7716 | 11. Contract or Grant No. DOT-TSC-1238 |
| 9. Performing Organization Name and Address Teledyne Systems Company* 19601 Nordhoff Street Northridge, CA. 91324 | | 13. Type of Report and Period Covered Final Report Oct. 1976-Feb. 1977 | |
| | | 14. Sponsoring Agency Code | |
| 12. Sponsoring Agency Name and Address U.S. Department of Transportation Urban Mass Transit Administration Office of Technology Development Washington, D.C. 20590 | | 15. Supplementary Notes *under contract to: U.S. Department of Transportation Transportation Systems Center Kendall Square Cambridge, Ma. 02142 | |
| 16. Abstract Results of the evaluation phase of a two phase program to develop an Automatic Vehicle Monitoring (AVM) System for the Southern California Rapid Transit District in Los Angeles, California. Tests were conducted in Philadelphia, Pa. on a LORAN based location subsystem to evaluate system and subsystem performance on fixed route and random route vehicles. Performance characteristics measured include location accuracy, time of passage accuracy, and coverage. | | | |
| 17. Key Words Vehicle Location Automatic Vehicle Monitoring LORAN C AVM | | 18. Distribution Statement DOCUMENT IS AVAILABLE TO THE U.S. PUBLIC THROUGH THE NATIONAL TECHNICAL INFORMATION SERVICE, SPRINGFIELD, VIRGINIA 22161 | |
| 19. Security Classif. (of this report) UNCLASSIFIED | 20. Security Classif. (of this page) UNCLASSIFIED | 21. No. of Pages | 22. Price |

REPORT NO. DOT-TSC-1238

LORAN AUTOMATIC VEHICLE MONITORING SYSTEM

TELEDYNE SYSTEMS COMPANY
19601 Nordhoff St.
Northridge, Calif. 91324



PHASE I FINAL REPORT

VOLUME I
TEST RESULTS

MARCH 1977

Availability is unlimited. Document may be released to the Clearinghouse for Federal Scientific and Technical Information, Springfield, Virginia 22151, for sale to the public.

Prepared for
U. S. DEPARTMENT OF TRANSPORTATION
TRANSPORTATION SYSTEMS CENTER
CAMBRIDGE, MASS. 02142

03891

TK
6570
.M6
S72
v.1

TABLE OF CONTENTS

| <u>Section</u> | | <u>Page</u> |
|----------------|--|-------------|
| 1 | EXECUTIVE SUMMARY | 1-1 |
| 1.1 | Program Objectives | 1-2 |
| 1.2 | LORAN-C Principles of Operation | 1-3 |
| 1.3 | LORAN AVM System Description | 1-7 |
| 1.3.1 | LORAN AVM Location Subsystem | 1-9 |
| 1.4 | Test Description | 1-13 |
| 1.5 | Equipment Description | 1-18 |
| 1.6 | Data Reduction and Analysis | 1-23 |
| 1.7 | Data Results Summary | 1-25 |
| 2 | TEST DESCRIPTION | 2-1 |
| 2.1 | General | 2-1 |
| 2.1.1 | System and Subsystem Accuracy Requirements | 2-1 |
| 2.2 | The LORAN Navigation System | 2-1 |
| 2.2.1 | Introduction | 2-1 |
| 2.2.2 | Theory | 2-3 |
| 2.2.3 | Operation | 2-5 |
| 2.2.4 | Signal Format | 2-5 |
| 2.3 | LAVM System Description | 2-7 |
| 2.4 | Area Calibration | 2-9 |
| 2.5 | Fixed Route Test | 2-14 |
| 2.5.1 | Test Procedure | 2-15 |
| 2.6 | Random Route Test | 2-16 |
| 2.6.1 | Test Procedure | 2-16 |
| 2.7 | Special Case Tests | 2-24 |
| 2.7.1 | Augmentor Coverage vs Vehicle Speed, Test #30101-30112 | 2-24 |
| 2.7.2 | Augmentor Coverage vs Elevation, Test #30201-30230 | 2-24 |
| 2.7.3 | Augmentor Interference, Test #30301-30310 | 2-25 |
| 2.7.4 | Augmentor Coverage vs Traffic Conditions, Test #30401-30410 | 2-25 |

TABLE OF CONTENTS (Continued)

| <u>Section</u> | | <u>Page</u> |
|----------------|---|-------------|
| | 2.7.5 Radio Frequency Interference Tests, Test #31001-31013 | 2-25 |
| | 2.7.6 Augmentor Antenna Pattern, Test #32001-32003 | 2-25 |
| | 2.7.7 LORAN Position Lag vs Vehicle Speed, Test #30501-30510 | 2-25 |
| | 2.7.8 Unusual LORAN Coverage, Test #30601 | 2-25 |
| | 2.7.9 LORAN Only Location Test, Test #30701 | 2-25 |
| | 2.7.10 LORAN Repeatability, Test #30702 and 30703 | 2-26 |
| 3 | TEST CONFIGURATION | 3-1 |
| | 3.1 General | 3-1 |
| | 3.2 Mobile Equipment | 3-1 |
| | 3.2.1 LAVM Equipment | 3-2 |
| | 3.2.2 Test Instrumentation Equipment | 3-5 |
| | 3.3 Monitor Station Equipment | 3-13 |
| | 3.4 Mini Station Equipment | 3-13 |
| | 3.5 Augmentor Deployment | 3-18 |
| | 3.5.1 Augmentor Operation | 3-18 |
| | 3.6 Equipment Operational Requirements | 3-25 |
| | 3.7 Human Operational Requirements Checklist | 3-28 |
| 4 | TEST DATA | 4-1 |
| | 4.1 General | 4-1 |
| | 4.2 Data Recording Frequency | 4-1 |
| | 4.3 Data Content | 4-1 |
| | 4.4 Number of Measurements | 4-5 |
| | 4.5 Special Case - General | 4-5 |
| | 4.5.1 Augmentor Coverage and Elevation Tests | 4-5 |
| | 4.5.2 Augmentor Interference Tests | 4-8 |
| | 4.5.3 Augmentor Coverage in Traffic Conditions Test | 4-10 |
| | 4.5.4 Augmentor Radio Interference Tests | 4-10 |

TABLE OF CONTENTS (Continued)

| <u>Section</u> | | <u>Page</u> |
|----------------|--|-------------|
| | 4.5.5 Augmentor Antenna Pattern Tests | 4-14 |
| | 4.5.6 LORAN Position Lag, Vehicle Speed Tests | 4-14 |
| | 4.5.7 LORAN Coverage Along a Steel Bridge. | 4-15 |
| | 4.5.8 LORAN Only Location Test | 4-16 |
| | 4.5.9 LORAN Repeatability Tests | 4-16 |
| 4.6 | Calibration Data | 4-17 |
| | 4.6.1 Data Requirements | 4-17 |
| | 4.6.2 Procedure. | 4-17 |
| 4.7 | Time of Passage Measurement Description | 4-19 |
| | 4.7.1 Phase II Mechanization | 4-19 |
| | 4.7.2 System Errors | 4-20 |
| | 4.7.3 Phase I Test Mechanization | 4-21 |
| 5 | DATA ANALYSIS AND REDUCTION TECHNIQUES. | 5-1 |
| | 5.1 Introduction | 5-1 |
| | 5.2 Calibration Analysis | 5-1 |
| | 5.3 Determination of Position and Time of Passage Errors. | 5-3 |
| | 5.3.1 Data Analysis Requirements | 5-3 |
| | 5.3.2 Sequence of Data Duplication Reduction and Analysis | 5-4 |
| | 5.3.3 Data Reduction | 5-5 |
| | 5.4 Simulation of Missed Data | 5-11 |
| 6 | TEST RESULTS | 6-1 |
| | 6.1 Test Problems - Their Effect on Final Results | 6-1 |
| | 6.1.1 Low Temperature Augmentor Failure | 6-1 |
| | 6.2 Fixed Route Tests | 6-6 |
| | 6.2.1 Tests 10002 through 10012 | 6-6 |
| | 6.2.2 Tests 10012 through 10047 | 6-9 |
| | 6.2.3 Test 10012 through 10047, Less 10016 and 10017. | 6-15 |
| | 6.2.4 Tests 10026 through 10047. | 6-17 |

TABLE OF CONTENTS (Continued)

| <u>Section</u> | | <u>Page</u> |
|----------------|---|-------------|
| 6.2.5 | Time of Passage and Augmentor Detection | 6-32 |
| 6.2.6 | 'Augmentorless' Time of Passage Measurement | 6-33 |
| 6.2.7 | Comparison of Location Subsystem and System Simulation Results | 6-35 |
| 6.3 | Random Route Tests | 6-37 |
| 6.3.1 | Location Subsystem | 6-40 |
| 6.3.2 | System Simulation | 6-40 |
| 6.3.3 | System Simulation With 5% Missing Data | 6-44 |
| 6.3.4 | Coverage | 6-44 |
| 6.4 | Special Case Tests | 6-45 |
| 6.4.1 | LORAN Tests | 6-45 |
| 6.4.2 | Augmentor Tests | 6-62 |
| 6.5 | Fixed Route SNR Analysis | 6-76 |
| 6.6 | Long Term LORAN Stability | 6-84 |
| 6.7 | Summary and Conclusions | 6-86 |
| 6.7.1 | Fixed Route Tests | 6-86 |
| 6.7.2 | Random Route Tests | 6-87 |
| 6.7.3 | Special Case Tests | 6-87 |
| 6.7.4 | Conclusions | 6-87 |
| 7 | DESIGN CHANGES REQUIRED TO MEET PHASE II REQUIREMENTS | 7-1 |
| 7.1 | Introduction | 7-1 |
| 7.2 | Fixed Route Location Subsystem Improvements | 7-2 |
| 7.2.1 | Time of Passage Improvements | 7-2 |
| 7.2.2 | Fixed Route Algorithm Improvements | 7-4 |
| 7.3 | Random Route Location Subsystem Improvements | 7-5 |
| 7.3.1 | Software Algorithm Improvements | 7-5 |
| 7.3.2 | Random Route Differential Odometer | 7-7 |

TABLE OF CONTENTS (Continued)

| <u>Section</u> | | <u>Page</u> |
|----------------|--|-------------|
| 7.4 | Implications of Los Angeles LORAN Signal Quality | 7-8 |
| 7.4.1 | Introduction | 7-8 |
| 7.4.2 | Predicted vs Actual SNR, Field Strength | 7-8 |
| 7.4.3 | Phase II Augmentor Deployment | 7-12 |
| 8 | REQUIRED PERMITS IN LOS ANGELES. | 8-1 |
| 8.1 | Introduction | 8-1 |
| 8.2 | Essential Approvals Obtained for Phase I | 8-1 |
| 8.3 | Permits and Licenses Required in Los Angeles | 8-2 |
| 8.4 | Preliminary Discussions with Cognizant Agencies | 8-4 |
| 9 | TEST ACCOMPLISHMENTS VS PROPOSAL | 9-1 |
| 9.1 | Proposal Accuracy, System & Subsystem | 9-1 |
| 9.2 | Phase I Test Results | 9-1 |
| 9.2.1 | Fixed Route | 9-1 |
| 9.2.2 | Random Route | 9-1 |

LIST OF ILLUSTRATIONS

| <u>Figure</u> | | <u>Page</u> |
|---------------|--|-------------|
| 1-1 | Hyperbolic Fix Geometry | 1-4 |
| 1-2 | Time Difference Location Fix | 1-4 |
| 1-3 | LORAN-C Pulse | 1-6 |
| 1-4 | GRI | 1-6 |
| 1-5 | LORAN AVM System Components | 1-8 |
| 1-6 | Location Subsystem | 1-7 |
| 1-7 | LORAN AVM Receiver | 1-11 |
| 1-8 | Block Diagram of Augmentor | 1-12 |
| 1-9 | Revised Fixed Route Test | 1-14 |
| 1-10 | Random Route Test | 1-15 |
| 1-11 | Test Vehicle | 1-19 |
| 1-12 | Magnetic Tape Recorder and Test Console | 1-19 |
| 1-13A | Typical Augmentor Installation | 1-20 |
| 1-13B | Typical Augmentor Installation | 1-20 |
| 1-13C | Typical Augmentor Installation | 1-20 |
| 1-14 | Fixed Route Augmentor Deployment | 1-21 |
| 1-15 | LORAN-C Mini Station | 1-22 |
| 2-1 | LORAN-C Coverage | 2-2 |
| 2-2 | Hyperbolic Fix Geometry | 2-4 |
| 2-3A | Example of Received LORAN-C Signal | 2-6 |
| 2-3B | LORAN-C Signal Format | 2-6 |
| 2-4 | LAVM System | 2-8 |
| 2-5 | System Interface Diagram | 2-9 |
| 2-6 | LORAN-C Chain for Phase I Tests | 2-10 |
| 2-7 | Philadelphia Test Area and X-Y Grid Overlays | 2-11 |
| 2-8 | Test Area and Calibration Points | 2-13 |
| 2-9 | Fixed Route Test - Original | 2-17 |
| 2-10 | Fixed Route Test - Revised | 2-18 |

LIST OF ILLUSTRATIONS (Continued)

| <u>Figure</u> | | <u>Page</u> |
|---------------|--|-------------|
| 2-11 | Fixed Route Augmentor Deployment - Original | 2-19 |
| 2-12 | Fixed Route Augmentor Deployment - Revised | 2-20 |
| 2-13 | Random Route Test | 2-22 |
| 2-14 | Random Route Augmentor Deployment | 2-23 |
| 2-15 | LORAN Only Test Area | 2-27 |
| 2-16 | Special Case Test Augmentor Coverage vs Traffic Conditions . . . | 2-28 |
| 2-17 | Special Case Bridge Test | 2-29 |
| 3-1 | Block Diagram - LAVM Equipment | 3-3 |
| 3-2 | Micro-Locator LORAN Receiver and Test Console | 3-4 |
| 3-3 | Block Diagram - Augmentor | 3-5 |
| 3-4 | Test Instrumentation Equipment Block Diagram | 3-6 |
| 3-5 | Test Vehicle, Generator & 5th Wheel | 3-7 |
| 3-6 | Magnetic Tape Recorder and Test Console | 3-8 |
| 3-7 | Test Equipment in Rear of Van | 3-8 |
| 3-8 | LAVM Test Console | 3-9 |
| 3-9 | AVM Test Console Block Diagram | 3-10 |
| 3-10 | Monitor Recorder Interface | 3-14 |
| 3-11A | Monitor Station TD Recording | 3-15 |
| 3-11B | Monitor Station | 3-15 |
| 3-12 | LORAN C Mini Station | 3-17 |
| 3-13 | Transmitter Tower Diagram | 3-19 |
| 3-14 | Tow Installation | 3-20 |
| 3-15 | Fixed Route Augmentors | 3-21 |
| 3-16 | Random Route Augmentors | 3-22 |
| 3-17A | Typical Augmentor Installation | 3-23 |
| 3-17B | Typical Augmentor Installation | 3-23 |
| 3-17C | Typical Augmentor Installation | 3-23 |
| 3-18 | Unmodified Transmitter | 3-24 |

LIST OF ILLUSTRATIONS (Continued)

| <u>Figure</u> | | <u>Page</u> |
|---------------|---|-------------|
| 3-19 | Modified Transmitter Block Diagram | 3-25 |
| 4-1 | Test Data Format | 4-2 |
| 4-2 | Test Vehicle and Mobile Supporting Structure (Augmentor Shown Atop Ladder) | 4-6 |
| 4-3 | Runway Path (Shown to Left of Vehicle) and Mobile Supporting Structure | 4-7 |
| 4-4 | Augmentor Interference Test | 4-9 |
| 4-5A | Special Case Test Augmentor Coverage vs Traffic Conditions | 4-11 |
| 4-5B | Test Augmentor for Traffic Special Case Test (Augmentor Shown at 28 Feet Elevation) | 4-12 |
| 4-6 | Test Augmentor for Traffic Special Case Test (Elevation of Test Augmentor was adjusted for each special case run) | 4-13 |
| 4-7 | Calibration Area | 4-18 |
| 5-1 | Data Handling Flow | 5-5 |
| 6-1A | Odometer/Generator Power Problem Typical Normal Operation | 6-5 |
| 6-1B | Odometer/Generator Power Problem Odometer Fail Condition | 6-5 |
| 6-2A | Location Subsystem Histogram (Fixed Route Tests #10001-10012) December 1976 | 6-7 |
| 6-2B | Location Subsystem Cumulative Error (Fixed Route Tests #10001-10012) December 1976 | 6-7 |
| 6-3A | Location Accuracy Histogram System Simulation (Fixed Route Tests #10001-10012) December 1976 | 6-10 |
| 6-3B | Cumulative Location Error System Simulation (Fixed Route Tests #10001-10012) December 1976 | 6-10 |
| 6-4A | Location Subsystem Histogram (Fixed Route Tests (All) #10012-10047) | 6-11 |
| 6-4B | Location Subsystem Cumulative Error (Fixed Route Tests (All) #10012-10047) | 6-11 |

LIST OF ILLUSTRATIONS (Continued)

| <u>Figure</u> | | <u>Page</u> |
|---------------|--|-------------|
| 6-5A | Location Accuracy Histogram (System Simulation) (Fixed Route Tests #10012-10047) | 6-13 |
| 6-5B | Cumulative Location Error (System Simulation) (Fixed Route Tests #10012-10047) | 6-13 |
| 6-6A | Time of Passage Error Histogram (Test 10012-10047) | 6-14 |
| 6-6B | Time of Passage Cumulative Error (Test 10012-10047) | 6-14 |
| 6-7A | Location Accuracy Histogram (System Simulation With 5% Missing Data) (Fixed Route Tests #10012-10047) | 6-16 |
| 6-7B | Cumulative Location Error (System Simulation With 5% Missing Data) (Fixed Route Tests #10012-10047) | 6-16 |
| 6-8A | Location Subsystem Histogram (Fixed Route Tests (All) Less #10016 and 10017) | 6-18 |
| 6-8B | Location Subsystem Cumulative Error (Fixed Route Tests (All) Less #10016 and 10017) | 6-18 |
| 6-9A | Location Accuracy Histogram (System Simulation) (Fixed Route Tests (All) Less #10016 and 10017) | 6-19 |
| 6-9B | Cumulative Location Error (System Simulation) (Fixed Route Tests (All) Less #10016 and 10017) | 6-19 |
| 6-10A | Time of Passage Error Histogram (Fixed Route Tests (All) Except #10016 and 10017) | 6-20 |
| 6-10B | Time of Passage Cumulative Error (Fixed Route Tests (All) Except #10016 and 10017) | 6-20 |
| 6-11A | Location Accuracy Histogram (System Simulation With 5% Missing Data) (Fixed Route Tests (All) Except #10016 and 10017) | 6-21 |
| 6-11B | Cumulative Location Error (System Simulation With 5% Missing Data) (Fixed Route Tests (All) Except #10016 and 10017) | 6-21 |
| 6-12A | Location Subsystem Error Histogram (Fixed Route Tests #10026-10047) | 6-23 |
| 6-12B | Location Subsystem Cumulative Error (Fixed Route Tests #10026-10047) | 6-23 |

LIST OF ILLUSTRATIONS (Continued)

| <u>Figure</u> | <u>Page</u> |
|---|-------------|
| 6-13A Location Accuracy Histogram (System Simulation) (Fixed Route Tests #10026-10047) | 6-24 |
| 6-13B Cumulative Location Error (System Simulation) (Fixed Route Tests #10026-10047) | 6-24 |
| 6-14A Time of Passage Histogram (Fixed Route Tests #10026-10047) | 6-26 |
| 6-14B Time of Passage Cumulative Error (Fixed Route Tests #10026-10047) | 6-26 |
| 6-15A Location Accuracy Histogram (System Simulation With 5% Missing Data) (Fixed Route Tests #10026-10047) | 6-27 |
| 6-15B Cumulative Location Error (System Simulation With 5% Missing Data) (Fixed Route Tests #10026-10047) | 6-27 |
| 6-16A Time of Passage Histogram (Stop Time Points) | 6-28 |
| 6-16B Time of Passage Cumulative Error (Stop Time Points) | 6-28 |
| 6-17A Time of Passage Histogram (All Points-Dead Time Removed) | 6-29 |
| 6-17B Time of Passage Cumulative Error (All Points - Dead Time Removed) | 6-29 |
| 6-18A Time of Passage Histogram (No Stop Time Points) | 6-30 |
| 6-18B Time of Passage Cumulative Error (No Stop Time Points) | 6-30 |
| 6-19A Location Subsystem Histogram (Random Route Tests #20001-20005) | 6-38 |
| 6-19B Location Subsystem Cumulative Error (Random Route Tests #20001-20005) | 6-38 |
| 6-20A Location Accuracy Histogram (System Simulation) (Random Route Tests #20001-20005) | 6-39 |
| 6-20B Cumulative Location Error (System Simulation) (Random Route Tests #20001-20005) | 6-39 |
| 6-21A Location Accuracy Histogram (System Simulation With 5% Missing Data) (Random Route Tests #20001-20005) | 6-41 |
| 6-21B Cumulative Location Error (System Simulation With 5% Missing Data) (Random Route Tests #20001-20005) | 6-41 |

LIST OF ILLUSTRATIONS (Continued)

| <u>Figure</u> | | <u>Page</u> |
|---------------|--|-------------|
| 6-22A | Location Accuracy Histogram (System Simulation With 5% Missing Data and Improved Software) (Random Route Tests #20001-20005) | 6-42 |
| 6-22B | Cumulative Location Error (System Simulation With 5% Missing Data and Improved Software) (Random Route Tests #20001-20005) | 6-42 |
| 6-23A | Location Accuracy Histogram (System Simulation and Improved Software) (Random Route Tests #20001-20005) | 6-43 |
| 6-23B | Cumulative Location Error (System Simulation and Improved Software) (Random Route Tests #20001-20005) | 6-43 |
| 6-24A | LORAN Only Test - Location Accuracy Histogram (32 Second Fixed Polling) | 6-46 |
| 6-24B | LORAN Only Test - Location Cumulative Error (32 Second Polling) | 6-46 |
| 6-25 | Runway Path and Checkpoint Diagram | 6-47 |
| 6-26 | LORAN Speed/Lag Tests - Radial Error vs Speed | 6-48 |
| 6-27A | Vehicle Speed vs Detection Distance | 6-61 |
| 6-27B | Vehicle Speed vs Signal Loss Distance | 6-61 |
| 6-28A | Augmentor Elevation vs Detection Distance | 6-65 |
| 6-28B | Elevation vs Loss Distance | 6-65 |
| 6-29 | Augmentor Range vs Elevation | 6-70 |
| 6-30 | Augmentor Separation Distance vs Number of Correct Detections (Cumulative) | 6-71 |
| 6-31A | Augmentor Detection Distance (In Traffic) vs Elevation | 6-74 |
| 6-31B | Augmentor Signal Loss Distance (In Traffic) vs Elevation | 6-74 |
| 6-32 | RFI Test - Augmentor Signal Strength vs Distance | 6-76 |
| 6-33 | Antenna Pattern Test - Elevation = 10-20 Ft. | 6-77 |
| 6-34 | Test Area Street Map | 6-79 |
| 6-35 | Location Subsystem Daytime Accuracy (Fixed Route Tests #10026-10047) | 6-82 |

LIST OF ILLUSTRATIONS (Continued)

| <u>Figure</u> | | <u>Page</u> |
|---------------|--|-------------|
| 6-36 | Location Subsystem Nighttime Accuracy (Fixed Route Tests #10026-10047) | 6-82 |
| 6-37 | Fixed Route Cumulative Error by Time of Day | 6-83 |
| 7-1 | LORAN Coverage in the Phase II Random Route Area | 7-11 |
| 8-1 | Planning Schedule for Licenses, Permits and Agreements | 8-6 |

SECTION 1
EXECUTIVE SUMMARY

This test report presents the results of a highly successful field test of the LORAN AVM system. The test was very comprehensive and while certain problems were encountered, the results demonstrate that the LORAN AVM system is a leading candidate for the area-wide multi-user system described in the Request for Proposal.

The test results show the system to be compatible with fixed route location accuracy requirements and when the modifications presented herein are considered, time of passage and random route location accuracy are within the stated requirements.

A complete set of data reduction results in each of the many test categories is presented in Section 6. Table 1-1 below summarizes the results of the system level simulations for fixed and random route tests along with the specified requirements.

Table 1-1A Fixed Route Test Results Summary

| Fixed Route System Simulation | Confidence Level | Required Accuracy | Test Results |
|-------------------------------|------------------|-------------------|---------------------------|
| Location Accuracy | 95.0% | 300 ft. | 287.79 ft. ⁽¹⁾ |
| | 99.5% | 450 ft. | 369.60 ft. ⁽¹⁾ |
| Time of Passage | 95.0% | <u>+15</u> sec. | 8 sec. ⁽²⁾ |
| | 99.5% | <u>+60</u> sec. | 16 sec. ⁽²⁾ |

Table 1-1B Random Route Test Results Summary

| Random Route System Simulation | Confidence Level | Required Accuracy | Test Results |
|--------------------------------|------------------|-------------------|---------------------------|
| Location Accuracy | 95.0% | 300 ft. | 475.89 ft. ⁽³⁾ |
| | 99.5% | 450 ft. | 819.17 ft ⁽³⁾ |

- (1) Results of last 18 fixed route runs containing no equipment malfunctions
- (2) Results with dead time removed
- (3) Results with improved software

1.1 PROGRAM OBJECTIVES

The end result of this two phase AVM development program is a functionally optimal operating system capable of providing location and status information for all types of vehicle fleet operators. The objective of Phase I is to evaluate vehicle location technology and to provide a baseline for further development work. In Phase II the system will be fully developed and put into operational status at the Southern California Rapid Transit District in Los Angeles. The Phase II system is highly user oriented. Its operational characteristics are based on operator need rather than supplier capability. The system thus developed will be available to all potential AVM users in the transit industry as well as law enforcement or any other candidate industry.

The Phase I test program was conducted in Philadelphia in order to provide a high degree of confidence of the eventual success of the program. LORAN coverage conditions in Philadelphia are far from optimum. A large high rise section with narrow streets and multi-frequency interference sources coupled with long distances to the LORAN transmitters combined to provide a severe operating environment in which to prove the system. However, the results obtained are very encouraging and did demonstrate that LORAN can be integrated with other vehicle sensors to provide an accurate vehicle monitoring system.

In brief, LORAN-C is an electronic navigation system that enables the user to determine very precisely his position anywhere within the designated coverage area. Currently, that coverage area encompasses more than 16 million square miles of the earth's surface and additional coverage can be provided at any time, in any location through the addition of portable LORAN transmitter stations. It is this electronic grid which provides the basic location capability for Teledyne's LORAN vehicle location system.

1.2 LORAN-C PRINCIPLES OF OPERATION

LORAN-C is a pulsed low-frequency (LF), hyperbolic radio navigation system. It derives its high accuracy from time difference measurements of the pulsed signals and the inherent stability of LF propagation. The wide coverage areas are made possible by the low propagation losses of LF groundwaves and the resultant long baseline lengths (station-to-station separation).

These navigation systems operates on the principle that the difference in time of arrival of signals from two stations, observed at a point in the coverage area, is a measure of the difference in distance from the point of observation to each of the stations (See Figures 1-1 and 1-2). The locus of all points having the same observed difference in distance to a pair of stations is a hyperbola, called a line of position (LOP). The intersection of two or more LOP's defines the position of the observer. The accuracy of any hyperbolic navigation system depends on the observer's ability to measure the difference between the times of arrival of two signals (time difference, or TD), and his knowledge of the propagation conditions, so that the time difference can be converted to LOPs.

In identifying the proper frequency for a radio navigation system which will give wide coverage and high accuracy, various physical factors must be considered. The basic limitation on accuracy is the velocity of propagation of radio energy, approximately one foot per nanosecond (1 ft/nsec). Thus, for accuracies on the order of tens or hundreds of feet, measurements must be made to tens or hundreds

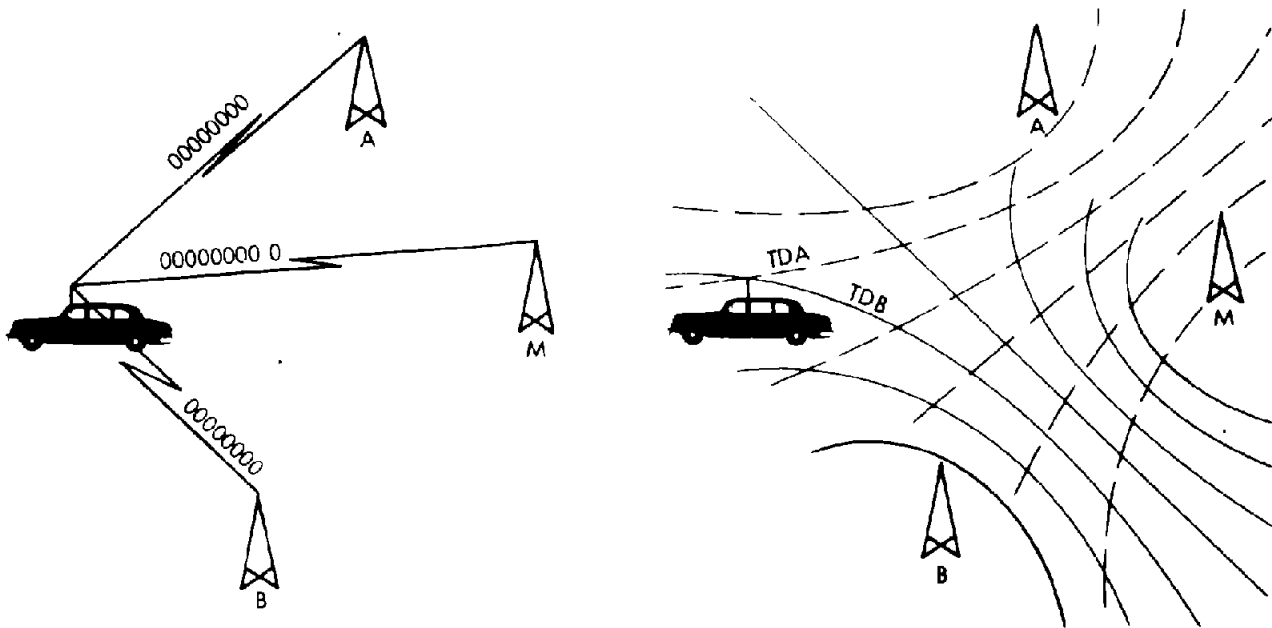
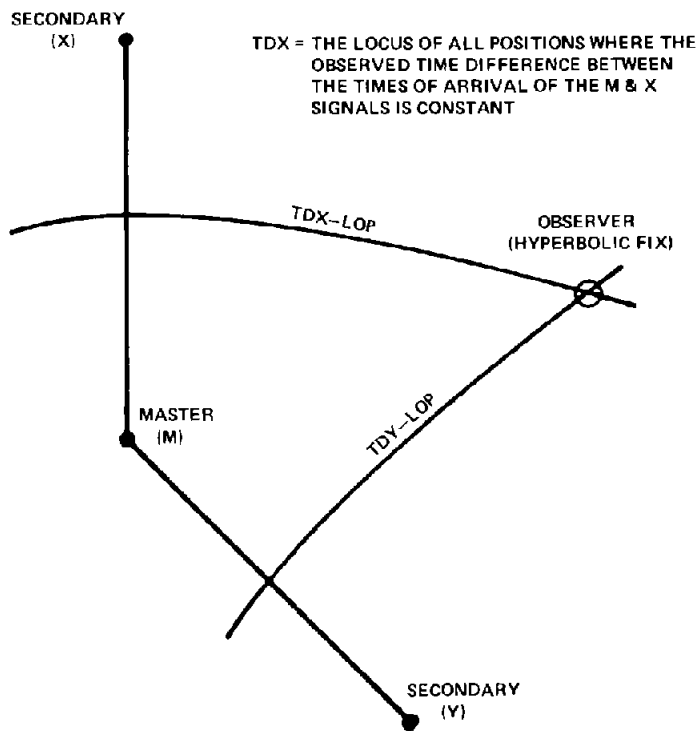

Figure 1-1. Hyperbolic Fix Geometry

T72270



T101410

Figure 1-2. Time Difference Location Fix

of nanoseconds. Also the propagation conditions must be reliably predictable (mathematically or from survey) to tens or hundreds of nanoseconds.

To take advantage of the stable propagation characteristics and long range of the LF band, 100 kilohertz (kHz) was chosen as the center frequency of the LORAN-C system. The LORAN-C pulse shape is such that 99% of the radiated energy is contained between the frequencies of 80 and 120 KHz.

Ranges of 800 to 1200 nautical miles (NM) are typical, depending on transmitter power, receiver sensitivity, and losses over the signal path. Variations in propagation losses, and velocity, increase with distance from the transmitters. These errors, and those introduced by receivers, will normally result in position variations of 50 to 200 feet at 200 NM, increasing to approximately 500 feet at 1000 NM. Position errors are significantly reduced when LORAN-C is used in a repeatability mode similar to that used in automatic vehicle location systems.

LORAN-C chains are comprised of a master transmitting station, two or more secondary transmitting stations and, if necessary, system area monitor (SAM) stations. The transmitting stations are located such that the signals from the master and at least two secondary stations can be received throughout the desired coverage area. For convenience, the master station is designated by the letter "M" and the secondary stations are designated W, X, Y, or Z. Thus, a particular master-secondary pair and the TD which it produces can be referred to by the letter designations of both stations or just that of the secondary (e.g., MX time difference or TDX.)

The transmitting stations of a LORAN-C chain transmit groups of pulses at a specified group repetition interval (GRI). Each pulse has a 100 kHz carrier and is of the shape described in Figure 1-3. For each chain a minimum GRI is selected of sufficient length so that it contains time for transmission of the pulse group from each station (10,000 microseconds for the master and 8000 microseconds for each secondary) plus time between each pulse group so that signals from two

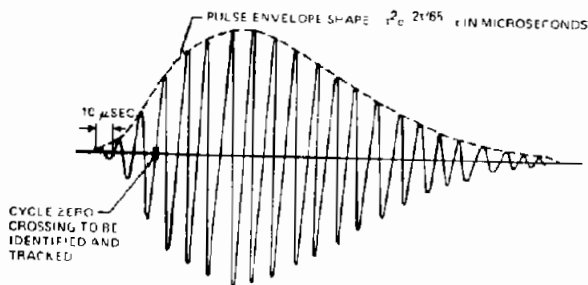

T102104

Figure 1-3. LORAN-C Pulse

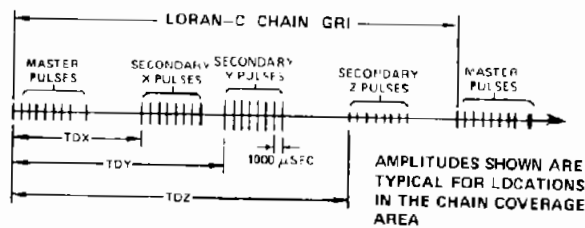

T102105

Figure 1-4.

or more stations cannot overlap in time anywhere in the coverage area. (See Figure 1-4. Thus, with respect to the time of arrival of the master, a secondary station will delay its own transmissions for a specified time, called the secondary coding delay. The minimum GRI is therefore a direct function of the number of stations and the distance between them. A GRI for the chain is then selected so that adjacent chains do not cause mutual (cross-rate) interference. The GRI is defined to begin coincident with the start of the first pulse of the master group.

Each station transmits one pulse group per GRI. The master pulse group consists of eight pulses spaced 1000 microseconds apart, and a ninth pulse 2000 microseconds after the eighth. Secondary pulse groups contain eight pulses spaced 1000 microseconds apart.

Multiple pulses are used so that more signal energy is available at the receiver, improving significantly the signal-to-noise ratio without having to increase the peak transmitted power capability of the transmitters.

The rate structure for LORAN-C is limited in theory to GRI's of 00010 to 99990 microseconds in 10 microsecond steps. In actual practice the GRI's will be between 40000 and 99990 microseconds with limits placed on rates actually selected. The designation of a LORAN-C rate is by the first four digits of the specific GRI.

1.3 LORAN AVM SYSTEM DESCRIPTION

In its simplest form, the LORAN AVM concept is to provide LORAN location data for each vehicle being tracked at a central base station. The outputs of auxillary sensors which are used to smooth the LORAN derived location. Since the utilization of any such auxillary location sensors is not fundamental to position derivation, less sophisticated and therefore less costly sensors may be utilized. A summary description of each of the elements of the location subsystem follows.

Figure 1-5 is a diagram of the LORAN AVM system showing the system components. The system as shown includes:

- Vehicle Position Location Equipment
- Communications
- Base Station Facilities
- Wayside equipment such as LORAN sign post augmentors
- LORAN Transmitting System

Since the Phase I test focused primarily on the location subsystem, this will be described in greater detail.

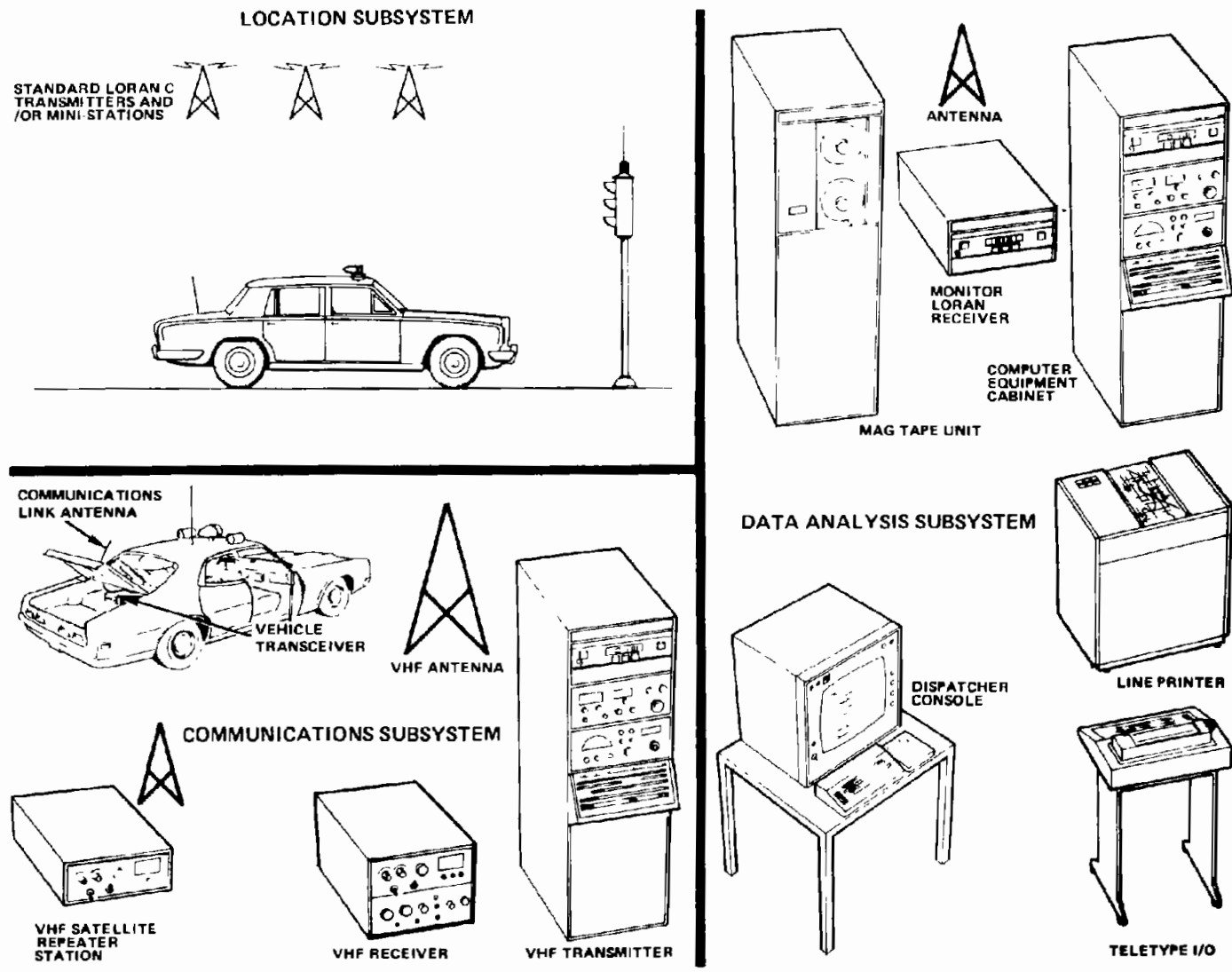
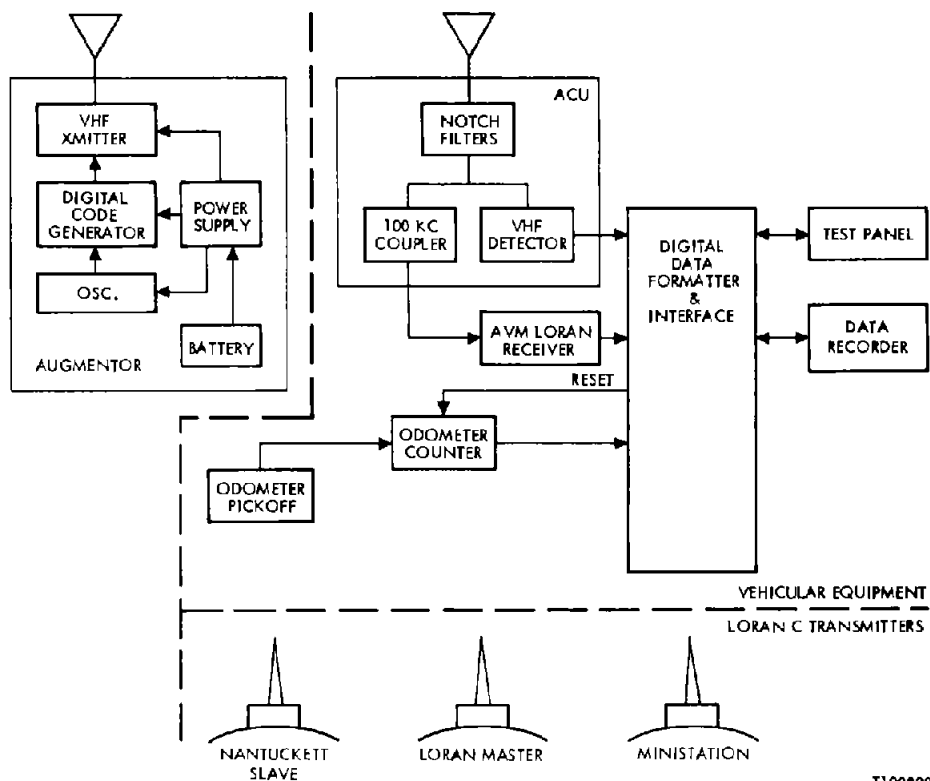

Figure 1-5. LORAN AVM System Components

The LORAN AVM Location Subsystem consists of the vehicular and wayside equipment depicted in Figure 1-6. While there may be minor differences in some specific components as a function of the type of vehicle (for example, transit bus vs supervision auto), the rudiments of the location subsystem are identical in every instance. Augmentors were battery powered for Phase I.

1.3.1 LORAN AVM Location Subsystem

The system is truly modular in that, to the basic LORAN location capability, it is possible to physically and functionally add auxiliary sensor components which enhance the overall system performance in direct proportion to their number. This feature also facilitates trouble-shooting, maintenance, and testing. The following detailed descriptions of each subsystem component is arranged in order of descending importance to location accuracy.



T100828

Figure 1-6. Location Subsystem

1.3.1.1 AVM LORAN Receiver - The LORAN receiver utilized in Phase I is the most modern LORAN receiver available in the world. It is a fourth generation instrument which reflects not only careful consideration of optimal LORAN receiver design parameters but a real world application of the tremendous increase in semiconductor technology. The result of a two year development program, this receiver is now available for application to the AVM problem with no further development.

Indeed, careful consideration of the LORAN signal characteristics in urban areas has been maintained throughout the development program. Since AVM represents one of the largest volume applications of the new low cost receiver, the flexibility necessary to optimize receiver characteristics for AVM use has been built in. This has only been possible, of course, because of concurrent Teledyne AVM testing. Figure 1-7 is a photograph of the LORAN AVM receiver and the antenna coupler.

1.3.1.2 Vehicle Odometer - The odometer used was specifically designed and fabricated to integrate easily with the equipment (transit vehicles) involved. The vehicle equipment consists of a mechanism for converting wheel rotation to electrical impulses or switch closures. The device used is a Hall effect magnetic pickoff similar to many types used to monitor and control rotating machinery. For the Phase I test, a fifth wheel odometer with a one foot resolution was included but only for test instrumentation purposes. It was not used in the vehicle location process.

1.3.1.3 Augmentor Device - The augmentor device which was demonstrated in Philadelphia was identical in function and operation to the production device for Phase II. A block diagram of the device is shown in Figure 1-8. The VHF transmitter is a low power, short range device. The remainder of the components are self explanatory except that the code specified in the code generator is in the

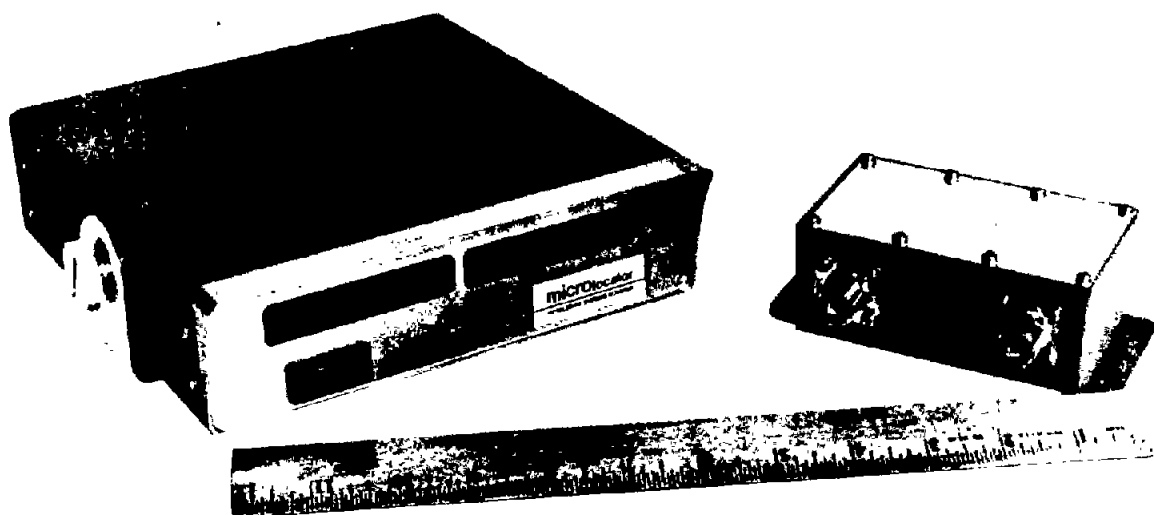

P110104

Figure 1-7. LORAN AVM Receiver

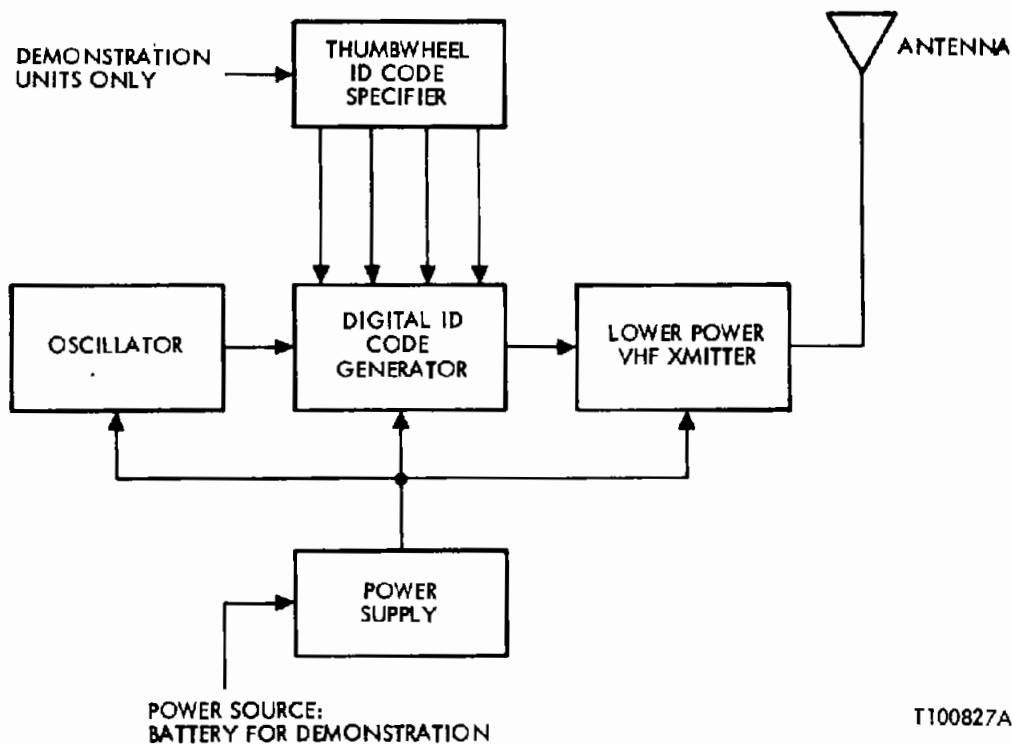

Figure 1-8. Block Diagram of Augmentor

form of a time period between pulses instead of the more conventional binary or BCD number transmission. This simplifies the vehicle and augmentor device hardware and increases reliability. More detailed information on the LORAN C navigation system is included in Section 2.

The LORAN AVM system includes a miniature LORAN C receiver in each vehicle along with two supplementary sensors: A precision odometer and an augmentor receiver. Augmentors are miniature 1 watt radio transmitters with a nominal range of 50 feet and continuously transmit. They are located on street poles throughout the operational area. Their purpose is to supply high precision location information at time points and other places without good LORAN signal coverage. A minimal number are needed for a typical city, i. e., 31 for Los Angeles, California.

Data from all three vehicle sensors is transmitted to the base station each time the vehicle is polled. From this data, the base station computer updates the location of each vehicle being monitored and stores the latest data for display upon command.

1.4 TEST DESCRIPTION

Tests were conducted in three categories: Fixed Route, Random Route, and Special Cases. Each category of test will be described.

Fixed Route Tests

Fixed route tests began on December 6, 1976. A route was laid out which traversed all types of urban environment from dense high rise to low rise residential. The original route contained 105 checkpoints and 12 time points. The test vehicle traversed the route with checkpoint or timepoint passage denoted by the operator pressing a test console button which in turn set a flag in the data marking the true vehicle location. Data was continuously recorded at one second intervals on magnetic tape. Each data record included LORAN time difference A & B, system odometer, 5th wheel odometer, checkpoint ID, test number, ID number of the last detected augmentor, various flags denoting checkpoint passage, LORAN signal quality, and augmentor detection.

Ten such fixed route tests were completed with octal test numbers 10001 through 10012. During these tests, an inordinate number of augmentors were not detected or decoded as the test vehicle passed. After ten tests on which 27% of the possible augmentor detections were missed, testing was suspended to allow time to identify and correct the problem. During the test suspension, the fixed route was extended to include 103 checkpoints and 15 timepoints, this for the purpose of reducing the total number of test runs. Figure 1-9 shows this test route. Thirty tests were run on the extended course starting on January 31, 1977. A total of over 3500 checkpoint and 438 timepoint measurements were made. The only significant occurrence

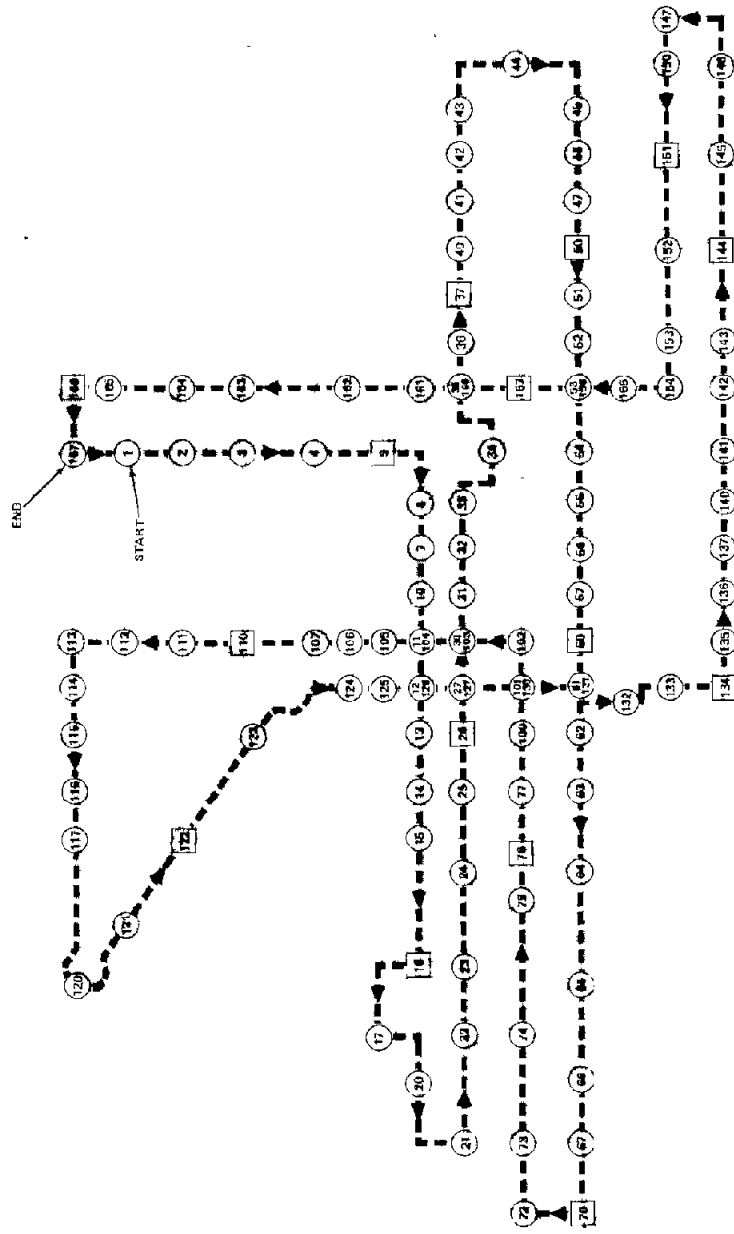

LEGEND
 □ TIMEPOINT
 ○ CHECKPOINT
 - - - PATH

T108795

Figure 1-9. Revised Fixed Route Test

LEGEND
○ CHECKPOINTS - SEQUENTIALLY NUMBERED (OCTAL)
- - - PATH

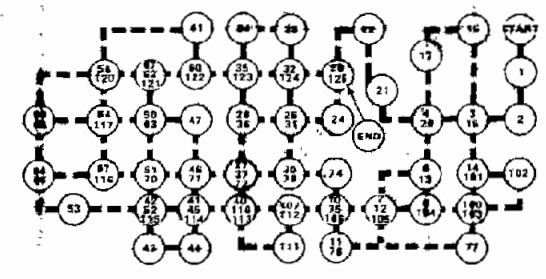

T108793

Figure 1-10. Random Route Test

during this period was the observation of an erratic system odometer display on February 4. The problem was traced to low voltage from the new AC motor-generator and the problem was corrected.

Random Route Tests

Random route tests were conducted on February 8. The test process was identical to the fixed route tests except there were no time points and the route was not known in advance. Figure 1-10 shows the random route tests.

Special Case Tests

Special case tests were performed at various times throughout the test period. Many different tests were conducted to evaluate subsystem components. A list and brief description of all tests performed is given below.

- Augmentor Coverage vs Vehicle Speed

The purpose of this test was to measure the variation in coverage (detection range and ID number decoding) and location accuracy as a function of vehicle speed. Data was collected as the test vehicle passed a fixed augmentor at various speeds in order to measure the variation in detection range and to see if errors in augmentor ID number decoding occurred. No ID code errors were recorded.

- Augmentor Coverage vs Elevation

The purpose of this test was to determine what effect elevation has on augmentor coverage and location accuracy. Data was collected as the test vehicle passed an augmentor at the same location but with varying elevation.

- Augmentor Interference

The purpose of this test was to determine the minimum safe distance between two operating augmentors which allows each device to be detected without interference from the other.

- Augmentor Coverage vs Traffic Conditions

The purpose of this test was to determine if heavy traffic which includes trucks and transit busses will significantly interfere with augmentor detection and ID code recovery. The effects of augmentor elevation in this type environment was measured.

- Radio Frequency Interference Tests

The purpose of this test was to determine if any out-of-band frequencies are emitted by the augmentor. None were measured.

- Augmentor Antenna Pattern

The purpose of this test was to generate a representative augmentor antenna pattern.

- LORAN Position Lag vs Vehicle Speed

The purpose of this test was to measure any discernible lag in LORAN derived position which was a function of vehicle speed.

- Unusual LORAN Coverage Test

The purpose of this test was to determine LORAN location accuracy in an unusual coverage area such as a long steel bridge.

- LORAN ONLY Location Test

The purpose of the LORAN ONLY Location Test was to measure the accuracy of the LORAN portion of the location subsystem exclusive of any other sensors. No augmentor data was used in this test.

- LORAN Repeatability

The purpose of this test was to measure the repeatability accuracy of the LORAN data.

1.5 EQUIPMENT DESCRIPTION

A large amount of equipment was installed in and around the test area. All equipment used to conduct the tests is described in Section 3 of this report. In general, equipment can be summarized as mobile, wayside, and support equipment.

Mobile Equipment

All mobile equipment was installed in the test vehicle, a Dodge van (See Figure 1-11). It consisted of the AVM location subsystem components such as the miniature LORAN receiver, system odometer, and augmentor receiver. The majority of the mobile equipment was for test instrumentation purposes. This equipment consisted of a 10 channel incremental magnetic tape recorder, the 5th wheel odometer, an oscilloscope, a test console (Shown in Figure 1-12) containing data formatting and control and display functions, a wave analyzer, and a 115 VAC motor-generator for instrumentation equipment power.

Wayside Equipment

Wayside equipment consisted of 16 augmentors installed on the fixed route and 38 installed in the random route area. All were battery powered and mounted on street lamp poles. Figure 1-13A, B, and C show typical augmentor installations. Figure 1-14 shows fixed route augmentor deployment.

Support Equipment

Support equipment consisted of a mini LORAN-C station installed in Limerick township and a monitor station installed in the Marriott Hotel. The ministation (shown in Figure 1-15) was used in conjunction with the East Coast LORAN-C chain to provide adequate LORAN signal coverage and the monitor station provides a hard copy strip chart recording of time difference stability during testing.



Figure 1-11. Test Vehicle

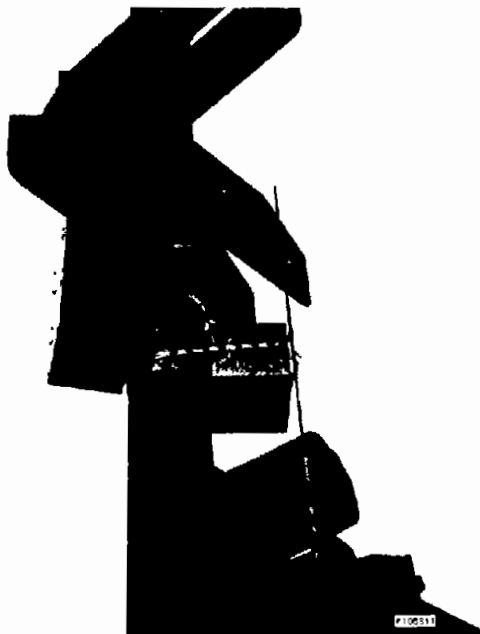

Figure 1-12. Magnetic Tape Recorder and Test Console



P108810

Figure 1-13A. Typical Augmentor Installation



P108811

Figure 1-13B. Typical Augmentor Installation



P108812

Figure 3-13C. Typical Augmentor Installation

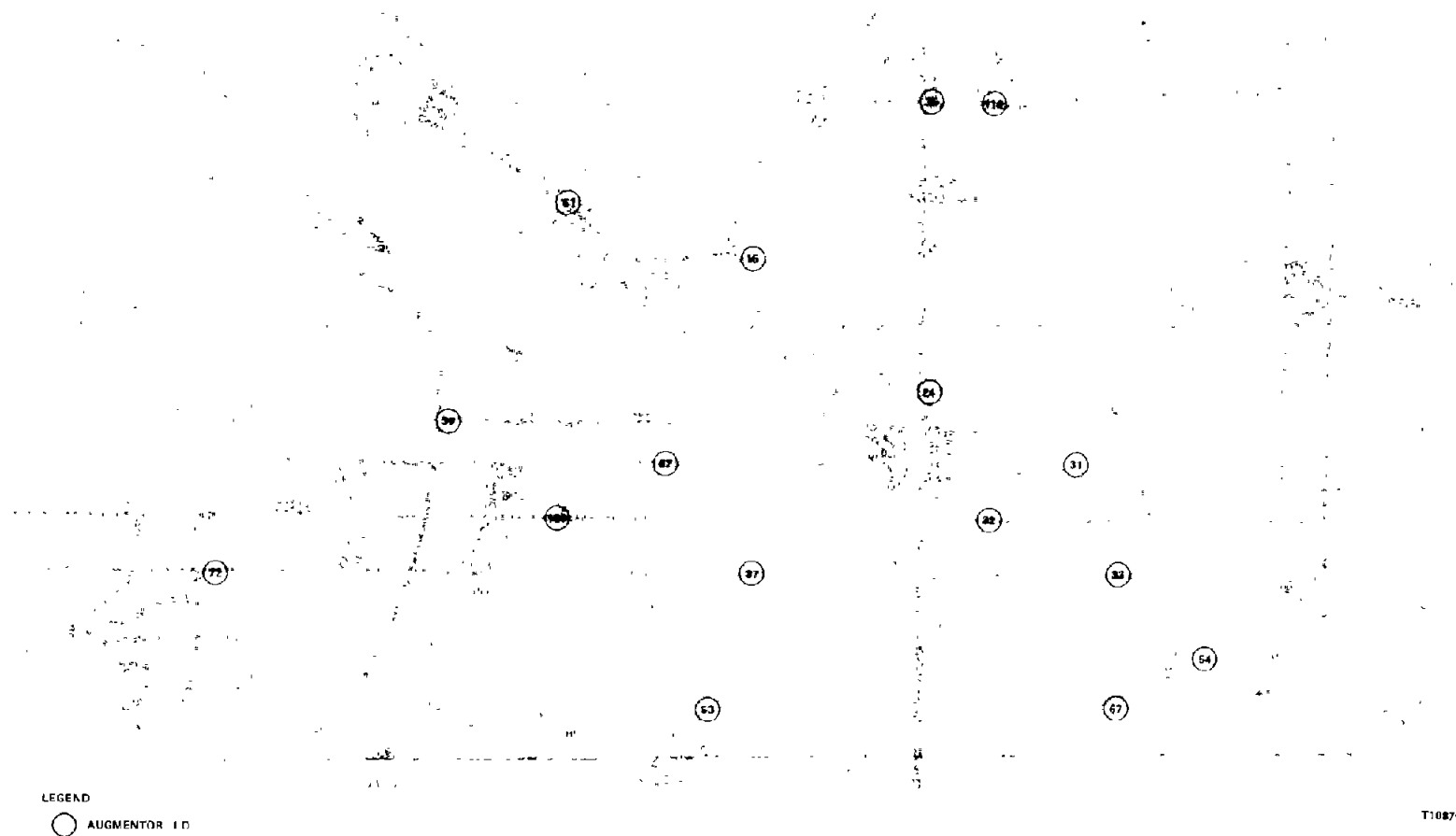
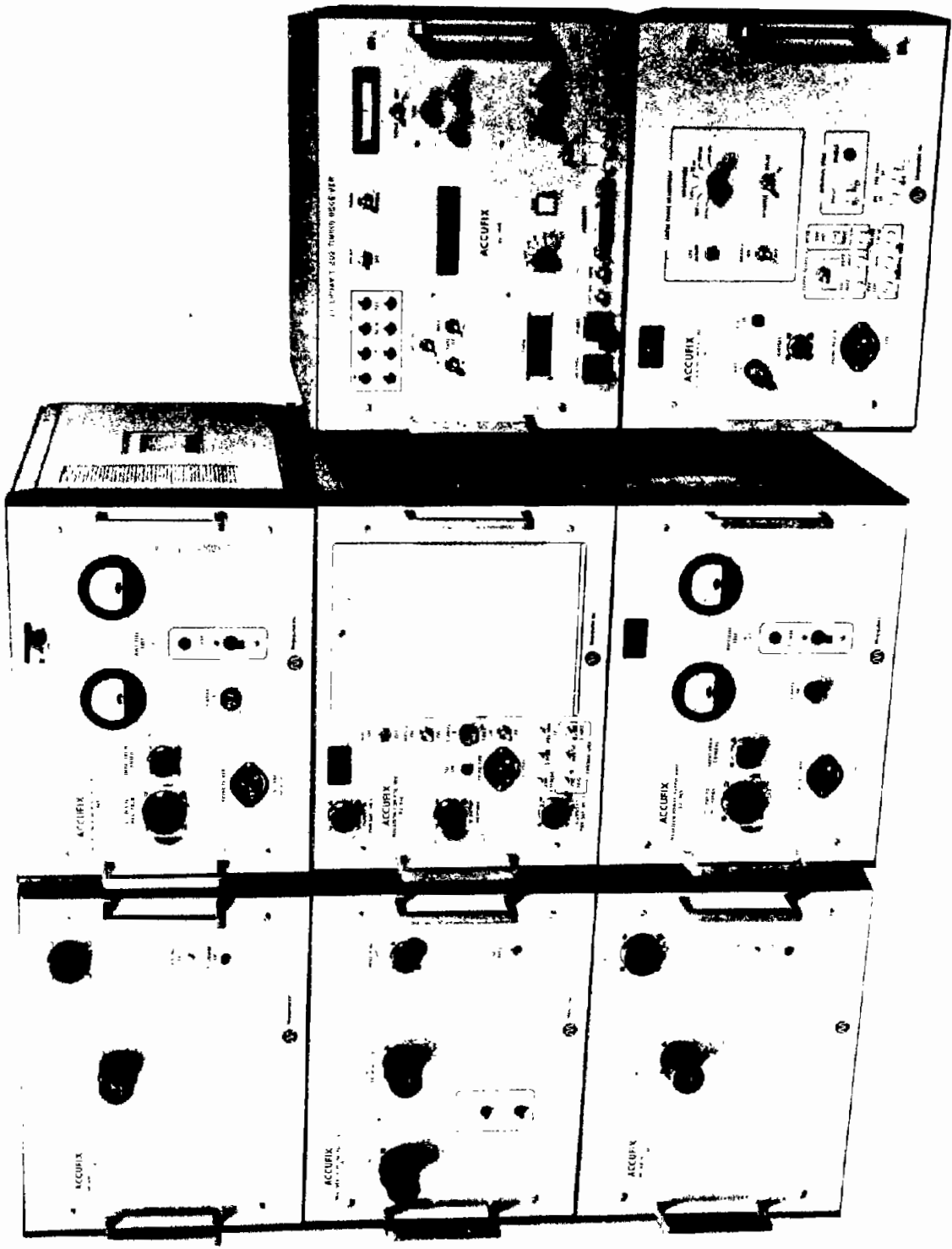

Figure 1-14. Fixed Route Augmentor Deployment



P91591

Figure 1-15. LORAN-C Mini Station

1.6 DATA REDUCTION AND ANALYSIS

The data from each test conducted was recorded on a separate magnetic tape. All data reduction was done off-line using software packages which accurately reflect the position processing techniques to be used in Phase II except for those modifications discussed in Section 7. Each fixed route and random route test tape was submitted to various software routines, each one providing a set of error statistics in a specific category of tests. Following is a description of each category of data reduction which was performed on all fixed route and random route test tapes.

Location Subsystem Runs

The location subsystem software examines only data which was recorded in the test vehicle during the one second interval when the vehicle was at or passing through a checkpoint. Since checkpoints were almost always at intersections and very few intersections on either route were skipped, this test represents data recorded in approximately 400 to 500 foot increments without regard to time. The software first made a vehicle location determination using past location information plus new data recorded at the checkpoint. This data include time difference A, time difference B, LORAN valid/not valid status, odometer, and any new augmentor ID codes detected since the last checkpoint was passed. After computing vehicle position, the software analysis routine which was built in, compared the computed position with the known position of the checkpoint since this information was resident in the given data set. The X error component, Y error component, and radial error were then calculated for each checkpoint. At the end of the run a sequential list of radial errors by checkpoint is printed. This list also includes the LORAN error at each point. The final list generated is a ranked list of LORAN and radial errors in ascending order; this for the purpose of determining the 95th and 99.5th percentile error.

System Simulation Runs

System simulation runs differ from location subsystem runs only in the data used to update each new location calculation. Where location subsystem runs used data recorded at each checkpoint, system simulation runs ignored checkpoints and instead automatically selected data as recorded every 32 seconds. The purpose of this run was to faithfully produce error statistics for the system as it is actually expected to be used. Seldom, if ever, did the data sampled each 32 second interval coincide with data taken at intersections. The time-dependent data sample tended to occur between intersections as one would expect. In order to compute X & Y component errors as well as radial errors, true position also was calculated in a separate package called TRUPOS. This package is described in Section 5. As with the location subsystem runs, the system simulation runs presented a sequential and a ranked listing of LORAN and radial errors at the end.

System Simulation with 5% Missing Data

These runs were also made on each test tape and were identical to the system simulation runs with one exception: 5% of the 32-second data samples were deleted at random to simulate communications subsystem outages. These runs provided the most accurate simulation of system performance.

Time of Passage

Time of passage error calculations were made in the system simulation runs, with and without 5% missing data. Errors in time of passage at selected time points were computed by examining the test tape for true time of passage (denoted in the data by a flag set at the depression of the checkpoint button by the test operator) and the system estimate of time of passage as provided by the augmentor detection flags. This process is explained in detail in Section 4.

Coverage

System coverage statistics were determined by running the system simulation software four times on each test tape selected. Each run was manually offset in time by the computer operator by 8 seconds so that for each test tape analyzed, separate system simulation computer runs were generated. By combining the results of all four runs for a test tape, errors were provided at eight second intervals. This allowed the data analyst to collect errors in each 0.1 mile segment of the test route and calculate a mean error. Due to the magnitude of the data processing task to measure coverage, 25% of the test tapes were analyzed in this manner.

1.7 DATA RESULTS SUMMARY

The test program was very comprehensive with results obtained in many categories. Tables 1-2A, 1-2B, and 1-2C present the more meaningful results. A brief explanation of each category is provided for clarity. Section 6 contains all test results with detailed descriptions of each test category. Section 7 discusses methods of improving these results including simulations performed on the actual data.

Table 1-2A. Fixed Route Test Results

| Fixed Route Test Results | | Confidence Level | Runs (1) 10001 - 10012 | Runs 10026 - 10047 | Runs (2) 10012 - 10047 | 10012-10047 Less (2) 10016&10017 |
|-------------------------------|--|------------------|------------------------------|--------------------------|------------------------------|--|
| SYSTEM SIMULATION | 32 second fixed polling | 95% 99.5% | 269.45' 787.38' | 287.79' 369.60' | 1,648.51' 5,087,946' | 320.56' 4,909.913' |
| | 32 second fixed polling w/5% missed data | 95% 99.5% | | 291' 383' | 1,113' 4,909,901' | 326' 4,909,908' |
| | Time of passage | 95% 99.5% | 47 sec 65 sec | 26 sec (3) 42 sec | 32 sec 49 sec | 33 sec 47 sec |
| LOCATION SUBSYSTEM | | 95% 99.5% | 318.66' 1,457.62' | 303.34' 5,186.65' | 1,269.16' 4,914,435' | 352.79' 4,914,435' |
| COVERAGE: Mean Error 450 feet | | Mean | | 98% | 78.3% | 78.3% |

1-26

- (1) Tests conducted with malfunctioning augmentors
- (2) Tests conducted with malfunctioning motor-generator
- (3) See Section 7 for technique to reduce errors to 8 seconds and 16 seconds

Table 1-2B. Random Route Test Results

| Random Route Test Results | | Confidence Level | Original Software | Improved Software |
|---------------------------|--|------------------|-------------------|-------------------|
| SYSTEM SIMULATION | 32 second fixed polling | 95% | 691.16' | 475.89' |
| | | 99.5% | 1,293.11' | 819.17' |
| | 32 second fixed polling W/5% Missed Data | 95% | 752.55' | 472.94' |
| | | 99.5% | 1,293.11' | 819.17' |
| LOCATION SUBSYSTEM | | 95% | 358.52' | |
| | | 99.5% | 1,222.96' | |
| COVERAGE | | Mean | 98% | 98% |

Table 1-2C. LORAN Only Test Results

| Special Care Test Results (4) | Confidence Level | LORAN Only |
|-------------------------------|------------------|------------|
| LOCATION SUBSYSTEM | 95% | 325.32' |
| | 99.5% | 375.68' |

(4) These results were obtained in a low rise part of the city using the LORAN sensor only without benefit of augmentors.

SECTION 2
TEST DESCRIPTION

2.1 GENERAL

This section describes the tests performed in detail. In addition, a description of the LORAN navigation system and the LORAN vehicle location system is included.

2.1.1 System and Subsystem Accuracy Requirements

The system and location subsystem accuracy requirements are a radial error of less than 300 feet for 95% of all possible true locations, less than 450 feet for 99.5% of all possible true locations.

For fixed route tests, time of passage shall be measured to ± 15 seconds for 95% of all measurements, ± 60 seconds for 99.5% of all measurements. In addition, for the location subsystem, all measurements of true location on any 0.1 mile segment of any travelway, the mean average of the corresponding location subsystem errors shall not exceed 450 feet.

2.2 THE LORAN NAVIGATION SYSTEM

2.2.1 Introduction

LORAN-C is a pulsed, low-frequency (LF), hyperbolic radio aid-to-navigation. It derives its high accuracy from time difference measurements of the pulsed carrier and the inherent stability of LF propagation. The wide coverage area is made possible by the low propagation losses of LF groundwaves and the resultant long baseline lengths (station-to-station separation). The Coast Guard now operates 9 LORAN-C chains (including one on the west coast of the United States) using 35 transmitting stations to provide coverage over 12,000,000 square miles (see Figure 2-1).

LORAN-C COVERAGE

2-2

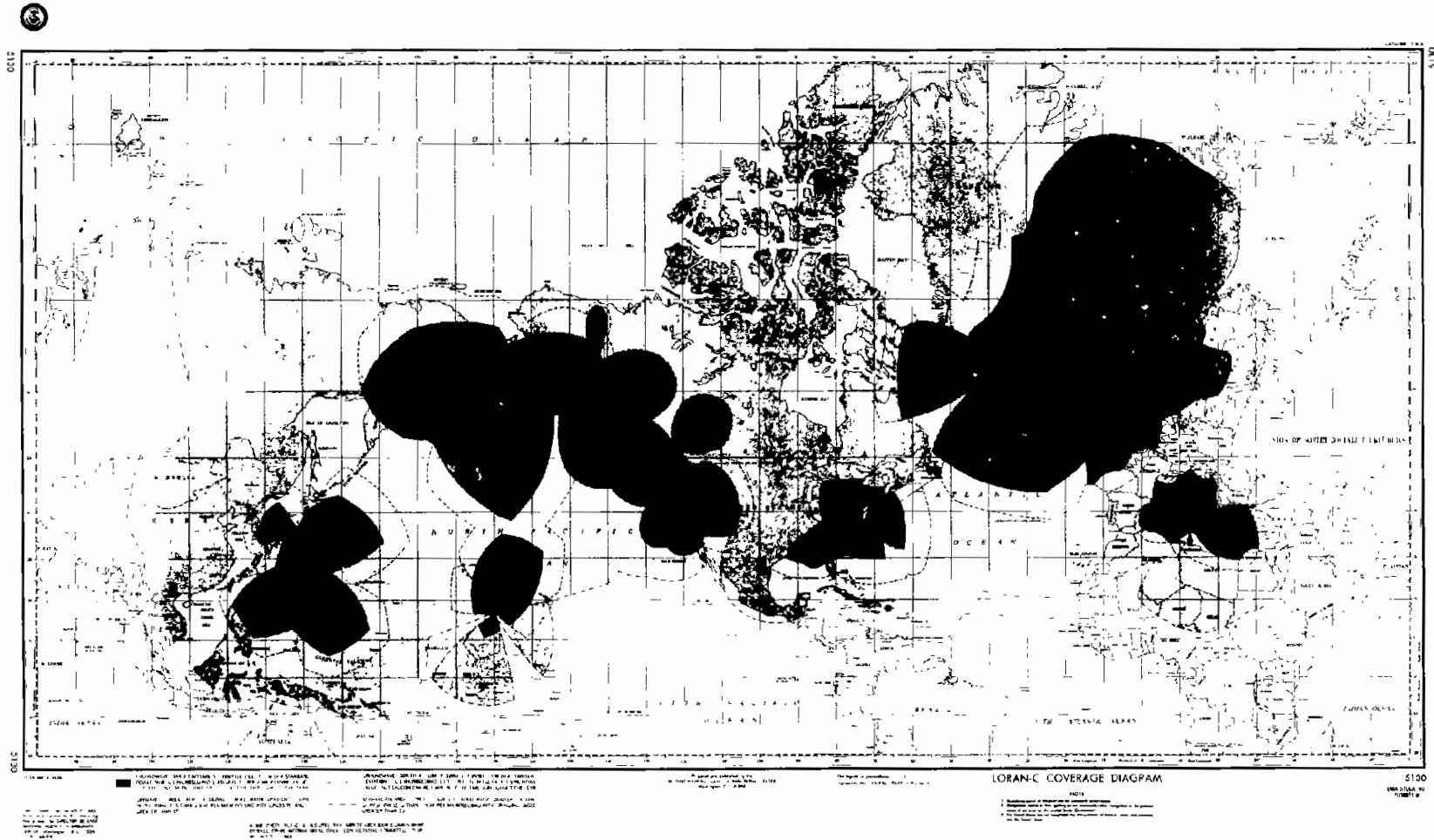

Figure 2-1. LORAN-C Coverage

T107336

2. 2. 2 Theory

Hyperbolic radio aids-to-navigation operate on the principle that the difference of time of arrival of signals from two stations, observed at a point in the coverage area, is a measure of the difference in distance from the point of observation to each of the stations (see Figure 2-2). The locus of all points having the same observed difference in distance to a pair of stations is a hyperbola and is a line of position (LOP). The intersection of two or more LOP's defines the position of the observer. The accuracy of hyperbolic radio aids-to-navigation depends on the observer's ability to measure the difference between the times of arrival of two signals (time difference or TD) and his knowledge of the propagation conditions so that the time differences can be converted to LOP's.

In identifying the proper frequency for a radio navigation system which will give wide coverage and high accuracy, various physical factors must be considered. The basic limitation on accuracy is the velocity of propagation of radio energy, approximately one foot per nanosecond (1 ft/ns). Thus for accuracies on the order of tens or hundreds of feet, measurements must be made to tens or hundreds of nanoseconds. Also the propagation conditions must be reliably predictable (mathematically or from survey) to tens or hundreds of nanoseconds.

Very Low Frequency (VLF) signals propagate primarily by skywave or the waveguide mode and predictability of this propagation suffers from the lack of real-time knowledge of ionospheric conditions. Low Frequency (LF) signals meet the requirements for time measurement accuracy and the ability to predict groundwave propagation conditions although they are subject to skywave interference at long ranges. Medium and High Frequency (MF and HF) signals meet the time measurement capabilities but suffer high propagation losses over land reducing their range. They also suffer loss of propagation predictability due to natural and man-made physical features whose size is a significant fraction of a wavelength. Higher frequency signals (VHF and above) are range limited to line-of-sight. Thus 100 kHz was chosen for LORAN-C and D to take advantage of the stable propagation characteristics and long range of the LF band. Pulsed and coded signals are used to minimize the effects of skywave interference.

2-4

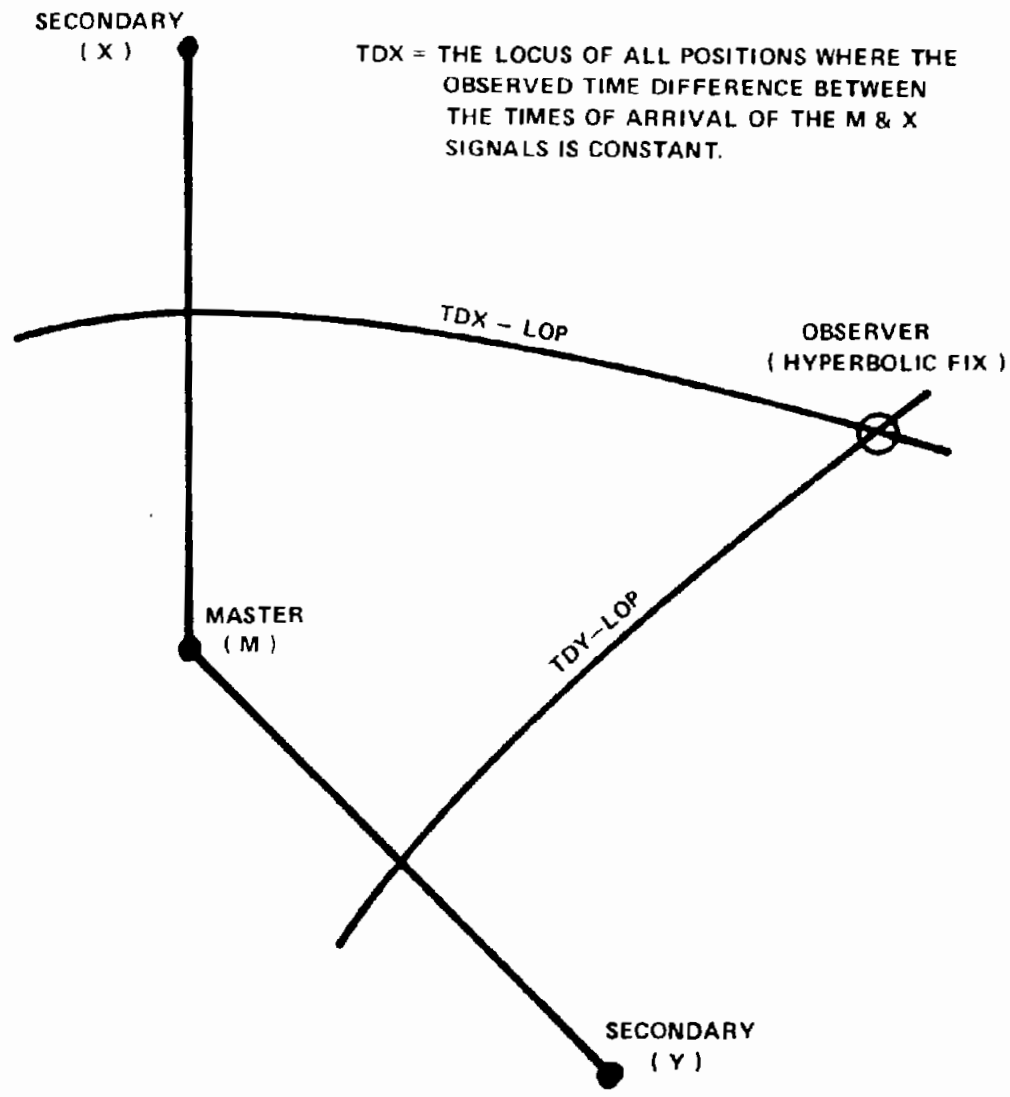

T101410

Figure 2-2. Hyperbolic Fix Geometry

2.2.3 Operation

LORAN-C chains are comprised of a master transmitting station, two or more secondary transmitting stations and, if necessary, system area monitor (SAM) stations. The transmitting stations are located such that the signals from the master and at least two secondary stations can be received throughout the desired coverage area. For convenience, the master station is designated by the letter "M" and the secondary stations are designated X, Y, Z, W, based on the order in which they transmit. Thus a particular master-secondary pair and the TD which it produces can be referred to by the letter designations of both stations or just that of the secondary (e. g. MX time difference or TDX).

The LORAN-C system as it operates today has maintained a record of 99.7% availability, not including scheduled off-air maintenance which reduces that figure to 99%. New equipment is presently being developed which will permit on-air maintenance, and also improve the system availability, with a goal of better than 99.7%, including all interruptions to service.

2.2.4 Signal Format

The transmitting stations of a LORAN-C chain transmit groups of pulses at a specified group repetition interval (GRI) (see Figure 2-3a). For each chain a minimum GRI is selected of sufficient length so that it contains time for transmission of the pulse group from each station (10 milliseconds for the master and 8 milliseconds for each secondary) plus time between each pulse group so that signals from 2 or more stations cannot overlap in time anywhere in the coverage area. The minimum GRI is therefore a direct function of the number of stations and the distance between them. A GRI for the chain is then selected so that adjacent chains do not cause mutual (cross-rate) interference. The GRI is defined to begin coincident with the start of the first pulse of the master group.

LORAN-C pulses and pulse groups: Each station transmits one pulse group per GRI. The master pulse group consists of eight pulses spaced 1000 microseconds apart, and a ninth pulse 2000 microseconds after the eighth. Secondary pulse

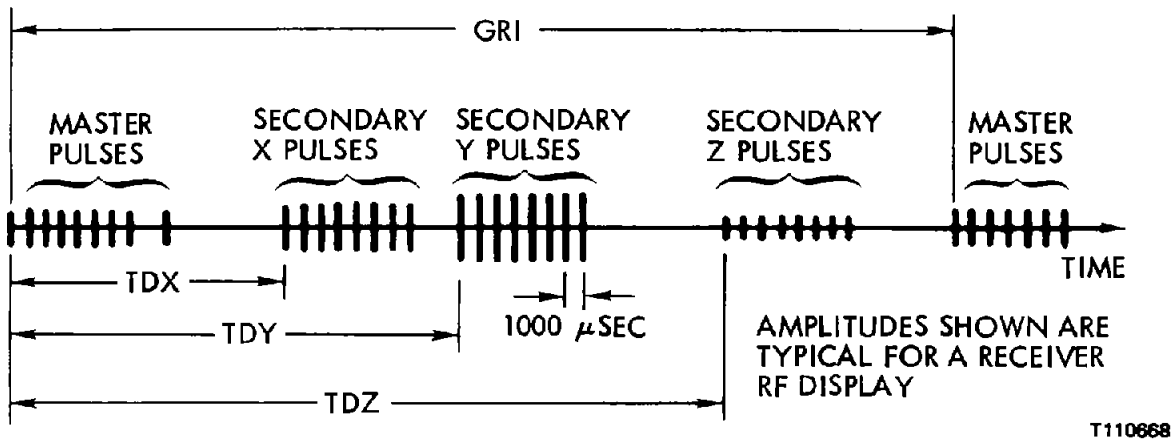

Figure 2-3a. Example of Received LORAN-C Signal

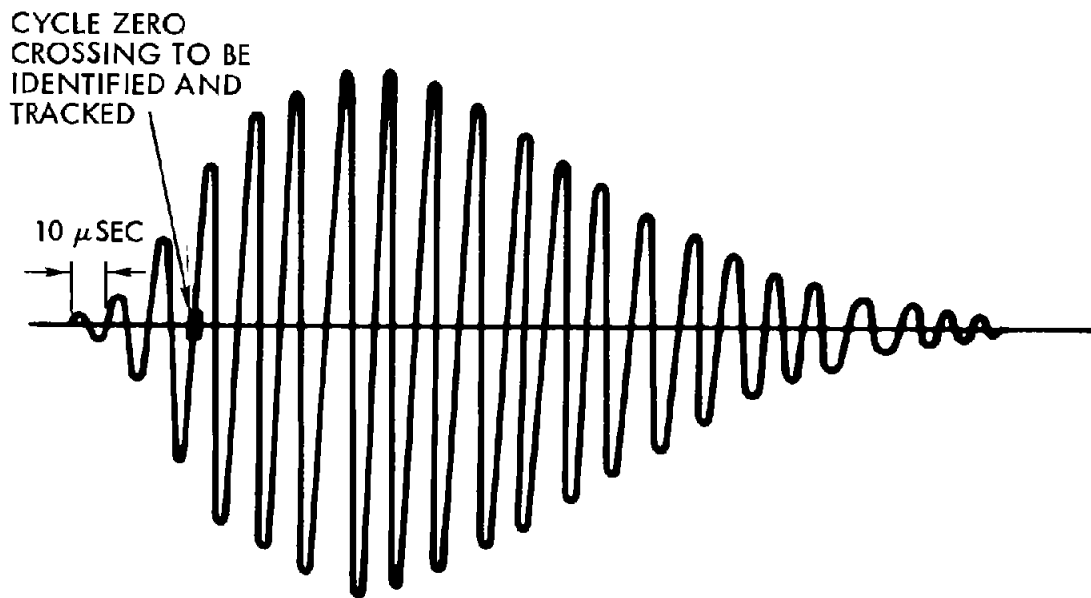

Figure 2-3b. LORAN-C Signal Format

groups contain eight pulses spaced 1000 microseconds apart. Eight pulses, rather than one, are used so that more signal energy is available at the receiver, improving significantly the signal to noise ratio without having to increase the peak transmitted power capability of the transmitters. The master's ninth pulse is used for visual identification of the master and for blink. Blink is accomplished by turning the ninth pulse on and off in a specified code. The secondary station of the unusable pair also blinks by turning its first two pulses on and off.

2.3 LAVM SYSTEM DESCRIPTION

The LORAN Automatic Vehicle Monitoring System consists of three related subsystems: Location Subsystem, Communications Subsystem, and Data Analysis Subsystem. Figure 2-4 shows the system and component subsystems while Figure 2-5 shows how the subsystems interact to perform the system function. As shown, the Location Subsystem contains the vehicular sensors which record LORAN time difference, odometer, and augmentor ID numbers as the vehicle moves about the city. The communications subsystem gathers and formats this data, transmitting it to the base station on command. The data analysis subsystem processes all incoming data, continually updating position for each vehicle being tracked.

The Location Subsystem includes augmentors. Augmentors are small 1 watt radio transmitters placed strategically throughout the test area. They serve two purposes: They provide high accuracy location information in areas which do not receive good quality LORAN signals and they provide an accurate method of determining time of passage for fixed route vehicles.

The Phase I program tested the location subsystem hardware and simulated the remainder of the system on IBM 370 computer equipment.

The LORAN chain used for all testing was the U. S. East Coast Chain (SS-7) augmented by a temporary ministation which was utilized as the B slave. This

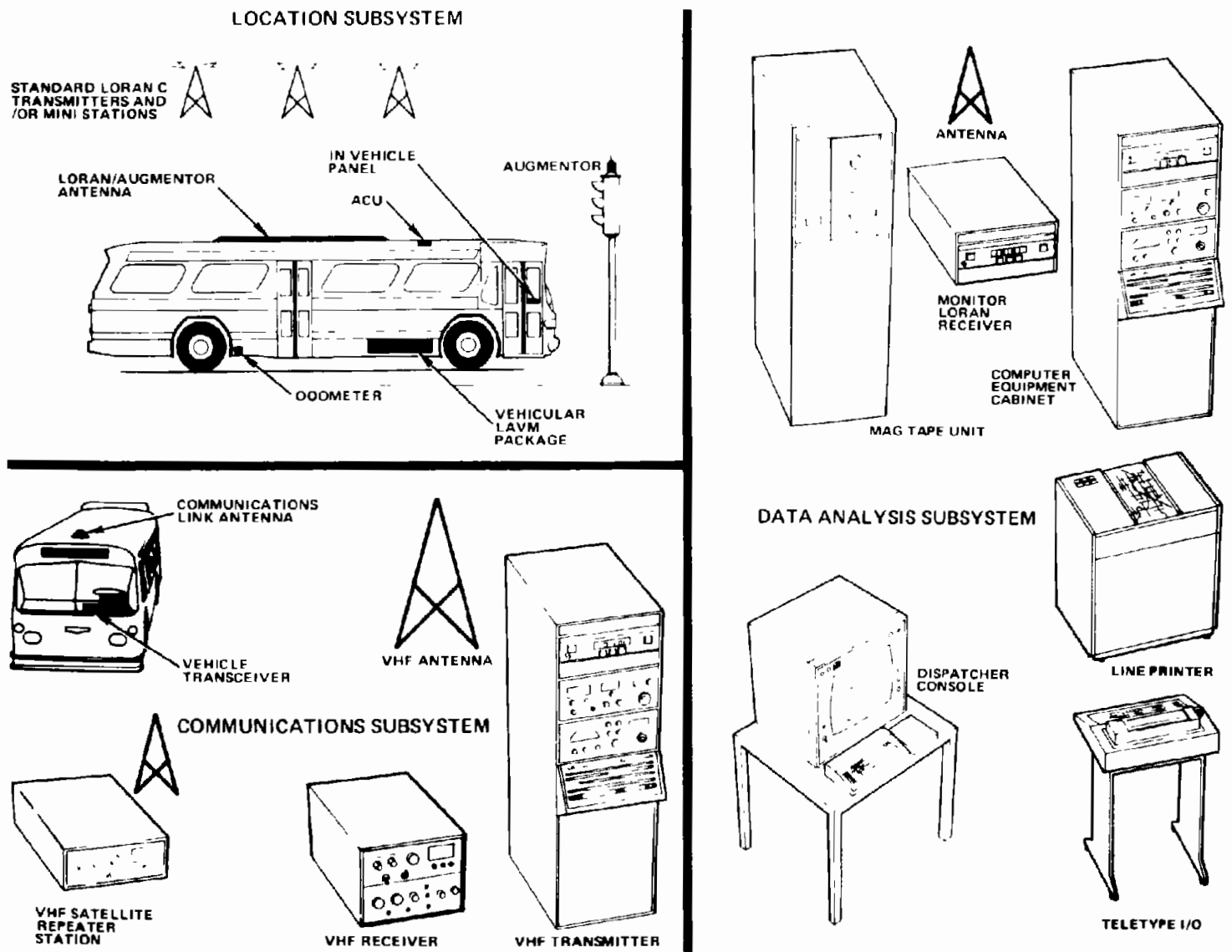
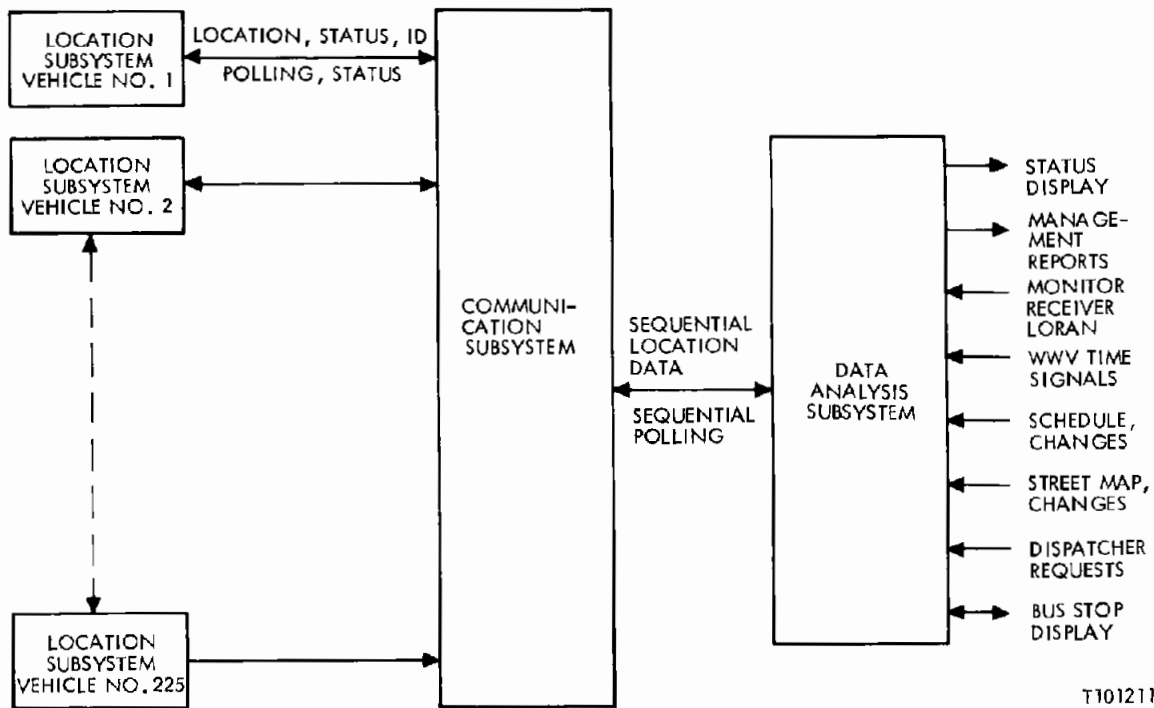

Figure 2-4. LAVM System



T101211

Figure 2-5. System Interface Diagram

equipment is described in detail in Section 3. U.S. East Coast Stations used were the master at Cape Fear, North Carolina and the slave at Nantucket Island, Massachusetts. Figure 2-6 shows these stations and the chain geometry.

To facilitate the location accuracy calculations, an X-Y grid overlay was used. Figure 2-7 shows the test area with the grid overlay. As can be seen, the grid was 7,500 feet by 14,500 feet. This grid provided a means of establishing true location coordinates for all calibration points, check points, and time points.

2.4 AREA CALIBRATION

The purpose of calibration of the test area is to provide a reference set of time difference coordinates for each checkpoint. Once this is done TD measurements made at any point may then be compared with the reference set, an apparent

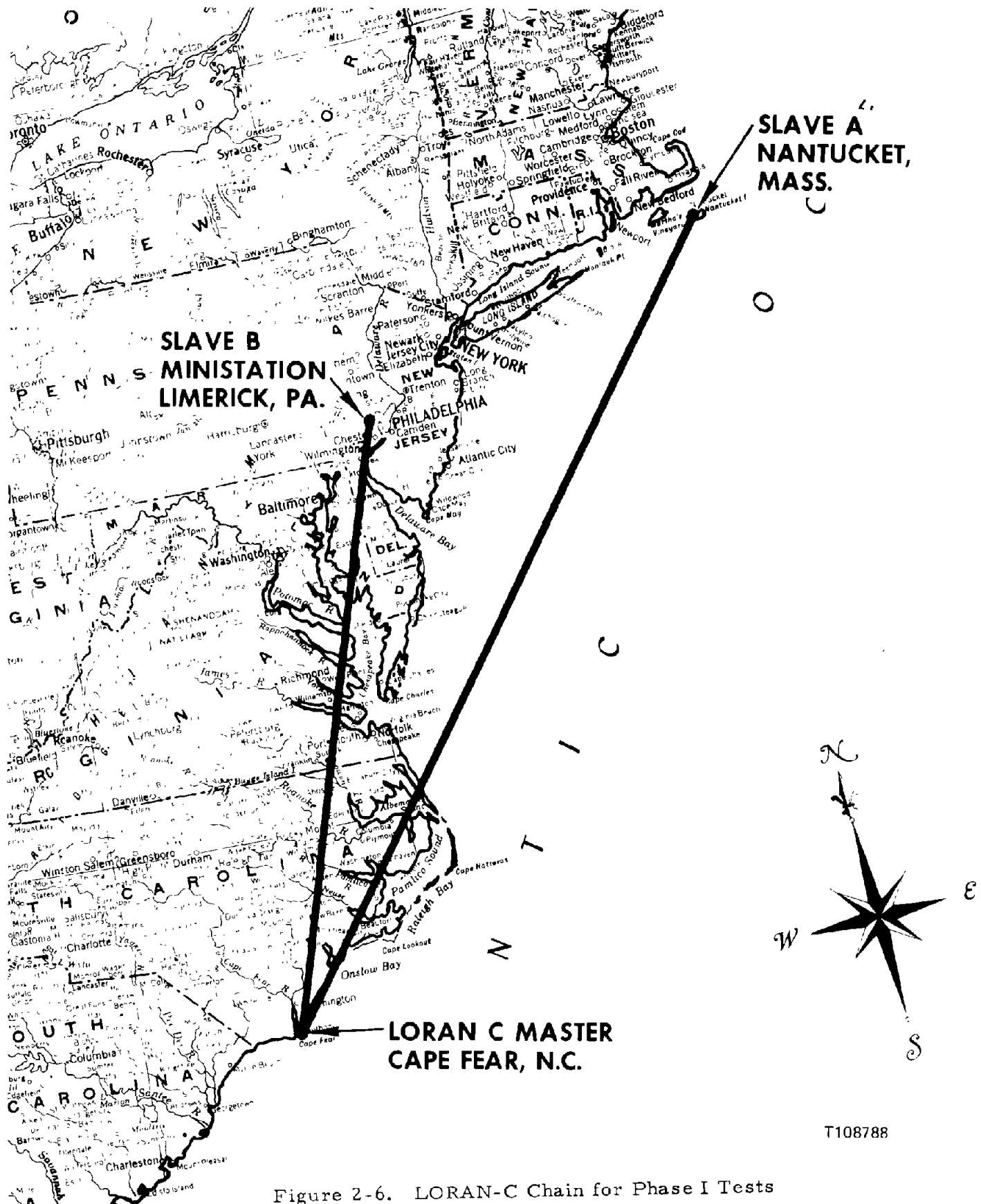

Figure 2-6. LORAN-C Chain for Phase I Tests

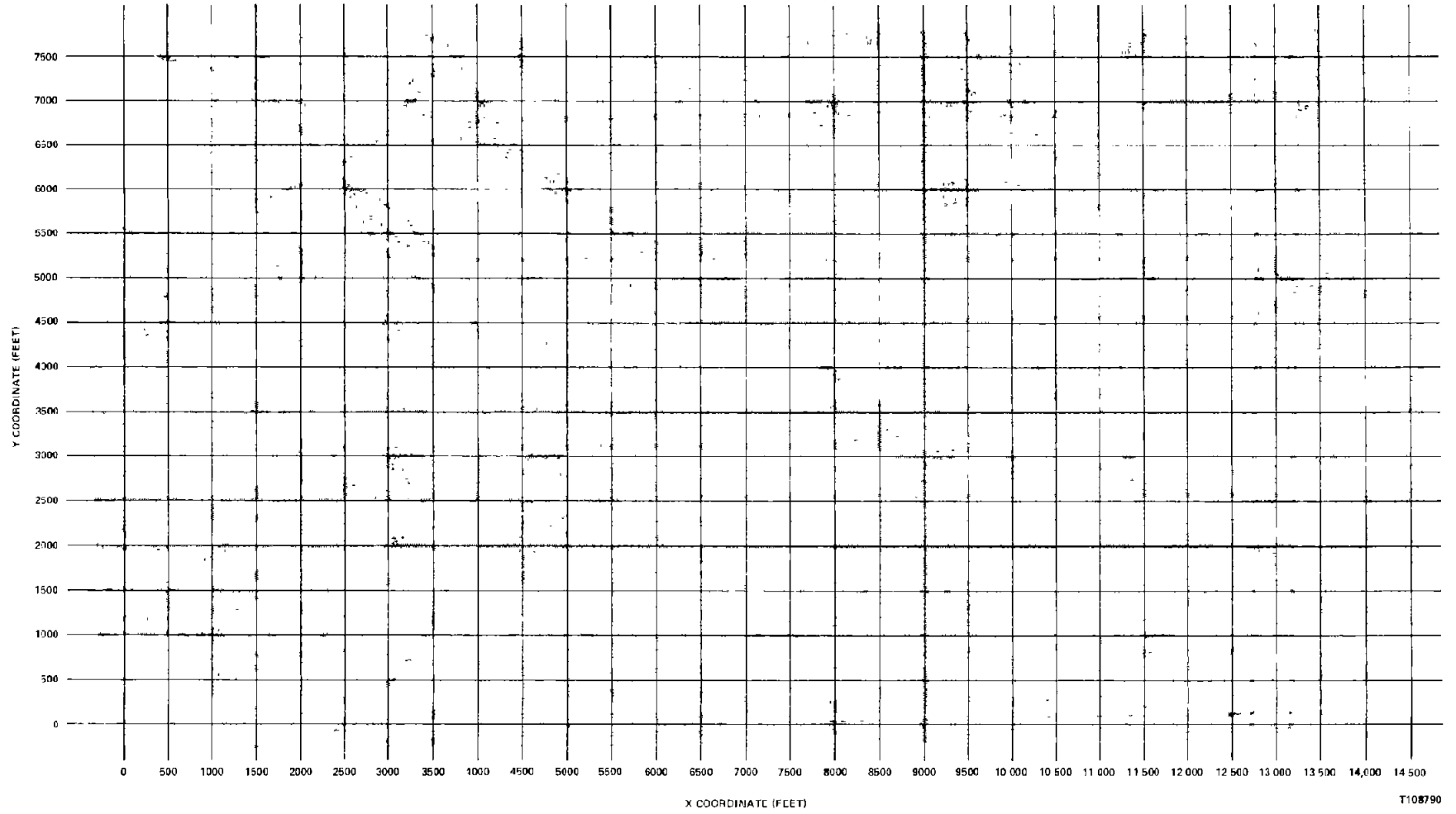

Figure 2-7. Philadelphia Test Area and X-Y Grid Overlays

X-Y location computed, and a radial error calculated. In a perfect LORAN environment, four calibration points will suffice. Perfect LORAN implies a regular TD gradient over the entire test area which is seldom the case in urban locations. Anomalies or distortion of the LOP's require additional calibration points in and around the anomaly. In the Philadelphia area, anomalies are common and sometimes severe. To compensate for the distorted grid many times more calibration points are required. The calibration task is further complicated by the fact that TD anomalies are most prevalent in areas which suffer from high signal attenuation due to tall buildings and narrow streets. Often no LORAN measurements are possible in such areas. Those portions of the test area which cannot be adequately calibrated are abandoned in a LORAN sense. Augmentors are installed to provide 100% location coverage in and around the no LORAN coverage area. Fixed route tests lend themselves nicely to such straight forward augmentor deployment. Random route tests are more difficult, usually resulting in a larger quantity of augmentors.

Figure 2-8 shows the test area and calibration points. Appendix A lists the time difference data measured along with X-Y coordinates of each location.

The calibration data was recorded starting on October 12, 1976 and completed November 2, 1976. Over 395 locations were calibrated on 19 magnetic data tapes. Test numbers used on calibration tapes are shown in the table below:

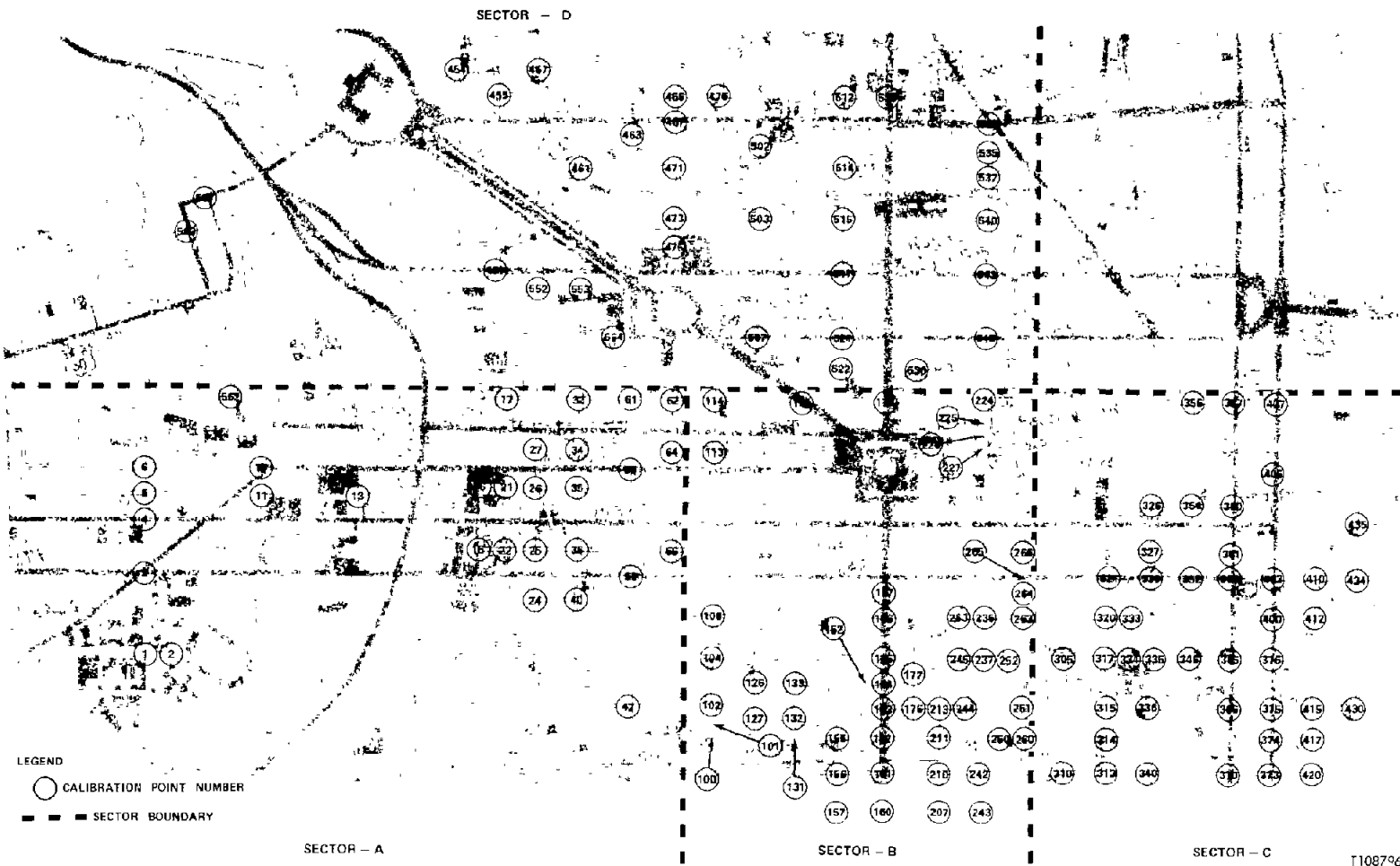

Figure 2-8. Test Area and Calibration Points

Table 2-1

| <u>Tape No.</u> | <u>Date</u> | <u>Sector</u> |
|-----------------|-------------|-----------------|
| 00002 | 10/12/76 | A |
| 00003 | 10/13/76 | B |
| 00004 | 10/13/76 | B |
| 00005 | 10/14/76 | B |
| 00006 | 10/14/76 | B |
| 00007 | 10/18/76 | B |
| 00010 | 10/18/76 | B |
| 00011 | 10/19/76 | B |
| 00012 | 10/20/76 | C |
| 00013 | 10/20/76 | C |
| 00014 | 10/20/76 | C |
| 00015 | 10/20/76 | C |
| 00016 | 10/21/76 | D |
| 00017 | 10/21/76 | D |
| 00020 | 10/21/76 | A |
| 00021 | 10/22/76 | A |
| 00022 | 10/22/76 | A |
| 00023 | 10/31/76 | LORAN only area |
| 00026 | 11/02/76 | Bridge Cal area |

2.5 FIXED ROUTE TEST

The purpose of the fixed route test was to demonstrate the ability of the AVM system to meet the accuracy and operational requirements of transit vehicles in a major urban center.

2.5.1 Test Procedure

The test was conducted as the test vehicle drove the prescribed fixed route. At designated checkpoints, the 'enter' button on the test console was pushed. This caused a flag to be set in the test data being continuously and automatically recorded. This data was later processed off line by the system software to provide test results. Time points and checkpoints were handled in an identical manner. Since the checkpoint and timepoint number designations were pre-defined, the software was able to store the timepoint designations. At these points a time-of-passage error was calculated in addition to a location error as was the case at checkpoints.

The fixed route tests were conducted on the days and times shown below in Table 2-2. Those that were shortened or affected by circumstances beyond operator control are indicated.

Table 2-2. Fixed Route Tests

| <u>Test No.</u> | <u>Date</u> | <u>Time (Est)</u> | <u>Comment</u> |
|-----------------|-------------|-------------------|--|
| 10001 | 12/6/76 | 1458 | Augmentor malfunction Run short due to generator failure |
| 10002 | 12/6/76 | 1909 | |
| 10003 | 12/7/76 | 1039 | |
| 10004 | 12/7/76 | 1522 | |
| 10005 | 12/7/76 | 1030 | |
| 10006 | 12/8/76 | 1413 | |
| 10007 | 12/8/76 | 1503 | |
| 10010 | 12/8/76 | 1900 | |
| 10011 | 12/13/76 | - | |
| 10012 | 12/13/76 | 1746 | |
| 10012 | 1/31/77 | 1007 | |
| 10013 | 1/31/77 | 1301 | Motor-generator malfunction |
| 10014 | 1/31/77 | 1453 | |
| 10015 | 1/31/77 | 1631 | |
| 10016 | 2/1/77 | 1002 | Run short due to fire on route Run short due to fire on route |
| 10017 | 2/1/77 | 1119 | |
| 10020 | 2/2/77 | 0942 | Motor-generator malfunction |
| 10021 | 2/2/77 | 1113 | |
| 10022 | 2/2/77 | 1420 | |
| 10023 | 2/2/77 | 1556 | |
| 10024 | 2/2/77 | 1726 | |
| 10025 | 2/3/77 | 0901 | |
| 10026 | 2/4/77 | 0844 | |
| 10027 | 2/4/77 | 1006 | |
| 10030 | 2/4/77 | 1134 | |
| 10031 | 2/4/77 | 1448 | |
| 10032 | 2/4/77 | 1636 | |
| 10033 | 2/4/77 | 1817 | |
| 10034 | 2/4/77 | 1938 | |
| 10035 | 2/5/77 | 1804 | |
| 10036 | 2/5/77 | 1928 | |
| 10037 | 2/6/77 | 0854 | |
| 10040 | 2/6/77 | 0956 | |
| 10041 | 2/6/77 | 1105 | |
| 10042 | 2/6/77 | 1216 | |
| 10043 | 2/6/77 | 1338 | |
| 10044 | 2/6/77 | 1539 | |
| 10045 | 2/6/77 | 1758 | |
| 10046 | 2/6/77 | 1809 | |
| 10047 | 2/6/77 | 1930 | |

There were two fixed route courses run between December 1976 and February 1977. The reasons for this were:

- a. An augmentor detection problem arose during the first ten fixed route runs, testing was suspended for analysis and correction of the difficulty; and,
- b. During this period, thought was given to making the fixed route path longer with more timepoints and checkpoints so as to reduce the number of runs required.

The fixed route (including checkpoints and timepoints) used for test numbers 10001 thru 10012 in December 1976 is shown in Figure 2-9. The extended fixed route used for test numbers 10012 to 10047 in February 1977 is shown in Figure 2-10. Likewise, Figure 2-11 shows the placement of augmentors for runs 10001 thru 10012, and Figure 2-12 shows those for runs 10012 thru 10047. Appendix C to the report contains the detailed coordinate locations at intersections for each augmentor used in the test.

2.6 RANDOM ROUTE TEST

The purpose of the random route test was to demonstrate the ability of the AVM system to meet the accuracy and operational requirements of various supervisory and vaulted transit vehicles as well as other potential AVM users whose path in the coverage area is not known in advance.

2.6.1 Test Procedure

The random route test was conducted in a manner very similar to the fixed route test with some exceptions: There were no time points and the route was not known in advance. At designated checkpoints the 'enter' button was pushed which set the data flag used by the software as the signal to process position. Figure 2-13 shows the random route test area with the route driven and checkpoints. Figure 2-14 shows the Augmentor locations in the Random Route Area.

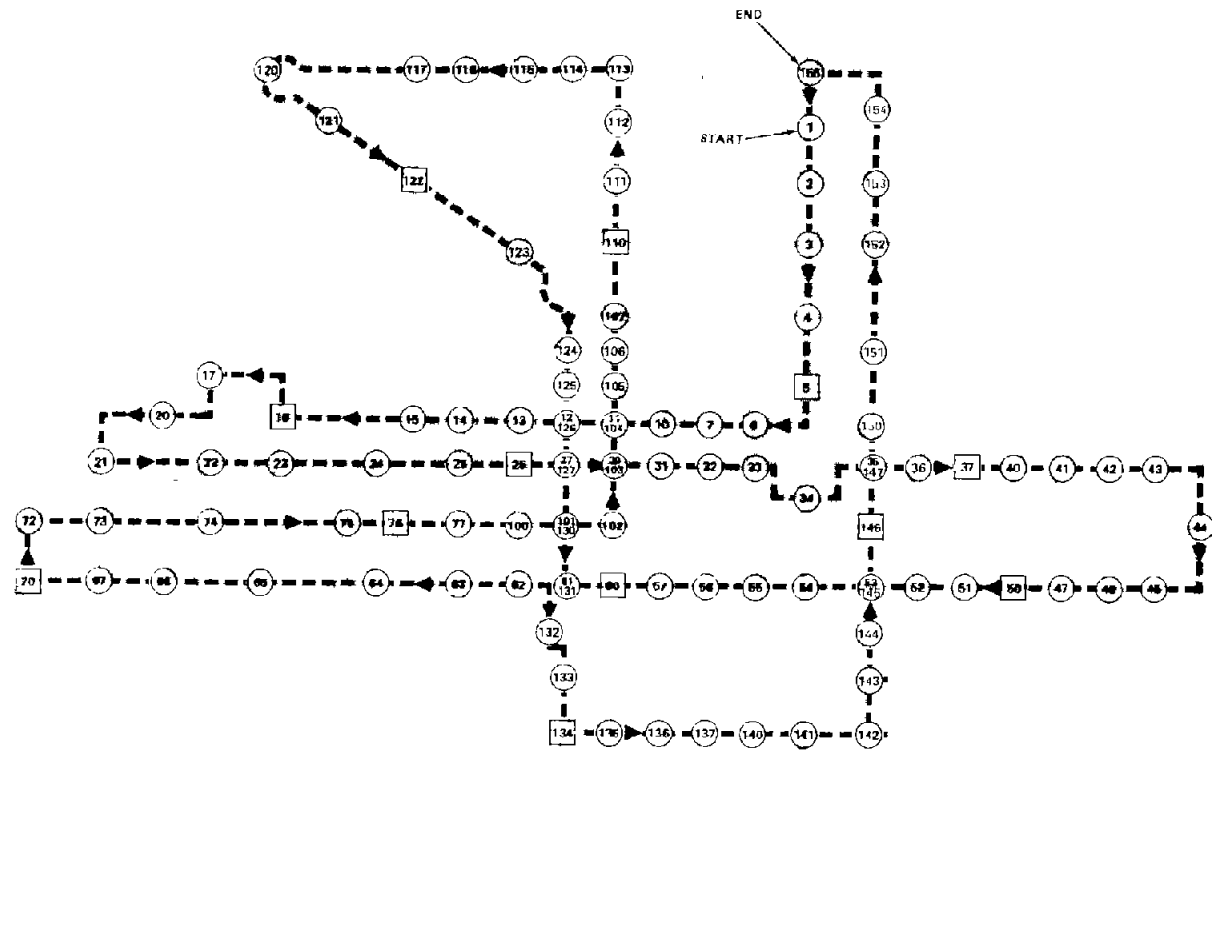

T109795.1

Figure 2-9. Fixed Route Test - Original

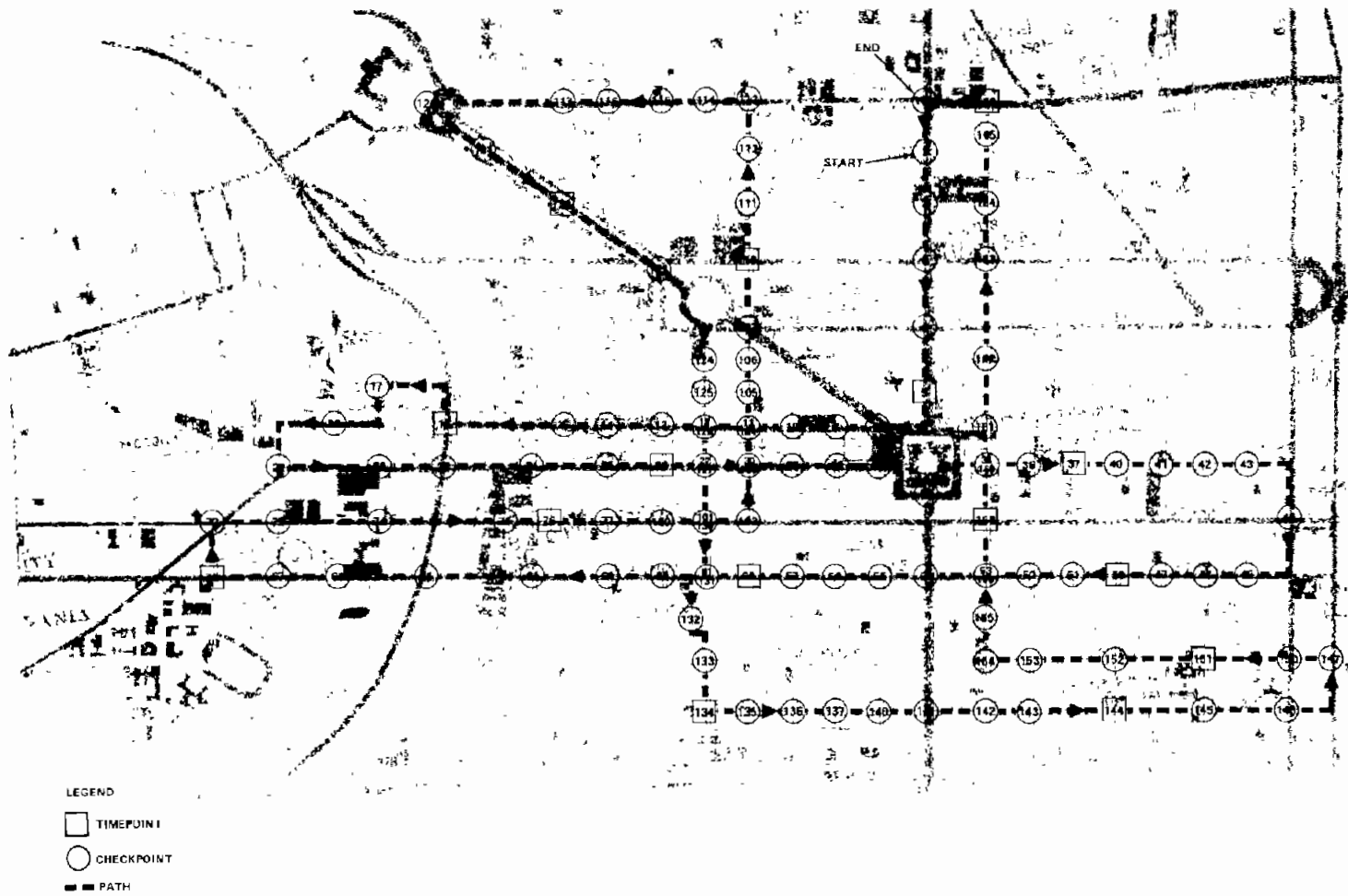

T108795

Figure 2-10. Fixed Route Test - Revised

2-19

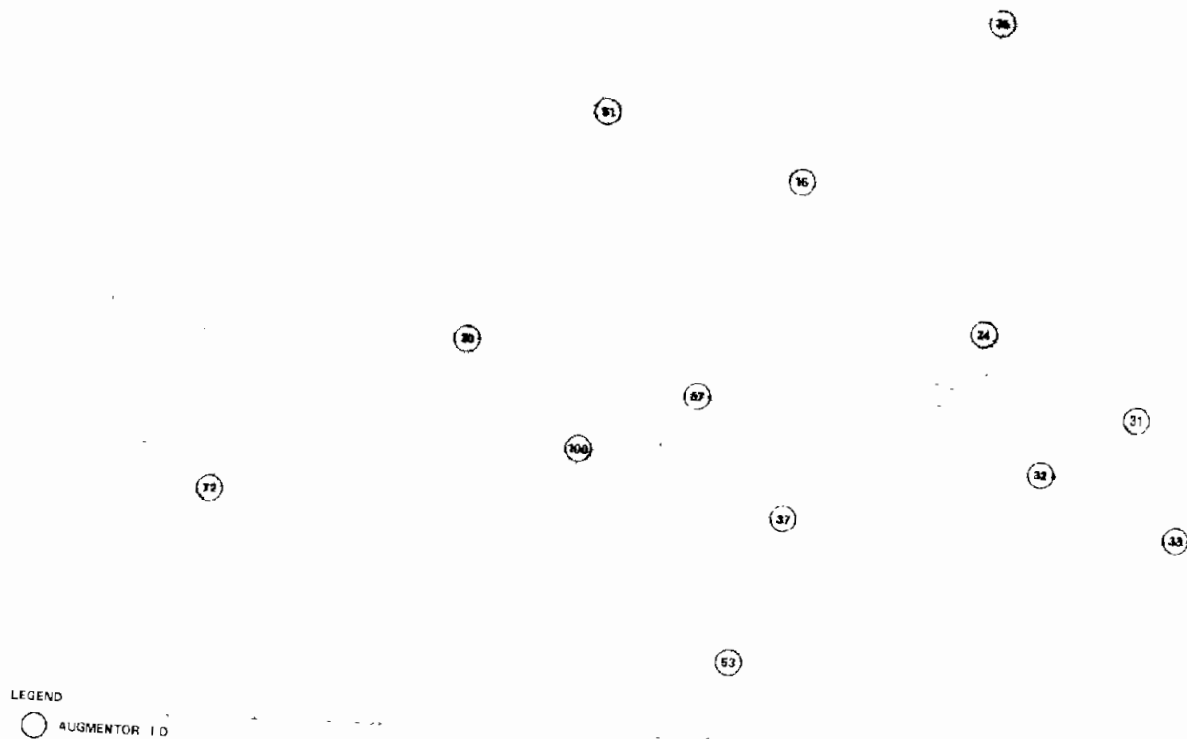

T108794.1

Figure 2-11. Fixed Route Augmentor Deployment - Original

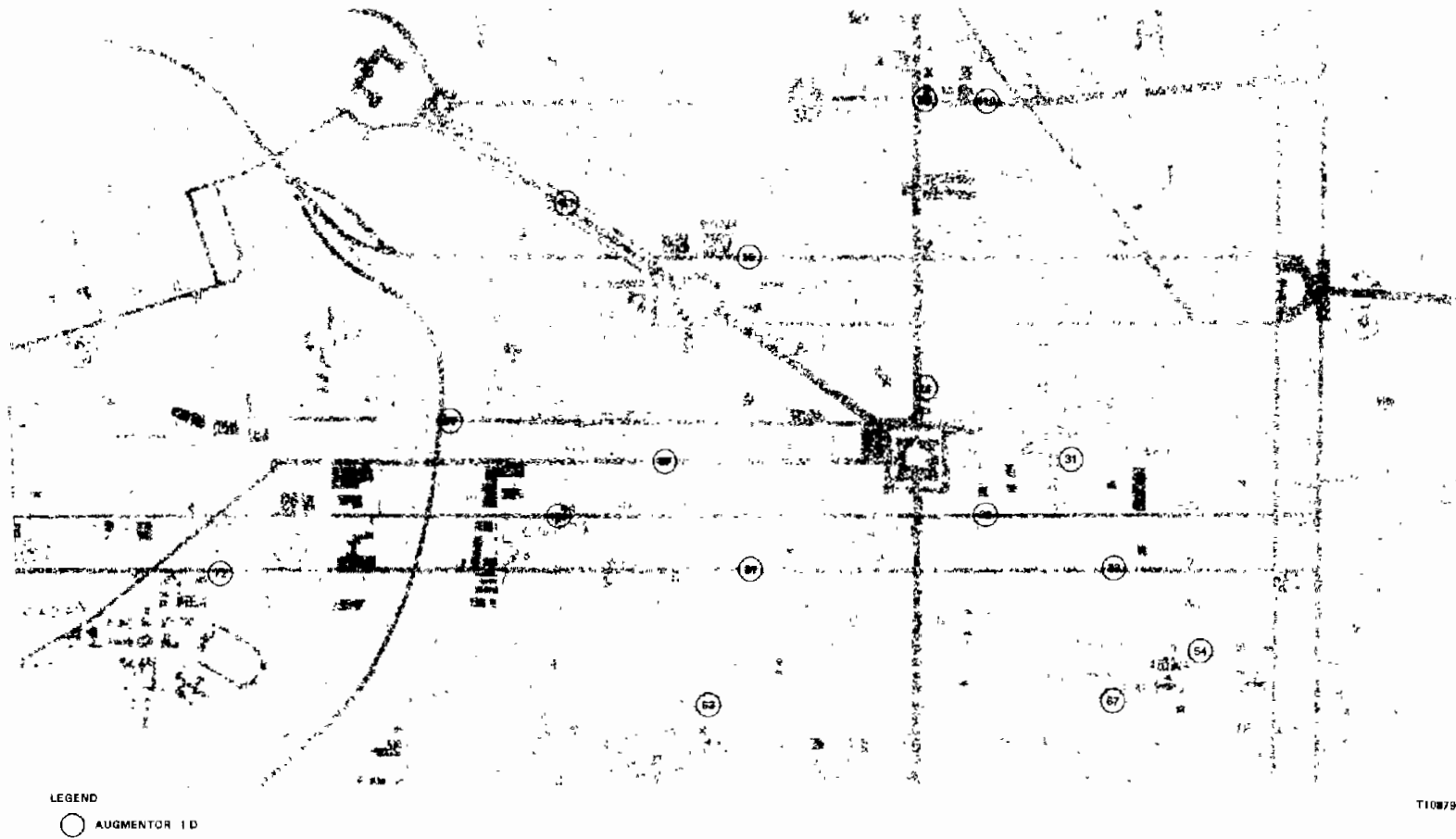
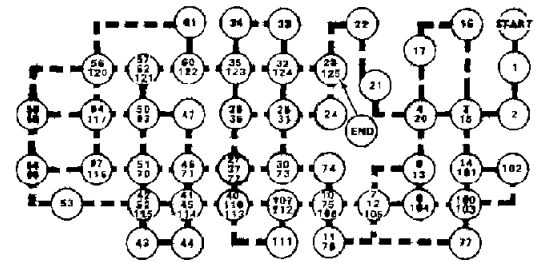

Figure 2-12. Fixed Route Augmentor Deployment - Revised

LEGEND
○ CHECKPOINTS - SEQUENTIALLY NUMBERED (OCTAL)
--- PATH



T108793

Figure 2-13. Random Route Test

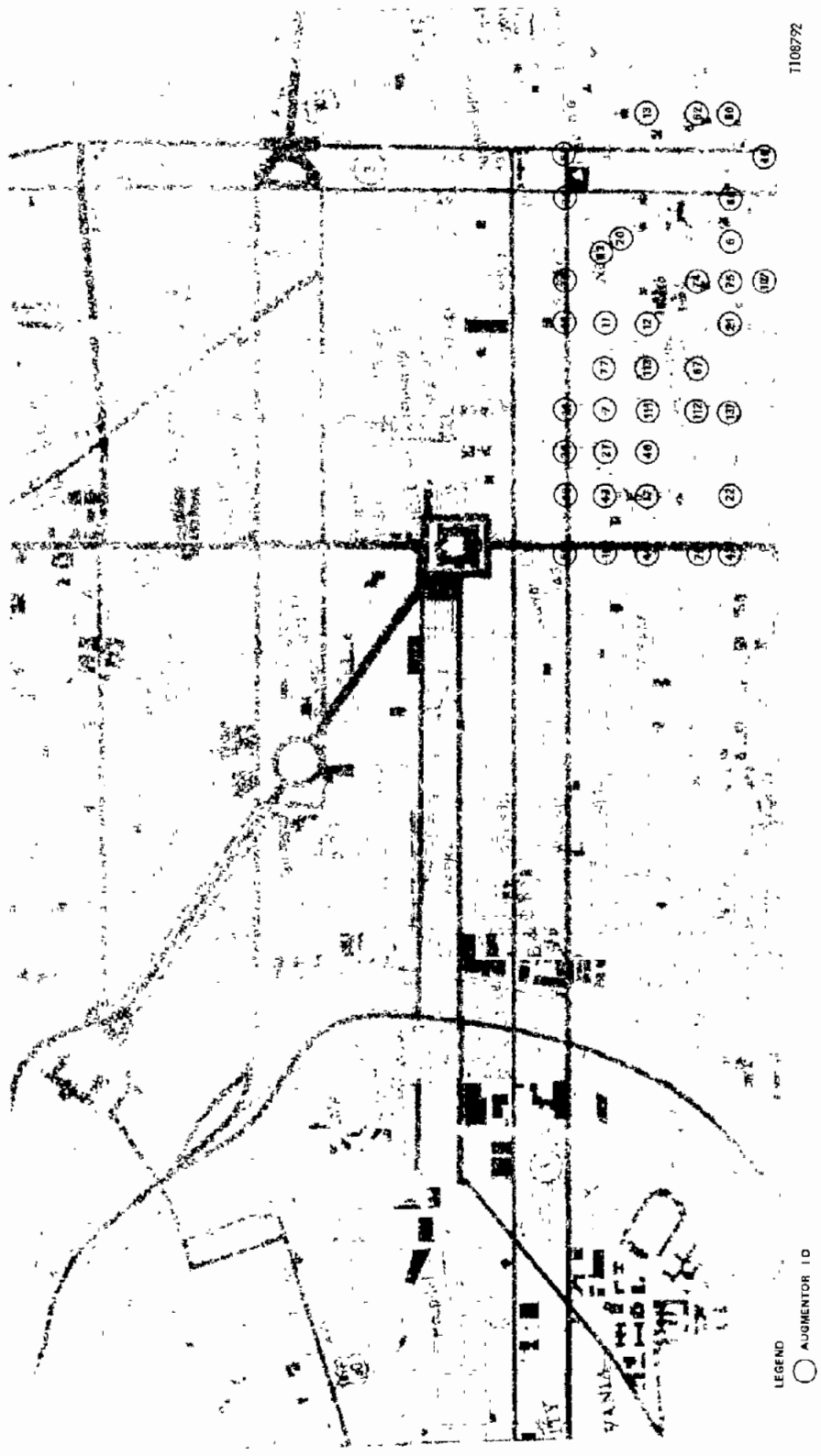

Figure 2-14. Random Route Augmentor Deployment

These tests were the last ones conducted in Phase I. Table 2-3 shows the test numbers and times.

Table 2-3. Random Route Tests

| <u>Test No.</u> | <u>Date</u> | <u>Time (Est)</u> |
|-----------------|-------------|-------------------|
| 20001 | 2/8/77 | 1655 |
| 20002 | 2/8/77 | 1809 |
| 20003 | 2/8/77 | 1911 |
| 20004 | 2/8/77 | 2008 |
| 20005 | 2/8/77 | 2110 |

Other than in test 20001, no procedural difficulties were encountered. In the first test, the augmentors on 8th Street (except for 8th and South) were inadvertently left off. At checkpoint seventy-four (74) this situation was realized, the test vehicle was momentarily stopped, and the 8th Street augmentors were turned on.

2.7 SPECIAL CASE TESTS

Various special case tests were conducted to evaluate the characteristics of elements of the location subsystem. These tests included tests of the LORAN system and of augmentors under different controlled conditions. A brief description of each test is given below. Detailed discussions of the tests are given together with results in Sections 4 and 6 respectively.

2.7.1 Augmentor Coverage vs Vehicle Speed, Test #30101 - 30112

The range and detection capabilities of typical augmentors were measured at vehicle speeds of from 10 to 75 mph.

2.7.2 Augmentor Coverage vs Elevation, Test #30201 - 30230

The range and detection capabilities of typical augmentors were measured at augmentor elevations of from 10 to 30 feet.

2.7.3 Augmentor Interference, Test #30301 - 30310

Mutual interference between two augmentors located from 50 to 200 feet apart was measured.

2.7.4 Augmentor Coverage vs Traffic Conditions, Test #30401 - 30410

The range and detection capabilities of typical augmentors were measured in heavy traffic.

2.7.5 Radio Frequency Interference Tests, Test #31001 - 31013

The bandwidth and emission characteristics of a typical augmentor were measured to determine whether an augmentor could generate any RFI.

2.7.6 Augmentor Antenna Pattern, Test #32001 - 32003

The antenna pattern of a typical augmentor was measured.

2.7.7 LORAN Position Lag vs Vehicle Speed, Test #30501 - 30510

LORAN position data was recorded over a statically calibrated course at vehicle speeds of from 10 to 40 mph.

2.7.8 Unusual LORAN Coverage, Test #30601

LORAN position data was recorded on the Ben Franklin Bridge.

2.7.9 LORAN Only Location Test, Test #30701

A fixed route test was conducted in a specially calibrated area. No augmentors were used for location derivation. Position was determined by LORAN measurements.

2.7.10 LORAN Repeatability, Test #30702 and 30703

The LORAN only test (2.4.9) was repeated to demonstrate the repeatability quality of LORAN measurements.

All special case tests were conducted on an unused runway at the Philadelphia Naval Base on February 6, 1977 except tests 2.7.9 and 2.7.10 which were run in an area north of the hi rise section, 2.7.8 which was run on the Ben Franklin Bridge, 2.7.4 which was run on a course which circled Philadelphia City Hall, and 2.7.6 which was run in the Teledyne parking lot in Northridge, California. Figure 2-15 shows the LORAN only area, Figure 2-16 shows the City Hall course, and Figure 2-17 shows the Ben Franklin Bridge course.

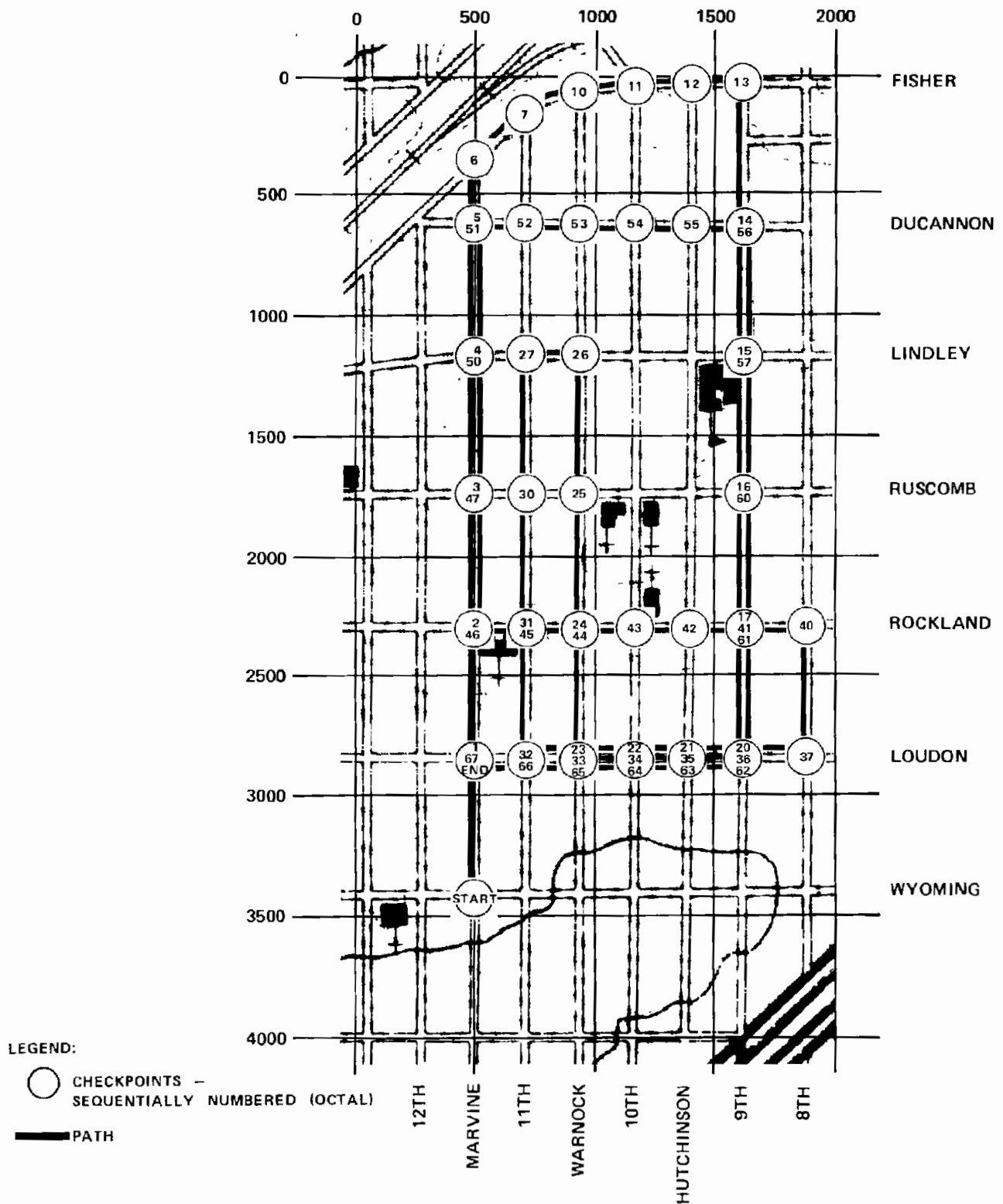

T105708A

Figure 2-15. LORAN Only Test Area

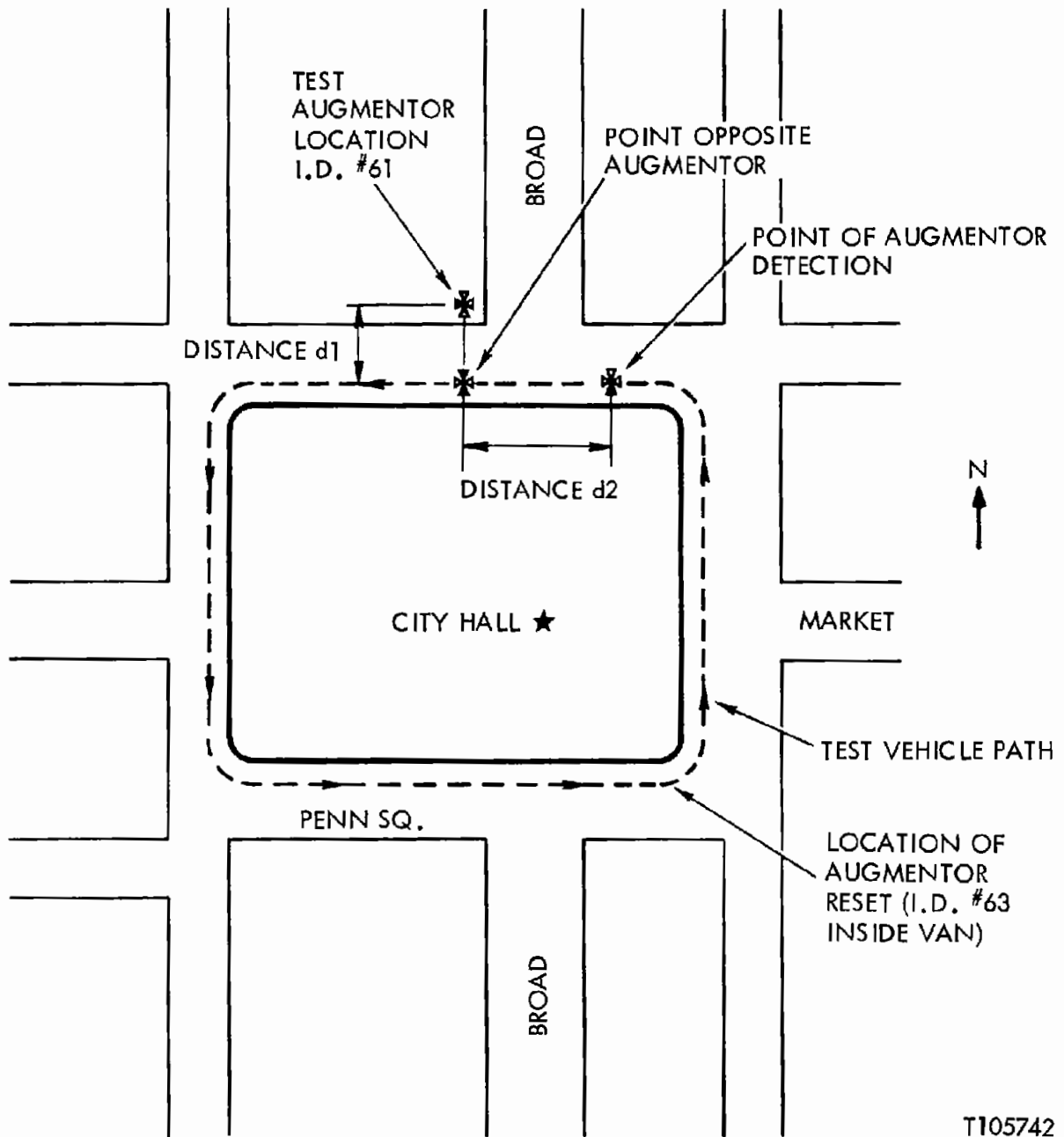

T105742

Figure 2-16. Special Case Test Augmentor Coverage vs Traffic Conditions

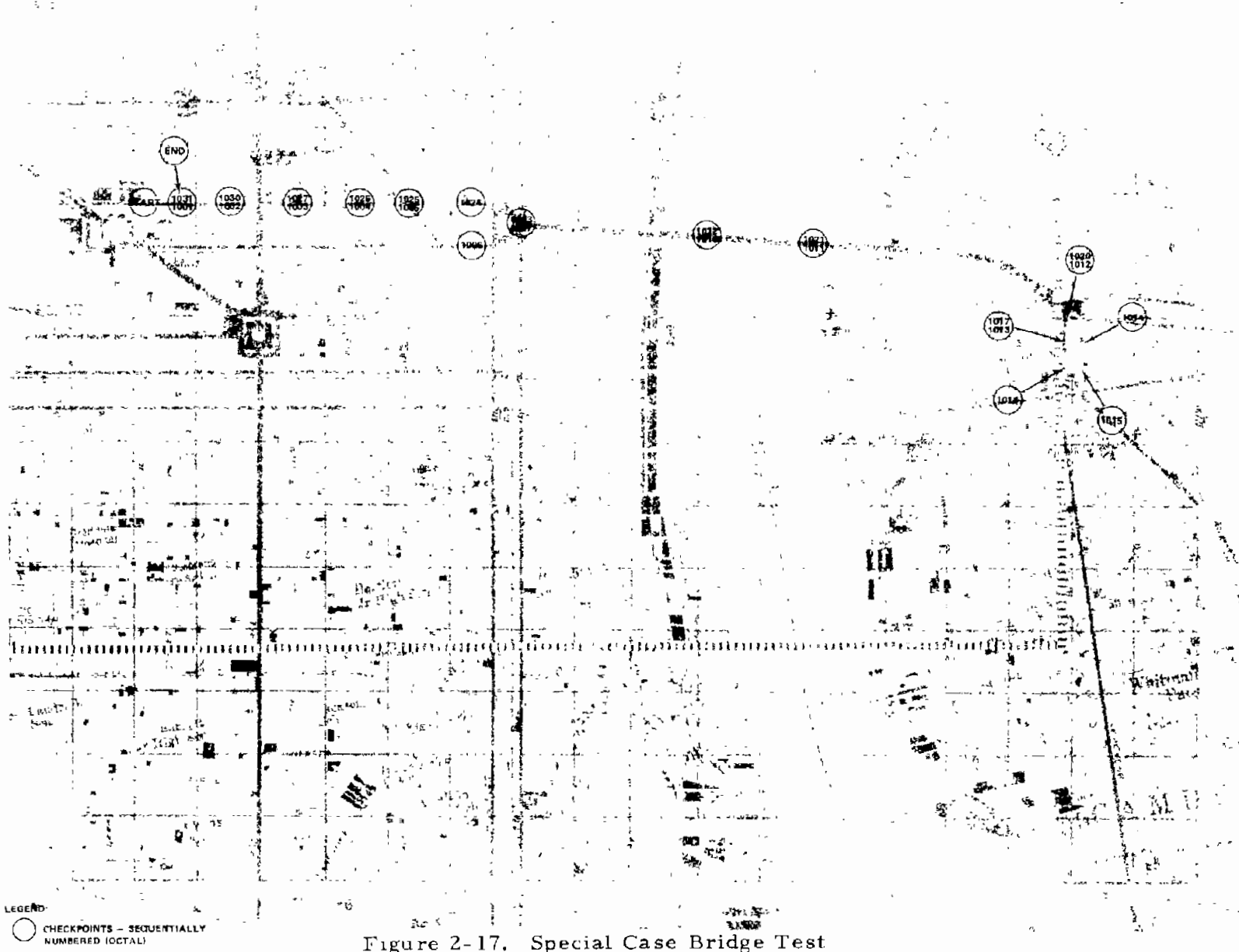

Figure 2-17. Special Case Bridge Test

SECTION 3

TEST CONFIGURATION

3.1 GENERAL

The mobile and base equipment was the same for all tests. As per the RFP, all Phase I equipment was functionally equivalent to the proposed Phase II equipment. Table 3-1 compares the major location subsystem elements for the two phases.

Table 3-1. Phase I - Phase II Location Subsystem Equipment Comparison

| Location Subsystem Element | Power Requirement | Size | Function |
|----------------------------|-----------------------|-----------------------|-----------------------|
| LORAN Receiver | Identical to Phase II | Phase II Smaller | Identical to Phase II |
| ACU | Identical to Phase II | Identical to Phase II | Identical to Phase II |
| Odometer | Identical to Phase II | Identical to Phase II | Identical to Phase II |
| Augmentor Receiver | Identical to Phase II | Identical to Phase II | Identical to Phase II |
| Digital Interface | Phase II Less | Phase II Smaller | Phase II Simpler |

The instrumentation equipment included in Phase I is not required for Phase II. This includes the test console, its displays, indicators, and input switches.

3.2 MOBILE EQUIPMENT

Mobile equipment falls into two categories: LAVM equipment and test instrumentation equipment. The former is the equipment being tested, the latter consists of all equipment required to measure and assess LAVM equipment performance.

3.2.1 LAVM Equipment

Figure 3-1 is a diagram of all LAVM equipment which was tested in Philadelphia. It is the prototype of the LAVM location subsystem. A brief description of each element is presented here.

3.2.1.1 Microlocator - The microlocator is the basic LORAN receiver which measures time-of-arrival of three (or more) LORAN C signals and outputs exact time differences used in the position location process. This receiver is the most modern available today and includes features specifically included to enhance its operation in the urban environment. Small size and low power have been achieved thru extensive application of the latest custom MOS/LSI integrated circuit and mini-processor technology. The Microlocator is shown atop the test console in Figure 3-2.

3.2.1.2 ACU (Antenna Coupler Unit) - The ACU matches the Antenna impedance to the microlocator front end. It also extracts the augmentor carrier frequency, 72.96 MHz, and sends this signal separately to the augmentor receiver. In this way, only one antenna is required for the complete LAVM system.

3.2.1.3 Left, Right Odometer Pickup - The odometers are hall effect proximity sensors permanently installed on the test vehicle. One device was installed near each front wheel. They sense proximity to 10 magnets which were installed on the inside of each wheel. Wheel rotation causes outputs which can be counted in the LAVM equipment and used to determine distance traveled.

3.2.1.4 Augmentor Receiver - The augmentor receiver is a circuit for detecting and demodulating the 72.96 MHz signal generated by the augmentor.

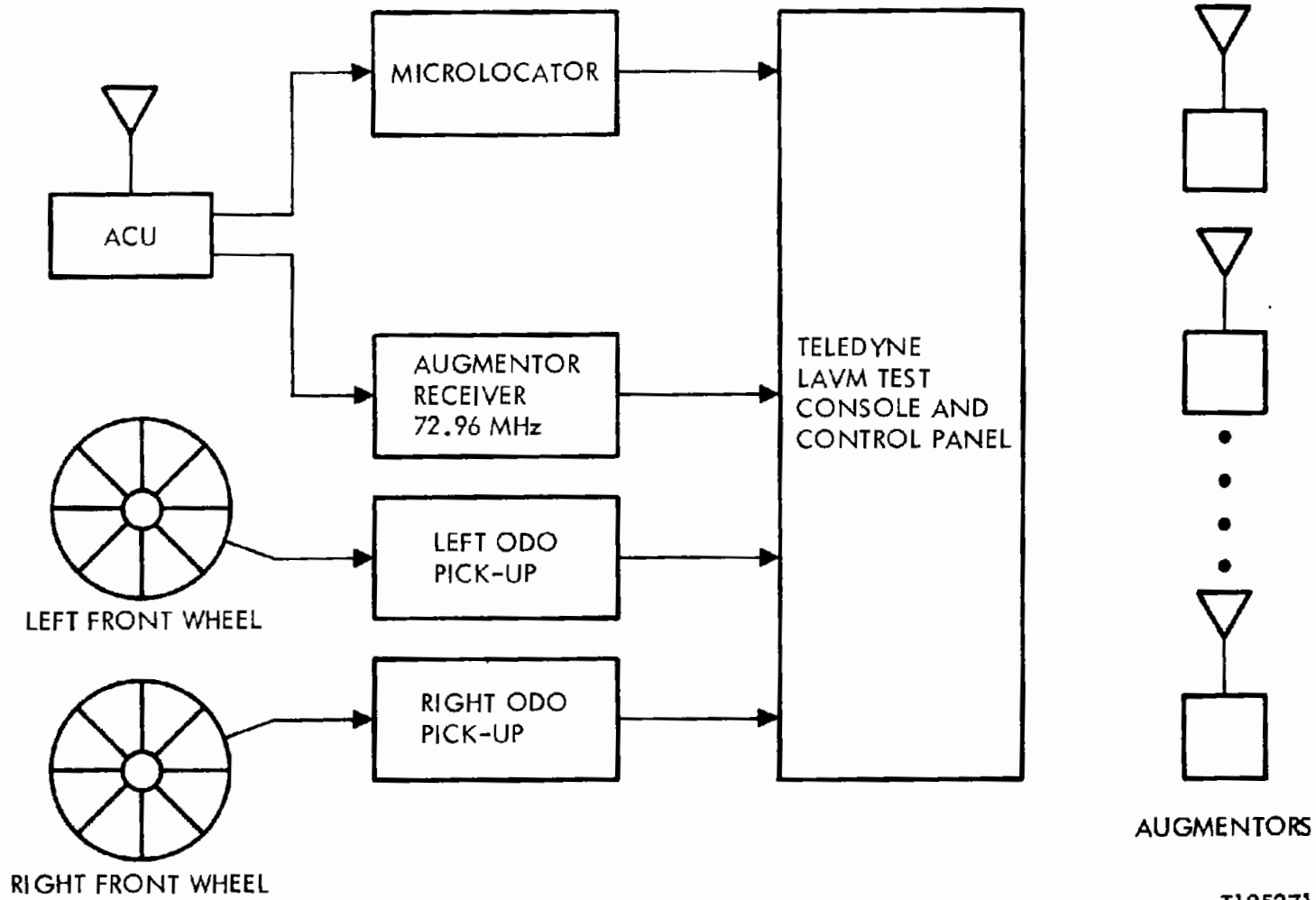

T105271

Figure 3-1. Block Diagram - LAVM Equipment

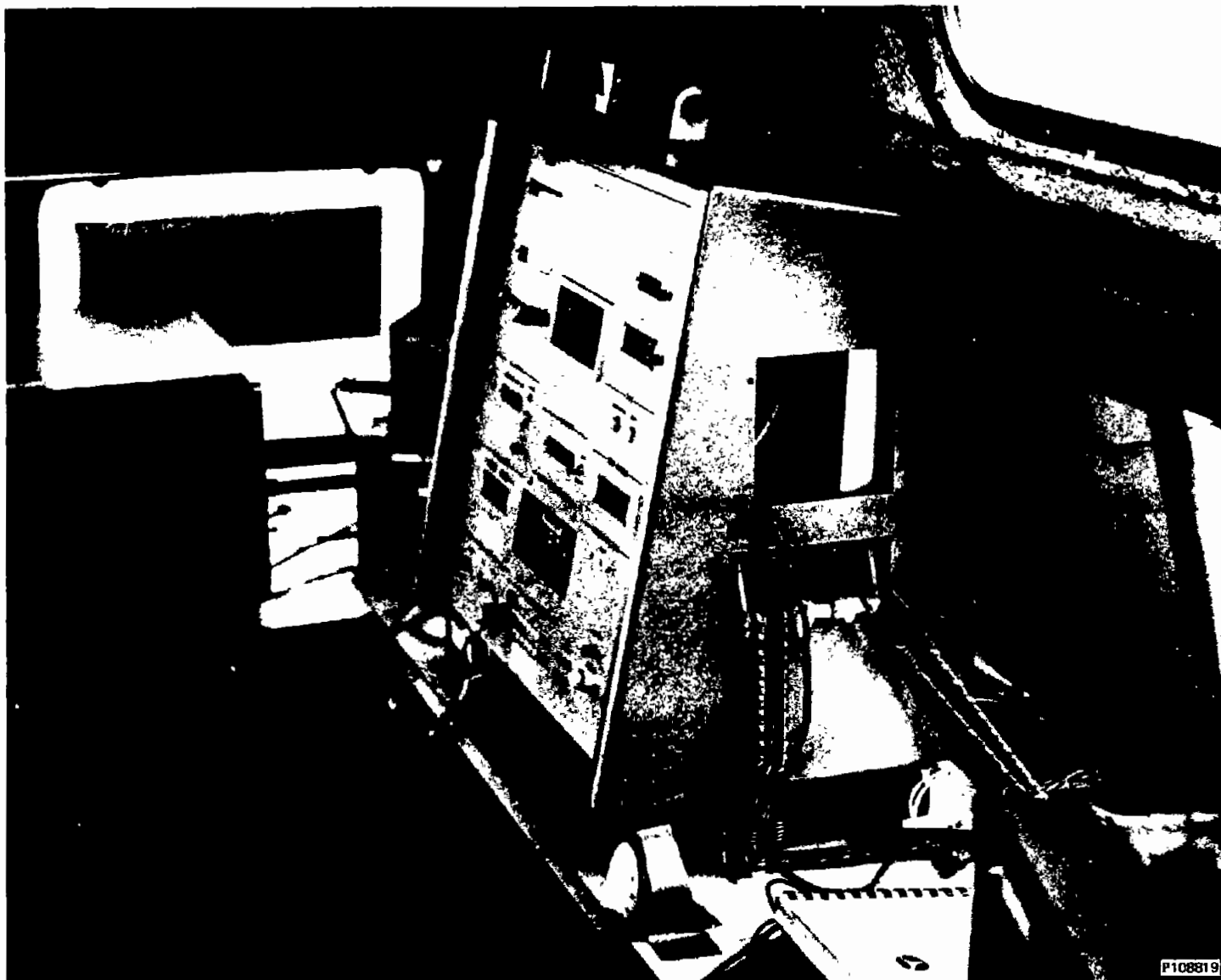

Figure 3-2. Micro-Locator LORAN Receiver and Test Console

3.2.1.5 Augmentors - Augmentors are wayside devices which emit a pulse-coded 72.96 MHz carrier with a range of from 50 to 75 feet. The devices tested in Philadelphia were battery powered. Figure 3-3 is a block diagram of a typical augmentor.

3.2.1.6 LAVM Test Console - The LAVM test console contained all the circuits required to gather, hold, format, and output the LAVM data message. In the test system, this message was expanded to include all required test instrumentation data and outputted to a magnetic tape recorder for off-line reduction and analysis. The test console is described in detail in Section 3.2.2.6.

3.2.2 Test Instrumentation Equipment

Figure 3-4 is a block diagram of the test instrumentation equipment. A brief description of each element is presented here.

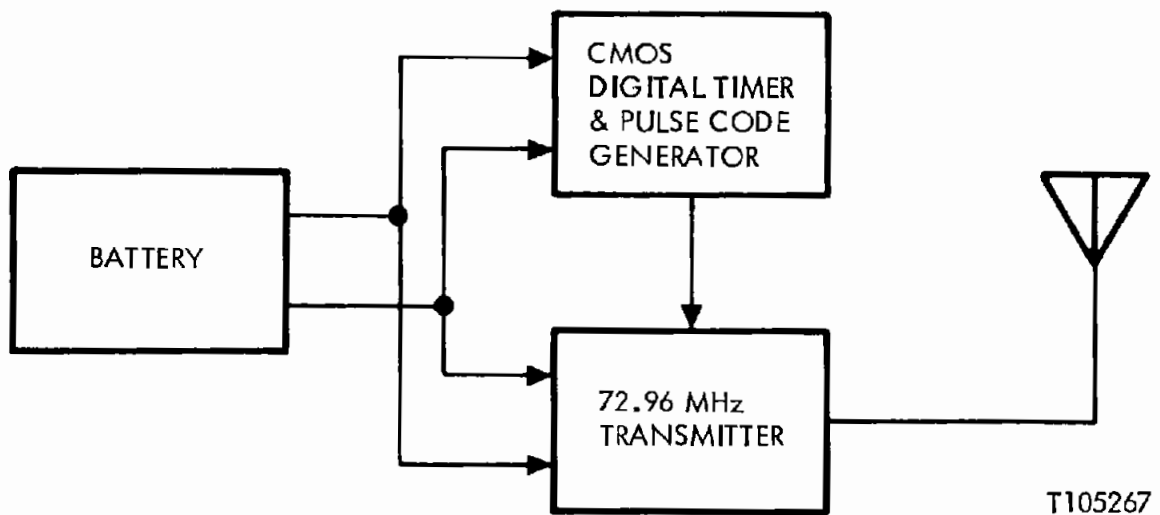
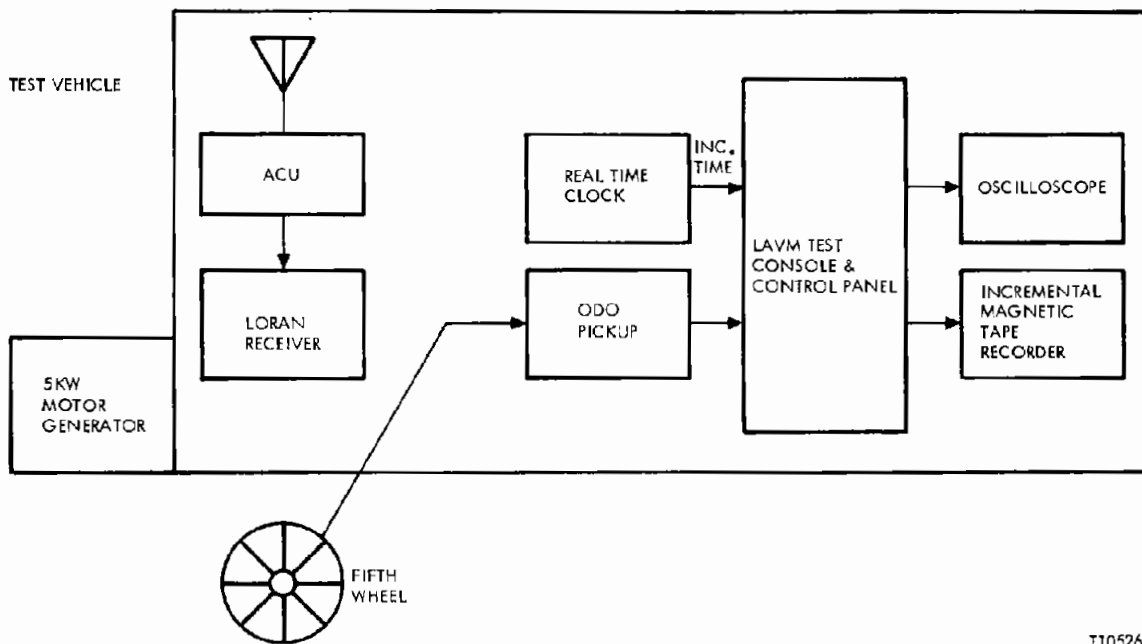

Figure 3-3. Block Diagram - Augmentor



T105268

Figure 3-4. Test Instrumentation Equipment Block Diagram

3.2.2.1 Test Vehicle and Motor-Generator - The test vehicle was a 1975 Dodge Maxi-van equipped with a 5 KW 115 VAC motor-generator. It contained all LAVM and test instrumentation equipment except augmentors. The power generated was used only for instrumentation equipment, however, since the LAVM equipment was powered by the vehicle's 12 VDC system. Figure 3-5 shows the van and generator.

3.2.2.2 Fifth Wheel - The fifth wheel was a high precision odometer used to determine exact distance traveled for error analysis. The device has a specified accuracy of 1% of distance traveled. The fifth wheel can be seen in Figure 3-5.

3.2.2.3 Real Time Clock - The real time clock display time-of-day for test data synchronization and also outputs incremental time to the magnetic tape via the test console.

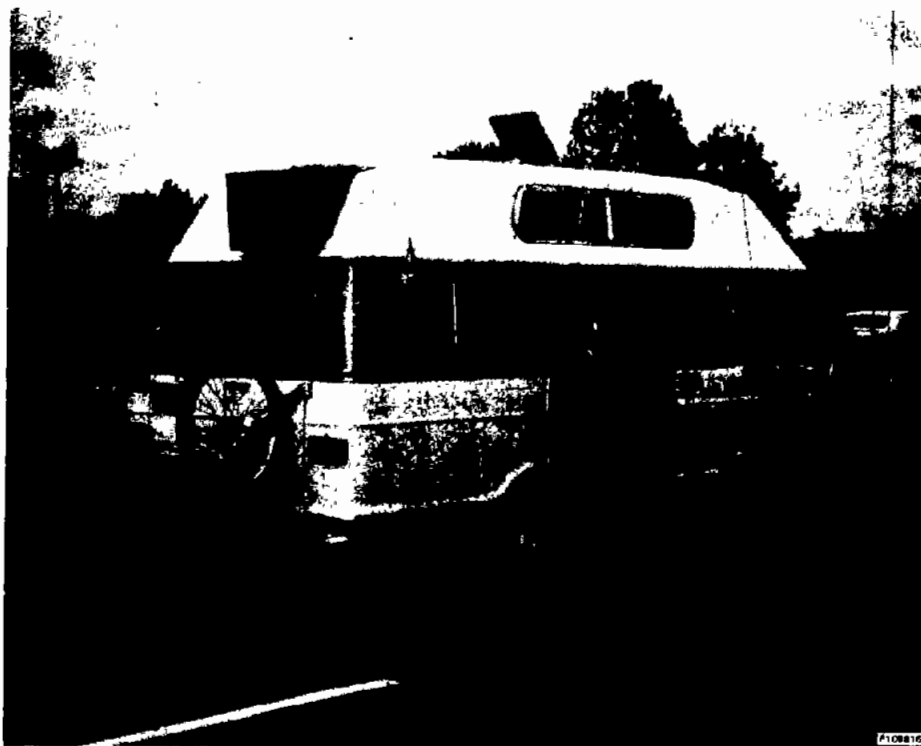

Figure 3-5. Test Vehicle, Generator & 5th Wheel

3.2.2.4 Magnetic Tape Recorder - The tape recorder was a 10 channel incremental write-only unit. All test and instrumentation data was written on this tape in the format described in Section 4. Figure 3-6 shows a partial view of the recorder on the right.

3.2.2.5 Oscilloscope - An oscilloscope was used to monitor the output of the bandpass filter in the microlocator for information only. It was not used in position location or test instrumentation. The oscilloscope and its position relative to the other test equipment in the vehicle can be seen in Figure 3-7 behind the test console at the rear of the van.

3.2.2.6 Test Console and Control Panel - Figure 3-8 shows the front panel of the LAVM test console. This unit was permanently installed in the test vehicle. It served three functional needs:

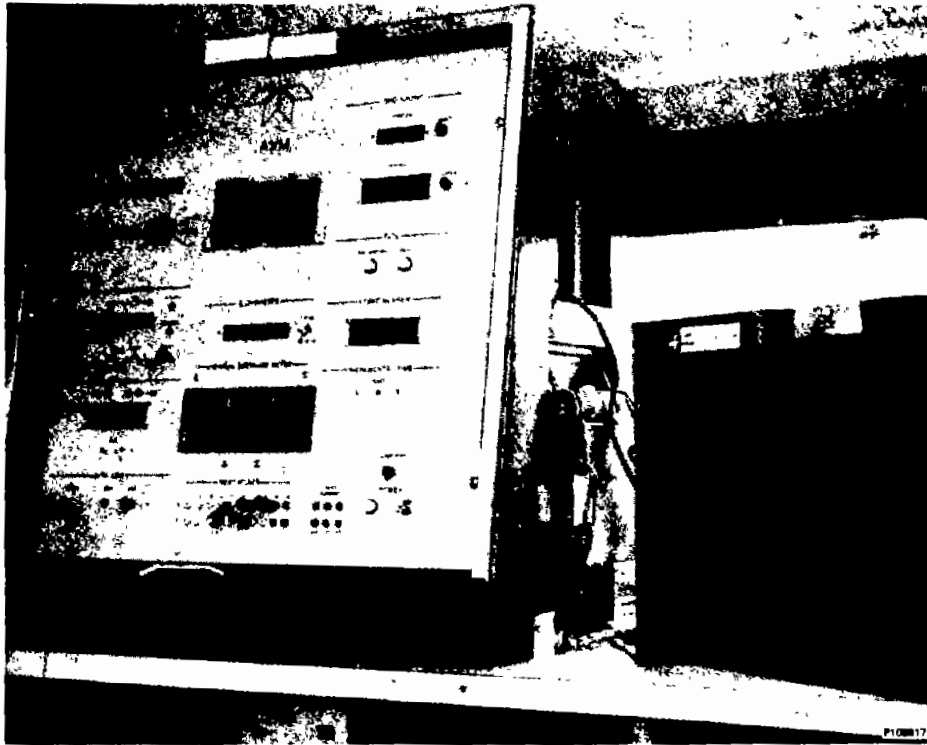

Figure 3-6. Magnetic Tape Recorder and Test Console



Figure 3-7. Test Equipment in Rear of Van

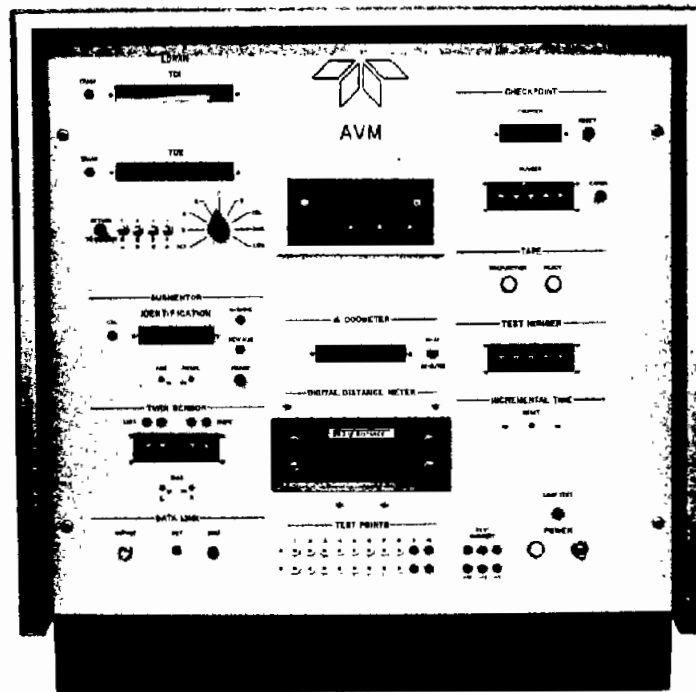

Figure 3-8. LAVM Test Console

- a. It allowed the test operator to input data such as checkpoint number, test number, and checkpoint arrive.
- b. It displayed all sensor outputs such as LORAN time difference, augmentor ID, and odometer.
- c. It collected all the sensor data, formatted it along with other relevant information such as equipment status and incremental time and presented it to the tape recorder along with the appropriate "write" commands. A brief description of its displays and controls follows. See Figure 3-9.
 - "TD1" and "TD2" are the two time difference displays. Each display presents the latest TD measurement from the Microlocator, in its entirety, i. e., 16,254.62 (microseconds). Note that this is essentially 'raw' TD data (not averaged) and slightly

different from the data put on tape which is an average of 16 TD measurements. It should also be noted that while the complete time difference binary number out of the microlocator is 22 bits long, only 13 bits are put on tape. This is because the 9 most significant bits are constant over an area much larger than either of the Phase I or Phase II test areas.

- "Track" indicators next to each TD display denote (when illuminated) that both the master and slave receiver phaselock loops are in the track mode.
- Under the TD displays is a set of switches which allow the test operator to return any or all tracking loops to the search mode. Tracking loops are sometimes returned to search during the calibration process in order to measure 'Time-to-Track'. This is the time for the receiver to automatically identify and lock on to all three LORAN signals. It is an indicator of LORAN coverage quality. Also located here is a rotary switch which allows the test operator to use the TD2 display to show selected receiver status registers such as signal-to-noise ratio, envelope discrepancy and velocity magnitude.
- "Augmentor Identification" is a display that shows the ID number of the last detected augmentor. Next to this display is an indicator which denotes the acquisition of a new (different ID from the last) augmentor. This is simply to call the operator's attention to the detection of a new augmentor. The pushbutton below will reset the "New Aug" indicator.
- "AGC" and "RANGE" are recessed potentiometers for periodic augmentor receiver calibration. Once set for test, no further adjustment is made to them.

- "DATA LINK" denotes panel outputs from the microlocator digital time difference output. A "XMIT" pushbutton is provided which, when depressed, will cause the microlocator to output digital data containing the latest TD measurements. This is not used in the present AVM Test Procedure but was included in the test console to increase its utility.
- The time of day clock is mounted in the center of the panel.
- "Odometer" display shows the accumulated number of impulses (not feet of travel) in either of two registers. The operator may select which register he wishes displayed by means of the switch just to the right of the display. In the "Aug-Aug" position the register which accumulates impulses between consecutive augmentor detections is displayed; in the "Aug-Rep/Rep-Rep" position, the register which accumulates impulses from report to report or from augmentor detection to report is displayed. This is the primary odometer information used in position processing. The register is reset every report (automatic or manual) and on every "New Augmentor" flag.
- "Digital Distance Meter" is the readout portion of the fifth wheel odometer. The display overflows at 5,280 feet. The output of the fifth wheel is also accumulated in the test console and included in each data message to provide a continuous measure of distance traveled.
- "Number" is a 5 digit octal thumbwheel bank used to enter the checkpoint number. Each time the "enter" pushbutton is depressed the checkpoint number is read and put on tape along with all sensor data. The "counter" display indicates the total number of times the "enter" button has been pushed. It accumulates until reset by the nearby pushbutton switch.

- "Tape Malfunction" and "Ready" lights are remote indicators of signals generated in the magnetic tape recorder.
- "Test Number" is a 5 octal digit thumbwheel bank which allows the operator to keep better track of recorded data. This number appears in every tape record.

3.3 MONITOR STATION EQUIPMENT

The monitor station provided a continuous daily hard copy record on the LORAN chain stability. Any variations in chain timing were automatically recorded and used in post-test data evaluation.

The monitor station consisted of a LORAN receiver, ACU, strip chart recorder and interface. This equipment operated continually during the calibration and test process. No significant time difference deviations which could affect location measurements were noted. In particular, the ministration exhibited remarkably stable timing characteristics throughout the Phase I program.

The recorder was a two channel analog device. It recorded the 1 microsecond and 100 nanosecond number of each time difference being measured. For example, if TDA (Nantuckett) was 51,744.3 microseconds, the 4.3 part of the digital time difference was converted to an analog signal in the recorder interface (see Figure 3-10). The recorder was scaled so that each large division equals 1 microsecond and each small one 100 nanoseconds (see Figure 3-11A). The range of each channel is from 0.0 to 9.9 microseconds which is sufficient to record any timing variations. Figure 3-11B is a photograph of the monitor station.

The monitor station was located at the Marriott Motor Hotel.

3.4 MINI STATION EQUIPMENT

A LORAN C ministration was temporarily installed in Limerick Township, PA. for the duration of the Phase I Program. Standard LORAN C coverage in the Philadelphia area has been shown to be inadequate in view of the location accuracy required. In particular, the LORAN C Slave at Dana, Indiana does not provide the

3-14

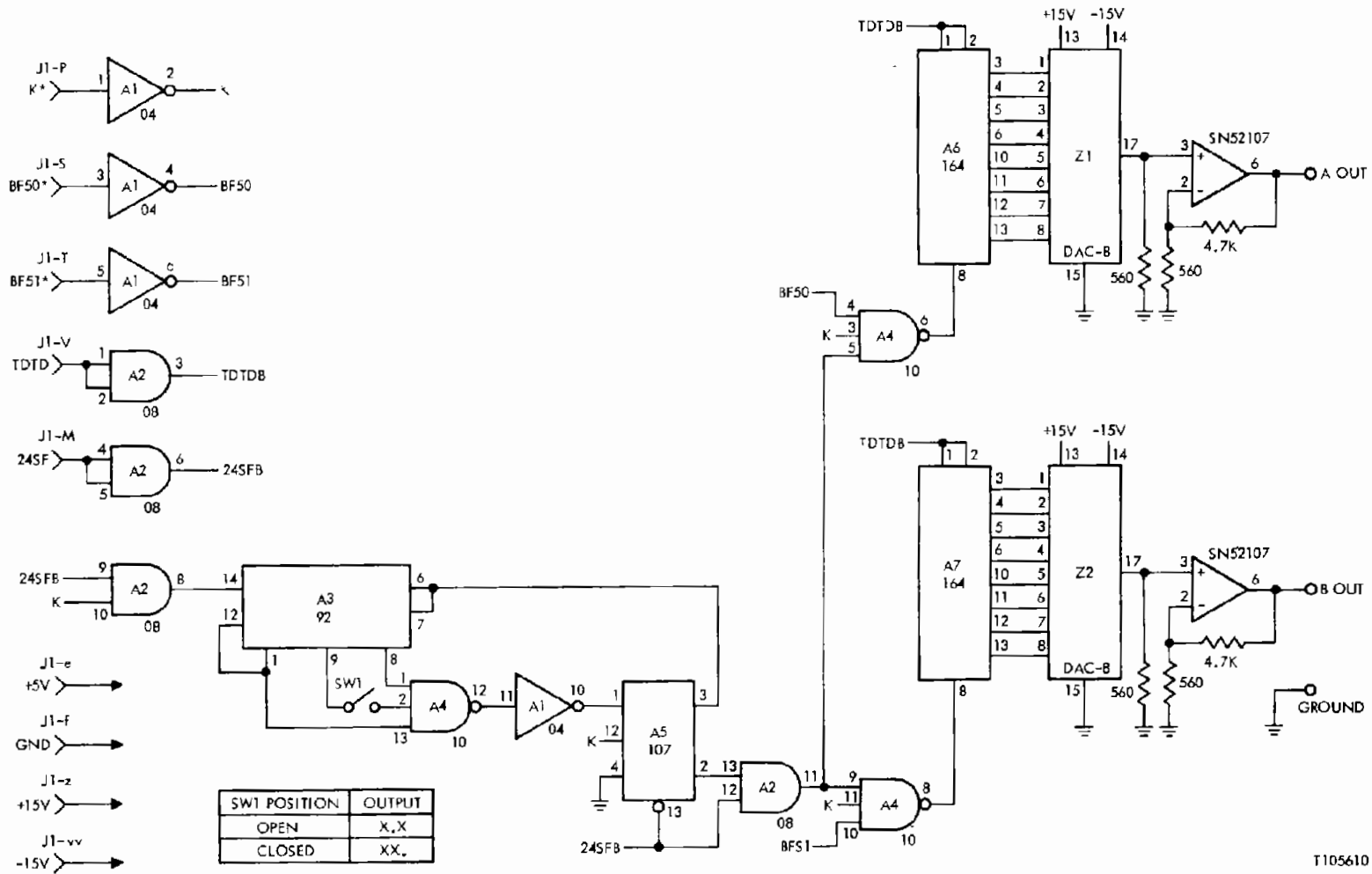

T105610

Figure 3-10. Monitor Recorder Interface

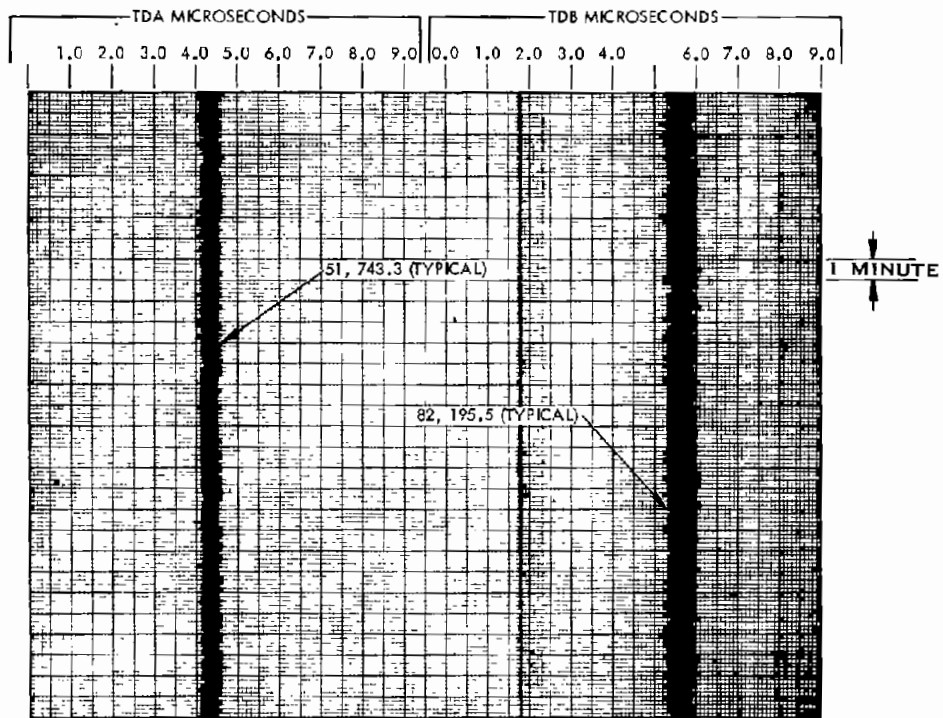

T105754

Figure 3-11A. Monitor Station TD Recording

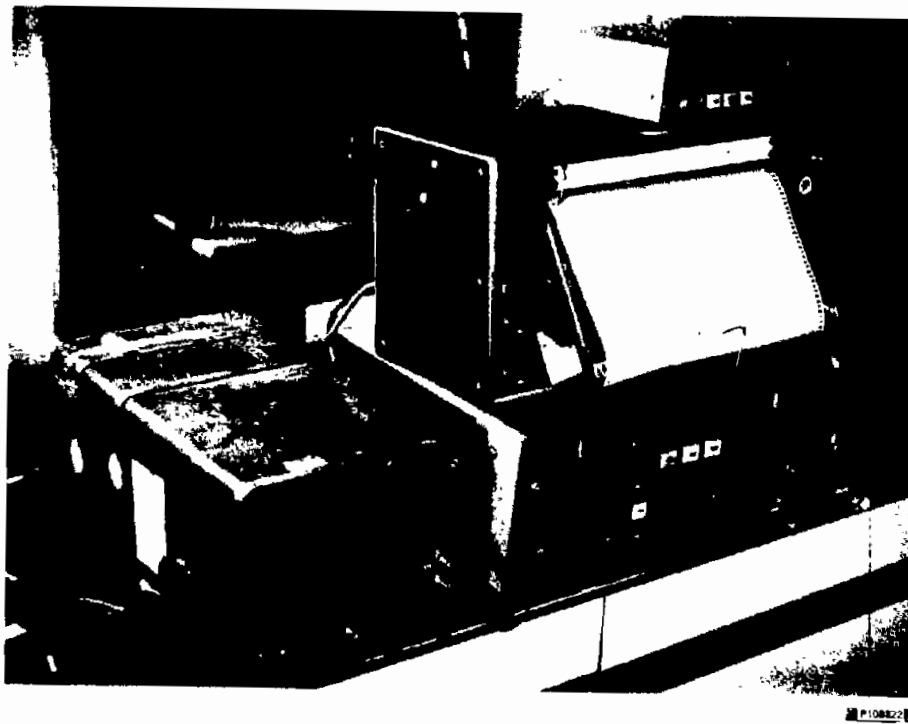

P108823

Figure 3-11B. Monitor Station

P108823

test area with signals of sufficient strength and quality required to meet the objectives. The ministation was assigned a coding delay of 82,000 microseconds by the U.S. Coast Guard and authorized to transmit at a nominal radiated power of 100 watts. This station was synchronized to the U.S. East Coast Master and used in conjunction with the Slave Station at Nantucket Is., Mass. to provide the necessary LORAN coverage. The station performed flawlessly on a daily basis for the entirety of the 5-month program.

The mini station equipment is shown in Figure 3-12. This equipment consists of the following units:

- Time Unit
- Power Supply No. 1
- Power Supply No. 2
- Megatron No. 1
- Megatron No. 2
- Control Unit
- Output Network
- Timing Receiver

Transmitter Characteristics were as follows:

- Frequency - 100 KHz
- Emission Designator - 20P2
- Radiated Power - 100 Watts @ Peak of Pulse
- Average Input Power From Final - 2 KW
- Peak Power @ Final Amp - 15 KW
- Spectrum - 99% of Energy within 80 KHz - 120 KHz Band
- Timing Stability - U.S. East Coast Master ± 25 nSec
- GRI - 9930 (SS7)
- Coding Delay - 82,002.5 microseconds

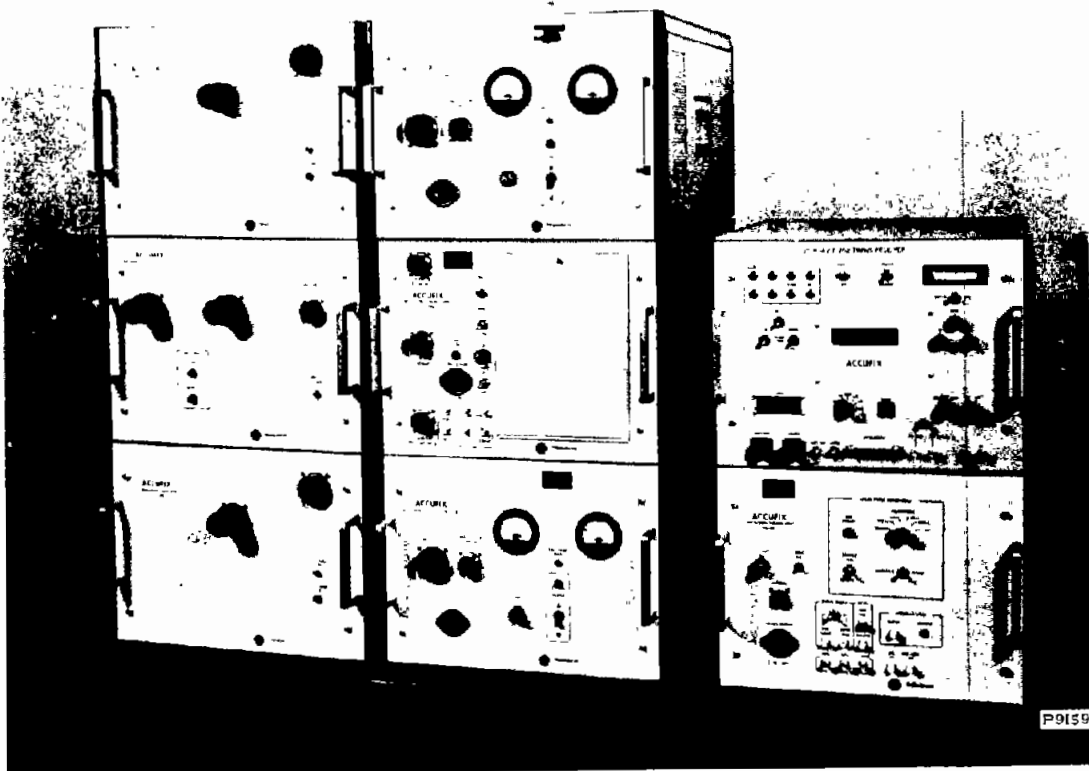

Figure 3-12. LORAN C Mini Station

The ministration was located at

75° 30' 14" W

40° 12' 47" N

99 Limerick Road

Royersford, Pa. 19468

The transmitting antenna was a 100 foot top loaded aluminum tower with sixteen 100 foot ground plane radials. Figure 3-13 is a diagram of the tower, Figure 3-14 is a photograph of the actual installation.

3.5 AUGMENTOR DEPLOYMENT

Fifty-three augmentors were deployed for Phase 1 tests. Except for time-points, augmentor deployment is a function of LORAN coverage. That is, augmentors were installed where the lack of adequate LORAN signal coverage indicates they were required. Deployment for the random route test was not the same as that for the fixed route test. This is because the random route test area had spotty LORAN coverage. Without a priori knowledge of the test route, a worst case situation was assumed. This would be a route which goes continually in and out of good LORAN coverage making very dense augmentor deployment mandatory. The fixed route, on the other hand, traverses sections of good LORAN coverage which resulted in augmentors only located at time points. Figure 3-15 shows final fixed route augmentor locations, and Figure 3-16 shows those used on the random route. Figure 3-17A, B, C show typical augmentor installations. The exact locations and coordinates of augmentors at specific intersections are given in Appendix C.

3.5.1 Augmentor Operation

Augmentors are low power radio frequency transmitters which are designed to be mounted at or near an intersection on a traffic signal or lamp post. They transmit a time coded signal at a frequency of 72.960 megacycles which the detector circuit in the LAVM ACU will recognize. The time code for each augmentor in the system is unique. A block diagram is shown in Figure 3-18. The thumbwheel switches

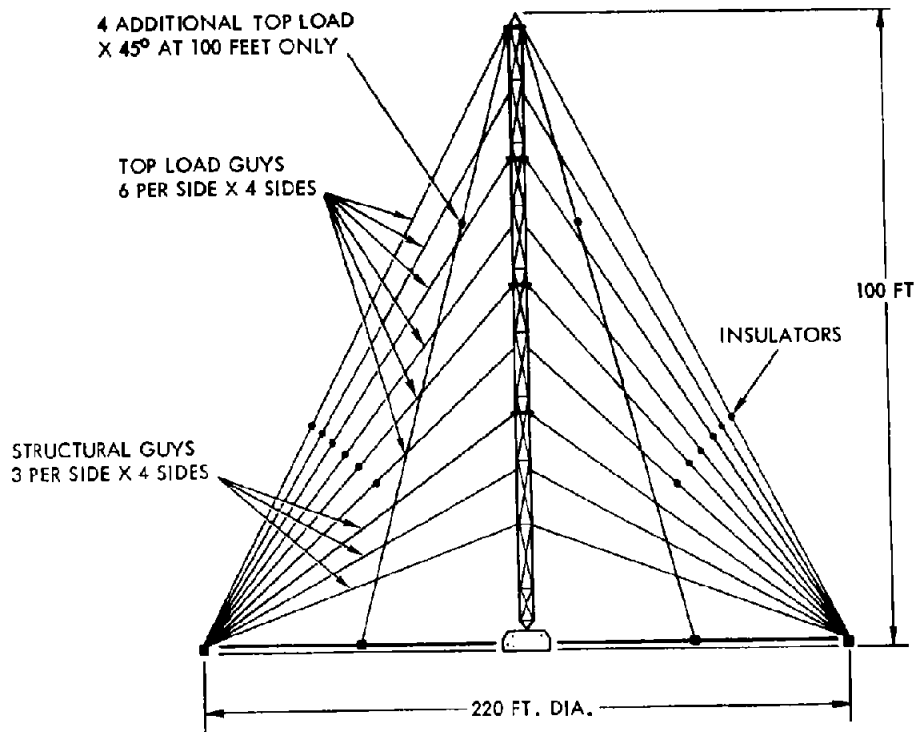

TOWER SECTION

100 FT
90 FT
80 FT
70 FT
60 FT
50 FT

TOP LOAD LENGTH

94.3 FT (8 REQUIRED)
89.7 FT (4 REQUIRED)
85.3 FT (4 REQUIRED)
81.3 FT (4 REQUIRED)
77.7 FT (4 REQUIRED)
74.5 FT (4 REQUIRED)

GROUND PLANE 16
RADIAL WIRES
(100 FOOT RADIUS)

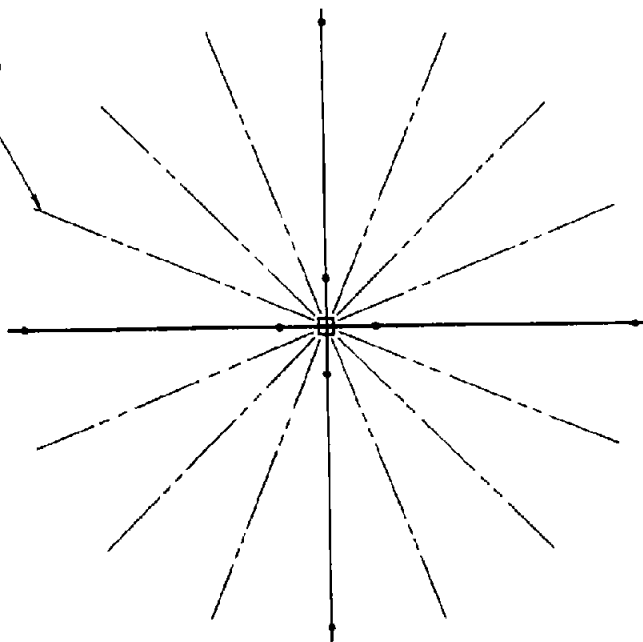

T92864

Figure 3-13. Transmitter Tower Diagram

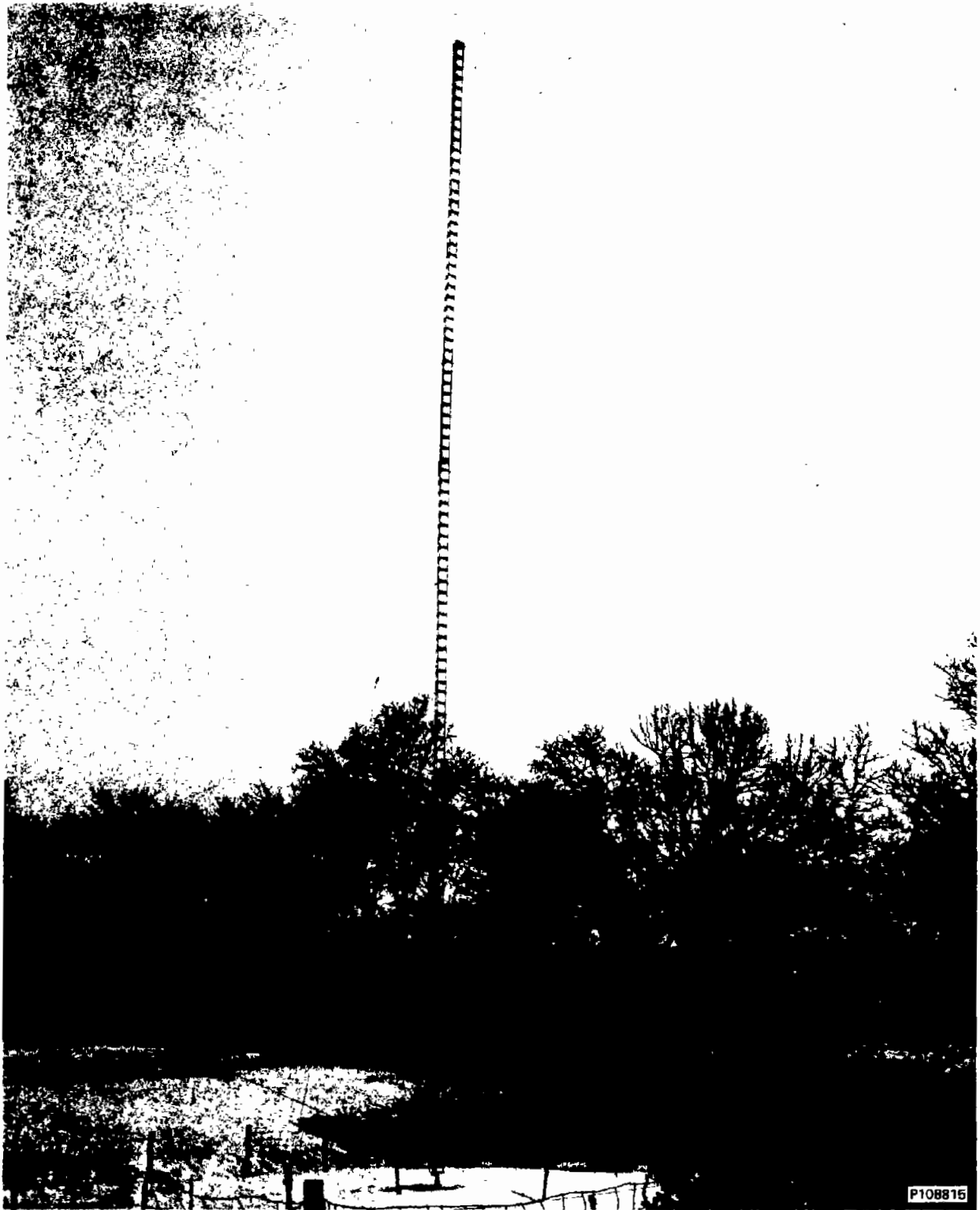

Figure 3-14. Tower Installation

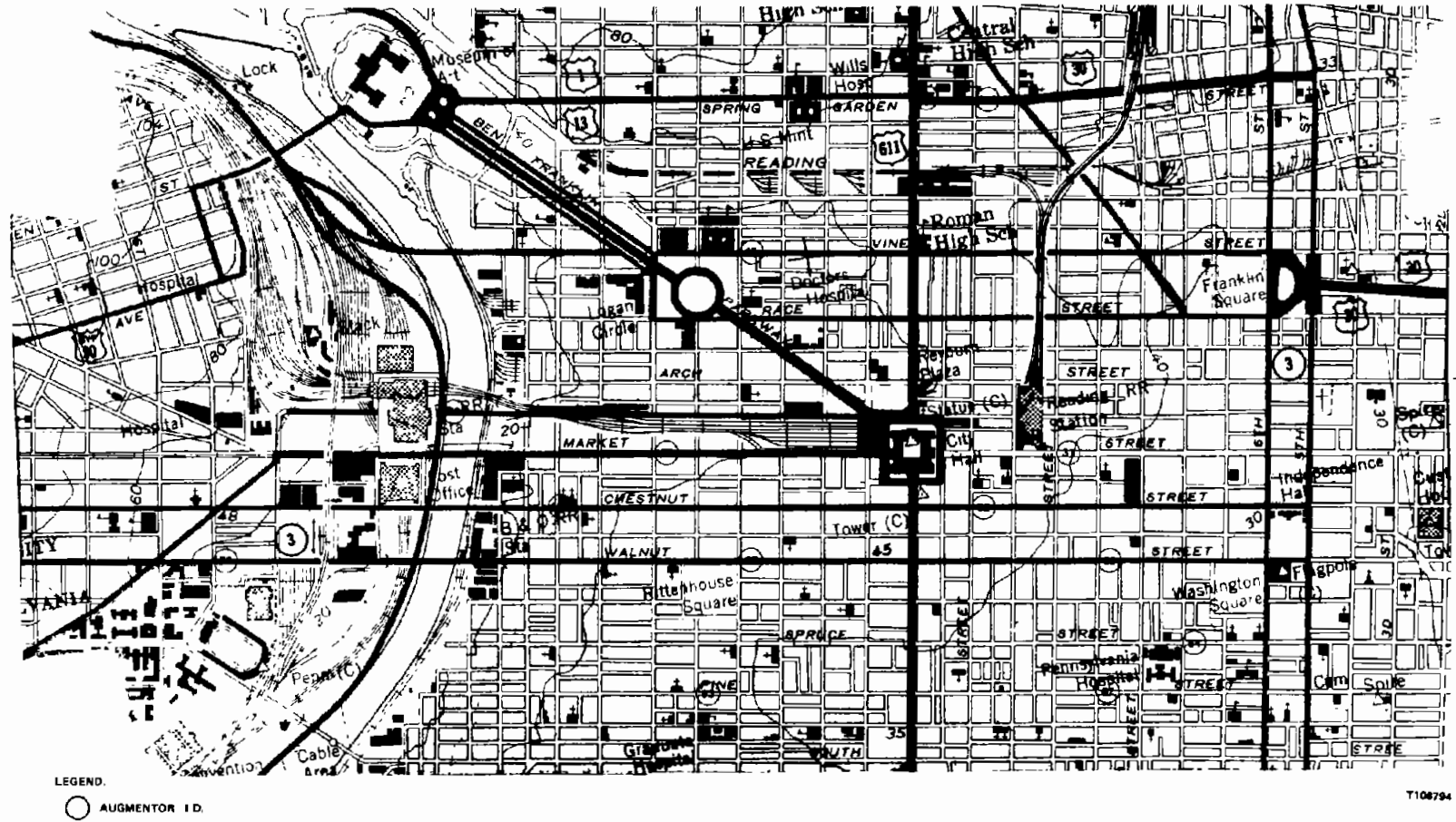

Figure 3-15. Fixed Route Augmentors

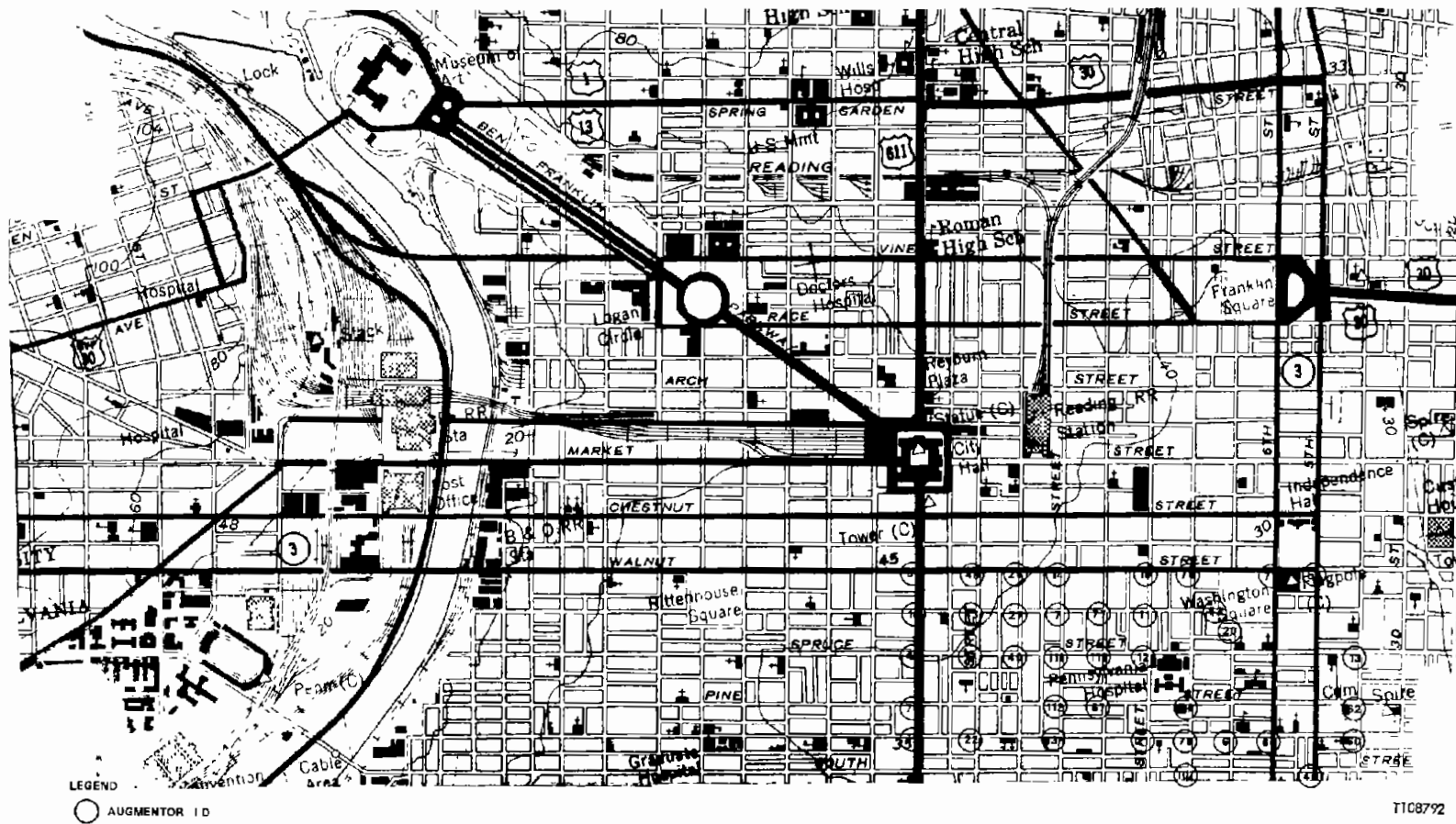

Figure 3-16. Random Route Augmentors



P108810

Figure 3-17A. Typical Augmentor Installation



P108811

Figure 3-17B. Typical Fixed Route Augmentor Installation

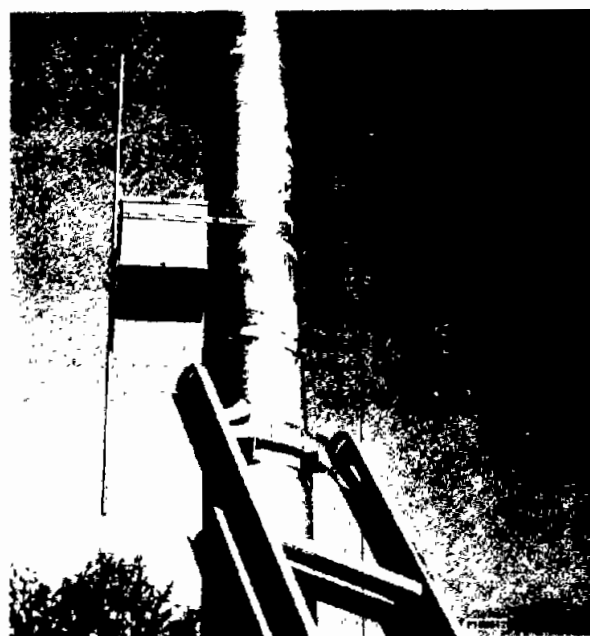

P108812

Figure 3-17C. Typical Random Route Augmentor Installation

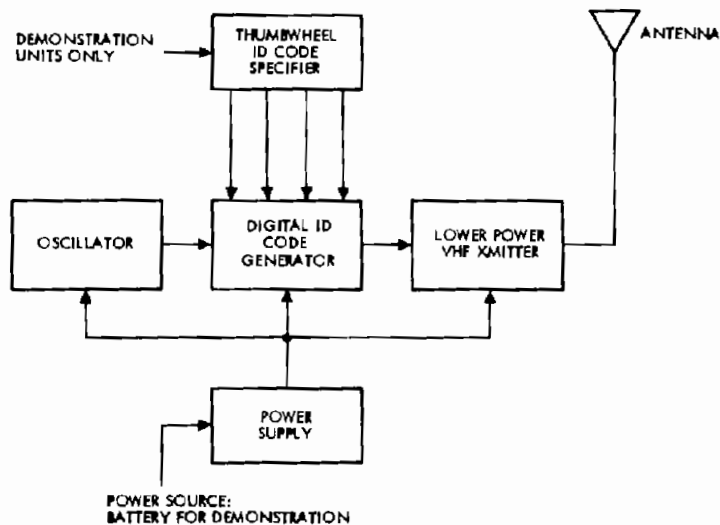

T100627A

Figure 3-18. Augmentor Block Diagram

shown in the diagram are for demonstration or test purposes only and are not required in production units. Each element of the augmentor is simple and unsophisticated for high reliability. The oscillator is a purchased item very similar to the oscillator used in the LAVM receiver. This is a small, reliable unit with a modest stability specification of 1×10^{-5} .

The code specified in the code generation is in the form of a time period between pulses rather than the more conventional binary or BCD number transmission. This simplifies vehicle and augmentor hardware and increases reliability. Figure 3-19 is a timing diagram of the coding technique used. Detection of an augmentor signal consists of recognition of the 240 microsecond start pulse and the 360 microsecond stop pulse. The time between these pulses must be within a predetermined limit or no detection is made. Any combination of signals which meet this criteria will constitute an augmentor detection, while the time from

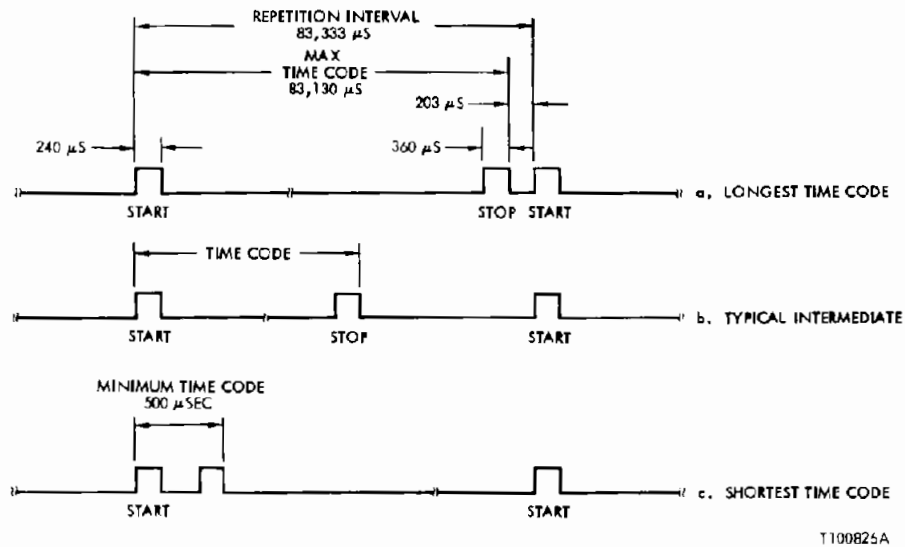

Figure 3-19. Augmentor Timing Code

start pulse falling edge to stop pulse falling edge will uniquely identify an augmentor. Noise which occurs between pulses has no effect unless it occurs after the start pulse and causes the receiver to produce an artificial pulse exactly 360 microseconds long.

3.6 EQUIPMENT OPERATIONAL REQUIREMENTS

Equipment Calibration was required on some items prior to formal testing and monitored during testing to assure proper operation of support hardware. Those items requiring no calibration were:

- a. Antenna Coupler Unit
- b. Test Console
- c. Monitor Station

Hardware which required calibration prior to the start of formal testing and then was not changed thereafter was:

a. Microlocator

1. Notches set for 92.5 KHz interference.
2. Oscillator was replaced due to large drifting and instability (new oscillator was set to center frequency of 3.2 MHz \pm 5 Hz)
- no problems thereafter.

b. Left and Right Odometers

Scaling was accomplished prior to tests and the figure used was .7477567 feet per output pulse.

c. Augmentor Receiver

A sensitivity and AGC adjustment was made prior to testing.

d. Augmentors

Exclusive of the temperature modifications discussed previously, each augmentor was adjusted for transmitting range by the adjustment of augmentor and/or antenna height (see Special Case Tests - Section 6).

e. Fifth Wheel

Calibration of the fifth wheel was accomplished by running a measured mile prior to the tests. This was accomplished by adjusting the tire pressure. The pressure selected was 28 PSI.

f. Magnetic Tape Recorder

Lubrication and electrical calibration of the magnetic tape recorder was performed in Philadelphia prior to commencement of testing at Sorbus, Inc.

Items which required daily spot checks and preventative maintenance were:

a. Motor Generator

The oil was changed daily in the motor-generator. The original generator was replaced just after the start of testing due to a catastrophic internal failure of the motor caused by rapid oil loss. The new generator was obtained and installed within one day and did not cause more than a 24 hour delay in tests.

Due to the severe cold and ice conditions, the generator and exposed gas tank were kept covered and double insulated at night to prevent ice and/or water from entering the tank.

Daily checks were made on the line voltage from the generator after the low voltage problem was discovered.

b. LORAN Mini-Station

The LORAN Mini-Station located in Limerick was calibrated daily each morning prior to testing. This was accomplished by using the monitor station at the Marriott Hotel which was previously discussed.

c. Fifth Wheel

The fifth wheel tire pressure was verified daily to be 28 PSI (the calibration pressure).

d. Test Vehicle

The test vehicle was serviced every 1000 miles for oil changes, lubrication, and engine tune-up. In additional daily spot checks were made to all vehicle systems.

3.7 HUMAN OPERATIONAL REQUIREMENTS CHECKLIST

In addition to the operational requirements of the equipment, a check list was devised to help limit any human operational errors that could arise. The check list in its final form is shown below:

- a. Pre-Run:
 - Gas Vehicle
 - Gas Generator
 - Check 5th Wheel Pressure (28 psi)
 - Gas Tank Secure
 - Rotating Beacon Secure
 - Electrical Wires Clear of Exhaust
 - Electrical Wires Clear of 5th Wheel
 - Generator Gas Cap Loosened and Secure
 - Start Generator-Run 30 Min
 - Start Vehicle and Warm-Up - 30 Min
 - Check Magnetic Data and Audio Tapes Aboard
 - Initialize Strip Chart Monitor and Calibrate Mini-Station
 - Drain any H₂O from Gas Tank Drain
 - Check Line Voltage = 110 Vac

- b. Run:
 - Test Console On
 - Oscilloscope On
 - Power Filter On
 - LORAN Receiver On
 - Digital Recorder On
 - Proceed to Starting Point

- c. Pre-Test: Unlock 5th Wheel and Lower
Label Audio and Magnetic Data Tape
Load Magnetic Data and Audio Tape
Record Test/Tape Numbers in Log Book
Address Audio Tape
Set Master Console Clock to Real Time
Set in Test Number on Console
Set in 1st Checkpoint Number on Console
Set "ODO" Switch Down
Reset Checkpoint Counter
5th Wheel Switch On
Auto/Manual Switch in Manual
Telephone On
Verify Augmentors on and Status
Write File Gap on Magnetic Data Tape
Zero Incremental Time and Record Time
Dynamic Run Switch Down
Warning Lights On
Start Test
- d. Post-Test: Insert Illegal Checkpoint Number "07777"
Dynamic Run Switch Up
Rewind Data Tape, Secure and Check Label
Write 10 File Gaps on Data Tape
- e. (If Final Run): Raise 5th Wheel
Oscilloscope Off
LORAN Receiver Off
Power Filter Off
Test Console Off
Digital Recorder Off
Audio Recorder Off

Generator Off
Warning Lights Off
Secure and Tighten Gas Cap
Call Ministration and Shutdown
Cover Generator and Tank

SECTION 4

TEST DATA

4.1 GENERAL

Data acquired in the fixed route and random route tests was to the format in Figure 4-1. Special case test data varied with each special test and is discussed in subsection 4.5.

4.2 DATA RECORDING FREQUENCY

Data was automatically recorded once per second. Flags were set in the data to indicate specific events such as a checkpoint passing or a new augmentor detection.

4.3 DATA CONTENT

Each automatic record contained the complete set of data shown in Figure 4-1. This data consisted of ten 16 bit blocks. A description of each block is given here with reference to the figure.

Test Number - This is a 5 digit octal number read directly from panel thumbwheel switches. It was used to identify each test. Table 4-1 is a listing of all test numbers and associated tests.

TDA - This is the thirteen least significant bits of time difference A. It is truncated from its complete length of 19 bits to save space. This is possible since the higher order bits do not change over a moderate size area such as the Philadelphia test area. The two most significant bits are flags to indicate if the Slave A transmitter is blinking and if the time difference is valid. The receiver tracking loop must be locked up and in the track mode on Slave A in order to post a 'one' in the most significant location.

TDB - This is the identical information on the B Slave.

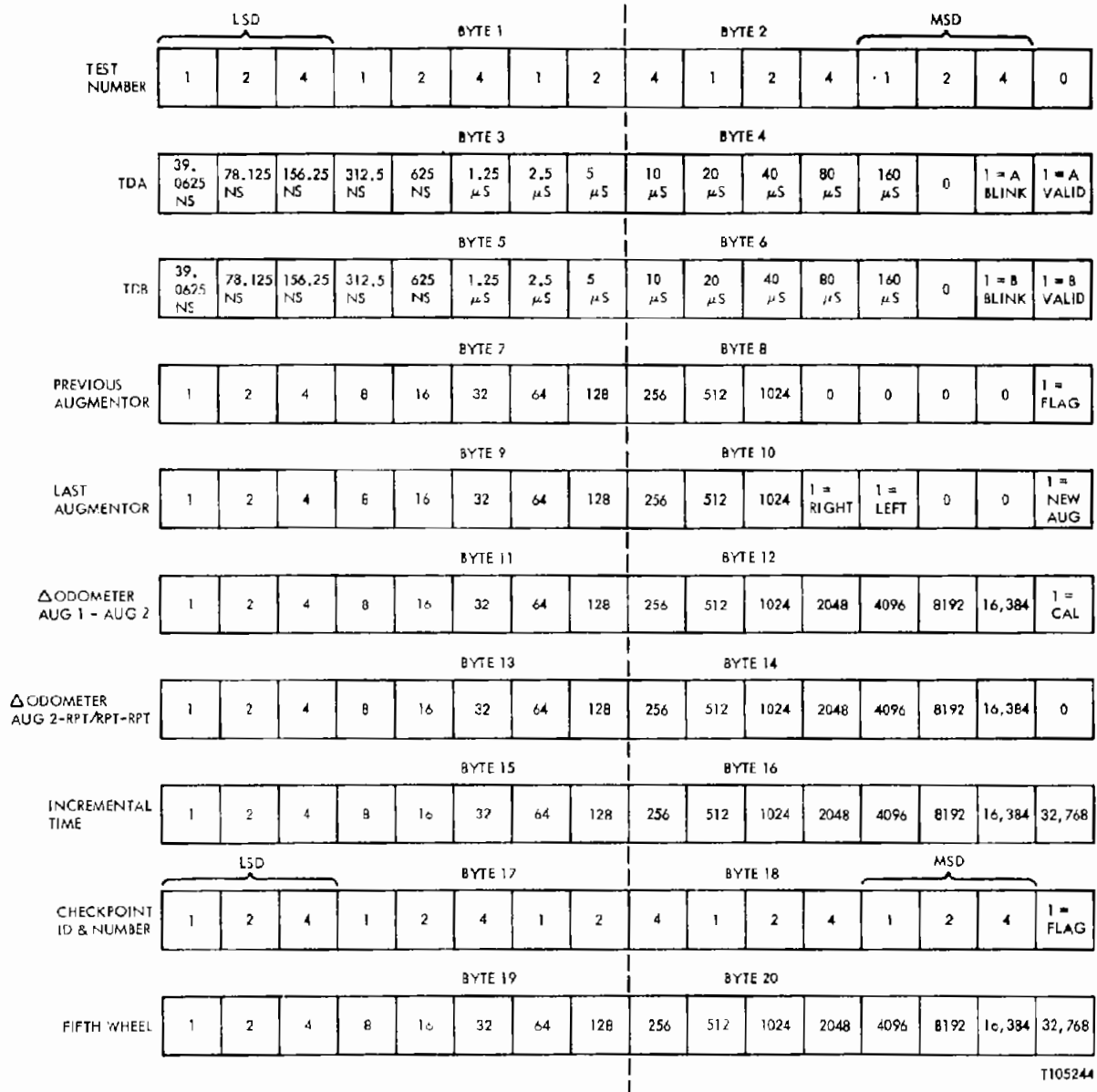

Figure 4-1. Test Data Format

Table 4-1. Assigned Test Numbers

FIXED ROUTE TEST

| | <u>Test Number</u> | <u>Run</u> |
|---------------------|--------------------|------------|
| | 10001 | 1 |
| | 10002 | 2 |
| | ' | ' |
| | ' | ' |
| Test Numbers | { 10012 | 10 |
| Duplicated in Error | { 10012 | 11 |
| | ' | ' |
| | ' | ' |
| | ' | ' |
| | 10047 | 40 |

RANDOM ROUTE TEST

| <u>Test Number</u> | <u>Run</u> |
|--------------------|------------|
| 20001 | 1 |
| 20002 | 2 |
| 20003 | 3 |
| 20004 | 4 |
| 20005 | 5 |

SPECIAL CASE TESTS

| <u>Test Number</u> | <u>Test Name</u> |
|--------------------|---------------------------------|
| 30101-30112 | Augmentor Coverage vs Speed |
| 30201-30230 | Augmentor Coverage vs Elevation |
| 30301-30310 | Augmentor Interference |
| 30401-30410 | Augmentor Coverage vs Traffic |
| 30501-30510 | LORAN Lag vs Speed |
| 30601 | Unusual LORAN Coverage |
| 30701 | LORAN Only Test |
| 30702-30703 | LORAN Repeatability |
| 31001-31013 | Augmentor RFI |
| 32001-32003 | Augmentor Antenna Pattern |

Previous Augmentor - This is a four digit octal decode of the ID number of the Next-To-Last Augmentor detected. The most significant location contains a flag which is set by logic in the system odometer section. This logic sets the flag after the vehicle has moved 54 feet from the initial augmentor detection. This flag will normally be set when the vehicle is adjacent to the detected augmentor and as such becomes the AVM system's best estimate of when the vehicle is at the augmentor. This flag is used by the software to calculate time of passage at fixed route time points. A discussion of this computation is given later in this section. Note that while this flag is located in the 'previous augmentor' data block, it is set as part of the detection process of the latest augmentor detected which is referred to as the 'last augmentor.' This flag is sometimes referred to as the time flag.

Last Augmentor - This is a four digit octal decode of the ID number of the last detected augmentor. The most significant bit contains a flag which is set by logic in the system odometer section. This logic sets the flag after the vehicle has moved feet from the point where the time flag was set.

ΔOdometer Aug1-Aug2 - This is a 15 bit register which accumulates the system odometer output. It is reset only upon detection of a valid augmentor ID. It is used in the odometer calibration scheme which was not tested in Phase I.

ΔOdometer Aug2-REPT/RPT-RPT - This is a 16 bit register which accumulates the system odometer output. It is reset each time data is recorded. The summation of values in this register is the total distance traveled.

Incremental Time - This is a 16 bit register which is incremented once per second throughout all tests. It was manually reset at the start of each run and the time-of-day recorded. In this way the time of day of any event on the test may be determined.

Checkpoint ID & Number - This is a five digit octal number read directly from panel thumbwheel switches. It is the means by which the test operator records the number ID of each checkpoint and time point. The most significant location is a flag which is set by a depression of the 'enter' pushbutton.

Fifth Wheel - This is a 16 bit register which is incremented by outputs from the fifth wheel. Each output indicates one foot of travel. Information in this register is not used by the location subsystem to derive location but is used by the system simulation software.

4.4 NUMBER OF MEASUREMENTS

The fixed route test contained 450 time point measurements and 3090 checkpoint measurements. The random route test contained 475 checkpoint measurements. Results are presented in Section 6.

4.5 SPECIAL CASE - GENERAL

Since most of the special case testing was not conducive to automatic data recording, individual data sheets and manual data recording were used. All data sheets are included in Appendix B. Various measurements, described in the following subsections were made of the variables in augmentor coverage, detection and interference. Coverage being defined as the radial distance from an augmentor antenna to a mobile antenna at the point of initial detection and at the point of detection loss.

Some of the special case tests, namely those involving LORAN coverage, did utilize the automatic data recording format described in Sections 4.2 through 4.3.

4.5.1 Augmentor Coverage and Elevation Tests

In order to perform these tests, a mobile test vehicle and portable, supporting augmentor structures were utilized as shown in Figure 4-2. These were positioned and maneuvered at the Philadelphia Naval Base Airfield. Due to snow and ice as can be seen in Figure 4-3, a long but very narrow pathway which was plowed by Navy personnel was utilized on the runway. The measurements recorded were:



Figure 4-2. Test Vehicle and Mobile Supporting Structure (Augmentor Shown At Top of Ladder)

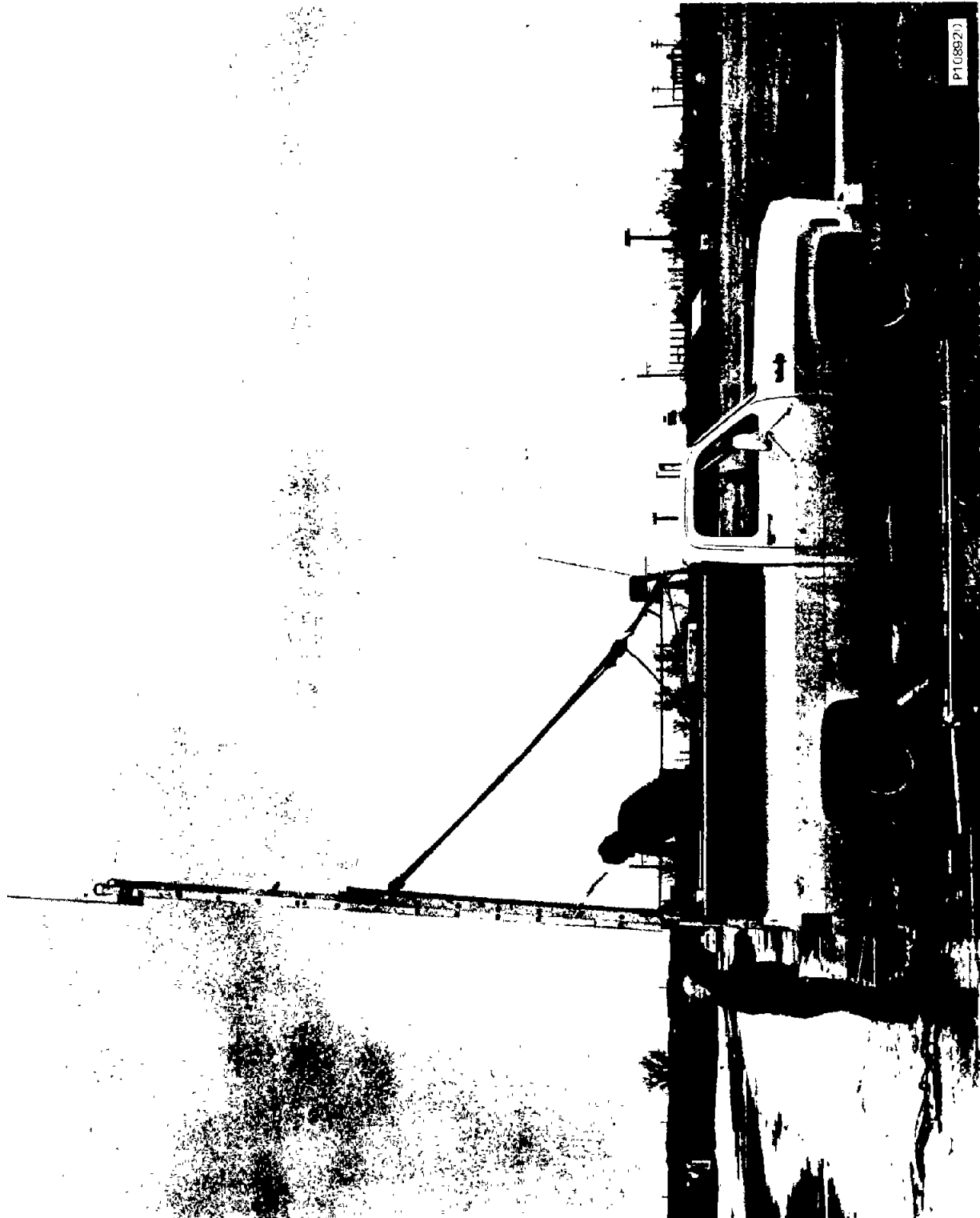

Figure 4-3. Runway Path (Shown to left of vehicle) and Mobile Supporting Structure

Vehicle Speed (MPH), Augmentor Elevation (Feet), Augmentor I.D. Number, and detection/loss distances (feet). The test vehicle passed within 20 feet of the augmentor under test, traveling in a straight line when approaching and departing the augmentor.

The test console odometer logic was set such that the new augmentor identification code number appeared at the instant of positive augmentor detection. When this number appeared, the fifth wheel odometer was utilized to measure the detection distance. The loss distance was measured similarly; however, loss was determined at the point where the "acquire" light on the test console first extinguished after passing an augmentor.

After each test run an augmentor which was carried in the test vehicle with a different I.D. number from the test augmentor was switched on momentarily to reset the "new augmentor detection logic" in the test console. This was required since the system does not detect two consecutive augmentors with the same I.D.

4.5.2 Augmentor Interference Tests

These tests were conducted at the Philadelphia Naval base site to determine the minimum safe distance between two operating augmentors which allows for each to be detected without interference from the other. The same equipment was utilized as in paragraph 4.5.1 with the addition of one augmentor and supporting structure. The two augmentors were separated by four different separation distances of 50, 100, 150, and 200 feet, respectively.

Using the same driving procedure as in paragraph 4.5.1, the test vehicle made runs at 30 MPH and the detection or non-detection of the two augmentors was indicated on the data sheets. Detection was as defined in paragraph 4.5.1.

The augmentors were positioned as shown in Figure 4-4.

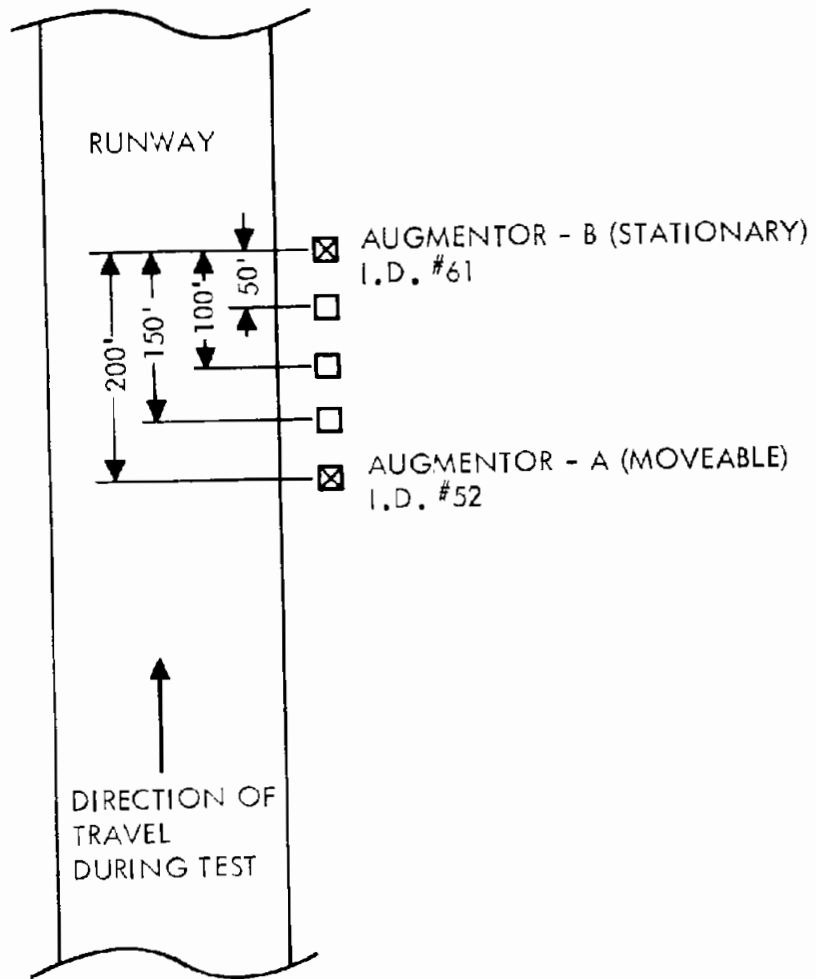

T108917

Figure 4-4. Augmentor Interference Test

4.5.3 Augmentor Coverage in Traffic Conditions Test

In order to determine the effects of traffic (including trucks and busses) and buildings on augmentor coverage and detection, a test similar to that described in paragraph 4.5.1 was conducted on the streets surrounding City Hall: 15th, Penn Square, Juniper, and JFK Boulevard.

An augmentor was positioned on a street light pole along the North side of JFK Boulevard as shown in Figures 4-5A, 4-5B, and 4-6. The detection distance and loss of signal distance (as defined in paragraph 4.5.1) and the elevation of the augmentor were measured (feet) and recorded on the data sheet while the van traveled in a counter clockwise path around city hall.

The test vehicle traveled in the farthest lane from the augmentor and the next closer lane. The distances of both lanes is shown on the data sheet. An augmentor to reset the "new augmentor detection logic" in the test console was kept inside the test vehicle and switched momentarily on at Broad Street and Penn Square. This was required just as in paragraph 4.5.1. All distances were measured utilizing the fifth wheel odometer. Anytime that large vehicles (trucks or busses) were between the test augmentor and the test vehicle, that information was recorded on the data sheet.

4.5.4 Augmentor Radio Interference Tests

In order to test for any out of band frequencies that may be emitted by augmentors, a spectrum analyzer consisting of the following modules was used:

| | |
|------------------------|-----------------|
| 141S (Hewlett Packard) | Display Section |
| 8552A | IF Section |
| 8553L | HF Section |

The test area was the parking lot of the Marriott Hotel, City Line Avenue and Monument Road in Philadelphia.

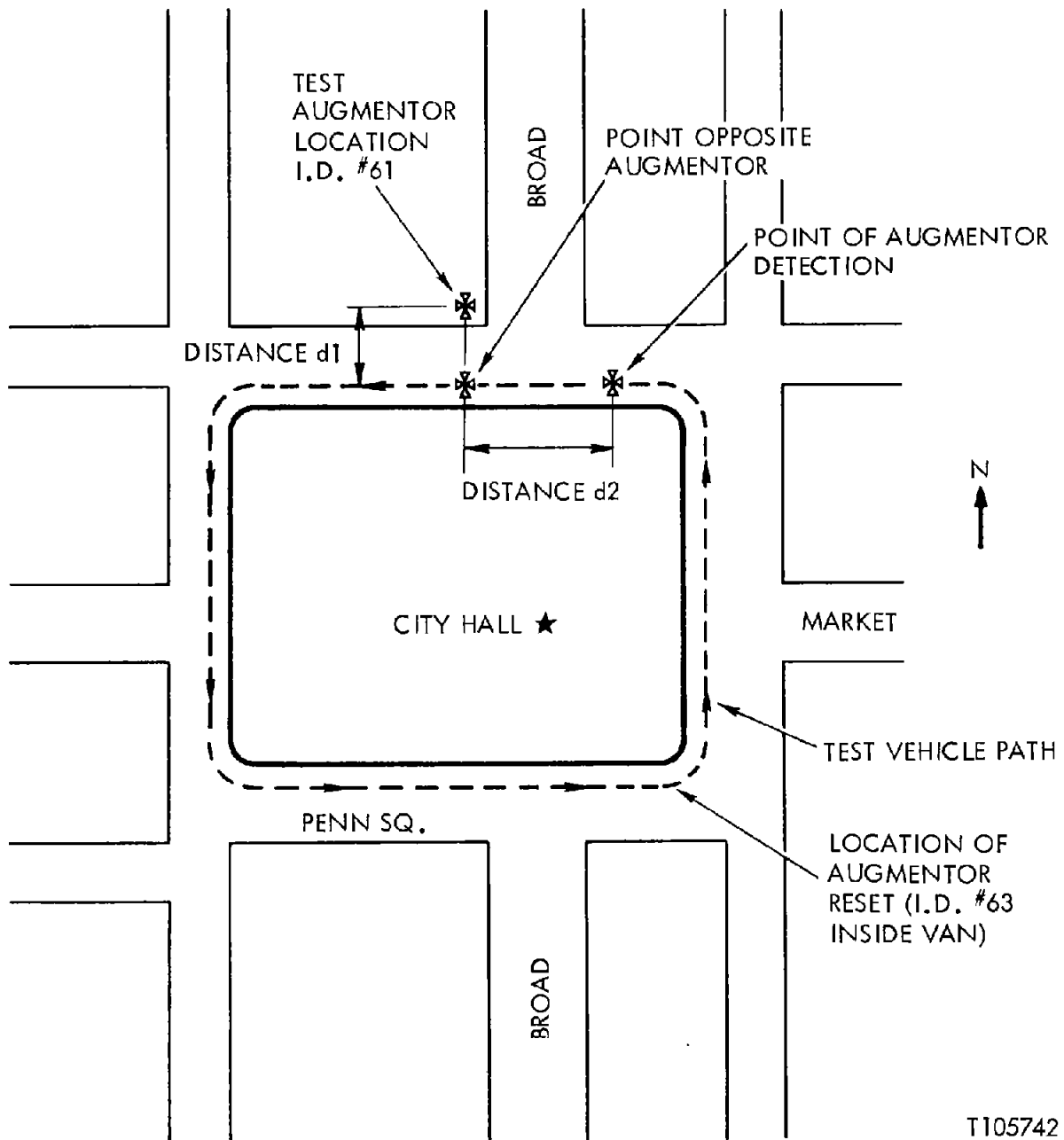

Figure 4-5A. Special Case Test Augmentor Coverage vs Traffic Conditions



Figure 4-5B. Test Augmentor for Traffic Special Case Test
(Augmentor Shown At 28 Feet Elevation)

P100927

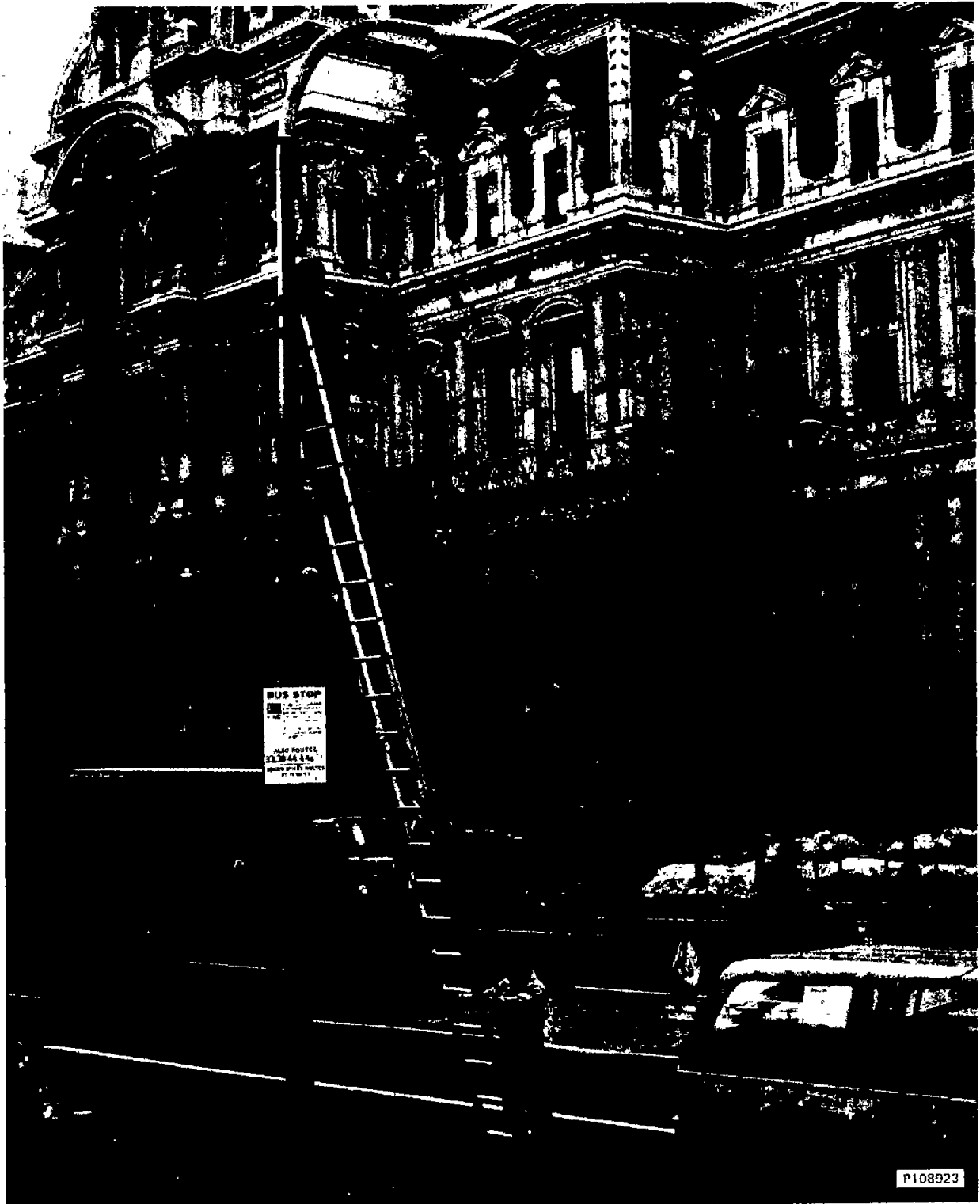

Figure 4-6. Test Augmentor for Traffic Special Case Test
(Elevation of Test Augmentor was adjusted for each special case run)

The Spectrum Analyzer was secured in the mobile test vehicle which was stationary during the test in the middle of the parking lot. A 102 in. vertical whip antenna which was mounted on the test vehicle was used as the RF pickup and input to the analyzer.

The Augmentor under test was positioned at the start of the tests at 10 feet from the vehicle antenna and at an elevation of 5 feet. Ambient frequencies were recorded on the data sheet with the Augmentor off. The Augmentor was then switched on and the frequencies and amplitudes of any new emissions were recorded on the data sheets. This test was repeated at greater distances until the Augmentor emission was non-detectable in the ambient noise present. These distances were also recorded on the data sheets.

The 3 db bandwidth of the center frequency emitted by the augmentor was also noted on the data sheet for the 10 ft. distance.

4.5.5 Augmentor Antenna Pattern Tests

The antenna pattern tests were conducted in the parking lot of Teledyne Systems Company in Northridge, California. The test augmentor was located on a metal light pole at various elevations as shown on the data sheets. The mobile test vehicle approached the light pole from eight equally spaced directions separated by 45° intervals. Utilizing the fifth wheel, the distance in feet was recorded on the data sheets for the detection of the augmentor (detection as defined in Paragraph 4.5.1). A reset augmentor was utilized to reset the I.D. code as specified in Paragraph 4.5.1. The orientation of the augmentor with respect to the light pole was indicated on each data sheet.

4.5.6 LORAN Position Lag, Vehicle Speed Tests

This test was conducted to determine any discernible lag in LORAN derived position as a function of vehicle speed. The test area was the Philadelphia Naval Base Airfield as in paragraph 4.5.1.

Seven checkpoints were marked with plainly visible orange cones. The checkpoints were 250 feet apart and each was assigned a unique number from one to seven.

The mobile test vehicle then was used to record ten readings of LORAN position information for each checkpoint on data recording tape utilizing the automatic data recording equipment previously discussed. The method of data gathering was exactly like the method used in recording calibration information in the city of Philadelphia. A discrete test number of 37777 was assigned to the calibration section of recording tape.

After the completion of calibration, the vehicle speed runs commenced. Each run was made in a straight line on the plowed runway. The acceleration path was 600 feet long, the test area 1750 feet long, and the deceleration area was 400 feet. Snow and ice on the runway prevented speeds greater than 40 MPH due to the short deceleration area.

Eight runs were made, each being assigned a discrete test number and the vehicle speeds noted for each test. The automatic data recording equipment was utilized with the identical procedure being used as for dynamic fixed or random route runs. The proper checkpoint number was set in for each cone and the checkpoint button on the console was depressed for each checkpoint when the vehicle was adjacent to the cone.

The data tape recording consists of the same categories data recorded for fixed and random route runs, and the content of the data dump of that tape will be discussed in Section 6.

4.5.7 LORAN Coverage Along a Steel Bridge

To determine the location accuracy of LORAN along a steel bridge, a test run was made on the Benjamin Franklin Bridge. The manner of recording data was identical to that of fixed and random route test runs. Seven checkpoints were used on the Pennsylvania side of the bridge and seven on the New Jersey side. Two checkpoints

were used on the bridge itself, and these were at the bridge supports which are identified in Section 6.

Previous calibration data consisting of nine locations along the East and West side of the bridge was recorded to analyze the bridge run data, as discussed later in this section. The calibration data is given in Appendix A.

The route used and associated checkpoints were detailed in Section 2 of the report and consisted of traveling East and Westbound through the selected test route thus making a complete round trip.

All data parameters recorded were the same as discussed for the random and fixed route tests.

4.5.8 LORAN Only Location Test

The accuracy of the LORAN portion of the location subsystem exclusive of any augmentors was measured in this test. The data recorded were the same parameters as for the fixed route; however, no augmentor data is used in the tests or analysis.

The area selected for the LORAN only tests was bounded by Fisher, Wyoming, 8th and 12th streets. A detailed description of the route, area, and checkpoints was given in Section 2. There were no augmentors installed within the area to aid in position determination.

4.5.9 LORAN Repeatability Tests

The repeatability accuracy of the LORAN data was measured by repeating the LORAN only test discussed in paragraph 4.5.8. The test was conducted on a different day from the LORAN only test. The route, area and recorded data were identical to that in the LORAN only test.

4.6 CALIBRATION DATA

4.6.1 Data Requirements - The following data was recorded for each of the calibration points:

- a. Point Location (street intersection names)
- b. Point X and Y Coordinates
- c. Mean TDA and TDB
- d. Standard Deviation of TDA and TDB
- e. Raw TDA and TDB Measurements (minimum of 10 each)
- f. Calibration Point Identification Number (5 digit octal)

4.6.2 Procedure - The calibration procedure consisted of driving the test van to each designated calibration point and recording static LORAN time difference measurement on magnetic tape. Ten measurements of each time difference were required as a minimum. Appendix A contains all of the calibration data obtained in these tests together with a listing of the software program used to reduce the information. A sample reduction tab run is included.

In addition to the automatic data recording of calibration time differences, an audio tape was made, and the vehicle location coordinates together with calibration point, identification were placed on these tapes.

Calibration data was taken for the fixed, random, LORAN only and Bridge route areas. Figure 4-7 shows the calibration points for the fixed and random route areas. All intersections within the LORAN only area were calibrated. The calibration points for the bridge run are shown in Appendix A.

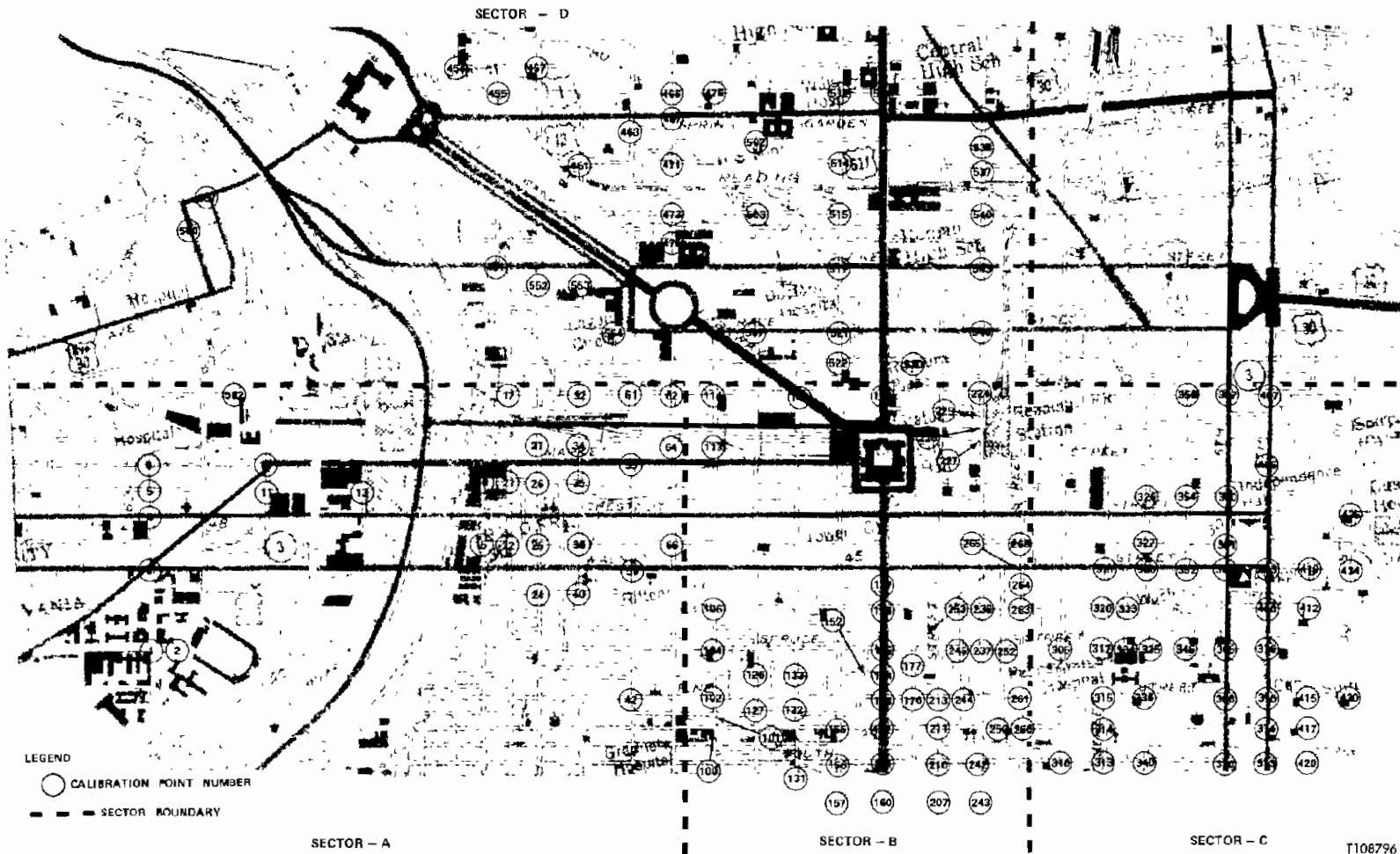

Figure 4-7. Calibration Area

4.7 TIME OF PASSAGE MEASUREMENT DESCRIPTION

The following is a description of the time of passage measurement process in the Phase II LAVM System, followed by the Phase I mechanization which simulates it.

4.7.1 Phase II Mechanization

Assume that a vehicle is approaching an augmentor located at a time point, and assume that the augmentor signal has a range, r , of 54 feet.

The following is a step by step description of the time of passage measurement:

- a. When the vehicle reaches a point approximately r feet from the augmentor, the carrier frequency of 72.96 MHz is detected causing the augmentor receiver AGC signal to go "low" or to near 0 VDC.
- b. When the AGC signal goes low, it enables the augmentor ID number decoding logic.
- c. The decoding logic decodes the augmentor ID number and then automatically checks for three successive identical decodes. This is for reliability purposes. When this requirement is satisfied, the time of passage (T.O.P.) odometer is reset.
- d. The T.O.P. odometer begins to measure a programmed distance which is set to be equal to r , the augmentor range.
- e. At the end of this distance r , the T.O.P. odometer sets a flag in the data interface called the 'time flag.' This flag in turn resets an incremental time counter with a resolution of 1 second. This counter will continue to count until the next report cycle at which time its contents are placed in the appropriate location in the vehicle-base data message.

In a perfect situation, this flag will be set at the exact instant that the vehicle passes the time point. Variations will occur as a function of augmentor range.

- f. The T.O.P. odometer measures out an additional 54 feet and then sets another flag called the "new augmentor flag." This flag causes the ID number of the detected augmentor to be placed in the base station message.

This sequence is repeated each time the vehicle passes an augmentor.

The process by which the LAVM system determines time of passage is described next.

Upon each vehicle report, the computer receives the following information with which to determine time of passage:

- a. Augmentor ID Number; and,
- b. Incremental time, in seconds, since the time flag was set.

The computer does the following:

- a. Checks augmentor ID code for corresponding location on the fixed route; and,
- b. Subtracts the reported incremental time from the time of day the report was received. This gives the time of day that the time flag was set.

This time is the LAVM System estimate of the time of passage at the time point.

4.7.2 System Errors

System errors are directly proportional to augmentor range and to a lesser extent, to vehicle velocity. If the augmentor range is significantly different from the nominal programmed range, the time flag will be set either early (before the vehicle reaches the time point) or late (after passing the time point). This will show up as an error in the time of passage, the magnitude of which

is a function of vehicle velocity. At speeds of 10 or more miles an hour, a 25% variation in augmentor range will produce small errors in time of passage. If the vehicle stops near a time point where the augmentor range is too great or too small, the time the vehicle stands will appear in the time of passage error since it is an odometer, not a clock that actually determines the system time of passage.

4.7.3 Phase I Test Mechanization

The Phase I System mechanization differs from the preceding description only slightly. In Phase I, the incremental time storage after the time flag is set will take place in software instead of the vehicle hardware. Data reduction and analysis will include simulation of the 32.4 second polling rate. Time of Passage errors will be calculated based on this rate.

The other differences for Phase I all involve displays on the test console not available for Phase II. The AGC Signal, the new augmentor flag, and the decoded augmentor ID number are all displayed to assist the operator.

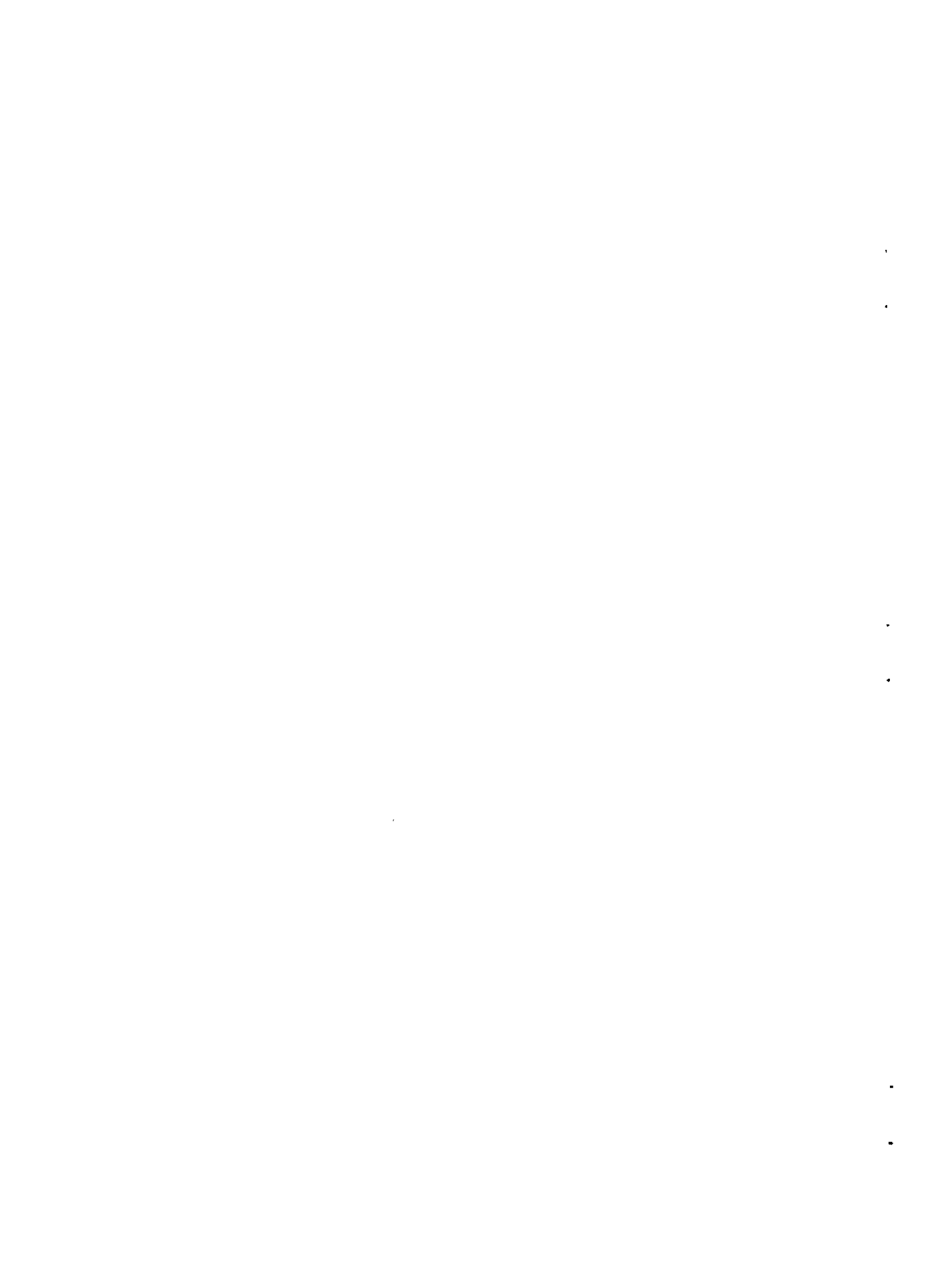

SECTION 5

DATA ANALYSIS AND REDUCTION TECHNIQUES

5.1 INTRODUCTION

The purpose of this section is to describe the techniques employed in analyzing and reducing the data obtained from the phase I test. A fundamental component of the Teledyne AVM system is the conversion of receiver measured Loran time difference to local X, Y coordinates by means of a polynomial fit. The coefficients of the coordinate conversion polynomials are inputs to the position processing software and are obtained from an analysis of the calibration data. Therefore, it is appropriate to discuss the reduction and analysis of the calibration data in this section. The other topics discussed in this section are the determination and treatment of the location subsystem and system position errors and time point errors.

5.2 CALIBRATION ANALYSIS

To develop a method for converting from Loran time differences to local X, Y coordinates, the test area was broken up into 4 calibration sectors, each sector containing a relatively large number of calibration points whose coordinates are accurately known in the reference X, Y coordinate system. At each calibration point, long term time averages (several seconds) were obtained for TDA and TDB. In addition, at each point, sample standard deviations of TDA and TDB were obtained. For a given sector, the \overline{TDA} , \overline{TDB} and σ_A , σ_B values were inspected to select a reference point with coordinates X_{REF} , Y_{REF} , had the property that it was geometrically central to the sector and that it had plausible average TDA, TDB with small sample standard deviations.

If TDAR, TDBR denote the average time differences at the reference point and if X_{REF} , Y_{REF} denote the rectangular coordinates of the reference point, then the

assumption is made that for the i th calibration point in the region that the computed value of the coordinates are given by:

$$\begin{aligned}
 X_c(i) = & X_{REF} + a_1(TDA(i)-TDAR) + a_2(TDB(i)-TDBR) \\
 & + a_3(TDA(i)-TDAR)^2 + a_4(TDA(i)-TDAR)(TDB(i)-TDBR) \\
 & + a_5(TDB(i)-TDBR)^2
 \end{aligned} \tag{1}$$

and

$$\begin{aligned}
 Y_c(i) = & Y_{REF} + b_1(TDA(i)-TDAR) + b_2(TDB(i)-TDBR) \\
 & + b_3(TDA(i)-TDAR)^2 + b_4(TDA(i)-TDAR)(TDB(i)-TDBR) \\
 & + b_5(TDB(i)-TDBR)^2
 \end{aligned} \tag{2}$$

where $TDA(i)$, $TDB(i)$ are the averaged time differences recorded at the i th calibration point.

The coefficients a_i , b_i are determined by a weighted least squares fit, where the weighting is determined by the calculated sample standard deviations of the time difference data at the calibration points. More precisely, if $X_T(i)$, $Y_T(i)$ are the known coordinates of the i th calibration point and if $\sigma_A(i)$, $\sigma_B(i)$ are the sample time difference standard deviations associated with the i th calibration point then the a_i , b_i coefficients are chosen to minimize the following weighted square error criterion functions.

$$Q_A = \sum_{i=1}^N \frac{(X_c(i) - X_T(i))^2}{\sigma_A^2(i) + \sigma_B^2(i)} \tag{3}$$

$$Q_B = \sum_{i=1}^N \frac{(Y_c(i) - Y_T(i))^2}{\sigma_A^2(i) + \sigma_B^2(i)} \tag{4}$$

In particular the values of the a_i , b_i coefficients which minimize Q_A , Q_B are given by setting the partial derivatives of Q_A , Q_B with respect to the a_i , b_i coefficients equal to zero and solving the resulting system of linear equations, i. e.

$$\frac{\partial Q_A}{\partial a_i} = 0, i = 1, 2, 3, 4, 5 \quad (5)$$

$$\frac{\partial Q_B}{\partial b_i} = 0, i = 1, 2, 3, 4, 5 \quad (6)$$

A computer program has been written which accepts as inputs the true coordinates of the calibration points, the averaged time differences, their standard deviations the reference point coordinates and their associated time differences. The program outputs: (1) the a_i , b_i conversion coefficients (2) a radial error map of the calibration sectors (3) a statistical summary by sector of the residual radial errors. This permits the elimination of points with anomalous TD values. The process may be repeated, if desired, with a different reference point to determine the stability of the conversion coefficients and the residual radial error distribution. A listing and sample run of this program is shown in Appendix E for the calibration which was performed for the bridge test.

5.3 DETERMINATION OF POSITION AND TIME OF PASSAGE ERRORS

5.3.1 Data Analysis Requirements

For the fixed and random route tests, the data analysis requirements were as follows. An IBM 370 system which can accept magnetic tape inputs was required. The core storage requirement for the FORTRAN program which performed the off line data reduction was 350K bytes. The same software was used to reduce the data for two of the special tests - namely the LORAN only fixed route and LORAN Bridge Run, as well as the timing point accuracy tests.

5.3.2 Sequence of Data Duplication Reduction and Analysis

During the Philadelphia tests the data was recorded on magnetic tape using a high quality commercially available tape recorder. Data was recorded on tape at the nominal reporting interval of 1 second which is the data required to determine the vehicle position and to time tag the particular event. In addition, at the checkpoints the same data was recorded as at the nominally synchronous reporting intervals, and vehicle position and position error were calculated.

A FORTRAN IV Computer program was written for the IBM 370 computer which accepted the magnetic tape inputs and computed reported vehicle positions in both X, Y and street reference systems at specified intervals as well as at the checkpoints. This software has the capability of accepting checkpoint position and input data hardware generated vehicle time of passage data so that appropriate position and timing errors can be calculated and displayed in a mutually agreed upon set of summary statistical formats. The magnetic tapes and software analysis program together with the necessary documentation were made available to DOT so that they may make their own statistical analysis of the location subsystem tests. A computer program written in FORTRAN was used to process the data read in from magnetic tape. Data processing was performed utilizing an IBM 370 computer. The following computations were made:

- a. Reported vehicle positions in X and Y coordinates and street reference.
- b. Reported intermediate checkpoints in X and Y coordinates and street reference.
- c. Computed position errors..
- d. Computed timing errors.

Figure 5-1 shows the Overall Data Handling Flow described in this paragraph.

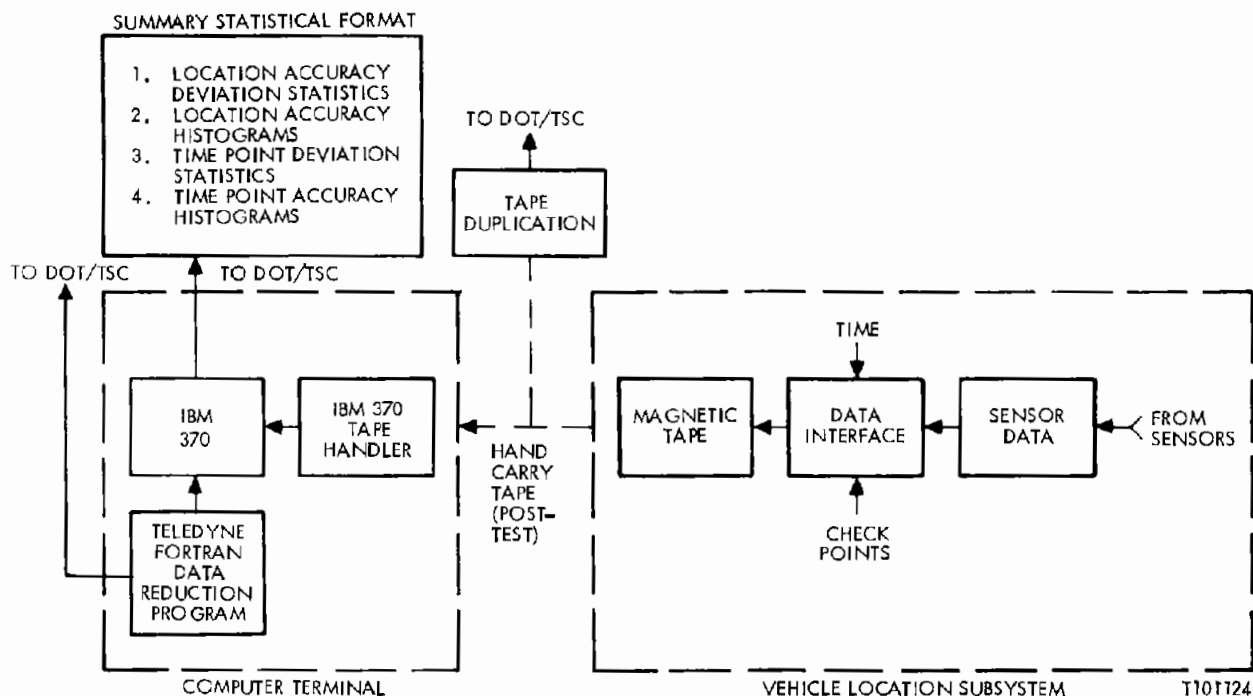

Figure 5-1. Data Handling Flow

5.3.3 Data Reduction

5.3.3.1 Algorithms - The algorithms which are required for the data analysis may be divided into two classes - namely, those algorithms which compute vehicle position from the sensor inputs and those algorithms which are used to compute the descriptive statistics for the statistical summary. The position processing algorithms will be described first. Detailed descriptions of position processing and statistical algorithms were described in detail in the software documentation submittal.

5.3.3.2 Fixed Route Algorithm - The fixed route algorithm operates as follows: At any given reporting interval, the vehicle obtains one of two possible data sets. First, an indication that an augmentor has been acquired, the augmentor identifier and the distance traveled from the augmentor. Second, the odometer reading

from the last position report and a pair of time differences with their valid/invalid status indicators. If an augmentor is detected, the new vehicle position is computed by projecting along the fixed route a distance corresponding to the odometer reading since passage of the augmentor. In the second situation, the algorithm monitors the status of the time differences. If they are valid, a conversion to X, Y coordinates is performed. A reasonability check is then made with the odometer reading from the last report. If it is satisfied, the algorithm then projects the converted X, Y LORAN position onto an appropriate segment of the fixed route. The new vehicle position is obtained by taking a weighted average of the LORAN projected position and the odometer projected distance along the fixed route. The relative LORAN/odometer weighting factors used in the Philadelphia test were determined on the basis of fixed route dry runs conducted by Teledyne. The weighting factors are dependent upon the relative accuracies of the LORAN and odometer information, hence are geography dependent. For the Salt Lake City demonstration, the best odometer/LORAN weighting was 75%/25%, respectively. Dry run fixed route test showed that this weighting was also suitable for the Philadelphia tests. If the LORAN time differences are not both valid or if the converted LORAN X, Y coordinates are incompatible with the odometer measurement then the new vehicle position is fixed by dead reckoning along the fixed route from the last computed position a distance corresponding to the measured odometer reading.

The algorithm also has the capability of detecting departures from the fixed route and monitoring subsequent computed positions for route returns. Route departures are detected by monitoring the distance between (XL, YL) the converted LORAN coordinates and their projected point (XLP, YLP) upon the appropriate segment of the fixed route. When this distance exceeds a threshold three times in succession, a route departure is declared. The point of departure is declared to be that point where the threshold was first exceeded.

5.3.3.3 Random Route Algorithm - The random route software differs from the fixed route in that no apriori knowledge is available about the trajectory of the vehicle. This means that odometer information alone is insufficient to determine a new position based upon past position and that a detailed street map must be stored in the computer.

The received time differences are examined for status. If they are valid a conversion is made to X, Y coordinates. The converted X, Y point is compared to the last computed position and this distance is compared with the odometer reading for compatibility. If these tests are passed then the new vehicle position is determined by projection of the converted LORAN (X, Y) point down upon the closest point in the random route. If the time differences are not valid or if the odometer reasonability test is failed, then the new vehicle position is determined by a straight line extrapolation through the last two computed points along a distance given by the odometer reading with a subsequent projection upon the stored random route street map.

Augmentor data was used for position reset capability. In addition various reasonability checks were introduced to correlate converted LORAN X, Y coordinates with respect to prior computed positions to verify that they were compatible with odometer measurements.

5.3.3.4 Statistical Calculations - For the location subsystem error determination the vehicle position was calculated, using the algorithms just described, every time the check point bit was set. This occurred at known locations which were passed to the computer via punched card input. Thus, for the location subsystem tests, the true value of the vehicle position was known exactly at the checkpoints so that appropriate error determinations could be made. At the system level, vehicle position was computed at a fixed polling rate of once every 32 seconds. An immediate consequence of the fixed polling rate is that at the designated poll times the true value of the vehicle position is not known a priori,

hence must be computed in order to provide a basis for statistical determination of errors. This function was performed on software by a subroutine called TRUPOS. This subroutine calculated true vehicle position at the fixed polling time by using knowledge of the vehicle test path, and the distance traversed from the last checkpoint whose bit was set as determined from the fifth wheel odometer. In this way it was possible to calculate accurate, true positions of the vehicle at the poll times. It should be noted that the information inputs to TRUPOS are denied to the routines that perform the system calculations of the vehicle position, since checkpoint and fifth wheel information are not legitimate inputs for system position determination. TRUPOS was used only to determine true vehicle location for error analysis of system simulations. It was not used in the LAVM position processing routines.

The statistical processing software was designed to provide the maximum amount of statistical information associated with a given run. As described in a previous section, the vehicle positioning algorithms calculate X_L , Y_L , X_{LP} , Y_{LP} , X_{NEW} , Y_{NEW} which are respectively: LORAN converted coordinates, LORAN projected coordinates and system position coordinates of the vehicle. If $X_T(i)$, $Y_T(i)$ denote true vehicle coordinates of a computed point along the route then the following errors are calculated and associated with a given point.

$$\begin{aligned} \Delta X_L(i) &= X_L(i) - X_T(i), \quad \Delta Y_L(i) = Y_L(i) - Y_T(i) \\ \Delta R_L(i) &= \sqrt{\Delta X_L(i)^2 + \Delta Y_L(i)^2} \end{aligned} \quad (7)$$

$$\begin{aligned} \Delta X_{LP} &= X_{LP}(i) - X_T(i), \quad \Delta Y_{LP}(i) = Y_{LP}(i) - Y_T(i) \\ \Delta R_{LP}(i) &= \sqrt{\Delta X_{LP}^2(i) + \Delta Y_{LP}^2(i)} \end{aligned} \quad (8)$$

$$\begin{aligned} \Delta X_{NEW}(i) &= X_{NEW}(i) - X_T(i), \quad \Delta Y_{NEW}(i) = Y_{NEW}(i) - Y_T(i) \\ \Delta R_{NEW}(i) &= \sqrt{\Delta X_{NEW}^2(i) + \Delta Y_{NEW}^2(i)} \end{aligned} \quad (9)$$

These error measures are calculated and displayed as functions of time and position along the vehicle path. The radial errors ΔR_L , ΔR_{LP} , ΔR_{NEW} are ranked, and the rank order statistics are displayed for convenient summary and percentile determination. The following summary statistics are also calculated and displayed.

LORAN Only: N

$$\Delta \bar{X}_L = \frac{1}{N} \sum_{i=1}^N \Delta X_L(i) \quad (10)$$

$$\sigma_{XL} = \sqrt{\frac{1}{N} \sum_{i=1}^N (\Delta X_L(i) - \Delta \bar{X}_L)^2} \quad (11)$$

$$\Delta \bar{Y}_L = \frac{1}{N} \sum_{i=1}^N \Delta Y_L(i) \quad (12)$$

$$\sigma_{YL} = \sqrt{\frac{1}{N} \sum_{i=1}^N (\Delta Y_L(i) - \Delta \bar{Y}_L)^2} \quad (13)$$

$$\Delta \bar{R}_L = \frac{1}{N} \sum_{i=1}^N \Delta R_L(i) \quad (14)$$

$$\sigma_{RL} = \sqrt{\frac{1}{N} \sum_{i=1}^N (\Delta R_L(i) - \Delta \bar{R}_L)^2} \quad (15)$$

LORAN Projected:

$$\Delta \bar{X}_{LP} = \frac{1}{N} \sum_{i=1}^N \Delta X_{LP}(i) \quad (16)$$

$$\sigma_{X_{LP}} = \sqrt{\frac{1}{N} \sum_{i=1}^N (\Delta X_{LP}(i) - \Delta \bar{X}_{LP})^2} \quad (17)$$

$$\Delta \bar{Y}_{LP} = \frac{1}{N} \sum_{i=1}^N \Delta Y_{LP}(i) \quad (18)$$

$$\sigma_{Y_{LP}} = \sqrt{\frac{1}{N} \sum_{i=1}^N (\Delta Y_{LP}(i) - \Delta \bar{Y}_{LP})^2} \quad (19)$$

$$\Delta \bar{R}_{LP} = \frac{1}{N} \sum_{i=1}^N \Delta R_{LP}(i) \quad (20)$$

$$\sigma_{R_{LP}} = \sqrt{\frac{1}{N} \sum_{i=1}^N (\Delta R_{LP}(i) - \Delta \bar{R}_{LP})^2} \quad (21)$$

System:

$$\Delta \bar{X}_{NEW} = \frac{1}{N} \sum_{i=1}^N \Delta X_{NEW}(i) \quad (22)$$

$$\sigma_{X_{NEW}} = \sqrt{\frac{1}{N} \sum_{i=1}^N (\Delta X_{NEW}(i) - \Delta \bar{X}_{NEW})^2} \quad (23)$$

$$\Delta \bar{Y}_{NEW} = \frac{1}{N} \sum_{i=1}^N \Delta Y_{NEW}(i) \quad (24)$$

$$\sigma_{Y_{NEW}} = \sqrt{\frac{1}{N} \sum_{i=1}^N (\Delta Y_{NEW}(i) - \Delta \bar{Y}_{NEW})^2} \quad (25)$$

$$\Delta \bar{R}_{NEW} = \frac{1}{N} \sum_{i=1}^N \Delta R_{NEW}(i) \quad (26)$$

$$\sigma_{R_{NEW}} = \sqrt{\frac{1}{N} \sum_{i=1}^N (\Delta R_{NEW}(i) - \Delta \bar{R}_{NEW})^2} \quad (27)$$

Table 5-1 is part of the output of the processing software for fixed route test 10044. It shows the indicated components of the computed Loran error as a function of time and vehicle position along the route. The "BAD" indication in the right hand column indicates that Loran was not valid at these points and hence Loran errors computed at those times have no meaning. Table 5-2 displays the Loran projected and system errors along the route. Table 5-3 shows the radial error sequence along the route while Table 5-4 shows the rank order statistics of the various radial errors. In Table 5-4 the 67, 90 and 95th percentile errors are set in relief for convenience. Finally Table 5-5 shows the mean and standard deviation summaries of the position errors as well as the time of passage errors.

Time of passage errors are calculated at various augmentors along the fixed route by taking the difference between the recorded time at which the time flag bit is set and the time at which the check point bit is set. The time flag bit is automatically set in accordance with an elapsed distance being traversed after entering the acquisition region of an augmentor.

5.4 SIMULATION OF MISSED DATA

The effects of missing data reports on system performance were simulated in the following way. The tape was first run through the PRERUN program to create the data set on disk upon which the software normally operates. An EDIT program was then used which operates on the created data set by eliminating a pre-determined subset of those records corresponding to 32 second polling times at which vehicle position is usually computed. This edited data set is then used to drive the positioning software, the results being those that the system would determine if faulty data transmissions occurred at those times which were edited out. The actual times at which data outages were simulated were obtained by using uniformly distributed random numbers furnished by Mitre Corporation.

Table 5-1. Fixed Route Test #10044 Loran Errors (32 Second Polling) (Sheet 2 of 2)

Table with columns: CKPT, TIME, TDA, TDB, XTRUE, YTRUE, XL, VL, DK/L, DY/L, ERR/L, LORAN. Rows contain numerical data for various checkpoints and time intervals, ending with a 'BAD' status for each.

5-13

Table 5-2. Fixed Route Test #10044 Projected Errors (Sheet 1 of 2)

| SUMMARY OF SYSTEM AND LORAN-PROJECTED ERRORS ALONG ROUTE | | | | | | | | | | | | |
|--|----------|---------|----------|---------|----------|----------|----------|----------|---------|---------|---------|---------|
| CKPT | XTRUE | YTRUE | XLP | YLP | DX/LP | DY/LP | FRR/LP | XNEW | YNEW | DX/NEW | DY/NEW | ERR/NEW |
| 2 | 9000.00 | 6281.00 | 0.0 | 0.0 | -9000.00 | -6281.00 | 10975.02 | 9000.00 | 6299.87 | 0.0 | 18.87 | 18.87 |
| 3 | 9000.00 | 5748.00 | 8999.99 | 5466.21 | -0.01 | -281.79 | 281.79 | 9000.00 | 5730.08 | 0.0 | -17.92 | 17.92 |
| 4 | 9000.00 | 5082.00 | 8999.99 | 4847.26 | -0.01 | -234.74 | 234.74 | 9000.00 | 5069.06 | 0.0 | -12.94 | 12.94 |
| 5 | 9000.00 | 3996.00 | 8999.99 | 4847.26 | -0.01 | 861.26 | 861.26 | 9000.00 | 3918.06 | 0.0 | -67.94 | 67.94 |
| 6 | 9000.00 | 3781.00 | 8775.73 | 3438.00 | -224.27 | -343.00 | 409.81 | 9000.00 | 3713.18 | 0.0 | -67.82 | 67.82 |
| 6 | 8827.00 | 3438.00 | 8610.96 | 3438.00 | -216.04 | -0.00 | 216.04 | 8721.04 | 3438.00 | -105.96 | 0.0 | 105.96 |
| 7 | 8332.00 | 3438.00 | 8610.96 | 3438.00 | 278.96 | -0.00 | 278.96 | 8431.61 | 3438.00 | 99.61 | -0.00 | 99.61 |
| 11 | 7409.00 | 3438.00 | 8610.96 | 3438.00 | 1201.96 | -0.00 | 1201.96 | 7506.64 | 3438.00 | 97.64 | -0.00 | 97.64 |
| 13 | 6433.00 | 3438.00 | 8610.96 | 3438.00 | 2177.96 | -0.00 | 2177.96 | 6534.55 | 3438.00 | 101.55 | -0.00 | 101.55 |
| 13 | 6258.00 | 3438.00 | 8610.96 | 3438.00 | 2352.96 | -0.00 | 2352.96 | 6371.54 | 3438.00 | 113.54 | -0.00 | 113.54 |
| 16 | 4848.00 | 3438.00 | 4733.57 | 3438.00 | -114.43 | -0.00 | 114.43 | 4906.03 | 3438.00 | 58.03 | -0.00 | 58.03 |
| 17 | 4064.81 | 3768.04 | 4733.57 | 3438.00 | 668.76 | -330.04 | 745.77 | 4066.49 | 3745.93 | 1.69 | -22.11 | 22.18 |
| 20 | 3383.00 | 3641.00 | 3383.00 | 3452.26 | -0.00 | -188.74 | 188.74 | 3383.00 | 3718.93 | 0.0 | 77.93 | 77.93 |
| 21 | 2305.00 | 3401.00 | 2305.00 | 3293.46 | -0.00 | -107.54 | 107.54 | 2423.28 | 3438.00 | 116.28 | 37.00 | 123.93 |
| 22 | 3023.00 | 3180.00 | 2305.00 | 3293.46 | -718.00 | 113.46 | 726.91 | 2958.37 | 3180.00 | -64.63 | 0.0 | 64.63 |
| 23 | 3775.00 | 3180.00 | 3484.33 | 3180.00 | -290.67 | -0.00 | 290.67 | 3705.38 | 3180.00 | -69.62 | 0.0 | 69.62 |
| 24 | 4265.00 | 3180.00 | 3979.25 | 3180.00 | -285.75 | -0.00 | 285.75 | 4146.55 | 3180.00 | -118.44 | 0.0 | 118.44 |
| 24 | 4890.00 | 3180.00 | 4861.21 | 3180.00 | -28.79 | -0.00 | 28.79 | 4791.81 | 3180.00 | -98.18 | -0.00 | 98.18 |
| 25 | 5566.00 | 3180.00 | 5399.85 | 3180.00 | -166.14 | -0.00 | 166.14 | 5495.66 | 3180.00 | -70.34 | -0.00 | 70.34 |
| 26 | 6207.00 | 3180.00 | 5998.48 | 3180.00 | -208.51 | -0.00 | 208.51 | 6097.49 | 3180.00 | -109.50 | -0.00 | 109.50 |
| 27 | 6231.00 | 3180.00 | 6212.74 | 3180.00 | -18.26 | -0.00 | 18.26 | 6113.94 | 3180.00 | -117.06 | -0.00 | 117.06 |
| 27 | 6752.00 | 3180.00 | 6212.74 | 3180.00 | -539.26 | -0.00 | 539.26 | 6741.71 | 3180.00 | -10.28 | 0.0 | 10.28 |
| 31 | 7593.00 | 3180.00 | 6212.74 | 3180.00 | -1380.26 | -0.00 | 1380.26 | 7566.48 | 3180.00 | -26.51 | 0.0 | 26.51 |
| 33 | 8425.00 | 3180.00 | 6212.74 | 3180.00 | -2212.26 | -0.00 | 2212.26 | 8393.50 | 3180.00 | -31.50 | 0.0 | 31.50 |
| 34 | 8652.24 | 3000.44 | 6212.74 | 3180.00 | -2439.50 | 179.56 | 2446.10 | 8631.93 | 3027.01 | -20.31 | -26.57 | 33.44 |
| 35 | 9266.00 | 3003.97 | 6212.74 | 3180.00 | -3053.26 | 176.03 | 3058.33 | 9266.00 | 3027.94 | 0.0 | 23.97 | 23.97 |
| 36 | 10096.00 | 3180.00 | 6212.74 | 3180.00 | -3883.26 | -0.00 | 3883.26 | 10051.62 | 3180.00 | -44.38 | 0.0 | 44.38 |
| 40 | 11019.00 | 3180.00 | 6212.74 | 3180.00 | -4806.26 | -0.00 | 4806.26 | 11114.36 | 3180.00 | 95.36 | 0.0 | 95.36 |
| 42 | 11536.00 | 3180.00 | 6212.74 | 3180.00 | -5623.26 | -0.00 | 5623.26 | 11912.21 | 3180.00 | 76.21 | 0.0 | 76.21 |
| 44 | 12695.00 | 3123.00 | 12695.00 | 2521.18 | 0.0 | -601.82 | 601.82 | 12695.00 | 3007.18 | 0.0 | -115.84 | 115.84 |
| 44 | 12695.00 | 2705.00 | 12695.00 | 2397.73 | 0.0 | -307.27 | 307.27 | 12695.00 | 2542.99 | 0.0 | -162.01 | 162.01 |
| 45 | 12695.00 | 2093.00 | 12551.84 | 2063.00 | -143.16 | -30.00 | 146.27 | 12549.80 | 2063.00 | -145.20 | -30.00 | 148.27 |
| 45 | 12361.00 | 2063.00 | 11921.03 | 2063.00 | -439.97 | -0.00 | 439.97 | 12121.17 | 2063.00 | -239.83 | -0.00 | 239.83 |
| 46 | 11726.00 | 2063.00 | 11574.61 | 2063.00 | -151.39 | -0.00 | 151.39 | 11519.05 | 2063.00 | -206.95 | -0.00 | 206.95 |
| 50 | 10957.00 | 2063.00 | 11574.61 | 2063.00 | 617.61 | -0.00 | 617.61 | 10907.42 | 2063.00 | -49.58 | 0.0 | 49.58 |
| 51 | 10427.00 | 2063.00 | 10872.44 | 2063.00 | 445.44 | -0.00 | 445.44 | 10474.70 | 2063.00 | 47.70 | -0.00 | 47.70 |
| 53 | 10064.00 | 2063.00 | 9653.89 | 2063.00 | -410.11 | -0.00 | 410.11 | 10147.18 | 2063.00 | 83.18 | -0.00 | 83.18 |
| 53 | 9619.00 | 2063.00 | 9653.89 | 2063.00 | 34.89 | -0.00 | 34.89 | 9703.76 | 2063.00 | 84.76 | -0.00 | 84.76 |
| 55 | 8805.00 | 2063.00 | 9653.89 | 2063.00 | 848.89 | -0.00 | 848.89 | 8842.34 | 2063.00 | 37.34 | -0.00 | 37.34 |
| 55 | 8573.00 | 2063.00 | 9653.89 | 2063.00 | 1080.89 | -0.00 | 1080.89 | 8612.78 | 2063.00 | 39.78 | -0.00 | 39.78 |
| 56 | 8037.00 | 2063.00 | 9653.89 | 2063.00 | 1616.89 | -0.00 | 1616.89 | 8059.44 | 2063.00 | 22.44 | -0.00 | 22.44 |
| 60 | 7280.00 | 2063.00 | 9653.89 | 2063.00 | 2373.89 | -0.00 | 2373.89 | 7382.72 | 2063.00 | 102.72 | -0.00 | 102.72 |
| 62 | 6621.00 | 2063.00 | 9653.89 | 2063.00 | 3032.89 | -0.00 | 3032.89 | 6718.50 | 2063.00 | 97.50 | 0.0 | 97.50 |
| 62 | 6325.00 | 2063.00 | 6074.61 | 2063.00 | -250.39 | -0.00 | 250.39 | 6423.14 | 2063.00 | 98.14 | 0.0 | 98.14 |
| 63 | 5890.00 | 2063.00 | 5776.83 | 2063.00 | -113.17 | -0.00 | 113.17 | 5999.91 | 2063.00 | 109.91 | 0.0 | 109.91 |
| 64 | 5170.00 | 2063.00 | 5081.13 | 2063.00 | -88.88 | -0.00 | 88.88 | 5221.73 | 2063.00 | 51.73 | -0.00 | 51.73 |
| 65 | 4009.00 | 2063.00 | 3763.10 | 2063.00 | -245.90 | -0.00 | 245.90 | 3976.03 | 2063.00 | -32.97 | -0.00 | 32.97 |
| 66 | 3125.00 | 2063.00 | 2800.81 | 2063.00 | -324.19 | -0.00 | 324.19 | 2992.42 | 2063.00 | -132.58 | -0.00 | 132.58 |
| 70 | 1966.00 | 2063.00 | 1674.81 | 2063.00 | -291.19 | -0.00 | 291.19 | 1807.77 | 2063.00 | -158.23 | -0.00 | 158.23 |
| 70 | 1601.00 | 2068.00 | 1601.00 | 2063.00 | 0.0 | -5.00 | 5.00 | 1603.54 | 2063.00 | 2.54 | -5.00 | 5.61 |
| 72 | 1601.00 | 2365.00 | 1601.00 | 2063.00 | 0.0 | -302.00 | 302.00 | 1601.00 | 2343.41 | 0.0 | -21.59 | 21.59 |
| 72 | 1601.00 | 2595.00 | 1601.00 | 2351.94 | -0.00 | -243.06 | 243.06 | 1601.00 | 2517.71 | -0.00 | -77.29 | 77.29 |
| 73 | 2130.00 | 2633.00 | 1887.96 | 2633.00 | -242.04 | -0.00 | 242.04 | 2016.98 | 2633.00 | -113.02 | 0.0 | 113.02 |
| 74 | 2889.00 | 2633.00 | 1887.96 | 2633.00 | -1001.04 | -0.00 | 1001.04 | 2677.25 | 2633.00 | -211.75 | 0.0 | 211.75 |
| 75 | 3687.00 | 2633.00 | 1887.96 | 2633.00 | -1799.04 | -0.00 | 1799.04 | 3454.91 | 2633.00 | -232.09 | 0.0 | 232.09 |
| 76 | 4822.00 | 2633.00 | 1887.96 | 2633.00 | -2934.03 | -0.00 | 2934.03 | 4645.34 | 2633.00 | -176.66 | 0.0 | 176.66 |
| 76 | 5072.00 | 2633.00 | 1887.96 | 2633.00 | -3184.03 | -0.00 | 3184.03 | 5027.75 | 2633.00 | -44.25 | 0.0 | 44.25 |

5-14

Table 5-3. Fixed Route Test #10044 Radial Error Sequence (Sheet 1 of 3)

| ***** | | RADIAL ERRORS SEQUENCE ***** | | ***** | |
|-------|--------|------------------------------|----------|-------|-----------------|
| CKID | SYSTEM | CKID | LORAN | CKID | LORAN-PROJECTED |
| 2 | 18.07 | 2 | 10975.02 | 2 | 10975.02 |
| 3 | 17.92 | 3 | 435.38 | 3 | 281.79 |
| 4 | 12.94 | 4 | 334.12 | 4 | 234.74 |
| 5 | 67.94 | 5 | 893.48 | 5 | 861.26 |
| 6 | 67.82 | 6 | 339.84 | 6 | 409.81 |
| 6 | 105.96 | 6 | 286.06 | 6 | 216.04 |
| 7 | 99.61 | 7 | 336.12 | 7 | 278.96 |
| 11 | 97.64 | 11 | 1216.50 | 11 | 1201.96 |
| 13 | 101.55 | 13 | 2186.02 | 13 | 2177.96 |
| 13 | 113.54 | 13 | 2360.42 | 13 | 2352.96 |
| 16 | 58.03 | 16 | 147.73 | 16 | 114.43 |
| 17 | 22.18 | 17 | 791.57 | 17 | 745.77 |
| 20 | 77.93 | 20 | 350.10 | 20 | 188.74 |
| 21 | 123.93 | 21 | 220.15 | 21 | 107.54 |
| 22 | 64.63 | 22 | 917.14 | 22 | 726.91 |
| 23 | 69.62 | 23 | 356.28 | 23 | 290.67 |
| 24 | 118.44 | 24 | 389.63 | 24 | 285.75 |
| 24 | 98.18 | 24 | 361.19 | 24 | 28.79 |
| 25 | 70.34 | 25 | 320.50 | 25 | 166.14 |
| 26 | 109.50 | 26 | 223.96 | 26 | 208.51 |
| 27 | 117.06 | 27 | 248.72 | 27 | 18.26 |
| 27 | 10.28 | 27 | 593.57 | 27 | 539.26 |
| 31 | 26.51 | 31 | 1402.37 | 31 | 1380.26 |
| 33 | 31.50 | 33 | 2226.12 | 33 | 2212.26 |
| 34 | 33.44 | 34 | 2440.46 | 34 | 2446.10 |
| 35 | 23.97 | 35 | 3054.11 | 35 | 3058.33 |
| 36 | 44.38 | 36 | 3891.17 | 36 | 3883.26 |
| 40 | 95.36 | 40 | 4812.65 | 40 | 4806.26 |
| 42 | 76.21 | 42 | 5628.73 | 42 | 5623.26 |
| 44 | 115.84 | 44 | 630.82 | 44 | 601.82 |
| 44 | 162.01 | 44 | 360.53 | 44 | 307.27 |
| 45 | 148.27 | 45 | 396.62 | 45 | 146.27 |
| 45 | 239.83 | 45 | 534.01 | 45 | 439.97 |
| 46 | 206.95 | 46 | 251.10 | 46 | 151.39 |
| 50 | 49.58 | 50 | 849.29 | 50 | 617.61 |
| 51 | 47.70 | 51 | 486.13 | 51 | 445.44 |
| 53 | 83.18 | 53 | 534.84 | 53 | 410.11 |
| 53 | 84.76 | 53 | 345.09 | 53 | 34.89 |
| 55 | 37.34 | 55 | 915.70 | 55 | 848.89 |
| 55 | 39.78 | 55 | 1134.11 | 55 | 1080.89 |
| 56 | 22.44 | 56 | 1652.95 | 56 | 1616.89 |
| 60 | 102.72 | 60 | 2398.60 | 60 | 2373.89 |
| 62 | 97.50 | 62 | 3052.27 | 62 | 3032.89 |
| 62 | 98.14 | 62 | 504.17 | 62 | 250.39 |
| 63 | 109.91 | 63 | 321.73 | 63 | 113.17 |
| 64 | 51.73 | 64 | 269.54 | 64 | 88.88 |
| 65 | 32.97 | 65 | 292.74 | 65 | 245.90 |
| 66 | 132.58 | 66 | 419.57 | 66 | 324.19 |
| 70 | 158.23 | 70 | 338.10 | 70 | 291.19 |
| 70 | 5.61 | 70 | 252.27 | 70 | 5.00 |
| 72 | 21.59 | 72 | 529.04 | 72 | 302.00 |
| 72 | 77.29 | 72 | 293.92 | 72 | 243.06 |
| 73 | 113.02 | 73 | 356.45 | 73 | 242.04 |
| 74 | 211.75 | 74 | 1034.67 | 74 | 1001.04 |

5-16

Table 5-3. Fixed Route Test #10044 Radial Error Sequence (Sheet 2 of 3)

| CKID | SYSTEM | RADIAL ERRORS | SÉQUENCE | CKID | LORAN | CKID | LORAN-PROJECTED |
|------|--------|---------------|----------|------|---------|------|-----------------|
| 75 | 232.09 | 75 | 1817.97 | 75 | 1799.04 | | |
| 76 | 176.66 | 76 | 2945.68 | 76 | 2934.03 | | |
| 76 | 44.25 | 76 | 3194.77 | 76 | 3164.03 | | |
| 77 | 1.50 | 77 | 3398.13 | 77 | 3386.03 | | |
| 100 | 56.16 | 100 | 4338.93 | 100 | 4331.03 | | |
| 100 | 43.57 | 100 | 4377.86 | 100 | 4370.04 | | |
| 102 | 41.77 | 102 | 5107.74 | 102 | 5101.03 | | |
| 103 | 84.68 | 103 | 5331.02 | 103 | 5299.66 | | |
| 104 | 82.00 | 104 | 5376.54 | 104 | 5332.36 | | |
| 106 | 48.49 | 106 | 5613.05 | 106 | 5529.22 | | |
| 106 | 45.46 | 106 | 5668.92 | 106 | 5578.52 | | |
| 110 | 162.19 | 110 | 413.44 | 110 | 378.36 | | |
| 111 | 64.35 | 111 | 1496.67 | 111 | 1487.36 | | |
| 113 | 30.59 | 113 | 245.69 | 113 | 215.77 | | |
| 114 | 112.14 | 114 | 325.30 | 114 | 292.91 | | |
| 116 | 109.13 | 116 | 207.77 | 116 | 166.43 | | |
| 120 | 106.68 | 120 | 265.32 | 120 | 121.13 | | |
| 120 | 106.67 | 120 | 260.91 | 120 | 71.91 | | |
| 120 | 207.83 | 120 | 252.35 | 120 | 184.96 | | |
| 120 | 162.50 | 120 | 235.63 | 120 | 131.90 | | |
| 121 | 646.35 | 121 | 468.31 | 121 | 295.28 | | |
| 121 | 645.59 | 121 | 448.95 | 121 | 291.87 | | |
| 122 | 542.83 | 122 | 194.04 | 122 | 126.50 | | |
| 122 | 502.29 | 122 | 317.65 | 122 | 103.32 | | |
| 123 | 35.75 | 123 | 531.10 | 123 | 432.91 | | |
| 124 | 119.30 | 124 | 286.55 | 124 | 142.22 | | |
| 125 | 89.03 | 125 | 249.54 | 125 | 134.33 | | |
| 126 | 83.81 | 126 | 348.32 | 126 | 277.67 | | |
| 127 | 49.11 | 127 | 305.46 | 127 | 124.79 | | |
| 130 | 101.69 | 130 | 243.76 | 130 | 137.63 | | |
| 132 | 177.16 | 132 | 779.26 | 132 | 475.00 | | |
| 133 | 243.76 | 133 | 639.16 | 133 | 571.47 | | |
| 135 | 2.20 | 135 | 507.97 | 135 | 261.75 | | |
| 136 | 52.54 | 136 | 1227.72 | 136 | 911.62 | | |
| 140 | 36.39 | 140 | 464.11 | 140 | 53.78 | | |
| 141 | 52.33 | 141 | 357.76 | 141 | 44.16 | | |
| 141 | 51.32 | 141 | 332.86 | 141 | 136.20 | | |
| 142 | 3.61 | 142 | 318.07 | 142 | 67.29 | | |
| 143 | 52.00 | 143 | 343.99 | 143 | 283.55 | | |
| 144 | 94.01 | 144 | 425.05 | 144 | 379.02 | | |
| 144 | 23.29 | 144 | 1175.86 | 144 | 1160.02 | | |
| 145 | 26.21 | 145 | 262.76 | 145 | 169.82 | | |
| 146 | 7.75 | 146 | 283.18 | 146 | 161.64 | | |
| 146 | 79.98 | 146 | 398.23 | 146 | 295.66 | | |
| 147 | 125.28 | 147 | 407.18 | 147 | 282.91 | | |
| 147 | 165.46 | 147 | 153.32 | 147 | 218.94 | | |
| 150 | 139.63 | 150 | 492.69 | 150 | 556.91 | | |
| 151 | 115.45 | 151 | 1155.94 | 151 | 1184.73 | | |
| 151 | 116.75 | 151 | 1330.41 | 151 | 1355.50 | | |
| 152 | 72.13 | 152 | 1675.16 | 152 | 1695.16 | | |
| 152 | 73.31 | 152 | 1734.19 | 152 | 1753.51 | | |
| 153 | 82.45 | 153 | 2439.26 | 153 | 2453.04 | | |
| 154 | 89.45 | 154 | 5300.19 | 154 | 4981.61 | | |
| 155 | 70.96 | 155 | 4977.77 | 155 | 4588.24 | | |

5-17

Table 5-3. Fixed Route Test #10044 Radial Error Sequence (Sheet 3 of 3)

| ***** | | RADIAL ERRORS SEQUENCE ***** | | ***** | |
|-------|--------|------------------------------|---------|-------|-----------------|
| CKID | SYSTEM | CKID | LORAN | CKID | LORAN-PROJECTED |
| 156 | 87.55 | 156 | 6234.91 | 156 | 5108.61 |
| 156 | 87.77 | 156 | 6013.93 | 156 | 4887.64 |
| 157 | 48.51 | 157 | 5280.01 | 157 | 4153.75 |
| 161 | 70.97 | 161 | 4524.11 | 161 | 3397.93 |
| 162 | 260.23 | 162 | 3830.24 | 162 | 2704.17 |
| 163 | 56.88 | 163 | 3403.34 | 163 | 2277.39 |
| 164 | 88.82 | 164 | 2891.51 | 164 | 1765.79 |
| 164 | 89.99 | 164 | 2415.72 | 164 | 1290.46 |
| 165 | 303.84 | 165 | 1026.62 | 165 | 996.01 |
| 167 | 339.25 | 167 | 1353.54 | 167 | 1403.85 |

T109233

Table 5-4. Fixed Route Test #10044 Rank Order Statistics (Sheet 1 of 3)

| ***** | | ***** | | RADIAL ERRORS RANKED | | ***** | |
|-------|--------|-------|--------|----------------------|-----------------|-------|--|
| CKID | SYSTEM | CKID | LORAN | CKID | LORAN-PROJECTED | | |
| 77 | 1.50 | 16 | 147.73 | 70 | 5.00 | | |
| 135 | 2.20 | 147 | 153.32 | 27 | 16.26 | | |
| 142 | 3.61 | 122 | 194.04 | 24 | 26.79 | | |
| 70 | 5.61 | 116 | 207.77 | 53 | 34.89 | | |
| 146 | 7.75 | 21 | 220.15 | 141 | 44.16 | | |
| 27 | 10.28 | 26 | 223.96 | 140 | 53.78 | | |
| 4 | 12.94 | 120 | 235.63 | 142 | 67.29 | | |
| 3 | 17.92 | 130 | 243.76 | 120 | 71.91 | | |
| 2 | 18.87 | 113 | 245.69 | 64 | 88.88 | | |
| 72 | 21.59 | 27 | 248.72 | 122 | 103.32 | | |
| 17 | 22.18 | 125 | 249.54 | 21 | 107.54 | | |
| 56 | 22.44 | 46 | 251.10 | 63 | 113.17 | | |
| 144 | 23.29 | 70 | 252.27 | 16 | 114.43 | | |
| 35 | 23.97 | 120 | 252.35 | 120 | 121.13 | | |
| 145 | 26.21 | 145 | 262.76 | 127 | 124.79 | | |
| 31 | 26.51 | 120 | 265.32 | 122 | 126.50 | | |
| 113 | 30.59 | 64 | 269.54 | 120 | 131.90 | | |
| 33 | 31.50 | 120 | 280.91 | 125 | 134.33 | | |
| 65 | 32.97 | 146 | 283.18 | 141 | 136.20 | | |
| 34 | 33.44 | 6 | 286.06 | 130 | 137.63 | | |
| 123 | 35.75 | 124 | 286.55 | 124 | 142.22 | | |
| 140 | 36.39 | 65 | 292.74 | 45 | 146.27 | | |
| 55 | 37.34 | 72 | 293.92 | 46 | 151.39 | | |
| 55 | 39.78 | 127 | 305.46 | 146 | 161.64 | | |
| 102 | 41.77 | 122 | 317.65 | 25 | 166.14 | | |
| 100 | 43.57 | 142 | 318.07 | 116 | 166.43 | | |
| 76 | 44.25 | 25 | 320.50 | 145 | 169.82 | | |
| 36 | 44.38 | 63 | 321.73 | 120 | 184.96 | | |
| 51 | 47.70 | 114 | 325.30 | 20 | 188.74 | | |
| 106 | 48.49 | 141 | 332.86 | 26 | 203.51 | | |
| 157 | 48.51 | 4 | 334.12 | 113 | 215.77 | | |
| 127 | 49.11 | 7 | 336.12 | 6 | 216.04 | | |
| 106 | 49.46 | 70 | 338.10 | 147 | 218.94 | | |
| 50 | 49.58 | 6 | 339.84 | 4 | 234.74 | | |
| 141 | 51.32 | 143 | 343.99 | 73 | 242.04 | | |
| 64 | 51.73 | 53 | 345.09 | 72 | 243.06 | | |
| 143 | 52.00 | 126 | 348.32 | 65 | 245.90 | | |
| 141 | 52.33 | 20 | 350.10 | 62 | 250.39 | | |
| 136 | 52.54 | 23 | 356.28 | 135 | 261.75 | | |
| 100 | 56.16 | 73 | 356.45 | 126 | 277.67 | | |
| 163 | 56.88 | 141 | 357.76 | 7 | 278.96 | | |
| 16 | 58.03 | 44 | 360.53 | 3 | 281.79 | | |
| 111 | 64.35 | 24 | 361.19 | 147 | 282.91 | | |
| 22 | 64.63 | 24 | 389.63 | 143 | 283.55 | | |
| 6 | 67.82 | 45 | 396.62 | 24 | 285.75 | | |
| 5 | 67.94 | 146 | 398.23 | 23 | 290.67 | | |
| 23 | 69.62 | 147 | 407.18 | 70 | 291.19 | | |
| 25 | 70.34 | 110 | 413.44 | 121 | 291.87 | | |
| 155 | 70.96 | 66 | 419.57 | 114 | 292.91 | | |
| 161 | 70.97 | 144 | 425.05 | 121 | 295.28 | | |
| 152 | 72.13 | 3 | 435.38 | 146 | 295.66 | | |
| 152 | 73.31 | 121 | 448.95 | 72 | 302.00 | | |
| 42 | 76.21 | 140 | 464.11 | 44 | 307.27 | | |
| 72 | 77.29 | 121 | 466.31 | 66 | 324.19 | | |

5-19

Table 5-4. Fixed Route Test #10044 Rank Order Statistics (Sheet 2 of 3)

| ***** | | RADIAL ERRORS RANKED | | ***** | |
|---------------------------|--------|----------------------|---------|-------|-----------------|
| CKID | SYSTEM | CKID | LORAN | CKID | LORAN-PROJECTED |
| 20 | 77.93 | 51 | 486.13 | 110 | 378.36 |
| 146 | 79.98 | 150 | 492.69 | 144 | 379.02 |
| 104 | 82.00 | 62 | 504.17 | 6 | 409.81 |
| 153 | 82.45 | 135 | 507.97 | 53 | 410.11 |
| 53 | 83.18 | 72 | 529.04 | 123 | 432.91 |
| 126 | 83.81 | 123 | 531.10 | 45 | 439.97 |
| 103 | 84.68 | 45 | 534.01 | 51 | 445.44 |
| 53 | 84.76 | 53 | 534.84 | 132 | 475.00 |
| 156 | 87.55 | 27 | 593.57 | 27 | 539.26 |
| 156 | 87.77 | 44 | 630.82 | 150 | 556.91 |
| 164 | 88.82 | 133 | 639.16 | 133 | 571.47 |
| 125 | 89.03 | 50 | 649.29 | 44 | 601.82 |
| 154 | 89.45 | 132 | 779.26 | 50 | 617.61 |
| 164 | 89.99 | 17 | 791.57 | 22 | 726.91 |
| 144 | 94.01 | 5 | 893.48 | 17 | 745.77 |
| 40 | 95.36 | 55 | 915.70 | 55 | 848.89 |
| 62 | 97.50 | 22 | 917.14 | 5 | 861.26 |
| 11 | 97.64 | 165 | 1026.62 | 136 | 911.62 |
| 62 | 98.14 | 74 | 1034.67 | 165 | 946.01 |
| 24 | 98.18 | 55 | 1134.11 | 74 | 1001.04 |
| 7 | 99.61 | 151 | 1155.94 | 55 | 1080.89 |
| 13 | 101.55 | 144 | 1175.86 | 144 | 1160.02 |
| 130 | 101.69 | 11 | 1216.50 | 151 | 1184.73 |
| 60 | 102.72 | 136 | 1227.72 | 11 | 1201.96 |
| 6 | 105.96 | 151 | 1330.41 | 164 | 1290.46 |
| 120 | 106.67 | 167 | 1353.54 | 151 | 1355.50 |
| ----- 67 PERCENTILE ----- | | | | | |
| 120 | 106.68 | 31 | 1402.37 | 31 | 1380.26 |
| 116 | 109.13 | 111 | 1496.67 | 167 | 1403.85 |
| 26 | 109.50 | 56 | 1652.95 | 111 | 1487.36 |
| 63 | 109.91 | 152 | 1675.16 | 56 | 1616.89 |
| 114 | 112.14 | 152 | 1734.19 | 152 | 1695.16 |
| 73 | 113.02 | 75 | 1817.97 | 152 | 1753.51 |
| 13 | 113.54 | 13 | 2186.02 | 164 | 1765.79 |
| 151 | 115.45 | 33 | 2226.12 | 75 | 1799.04 |
| 44 | 115.84 | 13 | 2360.42 | 13 | 2177.96 |
| 151 | 116.75 | 60 | 2398.60 | 33 | 2212.26 |
| 27 | 117.06 | 164 | 2415.72 | 163 | 2277.39 |
| 24 | 118.44 | 153 | 2439.26 | 13 | 2352.96 |
| 124 | 119.30 | 34 | 2440.46 | 60 | 2373.89 |
| 21 | 123.93 | 164 | 2891.51 | 34 | 2446.10 |
| 147 | 125.28 | 76 | 2945.68 | 153 | 2453.04 |
| 66 | 132.58 | 62 | 3052.27 | 162 | 2704.17 |
| 150 | 139.63 | 35 | 3054.11 | 76 | 2934.03 |
| 45 | 148.27 | 76 | 3194.77 | 62 | 3032.89 |
| 70 | 158.23 | 77 | 3398.13 | 35 | 3058.33 |
| 44 | 162.01 | 163 | 3403.34 | 76 | 3184.03 |
| 110 | 162.19 | 162 | 3630.24 | 77 | 3388.03 |
| 120 | 162.50 | 36 | 3691.17 | 161 | 3397.93 |
| 147 | 165.46 | 100 | 4338.93 | 36 | 3663.26 |
| 76 | 176.66 | 100 | 4377.86 | 157 | 4153.75 |
| 132 | 177.16 | 161 | 4524.11 | 100 | 4331.03 |
| 46 | 206.95 | 40 | 4812.65 | 100 | 4370.04 |
| 120 | 207.83 | 155 | 4977.77 | 155 | 4588.24 |
| ----- 90 PERCENTILE ----- | | | | | |
| 74 | 211.75 | 102 | 5107.74 | 40 | 4806.26 |

5-20

Table 5-4. Fixed Route Test #10044 Rank Order Statistics (Sheet 3 of 3)

| ***** | | RADIAL ERRORS RANKED | | ***** | |
|---------------------------|--------|----------------------|----------|-------|-----------------|
| CKID | SYSTEM | CKID | LORAN | CKID | LORAN-PROJECTED |
| 75 | 232.09 | 157 | 5280.01 | 156 | 4887.64 |
| 45 | 239.83 | 154 | 5300.19 | 154 | 4981.61 |
| 133 | 243.76 | 103 | 5331.02 | 102 | 5101.03 |
| 162 | 260.23 | 104 | 5376.54 | 156 | 5108.61 |
| 165 | 303.84 | 106 | 5613.05 | 103 | 5299.86 |
| ----- 95 PERCENTILE ----- | | | | | |
| 167 | 339.25 | 42 | 5628.73 | 104 | 5332.36 |
| 122 | 502.29 | 106 | 5668.92 | 106 | 5529.22 |
| 127 | 542.83 | 156 | 6013.93 | 106 | 5578.52 |
| 124 | 645.58 | 156 | 6234.91 | 42 | 5623.26 |
| 124 | 646.35 | 2 | 10975.02 | 2 | 10975.02 |

T109230

Table 5-5. Fixed Route Test #10044 Statistical Summaries

| | | MEAN | SIGMA |
|---------|------------|-----------------|----------------|
| SYSTEM | DELTA-X | 0.96515265E 01 | 0.13141924E 03 |
| | DELTA-Y | -0.34443909E 02 | 0.70396194E 02 |
| | RADIAL-ERR | 0.10637006E 03 | 0.11002646E 03 |
| LORAN | DELTA-X | -0.57376025E 03 | 0.16592148E 04 |
| | DELTA-Y | 0.36241776E 02 | 0.15266863E 04 |
| | RADIAL-ERR | 0.15604805E 04 | 0.19143675E 04 |
| LORAN-O | DELTA-X | -0.55052661E 03 | 0.18446111E 04 |
| | DELTA-Y | 0.12297772E 03 | 0.12944377E 04 |
| | RADIAL-ERR | 0.13985396E 04 | 0.18510681E 04 |

MEAN TIME POINT ERROR= 4.60 TIME POINT ERROR SIGMA= 5.65

TIME POINT TIME POINT ERRORS

| | |
|-----|-------|
| 5 | 5.00 |
| 16 | 3.00 |
| 26 | 24.00 |
| 37 | 4.00 |
| 50 | 6.00 |
| 60 | 1.00 |
| 70 | 8.00 |
| 76 | 5.00 |
| 110 | 0.0 |
| 122 | 5.00 |
| 134 | 3.00 |
| 144 | 3.00 |
| 151 | 1.00 |
| 157 | 0.0 |
| 166 | 1.00 |

RANK ORDER STATISTICS OF TIME POINT ERRORS

| | |
|-----|-------|
| 110 | 0.0 |
| 157 | 0.0 |
| 60 | 1.00 |
| 151 | 1.00 |
| 166 | 1.00 |
| 16 | 3.00 |
| 134 | 3.00 |
| 144 | 3.00 |
| 37 | 4.00 |
| 5 | 5.00 |
| 76 | 5.00 |
| 122 | 5.00 |
| 50 | 6.00 |
| 70 | 8.00 |
| 26 | 24.00 |

SECTION 6

TEST RESULTS

This section presents the detailed results of all tests performed. Implications of these results as applied to the Phase II Program are discussed but specific system modifications proposed as a result of Phase I test results are presented in Section 7.

Results are presented by test category starting with Fixed Route Tests, followed by Random Route Tests and Special Case Tests. Within each test category sub-system and system simulation results are discussed. Table 6-1 is a summary table of all test results.

The results clearly show the LORAN AVM System to be fully compliant with fixed route operational requirements and that a minimal amount of developmental effort is required to reduce the random route errors to within specified limits.

6.1 TEST PROBLEMS - THEIR EFFECT ON FINAL RESULTS

Two problems occurred during the test program which contributed significantly to the errors reported in the results. The problems will not occur in production equipment. Table 6-2 identifies which tests were affected by these problems and to what extent. The remainder of this section explains the effects fully so as to allow a complete understanding of the different categories of test results.

6.1.1 Low Temperature Augmentor Failure

The winter of 1976-77 was the coldest in the history of the city of Philadelphia, whose weather records date back 187 years. Under such extreme environmental conditions it is not surprising that the operation of some experimental equipment was faulty. These malfunctions were limited to the augmentors which were installed on street lamp poles and were subjected to the prevailing environment 24 hours per day. No other equipment tested exhibited any temperature effects. The LORAN C ministration, for example, operated every day an average of 14 hours

Table 6-1A. Fixed Route Test Results

| Fixed Route Test Results | | Confidence Level | Runs(1) 10001- 10012 | Runs 10026- 10047 | Runs(2) 10012- 10047 | 10012-10047 Less (2) 10016 & 10017 |
|-------------------------------|--|------------------|----------------------------|-------------------------|----------------------------|--|
| SYSTEM SIMULATION | 32 second fixed polling | 95% 99.5% | 269.45' 787.38' | 287.79' 369.60' | 1,648.51' 5,087,946' | 320.56' 4,909,913' |
| | 32 second fixed polling w/5% missed data | 95% 99.5% | | 291' 383' | 1,113' 4,909,901 | 326' 4,909,908' |
| | Time of passage | 95% 99.5% | 47 sec 65 sec | 26 sec (3) 42 sec | 32 sec 49 sec | 33 sec 47 sec |
| LOCATION SUBSYSTEM | | 95% 99.5% | 318.66' 1,457.62' | 303.34' 5,186.65' | 1,269.16' 4,914,435' | 352.79' 4,914,435' |
| COVERAGE: Mean Error 450 Feet | | Mean | | 98% | 78.3% | 78.3% |

(1) Tests Conducted with Malfunctioning Augmentors

(2) Tests Conducted with Malfunctioning Motor-Generator

(3) See Section 7 for Technique to Reduce Errors to 8 Seconds and 16 Seconds

Table 6-1B. Random Route Test Results

| | | | Software | |
|----------------------|--|--------------|----------------------|----------------------|
| | | | Original | Improved |
| SYSTEM SIMULATION | 32 second fixed polling | 95% 99.5% | 691.16' 1,293.11' | 475.89' 819.17' |
| | 32 second fixed polling w/5% missed data | 95% 99.5% | 752.55' 1,293.11' | 472.94' 819.17' |
| | LOCATION SUBSYSTEM | | 95% 99.5% | 358.52' 1,222.96' |
| COVERAGE | | Mean | 98% | 98% |

Table 6-1C. Special Case Test Results

| Special Case Test Results (4) | Confidence Level | LORAN Only |
|-------------------------------|------------------|------------|
| LOCATION SUBSYSTEM | 95% | 325.32' |
| | 99.5% | 375.68' |
| SYSTEM SIMULATION | 95% | 269.45' |
| | 99.5% | 787.37' |

(4) These results were obtained in a low rise part of the city using the LORAN sensor only without benefit of augmentors.

Table 6-2. Runs Affected by Test Instrumentation Problems

| Problem | Runs Affected | Result |
|--|-----------------------------|---|
| Low Temperature Augmentor Failure | 10001 - 10012 (10 Tests) | 27% of possible augmentor detections missed. Some incorrect ID decodes. |
| Low Voltage (85 - 95 VAC) & Low Frequency from motor-generator | 10012 - 10025 (12 tests) | False counts in odometer logic, erratic recording of LORAN time difference numbers. |

with no adverse effects from the low temperatures. This section will discuss the effects of missed augmentors and incorrect ID codes, both occurring before the problem was corrected.

The temperature related augmentor failure caused the ID pulse widths and spacing to vary. This, in turn, resulted in rejection of the augmentor ID by the AVM augmentor decode logic in the test vehicle. Failure to properly detect malfunctioning augmentors deprived the system of the high precision location update usually available. This had negligible effects on the 95% location accuracy number since the primary function of augmentors on the fixed route is to provide time of passage data. Occasionally, a malfunctioning augmentor would output an

incorrect ID code. In the worst case, the incorrect code was identical to the legitimate code of another augmentor on the fixed route. In this situation, the vehicle location was erroneously put near the incorrect augmentor. When this happened, the AVM System was always able to eventually reconcile the problem and correctly locate the vehicle within 300 feet. During the time it took to correct the problem, a number of measurements with very large errors were recorded. These errors had a significant effect on the 99.5% number. Instead of 370 feet which the system is capable of, 787 feet was recorded due to 10 measurements with errors over 700 feet.

A secondary effect of the original augmentor temperature problem had a much more significant effect on subsequent fixed route test results. In an attempt to compensate in software for the augmentor hardware problems, a change was implemented which prevented the system from using any augmentor information which is not consistent with the latest system vehicle location. Later in the tests, after the augmentor problem had been corrected, this had a very deleterious effect. It prevented proper augmentor ID detections from immediately correcting large location errors resulting from other extra-system problems. These problems are discussed in paragraph 6.1.2.

The augmentor temperature problem was corrected during the December-January period when testing was suspended. It did not occur on any subsequent tests.

6.1.2 Low Voltage Motor-Generator Problem

The original motor-generator on the test vehicle failed on December 8 after test 10010. A new unit was obtained under emergency conditions and installed by December 13. All subsequent testing was conducted using power from this unit. After conducting two more tests (10011 and 10012) testing was suspended until January 31 to allow time to solve the augmentor problem. When testing was resumed, the motor-generator was adjusted to prevent a recurring misfire problem in the engine. This adjustment caused the motor to run slower than normal with

a corresponding reduction in output voltage. When discovered, instead of a nominal 115 VAC, the generator was outputting only 90 VAC. Twelve fixed route runs were made with the generator at low voltage (runs 10012 through 10025).

The regulation drop-out voltage for the test console power supplies is nominally 90 VAC. As the generator voltage varied during a run, the console logic voltage would occasionally go out of tolerance when its input fell below 90 volts. Under these conditions, erroneous data was recorded on magnetic tape. The AVM System odometer data was most susceptible to this problem, probably because this data line was normally true (high voltage), going false (zero volts) at each increment of travel. Each time the power supplies dropped out of regulation, the odometer logic saw this as indication of distance traveled when, in fact, the vehicle may not have even moved at all. Figure 6-1 is a portion of data taken from the engineering unit dumps of a run with bad data and a run made after the problem was corrected. In both figures, data is written at a once per second rate with the AVM System odometer list on the left, incremental time in the center, and cumulative distance traveled as recorded by the fifth wheel on the right.

Figure 6-1A shows correct data in that the system odometer indicates the distance traveled in feet in one second and in each case this distance equals the difference in adjacent lines of the cumulative fifth wheel column. Figure 6-1B clearly shows the effect of the low voltage problem. Successive lines indicate one second distances of 490.528 ft., 687.936 ft., 705.135 ft., 758.973 ft., and 351.446 ft., while the corresponding column indicates distances of 18 ft., 21 ft., 23 ft., 25 ft., and 25 ft. Unfortunately, the erroneous system odometer data was used to calculate location. It is not surprising that large errors resulted. All runs made while the voltage varied between 85 and 90 volts show sporadic sections of contaminated data. Two such runs, 10016 and 10017, are almost entirely ruined.

| | | |
|--------|-------|----------|
| 28.415 | 962.0 | 15594.00 |
| 26.919 | 963.0 | 15621.00 |
| 16.451 | 964.0 | 15647.00 |
| 23.928 | 965.0 | 15672.00 |
| 20.937 | 966.0 | 15693.00 |
| 17.946 | 967.0 | 15711.00 |
| 14.955 | 968.0 | 15726.00 |
| 11.964 | 969.0 | 15738.00 |
| 6.730 | 970.0 | 15744.00 |
| 1.496 | 971.0 | 15746.00 |
| 0.0 | 972.0 | 15746.00 |
| 0.0 | 973.0 | 15746.00 |
| 0.0 | 974.0 | 15746.00 |
| 0.0 | 975.0 | 15746.00 |

T109164-1

Figure 6-1A. Odometer/Generator Power Problem
Typical Normal Operation

| | | |
|---------|--------|----------|
| 8.973 | 2016.0 | 28613.00 |
| 13.460 | 2017.0 | 28626.00 |
| 14.955 | 2018.0 | 28642.00 |
| 490.528 | 2019.0 | 28660.00 |
| 687.936 | 2020.0 | 28681.00 |
| 705.135 | 2021.0 | 28704.00 |
| 758.973 | 2022.0 | 28729.00 |
| 351.446 | 2023.0 | 28754.00 |
| 26.171 | 2024.0 | 28780.00 |
| 26.171 | 2025.0 | 28806.00 |
| 25.424 | 2026.0 | 28832.00 |
| 26.171 | 2027.0 | 28858.00 |

T109164-2

Figure 6-1B. Odometer/Generator Power Problem
Odometer Fail Condition

In order to present the results of all tests but at the same time to show the true system performance capability, three categories of results are presented: all tests (10012 through 10047); all tests less 10016 and 10017; and, tests 10026 through 10047. The reason for each category is as follows: program requirements do not allow detection of any test data, hence the category including results of all tests. Tests 10016 and 10017 show almost total contamination from start to finish by the low voltage problem. The second category of results does not include data from these tests. Since the motor-generator is part of the test support equipment and not the AVM System, a category of results is presented which is made from tests 10026 through 10047. These are all tests conducted after the generator problem was corrected and demonstrates the true system capability.

6.2 FIXED ROUTE TESTS

6.2.1 Tests 10001 through 10012 (with augmentor malfunction) December 6 through December 13, 1976

6.2.1.1 Location Subsystem - For the location subsystem the error at the 95th percentile was 318.66 feet. At the 99.5th percentile it was 1,457.62 feet. Figure 6-2 is a histogram and cumulative error curve for the location subsystem, runs 10001 through 10012.

The 99.5% number is not indicative of the system capability. It is the result of a problem in the augmentor transmitter circuit at low temperature which plagued this set of runs, ultimately resulting in the suspension of testing. When the augmentor transmitter malfunctioned, it resulted in one of two symptoms: no ID number at all was decoded as the test vehicle passed, or an incorrect number was decoded. The latter symptom was the more troublesome if the incorrectly decoded number happened to be the same as a legitimate ID at another time point on the route. In this unfortunate circumstance, the incorrect augmentor ID results in a new position update at an erroneous location which could be many thousands of feet away from the true location. This did happen with interesting results. On test 10010 as the vehicle passed augmentor ID 33 at 10th St. and Walnut, ID 32 was

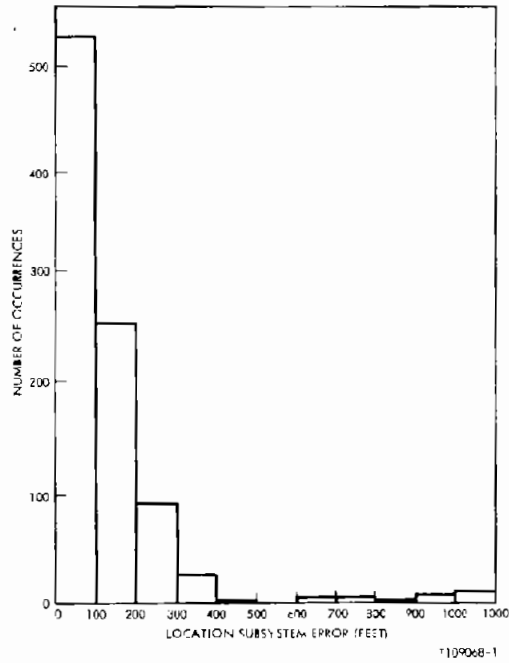

Figure 6-2A. Location Subsystem Histogram
 (Fixed Route Tests #10001 - 10012)
 December 1976

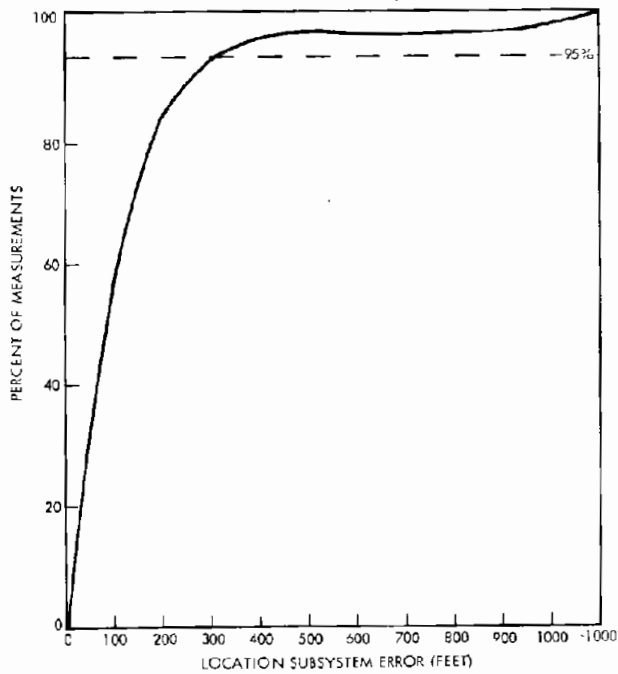

Figure 6-2B. Location Subsystem Cumulative Error
 (Fixed Route Tests #10001 - 10012)
 December 1976

decoded. It happens that 32 is the legitimate ID of an augmentor at 13th St. and Chestnut. At this point, the system located the test vehicle near 13th and Chestnut and, of course, produced large errors as the test vehicle continued along Walnut St. After three successive reports, the apparent LORAN errors were so large that the system declared the vehicle off the fixed route. In this mode, the vehicle is continually tracked using LORAN data only while the system continues to project the LORAN derived location onto the nearest segment of the fixed route. Since the vehicle had not actually left the route but only had been "spoofed" by a malfunctioning augmentor, it is of some interest to examine the run to see how long it took the system to determine the true location of the vehicle. The computer run shows that at the first checkpoint after declaring route departure (3 checkpoints after the false aug detection), the system error was 190.74 ft., which means that the raw LORAN location data put the vehicle within 200 feet of its true location. At the next two checkpoints the errors were 220.68 ft. and 318.66 ft. These were also based only on raw LORAN information. At the next checkpoint the conditions for declaring a return to the fixed route were satisfied. The system made the correct "returned to route" declaration and located the point at which the return was made with an error of only 112.85 ft.

The artificial route departure described above and other location problems caused by malfunctioning augmentors caused the 99.5% error to be larger than it would otherwise have been.

6.2.1.2 System Simulation - The system simulation for runs 10001 through 10012 produced a location accuracy of 269.45 ft. at the 95th percentile and 787.37 ft. at the 99.5th percentile. A histogram and cumulative error plot is shown in Figure 6-3. As with the location subsystem runs, augmentor malfunctions had some effect on the 99.5%. This is primarily because the data rate of 32 seconds is higher than the average rate resulting from updates only at checkpoints. The higher data rate and nominally higher quality LORAN available at non-street-intersection sample points produces a markedly superior error distribution which can be seen through out the test results.

The system simulation of time of passage produced predictably poor results on these runs with their known augmentor malfunctions. The error at the 95th percentile was 47 seconds, 65 seconds at the 99.5th. Significantly better results were obtained in subsequent tests conducted after the augmentor low temperature problem was solved. See paragraph 6.2.2.6.

6.2.2 Tests 10012 through 10047

These tests were run during the January 31 to February 6 time period. Some of the first 12 tests (10012 through 10025) contain data affected by the low voltage condition described in paragraph 6.1.

6.2.2.1 Location Subsystem - The error at the 95th percentile for all 30 runs was 1,269.16 feet for the location subsystem. At the 99.5th percentile the error was 4,914,435 ft due to the generator malfunction. Figure 6-4 shows the distribution of all errors for these tests.

These results are dominated by results of the early tests as will be shown later. The 99.5% error should be discussed. It is an artificial number which is the product of a computer software overflow in the position location routine. It results from test data inputs containing LORAN TDA and TDB numbers hundreds of microseconds away from the expected range of values in the Philadelphia area. The 4 million feet numbers are artificial in that a gross manual coordinate conversion shows that errors of about 50,000 feet would have resulted had the software been scaled to handle this large range of time difference values. It is highly likely that these time difference numbers were a result of the low voltage problems in the test console since this unit is powered by the motor generator. The numbers put on tape are the output of a time difference averaging circuit in the test console. In addition, this condition only occurred during the first tests. It did not occur after the electrical problem was corrected. Finally, time difference errors of this magnitude would certainly have attracted the attention of the test operator and witnesses since the LORAN receiver outputs are displayed. No notes or observation of improper time differences were made during any of the test runs.

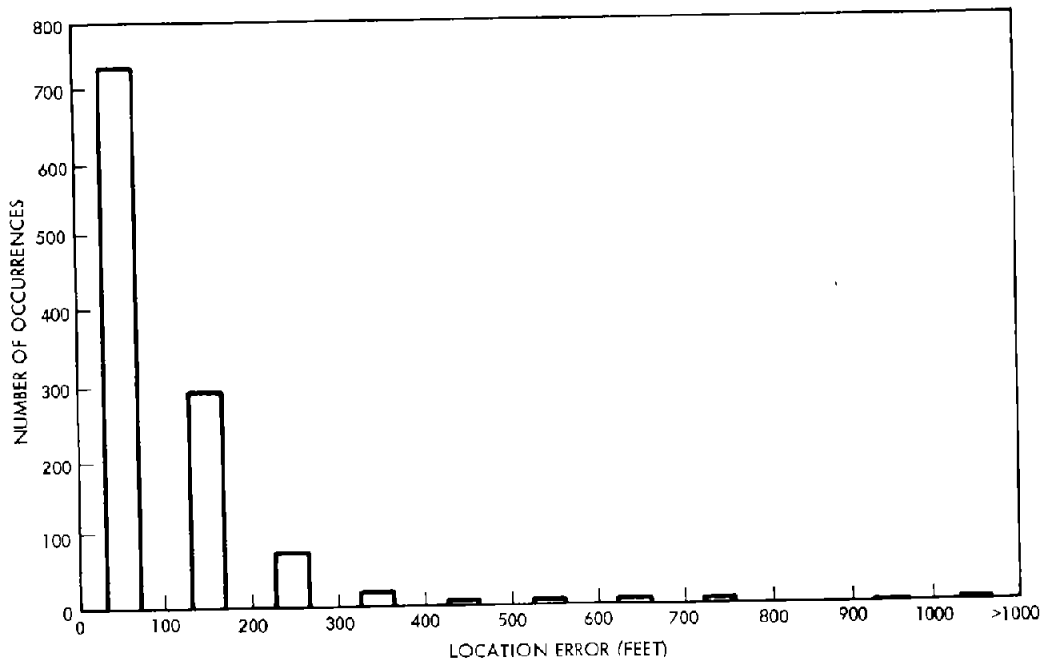

T109073-1

Figure 6-3A. Location Accuracy Histogram (System Simulation)
 (Fixed Route Tests #10001 - 10012)
 December 1976

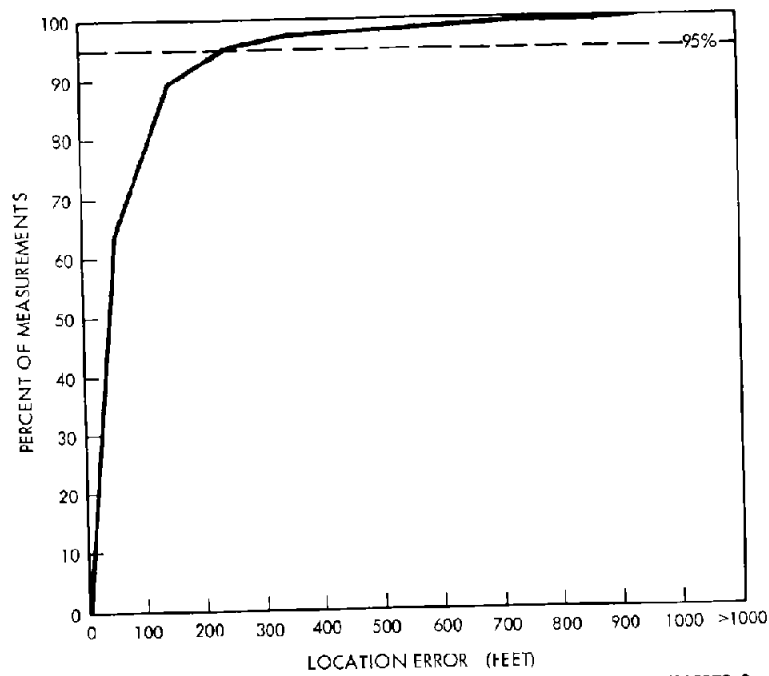

T109073-2

Figure 6-3B. Cumulative Location Error (System Simulation)
 (Fixed Route Tests #10001 - 10012)
 December 1976

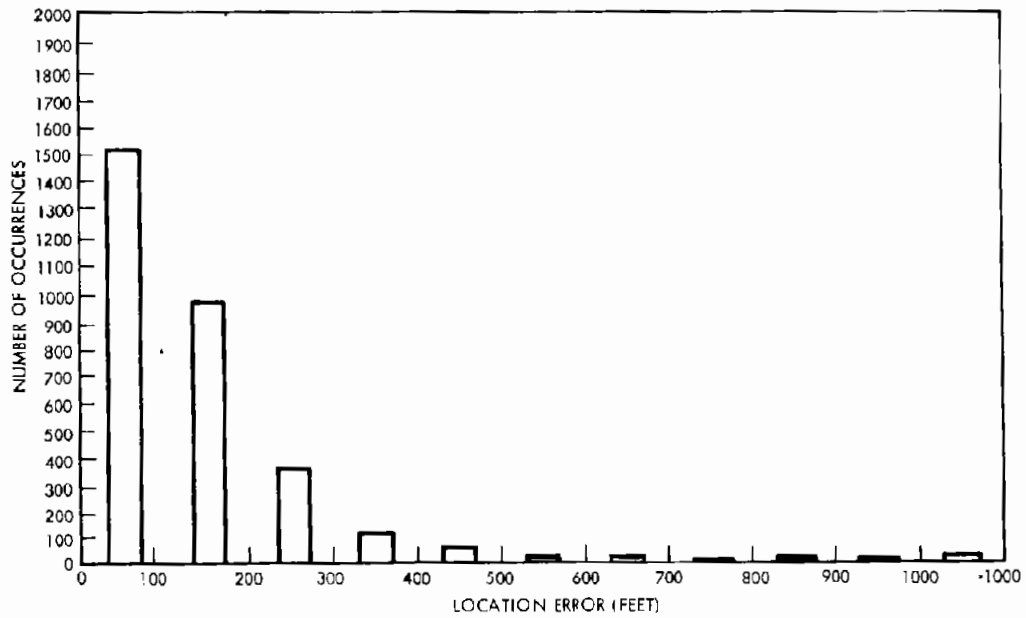

T109007-1

Figure 6-4A. Location Subsystem Histogram
(Fixed Route Tests (All) #10012 - 10047)

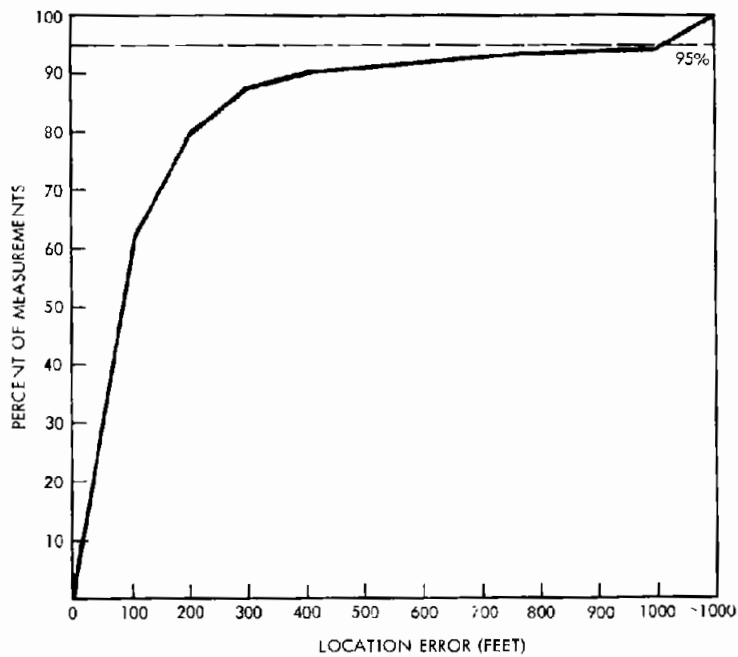

T109007-2

Figure 6-4B. Location Subsystem Cumulative Error
(Fixed Route Tests (All) #10012 - 10047)

6.2.2.2 System Simulation - The results of the system simulation for all runs is also dominated by errors contained in the early tests. The error at the 95th percentile was 1,648.51 feet; at the 99.5th percentile the error was 5,087,946 feet. Figure 6-5 shows the distribution of these errors.

The time of passage errors were not affected by the electrical problems to the same degree the location errors were. This is probably because the odometer, which was most vulnerable as previously discussed, is not as significant in the time of passage determination process. It is only used to measure a distance of 50 feet from initial augmentor detection. Erratic odometer data could only have a minimal effect at most. The error at the 95th percentile was 32 seconds; at the 99.5th it was 49 seconds. Figure 6-6 shows the error distribution. These results are indicative of the true system characteristics since they are relatively independent of any known extra-system problem. Results to be discussed later in this section tend to corroborate this. While 32 seconds - 95% is in excess of the specified requirement, post-test analysis has been completed showing that with some modifications and a door open-closed sensor, the 15 second 95% requirement can be met. A more detailed discussion of the error sources in the Phase I tests, plus a proposed mechanization for Phase II which is compliant, is presented in Section 7. Paragraph 6.2.6 describes an algorithm for determining time of passage at any point without benefit of an augmentor. A comparison of results is given in Table 6-4. Analytic error calculations for this algorithm are discussed along with the results of manual application of this algorithm to Phase I test data.

6.2.2.3 System Simulation with 5% Lost Data - The system simulation described in paragraph 6.2.2.2 was repeated for all 30 tests with a random 5% of all data deleted. This simulates the practical system operating conditions. Results do not significantly differ from the straight simulation. The error at the 95th percentile was 1,113 feet and 4,909,901 feet at the 99.5th percentile. Error distribution is shown in Figure 6-7.

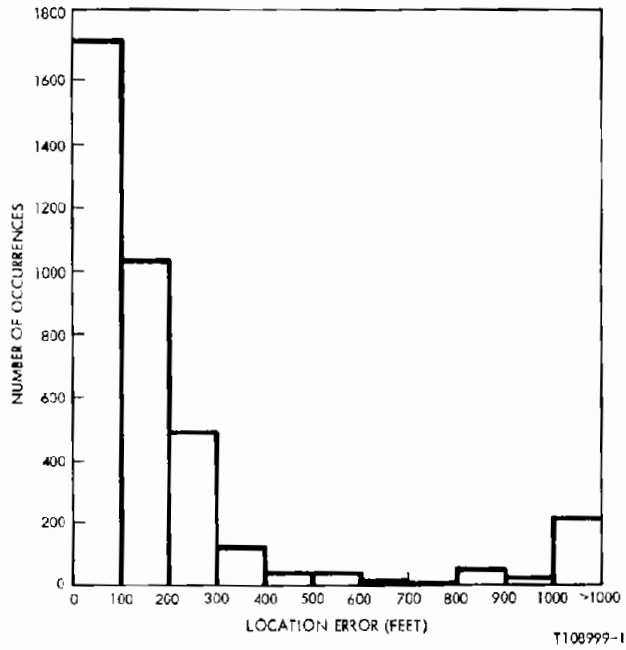

Figure 6-5A. Location Accuracy Histogram (System Simulation)
(Fixed Route Tests #10012 - 10047)

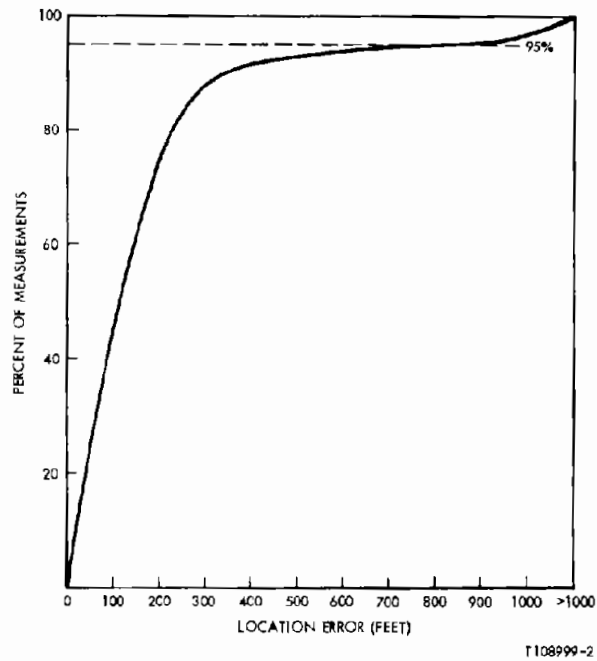
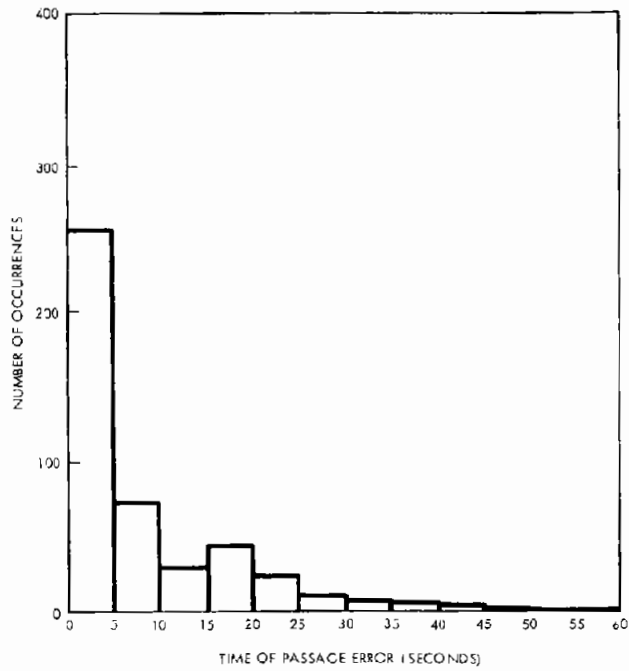
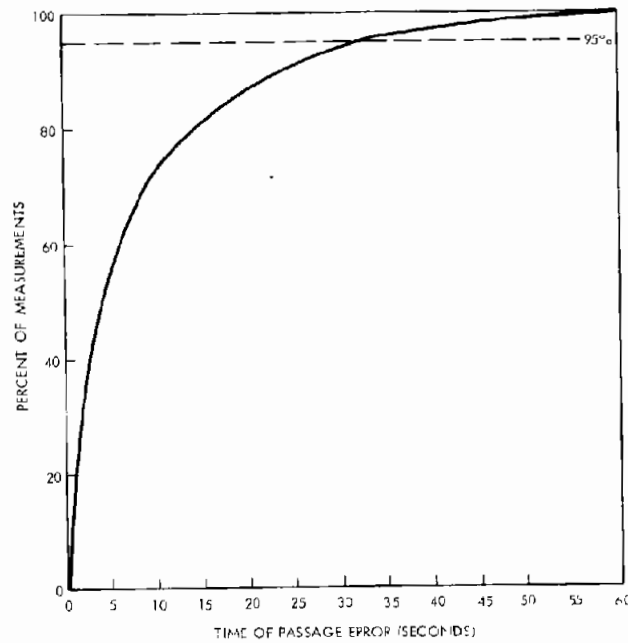

Figure 6-5B. Cumulative Location Error (System Simulation)
(Fixed Route Tests #10012 - 10047)



T109005-1

Figure 6-6A. Time of Passage Error Histogram
(Test 10012 - 10047)



T109005-2

Figure 6-6B. Time of Passage Cumulative Error
(Test 10012 - 10047)

6.2.2.4 Coverage - Coverage was provided over 78.3% of the fixed route when all 30 tests are considered. Coverage is defined as a mean error of less than 450 feet over any .1 mile segment of roadway. It should not be confused with coverage in the LORAN sense. The extent and quality of the LORAN coverage is addressed in paragraph 6.5.

As previously discussed, electrical problems contributed to large errors at many places along the route. In particular for those measurements which resulted in an overflow in software, very large errors were recorded. These errors dominate the coverage figure. Obviously, if an error in excess of 4 million feet is averaged with anything in a .1 mile segment the mean will be greater than 450 feet.

6.2.3 Tests 10012 through 10047, Less 10016 and 10017

A separate set of results was compiled using all data collected except tests 10016 and 10017. These two tests were most severely affected by the electrical problem.

6.2.3.1 Location Subsystem - The location subsystem error at the 95th percentile was 352.79 feet. At the 99.5th percentile it was 4,914,435 feet. Error distribution for this data set is shown in Figure 6-8. Since severe and extensive electrical problems occurred during tests 10013 and 10024 which are included here, these results also are dominated by bad tests although not to the same extent as the previous set.

6.2.3.2 System Simulation - The system simulation for these tests produced an error at the 95th percentile of 320.56 feet and 4,909,913 feet at the 99.5th percentile. A histogram and cumulative error plot is given in Figure 6-9.

The system simulation of time of passage showed an error of 33 seconds 95% and 47 seconds 99.5%. These results differ only slightly from those obtained for all 30 runs as would be expected. See Figure 6-10 for error distribution curves.

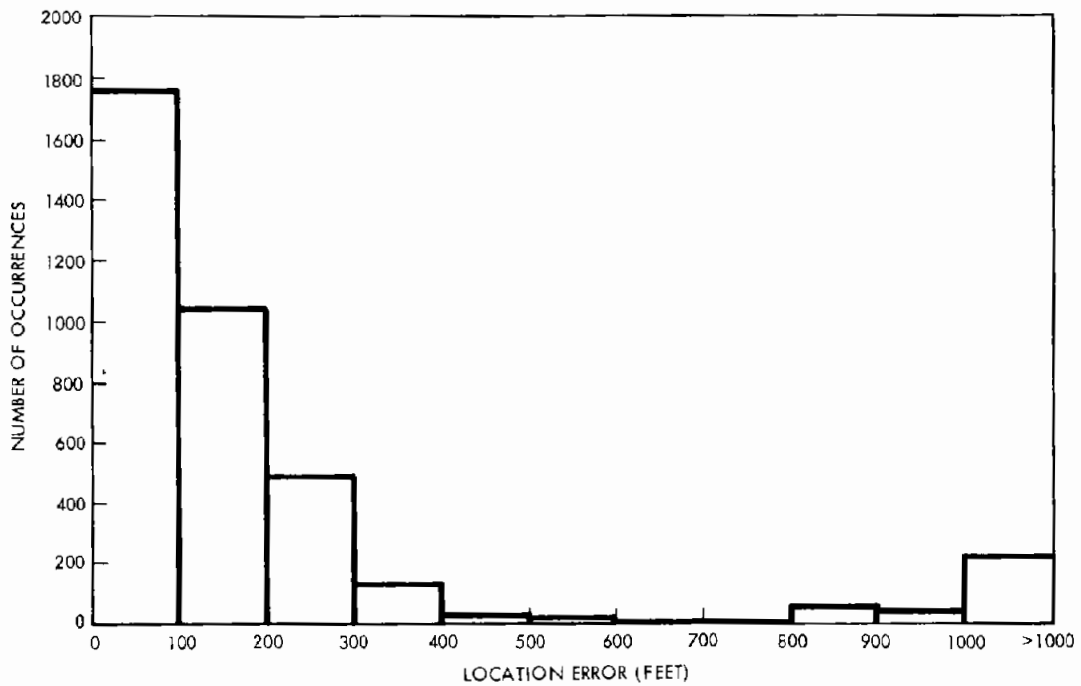

T109071-1

Figure 6-7A. Location Accuracy Histogram
 (System Simulation With 5% Missing Data)
 (Fixed Route Tests #10012 - 10047)

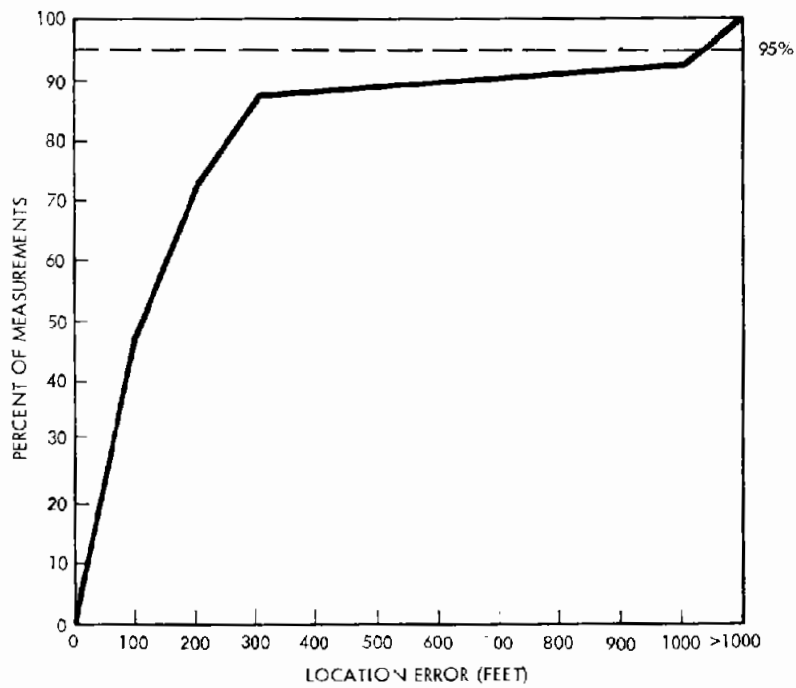

T109071-2

Figure 6-7B. Cumulative Location Error
 (System Simulation With 5% Missing Data)
 (Fixed Route Tests #10012 - 10047)

6.2.3.3 System Simulation with 5% Missing Data - When the system simulation was repeated with a random 5% of the data deleted the error at the 95th percentile was 326 feet; at the 99.5th percentile it was 4,909,908 feet. A histogram and cumulative error curve is shown in Figure 6-11.

6.2.2.4 Coverage - As explained in paragraph 6.2.2.3, coverage statistics are dominated by contaminated data. For this category of tests, coverage was 450 feet or less for 78.3% of the measurements.

6.2.4 Tests 10026 through 10047 (No Generator Problems)

The electrical problem in the test support equipment was identified and corrected after Test 10025. This category of tests has no external forces acting on it and as such presents the most accurate portrayal of system accuracy capability. This test category covers 18 passes around the fixed route course covering a total of almost 250 miles. A total of over 2,000 checkpoints and 270 time points were passed. In itself this represents a very comprehensive test.

6.2.4.1 Location Subsystem - The error at the 95th percentile for the Location Subsystem runs was 303.34 feet. At the 99.5th percentile the error was 5,186.65 feet. Error distribution curves are given in Figure 6-12. The 95% error is less than 4 feet greater than the required accuracy but the 99.5% figure should be explained. Of the 2,019 measurements made at checkpoints, 12 contained errors greater than 2,000 feet. These errors were the source of the 99.5% error figure. Examination reveals that 9 of the 12 occurred on Test 10030 and were the result of a LORAN cycle slip in time difference B. The cycle slip occurred just prior to checkpoing 151 at 8th and Spruce, probably the result of a temporary low SNR condition. The next few checkpoints are at checkpoints with consistently a poor SNR. Under these conditions, it is difficult or impossible for the LORAN receiver to make cycle corrections.

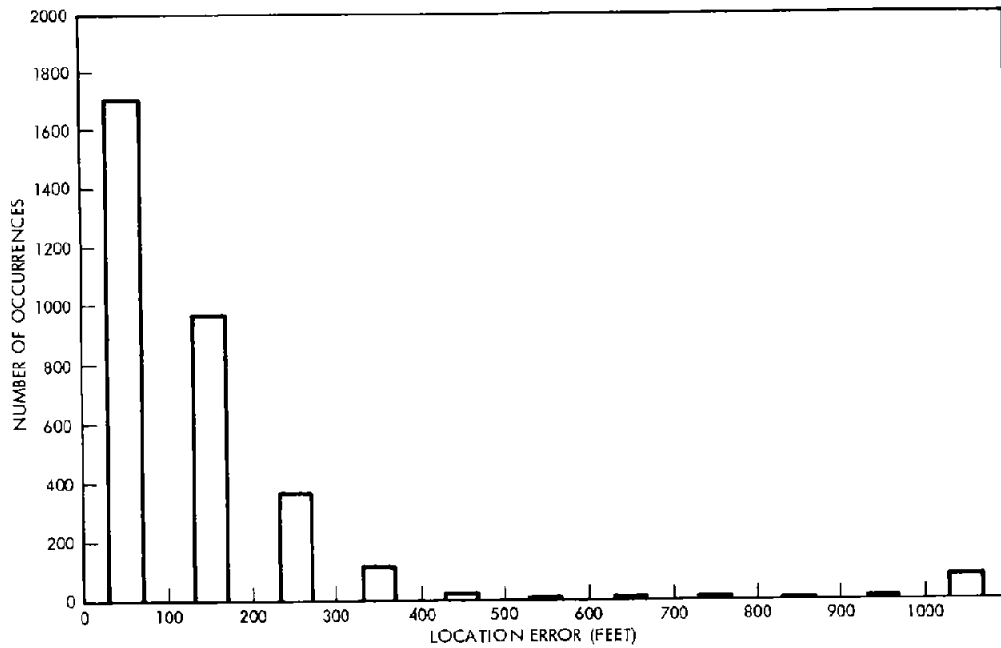

T109006-1

Figure 6-8A. Location Subsystem Histogram
(Fixed Route Tests (All) Less #10016 and 10017)

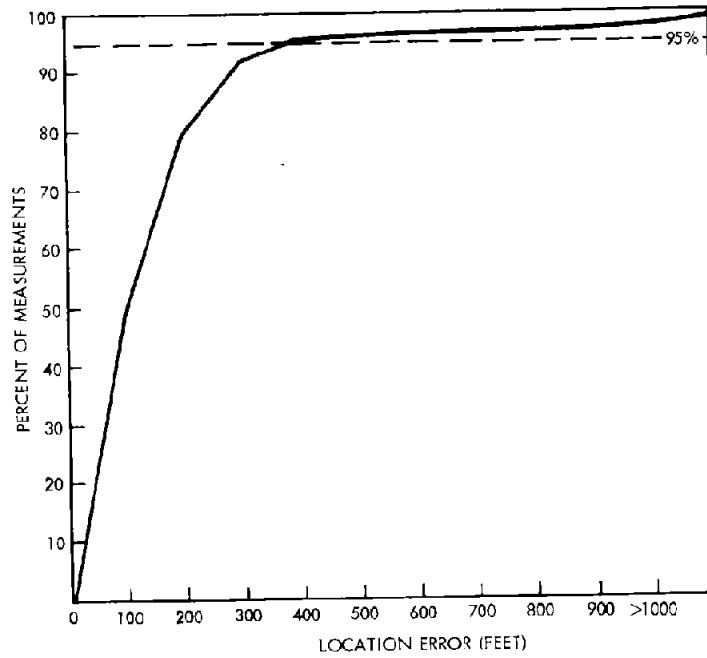

T109006-2

Figure 6-8B. Location Subsystem Cumulative Error
(Fixed Route Tests (All) Less #10016 and 10017)

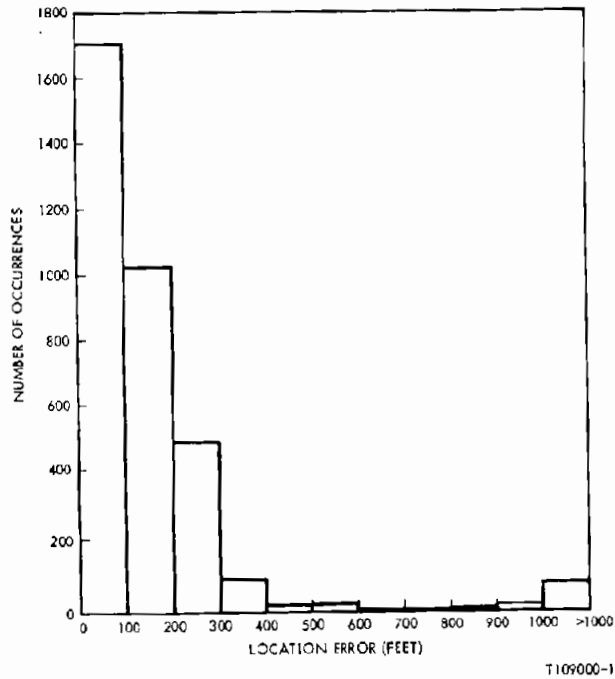

Figure 6-9A. Location Accuracy Histogram (System Simulation)
 (Fixed Route Tests (All) Less #10016 and 10017)

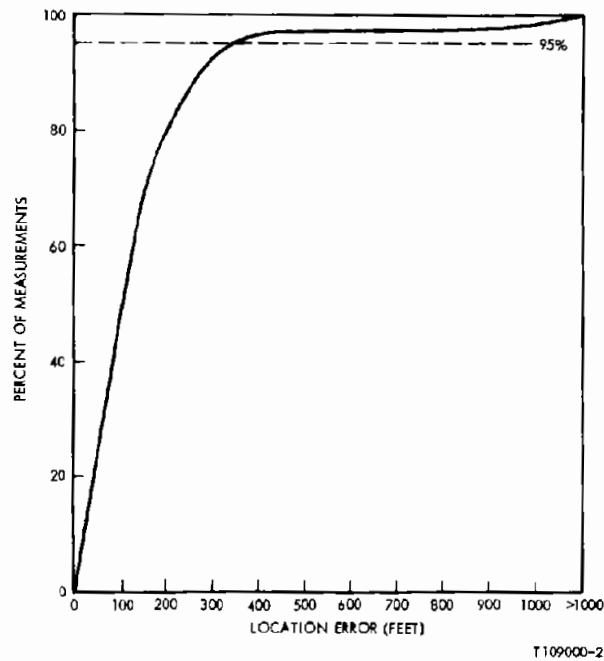

Figure 6-9B. Cumulative Location Error (System Simulation)
 (Fixed Route Tests (All) Less #10016 and 10017)

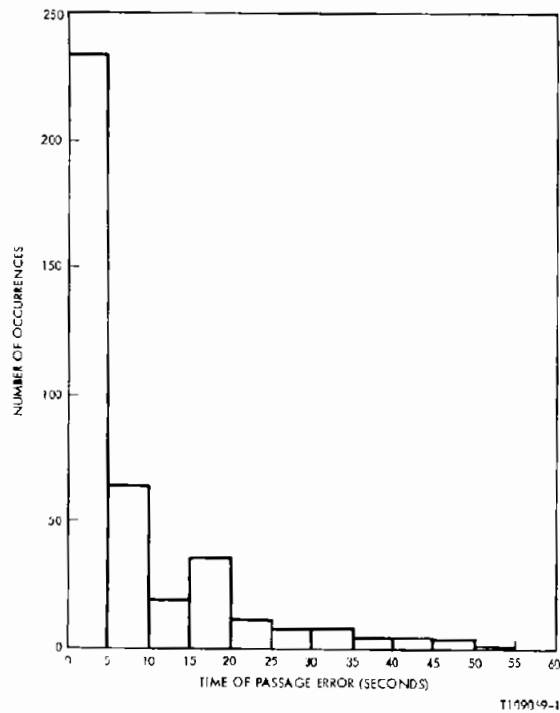

Figure 10A. Time of Passage Error Histogram
(Fixed Route Tests (All) Except #10016 and 10017)

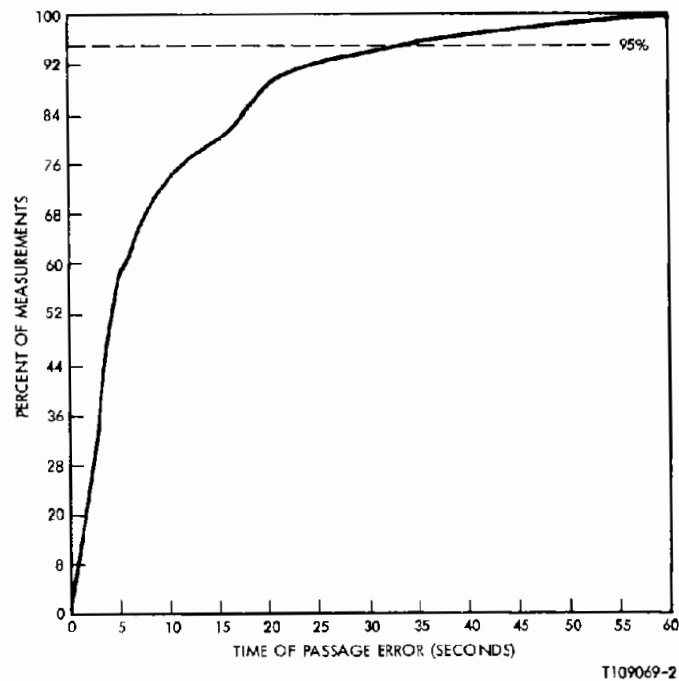

Figure 6-10B. Time of Passage Cumulative Error
(Fixed Route Tests (All) Except #10016 and 10017)

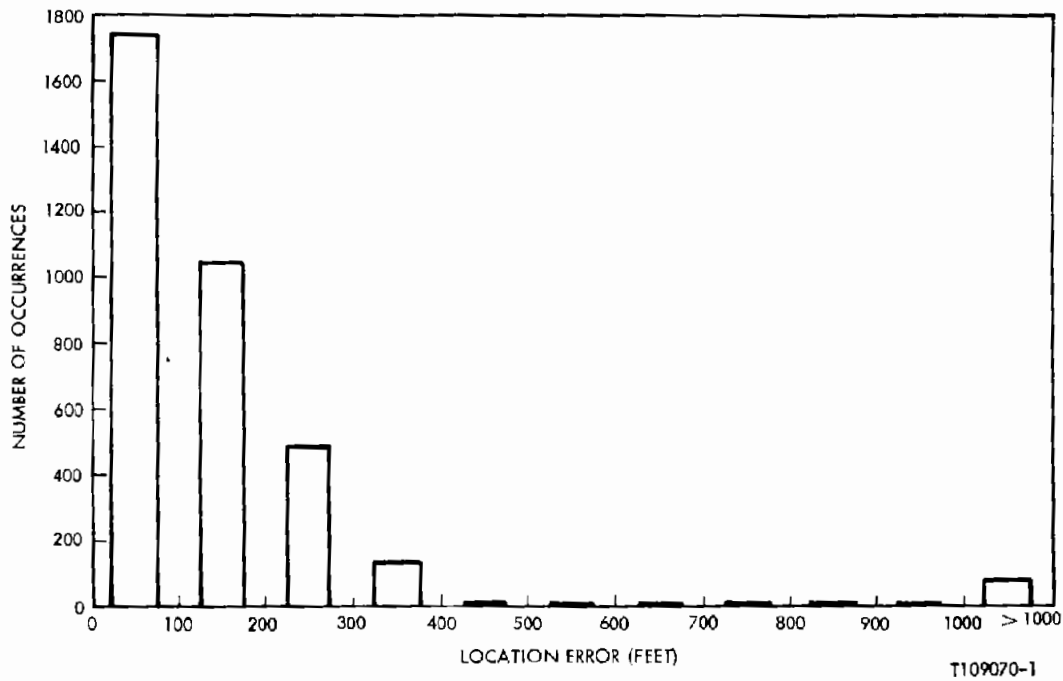

Figure 6-11A. Location Accuracy Histogram
 (System Simulation With 5% Missing Data)
 (Fixed Route Tests (All) Except #10016 and 10017)

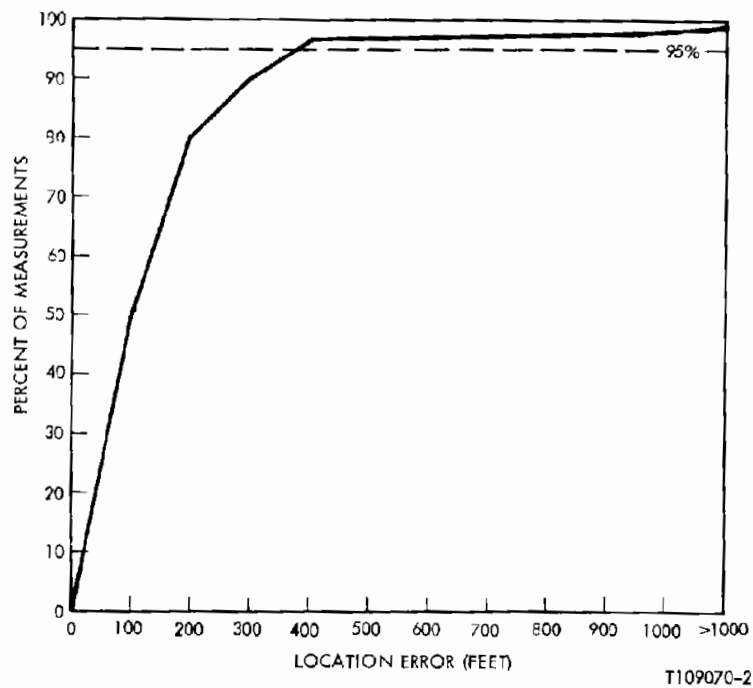
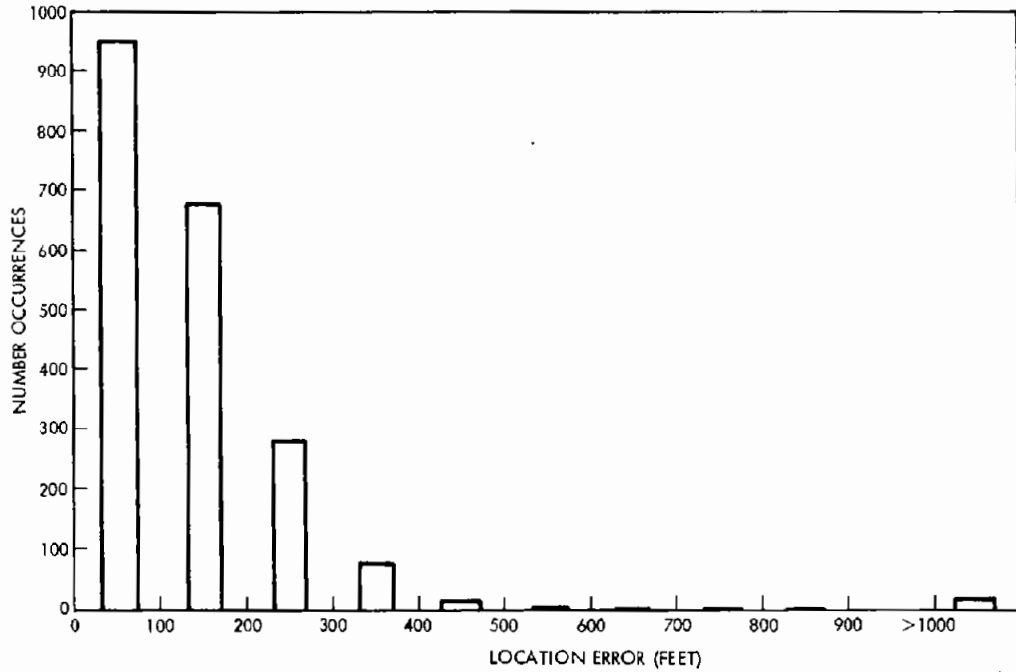
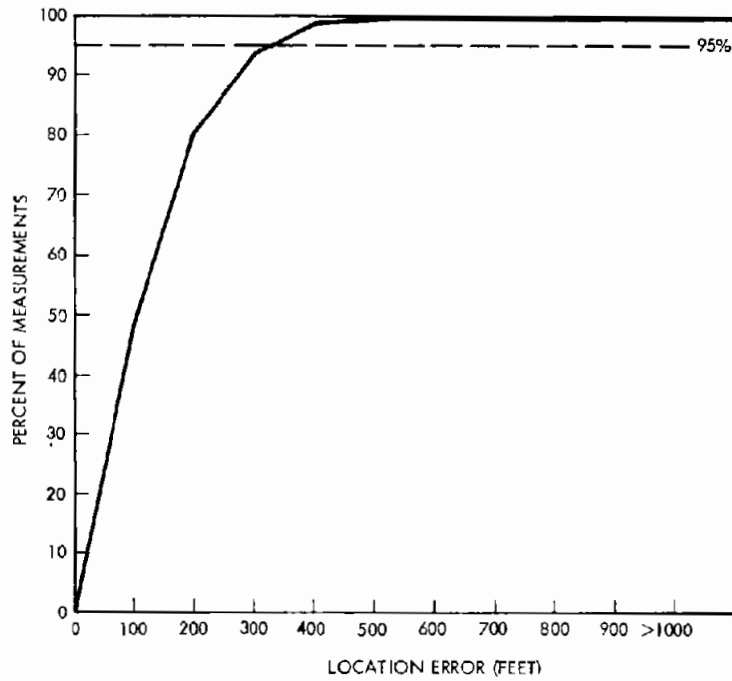

Figure 6-11B. Cumulative Location Error
 (System Simulation With 5% Missing Data)
 (Fixed Route Tests (All) Except #10016 and 10017)



T109008-1

Figure 6-12A. Location Subsystem Error Histogram
(Fixed Route Tests #10026 - 10047)



T109008-2

Figure 6-12B. Location Subsystem Cumulative Error
(Fixed Route Tests #10026 - 10047)

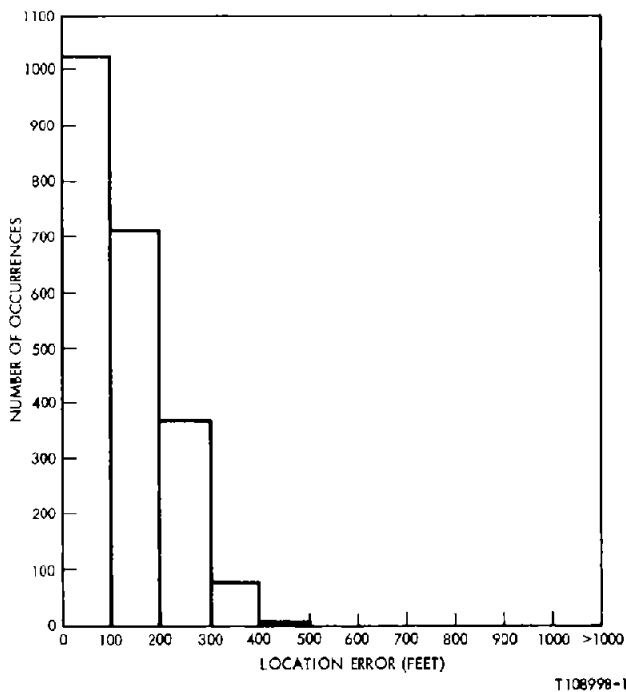

T108998-1

Figure 6-13A. Location Accuracy Histogram (System Simulation)
(Fixed Route Tests #10026 - 10047)

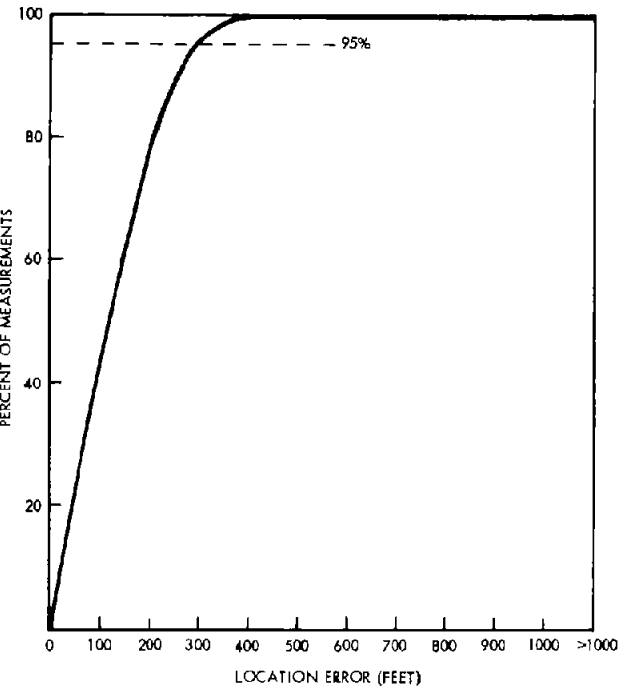

T108998-2

Figure 6-13B. Cumulative Location Error (System Simulation)
(Fixed Route Tests #10026 - 10047)

The result, on this test run, was a string of measurements (151 through 165) with the LORAN receiver on the wrong cycle. After three such measurements the software declares a route departure. Ordinarily, the route departure condition would be reconciled the first time an augmentor was detected. Such an augmentor was detected at Checkpoint 157 (Aug #32) but the information rejected because of the software modification inserted earlier to prevent location errors resulting from inconsistent augmentor detections. It is obvious that if the augmentor detection had been used, the large errors at Checkpoints 157 through 165 would have been prevented. Section 7 will discuss further the manner in which augmentor detections will be used in the Phase II program.

6.2.4.2 System Simulation - System simulation results for the 18 good runs show an error at the 95th percentile of 287.79 feet; at the 99.5th percentile the error was 369.60 feet. These are fully compatible with DOT requirements. Error distribution curves are given in Figure 6-13. These results speak for themselves. They are based on 2184 measurements made over three days and nights of testing. Of the over two thousand measurements, only 1 had an error larger than 500 feet and only 5 had an error larger than 400 feet.

The time of passage errors for these runs were 26 seconds, 95%, and 42 seconds, 99.5%. Figure 6-14 shows these results. Some improvement is necessary to comply with the given requirements. Section 7 discusses a practical modification to the AVM System which will lower the time of passage errors to acceptable limits.

6.2.4.3 System Simulation With 5% Missing Data - These results are the most significant of the entire Phase I tests. Phase I was conducted to demonstrate the ability to perform in Phase II. The truest simulation of Phase II operation is the system simulation with missing data. Under conditions considerably less favorable than Los Angeles, the LORAN AVM System had an error of 291 feet at the 95th percentile and 383 feet at the 99.5th percentile. Both figures are under the stated requirements. Error distribution curves are presented in Figure 6-15.

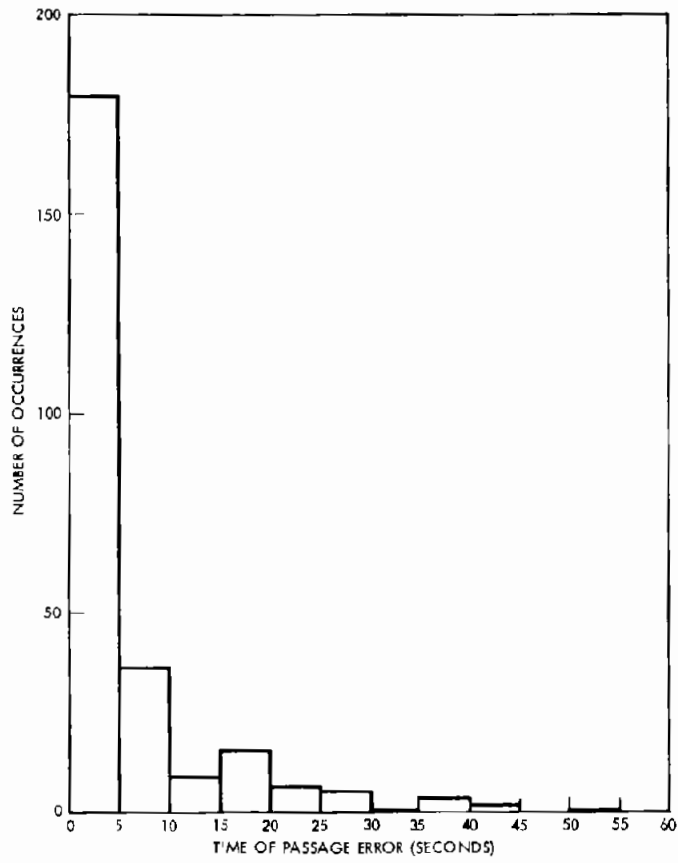

T109067-1

Figure 6-14A. Time of Passage Histogram
(Fixed Route Tests #10026 - 10047)

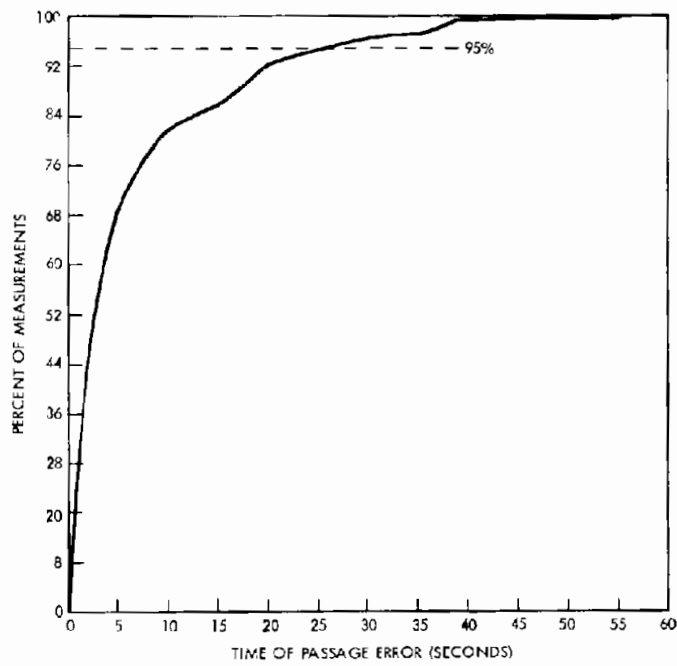

T109067-2

Figure 6-14B. Time of Passage Cumulative Error
(Fixed Route Tests #10026 - 10047)

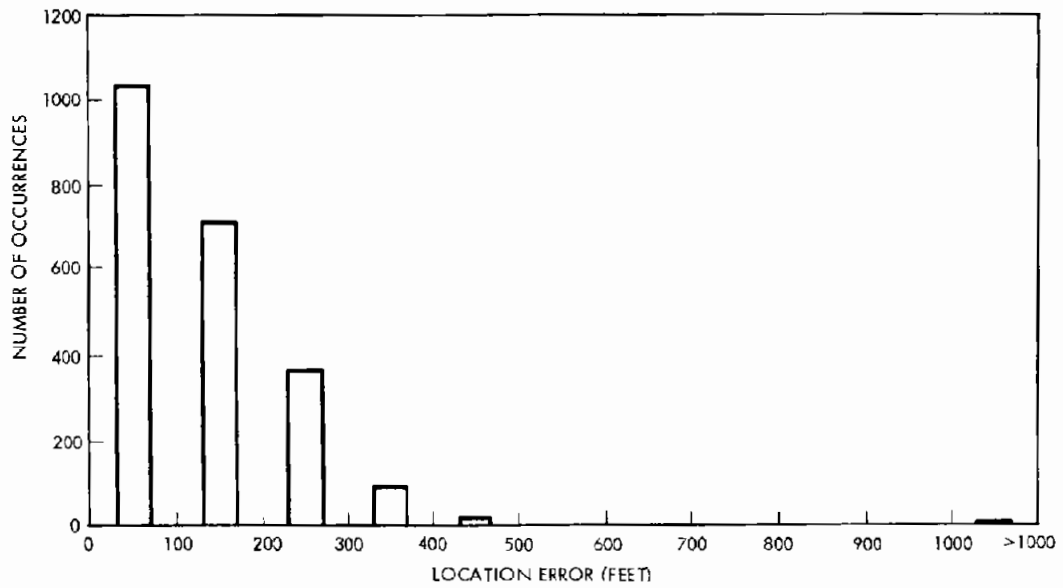

T109072-1

Figure 6-15A. Location Accuracy Histogram
 (System Simulation With 5% Missing Data)
 (Fixed Route Tests #10026 - 10047)

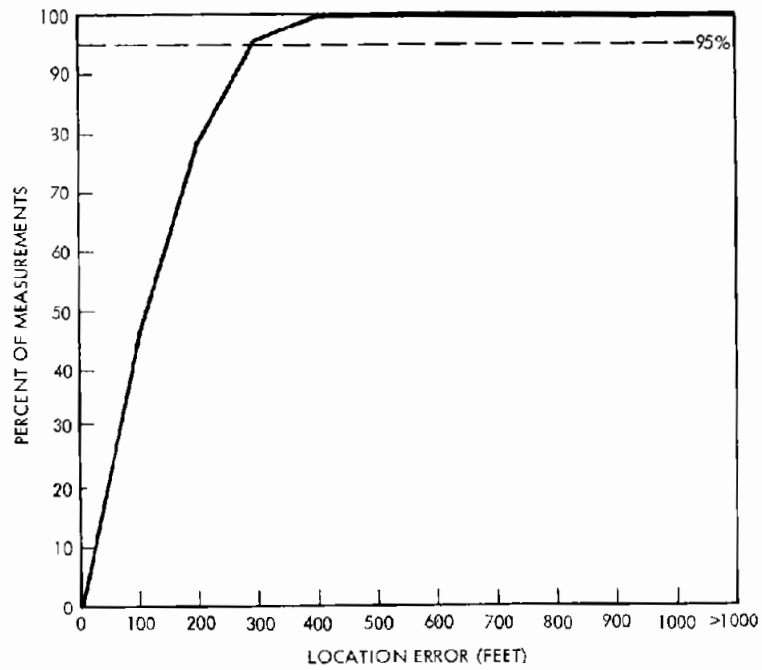

T109072-2

Figure 6-15B. Cumulative Location Error
 (System Simulation With 5% Missing Data)
 (Fixed Route Tests #10026 - 10047)

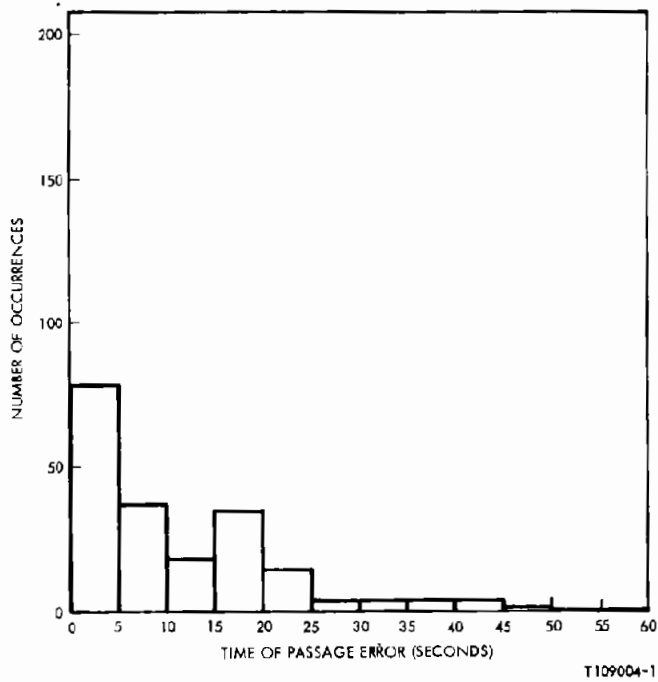

Figure 6-16A. Time of Passage Histogram (Stop Time Points)

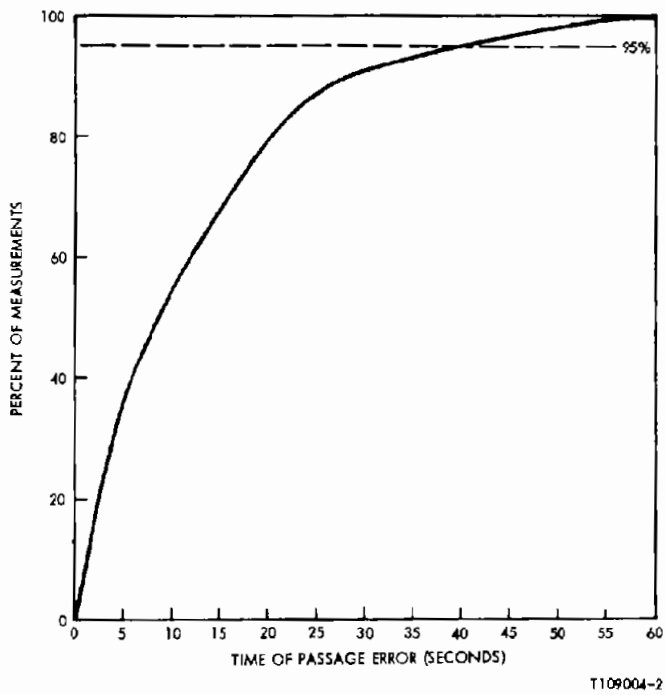
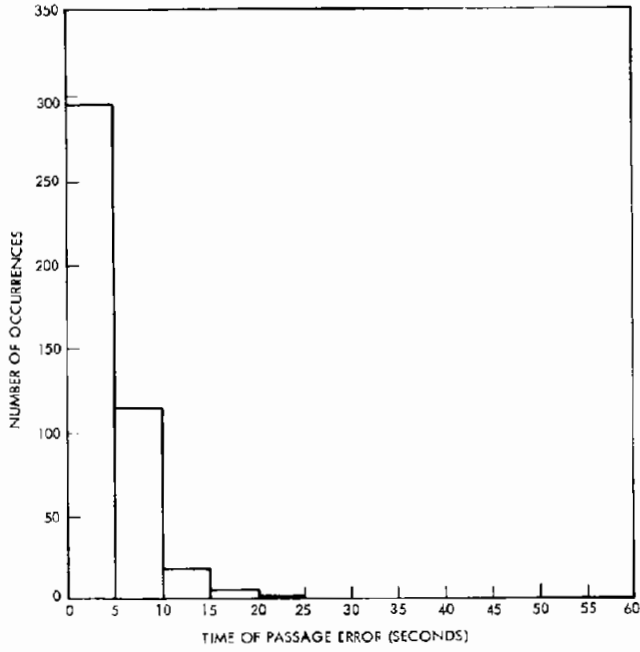
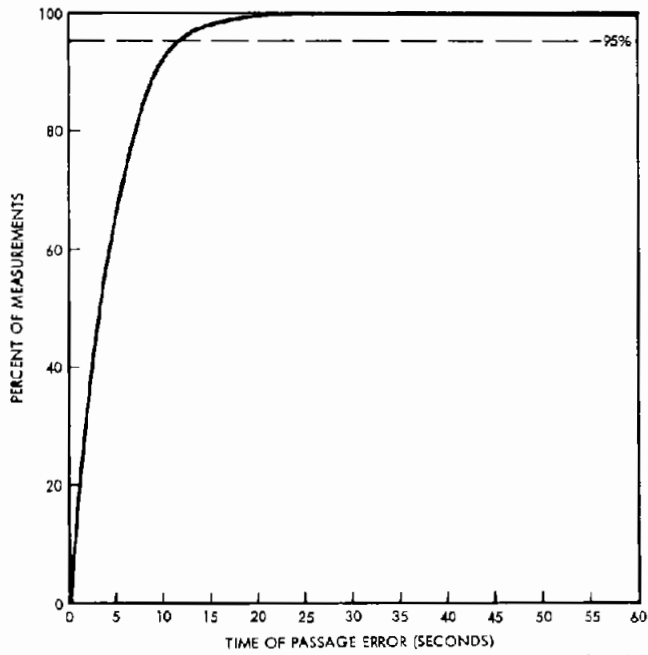

Figure 6-16B. Time of Passage Cumulative Error (Stop Time Points)



T109001-1

Figure 6-17A. Time of Passage Histogram
(All Points - Dead Time Removed)



T109001-2

Figure 6-17B. Time of Passage Cumulative Error
(All Points - Dead Time Removed)

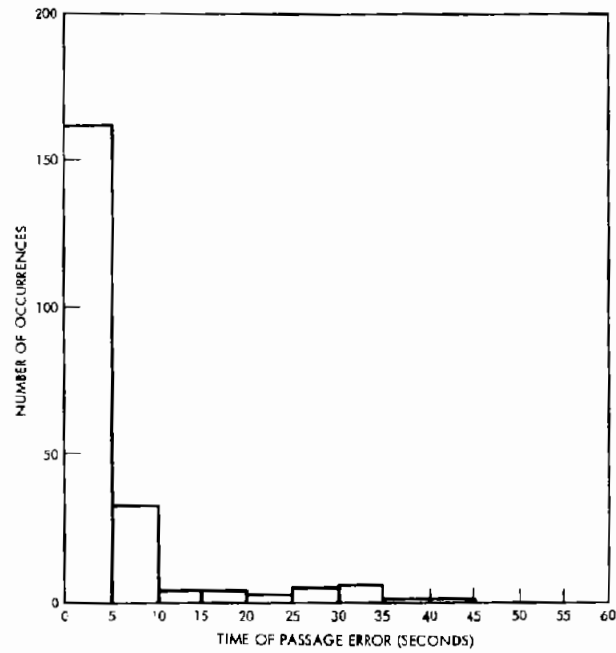

T109003-1

Figure 6-18A. Time of Passage Histogram
(No Stop Time Points)

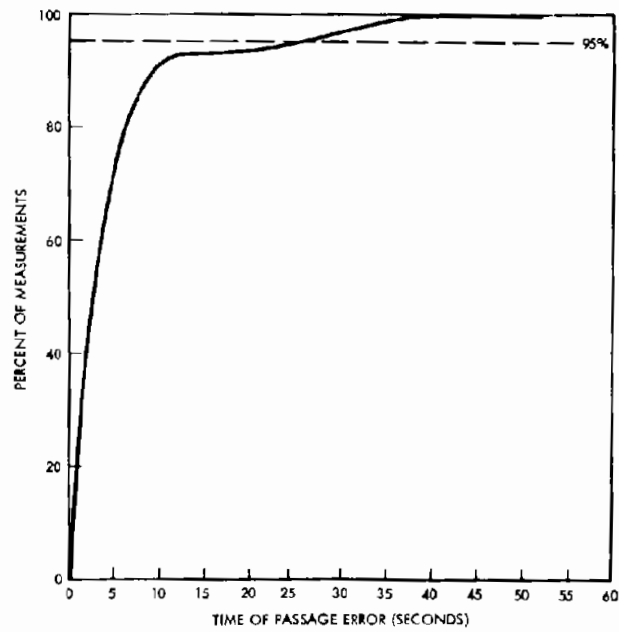

T109003-2

Figure 6-18B. Time of Passage Cumulative Error
(No Stop Time Points)

Table 6-3. Augmentor Detections

| Augmentor ID | Time Point No. | Street Location | Test(s) Not Detected | Date |
|--------------|----------------|----------------------|----------------------|---------|
| 24 | 5 | Broad & Arch | No Misses | |
| 30 | 16 | JFK & Expressway | 10017 | Feb. 1 |
| 57 | 26 | 20th & Market | No Misses | |
| 31 | 37 | 11th & Market | No Misses | |
| 33 | 50 | 10th & Walnut | No Misses | |
| 37 | 60 | 18th & Walnut | 10012 | Jan. 31 |
| 72 | 70 | 33rd & Walnut | No Misses | |
| 100 | 76 | 22nd & Chestnut | 10035 | Feb. 5 |
| 15 | 110 | 18th & Vine | 10016 | Feb. 1 |
| 51 | 122 | 22nd & BF Pkwy | No Misses | |
| 53 | 134 | 19th & Pine | No Misses | |
| 67 | 144 | 10th & Pine | 10017 | Feb. 1 |
| 54 | 151 | 8th & Spruce | No Misses | |
| 32 | 157 | 13th & Chestnut | No Misses | |
| 110 | 166 | 13th & Spring Garden | 10026 | Feb. 4 |
| | | | 10027 | Feb. 4 |
| | | | 10030 | Feb. 4 |
| | | | 10031 | Feb. 4 |
| | | | 10032 | Feb. 4 |
| | | | 10033 | Feb. 4 |
| | | | 10034 | Feb. 4 |

6.2.4.4 Coverage - Coverage data shows a mean error of less than 450 feet over 98% of the fixed route. The 2% of mean errors over 450 feet occurred in poor SNR areas and could easily have been corrected, if necessary, by either an augmentor or minor software modification. Total no coverage area is only .3 mile out of almost 14 miles of fixed route.

6.2.5 Time of Passage and Augmentor Detection

Time of passage errors and augmentor detection percentages are examined in this section.

6.2.5.1 Time Point Augmentor Detection Percentage - A total of 448 time point augmentor detections was possible on the 30 tests, 10012 through 10047. The fixed route course had 15 time points spaced at approximately 1 mile intervals. Two time points were not passed due to street closure for fire fighting equipment. Of the 448 possible detections, 436 were properly made for a percentage of 97%. Table 6-3 lists the missed augmentors. Figure 6-16 shows the error curve at stop time points only, and Figure 6-17 shows the same thing, only with "dead time" (not moving) removed. Figure 6-18 shows non-stop time point errors only.

6.2.5.2 Missed Augmentors - Of the 12 missed augmentors, 5 appear to be random misses, probably due to temporary conditions near the augmentor at the time of passage. Interference from vehicle ignition, for example, occasionally was seen at the 72 MHz augmentor frequency. One and one tenth per cent (5 out of 448) does not appear to be an inordinately high percentage of misses. The other 7 misses all occurred at the same augmentor on the same day (Aug ID 110 at 13th and Spring Garden on February 4). These misses can be explained. They were caused by interference from Aug 35 which was located about 600 feet away at Broad and Spring Garden. A change in radiated power at Aug 35 apparently took place between January 31 and February 3, since the 10 tests made during this period all show proper detection of Aug 110. The most likely cause of the radiated power change was an increase in ambient temperature since both the

augmentor transmitters and the carbon zinc battery used to power them have characteristics which vary with temperature - especially in the range of 0°F to 35°F which were experienced. Confirmation that #35 was interfering with #110 on February 4 was made by reducing the radiated power at #35 prior to the first test run on February 5. No additional difficulties were encountered. Also, examination of the data collected on test runs 10026 through 10034 show that Aug 35 was detected quite early as it was passed indicating excessive power.

A method for determining time of passage without utilizing an augmentor at the time point is examined and evaluated in Section 7. This method offers a reliable backup method for determining time of passage in Phase II. With some improvement in accuracy the augmentorless method could become the prime source of time of passage information for Phase II at a considerable cost savings.

6.2.6 Time of Passage Error Analysis

An analysis of the time of passage errors shows that the statistics are dominated by errors at stop time points. (See figure 6-16) This is because the mechanization tested in Phase I did not incorporate a door open/closed sensor which could have been used to determine the time during which the vehicle was actually stopped at the time point. Without this sensor, the system error was subject to time accrued when the vehicle was stopped. If the 'time flag' had not been set at the time the vehicle came to rest, all time spent at a standstill was accumulated as time of passage error. (For additional time of passage mechanization information, see 'Time of Passage Measurement' description at the conclusion of Section 4.)

Paragraph 7.2.1.2 in Section 7 explains how dead time may be removed from the TOP statistics. Figure 6-17 shows the systematic errors in the system with dead time removed. Figure 6-18 confirms the fact that dead time at stop time points caused excessive errors. The results in Figure 6-18 (no stop time

points) are not as good as the 'no dead time' results of Figure 6-17 because some time points were 'no stop' in name only.

At many points called 'no stop', the vehicle was usually stopped either for prevailing traffic or traffic signals.

6.2.7 "Augmentorless" Time of Passage Measurement

A method of determining time of passage without benefit of an augmentor detection was developed using actual Phase I test data. The reason for this development is two-fold: to provide a back-up method in the event of a missed augmentor, and to provide a basis for an optional time of passage mechanization described in paragraph 7.2.1.

In its simplest form, the system notes the two-position location determination it makes in the normal course of tracking the vehicle which bracket the time point. It assumes a constant vehicle velocity between these two points. The time of passage may be estimated from this data. The measurement will be in error by the amount the vehicle velocity varies from the assumed constant rate.

Software to make this determination was not available at the time of test data reduction but the process is simple enough to be calculated manually over a limited number of instances. All time point passages on test run 10044 were evaluated using this process. The results are shown in Table 6-4. Examination of this table shows a similar trend in the augmentorless method to produce large errors at stop time points. A practical method of removing stop time point errors is presented in paragraph 7.2.1. The method is comparable to the augmentor method, and with the addition of odometer and door status information, also discussed in paragraph 7.2.1, it represents a viable and legitimate alternative. It should be thoroughly evaluated early in Phase II in view of the obvious cost savings.

Table 6-4. Comparison of Time of Passage Errors

| Checkpoint | Time of Passage Error | | Stop/ No Stop |
|------------|-------------------------------------|---------------------|------------------|
| | Manual "Augmentorless" Method | Augmentor Method | |
| 5 | 2 sec | 5 sec | Stop |
| 16 | 6 sec | 3 sec | No Stop |
| 26 | 15 sec | 24 sec | Stop |
| 37 | 1 sec | 4 sec | No Stop |
| 50 | 1 sec | 6 sec | Stop |
| 60 | 2 sec | 1 sec | No Stop |
| 70 | 13 sec | 8 sec | Stop |
| 76 | 1 sec | 5 sec | Stop |
| 110 | 5 sec | 0 sec | No Stop |
| 122 | 18 sec | 5 sec | Stop |
| 134 | 14 sec | 3 sec | No Stop |
| 144 | 1 sec | 3 sec | No Stop |
| 151 | 9 Sec | 1 Sec | Stop |
| 157 | 2 sec | 0 sec | No Stop |
| 166 | 11 sec | 1 sec | No Stop |

Table 6-5. Fixed Polling/Location Subsystem - 95% Errors

| | | All Runs Less 10016 & 10017 | Runs 10026 - 10047 |
|-----------------|--------------------|--------------------------------|-----------------------|
| FIXED ROUTE | Fixed Polling | 320.56 | 269.45 |
| | Location Subsystem | 352.79 | 318.66 |
| | | | All Runs |
| RANDOM ROUTE | Fixed Polling | 697.76 | |
| | Location Subsystem | 358.52 | |

6.2.8 Comparison of Location Subsystem and System Simulation Results

Fixed Route and Random Route results have been compiled by two different methods - Location Subsystem and System Simulation. The Location Subsystem results have been determined by comparing true position and estimated position at arbitrarily located checkpoints. The System Simulation results have been determined by comparing position at the fixed reporting interval of 32 seconds used in the Teledyne position reporting concept. These results are compared in Table 6-5. In the Fixed Route results, the fixed polling errors are somewhat less than location subsystem errors. In the Random Route, the tendency was reversed. The paragraphs below explain these differences.

6.2.8.1 Fixed Route - The Fixed Route analysis has shown a tendency for the Fixed Polling (system simulation) to have slightly better accuracy than the Location Subsystem. The table above shows this tendency in both the "All Runs Less 10016 and 10017" and "Runs 10026 - 10047" analysis. The Location Algorithm has two characteristics which cause the Fixed Polling results to be slightly better than the Location Subsystem results:

1. The fixed-route location algorithm weights LORAN position 25% and the odometer position 75% to reduce the LORAN position variance. This position filtering technique is sensitive to the distance between position reports/computations. The reporting intervals for Runs 10026 - 10047 compare as follows:

| | <u>Total Records</u> | <u>Average Distance Between Reports</u> |
|--------------------|--------------------------|---|
| Fixed Polling | 2,324 | 557 ft. |
| Location Subsystem | 2,113 | 613 ft. |

The average distance between reports for fixed polling is 557 feet, compared to 613 feet for the location subsystem. Therefore, a tendency for the fixed polling results to be slightly better is expected. It is not possible to quantify this improvement due to the many other characteristics of the algorithm which interact, for example, augmentor position updates at time points.

2. The location subsystem test had a predominance of checkpoints at street intersections where LORAN positions are known to be poorer than at mid-block. This is apparently due to more overhead and underground power lines near intersections. The fixed polling test resulted in more mid-block computations, with expected better accuracy. The effect is more important than would have been expected. On Runs 10021 and 10030, the location subsystem declared route departures with significant errors because three consecutive reports had LORAN errors greater than 1,500 feet.

The Fixed Polling did not declare route departure in either case because large LORAN errors with validity flags enabled did not occur on three consecutive reports. Because of this effect, Run 10026 - 10047 had 24 errors over 450 feet on the location subsystem, and only 2 errors over 450 feet on the fixed polling.

6.2.8.2 Random Route - The random route data reduction results show a significant difference in accuracy between fixed polling and location subsystem. The fixed polling results are almost twice the error of the location subsystem results. This is due to the test technique and the random route location algorithm difficulty in determining vehicle direction from an intersection.

The location subsystem checkpoints were all at intersections, about half of which had augmentors. Therefore, the location subsystem would be expected to produce significantly improved results compared to another technique which might never report position coincident with an augmentor detection.

When fixed polling runs were made, almost all position computations were made well away from augmentor detections. Therefore, the random route algorithm's ability to determine direction from intersection would determine the performance level achieved. As conceived and implemented for these tests, the algorithm was somewhat deficient in this regard, resulting in the errors shown previously in Table 6-5.

Section 7 explains an improvement to the algorithm which more heavily weights LORAN position and improves the fixed polling accuracy by more correctly estimating vehicle direction of travel. This change reduces the Fixed Polling error to approximately 450 feet. This is still more than the Location Subsystem error, but in a random route, this variation between fixed polling and location subsystem will always occur if the location subsystem checkpoints are always at intersections with a relatively high density of augmentors.

6.3 RANDOM ROUTE TESTS

Two sets of results are presented for the Random Route tests. The first set is the result of test data processed by the original Random Route location software. The second set is the output of the identical software with a minor modification. The modification allows the vehicle location subroutine to use valid LORAN information and an augmentor detection when both occur within a given 32-second polling interval. The original subroutine uses only the augmentor detection and last good location to update position. This many times results in a large error at the first simulated poll after a turn. It has little effect on the location subsystem results but improves the system simulation results by more than 30%. Additional improvements are discussed in Section 7.

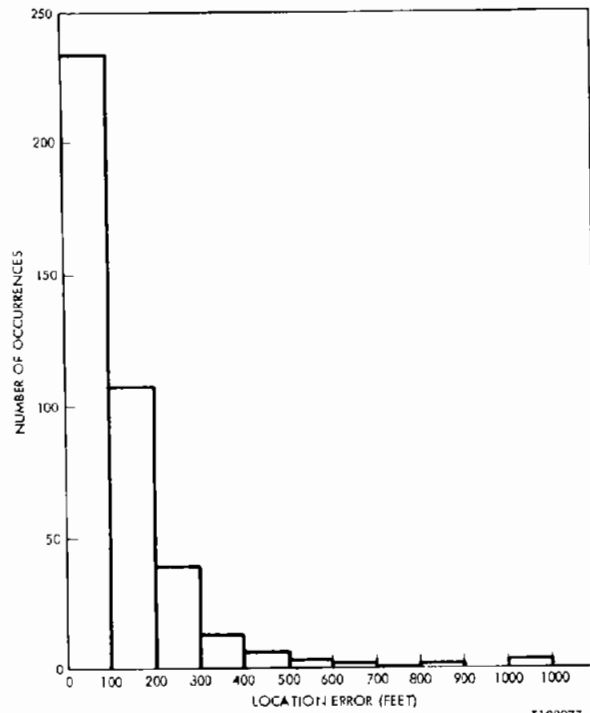

T109077-1

Figure 6-19A. Location Subsystem Histogram
(Random Route Tests #20001 - 20005)

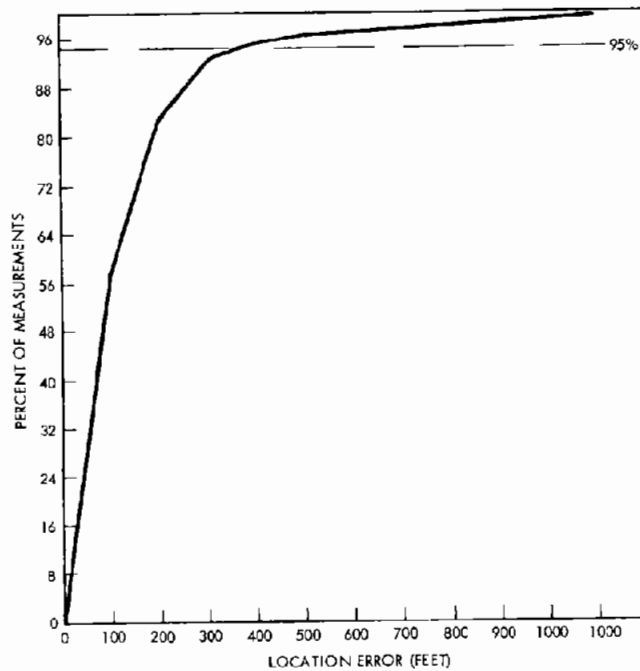

T109077-2

Figure 6-19B. Location Subsystem Cumulative Error
(Random Route Tests #20001 - 20005)

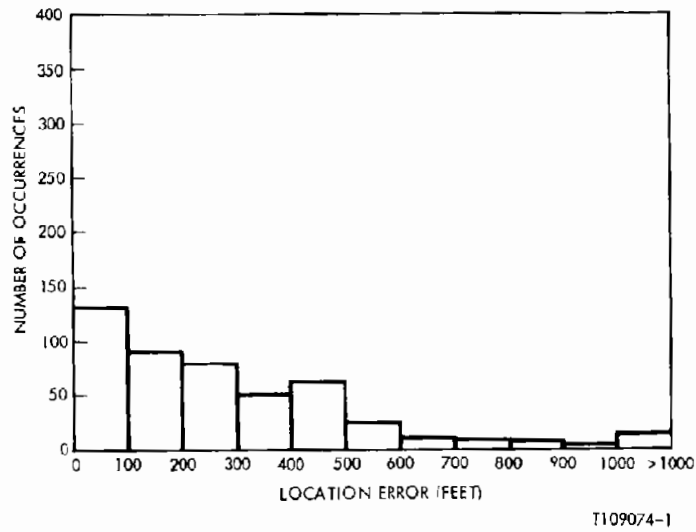

Figure 6-20A. Location Accuracy Histogram (System Simulation)
 (Random Route Tests #20001 - 20005)

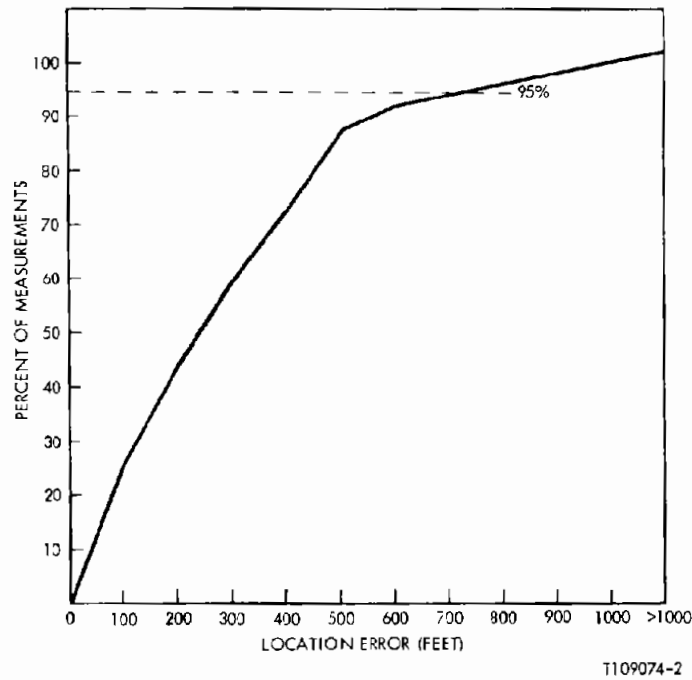

Figure 6-20B. Cumulative Location Error (System Simulation)
 (Random Route Tests #20001 - 20005)

6.3.1 Location Subsystem

The location subsystem error at the 95th percentile was 358.52 feet. At the 99.5th percentile it was 1,222.96 feet. Error distribution curves are shown in Figure 6-19. The 99.5% result is enough over the specified requirement to warrant a more detailed examination. The source of the 1,222.96 feet figure is found to be three measurements out of 406 with an error over 1,000 feet. As the histogram shows, 97.5% of all measurements had an error of less than 500 feet. While 1,222 feet, 99.5%, is by itself a disappointing statistic, realization that the 97.5% number is under 500 feet tends to put it in proper perspective.

In a like manner, the 95% figure of 358 feet should be compared with a 93% figure of under 300 feet. In light of these figures, it is clear that only a very slight improvement in Location Subsystem accuracy is required to be fully compliant.

6.3.2 System Simulation

The system simulation of the random route tests gave a result at the 95th percentile of 691.16 feet and 819.17 feet at the 99.5 percentile. See Figure 6-20 for error distribution. These results are considerably in excess of the system requirements. Post-test examination of the random route location software revealed obvious means of improving accuracy. Two of the simpler improvements were implemented and the test data rerun. A marked improvement in system accuracy resulted. These results are shown previously in Table 6-1C under "improved software." As the table shows, the error at the 95th percentile was reduced to 475.89 feet and the 99.5% error came out 819.17 feet. See Figure 6-22 and 6-23 for the improved software error distribution. Obviously, additional improvement is needed. Time did not allow more elaborate software modifications to be evaluated for inclusion in this report. Some powerful software changes are discussed in Section 7, however, which have the potential of driving system errors below the specified values. In addition, some hardware modifications are discussed which could contribute a great deal to a more accurate random route system.

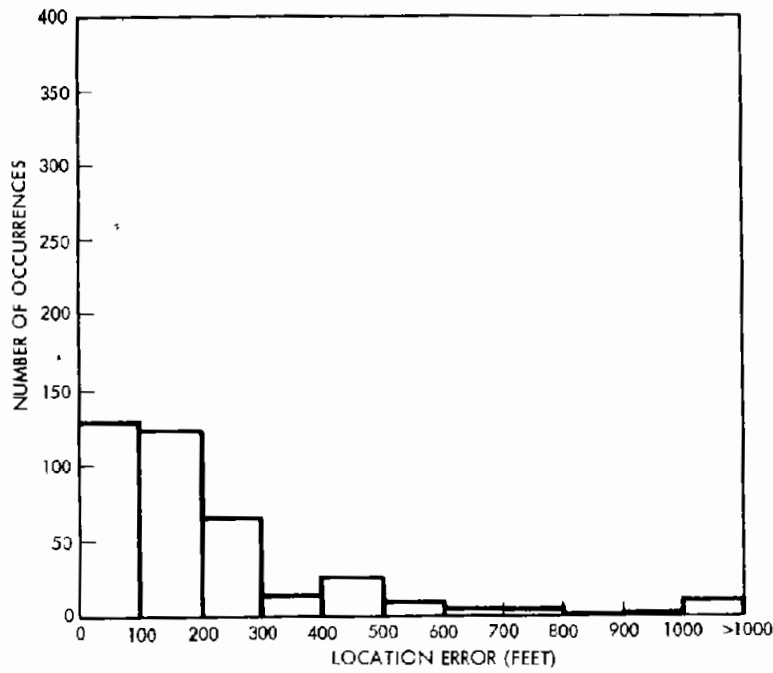

T109078-1

Figure 6-21A. Location Accuracy Histogram
(System Simulation With 5% Missing Data)
(Random Route Tests #20001 - 20005)

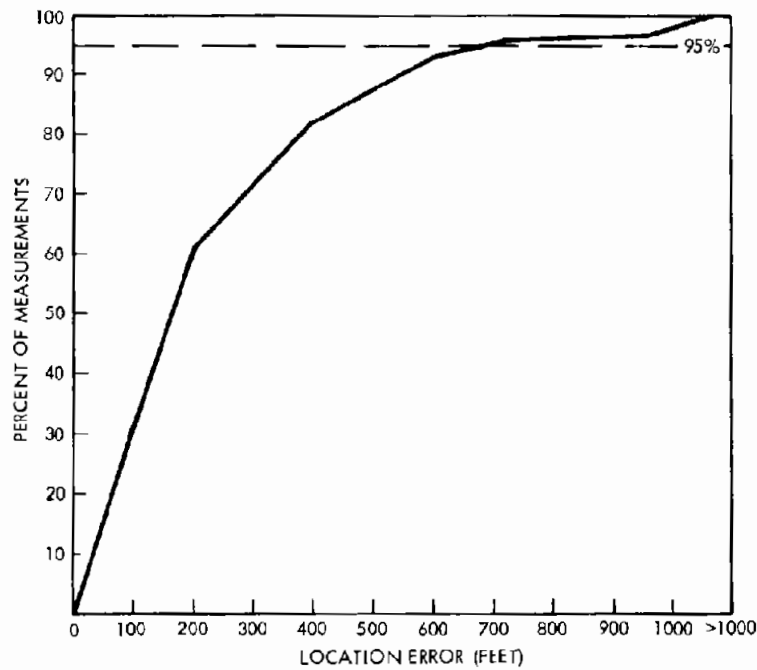

T109078-2

Figure 6-21B. Cumulative Location Error
(System Simulation With 5% Missing Data)
(Random Route Tests #20001 - 20005)

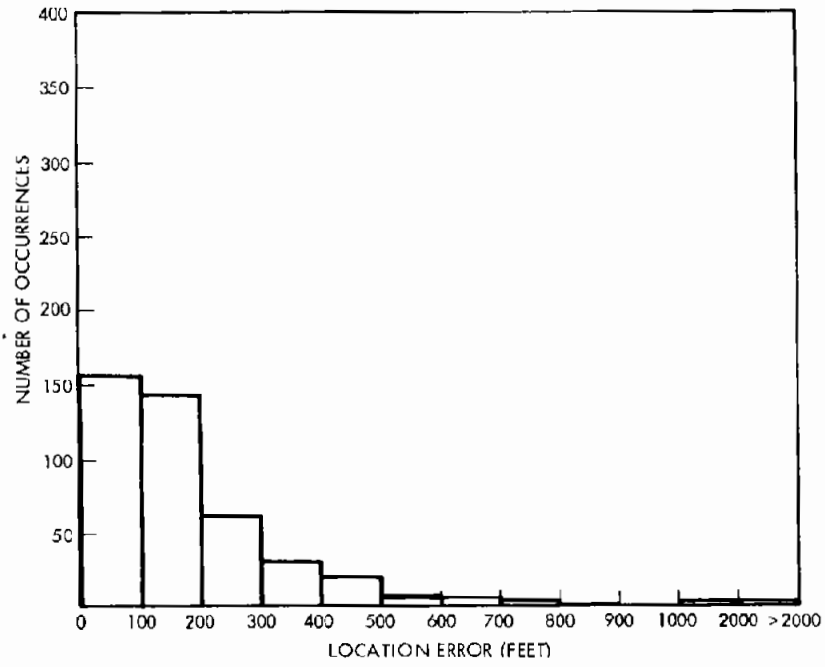

T109076-1

Figure 6-22A. Location Accuracy Histogram
 (System Simulation With 5% Missing Data and Improved Software)
 (Random Route Tests #20001 - 20005)

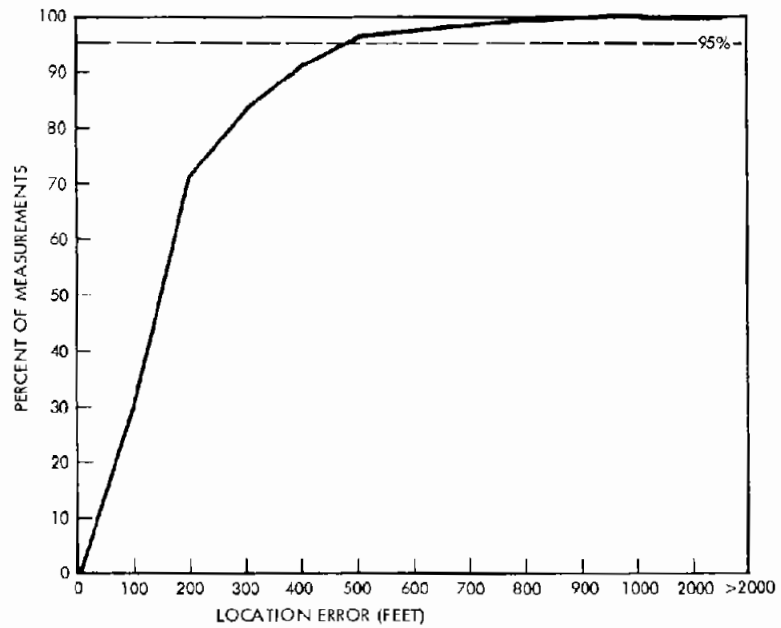

T109076-2

Figure 6-22B. Cumulative Location Error
 (System Simulation With 5% Missing Data and Improved Software)
 (Random Route Tests #20001 - 20005)

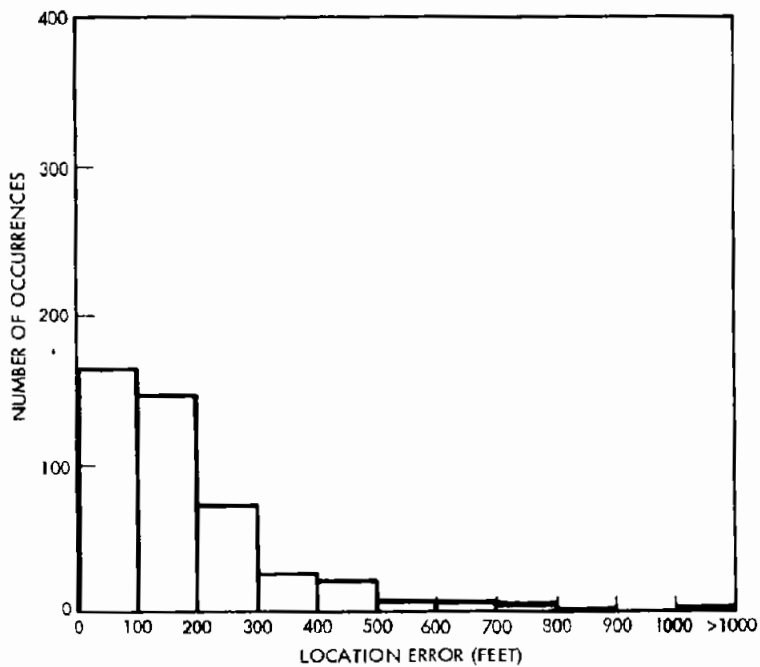

T109075-1

Figure 6-23A. Location Accuracy Histogram
(System Simulation and Improved Software)
(Random Route Tests #20001 - 20005)

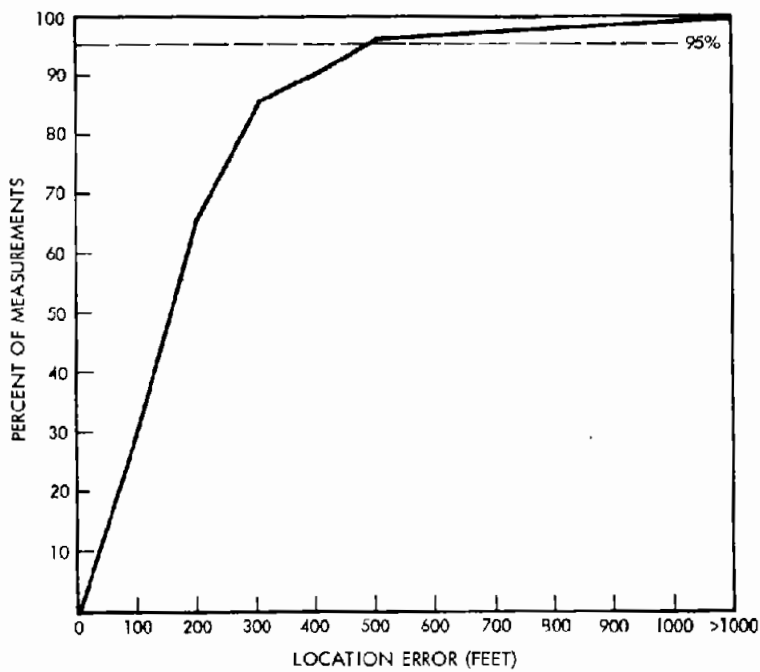

T109075-2

Figure 6-23B. Cumulative Location Error
(System Simulation and Improved Software)
(Random Route Tests #20001 - 20005)

6.3.3 System Simulation With 5% Missing Data

With 5% of the data removed the errors using the original software were slightly degraded; at the 95th percentile 752.55 feet and 1,293.11 feet at the 99.5 percentile. Using improved software they were 472.94 feet and 819.17 feet, respectively. As with the fixed route results, missing 5% of the data did not appreciably decrease accuracy. Improvement is required, however, as discussed in paragraph 6.3.2. See Figures 6-21 and 6-23 for error distributions of original and improved software, respectively.

6.3.4 Coverage

Coverage over the random route test course was 98% using either the original or improved software. That is, in only 2% of the test route did the mean error over any .1 mile segment exceed 450 feet. The reason this can be so while at the same time having large errors at the 95th and 99.5th percentiles lies in the geometrical characteristics of the large errors. Large (over 350 feet) errors only occur at simulated vehicle polls immediately after the vehicle has turned a corner. If the turn was not properly detected, a large error resulted at the first subsequent poll but by the next poll the LORAN position would clearly indicate the new street that the vehicle had turned onto. When calculating coverage, then, large errors which sometimes resulted immediately after a turn were always averaged with the relatively small errors within the same 0.1 mile segment. The result was a mean for the the segment almost always less than 450 feet. The reason the coverage figure wasn't 100% was because in two instances, turns were made at successive intersections and the polling timing was such that more than one large error fell within the same .1 mile interval.

Since the characteristic grouping of larger errors just after a turn can be seen in the system simulation results as well, the probability is high that any software or hardware modifications for Phase II, that improve the overall error statistics, will also improve the coverage figure. Obviously, only a slight improvement is needed to provide 100% coverage.

6.4 SPECIAL CASE TESTS

Many special case tests were run to evaluate specific components of the overall AVM System. The results of these tests are presented here by component.

6.4.1 LORAN Tests

There were four special case LORAN tests: LORAN Only Area Tests, LORAN Only Bridge Tests, LORAN Only Repeatability Tests, and LORAN Speed Effect Tests.

The results of the tests are shown in Tables 6-6 through 6-17. Graphical results are shown where appropriate.

6.4.1.1 LORAN Only Test - The LORAN Only Test was run to demonstrate the location accuracy of the LORAN system component without benefit of any augmentor updates. The test was run in an area with good SNR although this was still poorer overall than the measured SNR in Los Angeles. The results show an error of 325.32 feet at the 95th percentile and 375.68 feet at the 99.5th percentile. A Phase II study should be made of a LORAN only system which derives location and time of passage solely from LORAN and odometer inputs. Some degradation in performance would be analyzed in a trade off with reduced costs of deleting all augmentors. Error distribution of the LORAN Only Test results is shown in Figure 6-24.

6.4.1.2 LORAN Speed/Lag Test - The results of the LORAN Speed Tests are given in Tables 6-6 through 6-15 and Figure 6-26. Figure 6-25 depicts the path and important measurements for the interpretation of the data. Calibration information was taken just as for the random and fixed routes. The results of the calibration are shown in Table 6-6. The gradient along the path used was .00186 microsecond/foot for time difference "A" and .00107 microsecond/foot for time difference "B." The Root Sum Square (RSS) standard deviation for TDA and TDB calibration was 69.4 feet. Tables 6-8 through 6-15 show the results of the speed tests in terms of radial, TDA, and TDB errors in feet for 10, 20, 30 and 40 MPH, respectively.

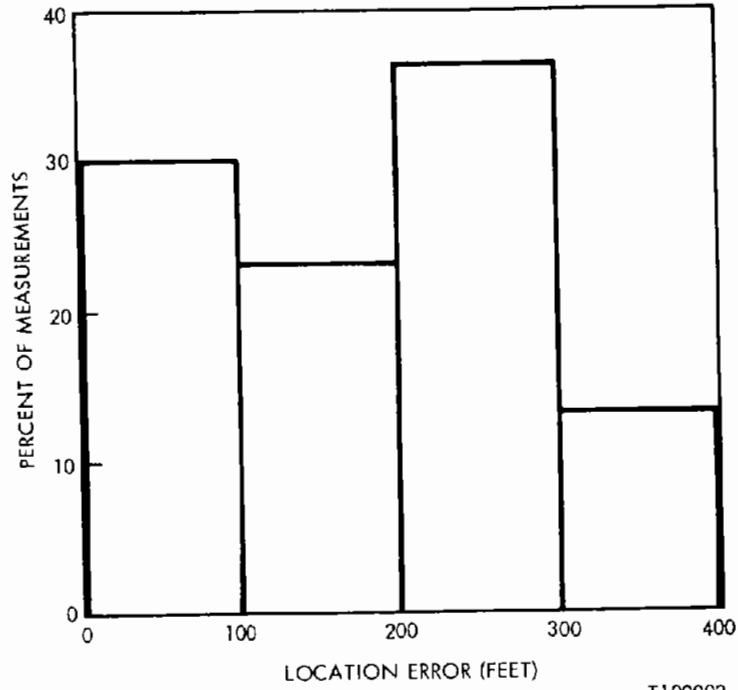

T109002

Figure 6-24A. LORAN Only Test - Location Accuracy Histogram (32 Second Fixed Polling)

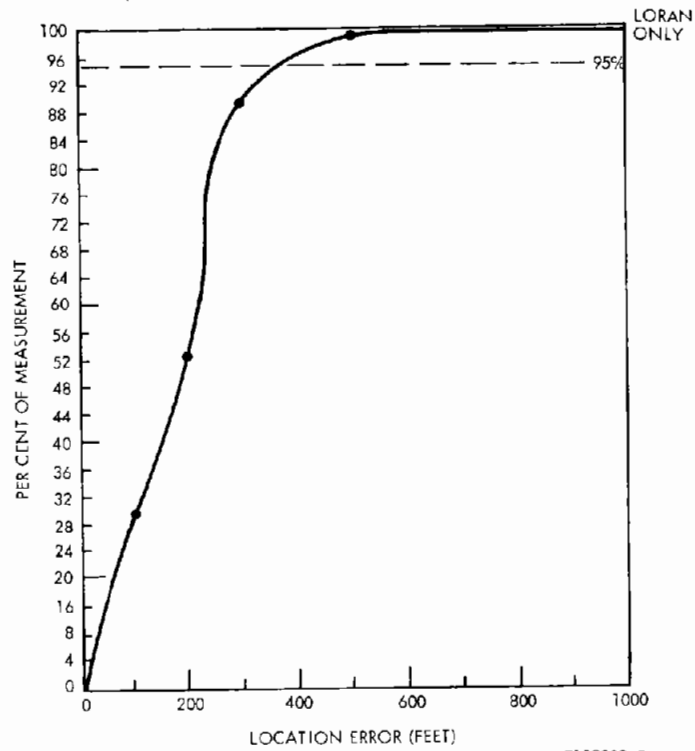

T109002-2

Figure 6-24B. LORAN Only Test - Location Cumulative Error (32 Second Polling)

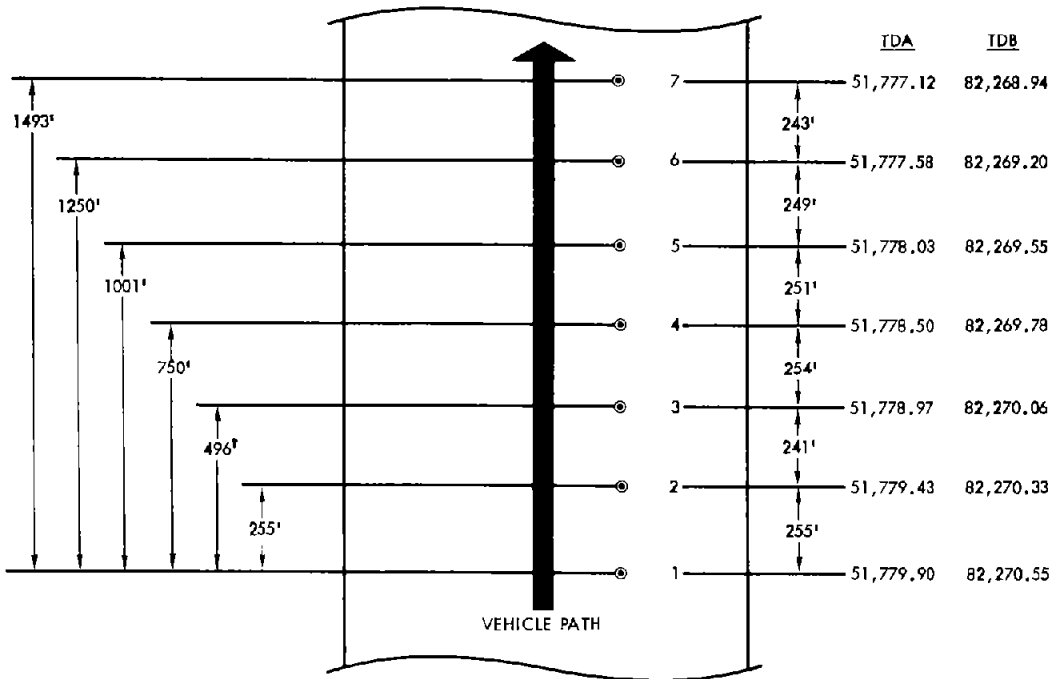

T108989-1

Figure 6-25. Runway Path and Checkpoint Diagram

Table 6-6. LORAN Speed/Lag Tests - Calibration Data

| CHECKPOINT | LOCATION (FT) | TIME DIFFERENCE | | ΔTD | |
|------------|---------------|-----------------|------------|------------|------------|
| | | TDA (μSEC) | TDB (μSEC) | TDA (μSEC) | TDB (μSEC) |
| 1 | 0 | 51,779.90 | 82,270.55 | 0 | 0 |
| 2 | 255 | 51,779.43 | 82,270.33 | -0.47 | -0.22 |
| 3 | 496 | 51,778.97 | 82,270.06 | -0.93 | -0.49 |
| 4 | 750 | 51,778.50 | 82,269.78 | -1.40 | -0.77 |
| 5 | 1001 | 51,778.03 | 82,269.55 | -1.87 | -1.00 |
| 6 | 1250 | 51,777.58 | 82,269.20 | -2.32 | -1.35 |
| 7 | 1493 | 51,777.12 | 82,268.94 | -2.78 | -1.61 |

GRADIENT TDA = 0.00186 μSEC / FT } ALONG PATH TRAVELED
 TDB = 0.00107 μSEC / FT }

T108989-2

Table 6-7. Summary of Results - LORAN/Speed Tests

| SPEED (MPH) | RSS ERROR (FT) | | TDA ERROR (FT) | | YDB ERROR (FT) | |
|-------------|----------------|------|----------------|------|----------------|------|
| | | AVG | | AVG | | AVG |
| 10 | 64 | 62.5 | 32 | 33.5 | 56 | 53.0 |
| | 61 | | 35 | | 50 | |
| 20 | 90 | 83.0 | 41 | 34.0 | 80 | 75.5 |
| | 76 | | 27 | | 71 | |
| 30 | 78 | 90.0 | 42 | 45.0 | 93 | 77.5 |
| | 102 | | 48 | | 62 | |
| 40 | 82 | 93.0 | 48 | 64.5 | 66 | 66.0 |
| | 104 | | 81 | | 66 | |

T108997-1

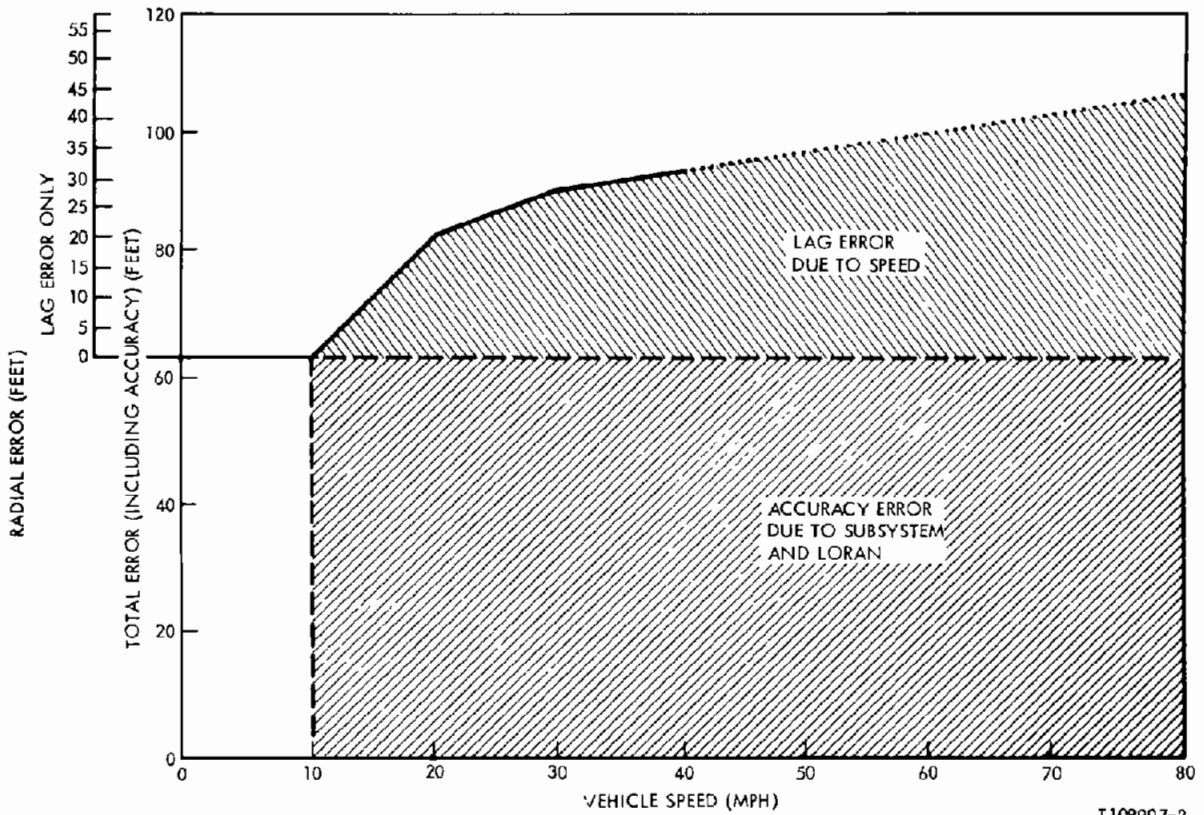

Figure 6-26. LORAN Speed/Lag Tests - Radial Error vs Speed

T108997-2

Tables 6-8A, B, and C

Table 6-8A. 10 MPH LORAN Speed/Lag Test Data (Test #30501)

| Checkpoint | TDA (μ Sec) | | Δ | TDB (μ Sec) | | Δ |
|------------|------------------|-----------|----------|------------------|-----------|----------|
| | Cal Run | Test Run | | Cal Run | Test Run | |
| 7 | 51,777.12 | 51,777.07 | .05 | 82,268.94 | 82,268.95 | .01 |
| 6 | 51,777.58 | 51,777.46 | .12 | 82,269.20 | 82,269.10 | .10 |
| 5 | 51,778.03 | 51,778.09 | .06 | 82,269.55 | 82,269.41 | .14 |
| 4 | 51,778.50 | 51,778.48 | .02 | 82,269.78 | 82,269.84 | .06 |
| 3 | 51,778.97 | 51,778.95 | .02 | 82,270.06 | 82,270.12 | .06 |
| 2 | 51,779.43 | 51,779.38 | .05 | 82,270.33 | 82,270.35 | .02 |
| 1 | 51,779.90 | 51,779.80 | .10 | 82,270.55 | 82,270.51 | .04 |

Table 6-8B. Results in LORAN μ Sec

| |
|--|
| Δ TDA Mean = .060 μ sec Δ TDB Mean = .061 μ sec |
|--|

Table 6-8C. Results in Feet**

| |
|--|
| Δ TDA Mean = 32 feet Δ TDB Mean = 56 feet |
| * Δ_R Mean = 64 feet |

**Results obtained by using gradients determined in calibration data (Table 6-6):

$$\left. \begin{array}{l} \text{TDA Gradient} = .00186 \mu\text{sec/foot} \\ \text{TDB Gradient} = .00107 \mu\text{sec/foot} \end{array} \right\} \text{Along Path Travelled}$$

$$* \Delta_R = \sqrt{|\Delta_{\text{TDA}}|_{\text{MEAN}}^2 + |\Delta_{\text{TDB}}|_{\text{MEAN}}^2}$$

Tables 6-9A, B, C

Table 6-9A. 10 MPH LORAN Speed/Lag Test Data (Test #30502)

| Checkpoint | TDA (μSec) | | Δ | TDB (μSec) | | Δ |
|------------|-------------------------|-----------|----------|-------------------------|-----------|----------|
| | Cal Run | Test Run | | Cal Run | Test Run | |
| 1 | 51,779.90 | 51,779.96 | .06 | 82,270.55 | 82,270.62 | .07 |
| 2 | 51,779.43 | 51,779.53 | .10 | 82,270.33 | 82,270.35 | .02 |
| 3 | 51,778.97 | 51,779.02 | .05 | 82,270.06 | 82,270.16 | .10 |
| 4 | 51,778.50 | 51,778.52 | .02 | 82,269.78 | 82,269.69 | .08 |
| 5 | 51,778.03 | 51,778.12 | .09 | 82,269.55 | 82,269.53 | .02 |
| 6 | 51,777.58 | 51,777.65 | .07 | 82,269.20 | 82,269.26 | .06 |
| 7 | 51,777.12 | 51,777.19 | .07 | 82,268.94 | 82,268.91 | .03 |

Table 6-9B. Results in LORAN μSec

| |
|---|
| Δ TDA Mean = .066 μsec Δ TDB Mean = .054 μsec |
|---|

Table 6-9C. Results in Feet**

| |
|--|
| Δ TDA Mean = 35 feet Δ TDB Mean = 50 feet |
| * Δ_R Mean = 61 feet |

**Results obtained by using gradients determined in calibration data (Table 6-6):

$$\left. \begin{array}{l} \text{TDA Gradient} = .00186 \mu\text{Sec/Ft} \\ \text{TDB Gradient} = .00107 \mu\text{Sec/Ft} \end{array} \right\} \text{Along Path Travelled}$$

$$* \Delta_R = \sqrt{|\Delta_{\text{TDA MEAN}}|^2 + |\Delta_{\text{TDB MEAN}}|^2}$$

Tables 6-10A, B, C

Table 6-10A. 20 MPH LORAN Speed/Lag Test Data (Test #30503)

| Checkpoint | TDA (μ Sec) | | Δ | TDB (μ Sec) | | Δ |
|------------|------------------|-----------|----------|------------------|-----------|----------|
| | Cal Run | Test Run | | Cal Run | Test Run | |
| 7 | 51,777.12 | 51,777.07 | .05 | 82,268.94 | 82,268.83 | .11 |
| 6 | 51,777.58 | 51,777.62 | .04 | 82,269.20 | 82,269.18 | .02 |
| 5 | 51,778.03 | 51,778.05 | .02 | 82,269.55 | 82,269.45 | .10 |
| 4 | 51,778.50 | 51,778.48 | .02 | 82,269.78 | 82,269.77 | .01 |
| 3 | 51,778.97 | 51,778.83 | .14 | 82,270.06 | 82,269.84 | .22 |
| 2 | 51,779.43 | 51,779.34 | .09 | 82,270.33 | 82,270.31 | .02 |
| 1 | 51,779.90 | 51,779.73 | .17 | 82,270.55 | 82,270.43 | .12 |

Table 6-10B. Results in LORAN μ Sec

| |
|--|
| Δ TDA Mean = .076 μ sec Δ TDB Mean = .086 μ sec |
|--|

Table 6-10C. Results in Feet**

| |
|--|
| Δ TDA Mean = 41 feet Δ TDB Mean = 80 feet |
| * Δ_R Mean = 90 feet |

**Results obtained by using gradients determined in Calibration data (Table 6-6):

$$\left. \begin{array}{l} \text{TDA Gradient} = .00186 \mu\text{Sec/Ft} \\ \text{TDB Gradient} = .00107 \mu\text{Sec/Ft} \end{array} \right\} \text{Along Path Travelled}$$

$$* \Delta_R = \sqrt{|\Delta_{\text{TDA MEAN}}|^2 + |\Delta_{\text{TDB MEAN}}|^2}$$

Tables 6-11A, B, C

Table 6-11A. 20 MPH LORAN Speed/Lag Test Data (Test #30504)

| Checkpoint | TDA (μ Sec) | | Δ | TDB (μ Sec) | | Δ |
|------------|------------------|-----------|----------|------------------|-----------|----------|
| | Cal Run | Test Run | | Cal Run | Test Run | |
| 1 | 51,779.90 | 51,779.88 | .02 | 82,270.55 | 82,270.66 | .11 |
| 2 | 51,779.43 | 51,779.49 | .06 | 82,270.33 | 82,270.27 | .07 |
| 3 | 51,778.97 | 51,779.06 | .09 | 82,270.06 | 82,270.04 | .02 |
| 4 | 51,778.50 | 51,778.55 | .05 | 82,269.78 | 82,269.88 | .10 |
| 5 | 51,778.03 | 51,778.09 | .06 | 82,269.55 | 82,269.57 | .02 |
| 6 | 51,777.58 | 51,777.58 | -0- | 82,269.20 | 82,269.06 | .14 |
| 7 | 51,777.12 | 51,777.19 | .07 | 82,268.94 | 82,269.02 | .08 |

Table 6-11B. Results in LORAN μ Sec

| Δ | TDA Mean = .050 μ sec | Δ | TDB Mean = .076 μ sec

Table 6-11C. Results in Feet**

| Δ | TDA Mean = 27 feet | Δ | TDB Mean = 71 feet

* Δ_R Mean = 76 feet

**Results obtained by using gradients determined in calibration data (Table 6-6):

TDA Gradient = .00186 μ Sec/Ft }
 TDB Gradient = .00107 μ Sec/Ft } Along Path Travelled

$$* \Delta_R = \sqrt{|\Delta_{TDA \text{ MEAN}}|^2 + |\Delta_{TDB \text{ MEAN}}|^2}$$

Tables 6-12A, B, C

Table 6-12A. 30 MPH LORAN Speed/Lag Test Data (Test #30505)

| Checkpoint | TDA (Sec) | | Δ | TDB (Sec) | | Δ |
|------------|------------|-----------|-----|------------|-----------|-----|
| | Cal Run | Test Run | | Cal Run | Test Run | |
| 7 | 51,777.12 | 51,776.99 | .13 | 82,268.94 | 82,268.83 | .11 |
| 6 | 51,777.58 | 51,777.46 | .12 | 82,269.20 | 82,269.02 | .18 |
| 5 | 51,778.03 | 51,778.01 | .02 | 82,269.55 | 82,269.53 | .02 |
| 4 | 51,778.50 | 51,778.40 | .10 | 82,269.78 | 82,269.65 | .13 |
| 3 | 51,778.97 | 51,778.95 | .02 | 82,270.06 | 82,269.88 | .18 |
| 2 | 51,779.43 | 51,779.33 | .10 | 82,270.33 | 82,270.31 | .02 |
| 1 | 51,779.90 | 51,779.84 | .06 | 82,270.55 | 82,270.62 | .07 |

Table 6-12B. Results in LORAN μSec

| |
|--|
| Δ TDA Mean = .079 μsec Δ TDB Mean = .10 μsec |
|--|

Table 6-12C. Results in Feet**

| |
|---|
| Δ TDA Mean = 42 feet Δ TDB Mean = 93 feet * Δ _R Mean = 102 feet |
|---|

**Results obtained by using gradients determined in calibration data (Table 6-6):

$$\left. \begin{aligned} \text{TDA Gradient} &= .00186 \mu\text{Sec}/\text{Ft} \\ \text{TDB Gradient} &= .00107 \mu\text{Sec}/\text{Ft} \end{aligned} \right\} \text{Along Path Travelled}$$

$$* \Delta_R = \sqrt{\frac{|\Delta_{\text{TDA}}|_{\text{MEAN}}^2 + |\Delta_{\text{TDB}}|_{\text{MEAN}}^2}$$

Tables 6-13A, B, C

Table 6-13A. 30 MPH LORAN Speed/Lag Test Data (Test #30506)

| Checkpoint | TDA (μ Sec) | | Δ | TDB (μ Sec) | | Δ |
|------------|------------------|-----------|----------|------------------|-----------|----------|
| | Cal Run | Test Run | | Cal Run | Test Run | |
| 1 | 51,779.90 | 51,779.96 | .06 | 82,270.55 | 82,270.62 | .07 |
| 2 | 51,779.43 | 51,779.53 | .10 | 82,270.33 | 82,270.43 | .10 |
| 3 | 51,778.97 | 51,779.02 | .05 | 82,270.06 | 82,270.02 | .04 |
| 4 | 51,778.50 | 51,778.59 | .09 | 82,269.78 | 82,269.73 | .05 |
| 5 | 51,778.03 | 51,778.05 | .02 | 82,269.55 | 82,269.61 | .06 |
| 6 | 51,777.58 | 51,777.70 | .12 | 82,269.20 | 82,269.10 | .10 |
| 7 | 51,777.12 | 51,777.30 | .18 | 82,268.94 | 82,268.98 | .04 |

Table 6-13B. Results in LORAN μ Sec

| |
|--|
| Δ TDA Mean = .089 μ sec Δ TDB Mean = .066 μ sec |
|--|

Table 6-13C. Results in Feet**

| |
|--|
| Δ TDA Mean = 48 feet Δ TDB Mean = 62 feet |
| * Δ_R Mean = 78 feet |

**Results obtained by using gradients determined in calibration data (Table 6-6):

$$\left. \begin{array}{l} \text{TDA Gradient} = .00186 \mu\text{Sec/Ft} \\ \text{TDB Gradient} = .00107 \mu\text{Sec/Ft} \end{array} \right\} \text{Along Path Travelled}$$

$$* \Delta_R = \sqrt{|\Delta_{\text{TDA MEAN}}|^2 + |\Delta_{\text{TDB MEAN}}|^2}$$

Table 6-14A, B, C

Table 6-14A. 40 MPH LORAN Speed/Lag Test Data (Test #30507)

| Checkpoint | TDA (μ Sec) | | Δ | TDB (μ Sec) | | Δ |
|------------|------------------|-----------|----------|------------------|-----------|----------|
| | Cal Run | Test Run | | Cal Run | Test Run | |
| 7 | 51,777.12 | 51,777.03 | .09 | 82,268.94 | 82,268.95 | .01 |
| 6 | 51,777.58 | 51,777.50 | .08 | 82,269.20 | 82,269.02 | .18 |
| 5 | 51,778.03 | 51,778.01 | .02 | 82,269.55 | 82,269.45 | .10 |
| 4 | 51,778.50 | 51,778.40 | .10 | 82,269.78 | 82,269.80 | .02 |
| 3 | 51,778.97 | 51,778.79 | .18 | 82,270.06 | 82,270.04 | .02 |
| 2 | 51,779.43 | 51,779.34 | .09 | 82,270.33 | 82,270.20 | .13 |
| 1 | 51,779.90 | 51,779.84 | .06 | 82,270.55 | 82,270.51 | .04 |

Table 6-14B. Results in LORAN μ Sec

| |
|---|
| $ \Delta $ TDA Mean = .089 μ sec $ \Delta $ TDB Mean = .071 μ sec |
|---|

Table 6-14C. Results in Feet**

| |
|---|
| $ \Delta $ TDA Mean = 48 feet $ \Delta $ TDB Mean = 66 feet $*\Delta_R$ Mean = 82 feet |
|---|

**Results obtained by using gradients determined in calibration data (table 6-6):

$$\left. \begin{array}{l} \text{TDA Gradient} = .00186 \mu\text{Sec/Ft} \\ \text{TDB Gradient} = .00107 \mu\text{Sec/Ft} \end{array} \right\} \text{Along Path Travelled}$$

$$*\Delta_R = \sqrt{\left| \frac{\Delta_{\text{TDA}}}{\text{MEAN}} \right|^2 + \left| \frac{\Delta_{\text{TDB}}}{\text{MEAN}} \right|^2}$$

Tables 6-15A, B, C

Table 6-15A. 40 MPH LORAN Speed/Lag Test Data (Test #30510)

| Checkpoint | TDA (μ Sec) | | Δ | TDB (μ Sec) | | Δ |
|------------|------------------|-----------|----------|------------------|-----------|----------|
| | Cal Run | Test Run | | Cal Run | Test Run | |
| 1 | 51,779.90 | 51,779.96 | .06 | 82,270.55 | 82,270.59 | .04 |
| 2 | 51,779.43 | 51,779.57 | .14 | 82,270.33 | 82,270.43 | .10 |
| 3 | 51,778.97 | 51,779.10 | .13 | 82,270.06 | 82,270.04 | .02 |
| 4 | 51,778.50 | 51,778.67 | .17 | 82,269.78 | 82,269.92 | .14 |
| 5 | 51,778.03 | 51,778.14 | .13 | 82,269.55 | 82,269.45 | .10 |
| 6 | 51,777.58 | 51,777.77 | .19 | 82,269.20 | 82,269.26 | .06 |
| 7 | 51,777.12 | 51,777.34 | .22 | 82,268.94 | 82,268.98 | .04 |

Table 6-15B. Results in LORAN μ Sec

| |
|---|
| Δ TDA Mean = .15 μ sec Δ TDB Mean = .071 μ sec |
|---|

Table 6-15C. Results in Feet**

| |
|--|
| Δ TDA Mean = 81 feet Δ TDB Mean = 66 feet |
| * Δ_R Mean = 104 feet |

** Results obtained by using gradients determined in calibration data (Table 6-6):

$$\left. \begin{aligned} \text{TDA Gradient} &= .00186 \mu\text{Sec/Ft} \\ \text{TDB Gradient} &= .00107 \mu\text{Sec/Ft} \end{aligned} \right\} \text{Along Path Travelled}$$

$$* \Delta_R = \sqrt{|\Delta_{\text{TDA}}|_{\text{MEAN}}^2 + |\Delta_{\text{TDB}}|_{\text{MEAN}}^2}$$

TABLE 6-16A
 LORAN BRIDGE TEST
 RADIAL ERRORS IN CHECKPOINT SEQUENCE

| LOCATION | CHECKPOINT NUMBER | SYSTEM RADIAL ERROR |
|------------------------|----------------------|------------------------|
| Philadelphia Eastbound | 1001 | 27.86 |
| | 1002 | 36.29 |
| | 1003 | 27.95 |
| | 1004 | 8.81 |
| | 1005 | 44.17 |
| | 1006 | 36.84 |
| | 1007 | 102.64 |
| Bridge West | 1010 | 149.46 |
| Bridge East | 1011 | 188.32 |
| Camden, N. J. | 1012 | 378.35 |
| | 1013 | 58.46 |
| | 1014 | 20.92 |
| | 1015 | 31.77 |
| | 1016 | 48.89 |
| | 1017 | 154.01 |
| | 1020 | 170.97 |
| Bridge East | 1021 | 73.59 |
| Bridge West | 1022 | 91.51 |
| Philadelphia Westbound | 1023 | 107.73 |
| | 1024 | 137.54 |
| | 1025 | 167.94 |
| | 1026 | 83.45 |
| | 1027 | 35.23 |
| | 1030 | 34.90 |
| | 1031 | 42.64 |

TABLE 6-16B

LORAN BRIDGE TEST
RADIAL ERRORS RANKED

| CHECKPOINT NUMBER | SYSTEM RADIAL ERROR |
|----------------------|------------------------|
| 1004 | 8.81 |
| 1014 | 20.92 |
| 1001 | 27.86 |
| 1003 | 27.95 |
| 1015 | 31.77 |
| 1030 | 34.90 |
| 1027 | 35.23 |
| 1002 | 36.29 |
| 1006 | 36.84 |
| 1031 | 42.64 |
| 1005 | 44.17 |
| 1016 | 48.89 |
| 1013 | 58.46 |
| 1021 | 73.59 |
| 1026 | 83.45 |
| 1022 | 91.51 |
| 1007 | 102.64 |
| 1023 | 107.73 |
| 1024 | 137.54 |
| 1010 | 149.46 |
| 1017 | 154.01 |
| 1025 | 167.94 |
| 1020 | 170.97 |
| 1011 | 188.32 |
| 1012 | 378.35 |

A summary of all of these errors is given in Table 6-7 and the Radial Error is plotted graphically in Figure 6-26 and projected to 80 MPH.

The results as indicated in Figure 6-26 show that as the vehicle speed increased, the radial error in feet increased; the increase is due to lag in sensed LORAN position, and it was at a decreasing rate. At speeds above 30 MPH, the error increased at less than 3 feet per 10 MPH. At the 30 MPH speed, the error, due to lag, was 27 feet. The absolute error is shown as 90 feet at 30 MPH. Sixty-three feet is due to LORAN/System error (this follows closely with the standard deviation for calibration of 69.41).

6.4.1.3 LORAN Bridge Test - The results of the special case LORAN Only bridge run gave a 95% accuracy of 188 feet radial error for the entire route of 6.2 miles and twenty-five checkpoints. Passing over the Benjamin Franklin Bridge (1 mile long) the errors at four locations were: 150, 188, 74, and 92 feet. These locations were the bridge supports in the Delaware River. Table 6-16 shows the errors and locations. The 99% error for the run was 378 feet. The detailed bridge route was shown previously in Section 2, Figure 2-8.

6.4.1.4 LORAN Repeatability - Table 6-17 compares LORAN position by checkpoint for two different tests in the LORAN Only area. Neglecting three points in Test 30703 where the SNR was very bad, the mean difference is 199.29 feet. One conclusion that can be made is that LORAN repeatability errors are considerably lower than absolute errors. LORAN proponents have been aware of this fact for many years. The LORAN AVM System takes advantage of this taking many calibration points in a given test area. The location algorithm converts TDA and TDB to X and Y coordinates, using the closest (physically) calibration points. In this manner the coordinate conversion errors approach the repeatability errors as a limit.

TABLE 6-17

LORAN REPEATABILITY

| TRUE LOCATION | | TEST 30701 LORAN COCATION | | TEST 30703 LORAN LOCATION | | ΔX | ΔY | Radial Difference |
|---------------|---------|------------------------------|---------|------------------------------|----------|----------|----------|----------------------|
| X | Y | X | Y | X | Y | | | |
| 500.00 | 2836.00 | 854.17 | 2858.04 | 918.95 | 2952.77 | 64.78 | 94.73 | 116.48 |
| 500.00 | 2273.00 | 691.02 | 2372.72 | 918.95 | 2952.95 | 227.93 | 580.05 | 623.23 |
| 500.00 | 1723.00 | 902.77 | 2048.31 | 32264.13 | 16502.27 | 31361.36 | 14453.96 | - |
| 500.00 | 1156.00 | 695.39 | 1069.55 | 29854.30 | 14344.70 | 29158.91 | 13275.15 | - |
| 500.00 | 617.00 | 738.93 | 1342.37 | 30928.48 | 15193.27 | 30189.55 | 13850.90 | - |
| 500.00 | 348.00 | 1295.28 | -265.08 | 1252.28 | -229.04 | 43.00 | 36.04 | 56.11 |
| 727.00 | 152.00 | 840.71 | 722.76 | 1036.60 | 761.41 | 195.89 | 38.65 | 199.67 |
| 945.00 | 51.00 | 942.07 | 315.75 | 963.57 | 258.70 | 21.50 | 57.05 | 60.97 |
| 1172.00 | 16.00 | 1038.69 | 113.45 | 1102.81 | 77.51 | 64.12 | 35.94 | 73.51 |
| 1391.00 | 16.00 | 1344.63 | -103.81 | 1386.72 | -9.64 | 42.09 | 94.17 | 103.15 |
| 1633.00 | 16.00 | 1520.01 | -130.56 | 1511.23 | -166.36 | 8.78 | 35.80 | 36.86 |
| 1633.00 | 617.00 | 2018.24 | 890.09 | 2230.04 | 970.08 | 211.08 | 79.99 | 226.40 |
| 1633.00 | 1156.00 | 1533.01 | 1236.81 | 1485.39 | 1131.69 | 47.62 | 105.12 | 115.40 |
| 1633.00 | 1723.00 | 1349.04 | 1658.93 | 1550.76 | 1616.36 | 201.72 | 42.57 | 206.16 |
| 1633.00 | 2273.00 | 1712.24 | 2526.50 | 1661.76 | 2331.30 | 50.48 | 195.20 | 201.62 |
| 1633.00 | 2836.00 | 1085.97 | 2643.89 | 1943.14 | 2944.16 | 857.17 | 300.27 | 908.24 |
| 1391.00 | 2836.00 | 1109.85 | 2705.41 | 1256.97 | 2800.91 | 147.12 | 95.50 | 175.40 |
| 1172.00 | 2836.00 | 839.40 | 2866.83 | 914.75 | 2729.02 | 75.35 | 137.81 | 157.06 |
| 945.00 | 2836.00 | 944.77 | 2773.15 | 947.42 | 2819.67 | 2.65 | 46.52 | 46.60 |
| 945.00 | 2273.00 | 878.73 | 2178.16 | 947.42 | 2819.67 | 68.69 | 641.51 | 645.18 |
| 945.00 | 1723.00 | 710.33 | 1645.10 | 734.77 | 1719.61 | 24.44 | 74.51 | 78.42 |
| 945.00 | 1156.00 | 681.06 | 1686.38 | 683.71 | 1925.94 | 2.65 | 238.86 | 238.88 |
| 727.00 | 1156.00 | 703.72 | 1209.34 | 711.78 | 1192.69 | 8.06 | 16.65 | 18.50 |
| 727.00 | 1723.00 | 649.83 | 1647.62 | 649.83 | 1647.62 | 0 | 0 | 0 |
| 727.00 | 2273.00 | 765.44 | 2499.52 | 749.69 | 2528.29 | 15.75 | 28.77 | 32.80 |
| 727.00 | 2836.00 | 871.56 | 2850.57 | 971.37 | 2991.81 | 99.81 | 141.24 | 172.95 |
| 945.00 | 2836.00 | 897.13 | 2826.74 | 1030.94 | 2833.58 | 133.81 | 6.84 | 133.99 |
| 1172.00 | 2836.00 | 1034.35 | 2925.55 | 1000.01 | 2879.35 | 34.34 | 46.20 | 57.56 |
| 1391.00 | 2836.00 | 933.71 | 2742.82 | 1160.71 | 2829.89 | 227.00 | 87.07 | 243.13 |
| 1633.00 | 2836.00 | 1009.95 | 2592.67 | 1157.16 | 2667.86 | 147.21 | 75.19 | 165.30 |
| 1898.00 | 2836.00 | 1350.65 | 2560.71 | 1701.10 | 2776.14 | 350.45 | 215.43 | 411.37 |
| 1898.00 | 2273.00 | 2185.47 | 2408.04 | 2595.27 | 2600.23 | 409.80 | 129.19 | 452.63 |
| 1633.00 | 2273.00 | 1405.59 | 2361.79 | 1845.14 | 2676.59 | 439.55 | 314.80 | 540.65 |
| 1391.00 | 2273.00 | 1669.09 | 2640.55 | 1784.90 | 2617.10 | 115.81 | 23.45 | 118.16 |
| 1172.00 | 2273.00 | 1240.74 | 3593.40 | 1349.04 | 3489.18 | 108.30 | 104.22 | 150.30 |
| 945.00 | 2273.00 | 1012.37 | 2548.61 | 1089.36 | 2600.35 | 16.99 | 51.74 | 92.76 |
| 727.00 | 2273.00 | 790.70 | 2409.60 | 812.47 | 2404.39 | 21.77 | 5.21 | 22.39 |
| 500.00 | 2273.00 | 702.54 | 2449.05 | 742.70 | 2499.89 | 40.16 | 50.84 | 64.79 |
| 500.00 | 1723.00 | 728.79 | 1960.75 | 683.70 | 1885.15 | 45.09 | 75.60 | 88.25 |
| 500.00 | 1156.00 | 708.88 | 1079.60 | 714.97 | 1031.58 | 6.09 | 48.02 | 48.40 |
| 500.00 | 617.00 | 717.98 | 989.58 | 712.14 | 1136.72 | 3.16 | 147.14 | 147.18 |
| 727.00 | 617.00 | 660.90 | 1328.10 | 678.65 | 1254.15 | 17.75 | 82.95 | 84.83 |
| 945.00 | 617.00 | 728.44 | 1185.11 | 801.80 | 970.08 | 73.36 | 215.03 | 227.20 |
| 1172.00 | 617.00 | 1093.04 | 943.24 | 1070.55 | 901.50 | 22.49 | 41.74 | 47.41 |
| 1391.00 | 617.00 | 1465.22 | 942.93 | 1563.13 | 981.25 | 97.91 | 38.32 | 105.14 |
| 1633.00 | 617.00 | 2640.06 | 1465.91 | 2435.93 | 1369.31 | 204.13 | 96.60 | 225.83 |
| 1633.00 | 1156.00 | 1358.52 | 1074.10 | 1540.52 | 1067.15 | 182.00 | 6.95 | 182.13 |
| 1633.00 | 1723.00 | 1250.65 | 1595.50 | 1505.75 | 1685.32 | 255.10 | 89.82 | 270.45 |
| 1633.00 | 2273.00 | 1620.03 | 2140.03 | 1456.88 | 2557.20 | 163.15 | 417.17 | 447.94 |
| 1633.00 | 2836.00 | 1632.85 | 2942.59 | 1122.40 | 2736.49 | 510.45 | 206.10 | 550.49 |
| 1391.00 | 2836.00 | 1042.69 | 2728.70 | 1192.08 | 2804.81 | 149.39 | 76.11 | 167.66 |
| 1172.00 | 2836.00 | 812.47 | 2404.39 | 892.44 | 2910.51 | 79.97 | 506.12 | 512.40 |
| 945.00 | 2836.00 | 921.01 | 2822.58 | 925.29 | 2759.05 | 4.28 | 63.53 | 63.67 |
| 727.00 | 2836.00 | 881.79 | 2880.42 | 930.02 | 2917.44 | 30.21 | 37.02 | 47.78 |
| 500.00 | 2836.00 | 867.59 | 2869.05 | 851.58 | 2791.05 | 16.01 | 78.00 | 79.63 |

T109299

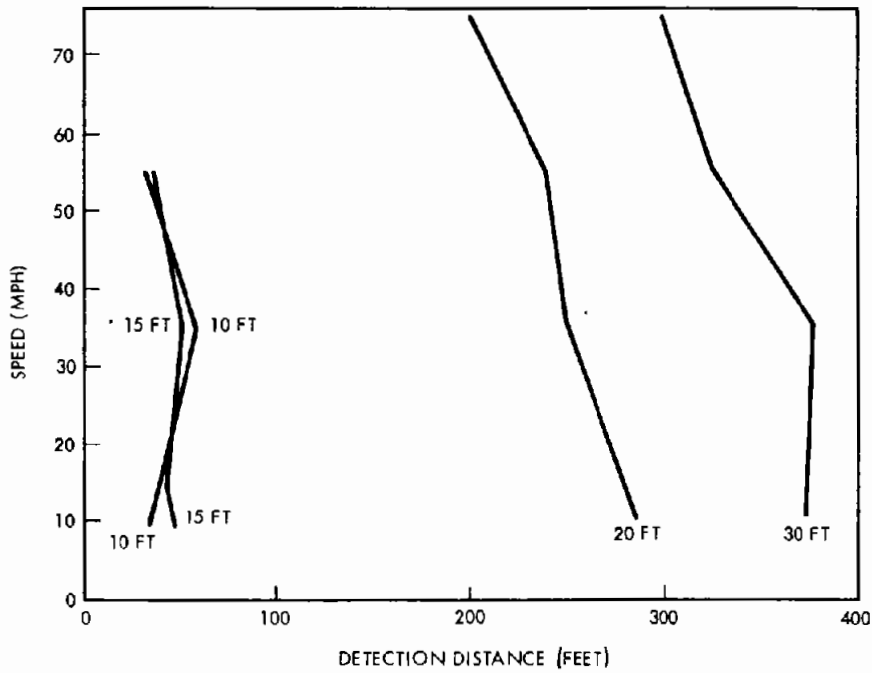

T108990-1

Figure 6-27A. Vehicle Speed Vs. Detection Distance

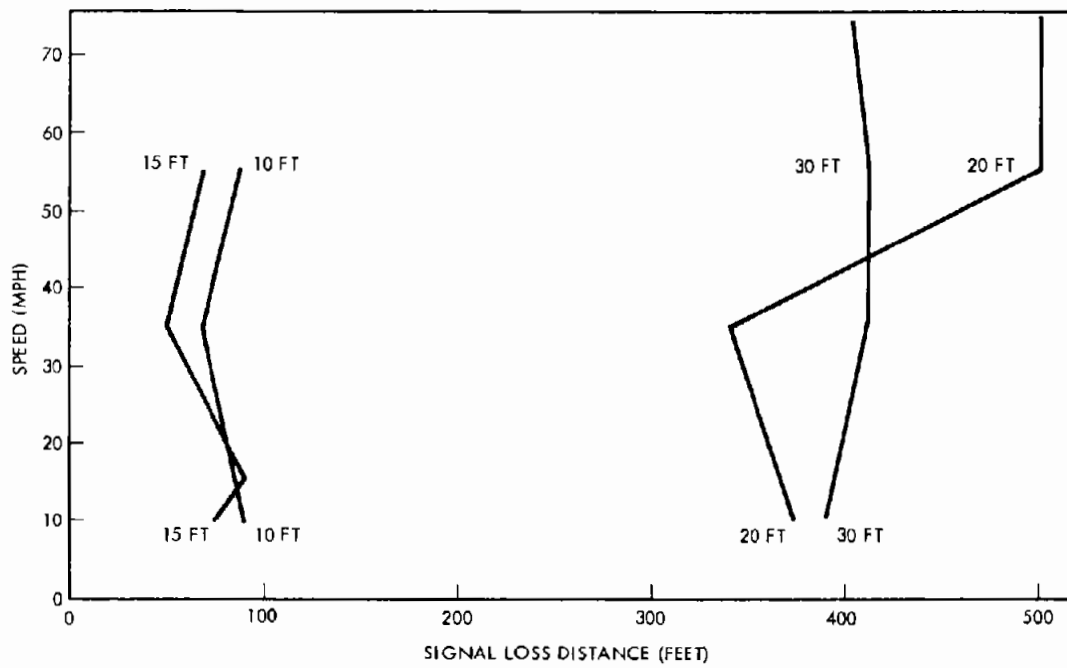

T108990-2

Figure 6-27B. Vehicle Speed Vs. Signal Loss Distance

6.4.2 Augmentor Tests

The results from the raw data sheets for the special case augmentor tests have been tabulated in Tables 6-18 through 6-23. Each table has an associated chart showing the results in a graphical fashion.

6.4.2.1 Augmentor Coverage vs. Vehicle Speed - The results of the augmentor coverage versus vehicle speed tests are shown in Table 6-18 and Figure 6-27. As can be seen in Figure 6-27A, at low augmentor elevations of 10 feet and 15 feet, the speed of the vehicle (10 to 55 MPH) had little effect on the detection and signal loss distances. Detection distances ranged from 30 to 60 feet prior to reaching an augmentor, and loss distances ranged from 50 to 90 after passing an augmentor.

At higher elevations of 20 and 30 feet, a noticeable decrease in the detection distance occurred as can be seen in the chart. The detection distance decreased approximately 80 feet in each case as the vehicle speed increased from 10 to 75 MPH.

The results of the signal loss tests at the higher elevations of 20 and 30 feet were variable. At 30 feet there was no noticeable change (less than 20 feet) as vehicle speed ranged from 10 to 75 MPH; however, at a 20 foot elevation, no clear results were apparent: the change in loss distance decreased 30 feet and then increased 160 feet as vehicle speed increased from 10 to 75 MPH.

Table 6-18A. Augmentor Coverage Special Case Tests
(Elevation Constant - 10 Ft)

| Vehicle Speed (MPH) | Detection (Ft) | Loss (Ft) | Reaction Distance (Ft) | Actual | | Distance | |
|---------------------|----------------|-----------|------------------------|-------------------|------|--------------|------|
| | | | | Detection/Average | | Loss/Average | |
| | | | | (Ft) | (Ft) | (Ft) | (Ft) |
| 10 | 32 | 95 | 10 | 42 | 38 | 85 | 88 |
| 10 | 24 | 101 | 10 | 34 | | 91 | |
| 35 | 8 | 100 | 44 | 52 | 59 | 56 | 66.5 |
| 35 | 22 | 121 | 44 | 66 | | 77 | |
| 55 | *-72 | 165 | 88 | 16 | 33.5 | 77 | 85 |
| 55 | *-37 | 181 | 88 | 51 | | 93 | |

*A Negative Distance indicates marked detection occurred after passing Augmentor

Table 6-18B. Augmentor Coverage Special Case Tests
(Elevation Constant - 15 Ft)

| Vehicle Speed (MPH) | Measured Detection (Ft) | Distance Loss (Ft) | Reaction Distance (Ft) | Actual | | Distance | |
|---------------------|-------------------------|--------------------|------------------------|-------------------|------|--------------|------|
| | | | | Detection/Average | | Loss/Average | |
| | | | | (Ft) | (Ft) | (Ft) | (Ft) |
| 10 | 37 | 85 | 10 | 47 | 46 | 75 | 77.5 |
| 10 | 35 | 90 | 10 | 45 | | 80 | |
| 15 | 23 | 108 | 20 | 43 | 42 | 88 | 89 |
| 15 | 21 | 110 | 20 | 41 | | 90 | |
| 35 | 5 | 95 | 44 | 49 | 51.5 | 51 | 49 |
| 35 | 10 | 91 | 44 | 54 | | 47 | |
| 55 | -60 | 160 | 88 | 28 | 33 | 72 | 67 |
| 55 | -50 | 150 | 88 | 38 | | 62 | |

In summary, the results of the vehicle speed tests show that at elevations of 15 feet and less, vehicle speed has no noticeable effect on either detection or loss. At higher elevations up to 30 feet increasing the vehicle speed up to 75 MPH decreases the detection distance as much as 80 feet.

6.4.2.2 Augmentor Coverage and Elevation - Figure 6-28 and Table 6-19 represent the results of the Augmentor Coverage versus Augmentor Elevation tests. At all vehicle speeds (10, 35, 55, and 75 MPH) the detection distance of the Augmentors increased with Augmentor Elevation. The increase followed the same pattern for 10, 35 and 55 MPH: there was virtually no increase in detection distance (15 Ft or less) as elevation increased from 10 to 15 feet. At this point a large increase in detection distance occurred: as elevation increased 5 more feet, an increase of from 200 to 240 feet was noted. Then as the elevation was further increased 10 more feet, a more gradual increase in detection distance of 85 to 130 feet occurred. At 75 MPH only two data points were plotted, and the results showed an increase of 100 feet in detection distance as elevation was raised 10 feet in going from 20 to a 30 foot height.

The curves plotted in Figure 6-28B to depict the effect of elevation on loss distance show that for vehicle speeds of 10, 35, and 55 MPH a small decrease in the loss distance of up to 20 feet took place in raising the elevation 5 feet from the 10 to 15 foot level. As the elevation was raised from the 15 to 20 foot height a large increase in loss distance of from 290 to 430 feet occurred. At this point, as the elevation was increased 10 feet to the 30 foot height, results varied with a small increase of 20 feet at 10 MPH to decreases of 30 and 80 feet at 35 and 55 MPH, respectively. Again at 75 MPH, only two data points were plotted, and these show a decrease in signal loss distance of 100 feet as elevation was raised from the 20 to 30 foot level.

In summary, these results show that as elevation increases the detection distance of an augmentor increases, and the effect is much more pronounced at heights above 15 feet. An increase of 10 to 17 feet in detection distance can be seen with each foot of increased elevation. Loss distances also increase with increases in elevation with the most pronounced increase at the 15 to 20 foot level; however, at lower elevations (below 15 feet) and higher elevations (above 20 feet) small decreases or increases in loss distance can occur.

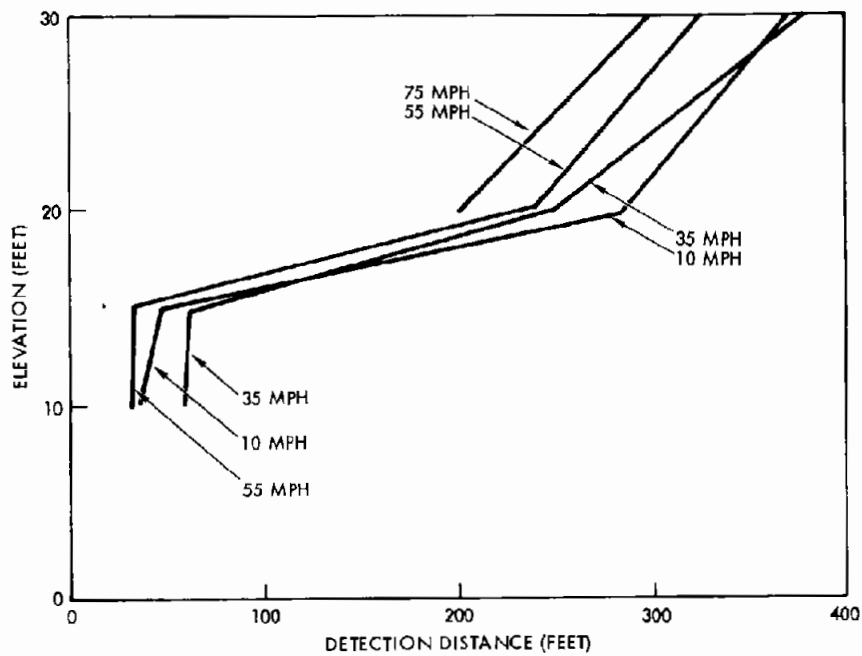

T108991-1

Figure 6-28A. Augmentor Elevation Vs. Detection Distance

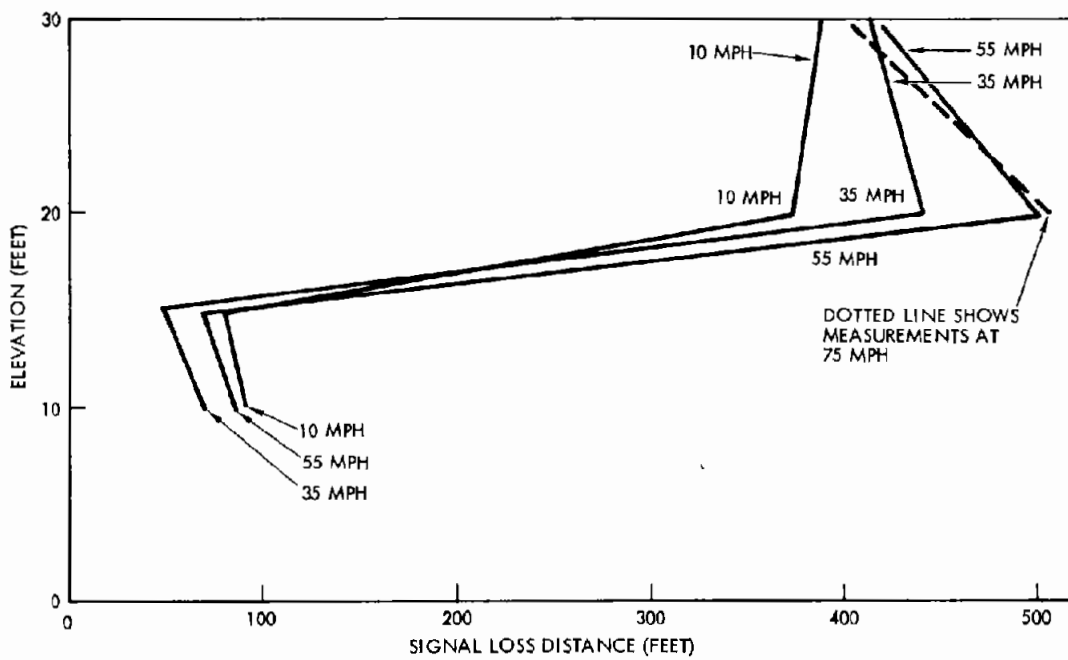

T108991-2

Figure 6-28B. Elevation Vs. Loss Distance

Table 6-18C. Augmentor Coverage Special Case Tests
(Elevation Constant - 20 Ft)

| Vehicle Speed (MPH) | Measured Detection (Ft) | Distance Loss (Ft) | Reaction Distance (Ft) | Actual | | Distance | |
|---------------------|-------------------------|--------------------|------------------------|-------------------|-------|--------------|-------|
| | | | | Detection/Average | | Loss/Average | |
| | | | | (Ft) | (Ft) | (Ft) | (Ft) |
| 10 | 297 | 378 | 10 | 307 | 285.5 | 368 | 373.5 |
| 10 | 254 | 389 | 10 | 264 | | 379 | |
| 35 | 214 | 244 | 44 | 258 | 248.5 | 200 | 340.5 |
| 35 | 195 | 525 | 44 | 239 | | 481 | |
| 55 | 161 | 624 | 88 | 249 | 239.5 | 536 | 502.5 |
| 55 | 142 | 557 | 88 | 230 | | 469 | |
| 75 | 32 | 588 | 100 | 132 | 200.5 | 488 | 503.5 |
| 75 | 169 | 619 | 100 | 269 | | 519 | |

Table 6-18D. Augmentor Coverage Special Case Tests
(Elevation Constant - 30 Ft)

| Vehicle Speed (MPH) | Measured Detection (Ft) | Distance Loss (Ft) | Reaction Distance (Ft) | Actual | | Distance | |
|---------------------|-------------------------|--------------------|------------------------|-------------------|-------|--------------|-------|
| | | | | Detection/Average | | Loss/Average | |
| | | | | (Ft) | (Ft) | (Ft) | (Ft) |
| 10 | 368 | 391 | 10 | 378 | 374.5 | 381 | 387 |
| 10 | 361 | 403 | 10 | 371 | | 393 | |
| 35 | 342 | 452 | 44 | 386 | 378 | 408 | 413 |
| 35 | 326 | 462 | 44 | 370 | | 418 | |
| 55 | 217 | 497 | 88 | 305 | 324.5 | 409 | 413 |
| 55 | 256 | 505 | 88 | 344 | | 417 | |
| 75 | 202 | 518 | 100 | 302 | 296 | 418 | 404.5 |
| 75 | 190 | 491 | 100 | 290 | | 391 | |

Table 6-19A. Augmentor Coverage Special Case Tests (Vehicle Speed Constant - 75 MPH)

| Augmentor Elevation (Ft) | Measured Distance | | Reaction Distance (Ft) | Actual Distance | | | |
|--------------------------|-------------------|-----------|------------------------|-------------------|-------|--------------|-------|
| | Detection (Ft) | Loss (Ft) | | Detection/Average | | Loss/Average | |
| | | | | (Ft) | (Ft) | (Ft) | (Ft) |
| 20 | 169 | 619 | 100 | 269 | 200.5 | 519 | 503.5 |
| 20 | 32 | 588 | 100 | 132 | | 488 | |
| 30 | 202 | 518 | 100 | 302 | 296 | 418 | 404.5 |
| 30 | 190 | 491 | 100 | 290 | | 391 | |

6-67

Table 6-19B. Augmentor Coverage Special Case Tests (Vehicle Speed Constant - 55 MPH)

| Augmentor Elevation (Ft) | Measured Distance | | Reaction Distance (Ft) | Actual Distance | | | |
|--------------------------|-------------------|-----------|------------------------|-------------------|-------|--------------|-------|
| | Detection (Ft) | Loss (Ft) | | Detection/Average | | Loss/Average | |
| | | | | (Ft) | (Ft) | (Ft) | (Ft) |
| 10 | *-72 | 165 | 88 | 16 | 33.5 | 77 | 85 |
| 10 | *-37 | 181 | 88 | 51 | | 93 | |
| 15 | *-60 | 160 | 88 | 78 | 33 | 72 | 67 |
| 15 | *-50 | 150 | 88 | 38 | | 62 | |
| 20 | 161 | 624 | 88 | 249 | 239.5 | 536 | 502.5 |
| 20 | 142 | 557 | 88 | 230 | | 469 | |
| 30 | 217 | 497 | 88 | 305 | 324.5 | 409 | 413 |
| 30 | 256 | 505 | 88 | 344 | | 417 | |

*Negative distance indicates detection was marked after passage of augmentor.

6.4.2.3 Augmentor Range - Augmentor Range is defined as the sum of the detection and loss distances. Using the figures from Tables 6-19A through 6-19D for augmentor coverage, the augmentor range has been calculated and is shown in Table 6-20 for each elevation and speed. It can be seen that vehicle speed had no one particular effect upon augmentor range. The range values both increased and decreased slightly (from 1 to 60 feet) as speed increased. The ranges were grouped about their mean at each elevation as follows:

| <u>Elevation</u> | <u>Mean</u> | <u>Deviation Limits</u> |
|------------------|-------------|-------------------------|
| 10 ft | 123 ft | -5, + 8 ft |
| 15 ft | 113.5 | -13.5, + 17.5 |
| 20 ft | 697.8 | -38.8, + 43.2 |
| 30 ft | 747.3 | -47.3, + 43.7 |

The mean ranges are plotted in Figure 6-29. As Augmentor Elevation increased from the 10 to 15 foot elevation, only a slight decrease of 10 foot of range occurred. In going from 15 to 20 foot elevation a large increase in range of 584 feet was observed. Finally, in going from the 20 to 30 foot height, an increase of 50 foot in range was noted.

In summary, these results indicate at low elevations of 10 to 15 feet, small Augmentor ranges of less than 125 feet occur. At higher elevations to 30 feet large ranges of up to 750 feet occur, and at these elevations above 15 feet, increases in elevation cause large increases in range.

6.4.2.4 Augmentor Interference Tests - The results of the Augmentor Interference tests are given in Table 6-21 and Figure 6-30. From the data analyzed, interference between augmentors which can cause erroneous detections or non-detections occurred as the separation between augmentors was reduced to 100 feet. The number of incorrect detections at this distance was one out of four attempts. This situation worsened as the distance was further reduced to 50 feet. The incorrect detections in this case were observed to be three out of four attempts.

Table 6-19C. Augmentor Coverage Special Case Tests (Vehicle Speed Constant - 35 MPH)

| Augmentor Elevation (Ft) | Measured Distance | | Reaction Distance (Ft) | Actual Distance | | | |
|--------------------------|-------------------|-----------|------------------------|-------------------|-------|--------------|-------|
| | Detection (Ft) | Loss (Ft) | | Detection/Average | | Loss/Average | |
| | | | | (Ft) | (Ft) | (Ft) | (Ft) |
| 10 | 8 | 100 | 44 | 52 | 59 | 56 | 66.5 |
| 10 | 22 | 121 | 44 | 66 | | 77 | |
| 15 | 5 | 95 | 44 | 49 | 51.5 | 51 | 49 |
| 15 | 10 | 91 | 44 | 54 | | 47 | |
| 20 | 214 | 444 | 44 | 258 | 248.5 | 400 | 440.5 |
| 20 | 195 | 525 | 44 | 239 | | 481 | |
| 30 | 342 | 452 | 44 | 386 | 378 | 408 | 413 |
| 30 | 326 | 462 | 44 | 370 | | 418 | |

Table 6-19D. Augmentor Coverage Special Case Tests (Vehicle Speed Constant - 15 MPH)

| Augmentor Elevation (Ft) | Measured Distance | | Reaction Distance (Ft) | Actual Distance | | | |
|--------------------------|-------------------|-----------|------------------------|-------------------|------|--------------|------|
| | Detection (Ft) | Loss (Ft) | | Detection/Average | | Loss/Average | |
| | | | | (Ft) | (Ft) | (Ft) | (Ft) |
| 15 | 23 | 108 | 20 | 43 | 42 | 88 | 89 |
| 15 | 21 | 110 | 20 | 41 | | 90 | |

Table 6-19E. Augmentor Coverage Special Case Tests (Vehicle Speed Constant - 10 MPH)

| Augmentor Elevation (Ft) | Measured Distance | | Reaction Distance (Ft) | Actual Distance | | | |
|--------------------------|-------------------|-----------|------------------------|-------------------|-------|--------------|-------|
| | Detection (Ft) | Loss (Ft) | | Detection/Average | | Loss/Average | |
| | | | | (Ft) | (Ft) | (Ft) | (Ft) |
| 10 | 32 | 95 | 10 | 42 | 38 | 85 | 88 |
| 10 | 24 | 101 | 10 | 34 | | 91 | |
| 15 | 37 | 85 | 10 | 47 | 46 | 75 | 77.5 |
| 15 | 35 | 90 | 10 | 45 | | 80 | |
| 20 | 297 | 378 | 10 | 307 | 285.5 | 368 | 373.5 |
| 20 | 254 | 389 | 10 | 264 | | 379 | |
| 30 | 368 | 391 | 10 | 378 | 374.5 | 381 | 387 |
| 30 | 361 | 403 | 10 | 371 | | 393 | |

69-9

Table 6-20. Augmentor Range and Elevation

| AUGMENTOR ELEVATION (FT) | AUGMENTOR RANGE (FT) | | | | |
|--------------------------|----------------------|--------|--------|--------|--------|
| | 10 MPH | 15 MPH | 35 MPH | 55 MPH | 75 MPH |
| 10 | 126 | - | 125 | 118 | - |
| 15 | 123 | 131 | 100 | 100 | - |
| 20 | 659 | - | 688 | 741 | 703 |
| 30 | 761 | - | 791 | 737 | 700 |

T108992-1

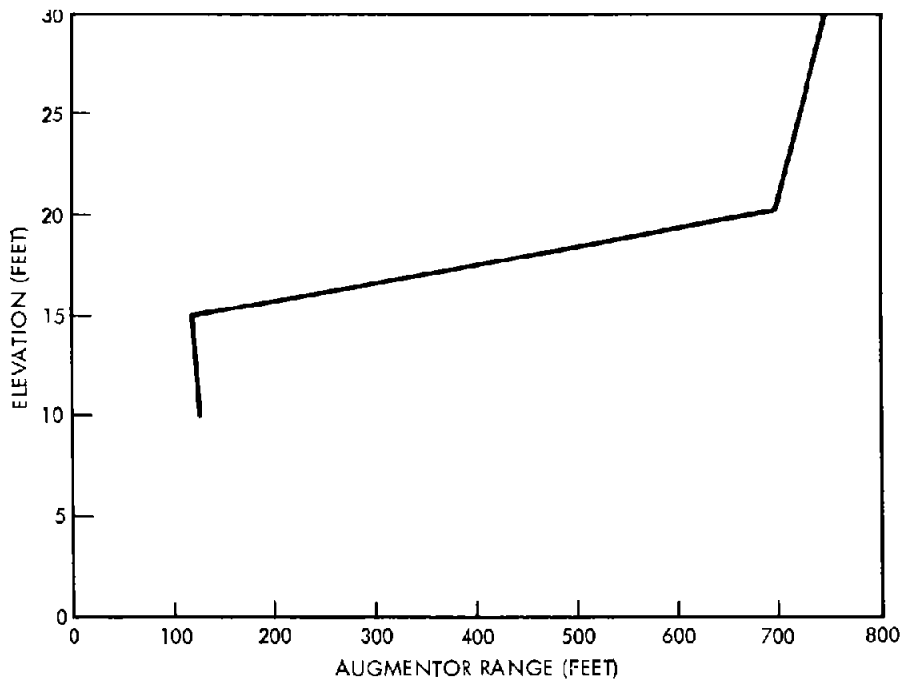

T108992-2

Figure 6-29. Augmentor Range Vs. Elevation

Table 6-21. Augmentor Interference Special Case Test

| Augmentor Separation (Ft) | Correct Detections (Number) | Cumulative Correct Detections |
|---------------------------|-----------------------------|-------------------------------|
| 200 | 4 | 4 |
| 150 | 4 | 8 |
| 100 | 3 | 11 |
| 50 | 1 | 12 |

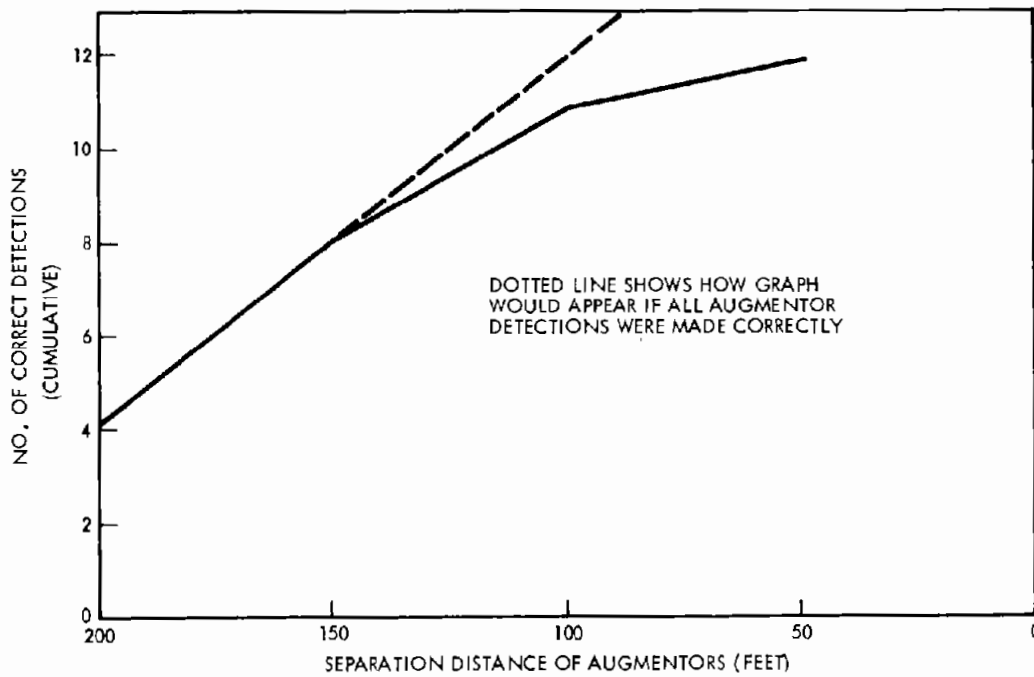

T108993

Figure 6-30. Augmentor Separation Distance vs. Number of Correct Detections (Cumulative)

6.4.2.5 Augmentor Detection in Traffic - In traffic the augmentor detection distance increased as the augmentor elevation increased. At a 10 foot elevation the detection distance was 205 feet and increased to 670 feet at a 28 foot elevation. Table 6-22 and Figures 6-31 show the results of the test.

At the 28 foot elevation, the 670 foot detection range may be invalid. Due to the geometry of the test course, as the test vehicle came around the corner of Juniper to JFK, the augmentor was immediately detected. The augmentor could not be located such that a greater distance between the augmentor and test vehicle could be obtained.

The loss distance in traffic showed an increase of 110 feet as the elevation was increased from the 10 to 15 foot level. From this elevation on up to 28 feet, the changes in the signal loss distance varied with both a slight decline in the distance (35 feet) at the 20 foot height and then a slight increase (15 feet) at the final 28 foot height.

In summary, the detection distance increased 470 feet as the augmentor elevation was raised 18 feet, and the loss distance increased 110 feet for a five foot increase in elevation up to a 15 foot height and then remained nearly constant as the elevation was raised 13 more feet.

6.4.2.6 Augmentor RFI Tests - The data from the Augmentor RFI tests is given in Table 6-23 and plotted in Figure 6-32. The 3 dB bandwidth (from data sheet) of the center frequency of 72.96 MHz was 350 Hz. Figure 6-32 shows the decrease in signal strength of the 72.96 MHz carrier as it was located farther and farther from the test vehicle. Signal loss occurred at 100 feet. The decrease in signal strength seemed to follow a curve of 0.25 dB/ft.

6.4.2.7 Augmentor Antenna Pattern Test - Figure 6-33 represents the antenna pattern of the test augmentor. Except for the ten foot elevation the antenna patterns appeared nearly symmetrical with no apparent lobes. At all elevations

TABLE 6-22

AUGMENTOR COVERAGE IN TRAFFIC
SPECIAL CASE TEST

| AUGMENTOR ELEVATION (FT) | DETECTION DISTANCE (FT) | AVERAGE DETECTION DISTANCE (FT) | LOSS DISTANCE (FT) | AVERAGE LOSS DISTANCE (FT) |
|--------------------------------|-------------------------------|--|--------------------------|-------------------------------------|
| 10 | 240 | <u>213.5</u> | 151 | <u>188</u> |
| 10 | 208 | | 171 | |
| 10 | 217 | | 217 | |
| 10 | 189 | | 213 | |
| 15 | 392 | <u>318.2</u> | 298 | <u>313</u> |
| 15 | 275 | | 392 | |
| 15 | 297 | | 302 | |
| 15 | 309 | | 260 | |
| 20 | 336 | <u>334.5</u> | 194 | <u>275.7</u> |
| 20 | 309 | | 357 | |
| 20 | 331 | | 292 | |
| 20 | 362 | | 260 | |
| 28 | *650 | <u>*672</u> | 268 | <u>287.2</u> |
| 28 | *689 | | 323 | |
| 28 | *655 | | 240 | |
| 28 | *694 | | 318 | |

* Augmentor received as it came into view around corner. Straight line distance to augmentor not long enough for good measurement.

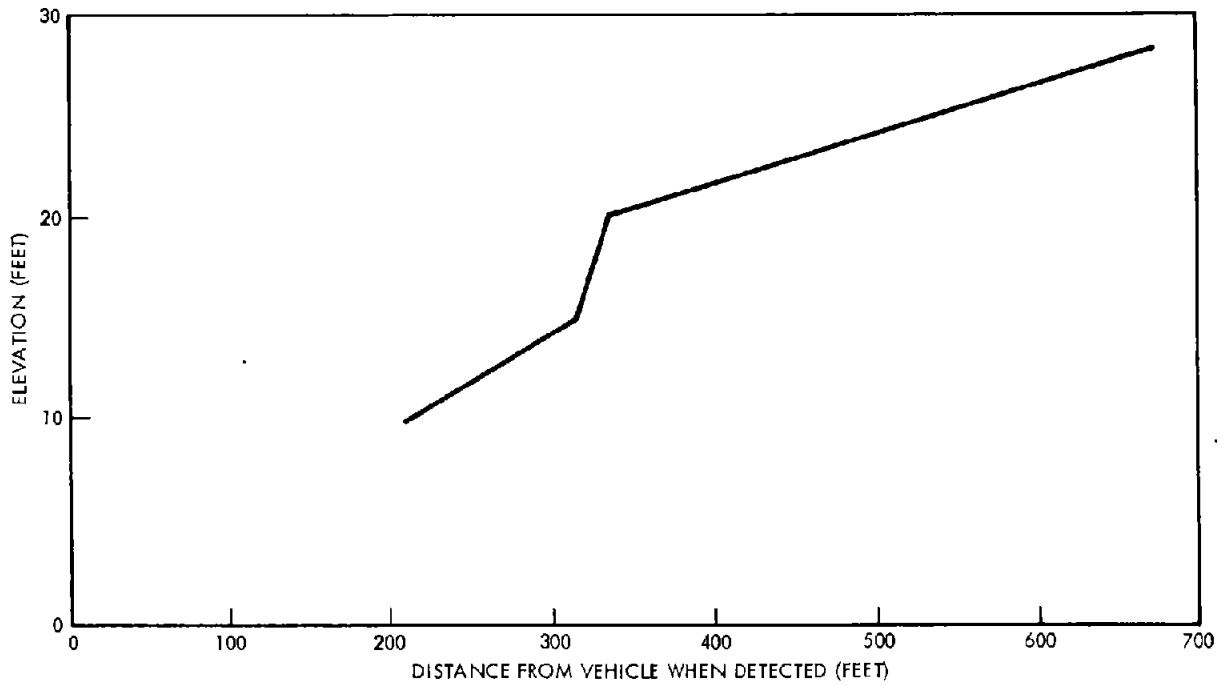

T108994-1

Figure 6-31A. Augmentor Detection Distance (In Traffic) Vs. Elevation

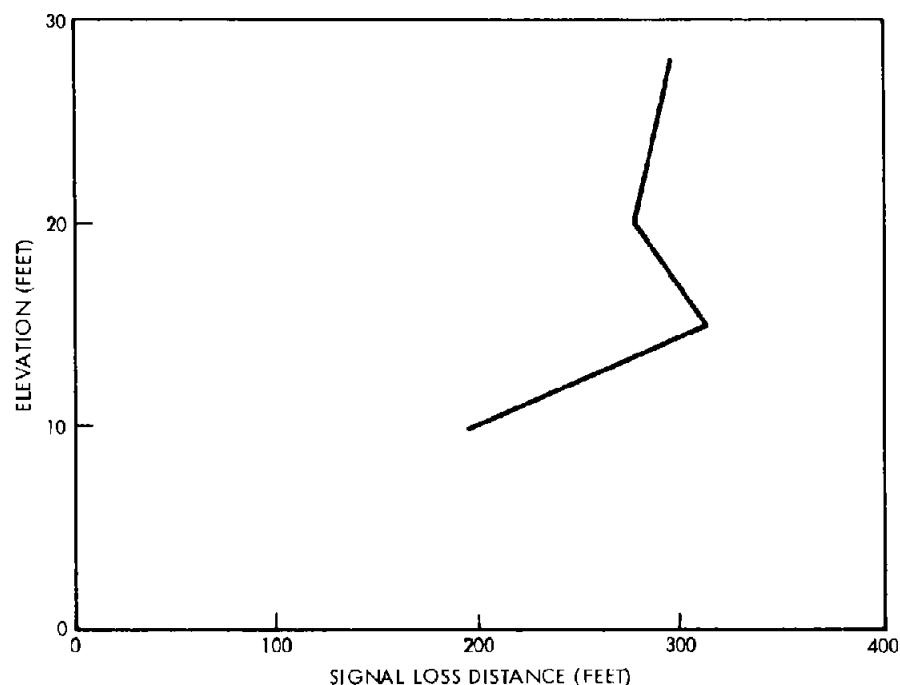

T108994-2

Figure 6-31B. Augmentor Signal Loss Distance (In Traffic) Vs. Elevation

TABLE 6-23

AUGMENTOR RFI TESTS

SPECIAL CASE TEST

| AUGMENTOR DISTANCE (FT) | CENTER FREQUENCY, 72.96 MHZ RELATIVE AMPLITUDE (Db) |
|-------------------------------|---|
| 10 | -36 |
| 20 | -40 |
| 30 | -54 |
| 40 | -50 |
| 50 | -57 |
| 60 | -58 |
| 70 | -58 |
| 80 | -62 |
| 90 | -60 |
| 100 | In ambient noise |

1. No measurable side bands
2. 3db bandwidth = 350 Hertz
3. Ambient noise = -70 db (with and without augmentor on)

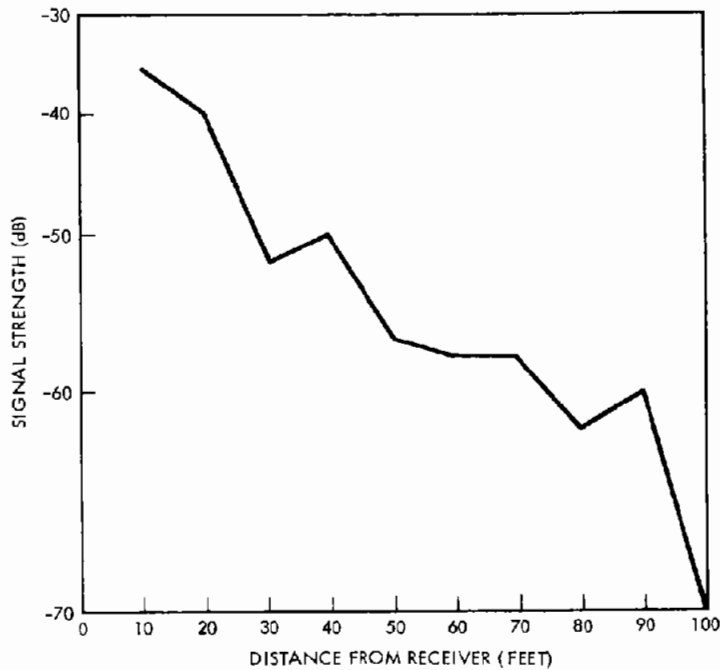

T108995

Figure 6-32. RFI Test - Augmentor Signal Strength versus Distance

(10', 15', and 20') the range increased with elevation (with the exception of one data point at the 20 feet elevation).

Maximum range was 180' at an elevation of 20'. Minimum range was 65' at an elevation of 10'.

6.5 FIXED ROUTE SNR ANALYSIS

An analysis of fixed route results was conducted to determine the effect of poor SNR on system accuracy. First, the portions of the fixed route with SNR below 0 dB were determined. Figure 6-34 shows sections of the fixed route which consistently exhibited SNR's of less than 0 dB. Most of the bad SNR sections are due to legitimate signal attenuation in high rise sections of the city. Other sources did contribute to apparent low SNR conditions such as bridge underpasses

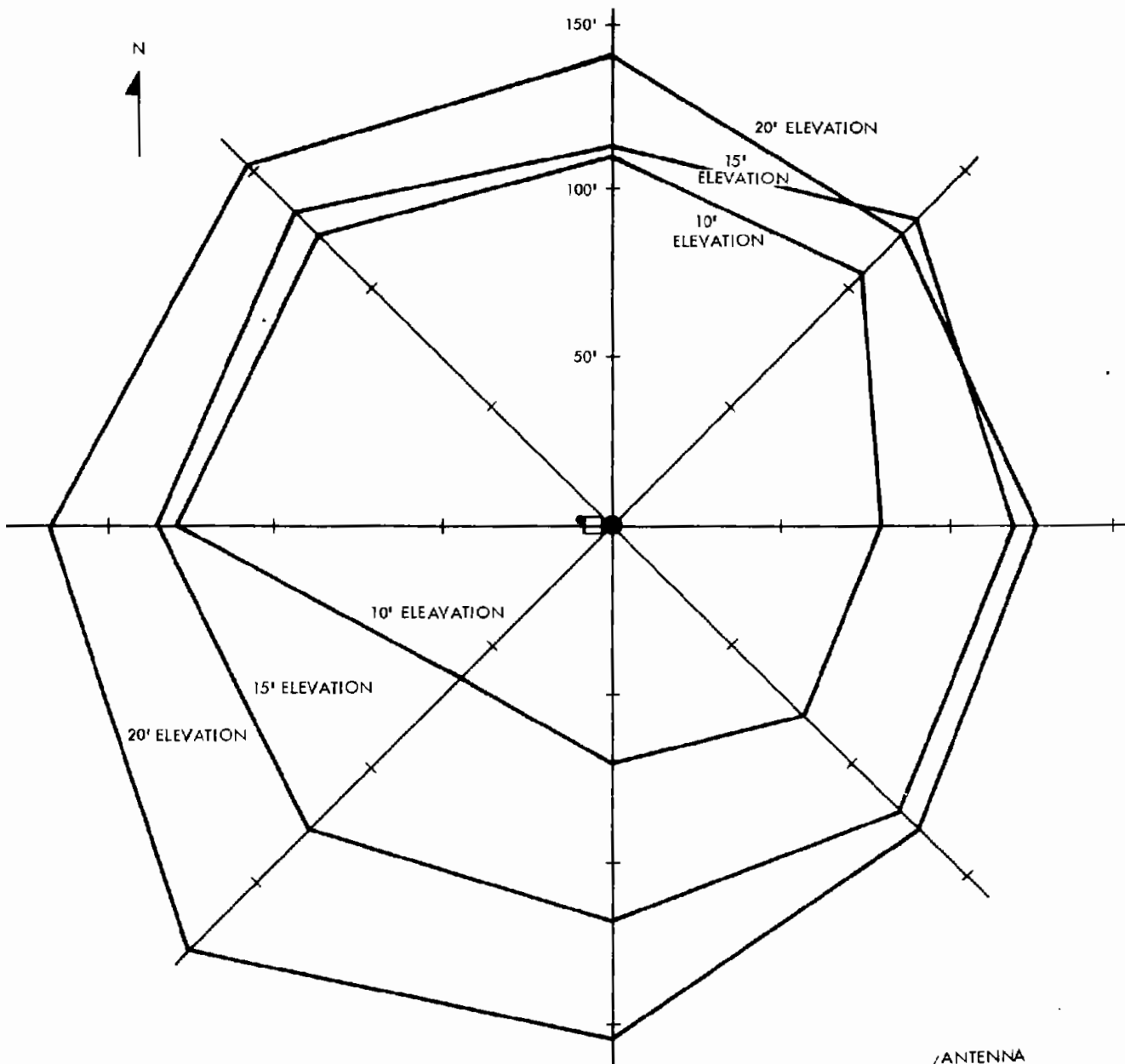

NOTE: AUGMENTOR POLE CONFIGURATION SHOWN

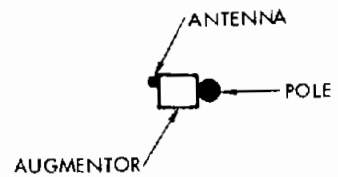

1/4" = 10 FT
 (ALL DISTANCES IN FEET)

T108996

Figure 6-33. Antenna Pattern Test - Elevation = 10 - 20 Ft.

Low SNR conditions are constant for each test run and tend to be repetitive. On the average, 21% of the fixed route test was run in low SNR area. To determine the errors for good and bad SNR measurements, 13 checkpoints were selected which consistently fell in bad SNR areas. These points and the error measured at each one by test run number are listed in Table 6-24. In a similar manner, 11 points in consistently good SNR areas were examined. These points and the errors measured for each run are given in Table 6-25. Of course errors are recorded in both sets which are independent of the AVM System. Some errors recorded on test 10013, for example, are artificial in that the source was not the system being tested but support equipment used for data instrumentation. See paragraph 6.1 for a complete explanation of these problems.

At the bottom of each column in Tables 6-24 and 6-25, the mean is calculated using all data and again with erroneous data omitted. Finally, the mean of all means is calculated. Comparing good and bad SNR error figures shows the bad SNR errors slightly better than the good SNR errors. This is due to the fact that location calculations along the route are not independent but part of a continuous tracking algorithm. In addition, utilization of the odometer information when bad SNR indications are recorded improves performance. LORAN quality indications (TDA, TDB VALID FLAGS) are contained in the data and prevent the system from performing location calculations based upon poor LORAN information. The simplest conclusion provided by this analysis is that SNR alone is not necessarily a good index of AVM System accuracy.

Another analysis of fixed route errors was conducted in relation to SNR and LORAN signal quality. Errors recorded on daylight tests were compared with night time test errors. To present clear results, only results from tests 10026 through 10047 were used. Histograms in Figures 6-35 and 6-36 show the errors for day and night. Figure 6-37 is a cumulative error plot for both data sets which clearly shows a slight superiority in the night data. While there is generally an

6-79

■ SNR ≤ 6dB

T108794.2

Figure 6-34. Test Area Street Map

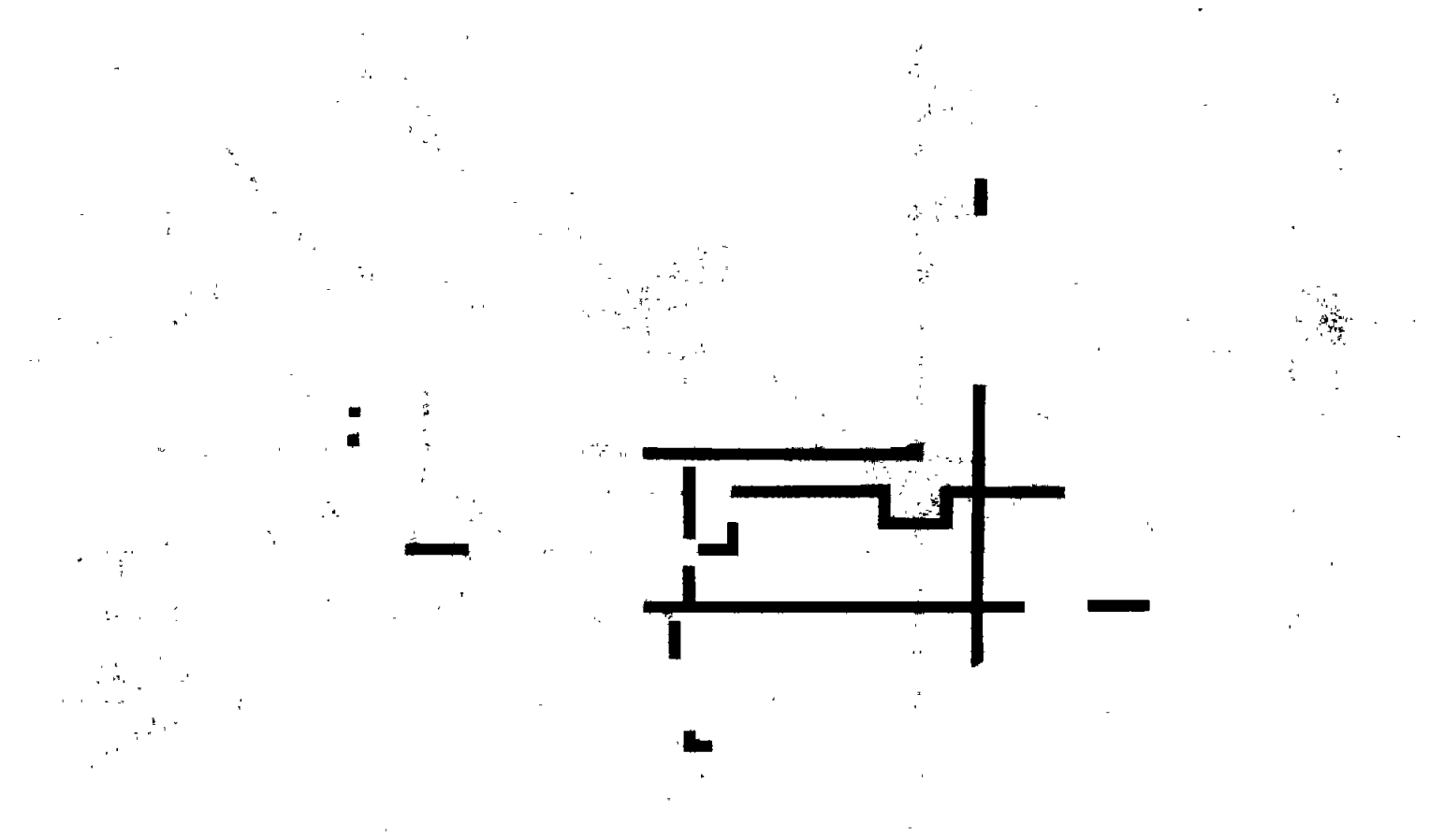

Table 6-24. Bad SNR Error Analysis

| Run | Ckpt 7 | Ckpt 10 | Ckpt 11 | Ckpt 34 | Ckpt 35 | Ckpt 53 | Ckpt 55 | Ckpt 57 | Ckpt 61 | Ckpt 104 | Ckpt 131 | Ckpt 156 | Ckpt 160 |
|------------------------------------|-----------|------------|------------|------------|------------|------------|------------|------------|------------|-------------|-------------|-------------|-------------|
| 10012 | 10 | 9 | 10 | 59 | 121 | 40 | 32 | 21 | 951 | 102 | 235 | 26 | 47 |
| 10013 | 10 | 3 | 45 | 52 | 36 | 5,095,985 | 5,095,979 | 5,095,974 | 4,914,442 | 43 | 196 | 130 | 38 |
| 10014 | 70 | 61 | 59 | 9 | 83 | 39 | 30 | - | 121 | 48 | 116 | 160 | 25 |
| 10015 | 40 | 44 | 25 | 6 | 92 | 42 | 51 | 29 | 83 | 28 | 133 | 153 | 54 |
| 10016 | 845 | 1058 | 1285 | 1064 | 1218 | 660 | 1163 | 1553 | 269 | 7002 | 2233 | 1107 | - |
| 10017 | 906 | 1126 | 1363 | 1379 | 1553 | 751 | 1293 | 1748 | 322 | 1059 | 2214 | 546 | - |
| 10020 | 45 | 30 | 29 | 29 | 100 | 75 | 74 | 64 | 68 | 48 | 125 | 72 | 6 |
| 10021 | 8 | 11 | 27 | 67 | 129 | 119 | 133 | 105 | 24 | 61 | 134 | 221 | - |
| 10022 | 49 | 36 | 60 | 8428 | 9084 | 46 | 52 | 38 | 21 | 68 | 131 | 83 | 18 |
| 10023 | 201 | 199 | 139 | 39 | 90 | 67 | 82 | 68 | 79 | 104 | 106 | 115 | 16 |
| 10024 | 854 | 1079 | 1298 | 1220 | 1335 | 741 | 1043 | 1157 | 115 | 10 | 69 | 130 | 21 |
| 10025 | 76 | 77 | 67 | 5 | 81 | 178 | 180 | 163 | 13 | 37 | 110 | 125 | 10 |
| 10026 | 146 | 149 | 161 | 77 | 163 | 187 | 190 | 210 | 308 | 140 | 8 | 210 | 179 |
| 10027 | 226 | 207 | 196 | 81 | 176 | 298 | 287 | 304 | 272 | 15 | 72 | 21 | 247 |
| 10030 | 275 | 263 | 270 | 45 | 135 | 208 | 209 | 237 | 290 | 139 | 62 | 11,362 | 10,686 |
| 10031 | 145 | 177 | 164 | 16 | 72 | 198 | 190 | 226 | 261 | 24 | 27 | 217 | 198 |
| 10032 | 224 | 233 | 201 | 259 | 337 | 178 | 183 | 215 | 302 | 214 | 34 | 19 | 191 |
| 10033 | 41 | 73 | 95 | 20 | 60 | 106 | 94 | 122 | 291 | 12 | 32 | 63 | 207 |
| 10034 | 63 | 57 | 38 | 26 | 34 | 178 | 175 | 190 | 293 | 68 | 102 | 135 | 125 |
| 10035 | 110 | 87 | 47 | 44 | 12 | 45 | 30 | 23 | 83 | 110 | 137 | 54 | 3 |
| 10036 | 113 | 69 | 115 | 55 | 14 | 87 | 122 | 83 | 20 | 40 | 105 | 182 | 51 |
| 10037 | 84 | 113 | 137 | 185 | 289 | 81 | 95 | 68 | 85 | 11 | 166 | 72 | 45 |
| 10040 | 57 | 38 | 45 | 243 | 337 | 116 | 133 | 107 | 152 | 192 | 138 | 120 | 39 |
| 10041 | 50 | 75 | 40 | 6 | 106 | 55 | 20 | 6 | 77 | 64 | 140 | 49 | 64 |
| 10042 | 31 | 18 | 27 | 29 | 76 | 73 | 70 | 61 | 60 | 68 | 96 | 20 | 52 |
| 10043 | 21 | 24 | 22 | 60 | 39 | 4 | 5 | 14 | 66 | 54 | 144 | 42 | 51 |
| 10044 | 115 | 103 | 118 | 28 | 56 | 113 | 116 | 85 | 97 | 69 | 104 | 96 | 69 |
| 10045 | 64 | 77 | 75 | 63 | 123 | 108 | 89 | 68 | 111 | 70 | 130 | 75 | 50 |
| 10046 | 46 | 47 | 29 | 135 | 204 | 4 | 25 | 14 | 101 | 60 | 24 | 33 | 58 |
| 10047 | 31 | 15 | 26 | 40 | 121 | 23 | 27 | 51 | 37 | 27 | 163 | 80 | 59 |
| Mean (All Data) | 165 | 185 | 210 | 459 | 543 | 170,026 | 170,072 | 175,966 | 163,980 | 335 | 250 | 524 | 467 |
| Mean (Bad Data Omitted) | 87 | 85 | 38 | 65 | 119 | 126 | 104 | 103 | 144 | 69 | 109 | 100 | 74 |
| Mean Mean - 52,552' (All Data) | | | | | | | | | | | | | |
| Mean Mean - 98' (Bad Data Omitted) | | | | | | | | | | | | | |

08-9

Table 6-25. Good SNR Error Analysis

| Run | Ckpt 21 | Ckpt 22 | Ckpt 23 | Ckpt 44 | Ckpt 113 | Ckpt 114 | Ckpt 116 | Ckpt 143 | Ckpt 144 | Ckpt 145 | Ckpt 147 |
|-------------------------------------|------------|------------|------------|------------|-------------|-------------|-------------|-------------|-------------|-------------|-------------|
| 10012 | - | 262 | 340 | 271 | 34 | 26 | 4 | 118 | 140 | 42 | 25 |
| 10013 | 43 | 90 | 178 | 5,222,106 | 136 | 27 | 39 | 173 | 191 | 79 | 63 |
| 10014 | 215 | - | 279 | 185 | 90 | 18 | 120 | 97 | 4 | 26 | 92 |
| 10015 | 35 | 29 | 132 | 211 | 237 | 148 | 16 | 110 | 1 | 62 | 18 |
| 10016 | 324 | 471 | 486 | 809 | 10,506 | 10,568 | 10,781 | 1635 | 2127 | 450 | 978 |
| 10017 | 3256 | 1603 | 753 | 1058 | 929 | 833 | 1460 | 1634 | 2118 | 2561 | 2991 |
| 10020 | 96 | 145 | 214 | 136 | 305 | 172 | 32 | 165 | 220 | 88 | 48 |
| 10024 | 1229 | 364 | 1159 | 552 | 239 | 235 | 54 | 81 | 61 | 44 | 55 |
| 10022 | 6677 | 6775 | 6860 | 427 | 176 | 116 | 8 | 95 | 80 | 16 | 6 |
| 10023 | 43 | 161 | 283 | 327 | 202 | 139 | 116 | 225 | 46 | 199 | 98 |
| 10021 | 79 | 152 | 243 | 32 | 279 | 144 | 39 | 146 | 45 | 9 | 41 |
| 10025 | 94 | 126 | 180 | 120 | 43 | 43 | 84 | 37 | 128 | 57 | 63 |
| 10026 | 116 | 157 | 210 | 51 | 272 | 192 | 153 | 84 | 95 | 144 | 117 |
| 10027 | 294 | 413 | 408 | 135 | 182 | 131 | 83 | 73 | 152 | 150 | 103 |
| 10030 | 258 | 301 | 268 | 16 | 230 | 171 | 155 | 24 | 54 | 77 | 0 |
| 10031 | 258 | 262 | 276 | 147 | 273 | 288 | 142 | 130 | 178 | 111 | 117 |
| 10032 | 258 | 298 | 263 | 103 | 136 | 101 | 5 | 125 | 169 | 151 | 115 |
| 10033 | 171 | 180 | 219 | 227 | 185 | 70 | 22 | 126 | 157 | 239 | 96 |
| 10034 | 111 | 148 | 176 | 38 | 212 | 148 | 64 | 142 | 152 | 144 | 130 |
| 10035 | 46 | 110 | 174 | 76 | 84 | 9 | 91 | 25 | 79 | 161 | 186 |
| 10036 | 32 | 74 | 134 | 121 | 288 | 282 | 209 | 409 | 1113 | 311 | 341 |
| 10037 | 99 | 113 | 212 | 189 | 307 | 200 | 31 | 149 | 26 | 29 | 108 |
| 10040 | 1 | 86 | 169 | 70 | 312 | - | 67 | 77 | 13 | 7 | 54 |
| 10041 | 26 | 28 | 66 | 206 | 53 | 2 | 4 | 85 | 29 | 7 | 8 |
| 10042 | 115 | 177 | 216 | 108 | 267 | 161 | 197 | 86 | 124 | 91 | 38 |
| 10043 | 78 | 130 | 174 | 210 | 308 | 306 | 187 | 134 | 14 | 43 | 34 |
| 10044 | 50 | 69 | 156 | 86 | 165 | 92 | 22 | 61 | 25 | 12 | 100 |
| 10045 | 117 | 123 | 188 | 38 | 287 | 172 | 68 | 18 | 97 | 24 | 29 |
| 10046 | 21 | 97 | 138 | 9 | 302 | 294 | 181 | 44 | 130 | 22 | 20 |
| 10047 | 39 | 104 | 104 | 9 | 301 | 284 | 236 | 68 | 19 | 26 | 73 |
| Mean (All Data) | 489 | 450 | 489 | 174,269 | 578 | 530 | 489 | 213 | 260 | 169 | 205 |
| Mean (Bad Data Omitted) | 116 | 173 | 218 | 125 | 211 | 147 | 87 | 111 | 90 | 85 | 78 |
| Mean Mean - 16,195' (All Data) | | | | | | | | | | | |
| Mean Mean - 131' (Bad Data Omitted) | | | | | | | | | | | |

6-81

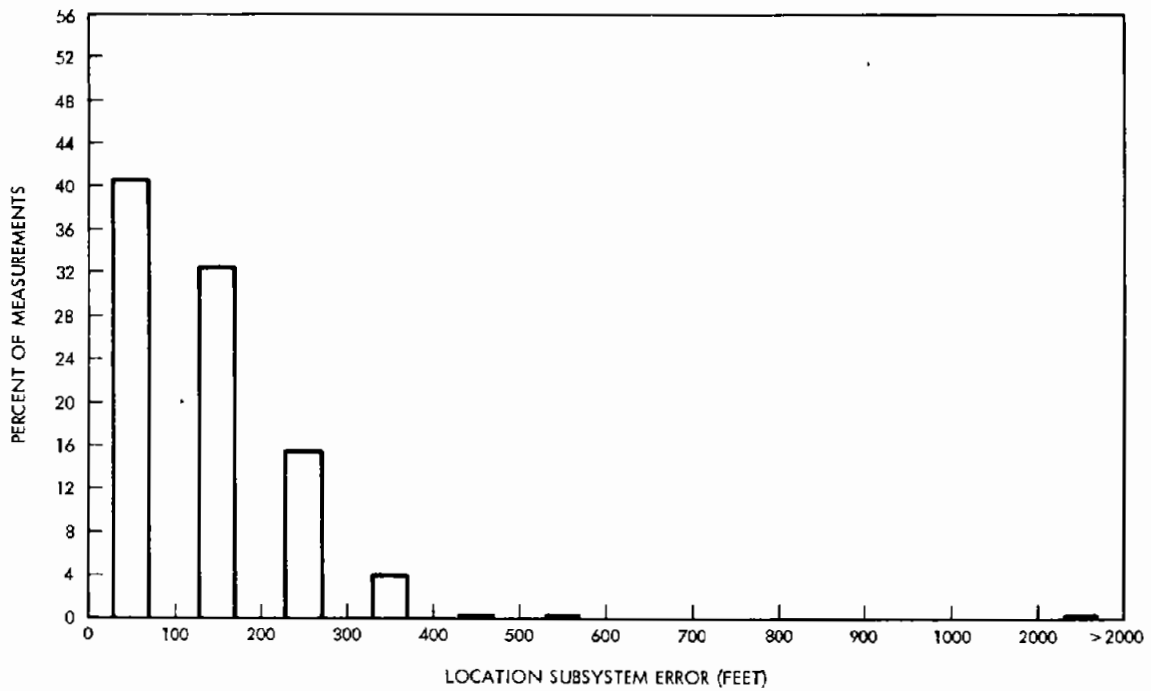

T109208

Figure 6-35. Location Subsystem Daytime Accuracy
(Fixed Route Tests #10026 - 10047)

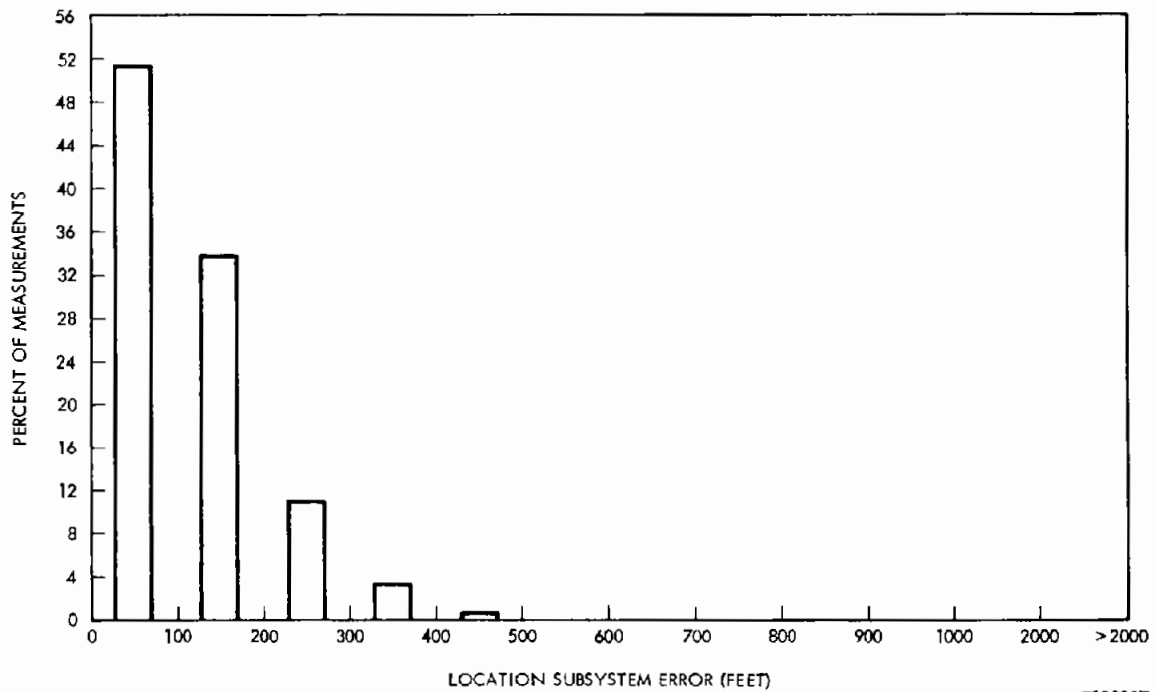

T109207

Figure 6-36. Location Subsystem Nighttime Accuracy
(Fixed Route Tests #10026 - 10047)

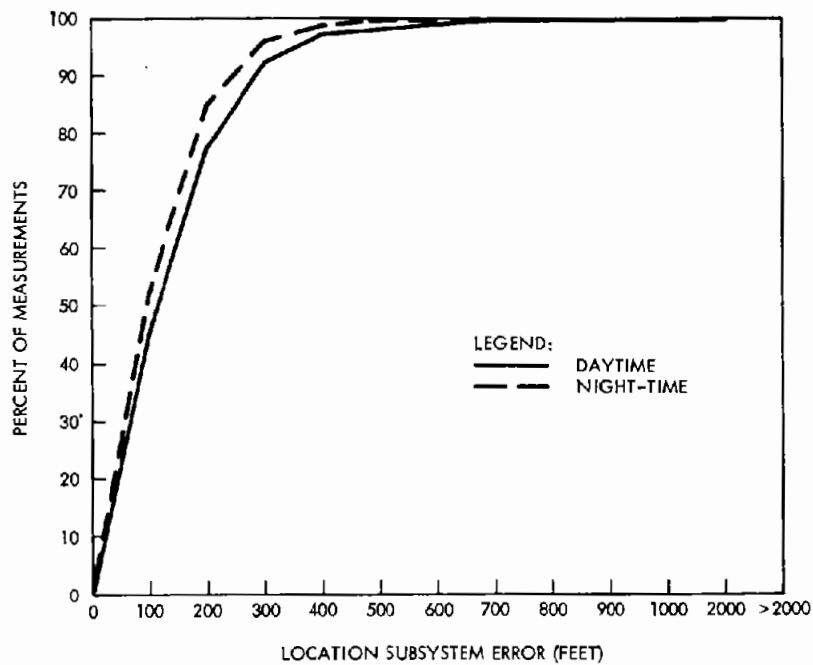

Figure 6-37. Fixed Route Cumulative Error By Time of Day

improvement in signal conditions in the 80 - 120 kHz band after sunset, a much more realistic explanation of the improvement is a decrease in local noise and interference sources as the activity in the city slows down at the end of the day. In band interference is a major source of LORAN errors because it contaminates the LORAN measurements without triggering low SNR indicators. After dark, many such interference sources such as business electrical equipment, spurious radio transmissions, and high voltage power transmission slow down or cease.

6.6 LONG TERM LORAN STABILITY

The Phase I tests offer a unique opportunity to examine changes in time difference measurements over a long (5 years) period. Teledyne Systems Company has been conducting Loran Sensor Tests in Philadelphia since 1971 when the U. S. Department of Transportation, Urban Mass Transit Administration sponsored one of the first test programs. Teledyne participated in this program and is therefor able to compare data recorded at certain locations over this period.

Only calibration data can be compared as opposed to test data. Calibration data represents a relatively stable short term (1 minute) mean since calibration time differences are always an average of from 10-100 consecutive samples. Test data on the other hand, is typically a 'snap shot', one-time measurement subject to vibrations due to jitter. In addition, it is usually difficult to determine exactly where a test measurement was taken since the vehicle containing the LORAN Receiver is usually in motion when recording data.

The 1971 test program used standard LORAN transmitters at Carolina Beach (Master), Nantucket Island (Slave A) and Dana, Indiana (Slave B). In 1977, a local ministation was used in place of the Dana Slave. Therefor, only one time difference (master-Nantucket) is common to both tests.

A comparison of calibration data from the two programs shows three common points. These three points with the time differences measured are given in Table 6-26.

The significant information in the table is that the change in time difference appears to be systematic and fairly constant. All three time differences moved in the same direction by an amount differing a maximum of 232 nanoseconds. This is significant because any systematic time difference grid pertubations will affect the base station monitor receiver in an identical manner. The monitor receiver feeds continuous corrections into the position processing computer which will negate any affect on system accuracy that TD grid shifts would otherwise have.

Table 6-26. Comparison of 1971 and 1976 TD Measurements

| Location | Master-Nantucket TD (μsec) | | ΔTD (μsec) |
|------------------|---|------------|---------------------------------------|
| | 1971 | 1976 | |
| 1 Broad - Arch | 51,751.348 | 51,750.620 | -0.728 |
| 2 18th - Spruce | 51,757.604 | 51,757.057 | -0.547 |
| 3 16th - Lombard | 51,757.838 | 51,757.059 | -0.779 |

6.7 SUMMARY AND CONCLUSIONS

The Phase I program contained many different types of tests and analyses for the purpose of providing a thorough evaluation of the LORAN AVM system. System and subsystem accuracy were measured for fixed and random route vehicles. Time of passage, area coverage, and performance in unusual locations were measured in addition to a battery of system component evaluation tests. The results of such a test program are necessarily voluminous. This section will summarize the results of the various tests and draw the resultant conclusions. Detailed Data are presented in the appendices.

6.7.1 Fixed Route Tests

Ten fixed route tests were run in December of 1976 after which testing was suspended to correct a repetitive augmentor malfunction. During the test suspension, the fixed route was extended. Thirty extended fixed route tests were run in January and February of 1976. During the first twelve of these test the motor-generator periodically malfunctioned, contaminating much of the data. The last twelve fixed route runs were made with no instrumentation-system problems and yield conclusive evidence that the LORAN AVM is an operational vehicle location system capable of meeting Department of Transportation requirements. System shortcomings which were noted have been thoroughly analyzed with corrective action described and satisfactorily demonstrated on the actual test data.

6.7.2 Random Route Tests

The tests showed the system capable of locating a random route vehicle within 472.94 feet 95% of the time. Methods for improving system accuracy have been presented and analyzed. It is not unreasonable to expect that incorporation of some or all of the techniques described will allow the system to meet the 300 feet 95% requirement.

6.7.3 Special Case Tests

Many special case tests were run to determine component characteristics independent of the AVM system. The results of these tests will be valuable in the Phase II implementation. Other special case tests demonstrated that the system operates reliably in unusual location such as the Ben Franklin Bridge. The "LORAN Only" special case test showed that the system is capable of providing the specified accuracy in a low rise area without benefit of any augmentors.

6.7.4 Conclusions

The LORAN AVM system has demonstrated its ability to meet fixed route accuracy requirements. A method for meeting the time of passage and random route accuracy has been presented. All this has been accomplished in an environment far less benign in every way than the Phase II city. Extreme environmental conditions and prototype equipment uncertainties did not prevent the system from demonstrating a real capability consistent with the Phase I test objectives.

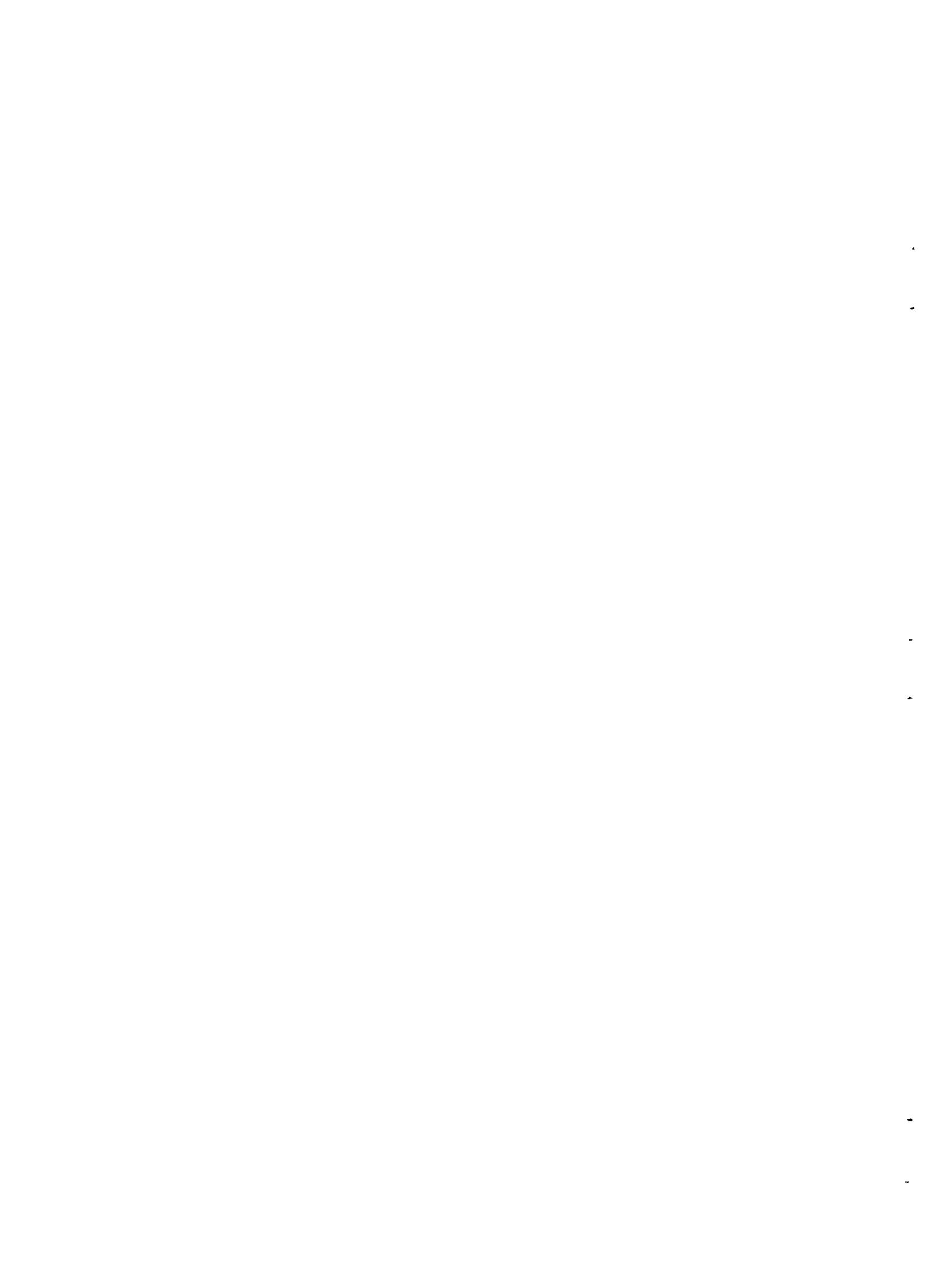

SECTION 7

DESIGN CHANGES REQUIRED TO MEET PHASE II REQUIREMENTS

7.1 INTRODUCTION

Teledyne's AVM system has been in development since 1970. The system has been improved continuously to especially meet as many user requirements as possible. And indeed, user AVM requirements have been continuously changing as it has been possible to adapt AVM into more facets of overall vehicle deployment. Since Teledyne has continued to strive for the best combination of system simplicity and system performance, some of the equipment and software algorithms were used for the first time during the Phase I tests described in this report. During the data reduction effort following these tests, several location subsystem improvements became obvious. These improvements primarily enhance system performance and reliability, at very little additional cost.

Briefly, these improvements are grouped according to location subsystem type.

Fixed Route

- a. Improve time-of-passage (T. O. P.) estimate by incorporating a door closing switch and odometer in the T. O. P. algorithm.
- b. Reduce system costs by not using Augmentors at every Timing Point in good LORAN coverage.
- c. Modify the software algorithm to always use Augmentor detections.
- d. Incorporate reasonableness checks between position reports to detect odometer and LORAN coordinate anomalies.

Random Route

- a. Software algorithm improvements to enhance determination of direction of travel.
- b. Position reasonableness checks between position reports to prevent inordinate jumps in estimated vehicle position.

- c. Evaluation and possible incorporation of a vehicle turn sensor using differential odometers.

System performance improvements will also be realized in the Los Angeles system due to the very strong signal-to-noise ratios compared to those estimated at the time of the proposal. The sections following discuss each of these system improvements.

7.2 FIXED ROUTE LOCATION SUBSYSTEM IMPROVEMENTS

Improvements in the time-of-passage concept and position algorithm to prevent unreasonably large position offsets have resulted from the Phase I tests and subsequent data reductions.

7.2.1 Time of Passage Improvements

7.2.1.1 Phase I Time of Passage Error Analysis - An examination of the source of time of passage errors in the Phase I tests reveals that they were highly dependent on 'dead time' or the time the test vehicle stopped at the time point. For example, at the 224 time points passed where the vehicle did not stop, the error at the 95th percentile was 8 seconds and at the 99.5th was 16 seconds. Overall test accuracy was reduced by the 39 second 95% error recorded at time points where the test vehicle stopped. The source of large errors at stop time points in each case was the following sequence; the time flag (system estimation of time of passage, see Section 4.7) is set just before the vehicle stops at the time point. All the time spent stopped is accrued against the system since vehicle departure from the time point is the criteria for error measurement. Utilization of additional available information will make a dramatic improvement in time of passage accuracy.

7.2.1.2 Phase II Time of Passage Mechanization - The two additional sources of information which can be used by the system to improve time of passage accuracy are the odometer and the state (open, closed) of the vehicle doors. Dead time can clearly be removed if the system sees that the vehicle is (a) at, or very near a time point and (b) is not moving (odometer change is zero). The same two pieces of information will allow the system to also make an accurate estimate of

time of arrival as well as departure. The Phase II mechanization will operate in the following manner:

- a. The augmentor will be located 50 feet ahead of the time point insuring that the time flag in the vehicle equipment is set prior to arrival at the time point.
- b. The next 100 feet of vehicle travel is monitored to see if the odometer stops and/or if the doors open.
- c. If the odometer does not stop in this interval, time of passage is recorded at the instant the system detects that the vehicle has passed a point 50 feet after augmentor detection. Phase I results show that the errors under these conditions will be 8 seconds 95%, 16 seconds 99.5%.
- d. If the vehicle does stop during this interval, the instant the odometer goes to zero is stored and sent back at the next polling time as 'time of arrival'.
- e. When the doors close and the vehicle begins to move, the time is stored and duly reported as 'time of departure'.

This method makes optimum usage of the information available. An interesting option available for Phase II is the augmentor-less time of passage (T.O.P.) mechanization.

7.2.1.3 Optional Phase II T.O.P. Mechanization - Examination of the scheme described above shows that the precise T.O.P. information is derived from the odometer and the door sensor, the augmentor is used only to bound the area in which the odometer and door sensor outputs are monitored. More precisely, the augmentor is only used to indicate approach to the time point location. This information is already resident in the system computer since it is tracking the vehicle with each 32.4 second polling update. All the system requires in addition to the information it already has is (1) did the odometer stop in the last polling interval (if so, at what time) and (2) did the odometer start during the last polling

interval (if so, at what time). Inclusion of door open/closed data can be used to confirm and insure that the vehicle truly stopped if the odometer so indicates. Since time points are typically one mile or more apart there is little chance of ambiguity. The obvious advantage of this T.O.P. method is the deletion of all augmentors on fixed route lines in Phase II.

7.2.2 Fixed Route Algorithm Improvements

7.2.2.1 Phase I Fixed Route Error Analysis - Extremely large errors of more than 5 million feet on Run 10013 has been analyzed carefully. These large errors have been shown to be the result of a low voltage ac generator condition causing errors in the odometer. The location subsystem recovered these large error excursions after approximately 20 fixed polling reporting intervals. Three augmentors were passed during the period of time these large errors occurred. The system recovered to normal errors when the LORAN receiver reacquired signals and a "valid" augmentor was passed.

The algorithm had been designed to make a reasonableness check each time an Augmentor was detected. The position derived from the Augmentor detection was compared with the LORAN plotted position. If the LORAN position was greater than 500 feet from the Augmentor position, the algorithm assumed that this was a false Augmentor detection and ignored it. This portion of the Algorithm was added when the Augmentors were operating unreliably due to cold weather. The Augmentors were subsequently modified, and not a single false augmentor detection was made throughout the 30 Fixed Route and 5 Random Route runs.

7.2.2.2 Phase II Fixed Route Algorithm Improvement - Since false Augmentor detections have been demonstrated to occur very rarely if at all in a properly operating system, the Phase II system will not use the reasonableness check described above. If this had been done during Phase I, the first Augmentor detected after the large error was recorded would have accurately reset the vehicle position to the correct position on the route.

The large position excursions experienced in the first runs of Phase I were induced by noise caused by a faulty generator loading large odometer numbers into the odometer register. Sometimes this noise caused several hundred feet to be injected into the register in a one second update period. This observation suggests that a reasonableness check on the vehicle odometer between position reports could be useful. Teledyne will incorporate a simple test into system software which compares the odometer distance between position reports. If the reported distance exceeds a pre-determined reasonable value, it will not be used in updating vehicle position. The LORAN measurement will be used without odometer smoothing in this case.

7.3 RANDOM ROUTE LOCATION SUBSYSTEM IMPROVEMENTS

The Phase I data analysis results showed an accuracy of 691 feet at the 95th percentile. This was shown to be improved to 458 feet by simple software modifications to use more LORAN data and to improve position projection onto a street more accurately. These improvements are described below.

7.3.1 Software Algorithm Improvements

7.3.1.1 Phase I Random Route Error Analysis - When analyzing the system simulation test results from Phase I, it was evident that the original algorithm needed improvement in determining direction of vehicle travel. The algorithm tested determined direction of travel by assuming a straight line through the previous two position reports. This simple algorithm did not take maximum advantage of the good LORAN data to determine good position and direction of travel. Augmentor detections were also not used to maximum advantage because street projected position was allowed on streets other than those in which the Augmentor was located. Good LORAN position was also tossed out by the tested algorithm due to a reasonableness check that was referenced to poor position updates. The paragraphs below describe the modifications.

7.3.1.2 Phase II Improvement - In the original random route software a reasonability check was imposed which required that the computed absolute difference between the LORAN converted coordinates and the measured odo

distance over the last interval be less than twice the measured odo distance before the LORAN coordinates were used in the update. It was found that this rule tended to prevent a position update in cases where there were several consecutive reports with invalid LORAN. This was because with invalid LORAN, no new LORAN coordinates were computed in spite of the fact that the odometer indicated that the vehicle had moved. To correct this a simple change was made to the LORAN reasonability test so that the odo was accumulated from the last point at which the LORAN was both valid and passed the odo reasonability test. That is, at any point where LORAN was valid, the new reasonability test computes the radial distance from the converted LORAN point to the last computed system position where LORAN was used. If this distance does not exceed twice the accumulated odo, then the converted LORAN coordinates are used in the position update.

It was also observed in intervals where an augmentor was detected, that big errors were sometimes incurred by using two point dead reckoning and projecting down onto the closest street. Considerable improvement could be made in these cases by another simple change, namely by projecting down only on one of the two streets that the augmentor is known to lie upon. This change was also implemented to yield the results labeled "improved software" random route runs.

Hindsight has revealed that the random route software could have been strengthened by making greater use of the available odometer information which proved to be quite reliable. There are cases where consecutive computed vehicle positions are separated by distanced considerably greater than the measured odo. Simple changes can be made to the existing random route software to ensure that this doesn't occur. Perhaps a more serious short coming was failure to make use of known directivity of streets. Intelligent use of this information would have been very useful in resolving position ambiguities.

In an effort to strengthen the random route software a subroutine called GROPE has been developed. It has the feature that successive reported vehicle positions are always separated by a street map distance equal to the accumulated odometer. It makes a much greater use of the stored street map information and automatically gives a higher weighting to the odometer information with a resultant damping of the LORAN data. The present intent is to use the available Phase I random

route data base and to experiment with GROPE, the incorporation of street directivity information and the incorporation of some of the aforementioned reasonability tests to obtain an optimized version of the random route software for Phase II.

7.3.2 Random Route Differential Odometer

Teledyne installed odometer pickoffs on the Test Vehicle for the Phase I tests, to assure that these tests used the same odometer proposed in Phase II. The odometer pickoff works on the magnetic hall-effect principle, with a simple sensor unit mounted on each front wheel. This design proved flawless during the Philadelphia tests and will be used in Phase II. (Note - odometer register problems experienced during the first portion of the Fixed Route tests were due to a faulty ac generator).

During the Phase I tests the two front wheel odo sensors were sent to one register in the vehicle equipment for accumulation. The register was scaled properly since it was being updated from two odometers. The effect of vehicle turns were averaged out in this register.

For no cost or other system impact, the two odo pickoff data could be accumulated in two smaller registers simultaneously and included in the position report to the Base Station. The software would be modified to average these two smaller odo numbers to determine vehicle distance for each reporting interval, and the computer would calculate the difference between the odo numbers to determine if a turn was made during the reporting interval. The direction of turn could also be determined.

This concept offers another improvement to the Phase II Random Route software at no cost. The additional information of turn and direction for each reporting interval will enhance the performance. This investigation will be coincident with the testing of the GROPE software.

7.4 IMPLICATIONS OF LOS ANGELES LORAN SIGNAL QUALITY

7.4.1 Introduction

Prior to installation of the West Coast LORAN C chain, signal strength and signal-to-noise ratio estimates were prepared for the Los Angeles Phase II area. With the chain now operating on a continuous basis, actual measurements have been made in the area. Implications of these measurements on system performance and required augmentor density are examined.

7.4.2 Predicted vs Actual SNR, Field Strength

The characteristics of the West Coast LORAN C chain are given in Table 7-1 early field strength and SNR predictions and results of field measurements are given in Table 7-2. The table indicates considerably better LORAN signal quality than was originally predicted. The high rise measurements indicate that most locations have adequate LORAN signals with very few no coverage points. Figure 7-1 shows the Phase II Random Route area which includes the down town hi rise section.

The results of a LORAN spectrum survey are plotted in this figure. The results are very encouraging.

It is significant to note that the Phase I tests in Philadelphia were conducted using a portable transmitter whose distance from the test area (25 miles) and transmitted power (100 watts) was adjusted to simulate the weakest signal condition expected in Los Angeles. It is now known that this was 8 db weaker than the actual condition. Phase I results would have been substantially improved particularly in Random Route tests if this actual condition had been known and the portable transmitter been adjusted accordingly. Significant improvements will result in the Teledyne Phase II system as a result.

- a. Augmentor requirements were expected to be 192 plus Time Points. The number will now decrease to 31. (See next section.)
- b. System performance in terms of accuracy will be better - fixed route will be even further below the requirements and random route will be reduced to be close to the requirements.

Table 7-1. West Coast U.S.A. LORAN C Chain

| Rate 9940 (99,400 Microseconds GRI) | | | | | |
|--|------------------------|----------------------|------------------------|--|----------------|
| Station/Location | Function | Baseline | Coding Delay | Antenna | Radiated Power |
| Fallon, Nevada 39° 33' 6.38" N 118° 49' 56.20" W | Master | 0.0 | 0 | 190 Meters Top Loaded Monopole | 450 KW |
| Middle Town, Calif. 38° 46' 56.76" N 122° 29' 44.30" W | Secondary (Slave A) | 1094.52 Microsec. | 27,000 Microseconds | 190 Meters Top Loaded Monopole | 450 KW |
| Searchlight, Nev. 35° 19' 18.11" N 114° 48' 17.35" W | Secondary (Slave B) | 1967.21 Microsec. | 40,000 Microseconds | 210 Meters Sectionalized LORAN Tower | 450 KW |

Table 7-2. Predicted and Measured SNR and Field Strength

| Station | Predicted | | | | Measured | | | |
|---------|-----------|-----------------|---------|-----------------|----------|-----------------|------------------------------|-----------------|
| | Lo Rise | | Hi Rise | | Lo Rise | | Hi Rise | |
| | SNR | Field Strength* | SNR | Field Strength* | SNR | Field Strength* | SNR | Field Strength* |
| Master | +9 db | 62 | +4 db | 62 | +17.4 | 64.2 | -3 db min +11 db max | 64.2 |
| Slave A | +21 db | 74 | +16 db | 74 | +29.9 | 76.8 | +6 db min +19.4 db max | 76.8 |
| Slave B | +43 db | 96 | +38 db | 96 | +36.2 | 83.0 | +10.5 db min +24.9 db max | 83.0 |

*Field Strength in db above 1 Microvolt per meter

- LEGEND
- HIGH RISE AREA
 - POOR LORAN AREA (LOW SNR)
 - GOOD LORAN AREA (MEASUREMENT TAKEN HERE)
 - ⊕ MARGINAL LORAN AREA

NOTE AT THE TIME THIS DATA WAS TAKEN, THE WEST COAST LORAN-C CHAIN (9940) WAS ON THE AIR BUT NOT OFFICIALLY CALIBRATED. THE TIME DIFFERENCES MAY CHANGE, BUT THE GRADIENT WILL REMAIN THE SAME

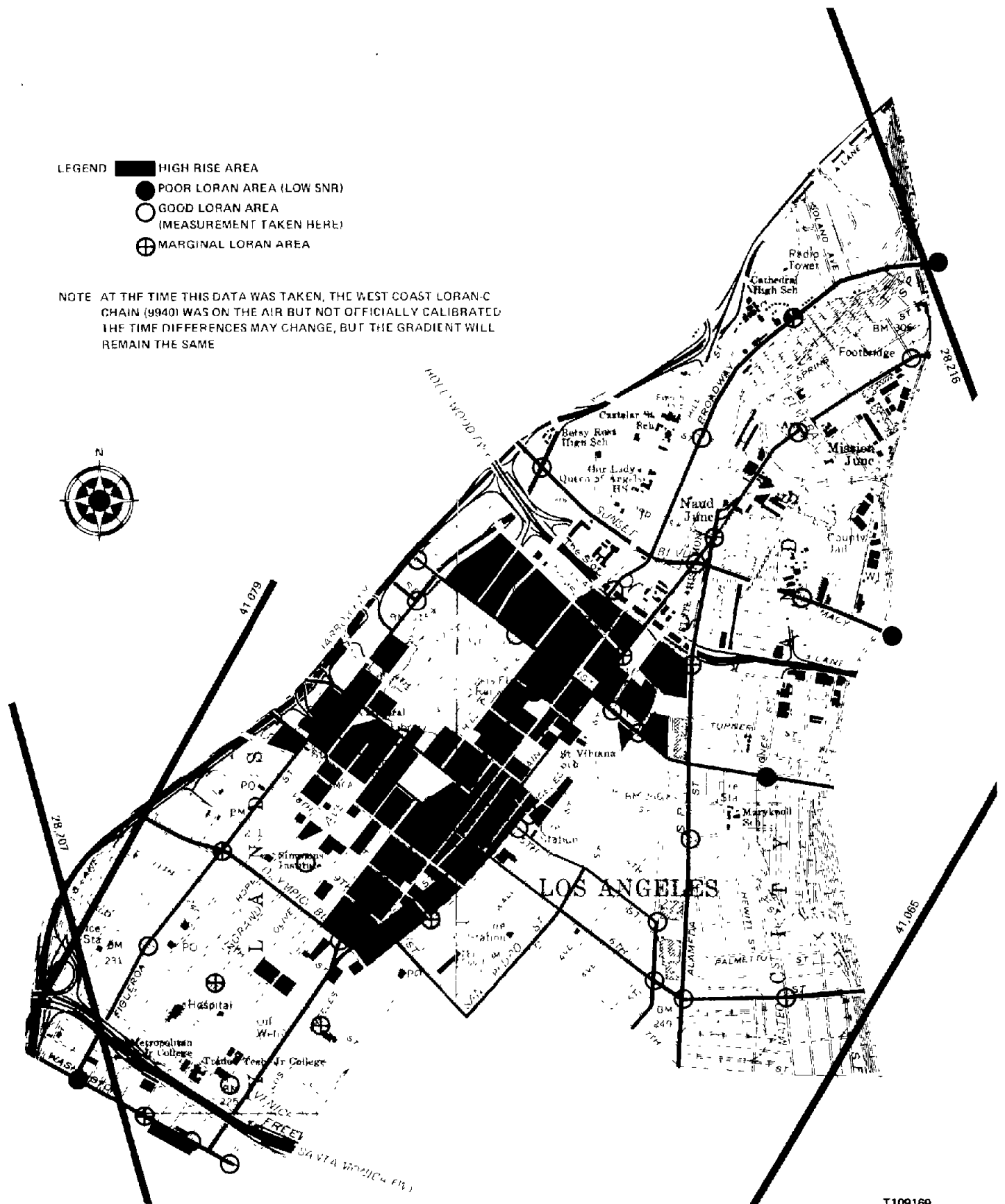

T109169

Figure 7-1. LORAN Coverage in the Phase II Random Route Area

- c. The Teledyne system may be extended to other areas and users with greater confidence as a result.

7.4.3 Phase II Augmentor Deployment

Based upon the SNR and signal strength measurements given in Table 7-2 no augmentors other than any required for time of passage measurement will be required for fixed route coverage.

Eventual expansion of AVM system utilization up to and including all SCRTD routes may be accommodated without additional augmentors save time of passage requirements. Of course, successful development of an 'augmentor-less' time of passage measurement scheme will remove the requirement for any augmentors for fixed route deployment.

Random route coverage to the stated accuracy of 300 feet 95% will still require some augmentors. Figure 7-1 shows 9 points within the random route area which do not have adequate LORAN. An additional 6 points are shown with an SNR in the range +6 db to +12 db. Conceding that not every possible street intersection was surveyed (as will be the case in Phase II), the points shown should be interpreted as indicative of conditions in the immediate (1 block radius) vicinity. Further conceding that an SNR of more than +12 db does not automatically guarantee a location determination to within 300 feet, the proposed Phase II augmentor figure is still an estimate. At the same time, however, the earlier estimate of 192 augmentors in addition to time points is clearly excessive. The current estimate of 31 augmentors in the random route area is based on present knowledge of conditions in the area. As more survey work is completed during Phase II it should be expected that the estimate of 31 augmentors will again be changed with the probability of decreasing requirements equal to that of increasing.

SECTION 8

REQUIRED PERMITS IN LOS ANGELES

8.1 INTRODUCTION

Adequate detailed planning for installation of a large AVM system in Los Angeles is extremely important even down to the color of the last mounting bracket. Several permits and licenses will be required. This section describes the requirements and the initial contacts made with the various Federal, State, County and City agencies and even the sub-departments within these agencies. Most have guarded cooperation in their discussions and letters and all will reluctantly agree to reasonable requests on a hold harmless basis.

This section describes the permits secured for the Philadelphia Phase I tests, lists the permits and licenses required for Los Angeles and describes the discussions conducted so far with the cognizant agencies.

8.2 ESSENTIAL APPROVALS OBTAINED FOR PHASE I

The Teledyne letter dated 20 September 1976 reference PS/278/RSS-76 (Attachment 1) was written to the city of Philadelphia, Department of Streets requesting their cooperation in order to conduct the "DOT" LAVM Program. This letter requested permission to install, test and operate the LAVM system on the streets of Philadelphia. Permission was granted on 6 October 1976 by letter from the Department of Streets to Teledyne. A certificate of insurance (part of Attachment 1) for \$1,000,000 and a "hold harmless" agreement letter from Teledyne dated 23 September 1976 per file reference PS/278/RSS-76 was delivered to the Department of Streets to satisfy all of their requirements. A favorable response was received on October 6, 1976 (Attachment 2).

Initial telephone conversations with the FCC in Los Angeles and Washington, D.C. led to a contact with Mrs. Fowler (Attachment 3) of the licensing section for experimental (RESEARCH). Her department issued the KG2X LB call sign, file number 7244-ER-PL-76 (Attachment 4) for use by Teledyne until termination of

the government contract effort in Philadelphia. As a result of the performance in Philadelphia, a permanent license request will be processed for the Los Angeles area system installation as requested by the FCC. Since concurrent operation was not scheduled the FCC asked Teledyne to wait until the Philadelphia tests were completed before filing for the Los Angeles license on Form #400.

8.3 PERMITS AND LICENSES REQUIRED IN LOS ANGELES

The experience in Philadelphia provided an invaluable background and aid for planning the LAVM operational system installation in Los Angeles.

This operational phase will require permanent FCC licenses for transmitters and use permits for installation of the equipments and associated power connections. Safety and fire hazard inspections are also required in most cities. State, county and city governments all have regulations and inspections associated with highway safety. The Teledyne approach for securing approvals and licenses for Los Angeles will follow the same pattern employed in Philadelphia except for the more permanent nature of the installations.

It is necessary to file for licenses by completing FCC Forms #400 (or Form #425 if 470-512 MHZ band is requested), a work copy is attached (Attachment 5) for the augmentors. The other two licenses are really AVM upgrading and the #400 forms are already filed by the SCRTD for the base station KMA 454 and the mobile so it is only necessary to modify them to include the operation of AVM under section 93.120, subsection (d) of the Commission's rules, which are:

"Each application to license an AVM system shall include the following as supplemental information"

1. A detailed description of the manner in which the system will operate, including a map or diagram.
2. For wide band frequency operation, the necessary or occupied bandwidth of emission whichever is greater.

3. The data transmission characteristics as follows:
 - (i) The vehicle location update rates;
 - (ii) Specific transmitter modulation techniques used;
 - (iii) For codes and timing scheme: A table of bit sequences and their alpha-numeric or indicator equivalents, and a statement of bit rise time, bit transmission rates, bit duration, and interval between bits;
 - (iv) A statement of amplitude-versus-time of the interrogation and reply formats, and an example of a typical message transmission and any synchronizing pulses utilized;
4. A plan to show implementation schedule during the initial license term.

Technical Standards

1. AVM stations authorized for operation below 512 MHz must comply with the technical standards applicable to the frequency bands prescribed in this chapter, including the requirement for type acceptance of equipment used.
2. Pending final development of technical standards, utilization of non-type accepted transmitters by AVM stations authorized for operation above 512 MHz will be permissible, provided that:
 - (i) The output power of transmitters used in pulse ranging systems shall not exceed 1 kW PEP (The Teledyne Systems design employs LORAN-C and these transmitters are not required).
 - (ii) The output power of transmitters used in non-pulse ranging systems shall not exceed 300 watts. (All AVM transmitters in the Teledyne Systems are less than 300 watts).
 - (iii) Emissions will be authorized on a case-by-case basis dependent on the requirements of the specific techniques utilized. The Teledyne Systems Augmentor design of the 1/10 watt checkpoint variety is described in detail under each applicable section as required by the above FCC rules.

A description of the Operation of the AVM system for the FCC in appropriate format is presented in Attachment 10.

Phase II will also require several permits from different governmental agencies to allow installation and operation of the AVM equipment on their respective facilities or property. Table 8-1 below is composed of eight categories all of which are essential or may be needed depending upon future route assignments. The entire gamit is summarized in Table 8-1 with comments, names, phone numbers and locations. Other comments regarding phone conversation and letters are inserted at appropriate places throughout this section. Figure 8-1 is a Planning Schedule for the essential licenses, permits and agreements based upon preliminary conversations with available staff personnel. Letters of response to our letters will be inserted in the Appendix as they are received.

8.4 PRELIMINARY DISCUSSIONS WITH COGNIZANT AGENCIES

In order to satisfy the requirements for preliminary discussions with cognizant agencies, it was considered essential to talk to Frank Barnes, General Manager of SCRTD and Jack Penwell who is the SCRTD Chief Engineer as well as Mr. Skiles, Chief Traffic Engineer L. A. City, George Eslinger, Assistant Director of the Bureau of Street Lighting for the city of Los Angeles and Richard Lukas, Principal Street Lighting Engineer for the city of Los Angeles. Richard Lukas is located at Room 510 City Hall East, Los Angeles, 91002, and the phone number is 485-5918. Richard is the principal source of information for permits which must go through the chain of command for approval. The Board of Public Works is the final approval point.

Teledyne was informed by Mr. Lukas that a temporary permit was issued to the Aerospace Corp., by the L.A. City Board of Public Works for one year for installing location equipment on L.A. City lighting poles and structures. Mr. Lukas did emphasize the fact that this was a temporary permit, and that he and his bosses were not really in favor of recommending permit approvals to the Board of Public Works for any permanent structures attached to city lighting polls and most especially if city power is required for such devices. He informed Teledyne that

Table 8-1. Check-Off Summary Table of Number and Types of Permits Required For Permanent LAVM System Installation In Los Angeles

| CATEGORY | AGENCY | COMMENTS (NUMBER OF PERMITS & LICENSES) |
|----------|--|--|
| 1 | FCC Base Mobile Augmentors | (3) Licenses plus documentation (93.120) of AVM System Specs. KMA 454 Base Station for existing SCRTD voice plus audio applique unit to add data with same bandwidth. Modify existing license for AVM with data attached section 93.120 Item "D" Apply for new license for LA with Form No. 400. Attach Section 93.120 Item "D" |
| 2 | AVM Frequency Coordination & Assignment Policy with User Group FCC 93.8 and 93.9 | Dorothy Probst, FCC, Long Beach, Calif. (426-4451) is local FCC contact and Larry Guy .. the Local Radio Inspector. The SCRTD Trade Association User Group is Wm. Barnich of National Association of Motor Bus Owners, Wash., D.C (202) 293 5890. He related that his approval is forwarded to Chas. Fonger who is Mr. Frequency Coordinator for the FCC in Washington, D.C. |
| 3 | Cal State Highway | George Glanzmann Permit Dept/Lloyd Brown Encroachments Dept. (1) Permit is required if augmentors are required on any state highway - few if any are anticipated - however a letter is prepared to request their cooperation and explain the function of the SCRTD/DOT AVM - System (620 2206) |
| 4 | LA County Road Department | Road permits Jim Keller, Insp /H.J. O'Rourke, Utility Eng. 798 3817 (1) Permit is required if augmentors are required on county roads or highways - in area near L.A. City - L.A. City Traffic service some areas - A good county - City relationship was indicated. |
| 5 | LA City Public Works "LATC" Dept "LA Street Dept. Lighting" | The L A City Dept. of Public Works must issue a permit for public property use. The specific department must evaluate the proposal and respond. Comments are discussed in the text of this section for TRAFFIC and LIGHTING. (1) Permit is required for LA City The "Traffic Controls" appear to offer the most advantageous points to mount augmentors. A letter of response is anticipated. In certain areas more standards are available for mounting augmentors, see text for details. A letter of response is anticipated. |
| 6 | Public Utilities and Transportation | John Mumaw Asst. Gen. Mgr 485 2755 Room 1600 City Hall L.A. 90012. Would require (1) permit and (1) "use agreement". Many acres of strategic land is available with power for Augmentors or Receiving sites or Base Stations for extended coverage or system expansion. |
| 7 | Other Cities Santa Monica | Attached letter indicating a cooperative attitude letter received from Director or General Services. |
| 8 | Other Cities and Counties if AVM Service is Extended. | As needed for expansion use - same approach as above. |

9-8

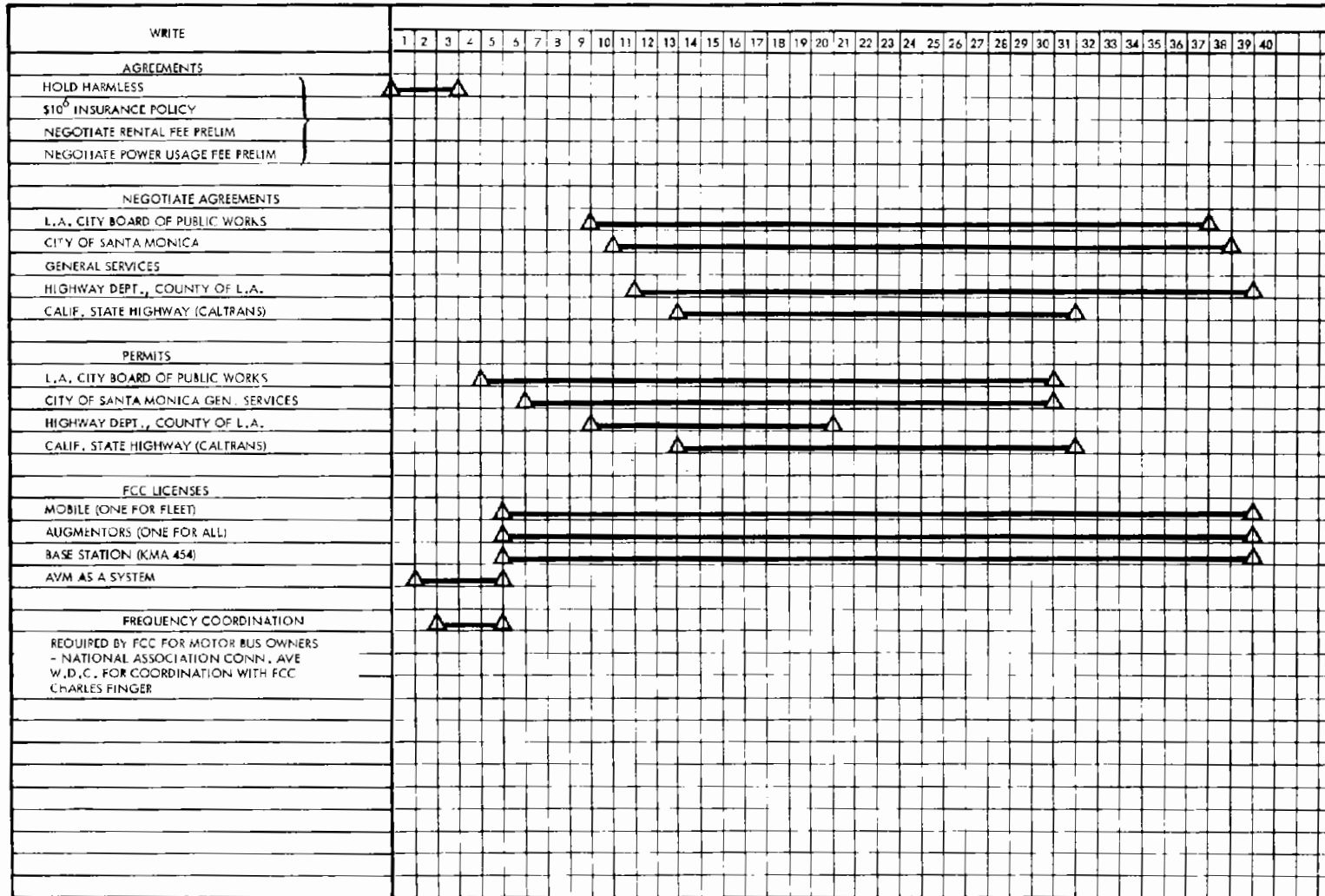

LEGEND
 ▲ SCHEDULE EVENT ONE TIME ▲ COMPLETED EVENT ▲-▲ PROGRESS ALONG TIME SPAN ◇ ANTICIPATED SLIPPAGE ISSUE DATE 3/29/77 T109257
 ▲ RESCHEDULED EVENT NUMBER ▲-▲ SCHEDULED EVENT TIME SPAN ▲-▶ CONTINUOUS ACTION ◆ ACTUAL SLIPPAGE (COMPLETED) STATUS DATE _____
 ▲ INDICATES RESCHEDULING SEQUENCE

F16283

Figure 8-1. Planning Schedule For Licenses, Permits and Agreements

we should plan for a minimum of three months to receive an official permit or rejection from the Board of Public Works, Rm. 353, City Hall, Los Angeles, Calif. 91002, and that a more realistic time of six months could be expected under some conditions.

It was Mr. Lukas' opinion that employing street lighting power from the Department of Public Works was undesirable from their point of view and lighting is most often of the high voltage series type. He also stated that it would be necessary to make pecuniary arrangements for the use of such power even though less than one watt per augmentor was required, and installing meters was not very practical or desirable.

The Director of General Services for the City of Santa Monica, Stanley Scholl, 1685 Main Street, Santa Monica, Calif. 90401 was much more encouraging than Mr. Lukas. A discussion with Stanley on 3/18/77 was very favorable and he has written a letter stating that he understands our augmentor installation desires for the SCRTD and is willing to go along with anything reasonable such as the Hold Harmless Clause and insurance policy which were acceptable in Philadelphia. Mr. School's letter is included as Attachment 6.

Mr. Karl Jagenburg, Senior Traffic Engineer for the Los Angeles Traffic Division was cooperative in our discussions about mounting SCRTD/DOT miniature 1/10 watt augmentors on their existing structures. The result must be aesthetically pleasing but above all, his traffic engineers must ascertain for themselves the fact that no interference or false traffic control signal triggering (especially reed relays) will ever occur because of the augmentors, before a final use permit or agreement is ever considered. He has promised to confirm immediately in writing an answer to my letter (Attachment 7) requesting a statement of guarded cooperation. This is therefore the most likely solution to mounting and powering up the required Augmentors.

Conversation with the office of Public Utilities and Transportation Room 1600 City Hall (485 2755) reveal a very cooperative attitude and offer many ideal locations for additional Base Stations, Remote Receiving Sites and Augmentors. John Mumaw is Asst. Gen. Mgr. of this department and has always been very cooperative.

Letters to the Los Angeles Road Department (Attachment 8) and California Department of Transportation (Attachment 9) are included to show contact has been established with those agencies and that Teledyne is expecting responses from each.



20 September 1976

In Reply Refer To: PS/278/RSS-76

Mr. Werner Behrend
Staff Engineer
Street Lighting Section
Room 800, Municipal Services Bldg.
15th Street and JFK Boulevard
Philadelphia, Pa. 19107

Dear Mr. Behrend:

Teledyne Systems Co. requests permission to install temporary and portable miniature radio transmitters on street lighting poles at certain specific locations in Philadelphia. These devices are a part of Teledyne's LORAN Vehicle Location System which will be tested in Philadelphia under contract to the U. S. Department of Transportation; Transportation Systems Center, Cambridge, Mass. Tests are scheduled to be run during October 18 thru December 14 time period. Details of the miniature radio devices, called augmentors are listed below:

- 1) Size: 6" x 6" x 6"
- 2) Weight: 3 1/2 lbs max.
- 3) Power: Self contained 6 volt battery
- 4) Mounting provision: flexible metal straps.
- 5) Elevation: approximately 15 feet
- 6) Radiated signal: 1 milliwatt maximum on 72.96 MHz carrier frequency. (Responsibility for FCC approval and permits is borne by Teledyne Systems Co.)
- 7) Number of augmentors: 66, located at various times at any of approximately 200 locations.

No interference with or damage to city property or personnel is anticipated. Installation is temporary and does not require any holes or other modification of any kind to city property.

In Reply Refer to: PS/278/RSS-76
20 September 1976
Page 2

Please find enclosed the following documents:

- a. Statement of Liability Insurance of Teledyne Incorporated and Teledyne Systems Company.
- b. City of Philadelphia 'Hold Harmless' Letter.
- c. List of intersections in the City of Philadelphia where nearest street light pole may be utilized. Not all will be utilized at one time and many will not be used at all. The total will never exceed 66 at one time. This list is preliminary. A final list will be submitted on or before October 29, 1976.
- d. Booklet describing system to be tested.

Teledyne Systems will be grateful for any assistance you can provide. Should you have any questions or require additional information, please do not hesitate to contact me at (213) 886-2211, extension 2873.

Yours truly,

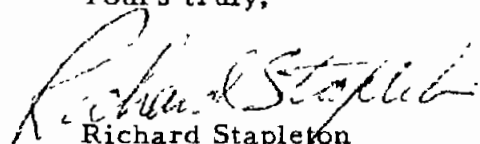
Richard Stapleton
LAVM Program Manager

RSS:nt
Encls.

cc: L. Kent, Teledyne Systems
F. Robinson, Teledyne Systems

Attachment 1



CERTIFICATE
OF
INSURANCE

- ARGONAUT INSURANCE COMPANY
HOME OFFICE: MENLO PARK, CALIFORNIA
- ARGONAUT-MIDWEST INSURANCE COMPANY
HOME OFFICE: CHICAGO, ILLINOIS
- ARGONAUT-NORTHWEST INSURANCE COMPANY
HOME OFFICE: PORTLAND, OREGON
- ARGONAUT-NORTHWEST INSURANCE COMPANY
HOME OFFICE: PORTLAND, OREGON
- ARGONAUT-SOUTHWEST INSURANCE COMPANY
HOME OFFICE: METairie, LOUISIANA

SEP 22 1976

This is to certify that the COMPANY designated above has issued to the named insured the policy(s) enumerated below, subject to all the terms of such policy(s). This Certificate of Insurance neither affirmatively nor negatively amends, extends or alters the coverage afforded by such policy(s). In the event of any material change in or cancellation of the policy(s), the COMPANY will make every effort to notify this certificate holder, but undertakes no responsibility of failure to do so.

CERTIFICATE HOLDER AND ADDRESS

City of Philadelphia
Street Lighting Section
Room 800, Municipal Services Building
15th and JFK
Philadelphia, PA 19107

NAMED INSURED AND ADDRESS

TELEDYNE, INC. AND ALL SUBSIDIARY OR PROPRIETARY COMPANIES OR DIVISIONS INCLUDING
Teledyne Systems Company
1901 AVENUE OF THE STARS
LOS ANGELES, CALIFORNIA 90067

Attn: Mr. Werner Behrend
Staff Engineer

If certificate holder is a loss payee with respect to the described auto, check here

| POLICY NUMBER | KIND OF INSURANCE AND COVERAGES | LIMITS | EXPIRATION |
|------------------|---|---|----------------|
| WC 20 330 074000 | WORKMEN'S COMPENSATION EMPLOYER'S LIABILITY BODILY INJURY LIABILITY -- EXCEPT AUTOMOBILE * | Statutory \$ 1,000,000 each accident \$ 1,000,000 each occurrence | Until Canceled |
| MA-20 328 074013 | PROPERTY DAMAGE LIABILITY -- EXCEPT AUTOMOBILE * | Combined products \$ Single each occurrence \$ per person \$ Limit product \$ contractual | Until Canceled |
| MA 20 328 074013 | BODILY INJURY LIABILITY -- AUTOMOBILE | Included each person \$ each accident \$ in each occurrence | Until Canceled |
| MA 20 328 074013 | PROPERTY DAMAGE LIABILITY -- AUTOMOBILE MEDICAL PAYMENTS -- AUTOMOBILE PHYSICAL DAMAGE -- AUTOMOBILE -- ACTUAL CASH VALUE UNLESS OTHERWISE STATED COMPREHENSIVE COLLISION OR UPSET FIRE AND THEFT | Above each accident \$ up to occurrence \$ in person \$ LESS \$ deductible | Until Canceled |

* IF COMPREHENSIVE LIABILITY, CHECK HERE

Description of Operations, Locations, or Automobiles Covered, or Additional Coverages, or Special Condition

Workers' Compensation

ALL OPERATIONS WORLDWIDE INCLUDING FOR LONGSHOREMEN'S AND HARBOR WORKER'S ACT, COVERED BY COMPENSATION MARITIME MASTER OR MEMBERS OR CREW INCLUDING TRANSPORTATION, WAGES, MAINTENANCE AND CURS

PRODUCER AND ADDRESS

Johnson & Higgins
4201 Wilshire Blvd.
Los Angeles, California 90010

ARGONAUT INSURANCE COMPANY
ARGONAUT-MIDWEST INSURANCE COMPANY
ARGONAUT-SOUTHWEST INSURANCE COMPANY
ARGONAUT-NORTHWEST INSURANCE COMPANY

Lawrence C. Roberts
PRESIDENT

J. Keble
SECRETARY

8-11

PRESIDENT

SECRETARY

DATE: AT

Los Angeles

September 21, 1976



CITY OF PHILADELPHIA

DEPARTMENT OF STREETS
840 Municipal Services Building
Philadelphia, Pa. 19107

DAVID J. DAMIANO
Commissioner

October 6, 1976

Mr. Richard Stapleton
LMI Program Manager
Teledyne Systems Co.
19601 Nordhoff Street
Northridge, California 91324

Dear Mr. Stapleton:

In response to your request of September 20th, 1976, the City of Philadelphia herewith grants Teledyne Systems Co. permission to temporarily install portable miniature radio transmitters on street light poles at locations requested.

These installations shall be in accordance with your letter of above date and shall be covered by your "certificate of insurance" and "hold harmless" agreement.

If we can be of further assistance please contact this office.

Sincerely yours,

A handwritten signature in cursive script, appearing to read "Werner Behrend".

Werner Behrend P.E.
Staff Engineer

WB/st

**TELEDYNE
SYSTEMS COMPANY**

19601 NORDHOFF STREET
NORTHRIDGE, CALIFORNIA 91324
(213) 886-2211

31 May 1976

In reply refer to: PS/119/PJI-70

Mrs. Fowler, Applications Examiner
Federal Communications Commission
Washington, D. C. 20554

Subject: Philadelphia, Pennsylvania and Los Angeles, California License
for 72,960 MHz Sign Post Radiators for AVM (DOT Contract)

Reference: Telephone conversations on low powered AVM Sign Post Radiators
on 7 April 1976

Dear Mrs. Fowler:

We are pleased to have completed our contract negotiations with DOT (UMTA) for the first experimental research AVM systems to be contracted for by the U. S. Government. Now we are in need of signpost (sometimes called augmentors) license approvals for Philadelphia and Los Angeles. These 72.960 MHz calibration points are street location points per our Government contract. The input power is less than (1/5) one fifth of a watt. Twenty units maximum will be employed within a mile of City Hall in Philadelphia for six months or so and 200 units maximum will be employed in Los Angeles within ten miles of City Hall for an indefinite period. These coded position locators are of an "experimental research" nature and identical except for their unique identifier codes.

Enclosed please find FCC forms 400 completed and awaiting your further instructions. We are still not in receipt of the other forms 440 - 441 and 440A. I requested them from Washington, D. C. and Los Angeles but none have arrived (slow mail?) in the last three weeks so if the information on form 400 is not adequate please send the correct forms by registered mail as soon as possible. Our scheduled Teledyne-Government commitments are firm and our work is now in process. Please ask Mr. Bromery if his letter to me has been mailed.

Sincerely,

Phineas J. Icenbice, Jr.

PJI:tla
Enclosure

APRIL 1975

United States of America
Federal Communications Commission

Budget Bureau No. 52 R0172

Attachment 3

80000

AUTHORIZATION

Call Sign _____ File No. _____

| 1(a) Frequencies MHz | 1(b) No. of transmitters | | | 1(c) Emission | 1(d) Input Power Watts |
|-------------------------|--------------------------|--------|-------|---------------|---------------------------|
| | Base Land Fixed | Mobile | Other | | |
| 72.960 | 20 | 0 | 0 | | 170 watts |

Antenna painting and lighting specifications _____
 Special Conditions _____
 This authorization effective _____
 and will expire 3 00 AM EST _____
 and is subject to further conditions as set forth on reverse side. If the station authorized herein is not placed in operation within eight months this authorization becomes invalid and must be returned to the Commission for cancellation unless an extension of completion date has been authorized.

Federal Communications Commission

Chief, Safety & Special Radio Services Bureau



1(e) Show No. of mobile units in each of following categories: Land vehicle _____
 No mobile units.
 Marine _____
 Aircraft _____
 Other _____

6(a) Name of Radio Service _____
 (b) Class of station _____
 Base Mobile Other

City: Los Angeles Philadelphia
 County: Los Angeles Philadelphia
 State: California Pennsylvania

7(a) Name (see instructions) _____
 (b) Mailing address (number, street, city, state & zip code) _____

Latitude: 39° 57' 08.596" N Longitude: 118° 14' 22.871" W

3 Local of communication: City of Philadelphia and City of Los Angeles (DOT)

4 If mobile units, or other class of station at temporary locations are included in this authorization show area of operation _____

5 a Overall height above ground of:
 (1) tip of antenna 20 ft (2) antenna supporting structure 20 ft

5 b Elevation of ground above mean sea level at antenna site 40' to 290' ft

8 Would a Commission grant of this application be a major action as defined by Section 1.1305 of the Commission's rules? Yes No

If yes, submit the required statement (See Section 1.1311 of the Commission's rules). If no, give explanation _____

9 State whether applicant is (Check one):
 Individual Partnership Association Corporation Governmental Entity

10 Is communication service to be received from or rendered to another person (see instructions)? If Yes, name of person is _____ Yes No

11 (a) Will applicant own the radio equipment? Yes No
 If answer is No, give name of owner _____
 (a)(2) If not the owner of the radio equipment is applicant a party to a lease or other agreement under which control will be exercised in the same manner as if the equipment were owned by the applicant? Yes No

(b) Will applicant have unlimited access to the equipment and will effect measures to prevent use of the radio equipment by unauthorized person? Yes No

12 Attach functional system diagram showing details of proposed radio system and include such other supplementary data as required by specific rules _____

13 If it is proposed to use a transmitter which does not appear on the Commission's Radio Equipment List, or if the transmitter is listed but not designated for use in the particular radio service named in item 6(a) of this application describe such transmitter in detail (See instructions) _____

14 Will the facilities be located on land under jurisdiction of the U.S. Forest Service or the Bureau of Land Management? Yes No
 (If yes, attach statement) _____

15 Statement of eligibility _____

(Use space on the reverse of this page)

All the statements made in the application and attached exhibits () hereof and are incorporated herein as if set out in full in the application. The applicant certifies that he has a current copy of the Commission's Rules governing the radio service named in Item 6(a) above. The applicant waives any claim to the use of any particular frequency or of the ether as against the regulatory power of the United States because of the previous use of the same whether by license or otherwise, and requests an authorization in accordance with this application. Neither applicant nor any member thereof is a foreign government or a representative thereof.

I CERTIFY that the statements in this application are true, complete, and correct to the best of my knowledge and belief and are made in good faith. *IPATT CITY FOR INFO. 6/10/75*

REMEMBER TO INCLUDE FREQUENCY COORDINATION, IF REQUIRED

SIGNATURE _____ DATE _____
(Designate appropriate classification below)

DO NOT WRITE IN THIS BLOCK

8-14

INDIVIDUAL APPLICANT MEMBER OF CORPORATION PARTNERSHIP OFFICER OF APPLICANT CORPORATION OFFICER WHO IS ALSO A MEMBER OF THE APPLICANT ASSOCIATION

WITFUL FALSE STATEMENTS MADE ON THIS FORM ARE PUNISHABLE BY FINE AND IMPRISONMENT US

Attachment 4

EXPERIMENTAL

RADIO STATION CONSTRUCTION PERMIT

EXPERIMENTAL (RESEARCH)
(Nature of service)

AND
LICENSE

K G 2 X L B (new)
(Call sign)

CONTRACT DEVELOPMENTAL XC FX
(Class of station)

7244-ER-PL-76
(File number)

NAME TELEDYNE INDUSTRIES, INC., d/b/a TELEDYNE SYSTEMS COMPANY

Philadelphia (Philadelphia) Pennsylvania - Lat. 39 57 08.596N;
(Location of station) Long. 75 09 50.473 W.

(Location of authorized remote control point)

Subject to the provisions of the Communications Act of 1934, subsequent acts, and treaties, and all regulations heretofore or hereafter made by this Commission, and further subject to the conditions and requirements set forth in this license, the licensee hereof is hereby authorized to use and operate the radio transmitting facilities hereinafter described for radio communication.

| Frequency | Emission Designator | Authorized Power (Watts) | Special Provisions |
|------------|---------------------|--------------------------|--------------------|
| 72.960 MHz | .1A1 | 0.170 | |

Equipment: (20) health Co., Model GDA-1057-1

Frequency Tolerance: .002%; Hours of Operation: Unlimited

Operation: In accordance with Section 5.202(c) of the Commission's Rules.

Special Conditions:

(1) This authorization is issued for the express purpose of conducting experimental operations described in the related application and required by U.S. Department of Transportation Contract No. Gov't RFP No. TSC/432-0017-RN. The use of this radio station in any other manner or for any other purpose will constitute a violation of the privileges herein authorized.

(2) Except as subsequently authorized by the Commission, this radio station shall not be operated after the expiration date of the contract designated in the related application and enumerated above.

The above frequencies are assigned on a temporary basis only and are subject to change at any time without hearing.

This authorization is granted subject to the condition that no harmful interference is caused to any other station or service and may be cancelled at any time without hearing if, in the judgment of the Commission, such action should be necessary.

This license is issued on the licensee's representation that the statements contained in licensee's application are true and that the undertakings therein contained, so far as they are consistent herewith, will be carried out in good faith. The licensee shall, during the term of this license, render such service as will serve public interest, convenience, or necessity to the full extent of the privileges herein conferred.

This license shall not vest in the licensee any right to operate the station nor any right in the use of the frequencies designated in the license beyond the term hereof, nor in any other manner than authorized herein. Neither the license nor the right granted hereunder shall be assigned or otherwise transferred in violation of the Communications Act of 1934. This license is subject to the right of use or control by the Government of the United States conferred by Section 606 of the Communications Act of 1934.

This authorization effective February 14, 1977 and will expire 3:00 A.M. EST October 1, 1978 or on the expiration of the contract designated above, whichever is earlier.

FEDERAL COMMUNICATIONS COMMISSION



RECEIVED

FEB 23 1977

CONTRACTS DEPT.

FCC Form 400
APRIL 1975

United States of America
Federal Communications Commission

Form Approved
Budget Bureau No. 52-R0132

APPLICANT'S FILE COPY

DO NOT WRITE IN THIS BLOCK

| 1(a) Frequencies MHz | 1(b) No. of transmitters | | | 1(c) Emission | 1(d) Input Power Watts |
|-------------------------|--------------------------|--------|-------|---------------|---------------------------|
| | Base-Land-Fixed | Mobile | Other | | |
| | | | | | |

1(e) Show No. of mobile units in each of following

Categories: Land vehicle _____ aircraft _____
 Hand carried _____ marine _____ paging _____ receivers _____

2 Location of transmitter(s) at fixed location

Number and Street (or other indication of location)

City _____ County _____ State _____

Latitude _____ Longitude _____

3 Location of central point(s)

4 If mobile units, or other class of station at temporary locations, are included in this authorization, show area of operation

5(a) Overall height above ground of

(1) tip of antenna _____ ft (2) antenna supporting structure _____ ft

(b) Elevation of ground above mean sea level at antenna site _____ ft

Call Sign _____ File No _____

Antenna painting and lighting specifications _____

Special Conditions _____

This authorization effective _____
 and will expire 3 00 AM EST _____

and is subject to further conditions as set forth on reverse side. If the station authorized herein is not placed in operation within eight months this authorization becomes invalid and must be returned to the Commission for cancellation unless an extension of completion date has been authorized.

Federal Communications Commission



Chief, Safety & Special Radio Services Bureau

6(a) Name of Radio Service _____
 (b) Class of station _____

Base Mobile Other

7(a) Name (see instructions) _____

(b) Mailing address (number, street, city, state & zip code) _____

8 Would a Commission grant of this application be a major action as defined by Section 1.1305 of the Commission's rules? Yes No

If yes, submit the required statement (See Section 1.1311 of the Commission's rules)

9 State whether applicant is (Check one)

Individual Partnership Association Corporation Governmental Entity

10 Is communication service to be received from or rendered to another person (see instructions)? If "Yes", name of person is _____ Yes No

11 (a)(1) Will applicant own the radio equipment? Yes No
 If answer is "No" give name of owner _____

(a)(2) If not the owner of the radio equipment, is applicant a party to a lease or other agreement under which control of the equipment is exercised in the same manner as if the equipment were owned by the applicant? Yes No

(b) Will applicant have unlimited access to the equipment and will adequate measures be taken to prevent use of the radio equipment by unauthorized persons? Yes No

12 Attach functional system diagram showing details of proposed radio system and include such other supplementary data as required by the rules

13 If it is proposed to use a transmitter which is not on the Commission's "Radio Equipment List" or if the transmitter is listed but not designated for a particular radio service named in Item 6(a) of this application, describe such transmitter in detail (see instructions)

14 Will the facilities be located on land under jurisdiction of the U.S. Forest Service or the Bureau of Land Management? Yes No
 (If yes, attach statement)

15 Statement of eligibility _____

(Use space on the reverse of this page)

16 (a) Application for (Check one):
 New station Assignment of authorization Reinstatement of expired authorization
 Modification

(b) If for modification, state modification proposed _____

(c) If this application is for a radio service already authorized, give call sign _____ (d) Give points of communication (call signs) _____

(e) Is this station authorized for any other radio service indicated in Item 6(a)? Yes No

17 If antenna will be mounted on an existing antenna structure: (a) Give name of a licensee using this structure, his call sign and radio service and the current painting and lighting specifications required by the Commission for this antenna structure _____

(b) If your proposed antenna will increase the height of the existing structure, give overall height above ground of the tip of the proposed antenna structure _____

18(a) Will the antenna extend more than 20 feet above the ground or more than 20 feet above the free natural formation or existing man-made structure (other than an antenna structure) on which it is mounted? If "Yes" answer (b), (d), (e) Yes No

(c) Distance and direction to nearest runway of nearest aircraft landing area _____ (d) Name of landing area _____

(e) Has notice of the proposed construction of the antenna structure been filed with the FAA? If "Yes", state when and the name under which it was filed and the FAA regional office where it was filed. Use space on the reverse of this page. Yes No

All statements made in the application and attached exhibits (including but not limited to the following) are considered material representations, and all the exhibits are a material part hereof and are incorporated herein by reference. The applicant certifies that he has a current copy of the Commission's Rules governing the radio service named in Item 6(a) above. The applicant waives any claim to the use of any particular frequency or of the other as against the regulatory power of the United States because of the previous use of the frequency, whether by license or otherwise, or if requests an allocation in accordance with this application. Neither applicant nor any member thereof is a foreign government or a representative thereof.

I CERTIFY that the statements in this application are true, complete, and correct to the best of my knowledge and belief and are made in good faith.

REMEMBER TO INCLUDE FREQUENCY COORDINATION IF REQUIRED

SIGNATURE _____ DATE _____

DO NOT WRITE IN THIS BLOCK

8-16 INDIVIDUAL APPLICANT MEMBER OF APPLICANT PARTNERSHIP OFFICER OF APPLICANT CORPORATION OFFICER WHO IS ALSO A MEMBER OF THE APPLICANT ASSOCIATION OFFICIAL OF GOVERNMENTAL ENTITY

WILLFUL FALSE STATEMENTS MADE ON THIS FORM ARE PUNISHABLE BY FINE AND IMPRISONMENT U.S. CODE, TITLE 18, SECTION 1001



CITY OF
SANTA MONICA
CALIFORNIA

OFFICE OF THE DIRECTOR OF PUBLIC WORKS
1685 MAIN STREET, 393-9975
SANTA MONICA, CALIF. 90401

March 18, 1977

Teledyne Systems Corporation
19300 Nordhoff Street
Northridge, California

Attention: Mr. Phineas Icebice

Gentlemen:

This will confirm our conversation today regarding your desire to coordinate the placement of several devices to be located on approximately six street light poles in Santa Monica by SCRTD, for the monitoring of the locations of the SCRTD busses.

As we mentioned to you, the City of Santa Monica will cooperate on this project since it will improve public transportation. It is our understanding that the City of Santa Monica will be held harmless from any liability which may occur from the installation or operation of these devices.

It is our understanding that these devices are approximately 12" x 12" x 6" in size and thus relatively unobtrusive.

We understand that a meeting will be held to discuss and describe this project in detail within the next few months. We will look forward to being invited to that meeting.

Very truly yours,

Stanley E. Scholl
Director of
General Services

SES:fs

 **TELEDYNE
SYSTEMS COMPANY**

19501 NORDHOLT STREET
NORTHRIDGE, CALIFORNIA 91324
(213) 886-2211

March 25, 1977

Mr. Karl Jagenburg
Senior Traffic Engineer
Dept. of Traffic
1200 City Hall
Los Angeles, California 90012

Dear Sir:

It was a pleasure talking to you today about our favorite subject Automatic Vehicle Location "AVM" for the SCRTD/DOT in Los Angeles. This system employs the Coast Guard LORAN-C signals and provides the BASE STATION with vehicle map position within 300 feet 95% of the time. Polling of each vehicle is once every 32.4 seconds. The 1/10 watt vhf augmentors that we were discussing are less than 6" x 6" x 6" in size with a primary power requirement of less than one watt per augmentor. Only a few of these units are required as accurate time and position check points. The exact number for the entire LA basin is a function of the forthcoming SCRTD/Dept. of Transportation specifications, the Teledyne system would use fewer augmentors than other systems because of the fact that the Teledyne LORAN-C system design is the only LORAN-C system for vehicle location.

We were very successful in Philadelphia where we gave the city a Hold-Harmless agreement and an insurance policy for \$1,000,000. Tests have been conducted in Philadelphia for DOT by Teledyne for the past four years.

A letter of response from you stating that Teledyne Systems Co. did request your cooperation in seeking a use permit for installation the SCRTD Augmentors in Los Angeles on a non-interference basis would be appreciated.

Sincerely,

P. J. Icenblee, Jr.

PJI:nt
Enclosure: AVM Brochure

cc: Dean Terry, Sr. Design Engr.

**TELEDYNE
SYSTEMS COMPANY**

19601 NORDHOFF CIRCLE

NORTHRIDGE, CALIFORNIA 91324

(213) 886-2211

30 March 1977

Mr. Henry J. O'Rourke, Utility Eng.
Los Angeles Road Department
1540 Alcazar Street
Los Angeles, California 90033

Dear Sir:

It was a pleasure talking to your office today about our favorite subject Automatic Vehicle Location "AVM" for the SCRTD/DOT in Los Angeles. This system employs the Coast Guard LORAN-C signals and provides the BASE STATION with vehicle map position within 300 feet 95% of the time. Polling of each vehicle is once every 32.4 seconds. The 1/10 watt vhf augmentors that we were discussing are less than 6" x 6" x 6" in size with a primary power requirement of less than one watt per augmentor. Only a few of these units are required as accurate time and position check points. The exact number for the entire LA basin is a function of the forthcoming SCRTD/Department of Transportation specifications, the Teledyne system would use fewer augmentors than other systems because of the fact that the Teledyne LORAN-C system design is the only LORAN-C system for vehicle location.

We were very successful in Philadelphia where we gave the city a Hold-Harmless agreement and an insurance policy for \$1,000,000. Tests have been conducted in Philadelphia for DOT by Teledyne for the past four years.

A letter of response from you stating that Teledyne Systems Company did request your cooperation in seeking a use permit for installation of the SCRTD Augmentors in the Los Angeles area on a non-interference basis would be appreciated.

Sincerely,

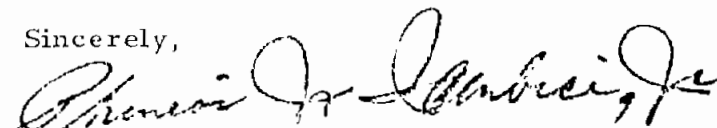

P.J. Icenbice, Jr.

PJI:sla

Enclosure: AVM Brochure

cc: Mr. Jim Keller, Head Inspector L.A. Co. Road Department

**TELEDYNE
SYSTEMS COMPANY**

19601 NORDHOFF STREET
NORTH-RIDGE CALIFORNIA 91324
(213) 886-4211

30 March 1977

Mr. Lloyd Brown
Caltrans Encroachments/Permits
California Department of Transportation
District - 7
P. O. Box 2304
Terminal Annex, Room 124
Los Angeles, California 90051

Dear Sir:

It was a pleasure talking to you today about our favorite subject Automatic Vehicle Location "AVM" for the SCRTD/DOT in Los Angeles. This system employs the Coast Guard LORAN-C signals and provides the BASE STATION with vehicle map position within 300 feet 95% of the time. Polling of each vehicle is once every 32.4 seconds. The 1/10 watt vhf augmentors that we were discussing are less than 6" x 6" x 6" in size with a primary power requirement of less than one watt per augmentor. Only a few of these units are required as accurate time and position check points. The exact number for the entire LA basin is a function of the forth coming SCRTD/Department of Transportation specifications, the Teledyne system would use fewer augmentors than other systems because of the fact that the Teledyne LORAN-C system design is the only LORAN-C system for vehicle location.

We were very glad to learn that you are cooperating with other similar AVM installations on the freeways.

A letter of response from you stating that Teledyne Systems Company did request your cooperation in seeking a use permit for installation of the SCRTD Augmentors in the Los Angeles area on a non-interference basis would be appreciated. We understand that the exact locations are required in a letter before you can issue a permit.

Sincerely,

P. J. Icenbice, Jr.

PJI:tla
Enclosure: AVM Brochure

ATTACH THIS SECTION TO EACH AVM LICENSE APPLICATION

SUPPLEMENTAL INFORMATION FOR AVM SYSTEM AS REQUIRED BY FCC REGULATIONS 93.120 Subsection (d)

AVM SYSTEM TECHNICAL INFORMATION (Teledyne Systems)

FCC Item (1)

A detailed description of the manner in which the system will operate, including a map or diagram.

Figure 1-6 is the AVM Pictorial Diagram of the system and the associated signal flow block diagram is Figure 1-9.

The block diagram (Figure 1-9) LAVM system block diagram is divided into four main sections from left to right: The Augmentor - this is a small 6" x 6" x 6" (or less) box which houses the checkpoint generator or low power (1/10 watt) VHF sign post marker beacon which is mounted on or near the traffic lane and employs a coded adjustable output signal adequate for identification up to 300 feet. In strong LORAN-C signal areas (like LA) very few augmentors are required for position and time point because the Teledyne System is a RANDOM ROUTE positioning system.

The Satellite Receiving Site is a remote site of antennas and receivers dedicated to receiving the UHF vehicular signals in the face of multipath propagation anomalies and relaying them to the Base Station for processing, recording and displaying the data. The Base Station is also the dispatching center or command and control central with the VHF/UHF voice and digital data transmitters and the computing center for data reduction, display and control for the entire "AVM System."

The Vehicular Installation is composed of an existing late model UHF transceiver interfaced to a digital data applique unit so that the LORAN-C location signals, Augmentor signals, data sensor signals and UHF polling signals are coupled into and out of the AVM mobile environment and back to the Base Station. The existing UHF transceiver can be used in the normal voice mode, digital data mode or

Attachment 10

in the COVERT alarm mode. The COVERT emergency alarm switch is capable of being actuated without an intruders detection so that the vehicle identification and location are automatically transmitted for assistance.

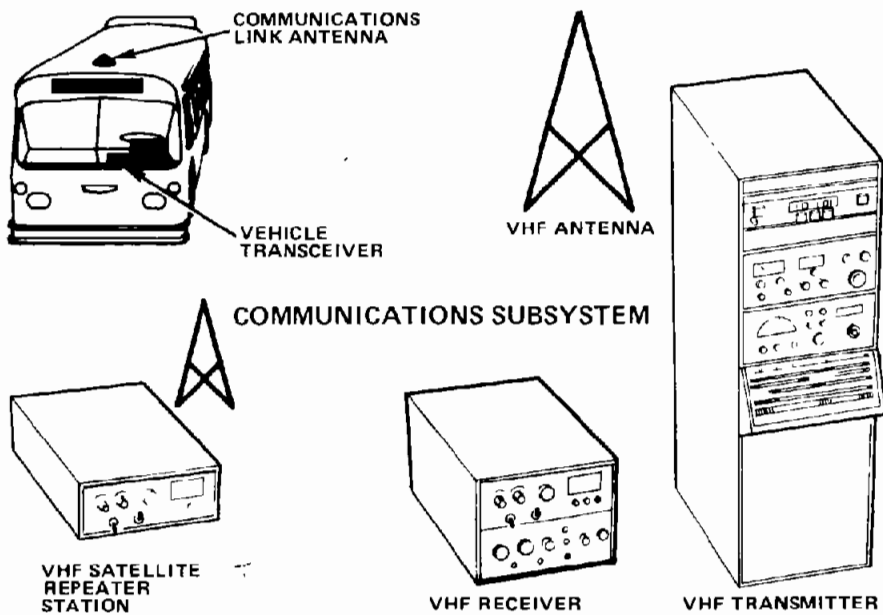
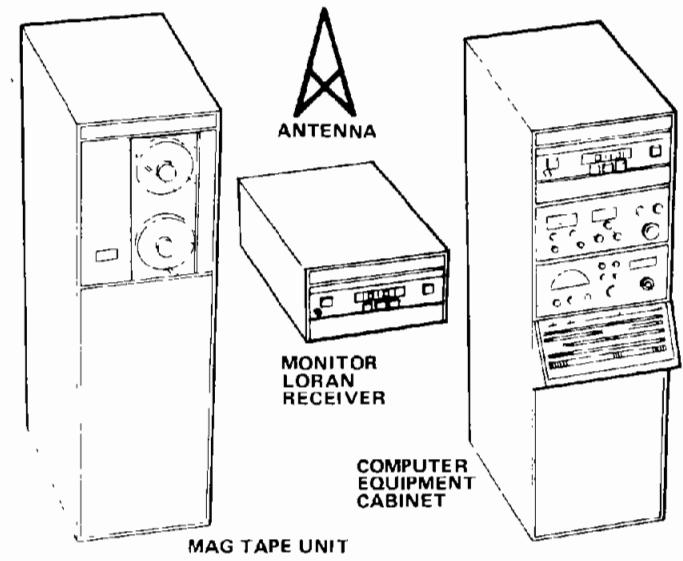
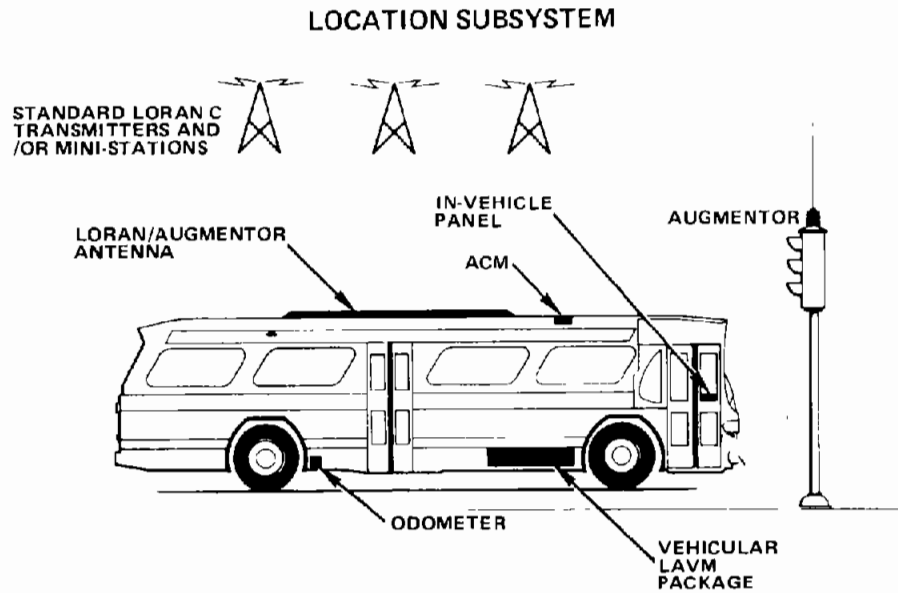

DATA ANALYSIS SUBSYSTEM

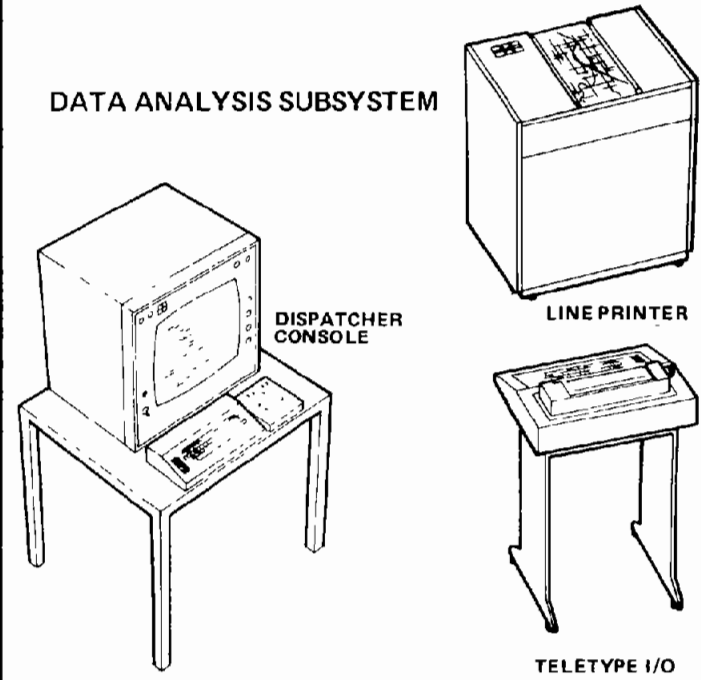
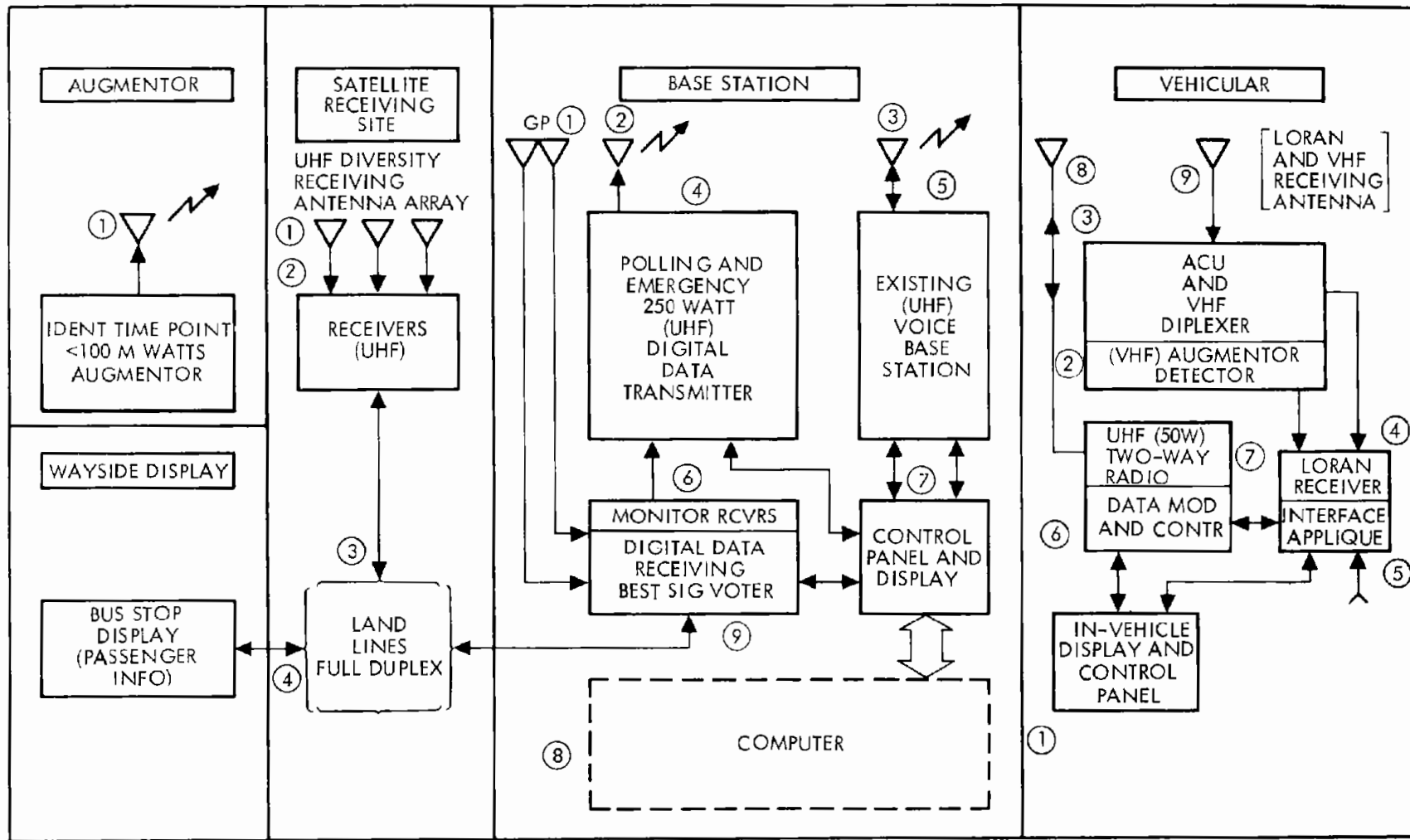

Figure 1-6. LAVM System



T100744

Figure 1-9. LAVM System Block Diagram

Attachment 10

FCC Item (2)

For wide band frequency operation the necessary or occupied bandwidth of emission whichever is greater.

The Teledyne AVM System does not require a modulation index or bandwidth in excess of the existing licensed SCRTD voice system bandwidth for Mobile-to-Base and Base-to-Mobile Digital Data transmissions. The 1/10 watt Augmentor does however require a wider bandwidth. Side bands are 100 KHz removed (upper and lower) from the 72.960 MHz at a level measured on the H. P. Spectrum Analyzer at 50 db below the carrier of 1/10 watt. The pulse rise and fall time is approximately forty microseconds and the pulse length of the shortest pulse is eighty microseconds.

FCC Item (3)

The data transmission characteristics are as follows:

(i) Vehicle location update rates:

Table 1-7. Message Structure and Rates

| | |
|--|--------------------------------|
| Reporting (for each vehicle) | 1 time per 32.4 sec |
| Emergency report | 1 time per 8.1 sec |
| No. of vehicles | 225 |
| Base station polling message | 64 bits/message |
| Base station emergency polling | 64 bits/message |
| Data rate of vehicular transmissions | 1200 bit/sec or .833 msec/bit |
| Data rate of base station transmissions | 600 bits/sec or 1.666 msec/bit |
| Vehicular message length in bits | (108) msg + (16) sync = 124 |
| Time guard tolerance between vehicular reports | 16.666 mseconds |
| Message rate (base) | 600 bits/sec |
| Message rate (vehicle) | 1200 bits/sec |
| Frequency stability (vehicular) | 1 part in 10^6 |

Attachment 10

FCC Item

(ii) Specific Transmitter modulation techniques used:

SCRTD (KMA 454) "BASE STATION" is licensed to transmit voice in the UHF BAND. The plan is to audio modulate with digital data by adding a digital data V.F. bandwidth applique unit so that (KMA 454) can transmit 600 bits/sec of PM/FSK audio bandwidth digital data or voice. The "vehicular stations" or "MOBILES" are interfaced with the same type of "APPLIQUE UNIT" as the Base Station except that 1200 bits/sec of digital data is the MOBILE data rate. Both ends of the UHF link retain their same modulation techniques and can transmit from the microphone or from the digital data applique units. In the case of the low powered augmentors the modulation is ON-OFF amplitude keying as employed in KG2XLB issued for Philadelphia which is 72.960 MHz (.1 A1) emission designator and 0.170 watts authorized power. (Experiment License Attached).

FCC Item

(iii) For codes and timing scheme: A table of bit sequences and their alpha-numeric or indicator equivalents, and a statement of bit rise time, bit transmission rates, bit duration, and interval between bits:

(iv) A statement of amplitude-versus-time of the interrogation and reply formats, and an example of a typical message transmission and any synchronizing pulses utilized:

Each vehicle poll contains 2 synchronization codes of 8 bits each and 4 data blocks of 12 bits each. This makes each poll 64 bits long and requires 120 milliseconds to transmit at a 600 bits per second rate including the 13.333 millisecond guard time. Specific information content of each data block is listed in Table 2-5.

This data is self explanatory. Note that each data block contains its own 5 bit hamming code which allows for detection and correction of single bit errors and detection of multiple bit errors on a block-by-block basis.

Attachment 10

Polling Message Discretes - Certain bits in each polling message are designated as discretes. These bits are used to transmit specific pieces of information according to Table 2-6.

Vehicle to Base Information - Figure 2-9 shows the entire vehicle fleet data transmission sequence. The 32.4 second report cycle time is divided into 270 vehicle report slots corresponding to the 270 possible polls (18 x 15 = 270). Each vehicle when polled transmits 124 data bits in 120 milliseconds which includes 16.67 milliseconds of guard time for each vehicle transmission. This is done at a 1200 bits per second rate.

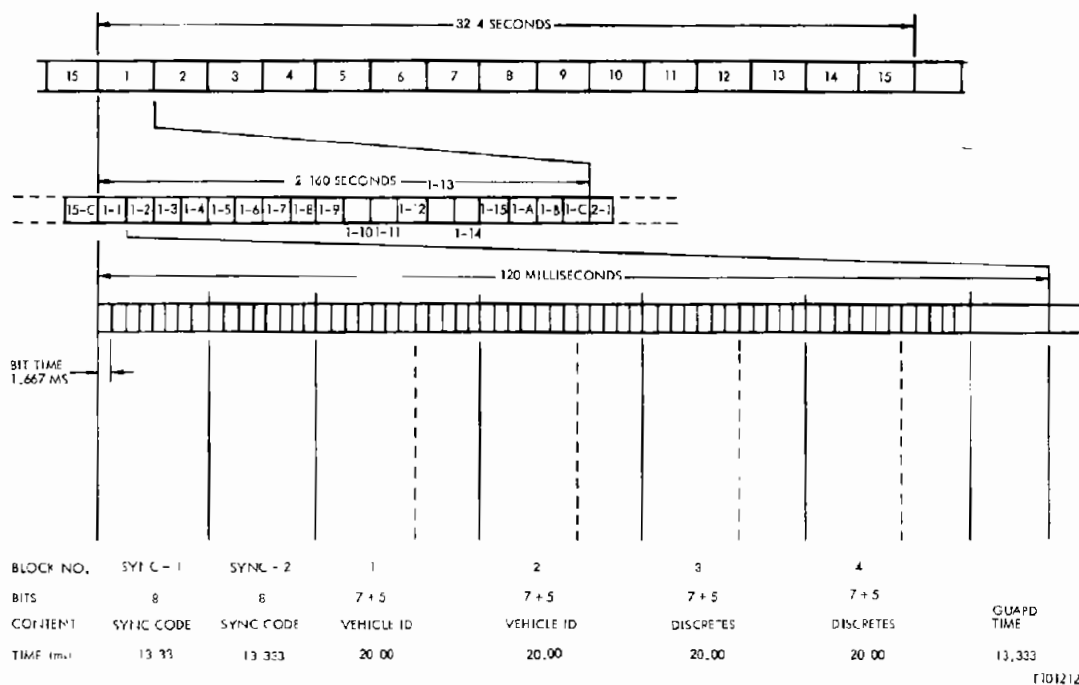

Figure 2-8. Fleet Polling Sequence

Attachment 10

Table 2-5. Polling Message Block Content

| DATA BLOCK | BIT NUMBER | | | | | | | | | | | | |
|--------------------------|-------------------------------|--|----------------------------|--------------------------|------------------|-------------------------|---------------------------------|---|---|----------------------------|----|----|--|
| | 1 | 2 | 3 | 4 | 5 | 6 | 7 | 8 | 9 | 10 | 11 | 12 | |
| 1 SYNCHRONIZATION - 1 | | | | SYNC CODE | | | | | | | | | |
| 2 SYNCHRONIZATION - 2 | | | | SYNC CODE | | | | | | | | | |
| 3 VEHICLE ID LSB | 1 LEAST SIGNIFICANT BIT | 2 | 4 | 8 | 16 | 32 | 64 | | | BLOCK 3 HAMMING CODE | | | |
| 4 VEHICLE ID MSB | 128 | 256 | 512 | 1024 | 2048 | 4096 | 8192 MOST SIGNIFICANT BIT | | | BLOCK 4 HAMMING CODE | | | |
| 5 DISCRETE | MESSAGE ACKNOWLEDGE | COMMUNICATIONS REQUEST ACKNOWLEDGE | TIME SYNC | EMERGENCY ACKNOWLEDGE | SPARE | SPARE | SPARE | | | BLOCK 5 HAMMING CODE | | | |
| 6 DISCRETE | SCHEDULE STATUS OK | SCHEDULE STATUS EARLY | SCHEDULE STATUS LATE | START RUN | STATUS CHANGE | CALIBRATION REQUIRED | EMERGENCY STATUS REQUEST | | | BLOCK 6 HAMMING CODE | | | |

T101213

Attachment 10

Specific content of each transmission is listed in Tables 2-6 and 2-7. Since detection of an augmentor automatically overrides the LORAN.

Table 2-6. Polling Message Discretes

| Note | Discrete | | Meaning |
|------|------------|-----|---|
| | Data Block | Bit | |
| 1. | 5 | 1 | <u>BIT = 0</u> means "last message from vehicle was received and verified. OK to dump from vehicle memory." |
| | 5 | 2 | <u>BIT = 1</u> means "dispatcher acknowledges prior vehicle request for voice communications." |
| | 5 | 3 | <u>BIT = 1</u> means "synchronize vehicle chronometer to exact half hour." |
| | 5 | 4 | <u>BIT = 1</u> means "dispatcher acknowledges vehicle is in emergency status." No display function. |
| | 6 | 1 | <u>BIT = 0</u> means "vehicle is within schedule tolerance." |
| | 6 | 2 | <u>BIT = 0</u> means "vehicle is ahead of schedule." |
| | 6 | 3 | <u>BIT = 0</u> means "vehicle is behind schedule." |
| 2. | 6 | 4 | <u>BIT = 1</u> means "vehicle should start scheduled run." |
| | 6 | 5 | <u>BIT = 1</u> means "vehicle status has just changed." |
| | 6 | 6 | <u>BIT = 1</u> commands vehicle to "store ID of two successive augmentors" for calibration purposes |
| 3. | 6 | 7 | <u>BIT = 1</u> asks "any vehicle in emergency status to report immediately." |

Note 1. Bit is sent once per hour exactly on half hour. All vehicles receive and synchronize regardless of poll address.

Note 2. Bit is periodically sent to each vehicle. Remains on until vehicle has sent message containing two augmentors ID's which satisfy calibration requirements.

Note 3. Bit is sent once per 15 vehicle polling block. This is special poll designated "A" in Figure 2-9. All vehicles receive - all vehicles with unacknowledged alarm condition reply.

Attachment 10

Table 2-8. Vehicle Information Content (LORAN Data)

| DATA BLOCK | 1 | 2 | 3 | 4 | 5 | 6 | 7 | 8 | 9 | 10 | 11 | 12 |
|--|-------------------------------------|-----------------------|-----------------------|----------------------|------------------------------|-----------------------|-------------------------------------|---|--------------------------|----|----|----|
| 1 SYNCHRONIZATION - 1 | ← SYNC CODE → | | | | | | | | X | | | |
| 2 SYNCHRONIZATION - 2 | ← SYNC CODE → | | | | | | | | X | | | |
| 3 TIME DIFFERENCE A LSBS | 39.0±25 NANOSECONDS | 78.125 NANOSECONDS | 156.25 NANOSECONDS | 312.5 NANOSECONDS | 625 NANOSECONDS | 1.25 MICROSECONDS | 2.50 MICROSECONDS | | BLOCK 3 HAMMING CODE | | | |
| 4 TIME DIFFERENCE B MSBS | 5.0 MICROSECONDS | 10.0 MICROSECONDS | 20.0 MICROSECONDS | 40.0 MICROSECONDS | 80.0 MICROSECONDS | 160.0 MICROSECONDS | LORAN DATA IDENTIFIER BIT = 0 | | BLOCK 4 HAMMING CODE | | | |
| 5 TIME DIFFERENCE B LSBS | 39.0±25 NANOSECONDS | 78.125 NANOSECONDS | 156.25 NANOSECONDS | 312.5 NANOSECONDS | 625 NANOSECONDS | 1.25 MICROSECONDS | 2.50 MICROSECONDS | | BLOCK 5 HAMMING CODE | | | |
| 6 TIME DIFFERENCE B MSBS | 5.0 MICROSECONDS | 10.0 MICROSECONDS | 20.0 MICROSECONDS | 40.0 MICROSECONDS | 80.0 MICROSECONDS | 160.0 MICROSECONDS | LORAN DATA VALID BIT = 1 | | BLOCK 6 HAMMING CODE | | | |
| 7 ODOMETER SINCE LAST REPORT LSBS | | 2 | 4 | 8 | 16 | 32 | 54 | | BLOCK 7 HAMMING CODE | | | |
| 8 ODOMETER SINCE LAST REPORT MSBS DISCRETES | 128 | 256 | 512 | 1024 | VEHICLE SERVICE STATUS | OPERATOR STATUS | RESPONDING TO CALL | | BLOCK 8 HAMMING CODE | | | |
| 9 SPECIAL WORD-1 | ← SEE TABLE II-8 AND FIG. II-2.11 → | | | | | | | | BLOCK 9 HAMMING CODE | | | |
| 10 SPECIAL WORD-2 | ← SEE TABLE II-8 AND FIG. II-2.11 → | | | | | | | | BLOCK 10 HAMMING CODE | | | |
| 11 DISCRETE AND BLOCK IDENTIFICATION | SEE TABLE II-8 AND FIG. II-2.11 | | | SPARE | COMMUNICATION REQUEST | SPARE | EMERGENCY | | BLOCK 11 HAMMING CODE | | | |

T101217

Attachment 10

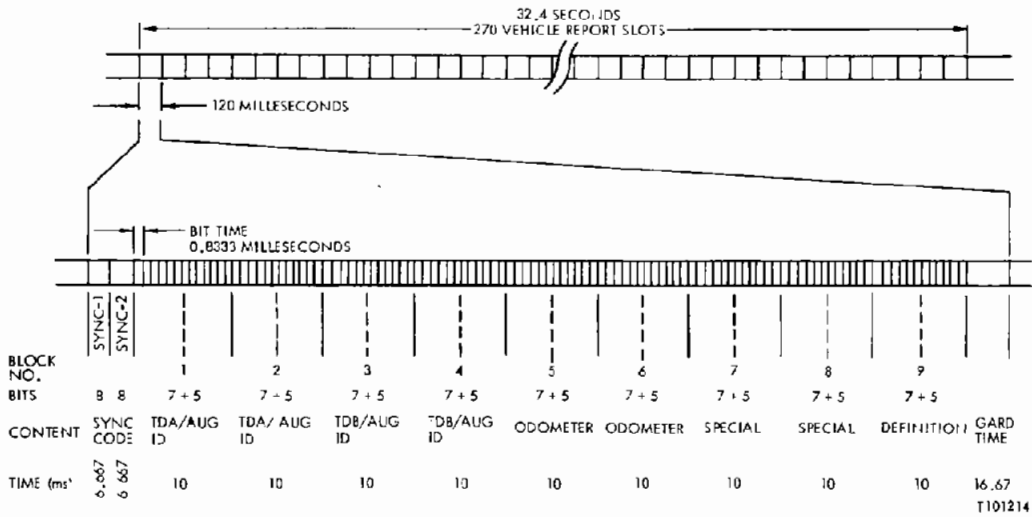
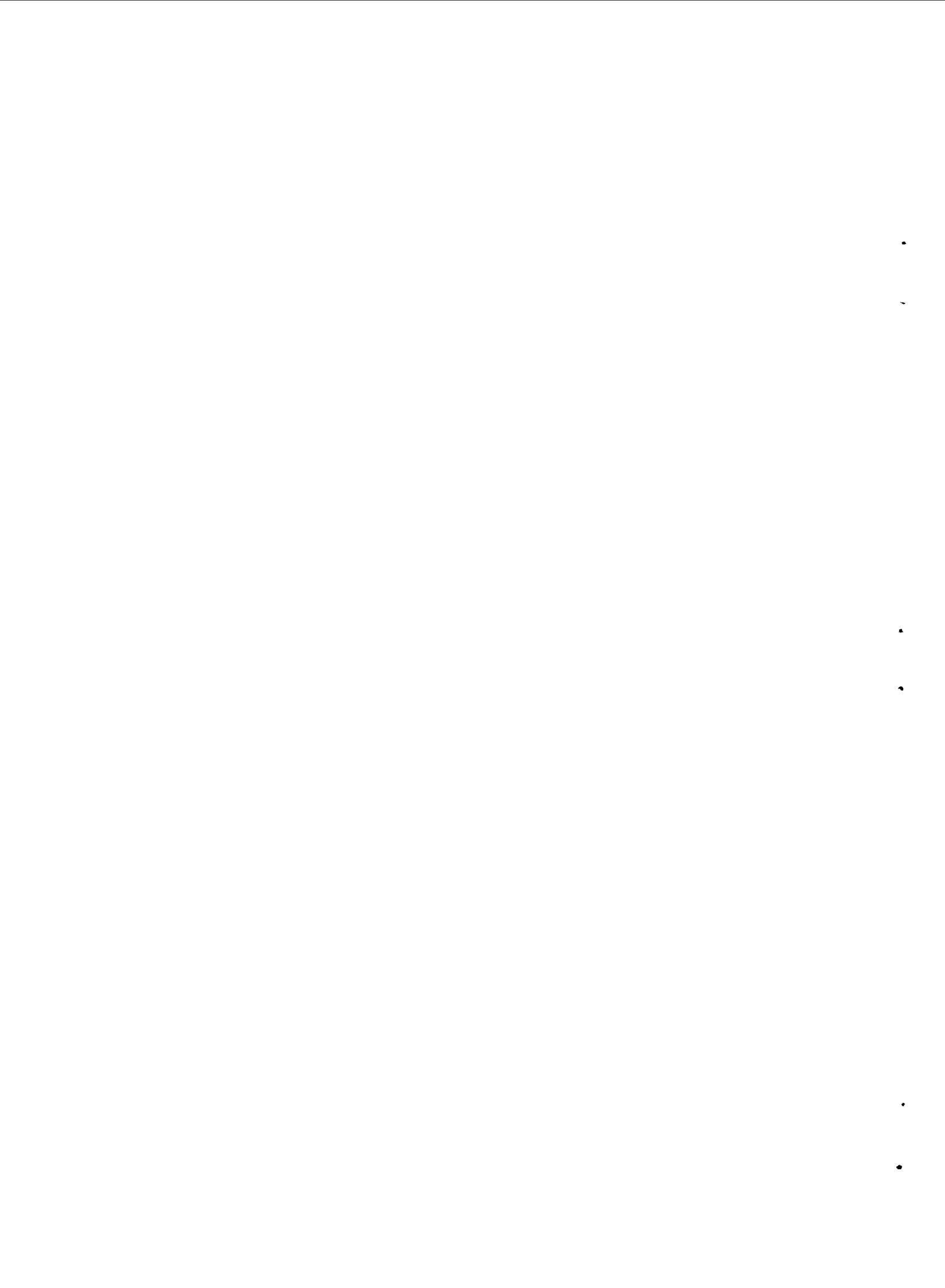

Figure 2-9. Vehicle Transmission Sequence

Table 2-7. Vehicle Information Content (Augmentor Data)

| DATA BLOCK | 1 | 2 | 3 | 4 | 5 | 6 | 7 | 8 | 9 | 10 | 11 | 12 |
|--|--------------------------------------|-----|-------|-----------------|------------------------------|--------------------|--|--------------------------|---|----|----|----|
| 1 SYNCHRONIZATION - 1 | ← | | ← | | ← | | ← | | X | | | |
| 2 SYNCHRONIZATION - 2 | ← | | ← | | ← | | ← | | X | | | |
| 3 NEXT TO LAST AUGMENTOR ID LS3 TURN INDICATOR | 1 | 2 | 4 | 8 | 16 | 32 | 64 | BLOCK 3 HAMMING CODE | | | | |
| 4 NEXT TO LAST AUGMENTOR ID MSB TURN INDICATOR | 128 | 256 | 512 | 1024 | SPARE | SPARE | AUGMENTOR DATA IDENTIFIER BIT - 1 | BLOCK 4 HAMMING CODE | | | | |
| 5 LAST AUGMENTOR ID LS3 TURN INDICATOR | 1 | 2 | 4 | 8 | 16 | 32 | 64 | BLOCK 5 HAMMING CODE | | | | |
| 6 LAST AUGMENTOR ID MSB TURN INDICATOR | 128 | 256 | 512 | 1024 | TURN IND + (CCW) | TURN IND - (CW) | SPARE | BLOCK 6 HAMMING CODE | | | | |
| 7 ODOMETER SINCE LAST AUGMENTOR (LSB) | 1 | 2 | 4 | 8 | 16 | 32 | 64 | BLOCK 7 HAMMING CODE | | | | |
| 8 ODOMETER SINCE LAST AUGMENTOR (MSB) DISCRETES | 128 | 256 | 512 | 1024 | VEHICLE SERVICE STATUS | OPERATOR STATUS | RESPOND- ING TO CALL | BLOCK 8 HAMMING CODE | | | | |
| 9 SPECIAL WORD - 1 | ← SEE TABLE II-8 AND FIG. II-2, 11 → | | | | | | | BLOCK 9 HAMMING CODE | | | | |
| 10 SPECIAL WORD - 2 | ← SEE TABLE II-8 AND FIG. II-2, 11 → | | | | | | | BLOCK 10 HAMMING CODE | | | | |
| 11 DISCRETE AND BLOCK IDENTIFICATION | ← SEE TABLE II-8 AND FIG. II-2, 11 → | | SPARE | COMM REQUEST | SPARE | EMERG- ENCY | BLOCK 11 HAMMING CODE | | | | | |

T101215



LAVM PROGRAM MAJOR MILESTONE SCHEDULE

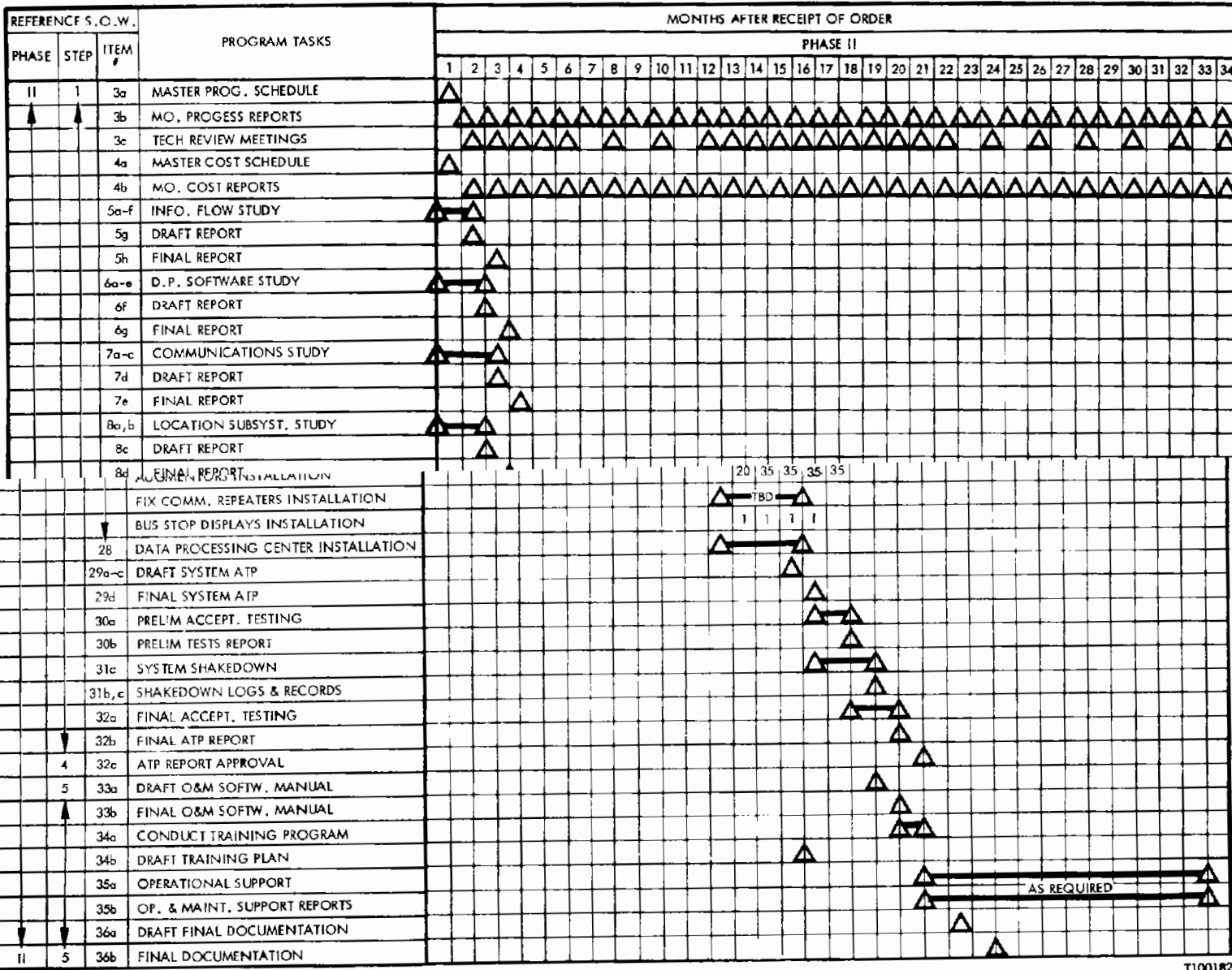

show implementation during the initial program Major Milestone Schedule
 8-32

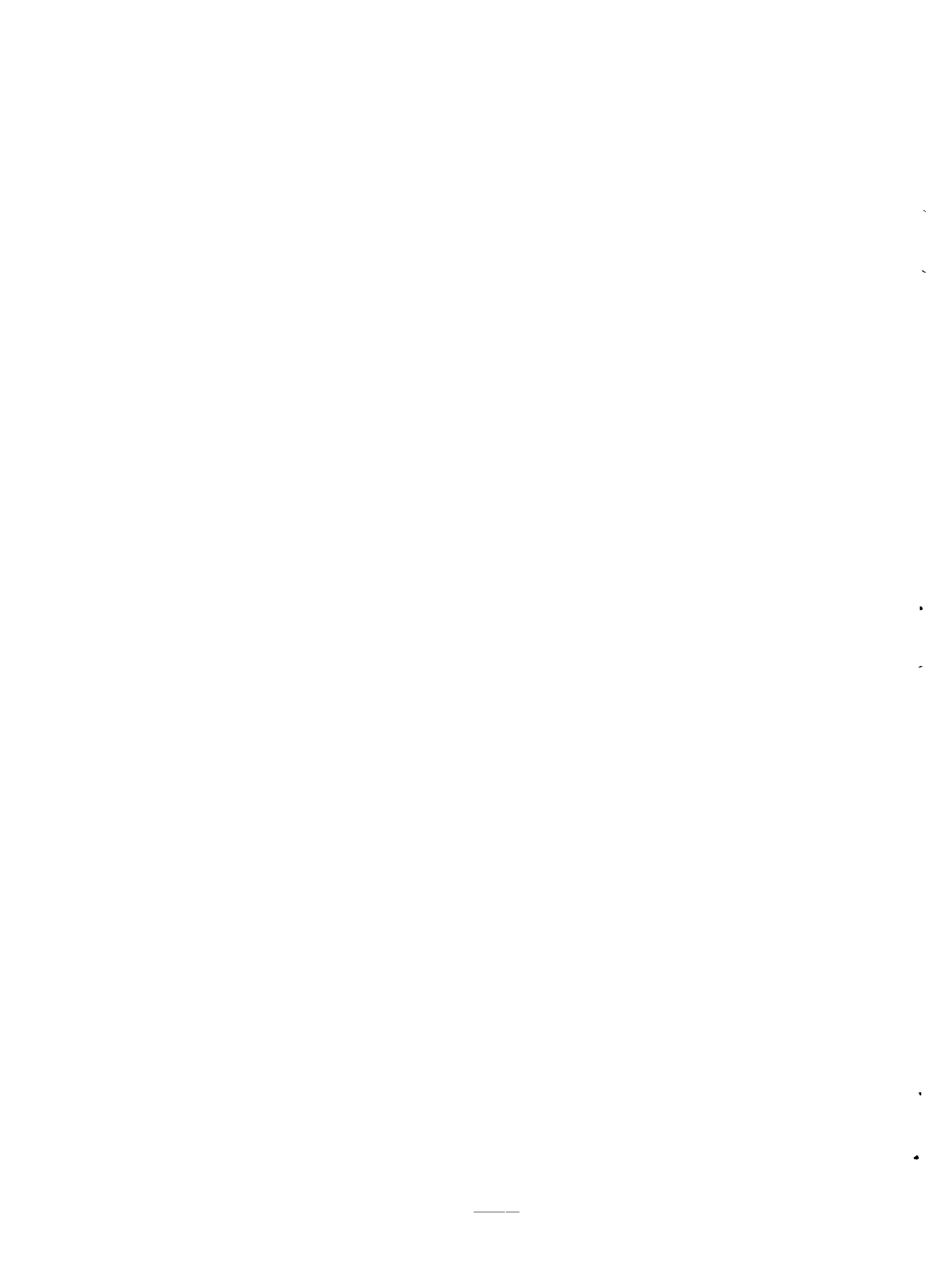

Attachment 10

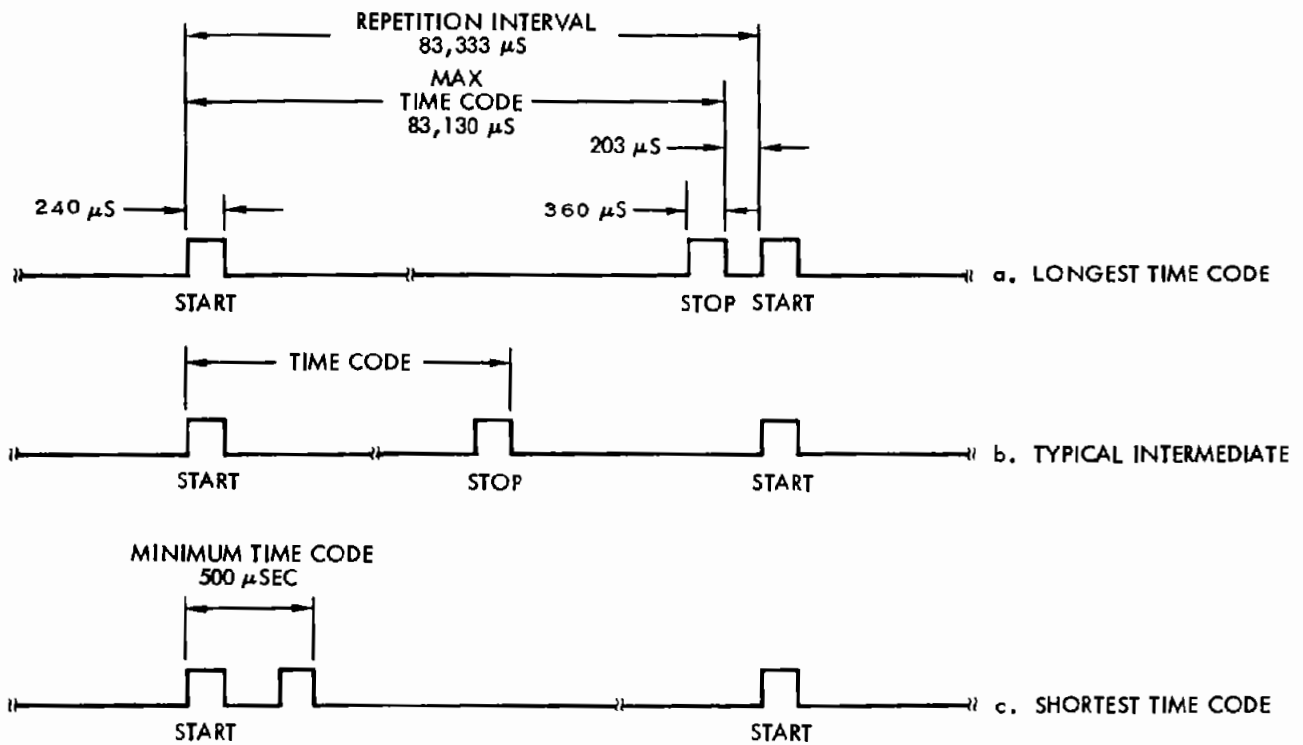

T100826

Figure 2-28. Augmentor Timing Code

MODULATION IS ON-OFF CARRIER KEYING. TRANSMISSION FORMAT:

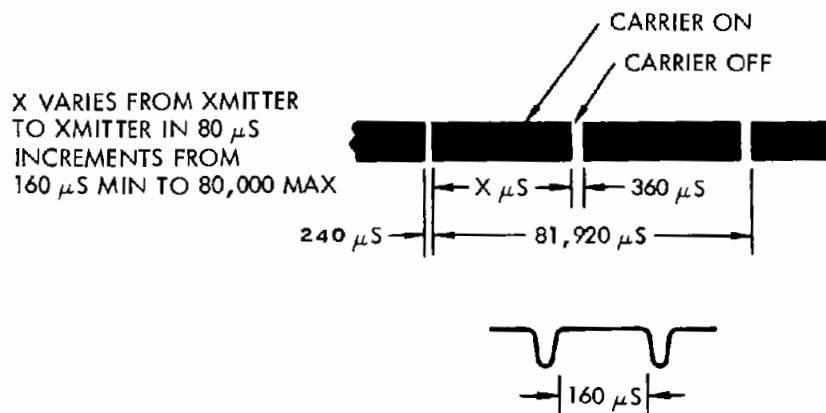

ASSUME A 40 μ SEC RISE TIME $\left[f = \frac{1}{4} = \frac{1}{40 \times 10^{-6}} = \frac{10^6}{40} \right] = \frac{1}{4} 10^5 = 25 \text{ KHz}$

DOUBLE SIDEBAND AM

DSB = 8f = BW (BANDWIDTH)

$\therefore \text{BW} = 8 \times \frac{1}{4} \times 10^5 = 2 \times 10^5 \text{ OR BW} = 200 \text{ KHz}$

T109261



SECTION 9

TEST ACCOMPLISHMENTS VS PROPOSAL

9.1 PROPOSAL ACCURACY, SYSTEM & SUBSYSTEM

The LORAN AVM proposal predicted a fixed route system and subsystem accuracy of 176' 95% in good LORAN areas and 150' 95% in no LORAN area with augmentors. Random route performance was predicted to be 230' and 150', both 95%. These accuracy predictions were based upon analytical system simulations and error models. Small errors in the no LORAN areas were the result of extensive simulated augmentor implementation in the simulations. The system was designed to exceed the requirements by a significant margin in order to allow for 'real world' variations in conditions which are difficult or impossible to simulate.

9.2 PHASE I TEST RESULTS

9.2.1 Fixed Route

Phase I results which portray LAVM system and subsystem accuracy without compromise show 303.34' 95% error for location subsystem measurements and 287.79' 95% error for the system simulation.

While these errors exceed earlier simulation results, they are clearly consistent with the stated accuracy requirements. System deficiencies uncovered in the Phase I tests are limited to 95% time of passage accuracy (26 seconds vs 15 seconds) and 2% of the route which has a mean error of greater than 450 feet as stated in the coverage specification. Both subjects are discussed in detail in Section 7. Methods for improving time of passage accuracy while reducing system costs are presented with extrapolated errors derived from the Phase I data of 8 seconds 95%.

9.2.2 Random Route

Random Route Phase I test results fell short of simulation-based predictions. The source of the large (over 300') errors lies without exception in failure of the system to correctly identify the direction of travel. Short term modification to the random route software produced instantaneous improvement. System simulation results

were improved 69% from 691' to 476' with a few minor modifications. While the random route results are at first glance disappointing, the dramatic improvement made with a few simple modifications to software is indicative of the amount of improvement possible. The practical experience gained in Phase I has served one of the primary purposes of the program; to confirm and verify those aspects of the proposed system which are consistent with the requirements and to highlight any system characteristics which need improvement. With the Phase I test results, the improved software already demonstrated, and the additional improvements discussed in Section 7, a firm base for a successful Phase II development program has been established. Optimal LORAN conditions in the Los Angeles area tend only to increase the already high probability of a very successful Phase II program.